

Electronic Design. 4

VOL. 26 NO.

FOR ENGINEERS AND ENGINEERING MANAGERS — WORLDWIDE

FEB. 15, 1978

Microprocessor programming has never been easier. An all-in-one development station lets you link assembly-language, PL/M and Fortran programs. ROM-based

software includes an assembler, a text editor, and all peripheral interfaces. In-circuit emulation provides hardware and software debugging and more. See p. 117.

ISIS-II, V3.2
-ASM80 PROG1.SRC

ISIS-II 8080/8085 MACRO ASSEMBLER, V2.0

ASSEMBLY COMPLETE, NO ERRORS
-PLM80 PROG2.SRC

ISIS-II PL/M-80 COMPILER V3.0

PL/M-80 COMPILATION COMPLETE.
PROG3.SRC

FORTRAN-80 COMPILER V1.0

COMPILATION COMPLETE

61.OBJ,PROG2.OBJ,PROG3.OBJ;SYSTEM.LIB TO MYPROG.OBJ

MYPROG.OBJ CODE(4000H)

PROGRAM ERROR(S)

PROGRAM ERROR(S)



The World's First SIP Trimmer...

A new space saver from Bourns.

Now there's a new dimension in space savings... the Model 20 Trimpot® SIP Cermet Trimmer... a standard SIP, designed to meet your high density PC board needs.

With no sacrifice in performance, the Model 20 trimmer occupies only 25% of the precious board space used by comparable DIP configurations and only 50% of that used by conventional 3/4" rectangular trimmers. Featuring .100-inch spacing and a lower board profile... only .185-inches off the board... it's priced at a modest 75¢* in 1,000 to 4,999 quantities. And, it's available in 18 standard resistance values ranging from 10 ohms to 5 megohms.

Conquer your space problems. Send today for complete details on the Model 20 SIP trimmer... the latest of many space saving "firsts" from Bourns.

TRIMPOT PRODUCTS DIVISION, BOURNS, INC., 1200 Columbia Avenue, Riverside, CA 92507. Phone: 714 781-5050 — TWX: 910 332-1252.

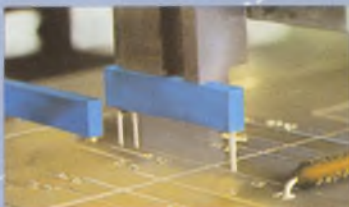

The Model 20 SIP trimmer... machine insertable and compatible with automatic test equipment for significant cost savings.

*Domestic U.S.A. price only.



BOURNS®

International Marketing Affiliates: European Headquarters — Switzerland 042/23 22 42 • Belgium 02/218 2005 • France 01/2039633 • Germany 0711/24 29 36 • Italy 02/32 56 88 • Netherlands 70/87 44 00 • United Kingdom 01/572 6531 • Norway 2/71 18 72 • Sweden 764/20 110 • Japan 075/921 9111 • Australia 02/55-0411 03/95-9568 • Israel 77 71 15/6/7

For Immediate Application — Circle 130
For Future Application — Circle 230

It's a stand-alone sweep-signal generator that provides all the performance of much higher priced competitive instruments.

To back up that sweeping statement, consider the following: The Model 2002 sweeps from 1 MHz to 2.5 GHz in four bands with 20 milliwatt output, $\pm 1\%$ display linearity, and ± 0.5 dB flatness. Consider also that it includes an internal 10 dB per step attenuator which in conjunction with a continuously variable pin diode attenuator

results in an output power range of +13 to -77 dBm. Plus a band-stacking option that lets you cover the entire 1 to 2500 MHz frequency range in one sweep. A ± 2 dB amplitude slope adjustment that compensates for frequency dependent variations in test set-ups is also available along with a deluxe marker module containing 1, 10, 50 and 100 MHz harmonic markers that operate over the entire frequency range of the unit. Finally, consider the price: \$2,700 for the basic

unit and only a total of \$3,200 if ordered with the bandstacking, deluxe marker module and slope adjustment options. Compare the prices against those of available competitive units.

WAVETEK Indiana Incorporated,
66 N. First Ave., P.O. Box 190
Beech Grove, Indiana 46107
Telephone: (317) 783-3221
TWX 810-341-3226

WAVETEK®

CIRCLE NUMBER 2

A sweeping statement about our Model 2002:



Need RF Components In a Hurry?

Mini-Circuits' distributors now stock Mixers, Amplifiers, Power Splitters/Combiners, Directional Couplers, RF Transformers, Limiters and Frequency Doublers for quick off-the-shelf delivery. . . everywhere.

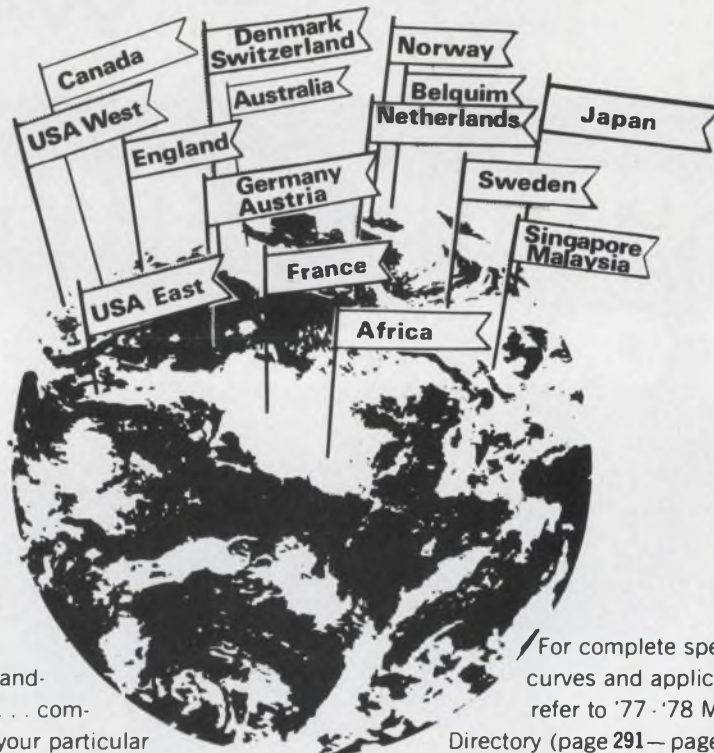

Fast off-the-shelf product availability . . . for those demanding "quick turnaround" jobs . . . competent technical backup for your particular need . . . rapid response to your individual design-related problems . . . now closer than ever with Mini-Circuits' worldwide distribution network.

For complete specifications, performance curves and application information, please refer to '77-'78 MicroWaves' Product Data Directory (page 291—page 482), '77-'78 Gold Book (page 817—page 1008) and '77-'78 EEM (page 3006—page 3055) For your own personal 100-page RF COMPONENTS DESIGNERS' GUIDE, circle Reader Service Number 3.

NORTHERN CALIFORNIA
Penn-Stock
 105 Fremont Ave.
 Los Altos, CA 94022
 (415) 948-6533

SO. CALIFORNIA
 Crown Electronics
 11440 Collins St.
 N. Hollywood, CA 91601
 (213) 877-3550

**METROPOLITAN NEW YORK
 NORTHERN NEW JERSEY
 WESTCHESTER COUNTY**
 Microwave Distributors
 61 Mall Drive
 Commack, N.Y. 11725
 (516) 543-4771

AUSTRALIA
 General Electronic Services
 99 Alexander St.
 New South Wales, Australia 2065
 PH. 439-2488/439-2399

Rogers Electronics
 65 Magill Road
 Stepney, So. Australia 5069
 PH. (08) 42 6666

ENGLAND
 Dale Electronics
 Dale House
 Wharf Road, Frimley Green
 Camberly Surrey, England GU16 6LF
 DEEPCUT (025 16) 5094

FRANCE
 S.C.I.E. D.I.M.E.S.
 31 Rue George Sand
 91120 Palaiseau, France
 PH. 928 38 55/928 19 14

**GERMANY, AUSTRIA,
 SWITZERLAND, DENMARK**
 Industrial Electronics GMBH
 6000 Frankfurt Main 1
 Kluberstrasse 14, West Germany
 PH. (0611) 724752

SWEDEN
 Integrerad Elektronik AB
 Box 435-182 51
 Djursholm, Sweden
 PH. 08/7530330

SINGAPORE & MALAYSIA
 Electronics Trading Co. (PTE) Ltd
 87 Bukit Timah Road
 Republic of Singapore 9
 PH. 362108/329137

EASTERN CANADA
 RF Specialists
 PO Box 1419
 Brockville, Ontario K6V5Y6
 (613) 345 2343

JAPAN
 Densho Kaisha, Ltd
 Eguchi Building 8-1-1 Chome
 Hamamatsucho Minato-Ku
 Tokyo, Japan
 PH. (03) 4360041

NETHERLANDS
LUXEMBOURG, BELGIUM
 Cormex
 Veldweg 11
 Hattem, Holland
 PH. 05-206-1214

NORWAY
 Datamatik As
 Ostenstoveien 62
 Oslo 6, Norway
 PH. (02) 266330

AFRICA
 Afrita (PTY) Ltd.
 P.O. Box 9813
 Johannesburg 2000,
 South Africa
 PH. 22-2733/34/41



2625 East 14th Street Brooklyn, New York 11235 (212) 769-0200
 Domestic and International Telex 125460 International Telex 620156

29 Rev/Orig.

NEWS

- 23 **News Scope**
- 26 **Analog chips are becoming systems:** New LSI merges analog and digital technology.
- 32 **MOS-controlled triac** combines low input power, high output power.
- 36 **IC accelerometer** is designed to be used in heart research.
- 39 **Washington Report**

TECHNOLOGY

- 54 **FOCUS on indicator lamps and LEDs:** The lamp's light output is crucial in indicator assemblies, so engineers must understand light measurements to interpret specs wisely. But lamp makers often spec light output unclearly.
- 68 **Graphics CRT displays are easy** with raster-scan imaging. Add a μ P and you'll enjoy detailed, steady pictures in color or black-and-white.
- 76 **Directly viewed incandescent displays** are hard to beat for brightness and choice of colors. TTL-compatible, they are easy to control and multiplex.
- 84 **Control EMI from power supplies** with computer-aided circuit analysis. You should not only save money, size and weight, but time to boot.
- 94 **Hold that line.** To regulate your computer's input ac, send in a regulator that scores well on output impedance, power handling and noise.
- 98 **Ideas for Design:**
Positive reference-voltage IC goes negative with an extra component.
Multitask μ P executive routine uses only six instructions.
Solid-state relay improved with zero-volt switching circuit.
Regulate motor-shaft speed better with an active bridge.
- 113 **International Technology**

PRODUCTS

- 117 **Micro/Mini Computing:** All-in-one development station makes programming easier, faster and less expensive.
- 135 **Modules & Subassemblies:** Data-acquisition system slips inside its PDP-11 host computer.
- 148 **Instrumentation:** Bus analyzer 'thinks big' but goes for small price.
- 150 **Instrumentation:** Timer programs output cycles with IBM card.
- 166 **Data Processing:** Fiber optic system aims at digital data links.
- | | |
|--------------------------|---------------------------|
| 152 ICs & Semiconductors | 176 Packaging & Materials |
| 172 Components | 180 Power Sources |

DEPARTMENTS

- | | |
|--------------------------------------|--------------------------------|
| 51 Editorial: The systems man | |
| 7 Across the Desk | 189 Employment Opportunities |
| 180 Evaluation Samples | 194 Advertisers' Index |
| 180 Application Notes | 194 Information Retrieval Card |
| 182 New Literature | |

Cover: Photo by Rob Janoff, courtesy of Intel Corp.

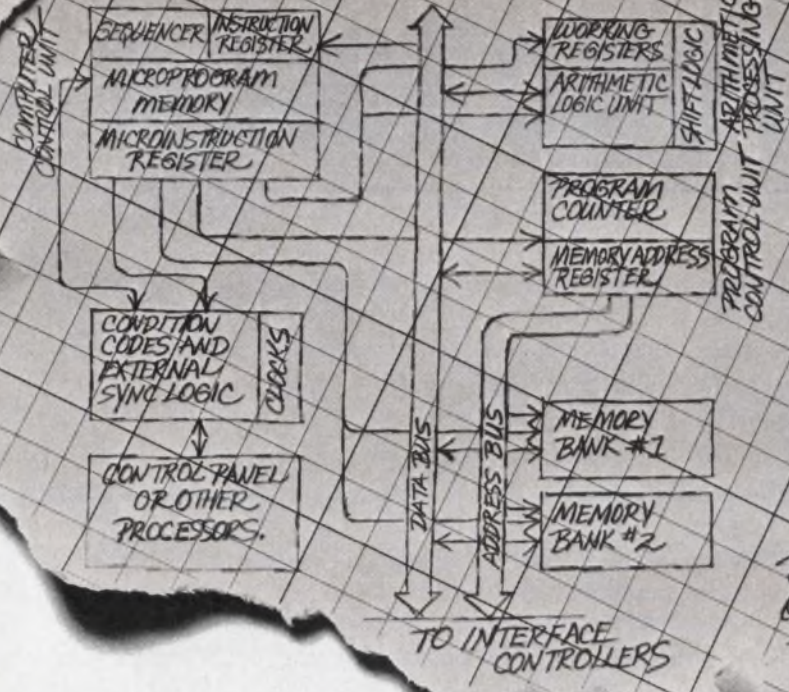

THE MACHINE CONTAINS AN ARITHMETIC PROCESSOR, A PROGRAM CONTROL UNIT, DMA, INTERRUPT AND OTHER CIRCUITS. THE CONTROL LINES FOR ALL THOSE CIRCUITS COME FROM A BIPOLAR MEMORY WHICH IS PART OF THE COMPUTER CONTROL UNIT. EACH WORD IS ~~USED~~ A MICROINSTRUCTION, THEY ARE SELECTED FROM THE MEMORY BY A SEQUENCER, THEN DEPOSITED IN A REGISTER. FROM THERE, THEY CONTROL ALL THE SYSTEM'S PARTS, INCLUDING THE SELECTION OF THE NEXT MICROINSTRUCTION TO BE EXECUTED.

FIGURE 1. GENERALIZED COMPUTER ARCHITECTURE

Advanced Micro Devices announces an advanced course in microprogrammable microprocessing.

Step by step, function by function, month by month, we'll build a fast, powerful, micro-programmed machine.

And on December 31, 1978, you'll know what we know. As it turns out, that's quite a lot.

BUILD A MICROCOMPUTER THIS YEAR.

CHAPTER ONE: COMPUTER ARCHITECTURE.

Modern digital processors are built using one of two techniques: A fixed-instruction MOS processor, such as the 8080A or 8085, or a microprogrammed TTL design. Because of the extremely low cost and small size of the microcomputer built around a fixed-instruction microprocessor, this approach is dominant.

But, not all problems can be solved with an 8080A or 8085. They may not be fast enough. And, applications requiring more than 8 bits of precision, substantial amounts of arithmetic processing, adherence to a pre-defined instruction set or blazing speed need something more than MOS has to offer. You need microprogramming capability. You need bipolar LSI.

During the year, you'll be meeting several new members of the Am2900 Family, a series of low-power Schottky LSI devices specifically designed for microprogrammed machines.

Your microcomputer can have instruction execution as short as 100 nanoseconds, multiplication as fast as 4 microseconds and division in just 8 microseconds.

So clear some space. In your office. In your home. In your brain.

BUILD YOUR LIBRARY, TOO.

Each of these messages is backed by a ton of theory and applications information. Send in this coupon, and we'll send you Chapter One and tell you how to get the whole book.

Advanced Micro Devices	2-78-ED
901 Thompson Place	
Sunnyvale, California 94086	
I want to build a microcomputer this year. Sign me up.	
Name _____	
Title _____	Mail Stop _____
Company _____	
Address _____	
City _____	State _____ Zip _____

Advanced Micro Devices



Multiple technologies. One product: excellence.
901 Thompson Place, Sunnyvale, California 94086
Telephone (408) 732-2400

Next month, Chapter Two: Microprogrammed Control.●

dependability

Our customers just plug in our power supplies and forget about them. Fortunately, these same customers don't forget about us. Which helps to explain why we are now the world's largest manufacturer of SCR supplies.

In a word: dependability. In another word: reliability.



One- and three-phase rack-mounted power supplies from 500 to 10,000 watts. Call TOLL FREE 800-631-4298 for complete information and prices, or write for our catalog.



ELECTRONIC MEASUREMENTS INC.

405 Essex Road, Neptune, N.J. 07753
Phone: (New Jersey) 201-922-9300. TOLL FREE 800-631-4298
Specialists in Power Conversion Equipment

Publisher

William Maass

Editors

Editorial Offices
50 Essex St.
Rochelle Park, NJ 07662
(201) 843-0550
TWX: 710-990-5071
(HAYDENPUB ROPK)
Cable: Haydenpubs Rochellepark

Editor-in-Chief George Rostky

Managing Editors:

Ralph Dobriner
Michael Elphick

Senior Associate Editor

Stanley Runyon

Associate Editors:

Sid Adlerstein
Nicholas Bodley
Dave Bursky
Morris Grossman
Gene Heftman
Andy Santoni
Max Schindler

Contributing Editors:

Peter N. Budzilovich, Jules H. Gilder,
Sidney Moskowitz, Nathan Sussman

Editorial Field Offices

East

Jim McDermott, Eastern Editor
P.O. Box 272
Easthampton, MA 01027
(413) 527-3632

West

Dick Hackmeister, Western Editor
8939 S. Sepulveda Blvd., Suite 414
Los Angeles, CA 90045
(213) 641-6544
TWX-1-910-328-7240

Dave Barnes, Western Editor
465 S. Mathilda, Suite 302
Sunnyvale, CA 94086
(408) 736-6667

Editorial Production

Marjorie A. Duffy, Production Editor
James Keane, Copy Editor

Art

Art Director, William Kelly
Richard Luce, Anthony J. Fischetto

Business Manager

Thomas E. Vachon

Production

Manager, Dollie S. Viebig
Nancy Hurey

Circulation

Director, Barbara Freundlich
Senior Assistant, Gail Stone

Information Retrieval

Paula Greenleaf

Advertising Promotion

Judith Nappo

Reprints

Maxine Sassano

Across the desk

The hazards of JEDEC

The Focus on Power Transistors and Thyristors (ED No. 23, Nov. 8, 1977, p. 52) contains much good information. Especially pertinent is the forthright advice offered on the hazards that lie in wait for the designer who puts too much faith in JEDEC numbers, and not enough reliance on an understanding of the uncontrolled parameters that can so easily change without warning.

Design engineers should note that the "H" suffix, as applied in RCA's (and others') 2N3055H, represents a marketing game, not a JEDEC-recognized and authorized suffix. The same part may emerge soon as the 2N3055A, but meanwhile designers need to be careful in assuming JEDEC control in a situation where manufacturers have chosen to disregard well established JEDEC rules.

Perhaps less clear is your Focus's discussion of temperature derating. The author would have been more to the point to say: "If you want to dissipate 115 W and permit the junction temperature to go to 200 C, then the case temperature for a device with a thermal resistance of 1.5 C/W has to be held at $(200 - 1.5 \times 115) = 27.5$ C."

The designer would then face two important questions: How realistic is it to try keeping the case that cool in his product's operating environment? And how close to the rated maximum of 200 C dare he go in light of his overall reliability constraints?

Furthermore, the author doesn't even mention the use of heatsinks or heat radiators. Certainly it goes without saying that every 115-W device is intended to be cooled by a heat sink or radiator.

Lawrence W. Johnson

Hewlett-Packard
3500 Deer Creek Rd.
Palo Alto, CA 94304

Misplaced Caption Dept.



Hang on a moment. He's coming out of the meeting. I'll see if he can talk to you now.

Sorry. That's Domenikos Theotokopoulos's (El Greco) "The Burial of Count Orgaz," which hangs in the Saint Tomé church, Toledo, Spain.

Our good data sheets could be better

I read your Focus article on Power Transistors and Thyristors (ED No. 23, Nov. 8, 1977, p. 52) with keen interest. You correctly point out many of the wrongs and rights that the semiconductor industry does in attempting to specify these power products properly.

However, some clarifying points are in order. The attempt by RCA to differentiate the single-diffused from the epitaxial-base 2N3055 was done by adding a suffix "H" for the Hometaxial single-diffused structure, not for the

(continued on page 8)

JANCO ROTARY SWITCHES

offer **SIMPLE**
solutions to complex
switching problems!



P-C Rotary Switches

"THE MIGHTY MINIATURE"

Optimum simplicity! Features the sophisticated circuitry of a coded switch plus all the advantages of a sealed rotary... and it's only .6" in diameter and .5" deep (from mounting face to the base of the pin terminals). Mounting is simpler! Wiring is simpler! Available in 8, 10, 12 positions. 1" diameter is available in up to 24 positions.

PUSH-BUTTON Rotary Switches

Unique in design by virtue of their simplicity, these Janco rotary switches also function accurately and quickly in the most adverse environmental conditions. Can be "ganged" together for high density packaging. Available in bi-directional and uni-directional in 8, 10, 12, 15 positions with codes galore! And Janco switches are QPL, too!



Rotary Selector Switches

Standard rotary selector switches, power, miniature, micro-miniature, solenoid operated, keylock, momentary, etc. ... Janco has the rotary switch for your application. Proof is in the usage! Almost every military and commercial craft that flies has been using Janco rotary switches for over 30 years!

Janco
CORPORATION

3111 Winona Ave., Burbank, CA. 91504
Phone 213-845-7473 • TWX 910-498-2701

CIRCLE NUMBER 5

Electronic Design welcomes the opinions of its readers on the issues raised in the magazine's editorial columns. Address letters to Managing Editor, Electronic Design, 50 Essex St., Rochelle Park, NJ 07662. Try to keep letters under 200 words. Letters must be signed. Names will be withheld upon request.

Across the desk

(continued from page 7)

epitaxial one. JEDEC has now ruled RCA as well as Motorola and others that followed RCA, out of order, and the "H" will not be used.

Motorola, prior to the use of the "H" suffix by RCA, had requested an "A" suffix in compliance with JEDEC rules for essentially the same specification as the 2N3055H. Our petition was blocked by RCA and others, but now we have resubmitted the "A" request and believe it will be granted.

The JEDEC rules, rightly or wrongly, do not identify process information. JEDEC registration merely tries to provide a standard for electrical, mechanical and thermal ratings and specs, which, if met, should allow a semiconductor device to work in the same application despite other differences. But interchangeability problems will still persist, because there are subtle differences even with processes that appear identical. To help prevent such problems, Motorola has a standard operating procedure, whereby users are notified of all critical process changes early enough for trial and acceptance prior to product shipment.

Your Focus states that safe-operation-area (SOA) curves are included because of JEDEC, implying that without JEDEC they might not be provided. But what is JEDEC? The power-transistor committee consists of 11 representatives from the semiconductor industry—Delco, Fairchild, GE, GSI, IR, Motorola, RCA, Solitron, STC, TRW and Westinghouse. IBM supplies the only "user" representative. And the National Bureau of Standards has observers at most meetings. So, in reality, power-transistor companies developed the SOA concept and included it willingly on data sheets. Motorola used the SOA concept back in the early germanium days. And RCA has been a pioneer for a self-imposed "everything-including-the-warts" concept.

Also, the arbitrary use of a 25-C case temperature is not as ridiculous as it seems. We know of several applications at very high currents that use water cooling to keep the case temperatures at no more than 30 C. So where does the supplier draw the line? Moreover, both the supplier and the user can easily measure case temperature.

Nevertheless, your criticism of the lack of high-temperature specifica-

tions is valid. Still Motorola, especially for its Switchmode series, gives seven limit specifications at 100-C and one at 150-C case temperatures, and the allowable power dissipation both at 25-C and 100-C case temperatures. Also, the reverse-bias-safe-operating-area (RBSOA) limit curves are good at 100 C, and the forward-bias SOA have derating curves. These curves are "specified ratings," not typical design information.

Your comments on $E_{s/b}$ are very good. We agree, that the RBSOA curve, which is a clamped voltage-current limit, is a more useful concept, since it avoids the single-circuit fallacy of $E_{s/b}$ and reflects what most users find very practical. Of course, power transistors with high $E_{s/b}$ capability would permit snubbers and clamps, to be eliminated, but so far this is beyond the state of the art. However, your statement that $E_{s/b}$ depends on several variables should not have included the use of a clamp, since $E_{s/b}$ by definition is an unclamped capability.

Despite these minor clarifications, we feel that the over-all effect of your article is good—to warn the user to study the data sheets in detail, which we welcome. We feel Motorola's data sheets are very good, now. Can they be improved? You bet! And we are trying to do so with each new issue.

Ralph Greenburg
Manager,

Power Products Planning

Motorola Inc.
5005 E. McDowell Rd.
Phoenix, AZ 85008

A diode is missing, and '8' should be 'B'

Some typographical errors have crept into my Idea for Design, "Buffer Circuit for Line Driver Protects Against Shorts and ± 325 -V Surges" (ED No. 23, Nov. 8, 1977, p. 102). Fig. 3 should have a 1N4004 rectifier in the line between the 2N5416 collector terminal and the junction with the two 51-k Ω resistors that lead to the 0.01- μ F output capacitor. The anode of the 1N4004 should be connected to the collector. Also, all zener diodes shown are 1N5363Bs, not 1N53638s.

Roxton Baker
Design Engineer

C-E Power Systems
Combustion Engineering Inc.
100 Prospect Hill Rd.
Windsor, CT 06095

Me an editor?

If you'd like to be among the first to know (and write about) what's going on in the electronics industry, you might enjoy being an editor.

We have openings at our home office in Rochelle Park, NJ. Call Ralph Dobriner at (201) 843-0550.

A matter of clarity

Our article, "Exploit Existing NOVA Software by Designing Computer Systems Around the MicroNOVA..." (ED No. 19, Sept. 13, 1977, p. 54) contained several inaccuracies.

The last two sentences of the paragraph before the subhead, "Other circuits help the processor" (p. 56), should read: "During a Refresh operation, the CPU specifies a group equivalent to 1/64 of all the memory locations to be refreshed, but transfers no data. The refresh address is selected by a 6-bit refresh-address register placed on the lower six address lines."

Daniel Falkoff
Design Engineer

Natalio Kerllenevich
Design Engineer

Philip M. Kreiker
Design Engineer

Data General
Route 9
Westboro, MA 01581

'Science' of namechanging

It's a funny thing. Everybody knows who heals people (doctors do that), and everybody knows who defends people in court (lawyers do that). But nobody really knows who sends our men into space and builds our computers. The news media always use the term "scientists."

Is it any wonder that the engineering community does not have the status of doctors and lawyers? Nobody knows who we are or what we do. It wasn't until I was a sophomore in college that I discovered that what I wanted to be was an "engineer." I'd thought I wanted to be a scientist.

Maybe we should change our name. "Electrical and Electronic Scientists" has a very good ring—and would be recognized instantly by the public.

Richard Walbaum
President

Flow Master
2900 Baylor St.
Bakersfield, CA 93305

hp MEASUREMENT COMPUTATION **news**

product advances from Hewlett-Packard

FEBRUARY, 1978



Whether used on the bench or combined with a desktop computer for automatic measurements, this 1500 MHz spectrum analyzer brings new power to frequency-domain measurements.

Microprocessor-based 1.5 GHz spectrum analyzer offers state-of-the-art performance and usability

Ten-hertz resolution at 1500 MHz! That's just one of the major contributions of the new HP 8568A Spectrum Analyzer. This 100 Hz-to-1500 MHz analyzer's measurement range is -137 to $+30$ dBm, it measures signal frequencies to counter

accuracy, it can measure 50-Hz sidebands that are 60 dB down, and its spurious-free dynamic range is ≥ 85 dB.

As you can see from the illustration, the analyzer's functions and operating state are keyboard selected. The instrument's

internal microcomputer administers controls, calculates and manipulates data (including correcting for hardware inaccuracies), and provides new and useful operating features. Among these are tunable markers that greatly speed measurements, automatic peak search, automatic signal track, and complete CRT labeling of all pertinent operating conditions.

(continued on third page)

IN THIS ISSUE

Semiconductor memory at 5¢ a byte • Software libraries for System 45 • Programmable IC tester

Catch those elusive errors with HP's new 150 Mb/s error detection system

At a time when high speed digital transmission is beginning to be commercially exploited, Hewlett-Packard introduces a new 150 Mb/s bit error rate measurement system. The 3762A Data Generator and 3763A Error Detector are specifically designed for field evaluation, commissioning and maintenance of digital line and radio equipment. The measurements performed by the system are:

- binary bit-by-bit error detection on binary and coded signals
- clock frequency offset generation and measurement

The 3762A/3763A system strikes a fine balance between dedication and flexibility. Thanks to a wide variety of options available, it can be configured to meet the specialized requirements of existing systems such as cable and radio. At the same time, flexibility is retained to meet the developing needs of new systems such as optical fiber. Choices of internal clock frequencies, data formats, interface levels and impedance are available.

Key new features of the 3762A/3763A include a $2^{23}-1$ PRBS test pattern and new interface code for high speed systems, input equalization for interconnecting cable loss, and zero block injection to check the pattern dependence of systems. Burst gating inputs allow the 3762A/3763A to operate in burst mode for TDMA satellite applications. To extend the capability further, outputs from the 3763A to an external counter, printer and pen recorder allow unattended long term measurements and error distribution analyses.

For complete details, check B on the HP Reply Card.

Hewlett-Packard's new 3762A/3763A being used to check a 120 Mb/s coaxial line system.



Programmable IC Tester cuts production costs



HP's IC tester is easy for your operator to use and its capability of generating the needed test programs gives you full control of testing schedules.

More and more people are finding that pretesting ICs cuts production costs significantly. For example, finding the bad ICs before they get loaded into your PC board can save you up to \$10 each.

HP's cost effective solution to IC testing is the new 5046A Digital IC Test System. It is easy for your operator to use and you retain full control of the test programs. Choose from any of the standard tests in our growing library of 1200 programs, write your own programs, or buy ours and modify them to suit your needs.

The HP 9825A computing controller comes with the system, and you can use it for other tasks when it's not needed for writing test programs. If you already have a 9825A, order the 5046A without it and save money.

With the 5046A you get HP's versatile 5045A Digital IC Tester which is capable of testing all major logic families including ECL, CMOS, TTL, and DTL. The programming system gives you easy access to the tester's unique versatility. Any IC pin can act as input, output, or clock. Currents and voltages can be set up individually for each IC pin and 16 separate tests can be made on each IC.

Interface to a wide range of automatic IC handlers—even many of the lower cost ones—is simple, reliable, and economical with standard options.

For more information, check C on the HP Reply Card.

New SLMS makes major contribution to high-density FDM system management

HP's new 3747A/B Selective Level Measuring Sets, extended frequency versions of the current 3745A/B SLMS's, are designed to make fast, accurate selective level measurements on frequency-division multiplexed (FDM) baseband signals. A built-in frequency synthesizer gives accurate and stable tuning to the precise frequency at which the measurement is to be made, thus simplifying the tuning of the SLMS. Tuning is to a 10 Hz resolution over the frequency range 10 kHz to 90 MHz.

Three basic measurement filters are provided: **1)** a 22 Hz Pilot filter; **2)** either a 3.1 kHz or 2.5 kHz Channel filter (for 4 kHz or 3 kHz channel spacings) and; **3)** a 48 kHz Group filter. Weighted and notch filters for noise measurements are available as options.

The SLMS is internally controlled by a microprocessor, which provides several ease-of-use and time-saving features. As well as tuning exactly to an entered frequency, the SLMS can refer to the BELL or CCITT multiplex frequency plans in its memory and automatically tune to the correct frequency at any level in the multiplex. (Other frequency plans can be installed by special order.) Thus, 250 pilot measurements could be made in about 2 minutes, or 2700 channel powers or carrier leaks could be measured in about 15 minutes.

For more details on this new SLMS check D on the HP Reply Card.

Fully programmable via the HP Interface Bus, the SLMS's can form the basis for powerful, fully-automatic surveillance of multichannel communications systems.

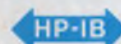

Application note tells how to calibrate accelerometers automatically

A new, three-page application note, "Automatic Accelerometer Calibration", from Hewlett-Packard describes how HP's Data Acquisition System is being used to calibrate accelerometers. In tests made by the U.S. Army, accelerometers are used to measure the ground impact force on the cargo and its container package in order to relate the cargo's survivability to the force.

For your complimentary copy of this Application Note 204-1, check **W** on the HP Reply Card.

Powerful new spectrum analyzer

(continued from first page)

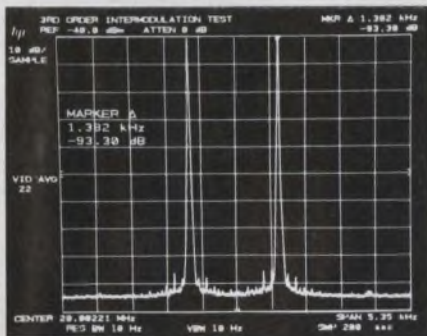

Two-tone test using 8568A shows 3rd-order intermodulation products >85 dB down.

All of the keyboard functions are remotely programmable via the HP Interface Bus such that the 8568A analyzer and HP 9825A desktop computer combine to form a friendly yet powerful automatic system with tremendous measurement capabilities. Challenging applications that can benefit from the spectrum analyzer-computing controller combination include electromagnetic interference (EMI) testing and spectrum surveillance.

To learn more about this revolutionary advancement in spectrum analysis, check **A** on the HP Reply Card.

Make timing measurements easily and accurately with two new high-frequency scopes

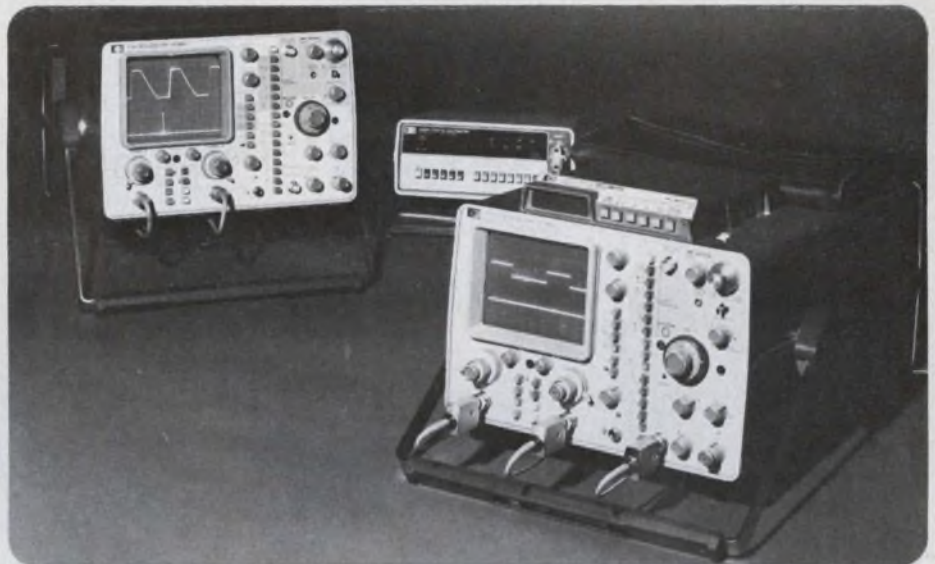

Like all new high-frequency HP oscilloscopes, the 1715A and 1725A have switch selectable 50 Ω or 1 M Ω inputs. And the 1725A with 275 MHz bandwidth, is the fastest 1 M Ω input oscilloscope available which reduces the need for active probes when working with fast logic near maximum fanout.

Now you can choose from two new HP delta time oscilloscopes which make timing measurements easily, with greater repeatability and one percent accuracy—the 1715A with 200 MHz bandwidth, or the 1725A with 275 MHz bandwidth. Both offer an optional, built-in DMM for direct delta time readout, plus autoranging AC/DC volts, amps, and ohms.

A large 8 \times 10-centimeter CRT provides a dual, bright, crisp display on which timing measurements can be made conveniently and accurately, using the Hewlett-Packard developed delta time technique. This technique makes timing measurements such as transition times, propagation delay, clock phasing, and other high-speed digital timing measurements faster and with more repeatability than was previously possible with standard delayed sweep oscilloscopes. For easier percentage measurements, reference lines of 0 and 100% are 5 divisions apart so that each division represents 20% of the reference amplitude. Auto focus and intensity control circuits reduce the need for frequent intensity and focus adjustments, as well as improving CRT life.

Measurement capability is further enhanced by the logically arranged, easy-to-use front panel controls which speed

operator familiarization, reduce the possibility of measurement errors and thus improve accuracy. Selectable 1 M Ω and 50 Ω input impedance make it easy to select the best input impedance for your measurement. Sweep speeds from 10 ns/div to 0.5 s/div allow you to expand your signals for maximum resolution and a \times 10 magnifier provides one ns/div sweep speed for critical timing measurements.

In addition to faster and more accurate delta time measurements, both new oscilloscopes offer you a selection of channel A or B as the starting point for delta time measurements. This often eliminates the need to move probes and simplifies trace overlap for zeroing. But you can select conventional delayed sweep with the flip of a switch, for simple trace expansion. The optional autoranging 3 $\frac{1}{2}$ -digit DMM can be factory installed. Or, for easy field installation, a kit is available. Another option, HP's "Gold Button", gives you pushbutton selection of either time domain or data domain when the 1715A or 1725A is used with HP's 1607A Logic State Analyzer.

For more details, check **E** on the HP Reply Card.

Eleven software libraries for HP's new System 45 save costly programming time



System 45, the newest member of the Series 9800 Desktop Computers, combines with our 11 software libraries to save you costly programming time. Depending on your application, System 45 with its CRT and our software provide either a total solution or convenient building blocks for developing your specialized programs. This is what's available:

- **Utility Library**-consisting of two dozen useful, general purpose programs, free with each System 45.
- **Numerical Analysis**-50 powerful routines to handle fourier analysis and differential equations.
- **Regression Analysis**-a comprehensive package of programs for linear, stepwise and polynomial regression.
- **Basic Statistics & Data Manipulation**-programs to perform a wide variety of operations from means

and standard deviations to complicated correlation coefficient calculations.

- **Waveform Analysis**-a unique group of programs to analyze large volumes of data based on fast fourier transform routines.
- **Management Science**-four libraries for text processing, linear programming, forecasting and graphics, and network analysis.
- **Business Administration**-libraries for payroll and inventory control.

For more information on System 45, check G on the HP Reply Card. For additional details on each of the software libraries, check H for Numerical Analysis; I for Regression Analysis; J for Basic Statistics & Data Manipulation; K for Waveform Analysis; L for Management Science; and M for Business Administration.

New microwave synthesizer application note

Application Note 218-2, *Obtaining Millihertz Resolution from the 8671A and 8672A*, the second from the Microwave Synthesizer Series, is now available.

The note describes how the HP 8671A and 8672A Microwave Synthesizers can be used in combination with other HP

synthesizers to obtain resolution as fine as 1-3 mHz across the 2-18 GHz band. Some sample calculator sub-routines are given to aid programming of the system.

For your complimentary copy of Application Note 218-2, please check X on the HP Reply Card.

New meter makes fiber optic power measurements with ease and accuracy

A new power sensor/power meter combination designed specifically for measurements of signal power in single optical fibers is now available from Hewlett-Packard. By using the well-known detection principle of a thermistor bridge, absolute power is indicated on a meter.

The HP 84801A Power Sensor contains the thermistor elements, one of which is optically coupled to a single fiber pigtail, one meter long with a core diameter of 200 μm . (Dupont PFX-S120R, plastic-clad). This large diameter relative to commonly-used single fibers permits low loss couplings. Numerical aperture is 0.4, nominal.

The HP 432A Power Meter operates the thermistor sensor in a balanced bridge. Since the thermistor is virtually a black body, it efficiently converts the optical power to heat. This tends to unbalance the thermistor bridge and the power necessary to rebalance is metered. Thus, direct, absolute power measurement is obtained with high confidence and convenience.

Absolute accuracies ranging from 7% to 14% are specified over a dynamic power range of 1 μW to 10 mW. The full spectral range is 600 nm to 1200 nm, with four calibration points traceable to the National Bureau of Standards at 650, 820, 1050 and 1150 nm.

If you'd like more information on this first Hewlett-Packard entry into the fiber optic communications field, check F on the HP Reply Card.

Optical power in single fibers can now be measured with HP's 84801A/432A system.

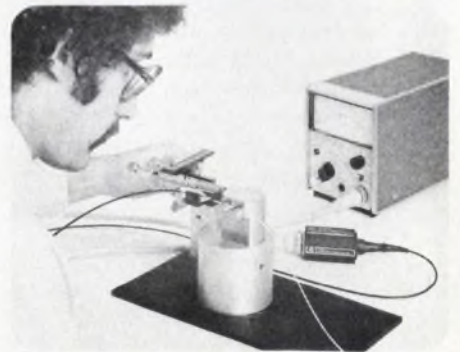

Advances in time interval instrumentation

With HP's 5370A Universal Time Counter you can measure time intervals with a resolution of 20 picoseconds—that's five times better than counters did before. It also automatically computes statistical data. And the new HP 5359A Time Synthesizer generates pulses whose time delay and width are adjustable in 50 picosecond steps—that's 20 times better than delay generators did before.

Uses for these advancements are in semiconductor testing, radar and laser ranging, digital communications, computer testing, nuclear studies, and calibration. The 5359A can also generate precise delayed sweeps for oscilloscopes and very accurately time-position the external gates of frequency counters.

Using the 5370A's keyboard, you can quickly set up to compute pulse jitter, minimum and maximum time interval, mean time, and standard deviation. The 5370A is also a full capability universal counter, measuring period and frequency from 0 to 100 MHz with up to eleven digits of information in one second measurement time.

Major specifications for the 5359A Time Synthesizer include: delay range, 0 to 160 ns; pulse width, 5 ns to 160 ns; amplitude adjustable 0.5 to 5 V into 50 ohms; offset adjustable ± 1 V. All are controllable by the 5359A front panel keyboard or system commands. Calibration is automatic.

For details on the 5359A, check N on the HP Reply Card. For the 5370A, check O.



Microprocessors make both models easy-to-use and versatile in benchtop or systems use, as in the above VCO tester.

Programmable, 4-color plotters output computer data with fidelity and speed

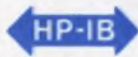

Two new HP plotters, the 7221A and the 9872A, prepare high quality, four-color plots with unprecedented ease. Controlling these plotters is an HP designed microprocessor which enables dramatically fast, precise, and convenient plotting not available in earlier plotters. Although similar in appearance, the two plotters were designed to fulfill two different needs: 1) direct connection to desktop computers, or other controllers using a standard parallel interface, and 2) connection in a serial communication link to a host computer or terminal.

Both plotters feature user-initiated confidence test to verify their overall mechanical and electrical operation. A built-in self-test allows service personnel to perform a series of tests without the use of external test equipment.

Graphic Plotter for Local Operation

The 9872A interfaces to your controller through the HP-IB interface. Using an easily understood, two-letter mnemonic graphics language, the HP-GL, you can start plotting with only a minimum of programming experience. With 38 graphic instructions, you can select any of four pens, designate any one of five resident character sets, and define any one of

seven line types. To enhance the graph, you can change the slant, size, and direction of the characters, program the pen speed, draw arcs with tick marks, and identify traces with symbols. Window plotting permits error-free off-scale data handling.

For further details, check Q on the HP Reply Card.

Remote Terminal Graphic Plotter

The 7221A, with an RS-232C/CCITT V.24 interface, features three modes of operation for efficient use of expensive computer time. These three modes are: direct communication with the terminal, standby, and on-line to the host computer. In addition to sharing many of the graphic functions of the 9872A, the 7221A further reduces communication time through resident arc and circle generation, programmable macroinstructions, definable dashed lines, internal characters, and built-in buffer.

Check P on the HP Reply Card for details.

Convert HP-PLOT/21 for use on your system

A further enhancement of the 7221A is provided by the HP-PLOT/21 software package. Consisting of 86 FORTRAN IV subroutines for HP 3000 Series II, GE MARK III timeshare and TYMESHARE X systems, HP-PLOT/21 makes the advanced capabilities of the 7221A easily accessible. For use with other systems, our Applications Note 229-1 provides information to help the systems programmers determine the feasibility of converting the HP-PLOT/21 to operate on their systems. For your complimentary copy of AN 229-1, check Y on the HP Reply Card.

Up to 1.8 million bytes of fault-control semiconductor memory—at 5¢ a byte*

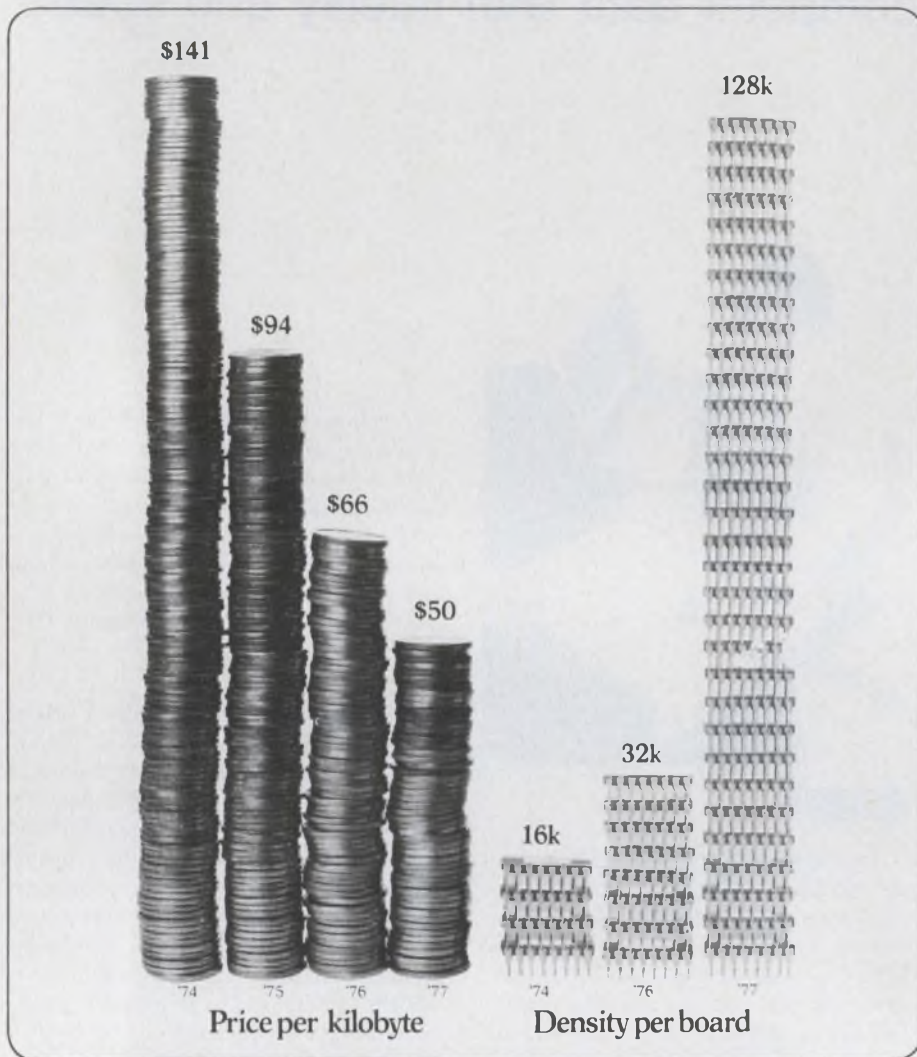

Hewlett-Packard's high-capacity memory packs one megabyte of "fault-control memory" in a compact 131 cm (12¼ in) high HP 21MX mainframe—all for only 5 cents a byte.

Hewlett-Packard made an early commitment to semiconductor memory. Since 1974, we have been able to offer memory to our customers at price decreases averaging 30% a year, in part the result of increased memory density.

The newest module, HP 12747, quadruples capacity from 32k to 128k bytes utilizing 16k-bit, N-Channel, MOS/RAM memory chips—the first in use by a major manufacturer of small computers.

Memory for 21MX K, M, and E series computers and HP 1000 computer systems can now be expanded to a maximum of 1.8 megabytes. Upgrading from your present 21MX system to larger memories is also possible.

A new fault-control memory system provides for detection and correction of all

single bit memory errors using the standard 21-bit Hamming code. But, because there is always the chance of a double bit error, we added a 22nd parity bit to the Hamming code, enabling us to detect all double errors. Programs will continue running and data will be protected even if a memory chip malfunctions.

Fault control memory is available as an optional controller with its associated check bit arrays.

Density and reliability are not the only advantages of semiconductor memory. Cost savings is another.

*Domestic U.S.A. only

For more information, check R on the HP Reply Card.

New DC power supply catalog from HP

Choosing the right power supply for your application is easy with HP's new *DC Power Supply Catalog*. This 128-page catalog contains product descriptions, photographs, outline drawings, specification, and prices for HP's complete line of power supplies covering the range from 10 W to 11 kW. Products include:

- General-purpose lab and system power supplies
- Precision voltage and current sources
- Digitally programmable power sources

Included is a section detailing several methods to control DC power supplies using the HP Interface Bus. In addition, another section covers power supply ac and load connections.

For your free copy, check Z on the HP Reply Card.

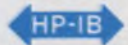

HEWLETT-PACKARD COMPONENT NEWS

New packaged GaAs FET offers low noise and moderate power

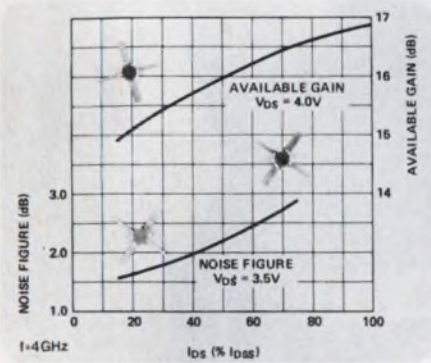

Linear output power of new 1-micron GaAs FET provides the design engineer with a superior device usable over the broad range of frequencies, 2 to 12 GHz.

HP's new packaged GaAs FET, the HFET-1101, is a cost-effective and rugged transistor which is easy to work with and yields superior performance. It is characterized for low noise and moderate power requirements in the 2 to 12 GHz range, with typical noise figure of 1.6 dB (2.2 dB max) and 11 dB typical associated gain at 4 GHz.

When tuned for maximum output power at +5 dBm input, linear output (1 dB compression) is typically 35 mW at 4 GHz and 25 mW at 8 GHz. The HFET-1101 is useful as a low noise second stage or output stage in the 2 to 8 GHz range for broad and narrow band applications such as land and satellite communications and radar.

The HFET-1101 is packaged in the HPAC-100A, a rugged, hermetic 2.5 mm (0.1 in) square metal/ceramic package. High reliability tested versions of this device can be specified. A chip version, the HFET-1000 is also available.

For performance specifications on both the package and chip versions, check S on the HP Reply Card.

HP increases distribution outlets for semiconductor components

HP component products are now available from 21 additional stocking locations in the U.S. and Canada.

Hamilton/Avnet, the largest electronics distributor in the world, and Pioneer-Standard, Inc., a leading regional distributor in the U.S. have recently been franchised in selected markets.

Customers may now obtain HP components from the following branches of Hamilton/Avnet: Phoenix, Az; Culver City, San Diego and Mountain View, CA; Denver, CO; Chicago, IL; Kansas City, KS; St. Louis, MO; Detroit, MI; Minneapolis, MN; Albuquerque, NM; Salt Lake City, UT; Seattle, WA; Milwaukee, WI; and Toronto, Montreal and Ottawa in Canada. In addition, Pioneer-Standard, Inc. is marketing HP components from its offices in Cleveland and Dayton, OH; Pittsburgh, PA; and Indianapolis, IN.

Both distributors will carry HP's full line of semiconductor components. These include LEDs, infra-red detectors, optically-coupled isolators, solid state numeric and alphanumeric displays, microwave diodes, and RF and general purpose diodes, plus microwave transistors.

Hewlett-Packard began selling its components through distribution in 1972. HP's network of distributors also includes Hall-Mark Electronics Corp., Schweber Electronics Corp., Wyle Distribution Group, Wilshire Electronics Group in the U.S. and Zentronics in Canada. In addition, a number of international distributors make HP components available worldwide.

For a complete listing of HP component product distributors, check U on the HP Reply Card.

HP's Schottky diode—world's first in a DO-35 package

With a low forward voltage of 410 mV, the HSCH-1001 (1N6263) is a functional replacement for many germanium diodes.

It offers switching speed in the picosecond range, a breakdown voltage of 60V, a temperature rating of -65°C to $+200^{\circ}\text{C}$ and is in a hermetic-glass package rugged enough for automatic insertion. Applications include waveform clipping, clamping and sampling, transistor speed-up, RF signal detection, and power monitoring.

As the world's first Schottky barrier diode in the industry standard DO-35 package, the HSCH-1001 gives you a reliable, high performance alternative for your general purpose switching needs.

For details, check T on the HP Reply Card.

The HSCH-1001 is offered in the low-cost DO-35 hermetic package. It is rugged enough for automatic insertion equipment and can be supplied in tape or reel.

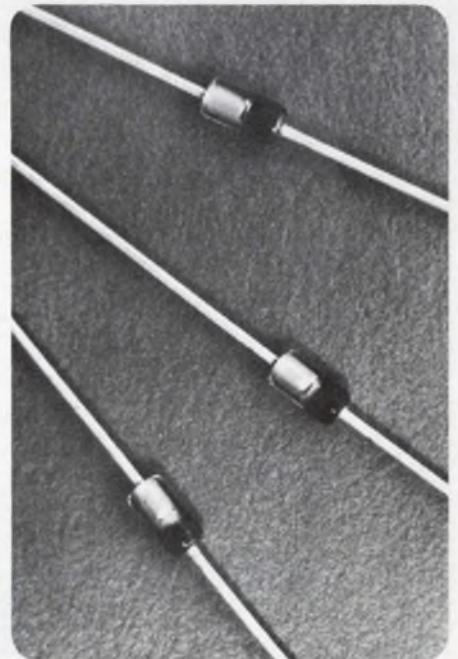

New HP-IB digital multimeter cuts cost of data gathering

Hewlett-Packard's new 3438A DMM has a built-in HP-IB interface for automatic low cost data collection. This 3½-digit multimeter has five full functions with volt-ohm autoranging. Ten milliohm and 100 μ V AC and DC sensitivities make the 3438A excellent for gathering data from various types of transducers.

The 3438A may be used in a talk-only mode with a companion HP 5150A printer to record data on tape. The 5150A recorder includes a clock pacer to control unattended data gathering. Transducer outputs can be normalized or linearized while measurements are made, using a controlling computer such as the HP 9825A. Data may also be stored in the HP 9825A tape cassette for later use.

Whether you use HP's 3438A in manual or autoranging mode, in a system or on the bench, it will always indicate with lighted annunciators, the most commonly understood engineering units. If an improper selection of function and range is chosen, an overload indication on the display informs the operator that a measurement error was made.



Now you can have a 3½-digit multimeter for use in low-cost data acquisition. Used with a controlling computer and scanner, data may be recorded on cassette tape for later use, or analyzed as it is received for process control.

For additional information on this item, check V on the HP Reply Card.

East-4 Choke Cherry Road, Rockville, MD 20850.
Ph. (301) 948-6370.
South-P.O. Box 10505, Atlanta, GA 30348.
Ph. (404) 434-4000.
Midwest-5201 Tollview Dr., Rolling Meadows, IL 60008.
Ph. (312) 255-9800.
West-3939 Lankershim Blvd, North Hollywood, CA 91604. Ph. (213) 877-1282.
Europe-Central Mailing Depot, P.O. Box 529, Amstelveen-1134, Netherlands.
Ph. (020) 47 20 21
Japan-Yokogawa-Hewlett-Packard Ltd., Ohashi Bldg., 1-59-1 Yoyogi, Shibuya-ku, Tokyo 151. Ph. 03-370-2281/92.

HEWLETT  PACKARD

 **MEASUREMENT news**
COMPUTATION
product advances from Hewlett-Packard

January/February 1978

New product information from

HEWLETT-PACKARD

Editor: Bojana Fazarinc-Bitencourt

Editorial Offices:

1507 Page Mill Road
Palo Alto, California, 94304 U.S.A.

Want mass terminations for I/O interconnecting? We have the widest choice.

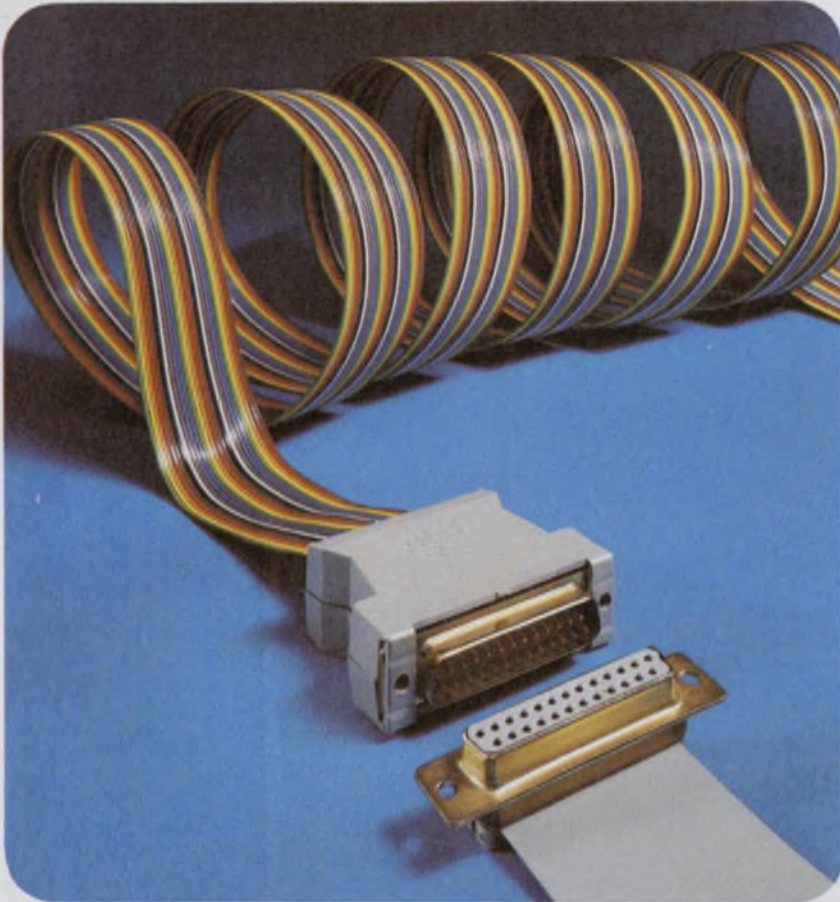

Now Scotchflex brand DELTA Connectors bring the proved labor-savings of 3M's mass termination system to subminiature connections. DELTA series components include pin and socket connectors, junction shells, 25-conductor flat cable and strain relief clips. These system assemblies interface directly with all other industry standard "D" series subminiature connectors. They're also compatible with all connectors in our complete Scotchflex line.



A family of Scotchflex male plug connectors is now available in sizes from 10 to 50 contacts to mate with Scotchflex socket connectors for T-tap or mid-span connections or rack and panel applications.

"Scotchflex" is a registered trademark of 3M Co.

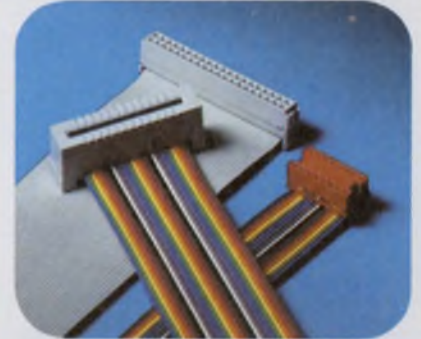

Our broad line of Scotchflex socket connectors includes a variety of 12 different sizes and center spacings to fit standard wrap panels and custom configurations. Also offered are Scotchflex card-edge connectors in sizes for 20 to 50 conductors.

Only 3M offers you so wide a choice of mass terminating flat cable and system components for fast, economical assembly of I/O interconnections between modules or sub-assemblies in your equipment designs. Plus off-the-shelf availability from experienced distributors, and the unmatched experience of the people who pioneered electronic mass terminations.

For more information on Scotchflex products call 612-733-3350.

Scotchflex[®]
systems
from 3M.
The source.



See our
catalog in EEM,
page 1056

Fluke Counters.



What's in a name?

CIRCLE 7 FOR 1900 SERIES LITERATURE

A glance at our counter guide shows how broad a selection you have when you choose the Fluke name.

Pick resolution from six to nine digits, and top-end frequencies from 80-1250 MHz. Notice that all Fluke counters are multi-function, from the frequency/period/totalize capability of the 1900A to the six-function 1953A Universal Counter-Timer. All models have input signal conditioning for reliable readings in the presence of noise, distortion, and ringing, and most have attenuators for increased dynamic range. So for R&D, GENERAL BENCH or PRODUCTION LINE applications, buy exactly what you need over an affordable, performance-effective price range.

For FIELD MAINTENANCE AND SERVICE, most of the line is available with an optional rechargeable battery pack installed inside the compact, portable case. Let autoranging keep the display full at all times for "hands-off" convenience, and rely upon autoreset to eliminate erroneous

RFI-shielded, and TCXO timebases are available for the kind of high accuracy you might need over environmental extremes. And if you choose the 1920A, you can get a resolution multiplier for high-resolution audio measurements.

If you have an ADVANCED BENCH or SYSTEMS application, the 1953A was designed for you. With fully programmable ranges and functions (including trigger level), the 1953A is available with



Fluke 1953A: a name and number to remember for perfection in programmable counter-timers.

IEEE-488 or BCD parallel options, at a price more than \$1,000 less than the competition's similarly-equipped models.

CALL (800) 426-0361, TOLL FREE and let us show you how the Fluke name is as meaningful

Counter Selection Guide	1900A	1910A	1911A	1912A	1920A	1925A	1952B	1953A
Number of Digits	6	7	7	7	9	9	7/8	9
Frequency (MHz) <i>Basic Unit Options</i>	80	125	250	520	520 1250	125 520	80	125 1250
Period	•	•	•	•		•	•	•
Totalize	•	•	•	•		•	•	•
Time Interval							•	•
Ratio		•*	•*	•*	•*	•*	•	•
A gtd by B							•	•
Sensitivity (mV)	25	15	15	15	15	15	50	30
Trigger Level Control		•	•	•		•	•	•
External Timebase Input		•	•	•	•	•	•	•
Battery Option	•	•	•	•	•			
TCXO Option		•	•	•	•	•	•	•
Ovenized Timebase Option						•		•
DOU Option	•	•	•	•	•	Std		•
Autoreset	•	•	•	•	•	•		
Autorange	•	•	•	•		•		
U.S. Price Basic Model (No Options)	\$345	\$395	\$495	\$620	\$995	\$750	\$795	\$995

partial-readings. In the Fluke tradition, they'll take a real field beating, too.

COMMUNICATIONS people find the 1911A through 1925A attractive for VHF/UHF measurements. They're so sensitive that a simple optional whip on the 50-Ohm fuse-protected input makes transmitter checks quick and easy. With automatic clean dropout, you'll always be right because the reading goes to zero with a fading signal. They're

in counters as it has been for other fine test and measurement instrumentation for the last 30 years. It's your assurance you've bought the best, backed by more than 32 service centers in 18 countries, worldwide.

John Fluke Mfg. Co., Inc., P.O. Box 43210, Mountlake Terrace, WA 98043. In Europe, contact Fluke (Nederland) B.V., P.O. Box 5053, Tilburg, The Netherlands. Tel. (013) 673973. Telex: 52237.

*Using external timebase input

Command Performance: Demand Fluke Counters.



2102-8007

CIRCLE 8 FOR 1953A LITERATURE ONLY
ELECTRONIC DESIGN 4, February 15, 1978

OUR COMP KILLERS ARE ON THE "MOST WANTED" LIST.

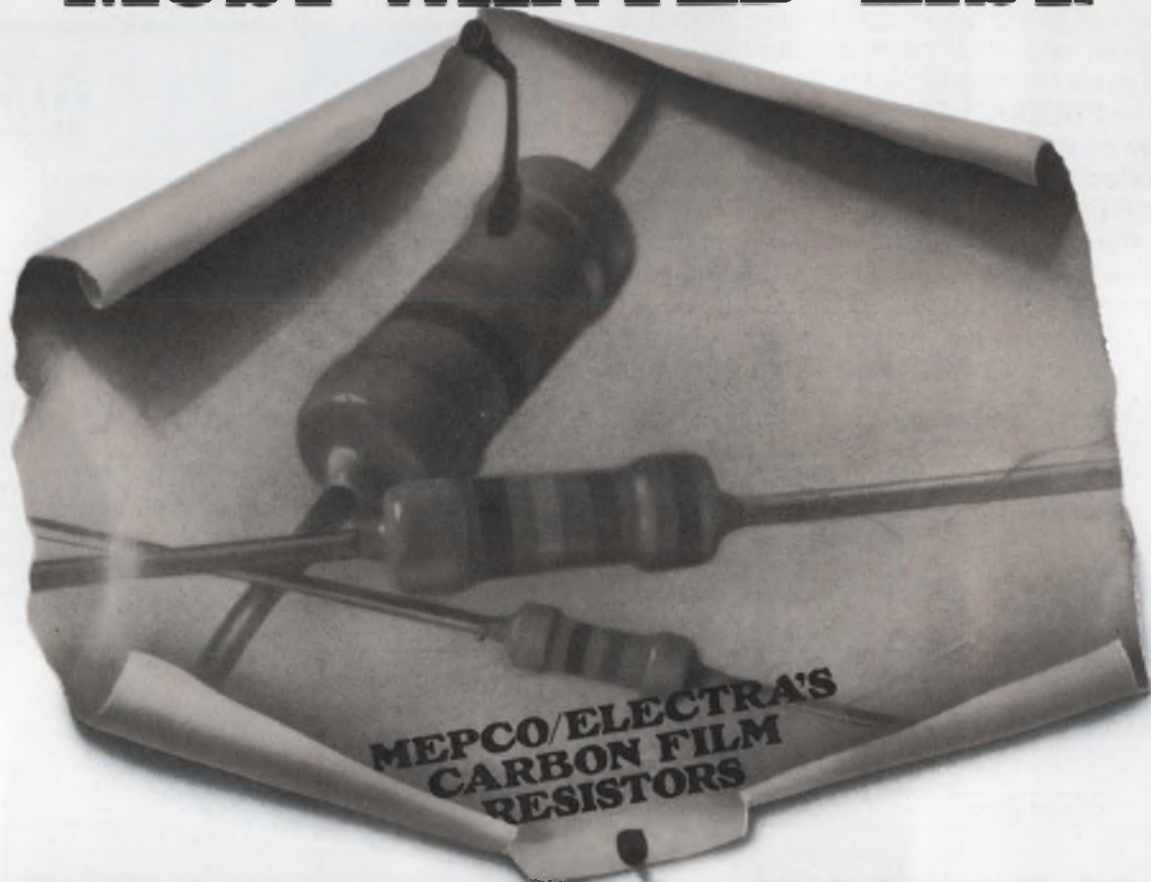

PERFORM BEST • COST LESS AVAILABLE EVERYWHERE

We're on the "Most Wanted" list because of better performance and lower unit cost. Talk to the leading Design Engineers who have made this move from carbon comp to carbon film resistors. It's the way the industry is going.

MEPCO/ELECTRA CR Series resistors can broaden your design capabilities quickly.

Choose from 1/8, 1/4, or 1/2-watt power ratings. In tolerances of 2 or 5 percent. And in the widest resistance range ever offered in a high-performance low-cost film resistor.

You can get immediate deliveries in quantity from an authorized distributor in your local buying area.

The **CR Series** carbon film resistors feature a low negative temperature coefficient, lower power and voltage coefficients, plus higher initial accuracy, long-term stability and much greater moisture resistance than carbon comps.

The industry's going to carbon film resistors. Come on over to the "Most Wanted" Comp Killers from **Mepco/Electra**. Write or **CALL M/E** for technical data and samples. **MEPCO/ELECTRA, INC.**, Columbia Road, Morristown, NJ 07960 (201) 539-2000.



CIRCLE NUMBER 9



Aircraft weather radar puts radome on the wing

The first practical weather radar system for single-engine, general-aviation aircraft combines a small, light-weight radar with a high-efficiency radome that slips over the leading edge of the wing.

This combination succeeds where other experimental radar systems have failed, mainly because previous radome systems were too bulky and heavy. And a dipole array that would sit on a plane wing's leading edge has not yet proven practical. The radome, from Norton Co. (Akron, OH) weighs just 10 lb.

The radar, a Bendix Avionics RDR-160, is a 6-kW, X-band system with a 10-in. dish antenna specifically designed for single-engine planes. The Bendix Ft. Lauderdale Division has made the radar about 8 lb lighter than a standard weather radar by reducing the packages in the radar system from three to two.

One 12-lb section, sitting on the wing, integrates the receive-transmit electronics with the antenna system. Weight and space are saved here by using, for the first time, a positive-pulse magnetron, instead of the usual strapped-vane.

Space requirements are tightened further by eliminating a driving mechanism used in a standard weather-radar antenna to tilt the entire dish assembly up or down. All this has been replaced by a flexible feed for the tilt function. Like a standard antenna, the Bendix unit scans left and right in azimuth.

The other radar package is a 7-lb panel-mounted scope indicator unit that presents a picture of storms as far away as 160 nautical miles. The presentation is digital, and the electronics required to process the analog returns from the radar and convert them to digital levels on the scope is contained in the panel package.

The Norton radome has an average transmission efficiency of 94% and can accommodate either the Bendix 10-in. circular-dish antenna or a 12-in. para-



Radome on wing's leading edge contains weather radar system.

bolic antenna. Sitting over the leading edge of the wings of several Beechcraft Bonanza models (for which it is approved by the FAA) the radome doesn't require the aircraft structure to be modified in any way. Moreover, it doesn't alter the basic flight characteristics noticeably.

The combined radar-radome system costs \$11,000 installed.

Mini handles more users simultaneously, efficiently

Minicomputers generally lose efficiency when handling over 15 or 20 users in multitask, data-service applications. But with new architectural and operating-system features, Data General's M/600 Input/Output Management System can service up to 64 concurrent users efficiently. In fact, this recently announced system performs well enough to compete with middle-range "mainframe" computers. Its 1-Mbyte semiconductor memory makes it the largest of Data General's Eclipse line.

Other key features include:

- A three-level I/O management system, to provide efficient transfer of data for different classes of peripherals.
- A demand-paged memory-management facility that uses an interleaved store instead of the conventional cache-type store.
- On-line diagnostic techniques that run continuously to detect potential problems before breakdown occurs.

The M600's three-level hierarchy consists of a high-speed burst multiplexer channel, a standard data channel and an independent input/output processor.

The burst multiplexer provides a high speed direct-communications path between the main memory and high-performance peripherals like fixed-head-disc subsystems and 96 or 100-Mbyte disc-storage subsystems. Data can be transferred up to 10 Mbytes/s.

Up to eight high-speed controllers can connect to the M/600 burst multiplexer, for a potential 6-billion bytes of storage.

The standard data channel handles communications between the system's job processor—the main processing unit—and medium-speed peripheral equipment such as magnetic-tape and cartridge-disc drives. The channel also works as a 2.5-Mbyte/s interface between the job processor and the third-level I/O processor, which handles up to 64 low-speed display and printer terminals.

The M/600's demand-paged memory facility increases the effective memory capacity far above the one actually present by dividing each user's memory space into pages, and keeping only the active ones in the main memory. The other pages are stored on fast-access devices like fixed-head discs. To reduce the memory-swapping overhead, the operating system executive has an adaptive page-replacement algorithm to ensure that the user's working set of pages are in the main memory at all times.

For programming-language support, Data General has Fortran IV, optimizing Fortran V, and extended Basic. P1/I and DG-L are also available. RJE80 and HASP II package options enable the M/600 system to communicate with other Data General computers or with IBM-compatible systems.

Price is from \$160,000 to \$395,000.

CIRCLE NO. 430

Computer programs cut IC design time in half

By combining computer programs that simulate the functions and timing of digital integrated circuits with programs that generate test procedures for the devices, IC designers at Bell Labs have halved the time it takes IC manufacturers to put a newly conceived device into production.

The computer programs also help cut

turnaround time for modifying existing circuits to less than a month, says Dick Jacobs, head of the IC design departments at Murray Hill, NJ, and Allentown, PA. With standard procedures, such changes can take as long as it takes to develop a new circuit—a year or more.

The key to saving time is to reduce errors in design and layout, says Jacobs, who notes that circuits with complexities as high as 3300 gates and 7000 bits of memory normally have two or three errors in their original designs. Tracking down these errors is "the most painful part of the design," he says. Bell Labs' new combination programs relieve the pain by yielding circuits with "essentially zero errors."

The programs allow a Bell Labs engineer to generate a single set of cards corresponding to one design. Since logic and timing simulation is provided by the programs, there's no need for a breadboard, says Jacobs.

The programs also help generate test procedures for the device. Not only that, they can determine if some failures cannot be detected, so the chip can be redesigned for testability.

Thanks to these new programs, the time it takes Bell Labs to lay out an integrated circuit has been cut by a factor of four, says Jacobs, despite an increase in complexity by a factor of five.

Pro digital-audio tape recorders on the way

Digital-audio tape recording is on the verge of entering the professional audio field. Recorders are due from 3M and Mitsubishi by the end of this year.

Both digital tape systems will offer performance far superior to the best available from analog machines. The best analog signal-to-noise ratio is about 68 dB, while 3M gives better than 90 dB, and Mitsubishi better than 85 dB. Distortion is also much better, especially at high signal levels. Where analog machines reach a few percent, 3M has less than 0.03%, and Mitsubishi less than 0.01%.

The frequency response of both digital recorders is very good. From 30 Hz to 15 kHz, 3M's is ± 0.3 dB; from dc to 20 kHz, Mitsubishi's is ± 0.5 dB.

Another advantage is that copying the audio at all, provided it stays in digital form.

Digital audio recording is done by

sampling the incoming audio, converting it to digital form, and rerecording the digital signal on the tape. In playback, the digital signal is buffered and retimed to eliminate wow and flutter. The retimed signal is then converted back to analog audio.

The professional system from 3M (St. Paul, MN), developed jointly with the British Broadcasting Corporation, actually consists of two machines, one a 32-channel, the other a 4-channel. (The user has a choice of recording on two or all four channels.) A recording is first made on the 32-channel machine. It is then played back, mixed down in a conventional console, and rerecorded on the other machine. The tape, specially developed for the 3M machines, is 1 in. wide for the 32-channel, and 1/4 in. wide for the 4-channel. Tape speed for both machines is 45 in/s, with a running time of more than 30 minutes for a 12 1/2-in. reel, and 45 minutes for a 14-in. reel.

The 3M digital audio is PCM-encoded as 16-bit words, which are protected from bit errors by an error-correcting scheme developed by the BBC. The words are grouped into blocks, which are given cyclic-redundancy and parity checks. If these checks show errors, the bad audio is reconstructed.

The digitized audio is recorded on one tape track per audio channel, with a density of about 28,000 bits/in.

The professional machine developed by Mitsubishi (Tokyo) has two audio channels, which are recorded as two tracks on 1/4-in. tape running at 15 in/s. The audio is PCM-encoded in this machine as well.

User-terminal protocol standard ready for review

A proposed standard for computer user-terminal protocols would apply anytime a Federal government user seeks access to or exit from one or more computer services.

User-terminal protocols permit a user at a keyboard terminal to send and receive standardized messages that permit access to computer services available at that terminal from one or more computer systems over any type of communications facility. But right now the protocols from computer-service suppliers aren't standardized, which makes it difficult for users to select at any one time the one service that is most suitable.

The standard protocol would standardize user, system and error mes-

sages, user and system signals and message sequences, and provide a list of definitions.

The provisions of the standard would be mandatory and would go into effect a year after it is issued.

The bureau is seeking comments on the proposed standard from all interested parties. Comments and questions should be addressed to the Associate Director for ADP Standards, Institute for Computer Sciences and Technology, National Bureau of Standards, Washington, DC 20234. Comments must be received on or before March 13, 1978. Single copies of the *Federal Register* notice may be obtained from the above address.

Disposable keys open μ P-controlled locks

Paper or plastic keys encoded with perforations, magnetic stripes, bar codes, or any other combination can open doors secured with microprocessor-controlled locks. The locks automatically adjust to a new combination and cancel any previously assigned keys.

Under development at Arthur D. Little Inc., Cambridge, MA, the locks contain nonvolatile programmable read-only memories that can be reprogrammed as keys succeed one another. A central keymaking device, called a KeyMint, has a supply of uncoded keys that can be encoded with the old and new combinations so that only an authorized key can change a combination.

Applications for the devices include industrial security and hotels.

One example of industrial security is imprinting new codes on pay slips or check stubs of authorized employees, so that keys are valid only between salary dates. Keys of former employees are automatically rendered unusable.

In a hotel, the guest keys can be changed with each room rental, while the keys of hotel employees remain unchanged. Further, a maid's key can be programmed not to open a lock while the privacy switch is engaged, but a supervisor's key can override this setting.

The project is in the prototype stage. An operating door lock has been built, and a preproduction version designed, with an NEC 4-bit microprocessor and a General Instrument's 1400-bit electrically-alterable ROM.



Your lights Vs. Our LED Lites.



You could be making a glaring mistake if you're not using Brite-Lites. The LED lamps that really are 25x (50 med vs. 2 med) or brighter and more reliable than all the rest. They leave other LEDs in the shadows. Brite-Lites are

tested and proven winners time after time in application after application.

We out-perform good, old fashioned incandescents, too. Brite-Lites shine with the incandescent-type brightness you need, while giving you solid-state durability. Average lamp life is about 100,000 hours plus, 10 times greater than incandescents.

Our packages really meet your needs. Brite-Lites offer you snap-on numbers from 1.6 to 28 volts and 10 to 35 milliamps. All our Lites are available in transparent or translucent red, amber or green.

We deliver the goods. There are no guessing games. When you order Brite-Lites, they arrive on time, every time. And they work. There are no empty claims. They're proven facts. We'd like to prove our point against any lamp you're currently contemplating or using. Won't you let us put the Brite-Lite gleam into your applications.

"The brightest LED lamps in the business."



303 N. OAK STREET, INGLEWOOD, CALIFORNIA 90301

(213) 677-6166

A Preview of the Solid-State Circuits Conference

Analog chips are becoming systems: New LSI merges analog and digital

Many of the integrated circuits to be described at this week's International Solid-State Circuits Conference in San Francisco are complex enough to be considered "systems on a chip." Indeed, several of these "systems" even contain analog and digital circuits on the same chip. They include:

- A single chip that contains both a/d and d/a converters, as well as counters, comparators, op amps, and random logic.

- A single chip that combines linear CMOS/SOS (silicon-on-sapphire) with digital circuitry.

- A single chip that contains a complete 10-bit a/d converter, with reference and clock.

But analog-digital chips won't be the only chip systems highlighted. Other developments reported include:

- Precision audio-frequency filters with the capacitors right on the chip.

- A sample-and-hold IC that uses no

FETs, yet has low droop with a reasonable value of hold capacitor.

- A chip that combines a photodiode with signal-processing circuitry.

- MOS voltage references.

Analog-digital LSI isn't really new, according to Paul Brokaw, Director of Product Planning at Analog Devices Semiconductor, Wilmington, MA: "Suddenly we wake up and realize it's been around for a while." A data-acquisition system on a chip, a single-chip DMM circuit and a single-chip TV chroma circuit are examples of existing analog-digital LSI circuits.

Chip size or complexity?

But what constitutes analog-digital LSI? Some industry leaders point to chip size, stressing a minimum 10,000 to 20,000 mil², while others use complexity as the criterion. But the latter is much harder to measure than for purely digital LSI. The "equivalent gate count" used for purely digital LSI doesn't have an analog counterpart.

For example, there's no such thing as an analog chip containing 24 general-purpose uncommitted op amps.

One possible way of measuring complexity is by counting what Brokaw calls "irreducible elements," such as op amps, comparators, and analog switches. However, analog circuitry cannot be completely organized into such neat categories. Those who define analog-digital LSI by complexity agree that anything as complex as a complete 10-bit a/d converter on a chip qualifies.

This dual LSI technology has been made possible by steady, if unspectacular improvements in process technology. Specific developments include higher-resolution masking, ion implantation, dry processing and trimming at the wafer stage. The process technologies are basically digital, with adaptations to accommodate analog circuitry. The technologies used are linear-compatible I²L, mixed MOS and bipolar, NMOS, and in one notable instance, linear CMOS/SOS.

For example, a chip that uses linear-

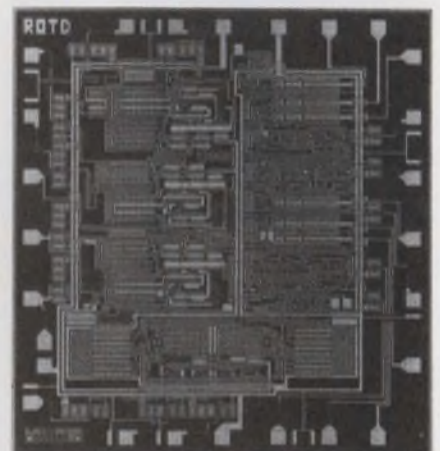
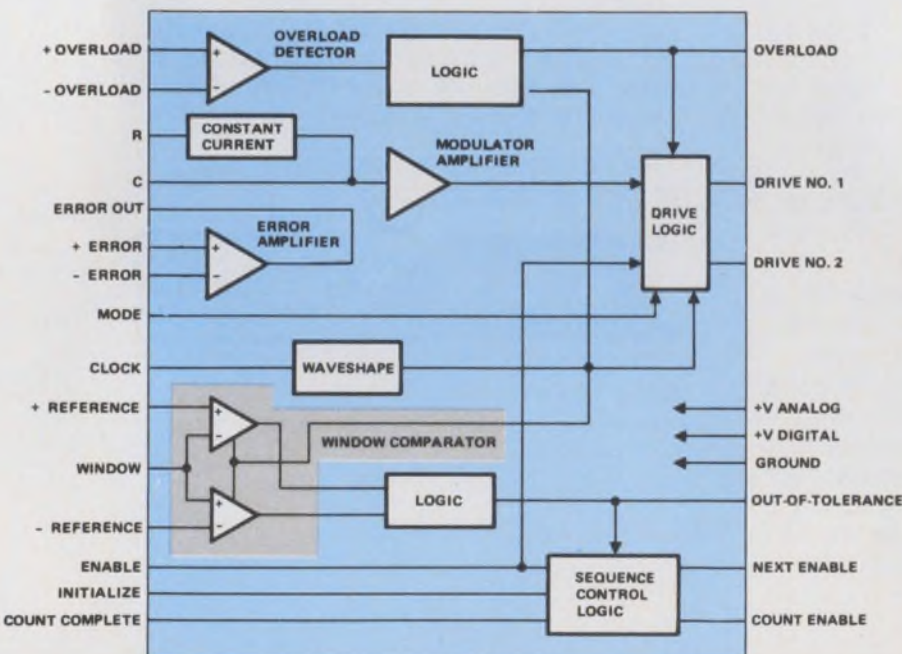

Analog-digital LSI chip contains three CMOS op amps and digital circuitry on a sapphire substrate. It's a regulator for a switching power supply. Made by Rockwell International, it's among the first silicon-on-sapphire ICs containing linear circuitry.

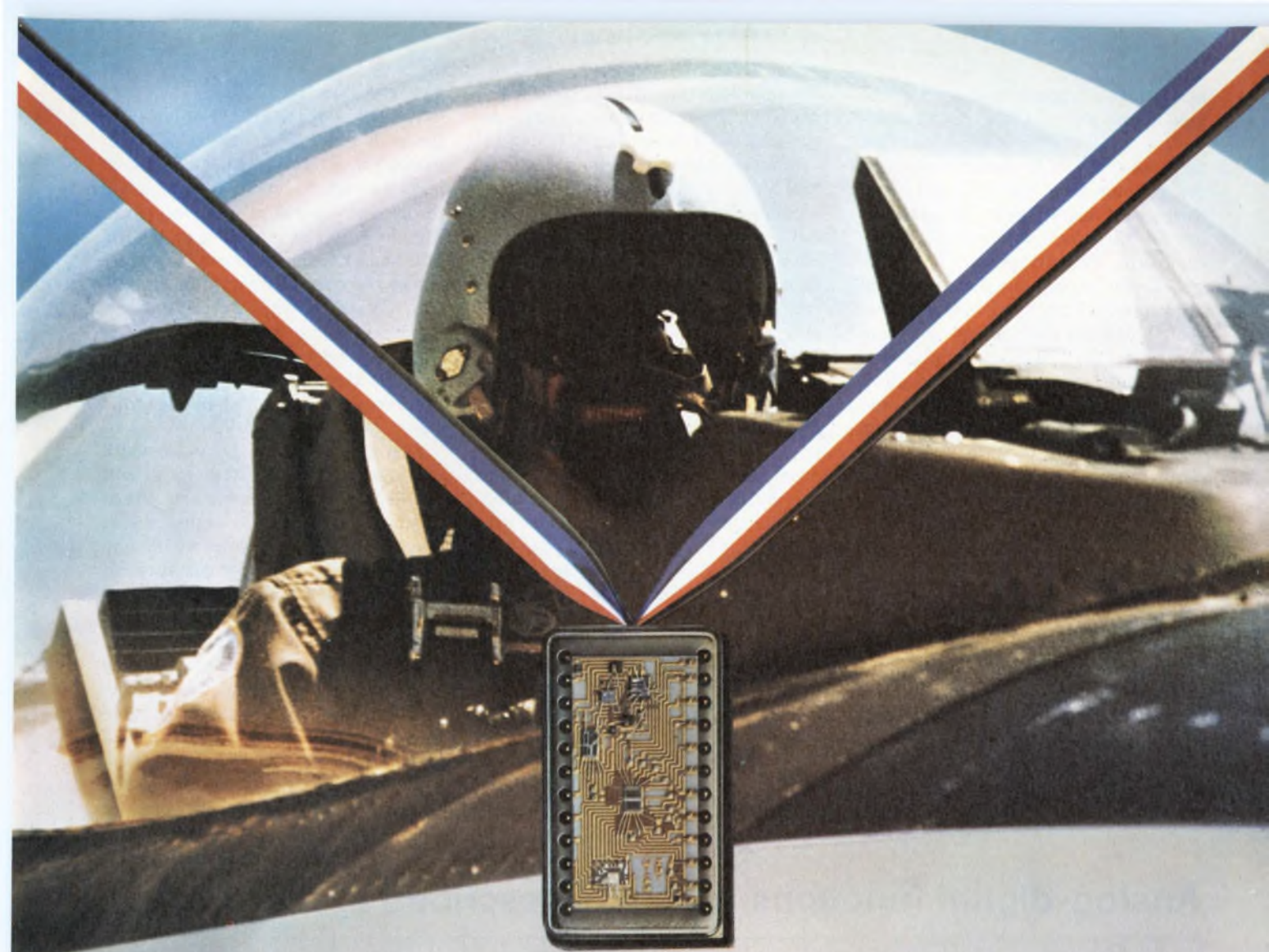

Hybrid Systems: Recognized For Performance

Performance when it counts. When there's no room for a second chance or second best. For more than a decade, Hybrid Systems has been building quality products that take systems designers where they want to go. Data converters. Thin film resistors. Hybrid IC's.

We're proud of our reputation as a world leader in thin film technology, and we work hard to stay up front. Our "State of the Art" performance is a combination of product reliability, imagination, and the right kind of experience. Nearly a third of our employees are directly assigned to quality assurance and testing.



Our manufacturing techniques are MIL-certified. Hybrid Systems' products all meet MIL-M-38510C Class B standards by 100% screening per method 5004.3 of MIL-STD-883A. Class A processing can be provided. Our precision resistor networks incorporate proprietary thin film nichrome ladder networks

for superior performance in tracking and matching. Important achievements in basic design and hybrid circuit construction provide the system designer with greater flexibility, savings in space and weight, and the ultimate in reliability.

Not all of our products are airborne. But we design our military, commercial and industrial products to the same basic criteria. Send for our latest catalog. It offers 12 new series of hybrid IC data converters — 12 new ways to write your own ticket to the kind of performance your products deserve.

When the chips are down...

Hybrid Systems
CORPORATION

Crosby Drive, Bedford, MA 01730
Phone (617) 275-1570
(TWX 710-326-7584 HYBRIDSYS BFRD)

In Europe: Hybrid Systems GmbH, 61 Darmstadt, Luisenplatz 4, Germany
Tel. 6151-291595 (TELEX 419390 HYSY D)

In The United Kingdom: Hybrid (Component) Systems U.K. Ltd
12A Park Street, Camberley, Surrey
Tel. (0276) 28128 (TELEX 858720 HYBRID G)

A/D & D/A Converters • Thin Film Resistors • Hybrid Integrated Circuits

compatible I²L to combine a variety of analog and digital functions for automotive speed control will be described in a paper by R.B. Jarrett, who is a design engineer in the Automotive and Special Products Group, Linear Integrated Circuits, of Motorola Semiconductor, Phoenix, AZ.

This chip is part of a developmental auto speed-control system. One of several things the system can do is hold the car to a desired speed. Inputs to the chip come from the gas pedal, a variable-reluctance speed pickup, and four control buttons on the steering wheel.

When the system is used to hold the car to a desired speed, the driver pushes one of the buttons, which causes the car's speed to be stored digitally.

Throttle control

The desired speed is converted to analog form by a 9-bit d/a converter, then compared by an analog circuit with the actual speed, which is obtained from the variable-reluctance pickup. The result of this comparison drives two solenoid valves controlling

the engine throttle. The throttle is air-actuated, so one valve opens the throttle, and the other closes it.

The commands from the four push-buttons are multiplexed (to save three wires) by encoding them with a simple 4-bit d/a converter at the steering wheel. The commands are demultiplexed by a 4-bit a/d converter on the chip, which also contains op amps, counters, and random logic. One of the counters is probably used for tachometer-type speed measurement.

Another analog-digital LSI chip to be described at the ISSCC contains three op amps. While this may not seem novel, there is a new twist. The op amps are *linear SOS* (silicon-on-sapphire) circuits, and CMOS at that. Apparently, this chip and one other not described at the ISSCC contain the only linear SOS circuits being made in the U.S.

The IC, reported on by Ross M. Orndorff and Daryl T. Butcher of Rockwell International Corp. (Anaheim, CA), is used in switching-regulated power supplies. It regulates the supply's output, drives the power switches (off-chip) in the regulator circuit, senses current overload, and sequences the supply in multi-output

power systems.

The specs of the CMOS op amps in the chip are quite respectable. Gain bandwidth is 50 MHz, which may seem high for such functions as comparing the supply's output with the reference. But the chip can modulate at 1 MHz, so it looks capable of driving very fast power switches. Drive outputs are 400-ohm CMOS switches.

Other op-amp specs include more than 80-dB open-loop gain, CMRR of 85 dB, a slew rate of 30 V/ μ s, saturation recovery time of 1.5 μ s max, and offset voltage of 10 mV.

Regulation is done by pulse-width modulation, using a ramp-type circuit on the chip. Current overload is sensed by an off-chip shunt. A signal is sent from the shunt to a dedicated op amp and logic on the chip, which turn off the power switch in the regulator immediately. The switch is turned back on with the next clock pulse.

While pulse-width modulation may prove handy for power switches, pulse-code modulation is proving essential to converting telephone systems to digital transmission. The next few years will see a great many digital channels installed, and PCM become the standard

Analog-digital functions on chips described at the ISSCC.

Organization	Function	Op Amps	Comparators	Oscillators	Precision-Ratio Capacitor Arrays	Analog Switches	Photo Diode	Output Drivers	On-Chip Reference	A/D Converter	Nonlinear A/D Converter	Other Linear Circuits	Digital Circuits	D/A Converter	Nonlinear D/A Converter	Sample-And-Hold Circuit	Phase-Locked Loop	More Than One Chip
Sprague	Motion Detector			•			•	•				•	•					
Hitachi	Appliance Control							•				•	•					
Motorola Semiconductor	Auto Speed Control	•	•							•			•	•				
Univ. of Calif./Berkeley	Precision Audio Filter	•			•							•					•	•
Univ. of Calif./Berkeley	Precision Audio Filter	•			•	•												
National Semiconductor	PCM Codec		•			•			•				•		•	•		•
Intel	PCM Codec										•		•		•			
Siliconix	Codec				•	•						•						•
Siemens	Companding Codec DAC					•			•			•						•
Rockwell International	Switching Regulator Control	•	•					•				•	•					
National Semiconductor	Light Sensor		•				•		•			•						
Analog Devices	A/D Converter		•			•			•			•	•					



I Dreamed...

I bought a 12 Bit Data Acquisition System for \$137.50*

That's no dream. You can slash costs today with a μ p-compatible, 16 channel, dual-in-line system. By combining our MN7130 multiplexed S/H amplifier and our popular ADC80 12 Bit A/D, you achieve a 30KHz thruput rate in only 2 DIP's! Wake up to Micro Networks, where designers' dreams are realized.

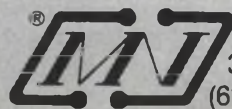

Micro Networks Corporation

324 Clark Street, Worcester, Massachusetts 01606
(617) 852-5400 • TWX: 710-340-0067

CIRCLE NUMBER 12

*100 quantities.

for digital transmission. But this standard will depend upon having low-cost coder-decoders (Codecs) to convert both ways between analog and PCM digital signals.

Enter the analog-digital chip

A complete conversion from analog to digital requires low-pass filtering, sampling, holding, and nonlinear conversion to digital form. Conversion the other way is also nonlinear, followed by low-pass filtering. If possible, one IC should do all of this.

Encouraging progress toward this goal will be reported in a session on PCM Codecs, and one of the papers, from Intel, will describe a single-chip design NMOS Codec. Not only that, but a two-chip design will be unveiled by James B. Cecil, Edwin M. W. Chow, John A. Flink, James E. Solomon of National Semiconductor, Santa Clara, CA; Tommy Svensson of Ellemtel, Stockholm, Sweden, and C. Gunnar Svala or North Electric Co. in Columbus, OH.

One chip, made with bipolar technology, contains a sample-and-hold, a comparator, and a stable reference. The other chip contains a diffused nonlinear ladder, a 128-to-1 analog switch,

a CMOS successive-approximation register, and a CMOS high-speed (up to 2 Mbits/s) serial input buffer for incoming PCM data.

In this two-chip Codec, the nonlinear d/a converter is time-shared between decoding and providing feedback for encoding. This converter includes a modification of the standard R-2R ladder network to make a direct nonlinear conversion from PCM digital data to quantized analog voltage.

In this ladder network, the resistors of value R are in series between the reference voltage and ground. The nodes between the R's are loaded by resistors of value 2R going to ground. It turns out that the voltages at these nodes correspond to the chord endpoints in the μ and A encoding laws. To interpolate between these endpoints, each R is subdivided to provide 16 taps for each chord. Since there are eight chords, there are 128 taps in all. The PCM digital data are decoded directly by the 128-to-1 analog switch to select one of these taps.

Still, the big IC story is really one-chip systems. Indeed, a complete 10-bit a/d converter on a chip is expected to be announced soon by Analog Devices.

According to preliminary informa-

tion from the company, this converter can be used without any other components, even though it has no sample-and-hold, and a full-scale trimmer is optional. The clock and reference are on the chip. Inputs are the voltage to be converted, and a convert-command line which can also float the three-state digital outputs. An output line tells when the data are ready.

This I²L chip contains a d/a converter, voltage reference, comparator, successive-approximation register, clock, and three-state output buffers. The d/a's ladder network is made of thin-film resistors, which are laser-trimmed at the wafer stage.

The input signal range can be 0 to +10 or -5 to +5 V and is selected by floating or grounding a pin. Outputs will sink 3.2 mA.

The analog-input resistance is about 5 k Ω . It has been made slightly more sensitive than nominal full scale, so that a 50- Ω trimmer can be used to adjust for exact full scale. With no trimmer, about three counts are lost from the top of the digital output.

The convert-command line is labeled BLANK & CONVERT CONTROL. When this line is high, the data outputs float; when it goes low, conversion starts. The outputs remain floating until conversion is complete. When conversion is complete, the DATA READY line, which is an open-collector output, goes low.

In summary, the outlook for analog-digital LSI chips is very encouraging. But there are other combinations of analog circuits being put on chips as well.

On-chip caps for audio filters

For example, precision, high-order audio-frequency filters, essential to telecommunications, instrumentation, and PCM systems, have always needed discrete, "off-chip" precision resistors and capacitors.

In a paper, to be revealed by Khen-Sang Tan and Paul R. Gray, of the University of California at Berkeley, a low-pass filter is made from IC capacitors with precisely controlled capacitance ratios, analog differential integrators, and a phase-locked loop (PLL). The filter has 0.1-dB passband ripple, with fifth-order Chebyshev response. Cutoff frequency is 8 kHz. In experimental form, the filter consists of several 90 by 100-mil chips.

The filter contains five differential integrators in an active-ladder configuration. Each integrator, in turn,

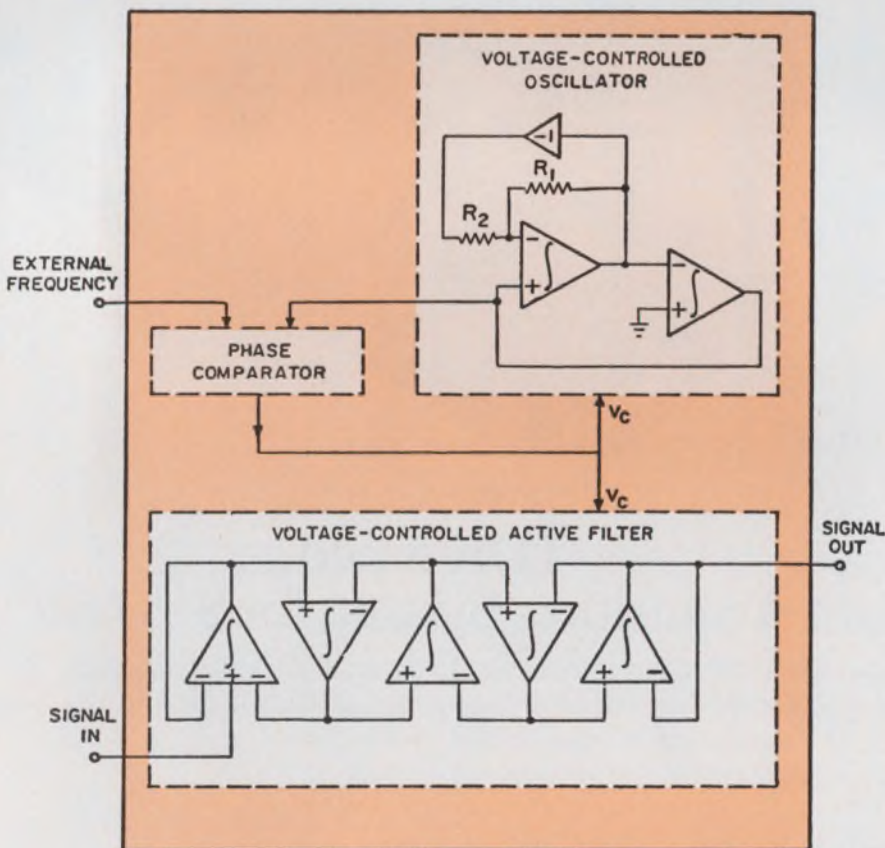

Precision IC analog filter uses a PLL to set and maintain cutoff frequency. Matched integrators keep cutoff and external frequencies the same.

Heinemann introduces a new product...

Help.



800-257-9590*

Now we've made it easier than ever to solve your circuit protection and control problems: a call to 800-257-9590 puts you instantly in touch with a Heinemann technical-service engineer who can help you apply circuit protectors and solid-state relays in innovative, cost-saving ways.

For example, you might ask our technical engineer to help reduce costs with close-tolerance overload protection. It will help cut down component oversizing — a costly proposition you can do without.

Or do you have a piece of equipment that must be shut down if a limit is exceeded (pressure too high, tank over-filled, etc.)? Our technical engineer can explain how a circuit breaker can be the most cost-effective limit control to shut down the equipment — and provide overcurrent protection to boot.

A Heinemann hydraulic-magnetic circuit breaker or solid-state relay may very well be the inexpensive solution to your control or protection problem. All you have to do is keep our number handy:

800-257-9590

It's like having your own personal design expert at your fingertips!

Help with:

Circuit protection

We have everything you need to protect your circuits... from breakers with 10,000A interrupting capacity to an inexpensive alternative to the bothersome cylindrical fuse. And we'll be glad to help you with information about time delays, ratings, and even UL and NEC requirements.

Equipment protection

We've helped many engineers protect their equipment inexpensively from out-of-limit conditions like high temperature, high pressure, low flow rate, etc. Just give us a call and learn what we can do for you.

Control

Applying solid-state relays is tricky. We'll tell you how to watch out for high dv/dt, transients, and inadvertent turn-on. And we'll explain how our solid-state relays' special features help protect your equipment from failures.

"Special" products

Did you ever spend too much time trying to get a component or rating that no one seemed to make? Just give us a call. Many "specials" are standard at Heinemann. And with our Jet Start fast delivery, you might have that "special" sooner than you think.



HEINEMANN

Trenton, New Jersey 08650

We keep you out of trouble.

*Mon.-Fri. 8:30AM-4:30PM Eastern Time

consists of a differential-input transconductance amplifier, which drives a FET-input inverting amplifier. The integrating capacitor, on the order of tens of picofarads, is connected between input and output of the inverting amplifier.

To obtain a time constant in the tens of microseconds with such a small capacitor, the output transconductance of the first amplifier has to be on the order of 0.1 microsiemens. Furthermore, the transconductance must also be voltage-controllable, so the filter's cutoff frequency can be changed.

The cutoff frequency, which is determined by the integrator time ("gain") constants, changes with temperature and process variations. A phase-locked loop compensates for these variations to keep the filter on frequency. As a result, the filter's frequency matches an external reference frequency, which can be as stable as necessary.

The voltage-controlled oscillator in the PLL uses two voltage-controlled integrators to determine its frequency. These integrators are identical to those in the filter. The PLL's frequency-control voltage, which is fed back to the VCO, is also sent to the filter's integrators. Therefore, the voltage needed to keep the oscillator on frequency is also what's needed to keep the filter on frequency.

Another IC development solves a problem created by using FETs in the input stage of the output buffer amplifier in a sample-and-hold circuit. These FETs provide low droop in the hold mode, with reasonable values of hold capacitors. However, when FETs get hot, the increase in gate current negates their advantages. FETs are also used in some s/h circuits to switch

the hold capacitor to the input during sampling, but their feedthrough capacitance can be large enough to cause problems.

A new sample-and-hold IC, which uses no FETs, has low droop even when the chip is hot, and charges the hold capacitor with a current of 50 mA during large-signal acquisition. Quiescent power drain is only 5 mA, however. Slated to be reported by George Erdi, Design Engineering Manager, and Paul Henneuse, Senior Engineer, of Precision Monolithics, Inc. (Santa Clara, CA), the IC consists of input and output buffer amplifiers, a diode-bridge analog switch, a gated current-booster amplifier, and various gating circuits to switch the circuit between sample and hold modes.

When the IC is sampling, the input buffer amplifier charges the hold capacitor to the new input voltage through the diode switch. However, the diode switch operates with only 1 mA, which is not enough to charge the hold capacitor completely when the input has made a large change. In such cases, the current-booster amplifier takes over and charges the hold capacitor at 50 mA until the hold capacitor is within about 80 mV of the input. At that point, the booster turns off smoothly and the diode-bridge switch takes care of the remaining difference.

The output buffer amplifier operates in two modes: fast-slew, and low-input-current. The first two stages of the buffer are a differential amplifier consisting of cascaded emitter followers that use superbeta transistors. During sampling, the first stage emitters have 100- μ A loads; these loads are turned off during the hold mode. In hold, the input transistors have a gain of 2000 with a collector current of only 50 nA,

which is made possible by silicon-nitride passivation.

When used with a 5-nF hold capacitor, this sample-and-hold IC has a droop rate of 5 mV/s, which rises to 10 mV/s from 0 to 70 C, and to 120 mV/s from -55 to 125 C. The sample-to-hold current ratio is 10^9 mA/mA from 0 to 70 C; gain linearity is 0.01%; aperture time is 50 ns, acquisition time to 0.1% is 3.5 μ s, and charge transfer is 5 picocoulombs.

Another chip combination, photodiodes with processing circuitry, is found in an IC to be reported on by W. A. Gontowski and R. W. Lutz of Sprague Electric Co. in Worcester, MA. The chip senses a change in the illumination falling on the photodiode, and the rate at which the illumination changes determines whether the chip will trigger. The rate needed for triggering is set by external components. If the change is more than 10% and fast enough, the chip generates a tone with enough power for an audible alarm. It has a separate visual-alarm output as well.

The circuit is alarming

Not surprisingly, then, the IC, originally designed for a toy, is also suitable for an intrusion alarm. Noting that the motion of objects in the field of view is likely to change the amount of light on the IC, Gontowski and Lutz call their IC a motion detector. With proper optics, the chip can detect a flag fluttering 50 ft away. When used as an intrusion alarm, it requires no light source.

The chip also has two oscillators: One is for the audible alarm, and the other is a clock oscillator for the toy functions. ■■

MOS-controlled triac combines low input power, high output power

A new high-voltage, high-current integrable switch is based on double-diffused (DMOS) technology and is the first high-power switching device with

a MOS gate. As a result, the power gain of the TRIMOS (for "MOS-controlled triac") is high—a few picowatts control tens or even hundreds of watts. And despite the high output currents and voltages, the excellent isolation of the insulated MOS gate requires only low-

power control circuitry, which may be fabricated on the same chip. The MOS gate needs only a few volts at 10 or 20 picoamperes.

This regenerative device may be integrated with other MOS components for a host of new applications in cross-

Dave Barnes
Western Editor

NEW

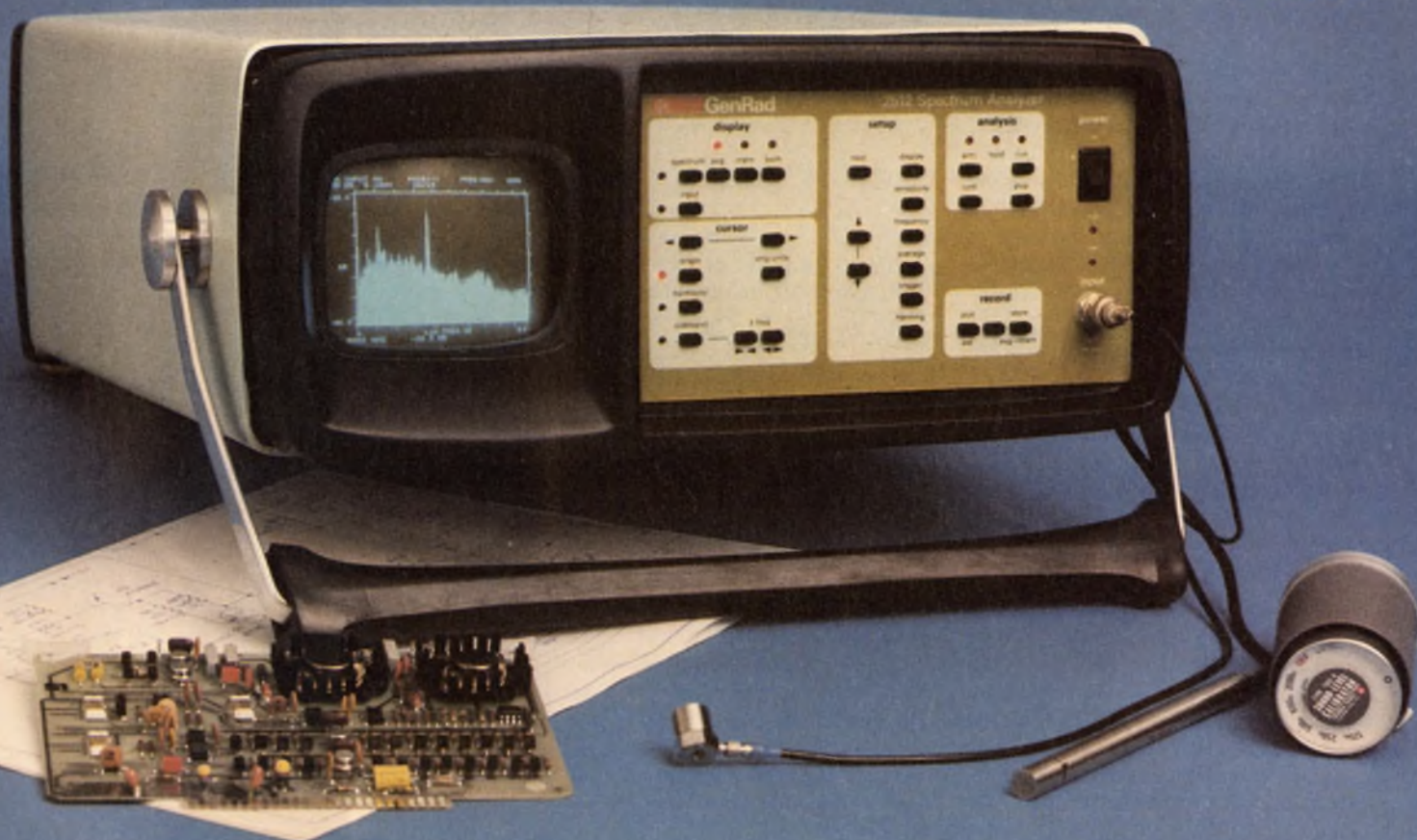

New Portable Spectrum Analyzer for electrical, vibration and acoustic testing.

GenRad's 2512 spectrum analyzer gives you the power, speed and accuracy you need for studying sound and vibration problems—all neatly packaged in a light-weight portable instrument.

We didn't compromise

All of the features of earlier generations of spectrum analyzers are included in the 2512 *plus* higher real-time bandwidth, a stable raster-scan display and a simple operator interface. More specifically, the 2512 offers

- fast 400-line spectrum analysis to 100 kHz
- real-time analysis to 20 kHz
- 1 mv full scale input sensitivity
- completely calibrated displays in volts or engineering units
- uncomplicated control panel

You'll benefit from the fast, precise measurements and high confidence in data.

Easier to use than an oscilloscope

The front panel has a minimal number of pushbutton controls. The operator deals with only one function at a time due to the sophisticated interaction between the display and controls. Operation of similar equipment often requires a thorough understanding of a maze of switches, knobs, and buttons.

And it's ideal for lab or field applications

Lightweight at approximately 38 pounds, the 2512 is compact enough to carry conveniently to the most remote sites.

Request complete information from GenRad,
2855 Bowers Avenue, Santa Clara, CA 95051 — 408/985-0700

 **GenRad**

CIRCLE NUMBER 14

(continued from page 32)

point switching, output stages, and power control.

A wide range of switching currents has been demonstrated as well as a MOS gate control to turn off the triac. Typical turn-on and turn-off times are about 200 ns, and single-pulse slew capability exceeds 1000 V/ μ s.

Area for area, the new device provides lower on resistance than a DMOS transistor. If a 0.5-mm-square area of a chip is used, a 200-V DMOS transistor provides an on resistance of 50 to 100 Ω . But the 200-V TRIMOS provides an on resistance of only 5 to 10 Ω , according to its developers, James Plummer and Brad Scharf of the Stanford University Integrated Circuits Lab.

For ultrasonic uses

Scharf and Plummer who will describe the structure and operation of the new TRIMOS at the ISSCC in San Francisco this week, developed the device to suit an ultrasound application at Stanford University. The ultrasonic imaging system under development requires analog multiplexers for 5-MHz

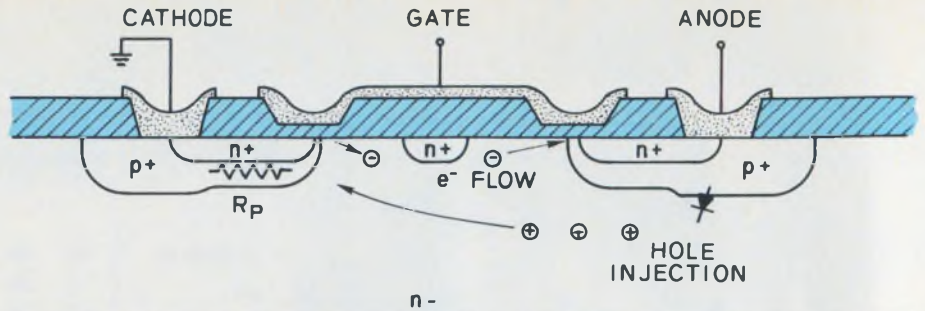

TRIMOS consists of two DMOS transistors merged together, with a common drain and an insulated metal gate.

transducer drive currents of a peak 0.5 A at about 200 V.

The DMOS transistors originally used handled the voltage and currents adequately. But an intrinsic diode between the drain and source made it difficult to tie two transistors to the same transducer.

"We were seeking a symmetric device, with no diode, so that our analog multiplexer could be used more flexibly," explains Dr. Plummer, associate director of the laboratory. "In merging two high-voltage DMOS transistors around the same drain, we got the symmetry, and the regeneration fea-

ture as well." Plummer feels the TRIMOS should find applications in many areas now served by current-controlled pnpn switches, which offer poor input isolation.

A cross-sectional drawing of the TRIMOS and a photomicrograph show the dual DMOS transistors and their common drain. Contact is made to the source and diffused channel of each DMOS, to form symmetrical anode and cathode contacts, and to the shared gate metal to form the control electrode.

With the cathode grounded and the gate held below the positive DMOS

Time Delay Relays

More design options with delays of .01 seconds to a year... and more.

Widest choice of timing modes, voltages, mountings, enclosures and contact arrangements. Save design time by selecting a standard

P&B time delay relay. Or, we'll make a special for you if your application

demands it. All built to P&B's high standards of quality and performance. Potter & Brumfield Division

AMF Incorporated, 200 Richland Creek Dr., Princeton, IN 47671. 812/386-1000.



CIRCLE NUMBER 15

Potter & Brumfield

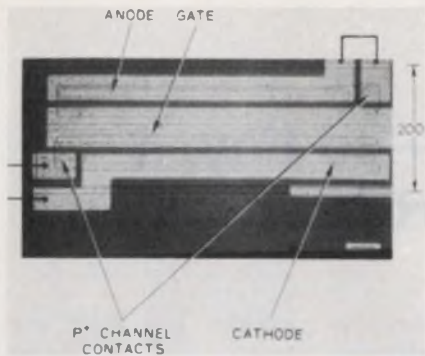

This photomicrograph shows simple geometry of the TRIMOS. Other MOS devices can be produced on the same chip, adjacent to TRIMOS devices.

threshold voltage, the pn^- junction at the cathode end blocks any applied positive anode voltage, which holds the switch off up to its breakdown voltage (200 V at present).

For gate potentials above threshold, there are three distinct regions of operation. In the low-level realm, anode potentials of less than about 1.5 V allow both DMOS channels to become inverted. Both transistors are in their linear regions and all the anode-to-cathode current is carried by electrons at the surface. The device exhibits the

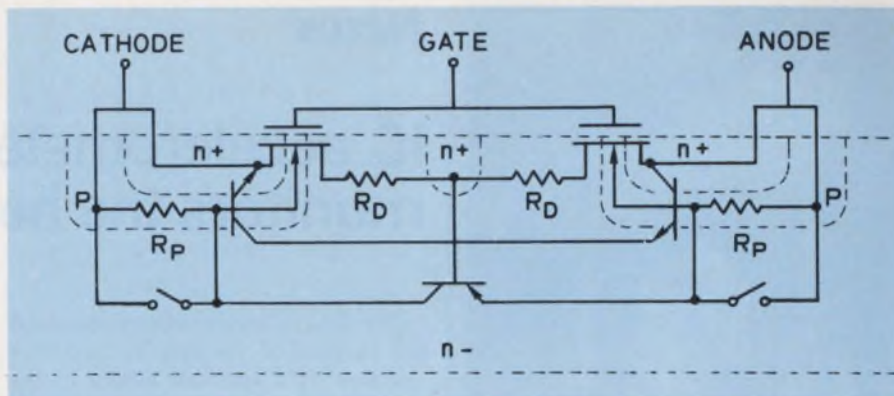

TRIMOS can be viewed as several merged conventional components, although it is actually a single regenerative device.

low-on-resistance I-V characteristics of two short-channel (2.5μ) DMOS transistors in series.

The intermediate level of operation occurs for increasing anode bias, which causes the $p+n^-$ anode junction to become forward-biased and to serve as the emitter of a wide-base pnp lateral transistor. The junction's injected holes drift and diffuse to the cathode p region, where they are collected to contribute an added component to the device current. The result is an increase in transconductance.

As the pnp collector current increases with anode or gate potential, its flow through the pinched resistor R_p raises the potential of the cathode's p region beneath the gate and begins to turn on the vertical npn transistor inherent in the DMOS structure. This npn and the pnp form a four-layer diode that regeneratively switches when the alphas of the pnp and npn transistors add up to one. In its "on" state, TRIMOS exhibits a dynamic resistance of less than 10Ω and can pass currents of several amps. ■■

...and other solutions to your tough design problems are found in P&B's growing product line.

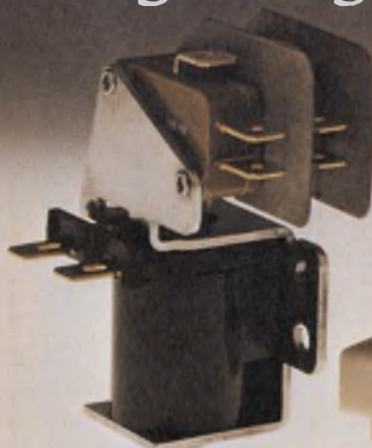
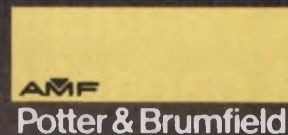

NEW low-cost S87R industrial relay. UL recognized. Contacts rated to 20 amps, 277V AC, 50,000 operations at rated load. Contact forms to 2C. Ideal for vending machines, HVAC, home appliances and machine tool controls.

CIRCLE NUMBER 151



NEWT10 PC Board Relay. Now sealed for flow soldering and immersion cleaning. Only .425" high allowing 0.6" center-to-center spacing. Ideal for high density applications. Choice of 2, 4 and 6 Form C contacts for 0.1 to 3 amp switching @ 28V DC.

CIRCLE NUMBER 152



W58 thermal circuit breaker. Positive snap action switching up to 35 amps for under \$1.00 in quantity. Exclusive blade design. Pressure actually increases until contacts open... with a "snap." Trip times at 200% of rated load—1 to 4 amp models 10 to 45 seconds, 5 to 35 amp models, 6 to 30 seconds.

CIRCLE NUMBER 153



NEW EAX solid state AC relay. Thyristor controlled and isolated by pulse transformer circuit. Can be driven directly by logic circuits such as TTL, MOS and HTL. Terminals for 0.1" grid printed circuit board mounting. Rated 1.2 amps, 120V AC.

CIRCLE NUMBER 154

IC accelerometer—so tiny, it monitors the heart from within

The first IC accelerometer developed for biomedical research is less than one-tenth the size and weight of the smallest commercially available miniature accelerometers. With such a small, implantable transducer available, new kinds of heart and fetus research become feasible.

Weighing less than 0.02 g, in a $2 \times 3 \times 0.6$ mm package, the accelerometer is small enough for a matrix of several accelerometers to be sutured to the heart muscle to measure the motion of the heart wall over the cardiac cycle. This technique may, in time, signal the early phases of coronary occlusion, a prelude to a heart attack.

In another proposed application, the IC transducer may be used to measure the motion of a fetus within the uterus, to provide information about fetal heart output, and to indicate that a fetus is in trouble, in time to prevent serious injury or death.

Only a few implanted accelerometer studies have ever been done, mainly because researchers have been ham-

pered by transducer size. Small size and mass prevent mechanical loading of the organ being measured, and allow several accelerometers to be used within a small region of the body. One-mil platinum wires are used with the new IC accelerometer to provide flexibility and minimize any of the loading effects.

The accelerometer will be described in a paper at ISSCC this week by its developer, Dr. Lynn Roylance. She researched, designed, fabricated and tested it at Stanford University's Integrated Circuits Laboratory, in Palo Alto, CA, under the supervision of James B. Angell, Professor of Electrical Engineering and co-author of the paper.

The accelerometer's active element, sealed within a glass-silicon-glass sandwich, is a very thin ($15 \mu\text{m}$) cantilevered beam of silicon. A silicon or gold mass is mounted at the free end of the beam. A $200\text{-}\mu\text{m}$ -thick silicon supporting rim surrounding the beam and the mass provides mounting for

variable capacitors

... made by Johanson, of course! Quality without compromise is our target in the design and manufacture of capacitors in sizes, mounting configurations and capacitance values to meet every application. Perhaps that's why—for nearly three decades—superior variable capacitors have been synonymous with the name Johanson, where standards of excellence always come first.

Electronic accuracy through mechanical precision.

Johanson

MANUFACTURING CORPORATION
Rockaway Valley Road
Boonton, N.J. 07005
(201) 334-2676, TWX 710-987-8367

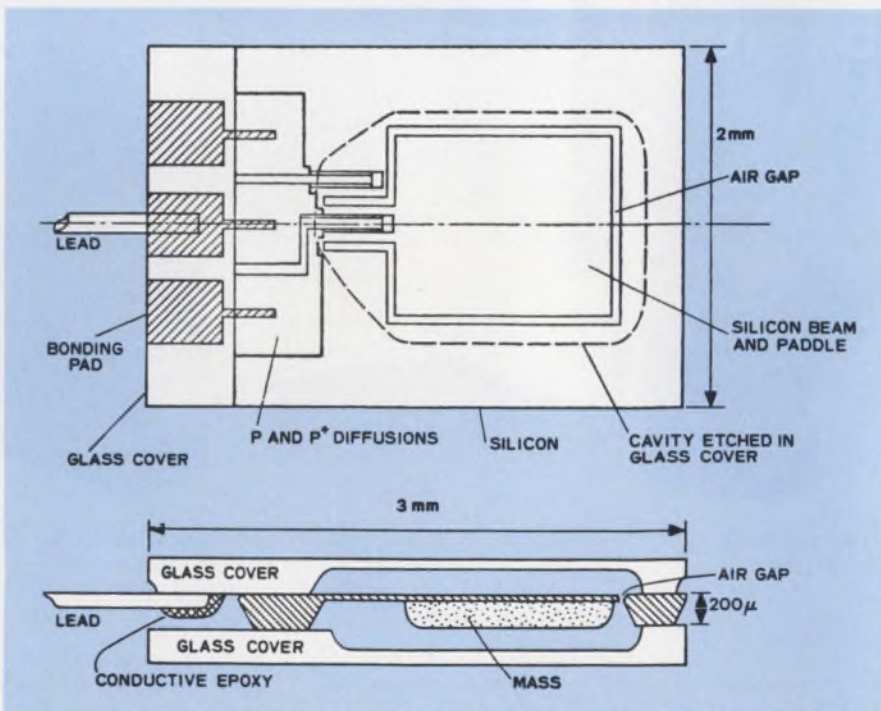

This bottom view of a monolithic IC accelerometer element shows silicon mass, the surrounding air gap, and a thin silicon cantilever beam (right).

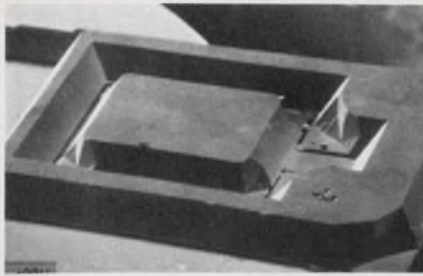

The active element, a 7500- Ω diffused resistor on a thin beam (just left of the mass), changes resistance in proportion to acceleration.

the cantilever and space for contacts.

A resistor diffused into the top surface of the beam changes value with acceleration caused by the stress induced in the beam. A second resistor, placed in an unstressed region, is used for temperature compensation.

Several hundred accelerometers can be fabricated per silicon wafer with standard IC photolithographic and diffusion techniques, plus anisotropic etching to shape the silicon. The 55° slant surfaces shown on the accelerometer are principal crystallographic planes of the silicon, exposed by the nonuniform action of the potassium hydroxide etchant, which attacks some planes of silicon about 100 times faster than other planes.

The accelerometer detects one-axis accelerations down to 0.01 g over a 100-Hz bandwidth, with an upper acceleration limit of 50 g. But the versatile beam-geometry design allows the sensitivity to be varied readily over several orders of magnitude, yet remain tightly controlled.

Increasing the sensitivity has two tradeoff effects. The maximum acceleration the transducer can withstand decreases proportionally, and the resonant frequency drops, limiting the useful bandwidth.

The frequency response is essentially that of an ideal two-pole system, with the resonance typically between 500 and 2000 Hz. With air in the cavity, the damping factor is 0.005, but with a five-centipoise fluid, such as a light silicone oil, 0.7 critical damping can be achieved.

Accelerometers have been made with sensitivities ranging from 0.005% to 0.2% resistance change per g; corresponding operating ranges are ± 200 g to ± 30 g. Accelerations less than 0.001 g can be detected.

The miniature accelerometer's performance compares very well with that of the small strain-gauge accelerometers available commercially. ■■

ELECTRONIC INDUSTRY DECISION MAKERS:

6 WAYS TO IMPROVE YOUR PRESENT LED MOUNTING SYSTEM

CLIPLITE™



PAT. PEND. U.S. & FOREIGN

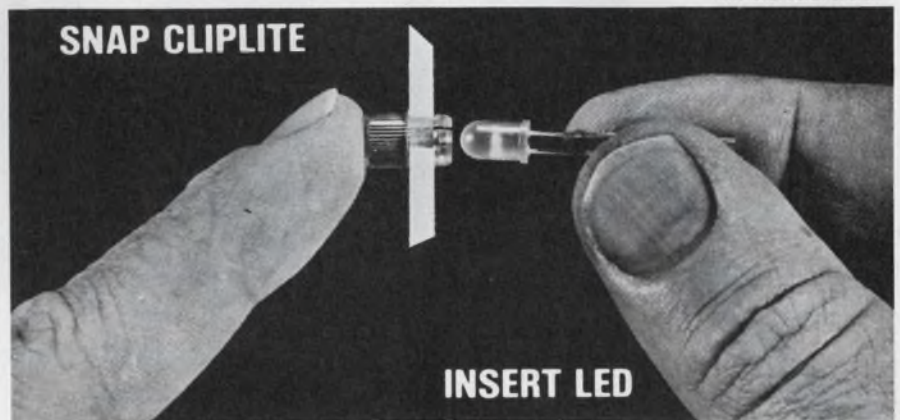

- 1. EASIER TO INSTALL** — Simple 2-step mounting requires no tools. Just snap CLIPLITE into panel hole and insert LED. That's all there is to it. . . . installs in just 6 seconds!
- 2. LOWER ASSEMBLY COST** — including installation and labor, you save 20% per unit.
- 3. 100% GREATER VISIBILITY** — CLIPLITE provides 180 degrees visibility using a point source LED and is 5 times brighter than normal diffused LED. Comes in 5 colors, red, amber, green, yellow and clear.
- 4. SECURE LED MOUNTING** — No LED back-out.
- 5. TOTAL LED PROTECTION** — CLIPLITE completely encloses LED.
- 6. MOISTURE SEALS** — No more worries about spilled liquids or water damage. No more logic failures due to static electricity.

Cliplites are also available in Incandescent and Neon models.

SPECIAL OFFER!

PLACE YOUR TRIAL ORDER TODAY

Special Pricing for Trial Order Only		ED2-8
PLEASE SHIP:	<input type="checkbox"/> 100 CLIPLITES \$10.00	<input type="checkbox"/> LITERATURE
NAME _____	COMPANY _____	
ADDRESS _____		
CITY _____	STATE _____	ZIP _____
 VISUAL COMMUNICATIONS COMPANY P.O. BOX 986 EL SEGUNDO, CALIFORNIA 90245 (213) 822-4727		

CIRCLE NUMBER 18



Call on the cube...

Ferroxcube Component Distribution Centers Stocking Points

Ferroxcube
1393 Main St.
Waltham, MA 02154
(617) 899-7103

Elma Ferrite Labs
P.O. Box 395
Woodstock, NY 12498
(914) 879-2497

Kahgan Components Corp.
556 Peninsula Blvd.
Hempstead, NY 11550
(516) 538-2300

Eastern Components, Inc.
1407 Bethlehem Pike
Flourtown, PA 19031
(215) 836-1616

Ferroxcube
176 Scott St.
Elk Grove Village, IL 60007
(312) 640-2630

Ferroxcube
8589 Canoga Ave.
Canoga Park, CA.
(213) 998-7311

**Philips Electron
Devices, Ltd.**
601 Milner Ave.
Scarborough, Ont. M1B 1M8
(416) 292-6161



Division of Amperex Electronic Corporation
A North American Philips Company
Saugerties, N.Y. 12477 (914) 246-2811

Industry will gain slightly from Carter budget

Congress should find little to quarrel with in those areas concerning the electronics industry—defense and space—in the \$500.2-billion federal budget submitted by President Carter Jan. 23. Lacking such controversial items as the B-1 bomber, which fueled Congressional debate last year, the new budget reflects President Carter's desire to stress a steady buildup in the development and production of previously approved weapons, particularly those needed to strengthen NATO forces.

The Administration sidestepped such potentially explosive issues as a new MX mobile intercontinental missile and new aircraft carriers for the Defense Department, and a fifth Space Shuttle reusable orbiting spacecraft for the National Aeronautics and Space Administration.

At any rate, there will be a few more defense and space dollars for the electronics industry. All the main ingredients of the defense budget available to industry are slated to grow during fiscal year 1979, which begins Oct. 1. Operations and maintenance will grow from \$35.1-billion to \$38.1-billion, procurement from \$30.3-billion to \$32-billion, and research, development, test and evaluation from \$11.4-billion to \$12.5-billion. This accounts for two-thirds of the \$126-billion in spending authority being sought for the Pentagon. The NASA budget, almost all of which is available to industry, is due to grow from \$4.06-billion this year to \$4.37-billion in fiscal 1979.

There won't be many new programs

However, the only new defense programs of any substance to be approved for the fiscal 1979 budget are the Navy's F-18 naval strike fighter and the Air Force's Advanced Tanker/Cargo Aircraft (AT/CA), both to be built by McDonnell Douglas. The Navy will order the first five fighters (out of the planned total procurement of 800 aircraft) under an \$864.8-million request. The Air Force will order the first two AT/CAs, which are militarized versions of the DC-10 jumbo jet.

Cruise missiles continue to receive high priority. The proposed budget includes \$416.1-million for continued development and additional procurement of the Air Force's Air Launched Cruise Missile (ALCM) being built by Boeing; \$152.1-million for continued development of the Navy's Tomahawk cruise missile by General Dynamics, and initial development of a Ground Launched Cruise Missile (GLCM) for the Air Force based on the Tomahawk design. A competition between the ALCM and Tomahawk is planned for 1979, and only one is expected to go into full-scale production.

At NASA, the largest share of the budget is committed to the Space Shuttle, which, having tested successfully at Edwards (California) Air Force Base last year, is due to make its first orbital flight in June, 1979. The Shuttle is slated to get \$1.4-billion in the new budget (\$985-million for continued development and \$454-million for production).

In announcing plans for the Shuttle, NASA Administrator Robert A. Frosch disclosed that the President had approved only four Orbiter spacecraft. NASA

will keep two, one will go to the Air Force, and a fourth will probably be shared by the two organizations. Another Orbiter had been sought for the Air Force, but Frosch said that decision could be postponed until the budget for fiscal 1981 is submitted.

One indicator of the impact the defense and space budgets will have on industry is the government-employment estimates for the coming year. Defense-industry employment is projected to grow from 1,930,000 to 2,050,000, which will more than offset an anticipated decline in military and civilian government employment from 3,080,000 to 3,057,000. NASA estimates that its contractor work force will grow slightly from 102,800 to 104,300. Government employment will be frozen at 23,237.

More dollars—but not much more

However, with the inflation rate estimated by defense planners to continue at 6%, real growth in defense spending should be only about 3.5% in fiscal 1979. Although the Defense Department is asking for \$126-billion in spending authority, it's expected to spend just \$115.2-billion. For the current fiscal year, Congress appropriated \$116.8-billion, and spending is estimated to reach \$105.3-billion by the end of the year.

This growth is substantially less than projected by former president Ford, who had planned to ask Congress for \$134.4-billion in defense appropriations for fiscal 1979 and \$165.9-billion by fiscal 1982. President Carter, who promised to cut defense spending by \$5-billion to \$7-billion during his 1976 presidential campaign, is now projecting continued growth in defense budgets to \$160.5-billion by fiscal 1982.

Besides the decision to halt production of the B-1 and keep it in the R&D category, major cuts in next year's shipbuilding programs helped prevent the defense budget from getting any higher than it did, according to Defense Secretary Harold Brown. Shipbuilding expenditures will be down \$1.1-billion below this year's level, and no aircraft carriers will be funded. In fact, the entire shipbuilding program is being reviewed by the White House, and findings are expected to be conveyed to Congress in March.

The Air Force had high hopes of accelerating development of the MX to replace the canceled B-1, but Secretary Brown cut fiscal 1979's request for this program to \$158.2-million—only slightly more than this year's \$134.4-million and well below the \$400-million planned for fiscal 1979 by the Ford administration. MX is expected to be a \$30-billion program, bigger even than the B-1 (\$24.8-billion)—if it ever enters production.

Advanced programs will have to wait

Other advanced development programs wiped out by Brown include the Navy's high-speed Surface Effects Ship (SES), for which \$333-million had been appropriated in previous years; a new Air Force jet-powered cargo aircraft known as the Advance Medium STOL (short take-off & landing) transport, for which McDonnell Douglas and Boeing had built prototypes; and a new air-defense fighter aircraft, the Follow On Interceptor (FOI), which was expected to be a longer-flying version of the McDonnell Douglas F-15 Air Force fighter.

NASA, meanwhile, has postponed asking for new unmanned spacecraft for making observations of gamma rays in space and for orbiting the moon to make additional surveys of the lunar surface.

Over-all, federal support of research and development is due to rise for the ninth consecutive year—from \$26.3-billion in the last budget to \$27.9-billion in the new one. An additional \$1.3-billion will be committed for new R&D facilities, but that's down from this year's \$1.7-billion.



Fill in the Blank.

If you're concerned about fitting your test and measurement equipment to a specific application, take this test. There's only one question so give it a try.

See if you can answer this: The TEKTRONIX TM 500 family of modular instruments includes (check one)

- DMMs
- Counters
- Generators
- Amplifiers
- Power Supplies
- Oscilloscopes
- Logic Analyzers
- Word Recognizers
- Digital Delay
- All of the above, plus

If you checked "All of the above, plus _____," nice going. You're close. But what did you put in The blank? An analog multiplier? Relay circuit? Switches for signal routing? Test oscillators at pre-set frequencies? Digital logic circuits? Converters? Special processors?

To be completely correct, your answer should include any one of these, or some other non-standard item, because TM 500 configurabil-

ity not only allows you to choose from over 30 ready-to-go, compact plug-ins for testing and measuring, but the mainframe also makes room for compatible custom plug-ins you assemble yourself with a TM 500 custom Plug-in Kit.

A TM 500 custom Plug-in Kit includes a perforated main circuit board, all mechanical components to assemble a complete plug-in, plus instructions on mainframe electrical compatibility.



The kits are available in both single and double compartment sizes. One single compartment version includes all the components for 3 voltage regulators at the rear of the board. With your TM 500 you can receive on request TM 500 Construction Notes to build special-purpose instruments including parts lists and schematics.

So, by just filling in a blank plug-in, your TM 500 can measure up to just about any highly specialized application, saving you hours of set-up time.



Whether you need a rackmount, roll-around or go-anywhere portable, the TM 500 gives you one tidy instrument with a lot of plug-ins, not a lot of plugs. It's configurable other ways, too.

Ask your local Tektronix Field Engineer. He can fill in all the blanks.

TM 500 Designed for Configurability

For configurable, accurate and reliable test and measurement instrumentation, contact: Tektronix, Inc., P.O. Box 500, Beaverton, Oregon 97077, (503) 644-0161 Ext. 5283. In Europe: Tektronix Limited, P.O. Box 36, St. Peter Port, Guernsey, Channel Islands.

Tektronix
COMMITTED TO EXCELLENCE

odds • on choice

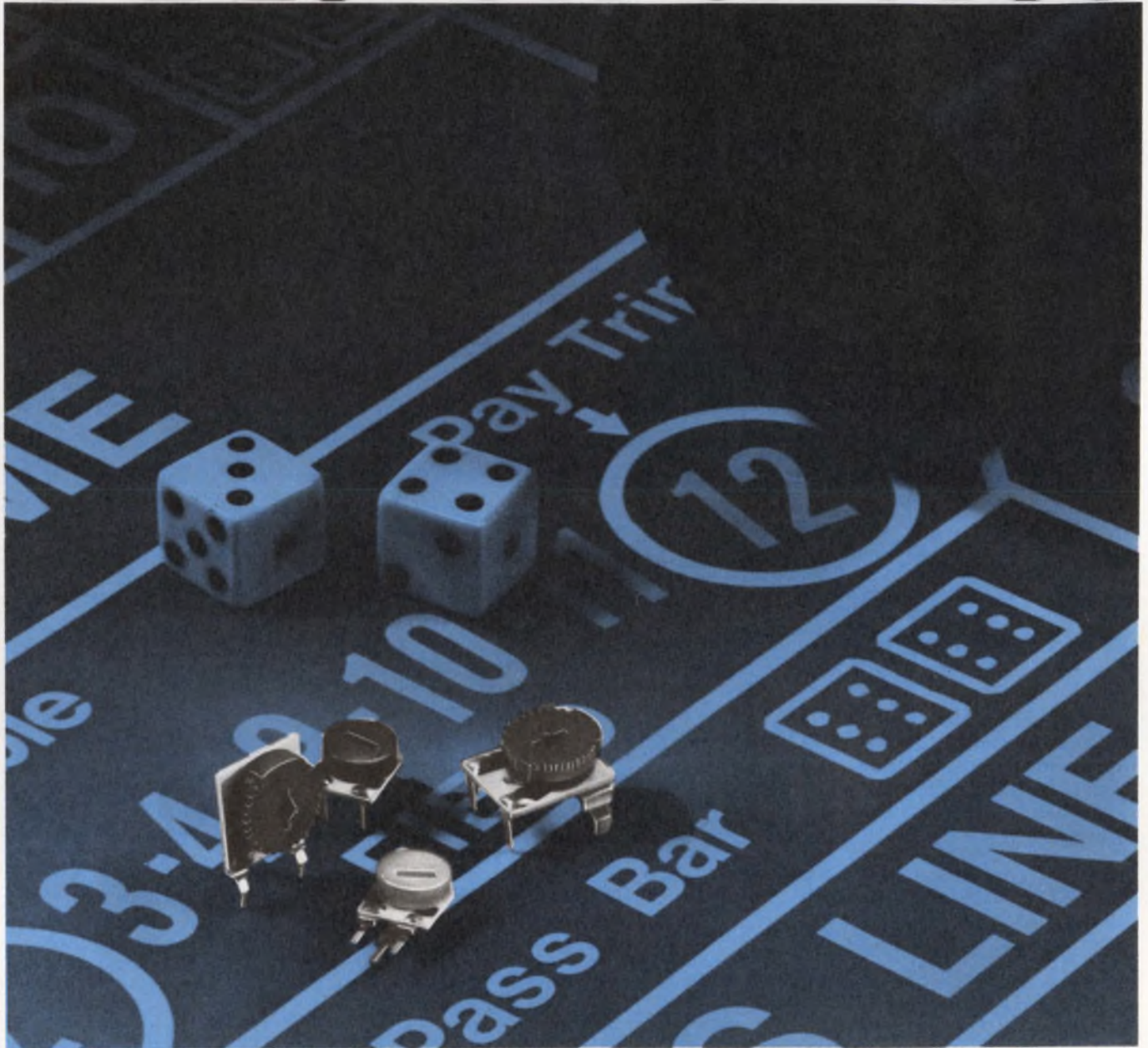

in trimming potentiometers

Take the gamble out of "set and forget" circuit adjustments in both consumer and industrial applications with our new RVA/RVG subminiature carbon and cermet trimming potentiometers.

All standard resistances in 1/5, 1/3, 1/2 and 1 watt ratings with either vertical or horizontal mountings, are included in the line. Manufactured on a stable alumina base these pots stay put and have an extremely high resistance to adverse environments, shock, vibration, humidity and solder flux.

Odds are these new tiny trimmers are just what you require. Write for complete catalog to: Murata Corporation of America, 1148 Franklin Road S.E., Marietta, Georgia 30067. Phone: 404-952-9777.

first in ceramics

muRata

CORPORATION
OF AMERICA

Now...LOOK at GPIB Activity:

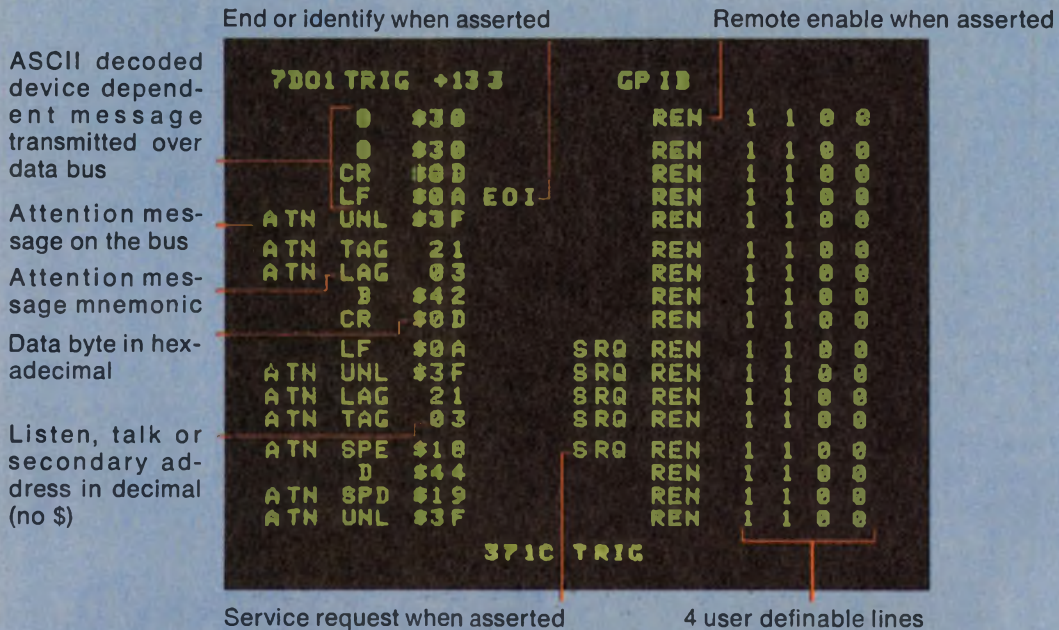

ASCII decoded device dependent message transmitted over data bus

Attention message on the bus

Attention message mnemonic

Data byte in hexadecimal

Listen, talk or secondary address in decimal (no \$)

Announcing *visible* GPIB communications at the touch of a button: the new TEKTRONIX DF2 Display Formatter. The DF2 monitors *and displays* activity on the GPIB bus as disassembled instructions in familiar IEEE 488 mnemonics.

Touch another button, and information is displayed in ASCII format, with further character decode in hex, binary, or octal—all on the same display.

The DF2 Display Formatter works with our 7D01 Logic Analyzer: for the first time, you have a complete logic analysis tool that can deal specifically with GPIB activity. And that means GPIB design and integration is now faster. Simpler. And more convenient.

Designing A Controller? Use The DF2!

It's plug-to-plug compatible with GPIB controllers so you monitor commands at a glance.

Designing Talkers/Listeners? Use The DF2!

Now it's simple to make sure talkers are responding properly to the controller and listeners are receiving correct data.

Integrating GPIB Systems? Use The DF2!

You know monitoring and displaying bus events and their sequence are essential for effective integration of multi-vendor GPIB products. Now you have the essential tool: use the DF2 to analyze any specific data transaction you wish.

You'll also find the DF2 a powerful service tool. Observe GPIB bus activity to simplify troubleshooting and keep your system up and running properly.

The DF2 Display Formatter also provides displays in timing and mapping modes as well as state tables in binary, hexadecimal, or octal notation. Combined with the DF2, our 7D01 Logic Analyzer is the most comprehensive and versatile logic analysis tool available today. And because the 7D01 Logic Analyzer System is compatible with *any* TEKTRONIX 7000 Series oscilloscope, you may already own part of a Logic Analyzer package.

TEKTRONIX Logic Analyzers: we call them The Versatile Ones.

Now, with the unique and exclusive DF2 Display Formatter, they're more versatile than ever.

And GPIB is a lot more visible.

Call your local Tektronix Field Engineer for more information about the DF2 and about our free, one-day Logic Analyzer seminar. Or write Tektronix, Inc., P.O. Box 500, Delivery Station 76-260, Beaverton, Oregon 97077. In Europe, write Tektronix Limited, P.O. Box 36, St. Peter Port, Guernsey, Channel Islands.

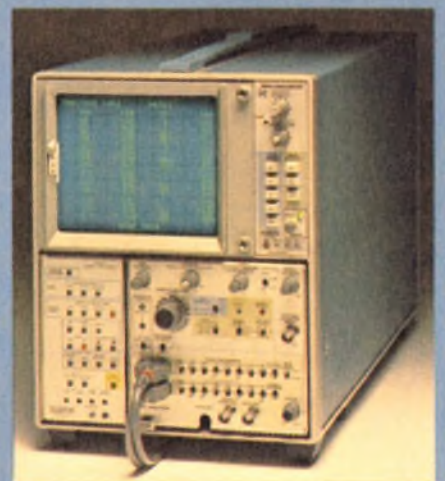

Tektronix
COMMITTED TO EXCELLENCE

TEKTRONIX Logic Analyzers: The Versatile Ones

FOR TECHNICAL DATA, CIRCLE 23

FOR DEMONSTRATION, CIRCLE 24

Coming through...

with a vital part in product design

It's what's up front that counts. That's why it pays off to involve Belden in the early stages of a project.

We know the codes, specs and electrical/environmental parameters you're faced with. We've come through with answers to some extraordinary new applications.

As much as any component, wire, cable and cord, can make a critical difference in your product's performance. And your costs. By drawing on thousands of high-quality standards—and a wealth of custom engineering knowhow—we can tailor an answer to fit your needs. Exactly.

We can even help you cope with the economics of wire processing, assembly and installation. Our problem solving experience ranges from innovative

packaging to total manufacturing analysis.

Whether you need cord sets, special harnesses, shielded cable construction, flat cable—or help putting it all together, involve a Belden Wire Specialist. He'll come through with everything we've got. For answers right now, phone:

317-966-6661 Electronic Division or mark 400 on reader service card.

312-986-1600 Electrical Division or mark 401 on reader service card.

312-887-1800 Transportation Division or mark 402 on reader service card.

Or write Belden Corporation, 2000 S. Batavia Ave., Geneva, IL 60134

BELDEN



Coming through...
with new ideas for moving electrical energy

LEARN Microprocessor Operation, Interfacing and Programming with

The New **HEATHKIT** Microprocessor Course!

Update your knowledge of today's changing technology!

Today, more than ever, you *must* stay on top of the very newest technology, or risk falling behind as new people with up-to-the-minute knowledge come into your field. Heath's new self-instruction microprocessor course is designed to do just that — it's the easiest, fastest and most cost-efficient way available to master microprocessor operation and applications! It even equips you to *continue* learning and developing on your own!

Working with the popular 6800 microprocessor, you'll explore this exciting field in 3 easy steps! In step 1, using proven self-instruction text materials, you'll learn about micro-computer basics, number systems and codes, computer arithmetic, programming, 6800 capabilities and interfacing and more. In step 2, with the aid of audio visuals included, you'll go deeper into programming, designing with microprocessors and semiconductor memories. Then, in step 3, you'll actually perform 19 "hands on" experiments with the optional trainer designed to reinforce the theory you've mastered to that point!

The ET-3400 Trainer kit, designed to accompany your course, features the popular 6800 microprocessor. It is actually a miniature digital computer in itself, complete with a: 1K ROM monitor program; 6 digit LED display for address and data readout; 17-key hexadecimal keyboard for entering programs, data and control; 256 bytes of RAM (expandable to 512 bytes with the chips supplied in the course); breadboarding socket; 8 buffered LED's for display of logic states; 8 SPST switches for binary input plus an on-board power supply with +5, +12 and -12 volt outputs.

The Course comes complete with 62 electronic components, including a 6280 PIA, two 2112 RAM's, a 1406 digital-to-analog converter, 741 and 301 op amps and more. Includes audio visual aids such as an audio cassette, colorful flip charts and programmed learning text material in two deluxe permanent binders.

Complete the optional exam and receive a Certificate of Achievement and 8.0 Continuing Education Units (CEU's) — a nationally accepted means of recognizing participation in non-credit adult education. (Note: Microprocessor Course requires completion of Digital Techniques Course or equivalent knowledge.)

ORDER ETS-3400
(Course and Trainer kit) **\$269⁹⁵**
(Add \$3.06 shipping and handling)

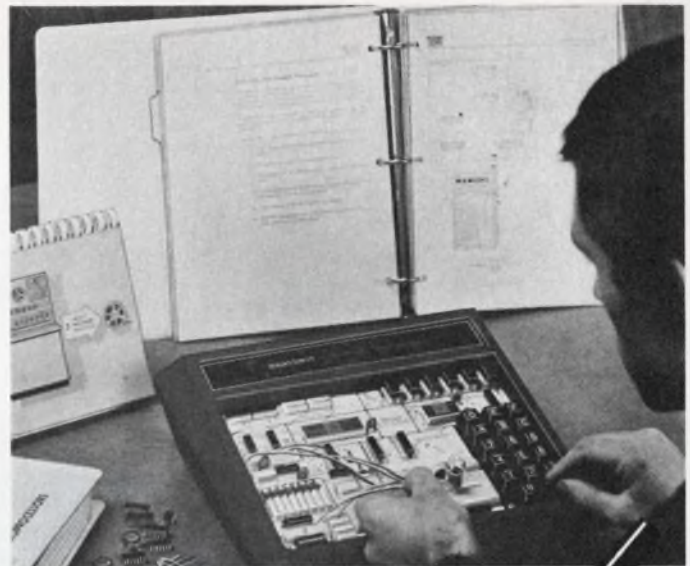

**FREE
SOLDERING IRON!**

Included with your Course at no extra cost — this pencil-style soldering iron that's perfect for printed circuit work — a \$7.95 comparable value — yours FREE!

MONEY-BACK GUARANTEE!

If you are not 100% satisfied with your Heathkit Course, we will refund the full purchase price of the course text material, less trainer.

NEED DIGITAL TECHNIQUES TRAINING?

Comprehensive Digital Techniques Course — the background you need to understand computer and modern electronics technology! Digital fundamentals, semi-conductor devices for digital applications, Boolean algebra, flip-flops and registers, sequential and combinational logic circuits, digital design and an introduction to computers and more! The course includes programmed instruction text, audio-visual aids, parts for experiments and more.

Digital Design Experimenter/Trainer lets you perform all the experiments in your course, then develop and test your own projects.

Features solderless breadboard sockets, 4 binary data switches, 2 "no bounce" switches to pulse logic circuits, 3-frequency pulse clock generators, 4 LED's for visual indication of logic states plus 3 regulated power supplies. Upon completion of the optional final exam, you receive a Certificate of Achievement and 4.0 Continuing Education Units.

ORDER EES-3201 (Course and Trainer Kit) **\$119⁹⁵**
(Add \$3.64 shipping and handling)

SAVE TIME--ORDER BY PHONE Call (616) 982-3411

HEATH
Schlumberger
Heath Company, Dept. 511-380
Benton Harbor, Michigan 49022

Gentlemen: Please send me the item(s) checked below and include my FREE Soldering Iron.

- Microprocessor Course and Trainer (ETS-3400) \$269.95
(+ \$3.06 shipping & handling)
- Microprocessor Course only (EE-3401) \$89.95
(+ \$2.23 shipping & handling)
- Microprocessor Trainer kit only (ET-3400) \$189.95
(+ \$1.69 shipping & handling)
- Digital Techniques Course and Trainer kit
(EES-3201) \$119.95
(+ \$3.64 shipping & handling)

Prices subject to change without notice

OR, MAIL COUPON TODAY!

I enclose check money order for \$_____ ; OR,
(Michigan residents, add 4% sales tax)

CHARGE to my VISA/BankAmericard Master Charge
Account # _____ Exp. Date _____

Master Charge Code # _____

Signature _____
Necessary to send merchandise

NAME _____
Please print

ADDRESS _____

CITY _____ STATE _____ ZIP _____

Give your product

with Burroughs SELF-SCAN® II gas plasma displays—

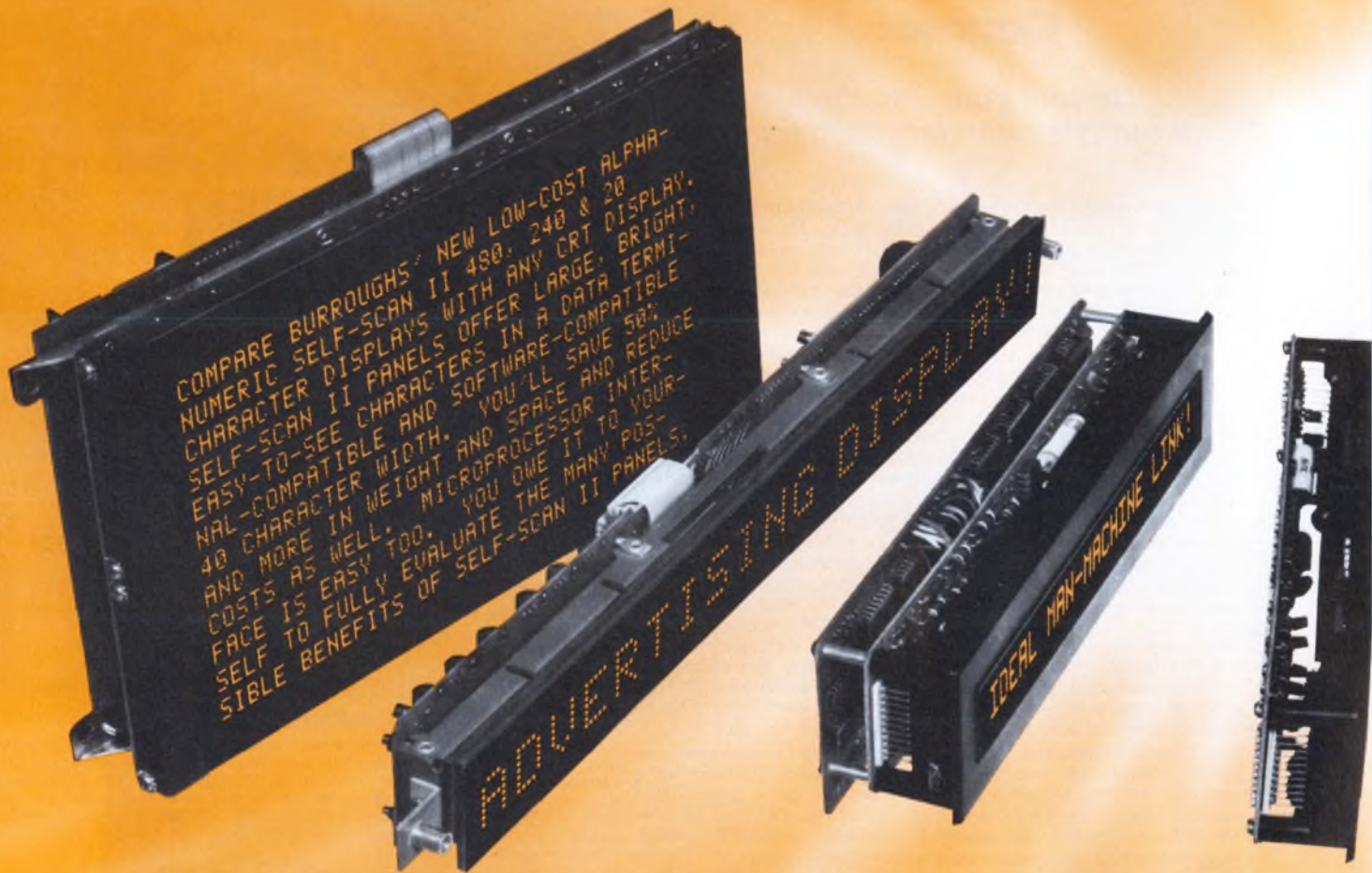

Burroughs SELF-SCAN displays provide bright, easy-to-read alphanumeric readout that will enhance the saleability of your product. Over one-quarter million have been built into everything from word processors to data terminals to paint matching machines.

And now they're easier than ever to use. Optionally available microprocessor-based controllers save you most of the time normally spent to "design-in" a display.

Give your product the visual excitement and dependability of SELF-SCAN displays. You'll benefit from each of these features:

- Thin cross-section (under 2" with electronics) to keep your product's design efficient and low-cost.

- Neon-orange characters are uniformly bright, flicker- and distortion-free, easy-to-read in high ambient light and at night without eye strain.
- Easy interface with microprocessor-based systems.
- Any of over 100 languages can be displayed with many special effects possible (such as word blinking).
- Low power requirements, low heat buildup.

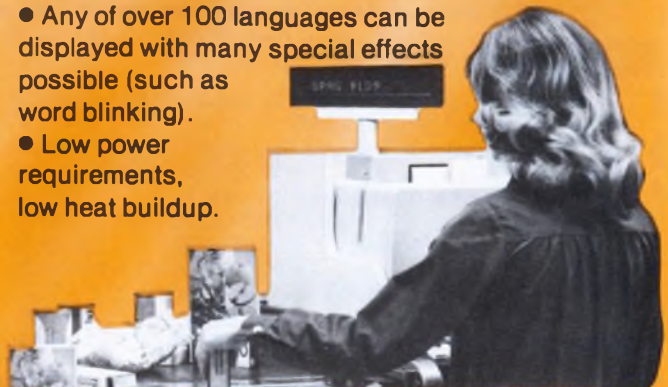

visual superiority

now available with microprocessor control.

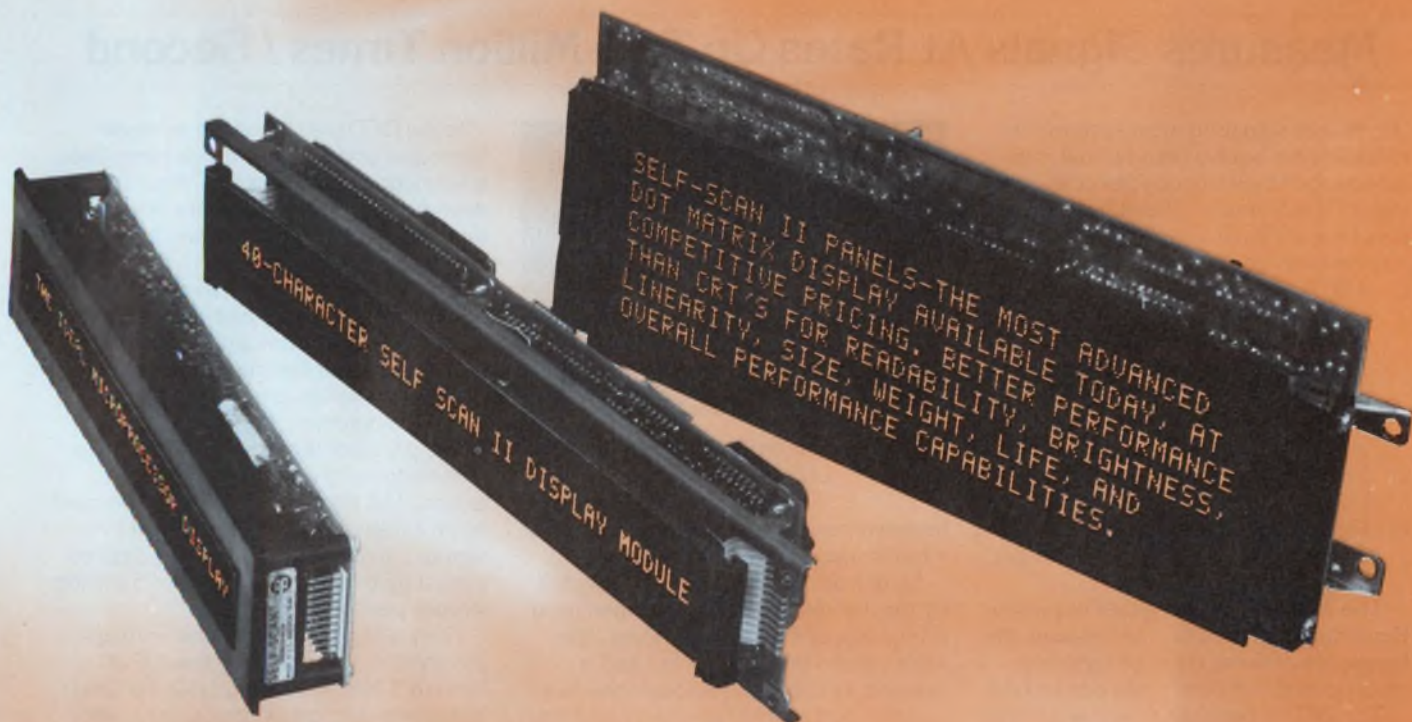

- Fewer connections required than with other displays.
- Long service life even where vibration, temperature and high humidity are present.
- No danger of implosion or X-ray radiation.

Choose from our complete line. SELF-SCAN panels are available in both single and multi-line displays with and without memory. Our single-line models, in 16, 20, 32 or 40 characters, are compact, low-cost and extremely dependable. The 20-character panel is stackable and buttable for creating large message panels. Single-line panels range in price from \$112 in 100-unit quantities.

Low-cost SELF-SCAN multi-line displays in 240 and 480-character sizes are rapidly replacing many CRT displays. They give you excellent message readability, big space and weight savings, plus 3 times the life of most CRT's. Prices range from \$311 in 100-unit quantities.



Give your product the visual advantages of SELF-SCAN displays. Write or call for specifications.

Burroughs Corporation, Electronic Components Division, P.O. Box 1226, Plainfield, NJ 07061 or call (201) 757-5000.

Overseas, contact Burroughs ECD International, Buckingham House, The Broadway, Stanmore, Middlesex, England. Telephone 44-9237-70545.

the first name in displays
the last word in displays

Burroughs



Ultra High Speed Digital Microwave Frequency Meter

Measures Signals At Rates Up To 5 Million Times / Second

Microwave signals in most systems are modulated in such a manner that measurement of their frequencies at any given instant is extremely difficult by conventional means such as counting. Typical microwave signals include:

- 100% amplitude modulation with pulse widths from 100 nanoseconds to CW
- Bi-phase or quadrature modulated carriers
- Frequency modulation within a pulse (chirp)
- Interpulse frequency modulation (frequency agile)
- Frequency modulation during settling of fast voltage controlled oscillators (post tuning drift)

The Anaren line of Digital Frequency Discriminators (DFD's) can measure the frequency of these types of signals at rates up to five million times per second.

The DFD is basically a microwave inter-

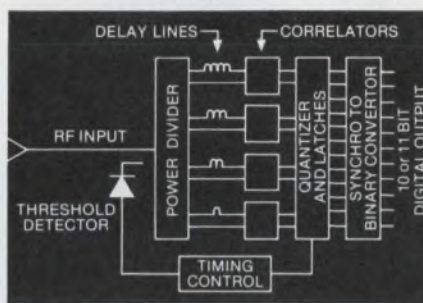

Figure 2 - Anaren Digital Frequency Discriminator

ferometer and is very similar to the optical interferometer (See Figure 1).

Light from a point source is collected by the first lens and is transformed from a spherical to a plane wave front. The wave passes through a prism and is skewed, as shown, at an angle that is a function of the prism geometry and the wavelength of the light signal. A second lens focuses the signal to a point in the image plane that is unique to the wavelength (and therefore, the frequency of the signal).

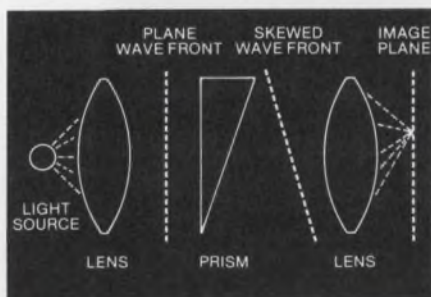

Figure 1 - Optical Interferometer

Model No.	182105	182135	182106	182136	182107	182137	182108	182138	182109	182139
Operating Frequency (GHz)	1.0 to 2.0		2.0 to 4.0		4.0 to 8.0		8.0 to 12.0		12.0 to 18.0	
Mean Frequency Resolution (MHz)	1.25 0.625		2.5 1.25		5.0 2.5		5.0 2.5		10.0 5.0	
RMS Frequency Accuracy (MHz)	0.6 0.3		1.2 0.6		2.4 1.2		2.4 1.2		5.0 2.5	
Input Power Levels (dBm)	-1 to +7		-1 to +7		-1 to +7		-1 to +7		-1 to +7	
RF Pulse Width (ns)	150 to CW		100 to CW		100 to CW		100 to CW		100 to CW	
Max. Instantaneous FM Rate (MHz / μ sec)	50		100		200		200		400	

Electrical Specifications

Contact your local Anaren Technical Representative for a copy of the DFD Technical Manual, Pub. M1804-77, or write/phone below. Delivery 12 weeks ARO.

Anaren Microwave, Inc., 185 Ainsley Drive, Syracuse, N.Y., U.S.A. Tel. (315) 476-7901, TWX 710-541-1507, Telex 937351; Western Regional Office, 7995 E. Hampden, Denver, Colorado 80231, Tel. (303) 755-0733; Canada, Louis Albert Associates, Inc. 2264 Stevenage Drive, P.O. Box 8526, Ottawa, Ontario K1G 3H9, Tel. (613) 737-5941, TWX 610-562-8918; Europe, Anaren International, P.O. Box 15, Newbury RG13 4JE, Berkshire, Great Britain, Tel. 0635-67500, Telex 27950.

Anaren

Mostek Z80.

It's just the most powerful 8-bit microcomputer family you can buy.

Powerful features make Mostek's Z80 the best 8-bit microcomputer available. The Z80 CPU interfaces directly with standard dynamic memories and provides both refresh and timing signals. The results: easier system design with fewer components. The Z80 is software compatible with the 8080A yet has 80 additional instructions. Other features are: powerful I/O block transfer capability; extremely fast interrupt response; and a memory block transfer ability that moves up to 65K bytes with a single instruction.

Four additional peripheral circuits implement fast I/O transfers and provide counting and timing functions with minimal CPU overhead. Mostek's Z80 family includes the MK 3880 Central Processing Unit; MK 3881 Parallel Input/Output Controller;

MK3882 Counter Timer Circuit; MK3883 Direct Memory Access Controller; and the MK 3884 Serial Input/Output Controller. The 3880, 3881 and 3882 are available now with the DMA and SIO to be sampled soon. All components operate on a single +5 Volt power supply.

A wide support base and a broad line of industry standard memories make Mostek your best source for microcomputer products. Contact Mostek at 1215 West Crosby Road, Carrollton, Texas 75006; telephone (214) 242-0444. In Europe, contact Mostek GmbH, West Germany; telephone (0711) 701096.

MOSTEK®

CIRCLE NUMBER 28

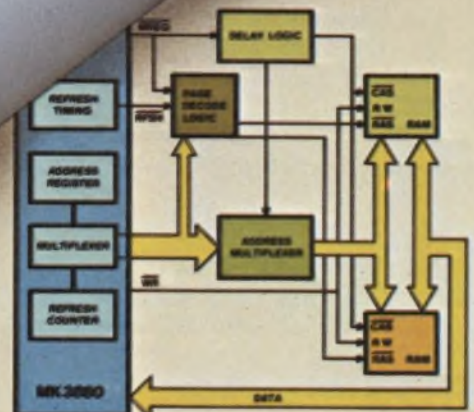

Z80 DYNAMIC RAM INTERFACE

When you need indicator lights or more than indicator lights...



Come to the Number 1 supplier in the world—Dialight—for the widest choice of indicators for your every application.

You'll find the largest selection of UL & CSA listed, and QPL approved, indicator lights.

Whether small or large, LED, incandescent or neon, you have over 1,500,000 design combinations to choose from. And your choices include a full range of lens shapes, finishes, legends and colors from red, green

and amber to blue, yellow, white and clear. Designed for consumer, industrial and MIL-SPEC requirements.

We've developed a particularly easy way for you to find out exactly what you need out of the millions of indicators we have. It's a special 60-page Indicator Light Selector Guide. For your free copy, which includes a list of stocking distributors in the U.S. and Canada, contact us today.

DIALIGHT
A North American Philips Company

Dialight meets your needs.

Dialight, 203 Harrison Place, Brooklyn, N.Y. 11237 (212) 497-7600

CIRCLE NUMBER 29

The systems man

Jack was a systems man—in every fiber of his body. He believed fervently that all human activity—and certainly business and engineering activity—should be systematized. If things are not run by systems, he reasoned, they're run by accident. And then, of course, why bother?

So it came as no surprise, when Jack was brought in as VP Engineering, that he started setting up systems. He began with reliability. He wanted a system for gathering information, then acting on it methodically, to improve reliability.

On his first interview with Charlie, the chief engineer, he challenged: "How many of your instruments come back for repair?"

"That depends on the instrument," Charlie told him, then showed, as examples, that lots of Model 23s were coming back for repair these days, but hardly any Model 85s. When Charlie added that nothing was being done to improve the 23 because the returns-for-repair problem would soon go away, Jack almost flew into a rage.

If a problem's going to go away by itself, he fumed, we don't need engineers. And why had nothing been done to improve the 23? And were there frequency-of-repair records to guide design modifications and to help set spare-parts inventories? And did records show if failures were due to component, design or manufacturing faults? And don't we have records to identify poor vendors and poor components? And, by golly, we're going to get some systems to monitor all of this so that we can take intelligent action.

"Oh, we've got all that," Charlie told him. "It's just that we decided not to modify the 23 because it's almost 20 years old. It hasn't been in the catalog for 10 years. Eventually, we expect Model 23 customers to buy the Model 85 instead of repairing the old box."

When Jack simmered down, his enthusiasm for systems was in no way lessened, but he was slightly older and a good bit wiser. He learned that he was not alone in appreciating the value in systematic approaches to things. And he had learned, too, that it's often wise to know the facts before trying to cure them.



GEORGE ROSTKY
Editor-in-Chief

FASCO THE ENERGY SAVER!

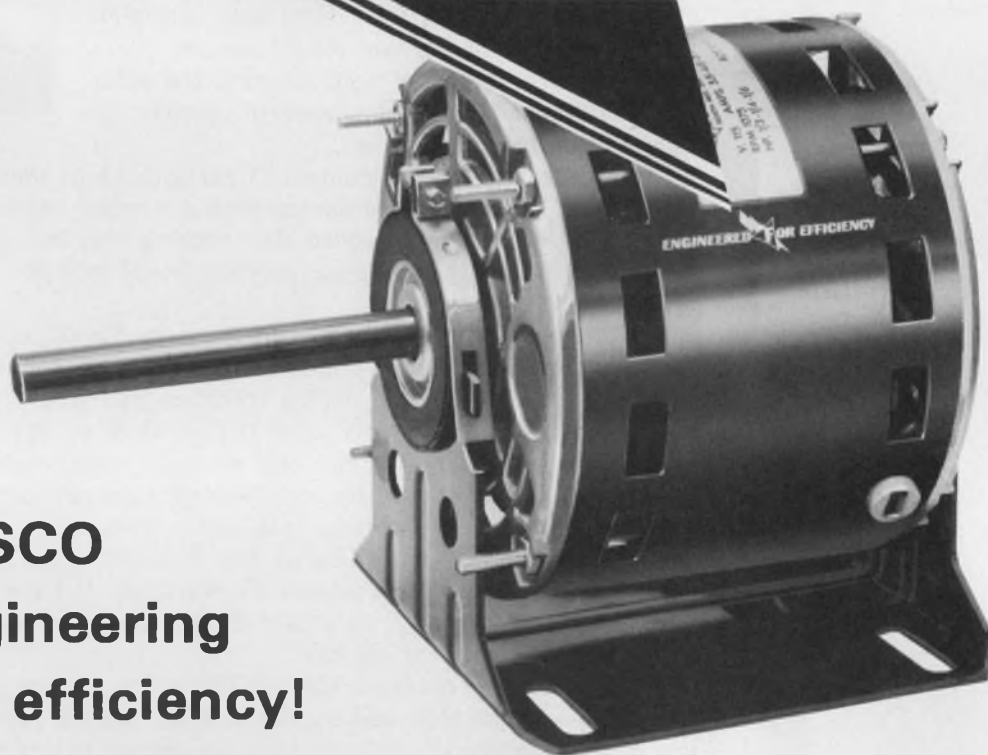

**At FASCO
... engineering
means efficiency!**

FASCO has long been a leading manufacturer of quality fractional horsepower electric motors . . . motors that provide maximum performance, durability and efficient operation.

Your product's power specifications will be carefully analyzed by Fasco engineers to provide the proper size, type, speed, torque, starting requirements and other construction characteristics so necessary in producing the optimum "Energy/Efficiency/Ratio" at the lowest cost.

Fasco's full line of shaded pole, permanent split capacitor, or split phase fhp motors . . . as well as a wide selection of centrifugal and

Transflo® blowers in ranges from 1/500th to 1 H.P. are readily adaptable to your most demanding requirements.

Let Fasco's efficiency experts assist you in solving your product power problems with motors that are "Engineered For Efficiency". Sales offices located in major cities are staffed by factory-trained personnel . . . call now for an energy saving discussion.



FASCO® INDUSTRIES, INC.

MOTOR GROUP HEADQUARTERS
1600 W. Jackson Street, Ozark, Missouri 65721

Berg Minisert Sockets display "high reliability" on Tektronix Oscilloscopes

The Berg Minisert™ is a miniature, low-profile P.C. socket which allows .400"-tight board-to-board spacing. The Minisert provides positive, functional reliability over repeated insertion/withdrawal cycling; its elastomeric seal keeps out contaminants.

Tektronix likes the repeated pluggability the Minisert socket affords in using transistors, LED's, lamps, IC's and other components. Tektronix has found it can rely on Berg Electronics . . . to supply the product and the application machines

that precisely meet its interconnection needs.

Berg is experienced. We read interconnection needs like Tektronix reads waveforms. We have the products, the background and the back-up to do the job. Your job. Let's work on it, together. Berg Electronics, Division, E. I. du Pont de Nemours & Co., New Cumberland, Pa. 17070—Phone (717) 938-6711.



BERG ELECTRONICS

CIRCLE NUMBER 31

We serve special interests—yours!

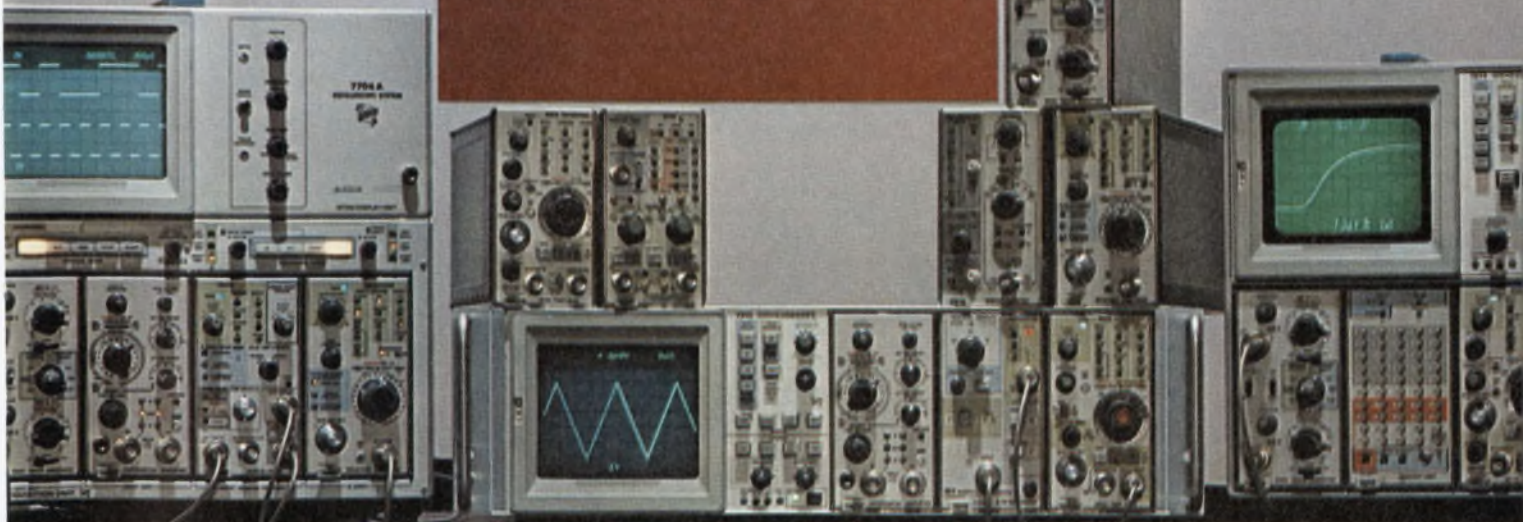
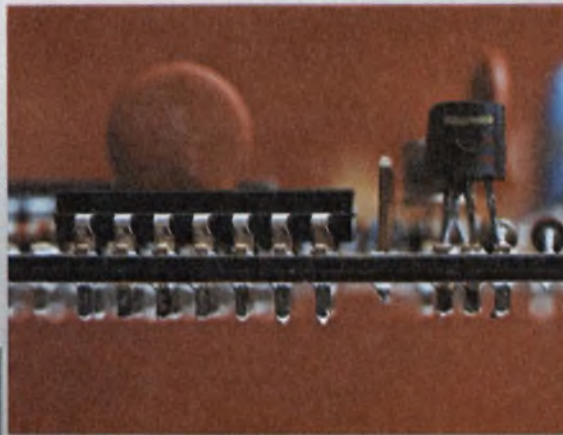

FOCUS

on
Lamps

Unlighted indicator assemblies look like so many gum drops. Only when they are lighted can you discover considerable differences in brightness, visibility range and longevity among units. The lamp inside the assembly makes most of the difference. Yet brightness specs, and to a lesser extent life specs, are confusing. And limited LED viewing angles are often downplayed in catalogs and spec sheets.

Indicator lamps—incandescent, LED and neon—

compete for places in indicator assemblies. For high brightness, wide viewing angle and color variety, incandescents still beat them all, despite gobbling the most power for a given amount of light.

Incandescent miniature and subminiature lamps produce from 0.006 to over 50 MSCP (mean spherical candlepower), according to one GE catalog; indicator neons, 0.06 to 0.15 lm (lumens) at 1 mA, according to Signalite; and LEDs, 1 to 40 mcd (millicandellas), according to Monsanto.

Morris Grossman
Associate Editor

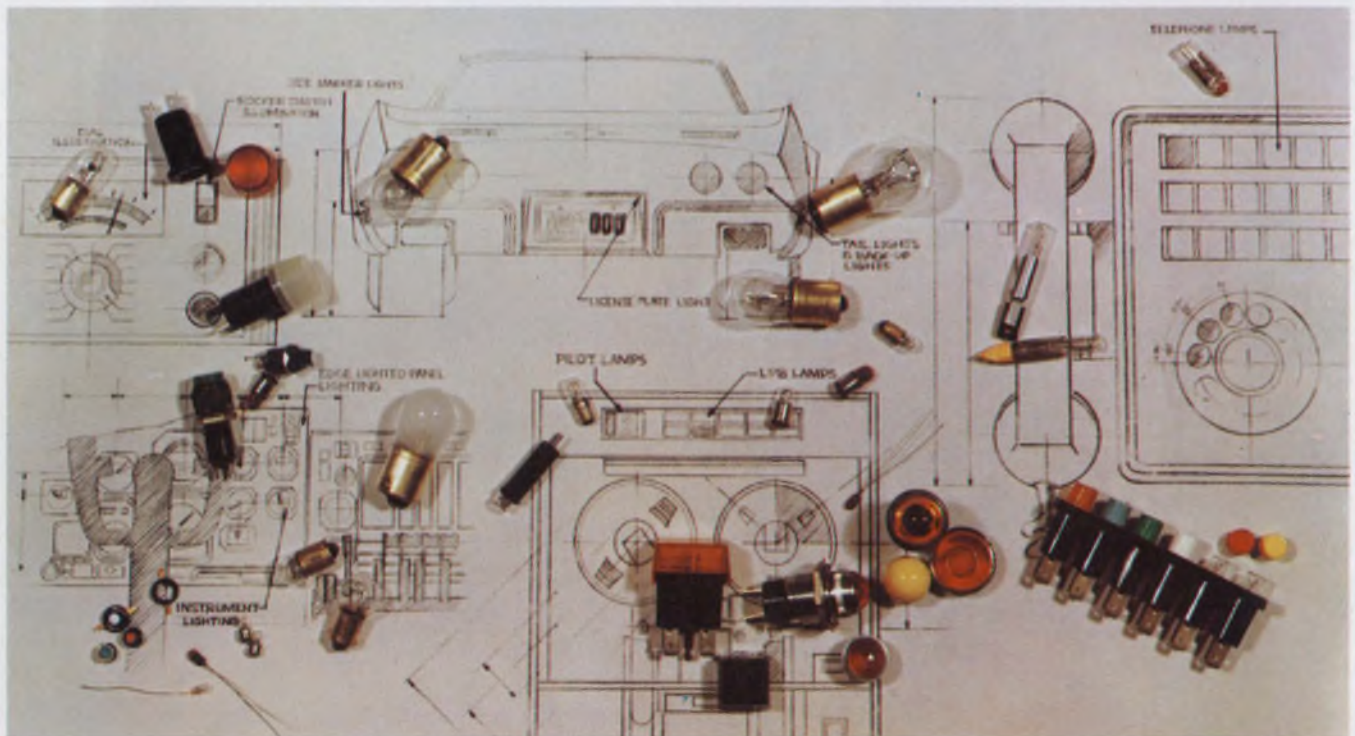

Incandescent indicator lamps come in many sizes, shapes and basing arrangements for almost any application, as

illustrated by this collection from Sylvania's comprehensive line of miniature incandescent lamps.

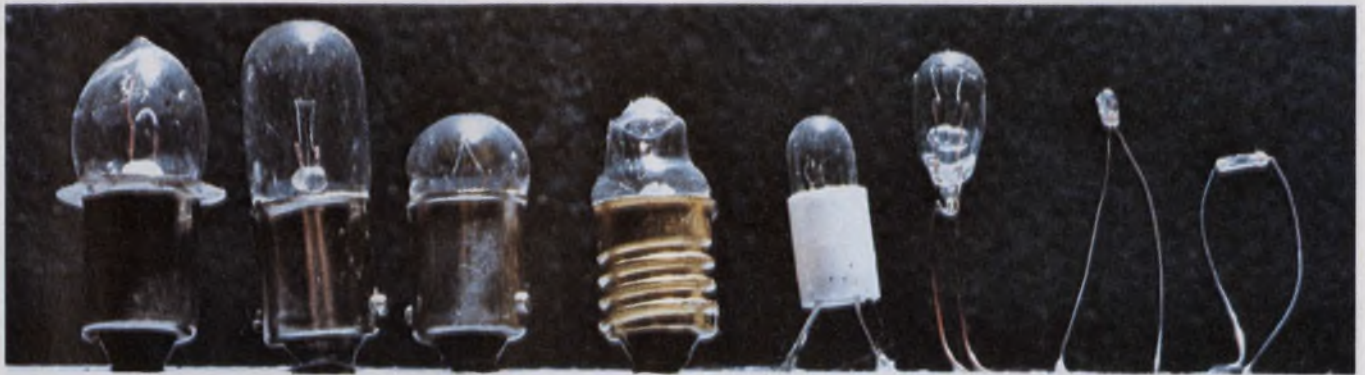

Offshore sources provide stiff competition to domestic lamp manufacturers. This family portrait of incandescent

lamps from Shogyo International is only part of the product line available from the company.

Confused with the light measurement units? Don't feel too bad. Photometric units are generally unfamiliar to electronics designers (see box). And lamp manufacturers add to the confusion by lack of uniformity in terms and by not clearly defining the units they use.

If lamp makers would standardize on the latest International System of Metric Units (SI units), comparison could be easy. But each technology continues to cling to its traditional approach. For example, "candlepower," an obsolete word for light intensity, is *not* a photometric unit. In GE's miniature and subminiature-lamp catalogs, candlepower is apparently measured in candelas, which *is* a recognized unit. But GE never really comes out and says so.

However, you could reach this conclusion if you know what a lumen is. "To convert mean spherical candlepower to lumens, multiply by 12.57 (4π)," the GE catalogs say. Apparently, you are expected to know that 1 lumen/steradian equals 1 candela. In addition, the term "mean spherical" is not defined by GE, but of course, the implication is that the value is the total light flux output in lumens divided by 4π steradians.

GE is not alone in loosely defining terms. Sylvania defines "mean spherical" as an "average of the luminous intensity in all directions" in its catalog. But Sylvania at least describes intensity in MSCD (mean spherical candelas). Since GE and Sylvania seem to list the same intensity values for equivalent lamps, you can assume that MSCP and MSCD are really the same photometric units and that both companies are "averaging" in the same way. Note: The word "average" is a generic term. There are many kinds of averages. A so-called weighted average in statistical analysis is called the arithmetic mean, or simply "mean."

But what is really disturbing is the mixing of old English and SI photometric units for two different characteristics of a particular lamp. In addition to

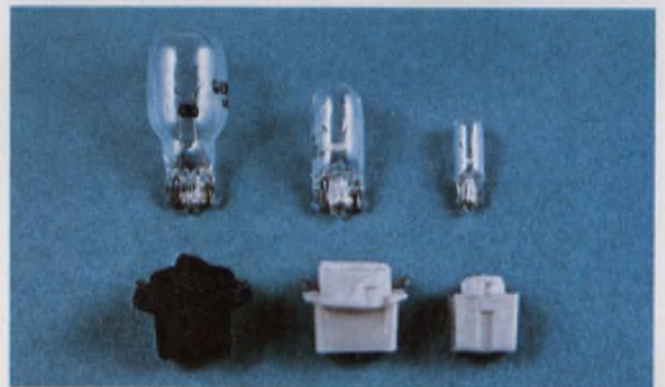

Wedge-based incandescent lamps, shown in the size range made by GE, are cheaper than lamps with metal or ceramic bases (top). Many manufacturers make special sockets that securely hold these lamps. But for high light intensity in a small space, halogen-cycle lamps made by GE and others, are dramatically smaller than ordinary vacuum lamps for the same light output (bottom).



LED solid-state indicator lamps, such as these Jupiter units made by IEE, come in red, green, yellow and amber. Dome-shaped housings include sizes from T-1 through T-1-3/4. Fresnel-lens wide viewing-angle units in size T-2 are available with round or square tops.

mean spherical intensity, tubular T-2 lamps have an additional photometric spec called "end foot-candles,"—a measure of the portion of light that passes through a 0.25-in. aperture at the lamp's end. Both GE and Sylvania use the same unit here. Candelas used for light intensity are valid SI metric units, but foot-



candles are obsolete English units for illuminance—the amount of light that falls on a surface from an outside source. To be consistent, the SI unit for illuminance—lux, or lumens per square meter—should be used.

If you make the same loose assumptions for neon lamps as is done for incandescents—averaging the total light flux around the 4π steradians of a whole sphere—then a neon's "intensity" range becomes 0.06 to 0.15 lm divided by 12.6, or 4.8 to 11.9 mcd per milliamper (normally rated at 0.25 to 2.5 mA) compared to the incandescent's range of 6 to 50,000 mcd. LED intensities range between 1 and 40 mcd.

The real world isn't so shiny

Although imprecise about lamp-intensity units, incandescent-lamp makers are most careful to explain that their rated lamp lives are based on "averages" of lamps tested on stationary racks, under closely controlled laboratory conditions and energized with regulated ac power. Perhaps this great care results from the frequently large discrepancy between the rated and actual lives. Actual use seldom duplicates the benign conditions of lamp life tests.

Incandescent-lamp life is very sensitive to voltage, shock and vibration and the frequency of on/off cycling. A 5% rise of a lamp's voltage above its design level can reduce life by 50%—life varies inversely as the twelfth power of voltage. Furthermore, on/off



Because they are small, LEDs can be arranged easily into arrays. Dialight's 555 lamps are packaged on a rectangular plastic block with built-in resistors and leads for mounting on PC boards. Ten LED units, side by side, need only one inch of space on a board.

cycling applies thermal, hence, mechanical stresses to an incandescent's filament, which also shortens life.

In addition, the mechanical resonant frequency of the filament, its support and the lead wires strongly influence a lamp's resistance to mechanical shock and vibration. Thus, catalogs correctly recommend low-voltage filaments, which are short and rigid and have high resonant frequencies. High-voltage units, however, more readily respond to shock and vibration and eventually their long filaments break under the abuse. But the catalogs give little data to guide you in such a selection. One catalog, merely says that "some lamps, such as 6.3-V panel units, incorporate mounting arrangements specially tuned to resonant frequencies that protect the filament against shock and vibration." But no quantitative data are provided, nor are the lamps in question clearly identified.

Unfortunately, except for idealized life-vs-voltage curves, catalogs and spec sheets don't provide much quantitative data that would allow a design engineer to estimate for himself the effect of these various factors on lamp life. And even the life-vs-voltage curves have limited value. They usually come with a warning that they aren't accurate beyond 95 to 110% of the design voltage, which is only a tiny portion of the over-all curve (see the incandescent-lamp life-output curves).

The major lamp manufacturers imply in their literature that they have stacks of data on these life factors. So why must you ask for them?

Dc shortens lamp life

Moreover, unless you diligently read footnotes, you'll miss the important point that operating an incandescent lamp on dc greatly reduces its life. Dc operation is doubly significant today because of the increasing use of lamps with dc in solid-state circuitry.

One reason life is shortened with dc stems from lighting a lamp through a series resistor or semiconductor device to obtain the correct lamp voltage. Unfortunately, an incandescent's resistance increases with age; consequently, so does the voltage across the lamp increase as it ages. The result is a lamp life that is about half of what it would be when the lamp operates from a low-impedance, constant-voltage source, such as ac from a well regulated transformer.

Another, even more deadly life reducer—filament notching, or the uneven evaporation of the filament—also stems from dc operation. This factor is particularly important in small, bright lamps, whose filaments operate in the usual 1700-to-2300-K range. For reasons not fully understood, ac appears to cause much less notching than dc. Thus ac-operated lamps can last from two to 10 times as long as dc-operated lamps.

Filament evaporation is the basic mechanism limiting an incandescent lamp's life. Unfortunately, evaporation is not uniform because of unavoidable material impurities, localized effects of cold working,

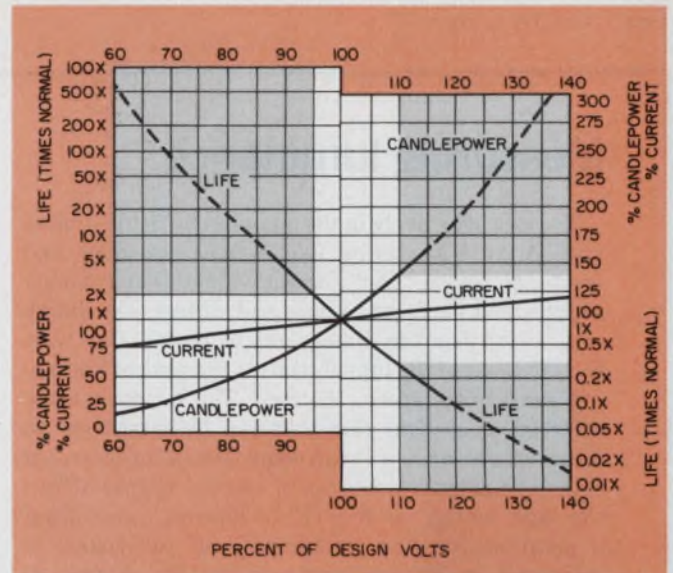

Life and light-output curves for incandescent lamps provide reasonably accurate values only between 95 and 110% of rated volts, and when operated on ac in a benign environment. But for lamps rated over 5000 hours and for halogen-cycle incandescent lamps, you must check with the manufacturer.

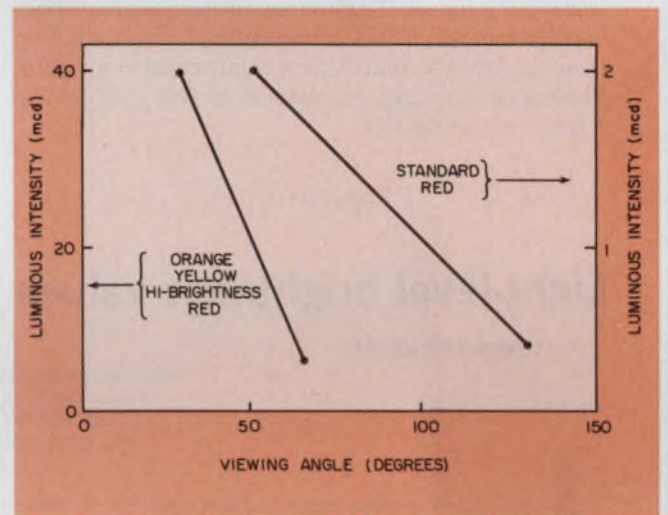

When evaluating a LED's luminous intensity, consider its rated viewing angle. LED intensity falls off as the angle increases, according to this plot supplied by Monsanto. In addition, LED intensity must be evaluated at one drive current—usually between 5 and 20 mA—for valid comparisons. Manufacturers of similar devices don't always rate them at the same current.

and nonuniform temperature distribution. In small lamps, thin filaments—often only 0.001 in. in diameter—are more rapidly cut through by notching than thick ones, because the rate of notching is independent of the thickness of the filament. Fortunately, "long-lived" lamps, those with design lives of 10,000 to 100,000 h, operate below 1700 K and consequently aren't significantly affected by notching.

Another way to reduce an incandescent's life is to operate it in a flashing mode.

(continued on page 58)

Measuring luminance

To work effectively in the optoelectric field requires familiarity with terms like *lumens*, *candelas* and *lamberts*, and a "feel" for the values that common sources and surfaces radiate and reflect (see chart).

A lumen has the dimensions of power. One watt is equivalent to 680 lumens (lm) at the peak of human-eye sensitivity (green, 555 nm). The lumen is often referred to as *light flux* that can be spread out to illuminate a surface. It can come from a concentrated source or extended sources of various shapes. When the light energy, or flux (F) in lumens, comes from a point source, the intensity (I) of the source is measured in lumens/steradian (lm/sr). A unit of intensity is called the candela (cd) and equals 1 lm/sr.

A steradian is a unit of solid angle. There are 4π steradians to a sphere. This is analogous to the radian in two-dimension geometry, in which there are 2π radians per circle (360°). Because there are $4\pi \approx 12.6$ steradians in a sphere, the total flux that one candela generates is 12.6 lumens, or $4\pi I$ lumens for a point source of intensity, I. Of course, we have assumed that a point source radiates uniformly in all directions. For a small area, A, that is at a right angle to a radius from a point source, the amount of flux striking the area is approximately

$$F(\text{lumens}) \approx A(I/r^2),$$

where r is the distance from source to surface. Flux radiating in all directions spreads out as the square of the distance from a point source.

While many light sources, like LEDs, approximate point sources, many bar and panel-type lights are better described as area sources. The intensity of point-source LEDs is generally specified in candelas, or millicandelas (mcd), but displays and indicators that are area-like need another kind of measure that accounts for the different geometry. Photometric specialists use the lambert to describe the brightness of area-type sources. The lambert is related to the candela by a constant and an area factor to take care of the geometry difference—at least in theory—making the lambert and candela more comparable on a radiated-energy basis. Note that the word *intensity* is used to describe *point sources*, and *brightness* is reserved for *area sources*.

Theoretically, a small area is assumed to radiate (or reflect) on one side only. Therefore only half as much flux comes out of the area compared with a point source. Another assumption is that the surface is perfectly diffuse and radiates or reflects according to Lambert's law of cosines—the emission brightness varies as the cosine of the angle from a normal to the area. In practice this is only approximated, but the factor is needed to relate point and area-source intensity and brightness units.

Because of Lambert's law, an area source emits half again as much flux as a point source. Only 1/4 (4π)

Light-level brightness values of common objects

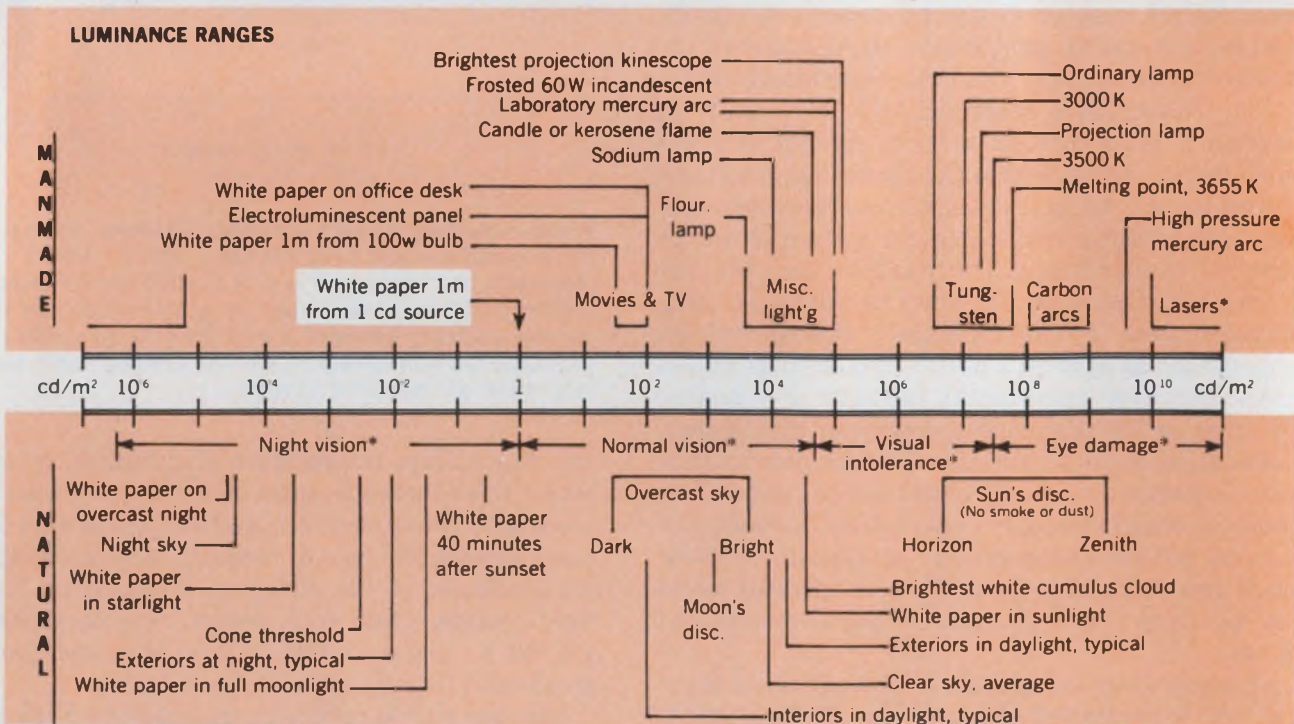

*Actual ranges depend on spectral makeup of radiation

Courtesy of Parker Publishing: Technician's Guide to the Solid State by M. Grossman

steradians of total flux can theoretically come out of a small area source. Therefore,

$$1 \text{ lambert} = 1 \text{ lumen}/(\text{sr}\cdot\text{cm}^2) = (1/\pi) (\text{cd}/\text{cm}^2)$$

$$= (10,000/\pi) (\text{cd}/\text{m}^2) = 3183 \text{ cd}/\text{m}^2.$$

The cm^2 , or m^2 , dimension is needed to spread the given flux over the source's area.

From here on, photometric units become a semantic nightmare. The distinction between intensity and brightness is subtle enough, but photometric specialists have "refined" these terms and replaced them with "luminous intensity" and luminance, respectively. Many other confusing terms have been introduced, and now supposedly obsolete terminology exists side

by side with newer—and not much clearer—words, like "illuminance" and "irradiance" for illumination (surface brightness from an external source), and obsolete "candlepower," which is replaced by the terms luminous intensity and luminance.

The number of equivalent units that exists to describe each quality is beyond belief (see abridged conversion tables). Units like hefners, nox, carcel units, the English sperm candle and candlepower abound, but have been left off the tables.

Fortunately, by relating all units back to lumens or watts, you can usually work your way out of any difficulty. If manufacturers would stick to the so-called radiometric system of units for specifying optoelectronic devices—watts/ m^2 , watts/steradian, etc.—the confusion would be very much reduced.

Converting radiometric and photometric units

Radiometric and photometric equations and units				
Definition	Radiometric		Photometric	
	Name	Unit (SI)	Name	Unit (SI*)
Energy	radiant energy	joule	luminous energy	lumen-sec
Energy per unit time = power = flux	radiant flux	watt	luminous flux	lumen
Power input per unit area	irradiance	W/ m^2	illuminance	lm/ m^2 lux
Power per unit area	radiant exitance	W/ m^2	luminous intensity	lm/ m^2
Power per unit solid angle	radiant intensity	W/steradian	luminous intensity	candela
Power per unit solid angle per unit projected	radiance	W/ m^2 steradian	luminance	candela/ m^2

Illumination conversion factors				
1 lumen = 1/680 lightwatt (at 555 nm)		1 watt · second = 1 joule = 10^7 ergs		
1 lumen · hour = 60 lumen · minutes		1 phot = 1 lumen/ cm^2		
1 footcandle = 1 lumen/ ft^2		1 lux = 1 lumen/ m^2 *		
Number of Multiplied by Equals number of	Footcandles	Lux*	Phots	Milliphots
Footcandles	1	0.0929	929	0.929
Lux*	10.76	1	10,000	10
Phots	0.00108	0.0001	1	0.001
Milliphots	1.076	0.1	1,000	1

Luminance conversion factors						
1 nit = 1 candela/ m^2 *						
1 stilb = 1 candela/ cm^2						
1 apostilb (international) = 0.1 millilambert = 1 blondel						
1 lambert = 1,000 millilamberts						
Number of Multiplied by Equals number of	Foot-lamberts	Candelas / m^2	Milli-lamberts	Candelas / in^2	Candelas / ft^2	Stilbs
Footlamberts	1	0.2919	0.929	452	3.142	2,919
Candelas/ m^2 *	3.426	1	3.183	1,550	10.76	10,000
Millilamberts	1.076	0.3142	1	487	3.382	3,142
Candelas/ in^2	0.00221	0.000645	0.00205	1	0.00694	6.45
Candelas / ft^2	0.3183	0.0929	0.2957	144	1	929
Stilbs	0.00034	0.0001	0.00032	0.155	0.00108	1

*International system of metric units—recommended standard

Courtesy of Parker Publishing: Technician's Guide to the Solid State by M. Grossman

But flashing lamps are better attention grabbers for a given intensity of light than steady burners. Sylvania says that a 1-ms flash is about five times more effective than a steady source; 100-ms flashes are only two to three times more effective. And GE claims that its subminiature lamps can be operated as flashers with "generally no sacrifice in life as long as the light output as a flasher doesn't exceed that of steady burning."

Careful! Does GE mean that the flasher's peak intensity—not total light output—should be the same as the rating? With short duty cycles, very high bursts of energy to the filament would be required to produce light output equivalent to the energy content of steady burning. Such high peak voltage and temperatures will damage incandescent filaments.

What's more, the flashing rate shouldn't excite the filament's mechanical resonant frequency—a factor rarely mentioned. At resonance, thermal energy can couple into the mechanical system to produce mechanical vibrations (a singing filament). The flash rate need only be a subharmonic of the resonant frequency to excite the filament. Singing filaments often occur with dimmer (time modulation) controls on 60-Hz power.

Lamps operating at 10 to 28 V have lower over-all

resonance frequencies than low-voltage, 6.3 and 5-V lamps. High-voltage lamps usually have long, finely coiled filaments with many resonant points. The coiled filament turns short easily when vibrating, putting excess voltage on the rest of the filament. Such generalized information is freely given in the catalogs. But getting specific resonance data on particular lamps is tough. It's not on the spec sheets, and even if a manufacturer has it for a specific lamp, it's often difficult to pry it out of him.

However, you don't have to flash a lamp continuously to affect its life. When you merely turn a lamp on and off frequently, the cooling and heating cycling fatigues filaments and supports. Interestingly, a tungsten filament is more fragile at room temperature than at high temperatures. In cooling—between 350 and 250 C—the filament passes through a ductile/brittle region below which breakage is most likely.

Inrush current becomes important, too, at low on/off frequencies. Inrush current with a lamp starting at room temperature can be as high as 12 times normal and last for 20 to 40 ms. Thus several lamps on the same circuit can cause the circuit breaker to trip when they are turned on cold.

Geometry makes a difference

The geometry of a LED's construction and its lens, if any, tremendously affects the amount of radiation that is finally emitted after the unit's internal quantum efficiency takes its toll. A major problem in LED construction—and a source of loss—is how to affix the front electrical contact so that the contact resistance is low—without, at the same time, blocking any significant amount of radiation.

Many arrangements have been devised for extracting the maximum amount of radiation. The most common structure is flat, with the only usable light emitted from the top of the chip. Several types use a miniature parabola that collects the edge emission and directs it forward along with the top surface emission. Some edge-emitter types use large top contacts to improve electrical efficiency and depend mainly on the edge emission for the light output.

Though a reflector can significantly improve the performance of a LED, even better results can be obtained when the structure allows more of the radiation generated within the chip to have access to the outside. A substance like gallium arsenide has a high index of refraction (about 3.6) so that radiation that arrives at a flat surface with an angle greater than 16° from the normal is reflected back into the chip. If the chip's active material is shaped like a dome, the light arrives at this surface almost normally everywhere, and very little is reflected back. Even though the material is far from transparent, efficiency is improved 10 times over a typical flat structure. If the material were perfectly transparent, the improvement would be closer to 25 times.

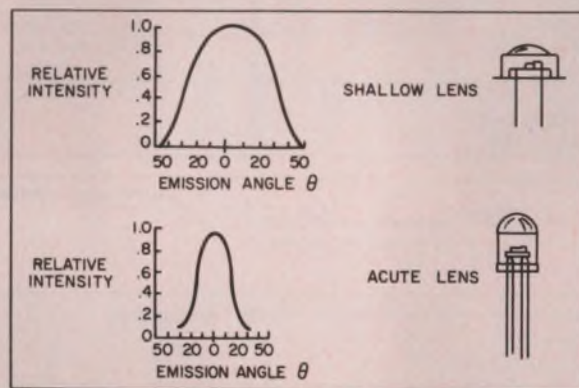

Plastic or glass lenses allow the light that does emerge to be concentrated or distributed. A shallow or Fresnel-type lens allows a broad emission angle and an acute lens, much thicker in the middle than at its edge, provides a narrower beam.

A diffuser-type lens is sometimes advantageous. A good diffuser lens will lose not more than 10% of the light, but it can greatly enhance the contrast of the emitted light against ambient light and spread the LED's light over a wide viewing angle. A colored lens can also help avoid ambient washout. A clear lens, however, will allow the reflection of ambient light, which can often wash out the LED's light output. And since the light from a LED originates from a relatively small area and is very intense, viewing through a clear lens can be uncomfortable.

Of course, with rapid flashing, the lamp filament doesn't cool to room temperature between flashes, and inrush current is much less. Also, you can reduce inrush current by maintaining a low value of preheating voltage (about 1% of normal) when the lamp is off.

The rate of decay of inrush current depends upon the heat capacity of the filament. For tungsten, about 350 joules/gram are needed to reach 2500 K. Thus, a popular midsize 28-V lamp, the 327, requires only about 0.045 J of energy and roughly 1 ms to heat, and it takes several milliseconds to get rid of this heat. But data on these properties, too, are not found in catalogs or are difficult to obtain. It's probably easier to dig up your own data experimentally from a representative sampling of lamps.

Keep cool to live long

Getting rid of incandescent-lamp heat is another important factor largely ignored in catalogs. A cool bulb temperature is necessary for a long lamp life. In general, miniature vacuum lamps should be operated with the hottest bulb spot no higher than 100 C. Higher temperatures greatly accelerate bulb darkening and eventual filament failure.

Since the lamp's vacuum is almost a perfect insulator to the glass bulb, most of the heat conduction to the ambient is via the filament supports and through the lamp's base, though some heat reaches the bulb via infrared radiation from the filament. But the newer all-glass wedge-base lamps have no metal or ceramic base, so heat dissipation depends totally on the bulb. Seldom are you advised to use heat-sink grease to improve the thermal coupling of such lamps to their holders. Of course, the holder then must be able to get rid of the heat.

Clearly, it's best to mount the lamp to encourage convection—the free passage of air across the bulb to the atmosphere, especially from below. And if many lamps are used in a display, you should be careful to prevent their heat from disturbing other heat-sensitive components.

But note: Halogen lamps operate at higher temperatures than vacuum types. The wall temperatures of halogen-cycle should be kept above 250 C. And hot spots on bulb walls can go as high as 700 C in normal operation without harming the lamps. But watch out for the surroundings. Special care must be taken with housings for such lamps. The kindling point of many materials is less than 700 C. And though, 700 C doesn't harm the bulb, lamp-base temperatures should not exceed 350 C, because the lamp's lead wires may deteriorate and base cement may loosen at higher temperatures.

High temperatures are necessary for the halogen-cycle effect. When vaporized, a halogen such as iodine sealed into a high-temperature glass envelope, combines with tungsten evaporated from the filament and redeposits tungsten back on the filament, instead of on the bulb. Thus the filament lasts longer and the

bulb doesn't blacken. Halogen lamps maintain 85 to 95% of their light output for 70% of their lives—a 50% improvement compared to vacuum-type incandescent lamps, according to GE. Furthermore, for a given light output, a halogen lamp is about 1/6 the size of a vacuum type.

LEDs produce less heat

Where indicators are closely packed into clusters and rows, as in master test panels for telephone systems, and myriads of lamps are on constantly, incandescents can give off enough heat to damage jack cords hanging down in front of such panels. By contrast, you can hold a glowing LED comfortably. Moreover, well made LEDs have half lives in excess of 200,000 h—about 23 yrs of continuous use. It never really burns out, but simply grows dimmer.

"Before, when we used incandescents, we had to test every lamp routinely to make sure it was working and was indicating a real circuit malfunction," reports Henry M. Bradley, Senior Engineer with Southern New England Telephone Co. "The T-2s we used might last anywhere from 20 to 5000 hours, so you never knew when they might go out. With LEDs, frequent testing isn't necessary."

Chicago Miniature Lamp's CM4-9031 LED indicators in standard telephone slide-base mountings fit T-2 sockets. But, though many LED styles are packaged to "replace" incandescents, LEDs and incandescents aren't completely interchangeable. Furthermore, LEDs shouldn't be mixed with incandescents in closely spaced groups, because heat from the incandescents can destroy the LEDs.

LEDs are usually rated at a 25-C ambient, which is unrealistic in many equipments. But a more-realistic 80-C temperature causes light intensity to drop to about 75% of rated. And continuous operation at 80 C or higher makes the LED grow dim at an accelerated rate. At low temperatures, however, LEDs become very efficient. At -50 C, their intensity may climb as high as 200% above rated. But even though incandescents can safely operate in much higher ambients than LEDs, a low temperature like -50 C can often crack the glass envelope or seal because when the lamps are turned off, cooling is too rapid.

Also drive requirements are very different for LEDs and incandescents. A LED always needs a series ballast resistor to limit its current, whereas an incandescent is best operated from a low-impedance source. And if the power is an ac source, a LED will probably need a series diode in addition to the series resistor. Although LEDs are diodes, their reverse breakdown voltages are low—usually 3 to 6 V.

Furthermore, a LED's light distribution is highly directional (see box), unlike incandescents, which are usually more evenly distributed. Most of a LED's light is radiated straight ahead, with very little to the sides. And since beam patterns vary greatly among different LED types, manufacturers often provide spacial light distribution curves. The so-called LED viewing angle

—often called the half-intensity viewing angle—is the angle between points where the light intensity is at least 50% of the peak. Narrow-viewing angle ratings run around 28°; wide angles, about 65°.

However, low-cost lenses, such as Visual Communications' Cliplite lenses, which feature striated lines and Fresnel rings, can provide a 180° viewing angle from so-called point-source, T-1-3/4 LEDs. And LED indicator assemblies, such as Data Display Products' LEDy Bugs, are viewable "with considerable brightness" over 180°, also because of a Fresnel-lens.

Beware of typical specs

However, the peak, or midpoint, light intensity usually listed in LED spec sheets as typical is meaningless without a *guaranteed minimum*. A given LED manufacturing run provides a wide range of intensities. Finished LEDs must then be sorted into intensity groups. Those with low light outputs are weeded out, hopefully, and dumped at bargain prices. The brighter ones, above the guaranteed minimum, are sold to more demanding customers at higher prices.

Another so-called typical spec—forward-voltage—needs a *maximum value* to be useful to the design engineer. But this maximum voltage is not a safety-limit value, as its name might imply. Maximum forward voltage is the level that ensures that every LED in a selected group of LEDs lights and draws at least a specified forward current. A common specified test current for indicator LEDs is 20 mA.

While you're at it, watch those typical wavelength specs. The human eye may not notice small changes at the red end of the visible spectrum, but green, yellow and orange LEDs should be right on the nose, or else you'll see the difference. This specification is especially important when purchasing "equivalents" from second sources.

But even if the LEDs meet all the minimum and

maximum specs in *initial tests*, you still can get many with weak semiconductor junctions or with excess stresses in their protective epoxy coatings. Failures will show up too late—after the LEDs are soldered into PC boards, or worse, in the field when heated and cooled during normal operation.

For reliable operation, you're strongly advised to specify a series of "torture" tests, to be performed by the supplier, if you trust him, or to be included as part of your incoming inspection. Manufacturers report that the most common user abuse is excess temperature cycling. But can poor quality control by the manufacturer be part of this problem?

In defense of LED suppliers, however, most suppliers specify a maximum soldering temperature of 260 C for only 5 s, which isn't always heeded. Typical wave-soldering machines have no problem operating economically within this limit. But when throughput is pushed by zealous board assemblers, the wave-soldering machine is likely to be operated at a higher temperature. Although temperatures above 260 C might be tolerated by most silicon devices, LEDs will suffer. Also, uncontrolled hand-soldering temperatures often cause overheating problems for LEDs.

Finally, the lead spacing on LEDs may not be standard. This oversight can prove not only annoying but costly. If you follow the usual 0.1-in. standard spacing on your PC boards, take heart: Litronix will shortly announce the RL-4480 line of LEDs in three brightness categories with leads spaced according to this standard.

Neons for high voltages

While both incandescents and LEDs operate best at low voltages, neons make good, low-cost, long-lived pilot lights for appliances that operate at power-mains voltages. High-brightness neons—about 23 mcd when operated at 2 mA—have standard initial max. breakdown (lighting) voltages of 95 V ac and 136 V dc, while standard-brightness lamps—about 2.5 mcd at 0.5 mA—need at least 65 V ac or 90 V dc. Note that the brightness of neons is comparable to LEDs, but neons cost much less than LEDs and are generally much more rugged.

Unfortunately, the life of neons is lower—generally about 25,000 h. And like LEDs, neons fade away with age. But standard and high-brightness units have different end-of-life criteria. Standard-brightness lamps are rated by Signalite for an end of life at the 50% light-output point. And a high-brightness neon's life ends when its firing voltage rises above the rated value.

Higher-than-rated currents reduce life proportional to the 3rd power in standard lamps and to the 4.5th power in high-brightness lamps. A mere 25% increase in current in a high-brightness unit rated at 25,000 h reduces its life to 8700 h.

Like incandescents, neon lamps live longer on ac than dc. Of course, the usual rated life for neon

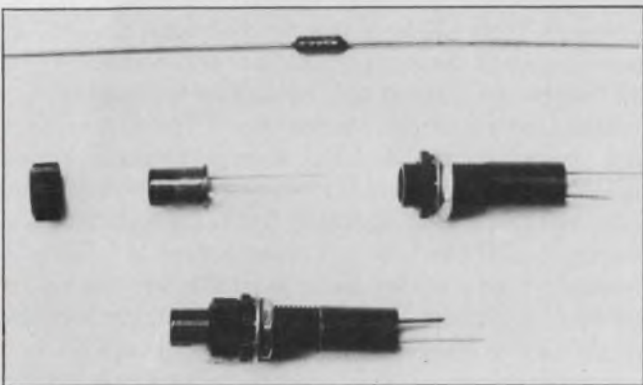

One way to hold a lamp: a universal LED holder with an insertable resistor. Data Display's PS200 unit accepts a LED and resistor for a supply voltage of your choice. The PS200 can accommodate the illustrated LEDy Bug, which has a 180° viewing angle and comes in red, amber and green. The wide viewing angle is produced by the Bug's flat-topped cylindrical lexan Fresnel lens.

indicator lamps is given for ac operation: The numbers look better. Dc cuts life to 50 to 60% of the ac value.

But unlike incandescents and LEDs, neons are limited to a single color, orange, which is produced by the combination of two wavelength bands—550 to 750 nm and 820 to 870 nm. You can get special lamps filled with argon gas, but the color is blue-violet (with some invisible ultraviolet), which doesn't look too bright. Some manufacturers can supply a fluorescent-green "neon"—which doesn't use neon, but an ultraviolet-producing gas mixture and a green-fluorescing coating inside the lamp bulb.

Like incandescents, you may flash a neon lamp at, say, a 10% duty cycle, but it doesn't mean you can allow 10 times the rated current to flow for the short interval without paying for it. Although average current may be the rated value, 10-times rated current during the short conduction interval would use up a high-brightness-lamp's life 31,000 times faster than normal. Under such conditions, a 10-ms on-time is the equivalent of about 5 min of normal steady burning at rated current. If the rated life is 15,000 h (60% of 25,000 h with dc), the lamp's life is only about 5 h.

Whereas an incandescent can operate safely in an ambient of 100 C and even higher, neons, like LEDs, should not be exposed to high temperatures. Signalite recommends a maximum of about 75 C, even lower than the maximum 80 C for most LEDs. High temperatures cause chemical changes within a neon lamp that permanently modify its characteristics.

Of course, as with incandescents and LEDs, you must exercise care when bending leads near the glass envelope. Bends should be made at least 1/8 in. from the lamp's lead-bulb seal (called a "press"), according to Signalite's instructions.

One undesirable characteristic that is unique to neon lamps is flicker. But rarely is it mentioned. The phenomenon results when the neon corona discharge moves erratically from one portion of an electrode to another. If you are buying a lot of neon lamps, insist

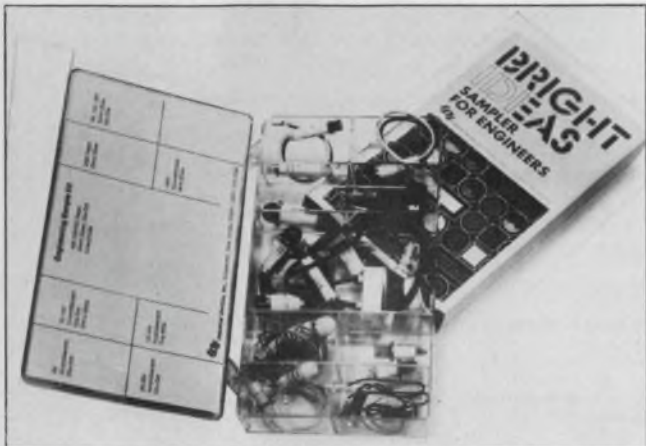

Lamp-holder kits are available like this collection from Industrial Devices, which contains working samples of a large variety of indicator-lamp holders for LED, neon and incandescent lamps.

that the number of lamps that flicker in any lot doesn't exceed, say 2.5%, which Signalite considers to be a reasonably low level. And get the guarantee in writing.

But having become aware of the pitfalls in choosing lamps, don't get dazzled with the lamp and completely forget the lampholder. Despite the major importance of the lamp, electronic engineers often specify a complete assembly selected from a lamp-housing manufacturer's catalog, and pay little attention to the lamp inside. Of course, the better lamp-housing makers carefully consider the characteristics of the lamps and are more than mere "machine shops" turning out gum-drop units. ■■

Need more information?

For further information on indicator lamps, readers may consult the manufacturers listed here by circling the appropriate numbers on the reader service card. More information on specific vendor lines may be found in ELECTRONIC DESIGN'S GOLD BOOK. Not all vendors listed here make their own lamps, but they can usually supply specified lamps with their lamp holders and displays.

- AC Interface, Inc., 2925 College Ave., Unit 1, Costa Mesa, CA 92626 (714) 979-9830 **Circle No. 567**
 Adronics Inc., 9 Sand Park Ave., Cedar Grove, NJ 07009 (201) 746-6060 **Circle No. 440**
 Aerolite Electronics Corp., 2207 Summit Ave., Union City, NJ 07087, (201) 863-2955 **Circle No. 441**
 Alco Electronic Prods. Inc., 1551 Osgood St., North Andover, MA 01845 (617) 685-4371 **Circle No. 442**
 Alden Products Co., 117 N. Main St., Brockton, MA 02403 (617) 583-0160 **Circle No. 443**
 Amglo Corp., 5301 Wesley Ter., Rosemont, IL 60018 (312) 671-4321 **Circle No. 444**
 AMP Special Industries, Valley Forge, PA 19482 (215) 647-1000 **Circle No. 445**
 Anacom General Corp., Med-Tek Div., 1160 E. Ash Ave., Fullerton, CA 92631 (714) 992-0223 **Circle No. 446**
 APR Schultronic GmbH, Grunwalder Str., 157a, D8000 Munich, West Germany, 089/644014 **Circle No. 447**
 Arcoelectric Corp., 11120 Chandler Blvd., North Hollywood, CA 91603 (213) 877-6969 **Circle No. 448**
 Aristo-Craft Miniatures, 314 Fifth Ave., New York, NY 10001 (212) 279-9034 **Circle No. 449**
 Aristo Grid Lamp Products, 65 Harbor Rd., Port Washington, NY 11050 (516) 767-6575 **Circle No. 450**
 Bishop Industrial Controls Ltd., 15 Gordon Rd., Portslade-by-Sea, Brighton, Sussex BN4 1GH, UK, 0273-411333 **Circle No. 451**
 Bohemia Mfg., 84 Midland Ave., Montclair, NJ 07042 (201) 746-6998 **Circle No. 452**
 Boss Industrial Mouldings Ltd., Unit 1, Higgs Indl Est., 2 Herne Hill Rd., London SE24 OAU, England, 01-737-2383 **Circle No. 453**
 AF Bulgin & Co. Ltd., Bypass Rd Barking, Essex IG110AZ, England, 01-594-5588 **Circle No. 454**
 Carley, 1502 W. 228 St., Torrance, CA 90501 (213) 325-8474 **Circle No. 568**
 Chicago Miniature/Drake Mfg Co., 4433 N. Ravenswood Ave., Chicago, IL 60640 (312) 784-1020 **Circle No. 455**
 Chicago Switch Inc., 2039 W. Wabansia Ave., Chicago, IL 60647 (312) 489-5500 **Circle No. 456**
 Circon Corp., 749 Ward Dr., Santa Barbara, CA 93111 (805) 967-0404 **Circle No. 457**
 Cole-Hersee Co., 20 Old Colony Ave., South Boston, MA 02127 (617) 268-2190 **Circle No. 458**
 Colstar Ltd., 233-243 Wimbledon Pk. Rd., London SW18, England, 01-874-4362 **Circle No. 459**
 Component Services (London) Ltd., South St., Hertford Herts, UK, Hertford 57766 **Circle No. 460**
 Compu-Lite Corp., 711-F12 W. 17th St., Costa Mesa, CA 92627 (714) 645-1501 **Circle No. 461**
 Craig & Derricott Ltd., Hall Lane, Walsall Wood, Walsall Staffs WS9 9AS, Great Britain 054-33-5541 **Circle No. 462**
 Cutler-Hammer, 4201 N. 27 St., Milwaukee, WI 53216 (414) 442-7800 **Circle No. 463**
 Data Display Products, P.O. Box 91072, Los Angeles, CA 90009 (213) 641-1232 **Circle No. 464**
 Dialight, 203 Harrison Pl., Brooklyn, NY 11237 (212) 497-7600 **Circle No. 465**
 Digital Components Corp., 19 Grant St., Linden, NJ 07036 (201) 925-0200 **Circle No. 466**

(continued on page 64)

- Discom Inds. Inc., 61 S.W. 5th Ct., Pompano Beach, FL 33060. (305) 782-7424.
Circle No. 467
- Display Devices Inc., 130 W. East St., Encinitas, CA 92024. (714) 753-0113.
Circle No. 468
- Dowty Electrics Ltd., Cheltenham Rd., Gloucester GL2 9QH, Great Britain.
045-271-2041.
Circle No. 469
- Dupree Inc., Western Indicator Div., 9835 Dupree St., P.O. Box 3156, South
El Monte, CA 91733. (213) 442-4700.
Circle No. 470
- Eagle Electronic Mfg Co., 45-31 Court Sq., Long Island City, NY 11101. (212)
937-8000.
Circle No. 471
- Eder Instrument Co., Inc., 5115E N. Ravenswood Ave., Chicago, IL 60640. (312)
769-1944.
Circle No. 472
- Electro Mechanical Components Inc., 1826 N. Floradale, South El Monte, CA
91733. (213) 442-7180.
Circle No. 473
- ELT Inc., Glow Lite Div., Box 698, Pauls Valley, OK 73075. (405) 238-5541.
Circle No. 474
- Engel & Gibbs Ltd., Elstree Way, Boreham Wood Herts WD6 1SQ, Great Britain.
01-953-2291.
Circle No. 475
- English Electric Valve Co. Ltd., Waterhouse Ln., Chelmsford Essex, England
CM12QU 02-45-6-1777.
Circle No. 476
- Ferranti Electric Inc., E. Bethpage Rd., Plainview, NY 11803. (516) 293-8383.
Circle No. 477
- GC Electronics, 400 S. Wyman St., Rockford, IL 61101. (815) 968-9661.
Circle No. 478
- General Electric Co., Miniature Lamp Products, Nela Park, Cleveland, OH
44112. (216) 226-2121.
Circle No. 479
- General Instrument, Signalite, 1933 Heck Ave., Neptune, NJ 07753. (201)
775-2490.
Circle No. 480
- General Time, Mineco Div., 135 S. Main, Thomaston, CT 06787. (203)
283-8261.
Circle No. 481
- Genisco Technology Corp., Eldema Div., 18435 Susana Rd., Compton, CA
90221. (213) 537-4750.
Circle No. 482
- Gillway Technical Lamp, 272 New Boston Pk., Woburn, MA 01801. (617)
935-4442.
Circle No. 483
- Gould Inc., Control & Systems Div., 950 Charter St., Redwood City, CA 94063.
(415) 365-8111.
Circle No. 484
- Grimes Mfg Co., 515 N. Russell St., Urbana, OH 43078. (513) 652-1431.
Circle No. 485
- GTE Sylvania Inc., Miniature Lighting Products, W. Main St., Hillsboro, NH
03244. (603) 464-5533.
Circle No. 486
- Hamai Electric Lamp Co. Ltd., 9-26 Kasuga 1 Chome Bunkyo-Ku, Tokyo 112,
Japan. 03-813-8811.
Circle No. 487
- Hewlett-Packard Co., Page Mill Rd., Palo Alto, CA 94304. (415) 493-1501.
Circle No. 488
- Hoffman Engineering Corp., 183R Sound Beach, Old Greenwich, CT 06870.
(203) 637-1719.
Circle No. 489
- IEE Inc., 7740 Lemona Ave., Van Nuys, CA 91405. (213) 787-0311.
Circle No. 490
- Imtronics Industries Ltd., 813 2nd St., Ronkonkoma, NY 11779. (516)
981-3434.
Circle No. 491
- Industrial Devices Inc., Edgewater, NJ 07020. (201) 224-4700.
Circle No. 492
- Info-Lite Corp., 46-10 104th St., Corona, NY 11368. (212) 476-1287.
Circle No. 493
- Inter-Market Inc., 1946 Lehigh Ave., Glenview, IL 60025. (312) 729-5330.
Circle No. 494
- JKL Components Corp., 2226 Barry Ave., West Los Angeles, CA 90064. (213)
478-3591.
Circle No. 495
- JPI Inc., 1507 San Vicente Blvd., Santa Monica, CA 90402. (213) 395-2018.
Circle No. 496
- HR Kirkland Co., 8-10 King St., Morristown, NJ 07960. (201) 538-2777.
Circle No. 497
- Kollmorgen Corp., Macbeth Sales Corp., Rd-3 Jeanne Dr., Newburgh, NY 12550.
(914) 564-6300.
Circle No. 498
- Korry Mfg Co., 223 8th Ave., North Seattle, WA 98109. (206) 223-5400.
Circle No. 499
- Lake Engineering Co., 123 Manville Rd., Scarborough, Ont, Canada M1L4J8.
(416) 751-5980.
Circle No. 500
- Ledco Inc., 2025 W. County Rd. C., St. Paul, MN 55113. (612) 631-0680.
Circle No. 501
- Ledex Inc., 123 Webster St., Dayton, OH 45401. (513) 224-9891.
Circle No. 502
- Leecraft Mfg Co. Inc., 21-16 44th Rd., Long Island City, NY 11101. (212)
392-8800.
Circle No. 503
- Lenox Instrument Co. Inc., 111 E. Luray St., Philadelphia, PA 19120. (215)
324-4543.
Circle No. 504
- Litronix Inc., 19000 Homestead Rd., Cupertino, CA 95014. (408) 257-7910.
Circle No. 505
- Littelfuse Inc., 800 E. Northwest Hwy., Des Plaines, IL 60016. (312) 824-1188.
Circle No. 506
- J. Lucas Inds. Ltd., Great King St., Birmingham, B192XF, England.
021-554-5252.
Circle No. 507
- LVC Industries Inc., 135-25 37th Ave., Flushing, NY 11354. (212) 939-9777.
Circle No. 508
- Master Specialties Co., 1640 Monrovia Ave., Costa Mesa, CA 92627. (714)
642-2427.
Circle No. 509
- Monsanto, Electronics Div., 3400 Hillview Ave., Palo Alto, CA 94304. (415)
493-3300.
Circle No. 510
- Mouser Corp., 11511 Woodside Ave., Lakeside, CA 92040. (714) 449-2220.
Circle No. 511
- Mura Corp., 177 Cantiague Rock Rd., Westbury, NY 11590. (516) 935-3640.
Circle No. 512
- National Semiconductor Corp., 2900 Semiconductor Dr., Santa Clara, CA
95051. (408) 732-5000.
Circle No. 513
- Neico Microwave Co., 149 Middlesex Pk., Burlington, MA 01803. (617)
890-3535.
Circle No. 514
- Neovoi SA, Llansa 22, Barcelona-15, Spain. 224-6031.
Circle No. 515
- Nore Microwave Ltd., 36 Towerfield Rd Shoeburyness, Southend-on-Sea, Essex,
England. 037-08-4255.
Circle No. 516
- Oak Inds. Inc., Illuminated Products Inc., 2620 S. Susan St., P.O. Box 11930,
Santa Ana, CA 92711. (714) 540-9471.
Circle No. 517
- Opcoa Div., IDS Inc., 330 Talmadge Rd., Edison NJ 08817. (201) 287-0355.
Circle No. 518
- Oppenheimer Precision Products, 2475 Wyandotte Rd., Willow Grove, PA
19090. (215) 659-6000.
Circle No. 519
- Oshino Electric Lamp Works Ltd., 2-5-2 Minami-Shinagawa, Shinagawa-Ku,
Tokyo, Japan. (03) 471-8548.
Circle No. 520
- Oslo Controls Inc., 417 Washington, North Haven, CT 06473. (203) 239-3515.
Circle No. 521
- Oxley Inc., Plaza Suite 900 One Park Plaza, 3250 Wilshire Blvd., Los Angeles,
CA 90010. (213) 383-8270.
Circle No. 522
- Panasonic Co., Industrial Components, Panasonic Way, Secaucus, NJ 07094.
(201) 348-7000.
Circle No. 523
- Panelgraphic Corp., P.O. Box 1265, West Caldwell, NJ 07006. (201) 227-1500.
Circle No. 524
- Penn Keystone Corp., 14 Division St., Ansonia, CT 06401. (203) 734-3301.
Circle No. 525
- Permonite Mfg. Co., 4700 W. Chase Ave., Chicago, IL 60646. (312) 679-5000.
Circle No. 526
- NA Philips Lighting Corp., Miniature/Optics Div., Bank St., Hightstown, NJ
08520. (609) 448-4000.
Circle No. 527
- Philmore Mfg. Co. Inc., 40 Inip Dr., Inwood, NY 11696. (516) 239-6161.
Circle No. 528
- Plessey Co. Ltd., Aerospace Electrical Components, Abbey Werke, Titchfield
Fareham Hampshire, England. 032-944-3031.
Circle No. 529
- Precision Lamp Inc., 950 N. Rengstorff Ave., Mountain View, CA 94043. (415)
965-1333.
Circle No. 530
- Radatron Inc., 2424 Niagara Falls Blvd., North Tonawanda, NY 14120. (716)
731-4171.
Circle No. 531
- Refac Electronics Corp., Pinlites Div./Wild Rover Div., P.O. Box 809, W. Hill
Rd., Winsted, CT 06098. (203) 379-2731.
Circle No. 532
- Relay Specialties Inc., 1300 Plaza Rd., Fair Lawn, NJ 07410. (201) 797-3313.
Circle No. 533
- TL Robinson Co. Inc., Electronic Div., P.O. Box D., East Aurora, NY 14052.
(716) 652-2111.
Circle No. 534
- Rochet Jean SA, 3bis Rue de Congress, 92604 Asnieres, France. 733-3120.
Circle No. 535
- Sakata International Inc., 651 Bonnie Ln., Elk Grove Village, IL 60007. (312)
593-3211.
Circle No. 536
- Shelly Associates, 1562 Reynolds Ave., Irvine, CA 92714. (714) 549-3414.
Circle No. 537
- Shigoto Industries Ltd., 350 Fifth Ave., New York, NY 10001. (212) 695-0200.
Circle No. 538
- Shogyo International Corp., 300 Northern Blvd., Great Neck, NY 11021. (516)
466-0911.
Circle No. 539
- Sloan Co., 7704 San Fernando Rd., Sun Valley, CA 91352. (213) 875-1123.
Circle No. 540
- Solderberg Mfg. Co., 2082 Currier Rd., Walnut, CA 91789. (714) 595-1291.
Circle No. 541
- Solitratics Engineering Ltd., 1531 Star House Harbour Centre, Kowloon, Hong
Kong. 3678145.
Circle No. 542
- Sorenson Lighted Controls Inc., 530 Oakwood Ave., West Hartford, CT 06110.
(203) 236-3267.
Circle No. 543
- Swieco Inc., 1518 E. Lancaster, Fort Worth, TX 76101. (817) 335-6521.
Circle No. 544
- Switchcraft Inc., 5555 N. Elston Ave., Chicago, IL 60630. (312) 792-2700.
Circle No. 545
- Tau Electronic Prods Inc., Keystone Pk., Emporium, PA 15834. (814) 483-3356.
Circle No. 546
- Techni-Tool Inc., N 5 Apollo Rd., Plymouth Meeting, PA 19462. (215) 825-4990.
Circle No. 547
- TEC Inc., Components Div., 2727 N. Fairview Ave., Tucson, AZ 85705. (602)
792-2230.
Circle No. 548
- Telaquick Corp., 7686 Richmond Hwy., Alexandria, VA 22036. (703) 765-8089.
Circle No. 549
- AEG Telefunken Corp., 570 Sylvan Ave., Englewood Cliffs, NJ 07632. (201)
568-8570.
Circle No. 550
- Thomson CSF, Semiconducteurs Sescosem, 50 ure JP Timbaud, Courbevoie
92, France. 788-5001.
Circle No. 551
- Trans Trade Int. Pvba, 114 Brusselbaan, 9402 Meerbeke Ninove, Belgium.
054-334-504.
Circle No. 552
- Truco Inc., Box 95, Simsbury, CT 06070. (203) 658-0200.
Circle No. 553
- UCE Inc., 20 N. Main St., Norwalk, CT 06854. (203) 838-7509.
Circle No. 554
- Union Carbide Corp., Battery Products Div., 270 Park Ave., New York, NY 10017.
(212) 551-3736.
Circle No. 555
- Valtec Corp., Electro Fiberoptics, 99B Hartwell St., West Boylston, MA 01583.
(617) 835-6082.
Circle No. 556
- Vemaline Products Co. Inc., P.O. Box 3, Wyckoff, NJ 07481. (201) 891-3200.
Circle No. 557
- Visual Communications Co., P.O. Box 986, El Segundo, CA 90245. (213)
822-4727.
Circle No. 558
- Vitality Ltd., Beetons Way, Bury St. Edmunds, Suffolk, England.
Circle No. 559
- Wagner Electric Corp., 100 Misty Ln., Parsippany, NJ 07054. (201) 386-9300.
Circle No. 560
- Waldom Electronics Inc., 4637 W. 53 St., Chicago, IL 60632. (312) 585-1212.
Circle No. 561
- Wallace Stanley K., Suite 216, 13902 N. Date Mabry Hwy., Tampa, FL 33624.
(813) 961-1037.
Circle No. 562
- Wamco Technical Sales Corp., 705 W. 15, Costa Mesa, CA 92627. (714)
642-5100.
Circle No. 563
- Welch Allyn Inc., Jordan Rd., Skaneateles Falls, NY 13153. (315) 685-5788.
Circle No. 564
- Westinghouse Electric Corp., Lamps Div., 1 Westinghouse Plaza, Bloomfield,
NJ 07003. (201) 465-0222.
Circle No. 565
- Workman Electronics Prods Inc., P.O. Box 3828, Sarasota, FL 33578. (813)
371-4242.
Circle No. 566

The double-sided floppy from number 1

**Double storage capacity.
Double media selection.
Double access speed.**

Double your storage power with SA 850/851

Store twice as much data as a single-sided, double density drive, four times that of an IBM single-sided single density disk. Reach that data more than twice as fast with two heads and track-to-track access time of 3 ms. Choose from a wider selection of media—single or double-sided, single or double density, sector or hard sector formats.

Capacity. The SA 850/851 gives you twice as much storage capacity as a single-sided, double density drive. Yet it requires no more cabinet space. One drive packs up to 1600 kbytes unformatted, or 1200 kbytes formatted.

Double density gives you 1600 kbytes—compatible and equivalent to the newly

announced IBM S/34 two-sided drive. The Shugart

SA 850/851 is available now and this drive accepts

FM and double density MFM or M²FM encoding.

Speed. Data access is faster, too. Just 3 ms track-to-track.

Average seek time, including settling, is 91 ms.

That's 71 ms faster than IBM's two-sided floppy.

Remember lead screw actuators? Now you can forget them.

The key to faster access is the new Shugart Fasflex™ metal band actuator which provides faster access time with positive, low friction head movement. This more efficient actuator requires less than half the power used by standard lead screw actuators.

Compatibility. Media compatible. SA 850/851 drives read and write data on any industry standard single-sided, single or double density diskette, two-sided IBM Diskette 2, 2D or equivalent. Drive Compatible.

Upgrading from your existing SA 800/801 is easy. The SA 850/851 is identical in

size, outline and electrical interface. Rack mounting? You've got it with the "skinny"

SA 850R/851R version. Two units mount side-by-side in a 19-inch RETMA rack.

Even more reliable. Data integrity and system reliability begin with Shugart's own read/write head—the same glass bonded ferrite/barium titanate head proven in more than 100,000 installations.

Drive mechanical integrity rests on the same industry accepted die cast aluminum chassis technology used in all Shugart Drives. This rock solid recording platform is not a place to cut costs. Shugart keeps data safe, too. Write protect circuitry and a new I/O controlled programmable door lock for better data security are standard.

First. Shugart has a habit of being first.

First with an IBM-compatible drive. First with double density drives. First with the minifloppy®. And now first to deliver a double-sided drive.

Two out of three OEM's specify Shugart. They get more experience, more technology, more support.

See both sides now. See how Shugart double-sided floppy drives can give your system bigger, more accessible storage in the same space.

Then listen closely to the OEM price. Doubling storage capacity was never more affordable.

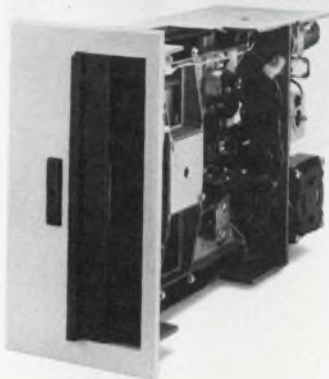
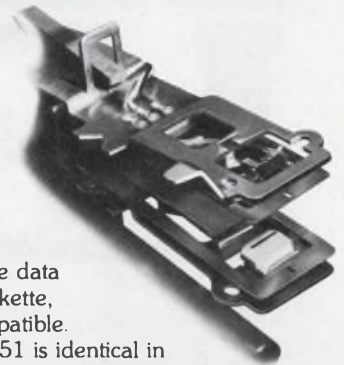

**The Leader
In Low Cost
Disk Storage**

 **Shugart Associates**

415 Oakmead Parkway, Sunnyvale, California 94086

Telephone: (408) 733-0100

West Coast Sales/Service: Telephone: (408) 252-6860

East Coast Sales/Service: Telephone: (617) 890-0808

Europe Sales/Service: 3, Place Gustave Eiffel, Silic 311

94588 Rungis, France Telephone: (1) 686-00-85

*Fasflex actuator trademark of Shugart Associates

NATIONAL REALLY GETS THE LED OUT.

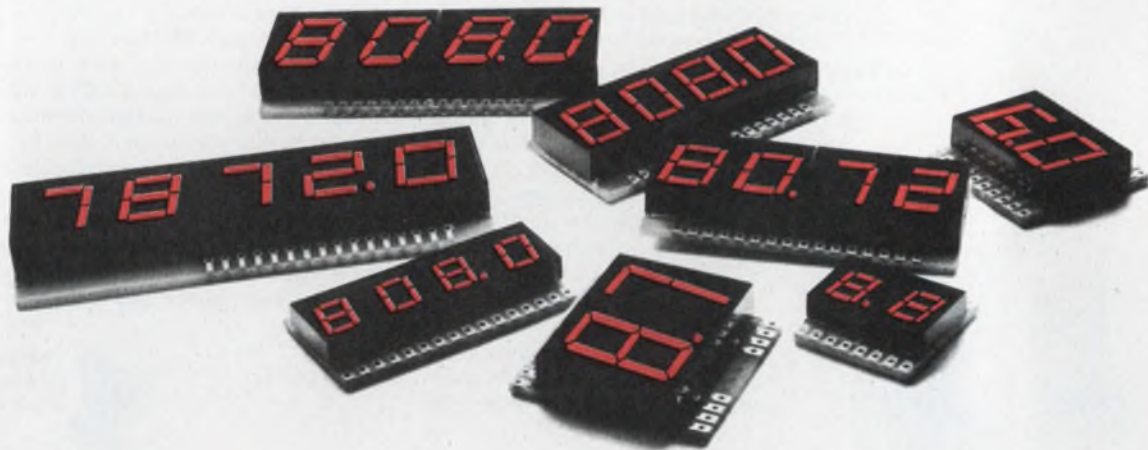

In case you didn't know it, National Semiconductor is in the LED business. In a big way.

With a full line of off-the-shelf multi-digit numeric displays, general purpose LED lamps, panel indicator lamps, and special feature lamps. Plus a full selection of LED segment drivers and digit drivers.

All displays are multi-digit packages (0.3, 0.5, 0.7 inch high), pre-matched for brightness.

Packages, both dual and quad, are end stackable.

All units are PC board mounted for low cost.

Our units are available common cathode or common anode, multiplexed or direct drive.

And if our standard products don't fit your needs, maybe we can whip up something special for you.

But another reason why we're making it big in LEDs is that we're *pricing it small* in LEDs.

While most manufacturers are still into expensive single digit displays, we make only multi-digit ones.

And the manufacturing efficiencies that result are what allow us to price our products so low.

Where, you might ask (and we hope you do), can you find out more about these LEDs of ours?

National Semiconductor
2900 Semiconductor Drive
Santa Clara, CA 95051

ED 2/15

Gentlemen:

Get the LED out... please send me your new LED product catalog. I am

- | | |
|--|--|
| <input type="checkbox"/> Very interested | <input type="checkbox"/> Moderately interested |
| <input type="checkbox"/> Uninterested but I like filling out coupons | <input type="checkbox"/> Fretful |
| | <input type="checkbox"/> Vegetarian |

Name _____ Title _____

Company _____

Address _____

City _____ State _____ Zip _____

 **National Semiconductor**

Graphics CRT displays are easy to design with raster-scan imaging. Add a microprocessor and you'll enjoy detailed, steady pictures in color or black-and-white.

Once you've decided on a μ P-based graphics display, you'll turn to the raster-scan method for its low-cost, standard TV monitor, easily refreshed, flicker-free images in color or grey scale, and its high resolution—up to 1024 points, or dots.

When designing your graphics display keep spatial resolution as low as you can. The basic graphics-display element is a dot known as a pixel. If, say, a graphics-display raster has 64×64 individual dots, and each dot can be one of eight colors, the display will have 4096 pixels, with a resolution of 3 bits/pixel.

The minimum resolution for serious work, however, is a 256×256 -dot raster. Higher resolution, 512×512 , will satisfy almost all applications, whereas 512×1024 resolution is the limit for graphics displays using a standard TV monitor.

The required color/grey-scale resolution in bits/pixel depends, of course, on the application. One bit/pixel usually suffices for curves, waveforms or alphanumerics; three bits/pixel give eight different colors or grey-scale levels. For broadcasting applications, eight bits/pixel is an accepted standard to generate an image roughly similar to the normal broadcast analog TV signal.

Memory isn't far behind

Once you've selected the resolution, the refresh memory, usually dynamic, is your next concern. Automatic refresh of dynamic memories can be incorporated into normal TV-scan timing with very little additional circuitry.

But before you can generate a raster-scan graphics display, you'll have to solve two conflicting refresh-memory problems: how big and how fast. On the one hand, the amount of stored information for one TV image can be as much as a couple of megabits; on the other hand, the memory must have fast access.

For just a standard 256×256 display, with 8 bits/pixel (256 different colors or grey-scale levels), the number of required bits = $256 \times 256 \times 8 = 2^{19} = 524,288$ bits, requiring 128 4-k dynamic-memory

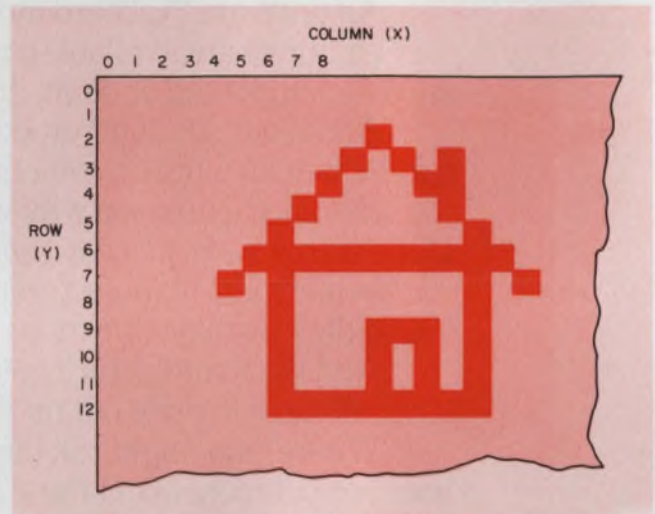

1. Building an image with dots is a simple way to generate a graphics display. Each dot can be assigned a color or, for black-and-white pictures, a grey-scale value.

ICs. There's no easy way to solve this problem. Fortunately, with the price per bit of the newest semiconductor memories going down, and density going up, at least the physical size and price of refresh memory are shrinking. (Note: just 32 16-k RAMs suffice in this example.)

Basically, there are three ways to store a graphics image in a refresh memory. The simplest, but not the cheapest, is dot-by-dot imaging, which breaks an image into a series of dots, then stores the parameters for each dot—intensity, saturation and hue for color, grey-scale level for black and white (Fig. 1). The only disadvantage is the large amount of refresh memory required.

When the amount of displayed information is too small for the total number of possible dots, you can save memory with a point plot, which stores in a table only those points actually displayed. If in a 256×256 display, with 8 bits/pixel, the total number of displayed dots is 1024, then the size of the refresh memory is $1024 \times (8 + 8 + 8) = 24,576$ bits. Of course, along with the pixel data, the X and Y positions of the displayed pixels must be stored.

The point-plot method can save memory only up to a "point." In the outlined example of Fig. 1, if more

Branko Matic, Engineering Manager, and **Lorne Trotter**, Marketing Manager, Matrox Electronic Systems, P.O. Box 56, Ahuntsic Station, Montreal, Quebec, Canada, H3L 3N5.

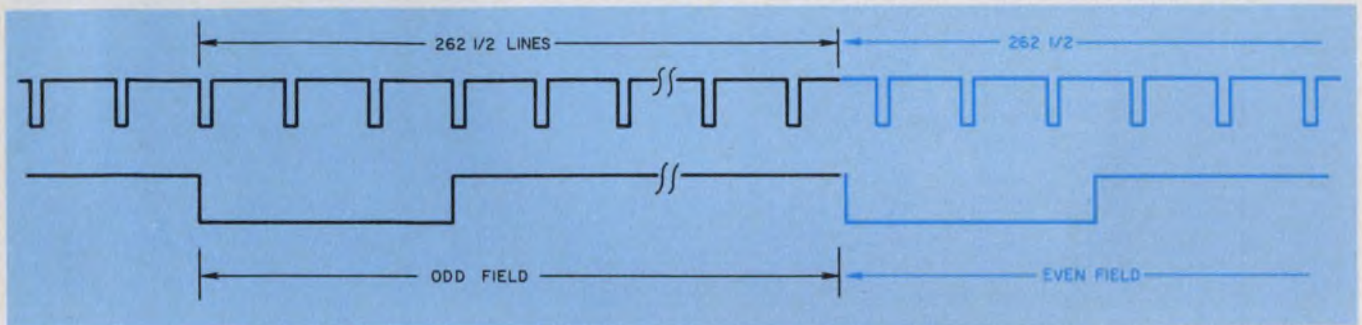

2. **Interlacing the video lines** doubles the resolution. A display is interlaced by shifting the vertical sync pulse on

alternate odd and even fields. However, when that is done, refresh rate drops by half.

than 1/16 of the dots are illuminated, the image plot method requires less memory. And since the point plot is difficult to implement on a raster scan, it is most suitable for positionable X-Y displays. Note that for X-Y displays, refresh time and flicker become problems as the table gets longer.

A third method, known as character plot, is applied most often to TV games and other special displays. If a graphics image can be broken into a number of smaller fixed images, a simpler system can be designed. For example, an alphanumeric display is a fixed set of small images (character-set fonts) that are "randomly" positioned on the screen to form a message.

In video games, a set of fixed images (players, ball, paddle, etc.) are stored in ROM or RAM, then displayed on the screen at different positions. The advantage here is that the fixed-image set can be changed easily with software. A character-plot display can provide a limited repertoire of high-resolution patterns while using relatively little refresh memory.

Now you're ready for the TV sync generator. Graphics systems are similar in design to alphanumeric displays (see ED No. 19, Sept. 13, 1977, p. 68). For one thing, a TV sync generator is central to both displays. All necessary timing is generated by the decoding of appropriate counter states, and the generator provides all signals for refresh-memory, scanning and horizontal and vertical TV synchronization and blanking.

The resolution you have decided on plays a key role in the design of the sync generator. So do your image or plot techniques and your refresh memory.



The Mona Lisa in eight grey levels and in eight-level pseudocolor (colors arbitrarily assigned to grey levels) demonstrate the capabilities of raster-scan graphics. The color image is produced on a standard color monitor.

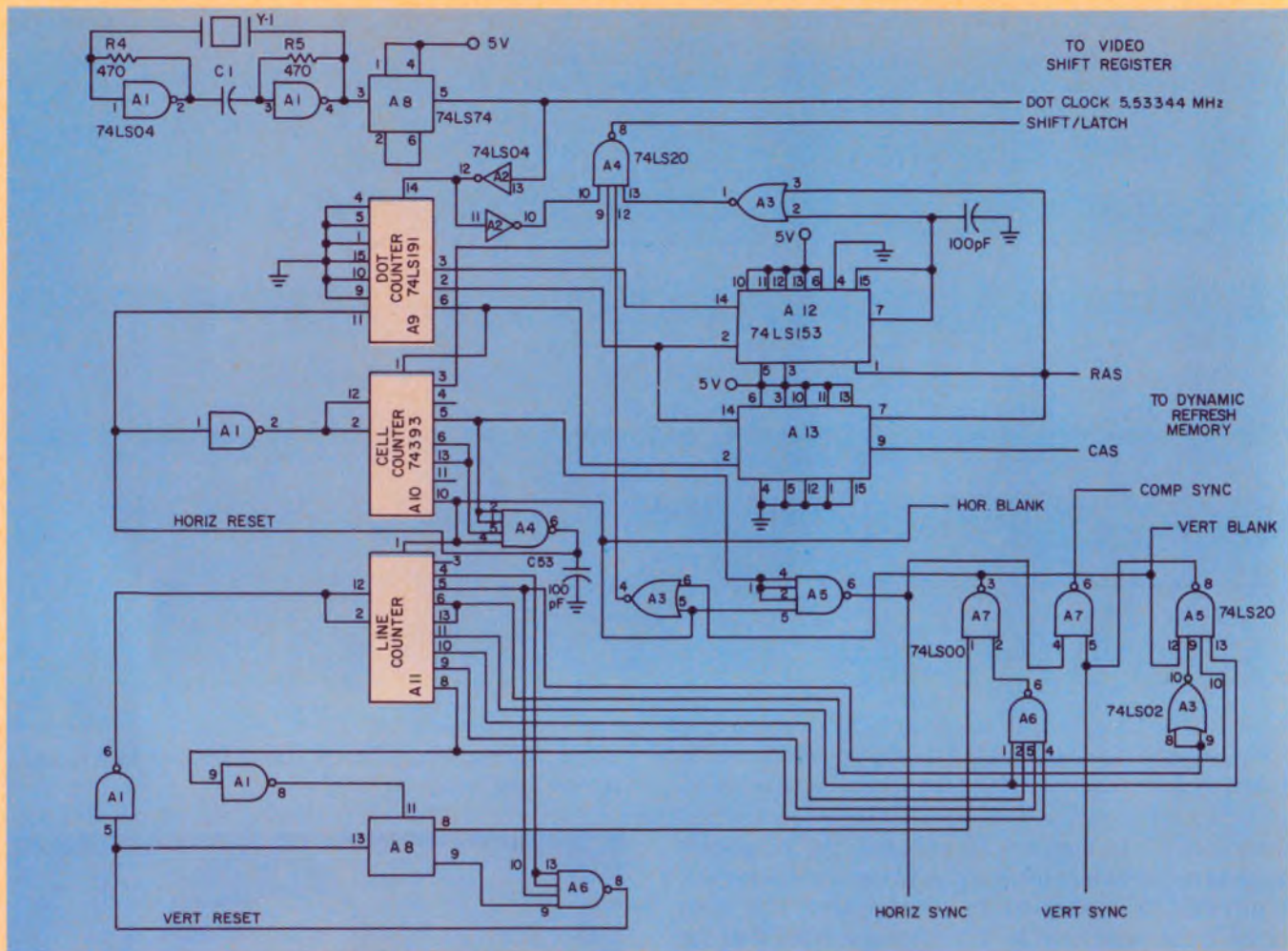

3. The design of the sync generator determines the timing, scanning and resolution characteristics of the

display. Vertical and horizontal sync and memory-refresh signals stem from decoded counter outputs.

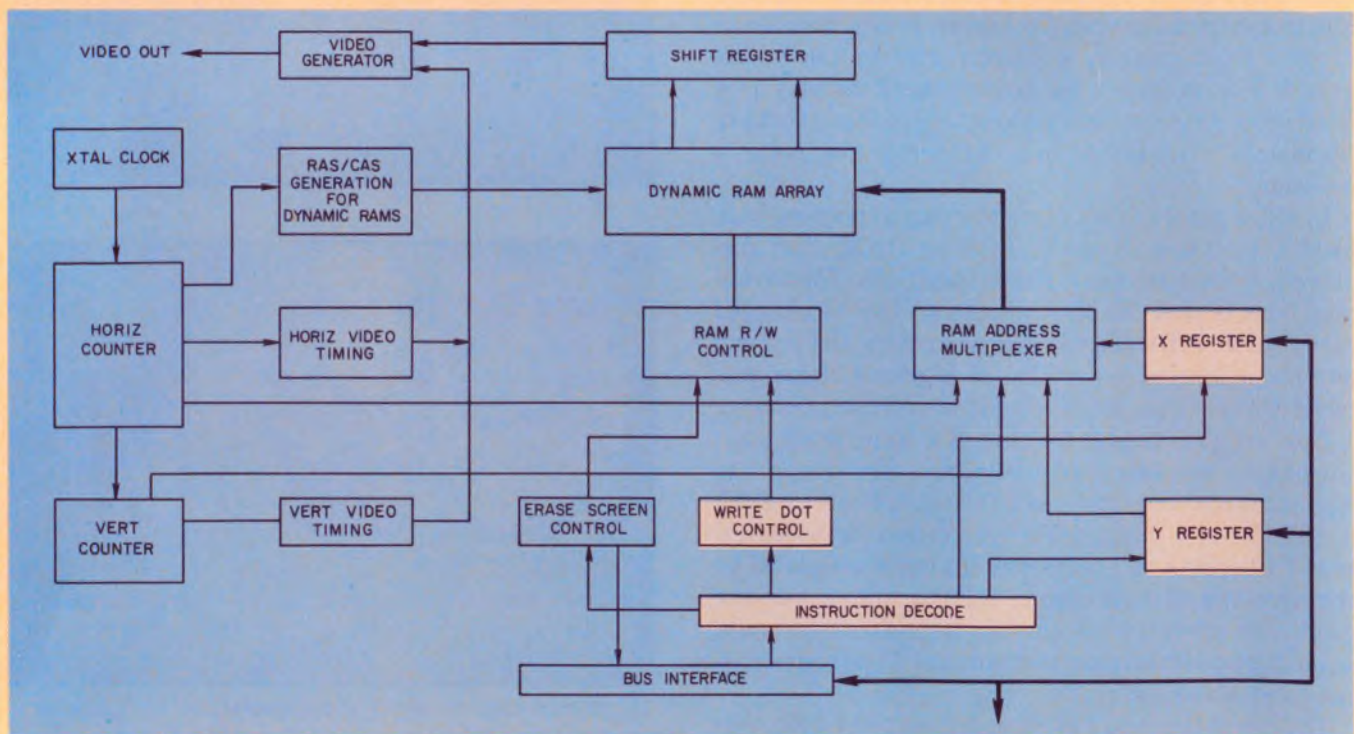

4. A variation of address interlacing saves memory by addressing each picture dot from X-Y position registers.

A software command then controls each dot. In this way, a few locations can control thousands of bits.

For a character plot, the graphics interface is almost identical to that for alphanumeric CRT displays, with the character-generator ROM replaced with one containing graphics symbols. An addressable RAM is yet another choice, allowing the table of symbols to be changed to suit various applications.

An image-plot interface also parallels the one for alphanumeric displays: The screen is broken up into a number of cells, with each, say, composed of eight or 16 dots by 1 line. The dot clock frequency is given by $f_{\text{dot}} = f_{\text{line}} \times \text{number of lines} \times \text{number of cells per line} \times \text{number of horizontal dots per cell}$.

Designing the sync generator

Suppose you want a 256×256 standard American monitor display. Since a standard TV works with 262 lines and requires 10 to 20% of the total number of lines for vertical retrace, you can't display 256 lines on the American standard. You must choose a non-standard number of video lines, or reduce the number of displayed lines. Say you choose 240 displayed lines and 262 video lines. You can reserve 22 lines for vertical retrace.

For the horizontal direction, choose a 16-dot cell. Sixteen cells yield the desired 256-point resolution. Allow six more cells for retrace, for a total of 22 cells per line. Note $f_{\text{line}} = 60 \text{ Hz}$. Therefore:

$$f_{\text{dot}} = 60 \times 262 \times 22 \times 16$$

$$= 5.53344 \text{ MHz.}$$

The restriction on the total number of video lines per field appears to limit severely the vertical resolution of raster-scan graphics. Fortunately, interlacing—inserting a second set of lines between the first set's—can double the number of lines. The even lines—0, 2, 4...524—are scanned first, then all odd lines. Each set of lines contains different data.

The sync generator will have to do some fancy electronic footwork to produce an interlaced display. The trick is to shift the position of the vertical sync pulse, relative to horizontal sync, on each alternate field (Fig. 2). In one field, vertical sync starts at the beginning of a line (odd lines scanned); in the other, vertical sync starts in the middle of a line (even lines scanned). In both cases, horizontal sync is not interrupted, and vertical sync has a total length of three or four lines.

Consequently, the lines of one field are shifted by half a line space with respect to the lines of the other field. Whether the odd or even lines are to be displayed is indicated to the refresh memory by a field signal coming from the sync generator.

Interlacing has some disadvantages, however. First, the circuitry is complex. Second, the over-all refresh rate drops to half that of noninterlaced units, so the display can flicker when you use a CRT with standard P4 phosphor. So when you need high-resolution line

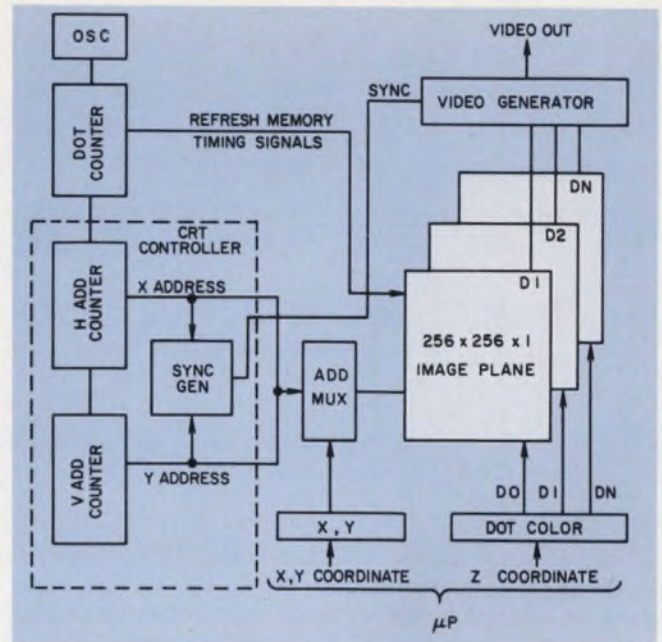

5. In a simple image system, a CRT controller drives a desired number of memory, or image, planes. Both color and black-and-white are possible, with grey level increasing with the number of planes.

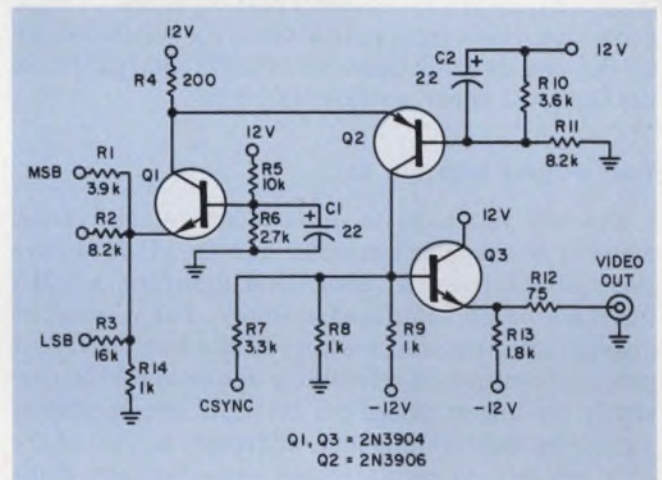

6. Video output is generated in a fast d/a converter that combines and transforms the 3-bit outputs of the image-plane video registers.

drawings, use CRTs with P33 or P39 high-persistence phosphors. When images are to be displayed, both fields contain almost identical information, which the eye is able to integrate, and flicker is not noticeable. Thus P4 is OK here.

All timing signals for refresh memory, latch, video-shift clock, μP synchronization, as well as horizontal and vertical sync and blank, can be decoded by combining different outputs of the sync-generator counters. In particular, dynamic RAM refresh signals—RAS, CAS, μP synchronization—are derived from the dot clock. Horizontal and vertical timing are decoded from the cell counter and line counter, respectively (Fig. 3).

Normally, only 10 to 20 MSI and SSI TTL IC circuits

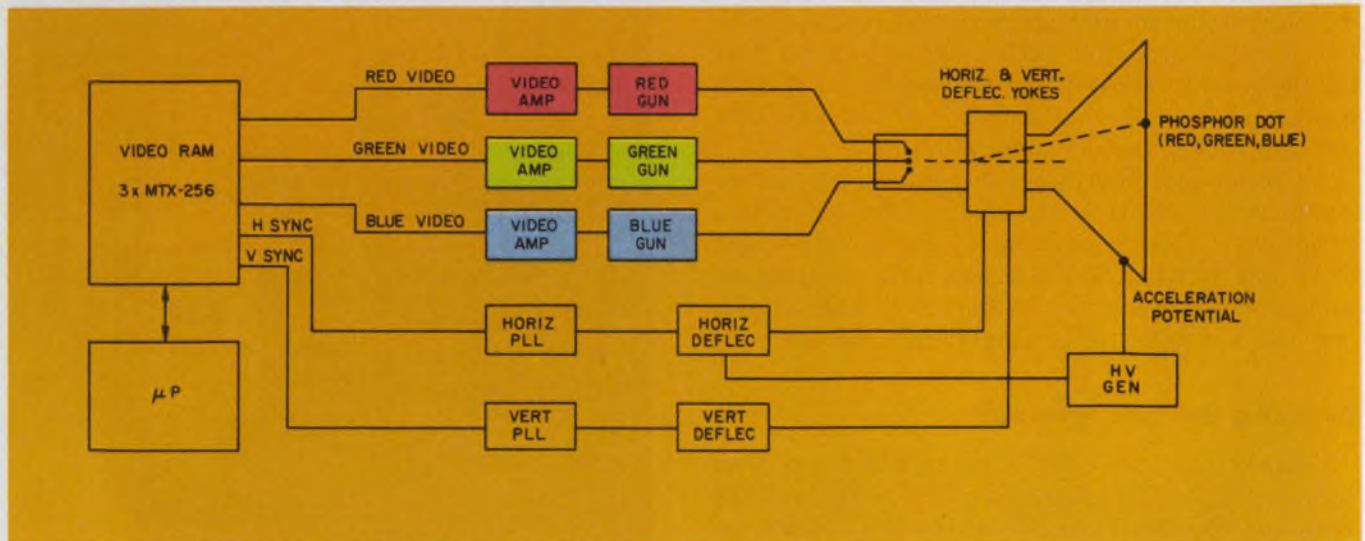

7. **Driving a color-TV monitor:** Digital signals turn color guns on and off to form one of eight colors by mixing

the correct proportions of the three primary colors. To get more colors, add image planes and d/a converters.

will be needed to design your own TV sync generator. Several semiconductor manufacturers have recently announced CRT controller chips. Although intended for alphanumeric displays, they can be used for simple graphics displays to replace a portion of the TV sync generator. However, external circuitry is still needed: all dot and dynamic-memory refresh and read-write timing must occur outside the chip.

The μP gets into the act

Now all you have to do is interface the refresh memory to the sync generator and the μP . You have three alternatives: a video RAM interface, a DMA interface or an interlaced memory. For a graphics display, an interlaced memory is the best because it provides continuous refresh for dynamic RAMs, currently the lowest priced per bit of all semiconductor memories. Refresh memory, addressed as part of the μP 's memory, is regularly and systematically made available to both the sync generator and external address circuits.

An address multiplexer controls access to the memory, and the multiplexer alternates between the sync generator and external address circuits. Switching can be controlled by the sync generator or by the μP 's state sequencer.

The sync generator continuously scans the image memory without interruption, which produces refresh. And special dynamic-RAM refresh signals, like RAS, and CAS, can be decoded from the dot counter.

The refresh memory is partitioned in such a way that a number of bits, equal to the length of the dot counter (usually 8 or 16 dots), loads into the video shift register in parallel. This method of organization allows relatively slow memories since information is read out in parallel.

However, the image memory size often surpasses the total addressing range of the μP . Also, it becomes

awkward to map points on the screen to a particular address/data bus position.

Using X-Y registers

An approach more elegant than interlaced memory relies on hardware to map the refresh memory into a pair of X-Y registers (Fig. 4). A given dot can then be turned on or off by a separate command after it is addressed by the registers. The advantage to this technique is that just two locations can address up to 262,000 bits (for a 512×512 display). Other advantages accrue: X-Y addressing is easy with software and the method allows easy color/grey-scale imaging. Note that only one dot at a time is written to or read from via the image-data-bit line.

To implement a color/grey-scale imaging system, a single sync generator/CRT controller drives multiple, identical image-memory planes (Fig. 5). The same X-Y registers and address multiplexer drive all image memories. Each image plane consists of a RAM array, video-shift register and image data-bit line. It is convenient to tie the image data-bit lines to different data-bus bits, so you can address all image planes simultaneously using the data bus as a Z coordinate.

You can combine the outputs of the video shift registers to form a color/grey-scale imaging system. Connect the video outputs to a high-speed d/a converter as shown in Fig. 6. Increasing the number of image planes improves the number of grey levels in the image; three planes give eight grey levels, four memories produce 16 levels.

A variation of the shift-register technique, found in several commercial single-board graphics controllers, operates the sync generator as a master or slave. The outputs of all cards are fully synchronous and can be combined.

Going to color is one way to get more image contrast, as well as more resolution per dot. In image process-

ing, color is a must. And, of course, a color display can increase a product's marketing appeal.

Generating color

The simplest color graphics display is an eight-color system, in which each of three primary-color CRT electron guns is turned on or off by a digital signal (Fig. 7). If you need more colors, use more image planes, with an appropriate d/a converter for each primary color. The best results for graphics imaging applications are obtained with RGB monitors, in which the three primary color signals—red, green and blue—are direct inputs to the monitor.

TV monitors using a single, composite, color-signal input are not recommended because the color bandwidth is inherently low. A color encoder circuit would also be required to generate the correct composite color video signal. In choosing the correct color monitor for a given application, you must ensure that the color-dot density on the tube face is fine enough for the required resolution.

Pictures generated by feeding a TV camera output through a slow-scan a/d converter illustrate the imaging capabilities of graphics systems (Mona Lisa photos). The 3-bit digitized output is stored, via a μP , in a three-card Matrox MTX-256**2 graphics system. In turn, feeding the outputs of the three cards to a 3-bit d/a converter produces pictures with eight discrete grey levels. And delivering the card outputs to the red, blue and green inputs of an RGB color monitor produces pseudocolored, eight-color pictures. (In pseudocoloring, a different color is assigned arbitrarily to each grey level in the original picture.)

If alphanumeric characters are also to be displayed, characters can be interpreted as graphics figures and plotted dot-by-dot from a list in the computer memory. In this way, you get great flexibility in character size, set and position on the screen. The main disadvantage is that writing dot-by-dot is relatively slow.

Handling alphanumerics

Alternatively, you can superimpose alphanumeric and graphics video signals. The μP treats the alpha and graphics interfaces as separate peripheral units, and superposition can occur either digitally, by ORing alpha and graphics video, or by adding the two video signals to a resistor network. Obviously the alpha and graphics displays must be synchronized.

For low or medium-volume OEM applications, it is usually more economical to buy off-the-shelf graphics displays. These come basically as plug-in boards for popular computer buses, including Intel SBC, Digital Equipment LSI-11, HP 21MX, and the S100 bus; as self-contained systems with card cage, power supply and display processor; or as terminals with built-in CRT and keyboard.

Board-level graphics are the least expensive and

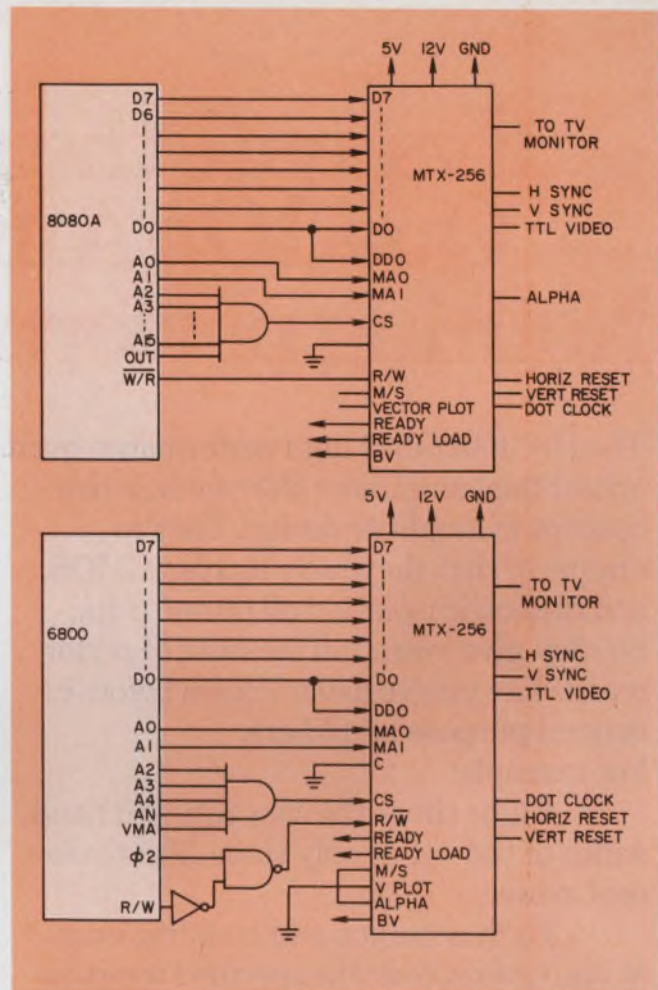

8. **Interfacing commercial graphics boards** with the popular 8080 and 6800 μP s calls for little external circuitry. Keyboards, joysticks and other I/O devices can be added. Programs in ROM determine system capabilities.

most flexible for many applications. Companies such as Matrox, Intermedia, Hewlett-Packard, Cromemco and Miniterm Associates offer plug-in boards for many popular mini or microcomputer buses. Prices range from \$400 to a couple of thousand dollars, depending on resolution and quantity.

Boards are usually easy to interface with the 8080 or 6800 μP s (Fig. 8). Add RAM, ROM and other I/O devices, and you can configure a very powerful system. Typical I/O devices include keyboards, data tablets, joysticks, and light pen. The capabilities of such a system are determined completely by the software in the program ROM.

Other features can be very helpful in certain graphics applications. A read-refresh memory function allows the μP to read back the displayed image, update it and write it back, which saves considerable time and storage. Additional hardware features include clear screen, scroll image, inverse video, and drawing a straight line between two dots. Those functions are often incorporated in an optional block, called a display processor. ■■

Evaluate the most advanced Quad Op Amps ever made. Nothing performs quite like them.

The HA 4602/4622 high performance quad operational amplifiers offer a whole new concept in amplifier design. They're unique in that they have bipolar, CMOS, and dielectric isolation all on one chip. So they give you a full measure of performance like you've never known before in general purpose amplifiers.

For example:

- Eight times the slew rate and bandwidth of the 741 at only three-fifths quiescent power.
- High accuracy and stability, even at high gains, over the specified temperature ranges.
- Monolithic construction to provide optimum parameter matching and temperature tracking.
- High performance and a quad structure which is ideal for active filter applications.

Standard Features. Both Harris high performance quad amps have standard features you won't find in any other quad amps. The 4602 typically offers a slew rate of $4V/\mu\text{sec}$, unity gain bandwidth of 8MHz, input noise voltage of $8\text{NV}/\sqrt{\text{Hz}}$ and input offset voltage of 0.3mV. The 4622 is uncompensated and provides stability at $A_v > 10V/V$, gain bandwidth

of 70MHz and a slew rate of $25V/\mu\text{sec}$.

Performance/Price. Impressed with this high performance? You'll be just as impressed by the price. For military use the HA 4622-2 and HA 4602-2 cost \$9.90. For commercial, the HA 4625-5 and the HA 4605-5 cost \$4.95 (100-up prices).

Economy Too. For those of you more inclined to go the economy route, there's our very popular HA 4741 quad op amp. With its superior bandwidth of 3.5MHz, slew rate of $1.6V/\mu\text{sec}$ and input voltage noise of $9\text{NV}/\sqrt{\text{Hz}}$, it offers a lot of amp for the money. For instance, the HA 4741 for military usage costs just \$4.60, while the HA 4741 for commercial costs \$2.15 in ceramic, and \$1.65 in epoxy (100-up).

And Fast Delivery. Right now we have a full inventory of quad op amps. Evaluate now and step up to high performance. For complete specifications, call the Harris Hot Line, or write: **Harris Semiconductor Products Division, P.O. Box 883, Melbourne, Florida 32901.**

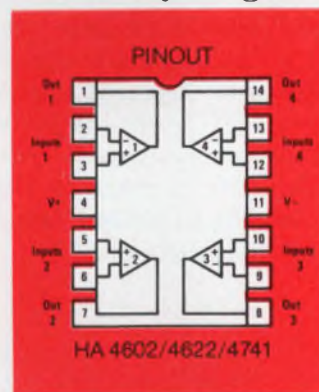

HARRIS HOT LINE!
1-800-528-6050, Ext. 455

Call toll-free for phone number of your nearby Harris sales office, authorized distributor or expedited literature service.

Harris Technology
...Your Competitive Edge



HARRIS
SEMICONDUCTOR
PRODUCTS DIVISION
A DIVISION OF HARRIS CORPORATION



Directly viewed incandescent displays

are hard to beat for high brightness and choice of colors. TTL-compatible, they also are easy to control and multiplex.

Directly viewed incandescent alphanumeric indicators make extremely bright, highly visible data displays for high-ambient-light surroundings such as in airplane cockpits and taxi meters, gasoline pumps and many outdoor applications. Although incandescents use more power per digit than most other types of displays, they also are the brightest—about 9000 to 13,000 foot-lamberts (see comparison table). And the light output can be varied easily to maintain a good contrast to the ambient-light level. Furthermore, almost any color can be displayed merely by slipping the proper filter over the front of the display.

Incandescent displays are made also as indirectly viewed units. Indirectly viewed displays contain replaceable light bulbs that illuminate segmented bars (or project characters or messages on a screen) via fiber-optic arrays, or molded-plastic or glass-focusing rods. Directly viewed displays have tungsten filaments that directly form the segments (though some manufacturers, such as Chicago Miniature, Info-Lite and IEE arrange individual bulbs in a matrix, usually a 5 × 7 configuration).

Indirectly viewed units that usually use 5-V, 20-to-30-mA lamps, such as Master Specialties units, are rated at about 1000 ft-L light output. However, directly viewed segmented units, such as the 4-to-5-V, 10-to-18-mA Pinlite displays made by REFAC, are almost ten times brighter—about 9000 ft-L. Moreover, directly viewed units are more compact, consume less power, are mechanically simpler and more rugged. For example, RCA's Numitrons enclose the filaments in a vacuum tube and REFAC's Pinlite displays use a tough, flat, metal-backed package sealed with a glass front. And some segmented devices even pass MIL-STD-202 vibration tests.

One apparent advantage of indirectly viewed displays is that low-cost individual lamps can be replaced when they burn out, whereas a single segment burning out in a directly viewed unit forces you to discard the complete device. However, the segmented displays last an average 100,000 hours or more (Fig. 1a) before even a single segment burns out.



This flight-navigation-management panel uses both seven-segment numerical and 16-segment alphanumeric displays, such as these Pinlite incandescent units made by REFAC. They provide high visibility in the high ambient light found in aircraft cockpits. Color filters help increase it even more. The display on this Garrett AirNAV 100 & 200 keyboard is telling the pilot that he is 103.8 nautical miles or 19 minutes from way point 1.

But the key to good visibility in high ambient-light conditions is contrast ratio—the difference between ambient light reflected from the display's background and the segment's output-light intensity, all divided by the segment's intensity.

High contrast with directly viewed units

With over 9000 ft-L of light brightness, directly viewed devices easily provide high contrast ratios in high ambient light. In addition, light filters can enhance contrast ratio by cutting down on reflected glare—a popular filter uses circular polarization. The contrast ratio of a typical filtered Pinlite display in an aircraft cockpit in bright sunlight is about 8:1, much higher than the 2 to 3:1 generally considered adequate for reasonably good visibility.

A circular-polarizing filter made by the Polaroid Corp. prevents ambient light from reflecting off the interior of the display. But most of these filters also attenuate about 90% of the light. Thus, a display rated

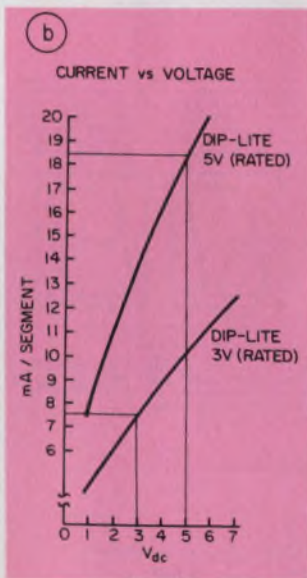
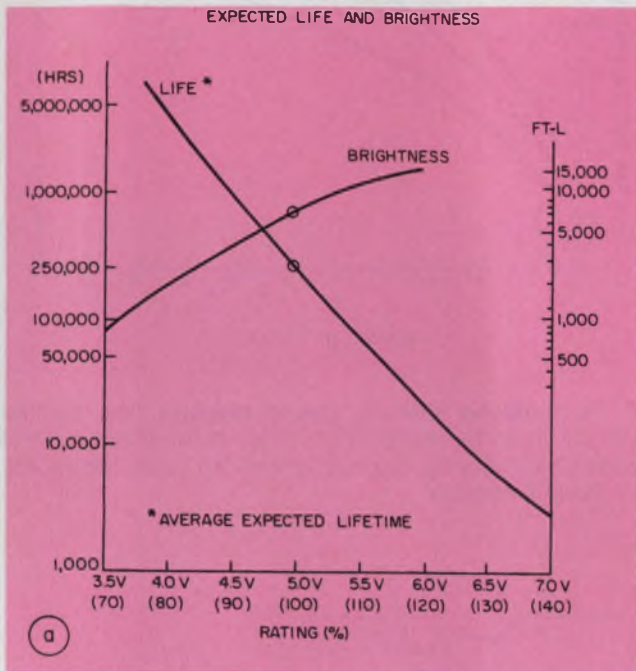

1. The life of directly viewed incandescent, segmented-filament displays (a) depends on the applied voltage. Of course, you get higher brightness as the voltage and current go up (b), but shorter life. Yet, display brightness is usually more than adequate at a voltage that allows a life of over 100,000 hours.

at 9000 ft-L would deliver only 900 ft-L through a polarizing filter.

However, because such a filter cuts down more glare and reflections than desired light, contrast, and thus visibility, is enhanced. Some filters work merely because of nonglare or matte finishes on the filter's surface. In addition, filters can be made of conductive glass to provide electromagnetic shielding, and may be sealed to protect against moisture and dust.

But how do you objectively compare display visibility among competing techniques, when different photometric units are used for each, and common

English words have special technical meanings that are far from obvious?

Brightness and intensity mean different things

The word "intensity" usually describes point light sources like LEDs, and "brightness" is reserved for extended sources, like incandescent-segment filaments. The distinction between intensity and brightness is vague enough, but photometric specialists have "refined" even these terms and replaced them with "luminous intensity" and "luminance," respectively.

The "intensity" of LEDs is rated in candelas (cd). But as you already know, the "brightness" of incandescent segmented displays is rated in foot-lamberts, where 1 ft-L = 0.3183 cd/ft². However, candelas and candelas per square foot aren't comparable. So much for comparisons.

As a matter of fact, the brightness of an incandescent display is hard to measure. Since segment filaments are small in diameter, usually less than 0.001 in., specialized equipment is needed to measure their brightness. True foot-lambert readings depend on being able to focus only on the filament. If the light meter "sees" background as well as filament, the readings taken are diluted—integrated with the background. Also, brightness isn't uniform along the whole length of a filament, so several measurements must be made and averaged. A typical method measures light outputs in foot-lamberts at one-fourth, one-half and three-fourths portions along a filament. These three readings are repeated on three other randomly selected segments in a display, and the nine readings are averaged.

Another method "looks" at the entire front face of the display with all segments on. Of course, such measurements don't provide absolute values that you can compare against, say, a National Bureau of Standards brightness standard. However, with periodic calibration against a "standard" unit of your own, the relative measurements can serve as an internal quality-control criterion. Some users find it very effective merely to "eyeball" the displays and depend on judgment for quality control.

Driving incandescent displays

Though measuring the brightness of displays may be confusing, driving incandescent displays is relatively clear-cut. Incandescent displays are TTL-compatible. To take care of cold turn-on surges, the load-current capability of the driver should be double the maximum steady current of the display segment. For example,

a good choice for a direct decoder/driver for a Pinlite MD-650, whose maximum steady current can go to 20 mA, is a 5447, which can handle 40 mA (Fig. 1b).

You can generally save money, parts and space when four or more characters are multiplexed instead of directly driven. Multiplexing shares a single decoder among many display units by taking advantage of the thermal time constant of the hot filament and the persistence of the human eye. Each unit is electrically on for only a short time but appears to be visually on continuously.

However, you must observe some circuit precautions. To prevent the tungsten filaments from self-resonating, make sure that the multiplexing recurrence rate is higher than 1 kHz, which is well above the usual filament thermal constant. At resonance, the filaments can be damaged or distorted, but too far below resonance, they may flicker. Although combinations of high-voltage drive values and repetition rates well below the thermal time constant can be found so that the display appears to produce its nominal rated light output, the true filament temperature will be higher than normal and shorten the display's life.

Furthermore, no more than 12 digits should be multiplexed, or else the duty cycle won't be kept higher than 8%. Below an 8% duty cycle, the display may flicker and produce uneven brightness. Moreover, evidence shows that duty cycles lower than 8% cause filaments to degrade because of thermal stressing.

To select the correct multiplexing voltage, V_{mx} , use the following formula:

$$V_{mx} \approx \sqrt{\text{Number of displays}} \times \text{Nominal display voltage.}$$

Typical V_{mx} curves are shown for 3, 4 and 5-V units in Fig. 2. But note that voltage drops across any diodes and ICs in series with the filaments must be added to the plotted values.

Multiplexing circuits in detail

A basic multiplexing circuit in block form, Fig. 3a, shows a single seven-segment decoder/driver time-shared between two digit displays by a scan counter. Isolation diodes in series with each filament segment must be employed to prevent "sneak" electrical paths. LEDs don't need such diodes, because the LEDs are diodes, but they do need current-limiting resistors. Another circuit, Fig. 3b, replaces the diodes with individual driver/decoders. If memory is required, driver/decoder/latches also can be used.

Fig. 4 details the most commonly used multiplexing circuit. Corresponding display segments from all decades are connected in parallel to the seven outputs of a single 4-bit BCD-input-to-seven-segment-output decoder. A three-bit BCD output from a counter drives a BCD-to-decimal decoder, whose outputs then drive transistor Darlington circuits, which successively apply voltage to display-filament decades.

A fail-safe circuit detects clock failure and disables

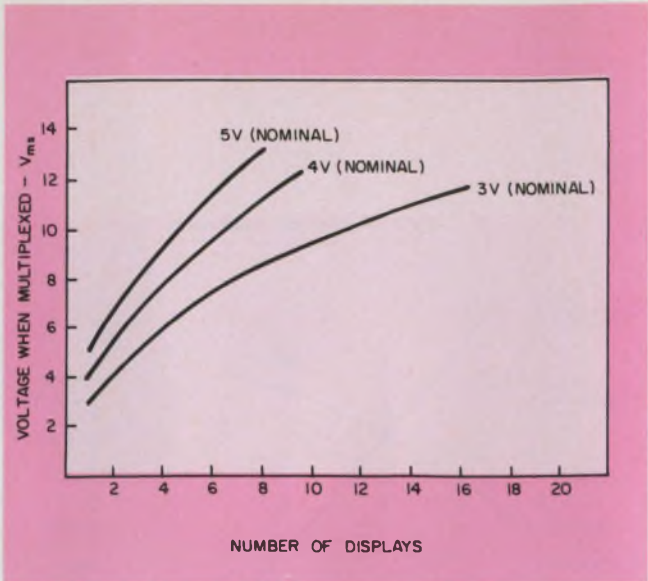

2. To multiplex directly viewed displays, the applied voltage must be higher than nominal to attain normal brightness, because the duty cycle can be as low as 8% in 12-unit displays.

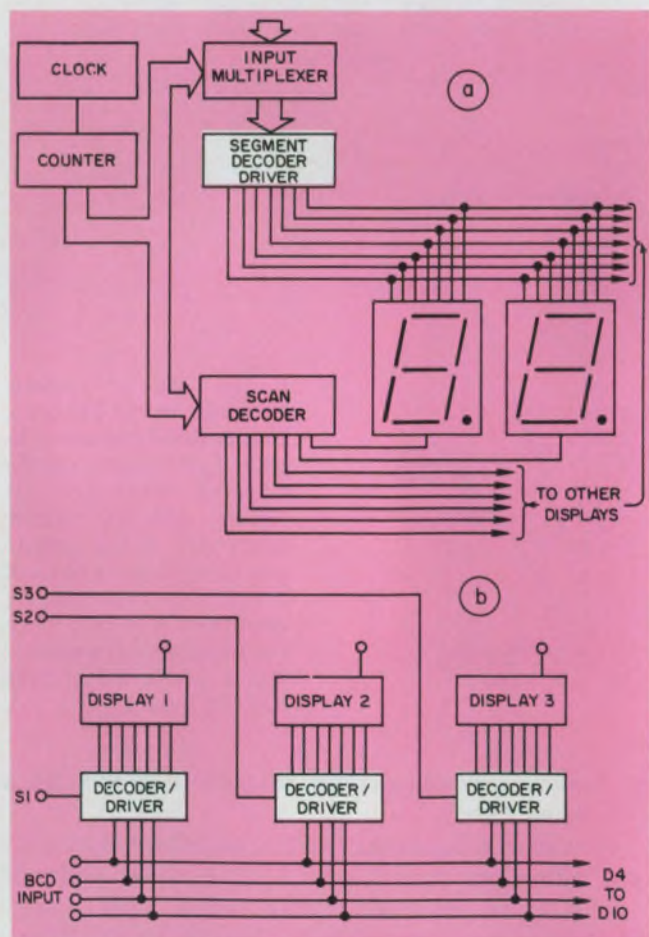

3. Two forms of multiplexing circuits are commonly used. In the most popular, a single seven-segment decoder drives the display units one at a time (a), but isolation diodes are needed in series with each filament to avoid sneak circuits. A circuit that uses a separate decoder/driver for each unit (b) can include a latch to hold the display on after a single scan.

Comparison of character displays

	Fluorescent	Gas discharge	Incandescent	LCD (dynamic scattering)	LCD (field effect)	LED	Nixie
Brightness	Good	Good to excellent	Excellent	Not applicable	Not applicable	Good	Good to excellent
Contrast ratio	10:1	20:1	20:1	20:1	20:1	10:1	8:1
Voltage	15 to 25 V	180 V	5 V	18 V	3 to 7 V	5 V	175 V
Temperature range (°C)	-55 to +100	0 to +55	-55 to +100	0 to +80	0 to +70	-55 to +100	0 to +70
Switching speed	1 ms	1 ms	150 μs	300 ms	100 to 300 ms	1 ms	150 ms
Colors	Blue-Green, others with filters	Orange, others with filters	All, with filters	Depends on illumination	Depends on illumination	Red, orange, yellow, green	Neon orange
Appearance	Excellent	Excellent	Excellent	Good	Good	Good	Fair
Font	7 segments	7 and 16 seg. dot matrix	7 and 16 segments	7 and 16 segments	7 and 16 segments	7 and 16 seg. dot matrix	Individual characters
Vertical size	0.5 to 0.75 in.	0.2 to 1.0 in.	Up to 1 in.	0.2 to 8 in.	0.2 to 2 in.	0.1 to 0.6 in.	0.3 to 2 in.
Power/digit	100 mW	30 to 100 mW	250 mW to 1 W	100 mW	1 to 10 mW	10 to 140 mW	350 mW
Life in hours	100,000	30,000	100,000	10,000	10,000	100,000+	200,000
Viewing angle	150°	120°	150°	90 to 150°	90 to 120°	150°	100°
Ease of mounting	Good	Fair	Excellent	Poor	Poor	Excellent	Good
Ruggedness	Poor	Fair	Excellent	Good	Good	Excellent	Poor
MOS compatibility	Yes	Yes	No	Yes	Yes	Small Yes Large No	No
Safety factors	Contain phosphors	Contain mercury	No special precautions	No special precautions	No special precautions	No special precautions	No special precautions
Driving circuit	Low voltage standard semiconductors	High voltage standard semiconductors	Low voltage standard semiconductors	Ac operation only, low voltage standard semiconductors	Ac operation only, low voltage standard semiconductors	Low voltage standard semiconductors	

the address to avoid voltage from being applied for an excessively long time to any one display. Incoming clock pulses charge capacitor C_1 via diode D_1 to the peak voltage of the incoming pulses. The voltage across C_1 keeps transistor Q_1 on as long as the clock pulses are present. Thus transistor Q_1 's collector keeps the most-significant digit of the scan decoder normally low. Should the clock fail, the transistor collector goes high and the scan decoder addresses the two unused outputs, O_8 and O_9 . With the components shown, the circuit operates satisfactorily from 1 kHz up, with duty-cycle pulse widths down to 8%.

Another circuit uses the storage capability of a seven-segment decoder/driver/latch combination, such as the DDL-20 made by REFAC (Fig. 5). Here, BCD-input display information is addressed in parallel to several decoder/driver/latches, while individual strobing lines from a scan decoder turn on one at a time. Isolation diodes aren't required since there aren't any sneak circuits. And the circuit consumes less power than that of Fig. 4, because there are no diode losses and no need for a failure-detection system.

Also the multiplex voltage requirement is lower.

Many seven-segment decoder/driver and decoder/driver/latch IC packages are available, and some come packaged inside the display's connector.

The multiplexing systems previously described in Figs. 2a and 2b can be used with 16-segment alphanumeric displays also, but IC-packaged ASCII-to-16-segment decoder/drivers aren't available yet. However, REFAC has a hybrid-packaged 16-segment decoder/driver in a $1.2 \times 1 \times 3/4$ -in. case with 24-pin DIP terminations. Development is under way for a more compact, versatile decoder/driver that will have latch capability and perform over the military-temperature range.

"Keep-alives" don't help

One question remains to be answered: Do "keep-alive" resistors increase the life and reliability of tungsten-filament displays? This may be true for an indirectly viewed filament display, which uses replaceable lamps, but it's not necessarily true for a

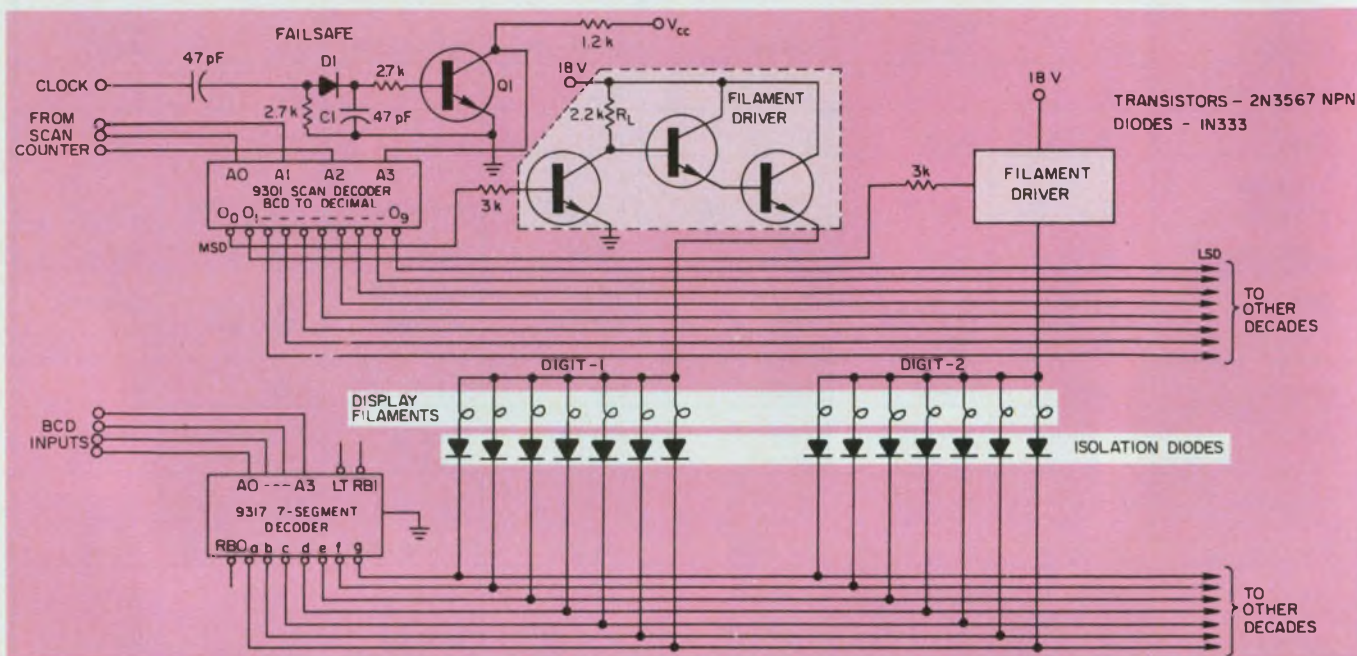

4. A detailed implementation of the multiplexing circuit represented by the block diagram of Fig. 3a shows the

separate isolating diodes and Darlington driver circuits needed for each display unit.

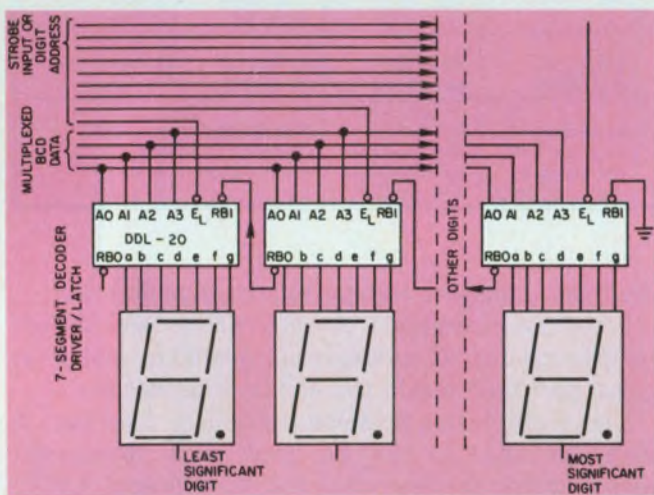

5. Separate decoder/driver/latch ICs are needed for each display unit in the multiplexer circuit of Fig. 3b, but the isolating diodes of Fig. 4 are no longer needed.

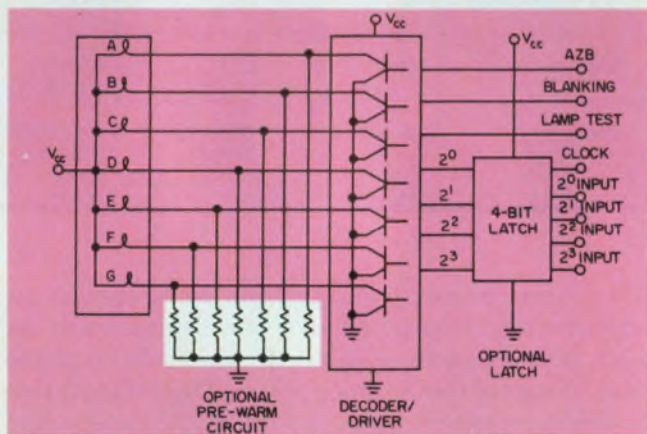

6. Though prewarming resistors are not needed to lengthen the life of a directly viewed incandescent display, many designers incorporate them anyway to reduce surge currents that can overload or even damage display driver circuits, which otherwise are adequate for the load.

directly viewed display.

Conventional tungsten lamps for area illumination operate at high temperatures, about 2500 K. However, since the filament in directly viewed displays need only provide enough light to define characters rather than illuminate a given area, it can operate much cooler. Consequently, in-rush current from a cold turn-on is much less of a shock for directly viewed displays than it is for indirectly viewed ones.

To reduce the shock of cold-tungsten surge, you can

use a low-current bypass around the filament drivers (Fig. 6), which keeps the filaments hot enough to prevent a high cold-current surge, but not to provide luminance. However, in directly viewed incandescents, the effects of reduction in cold-segment current surge is often offset by the degradation in life that results from the constant current through the filament. Nevertheless, many designers still use heater resistors to minimize any detrimental surge effects on driver and logic circuits. ■

HAMMER DRIVER

WE JUST PUT TWO BIG HAMMERS IN ONE SMALL PACKAGE WITHOUT DRIVING COSTS UP.

If you're looking for higher current and higher voltage without paying higher prices, Fairchild's new SH3011 Dual 5-amp Hammer Driver hits the nail on the head.

BIG SAVINGS.

Our new dual hammer driver was designed as an alternative to 2½" x 2½" circuit boards that end up costing you a small fortune in time and parts.

So now whenever you need high-power for driving impact printer heads, solenoids or motor controls, you can plug in a SH3011 and save about half the TTL gates, darlings and transistors you'd need otherwise.

Which, in turn, saves you insertion time, production time, test time, labor and inventory.

And all those savings added together can greatly reduce your overall system cost.

BIG PERFORMANCE.

Each of the SH3011's two independent hammers is capable of sinking 5-amps of current. Each output is designed to withstand 80 volts between the collector and emitter. And each driver is TTL compatible.

The SH3011 comes compactly and hermetically sealed in a steel, 8 lead TO-3 package to improve reliability and eliminate heat sink.

For details on our newest Hybrid (or on any of our other Hybrid products), just contact your Fairchild sales office, distributor or representative today. Or use the direct line at the bottom of this ad to reach our Hybrid Division. Fairchild Camera and Instrument Corporation, 464 Ellis St., Mountain View, CA 94042. Tel: (415) 962-3771. TWX: 910-379-6435.

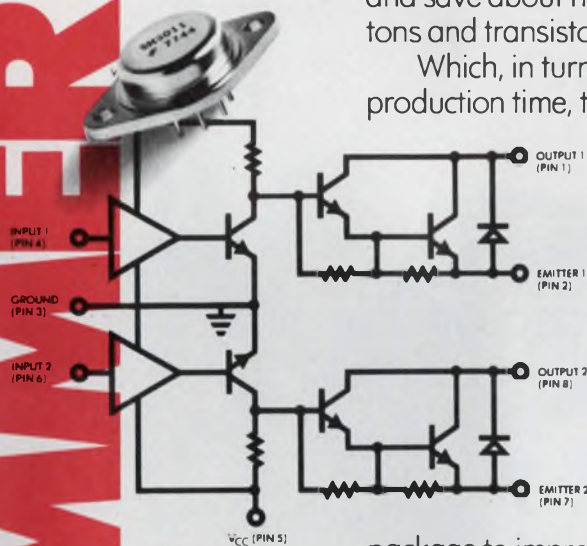

FAIRCHILD

**CALL US ON IT.
(415) 962-3771**

Introducing the Motorola baud rate generator.

Twice the component in half the space.

Now you can get a dual-programmable baud rate generator with a self-contained quartz crystal in hybrid form. All wrapped in a .2" high DIP package which takes up just half the board space of conventional generators.

It's the Motorola K1135A. Our baud rate generator eliminates the need for separate crystals and chips. It cuts out starting problems. You don't have to cope with spurious oscillations that mean expensive "end of the line" rework. And the self-contained packaging

means easy control over inventory.

For price list, rep list and data sheet, call Barney Ill at (312) 451-1000. Or write Motorola, Component Products Department, 2553 N. Edgington, Franklin Park, Illinois 60131.



MOTOROLA INC.
Component Products

CIRCLE NUMBER 35

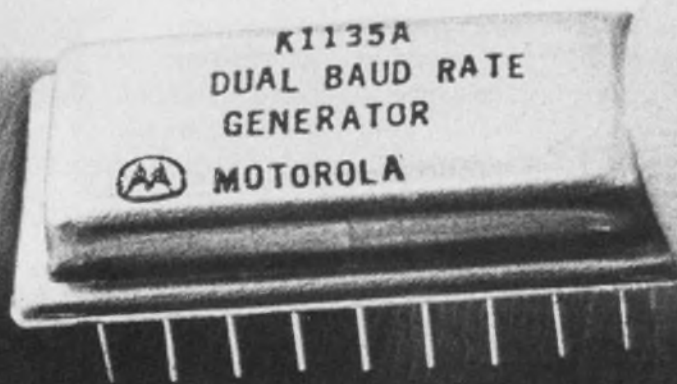

Look at the price.



The Racal-Dana 5000 is the lowest-priced of any 5½ digit multimeter with IEEE-STD-488 GPIB interface.

And a simple programming string makes it the easiest to program, easiest to use of any comparable 5½ digit multimeter.

The Racal-Dana 5000 costs less to buy and less to use. And it maintains the same high quality standards you've come to expect in any Racal-Dana instrument.

Now that you've seen the price, take a look at the specs. Call or write today for complete information on the Racal-Dana 5000. It's a price/performance combination that can't be beat.

By the way, if you already own a Racal-Dana 5000, you can upgrade it to a smart system with Racal-Dana's piggy-back GPIB option.

RACAL-DANA
Others measure by us.

Racal-Dana Instruments, Inc., 18912 Von Karman Avenue, Irvine, CA 92715, Phone: 714/833-1234

Control EMI from power supplies

with computer-aided circuit analysis. You should not only save money, size and weight, but time to boot.

You are better off using computer-aided analysis to restrict emissions from power supplies for sensitive applications like military equipment. The traditional approach to controlling electromagnetic interference (EMI)—putting in some “catalog” filters, shielding thoroughly, testing and fixing—may burden the final product with excessive weight and size, jack up manufacturing costs and engineering expenses, or cause big delays.

Moreover, since EMI is only one of many design specifications you'll be facing, you may have to trade EMI margin (especially at low frequencies) for more important factors, so you need accurate predictions of circuit performance. Computer-aided analysis also prevents unpleasant surprises due to interaction between low and high frequency filters and other components, and helps you with the MIL-STD-220 attenuation specs which are often hard to apply. Finally, analytical design takes the major parasitic circuit elements into account that limit power supply performance, and also line-impedance stabilization circuits that affect filter performance.

Computer-aided design (CAD) has helped control emissions from a very compact Army helicopter navigational computer with built-in display (ED No. 25, Dec. 6, 1977, p. 76). Measured emissions matched CAD predictions within 1 to 6 dB over a 160 kHz bandwidth and 90 dB dynamic range (Fig.1). In this design, input current is independent of the input voltage, but not the load. So low-frequency noise current contains narrow pulses stemming from the inverter's zero transitions, and contributions from an active load. The analytical approach, however, also applies to most other popular dc and ac power-supply architectures.

Before you jump into designing a low-EMI power supply, carefully study what limits are in force. As it applies to power supplies, MIL-STD-461A restricts the following emissions:

1. Conducted audio and rf-current emissions emanating from primary power leads.
2. Conducted audio and rf susceptibility in the

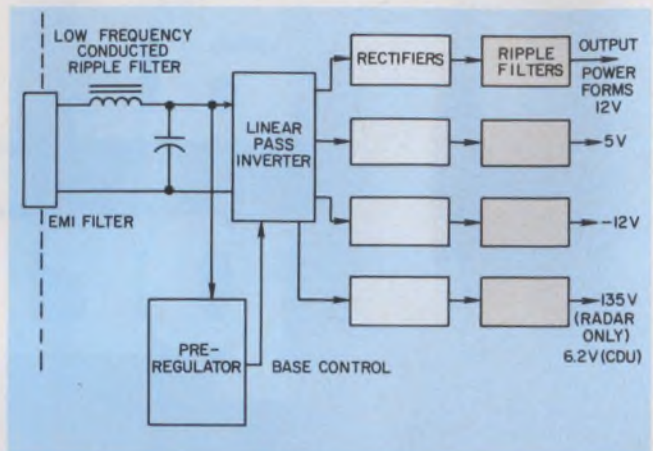

1. The power supply used as a design example has a lossy linear preregulator because the loads consume little power and draw fairly constant current.

primary power leads.

3. Conducted rf emissions emanating from other signal leads, caused by incidental coupling between wires in harnesses, housings and PC boards.

4. Radiated emissions from housing apertures, joints and controls, and from external leads.

The first two limits are treated directly by CAD. To satisfy the third and fourth, design your supply system with the fewest possible connecting wires and boxes. If you control emission currents in the external leads, radiated emissions from the external wires will usually fall within the specified limits. Shielding a cable run between boxes is usually pointless because the primary-power system renders complete shielding impractical. Furthermore, primary power emissions are usually orders of magnitude stronger than the incidental rf pickup in interbox wires. Indeed, much of the suspected interbox interference in aircraft (as well as in buildings) is really caused by radiation from primary power leads into faraway components acting as receiving antennas.

To add spice to the specs, Army, Navy and Air Force requirements differ radically for similar equipment. The low frequency range, where the differences are most pronounced, fortunately poses few interference problems.

Since each power supply architecture has advantages and disadvantages, make an EMI tradeoff chart, and choose the optimum approach for your

Table 1. Tradeoffs for a helicopter power supply

Choice	Significant advantages	Major disadvantages
No post-regulators	Greatly reduced parts count, size and cost.	Some local decoupling is required.
Preregulator combined with power converter	Saves additional parts. Emission currents are low, as are filter cost, size, and weight.	Very poor efficiency makes this choice practical only for small loads, and requires good thermal design.
Separate supplies in each of two subsystem boxes	Lower wiring and shielding cost and weight, high reliability.	Cost of the second supply.

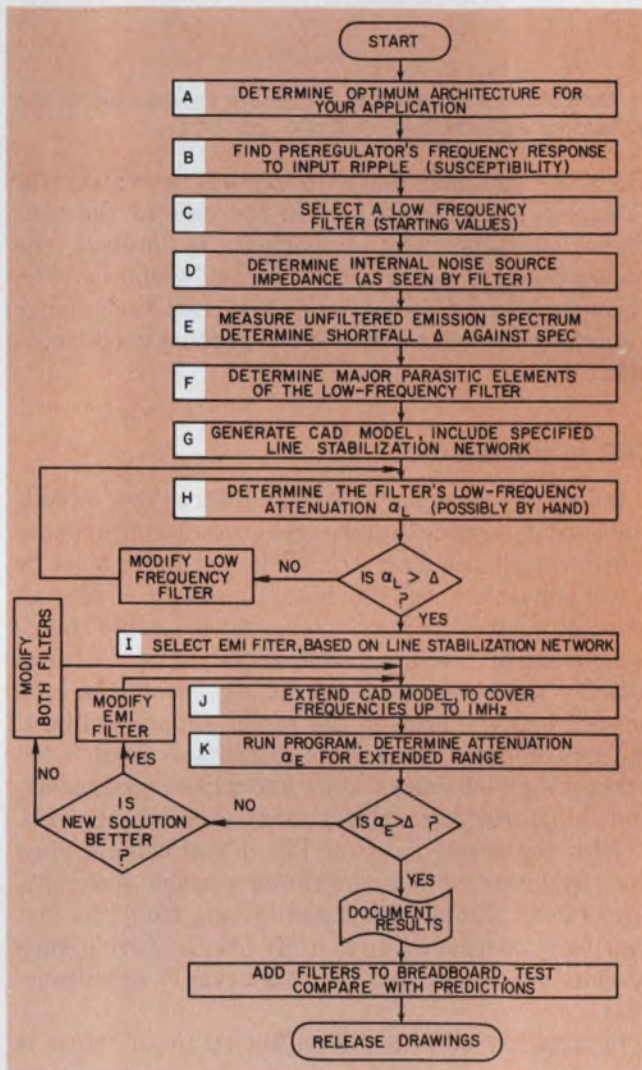

2. A flow chart for the design procedure calls out the steps to be followed (A through G, also in the text.)

system. Some items you may want to trade off are cost, size, weight, load magnitude, interface details, load-noise generation, and power converter noise generation. For the helicopter example, the choices are summarized in Table 1.

The preregulator in Fig. 1 provides good line regulation, but only modest load regulation. The ripples from converter and dynamic load currents are an order of magnitude higher than with postregulators,

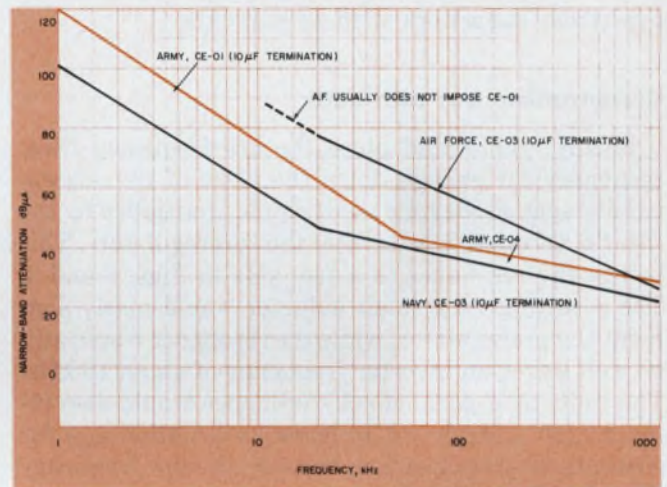

3. Conducted-emission limits of MIL-STD-461A differ for the Army, Navy, and Air Force. So do the terminations prescribed by the three service branches for testing.

but in the helicopter example the noise-sensitive loads were small and local active filters—which are generally simple and work well—proved adequate.

Make sure to choose a converter where frequency and intermodulation products will neither excite filter resonances, nor interfere with receiver i-f frequencies. The outstanding advantages of the architecture in Fig. 1 are low cost and low emission current (the ac components of the primary input current). All other preregulator types generate much higher emission currents.

For a flow chart of the design procedure to be used, check Fig. 2. Following it step by step; first determine the architecture (step A), then the preregulator's frequency response (step B). Measure the response, and—if needed—model it. Since the inverter switches are also series-pass elements, each transistor exerts linear control within its half-cycle of inverter operation. Conventional closed-loop effects limit the frequency response.

Select a low-frequency filter (step C). Part of its purpose is to add conducted-susceptibility protection where the regulator runs out of gain. If the filter is placed ahead of any switch, it acts directly upon any externally applied ripple frequency. Other architectures may have reversed order—e.g., a switching pre-

regulator or full-wave rectifier makes a rather decent balanced modulator. The filter then has to contend with sum and difference frequencies of the applied ripple and the switch (or ac) line, while the input fundamental frequencies are rejected.

This filter must also reduce low-frequency emissions from the power converter and from any active loads. Active voltage regulators don't isolate ac load currents from the input, as do passive filters, which store energy. But don't choose unnecessarily low frequencies—unless you want to add size, weight and cost. Remember that LC filters always resonate somewhere; a resonance can amplify emission, and overstress capacitors with ac currents.

Compromise, but with care

Ideally, you would place the low-frequency filter resonance far enough down the slope of the susceptibility spec so that the input ripple, multiplied by the filter's Q doesn't saturate the preregulator. This brings the resonance to a few kHz in Figs. 3 and 4. The resulting very small inductor would nicely augment the preregulator, while the resonance would still be well below an inverter frequency of about 10 kHz. The inductor's parallel self-resonance would also remain high enough not to leave an isolation gap for susceptibility or emission, between the low frequency filter and the EMI filter.

However, other considerations may prevent you from choosing the optimum filter resonance frequency. The helicopter, for example, contained a variable duty cycle dimmer whose frequency was set to 1700 Hz so that its large interference currents fell into the region of high spec limits (see the Army curve in Fig. 3). To help reduce these emissions, the filter had to resonate well below the dimmer frequency.

You can control resonant Q by either choosing as high an inductor resistance as your power budget allows, or using a low L/C ratio for the filter's LC product, to reduce the filter's impedance. Keep in mind that the preregulator presents a high ac impedance to the filter so that a small input voltage change does not affect the current, and the filter's Q isn't limited by the reflected load.

If the best compromise for Q still does not meet

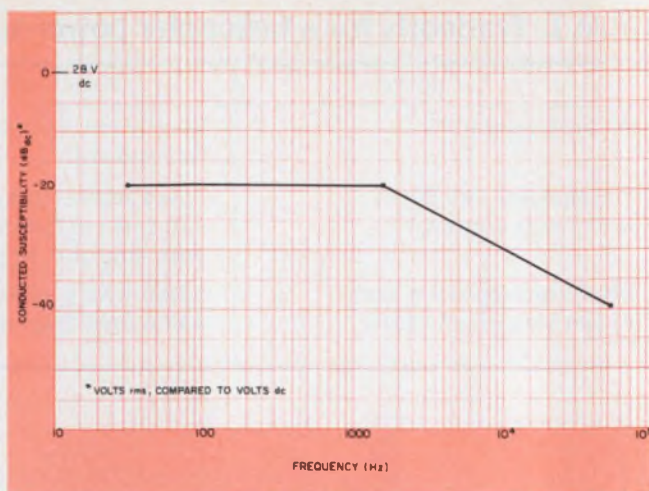

4. **Conducted-susceptibility limits** are referenced to the output voltage—in this example, 28 V dc.

the spec, you may have to request a waiver for susceptibility at resonance. In the case of the helicopter, it was most important to protect the customer's lowest-frequency receiver "windows" (Fig. 5), and to hold down size, weight and cost. So challenge a specification when a waiver can produce good trade-offs.

CAD to the rescue

Before you can apply a CAD program to your circuit, you must determine the noise generator's approximate source impedance (step D). Without filters, most dc power converters look like high-impedance ac sources (current sources). Emission current is simply the ac component of the input current, but it is useful to consider the power converter as a generator and the dc source as the load. In the power supply of Fig. 1, the two inverter transistors alternately switch between a high impedance state and a linear-pass state, and the preregulator bleeds away excess base drive.

With the preregulator of Fig. 1 you achieve good line regulation while maintaining a nearly ideal 50% duty factor. The ac component stems from the fact that both transistors switch off briefly during each transition to ensure that they are never on simultaneously.

Because the current drawn during the on state is

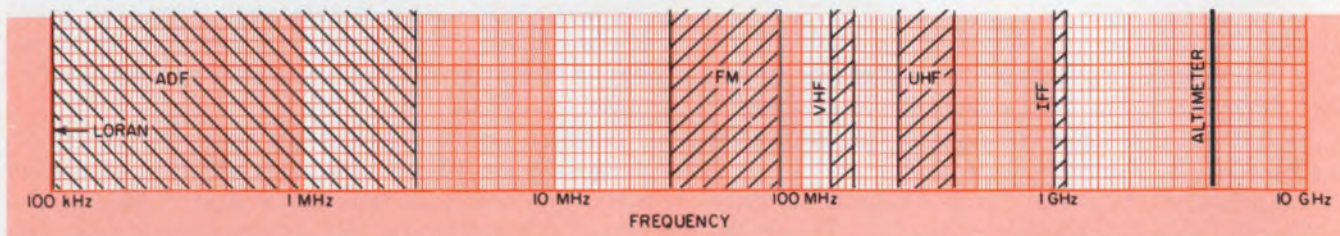

5. **Without knowing the rf environment** of a power supply, intelligent tradeoffs are impossible. The Army helicopter

used as a design example is packed with receivers. Some antennas are only inches away from power leads.

nearly independent of line voltage, the emission waveform is a train of narrow constant-current pulses whose peak value is equal to the dc level. The emission's fundamental frequency is 22 kHz (twice the inverter frequency) and has a very flat comb spectrum. Lower-level components exist at the inverter frequency and its odd multiples (Fig. 6) because of the asymmetrical width of each cycle's two current pulses (caused by transistor-speed imbalances). For the helicopter, emissions from the display dimmer were similarly represented by an additional current source.

The frequency spectrum of an unfiltered source is more easily—and more accurately—measured than calculated (Step E). Use an engineering breadboard power supply at full load. However, you don't have to simulate digital logic loads at this point, because their frequencies are so high that there is little chance for interaction with the filter. Besides, the logic loads' effect on power-line emissions is very sensitive to packaging and shouldn't be measured in the breadboard form. The emission current must be bypassed with a broadband short circuit such as a 10- μ F coaxial feedthrough capacitor.

For measuring the unfiltered source use a very low-impedance lab supply, rated for two or three times the needed capacity, and either calibrated tunable

voltmeter (wavemeter) or a spectrum analyzer. (Fig. 6 shows the composite unfiltered spectrum for the design example, taken from a series of measurements.)

How close did you get?

In Fig. 3, the customer's specified emission limit, MIL-STD-461A, is overlaid on the spectrum. The shaded area indicates where emissions exceed the spec, and gives you a feel for the required filtering.

You want to predict the effect of the filter as accurately as possible, which requires a CAD program like ECAP, (step F). But to use CAD, you need a complete equivalent circuit, including parasitics. In a properly packaged power supply, these consist of the inductor's distributed capacity, equivalent series resistance (ESR), and capacitor residual inductance. Lead inductance is important and can help or hinder the desired attenuation—depending on the layout—because power-supply filters work at very low impedance levels. A 50- μ F wet-slug tantalum capacitor has around 50-nH parasitic inductance (depending on lead length), and this combination resonates at a low 100 kHz. A 0.05- μ F tubular bypass capacitor with 1-in. leads raises the series resonant point to around 3.3 MHz.

Fig. 7 shows the effects of proper and improper

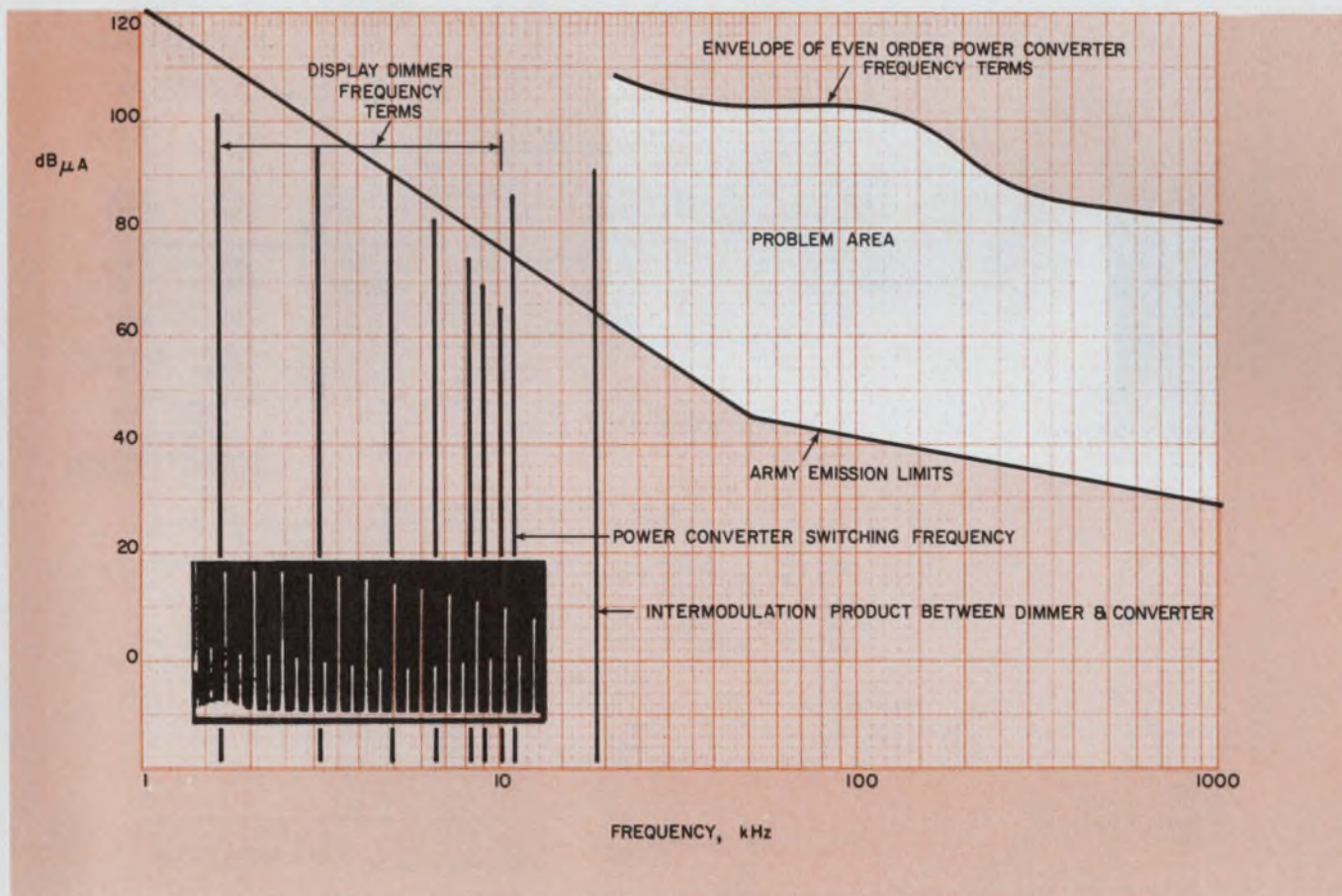

6. Emissions measured with a spectrum analyzer (insets) must be combined and compared with the spec limits

(colored line). The problem area (white) must be eliminated with low-pass filters.

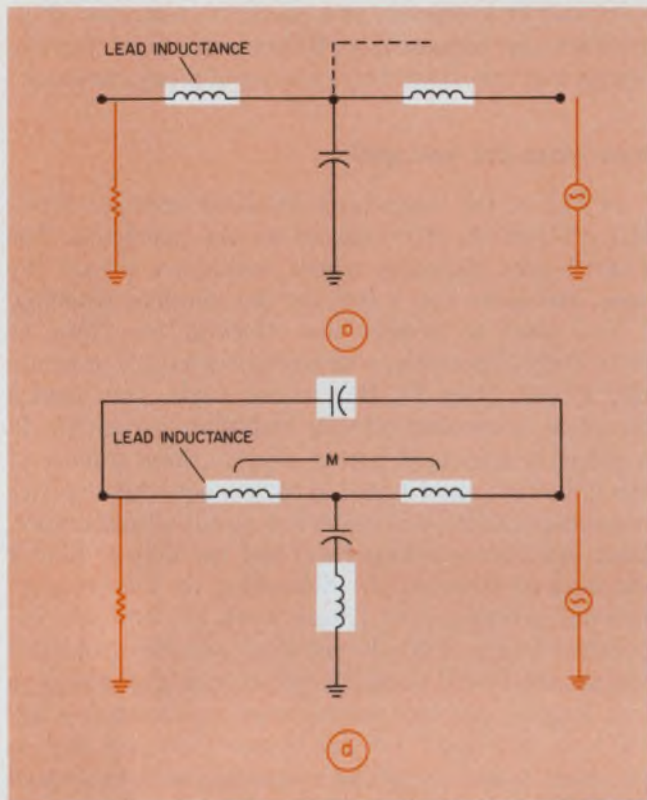

7. Parasitic elements can help or hurt. Those of a coaxial feedthrough capacitor with bulkhead mounting (a) help, while a discrete capacitor's parasitics (b) hurt.

packaging on the circuit model. To optimize packaging, the electrical and mechanical product designers must work together closely. Put as much lead inductance as possible into the load current bus, and as little as possible into the shunt path.

The next significant parasitic reactance—inductor capacity—is easy to determine. Connecting the inductor through a 100-k Ω resistor across a signal generator. Then find the resonance frequency with a lightly coupled oscilloscope, and calculate the capacitance. Finally, measure the choke resistance with a dc bridge. Don't increase this value to compensate for skin effect, because the effect of resistance on Q is biggest when the circuit resonates at low frequency.

Parasitics everywhere

In the complete low-frequency filter (Fig. 8) the capacitor actually consists of two 22- μ F wet-slug tantalum capacitors in parallel. The 24-nH series inductance consists of 25 nH of self-inductance, in series with 22 nH of parasitic inductance from the two 1/2-in., AWG-22 leads of each capacitor. The 0.61- Ω resistance is the sum of an overload sensor (0.6 Ω) and the measured value of ESR (calculated from the measured dissipation factor D) at 10 kHz. Since ESR appears to exhibit a frequency dependence, you would be wrong to use the ESR at the commonly specified

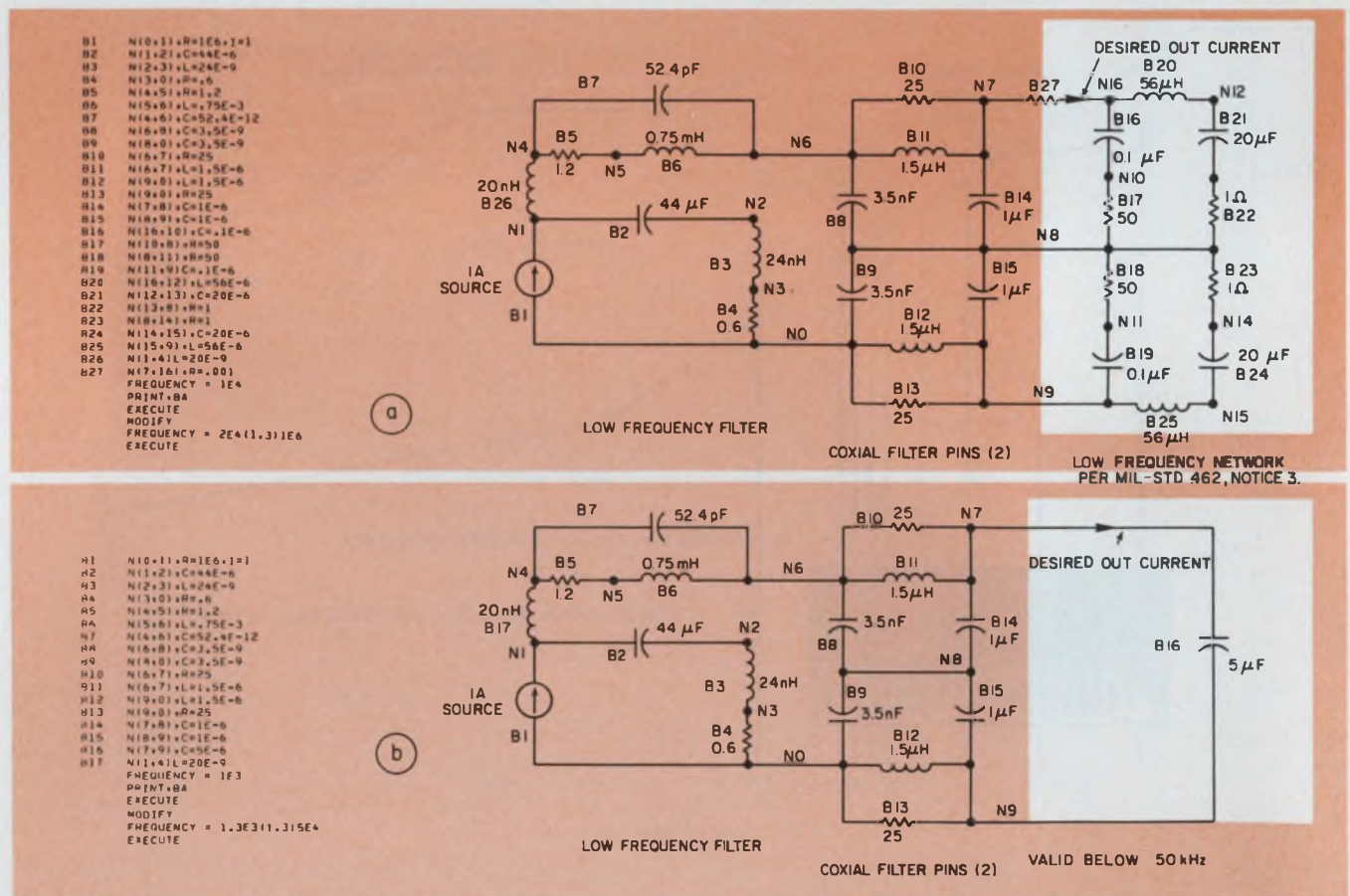

8. The ECAP model for frequencies above 50 kHz (a) is much more complex than the one for lower frequencies

(b). This is because the Army's test specification requires use of a fairly complex low-frequency network.

Table 2. Comparison between predicted and measured results

Frequency (kHz)	Driver magnitude (dB μ A)	Predicted filter atten (dB)	Predicted emission level (dB μ A)	Measured emission level (dB μ A)	Error (dB)	Army emission limit (dB μ A)	Actual margin (dB)
1.8	100	14	86	92	-6	108	16
5.4	81	28	53	58	-5	84	26
22	108	46	62	58	4	63	5
62	102	72	30	25	5	44	19
84	102	79	23	20	3	42	22
100	102	85	17	18	-1	40	22
160	98	94	4	8	-4	38	30
200	92	100	-8	8	-16	37	29

frequency of 120 Hz. Although ESR increases by a factor of 10 at 50C, you can disregard that because emissions are only measured in the laboratory, and besides, the power supply warms up very quickly.

It is quite important, however, that you measure and model your low-frequency inductor at the dc current and ac voltage that it will see in actual use. Inductor weight and cost rise quickly with size, and you can't afford enough extra iron to make the inductor work in a linear region. Consequently, inductance usually changes rapidly with dc operating bias.

The topological circuit model (step G) is relatively independent of whatever CAD program you end up using. For the helicopter supply, IBM ECAP was used, and branch and node nomenclature have been included in Fig. 8.

Since the Army tests specified two different line terminations, one below, the other above 50 kHz, two separate models were made. The corresponding changes for low frequency are shown in Fig. 8. Although you haven't added an EMI filter at this point, the complete ECAP listing includes these components, because they will soon be needed.

Only a coaxial capacitor has a high enough self-resonance to be effective above the audio-ultrasonic transition band where the low-frequency filter resonates. Before you choose specific components, a few simple calculations on a pocket calculator can provide you with a good starting point (step H).

When you adjust the low-frequency filter's elements, remember that you chose this filter to control susceptibility, and that your basic design constraints may be strongly affected by the filter's relatively large circuit components.

So, determine the low frequency filter's frequency response to an ac current source. It is generally easier to plot the unfiltered emissions from a constant amplitude source and manually add the filter attenuation to the previously measured levels. However, some newer modeling programs such as NCSS Inc.'s ISPICE permit empirical data, even equations, to be inserted rather easily into topological circuit models.

Because the basic IBM ECAP program does not convert the results to dB, you may find a pocket calculator, pencil and semilog paper quite adequate

for the first iteration. Some desk calculators, such as the HP9825, have very convenient interactive forms of ac ECAP, convert the answers to dB and plot it. Unfortunately, the HP9825 program has a fixed 1-V voltage source and does not handle branch currents.

So far, you haven't really needed a CAD program. But once you add the topology of a pair of EMI filters, (step I), the network becomes far too complex for manual evaluation, much less intuitive understanding by inspection. Keep in mind that discrete coaxial filters with low frequency corners and steep slopes often exhibit sharp ultrasonic resonances that can actually amplify emissions.

Pick a pair of values

Before you decide on filter values, define limitations imposed by size, weight, cost, voltage, current, standard-parts-list requirements and reliability. Some of these constraints may limit envelope ranges. Next determine the filter's optimum topology. If your termination network approaches 50 Ω at higher frequencies, a Π or L network (with capacitor facing the input) is quite effective. However, even a 1- μ F capacitor—the largest generally available—becomes meaningless when paralleled with the 10- μ F capacitor used in the Navy and Air Force emissions test. So, a T or reversed-L filter would be most useful in these cases. Indeed, attenuation data measured to MIL-STD-220 may actually misguide you: In a 50- Ω system with a given filter volume, a Π is more efficient than a T or L, and usually has a lower specified corner frequency.

To resolve the paradox, specify a filter model by topology, element values and tolerances. Examine MIL-STD-220 data above 10 MHz to control potential parasitic behavior in the vhf and uhf bands.

How do you determine for your modeling what's inside the filter? Measuring is poor practice because the topology usually isn't fixed. Another vendor or even a later production run could meet the specified attenuation with different components. If the filter is asymmetrical to boot (like the one in Fig. 8) it would be almost impossible to define by external measurement. The best thing to do is talk to the vendor's

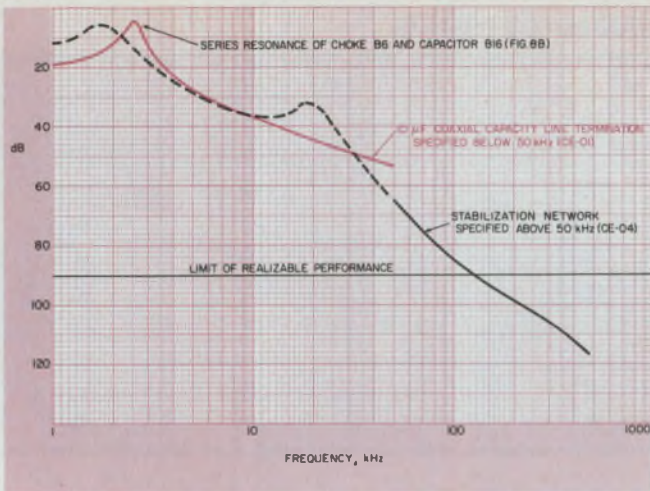

9. The filter attenuation predicted by ECAP shows a resonance around 2 kHz. A second one (white) disappears after you connect the 10- μ F coaxial line terminations specified under MIL-STD-462, method CE-01.

design engineers. Once they understand why you need the data, they are likely to cooperate because they too can benefit from modeling. Your filter vendor can likely give you a "shopping list" of available filters to try in your CAD model. Once you have an accurate model, you can quickly and economically iterate it as many times as necessary to optimize your design (steps J and K).

For the results of both the high and low-frequency ECAP runs check Fig. 9. The previously described loss of attenuation of a Π network against a 10- μ F termination shows up very dramatically at the 50-kHz transition frequency of the two models. This presented no problem in the Army helicopter application, but if you wanted to sell the power supply to the Navy—knowing that it had been tested successfully to MIL-STD-461—you'd be in for an unpleasant surprise.

Note that the 2.6-kHz resonance (Fig. 9) is caused

by elements at opposite ends of the model. Inspecting the complex model without CAD certainly doesn't hint at this resonance, which fortunately does not coincide with an emission line and therefore poses no problem. But you would not find it by merely testing the filter circuit, with a lab supply for a power source.

For very low emission frequencies, where the reactance of the 10- μ F capacitor is a few ohms, it's advisable to insert some impedance between the dc source and the capacitor. MIL-STD-461 does not prescribe what to do on the other side of the network.

The proof of the pudding

Table 2 summarizes the test results for the design example. At one point, emissions just grazed the spec, but the customer had been forewarned, and had given his consent. The measured values in Table 2 stem from the official test report, and agree closely with the values predicted by ECAP. Differences at lower frequencies are most likely caused by the typical excess capacity of wet-slug tantalum capacitors over the minimum specified values. Above 160 kHz the actual attenuation exceeds the prediction substantially, but as most stray coupling mechanisms increase directly with frequency, some degradation must be expected.

Achieving desired attenuation with economical production techniques is a real problem when space is limited. Discrete tubular filters are the best choice for two or three wires. But the realizable isolation is limited by the isolation between the wires at the two ends of the filter, and you will usually have to mount the filter in the package wall.

A filter pin connector may be more economical for a larger number of leads, because it automatically isolates the quiet from the noisy side. To improve isolation even further, the power supply for the helicopter was designed so that the end of that

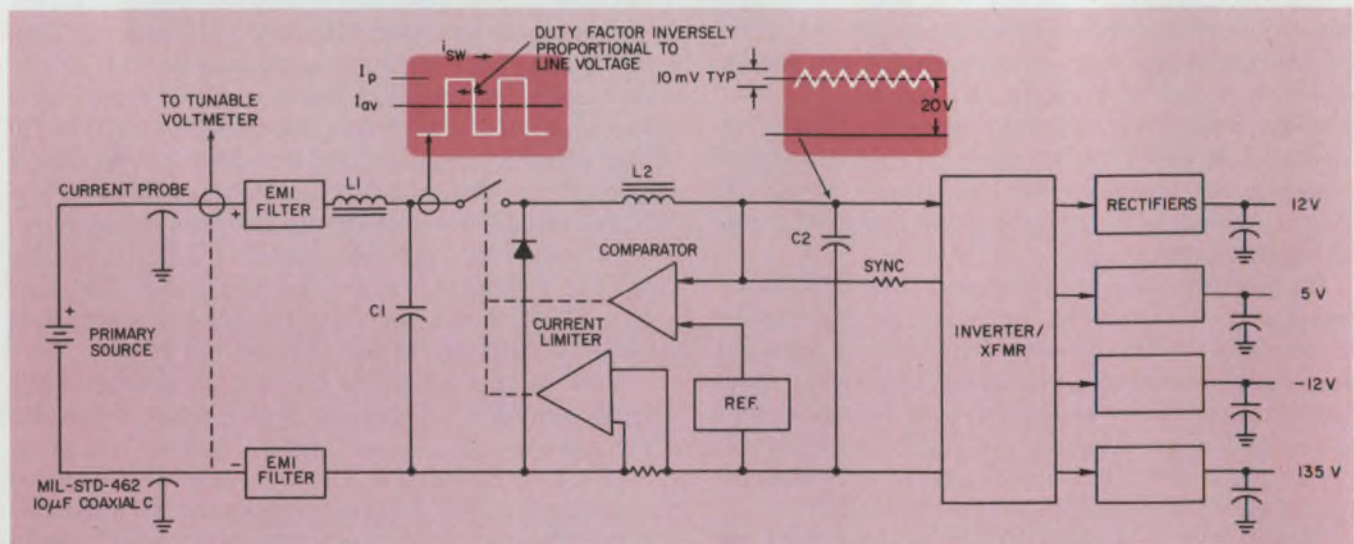

10. An alternate power-supply architecture, using regulation by variable duty-cycle switching, would be better

for large loads. In the example of Fig. 1, the load current was smaller and essentially constant.

subassembly was also the end of the box, eliminating extra connectors and harnesses.

Still, why should filters be optimized for a particular customer's specified test load rather than the low-impedance power distribution system that the supply sees in the real world? Quite simply, it's a compromise. A 10- μ F capacitor in the Navy's spec appears overly pessimistic while the Army's 50- Ω stabilization network is probably optimistic.

Above 100 kHz, the impedance of airborne power-distribution systems varies too much to be characterized. While impedance generally rises with frequency, line resonances and discrete load reactances create wild impedance swings. The service branches compensate by over specifying emission limits at lower frequencies in different ways, supposedly, because of the different environments in which their equipments operate. The Navy and Air Force provide two limit extremes, with the Army in the middle (Fig. 3).

Navy emission limits are difficult to achieve with many power-supply architectures, particularly those with 400-Hz primaries. More realistically, the Air Force only requires emission limits below 20 kHz if the application warrants it. Above 2 MHz, requirements of all service branches converge on 10 μ A for discrete narrow-band terms, because there the risk of radiating into a receiving antenna gets much higher.

Effective receiver sensitivity generally rises with increasing frequency because atmospheric noise falls off and local, man-made noise threatens to become more serious. Because most coupling modes between wires act as high-pass filters in the near zone, you can usually control conducted emissions in this region simply by packaging the EMI filter properly. Almost any coaxial filter other than a straight capacitor will work if it is properly installed to realize high isolation (Table 2).

If you test a low-powered box to MIL-STD-461, requirements CE-01 and 03, and the aircraft is large enough to have separate power leads to the source, the region up to a few hundred kHz poses little inter-system interference risk. So take advantage of any freedom the standard gives you, to run the test.

Not all power supplies are alike

The design example discussed so far has about as low a conducted-emission level as is possible, but at the expense of efficiency. Supplies for higher load power often cannot afford the high internal dissipation and primary power consumption of the supply in Fig. 1. Rather, a variable duty cycle preregulator (Fig. 10) is commonly used for high-efficiency applications. Control of conducted emissions then becomes more serious. Not only is the exciting load current higher, but the ac (fundamental)-to-dc current ratio jumps from the -30 dB-level to about 0 dB.

A variable duty-cycle switch guzzles input current in intermittent gulps. But the filter composed of L_2 and C_2 (Fig. 10) is required for the preregulator's basic

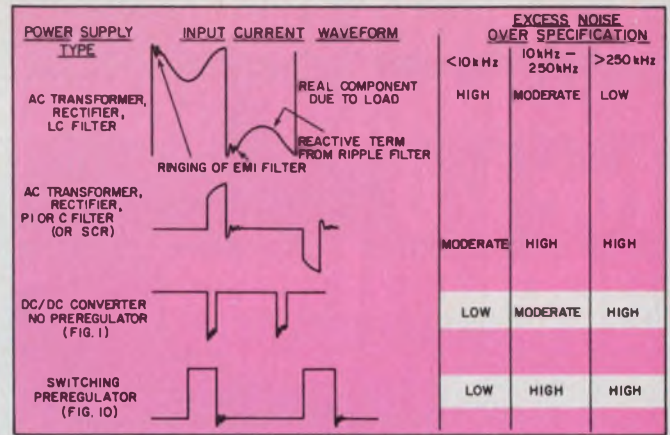

11. Input current waveforms differ between power supply types, including those of Figs. 1 and 10.

operation, and does nothing to control conducted emissions. Consequently, the emission current could exceed spec limits by many dB, depending on the load, and which service branch is involved. The EMI filters of Fig. 10 may adequately control emissions above about 100 kHz in such a supply, but would probably amplify emissions at the first few spectral lines.

So, you need the best design for the low-frequency emission control filter L_1-C_1 you can get, and that requires CAD. This powerful design tool also helps you minimize ringing problems in the filter, and reduce EMI even more. In a switching supply, inductor L_2 provides a current source in the emissions model. However, its magnitude is much higher than that in the helicopter study. Worst-case emissions don't occur at 50% duty factor because in this situation the even-order terms cancel, while the fundamental increases only slightly. A 33% duty factor is a good compromise for worst-case analysis.

An ac power supply with choke-input load filters also presents a current source to the EMI circuit model. A static resistive load creates a square wave term at the line frequency and the output filter superimposes a term at twice line frequency, chopped by the square wave (Fig. 11). Capacitive load filters, on the other hand, create voltage emission sources that are harder to characterize, but seldom would you use one where conducted-emissions currents are important. These filters generate very flat frequency combs, which extend out to limits dictated by the rectifier's, and the transformer's, parasitic impedances. Low-frequency emissions are a problem with both filter types since there is no low-frequency filter between the emission source and the EMI filter. Consequently, large EMI filters with low corner frequencies are required, ringing problems abound. Even with CAD, you will often require EMI-spec waivers. But computer modeling will strengthen your case. ■■

Acknowledgment

The authors appreciate the cooperation of Bendix, Electrical Products Div., which performed extensive work to provide an exact CAD model of the discussed low-frequency filter.

A whole new connector series for I/O applications



The introduction of our new BLUE MACS® Ribbon Connectors, designed in accordance with IEEE Standard 488, represents another Ansley engineering breakthrough in lower installed cost mass termination technology.

Ansley's BLUE MACS Ribbon Connector series terminates to standard 50 mil pitch cable which provides complete compatibility with all the other connectors in the system.

The Ribbon Connector incorporates all the BLUE MACS benefits, including the 4-point TULIP® contact for maximum termination reliability, and a one-piece design for fast, low cost assembly and positive cable-to-contact alignment.

This line is added to our complete family of "D" Series connectors now available from stock in 9, 15, 25 and 37 pin configurations. In addition, we offer a wide variety of UL listed jacketed cable for external use with these connectors.

This allows you more freedom when selecting connectors for future design.

All connectors are available with a broad selection of mounting hardware to various strain relief configurations. For the full reliability/cost effectiveness story and technical data, call or write:

T&B / Ansley

The mass termination company.

T&B/Ansley Corporation • Subsidiary of Thomas & Betts Corporation
3208 Humboldt St. • Los Angeles, CA 90031 • Tel. (213) 223-2331
TELEX 68-6109 • TWX 910-321-3938

CIRCLE NUMBER 38

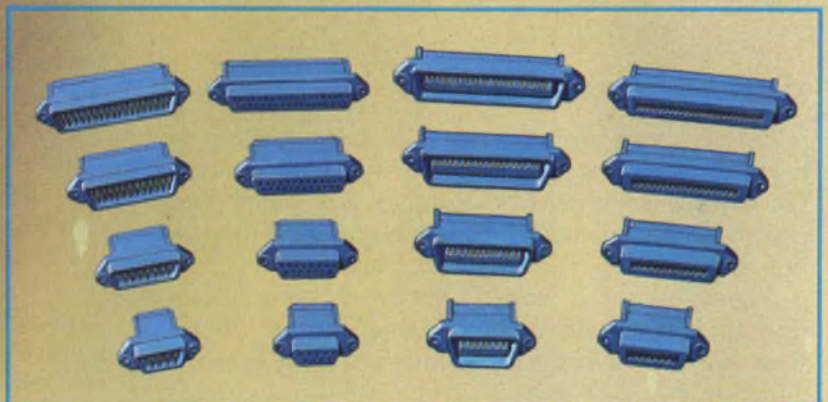

SEE US AT
NEPCON '78 WEST
BOOTH 130

STOCKED AND SOLD THROUGH AUTHORIZED ANSLEY DISTRIBUTORS.

International T&B/Ansley Offices: AUSTRALIA, Brookvale, (02) 938-1713 • AUSTRIA, Vienna, (222) 6232365 • CANADA, Iberville, Quebec, (514) 658-6611 • ENGLAND, Luton, (0582) 597-271 • FRANCE, Rungis, 687-23-85 • HOLLAND, Zoetermeer, (79) 214688 • ITALY, Milano, 02-4986451 • JAPAN, Tokyo, 03-354-9661 • SINGAPORE (65) 2923711 • SOUTH AFRICA, Benrose 24-8134 • SPAIN, Barcelona, (93) 212-8607 • SWEDEN, Upplands Vasby, 0760-86140 • SWITZERLAND, Hombrechtikon, (04155) 422791 • WEST GERMANY, Dreieich bei Frankfurt, 06103-8 20 21 •

Surprise!

Another missed delivery on MECL III parts may not be the kind of surprise you were looking for, but it could be the best thing that's happened to you all month.

Because Plessey's ECL III is available from stock.

You can get our ECL III devices as identical "me-too" plug-ins, including the lo-Z parts you can't get any-
place else.

Or you can get Plessey ECL III with lower delays and much higher operating speeds. Our SP16F60, for example, is the world's fastest Dual 4-Input OR/NOR Gate, with a switching speed of just 500 pico-seconds. And all our other products are available with typical values as good as MECL's maximums, and maximums

that have to be experienced to be believed.

We can select for certain specifications (such as threshold voltage or slew rate on our SP1650/1, toggle rates or delays on our SP1670). We'll

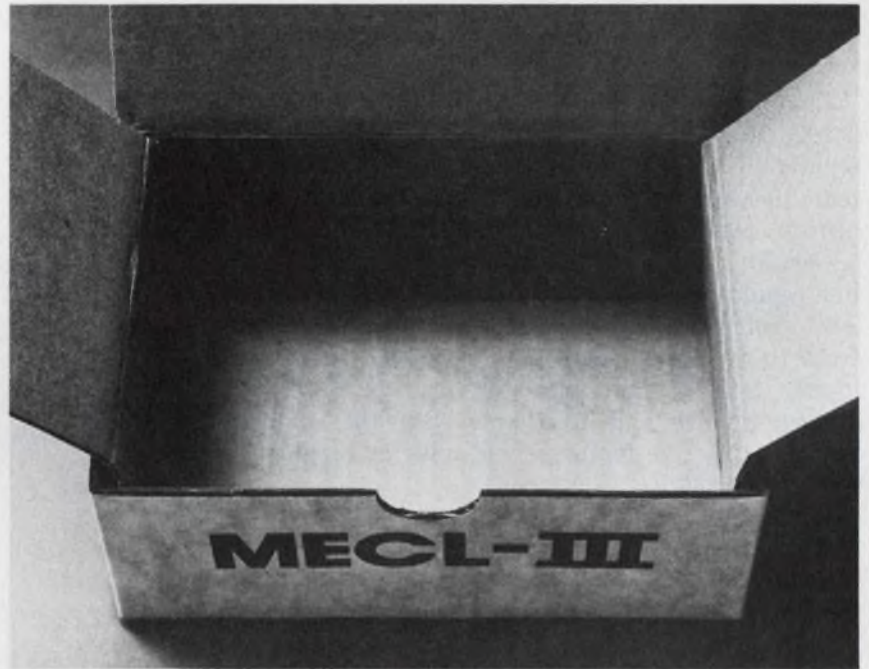

even screen to 883B if you need it.

And all this comes with the reliability you've come to expect from Plessey, so call or write for ECL III details today.

We think you're more than ready for a pleasant surprise.



**PLESSEY
SEMICONDUCTORS**

1641 Kaiser Avenue, Irvine, CA 92714. (714) 540-9979

PLESSEY'S ECL III IN STOCK:

SP1648	Voltage controlled oscillator	
SP1650	Dual A/D comparator	Hi-Z
SP1651	"	Lo-Z
SP1658	Voltage controlled multivibrator	
SP1660	Dual 4-1/P OR/NOR gate	Hi-Z
SP1661	"	Lo-Z
SP1662	Quad 2-1/P NOR gate	Hi-Z
SP1663	"	Lo-Z
SP1664	Quad 2-1/P OR gate	Hi-Z
SP1665	"	Lo-Z
SP1666	Dual clocked R-S Flip-Flop	Hi-Z
SP1667	"	Lo-Z
SP1668	Dual clock latch	Hi-Z
SP1669	"	Lo-Z
SP1670	Master-slave D Flip-Flop	Hi-Z
SP1671	"	Lo-Z
SP1672	Triple 2-1/P exclusive-OR gate	Hi-Z
SP1673	"	Lo-Z
SP1674	Triple 2-1/P exclusive NOR gate	Hi-Z
SP1675	"	Lo-Z
SP1690	UHF prescaler type D Flip-Flop	
SP1692	Quad line receiver	
SP16F60	Dual 4-1/P OR/NOR gate	

After what I've been through, your ECL III sounds incredible:

- Call me with proof—I'm ready to be convinced.
- Don't call me—just send me the following parts and bill me:

_____ Qty _____
_____ Qty _____
_____ Qty _____

Name _____

Telephone _____

Company _____

Address _____

City/State/ZIP _____

Plessey Semiconductors, 1641 Kaiser Avenue, Irvine, CA 92714.
Telephone (714) 540-9979

State-of-the-art brought down to earth

Hold that line.

To regulate your computer's input ac economically, send in a regulator that scores well on output impedance, power handling, noise, response and maintenance.

Computers "play" well only when their input ac voltage stays in bounds. But ac power lines perform erratically at best and may even fumble the ball. Then, team up your system with a line regulator; but you'll have to choose from a wide field.

Certainly, the various types have similarities. Most line regulators produce outputs that vary only up to $\pm 5\%$ from nominal in the face of variations ranging from 10 or 15% under to 10 or 20% over the nominal input. And all line regulators can be filtered to suppress noise and transients. But for computer applications, five features will make or break it for line regulators:

- Response time.
- Cost.
- Maintenance requirements.
- Power-handling capacity.
- Output impedance.

For computer applications, a line regulator's output impedance is particularly important because momentarily high demand (current to the load) causes voltage sags proportional to the regulator's output impedance. And computers plus peripherals often pull heavy current surges—especially with the dc switching regulators and high-starting-current motors increasingly common in computer equipment.

How they line up

Often, to compensate for output impedance, a line regulator's power capacity must be double or even triple the system's average demand. The result? Heavier and bulkier regulators that cost more (see the regulator comparison table).

Motor-driven regulators are inexpensive as a rule and can handle high kVA loads (Fig. 1). But the problem is that they respond slowly to input voltage or load changes. And frequent maintenance and high output impedance pile on to take motor-driven units out of the computer game.

Saturable reactors—step-up autotransformers with feedback-controlled series impedances—have notable pulses: wide load range, low maintenance require-

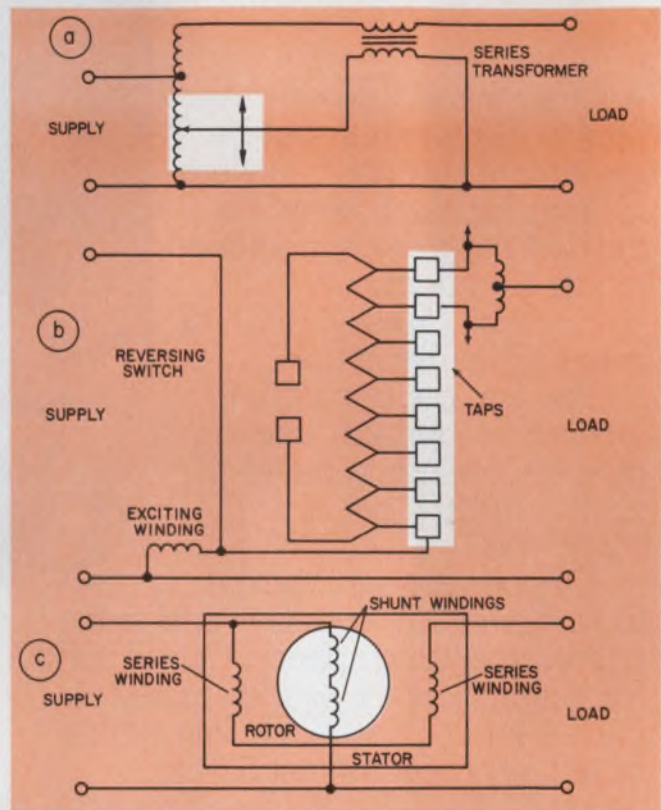

1. **Three motor-driven regulators** are commonly used. Driven brushes (a) move across many taps to buck or boost the series transformer for a $\pm 15\%$ correction range. Motorized rotary-switch fingers (b) provide a $\pm 10\%$ correction range, and a reversing switch changes the connection from buck to boost, as needed. The rotor is turned for a $\pm 15\%$ range in an induction regulator (c).

ments and relatively low cost (Fig. 2). Most computers, however, can't tolerate either of the saturable reactor's main drawbacks—sluggish response (dragged out over five to 10 input cycles) and towering output impedance (often a full 30% of the load impedance). So saturable reactors, though tempting for large computer installations because of low cost, are at best stop-gaps.

Like the saturable reactor, another regulator, the ferroresonant transformer (Fig. 3), requires little maintenance and is inexpensive. Better yet, it isn't as sluggish (its response takes two cycles). Unfortunately, poor capacity for handling momentary overloads (output collapses at 150% of full load) and

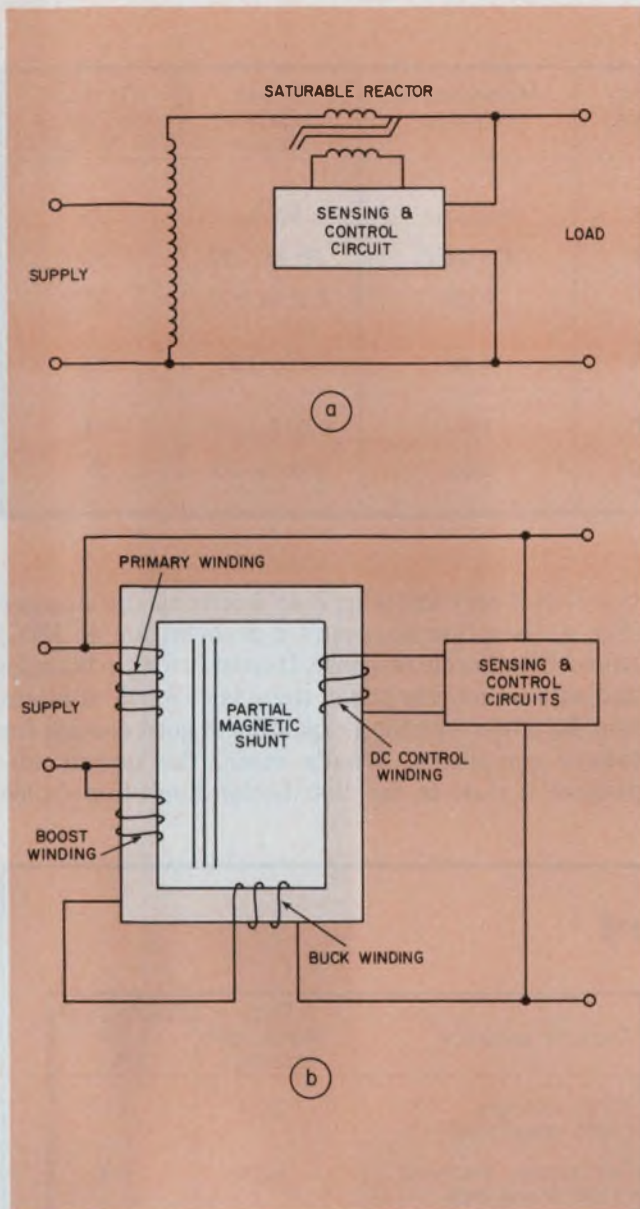

2. **Saturable reactors** (a) correct $\pm 15\%$ via sensing and control circuits that govern the dc into a control winding. Another magnetic regulator (b) has all the windings of the saturable reactor—but on one core. Primary, boosting and bucking windings act as a step-up autotransformer. Core saturation holds the output steady.

high output impedance (30% of load) veto ferroresonants for most computer systems.

Indeed, with computers using SCR or transistor-switching dc power supplies or, for that matter, any high-inrush or high periodic-demand load, ferroresonant regulators must be oversized. Motors, such as those used in computer equipment, often draw four to five times normal operating current at turn-on.

In addition, disc or tape drives in a computer facility often must be isolated from the ferroresonant transformer that feeds the central processor. And there goes your economy.

Switchers of course are the nemesis of ferroresonant regulators—they draw notoriously high-current

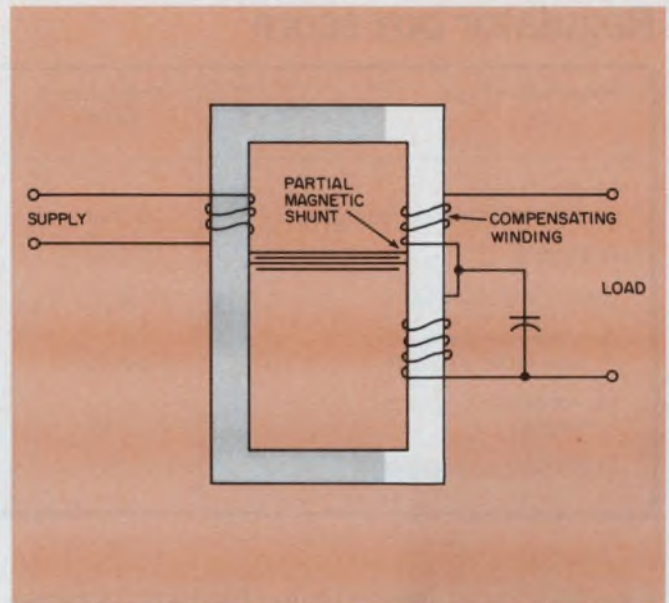

3. **The primary of a simple ferromagnetic regulator** operates like a normal transformer's but the secondary is kept saturated over a $\pm 15\%$ range by a tank circuit. This resonance means frequency dependent operation.

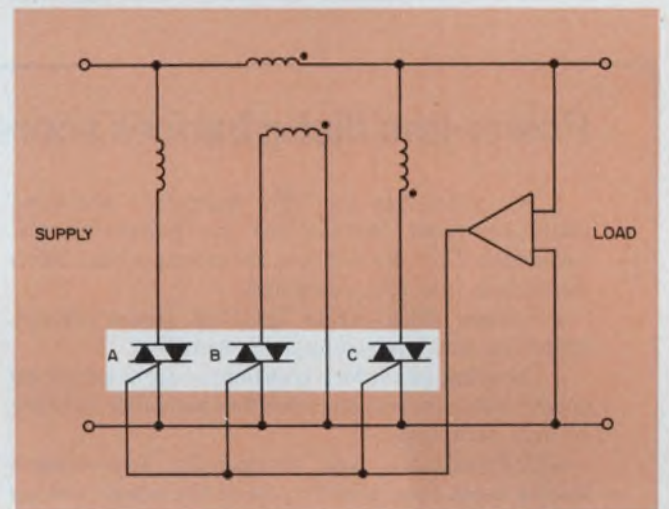

4. **Electronic tap changers** resemble autotransformers with step-up and step-down capability. Here the correction range depends on the number of switches. Switch A closes for step-up, B for no change, and C for step-down.

pulses for short durations. Peak currents in them are so towering that current readings from typical clip-on peak-reading ammeters often fall short of reality by as much as three to seven times.

Size is no defense in the noise game

One drawback that motor-driven regulators, saturable reactors and ferroresonant transformers have in common is that they have trouble keeping line noise from computer loads. And this holds across the computer-size spectrum—from the largest data-processing facility down to microcomputer-based systems. Most motor-driven regulators and saturable reactors

Regulator box score

Regulator type	Response time	Cost (¢/VA)	Maintenance required	Power capability (kVA)	Output Impedance (% of load)
Motor-driven mechanical tap changer	1 min	6	Periodic	50 up	10
Induction	5 s	8	Periodic	10 to 100	20
Electromechanical	5 s	16	High	2.5 to 500	30
No moving parts saturable reactor	5 to 10 C	15	Low	1 to 100	30
Ferroresonant transformer	2 C	20	Low	0.015 to 3	30
Electronic tap changer	1/2 C	20	Low	0.5 to 20	2

have little or no inherent noise filtering. Ferroresonant transformers have limited noise filtering.

Filtering, of course, can be added to each of these regulators. Just tack an L-C network onto the regulator's output. Line noise is attenuated—but then the output impedance goes up.

With all the drawbacks described, one regulator

type that is very tempting is an electronic tap changer (Fig. 4). Reaction time isn't a problem for an ETC, not with half-cycle response. Its cost is within bounds, and with no moving parts, there isn't much to maintain. Its power-handling capability is good enough for today's computers. What's more, the output impedance is close to the distribution line's impedance

Power-line disturbances scorecard

A few years ago, two IBM engineers¹ monitored many computer installations for power-line disturbances. They divided line disturbances that affect computers into four categories:

- Voltage spikes—from lightning, power network switching and user-equipment operation;
- Decaying oscillatory transients—from switching power-factor-correction capacitors and other network or load switching;
- Undervoltages, and occasionally, overvoltages lasting more than a half cycle of the power voltage—from faults and the action of fault-clearing devices;
- Outages—total voltage loss for longer than one half cycle.

While individual voltage spikes are typically brief (10 to 100 μ s), bursts of such pulses sometimes last for several milliseconds. The nominal ac-voltage peak changes by 150%. Also nanoseconds spikes occurred.

Oscillatory transients span the frequency range from 400 Hz to over 5 kHz. Their initial amplitudes are often 100% of nominal peak voltage. Usually they decay to zero within one ac-input cycle.

Undervoltages and overvoltages are sometimes caused by large changes of load and the resulting utility responses to these load variations.

Data from 109 months of monitoring are summarized in the "scorecard" table. Variations within the thresholds used in the "scorecard" were not recorded. (These minor disturbances are assumed not to affect the performance of the computers.)

Type of variation	Rate (times per month)	Fraction of total (%)
Undervoltages (10% threshold)	14.4	11
Oscillatory, decaying (15% threshold)	62.6	49
Voltage spikes (25% threshold)	50.7	39.5
Voltage outage	0.6	0.5
Total	128.3	100

Voltages outside the limits are considered capable of causing problems in computers. These problems take the form of errors, memory loss, program loss, and even complete shut-down.

Too often these problems are lumped with "computer" or "data-entry" faults. Except for voltage outages, the other power-line aberrations are hard to detect without unusual equipment.

So, usually, the programmer, keypuncher and service representative share the blame. And even after costly "fixes," these random flaws continue.

Reference

1. Allen, G.W., and Segall, D., "Monitoring of Computer Installations for Power Line Disturbances," *Proc. PES Winter Meeting*, Jan. 27, 1974, Paper C-74-199-6, IEEE.

—in other words, very low.

The ETC uses an autotransformer with a number of input or output taps, which are switched appropriately, at zero-voltage crossover to eliminate noise. So the output voltage is automatically boosted-up or bucked-down as needed. Though the input varies, the output voltage can be kept within a narrow error band. The number of taps determines the width of the long-term output-voltage band.

An ETC's half-cycle response to input-line or load changes mates well with most computers. Usually, computers continue to operate during a complete cycle of power-line loss. So a regulator that responds within a half-cycle normally meets a computer's requirements. Obviously, regulators with above-one-cycle responses are inadequate.

But, in spite of the several good points that suit them to computers, ETCs are still only transformers. So filters must be added to suppress power-line noise. Then the ETC's low output impedance becomes a less-advantageous high output impedance.

An ultra-isolation transformer, however, can protect computers from random power-line voltage deviations. It provides common-mode-noise attenuation of 125 dB and transverse-mode attenuation of 70 dB, virtually eliminating all power-line transients. And because of its low output impedance, an ultra-isolation transformer provides noise attenuation without the penalty of high insertion losses.

But this super-transformer does have one drawback—it can't regulate against long-term conditions.

The answer is teamwork

So to regulate today's utility lines for today's computers, team up an ultra-isolation transformer with an ETC. The result? High-quality regulation and filtering, low impedance, high efficiency, fast response and low maintenance.

This tandem regulator responds in less than one cycle and costs approximately 20¢ per VA. Maintenance requirements are very low and the power capability easily covers the required range for most computer installations. The output impedance is under 5% of the load impedance and the minimum efficiency is 94%. Compare this with the 15 to 20% efficiencies of line regulators that aren't motor-driven.

As good as the tandem device is, it isn't the ultimate. Complete voltage outages (0.5% of all disturbances) still slip the net. None of the regulating devices described continues to operate after input power fails.

While tandem-type line conditioners guard against virtually all the disturbances that affect computer operation, only an uninterruptible power source provides complete protection. But a UPS costs from five to ten times as much as an ordinary line conditioner.

Certainly this often may be too severe a price to pay for moving from 99.5 to 100% protection. However, there are installations where *any* lost computer time is so serious that the UPS makes sense. ■■

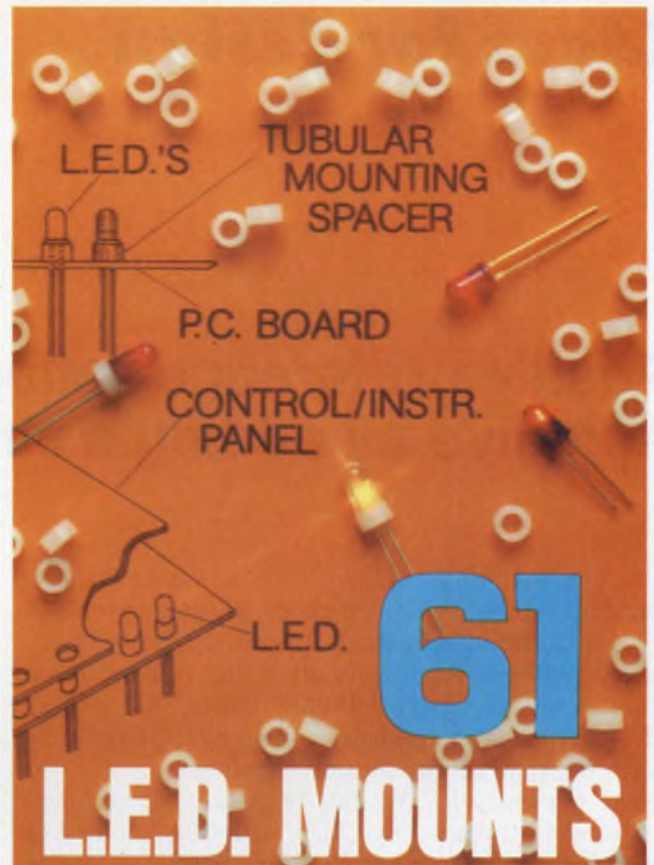

THE ULTRA LOW-COST ANSWER TO IMPROVED ALIGNMENT ON P.C.B.'s

ELEVATE AND PROTECT L.E.D.'s TO HEIGHTS OF .080" TO .380" IN .005" INCREMENTS

61 standard sizes of helpful Nylon Spacers answer a wide variety of L.E.D. applications, providing product uniformity, production ease and substantial savings by the elimination of scrap and rejections.

Made of U.L. rated 94 V-2 material, these inexpensive BIVAR production aids uniformly space L.E.D.'s, maintaining parallel bases to mounting surfaces and prevention of parallax.

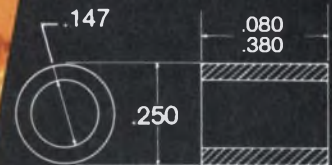
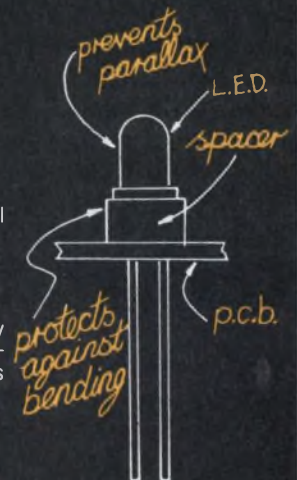

NEW COMPONENT MOUNTS both wash away and permanent styles are detailed with prices in this FREE catalog.

PACKAGING PROGRESS
BY **Bivar**

BIVAR, INC.,
1617 E. Edinger Ave.,
Santa Ana, CA 92705.
(714) 547-5832

CIRCLE NUMBER 40

Positive reference-voltage IC is flipped negative by adding a single component

A so-called "mirror-image" effect lets you use three-terminal reference ICs, which are all positive-output devices, to build negative voltage references. In the basic negative-reference circuit of Fig. 1, the addition of op amp A_2 (PMI's OP-02E) allows A_1 's (PMI's REF-02E) positive reference voltage to flip over to its exact negative at the output terminals.

The reference IC, A_1 , has its positive output connected in the negative-feedback path of A_2 . Since A_2 's noninverting (+) input is grounded, pin 6 of A_1 is also grounded. This forces A_1 's negative-output terminal (pin 4) to drop below ground to the negative magnitude of its voltage (5 V for the REF-02E or 10 V for a REF-01 and Analog Devices AD580). About 5 mA of output current is delivered from A_2 . Output voltage is optionally adjusted by R_1 , which trims the voltage by $\pm 6\%$, typically. Input-line-regulation error, 80 dB or better, results from combining the rejection coefficients of both A_1 and A_2 .

Temperature stability can be a problem since each active device contributes to the drift. A_1 's tempco is 8.5 ppm/ $^{\circ}\text{C}$ max, while A_2 's maximum drift of $8 \mu\text{V}/^{\circ}\text{C}$

is equivalent to 1.6 ppm/ $^{\circ}\text{C}$. Total drift of the circuit, therefore, is about 10 ppm/ $^{\circ}\text{C}$.

You can adapt the basic circuit to scale output voltages (Fig. 2), which are a multiple of the reference voltage. In this circuit, the R_1 , R_2 voltage divider multiplies A_1 's reference voltage by $(R_1 + R_2)/R_2$, and A_1 and A_2 operate essentially as in Fig. 1. Note that this circuit operates from a single negative supply, which gives it inherently better supply rejection than the basic circuit.

To make sure the circuit starts when power is applied, the R_5 , R_6 , D_1 network must be included. At start-up, but before A_1 comes up to its correct voltage level, the voltage across R_1 drives A_2 's output negative (-5 V). Once A_1 's output reaches its correct level, D_1 is zero-biased and contributes no error. Temperature stability may be slightly degraded by R_1 and R_2 , so resistors with low tracking tempcos should be used for best results.

Walter G. Jung, Consultant, Forest Hill, MD 21050.

CIRCLE NO. 311

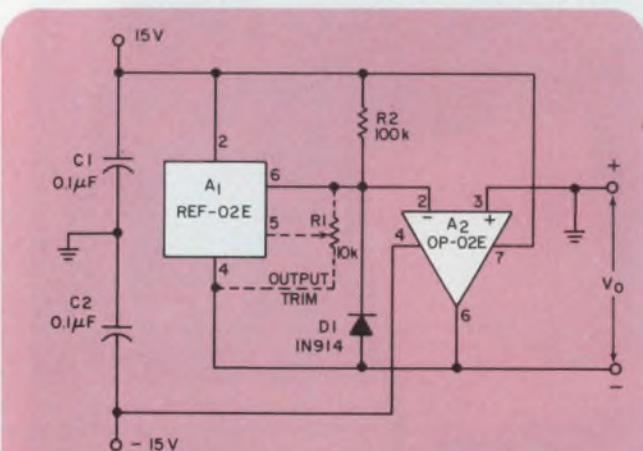

1. A negative-reference supply, built with a positive reference IC (A_1), uses op amp A_2 to invert A_1 's positive output voltage to an exact mirror-image negative at A_2 's output terminals.

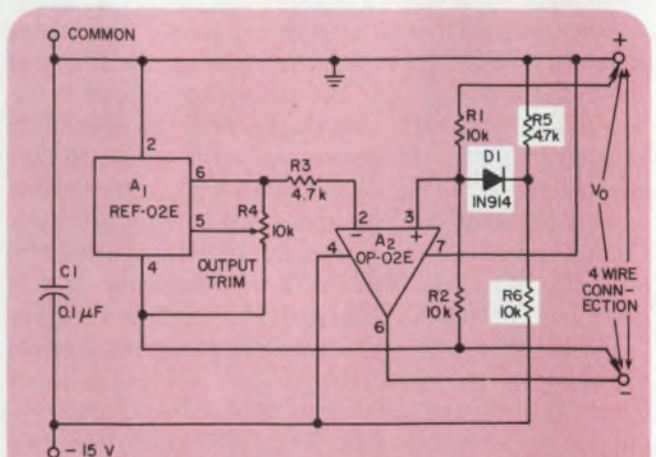

2. To get a multiple of the reference source voltage, add R_1 and R_2 to the basic circuit of Fig. 1. The R_5 , R_6 , D_1 network assures start-up when power is applied without degrading performance.

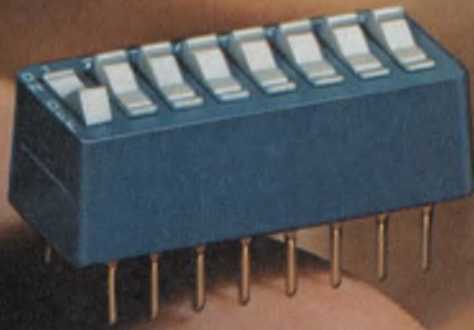

How an 80¢ AMP switch cut manufacturing time and costs. And created a new technology.

Many companies don't call AMP until they need electrical connectors or switches. But why wait till then? If you involve us early enough, we can help you save money. A lot of money.

Here's an example:

Programming printed circuit boards used to involve installing an intricate network of jumper wires and plugs.

Until a customer asked us to find a better way.

We invented the DIP switch, which made programming p-c boards as easy as pushing number-coded actuators.

As a result, our customer was

able to produce standardized boards that they could easily and quickly customize according to orders.

They saved hundreds of thousands of dollars in manufacturing and inventory costs. And a whole new technology was born.

Can we produce the same kind of savings for you?

If your company manufactures electrical/electronic products, the

answer is probably yes. But it's important for you to call us in early.

That's when our experience in developing connectors, switches and application equipment for hundreds of industries worldwide can help you the most.

Early Involvement.

At AMP, we call this approach to solving our customers' problems "Early Involvement." It's our better way. And it's what makes an 80¢ DIP switch worth so much more than 80¢.

For a copy of our new DIP switch catalog, call Customer Service at (717) 564-0100.

Or write to AMP Incorporated, Harrisburg, PA 17105.

AMP
INCORPORATED
AMP has a better way.

Barcelona • Brussels • Buenos Aires • Frankfurt • Harrisburg • Helsinki • 's-Hertogenbosch • London • Luzern • Mexico City • Montreal
Paris • Puerto Rico • Sao Paulo • Stockholm • Sydney • Turin • Toronto • Tokyo

CIRCLE NUMBER 41

If you're looking for efficiency...

You're probably looking at automatic component insertion. And AVX packages more kinds of capacitors for automatic insertion than any other capacitor manufacturer.

You can get commercial molded axials or military CK and CKR ratings, taped and reeled to your exact specification, ready to run on your automated lines. Our GlasGuard® glass-enclosed axial is also

available in reels, as are SpinGuards®, AVX's low-cost, conformally coated axials. Then there's

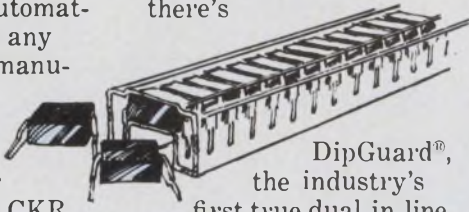

DipGuard®, the industry's first true dual-in-line multilayer ceramic

capacitor. It comes packaged in tubes for the new generation of automatic component insertion systems. One is just right for your application.

AVX's major investments in automatic manufacturing techniques have given us the leadership in bringing down the cost of multilayer ceramic

capacitors. Now, our advances in capacitor packaging give you the opportunity for leadership in bringing down

your cost of circuit board assembly.

Call your AVX representative with your capacitor requirements and details of your capacitor insertion techniques. He'll save you money right across the board.



... look to AVX.

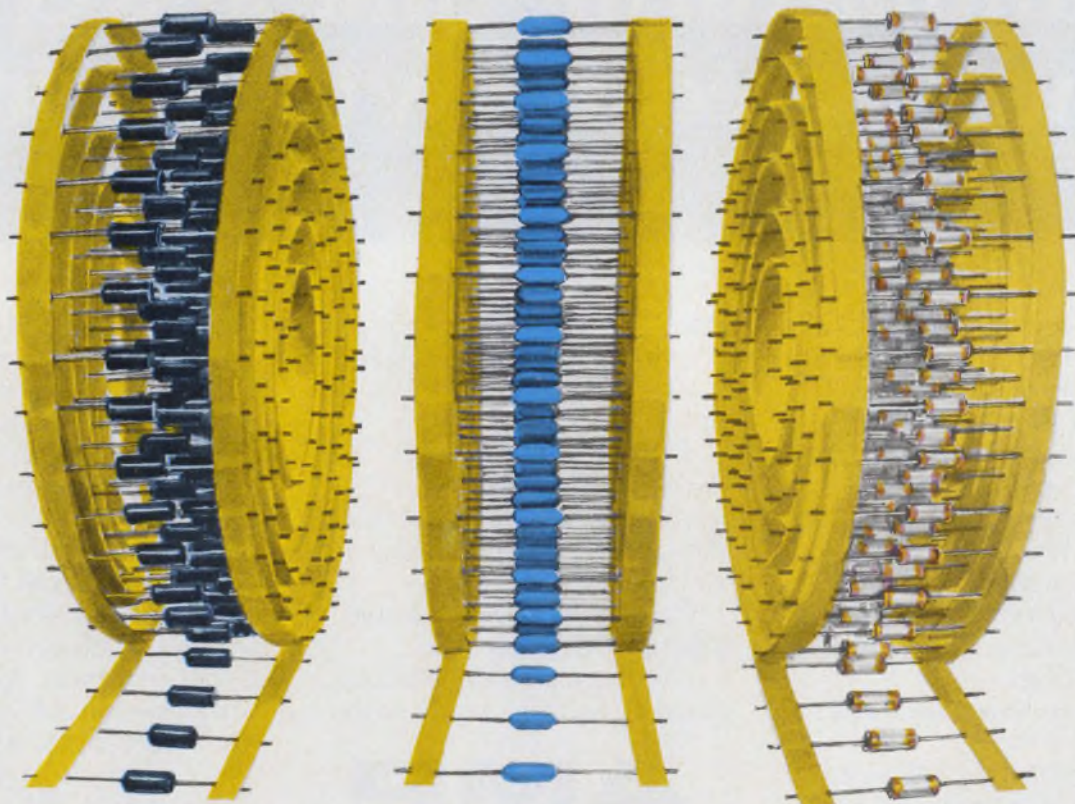

AVX CERAMICS

AVX Ceramics, P.O. Box 867, Myrtle Beach, SC 29577 (803) 448-3191
 TWX: 810-661-2252; Olean, NY 14760 (716) 372-6611 TWX: 510-245-2815
 AVX Limited, Aldershot, Hampshire, GU12 4RG England, Tel: Aldershot (0252) 312131 Telex: 858473

CIRCLE NUMBER 42

Ideas for design

Multitask μ P executive routine uses only six instructions

Here's a simple six-instruction subroutine that lets your 6800 microprocessor control several external processes simultaneously. To use it, organize your software as follows:

1. Set up a process-control block as shown for each process to be controlled.

2. Write a program for each process as if no other programs are running in the same microprocessor.

3. Insert JSR SPND instructions into each program at convenient points to allow other programs to run.

Whenever a process suspends itself by executing a subroutine jump to SPND, the SPND routine swaps the process-control block pointer (PCB) and the stack pointer to set up the next process. Then a simple return instruction causes the program for that process to start running again where it left off. Each process-control block contains at least two parameters: a pointer to the next control block and a stack pointer

A six-instruction executive routine

SPND	LDX PCB	SET INDEX REGISTER TO CURRENT CONTROL BLOCK
	STS 2,X	SAVE CURRENT STACK POINTER
	LDX X	SET INDEX REGISTER TO NEXT CONTROL BLOCK
	STX PCB	SAVE CONTROL BLOCK POINTER
	LDS 2,X	GET NEW STACK POINTER
	RTS	RETURN TO PROCESS

Process-control block

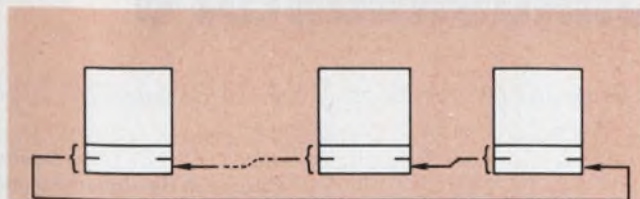
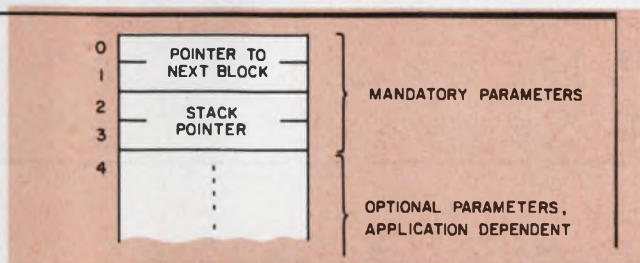

Each block points to the next in a circular list.

“It’s a snap to switch AMP side-actuated types, even in a stack.”

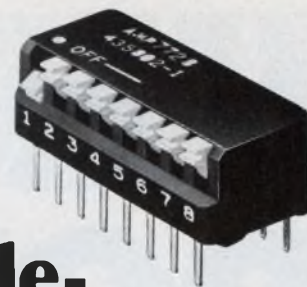

You can program a card without removing it from the cage with these right-angle DIP switches.

They can be actuated easily from the edge of the board. And they can be commoned to provide multi-pole configurations.

They also have the inherent advantages of DIP switches such as: Very low profile for complete compatibility with other packaging components. Fully sealed base for protection and assurance of excellent electrical and mechanical performance. And more—including AMP technical aid. We’re ready to work with you because we believe you’re entitled to it. And the sooner the better. Because that’s when we can help the most.

AMP right-angle DIP switches come in the industry’s widest range of sizes. They are particularly applicable in computer and instrument card cages, avionics systems and communications equipment.

For more information on them, just call Customer Service at (717) 564-0100. Or write AMP Incorporated, Harrisburg, PA 17105.

AMP is a trademark of AMP Incorporated.

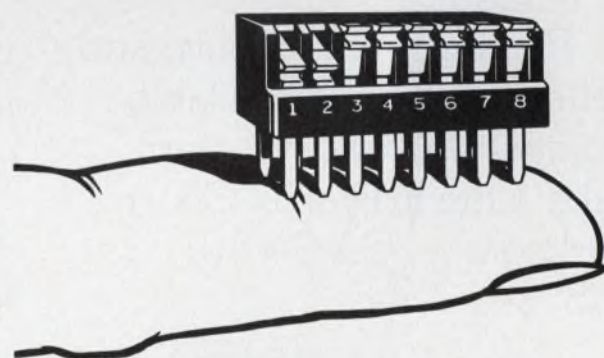

AMP has a better way in DIP switching.

AMP INCORPORATED

VHF/UHF POWER

NEC's new series of silicon power transistors lets you tailor a power chain to suit your power output requirements. Maybe it's a hand-held transceiver or land mobile radio. Whatever the application, you can count on up to 35 watts at the antenna, through 900 MHz.

Gain and reliability are extraordinary — the result of proprietary fabrication techniques.

Pricing is competitive and, better yet, they're available. Contact California Eastern Labs, One Edwards Court, Burlingame, CA 94010. (415) 342-7744.

SERIES	TYPICAL APPLICATION	TYPICAL OPERATION			
		V _{CC} (V)	P _{in} (Watts)	P _{out} (Watts)	Frequency (MHz)
NE0202	2 watt device for a hand-held transceiver or mobile radio	7.2	0.20	2.0	175
		13.5	0.10	2.5	175
NE0203	3 watt driver for mobile radio	13.5	0.063	3.5	175
NE0206	6 watt device for a hand-held transceiver	7.2	0.71	6.3	175
NE0207	7 watt device for a hand-held transceiver	7.2	0.71	7.0	175
NE0210	8 watt device for mobile radio	13.5	0.40	8.3	175
NE0220	20 watt device for mobile radio	13.5	2.6	20	175
NE0235	35 watt device for mobile radio	13.5	8.0	37	175
NE0502	1 watt device for a hand-held transceiver	7.2	0.13	1.4	500
NE0503	3 watt driver for NE0510	12.6	0.32	3.1	500
NE0504	4 watt device for a hand-held transceiver	7.2	0.89	4.0	500
NE0510	9 watt device for mobile radio	12.6	2.6	9.0	500
NE0520	18 watt device for mobile radio	12.6	6.4	18	500
NE0801	1 watt driver for NE0804	13.5	0.10	1.2	860
NE0804	4 watt driver for NE0810	13.5	0.90	5.0	860
NE0810	10 watt device for mobile radio	13.5	4.0	11	860

NEC microwave semiconductors

California Eastern Laboratories, Inc.

Exclusive sales agent for Nippon Electric Co., Ltd. Microwave Semiconductor Products. U.S.A. Canada Europe

U.S. Headquarters and Warehouse — California Eastern Laboratories, Inc., One Edwards Court — P.O. Box 915, Burlingame, CA 94010, (415) 342-7744 • **Eastern Office** — California Eastern Laboratories, Inc., 3 New England Executive Park, Burlington, MA 01803, (617) 272-2300 • **Southwest Office** — California Eastern Laboratories, Inc., 4236 North Brown Ave., Scottsdale, AZ 85251, (602) 945-1381 • **European Headquarters and Warehouse** — California Eastern Laboratories, International, B.V., Havenstraat 8a — Postbus 1258, Zaandam, Nederland, 075-169740 • **Southern California Office** — California Eastern Laboratories, Inc., 2182 Dupont Drive — Suite #9, Irvine, CA 92715, (714) 752-1665

(continued from page 101)

for the current control block. The control blocks are arranged in a circular list so that SPND will automatically return to the first block after executing the last.

A sample program illustrates how process control
(continued on page 105)

Start-up routine

```
* SET INDEX REG-  
* ISTER TO FIRST  
* CONTROL BLOCK,  
* GET CORRESPONDING  
* STACK POINTER,  
* AND BEGIN EXECUTION:  
*  
START LDX PCB  
      LDS 2,X  
      RTS
```

A sample program

```
* APPLICATION DEPENDENT  
* PROCESS CONTROL BLOCK  
* PARAMETERS:  
*  
MODE      EQU 4  
STAT      EQU 5  
BUFIN     EQU 6  
BUFOUT    EQU 8  
*  
* FETCH A BUFFER. IF  
* NO BUFFERS ARE AVAIL-  
* ABLE, SUSPEND AND TRY  
* AGAIN:  
*  
IDLE      JSR BUFGET  
          BNE READY  
          JSR SPND  
          BRA IDLE  
*  
* PREPARE TO RECEIVE:  
*  
READY     LDX PCB  
          CLR STAT,X  
          LDAA #1  
          STAA MODE,X  
          JSR RCV  
*  
* SUSPEND. THEN, IF  
* AN INPUT MESSAGE HAS  
* BEGUN, GO TO INPUT.  
* IF AN OUTPUT MESSAGE  
* IS WAITING, GO TO  
* OUTPUT. OTHERWISE,  
* REPEAT:  
*  
LOOP      JSR SPND  
          LDAA STAT,X  
          BNE INPUT  
          LDX BUFOUT,X  
          BNE OUTPUT  
          BRA LOOP
```

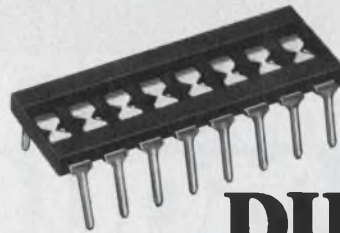

“AMP DIP shunts make manual programming easy at low cost.”

You can program right on the board without special tooling. With the standard version, you just cut the conductive straps or leave them intact to achieve open or closed circuitry. With the more versatile insulation displacement package, you make connections by inserting #27 magnet wire in the displacement slots.

Either way, you achieve reliable programming easily and inexpensively. And if a change is necessary, both can be quickly altered or replaced.

Today AMP DIP shunts are used extensively in instrumentation, computers, industrial controls, almost anywhere simple programming is desired. And wherever you use them AMP technical support will be there, too. It's an integral part of the way we do business, and has been for over 35 years.

For more information on AMP DIP shunts, just call Customer Service at (717) 564-0100. Or write AMP Incorporated, Harrisburg, PA 17105.

AMP is a trademark of AMP Incorporated.

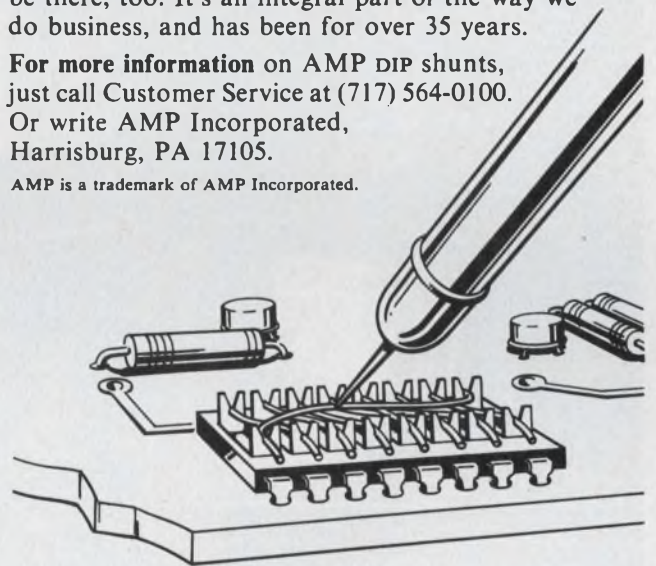

AMP has a better way in DIP switching.

AMP

INCORPORATED

CIRCLE NUMBER 45

THE BEST VALUE IN OSCILLOSCOPES COMES IN MANY MODELS.

When you choose a Gould oscilloscope — regardless of the model — you get reliability, versatile performance and a modest price tag. All of which adds up to true value. Over the years, Gould has earned a well-deserved

reputation for building reliable instruments. Prompt, efficient service is available through a worldwide network of service centers. And all Gould oscilloscopes carry a full two-year warranty covering all parts and labor exclusive of fuses, calibration and minor maintenance. Look to Gould for your best value in oscilloscopes.

For more information contact Gould, Instruments Division, 3631 Perkins Ave.,

Cleveland, OH 44114. In Europe contact Gould Advance Ltd., Roebuck Rd., Hainault, Essex, CB10 1EJ England.

For brochure call toll-free (800) 325-6400, Ext. 77. In Missouri: (800) 342-6600.



Gould OS 245A

- DC to 10 MHz
- Dual trace
- 4 inch CRT
- 5 mV/div sensitivity
- Only 11 pounds



Gould OS 3300 B

- DC to 50 MHz
- Dual trace
- Two independent timebases
- Mixed sweep
- 1 mV/div sensitivity
- Channel Sum and Difference



Gould OS 1100

- DC to 30 MHz
- Dual trace
- 1 mV/div sensitivity
- Delayed timebase
- Channel Sum and Difference

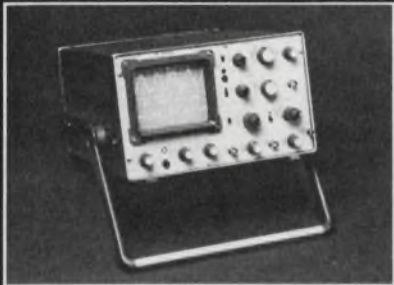

Gould OS 260

- DC to 15 MHz
- True dual beam
- High brightness CRT
- 2 mV/div sensitivity
- Single Sweep
- Switched X—YY



Gould OS 4000

- DC to 10 MHz — dual trace — digital storage (RAM) — no deterioration of stored trace — pre-trigger viewing — output to analog and digital recorders — simultaneous stored and real time viewing.

 **GOULD**

Ideas for design

(continued from page 103)

blocks and SPND instructions work together. Only the idle loop is shown. The complete program supervises an interrupt routine, which handles message flow to and from a teletypewriter. The program sets the teletypewriter port to receive, then waits for the interrupt routine to receive the first character. If an output message arrives first, the port is switched to output, and the message is printed on the teletypewriter. Notice that the program always suspends itself while waiting for something to happen.

All communication between background and interrupt levels occurs via the process-control block. MODE, for example, tells the interrupt routine whether to send or receive. STAT tells the background program that the interrupt routine has started or completed the message. BUFIN and BUFOUT are pointers to tell the interrupt routine where to store an input message or find an output message in microprocessor memory.

In a typical communications application, there might be several I/O ports, each having its own process-control block. Each control block may have a separate background program, or a single program may be shared by all control blocks. The sample program can be shared by multiple control blocks, because

- All data references are either to or through the control block.
- Each control block has its own return address stack.

Be careful with this multitask operation, however. Remember:

1. Processes aren't suspended by a "time-slicing" interrupt, but must suspend themselves often enough to let other programs run.

2. Processes should suspend themselves only at points where it is safe to lose the register contents, since SPND doesn't restore any registers except the stack pointer. (If this is a problem, register-save-and-restore instructions can easily be added to the SPND routine.)

3. Interrupts may remain enabled continuously, but every control block's return-address stack should be large enough to accommodate every interrupt routine's worst-case requirements.

4. All control blocks and stacks as well as the PCB pointer must contain proper initial values before starting the system. A brief start-up routine initiates normal operation.

David W. Johnson, formerly Senior Engineer with Control Data Corp., Santa Ana, CA 92704 now with NCR Corp., 3325 Platt Springs Rd., West Columbia, SC 29169.

CIRCLE NO. 312

"AMP DIP switches help to reduce wiring costs"

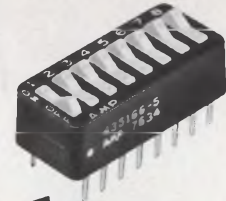

When you mount any AMP DIP switch directly to the pc board you gain many advantages. They eliminate expensive interconnect wiring, reducing the possibility of line failure.

They also speed production. Because they can be flow, wave or dip soldered quickly and easily. No mounting hardware is necessary.

And no matter what kind of DIP switching capability you're looking for, chances are you'll find it in the AMP line. Because it's the broadest available anywhere. Application areas include everything from personal communications and remote terminals to general purpose computers and industrial instrumentation. And you can count on our help in every one . . . solid technical aid that's available as early as you want it, even in the product planning stage.

For more information on AMP standard DIP switches and AMP technical support, just call Customer Service at (717) 564-0100. Or write AMP Incorporated, Harrisburg, PA 17105.

AMP is a trademark of AMP Incorporated

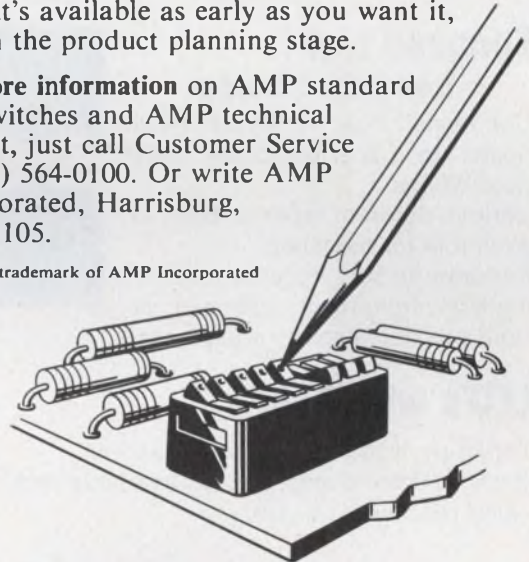

AMP has a better way in DIP switching.

AMP INCORPORATED

CIRCLE NUMBER 47

LAMPS SUB-MINIATURE FROM OSHINO

■ Reliable Incandescent **New!** Tipless Bead-seal Lamp T-1 1/4 & T-1 3/4

- **Easy to handle...** No sharp tips anywhere on the glass bulb help prevent breaking of seal (Photo A).
- **Saves PC board costs...** Can be mounted directly to PCB, the same as Bi-Pin lamps (Photo B).
- **Increased reliability...** Stronger seal, higher vacuum level, tighter filament mounting.
- **Abundant types...** Up to 60V lamps in the same size bulb are available, even for T-1 1/4 size.

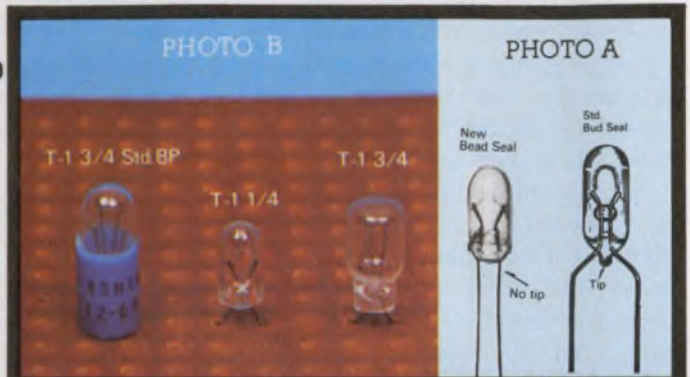

■ New for PC Board —Plastic Bayonet Base

No soldering or socket required. But it's still replaceable without a tool.
Costs even less than a Wedge-Base Lamp + Socket!
Just make a simple opening in the PCB.



■ Focused Light —Lens End Lamp

Condensed light by lens-end bulb opens up a host of optical design possibilities.
Various different types of base are available for mounting.
Recommended applications are medical equipment, computer peripherals and security equipment.

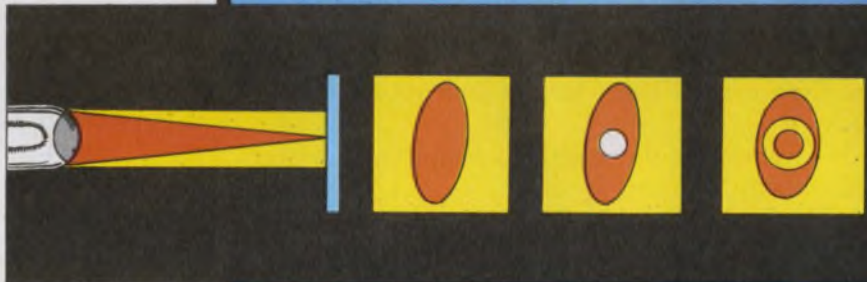

■ LED's with Bases

Direct replaceable with incandescent.
3 colors (Red, Green, Yellow) available with incorporated resistor for 5~28V.

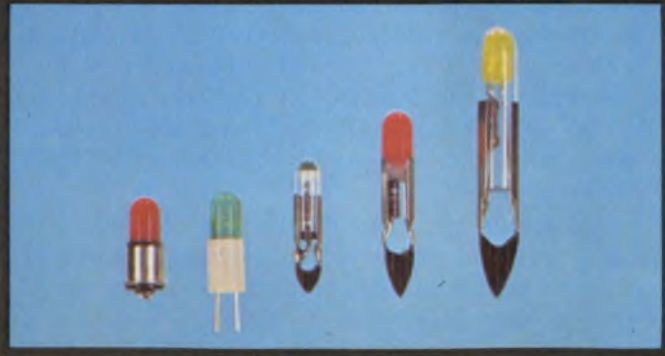

**SUBMINIATURE
LAMP
SPECIALISTS**

● For detailed literature and sample, call or write:
WAMCO TECHNICAL SALES, INC.

705 W. 16th Street, Costa Mesa, California 92627
TEL: (714) 833-9361 TELEX: 678459

OSHINO ELECTRIC LAMP WORKS, LTD.
Shinagawa, Tokyo, Japan.

Ideas for design

Solid-state relay improved with zero-volt switching circuit

With a simple modification, an opto-isolated solid-state relay previously published as an Idea for Design (ED No. 2, Jan. 18, 1977, p. 96) produces precise zero-voltage switching of a triac, while maintaining opto-isolation.

In the modified circuit, a 24-V pk-pk clipped sine wave develops across the zener diodes, D_1 and D_2 , when the zeners are driven from an ac line through current-limiting resistor R_1 . The clipped sine wave, further "squared-up" by inverting amplifier Q_1 , feeds a 741 op-amp differentiator. Capacitor C_4 limits the high-frequency response of the differentiator, and C_3 and R_4 act as a differentiator network.

The output of the 741—a series of positive and negative-voltage spikes—is routed via diodes D_6 through D_9 and opto-isolator phototransistor Q_2 to the triac gate. The voltage spikes, which occur at the square-wave transitions, are in step with the zero-voltage crossings of the ac line. Also, the spikes have the right polarity to trigger the triac efficiently in the $I+$ and $III-$ modes.

Trigger pulses appear at the triac gate only when the LED of the opto-isolator, D_5 , is on, which causes phototransistor Q_2 to conduct. Supply voltages of about ± 12 V for the 741 and inverting amplifier Q_1 are provided by diodes D_3 and D_4 and capacitors C_1 and C_2 .

Devlin M. Gualtieri, Dept. of Chemistry, University of Pittsburgh, Pittsburgh, PA 15260.

CIRCLE NO. 313

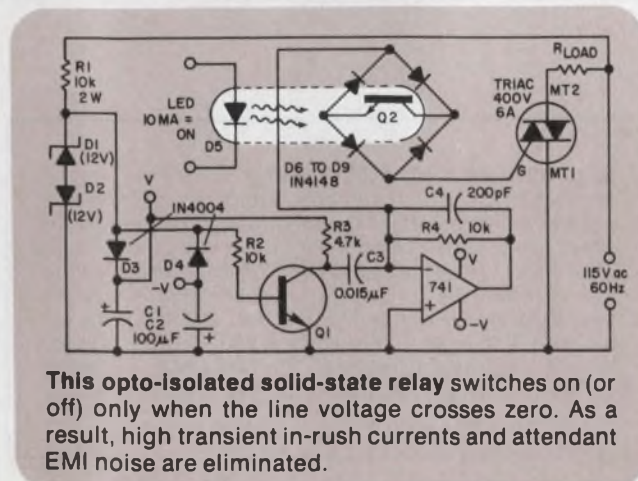

This opto-isolated solid-state relay switches on (or off) only when the line voltage crosses zero. As a result, high transient in-rush currents and attendant EMI noise are eliminated.



“We save on both installation and maintenance with AMP LED switches.”

You can't beat them for printed circuit board fault indication or field service. You get continual and immediate visible indication of switch and circuit operation. As a result, diagnosis is simpler and both servicing and downtime are reduced. Installation is easy, too, because of the compact package design.

You can count on excellent reliability with AMP LED DIP switches. They have a cycle life of at least 7,000 cycles per pole, the ability to withstand temperatures ranging from -73.3°C to 135°C , and the ruggedness to take vibration, shock, and environmental extremes. Standard or momentary actuators are available. They can be used in a broad range of applications including computers, instrumentation, controls,

communications . . . in fact, anywhere operator feedback display is desired.

And don't forget AMP technical service. You get it whenever you need it, from product conception through application.

For more information on the full line, just call Customer Service at (717) 564-0100.

Or write
AMP Incorporated,
Harrisburg, PA 17105.

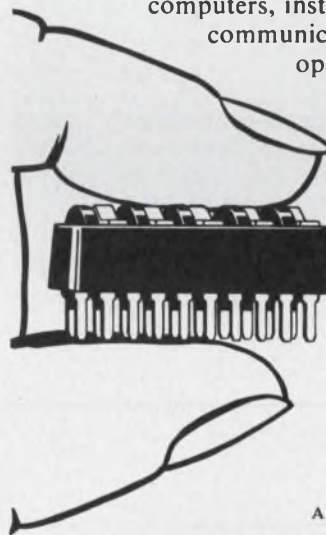

AMP is a trademark of AMP Incorporated

AMP has a better way in DIP switching.

AMP

INCORPORATED

CIRCLE NUMBER 49

Regulate motor-shaft speed better with an active bridge

Improve control of motor-shaft speed by putting your motor winding into a leg of an active bridge. What's more, with a μ A 759 power op amp as the active device, the circuit in the figure will make shaft speed proportional to the input voltage, E_{in} .

If you select the ratio of a motor's winding re-

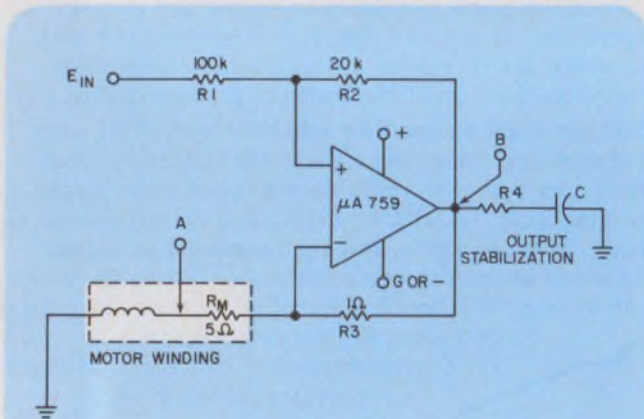

Motor-shaft speed is accurately controlled by making the motor winding a component of an active bridge. To obtain balance, resistors must be selected in the proper ratio to the winding resistance.

sistance to the bridge resistors for bridge balance, winding resistance will be actively cancelled. Then the motor speed becomes directly proportional to the op-amp's low-level input control voltage. In addition, the circuit improves performance under varying motor-load conditions. With winding resistance cancelled, motor shaft speed becomes independent of load.

Winding resistance R_m ($5\ \Omega$) is five times larger than R_3 ($1\ \Omega$) on the inverting side of the op amp. In the upper leg, R_1 and R_2 also have a 5:1 ratio—but at much higher resistance values to minimize loading of E_{in} . Since the ratio of the resistances in both legs of the bridge is the same, and the op amp differential input voltage is low, E_{in} equals the voltage at point A.

An increase in motor load causes a larger current to flow through the winding—this increases the drop across R_m . The output voltage at point B then rises proportionately to balance the voltage at A. If motor load decreases, the opposite voltage relationships occur. A network for frequency stabilization of the output, may be required, such as R_4, C , but it depends on the characteristics of your motor.

James M. Pihl, Design Engineer, Physio-Control Corp., 11811 Willows Rd., Redmond, WA 98052.

CIRCLE NO. 314

IFD Winner for October 11, 1977

C. E. Musser, Jr., Design Engineer, General Electric Co., P.O. Box 5000, Binghamton, NY 13902. His idea, "Circuit Detects and Remembers Bipolar Analog Signals" has been voted the most valuable of Issue Award.

Vote for the Best Idea in this issue by circling the number of your selection on the Reader Service Card at the back of this issue.

SEND US YOUR IDEAS FOR DESIGN. You may win a grand total of \$1050 (cash)! Here's how. Submit your IFD describing a new and important circuit or design technique, the clever use of a new component or test equipment, packaging tips, cost-saving ideas to our Ideas for Design editor. Ideas can only be considered for publication if they are submitted exclusively to ELECTRONIC DESIGN. You will receive \$20 for each published idea, \$30 more if it is voted best of issue by our readers. The best-of-issue winners become eligible for the Idea of the Year award of \$1000.

Imagine what you could do with an RF link so small and yet so versatile.

**Imagine
the size...** Repco's transmitters and receivers measure only 3.32" square, so no matter how tight the packaging requirement, we've got your link!

**Imagine
the low cost...** In almost any telemetry application you may consider Repco beats the cost of hard wire hands down. In fact, Repco's low cost RF links could probably be saving money on a job you're designing right now. Why not find out?

**Imagine
the versatility...**

How could any link so small and so low cost offer so many performance features—Frequencies of 25-50 Mhz, 72-76 Mhz, 132-174 Mhz, 450-470 Mhz • voice, low-speed digital or tone operation • 0.4 to 25 watt Tx output • unique modular circuit design for easy maintenance and design flexibility.

Versatility of applications? We wrote the book on it. And we'll send you a copy free of charge. Write today for Repco's brand new RF links applications book, and we'll also include our latest performance specifications and price list.

 **Repro** Inc.

A subsidiary of Scope, Inc.
P.O. Box 7065
Orlando, FL 32854
(305) 843-8484
TWX 810-850-0120
Telex 56-6536

CIRCLE NUMBER 94



Compare construction and see why our high current $V_{CE(sat)}$ is lowest.



Lowest $V_{CE(sat)}$ means highest efficiency—this is especially important with transistor operation above 30 Amps. As you know, at high currents most transistors also have $V_{CE(sat)}$ in excess of 1.5 Volts. Such high $V_{CE(sat)}$ causes loss of efficiency, excess heating and heat-induced reliability problems. PowerTech transistors have a *maximum* $V_{CE(sat)}$ rating of *less than* 0.75 Volts at anywhere from 50 to 300 Amps. Compare these ratings to others and judge for yourself.

Copper makes the difference.

We use extra-heavy copper metalizing on our bigger, beefier chip:—thereby assuring maximum thermal and electrical conductivity and yielding the lowest $V_{CE(sat)}$. Their smaller chips use thin aluminum-metalizing with fragile, current-limiting wires (*ours* have solid copper posts).

Which would you rather have your circuit depend on? And we don't stop there. To guarantee rapid delivery, we pre-mount our chip on an integral moly-copper heat sink so we can categorize and pre-test the module at high currents to insure maximum reliability prior to mounting in the package of your choice (again 100% tested to the most stringent MIL/AERO specs). They, on the other hand, must first mount their chip on the package, then test to determine if it's shippable.

Delivery and prices.

Our catalogs come complete with prices . . . we don't believe in secrets.

While our initial device cost may be slightly higher, in the long run we believe you'll find that it's less expensive to use transistors that keep on working.

We rely on direct factory-to-customer contact to ensure 100% responsiveness, backed up by the flexibility of chips already built, pre-tested and ready for whatever electrical/packaging requirements you may have.

But see for yourself: call for further information and assistance: Sales Engineering, PowerTech, Inc., 0-02 Fair Lawn Ave., Fair Lawn, N.J. 07410: (201) 791-5050.

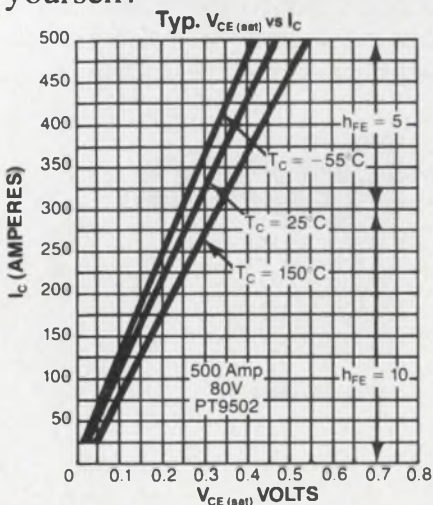

TYPICAL PRODUCTS			
$V_{CE(sat)}$ Max.	V_{CE}	PART NO.	
0.5V @ 300A	80V	PT-9502	
0.35V @ 200A	120V	PT-9503	
0.75V @ 100A	200V	PT-4500	
0.75V @ 70A	120V	2N5927	
0.75V @ 60A	400V	PT-4503	
JAN-TX Types Also Available			
Guaranteed SOA			

PowerTech, Inc.

"BIG IDEAS IN BIG POWER"
CIRCLE NUMBER 85

MORE BIG TALK ON ECLIPSE SYSTEMS.



First, we brought you AOS, the most intelligent multiprogramming operating system to be found on a small computer. Now we bring you the fastest, largest and most efficient version of PL/I ever implemented on a minicomputer. And that's not just talk. It's available now on all multiprogramming Data



General ECLIPSE systems. So now you can take advantage of the sophistication and efficiency of big computer PL/I without having to buy a big computer. PL/I is just one more reason why Data General is the computer company that really talks sense. Call (617) 366-8911, Extension 4735. Or write.

 **Data General**

We make computers that make sense

Data General Corporation, Westboro, MA 01581, (617) 366-8911. Data General (Canada) Ltd., Ontario. Data General Europe, 61 rue de Courcelles, Paris, France, 766.51.78. Data General Australia, (03) 89-0633. Data General Ltda., Sao Paulo, Brazil, 543-0138. © Data General Corporation, 1978.

CIRCLE NUMBER 51

abbott

POWER SUPPLIES

2,685 answers to power supply questions.

Answers to better power and thermal efficiency. Answers to size and weight reductions. Answers to available off-the-shelf covered/open frame power supplies and transformers. And price and delivery answers.

These and many more answers can be found in our three product catalogs. And they're yours. Free. Just circle reader card number. Better yet, write or call Abbott. The Power Supply Specialist.

Power Supply Catalog — Comprehensive 60-pager describes our full line of 1,573 hi-efficiency, hermetically sealed, single and dual output power supplies and switcher modules. Inputs of 60 and 400Hz and DC are available with outputs from 3VDC to 740VDC, 1 to 250 Watts. Prices start as low as \$174 for 2-4 units.

Circle Card Number 90

Industrial Power Supply Catalog — Some 279 of our low cost, high quality OEM power modules are detailed in this 16-pager. Includes covered/open frame, AC to DC single, dual and triple output versions, with outputs from 5 to 36VDC, 0.5 to 320 Watts. Plus DC to AC converters with 50 and 60Hz outputs. Priced as low as \$35 for up to 24 units.

Circle Card Number 91

Transformer Catalog — A 20-pager for the do-it-yourself power supply designer with instructions on how to specify for your custom units. Also covers 833 of our standard military, industrial and miniature pcb power transformers. Included are 60 and 400Hz, single phase input units, with prices starting as low as \$5.10 for up to 9 pieces.

Circle Card Number 92

See Power Supply Section 4000, and Transformer Section 5600, Vol. 2, of your EEM catalog; or Power Supply Section 4500, and Transformer Section 0400, Vol. 2, of your GOLD BOOK for complete information on Abbott products.

abbott transistor

LABORATORIES, INCORPORATED

General Offices
5200 W. Jefferson Blvd., Los Angeles 90016
(213) 936-8185 Telex: 69-1398

Eastern Office
1224 Anderson Ave., Fort Lee, N.J. 07024
(201) 224-6900 Telex: 13-5332

Ferroelectric memory protects its information

A low-cost, nonvolatile analog memory with nondestructive readout is now possible thanks to newer lead titanate-lead zirconate ferroelectric materials. The memory, developed by researchers at Philips' Forschungslaboratorium in Aachen, West Germany, uses these ferroelectric materials to store levels of brightness and contrast in TV sets or hold telephone numbers frequently called in an automatic telephone device, among other things.

Information is stored in these materials by applying a voltage that polarizes the material to an extent determined by the voltage. The maximum value of an input quantity can be stored with 30 V in the memory. The input stored is not, however, directly proportional to the applied voltage because, like magnetic cores, the ferroelectrics have a nonlinear hysteresis curve.

The memory has a ferroelectric ceramic disc with an identical electrode pattern on both faces (see Fig.). The central electrode pair (D) is driven by

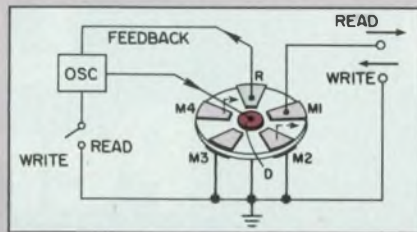

the oscillator to excite a radial vibration in the material, which is also piezoelectric.

The material between both the D and R electrodes is permanently polarized. The R electrode pair generates a feedback signal that drives the disc at its resonant frequency.

The memory cells are formed by the M electrode pairs located around the disc's circumference. To write analog information in, the memory cells are polarized by a voltage in one direction with the oscillator turned off. To retrieve the information, the oscillator is turned on and the information is read out as voltages across the M electrodes developed by the piezoelectric vibrations of the disc.

rotation at start-up, the design permits a motor to be reversed at full speed without harm. This feature will prove attractive for fan drives where shaded-pole motors already are widely used.

In a standard shaded-pole motor, the main pole of the stator carries a shading ring on one leg of its poleface. The shading ring, a single-turn, short-circuited winding, produces a flux lag that generates torque in a preferred direction. In theory, a shaded-pole motor having two shading rings, one on each leg of the main poleface, could be reversed by open-circuiting one ring and short-circuiting the other. But such motors are rare.

In the reversing design developed by Dr. S Williamson of the Dept. of Engineering at the University of Aberdeen, all the main-pole coils are connected in series as a "main winding," which produces reference magnetic fields around the stator periphery. The auxiliary-pole coils are similarly connected to provide a reversible field.

When the main and auxiliary windings are connected initially to a single-phase line, pole-flux phase shifts produce a torque in one direction. Reversing the connections to the auxiliary windings reverses the flux in these windings, with respect to that in the main windings. This produces rotation in the opposite direction.

Two poles instead of one make motor reversible

Conventional shaded-pole motors run in one direction. But by splitting the single pole of a motor into a wound main pole and an auxiliary pole with

its own winding and shading ring, a researcher in Scotland has produced a reversible motor.

Besides being able to reverse the

Tomograph makes fast scans

A "third-generation" computer tomograph, the first developed in Germany, is said to be capable of performing a complete scan of the body in as little as 2.5 seconds.

Developed by Siemens in West Germany, the X-ray diagnostic instrument—called Somatom—is capable of taking transverse tomograms of the entire body from the skull to the extremities. Up to 14 scans can be taken in less than 5 minutes. Each scan covers an 8-mm or a 4-mm thick slice, and a tomogram is available on the monitor at once.

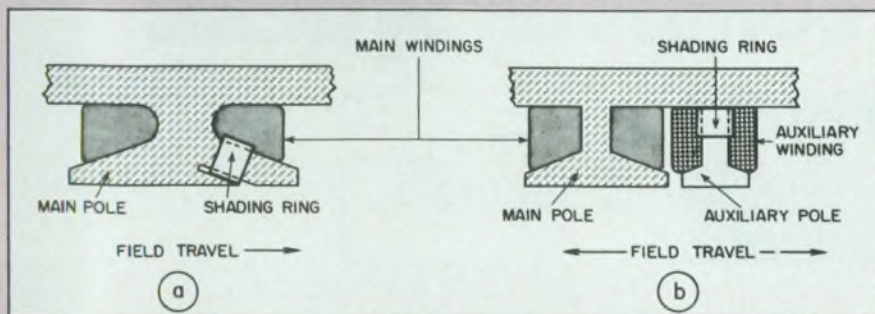

NOW DELIVERING

A Half Million Word Computer



THE ROLM 1666. Memory expansion to 576K words. Transparent mapping into 64K blocks for six users. Four-way memory protection. Privileged instructions with I/O allocation & protection.

A Whole Line of Peripherals & Software



THE PACKAGE. Complete selection of peripherals. Both military & commercial specs. Fully integrated & documented. Supported by a wide range of systems software including RMX/RDOS.

That's Why We're #1 in Mil-Spec Computer Systems

ROLM

MIL-SPEC
Computers

4900 Old Ironsides Drive, Santa Clara, CA 95050. (408) 988-2900. TWX 910-338-7350.

In Europe: 645 Hanau, Muehlstrasse 19, Germany, 06181 15011, TWX 418-4170.

CIRCLE NUMBER 53

Type A 1/4" trimmers. A reliable cure for cramped PCB's.

Our Type A 1/4" cermet trimmer gives you low profile, lowest TCR for a tiny package of high performance... and an ideal solution for cramped printed circuit boards. 10 ohms to 2.5 megs. 0.5 watt at 85°C. -55°C to +150°C temperature range. You get great variety plus greater savings, too. \$0.96 each—1000 piece lot. We have what you need; our distributors have it when your need is now. Ask for Publication 5238.

Multi-finger contact
for low CRV and fine adjustability.

Immersion sealed
for safe board washing.

Exclusive cermet resistance material
on alumina substrate results in TCR of 35 PPM/°C typically.

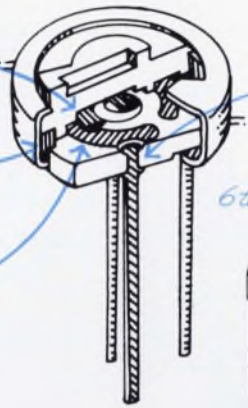

Surged terminals
securely anchored with redundant connections.

6 terminal options

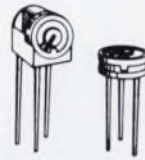

Actual size

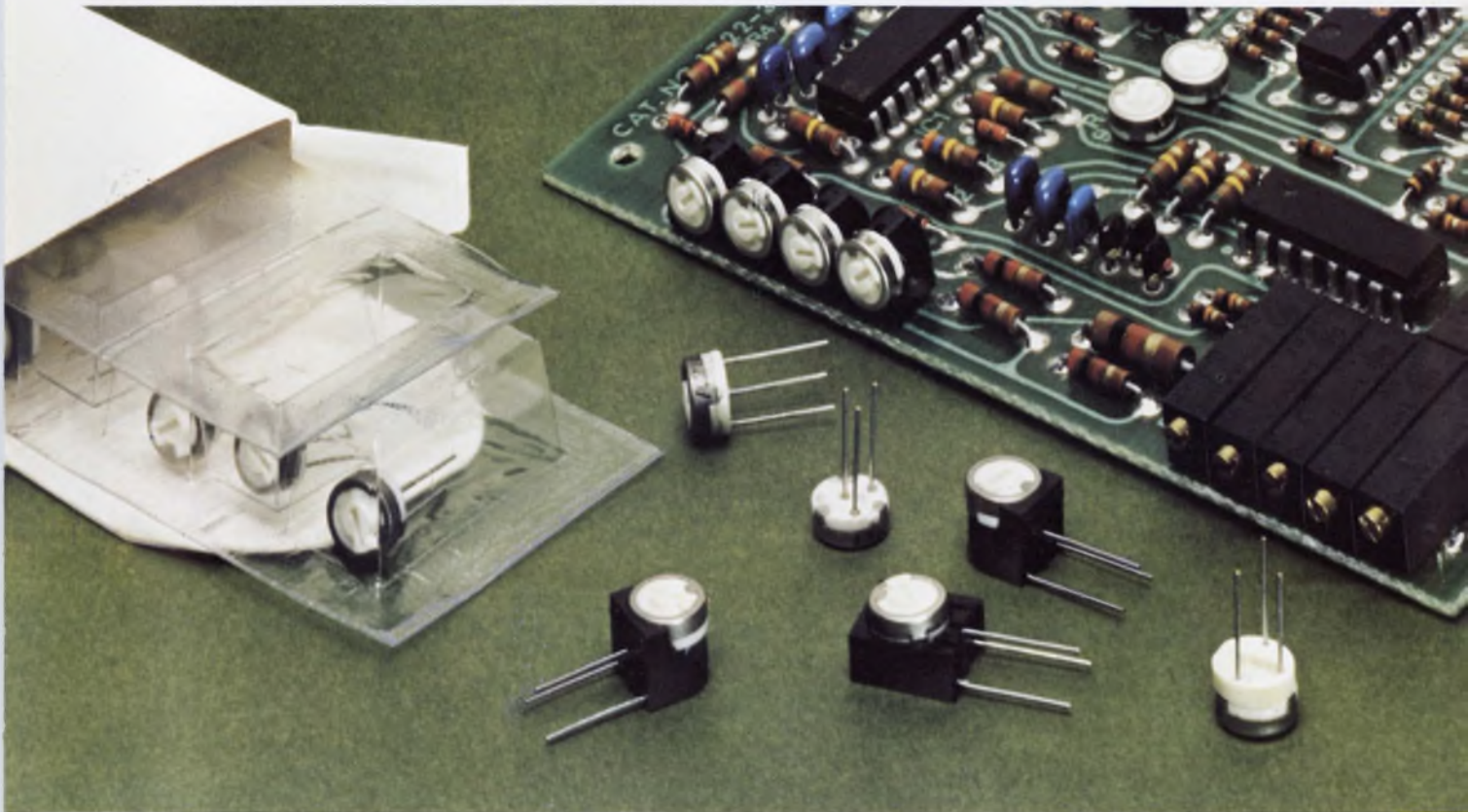

Quality in the best tradition.



ALLEN-BRADLEY
Milwaukee, Wisconsin 53204

CONTACT YOUR
ALLEN-BRADLEY DISTRIBUTOR OR
WRITE TO ELECTRONICS DIVISION

EC159

Four very small ways to improve on your PC design.

With four types of switches—rockers, pushbuttons, toggles and DIPs—Cutler-Hammer offers one of the industry's broadest and most unique selections of PC subminiatures.

Each of the hundreds of available styles provides the reliability you've come to expect from Cutler-Hammer. With ratings to 6 amps, each conforms to standard circuit board mounting requirements.

PC switches, along with accessories and decorative hardware, are distributor stocked for local availability. And since most are manufactured in the United States, we offer fast reaction time on solder lug and wire wrap terminal variations, as well.

To improve your next design in any number of small ways, contact your Cutler-Hammer Sales Office or Switch Distributor.

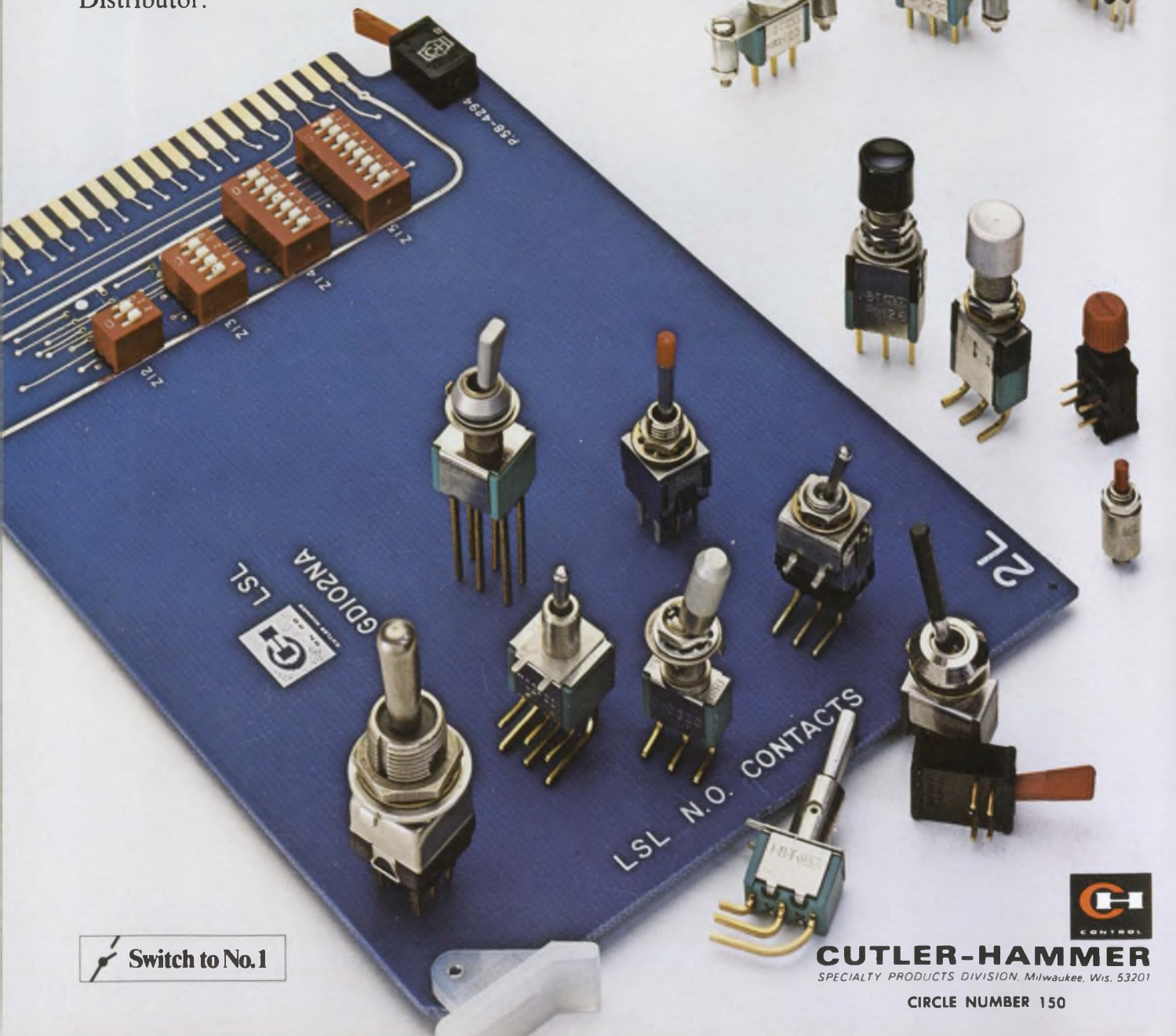

Switch to No.1

CUTLER-HAMMER
SPECIALTY PRODUCTS DIVISION, Milwaukee, Wis. 53201

CIRCLE NUMBER 150

Ceramic Chip Capacitors

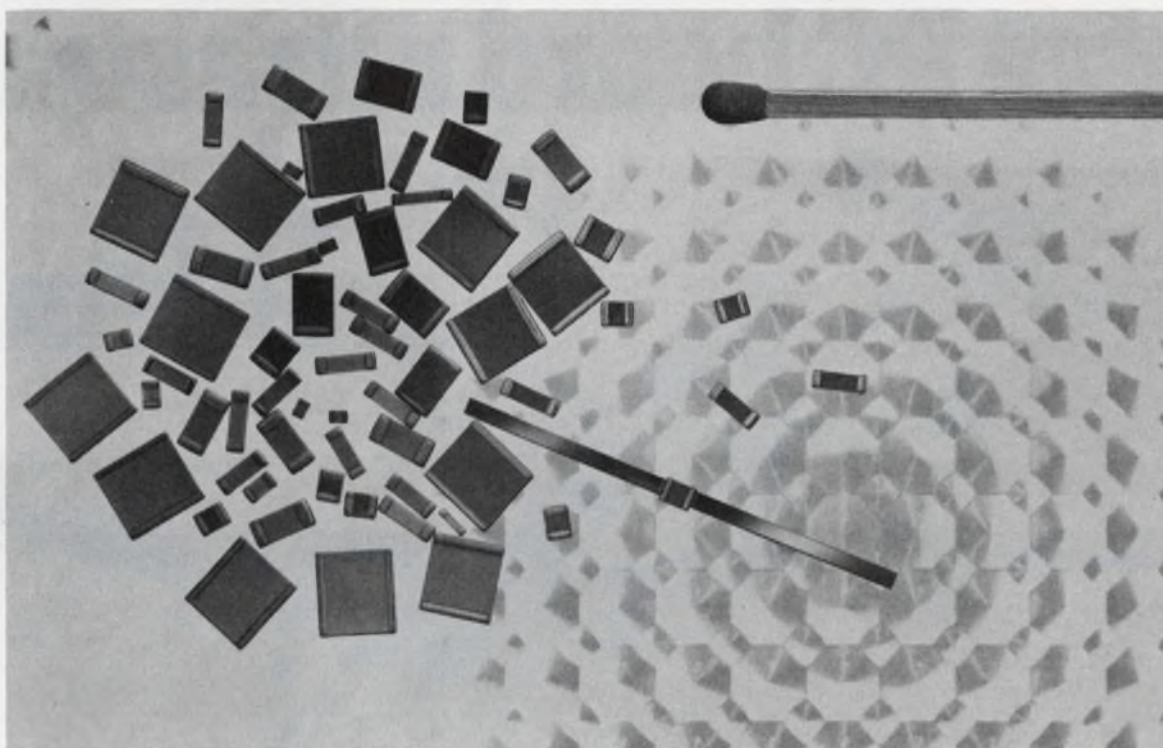

Four dielectrics. Part Markings.

Silver Leads. 11 Sizes. Values to 1.0 μ F.

Our ceramic chip capacitors are known as "The Best" the world over.

Why? Partly because we've earned a reputation as *the* high-quality capacitor manufacturer over the past 30 years.

Partly because we now supply 20% of the chip capacitors for world-wide markets.

But mostly because our entire business is based on providing "The Best" capacitors available.

Our customers are exacting — that's why they put our chips in heart pacemakers, medical monitoring equipment, safety devices and telecommunications products.

If your circuits must operate as reliably as these, you'll want "The Best" in them. Write to us and we'll send you a "VEE JEM" Ceramic Chip folder — the book on "The Best."



Vitramon[®]

Vitramon Limited (London)
Vitramon GmbH (Stuttgart)
Vitramon France S.A.R.L. (Paris)

Vitramon North America
Division of Vitramon, Incorporated
Box 544, Bridgeport, Conn. 06601
Tel: (203) 268-6261

Vitramon Pty. Limited (Sydney)
Vitramon Japan Limited (Tokyo)
QCI Corporation (Farmingdale, N.J.)

Arrow-M Amber Relays

solve PC board ultrasonic cleaning problems.



Arrow-M's leak-free Amber Relays are N₂ gas-filled and sealed in plastic so they're simple to clean with most degreasers and detergent cleaners, without affecting the maximum contact reliability of the relays.

And, Arrow-M can help you substantially reduce your labor costs! Just use Arrow-M Amber Relays on your PC board in conjunction with automatic wave soldering, instead of costly hand soldering.

The total savings are even greater when you use Arrow-M Amber Relays. Arrow-M Amber

Relay prices are right in line with standard non-seal types.

Arrow-M Amber Relays. When you want maximum reliability and maximum savings. And only Arrow-M makes them.

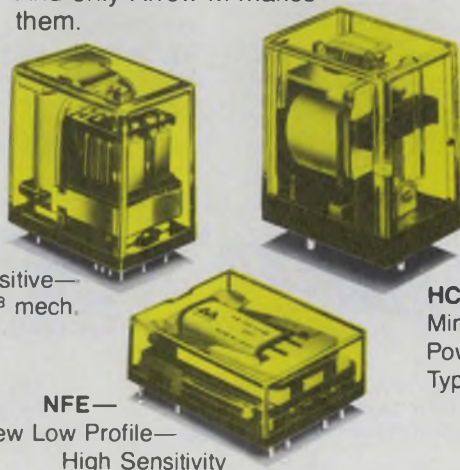

KE—Sensitive—
Long Life—10⁸ mech.

NFE—
New Low Profile—
High Sensitivity

HCE—
Miniature
Power
Type.

**Relays
for advanced
technology.**

For more information on exact specifications, write or call your nearest Arrow-M office.

Arrow-M Corporation
250 Sheffield Street
Mountainside, N.J. 07092
(201) 232-4260

Western Office:
22010 South Wilmington Ave.
Suites 300 & 301
Carson, California 90745
(213) 775-3512



Arrow-M
Member of Matsushita Group

New products

All-in-one development station makes programming easier, faster and less expensive

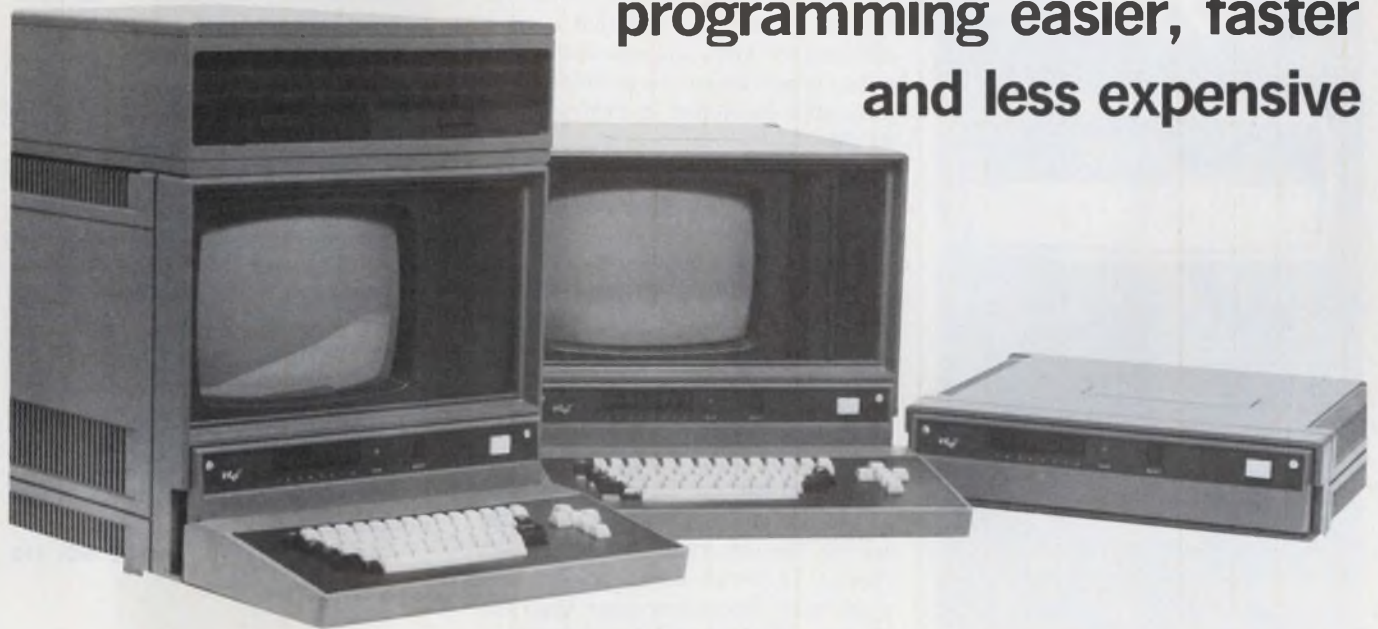

Intel, 3065 Bowers Ave., Santa Clara, CA 95051. Paul Rosenfeld (408) 246-8080. P&A: See text.

Able to program more than half a dozen processors in assembly language, PL/M or Fortran, while minimizing the development time for both hardware and software...it's "super-system." Well, not quite, although the total of features available in Intel's Intellec Series II make a potent package for programming 8080, 8085 and 8048 families.

Actually, there are three development systems: the low-cost 210, the midrange 220, and the top-of-the-line 230.

Compared to the earlier Intellec MDS-800 systems, the three new units cost about 30% less, are 15 to 25% faster, and take up about 50% less volume. Respective prices for the base models are \$3250, \$7425 and \$12,900.

All three contain built-in interfaces for a TTY, a CRT terminal, a printer, a high-speed tape reader/punch and universal PROM programmer.

The Model 210, the smallest of the three, comes in a four-slot chassis that is 19.13 × 17.37 × 4.81 in. It contains a single circuit board with CPU, 32

kbytes of RAM and all control software in 4 kbytes of ROM. All members of both the MCS-80/85 and MCS-48 processor families can be handled (8080, 8085, 8021, 8041, 8048 etc.).

When the 210 works with a user-supplied terminal, programs can be written, debugged, assembled, compiled and executed, all with the system's ROM resident-editor/assembler. And to minimize the chance of faulty components in the system, there is even a built-in self-test capability.

Other features include eight levels of nested, maskable, priority interrupt, software compatibility with previous Intellec systems, a Multibus interface, multiprocessor and DMA capability, and simple upgradability to other Series II systems.

With the 220, you get much more in a much bigger package—measuring 19.13 × 17.37 × 15.81 in. (excluding the keyboard, which measures 9 × 17.37 × 3 in.). The 220 has an integral 2000-character CRT with detachable keyboard, an integral 256-kbyte floppy disc drive expandable to 2 Mbytes, and the ISIS-II diskette operating system with relocating macroassembler linker and locator. Of course, all the features

of the 210 are in the 220.

The ISIS-II operating system performs all file handling operations, leaving you free to concentrate on your own application. Also available are in-circuit emulator (ICE) modules that permit actual real-time program development.

At the top, the 230 not only has all the features of the 220 but also comes with 64 kbytes of RAM, 1 Mbyte of disc-storage space, and complete high-level language support capability to permit program development in either assembly language, PL/M or ANSI-1977 Fortran—or any combination of them.

Unlike the 210 and 220, the 230 is a two-package system. One cabinet, 19.13 × 17.37 × 15.81-in., contains the CRT, CPU and card cage, a 9 × 17.37 × 3-in. keyboard case, and enough room for five more boards. The other cabinet, 19.13 × 17.6 × 5.5 in., contains two floppy-disc drives capable of double-density operation.

The I/O subsystem in the 230 consists of two parts, one of which contains two serial channels that can operate from 110 to 9600 baud asynchronously or from 150 baud to 56 kbaud

(continued on page 118)

NOW WITH BUS CONTROL: S-D's NEW 4½-DIGIT DVM



Check the outstanding features of Systron-Donner's new 4½-digit Model 7244A multimeter:

- IEEE-488 Interface
- Front Panel Address indicators
- Front Panel Function indicators
- True RMS
- 20,000 count display
- D.C. Accuracy $\pm 0.02\%$
- Autoranging
- Optional rear inputs
- Price \$945

Model 7244A is but one of a complete new family of S-D's 4½-digit DVM's. Be sure to ask us about our classy new portables and new "thin-line" systems models.

Contact your local Scientific Devices office or Systron-Donner at 10 Systron Drive, Concord, CA 94518. Phone (415) 676-5000.



SYSTRON DONNER

CIRCLE NUMBER 56

MICRO/MINI COMPUTING

(continued from page 117)

synchronously. The other part consists of the interface for the integral CRT, keyboard and standard peripherals such as printers, tape-reader/punch and PROM programmer.

The high-level software available in the Model 230 permits you to link together routines that have been developed in the language that is most efficient for you—thus, assembly-language programs can be combined with programs developed in Fortran or in PL/M.

All three systems are designed for 0 to 35-C operating environments and require 115/230 V ac, 50 to 60 Hz.

The Series II systems are restricted to the Intel family of processors, which, even though are widely alternate-sourced cannot satisfy every application. However, some "universal" development systems, such as the 8002 offered by Tektronix (Beaverton, OR) can do many of the things the high-end Model 230 can do. But you'll have to pay well over \$15,000 for what the 230 can do for less than \$13,000. Nevertheless, if you're doing development work with processors other than the MCS-48, MCS-80 or MCS-85 families, a universal system may be required.

The Intel systems are much more compact than many of the available development systems. As a matter of fact, they can just about be loaded onto a cart and wheeled about from workbench to workbench. However, for portability, you should also consider the MUPRO-80 made by Mupro (Sunnyvale, CA). Housed in a 4.6 x 6.6 x 15-in. case, the program-development/in-circuit emulator system offers programming capability in BSAL, a specially developed block-structured assembly language. The Mupro system, though, is limited to only the 8080 and 8085 processors.

Options for the Intel 210, 220 and 230 include ICE modules for 8080s, 8048s and 8085s, and they cost \$1750, \$1950 and \$2700, respectively. In addition, kits for upgrading the 210 and 230 enable them to match the 230, any of the SBC-80 family memories and I/O cards, and such large peripherals as printers, disc drives, PROM programmers and paper-tape readers.

Delivery of the Intel systems is from stock.

Intel
Mupro
Tektronix

CIRCLE NO. 301
CIRCLE NO. 302
CIRCLE NO. 303

Data-acquisition unit slides into Motorola μ C

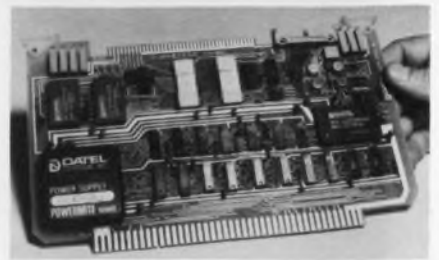

Datel Systems, 1020 Turnpike St., Canton, MA 02021. Lawrence Copeland (617) 828-8000. From \$419; 4 to 8 wks.

The ST-6800 is an a/d-d/a data-acquisition/distribution peripheral on a single PC board. It fits inside of and is bus-compatible with Motorola's M6800 EXORcisor microcomputers. The ST-6800 uses the +5-V power from the computer bus and generates its own ± 15 V for analog circuits. The device accepts 32 single-ended or 16 differential analog inputs and digitizes them to 12-bit binary data words. The data samples are then placed on the 6800 bus in byte pairs. Effective channel throughput rates of up to 30,000 samples/s are possible.

CIRCLE NO. 310

Minifloppy-disc storage installs in SS-50 bus



PerCom Data, 318 Barnes, Garland, TX 75042. (214) 276-1968. 2 to 3 wks.

The LFD-400 is a minifloppy-disc memory system for the SS-50 bus developed by Southwest Technical Products for their 6800 based micro-computer. A one-drive system includes a controller PC board, PROM disc operating system, disc drive and drive power supply, two minidiskettes, and an enclosure to house the drive and power supply. The controller board, which is installed in an SS-50 bus slot of the host computer, includes low-voltage regulators, a "bit-shifting" compensation circuit and provision for 3 kbytes of PROM.

CIRCLE NO. 315

A simple warning. New LED flashes on/off all by itself.

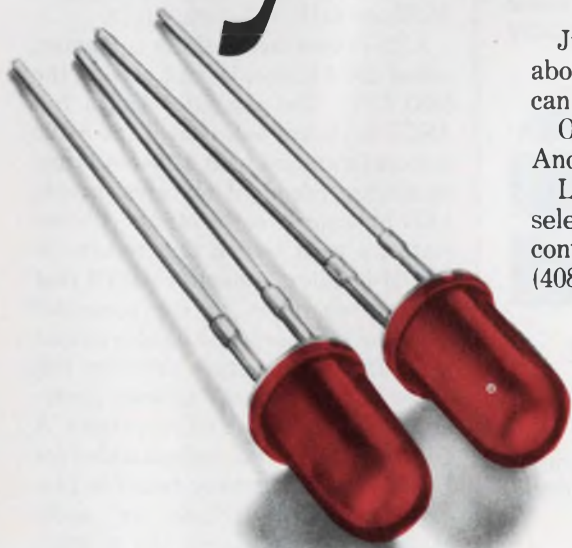

Just apply 5 volts and our FRL-4403 flashes an attention-getting signal about three times a second. A built-in IC switches it on and off. And you can drive it directly by TTL and CMOS circuits.

Our "flasher" simplifies your design. Saves parts. Saves assembly labor. And it's priced to produce a net saving in the cost of your product.

Litronix recently affiliated with Siemens to bring you the broadest selection of optoelectronics available anywhere. For details on FRL-4403 contact Litronix, 19000 Homestead Road, Cupertino, Calif. 95014. Phone (408) 257-7910.

**From the New Giant
in optoelectronics**

litronix

An affiliate of Siemens.

GE miniature lamps offer you gigantic design advantages.

With 11 new wedge base GE lamps, you have more choices than ever.

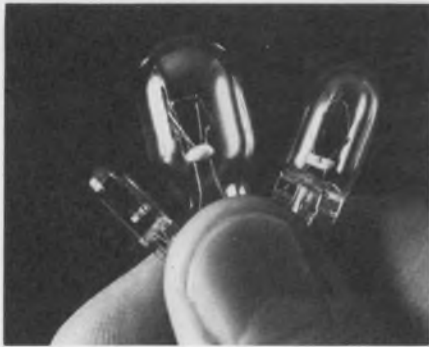

Enjoy new design freedom with this expanded line of GE all-glass wedge base lamps. And keep enjoying the inherent benefits of the line: savings in weight, space, time and costs. GE now offers more than 30 wedge base lamps in three sizes: miniature lamps T-3/4 (10 mm diam.) and T-5 (15 mm diam.); subminiature lamp T-1 3/4 (6 mm diam.). Voltages range from 2.5 V to 28 V. Candlepower from 0.03 to 21 cd.

Use GE wedge base lamps with confidence for indicator, marker and general illumination applications, especially where space is at a premium. You may enjoy lower systems cost than with metal-based lamps and LED's. They're easy to insert and remove; have no soldered connections to corrode or break; and the filament is always oriented the same in relation to the base.

To start saving with GE wedge base lamps now, send for the latest bulletin on GE's expanded line. Order #3-5259R2. It's free.

For whiter, brighter light use GE halogen-cycle lamps.

GE halogen-cycle lamps offer you very high light output from a very small package. They can provide better light efficiency because the bulb doesn't blacken and because of accurate filament placement. Many have uniform bulb tops (no tip).

You get a whiter light than from comparable incandescent lamps because of higher color temperature operation. And they maintain their high initial output level for virtually the life of the lamp.

Because of their lower electrical power requirements, you also save on operating costs vs. comparable incandescent lamps. Some halogen lamps have long design life for low maintenance costs, too.

You can use GE halogen-cycle lamps with confidence when your design needs call for a lot of light in restricted space. For greatly expanded information on GE halogen-cycle lamps, send for your free copy of the new GE bulletin #3-5257-R.

How to order lamp samples and important new free catalogs.

For catalogs and information on how to get lamp samples, call your local GE Miniature Lamp Products Representative or write: General Electric, Miniature Lamp Products Department #3382, Nela Park, Cleveland, Ohio 44112.

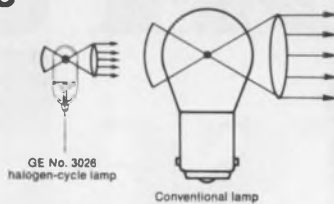

GENERAL ELECTRIC

CIRCLE NUMBER 58

MICRO/MINI COMPUTING

Self-contained micro is RFI protected

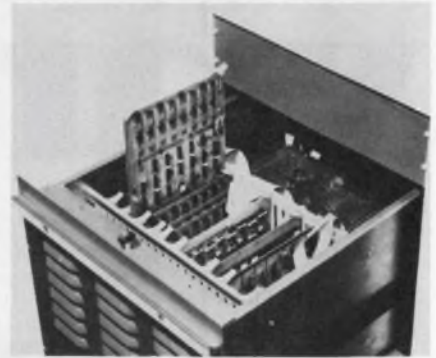

Labtest Equipment, 11828 La Grange Ave., Los Angeles, CA 90025. Wesley Kemp (213) 478-2518. \$6500; 2 wks.

The Model 300 microcomputer uses no front-panel switches, is completely self-contained in a metal RFI enclosure and includes extensive RFI and noise filtering. The micro is based on the Intel 8080 microprocessor. Included are a 10-k memory, one I/O board, power panel, cables and connectors, two fans, power supply, I/O ports, and a 22-slot motherboard. The system operates with TTY or CRT and keyboard options.

CIRCLE NO. 316

Desktop computer is in 25-lb package

Pertec Computer, 21111 Erwin St., Woodland Hills, CA 91367. Neil McElwee (213) 999-2020. \$1449.

A 25-lb compact desktop computer, called the Attache, is built around the 8080 CPU. The computer has a full ASCII keyboard and it uses the S-100 bus configuration with a 10-slot board capability. Standard features include LED indicators for on/off and system status; a reset switch that returns to PROM monitor; a monitor PROM that controls operation of the computer from the keyboard; and a video output jack. The video output provides full upper and lower case character generation with 16 lines of 64 characters. A 1-k RAM with extra sockets added for PROMs on the turnkey board is provided. Options include an audio cassette recorder board, 110 to 9600-baud RS-232 port, floppy disc systems and software.

CIRCLE NO. 317

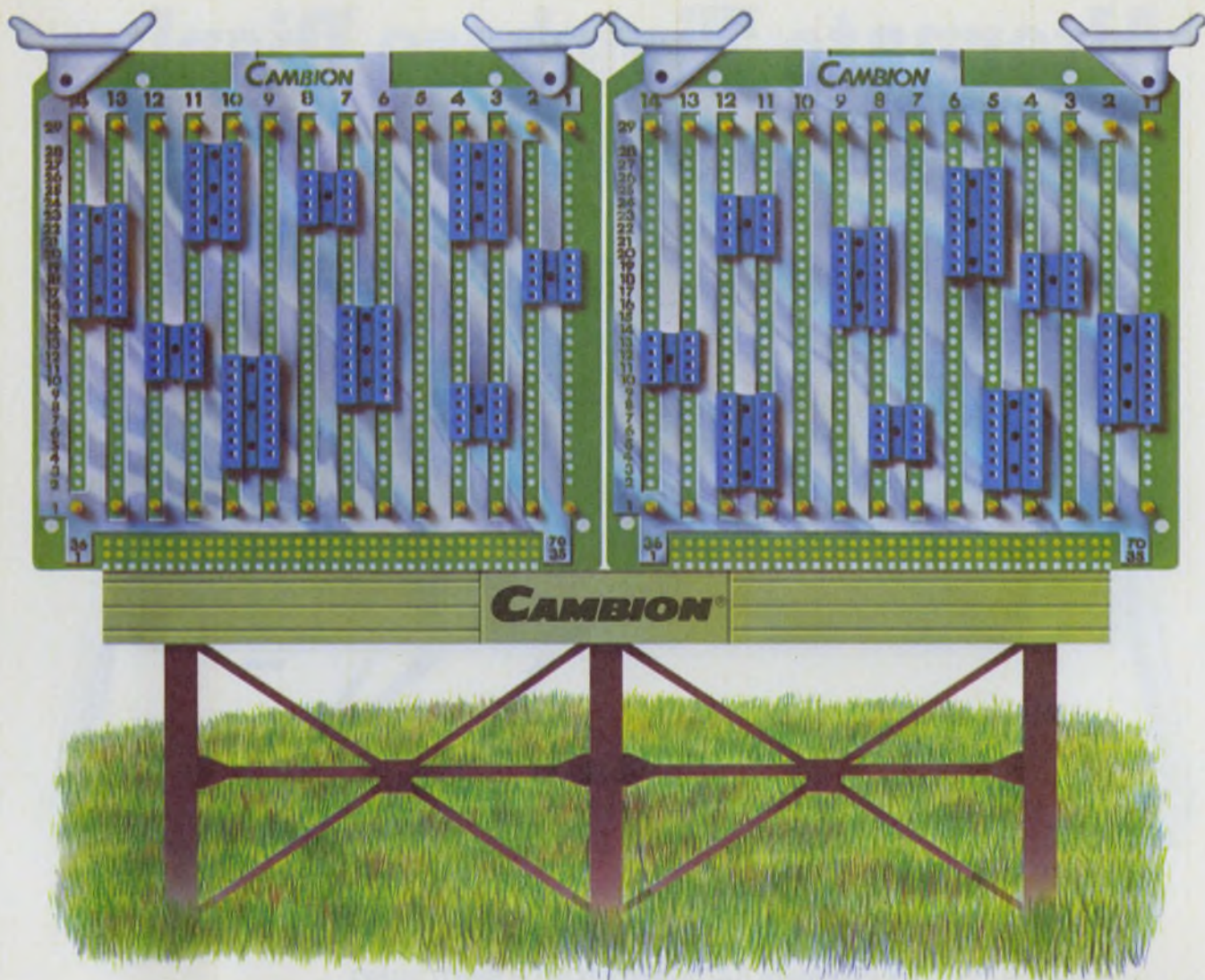

Things are looking up. Thanks to Buildboards by CAMBION. A totally new way of looking for, and getting, the right connection.

You design it. New CAMBION Buildboards are versatile, design-it-yourself, wrappable IC socket boards. They come in 4 standard sizes, with 3 general purpose board styles per size. Some Buildboards take popular 14 and 16 pin types intermixed; some take any mix of CAMBION sockets from 6 to 64 pin simultaneously, so designers get unmatched flexibility. What's more, they're pre-drilled, include distributed voltage and ground, and accommodate standard CAMBION wrappost sockets as well as other standard IC interconnecting hardware.

You build it or we'll build it. An ingenious CAMBION Overlay — Underlay Tracing System

makes it easy for designers to define their own Buildboards. Then you can build your own board. Or CAMBION will build it for you. Either way, Buildboards are quicker and more economical. If CAMBION is the fabricator, just send us the overlay drawing or a reproducible copy. We'll assign you a part number without charge, quote on the quantity you desire, then build, inspect and guarantee wrapability on every board. Wire wrapping service is available as an added option.

So stop, look and grow. With the socket boards sure to be seen in all the best shops. Buildboards. A great new right connection from CAMBION. Write or call: Cambridge Thermionic Corporation, 445 Concord Avenue, Cambridge, MA 02138. Phone: (617) 491-5400.

Buildboards by CAMBION.

Guaranteed to be the right connection.

Alternate Timebase Display

Gives you the whole picture for \$1425.*

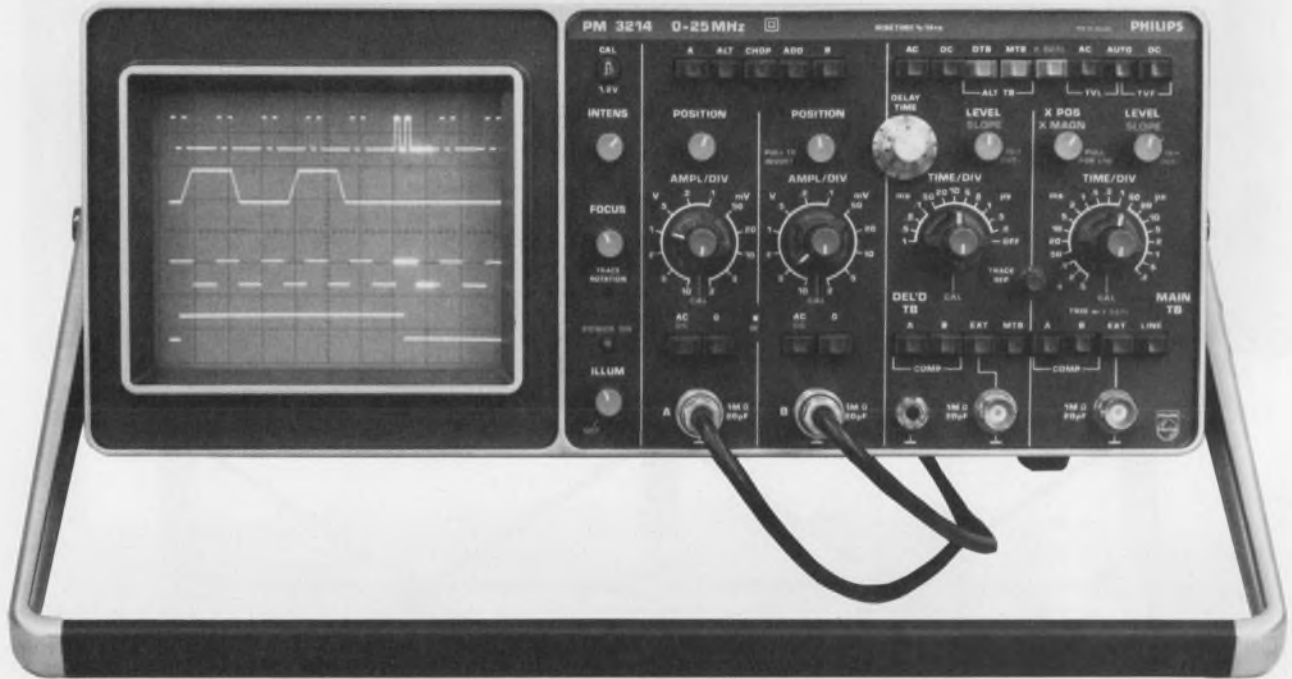

Continuous indication of where DELAYED T.B. measurements are taken.

- Eliminate BACK-AND-FORTH SWITCHING
- Forget MIXED-SWEEP limitations

The PM 3214 is the latest addition to the Philips oscilloscope family. At 25 MHz and 2mV sensitivity, the PM 3214 incorporates all the triggering facilities found on the latest, most expensive oscilloscopes available: AC, DC, TV and an auto position that derives its trigger from the peak to peak signal input. Trigger selection from either channel, line and external sources as well as composite triggering for ASYNCHRONOUS signals.

Composite triggering in A-B mode derives its source from the differential signal, allowing measurement of signals riding on high AC or DC components.

The 18.5 lb. portable is double insulated and even has an internal battery option. Supplied with two probes and a protective front cover, the PM 3214 is a money saving solution to many oscilloscope requirements.

If you don't need DELAYED TIMEBASE the economy priced PM 3212 has all the triggering and overall performance of the PM 3214 at only \$1,155.00*.

For immediate detailed information utilize our toll-free Hotline number: 800 631-7172. (New Jersey residents call collect), or contact: Philips Test & Measuring Instruments, Inc.

In the U.S.:
85 Mc Kee Drive
Mahwah, New Jersey 07430
Tel. (201) 529-3800

In Canada:
6 Leswyn Road
Toronto, Ontario, Canada M6A 1K2
Tel. (416) 789-7188

* U.S. Domestic prices only



PHILIPS

CIRCLE NUMBER 60

Licon has more economical ways to light and control switch action.

If you sat down . . . took the best features of all low cost, low energy lighted pushbutton switches . . . you'd come up with the same thing we did . . . the LICON® Series 05 Lighted Pushbutton Switches. These are the switches you asked for.

Here are the ideal LPB switches for office machines, computers, appliances, home entertainment, etc. wherever requirements dictate low level switching, economy and high reliability. The Licon Series 05 Switch is available in momentary and maintained action plus lighted, non-lighted versions. The maintained action style offers "dual indication", light and lens position. Available in both double and single pole styles — single pole N.O., double pole N.O. and SPDT styles. Exclusive design offers smooth, pleasing "feel" plus snap-in bezel mounting that assures rigid retention. These amazing little switches also feature bifurcated, silver plated contacts. .110 quick disconnect or PC board terminals, a rainbow of colored lens cap choices and U.L. Listing.

05 Series Switches fit .625 square panel hole size; accept low cost T 1 $\frac{3}{4}$ wedge base lamp. Relamp from front panel. .25 Amp., 125 VAC rating. In addition, all these features are available in a compatible L.E.D. version complete with L.E.D. display lens.

05-6 Series Switches mount in a .750 square panel cutout. Use versatile front panel replaceable T 1 $\frac{3}{4}$ flange base lamp. Offered in .25 or 3 Amp versions. 125 VAC rating. Lens barriers are available.

We've got more to talk about too. Ask for full details, contact your local Licon Distributor, or call or write for our Switch Catalog: LICON, 6615 West Irving Park Road, Chicago, Illinois 60634. Phone (312) 282-4040 TWX: 910-221-0275.



LICON

A DIVISION OF ILLINOIS TOOL WORKS INC.

© Illinois Tool Works Inc. 1978

CIRCLE 61 FOR DETAILS

CIRCLE 62 TO HAVE A SALESMAN CALL

MICRO/MINI COMPUTING

Multiline buffers extend CRTs up to 4000 ft



BPI Electronics, 4470 S.W. 74th Ave., Miami, FL 33155. (800) 327-2252. \$149/\$195; 6 wks.

A single Model 8 multiline buffer permits CRTs and other RS-232C compatible terminals to be located up to 4000 ft from the computer without the use of modems. The Model 8 includes eight fully buffered lines permitting buffering of up to four terminals. The Model 18 has 18 fully buffered lines conforming to all signals described in the EIA Spec.

CIRCLE NO. 318

Micro permits fast prototyping of software



Process Computer Systems, 750 N. Maple Rd., Saline, MI 48176. Tim Pellegrino (313) 429-4971. \$2460.

The Protopac microcomputer permits fast prototyping of software for demonstration set-ups, as well as software modification in dynamic environments. Capabilities of the system are: DIM (declares arrays), LET expression (arithmetic evaluations), IF expression THEN NN (conditional transfer statements), FOR/NEXT (program iteration), GOSUB/RETURN (internal subroutine usage), logic ANDs and ORs permitted in expressions, and memory reference facilities.

CIRCLE NO. 319

MAKING MEMORIES

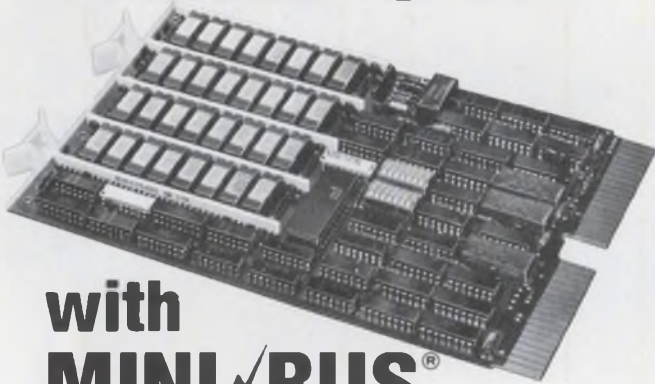

with MINI/BUS[®] PC BOARD BUS BARS

See us at NEPCON
West Booth 3028

A high density add-in expansion memory for the DEC LSI-11, MSC 4601, packs up to 32K words of memory in a single option slot. Mini/Bus helps make it all possible, and with a mean time between failures of 100,000 hours.

Monolithic Systems Corporation engineers used Mini/Bus to solve size constraint problems, shorten assembly time, simplify testing, eliminate numerous filter capacitors, and increase reliability.

For more details on how Mini/Bus can handle your design problem, contact the Mini/Bus product specialist at

ROGERS CORPORATION

Chandler, Arizona 85224
(602) 963-4584

ROGERS

EUROPE: Mektron NV, Gent, Belgium JAPAN: Nippon Mektron, Tokyo

DEC and LSI-11 are registered trademarks of Digital Equipment Corp.

CIRCLE NUMBER 63

Four-headed floppy stores up to 3.2 Mbytes

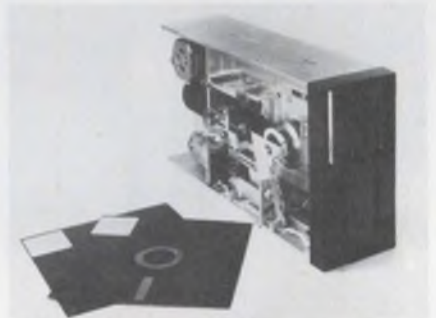

PerSci, 12210 Nebraska Ave., West Los Angeles, CA 90025. (213) 820-3764. \$1595.

The Model 299 "four-headed" flexible-disc drive stores up to 3.2 Mbytes of data in the space required by a standard-size floppy drive. The diskette drive interfaces to 8080, 6800 and Z-80 based systems and reads and writes both sides of two 8-in. diskettes. Data can be encoded in single or double density in IBM-compatible soft-sectored formats or expanded hard and soft-sectored formats on IBM Diskette I, II, IID or equivalent media. The drive stores up to 1 Mbyte of data in IBM type format, 1.6 Mbytes unformatted single-density and up to 3.2 Mbytes in unformatted double-density encoding. Average seek time is 33 ms. A full-stroke 76-track seek is performed in 100 ms.

CIRCLE NO. 320

New, 16 Bit Microcircuit D/A Converter

Datel has it...



Two versions to choose from:

DAC-HP16BMC

- ▶ 16 Bit Binary Resolution
- ▶ 15 ppm/°C Max. Tempco
- ▶ ±0.003% Linearity
- ▶ 0 to +10V, ±5V Output
- ▶ 35 μsec. Settling Time

DAC-HP16DMC

- ▶ 4 Digit BCD Resolution
- ▶ 15 ppm/°C Max. Tempco
- ▶ ±0.005% Linearity
- ▶ 0 to +10V Output
- ▶ 15 μsec. Settling Time

\$7750*
(100's)

Price, both versions: \$119.00* (1-24)

*U.S.A. domestic prices only

When high resolution and stability are demanded, Datel's DAC-HP series provides the performance — applications such as precision signal reconstruction, automatic test systems, and ultra-linear ramp generation. DAC-HP's excellent performance results from special low tempco nichrome thin-film resistors, laser trimmed for optimum linearity, and a low tempco zener reference circuit. Operating temperature range is 0 to 70°C, with models available for -25 to +85 and -55 to +125°C operation.

DATEL
SYSTEMS, INC.

1020 Turnpike Street, Canton, MA 02021
TEL: (617) 828-8000 TWX: 710-348-0135

Santa Ana, (714) 835-2751, (L.A.) (213) 933-7256 • Sunnyvale, CA (408) 733-2424 • Gaithersburg, MD (301) 840-9490 • Houston, (713) 932-1130 • Irving, TX (214) 256-4444
OVERSEAS: DATEL (UK) LTD—TEL: ANDOVER (0264) 51055 • DATEL SYSTEMS SARL 620-06-74 • DATELEK SYSTEMS GmbH (089) 77 60 95

CIRCLE NUMBER 64

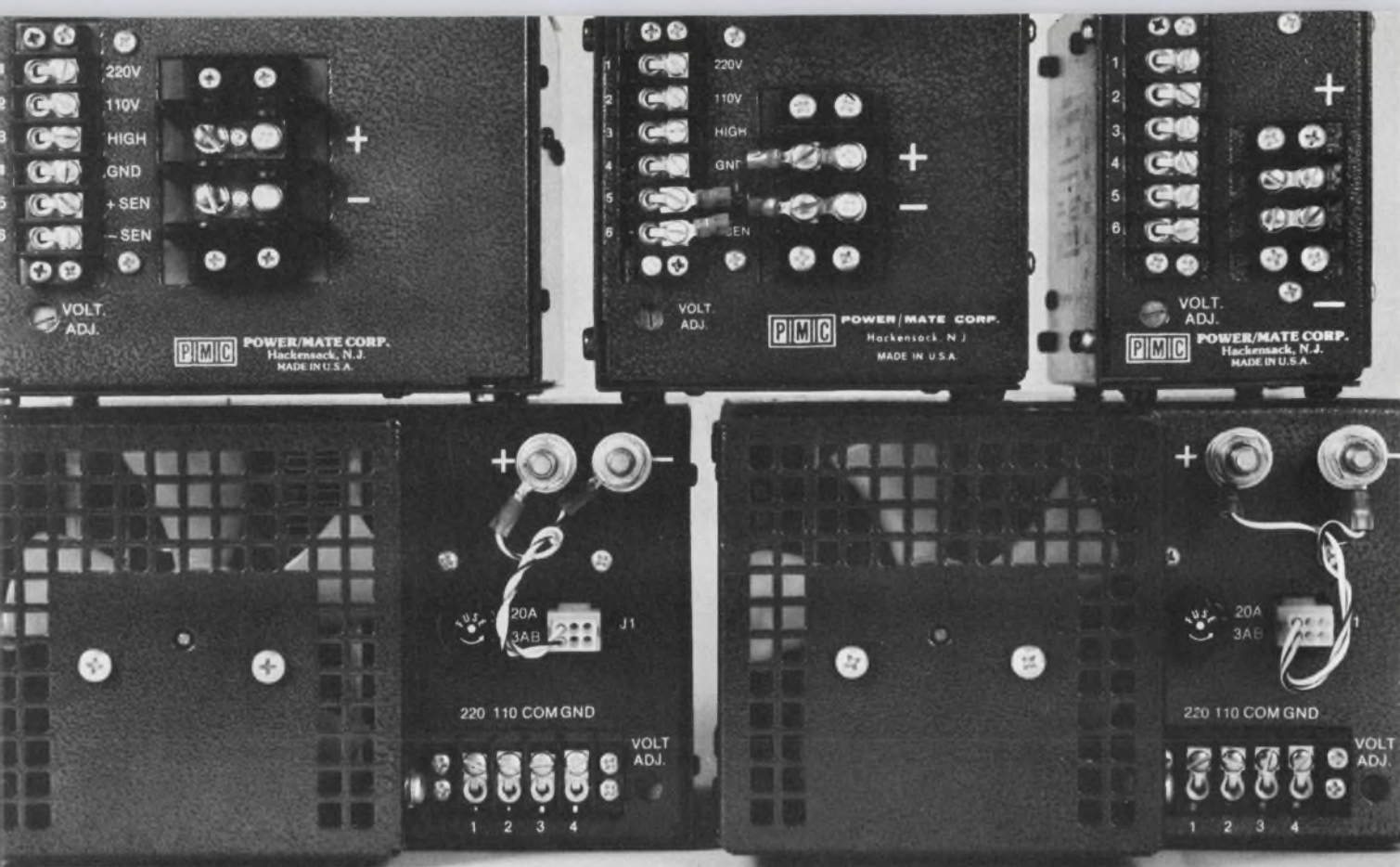

With 87 different switching supplies to choose from, no wonder people are switching to Power/Mate.

But at Power-Mate we know it's not enough to offer you 87 different switching models in 10 different case sizes.

From 2 volts to 28.

In currents all the way up to 200 amps.

And we know it's not enough to build them to the highest quality standards in the industry.

Standards you've come to expect from Power-Mate.

When you need a switcher fast, your entire business could depend on ours.

So Power-Mate stocks all models

for immediate delivery on every switching model we make from both our East and West Coast plants.

The same goes for our open frame, modular and miniature models, as well as our laboratory supplies.

Whether starting from scratch, updating your system, or in need of emergency service, it's good to keep Power-Mate's name and number in mind.

Because knowing where to get the switchers you want isn't much good, unless you can get them when you want them.



POWER/MATE CORP.

514 S. River St./Hackensack, New Jersey 07601/(201) 343-6294/TWX (710) 990-5023
17942 Skypark Circle/Irvine, California 92714/(714) 957-1606/TWX (910) 595-1766

The world's largest supplier of quality power supplies.

POWER MISER DPM



Includes
VOM, DVM
Descriptors



19.99 kΩ
mA
mV
ACDC

Datel's Battery- Powered Breakthrough

Model DM-3100U1 DPM

- True balanced differential inputs
- 3½ digit Liquid Crystal Display
- User-installed mA, Ω, mV ranges
- Includes VOM, DVM Descriptors: mA, mV, kΩ, AC, DC
- Operates from 5 to 8 Vdc @ 6 mA or 9 to 15 Vdc @ 3 mA
- \$69 (singles)

\$4900
(100's)



D **DATEL**
SYSTEMS, INC.

1020 Turnpike St., Canton MA 02021
TEL (617) 828-8000 / TWX 710-348-0135
• Santa Ana, CA (714) 835-2751
• LA Exchange (213) 933-7256
• Sunnyvale, CA (408) 733-2424
• Gaithersburg, MD (301) 840-9490
• Houston, TX (713) 932-1130 1132
• Irving, TX (214) 256-4444
• Tokyo, Japan 793-1031, Osaka, Japan
(06) 354-2025 • Andover, UK (0264)
51055 • Paris, Fr. 620 06 74
• Muenchen, W. Ger. (089) 776095

MICRO/MINI COMPUTING

I/O board contains most parts for micro

Infinite, 1924 Waverly Pl., Melbourne, FL 32901. W.J. Haberhern Jr. (305) 724-1588. \$282.

The MFIO-1 is an S-100 compatible general-purpose I/O board that contains most of the circuitry required for

a complete microcomputer. Included are: memory or I/O-mapped parallel-input port for keyboard, memory or I/O-mapped serial I/O port with crystal-controlled switch-selectable data rates of 50 to 19,200 baud, jumper-selectable RS-232 or 20-mA current loop, memory or I/O-mapped cassette interface with switch-selectable data rates of 300, 600, 1200 and 2400 baud, 128 bytes of RAM and slots for two 2708 EPROMs.

CIRCLE NO. 321

HYCOM PRINTERS RELIABLE, FAST, LOW-COST.

Whenever you need alphanumeric, dot matrix discharge printers—whether small and portable 12 column or 16 and 21 column work-horse varieties that can go over 100 million characters without trouble; or our largest 48 column, 144 character/second unit for larger printout capability—come to Hycom. With the smallest about \$50 and the largest about \$125 in 100 quantity, we're low priced too.

Evaluate one today; and do it easily with our Interface Board. We're brand X, but better.

Call or write: Hycom 16841 Armstrong Ave. Irvine, CA 92714 (714) 557-5252

HYCOM

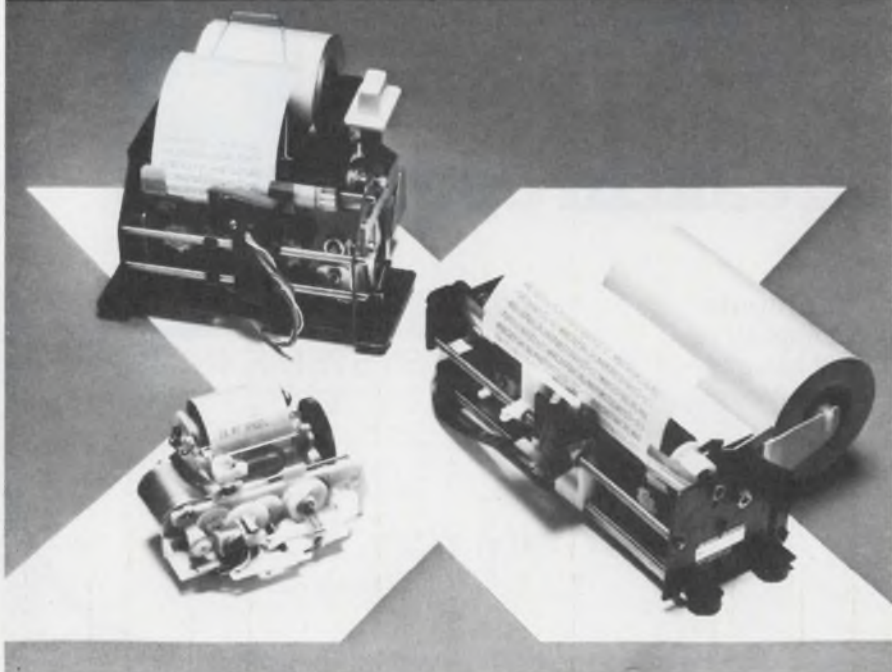

CIRCLE NUMBER 67

Computer system occupies just one cubic foot



RDA, 5012 Herzel Pl., Beltsville, MD 20705. W.R. Davies (301) 937-2215. From \$4595; 4 wks.

The RD-11C stand-alone computer system occupies one cubic foot of space. Based on the DEC LSI-11 CPU, the computer is teamed with a dual micro-floppy subsystem with 205 kbytes of storage. The entire system with up to 64 kbytes of RAM, four serial interfaces, dual micro-floppies, two quad expansion slots and a switching power supply is housed in a desktop enclosure, 12.5 × 8.5 × 16.75 in. Available peripherals include magnetic tape, paper tape, punched card and printers. Both analog-to-digital and digital-to-analog subsystems are available as plug-in modules.

CIRCLE NO. 322

PROM board mates Intel or National units

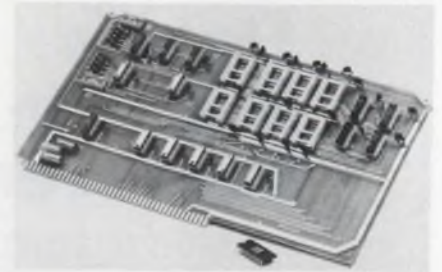

Electronic Solutions, 7969 Engineer Rd., San Diego, CA 92111. Dick Van Antwerp (714) 292-0242. \$186; stock to 3 wks.

The PROM-8 is an 8-kbyte PROM board compatible with Intel's SBC 80/10 and National's BLC 80/10 single-board computers. The board contains sockets for eight 2708 EPROMs and is divided into two 4-k segments. Address selection is done via jumpers and base addresses fall on 4-k boundaries.

CIRCLE NO. 323

Datel's A/D-D/A I/O Peripheral Boards for the M6800 Microcomputers

MODEL ST-6800

- ▶ Slides directly into Motorola's M6800 EXOR-ciser Microcomputer
- ▶ Includes 32 Single-ended or 16 Differential A/D Channels plus 2 D/A Channels on one board
- ▶ Expandable up to 128 A/D and/or D/A Channels
- ▶ Powerful paper tape diagnostic software included!
- ▶ Comprehensive systems manual included!
- ▶ Prices from \$419

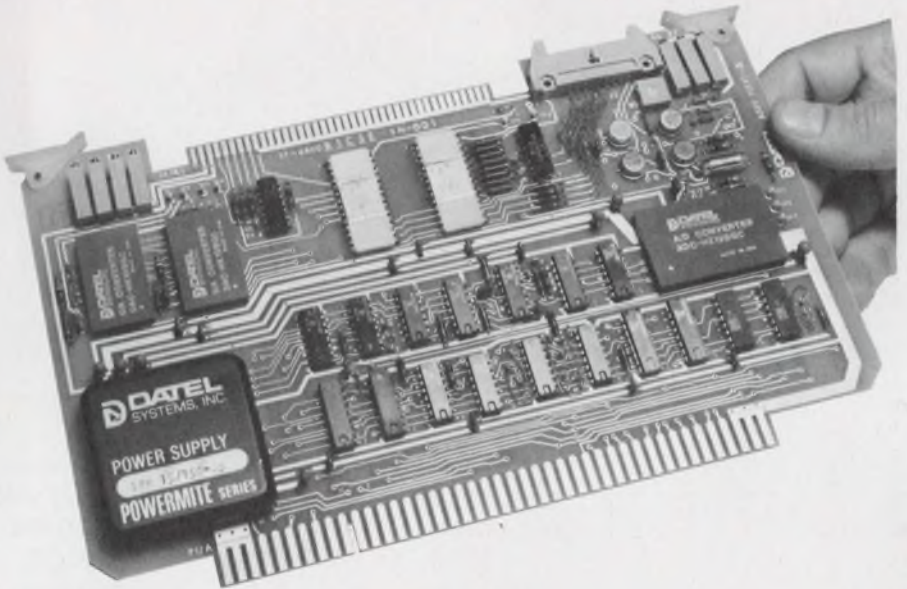

You'll find more specifications on this product and more than 300 data conversion circuits and systems in Gold Book.

Just check Gold Book's Volume 3. That's Datel's complete Engineering Product Handbook, in its own separate volume. More than 290 pages of D/A & A/D Converters, Multiplexers, Sample-Holds, Op Amps, Power Supplies, Digital Panel Meters and Printers, Digital Panel Instruments, Data Loggers, Digital Cassette Recorders, and Data Acquisition Systems. Each fully detailed on individual data sheets. And it's available to you in Gold Book.



 **DATEL**
SYSTEMS, INC.

1020 Turnpike Street, Canton, MA 02021
TEL: (617) 828-8000 TWX: 710-348-0135

See Electronic Design's
1977-78 "Gold Book"-Vol. 3, page 146

Santa Ana, (714) 835-2751, (L.A.) (213) 933-7256 • Sunnyvale, CA (408) 733-2424 • Gaithersburg, MD (301) 840-9490 • Houston, (713) 932-1130 • Irving, TX (214) 256-4444
OVERSEAS: DATEL (UK) LTD - TEL: ANDOVER (0264) 51055 • DATEL SYSTEMS SARL 620-06-74 • DATELEK SYSTEMS GmbH (089) 77-60-95

CIRCLE NUMBER 68

"There are tides taken at the

"Today, that tide is 4K memory."

Intersil, 1967-

CMOS or NMOS, you'll find that Intersil is a leader in the memory market. For instance, Intersil has delivered a total of over 20 million RAM's to date. Not counting our complete add-on and add-in memory systems.

THE COMPETITIVE EDGE.

As a leader in 4K memory, we offer you a choice of low power CMOS or advanced NMOS memory products. In CMOS, 4K RAM and 4K EPROMs. In NMOS, 4K static and dynamic RAM's. All, in standard DIP's. All, from a single source: Intersil.

4K CMOS EPROM's.

Intersil's 4K proprietary CMOS EPROM, the IM6603/04, offers the low power benefit typical of CMOS: An up to 10,000:1 power consumption advantage over competitive EPROM's. At the same time, it may operate on either TTL or dual MOS supplies. Static and synchronous operation results in very fast access time. Three state outputs and chip select offer easy system expansion. And, they're both UV erasable and electrically programmable. Either 1024x4 or 512x8.

4K NMOS STATIC RAM'S.

The IM7114/2114, and IM7141's are high performance static RAM's that offer you definite design advantages: Simple interface with a wide variety of micro-processor components; no need to refresh; a low power requirement that can effect an up to 30 percent power saving over the nearest competitor.

Lower power means lower operating costs, lower cooling costs, and lower PC board costs.

With pin compatibility to the RAM's you're using now. In either 1Kx4 or 4Kx1 configuration.



in the affairs of men which, flood, lead on to fortune."

William Shakespeare, 1564-1616

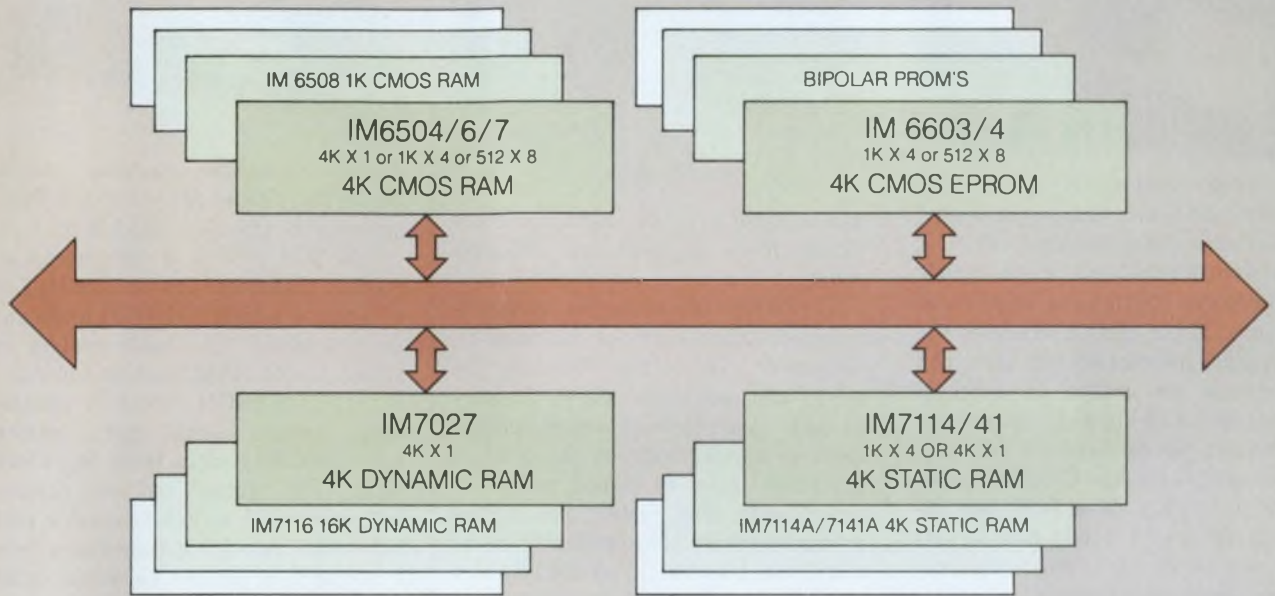

4K CMOS STATIC RAM's.

Over the years, Intersil has shipped more CMOS RAM's than any other manufacturer. By mid-year, we'll be adding a new dimension to our line of 1K RAM's with a series of new 4096 bit static RAM's, including the IM6504 (4096x1), the IM6506 (1024x4), and the IM6507 (512x8). Offering power benefits typical of CMOS, plus TTL compatibility, the new IM6504 will be ideally suited to memory systems requiring low power, non-volatility and high performance.

4K DYNAMIC RAM's.

The IM7027/MK4027 dynamic RAM is a second generation dynamic RAM that offers you substantial improvement in page mode, read/write timing and speeds up to 120ns access and 250ns cycle time. It's specifically designed for EDP, computer mainframe memory, microprocessor and microcomputer applications. Speed and power, coupled to a lower power dissipation, mean lower overall costs. Pin compatible with the slower speed, higher power RAM's you've been using.

CIRCLE NUMBER 69

THE TIDE IS WITH US. AND WE'RE WITH YOU.

At Intersil, we're working at the state of the art in memory components and subsystems. That means you can depend on Intersil to supply a full range of memory components in both low power CMOS and second generation NMOS technologies. And 4K memory is just one of the fields in which we excel. Our aim is not just to reach the crest of the wave; but to remain there. If that's the way you're thinking, join us. Today, the tide is running with 4K memory. And the flood is just beginning.

INTERSIL

Digital Products: CMOS Dept. - NMOS Dept.
10710 North Tantau Ave., Cupertino, CA 95014
Tel: (408) 996-5000 TWX: 910-338-0171
(800) 538-7930 (outside California)

Gentlemen,

Send me your literature on:

- 4K CMOS EPROM's 4K CMOS Static RAM's
 4K NMOS Dynamic RAM 4K NMOS Static RAM's
 Send me Intersil's New 20 x 24 Shakespeare Poster

Name _____
 Company _____
 Address _____
 City _____ State _____ Mailing Code _____
 Country _____

MICRO/MINI COMPUTING

Mini CPU is on one chip



Fairchild Semiconductor Products, 464 Ellis St., Mountain View, CA 94042. Bill Callahan (415) 962-3816. \$750.

The 9440 Microflame is a complete minicomputer CPU on one chip. Packaged in a 40-pin DIP it executes the NOVA 2200 instruction set. Data and instructions are stored in external memory and a 16-bit-wide, three-state information bus carries both data and addresses between the CPU and other computer circuits. The 9440 can address 32,768 16-bit words, and its I/O ports can serve up to 63 peripheral devices using programmed I/O, interrupt-driver I/O or direct memory access.

CIRCLE NO. 324

I/O board uses 8251 USART

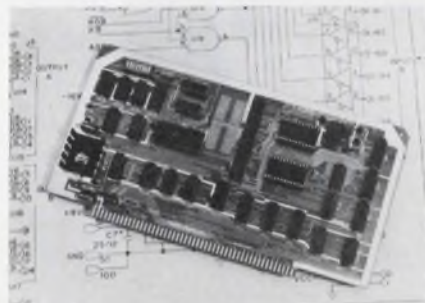

Vector Graphic, 790 Hampshire Rd., Westlake Village, CA 91361. Lore Horp (805) 497-6853. \$155 (kit), \$195 (assembled).

The Bit Streamer I/O board combines two parallel input and output ports and a serial I/O port using an 8251 programmable universal synchronous/asynchronous receiver-transmitter (USART). Communications with board circuitry is accomplished by the CPU. One parallel port also can be used as a keyboard input port. The board interfaces to an S-100 bus and can be configured for a wide variety of communication formats.

CIRCLE NO. 325

Self-contained computer develops software



Noval, 8401 Aero Dr., San Diego, CA 92123. Jerry Hansen (714) 277-8700. \$3385; 4 to 6 wks.

The Model 760 computer system is a self-contained unit for software development. Interaction between the editor and assembler allows the user to edit, assemble and debug applications programs without the need to externally save or reload source or object code. The system has a Z-80 microprocessor, 32-kbyte RAM plus an additional 1-k scratchpad and 1-k video refresh memory. Also included are a programmable character generator, 3k system-utility routines on PROM, 12-in. TV monitor, digital cassette recorder, 32-column matrix printer and a full keyboard. There are three 8-bit parallel I/O ports for general-purpose use and a programmable audio-tone generator and speaker within the enclosure.

CIRCLE NO. 326

Static RAM runs with any S-100 system

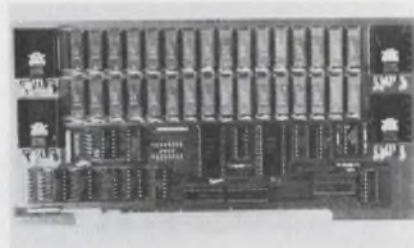

Digital Micro Systems, Box 1212, Orem, UT 84057. (801) 224-2102. \$595.

A 16-k static RAM for the S-100 bus uses the 2114 memory chip. The board runs with any S-100 system including Z-80 systems at the full 4-MHz clock rate. The memory has individually addressable 4-k blocks, software write protection in 4-k blocks and a paging or block-select feature that allows memory expansion beyond 64 k.

CIRCLE NO. 327

μ C uses Z-80 and AMD9511 on one board

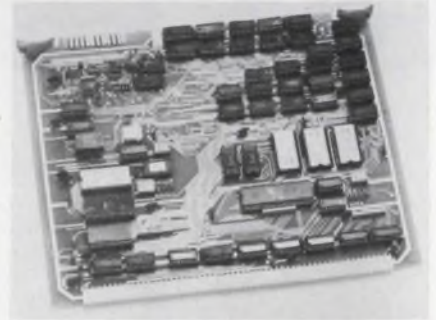

Process Computer Systems, 750 W. Maple Rd., Saline, MI 48176. Tim Pellegrino (313) 429-4971. \$495/\$795.

The PCS 1880 is a microcomputer module that uses both the 4-MHz Z-80 μ P and the 4-MHz AMD9511 math unit on one board. The basic system includes 1 k of RAM, sockets for 3 or 6 kbytes of EPROM, optically isolated three-function serial port, switch-selectable data rates from 50 to 9600 baud, five internal vectored priority interrupts and switch-selectable real-time clock providing time bases from 1 ms to 1 h. In the hardware math version, the AMD9511 provides a math package that includes add, subtract, multiply, divide, floating point, square root and trig functions.

CIRCLE NO. 328

Disc system upgrades Heathkit H8 to Z-80

Info 2000, 20630 S. Leapwood Ave., Carson, CA 90746. (213) 532-1702. \$2750; 4 wks.

Heathkit users may add the Info 2000 disc system and upgrade their 8080 computer to a Z-80 system by replacing the Heathkit 8080 CPU board with the Z-80/disc adapter board. The complete system includes PerSci dual-diskette drives, power supply, case, intelligent controller, adapter, cables and disc monitor in EPROM. The adapter board contains the Z-80 microprocessor and all support chips, 7-k EPROM, 1-k scratchpad RAM for the disc monitor and all necessary logic for interfacing the disc system to the H8. With these modifications, the H8 can operate in either of two switch-selectable modes. One mode enables continued use of the H8 EPROM monitor with the existing Heathkit software. No modification is required and the H8 performs at Z-80 speed.

CIRCLE NO. 329

Opening new frontiers with electro optics

Just what the doctors ordered: RCA-developed PMTs that allow whole-body CT scanning in only 2 seconds.

Computerized tomographic (CT) X-ray scanners are creating a lot of excitement in medical circles. Unlike conventional X-rays, where a dense object can block out something important such as a tumor, a CT scan from hundreds of directions produces a highly revealing, complete cross-sectional view of the patient.

Vital links in this process are the hundreds of photomultiplier tubes which measure light scintillations caused by X-ray beams passing through the body and striking individual crystal detectors. RCA, of course, has a long background in the design and manufacture of PMTs. So we've been able to provide extremely reliable tubes with the performance required for critical measurements at ever-faster scanning speeds—

users report as fast as 2 seconds.

These PMTs feature a wide dynamic operating range due to a highly conductive cathode surface and low anode dark current characteristics. Cathode currents of several nanoamperes and anode dark current in the picoampere range are possible when using the PMTs at operating voltages around 600 volts, characteristic of most CT scanning systems.

Two sizes of RCA 10-stage head-on tubes are being used in scanners. The 4886 has a 3/4" diameter and the S83001E a 1/2" diameter bialkali photocathode.

They represent a clear case where RCA saw a need and applied years of PMT experience to meeting it. Now, what can we do for you?

For spectroscopists: PMT with improved responsivity out to 850 nanometers.

The popular RCA 4840 1-1/8" dia., 9-stage PMT has been improved again. Its high responsivity now extends over a broader spectral range—to 850 nm typical. And there are some other benefits from buying this RCA tube. The assurance that comes from domestic manufacture. Prompt delivery. Price—about \$55. And in-depth application support from people who really know how to help you get the most from a PMT.

So if you're involved in broadband spectroscopic analysis or low-level light detection systems—analyze the extra benefits you get from buying your PMTs from RCA.

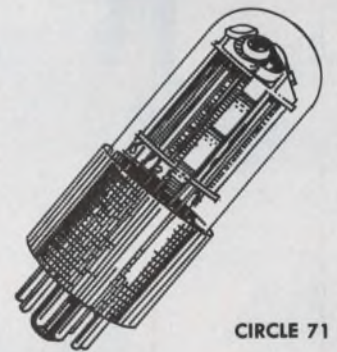
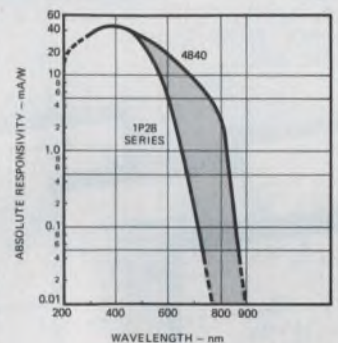
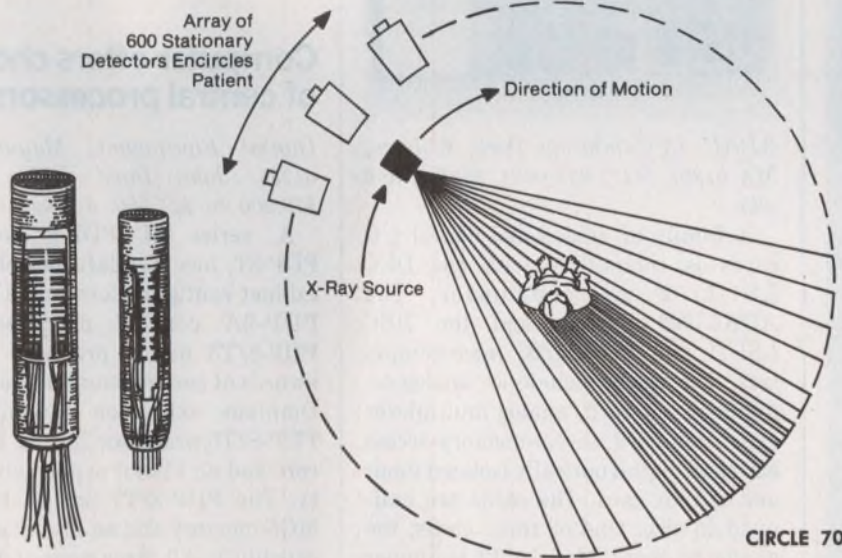

If electro optics can solve your problem, remember: EO and RCA are practically synonymous. No one offers a broader product spectrum. Or more success in meeting special needs. Call us for design help or product information. RCA Electro Optics, Lancaster, PA 17604. Phone 717-397-7661. Sunbury-on-Thames, Middlesex TW16 7HW, England; Ste.-Anne-de-Bellevue, Quebec, Canada; Sao Paulo, Brazil; Hong Kong.

RCA

FOUR MOST...

In Sample & Holds

A quartet of feature-packed sample & hold amplifiers offering cost/performance that will amaze you.

A-880 Module: 1 μ s acquisition time to $\pm 0.01\%$, 5ns aperture time, dielectric absorption $< 0.003\%$ over 5 μ sec, small 2x2x0.4" size **\$105.00 (1-24)**

A-881 Module: 500ns acquisition time to $\pm 0.01\%$, 5ns aperture time with $< .2$ ns jitter, small 2x2x0.5" size **\$180.00 (1-24)**

A-882 Module: 6 μ s acquisition time to $\pm .0007\%$, 25ns aperture time, droop rate $< 1 \mu$ V/ μ sec, only 16-bit S&H now on the market **only \$85.00 (1-24)**

A-883 Module: 15ns (25ns) acquisition time to 1% (.2%), aperture jitter 20ps, TTL or ECL control option. **check the price \$249.00 (1-24)**

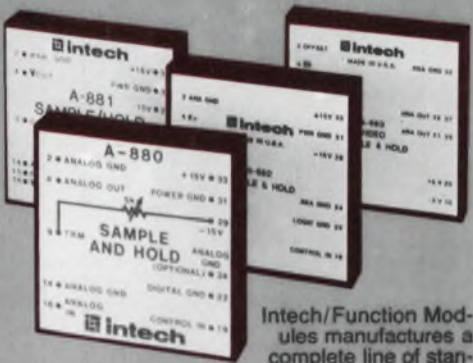

Intech/Function Modules manufactures a complete line of standard signal conditioning,

data conversion and non-linear products, as well as, custom designs to fit varied applications, both industrial and military.

For further application and ordering information contact:



intech / function modules

282 Brokaw Road, Santa Clara, California 95050
Phone (408) 244-0500 TWX: 910-338-0254

Ask Us When You're Ready To Convert

MICRO/MINI COMPUTING

Disc drive packs 10 to 80 Mbytes

R2E of America, 3406 University Ave. S.E., Minneapolis, MN 55414. Ron Larsen (216) 562-9908.

A 10 to 80-Mbyte disc system with removable media plugs into the Mical C microcomputer system. The drive packs 10 Mbytes onto a removable or fixed-platter, 10.5 in. diameter disc. The removable disc cartridge is 11 in. square \times 1 in. high. The system can use up to four drives, each with a 10-Mbyte fixed and/or 10-Mbyte removable disc. The data transfer is 920 kbytes/s. A Mical C System with 10 Mbyte disc costs \$15,950 and delivery is 90 days.

CIRCLE NO. 330

I/O cards are compatible with LSI-11/2 μ C

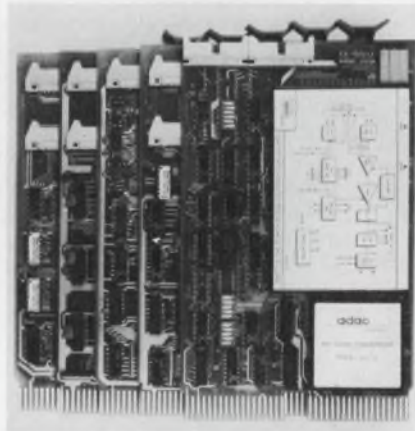

ADAC, 15 Cummings Park, Woburn, MA 01801. (617) 935-6668. \$595; 4 to 6 wks.

A family of analog and digital I/O cards is compatible with the DEC LSI-11/2 microcomputer, the ADAC1000 System and the DEC LSI-11 and PDP-11/03 microcomputers. The cards include an analog-to-digital input card, analog multiplexer expansion card, direct-memory-access card and digital optically isolated input and output card. The cards are half-quad in size. One of these cards, the analog to digital Model 1012, is jumper selectable to accommodate either 16 single-ended, 16 pseudo differential or 8 fully differential analog inputs. Four input ranges of ± 10 , $+5$, 0 to 5 and 0 to 10 -V FS are also jumper selectable. Resolution is 12 bits with a throughput rate of 35 kHz.

CIRCLE NO. 331

◀ CIRCLE NUMBER 72

Single-chip μ C has twice memory of MCS-48s

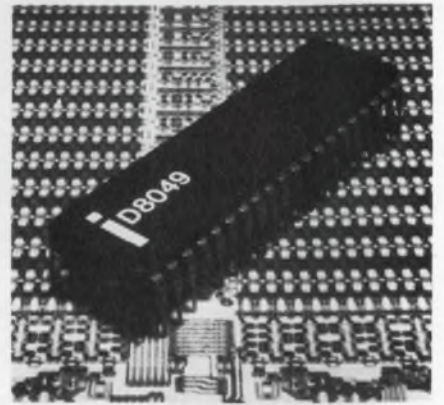

Intel, 3065 Bowers Ave., Santa Clara, CA 95051. Rob Walker (408) 249-8027. Under \$10.

The 8049/8039 single-chip microcomputers contain all elements including memory on a single chip. The chips have 128 bytes of read/write memory, twice that of other MCS-48 devices. In addition, the 8049 contains 2048 bytes of program memory. Both chips contain an 8-bit general-purpose central processor, three programmable 8-bit I/O ports and eight other control and timing lines, programmable interval timer/event counter, priority interrupt controls, system clock generator and a full set of system controls and utilities. The 8039 is the equivalent of the 8049 without program memory.

CIRCLE NO. 332

Computer offers choice of central processors

Digital Equipment, Maynard, MA 01754. John Bond (617) 493-3300. \$19,200 to \$24,500. 8 wks.

A series of PDP-8 computers, PDP-8T, has standard peripheral and cabinet configurations and a choice of PDP-8A central processors. The PDP-8/T3 has a processor with 16 kwords of core memory and a four-slot Omnibus expansion capability. The PDP-8/T5 processor has 32 kwords of core and an 11-slot expansion capability. The PDP-8/T7 has 64 kwords of MOS memory and an 11-slot expansion capability. All three computers include a 1.6×10^6 12-bit-word removable-disc cartridge drive and a 3.2×10^6 12-bit-word nonremovable disc drive; a DECwriter II terminal printer, a VT52 CRT with the RTS/8 real-time operating system and the OS/8 operating system as standard software.

CIRCLE NO. 333

Data-acquisition system slips inside its PDP-11 host computer

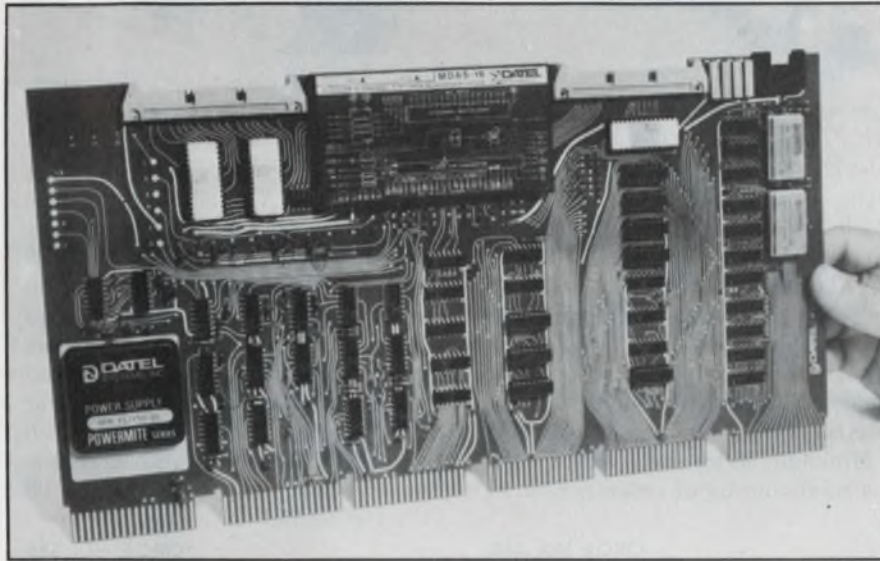

Datel Systems, 1020 Turnpike St., Canton, MA 02021. L. Copeland (617) 828-8000. See text; 4 to 8 wks.

With Datel's new single-board data-acquisition system, you'll have an easy time connecting your minicomputer to analog voltages that represent physical variables like temperature and pressure. You just slide the ST-PDP 1X1C5 right inside the PDP-11 minicomputer from Digital Equipment Corp.

The price is quite attractive. A basic 64-a/d-channel system in Datel's Sine Trac PDP series of data-acquisition cards starts at \$1235 in single quantities.

Operating on 5 V dc from the computer backplane, the ST-PDP 1X1C5 even generates its own ± 15 -V analog power. So all you have to do is wire the analog inputs to the basic system, and you'll have 64 single-ended or 32 differential-input channels that are selectively digitized into 12-bit words.

These data are placed on the PDP-11's Unibus via an assembly-language program on the diagnostic tape that comes with the card. The ST-PDP 1X1C5 then operates either under program control or in an interrupt addressing mode.

Minutes after the system is installed and the paper tape is loaded, the diagnostic program can put the system "on the air," printing out on your

teletypewriter. A complete printout of the diagnostic program is contained in a comprehensive systems manual, which comes with the system.

Options bring a system all the way up to 256 a/d or d/a channels, which can be located either locally (at the computer) or remotely. With an option for direct memory access (DMA), the 20- μ s conversion speed of the system a/d's can put through 45,000 samples per second.

If your PDP-11 is so loaded that there's no spare card slot for the data-acquisition system, Datel can supply the BB-11 connector blocks required by the computer. These connectors come completely wired, with leads for the inputs—but they cost \$540. And cost might well be the deciding factor when you choose an analog interface for your PDP-11. ADAC (Woburn, MA) sells a basic 64-channel PDP-11 system, the 635-11, for \$1595. ADAC's slide-in zips data along at 35,000 samples per second without DMA.

Digital Equipment Corp. (Maynard, MA) offers, for \$3750, a two-card system consisting of the AM 11K multiplexer and the AD 11K a/d converter. Though this system gives you just 60 channels, you do get automatic zeroing.

Datel
ADAC
DEC

CIRCLE NO. 307

CIRCLE NO. 308

CIRCLE NO. 309

CIRCLE NUMBER 73 ▶

Build better resolution, accuracy and stability...

for a lot less money!



An all-new lineup of high-resolution D/A Converters

Compare these features!

- Selectable current or voltage output
- 14 and 16-bits binary available
- 4 and $\pm 4\frac{1}{2}$ digits BCD
- Low non-linearity and non-linearity drift
- 168 hours burn-in at 85°C
- Delivery off-the-shelf

You'll enjoy more resolution, accuracy and temperature stability for the price with the complete team of Intech/Function Modules high-resolution Digital-to-Analog Converters than from any others available... anywhere. Each DAC—packaged in a 2" x 3" x .4" case—has a built-in temperature-compensated reference network, ± 2 ppm/°C binary or BCD weighted wire-wound resistor network, fast current switches and op-amp. Plus, every model provides optional external offset and gain adjustments, too!

MODEL	RESOLUTION	ACCURACY	STABILITY	PRICE [1-24]
414-BIN	14-Bit Binary	$\pm 0.003\%$	± 3 ppm/°C	\$156.00
416-BIN	16-Bit Binary	$\pm 0.002\%$	± 2 ppm/°C	\$184.00
416-BCD	4-Digit BCD	$\pm 0.005\%$	± 3 ppm/°C	\$187.00
418-BCD	$\pm 4\frac{1}{2}$ -Digit BCD	$\pm 0.005\%$	± 3 ppm/°C	\$205.00



intech / function modules

282 Brokaw Road, Santa Clara, California 95050
Phone (408) 244-0500 TWX: 910-338-0254

Ask Us When You're Ready To Convert

MODULES & SUBASSEMBLIES
Crystal oscillators cover
5 to 500 MHz range

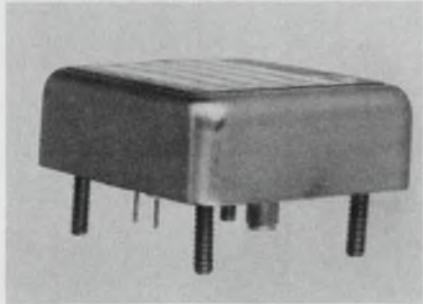

Vectron Lab, 166 Glover Ave., Norwalk, CT 06850. (203) 853-4433. \$140 up; ¼ to 10 wks.

The CO-233FW crystal oscillator provides a stable output at any specified frequency in the 5 to 500-MHz range. Stability is $\pm 0.0025\%$ from 0 to 70 C and output level is 0.5 V rms into 50 Ω (+7 dBm), with +13 dBm optional. While the oscillator is factory set to within $\pm 0.001\%$ of the specified frequency, an adjustment for setting to $\pm 0.0001\%$ is optionally available. The package size is 2 x 2 x 3/4 in.

CIRCLE NO. 334

Light pen has
2-way activator



Information Control, 9610 Bellanca Ave., Los Angeles, CA 90045. (213) 641-8520. \$195 (100 qty).

The LP-212 Light Pen has both "Push Tip" (the operator presses the pen against the CRT) and "Touch Sense" (the operator touches the tip of the pen with the index finger for each desired hit) activation. On tight targets, luminous sensitivity is 2 ft-lamberts. Response time is 300 ns. Spectral response is from 4200 to 1000 Å. Minimum vector speed is 20 cm/ms at a minimum input separation of 20 μ s.

CIRCLE NO. 335

Tape transport handles
3M cartridge

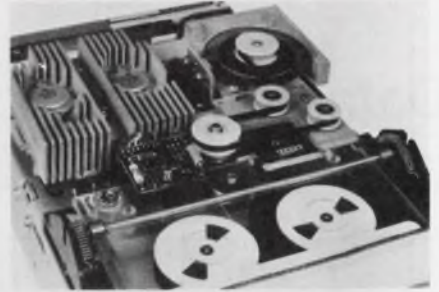

Qantex, 200 Terminal Dr., Plainview, NY 11803. Leon Malmed (516) 681-8350. \$920; stock to 4 wks.

The Model 650 tape transport uses the 3M DC300A data cartridge. The transport makes an OEM memory module capable of storing up to 23 Mbits of unformatted digital data on the four tracks of a DC300A cartridge's 300 ft of 1/4-in. tape. The transport provides precise 30 in./s tape speed that yields a 48-kbits/in. data transfer rate. This data throughput fills up a typical CRT terminal in about 1/2 s. The transport drives the tape at 90 in./s for rewind or fast search.

CIRCLE NO. 336

Salon international des Composants Electroniques
 3-8 avril 78 - Paris

All electronic components + measuring instruments, material and products + equipment and methods specific to the manufacture and installation of electronic components.



Further particulars and free entrance cards on request: International Trade Shows
 1350 Avenue of the Americas,
 New York, N.Y. 10019
 (212) 582.4960 - Tx 237 757 Fren Ur

Don't miss it, others won't.

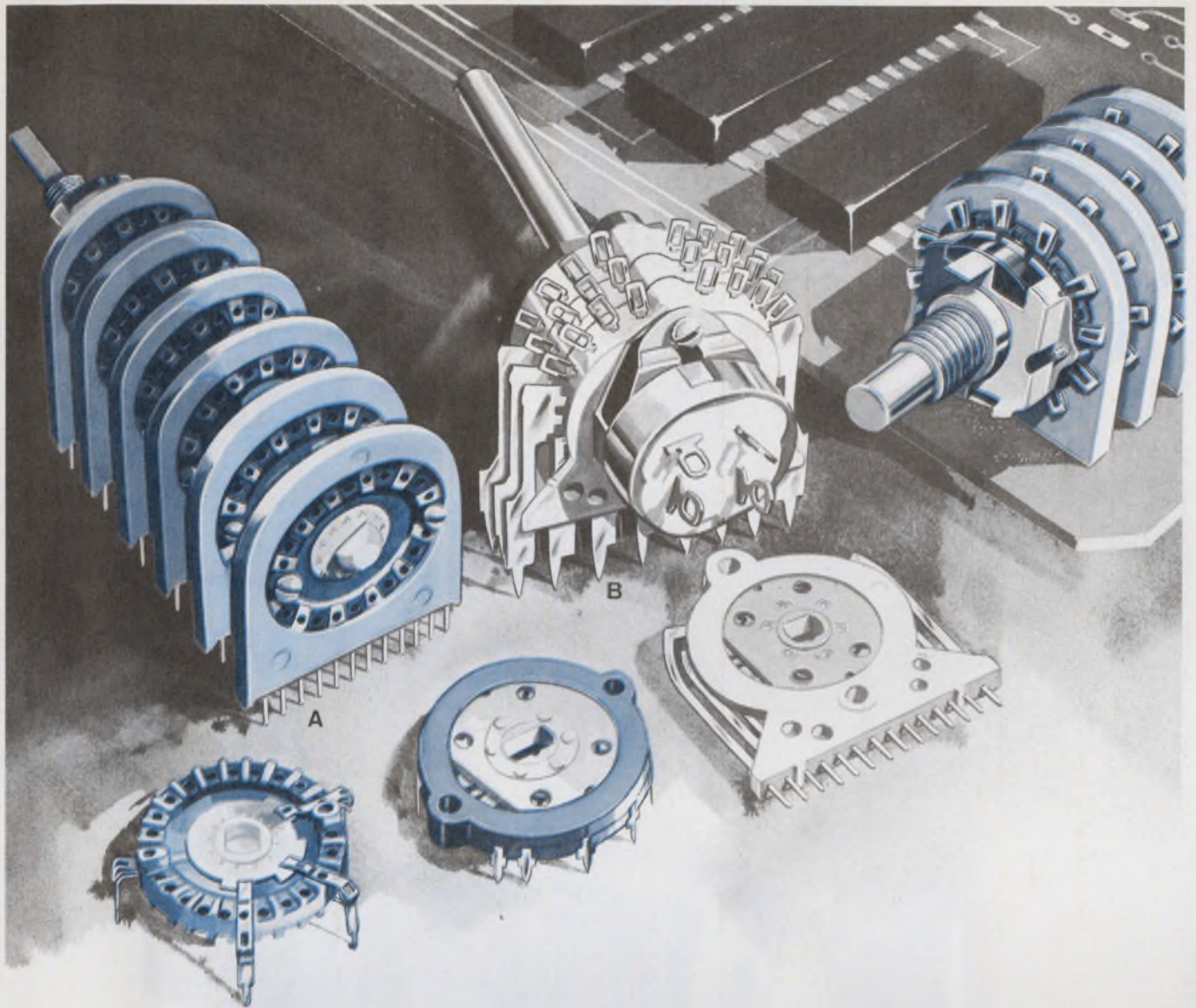

Handle most PC needs with rugged, compact CTS rotary switches.

Specify CTS and satisfy nearly every printed circuit switch mounting requirement. Cut production time, too. And at lower cost than with conventional wiring.

Choose from thousands of variations of shorting, nonshorting or mixed circuitry; plus a wide selection of index assemblies and wafer constructions for either perpendicular or parallel PCB mounting. Available in combination with AC power switches and variable resistors. You get a one-source supply for the complete switch package.

Two popular choices include the new CTS Series 223 parallel mount style (view A) measuring only $1\frac{1}{16}$ " wide by $1\frac{3}{8}$ " above the PC board permitting 12 PC terminals on .100" centers; up to 1-pole, 11-position circuitry. An optional 13th PC or solder lug terminal

gives a full 12-position switching capacity. Shown at (B) above is the CTS Series 227 rotary selector switch, which provides years of virtual problem-free performance in all kinds of applications. Parallel mount...single or multiple wafer constructions...compact $1\frac{1}{16}$ " wide by $1\frac{1}{32}$ " above PC board. One and two wafer designs are also available with shaft axis perpendicular to board. Ask about our NEW 14-terminal 1-pole, 12-position or 2-pole, 6-position PC switches, too.

Made to your exact specifications CTS switches assure proven reliability, design flexibility and MIL quality. Call your CTS representative or write **CTS Corporation**, 905 N. West Blvd., Elkhart, IN 46514. Phone: (219) 293-7511.

CTS CORPORATION
ELKHART, INDIANA



CIRCLE NUMBER 46

**DATA
PRECISION
GIVES
YOU
PORTABILITY
AND MUCH
MORE.**



Data Precision's leadership in digital instrumentation is based on high-value product planning, years-ahead engineering, and painstaking quality control. As a result, nearly 100,000 Data Precision instruments are now providing dependable service, at sustained accuracy, all over the world. Each model is designed to respond to different user price/performance needs, and has been optimized for a particular class of applications. The instrument for your specific requirements will deliver the accuracy and reliability your work demands.

In addition to the following portables, Data Precision manufactures a complete line of bench and system multimeters and additional counters.



Model 175 Portable 3 1/2-Digit DMM — \$189

Our Model 175 gives you 32 ranges of measurement capability, six functions, 0.1% DCV accuracy, and 100 microvolts resolution.

You can measure DCV from ± 100 microvolts to ± 1000 V, ACV from 100 microvolts to 500V with a frequency response of 30Hz to 50kHz, DC Current from ± 100 nanoAmps to ± 2 A, AC Current from 100 nanoAmps to 2A with a frequency response of 30Hz to 50kHz. Resistance from 100 milliohms to 20 Megohms in two excitation voltages.

The 175 also features auto-polarity, automatic zero, 100% overrange, and a big, bright 0.43" LED display.



Model 245 Portable 4 1/2-Digit DMM — \$295

The more than 50,000 units currently in use in the field attest to the outstanding performance and wide acceptance of this portable multimeter.

The Model 245 is a lab-quality, 5-function instrument with a basic DC accuracy of $\pm 0.05\%$ of input ± 1 l.s.d., .005% resolution and 100% overranging.

It will measure ACV (100 μ V to 500V RMS), DCV $\pm 100\mu$ V to 1000V, Resistance 100 milliohms to 20 Megohms, AC and DC Current 1 microamp to 2 Amps, AC voltage/current response 30Hz to 50kHz. And it has a large, easy-to-read display.



Model 248 Portable 4 1/2-Digit DMM, 10 μ V resolution, True RMS — \$345

This high-resolution instrument measures Resistance 100m Ω to 20M Ω , DC Volts $\pm 10\mu$ V to ± 1 kV, True RMS AC Volts 10 μ V to 500V, both DC Current and True RMS AC Current 10 nanoAmps to 2A. The Model 248 features sensitivity of 10 μ V. Basic DC accuracy is $\pm 0.05\%$ of input ± 1 l.s.d., guaranteed for a full year, 100% overrange, overload protection, and large LED display.

Complete Package

Data Precision Portable DMM's include rechargeable NiCd battery module, a pair of test leads, line cord with charger, carrying case, instruction manual, and individual test documentation — a complete report on your instrument, including temperature test results.

Optional Accessories

You can make your DMM even more versatile with optional accessories, including a 40KV high voltage probe, AC clamp-on current probes (150A or 1000A), RF probe bench stand, rack mount, mini-to-standard banana adaptor, deluxe leather case, and high impact fiberglass carrying case.



Model 585 Portable, 250 MHz, 8-Digit Frequency Counter — \$345

This 8-digit counter will measure frequency from 10Hz to 250MHz — always reading directly in MHz, with correctly positioned decimal point. Resolution is 0.1Hz.

This counter has excellent sensitivity — 10mV RMS to 50MHz, 50mV RMS to 250MHz — as well as dual Input Impedance (50 Ω /1M Ω); a wide-range 3 position attenuator; 3 gate times (10 sec., 1 sec., 0.1 sec.); resolution: 0.1Hz, 1Hz, 10Hz and a bright 0.3" LED display.

Model 585 comes complete with rechargeable NiCd batteries, line cord charger, (operates on line and battery) carrying case, full instruction manual, Certificate of Conformance, and final test data.

For complete information or a demonstration, call your local Data Precision representative or Data Precision Corporation, Audubon Road, Wakefield, MA. 01880, U.S.A., (617) 246-1600. TELEX (0650) 949341.

 **DATA PRECISION**[®]
...years ahead

Pulse Engineering again broadens its Delay Line Series

Digital Delay Modules

14 PIN CATALOG NUMBER	16 PIN CATALOG NUMBER	TOTAL DELAY (ns)	TAP DELAY (ns)	RISE TIME (ns) (MAX)
21197	21215	25	5	3
21198	21216	50	10	3
21199	21217	100	20	3
21212	21218	150	30	4
21213	21219	200	40	4
21214	21220	250	50	4

Dynamic RAM Timing Modules

14 PIN CATALOG NUMBER	TOTAL DELAY AT EACH TAP (ns)					RISE TIME (ns) (MAX)
	1	2	3	4	out	
21235	25	45	160	185	340	4
21236	30	80	220	250	400	4
21237	40	100	265	290	440	4
21238	85	140	320	345	515	5

For complete information write for data sheets 772-3, 772-4, 772-7

OFFICES IN:
Atlanta
Chicago
Needham
Santa Clara
Los Angeles

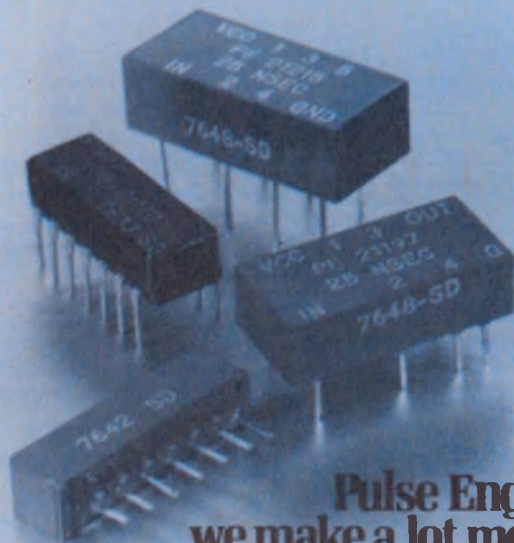

**Pulse Engineering--
we make a lot more
than just pulse
transformers.**

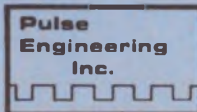

A Varian Subsidiary

P.O. Box 12235, San Diego, California 92112. Phone (714) 279-5900

CIRCLE NUMBER 78

MODULES & SUBASSEMBLIES

Printer has built-in microprocessor



United Systems, 918 Woodley Rd., Dayton, OH 45403. Dick Dale (513) 254-6259. \$595 to \$795; 11 wks.

The DigiTec Models 6310, 6320 and 6330 printers have internal μ Ps that simplify interfacing and reduce the component count as much as 10 to 1. The printers use the electrosensitive-printing technique, giving quiet operation and a high-contrast printout. The μ P delivers double-font printing and variable data formats. A crystal-controlled 24-h clock plus a day and month calendar operate even with the printer turned off. The 6310 takes data rates from 110 to 600 baud. The 6320 operates up to 1200 baud and the 6330 with an 8-bit parallel-bus input accepts data rates up to 1000 char/s.

CIRCLE NO. 337

Build data-acquisition system with DIPs

Micro Networks, 324 Clark St., Worcester, MA 01606. (617) 852-5400. See text.

You can build a data-acquisition system on the same board as your microprocessor using standard DIP components. The MN7130 multiplexed sample/hold amplifier contains all the system's front-end components including two 8-channel analog multiplexers, instrumentation amplifier and sample/hold amplifier. The multiplexers are digitally addressable and can be connected for either 16 single-ended or eight differential-input channels. The second package in the system is the ADC 80 12-bit a/d converter. The only other components required are two 10-turn trimpots, power supply bypass capacitors and a few logic packages to interface the microprocessor. The MN7130 price is \$90 and the ADC 80 is \$47.50 in 100 quantity.

CIRCLE NO. 338

Intel delivers 16K ROMs. In two weeks.

Finally, there's a realistic solution to your need for fast, fast delivery on 2316E 16K ROM orders. It's Intel's "OTP Program." And it puts parts in your hands just two weeks after you place your order with Intel. Not six weeks. Not four. Two weeks.

OTP is the key. It means One Time Programmable. When you place an order for a thousand or more 2316E ROMs, you'll get 25 programmed OTP 2616 EPROMs just 14 days later. That's the kind of offer only Intel can make. Then we'll ship 100 masked ROMs just six weeks A.R.O., up to 1000 more two weeks after that. No extra charge for the special service. No rushing the ROM process. And no production delays for you. The same goes for 2308 8K ROMs, using OTP 2608 EPROMs.

Call any of our sales offices, listed below, for details. When it comes to fast turnaround on ROMs, Intel means business.

ALABAMA
Glen White
Associates
Huntsville
(205) 883-9394

ARIZONA
Intel Corp.
Phoenix
(602) 242-7205

CALIFORNIA
Mac-1
Berkeley
(415) 843-7625

Mac-1
Cupertino
(408) 257-9880

Mac-1
Fountain Valley
(714) 839-3341

Intel Corp.
Santa Ana
(714) 835-9642

Earle Associates, Inc.
San Diego
(714) 278-5441

Intel Corp.
Sherman Oaks
(213) 986-9510

Intel Corp.
Sunnyvale
(408) 738-3870

COLORADO
Intel Corp.
Denver
(303) 758-8086

CONNECTICUT
Intel Corp.
Danbury
(203) 792-8366

FLORIDA
Intel Corp.
Fr. Lauderdale
(305) 771-0600

Intel Corp.
Orlando
(305) 628-2393

ILLINOIS
Intel Corp.
Oakbrook
(312) 325-9510

IOWA
Technical
Representatives, Inc.
Cedar Rapids
(319) 393-5510

KANSAS
Technical
Representatives, Inc.
Lenexa
(314) 888-0212

MARYLAND
Glen White Associates
Timonium
(301) 252-6360

Intel Corp.
Timonium
(301) 252-7742

MASSACHUSETTS
Intel Corp.
Chelmsford
(617) 256-6567

MICHIGAN
Intel Corp.
Southfield
(313) 353-0920

MINNESOTA
Intel Corp.
Bloomington
(612) 835-6722

MISSOURI
Technical
Representatives, Inc.
Hazelwood
(314) 731-5200

NEW JERSEY
Intel Corp.
Edison
(201) 985-9100

NEW YORK
Intel Corp.
Hauppauge
(516) 231-3300

Intel Corp.
Rochester
(716) 328-7340

T-Squared
Pittsford
(716) 248-5005

T-Squared
Syracuse
(315) 463-8592

Intel Corp.
Poughkeepsie
(914) 473-2303

NORTH CAROLINA
Glen White
Associates
Raleigh
(919) 787-7016

OHIO
Intel Corp.
Dayton
(513) 890-5350

Intel Corp.
Euclid
(216) 289-0101

OREGON
ES/Chase Co.
(503) 620-9616

PENNSYLVANIA
Intel Corp.
(215) 542-9444

TENNESSEE
Glen White Associates
Jonesboro
(615) 477-8850

Glen White Associates
Germantown
(901) 754-0483

Glen White Associates
Hickson
(615) 842-7799

TEXAS
Intel Corp.
Houston
(713) 771-5781

Myrosystems
Marketing Inc.
Dallas
(214) 238-7157

Myrosystems
Marketing Inc.
Houston
(713) 783-2900

Intel Corp.
Dallas
(214) 241-9521

VIRGINIA
Glen White Associates
Colonial Beach
(804) 224-4871

Glen White Associates
Lynchburg
(804) 384-6920

WASHINGTON
ES/Chase Co.
Seattle
(206) 762-4824

CANADA
Intel Corp.
Ottawa, Ontario
(613) 232-8576

Multitek, Inc.
Ottawa, Ontario
(613) 825-4553

intel delivers.

CIRCLE NUMBER 79

MODULES & SUBASSEMBLIES

Telephone encoder yields all 16 tone pairs

Data Signal, 40-44 Hunt St., Watertown, MA 02172. Clarence Walker (617) 926-5080. \$24.95; stock to 3 wks.

The Model DTE-100 dual tone encoder is an epoxy-encapsulated dual-frequency signal-generator module that provides all of the 16 tone pairs required for multifrequency telephone-tone dialing. The unit has an internal voltage regulator and ceramic oscillator and requires no external components to operate. Specs include 900-mV rms adjustable composite output into 600 Ω , ± 1.7 -dB high-frequency pre-emphasis, $\pm 0.3\%$ output stability versus line voltage, 5% total harmonic distortion, $\pm 0.25\%$ frequency stability from -55 to $+80$ C, 100-mW power drain and dimensions of $2 \times 2 \times 0.5$ in.

CIRCLE NO. 339

Switch-select 10 cut-offs in active LP filter



Linear Networks, P.O. Box 775, Westminster, CA 92683. Jim Hogen (213) 430-9342. \$128; stock to 3 wks.

The Model L1402V active low-pass filter networks with four-pole Butterworth or Bessel frequency responses have mechanically switched cut-off frequencies that can be selected by setting four 10-position switches. Standard nominal cut-off frequencies are 10, 100 and 1000 Hz. For each nominal frequency, the cut-off can be switched from 40 to 300% in 10 steps. Other cut-off frequencies and switching schedules are available on special order.

CIRCLE NO. 340

Dual drivers each sink heavy loads

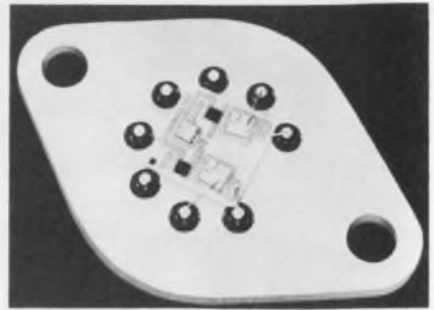

Fairchild Camera & Instrument, 464 Ellis St., Mountain View, CA 94042. Bill Callahan (415) 962-3816. \$5.00 (100 qty); stock.

The SH3011 has two independent drivers, each capable of sinking 5 A. The hybrid device can withstand 80 V between collector and emitter of the output transistors, which makes it suited for use in high-voltage impact printers, stepper-motor controls, solenoid drivers and large printers. Inputs are fully TTL compatible and the device is packaged in a TO-3 metal can.

CIRCLE NO. 341

QUICK-MATE

Snap-in LED with resistor ballast.

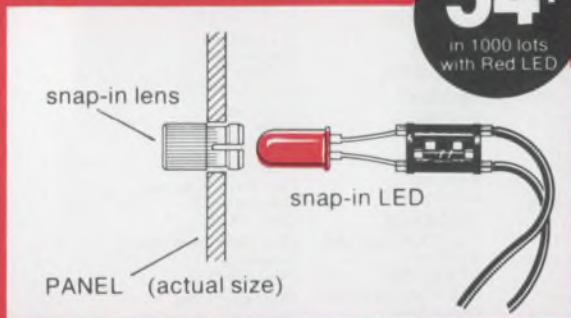

Low unit cost and speed of installation makes this package extremely economical. Lens mounts from front of panel; wired LED indicator light snaps into lens behind panel for instant installation with no tools required. 20 MA device complete with ballast, resistor (for up to 28 volts) and 6" wire leads. Also available with w/std clip and ring mount. Variety of lens colors. Available from: **Sorenson Lighted Controls, Inc.**, 530 Oakwood Avenue, West Hartford, CT 06110.

SoLiCo

CIRCLE NUMBER 80

IM1000 UNIVERSAL PROM PROGRAMMER



- HIGHEST PERFORMANCE/PRICE RATIO
- CAPABILITY TO PROGRAM ANY PROM FROM ALL MANUFACTURERS
- COMPACT FOR PORTABILITY
- TWO RS232 I/O PORTS FOR INTERFACING TO MICROCOMPUTER DEVELOPMENT SYSTEM OR TIMESHARE COMPUTERS
- 32000 BIT RAM FOR FULL EDITING OF PROM DATA

The IM1000 sells for \$1695. Personality Modules \$330. Contact us for a demonstration by our nationwide representatives.

TEL: 301/340-7505

IM International Microsystems, Inc.
638 Loftstrand Lane
Rockville, Md. 20850

CIRCLE NUMBER 81

ELECTRONIC DESIGN 4, February 15, 1978

The IC Switching Regulator that has everything!

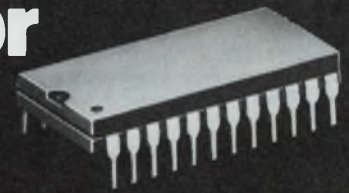

The Ferranti Model ZN1066E Pulse Width Modulator for use in: Switching Regulated Power Supplies, Motor Speed Controllers, DC/DC Converters and much more.

Features:

- High Efficiency
- 0-100% duty cycle control
- Zero overlap of external output transistors guaranteed
- Single ended or complimentary output drive
- Up to 120 mA output drive
- Output frequency adjustable to 500 KHz
- On-chip amplifiers for voltage and current control

- Short circuit protected
- 2.6 V stable reference, ± 50 PPM/ $^{\circ}$ C
- Soft start capability
- Inhibit and synchronizing inputs
- Major circuit functions externally accessible

better by design

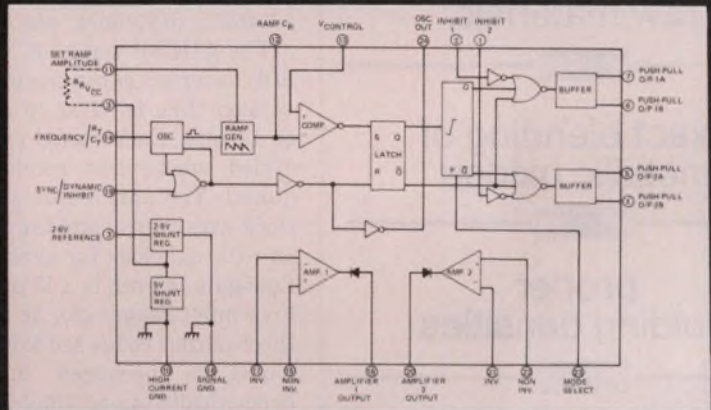

FOR COMPLETE SPECIFICATIONS, CONTACT: FERRANTI ELECTRIC, INC. / SEMICONDUCTOR PRODUCTS EAST BETHPAGE ROAD, PLAINVIEW, NEW YORK 11803 PHONE: (516) 293-8383 / TWX: 510-224-6483

CIRCLE NUMBER 82

DEPENDABLE

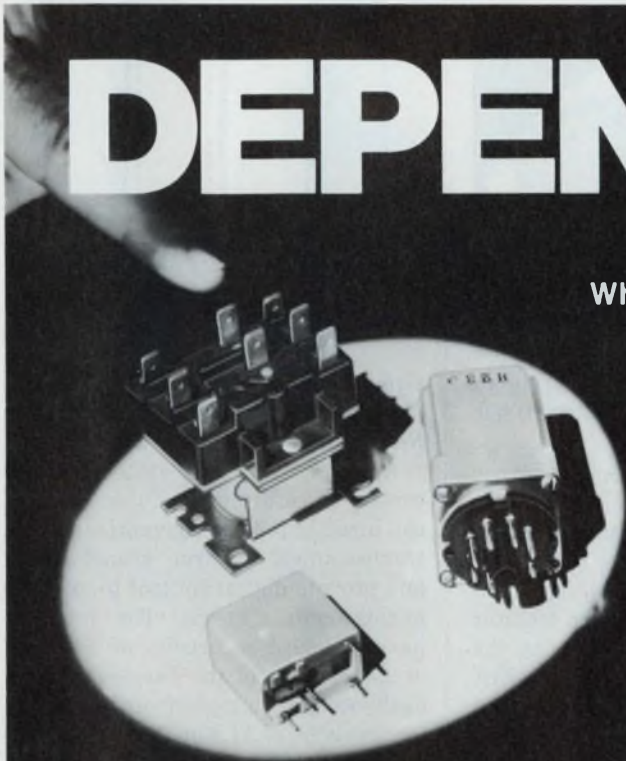

Whether you're looking for a sensitive miniature D.C. relay or a versatile A.C. power contactor, rely on Essex/Stancor.

Our relays and contactors are dependable! At Essex, we engineer for performance and doublecheck for quality. That's why you control it better when you control it with Essex. Essex/Stancor products are available off-the-shelf from electronic distributors everywhere. For more information, see your local distributor or write us for our free catalog:



Essex/Stancor,
3501 W. Addison St.,
Chicago, IL 60618, 312 / 463-7400

IN STOCK

20 ohm to 1 Meg ohm
ROD THERMISTORS

quality checked in
every
step of production



scrutiny of
raw materials



exact blending of
metallic oxides



proper
molding densities



precise sintering
conditions



uniform contacts
applied automatically



automated
wiring machines



solid state equipment
checks resistance



Eleven types with low/medium temperature coefficient and ten types with high temperature coefficient . . . You can order one thousand to one million, or send for Bulletin T-502 and find out about all types of Keystone quality thermistors.

Keystone
CARBON COMPANY

Thermistor Division
St. Marys, Pa. 15857
Phone 814/781-1591
CIRCLE NUMBER 84

MODULES & SUBASSEMBLIES

12-bit a/d converters
draw low power

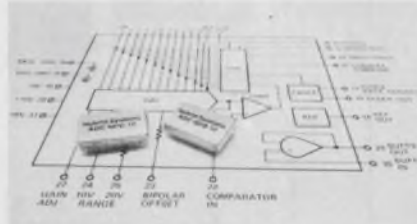

Hybrid Systems, Crosby Dr., Bedford, MA 01730. Larry Lauenger (617) 275-1570. \$194/\$214; stock to 4 wks.

The ADC581 series of 12-bit hybrid a/d converters consumes 570 mW. Conversion time is 30 μ s to a $\pm 1/2$ LSB of 12 bits. Each model can be short-cycled where less resolution is required. The unit features an internal clock-rate control and the option to use an external clock for synchronization. Low-gain tempco is ± 15 ppm/ $^{\circ}$ C max. Five input ranges can be selected and three output codes are available. Each model is packaged in a 32-pin hermetically sealed, dual-in-line metal case.

CIRCLE NO. 342

Modem monitor
isolates failures

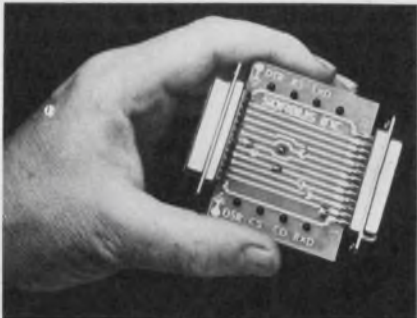

Sorbus, 150 Allendale Rd., King of Prussia, PA 19406. (215) 265-6700. \$89; 4 to 8 wks.

A compact signal-display device, Traffic Light, placed in-line between data sets and data-communication terminals isolates failures. The unit monitors without disrupting communications. The pocket-size monitor uses LEDs to constantly display the status of seven key signals on the EIA RS-232 25-pin interface. The signals monitored are transmitted data, received data, request-to-send, clear-to-send, data-set ready, carrier detect and data-terminal ready. A spare LED circuit shows the status of any other signal. Test points are provided for scopes, meters and logic probes.

CIRCLE NO. 343

16-bit d/a converters
sub for Intech type

CPS, 110 Wolfe Rd., Sunnyvale, CA 94086. (408) 738-0530. See text; stock.

Two 16-bit d/a converters are offered as a second source to the Function Modules/Intech type 416-BIN. The first, Model CYDAC416-BIN, is an exact equivalent available at \$155 each. The higher performance model, CYDAC416A-BIN, is a plug-in replacement with settling time of 50 μ s, stability of 1 ppm/ $^{\circ}$ C and true 16-bit, 1/2 LSB accuracy and is available at \$265. Either version comes in a 2 \times 3 \times .4-in. modular package with a built-in temperature-reference network. The devices accept either straight-binary inputs, for unipolar operations, or off-set input, for bipolar operations.

CIRCLE NO. 344

Modules give digital
control to analog servos



Computer Conversions, 6 Dunton Ct., East Northport, NY 11731. Stephen Renard (516) 261-3300. \$350; 4 wks.

A series of solid-state synchro control-transformer modules, SCT 40, can directly replace conventional electromechanical control transformers and provide digital control to existing analog-servo systems. The modules have standard accuracies of ± 6 , ± 15 or ± 30 minutes of arc. They simultaneously accept one input from a synchro (or resolver) of 11.8 or 90 V at 400 Hz or 90 V at 60 Hz and another input coded in 14, 12 or 10-bit binary. The output is the sine of the difference between two input angles. Bidirectional input data are accepted and no adjustments are required.

CIRCLE NO. 345

When battery life is critical, there's nothing even close to a TRW LVA zener

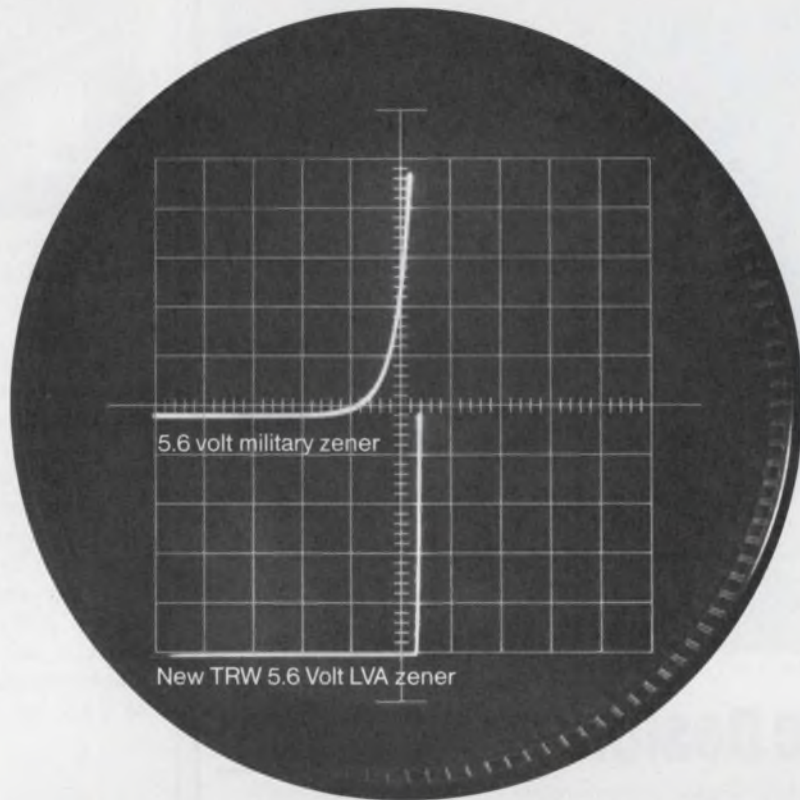

**The sharpest knee below 10 volts
for up to 10 times the battery life.**

In medical equipment, testing devices, watches, pocket pagers—wherever battery life is critical—no other zener can approach a TRW LVA.

TRW's Low Voltage Avalanche zeners are also ideal for instrumentation and logic circuitry where as highly stable zeners they provide extremely constant reference voltage yet draw as little as 50 microamps. True, they cost more. But where battery life is more important than a dollar or so, or when you have to load in transistors and resistors to minimize battery drain, it pays to use TRW LVA's. For your convenience, they're available in several package configurations and chips.

For immediate action and applications assistance, call John Power (213) 679-4561.

TRW Power Semiconductors,
An Electronic Components Division of TRW, Inc.,
14520 Aviation Boulevard, Lawndale, California 90260

Please send me data sheets on TRW's LVA zeners.

Please send samples of _____ devices.
(Voltage)

Name _____

Company Name _____

Address _____

City _____

State _____

Zip _____

ED

TRW POWER SEMICONDUCTORS

ANOTHER PRODUCT OF A COMPANY CALLED TRW

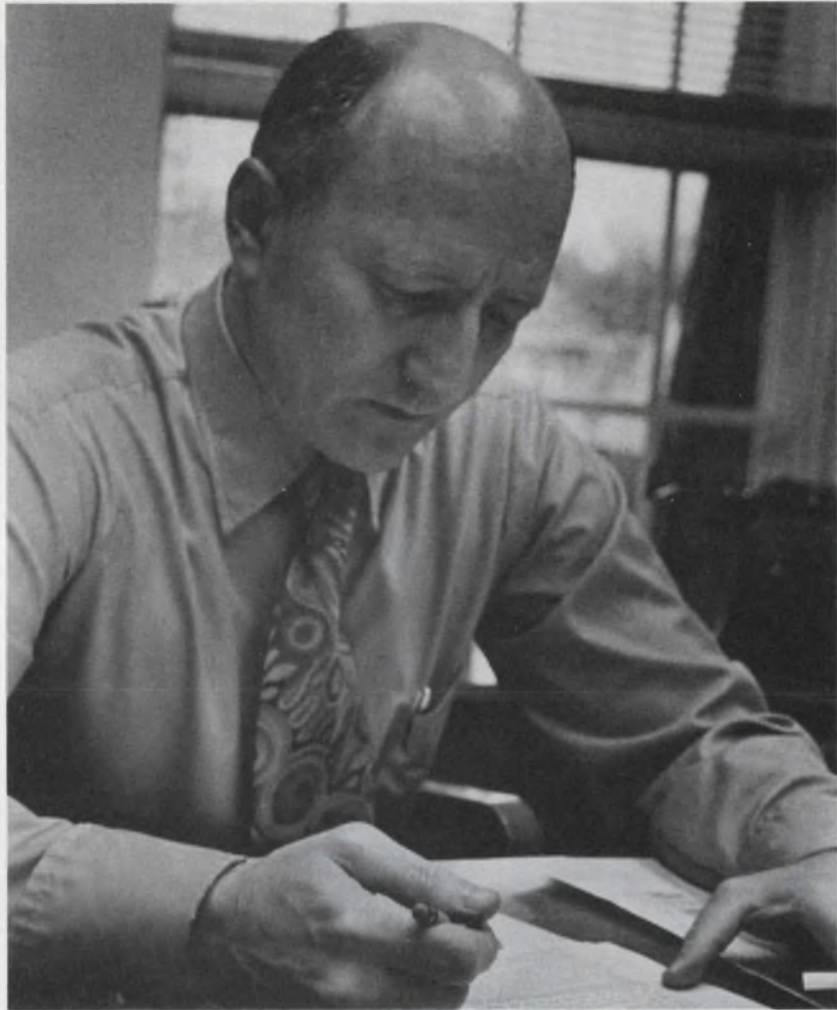

George Rostky, Editor-in-Chief, *Electronic Design*

Electronic Design WANTS YOU

If you have solved a tricky or unusual design problem... if you have experience in a special area that will aid the design process... if you have simplified a circuit or developed a practical design aid *why not share it with your fellow engineer-readers of Electronic Design?*

Each man has his own motivation for writing an article. Here are just a few:

- To help other engineers do their jobs better.
- To help build your company's image.
- To raise your professional status and speed your advancement.
- To increase your own knowledge.

To encourage authors to submit material to us, and to make it easier, we've prepared a special AUTHOR'S GUIDE that's yours for the asking. Contents include:

- Why write?
- Why write for *Electronic Design*?
- Which articles will *Electronic Design* accept?
- How long should it be?
- What form should it take?
- Tips on structure.
- Tips on writing.
- Tips on getting it done.
- 7 Tests you can apply to your article.
- What happens to your article?
- Where to send it.

Why not get started today? Payment can range as high as \$200 for an article contributed in a single issue.



FOR FREE
Electronic Design
AUTHOR'S GUIDE
CIRCLE NUMBER 300

MODULES & SUBASSEMBLIES

**10 and 12-bit d/a's
 operate from ± 12 V dc**



Burr-Brown, International Airport Industrial Park, Tucson, AZ 85734. Steve Howard (602) 294-1431. \$47.00/\$49.50 (100 qty).

The Models ACD80AGZ-12 and ADC80AGZ-10 a/d converters operate from ± 11.4 to ± 16 -V-dc supplies making them compatible with ± 12 -V applications. The 32-pin ceramic package includes a logic supply of +4.75 to +16 V dc. Conversion speeds are 25 μ s for 12-bit and 21 μ s for 10-bit resolution. Linearity error is $\pm 1/2$ LSB max; gain drift is ± 30 ppm/ $^{\circ}$ C. Internal scaling resistors are provided for programmable selection of analog input ranges of ± 2.5 , ± 5 , ± 10 and 0 to +10 V.

CIRCLE NO. 346

Amplifier isolates high input/output voltage

Intronics, 57 Chapel St., Newton, MA 02158. Dick Sakakeeny (617) 332-7350. \$58; stock to 4 wks.

The Model IA286 isolation amplifier has gain adjustable from 1 to 100, isolated power (± 10 V at 10 mA), and isolated output section for input common-mode voltages up to ± 5 -kV dc, 6.5-kV pk. The input circuit presents a differential impedance of 10^{12} Ω in parallel with 3 pF and a common-mode impedance of 10^9 Ω in parallel with 10 pF. Input noise is held to 8 μ V pk-pk, measured in a band from 0.5 to 100 Hz, and 5 μ V rms in a band from 10 Hz to 1 kHz. Noise current is 10 pA pk-pk, from 10 Hz to 1 kHz. The input section includes a ± 10 -V dc, 10-mA supply for powering an external transducer or circuit.

CIRCLE NO. 347

There's a Simpson DPM that's right for your application

All Simpson DPM's feature:

- 0.1% accuracy
- 3-1/2 digit readout
- Automatic zero and polarity
- Dependable LSI circuitry
- Choice of 120/240 V AC or 5 V DC operation
- Panel cutout 1.682" x 3.622". Adaptors available for IEC/DIN and other domestic cutouts
- Input/output edge connector included
- Full 200 hour burn-in
- Backed by the Simpson one-year warranty



Model 2860

The Dedicated DPM

New Series 2860—high performance at a low price

from **\$4940***

- 9 stock ranges available
- Bright 0.43" LED readout

The Systems DPM

Deluxe Series 2850—printer/computer interfacing capability and options for custom applications

\$92*

- 9 stock ranges
- Specials available including AC ranges
- Choice of 0.43" LED or 0.55" planar gas discharge display
- BCD output standard

• 100-lot OEM prices

Available From
Electronic Distributors
Everywhere

Write for Bulletin P612
containing complete
technical specifications.



Model 2850



Model 2852

SIMPSON ELECTRIC COMPANY

853 Dundee Avenue, Elgin, Illinois 60120
(312) 697-2260 • Cable SIMELCO • Telex 72-2416

IN CANADA: Bach-Simpson, Ltd., London, Ontario

IN ENGLAND: Bach-Simpson (U.K.) Ltd., Wadebridge, Cornwall

IN INDIA: Ruttonsha-Simpson Private, Ltd., Vikhroli, Bombay

CIRCLE NUMBER 86

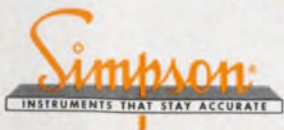

KATY INDUSTRIES



INDUSTRIAL
EQUIPMENT
GROUP

Bus analyzer 'thinks big' but goes for small price

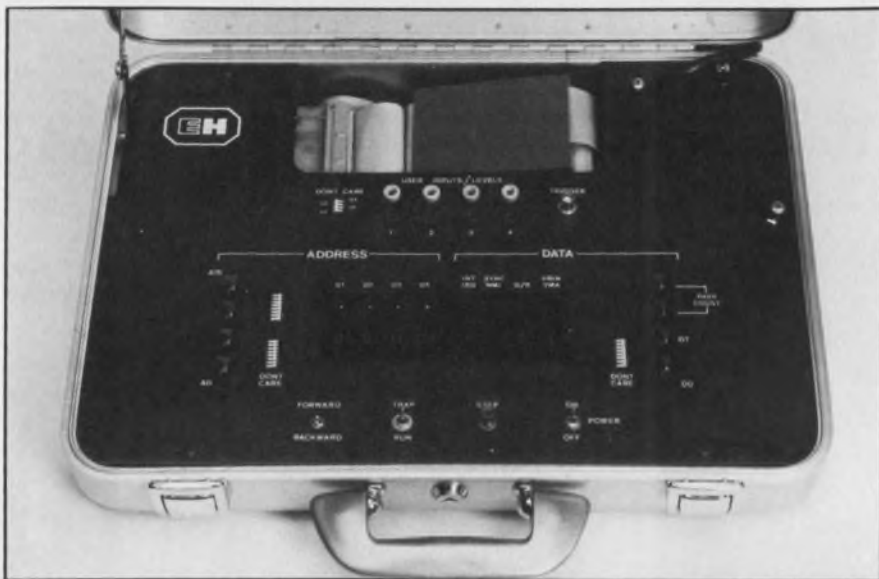

E-H International, 515 11th St., Oakland, CA 94504. Jay Long (415) 834-3030. \$1000 (basic), 30 days.

The MBA-1 is the first inexpensive (\$1000) logic analyzer to offer a large memory. The unit can trap 128 32-bit words at clock rates up to 5 MHz. Made for real-time monitoring of μ P-based systems, the MBA-1 Micro Bus Analyzer offers interchangeable probes for the 8080, the 6800, or the Z-80. You select the appropriate probe, plug one end into the MBA-1, and clip the other end onto the μ P.

The MBA-1 captures a 128-word sequential block of data in memory. It traps the last 32 words before the selected trigger and the first 96 after. Of the 32 bits in each word stored, 28 come from the μ P itself—16 address bits, 8 data bits, and 4 μ P status bits. The others come from four external input lines brought to the MBA-1 front-panel jacks.

The ONE/ZERO values of all 32 bits are clocked into MBA-1 memory at the μ P clock rate. Thus the trapped data will span a full 123 μ P commands only if they are single-clock-cycle instructions. But ordinarily, two and three-clock-period commands are interspersed, so that the effective capacity of the "snapshot" is significantly less than 128 lines of machine-language code. (For more on this feature, see "Focus on Logic and μ P Analyzers," ED No. 3, Feb. 1, 1977, p. 40.)

Data are displayed on six hex LED digits for address and data and eight single LEDs. Together, these show one full 32-bit word at a time. Also, the display can be stepped back and forth through the memory.

Since no scope is required for this data-domain analyzer, no scope display signals are available from the digital memory. But the MBA-1 does output a scope trigger signal each time its trigger-conditions are met so waveform investigations are possible.

Trapping occurs when 36 specified bit conditions are met, as set by front-panel switches. Two hex thumbwheels, called pass-count switches, permit trapping to be delayed by up to 256 (FF) trigger events. You select the number by setting four hex thumbwheel switches for the 16 bits of address, two hex thumbwheels for the eight bits of data, and "don't-care" miniswitches for address and data and for the four bits of external input data.

Input-impedance of the E-H analyzer is 10 M Ω in parallel with 10 pF. Logic thresholds are 0.8 V max for a ZERO and 2.0 V min for a ONE. The probes are buffered.

Self-contained in an 18 x 13 x 4-in. attache case, the 12-lb unit operates over 0 to 50 C.

The \$1000 base price does not include the personality probes, which cost about \$200 each.

CIRCLE NO. 304

Logic monitor looks 'inside' digital ICs

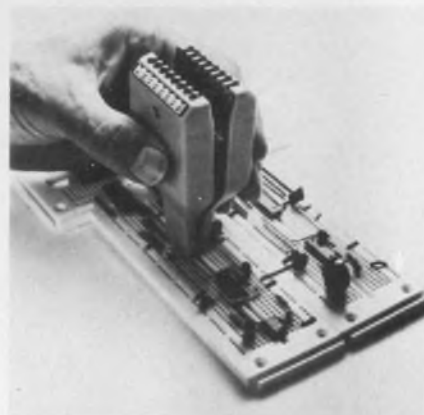

Continental Specialties, 70 Fulton Ter., New Haven, CT 06509. (203) 624-3103. \$74.95.

Peek "inside" digital ICs with a 16-channel clip-on logic monitor, Model LM-1. A LED at each pin indicates the state of that pin by lighting or remaining dark. By monitoring an entire 14 or 16-pin DIP at once, the logic monitor reveals the action of the package as a whole. The device tests DTL, TTL, HTL and CMOS logic families. It automatically seeks out the highest positive and lowest negative voltage levels and draws its power from the IC under test. Individual comparators at each pin drive labeled LEDs on for a HIGH and off for a LOW logic level.

CIRCLE NO. 348

Function gen spans 0.2 Hz to 3 MHz



Krohn-Hite, Avon Industrial Park, Avon, MA 02322. Ernie Lutfy (617) 580-1660. \$245; 4 wks.

The Model 1000 function generator provides sine, square and triangle waveforms from 0.2 Hz to 3 MHz, with adjustable amplitude from 5 mV to 20 V pk-pk. Included are a 1500:1 manual tuning dial with 5% fine-tune vernier, external voltage control of frequency, control voltage output and auxiliary TTL output with 15-ns rise and fall. Frequency response is better than 0.1 dB and distortion is typically 0.25%.

CIRCLE NO. 349

THE CENTRALAB EDGE in disc capacitors



Any Lead Variation You Need

At Centralab we are concerned with the same things you are – performance, reliability, on-time delivery. But any ceramic disc capacitor supplier can say that. We go that critical step further; we give you a choice of leads to help you cut your manufacturing costs.

Our standard leads include stand-off types to prevent solder damage; snap-in types to avoid fall-out during assembly; short leads for low profile; long leads for those hard-to-reach placements.

We'll go even further. On minimum OEM order, we'll make any lead configuration (under 3½") you need. Just tell us your manufacturing problem; we'll give you a cost-effective answer.

And don't forget our tape-and-reel packaging for automatic insertion.

Cost savings *in use*. That's the competitive edge you get from Centralab. The Centralab Edge.

Products you need from people who care.



CENTRALAB/USCC
Electronics • GLOBE-UNION INC.

7158 Merchant Ave., El Paso, TX 79915 (915) 779-3961

CIRCLE NUMBER 88

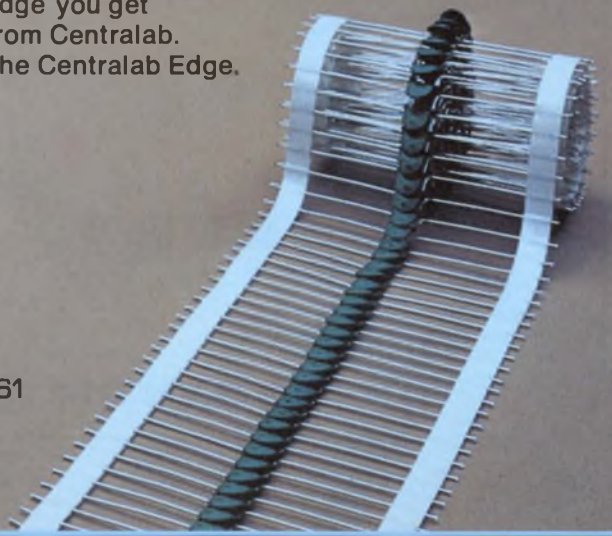

INSTRUMENTATION

Timer programs output cycles with 100-division IBM card



Xanadu Controls, Div. of Valcor Engineering, 45 Fadem Rd., Springfield, NJ 07081. Peter Mesniaeff (201) 467-8100. P&A: See text.

You can time sequences on parallel channels without the usual fuss using the Xanadu Controls universal programmable timer, the UP Timer. To set precise, repeatable sequences, all you do is mark the IBM card that comes with the timer, slide it into the timer's reader and hit a button. The instrument does the rest. It memorizes the on-off intervals marked on the card and opens and closes the output-reed

or solid-state relays at the appropriate moments.

Up to 10 timing tracks are available, and cycle durations can be set on thumbwheel switches to last anywhere between 10 milliseconds and 100 hours. Each cycle is divided into 100 divisions. Those segments darkened on the IBM card represent the ON condition; those unmarked represent OFF.

To change a program, just slide in a different card, and off you go. You can store a bunch of cards for various applications, and change programs quickly when necessary.

The Xanadu instrument can repeat a given program, stop after a single cycle, or "pause"—that is, freeze in the state just before switching to the pause mode. A LED display shows the status of the various cycle and time relationships.

The UP Timer goes for \$1066 to \$1588, depending on the number of channels. Delivery is from stock.

CIRCLE NO. 305

Band-reject filters cover 225 to 400 MHz



K & L Microwave, 408 Coles Circle, Salisbury, MD 21801. Charles Schaub (301) 749-2424.

The TND tunable band-reject filter covers the frequency range of 225 to 400 MHz and has a direct readout with frequency resolution of 100 kHz throughout the range. The filter is in a one-piece aluminum housing with plated cavities to achieve a high "Q." A constant 0.05-dB Chebyshev-ripple response is maintained by varying the loaded capacitance of each section inversely as the frequency is increased. Resettability of the direct readout, which is calibrated to the notch frequency, is within ± 500 kHz.

CIRCLE NO. 350

S-D puts the squeeze on time code!

Systron-Donner's new compact-sized family of precision time code equipment offers you everything you could possibly need in generators, readers, and remote displays. All 8700 series models measure just 1 3/4" high x 9 1/2" wide. These advanced instruments generate, read and display standard modulated serial time codes. Both the time code reader and generator may be powered by either 115 VAC or 12 VDC. For digital system operation, a parallel BCD output with computer read command is available as an option on the reader and generator.

For complete details on the very latest in time code technology, contact your local Scientific Devices office or Systron-Donner, Data Products Division, 935 Detroit Avenue, Concord, CA 94518. Phone (415) 798-9900.



Model 8781
Compact Remote Display



Model 8720
Compact Time Code Generator



Model 8730
Compact Time Code Reader

SYSTRON  DONNER

CIRCLE NUMBER 87

The Complete Solution to your F3870 and F8 Design-In Problems

The Formulator Development System



The Formulator family is designed to allow easy, efficient software development and real time hardware simulation of F8 or F3870 based systems. It is supported by a complete line of functional modules including memory, I/O and simulation cards that plug directly into the Formulator cardframe.

The Formulator can, itself, be used as the system breadboard. It provides microprocessor hardware, plus card slots for breadboarding your system. Thus the entire system may reside within the Formulator or in a combination of external and internal configurations.

In-Circuit Emulation

To develop, test and debug F8 and F3870 based products, Fairchild offers simulation options that extend the functional features of the micro-

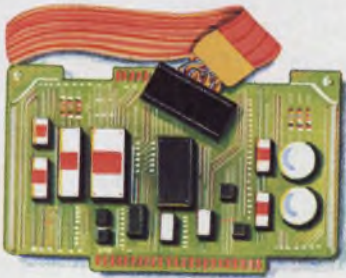

processor from the Formulator to the 40-pin socket on your breadboard. This allows complete ROM firmware development, real-time symbolic debugging of your breadboard and freezing of ROM codes during the breadboard stage.

PROM Prototypes

The 3870 Emulator is a PROM-based substitute for the F3870 microprocessor. The Emulator measures 5" x 7" and contains two 2708 or 2716 EROMs in place of the F3870 so ROM codes can be verified and easily changed if necessary.



The F3870 Emulator plugs directly into the F3870 40-pin socket in the production prototype via a short cable.

Powerful and Complete Software

The software consists of an operating system, utility programs and diagnostic routines; a monitor, text editor, assembler and debug package. It includes linking loader and relocating assembler and will operate in interactive or batch mode. The result is an easy to use, reliable, fast and extremely efficient capability for microprocessor based system development.

The Formulator-Floppy Disk Marriage

An inexpensive plug-in module interfaces the Formulator with up to four plug-compatible ICOM Floppy Disc Drives, providing over one megabyte of storage. If you prefer other Floppies an application note provides the information necessary to modify Drivers for your system.



And That Isn't All

There is a lot more to Fairchild's line of design aids: PCB modules, memory options, PROM programmer, application and peripheral options, design kits, one card micro-computers, software, user's guides and training courses.

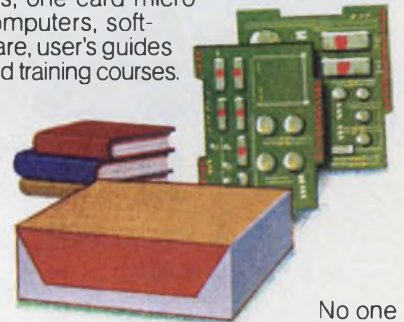

No one offers the extensive F8 and F3870 support that you can get from Fairchild. Just ask us about it.

Fairchild Instrumentation and Controls, a division of Fairchild Camera and Instrument Corp., 1725 Technology Drive, San Jose, California 95110 (408) 998-0123, Ext. 220.



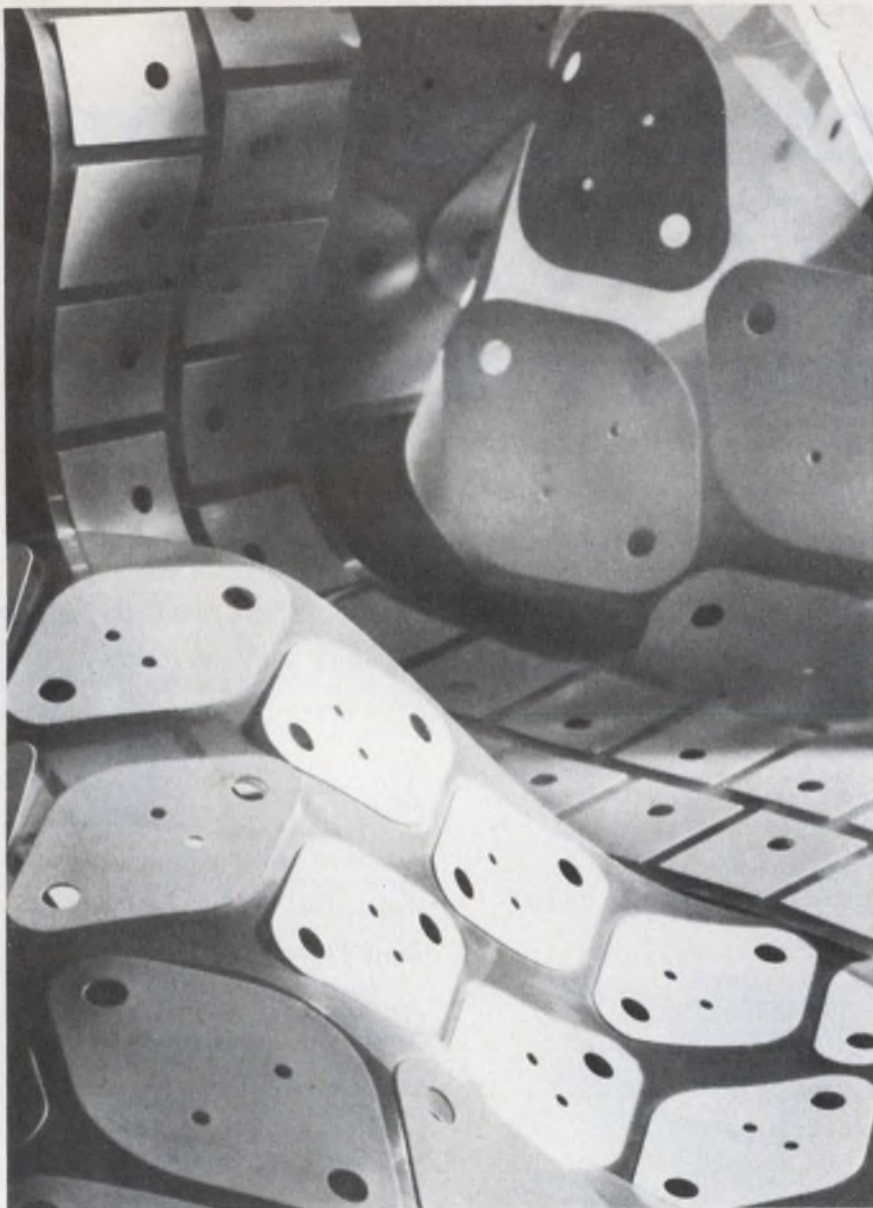

CHO-THERM-R Transistor Insulating Without Grease

Why mess around? With Chomerics CHO-THERM-R elastomers, you can get the thermal impedance of mica, BeO and other insulators . . .

without the need to use grease. Not only that, CHO-THERM-R is tough! Reinforced with glass cloth, the material resists tears and punctures. No more cracking of brittle insulators by overclamping.

CHO-THERM-R is available in different formulations to meet various price/performance requirements. Catalog describes Chomerics' family of thermally conductive products.



CHOMERICS

77 Dragon Court, Woburn, Massachusetts 01801
Tel. (617) 935-4850 / TWX 710-393-0173

CIRCLE NUMBER 93

ICs & SEMICONDUCTORS

Darlington's include commutating diodes



Kertron, 7516 Central Industrial Dr.,
Riviera Beach, FL 33404. (305)
848-9606. \$4.50/\$4.95 (100 qty); stock.

Hybrid Darlington devices (KDM922, 924, 902, 904) include emitter-base resistors and a high-speed commutating diode. Two transistors, KDM922 and 924, are available in the TO-66 package. The KDM922 has a BVCEO rating of 80 V. The KDM924 has a BVCEO rating of 120 V. The TO-5 packaged devices are the KDM902 and KDM904 with the KDM902 rated at 80 V and the KDM904 rated at 120 V. All the devices have a minimum current gain of 1000 at a collector current of 5 A and a collector voltage of 5 V.

CIRCLE NO. 352

Thrifty d/a converters are on monolithic chips

Micro Power Systems, 3100 Alfred St.,
Santa Clara, CA 95050. Tarlton Fleming
(408) 247-5350. See text; stock.

Four d/a converters, MP 7520G, 7520H, 7521G and 7521H, consist of a thin-film R-2R ladder plus a number of CMOS current switches on a monolithic chip. For most uses, these converters only require the addition of an output op amp and a voltage or current reference. The MP7520G and 7521G have 6-bit linearity, while the 7520H and 7521H are rated at 7 bits. The 7520 units have 10-bit resolution and are housed in a 16-pin DIP. The 7521s have 12-bit resolution and are housed in 18-pin DIPs. Prices in 1000 quantity are \$2.60 for the MP7520G; \$3.05 for the 7520H; \$2.85 for the 7521G and \$3.35 for the 7521H.

CIRCLE NO. 353

NEW X-Y RECORDER

**MORE RELIABLE
LESS EXPENSIVE
BECAUSE...**

"THE POT IS NOT"

**A capacitance
feedback transducer
replaces the
potentiometer
and slidewire -**

**neatly eliminating
the most troublesome
components in X-Y
servo systems**

- ★ No more slidewire cleanser
- ★ No more slidewire lubricant
- ★ No more slidewire

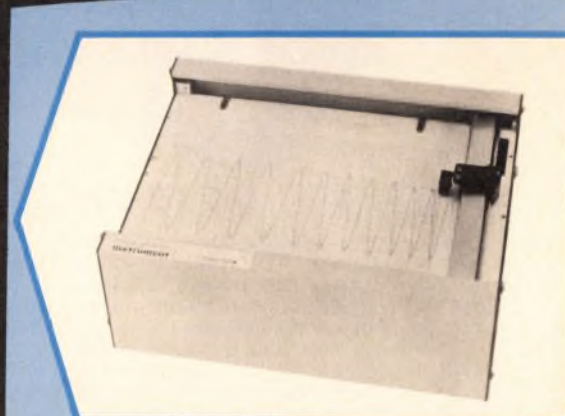

Prices start at \$895.*

**Send today for complete information on
the Series 100 - a new concept in low
cost X-Y recorders.**

**houston
instrument**

**THE
RECORDER
COMPANY**

DIVISION OF BAUSCH & LOMB

ONE HOUSTON SQUARE (at 8500 Cameron Road) AUSTIN, TEXAS 78753
(512) 837-2820 TWX 910-874-2022 cable HOINCO
TELECOPIER

EUROPEAN OFFICE Rochesterlaan 6 8240 Gistel Belgium
Phone 059/277445 Telex Bausch 81399

CIRCLE NUMBER 50

"Visit us at booth #223 at the Pittsburgh Conference in Cleveland Feb. 27-March 2."

* U.S. Domestic Price only

EPROMs are organized as 2048 eight-bit words

Motorola, 3501 Ed Bluestein Blvd., Austin, TX 78721. (512) 928-2600. \$29.25 (100 qty); samples available.

Two EPROMs are organized as eight-bit words. The MCM2716L and MCM2717L are n-channel silicon-gate

devices for operation with power supplies of +12, +5, and -5 V. Max access time and min cycle time is 450 ns. The MCM2716L is a pin-for-pin replacement for the TMS2716 and is pin-compatible to the MCM2708L, MCM2708P, MCM2708C and MCM68708L EPROMs. For mask-ROM compatibility, use the MCM2717L that is pin-compatible to the MCM68316E (2 k × 8 single 5-V supply, mask-programmable ROM). Both memories are in 24-pin ceramic "window" packages.

CIRCLE NO. 354

Octal latch is in 20-pin package

National Semiconductor, 2900 Semiconductor Dr., Santa Clara, CA 95051. Bob Bennett (408) 737-5720. \$1.80 (100 qty); stock.

The octal latch, MM54C373/74C373, is a 20-pin CMOS interface device. When its 8-bit latch enables are high, its Q outputs follow the D inputs. When the latch enables go low, data formerly at the D inputs are retained at the outputs until the latch enable returns to high. The device operates with a supply voltage from 3 to 15 V and noise immunity is about 45% of the supply voltage. Power consumed is 1 μW at 15 V. Drive current is 20 mA per output.

CIRCLE NO. 355

Photocoupler arrays have 2-μs response

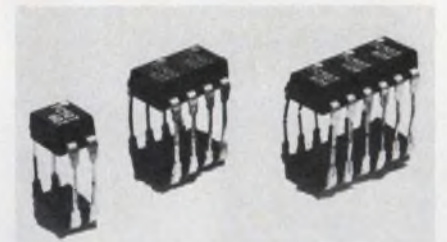

Quantrad, 139 Illinois St., El Segundo, CA 90245. (213) 322-2086. \$1.27 to \$3.81 (100 qty); stock to 4 wks.

The PC-507 series of single, dual and triple photocouplers are TTL compatible and have a response time of 2 μs. Collector to emitter voltage is 0.4 V (max), current transfer ratio is 50% and the reverse isolation voltage is 1500 V. The typical dark current is 1 × 10⁻⁹ A at a V_{CE} of 20 V. The units are housed in plastic DIPs.

CIRCLE NO. 356

Medium power transistor has 10-dB gain at 2 GHz

Avantek, 3175 Bowers Ave., Santa Clara, CA 95051. Bill Berridge (408) 249-0700. Stock.

The silicon bipolar microwave transistor, AT3850, typically produces 150 mW (at 1-dB gain compression) with 10 dB associated gain at 2 GHz. At 3 GHz, the output power is 100 mW with an associated gain of 8 dB. The transistor has platinum silicide contact structures to minimize contact resistance and a gold system that produces uniform conductors more than one micron thick. Package is a hermetic ceramic/metal 0.1-in. square stripline.

CIRCLE NO. 357

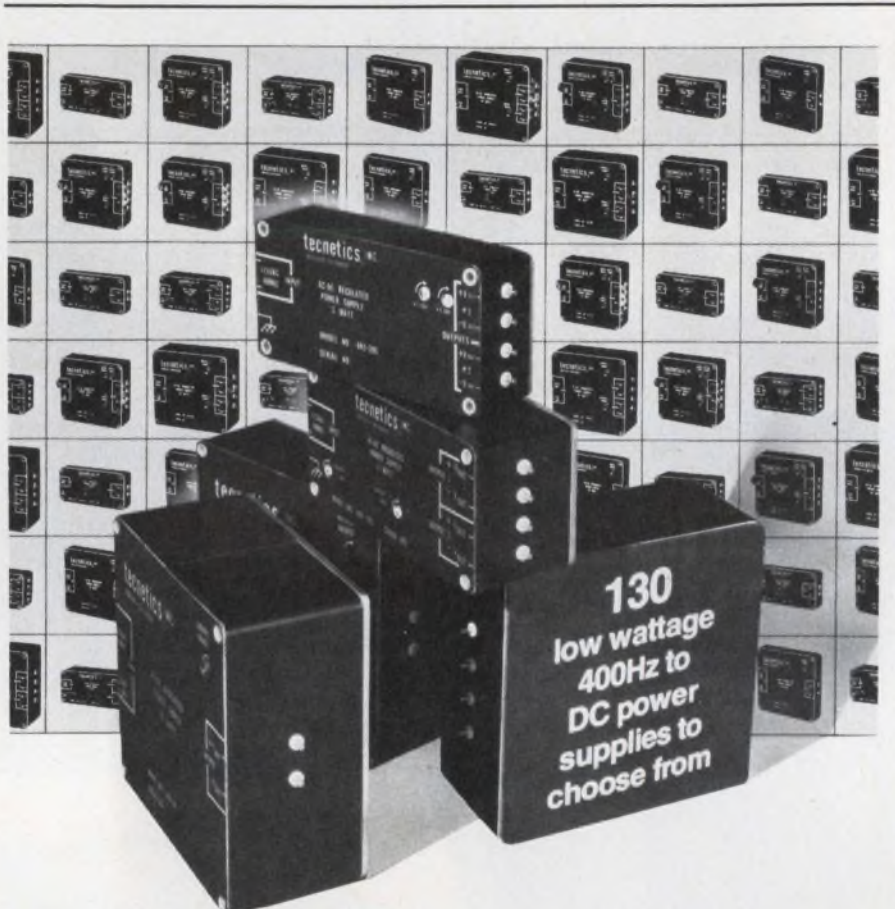

FREEDOM OF CHOICE FROM TECNETICS

Until now, the field has been pretty limited in low power, high reliability 400Hz to DC single phase power supplies. Tecnetics changed all that with the introduction of its new 400 Series.

There are over 130 different power supplies in all: 3, 6, 10, 15 and 20 watt units with single, dual and triple outputs. Output range is from 5 to 28 volts. Military type components are standard and High-Rel components are available. All fully documented and ready to go.

And, look at some of the specs: MTBF on single output units ranging from 70,000 hrs. standard to a mighty 180,000 hrs. on the High-Rel models, high efficiency, overload protection, excellent

regulation, full encapsulation, and thermal design with baseplate cooling.

So, when you're designing complex military hardware, airborne instrumentation, or anyplace you have 400Hz to DC power conversion requirements, look to Tecnetics wide selection of power supplies. Send for our catalog now.

	400 Series Prices (1-9)		
	Single	Dual	Triple
3W	\$200	\$245	\$295
6W	210	255	305
10W	230	275	325
15W	240	285	335
20W	250	295	365

Contact factory for prices on hi-rel units

tecnetics® The Power Conversion Specialists
P.O. Box 910, 1625 Range Street, Boulder, Colorado 80302 · (303) 442-3837 TWX 910-940-3246

The first 'go anywhere' printer/plotters are here.



Printout. Plots. CRT hard copy. Anywhere. From the world's most advanced electrostatic printer/plotters.

Compact design fits anywhere. Mount in a rack. Set on a desk. Or use our mobile cabinet base.

Rugged units go anywhere. Bounce them around in a truck. Run at a tilt aboard ship. They keep running. And they do it so quietly, you can use them in any office.

Best reliability. Nothing is more reliable than an electrostatic. MTBF exceeds 3000 hours. But we made this simple, direct means for putting information on paper, simpler. And that means even longer uptime.

Easy service. You can take this printer/plotter down to major component level and put it together again in less than twenty minutes. Self-diagnostics and modular design make trouble-shooting a breeze.

Forget adjustments with these exclusive self-aligning features. Backplate electrode self-aligns to writing head. Toner wiper bars self-align to toner channel. Even the programmable paper cutter is self-aligning. So is paper, because the exclusive differential drive keeps paper straight, without skew or tear.

The perfect fit. Run longer, anyplace. Repair faster, anytime. Use fewer spares, anywhere. Isn't this the kind of output your system deserves?

Check our readers' service number. A free brochure will tell you more. Or use the coupon, and get specific samples and interface information.

BIG OUTPUT

Models	printers, plotters and printer/plotters commercial and militarized
Resolution	100 or 200 (dots-per-inch)
Print speed	500 or 1000 (132-column lines per minute)
Plot speed	1.0 or 2.0 (inches per second) 4.4 or 8.5 (square feet per minute)
Interfaces	all popular computers and CRTs
Characters	96 ASCII (standard) 124 scientific/engineering (optional) 128 typesetting (optional)

SMALL PACKAGES

	Weight (pounds)	Height (inches)	Width (inches)	Depth (inches)
Desk top	100	17½	19	22½
Desk top with cabinet	160	46	19	22½
Rack-mount	120	21	19	22¾

VERSATEC
A XEROX COMPANY

2805 Bowers Avenue
Santa Clara, CA 95051
(408) 988-2800

Send brochure, samples and interface information

Samples:

- Medical
- Scientific
- Seismic
- Control
- Mapping
- Printing & publishing
- Halftone
- Business graphics

Models:

- Commercial (3000 series)
- Militarized (7000 series)

name

telephone

organization

address

city, state & zip

computer & operating system

application

SCR and diode bridges run 10 C cooler



Gentron, 6667 N. Sidney Pl., Milwaukee, WI 53209. Lance Kaufman (414) 351-1660. See text; stock.

In the B series of SCR and diode bridges, junction temperatures have been measured to be 10 C less than units of previous metal leak plate design. The number of thermal resistance paths has been reduced and the ceramic interfaces directly with the heat-sink mount surface. The devices are rated to 25 A. In addition to fast-on terminals in the B series, a BW series package is available with 6-in. wire leads. A typical B series unit with two SCRs and three diodes sells for \$8 in 1000 quantity.

CIRCLE NO. 358

Static RAM stores 1024 x 4 bits

Motorola, 3501 Ed Bluestein Blvd., Austin, TX 78721. (512) 928-2600. \$12.25 (100 qty); stock.

The MCM2114, a 1024 x 4-bit static RAM, requires no clocks, no timing strobes, nor refreshing because of fully static operation. Data-out and data-in are of the same polarity, and no address set-up time is required. Four speed ranges are available: 200, 250, 300 and 450 ns. Two power versions are the MCM2114 at 550 mW and the MCM21L14 at 385 mW (max), both using a single 5-V supply with ±10% tolerance. The memories are housed in plastic or ceramic 18-pin DIPs.

CIRCLE NO. 359

Ion-implanted diodes sub for Schottky types

Solid State Devices, 14830 Valley View Ave., La Mirada, CA 90638. Dee Peden (213) 921-9660. \$0.50 (5000 qty); stock to 4 wks.

A line of ion-implanted diodes have high forward conductance, low-reverse leakage and nanosecond switching-time characteristics similar to germanium and Schottky diodes. The 1E.5 through 10E.5 series have peak reverse voltages of 10, 20, 30, 40, 50, 70 and 100 V at 0.5-A rectified current. Peak repetitive forward current is 5 A and peak surge current is 25 A. The max forward-voltage drop is 375 mV at 1 mA and 850 mV at 500 mA. Max reverse leakage is 10 µA, while recovery time is 9 ns max. The diodes are in molded plastic TO-92 cases.

CIRCLE NO. 360

Single chip provides all FM-i-f functions

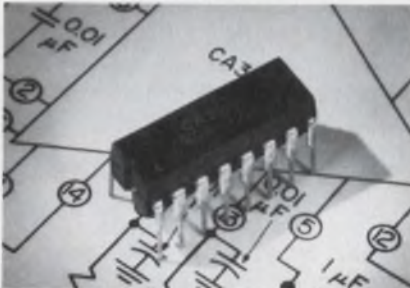

RCA Solid State, Route 202, Somerville, NJ 08876. (201) 685-6423. \$1.88 (100 qty); stock.

The CA3189E IC provides all the functions of a comprehensive FM-i-f system for use in high fidelity, automotive and communications receivers. The device contains externally programmable agc threshold, audio output level, and meter drive voltage that is depressed at very low signal levels. The circuit also includes power-supply regulators that maintain nearly constant current drain over the supply range of +8.5 to +16 V. Other features include a three-stage limiting amplifier, doubly balanced quadrature FM detector, audio amplifier, afc drive circuit, zero-point tuning meter output, agc circuit, and signal-to-noise mute drive voltage. The unit is housed in a 16-lead plastic DIP.

CIRCLE NO. 361

Call your nearest ISC sales representative.

- ALABAMA:** Huntsville
W. A. Brown Inst. Inc. 205/539-4411
- ARIZONA:** Phoenix
Thorson Co. 602/956-5300
- CALIFORNIA:** Goleta
Thorson Co. 805/964-8751
- CALIFORNIA:** Los Angeles
Thorson Co. 213/476-1241
- CALIFORNIA:** Mountain View
Thorson Co. 415/964-9300
- CALIFORNIA:** San Diego
Thorson Co. 714/298-8385
- CALIFORNIA:** Tustin
Thorson Co. 714/544-5121
- COLORADO:** Denver
Thorson Co. 303/759-0809
- FLORIDA:** Ft. Lauderdale
W. A. Brown Inst. Inc. 305/776-4800
- FLORIDA:** Melbourne
W. A. Brown Inst. Inc. 305/723-0766
- FLORIDA:** Orlando
W. A. Brown Inst. Inc. 305/425-5505
- FLORIDA:** Valparaiso
W. A. Brown Inst. Inc. 904/678-7932
- GEORGIA:** Atlanta
W. A. Brown Inst. Inc. 404/939-1674
- ILLINOIS:** Arlington Hts.
Future Systems 312/640-6091
- LOUISIANA:** Gretna
W. A. Brown Inst. Inc. 504/366-5766
- MARYLAND:** Bethesda
Bartlett Assoc. 301/656-3061
- MASSACHUSETTS:** Framingham
Bartlett Assoc. 617/879-7530
- MICHIGAN:** Madison Hts.
WKM Associates 313/588-2300
- NEW MEXICO:** Albuquerque
Thorson Co. 505/265-5655
- NEW YORK:** White Plains
Bartlett Assoc. 914/949-6476
- NORTH CAROLINA:** Durham
W. A. Brown Inst. Inc. 919/682-2383
- OHIO:** Cleveland
WKM Associates 216/267-0445
- OKLAHOMA:** Norman
Data Marketing Assoc. 405/364-8320
- PENNSYLVANIA:** Pittsburgh
WKM Associates 412/892-2953
- PENNSYLVANIA:** Wayne
Bartlett Assoc. 215/688-7325
- SOUTH CAROLINA:** Columbia
W. A. Brown Inst. Inc. 803/798-3297
- TENNESSEE:** Knoxville
McCoin Elec. Equip. 615/584-8411
- TEXAS:** Austin
Data Marketing Assoc. 512/451-5174
- TEXAS:** Dallas
Data Marketing Assoc. 214/661-0300
- TEXAS:** Houston
Data Marketing Assoc. 713/780-2511
- TEXAS:** San Antonio
Data Marketing Assoc. 512/828-0937
- WASHINGTON:** Bellevue
Thorson Co. 206/455-9180
- AUSTRALIA:** Mt. Waverly, Victoria
Anderson Digital Elec. 03-543-2077
- CANADA:** Montreal
Cantec Rep. 514/620-3121
- CANADA:** Ottawa
Cantec Rep. 613/225-0363
- CANADA:** Toronto
Cantec Rep. 416/624-9696
- EUROPE:** England
Techex. Ltd. 0202-293-115
- EUROPE:** France
Peritec 749-40-37
- EUROPE:** Switzerland
Interest, AG 031-224481
- JAPAN:** Tokyo
Munzing International 586-2701



Intelligent Systems Corp.

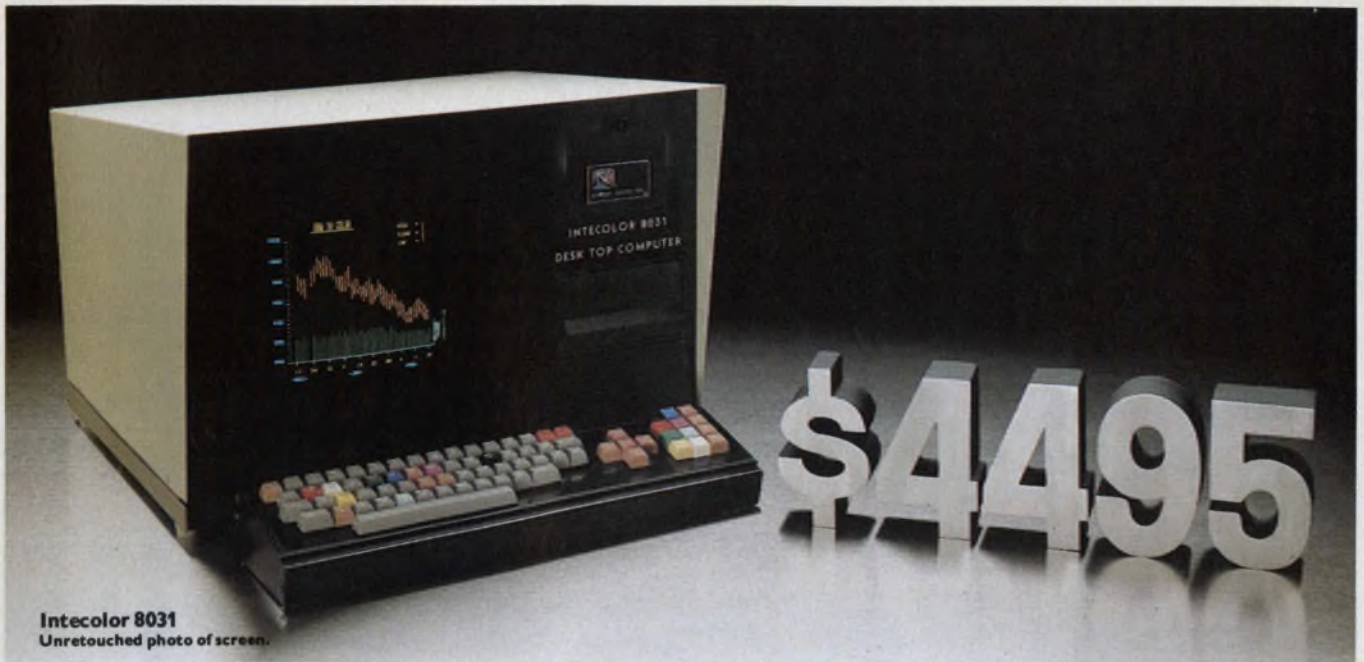

Intecolor 8031
Unretouched photo of screen.

Two very sophisticated desk top computers with two very unsophisticated price tags.

We're Intelligent Systems Corporation and we've developed two brand-new stand-alone desk top systems. Both are capable of handling an incredibly diverse range of business, control, research and financial applications—in color. Both have a better price/performance ratio than any other compact computer system on the market.

Take a look at the Intecolor 8031. A compact 13-inch 8-color CRT, it comes complete with graphics hardware and software, a built-in mini disk drive for extra storage, plus "File Handling BASIC" which lets you create, delete, and retrieve program segments from storage, by name.

Now take a look at the Intecolor 8051. Perfect if your needs call for a large-screen format. It comes with the same standard features as the 8031, but it has a

big 19-inch diagonal screen and external mini disk drive.

We also have a variety of options available for both units, including a convenient bi-directional desk top printer and a new 2708/2716 PROM programmer.

Contact the ISC representative nearest you for a working demonstration of these two highly sophisticated, versatile and dependable desk top systems. Prices are based on a one unit, cash-with-order basis. Guaranteed 30-day delivery or your money back.



Intelligent Systems Corp.,

5965 Peachtree Corners East
Norcross, Georgia 30071
Telephone 404-449-5961 TWX: 810-766-1581



Intecolor 8051
Unretouched photo of screen.



Is there life on Germanium?

Plenty.

The demand for our Germanium semiconductors continues to grow.

Germanium has advantages over Silicon for many applications; low saturation voltage, low battery drain for example. And we've just announced the world's first single-chip 100A power transistor, based of course on Germanium technology.

At GPD we make devices to all the well-known specs: JAN, EIA, and PRO-ELECTRON AD, ADY, ADZ, ASZ, AU, AUY and ASY.

And we can now replace practically all the Germanium products you used to buy from Motorola (MP500-506, 2N4276-4283, 4048-4053), Delco (DTG110, 2N1100, DTG2000-2400A), GE (2N319-324, 524-526, 1370-1381, 1413-1415, 1924-1926), Siemens, Mullard, SGS-ATES, and Thomson.

Our range goes from 150mW small signal to 100A power, in packages of all shapes and sizes.

Germanium is here to stay.

We'll be making Germanium devices as long as you, the customer want them.

Send for our latest catalogue or let us know your specific problem.

GPD, Box 65, Shawsheen Village Station, Andover, Mass, 01810.
Tel: (617) 475-5982.
Telex: 94-7150 GPD Andr.

Germanium Power Devices Corporation

The Germanium Manufacturers

UK Representative Wintronics PO Box 24 E. Grinstead, Sussex. 034287-277 **UK Agents** Jermyn Industries Sevenoaks, Kent. Sevenoaks (0732) 50144 Tlx 851 95142/Consort Electronics Ltd Rosebank Parade, Reading Road, Yately, Camberley, Surrey, Yately (0252) 871717 Tlx 851-858809 **Norway** Nordisk Elektronik (Norge) A/S Mustadsvei 1 Postboks 91-Lilleaker, Oslo 2 0752-13800 Tlx 856-16963 **Italy** Syscom Elettronica Spa, Via Gran Sasso 35, 20092 Cinisello Balsamo, Milano 92.89.251/2/3 and 92.89.159 Tlx 843-36118 (Syscom)/Eurelettronica S.r.L. Sede: 20145 Milano, Via Mascheroni, 19, 4981851/2/3/4/5 Tlx 39102 Thomelec/UFF, Regionale: 00197 Roma, Via B. Oriani, 32, 895394 Tlx 61358 Thomelec/UFF, Regionale: 40138 Bologna, Via Massarenti, 410/3, 534062 **Belgium, Holland, Luxembourg** B.V. Laboratorium Voor Electronentechniek Dioxide, Hollantlaan 22 Utrecht 030-884214 Tlx 844-47388/ Rue Picard 202 Picardstraat 1020 Bruxelles, (02) 4285105 Tlx 846-25903 **Austria, Hungary, Czechoslovakia, Yugoslavia** Rieger GmbH Marxergasse 10 A-1030 Wien 3, (0222) 734684-0 Tlx 847-1-1087 **Union of South Africa** L'Electron Enterprises (Pty) Ltd P.O. Box 19544 Johannesburg 2000, 22-3363/4/5 Tlx 960-80671 **Denmark** E.V. Johanssen Elektronik A/S Svanevej 12 DK-2400 Copenhagen NV 451839022 Tlx 855-16522/GDS-Henckel Elektronik ApS Fyrevangen 4 DK-4622 Havdrup, (03) 38-5716 Tlx 855-43168 **Portugal** Diltram Componentes Electronica, Lda Av. Miguel Bombarda 133, 1 D Lisboa 1, 45313 **France** TMC 125 Rue Anatole-France 93121 La Courneuve, 833-33-74 ext. 189 Tlx 842-210311F (Publi) **Sweden** Integrerad Elektronik P.O. Box 43 S-182 51 Djursholm, (08) 753-03-30 Tlx 854-10282 **Switzerland** GDC Müller S.A. 8 rue de l'Aubepine C. P. 77 1211 Geneva 9, 215977 Tlx 845-59434/Omni Ray AG 8008 Zurich Dufourstrasse 56 (01) 478200 Tlx 845-53239 **West Germany** Solcomp GmbH Wargauer Str. 46, 8000 München 90 089-69 65 66 Tlx 841-05-22870.

5 thru 120 Volt lamps, all in a single socket. Now that's a system!

Sylvania Mix 'n Match. The only system that offers you the universal parts flexibility built around two series of T-2 slide base lamps. The first is our Pilot Lamp series spanning 5 to 120 volts. The second is our Indicator Lamp series from 4 to 48 volts.

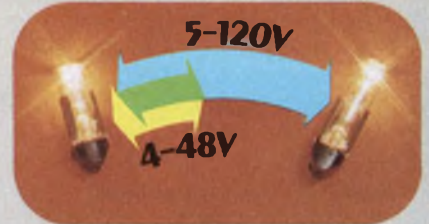

All the lamps in each series are physically identical. So sockets and lenses are fully compatible. And in a number of instances, lenses and caps are even interchangeable between series.

As you can see, our system is calculated to make life a lot easier for everyone.

From the guy who builds the prototypes, to the guy who does the purchasing, to the guy who controls production inventory. To find out just how easy, clip the coupon and send for our handsome 17" x 22" wall chart that graphically highlights the universal parts compatibility of the Sylvania Mix 'n Match System.

SYLVANIA
Mix 'n Match
SYSTEM

GTE Sylvania
Miniature Lighting Products
West Main Street
Hillsboro, N.H. 03244
Tel: 603-464-5533

Why should I have to change the socket and the lens whenever I change the lamp voltage? Send me your FREE wall chart on the system that's calculated to make life easier for everyone.

NAME

COMPANY

STREET

CITY

STATE

ZIP

GTE SYLVANIA

CIRCLE NUMBER 99

DC Servo Control

Buy one piece of equipment that does the job of several...

The Servo-Tek Bi-Mode DC Servo can be programmed to operate as either a bidirectional speed regulator or positioning servo. Easy conversion from one mode to the other results in cost savings. Features include:

- Adjustable, stepless bidirectional speed control
- Dynamic speed range in excess of 2000:1
- High accuracy with load, line voltage, temperature variations
- Adjustable output torque control
- Controlled deceleration capability
- Remote programming capability
- Easily applied to positioning control

Prices range from \$417 up, depending on gear ratio.

Prices subject to change without notice.

FREE CATALOG of rotating components available.

Be Selective, Turn To...

SERVO-TEK
PRODUCTS COMPANY

1086 Goffle Road, Hawthorne, NJ 07506 • 201-427-3100

Servo-Tek of California, Inc.

8155 Van Nuys Blvd., Van Nuys, CA 91402 • 213-786-0690



SERVO-TEK
ALL AMERICAN
ENGINEERED

CIRCLE NUMBER 100

MICROPROCESSOR CORE MEMORIES

FOR THE LSI-11, 8080, 6800, IMP-16P, S100

- NON-VOLATILE.
- PIN-TO-PIN COMPATIBILITY.
- POWER MONITORING FOR DATA PROTECTION.

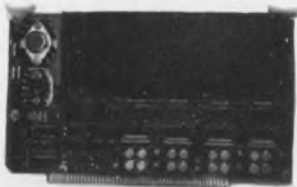

MM-S100 8K X 8

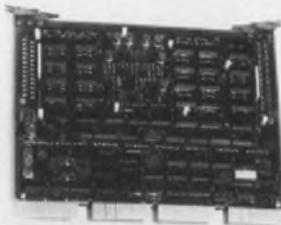

MM-1103 8K X 16

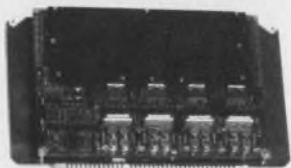

MM-6800 8K X 8

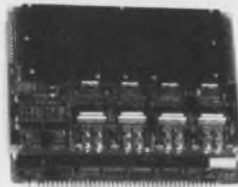

MM-8080 8K X 8

- MM-1103 —Plugs directly to DEC LSI-11 and PDP 11-03 computer.
 MM-8080 —Plugs directly to Intel's MCS 8 and MCS 80 Microcomputer.
 MM-8080A —Plugs directly to Intel's MDS 800 and SBC 80/10 Microcomputer.
 MM-6800 —Plugs directly to Motorola's EXORciser and compatible with the Evaluation Modules.
 MM-16P —Plugs directly to National's IMP-16P Microcomputer.
 MM-S100 —Plugs directly to Imsai 8080, Altair and Sol Microcomputers



9438 Irontdale Ave., Chatsworth, California
Tel: (213) 998-0070

CIRCLE NUMBER 102

ICs & SEMICONDUCTORS

Dynamic RAM has 4 k × 1-bit storage

Motorola, 3501 Ed Bluestein Blvd., Austin, TX 78721. (512) 928-2600. \$5.75 (100 qty); stock.

The MCM4096 is a 4 k × 1-bit dynamic RAM using n-channel silicon gate technology. All inputs are TTL compatible and the output is three-state TTL compatible. Each of the 64-row addresses requires a memory cycle every 2 ms to refresh the contents of the RAM. Max power dissipation is 445 mW in the active mode and 19 mW for standby. Three speeds are available: 250, 300 and 350 ns (max access time). Package types are 16-pin ceramic or frit-seal ceramic.

CIRCLE NO. 362

Power Darlingtons are qualified to MIL spec

Silicon Transistor, Katrina Rd., Chelmsford, MA 01824. Bill Schromm (617) 256-3321. \$6.45 to \$10.80 (100 qty); bonded stock.

The JAN/JTX 2N6283 and JAN/JTX 2N6284 silicon power Darlington transistors have been qualified to MIL-S-19500/504 (USAF). The transistors are hermetically packaged in TO-3, metal cases. V_{CE0} is 80 and 100 V, respectively, and continuous collector current is 20 A. The dc gain is specified at 750 to 18,000 at an I_C of 10 A. The collector-emitter saturation voltage is 2 V at 10 A.

CIRCLE NO. 363

Prescaler requires only a single 5-V supply

Plessey Semiconductors, 1641 Kaiser Ave., Irvine, CA 92714. Bob Huish (714) 540-9979. \$39 (100 qty); stock.

The SP8610 is a ÷4 prescaler that requires only a single 5-V-dc supply. The device has a maximum operating frequency of 1 GHz from 0 to 70 C. Capacitive or dc input coupling may be used and ECL-compatible complementary emitter-follower outputs are provided. The unit has a 100-Ω line drive capability. Power dissipation is 350 mW. Output swing is 600 mV.

CIRCLE NO. 364



NEW! CATALOG



NEW! MOTORS

*Higher Hp.
(up to 1/2)*

425 STOCK fhp (1/2000 to 1/2 Hp) motors, gearmotors, and speed/torque controls listed. Included are Bodine's new TEFC 48 frame A-C induction motors and gearmotors. Also new 32 and 42 frame PM D-C motors, gearmotors and speed controls.

32 pages packed with over 150 photos, charts, diagrams and graphs. Plus helpful information on proper selection and application, mounting, performance, safety, custom designing... Send for Catalog S-6, or see your Bodine Distributor (your now source for all items in Catalog S-6).

**BODINE
ELECTRIC
COMPANY**

Bodine Electric Co., 2500 W. Bradley Pl., Chicago, IL 60618

CIRCLE NUMBER 103

**You get
what
you
spec!**



When it comes to thermostats, PCI supplies just what you need.

Say you're designing computer terminals, power supplies, business machines, or other electrical or electronic equipment. You need precise temperature control to meet critical standards. You need a precision thermostat. At a competitive price.

Look no further. Specify PCI Series 5003 wafer type thermostats. They're U.L. recognized. Rated 5A res., 120V ac., they'll operate within a range of -20°F to 350°F. You specify the setting. We give you a standard tolerance range of ±5°F to ±8°F... to a minimum of ±2°F to ±5°F. Differentials are as low as 8°F. Each thermostat is factory set and sealed. Also provided... a selection of mounting and terminal configurations. 240V ac (Series 5004) units can also be supplied — also U.L. recognized.

Send for Application Data Form.

PCI thermostats...100% inspected.

PROTECTIVE **pci** CONTROLS INC.

A subsidiary of North American Philips Controls Corp.
Frederick, Md. 21701 • (301) 663-5141

CIRCLE 131 FOR INFORMATION ONLY
CIRCLE 132 FOR IMMEDIATE NEED

STANDOFFS & SPACERS



We stand out in standoffs and spacers, both regular and hinged. Not to mention our complete line of electronic components.

To give you an idea of how we cover you: In standoffs and spacers alone, we carry over 300 assorted sizes and styles. Aluminum, brass and phenolic, tapped or thru-hole for all thread sizes. We have them for every possible application.

HINGED STANDOFFS

In hinged standoffs we have a variety of sizes. Ideal for P.C. Boards and Terminal Boards, to give you easy access for testing and faster maintenance. The applications are unlimited and time saving. You cut the cost of servicing your equipment and interconnect circuits without danger of shorting.

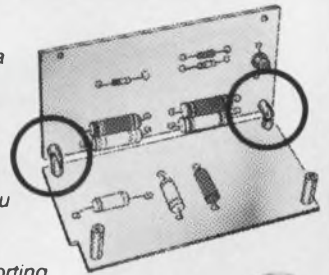

So, whatever you want, the odds are we have it — catalogued for your quick and easy selection. And for immediate delivery from stock. What we do not catalog, we can design and make for you in any size or material... (There's no charge for our engineering service.) We do everything ourselves, both designing and manufacturing. All of which makes for high quality and low prices.



Ask for our new 3 color easy-to-read 8 1/2" x 11" Engineering Wall Chart. It's Free!



NEW FREE CATALOG ON REQUEST

KEYSTONE

ELECTRONICS CORP.

TWX 710-581-2861 CABLE-KEYELCO

49 BLEECKER STREET, NEW YORK, N.Y. 10012 212-475-4600

CIRCLE NUMBER 105

ICs & SEMICONDUCTORS

2-mA reference diodes have high stability

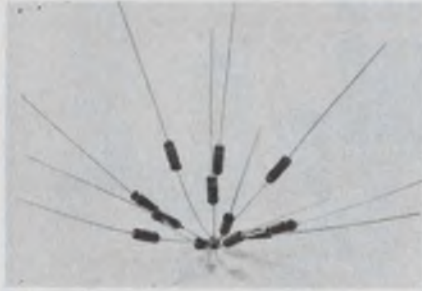

CODI, Pollitt Dr. S., Fair Lawn, NJ 07410. John Halgren (201) 797-3900. \$33 (100 qty); stock to 6 wks.

The PRD2005 voltage reference diodes have a time stability of 5 ppm per year, 2 ppm per 1000 h of operation. Nominal operating current is 2 mA at 6.4 V. The PRD2030 provides stability of 30 ppm per year and 5 ppm per 1000 h. Other specs include a 1 ppm output noise figure and a 1 ppm tempco at zero tempco current from 25 to 45 C.

CIRCLE NO. 365

Monolithic 12-bit d/a has high speed

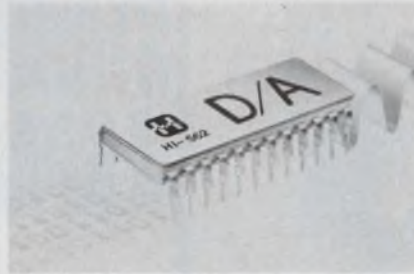

Harris Semiconductor, P.O. Box 883, Melbourne, FL 32901. (305) 724-7430. \$29 (100 qty); stock.

The HI-562 is a 12-bit monolithic d/a converter that has fast current-output settling to $\pm 1/2$ LSB in 200 ns (typical); 400 ns (max). The output-current capability is 5 mA. In addition to an external reference, the device requires a +4.75 to +12-V logic supply and a -15-V supply for operation. Digital inputs are TTL/DTL/CMOS compatible. Packaging is a hermetic 24-pin DIP and the operating temperature range is 0 to 75 C.

CIRCLE NO. 366

Low-drop HV rectifiers give 99.8% efficiency

	HVM 20	HVM 40	HVM 50	HVM 60	
Transient Voltage	2500	5000	4000	4000	VOLTS
Surge	2000	4000	3000	4000	VOLTS
Current to 50° Ambient*	250	250	250	250	mA
3 msec	30	30	30	30	AMPS
ig at 250 mA	8	8	8	8	VOLTS
Reverse Current	10	10	10	10	μ A
at 125°C Ambient	100	100	100	100	μ A
Operating Range	-50°C to +125°C				
Temp	-50°C to +150°C				
See 50°C & 125°C					

Solid State Devices, 14830 Valley View Ave., La Mirada, CA 90638. (213) 921-9660. \$0.90 to \$2.00; stock to 4 wks.

A line of 2 to 6-kV rectifiers, HVM, rated at 250 mA, has a reverse current of 100 μ A at 125 C and 8-V max forward-voltage drop at rated current. The devices dissipate a maximum of 2.8 W, producing a rectification efficiency of more than 99.8%. The rectifiers withstand peak recurrent transient voltages 1.2 times rated blocking voltage. They also take 30-A current surges for up to 8.3 ms. Cases are 0.63 \times 0.43 \times 0.22 in.

CIRCLE NO. 367

TYPE 224M FABMIKA® CAPACITORS



THE ECONOMICAL HIGH-VOLTAGE MICA

- Film-wrapped reconstituted mica capacitors ideal for airborne electronics . . . also well-suited for ground equipment applications including radio transmitters, induction heating equipment, electrostatic precipitators.
- High dielectric strength, small size, high temperature performance, low temperature coefficient of capacitance.
- Capacitance values range from .0018 to 1.0 μ F in voltage ratings from 1500 to 7500 WVDC.

Write for Engineering Bulletin 1735 to Technical Literature Service, Sprague Electric Co. 347 Marshall St., North Adams, Mass. 01247.

THE BROAD-LINE PRODUCER OF ELECTRONIC PARTS



General Cable subsidiary

CIRCLE NUMBER 106

TYPE 715P FILMITE® 'L' CAPACITORS



LOW DISSIPATION FACTOR

- Polypropylene film dielectric . . . similar to polystyrene in high a-c current-carrying capability, but has added advantage of 105°C operation.
- Conformally coated with flame retardant epoxy.
- Ideal in solid-state TV vertical circuits, r-f generators, pulse-forming networks, plus other applications where high a-c current flow is found.
- Capacitance change with temperature less than 3% over operating temperature range of -55°C to +85°C.
- Capacitance values from .001 to .47 μ F, voltage ratings from 400 to 1600 WVDC.

Write for Engineering Bulletin 2090 to Technical Literature Service, Sprague Electric Co. 347 Marshall St., North Adams, Mass. 01247.

THE BROAD-LINE PRODUCER OF ELECTRONIC PARTS



General Cable subsidiary

CIRCLE NUMBER 107

ELECTRONIC DESIGN 4, February 15, 1978

CMOS device is d/a 8-bit multiplier

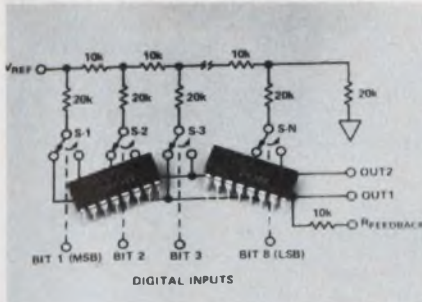

Analog Devices, 829 Woburn St., Wilmington, MA 01887. Jeff Riskin (617) 935-5565. \$2 to \$7.50; stock.

A multiplying CMOS d/a converter, AD7523, provides 8-bit resolution and 10-bit accuracy. The device does four-quadrant multiplying and has a settling time under 100 ns. Three versions are the AD7523JN that provides linearity of $\pm 1/2$ LSB, the AD7523KN providing $\pm 1/4$ LSB and the AD7523LN providing $\pm 1/8$ LSB. All have a feedthrough of $1/2$ LSB at 200 kHz. The units are in 16-pin plastic DIPs.

CIRCLE NO. 368

Fast-switching SCR is for high-power switching

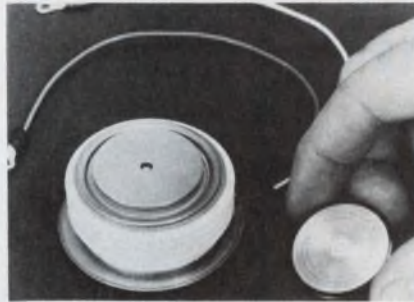

Westinghouse, Youngway, PA 15697. (412) 925-7272. See text; stock.

The fast-switching SCR, T72H, allows the design of high-power frequency inverters with low duty cycle operation and reduced snubber circuitry for greater efficiency. The SCR is rated at 100 to 1200 V. Turn-off time is 25 to 50 μ s for the 250 or 350-A devices and 30 to 50 μ s for the 450-A device. The devices are available in air and water-cooled assemblies. Typical price is \$352.50 for the 350-A, 1200-V, 25 μ s unit.

CIRCLE NO. 369

Ultra-linear transistor has 1.6-dB NF at 500 MHz



TRW Semiconductors, 14520 Aviation Blvd., Lawndale, CA 90260. Dan Faigenblat (213) 679-4561. \$1.32; 4 to 8 wks.

The TP491 ultra-linear transistor has a noise figure of 1.6 dB at 500 MHz and is suitable for CATV, MATV and other uhf and vhf use. Maximum collector-emitter breakdown voltage is 14 V and the collector current capability is 50 mA. At 500 MHz, the cut-off frequency is 3.2 GHz and power gain is 14.8 dB.

CIRCLE NO. 370

SERIES 207C300/207C400 MODULES



ACTIVE FILTERS FOR USE WITH MODEMS

- Designed for low speed modem applications.
- Provide all necessary filtering for originate only, answer only, or answer/originate operation.
- Series 207C300 transmit modules feature 6-pole filter to suppress output sidebands, reduce harmonic distortion.
- Series 207C400 receive modules include 10-pole filter to eliminate noise and local carrier signals.
- Absolute max. ratings include supply voltages of +18V (V_{cc}), -18V (V_{ee}), 5.5V (V_{od}). Operating temp. range is 0° to +70°C. Storage temp. range is -40° to +125°C.

Write for Engineering Bulletin 22113 to Technical Literature Service, Sprague Electric Co., 347 Marshall St., North Adams, Mass. 01247.

THE BROAD-LINE PRODUCER OF ELECTRONIC PARTS

45Z-7130R1
SPRAGUE
THE MARK OF RELIABILITY

General Cable subsidiary

SERIES JX5400 FILTERS

... U.L. Recognized



SUPPRESS POWER LINE EMI

- Reduce noise emanating from or interfering with equipment.
- Furnished in 4 different circuit configurations suppressing both common mode (line-to-ground) and differential mode (line-to-line) interference.
- Ideal for filtering external transients in 150 KHz—30 MHz range in equipment containing low-level logic circuitry.

Write for Engineering Bulletin 8212 to Technical Literature Service, Sprague Electric Co., 347 Marshall St., North Adams, Mass. 01247.

THE BROAD-LINE PRODUCER OF ELECTRONIC PARTS

45F-7152
SPRAGUE
THE MARK OF RELIABILITY

General Cable subsidiary

CIRCLE NUMBER 108

ELECTRONIC DESIGN 4, February 15, 1978

CIRCLE NUMBER 109

163

CUSTOM LED DISPLAYS ARE STANDARD WITH US...

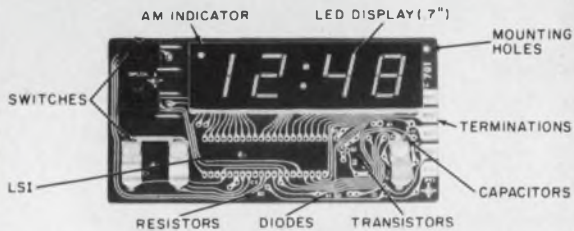

OPCOA is the largest LED supplier of high reliability custom display systems. These cost effective systems integrate the LED semiconductor and optics on the PC board with other active and passive components such as IC's, including LSI's, switches, potentiometers and resistors. OPCOA Integrated LED Display Systems feature high brightness, ease of repair, long life and low cost. If you've got a tough problem and need a cost effective custom solution... contact us today!



330 Talmadge Road
Edison, New Jersey 08817
Tel. (210) 287-0355
TWX 710-998-0555

CIRCLE NUMBER 110

IVO's industrial strength 5-digit counter-controller.

Your best choice in electronic preset counters.

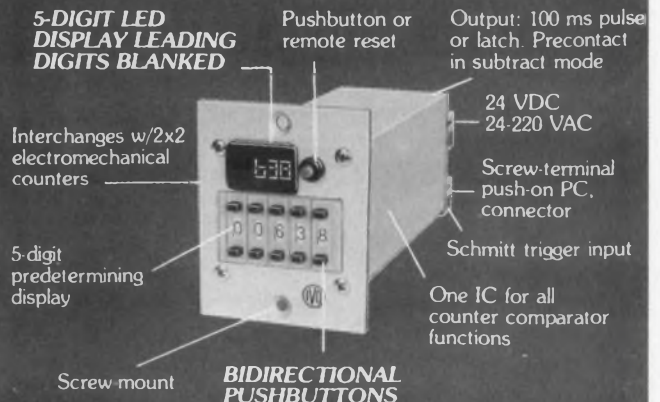

Built for hard industrial use, the NE 638 allows full 5-digit pushbutton control. Available in either adding or subtracting. It is compact: 2 x 2 x 5.6 inches. The case is aluminum. It protects against damage and shields

from electrical noise. It has a push-on PC connector with screw-down terminals. AC and DC models low power consumption: rated at 8 VA. **AND IT'S ECONOMICAL.** Send for complete data.



Your business partner in counting and controlling.

IVO Industries, Inc. 1109 Green Grove Rd., P.O., Box 36, Neptune, N.J. 07753. 201-922-3600.

CIRCLE NUMBER 112

LIGHTED INSTRUMENT SWITCHES

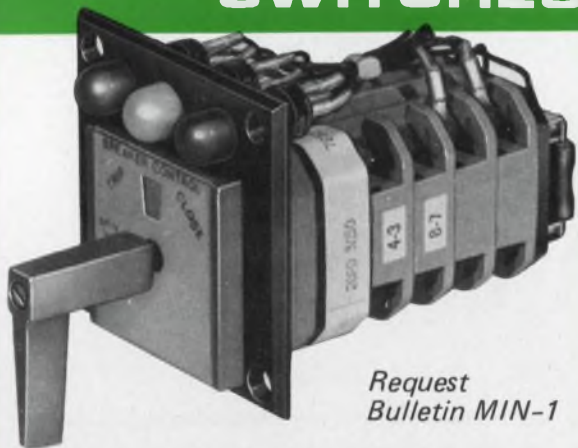

Request Bulletin MIN-1

- Space Savings — Mount on 3" centers
- Switch Ratings — Up to 600V-20A
- Available with 2 or 3 Lights
- All lights have push-to-test feature
- All lights removable from front of panel



Weymouth, Massachusetts 02188
Telephone: 617/335/5200 • TWX: 710/388/0377

CIRCLE NUMBER 111

FREE!

EDMUND SCIENTIFIC

ELECTRONICS
OPTICS
SOLAR ENERGY
MAGNETS
LASERS

O.E.M. COMPONENTS
LABWARE
MIRRORS
SURPLUS



164 PAGE CATALOG

- Over 4,000 unusual bargains for science and industry
- In-stock supplies for engineers, experimenters, research labs, hobbyists, etc.
- Order direct and save — buy with complete confidence... every item carries the famous Edmund 30-day money-back guarantee.
- Simply mail this coupon for the newest Edmund catalog.

RUSH LATEST FREE EDMUND CATALOG

EDMUND SCIENTIFIC CO.
Dept. DA04, Edscorp Building, Barrington, N.J. 08007

Name _____
Address _____
City _____ State _____ Zip _____

CIRCLE NUMBER 113

ELECTRONIC DESIGN 4, February 15, 1978

Introducing the Incredible DATALOGGER 2000

... an easy-to-operate ... simple to understand ...



DATA INFORMATION CENTER that speaks your language!

It's incredible but ... the Datalogger 2000 can measure 4 parameters that you've chosen ... offer 2000 internal alarms ... manage your data collection and report it in your language ... and still remain 'pushbutton-simple' to operate.

The Digitec DATA INFORMATION CENTER features:

- **Multi-Parameter capability**
Combine up to 4 of the 38 field interchangeable signal conditioning modules for measuring:
 - Temperature (Thermocouple, Thermistor, RTD)
 - DC Voltage, DC Auto-ranging
 - AC Voltage, True RMS
 - Transmitter output
- **Up to 20 channels internal—expandable to 1000.**
- **±25,000 count display (4½ digits) of measured data.**
- **Alphanumeric printout.**
- **Exclusive skip-channel capability.**
- **24-hour clock and Julian date.**
- **Internal microprocessor.**
- **Pushbutton programming.**

And these options can make your DATA INFORMATION CENTER even more versatile!

- **Internal alarms**
Up to 2000 individual set-points.
4-level limits assignable per channel.
- **English messages**
6-character message assignable to each limit which eliminates the need for translation codes and look-up tables.
- **Data outputs**
Isolated BCD.
Isolated RS-232-C, TTY compatible, with selectable baud rates from 110 to 9600.

From the leaders in data acquisition, the Datalogger 2000 delivers all the traditional Digitec qualities—premium components, designer styling and reliable performance.

For a free brochure that explains how your measuring and collecting of data can be made simple, write or call:

Don Gerdeman, our Datalogger Specialist.

Digitec

**UNITED
SYSTEMS
CORPORATION**

918 Woodley Road, Dayton, Ohio 45403
(513) 254-6251, TWX (810) 459-1728

**UNDER
\$3000**

...it's incredible

*United Systems Corp.™
Precision measurements to count on.*

Fiber-optic system aims at digital data links

RCA Electro Optics and Devices, Lancaster, PA 17604. Ted Grabowski (717) 397-7661. P&A: See text.

A fiber-optic digital data communications link, the C86003E from RCA Electro Optics, consists of a transmitter and receiver, each in a rectangular box measuring less than two inches on a side and an inch deep.

The transmitter contains a GaAlAs (gallium aluminum arsenide) light-emitting diode and drive circuitry. A fiber-optic cable is internally coupled from the emitting region of the LED chip to an optical bulkhead connector, which interfaces with a DuPont PFXS120 single silica optical fiber. Other fibers can be accommodated to meet customer needs.

The transmitter provides a peak optical power of at least 100 μ W. Input is TTL-compatible with a fan-in of three loads, and can accept signals up to 20 Mbits/s for NRZ (nonreturn-to-zero) coding or 10 Mbits/s for RZ coding. The transmitter requires 5 V \pm 5% at 250 mA.



The receiver uses a silicon p-i-n photodiode with amplifier and threshold drive circuits to convert input light pulses to TTL output signals.

The receiver's output can drive four TTL loads over the same frequency range as the transmitter. Optical sensitivity is 2 μ W, with a calculated bit error rate of 10^{-9} for this minimum optical signal.

The receiver requires three power supplies: 6 to 8 V at 30 mA, -6 to -8 V at 20 mA, and a diode bias of 6 to 75 V.

In small quantities, the initial price is between \$700 and \$1000 per system. Delivery takes 60 days.

CIRCLE NO. 306

Character buffer is pollable

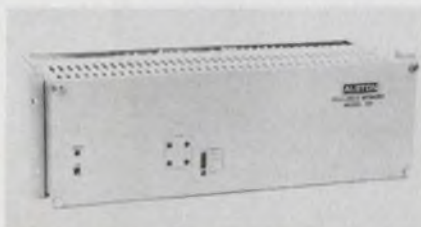

Alston Div., Conrac, 1724 S. Mountain Ave., Duarte, CA 91010. Jack Choate (213) 357-2121.

The Model 721Z buffers data or messages, consisting of ASCII characters, in centralized polling applications over switched telephone networks. The unit has a microprocessor-based control section and up to 16 memory modules in a small card file. An input port connects the data/message source. An output port connects to a telephone line for polling by a distant location via dial-up connection over the public switched network.

CIRCLE NO. 371

Multiplexer yields one data stream from two

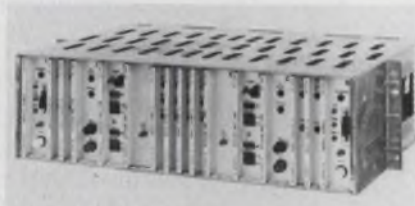

Wescom, P.O. Box 458, Downers Grove, IL 60515. (312) 852-8282.

The 350 M1C asynchronous bipolar multiplexer relieves overcrowded cable facilities by combining two T1 (1.544 Mbits/s) input streams into a single T1C (3.152 Mbit/s) output stream. The device is compatible with Western Electric's M1C multiplexer, and with D3, D2 or D1D encoding formats. The 350 M1C consists of eight modules with two multiplexers per shelf. The 12-in. deep shelves mount in a 19-in. rack. Power is supplied from a -48-V office battery.

CIRCLE NO. 372

Modem-sharing unit cuts hardware and line costs

Strayton, 40 William St., Wellesley, MA 02181. John Duy (617) 237-3220. \$550; 4 wks.

The modem-sharing device, Model 835MSD, permits up to four stand-alone or clustered intelligent terminals to communicate through a single modem, reducing line and hardware costs of data communication networks. The intelligent 835 MSD serial distributor passes control signals from I/O devices along to modems. Only one "request to send" signal from one modem is accepted at any time; the other terminals are "locked out" until the modem at the other end has received an "end of transmission" message.

CIRCLE NO. 373

Printers operate at 160 char/s

Datapoint, 9725 Datapoint Dr., San Antonio, TX 78284. Hal Morrow (512) 699-7059. \$5540/\$4540.

Two models of the Freedom Printer operate at 160 char/s. The 9236 parallel-data printer is a system printer for business DP systems with parallel data output. Its address and control code sequences are identical to those of the 80 char/s Model 9232. Another model, the 9235, accepts serial data and is a receive-only terminal printer for business time-sharing systems. It may also be connected to video displays for hard-copy output.

CIRCLE NO. 374

Video adapter prints out displays

Honeywell Test Instruments, P.O. Box 5227, Denver, CO 80217. R.T. Michel (303) 771-4700.

A video adapter for the Honeywell 1856A and LS-6A line-scan recorders enables the recorders to print out framed images from composite video signals. The adapter produces a 16 x 12-cm printout of a display, gray scale, characters or graphics within seconds. The recorder can be switched from normal line scan to video frame operation. The adapter can provide printouts from scan converters, computer terminals and video tape or disc recorders. It operates with either 525-line, 60-Hz, or 625-line, 50-Hz, field rates.

CIRCLE NO. 375

What's TRW up to now?

Optimizing metal film.



TRW thin film resistors optimize parameters like real estate, accuracy, speed, reliability, and resistance range.

In discrete devices, sets, or networks.

For instance, our ultra-precision MAR series does all of the above with absolute TC's and tolerances to ± 5 ppm/ $^{\circ}$ C, $\pm 0.1\%$. Our smallest discrete uses $< .016$ in 2 of PCB space. Complex sets and networks include 16 Bit Binary Ladders, input

attenuators and others up to 28 pins.

In straightforward precision, we have a range of standards in R2R Ladder, MIL-R-83401 flat pack, and RNC resistors with a verified MTBF of 280×10^6 unit hours.

Contact TRW/IRC Resistors, 4222 South Staples, Corpus Christi, Texas 78411. (512) 854-4872, Dept. M. For standards in all types of resistors, call your local TRW distributor.

TRW IRC RESISTORS

ANOTHER PRODUCT OF A COMPANY CALLED TRW

DATA PROCESSING

Mini diskette system stores and edits

Western Telematic, 2435 S. Anne St., Santa Ana, CA 92704. (714) 979-03363. \$1750.

The DataMate minifloppy disc system is a data storage and editing unit that connects between any RS-232

asynchronous ASCII-coded display terminal and its modem. The system stores 560 addressable records of up to 128 characters. Selective data rates go to 9600 baud. Editing features include backspace erase, insert, delete, skip, go-to link, printable line ID, and auto line feed. Search modes are: Mode 1, find variable and read to stop code; Mode 2, find each occurrence of variable.

CIRCLE NO. 376

Mobile unit stores and transmits data



Micon Industries, 252 Oak St., Oakland, CA 94607. Bill Northfield (415) 763-6033. \$1995.

Cassetterm II is a mobile storage and telecommunications device that transmits data at 110 or 300 baud. The device includes a minicassette memory system for serial storage of up to 40,000 alphanumeric characters per cassette, a universal acoustic coupler, a 32-character display panel and full ASCII compatibility. The unit is powered by internal rechargeable batteries, and measures 3 x 8 x 10 in.

CIRCLE NO. 377

IEE LIGHTS UP YOUR LIFE!

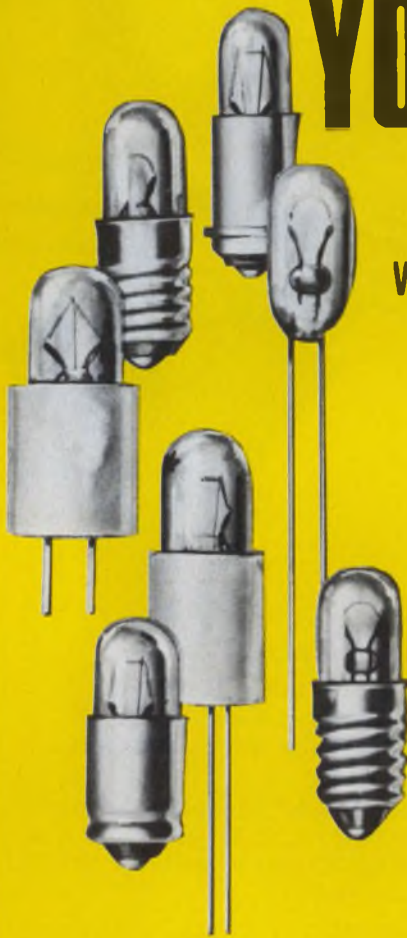

with IEE•ELECTRA T-1 subminiature lamps

- We can solve your critical application problems
- Choice of all base configurations
- Broad electrical range: 1.35 to 28 volts; .012 to .350 amps; .003 to 1.6 MSCP
- IEE is on the Qualified Products List of W-L-00111-1
- Precision placed filaments; seamless envelopes for absolute clarity
- Controlled aging at rated voltages to insure filament stabilization and elimination of early random failures
- In stock — Available through IEE stocking distributors

IEE The Display Maker

Industrial Electronic Engineers, Inc.
7740 Leona Ave., Van Nuys, California 91405
Telephone: (213) 787-0311 • TWX 910-495-1707

CIRCLE NUMBER 119

Kit converts Selectric into hard-copy terminal

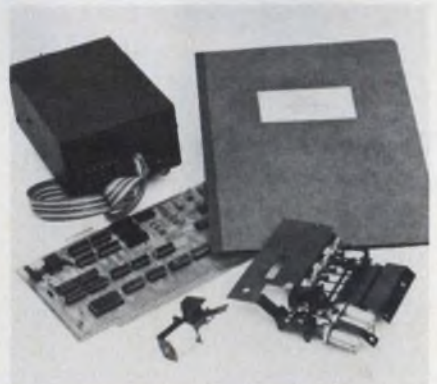

ESCON, 171 Mayhew Way, Pleasant Hill, CA 94523. (415) 935-4590. \$455.

A kit that converts an IBM electric typewriter into a hard-copy output terminal includes interface card, power supply and driver, cables and all mechanical parts. The kit fits all models and installs without drilling holes or cutting metal parts. The profile of the typewriter remains unchanged and its normal operation is not affected. The kit is compatible with computers using the S-100 bus.

CIRCLE NO. 378

Only one thing beats our Super-Mini Impact Printer...

Why stop with the data/text versatility of our 120 cps, 20-column multiple-copy mini. It works even harder as a complete system. Teamed with its own microprocessor interface and power supply, there's virtually nothing our DMPT-3 can't handle — from telemetry to process control, from unattended system recording to providing hard-copy data terminal output, even in POS and inventory control. Mated with any ASCII system, it takes either parallel or serial input at speeds up to 16 KHz or 1200 bps.

Alone or as a system, of course, the industry's smallest alphanumeric impact printer lets you economize with ordinary adding machine roll paper.

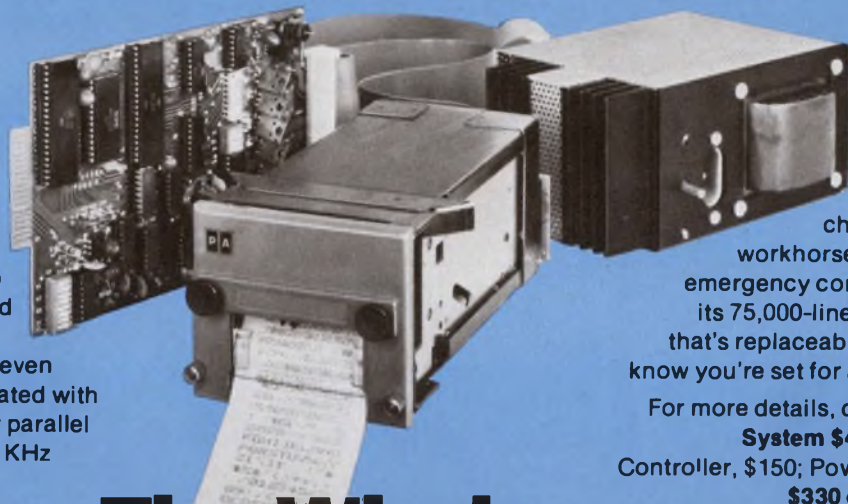

With both full alphanumeric and enhanced characters, our little workhorse calls attention to emergency conditions. And with its 75,000-line life, ink cartridge that's replaceable in seconds, you know you're set for a good, long time.

For more details, call or write today.
System \$452 (Printer, \$192; Controller, \$150; Power Supply, \$110);
\$330 complete in 100's.

The Whole System



PRACTICAL AUTOMATION, INC.
 Trap Falls Road,
 Shelton, Conn. 06484
 Tel.: (203) 929-5381

CIRCLE NUMBER 120

Our 50-watt switch. The low-cost alternative.



Switch up to 7 times the power of a similar-size reed switch with our new axial-travel switch. Handle inductive loads without arc suppression. Just like triacs.

Buy the 50-watt version with tungsten contacts for only 33¢ in quantities of 25,000. Or the 25-watt model with standard contacts for even less.

Call or write for details on the ATS.



EAC Electronic Applications Company

4918 Santa Anita Avenue,
 El Monte, California 91734
 213/442-3212 TWX 910/587-3351

CIRCLE NUMBER 121

ELECTRONIC DESIGN 4, February 15, 1978

The desoldering system the industry has been waiting 10 years for.

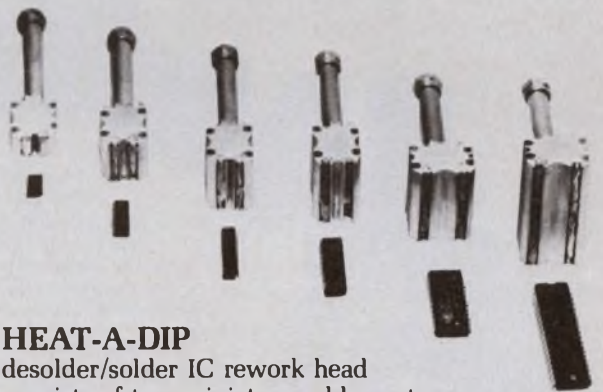

HEAT-A-DIP

desolder/solder IC rework head consists of two miniature solder pots in a dual in-line configuration to fit all IC sizes of 0.3" to 0.6" and 6 to 40 pins in six models. HEAT-A-DIP can be used with any temperature controlled iron, eliminating any problem of PCB measeling. ICs can be removed and a new one inserted in 5 to 10 seconds. Fast and inexpensive. Contact your local distributor.

Micro Electronic Systems Inc.

8 Kevin Drive, Danbury, CT 06810 Tel. (203) 746-2525, Telex 969659
 Distributor stocked throughout the U.S.A.

See booth G-201 and NEPCON WEST and 412 at Southeast Printed Circuits & Microelectronics Exposition

CIRCLE NUMBER 122

DATA PROCESSING

Coupler transfers data to and from computer I/O

Daltec Systems, P.O. Box 157, Onandaga Branch, Syracuse, NY 13215. Joe Strock (315) 699-3830. \$800; 12 wks.

The data intercoupler, Model D1488, can transfer BCD and binary data to and from computer I/Os in excess of

30 kbytes/s. The device can act as a controller; it makes any digital instrument compatible with the IEEE 488-1975 bus. The data format is programmable. Options include remote data accumulation with an RS232C link, double-buffered outputs to assure simultaneous change of all bits, and optical isolation to eliminate system ground loop problems. A front-panel keyboard and display are also available.

CIRCLE NO. 379

Line printer runs at 300 lines/min



Miltope, 9 Fairchild Ave., Plainview, NY 11803. Bill Jennings (516) 938-9500. \$3000 to \$4000; 12 wks.

The LP3036 line printer provides 300-line/min printout in 36, 42 or 60-column format or character-at-a-time operation for message/compose terminal use. The printer has low-inertia voice-coil actuators that apply pressure to paper against a rotating helical scanner to print characters in a 9 x 7 matrix. Each actuator scans multiple columns and travels only 0.002 in. The basic unit is a 10-char/in., 36-column printer. The printers meet the environmental requirements of MIL-T-21200, MIL-E-16400, MIL-E-5400 and EMI per MIL-STD-461.

CIRCLE NO. 380

TTY monitor module switches and patches

International Data Sciences, 100 Nashua St., Providence, RI 02904. (401) 274-5100. \$300; 4 wks.

The Model-8916 A/B selector, patch and monitor module for teletypewriters contains the switching, patching and serial monitoring functions for two independent data channels at the terminal-modem interface. The modules operate with the Model-8964 controller and power module. Bulk switching of up to eight 8916 modules is performed by means of a master A/B switch on each 8916. Magnetic latching relays ensure system immunity from power failures and line transients. Jacks allow patching and serial monitoring of signals at the TTY current interface.

CIRCLE NO. 381

Pinlite® displays.

Almost an endless variety.



Every day the variety of high-contrast Pinlite incandescent digital displays gets more endless as we add new, feature-packed models to meet the needs of military, avionics, marine, and business machine applications. And we're adding complementary connectors and connector/diode assemblies to make them easier to package, too.

Even though we've expanded our line, every Pinlite display still incorporates all those outstanding features you need, including 9,000 foot lambert brightness, 120° viewing angle, per-segment life of over 100,000 hours, wide operating temperature range, and direct compatibility with standard TTL driving networks and multiplex circuits. Every one of our 3/16" to 5/8" characters is enhanced by our patented cross-over filament arrangement which eliminates open corners for improved readability.

With Pinlite displays now more available right from stock, it will pay you to check them out. Write or call today for the whole story.



REFAC
electronics corporation.

P.O. Box 809, Winsted, CT 06098 (203) 379-2731

CIRCLE NUMBER 123

Introducing the King of the Static RAM Family



We brought you the first 4K static RAM — and delivered it a year and a half ahead of anyone else. We were the first to put it and its many descendents into volume production.

Now we'd like you to meet the new King of the Static RAMs . . . the 1K x 8, 300 nsec SEMI 8108. Look at his credentials!

A 1K Byte memory system in a single package.

300 nsec access time. The speed you'll need for microprocessor systems.

Low operating power — just 33 μ W per bit. (7 μ W per bit standby.)

Packaged in industry standard 22-pin DIP, for a 30% saving in board space over 18-pin 4K devices.

The new King will soon mount his throne to lead you to new design conquests. Call or write us for advance technical information.

Memory at Work

SEMI, INC.

A subsidiary of Electronic Memories & Magnetics Corp., 3883 N. 28th Ave., Phoenix, Arizona 85107 (602) 263-0202

ALABAMA: Gentry Associates, Huntsville 205/534-9771 • **ARIZONA:** EMM, Phoenix 602/263-0202 • **CALIFORNIA:** EMM, Hawthorne 213/644-9881; EMM, Los Alamitos 213/598-8705; EMM, Burlingame 415/692-4251; Varigon, El Segundo 213/322-1120 • **FLORIDA:** Gentry Assoc., Orlando 305/894-4401 • **GEORGIA:** Gentry Assoc., Atlanta 404/455-1206 • **ILLINOIS:** EMM, Des Plaines 312/297-7090 • **MASSACHUSETTS:** EMM, Lexington 617/861-9650 • **MINNESOTA:** EMM, Hopkins 612/933-7115 • **NEW JERSEY:** EMM, Cherry Hill 609/779-7911 • **NEW YORK:** EMM, Melville 516/423-5800 • **TEXAS:** EMM, Dallas 214/231-2539; Young Sales, Dallas 214/341-2900 • **WASHINGTON:** The Thorson Co., Bellvue 206/455-9180 • **CANADA:** Cantec, Ottawa 613/255-0363

COMPONENTS

Get a circuit protector for \$1.00 plus blown fuse



Heinemann Electric, P.O. Box CNO1908, Trenton, NJ 08650. (609) 882-4800. See text.

Heinemann will send you a sample of its new RE-Cirk-It circuit protector, the successor to the fuse, for a dollar and a blown fuse. The device protects like a fuse, but is resettable. It is cost-competitive with fuses and fuseholders and installs in the same panel space as a conventional 0.625-in. diameter fuseholder. The protector trips instantaneously on short circuits and with delay on sustained overloads. It can only be electrically tripped, and it can't be turned off or held against a fault. Current ratings are from 0.25 through 10 A. The units are UL-recognized and CSA-approved.

CIRCLE NO. 382

Heat dissipators serve TO-3 devices

International Electronic Research, 135 W. Magnolia Blvd., Burbank, CA 91502. Ed Byrne (213) 849-2481. \$0.238 (5000 qty); stock.

LA 363 heat dissipators can serve all TO-3 semiconductor devices. The dissipators are up to 23% more efficient in high power ranges than conventional "push-on" style heat sinks. Because the dissipators attach to semiconductor bases where most of the heat originates, rather than to the can, the dissipators are more efficient. Staggered fingers maximize radiation and convection cooling. In forced-air modes, the design maximizes air turbulence, which increases the heat transfer efficiency.

CIRCLE NO. 383

DPMs sub for 4-1/2-in. analog meters

R.T. Engineering Service, 171 E. Forbes Blvd., Mansfield, MA 02048. Tom Crowell (617) 339-9339. \$187; stock.

The universal digital panel meter, DPM-31, is a mechanical replacement for standard 4-1/2-in. analog meters. The meter is designed around a 3-digit DPM, is ac powered and has universal range adjustment for dc and ac input signals. Jumpers on the rear select full-scale input ranges of 50 mV dc (100 mV ac), 5 V dc (100 V ac), 50 V dc (100 V ac) and 500 V dc (460 V ac). The full-scale readout of 999 can be programmed by means of an internal multi-turn pot. Accuracy is 0.5% of reading ± 1 digit. Input resistance is 20 k Ω /V dc and 9 k Ω /V ac. Max signal frequency is 2 kHz.

CIRCLE NO. 384

Thumbwheel switches have PC stators

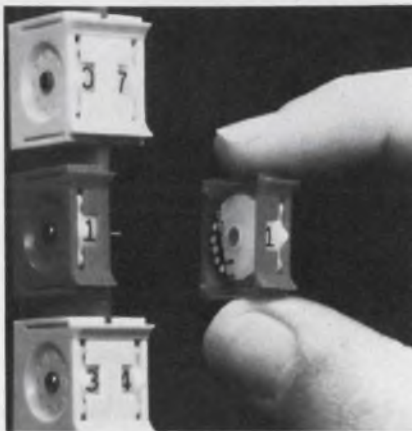

AMP, Harrisburg, PA 17105. (717) 564-0100.

In a new thumbwheel switch concept, AMP provides the usual rotor and housing; however, the stator is in the form of artwork which is used to produce a photo-etch PC-board master. Eliminating the fabricated stator results in substantial material and manufacturing cost savings. Also, electrical connections to the stator contacts are eliminated. A single 0.85 \times 0.83 \times 0.3-in. housing contains the rotating contacts. Current ratings are 1.5 A, non-switching, and 0.125 A, switching. Stator artwork is available for outputs in decimal BCD, BCD-9 complements and other codings. Special orders for variations in output codes as well as artwork patterns, wheel marking and housing colors can be accommodated.

CIRCLE NO. 385

Tantalum capacitors dipped in epoxy

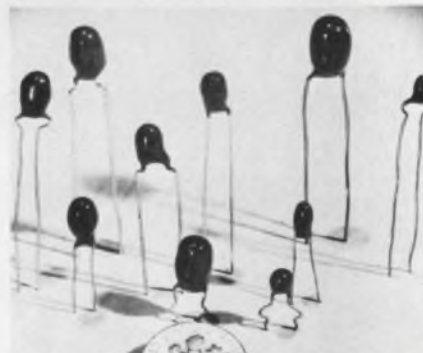

Siemens, 186 Wood Ave. S., Iselin, NJ 08830. (201) 494-1000. See text.

A line of economy miniature epoxy-dipped solid-tantalum capacitors, ST841/842, includes sizes from 0.1 to 680 μ F in eight voltage ratings from 3 to 50 V. Tolerances of 5, 10 or 20% are available. The capacitors have radial leads and are available with straight or "lock-in" crimp leads for easy PC-board insertion. Typical high-quantity OEM pricing is in the 6 to 8-cent range.

CIRCLE NO. 386

Submini toggle switch features locking lever

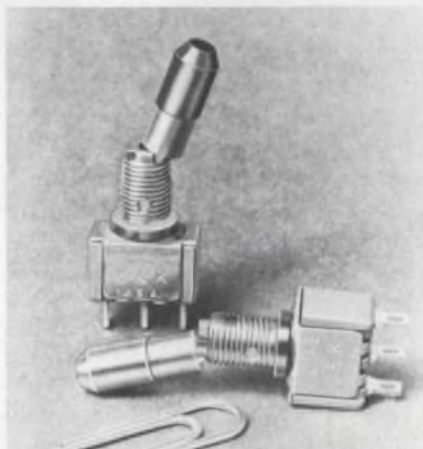

C & K Components, 103 Morse St., Watertown, MA 02172. Jim Martinec (617) 926-0800. Free sample.

An accident-prevention toggle switch option, the K1 locking lever, is available on a line of subminiature SPDT, DPDT, 3PDT and 4PDT switches. Lock-slots milled into the top of the bushing secure the switch in any one of up to three positions. To move the switch from one position to another, you must pull upward on the lever and then move the actuator to the desired position. This built-in safety feature prevents accidental tripping of the switch in critical switching applications.

CIRCLE NO. 387



In the financial community, you have to move money to make money. Since data communications among widely dispersed locations are the lifeblood of banking, insurance, and other financial institutions, it's not surprising that many of the big ones choose Universal Data Systems as their modem supplier.

Some of these institutions choose UDS because they like the technical superiority of CMOS design in 103s, 201s, 202s or ACUs. Others select the RM-16 for fast, reliable 16-channel communication. For economy, others like the two-wire full-duplex 1200 bps capability of the UDS 12 • 12 and the direct access provided by FCC-approved DAAs.

If you're a datacomm user or an OEM and you have a similar need for confidence in communications, follow the smart money — discuss your modem requirements with Universal Data Systems, 4900 Bradford Drive, Huntsville, Alabama 35805. Telephone 205/837-8100; TWX 810/726-2100.



**universal
data
systems**

Confidence In Communications

Universal Modems Make Money Move

U.S. & foreign patents

SAY GOODBYE to old manual wire wrapping tools!

**NEW P184
SLIT-N-WRAP**
tool with Tefzel
wire makes
connections as
reliable as
other wrap tools.

Now you can wrap
thick insulated wire
4 TIMES FASTER
with
NO pre-cutting
NO pre-stripping
DAISY CHAIN
RUNS.

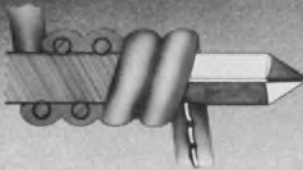

Insulation is slit
open before
wrapping on post,
not between
posts. No unwanted
cut-thru.

P184, with
100' of 28
gage Tefzel
wire, \$29.50.

P184-4T with batteries and recharger, \$80.00 (includes P184).
P184-4T1 110V AC, \$89.00 (includes P184). Tefzel wire, 28 gage, various
colors, \$4.18/100 ft. If not available locally, factory order—add \$2 handling charge.

Vector

ELECTRONIC COMPANY, INC., 12460 Gladstone Av., Sylmar, CA 91342
phone (213) 365-9661, twx 910-496-1539
571177

CIRCLE NUMBER 126

COMPONENTS

Thumbwheel switches set digital time-delay relay

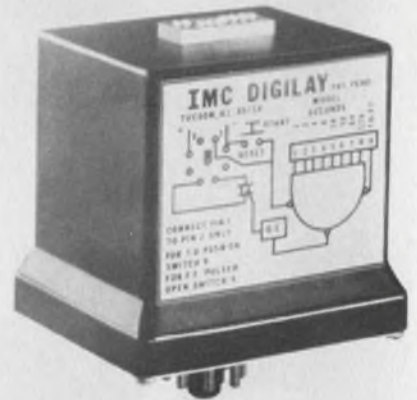

*International Microtronics, 4016 E.
Tennessee St., Tucson, AZ 85714. Dr.
Otto Fest (602) 748-7900. \$79; stock to
4 wks.*

A low-power, solid-state, time-delay relay set by direct-reading thumbwheel switches operates from 12 V dc. Series 280 Digilay times, in on or off modes, from 1 ms to 9999 s. Accuracy and repeatability is $\pm 0.5\%$. Maximum power turn-on time is 30 ms and minimum power-recycle time is 10 ms. External frequency modulation permits fine tuning of the oscillator's base frequency or, with an external waveform, actual modulation of the time delay. Three switch options are spdt relay, spdt reed relay and spdt triac.

CIRCLE NO. 388

Electronic counter adds and subtracts 8 digits



*Kessler-Ellis, Atlantic Highlands, NJ
07716. Dick Laird (800) 631-2165.*

The Type K 8-digit electronic counter has a 0.17-in. LED display that adds and subtracts while recording even overlapping count inputs. The device has a built-in battery that self-charges and supports data for six months. Packaging is in a 1 x 2-in. case.

CIRCLE NO. 389

ALCOSWITCH® PC mountables

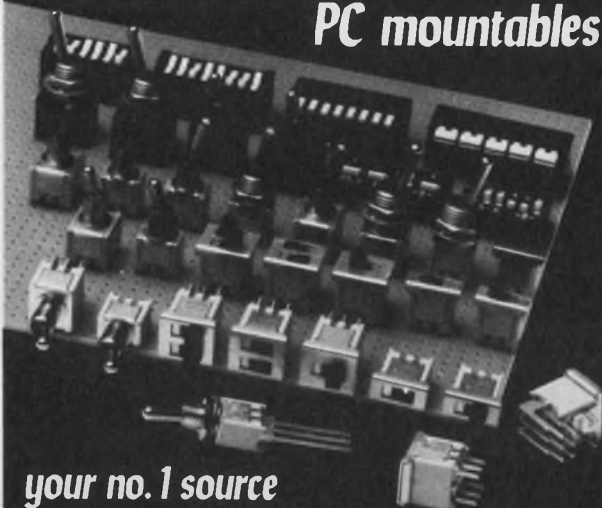

your no. 1 source

Alco offers the best variety in PC switches including: DIPS, slides, toggles, pushbuttons, etc. with mounting options. All types feature 0.1" centers and gold plated contacts for low level needs. Competitive pricing. Ample inventory of all models for limited production needs. Call or write today!

ALCO ELECTRONIC PRODUCTS, INC.
1000 INDUSTRIAL AVENUE, NORTH ANDOVER, MA 01861

Tel: (617) 685-4371

TWx: 710 342-0552

A SUBSIDIARY OF **AUGAT** INC.

CIRCLE NUMBER 127

Elmwood makes Sense

Why overspecify? Choose the fast-response snap-acting Elmwood thermostat model that just fits your needs. Choose the levels of tolerance and differential that are right for your product, without wasted details or dollars.

For worldwide sales many Elmwood models meet CSA and European requirements (and DIN norms), as well as U.L. Ratings are to 15 amps, for exposures -65°F to 550°F (-54°C to 288°C), and each unit is factory pre-set, tested and tamperproof. Doesn't Elmwood make Sense? Ask for prototypes.



Elmwood Sensors, Inc. 1655 Elmwood Avenue, Cranston, R. I. 02907
PH 401/781-6500. Twx 710-381-6413.

European Div., Elmwood Sensors, Ltd.,
North Shields, Tyne and Wear, NE29 8SA
England Ph (089) 45-82821. Telex: 53284



Elmwood Sensors

Precision Controls

CIRCLE NUMBER 129



The Seastrom Touch



FREE 250 page illustrated catalog with 30,000 part numbers in stock for immediate delivery . . . all types of washers, shims, spacers, lugs, clips, clamps, plugs, insulators, military standards, etc.

NEW PRODUCT!

U-TYPE Sheet metal nuts now available. Send for your FREE U-Nut catalog.



SEASTROM

MANUFACTURING CO., INC.

701 Sonora Ave. • Glendale, Calif. 91201
(213) 245-9121 TWX 910-497-2271

CIRCLE 135 FOR U-NUT CATALOG
CIRCLE 136 FOR BOTH CATALOGS

PACKAGING & MATERIALS

Cables match D plugs to DIP sockets



Aries Electronics, P.O. Box 231, Frenchtown, NJ 08825. (201) 996-4096.

D-type subminiature connectors with 9, 15, 25, 37 and 50 pins are in ready-to-install flat-cable assemblies that fit DIP sockets. Connections are soldered; backshell potting provides cable strain relief. The cable can exit from back or sides of the connector. Normally the cable is EIA color-coded 26 AWG wire. Cable ends come stripped and tinned or terminated into a covered DIP header, ready to solder into a PC board or plugged into a DIP socket.

CIRCLE NO. 390

High density connectors handle 24 to 96 pins



Elco Corp., 2250 Park Pl., El Segundo, CA 90245. Karl Neumuller (814) 643-0700.

The 0.1-in. Series 8223 connector can be ordered with 24 to 96 contacts in a wide range of termination styles. Applicable PC cards range from 1/16 to 1/8 in. Current rating is 5 A using 22 AWG wire and contact resistance is 6 mΩ. Insulators are diallyl phthalate, glass-filled and flame resistant per MIL-M-14F. With Mil plating, the connectors qualify to MIL-C-55302.

CIRCLE NO. 391

Panel-mounting frame holds standard boards



EECO, 1441 E. Chestnut Ave., Santa Ana, CA 92701. (714) 835-6000. \$1775; stock.

Model 14G frames hold standard-sized pin-in-board wrapped-wire panels with widths of 2.7, 5.4, 10.8 or 15.8 in. The frames can be assembled or reassembled to hold either 6.9 or 7.5-in.-high panels. The panels mount on extruded-aluminum side rails. The end pieces provide firm snap-in positioning in a 19-in. drawer. Depressing the end pieces at the locking points permits you to swing the frame up for full access, or to remove it completely from the drawer.

CIRCLE NO. 392

Manual lead former cranks out 20,000/h



Henry Mann, Box 496, Huntington Valley, PA 19006. (800) 523-1960. \$495; stock.

The Gatlin-Gun lead former prepares leads at the rate of 20,000/h on taped components. The device makes right-angle cuts and bends with five interchangeable forming assemblies. They can produce lead lengths from 0.125 to 0.365 in. Lead spacing is adjustable from 0.2 to 1.6 in., in either symmetric or asymmetrical configurations.

CIRCLE NO. 393

NOW BEI WILL GIVE YOU 30 DAY DELIVERY ON INCREMENTAL ENCODERS



H25



L25

ANNOUNCING THE 25 SERIES INDUSTRIAL OPTICAL INCREMENTAL ENCODERS

Our new Industrial Encoder Division now offers you the solid quality you expect from BEI PLUS 30 day shipment. Both the low torque, instrument grade L25 and the heavy duty H25 are packaged in size 25 aluminum housings and are available with code disk resolutions from 1 to 2540 cycles per turn. Both can be ordered in a wide array of mechanical and electronic configurations with pulsed and square wave count multiplication. BEI encoders in 30 days! You no longer need to settle for less.

BEI Electronics, Inc.

Controls and
Instruments
Division



Industrial
Encoder
Division

Little Rock, Arkansas

Goleta, California

Exclusive manufacturers of the BALDWIN® encoder
1101 McAlmont Street Little Rock, AR 72203
(501) 372-7351 TWX 910-722-7384

CIRCLE NUMBER 137

Micro-Mini BITE* Indicator with Internal Switching



Actual
Size

Minelco's magnetic-latching BITE* Indicator MI70 is the latest in miniaturization and reliability, meeting all MIL-E-5400 requirements. It offers a dual-view, low-profile environmentally-sealed case for PC or panel, with outstanding vibration characteristics. Best of all: Minelco can provide internal means for isolated signal switching to eliminate latching relays, or switching for integral control of coil circuits, as well as suppression and steering diodes. The MI70 is available in 6 to 28 vdc, for temps -65°C to $+105^{\circ}\text{C}$. Write or call for details.

*Built-In-Test-Equipment

MINELCO

a **TALLEY INDUSTRIES** Company
135 South Main Street Thomaston, Conn. 06787
Phone 203-283-8261

CIRCLE NUMBER 138

CIRCLE NUMBER 139 ►

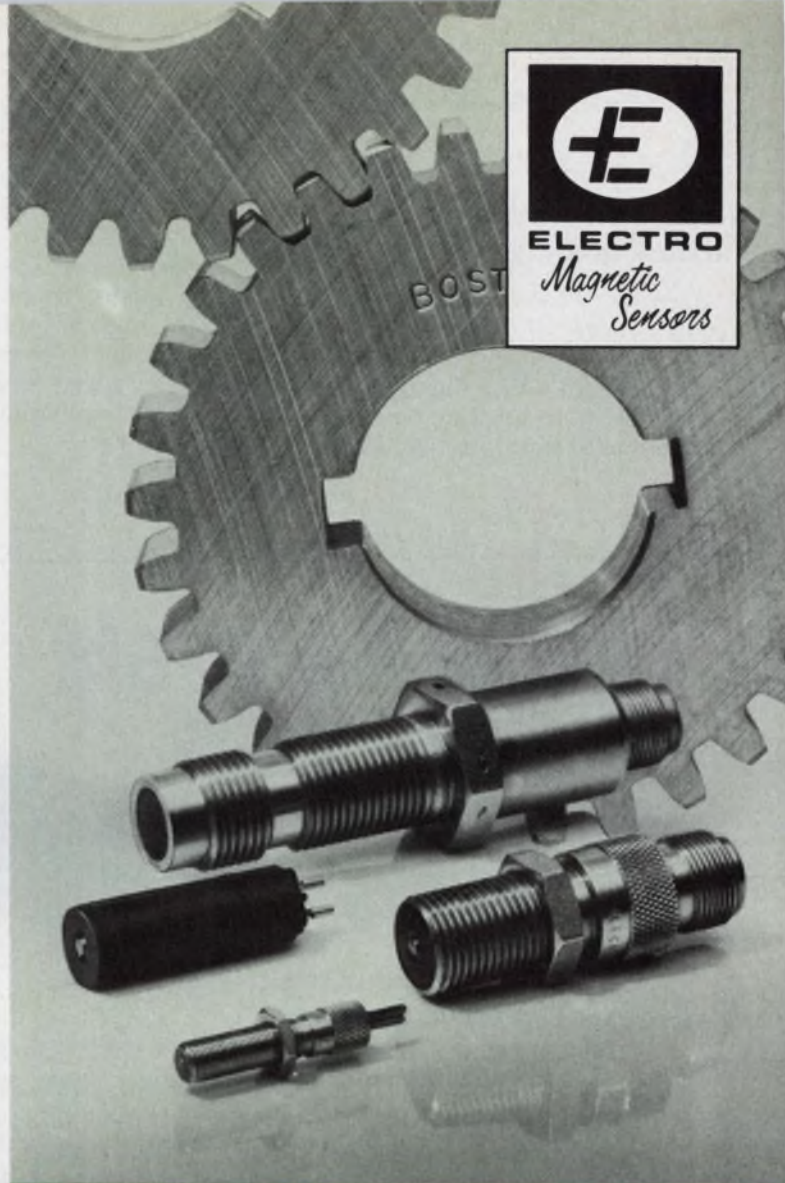

For sensing motion ... there's only ONE!

ELECTRO gives you the complete capability . . . from prototype designs to high-volume production. We have pioneered in the development of magnetic sensors for more than 35 years and currently produce industry's most complete line of sensors including:

- General-Purpose Sensors For Instrumentation
- High-Reliability Designs For The Transportation Industry
- Low-Cost, Molded-Plastic Sensors For Computer Peripheral, Appliance And Automotive Applications.

Our sensor designs have been copied and imitated . . . but never duplicated. We suggest the reason lies in our experience . . . we've been at it longer than anyone else.

If you want to know more about the proven advantages of ELECTRO sensors write or call Electro Corporation, P.O. Box 3049, Sarasota, Florida 33578, 813-355-8411.



BNC connectors install quickly

Cambridge Products, 244 Woodland Ave., Bloomfield, CT 06002. Ed Selig (203) 243-1761. \$0.90/\$1.15 (100 qty).

Two Fastfit BNC connectors assemble easily and rapidly. The crimp version has a body assembly and crimp

ferrule for the braid. The field-installable version is a one-piece connector with no loose parts. Both types use a self-energizing contact, pre-assembled into the body. The contact captures the cable's center conductor upon assembly. The field-installable BNC is simply twisted on to the cable and attaches in seconds without the use of tools or solder. The crimp connector requires crimping of the braid only. Both versions are available for RG-58 and RG-59 cables.

CIRCLE NO. 394

NEW 8 & 10-Bit Hybrid D/A's settle in 25 NS:



The fastest hybrid micro-circuit D/A converters on the market. That's what the Computer Labs HDS-0820 and HDS-1025 are since they exhibit settling times as low as 25 ns. And even though their power dissipation of less than 3/4 watt is almost one-half that of competitive D/A's, a full 10 mA output current is maintained. So they can be used to drive transmission lines or other low-impedance loads, directly.

Active laser trimming has been used in the construction of the HDS Series to produce high accuracy and adjustment-free performance. Each is housed in a 24-pin DIP case and has an internal precision reference. They are ideally suited to operate with high-speed A/D converters, CRT displays, television picture reconstruction equipment, automatic test equipment, and much more. Call

or write now for more information on these outstanding hybrid converters.



COMPUTER LABS

TWX 510-922-7954

505 EDWARDIA DR. • GREENSBORO, N. C. 27409 • 919/292-6427

COMPUTER LABS, INCORPORATED

CIRCLE NUMBER 140

Harnessing system shows wire-end points

RG Systems, 80 Fountain St., Pawtucket, RI 02860. Joe Rheame (401) 728-6140. \$3500.

The harness fabrication system, Model 201-A, is a programmed sequential wiring system that eliminates wire-run lists and operator search time. It uses LEDs to illuminate the origin and destination of each wire on the board. After automatically testing installed wires, the device indicates, in proper sequence, the next wire to be installed. A corresponding LED at the storage bin lights up to indicate which pre-cut wire to use. The system is field expandable to handle harnesses with up to 300 wires.

CIRCLE NO. 395

One-part coating is electrically conductive

Electro-Kinetic Systems, 2500 E. Ridley Ave., Chester, PA 19013. (215) 876-6192. \$75/gal; stock.

A one-part electrically conductive coating, X-Coat 200, can be used for rf shielding, electrostatic discharging and grounding. Based on specially processed base metals, the coating exhibits a resistivity of less than 5 Ω /ft² and may be applied by spraying, dipping or rolling. The coating can provide shielding of up to 50 dB at most frequencies.

CIRCLE NO. 396

Semiconductor cooler needs less space

Wakefield Engineering, 77 Audubon Rd., Wakefield, MA 01880. Joe Piazza (617) 245-5900.

The FCA-880 semiconductor cooling package gives high cooling performance with a small sized unit, because high-fin-density extrusions provide efficient thermal coupling to the atmosphere. The space between fins is as little as 1/10 the height, which doubles the cooling efficiency compared to other types. The FCA-880 is a confined airflow package that provides cooling for over 30 discrete devices. The assemblies can be any length in 6-in. increments and come in a variety of hole patterns.

CIRCLE NO. 397

Now at ITC Suppliers!



Gemtime®

the New Adjustable Electronic Time-Delay/Interval Plug-In Solid-State Timer

- Plug-in/Plug-out convenience
- DC polarity protection
- Full 10 amp. loading
- AC or DC voltages
- Timing light
- Fast reset times
- Built-in transient voltage protection
- Repeat accuracy as high as $\pm 0.75\%$ of setting
- Cycles from 1 sec. to 10 hours
- Competitively priced
- Choice of Knob-adjustable, Lock-Nut or Fixed-time models

For more information, or the name of your nearest Gemtime distributor, write or call:



INDUSTRIAL TIMER

AN ESTERLINE COMPANY

Industrial Timer Corporation, U.S. Highway 287,
Parsippany, N.J. 07054 • (201) 887-2200 • Telex: 13-6494

CIRCLE NUMBER 141

ELECTRONIC DESIGN 4, February 15, 1978

How do you resolve two signals spaced 1 Hz apart at 2 MHz?

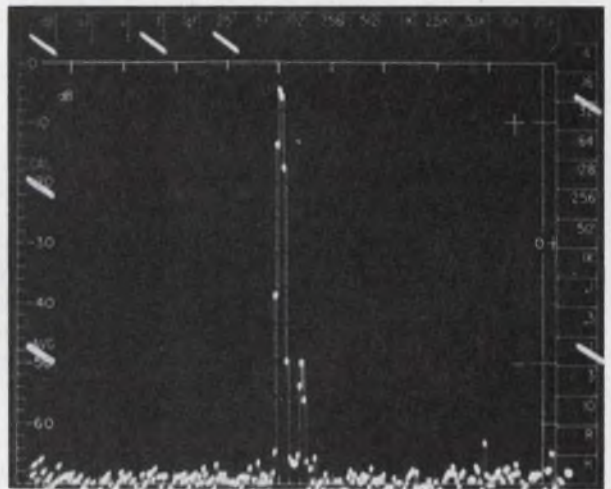

With an EMR Model 1510 Digital Real-Time Spectrum Analyzer and EMR Model 1520 Digital Spectrum Translator. Simply add the optional EMR Model 1521 Range Extension Module to the 1520 Translator, and you have real-time spectrum analysis at frequencies up to 2 MHz!



The CRT photograph illustrates the result. The input signal consisted of two discrete frequencies spaced 1.0 Hz apart, with a 50 dB difference in amplitude. The frequency range covered is 25.6 Hz centered about 1.990000 MHz, and the frequency resolution is 0.1 Hz!

Only EMR offers that much resolution at frequencies up to 2 MHz in real time.

So if you have an analysis problem requiring high-resolution/high-frequency real-time spectrum analysis, contact EMR . . . we will arrange for a demonstration or detailed information.

Sangamo Weston, EMR Telemetry Division
P.O. Box 3041, Sarasota, FL 33578
813-371-0811

SANGAMO WESTON

Schlumberger

CIRCLE NUMBER 142

POWER SOURCES

Dc/dc power converters deliver ± 15 V at 60 mA

Intronics, 57 Chapel St., Newton, MA 02158. Dick Sakakeeny (617) 332-7350. \$59; 2 to 4 wks.

DCI dc converters deliver floating power at ± 15 V dc at 60 mA. Regulation is 0.05% for line and load variations and output ripple is 11 mV. Input to output isolation is $10^{11} \Omega$ in parallel with 5 pF and breakdown voltage is 800 V dc. Three models offer a choice of operation from 5, 12 or 28 V dc. Size is $3 \times 2 \times 0.6$ in.

CIRCLE NO. 398

Power 10-W dc/dc units from a choice of inputs



Reliability, P.O. Box 37409, Houston, TX 77036. Bob Miller (713) 492-0550. \$89; 6 wks.

Single and dual-output dc to dc power sources operate from input voltages of 5, 12 or 24 V. Single outputs are 5 V at 2 A. Dual outputs are 12 V at 425 mA or 15 V at 330 mA. All units are encapsulated in a metal case and have line regulation of 0.02% from no-load to full-load and load regulation of 0.02% from low-line to high-line. Max output ripple is 1 mV rms and 20 mV pk-pk, while input-reflected ripple is 1% of max input voltage.

CIRCLE NO. 399

Regulator adjusts from -2 to -24 V at 5 A

Fairchild Semiconductor, 464 Ellis St., Mountain View, CA 94042. Bill Callahan (415) 962-3816. \$7.15 (100 qty); stock.

The $\mu A79HGKC$ negative-voltage regulator features adjustable output between -2 and -24 V at 5 A with a resistor divider. The device is packaged in a 4-pin TO-3 case with a rated power dissipation of 50 W at 25 C. The case is electrically neutral, eliminating need for insulating washers.

CIRCLE NO. 403

Evaluation samples

Switches

Rocker, toggle and lever-operated subminiature switches come in a wide variety of function, actuation, termination and mounting options, and contacts for low-level circuits, or for up to 5 A at 125 V ac, 2 A at 250 V ac. Dialight.

CIRCLE NO. 404

Insulators

The Insul-Cote system offers mica and film insulators pre-coated with thermal grease heat-sealed in 2000 piece "ammo pack" continuous strips. The strips are fed into automated dispensers, which present the coated insulators one at a time for production-line use. Three machine styles are available (from semi-automatic to variable-speed automatic). Prices and specifications are included in a 4-page brochure. A product sample is available. Thermalloy.

CIRCLE NO. 405

Substrates

RT/duroid 5870 microwave-circuit substrate clad with conductive material comes in 5×8 -in. samples. The glass microfiber-reinforced PTFE has a dielectric constant of $2.34 \pm 0.03\%$ at 10^6 through 10^{10} Hz. Rogers Corp.

CIRCLE NO. 406

25-A bridge rectifiers

Silicon-bridge rectifiers are rated at 25 A, have a 300-A surge; and peak reverse voltages from 50 to 1000 V. The Series PB bridges are 1.125 in. sq. by 0.438 in. high; have 1500-V-rms dielectric strength, U.L. component recognition, and 0.25-in. quick-connect terminals. Free samples to OEMs who outline their application. Electronic Devices.

CIRCLE NO. 407

Application notes

Glass-to-metal seals

The technology and materials used to produce hermetically sealed packages such as TO headers, relay headers, dual in-line packs, flat packs, single-pin terminals, frame packages, and cold-weld packs is explained in a six-page article. Airpax Electronics, Cambridge, MD

CIRCLE NO. 408

X-Y recorders

Several traditional and not-so-traditional methods of reducing effects of common-mode noise are described in "X-Y Recorder Input Configuration and Input Noise." Hewlett-Packard, Palo Alto, CA

CIRCLE NO. 409

Digital tester

Applications information, concerning the 851 digital tester, consists of a data sheet, 13 technique briefs, and 5 application notes. The data sheet provides specifications; the technique briefs explain how to use the tester in troubleshooting disc drives, tape drives, terminals, data-communications devices, and microprocessor systems. Tektronix, Beaverton, OR

CIRCLE NO. 410

Count controls

A 40-page comprehensive training manual illustrates operating principles, design and application of count controls. The booklet contains photos, circuitry and wiring diagrams, sequence and program charts. Eagle Signal Div., Gulf & Western, Davenport, IA

CIRCLE NO. 411

A/d-d/a converter testing

An eight-page application note discusses a/d and d/a converter specifications and testing. Examples of testing techniques are completely defined and illustrated. GenRad, Concord, MA

CIRCLE NO. 412



FLAT SPRINGS

from Instrument Specialties
cut your product's cost
and improve performance!



Beryllium copper springs from Instrument Specialties can cut your installed costs several ways. 1/S springs are more uniform, speeding assembly, because we heat-treat them *after* forming, in special fixtures. They can be delivered on strips, saving time at incoming inspection. They can be detached singly, without burrs, along precise score lines, eliminating tangling. Or, the strips can be designed for automatic assembly, virtually eliminating hand work.



What's more, Instrument Specialties springs improve your product's performance... ensure longer life... and protect *your* reputation—because they're precision-made of beryllium copper, with its inherently superior endurance life, conductivity and reliability.

We can stamp them with proprietary dies made and held exclusively for you, or, in some cases, adapt our standard tools. Or, photo-etch them, when short runs make expensive tools uneconomical.



Our catalog gives you complete information. It's free for the asking. Write today to Dept. ED-83.



INSTRUMENT SPECIALTIES CO., INC.
Little Falls, New Jersey 07424
telephone: 201-256-3500 twx: 710-988-5732
Specialists in beryllium copper since 1938



"Talk
about

SINGLE OUTPUT

OPEN
FRAMES

NUMBER
1
IN OPEN
FRAMES

POWER-ONE
IS NO. 1 FOR...

Quality — Two-year warranty,
UL Recognized, CSA Certified

Delivery — "Off-the-shelf" —
Nationwide

Reliability — Every unit —
2-hour burn-in plus 2 full
functional tests

Variety — 55 Single Output
models in 8 different case sizes
in 4 basic series . . .

Standard — 5V to 24V — 1.2A to 18A
— Remote sensing — $\pm .02\%$
regulation

Hi-Vol — 2V to 260V — 0.1A to 18A —
115/230 VAC input — OVP on 5V
models — $\pm .05\%$ regulation

High Power — 5V to 28V — 10A to 35A
— 115/230 VAC input — OVP on 5V
models — Remote sensing — $\pm .01\%$
regulation — True master/slave
operation

High Efficiency — Ultra-reliable linear
design — Efficiency up to 66% —
RFI/EMI free operation

And still at the same 1973 prices

NEW '78 CATALOG!

Get your free copy now!

"Think
about

POWER-one INC.
D.C. POWER SUPPLIES

Power One Drive • Camarillo, CA 93010
(805) 484-2806 • TWX 910-336-1297



CIRCLE NUMBER 144

New literature

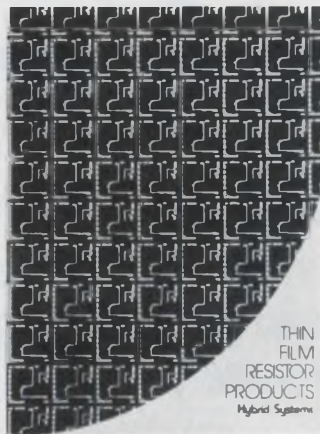

THIN
FILM
RESISTOR
PRODUCTS
Hybrid Systems

Thin-film resistors

A six-page brochure describes thin-film resistors. Hybrid Systems, Bedford, MA

CIRCLE NO. 413

Minicomputers

Hardware and software features of the Eclipse S/130 systems are detailed in a 16-page brochure. Topics include computation abilities, languages, operating systems, programming aids, peripherals and typical-system configurations. Data General, Westboro, MA

CIRCLE NO. 414

Conductive cells

Eight data sheets provide applications, specifications and dimensions of plastic and glass conductivity cells. Other information includes a quick-reference chart listing standard features and available questions. Beckman Instruments, Cedar Grove Operations, Cedar Grove, NJ

CIRCLE NO. 415

IC log amps

Ultraminiature and miniature IC logarithmic amplifiers, spanning 30 to 160 MHz, are featured in a data sheet. Outline drawings with English/metric dimensions, a pulse response photo, typical input-output characteristics, and a discussion of dc outputs are included. RHG Electronics Laboratory, Deer Park, NY

CIRCLE NO. 416

Pressure transducers

In addition to complete descriptions and specifications for National pressure gauges and differential pressure devices, a 145-page book gives detailed discussions of the how and why of transducer applications, from barometers and medical electronics to refrigeration and building control. This informative handbook can be ordered for \$4.00 postpaid. National Semiconductor, 2900 Semiconductor Dr., Santa Clara, CA 95051

CIRCLE NO. 417

μ P display interface

Descriptions and tables summarizing the physical and electrical characteristics of microprocessor-display interfaces are included in a four-page brochure. Matrox, Montreal, Quebec

CIRCLE NO. 418

DIP switch

Photos, description, features, options, technical specifications and code truth tables for a 16-position binary-coded DIP switch are given in a four-page brochure. EECO, Santa Ana, CA

CIRCLE NO. 419

Analog components

Application information, electrical characteristics, dimensional drawings and photographs of synchros, resolvers, gimbal pickoffs, stepper motors, torque motors, ac and dc servo motors, and tachometers are given in a 48-page catalog. Clifton Precision, Clifton Heights, PA

CIRCLE NO. 420

Dc power supplies

A 16-page booklet provides instructions, graphs, charts, tables and application notes for the power-supply designer who wishes to create a custom system from readily available sub-modules and accessories. Powertec, Chatsworth, CA

CIRCLE NO. 421

Digital panel meters

Specifications of solid-state digital panel meters are included in an eight-page brochure. Fairchild Camera and Instrument, Instrument Operation, San Jose, CA

CIRCLE NO. 422

Analog panel instruments

API series analog panel instruments are highlighted in a four-page brochure. LFE Corp., Waltham, MA

CIRCLE NO. 423

Leads, connectors

Nearly 250 interconnecting leads and hermetic connectors for high-voltage applications are described in a 74-page catalog. The catalog includes electrical and mechanical specifications along with application and dimensional data. AMP, Elizabethtown, PA

CIRCLE NO. 424

Holography, laser systems

A 100-page publication describes nearly 1000 holography and laser systems. Extensive technical-product information is included along with application data. Information is fully illustrated with curves, graphs and other test data, all produced by sophisticated computer-based test techniques. Newport Research Corp., Fountain Valley, CA

CIRCLE NO. 425

Printers

Dot matrix printers capable of printing 64 characters in 40 columns at 50 cps are featured in a four-page brochure. Anadex, Chatsworth, CA

CIRCLE NO. 426

Diodes and transistors

A 238-page publication contains detailed device characterization and applications information on diodes, transistors, voltage suppressors and switching transistors. For ease of use, the catalog lists the devices numerically within specific categories. Both JEDEC and General Semiconductor type numbers are shown in each product section. General Semiconductor, Tempe, AZ

CIRCLE NO. 427

Rental test equipment

Nearly 200 pieces of telecommunications test equipment is covered in an eight-page catalog. Electro Rent, Burbank, CA

CIRCLE NO. 428

ATTACK the hours of work you hate

Using spec sheets and manufacturer's catalogs to find semiconductor technical information is stealing your valuable time.

But now there's a system that can reduce your reference hours to minutes. Puts technical data on worldwide Microcomputers, Integrated Circuits, Discrete Devices and Optoelectronics components at your fingertips.

The D.A.T.A. BOOKS Electronics Information Series. D.A.T.A. engineers have successfully combined your data needs with standardized values, terms and definitions. Here are the tens of thousands of semiconductors manufactured in the U.S. and around the world — arranged by key parameters for your quick and easy comparison. Fast information that's accurate, dependable, up to date.

Just circle the reader response number. We'll send you our new 10 page brochure explaining the unique time-saving D.A.T.A. BOOKS™ System.

FREE

10 Page Brochure.

*Tells how you can
eliminate the hours
of work you hate.*

D.A.T.A. BOOKS

D.A.T.A., INC.

A Cordura Company

45 U.S. Highway 46, Pine Brook, New Jersey 07058

Telephone: (201) 227-3740

CIRCLE NUMBER 145

Clairex optical switches

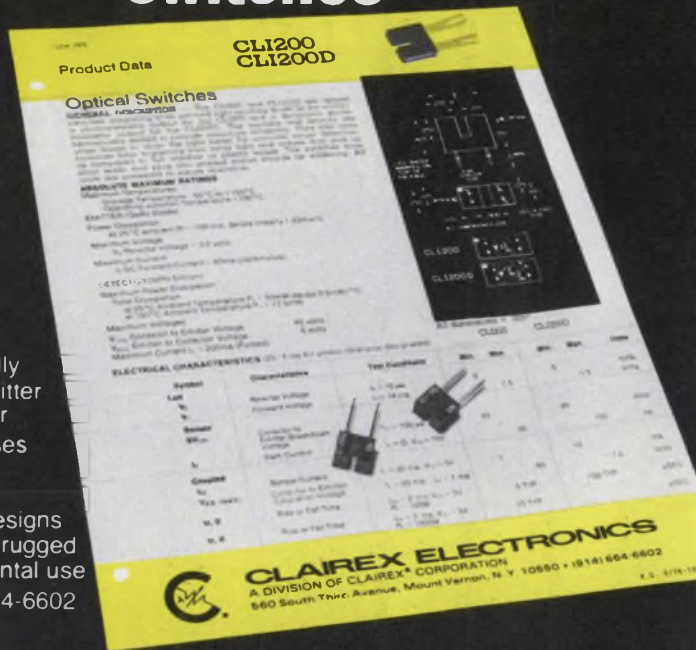

- Hermetically sealed emitter and sensor
- Glass lenses
- Standard designs
- Custom designs
- Potted for rugged environmental use

Call (914) 664-6602

CLAIREX ELECTRONICS

A Division of Clairex Corporation

CIRCLE NUMBER 146

High-Performance Amplifiers

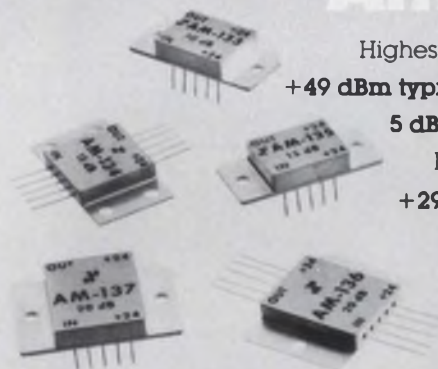

Highest Dynamic Range Available

+49 dBm typical midband 3rd Order Intercept

5 dB typical midband Noise Figure

Highest Output Power

**+29 dBm typical midband
1 dB Compression**

Frequency Range 5 - 200 MHz

Gain 10, 15, 20, 25 or 30 dB

Ten FLAT-PACK or PLATFORM Anzac amplifiers (AM-132/133, 134/135, 136/137, 138/139, 140/141) provide the best performance available in

miniature amplifiers. Price ranges from \$135 per unit to \$195 in 1-5 quantities. ALL MODELS IMMEDIATELY AVAILABLE FROM STOCK.

Complete details in ANZAC CATALOG provided as Part 2 of the 1977-78 MICROWAVES PRODUCT DATA DIRECTORY



**...the
qualitative
difference.**

39 Green Street, Waltham, MA 02154 (617) 899-1900 TWX 710 324-6484

CIRCLE NUMBER 147

Electronic Design

Advertising Sales Staff

Susan G. Apolant
Sales Coordinator

Rochelle Park, NJ 07662

Robert W. Gascoigne
Thomas P. Barth
Stan Tessler
Constance McKinley
50 Essex St.
(201) 843-0550
TWX: 710-990-5071
(HAYDENPUB ROPK)

Philadelphia

Thomas P. Barth
(201) 843-0550

Boston 02178

Gene Pritchard
P.O. Box 379
Belmont, MA 02178
(617) 489-2340

Chicago 60611

Thomas P. Kavooras
Berry Conner, Jr.
200 East Ontario
(312) 337-0588

Cleveland

Thomas P. Kavooras
(312) 337-0588

Los Angeles 90045

Stanley I. Ehrenclou
Burt Underwood
8939 Sepulveda Blvd.
(213) 641-6544

Texas

Burt Underwood
(213) 641-6544

San Francisco

Robert A. Lukas
465 S. Mathilda, Suite 302
Sunnyvale, CA 94086
(408) 736-6667

England

Constance McKinley
50 Essex St.
Rochelle Park, N.J. 07662
Phone: (201) 843-0550

Europe

Sanders, W. J. M.
Raadhuisstraat 24
Graft-De Ryp, Holland
Phone: 02997-1303
Telegrams: Euradteam-Amsterdam
Telex: 13039-SIPAS

G. Nebut

Promotion Presse Internationale
7 ter Cour des Petites Ecuries
75010 Paris, France
Telephone: 5231917, 1918, 1919

Dieter Wollenberg

Erikastrasse 8
D-8011 Baldham/Muenchen
Germany
Telephone: 0 8106/4541

Tokyo

Haruki Hirayama
EMS, Inc.
5th Floor, Lila Bldg.,
4-9-8 Roppongi
Minato-ku, Tokyo, Japan
Phone: 402-4556
Cable: EMSINCPERIOD, Tokyo

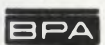

Electronic Design

ELECTRONIC DESIGN's function is:

- To aid progress in the electronics manufacturing industry by promoting good design.
- To give the electronic design engineer concepts and ideas that make his job easier and more productive.
- To provide a central source of timely electronics information.
- To promote communication among members of the electronics engineering community.

Want a subscription? ELECTRONIC DESIGN is circulated free of charge to those individuals in the United States and Western Europe who function in design and development engineering in companies that incorporate electronics in their end product and government or military agencies involved in electronics activities. For a free subscription, use the application form bound in the magazine or write for an application form.

If you do not qualify, paid subscription rates are as follows: \$30.00 per year (26 issues) U.S./Canada/Mexico, \$40.00 per year (26 issues) all other countries. Single copies are \$2.50 U.S. and all other countries. The Gold Book (27th issue) may be purchased for \$30.00 U.S./Canada/Mexico, and \$40.00 all other countries.

If you change your address, send us an old mailing label and your new address; there is generally a postcard for this in the magazine. You will have to requalify to continue receiving ELECTRONIC DESIGN free.

The accuracy policy of ELECTRONIC DESIGN is:

- To make diligent efforts to ensure the accuracy of editorial matter.
- To publish prompt corrections whenever inaccuracies are brought to our attention. Corrections appear in "Across the Desk."
- To encourage our readers as responsible members of our business community to report to us misleading or fraudulent advertising.
- To refuse any advertisement deemed to be misleading or fraudulent.

Individual article reprints and microfilm copies of complete annual volumes are available. Reprints cost \$6.00 each, prepaid (\$5.00 for each additional copy of the same article), no matter how long the article. Microfilmed volumes cost \$23 for 1976 (Vol. 24); \$30 for 1973-75 (Vols. 21-23), varied prices for 1952-72 (Vols. 1-20). Prices may change. For further details and to place orders, contact Customer Services Dept. University Microfilms, 300 N. Zeeb Rd., Ann Arbor, MI 48106. (313) 761-4700.

Want to contact us? If you have any comments or wish to submit a manuscript or article outline, address your correspondence to:

Editor
ELECTRONIC DESIGN
50 Essex St.
Rochelle Park, NJ 07662

CIRCLE NUMBER 148 ►

We've got everything in the book

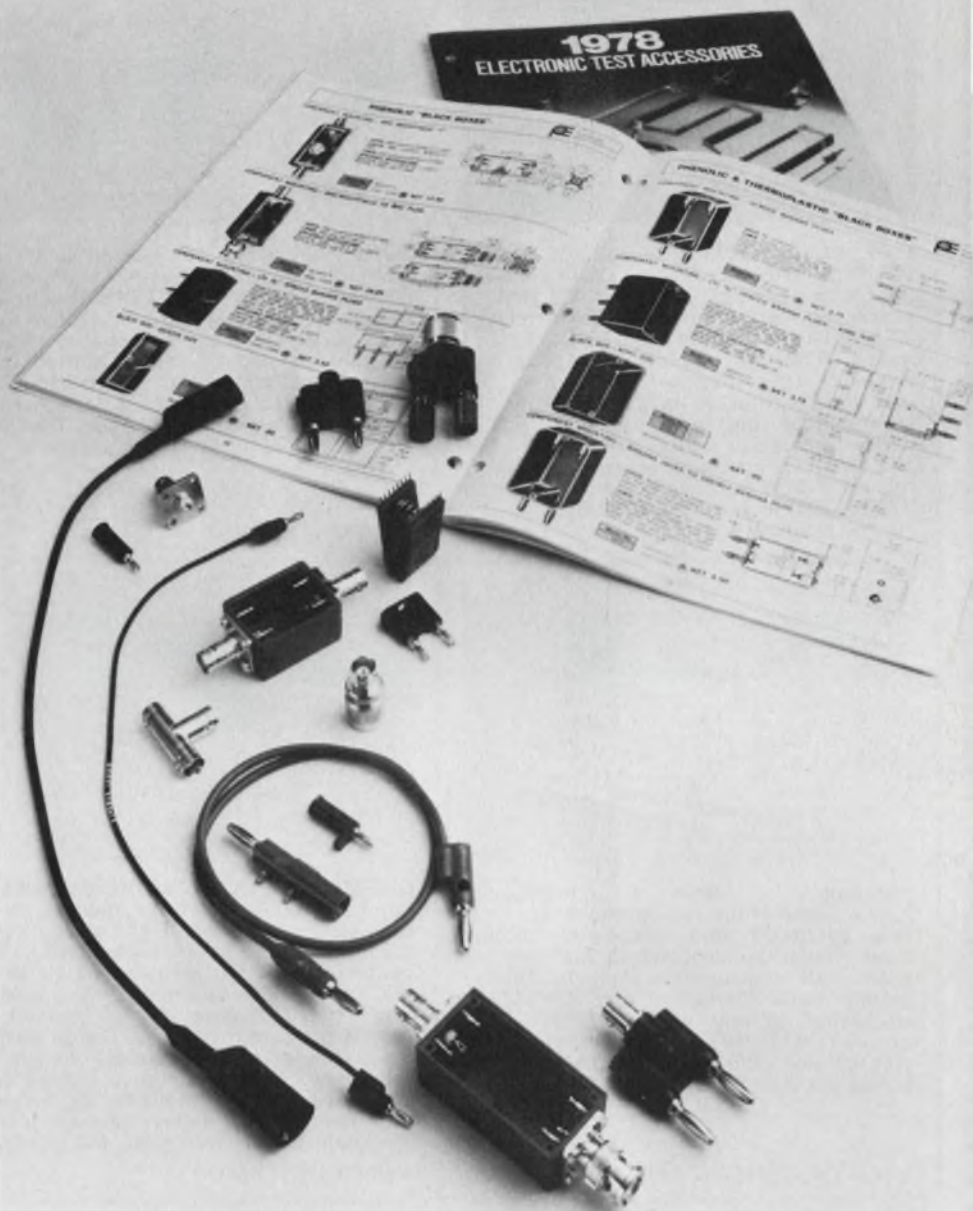

and it's yours free.

You'll find more than 600 electronic test accessories between the covers of ITT Pomona Electronics new 90-page catalog for 1978.

You can "probe" it for probes, "dip" into it for the DIP CLIP™ test clips, and "grab" it when you need Grabber™ mini test clips. Or you can check into it for

adaptors, plugs, boxes, cable assemblies, jumpers and lots more, including 42 new items just introduced

It's your best single source of top quality products for every phase of electronic testing. And it's yours for the asking.

Send for a free copy today. See our pages in EEM.

AVAILABLE THROUGH YOUR FAVORITE ELECTRONIC PARTS DISTRIBUTOR

ITT POMONA ELECTRONICS

1500 East Ninth St., Pomona, Calif. 91766
Telephone (714) 623-3463 • TWX: 910-581-3822



quick ads

New and current products
for the electronic designer
presented by their manufacturers.



LOW COST MICROPROCESSOR POWER SOURCE This low cost DC-DC Power Source is specifically for use with microprocessors and microprocessor related IC's such as RAM's and EROMS. The model 3M5UI2-5 provides +12 volts and minus 5 volts from a 5 volt input. The unit incorporates a highly efficient filter to minimize the input reflected ripple. Order evaluation units from stock. For pricing and a brochure, contact Reliability, Inc. at P.O. Box 37409, Houston, Texas 77036. Phone is (713) 492-0550.

DC-DC POWER SOURCE

181

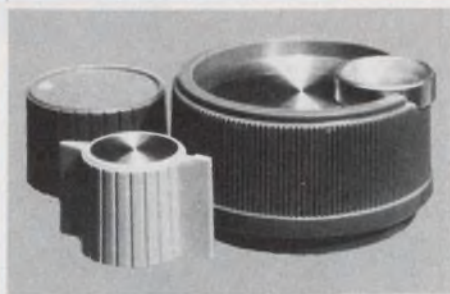

CONTROL KNOBS Full line of plastic and aluminum control knobs is manufactured by Radial Controls. All knobs are of the set screw type and are available in a wide variety of sizes and shapes. Standard shapes include round, skirted, bar, spinner, and concentric. Plastic knobs are supplied in four standard colors. A catalog is available from Radial Controls, 2555 East 55th Place, Indianapolis, IN 46220

CONTROL KNOBS

184



LOW COST QUARTZ CRYSTALS Use Statek 10 to 300 kHz quartz crystals in TO-5s . . . they eliminate count down for oscillators, filters, tone generators, timers . . . They're rugged, accurate & resistant to high vibration and shock. Prices low as \$1.70 ea. in 1000 qty. Send your written application & we'll send you a sample. Call or write for literature. Details in Gold Book and EEM * STATEK CORP. * 512 N. Main, Orange, Ca. 92668 * (714) 639-7810 * Telex 67-8394

QUARTZ CRYSTALS

187



For Sale . . . Now . . . more than 2,471 state-of-the-art instruments, and this \$1890.00 465 Tektronix Portable Dual Trace Oscilloscope is just one of them. All instruments include 90-day Money Back Guarantee with immediate worldwide delivery. Call (617) 273-2777 or (213) 993-7368 TODAY, or write for a free catalog. REI Sales Company, 19347 Londelius Street, Northridge, CA 91324.

USED INSTRUMENT SALES

182

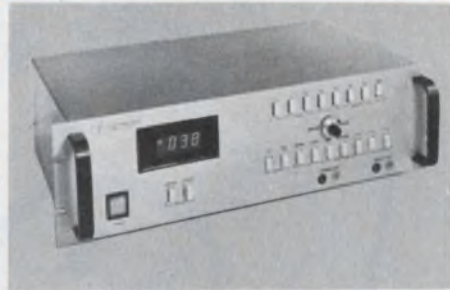

DIGITAL DISPLAY ELECTRONIC SWEEP GENERATOR WS8-10D. Three stepless noise-free ramp functions. Eight sweep rates (.5 minutes to 100 minutes std.), two continuously adjustable ranges (0 to $\pm .2V$, 0 to $\pm 2V$), automatic sweep centering. "Hold" feature. Digital readout of output or %, either range. Digital signals for computer analyzer, analog signals for recorder. X-Y recorder drive independent of range setting. Remote or cabinet-mounted. Write Walker Scientific, Inc., Rockdale Street, Worcester, MA 01606.

SWEEP GENERATOR

185

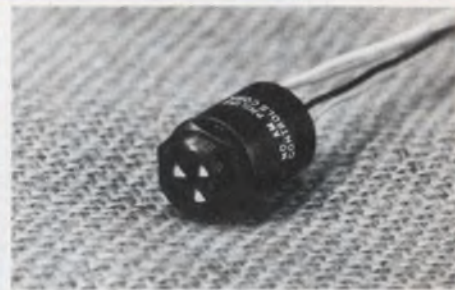

ELECTRIC RESET "BITE" INDICATOR Meets M83827/02. Monitors systems or components. Pinpoints malfunctions by providing automatic and permanent (until reset) warning of fault condition. Miniature size. Can be compactly grouped. 3 to 28V dc. 40 ms response. Wire leads or turret terminals. North American Philips Controls Corp., Cheshire, Conn. 06410.

"BITE" INDICATOR

188



DIGITAL DC CLAMP-ON AMMETER . . . No need to break the circuit, simply clamp around the conductor and read the current. • Measure DC current 1-800 Amps • Checks all DC waveforms, including SCR circuits • Remote Digital readout • Simple operation - Inexpensive • Accuracy $1\frac{1}{2}\% \pm$ a digit. Also checks 1-800 volts DC with conventional voltage probes provided. PACER INDUSTRIES, INC., 704 E. Grand Avenue, Dept. 112, Chippewa Falls, WI 54729 (715) 723-7110

DIGITAL DC CLAMP-ON AMMETER

183



CUSTOM THICK FILM HYBRIDS BY PARLEX. Custom designed thick film and hybrid assemblies are produced in long and short runs. Precision resistors, capacitors, DIP and discrete semi-conductors packaged with skill and imagination, including flex circuits and flat cable. Request our catalog or send specifications to: Parlex Corp., 145 Milk St., Methuen, MA 01844. Tel: 617-685-4341.

THICK FILM HYBRIDS

186

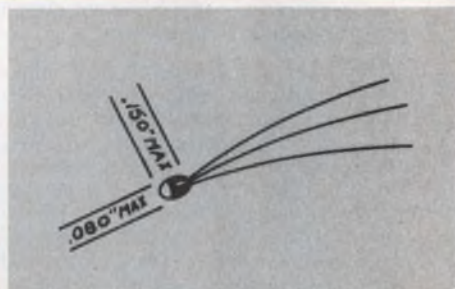

LINEAR THERMISTORS. Small size, $\pm 0.2\%$ linearity, long-term stability, $\pm 0.15^\circ C$ interchangeability. YSI Thermi-linear® thermistors translate -30 to $+100^\circ C$ temperature data for digital readout and precision temperature compensation. A simple signal conditioner provides linear outputs to 30 mV/ $^\circ$ with numeric correspondence. Ideal building blocks for sensitive, stable, digital, readout systems. Industrial Division, Yellow Springs Instrument Co., Inc., Yellow Springs, OH 45387.

LINEAR THERMISTORS

189

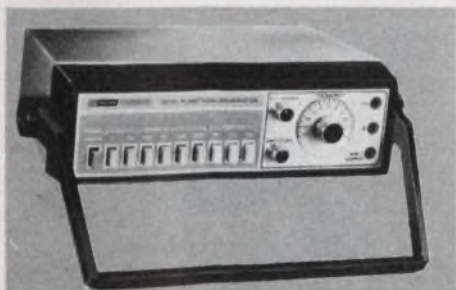

LOW DISTORTION FUNCTION GENERATOR ONLY \$175. Frequency coverage spans 0.1Hz to 1MHz in six ranges. VCO can be externally swept. Generates sine, square, triangle and square TTL waveforms. Sine-wave distortion is under 1%; square-wave symmetry and triangle-wave accuracy are a near-perfect 99% at 100-kHz. Includes variable $\pm 5\text{VDC}$ offset. Model 3010. B&K-PRECISION, 6460 W. Cortland Ave., Chicago, IL 60635 (312) 889-9087.

FUNCTION GENERATOR

190

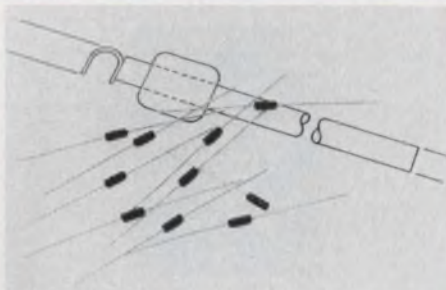

JAN SPEARLESS CURRENT REGULATOR DIODES. The JAN-TX IN5293-IN5314 series has been requalified, utilizing the "C" Bend construction to improve reliability under thermal and mechanical stress. Designed to couple high impedance with current regulation, these diodes simplify and improve circuit performance. They provide constant current over a wide range (3V - 100V) and flexibility to connect in parallel for higher current. Teledyne Crystals, 147 Sherman St., Cambridge, Mass., 02140 (617) 491-1670.

JAN CURRENT REGULATOR DIODE 193

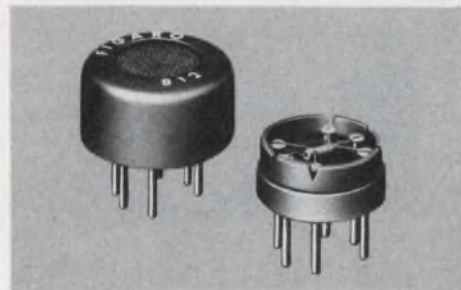

FIGARO GAS SENSOR TGS is a gas sensitive semiconductor. When combustible gas is absorbed on the sensor surface, a marked decrease of electrical resistance occurs. Major features of the sensor include high sensitivity, long term reliability and low cost. The applications are: GAS-LEAK ALARM, AUTOMATIC FAN CONTROL, FIRE ALARM, ALCOHOL DETECTOR, etc. Figaro Engineering Inc., North America Office-3303 Harbor Boulevard, Suite D-8, Costa Mesa, Calif. 92626 Tel: (714) 751-4103 Telex: 678396

GAS SENSOR

196

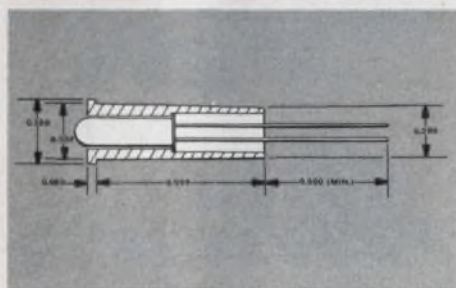

THE LOWEST COST LED LAMP ASSEMBLY In The Industry. Imtronics Light Emitting Diode Lamp Assemblies, consisting of a durable thermoplastic holder and LED are available with either white or black holders and with a variety of lamp colors. Rugged construction and wire wrappable leads allows for easy installation & high reliability, low power consumption, compatibility with ICs and long life ideal in many applications. IMTRONICS INDUSTRIES LTD., 813 2nd St., Ronkonkoma, N.Y. 11779 (516) 981-3434

LED LAMP ASSEMBLY

191



CONTINUITY CHECKER PLUS Model 113 offers separately adjustable low (1K) and high (250K) input impedance connections which allow setting the resistance value that determines continuity. Visual and adjustable audio indication of continuity can be set for continuous or a one second pulse operation. SIZE: 4" x 2 7/8" x 1 9/16" PRICE: (including batteries) \$29.95 CINCINNATI ELECTROSYSTEMS, INC., 469 Wards Corner Road, Loveland, Ohio 45140, (513) 831-4347

CONTINUITY CHECKER PLUS

194

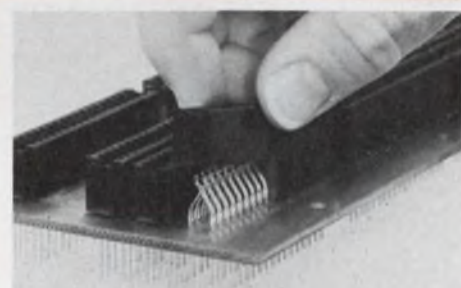

PRINTED CIRCUIT BACKPANEL SYSTEM featuring gas tight, press fit, replaceable contacts. The Kalmus precision printed circuit backpanel employs precision double sided plated thru hole technology combined with the latest advance in card edge connectors - the press fit compliant pin. The backpanel can be ordered in any size up to 24" x 36" with connector center spacings of .100, .125 and .156, and any thickness from .093" to .125". KALMUS & ASSOCIATES, INC., 2424 S 25th Ave, Broadview, IL 60153. (312) 626-8100.

PC BACKPANEL SYSTEM

197



AUTOMATIC RLC Tester. The GR 1657 DigiBridge measures R, L, C, D and Q. 0.2% Accuracy and FIVE full digit display for R, L, and C. No calibration is ever required due to μP control. Selectable test frequencies of 1 kHz and 120 Hz. Selectable series and parallel measurement modes. Built-in HI-REL Kelvin test fixture handles both axial and radial lead components. GenRad, 300 Baker Ave., Concord, MA 01742, 617-369-8770.

GENRAD

192

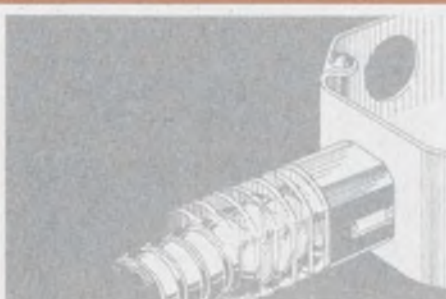

Here's the new snap-in conduit connector from AMP. Just screw it on the conduit and snap it in the junction box. No bushings, no screws, no tools. Installation time is cut to seconds. It's UL listed and CSA certified. For more information, call Customer Service at (717) 564-0100. Or write AMP Incorporated, Harrisburg, PA 17105.

AMP SNAP-IN CONDUIT CONNECTOR 195



NEW DESKTOP TAPE READER—all you do is plug this Smart Box in. Up to 300 cps—RS232C, Current loop, parallel I/O—and quality built. State-of-the-art fiber optics, photo transistor read head, dual-sprocket drive. Outstanding for flexibility and simplicity. Low cost. Decitek, 250 Chandler Street, Worcester, MA 01602 (617) 798-8731.

NEW DESKTOP TAPE READER

198



Overcurrent Protector, manual reset eliminates fuse replacement. Convenient panel mounting. 19 fractional ratings from 0.1 to 5 amp. Other models up to 400 amp. Trip-free and fool-proof, UL and CSA approved. High quality, low cost \$1.49 ea. in 1000 lots. E-T-A Circuit Breakers, 7400 N. Crounse Rd., Chicago, Ill. 60648. Tel: (312) 647-8303. Telex: 253780.

CIRCUIT BREAKER

199



Free New catalog contains over 34,500 quality power supplies from the world's largest manufacturer, Power/Mate Corp. Power Supplies for every application including submodulars, open frame, variorated, encapsulated, laboratory & system. All units UL approved and meet most military and commercial specs for industrial and computer uses. Power/Mate Corp., 514 S. River St., Hackensack, NJ 07601 (201) 343-6294

POWER SUPPLIES

202



BASICS OF AC & DC LINEAR SOLENOIDS BROCHURE 16-Page "Dormeyer Coach's" treatise on fundamentals of applying AC and DC linear solenoids for commercial and consumer equipment. "Solenoids . . . What They Are, How To Use Them" covers essentials of construction, operation, standard types, typical usage, effect of duty cycles and ambient temperature, plus provides a handy trouble-shooting chart. FREE. Dormeyer Industries, 3418 N. Milwaukee Ave., Dept. ED, Chicago, IL. 60641. Phone: (312) 283-4000.

BASIC BROCHURE ON SOLENOIDS

205



SEIKO MECHANICAL FILTERS FOR CARRIER TELEPHONE SYSTEM. Center frequencies: 2600Hz and 3825Hz, 3dB Bandwidth; 50Hz, 25dB Bandwidth; 250Hz, Insertion Loss; 5dB Impedance; 30Ω, Size: 1.642(L) x 0.421(W) x 0.555(H) inches. Hermetically sealed, sharp selectivity, good temperature characteristics. Also available from 280Hz to 100kHz. SEIKO INSTRUMENTS, INC., 2990 West Lomita Blvd., Torrance, Ca 90505 (213) 530-3400 Telex: 25-910-347-7307 SEIKOINSTRNC

MECHANICAL FILTERS

200



MICROPROCESSOR DATA MANUAL, edited by Dave Bursky, of *Electronic Design Magazine*. Contains a data page for each microprocessor, from over 30 manufacturers, with its family of support circuits, architecture, available software, and the unit's instruction set. #5114-X, 128 pages, \$7.95. Circle the Info Retrieval Number to order your 15-day exam copy. When billed, remit or return the book with no obligation. Hayden Book Co., 50 Essex St., Rochelle Park, N.J. 07662. Offer good in U.S.A. and Canada only.

203



OEM HeNe Redline™ Lasers offer design engineers output powers from 2mW to 6mW and are used for measuring quality control, reading and writing. They're used in facsimile transceivers, graphics, industrial bar code readers, alignment systems, surface inspection devices and a dozen other applications. Coherent offers singular laser units or integrated systems complete with acousto-optic modulator and power supply driven by TTL logic levels. Contact Coherent, 3210 Porter Drive, Palo Alto, CA 94304. (415) 493-2111.

LASERS

206

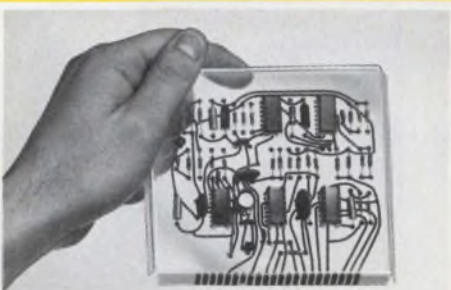

NEW PC DESIGN FREEDOM with Rogers Mektron® circuits now enable use of any insulator down to .015" with metal foils from .001" to .015" of anything from stainless steel to lead. Certain post-formable insulation can convert into complete chassis. Patterns mechanically generated. Call or write Rogers Corporation, 5259 Minola Drive, Lithonia, Georgia 30058 (404) 981-9830

MEKTRON PC's

201



NO-DRIFT NORTH SEEKER MODEL NS13-0101-1 for automatic navigation systems. Provides 360° azimuth through 45° pitch and roll. Uses standard flux gate coil suspended on universal pivot. Continuously registers reference to magnetic North within 2°. Synchro or pot output. Internal DC inverter. Requires 24 to 30V DC. Uses 0.130 amps. Weighs 1.6 pounds. Can eliminate need for more expensive gyros. Humphrey, Inc., 9212 Balboa Ave., San Diego, CA 92123. Phone (714) 565-6631.

NO DRIFT NORTH SEEKER

204



Free evaluation samples of new rocker, toggle and lever-operated subminiature switches are now available from Dialight, a North American Philips Company. This made-in Brooklyn switch line offers a full range of actuator sizes, styles, colors; also function, termination and mounting options; plus contacts for low-level circuits or for up to 5A at 125 VAC, 2A at 250 VAC. For free representative samples and new catalog, contact Dialight, 203 Harrison Place, Brooklyn, N.Y. 11237 (212) 497-7600.

ROCKER/TOGGLE SUBMINIATURES

207

Mini/Micro 78

THE MINICOMPUTER/MICROCOMPUTER CONFERENCE AND EXPOSITION
APRIL 18-19-20 • CIVIC CENTER • PHILADELPHIA, PENNSYLVANIA

LOOK at over a half mile of product displays by the industry leaders! A "supermarket" of mini/micro computer systems, peripherals, and industry services all under one roof in the spacious Philadelphia Civic Center. The MINI/MICRO COMPUTER EXHIBITION will be the largest in the East in 1978, and one of the largest in the country. Many new products have been introduced at previous exhibitions.

LISTEN to almost 100 industry speakers in about 20 conference sessions discuss a wide array of topics of interest and value to you. And all sessions will be held in meeting rooms located just an escalator ride away from the exposition floor.

CONTRIBUTE your experience and expertise. A question, answer, and comment time is held at the end of each session at the MINI/MICRO COMPUTER CONFERENCE to encourage an informal and valuable interchange of information between both session speakers and those in the audience.

PROFIT by taking home facts and ideas important to you and the firm you represent. The opportunity to do so will be in Philadelphia this April 18-20. You'll be an important part of an estimated international audience of 10,000 industry professionals who'll look, listen, contribute, and profit by their attendance.

SPECIAL SEMINARS: MONDAY, APRIL 17
MINI/MICROCOMPUTER APPLICATIONS

COURSE OBJECTIVE: Beginning with a brief review of microcomputer hardware and software, this applications course is intended to build on your knowledge of basic hardware configurations, memory systems, I/O Schema, and debugging methods. Understanding the differences in approach for applying minicomputers and microcomputers will be the theme of the course. The emphasis will be on microcomputer applications. Specifically, the software development process, development of the hardware system, hardware/software tradeoffs, interfacing, system specification, and some development cases will be covered. A general understanding of the process is one goal of the course. The course will close with an explanation of the important highlights of the hardware development process.

COURSE OUTLINE:

1. Reminder on current minicomputer characteristics and capabilities.
2. Review of microcomputer hardware and software.
3. The software development process.
4. Development of the hardware system.
5. Hardware, software tradeoffs.
6. Interfacing.
7. System Specification.
8. Some Development Case Studies.

Sponsor: The Institute of Electrical and Electronics Engineers (IEEE)

WEDNESDAY, APRIL 19
STEP-BY-STEP DESIGN OF MICROPROCESSOR SYSTEMS

The aim of the course is to expose the participants to step-by-step procedures for the design and implementation of microprocessor systems using the following modes of operation: (1) Wait/go; (2) Test-and-go (test and skip); (3) Interrupts; and (4) Direct Memory Access.

The design procedures which are accomplished in five well-defined steps, will be demonstrated and verified experimentally in class. Lecturer: Prof. D. Zissos, The University of Calgary, Canada.

Sponsor: The International Society for Mini and Microcomputers (ISMM)



To: **MINI/MICRO COMPUTER CONFERENCE AND EXPOSITION**
5528 E. La Palma Avenue, Suite 1, Anaheim, CA 92807, Phone: (714) 528-2400

My Primary Interest Is:

- Attending.** Please send me a Preview Program listing information on sessions/papers, exhibitors, and hotel reservations.
- Exhibiting.** Please send a copy of the Exhibit Prospectus.

Please type or print

Name _____

Title _____

Company _____

Address _____ M/S _____

City _____ State _____ Zip _____

Electronic Design

recruitment and classified ads

Engineering Specialists

"A Professional Approach to Your Career Growth"

Are you at a career impasse? Are your abilities being stretched to the fullest? If not, take a positive approach and talk to the specialists at Gray Kimball Associates. Our nationwide roster of blue-chip clients have come to rely on us in recruiting top-echelon engineering talent. All fees/expenses paid by our clients.

Challenging positions available nationwide include:

RF Engineers

Signal Processing
Phase Lock Loop
Spread Spectrum Analysis
Secure Communication

Software Engrs/ Programmers

Real-Time
Mini-Computer

Digital/Analog Engineers

Microprocessors
Display Systems
EW Systems

Reliability/ Maintainability Engineers

Now is the time to arrange a confidential interview with

Lou Basso (516) 799-5400

or send your resume in confidence to:

GRAY KIMBALL ASSOCIATES INC.

660 Bway, Massapequa, N.Y. 11758

Our clients are equal opportunity employers

PLACE YOUR AD AT ONLY \$55 PER COLUMN INCH
— GET A REPEAT AD FREE!

With our 2 for 1 plan, your net cost in *Electronic Design* is only \$27.50 per column inch, lowest among all the national newspapers and electronics media. You get a total of 165,418 exposures to OEM engineers and engineering managers (not counting 11,688 more among general or corporate managers) at only 33¢ per thousand! You can't beat the price. You can't beat the coverage and you can't beat the quality.

YOU REACH ENGINEERS WITH TITLES LIKE THESE:

- Chief Engineer • Development Engineer • Design Engineer • Project Engineer • Electronic Engineer • Engineer-Supervisor • Section Leader • Staff Engineer • Systems Engineer • Test Engineer • Standards Engineer • Master Engineer

Electronic Design RECRUITMENT ADVERTISING RATES

15% commission to recognized agencies supplying offset film negatives. 2% 10 days, net 30 days. Four column makeup. Column width 1-3/4" x 10"

SPACE	DIMENSIONS		COST
	Wide	Deep	
One column inch	1-3/4"	x 1"	\$55
2 col in	1-3/4"	x 2"	\$110
1/16 page (1/4 col)	1-3/4"	x 2-1/2"	\$130
1/8 page (1/2 col)	1-3/4"	x 5"	\$275
1/4 page (1 col)	1-3/4"	x 10" Vert	\$550
	3-1/2"	x 5" Hor	
1/2 page (2 cols)	3-1/2"	x 10" Vert	\$1100
	7"	x 5" Hor	
3/4 page (3 cols)	5-1/4"	x 10"	\$1650
1 page	7"	x 10"	\$2200

NOTE: EACH RECRUITMENT AD YOU PLACE WILL BE REPEATED FREE OF CHARGE!

Camera-ready film (right reading negatives, emulsion side down) or camera-ready mechanicals must be received by deadline. Or, if you wish us to set your ad (typesetting is free) simply pick up the phone and call our RECRUITMENT HOT LINE — (201) 843-0550. Ask for: Constance McKinley

VOUGHT CORPORATION

Dallas, Texas

Our wide variety of activities in aircraft, missiles, space and support equipment programs have generated interesting and challenging work assignments for:

ELECTRONIC HARDWARE DESIGNERS

Requires engineering degree and three or more years experience in hardware design of:

- Digital Video Processors
- Computer Graphics
- Computer Interfaces and Controllers

Experience in flight simulator development is preferred.

ELECTRO-OPTICS ENGINEERS

Requires engineering or physics degree and experience in military electro-optical systems. Must have background in EO modeling and computer simulation and analysis of EO systems and related components. Must be familiar with available materials components and devices for implementing imaging and non-imaging EO systems.

SIGNAL PROCESSORS

Requires electrical engineering degree and recent analytical and design experience in processing of signals derived by scanning non-imaging electro-optical sensors using complex focal plane arrays to perform both search and tracking functions.

DIGITAL PROCESSORS

Requires electrical engineering degree and experience with application and integration of digital computers in military avionics including development of overall system architecture. Experience must include development of operational software.

These jobs are located in the Dallas metroplex which has excellent schools, lower than average cost of living and outstanding recreational facilities.

Vought offers relocation assistance, excellent employee benefits and competitive salaries. If your qualifications match any of these jobs, send resumes to:

Professional Placement
VOUGHT CORPORATION
P.O. BOX 5907
Dallas, Texas 75222
Equal Opportunity Employer

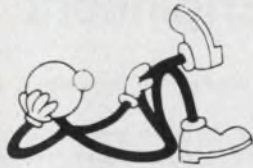

EFFORTLESS . . .

If you're ready to move on with your career, it can be a lot easier than you expect

We are the members of



who work extensively with electronics industry leaders. The companies we service have many openings and pay for us to search you out

Send your resume to the office nearest you. Then sit back and relax while we do the work.

BRENTWOOD PERSONNEL ASSOCIATES

Electronics Division
1280 Route 46
Parsippany, New Jersey 07054
(201) 335-8700

CAREER SPECIALISTS, INC.

4600 El Camino Real, Suite 206
Los Altos, California 94022
(415) 941-3200

STAFF DYNAMICS, U.E.

26 Sixth Street
Stamford, Connecticut 06905
(203) 324-6191

PETER A. KECHIK & ASSOCIATES, INC.

1420 Renaissance Drive
Park Ridge, Illinois 60068
(312) 298-1148

HAMPSHIRE ASSOCIATES, INC.

51 East 42nd Street, Suite 414
New York, New York 10017
(212) 697-6327

AVAILABILITY, INC.

Suite 285
5401 W. Kennedy Blvd.
Tampa, Florida 33609
(813) 872-2631

190 associates internationally

Engineering

NORTHROP DESIGN ENGINEERING

*great purposes...
greater achievements*



Establishing goals that challenge your ability. . . creates a sound beginning. Advancing beyond those objectives. . . instills pride.

At Northrop Defense Systems Division, a leader in advanced Electronic Countermeasure technology, we provide the guidance and professional freedom necessary for creative problem-solving and maintaining our leadership in the state-of-the-art.

If you are a Design Engineer with the following qualifications and possess a strong drive toward self-fulfillment, we invite you to consider an exciting career at Northrop.

- * 5-10 years experience in electronics and electromechanical high density packaging of military support equipment. Knowledge of investment casting and metal fabrication method processes.
- * RF design and analysis. Octave bandwidth MIC and stripline components. ECM TWT and equipment experience, plus familiarity with MIL-STD-38510 and 5400E requirements.
- * PROJECT ENGINEER with background in power supplies, modulators and high power TWT's required. Will be responsible for design and development of ECM transmitter.

In addition to the opportunity to join one of the finest engineering teams in the nation, we offer an excellent salary/benefits program. Qualified individuals are invited to send brief letter or resume in confidence, to:

Director—Design Engineering
Department E21

NORTHROP CORPORATION

Defense Systems Division

600 Hicks Road, Rolling Meadows, Illinois 60008

An equal opportunity employer m/f

NORTHROP



**HOW TO PLACE YOUR AD
CALL THE RECRUITMENT
HOT LINE 201-843-0550**

Constance McKinley
RECRUITMENT ADVERTISING MANAGER
ELECTRONIC DESIGN
50 Essex Street, Rochelle Park, New Jersey 07662

POWER SUPPLY ENGINEERS

Junior and Senior Level

Relocation to Dallas, Texas Area

Heavy experience with DC to DC, linear, and high frequency switchers. Openings on all levels with a rapidly growing high technology company. Send resume or contact

REACOR, INC.

718 Lingco Drive, Richardson, Tex. 75081
or call (214) 231-7218

2 RECRUITMENT ADS
FOR THE PRICE OF **1**

ELECTRONIC PROJECT ENGINEERS

Design of Industrial Control Systems and 1 to 20 kVA Inverters. A BSEE and 5 years experience desirable. Excellent starting salary and comprehensive benefits. Located in suburb of Chicago.

ELECTRO-PAC[®] DIVISION



Gerald Servos
129 Laura Drive
Addison, Il. 60101
(312) 543-6200

MICROWAVE SYSTEMS ENGINEER

Midwestern Relay Co. a video and message data common carrier operating in Wis., Minn., Ill. has a challenging position for an engineer with BSEE or equivalent or experience in microwave system design and path analysis FCC filing and frequency coordination experience desirable, but not essential. Send resume in confidence to:

Operations Manager
MIDWESTERN RELAY CO.

P.O. Box 68
Rubicon, WI 53078

An Equal Opportunity Employer

Research Engineers

Leading Southwest research and development organization has immediate openings for:

Senior Instrumentation Engineer — MSEE plus 5 yrs. experience in design and development of analog and digital solid state circuitry and systems. Desirable prior experience should include project supervision, minicomputer interface design, microprocessors and instrumentation development.

Senior Electronics Engineer — MSEE or Ph.D. plus 5 yrs. experience in digital communication systems design and testing. Assignments will involve point-of-sale terminal polling strategies and equipment, simulation of digital communication network and systems and error rate prediction.

Senior Electronics Engineer — BSEE plus 7 yrs. experience in automatic test equipment using minicomputers and microprocessors. Assignments will include development of automatic test equipment for machinery and electronics.

Electronic Engineers — BSEE plus education background or experience in microprocessors systems design, automatic test equipment or digital communications. Wide variety of challenging project assignment.

Electrical Engineer — BSEE plus 3-5 years experience with electrical power equipment in offshore/underwater environments

All positions located in sunny San Antonio. Salary based on qualifications. Excellent benefits. Send resume, with references, in complete confidence to:

Director of Personnel

Southwest Research Institute

P.O. Drawer 28510

San Antonio, Texas 78284



Electronic Design

BRINGS YOU
THE HIGHEST
NUMBER OF
QUALIFIED EOEM
ENGINEERS AND
ENGINEERING
MANAGERS
ANYWHERE
... AT THE
LOWEST COST
ANYWHERE!

RELIABILITY MAINTAINABILITY

Participate in Shipboard electronic systems acquisition management. Perform engineering evaluations, develop reliability, maintainability and test specifications. BSEE or equivalent with 5 years experience.

Please forward resumes to:

Mr. L. Orlando

**General Research Corporation
(SWL DIVISION)**

Suite 700 Park Place
7926 Jones Branch Drive
McLean, Virginia 22101

Equal Opportunity Employer

TEXAS POSITIONS

Engineering, EDP & technical openings throughout Texas & the U.S. 100% fee paid. Send your resume in confidence to
ENGINEERING/EDP SEARCH (Agency)
84 N.E. Loop 410, Suite 124E
San Antonio, Texas 78216

**KEEP
Electronic Design's
GOLD BOOK
HANDY**

ELECTRICAL ENGINEERS

An NYSE company, located in the southern Midwest and involved in the design, manufacture and sale of air pollution control equipment for industrial and utility applications, is currently seeking to add qualified Electrical Engineers to its staff in the following positions:

ELECTRICAL DESIGN

This individual must be experienced in design of large industrial electrical systems and in the supervision of electrical designers. Duties will include vendor contact in specifying and selecting equipment, and preparing "scope of work" for electrical contractors.

PRECIPITATOR START-UP SPECIALIST

This individual must be experienced in the start-up and troubleshooting of large electrostatic precipitators or large industrial electrical systems. Duties will include on-site start-up of large precipitator systems and coordinating with engineering and marketing to follow through and solve any problems as necessary to insure timely and successful startup. This position will require 75% travel.

These positions offer the opportunity to gain knowledge of widely varied systems in many different industries. Both offer competitive salaries and excellent benefits.

For confidential consideration please send your resume with salary requirements to:

Steve Sons

P.O. Box 21181

Louisville, Kentucky 40221

An Equal Opportunity Employer M/F

Field Engineer

Sencore, a leading manufacturer of test equipment for the consumer service, communications, and industrial maintenance markets, has an exciting position for a well rounded FIELD ENGINEER.

Duties will include writing application manuals for our line of O-Scopes, Freq. Counters, DVM's, Video/CB/Stereo Analyzers and more. You also write and produce video tape programs for training and sales. You'll travel 5-10 days per month, working with major TV, VTR, Audio, Stereo, communications and computer manufacturers from a design and approval standpoint. Also involved is technical training of Sales Engineers both in-house and in the field.

We need a minimum Associate Degree, with EE or BSEE preferred. We desire an individual experienced in Field Engineering with a high degree of communication skills.

\$12k-\$18k starting salary, with profit sharing, insurance package, and expense account while traveling.

If you would like to work with a dynamic firm, in a key position, where your decisions will help break new markets . . .

WRITE OR CALL:

E. A. Bowden
(605) 339-0100

SENCORE, INC.
3200 Sencore Drive
Sioux Falls, South Dakota 57107

ELECTRONIC ENGINEERS OR TECHNICIANS

To sell instrument product line part time. Instruments test, calibrate or control electronic circuits. Price range \$20-100. Contact:

Don Horn
CINCINNATI
ELECTROSYSTEMS, INC.

469 Wards Corner Rd.
Loveland, Ohio 45140
(513) 831-4347

TIRED OF SNOW AND ICE?

There's a place in the sunbelt for you!

Company retained professional recruiters

DUNHILL OF DAYTONA BEACH

1320 Oak Forest Drive
Ormond Beach, Florida 32074
(904) 673-2333

HP and YOU in Oregon!

SEE US DURING THE ISSC CONFERENCE IN San Francisco February 14-17

Technical staff members will be available in our HOSPITALITY SUITE to answer your questions.

For suite location and advance information, call Diane Pugh in Corvallis, (503) 757-2000, Ext. 2023, or call us during the conference at (415) 397-7039.

Hewlett-Packard's Corvallis Division, responsible for the development and manufacture of the most advanced personal calculator products, has challenging career opportunities in the Integrated Circuits Department.

I.C. PRODUCT DEVELOPMENT ENGINEERS/MTS

Responsible for the coordination of new I.C. development, device modeling, yield analysis and cost reduction engineering on production circuits. Requires experience in I.C. design, applications, or product engineering.

I.C. TEST ENGINEERS/MTS

Involves I.C. test system management including hardware design, software development, and diagnosis of the functional test systems (Megatest and Fairchild Sentry). Related experience required.

MOS AND LCD PROCESS ENGINEERS/MTS

Hands-on diffusion and masking in the LSI operation/process & test development in the LCD operation; our commitment to engineering excellence provides ample opportunity for state-of-the-art process development. Related experience required.

EQUIPMENT DEVELOPMENT ENGINEERS/MTS

Responsible for equipment design, feasibility tests, evaluation studies and installation for wafer fab, liquid crystal and thin film operations. Engineering experience in chemical processes and material required.

Corvallis is situated in the beautiful mid-Willamette Valley, 1 1/2 hours drive from the Oregon Coast, the Cascade Mountains, and Portland, the beautiful "City of Roses." Corvallis provides a university atmosphere with skiing, fishing, sailing and hiking in the picturesque nearby surroundings. The Pacific Northwest provides the opportunity to learn, explore and be challenged.

HP offers outstanding benefits, including flexible working hours, cash profit sharing and stock purchase program. If you cannot meet with us at the show, please send your resume in confidence to Diane Pugh, 1000 N.E. Circle Blvd., Corvallis, Oregon 97330. An equal opportunity employer.

Corvallis Division

HEWLETT  PACKARD

Advertiser's index

Advertiser	page	Advertiser	page	Advertiser	page
AMP Incorporated.	99,101,103,105,107,187	GTE Sylvania.	159	Philips Test & Measuring Instruments, Inc.	122
AVX Ceramics Corporation.	100	GenRad.	33,187	Plessey Semiconductors.	93,*114F-G
Abbott Transistor Laboratories, Inc.	112	General Electric Company, Miniature Lamp Products Department.	120	Potter & Brumfield, Division of AMF, Incorporated.	34,35
Advanced Micro Devices.	4,5	Germanium Power Devices Corp.	158	Power/Mate Corp.	126,188
Aham Tor.	82 A-F	Gould, Inc., Instrument Systems Division.	104	Power One, Inc.	182
Alco Electronic Products, Inc.	174	Harris Semiconductor, A Division of Harris Corporation.	74,75	Power Tech, Inc.	110
Allen Bradley, Electronics Division.	114A	Hayden Book Company, Inc.	143,188	Practical Automation Inc.	169
Anaren Microwave, Inc.	48	Heath Company.	45	Pulse Engineering, Inc.	140
Anzac Electronics, Division of Adams-Russell Co., Inc.	184	Heinemann Electric Company.	31		
Arrow-M Corp.	116	Hewlett-Packard.	9-16,17,18	RCA Electro Optics.	*132,133
		Houston Instrument, The Recorder Company.	153	RCA Solid State Division.	Cover IV
B & K Precision.	187	Humphrey, Inc.	188	REI Sales Company.	186
BEI Electronics, Inc.	177	Hybrid Systems Corporation.	27	Racal-Dana Instruments Inc.	83
Belden Corporation.	44	Hycom.	128	Radiol Controls.	186
Berg Electronics, Inc.	53			Refac Electronics Corporation.	170
Bivar, Inc.	97	IEE.	168	Reliability, Inc.	186
Bodine Co., The.	161	ITT Pomona Electronics.	185	Recco, Incorporated.	109
Bourns, Inc., Trimpot Products Division.	Cover II	IVO Industries, Inc.	164	Rogers Corporation.	124,180
*Burr-Brown Research Corporation.	146	Imtronics Industries, Inc.	187	Rolm Corporation.	114
Burroughs Corporation.	46,47	Industrial Timer, A Unit of Esterline Corporation.	179		
		Instrument Specialties Company.	181	Salon International des Composants Electroniques.	136
CTS Corporation.	137	Intech, Incorporated.	134,135	Seastrom Manufacturing Co., Inc.	176
California Eastern Laboratories, Inc.	102	Intel Memory Systems.	141	Seiko Instruments, Inc.	188
Cambridge Thermionic Corporation.	121	Intelligent Systems, Inc.	156,157	Servo-Tek Products Company.	160
Centralab/USCC.	149	International Microsystems.	142	Shugart Associates.	65
Chometrics, Inc.	152	Intersil.	130,131	Simpson Electric Company.	147
Cincinnati ElectroSystems, Inc.	187			Sorensen Lighted Controls, Inc.	142
Clairex Electronics, A Division of Clairex Corporation.	184	Janco Corporation.	7	Sprague Electric Company.	162,163
Coherent Radiation, Laser Division.	188	Johanson Manufacturing Corp.	36	Statek Corp.	186
Computer Labs, Inc.	178			Systron-Donner.	118,150
Cutler-Hammer, Specialty Products Division.	114B				
		Kalmus Associates, Inc.	187	T & B/Ansley Corporation.	92
D.A.T.A. Books.	183	Keystone Carbon Company.	144	TRW/IRC Resistors, an Electronic Components Division of TRW, Inc.	167
Data Display Products.	25	Keystone Electronics Corporation.	161	TRW Power Semiconductors, an Electronic Components Division of TRW, Inc.	145
Data General Corporation.	111			Tectetics, Inc.	154
Data Precision Corporation.	138,139	Licon, Division of Illinois Tool Works, Inc.	123	Tektronix, Inc.	41, 43
Datel Systems, Inc.	125,127,129	Litronix, Inc.	119	Teledyne Crystalonics.	187
Decitek, A Division of Jamesbury Corp.	187				
Dialight, A North American Phillips Company.	50,188	3M Company.	19	United Systems Corporation, A Subsidiary of Monsanto.	165
Dormeyer Industries, Inc.	188	Mepco/Electra, Inc.	22	Universal Data Systems.	173
		Micro Electronic Systems, Inc.	169		
*EMI Ltd. SE Labs.	122,123	Micro Memory, Inc.	160	Vector Electronic Co., Inc.	174
EMM Semi, a subsidiary of Electronic Memories & Magnetics Corporation.	171	Micro Networks Corporation.	29	Versatec, Inc.	155
EMR Telemetry, Weston Instruments, Inc.	179	Minelco Division, General Time.	177	Vitramon North America Division of Vitramon Incorporation.	115
E-T-A Circuit Breakers.	188	Mini-Circuits Laboratory, A Division of Scientific Components Corp.	2	Visual Communications Company.	37
Edmund Scientific Company.	164	Mini/Micro Computer Conference and Exposition.	189		
Electro Corporation.	177	Mostek Corporation.	49	Walker Scientific, Inc.	186
Electro Switch Corp.	164	Motorola Components Products Dept.	82	Wavetek Indiana Incorporated.	1
Electronic Applications Co.	169	MuRata Corporation of America.	42		
Electronic Design.	146			Yellow Springs Instrument Co., Inc.	186
Electronic Measurements, Inc.	6	National Semiconductor Corporation.	66,67		
Elmwood Sensors, Inc.	175	North American Philips Controls Corp.	161,186		
Essex Group, Sub. of United Technologies.	143				
		Opcoa, Inc.	164		
Fairchild Semiconductor, A Division of Fairchild Camera and Instrument Corporation.	81	Oshino Electric Lamp Works, Ltd.	106		
Fairchild Systems Technology, A Division of Fairchild Camera and Instrument Corporation.	151				
Fasco Industries, Inc.	52	Pacer Industries, Inc.	186		
Ferranti Electric, Inc.	143	Panasonic Electronic Components.	Cover III		
Ferrocube Corporation.	38	Parlex Corporation.	186		
Figaro Engineering, Inc.	187	*Philips Electronic Components and Materials.	114E,114H		
Fluke Mfg. Co., Inc., John.	20,21				

*Advertisers in non-U.S. edition

Panasonic ZNR[®] transient/surge absorbers go where others fear to tread.



Panasonic ZNRs provide a reliable, economical approach to the problem of protecting AC and DC circuits against repeated high voltage transients (positive or negative) and surges such as those produced by lightning, switching and noise spikes.

Just one of our ZNRs can replace the pair of back-to-back Zeners you may now be using in your circuit. And they're an excellent alternative to Varistors, RC circuits and spark gaps, too.

ZNRs are ideal for ground fault interrupter circuits, input line transient protection, microwave ovens, TVs, video displays, and just about any

AC or DC circuit that is vulnerable to current surges and spikes.

Fast response time.

Panasonic ZNRs are zinc-oxide non-linear resistors whose ohmic value changes in less than 50 nsec when subjected to impulse surges. This eliminates the discharge lag inherent in gap-type arrestors.

Available from stock.

AC circuits ranging from 14V to 1000V, and DC circuits from 18V through 1465V, can be protected with Panasonic ZNRs. All line transient ZNRs are U.L. listed. For complete details, samples and prices, write or call Panasonic Electronic Components, One Panasonic Way, Secaucus, N.J. 07094. (201) 348-7282.

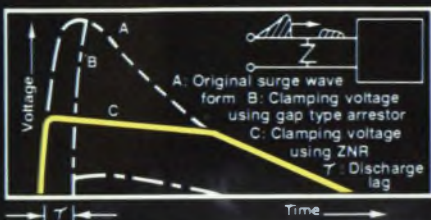

Panasonic
just slightly ahead of our time

CIRCLE NUMBER 231

RCA. Newsmaker in Linear.

Introducing the next generation of FM-IF system LICs.

RCA's new CA3189 FM-IF system lets you offer FM buyers a whole new world of features. It goes even beyond our milestone CA3089, which still has enough pluses to satisfy most FM-IF system needs.

But maybe you're looking ahead. Designing step-up features into your product line. In that case, the CA3189 is for you. It gives you things like deviation muting built right on the chip.

Programmable RF AGC

threshold. A big 4-6 dB improvement in signal-to-noise ratio. AFC drive circuit. Output signal to drive a tuning meter and/or provide stereo switching logic. All in addition to the features that made our CA3089 so popular. And all at a 3089 price.

Your distributor has it now.

The next-generation FM-IF system is already on distributors' shelves. Ready to help you design new performance features into your FM products.

For more information, contact your local RCA Solid State distributor. Or contact RCA Solid State headquarters in Somerville, NJ; Sunbury-on-Thames, Middlesex, England; Quickborn 2085, W. Germany; Ste.-Anne-de-Bellevue, Quebec, Canada; Sao Paulo, Brazil; Tokyo, Japan.

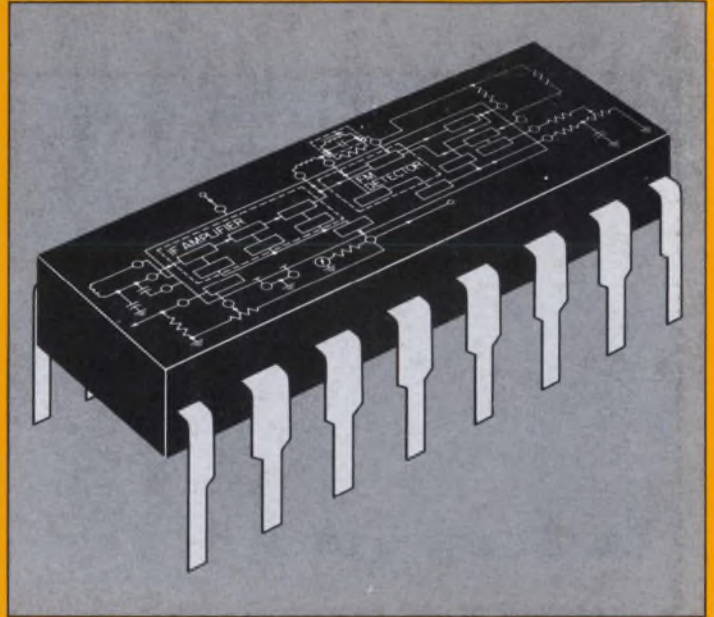

RCA Linear IC experience is working for you.

CIRCLE NUMBER 232

RCA