

There's progress in instruments in all areas. Equipment that can calibrate, correct, test or diagnose itself may soon be commonplace. Also, more synthesized signal

gens and temperature-measuring instruments are appearing on the scene. In addition, the 488 bus is finding ever wider use, despite some problems. See page 43.



Another Colorful Innovation...

Conductive Plastic Trimmers at Carbon Prices.

Just when you thought "low cost" also meant "low performance", along comes the dazzling new Bourns® Model 3355. Compare it to the CTS 201, Mepco 46X or Piher PT15. Our revolutionary conductive plastic element vs. their carbon . . . fact is we outperform them all. To prove it, we spec important characteristics such as CRV at 1% and a TC of 500 PPM/°C . . . the others don't. And only the 3355 has board-wash capability, a UL-94V-1 flammability rating and an optional choice of nine rotor colors. The standard blue is priced at just 11¢ each (100,000 pieces) . . . about what you'd expect to pay for the lower performance carbon types.

Send today for complete details on a colorful new way to design in superior performance for your cost effective needs — the Model 3355 Trimmer. Direct or through your local distributor.

TRIMPOT PRODUCTS DIVISION, BOURNS, INC., 1200 Columbia Ave., Riverside, CA 92507. Phone: 714 781-5050 — TWX: 910 332-1252.

CATALOG SHEET SPECIFICATION COMPARISONS

CHARACTERISTIC	BOURNS 3355	CTS 201*	MEPCO 46X*	PIHER PT15*
Element	Conductive Plastic	Carbon	Carbon	Carbon
Temperature Coefficient	500 PPM/°C	No Spec	No Spec	1000 PPM/°C
Contact Resistance Variation	1.0% max.	No Spec	No Spec	No Spec
Power Rating	.25 W at 70°C	.25 W at 55°C	.25 W at 55°C	.25 W at 40°C
Flammability	UL-94V-1	No Spec	No Spec	UL-94
Board Wash Capability	Yes	No Spec	No Spec	No Spec

* Source: CTS Series 201 Data Sheet, Mepco Data Sheet ME1004, Piher Data Sheet F-2002 Rev 7/73



International Marketing Affiliates: European Headquarters — Switzerland 042/23 22 42 • Belgium 02/218 2005 • France 01/2039633 • Germany 0711/24 29 36 • Italy 02/32 56 88 • Netherlands 70/87 44 00 • United Kingdom 01/572 6531 • Norway 2/71 18 72 • Sweden 764/20 110 • Japan 075/921 9111 • Australia 02/55-0411 03/95-9566 • Israel 77 71 15/6/7

For Immediate Application — Circle 130

For Future Application — Circle 230

Our Model 3001 starts at \$2,750. For that you get a signal generator that's already frequency programmable with 0.001% accuracy over the 1 to 520 MHz frequency range. If you also want to program your output power, we have a programmable attenuator option available for \$500.

If you'd like to spend a little more, add our external frequency standard option for \$150. That makes the accuracy the same as your standard. Or spend another \$500 for an internal reference frequency standard with 5×10^{-9} day stability. But if you want to spend much more than that, you're going to have to buy some-

body else's signal generator. Count on at least \$10,000. Frankly, we think your money would be better spent buying another Wavetek Model 3001.

Here's another advantage. If you need to get on the bus (now or later), our new Model 3910 Converter makes you GPIB compatible. But before you spend anything on any signal generator, get a demonstration of our Model 3001. That won't cost you a cent.

SPECIFICATIONS

Frequency Range: 1-520 MHz
Accuracy: $\pm .001\%$
Resolution: 1 kHz

Stability: 0.2 ppm per hour
Output Range: +13 dBm to -137 dBm

Flatness: ± 0.75 dB
AM Modulation: 0-90%
FM Deviation: 0-10 kHz and 0-100 kHz

Internal Modulation Rates: 400 Hz and 1 kHz

WAVETEK Indiana Incorporated,
P.O. Box 190, 66 North First Avenue,
Beech Grove, Indiana 46107,
Phone (317) 783-3221,
TWX 810-341-3226.

WAVETEK®
CIRCLE NUMBER 2

You can pay a lot more for a programmable signal generator. But why?

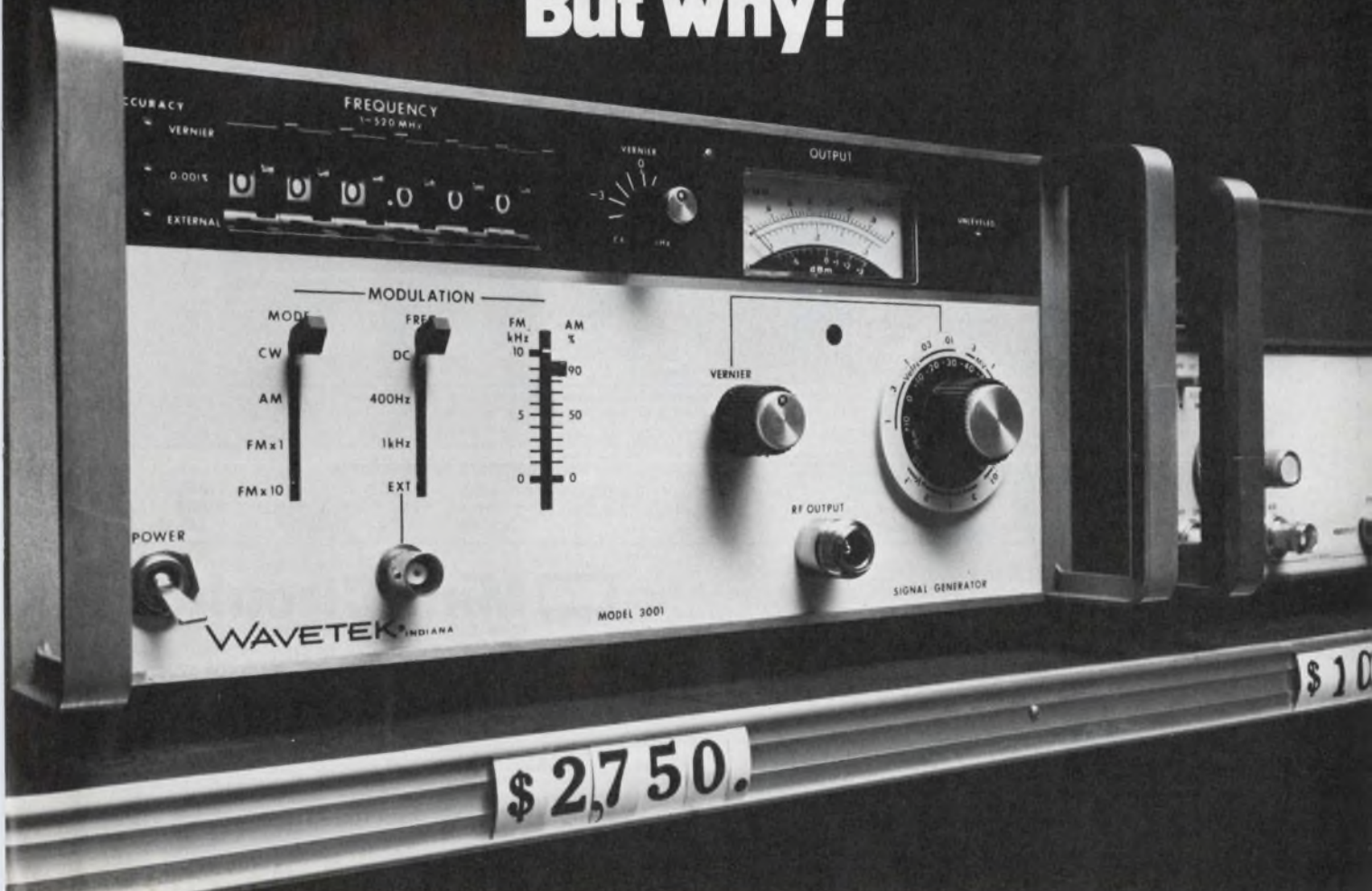

RF TRANSFORMERS

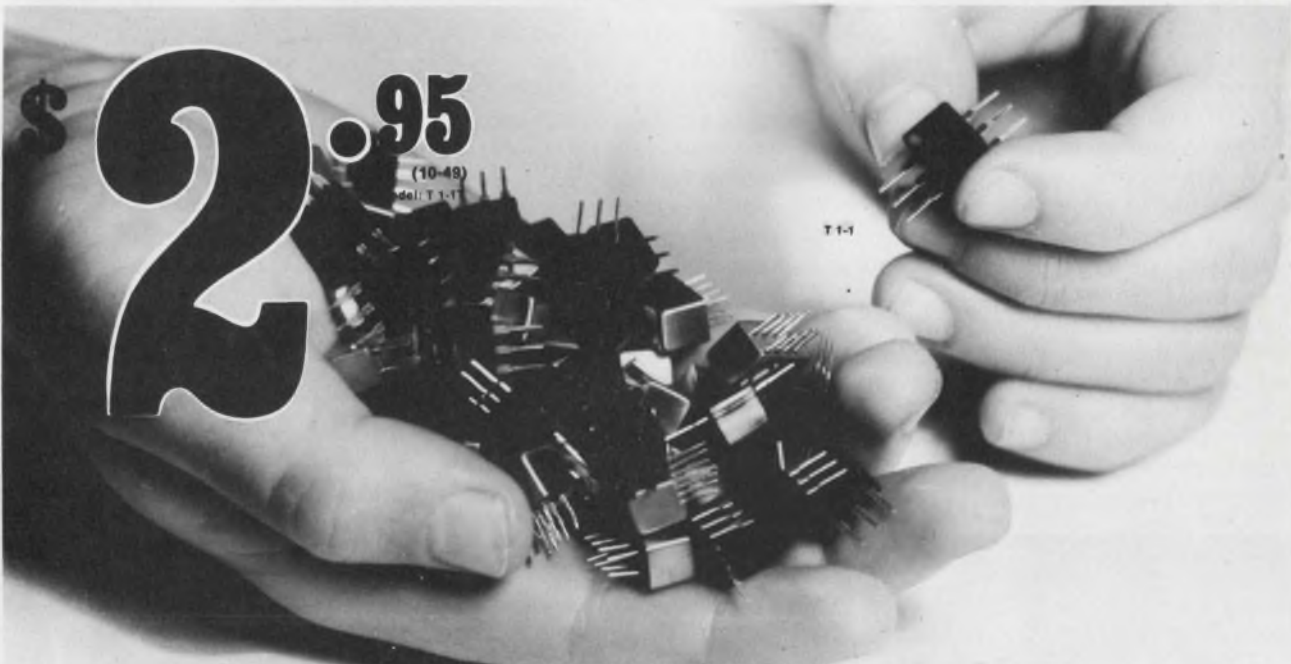

Have it your way! 36 models to choose from, 10KHz-800MHz

It costs less to buy Mini-Circuits wideband RF transformers. The T-series (plastic case) and TMO series (hermetically sealed metal case) RF transformers

operate with impedance levels from 12.5 ohms to 800 ohms and have low insertion loss, 0.5 dB typ. High reliability is associated with every transformer. Every

production run is 100% tested, and every unit must pass our rigid inspection and high quality standards. Of course, our one-year guarantee applies to these units.

DC ISOLATED PRIMARY & SECONDARY						
Model	TMO 1-1	TMO 1.5-1	TMO 2.5-1	TMO 4-1	TMO 9-1	TMO 16-1
Metal Case	TMO 1-1	TMO 1.5-1	TMO 2.5-1	TMO 4-1	TMO 9-1	TMO 16-1
Plastic Case	T 1-1	T 1.5-1	T 2.5-1	T 4-1	T 9-1	T 16-1
Freq. Range, MHz	15-400	1-300	.01-100	.02-200	.15-200	3-120
Impedance Ratio	1	1.5	2.5	4	9	16
Max. Insertion Loss	MHz	MHz	MHz	MHz	MHz	MHz
3 dB	15-400	1-300	.01-100	.02-200	.15-200	3-120
2 dB	35-200	2-150	.02-50	05-150	3-150	7-80
1 dB	2-50	.5-80	.05-20	1-100	2-40	5-20
Price, Model TMO	\$4.95	\$6.25	\$5.95	\$5.95	\$5.45	\$5.95
(10-49) Model T	\$2.95	\$3.95	\$3.95	\$3.95	\$3.45	\$3.95

UNBALANCED PRIMARY & SECONDARY					
Model	TMO 2-1	TMO 3-1	TMO 4-2	TMO 8-1	TMO 14-1
Metal Case	TMO 2-1	TMO 3-1	TMO 4-2	TMO 8-1	TMO 14-1
Plastic Case	T 2-1	T 3-1	T 4-2	T 8-1	T 14-1
Freq. Range, MHz	015-600	5-800	5-800	15-250	2-150
Impedance Ratio	2	3	4	8	14
Max. Insertion Loss	MHz	MHz	MHz	MHz	MHz
3 dB	015-600	5-800	2-800	15-250	2-150
2 dB	02-400	2-400	5-500	25-200	5-100
1 dB	05-200		2-250	2-100	2-50
Price, Model TMO	\$5.45	\$6.25	\$5.45	\$5.45	\$6.25
(10-49) Model T	\$3.45	\$4.25	\$3.45	\$3.45	\$4.25

DC ISOLATED PRIMARY & SECONDARY CENTER-TAP SECONDARY								
Model	TMO 1-1T	TMO 2-1T	TMO 2.5-1T	TMO 3-1T	TMO 4-1	TMO 8-1T	TMO 15-1T	TMO 15-1T
Metal Case	TMO 1-1T	TMO 2-1T	TMO 2.5-1T	TMO 3-1T	TMO 4-1	TMO 8-1T	TMO 15-1T	TMO 15-1T
Plastic Case	T 1-1T	T 2-1T	T 2.5-1T	T 3-1T	T 4-1	T 8-1T	T 15-1T	T 15-1T
Freq. Range, MHz	05-200	07-200	.01-100	05-250	2-350	3-300	3-120	3-120
Impedance Ratio	1	2	2.5	3	4	5	13	13
Max. Insertion Loss	MHz	MHz	MHz	MHz	MHz	MHz	MHz	MHz
3 dB	05-200	07-200	01-100	05-250	2-350	3-300	3-120	3-120
2 dB	08-150	1-100	02-50	1-200	35-300	6-200	7-80	7-80
1 dB	2-80	5-50	05-20	5-70	2-100	5-100	5-20	5-20
Maximum Amplitude Unbalance MHz								
1 dB	5-80	1-50	1-20	1-70	5-100	10-100	5-20	5-20
5 dB	05-200	07-200	01-100	05-250	2-350	3-300	3-120	3-120
Maximum Phase Unbalance Degree MHz								
1°	5-80	1-50	1-20	1-70	5-100	10-100	5-20	5-20
5°	05-200	07-200	01-100	05-250	2-350	3-300	3-120	3-120
Price (10-49)								
Model TMO	\$5.95	\$8.25	\$8.25	\$5.95	\$4.95	\$8.25	\$6.25	\$6.25
Model T	\$3.95	\$4.25	\$4.25	\$3.95	\$2.95	\$4.25	\$4.25	\$4.25

Primary Impedance: 50 ohms	TMO-series	T-series
Total Input Power: 1/2 watt	25 cu. inches	02 cu. inches
	07 ounces	01 ounces

Designers Kit Available

(TK-1) — 2 transformers of each type T1-1, T2-1, T4-1, T9-1, T16-1
\$32.00

(TK-2) — 2 transformers of each type TMO1-1, TMO2-1, TMO4-1, TMO9-1, TMO16-1
\$49.50

WE'VE GROWN

Customer acceptance of our products has been so overwhelming, we've been forced to move to larger facilities — THANKS.

International Representatives: □ AFRICA: Afrira (PTY) Ltd, P.O. Box 9813, Johannesburg 2000, S. Africa □ AUSTRALIA: General Electronic Services, 99 Alexander Street, New South Wales, Australia 2065 □ ENGLAND: Dale Electronics, Dale House, Wharf Road, Frimley Green, Camberley Surrey □ EASTERN CANADA: B.D. Hummel, 2224 Maynard Avenue, Utica, NY 13502 (315) 736-7821 □ FRANCE: SCIE - DIMES, 31 Rue George - Sand, 91120 Palaiseau, France □ GERMANY, AUSTRIA, SWITZERLAND, DENMARK: Industrial Electronics GMBH, 6000 Frankfurt/Main Klüberstrasse 14 West Germany □ INDIA: Gaekwar Enterprise, Kama Mahal, M.L. Dananukar Marg, Bombay 400 026, India □ ISRAEL: Vectronics Ltd., 69 Gordon Street, Tel-Aviv, Israel □ NETHERLANDS, BELGIUM, LUXEMBOURG: Comex, Veldweg II, Hattem, Holland

OUR NEW ADDRESS AND PHONE NO. IS:

Mini-Circuits
MINI-CIRCUITS LABORATORY

A Division of Scientific Components Corp.

2625 East 14th Street Brooklyn, New York 11235 (212) 769-0200
Domestic and International Telex 125460 International Telex 620156

□ NORWAY: Datamatik AS, Ostensjoveien 62, Oslo 6, Norway □ SINGAPORE & MALAYSIA: Electronics Trading Co. (PTE) Ltd, 87 Bukit Timah Road, Singapore 9, Malay Peninsula □ SWEDEN: Interlegard Elektronik AB, Box 43, S-18251, Djursholm, Sweden

U.S. Distributors: □ NORTHERN CALIFORNIA: PENN-STOCK Co., Foothill Office Center, 105 Fremont Avenue, Los Altos, CA 94022 (415) 948-6533 □ SOUTHERN CALIFORNIA, ARIZONA: Crown Electronics, 11440 Collins Street, No. Hollywood, CA 91601 (213) 877-3550

NEW YORK: MICROWAVE DISTRIBUTORS COMPANY
61 Mail Drive, Commack, N.Y. 11725 516 543-4776

NEWS

- 21 **News Scope**
33 **Washington Report**
43 **Instrument '77 special issue**, featuring major trends in instruments.
48 **Standard interface bus**—What's wrong with 488? Not much, but...
56 **Self-testing**—What's wrong with your instrument? It may tell you.
64 **Board testers**—Testing circuit cards can be a 'monstrous' job.
76 **Precise signal sources**—Sig gens, synthesizers—and a capable offspring.
86 **Measuring temperatures**—Knowing temps can improve your design.
96 **John Fluke** speaks on the future of the voltmeter.

TECHNOLOGY

- 104 **Design an IEEE-488 bus** into an FPLA, and speed system operation. An extra benefit: The technique allows you to interface any number of instruments.
114 **Standardized interfaces isolate** a control computer from its remote processors. You gain design freedom, improve reliability, and save money, too.
124 **Speed up PLLs** in digital synthesizers. At least three methods can boost VCO slew rate in locked loops. Choose the best for your system.
130 **Let your scope measure its own** rise time—almost. Using the scope's internal generator, you not only can pin down an accurate t_r , but do it for less money.
136 **Test converters fast**. A simple circuit quickly finds nonlinearity, missing codes and other errors. Best of all, the circuit handles many kinds of converters.
142 **Process controls are evolving fast**. In set-point systems, logic often outperforms familiar analog circuits such as comparators and conditioners.
148 **Improve your digital recorder** with a latch circuit that catches all unexpected pulses. The circuit offers a choice of operating accuracies, too.
154 **Adjust ferrite-core constants**, to suit your coil design needs. You needn't be limited to those shapes and sizes you find in the catalogs.
160 **Ideas for Design:**
Precision peak-to-peak ac/dc converter uses single-supply op-amp.
Square-to-triangle converter provides constant amplitude, rapid response.
Build a versatile nonsequential controller that is faster than a μP .
171 **International Technology**

PRODUCTS

- | | |
|--|-----------------------------|
| 175 Instrumentation: Digital process monitor uses PROM for scaling. | |
| 183 Micro/Mini Computing | 222 Power Sources |
| 192 ICs & Semiconductors | 224 Modules & Subassemblies |
| 200 Components | 242 Packaging & Materials |
| 212 Data Processing | |

DEPARTMENTS

- | | |
|--|--------------------------------|
| 41 Editorial: The smart executive | |
| 7 Across the Desk | 262 Employment Opportunities |
| 251 Application Notes | 266 Product Index |
| 252 New Literature | 268 Advertisers' Index |
| 256 Bulletin Board | 268 Information Retrieval Card |

Cover: Photo by Art Director, Bill Kelly.

Intel delivers the 8085, designers just

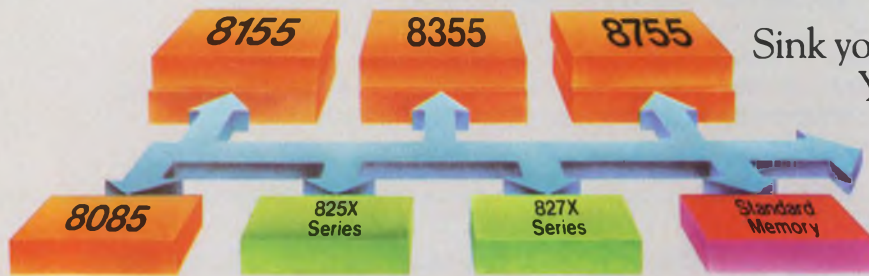

Sink your teeth into Intel's new 8085. You'll find it's the only micro-computer that combines the performance, economic advantages and total support it takes to be recognized as

the new industry standard. So it's no surprise that there are already four announced sources for the 8085. In fact, the deeper you go, the better the 8085 gets.

The 8085, even more than the 8080 it succeeds, is a total design solution, not just a component. It delivers higher performance, for capabilities far beyond the 8080's. It has a higher level of integration, so you can design your products with fewer components, making them more competitive and more profitable. And to help you get those products to market quicker we've given the 8085 the industry's broadest base of system and development support.

Yet the 8085 is fully compatible with the 8080. So your investment in existing designs is protected, and implementing new designs is simplified by the wealth of 8080 software and peripherals at your disposal.

It all adds up to a design solution you won't be able to resist. That's true for a broad range of applications. The 8085 can be designed in as an economical stand-alone three-chip system using the 8085 CPU, the 8155 256-byte RAM with I/O and timer, and the 8755 2K-byte EPROM with I/O or its interchangeable 8355 ROM with I/O.

You can expand this basic system for larger applications using additional RAM, ROM, EPROM and Intel's complete family of first and second generation peripheral controllers, including our four new programmable peripheral controller chips—the 8271* Floppy Disc Controller, 8273* Synchronous Data Link Controller, 8275 CRT Controller and 8279 Keyboard/Display Interface. All these components including 8755 EPROM operate from a single +5V supply.



the new microcomputer can't resist.

A multiplexed data/address bus permits integration of many auxiliary system functions—such as clock generation, system control and multiple interrupts—onto the 8085 chip while maintaining 8080 compatibility and the same 40-pin package. And forward-thinking engineers will realize that it is also a link to Intel's future generation microcomputer products.

No microcomputer can match the 8085 as a total design solution because no microcomputer can come close to the 8085's support base. Support for the 8085 includes the Intellec® microcomputer development system with resident PL/M, the high level programming language that can cut months off your software development time. Intellec is the only development system with ICE-85™, providing in-system emulation for faster system development and debugging. Then there's application assistance, training classes and seminars worldwide. And a comprehensive development software library at your disposal.

The quickest way to get a taste of the 8085's power and versatility is with the SDK-85 System Design Kit. It's available now for only \$250. You can order SDK-85 and all MCS-85™ components directly from your nearest Intel distributor: Almac/Stroum, Components Specialties, Cramer, Hamilton/Avnet, Harvey Electronics, Industrial Components, Pioneer, Sheridan, L.A. Varah, Wyle Liberty/Elmar or Zentronics.

Or, for more information on the 8085 and SDK-85, use the reader service card or write: Intel Corporation, 3065 Bowers Avenue, Santa Clara, California 95051. Telephone: (408) 246-7501.

intel® delivers.

MCS-85™ Microcomputer System Components Family

8085 CPU with system bus control, system clock generator, serial I/O and 4-level interrupt control.

8155/8156 RAM, I/O & Timer. 256-byte static RAM, 22 I/O lines, 14-bit programmable interval timer/event counter.

8355 ROM & I/O. 2048-byte masked ROM, 16 I/O lines. Interchangeable with 8755.

8755 Erasable PROM & I/O. 2048-byte UV erasable and electrically reprogrammable EPROM. Interchangeable with 8355.

Compatible MCS-80™/MCS-85™ Peripheral Components

General Purpose

8251 Programmable Communications Interface

8253 Programmable Interval Timer

8255 Programmable Peripheral Interface

8257 Programmable DMA Controller

8259 Programmable Interrupt Controller

8205 High Speed 1 out of 8 Binary Decoder

8212 8-bit Input/Output Port (Latch/Buffer)

8216/8226 4-bit Parallel Bidirectional Bus Driver

Dedicated Function

8271 Programmable Floppy Disk Controller

8273 SDLC Protocol Controller

8275 Programmable CRT Controller

8279 Programmable Keyboard/Display Interface

Performance Matched Standard Memory

Static RAM

2114 1024x4-bit, 450 nsec, 18 pin

2142 1024x4-bit, 450 nsec, 20 pin

8101A-4 256x4-bit, 450 nsec, separate I/O

8102A-4 1024x1-bit, 450 nsec, separate I/O

8111A-4 256x4-bit, 450 nsec, common I/O

ROM/EPROM

2716 2048x8-bit Erasable PROM, 450 nsec

2708 1024x8-bit Erasable PROM, 450 nsec

2316E 2048x8-bit Masked ROM, 450 nsec

8308 1024x8-bit Masked ROM, 450 nsec

MEET OUR family of high VOLTAGE TEST PROBES

In 1967 we introduced the first high voltage test probe with a built-in meter. It became so popular that we have been adding new models ever since. Now there are five different versions to satisfy the demands of radio, television, appliance, audio, and electrical repair men in a wide variety of high voltage testing applications.

The five models are briefly described below. Our general catalog contains complete applications information, illustrations, specifications, and prices. Write for your free copy.

MODEL 4242—42,000 volts DC.
Negative ground.

MODEL 3157—15,000 volts DC.
Negative ground.

MODEL 4312—15,000 volts DC.
Positive ground.

MODEL 3163—6,000 volts DC.
Negative ground.

MODEL 3200—10,000 volts AC.

AVAILABLE THROUGH YOUR
FAVORITE ELECTRONIC PARTS DISTRIBUTOR

ITT POMONA ELECTRONICS

1500 East Ninth St., Pomona, Calif. 91766
Telephone (714) 623-3463, TWX: 910-581-3822

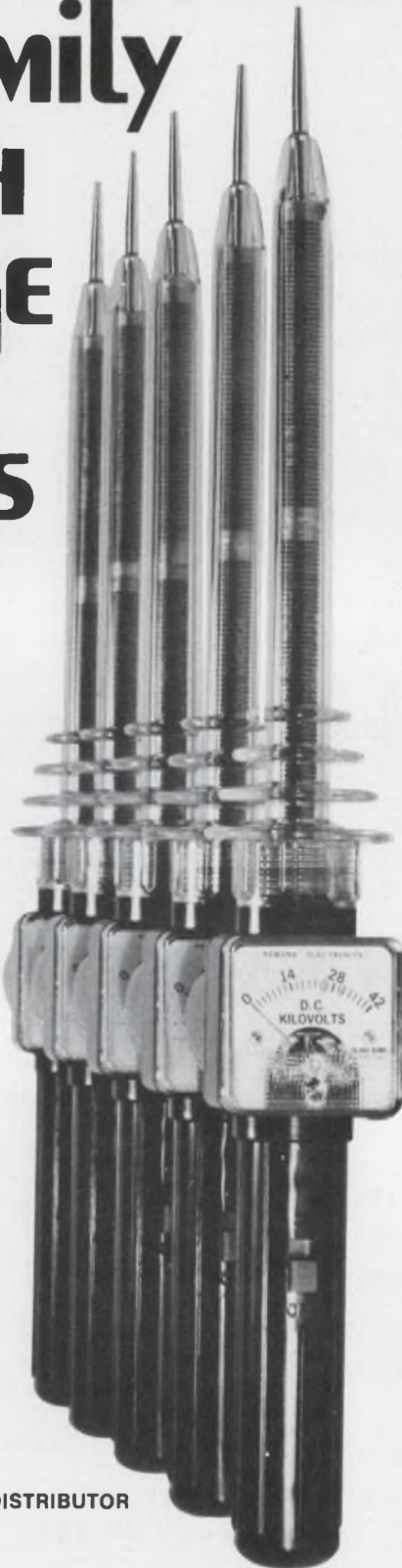

Sr. Vice President, Publisher

Peter Coley

Editors

Editorial Offices
50 Essex St.
Rochelle Park, NJ 07662
(201) 843-0550
TWX: 710-990-5071
(HAYDENPUB ROPK)
Cable: Haydenpubs Rochellepark

Editor-in-Chief George Rostky

Managing Editors:

Ralph Dobriner
Michael Elphick

Senior Associate Editor

Stanley Runyon

Associate Editors:

Sid Adlerstein
Dave Bursky
Morris Grossman
Gene Heftman
Andy Santoni
Max Schindler

Contributing Editors:

Peter N. Budzilovich, Jules H. Gilder,
Sidney Moskowitz, Nathan Sussman

Editorial Field Offices

East

Jim McDermott, Eastern Editor
P.O. Box 272
Easthampton, MA 01027
(413) 527-3632

West

Dick Hackmeister, Western Editor
8939 S. Sepulveda Blvd., Suite 414
Los Angeles, CA 90045
(213) 641-6544
TWX: 1-910-328-7240
Dave Barnes, Western Editor
465 S. Mathilda, Suite 302
Sunnyvale, CA 94086
(408) 736-6667

Editorial Production

Marjorie A. Duffy, Production Editor
James Keane, Copy Editor

Art

Art Director, William Kelly
Richard Luce, Anthony J. Fischetto

Production

Manager, Dollie S. Viebig
Helen De Polo, Nancy Hurey

Circulation

Director, Barbara Freundlich

Information Retrieval

Paula Greenleaf

Advertising Promotion

Judith Nappo

Reprints

Maxine Correal

Across the desk

What about Berliner?

I was astounded to find my grandfather's name conspicuous by its absence from your voluminous spread on the history of the telephone (ED No. 18, Sept. 1, 1977, p. 42). For your information, it was Emile Berliner's microphone that established the Bell System commercially, and saved it from destruction at the hands of the then-powerful Western Union.

In the Bell System's own publication, *Ten Men & The Telephone*, Emile Berliner is listed second only to Dr. Bell himself. Oh yes, you do mention my grandfather and Francis Blake—incorrectly, at that. But you do not see fit to include these two greats in your chart on p. 43, despite the fact that it was "the three B's" who put AT&T firmly on the map.

Oliver Berliner

Maker of the Microphone Award
P.O. Box 921
Beverly Hills, CA 90213

More capable than that

For future reference, there appears to be some confusion between the VDP-1000 and the VDP-400 video display processors from Lear Siegler (ED No. 16, Aug-2, 1977, p. 128), both of which were announced concurrently at the National Computer Conference. The first two sentences of your presentation are accurate for the VDP-1000. But 8 kwords of ROM, 3 kwords of refresh and scrolling, and 5 kwords for user discretion are characteristics of the VDP-400, not the VDP-1000. The VDP 1000, in fact, is envisioned as totally user-programmable, including the terminal-handling program. Thus, all 16 or 32 kwords are left to user discretion with the VDP-1000.

Moreover, the VDP-400 does not

have VMOS, floppy-disc or stand-alone computing capability. It costs \$2500.

Charles Ramsey

LeAunce & Reiser
Public Relations/Advertising
3189 Airway Avenue B
Costa Mesa, CA 92626

CIRCLE NO. 557

Misplaced Caption Dept.



Whaddaya mean the circuit blew?

Sorry. That's Jacopo Robusti's (Tintoretto) "Portrait of Vincenzo Morosini," which hangs in the National Gallery in London.

(continued on page 8)

Electronic Design welcomes the opinions of its readers on the issues raised in the magazine's editorial columns. Address letters to Managing Editor, Electronic Design, 50 Essex St., Rochelle Park, NJ 07662. Try to keep letters under 200 words. Letters must be signed. Names will be withheld upon request.

BIG POWER SUPPLIES



IN LITTLE PACKAGES

**AC-DC and DC-DC
miniaturized power converters
that deliver 3.9 watts
per cubic inch.**

- AC inputs: 115-220 VAC, 47-500 Hz.
- DC inputs: 12, 28, 48, 115 & 150 VDC.
- 1 to 6 isolated and regulated DC outputs from 4.2 to 300 VDC.
- Line and load regulation to 0.1%.
- Up to 800 watts per output.
- Efficiencies to 85%.
- Design-As-You-Order construction from standard sub-modules . . . over 1200 possible configurations.
- Completed converters provided in tested and encapsulated, conduction cooled packages in just days.

See for yourself how we've packed the power and performance in . . . request our actual size "little black box" punch out kit and catalog today!

Call us collect . . . ask for Jim Dunn.



ARNOLD MAGNETICS CORPORATION

11520 W. Jefferson Blvd.
Culver City, Ca. 90230 • (213) 870-7014

CIRCLE NUMBER 6

Across the desk

(continued from page 7)

Over 40 and out

Your career and salary survey (ED No. 16, August 2, 1977, p. 36) offers convincing proof of age discrimination in employing U.S. EEs. "Just as in the oldest profession, inexperience is rewarded most in electrical engineering" (Irwin Feerst).

Strip off the under-25 newbies who can't find the john yet and you have an interesting age vs response plot from your random survey. Plot that along with the number of EEs who graduated for each age group and you are left with one conclusion. There are a hell of a lot of older ex-EEs. If you're over 40, pray. Under 40, start planning for a new career. Not all ex-engineers can get elected president.

Dave Weigand, PE

904 Tyson Dr.
West Chester, PA 19380

Hidden treasure

John L. Alexander in his "Across the Desk" letter "Wage Busting Is The Real Issue" (ED No. 12, June 7, 1977, p. 8) states: "The fringe benefits for government employees lie in the area of 70% of their salaries...." My colleagues and I are looking for our short-fall of 40%.

W. M. Weinbach
Electronics Engineer

Naval Surface Weapons Center
White Oak Laboratory
White Oak, MD 20910.

Dept. of corrections

Responding to questions raised by Amarnath Sethuraman of the Astronautics Corp. of America in Milwaukee, Robert J. Stetson, author of "Design Your Own Data Terminal..." (ED No. 16, August 2, 1977, p. 56) offers the following corrections:

In Fig. 1, OS2 should be rerouted to the Printer Function Control. In Fig. 2, the inverter on PE should be designated 7404, not 7408. Also, the 39- Ω resistor should be raised to 390 Ω . And the overrun-error-latch transistor labeled 2N3563 should be 2N3568.

In Fig. 3, decoded outputs from A₁ and A₂ should not be labeled 9, but 7. In Fig. 9, the gate whose output is \overline{INH} should be 7408, not 7400.

On p. 57, column left, lines 10 and

11, "...load-timing generator, the Count Down signal from the memory-ready. Printer-timing logic..." should be changed to "...load-timing generator. The Count Down signal from the memory-read/printer-timing logic..."

On p. 59, column right, line 1 (Fig. 3) should be (Fig. 4). And on p. 61, column right, eight lines from the bottom, the Load signal is actually a Latch signal.

Inversion signs have been omitted from some signals. But timing is the essence in those cases and not polarity, which can be adjusted simply.

In addition to the corrections prompted by Mr. Sethuraman's questions, Mr. Stetson would like to change "serial 6-bit" on p. 56, column right, lines 10 and 12, to "serial 8-bit."

LSI chips do it, too

Your article in the August 2, 1977, issue (ED No. 16, p. 56) on how to interface the Victor Comptometer IMP 130 dot-matrix printer was well done. I wish to add, however, that now you can buy LSI chips that do the job.

For example, the Cybernetic Micro Systems CY 480 Universal Printer Controller is a single-chip, 40-pin LSI device that controls 5 x 7 dot-matrix printers, including Victor, LRC, and Practical Automation models. Features include:

- 96-character (upper and lower case ASCII) generator.
- 48-character line storage.
- Variable-character-inch printing density.
- Graphics capability.

Erik K. Huang
Project Engineer

Microprocessor Systems Design
2460 Embarcadero Way
Palo Alto, CA 94303

CIRCLE NO. 558

Yehudi plot thickens

In answer to I. Borditch's query (ED No. 11, May 24, 1977, p. 7) about the "Yehudi circuit": If my memory serves me right, my mother had a 78-rpm platter with the song, "Who's Yehudi?", a humorous song whose lyrics I cannot recall. The record was darn near 3/16 in. thick, so it had to be an early 78. Perhaps an old-timer will remember this song and be able to tell you more.

Norm Andrews

Tracor Marine
St. Croix Operations
Gallows Bay—Christiansted
St. Croix, U.S. Virgin Islands 00820

New Books

Electrical Wiring—Industrial: Code, Theory, Plans, Specifications, Installation Methods—R. L. Smith, Van Nostrand Reinhold, 450 West 33rd St., New York, NY 10001, 135 p. \$9.95

CIRCLE NO. 559

Active Network Design—C. S. Lindquist, Steward & Sons, P.O. Box 15282, Long Beach, CA 90815, 749 p. \$21.95.

CIRCLE NO. 560

Memory Databook—National Semiconductor, 2900 Semiconductor Drive, Santa Clara, CA 95051, 550 p. \$4.

CIRCLE NO. 561

FET Databook—National Semiconductor, 2900 Semiconductor Drive, Santa Clara, CA 95051, 277 p. \$3.

CIRCLE NO. 562

Microprocessors & Small Digital Computer Systems for Engineers & Scientists—G.A. Korn, McGraw-Hill Book Co., 1221 Avenue of the Americas, New York, NY 10020, 390 p. \$24.50.

CIRCLE NO. 563

Electronic Meters: Techniques and Troubleshooting—Miles Ritter-Sanders, Jr., Prentice Hall Inc., Englewood Cliffs, NJ 07662, 299 p. \$16.95.

CIRCLE NO. 564

Optoelectronics Applications Manual, prepared by Hewlett-Packard, McGraw-Hill Book Co., 1221 Avenue of the Americas, New York, NY 10020, 268 p. \$19.95.

CIRCLE NO. 565

Me an editor?

If you'd like to be among the first to know (and write about) what's going on in the electronics industry, you might enjoy being an editor.

We have openings at our home office in Rochelle Park, NJ. Call Ralph Dobriner at (201) 843-0550.

We got the name wrong

The magnetic-tape transport system described in ED No. 22, Oct. 25, 1977, p. 28 was not developed by Micro Components Corp., Waltham, MA. It was developed by Micro Communications Corp., 80 Bacon St., Waltham, MA. 02154; (617) 899-8111

CIRCLE NO. 567

hp MEASUREMENT COMPUTATION NEWS

product advances from Hewlett-Packard

NOVEMBER 1977

HP's new System 45: an efficient way to handle a small department's computing needs

In its compact, desktop-sized chassis, HP's new Series 9800 System 45 blends the speed and power of a minicomputer with the friendliness and convenience of a programmable desktop calculator. System 45 incorporates in a single package the high performance hardware and accessibility that scientists, engineers, designers and managers need to solve computational problems right in their own work area.

In less than 35.1 kilograms (77.5 pounds) System 45 integrates:

- an interactive keyboard with alphanumeric, control, editing, and special function keys.
- a dual processor that provides overlapped processing for increased throughput.
- a CRT with high-resolution graphics capability and an alphanumeric mode that offers an 80-character, 24-line screen.
- two built-in, 217k byte, high-speed tape transports, one of which is optional.
- 16k bytes of read/write memory expandable to 64k bytes.
- a unified mass storage that permits available storage devices to be addressed with device independent commands.
- ready-made I/O capability for BCD, bit parallel, bit serial, real-time clock and HP-IB interfaces.
- a powerful language—ANSI standard BASIC, with FORTRAN-like capabilities available on command—plus a library of utility and application programs.

For scientific computation and data analysis, System 45 handles data characterizations, statistical and numerical analyses, and other complex routines.



HP's new System 45 is an integrated system with built-in peripherals that provide a new level of speed, power and flexibility; easy-to-use turnkey system uses enhanced BASIC.

For computer aided design, System 45 places the entire design process directly under your control. It lets you display parts tables, parts cross sections, or produce complete drawings.

For data acquisition, System 45 interfaces directly with instrumentation, with 15 levels of interrupt for flexible control.

For business administration, System 45 lets you increase efficiency in various areas of business such as: forecasting, in-

ventory control, payroll, optimization and even text processing.

System 45 is also expandable. To meet your needs in the future, HP offers you an extensive line of peripherals including: flexible disks, large fixed discs (up to 50M bytes), a full page printer, plotters and more.

For more information, check B on the HP Reply Card.

IN THIS ISSUE

Large P-N junction displays • SOS μ P in two new 180 cps printers • New flexible synthesizer

New signal source combines choice of waveform and high accuracy with easy programming

Its very wide frequency range of 0.001 Hz to 50 MHz makes the 8165A the fastest waveform generator of its kind. Output amplitude and signal quality satisfy many analog and digital applications. Its easy-to-use HP-IB interface ensures rapid system integration at minimum cost.

The 8165A programmable signal source generates precision sines, square waves, pulses and triangles. Crystal control provides a frequency accuracy of 0.001% across the entire range.

Its variable, 20V peak-to-peak amplitude, and clean, 5 ns transition time pulses are perfect for digital applications. Amplitude and offset are programmable with 2% accuracy to 5 MHz.

Microprocessor control sets new standards in operator convenience. Keyboard and LED's together with the instrument's high accuracy, allow direct entry and display of desired waveform parameters.

In systems, the intelligent 8165A cuts software development costs and computer

time. Keystroke programmable means identical control sequences for front panel and bus-entered commands. Programming mnemonics for all keys are indicated on the front panel. Error detection and learn mode are also provided.

The 8165A stores parameters for 10 complete waveforms. An entire waveform can be stored and subsequently recalled simply by pressing two panel keys or by a single program step. Batteries provide storage of all parameters for up to four weeks.

External trigger, synchronous gate, counted burst, VCO, FM and optional sweep modes provide the flexibility to use the 8165A in many different applications. The selectable 50 ohm source may be disabled, inverted or operated in dc mode. All specifications are guaranteed from 0 to 50°C for full confidence in system applications.

For more information check K on the HP Reply Card.

The 8165A offers choice of waveforms, wide frequency range, variable 20V amplitude, dc offset, direct parameter entry and readout, full HP-IB programmability.



Extend signal capability of popular 8654 and 8640 generators down to 10 kHz



New HF down converter now covers test applications in the 10 kHz to 11 MHz band.

A new down-converter, HP 11710B, translates signal inputs of 50.01 to 61.00 MHz from RF signal sources such as the HP 8654 and 8640 to the 10 kHz to 11 MHz frequency range. This wider frequency coverage provides a convenient extension to other applications such as IF testing at 262 kHz.

The 11710B preserves both the AM or FM modulation of the input signal. In fact, it permits higher FM peak deviations than the generators themselves.

Output flatness is ± 0.5 dB referenced to 4 MHz and level accuracy is ± 1 dB + input level accuracy. Harmonics are greater than 35 dB below carrier (dBc) and spurious signals are below -60 dBc.

The internal reference oscillator is stable enough to yield a drift of less than 0.05 ppm/hr. and typical overall frequency accuracy of ± 2 ppm.

A function selector allows straight-through switching so the total range (0.01 to 1100 MHz) of the signal source is available at the 11710B output port. Source inputs are tracked from 0 to -107 dBm in the down-converted mode and there is less than 1 dB loss in the straight-through modes.

For more information, check M on the HP Reply Card.

Extensive program support for HP 67/97

Hewlett-Packard presents a large selection of problem-solving software for personal programmable calculators. The software works with the HP-67 and HP-97 calculators to provide solutions for a wide range of applications including engineering, science or business.

You can solve your computational problems without writing programs—by using the Application Pacs. And with our Users' Library Solutions, you follow the easy step-by-step instructions to enter the program yourself.

Application Pacs. Each Pac contains an instruction manual with up to 25 pre-programmed magnetic cards. Current Pacs include Statistics, Math, Business, Surveying, Games, Electrical and Mechanical Engineering—plus the new Navigation, Civil Engineering and Clinical Lab Pacs. They save you time and trouble researching, writing, debugging and documenting.

The Users' Library. Over 1000 HP-67/97 programs and over 5000 easily modified HP-65 programs are currently available from the Library.

Users' Library Solutions Books A series of comprehensive books containing the most popular programs from our Users' Library covering applications in Engineering, Home Construction Estimating, Aviation, Energy Conservation and more. Each booklet contains 10 to 12 programs.

For more details on these calculators and these programs, check A on the HP Reply Card.



New software solutions for the HP-67 and HP-97 have been added to help increase your problem solving potential.

New sweeper plug-ins offer expanded wideband performance



Double-octave and communications band RF plug-ins for HP 8620C sweeper provide 2.0 to 8.6 GHz frequency coverage.

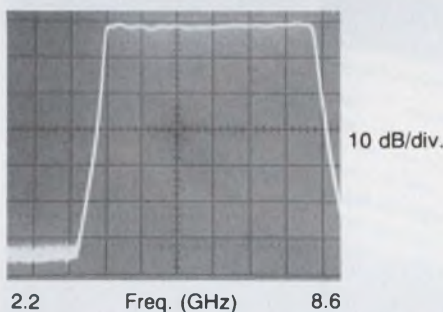

Insertion characteristics of 4-8 GHz bandpass filter. Lower rejection band (left portion of trace) shows freedom from harmonics in HP 86240B RF source.

Three new RF plug-ins with double-octave frequency coverage have been added to the HP 8620 Sweep Oscillator family.

The new HP 86240B covers 2.0 to 8.4 GHz with up to 20 mW output (leveled to $\pm 1/2$ dB), yet its harmonic content at 10 mW output is more than 50 dB down. This is achieved by incorporating a YIG filter into the same magnet housing containing

the oscillator-tuning YIG sphere. The high power is achieved through use of a 100 mW GaAs FET amplifier ahead of the YIG filter.

Model 86240A, the non-filtered version of the 86240B, delivers over 40 mW output, has competitively low harmonics, and is attractively priced.

With frequency coverage from 3.6 to 8.6 GHz, the new 86240C is the ideal upconverter for RF distortion analysis of 4, 6 and 8 GHz microwave radio links. Group delay is ≤ 1 ns over 30 MHz sweeps, and linearity is $\leq 0.5\%$. This plug-in delivers 40 mW output and has 10 MHz FM bandwidth for noise loading applications.

For more information on these and other RF units for the 8620C sweeper, check N on the HP Reply Card.

HP Journal features NMOS-II

An article of interest, regarding HP's on-going research and development in LSI technology, is featured in the November 1977 issue of the HP Journal. It deals with HP's NMOS-II process, which made possible the high-performance, large-scale integrated circuits for fast 16-bit micro-

processors, 16k read-only memories and a variety of special purpose random-logic chips.

The newest product featuring NMOS-II is the System 45 (cover article).

For your copy of the HP Journal, check P on the HP Reply Card.

New logic state analyzer is portable, totally programmable

Can signature analysis make your service operation more efficient?



A new small but powerful logic state analyzer interacts with its user through an easy-to-master keyboard. And, its programmability option provides the capability of a functional automatic digital test station.

The new 1602A logic state analyzer was designed for ease of use in production, field service and engineering. The layout of the keyboard leads you through a natural progression of keystrokes and entries are displayed, enabling you to check their accuracy every step of the way.

For use in design and troubleshooting of digital systems, the 16-bit wide and 64-word deep memory operates at clock speeds to 10 MHz, allowing the instrument to capture virtually any 64-word sequence in a system.

Measurements of system activity are displayed on the analyzer's LED readout in hexadecimal, decimal, octal, or binary format, eliminating the need for base conversions by the operator.

For more consistent and repeatable measurements, the HP Interface Bus op-

tion allows you to make automated functional tests of digital systems. The HP-IB option makes the 1602A totally programmable and able to dump its 64-word memory into the bus on command, for analysis by a desktop computing controller such as the HP 9825A.

Simplicity of use is also apparent in the quick connect and disconnect standard edge connector on the probe. Point-to-point probing on new equipment installed with similar connectors is now fast and easy. The single pod contains all 16 data lines, clock, qualifier and ground.

Weighing only 4.5 kg (ten pounds), it is small enough to fit into a briefcase. The price is small, too.

For more details, check E on the HP Reply Card.

There's a good chance that it can. HP and over 100 other companies are currently implementing this new digital service strategy. And, they are cutting repair times, reducing spares inventories and streamlining documentation.

Today's microprocessor-based products are tough to troubleshoot. Tomorrow's digital products may be tougher, and the costs of board exchange, the traditional digital service strategy, tend to escalate rapidly in fast-growth, high-technology product lines.

Design signature analysis into your new products. Document the troubleshooting procedures with the appropriate signatures. Then, use the HP 5004A Signature Analyzer for component-level troubleshooting:

- on-site
- at the field office
- at the service center
- on the production line

This portable tester detects and displays unique signatures associated with nodes in digital products. By comparing actual signatures to correct ones as shown in the product manual, a technician can backtrace to the faulty node in a malfunctioning product.

Check into signature analysis. Make your service operation more efficient and prepare for the future at the same time.

For a data sheet and an application note, check J on the HP Reply Card.



Many companies are streamlining field service of microprocessor-based products by troubleshooting to the component level with the 5004A signature analyzer.

New 4½ digit autoranging DMM with 1 mΩ, 1 μV dc, 10 μV ac sensitivity

The new HP 3466A 4½ digit, six-function autoranging digital multimeter combines low cost with high accuracy for both bench and field use.

Dc measurements can be made from 1 μV to 1.2 kV with a mid-range accuracy of ±0.03%. True rms ac measurement range is from 10 μV to 1200 volts with a mid-range accuracy of ±0.03% over a 20 Hz to 100 kHz bandwidth.

Ac and dc current measurement range is 10 nanoamps to two amps. Resistance range is 1 milliohm to 20 megohms with a mid-range accuracy of ±0.03%.

An ohm zero adjustment on the front panel is provided. Milliohms may be offset on the front panel, allowing the zeroing out of test leads when making printed circuit, transformer, coil, or switch contact measurements.

A new diode test measurement capability is offered. The 3466A DMM displays the voltage drop across the diode junction in the forward direction, allowing the user to measure and identify germanium, silicon, light-emitting and Schottky diodes in units of volts, even though the instrument is in the ohms function.

The standard HP 3466A includes rechargeable, lead-acid batteries which provide 8 hours of continuous use. Option 001 offers ac power only. Should battery power be required in the future, the DMM can easily be modified in the field.

For more information, check H on the HP Reply Card.



Because of its ability to make wideband selectable ac plus dc true rms voltage and current measurements, the new HP 3466A digital multimeter can also measure such signals as digital pulse trains and sinusoidal waveforms.

Hard copy made easy with two new smart printers



A "smart printing" algorithm selects the optimal path and speed for the print head of two new printers. You also get high resolution print that is crisp, clear and readable—even on the sixth sheet of a multiple-part form.

Two new "smart" printers operating at 180 characters per second are now available from Hewlett-Packard. Both printers are controlled by a silicon-on-sapphire (SOS) microprocessor system designed by HP. The HP 2631 is designed for environments requiring a low-cost, high-performance printer. The HP 2635, with a keyboard, is suited to interactive environments.

The microprocessor control optimizes data manipulations, and printing and control functions. Consider the path taken by the print head. It is fast and bi-directional, that is, the printer chooses the most efficient direction to print: right to left or left to right, increasing throughput as much as 50%. By the time one line is printed, the next several lines have been processed and stored in a buffer.

When ten or more adjacent spaces have been detected within a line, the head speeds to the next printable character at an accelerated rate of 450 cps.

The HP 2631/2635 offer as standard

features those capabilities that are often optional on other printers. For example, there are three print modes that can be intermixed on a line—normal, expanded, (for titles and headings) and compressed. Vertical line spacing is variable under program control; the choices are 1, 2, 3, 4, 6, 8 or 12 lines per inch.

Both printers support the entire US ASCII 128-character set, including control codes which are accessible through the display functions. Use of a 7-column by 9-row dot matrix allows printing of true descenders, commas, semi-colons, and underlining. The printers also accommodate subscripts and superscripts.

A variety of interfaces are available including HP-IB, 8-bit duplex, 8-bit differential, and a general purpose parallel interface for OEM applications.

For more information, check F on the HP Reply Card.

New HP-IB switches for automatic test systems

HP-IB

The availability of individual HP-IB switch products gives you modularity and flexibility in the design of your automatic test equipment (ATE) system.

These microprocessor-based switch products provide a flexible, high-performance and cost-effective solution for computer and desktop controller-based systems.



Up to 8 switch mainframes are controlled by the microprocessor-based **HP 9411A Switch Controller**, also capable of performing comprehensive self tests and fault isolation of all signal relays in the switching units.

Three new switches provide commercially available solutions to an important part of the ATE system—connecting the system to the unit-under-test (UUT).



HP 9412A Modular Switch provides high-density, multi-function switching of signals up to 10 MHz. The built-in interface panel eliminates the massive cabling normally found in ATE switching configurations and significantly improves signal performance. The 9412A accommodates five types of switch cards in any combination up to a total of 25 cards.



HP 9413A VHF Switch provides flexible high-frequency switching of pulse and video signals up to 500 MHz. The unit accommodates up to 12 coaxial switch modules of two types: dual 1×4 or single 1×8 .

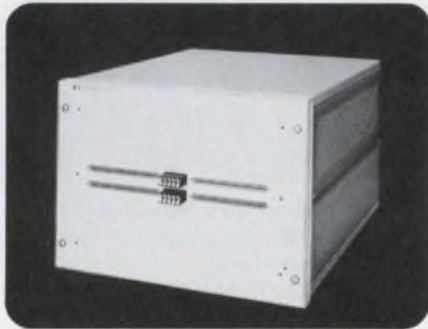

HP 9414A Matrix Switch provides maximum flexibility for high-density, high-performance switching, allowing any UUT pin to be switched to any instrument in the ATE system. The 16-input Matrix Switch can be configured in 30-pin increments (UUT pins) up to 120 pins, expandable to 240 pins.

New automatic test systems are also available from Hewlett-Packard complete with HP-IB hardware and new software. The system controller is the HP 1000 with HP's powerful Real Time Executive (RTE) operating system. RTE allows concurrent program preparation and testing. Comprehensive test program languages are available including BASIC, FORTRAN IV and TESTAID-III for digital testing.

For more information on individual HP-IB switch products and the new generation HP automatic test system, check L on the HP Reply Card.

Current tracing: a better way to detect supply to ground shorts

You've got a tight schedule to meet and those five bad boards on your desk can make the difference. Unfortunately, every one of them has a power supply to ground short and you don't have the time it takes to repair them. Each of the boards is valuable, so you don't want to scrap them, but it would take a couple of hours to fix each one and when you were finished, chances are the circuit traces would be damaged, IC legs cut and resoldered, or worse.

Well, there's a better way—current tracing. This technique allows you to find V_{cc} to ground shorts in minutes, using two powerful hand-held IC troubleshooters from HP.

One, the 546A Logic Pulser, is connected between supply and ground on the unpowered faulty board and push-button programmed to output a 100 Hz pulse stream. The pulser delivers 650 mA current pulses that are easy to trace right to the one faulty point on the board.

The 547A Current Tracer allows you to find faults based on one simple principle: current flows to the lowest impedance point in a circuit, in this case a short between V_{cc} and ground. So, just adjust the sensitivity control so the tracer's lamp is about half-brilliance and follow current pulses to the fault.

No board scrapping, no trace cutting, no unnecessary unsoldering and still the boards are repaired in a fraction of the time possible using any other method.

For more information, check C on the HP Reply Card.

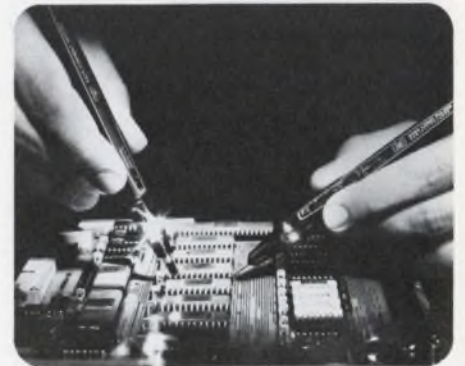

HP's 546A Pulser and 547A Tracer help locate logic damage to the circuit under test.

Sliding load for 3.5mm coaxial lines operates from 2.0 to 26.5 GHz

For impedance measurements in coaxial transmission lines, the ultimate standard for a matched line is a sliding load. By sliding the load element along the line, its own small reflection effect can be eliminated.

Since the new APC-3.5 connector now permits design activity in 3.5 mm coaxial lines above 18 GHz, HP's new 911C sliding load will provide for more accurate measurements from 2.0 to 26.5 GHz.

The 911C features interchangeable APC-3.5 fittings—either male or female connectors may be checked. For minimum discontinuity, the center con-

ductor slides and locks. The movable terminating element has 5.5 cm travel—greater than $\lambda/4$ at the lowest operating frequency.

The connector and transmission line reflection coefficient for the female configuration is $<.02 + .001 \times f$ (where f is frequency in GHz) 2 to 26.5 GHz. The male version is $<.02$ across the full band. For the load element itself, the maximum reflection coefficient is <0.01 from 2 to 10 GHz and <0.035 from 10 to 26.5 GHz.

For details, check D on the HP Reply Card.

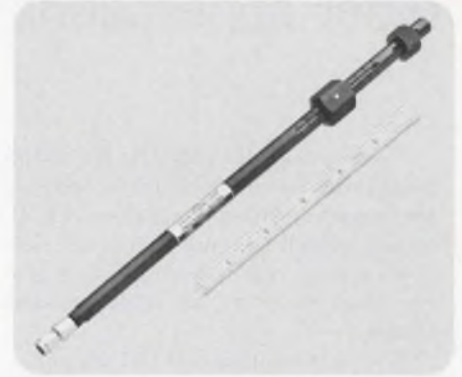

New sliding load provides well matched termination for APC-3.5 component test.

HEWLETT-PACKARD COMPONENT NEWS

New displays with high light output

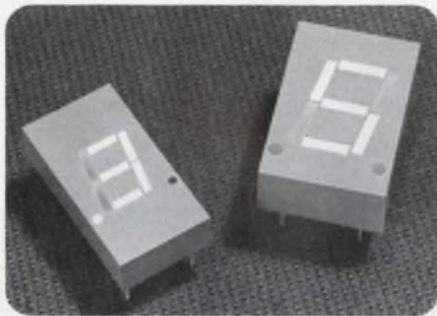

New large junction seven-segment displays are categorized for luminous intensity.

Now available from Hewlett-Packard are new, high-efficiency red, and yellow displays designed for use in high light ambient conditions.

Output is typically 2300 millicandellas per segment at 100 mA peak, 20 mA average. These displays are designed for use in instruments, airplane cockpits, weighing scales and point of sale terminals.

The seven-segment displays offer a wide viewing angle and are easily mounted on P.C. boards or sockets. DIP spacing is the industry standard 7.62 mm

(0.3 in.) on 2.54 mm (0.1 in.) centers.

The HDSP-3530/4030 are 7.62 mm (0.3 in.) high while the HDSP-3730/4130 are 10.9 mm (0.43 in.). These devices utilize high efficiency LED chips made from GaAsP on a transparent GaP substrate. The LEDs have a large area P-N junction permitting higher peak currents.

For more specifications, check I on the HP Reply Card.

HP publishes optoelectronics applications manual

Practical solutions to the most common applications problems of optoelectronic devices are fully analyzed in Hewlett-Packard's *Optoelectronics Applications Manual*, one of the first books on these versatile design tools from a leading firm in the field.

The *Manual* covers such subjects as photometry/radiometry, contrast enhancement in visible displays, and reliability of optoelectronic components and their mechanical handling.

Designed both as a practical guide to the use of optoelectronic devices and as a foundation for the development of new de-

sign ideas, this volume demonstrates the broad potential for these components that exists in systems being designed today.

Of special interest to experienced designers is the *Manual's* treatment of CTR degradation, a controversial and frequently misunderstood subject among users of optically coupled isolators.

Members of the applications engineering staff of the Hewlett-Packard Optoelectronics Division were involved in the preparation of the *Manual*, published by McGraw-Hill.

Copies are available from your HP franchised distributor.

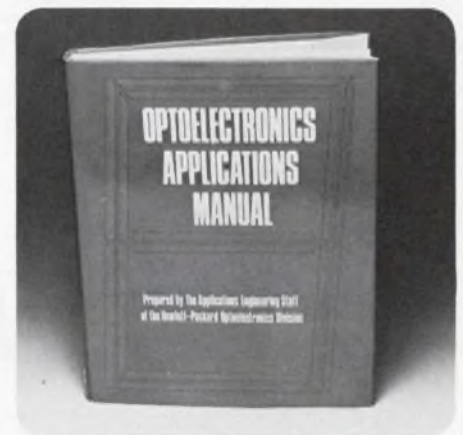

Flexible synthesizer uses μ P for FDM testing and other applications requiring precision signal source

The new 200 Hz to 80 MHz HP 3335A Synthesizer/Level Generator is designed for frequency division multiplex (FDM) testing as well as traditional synthesizer applications such as testing filters, mixers, phase detectors, attenuators or modulators.

With a resolution of 0.001 Hz and amplitude flatness of 0.15 dB over its entire range, the 3335A is useful for applications including testing of low-density carrier, radio baseband, high density cable carrier, in R & D, and in production tests. For automated instrumentation systems, the unit includes the HP Interface Bus as standard.

Microprocessor control provides flexibility in this moderate cost, high resolution synthesizer. In the sweep mode, the microprocessor computes the individual frequencies on each side of the center frequency and then controls automatic, manual and single sweep modes. At turn-on, the μ P sets the instrument to 1 MHz and minimum amplitude so output loads will not be damaged.

Up to ten different instrument settings including frequency, amplitude, sweep width and center frequency may be stored in the ten memory registers for later recall—useful in a production environment where a specific list of repetitive test functions must be performed.



New microprocessor-based frequency synthesizer is used in applications wherever a high resolution, precision amplitude test signal is needed.

The 3335A synthesizer may be used as a tracking generator for the HP 3745A/B Selective Level Measuring Set for fast, accurate loop-back measurements and for end-to-end measurements. For unattended performance checks of systems on-line or for offset tracking of systems off-line, the generator/receiver system may be controlled via the HP Interface Bus.

Standard version of the 3335A synthesizer provides 50 and 75-ohm unbalanced outputs. Other options accommodate North American and CCITT communications applications.

For additional information on the synthesizer, check G on the HP Reply Card. For details on the 3745A/BSLMS, check O on the HP Reply Card.

East-1 Chuke Cherry Road, Rockville, MD 20850.

Ph. (301) 948-6370.

South-P.O. Box 10505, Atlanta, GA 30348.

Ph. (404) 434-4000.

Midwest-5201 Tollview Dr., Rolling Meadows, IL 60008.

Ph. (312) 255-9800.

West-3939 Lankershim Blvd, North Hollywood, CA

91604. Ph. (213) 877-1282.

Europe-Central Mailing Depot, P.O. Box 529.

Amstelveen-1134, Netherlands.

Ph. (020) 47 20 21

Japan-Yokogawa-Hewlett-Packard Ltd., Ohashi

Bldg., 1-59-1 Yoyogi, Shibuya-ku,

Tokyo 151, Ph. 03-370-2281/92.

MEASUREMENT **news**
COMPUTATION
product advances from Hewlett-Packard

November/December 1977

New product information from
HEWLETT-PACKARD

Editor: Iona M. Smith

Editorial Offices:

1507 Page Mill Road
Palo Alto, California, 94304 U.S.A.

HEWLETT  **PACKARD**

PMI announces two



COMPLETE

monolithic 10-bit DAC's.



Good news! Two new ten-bit digital-to-analog converters from the folks who know how to make them monolithically. And each is completely "complete." Includes internal reference and output op amp. They are fast (1.5 μ sec settling time), with voltage outputs, yet consume only 350mW (max) over the entire military temp range (-55°C to $+125^{\circ}\text{C}$).

DAC-05: Sign-magnitude coding (sign-plus-ten-bits).

DAC-06: Two's complement coding.

Both DACs are available now specified over the full temp range. Off the shelf to MIL STD-883A Level B. Reliability is enhanced by 100% burn-in, hermetic packaging for all parts, PMI's famous triple passivation, low noise process and no laser trimming.

Data sheets are ready. Parts are on the shelf. Write, wire or phone. Precision Monolithics, Inc., 1500 Space Park Drive, Santa Clara, CA 95050. (408) 246-9222. TWX: 910-338-0528.



CIRCLE NUMBER 7

MEPCO/ELECTRA

GPR 5000X

**RESISTOR...
ONE SIZE
ONE STYLE**

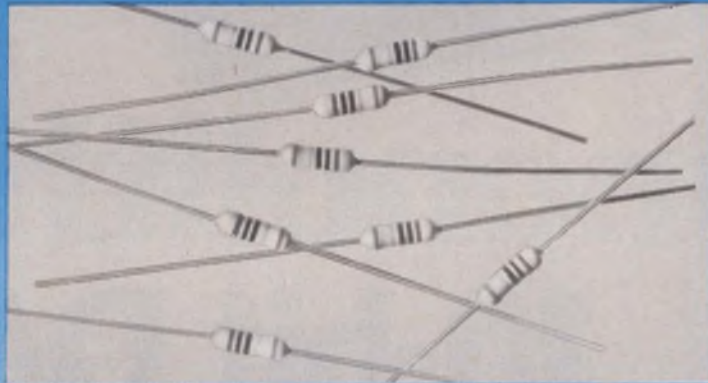

For all general purpose applications

Until now, buying General Purpose resistors meant trading off one requirement to get another—buying 2 or more styles to cover your resistance requirements—giving up board space to get more power dissipation.

MEPCO/ELECTRA'S GPR 5000X has changed all that. Now you can get everything you need for all your general purpose applications — automotive, consumer, computer—in just one resistor style, one resistor size. Reduce your resistor inventory.

**MEPCO/ELECTRA GPR 5000X:
DUAL RATED— $\frac{1}{4}W$ & $\frac{1}{2}W$.**

One resistor can be used in both $\frac{1}{4}$ and $\frac{1}{2}W$ applications, which means dual power handling capability in the smallest possible size.

BROADER RESISTANCE RANGE— 10Ω to $22M\Omega$

Widest resistance range for any resistor with comparable tolerance and T.C.'s.

REPLACES RL07 AND RL20—

Perfect replacement for both these MIL styles with the added plus of a broader resistance range, dual rated ... and at a better price.

CWV—350V Max.

STANDARD TOLERANCE—2%

STANDARD T.C.— ± 200 PPM

In the market for a true general purpose resistor that offers "trade-ups" rather than "trade-offs"? Find out about GPR 5000X. For more information ... "Call M/E" at (817) 325-7871. Or write **MEPCO/ELECTRA Inc.**, P.O. Box 760, Mineral Wells, Texas 76067.



CIRCLE NUMBER 8

Bell modems face redesign to meet FCC demands

By declining to review a lower court decision, the Supreme Court is forcing the Bell System to redesign its modems to bring them into compliance with FCC specifications. Though Bell is seeking to delay implementation of the decision, as of now it must have new equipment, perhaps as soon as January 1—or face giving up the modem market to independent suppliers that already have FCC registration.

The FCC requires that modems meet a set of standards to guarantee that no harm will come to the Bell system or its employees when the equipment is tied directly to telephone lines. But when the FCC demanded that Bell meet the same set of standards, the company balked, pointing out that since modems are installed and maintained by its own technicians, not by customers, the equipment is unlikely to cause hazards.

While Bell modems can meet most of the safety aspects of the FCC's rules, some cannot meet all the requirements. For example, a modem cannot have user-accessible controls, such as strapping connections, that can be configured so that a hazard exists. "Older modems would not pass the test," says Bob Hamer, product and services marketing manager at Bell in Morristown, NJ.

Under a "grandfather" clause in the FCC rules, Bell will continue to support the hundred or so different modem models that are already in the field. Bell modems and independent modems that are connected via data-access arrangement (DAA) modules need not be replaced, though all new models must have FCC registration before they can be installed on telephone lines.

In the past, a modem customer had to have the telephone company install a DAA before hooking up a modem from an independent supplier. The DAA rented for about \$5 a month after a \$10 installation charge.

Now, the protective functions of the DAA must be incorporated into the modem itself. The user has the tele-

phone company install a data jack, which interfaces directly with the modem. The phone company installs the proper data jack when the customer gives the model or registration number of the modem. There is a one-time installation charge of about \$30, and no rental fee.

The Bell System will likely discontinue offering DAAs after January 1, though units already in the field will continue to be maintained, says Hamer.

The advantage to the customer of the new arrangement is lower cost, says Ken Krechmer, national sales manager at Vadec Corp., Sunnyvale, CA. Incorporating the features of the DAA into a modem raises its price about \$30, so the total additional cost—including the \$20 additional installation cost of the data jack—is about \$50. But this additional cost will be paid back in 10 months because the \$5 monthly charge for the DAA is eliminated.

Krechmer says that evidence of customer interest in direct-connected modems is the higher sales of the newer units—in one case, 1000 units per month compared with 200 units per month of a similar modem that lacks registered protective circuitry. This increase comes in spite of a lack of data jacks in some areas, he points out.

Hamer concedes that there is a shortage of data jacks, due in large part to an inability to forecast demand for modems from independent suppliers. "You don't know how many are needed, but we'll catch up, I'm sure," he says.

At the same time, Bell is working on upgrades of some models to bring them into compliance, and may need completely new designs to replace units that are older or would be too expensive to rework. Though the FCC has not yet set a deadline for compliance, its original effective date for industry compliance was January 1, 1978.

Yet Bell is seeking a delay beyond the January 1 deadline to gain time to bring equipment into compliance. Opposing Bell's request for a blanket

temporary waiver is the Independent Data Communications Manufacturers Association in Washington, DC. "We have a final judgement in court, but there will be at least one further proceeding at the FCC," says Herb Marks, general counsel to the IDCMA, which feels that the company has had enough time to study the standard, design equipment that complies, and have it registered at the FCC. In addition, the IDCMA feels the waiver request is too broad and indistinct. "There's a range of things they could be asking," says Marks.

As R & D spending goes, so goes our technology—down

The slow decline of American science and technology over the past decade continues, and if current levels of research and development spending don't improve, it's going to get a lot worse.

This ominous prediction was made recently by Dr. Thomas A. Vanderslice, vice president and group executive of General Electric's Special Systems and Products Group, in an address before the Atlanta Rotary Club.

While industry spending for R & D has just about kept pace with inflation, Vanderslice noted, the federal government's share of total R & D funds has dropped from almost two-thirds in 1966 to slightly over half in 1976. Even with the space programs taken out of the picture, the decline in R & D expenditures was still over 20% during the past decade, he pointed out.

Pointing to the impact of reduced federal spending for R & D on American universities, Vanderslice observed, "Perhaps the most drastic cutbacks made by the federal government have been in the graduate fellowship and traineeship programs—which provide the trained scientists and engineers we will need in the years ahead."

This 10-year decline in spending contrasts sharply with the significant and even dramatic increases in funding undertaken by many other industrialized nations. Over the past 10 years, West Germany has increased her R & D expenditures a striking 40%—and Japan has hiked hers a monumental 74%. These increases, together with the high growth of plant and equipment investments and favorable tax policies, are producing strong productivity gains.

As if things weren't grim enough, Vanderslice added that the U.S. share of patents filed worldwide as well as the number of U.S. patents awarded to American inventors have both declined in the past decade. Meanwhile, U.S. patents granted to foreign inventors have more than doubled—an eye-opening measure of the foreign technological invasion of U.S. markets. The favorable patent balance with Japan has been dropping steadily since 1962, with Japanese patents on inventions in the U.S. increasing some threefold.

All these trends make it essential to wonder just how long the U.S. can continue to enjoy its favorable technological balance of trade, according to the GE executive. The U.S., he pointed out, has consistently been selling four to five times more technologically intensive products to other nations than it has purchased from them. This has been a major contribution to U.S. jobs and has resulted in an improvement in our balance of trade.

IC tester handles 120-pin devices

With the electronics at the test socket converted from discrete to hybrid and monolithic form, the Sentry automatic test system from Fairchild Systems Technology Division can handle 120 pins—twice as many as before.

The Sentry VIII's circuitry, mounted on cards near the test socket, includes comparators, converters, and op amps used for such analog measurements as level and polarity. In earlier designs, the cards were too large to mount 120 of them close enough to the test socket to minimize measurement errors caused by stray capacitance and other effects.

Each of the Sentry VIII's pins can be programmed to act as an input driver, output comparator, input clock, bias supply, load, or input/output. The earlier Sentry VII system has the same flexibility, but only up to 60 pins, and the Sentry IV system has as many as 120 pins, but no more than 60 of them can be assigned to any one function at a time.

The \$500,000 Sentry VIII is designed for engineering characterization, start-up production, and incoming inspection testing of very-large-scale ICs. Microprocessors, random-access memories, and random-logic circuits that require a tester with 120 pins are in development and, in some cases, are already in production for internal use,

according to Gene Griggs, product marketing manager at Fairchild Systems Technology, San Jose, CA. Fairchild has already begun shipping Sentry VIII systems for such requirements, with "a significant number" going to Japan, he adds.

The Sentry VIII can perform functional tests at up to 10 MHz by feeding data into the device under test and comparing the device's outputs with expected values. In addition, the tester can check dc parameters at rates to 300 tests per second.

CIRCLE NO. 315

Direct addressing way up with 32-bit computer

A virtual memory that provides a direct-addressing capability of over 4-billion bytes is the main feature of the 32-bit VAX-11/780 (Virtual Address eXtension) computer. What's more, the virtual-memory operating system of this latest addition to Digital Equipment's PDP-11 line applies mainframe software technology so that programs much larger than the main memory can be run in a way that is transparent to the programmer.

The main memory contains an Error Correction Code MOS memory that uses 4-k MOS RAM chips. The smallest system configuration provides 128 kbytes of physical memory, expandable up to 2-million bytes. The instruction set, consisting of 234 instruc-



A new virtual memory system is contained in DEC's VAX-11/780.

tions, nine addressing modes and five data types, includes integral floating-point, packed-decimal arithmetic, character-string manipulation and context-switching instructions.

A diagnostic console contains an LSI-11 microcomputer that provides automatic consistency and error checking to detect abnormal use of instructions or illegal machine conditions.

Like other PDP-11s, the VAX-11/780 uses both DCL and MCR command languages and implements Fortran-IV-Plus, Basic-Plus-2 and COBOL languages. A unibus connects the 11/780 to peripherals.

The VAX-11/780 begins at \$130,000.

CIRCLE NO. 566

Small laser modulator requires less power

Cadmium-telluride-waveguide laser modulators, the first to be fabricated by proton bombardment, have several advantages over those made by conventional epitaxial-processes.

These modulators require but a fraction of the power to give the same degree of modulation as competing devices in the 3 to 10- μ m infrared region.

- The modulators are substantially smaller.

- The low optical absorption and high electro-optic coefficient of cadmium telluride permit these modulators to be fabricated in two forms: narrowband acousto-optic devices that use surface acoustic waves to deflect the laser beam, and broadband electro-optic devices that operate by shifting the phase of the laser frequency.

- They can be produced at substantially lower cost.

Developed for the design of compact low-power carbon dioxide laser radars for the Air Force at MIT's Lincoln Laboratory, Lexington, MA, the cadmium telluride devices may prove useful with other infrared lasers in gas and pollution monitoring equipment.

The waveguides, according to Laboratory researchers D.L. Spears and A.J. Strauss, are formed by bombarding the selected areas of cadmium telluride wafers with protons from a Van der Graff generator. The acousto-optic modulators, which have a bandwidth of 1 MHz, use 27-MHz surface acoustic waves generated by interdigital electrode transducers.

This MIT modulator produces the same modulation level as that of germanium modulators 10 times larger.

Can you find solutions to your design and cost problems from these standard Bivar Packaging Aids?

Yes. Because someone else probably had a similar problem before you did. In fact, during the past decade BIVAR has introduced nearly 1,000 standard products, most designed originally to solve costly Printed Circuit Board packaging or component mounting problems. These have resulted in lower assembly costs, fewer rejects and improved quality of product appearance and performance. Take for example, the advantages of accurately supporting transistors, capacitors and other devices. Components are protected, insulated against heat damage and uniformly positioned by using BIVAR **PERMANENT MOUNTS** and **SPACERS**, made of durable Nylon per MIL-M-20693A. Hundreds of standard styles for virtually any PCB component; low-cost and carried in stock by the thousands. For accurate, uniform component spacing above PCB surfaces, over 400 standard sizes of BIVAR **WASH-AWAY SPACERS** assure proper filletting and heat dissipation, and eliminate lead stresses

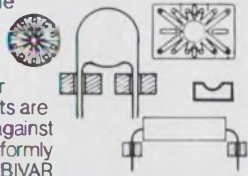

and strains, washing away in warm or hot running water without a trace of residue. These extremely low-cost devices, designed for exacting application for almost any component, substantially reduce rejects and rework.

BIVAR can mean the difference in cost-savings and real PCB packaging design flexibility with the industry's most complete line of **SNAP-IN CARD GUIDES**; lengths from 2 1/2" through 14", made of reinforced molded Nylon. Snap them into card cages or sheet metal at your spacing requirements. For 1/16" PCBs, these low-cost guides feature rigidity, card insertion and assembly ease, and are stocked for immediate shipment.

For new, demanding designs, BIVAR Flame Retardant Card Guides offer the same range of sizes made of 94 V-0 U.L. rated material; help the designer to meet flammability specifications. New **Deep Channel Card Guides**, with a .200" slot depth for maximum retention under shock and vibration or for larger PCBs. All stocked at low, cost-savings prices.

Components, circuitry and cards will be protected from undue stresses, and PCB insertion or removal will be easier with BIVAR **CARD EJECTORS**, designed for 1/16", 3/32", and 1/8" boards; 18 styles, including locking versions to prevent accidental card release. Molded from Nylon per MIL-M-20693A, and U.L. rated 94 V-2 material, these helpful ejectors meet most demanding requirements. Ejectors can be marked permanently for identification, are available in 13 standard colors and are furnished with stainless steel mounting pins.

BIVAR PCB HANDLES make circuit board handling easier and provide an excellent way to code or identify each board. Made from Natural White Nylon per MIL-M-20693A and U.L. rated 94 V-2 material, they meet demanding packaging specifications; standard colors and markings are available.

Yes, you can find solutions to your design and cost problems from this growing family of Packaging Aids. And, if you have special needs they can be answered too.

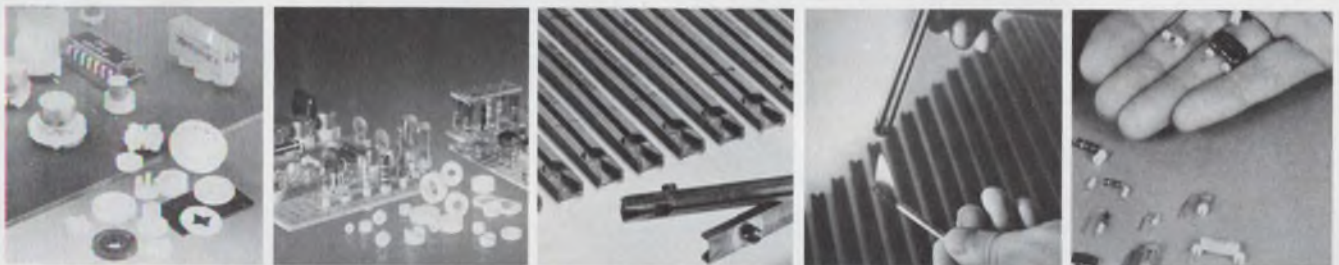
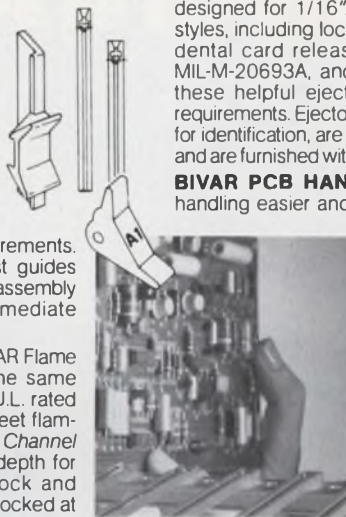

Whether you are mounting components on PCBs, or packaging completed PCBs, BIVAR can provide answers that will save time, money, and improve your product's appearance. Find out about the BIVAR "Cost Savers." Choose from over 900 standard products.

2 new catalogs and pricing free.

OVER 900 STOCKED PARTS.

NEW LIGHTED DISPLAY MOUNTS!



GAS DISCHARGE DISPLAY MOUNTS
Answer uniform production mounting problems, protecting glass seals, establishing parallel surfaces to PCB's and eliminating parallax. Mounting Pads are of Nylon per MIL-M-20693A, Comp. A, Type 1, U.L. rated 94V-2 material, and act as pin straightener, guiding leads into PCB hole pattern.

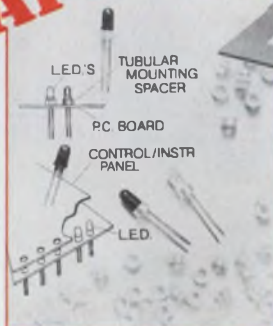

LED MOUNTING SPACERS
Firmly support LED's above PCB surfaces maintaining bases parallel to board surfaces, preventing parallax. Rigidity of mounts prevent bending or tilting of LED's during handling and final assembly. Heights from .080" through .380" in .005" increments. 61 standard sizes are available from stock.



PACKAGING PROGRESS
BY **Bivar**

BIVAR, INC., 1617 E. Edinger Avenue, Santa Ana, CA 92705 Phone (714) 547-5832

**Telecommunication
resources from
the technology leader.**

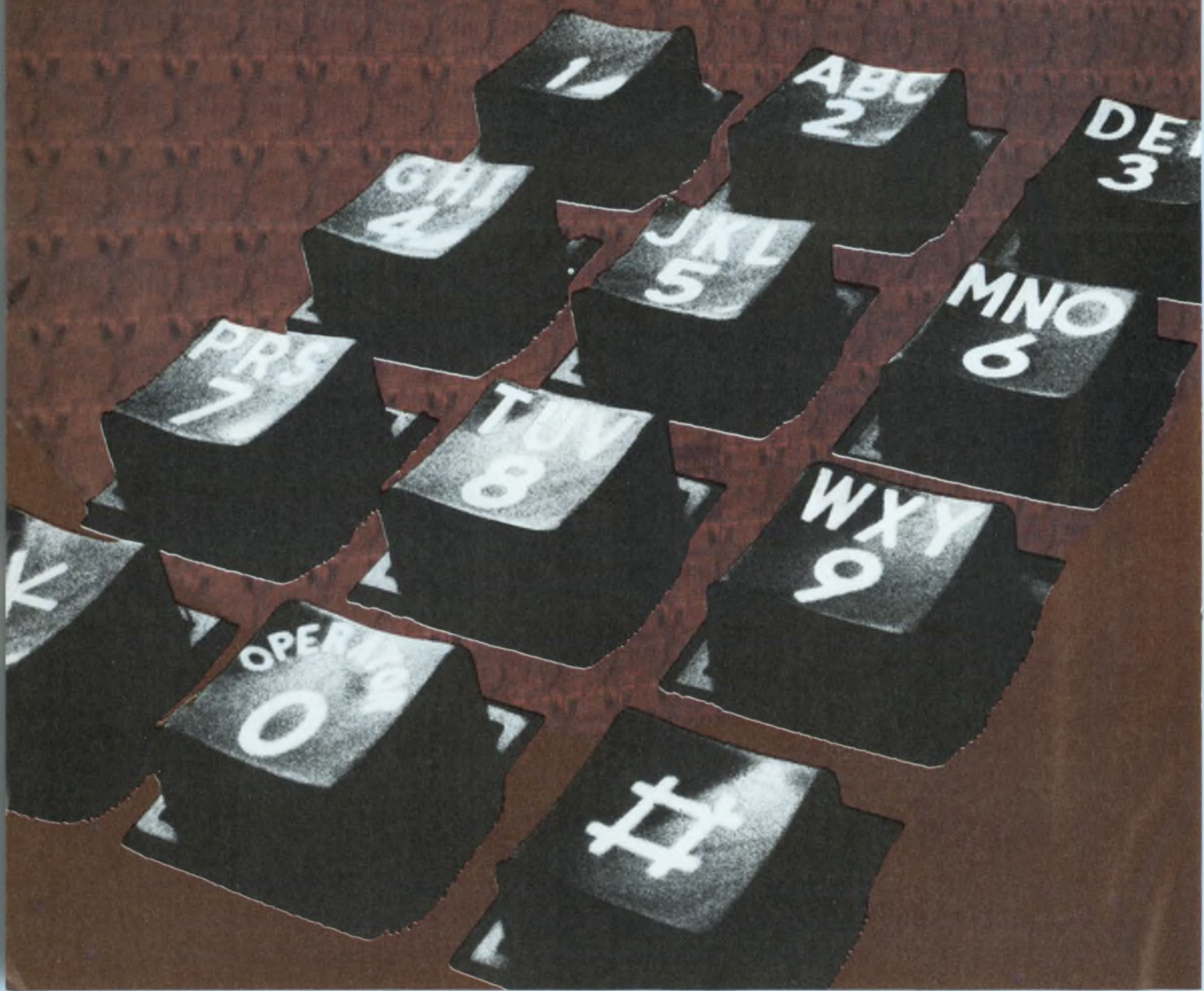

Tone dialers, tone receivers, pulse dialers, and repertory dialers from Mostek.

Mostek's high-technology leadership in MOS/LSI is not limited to high-performance memories and microcomputers. One of our most significant achievements has been in the telecommunications field. The Tone I™ series of integrated tone dialers—MK 5084, MK 5085 and MK 5086—first introduced in 1974, are today finding their way into over a million telephone products a year. From this technological expertise has evolved a

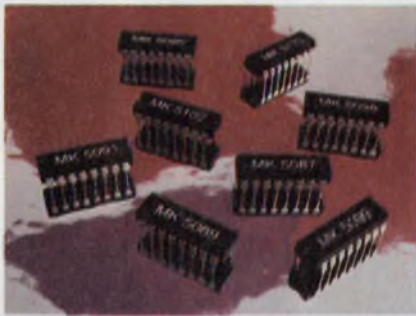

new generation of high-volume products designed for the telecommunication industry.

The new Tone II™ series of integrated tone dialers is leading



the way with even higher performance features. The MK 5089 and MK 5091 meet the *most stringent* requirements for an all-electronic telephone or CEPT compatibility. For U.S.A. telephone applications the MK 5090 fits perfectly. And the MK 5087 provides an upgraded pin-compatible replacement for the popular MK 5085 Tone I™ dialer. Packaged in 16-pin DIPs the Tone II™ series offers maximum system density for minimum cost. Mostek's new MK 5102 Inte-

grated Tone Receiver provides high quality DTMF detection and decoding in a 16-pin package, with single-power supply and full microprocessor compatibility.

The MK 5098 Integrated Pulse Dialer offers button-to-pulse conversion to a rotary dialing phone, using only direct line power. An 18-pin version, MK 5099, will be available with *re-dial* features.

Mostek's new MK 5170 Repertory Dialer lets you use your imagination to design a wide variety of telephone-user options. It features an *expandable* number set, display of number dialed and a repertoire of other attractive features.



Mostek is working to bring solutions to your products of the future: New ideas; new products; new resources, from the technology leader in telecommunications. Contact your

nearest Mostek sales office for complete product information.

MOSTEK

1215 West Crosby Road • Carrollton, Texas 75006 • (214) 242-0444
MOSTEK GmbH • West Germany • Telephone: (0711) 701096



Digital announces a PDP-8 with an enormous memory.

Something big has just happened to the world's most famous small computer. In fact, something enormous.

Digital has just put 128K of memory into the PDP-8.

This act is brought to you by a powerful new memory management option called KT8-A. And by two new MOS memory modules that fit large amounts of memory into small amounts of space. Simply by adding these 16K or 32K modules in whatever combination you choose, you now expand your PDP-8/A into something bigger. What's even better, you can mix MOS and core. And that means you can protect your program in non-volatile core while you expand your data base in MOS.

And thanks to the KT8-A all this memory is under new management. Not only does the KT8-A let you address up to 128K words of memory, but it also offers you memory relocation and memory protection, while asking little in operating system overhead so you get faster system performance.

What's the cost of these enormous advancements? That's the next attraction.

The new PDP-8A MOS memory models are available at prices that are as crowd-pleasing as their performance. For a 16K 8A205 you'll pay as little as \$3900 (quan. 1). 8A425 with 64K

is as low as \$11,000. And the top of the line 8A625 with 128K is yours for as little as \$18,050.

They're the new big-memory Eights from Digital. Step right up.

Large memories aren't our only new trick.

New hardware and software improvements are also in the PDP-8 spotlight.

The VK8-A is a new low cost PDP-8A option that provides high quality video output plus keyboard and printer interfaces. Video character generation uses a super-sharp 9x9 dot matrix for high resolution on single or multiple CRT monitors up to one thousand feet away.

Also new for PDP-8 users is MACREL/LINKER — a sophisticated assembler with MACRO facilities that lets you implement, expand and update your system faster while reducing software development time.

And last but not least there's DECNET 8 — a series of software protocols that let you

form your own PDP-8 network.

The PDP-8. Bigger. Smaller. And better than ever.

A short while ago, we made big news with DECstation 78. A low-end system that set new highs for ease of use and simplicity.

Now we're expanding the PDP-8 family up, as well as down, and that means new opportunities for OEMs and end-users alike. Look into what's happening with PDP-8s. Call your nearest Digital sales office today.

Or send the coupon to PDP-8 Marketing Communications, Digital Equipment Corporation, 129 Parker Street, PK3-1/M34, Maynard, Massachusetts 01754. European headquarters: 12, av. des Morgines, 1213 Petit-Lancy/Geneva. In Canada: Digital Equipment of Canada, Ltd.

digital

PDP-8 Marketing Communications
Digital Equipment Corporation, 129 Parker Street, PK3-1/M34,
Maynard, MA 01754

Please send additional information about the PDP-8 family.

Name _____ Title _____

Company _____

Address _____

City _____ State _____ Zip _____

Phone _____ OEM _____ End-User _____

Application _____

ED11227

Guildline Introduces the only 14 Million Count DVM on the Market Today

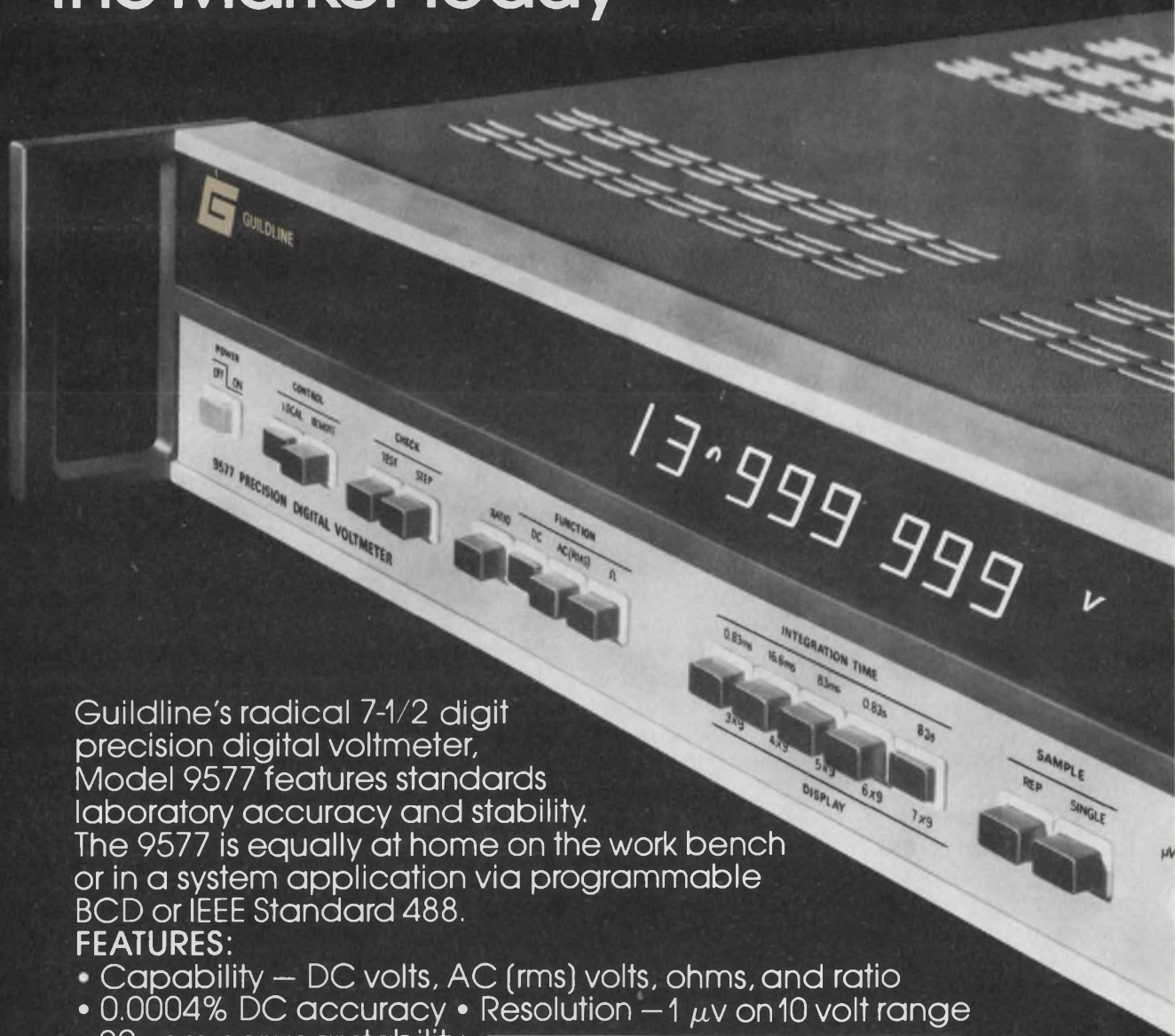

Guildline's radical 7-1/2 digit precision digital voltmeter, Model 9577 features standards laboratory accuracy and stability. The 9577 is equally at home on the work bench or in a system application via programmable BCD or IEEE Standard 488.

FEATURES:

- Capability — DC volts, AC (rms) volts, ohms, and ratio
- 0.0004% DC accuracy • Resolution — $1 \mu\text{v}$ on 10 volt range
- 20ppm per year stability
- Self-Check via front panel or system mode
- 500 readings per second
- $> 1000\text{G}\Omega$ input resistance • Digital Filtering



PRICE \$3995



Guildline Instruments, Inc.

2 Westchester Plaza., Elmsford, New York 10523 (914) 592-9101

Signetics Op Amps: Fast Performers Ready For Fast Delivery.

Choose from three new op amps with high slew rates. One specifies the industry's lowest noise: $4nV/\sqrt{Hz}$!

The next time you find yourself searching the specification tables for a high-performance op amp, be sure to search ours. You'll find a broad offering—more than 60 models, each with package and temperature options. You'll also discover three new entries, one of which is likely to provide that exceptional spec you need.

Our Quiet Performer: SE/NE5534.

If low noise is critical to your design, then you need our new SE/NE5534. There's not another op amp around with better noise performance. With input noise specified at $4nV/\sqrt{Hz}$ at 1 kHz, this device can drive a 600-ohm load. Great for quality audio equipment and instrumentation/control circuits. Our quiet performer also offers a generous 10-MHz bandwidth and a respectable $13V/\mu\text{sec}$ slew rate.

When you compare the SE/NE5534 with standards like the $\mu A741$ and LM307, you'll find that it offers superior performance—spec for spec. This outstanding op amp is internally compensated for gains equal to, or greater than, 3. And if you want to optimize frequency response for unity gain, capacitive load, low overshoot, etc., you can do so easily with an external capacitor.

Two For High Slew. For those designs demanding high slew rates, you should look into our super-fast performers—the SE/NE530 or SE/NE538. Internally compensated, both of these devices have excellent input characteristics.

The SE/NE530 is a superior replacement for any device in the $\mu A741$ family. With high slew rates of $18V/\mu\text{sec}$ (+1 gain) and $25V/\mu\text{sec}$ (-1 gain)—plus a small-signal bandwidth of 3 MHz—this op amp is a veritable workhorse for numerous applications. Selecting it over a 741-type device translates to improved performance, greater design flexibility and reduced inventory.

With the SE/NE538, you get $40V/\mu\text{sec}$ slew at a minimum gain of +5/-4. This guaranteed speed comes without power penalty, as the maximum supply current required is just 3 mA. If you're using op amps like the $\mu A741$, LM301A or BiFETs, you could be getting better performance with our 530 or 538.

Move up to better op amp performance. Move up to Signetics. For complete details, use the coupon below or contact your local Signetics distributor.

Signetics

a subsidiary of U.S. Philips Corporation

Signetics Corporation
811 East Arques Avenue
Sunnyvale, California 94086
Telephone 408/739-7700

To: Signetics Information Services, 811 E. Arques Ave.,
P.O. Box 9052, Sunnyvale, CA 94086

Please send technical data and sample(s) for the following op amp(s):

Low-Noise SE/NE5534 High Slew SE/NE530
 High Slew SE/NE538

My need is urgent; have an applications specialist phone me at once: () ext.

Name _____ Title _____

Company _____ Division _____

Address _____ MS _____

City _____ State _____ Zip _____

I'm also interested in any other op amps you offer for this application: _____ ED1122

The double-sided floppy from number 1

**Double storage capacity.
Double media selection.
Double access speed.**

Double your storage power with SA 850/851

Store twice as much data as a single-sided, double density drive, four times that of an IBM single-sided single density disk. Reach that data more than twice as fast with two heads and track-to-track access time of 3 ms. Choose from a wider selection of media—single or double-sided, single or double density, sector or hard sector formats. **Capacity.** The SA 850/851

gives you twice as much storage capacity as a single-sided, double density drive. Yet it requires no more cabinet space. One drive packs up to 1600 kbytes unformatted, or 1200 kbytes formatted.

Double density gives you 1600 kbytes—compatible and equivalent to the newly announced IBM S/34 two-sided drive. The Shugart

SA 850/851 is available now and this drive accepts

FM and double density MFM or M²FM encoding.

Speed. Data access is faster, too. Just 3 ms track-to-track.

Average seek time, including settling, is 91 ms.

That's 71 ms faster than IBM's two-sided floppy.

Remember lead screw actuators? Now you can forget them.

The key to faster access is the new Shugart Fasflex™ metal band actuator which provides faster access time with positive, low friction head movement. This more efficient actuator requires less than half the power used by standard lead screw actuators.

Compatibility. Media compatible. SA 850/851 drives read and write data on any industry standard single-sided, single or double density diskette, two-sided IBM Diskette 2, 2D or equivalent. Drive Compatible.

Upgrading from your existing SA 800/801 is easy. The SA 850/851 is identical in size, outline and electrical interface. Rack mounting? You've got it with the "skinny"

SA 850R/851R version. Two units mount side-by-side in a 19-inch RETMA rack.

Even more reliable. Data integrity and system reliability begin with Shugart's own read/write head—the same glass bonded ferrite/barium titanate head proven in more than 100,000 installations.

Drive mechanical integrity rests on the same industry accepted die cast aluminum chassis technology used in all Shugart Drives. This rock solid recording platform is not a place to cut costs. Shugart keeps data safe, too. Write protect circuitry and a new I/O controlled programmable door lock for better data security are standard. **First.** Shugart has a habit of being first.

First with an IBM-compatible drive. First with double density drives. First with the minifloppy®. And now first to deliver a double-sided drive.

Two out of three OEM's specify Shugart. They get more experience, more technology, more support. **See both sides now.** See how Shugart

double-sided floppy drives can give your system bigger, more accessible storage in the same space.

Then listen closely to the OEM price. Doubling storage capacity was never more affordable.



Shugart Associates

415 Oakmead Parkway, Sunnyvale, California 94086

Telephone: (408) 733-0100

West Coast Sales/Service: Telephone: (408) 252-6860

East Coast Sales/Service: Telephone: (617) 890-0808

Europe Sales/Service: 3, Place Gustave Eiffel, Silic 311

94588 Rungis, France Telephone: (1) 686-00-85

™Fasflex actuator trademark of Shugart Associates.

POWER TRANSISTOR

PRESENTING VMOS FROM A BIG TIME PRODUCER.

With a major producer like Fairchild behind it, you know VMOS is going to be a big star someday. So remember the name: Enhancement Mode Power Vertical Mosfet. Stagename: Fairchild VMOS.

VMOS transistors are going to make the big time by combining the advantages of vacuum tubes—or lower power FETS—with those of conventional power transistors.



AN AWARD WINNING PERFORMER.

Fairchild VMOS gives you high input impedance with direct interface to CMOS. It's capable of super switching times—10 ns at 1 A. It has

highly linear transfer characteristics, high GM, easy paralleling and biasing, protected gates, low $R_{ds(on)}$ and no second breakdown or thermal runaway. And here's the initial cast of characters:

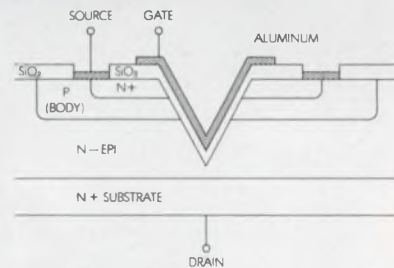

Cross-section of Fairchild's VMOS power transistor.

	Package	PD	ID	BVDSS
2N6657	TO-3	25 W	2.0 A	60 V
2N6658	TO-3	25 W	2.0 A	90 V
FVN2	TO-39	6.26 W	2.0 A	60 V
2N6661	TO-39	6.25 W	2.0 A	90 V

INTRODUCING A SUPERSTAR SUPPORTING CAST.

In addition to N-Channel VMOS, Fairchild is also producing the world's first P-Channel Power Mosfets with all the features of N-Channel. This

Device Type	Package	PD	ID (max)	BVDSS	$R_{ds(on)}$
FVPI	TO-3	25 W	2.0 A	60 V	6
FVP2	TO-39	6.25 W	1.5 A	60 V	12

means you can now get a complementary product line in VMOS technology from a major Power source.

FEATURE PERFORMANCE AT A MATINEE PRICE.

Whether you're designing CATV, MATV amplifiers, audio drivers, core memories, switching regulators, analog switches, pin diode drivers, lasers, transducer drivers, or microprocessor interfaces, state of the art designs are now possible. And just as importantly, they're now affordable with Fairchild Power VMOS. Here are some examples:

	100-999
2N6657	\$4.20
2N6658	\$5.05
FVN2	\$1.85
2N6661	\$2.95
FVPI	\$4.25
FVP2	\$1.85

NOW PLAYING AT A DISTRIBUTOR NEAR YOU.

For more information on VMOS, contact your Fairchild sales office or representative today. Or use the direct line at the bottom of this ad to reach our Power Division. Fairchild Camera and Instrument Corporation, 464 Ellis Street, Mountain View, CA 94042. Tel: (415) 962-3343. TWX: 910-379-6435.

FAIRCHILD
CALL US ON IT.
(415) 962-3343



Coming through...

with a vital part in product design

It's what's up front that counts. That's why it pays off to involve Belden in the early stages of a project.

We know the codes, specs and electrical/environmental parameters you're faced with. We've come through with answers to some extraordinary new applications.

As much as any component, wire, cable and cord, can make a critical difference in your product's performance. And your costs. By drawing on thousands of high-quality standards—and a wealth of custom engineering knowhow—we can tailor an answer to fit your needs. Exactly.

We can even help you cope with the economics of wire processing, assembly and installation. Our problem solving experience ranges from innovative

packaging to total manufacturing analysis.

Whether you need cord sets, special harnesses, shielded cable construction, flat cable—or help putting it all together, involve a Belden Wire Specialist. He'll come through with everything we've got. For answers right now, phone:

317-966-6661 Electronic Division or mark 400 on reader service card.

312-986-1600 Electrical Division or mark 401 on reader service card.

312-887-1800 Transportation Division or mark 402 on reader service card.

Or write Belden Corporation, 2000 S. Batavia Ave., Geneva, IL 60134

BELDEN



Coming through...
with new ideas for moving electrical energy

Washington report

Two contracts due on Army air-defense system

A \$3-billion system to protect Army units in the field against low-flying enemy aircraft should enter the competitive development phase Dec. 3, following Defense Department approval of the concept Nov. 15. The Division Air Defense (Divad) program involves a new radar-directed cannon to be mounted on Army tanks. It will replace a variety of existing antiaircraft defenses, including the 20-mm Vulcan gun, the Nike-Hercules and Hawk missiles, and the shoulder-fired Chaparral and Redeye missiles.

From five major competitors the Army expects to select two for parallel-development contracts covering a two-year "shoot-off," including side-by-side field trials. Two firms are proposing the Swedish Oerlikon 35-mm gun: Raytheon, which would use the Dutch Hollandse Signaal radar, and General Dynamics, which would use a modified version of its own Navy shipboard Phalanx radar. Sperry Rand is proposing a version of its own Vigilante 35-mm gun with the Signaal radar. Ford Aerospace has selected the Bofors 40-mm gun and the Westinghouse radar used on the F-16 fighter, and General Electric is proposing a ground version of its 30-mm GAU-8 gun used on the A-10 aircraft, and the F-16 radar.

The gun is needed, according to the Army, because the current low-level defenses have been outranged and can be outmaneuvered by newer Soviet fighters designed especially for low-altitude operations and by modern missile-armed Soviet helicopters. Divad will be installed first in the Army's M48 tanks, but will be adaptable to other U.S. tanks and NATO tanks. It will complement the long-range Patriot (formerly SAM-D) antiaircraft missile system due to enter production at Raytheon in 1980.

Hemispherical antenna works like four phased arrays

An antenna with a dome covered by passive phase shifters—and a single planar array of active phase shifters mounted at the bottom—will do the job of four separate phased arrays in providing complete hemispherical coverage for antiaircraft and antimissile defense. Nearing completion by Sperry Gyroscope Co. at Great Neck, NY, the antenna is slated for delivery next year to the Army Missile Command at Huntsville, AL.

The new antenna consists of a 113-in.-diameter array of 4544 active ferrite phase shifters covered by a 98-in.-high dome. On the dome are 24,283 passive shifters capable of providing 24 increments of phase delay. The 330-lb dome is made of resin-filled fiberglass honeycomb, and the whole system, including electronics, weighs 1330 lb.

In tests to be conducted by the Army, the antenna will be operated at C-band to evaluate its possible use in an advanced air defense system for the 1990s. However, company officials say the same design can be used to provide hemispherical coverage for aircraft by building a smaller X-band or K-band antenna that can be mounted on the nose or tail of a fighter.

A prototype model had been built by Sperry Gyroscope for a ballistic-missile defense system, but that program was canceled after the U.S.-Soviet treaty

limiting antiballistic missile systems. Another prototype is being tested for ship defense by the company at MacArthur Field, Long Island, using electronics from the Terrier shipboard missile system.

Electronic-materials experiments set for Space Shuttle

Five material-processing experiments—three applicable to the electronics industry—will ride along on an early orbital flight test of NASA's Space Shuttle, in 1979 or 1980.

The experiments will be placed in a package on the spacecraft and will require their own power supply and data-collection computer. The package itself will be completely automated and require no action by the Shuttle crew other than a command by one of the astronauts to begin the experiments.

Electronics-related experiments expected to exploit the zero-gravity properties of space include vapor growth of alloy-type semiconductor crystals (submitted by Dr. Herbert Wiedemeier of Rensselaer Polytechnic Institute), solid electrolytes containing dispersed particles (Dr. J. Bruce Wagner Jr., Arizona State University) and containerless preparation of advanced optical glasses (Ralph A. Happe, Rockwell International Corp.).

Neither the specific mission nor the exact configuration of the experiment package has been chosen, but NASA says the experiments are expected to be flown on one of the Shuttle's first six orbital flight tests.

Harmonic emissions limit may curve CB interference

The growing problem of citizen's band radios interfering with home-television reception can be solved by limiting CB harmonic emissions to 75 dB below their 4-W power limit. The solution was offered by the Electronics Industries Association to the Federal Communications Commission.

Harmonics have no communication value to the CB user, EIA explains, but may interfere with certain TV channels. While properly adjusted and operated CBs currently being manufactured aren't likely to interfere with TV sets, EIA said it suggested the new standard because interference sometimes occurs in high-density housing areas. One cause of CB interference, according to the industry group, is the use of illegal linear power amplifiers on the CB sets. The FCC is grappling with the problem of what it can do about these illegal amplifiers.

Capital Capsules: Latin American airlines have begun sharing weather data gathered by the GOES-2 satellite and collected by Lineas Aeros Nicaragua (LANCIA), which distributes the information in Miami to route flights around tropical storms in the Caribbean. LANCIA receives one visual image and one infrared image every hour. Sharing the data are LACSA (Costa Rica), Varig (Brazil), Lan Chile, Air Panama, Aerolineas Aviateca (Guatemala), Tan Airlines (Honduras), Aero Condor (Colombia) and Aero Peru. . . . **Citizen's band radio sets will be installed by the Coast Guard at its search-and-rescue centers to supplement its vhf-FM and 2182-kHz national maritime communications and distress system.** The Coast Guard hopes to respond more rapidly to calls for assistance from small craft, and intends to have the CB service available in time for the 1978 recreational boating season.

On the balance a T900-Series Oscilloscope gives you the most performance for your dollar

Low-cost oscilloscopes traditionally offer a compromise in performance in return for low price. Over-simplified circuits reduce accuracy and require frequent calibration. Cost cutting in the selection of components limits reliability. With many low-cost scopes, the specs are there, but the performance isn't.

There are no compromises with TEKTRONIX T900-Series Oscilloscopes. No corners have been cut where accuracy and reliability are concerned. And with six models to choose from, you can match the performance you require with your budget. Bandwidths range from 10 to 35 MHz. Four T900 Scopes feature dual trace and one has single shot storage. A rackmount model is also available.

The 35 MHz T935 with dual input channels and delayed sweep is well suited for the design, production and service of computer peripherals, point-of-sale terminals, machine controls and communications equipment.

The dual channel, 15 MHz T922 is an excellent choice for classes in basic electricity and electronics. The large, bright 8 x 10 cm display makes classroom demonstrations more visible. The easy-to-use control layout makes learning signal measurement techniques simple and straightforward.

When you buy a T900-Series Oscilloscope, you also receive the full support of the Tektronix worldwide sales and service organization. T900 Accessories include a wide selection of probes, a low-cost camera, a versatile stand for convenient scope positioning and a viewing hood.

Performance, reliability and service. That's why Tektronix is setting new standards for low-cost oscilloscopes.

- T921—DC to 15MHz; single trace, mono time base \$ 695*
- T922—DC to 15 MHz; dual trace, mono time base \$ 850*
- T932—DC to 35 MHz; dual trace, mono time base \$1125*
- T935—DC to 35 MHz; dual trace, with delayed sweep. \$1395*
- T912—Storage Model, DC to 10 MHz; dual trace, mono time base \$1300*
- T922R Rackmount—DC to 15 MHz; dual trace \$1175*

Voltage probes are included on all T900 Oscilloscopes except the T922R.

For complete specifications on the T900 Oscilloscope Family, contact your Tektronix Field Engineer. Or write Tektronix, Inc. P.O. Box 500, Beaverton, OR 97077. (503) 644-0161, Ext. T900. In Europe, write Tektronix Limited, P.O. Box 36, St. Peter Port, Guernsey, Channel Islands.

*U.S. sales prices are F.O.B. Beaverton, OR. For price and availability outside the U.S., please contact the nearest Tektronix Field Office, Distributor, or Representative.



Tektronix
COMMITTED TO EXCELLENCE

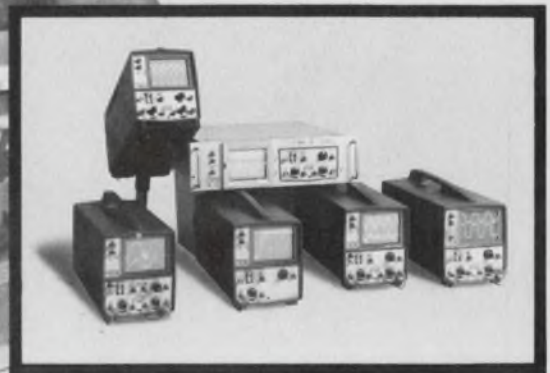

FOR TECHNICAL DATA, CIRCLE 234
FOR DEMONSTRATION, CIRCLE 235

990 OEM minicomputers.

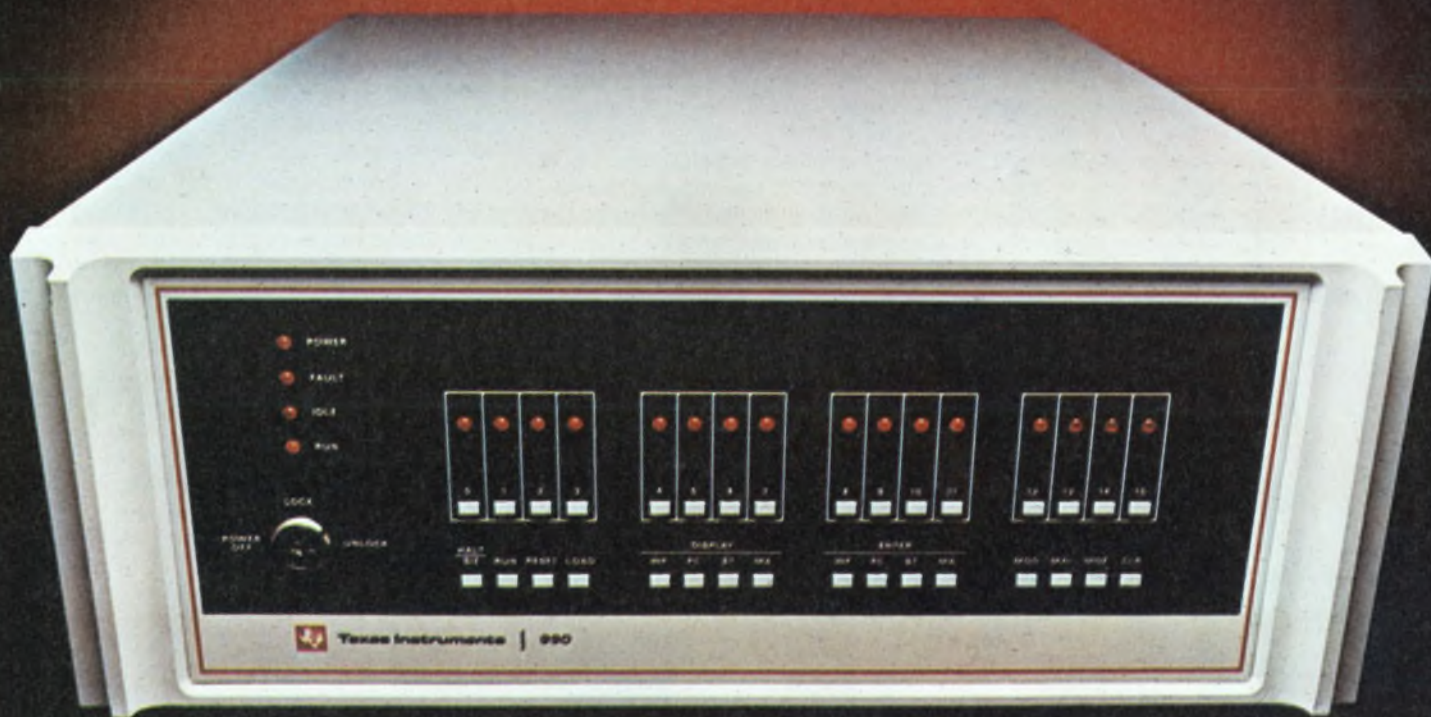

Built, backed and priced to sharpen your competitive edge.

TEXAS INSTRUMENTS.

The 990/10 minicomputer from TI brings superior value to both you and your customers.

Starting with field-proven hardware, the 990/10 delivers the reliability you expect from TI. And all the off-the-shelf support you need for user applications. You get standard software languages, a broad choice of peripherals and nationwide service.

Built for more processing power.

The 990/10 is the most powerful member of the 990 computer family. Its architecture provides features that give you maximum processing power for your money. Like hardware multiply and divide. A 16-level hardware



Peripheral Interface Modules

interrupt structure. 16 registers arranged in a workspace concept. I/O that's directly programmable through the Communications Register Unit (CRU) and autonomously through a high-speed data bus. And bit, byte and word addressing of memory.

Built for system flexibility.

In small or large configurations, the 990/10 design provides surprising flexibility for a small investment.

The CRU, with up to 4096 I/O lines, reduces interfacing costs by keeping controller complexity to a minimum. The TILINE* asynchronous high-



Model 911 Video Display Terminal

speed data bus can support both high- and low-speed devices and takes advantage of design simplicity for simultaneous data transfer between peripherals, the CPU and memory.

With the 990/10, you get a powerful instruction set with an extended operating feature that allows hardware to take over operations that software would normally execute. An optional mapping feature provides memory protection and memory expansion to 2 million bytes. And, optional error-correcting memory corrects single-bit errors for increased system reliability.



*DS 25/50
Disc Drives*

Full peripheral support.

As well as a range of standard peripherals, disk storage to 180 million bytes and magnetic tape with 800 and 1600 bpi options are available for low-cost mass storage and back-up.

A choice of software.

With common higher level languages, FORTRAN IV, COBOL and Multiuser BASIC, plus the 990/10 assembly language, you have all the tools you need for an efficient application program.

Both the disk-based and memory resident operating systems give you modularity and flexibility for system generation to meet application de-



*Model 979A
Tape Drive*

mands. We offer program development aids for creating and testing software, and communications software to support synchronous or asynchronous data transmission.

Backed with nationwide service.

Our responsibility to you doesn't end with the sale. We follow through with complete system training, plus a nationwide factory service network.

The TI 990/10 minicomputer. We build it, back it and price it the way you and your customers want it. You can start configuring a system now with our 990 Computer Systems Handbook on the upward-compatible family of the TMS 9900 microprocessor, 990/4 microcomputer and 990/10 minicomputer. For your free copy, send a letterhead request to Texas Instruments Incorporated, P.O. Box 1444, M/S 784, Houston, Texas 77001.



TEXAS INSTRUMENTS
INCORPORATED

CIRCLE NUMBER 18

Performance & Value.

MULTIMETERS



MODEL 175 Portable, 3½ Digit DMM \$189.00

With a basic DC accuracy of $\pm 0.1\%$ input ± 1 l.s.d., guaranteed for a full year, and $100\mu\text{V}$ resolution, the Model 175 is unsurpassed for accuracy and sensitivity. Battery and line operated and truly portable, it measures: DC Volts from $\pm 100\mu\text{V}$ to $\pm 1000\text{V}$; AC Volts from $100\mu\text{V}$ to 500V (30Hz to 50kHz); DC Current from $\pm 0.1\mu\text{A}$ to $\pm 2\text{A}$; AC Current from $0.1\mu\text{A}$ to 2A (30Hz to 50kHz); Resistance from $100\text{m}\Omega$ to $20\text{M}\Omega$ in two modes (HI excitation 2.5V and LO excitation 300mV).

The Model 175 also features auto-polarity, automatic zero, 100% over-range, big, bright 0.43" LED display and comes equipped with both rechargeable NiCd battery module and battery charger/line adaptor.

Size: $5\frac{1}{2}''\text{W} \times 1\frac{3}{4}''\text{H} \times 3\frac{1}{2}''\text{D}$
13.97 x 4.45 x 8.89 cm



MODEL 245 Portable, 4½ Digit DMM \$295.00

Ideal for field use, the Model 245 is a rugged, truly miniature, lab-quality, 5-function instrument featuring a basic DC accuracy of $\pm 0.05\%$ of input ± 1 l.s.d., .005% resolution, 100% overranging, equipped with both rechargeable battery pack and battery charger/line adaptor.

Model 245 measures ACV ($100\mu\text{V}$ to 500V RMS), DCV $\pm 100\mu\text{V}$ to 1000V , Resistance 100 milliohms to 20 Megohms, AC and DC current 1 microamp to 2 Amps. AC voltage/current response, 30Hz to 50kHz.

Size: $5\frac{1}{2}''\text{W} \times 1\frac{3}{4}''\text{H} \times 3\frac{1}{2}''\text{D}$
13.97 x 4.45 x 8.89 cm



MODEL 248 Portable, 4½ Digit DMM With True RMS Measurement \$345.00

This high-resolution instrument measures Resistance $100\text{m}\Omega$ to $20\text{M}\Omega$, DC Volts $\pm 10\mu\text{V}$ to $\pm 1\text{kV}$, True RMS AC Volts $10\mu\text{V}$ to 500V , both DC Current and True RMS AC Current 10 nanoAmps to 2A. The Model 248 features sensitivity of $10\mu\text{V}$. Basic DC accuracy is $\pm 0.05\%$ of input ± 1 l.s.d., guaranteed for a full year, 100% over-range, overload protection, large LED display, and comes complete with both rechargeable NiCd battery module and battery charger/line adaptor, with 6 hours of in-spec operation before requiring recharge.

Size: $5\frac{1}{2}''\text{W} \times 1\frac{3}{4}''\text{H} \times 3\frac{1}{2}''\text{D}$
13.97 x 4.45 x 8.89 cm



MODEL 1455 Bench/Portable 4½ Digit DMM \$355.00

Model 1455—all the virtues of a laboratory bench instrument with the added benefits of complete portability.

A five-function multimeter featuring $\frac{1}{2}''$ high display, and 100% overranging, Model 1455 measures $100\mu\text{V}$ to 1000VDC , $100\mu\text{V}$ to 500VAC ; resistance 100 milliohms to 20 Megohms; AC and DC current, 1 microamp to 2 Amps. AC response, 30Hz to 50kHz.

Basic DC accuracy is $\pm 0.02\%$ of input ± 1 l.s.d. for 6 months. Internal NiCd battery module and line cord recharger included.

MODEL 1450 4½ Digit DMM \$325.00

The same specifications and features as the Model 1455, line operation only.



MODEL 3400 System/Lab 4½ Digit \$795.00

Model 3400 is the world's most accurate systems/lab 4½ digit multimeter. It is a fully programmable system multimeter and a highly versatile stand-alone, autoranging laboratory multimeter. Remote triggering will allow 12 conversions per second.

Full 100% overranging, basic DCV accuracy of $\pm 0.007\%$ of input ± 1 l.s.d. for 6 months, measures from ± 10 microvolts to $\pm 1,000\text{VDC}$, ACV from 10 microvolts to 750V , resistance from 10 milliohms to 20 Megohms, AC/DC and DC/DC voltage ratio.

Also available with IEEE STD 488 interface unit Model 3410.

MODEL 3400R With True RMS \$895.00

The same specifications and features as Model 3400 but with TRUE RMS AC Volts \$895.00.

Also available with IEEE STD 488 interface unit Model 3410.

COUNTERS



MODEL 3500 5 1/2 Digit Precision DMM \$995.00

The Model 3500 is a full function, auto-ranging DMM with 6 month basic accuracy of $\pm 0.007\%$ of input, $\pm 0.001\%$ f.s. ± 1 l.s.d. Remote ranging and trigger, 20% overrange and 1/2 inch planor display.

- DCV $\pm 1 \mu\text{V}$ to ± 1000 volts. AC $1 \mu\text{V}$ to 700 volts. 30Hz to 100 kHz.
- Resistance 1 milliohm to 12 Megohms.
- 1000 M Ω Input Impedance through 10 VDC. 2 and 4 wire RatiohmTM Resistance Method. DC/DC and AC/DC Ratio, BCD output and voltage ratio are included at no extra cost.



MODEL 7500 5 1/2 Digit Programmable Systems Multimeter \$2995.00 Basic Price

Model 7500 is a 5 1/2 digit multi-speed instrument that will perform a full conversion 1000 times per second! It's completely programmable in function, range, mode, timing, and conversion speeds. DCV accuracy is $\pm 0.007\%$ of input $\pm 0.001\%$ range ± 1 l.s.d. for 6 months; sensitivity is rated at $1 \mu\text{V}$ and $1 \text{m}\Omega$; DCV and ACV measurement from $1 \mu\text{V}$ to 1000V. A true universal ratiometer, Model 7500 enables the user to choose both the numerator and denominator independently, and every measurement—DC Volts, AC Volts, and Resistance—can be made on a ratio basis to any other if desired.

Model 7500 provides for full incorporation into any computer-based, high-speed, multi-channel automatic test or data acquisition system. In addition, a broad range of standard options, including built-in microprocessor-controlled IEEE 488 BUS or RS232/TTY Output.



MODEL 585 Portable, 250 MHz, 8 Digit Frequency Counter \$345.00

A completely portable—battery and line operated—8 digit frequency counter, it will measure frequency from 10Hz to 250MHz, always reading directly in MHz, with correctly positioned decimal point. Resolution 0.1Hz. It also has an excellent sine-wave sensitivity (10m VRMS to 50MHz, 50m VRMS to 250MHz). Other features: dual Input Impedance (50 Ω /1M Ω), an Attenuator, 3 gate times and bright 0.3" LED display for optimum reliability. Includes NiCD Module, Charger, and Carrying Case. Optional antenna and other accessories.

Size: 5 1/2" W x 1 3/4" H x 3 1/2" D
13.97 x 4.45 x 8.89 cm.



MODEL 5740 100MHz, 7 Digit Multifunction Counter \$295.00

The Model 5740 measures Frequency, Period, Period Average, Total Events and Elapsed Time.

The Model 5740 measures: Sinewaves, Square Waves, Pulses, Pulse Pairs, Complex Waves • Frequency: 5 Hz to 100 MHz; 10 ms/100 ms/1 sec./10 sec. gate times, resolution to 0.1 Hz
• Period: 1/2 microsecond to 0.2 sec.
• Period Average: 10, 100 and 1000 periods • Total Events: 0 to 9,999,999 (unlimited with "overflow" indicator)
• Elapsed Time: 0 to 99,999.99 sec. (27.8 hrs) • Sensitivity to 10mV.

For complete information on these and other Data Precision instruments or a demonstration, contact your local Data Precision representative or Data Precision Corporation, Audubon Road, Wakefield, MA. 01880 USA (617) 246-1600. TELEX (0650) 949341.

All instruments under \$500. available from stock at local representatives.

DATA PRECISION®
...years ahead

DATA PRECISION U.S. REPRESENTATIVES

AL (205) 533-5896	MA (617) 245-5940	NY (S) (212) 895-7177
AZ (602) 253-6104	MD (301) 384-8500	OH (N) (216) 331-0900
CA (N) (408) 733-8690	MI (313) 482-1229	OH (S) (513) 433-8171
CA (S) (714) 540-7160	MN (612) 781-1611	OK (918) 936-3631
CO (800) 528-4512	MO (816) 358-7272	OR (503) 223-7617
CT (203) 525-7647	NC (919) 787-5818	TX (N) (214) 234-4137
FL (N) (813) 294-5815	NJ (S) (215) 925-8711	TX (S) (713) 461-4487
FL (S) (305) 491-7220	NJ (N) (800) 645-8016	TX (W) (512) 837-3881
GA (404) 945-4222	NM (800) 528-4512	UT (800) 528-4512
IL (312) 593-0282	NY (N) (315) 446-0220	VA (800) 638-2720
IN (317) 293-9827	NY (S) (516) 482-3500	WA (206) 763-2210

Protection that adds value . . .

Presto!

You've got a better product.

Your customers (and your boss) will love you for it. And all you did was design in a Heinemann circuit breaker instead of a fuse.

Clever indeed. Because a blown fuse means downtime. If the customer can't solve the problem himself, or can't find a spare, it means more downtime. And possibly even a service call. That costs you plenty—in reputation as well as money.

How good it is that an inexpensive Heinemann breaker, doubling as a power switch for your front panel, can turn that downtime into uptime . . . just one more way our products add value to your products.

Find out more in your free Protector Selector—a handy reference chart loaded with specs, capabilities, and even dimension drawings for twelve top-selling protector lines. Including electromechanical, solid-state, and hybrid devices to protect all manner of loads against shorts, overcurrent, overvoltage, and undervoltage—singly or in combination. Get it from your nearby Heinemann representative (listed in EEM) or Heinemann Electric Company, Trenton, NJ 08602. (609) 882-4800.

**another reason
Heinemann is
No. 1 in OEM circuit
protection**



HEINEMANN

We keep you out of trouble.

Factories in Trenton, Montreal, Dusseldorf,
Johannesburg, and Melbourne.

CIRCLE NUMBER 20



The smart executive

Charlie started a company some years ago and it prospered. Under his guidance, it became the leader in its field as sales grew almost every year till they leveled off at about \$10-million. Then the growth stopped.

Well, not exactly. In a good year, sales would rise to 11 or 12-million dollars, and in a poor year they would drop a million or two. Meanwhile, other companies passed Charlie's company and, despite his technical prowess, his company slipped to third and sometimes fourth in its field. Charlie got upset.

Since he was responsible for the growth to \$10-million, he reasoned, others must be responsible for the stagnation. So he spent lots of time issuing directives, shifting people around and changing company policies. Mostly this didn't accomplish much except to disorient and demoralize his staff. Sometimes a policy shift brought more income—more often it wreaked havoc.

Like most of us, Charlie had an ego. So it was almost impossible for him to see that one of his policies could cause damage. Instead, he saw the problems always in terms of poor execution or, simply, underling stupidity. To make matters worse, he let his people know just how inept he thought they were.

But one day something remarkable happened. With an insight rarely granted to most of us, Charlie was suddenly able to see himself clearly. He realized that while he was really good at developing a company to \$10-million, he was poor at developing it further. So he appointed Jack to the presidency, then stepped out of his way.

Though he insisted that Jack furnish regular and detailed plans and progress reports, he steadfastly refused to interfere in the operations of the company. When an engineer, out of habit, would ask Charlie to rule on something, he'd always defer the decision with "Why don't you talk to Jack about this? He's so good at these things."

Charlie's company is now up to \$20-million a year, and everybody always marvels at how brilliant Charlie was to appoint such a fine chief executive. Everybody knows that Jack's doing a fine job running the company. But there are lots of fine company chiefs like Jack. The Charlies of this world are rare. How many people do you know who are smart enough to say, "I wasn't smart enough to do this job, so I hired somebody smarter"?



GEORGE ROSTKY
Editor-in-Chief

Simplify your life and save a little real estate.

Introducing RM5 cores . . . another small accomplishment from The Cube.

Designing filters with standard pot cores? Or transformers with 3E2A material specs? And you just don't have enough space for the core set, connection terminals and mounting clips. We can make your job a little easier.

Save up to 40% of PC board real estate

Using our new RM5 square cores and bobbins, you can save up to 40% in mounting requirements compared to standard pot cores. You save real estate with no loss in performance specs. And, you save assembly time.

Like a pot core set, the square core is assembled from core halves enclosing a wound bobbin. The wound bobbin is placed in the bottom core half; the top core is put in place; two simple spring clips hold the set together; pins at the bottom of the clips fit the standard 0.1" PC board grid, firmly anchoring the assembly. That's all there is to it!

The new RM5 square core give the circuit designer the same classic combination of high Q, high stability of inductance, reliability and repeatability of characteristics as our established RM6 and RM8 cores. For filter applications it is available in 3D3, 3B7, 3B9 and 4C4 materials. For transformer applications it is available in 3E2A material. And it is produced in ungapped, fixed-gap and adjustable gap styles. For complete specs on RM square cores, bobbins and hardware, call on The Cube.



FERROXCUBE Division of Amperex Electronic Corporation,
Saugerties, New York 12477 (914) 246-2811
A North American Philips Company

Call
on the
cube



You Don't Have To Beg, Borrow Or Buy...

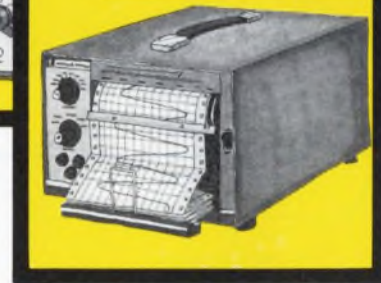
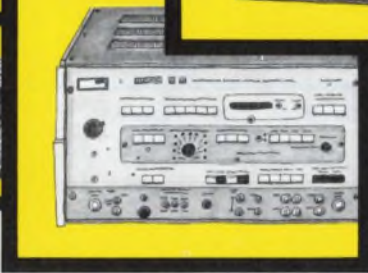
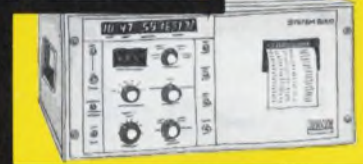
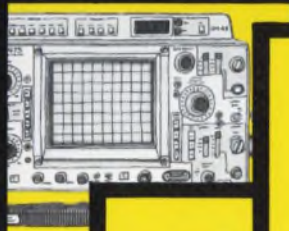
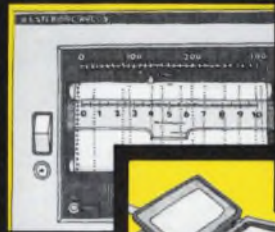
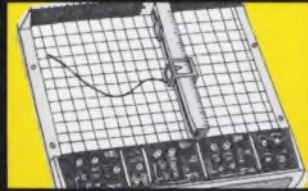

Rent'em From GE

Short or long-term instrument rentals give you flexibility and economy.

GE has over 9,000 instruments available for immediate shipment: □ Tek Scopes □ Biddle Megger Insulation Testers □ H-P Signal Generators □ Honeywell Oscillographs □ Complete Data Systems □ Esterline Angus Recorders □ GE Chart Recorders □ Modems □ Communication Terminals . . . all calibrated to the manufacturer's specs.

We have over 100 Sales/Service Centers,

and one of them is near you. In addition to maintaining our Rental Inventory, they can also repair and calibrate your own equipment.

Don't borrow someone else's GE Rental Catalog. **Call collect (518) 372-9900** or your nearest Sales/Service Center.

**Quick-rental[®]
instruments**

ALA. BIRMINGHAM (205) 925-3101 • ARIZ. PHOENIX (602) 278-8515 or 8516, TUCSON (602) 294-3139 • CAL. LOS ANGELES (213) 642-5350, SAN FRANCISCO (415) 436-9260 • COL. DENVER (303) 371-1260 • CONN. SOUTHINGTON (203) 621-4059 • FLA. JACKSONVILLE (904) 751-0610 • GA. ATLANTA (404) 457-5563 • ILL. CHICAGO (219) 933-4500 • IND. INDIANAPOLIS (317) 639-1565 • KY. LOUISVILLE (502) 452-3311 • LA. NEW ORLEANS (504) 367-6528 • MD. BALTIMORE (301) 332-4700 • MASS. BOSTON (617) 396-9600 Ext. 160, SPRINGFIELD (413) 781-1111 • MICH. DETROIT (313) 285-6700 Ext. 208 • MINN. MINNEAPOLIS (612) 522-4396 • MO. KANSAS CITY (816) 231-4377, ST. LOUIS (314) 965-7115 • N.J. CLIFTON (201) 471-6556 • N.Y. BUFFALO (716) 876-1200, SCHENECTADY (518) 385-2195 • N.Y.C. CLIFTON, N.J. (201) 471-6556 • N.C. CHARLOTTE (704) 525-0311 • OH. CINCINNATI (513) 874-8512, CLEVELAND (216) 523-6382, TOLEDO (419) 691-3501 • OR. PORTLAND (503) 221-5101 • PA. PHILADELPHIA (609) 424-4450, PITTSBURGH (412) 462-7400 • TEX. DALLAS (214) 357-7341, HOUSTON (713) 672-3570 • VA. RICHMOND (804) 232-6733 • WASH. SEATTLE (206) 854-0211 • W.V. CHARLESTON (304) 345-0920 • WISC. MILWAUKEE (414) 744-0110 • PUERTO RICO PONCE (809) 843-4225.

GENERAL  ELECTRIC



OHMITE
473A

OHMITE

**The truth about
resistors:**

THERE IS A DIFFERENCE.

If you use wirewound resistors, you probably specify either silicone or vitreous enamel coatings. Before you buy either coating, make sure you talk to someone who knows both. Because some companies that offer only one type of coating would have you believe that silicone and vitreous enamel work equally well in all applications and are therefore interchangeable.

Don't believe it.

The truth is this: many significant differences—in aging characteristics, resistance to heat, puncture, overloads and mechanical shock—not only can make a critical difference in your product's performance, but in your company's reputation, as well.

Let's look at just one coating characteristic that can make a big difference. Silicone coatings tend to out-gas, giving off silicone vapors. When a silicone-coated resistor is subjected to heavy overloads, the coating can fail catastrophically in a cloud of smoke. But even in

normal operation, silicone coatings can out-gas, contaminating sensitive equipment.

Many telephone equipment manufacturers have found, for example, that silicone deposits can foul relay contact surfaces, causing expensive maintenance and trouble-shooting headaches. So these manufacturers demand vitreous enamel-coated resistors for critical switching equipment.

Now, we're not saying that vitreous enamel is always the answer. Some applications call for vitreous. Some call for silicone. That's why Ohmite offers both. We can show you where one resistor works better and why; explain the options, costs and trade-offs involved. In fact, we can tailor a complete package to your overall resistive product requirements.

Before choosing one coated resistor over another, talk to the people who know resistors best: Ohmite.*

Ohmite Manufacturing Company, 3601 Howard Street, Skokie, IL 60076; 312-675-2600.

MAKE UP YOUR OWN MIND

Get a copy of our free brochure, "The truth about resistors:" It contains a wealth of performance characteristics and application experience covering silicone and vitreous enamel-coated resistors. Circle the reader service number for your copy today.

CIRCLE NUMBER 834

OHMITE®

makes the difference

**After all, who are you going to believe? A company that offers only silicone? Or vitreous enamel? Or a company that offers both?*

MOD-POT® offers still more. New switch. New conductive plastic element.

Allen-Bradley introduces a new rotary switch for the MOD-POT series. Designed for signal level circuits. Tested for current levels as low as 15 milliamps, with 5-volt open circuit. Plus new conductive plastic resistance elements with low turning torque for velvet-smooth rotation. And CRV of typically less than 0.2%. Linear and modified log tapers (CW and CCW) available from 100 ohms to 1 megohm. All feature smooth characteristics, particularly at resistance roll-on and roll-off positions. Come to the original source for MOD-POTS. We have what you need; our distributors have them when your need is now. Ask for Publication 5217.

Low detent torque
and low contact
resistance.

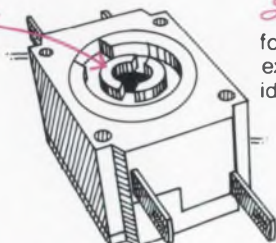

Smooth surface
for low turning torque,
excellent linearity and
ideal roll on/roll off.

*Variety of switch
options:* rotary
(CW or CCW actuation),
push-pull or momentary
push. Gang switching
capability

Vernier drives
and concentric shafts
also available.

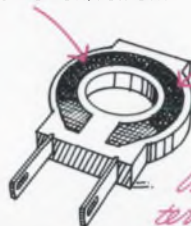

Conductive plastic
resistance track
is embedded into
substrate.

*Insert molded
terminals* Choice of
solder lug or PCB pins.



Quality in the best tradition.



ALLEN-BRADLEY
Milwaukee, Wisconsin 53204

CIRCLE NUMBER 835

EC165

Electronic Design

A probing look at key instrument areas:

What's wrong with the IEEE 488 bus.....	p. 48
Instruments that check themselves.....	p. 56
A roundup of circuit board testers.....	p. 64
Signal generators and synthesizers.....	p. 76
Temperature measuring instruments.....	p. 86
John Fluke speaks on the voltmeter.....	p. 96



ion on GenRad's new

The 1799

Digital/Analog Test System

An integrated system **designed** as a hybrid tester



Until now, if you wanted a combined digital/analog test system you had to choose between a digital tester with some added analog features or a powerful but expensive digital/analog tester which may well have had more capability than you needed. GenRad has now solved this problem by designing a fully integrated digital/analog test system in the medium-price range. By "fully integrated" we mean that the 1799 has been **designed** as a hybrid test system rather than merely being an enhanced digital

test system—as most medium-priced hybrid testers are. This means, for instance, that the software and the hardware "talk" to each other in an efficient manner, and that the measurement "instruments" (in reality, purpose-designed modules) are controlled by high-level language statements rather than a string of meaningless ASCII characters. This, and many other benefits of the integrated "second-generation" approach, makes for a more cost-effective solution to your testing problems.

The difference in software

300 BAKER AVENUE, CONCORD, MASSACHUSETTS 01742 • ATLANTA 404 394-5380 • BOSTON 617 646-0550 • CHICAGO 312 884-6900 • DALLAS 214 234-3357 • DAYTON 513 294-1500

CIRCLE NUMBER 843

Focus your attention

The 1795-HD Logic Test System

High performance at low cost



The GR 1795-HD is a new breed of logic-circuit test system. It contains the same program-preparation and diagnostic capabilities as the world-renowned GR 1792-series with CAPS, but at a much lower price. Now, for about the same initial investment required for much simpler systems, you can realize the cost effectiveness that can only

be provided by a computer-controlled, simulator-based system. The 1795-HD is ideally suited for use in manufacturing operations, service depots, and in R & D where the simulator-based system is ideal for ensuring that new designs possess a high degree of testability.

The CAPS VIII Test System software is available as an option with each of these systems. CAPS is the most proven, the most accurate and the most widely used program-preparation and diagnostic software for logic boards available in the world today. That's why we claim

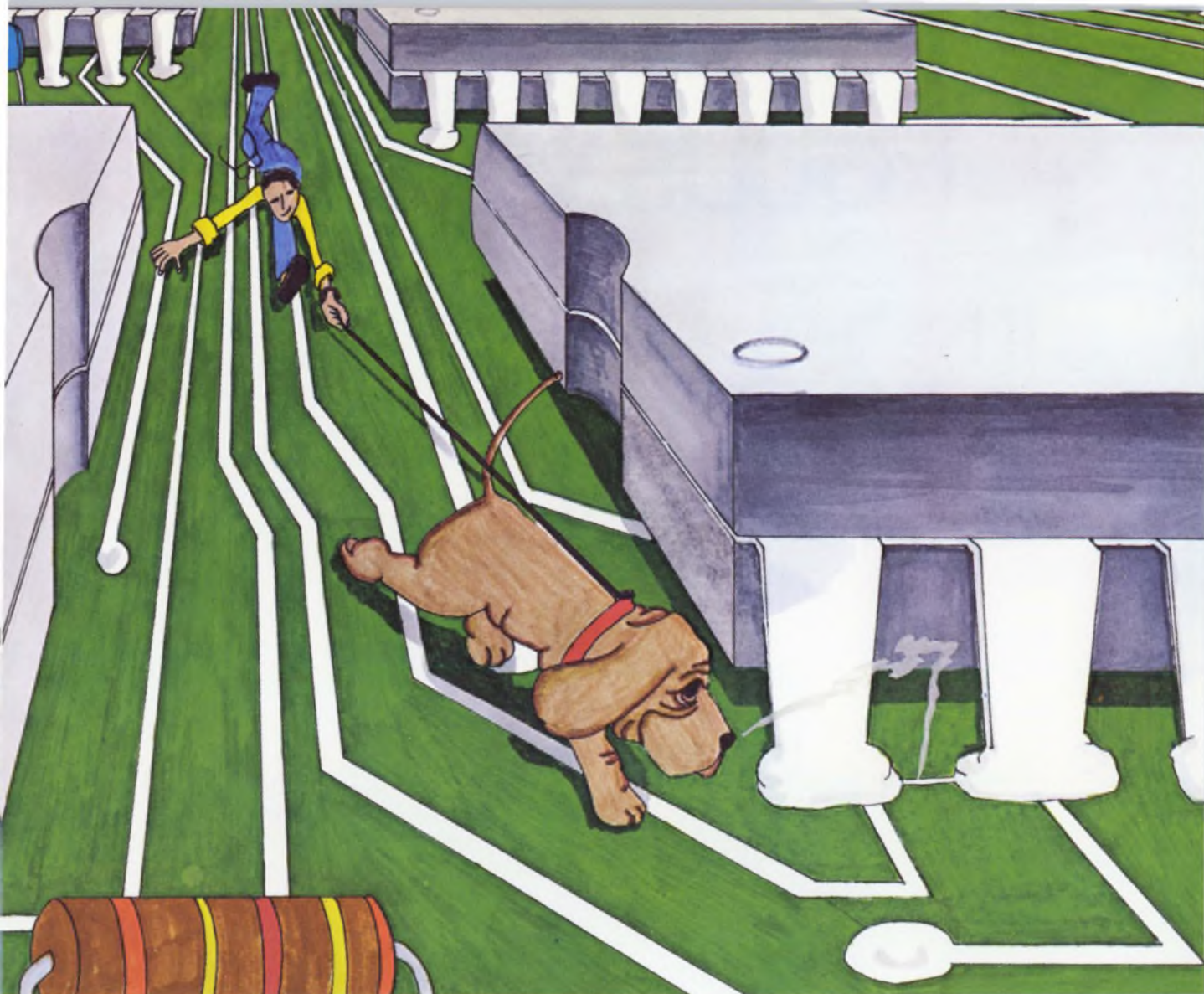

Track Down Your Faults With A Bug Hound.



The GenRad 2220 Bug Hound will track down your shorts, opens, bad ICs, etc. in a fraction of the time it takes you now, **including those hard-to-find shorts between power and ground.**

Even though your automatic board tester may be giving you good diagnostics, it is still only telling you the **electrical** location of the faults. Finding the **physical** location can still be a time-consuming and expensive task. The GenRad 2220 Bug Hound solves this problem by providing the repair technician with a variety of testing techniques in one self-contained little package.

It has a unique new phase-sensitive current-tracing probe* which makes it easy to trace the correct track even when many narrow tracks are running very close together. In addition, it has a dc tracing capability, a connectivity tester, an ac current source, and a dc current source.

The GenRad 2220 is easy to use and in most applications will pay for itself in just a couple of weeks.

*Patent Pending

300 BAKER AVENUE, CONCORD, MASSACHUSETTS 01742
 ATLANTA 404 394 5380 • BOSTON 617 846 0550 • CHICAGO 312 884 6900 • DALLAS 214 234 1357
 DAYTON 513 294 1500 • LOS ANGELES 314 540 9830 • NEW YORK NY 212 964 2722 • NJ 201 781 8990
 SAN FRANCISCO 408 985 0667 • WASHINGTON, DC 301 948 7071 • TORONTO 416 252 3395 • ZURICH 011 55 74 20



GenRad

CIRCLE NUMBER 841

Best PC Board Testers

The
1796

Digital/Analog Test System

An ATE system with large-scale integration of test capability



Complex digital boards using LSI chips such as microprocessors, RAMS, ROMS, UARTS, etc. are no longer beyond the reach of PC board testers. To diagnose boards containing such devices, GenRad designed a completely new system from the ground up... the

1796. Its technical highlights include high-speed digital driver/sensors (dc to over 1.5 MHz), sophisticated analog stimulus and measurement modules, and a flexible switching matrix and PCB interface capability.



GenRad

is the difference in testers

LOS ANGELES 714 540-9830 • NEW YORK (NY) 212 964-2722, (N.J.) 201 791-8990 • SAN FRANCISCO 408 985-0662 • WASHINGTON, DC 301 948-7071 • TORONTO 416 252-3395 • ZURICH (01) 55 24 20

CIRCLE NUMBER 844



Standard interface bus

What's wrong with 488? Not much, but. . .

Using the IEEE 488 standard instrument bus involves a lot more than buying bus-compatible instruments and a controller, taking them out of their boxes, plugging them together, and turning them on. There are problems, most of them minor. But being aware of problems *before* they happen can save hours of troubleshooting time.

The major hassle with IEEE 488 is its generality. While the standard writers tried to define the mechanical, electrical, and functional elements that allow instruments to communicate with each other over the bus, they purposely avoided restricting the operational characteristics of bus-compatible instruments so that an instrument using an IEEE 488 interface doesn't have to have a certain accuracy, speed, or set of ranges.

Doing the same thing differently

This generality, unfortunately, also means that different instruments are not prevented from doing the same things differently. Where one digital multimeter might be programmed for the 10-V full-scale range with a simple command, R10V, another DMM might require a series of seemingly meaningless alphanumeric characters.

Some examples of the commands needed to program different manufacturer's instruments are given in the applications manual for the Model 4051 graphic system controller from Tektronix Inc., Beaverton, OR. For example, 280 PRINT @W,32: "F5.67E3A1.23" sets a Wavetek Model 159 waveform generator for a 5.67-kHz sine wave with an amplitude of 1.23 V. A Fluke Model 6011A synthesized signal generator can be set

for a 1.234-V, 5.678-kHz sine wave with a similar—but not identical—command, 280 PRINT @F,32: "5.678E3H1.234V." But to set a Hewlett-Packard Model 3330B automatic synthesizer for 5.678 kHz at -9 dBm requires an entirely different command, 280 PRINT @H,32: "L5.678>N9<."

Codes even more obscure than those are applied to some frequency counters. To set a counter to remote operation and measure frequency with a gate time of 10 s, among other parameters, requires 280 PRINT @D,32: "FA+1,NNAY+Y," for the Dana Model 9000 microprocessing timer/counter; 280 PRINT @F,32: "F ØR4" for the Fluke Model 1953A universal counter/timer; and 280 PRINT @H,32: "E8FØGØ E9I1J1" for the Hewlett-Packard Model 5345A electronic counter.

Besides shying away from limiting the operation of an instrument, IEEE 488 was made general enough to simplify adding a compatible interface to older products, says Maris Graube, corporate interface engineer at Tektronix. Older instruments that are designed to communicate via relatively simple binary-coded decimal ports cannot easily be converted to IEEE 488 interfaces if the conversion requires a change in the coding within the machine, says Graube. "The tendency was to make the specification weak so that previous instruments meet the standard."

Flexibility isn't all bad

The coding flexibility can also help the instrument user, points out Don Loughry, corporate interface engineer at Hewlett-Packard Co. of Palo Alto, CA. The communications code can be chosen to take maximum advantage of the interface bus.

In transmitting data from an autoranging digital voltmeter, for example, both a floating point and

exponential response can be the simplest and least expensive to generate. Where very high speed is required, as in a data acquisition system, fixed-point numbers may be preferable.

Since the needs of the many engineers who join instruments into systems differ widely, a fixed standard could not meet even a majority of those needs, says Loughry. But a Recommended Practice is being developed to cover preferred methods for coding data for transmission on the IEEE bus. The document may be in the final stages of publication before the end of the year.

This addendum to IEEE 488 may solve another data-coding problem: Which bit first? Data words are sent over the bus's eight data lines in a bit-parallel, byte-serial format. But while the eight data lines determine which bit is most significant, the standard does not specify which byte—the first or last sent down the line—is most significant.

The user must determine which order an instrument's manufacturer has chosen by carefully examining the instrument's instruction manual. The system controller must then be programmed to organize the data bytes from each instrument in the proper sequence before performing any other operations on the data.

The recommended method for transmitting data is most-significant digit or character first, says HP's Loughry, and this technique will be incorporated in the document now being prepared.

Instruction manuals provided with bus-compatible

instruments also come under fire from some users. Often, precious little space is devoted to explaining how the bus operates and how the instrument's quirks affect its operation on the bus, says Dale Mack, development engineer in switch design at Tektronix. Worse yet, says Mack, most manuals have no sample programs to help the user develop his own system.

Manuals should get better

Instruction manuals should improve as manufacturers gain more experience building and applying bus-compatible instruments, and learn the best ways to take advantage of the standard interface. Not only that, but as more bus-compatible instruments are designed, sections dealing with the IEEE bus in their manuals will be improved versions of sections on the bus in current manuals. Since instruction books are usually written just as a product's design has been completed and production is about to begin, there is rarely enough time to write a thorough document from scratch. Instead, parts of previous manuals are reorganized and rewritten to match the differences between an older product and a new one, according to the senior technical writer at one instrument maker.

Yet another bus-related problem is EMI. But incorporating the standard interface into new instruments rather than adding it on to older designs, may help alleviate this bother.

Either the high-frequency square-wave clock of a

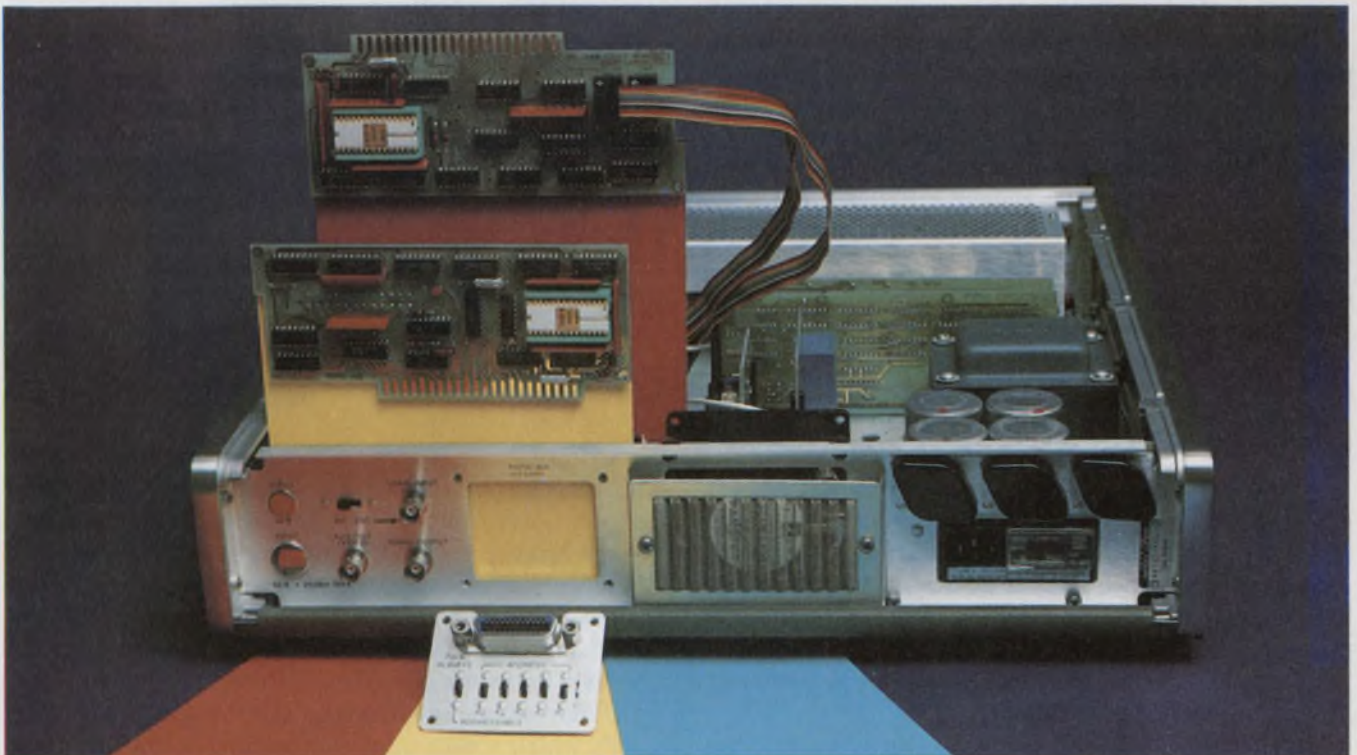

More instruments are getting on the bus. In this Hewlett-Packard 5341A microwave counter, the yellow-marked

card handles the bus protocol and the red-marked card converts data to a byte-serial, bit-parallel format.



The bus puts it all together: A Fluke 5100A calibrator provides signals and an 8500A DVM makes measurements

under the control of a Tektronix 4051. Here, they check the calibration of a hand-held DMM.

system controller or the clock signal built into an instrument's IEEE-488 interface-conversion board can generate enough electromagnetic interference to affect the readings of a very sensitive instrument such as a microvoltmeter or a picoammeter, says Frank Capell, product planning manager in the precision instruments business unit at John Fluke Mfg. Co., Inc., Mountlake Terrace, WA. But newer instruments can use the clock signal already in the product, instead of generating it separately for the interface board. This, along with more careful shielding, should help minimize the EMI problem, says Capell.

A matter of interpretation

Manufacturers' varying interpretations of IEEE 488 can also cause headaches, Capell adds. In one case, the controller built by one manufacturer responds to a request for service from a device on the bus when it sees a transition from ZERO to ONE on the service-request line. A controller built by another manufacturer responds to a voltage level on the service-request line.

Until engineers closely examined its operation, the former controller would intermittently fail to respond to a service request. "When things were thrashing

around, the controller ignored the signal," says Capell. If the controller was busy when the edge occurred, it missed the transition and could not respond to the request. "The whole bus would hang up, waiting for a response," Capell recalls.

The devices on the bus all met the standard. The controller met the standard. But problems still occurred because of ambiguities in IEEE 488.

The document talks about sending messages, and relates messages to specific voltage levels, notes HP's Loughry. The best way to guarantee meeting the spec is to design equipment to respond to levels. But, Loughry admits, "the way devices are built, they do trigger on an edge."

Different controllers also require different program languages, points out Joe Flink, vice-president of product development at Rockland Systems Corp., West Nyack, NY. While most use some version of Basic, a fairly easy program language to learn, some controllers use a completely different nomenclature.

"Each language has its own particular quirks," agrees Tektronix' Graube. Different languages have different advantages that can affect the ease and speed with which a controller can perform a specific function, he says. These varying good points also make it difficult to choose among the available products.

Computers are powerful controllers

The limitations on the IEEE-488 bus imposed by the relatively slow speed and inflexibility of calculator-based bus controllers can be overcome by making a minicomputer or single-board computer the core of an instrument system. Several suppliers make interfaces to the standard bus:

- Hewlett-Packard, which conceived the bus system, has been selling an interface package for its 21MX and 2100-series minicomputers through its Data Systems Division in Cupertino, CA, since last spring. Called the 59310B, the \$1000 hardware and software package enables a single mini to control several instrument clusters, allows the user to prepare programs on one terminal while the computer is

executing test programs from another terminal, and operates with more than one programming language.

- Digital Equipment Corp. supplies the IBV-11 to interface the firm's LSI-11 computer systems to the bus. The \$750 package consists of a printed-circuit card, a cable that ends in a 488-standard connector, a software package and sample programs.

- Ziatech Corp. of Cupertino, CA, has developed an interface card to tie the SBC 80 single-board computer into IEEE-488 instrument systems. The ZT 80 can plug directly into an SBC or MDS backplane and handles interface actions with its own 8080 micro-processor. An on-board memory on the \$950 board handles bus protocols and data buffering.

"I'm not sure how someone selects a controller without a knowledge of computers," says Graube.

Watch out for limits, too

While some difficulties with the IEEE bus stem from a lack of specifics, some users feel that problems may also be caused by restrictions the standard document does have. For example, no more than 15 devices may be interconnected by one contiguous bus. Moreover, the total transmission path length over the interconnecting cables cannot exceed 20 m. And the data rate across the interface on any signal line cannot exceed 1 Mb/s.

These limits cover the majority of systems likely to be tied together via a standard interface bus without excessively high costs, says HP's Loughry. Some

users, like Tektronix' Mack, think the limitation on the number of instruments could someday be a problem, though it hasn't proven so yet. The largest system Mack has so far put together, a tester for measuring switch contact resistance and bounce, ties only five instruments to the bus.

The bus's speed is sufficient, says Mack, though some of the instruments built to use the bus don't take full advantage. They take much longer than necessary to acknowledge the receipt of commands or data, and Mack would like to see manufacturers build-in faster handshake logic.

Meanwhile, as if there weren't enough problems, the International Electrotechnical Commission has its own version of the standard. So far, IEC's Technical Committee 66, Working Group 3, which was responsible for drafting the document, hasn't been able to choose an appropriate connector. While most American representatives favor a 24-pin connector that is common in the United States, some European manufacturers prefer a 25-pin connector more readily available in Europe.

Which version do you use?

As it stands now, the IEC's standard is identical to IEEE 488, except that it lacks a mechanical section. A separate document has been drafted to cover the mechanical requirements of the standard bus, including the 25-pin connector. But for the time being, users of the standard bus must specify that products they buy conform to IEEE 488. Products that comply with another version of the standard, like the IEC's, may not meet the same requirements.

But even with the problems, most bus users are happy with IEEE 488. "The fact that you can plug things together easily is of enormous benefit," says Rockland's Flink. "It's not the best, but it's certainly a great step forward," says Tektronix' Mack. With a little perseverance, an engineer can make good use of the standard, they agree. ■■



Basic-language programming and the standard bus simplify assembling test systems like this one with a Systron-Donner controller, DMM, counter, and power supply.



Choice!

New Dale MSP Networks let you match profile, power and package to meet your resistance needs.

Dale's new MSP single-in-line networks are the shape of things to come in resistance. Rugged. Machine insertable. And available in your choice of profiles: .350" with up to .3 watts per resistor or .195" (.19 watts) to meet critical board spacing requirements. Both are molded for extra protection. Both give you the kind of quality assurance we developed for Dale's SDM—the first network to meet MIL-R-83401. Sample the MSP now. It's available fast in quantity from stock... and it's only part of Dale's complete line of SIP and DIP networks.

Contact your Dale Representative or phone 402-371-0080

DALE ELECTRONICS, INC.
Box 74, Norfolk, Nebraska 68701
In Canada: Dale Electronics Canada Ltd.
In Europe: Dale Electronics GmbH,
8 Munchen 60, Falkweg 51, West Germany
A subsidiary of The Lionel Corporation.

CIRCLE NUMBER 351

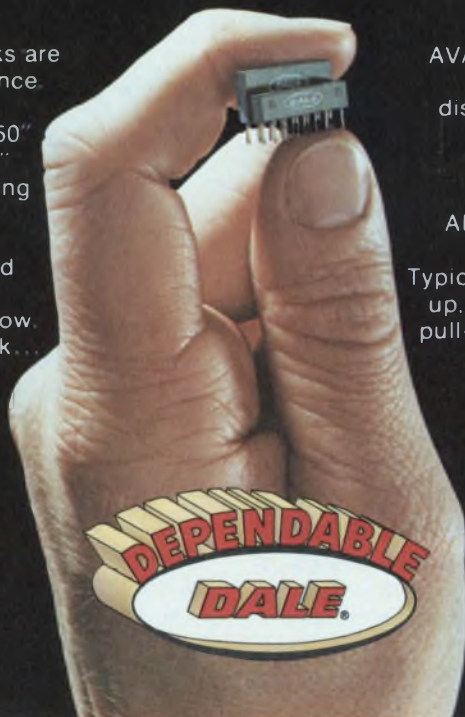

AVAILABLE FAST: .350" model (MSPXXXC) available in 1 week from factory or from distributor stock. 6, 8 or 10 pin models (-01 circuit) in 49 standard values. Consult factory for fast delivery times on other configurations and schematics.

APPLICATIONS: Standard circuit (-01) has 5, 7 or 9 resistors with 1 pin common. Typical applications include "wired OR" pull-up, power gate pull-up, MOS/ROM pull-up/pull-down, open collector pull-up, TTL input pull-down, TTL unused gate pull-up.

SPECIFICATIONS: Power: .350" model—3 watts max. per resistor; .195" model—19 watts max. per resistor. Resistance: 33 Ω to 1 Meg. standard. Tolerance: $\pm 2\%$ standard, T.C. ± 100 PPM/°C. T.C. Tracking: 50 PPM/°C. Operating Temperature: -55°C to +125°C.

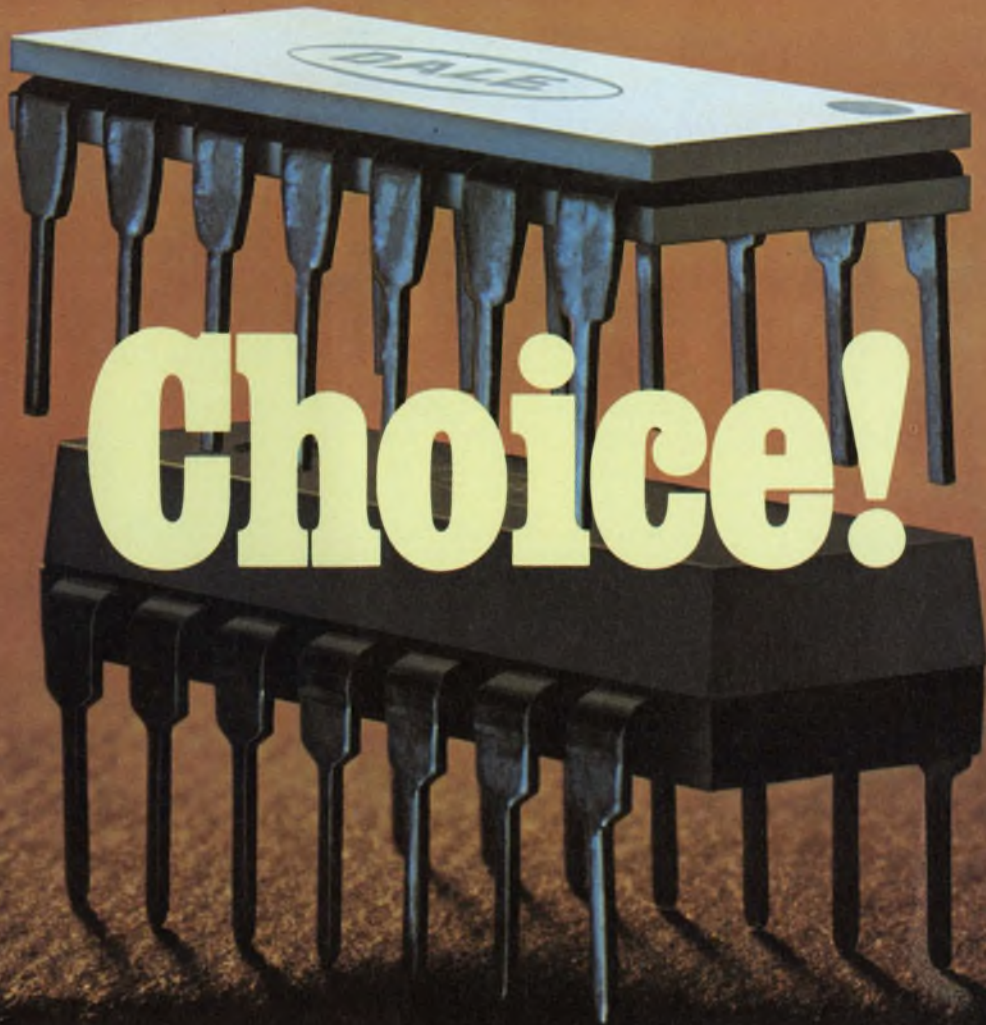

Dale DIP Resistor Networks meet your industrial and military requirements—from stock!

If you're using, or designing-in, thick film resistor networks—talk to Dale. Our DIP team features the MDP, a rugged new molded package ideal for low-cost industrial applications plus our SDM, the first dual-in-line network to be qualified for MIL-R-83401. Both give you time-saving availability from distributor or factory stock in 14 and 16 pin packages with a choice of two popular schematics. Write for sample of the MDP. It's machine insertable...interchangeable...and very competitively priced.

Contact your Dale Representative or phone 402-371-0080.

DALE ELECTRONICS, INC.
Box 74, Norfolk, Nebraska 68701
In Canada: Dale Electronics Canada Ltd.
In Europe: Dale Electronics GmbH,
8 München 60, Falkweg 51, West Germany
A subsidiary of The Lionel Corporation



AVAILABLE FAST: Both MDP (molded) and SDM (MIL-R-83401) immediately available from factory or distributor stock in 14 and 16 pin models. MDP available in 49 stock values from 33 Ω to 1 Megohm, 2% tolerance, 100 PPM/°C. SDM available in 18 stock values from 100 Ω to 100K Ω (2% tolerance, "M" or "K" levels).

STANDARD SCHEMATICS: 01 — 7 or 8 isolated resistors. 02 — 13 or 15 resistors with one pin common. Applications include: pull-up, pull-down, impedance balancing and current limiting. Other schematics also available.

For SIP resistor networks, ask about Dale's MSP. Available from stock in 6, 8, 10 pin models.

Quality Capacitors for the Automotive, Computer, Home Entertainment and Industrial Electronic Industries:

Aluminum Electrolytic Capacitors, Ceramic Capacitors, Film Capacitors, Oil Filled Capacitors—without P.C.B.'s, Metallized Paper Capacitors and Wax Paper Capacitors

REPRESENTATIVES

ALABAMA
Interop Assoc., Inc.
(205) 881-3677

ARIZONA
Chaparral-Dorton
(602) 263-0414

CALIFORNIA (Northern)
I² Incorporated
(408) 985-0400

CALIFORNIA (Southern)
J. J. Riley Assoc.
(213) 374-3468

COLORADO
Electrodyne
(303) 757-7679

FLORIDA (Northern)
This territory available.

FLORIDA (Southern)
This territory available.

GEORGIA
Interop Assoc., Inc.
(404) 394-7756

ILLINOIS
Midwest Electronic Ind.
(312) 777-9700

INDIANA
Midwest Electronic Ind.
(317) 253-0590

IOWA
Midwest Electronic Ind.
(319) 362-4410

KANSAS
Dy-Tronix, Inc.
(816) 737-1100

MASSACHUSETTS
This territory available.

MICHIGAN
Greiner Assoc., Inc.
(313) 499-0188

MINNESOTA
Robert W. Marshall Co.
(612) 929-0457

MISSOURI
Dy-Tronix, Inc.
(314) 731-5799

NEBRASKA
Dy-Tronix, Inc.
(816) 737-1100

NEW JERSEY (Northern)
Dolan Assoc.
(201) 382-2797

NEW JERSEY (Southern)
BGR Assoc.
(215) 657-3301

NEW YORK (Bohemia)
Migra Electronics
(516) 567-3555

NORTH CAROLINA
Component Sales
(919) 782-8433

OHIO (Cleveland)
KW Electronic Sales, Inc.
(216) 831-8292

OHIO (Dayton)
KW Electronic Sales, Inc.
(513) 890-2150

OHIO (Worthington)
KW Electronic Sales, Inc.
(614) 888-0483

PENNSYLVANIA (Eastern)
BGR Assoc.
(215) 657-3301

PENNSYLVANIA (Western)
KW Electronic Sales, Inc.
(412) 487-4300

TEXAS
William Reese Assoc.
(214) 638-6575

UTAH
Electrodyne
(801) 486-3801

WASHINGTON
Ray Over Sales
(206) 454-4551

BRITISH COLUMBIA
(Vancouver)
Ray Over Sales
(206) 695-6179

DISTRIBUTORS

West Coast

LOS ANGELES, CA
JACO Electronics
(213) 887-6400

PALO ALTO, CA
Eric Electronics
(415) 969-4500

SEATTLE, WA
Bell Industries
(206) 747-1515

Midwest

BEACHWOOD, OH
Sheridan Sales Co.
(216) 831-0130

CHICAGO, IL
Hall Mark Electronics
(312) 437-8800

CHICAGO, IL
Midwest Electronic Ind.
(312) 777-9700

DALLAS, TX
Hall Mark Electronics
(214) 231-6111

DALLAS, TX
KA Electronic Sales
(214) 634-7870

DAYTON, OH
Sheridan Sales Co.
(513) 277-8911

FARMINGTON, MI
Sheridan Sales Co.
(313) 477-3800

FLORISSANT, MO
Sheridan Sales Co.
(314) 837-5200

INDIANAPOLIS, IN
Sheridan Sales Co.
(317) 547-7777

MINNEAPOLIS, MN
Hall Mark Electronics
(612) 925-2944

OVERLAND PARK, KA
Sheridan Sales Co.
(913) 383-1636

READING, OH
Sheridan Sales Co.
(513) 761-5432

East Coast

HUNTSVILLE, AL
Hall Mark Electronics
(205) 539-0691

FT. LAUDERDALE, FL
N.R.C.
(305) 792-2600

ORLANDO, FL
Hall Mark Electronics
(305) 855-4020

HAUPPAGUE, LONG IS.
JACO Electronics
(516) 273-5500

BOHEMIA, NY
A.D.I. Electronics
(516) 567-3555

PHILADELPHIA, PA
Hall Mark Electronics
(215) 355-7300

PITTSBURGH, PA
Sheridan Sales Co.
(412) 244-1640

Canada

MONTREAL, QUEBEC
Audio Electronics, Inc.
(514) 735-6197

TORONTO, ONTARIO
Audio Electronics, Inc.
(416) 459-0720



NICHICON (AMERICA) CORPORATION • 6435 N. Proesel Ave. • Chicago, IL 60645 • (312) 679-6530
Division of NICHICON CAPACITOR LTD., Kyoto, Japan

The pulse of the industry.



CIRCLE NUMBER 23

Amphenol® 17-Series
rear-release
connectors,
contacts, and
crimpers.

Now with
insulation-support
crimp-contact
back end.

You asked for it. With our 17-Series, you can crimp any conductor size from 22 to 26 AWG and also crimp the insulation up to a maximum of 0.050" OD.

The connectors are 50% less costly to assemble. Snap several of our crimp Poke-Home® contacts in place in the time it normally takes for a single contact inserted with a tool. You can cut labor costs in half.

The contacts mean big savings for volume users. With our 15,000-contact capacity reels, you can save a bundle over loose contacts.

Our high-speed crimpers lower costs even more. Completely eliminate stripping with our stripper-crimper (up to 1500 terminations per hour). Our semi-automatic crimping machines handle up to 2000 terminations per hour. And our new hand crimp tool makes accurate, identical crimps—time after time.

Get them all — connectors, reeled contacts, crimpers. And get them now. For more details, call: Bob Ashley, (312) 986-3673 or write: Amphenol North America Division, Bunker Ramo Corporation, Dept. C17B, 900 Commerce Drive, Oak Brook, Illinois 60521.

The right idea
at the
right time.

Hand crimpers
and semi-automatic
crimping machine.



AMPHENOL



CIRCLE NUMBER 24



Self-testing

What's wrong with your instrument? It may tell you

“E 77, 4D01, +0.09032...” This isn't a coded communiqué from James Bond, but encrypted messages sent by ailing test and measuring instruments. Indeed, equipment that can calibrate, correct, test or diagnose itself—and tell the user what's wrong—may soon become commonplace as the latest spectrum analyzers, digital voltmeters, logic analyzers, X-Y recorders and other instruments move into lab, field and production. The benefits of such equipment are many; the disadvantages seem few.

Among the advantages: Calibration and maintenance are simpler, calibration periods are longer, troubleshooting is easier, and down time is shorter. In addition, users have more confidence in instrument measurements especially in unattended or automatic measurements. And in some cases, instrument performance is boosted.

The disadvantages aren't as easy to spell out, but a few critics of self-test say that the benefits are costly and don't necessarily justify the extra expense. Proponents reply that self-test mostly comes free. However, the two sides agree that not every instrument lends itself to self-testing.

Candidates for self-analysis

For example, equipment that is mainly analog in nature, like scopes and signal sources, doesn't. But a digitally based instrument, like a logic analyzer or DVM, does. Instruments that carry some sort of processor are natural candidates for self-analysis. In fact, the rise of self-calibration and diagnosis goes hand-in-hand with the rise of so-called “smart” test equipment.

Certainly, the introduction of microprocessors into

some T & M equipment is questionable. But once the μ P is tucked inside, it can easily make decisions and provide the control switching and storage needed for diagnostic routines and correcting errors.

One of the first instruments to feature μ P-controlled self-calibration and diagnosis is Systron-Donner's 7115 5-1/2-digit DVM. In the 7115, autocalibration reduces the number of possible error-producing components from about 33 to just four resistors and a voltage reference. Autocalibration occurs automatically at power up, or after every 100th, 1000th, or 10,000th measurement (as the user desires), or on an external command.

During autocal, the 7115's 4004 μ P makes 16 measurements that cover all the zero and full-scale points of all modes and ranges. The results of the measurements are stored as constants, which are applied



Diagnostic decisions: After the Tektronix 851 tests other equipment, it can help test itself. Just plug in the probes, step through the function switch and read the display.

Stanley Runyon
Senior Associate Editor

to a universal correction equation to give the final reading.

The constants also play a part in fault diagnosis. They take on predetermined error ranges based on the maximum expected drift caused by aging, temperature and other factors. If a constant exceeds the preset range, a warning indicator lights or an electrical flag is set. In effect, the instrument tells the user: "Investigate me; I might fail."

To check out the warning, a user lifts the 7115's cover, operates a diagnostics switch and, at the touch of a button, calls up each of the calibration constants for display on the unit's front-panel LEDs. A troubleshooting chart then directs him to a failed or suspicious board or component. Additional internal LEDs—34 of them—indicate operational status or possible failures.

To μ P or not to μ P

A microprocessor isn't mandatory for self-test, however, as Hewlett-Packard aptly demonstrated five years ago in its Model 3490A DMM—perhaps the first such instrument with extensive, built-in diagnostics. At the flip of a switch, the 3490A checks its timing signals and autoranging circuits, validates most of its logic, checks its 6-digit display, and displays results. The key? A microprogrammed, 4096-bit ROM.

HP's latest systems DMM, the μ P-based 3445A, goes even farther, with both autocal and a test function. In the 3445A, only four manual calibration adjustments are necessary—two each for dc volts and ohms. They are made on a rear-mounted plug-in

reference module that can be taken to a calibration lab without disturbing the input connections.

Since the modules are interchangeable, the DMM can go right on working once a spare module is plugged in. With the new module in, the instrument proceeds to eliminate gain and offset errors from its measurement results. How often depends on the DMM's operating mode.

When the 3445A is placed in the self-test mode, it compares all its autocalibration measurements against internally stored limits. If a measurement is out of tolerance, a number between 1 and 15 is displayed to indicate the source of the problem. A troubleshooting chart then points the way to the most probable cause.

Another systems DVM—from the industry leader in DVMs, John Fluke Manufacturing Co.—offers something called calibration memory. The feature is an option in its 8500A, an advanced bus-structured instrument in which each of the various functions, or modules (dc conditioning, ohms, ac, a/d conversion, etc.) resides on an I/O bus, each with its own address.

For every range and function, the calibration memory contains adjustment factors, which are obtained by taking readings at cardinal points while the instrument is in the cal mode. Once the range-cal error is in storage, the unit automatically computes the needed zero-to-end-scale correction and adds or subtracts it from the display.

When the 8500A is switched off, the cal correction can remain in storage for at least 90 days, taking power from an internal back-up battery. As a result, the unit can stay in the field longer before it is brought in for calibration certification.

Correction factors for zero drift, standard in the Fluke unit, are also stored. The zero offset in the most sensitive dc range is keyed into memory with a single stroke. Once stored, the offset disappears from the display and is automatically eliminated from all dc and ohms readings.

Getting better

Fluke's DVM is one example of performance being boosted by error-correcting techniques. The 8500A converts its input signals to digital form with a modified version of the company's well-known recirculating-remainder technique. The modification speeds up conversion tenfold by subtracting or adding correction values during successive steps in the conversion process. Interestingly, the 8080 μ P in the 8500A doesn't take part in the bidirectional correction technique.

Although the 8500A doesn't carry extensive self-test features, it can show any of 10 different error codes to identify some operator mistakes or internal hang-ups. For instance, if the filter module doesn't complete an I/O handshake, the DVM will so indicate. If the operator selects an invalid function—for example, a current measurement without a current-shunt module



Self-test in the HP 1602 logic-state analyzer provides verification of both operation and diagnostic routines. Error messages are displayed on the unit's readout.

—an error will be displayed and operation may be halted until a correct selection is made.

Another instrument is smart enough to test itself before it goes to work—the 4662 interactive digital plotter from Tektronix, the first one able to talk back to its host controller. When the 4662 is powered up, it automatically checks its RAM buffers and the ROM holding the controlling program. Then the pen moves automatically to the lower right corner to locate a reference, and the selected interface is enabled. Should an error be detected, the 4662 sounds a plotter bell.

Another self-test in the Tek plotter runs through a predetermined plot that lets the user examine all mechanical and electrical functions, excluding the interface.

If self-calibration makes a user more confident about an instrument's accuracy, and self-test ensures that an instrument is within specification, then the next giant step—self-diagnosis—makes life easier, if not for the user, then certainly for service personnel. This capability is demonstrated by some Hewlett-Packard logic and spectrum analyzers—instruments with perhaps the most extensive self-test and diagnostics available.

No price for self-analysis?

The HP instruments are evidence that diagnostics is not only a necessity in complex equipment, but that it is almost free if it is made part of a design right at the start.

Only 700 bytes of memory plus one I/O bit are needed for self-test in the 1602A, HP's latest logic-state analyzer. This feature costs only \$20 or \$30 in an instrument that goes for \$1800. The 1602 runs about 35 self-tests on power up to check ROM, I/O, read/write memory and other parts. If all is OK, all the LEDs light (all segments). If a failure shows up, the 1602 takes note, completes the remaining tests, then blinks an error message—E99.

To find out what failed, the user presses the "d" key, which causes the self-test to repeat. The 1602 stops at the first failure, and displays a detailed error message along with various test parameters. Pressing any key steps the self-test to the next test segment.

The 1602's keyboard can also be tested—with the 1602's help. Power is cycled off, then on, with the "C" key depressed, and resident diagnostics are called up. Then all 35 keys are pressed in a predefined order. A failed key produces an error message.

Another HP logic-state analyzer, the 1611A, also checks itself when the power goes on. It performs a checksum to verify its ROM contents, writes a test pattern to its RAM, and reads the pattern back to check accuracy. If all's well, "SELF TEST COMPLETED" is written on the unit's CRT—all under the control of a microprocessor.

Self-test in logic analyzers was originally intended to be part of the service procedure, according to Al DeVilbiff, design engineer for HP. But so well did the

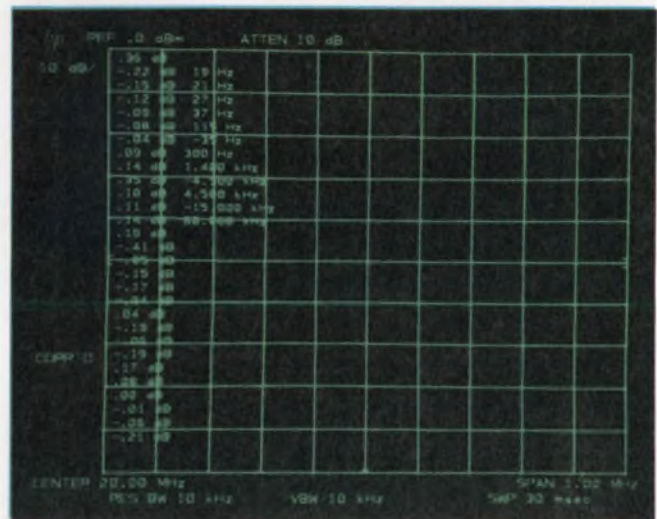

Without opening the cover, the user of this advanced HP spectrum analyzer (top) can check operation and localize failures. Data for correcting amplitude and frequency uncertainties can be measured, stored and displayed on the unit's own screen (bottom).

feature work—and inexpensively—that it is now aimed at users as well as service people.

Hal Goldberg, president of Data Precision, a noted test-equipment vendor, considers self-test useful in complex or automatic test equipment. But in other cases, it's a marketing ploy, not worth the extra money. Goldberg, too, sees service technicians and repair shops as the main benefactors.

Bill Giles, chief engineer for DVMs at Systron-Donner, believes that self-diagnosis at least should be incorporated only where applicable and aimed at service personnel who know what they're doing, not uneducated operators who may foul up the works. Otherwise, Giles feels, self-diagnosis, too, is simply a marketing gimmick.

Although self-test appears natural for some instruments, there may be a natural reluctance to offer the feature for another reason: It may be too effective.

Too much of a good thing?

When an instrument tests itself without being asked each time it's turned on, "minor" failures may be

indicated a bit too often. An untrained operator may interpret an error message to mean that his machine is broken, whether it is or not. And one thing manufacturers don't want is an increased warranty return rate.

Of course, self-test can be aimed at the major functional blocks, and the nitpicking ones eliminated from the instrument's repertoire. But with complex equipment, defining what constitutes a failure may not be so easy. And as HP's DeVilbiff points out, self-test can be better than human observation because a human's ability to recognize patterns is limited. On the other hand, a μP may not ignore a pattern seen as innocuous by a human.

Superior or not, self-test hasn't reached the point where troubleshooters can throw away their scopes and pulse generators. Far from it. Calibration labs needn't worry, either. Standards must still be kept and equipment calibrated to those standards. And many instrument makers, Philips Test and Measuring Instruments for one, don't offer the feature.

Stu Rauch, product engineer at Philips, puts self-test into perspective: "It's not really valid in, say, an oscilloscope unless the scope has digital data-domain techniques or storage. But with instrument systems or logic analyzers, self-check is easy to do without adding a lot of hardware. Calibration, however, is another story. That's a matter of strict design."

When asked if the recent appearance of μP s in scopes heralds the coming of self-cal in that breed of test instrument, Rauch declared that " μP s are appearing in scopes for one reason—they're a hot item, a user confusion factor, like fins on cars." Unlike scopes, however, spectrum analyzers are likely candidates for self-analysis, according to Rauch.

As a matter of fact, Hewlett-Packard has unwrapped a top-of-the-line spectrum analyzer with extensive self-cal and diagnostic features. As complex a free-standing instrument as is likely to be found, the HP 8568A sports not one but three internal processors.

Self-improvement is the best kind

Among the 8568A's "introspective" features are automatic calibration and correction for certain sources of amplitude and frequency uncertainty and a host of service aids that help localize hardware failures. With self-correction, amplitude uncertainties plunge from ± 3.6 dB to a low ± 0.4 dB. With its other inaccuracies added in, the HP unit measures down to -70 dBm with a total accuracy of ± 2 dB, and to a rockbottom ± 139.9 dBm, with 3-dB accuracy. These routine measurements require none of the elaborate, painstaking procedures usually associated with such signal analysis. Frequency correction is also routine.

For self-diagnosis, the HP analyzer exercises its I/O bus on turn-on, displays the status of various circuits on its CRT and offers shift-key functions for other checks. On top of these capabilities, the instrument



Self-calibration in a smart DMM consists of removing a reference module (top), adjusting the ohms and dc V functions, and replacing the module. You then hit the auto cal button (bottom), and the unit quickly corrects itself.

is designed for servicing with a desktop computer and with signature analysis, an HP troubleshooting technique that is rapidly finding its way into much of the company's new equipment. The 1611A logic-state analyzer also uses it. (For a detailed description of signature analysis, see ED No. 7, March 29, 1977, p. 19).

Meanwhile, various forms of self-test or self-cal have found their way into a wide variety of products. The line-up includes counters like Dana's 9000 micro-processing counter-timer, gauging systems like Moxon's 360 multipoint gauger, component testers from GenRad and an all-in-one digital tester, the Tektronix 851 multimeter/counter-timer/logic indicator.

What's next? Taking a cue from the available bibliography on redundant circuits, and considering the ever-increasing density and continually plunging prices of ICs, it isn't too hard to envision an instrument that can repair itself.

Sounds crazy? At least one engineer, HP's Mac Juneau, doesn't think the idea is far-fetched: "With LSI chips as big as the ones now coming out, I'd be very surprised if we didn't end up with, say, voltmeter front-ends that could be switched out if tested bad, with a new front-end switched in. The instrument could change its own parts automatically—all you need are a couple of scanning switches."

DVM, heal thyself. ■■

We started with the world's first miniature Dual In-line Package switch and now have types ranging from new mini-matrix slide switches and coded rotary switches to LED and side-actuated DIP types, to name a few.

And as we have from the beginning, we stand behind every one of them, new or old, with an offer of solid, technical support. Not because they need it. But because we believe you as an engineer, are entitled to it when you innovate. It's the kind of full support that says we're ready to work with you not only in product application and production but even earlier, in research and development, if you desire. And we think you'll find it a good way to keep an eye on the future of switching.

Among the most popular of our "future" switching innovations is the unique Mini-Matrix Slide Switch. It's especially useful for logic level matrix, switching applications. And our new programmable DIP Shunts offer another easy way to program manually. By simply opening or closing conductive straps.

But perhaps the most revolutionary switch of all is our unique, patented coded rotary switch. It switches the circuit instead of the contacts. Just as new, is our DIP Network Switch. It's designed for use with thick film capacitor and resistor chips for impedance switching and time delay functions.

As you can see, there are many more switching innovations, like our Standard Rotary switches and Pull-to-set types. For more information, just call AMP Customer Service at (717) 564-0100. Or write AMP Incorporated, Harrisburg, PA 17105.

AMP has a better way.

AMP
INCORPORATED
CIRCLE NUMBER 25

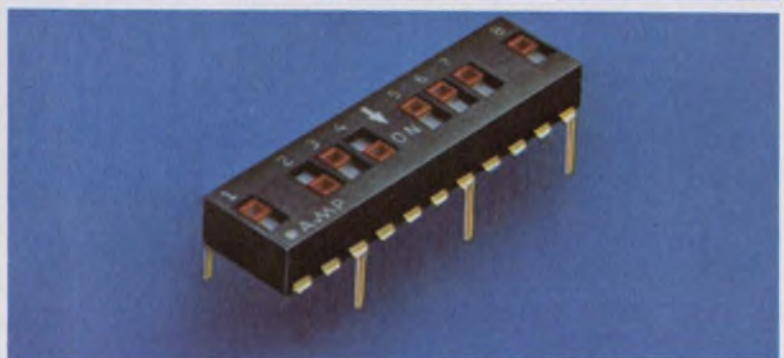
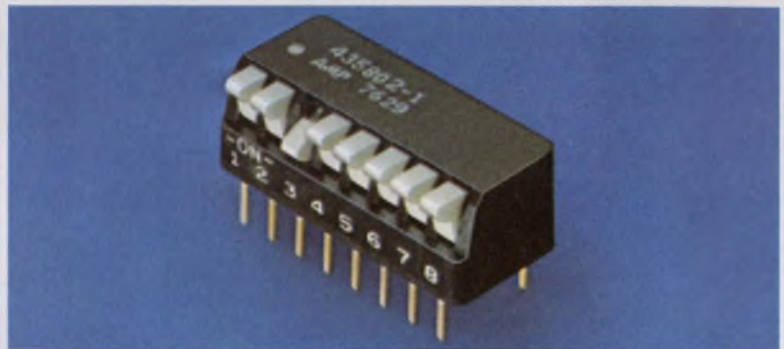
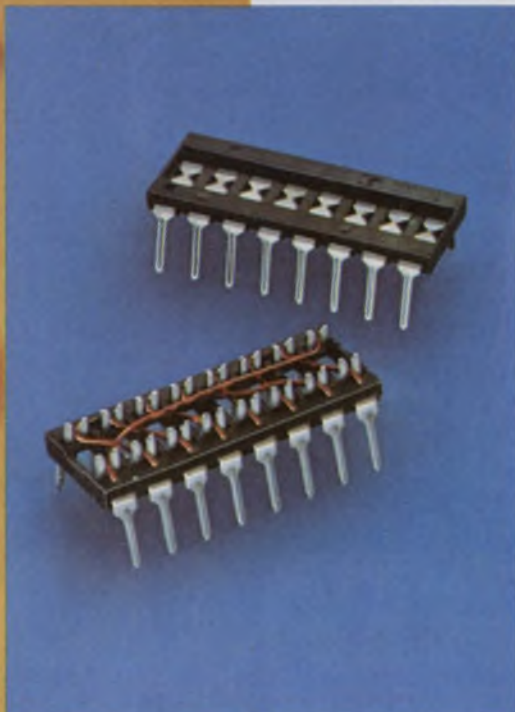



ARE YOU STILL PROGRAMMING MOS PROMS ONE AT A TIME?

Now you can increase production and attain higher yields with Data I/O's new Model 16 MOS Programmer.

The Model 16 programs up to sixteen MOS PROMs in parallel and provides the highest possible production throughput for the new 16K PROMs. The Model 16 also programs smaller PROMs such as 2704 and 2708. And to help you reduce production costs and increase yields the Model 16 gives you three important new benefits:

Continuity Test. Insures that the programming circuitry—including cables, connectors, sockets and PROM pins—are properly connected. Also insures that all PROMs are operational prior to programming.

Checksum. Guarantees that all data transfers are error-free.

Calibration. No extra equipment is required. A calibration mode provides indication that system is operating and in compliance with PROM manufacturers specifications.

Production throughput never before attainable. We'd like to tell you more. This fact filled tabloid gives you valuable information about PROM programming technology. To get your copy, circle reader service number or contact Data I/O Corporation, P.O. Box 308, Issaquah, WA 98027. Phone 206/455-3990.



HOW TO SELECT THE RIGHT PROM PROGRAMMER FOR YOUR NEEDS.

DATA I/O

THE PROM PROGRAMMER PEOPLE.

For more information, Circle No. 180

Fluke Sponsors New Series:

"One Great Family"



Tired of Reruns?

Fluke counters with a new series in the 5 Hz-520 MHz/time slot.

If you're paying over \$345 for a counter and getting frequency only, tune in on our new 1900-series of priced-right multimeters.

Five different models offer both time *and* frequency, with award-worthy performance and features; the ratings are terrific!

New Time and Frequency.

Last year's hit, the model 1900A, set the stage for this new series of multimeters by offering frequency, period, period average and totalize *standard* in one great counter.

Now all models in the series offer comparable features and value, with autoranging and autoreset as well.

Most models feature a trigger level control and battery option for reliable field use or line-cord-free bench operation. All typically have a 15 mV sensitivity (guaranteed on most!), plus a 0.5 ppm/month time base for long-term stability.

The Price is Right.

From this shared base of solid performance features,

we've built a series of counters with one model just right for your needs.

The new **1912A**, with a 520 MHz range and an extensive package of standard features, offers more capability for \$620* than you're likely to find anywhere. For 250 MHz measurement perfection, the **1911A** multimeter is a best-buy for only \$495.*

For lower frequency (125 MHz) applications, specify the **1910A** for \$395.* The **1900A**, years ahead in value, has been reduced to \$345* for even more cost-effective 80 MHz measurement.

For rugged environment applications in the 125 MHz area, you'll want the **1925A** with its RFI shielding and dust-resistant steel case. \$750* (For only \$225* more, a special prescaler option extends the 1925A's range to 520 MHz.)

Tune In and Count.

Call (800) 426-0361, toll free, for the location of the closest office or for complete technical literature. Then stop in for the great family picture, and review the extensive option list for better TCXOs, data outputs, and more. John Fluke Mfg. Co., Inc., P.O. Box 43210, Mountlake Terrace, WA 98043.

*U.S. price only.



1925A



1900A

Command Performance: Demand Fluke Multimeters.



2109-7003

CIRCLE 226 FOR LITERATURE

ELECTRONIC DESIGN 24, November 22, 1977

CIRCLE 227 FOR DEMONSTRATION



Board testers

Testing circuit cards can be a 'monstrous' job

Don't envy the engineer or manager responsible for circuit-card testing. Thanks to large-scale integration (LSI), today's cards are as complex as yesterday's complete systems. Circuits that formerly took up several complete cards are now squeezed into single chips—computers, data-acquisition systems, UARTs and phase-lock loops, to mention a few. For boards containing combinations of these IC monsters, designing efficient test systems often rivals the design effort for the board itself.

And that's only for testing. Many boards fail—and their faults must be identified for repair.

Of course, the cost of the testing and repair must be kept low. So ideally, testing, fault isolation and repair should be done rapidly by minimally trained unskilled workers. A system that allows untrained personnel to test and repair cards efficiently must be on-line as card production starts. So, test systems have to be finalized after cards are frozen, but before production starts—usually in a few hair-raising weeks. Even after production starts, cards frequently are redesigned, so the test system must be quickly changed.

Production-test engineers are now understandably asked to look to the future as well as the present. So all hardware and software bought or developed today should, with only minor modifications, serve for years to come—hopefully.

Technology to the rescue

Dedicated testers built in-house and with limited capability were once the mainstays of every production-test department. But now commercial general-purpose machines with great power and flex-



Teradyne's L125 Circuit Diagnostic System has two major configurations—one for digital boards, one for mixed analog-digital boards. By following instructions from the CRT, the operator works with the system's guided probe.

ibility abound. There are functional testers that check, via edge connectors, that boards perform their required system functions. And there are in-circuit testers that check individual components and connections. In fact, today's in-circuit testers handle boards containing the most complex LSIs, including microprocessors—and at high throughput rates, too.

Unlike the dedicated testers of the past, which usually died with the product they were designed for, the versatile instruments of the present test a multiplicity of boards. There are testers, not only for analog or digital circuits, but for mixed boards as well.

The versatility of most modern card testers comes from their internal computers, which vary in size and capability from microprocessors to the largest minis.

The more powerful computers enable test systems to organize test results and present them for statistical analysis. Many computer-based systems provide data logging, inspection and failure-diagnosis reports.

But you don't need a baseball bat to swat a fly. GenRad uses its 2220 Bug Hound to pick up where the automatic-test system leaves off. With the device's current-tracing probe, a technician can locate shorts, opens, malfunctioning ICs and other common PC-board faults. When tracing a fault, the probe itself guides the technician with indicating LEDs and audible tones. The Bug Hound contains a micro-voltmeter with two single-point probes, a 10-mA dc source and a conductivity tester.

Also notable among the smaller testers are Testline's Short-Stop and Short-Stop II. With these off-line devices, an operator can quickly locate short-circuits for repair, or troubleshoot pesky wired-OR buses that make μ C cards a minefield for testing.

First get the shorts out

But before the cards are tested, Teradyne advises that high-production runs be screened—by its L427 and L429 testers, of course—for those last few shorts that are left on a wave-soldered board after the obvious ones have been removed at visual inspection. These testers require no programming. They make contact with each circuit stripe and component pad by means of a "bed-of-nails" fixture containing "pogo" (spring-loaded) pins.

The L427 costs \$13,000, and handles 60,000 boards in one shift-year. The 429 handles 240,000 boards in a shift-year and, of course, costs more.

Other testers work even earlier in the card-production cycle. The FACT system by Hughes Aircraft tests boards even before their components are inserted. The pogo-pin field of FACT's bed-of-nails test head mates



A software simulator generates programs capable of testing 360 points on a UUT approximately 10,000 times a second on the DTS-70 from HP. Boards containing 220 MSIs can be tested with programs that an experienced person can prepare in about two weeks.

with the board under test through a glass-epoxy mask. A separate mask must be drilled for each card. The bare boards are tested for continuity and leakage under automatic, semiautomatic or keyboard control.

Functionally, these testers are simple—but not cheap. Systems with 500 to 1200 terminations cost from \$35,000 to \$45,000. A bed-of-nails fixture with 3000 terminations (not all are used in any one test, of course) costs between \$18,000 and \$30,000. Test heads cost \$2 to \$3 per point, and product-holding plates between \$300 and \$1500.

But once circuit cards contain their components, testing can get complicated. So logic simulators have been developed to make it easier. These sets of computer programs can imitate a circuit's response to a set of stimuli.

Since logic simulators contain a library of device characteristics, a device familiar to the simulator need only present its designation and interconnections to

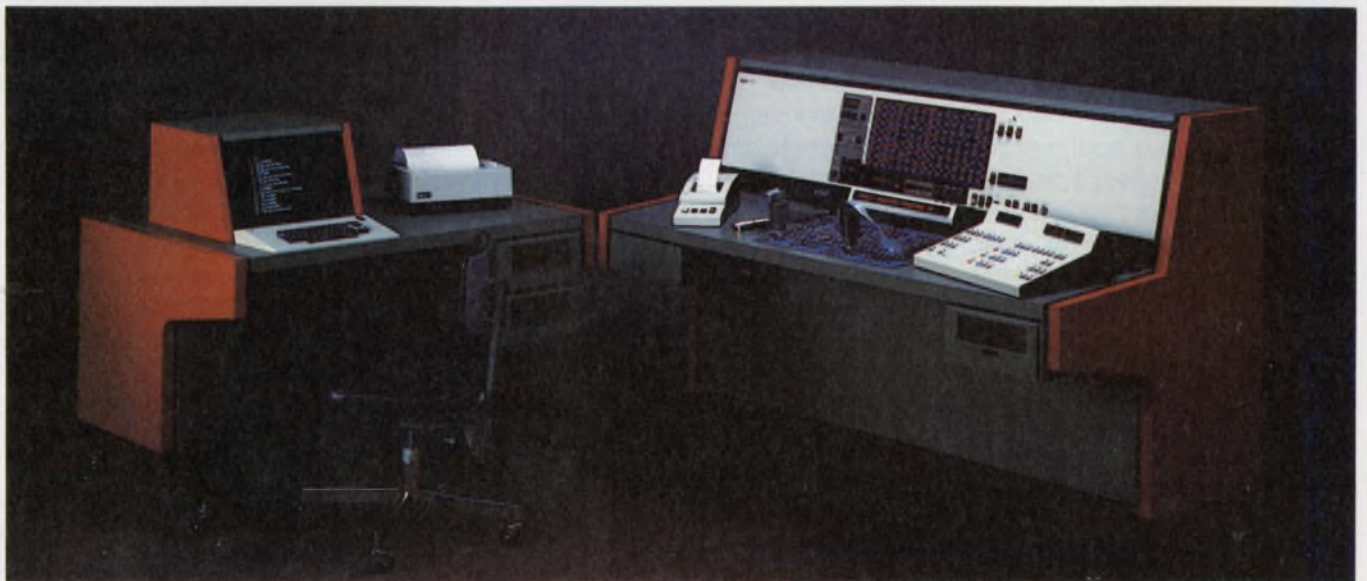

The Autotrack option for the Fluke Trender 3040A provides computer-guided diagnostics that allow a non-technical operator to troubleshoot even complex boards.

Once the defective circuit node has been isolated, the display presents a generic diagnostic message. The printer delivers a message that actually locates the fault.

the tester. From these simple data the programs develop the responses of the simulated unit under test (UUT).

One simulator-based system is GenRad's 1795-HD. In its learn/test mode, this system creates test programs automatically, using known-good reference boards as criteria. Once all internal nodal values of a reference board are recorded on a disc, the board becomes superfluous.

The DTS-70, a digital PC-board test system from HP, has a simulator-based test-program generator, Testaid III, which works into the system's automatic test-pattern generator. For programming ease, this tester offers three languages: Basic, Fortran and the company's own.

Simulator-based card-test systems are usually large and complex. The DTS-70 includes an HP 1000 computer that operates under a real-time-executive operating system. This multiprogramming software permits both multiple-terminal and multiple-test-station operation. The computer can also manage the test-data base.

Simulator-based machines aren't cheap. The GenRad 1795-HD, for example, starts at \$50,000.

Simulators check inputs

But logic simulators can do more than just mimic circuits—they compare the simulated outputs of both good and faulty boards for a given test pattern. This way, the simulator checks the usefulness of input patterns.

During test-pattern development, the results of this simulated monitoring are fed back as a list of undetectable faults—on a CRT or as hard copy. The number of faults not subject to scrutiny is then reduced by changing the input test patterns. When the level of detectable faults is acceptable, the test pattern is frozen.

To check the testability of board designs, the simulator-based GenRad 1795-HD uses its CAPS program-preparation and diagnostic software. By simulating proposed logic, it exposes design inconsistencies and analyzes logic and test programs even before the board prototypes are available.

Automatic program generation is a feature of the Auto-Learn software for Mirco System's Series 500 testers. These instruments use time-nodal signature testing from a known-good board for initial set-up. Test execution is from a stored test program. But the system's control μP can't do all that's required by itself—a technical operator must help.

Fault simulators test testers

After initial test programs are developed, a fault-simulation program sequentially faults each IC input and output while test patterns are run. This process checks the thoroughness of the testing by seeing that errors propagate to the board-edge connector. Fault

simulation, as implemented by Data Test in its 5800 Series testers, requires the operator to place the Test Clip probe in sequence on each IC of the UUT. When the test program must be changed, the operator is alerted instantly.

For microprocessors and other bus-oriented circuits, Computer Automation's Capable Model 4400 automatic test system identifies the signal bus closest to the fault, be it a component or a production defect. Then the AFR fault-resolution system, a combination of hardware and software, presents step-by-step instructions to an operator via a video-display terminal. These instructions tell the operator where to place the system's current-sensing probe while the system injects controlled-current pulses into the signal bus. Both the current pulses and the probe are software-controlled.

The operating principle of this level of fault isolation



There's so much testing power built into Tektronix's S-3260 that it can test complete boards as well as ICs. All that's needed is an additional test fixture.

is that any defect will either source or sink an abnormal current. The controlled current pulses are injected into the circuitry via the system's clip feature, which is first used without the probe to isolate the bus carrying a fault. The AFR costs \$7200 as an option to Capable Model's 4400 family of logic testers.

Hundreds of device-testing subroutines are contained in Faultfinders' Faults II software test-program generator for the FF101C and FF303 minicomputer-based in-circuit testers. Test programs generated by Faults II can isolate shorts, opens, or components that are bad, wrong, misoriented or out-of-spec.

The program-generation software, Z-Pact, for Zehntel's Troubleshooter 400 in-circuit tester, derives a fully formatted test program for cards containing both analog and digital components. The only input Z-Pact uses are a list of the components and their locations. The software interacts with the UUT to correct the test programs. To interact with the tester

via a CRT and a keyboard, a programmer need only be able to read schematics and recognize common component characteristics.

Through the Flash software package, Mirco Systems' Series 500 testers generate test programs that produce a printout (a fault dictionary) of error signatures and their causes, and a printout of scope-trace data. Programs are also produced for developing such test statistics as

- Test-program comprehensiveness, which is the ratio of detectable failures to total possible failures.
- Average fault-isolation resolution, which is the percentage of all failures isolated to one component, two components, etc.
- Average failure-dictionary entry, which is, for example, the failure isolated to 1.7 components.
- No-find list, which identifies undetectable failures.

Time-sharing terminals can be used to prepare and edit programs for Series-500 testers. Mirco Systems' programs are available through GE's Mark III time-sharing service.

Which inputs test best?

Whether testing relies on simulation or not, test-pattern inputs must be applied to the UUT. These inputs come from either hardware or software generators.

Hardware generators develop either fixed or pseudorandom patterns. The fixed patterns are usually in binary count or Gray code, and are used together with fixed-pattern-response testing, which requires no more than 16 bits per node.

Pseudorandom patterns, while statistically random during a test, are repeated in each test. A major advantage of pseudorandom patterns over fixed patterns is that they make program-preparation time shorter.

Test patterns from software generators are complex enough to check out almost any board. When software patterns are used, the UUT's responses must also be programmed. The resulting programmed-response generators can easily use millions of stored patterns to test a complex card. Naturally, an enormous memory is required. Also, testing a complex card takes many steps and thus a long time.

Hardware generators work faster than software-based systems. For hardware, there isn't as much time between steps in a sequence, because call-up from memory isn't required. Also, the bit rate for each step is usually higher with hardware.

One card-tester family that boasts both fixed and programmable pattern generation is the microcomputer-based 5800 series from Data Test. With its fixed patterns, the tester checks for transition-redundancy responses. With its programmed patterns, the tester checks for programmed responses. An option allows the three test stations in the 5800 family to perform either real-time or high-speed tests on logic boards

that contain such complex LSIs as μ Ps, UARTs, PIAs, RAMs and ROMs.

The basic 5800 system has 128 I/O pins and is expandable to 256. Tests are performed from the card-edge connector.

Mirco's Series-500 testers also generate test patterns from their hardware—pseudorandom test patterns whose relative frequencies are software-controlled. The Series 500 testers have a repertoire of 255 different hardware-controlled patterns, and the length of test-pattern sequence can be as much as 1×10^{12} bits. Either pseudorandom or programmed test



GenRad's current-tracing 2220 Bug Hound isolates faults on known-bad cards. The probe's LEDs and audible alarms pinpoint shorts, opens, bad ICs, and other troubles.

patterns can be created by software at 500-kbits per second. The Series 500s have from 64 to 224 I/O pins.

Because of hardware's short testing time, high-speed signals and minimal programming, sections of a card should be checked from hardware whenever possible. So obviously the tester being used must have both hardware and software test-pattern generators.

Start with cleared logic

But before any functional-test pattern is applied to a board containing memory elements, the board must be initialized. That is, the board's sequential logic must be brought to a predetermined state.

Determining whether or not a complex board is initialized can be difficult. Software generators usually initialize the UUT to a high level of confidence.

Only edge-connector testing requires card initialization. But when the card is tested component by component by means of onboard probing, initialization usually isn't necessary.

To test without initializing—to keep programming

simple and to locate faults for repair—in-circuit testers are often preferable to instruments that test from a card's connector. Testing to the component level requires access to each component, which can be accomplished via bed-of-nails fixtures, test clips or probes.

In addition to being accessed, the component under test must also be electrically isolated, temporarily, from the rest of the card. For isolating simple components and analog ICs, in-circuit testers use a guarding technique, which electrically isolates a component without breaking any physical connections.

The key to guarding is establishing two circuit points, a guarded node and a measurement node. An op amp forces the guarded node to the potential of the measuring node. Then, since no current passes between these nodes, the component can be measured as if the circuit between the two nodes is open. Guarding, therefore, is a form of bootstrapping.

For digital circuits, in-circuit testers use limited-energy pulsing. Superimposing the test-input state over the steady state (for microseconds, at most) isolates the device long enough for the required truth-table testing. Zehntel uses limited-current pulsing called "Isodrive," in its Troubleshooter 400, a μ P-board bed-of-nails tester.

Testline Instruments has found that the average time required to program in-circuit testing is ten ICs per hour. In many cases, the job can move much faster. But inadequate or inaccurate documentation puts a heavy burden on the time required to program tests.

Once the tester has been programmed, test time depends on the operator's ability to clip onto the IC. With average density (one IC and a few passive components per square inch) a 60-IC board can be tested in 2-1/2 minutes. High-density boards can be tested at ten ICs per minute. For boards with wired-OR buses, testing is even slower.

You can't find them all

Testline's users report a greater than 90% confidence level for their in-circuit-tested boards. But some problems are not resolved by Testline's in-circuit testing—open etches, resin-encapsulated leads and mistimed one-shots. Where timing-flow problems stem from marginal design rather than faults, in-circuit testing is ineffective.

Faultfinders' FF303 in-circuit tests both digital and analog components on the same board. Guarding, for analog testing, is combined with limited-energy pulsing, for digital checking. Prewired for 639 points, the standard system is expandable to 925.

For mixed analog-digital boards containing MSI devices, testing via the bed-of-nails fixture on Zehntel's Troubleshooter 400 usually takes only seconds per board. And by unskilled personnel. The system not only prints out specific rework instructions for each failure, but also generates statistical reports. Variable components like pots can be adjusted while

Where the faults lie

The greatest bulk of faults in high-production runs are workmanship errors—components are usually 100% tested before insertion, and designs are usually proven at this stage. Such faults as solder bridges, wrong polarities, missing parts and bent pins produce the lion's share of board rejects. Teradyne has found that, after visual inspection of wave-soldered boards in these large runs, the distribution of faults is typically:

Source Type	Workmanship	Components
Visual faults (80-90%)	Shorts, opens and misplaced components (80-90%)	Damaged components (1-5%)
Electrical faults (10-20%)	Invisible shorts, opens and plated-through holes (5-10%)	Device interactions, internal damage (5-10%)

they are being monitored in the working circuit.

Computers abound in another test system that handles mixed analog-digital boards—the Model 6000 Automatic Test System by Optimized Devices. Testing operations are governed by a DEC PDP Super-8 minicomputer with 16 k of core memory. For digital simulation and program preparation, a second PDP-8, with 32 k of core, is linked to the first computer. A microprocessor controls the system's digital-test sub-assembly, which is a Mirco Systems product.

There's lots of software to complete the 6000 system. The Testware package helps prepare programs for testing, data logging and fault isolation. The Diagnostic Tree package provides fault isolation to the component level on analog circuits. The power that the 6000 derives from all these interlinked processors is evident in such features as a programmable probe, a programmable overhead spot projector that guides the operator in probing, and even a computer-operated "screwdriver" option for in-circuit component adjustments.

Besides the usual programmable signal sources and measuring instruments, this tester offers waveform analysis and time-interval measurements to sub-nanosecond resolution. Moreover, analog and digital tests can be mixed in any order. It shouldn't be surprising, then, that all this capability costs from \$40,000 to \$100,000.

Locating the fault for repair

Software algorithms locate workmanship faults to a bad node on analog cards in Teradyne's L125A system. With a known-good reference board, the L125A learns and stores all the nodal impedances, which are then compared automatically to those of

the UUT. Because of the automatic operation, only minimal information is presented to the system's nontechnical operator.

Much more information, however, is presented to the programmer. Operating software runs a CRT screen divided into three sections—one section displays the results of a specific test; another shows the ac, dc or digital signal at the probe; a third serves as the display for the command console. Any test in a program can be directly modified from the keyboard.

A digital version, the L125, detects all errors including faulty components.

Good testers get better

Unadorned, the L125 comes in two major configurations—one for digital boards and one for mixed analog-digital boards. With the system's Guided Probe, a nontechnical operator can be instructed from a CRT. But to make the already sophisticated L125 test system faster during troubleshooting and easier to program, two levels of automation can be added. The M150 Automatic Prober eliminates the slow and error-prone operator from the probing process. The P400 Automatic Programming System works with off-line large computers. Basic device and circuit data are fed to the computer, then the P400 terminal produces a test program on mag tape.

In-circuit testers like the L125, which work with circuit impedances, can only locate faults to a bad node. Normally, several components share the same node—with buses, the number of components on a node can be staggering. For repair, then, the exact location of the trouble must be determined.

Faults on digital boards are automatically isolated to the malfunctioning component by Testline Instruments' AFIT 3000 and 4000 systems. These in-circuit testers supply full dynamic functional truth tables to the board through either a clip or a bed-of-nails fixture.

In the AFITs, an injected pulse overrides any malfunction in an IC; however, the pulse does not override solder bridges. Nor does it override etch shorts between lands. As a result, a defect is categorized as belonging to a component or to a land. All hard shorts are indicated as the first test result, and they must be removed before testing can continue.

Testline's AFIT 3000 is equipped with a dual-disc data base. One of them, a master library "Super Disc," holds over 2000 truth tables for standard ICs. The other disc serves as the data base for a specific UUT. Pertinent data are transferred, under write protection, from the Super Disc to the UUT's disc.

LSI-memory cards are trouble

The cards that are the most demanding on digital testers contain LSI-memory chips. So many locations must be exercised and, of course, the cards must ultimately work as part of a larger system.

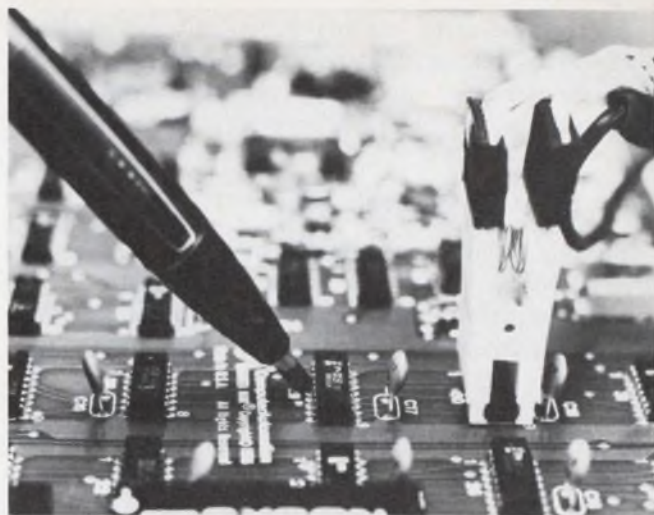

Current pulses are injected into signal lines by Computer Automation's Capable tester's Clever Clip to pinpoint faulty ICs—even on a microprocessor bus.

Dynamic testing is the key to acceptable in-system LSI-memory-card performance. This testing should be done under conditions that are as close as possible to those in the system, which means testing for direct-memory-access functions and for repeated reads and writes at 10-MHz clock rates. Because of the necessary complexity, memory-card test patterns often use millions of bits. Error-detection-and-correction logic must also be tested. For ECL especially, testing must cover more than just stuck bits—propagation and termination must also be checked.

One tester specifically geared for dynamic testing of LSI-memory boards is the two-computer MD-107 Memory System Analyzer from Macrodata. Two cascaded processors provide 10-Mbyte testing and a 10-Mbyte test-pattern generator. Fast test patterns are generated without using throughput-reducing overhead cycles.

For engineering, this system can double as a characterization tool (for shmoo plotting). For production, a CRT and hard-copy point out faults to an unskilled operator.

Fault-free LSI-memory boards don't need the detailed testing required by faulty boards. This is the philosophy behind Adar Associates' DR 12/25 memory-board tester. To save skilled man-hours, initial dc testing from the connector separates the functionally good and bad boards. The good boards then undergo a series of high-speed functional tests conducted by unskilled operators. Failed boards undergo a sequence of diagnostic tests that require a skilled operator to interact with the test system.

During a memory-board test, the DR 12/25 stores the locations of devices found to be faulty in a fast RAM. After the test, this Board Error Map is transferred to the system's minicomputer for display on a CRT and printout.

High-level test language plus user-oriented executives are provided by the system's ATLS 12/25

software. Features include provisions for multiple peripherals, statistical-data presentation, shmoo plotting, board-error mapping, error analyzing, and message processing—all under software control.

Keep the dynamic logic alive

Signals from known-good boards are used as test criteria by Fluke Trendar's 3040A Logictester, which runs at multibit rates to keep the dynamic logic in μ P and shift-register memories alive under test. Testing is speedy, since the logical behavior of each IC is supplied to the tester from a reference board.

Test-input sequences to this system are flexible. Merged sequencing allows engineering test codes to be mixed with machine-generated sequences.

After a board is found to be bad, the Logictester's Autotrack option provides computer-guided troubleshooting via its applications program, a troubleshooting algorithm that uses comparative diagnostics. With Autotrack, the 3040A can test and troubleshoot boards containing μ Ps and other LSI chips.

A 3040A Logictester with 240-pin capability costs between \$60,000 and \$95,000. The 3020A, a related logic-test system for production test, costs \$32,000. The most limited tester in the series, the 128-pin 3010A, costs \$15,000.

Not only does the System 390 from Instrumentation Engineering test boards containing memories and microprocessors, it also tests mixed analog-digital boards. The minicomputer-based system's simulator, Microsim, can imitate μ P-based assemblies down to 1-ns resolution, in real time. In addition, the usual simulator states—ONE, ZERO and UNKNOWN—are augmented by a three-state-logic D-state. With this fourth state, System 390 can simulate buses accurately—so important with μ Ps.

Faults can be located under end-use operating conditions. Under high-speed operation, a computer-guided probe locates digital faults; under dynamic conditions, analog faults. The 390 can test complex—even μ P-based—boards at programmable data and strobe rates.

Both the hardware and software of the System 390 can be serviced in the field via telephone-modem hookup. In testing, where minutes of tester down time can hurt, this ever-available servicing can sometimes save what could be nerve-wracking days of waiting.

Other testers can adapt to cards

Not all systems capable of testing complex cards are known for this ability. For example, Tektronix's S-3260 is primarily known for testing LSI chips. But this intricate machine can perform the high-level functional and parameteric tests that even complex boards require—with fixturing, it can be a powerful board tester. And in systems that cost tens and even hundreds of thousands of dollars, the cost of the required fixtures might be worth considering.

The S-3260's programming capabilities are extensive, including a disc-operating system, a high-level language, English-language hardware commands, operator interactive control, algorithmic test-pattern generation and a library of utility routines.

The system's measurement capabilities are just as impressive. Functional measurements can be made at 20-MHz clock rates. Dc parameters can be measured using Kelvin (four-wire) sensing, differential voltages, and nA sensing. Ac characteristics are measured dynamically and calibrated automatically.

The results of all tests are stored and can be analyzed by the system's statistical-software package, which generates reports and presents data graphically.

With infrared detection, just one sweep of the scanner performs the inspection, testing and troubleshooting simultaneously. Analog, digital or a combination of these circuits can be handled just as easily.

Infrared-scanner testers, like the Inspect System from Vanzetti Infrared, operate on the principle that a failure is just another mode of an assembly's operation. The failure mode is unwanted to be sure, but it can be readily identified by its unique infrared radiation characteristics—its signature. ■■

Need more information?

The products cited in this report don't necessarily represent the manufacturers' complete lines. For complete details, circle the appropriate reader service card number. More vendors and information may be found in ELECTRONIC DESIGN'S GOLD BOOK.

- Adar Assoc. Inc., 11 B North Ave., Burlington, MA 01803 (617) 273-1850.
(Abraham Bluestone) **Circle No. 475**
- Computer Automation, 18651 Von Karman, Irvine, CA 92713. (714) 833-8830
(D. Cutsforth) **Circle No. 476**
- Data Test Corp., 2450 Whitman Rd., Concord, CA 94518. (415) 689-3583 (Cal
Edmonds) **Circle No. 477**
- DIT-MCO Intl., 5612 Brighton Terrace, Kansas City, MO 64130. (816) 444-9700.
(W. C. Comer) **Circle No. 478**
- Faultfinders Inc., 15 Avis Dr., Latham, NY 12110. (518) 783-7786 (Tom
Coleman) **Circle No. 479**
- Fluke Trendar, 500 Clyde Ave., Mountain View, CA 94043 (415) 965-0350
(Noel Lyons) **Circle No. 480**
- GenRad, 300 Baker Ave., Concord, MA 01742. (617) 369-8770. (Robert T.
Szpila) **Circle No. 481**
- Hewlett-Packard, Loveland Instrument Div., Box 301, Loveland, CO 80537.
(303) 667-5000 (Walter Skowron) **Circle No. 482**
- Hughes Aircraft Co., Inc. Prod. Div., Fact Systems, 6155 El Camino Real,
Carlsbad, CA 92008. (714) 438-9191. (G.I. Croswell) **Circle No. 483**
- Instrumentation Engineering Inc., 769A Susquehanna Ave., Franklin Lakes,
NJ 07417. (201) 891-9300 (Art Desena) **Circle No. 484**
- Macrodata Corp., 6203 Variel Ave., Woodland Hills, CA 91364. (213) 887-5550.
(Alan Portnoy) **Circle No. 485**
- Membrain Ltd., Ferndown Indl. Estate, Wimborne, Dorset, England, 0202
893535. **Circle No. 486**
- Mirco Systems Inc., 10888 N. 19th Ave., Phoenix, AZ 85029. (602) 997-5931.
(Richard Bell) **Circle No. 487**
- Omnicom Inc., 5150 N. 16th St., Suite 253, Phoenix, AZ 85016. (602)
264-2475. **Circle No. 488**
- Optimized Devices, Inc., 220 Marble Ave., Pleasantville, NY 10570. (914)
769-6100. (Arthur Zuch) **Circle No. 489**
- Technology Marketing Inc., 3170 Redhill Ave., Costa Mesa, CA 92626. (714)
979-1100. (Jan Bosboom) **Circle No. 490**
- Tektronix, Box 500, Beaverton, OR 97077 (503) 644-0161. (Ken Hampton)
Circle No. 491
- Teradyne Inc., 183 Essex St., Boston, MA 02111. (617) 482-2700. (Robert
Sigsby) **Circle No. 492**
- Testline Instrument Inc., 1625 White Dr., Titusville, FL 32780. (305) 267-7212.
(Tom Simpson) **Circle No. 493**
- Vanzetti Infrared & Comp. Systems, 507 Neponset St., Canton, MA 02021.
(617) 828-4650. (Dr. Riccardo Vanzetti) **Circle No. 494**
- Zehntel Inc., 2440 Stanwell Dr., Concord, CA 94520. (415) 676-4200. (Craig
Pynn) **Circle No. 495**

DP Dialogue

Notes and observations from IBM that may prove of interest to the engineering community

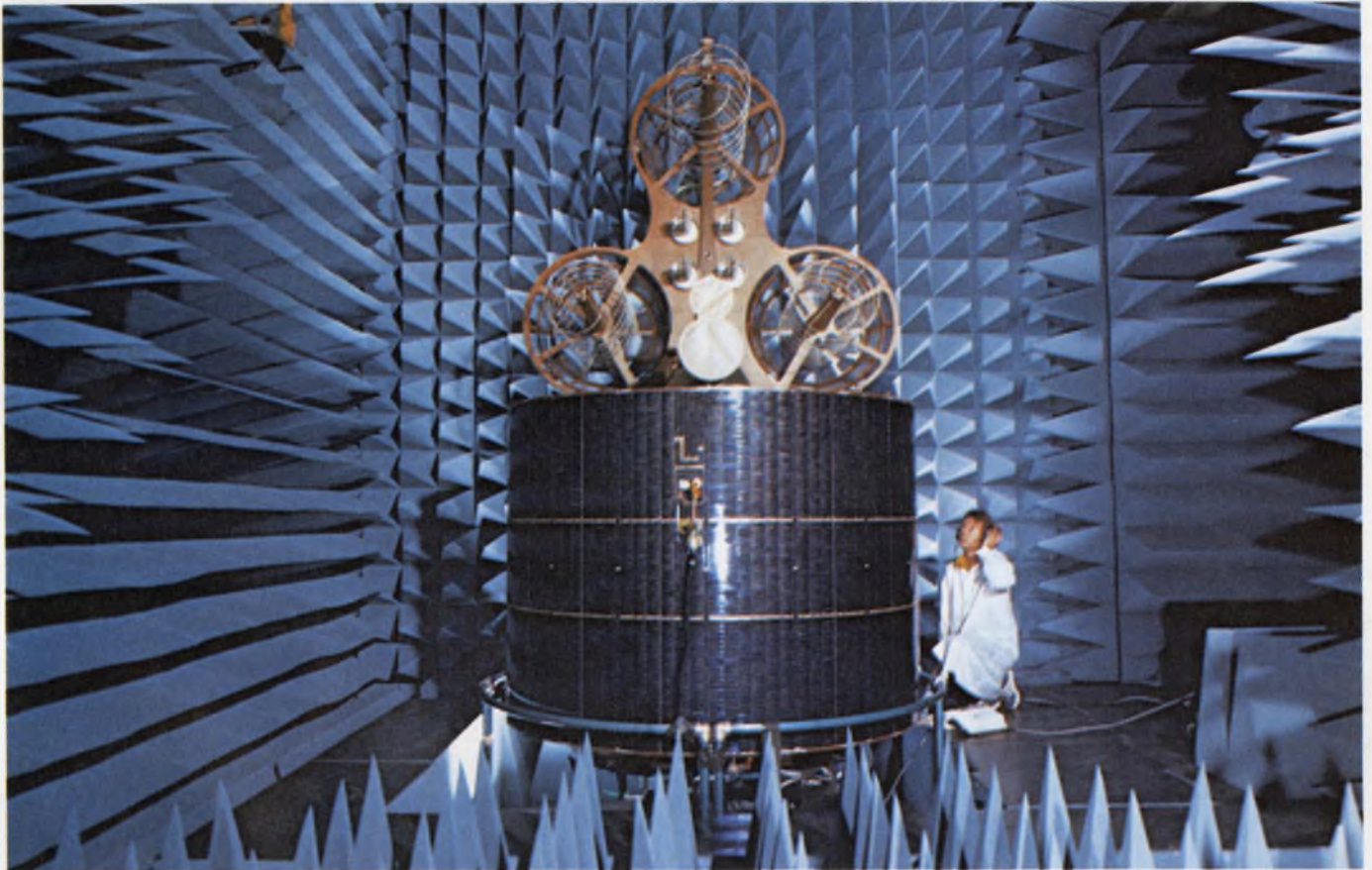

Marisat is a communications satellite made by Hughes to serve U.S. Naval and commercial maritime users. Here the satellite is placed in an anechoic chamber that isolates it from environmental electromagnetic and sound energy.

APL Brings the Computer to Hughes Engineers

Engineers at Hughes Aircraft Company communicate with an IBM computer through nearby terminals in a programming language called APL. A powerful language that can specify extensive computation with a few symbols, APL requires little experience or training in computer programming.

Says Robert Vuilleumier, a technical staff manager in Hughes' Los Angeles-based Space and Communications Group: "APL is a particular timesaver on problems which generate big data tables. For example, to tabulate the gain of a microwave antenna against temperature typically requires a listing of 17 columns by 30 lines. Preparing this table manually can take two days; the computer takes a few minutes.

"Quite often," Vuilleumier notes, "I need to recompute a table for a slightly different parameter value. Repeating the antenna analysis at a higher frequency would be an example. It takes only a moment to type in the new parameter and re-execute the program from the terminal."

Adds George Williams, an engineering project manager who was instrumental in APL development at the group: "APL is very effective for small jobs with their own data bases, and for spur-of-the-moment programming. I have seen users arrive at the terminal and depart so quickly I thought they'd changed their minds, but they had actually finished writing and executing their programs.

"I recently watched someone define

a plane on the basis of three points in space for a geometric calculation," he continues, "using only three lines of APL code. Conventional programming would have required three pages."

"In addition to engineers, managers use APL for manpower and budget planning, cost estimating for proposals, and facilities management," says Conrad Stensgaard, Jr.

Stensgaard, a senior staff engineer, helped install APL in the System/370 Model 158 in the Hughes Computation Center. "APL has brought the computer much closer to our users," he says, "lowering the 'threshold' of entrée to the machine for small tasks and making interactive computing directly available to the end user."

Simulated Spine Hastens Injury Research

The effect of a 30-mph automobile crash on the human trunk is shown by these drawings derived from a computer. A normal spine is at left; the center and right views show its position 20 and 40 milliseconds after impact.

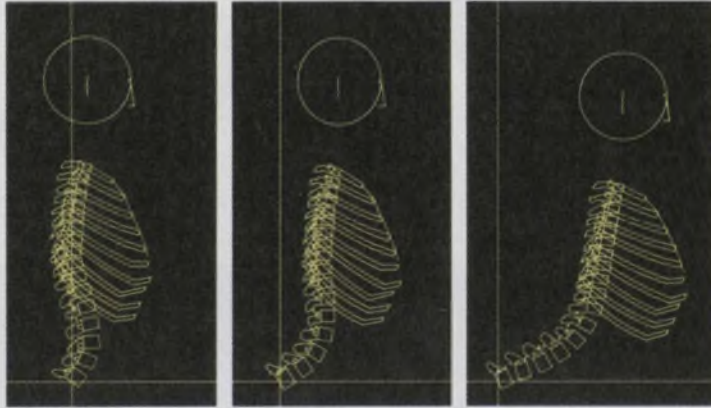

This insight into the complex mechanics of the backbone was made possible by a mathematical model of the spine, developed on an IBM System/370 Model 158 at the Chicago Circle campus of the University of Illinois, sponsored in part by the Aerospace Medical Research Laboratory. Engineers at the university are studying the effects of injuries and disease on the back.

The potential benefit is far-reaching, since eight million people in the U.S. suffer from back problems, and half a million currently wear braces.

"We don't know much about that sophisticated structure we call the

spine," says Dr. Albert B. Schultz, professor of mechanical engineering. "We're working with orthopedic surgeons to learn more, in the hope of preventing and treating back problems."

"Because we can apply engineering principles to the skeletal system," adds Dr. Ted B. Belytschko, professor of structural engineering, "we can sometimes determine in a few days responses to treatment which would take years to find by observing results of therapy."

In one experiment, the computer simulates the force applied to the spine by a therapeutic brace. "This helps show us the effectiveness of different modes of treatment," Dr. Schultz notes. "In treating lateral curvature of the spine, or scoliosis, the model has told us that applying pressure from the side will often be more effective than a stretching force."

By means of the computer model, engineers in the university group have predicted the effect of a hip-to-neck brace in a number of patients. The actual results of treatment supported the predictions in 80 percent of the cases.

Each year an additional 400,000 American workers incur back injuries; Dr. Schultz and his colleagues expect the computer model to help analyze their causes. The results will be available as guidance to therapists, orthopedists and industrial safety programs.

0.80000
0.88000
0.96000
1.04000
1.12000
1.20000
1.28000
1.36000
1.44000
1.52000
1.60000
1.68000
1.76000
1.84000
1.92000
2.00000
2.08000
2.16000
2.24000
2.32000
2.40000
2.48000
2.56000
2.64000

9.0176
8.8206
8.6076
8.3800
8.1378
7.8818
7.6128
7.3315
7.0387
6.7350
6.4214
6.0984
5.7671
5.4280
5.0822
4.7302
4.3730
4.0114
3.6461
3.2781
2.9080
2.5366
2.1648
1.7934

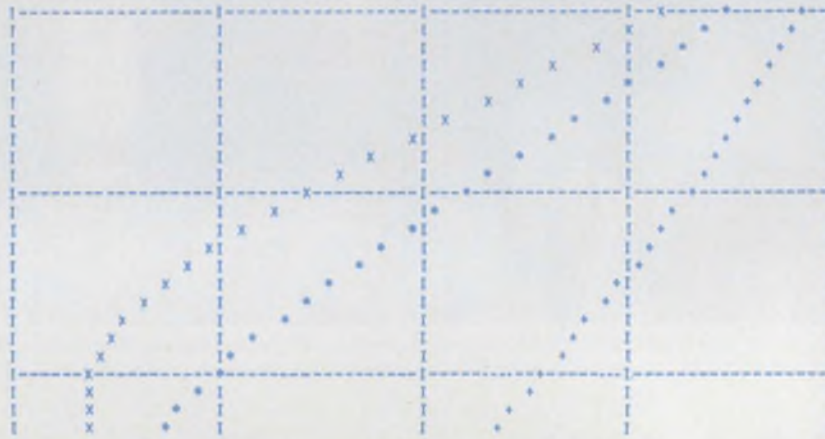

7.2734
6.7489
6.1912
5.6038
4.9908
4.3561
3.7037
3.0379
2.3625
1.6818
1.0900
0.42115
-0.25996
-1.0121
-1.6597
-2.2971
-2.8938
-3.4754
-4.0288
-4.5512
-5.0397
-5.4919
-5.9057
-6.2790

5.6987
4.9054
4.0750
3.2159
2.3369
1.4466
0.55393
-0.33255
-1.2043
-2.0532
-2.8712
-3.6508
-4.3850
-5.0673
-5.6918
-6.2532
-6.7468
-7.1688
-7.5161
-7.7861
-7.9774
-8.0891
-8.1211
-8.0742

Models Aid Study of Continuous Systems

Simulation as a means of investigating the behavior of a complex physical system is often far simpler and less time-consuming than seeking an analytical solution.

Engineers or designers can create computer models of almost any complex mechanical, electrical or other physical system—aerodynamic components, control systems or industrial processes, for example—by means of IBM's Continuous System Modeling Program III (CSMP III). It can also be used in the analysis of systems with discrete components such as digital filters, control elements or logic.

An engineer can readily describe a system to the computer in the CSMP

language, which includes 42 powerful functions for performing integration, differentiation, signal and function generation, Laplace transformation, and switching and logic.

Additionally, since Fortran IV is also a subset of the language, the user can build large functions and submodels specifically suited to his application. The CSMP III Library stores these functions, as well as arbitrary or experimental data, tables and complete models—any of which can be executed alone or in combination with other simulation elements.

The system to be modeled may be entered as a set of differential equations, or as interconnected blocks, each char-

acterized as a mathematical function. CSMP III simulates with time as the independent variable and stores the successive values of as many as 220 dependent variables. Up to 55 of these may be printed during the run, and as many as five may be print-plotted simultaneously. Trial runs quickly show which simplifications of the real system can be made with no significant loss in accuracy.

With its Graphics Feature, CSMP III can display up to four co-ordinate grids on an IBM 2250 Graphic Display Terminal, with up to four variables plotted on each grid. Experimental data can be displayed graphically and edited interactively before it is incorporated into a simulation model.

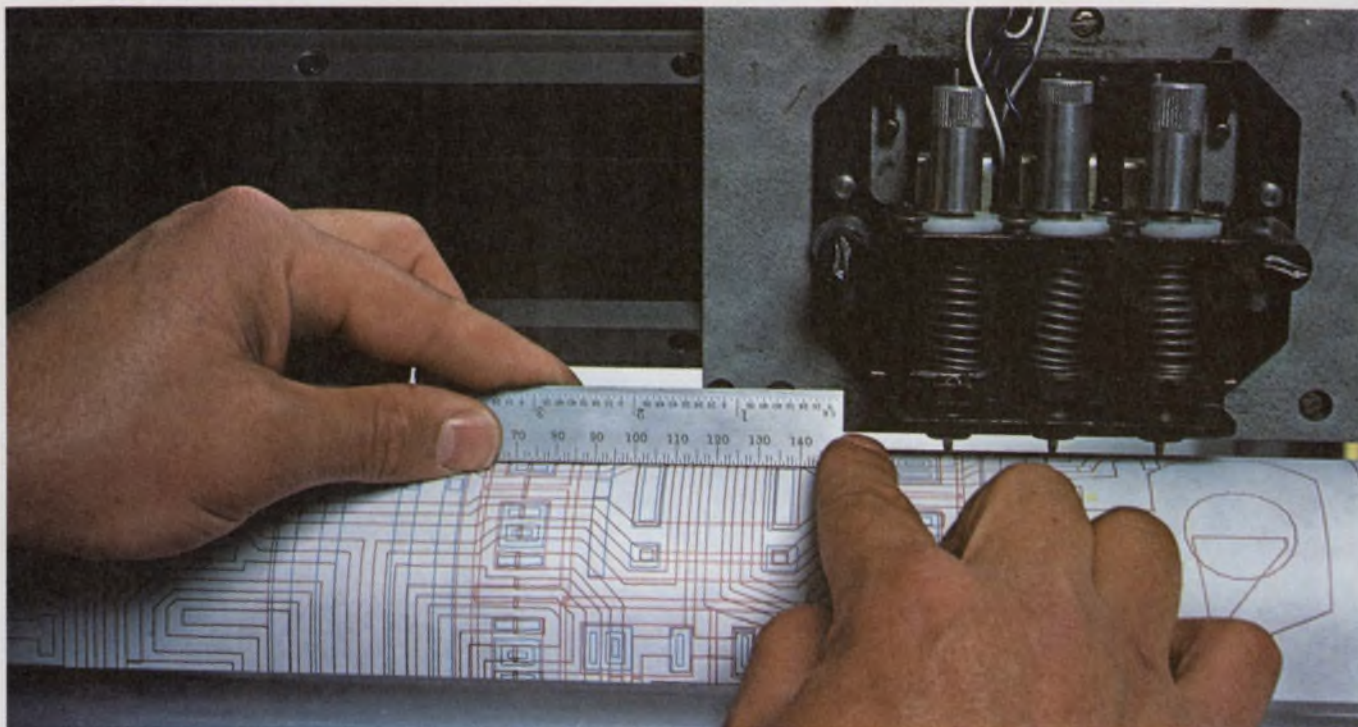

When computer-aided design of the integrated circuit chip is complete, a computer-driven plotter draws a three-color layout of the circuit in large scale.

Computer Designs and Fabricates Computer Circuits

Today's high-speed, high-capacity computer systems depend on advanced electronic devices using Large Scale Integration technology. This micro-miniaturized circuitry puts thousands of memory or logic circuits into a space a quarter-inch square or less, making possible speeds of billionths of a second.

At IBM's General Technology Division facility in Burlington, Vermont, the computer itself is instrumental in the design and production of these advanced semiconductor devices. Engineers there are using a System/370 Model 168 and IBM 2250 Graphic Display Terminals to design and produce the high-precision photo-masks that are critical to the fabrication of integrated circuit "chips." Intricate patterns are successively overlaid using a lithographic process to build a

finished chip containing thousands of individual memory cells.

To create a tentative design for a mask, an engineer draws lines with a light pen directly on the face of a graphic display terminal connected to the Model 168. The system automatically resolves the sketch into a precise pattern of straight lines and geometric shapes.

"It's easy to move elements around on the screen, trying alternative layouts until we find the optimum use of the space available on a chip," says Paul Serednicki, manager of computer-aided graphics. "We can rapidly try so many alternatives that we are finding much more efficient layouts than we ever could manually on a drafting board.

"Since the finished device usually consists of one memory cell pattern re-

peated many times," Serednicki adds, "the engineer can develop it once in detail. The system then replicates it the required thousands of times, automatically rotating it, generating mirror images and adding interconnections.

"Perhaps most significant, though, is that the computer generates a tape that guides automatic production of the mask itself in the final size. Previously, we had to draft the design by hand, and then use it as a guide in the preparation—also manual—of an oversized mask.

"Any change forced us to start over again from the beginning and repeat the manual process. Now we can go back at any time and make a change or improvement in the mask design. We can accommodate an engineering change in minutes instead of weeks."

Project Management Aids

These program products are powerful aids for management of projects in many different fields.

1. Project Management System IV (PMS IV) Creates precedence diagrams, helps to optimize the allocation of resources, calculate detailed work schedules and monitor work progress.

2. Project Analysis and Control System (PROJACS) Performs PERT/Critical Path Method time analysis and provides facilities for re-

source allocation, cost evaluation and network preparation.

3. MINIPERT An APL program for management of small projects. All functions are interactive and designed for use by planners and managers with little critical path experience.

For more information on these IBM Program Products, contact your local IBM branch office or write to the Editor of DP Dialogue at the address on the right.

DP Dialogue is designed to provide you with useful information about data processing applications, concepts and techniques. For more information about IBM products or services, contact your local IBM branch office, or write Editor, DP Dialogue, IBM Data Processing Division, White Plains, New York 10604.

IBM[®]

Data Processing Division

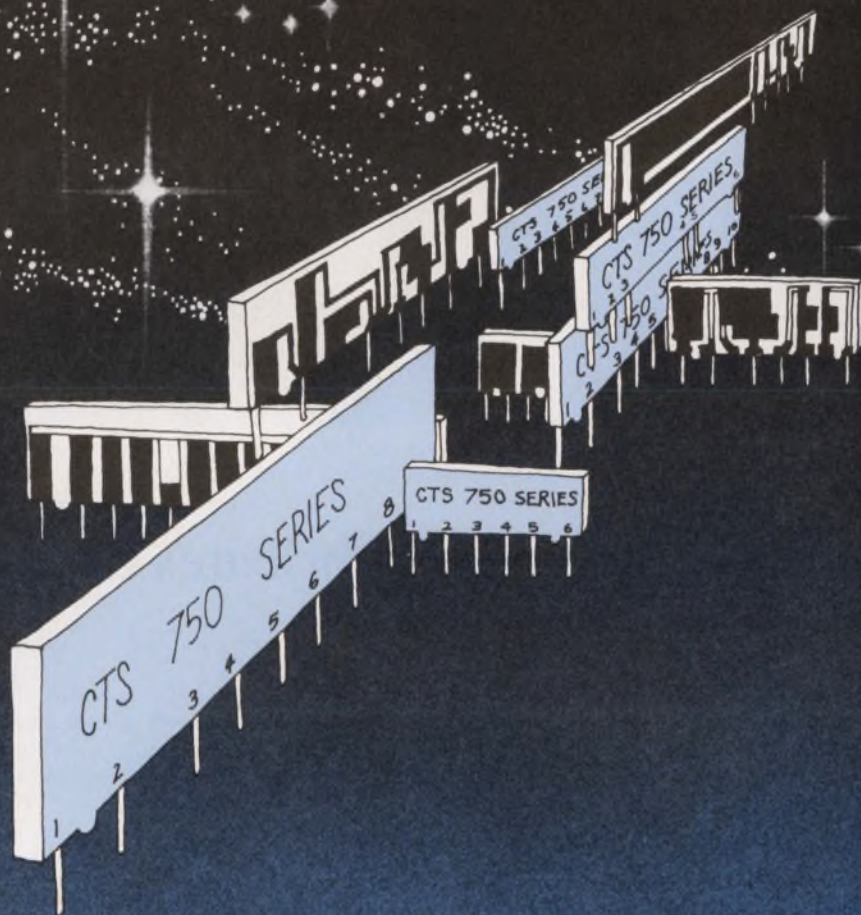

CTS conquers space.

And has for *well over a decade* with space saving Series 750 SIP cermet resistor networks. And with space a very important commodity in modern systems, you'll want to make CTS a very special source for your network needs.

You conserve valuable PCB space, enjoy greater system reliability, use fewer components, install easier—automatically, cut handling costs and derive faster inspection. CTS experience, technology and production capacity insure the highest quality, fastest delivery available.

Where one of our more than 130 *standard* off-the-shelf SIP's won't meet your circuit require-

ments, we'll custom design the resistor network you need in either conventional or low profile package configurations.

Be assured of ultra-high stability and reliability. Over 900 million hours of test data prove CTS reliability with an established failure rate of only 0.00051% per 1000 hours @ 95% confidence level—considerably superior to military failure level S of established reliability specs.

For your copy of our reliability report or complete resistor network data, write: **CTS OF BERNE, INC.**, 406 Parr Road, Berne, Indiana 46711. Phone (219) 589-3111.

CTS CORPORATION

Elkhart, Indiana

A world leader in cermet variable resistor technology.



ENCORE!

WESTON reintroduces the DMM 6000 autoranging portable

Better performance, new options, more accessories than any other low-priced field service DMM

The Weston DMM 6000 is making an encore. It was a great field service instrument when first introduced and proved itself in dozens of applications. Now it is even better. Improved circuitry has substantially reduced response time of the autoranging digital readout for faster measurements. Better contrast and longer life have been achieved for the LCD display. Brightly lit rooms or even direct sunlight do not affect readability.

New options offered with the 6000 include a manual rangehold operation feature and display backlighting for easy readability in dark locations.

New accessories extend the versatility of the 6000 to cover a host of special uses and applications to make it a more valuable measurement instrument.

These are new additions to an already proven superior field service instrument. The standard features that contributed to making it the best buy ever in a portable DMM still support the 6000. Autoranging in a low priced portable is unmatched by

any major instrument manufacturer. Low power circuitry that operates from two 9V transistor batteries with up to 350 hrs. life eliminates time consuming battery recharging. Weak battery condition is automatically indicated 8-10 hrs. in advance to eliminate lost time in the field.

Couple these major features with things such as automatic zero, automatic overrange, automatic minus polarity. Add in unusual features that include a full 10 amp AC/DC current range and a special "Hold" function for measurements in hard-to-reach locations. Package all this in a rugged, small, lightweight case. Offer it at the low price of \$195* with Weston quality manufacturing and worldwide service and nobody can match it. Bravo!

*Price in U.S. only

SANGAMO WESTON

Schlumberger

WESTON INSTRUMENTS

a DIVISION of SANGAMO WESTON, INC.

614 Frelinghuysen Avenue, Newark, N.J. 07114 (201) 242-2600

Canada: 1480 Dundas Highway, Mississauga, Ontario

Europe: Ingolstadtstr. 67a 8 München 46, W. Germany



High Voltage Probe



R.F. Probe



AC Clamp-on Probe



"Hold" Function Probe



Light Meter Attachment





Precise signal sourcing

Sig gens, synthesizers —and a capable offspring

Precision signal sources are a must for sophisticated testing. From stringent measurements on radio receivers to automated testing on production lines, the test inputs will most likely come from one of three types of instruments:

- Signal generators.
- Frequency synthesizers.
- Synthesized signal generators.

Signal generators combine modulated-signal capability with low-noise content and are ideal for narrowband receiver measurements. Frequency synthesizers get the nod where stable frequency is re-

quired, as in simulating local oscillator chains. Synthesized signal generators borrow some of the best features of the other two classes of instruments: stability (like a synthesizer) and calibrated output levels plus modulation capability (like a signal generator).

However, these categories aren't rigid. Every manufacturer packs his own special set of capabilities into different models of his signal-source line.

Generators for the tough tests

For performing sophisticated receiver tests, a signal generator can't be beaten. Signal-to-noise ratio, selectivity or rejection and gain-bandwidth characteristics are some of its primary applications. These tests

Gene Heftman
Associate Editor



Boonton's 102C/D signal generators are high-performance instruments for narrowband-receiver testing.

Phase-locking the 102D's output results in a frequency stability of less than 0.05 ppm/h.

require an instrument of calibrated and variable frequency range, calibrated and leveled output voltage, and one or more types of modulation capability.

A typical pair of signal generators for high-performance receiver testing are Boonton's 102C and 102D. Covering a frequency range of 0.45 to 520 MHz, their output power levels are calibrated and variable from +13 to -130 dBm. Output frequency modulation is provided in five ranges, from 3 to 300 kHz. Amplitude modulation from 0 to 100% at 400 Hz and 1 kHz rates is also built into the instruments.

An instrument similar to the Boonton pair is Hewlett-Packard's 8640B. It spans a slightly wider frequency range, 0.45 to 550 MHz, and an option can increase the frequency to 1024 MHz. The calibrated and leveled output amplitude is variable from +19 to -145 dBm. Modulation capabilities—amplitude, frequency and pulse—are built-in, with adjustable output levels ranging from 1 mV to 3 V.

Other comparable sig gens are Wavetek's 3001, Systron-Donner's 1702 and Marconi's new TF 2020.

Precise receiver measurements require an instrument that keeps the frequency from drifting. To get frequency stability, phase-lock techniques and crystal oscillators have been introduced, particularly in the newer synthesized signal generators. Locking the output to an internal, temperature-controlled crystal oscillator can produce stability figures on the order of 10^8 parts/h.

Phase-locking the output of Wavetek's 3001 synthesized generator has resulted in a frequency accuracy of 0.001% with a stability of 0.2 ppm/h. And a stability option gives an accuracy of 0.2 ppm with a stability of 5×10^{-9} parts/day.

Systron-Donner's 1702, described by the manufacturer as a synthesized signal source, uses a phase-lock method that doesn't depend on the timebase being temperature-controlled. A discriminator is summed with the modulator input to control the oscillator frequency. Frequency accuracy from this lock technique is spec'd at 0.07 ppm.

Often, a fine line separates sig-gen specs from those of newer synthesized varieties. Solid-state designs and improved oscillators, in addition to the phase-lock technique, are bringing the noise specs of synthesized generators closer to traditional sig gens.

In fact, Marconi's TF 2020, a synthesized signal generator by name, performs both as an accurate bench generator and as a programmable instrument for production testing. With an rf output level of ± 1 dB total accuracy and spurious noise levels 90 dB below the carrier, it carries a sig gen's specs. And like a frequency synthesizer, the instrument is stable to ± 1 part in 10^8 per day.

Probing deeper into data sheets

Speaking of specs, before a sig gen can be chosen to perform such critical receiver tests as adjacent channel selectivity and usable sensitivity, some impor-



An accurate, multiple-waveform generator, Wavetek's 172 synthesized-function generator is a departure from the usual sig gen. Nine different waveforms can be generated over a frequency range of 0.0001 Hz to 13 MHz.

tant specs need to be considered: phase noise, modulation distortion and leakage, among others.

For example, a generator used to test for adjacent channel selectivity—the ability of a receiver to differentiate between a desired signal and one in an adjacent channel—should have a low phase-noise spec. Most manufacturers specify the phase noise as a dB level at some frequency offset from the carrier.

HP and Boonton both pick the offset as a 20-kHz band around the carrier. In the HP 8640B, single-sideband phase noise is down more than 124 dB in the 460-to-900-MHz range, and 130 dB from 230 to 450 MHz.

Phase noise for Boonton's 102C and D is spec'd in dB/Hz. At 20-kHz offset, it's typically down by 125 dB. And all single-sideband noise has a typical noise floor of 135 dB/Hz.

Marconi has a guaranteed limit on phase noise. It's spec'd at -130 dB at 20 kHz in the TF 2020.

Another important receiver test, usable sensitivity, is measured by the SINAD ratio—signal + noise + distortion divided by noise + distortion at a receiver's output. The sig gen selected for this test must have low leakage and low modulation distortion.

But leakage specs can be complicated by how manufacturers make their measurements. Leakage for the HP 8660 synthesized generator is listed as a radiated and conducted limit per a MIL spec. But on the 8640B, leakage is listed as a certain voltage induced into a coil at a specified distance from the generator. Indeed, Boonton's data sheet doesn't give any numbers, but states that the company's machines can make unrestricted measurements on very sensitive receivers close to the instrument.

What it boils down to is this: The sensitivity of a particular receiver determines how much leakage it can tolerate.

Modulation distortion, while usually easier to locate

on a data sheet, is a more difficult concept to understand. That's because there are so many components of distortion to contend with. In addition to envelope distortion when amplitude-modulating, a small amount of FM, called incidental FM, occurs. And when frequency modulating, something called incidental AM, gets mixed in. Manufacturers list these specs individually, but the total harmonic distortion (THD) data should be checked first, to get an over-all picture of distortion.

AM distortion in Boonton's 102C and D units depends both on the percentage of modulation and the rate. With 30% modulation at a 1-kHz rate, THD is less than 1% and less than 3% at 90% modulation. FM distortion is a function of the operating frequency and decreases as frequency increases. Maximum THD at 100-kHz peak deviation is 1% in the 0.45 to 32.5-MHz band, but only 0.15% from 260 to 520 MHz.

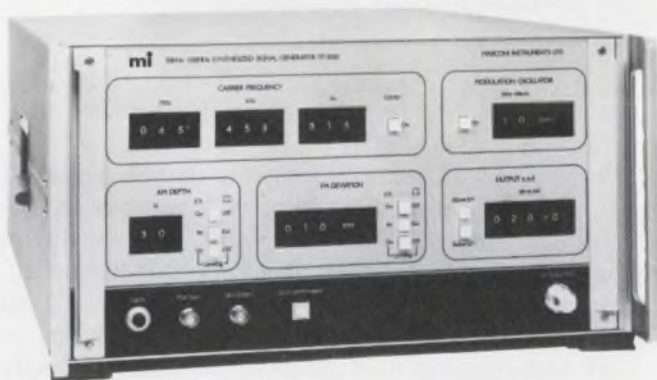

Marconi's TF 2020 synthesized signal generator can be operated manually as a bench generator, or automatically as a programmable generator. It's a 50 kHz to 520-MHz unit with AM and FM capability.

The AM distortion numbers are very similar for HP's 8640B. From 0 to 50% modulation at 400 Hz and 1 kHz rates, distortion is less than 1%. And from 50 to 90% at the same rates, it's less than 3%. FM distortion varies from less than 1% to less than 3%, depending on the deviation of the modulating signal.

Of course, sig gens serve in all the high-performance applications, but mainly as bench instruments. However, under computer control in an automated system, a "smart" synthesized generator can perform test routines that have been programmed-in.

Between generators—and synthesizers

The new kid on the block in precision signal sources, the synthesized signal generator, packs the futures of a signal generator and a frequency synthesizer into one box. In addition, both frequency and amplitude of the output can be programmable.

Where test conditions require many repetitive measurements, the ability of an instrument to store and recall input parameters can keep the costs of production down. And for programmability, what could be better than to have that modern-day saviour

built-in—the microprocessor?

An on-board processor is a primary feature of Fluke's 6010A and 6011A synthesized generators. These so-called "smart" instruments can store and recall up to 10 frequencies, modulation conditions and attenuator settings. As a bench instrument, the processor can even inform the operator that he is attempting to program a condition that the machine can't provide. And all machine functions are both front-panel and remotely programmable.

Although microprocessor-based units are a recent innovation, instruments with programming capability are not. Marconi's TF 2020, HP's 8660 and 8672A, and Wavetek's 3001 are all remotely programmable and can be used in automatic test systems.

In the TF 2020, parallel BCD instructions from a remote controller can program-in all front-panel instructions. HP offers an interface kit for the 8660A/C that provides a link-up to the company's 2100-series computers. The 8672A has programmability as a standard feature via the IEEE 488 interface bus. Wavetek's 3001 contains standard frequency programmability, with level programming available as an option. Fluke's 6010A and 6011A offer remote control via the IEEE 488 bus or the EIA Standard RS-232-C interface.

Although synthesized generators are applied in sophisticated measurements, they're a shade behind sig gens in performing the most stringent tests. That's because the broadband amplifiers, phase-locked loops and mixers used in the instruments generate noise products that appear at the output.

Any data sheet for a synthesized generator will actually define spectral purity by listing a particular synthesized generator's harmonic and nonharmonic spurious signals. Fluke's 6010A and 6011A designate all nonharmonic spurious signals as 60 dB below the carrier or -110 dBm, whichever is greater. Harmonics are spec'd at -50 dB at 1 MHz and -40 dB at 10 MHz.

The HP 8660's spectral purity also depends on the operating frequency. At 110 MHz, harmonics are 40 dB down, while up at 2600 MHz they're 20 dB down. Nonharmonic spurious are listed at -80 dB at 110 MHz.

Some data sheets list spurious signals in dBc, as a power level below the carrier. Above 120 MHz, a Marconi TF 2020 has nonharmonics at least 90 dBc. The number is 80 dBc when the frequency is below 120 MHz.

In an automatic test system, it's likely that the frequency of the instrument will have to be changed for different test conditions. How long it takes to switch from one frequency to another is directly related to the way in which the generator is designed.

Indirect generators—fast switchers

To generate the output of a synthesized generator, a crystal oscillator produces a reference signal that is then translated into a broad range of output



Frequency and amplitude in an HP 3335A are controlled by a microprocessor. Ten front-panel settings can be stored and recalled from the internal memory. A 200-Hz

to 80-MHz synthesizer, the instrument contains a special amplitude attenuator that is accurate to ± 0.04 dB over the entire frequency range.

frequencies. Either direct or indirect translation are used.

The direct method yields fast switching speeds, but opens the way to spurious outputs. Switching speed is typically 20 μ s.

Indirect methods, using phase-lock loops, are more popular in current instruments. Fewer spurious signals are generated because each lock loop generates only one frequency at a time. But switching speed is much slower, typically 1 to 2 ms.

Indeed, a TF 2020 with indirect translation, can take up to 50 ms before it's within 1 Hz of the final frequency value. And after 100 ms, an 8660 may still be 5 Hz from touchdown.

A microprocessor-based unit seems to have a clear advantage in switching speed. Operating on the low (10 Hz to 110 kHz) range of a Fluke 6010A, the final programmed value of frequency is within 10 Hz in less than 2 ms. In the high (10 Hz to 11 MHz) range, on the other hand, after 2 ms, the final frequency value is still 1 kHz away.

Switching time in HP's 8672A synthesized signal generator has been cut below that of the older 8660. The high-frequency 8672A has a range of 2 to 18 GHz, and switching time is spec'd in three different frequency intervals. In the highest interval, between 12.4 and 18 GHz, frequency is within 3 kHz of the final value in under 15 ms.

A candidate for the precision signal-source category is Wavetek's Model 172 function generator. It's quite different from any of the instruments discussed so far, because besides pure sine waves, it puts out such waveshapes as squares, triangles, pulses and ramps. Frequency coverage is quite broad— 10^{-4} Hz to 13

MHz, with a synthesizer option that yields an accuracy of 0.0005% of the programmed setting. Also, a built-in microprocessor provides interactive feedback to the operator when the unit is keyboard-operated.

The modulation capability of both sig gens and synthesized generators makes receiver testing the primary application. But when receiver components like filters and crystals need testing, a highly stable frequency source with a calibrated amplitude is most often used.

The super stable frequency synthesizers

Like sig gens, frequency synthesizers provide variable and accurate output frequency, and like synthesized generators, they are programmable. While they are classified as instruments with extremely high frequency stability and accuracy, they do suffer from high spurious signal content and poor sideband phase noise.

The current crop—from GenRad, Fluke, HP and Systron-Donner—has options that make frequencies super-stable, and noise specs that make them quieter than ever.

A GenRad 1062 synthesizer has a frequency range of 10 kHz to 500 MHz and a high or moderate stability option. A crystal oscillator in a temperature-controlled oven in the high option has a stability of better than 2×10^{-10} parts/ $^{\circ}$ C over 0 to 50 C. Drift is about 10^{-9} parts/day after one month of continuous operation, and less than 2×10^{-10} parts with a 10% line-voltage variation. The same option is available in the 1061, with a frequency range from dc to 160 MHz.

Noise specs for frequency synthesizers are listed in

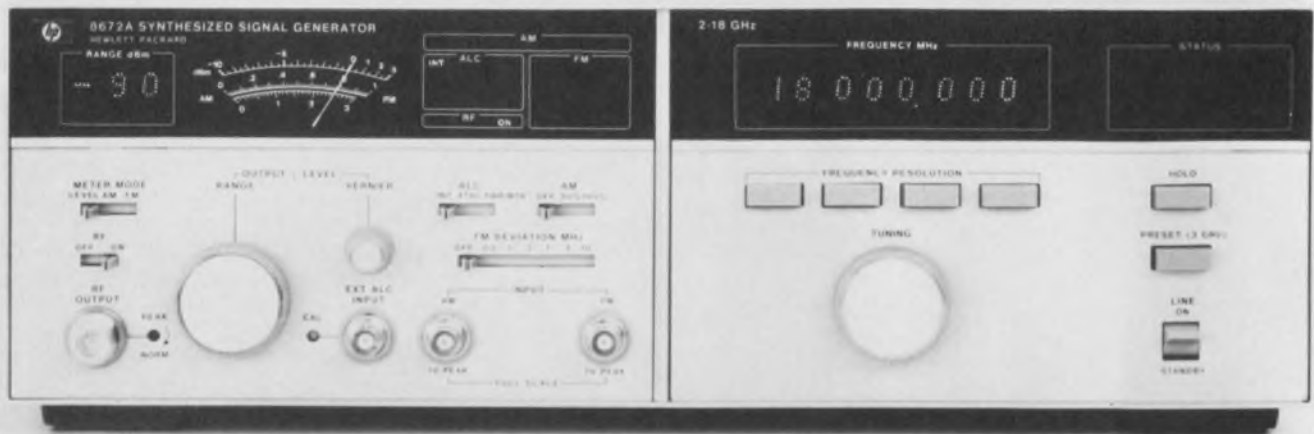

Calibrated microwave frequencies from 2 to 18 GHz are generated by the HP 8672A synthesized generator. High stability is provided by the internal crystal time base,

whose aging rate is less than 5×10^{-10} parts/day. All front-panel functions can be remotely programmed via the IEEE 488 interface bus.

the same way as for synthesized generators. Harmonic noise is listed in two bands for the HP 3335A synthesizer/level generator. From 200 Hz to 10 MHz, it's -45 dB and from 10 to 80 MHz, -40 dB. All nonharmonic spurious signals are more than 75 dB below the carrier or -125 dBm, whichever is greater.

In any synthesizer, the primary component of noise is related to phase rather than amplitude. Noise is generally specified as the maximum noise power in a 30-kHz bandwidth centered on, but excluding, the carrier. The spec sums all the random phase-modulation products generated internally.

A 1 to 40-MHz instrument, the Fluke 6039A frequency synthesizer, specs the single-sideband phase noise as a signal-to-noise ratio. At 100 Hz offset from the carrier, s/n is greater than 110 dB, while at 600 kHz, it's way down to 140 dB. For the 6160B, covering 1 to 160 MHz, s/n is 135 dB down at 600 kHz.

Systron-Donner's 1615 uses the dB-below-carrier method to spec phase noise. At 1-kHz offset, it's listed at -70 dBc, while at 100 kHz it goes down to -100 dBc.

Programmability is a feature of all synthesizers, and one, the HP 3335A, uses a microprocessor. The processor is a big help, because it allows the instrument to store front-panel settings for fast recall in repetitive tests.

BCD programming is featured in the Fluke 6039A and 6160B units. Frequency programming takes 34 parallel, TTL-compatible lines.

GenRad offers the 1167 Frequency Programmer to control its 1061 and 1062 synthesizers. The 1167 performs digital sweep in automatic test systems,



GenRad's 1062 frequency synthesizer switches frequency in 50 μ s. One-hundred data points in a digitally swept system can be scanned in 45 ms, with a 400- μ s dwell time for each measurement.

besides providing incremental frequency stepping and synthesized search.

A synthesizer, like a synthesized generator, has a switching speed spec to tell how fast it can change frequencies. Since both instruments are often used in automatic test systems, knowing when they are close to program frequency is important, so that the system computer will know when to begin a test.

With a GenRad 1062, how long it takes to lock onto the final frequency depends on how much the frequency changes. If the frequency changes by the highest increments (100 MHz), the 1062 will be 500 Hz from the final value after 50 μ s. But after 1 ms, it's only 3 Hz away. Using the lower frequency 1061, the



Frequency programmability is a standard feature of Wavetek's 3001 signal generator, and an option can

provide level programming. The instrument covers a frequency range of 1 to 520 MHz, accurate to 0.001%.

highest switching increment is 10 MHz. After 1 ms, the final value of frequency is less than 0.1 Hz off. Fluke's 6039A gives just one switching time number to consider. In less than 800 μ s the unit is within 100 Hz of its final value. But in the same 800 ms, the 6160B synthesizer is only 50 Hz away.

HP specs the switching and settling time of the frequency of its 3335A synthesizer as a phase angle. The frequency is within 90° of the final phase in under 20 ms. In addition, there's a switching time for amplitude—within ± 0.02 dB of the final value in less than 500 ms.■

Fluke's 6039A gives just one switching time number to consider. In less than 800 μ s the unit is within 100 Hz of its final value. But in the same 800 ms, the 6160B synthesizer is only 50 Hz away.

Need more information?

The products cited in this report don't necessarily represent the manufacturers' complete lines. For complete details, circle the appropriate reader service card number. More vendors and information may be found in ELECTRONIC DESIGN's GOLD BOOK

- Adret Corp., 1630 Manheim Pike, Lancaster, PA 17601. (717) 569-7059. Circle No. 496
- B&K Precision, Dynascan Corp., 6460 W. Cortland Ave., Chicago, IL 60635 (312) 889-9087. Circle No. 517
- Boonton Electronics Corp., Rte. 287 at Smith Rd., Parsippany, NJ 07054. (201) 887-5110. Circle No. 497
- Comstron SEG, 200 E. Sunrise Hwy., Freeport, NY 11520. (516) 546-9700. Circle No. 498
- Cushman Electronics, Inc., 830 Stewart Dr., Sunnyvale, CA 94086 (408) 739-6760. Circle No. 499
- Engelmann Microwave Co., Skyline Dr., Montville, NJ 07045. (201) 334-5700. Circle No. 500
- John Fluke Mfg. Co., P.O. Box 43210, Mountlake Terrace, WA 98043. (206) 774-2211. Circle No. 501
- GenRad, 200 Baker Ave., Concord, MA 01742. (617) 369-8770. Circle No. 502
- Gould Advance Ltd., Raynham Rd., Bishops Cleeve, Herts England. 027-95-5155. Circle No. 503

- Hewlett-Packard, 1501 Page Mill Rd., Palo Alto, CA 94304. (415) 493-1501. Circle No. 504
- Interstate Electronics Corp., 707 E. Vermont Ave., Anaheim, CA 92803. (714) 549-8282. Circle No. 505
- Kay Elemetrics Corp., 126 Maple Ave., Pine Brook, NJ 07058. (201) 227-2000. Circle No. 506
- Logi Metrics Inc., 121-03 Dupont St., Plainview, NY 11803. (516) 681-4700. Circle No. 507
- MCL Inc., 12 N. Beach La., La Grange, IL 60525. (312) 354-4350. Circle No. 508
- Marconi Instruments, 100 Stonehurst Ct., Northvale, NJ 07647. (201) 767-7250. Circle No. 509
- North American Philips Corp., 85 McKee Dr., Mahwah, NJ 07430. (201) 529-3800. Circle No. 510
- Racal Instruments Ltd., Duke St., Windsor, Berkshire SL41SB, England, Windsor 69811. Circle No. 511
- Rohde and Schwarz, Muehlendorferstrasse 15, D-8000 Munich 80, West Germany. (089) 4129-1. Circle No. 512
- Singer Instrumentation, 5340 Alla Rd., Los Angeles, CA 90066. (213) 822-3061. Circle No. 513
- Systron-Donner, Ten Systron Dr., Concord, CA 94518. (415) 676-5000. Circle No. 514
- Watkins-Johnson Co., 700 Quince Orchard Rd., Gaithersburg, MD 20760. (301) 948-7550. Circle No. 515
- Wavetek, 9045 Balboa Ave., San Diego, CA 93123. (714) 279-2200. Circle No. 516

Elastoplastic silicone resin. The conformal coating with imagination.

When you want a conformal coating that's more than a coating, use Dow Corning® R-4-3117 elastoplastic silicone. It lets you expand your imagination for improving and protecting your product's performance.

Strong and flexible.

Elastoplastic silicone helps your product take abuse from tough environments. And it gives, without giving in. This smooth, hard, clear coating also keeps your product clean by resisting dirt pickup.



Works well, hot or cold.

When you need a coating that takes the heat (up to 390 F/200 C), puts up with the cold (down to -85 F/-65 C), or both—elastoplastic silicone won't disappoint you.

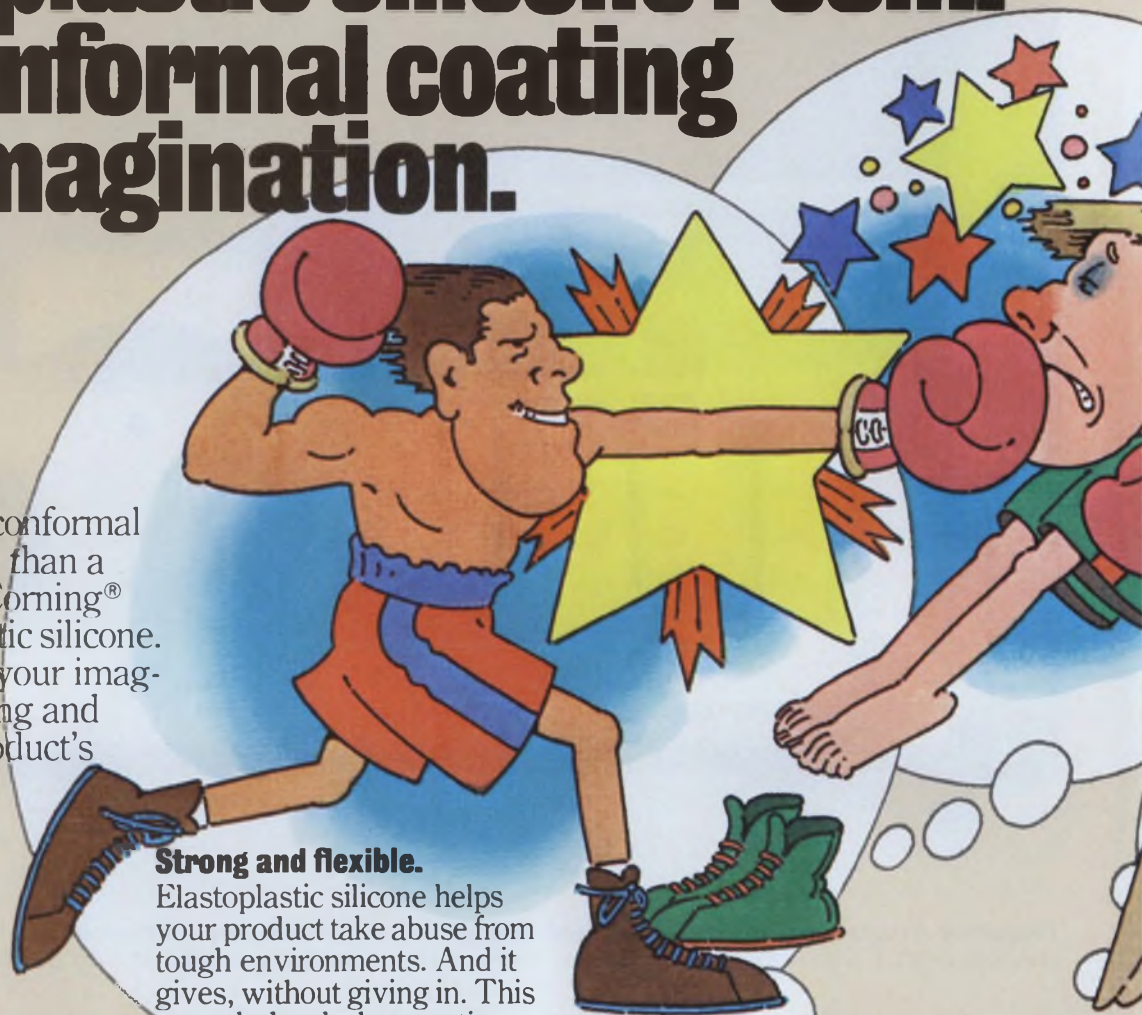

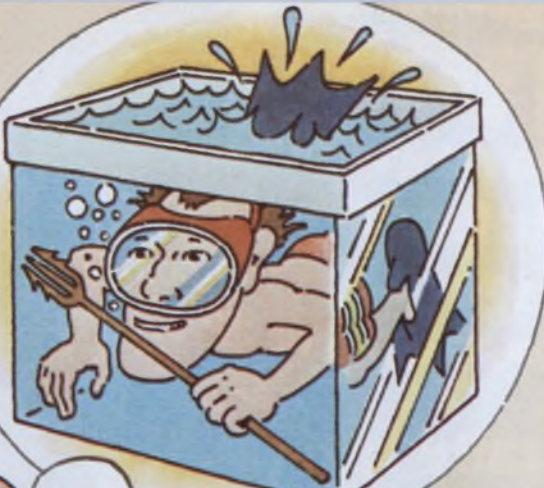

Keeps out moisture.

Because moisture permeability is extremely low, water or humidity won't spoil your product's performance.

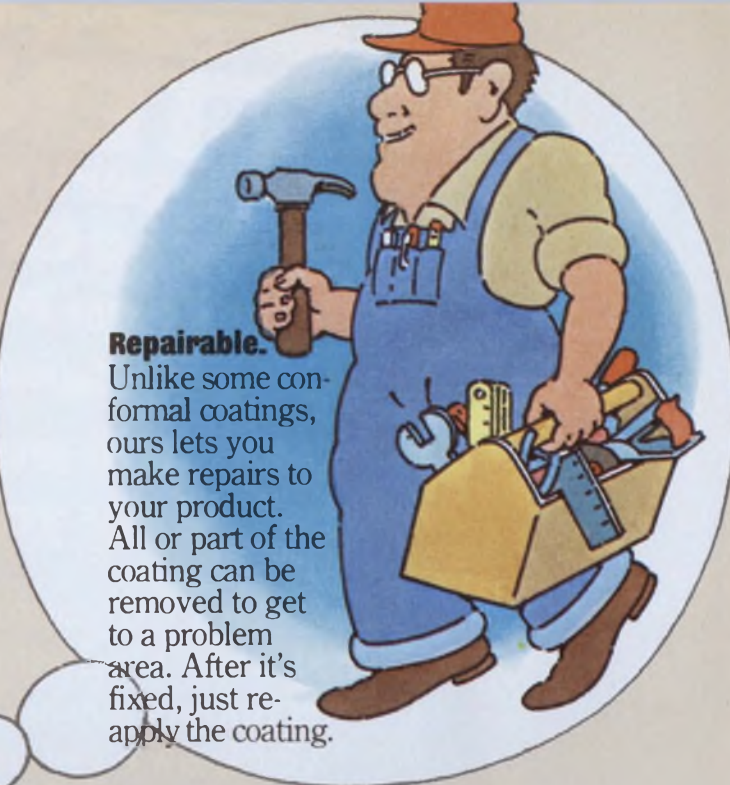

Repairable.

Unlike some conformal coatings, ours lets you make repairs to your product. All or part of the coating can be removed to get to a problem area. After it's fixed, just re-apply the coating.

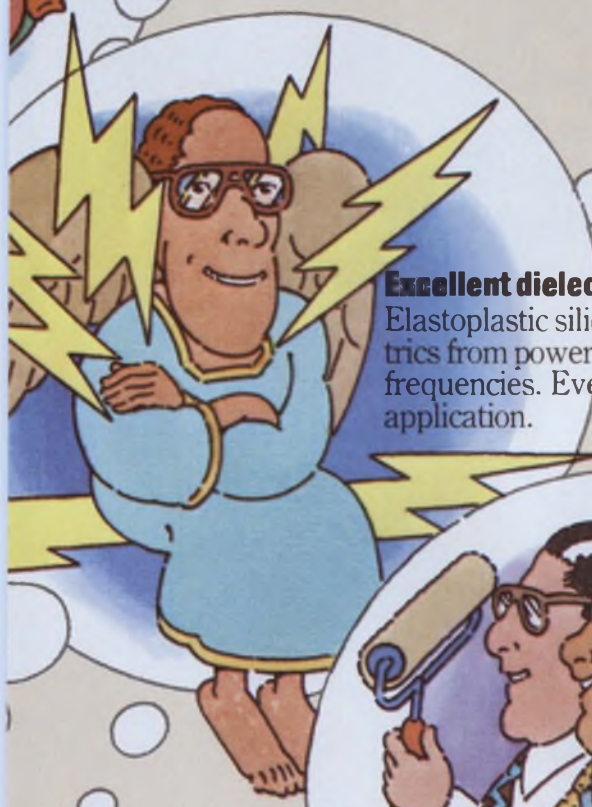

Excellent dielectric stability.

Elastoplastic silicone keeps its dielectrics from power through microwave frequencies. Even in high-humidity application.



Three easy ways to use.

Apply elastoplastic silicone the way you want. Brush, flow coat, or dip it on. As thin or thick as you need. For thicker films, you simply recoat it.

And choose the noncorrosive cure to match your process. At room temperature or under heat acceleration.

Try some.

By now, you've probably already imagined places you could use this versatile conformal coating. And you're sure to think of more.

That's why we'd like you to try some for yourself. For samples or complete product information on Dow Corning elastoplastic resin coating, fill out and mail the coupon below.

I want to see how I can benefit from elastoplastic silicone resin.

Send complete product literature.

I'd like to talk to a sales representative about getting a sample for evaluation.

Name _____

Title _____

Company _____

Address _____

City _____ State _____ Zip _____

Telephone _____

Mail to: Dow Corning Corporation,
Dept. B-7539,
Midland, Michigan 48640.

DOW CORNING

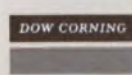

ATTENTION

-Engineering Managers
-Printed Circuit Board
Design Managers.

Are you still manually taping or digitizing your PC boards?

“Our truly automated design system, The Redac Mini, is economically and functionally viable for companies designing as few as 40 new boards a year. Moreover the system will enable smaller electronics companies to compete on level terms with the giants of industry.”

CIRCLE NUMBER 32



MANUAL LAYOUT, TAPING AND DIGITIZING ARE OBSOLETE!

- The Redac Mini is the only computer-based system to have all the automatic aids for total PC board design, plus direct designer involvement – at an economic price.
 - Automatic component placement.
 - Automatic track routing.
 - Automatic design rule checking.
 - Interactive refreshed graphics/light pen.
- With the Redac Mini a 24 hour turn-around from schematic to artwork is now a reality – as a design manager you know only too well how this would ease your scheduling.
- Even with all of its automatic aids the cost of the Redac Mini is considerably less than an Interactive Digitizer CAD System.
- The Mini uses standard DEC PDP11 hardware—if you already have the hardware we can supply the software only.

REDAC the design aid people
Redac Interactive Graphics Inc.
225 Great Road Littleton MA 01460
Phone 617-486-8751
617-486-8158

\$295

U.S. PRICE



YOUR BEST BUY IN SWEEP FUNCTION GENERATORS

The Krohn-Hite Model 1200 offers linear sweep (up or down) plus sine, square or triangle waveforms from .2Hz to 3 MHz. Features include: 1500:1 tuning dial plus vernier; external VC and CV output; push button control; DC offset control; auxiliary TTL output; separate HI and LO outputs and much more! Take advantage of this price while we're in a generous mood. Call (617) 580-1660 for more details.

245

U.S. PRICE



SECOND BEST

LESS SWEEP The new Model 1000 has all the quality features of the 1200 except sweep!

KH KROHN-HITE CORPORATION

Avon Industrial Park, Avon, Mass. 02322 • (617) 580-1660

SALES OFFICES: ALA., Huntsville (205) 534-9771; ARIZ., Scottsdale (602) 994-5461; CAL., San Jose (408) 292-3220, Inglewood (213) 674-6850; COL., Denver (303) 773-1218; CONN., W. Hartford (203) 525-7647, FLA., Orlando (305) 894-4401; GA., Atlanta (404) 455-1206; HAWAII, Honolulu (808) 941-1574; ILL., Arlington Hts (312) 394-3380; KS., Overland Park (903) 384-2710; LA., Lafayette (318) 984-3516; MASS., Wakefield (617) 245-5490; MICH., Southfield (313) 569-4497; MINN., St. Paul (612) 645-5816; MO., St. Louis (314) 731-5400; N.M., Albuquerque (505) 255-2330; N.J., Cherry Hill (609) 482-0059; N.Y., Elmont (516) 488-2100, Rochester (716) 328-2230, Syracuse (315) 437-6666, Vestal (607) 785-9947; N.C., Burlington (919) 227-3639; OHIO, Chesterland (216) 729-2222, Dayton (513) 434-8993; OKLA., Tulsa (918) 299-2636; ORE., Portland (503) 297-2248; TEX., Dallas (214) 661-0400, Houston (713) 688-1431; UTAH, Salt Lake City (801) 942-2081; VA., Falls Church (703) 573-8787; WA., Bellevue (206) 454-3400; CANADA, Montreal, Quebec (514) 341-7630, Ottawa, Ontario (613) 235-5121, Toronto, Ontario (416) 445-9900, Vancouver, British Columbia (604) 253-5555, Halifax, Nova Scotia (902) 454-8321, St. John's, Newfoundland (709) 726-2422.

CIRCLE NUMBER 33



Measuring temperatures

Knowing component temps can improve your design

Measuring temperatures has become critical to designing today's electronic equipment. For one thing, thermal-design calculations may not represent the real-life situation in equipment, and only by carefully measuring the temps of key elements will a designer be sure that semiconductor and other components don't exceed their maximum allowable temperature ratings. In addition, monitoring environmental chambers and test stands that operate at elevated temperatures to accelerate early failure rates are necessary to evaluate performance and protect prototype devices and equipment against damage from excessive heat. And locating hot spots with thermometer probes can facilitate and speed troubleshooting and trouble analysis.

Fortunately, a designer can choose from a wide range of temperature indicators and thermometers. There are simple stick-on elements that change color when a specific temp has been exceeded, and there are accurate digital thermometers that can monitor from one to as many as 20 or 30 sensors. Hand probes are now appearing that can be used with standard digital and analog voltmeters. And for someone willing or able to spend as much as \$45,000 on temperature analysis, thermographic systems are available to map temperature differentials of PC boards or other equipment—in color.

Stick-on indicators cost the least

At the low-cost end of the spectrum, temperature indicators are available in the form of stick-on labels, crayons, pellets, lacquers and inks. Not only do they cost little, they also have fast response, and don't conduct heat away from the device being measured.

Jim McDermott
Eastern Editor

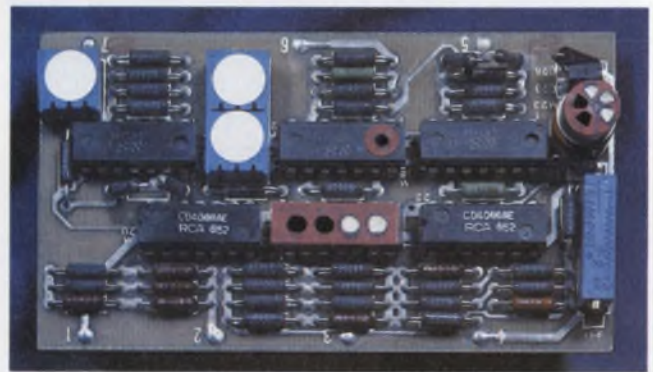

Adhesive-backed temperature-recording labels by Tela-temp change from white to black when a specified temperature has been exceeded. Here, labels are placed on ICs, transistors and heat sinks.



Thermocouples, thermistors or platinum-resistance sensors are used in these digital thermometers by Digitec. The meters display readings in °C or °F and have resolutions of 0.01, 0.1 or 1 C or F to match applications.

And a 1% indication accuracy can be achieved with them.

Temp indicators that are widely used are the temperature-sensitive labels, which are composed of one or more heat-sensitive spots. They are placed on components such as transistors, ICs and heat sinks (see photo). As a specified temperature is reached, an indicator circle changes from white to black. The color change is irreversible, so it becomes a permanent record.

These labels can also be affixed to products going out into the field to indicate the highest temperature the equipment will experience.

Crayon-type indicators tell that a fusible temperature has been reached by melting or changing color. They are generally provided in about 100 temperature ratings between 100 F and 2500 F, but their ratings can go as high as 3200 F. Where a surface may not accept the crayon, a temperature-indicating lacquer can be substituted over the same temperature ranges and with the same indicating accuracy.

Fusible pellets are also available, but they are primarily useful for monitoring higher temperatures such as heat zones in furnaces.

Thermocouples are popular sensors

Temperature sensors used with digital or analog thermometers fall into four general classes: thermocouples, thermistors, resistance-temperature detectors (RTDs) and junction semiconductor elements exploiting the variations in junction characteristics with temperature. Thermocouples cover the widest range of temperature measurement. Thermistors have the greatest sensitivity to temp changes. And RTDs have the highest stability. Semi elements are proving particularly useful in hand-held probes used for checking the temperatures of PC-board devices. Electronic digital thermometers range in price from \$250 to \$800 for thermocouple units and RTDs, and \$250 to \$500 for thermistor instruments. Prices depend upon such factors as resolution, accuracy and packaging.

Probably the most popular thermal sensor is the thermocouple, which is rugged and low-cost—for standard probes, around \$10. Thermocouples generate thermoelectricity, which was discovered by Seebeck in 1821 when he found that if two dissimilar metals are connected in a conducting loop and one end of the loop is hotter than the other, a voltage will be developed and a current will flow.

While early thermoelectric experiments were conducted with antimony, copper and lead, improved alloy-metal combinations have been developed over the years. They are identified by American National Standards Institute Type numbers (see table).

Two factors directly related to thermocouple characteristics affect the design of electronic thermometers:

- For accurate temperature measurements, the cool



This low-cost volt-ohmmeter has two ranges for measuring temperature. The temperature probe in this Triplet instrument Model 100-T is a thermistor that measures from 50 to 300 F.



This temperature probe with a solid-state-junction thermal sensor generates an EMF of 1 mV/°C. It can be used with the Valhalla Model 4440 digital multimeter or any other DMM with a 200-mV full-scale range and autopolarity for indicating negative temperature. It can measure from -50 to 150 C.

junction of a thermocouple loop, which is located at the instrument, must be maintained at a fixed reference temperature—usually 0 C (32 F).

- The output of thermocouples is highly nonlinear.

If the reference-junction temperature is fixed, the thermocouple voltage is nonlinear but predictable for different temperature ranges. The National Bureau of Standards has established accurate values of this voltage for standard thermocouples.

For many years literally baths of ice provided reference-junction temperature. But modern digital instruments use electronic equivalents. Where the



Temperature scales and an auxiliary hand probe permit the designer to measure device or component temperatures from -55 to 150 C or F with this Tektronix 851 digital tester.

instrument is designed to use one or more specific thermocouples, the cold junction is incorporated into the instrument. But if the meter has no internal cold-junction compensation, it must be provided externally.

For cold-junction compensation, Fluke uses circuitry that senses the temperature of the reference junction and generates a compensating voltage that makes the junction look to an electronic thermometer as if it were at 0 C (32 F). Omega Engineering's Model CJ cold-junction compensator, for meters without internal compensation, contains a special bridge network for the same purpose; it can be used with a variety of thermocouples.

Thermocouple outputs are low, from a few microvolts to 75 mV. Sensitive galvanometers and meter movements have been used, but digital measurement has superseded them because of higher accuracy and resolution, and faster readouts.

Accuracy is frequently specified on the order of 1 to 2 C or better—even as manufacturers disagree on just what constitutes accuracy and how it should be specified. Resolution is in the order of ± 1 C over a few hundred degrees, and ± 0.1 C or better for shorter spans.

More than a DVM

Thermocouples make selecting a digital thermometer a lot more involved than choosing a simple DVM, upon which it is based. Besides the errors inherent with digital voltmeters, there are thermocouple errors to consider, including the deviation from the NBS curve for the thermocouple used; the span of temperature being measured, which is a function of the reference voltage coefficient; the ambient tem-



Exceptionally high accuracy is provided by HP's Model 2804 quartz-crystal thermometer. Temperature range is -50 to 150 C and resolution is 0.0001 C.

perature error; and the reference-junction temperature error, among others.

Since thermocouple output voltage is nonlinear, compensation must be made in analog and digital thermometers. Analog meters employ nonlinear scales tailored to the thermocouple used. Digital-meter designers approach the problem differently, but in any event they break the thermocouple curve into segments providing the best possible fit to the NBS curve (see figure).

Digital thermometers using thermocouples generally use 10, 20, 25 or 32 break points. Fluke's 2100A series uses 64 segments plus a 4-k ROM that stores programs containing 256 possible slopes for each segment.

Both the 267 and 268 series of pyrometers by Newport Laboratories have a plug-in analog linearizer for each temp range. Called the Polylog, it changes the amplification factor of the input amplifier for 20 segments. The system equals the performance of a 20-segment digital or diode-function generator-linearizer, but without the drift and other problems associated with a diode-function generator.

A microprocessor-controlled thermocouple system, the Alnor 8800, monitors temperature at 32 points. It also has a 32-segment digital-linearizing circuit that is accurate to within 0.25 F or 0.25 C of NBS specs.

Where accuracy and resolution substantially higher than those obtained with thermocouple instruments are required, a digital thermometer like Hewlett-Packard's Model 2804A microprocessor-controlled quartz thermometer can be used. Unlike thermocouple instruments, this one is based on the sensitivity of a quartz crystal's essentially linear change in resonant frequency with temperature. Residual nonlinearities are further rejected by a curve-fitting technique that employs a PROM programmed for each crystal.

The 2804A thermometer has an accuracy of $.04$ C over a temperature range of -50 to 150 C and a resolution of $.0001$ C that is two orders of magnitude or better than comparable thermocouple, platinum or thermistor systems. A seven-digit readout displays

either centigrade or Fahrenheit. The instrument output is compatible with the HPIB bus system.

Thermocouples aren't the only sensors

Another important type of sensor used in electronic thermometers, the resistance-temperature detector (RTD), is a wound resistance element fabricated from pure platinum or other metals. Resistances range from 10 to 500 Ω . These RTDs have positive temperature coefficients and offer the best inherent linearity. But their output, or change in resistance with temperature, is low—about 0.4%/°C. Prices vary from about \$10 to \$100 for standard RTDs. Platinum reference elements traceable to NBS may cost several hundred dollars.

RTDs are generally used to cover broad temperature ranges. For example, the Digitec 5900 PC, with a platinum sensor, operates from -100 C to 600 C with a resolution and repeatability of 1°. Platinum resistance probes also provide the greatest composite accuracy over a broad temperature range.

Still another major temperature sensor, the thermistor, is a bulk semiconductor element with a negative coefficient of resistance. Basic cold resistance is in the order of a few hundred to a hundred thousand ohms.

For protection, thermistors are usually encapsulated in glass beads. Their output is highly nonlinear, but they have an exceptionally large change of resistance with temperature, about 4%/°C. Depending on the mounting and probe design, they go for about \$5 to \$50.

Digital thermometers have generally been available in either panel-meter or bench configurations, with many having provisions for battery operation. But now, hand-held, battery-powered units are also appearing.

One pocket-sized meter, Omega Engineering's \$250 Omegatemp, measures temperatures continuously over -55 to 999 C with a 1° resolution. Automatic cold-junction and linearizing circuits eliminate error due to variations in the thermocouple length and diameter. LEDs are used for the display. Accuracy is a 0.2% of reading \pm one digit.

Another hand-held meter measures temperatures over the MIL-standard range of -55 to 125 C—EDC Corp.'s \$239 T-Meter. Battery drain is minimized by a liquid-crystal display. Unlike other hand probes, the T-Meter uses a silicon diode as the temperature-sensing device, which minimizes the instrument complexity. The meter measures the change, with temperature, of the forward-voltage drop across the diode. Diodes are selected, and circuits inside the probe tailor the diode outputs for optimum linearity.

The standard T-Meter probe's accuracy is listed as ± 0.5 C over the MIL-standard range. For special applications covering only a 20° span in the MIL range, a special probe can obtain ± 0.1 C.

Besides electronic thermometers, both analog and

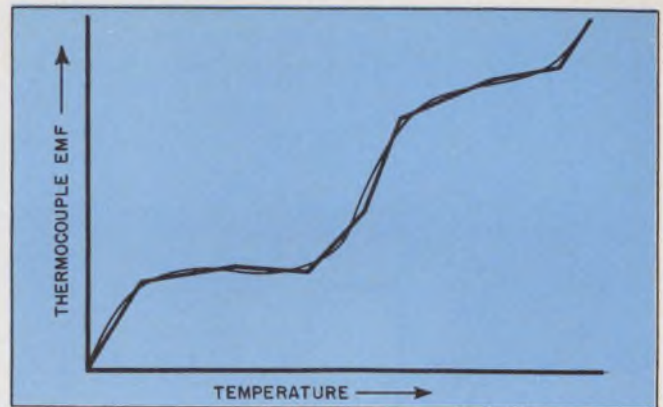

In thermometers using thermocouples, the nonlinear characteristics of the couple are approximated by line segments adapted to the particular thermocouple calibration curve referred to NBS data.

ANSI thermocouple types and ranges

Type	Thermocouple Material	Useful Temperature Range, °C
J	Iron vs Constantan	-270° to +1200°
K	Chromel vs Alumel	-270° to +1372°
T	Copper vs Constantan	-270° to +400°
E	Chromel vs Constantan	-670° to 1000°
R	Platinum vs Platinum 13% Rhodium	-50 to +1768°
S	Platinum vs Platinum 10% Rhodium	-50 to +1768°
B	Platinum 6% Rhodium vs Platinum 30% Rhodium	0° to +1830°
C	Tungsten 5% Rhenium vs Tungsten 26% Rhenium	0° to +2200°
G	Tungsten vs Tungsten 26% Rhenium	0° to +2700°

digital multimeters are available that, while not primarily intended for temperature measurement, do have temperature probes and temperature scales. For example, Triplet's Model 100-T analog volt-ammeter uses a thermistor probe to check for hot spots in PC circuits. The meter has two temperature scales: -50 F to 150 F and 50 F to 300 F.

Another example of this trend to incorporate temperature-test features is Tektronix's \$1995 851 digital tester. In addition to its many digital trouble-



Sixty thermocouples, thermistors, or RTDs can be scanned by the Fluke 2240B microprocessor-controlled Data Logger without special equipment. With it, as many

as 1000 can be scanned. Low-thermal-EMF switches permit the 2240B to measure voltages as low as 1 μ V and temperatures to within 0.1°C or F.

shooting functions, the 851 can use an optional temperature probe to display temperatures between -55 and 150 C, with an accuracy of 2 C and a resolution of 0.01 C. This feature is useful for locating malfunctioning memory chips in a large memory bank or in checking power supplies for hot spots.

Tektronix's P6430 Temperature Probe can be used optionally with the company's digital multimeters. Temperature is measured by an npn transistor sensor at the voltage-probe tip. Temperature is a function of emitter-base voltage.

Probes available for standard DMMs

As a matter of fact, dc voltmeters and multimeters *without* temperature scales can be converted into direct-reading thermometers by probes having a linear voltage-vs-temperature output. Fluke's 80T-150 \$125 universal temperature probe produces a readout of 1 mV/°C or 1 mV/°F, depending on the model used.

Temperature ranges are either -50 to 150 C or -58 to 302 F. DMM sensitivity of the meter scale used to read the temperature determines the resolution of the readings. A 150-mV range resolves any centigrade reading to 0.1°. The probe output can also operate

chart recorders. For the heat-sensing element, a microcircuit transistor is deposited on the small aluminum probe tip.

Battery-operated circuitry in a junction box that connects the probe lead to the meter monitors the temperature coefficient of the transistor's forward voltage drop, V_{be} . This is converted into a linear mV/°C or °F output.

Another universal probe that produces 1 mV/°C is manufactured by Valhalla Scientific for use with its Model 4440 Digital Multimeter Counter or any DMM having a 200-mV full-scale range. Operated by a 9-V battery, the probe incorporates a constant current bridge that monitors a solid-state sensor. Accurate to within $\pm 2^\circ$ from 0 to 100 C and $\pm 3^\circ$ from -50 to 150 C, the sensor is embedded in a low-mass brass tip for minimum thermal lag.

Infrared measurements count, too

One thing that the thermocouples, RTDs and other sensors discussed so far have in common is that they must touch the surface to be measured. But noncontact infrared measuring systems are proving useful for monitoring and detecting temperatures that are too high for thermocouples and RTDs—in the order of several thousand degrees.

Hand-held infrared "guns," like the one produced by Telatemp, can be pointed at a hot source to get a temperature reading. But these provide a readout of temperature integrated over a large area, and aren't useful for most electronic applications.

Meanwhile, a thermal-monitoring system with a fiber-optic probe that pinpoints areas of interest is finding considerable use. The probe by Vanzetti Infrared and Computer Systems not only helps monitor semiconductor crystal-growing processes but can also take a thermal profile of a PC board.

Infrared energy is picked up by the fiber-optic probe and fed to a high-gain infrared detector. The output



Fiber-optic probes permit infrared signal transmissions over distances that allow Vanzetti IR temperature-monitoring electronics to be removed from high-temperature environments without affecting the accuracy of the measurements.

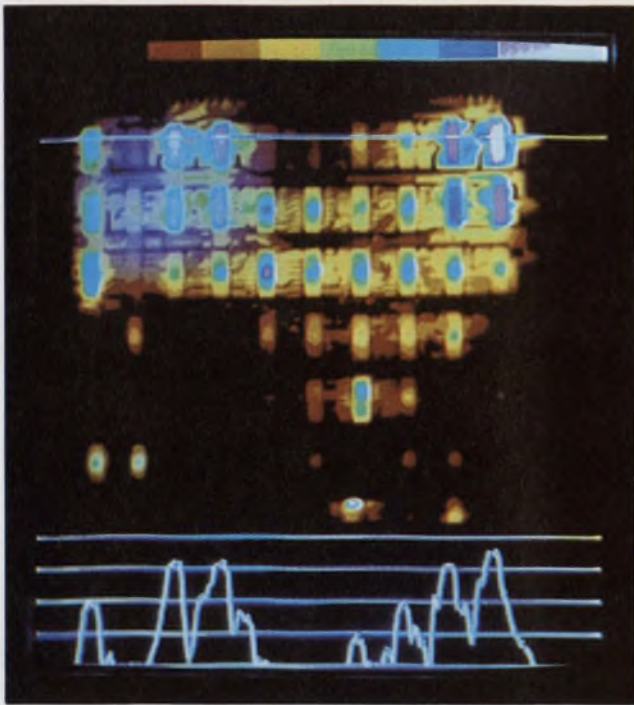

This color thermogram of a printed-circuit board reveals temperature profiles of 64 IC packages. White is hot, black is cold. The bottom scales denote the specific temperature range observed in the thermogram made by UTI-Spectrotherm's thermographic system.

of the detector can be amplified and processed for temperature, measurement or control. The readout is digital.

One application for the Vanzetti system is a digital IC component handler developed by Micro Component Technology in Minneapolis. The IC to be tested is first energized by a thermal matrix preprogrammed for it, then passed underneath the IR fiber-optic pickup head. The IC's temperature is checked and compared with the equipment's preset band limits. If the unit is within limits, a test-ready command is sent to the digital tester.

At the high-cost end of the temperature-measuring spectrum, heat from electronic circuits and components can also be vividly displayed on a TV screen by means of thermography. Systems with this capability are currently available from UTI-Spectrotherm, Barnes Engineering and AGA Aktibolag.

Running from about \$30,000 to \$45,000, these systems all use a slow-scan electromechanical scanning system to paint a picture of the infrared temperatures of the object being examined. Radiant energy from the object being scanned is focused onto a super-cooled detector. The detector's output is amplified and fed to a CRT-monitor screen on which varying shades of black and white represent temp differences. These differences are quantized by a color-scan converter that presents them in multiple shades of color, each hue representing a specific temperature.

The Color Quantizer used with UTI's Model 900 system, which has a 30 x 20-degree field of view, translates these grayish tones into 10 different, easily

distinguishable colors. And since a standard TV signal is used, this information can be recorded on tape.

In addition, Polaroid pictures may be taken of the thermograms.

Barnes's RM50 thermographic systems, on the other hand, is capable of microscopic inspection. Its lenses can magnify areas of interest three to 100 times. Polaroid pictures may also be taken of its thermogram images, and a video display and scan converter are available. ■■

Need more information?

The companies and products cited in this report have, of necessity, received only brief coverage. They have been selected for their illustrative qualities. Their product lines are identified here. The code to these products is: ET—electronic thermometers; TI—thermally sensitive indicators; IR—infrared thermometers; EM—electronic analog thermometers; MT—digital meters with provisions for measuring temperature; TS—thermograph systems. Many companies not mentioned may offer similar products.

- AGA Aktibolag, Lindigo, Sweden (AGA Corp., 550 County Ave., Secaucus, NJ 07094 (201) 866-3344) (TS) **CIRCLE NO. 519**
- Ainor Instrument Co., 7301 N. Caldwell Ave., Niles IL 60648 (312) 647-7866 (ET) **CIRCLE NO. 451**
- Analogic Corp., 1 Audubon Rd., Wakefield, MA 01880 (617) 246-0300 (ET) **CIRCLE NO. 452**
- Barnes Engineering, 30 Commerce Rd., Stamford, CT 06904 (203) 348-5381 (TS) **CIRCLE NO. 453**
- Digilin Inc., 3521 W. Pacific Ave., Burbank, CA 91505 (213) 846-1800 (ET) **CIRCLE NO. 454**
- Digitec (United Systems Corp.), P.O. Box 458, Dayton, OH 45401 (513) 254-6251 (ET) **CIRCLE NO. 455**
- Doric Scientific Div., Emerson Electric Co., 3883 Ruffin Rd., San Diego, CA 92123 (714) 565-4415 (ET) **CIRCLE NO. 456**
- E*², P.O. Box 404, Carpinteria, CA 93013 (805) 684-5461 (TI, IR) **CIRCLE NO. 457**
- ECD Corp., 196 Broadway, Cambridge, MA 02139 (617) 661-4400 (ET) **CIRCLE NO. 458**
- John Fluke Mfg. Co., Inc., P.O. Box 43210, Mountlake Terrace, WA 98043 (800) 426-0361 (ET, MT) **CIRCLE NO. 461**
- Heath Co., Benton Harbor, MI 49022 (616) 982-3236 (ET) **CIRCLE NO. 459**
- Hewlett-Packard, 1501 Page Mill Rd., Palo Alto, CA 94303 (415) 493-1501 (ET, MT) **CIRCLE NO. 460**
- Inframetrics Inc., 225 Crescent St., Waltham, MA 02154 (617) 891-6784 (TS) **CIRCLE NO. 520**
- Logical Technical Services, 71 W. 23 St., New York, NY 10010 (212) 741-8340 (MT) **CIRCLE NO. 518**
- 3M Co., 3M Center, Bldg. 219-1, St. Paul, MN 55101 (612) 733-7230 (TI) **CIRCLE NO. 462**
- Newport Labs, Inc., 630 E. Young St., Santa Ana, CA 92705 (714) 540-4914 (ET) **CIRCLE NO. 463**
- Omega Engineering, Inc., Box 4047, Stamford, CT 93680 (203) 359-1660 (ET, TI) **CIRCLE NO. 464**
- Precision Digital Corp., 368 Hillside Ave., Needham, MA 02194 (617) 449-2265 (ET) **CIRCLE NO. 465**
- Pyrometer Instrument Co., Inc., 234 Indl. Pkwy., Northvale, NJ 07647 (201) 768-2000 (ET) **CIRCLE NO. 466**
- Simpson Electric Co., Katy Inds., 933 Dundee Ave., Elgin, IL 60120 (312) 697-2260 (EM) **CIRCLE NO. 467**
- Tektronix, P.O. Box 500, Beaverton, OR 97077 (503) 644-0161 (MT) **CIRCLE NO. 468**
- Teletemp Corp., P.O. Box 5160, Fullerton, CA 92635 (714) 879-2901 (TI, IR) **CIRCLE NO. 469**
- Tempil Div., 2901 Hamilton Blvd., South Plainfield, NJ 07080 (201) 757-8300 (TI) **CIRCLE NO. 470**
- Triplett Corp., 286 Harmon Rd., Bluffton, OH 45817 (419) 358-5015 (EM) **CIRCLE NO. 471**
- UTI-Spectrotherm, 325 N. Mathilda Ave., Sunnyvale, CA 94086 (408) 738-3301 (TS) **CIRCLE NO. 472**
- Valhalla Scientific, 7707 Convoy Ct., San Diego, CA 92111 (714) 277-2732 (MT) **CIRCLE NO. 473**
- Vanzetti Infrared & Computers Systems, Inc., 607 Neponset St., Canton, MA 02021 (617) 828-4650 (IR) **CIRCLE NO. 474**
- Yokogawa Corp., 5 Westchester Plaza, Elmsford NY 10523 (914) 592-6767 (ET, EM) **CIRCLE NO. 521**

How do you squeeze
7000 feet of reliability
into a fighting
package?

Ask Hughes.

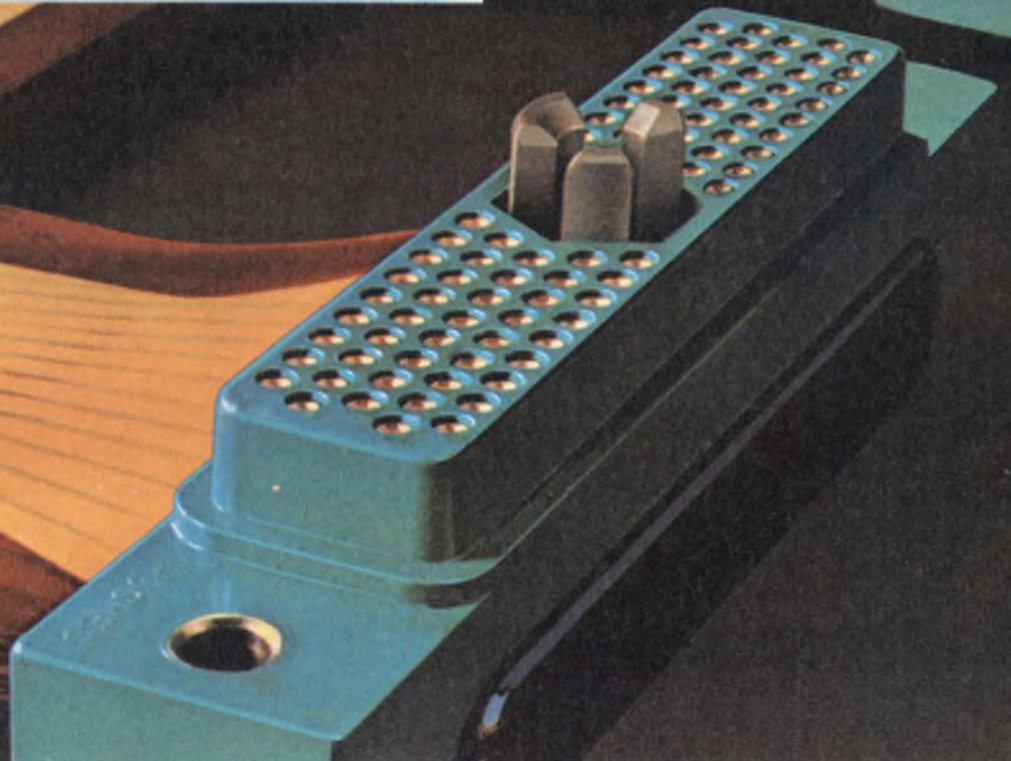



Total interconnection technology.

When it's a complex fighting machine like the Navy's A-6E and its TRAM target-sensing system's highly sophisticated avionics, you connect with Hughes capability. Hughes, because of our deep involvement in high-technology military and aerospace programs: Phoenix, Maverick, Lance, Minuteman, AWACS, F-14, F-15, Space Shuttle, Viking, Sonobuoy, F-4, A-7, Condor, Standard Missile, F-8, Trident, Hobo, Sprint, and many more.

With all that experience, we've developed not only the hardware and the circuitry, but also the concepts and design capability to solve the toughest interconnection problem. And the techniques to make it work. Aside from our design-to-system advanced packaging, we also offer umbilical and special connectors and off-the-shelf connectors.

Umbilical and other special connectors. Our umbilical on the new laser-guided Maverick is typical of our specials; we also have connectors on many of the country's airborne missiles where sure-fire operation is critical to national defense. Meeting your requirements is the challenge to us. We give priority to your special-connector problems. Solutions are just part of what we offer.

Off-the-shelf connectors. The new C-21 (MIL-C-85028) is another typical example of Hughes hi-rel technology. For high-altitude applications the C-21 has individual seals for up to 250 psi on the contacts, preventing altitude breathing and consequent contamination. It's a Hughes exclusive.

Our standard line also features subminiature rectangulars, standard size, subminiature circulars, and miniature rectangulars—better because they're super hi-density connectors. Our exclusive PolarHex™



Center Jackscrew coupling device makes it all possible. Another Hughes first is our HAC PAK™ connector (MIL-C-28804), the simplest way to connect round to flat cables.

Ask Hughes. Squeezing reliability into any sophisticated machine is no problem for you. Just ask Hughes Connecting Devices, 17150 Von Karman Avenue, Irvine, CA 92714, or call (714) 549-5701.



HUGHES

HUGHES AIRCRAFT COMPANY
CONNECTING DEVICES

Total interconnection technology: the hardware, the circuitry, and the concepts.

Faster is Better...



WIDE BANDWIDTH
1.0 GHz GBW min

SLEW RATE
1000 V μ sec min

FAST SETTLING
150nsec to 0.05% max

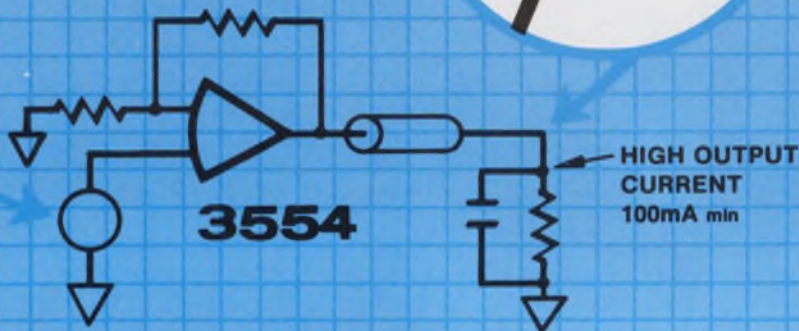

**HIGH OUTPUT
CURRENT**
100mA min

...When There Are No Performance Surprises!

Designing wideband or high speed equipment? Here's an op amp that puts it all together:

Fast slewing, fast settling, large gain-bandwidth product, excellent DC performance (drift of 15 μ V/ $^{\circ}$ C) and one that produces a full 100mA output!

The 3554 offers the best compromise when you must have top performance in these critical areas. It maintains gain accuracy with high frequency signals. Fast settling time

means better system accuracy with transient signal conditions. High output current lets you drive heavy loads with good total frequency response.

This FET differential input op amp, priced from \$39.60 in hundreds, is fully specified in an 8-page data sheet that includes 26 performance curves, typical application information and circuits.

Contact Burr-Brown, P.O. Box 11400, International Airport Industrial Park, Tucson, AZ 85734, U.S.A.
Phone: (602) 294-1431.



*Putting Technology
To Work For You*

CIRCLE NUMBER 34

Non-glare, high resolution monitor for clarity

THE TELETYPE MODEL 40 PRODUCT LINE OFFERS THE BRIGHTEST SELECTION OF INTERACTIVE DATA TERMINALS AVAILABLE ANYWHERE... WITH FORMALLY UNLIMITED APPLICATIONS AND WITH ALL THE FEATURES AND FUNCTIONALITY OF YOUR DATA HANDLING SYSTEMS, FASTER AND MORE ACCURATE.

THE VERSATILE MODEL 40 IS IDEALLY SUITED FOR ENTERING, STORING, DISPLAYING AND RECEIVING DATA OVER DIAL-UP SWITCHED OR POINT-TO-POINT PRIVATE LINE FACILITIES.

COMPATIBLE WITH TODAY'S PC COLS, THE MODEL 40 IS HIGHLY ADAPTABLE.

Human-engineered typewriter-like keyboard for ease of operation



Perhaps the best printers available in the industry



State-of-the-art CMOS/LSI electronics for outstanding reliability

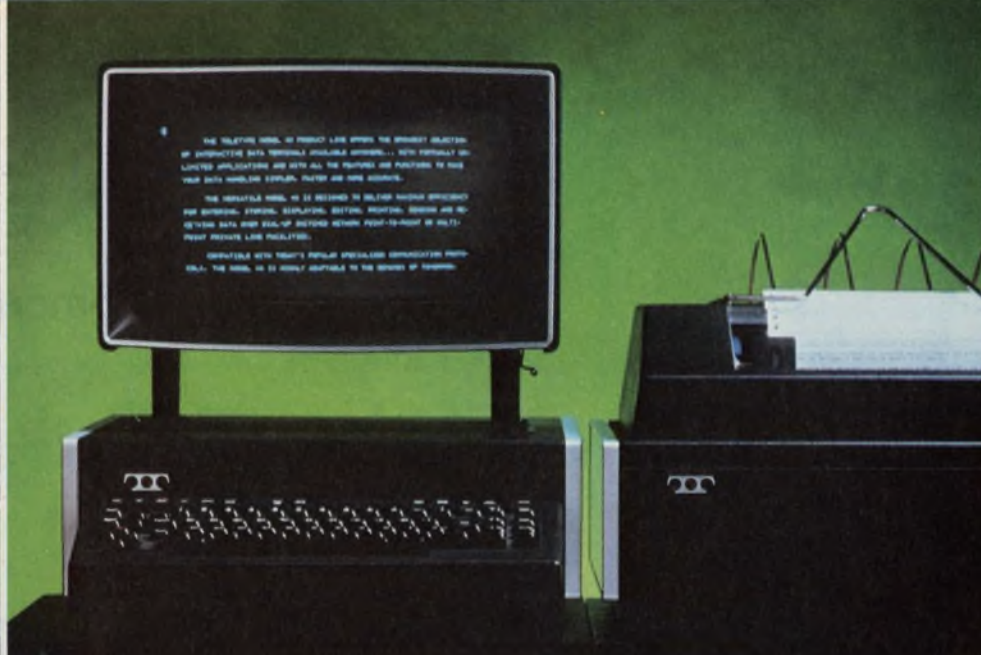
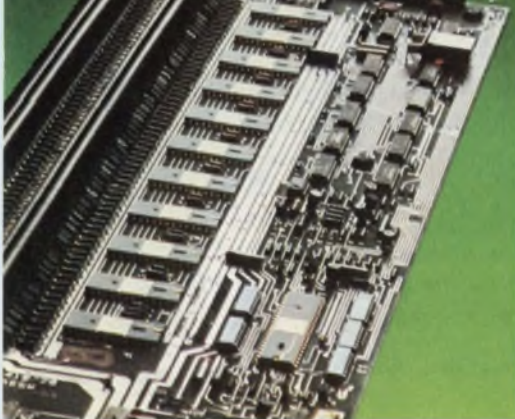

THE MODEL 40 IS SO GOOD, NOTHING EVEN COMES CLOSE. AND WE CAN PROVE IT, COMPONENT BY COMPONENT.

We're convinced the Teletype® model 40 product line matches—if not exceeds—any data terminal system on the market today. Because on a cost/performance basis, nothing even comes close.

The 40 printer, using a unique design, is incredibly dependable. And its CMOS/LSI drive electronics are so advanced and compact, they fit inside the printer itself on a single circuit card.

Our keyboard is anything but ordinary, too. Naturally, all controls are grouped according to function. But more importantly, the entire unit is human engineered to provide the most in throughput. Not only do the keys impart a typewriter feel, they're also contoured to the shape of the operators' fingers.

We admit we could have cut corners when we designed and built our display tube. But good enough wouldn't have been good enough. So we used a glare reducing screen. Even the display type is specially designed for legibility, with a flicker-free refresh rate of 60 times/second. Character separation and clarity are insured by a large 7 x 9 dot matrix. And the whole unit tilts through 20° for the best viewing angle.

As good as the individual components are, added together they put the model 40 product line in a class by itself. For more information, write or call: Teletype, 5555 Touhy Ave., Skokie, IL 60076. Phone 312/982-2000.



Teletype is a trademark and service mark registered in the United States Patent and Trademark Office.



Tomorrow's voltmeter

John Fluke of Fluke Mfg. speaks on The Future of the Voltmeter

Voltmeters haven't hit a dead end. While I don't foresee much significant technological advancement of the voltmeter art in the next few years, I don't foresee a dull future—far from it. Because, as with any other maturing product, technology isn't the whole story.

The excitement, the innovations, the breakthroughs that I see ahead are going to come about as we respond, not to new technology, but to new uses by new kinds of users.

We voltmeter manufacturers will invent, adapt and improve the product as always, but the focus will shift from the voltmeter's insides to its "impedance match" with the person who's using it.

We'll be using what I call an "asymptotic" technology—a rugged, low-power, lightweight, long-lived, accurate, low-cost set of solutions that are now beginning to approach the ultimate—giving the user an even better measurement tool.

To understand where this new user came from, who he is, and what kinds of instruments he needs, you have to look back. For the two decades covering 1949 to 1969, Uncle Sam was the main, most visible customer of all instrument manufacturers. As the biggest spender around, he had the most effect on directions in new products.

He almost "paid our way"—from the vacuum-tube voltmeter of the 1950s through the debut and development of the differential voltmeter, to the birth of all-solid-state DVMs.

Uncle Sam was no piker. He cared most about our top-line instruments, and even helped us get one more digit of accuracy every year—for a while.

But after the NASA, Defense Department and other cutbacks of 1969 and 1970, we had to find a new "main customer" with volume needs. And just when we needed a new customer, big industry began to need us.

Electronics had found its way into some industrial and commercial devices—copiers, coffee dispensers, numerically controlled milling machines and drill presses, among others. So meters were needed, mostly for field service, but also for production tests.

So we were ready to sell in real volume to industry. But industry didn't want or need DVMs or DMMs that had high accuracy, high prices, fancy specs, or regular recalibration procedures.

Industry wanted ruggedness and rock bottom prices. So we had to come up with both in a hurry, since there was no one else to sell to.

Ruggedness at low prices? Up to 1969, DVM manufacturers had never put out a product like that; really, they had been like spoiled kids. Electronics had grown up treating instruments as expensive laboratory delicacies; meters were sold only to other electronicers, who cuddled them. In 1969, instruments simply weren't ready for rough-and-tumble industrial use.

By 1972, however, some rugged DVMs using ICs were in volume production, including our Fluke Model 8000. The new *de facto* standard was 3 1/2 digits, rechargeable batteries, and a benchtop case 8 or 9 inches wide. And industry has been buying ever since.

This year's hand-holdable version, the 8020, is built to do the same job as the 8000—it has 3 1/2 digits, but it is also far more rugged, and lives through 1000-



volt overloads and 6000-volt transients in a calculator-sized tough plastic case; and it uses a 9-volt transistor radio battery. Now that's a practical DMM, and that's what industrial customers steered us into.

They make no bones about the most important spec, price. The Model 8000 was startlingly low-priced in 1972 at \$299, but the Model 8020, smaller, ruggeder, and better designed, is only \$169. The point is, even with inflation against us, we're giving the industry more performance for less cost. I think that trend will continue.

In the past seven years, industry has stepped up its use of electronics to cope with rising costs. And more consumer goods are being introduced that use electronics: washing machines, sewing machines, ovens, CBs, TV games, home computers, and a raft of other things. So industry wants more meters.

In many cases, virtually untrained people are using the meters, not only in the testing and servicing of consumer items, but also in the testing and servicing

of industrial equipment.

I think that's another trend that will continue. Nationally, the education level of technicians is going down as the military cuts back technical training from the year-to-two-years that it used to be. I hear that some technical schools now go for six weeks. So the low-end (bottom price and performance level) voltmeter has to be one that's right for this slightly trained tech.

I think the manufacturer of end-user machines will take the voltmeter or multimeter and make it support the whole field-service job for his product. Possibly it'll take more function power in the digital area, maybe signature analysis or special counters.

Don't be surprised if leading manufacturers go back to identifying faults and localizing them at the compo-

ment level. It costs a lot in inventory to have to replace modules or PC boards.

Tomorrow's voltmeter will have to be failure-proof, or closer to it than today's. If you're out on a manufacturing floor turning out electronic units in real volume, you can't have production test meters go down and make any money. What do you do with the workers?

Here, easy servicing isn't the answer; and in the real world, production people have no spare meters. The answer? A DMM that simply doesn't break, mechanically, electrically, thermally or any other way.

Hopefully, we'll be learning more about the failure modes of semiconductors, so we can do a better testing job. We do well today, applying voltage extremes while slewing temperature, rapidly. This thermally stresses the chips, and weeds out the weak ones.

Don't be looking for major improvements in measurement accuracy, however, or sweeping changes in the basic functions of the voltmeter. Reliability, convenience, human engineering, and easy-service provisions will get the attention, instead, I believe.

It's now a world of replacement, not repair. But when will voltmeters get there? Not in less than five years, I'd guess.

But in the meantime, repair is easy. The 8020 has a plug-in chip, a plug-in display, a PC board, a few discretes, switches, and that's all. Not much to fail, and most of it is pluggable.

The ruggedness and serviceability just beginning to show in tough new low-end instruments will per-

Who is John Fluke?

After earning a BSEE from the University of Washington and a master's degree from MIT, the man who gave his name to the digital voltmeter began his engineering career in 1936 with the General Electric Company in Schenectady, NY. Shortly afterwards, in Bridgeport, CT, Fluke won \$300—a fortune during the Depression—for a resistance-welding suggestion that saved money for GE. World War II and the Navy interrupted his career, and he found ways to degauss American ships to make them difficult for the Germans to locate. A young lieutenant commander whom Fluke worked for would later become a distinguished admiral—Hyman G. Rickover.

A civilian again, Fluke devised a wattmeter based on empirical square-law operation of some silicon carbide resistors. He began producing them in 1948 in the basement of his Springdale, CT, home with the help of one employee. Four years later he moved his rather larger company to Seattle, "God's country," and became the company's president, a position he retained until 1972 when John Zevenbergen was made President and Fluke was named Chairman of the Board and Chief Executive Officer.

With all his company responsibilities, Fluke has found time to serve on the American Security Council and on the President's Blue Ribbon Defense Panel. He has worked for the Secretary of the Army and the Department of Defense. He's recently finished a two-year stint as Chairman of the Electronic Test Equipment Committee for the Deputy Secretary of Defense. His committee's recommended improved purchasing methods will save millions.

A community-minded individual, Fluke has worked for the northwestern states' Junior Achievement organization. He has also supported the Seattle Symphony as Chairman of the Endowment Fund, Vice President and member of the Executive Committee,



and member of the Board of Trustees. Right now, he's on the executive committee of the Seattle Historical Society and a member of Seattle's Major League Sports Committee.

In addition to outside activities and long daily hours with his company, Fluke "putters around" in his 40 × 60-ft home workshop, collects early engineering texts, and restores selected test equipment of earlier decades. "Maybe when we tear things up again at the plant, we'll put in a little museum," he muses.

With his wife, Lyla, Fluke can look back on 40 years of marriage. They have two sons and a daughter, all in their thirties, and three grandchildren. John, Jr., another Stanford man, works for digital services in the Fluke organization. His father approves highly of John Jr.'s present assignment—cutting business costs.

meate the middle and high-end lines as well. The middle-sized, middle-priced voltmeters are the logical ones to address the digital LSI market, which suffers from a lack of tools. Five years from now, perhaps, the middle market will show some integration between the analog-input voltmeter of today and digital tools.

These voltmeters will also give technicians more messages, like "You're hooked up OK," or "You're hooked up wrong." That's the kind of thing that will continue to generate a middle market. Then, as now, we expect the middle to be a features race, offering some neat things beyond what the low-end units can do, for a few dollars extra.

The top-of-the-line meters will be flexible microprocessor-based instruments, competing on the basis of their "smarts." The features of such a meter will include how much calculating power it brings to the job, how well it can expand on short notice to become the hub of a little measurement "system," the messages it displays, and how it prompts the production operator.

Even with the high-end voltmeter, I keep coming back to that "new kind of operator." We'll design so as to make it easy for that not-too-technical tech to get right answers and only right answers. The μP will be guarding him against wrong hook-ups by averaging a series of readings to cancel out noise and hum, checking all values for reasonableness, and generally keeping him out of trouble.

We already have error displays lighting up on some instruments, to send the operator back to a "prompt sheet." This will tell him, for example, that to measure rms he has to push *two* buttons, not just one. In the next few years, there'll be more of this kind of help for the operator who may be new to the specific instrument, new to his job, or even new to the electronics field.

As for serviceability features on the high-end bench instruments, you're already seeing good modularity inside the case, and you'll see more diagnostics, plus readiness-test minidiagnostics for the end user.

The instrument's going to tell you where its problem is. It's going to say, "Hey, my ac converter isn't feeling too good." Kidding aside, the front-panel message lit up in block letters may be worded almost that plainly. The user will expect self-diagnosis in any top-of-the-line instrument, and get it.

We've got a start on the diagnostics already. We put a front-panel minicassette on our new 5100 calibrator, mainly to sequence calibration steps when putting another instrument through its paces. But soon you'll also be able to put a diagnostic cassette on that little tape deck, and have the calibrator check itself out.

The bus concept of the 5100 may lead our design people to develop many more aids. Three buses are involved, the IEEE 488 bus that talks with the outside world, the 8080 microprocessor bus, and an internal analog bus.

The bus orientation lets you define limits for each measurement, but never bothers the operator with them. The microprocessor will perhaps store upper and lower limits, compare the actual reading to the limits, and send the operator whatever display words you have programmed to indicate go or no-go.

A DVM or DMM of this kind—self-explanatory, self-checking, self-diagnostic—will be welcome in all kinds of test and experimental work being done by nonelectronickers, too. New fields to conquer.

I'm a realist. If a diesel engine had been built the way we were building voltmeters even as late as five years ago, the engine wouldn't go 10 miles. It just wouldn't last. But today's and tomorrow's new meters will hold up, because voltmeter manufacturers have learned from experience. The hard way.

I'll tell you frankly, we've had some disasters—every innovative company has—and every one of them can be traced back to some fault in engineering practices, or a misunderstanding of how the meter would be used, or what punishments it would have to stand.

But after seven years of really focusing on the industrial user, I think the knowledge is there. We've paid our dues, and we've learned, not just the Fluke people, but all the leading manufacturers. Competing for business tomorrow will require more engineering discipline than it did just a few years ago. Our design people, a unique breed, can deliver.

The pressure is on the design teams to foresee all the hazards, and optimize all the features. The testing people have to make sure they've really wrung out the new voltmeter or multimeter before it ever goes into production, and again when the first production units are made. They must make sure a new instrument is solid—in a far wider range of uses and environments than ever before. Solid, and effective.

That's as it should be; these are the things that happen in any industry as a product matures. ■■

More



Introducing the 920-D logic analyzer. Nine channels, 20 MHz and much, much more.

Don't let the low price mislead you. Biomatic's new 920-D stands up to logic analyzers costing twice, even three times as much. It includes the functional features design engineers ask for most. And combines them with 9½ pound portability, making the 920-D an ideal field troubleshooting tool.

Nine channels — not just eight — give you added capability for more applications. Use the extra channel for recording data, or to mark a trigger location. And select between trigger or clock qualifier. Attach the optional Biomatic 10-TC probe pod and you can select up to a 19-bit combinational trigger word.

The 920-D enables you to set a precise interval between the actual trigger and the start of recording, using either clock periods or number of trigger events. Or the pre-trigger recording mode can be selected to capture data from before the actual trigger. The logic threshold level is selectable — TTL, ECL

or variable. And you can record at rates from DC to 20 MHz.

Captured data, at 256 bits per channel, can then be displayed on any single channel scope or CRT display in timing diagram format.

Compare the 920-D with other logic analyzers, for both price and performance. Then ask yourself if you can afford to settle for less.

Don't let the 920-D's many features and high performance mislead you. It's priced less — far less — than any comparable logic analyzer.

In fact, the 920-D's \$1295** price tag makes it practical to put its extensive capabilities to work

wherever you design, debug or troubleshoot TTL logic.

The 920-D is a cost-effective first logic analyzer for most applications. Years of experience providing



Less

\$1295.00

BIOMATION 920-D LOGIC ANALYZER



thousands of engineers and technicians with the industry's leading family of logic analyzers has helped us design the 920-D with proven real-world features you can put to good use.

Low price makes the 920-D a great choice for your second... or third or fourth logic analyzer. You won't need

to stand in line or share your company's only

logic analyzer when you have a 920-D of your own.

We built the 920-D for lightweight portability. It weighs in at under 10 pounds and connects to

the nearest oscilloscope or CRT. That makes the 920-D the newest tool for field service.

Biomation has led the way in logic analyzer developments. Today there are seven Biomation analyzers, offering from 8 to 16 channels, 10 to 200 MHz capture rate, memory lengths from 256 bits to 2048 bits per channel and operating in both time and data domains.

What more can we tell you? Plenty. Ask for the 920-D product sheet. Or give us a call to arrange a demonstration. Ask for Ed Jacklitch (408) 255-9500. Or write Biomation, 10411 Bubb Road, Cupertino, CA 95014.

biomation

*U.S. price only

CIRCLE NUMBER 36



31 GATES
26 COUNTERS
17 MULTIPLEXERS
6 ARITHMETIC FUNCTIONS
22 DRIVERS/TRANSCIEVERS
47 REGISTERS/LATCHES
9 COMPARATORS
11 CLOCK CIRCUITS

LOW POWER SCHOTTKY

The new design standard. Low Power Schottky. From the leader. Texas Instruments.

Now there are 165 Low Power Schottky functions available from the leader, Texas Instruments. The broadest line in the industry... SSI, MSI and LSI circuits for every low-power, high-performance application... military systems, data processing, telecommunications, process control, with or without microprocessors. You'll find TI Low Power Schottky circuits provide greater reliability at a lower cost in less space with less power.

All of TI's innovative 54LS/74LS circuits feature typical speeds to 6 ns/gate with power dissipation of less than 2 mW. In fact, power requirements are 80% less than for standard TTL logic. Less heat is

generated. Less heat sinking is required. Low Power Schottky MSI and LSI circuits increase package density reducing package count

MORE NEW PRODUCTS

23 new Low Power Schottky circuits have been introduced in 1977 for a total of 165 since 1971... with more on the way.

- SN54LS/74LS673 16-Bit POSI Shift Register with Storage
- SN54LS/74LS674 16-Bit PISO Shift Register
- SN54LS/74LS322 8-Bit Shift Register w/Sign Extend
- SN54LS/74LS173 4-Bit D-type Register. 3-State

and the number of interconnections required. Costly pc board real estate is thus minimized.

And, TI's Low Power Schottky circuits cost less, as low as \$1.40 for a 74LS245N Octal Bus Transceiver and \$0.69 for a 74LS669N 4-Bit Binary Counter (100 pieces). Add it all together and the result is high performance and reliability at lower manufacturing costs.

Design with more confidence with the LS line that serves more of your needs for less. To learn more about system benefits, contact Texas Instruments Incorporated, P. O. Box 5012, M/S 308, Dallas, Texas 75222.

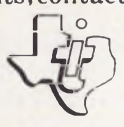

TEXAS INSTRUMENTS
INCORPORATED
CIRCLE NUMBER 37



S-D's new dual channel $\pm 18\text{v}$ pulse generator

THE LOGICAL CHOICE

Attention all of you working with 2 and 4-phase logic systems, bipolar logic, radar testing and simulation, and with complex waveforms of all types: the new S-D 110D dual-channel pulse generator is for you.

In one compact instrument, Model 110D contains two complete pulse generators with all pulse parameters separately controllable for each channel. You can also *mix* the channels to produce complex waveforms and *delay* one channel from another.

That's why you can produce a true 2-phase system (4-phase with two slaved 110D's) as well as double and triple pulse pairs and controllable pulse trains for data simulation. For

sheer variety of pulses, nothing today touches Model 110D.

Model 110D is the latest member of a growing family of S-D pulse generators whose distinguished ancestors — Data-pulse Models 110B, 110A, and 110—set the industry standards in their time.

Key 110D data:
Amplitude, $\pm 18\text{v}$
into 50 ohms • DC
offset to $\pm 18\text{v}$ • rise/fall
time variable from 5 ns to
500 millisecc • repetition
rate 50 MHz • Price \$2,250
(U.S. only). Get the facts
on the first modern-day

2-channel pulser.

Contact Scientific Devices or Systron-Donner at 10 Systron Drive, Concord, California 94518, Phone (415) 676-5000.

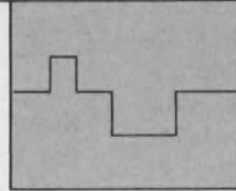
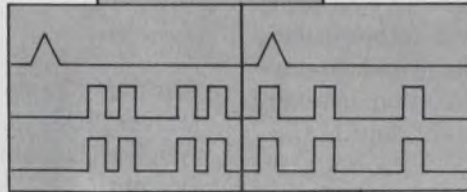
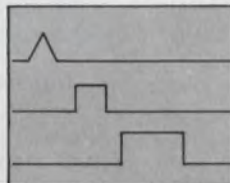

SYSTRON  DONNER

Design an IEEE-488 bus into an FPLA, and speed system operation. An extra benefit: The technique allows you to interface any number of programmable instruments.

To get high speeds in a digital-bus interface, avoid a software approach and go right to hardware. One such interface, the IEEE-488 standard bus for programmable instrumentation, can be easily designed with FPLAs. Nonextended, the standard can specify a system of up to 15 instruments. But otherwise systems of any size and complexity can be accommodated.

The interface bus decodes addresses and commands, and passes information back and forth between instruments via 16 signal lines. In effect, the addressed interface is transparent. Since each component of the system contains interface functions within itself, interconnections within the system take the form of passive cabling.

Eight functions are incorporated in the interface system: Acceptor Handshake, Source Handshake, Listener, Talker, Device Clear, Device Trigger, Service Request and Remote Local. For simplicity, the system does not contain a Controller function.

FPLA combined with D flip-flops

A good circuit design for this interface system is a synchronous sequential model, in which the outputs and the next state are functions of the present inputs and state. This general circuit realization uses an FPLA as a combinational logic element, and D flip-flops as memory devices (Fig. 1).

The Signetics 82S100 FPLA offers 16 inputs and eight three-state outputs, and the 74175 Quad-D flip-flop provides the minimum number of required inputs. Knowing that a D flip-flop retains the present state for only one unit time delay (one clock period), you must modify the original state diagrams defined by the standard. Take care that the present state does not change on the next clock, unless the transition requirements are fully satisfied.

The Talker function is typical of the eight interface functions (Fig. 2) and illustrates the design procedure. Treat two parts of the Talker-function state diagram as if you are dealing with two mutually independent

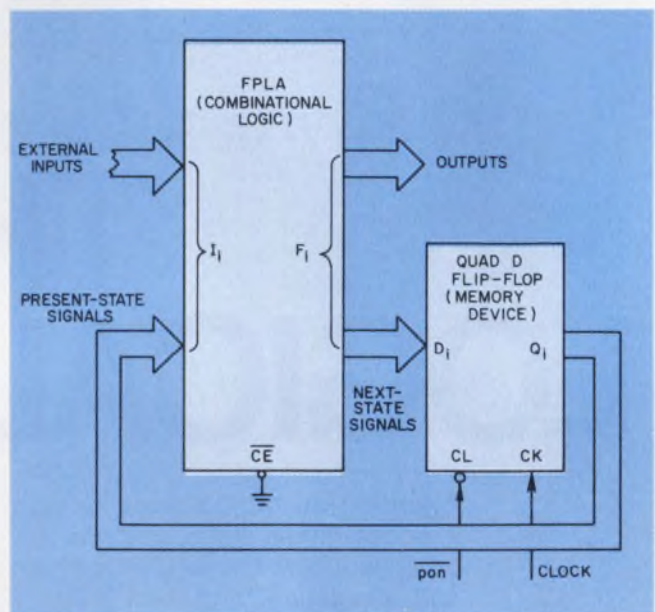

1. One way to design an IEEE-488 bus in hardware: Choose a synchronous sequential model implemented with an FPLA and quad-D flip-flops. Such a design works faster than a software version.

functions. To do this, assign states carefully. Assign states TIDS, TADS, TACS and SPAS the binary weighted combinations 0 through 3 (functions of flip-flop outputs Q_0 and Q_1 only). Assign states SPIS and SPMS the binary values of 0 and 1, respectively (functions of flip-flop output Q_2 only).

Furthermore, giving idling states TIDS and SPIS the binary combinations 00 and 0, respectively, forces the Talker function to enter the idle state during power-on reset (pon), and simplifies the transition from the present state to the idle state when an IFC signal appears (no transitional signals are required).

In the detailed Talker-function transition table (Table 1), if the function is in the TACS state ($Q_1 = 1$, $Q_0 = 0$), it will stay in that state as long as excitation signal f_5 is true. It will enter the next state, TADS ($Q_1 = 0$, $Q_0 = 1$) only if excitation signal f_6 is true. If at the end of any clock pulse both excitation signals (f_5 and f_6) are false, the function will enter idling state TIDS ($Q_1 = 0$, $Q_0 = 0$).

From the excitation signals derived in Table 1, calculate the excitation equations (Table 2), then

Vlado Lipovac, Engineer, ATE Systems Group, Grumman Aerospace Corp., Bethpage, NY 11714, and Se Jeung Oh, Chairman, Dept. of Electrical Engineering, The City College of New York, New York, NY 10031.

Table 1. Talker function transitions

Present state assignments $Q_2 Q_1 Q_0$	Next state $Q_2' Q_1' Q_0'$	External inputs	Present state signal	Excitation signals
TIDS X 0 0	X 0 1	h	$g_1 = \bar{Q}_1 \bar{Q}_0$	$f_1 = h \cdot g_1 = \overline{IFC_R} \cdot (ton + MTA \cdot \overline{ACDS}) \cdot \bar{Q}_1 \bar{Q}_0 = P_0 + P_1$
TADS X 0 1	X 0 1	$\bar{i} \cdot \bar{k} \cdot \bar{j} \cdot \overline{IFC_R}$	$g_2 = \bar{Q}_1 Q_0$	$f_2 = \bar{i} \cdot \bar{k} \cdot \bar{j} \cdot \overline{IFC_R} \cdot g_2 = (\overline{OTA} \cdot \overline{MLA} + \overline{ACDS}) \cdot \overline{ATN_R} \cdot \overline{IFC_R} \cdot \bar{Q}_1 Q_0 = P_2 + P_3$
	X 1 0	k		$f_3 = k \cdot g_2 = \overline{ATN_R} \cdot \overline{SPMS} \cdot \bar{Q}_1 Q_0 = P_4$
	X 1 1	j		$f_4 = j \cdot g_2 = \overline{ATN_R} \cdot \overline{SPMS} \cdot \bar{Q}_1 Q_0 = P_5$
TACS X 1 0	X 1 0	$\overline{IFC_R} \cdot \overline{ATN_R}$	$g_3 = Q_1 \bar{Q}_0$	$f_5 = \overline{IFC_R} \cdot \overline{ATN_R} \cdot g_3 = \overline{IFC_R} \cdot \overline{ATN_R} \cdot Q_1 \bar{Q}_0 = P_6$
	X 0 1	$\overline{ATN_R}$		$f_6 = \overline{ATN_R} \cdot g_3 = \overline{ATN_R} \cdot Q_1 \bar{Q}_0 = P_7$
SPAS X 1 1	X 1 1	$\overline{IFC_R} \cdot \overline{ATN_R}$	$g_4 = Q_1 Q_0$	$f_7 = \overline{IFC_R} \cdot \overline{ATN_R} \cdot g_4 = \overline{IFC_R} \cdot \overline{ATN_R} \cdot Q_1 Q_0 = P_8$
	X 0 1	$\overline{ATN_R}$		$f_8 = \overline{ATN_R} \cdot g_4 = \overline{ATN_R} \cdot Q_1 Q_0 = P_9$
SPIS 0 X X	1 X X	l	$g_5 = \bar{Q}_2$	$f_9 = l \cdot g_5 = \overline{IFC_R} \cdot \overline{SPE} \cdot \overline{ACDS} \cdot \bar{Q}_2 = P_{10}$
SPMS 1 X X	0 X X	$\bar{m} \cdot \overline{IFC_R}$	$g_6 = Q_2$	$f_{10} = \bar{m} \cdot \overline{IFC_R} \cdot g_6 = \overline{IFC_R} \cdot (\overline{SPD} + \overline{ACDS}) \cdot Q_2 = P_{11} + P_{12}$

Table 2. Excitation equations for T interface function

$D_0 = F_0 = f_1 + f_2 + f_4 + f_6 + f_7 + f_8 = P_0 + P_1 + P_2 + P_3 + P_5 + P_7 + P_8 + P_9$
 $D_1 = F_1 = f_3 + f_4 + f_5 + f_7 = P_4 + P_5 + P_6 + P_8$
 $D_2 = F_2 = f_9 + f_{10} = P_{10} + P_{11} + P_{12}$

Table 3. State-output equations for T interface function

$\overline{SPMS} = Q_2$
 $\overline{TACS} = F_3 = Q_1 \bar{Q}_0 = P_{13}$
 $\overline{SPAS} = F_4 = Q_1 Q_0 = P_{14}$

Table 4. T function program

	Inputs															Outputs										
	ton	SPD	SPE	OTA	MTA	MLA	IFC _R	ATN _R	SPMS	ACDS	Q ₂	Q ₁	Q ₀	SPAS	TACS	D ₂	D ₁	D ₀								
	11	14	13	12	11	10	9	8	7	6	5	4	3	2	1	0	F7	6	5	4	3	2	1	0		
P0	-	-	-	H	-	-	-	-	L	-	-	-	-	L	L	f1	A					
1	-	-	-	-	-	-	-	L	L	-	-	H	-	L	L	f2	A					
2	-	-	-	-	H	-	L	L	H	-	-	-	L	H	f3	A						
3	-	-	-	-	-	-	-	L	H	-	L	-	L	H	f4	A						
4	-	-	-	-	-	-	-	-	L	L	-	-	L	H	f5	A	.					
5	-	-	-	-	-	-	-	-	L	H	-	-	L	H	f6	A	A					
6	-	-	-	-	-	-	-	-	L	L	-	-	H	L	f7	A	.					
7	-	-	-	-	-	-	-	-	H	-	-	-	H	L	f8	A	.					
8	-	-	-	-	-	-	-	-	L	L	-	-	H	H	f9	A	A					
9	-	-	-	-	-	-	-	-	H	-	-	-	H	H	f10	A	.					
10	-	-	-	-	H	-	-	L	-	H	L	-	-	f11	.	.	A	.	.	.						
11	-	-	-	-	L	-	-	L	-	-	H	-	-		.	.	A	.	.	.						
12	-	-	-	-	-	-	-	L	-	-	L	H	-	-		.	.	A	.	.	.					
13	-	-	-	-	-	-	-	-	-	-	-	-	H	L		.	A					
14	-	-	-	-	-	-	-	-	-	-	-	-	H	H		A					
	Active Level																									
	H H H H H																									

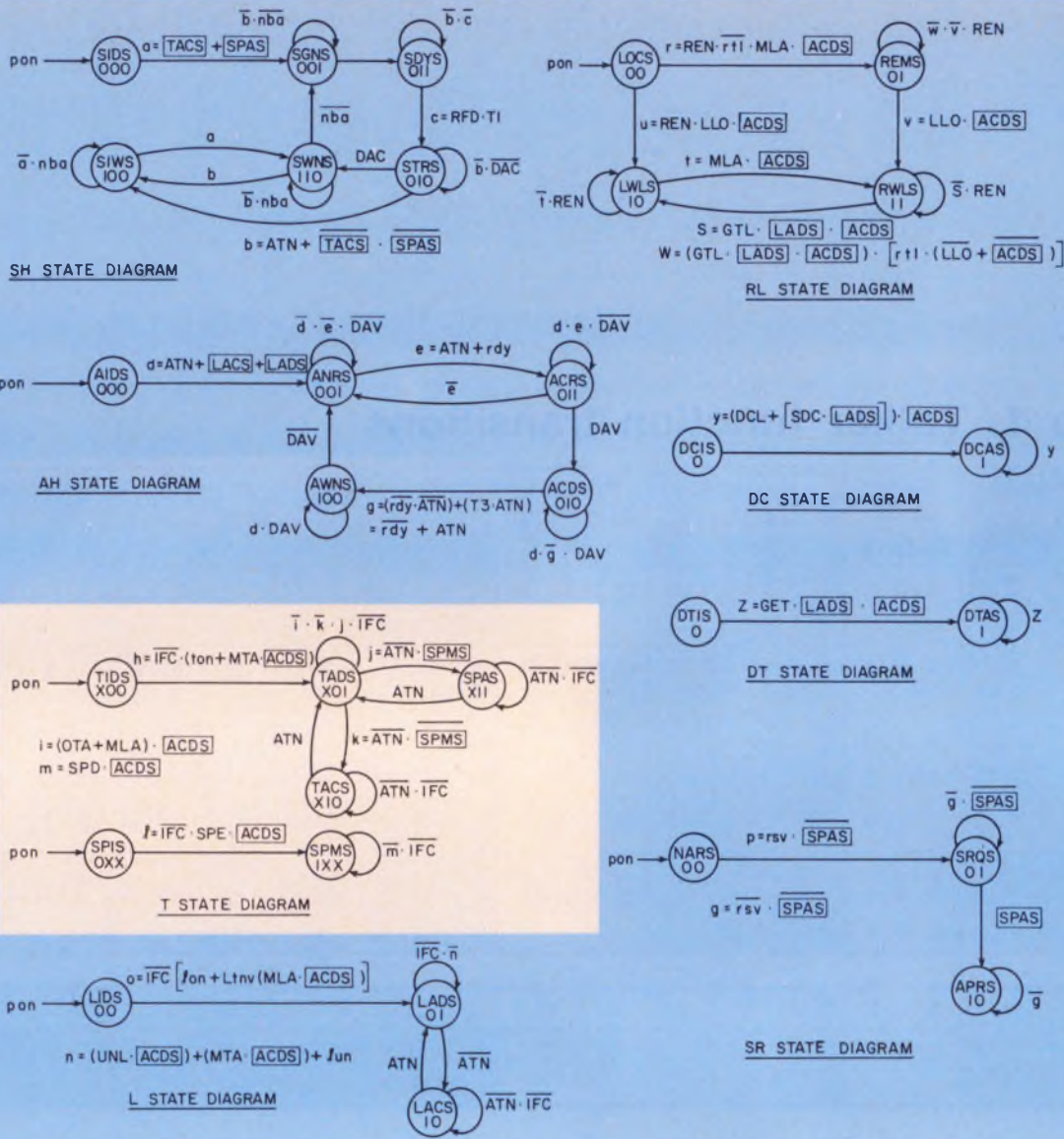

2. The IEEE-488 Standard's diagrams must be modified to accommodate the chosen model. In this partic-

ular case the model includes eight of the allowed ten functions.

derive the state-output equations directly from the state diagrams (Table 3). The excitation equations are OR functions of product (P) terms that are themselves AND functions of the external inputs and present states of the interface function. The program table is worked out as follows:

The AND matrix is programmed according to logical values of each individual input variable contained in each of the P terms. For instance, P term P_0 is given by

$$P_0 = t_{on} \cdot IFC_R \cdot \bar{Q}_0 \cdot \bar{Q}_1$$

Therefore, assign t_{on} and IFC_R a HIGH each, and Q_1 and Q_0 a LOW. All other inputs, including those unused, are "don't-cares." Only P_0 through P_{14} are programmed. The remaining 33 P terms are spares with which to alter the program, if necessary.

Next, program the OR matrix according to the excitation equations and state-output equations. For example, assign the F_0 output the excitation equation derived for D_0 . The P terms $P_0, P_1, P_2, P_3, P_5, P_7, P_8,$

and P_9 are programmed as an active HIGH. All other P terms in the F_0 output are programmed as a dot. The three unused outputs are spares for future program alterations or for new output functions.

The program for the T function is presented in Table 4 and a corresponding circuit realization in Fig. 3. The other functions—RL, SH, AH, L and SRQ—are designed similarly.

Expressions are simplified

The absence of a Controller function within the interface system simplifies certain transitional conditions containing Controller states (logical values for CACS and CTRS are always equivalent to ZERO). For example, the expression for transition from SIDS to SGNS state "a" reduces to

$$a = TACS \vee SPAS$$

The condition for transition from SDYS to STRS, $c = RFD \wedge T_1,$

Table 6. Interface Message Reference List

Mnemonic	Message	Interface Function(s)
Local messages received (by interface functions) MEMW MEMR end nba lon pon rdy rsv rtl ton	memory write memory read end new byte available listen only power on ready request service return to local talk only	SH L SH, AH, T, L,SR,RL AH SR RL T
Local messages sent AHINT SHINT SPINT DTINT DCINT	acceptor handshake interrupt source handshake interrupt serial poll interrupt device trigger interrupt device clear interrupt	
Remote messages received ATN DAB DAC DAV DCL END GET GTL IDY IFC LLO MLA MTA OTA PCG REN RFD RQS SDC SPD SPE STB UNL	attention data byte data accepted data valid device clear end group execute trigger go to local identify interface clear local lookout my listen address my talk address other talk address primary command group remote enable ready for data request service selected device clear serial poll disable serial poll enable status byte unlisten	SH,AH,T (via L) SH AH DC (via L) DT RL L T,L RL L,RL,T T,L T TE RL SH (via L) DC T T (via L) L
Remote messages sent DAC DAV END RFD RQS SRQ STB DAB DAC	data accepted data valid end ready for data request service service request status byte data byte data accepted	AH SH (via T) AH T SR (via T) (via T) AH

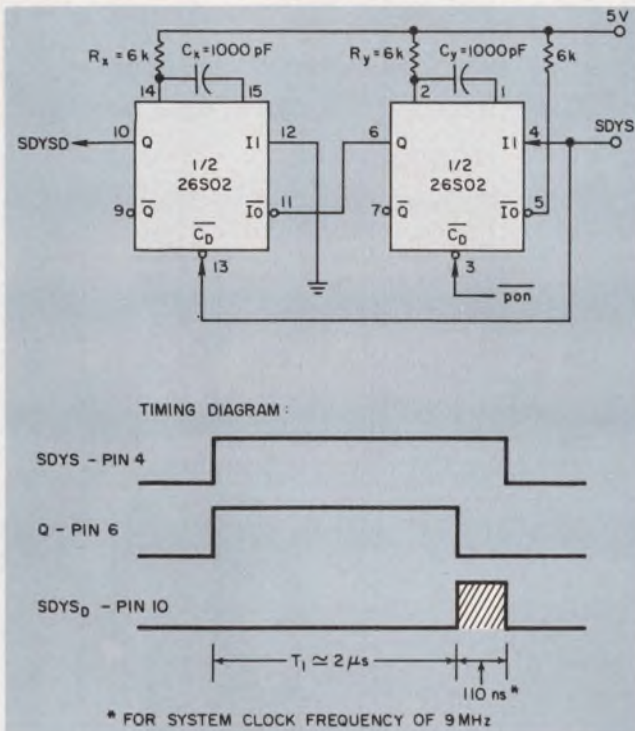

4. In the Source-handshake (SH) function, $SDYS_D$ (delayed source-delay state) is generated by a monostable multivibrator. Resistor R_x and capacitor C_x are chosen so that T_1 is about $2 \mu s$. Notice that $SDYS_D$ is reset as soon as $SDYS$ goes LOW.

IEEE-488-interface specifications

Interconnected devices: Up to 15 on one contiguous bus.

Interconnection path: Star or linear bus network over 20-m total transmission path.

Signal lines: 16 total—eight data lines and eight lines for control and status messages.

Message-transfer scheme: Byte-serial, bit-parallel asynchronous data transfer using an interlocked three-wire handshake technique.

Data rate: 1 Mbyte/s max over limited distances; 250 to 500 kbytes/s typical over full transmission path.

Interface functions: 10 total—five primary communication functions and five special-purpose functions.

Address capability: Primary addresses—31 talk and 31 listen; secondary (2-byte) addresses—961 talk and 961 listen.

Control shift: May be delegated, never assumed, with a maximum of one talker (up to 14 listeners) at a time.

Interface circuits: Driver and receiver circuits TTL-compatible.

IEEE-488 bus signal lines

Data lines (DI01-DI08) transfer bidirectional data and other messages in a byte-serial, bit-parallel manner.

Handshake lines (DAV, NRFD, NDAC) regulate data and message transfer. The information transfer asynchronously adjusts itself to the slowest currently active instrument.

Data Valid (DAV) is a remote message generated by the talker, indicates to the listener(s) that data on the bus are valid.

Not ready for data (NRFD) is a remote message generated by the listener(s): When detected true, it indicates to the talker that not all listeners are ready to accept the byte of data.

Not data accepted (NDAC) is a remote message generated by the listener(s): When detected false, it indicates to the talker that all listeners have accepted the byte of data, and data can be removed.

Management lines (IFC, REN, ATN, EOI, SRQ) control bus activity.

Interface clear (IFC) is a control-signal line that sets the interface system in a known quiescent state.

Remote enable (REN) sets devices to either remote or local control, in conjunction with other coded messages.

Attention (ATN) is a controller command: When ATN is true, addresses and universal commands are transmitted on only seven of the data lines, using the ASCII code. When ATN is false, any code of eight bits or less understood by both talker and listener(s) may be used.

End or identify (EOI) indicates the end of a multibyte transfer sequence. EOI in conjunction with ATN executes a polling sequence on devices with parallel-poll capability.

Service Request (SRQ), when detected true, indicates to the controller that some device on the bus wants attention.

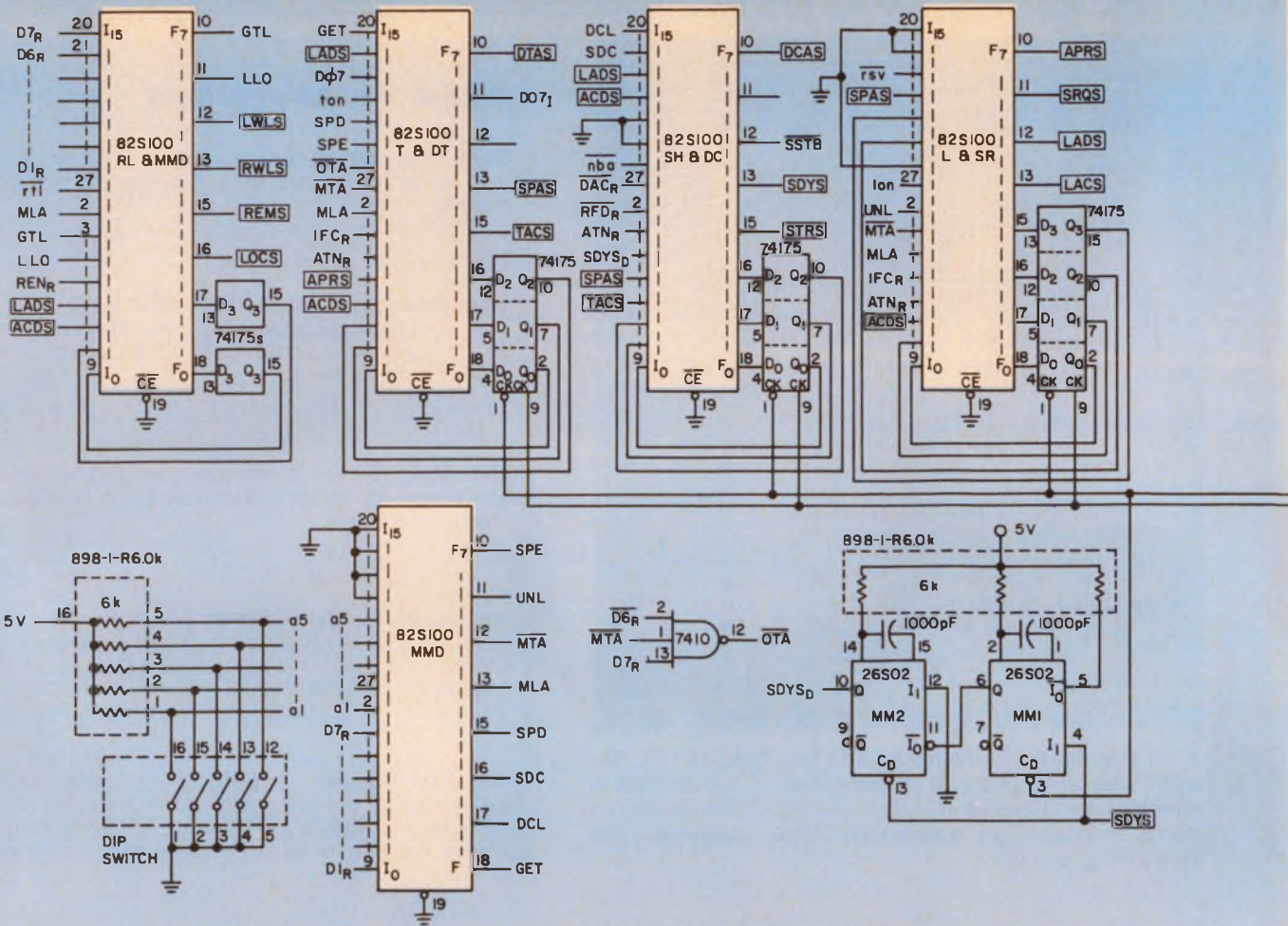

IEEE BUS MATING CONNECTOR

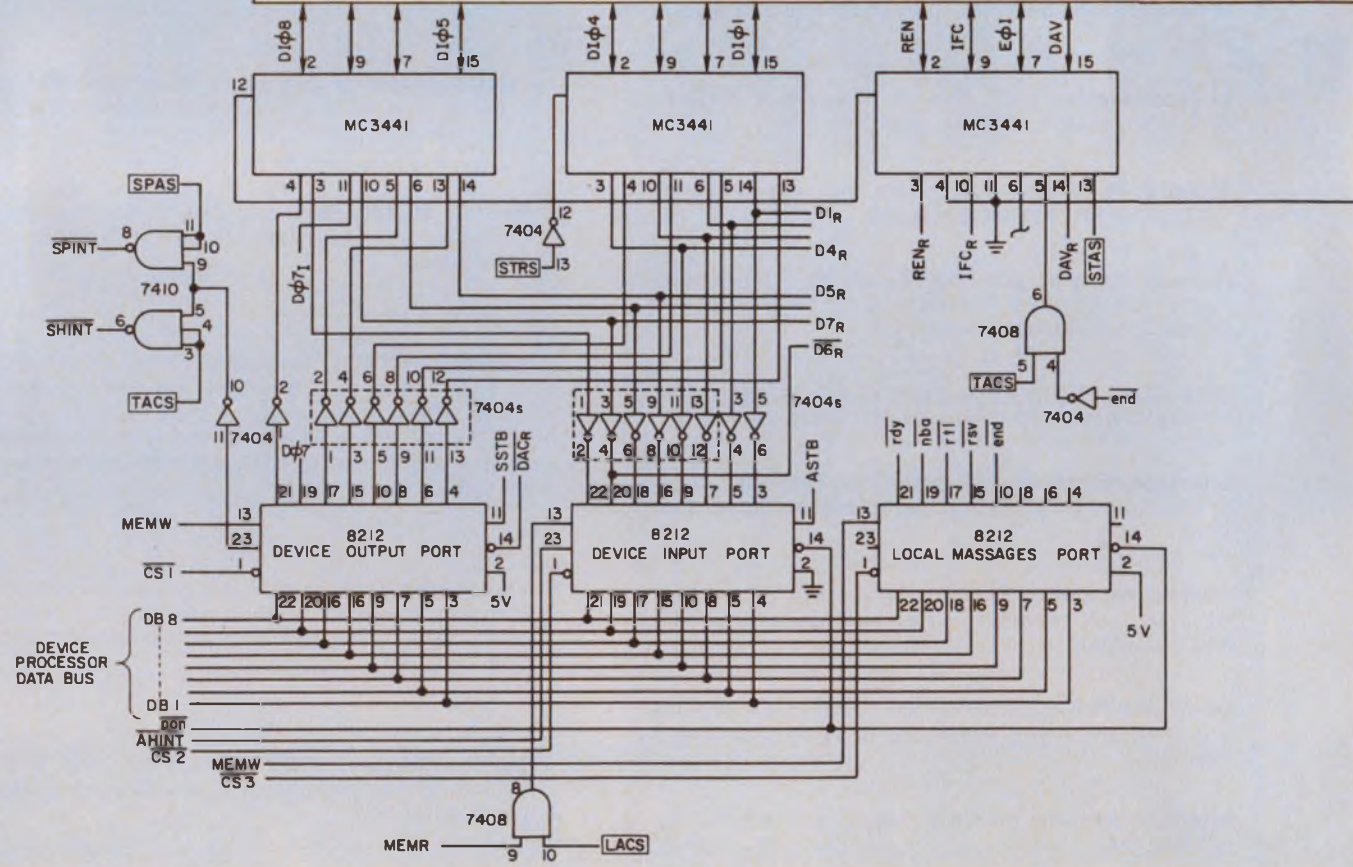

INTRODUCING DELCO ELECTRONICS' MONOLITHIC OPERATIONAL AMPLIFIER

If you're now using discrete power output transistors, we've got an alternative that gives you design versatility.

It's the DA-101—Delco's Monolithic Operational Amplifier—with all the circuitry you need in one compact package.

The Monolithic Operational Amplifier (MOA) has two separate gain and power stages contained in a modified dual-in-line package.

The DA-101 operates from a 10- to 16-volt DC supply and can be used in an audio bridge configuration with floating speaker output, or as two separate amplifier-speaker systems.

The MOA means weight savings in more ways than one. Besides reducing the total number of components you need, the MOA has a copper mounting surface to assure ample heat transfer to the convector. The tab negative or ground connection eliminates the need for mica insulation.

In fact, the design of one power megaphone showed a components weight savings of 65 per cent.

Our new MOA means added design application flexibility, too. In automotive and home entertainment systems, two-way communication systems, power megaphones, motor controls, various H switch applications, and more.

Another advantage of our Monolithic Operational Amplifier is its durability. It has integral protective circuitry for not only overvoltage, but

temperature, current conditions and shorted outputs as well.

And it can be mounted by either direct soldering to a printed circuit board or through the use of a suitable socket.

For more information, contact an authorized Delco distributor, your nearest Delco sales office, or return the coupon on the right.

ABSOLUTE MAXIMUM RATINGS

Supply Voltage	24V
Operating Voltage	16V
Peak Current	3A
Storage Temperature	-55°C to 150°C
Power Dissipation	22W

ELECTRICAL CHARACTERISTICS

	TYPICAL
$V_{CC} = 14V$ dc	
I_{idle} $P_{out} = 0W$	40mA
Differential Input Bias Current	0.80 μA
Open Loop Gain	90dB
Power Out @ 5% Distortion	
4 Ω Bridge	6W
4 Ω Non-bridge	3.5W

THERMAL CHARACTERISTICS

Thermal Resistance, $R_{\theta jc}$ (Typical)	4° C/W
---	--------

AUDIO BRIDGE CIRCUIT

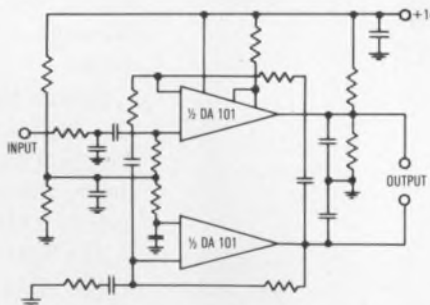

TWO SEPARATE AMPLIFIERS CIRCUIT

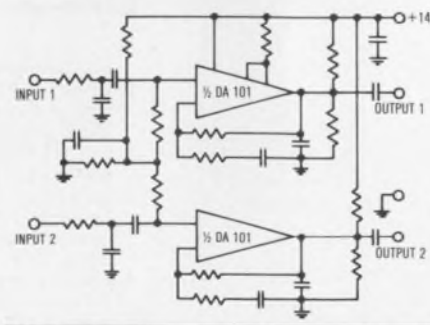

DERATING CURVE

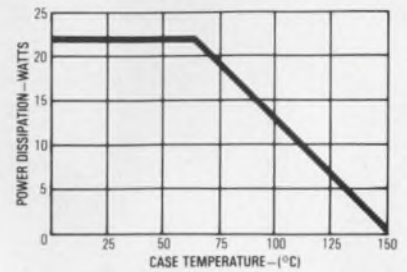

DIMENSIONS AND CONNECTIONS

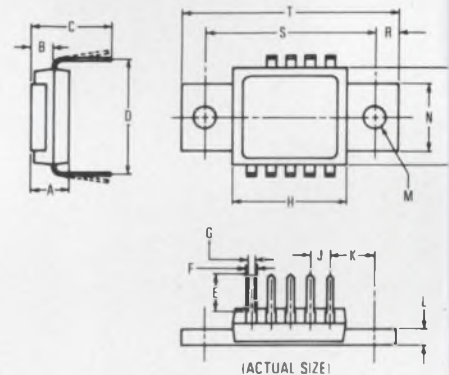

SYMBOL	INCHES		MILLIMETERS	
	MIN	MAX	MIN	MAX
A		220		5.59
B	127	133	3.22	3.38
C	423	443	10.746	11.254
D	628	632	15.95	16.05
E	215	225	5.463	5.717
F	.044	.048	1.13	1.21
G	015	019	0.39	0.47
H	644	650	16.37	16.52
J	.095	.105	2.413	2.667
K	.275	.285	6.983	7.237
L	.086	.096	2.183	2.437
M	.1220	.1280	3.100	3.250
N	.369	.379	9.373	9.627
P	.539	.549	13.693	13.947
R	.120	.130	3.053	3.307
S	.955	.965	24.253	24.507
T	1.199	1.219	30.446	30.954

**NOW AVAILABLE FROM THESE DISTRIBUTORS
IN PRODUCTION QUANTITIES.**

ALABAMA

HUNTSVILLE
Powell Electronics
(205) 539-2731

ARIZONA

PHOENIX
Sterling Electronics, Inc.
(602) 258-4531

CALIFORNIA

GARDENA
Bell Industries
Electronics Distributors Div
(213) 321-5802

GOLETA
R.P.S. Electronics, Inc.
(805) 964-6823

LOS ANGELES
Kierulff Electronics, Inc.
(213) 725-0325

R.P.S. Electronics, Inc.
(213) 748-1271

PALO ALTO
Kierulff Electronics, Inc.
(415) 968-6292

SAN DIEGO
Kierulff Electronics, Inc.
(714) 278-2112

R.P.S. Electronics, Inc.
(714) 292-5611

SUNNYVALE
Bell Industries
(408) 734-8570

COLORADO

DENVER
Kierulff Electronics, Inc.
(303) 371-6500

CONNECTICUT

NORWALK
Harvey Electronics
(203) 853-1515

FLORIDA

CLEARWATER
Diplomat/Southland
(813) 443-4514

MIAMI SPRINGS
Powell Electronics/Florida
(305) 592-3260

ILLINOIS

ELK GROVE VILLAGE
Kierulff Electronics, Inc.
(312) 640-0200

SKOKIE
Bell Industries
Electronics Distributors Div.
(312) 282-5400

INDIANA

INDIANAPOLIS
Graham Electronics
Supply, Inc.
(317) 634-8202

MARYLAND

BALTIMORE
RESCO/Baltimore
(301) 823-0070

MASSACHUSETTS

BILLERICA
Kierulff Electronics, Inc.
(617) 935-5134
(617) 667-8331

NEWTON
The Greene-Shaw Co., Inc.
(617) 969-8900

MICHIGAN

LIVONIA
Pioneer/Michigan
(313) 525-1800

MINNESOTA

MINNEAPOLIS
Stark Electronics Supply Co.
(612) 332-1325

MISSOURI

KANSAS CITY
Walters Radio Supply, Inc.
(816) 531-7015

ST. LOUIS
LCOMP-St. Louis
(314) 291-6200

NEW JERSEY

CINNAMINSON
Wilshire Electronics/
Philadelphia
(609) 786-8990
(215) 627-1920

CLIFTON
Wilshire Electronics/
New Jersey
(201) 340-1900
(212) 244-8930

NEW MEXICO

ALBUQUERQUE
Sterling Electronics
(505) 345-6601

NEW YORK

BINGHAMTON
Harvey Electronics
(607) 848-8211

BUFFALO
Summit Distributors, Inc.
(716) 884-3450

FARMINGDALE
Wilshire Electronics/
Long Island
(516) 293-5775

FREEPORT
Milgray/New York
(516) 546-6000

WOODBURY
Harvey Electronics
(516) 921-8700
(212) 895-9260

OHIO

CINCINNATI
United Radio, Inc.
(513) 761-4030

CLEVELAND
Pattison Supply Co
Industrial Electronics Div.
(216) 441-3000

DAYTON
Pioneer/Dayton
(513) 236-9900

PENNSYLVANIA

PHILADELPHIA
Almo Electronics
(215) 698-4000

PITTSBURGH
CAM/RPC Electronics
(412) 782-3770

SOUTH CAROLINA

COLUMBIA
Dixie Radio Supply Co., Inc.
(803) 779-5333

TEXAS

DALLAS
Sterling Electronics
(214) 357-9131

HOUSTON
Harrison Equipment
Co., Inc.
(713) 652-4700

Sterling Electronics
(713) 627-9800

WASHINGTON

SEATTLE
Kierulff Electronics, Inc.
(206) 575-4420

IN CANADA:

Zentronics Ltd.
Toronto (416) 635-2822
Ottawa (613) 238-6411
Montreal (514) 735-5361

**OVERSEAS:
EUROPEAN
INQUIRIES:**

European Parts &
Accessories Marketing
Group
General Motors Continental
Plant 2, Noorderlaan,
Postbus 9
B-2030, Antwerp, Belgium

**ALL OTHER
OVERSEAS
INQUIRIES:**

General Motors Overseas
Operations
Parts & Accessories Dept.
767 Fifth Avenue
New York, N.Y. 10022
(212) 486-4412

**DELCO ELECTRONICS
REGIONAL SALES
OFFICES**

Charlotte, North Carolina
28209
4600 Park Road
(704) 371-5160

Van Nuys, California 91404
Box 2968
(213) 988-7550

**GENERAL SALES
OFFICE**

700 E. Firmin, Kokomo,
Ind. 46901
(317) 459-1271



**FOR MORE INFORMATION ABOUT
DELCO'S NEW MONOLITHIC
OPERATIONAL AMPLIFIER, MAIL
THIS COUPON TO:**

**Delco Electronics Division
General Motors Corporation
Marketing Services MS A-213
700 E. Firmin Street
Kokomo, Indiana 46901**

NAME _____

TITLE _____

COMPANY _____

ADDRESS _____

CITY _____

STATE _____

ZIP _____

PHONE _____

01



ED1122

Standardized interfaces isolate

a control computer from its remote processors. You gain design freedom, improve reliability, and save money too.

Inexpensive microcomputers can handle many test and control operations with fewer than a dozen chips. But when these small computers must be integrated into a larger system, the interface with the control computer can become expensive. For instance, a relatively simple interface with the Camac system (see box) requires at least 45 small and medium-scale ICs.

Moreover, without guidelines for the construction of such interfaces, the proliferating designs within a large system make maintenance a nightmare. And the duplication of design effort is an expensive waste. A standard interface that connects a wide variety of 8 and 16-bit μ Ps to the serial Camac crate¹ is therefore long overdue.

Software beats hardware

Present Camac interfaces have been accomplished by wiring together many small and medium-scale ICs. A few programmable interface chips like the Programmable Peripheral Interface (PPI) of Intel and the Peripheral Interface Adapter (PIA) of Motorola are available, but they do not readily mate with the Camac "dataway" (bus structure), and so require a great deal of programming, even for simple data transfers.

It is much better to adopt the basic philosophy of μ Ps, namely to replace hardware with software. This calls for programmable controllers such as a micro-programmable sequencer. In a well-structured design, the microinstructions can directly control the interface.

Some of the relatively slow instructions required to access the Camac dataway (about 2- μ s cycle time) can then be replaced by a sequence of fast (200-ns) microinstructions. The resulting simplification of the μ P's software interface is an additional benefit.

To accommodate the predominant 16-bit mini-computers, the majority of data transfers in Camac use 16 bits, and the interface can be laid out for this word size.

In a block diagram of the standardized interface module (Fig. 1) the main functional blocks are a

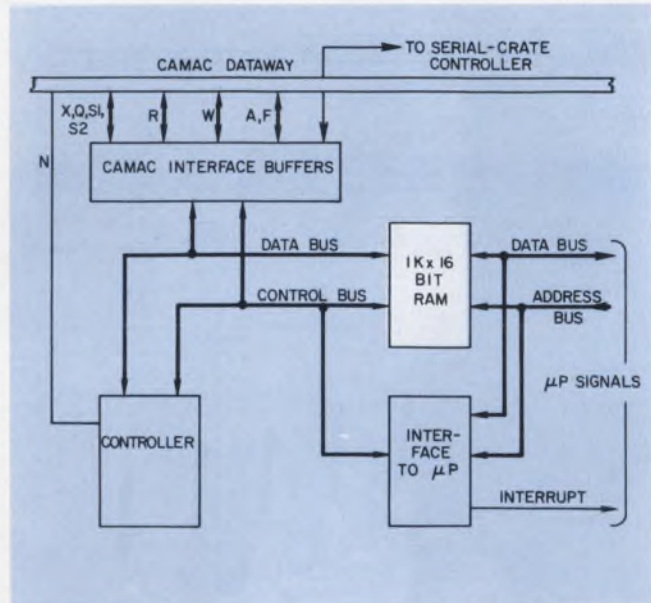

1. The block diagram of a Camac interface shows that all information passes over the Camac dataway.

1-k \times 16 bit RAM, interface to the μ P, Camac interface buffers, and an interface controller. The RAM acts as a buffer memory between Camac and the μ P—all data transfers between the two must temporarily be stored here. To the controller and Camac, the memory is configured as 1 k \times 16 bits, but to the μ P it may also be accessed as 2 k \times 8 bits. Camac commands coming from the μ P to be executed by the interface controller are, for instance, passed in this form.

The μ P interface contains control and status registers needed by the μ P to initiate the stored commands, and to read the controllers' responses. These registers can be interrupt signals that inform the μ P when a command has been executed.

Camac interface buffers, on the other hand, pass data between the internal data/control bus and the dataway. The controller is responsible for operating these buffers, and for generating the two dataway timing signals, S1 and S2.

The core of the interface module, the controller, consists of a microprogrammed sequencer and its associated microprogram memory. This controller initiates dataway cycles on command from the μ P, gives the required responses to Camac commands

Dr. Peter J. Horne, Fellow, and Dr. Olaf Kaestner, Fellow, European Organization for Nuclear Research, Geneva, Switzerland.

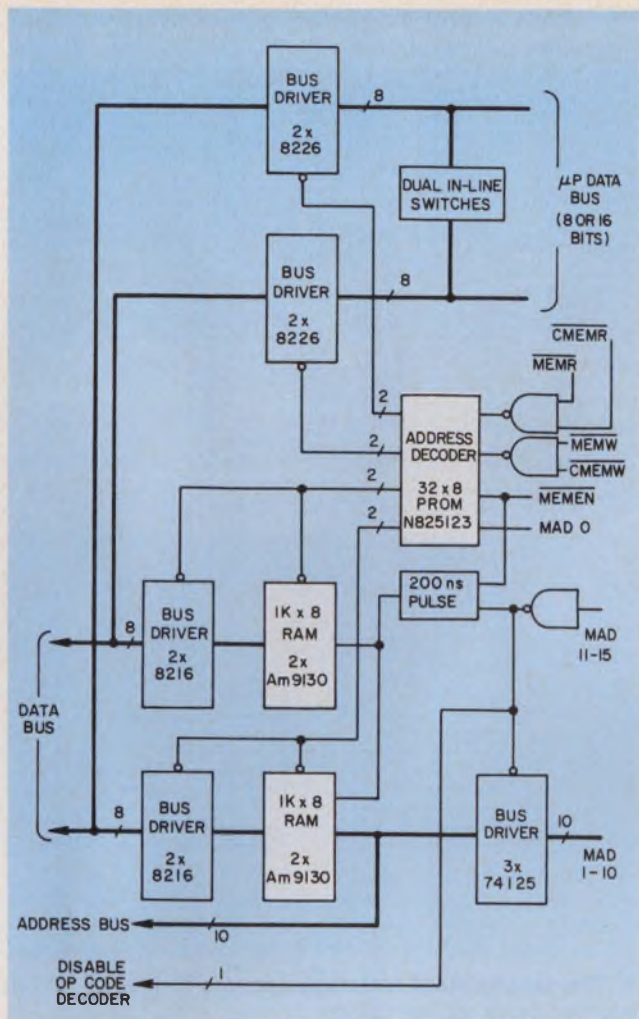

2. The interface memory consists of a 32 x 8 PROM, and two 1 k x 8 RAMs, followed by drivers.

issued by the central computer, and interrupts the μP when a "LAM" signal is received from a Camac module. LAM (look at me) is equivalent to an interrupt.

Organize your memories

The 1 k x 16 bits of data memory may be accessed by either the μP or the controller, because both control the address and data lines. To enable 16-bit as well as 8-bit μP s to access this memory, a 50-ns PROM (Signetics N82S123) interprets the memory as 1-k words or 2-k bytes (Fig. 2), and a set of dual in-line switches compresses the 16-bit data bus to eight bits when necessary.

When the μP is not accessing the RAM, the three-state buffers in Fig. 2 are in the high-impedance state, and isolate the μP from the memory. The controller may now access the memory without conflict between its address and data lines and those of the μP . But what if the controller wants to access the memory at the same time as the μP ? Unless a transfer is already underway, the μP gets priority because whenever the μP addresses the interface memory, it generates a

What is Camac?

Camac is a modular data-handling and interface system for on-line digital computers that is being widely used in Europe for industrial-process control, medical research and other applications. The Camac standard² has been specified by European nuclear research laboratories and adopted as an IEEE standard (583-1975, 595-1976, and 596-1976).

The heart of the Camac standard is a bus structure, the "dataway." Since all interface modules connect to this dataway, they are completely computer-independent.

Up to 25 such modules can be housed in a "crate," where the dataway runs in the rear. Two stations of each crate are reserved for the "crate controller," which interfaces dataway and computer.

Buses on the dataway

The most important lines of the dataway are a read and write bus, each 24 bits wide; a function bus, F, with 5 bits and a subaddress bus, A, with four bits, which together define the function to be executed by a module; a private station-select line, N, for each module; a private-alarm line, L, from each module to the crate controller; a bus line, X, to confirm "command accepted;" and a line, Q, for function and module-dependent response. Line L is often called "LAM" (look at me).

The crate controller generates a "busy" signal B, two timing signals for each dataway cycle (on bus lines S1 and S2) and the unaddressed control commands to clear, initialize or inhibit the modules on bus lines C, Z, I, respectively.

Crate controller types

Camac uses three types of crate controllers (CC):

- A "dedicated" CC that interfaces the dataway to the I/O bus of the computer.

- A "type A" CC, used with the highly parallel "branch highway," that bridges shorter crate/computer distances. The branch highway is controlled by a "branch driver" and accommodates up to seven crates. A branch driver can either be a normal Camac module in a crate or a dedicated driver that interfaces to the computer's I/O bus.

- A "serial" CC, used with the "serial highway," that bridges very large crate/computer distances. Up to 62 crates form a loop that begins and ends in a "serial driver"—the serial equivalent of a branch driver.

Command messages—either byte or bit-serial—are sent around the loop. A "demand message" is inserted by the serial CC into the loop whenever a LAM occurs in its crate. Microprocessors in a crate have access to the N lines via the serial CC. They can send demand messages to the computer by a handshake with the serial CC to ensure interference-free control of the dataway.

Interface controller word address μP's byte address

000 ₁₆	DATA TRANSFER MEMORY FOR BLOCK AND 'A' SCAN		F000 ₁₆
	MODES		
3E0			F7C0
3E2	DSA(0)	4 bytes	F7C4
3E4	DSA(1)	4 bytes	F7C8
3E6	DSA(2)	4 bytes	F7CC
3E8	DSA(3)	4 bytes	F7D0
3EA	DSA(4)	4 bytes	F7D4
3EC	DSA(5)	4 bytes	F7D8
3EE	DSA(6)	4 bytes	F7DC
3F0	DSA(7)	4 bytes	F7E0
3F2	DSA(8)	4 bytes	F7E4
3F4	DSA(9)	4 bytes	F7E8
3F5	DSA(10)	2 bytes	F7EA
3F6	DSA(11)	2 bytes	F7EC
3F7	DSA(12)	2 bytes	F7EE
3F8	DSA(13)	2 bytes not used	F7F0
3F9	DSA(14)	2 bytes	F7F2
3FA	DSA(15)	2 bytes	F7F4
3FB	LAM PATTERN	2 bytes	F7F4
	RESERVED		F7F6

3. A suggested interface memory map starts at 60 k to avoid interference. DSA means data storage address.

memory-enable signal.

The top 32 words of the data memory are reserved for storing Camac commands and associated data, an address for the memory address register (MAR), data for the counter (CNTR) and a demand message to the serial-crate controller. One additional word remains reserved where the controller can store a LAM pattern (interrupt vector).

A suggested start address for this interface memory, as seen by the μP, is F000₁₆ (=60 k), which most likely won't interfere with a program running on the microcomputer (Fig. 3). You can, however, alter the address for μPs that don't have a 64-k addressing range, such as the TMS 9900.

Camouflage the interface

To make an interface usable for many μPs, use only address, data, and memory read/write lines for its control. As a result, the interface module looks like a block of memory to the μP, and all control comes from predefined memory locations (Fig. 4). Four addresses are reserved for interface control:

Initiate command	address	(ICA)	(address = F800 ₁₆)
Inhibit Camac	(INC)	(address = F802 ₁₆)	

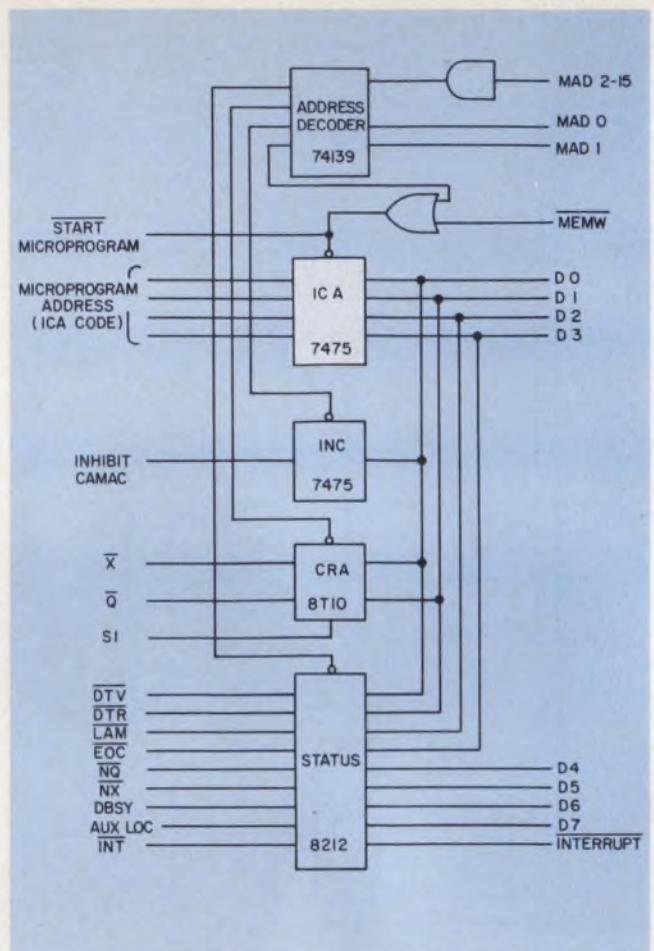

4. The standardized interface appears to the μP just as another block of memory.

Camac response

address	(CRA)	(address = F804 ₁₆)
Status word	(STATUS)	(address = F806 ₁₆)

When your μP wants to initiate a microprogram stored in the controller's microprogram memory, it writes to the proper ICA. These microprograms generate data transfers on the interface and Camac commands whose variables are stored in the interface memory (Fig. 4).

To initiate a particular microprogram, you must write a data value equal to its start address to the ICA after the requisite data have been placed in the correct memory location (Table 1).

While the μP performs data manipulations, it needs uninterrupted access to the interface memory. To prevent Camac from accessing the interface, the μP sets the Inhibit Camac bit by writing a One to address F802₁₆. Should the central computer initiate a Camac command to the interface module at this time, it will receive an "X" response, but no "Q" response as is normal. When the μP has data for the central computer, it can reset the Inhibit Camac bit to Zero, and stop execution until the data have been completely acquired.

The Camac response address (F804₁₆) holds the X and Q responses to the last dataway cycle, which has

Table 1. Microprogram parameters

Microprogram	ICA i i = data	DSA(i) Contents
Initiate Camac dataway cycle in single transfer mode	0	NAF , DATA
	1	NAF , DATA
	2	NAF , DATA
	3	NAF , DATA
	4	NAF , DATA
	5	NAF , DATA
	6	NAF , DATA
	7	NAF , DATA
8	NAF , DATA	
Generate Z, C, I	9	ZCI
Load counter	10	Count
Load MAR	11	Address
Load NAF	12	N, A, F
Initiate block transfer	13	-
Initiate transfer in scan mode	14	DATA
Initiate demand message and load LAM register	15	Demand message

Table 2. Decoded Camac functions

Com-mand	Response	Action
F(0)A(0)	X (Q, Note 1)	Read register
F(16)A(0)	X (Q, Note 1)	Write to MAR
F(16)A(1)	X (Q, Note 1)	Write to MAR, if the next command is F(16)A(0)
F(16)A(2)	X (Q, Note 1)	Write to MAR, if the next command is F(0)A(0)
F(24)A(0)	X (Q, Note 1)	Inform μ P of the termination of a write-to-memory sequence
F(24)A(1)	X (Q, Note 1)	Inform μ P of the termination of a read-from-memory sequence

Note 1: The Q-response is ONE if the Inhibit Camac bit is ZERO.

Table 3. Sequencer control lines

S ₀ Bits	S ₁ Bits	FE Bits	PUP Bits	Mne-monic	Action
0	0	1	0	NOP	Microprogram counter is used as next address
1	1	0	1	JSR	Push microprogram counter and jump to address on D bus
1	1	1	X	JMP	Jump to address on D bus
0	1	0	0	RTS	Jump to address on stack, and pop stack

been initiated by the "auxiliary controller" (interface module and μ P). By reading from F804₁₆, the μ P can test the state of the X and Q bits (bits 0 and 1, respectively).

A status word, located at address F806₁₆, is used by the interface controller to inform the μ P of a LAM demand in the crate, a successful access to the interface module from Camac, or the result of the last initiated microprogram.

Exchanging memories

The Camac interface includes the hardware for the interface controller to access the dataway (Fig. 5), and the hardware and firmware (microprograms) for Camac to access the interface memory. Camac commands generated by the auxiliary controller will be identified as "auxiliary" Camac commands.

The interface module is transparent to the central computer, which sees only the 1-k words of memory. A data transfer to or from this memory requires a sequence of at least three Camac commands (Table 2).

To write from the Camac computer to the interface memory, you need the following sequence of commands:

1. F(16)A(1): Load the MAR with address (0 to 1 k) of the memory location where data are to be stored. Bits W1 to W10 correspond to address bits A0 to A9.
2. F(16)A(0): Write the required data into the memory location pointed to by the contents of the MAR.

3. F(24)A(0): Inform the μ P that a write sequence to the interface memory has been terminated.

After each F(16)A(0) command the interface controller increments the contents of the MAR, which enables the central computer to write a block of data to the memory.

When the central computer wishes to read data from the interface memory, use the following sequence of commands:

1. F(16)A(2): Load the MAR with the address of the memory location from which data are to be read. This command also causes a microprogram in the interface controller to load the required data into the register, getting it ready for the next Read command.
2. F(0)A(0): Read the contents of the register, increment the MAR and cause the microprogram to read the next word of memory into the register. This is the word to which MAR points.
3. F(24)A(1): Inform the μ P that the read sequence from interface memory has been completed.

To read a whole block of data from the interface memory, only the F(0)A(0) command need be repeated.

An Am2909 microprogram sequencer and its associated 256 x 24-bit PROM (Fig. 6) form the center of the *microprogrammed* controller. In response to decoded Camac commands, and to commands by the μ P, the sequencer generates the necessary control

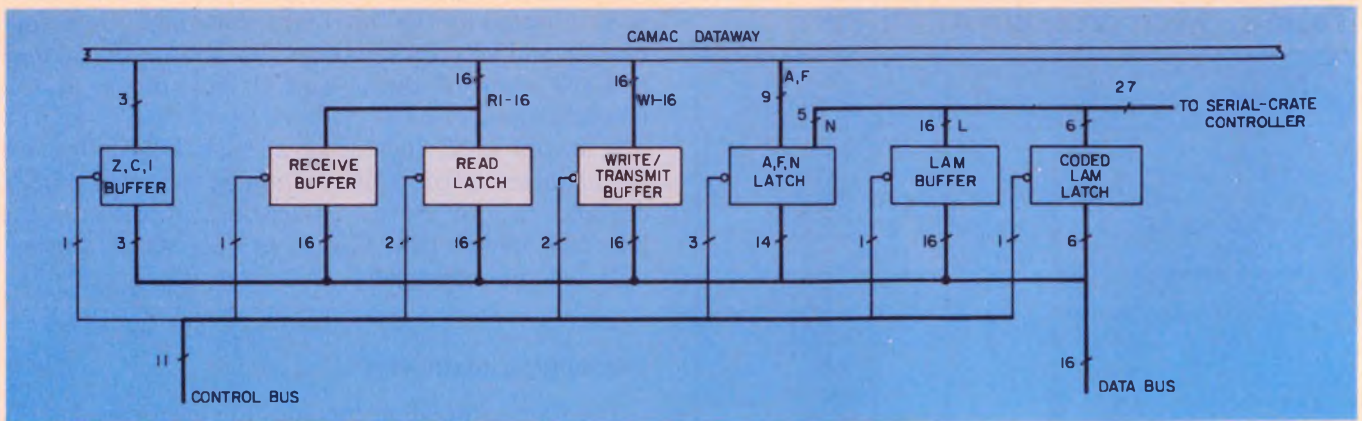

5. Interface buffers provide two-way data transfer between the interface and the central computer.

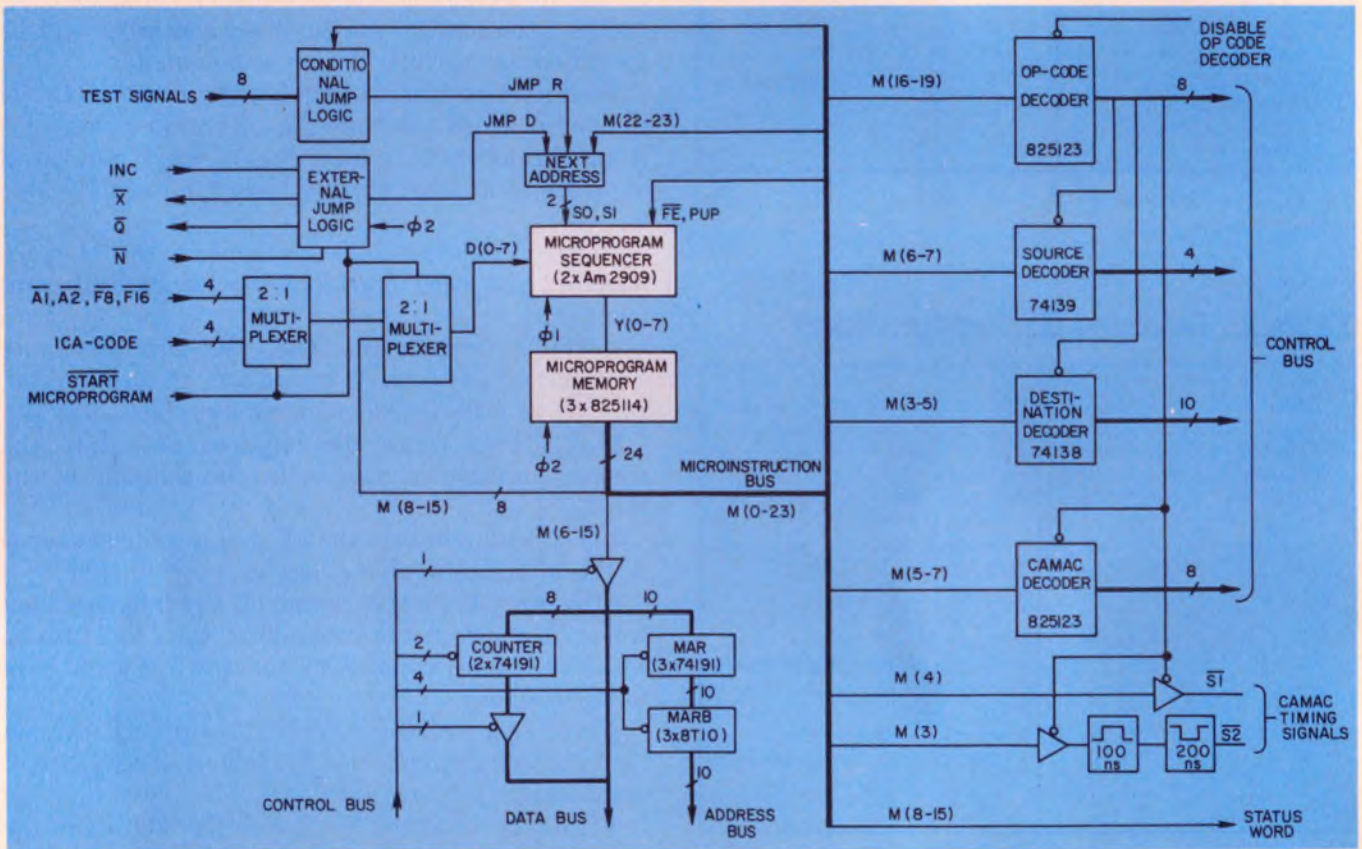

6. A microprogram sequencer and its associated PROM form the heart of the microprogrammed controller.

signals. The controller also checks for the occurrence of a LAM demand in the crate, and informs the μP when it happens.

The Am2909 microprogram sequencer is most suitable for the interface application because of its simple operation, and its speed (16.6-MHz maximum clock rate).⁵ The bipolar sequencer is a cascadable 4-bit slice device, and you need two of them in parallel to address 256 words of memory.

A control bus regulates the three other main interface blocks—memory, Camac buffers and μP interface. The data on this control bus at any particular instance depend on the microinstruction word that is held in its respective register.

The sequencer contains a four-input multiplexer to

select the source of the next microinstruction. It can be an address register, a direct input, a microprogram counter, or a four-word Push/Pop register file, as determined by the code (Table 3) on the S₀ and S₁ lines in Fig. 6. The direct inputs form the D bus and are connected to either four Camac command lines (A₁, A₂, F₈, F₁₆), or the four ICA data lines (Figs. 4 and 6), or an address field that contains the destination address in the microinstruction word for direct jumps. The choice is made by the Camac N line and the Start-microprogram line.

The four-word register file allows nested subroutine calls up to four levels and temporary data storage. The File Enable (FE) and Push/Pop (PUP) lines control the use of this file; however, only one level

of subroutine nesting is planned.

The microprogram counter holds the next sequential address, which in most cases will be the incremented present address on the I bus (Fig. 6). Other sources of the next microinstruction address are selected during a jump to an address on the D bus, a subroutine call or return, and a "forced" call from either Camac or the μP to the address on the D bus.

The microprogram sequencer is controlled by four bits— S_0 , S_1 , FE and PUP—which are contained in the microinstructions as bits 20 to 23. Their possible combinations are given in Table 3.

A special microinstruction set for the interface controller eases the task of writing microprograms. Each 24-bit microinstruction word is divided into a number of control fields (Tables 4 and 5), which are selected by an operational code (bits 16 to 19). There are 10 possible microinstructions for this application:

1. Move a word (MOV S_i , D_i).
2. Branch if condition is true (BRIF T_i , D_i).
3. Load destination with immediate data (LDI DA_i , D_i).
4. Increment or Decrement (INCR D_i ; DECR D_i).
5. Interrupt the μP (INT ST_i).
6. Camac operation (CAM CA_i , S_2 , S_1).
7. No operation (NOP).
8. Jump to subroutine (JSR D_i).
9. Unconditional jump (JMP D_i).
10. Return from subroutine (RTS).

One clock runs the show

The controller's timing is provided by one two-phase, 5-MHz clock. Phase 1 ($\Phi 1$) drives the microprogram sequencer, and phase 2 ($\Phi 2$) the microinstruction register. Since the access time of the N825114 PROM microprogram memory (256×8) is 60 ns, and the delay time from clock ($\Phi 1$) to the output of the Am2909 about 40 ns, the microinstruction is strobed by $\Phi 2$ into its register after 100-ns delay.

Because this instruction cycle relates directly to the timing of the Camac dataway, the interface controller can easily generate the 200-ns Camac timing signals (e.g. S_1 and S_2). The S_2 signal must, however, be generated 700 ns after the start of a Camac dataway cycle, which can therefore not be on an instruction boundary (Fig. 7). The S_2 signal is therefore generated by the 4th instruction after the start of a Camac dataway cycle, and delayed 100 ns by hardware before being clocked onto the dataway.

To allow use of the Am9130 1-k \times 4-bit, 200-ns RAM memory, all read microinstructions must be repeated twice—the $\Phi 1$ clock strobes data into the destination register, but the memory's access time requires that the data remain valid for the next $\Phi 1$ strobe.

Protocol may cause delay. . .

To transfer data between the central computer and the μP , you need a certain protocol. If the μP expects

Table 4. Command field descriptions

Bits	Mnemonic	Meaning
7 6		Sources (S_i)
0 0	MEM	The contents of the memory location whose address is held in MAR
0 1	LAM	The contents of the LAM register
1 0	CNTR	The contents of the counter
1 1	MAR	The contents of the memory address register
5 4 3		Destinations (D_i)
0 0 0	MEM	The memory location whose address is held in MAR
0 0 1	MAR	The memory address register
0 1 0	NAF	The NAF command register
0 1 1	SGLE	The SGLE register
1 0 0	CNTR	The counter
1 0 1	RREG	The CAMAC read register
1 1 0	MARB	The memory address register buffer
2 1 0		Test (T_i)
0 0 0	AUXLOC	Test the state of the auxiliary lockout bit
0 0 1	AUXREAD	Test the state of the auxiliary read bit
0 1 0	AUXTEST	Test the state of the auxiliary test bit
0 1 1	CNTRZ	Test the state of the counter = zero bit
1 0 0	Q	Test the state of the Q bit
1 0 1	DBSY	Test the state of the demand BUSY bit
1 1 0	X	Test the state of the X bit
1 1 1	LAM	Test the state of the LAM bit
6 5		Camac (CA_i)
0 0 0	MEM(R)	Auxiliary receive, read from the dataway to memory pointed at by contents of MAR
0 0 1	MEM(W)	Write to memory location whose address is held in MAR
0 1 0	MAR	Memory address register (write only from CAMAC)
0 1 1	RREG	Read the contents of the CAMAC read register
1 0 0	MEM(T)	Read the contents of memory location pointed at by MAR and transmit to CAMAC (auxiliary transmit)
1 0 1	NAF	Enable the NAF command register/buffer onto the dataway
1 1 0	ZCI	Generate the dataway common control signals

Table 5. Status field descriptions

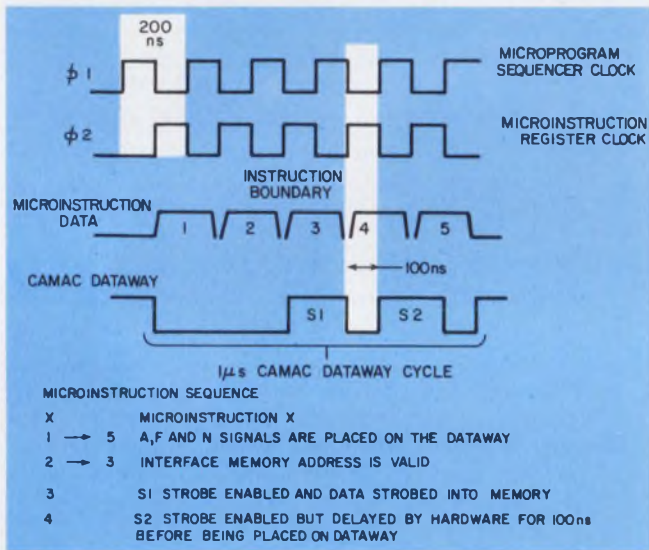
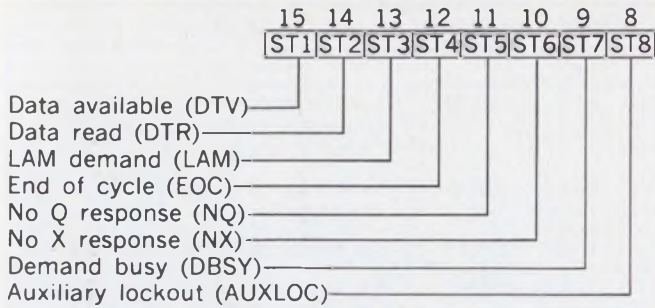

7. The timing relationship of S1 and S2 is imposed by the Camac specification. This example shows a read cycle.

data from the central computer, the μP must wait until it knows that the data transfer is completed. The interface controller uses the first bit in the status field description (ST1) to signal "data available" (DTV in Table 5).

If the data are located in a contiguous block of memory, it is necessary that one of the following three conditions be satisfied:

1. The data block's start address is known to the μP beforehand.
2. The MAR, having been loaded by Camac, is pointing at the start address.
3. The start address is stored in memory at DSA (11) and is ready for a load MAR command from the μP .

The second and third cases occur when the data in memory are to be written immediately to another module in the Camac crate. The first case, however, will probably be used most often, with the data block's size and start address specified in advance for any particular application.

While the μP uses the interface, the central computer must be prevented from interrupting. This is achieved when the μP sets the Inhibit Camac bit. With this bit set, the interface module gives X responses to all Camac commands, which signals that these

commands have not been executed. Before the central computer can load a second block of data into the memory, it must repeat the initial command until it receives both X and Q responses.

When the central computer expects data from the μP , the μP writes the data into the interface memory and informs the central computer of that by either transmitting a demand message or "dropping" the Inhibit-Camac bit. Transmitting a demand message is more efficient because the central computer then does not have to keep on testing the state of the interface module.

The data block's start address must either be known to the central computer beforehand, or the MAR must point at it. If the address always remains in the MAR, the central computer need not load this register prior to reading the data. It must, however, inform the μP that the data have been read, by sending the Camac command F(24)A(1).

...and barricade the databay

In a serial-crate controller, you may have to deny auxiliary controllers (interface and μP) access to the databay, by setting an "auxiliary lockout" bit (ACL). When a crate controller recognizes its address in an incoming message, it sets this bit automatically (Ref. 1, p. 81) and keeps it "on" until the required databay cycle terminates or an error is detected in the message.

The interface controller tests the condition of the ACL line before each μP -requested databay cycle. If ACL is active, the interface controller doesn't start the cycle but informs the μP by sending an interrupt, and setting the AUXLOC bit in the status register (Fig. 4).

In a 5-MHz byte-serial crate system, the maximum time that the ACL bit can be set is 4.7 μs ; thus, the μP should wait that long before reinitiating the Camac command. In systems that use the bit-serial mode, or have slower clock rates, the delay will be proportionately longer, and the μP will spend more time waiting for Camac commands to be executed. However, with an intelligent auxiliary controller in the system, the central computer should access the crate infrequently, and minimize μP delays. ■■

Acknowledgement

The authors wish to thank the CERN fellowship program for support of this work.

References

1. *Specification of the Camac Serial Highway and Serial Crate Controller Type L2*, Report EUR 6100e, Commission of the European Communities, Geel, Belgium, 1976, chapter 14.
2. "Camac: A Modular Instrumentation System for Data Handling," ESONE-Committee, Report EUR 4100, 1972, chapters 4, 5, and 6.
3. Horelick, D., Larsen, R. S.; "Camac: A Modular Standard," *IEEE Spectrum*, April, 1976, p. 50.
4. Chroust, G., "Parameters of Microprogrammed Interfaces," *Proceedings of the Second Symposium on Microprocessing and Microprogramming, October 12-14, Venice, 1976*, North Holland Publishing Co., Amsterdam, Holland, 1976, p. 51.
5. "Am2900 Bipolar Microprocessor Family," Advanced Micro Devices Inc., Sunnyvale, CA, 1976, p. 44

Flukemeter II.



Like the classic "Flukemeter" differential voltmeter of the fifties (inset), the new 8020A DMM offers a superb combination of performance and value for the seventies. Only \$169.*

You know Fluke for innovation in precision test and measurement instrumentation. For almost 30 years we've anticipated the measurement problems that come with fast-changing technology.

And we've done it again. Introducing the new 8020A digital multimeter.

The 8020A is built to the same high standards we've designed into its predecessors. The only difference is that the 8020A is smaller. And, of course, it costs a lot less.

You'll find the 8020A is the only DMM around with such impressive features for only \$169,* now and for

some time to come. Features that mean value and versatility, like 26 ranges and seven functions, including conductance (which measures leakage to $10^{10}\Omega$). And three-way overload protection. Hi-lo power ohms. And more.

In fact, the 8020A is 13 ozs. of pocketable benchtop instrument performance, in the Fluke tradition. Performance you can count on for up to 200 hours of use with its inexpensive 9V battery, single custom CMOS LSI chip and low-power, razor-sharp 3½-digit LCD display.

Great performance, low cost: *That's* Fluke tradition. Where else can you

get a field reliable tool built to precision lab standards? Or, factory calibration that's NBS traceable, with 0.25% dc accuracy? And, of course, the Fluke 8020A has a full year warranty including all specifications, with worldwide service backup.

The quickest way to get one is to call (800) 426-0361, toll free. Give us your chargecard number and we'll ship one immediately. Or, a "Ten-Pack" for only \$1521.* And we'll tell you the location of the closest Fluke office or distributor for a hands-on demonstration.

*U.S. price only.

Command Performance: Demand Fluke.



1809-7016

CIRCLE NUMBER 40 FOR LITERATURE

ELECTRONIC DESIGN 24, November 22, 1977

121



MODEL 70

The new standard for the CRT terminal industry from the first independent commercial CRT manufacturer.

- Microprocessor controlled
- 80 characters X 25 lines
- Upper/Lower case
- Eight function keys
- Tilt/Swivel screen

AND MUCH MORE



*Stability
Age
Beauty*

TEC, Incorporated

2727 N. FAIRVIEW AVENUE • TUCSON, ARIZONA USA 85705 • (602) 792-2230 • TWX 910-952-1377

AN EQUAL OPPORTUNITY EMPLOYER M/F, COMMITTED TO AFFIRMATIVE ACTION — A TEC INCORPORATED CORPORATE POLICY

CIRCLE NUMBER 41

A BROKEN AXLE COULD BE MORE THAN AN INCONVENIENCE.

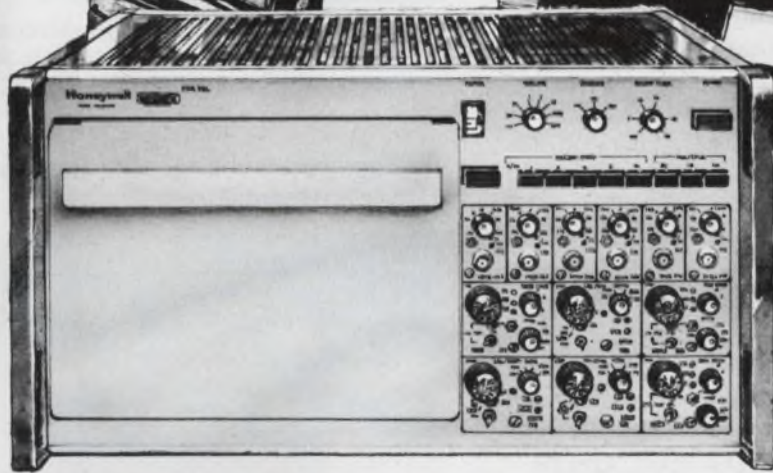

A leading manufacturer of roller coaster cars had a serious problem: defective axles. After futile attempts to pinpoint the cause, engineers installed strain-gages on one of the cars, put a Honeywell 1858 Visicorder and portable power source aboard, and sent the car around the track. Within minutes they had a complete graphic record of the stresses and strains encountered. And this pointed them toward a solution.

For such on-the-spot data acquisition, the 1858 is an obvious choice. It's exceptionally compact; 18 data channels with plug-in signal conditioning in a

package only 8-3/4 inches high. It's light and durable enough for field use, and it gives you the performance you expect from the most advanced lab system: frequency response from dc to 5000 Hz with no trace overshoot, input sensitivity from 100 μ V to 300V. The 1858 can be expanded to 32 channels and offers a complete selection of signal conditioning modules.

For more information on the 1858, or other Honeywell instrumentation recorders, call or write: Lloyd Moyer, Honeywell Test Instruments Division, Box 5227, Denver, CO 80217. (303) 771-4700.

WE'LL SHOW YOU A BETTER WAY.

Honeywell

CIRCLE NUMBER 42

Speed up PLLs in digital synthesizers.

At least three methods can boost VCO slew rate in locked loops. Choose the best for your system.

You can speed up a phase-locked loop (PLL) in digital frequency synthesizers at least three ways:

- Select circuit values to optimize the slew rate without sacrificing the other loop characteristics.
- Detect large changes in the count N and slew the VCO at a rate faster than normal loop dynamics allow.
- Tune the VCO frequency coarsely with the channel information along with frequency lock-in by the loop.

Fast lock-up—increasing the speed at which a digitally programmed frequency source moves between channels—is important, for instance, when a synthesizer generates both transmitter driver and receiver local-oscillator signals, and when the output must change by the i-f frequency of the receiver (when switching from transmit to receive).

Fast PLLs are also important in scanning receivers in which preprogrammed channels—perhaps widely spaced in frequency—are scanned, and receivers that time-share local-oscillator frequency. In each of these cases the maximum scanning or sharing rate is determined by how quickly the loop dynamics will allow the synthesizer-output frequency to change and stabilize between acceptable limits.

Analyzing the PLL

A typical PLL is composed of a phase detector, loop filter and VCO (Fig. 1). Since the detector is a digital, three-state circuit, its output is a pulse that lasts as long as the phase difference of the input signals—provided the input frequencies (more accurately, repetition rates) are identical. When the input rates differ, the output-pulse width changes between limits at a rate equal to the difference of the input rates.

A useful approximation relates the average output voltage to the input phase difference. If the frequencies are locked and the phase difference is 180°, you get the waveform in Fig. 2. If the height of the output is V_p , the average voltage is, of course, $V_p/2$. Since a three-state phase detector is linear from -2π to $+2\pi$ radians, the average voltage relative to the phase difference is $V_{av} = V_p \phi_D / 2\pi$, which yields a gain constant of $K_\phi = V_p / 2\pi$ volts/rad.

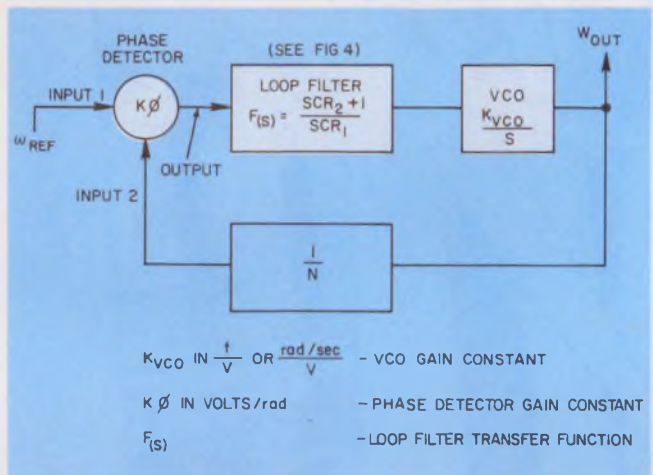

1. The most popular PLL synthesizer design consists of three major elements: a phase detector, a filter and a voltage-controlled oscillator.

Average pump voltages for dual and quad-D three-state phase detectors

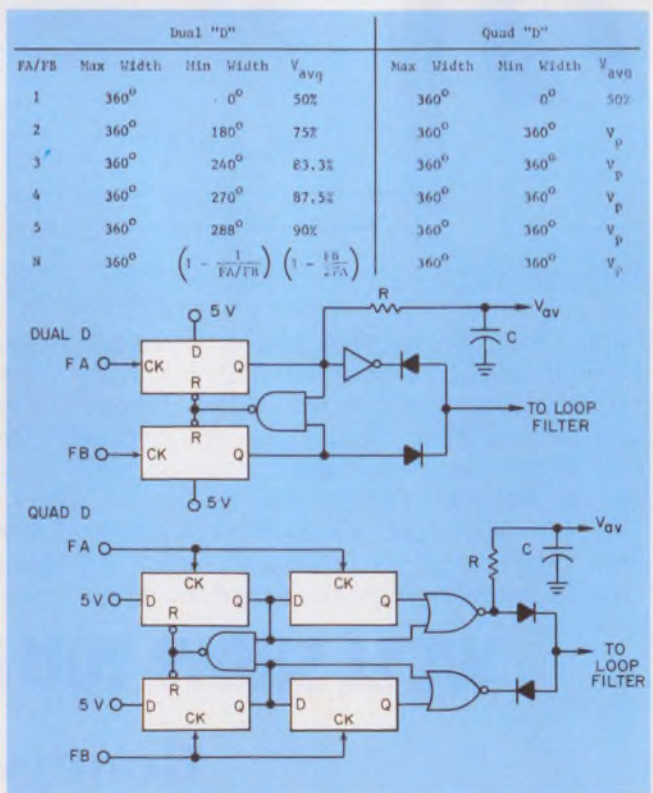

C.A. Sharpe, Project Engineer, Bendix Avionics Division, 2100 Northwest 62nd St., Fort Lauderdale, FL 33310.

When the input frequencies differ, the gain constant (not the same as the phase gain constant) may again relate the average output voltage to the frequency difference. The second PLL element, the loop filter, is often called a low-pass filter because of its general transfer function.

However, in the synthesizer of Fig. 1, the filter serves as an integrator that accepts the phase-detector pulse and raises or lowers a control-line voltage until there is zero phase error or no further input pulse (Fig. 3). The transfer function of the loop filter-integrator

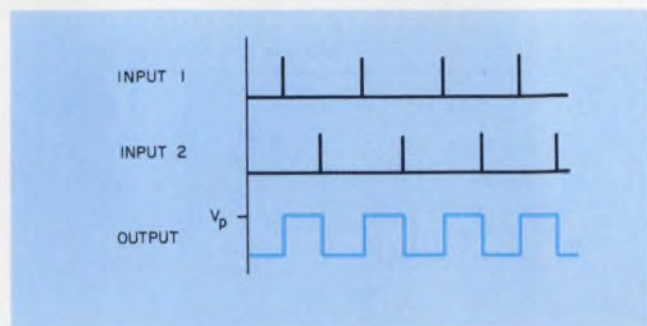

2. When the inputs to the phase detector are 180° out of phase, the output at lock is a pulse train.

is given by $(sCR_2 + 1)/sCR_1$.

The VCO is specified in units of $\Delta\omega/\Delta V$, since the frequency usually varies about a value far removed from zero. In this case, the actual VCO frequency is $\omega_K + K_V(V - V_K)$. To get the transfer function, the most useful quantity in loop analysis, run through the following operation:

$$\begin{aligned} \omega_{VCO} &= \omega_K + K_{VCO}(V - V_K), \\ \frac{\omega_{VCO} - \omega_K}{V - V_K} &= \frac{\Delta\omega}{\Delta V} \\ &= K_{VCO} \frac{\text{rad/s}}{V}. \end{aligned}$$

Since phase is the integral of frequency,

$$K_{VCO}(\theta) = \frac{1}{s} K_{VCO}(f).$$

In most analyses, the VCO-gain constant is taken to be

$$\frac{K}{s} \text{ rad/s/volt.}$$

In Fig. 4, assume the two inputs have the same repetition rates, but that input 1 leads input 2 in phase. That is, switch S connects to V_p with each positive transition of input 1, and opens with a positive transition of input 2. Note that the phase detector now alternates between a "pump" state in which the output equals V_p and a high-impedance state, in which the output line floats (see Table).

(A similar analysis holds if input 1 lags input 2. The output line alternates between open circuit and ground, for example, in a three-state phase detector: V_p , open circuit, $-V_p$.)

While the output line is high, the filter integrates

the input voltage, and lowers the control-line potential to that of the VCO. The equation for this mechanism is

$$\begin{aligned} V_{\text{control line}} &= V_{\text{initial}} - V_p \left[\frac{R_2}{R_1} + \frac{1}{R_1 C} \int_0^T dt \right] \\ &= V_{\text{initial}} - V_p \left[\text{transient} + \text{steady state} \right]. \end{aligned}$$

Note that the transient part of the solution comes from the pulsed output of the phase detector. Since there will be no output pulses either before or after

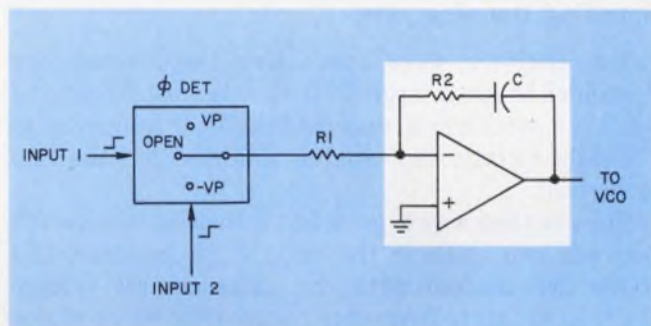

3. The filter in the synthesizer of Fig. 1 serves more as an integrator than a low-pass circuit.

the phase error appears, the steady-state part accounts for the change in control-line voltage, which moves to a new level to re-establish lock.

Therefore,

$$\left| \Delta V_{\text{control line}} \right| = V_p \frac{t}{R_1 C}$$

or

$$\frac{\Delta V}{t} = \frac{V_p}{R_1 C}.$$

The result of this last equation can be considered the control-line slew rate—the maximum speed at which the control line can move to the new required voltage. Multiply the slew rate by the VCO-gain constant and the result is the maximum rate at which the VCO frequency can change:

$$\begin{aligned} \frac{V_p}{R_1 C} \text{ V/s} \times K_{VCO} \frac{\text{rad/s}}{V} \times \frac{1}{2\pi} \text{ Hz/rad} &= \\ S_{VCO} \text{ Hz/s.} \end{aligned}$$

When shifting from receive to transmit, the VCO frequency must change by 10.7 MHz. The time(T) required to do this is the fastest rate you can get and is found from

$$T = \frac{10.7 \text{ MHz}}{S_{VCO}}$$

But since the average input to the loop filter is less than V_p , the actual time required will be longer than the calculated value. However, you can determine a worst-case lock time by assuming that V_p has the lowest possible average value with a frequency difference and that the lock-up transient occurs after the VCO frequency reaches the proper value. Thus,

Time (worst case) = lowest slew rate of VCO + lock-up transient

$$= \frac{\Delta f_{VCO}}{2S_{VCO}} + \frac{4}{\omega_n}$$

where ω_n = the natural frequency.

The actual time required falls between the best and worst-case values and depends upon the damping factor and the type of phase detector. With a quad-D detector, the average output voltage is very close to V_p and produces a much faster slew rate.¹

Speeding the slew rate

The analyses show that using the normal loop dynamics to get a large VCO slew is slow. What you need is a mechanism that gets the VCO frequency to the right vicinity immediately and then lets the loop lock itself.

The simplest way to get a fast transition is to switch between two VCOs in the loop. If, for instance, two VCOs are tracked with the same control voltage between separate frequency ranges (Fig. 4), no major control-voltage transition is required for a large frequency change.

When transmitting, VCO 1 is active and tuned by the control line. When receiving, VCO 2 is active and requires the same tracking voltage to generate a frequency that is 10.7 MHz lower than VCO 1 (in this example). The time required for lock, therefore, is the time required for the control line to compensate for any tracking error plus the regular lock-up transient of approximately four $\omega_n t$ units from the second-order curves.

You may want to simplify Fig. 4 when you can switch one VCO in range—add capacitance to the tank circuit (Fig. 5). Normally, the circuit is designed for a certain tracking response in the transmit mode. In keeping with Fig. 4, select values so that 2 V tunes the tank to 150 MHz and 8 V to 160 MHz. Energize the receive line to switch C_x in parallel with the tank and to lower the resonant frequency.

Next, adjust C_x so that the output frequency is exactly 10.7 MHz lower with the same control-voltage input. Now when the device switches from transmit to receive, you don't require much more control voltage than is needed for a single-channel change.

However, the techniques in Figs. 4 and 5 are very restrictive—you must know the exact frequency shift beforehand. This requirement is no problem for simple $R_x = T_x$ operation, but when the frequency shift continually changes, it can be.

More sophisticated approaches

In the optimization approach, the constraints on the loop's natural frequency and the damping factor define the lock-in performance for small frequency changes and determine the spectral purity of the VCO output. However, in any system using a three-state

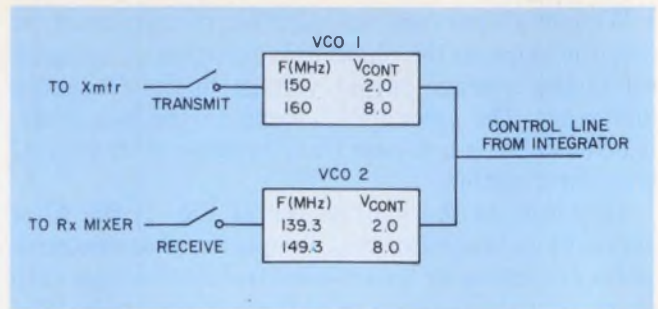

4. An easy way to speed operation: Switch between two VCOs working at different frequencies.

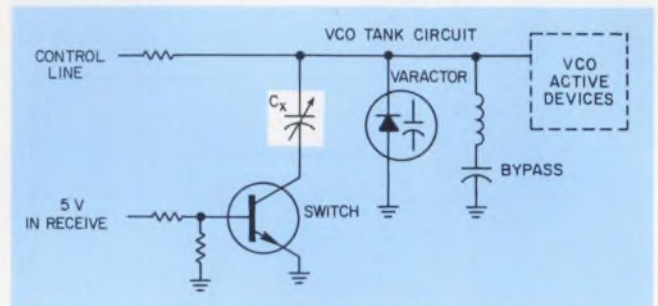

5. An alternative to two VCOs: Range-switch one VCO with capacitors in the tank circuit.

phase detector and an integrator, both ω_n and γ are free variables that can be specified by R_1 , R_2 and C in the integrator for any combination of N , K_v , and $K\phi$. Thus,

$$\omega_n^2 = \frac{K\phi K_v}{NR_1C}$$

and

$$\gamma = \frac{\omega_n R_2 C}{2}$$

Usually, you must decide whether to use an offset oscillator with a mixer, a fixed prescaler, or do direct counting. To decide, consider the usual tradeoffs: cost, space or availability. See if any of the loop constants can be optimized for slew rate:

T_L (approx) = $16/\omega_n^2$ (from second-order curves), where T_L equals the lock time.

From your analysis of absolute maximum slew rate,

$$\Delta V_{VCO} = \frac{V_p \max T_s}{R_1 C}$$

and

$$T_s^2 = \frac{\Delta V_{VCO}^2 R_1^2 C^2}{V_{p(max)}^2}$$

where T_s equals the slew time and V_{VCO} equals the voltage change required to slew the VCO from one end of the band to the other. However, $V_{p(max)} = 2 K\phi\pi$,

$$T_s^2 = \frac{V_{VCO}^2 R_1^2 C^2}{4\pi^2 K\phi^2}$$

and

$$\frac{T_s^2}{T_L^2} = \frac{\Delta V_{VCO}^2 R_1^2 C^2}{4\pi^2 K\phi^2} \times \frac{\omega_n^2}{16}$$

Substituting for ω_n^2

$$\begin{aligned} \text{let } M &= \frac{T_s^2}{T_L^2} \\ &= \frac{(\Delta V_{VCO})^2 (R_1)^2 C^2 K_\phi K_v}{(4\pi^2)(K_\phi^2 16NR_1 C)} \\ &= \frac{(\Delta V_{VCO}) R_1 C K_v}{K_\phi 64\pi^2 N} \end{aligned}$$

with T_s/T_L representing a measure of slew rate vs lock time.

Now examine the equations for M and ω_n .

You can readily see that to minimize M and keep ω_n constant, the confining variables are N and the $R_1 C$ product. If N is made very large to reduce M , ω_n can be kept constant by reducing the $R_1 C$ product—which further reduces M . Since ω_n determines the adjacent-channel lock time, selecting the system with the largest N results in the minimum slew rate. Note that the damping factor has not been mentioned. It is a free variable, a function of R_2 , and can be left for last.

Consequently, the slew rate in a direct counting system with a large N is greater than in a system designed around an offset oscillator. With an offset oscillator, the arrangement feeding the highest-difference frequency into the logic (requiring a larger N than with counting) will be the fastest. If the slew speed is still not fast enough, look into changing the loop dynamics.

Since ω_n and γ are constrained, by tradeoffs of spectrum purity and lock time, a combination of R_1 , R_2 , and C is specified at lock. However, while the loop is slewing to a new frequency, spectral purity is unimportant and ω_n can be raised to a higher value. This operation is quite simple. See Fig. 6.

Select R_1 and R_2 to give the desired ω_n and γ when the system is locked. Then select R_{1s} to give a much higher ω_n when the system is slewing. Finally, select R_{2s} to give an acceptable γ when R_{1s} is switched in. The switches can be FETs or inexpensive CMOS.

To determine when and how long to activate the switches, monitor the channel lines and detect any change occurring above a selected value. Or, for $R_x = T_x$ switching, use the key line. Either method can fire a one-shot for a fixed interval that you determine:

1. Select R_1 and R_2 for desired ω_n and γ when the PLL is locked.
2. Select R_{1s} and γ_s to give the desired slew time.
3. Fire the one-shot to activate the switch for slightly less than T_s .

When the PLL is out-of-lock, use the R_{1s} and R_{2s} constants for ω_n and γ . To use them, activate the one-shot with an instantaneous loss-of-lock detector.² If the one-shot period is slightly greater than that of the reference, R_{1s} and R_{2s} will switch-in as soon as lock is lost and out when it is re-established.

Finally, should you decide to coarse-tune the VCO, set the VCO frequency approximately at the correct

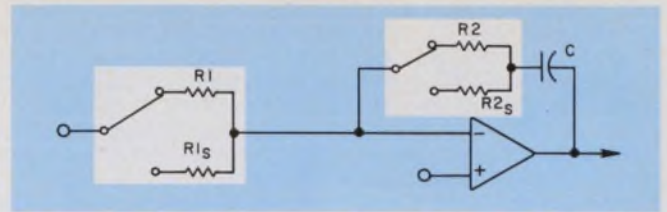

6. One way to speed-up a PLL is to select circuit resistance to give the desired natural frequency (ω_n) and loop gain.

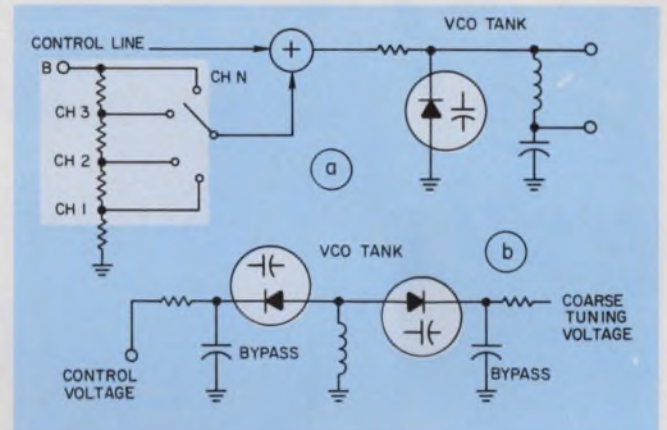

7. Coarse-tuning gets the VCO into the desired range fast. A summing network (a) does the tuning with channel information; varactors (b) do it with a tuning voltage.

frequency with an analog voltage determined by the selected channel. The control voltage supplied by the integrator maintains phase lock but only over a restricted range. The primary advantages of coarse-tuning are that you can set the frequency instantly to anywhere in the range with the coarse tuning, and the lock-up time becomes essentially the same as that of the adjacent-channel case. Two ways to coarse-tune the VCO are shown in Fig. 7a and 7b.

The summing circuit in Fig. 7a can be a passive resistor network or an op-amp configuration. If in the PLL of Fig. 1 the 150 to 160-MHz spread must be divided into 1-MHz increments on the coarse-voltage generator, the advantages of coarse-tuning become apparent. And since the dynamic range of the control line—hence the varactor-capacitance change—is much smaller than a direct method (which covers the full 10 MHz), VCO-temperature drift (encountered with offset mixing) is easily controlled.

Using two varactors as in Fig. 7b will usually save some space. Regardless of the method, however, take care to keep the coarse-voltage line as noise-free as possible. Any garbage on the line will directly modulate the VCO and substantially decrease spectrum purity. Of course, if you want FM (as in the case of an FM transmitter), it's easy to couple-in audio through a capacitor. ■■

References

1. Sharpe, C.A., "A Three-State Phase Detector Can Improve your Next PLL Design," *EDN*, Sept. 20, 1976, pp. 55-59.
2. Sharpe, C.A., "How Can You Be Sure that your PLL Is Really Locked In?," *EDN*, Feb. 20, 1977, pp. 109-111.



THE GREAT 4K STATIC RAM RACE

In a world of claims and counter-claims, one thing is clear. EMM SEMI is still in the lead. Of course, we not only had a healthy head start, but we field a whole family of 4K static RAMs.

We *delivered* the industry's first 4K static RAM in 1975, a full year and a half before anyone else. We are now delivering 7 basic static RAM types with many versions

of each, and producing them at a greater monthly rate than our nearest competitors combined.

By now we have more 4K static RAMs operating in a wider range of customer equipment than anyone else in the semiconductor memory business — from 10 Megabyte IBM add-on memory systems to hobbyist microprocessor kits.

Whatever your application, from mass storage to telecommunications, from medical electronics to toys and games, chances are there's an EMM SEMI static RAM just right for you. Please call or write today for full details — and ask about our byte oriented RAMs, too.

Memory at work  **EMM SEMI, Inc.**

a subsidiary of Electronic Memories & Magnetics Corporation • 3883 N. 28th Avenue, Phoenix, Arizona 85107 • (602) 263-0202

CIRCLE NUMBER 43

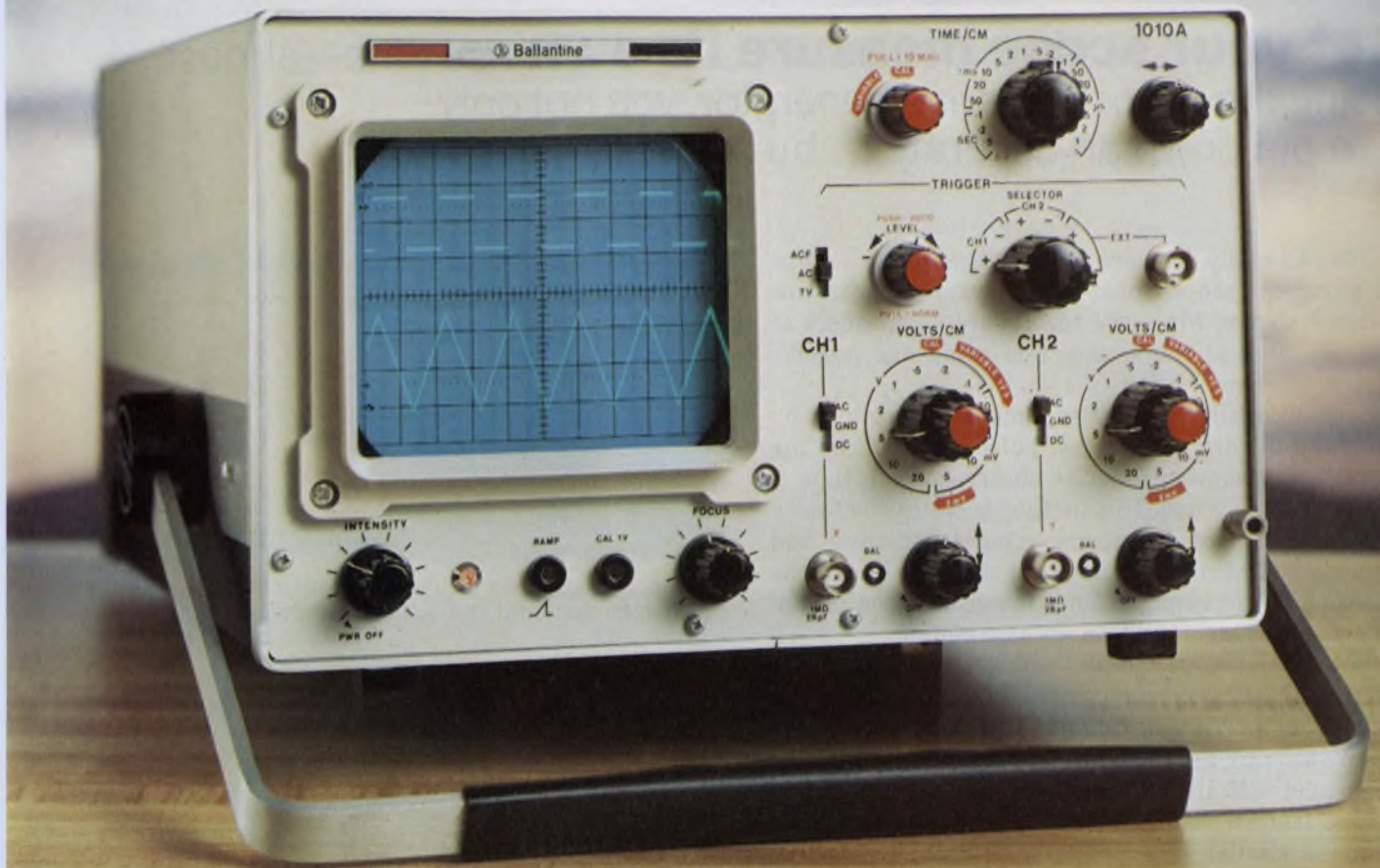

A SCOPE FOR ALL REASONS

Finally a professional oscilloscope to fit your basic needs.
 High quality, easy to maintain, and easy to use.
 Ideal for production, design laboratories, field service and schools.

Ballantine Model 1010A
Dual Channel and X-Y oscilloscope

- FREQUENCY:** DC to 15 MHz each channel
 24 nanosecond rise time. 15 MHz full scan
- SENSITIVITY:** 2 mV/cm to 20 Volts/cm
 Continuously variable gain.
- TIME BASE:** 100 ns/cm to 1.25 s/cm
 X10 Magnifier, Trigger beyond 20 MHz
- PORTABILITY:** Only 7 Kg. (15 pounds)
- DISPLAY:** 8 x 10 cm CRT with 3600 volts
- ECONOMY:** \$ 595

Ballantine

Ballantine Laboratories, Inc., Boonton, New Jersey 07005 USA

Available on GSA Contract GS-00S-04619, Stock Number 6625-00-472-9910.

CIRCLE NUMBER 44

Let your scope measure its own rise time—almost. Using the scope's internal generator, you not only can pin down an accurate t_r , but do it for less money.

You can easily measure your oscilloscope's rise time by using the scope's own square-wave generator as a signal source. Since the results are independent of the rise time of the source, you avoid one possible source of error.

Conventionally, scope rise time is determined by watching the output of a fast pulse generator on the scope and assuming that the observed delay time is the desired rise time. This method is costly *and* faulty because you need an expensive pulse generator and because you have to assume that the rise time of the pulse generator is many times faster than that of the scope—often an unwarranted assumption.

An equivalent circuit illustrates a scope's bandwidth limitation and points the way to measuring its t_r (Fig. 1). With most scopes, the input impedance given includes the probe's. An impedance of 10 M Ω in parallel with 10 pF is quite common. With the scope driven from a voltage source (zero impedance), the result is similar to a Bode plot (Fig. 2).

Working out the math

In Fig. 2, point f_1 represents the corner frequency associated with R and C_2 . With R equal to 10 M Ω , the problem is to find that value of C_2 that limits the bandwidth and increases the rise time. Start by finding the output voltage, e_o (Fig. 3):

$$e_o(s) = \frac{e_{in}(s)}{R_s C_T R C_2} \times \left[\frac{1}{s^2 + \frac{s(C_2 R_s + R_s C_T + R C_2)}{R_s R C_T C_2} + \frac{1}{R_s R C_T C_2}} \right]$$

with $C_T \gg C_2$,

$$e_o(s) = \frac{e_{in}(s)}{R_s R C_T C_2} \left[\frac{1}{\left(s + \frac{1}{R C_2}\right) \left(s + \frac{1}{R_s C_T}\right)} \right]$$

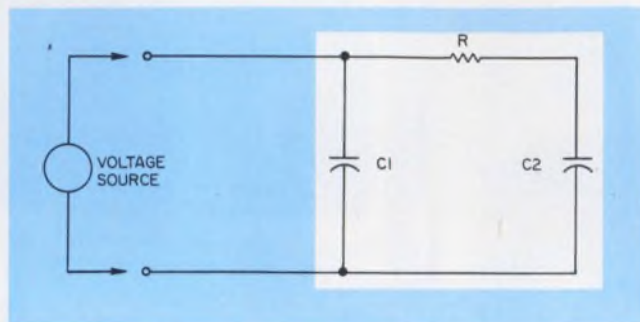

1. An oscilloscope's equivalent-input circuit shows the elements that limit the scope's bandwidth.

Let the input voltage, $e_{in}(s)$, be a step function. Then $e_{in}(s) = e_{in}/s$, and using partial fractions,

$$e_o(s) = \frac{e_{in}}{R_s R C_T C_2} \left[\frac{A}{s} + \frac{B}{s + \frac{1}{R C_2}} + \frac{C}{s + \frac{1}{R_s C_T}} \right],$$

where

$$A = R C_2 R_s C_T,$$

$$B = \frac{R_s C_T R^2 C_2^2}{R C_2 - R_s C_T},$$

$$C = \frac{R C_2 R_s C_T^2}{R C_2 - R_s C_T}.$$

After simplifying those equations, and taking the inverse Laplace transform, then the partial of $e_o(t)$ with respect to C_T ,

$$\frac{\partial e_o(t)}{\partial C_T} = \frac{(R C_2 C_T R_s + t R C_2 - t R_s C_T) e^{-\frac{t}{R_s C_T}} - C_2 C_T R_s R e^{-\frac{t}{R C_2}}}{C_T (R_s C_T - R C_2)^2} \quad (1)$$

Now take the partial derivative of $e_o(t)$ with respect to t . At the moment the measurement is made, $e_{in}(t)$ can be considered constant (Fig. 4):

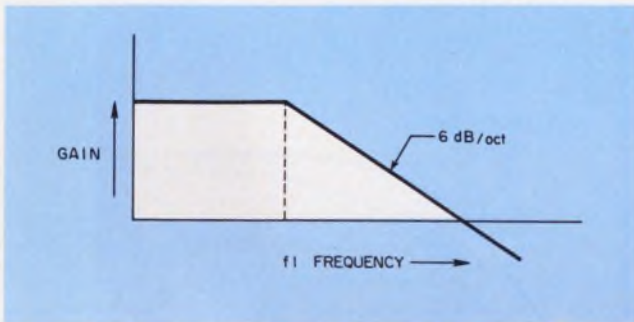

2. The frequency response of a scope's input circuit resembles that of a low-pass filter when the scope is driven from an ideal voltage source.

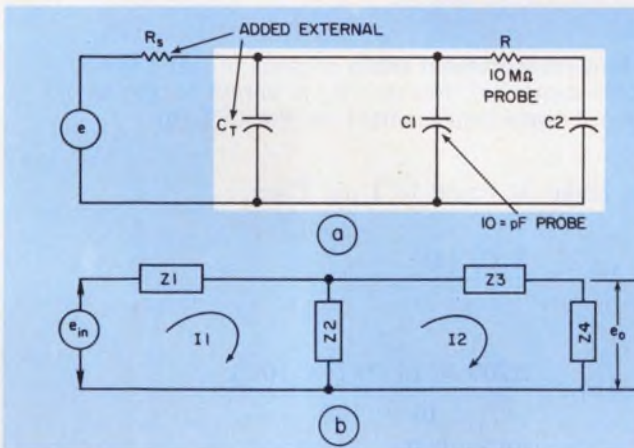

3. A complete scope circuit includes source and probe impedances (a). For calculating, the circuit is reduced to a generalized, equivalent form (b).

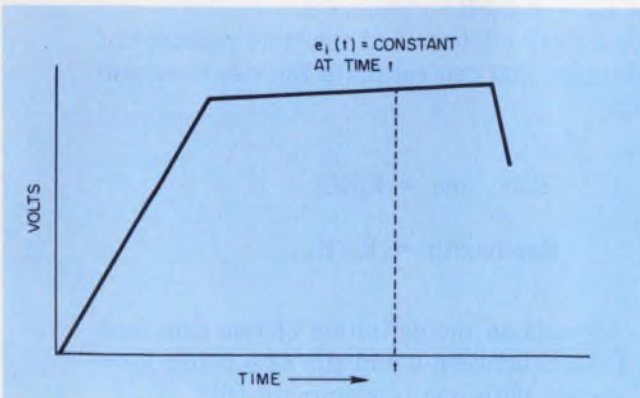

4. This voltage waveform of the scope calibrator shows that $e_{in}(t)$ is constant at the moment of measurement.

$$\frac{\partial e_o(t)}{\partial t} = \frac{e^{-t/R_s C_T} - e^{-t/RC_2}}{R_s C_T - RC_2} \quad (2)$$

Since

$$\frac{\partial e_o(t)}{\partial t} \times \frac{\partial C_T}{\partial e_o(t)} = \frac{\partial C_T}{\partial t},$$

inverting Eq. 1 and multiplying the inverted equation by Eq. 2 yields an expression for $\partial C_T/\partial t$:

$$\frac{\partial C_T}{\partial t} = \frac{R_s C_T - RC_2}{C_2 R_s R} \left[\frac{e^{-t \left(\frac{1}{R_s C_T} - \frac{1}{RC_2} \right)} - 1}{1 + \frac{t(RC_2 - R_s C_T)}{RC_2 C_T R_s}} \right] e^{-t \left(\frac{1}{R_s C_T} - \frac{1}{RC_2} \right)} - 1$$

Now,

$$\partial C_T = \Delta C_T \text{ if } C_T \gg \Delta C_T$$

and

$$\partial t = \Delta t \text{ if } t \gg \Delta t$$

where t = the point at which the measurement is made.

Therefore,

$$\frac{\Delta C_T}{\Delta t} = \frac{R_s C_T - RC_2}{C_2 R_s R} \times \frac{e^{-t \left(\frac{1}{R_s C_T} - \frac{1}{RC_2} \right)} - 1}{\left[1 + \frac{t(RC_2 - R_s C_T)}{RC_2 C_T R_s} \right] e^{-t \left(\frac{1}{R_s C_T} - \frac{1}{RC_2} \right)} - 1} \quad (3)$$

Using L'Hospital's rule to evaluate Eq. 3 at $R_s C_T = RC_2$, you get

$$\frac{\Delta C_T}{\Delta t} = \frac{2C_T}{t}$$

Not much equipment is needed

To obtain the scope's rise time, set up the equipment as shown in Fig. 5a. Select C_i to be 200 pF, and t to



now you have
a choice!

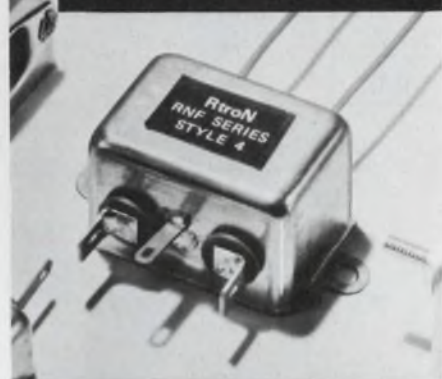

RFI/EMI FILTERS

For Data Processing,
Industrial Control and
Instrument Application

Rtron's RNF Type Filters represent three series of the most widely used, low cost filters available. Over 100 combinations of current and case style to choose from: "L" Series - low cost for general applications to combat line to ground noise; "P" Series - for suppression of line to line as well as line to ground interference; "T" Series - most effective for low impedance load applications. All types are UL Recognized and meet C.S.A. requirements. Rated at 115/250 VAC. Low leakage current insures safety.

For complete catalog and
details, write

Rtron corporation

P.O. Box 743, Skokie, Illinois 60076
(312) 679-7180

CIRCLE NUMBER 45

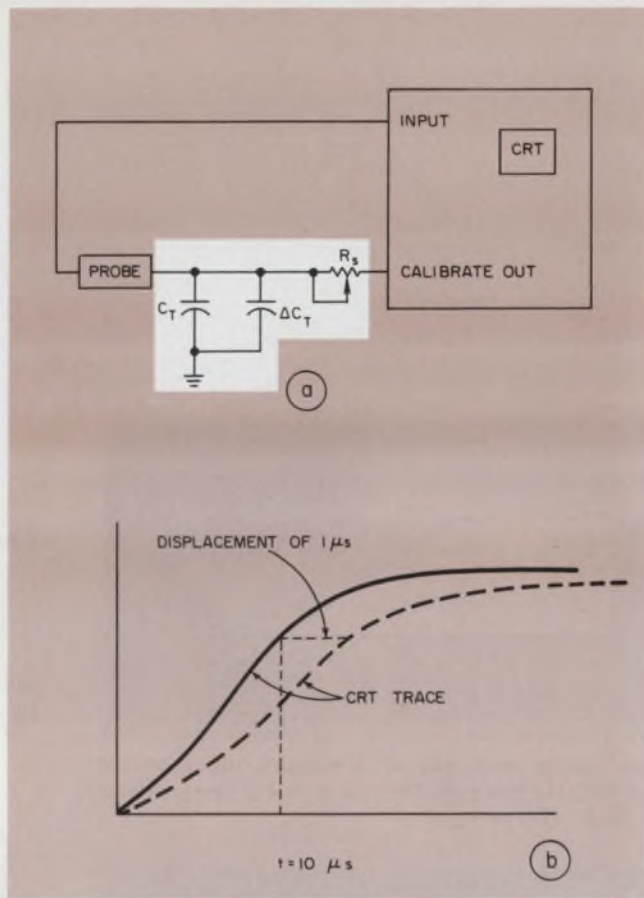

5. A rise-time-measurement setup consists of just a few circuit components (a). Resistor R_s is varied to get a predetermined trace displacement on the CRT (b).

be $10 \mu\text{s}$. Make Δt equal to $1 \mu\text{s}$. Then,

$$\Delta C_T = \frac{2 C_T (\Delta t)}{t}$$

$$\begin{aligned} \Delta C_T &= \frac{2(200 \times 10^{-12})(1 \times 10^{-6})}{10 \times 10^{-6}} \\ &= 40 \times 10^{-12}. \end{aligned}$$

Now, vary R_s until a ΔC_T of 40 pF produces a displacement on the CRT of $1 \mu\text{s}$ when measured at $10 \mu\text{s}$ (Fig. 5b). This value of R_s multiplied by C_T equals RC_2 , and $C_2 = R_s C_T / R$.

Now that you've determined the time constant of the oscilloscope, you can calculate the rise time and bandwidth:

$$\text{Rise time} = k_1 RC_2;$$

$$\text{Bandwidth} = K_2 / RC_2,$$

where k_1 depends on the definition of rise time and equals 1 for a t_r between 0 and the 62% point; $k_2 = 0.33$ for circuits with one predominate pole.

Note that the output resistance of the calibrator is part of R_s . ■■

Getting ready for the transition to non-PCB capacitors?

SPRAGUE IS READY!

For today's ecology-conscious world, Sprague offers five types of capacitors for a-c applications that meet industry needs for PCB-free capacitors. Utilizing non-toxic and non-

polluting materials, these non-PCB capacitors are **HERE NOW**, enabling you to prepare for the not-too-distant future, when PCB impregnants will no longer be available.



**TYPE 500P
ECCOL®
Heavy-Duty
Capacitors**

Over a million now in use in the computer industry. Estimated service life of some 90,000 hours. Non-toxic biodegradable impregnant. Improved performance characteristics; lower dissipation factor, less capacitance change over temperature range than that of PCB-impregnated capacitors. Capacitance range, 1 to 55 μ F. Available in four voltage ratings ranging from 330 VAC to 660 VAC.

Write for
Engineering Bulletin 4550.
CIRCLE NUMBER 161



**TYPE 520P
ECCOL®
General-Purpose
Capacitors**

Intended for the appliance industry and other applications which do not require heavy-duty use. Estimated service life of 60,000 hours at rated voltage and temperature. Non-toxic biodegradable impregnant. Pressure-activated current interrupter prevents case rupture in event of excessive internal pressure. Capacitance range, 1 to 50 μ F. Available in 330, 370, 440, and 660 VAC ratings.

Write for
Engineering Bulletin 4551.
CIRCLE NUMBER 162



**TYPE 440P
ALUMACLAD™
Appliance
Capacitors**

220 VAC UL recognized. Metallized polyester film dielectric system, uses no oil or liquid impregnant of any type. Tubular aluminum case, with epoxy end seals. Axial single-blade quick-connect terminals. Ratings from 4 to 15 μ F. Ideal for room air conditioners, recreational vehicle heating and air conditioning equipment, fan and blower motors, pump motors, refrigerators, electric typewriters, etc.

Write for
Engineering Bulletin 4601.
CIRCLE NUMBER 163



**TYPE 315P/325P
General-Purpose
Metallized-Film
Capacitors**

Low-loss metallized polypropylene film dielectric system. Type 315P, dry film; Type 325P, oil-filled, UL recognized. Pressure-activated current interrupter prevents case rupture in event of excessive internal pressure. **1/5 THE WEIGHT AND 1/3 THE SIZE OF COMPARABLE PAPER/OIL CAPACITORS.** Standard ratings from 4 to 60 μ F at 330 VAC, and from 4 to 45 μ F at 440 VAC.

Write for
Engineering Bulletin 4710.
CIRCLE NUMBER 164



**TYPE 365P/366P
ECCOL®
Commutating
Capacitors**

For non-sine wave applications. Non-toxic biodegradable impregnant has flash point of 430°F. Operate over wider temp. range with less cap. change. Type 365P has paper dielectric, with capacitance values from 2 to 75 μ F @ 200 and 300 VAC. Type 366P uses dual paper / polypropylene film dielectric for increased volt-ampere ratings, with capacitance range of .25 to 40 μ F @ voltages from 400 to 800 VAC.

Write for
Engineering Bulletin 4702.
CIRCLE NUMBER 165

For complete data on any of these capacitor types, write for the appropriate engineering bulletin(s) to: Technical Literature Service, Sprague Electric Co., 347 Marshall St., North Adams, Mass. 01247.

THE BROAD-LINE PRODUCER OF ELECTRONIC PARTS

SPRAGUE
THE MARK OF RELIABILITY



WE HAVE THE FITS

You'll find a fit for every PC board contact when you browse SAE's inventory. Study this list and imagine the combinations, permutations and amalgamations that make up the broadest line of edge connectors in the industry.

An abundance of contact spacings

Contact to contact, row to row, we've got a lot of numbers: .100/.125, .100/.150, .125/.250, .156/.140, .156/.188, .156/.200, .125/.145. There's more, but we don't have room in this ad.

A bunch of contact designs

Our most common is the bifurcated bellows, but we also offer modified bellows (leaf spring) and cantilever types.

A multitude of terminal configurations

Single row and dual row, wire wrap, dip solder, solder eyelet, insulation displacement (mass termination), right angle and clip wiring (.031/.062). Enough said.

A passel of plating options

Selective gold, gold inlay, gold over nickel, tin. Want more? Just ask.

A batch of housing materials

Thermoplastic polyester, glass filled nylon, phenolic and diallyl-phthalate.

And finally, a legion of options

Shorting contacts (make-before-break / break-before-make), polarizing keys, custom wire wrap tail lengths, hood assemblies, special markings. And you can have any connector with or without mounting ears.

All this and quality too

SAE does everything in house. From contact stamping and plating to injection molding and automated assembly. That's how we maintain the strictest quality control.

For a good fit in edge connectors, specify SAE. You can enjoy any combination of our unique design features and still have complete interchangeability with other brands.

SAE edge connectors are available through a nationwide network of representatives and distributors. See our product data in EEM, page 2213, and call in your order.

We're Stanford Applied Engineering, 340 Martin Avenue, Santa Clara, California 95050. 408/243-9200.



The OEM Connection

CIRCLE NUMBER 47

What's TRW up to now?

Metal film with muscle.

Our Metal Glaze™ resistors are rated 2 to 4 times mil spec power, yet retain precision resistor characteristics.

Now, with both strength and precision, you can take advantage of these thick film resistors and standardize on one size. Or benefit from an improved safety factor. For example, our 1/8W 1% device will handle 1/2W @ 70° C, or up to 40W pulse.

What's more, we've added a new 2W standard.

It takes 50% of the board space of the old 2W, yet is rated 3W @ 25° C. We're also in the process of substantially increasing resistance well into the megohms.

TRW metal films with muscle are available from 1/8W to 5W, 200 V to 15 KV, with 1, 2 and 5% tolerance. For standards in all types of resistors, contact your local TRW distributor. Or TRW/IRC Resistors, 401 N. Broad St., Philadelphia, Pa. 19108. (215) 922-8900, Dept. G.

TRW IRC RESISTORS

ANOTHER PRODUCT OF A COMPANY CALLED TRW

™ Metal Glaze is the TRW trademark for its thick metal film resistors.

CIRCLE NUMBER 48

Test converters fast. A simple circuit quickly finds nonlinearity, missing codes and other errors. Best of all, the circuit handles many kinds of converters.

One way to evaluate your d/a or a/d converter costs but a few hundred dollars and gives all the important error parameters in a matter of seconds. The line-up of errors determined includes zero and scale errors, nonlinearity and differential nonlinearity, quantizing errors, and missing codes. What's more, this method can handle many different converters after minor modifications—no small advantage when you think of the broad range of available converter products.

Of course, you can always monitor an analog signal at the converter input with a precision DVM and compare the input to the converter output. This is simple enough—but impractical, in most cases. For instance, a 10-bit converter requires the plotting of 1024 readings. Sure, you can automate the process. But you'll need sophisticated interface hardware and software routines. And automatic test equipment will run to around \$10,000 for hardware and at least that much for software.

How the circuit shapes up

But in the much quicker, much less expensive alternative, a storage scope is the only external piece of equipment. A ramp generator provides a linear-output voltage over the input range of the converter being tested (Fig. 1). The analog-input range of the circuit is 0 to 10.00 V. The ramp functions as a horizontal-amplifier input to the storage scope, as a reference for the difference amplifier and as an analog input to the device under test.

Zero and full-scale adjustments make possible accurate nonlinearity measurement. A d/a converter testing an a/d converter should introduce insignificant errors relative to the device under test. A 12-bit d/a with 0.01% accuracy suffices to test a 10-bit a/d.

Time delays associated with the a/d-converter path (relative to the slew rate of the ramp generator) are not a problem for successive-approximation a/d converters when the ramp generator slews at 2 V/s or less.

The complete test circuit can "ring out" such a/d products as National Semiconductor's 8-bit ADC0800

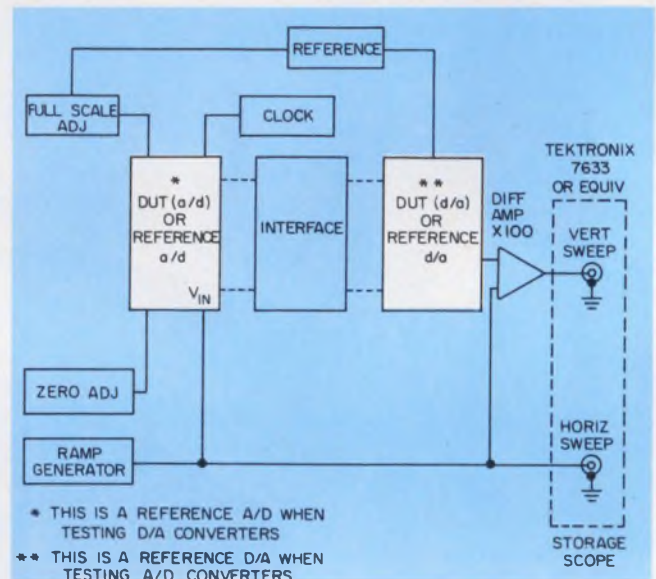

1. This converter tester checks d/a converters with a reference a/d converter and vice versa. Results are displayed on a storage scope.

and the 10-bit ADC1211 (Fig. 2). With a 12-bit a/d rather than a 12-bit d/a (DAC 1200), the circuit can test 8-bit or 10-bit d/a converters. Whatever converter is under test—d/a or a/d—the corresponding reference converter should be more accurate by at least two bits.¹

A buffered reference voltage (generated by the LM199) is provided for both the a/d and d/a converters, but isn't needed for converters with an internal reference. Resistor R_5 sets the reference level of the d/a, and a full-scale pot adjusts that of the a/d converter.

To generate a manual start-conversion pulse, close switch S_3 . However, you won't have to do it too often because the end-of-conversion signal ties back to the start-conversion input for each a/d converter. Consequently, the converters continuously convert as long as a signal is present. Trigger switch S_4 simply causes the horizontal-output amplifier to integrate linearly up to the full-scale voltage or to range downward to zero.

Next to the converter, difference-amplifier IC_6 and its associated resistors are most important to the circuit. With 0.01% film resistors, an amplifier gain

Dennis Dauenhauer, Pressure Transducer Marketing Manager, National Semiconductor, 2900 Semiconductor Dr., Santa Clara, CA 95051.

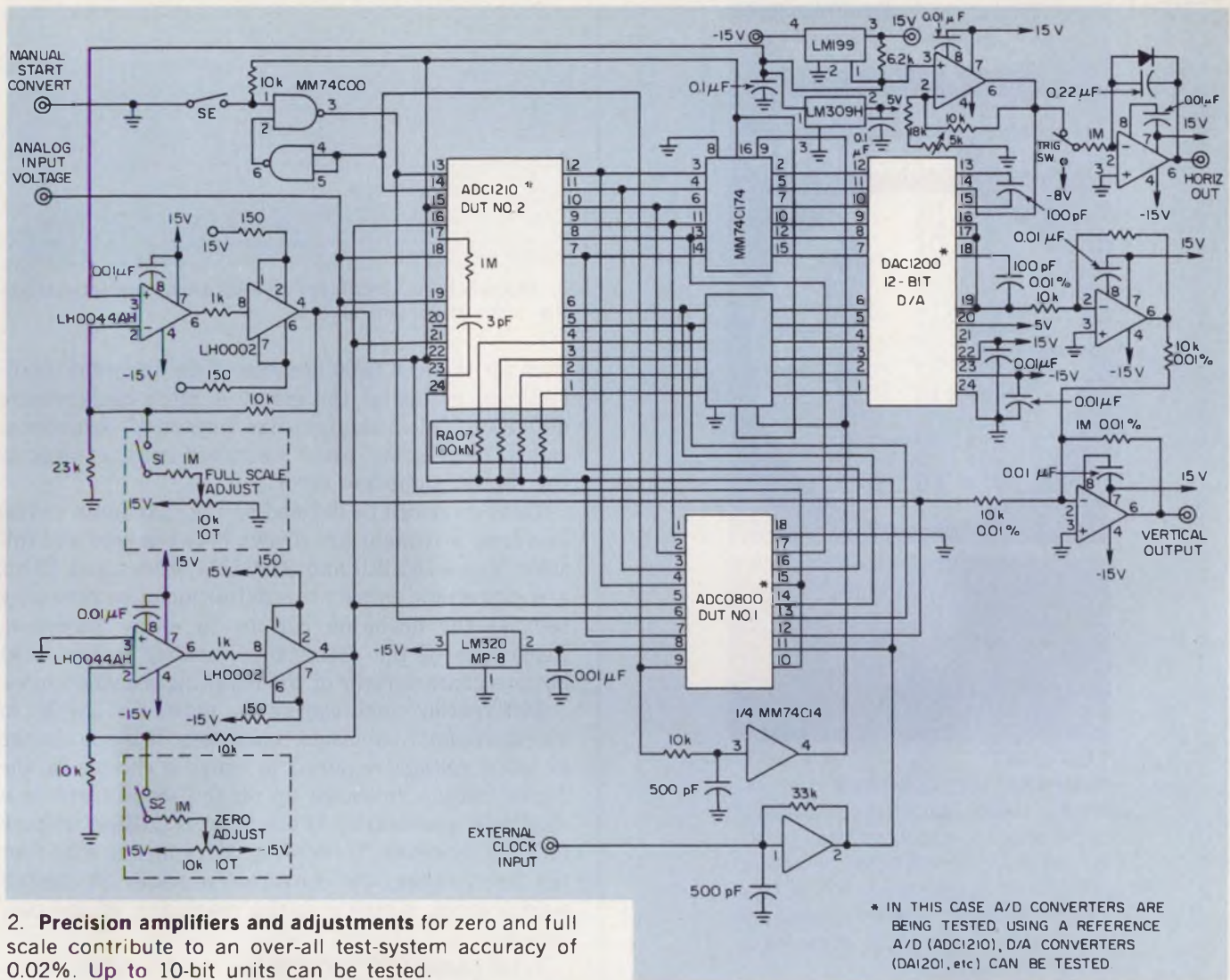

2. Precision amplifiers and adjustments for zero and full scale contribute to an over-all test-system accuracy of 0.02%. Up to 10-bit units can be tested.

of 100 and a true 12-bit d/a converter, system accuracy is 0.02% or better.

A jack lets you plug in an external clock should the 660-kHz internal one prove unsatisfactory. All interfaces between components are CMOS-compatible.

What the test results look like

Fig. 3 shows a typical output characteristic (not to scale) obtained when testing an ADC0800. To set the reference line, switch the vertical-channel (Y-axis amplifier) to dc and trigger the ramp generator. Make the adjustment with the scope's horizontal positioning. The vertical range should be set to 5 V/division to give an effective range of 50 mV/division for the channel.

Once you've completed the setup, you should have no problem pinning down converter errors. Zero error is simply a deviation from the reference line to the middle of the quantizing error when the input voltage is zero. All errors can be expressed as percents of full scale or in least significant bits. For a 0 to 10.24-V, analog-input, 8-bit converter,

$$1 \text{ LSB} = \frac{10.24}{2^8} \\ = 40 \text{ mV} \\ = 0.39\% \text{ fs.}$$

Scale error is similar to zero error except that it occurs when the analog-input voltage is at full scale. Both zero and scale error can be determined by leaving S_1 and S_2 open.

In most applications, linearity *per se* isn't important, but rather the slope—or sensitivity—of the transfer curve. For instance, consider an a/d converter that indicates the gasoline level in a tank and computes the remaining miles that can be traveled at the current rate of usage.

A large nonlinearity slope produces what appears to be good mileage over a certain range and poor mileage over another range. Specifying both the nonlinearity error and differential nonlinearity error provides an error band around which to limit the change in slope or rate of change.

Nonlinearity and other errors

Nonlinearity error can be defined two ways. The conventional "best-straight-line" definition (Fig. 4) is

Keystone THERMISTOR TASK MINDERS

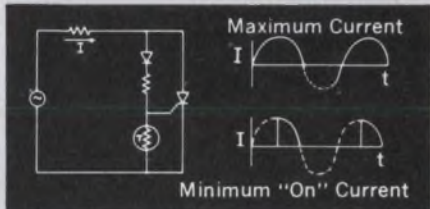
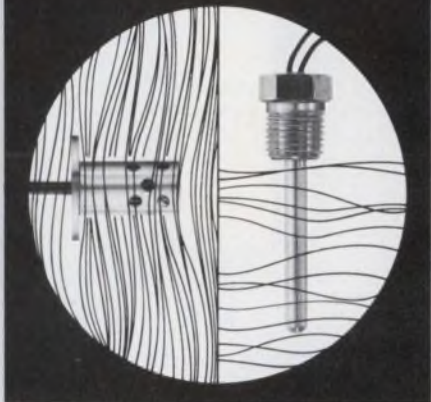

LOW-COST TEMPERATURE CONTROL

As the resistance of the thermistor decreases, a larger voltage is required to fire the SCR. In this circuit, conduction angles from 90° to 180° can be achieved. Thus, the minimum "on" current will be 50% of the maximum "on" current.

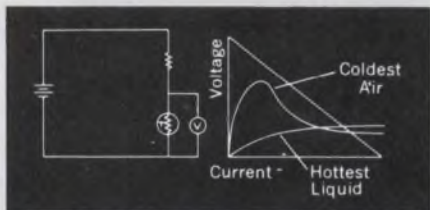

LIQUID LEVEL DETECTION

Taking advantage of the difference in dissipation constant between a liquid and a gas enables thermistors to serve as liquid level sensors over a wide range of temperatures.

Send for 12-page thermistor probe catalog detailing 23 styles and 6 applications.



Keystone

CARBON COMPANY
Thermistor Division
St. Marys, PA 15857
814/781-1591 • Telex 91-4517

CIRCLE NUMBER 49

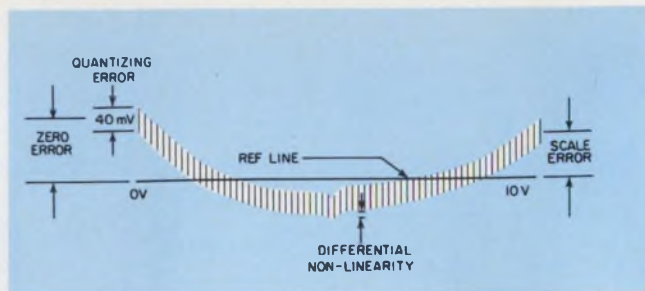

3. Output characteristic for an 8-bit a/d converter exhibits the most important errors.

used for the ADC0800 because of the inherent unidirectional nature of the error. A more conservative definition, "ideal straight-line linearity," sometimes called "total error," gives a number twice as large as the best-straight-line error.

Total error can be defined as the maximum deviation from a straight line drawn between zero and full scale. The ADC1210 and ADC1211, 10-bit and 12-bit a/d converters, employ this definition of nonlinearity because the deviation can be in either direction. Regardless of the definition, linearity is the most obvious characteristic of the resulting transfer curve.

Differential nonlinearity is most noticeable in successive-approximation converters. It is the change in input voltage required to cause a change in the digital output. It shows up on the scope trace as a change in nonlinearity at one point and offers a check for missing codes. No missing codes means that over the input range, the converter provides 2^n digital-output codes, where n is the resolution of the converter.

Total unadjusted error is the maximum deviation from an ideal a/d-converter transfer function, excluding quantizing error. The nonlinearity error of an unadjusted ADC0800 is in a direction that will decrease the total error. This means that some quantizing error exists, and that output transitions occur to correct for the zero error.

As a result, the unadjusted transfer curve of the device comes closer to the reference line between zero and full scale. In general, therefore, the total unadjusted error for the ADC0800 is either the zero or the scale error, whichever is greater—a characteristic peculiar to series-resistor type, successive-approximation converters.

Quantizing error is inherent in converters. An 8-bit converter can make no more than 256 changes in the output regardless of the input-voltage range. Therefore, any converter has 1 LSB of quantizing error. Ideally, the error appears as $\pm 1/2$ LSB around a straight-line approximation of the output characteristic. ■■

References

1. Dauenhauer, D.A., and Falco, D., "Analog to Digital Converter Testing," *Applications Note AN-179*, National Semiconductor, Santa Clara, CA, January, 1977.
2. Sherwin, J., "Specifying A/D and D/A Converters," *Applications Note AN-156*, National Semiconductor, Santa Clara, CA, February, 1976.

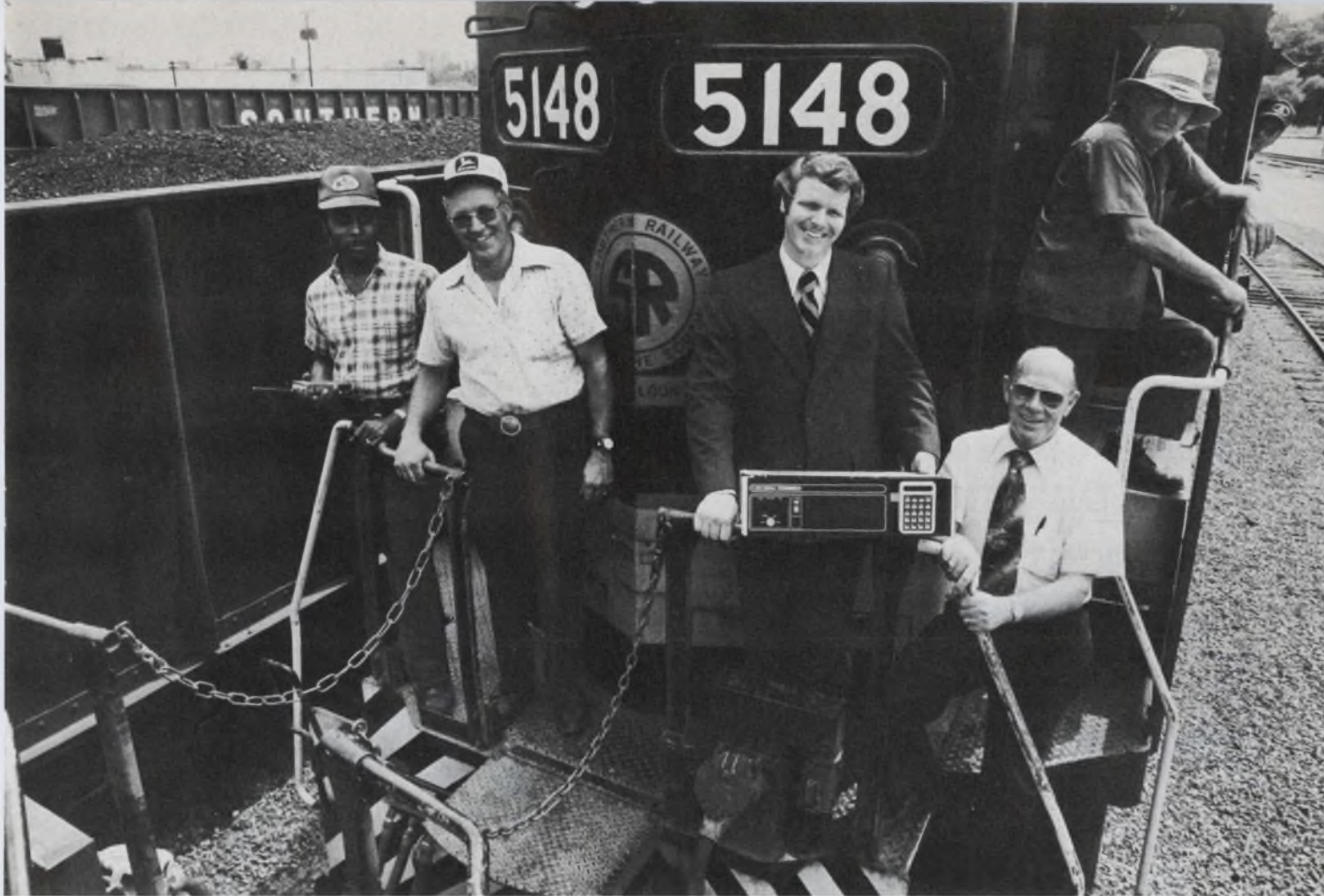

microNOVA keeps on trackin'.

Southern Railway has a long track record of being one of the most profitable rail systems in the country. To help stay on that track, they decided to increase the speed and flexibility of their online distributed communications network. So Southern Railway is now changing dumb terminals into intelligent ones throughout its rail system, using microNOVA microcomputers.

Southern Railway found that only the Data General microNOVA microcomputers could help them cut costs and keep track of some 75,000 freight cars moving over 10,500 miles of track, and do it the way Southern Railway wanted to. Controlling rolling inventory like that takes a lot of flexibility. And that's the big advantage Data General microNOVA microcompu-

ters bring to any application. Whether in a chip, on a board, or as a packaged system.

With the speed, flexibility and software of a minicomputer and the economies of microprocessor technology, microNOVA microcomputers let you do things your way. That's why they're setting track records in all kinds of applications.

Mail to: Data General, Westboro, MA 01581

- Send microNOVA technical literature.
 Send literature and have your sales representative call.

Name _____

Title _____

Company _____

Address _____ Tel. _____

City _____ State _____ Zip _____

NOVA is a registered trademark of Data General Corporation
 ©Data General Corporation, 1977

Data General, Westboro, MA 01581, (617) 366-8911. Data General (Canada) Ltd., Ontario. Data General Europe, 15 Rue Le Sueur, Paris 75116, France, 50-006-06. Data General Australia, Melbourne (03) 82-1361. ED1122

Data General
 It's smart business.

CIRCLE NUMBER 50

introducing...a new line of
low cost, absolute
shaft position encoders
**engineered for
maximum flexibility**
in physical and
electrical characteristics.

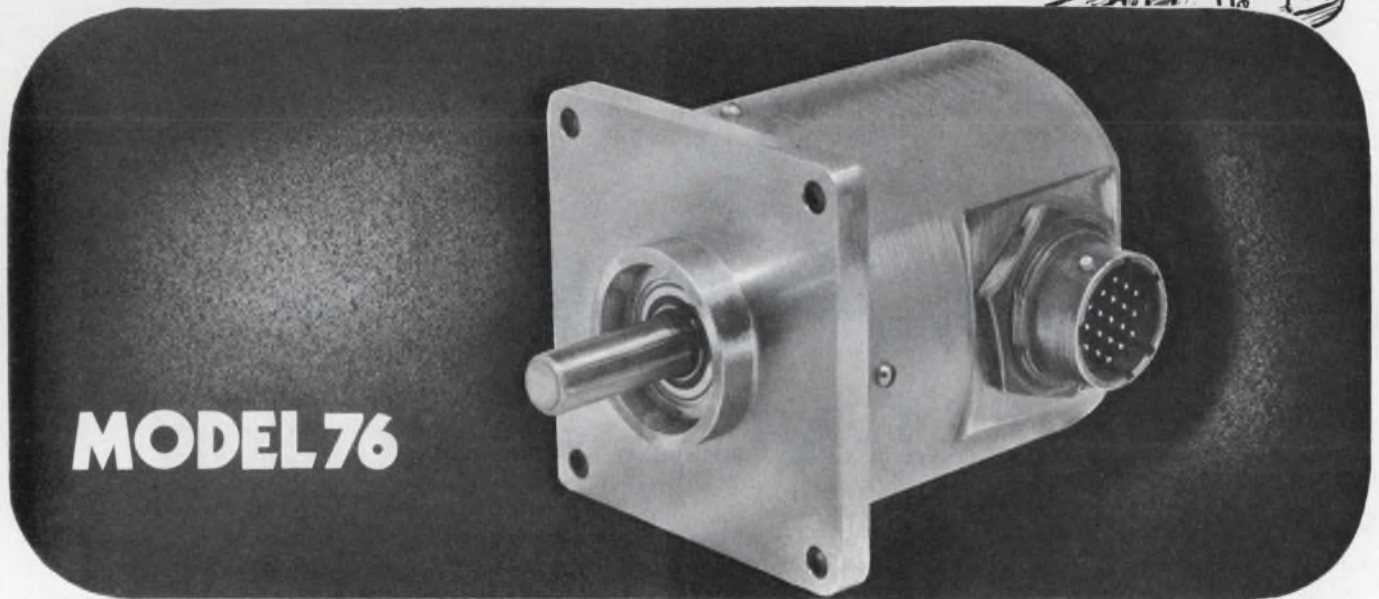
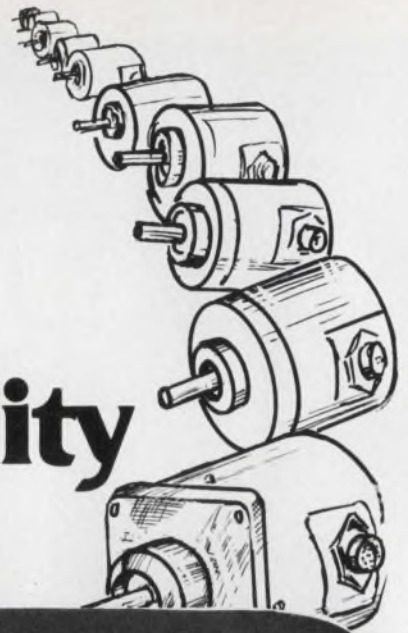

MODEL 76

- Solid state illumination source is guaranteed against failure for 5 years.
- Rugged frame... available in 3 mounting configurations.
- Offers a choice of 10 resolutions with DTL and TTL compatible outputs.
- Typical applications—NC machine tools, computing scales, material handling systems, antennas, navigation systems and a large variety of other uses.



ENCODER DIVISION

MARKETING DEPARTMENT
TELEPHONE (213) 341-6161/TWX 910-494-1229

20745 NORDHOFF STREET—CHATSWORTH, CALIFORNIA 91311

Now available... a new catalog showing
our full line of digital shaft encoders.

VACTEC Photodetectors

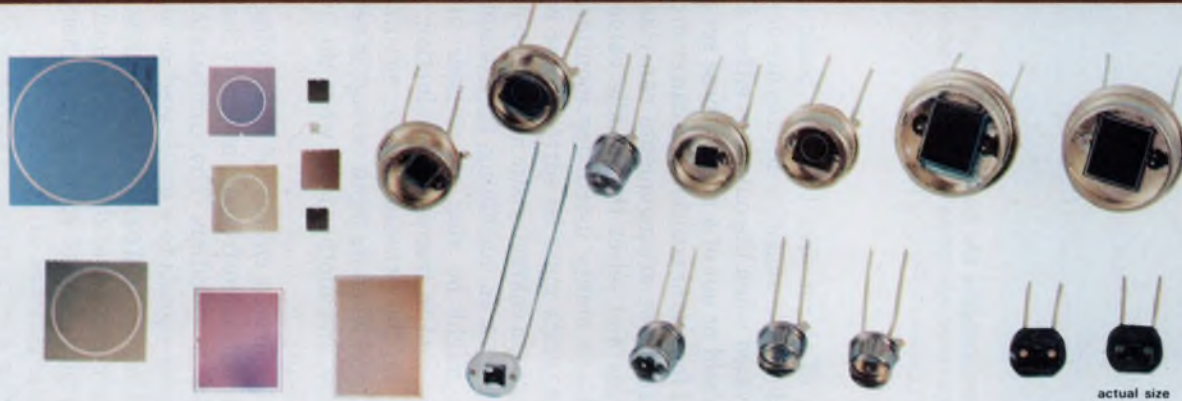

Chips approx. 1.6 x actual size

Dumb looking little chips for silicon are tough to advertise. They don't look like much, but they do remarkable things, if you can use microamperes of light current (at 100 f.c.) vs. picoamperes of dark current for a million-to-one signal-to-noise ratio. Linearity and stability are super with a surprising response to visible and blue light (400 nm). These BES (blue enhanced silicon) photodiodes are available in a variety of ceramic or metal hermetic packages so that you needn't be expert at handling these insignificant looking chips.

Even though our devices are as good as we say and reasonably priced, so what is different? Our dedication to this industry is remarkable for a small company. We have technology normally found at only the giants of the semi-conductor industry. At this one facility in Maryland Heights, Missouri, we not only make photodiodes and phototransistors but custom LSI light actuated CMOS IC's for the new Kodak cameras. Even more remarkably, we not only process these chips in entirety, we design the circuits. When you can do such processes as silicon gate CMOS, and epitaxy for bipolar, you learn a lot about silicon chemistry that necessarily spills over to the production of photodiodes and phototransistors. Coupling this with our photometric expertise gained through seventeen years of experience makes an unbeatable combination. We even assemble our own special purpose computers for testing both IC's, transistors, and diodes as well as making many of our own parts handlers to feed the parts into position for automatic testing with a calibrated light source. We don't just brag about "planar" processing, we do all types of silicon processing. This high level of silicon technology plus our exclusive dedication to photodetection must inevitably make our phototransistors and photodiodes a little better than the rest.

So that our CDS, selenium, silicon solar cell, and coupler departments won't feel left out, we make the best of those devices also. It's just that they have had their share of our advertising dollars in the past.

Talk to us but better yet, visit us and we think you'll not only be impressed but amazed. We'd like to work closely with your applications people, and making custom photodevices of any kind is no big deal for us at Vactec.

Write today for catalogs and more information: 2423 Northline Industrial Blvd., Maryland Heights, Mo. 63043 • (314) 872-8300

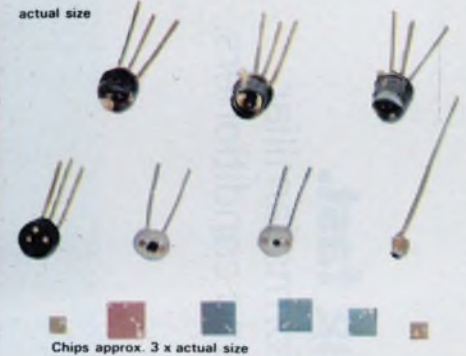

Almost equally as dull looking are the phototransistor and photodarlington. Since they don't look much different than the others, why buy ours? One reason is that we test what we specify. Not only are the wafers one hundred per cent probe tested, but once the devices are packaged (in equally insignificant looking packages), we one hundred per cent sort for light-current characteristics, dark current (leakage), and breakdown.

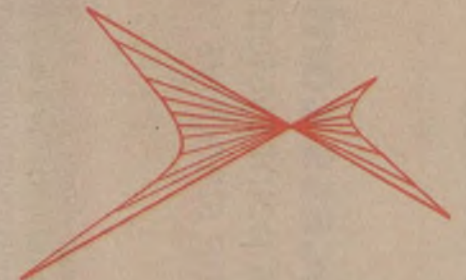

VACTEC, INC.

Process controls are evolving fast.

In set-point systems, logic often outperforms familiar analog standbys such as comparators and conditioners.

You can choose from a variety of technologies to monitor industrial-process variables. Electromechanical and electronic controls have replaced many earlier hydraulic and pneumatic systems. And, as controls become more complex, the electromechanical approach is yielding its popularity to electronic systems—both analog and digital. But which discipline is best?

Often the system you use will depend on how much alarm capability is required. An alarm can be a simple switch closure or the incredibly complex and exact control of a set of critical process variables.

Position, pressure and temperature are typical variables that require alarms. To sense a position limit, simple set-point controls can be implemented with mechanical contacts, adjusted along the axis of motion. For pressure and temperature, gauges are available with adjustable mechanical contacts that can provide set-point alarms.

In mechanical set-point systems, output functions such as actuator solenoids, motors, clutches and brakes are usually controlled directly via the same contacts that sense the set point. But these contacts of course, have chatter, speed, and life problems—which are often bypassed by substituting solid-state devices, such as triacs.

Electronics is spreading

At the front ends of industrial-control systems, electronic devices are steadily replacing mechanical ones for threshold setting. But these require an electrical-signal input. Transducers, therefore, are an important part of electronic set-point systems.

But most transducers are nonlinear over some part of their usable range. Where linearity is needed, a nonlinear transducer output can be conditioned. Also, signals representing several variables can be combined into a single function.

Sometimes measurement isn't enough

Another advantage of systems with electrical rather than mechanical outputs is that you can use a greater

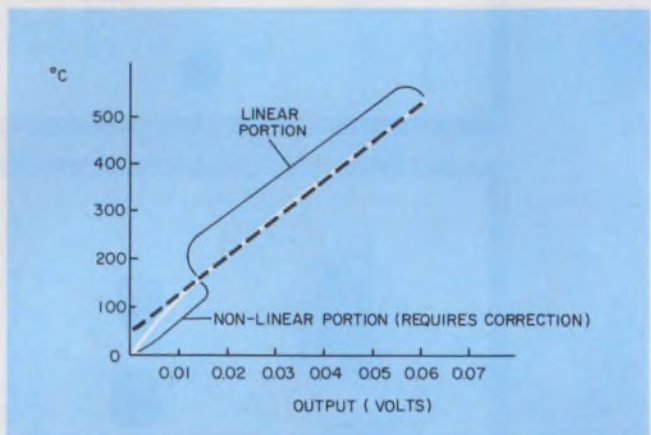

1. **Thermocouples are nonlinear.** Though the higher temperature response range is obviously nonlinear. Different thermocouple materials exhibit different characteristics.

variety of alarm circuits. Some basic alarm circuits using threshold-sensitive devices are described in Fig. 3. Activated when the output is either above or below a threshold or out of a range, these set-point controls can test for size or position and can even detect defects. Other set-point arrangements can classify parts by properties and select the middle value from among several—an ability useful for monitoring.

Often, units must be sorted—that is, grouped so that a certain characteristic is between predetermined sets of values. In machining, for example, the characteristic might be size; in resistor production, resistance; and in transistor production, current gain. In Fig. 4a, the two-comparator circuit provides one output level when its input voltage is between the two set points, and another level when the input is beyond these limits.

Fig. 5 shows a circuit for classifying materials or parts. Inputs come from transducers that measure the variables in question. The comparators match the transducer signals to a graduated series of reference levels. The resulting comparator outputs are processed with logic gates that develop the required functions. The outputs control sorting machinery via motors, solenoids, clutches or brakes.

Another sorting circuit is shown in Fig. 6. This time the median value is selected from three separate transducer inputs.

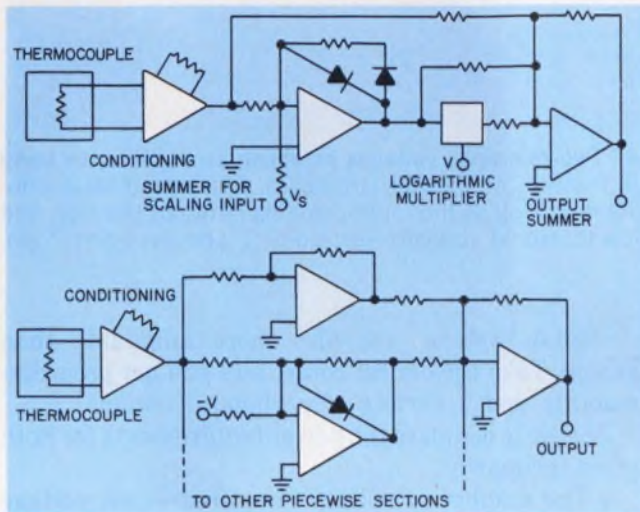

2. **Transducer outputs are linearized** in one of two ways: A nonlinear function in which V_s , a scaling input adjusted for proper offset, is applied continuously (a) or a piecewise-linear approximation (b) in which a series of similar summing circuits generates the separate sections of the curve. These are then summed.

The sorting schemes in Figs. 4a and 5 can use analog or digital comparators. Many of the parameters that limit comparator performance are familiar to op-amp users: finite gain, limited bandwidth, input and output voltage-and-current offsets, internal impedance, and drift due to temperature changes and aging. As with op amps, you can reduce these limitations with device selection, with error compensation or with temperature-controlled environments. Of course, these alternatives will add to the cost and complexity of your system.

Analog ICs can help

IC analog comparators are often the answer to this cost and complexity problem. These circuits are descendants of the differential or difference amplifier, which is noted for its exceptional dc-bias stability.

The basic analog-comparator circuit couples two transistors through their common emitters. The transistor bases provide the inputs.

If the transistors match, the voltage difference between the two inputs causes a current flow in the common emitters. But as this current varies, so do

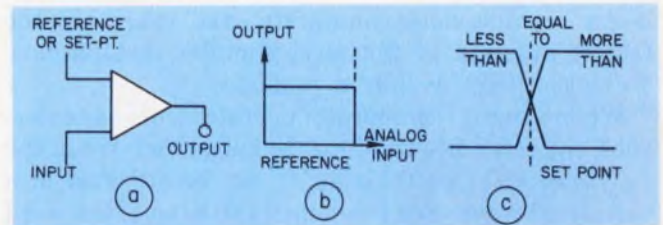

3. **The basic threshold circuit has two inputs:** a reference or set-point input and a control input (a). Analog circuits provide two distinct output states (b), while digital circuits can provide three distinct output states (c).

the junction temperatures of the transistors. And, as you know, many of the transistor parameters are affected by junction-temperature variations. Maintaining matched characteristics over a wide temperature range is difficult, so accuracy suffers.

Fortunately, IC technology can reduce many temperature-related drift problems. Because the transistors are near each other, their temperature differences are small. What's more, IC comparators use high-impedance inputs, followed by additional amplification. In this way, the signal current is kept low with respect to the dc operating current. For a moderate cost, these and other IC balancing techniques, produce analog comparators with high stability and fast response.

But whether IC, hybrid or discrete, analog comparators are necessarily high-gain devices. So take care to maintain the isolation between their input and output circuits. Since comparators can easily oscillate, with even just a little positive feedback, make sure that the inputs and outputs are isolated electrically, thermally and physically—especially at the power-input terminals.

Wherever electrical-noise level is high, as in many industrial environments, tap back part of the output to the comparator's inverting input. This negative feedback often prevents yet another potential instability—switching on noise.

For accuracy, go digital

But, perhaps the best solution to the accuracy problem, is a digital comparator. Such a device compares the input data to a reference on a bit-by-bit basis. In set-point control systems, digital com-

parators can provide better resolution, accuracy and long-term stability than can their analog counterparts.

In a digital comparator, an array of logic gates tests two words, the variable and the reference, against one another. Separate outputs indicate that the input word is less than, equal to, or greater than the reference word (Fig. 3c).

Temperature sensitivity is not a problem for digital comparators because the logic gates compare digital bits. Analog comparators, on the other hand, work with continuous levels. Furthermore, digital-logic levels provide noise immunity; and except in the fastest systems or the most complex installations, oscillation isn't usually a problem.

When a digital comparator operates from one reference, the reference word can be hardwired. When the reference is to be variable, it can be adjusted in a variety of ways. For frequent calculations, the word can be programmed by an on-line computer. For operator control, keyboards, thumbwheels or other coded switch arrays can set the reference.

Digital comparators can, of course, directly drive other digital elements. For example, a driven counter can select every Nth part that meets the criteria monitored by a set of digital comparators.

Condition with a ROM

Digital devices can also condition nonlinear input signals. For example, a ROM can store correction terms for the nonlinear output of a thermocouple like the one in Fig. 1. Of course, the thermocouple output must be digitized. Converting from analog to digital produces a word representing a temperature on the response curve. This word addresses a look-up table in the ROM. In this way, each input word is transformed into a corresponding output word that contains the proper correction factor.

When correction isn't needed, the inputs can come directly from a table of data points taken from the response curve. This table can also be stored in a ROM.

Even in systems requiring multipliers and dividers, digital components can replace the familiar analog workhorses—and handily. Digital multipliers and dividers can be built with available ICs. But often the carry operations are complex, which makes implementation with discrete logic both cumbersome and costly. When many systems are to be produced, a custom LSI chip can be practical. But if just a few systems are needed, use a microprocessor that can perform arithmetic operations efficiently.

Cost differences between analog and digital set-point systems are difficult to generalize. Sometimes, the lowest parts count results with an analog system, sometimes with digital. Usually, however, digital components cost less, so in all but the simplest cases, you can do more digitally for less money.

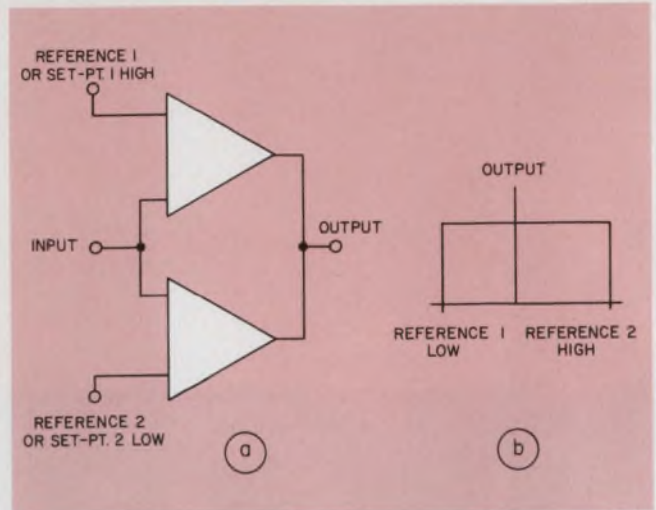

4. Two reference voltages establish an acceptance band in the two-comparator circuit (a). The output stays constant so long as the input remains between the high and low-threshold voltages—set-point 1 and set-point 2 (b).

Digital systems are also more adaptable than analog. Take the digital route, and you get programmability and a variety of peripheral options.

Be sure to compare the power requirements for both types, primarily:

- The number of voltages required—each voltage means, at least, another regulator.
- The total power required—this determines the supply size.
- The regulation needed.

The analog ICs used in set-point control generally require dual-polarity supplies, whereas logic ICs usually require only one voltage. Current requirements for analog systems are usually lower than those for TTL-logic systems, but higher than for MOS digital circuits. And supplies for digital systems usually need less stringent regulation.

Response times are usually not a critical factor in the analog-vs-digital choose-off. Both analog and digital comparators react in under 100 ns, typically. For very high speeds, however, you may be forced to use an analog comparator because the delays of cascaded stages add up in digital systems. A fast-logic family like ECL may prove too expensive.

Digital systems pull ahead

For repeatability, however, digital systems clearly outshine analog. Sensitivity (the response to small inputs) depends on easily controlled word length in digital comparators but on unyielding input parameters in analog comparators. While digital comparators are easily cascaded for increased word lengths (higher sensitivity), the transducers usually limit set-point system accuracy and sensitivity.

Safety and maintenance requirements are usually tied to individual systems. However, digital systems

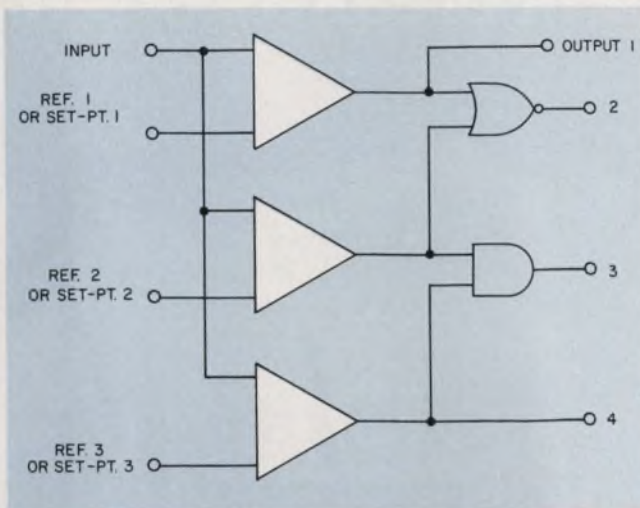

5. Comparators match the transducer signals to a graduated series of reference voltages. Appropriate logic gates combine the individual comparator outputs to develop the output functions needed for the desired grouping.

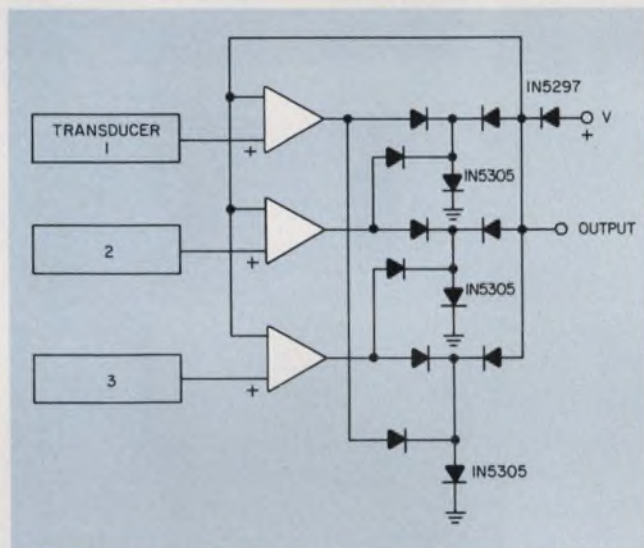

6. This three-comparator scheme selects the middle value of the three inputs. The median value is significant when transducers monitored this way are strategically located along the route of a production process.

eliminate the costly periodic adjustments common to analog set-point controls.

In set-point systems, reliability usually has but two major components: failure, which is proportional to complexity; and sensitivity to environmental factors, principal of which is temperature. Failure often results in a total loss of control whereas sensitivity to such factors as temperature usually causes drift and degraded control.

Since digital systems usually contain more stages, digital systems are more prone to permanent failure. Generally, however, a digital system failure is less likely than an analog system error. ■■

MICROPAC

LEADER IN

CUSTOM

THICK & THIN

HYBRID MICROCIRCUITS

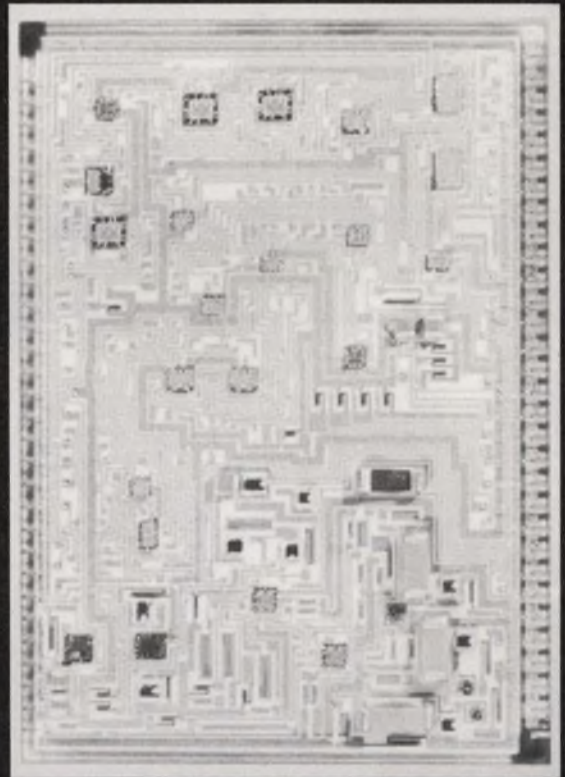

MICROPAC is a company dedicated to the design and manufacture of thick and thin film CUSTOM HYBRID MICROCIRCUITS for military and industrial applications.

... For your custom hybrid requirement, contact MICROPAC.

Write for Micropac Data Sheets on 10 amp Hybrid Voltage Regulators



MICROPAC INDUSTRIES, INC.

905 E. WALNUT ST. GARLAND, TEXAS 75040 Tel: 214-272-3571
TWX 910-860-5186

CIRCLE NUMBER 53

A software development breakthrough.



FORTTRAN compiler and relocatable macro assembler in a new custom software system for micros.

Now it's easier than ever to create smooth running custom software for PCS SuperPac 8080 A-*based microcomputers. And it takes less time, too. With SPDS. The SuperPac development system.

SPDS has resident software you'd expect to find only in minis. Like a FORTRAN compiler option for fast, easy programming in a language your programmers already know (look for BASIC soon). A cross-reference generator that lists constants, labels and addresses and really saves time when you're moving segments around. A relocatable assembler with full macro capability. And an up-down loader for directly loading software into a target system up to 1,000 feet away and calling it back to the development system

whenever you need it.

Choose the hardware tools you need. A desk console and dual floppy are standard. From there it's up to you. EPROM programmer, CRT terminal, choice of two line printers and paper tape reader are optional.

SPDS for SuperPac microcomputers. It's a software development breakthrough. From Process Computer Systems, of course. The full service microcomputer manufacturer.

* And, soon, for our new Z-80 based micros.

Tell me more. ■ SPDS ■ SuperPac ■ Please have salesman call.

Attach your business card here.

pcs

Success is PCS.

Process Computer Systems, Inc.
750 North Maple Road, Saline, Michigan 48176
313-429-4971 TWX 810-223-8153



Gould Oscilloscopes They have a name for reliability

Ask electronics people what the Gould name means to them and most would agree that reliability stands high on the list. In fact we are sure enough of our reliability to give you a 2-year warranty on our entire line of oscilloscopes.

Of course, performance is also important, so we offer you four oscilloscopes covering a frequency range from DC to 50MHz, plus a unique digital storage model with options for hard copy and binary output.

There's a Gould scope to suit your needs. Economy is also a consideration. Gould oscilloscopes are competitively priced. But because we build them for the long haul, your instrument pays dividends through years of trouble-free service. Reliability says it all and that's what the Gould name is all about. So when you're looking for reliability, look for our name. For oscilloscopes and other fine instruments, you can rely on Gould.

For details write Gould Inc., Instrument Systems Division, 3631 Perkins Avenue, Cleveland, Ohio 44114. Or call the number below.

FOR BROCHURE CALL TOLL FREE AT (800) 325-6400. EXTENSION 77.

In Missouri: (800) 342-6600



Improve your digital recorder with a latch circuit that catches all unexpected pulses. The circuit offers a choice of operating accuracies, too.

With a new latch circuit and a "bit" more memory, it's easy to overcome a serious shortcoming of conventional digital recorders. Many present recorder-latch modes don't always catch short, unexpected pulses occurring between clock samples, even if the pulse width is much more than, say, 10 ns (but less than the clock cycle time).

In a conventional front-end circuit, sampled data enter the input only during a clock pulse (Fig. 1). In a latch mode, data enter between clocks, as well, through PR and C₁ of flip-flop FF₁ in Fig. 1. The state of FF₂ controls the sign of the pulse caught between clocks—negative through C₁ when Q₂ = ONE, positive through PR when Q₂ = ZERO.

In four instances, a pulse between clocks will not be caught by conventional latch modes (Fig. 2). After a latch-mode activation, the data in each memory bit indicate the state either at the time of sampling or between samples. The state between samples will indicate a pulse only when the sample states on either side differ from the in-between state.

If the states of the two samples differ, one bit of memory is not enough to distinguish whether the in-between event is a pulse or a legitimate change of state (cases S₃, S₄ of Fig. 2). The latch circuit itself can't make this distinction, either—you need more memory and a different latch to solve the problem.

In cases S₁ and S₂ of Fig. 2, the latch circuit detects only the first of two pulses occurring between samples. In fact, with conventional latches, the detection of the first pulse inhibits the detection of the second.

More memory is needed

The new latch circuit uses two memory channels, one for the sample, the other for the latch (Fig. 3). State ONE in the latch memory indicates a pulse, and ZERO no pulse. By comparing the two memory channels, you can tell the pulse polarity.

The clock samples the signal, which is then stored at FF₀ until the next clock. The sample state serves as the initial state of FF₁, and its complement as the initial state of FF₂. Flip-flop FF₁ detects the first change between clocks—Q = ONE opens the NAND

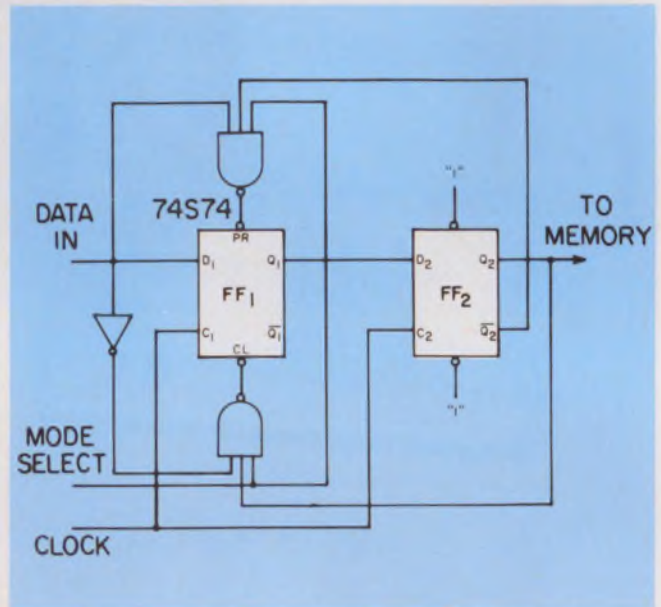

1. **Conventional recorder-latch circuit** captures data during clock transitions (M=ZERO) and unexpected pulses that occur between transitions (M=ONE). But not all unwanted pulses are caught.

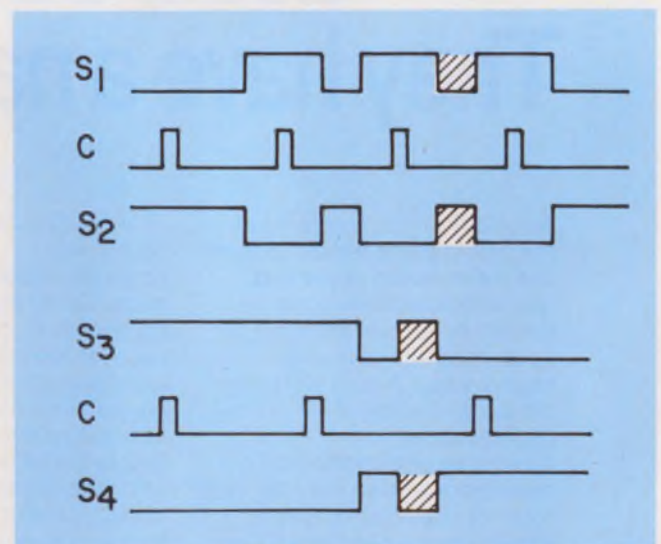

2. **Four cases occur (S₁ to S₄) in which conventional latches fail to capture transients or other undesirable pulses. In S₁ and S₂, the latch detects the first pulse, but is inhibited from catching the second. In S₃ and S₄, more memory is needed to tell between valid (sampled) data and glitches.**

Raphael Pessa, Head of Digital Laboratory, Department of Electrical Engineering, Ben-Gurion University of the Negev, Beer-Sheva, Israel.

gate to CL_1 , $Q = \text{ZERO}$ opens the NAND to PR_1 . Flip-flop FF_2 detects the second change— $Q_1 = \text{ONE}$ opens the NAND to CL_2 , $Q_1 = \text{ZERO}$ opens the NAND to PR_2 . At the next clock pulse, the result of pulse detection is stored at FF_3 , with a ONE indicating a pulse.

Pulse-detection decisions are made by the AND/OR logic at the input of FF_3 . The logic uses the sample states of both the previous clock (Q) and the present clock (D) and the changes detected between clocks (Q_1 and Q_2) to detect a pulse (Fig. 4).

Column NOC indicates the number of changes detected between clocks, and X (don't care) indicates that Q_2 is detected without Q_1 —an impossible situation. Previous state Q is needed because the detected changes, Q_1 and Q_2 , are with respect to Q .

To understand the role of the present sample state, look at the function of C_1 (Fig. 5). Signal C_1 ends the progress of change in flip-flops 1 and 2 through the preset or clear, depending on the internal delays of the NAND and FF_1 . The flip-flops must stabilize before the next sample to ensure that the correct initial states are entered.

Thus, C_1 increases the minimum detectable pulse width, a value greater than the delay in the AND/OR logic (DL_2) plus the delays of the NAND and FF_1 . The value can be decreased by DL_2 if the clock to FF_3 is delayed by DL_2 .

In the timing diagram of Fig. 5, the pulse between the pair of clocks is wide and the falling edge of the pulse occurs when C_1 is HIGH. So detection of the falling edge is inhibited by C_1 . The present sample state (D) in the AND/OR is necessary to distinguish between when one change indicates a pulse (groups 1 and 2 in Fig. 4) and when just one change occurs (groups 3 and 4 in Fig. 4).

As seen in the truth table, the new latch takes into account all possible pulse states between a pair of clock pulses. The second memory in the latch mode ensures that a pulse is detected in all possible states.

Better recorder flexibility

Besides detecting unexpected pulses, the latch enables you to choose either of two accuracies. Assume a logic signal with a minimum pulse duration, W_{\min} (the time between two successive transitions), and a minimum pulse-cycle time, T_{\min} . The signal is sampled at cycle time T by a logic recorder having 256 memory bits per channel and a maximum frequency of 10 MHz.

You can distinguish two operating possibilities;

1. $W_{\min} > T$, that is, wide signal pulses relative to T .
2. $W_{\min} < T < T_{\min}$, that is, short pulses relative to T .

4. **This pulse-decision truth table** accounts for all possible pulse states occurring between clocks. Column NOC indicates the number of changes between clocks (X = don't care).

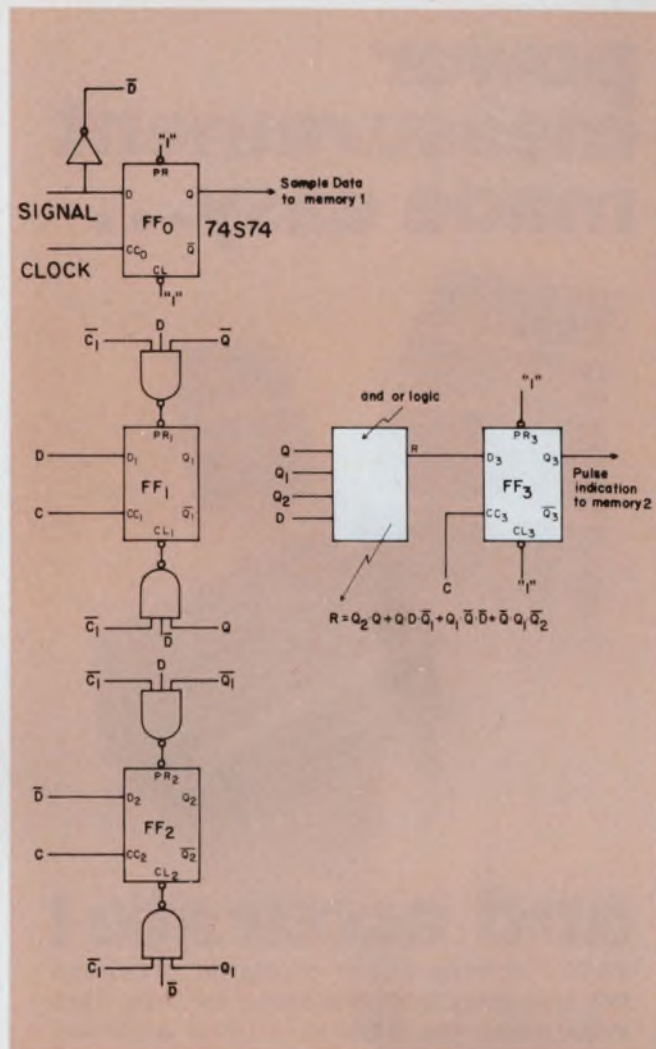

3. The redesigned latch captures sampled data in one memory, pulses in another. The logic at the input of FF_3 "detects" pulses based on previous sample states, present clock conditions and changes occurring between clocks.

	Q	D	Q1	Q2	R	NOC
GROUP 1	0	0	0	1	0	0
	0	0	1	1	1	1
	0	0	1	0	1	2
	0	0	0	0	X	X
2	1	1	1	0	0	0
	1	1	0	0	1	1
	1	1	1	1	X	X
3	0	1	0	1	0	0
	0	1	1	1	0	1
	0	1	0	0	X	X
4	1	0	1	0	0	0
	1	0	0	0	0	1
	1	0	0	1	1	2
	1	0	1	1	X	X

power measurement made easy...



and accurate!

YEW's complete line of digital precision low frequency instrumentation for True RMS Volts/Amps and Watts to $\pm 0.01\%$ accuracy.

Model	Accuracy	Range*		Frequency Range	Approx. Price
		V	A		
APR-2	$\pm 0.01\%$	120	5	DC&60Hz	\$18,000
2885-16 1Ø, 2W	$\pm 0.03\%$	75/100/ 150/300	0.5/1/2 5/10/20	20Hz-10KHz	\$4,995
2503-11 1Ø, 2W	$\pm 0.1\%$	3/10/30/100 300/600	0.1/0.3/1 3/6/10/30		
2503-13 3Ø, 3W	$\pm 0.1\%$	3/10/30/100 300/600	0.1/0.5/1 3/6/10/30	WATTS 40Hz to 1.2KHz V & A 25Hz to 2KHz	\$7,192
2504 1Ø, 2W	$\pm 0.25\%$	30, 60, 100 150/300	0.5/1/2 5/10		\$2,750
2505 3Ø, 4W	0.25%	100/150 300/600	2.5/10 20		\$7,300
2041 (analog) 1Ø, 2W	$\pm 0.5\%$	Various ranges to meet most requirements—25W to 12KW self-contained			DC and 25Hz-1KHz
2042 (analog) 3Ø, 3W				\$ 437	

*Watt Range = VA @ unity power factor

NOTE: Above instruments useable from 0.0 P.F. to 1.0 (unity) P.F.

When it comes to low frequency AC and DC digital instrumentation, the comprehensive YEW line is the most accurate and flexible available. What's more, it's the easiest to use—even by nontechnical factory personnel. Write for complete specifications. Yokogawa Corporation of America, 5 Westchester Plaza, Elmsford, N.Y. 10523, 914-592-6767.



CIRCLE NUMBER 56

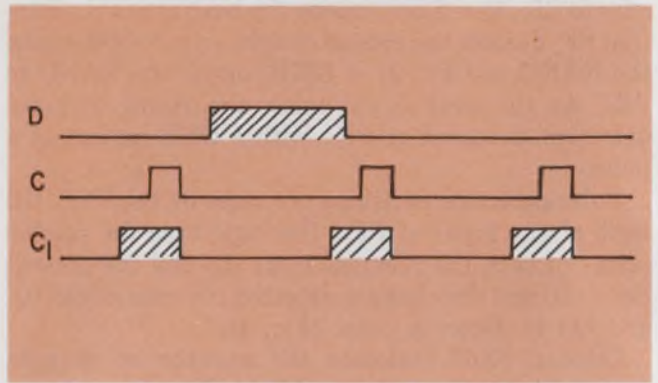

5. In the redesigned latch, signal C_1 ends the process of change in flip-flops 1 and 2 to "make way" for the next sample. The detection of the falling pulse edge is inhibited if the edge occurs when C_1 is High.

to T and having a low frequency with respect to the operating frequency.

In the first case, normal sampling will record all signal pulses, and the latch will catch unexpected pulses during the sampling interval. Because of the limited memory, the total sampling time is given by $256 \times T$. Decreasing T improves the accuracy, but decreases the total sampling time.

In the second case, normal sampling won't detect all the pulses. Assume a signal in which $W_{min} = 10$ ns and $T_{min} = 1$ ms. Only if $T < 10$ ns (or $f > 100$ MHz) will all the pulses be detected. For example, if $T = 5$ ns ($f = 200$ MHz), the accuracy is 5 ns and the total sampling time is 1280 ns (5×256).

The required 200-MHz logic recorder will be about 10 times more expensive than a 10-MHz unit. With the latch circuit and a separate memory, in addition to the normal sampling, all expected pulses will be detected at a much lower frequency ($f > 1$ kHz).

Second-case conditions ensure that no more than one pulse will be found between a pair of clock samples and that the latch circuit will detect that pulse. For example, if $T = 0.5$ ms ($f = 2$ kHz), the accuracy is 0.5 ms, and the sampling time is 128 ms (256×0.5).

Comparing the two examples of the different T's, you can see that when $T = 0.5$ ms, the latch improves the frequency and the sampling time 100,000 times, but decreases accuracy by the same factor. So you have a choice between low accuracy at low frequencies and greater sampling intervals and high accuracy at higher frequencies and shorter sampling intervals.

With low accuracy, the latch detects only expected pulses, but a minor improvement solves the problem. To register the unexpected pulses, the latch of Fig. 3 must have two states: a "one pulse" state and a "two or more pulses" state. The second state, which requires a third memory channel, indicates the unexpected pulse.

To make sure unexpected pulses are detected, add two flip-flops for second-pulse detection—like FF₁ and FF₂ for the one-pulse—and some logic for the second-state indication—like the AND/OR/FF₃ arrangement. ■■

**Need miniature audio transformers
in most popular configurations
in any of three sizes?**

TRW/UTC has a stock answer.

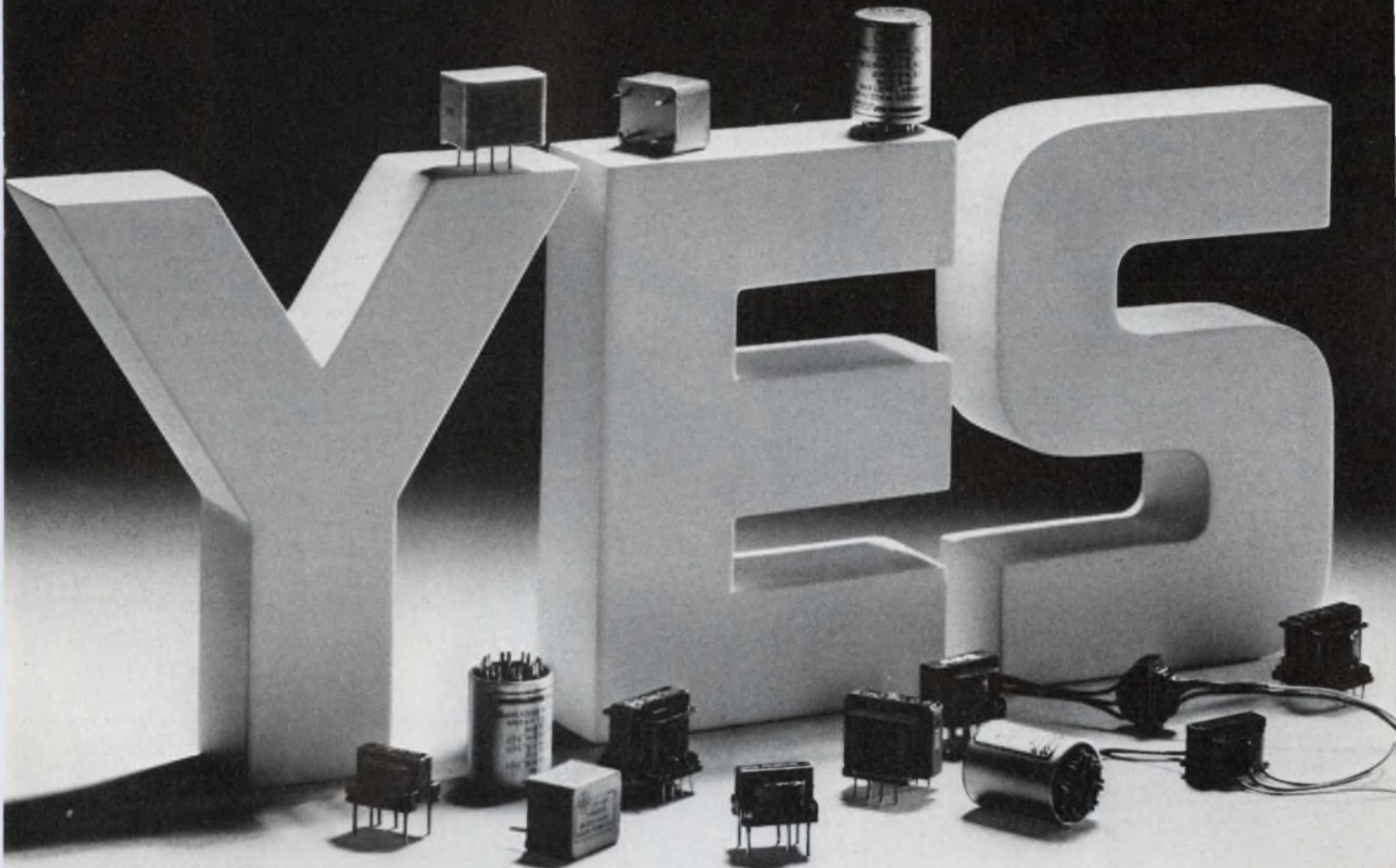

TRW/UTC has a line of miniature industrial audio or signal transformers that come in three wattage ratings. And, they're available in four different configurations.

To find the unit you need, check the table below.

	Ouncer	Subouncer	Sub-Subouncer
P.C. Board Mounting	PC-O Series	PC-SO Series	PC-SSO Series
Flexible Leads		SO Series	SSO Series
Molded		SO#P Series	SSO#P Series
Aluminum Housing	O Series		

Because our miniatures come in 4 styles, you have a choice. Now you can design our unit into your circuit in the manner most convenient for you.

For immediate off-the-shelf delivery check your authorized TRW/UTC local distributor. Or for more information on standards that are something special, contact TRW/UTC Transformers, an Operation of TRW Electronic Components, 150 Varick Street, New York, N.Y. 10013. Area Code: 212-255-3500.

TRW UTC TRANSFORMERS

ANOTHER PRODUCT OF A COMPANY CALLED TRW

CIRCLE NUMBER 57

SABRE X is Here!

Your ten best reasons for buying it are benefits no other tape recorder/reproducer provides

1. Programmable microprocessor control of tape speeds, operating modes, monitor/alarm and other diagnostic testing functions
2. Tape transport with ten speeds from 240 to 15/32 ips
3. 2⁹ time base expansion and/or contraction ratios
4. 10-speed switchable all-band Direct channel electronics
5. 10-speed switchable all-band FM channel electronics
6. 6 megabit digital data processing per track
7. Usable Direct/FM/Digital channel electronics at 240 ips
8. 88.8 hour record time per tape reel — the industry's longest
9. 4.0 MHz/Track direct Record/Reproduce system
10. The same manufacturing excellence that has made Sangamo a leader in tape recorders for over 16 years

IRIG tape recording/reproduction was never like this. But then, that's the whole point of SABRE X: pushing back the horizons of *our* technology to help you push back yours. We know your needs. So we've given you still more features, including serial

and/or parallel high density electronics, vacuum tape tensioning and modular design. We've made it easy to customize the unit with options ranging from coded computer control, data monitoring and a voice/time code to a tape servo and remote control. We've freed you for virtually unlimited applications, including data reduction, deep space, satellite and space networks, mass data storage and security. We've got your number: SABRE X.

For additional information, call or write:

Sangamo Weston, Inc.
Sangamo Data Recorder Division
P.O. Box 3347
Springfield, Illinois 62714
TEL (217) 544-6411

SANGAMO WESTON

Schlumberger

CIRCLE NUMBER 58



SABRE X

Put our new UART and BIT RATE GENERATOR together and what have you got?

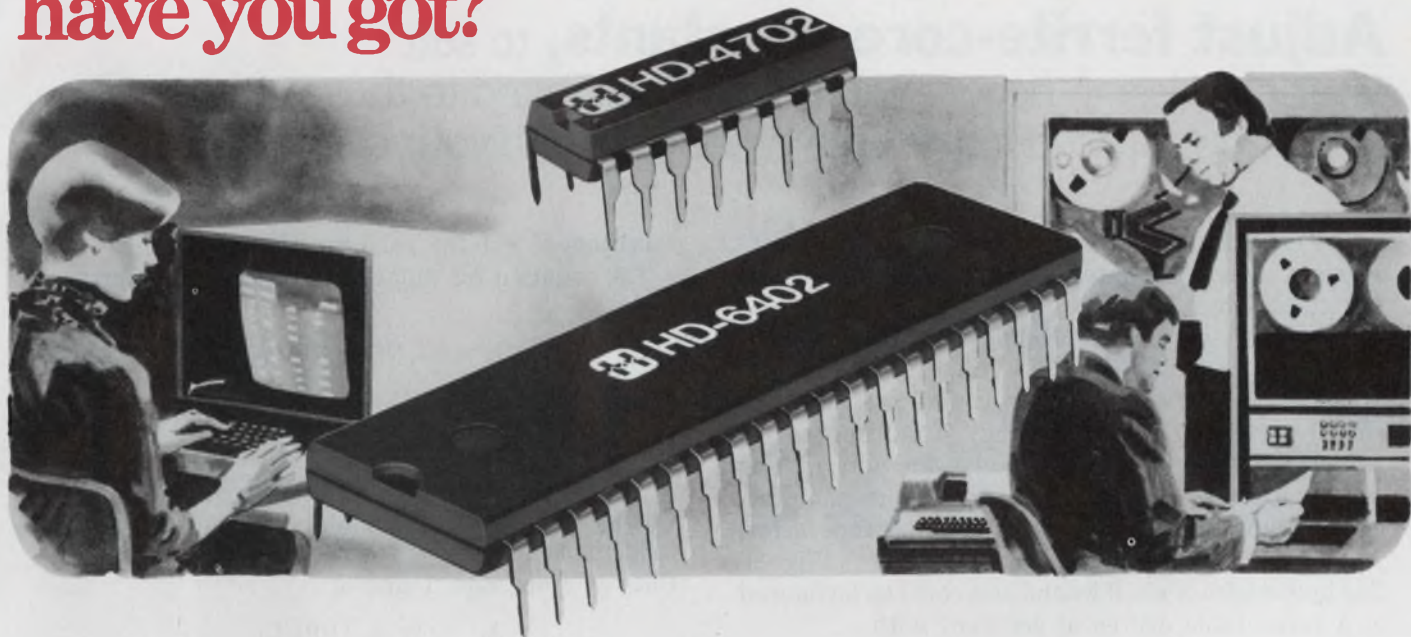

The first programmable CMOS Communications System.

With the Harris HD-6402/6402A CMOS/LSI, and HD-4702/6405 CMOS Bit Rate Generator, you can convert parallel data to serial and back again asynchronously, substantially reducing the amount of interconnect in your data acquisition systems.

Now, all it takes is two lines to connect terminals to computers, for example, instead of the spaghetti of wire used in older systems.

And, only with Harris do you enjoy the benefits of all-CMOS technology. Like less power consumption, permitting remote, hand-held battery-operated systems. Faster speed. Fewer and smaller components for added economy in equipment costs. Plus full temperature ranges, including military.

The Harris HD-6402/6402A, designed to replace the older and slower P-channel types, is the industry's first CMOS UART. It features an industry standard pinout. Single power supply—operates on 4 to 11 volts. And it's fast... 125K Baud... the *fastest* UART in operation today.

The Harris all-CMOS Bit Rate Generator provides the necessary clock signals for the UART. The HD-4702 generates 13 commonly used bit rates, while the HD-6405 provides two additional bits and consumes significantly less power, with no pull-up resistors.

If you've been waiting for CMOS for your modems, printers, peripherals, and remote data acquisition systems designs, your wait is over! Now Harris technology has something you can really work with. And you can start *today!*

For full details, call the Harris Hot Line, or write:
Harris Semiconductor, P.O. Box 883, Melbourne, FL 32901.

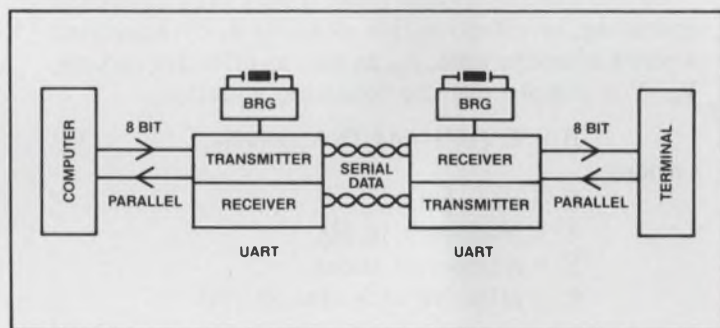

HD-4702/6405 FEATURES

- CMOS
- TTL Compatible
- Low Power Dissipation: 4.0mW TYP. (6405); 4.5mW TYP. (4702)
- Conforms to EIA RS-404
- One unit controls up to eight transmission channels
- On-chip input pull-up circuit (4702 only)
- 16 pin Cerdip and Epoxy dual-in-line packages
- Second source available

HD-6402/6402A FEATURES

- CMOS
- Operation from D.C. to 4.0MHz
- Low power—TYP. 10 mW @ 2.0MHz
- 4V to 11V operation
- Programmable word length, stop bits and parity
- Automatic data formatting and status generation
- Compatible with industry standard UART's
- Second source available

HARRIS HOT LINE!
1-800-528-6050, Ext. 455

Call toll-free for phone number of your nearby Harris sales office, authorized distributor or expedited literature service.

Harris Technology...Your Competitive Edge



HARRIS
SEMICONDUCTOR
PRODUCTS DIVISION

CIRCLE NUMBER 59

Adjust ferrite-core constants, to suit your coil design needs. You needn't be limited to those shapes and sizes you find in the catalogs—calculate your own.

The effective properties and dimensional core constants of magnetic materials for coils as supplied by ferrite-core manufacturers enable engineers to perform speedy and practical coil designs. Working with the basic material properties found in physicists' materials tables, engineers would find predicting in-circuit performance very difficult, if not impossible.

Instead of complicated formulas for determining coil inductance, most ferrite magnetic-core manufacturers supply core constants and an inductance factor, A_L , for particular core types and dimensions (Fig. 1). The inductance of a coil wound on a core can be figured to a respectable degree of accuracy with

$$L = A_L N^2 \text{ (nanohenries)} \quad (1)$$

However, the given A_L values are accurate only for the specific applications and flux densities that the core is tested and rated for—filters, pulse-transformers, power-inverters, etc.¹

So manufacturers also make it easy to calculate the operating, or effective flux density, B , by supplying a core's effective area, A_e , as well as effective volume, V_e . You simply use the following equation:

$$B = E (10^8)/4.44 f N A_e \text{ (gauss)}, \quad (2)$$

where

$$\begin{aligned} E &= \text{rms volts,} \\ f &= \text{frequency in Hz,} \\ N &= \text{number of turns,} \\ A_e &= \text{effective core area in cm}^2. \end{aligned}$$

To get the effective field strength, H_e , in the core or its air gap, if any, you need to know the effective length of the magnetic path, d_e , in cm. Use the following equation:

$$H_e = 4\pi NI/10d_e \text{ (oersteds)},$$

where I is the current in amperes through the coil. Again, manufacturers make the calculation easy by supplying values of d_e for their various core designs.

Cores don't always fit your needs

But what if listed core dimensions don't quite fit your needs? How can you adjust their dimensional

Michael I. Distefano, Manager of Quality Engineering, Indiana General Electronic Products, Crows Mill Rd., Kearsbey, NJ 08832.

constants to get the performance you want?

The equation for inductance also can be expressed with

$$L = 4\pi N^2 \mu_e (10^9)/C_1, \quad (3)$$

where

$$\begin{aligned} \mu_e &= \text{effective permeability,} \\ C_1 &= \text{a dimensional core constant.} \end{aligned}$$

Change the constant C_1 , and you can change the inductance for a given core-material permeability. Clearly, from Eqs. 1 and 3,

$$A_L = 4\pi \mu_e (10^9)/C_1.$$

The core constant C_1 , supplied by manufacturers for specific core sizes, can be calculated² from the summation,

$$C_1 = \sum_{i=1}^n d_i/A_i.$$

For a uniform toroid (Fig. 2a), then,

$$\begin{aligned} C_1 &= \int_{r_1}^{r_2} 2\pi r/(h \cdot dr) \\ &= 2\pi/h \cdot \log_n(r_2/r_1). \end{aligned} \quad (4)$$

For a more complex core, say, with four identifiable sections as in Fig. 2b, you must sum the separate sections. Therefore,

$$C_1 = \sum_{i=1}^4 \frac{d_i}{A_i} = \frac{d_1}{A_1} + \frac{d_2}{A_2} + 2 \frac{d_3}{A_3}.$$

Note that sections 3 and 4 are identical and combined in the last term.

In section 1, using the methods of Eq. 4, since

$$\frac{d_1}{A_1} = \pi/h \cdot \log_n(r_3/r_1).$$

In section 2, since $d_2 = (\pi - 2\phi) r_b$, then

$$\frac{d_2}{A_2} = (\pi - 2\phi)/h \cdot \log_n(r_2/r_1).$$

And in sections 3 and 4, to simplify calculations, since ϕ is relatively small, r_3 and r_2 can be averaged (Fig. 2c) and the approximate answer you obtain will cause little error. Then,

$$2 \frac{d_3}{A_3} \approx 20/[h \cdot \log_n(r_2 + r_3)/2r_1]$$

Changes in the core dimensions—radii r_1 , r_2 , r_3 and

POT CORE

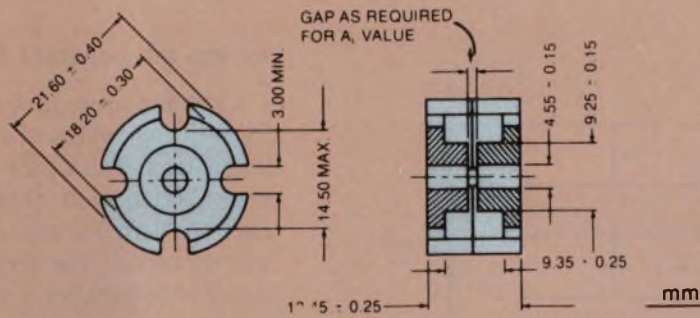

Core Constants

$C_i = 5.16\text{cm}^{-1}$
$d_e = 3.20\text{cm}$
$A_e = 0.619\text{cm}^2$
$V_e = 1.98\text{cm}^3$

$$\Delta_L = 250 \pm 3\%$$

$$\mu_e = 103$$

(a)

U CORE

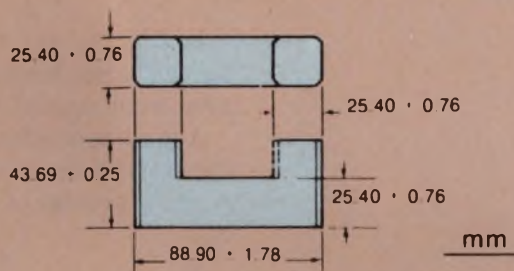
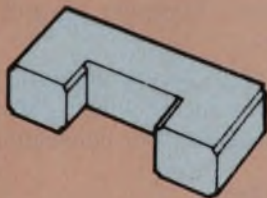

Core Constants

$C_i = 3.55\text{cm}^{-1}$
$d_e = 22.91\text{cm}$
$A_e = 6.45\text{cm}^2$
$V_e = 147.77\text{cm}^3$

$$\Delta_L = 13,300 (1.8 \text{ kG})$$

$$= 7970 (2.8 \text{ kG})$$

(b)

E CORE

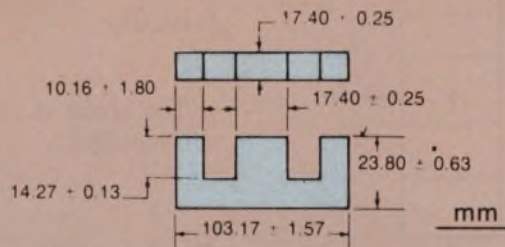
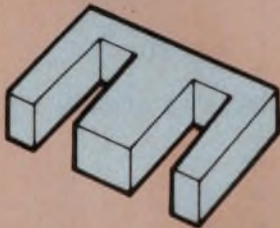

Core Constants

$C_i = 4.63\text{cm}^{-1}$
$d_e = 15.19\text{cm}$
$A_e = 3.28\text{cm}^2$
$V_e = 49.82\text{cm}^3$

$$\Delta_L = 9415 (1.8 \text{ kG})$$

$$= 5860 (2.8 \text{ kG})$$

(c)

1. **Ferrite coil and transformer cores** are usually specified in manufacturers' catalogs with effective values for both

their magnetic and dimensional constants. Effective values enable you to quickly design practical components.

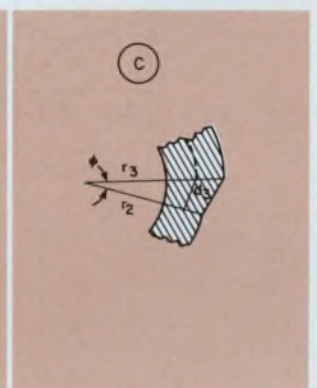
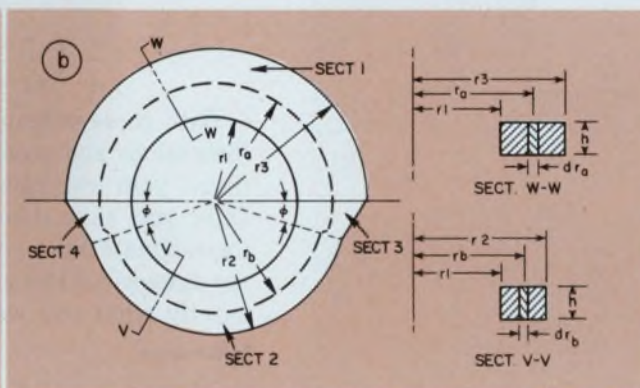
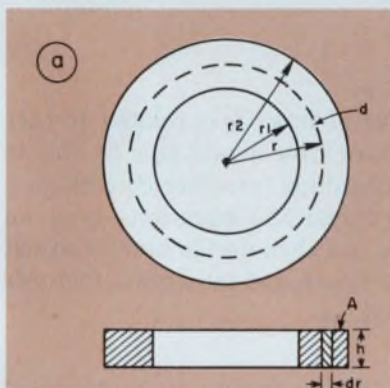

2. A simple toroid core (a) is easily evaluated to determine its important dimensional core constants, C_i , d_e and A_e . But more complex shapes (b) require that you sum the

various sections and make approximations (c) for some of the irregularly shaped parts. Core-constant equations allow you to adjust the dimensions as needed.

angle ϕ —can now be translated into their effect on C_1 and, in turn, their effect on A_L and inductance.

Solving the constant for E cores

A similar procedure for E cores provides the relationship between C_1 and the core's physical dimensions. For a pair of E cores with a rectangular cross section, you need consider only five sections, since the two Es are identical. And because each E is symmetrical, the area of the magnetic path in each half-E is in parallel with the other half, but in series with its counterpart in the other section of the pair; thus,

$$C_1 = \sum_{i=1}^5 \frac{d_i}{A_i}$$

In Fig. 3b, the dimensions of d_1 , d_2 and d_3 are obviously the lengths as shown. However, d_4 and d_5 need some special treatment.

A good approximation for d_4 is to use one-quarter the circumference of the mean circle whose radius, r_a , is the average of $b/2$ and $d/2$ (Fig. 3c); consequently,

$$\begin{aligned} d_4 &= 1/4 (2\pi) r_a \\ &= 1/4 (2\pi) \left(\frac{b/2 + d/2}{2} \right) \\ &= \frac{\pi}{8} (b + d). \end{aligned}$$

Similarly,

$$d_5 = \frac{\pi}{8} (c + d).$$

The areas, A_i , associated with sections 1, 2 and 3 are clearly,

$$\begin{aligned} A_1 &= ab \\ A_2 &= ad \\ A_3 &= ac. \end{aligned}$$

But for sections 4 and 5, you must make another approximation: Use the average of the sections' terminating cross-section areas, so that

$$\begin{aligned} A_4 &= (1/2) (ab + ad), \\ A_5 &= (1/2) (ac + ad). \end{aligned}$$

Now, the complete expression for C_1 can be written as

$$\begin{aligned} C_1 &= \frac{d_1}{ab} + \frac{d_2}{ad} + \frac{d_3}{ac} + \frac{\pi}{4} \left(\frac{b + d}{ab + ad} \right) \\ &+ \frac{\pi}{4} \left(\frac{c + d}{ac + ad} \right) \end{aligned}$$

With these examples of how C_1 is related to core dimensions and geometry, you should now be able to derive your own relationships for other core shapes. Once you have determined the equation—even an approximate one—you can then decide how to adjust the dimensions to your needs, and tell a manufacturer exactly what you want. ■■

References

1. Van der Poel, J. M., "Improve Inductor Design Accuracy," *Electronic Design*, Feb. 2, 1976, pp. 58-62.
2. "Calculation of the Effective Parameters of Magnetic Piece Parts," Publication 205, IEC Standard, International Electrotechnical Commission (ISO), Geneva, Switzerland.

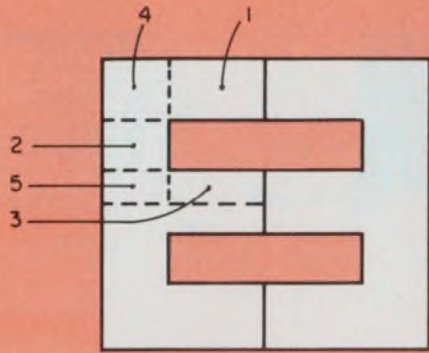

(a)

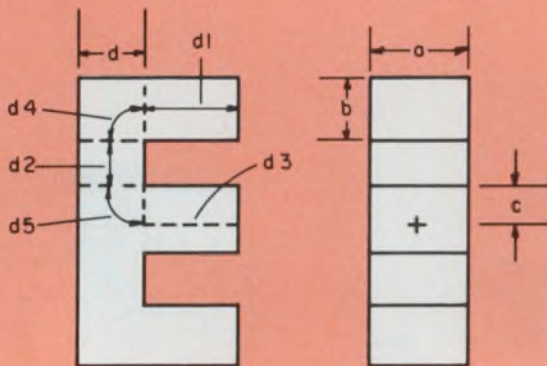

(b)

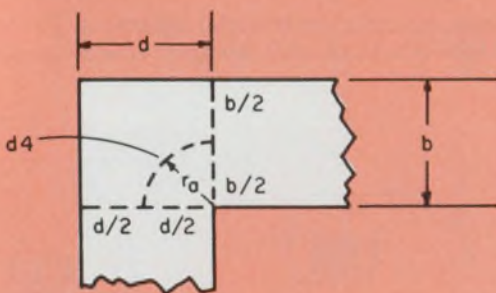

(c)

3. In evaluating the core constants for an E core (a), you can take advantage of its symmetry (b) and approximate the effective dimensions of the corner sections (c) to simplify the calculations.

HIGH VOLTAGE CHAMP



You're looking at one of many different Sprague dual and quad power drivers. Each leads its category in many ways.

Sprague pioneered the quad power driver for peripheral loads. Sprague was first to integrate transient suppression diodes for clamping inductive loads. Sprague led the way to lower supply currents and better noise margins, lower junction temperatures, higher breakdown voltages, and higher package dissipation.

SERIES UHP-400/500 Quad Power Drivers: These original Sprague power drivers contain the four logic functions: AND, NAND, OR, NOR. Transient-protected and open collector types are available. Also featured is the choice of three voltage ratings: 40 V, 70 V, and 100 V. All types come in plastic DIP, ceramic DIP, and flat pack. The ceramic DIP and flat pack meet all requirements for high-temperature, high reliability military and aerospace programs.

SERIES UDN-5700A Quad 2-Input Power Drivers and UDN-5700M Dual Power Drivers: These recently introduced drivers include the four basic logic functions and come with an 80-volt output rating. All are compatible with MOS logic. The input logic "0" (low) current is 100 μ A (max), and the logic "1" (high) current is 10 μ A (max) at an input voltage of 30 V. This allows interface directly from most CMOS and PMOS. Recommended V_{CC} operation is 5 V \pm 5%. Transient-suppression diodes are integrated.

SERIES UDN-3600M Dual 2-Input Power Drivers: These dual drivers complement the UDN-5700 Series and are compatible with MOS logic. They are pin-for-pin replacements for Series LM3600N. Sprague types offer reduced I_{CC} (on) currents for lower power, reduced noise problems, lower junction temperature, and higher package dissipation capability, plus 80 V breakdown.

UDN-5790/5791 Quad Drivers for PIN Diodes: These new devices have a 120 V maximum output voltage! Each output is capable of switching 300 mA. These units are available in both plastic and ceramic DIP packages. They permit users of discrete or hybrid PIN interface drivers to replace present components with a reliable monolithic design. Both inverting (5790) and non-inverting (5791) types are available.

For application engineering assistance, write or call George Tully or Paul Emerald, Semiconductor Division, Sprague Electric Company, 115 Northeast Cutoff, Worcester, Mass. 01606. Tel: 617/853-5000.

For Engineering Bulletins on the types in which you are interested, write to: Technical Literature Service, Sprague Electric Company, 347 Marshall Street, North Adams, Mass. 01247.

FOR FAST INFORMATION, CALL YOUR NEAREST SPRAGUE SALES OFFICE:

ALABAMA, Sprague Electric Co. 205-883-0520 • ARIZONA, Sprague Electric Co. 602-279-5435 • CALIFORNIA, Sprague Electric Co. 213-649-2600 Wm. J. Purdy Co. 415-347-7701 KCE Corp. 714-278-7640 • COLORADO, Wm. J. Purdy Co. 303-777-1411 • CONNECTICUT, Sprague Electric Co. 203-261-2551 • DIST. OF COLUMBIA, Sprague Electric Co. (Govt. sales only), 202-237-7820 • FLORIDA, Sprague Electric Co. 305-831-3636 • ILLINOIS, Sprague Electric Co. 312-296-6620 • INDIANA, Sprague Electric Co. 317-253-4247 • MASSACHUSETTS, Sprague Electric Co. 617-899-9100, Sprague Electric Co. 413-664-4411 • MICHIGAN, Sprague Electric Co. 517-787-3934 • MINNESOTA, HMR, Inc. 612-920-8200 • MISSOURI, Sprague Electric Co. 314-781-2420 • NEW JERSEY, Sprague Electric Co. 201-696-8200, Sprague Electric Co. 609-795-2299, Trinkle Sales Inc. 609-795-4200 • NEW MEXICO, Wm. J. Purdy Co. 505-266-7959 • NEW YORK, Sprague Electric Co. 516-549-4141 Wm. Ruth, Inc. 914-698-8600 Sprague Electric Co. 315-437-7311, Mar-Com Associates, 315-437-2843 • NORTH CAROLINA, Electronic Marketing Associates, 919-722-5151 • OHIO, Electronic Salesmasters, Inc. 800-362-2616, Sprague Electric Co. 513-278-0781 • PENNSYLVANIA, Sprague Electric Co. 215-467-5252, Trinkle Sales, Inc. 215-922-2080 • TEXAS, Sprague Electric Co. 214-235-1256 • VERMONT, Ray Perron & Co., Inc. 617-762-8114 • VIRGINIA, Sprague Electric Co. 703-463-9161 WASHINGTON, Sprague Electric Co. 206-632-7761 • CANADA (Ontario), Sprague Electric of Canada, Ltd. 416-766-6123 • CANADA (Quebec), Sprague Electric of Canada, Ltd. 514-683-9220



A General Cable subsidiary

Smaller than a breadbox The IMP* Controller

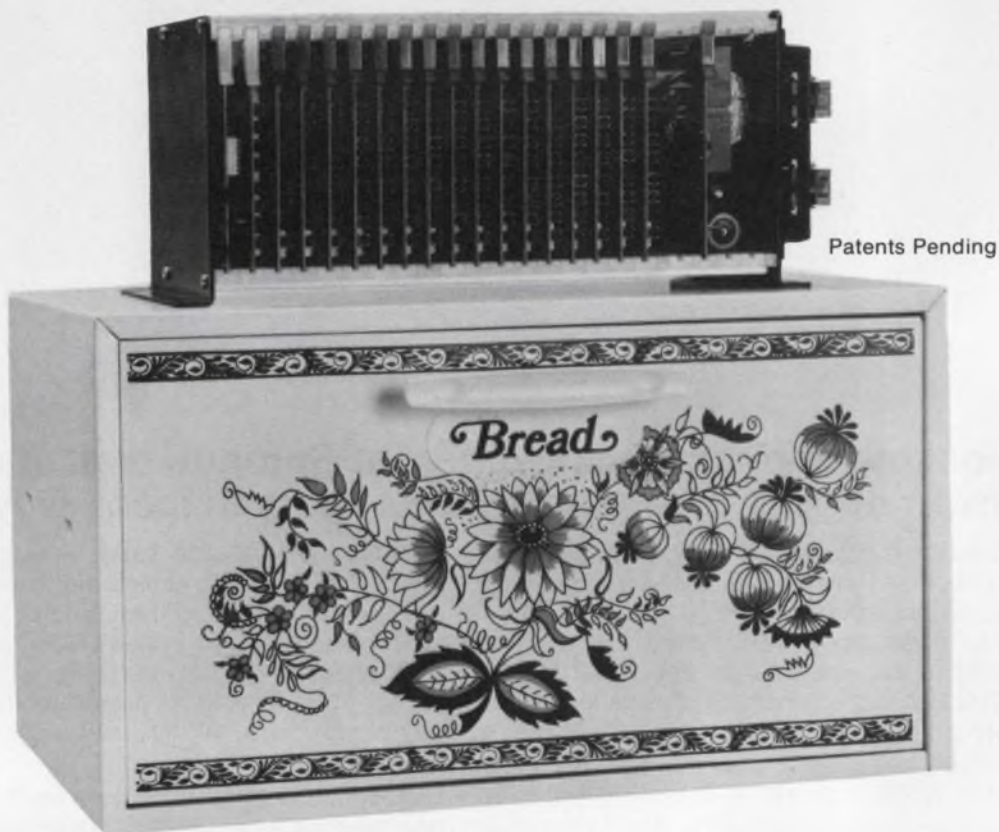

Reliable: Use the IMP with confidence. I/O and P.L.C. functions based on patents issued or pending give higher reliability than any other controller.

Serviceable: The IMP is easy to service. Modular design with pluggable printed circuit boards and power supply. Entire unit easily demounted in a few minutes. Local ASI representatives keep inventories on spare parts.

Versatile: The IMP economically accommodates systems from 8 to more than 500 I/O's (128 I/O Shown). Parts interchangeable for minimum inventory. Performs control functions not normally associated with programmable controllers.

Productive: The IMP is designed and built to perform accurately and reliably in a wide range of conditions. IMP reliability and ease of service mean a minimum of downtime.

*Industrial Modular Programmable

asi

AUTOMATION SYSTEMS, INC.

LANCER PARK • ELDORIDGE, IOWA 52748 • 319/285-8171

CIRCLE NUMBER 61

Now all in one package - a complete RF Analyzer for swept measurements

- transmission (gain/loss)
- reflection (return loss/SWR)
- absolute power
- absolute frequency

COMPLETE SYSTEM INCLUDING 1-1500 MHz SWEEPER

It's simple to get scalar swept-measurement information with Wiltron's new all-in-one RF Analyzer.

Just connect the input and/or output of the device to be measured to the Analyzer. No need to hunt for an array of couplers, amplifiers, cables and other equipment.

Besides being simple to use, this first-of-its-kind Analyzer gives you better accuracy than put-together setups.

The new Model 640 is small and convenient, yet it is a *complete measuring system*. It contains all of the needed test circuitry—sweeper, directional signal separator, calibrated amplifiers, detectors, and display system.

It's ready to measure the device under test.

WIDE PLUG-IN CHOICE

The sweeper and amplifiers are plug-ins, so you have maximum flexibility. Both log and linear amplifiers are available. A variety of external directional bridges, detectors, and RF fittings is also available so that you can measure in almost any setup, 50 or 75 ohms.

Small as it is, the sweeper is the equal of much larger sweepers. And it has the most complete frequency marker system known to be available in any-sized sweeper.

The amplifiers are gems. Low noise, wide range, stable, fast, complete with positionable reference traces and a ± 90 dB calibrated offset arrangement.

All of this adds up to:

- precise sweeps as wide as 1500 MHz or as narrow as 1 MHz.
- a 70 dB dynamic measuring range from +10 to -60 dBm.
- return loss measurable to below 54 dB (1.004 SWR).
- outstanding convenience.

CALL FOR DATA

The new 640 is discussed in a new issue of our *Wiltron Technical Review No. 7*

Send for a copy today, or phone us to arrange for a demo. Call now, because interest is already strong in this powerful new lab and production tool.

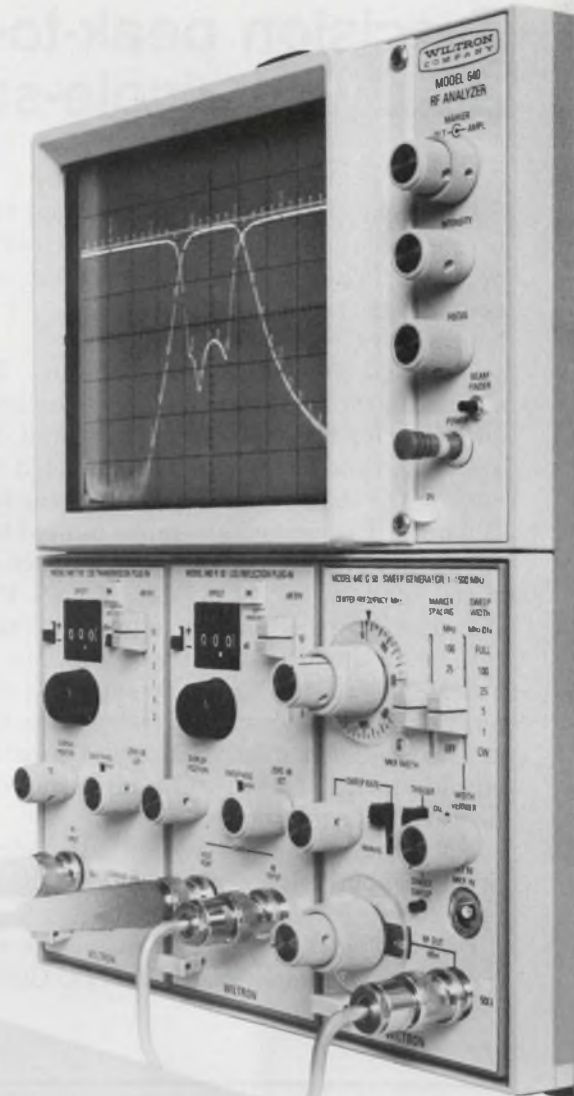

(Five plug-ins to meet your requirements)



Swept Signal Source

Log Amplifier with internal detector

Log Amplifier with internal SWR bridge and detector

Log Amplifier

Linear Amplifier



825 East Middlefield Road • Mountain View, CA 94043 • (415) 969-6500 • TWX 910-379-6578

Precision peak-to-peak ac-dc converter built with single-supply op-amp circuit

Overcome the forward voltage drops of the diodes in a conventional voltage-doubler circuit with two precision diodes, and the result is a fast, peak-to-peak ac-to-dc converter with wide dynamic range and bandwidth (see figure).

The peak-to-peak converter's input RC network should be chosen with a high-pass corner frequency adequate for the input frequency. And, the holding, or decay, time of the circuit is adjusted with the RC network at the output. For fast response, both input and output capacitors should be limited to about 0.02 μf maximum, and the source impedance of the input signal must be kept low—less than 1 $\text{k}\Omega$.

Because the CA3140 has an input-voltage range 300 mV below its negative-supply rail, the circuit can operate from a single positive supply. A single supply not only reduces cost, but also speeds the response of the precision diodes, D_1 and D_2 , as the op-amp outputs switch from saturated "negative" states to forward bias the diodes.

Note, that with the specified +15-V-dc power supply, the input voltage should be less than 11 V peak-to-peak.

Dan L. Vogler, President, Lintech Electronics, P.O. Box 25124, Albuquerque, NM 87125. CIRCLE NO. 311

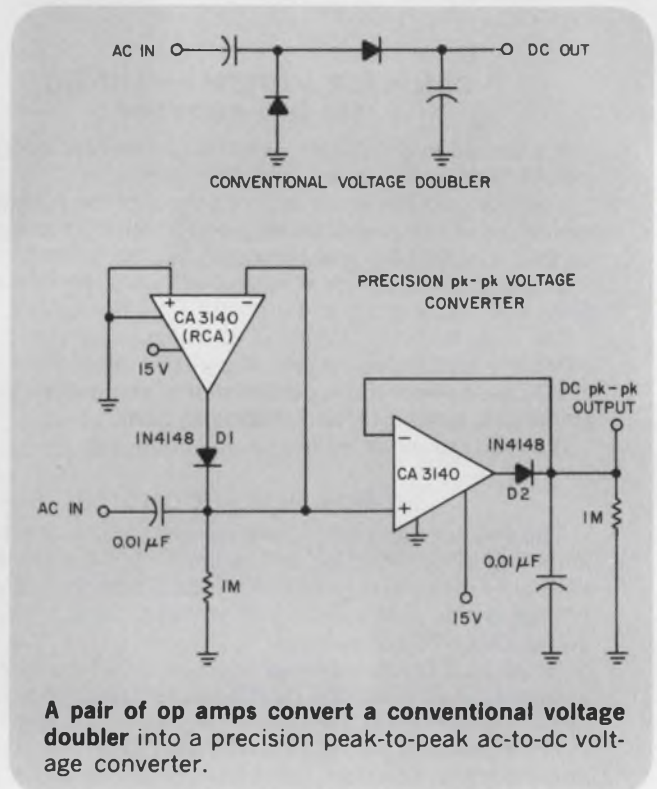

A pair of op amps convert a conventional voltage doubler into a precision peak-to-peak ac-to-dc voltage converter.

Square-to-triangle-wave converter provides constant amplitude, rapid response

Convert square waves into triangle waves over a wide frequency range for many applications, such as frequency synthesis and function generation. Triangle waves can be converted directly to other desired waveforms—square waves cannot.^{1,2,3}

Unlike most other converter approaches, the circuit in the figure

- Provides a constant output amplitude as the frequency is varied.
- Preserves a constant phase shift from input to output.

- Responds rapidly to abrupt frequency changes, with the output able to stabilize within one cycle. Furthermore, the input is TTL-compatible.

The circuit has three distinct sections: a period-to-voltage converter, an analog reciprocal generator and a ramp generator. In the period-to-voltage converter, three sections of a quad op amp, IC_1 , and a quad CMOS switch, IC_2 , generate a voltage, V_p , that is proportional to the period of the input square wave. Voltage V_p is updated every cycle. An accurate temperature-

(continued on page 162)

The NEW MODEL 3300 POCKET SIZE DVOM for all occasions. \$175

Triplet's New 3300 DVOM goes everywhere . . .

The brand new 5 function, 22 range Model 3300 DVOM has all the features you'll want at the bench . . . away from the bench. Like super readability, improved accuracy and extended battery life. And it's only 3" wide by 5-3/8" long by 1-3/8" deep.

This ultra-compact 3-1/2 digit DVOM offers a high intensity .3" LED display, low power ohms and typical DC accuracy of .5% of reading. You'll also get all the "automatics" that make life a lot simpler: Auto-polarity and auto-overrange.

1. **HAND-SIZE, 3-1/2 DIGIT**—Easy operation with 22 ranges including Hi/Low Power Ohms. Auto Polarity and overrange indication.
2. **OVERLOAD PROTECTION**—Protected up to 600 volts on all ranges with special 2A/600V fuse arrangement.
3. **BATTERY-PAC™**—Easily removed, snap-in Battery-Pac™ provides convenient field exchange for fully charged Pac. Battery-Pac™ rechargeable in tester or externally.

Complete with one year warranty, test leads, rechargeable Ni Cad batteries, AC Adapter Charger and instruction manual.

Ask your Triplet distributor to demonstrate the rugged little Model 3300 DVOM and show you our complete line of handy accessories, too.

TTT TRIPLETT
BLUFFTON, OHIO 45817
Phone (419) 358-5015





SPRING ASSEMBLIES

Instrument Specialties assumes all the headaches and guarantees quality!

Until recently, Instrument Specialties was known only for the superb quality and performance of our beryllium copper springs and spring contacts. Customers bought the springs, and frequently assembled them into molded blocks in their own plants—with varying degrees of success.

Now, Instrument Specialties can eliminate this divided responsibility. We can supply your contact springs attached to molded bases, and *guarantee to meet the specifications of the entire assembly!* We'll take complete responsibility for producing the plastic block, manufacturing the springs to exact specifications, and then assembling the parts through heat staking, press fitting, or ultrasonic welding. We can also weld or solder springs to other metal components.

Of course, this eliminates a lot of your procurement and assembly headaches. But most important, your assemblies fit and work the way you specified—Instrument Specialties guarantees it!

We'll be happy to discuss your specific needs—just phone. Or, for a free catalog, write today to Dept. ED-84.



INSTRUMENT SPECIALTIES CO., INC.

Little Falls, New Jersey 07424

telephone: 201-256-3500 twx: 710-988-5732

Specialists in beryllium copper since 1938

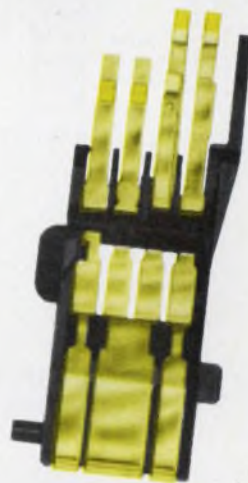
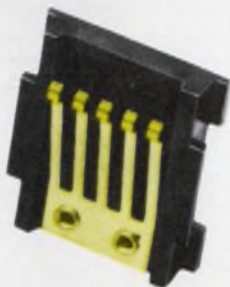

Build a versatile nonsequential controller that is faster than a microprocessor

Here's a controller that is faster than most microprocessors—and more versatile than the usual sequential controller. You can build this 64-state nonsequential controller with 13 ICs. It can operate at clock rates to 4 MHz and has up to 16 inputs and 16 outputs (Fig. 1).

The circuit is initialized by a Clear signal to the State-address register, IC₈ (Fig. 2). The output of the State-address register controls the six most-signifi-

cant address bits of all the PROMs, IC₅, IC₆, IC₇ and IC₉, not including address bit A₇. These six state-address-register bits determine which of the 16 inputs are addressed.

Since all inputs must synchronize with the clock, flip-flops IC₁ and IC₂ synchronize any asynchronous inputs. The input selected appears at the W output of the multiplexers, IC₃ and IC₄, and becomes the least-

(continued on page 166)

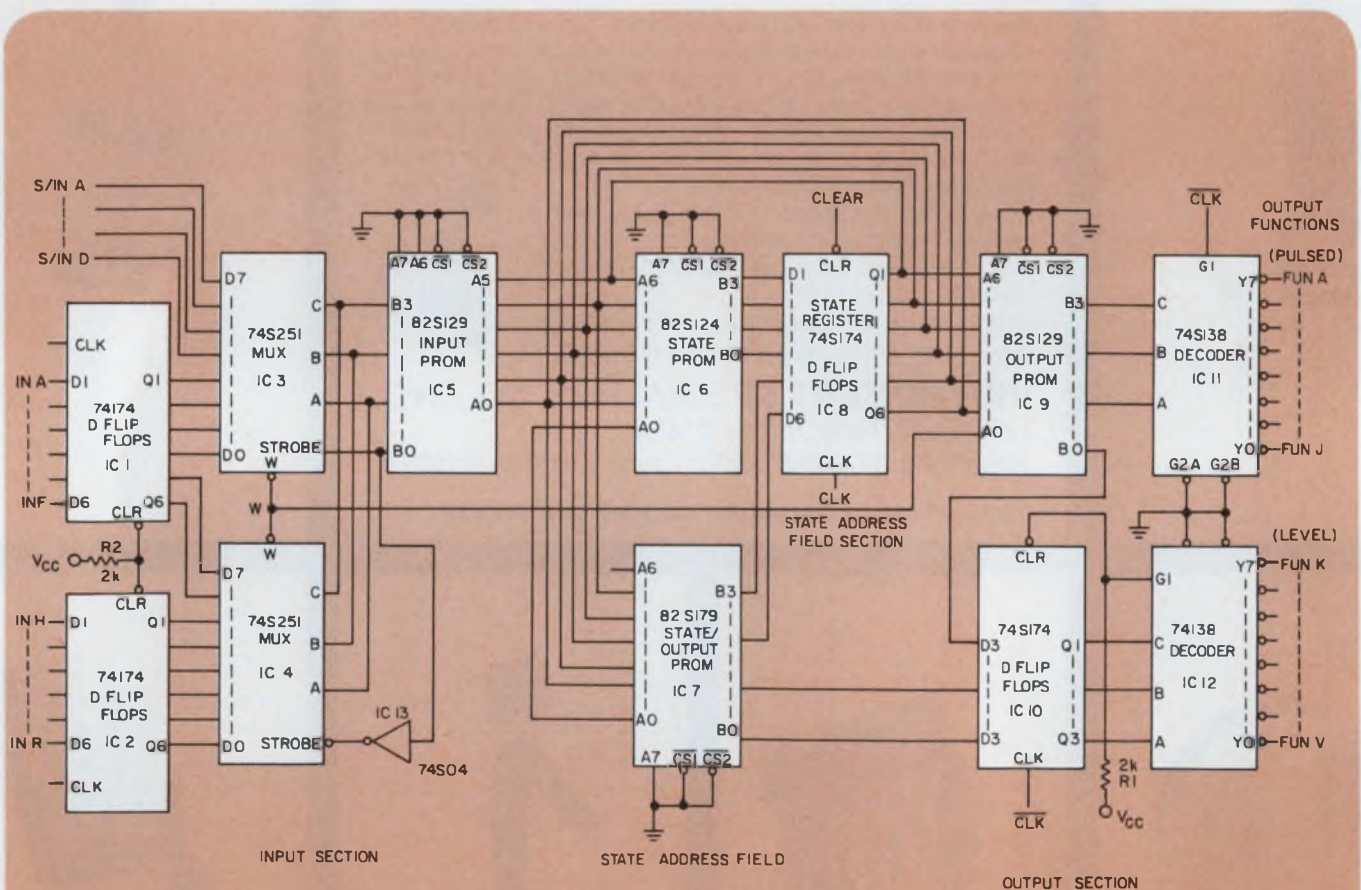

1. Monitor 16 digital inputs and control 16 outputs nonsequentially with this programmable controller.

The clock speed can be up to 4 MHz. At slower clock speeds, slower chips can reduce cost and power.

Datel's Microelectronic Data Acquisition System

HDAS-16/HDAS-8

- ▶ 16 Single-ended Channels or
8 Differential Channels
- ▶ 12 bits Resolution
- ▶ 50 KHz Throughput Rate
- ▶ Internal Instrumentation Amplifier
- ▶ Three-State Data Outputs
- ▶ Military and Commercial Temperature
range available
- ▶ 62-pin Miniature Package
- ▶ Priced at \$295.00* (1-9)

*U.S.A. domestic price only



COVERED BY GSA CONTRACT

You'll find complete specifications on this product and more than 300 data conversion circuits and systems in Gold Book.

Just check Gold Book's Volume 3. That's Datel's complete Engineering Product Handbook, in its own separate volume. More than 290 pages of D/A & A/D Converters, Multiplexers, Sample-Holds, Op Amps, Power Supplies, Digital Panel Meters and Printers, Digital Calibrators, Data Loggers, Digital Cassette Recorders, and Data Acquisition Systems. Each fully detailed on individual data sheets.

And it's available to you in Gold Book.

 **DATEL
SYSTEMS, INC.**

1020 Turnpike St., Canton, MA 02021
Phone: (617) 828-8000



See Electronic Design's
1977-78 "Gold Book"-Vol. 3, page 135

Santa Ana, CA (714) 835-2751, (L.A.) (213) 933-7256 • Sunnyvale, CA (408) 733-2424 • Gaithersburg, MD (301) 840-9490 • Houston, TX (713) 932-1130
OVERSEAS: DATEL (UK) LTD—TEL: ANDOVER (0264) 51055 • DATEL SYSTEMS SARL 620-06-74 • DATELEK SYSTEMS GmbH (089) 78-40-45

CIRCLE NUMBER 66

Ideas for design

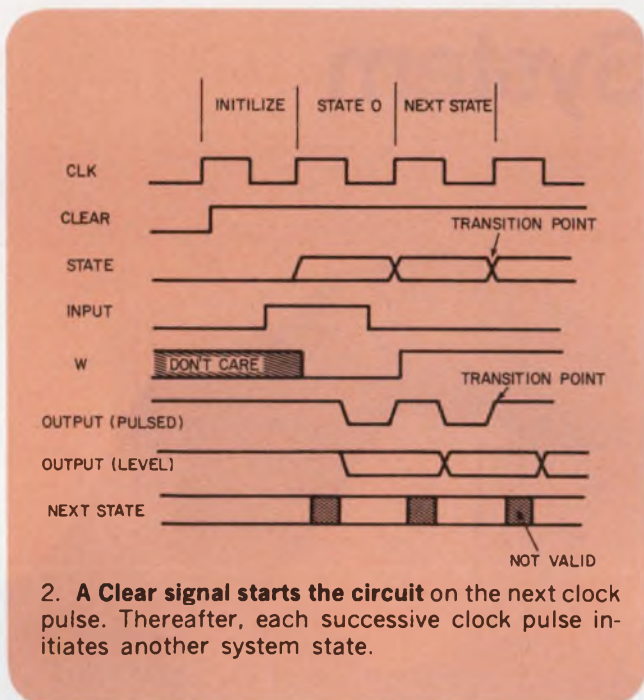

significant address bit of the state and output PROMs.

Before the falling edge of the clock pulse occurs, the addresses to decoder IC₁₁ and flip-flops IC₁₀ stabilize. The output selected at decoder IC₁₂ is clocked in on the negative edge of the clock and held until the next negative edge. At the next rising clock edge, the outputs of the State PROM, IC₆, are loaded into the State-address register, IC₈, which initiates the next cycle.

A typical flow chart shown in Fig. 3 will help you develop the coding needed to program the controller. Note: Only half the states and addresses of the PROM memories are used. The unused address lines of each

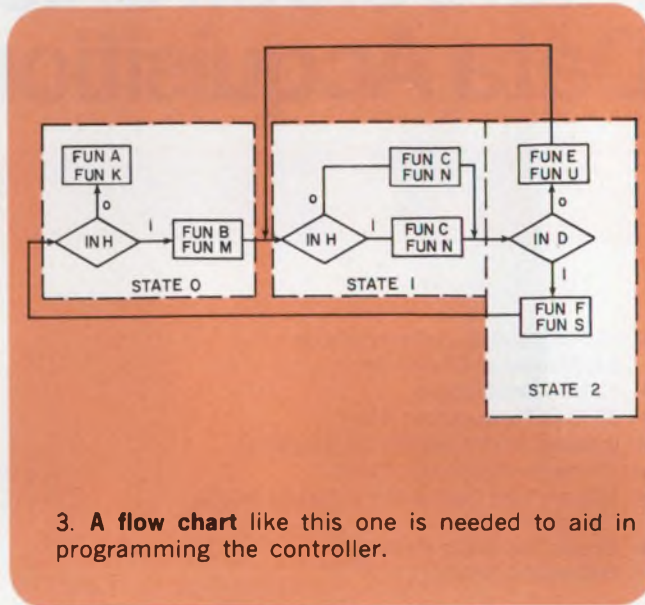

PROM, A₇, can double the states from 64 to 128, but the state register must then be changed to handle seven bits.

Another potential use for the A₇ address lines enables you to monitor an additional set of inputs. Merely duplicate the input section, address it with the same state bits and feed the new W output into the A₇ address lines of the state and output PROMs. In this way, you can look at two inputs simultaneously and allow up to four different responses to occur.

Harold J. Alber and Nancy L. Esken, Electronic Engineers, ASD/ENA, Wright-Paterson AFB, OH 45433.

CIRCLE NO. 313

IFD Winner of July 19, 1977

A. I. Ozkaynak, Technical Supervisor, The New Brunswick Electric Power Commission, Power System Development Div., 527 King St., Fredericton, N.B., Canada. His idea "Electronic Regulator for Car Alternators Switches On/Off Rapidly to Maintain 14 V" has been voted the Most Valuable of Issue Award.

Vote for the Best Idea in this Issue by circling the number of your selection on the Reader Service Card at the back of this issue.

SEND US YOUR IDEAS FOR DESIGN. You may win a grand total of \$1050 (cash)! Here's how. Submit your IFD describing a new and important circuit or design technique, the clever use of a new component or test equipment, packaging tips, cost-saving ideas to our Ideas for Design editor. Ideas can only be considered for publication if they are submitted exclusively to ELECTRONIC DESIGN. You will receive \$20 for each published idea. \$30 more if it is voted best of issue by our readers. The best-of-issue winners become eligible for the Idea of the Year award of \$1000.

Datel's 16 Bit, Microelectronic D/A Converters

DAC-HP16BMC & DAC-HP16DMC

- ▶ 16 Bit Binary or 4 Digit BCD Coding
- ▶ 15ppm/°C Tempco, max.
- ▶ Linearity to 0.003%
- ▶ 0 to +10V or ±5V Output
- ▶ 35μsec. Settling Time (Binary Version)
- ▶ Priced from \$119.00* (1-24)

\$77⁵⁰*
(100's)

*U.S.A. domestic prices only

COVERED BY GSA CONTRACT

You'll find complete specifications on this product and more than 300 data conversion circuits and systems in Gold Book.

Just check Gold Book's Volume 3. That's Datel's complete Engineering Product Handbook, in its own separate volume. More than 290 pages of D/A & A/D Converters, Multiplexers, Sample-Holds, Op Amps, Power Supplies, Digital Panel Meters and Printers, Digital Calibrators, Data Loggers, Digital Cassette Recorders, and Data Acquisition Systems. Each fully detailed on individual data sheets.

And it's available to you in Gold Book.

 **DATEL**
SYSTEMS, INC.

1020 Turnpike St., Canton, MA 02021
Phone: (617) 828-8000

DATEL
D/A CONVERTER
DAC-HP16BMC
MADE IN U.S.A.



See Electronic Design's
1977-78 "Gold Book"-Vol. 3, page 112

Santa Ana, CA (714) 835-2751, (L.A.) (213) 933-7256 • Sunnyvale, CA (408) 733-2424 • Gaithersburg, MD (301) 840-9490 • Houston, TX (713) 932-1130
OVERSEAS: DATEL (UK) LTD—TEL: ANDOVER (0264) 51055 • DATEL SYSTEMS SARL 620-06-74 • DATELEK SYSTEMS GmbH (089) 78-40-45

CIRCLE NUMBER 67

The Best

Das Beste

Les Meilleurs

I Migliori

Er Zijn Geen Betere

Det Bästa

Det Bedste

Los Mejores

Sarvottam

最高

The Best

Das Beste

Les Meilleurs

I Migliori

Er Zijn Geen Betere

Det Bästa

Det Bedste

Los Mejores

Sarvottam

最高

The Best

Das Beste

Les Meilleurs

I Migliori

'VITRAMON' Capacitors.

The best in
any language.

The high quality of our capacitors is known the world over.

In fact, our customers have been calling our products "The Best" for nearly three decades.

We developed the first commercial monolithic capacitor, utilizing our patented porcelain dielectric, and later wrote the industry's first high-quality specifications for ceramic capacitors.

As the industry grew in sophistication and size, we maintained a leadership position based on our technological developments and product quality.

We were once a small Connecticut company which catered almost exclusively to our nation's military needs. But our high-quality products helped us to grow. Now we build products for hundreds of commercial applications world wide — and we have two plants in the U.S.A. and companies in England, West Germany, France, Australia and Japan.

In short, high quality capacitors have put us all over the world map.

Today, more than ever before, it takes advanced engineering, research and technology just to survive — and our capacitors are still ranked as "The Best."

In fact, we've recently written a technical paper to point out how our in-house capabilities, controls and processes helped us to maintain our leadership position. Simply write to us and we'll send you a copy.

Why not? We wrote the book on monolithic capacitors — and are adding important, new chapters every year.

Providing you with "The Best" is what we do — whatever language you speak.

The logo for Vitramon, featuring the word "Vitramon" in a stylized, italicized, sans-serif font with a registered trademark symbol (®) to the upper right.

Vitramon Limited (London)
Vitramon GmbH (Stuttgart)
Vitramon France S.A.R.L. (Paris)

Vitramon North America
Division of Vitramon, Incorporated
Box 544, Bridgeport, Conn. 06601
Tel: (203) 268-6261

Vitramon Pty. Limited (Sydney)
Vitramon Japan Limited (Tokyo)
QCI Corporation (Farmingdale, N.J.)

Datel's New Low Priced Digital Panel Meter

MODEL DM-3100

FEATURES

- ▶ Miniature case with 0.5" LED display
- ▶ Bipolar, differential ± 2 VFS input
- ▶ 3½ Digit resolution with Autozeroing
- ▶ LCD display available at additional cost
- ▶ Additional ranges — customer programmable
- ▶ 4½ digit resolution also available—\$59 (100's)
- ▶ Additional current and ohmmeter capability — customer programmable

\$29*

\$35 (1-99) \$29 (100-499)



You'll find complete specifications on this product and more than 300 data conversion circuits and systems in Gold Book.

Just check Gold Book's Volume 3. That's Datel's complete Engineering Product Handbook, in its own separate volume. More than 290 pages of D/A & A/D Converters, Multiplexers, Sample-Holds, Op Amps, Power Supplies, Digital Panel Meters, and Printers, Digital Panel Instruments, Data Loggers, Digital Cassette Recorders, and Data Acquisition Systems. Each fully detailed on individual data sheets.

And it's available to you in Gold Book.



1020 Turnpike St., Canton, MA 02021
Phone: (617) 828-8000



See Electronic Design's 1977-78
"GOLD BOOK"-Vol. 3, page 226

Santa Ana, CA (714) 835-2751, (L.A.) (213) 933-7256 • Sunnyvale, CA (408) 733-2424 • Gaithersburg, MD (301) 840-9490 • Houston, TX (713) 932-1130
OVERSEAS: DATEL (UK) LTD—TEL: ANDOVER (0264) 51055 • DATEL SYSTEMS SARL 620-06-74 • DATELEK SYSTEMS GmbH (089) 78-40-45

CIRCLE NUMBER 69

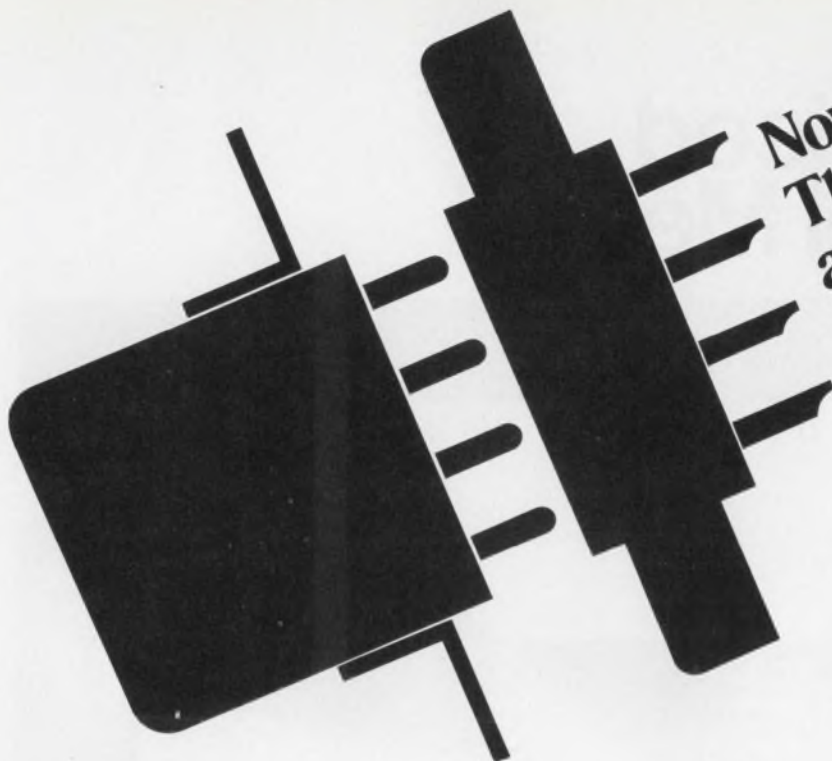

**Now!
There's one simple
answer to all of
your relay socket
needs.**

Us.

We have sockets for just about every crystal can relay made, including those by:

Babcock/Esterline
C. P. Clare
Deutsch
Electronic Specialty
Hi-G
Leach
Struthers-Dunn
Wabco

and more. We have them for relays meeting MIL-R-5757, MIL-R-6106, MS, Buweps, Buord, Navair, BAC... and other specifications in Electronics, Aerospace, and the Military.

Fact is, you'd have to use a very rare relay to miss our line.

How to order.

Our distributor nearest to you has on his shelf the popular sockets that mate with relays of the leading relay manufacturers. Tell him the relay you're using — he'll know the Viking socket that fits.

Quality is tops, of course. So is delivery time. So, call him. And make your life a little easier.

Or send for our detailed 16 page brochure. A copy is yours for the asking.

O.K. Send me your brochure on Viking Relay Sockets.

NAME _____

TITLE _____

COMPANY _____ M/S _____

ADDRESS _____

CITY _____

STATE _____ ZIP _____

TELEPHONE _____



Viking

CONNECTORS

Viking Industries, Inc./21001 Nordhoff St./Chatsworth, Ca. 91311, U.S.A./ (213) 341-4330

CIRCLE NUMBER 70

Modulating SAW devices is made simpler

FM-modulating surface-acoustic wave oscillators with conventional phase-shifting techniques can be complex and difficult. A simpler way is to make use of the magnetoelastic effect in a thin garnet film on which the SAW delay line is deposited. Central Research Laboratories of Thomson-CSF in Orsay, France has grown an yttrium-iron-garnet (YIG) film on a gallium-gadolinium-garnet film by means of liquid-phase epitaxy.

Gallium and gadolinium are exchanged within the YIG film to produce a Gd-Ga-YIG film 9 μm thick. A useful property of this film is that it can be easily saturated in the flat plane.

Next, a 1- μm zinc-oxide piezoelectric film is sputtered onto the magnetic film to form the SAW structure. Interdigital transducer electrodes formed on the oxide layer complete the device (Fig. 2).

When a magnetic field is applied to the delay line, the relative phase-velocity shifts, to give a modulation ratio,

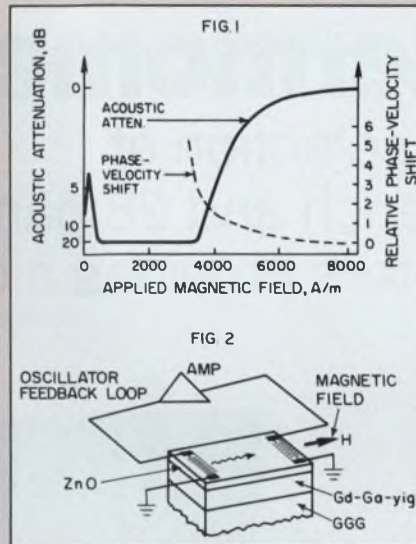

$\Delta f/f$, of about 2.2×10^{-3} (Fig. 1). Acoustic attenuation is also affected. With the present garnet material a 600-kHz frequency shift from an initial value of 340 MHz has been measured for a magnetic-field variation from 3820 to 10^5 A/m.

provides thermal insulation. The assembly is encapsulated.

With pairs of ICs from the same die, the transistors and resistors are closely matched and can be connected in a heat-balancing configuration as shown in the figure.

The voltage being measured, V_{rms} , heats resistor R_1 , and increases the TS_1 collector current. At the noninverting input of the op amp, the voltage decreases, which raises output V_o . This output, in turn, heats up R_2 , which increases the collector current of TS_2 —which tends to reduce V_o . When V_o equals the rms value of V_{rms} , a balance is reached.

The Philips circuit has 0.05% accuracy and the bandwidth is limited only by that of the op amp, so 100 kHz can be easily achieved. The response time is typically 100 ms to 90% of full scale deflection.

Radar calibration comes back to earth

A ground-based way to calibrate a radar in terms of a target's echo area rejects the effects of ground clutter just as effectively as suspending a sphere from a balloon—the usual calibration method.

In the new system, developed by England's Royal Radar Establishment, a pair of triangular trihedral corner reflectors rotate in a horizontal plane at about 200 rpm. The reflectors are attached to a vertical shaft with their open ends facing in opposite directions so that only the reflector turning away is seen by the radar. Towards the radar, a reflector produces a negligible signal.

When the reflector system is placed in the far field of the radar, near enough to ensure a high signal/noise ratio, audio-frequency doppler signals from in-phase and quadrature radar outputs can be derived by standard methods and recorded. These signals can subsequently be digitized and analyzed by a minicomputer to produce curves of power-spectral density against doppler frequency. The technique is particularly suitable for calibrating equipment used to track moving targets.

Rms voltage measured quickly and accurately

A new approach to measuring true rms voltage is said to be more accurate than the two currently used methods.

In one of the current techniques, a thermocouple is employed to measure heat generated when the measured voltage is applied to a resistive heating element. However, this method is slow, and its small output voltage requires error-free amplification.

In the second method, circuitry is used to square the input voltage, integrate the squared value and produce the square root of the integral, which is the rms value. But this method is prone to errors, and its bandwidth is limited by the performance of the analog multipliers used to form the squares and square roots.

The new rms-measuring system developed by Philips of Eindhoven con-

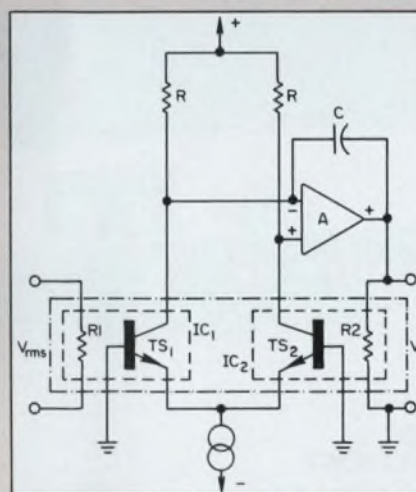

tains two identical integrated circuits each containing a resistor and a heat-sensing transistor. The ICs are mounted on a small glass plate, which

The most comprehensive line of thermometers!

United Systems' selection of 13 portable, 12 bench and 28 panel mount, digital thermometers provides a choice of:

SENSORS;

Thermistor, Thermocouple or
Platinum Resistance

RESOLUTION & REPEATABILITY;

1°, 0.1° or 0.01°

RANGES;

From -320° to +3200°F or from
-190° to +1600°C

DISPLAYS;

LCD or LED

POWER;

Integral batteries and
line operated

AND THAT'S NOT ALL;

Switch selectable °C and °F,
Multiple probe inputs,
Optional Analog Outputs,
Rugged LEXAN® Case,
Compact Sizes,

Prices from \$268.00!

Call or write for full details.



**UNITED
SYSTEMS
CORPORATION**

918 Woodley Road, Dayton, Ohio 45403
(513) 254-6251 TWX (810) 459-1728

*United Systems Corp.:
Precision measurements to count on*

CIRCLE 236 FOR PORTABLE

CIRCLE 237 FOR BENCH

CIRCLE 238 FOR PANEL MOUNT

Make us your headquarters for

EMI/RFI FILTERS



Passive Filter Headquarters:

Centralab Los Angeles is a one-stop source for reliable miniature ceramic low pass Feed Thru's/Filters. They're cost effective from 30 KHz to beyond 1 GHz. Threaded or solder mount for easy installation. Proven in AC as well as DC applications. Monolithic and multi-element. Standard products or computerized custom designs, including multi-circuit custom packages. Call Rich Colburn at (213) 240-4880.

Active Filter Headquarters:

That's Centralab Milwaukee. Solve design problems and cut costs with our thick film hybrids. Band pass, low pass, high pass and band reject. Cost effective for low to medium frequencies. Let us put our design and manufacturing expertise to work for you. Call Don Weiland at (414) 228-2872.



CENTRALAB
Electronics • GLOBE-UNION INC.

4561 Colorado Blvd., Los Angeles, California 90039
5757 North Green Bay Ave., Milwaukee, Wisconsin 53201

CERAMIC CAPACITORS • FILTERS • POTENTIOMETERS • SWITCHES
THICK FILM CIRCUITS • TRIMMER RESISTORS

Arrow-M R Relays

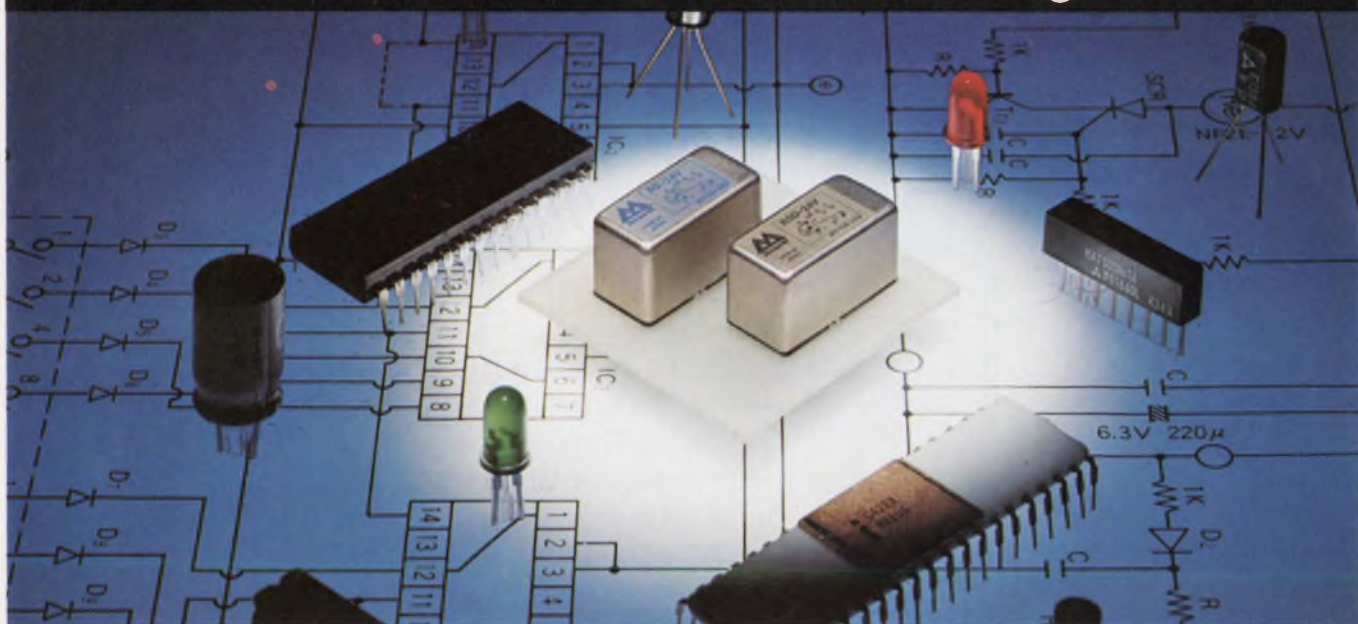

The many advantages and unique capabilities of Arrow-M's R Relays are far too extensive to be covered here. Therefore, we'd like to whet your creative appetite with a few outstanding facts:

1. Arrow-M R Relays are available in 1 Form C contacts which can carry a high current capacity of 1 Ampere 20 watts, and are capable of resisting welding at higher inrush currents. The dry circuit type which can switch current as low-level as 100uA is available in addition to the power type.

2. *High Speed:* Arrow-M R Relays can be operated at 500 cycles/sec.

The tiny power memory reed

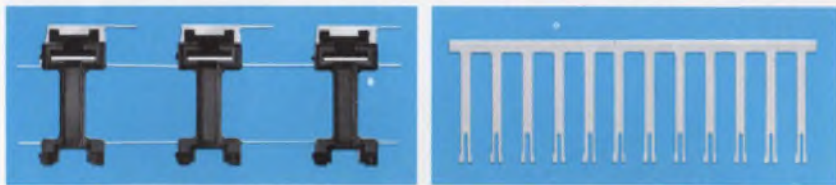

3. Greater reliability and lower cost, due to simultaneous automatic fabrication of coil bobbin, contact and terminal.

4. In addition to the standard there are 1 coil and 2 coil latching types, which are useful for logic circuit design as a memory component.

5. Not only can they be automatically wave soldered on PC boards with a high density of electronic parts, but they are simple to clean with most degreasers and detergents without affecting maximum contact reliability.

6. *High Sensitivity:* Minimum operating power: Single Side Stable 80 mw/Bistable 40 mw

7. *Longer Life:* Mechanical: More than 10^9 operations.
Electrical: More than 10^6 operations.
(1A 20vdc, 0.3A 110vac)

Hungry for more information?
For exact specifications
on all of our relays,
write or call your
nearest Arrow-M office.

Arrow-M Corporation
250 Sheffield Street
Mountainside, NJ 07092
(201) 232-4260

Mid-Western Office:
600 E. Higgins Rd.
Elk Grove Village, Ill. 60007
(312) 593-8535

Western Office:
22010 So. Wilmington Ave.
Suites 300 & 301
Carson, Calif. 90745
(213) 775-3512

Relays for Advanced Technology



CIRCLE NUMBER 73

New products

Digital process monitor uses PROM for scaling

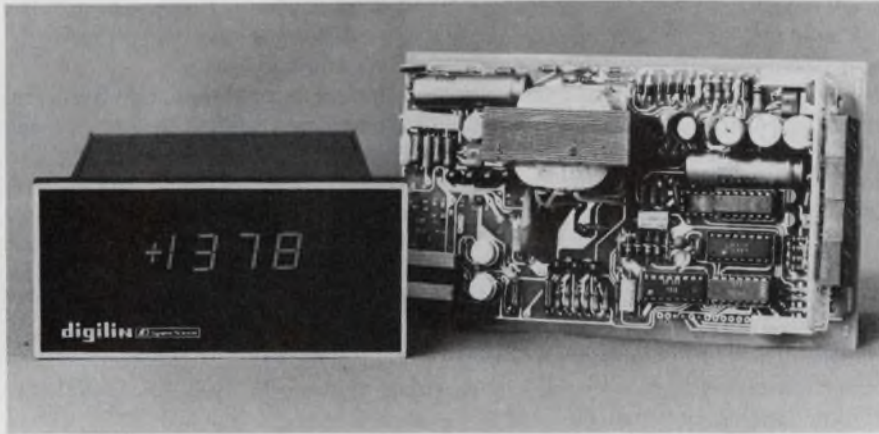

Dynamic Sciences Corp., 16150 Stagg St., Van Nuys, CA 91406. Roger Swire (213) 893-6341. P&A: See text.

The Digilin Series 7000, from Dynamic Sciences, looks much like other digital panel meters. But this DPM, called a "digital process monitor," uses a programmable read-only memory to "shape" the magnitude of nonlinear analog input signals directly into the desired engineering units.

Operating rather like indirect addressing in a computer, the PROM "buffers" the display from the analog input, and is programmed according to the nonlinearity of the function being monitored.

For example, the volume of liquid in a tank won't be directly proportional to the output from a pressure transducer mounted near the bottom of the tank. The nonlinear relationship will depend on many parameters: the size, shape and attitude of the vessel, the sensitivity and location of the transducer, the specific gravity of the liquid, and other factors. Dynamic Sciences will program the internal PROM of a Series 7000 meter to meet the specific requirements of a customer's application.

Inside the 7000, an input value is digitized to select a PROM address that

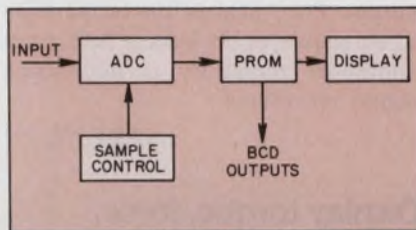

holds the correct display value for that particular value. Two trip points also burned into the PROM serve as limit switches and are available on two discrete output lines.

The 7000 has three input current ranges (0 to 1, 4 to 20, and 10 to 50 mA) and three voltage ranges (0 to 1, 1 to 5, and 0 to 10 V). Its over-all accuracy is spec'd at $\pm 0.1\% \pm 1$ bit. The 7000 provides 500-V-dc input-to-line isolation, and can be either triggered or set to sample asynchronously.

One 7000 costs \$568, and delivery takes 30 days. Two options are available—a TTL-compatible, BCD representation of the displayed value for \$50, and a high-intensity LED readout for \$15.

By early next year, the firm expects to offer a field-programmable option so that the PROM may be burned on-site.

CIRCLE NO. 301

Portable logic analyzer is primary/back-up unit

Biomation, 10411 Bubb Rd., Cupertino, CA 95014. Ed Jacklitch (408) 255-9500. \$1295; 8 wk.

A 9-channel logic analyzer (920 D) can be used as a medium-performance primary instrument or as an economical back-up unit. Its size is $6 \times 10.5 \times 17.25$ in., and it weighs 9.5 lb. It has connections for plugging into any oscilloscope or CRT. Built-in are a versatile auxiliary channel, clock or event-trigger delay, a 20-MHz record rate, combinational triggering and a 10-ns glitch-detection feature. The unit has a 9-bit \times 256-word memory capacity using a static RAM.

CIRCLE NO. 302

Dual-trace scope checks logic circuits



Tektronix, P.O. Box 500, Beaverton, OR 97077. Maury Floathe (503) 644-0161. \$1225.

Model-442 dual-trace oscilloscope provides the bandwidth (dc to 35 MHz) needed to troubleshoot most logic circuits. Its 2-mV/div sensitivity allows the user to display and measure low-level signals typical of those from magnetic storage or modems. Full X-Y capability plots Channel-1 vertically against Channel-2 horizontally. Calibrated sweep-speed range is from 10 ns/div to 0.5 s/div. The 150-mV external trigger sensitivity permits the user to trigger on TTL levels when a 10 \times probe is required to minimize capacitive coupling. The display measures 8×10 cm.

CIRCLE NO. 303

giga-trim capacitors for microcircuit designers

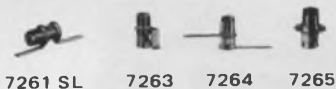
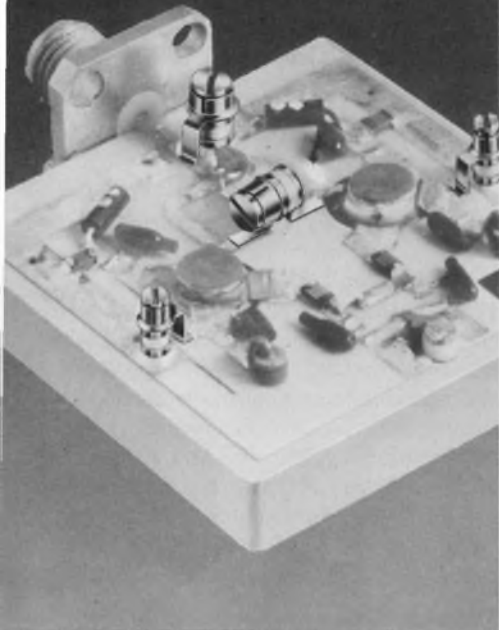

Giga-Trim® (gigahertz-trimmers) are tiny variable capacitors which provide a beautifully straight forward technique to fine tune RF hybrid circuits and MIC's into proper behavior. They replace time consuming cut-and-try adjustment techniques and trimming by interchange of fixed capacitors.

Applications include impedance matching of GHz transistor circuits, series or shunt "gap-trimming" of microstrips, external tweaking of cavities, and fine tuning of crystal oscillators.

Johanson

MANUFACTURING CORPORATION

BOONTON, NEW JERSEY 07005

201 / 334-2676

CIRCLE NUMBER 74

176

INSTRUMENTATION

Vary width and delay of 50-MHz pulse generator



Wavetek, P.O. Box 651, San Diego, CA 92112. John Roth (714) 279-2200. \$595; 6 wk.

The Model-802 50-MHz pulse generator features variable width and delay over the 5-Hz to 50-MHz operating range. Continuous, triggered, gated and external width operation are selectable with single, double or complement pulse outputs. Four simultaneously available outputs are a ± 10 -V variable, a fixed TTL, a fixed TTL complement and a TTL compatible sync output. The variable output has independently adjustable upper and lower pulse voltage levels. For optimum loading, internal 50- Ω termination is selectable on the variable output. Placement of the termination at the source, at the load, or both, gives additional versatility in minimizing signal reflections.

CIRCLE NO. 304

Display torque, force, power in metric/English



Electronic Systems Design, 317 W. University Dr., Arlington Heights, IL 60004. Orville Allen (312) 398-0550.

Digital speed/load processor, Model MP-7301, is an instrument that displays torque, force or power in metric, English or SI (Systems International d'Unites) units plus rpm. It gives a switch-selectable choice of reading torque, force or power. A simple jumper change quickly selects unit value, while rpm is displayed continuously. Interface circuitry for printers, chart recorders or other peripherals is optional.

CIRCLE NO. 305

Rf controller extends range of frequency meter



Weinschel Eng., Gaithersburg, MD 20670. Don Krivos (301) 948-3434. \$2795; stock to 8 wks.

The range of swept and fixed frequency measurement systems, having a 1-kHz, 100% square-wave modulated source, can be extended with a precision rf attenuation controller, Model 1811. The extended range is accurate to 0.02 dB per 10 dB. The device varies the power level at the insertion point in accurate steps of 10, 20, and 30 dB. An added feature is signal-source leveling, typically 0.0005 dB/dB (steady state).

CIRCLE NO. 306

Digital multimeter has one-button range



Leader Instruments, 151 Dupont St., Plainview, NY 11803. Patrick Redko (516) 822-9300. \$200.

One-button, semi-automatic range switching which facilitates fast and accurate measurements and eliminates time-consuming "knob-twisting" is among the features of the LDM-851. It is a battery operated 3-1/2 digit LED-display multimeter with crystal-controlled signal generator. Range coverage is from 1 mV to 1000 V in 16 ranges, ac/dc volts, dc current, plus fully automatic 20-M Ω resistance range.

CIRCLE NO. 307



Mi chiquita, si...mi C-Meter, no.

Don't ask. This man isn't going to compromise. He knows that the pushbutton speed, high accuracy (0.1%), compact size and versatility (0.1 pf to 0.2 farads) make him faster on the draw than any reactionary still shaping up circuits by measuring resistors.

With the C-Meter®, you'll measure capacitors as standard operating procedure. You'll waste no time twiddling and nulling, and you'll cut the need for

costly tight-tolerance capacitors or tweak pots. You'll be as speedy as Gonzales...and popular too. People just can't keep their hands off the C-Meter. You owe it to yourself to try one. Our reps are friendly and stock them at **\$289**.

Capacitors supplied by Apollo Electronics, Inc.

ECD CORP.
196 Broadway, Cambridge
Mass. 02139 (617) 661-4400



CIRCLE NUMBER 75

SALES OFFICES: AL, Huntsville (205) 533-5896; AZ, Scottsdale (602) 947-7841; CA, Costa Mesa (714) 540-7160; CA, Sunnyvale (408) 733-8690; CO, Denver (303) 750-1222; FL, Winter Haven (813) 294-5815; GA, Chamblee (404) 457-7117; IL, Elk Grove Vill (312) 593-0282; IN, Indianapolis (317) 293-9827; MD, Silver Spring (301) 622-4200; MA, Wakefield (617) 245-5940; MN, Minneapolis (612) 781-1611; MO, Kansas City (816) 358-7272; So. NJ/Philadelphia (215) 674-9600; NM, Albuquerque (505) 299-7658; NY, Great Neck (516) 482-3500, (212) 895-7177; Syracuse (315) 446-0220; NC, Raleigh (919) 787-5818; OH, Centerville (513) 433-8171; TX, Houston (713) 688-9971; TX, Richardson (214) 231-2573.

INSTRUMENTATION
Current gun-probe tests without contact



F. W. Bell, 4949 Freeway Drive East, Columbus, OH 43229. Chet Mitchell

(614) 888-7501. \$165.

A noncontact "current-gun" probe permits current measurements, from dc to 1 kHz, of zero to 200 A with any voltmeter, multimeter or scope. The probe has three controls: a range selector (to set the instrument for 1 V per 10 A or 1 V per 100 A); a zero adjustment (with or without a current being measured); and a push-to-read or lock-on switch. Self-contained batteries power the unit which has an accuracy of 2.5%.

CIRCLE NO. 308

Digital milli-ohmmeter has low 10-mΩ range



James G. Biddle, Plymouth Meeting, PA 19462. (215) 646-9200.

A "Tettex" compact milli-ohmmeter makes four-terminal low-resistance Kelvin measurements, and includes a low 10-mΩ range. The set has a 4-digit display, angled for improved readability, and convenient terminals at the back of the unit. The low 10-mA test current will not heat up or affect most test samples. Measurement accuracy is 0.5% with 10 μΩ resolution. BCD output is an option.

CIRCLE NO. 309

If you have trouble isolating your inputs from your outputs read this book.



This FREE book shows you how to stay out of trouble with low cost Analog Devices isolation amplifiers. Including our latest version, the 286J which offers improved performance for applications in instrumentation, industrial and bio-medical applications. This new design features multi-channel capability for applications in multi-channel data acquisition systems ranging from 2 to over 1000 isolated data points. (\$37 in 100's)

Radio baseband test-set tests low density units

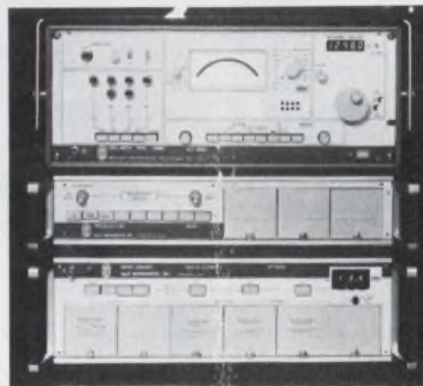

W & G Instruments, 119 Naylor Ave., Livingston, NJ 07039. (201) 994-0854. \$5355 to \$6600; stock.

The radio baseband test system (RBTS) is a general maintenance tool for radio systems of up to 960-channel capacity. The instrument acts as a selective level meter (for pilot tones, carrier leak, spurious-tone search, system frequency response and alignment), a wideband meter (for measurement of total system load), a voice channel meter (for level measurements, voice channel distortion and voiceband switching tones), and as a white noise test-set (for intermodulation distortion tests and idle-channel noise monitoring).

CIRCLE NO. 310

ANALOG DEVICES

P. O. Box 280 Norwood, MA 02062

Please send me your FREE "Isolation and Instrumentation Amplifiers Designers Guide" and 286J data sheet.

Name _____
 Title _____ Telephone _____
 Company _____
 Address _____
 City _____ State _____ Zip _____

ED1122

CIRCLE NUMBER 76

From a single CPU board



to a half million word super computer

That's the selection you get from Rolm's AN/UYK-19 family. It's the most complete line of Mil-Spec computers in the industry. And every piece is backed by extensive, updated, upward compatible software.

Delivery? 30 days or less because they're all standard products in continuous production. Plus they follow a modular concept for interchangeability, compatibility and upgrading.

Rolm completes the package with full nomenclature and an integrated line of both military and commercial peripherals.

In just seven years we've been able to put together a family plan that lowers your programming costs, reduces hardware costs, cuts out your risk and gives you quicker reaction time.

That's Why We're #1 in Mil-Spec Computer Systems

ROLM

MIL-SPEC
Computers

4900 Old Ironsides Drive, Santa Clara, CA 95050. (408) 988-2900. TWX 910-338-7350.

In Europe: 645 Hanau, Muehlstrasse 19, Germany, 06181 15011, TWX 418-4170.

CIRCLE NUMBER 77

INSTRUMENTATION

Digital multimeter reads ac and ac ratios

Dana Laboratories, 2401 Campus Dr., Irvine, CA 92715. N. Laengrich (714) 833-1234. \$3495; 12 wk.

The Model 5940, 5½-digit ratiometer, features four ranges of ac reference and four ranges of ac signal input (1,

10, 100, 1000 V). The instrument also features switchable front and rear input and switchable ac or dc coupling on the ac converters. Both the input and coupling configurations are front-panel switchable and/or remotely programmable. In addition to the ac/ac-ratio capability, it has five dc ranges with accuracies of $\pm 0.001\%$ of full scale (10 ppm), eight ranges of resistance, and 4-wire/4-quadrant dc ratio.

CIRCLE NO. 314

Modules adapt scope for audio measurements

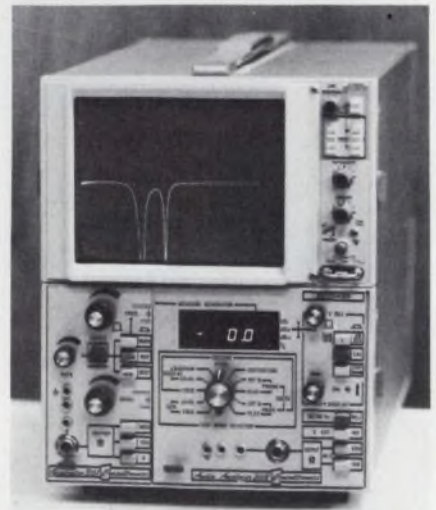

Consultronics, 500 Union Blvd., Totowa, NJ 07512. Peter Hame (201) 278-6456.

The 300-Series audio analyzer system—for measurements on telephone, program and data channels as well as broadcast facilities and equipment—is a series of modular plug-ins for a Tektronix 5111 mainframe. Modules include: the 301 generator, supplying swept and fixed signals; the 302 receiver that displays frequency, level, distortion and noise and also controls the storage-scope display; and the 306 stereo receiver that identifies phase and level difference between two channels. A remote-controlled, free-standing generator has a "dial-up" feature and program interrupt.

CIRCLE NO. 316

Testing low ESR Capacitors at 10 kHz/20 kHz



assures low "switching" power.

Due to its remarkable versatility, ESI's Model 296 Automatic LRC Meter now measures capacitors at 10 kHz or 20 kHz. You can quickly and accurately verify ESR to assure low power switching regulator power supplies. (As a dual frequency instrument the Model 296 is available with either of those higher frequencies, plus 1 kHz or 120 Hz as the second frequency.)

ESI's premier LRC tester gives you everything you could want—for now or the foreseeable future: Wide ranges, choice of any loss parameters—R, G, D or Q—with either L or C, direct reading or deviation display and field installable options. Options include dc resistance measurements and interfaces for GPIB, 11-bit serial bus, card readers and automatic handlers. Basic price (in the U.S.A. only) is \$5700.

- L,R,C,G + D&Q.
- % and units deviation.
- multiple limits.
- 2 farad range.
- dual frequencies.
- dual displays.
- dual voltages.
- active guard.
- 6 terminal connections.
- high accuracy.
- high speed measurement.
- programmable settling time.
- digital averaging.
- interface options.

Another ESI
"easy weeder"



Electro Scientific Industries
13900 N.W. Science Park Drive
Portland, Oregon 97229
Phone: 503/641-4141



CIRCLE NUMBER 78

Compact color generator subs for TV tuner

Science Workshop, P.O. Box 393, Bethpage, NY 11714. Murray Barlowe (516) 731-7628. \$89.95.

A two-in-one instrument, with a size of 2 x 2-3/4 x 6-3/4 in., acts as a TV tuner and 16-pattern color-dot/bar generator. The tuner-subber provides continuous electrical channel tuning. The color generator uses a MOS-LSI chip to provide 16 stable patterns—including rainbow, color bars, noise-free raster (for purity and gray scale), plus dots, lines and crosshatches. Composite video output is 1.5 V pk-pk and rf output is adjustable from channels 2 to 4. The unit has crystal-controlled master and color oscillators.

CIRCLE NO. 317

Berg Tri-Socket™ takes leads of all sizes in Modcomp Minicomputer Family

Berg Electronics' Tri-Socket is a .025" square wire-wrapping or solder-tab design which accommodates a variety of lead sizes. Its tri-cornered fins retract upon staking, providing gentle entry into the board. A solder rivet (precisely positioned above the fins) is ready for reflow.

Modular Computer Systems appreciates the reliability of the one-piece, Tri-Socket design and uses this socket in virtually all of its minicomputer models. Modcomp has found it can rely on Berg Electronics . . . to supply the terminals and the application machines that precisely

meet its interconnection needs.

Berg is experienced. We read interconnection needs like Modcomp reads compatibility requirements. We have the products, the background and the back-up to do the job. Your job. Let's work on it together. Berg Electronics Division, E. I. du Pont de Nemours and Company, New Cumberland, PA 17070 Phone 717-938-6711.

 **BERG ELECTRONICS**

CIRCLE NUMBER 79

We serve special interests—yours!

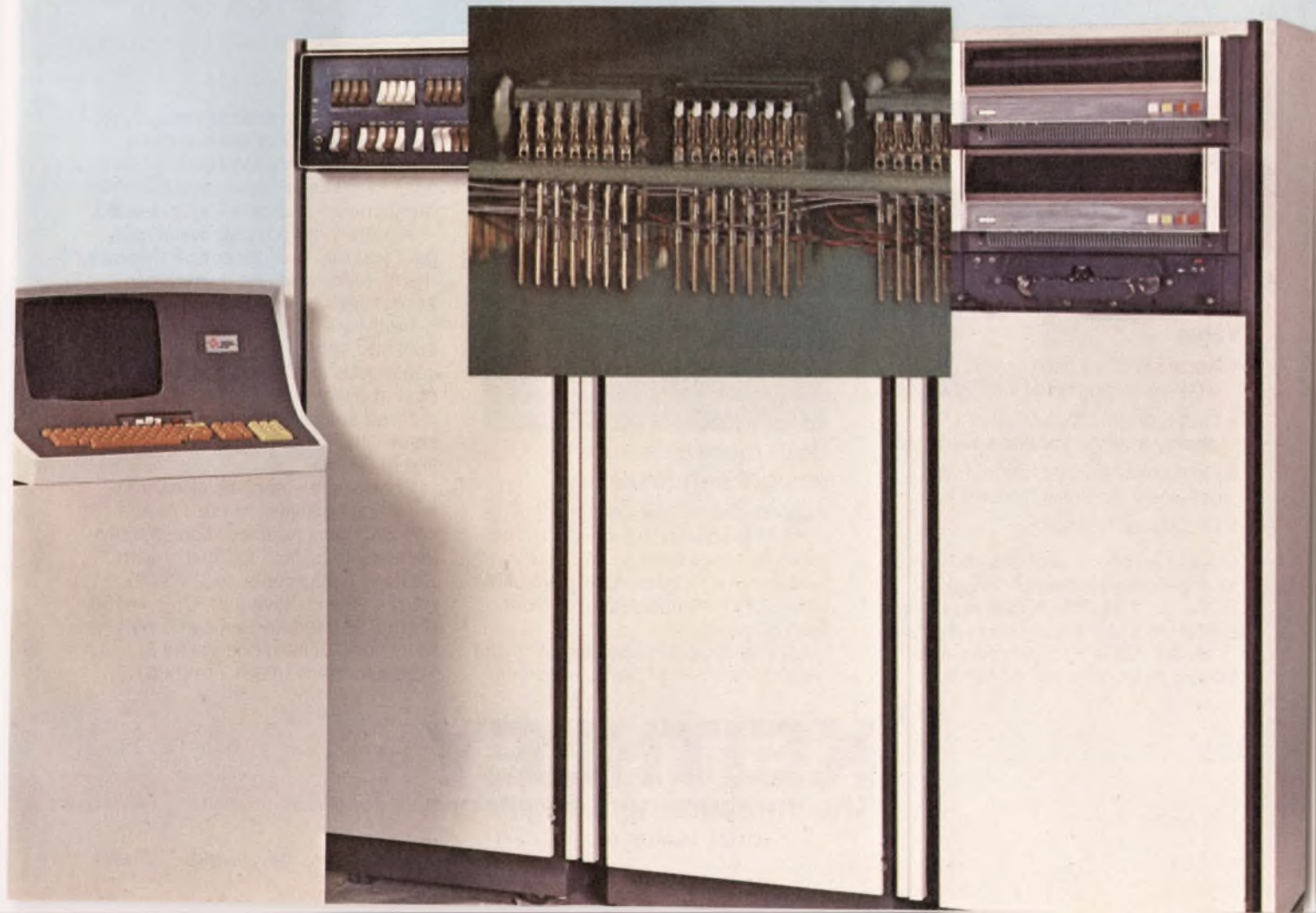
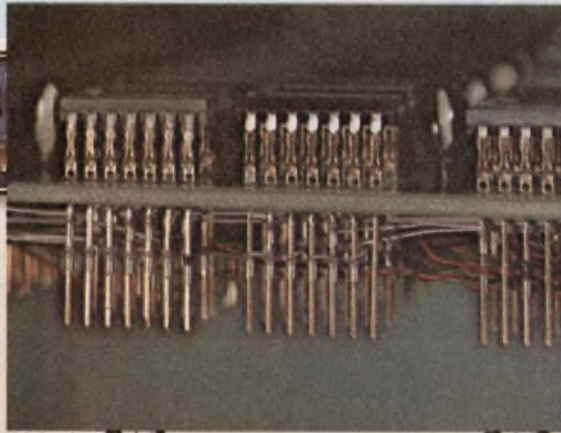



Model 178

Now... the next generation of bench DMMs!

Two New Keithley Models offer uncompromising performance and outstanding value.

- Accuracy 3½'s can't match: 0.04% + 1 digit on dc volts and ohms.
- Large, bright, 20,000-count LED display that's quick and easy to read.
- Convenient bench size that won't get "lost" yet doesn't crowd.
- Exceptional reliability.

Model 178 offers functions and ranges for most measurements: 100μV to 1200V dc, 100μV to 1000V ac, 0.1Ω to 20MΩ. At \$199* it is a remarkable value!

Model 179 is a full-function, multi-feature model offering the same

advantages as the 178. Plus TRMS AC; 10μV Sensitivity; Hi and Lo Ohms; AC and DC Current. Yet it's still half the price you'd expect. Only \$289*!

Model 179



Both models feature designed-in reliability.

Rugged circuits use a minimum of parts—high quality, off-the-shelf parts—carefully assembled and tested by Keithley (we've been making sensitive laboratory instrumentation for more than 30 years.)

Outstanding overload protection and rugged mechanical design keep both

units going even after severe abuse. One-year accuracy specifications minimize recalibration costs. Local assistance keeps downtime to a minimum should service ever be needed.

A battery option, user installable, gets you off "line" for critical measurements or for field use. Nine other accessories add versatility.

Keithley's 178 and 179 are designed, built and supported to provide continuous usability at the lowest total cost of ownership.

Need autoranging, more accuracy or sensitivity? See Keithley's complete line of DMMs.

For complete specifications and immediate delivery on the 178 and 179, call your local Keithley representative (see adjoining list). Or, call or write: Keithley Instruments, Inc., 28775 Aurora Road, Cleveland, Ohio 44139. (216) 248-0400. In Europe: D-800 München 70, Heiglhofstrasse 5, West Germany. (089) 7144065.

KEITHLEY

The measurement engineers.

*U.S. domestic price only.

CIRCLE NUMBER 80

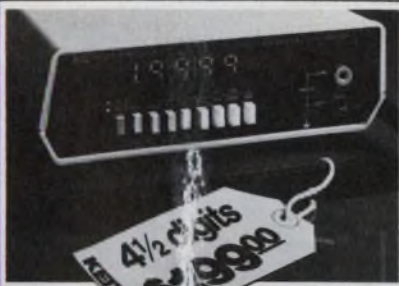

To order your Keithley DMM:

ALABAMA: Huntsville, (205) 883-8660
ARIZONA: Phoenix, (602) 944-9185
ARKANSAS: (214) 231-9489 (Dallas, TX)
CALIFORNIA: Los Angeles, (213) 836-6170
 San Diego, (714) 226-6605
 San Francisco (408) 247-8333
COLORADO: Denver, (303) 795-0250
CONNECTICUT: (800) 223-3409, Toll Free
DELAWARE: (215) 657-0330 (Philadelphia, PA)
DISTRICT OF COLUMBIA:
 (703) 573-8787 (Arlington, VA)
FLORIDA: Ft. Lauderdale, (305) 776-4800
 Melbourne, (305) 723-0766
 Orlando, (305) 425-5505
 Pensacola, (904) 243-6124
GEORGIA: Atlanta, (404) 939-1674
IDAHO: (303) 795-0250 (Denver, CO)
ILLINOIS: Chicago, (312) 585-5485
INDIANA: Indianapolis, (317) 293-0696
IOWA: Cedar Rapids, (319) 365-8071
KANSAS: Kansas City, (913) 492-7020
 Wichita, (316) 788-0621
KENTUCKY: Lexington, (517) 293-0696
 (Indianapolis, IN)
 Louisville, (216) 729-2222 (Cleveland, OH)
LOUISIANA: Baton Rouge, (504) 626-9701
MAINE: (617) 944-6660 (Boston, MA)
MARYLAND: Baltimore, (301) 321-1411
 South, (703) 573-8787 (Arlington, VA)
MASSACHUSETTS: Boston, (617) 944-6660
MICHIGAN: Detroit, (313) 569-4497
MINNESOTA: Minneapolis, (612) 559-1976
MISSISSIPPI: (504) 626-9701 (Baton Rouge, LA)
MISSOURI: St. Louis, (314) 426-7055
MONTANA: (303) 795-0250 (Denver, CO)
NEBRASKA: (913) 492-7020 (Kansas City, KS)
NEVADA: (213) 836-6170 (Los Angeles, CA)
NEW HAMPSHIRE: (617) 944-6660 (Boston, MA)
NEW JERSEY: North, (201) 368-0123
 South, (215) 657-0330 (Philadelphia, PA)
NEW MEXICO: Albuquerque, (505) 255-2440
NEW YORK: Metro New York, (201) 368-0123
 Syracuse, (315) 454-9314 (Paramus, NJ)
NORTH CAROLINA: Durham, (919) 682-2383
NORTH DAKOTA: (612) 559-1976 (Minneapolis, MN)
OHIO: Cleveland, (216) 729-2222
 Dayton, (513) 434-8993
OKLAHOMA: (214) 231-9489 (Dallas, TX)
OREGON: Portland, (503) 297-2248
PENNSYLVANIA: Philadelphia, (215) 657-0330
 Pittsburgh, (216) 729-2222 (Cleveland, OH)
RHODE ISLAND: (617) 944-6660 (Boston, MA)
SOUTH CAROLINA: Columbia, (803) 798-3297
SOUTH DAKOTA: (612) 559-1976 (Minneapolis, MN)
TENNESSEE: Oak Ridge, (615) 482-5761
TEXAS: Austin, (512) 451-7463
 Dallas, (214) 231-9489, Houston, (713) 783-1492
UTAH: (303) 795-0250 (Denver, CO)
VERMONT: (617) 944-6660 (Boston, MA)
VIRGINIA: Arlington, (703) 573-8787
WASHINGTON: Bellevue, (206) 454-3400
WEST VIRGINIA: (216) 729-2222 (Cleveland, OH)
WISCONSIN: Milwaukee, (414) 464-5555
WYOMING: (303) 795-0250 (Denver, CO)

CANADA

BRITISH COLUMBIA: Vancouver, (604) 732-7317
MANITOBA: Winnipeg, (204) 475-1732
ONTARIO: Toronto, (416) 638-0218
 Ottawa, (613) 521-8251
QUEBEC: Montreal, (514) 735-4565

EUROPE

FRANCE: Palaiseau, (01) 328-00-48
UNITED KINGDOM: Reading, Berks.
 (0734) 861287/88
WEST GERMANY: München, (089) 7144065

Or call Keithley's Toll Free
 DMM Hot Line (800) 321-0560

KEITHLEY
 The measurement engineers.

MICRO/MINI COMPUTING

Static memory has wide range of capacity

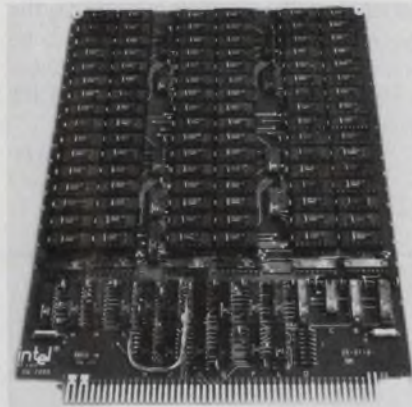

Intel Memory Systems, 1302 N. Mathilda Ave., Sunnyvale, CA 94086. Connie Magne (408) 745-7120. See text; 12-24 wk.

The in-7000 static semiconductor-memory system has a range of memory capacity of 16 to 256 kwords and 6 to 96 bits word size. The basic in-7000 card is available in four 16-k configurations: 16 k × 12, 20 or 24 bits. In each case, the user may change the card to the corresponding 32 k × 6, 8, 10 or 12 bits configuration by operating the byte-control input line. Read and write cycle times are 250 ns (7000 version), 350 ns (7001) and 500 ns (7002). Card is 8.175 × 10.5 in. and can be mounted on 1/2-in. centers. Cards of 16 k × 24 bits are priced from 0.28¢/bit. Complete systems cost less than 0.5¢/bit.

CIRCLE NO. 318

Build EPROM programmer with parts kit

Cramer Electronics, 85 Wells Ave., Newton, MA 02159. (617) 969-7700. \$99.95; stock.

The EPROM programmer kit is a complete package of the components, software and design documentation necessary to build a self-contained programmer for any 2708 (1-k × 8) or 2704 (512 × 8) EPROM. All timing requirements of the EPROM are taken care of by the hardware, allowing the programmer to operate asynchronously with the processor. The ability to read the EPROM from its socket has been provided, allowing the user to implement adaptive programming techniques, and/or allowing the user to verify the contents of the EPROM.

CIRCLE NO. 319

Digital output boards are for Motorola μCs

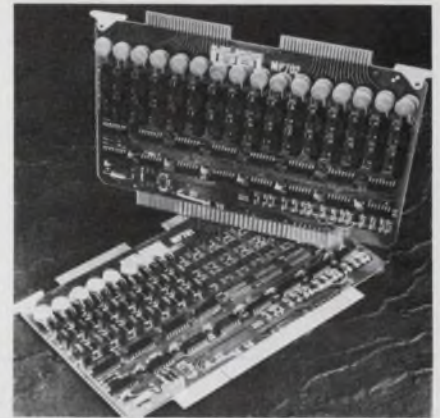

Burr-Brown, P.O. Box 11400, Tucson, AZ 85734. C.R. Teeple (602) 294-1431. \$295 to \$475; stock.

Users of Motorola Micromodule and EXORcisor μC systems can obtain a plug-compatible 16 or 32-channel isolated digital-output system that is memory mapped. The MP701 (16-channel) and MP702 (32-channel) systems provide all necessary control and timing circuitry and include contact-closure outputs rated at 28 V and 0.5 A. They are treated as memory by the CPU, for ease of programming. Eight output channels occupy one memory location.

CIRCLE NO. 320

μC system intended for OEM users



Electronic Product Assoc., 1157 Vega St., San Diego, CA 92110. Chuck Benet (714) 276-8911. \$695; stock.

Designed especially for the OEM, the M68-MBC μC comes complete with hex keyboard, 6-digit hex display, monitor program, general-purpose board, four-slot motherboard and flexible mounting system. The mounting frame, which will accept three peripheral boards has brackets to allow for front, back, side or 19-in. rack-panel mounting. The main computer board will accept up to 768 words of RAM, 2.5 k of PROM and TTY/CRT/cassette interface.

CIRCLE NO. 321

MICRO/MINI COMPUTING

Floppy disc reduces μ P assembly time

Fairchild Camera & Instrument, 1725 Technology Dr., San Jose, CA 95110. (408) 998-0123.

Formulator FD is a floppy-disc operating system for the F8 and F3870 μ P design aids. It reduces the time re-

quired to write, edit, assemble, execute and debug the μ P programs. The system has features such as batch or interactive operation, relocating assembler, linking loader, virtual I/O, string editing, and real-time symbolic debugging. When fully configured, the system consists of a Formulator, one or two dual-drive floppy-disc cabinets with intelligent controllers and a CRT or printing terminal.

CIRCLE NO. 322

Desktop μ C claims largest built-in storage



Hewlett-Packard, 1501 Page Mill Rd., Palo Alto, CA 94304. (415) 493-1501. \$12,000, 12 wks.

System 45, a desktop computer, is claimed to have the most powerful central processor and the largest built-in mass storage system in a desktop computer. Storage devices include a built-in 210 kbyte tape cartridge system, an external 460 kbyte flexible-disc drive, and a choice of external hard-disc drives with capabilities of 15 to 50 Mbytes. The basic system has 16 kbytes of read/write memory, with 13,498 bytes available to the user. This memory can be expanded to 64 kbytes, with 62,650 bytes available to the user. The system is 18.5 x 19 x 26.25 in. and weighs 75 lb.

CIRCLE NO. 323

Diskette storage units are IBM compatible

Per Sci, 12210 Nebraska Ave., W. Los Angeles, CA 90025. (213) 820-3764.

A series of IBM compatible mass storage systems for minicomputer applications has formatted data capacities to 1 Mbyte. The systems use the Model 277 dual diskette drives and are available in a variety of configurations: a one or two drive system complete with μ C-based controller, power supply and cabling; a one or two drive system with power supply and cabinet but without controller; a "slimline" system, 4.5 in. wide when vertically mounted, using one dual drive and a power supply in a table-top chassis. The 1070 controller, which can be used in the two-drive system, is also available for mounting in a host system. An "intelligent" controller, the 1070 includes an 8080 μ P and has an internal disc operating system in firmware. The systems are available with interfaces to most μ Cs.

CIRCLE NO. 324

Q: Is there a recorder just for spectrum analyzers?

A:

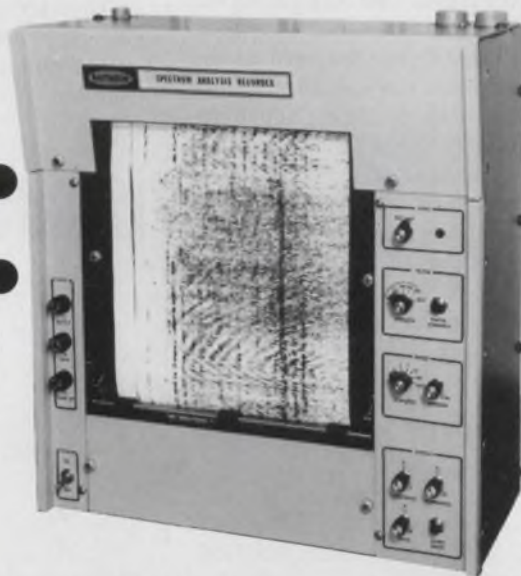

The new 19" rack-mounting SPECTRUM ANALYSIS RECORDER from Raytheon. It's the first dry paper line scanning recorder specifically developed for direct plug-in operation with commercially available spectrum analyzers.

Any new or existing spectrum analyzer equipped with the SAR-097 will have a lot more going for it. Like infinitely variable 100:1 speed range - 5 sec/scan to 50 milliscan... stylus position encoder... automatic recorder synchronization... computer/analyzer compatibility... high resolution and dynamic range... all-electronic drive. And more.

If you design and build - or buy and use - spectrum analyzers, you don't have to settle for multi-purpose recorders any more. The SAR-097 is here. For full details write the Marketing Manager, Raytheon Company, Ocean Systems Center, Portsmouth, Rhode Island, 02871. U.S.A. (401) 847-8000.

RAYTHEON

CIRCLE NUMBER 82

THE SWEETEST AM/FM MODULATION METER THIS SIDE OF HEAVEN.



...with features that are simply
unavailable on competing units
at any price.

Like a digital display for better accuracy on either AM or FM than any other meter; like built-in post-detection Butterworth filters; and the ability to be controlled and talk to your system through the IEEE-488 Bus.

Even more, the 82AD combines the "easy on the mind" features of automatic tuning and leveling found in the latest service-type modulation meters, with the versatility and accuracy of high-quality lab-type manual meters.

Music to your ears? Well listen to this:
Carrier Range: 10 MHz—1.2 GHz
Sensitivity: 10 mV to 520 MHz, 30 mV to 1.2 GHz
FM Deviation: 10, 100, 300 kHz fs
FM Accuracy: 2% of reading at rates from 30 Hz to 100 kHz
AM Range: 10, 100% fs
AM Accuracy: 2% of reading from 10 to 90% AM, 30 Hz to 100 kHz
BW Options:

IEEE-488 Bus Interface; battery supply
Ask your nearest Boonton rep to let you see the 82AD, and he'll also bring along a free record album containing hits of the Big Band Era. The record is yours to keep. But we're betting you'll want the 82AD, too. Write or call Boonton Electronics, Rt. 287 at Smith Rd., Parsippany, N.J. 07054; (201) 887-5110.

BOONTON



New terminals from old typewriters

Edityper, 26 Just Rd., Fairfield, NJ 07006. (201) 227-4141. See text.

With the introduction of an "in-between" package, Editype has broadened its Selectric-conversion offers. A kit (\$395) contains all parts to mechanically convert IBM Selectrics into input/output terminals. The new package includes the mechanical conversion and control electronics, installed, for parallel ASCII, at \$795. Full conversion to a TTY-like serial format still costs \$1455. Most Selectric models with serial numbers over 9,000,000 can be converted.

CIRCLE NO. 325

Use your calculator for off-the-job fun



Texas Instruments, P.O. Box 53, Attn: Leisure Library, Lubbock, TX 79408. \$35.

The Leisure Program library for the TI Programmable 58 and 59 calculators contains 20 different programs. They are useful to golfers, bowlers, chess players, football fans, bridge players, photographers and others interested in using the calculator for entertainment. In two of the programs, the alphabetic character and plotting capabilities of the calculators and PC-100A print unit can be used to create computer-type art or store and write out messages. Other diversions in the library are programs to calculate biorhythms, land a spacecraft on Mars, simulate sea battles and play Blackjack, Acey-Deucey, Craps, Nim, and other games.

CIRCLE NO. 326

I/O boards are for use with 8080-based μ Cs

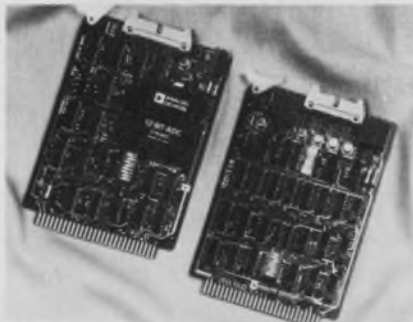

Analog Devices, P.O. Box 280, Route 1 Industrial Park, Norwood, MA 02062. Russ Ver Nooy (617) 329-4700. \$235 to \$330 (unit qty); stock.

A 16-channel data-acquisition board with eight or 12-bit resolution and a four-channel analog output board are both functionally, electrically, and mechanically compatible with Pro-Log's 4 and 8-bit μ Cs. The RTI-1220 data-acquisition and RT-1221 analog-output boards provide complete analog signal handling capability. They can function with 8080 and 6800 based μ Cs. The RTI-1220 accepts up to 16 single-ended or eight differential channels. On the RT-1221 are four analog output channels, each with 10-bit resolution. The board contains double-buffered registers, four 10-bit resolution, four-quadrant multiplying d/a converters, output amplifiers and two precision references.

CIRCLE NO. 327

8-bit analog I/O system ties into Motorola μ Cs

Burr-Brown, International Airport Industrial Park, Tucson, AZ 85734. C.R. Teeple (602) 294-1431. P&A: See text.

MP7400 Analog I/O System is an 8-bit plug-compatible system offered for Motorola's Micromodule Monoboard Microcomputer and EXORciser development system. It contains both analog input and output on a single board. Each board handles up to 64 single-ended or 32 differential input channels and two output channels. A high-gain instrumentation amplifier handles input levels as low as 10 mV FS. A basic 8-channel input-only board (or 16 channel single-ended) costs \$295. A fully-loaded board with 32 differential channels, or 64 single-ended, plus two output channels and dc/dc converter costs \$595.

CIRCLE NO. 328

Monsanto

Products Are Available from These Distributors:

AVNET ELECTRONICS
CESCO ELECTRONICS
DIPLOMAT/ALTALAND
ELMAR ELECTRONICS
HAMILTON/AVNET
HAMILTON ELECTRO SALES
HAMMOND ELECTRONICS, INC.
HARRISON EQUIPMENT CO.
KIERULFF ELECTRONICS
LIBERTY ELECTRONICS
R.A.E. ELECTRONICS
SCHWEBER ELECTRONICS
SEMICONDUCTOR SPECIALISTS
SHERIDAN SALES

For technical assistance contact our representative in your area:

A.P.J. Associates, Inc.
Plymouth, MI. (313) 459-1200

Beacon Electronic Associates
Huntsville, AL. (205) 861-5031
Ft. Lauderdale, FL. (305) 971-7320
Maitland, FL. (305) 647-3498
Atlanta, GA. (404) 351-3654
Charlotte, NC. (704) 525-7412
Oak Ridge, TN. (615) 482-2409
Falls Church, VA. (703) 534-7200

Bob Dean, Inc.
Ithaca, NY. (607) 272-2187

CMS Marketing
Oreland, PA. (215) 885-5106

Cantronics
Downsview, Ont. Canada. (416) 861-2494
Montreal, Que. Canada. (514) 341-5207

Comtronic Associates
Melville, L.I., N.Y. (516) 249-0505

CPS, Inc.
Orange, CT. (203) 795-3515

Datcom
Waltham, MA. (617) 891-4600

Mel Foster & Assoc.
Edina, MN. (612) 835-2252

Harvey King, Inc.
San Diego, CA. (714) 586-5252

Ed Landa Company
Los Angeles, CA. (213) 879-0770

Lorenz Sales Inc.
Cedar Rapids, IA. (319) 393-6912

Midwest Marketing Associates
Chagrin Falls, OH. (216) 247-6655
Dayton, OH. (513) 433-2511

Microsystems Marketing
Dallas, TX. (214) 238-7157
Houston, TX. (713) 783-2900

Spectrum Associates
Phoenix, AZ. (602) 997-8324

Straube Associates
Denver, CO. (303) 426-0890
Salt Lake City, UT. (801) 943-5650

Sumer, Inc.
Rolling Meadows, IL. (312) 394-4900
Milwaukee, WI. (414) 259-9060

Technical Representatives, Inc.
Olathe, KS. (913) 782-1177
Hazelwood, MO. (314) 731-5200

Valentine-Schillinger
Greenwood, IN. (317) 888-2260
South Bend, IN. (219) 291-8258

Waggoner-Ver Hill Associates
Pittsburgh, PA. (412) 241-5202

Western Technical Sales
Portland, OR. (503) 297-1711
Bellevue, WA. (206) 641-3900

No one has ever seen a lamp like this. It's our bright, new, revolutionary rectangular LED



OUR "LEGEND LAMP" PUTS LIGHT UP FRONT, WHERE YOU NEED IT.

The MV57124 rectangular LED from Monsanto gathers light from a high brightness chip and focuses it on a flat front surface. The shape of the lamp and the uniform illumination across a large emitting area (.15"x.25") makes the "legend lamp" an exciting, aesthetically pleasing element in your modern industrial panel design. It's available now in high brightness red and will soon be available in other colors.

STACKABLE: SIDE-BY-SIDE, OR END-TO-END.

The unique design of the MV57124 utilizes a special plastic to house the LED assembly, so that

no light is emitted from the sides or edges of the unit. All of the light is concentrated on the viewed surface. This means that lamps can be stacked, side-by-side in an X or Y direction, without light interference between units.

4 MCD BRIGHT. UNIFORM.

The MV57124 "legend lamp" uses Monsanto's high efficiency red emitter. The carefully engineered package makes maximum use of that emitted light, minimizing unusable light. Light output is a very bright 4 millicandelas at

20 mA forward current. That's up to 3 times the output of other rectangular lamps. So you can use the MV57124 as a legend backlight, a panel indicator, or a bargraph meter.

ANOTHER PERFORMANCE PRODUCT FROM MONSANTO.

This unique new product is a development from the technology and experience that is Monsanto. Our history as being one of the first suppliers of LED's has led to the features and characteristics of the "legend lamp."

FREE SAMPLE.

Write today, on your company letterhead, for a free sample. We'll also send you full specifications on our new MV57124.

Monsanto Commercial Products Co., Electronics Division, 3400 Hillview Ave., Palo Alto, CA 94304. Telephone: (415) 493-3300.

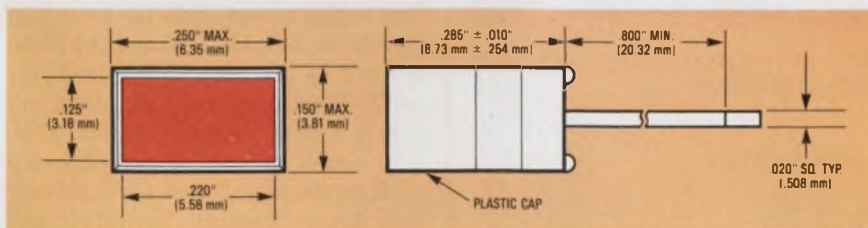

Monsanto:
the science
company.

MICRO/MINI COMPUTING

Synthesizer can be programmed to speak

Vocal Interface Div., Federal Screw Works, 500 Stephenson Highway, Troy, MI 48084. (313) 588-2050.

A phoneme synthesizer kit, the Votrax VSK, when used with a μ P, combines unlimited vocabulary, opera-

tional simplicity, and low data requirements. It can be programmed to speak, based on phonetic coding principles, producing all combinations of words and phrases. The use of phonetic coding permits the production of speech at low data rates, offering continuous speech at 20 characters/s and easy interfacing to any μ P system with an 8-bit parallel output. Fully assembled, the single circuit board measures less than 36 sq. in. It uses +5 and ± 12 -V supplies.

CIRCLE NO. 329

High-speed I/O expansion card based on 8080 μ P

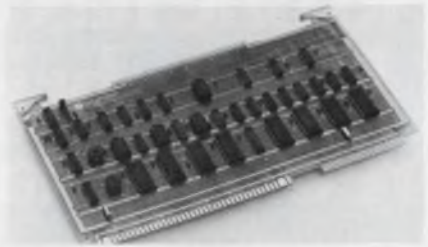

National Semiconductor, 2900 Semiconductor Dr., Santa Clara, CA 95051. Don Schare (408) 737-6597. \$189 (100 qty).

The BLC 508 I/O expansion card is based on the 8080 microprocessor and provides eight 8-bit parallel ports, four input and four output. The board can transfer data at rates as high as 1.3 Mbytes per port, the practical limits set by the peripherals of I/O handling software. The board connects to the system bus through an 86-pin card-edge, and has a 100-pin edge connector for parallel I/O. Data, address, and control signals are TTL compatible, and the board operates on +5 V dc. The four output ports have a variable width strobe available for peripherals, which is set in a range from 100 to 1600 ns by a plug-jumper on the board.

CIRCLE NO. 330

PDP-8 processors have up to 128-kword memory

Digital Equipment, Maynard, MA 01754. John Bond (617) 897-5111. See text.

Three PDP-8 processors and three options permit memory capacities up to four times the previously available maximum. The PDP8-A/205, 425, and 625 incorporate the KT8-A memory management option in all configurations employing more than 32 kwords of core, to the maximum 128 kwords. This option allows up to 128 kwords of memory to be addressed and the memory can be core, MOS, or mixed core and MOS memory modules. Also available is a MOS memory module, MS8-C. It comes in both 16 and 32-kword configurations and uses 4-k RAMs for high density memory. The KT8-A and MS8-C modules permit upgrading of current PDP-8As to 128-kword capacities. Prices range from \$3900 for a 16-kword PDP-8/A205 to \$18,050 for a 128-kword PDP-8/625. 16-kword and 32-kword MS8-C modules are \$1900 and \$3100, respectively.

CIRCLE NO. 331

High fashion electronics.

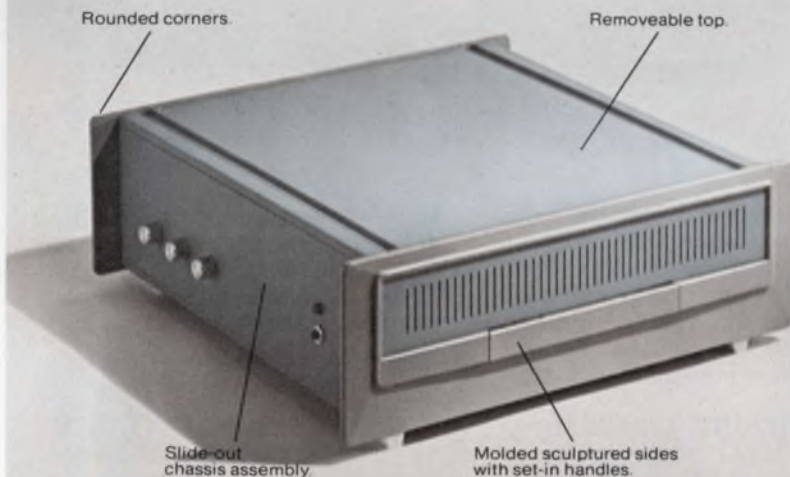

Optima enclosures give you such a quality look, your customers might just think they're custom made. You get rounded corners. Not boxy edges. Sleek set-in handles instead of the protruding variety. A choice of standard or special color combinations. And there's every convenience feature you could want. In every size you need.

Send for our catalog. For the same money you pay to get lost in the crowd, we'll dress you in high fashion glamour.

We make you look better

OPTIMA[®]
Scientific-Atlanta

2166 Mountain Industrial Blvd. Tucker, Ga. 30084 • Tel: (404) 939-6340
Europe: McKeltrick-Agnew, Macmerry, East Lothian,
Scotland, EH33 1EX • Telex: 72623

SEE US AT MIDCON - booth nos. 239-241

CIRCLE NUMBER 86



We'll Put You On The Bus

(Without Taking You For A Ride.)



Our new μ p-based interface couplers will link virtually any programmable instrument to the IEEE 488 bus even though their input and output is not bus compatible.

RS-232 TO BUS Here's a new, inexpensive way to convert your teletype to a 488 bus printer. For about \$900, the Model 4884 will provide a bi-directional data link between the parallel IEEE 488 bus and the RS-232 serial data path. And it's not limited to teletype. The 4884 will make any 20mA device such as printers and recorders bus-compatible.

DVMs AND COUNTERS TO BUS Building an ATE system? You may have a pool of older instruments, but the DVMs and counters aren't 488 compatible. For about \$800 you can buy a Model 4881 that will take data from any DVM, counter, or other instrument and put it on the bus.

BUS TO FREQUENCY SYNTHESIZERS AND PULSE GENERATORS Want to control stimulus devices?

For the same \$800, a Model 4882 can control any programmable instrument from the bus. Or, use it to just output parallel data. It responds to a status request from the controller and passes all data without alteration.

HOW ABOUT A BI-DIRECTIONAL COUPLER For about \$900, the 4884 combines capability and operational features of the 4881 and 4882 in one unit. It can be used to control or take data from a measuring device, accept program commands from the bus, pass the commands on to a DVM's control inputs, initiate readings and output data when addressed. You can even reduce it to "talk-only" or "listen-only" by setting the mode switches.

AND THERE'S MORE TO THE FAIRCHILD LINE Fairchild also offers other instruments. The 6600 takes paper tape input and interfaces to CRTs, modems or remote CPUs. The 1700 takes BCD output and interfaces with TTYs, CPUs modems and paper tape punches. Write: Fairchild Instrumentation, a unit of Fairchild Camera and Instrument Corp., 1725 Technology Drive, San Jose, CA 95110. Phone (408) 275-6600 or (408) 998-0123.

FAIRCHILD

CIRCLE NUMBER 87

Some of these components will probably never The others will just come close.

The SR, XL, XK and AV are solid state position sensors featuring almost infinite life. All offer zero speed operation with some up to 100 KHz. ES current sensor utilizes Hall-effect IC and protects against damage from short circuits or overcurrent conditions.

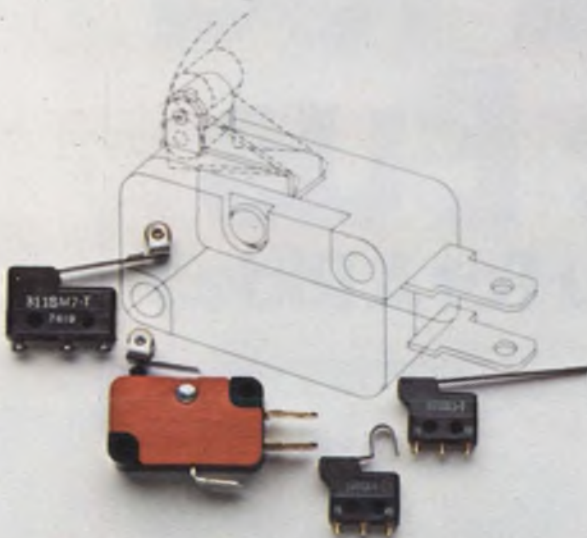

Snap-action V3, SM and SX switches offer wide variety of actuators, electrical capacity and termination.

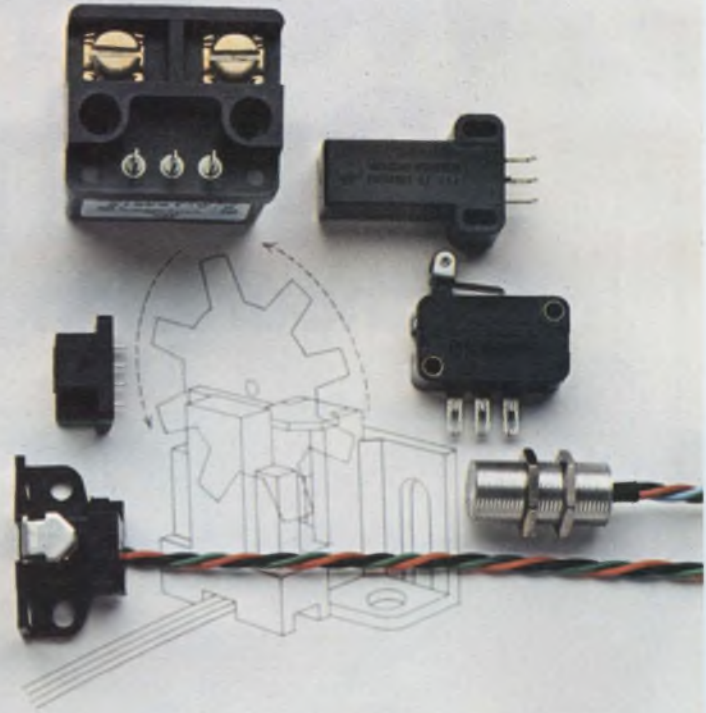

Mercury switches offer hermetic sealing, a variety of electrical capacity and broad temperature ranges at a low cost.

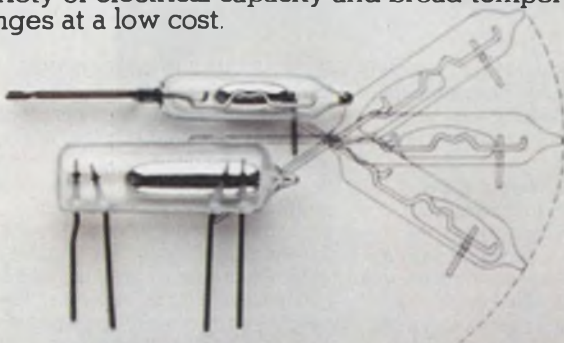

AML manual devices for low installed cost, electrical flexibility and attractive panel appearance. Series 8 miniature manual switches provide small size and wide variety of operators. DM offers inexpensive snap-in panel mount design.



Solid state keyboards provide high reliability no mechanical keyboard can offer. Panel sealed versions also available.



wear out.

The solid state keyboard, AML lighted push-buttons and sensors you see here will probably never wear out. Because they're all solid state.

Each is based on a Hall-effect integrated circuit. A circuit that's been tested through billions of operations without failing. And proven by performance in thousands of applications.

The precision electro-mechanical components you see here come close. Simply because of the careful way they're designed and put together.

Like the long-life versions of our snap-action V3, SM and SX precision switches. Available in a wide variety of sizes, electrical ratings, terminals, actuators, contact forms and operating characteristics — some tested to a mechanical life of over 10,000,000 operations.

MICRO SWITCH will provide you with field engineers for application assistance and a network of authorized distributors for local availability. Write us for details or call 815/235-6600.

And find out how you can get a component that goes on forever. Or at least comes very, very close.

MICRO SWITCH

FREEPORT ILLINOIS 61032

A DIVISION OF HONEYWELL

MICRO SWITCH products are available worldwide through Honeywell International.

MICRO/MINI COMPUTING

Line adaptor packs DEC type modules on 1 board

MDB Systems, 1995 N. Batavia, Orange, CA 92665. Gene Sylvester (714) 998-6900. \$650; stock.

MDL-11W serial line adaptor combines all the operational features of the DEC DL-11A, B, C, and D modules on a single board. Selection of any one of the four operational modes is accomplished through PC-mounted switches. Additional functions include switch-selectable address, interrupt vector, transmitter/receiver clock sources and baud rates. A 20-mA active current-loop is provided as are EIA RS232C interface drivers/receivers for local or remote terminal operation. The device features full or half duplex operation and 16 standard baud rates from 50 to 19.2 kbaud. The module is fully compatible with DEC operating and diagnostic software.

CIRCLE NO. 332

Industrial microcomputer has modular design

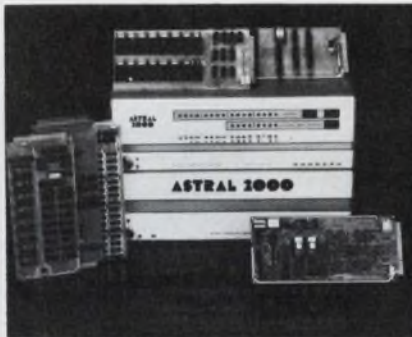

Astral Computer, 991 Commercial St., Palo Alto, CA 94303. Carl Kalb (415) 494-8048. From \$1500 (unit qty); stock.

The Model 2000 microcomputer, based on the 6800 μ P, is designed as a modular system. Separate cards contain the processor, memory, I/O and floppy-disc interface. The system is supported with an extended 8-k Basic, an assembler, a text editor and disc operating system software. All cards are 10 x 4.5 in. and have standard, dual 22-pin edge fingers. For the OEM interested in maximum access to registers, interrupts and system diagnostics, a full front panel enclosure can be provided with interrupt, register and data switches and hexadecimal and binary displays.

CIRCLE NO. 333

CAMAC system serves as monitor and controller

Kinetic Systems, 11 Maryknoll Dr., Lockport, IL 60441. (815) 838-0005.

A stand-alone system for monitoring and control applications, the 8010 uses Basic to communicate with CAMAC process I/O modules. The 8010 system is designed around the 3880 CAMAC μ C and contains a minifloppy disc drive and disc operating system. In the system is the following hardware: a 3880 μ C, a 3908 crate controller or 3909 auxiliary crate controller, a 3816 memory expansion module with 16 k of RAM and 1 k of PROM, a 3880 minifloppy disc-controller an SA-400 minifloppy disc-drive, and a CRT terminal.

CIRCLE NO. 334

Control micro-diskettes with LSI-based unit

Wangco, 5404 Jandy Pl., Los Angeles, CA 90066. (213) 390-8081. \$490; 4 wk.

The 8201 Micro-Controller is for use with 5 $\frac{1}{4}$ -inch diskette drives that provide a general host interface for use in 6800 and 8080-based μ C minicomputer and other byte-oriented systems. One version of the 8201 is pin compatible with the S-100 bus. Formatting is of a soft-sectored, modified-IBM type of 16-sectors per track, 128-bytes per sector. Functions include a diagnostic command which causes self-test operations on all diskettes and a duplicate function which automatically copies diskette information from one drive to another at one command from the host. The device will control up to four drives.

CIRCLE NO. 335

Single-card μ C is simple and easy to use

Environmental Technology, 2821 W. Sample, South Bend, IN 46619. Thad Jones (219) 233-1202. \$125 (100 qty); stock to 3 wk.

Little Bit, Model 900-0, is a single-card microcomputer having performance characteristics optimized for the requirements of bottom-end applications where hardware simplicity, ease of application, and low cost are primary considerations. Complete software, firmware, training and programming services are available. Programs for assisting in software development for Little Bit are also available.

CIRCLE NO. 336

ICs & SEMICONDUCTORS

Low-level logic turns on optically-coupled triac

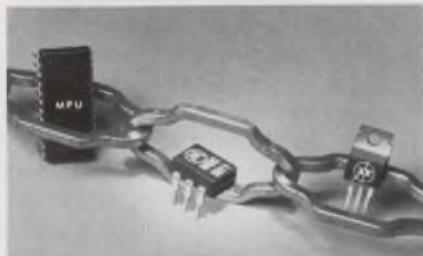

Motorola, P.O. Box 20912, Phoenix, AZ

85036. Harold Frede (602) 244-4556. \$1.60 (100 qty); stock.

An optical coupler, the MOC3011, provides 115-V-ac full-wave switching and isolation equivalent to an electromechanical relay—at the command of a low-level dc source such as IC logic. Used alone, the MOC3011 switches power-line loads up to 7.5 W. Kilowatt loads can be switched with a power triac driven by the MOC3011. The 6-pin coupler uses a GaAs LED that is driven by input currents of 10 mA at voltages as low as 2 V.

CIRCLE NO. 337

Epoxy package op amp sports lower price tag

Precision Monolithics, 1500 Space Park Dr., Santa Clara, CA 95050. Donn Soderquist (408) 246-9222. \$2 (100 qty); stock.

Packaged in an epoxy "B" mini-DIP, the PM725CP precision op amp gives a 35% savings compared to TO-99 packaged devices, plus compatibility with automatic insertion devices. The unit is directly interchangeable, mechanically and electrically, with Fairchild's 725PC and National's LM725CN. Typical specs are input offset voltage drift of $2 \mu\text{V}/^\circ\text{C}$, open loop gain of 3×10^6 , and input differential voltage protection of 30 V.

CIRCLE NO. 338

STOP

WAITING ON OUTPUT FROM YOUR MINI

You Are Wasting More In Dollars For Human Resources Than This LINE PRINTER Costs

2400 LPM - 80 COL.
MODEL 8210 - \$3450*

1400 LPM - 132 COL.
MODEL 8230 - \$3785*



FOR ORDERING INFORMATION CALL OR WRITE:

houston instrument

DIVISION OF BAUSCH & LOMB

ONE HOUSTON SQUARE (at 8500 Cameron Road) AUSTIN, TEXAS 78753
(512) 837-2820 TWX 910-874-2022 cable HOINCO
TELECOPIER

EUROPEAN OFFICE: Rochesterian B 8240 Gistel Belgium
Phone 066/277445 Telex Bauwh 19399

"the recorder company"

* Domestic USA Prices, Qty 1, End User

CIRCLE 88 FOR LITERATURE
CIRCLE 89 FOR DEMONSTRATION

Log-amps are for wideband i-f's

Plessey Semiconductors, 1641 Kaiser Ave., Irvine, CA 92714. Dennis Chant (714) 540-9979. \$42 (100 qty).

Two wideband logarithmic amplifier ICs are intended for receiver i-f's in the 30 to 240-MHz range. The SL1522 contains two SL1521 log-amplifier chips and a resistive divider to increase i-f strip dynamic range, while the SL1523 contains two SL1521 chips in parallel. Specifications are: 12-dB voltage gain; 300-MHz upper cut-off frequency; 3-dB noise figure; 1-mA maximum rectified video output; and operation over the full MIL range of -55 to $+125$ C. Up to five SL1521 stages can be cascaded with no external resistors, discretes, or interstage filters for 60 dB of compression from 60 to 240 MHz. The units are packaged in 8-lead TO-5 cans.

CIRCLE NO. 339

Small rectifier bridge operates at 6 A

Electronic Devices, 21 Gray Oaks Ave., Yonkers, NY 10701. Dennis Dean (914) 945-4400.

The Model PM minibrige rectifier assemblies are designed for 6-A operation. They are available for 50, 100, 200, 400, 600, and 800 peak reverse voltage operation with surge current ratings of 100 A. Dielectric strength is 1.5 kV rms. Units have diameters of 0.89 in. and come with 1-in. leads. They can be chassis or heat-sink mounted.

CIRCLE NO. 340

Anaren High Performance 10 and 11 Bit, 1-18 GHz

Digital IFMs

The Anaren Digital Frequency Discriminator (Digital IFM) is a crystal video detection system which measures the frequency of an RF signal on a single-pulse basis without knowledge of time of arrival or frequency of the signal. The DFD behaves like a synthetic channelized filter dividing the RF frequency band into 1024 (10 bit) or 2048 (11 bit) contiguous channels or cells.

Ten models are available. Series 182105-182109 has 10 bit capacity; Series 182135-182139, 11 bit. All models achieve fine frequency accuracy

and resolution with wide unambiguous bandwidth. Typical cell crossing error distributions for L and Ku band models are illustrated. This is a measure of frequency accuracy. Either automatic or external override mode operation is available to allow flexibility in differing signal environments.



Electrical Specifications

Model No.	182105	182106	182107	182108	182109
	182135	182136	182137	182138	182139
Operating Frequency (GHz)	1.0 to 2.0	2.0 to 4.0	4.0 to 8.0	8.0 to 12.0	12.0 to 18.0
Mean Frequency Resolution (MHz)	1.25 0.625	2.5 1.25	5.0 2.5	5.0 2.5	10.0 5.0
RMS Frequency Accuracy (MHz)	0.6 0.5	1.2 1.0	2.4 2.0	2.4 2.0	5.0 4.0
Input Power Levels (dBm)	-1 to +7	-1 to +7	-1 to +7	-1 to +7	-1 to +7
RF Pulse Width (ns)	150 to CW	100 to CW	100 to CW	100 to CW	100 to CW

These DFD's are capable of handling up to 5 million pulses per second.

Applications

- Radar pulse train de-interleaving
- Radar test range monitoring
- Measurement of frequency agile sources

Contact your local Anaren Technical Representative for a copy of the DFD Technical Manual, Pub. M1804-77, or write/phone below.

Deliver 12 weeks ARO.

Anaren Microwave, Inc., 185 Ainsley Drive, Syracuse, N.Y., U.S.A. Tel. (315) 476-7901. TWX 710-541-1507. Telex 937351; Western Regional Office, 7995 E. Hampden, Denver, Colorado 80231. Tel. (303) 755-0733; Canada, Louis Albert Associates, Inc. 2264 Stevenage Drive, P.O. Box 8526, Ottawa, Ontario K1G 3H9, Tel. (613) 737-5941. TWX 610-562-8918; Europe, Anaren International, P.O. Box 15, Newbury RG13 4JE, Berkshire, Great Britain. Tel. 0635-67500, Telex 27950.

Typical Cell Crossing Error Distribution

L-Band Models, 1-2 GHz
Operating Frequency

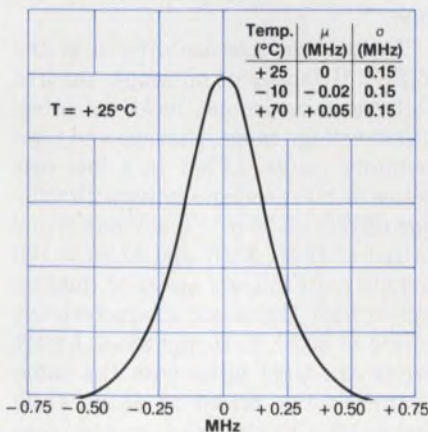

Ku Band Models, 12-18 GHz
Operating Frequency

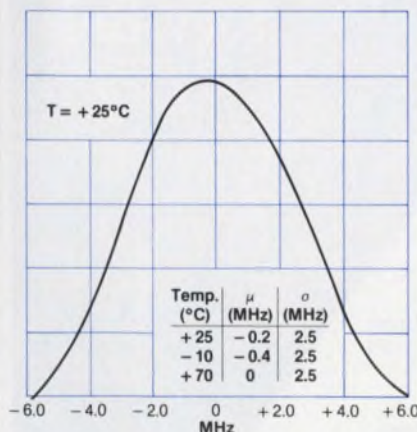

Add CAMAC* power to your IEEE-488 system

**CAMAC microcomputer and
488-interface modules make it easy!**

— note these CAMAC features —

- numerous I/O modules to choose from
- fast remote-point access via serial transmission
- powerful distributed control
- infinite expansion and flexibility
- proven worldwide in hundreds of installations
- quick deliveries; most modules stocked

KSC offers you a CAMAC-to-488 interface as well as a 488-controlled CAMAC system. Write or call for more information.

*IEEE-583 Modular Interface Standard for Computer Automated Measurement And Control



KineticSystems Corporation

Dept. ED11227 11 Maryknoll Drive Lockport, Illinois 60441 Phone (815) 838 0005

CIRCLE NUMBER 91

Now measure AC and DC on any voltmeter with the NEW **CURRENT GUN™** from **F.W. Bell**

The all-new Current Gun is a clamp-on instrument that lets you read AC and DC from 0 to 1 kHz and from 0 to 200A quickly, easily, safely — without breaking the connection. Use with any voltmeter . . . or get a reproduction of the wave form on a scope! Two ranges, 0 to 10A and 0 to 100A with 100% overrange. **Only three controls:** zero, range selector and press-to-read button.

Less than \$200

Accessories available to greatly expand ranges — higher and lower.
Request complete specs today.

Fw

A Subsidiary of The Arnold Engineering Company.



BELL INC.

4949 Freeway Drive East Columbus, Ohio 43229
Phone (614) 888-7501 TWX: 810-337-2851

CIRCLE NUMBER 92

ICs & SEMICONDUCTORS

LSI is floppy-disc formatter & controller

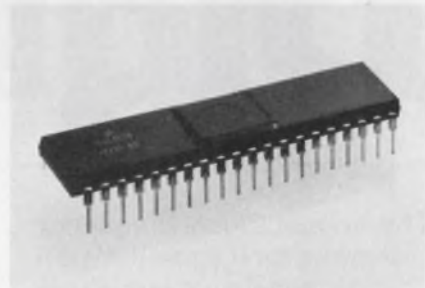

Western Digital, 3128 Red Hill Ave., Newport Beach, CA 92663. George Gregoire (714) 557-3550.

Model FD1781, an NMOS device, performs the functions of a floppy-disc controller/formatter. Features include: automatic track-seek with verification; selectable track to track stepping, head settling and engage times; double buffering of data; 8-bit bidirectional bus for data, control and status; and flexible formatting, including full compatibility with IBM 3740 data entry systems. It also provides data, data strobe and address mark input/output for reading and writing data. The controller can accommodate MFM, M²FM, group coding or other double-density encoding methods. All lines are TTL compatible.

CIRCLE NO. 341

FET-input op amps span wide range of specs

National Semiconductor, 2900 Semiconductor Dr., Santa Clara, CA 95051. Jim Solomon (408) 737-5622. P&A: See text.

Thirteen devices are offered in the BiFET II family of op amps. Devices fall into four groups, based on price, offset voltage range, package and temperature range. LF351 is a low cost series of plastic single units with voltage offsets of 10 mV, 5 mV and 2 mV priced at \$0.39, \$0.67 and \$1.66 in 100 quantity. LF353 is a series of dual op amps with the same characteristics priced at \$0.70, \$1.30 and \$3.06. LF347 series are quad units with the same characteristics priced at \$1.25, \$1.95 and \$5.99. LFT156 units are high performance single op amps in TO-5 packages featuring 0.5-mV and 1-mV offsets and are priced at \$18, \$10, \$12 and \$7.50.

CIRCLE NO. 342

When you need LEDs or more than LEDs...



Dialight is the first place to look. We can help you do more with LEDs... because we've done more with them.

Discrete LEDs come in a variety of sizes, shapes, colors (red, yellow, green in clear or diffused), with or without built-in resistors.

Low cost logic state fault indicators for trouble shooting complex circuits. Designed for close density PC board mounting.

High-brightness bi-color LEDs (red/green) suitable for go/no-go situations. Designed with unique

lenses for the extra visibility you'll want for your most critical applications.

Snap-in mounting LED indicators reduce labor cost. Available in red, yellow or green with or without built-in resistors.

Whatever you need in LEDs, Dialight's probably got it already. For your free 60-page selector guide and listing of our nationwide stocking distributors, contact us today.

DIALIGHT
A North American Philips Company

Dialight meets your needs.

Dialight, 203 Harrison Place, Brooklyn, N.Y. 11237 (212) 497-7600

CIRCLE NUMBER 93

ICs & SEMICONDUCTORS

Single chip makes 3-3/4 digit panel meter

National Semiconductor, 2900 Semiconductor Dr., Santa Clara, CA 95051. Bob Bennett (408) 737-5720. \$11.95 (100 qty); stock.

The ADD3701 CMOS IC requires only a display, an external voltage reference, a few passive components and a digit-driver to form a 3-3/4 digit

DVM system. It uses a 5-V supply to drive a multiplexed seven-segment output, and features differential input protection to 200 V. Overrange condition is displayed by "+OFL" or "-OFL." The DVM also includes auto-polarity and an on-chip clock that can be set by an external RC network, or can be driven from an external source. The segment output drivers can deliver up to 40 mA each, thus permitting direct drive of LED displays.

CIRCLE NO. 343

Single-chip μ C serves as high-speed counter/timer



Rockwell International, 3310 Miraloma Ave., Anaheim, CA 92803. Scotty Maxwell (714) 632-2321. \$9.30 (1000 qty).

The PPS-4/1 Model MM76C μ C can "crunch numbers" or control functions and simultaneously count inputs, events, perform timing, program fixed intervals, and generate variable-duty square waves. The device has five input control lines and 32 I/O ports, which include serial I/O capabilities that in combination with an on-chip clock circuit enable it to be synchronized with or by another μ P system. The on-chip counter functions as either a single 16-bit reference or as two independent 8-bit counters. It can count inputs ranging from 2 MHz to days-long frequencies. The processor comes in a 52-pin STM plastic package.

CIRCLE NO. 344

Here's a Paktron[®] Capacitor with a ONE...TWO...THREE punch!

- 1. Latest Type DVL Capacitor is three units in one
- 2. U.L. listed and C.S.A. approved
- 3. Three applications
Across-the-line
Line-by-pass
Antenna coupling
- .01 mfd to .47 mfd
- Tolerance of ± 10 or 20% in 125 AC voltage range
- Available through your local distributors

Request full details and catalog



PAKTRON

A DIVISION OF ILLINOIS TOOL WORKS INC.
900 Follin Lane, S.E., Vienna, Virginia 22180
Phone: (703) 281-2810 TWX 710-833-0682

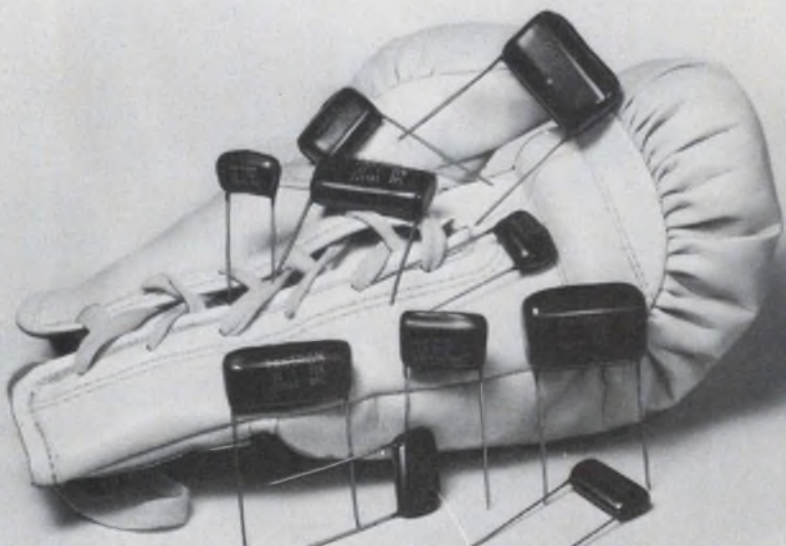

The Innovative Electronic Components Group of ITW PAKTRON and EMCON
© Illinois Tool Works Inc. 1977

Frequency prescaler is a power saver

Plessey Semiconductors, 1641 Kaiser Ave., Irvine, CA 92714. Dennis Chant (714) 540-9979. \$5.50 (100 qty).

Divide-by-100 prescalers, the SP8627, 28 and 29, consume only 1/4 the power of previously available units. The SP8629 is a divide-by-100 counter with a minimum toggle frequency of 150 MHz from 0 to 70 C; the SP8628, the same circuit with reset; and the SP8627, the same circuit with a divide-by-80 output. All three devices have a power consumption of 170 mW, typical, and feature ECL/TTL inputs and TTL outputs. They may be positive or negative edge-triggered in single-ended or differential input modes.

CIRCLE NO. 345

CIRCLE NUMBER 94

How fast can you measure rise time, fall time and pulse width?

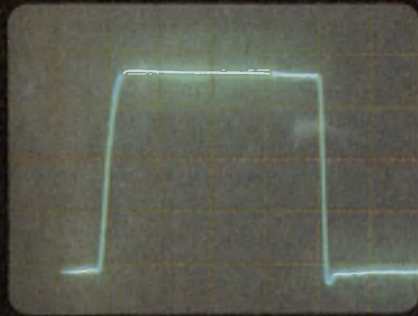

Your way.

(About 5 minutes.)

1. Connect signal to scope.
2. Adjust trace intensity.
3. Adjust focus.
4. Select VOLTS/DIV range.
5. Select TIME/DIV range.
6. Adjust vertical gain to fill screen for location of 10% & 90% points.
7. Locate 10% point.
8. Locate 90% point.
9. Determine horizontal displacement between 10% & 90% points.
10. Multiply displacement by horizontal scale factor.

That's RISE TIME. Only 9 more steps and you've got PULSE WIDTH and FALL TIME.

Our way.

(About 5 seconds.)

1. Connect signal.
2. Push button for RISE TIME.
3. Push button for PULSE WIDTH.
4. Push button for FALL TIME.

The rest is automatic.

Your move.

Give us a call and we'll tell you how the Dana 9000 Microprocessing Timer/Counter can solve your measurement problem the easy way.

DANA[®]

Others measure by us.

Dana Laboratories, Inc., 2401 Campus Drive, Irvine, CA 92715
Phone: 714/833-1234

Industry's First 14-Bit A/D In a DIP

- Highest resolution A/D available in a DIP
- Fully specified from 0° to 70°C
- +1/2 LSB linearity error
- 0.04% accuracy
- Conversion time: 250 μ sec max
- Power consumption: 230 mW typical
- Adjustment free
- 24-pin hermetic DIP

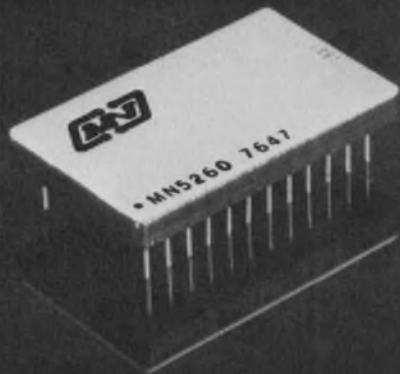

MN 5260
\$219.00*

* in 100 quantity



Micro Networks Corporation
324 Clark Street, Worcester, MA 01606
(617) 852-5400 TWX 710-340-0067

CIRCLE NUMBER 97

ICs & SEMICONDUCTORS

Plastic 8-k PROM is thrifty sub for EPROM

Motorola, 3501 Ed Bluestein Blvd., Austin TX 78721. (512) 928-2600. \$9.95 (100 qty); stock.

The silicon-gate PROM, MCM2708P, is a 1024 \times 8-bit memory and is a low-cost alternative for EPROMs. Its operation and programming are identical to the MCM2708L EPROM and is pin-for-pin compatible with 2708 type EPROMs and the MCM65308, MCM68308, and 2308 mask-programmable ROMs. Maximum access time is 450 ns, power supplies are +12 and \pm 5 V. The unit comes in a 24-pin plastic DIP.

CIRCLE NO. 346

Static n-channel ROM has 4096 words

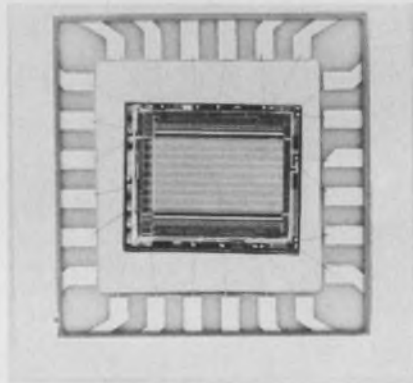

Rockwell Electronic Devices Div., 3310 Miraloma Ave., Anaheim, CA 92803. Scotty Maxwell (714) 632-2321. \$20.10 (100 qty).

A completely static n-channel ROM, organized as 4096 words by 8-bits, features a typical access time of 250 ns and uses 350 mW of power. The R2332 requires just a +5-V supply. Inputs are TTL compatible and have a 400-mV minimum noise immunity on both the HIGH and LOW levels. Each of the eight outputs have three-state drivers capable of driving 100 pF and a TTL gate. Two mask-programmable chip-select inputs allow four 32-k ROMs to be OR-tied without external decoding. Programming allows selection when the input is HIGH or LOW, or in a don't care mode. Both chip-select and chip-deselect delays are 100 ns.

CIRCLE NO. 347

Almost 40-k transistors crammed into ROM

Synertek, 3050 Coronado Dr., Santa Clara, CA 95051. (408) 984-8900. P&A: See text.

The SY2332, a 32-k ROM, contains close to 40,000 transistors. The 32k ROM features an access time of 450 ns with a 350-ns version to be available shortly. Organized as 4096 words \times 8 bits, the ROM requires only a 5-V supply. The device is TTL compatible and available in either ceramic or plastic 24-pin DIP. It costs \$35 in quantities of 100 to 999 with a one-time tooling fee of \$750 to \$1000.

CIRCLE NO. 348

Octal register replaces three parts

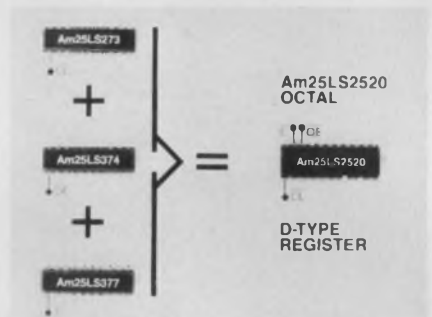

Advanced Micro Devices, 901 Thomson Pl., Sunnyvale, CA 94086. E. Sopkin (408) 732-2400. \$2.88 (100 qty); stock.

A low-power Schottky octal register offers features previously available in three separate devices. The Am25LS2520 consists of eight positive edge-triggered D-type flip-flops in a 22-pin, 0.4-in. center-to-center DIP. The device has the features of the 20-pin Am25LS273 (common clear), the Am25LS374 (common three-state enable) and the Am25LS377 (common clock enable) octal registers.

CIRCLE NO. 349

Enclosed diodes simplify circuitry

Underwriters Safety Device, 7300 W. Wilson Ave., Chicago, IL 60656. Jim Van Cura (312) 867-4600.

A series of enclosed diodes that reduce harness costs, provide simple, single circuitry and eliminate multiple or redundant systems is available with ratings of 1 through 5 A, at up to 400 PIV. They can be mounted in various assemblies in combination with circuit breakers or in special diode packing to meet customer specs.

CIRCLE NO. 350

Introducing the PMUX

The world's first programmable multiplexer

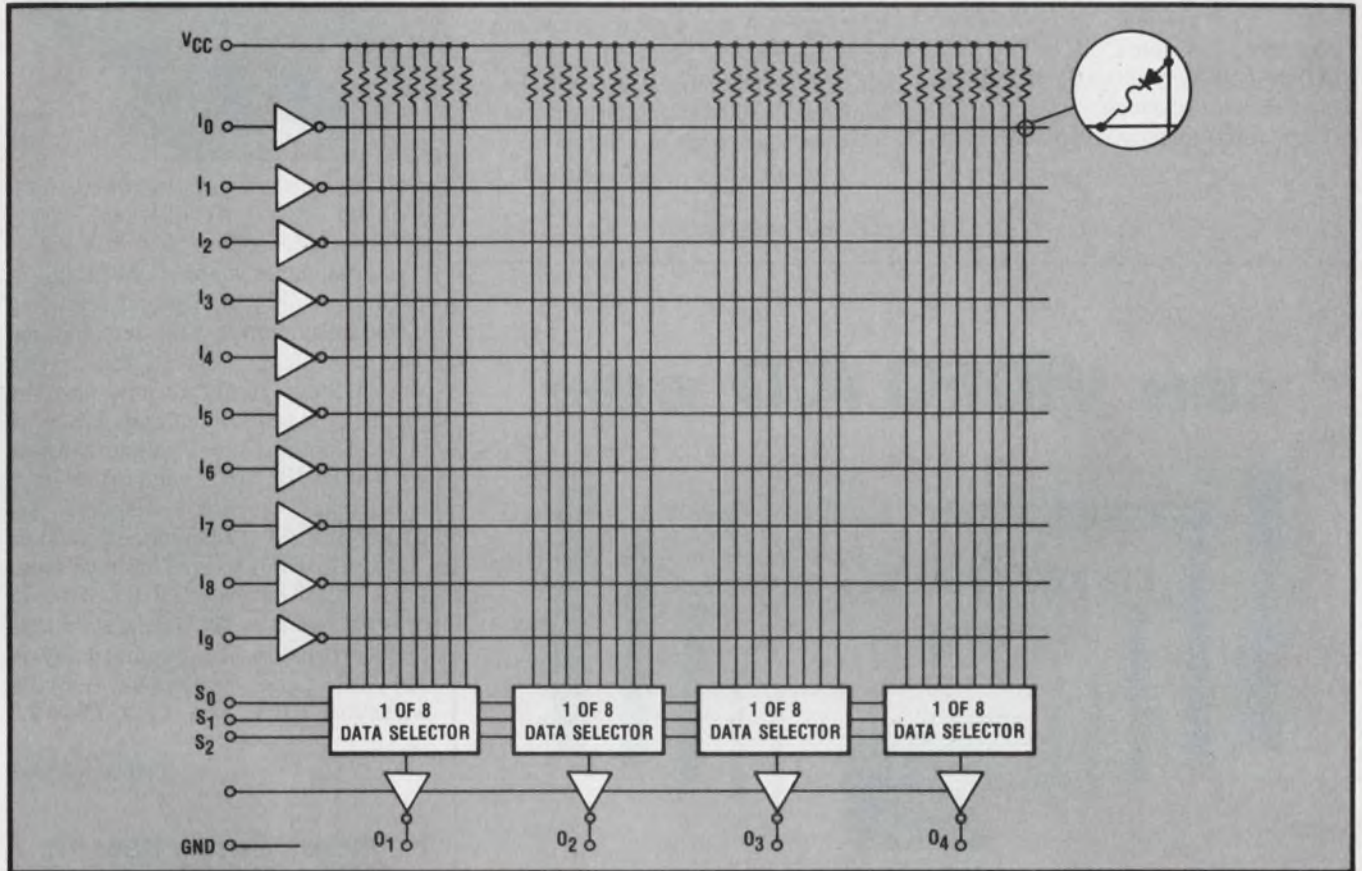

**THE
29693
IS:**

- A poor man's FPLA
- A sign extender
- A programmable data flow control
- A buffered programmable diode matrix
- A digital crosspoint array
- Easily programmed
- Fast, only 30nS typical (I_X to O_N)
- Economical, only \$4.25 at 100 pieces

Another first from

"The Specialists in Bipolar Microcomputer Components"

Field Sales Offices

California: Irvine (714) 833-9042, Mountain View (415) 969-3475.

Florida: St. Petersburg (813) 576-2221. **Illinois:** Des Plaines

(312) 297-5540. **Massachusetts:** Newton (617) 527-0030.

Minnesota: Minneapolis (612) 920-7935. **New Jersey:** Cherry Hill

(609) 663-4066. **New York:** Melville (516) 420-0700.



SEMICONDUCTOR DIVISION

Tell me more ...

- Full data and applications on your PMUX
- Your full Semiconductor Selection Guide

Name _____

Title _____

Company _____

Address _____

City _____

State _____ Zip _____

My phone number is _____

Mail to: Raytheon Company, Semiconductor Division
350 Ellis Street, Mt. View, CA 94042

COMPONENTS

Reed triggers hybrid ac-input relay

Potter & Brumfield, 200 Richland Creek Dr., Princeton, IN 47671. Bill Skidmore (812) 386-1000. \$11.40 to \$15.92 (100 qty); stock.

Each relay in series Type ECT is a

medium power, 120/240-V-ac, 50/60-Hz, SPST-NO solid-state switch controlled and isolated by a self-contained 120-V-ac-input reed relay. Operate time of the ECT is 50 ms max, and expected life at rated load is at least 10-million operations. Load ratings are 2, 4, 5, or 7 A at 0.4 pF when the relay is fastened to a 10 × 10 × 0.062-in. aluminum heat sink. A 9-A model also is offered, whose rating increases to 32 A when used with a heat sink.

CIRCLE NO. 353

Interface easily with display-only DPM



Datel Systems, 1020 Turnpike St., Canton, MA 02021. Gene Murphy (617) 828-8000. \$29 (100 qty); 6 to 8 wk.

Digital panel meter, DM-3100L, is for display-only applications featuring differential inputs and autozeroing. The interfacing task is eased with simple input configurations and the input can also be operated single-ended. Common-mode voltage range is ± 2 V at 80 dB CMR. Temperature drift is 50 ppm/ $^{\circ}$ C, with a displayed accuracy of 0.2% of reading, ± 1 count at $+25$ C. The DPM accepts input voltages from -2 V dc to $+2$ V dc, with an internal pad area left for input voltage divider resistors. Input impedance is 100 M Ω and protection circuits withstand 150 V. Size is 3 × 1.8 × 2.2 in.

CIRCLE NO. 354

8-Bits VIDEO A/D 16-MHz

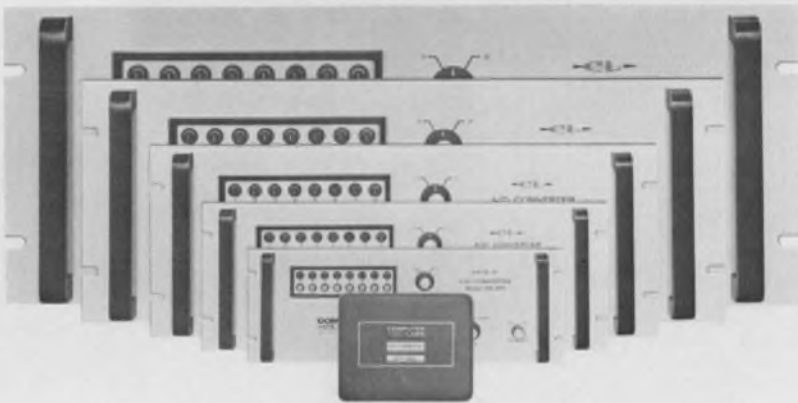

Now a small module!

The MATV-0816 is the first completely self-contained modular A/D with internal T & H and timing circuitry. And it's designed for PC-board mounting. This 8-bit, 16-MHz converter is designed for color TV digitizing at rates thru four times NTSC for digital video applications. It's also ideal for radar signal processing, laser pulse analysis, and medical electronics applications.

The encode command input, data-ready output, and digital bit outputs are all TTL compatible. Write or call us today for the complete story.

COMPUTER LABS

COMPUTER LABS, INCORPORATED
505 EDWARDIA DR. ● GREENSBORO, N. C. 27409
919/292-6427 ● TWX 510-922-7954

CIRCLE NUMBER 99

Keyboard family has one for each requirement

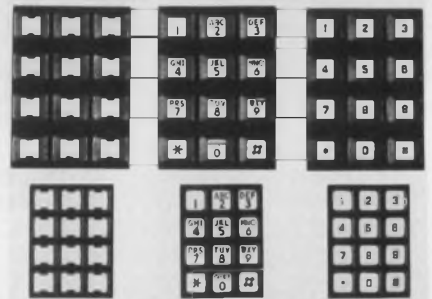

Grayhill, 561 Hillgrove Ave., La Grange, IL 60525. (312) 354-1040. \$6.30 to \$8.05 (100 qty).

A keyboard family offers choice of 12 or 16-button arrays plus choice of circuitry, mounting means, and leg-encoding. Circuitry options include matrix coding, single-pole/common-bus switching, 2-out-of-7 code or 2-out-of-8 code. Either the 3 × 4 or 4 × 4 array is available with post or screw-type flange mount. Legend choices include standard keyboard arrangements with molded-in legends, hot-stamped legends to order, and snap-on caps for self-legending of prototypes.

CIRCLE NO. 355

From the people who brought you IDIOM* United States Instrument Rentals introduces...

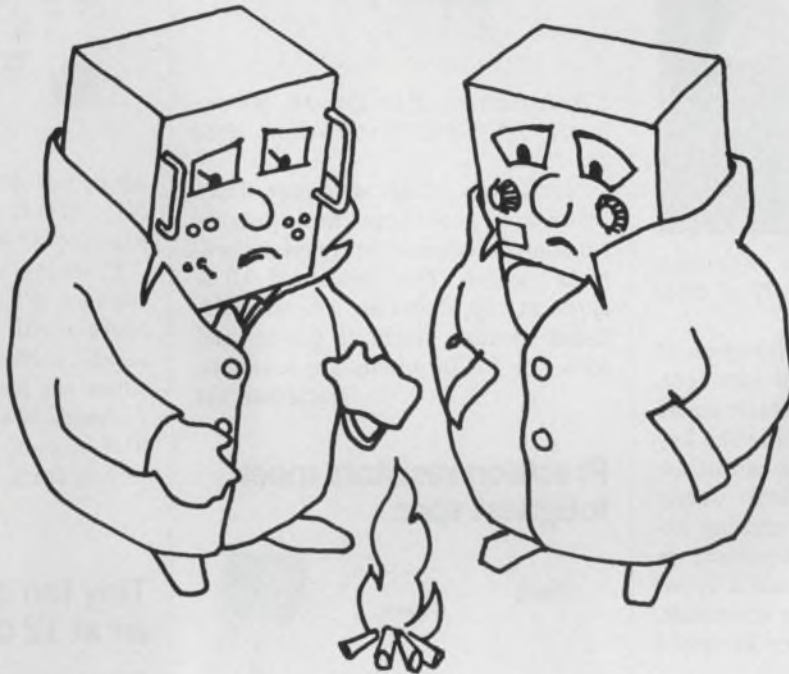

*Inventory Delivery Information in One Minute.

Unemployment Insurance (FOR TEST INSTRUMENTS)

Does it break your heart to see your test instruments just standing around idle while you're kept busy paying for them? Look around on your shelves . . . Are your test instruments not working to their full capacity because you don't need them all the time?

Well, U.S. Instrument Rentals believes that you shouldn't have to worry about paying *or* caring for instruments that are not working for you all the time. USIR feels that your valuable capital should be spent for equipment that can be employed all the time.

So, U.S. Instrument Rentals offers you Unemployment Insurance.

Unemployment Insurance means that by renting your test instruments from USIR only when you need them, you're protected against paying for idle equipment. You pay for our instruments *only* when they are working full-time for you. And when the job

is finished, you simply return the equipment to USIR until you need it again.

In addition, by renting from USIR, you're protected against those expensive calibration, maintenance and repair cost worries. We take care of all our instruments' needs.

And to insure that you get the equipment you need, USIR has thousands and thousands of instruments that are seeking gainful employment, giving you a better chance of finding the instrument that is just right for your needs.

So for a list of instruments you might like to employ and suggestions for solving your test equipment unemployment problems, send for our Unemployment Insurance Booklet . . . The USIR Rental Catalog. It's your best guide to full employment for test instruments.



Headquarters 951 Industrial Road San Carlos, CA 94070 (415) 592-9225

CIRCLE NUMBER 100



Six important questions to ask of any DMM that claims to be designed for field service.



We give you a choice of 3½ or 4½ digits, manual or autorange.

At Fluke, we've been building DMMs for a long time. We're the leader.

And if there's one thing we've learned over the years, it's that what works for the bench doesn't always work for the field.

But a lot of companies don't understand that. They'd like you to believe their DMM is perfect for field service. Just because they've put it in a different case.

Here's how to tell the difference:

1) Is the size and shape designed for the field?

How do you carry your tools? We designed the 8030A/8040A DMMs into an ideal shape after we researched the requirements of field service work. It's sized to fit in a case. And it's rugged, to take the beating field instruments must survive.



If it doesn't fit here, it's not for field service.

2) Does it have true rms ac?

Make sure you get usable accuracy. You'll need true rms ac to eliminate errors when measuring distorted waveforms. (And if you don't understand the importance of true rms, write for our bulletin on True RMS Measurement.)

3) Does it give full performance?

Just because it's a field instrument, you shouldn't sacrifice

performance. Demand five measurement functions in 26 ranges. Top specs, like our 8040A basic dc accuracy of $\pm 0.05\%$ or our 8030A basic dc accuracy of $\pm 0.1\%$. And the specifications are guaranteed for one year. Important extras, like diode test for measurement of semiconductor junctions in-circuit, high voltage protection, and self test feature. And a complete line of accessories: various battery options, and probes for measurement of rf voltages, high current ac, high voltage dc and temperature.

4) Do you have a choice of manual or autorange?

We offer two versions: the 8030A 3½ digit and the 8040A 4½ digit with autoranging. Because we know not all field service applications are alike.

5) What is the price?

A field service DMM is a tool, and should carry a practical price. Our 3½ digit 8030A is \$250.* Our 4½ digit 8040A is \$440.* Check around and you'll see how practical that is.

6) Do you trust the company that builds it?

We became the leader in DMMs for one reason only. We build digital multimeters that people trust and continue to use, year after year. We've sold hundreds of thousands of DMMs.

And every bit of that experience has gone into the 8030A and 8040A DMMs.

For data out today, dial our toll-free hotline, 800-426-0361. John Fluke Mfg. Co., Inc., P.O. Box 43210, Mountlake Terrace, WA 98043. Fluke (Nederland) B.V., P.O. Box 5053, Tilburg, The Netherlands. Phone: (013) 673-973 Telex: 52237.

* U.S. price only.

The field service DMMs for field service people.



the widest selection of SCR power supplies in the whole wide world

The off-the-shelf selection is almost endless, with 1- and 3-phase rack-mounted power supplies from 500 to 10,000 watts DC. Call for complete information and prices, or write for our catalog.



ELECTRONIC MEASUREMENTS INC.
405 Essex Road, Neptune, N.J. 07753
Phone (New Jersey) 201-922-9300 (Toll free) 800-631-4298
Specialists in Power Conversion Equipment

CIRCLE NUMBER 103

COMPONENTS

Mini isolation Xformers are for flea power

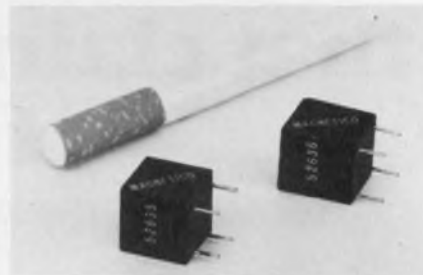

Magneto, 182 Morris Ave., Holtsville, NY 11742. Harold Eicher (516) 654-1166. \$5.90 (5000 qty); stock to 6 wk.

Encapsulated in a cube 1/2 in. on each side, transformers are offered for power-line isolation, reference voltage reduction, or those applications where isolated zero crossover detection of the power line is required. The normal input is 115 V, 60 Hz. Part 52635 provides 0.6 V at 0.1 mA and part 52636 provides 1.2 V at 0.1 mA. The units can provide constant output for input line variations, transients and most line spikes.

CIRCLE NO. 363

Touch-sensitive keyboard uses thick film

OAK TOUCH SENSITIVE SWITCHING SYSTEM

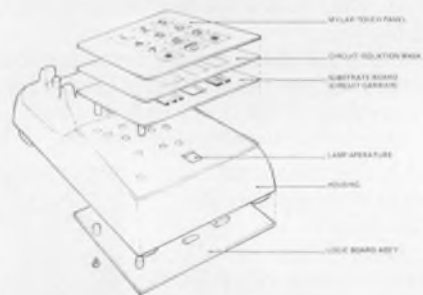

Oak Industries, Crystal Lake, IL 60014. Dodi Almcrantz (815) 459-5000.

A touch-sensitive keyboard, using thick-film techniques, provides a flat, sealed data-entry surface. With a smooth Mylar surface replacing the traditional pushbutton switches, the new switching system allows unusual graphic designs. It enables any number of switches, of the same or different size, to be printed on the Mylar sheet in any configuration. Since graphics on the Mylar surface replace pushbutton caps, any pictures or symbols can replace alphanumeric characters. By use of apertures in the housing, or in a special lamp isolation mask, any of the switches can be backlit.

CIRCLE NO. 364

The Best Way
to Measure

CUTOFF & BANDWIDTH PHASEMETRICS*

Phasemetrics is the most precise technique for cutoff and bandwidth measurements. In many passive and active circuits, (amplifiers, filters, tuned circuits, etc.), it is difficult to measure the "3dB-down" frequency with better than a few percent precision... particularly because it is difficult or impossible to establish the 0dB reference level, and because subtraction is involved. But, at cutoff, the phase shift is exactly 45° per pole (*by definition*), and the phase is easily referenced to the input signal. Hence, with a first-class phase meter — the Dranetz 305 — you can pinpoint the 3dB point within about 0.006dB (0.2%), *easily*. This 10 to 1 improvement also applies to measuring bandwidth and Q of resonant circuits and resonant frequencies ($\phi = 0^\circ$ at resonance). Neat? *Neat!*

The point is — a phase meter doesn't just measure *phase*. As many users know, the ultra-flexible, ultra-precise, fully automated "hands-off" Series 305 design equips you to measure many *other* parameters, faster and more accurately, *in terms of phase*:

- Amplifier/Network/Filter cutoff, resonance, and bandwidth.
- Distance, Directivity, and Tracking Resolution.
- Power-System Parameters (P.F., VARS, WATTS, phase balance).
- Network Immittances, Impedances, and Transfer Functions.
- Component Impedances, strays, Q, DF, AC/DC Resistance Ratios.
- Cable, Filter, Communications-Channel Group Delay and Bandwidth.

All this and much, much more is explained in our famous 24-page Applications Handbook of Precision Phase Measurement, available on request. In subsequent advertisements, we shall explore some of the other advantages of the PHASEMETRICS approach. If you don't want to wait, write or call today for your free Handbook. Dranetz Engineering Laboratories Incorporated, 2385 South Clinton Avenue, South Plainfield, New Jersey 07080. (201) 755-7080.

Got a problem we haven't listed? It may lend itself to a neat PHASEMETRICS solution. Ask us!

*We invented the term "Phasemetrics" to denote the art and science of making many different kinds of measurements in terms of phase, with less effort and uncertainty, using our state-of-the-art Series 305 Phase and Gain/Phase Instruments. We also invented "Phasea" ($\phi\alpha\sigma\epsilon\alpha$), the goddess of Phasemetrics.

For almost a decade, we have been the world leaders in phase instrumentation, and the Series 305 (a main frame with a dazzling array of wide-range and special-purpose plug-ins) has become the standard of the industry.



DRANETZ

CIRCLE NUMBER 836

Advanced Micro Devices fills in the blanks.

Advanced Micro Devices, Inc. • 901 Thompson Place, Sunnyvale, California 94086 • Telephone (408) 732-2400 •
Distributed nationally by Hamilton/Avnet, Cramer and Schweber •
Distributed regionally by Arrow, Bell, Century, Future, RAE and Sheridan.

The Texas Instruments TTL Data Book has most of the Schottky and Low-Power Schottky parts you need for most designs. Most. The Advanced Micro Devices book has the rest.

The 625-page AMD Schottky and Low-Power Schottky Data Book. It fills in all the blanks with a whole new generation of parts: Complex MSI/LSI, optimized to fit today's microprocessor and memory-oriented system architecture.

Many of these parts combine several functions in space-saving 20-pin packages. They'll create all kinds of new room on your PC boards. They'll cut your power usage dramatically, take away half your interconnections, and make your systems much, much faster.

These new parts are catching on so fast we've been getting alternate source commitments even before we can get them on the market. So when you're designing high performance digital systems, remember — don't do anything until you check both books.

The Advanced Micro Devices Schottky and Low-Power Schottky Data Book. Powerful solutions to microprocessor and memory design problems. Send us the coupon and we'll send you the book. (File it under "Schottky," right there next to that big gold one.)

For example:

8 Input Multiplexer With Control Register.

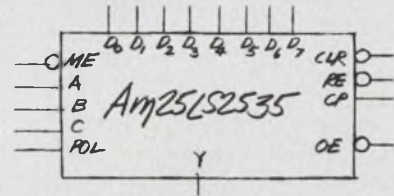

It's our way of saying three things: 54/74LS151 multiplexer plus 54/74LS175 register plus assorted gate packages. It's one 20-pin part that does the work of three or four 16-pin parts. You save space. You save money. You increase speed. By about 40%.

Programmable Up/Down Counter With 3 State Outputs

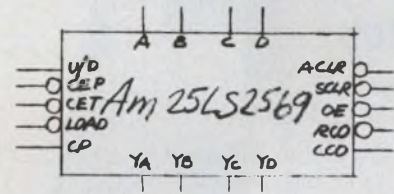

It does the work of a 54/74LS169A plus a three-state buffer plus two or three gate packages. Figure it out. You save lots of space. Add to that a savings of about 40% of your power, 40% of your time, and the total is mighty impressive.

Schottky and Low Power Schottky Data Book.

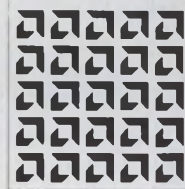

Fill in the blanks:

Name _____

Company _____

Mailing Address _____

Advanced Micro Devices

Bipolar LSI. N-channel, silicon gate MOS. Low-power Schottky. Multiple technologies. One product: excellence.



CIRCLE NUMBER 26

More than just the ABC's...

Now we give you the nitty-gritty on design for eight of the currently popular micro's!

Microprocessor Basics

Edited by
Michael S. Elphick

Two unique features make it different from the rest:

1. Unlike most books which either talk in general terms or cover only a single type of microprocessor, this book provides detailed coverage of these important models: 8080, 6800, F8, PACE, IMP, 2650, 1802, and 6100.
2. The first three sections of the book offer the beginner a foundation and the experienced designer a useful review of the general information that applies to all microprocessors.

For each microprocessor:

- The major advantages are highlighted to speed selection for a specific application.
- A detailed analysis of hardware and software features, support circuits, and design aids are given.
- All instructions are tabulated so you can easily follow the application examples and move rapidly to writing your own assembly language programs.

#5763-6, 224 pages,
paper, \$10.95

For more versatility
in micro design—turn to Hayden Book Co.!

For a good overview...

Microprocessors: New Directions for Designers

Edited by Edward A. Torrero

This popular collection of articles from recent issues of *Electronic Design* magazine provides an exceptionally well-rounded view of the micro world. It offers practical information, data, and advice on:

- how to select circuits
 - how to interpret their capabilities
 - how to extend their useful range
- Applications run from traffic control systems to small accounting equipment and from computer terminals to industrial-process controllers.

#5777-6, 144 pages,
paper, \$10.95

**SEND NO MONEY!
EXAMINE FREE FOR 15 DAYS!**



Hayden Book Company, Inc.

50 Essex Street, Rochelle Park, N.J. 07662

Please send me the book(s) checked below on 15-day exam. At the end of that time I will remit payment, plus postage and handling, or return the book(s) and owe nothing. Prices subject to change without notice. Offer good in U.S.A. and Canada only.

- Microprocessor Basics #5763-0** .. \$10.95
 Microprocessors #5777-6 10.95

NAME _____

FIRM _____

ADDRESS _____

CITY/STATE/ZIP _____

- I want to save money!** Payment enclosed. Publisher pays postage. Same 15-day return guarantee.

The New Giant in optoelectronics

**Affiliation with Siemens
gives Litronix all you
could want from an
optoelectronics source.**

**On OCTOBER 18,
1977,** Siemens A.G., an \$8 billion per year firm, acquired an 80% interest in Litronix through a wholly-owned subsidiary — bringing financial stability, new technologies and dozens of new products to the American firm.

Foremost among the new technologies and products are LCD displays, high-power infra-red emitters, green, yellow and red GaP LEDs, and a full line of photo detectors. Nearly all types of optoelectronic products will now be available from Litronix.

Litronix will operate under its own name and market all products in the U.S. and abroad through the same distributors and sales representatives as before.

All resources devoted to components

Litronix ceased manufacture of calculators and digital watches in January 1977. All the design and production capability once devoted to these products is now directed entirely to components. The component portion of the company's business has always been highly successful. Now, operating from a strong financial position, Litronix will resume its place as

the leading source of advanced, cost-effective optoelectronic components.

New, advanced products coming fast

Already in 1977 Litronix has developed 21 new products. With the recent affiliation, new product development is being further accelerated. The company's line of displays, lamps and other opto devices is being broadened and upgraded. Special emphasis is being placed on "intelligent" displays and indicators — devices which incorporate a display and integrated logic in the same package.

The recently introduced DL-1416 alphanumeric display, which interfaces exactly like a RAM, is an apt example. Such devices eliminate need for much associated interface and logic circuitry — simplifying design and producing a sizable net saving in the production cost of customers' products. Litronix is the uncontestable leader in this promising extension of optoelectronic integration.

When you have need for virtually anything in optoelectronics, contact Litronix at 19000 Homestead Road, Cupertino, California 95014. Phone (408) 257-7910.

litronix

An affiliate of Siemens.

CIRCLE NUMBER 838



*RIBBON CABLE
EASY-EFFICIENT
NEW, RELIABLE,
INTRODUCED A
SOCKETS & SWITCHES,
CONNECTORS, TERMINALS,
MANUFACTURER OF
MOLEX INC., WORLDWIDE
OF LISLE, ILLINOIS,
RECENTLY IN THE LAND*

Molex Franchised Stocking Distributors for Jet-Flecs™

Eastern Distributors

Components South, Inc.
Pompano Beach, FL
305/971-0350

Components Unlimited
Lynchburg, VA
804/384-6990

DRW Electronics
Watertown, MA
617/923-1900

General Radio Supply Co.
Camden, NJ
609/964-8560

Progress Electronics
Plainview, L.I., NY
516/433-1700

Pyttronic
Montgomeryville, PA
215/643-2850

Sheridan Sales Company
Beachwood, OH
216/831-0130

Sheridan Sales Company
Reading, OH
513/761-5432

Summit Distributors Inc.
Buffalo, NY
716/884-3450

Central Distributors

Industrial Components, Inc.
Minneapolis, MN
612/831-2666

Sub-Sem Electronics, Inc.
Crystal Lake, IL
815/459-4139 or
312/782-3954-55

Western Distributors

Force Electronics
Inglewood, CA
213/776-1324

Integrated Electronics
Denver, CO
303/534-6121

Peters-de Laet
Santa Clara, CA
408/248-9440

Peters-de Laet
South San Francisco, CA
415/873-9595

Solid State Electronics
Dallas, TX
214/352-2601

Solid State Electronics
Houston, TX
713/785-5436

Westates Electronics
Chatsworth, CA
213/341-4411

Westates Electronics
Costa Mesa, CA
714/549-8401

Westates Electronics
San Diego, CA
714/292-5693

Westates Electronics
Sunnyvale, CA
415/964-1700



jet-flecs

jet-flecs RIBBON CABLE

Part Number _____ Quantity (Feet) _____
 Number of Conductors _____ Conductor Size _____

APPLIANCE WIRING MATERIAL SUITABLE FOR INTERNAL WIRING OF ELECTRONIC COMPUTERS AND ELECTRIC BUSINESS MACHINES.

NOTES:
 Manufacturer's wire designation shall be the reverse side number of the product printed to be perfect. User shall determine the quantity of the product for its intended use, and assume all risk and liability in construction clearance.

LABELS AND STAMPS

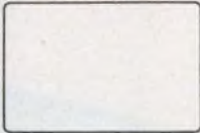

Q.A. APPROVALS

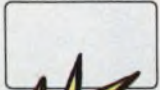

MANUFACTURING & SPECIFICATION INFORMATION:

U. L. Style No. _____
 Maximum Temperature Rating _____
 Maximum Voltage Rating _____
 Date of Manufacture _____
 Run Number _____



able Technology

2222 Wellington Court, Lisle, Illinois 60532

- 25 FEET
- 50 FEET
- 75 FEET

The Molex Jet-Flecs™ ribbon cable is manufactured under controlled techniques which produces a precision center-to-center controlled cable of predictable and consistent electrical characteristics.

The jet black ribbon cable is available in #28 AWG stranded (7/36) conductors. The first strand has a white color key marking. The ribbon cable design allows individual or groups of conductors to be separ-

ated from the cable through a zipping process.

Molex ribbon cables are U.L. listed at 105°C and 300 V RMS. They are also FR-1 rated under U.L. Flammability specifications.

Jet-Flecs™ ribbon cables are designed to mate with the Molex 4700 series Jet-Flecs™ connector system and compatible industry standard insulation displacement systems.

CIRCLE NUMBER 839

molex® ... Affordable Technology

Need ROM retention and RAM alterability?

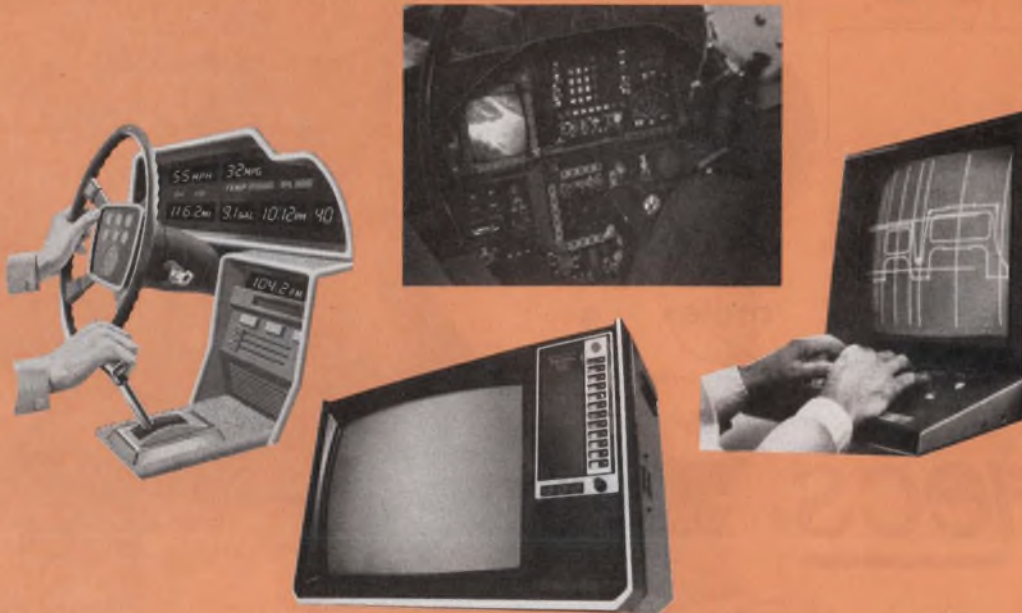

Design in Nitron Non-Volatile Memories.

Our Metal Nitride Oxide Silicon NVM are fully reprogrammable in-circuit. They offer long-duration storage security without battery backup or "power-on" auxiliaries.

HIGH DATA RETENTION

Data is secure for a minimum of 10,000 hours and can be read 10^{10} times between refresh cycles.

PROGRAM VERSATILITY

Nitron NVMs offer entire memory or word alterability. And it can all be done in-circuit a minimum of 10^5 times. Millisecond write times are ideal for applications in the human-response range.

SYSTEM COMPATIBILITY

We built in on-chip decoding, and TTL and CMOS compatibility. Plus, Nitron NVMs can be reprogrammed without additional power supplies or power supply switching.

PRODUCT AVAILABILITY

Nitron NVMs are available off-the-shelf for parallel data applications in 64x4 and 256x4 configurations;

and for serial data applications in 21x16, 16x18 and 1024x1 configurations. If you don't see what you need, tell us about it. We custom design NVMs, too.

Unique Nitron process puts silicon nitride and silicon dioxide layers between MOS gate and substrate. When voltage is applied, trapped charge offsets threshold voltage. Charge remains after voltage is removed.

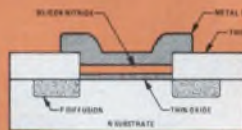

Need information fast? Call Nitron NVM Marketing at (408) 255-7550. Or fill in the coupon below for your NVM Fact Kit.

NITRON

Mail to:
NITRON NVM Marketing
10420 Bubb Road
Cupertino, CA 95014

TELL ME MORE!

I'm interested in (check box):

- | | |
|---|---|
| <input type="checkbox"/> 64x4
NC7040 | <input type="checkbox"/> 21x16
NC7033 |
| <input type="checkbox"/> 256x4
NC7050 | <input type="checkbox"/> 16x18
NC7035 |
| <input type="checkbox"/> 1024x1
NC7051 | <input type="checkbox"/> Complete
NVM Fact Kit |

Send to:

name & title _____

company _____

address _____

city _____

state _____

zip _____

ED-11

Precision film resistors rated 1/10 W at 85 C

Dale Electronics, P.O. Box 74, Norfolk, NE 68701. (402) 371-0080. \$0.40; 8 to 10 wk.

Precision metal-film resistors, PTF 55, are rated at 1/10 W at 85 C. They have a resistance range from 50 to 250 k Ω . Dimensions are 0.26 in. long by 0.094 in. diameter. Tolerances from $\pm 1\%$ down to $\pm 0.05\%$, with TCs of ± 15 ppm/ $^{\circ}\text{C}$ (T-10) and ± 10 ppm/ $^{\circ}\text{C}$ (T-13) are available.

CIRCLE NO. 365

LED indicator lamps sealed for protection

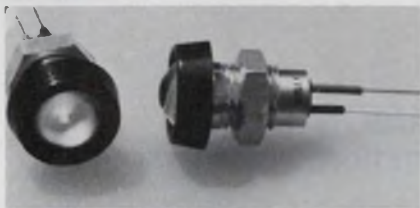

Oxley, 3250 Wilshire Blvd., Los Angeles, CA 90010. Ray Guthrie (213) 383-8270.

Solid-state indicator lamps, type PS/LH/8, for military-style rugged mounting use high-brightness, high-reliability LEDs. Panel sealed with PTFE sealing rings, the lamps embody sealed glass lenses and black shrouds to optimize the visual effect and protect the emitter in severe environments. Their aluminum-alloy bodies are compatible with standard chassis and provide electromagnetic shielding for military applications. The lamps are available in red, yellow and green.

CIRCLE NO. 366

DIP relay has low profile

Allied Control, 100 Relay Rd., Plantsville, CT 06479. (203) 621-6771.

A low-profiled DPDT, DIP relay stands only 0.38 in. high and fits within 0.5 in. spacing when mounted on a PC board. It fits standard 16-pin IC sockets and its footprints are interchangeable with similar-but-higher profile DIP relays. The relay has a sensitivity of 200 mW at pull-in. Its rating is 1-A resistive at 28-V-dc switching and 5-A carry ability. Typical operating time is 4 ms; release time is 1 ms. The relay's construction is sealed for wave soldering and cleaning.

CIRCLE NO. 367

Toggle switch can be used up to 2 GHz



Instru-Mech, 1275 Bloomfield Ave., Fairfield, NJ 07006. (201) 575-1860. \$5.50/\$6.50; stock.

The Type 10 toggle switch has low shunt capacitance (0.4 pF), so it can be used up to a frequency of 2 GHz. It does not require shielding and is for low-energy use. The size is subminiature. Type 20 has essentially the same characteristics, but performs up to 1 GHz. The switches have Teflon bodies which minimize dissipative and dielectric losses.

CIRCLE NO. 368

WHETHER YOU'RE COUNTING ONE THING EVERY NOW AND THEN OR FIVE HUNDRED MILLION EVERY SECOND, THIS CHIP CAN HELP YOU DO IT BETTER AND SAVE YOU MONEY, TOO.

It's the LS7031 6 decade MOS up counter with 8 decade latch and multiplexer.

It can count up to 5MHz on its own over its entire range of 4.75V to 15V.

It's the only MOS chip that allows you to attach prescalers and count up to 500 MHz.

But it's also so efficient and inexpensive that you'd do well to consider it when you're counting things that go a lot slower.

And it has power-saving features which make it suitable for portable instruments. Leading zero blanking and leading zero blanking override. Overflow outputs for 6, 7, or 8 decades.

Our customers—including some of the biggest manufacturers of frequency counters in the business—tell us it's the best counter chip they've ever seen.

We think you'll agree. Let us tell you more about it. Contact Ron Colino at (516) 271-0400.

LSI COMPUTER SYSTEMS INC.

1235 Walt Whitman Road
Melville, NY 11746
TWX: 510-226-7833.
Argentina Tel. 46-9549.
Germany Tel. 089/69 65 66/67.
Italy Tel. (02) 688.38.06
Japan Tel. (03) 449-7141/2.
U.K. Tel. 01 995 8495, Mr. Glyn Hall.

CIRCLE NUMBER 104

strip chart recorders

- OEM MODULES
- LOW PROFILE
- PACKAGED UNITS
- PORTABLE DC

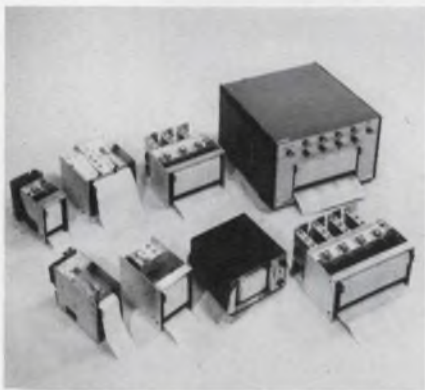

General Scannings thermal writing Strip Chart Recorders are available in a wide range of configurations and performance characteristics to meet virtually every recorder need.

You can select open-loop, velocity feedback or closed-loop operation; continuous roll or fan-feed paper; one to eight channels in channel widths of 20, 40, 50, 80 or 100mm; a variety of chart speeds; and either AC or DC operation.

Recorders can be furnished as modules for use by OEM's or fully packaged.



For complete details, circle readers' service number or write today for our full line Strip Chart Recorder Catalog.

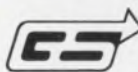

GENERAL SCANNING INC.
150 Coolidge Avenue
Watertown, MA. 02172
TEL: (617) 924-1010

CIRCLE NUMBER 105

COMPONENTS

Provide spot-cooling with centrifugal blower

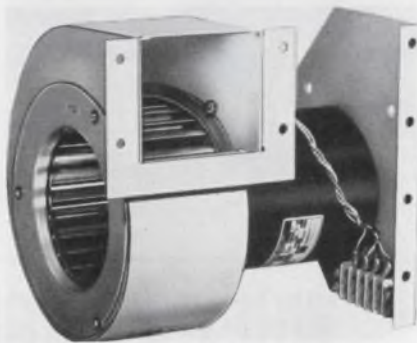

McLean Engineering Lab, 70 Washington Rd., Princeton Junction, NJ 08550. (609) 799-0100.

Twelve models of centrifugal blowers have performance ranging from 75 cfm to 325 cfm. Delivering maximum spot-cooling efficiency, each model is available in CW or CCW rotation and can be mounted in any position for effective air movement. Long-life motors can be provided for any ac frequency or power; single or three phase.

CIRCLE NO. 369

Precision pots last longer than carbon units



Beckman Instruments, Helipot Div., 2500 Harbor Blvd., Fullerton, CA 92634. (714) 871-4848.

Type 6180 precision potentiometers are rated at 5-million shaft revolutions, which is 50 times better than carbon composition pots. The 6180 consists of three, 7/8-in. diameter, single-turn, conductive-plastic models that differ only in bushing and shaft dimensions to accommodate mounting requirements. All provide 1-W power rating at 70 C with 125-C max operating temperature. Other features include an essentially infinite resolution, output smoothness of 0.1% max and nonflammable materials.

CIRCLE NO. 370

Mini film capacitors offered in TO-5 size

Inter-Technical Group, P.O. Box 23, Irvington, NY 10533. (914) 591-8822.

Subminiature film-dielectric capacitors come in sizes no bigger than a TO-5 case. The FKS2, MKS2 and FKC2 series have polyester and polycarbonate film-dielectrics about 0.002-mm thick. Lead spacings are either 5 mm or 7.5 mm. Capacitance values range from 150 pF to 1 μ F in either 63 V dc or 100 V dc ratings. The capacitors are vacuum encapsulated in epoxy for physical uniformity and resistance to environmental extremes. Operating temperatures are -55 to 100 C.

CIRCLE NO. 371

Use RFI filters in noisy switchers

Corcom, 2635 N. Kildare Ave., Chicago, IL 60639. (312) 384-7400. \$10.80 to \$33.35; stock.

SP type RFI power-line filters are for switching-type power-supply-noise suppression. They provide high insertion loss for both line-to-ground and line-to-line emissions throughout the frequency range. Filters are available in 3, 6 and 10-A versions. Max leakage current, line-to-ground, is 2.0 mA at 115 V ac 60 Hz. Size is 6.37 \times 2.0 \times 1.75 to 2.25 in. depending on model.

CIRCLE NO. 372

Circuit breaker doubles as snap-action switch

Airpax Electronics, Cambridge, MD 21613. (301) 228-4600. \$5.00.

The T11 magnetic circuit breaker doubles as an up-front, high-current power switch. The UL-recognized device features fast-make, fast-break snap-action contacts that have a more than 20 to 1 increase in open-contact gap over conventional switches. The series-trip spst T11 is available in six paddle-handle colors. They can be used at dc, 50 or 60 Hz. Current ratings are from 0.1 to 20 A at 32 V dc, 15 A at 120 V ac, 50/60 Hz and 400 Hz; and from 0.1 to 7.5 A at 50 V dc, 250 V ac, 50/60 Hz and 400 Hz. Short-circuit rupture capacity is 1000 A. A number of trip delays are available.

CIRCLE NO. 373

\$74.95 SOURCE.

It's CSC's DP-1: the automatic signal source that cuts hours from trouble-shooting TTL/DTL, CMOS and other popular logic circuits.

This compact, circuit-powered unit lets you inject signals at key points to test digital circuits with fast stimulus-response troubleshooting techniques. Just set a switch to the proper logic family; connect two clip-leads to the circuit's supply, and touch the DP-1 probe to a node. It automatically senses the circuit's condition (high or low state) and produces an opposite-polarity pulse of the proper level. That's all there is to it!

Versatility-flexibility. Select single-pulse or 100 pulse-per-second operation with the handy pushbutton control. A LED indicator signals single-shot or continuous mode. DP-1 can also be connected indefinitely, presenting a 300K impedance to the circuit under test. Short circuits can't harm it, even over prolonged periods. It's also protected against overvoltage up to 25V and reverse-polarity up to 50V.

For all its versatility, portability, operating ease and compact size, DP-1 is priced at only \$74.95—a fraction of what you'd expect to pay for a precision digital pulse source. See your CSC dealer today. Or call 203-624-3103 (East Coast) or 415-421-8872 (West Coast) for the name of your local stocking distributor and a full-line catalog.

Logic family switch— Sets proper pulse level for TTL/DTL or CMOS families

Rugged, high-impact plastic case— Built to take it in the lab or in the field

Protected— Features built-in short-circuit, overvoltage and reverse-polarity protection.

Operating mode pushbutton— Selects single-shot or 100 pps operation

LED Pulse indicator— Monitors operating mode

Interchangeable ground leads connection— provide ground-side input connection, where desired, via optional cables.

Interchangeable probe tips— For greater versatility. Straight tip supplied; optional alligator clip and insulated quick-connecting clip available.

Plug-in leads— 24" supplied, with non-corrosive nickel-silver alligator clips.

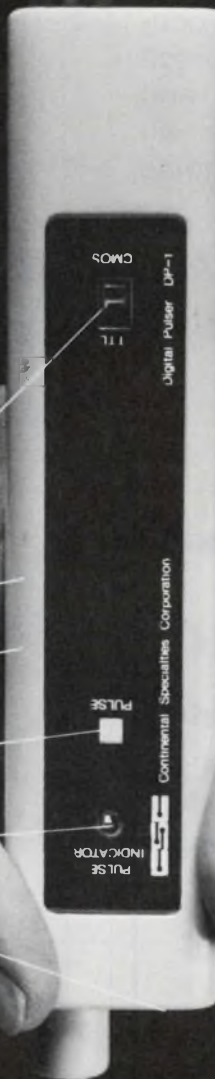

SPECIFICATIONS

Tri-state output— DP-1 is isolated from circuit under test. $Z \geq 300K$

Auto-polarity pulse sensing— DP-1 automatically produces proper polarity pulse for circuit under test: logic "0" level produces a "1" pulse, logic "1" level produces a "0" pulse

LED indicator— flashes once for single pulse, stays lit to indicate pulse train

Short-circuit protection— can pulse into short circuit continuously

Power— overvoltage protected to 25V, reverse-voltage protected to 50V; voltage range 4-18V, 30mA max.

Pulse modes— Single pulse: press pushbutton for one sec. or less. Pulse train (100pps): hold pushbutton down

Pulse specs

	TTL	CMOS
Pulse width	1.5usec \pm 30%	10usec \pm 30%
Fan out	60 loads	
Sink and Source	100mA source to 3.5V; sink to 6V	50mA source to logic 1; sink to logic 0
T_r	100nsec	100nsec
T_f	one TTL load, 500nsec	100K load, 8nsec

* T_r is directly proportional to load resistance

Dimensions (l x w x d) 5.8 x 1.0 x 0.7" (147 x 25.4 x 17.8mm)

Weight 3 oz. (0.85kg)

Power Leads plug-in 24" (610mm); color coded insulated clips, others available

ACTION	MOMENTARY PRESS OF PUSH-BUTTON	RELEASE PUSH-BUTTON	CONTINUOUS PRESS OF PUSHBUTTON (OVER 1 SEC.)
LED	FLASHES	OFF	ON
OUTPUT	DP-1 SENSES LOGIC 1 (HIGH) PRODUCES 0 PULSE OR 100 PPS PULSE TRAIN		
	LOGIC 1		
	LOGIC 0		
	DP-1 SENSES LOGIC 0 (LOW) PRODUCES 1 PULSE OR 100 PPS PULSE TRAIN		
LOGIC 1			
LOGIC 0			

NOTE: SEE SPECIFICATIONS FOR DUTY CYCLE

CONTINENTAL SPECIALTIES CORPORATION

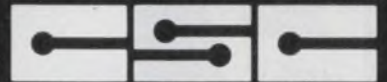

44 Kendall Street, Box 1942, New Haven, CT 06509
 203-624-3103 TWX 710-465-1227
 West Coast: 351 California St., San Francisco, CA 94104
 415-421-8872 TWX 910-372-7992
 Great Britain: CSC UK LTD
 Spur Road, North Feltham Trading Estate,
 Feltham, Middlesex, England
 01-890-8782 Int'l Telex: 851-881-3669



*Manufacturer's Recommended Resale

©1977 Continental Specialties Corporation

NEW FREE CATALOG

TROMPETER ELECTRONICS

has just published a new 40 page catalog T11, illustrating a complete line of coax, twinax, triax and quadrax connectors, patch panels, plugs, jacks, patch cords, cable assemblies, networks and accessories. The catalog includes an eight page technical discussion of noise in cable systems.



SEND FOR YOUR FREE COPY TODAY.

TROMPETER ELECTRONICS, INC.

8936 Comanche Avenue, Chatsworth, CA. 91311
(213) 882-1020/TWX: 910-494-1210

CIRCLE NUMBER 107

FREE!

EDMUND SCIENTIFIC

ELECTRONICS
OPTICS
SOLAR ENERGY
MAGNETS
LASERS

O.E.M. COMPONENTS
LABWARE
MIRRORS
SURPLUS

164 PAGE CATALOG

- Over 4,000 unusual bargains for science and industry
- In-stock supplies for engineers, experimenters, research labs, hobbyists, etc.
- Order direct and save — buy with complete confidence ... every item carries the famous Edmund 30-day money-back guarantee.
- Simply mail this coupon for the newest Edmund catalog.

RUSH LATEST FREE EDMUND CATALOG

EDMUND SCIENTIFIC CO.
Dept. DA22, Edscorp Building, Barrington, N.J. 08007

Name _____
Address _____
City _____ State _____ Zip _____

CIRCLE NUMBER 108

TYPE OF
Glass tubular capacitors, temperature range of -50° to 85° C, offer continuous operation at 85° for 10,000 hours. Standards thru 60 KVDC.

TYPE LK
CP70 style. Unusually good electrical characteristics in a very small unit. Used for filters, bypass and coupling. Temperature range, -55° to 105° C, 10,000 hours life at 85° C. Standards thru 50 KVDC.

DUAL DIELECTRIC CAPACITORS

Write for Literature.

Plastic Capacitors, Inc.
2623 N. Pulaski Road
Chicago, Illinois 60639
(312) 489-2229

"Serving industry for 25 years"

CIRCLE NUMBER 109

FOR HOME AND INDUSTRY

WORLD'S MOST PRACTICAL SOLDER HANDLING TOOLS

SOLDERING + DESOLDERING + RESOLDERING =

SOLDER Ability

ELEMENTARY TO ELITE

contact your local **DISTRIBUTOR**
inquiries invited

MOST PRODUCTS COVERED BY U.S. AND FOREIGN PATENTS AND PENDING APPLICATIONS

EDSYN INC.

1558 ARMINTA ST. VAN NUYS, CALIF. 91411
24 HR. PHONES (213) 788-2224 • A (213) 872-5175
CABLE: EDSYNEX VAN TEXAS-1489

144 PAGE TRAINING MANUAL
NEW! OVER 1,000
ILLUSTRATIONS

CIRCLE NUMBER 110
ELECTRONIC DESIGN 24, November 22, 1977

COMPONENTS

Tilt switch mounts on PC boards

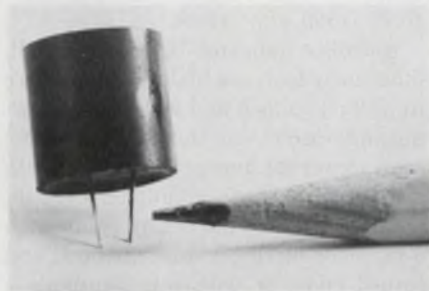

Fifth Dimension, 707 Alexander Rd., Princeton, NJ 08540. Bill Kinney (609) 452-1200. \$2.50; stock.

Tilt switch, TS7-1832, is an omnidirectional, mercury-switching capsule that is equipped with PC-board terminals, and is epoxy encapsulated. The switch may be mounted to a PC board and wave soldered. It is positioned normal to the board surface after soldering. Tilting the board 15° in any plane, from the horizontal, will cause the normally open contacts to close. The switch contacts are rated at 1.0 A, 115 V ac or 24 V dc.

CIRCLE NO. 374

Digital encoder eliminates noise, wear

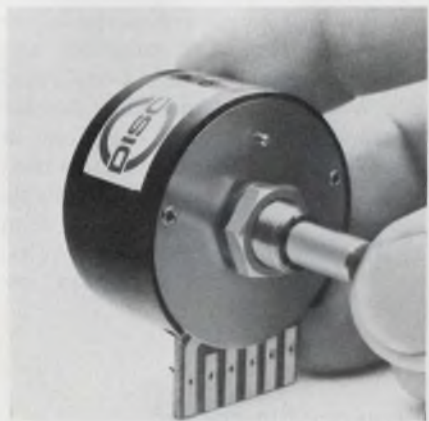

Disc Instruments, 102 E. Baker St., Costa Mesa, CA 92626. (714) 979-5300.

A digital output signal proportional to shaft rotation from a Panelcoder can replace old style analog potentiometers and eliminate noise and wiper wear. The encoder employs solid-state, LED sources and plugs in with a circuit-board edge-connector. Adjustable torque is built-in to prevent flywheel or knob movement under vibration. The unit operates manually at speeds to 100 rpm.

CIRCLE NO. 375

CIRCLE NUMBER 111 ►

be logical

cheat a little

Choose the capability you need from a whole new selection of **LOGIC ANALYZERS** and pay less!

Logic Analyzers

Delay Generators

Scope Multiplexers

Monitors

10MHz, 20MHz

4-8-16 Channels

MEMORY?

256 - 512 - 1024 deep - Expandable

DATA?

Timing Diagrams-Binary-Octal-Hexadecimal-Mapping

MORE?

External/Internal Clocking-Glitches-Single Event Capture-External Qualifiers

THEY'RE ALSO: MODULAR, EXPANDABLE, COMBINABLE

IT'S A FAMILY !

for more information call or write Pete Marra at our Oakland Office.



515 11TH STREET
OAKLAND, CALIFORNIA 94607
PHONE (415) 834-3030



SOLVED!

YOUR BUS-RELATED DATA RECORDING PROBLEMS



With Dylon's new GPIB (IEEE-488) tape recorders, you can now transfer data directly from the Bus to 1/2" magnetic tape. With NO interfacing. Just plug it in.

Once on tape, data may be transferred to your computer for analysis. Or it can be read back through the Bus to any GPIB-compatible minicomputer or calculator.

There's more. Much more.

To find out how Dylon GPIB tape recorders can solve Bus-related recording problems in your data collection system, please call or write our director of marketing.

Dylon

The Dylon Corporation
3670 Ruffin Road
San Diego, California 92123
(714) 292-5584

CIRCLE NUMBER 112

COMPONENTS

Keyboard switch wears booties

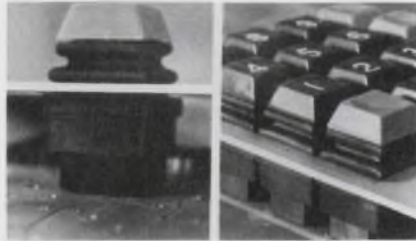

Mechanical Enterprises, 800 Forbes Pl., Springfield, VA 22151. Robert Twyford (703) 321-8282. \$0.43 (10,000 qty).

An environmentally sealed keyboard switch, T-5Q, is for circuit-board mounted, thru-panel use, including clusters to make a keyboard array. It has a neoprene sealing-boot, made in the form of a bellows. Doubleshot molded keytops are used for legending. The plungers have a total travel of 0.17 in. and an actuation force of 3.5 to 4 oz. They are available in both momentary and alternate actions with single and double-pole contacts.

CIRCLE NO. 376

Slide switch works at right angle

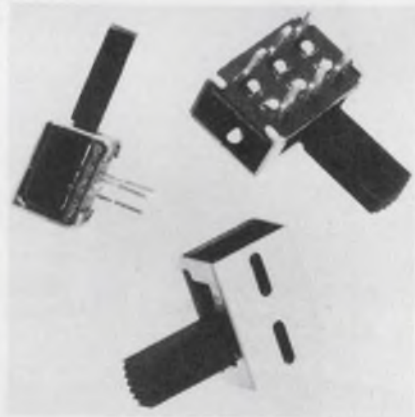

Stackpole Components, Farmville, VA 23901. Steve Smith (804) 392-4111.

For use where front-panel real estate is at a premium, "Side-Slide" side-actuated mini-switches can be the answer. With a height of 0.375 in. from PC board to case top, they mount where switching must be done at right angles to the board. Capable of UL listing or CSA certification of 3 A at 125 V ac, they are available in sp, dp and sp spring-return versions.

CIRCLE NO. 377

LED indicators are tiny and fast

Chicago Miniature Lamp Works, 4433 N. Ravenswood Ave., Chicago, IL 60640. George Neeno (312) 784-1020. \$0.90 (1000 qty); stock.

Astrolite indicator lights are small, inherently fast, use little power and are immune to shock and vibration. Viewing angle is 60°, and they can be readily seen across the average room. LEDs in a metallic package mount in 0.193-in. panel holes. The indicators come with 6-in. leads having 1/4-in. stripped and tinned ends, or with pin terminals.

CIRCLE NO. 378

Carbon-film resistors have dual-power rating

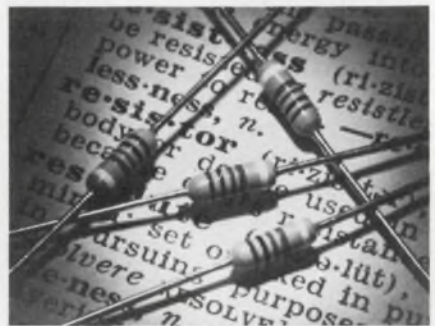

Mepco/Electra, Columbia Rd., Morristown, NJ 07960. (201) 539-2000.

GPR 5000X general-purpose resistors combine tight tolerance and temperature coefficient in a dual rated 1/4 W/1/2-W package. They are 2% tolerance, ±200-ppm-TC devices in 1/4-W packages, but can also be used in 1/2-W applications. The available resistance range covers from 10 Ω to 22 MΩ, with a max of 350 working volts.

CIRCLE NO. 379

Low-profile relays mount on PC boards

Struthers-Dunn, Lambda Rd., Pitman, NJ 08071. (609) 589-7500.

Low-profile relays, Type 400, may be mounted on PC boards with spacings of 19/32 in. between boards. Contact configurations from SPDT to 6PDT have a useful life of five-million operations at 1 A, 24 V dc. SPDT-relay load ratings are 2 A; multipole relays are 1 A. Latching and sealed units are available.

CIRCLE NO. 380

One Mallory THF capacitor can replace up to four CSR types in a switching power supply.

These small, solid-tantalum capacitors give you a per-unit substitution factor as high as one for four and can by-pass 4.5 amp rms at 100kHz. So by using these high ripple performance capacitors you save in space, weight and cost.

Specially designed for low equivalent series resistance, at frequencies from 1 kHz through 1 MHz. They're ideal for high frequency power supply switching, for regulator switching, or for bypassing or filtering unwanted ripple currents.

Because ESR is low, power losses are low. With the solid electrolyte and hermetic seal, long life is inherent. Electrical characteristics are very stable over a temperature range of -80°C through 125°C . Two case sizes: .29 x .69 and .35 x .79 inches.

Mallory THF capacitors are available in a wide range of ratings: 5.6 to $330\mu\text{F}$, 6 to 50VDC.

They're the result of Mallory's engineering program that's finding ways to produce high performance type capacitors at less cost to you.

Just ask your Mallory representative. Available direct, or through authorized Mallory Distributors in U.S. or overseas. Or call Help-Force Headquarters at (317) 856-3731. Mallory Capacitor Company, a division of P. R. Mallory & Co. Inc., Box 1284, Indianapolis, IN 46206.

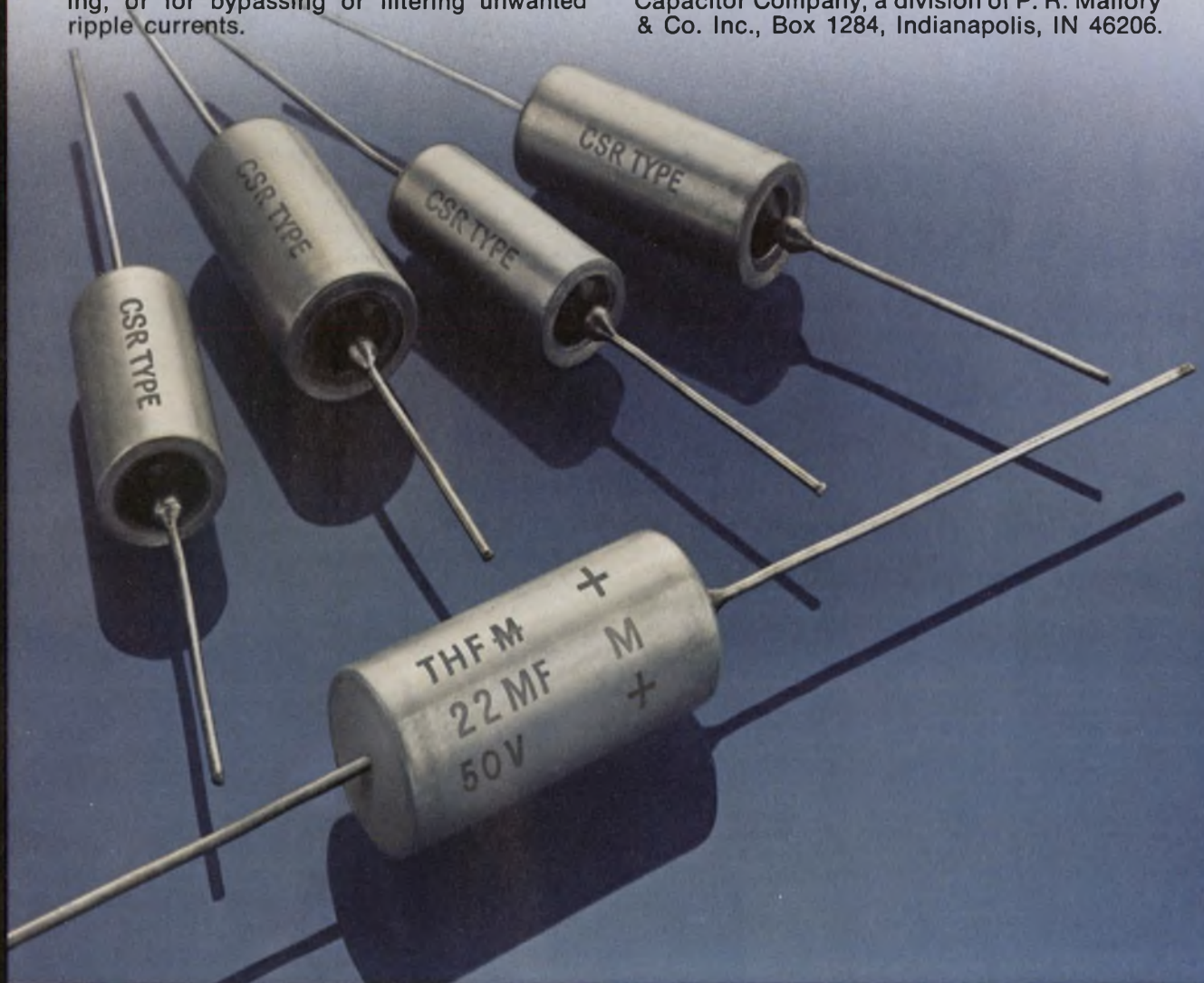

MALLORY

DATA PROCESSING

Terminal system has hard-copy output

Olivetti Corp. of America, 500 Park Ave., New York, NY 10022. Mike Poli (212) 371-5500. \$7500 to \$10,000 (5 up); stock.

TC808 terminal system is aimed at interactive or batch communications

with optional hard-copy output. It is for on-line communications and remote data entry users who require limited terminal intelligence, limited peripheral connections, and printed response. Standard equipment includes a central control unit, a synchronous or asynchronous line-control unit, and a work station with keyboard and printer. A 260-character display is available, as is an extra 8-k memory that can bring the basic memory size to 24 k.

CIRCLE NO. 381

Drum plotter zips along at speed of 2 in/s



California Computer Products, 2411 W. La Palma Ave., Anaheim, CA 92801. Carol Felton (714) 821-2541. \$8220 to \$11,960; 12 wk.

Model 1037, part of a new family of drum plotters, features one pen, and a plotting speed of 50 mm/s (2 in/s). Capability is field upgradeable to that of other plotters in the family—the single-pen, 112.5-mm/s (4.5 in/s), Model 1038, and the three-pen, 112.5-mm/s Model 1039.

CIRCLE NO. 382

Only two companies make 50-MHz, 16-channel logic analyzers.

Ours costs less and gives you Window-Trigger Storage.

Window-Trigger Storage. WITS, for short. It's more than a catchy name. It's a key feature of our new 50D16 logic analyzer that will let you catch the information you want better than ever before.

WITS eliminates triggering on data you're not interested in. Like noise, static—or even the anomalies found on computer or microprocessor buses at the time of device transfer. It works because you can insert up to three sample bits of time delay in the trigger. Along with this feature, you can count trigger events and capture data just before, or just after, the event you want.

The new 50D16 is one of only two 50-MHz, 16-channel asynchronous logic analyzers available. It's the better one. Because of WITS, because it's more compact, and because it costs less than the Other.

If you have to debug microprocessor-based systems—both hardware and software—you need



to know more about the 50D16. Especially about our new Data Formatter. It has time domain, data domain, mapping, and compare memory features. And, it eats software bugs alive.

The 50D16 is getting a lot of attention lately. Because of WITS and a lot more features than we can mention here. If you use logic analyzers in your lab, in field service, or in your product, we'd like to have your attention. For technical data and pricing, use the reader service number or call us today at (408) 446-4322.



**MATCHING WITS WITH BITS...
BP'S 50D16 WITH DISPLAY FORMATTER—**

The Giant Killers
BP INSTRUMENTS
10601 S. De Anza Blvd.
Cupertino, CA 95014

CIRCLE NUMBER 114

Data concentrator claims to shatter price barrier



Micom Systems, 9551 Irondale Ave., Chatsworth, CA 91311. Roger Evans (213) 882-6890. See text; 6 wk.

Micro800 is a 4 or 8-channel data concentrator, or smart multiplexer, providing multiplexing at lower cost than with conventional time-division multiplexers. Its statistical multiplexing method provides more efficient use of the shared telephone line or digital data link. Retransmission on error end-to-end is fully automatic. The device permits up to eight asynchronous data terminals to share a single line. Price is \$1870 for a 4-channel system, \$2630 for 8 channels.

CIRCLE NO. 383

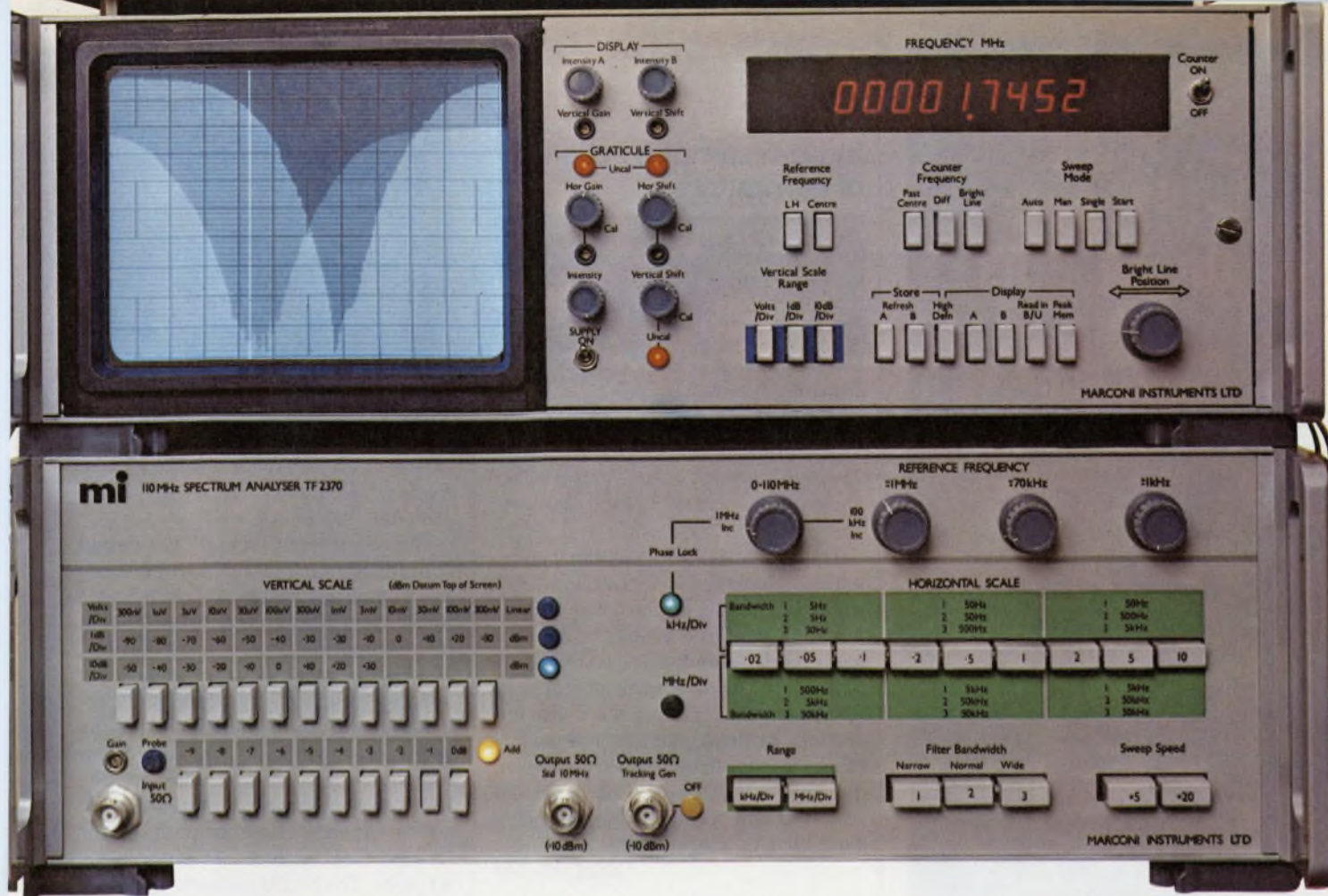

RF PERFORMANCE...is the most important feature in any Spectrum Analyzer..mi gives you the *best* in performance, and in value!

Save your skilled engineers for more important work with **mi** Model 2370 Spectrum Analyzer. *Simplify* complicated measurements such as *response, level, gain, signal purity, modulation* and many more. Forget everything you have heard about spectrum analyzers. **mi** Model 2370 is unique. It employs advanced technology to make it as easy to operate as a multimeter. The facts speak for themselves.

- Flicker-free high brightness TV display (No more storage tubes to replace)
- Electronic graticule can pin point position of waveform display for rapid analysis and measurement.
- Choice of vertical scales: linear, 10dB/div for 100dB display, and 1dB/div for 0.1dB resolving power.
- Counter **automatically** displays center frequency, identifies the frequency corresponding to the manually

adjusted 'bright line cursor', or the difference frequency between the two. All to an accuracy of 2Hz.

- Integral synchronous signal source for measuring *networks, filters, amplifiers, etc.*
- For comparative measurements, memory storage can retain one display indefinitely, for simultaneous display with waveform from items under test.
- **Automatic** adjustment of amplifier gain to *optimize* noise performance.
- **Automatic** selection of *optimum* sweep speed.
- With the 5Hz filter, signals 100Hz from a response at 0dB can be measured to better than -70dB.

Such speed and accuracy must be seen to be believed, call us for an enlightening demonstration.

mi **MARCONI INSTRUMENTS**
DIVISION OF MARCONI ELECTRONICS INC.

Marconi Instruments • 100 Stonehurst Court • Northvale, New Jersey 07647 • Tel: (201) 767-7250

Marconi instruments Limited • Longacres • St. Albans • Hertfordshire • England AL40JN • Tel: (0727) 59292

Marconi Instruments • 32 avenue des Ecoles • 91600 Savigny-Sur-Orge • France • Tel: 996.03.86

Marconi Messtechnik GmbH • 8000 Munchen 21 Jorgstrasse 74 • West Germany • Tel: (089) 58 20 41

750R-2

The Fastest 8-Bit DIP A/D On 24 Pins

- 100 ns/bit
- $\pm 1/2$ LSB linear over temperature
- 9 input ranges
- Adjustment free
- Serial and parallel outputs
- Extended temperature range available (-55° to 85°C)
- Hermetic 24-pin DIP
- Available with Mil-Std-883 Class B processing



MN 5101
\$234.00

(1 to 24 units)



Micro Networks Corporation
324 Clark Street, Worcester, MA 01606
(617) 852-5400 TWX 710-340-0067

CIRCLE NUMBER 116

DATA PROCESSING

System samples action of computers



Tesdata Systems, 7900 Westpark Dr., McLean, VA 22101. (703) 790-5580. \$115,000 to \$178,000.

Alpha Series of computer-performance management systems continuously sample performance of computers. They give real-time displays and report generation as system troubles occur. Each system operates in foreground/background via a disc operating system; continuous performance measurement data are stored on disc in the foreground, while system planning and trend reports are being generated in the background.

CIRCLE NO. 384

CRT terminal is TTY-compatible



Ann Arbor Terminals, 6107 Jackson Rd., Ann Arbor, MI 48103. Sarah Freeman (313) 769-0926. \$1620; 8 wk.

A TTY-compatible CRT terminal, Model 400D, is available with upper/lower-case display of double-size characters. Its refresh memory stores five pages in a 50-line by 40-character format. Ten lines of 40 characters are displayed at one time, with the remaining 40 lines accessible in either roll or scroll modes. Characters are written in a 7 x 10 dot matrix in a 10 x 12 dot field. The unit comes with RS232 data interface and RS170 video output for driving auxiliary monitors. Four case options are available.

CIRCLE NO. 385

Emulation unit allows mini to use IBM devices

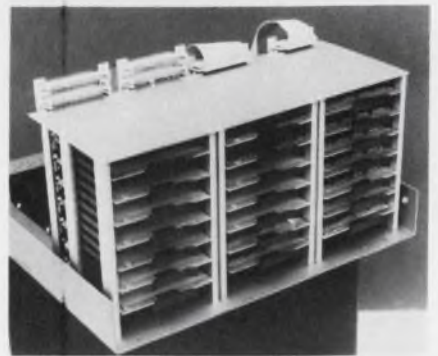

Information Products Systems, 6565 Rookin, Houston, TX 77074. (713) 776-0071. \$15,150; 8 wk.

The Selector Channel Emulation Unit (SCEU) increases a medium-scale minicomputer system's performance by allowing attachment of IBM (or IBM plug-compatible) peripheral devices. The SCEU generates the protocol sequences required by the IBM peripheral control unit in response to the operational commands of the minicomputer CPU. It also converts the IBM selector channel's 8-bit data path into the appropriate word-path size for its host CPU; either a 16-bit or a 32-bit word. The SCEU supports up to 255 different device control units at combined data transmission rates in excess of 2.4 Mbytes/s.

CIRCLE NO. 386

Line monitor accepts full duplex data



Epicom, Altamonte Springs, FL Roy Ostrander (305) 869-5000. \$3300.

A communications line-monitor, known as EPIVIEW, accepts full duplex data in either synchronous or asynchronous modes at speeds up to 100 kbits/s. Data are CRT displayed in ASCII, EBCDIC or hexadecimal codes. Other line disciplines are optionally available. It displays data on an integral 5-in. CRT, with selected segments accentuated by character blinking and/or reverse imaging. The instrument will also drive an optional 9-in. or 12-in. auxiliary CRT.

CIRCLE NO. 387

Our LED lamps are brighter by design.



It's no accident that our LED lamps are as bright as incandescents. We designed them that way. We also designed them to last ten times longer. At least ten years at 20 milliamps.

They're designed to use only half the power of an incandescent. To operate either pulsed or continuous without life loss. To respond to short pulses that elude incandescents. We designed them to give you a bright replace-

ment for incandescents. In a proven solid state package. Ready for immediate delivery. From sophisticated computer control panels to simple telephone pushbuttons, our Brite-Lite® LED lamps give you high reliability and longer life. Whatever your size or display requirements, there is a Brite-Lite for you. In red, amber or green. Transparent or translucent. With built-in resistors to handle up to 48 volts. From midget flanged snap-ins to space saving T² Lites. Now's the time to switch to our super bright Brite-Lites.

Our LED lamps are the brightest. And, when you are ready to select lamps, don't select them by accident. Give us a call and you'll see why Digital Equipment Corporation, the largest minicomputer manufacturer, has switched to the brightest LED lamps in the business.

"The brightest LED lamps in the business!"

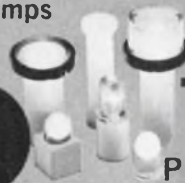

**DATA
DISPLAY
PRODUCTS**

303 NORTH OAK STREET, INGLEWOOD, CA 90301
TELEPHONE (213) 677-6166 • TWX 910-328-7205

Multiplexer cuts cost of data-line use

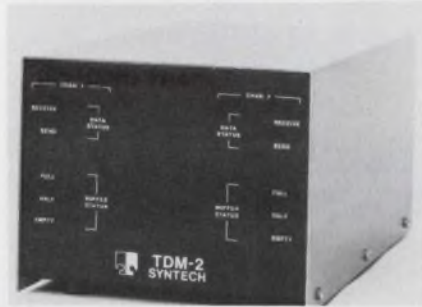

Syntech, 11810 Parklawn Dr., Rockville, MD 20852. (301) 770-0550.

TDM-2, a two-channel time-division multiplexer, enables the simultaneous transmission of two channels of asynchronous data over a single synchronous data-communication line. It is economically attractive whenever two or more data channels must be transmitted over a common distance of 50 or more miles. It can be used in private-line terminal-to-terminal or computer-to-terminal applications. It is usable in point-to-point or multi-point networks, and allows each channel to operate in the full duplex, half duplex or simplex mode. When used with split-stream synchronous modems, it can expand their capability to double the number of available channels.

CIRCLE NO. 388

System quickly finds communication problems



International Data Sciences, 100 Nashua St., Providence, RI 02904. (401) 274-5100. \$9975; 8 wk.

Hawk 4000 Datatrap uses a μ P, and lets you diagnose data-communication problems quickly. It is interactive and can monitor, transmit, and receive data between a modem and a terminal on a 9-in., 512-character screen. 2000 characters can be trapped and stored for later recall and study.

CIRCLE NO. 389

System puts 256 kbytes into mainframe memory

Interdata, 2 Crescent Pl., Oceanport, NJ 07757. (201) 229-4040.

A 16-bit processor, Model 8/16E, addresses up to 256 kbytes with its integral memory-management hardware. It has 16 general-purpose registers, an IBM-like instruction set, list processing instructions, dual I/O bus and 255 automatic I/O channels. Memory is available in 32-kbyte increments with an access time of 275 ns and cycle time of 750 ns.

CIRCLE NO. 390

Multichannel system monitors ten transducers

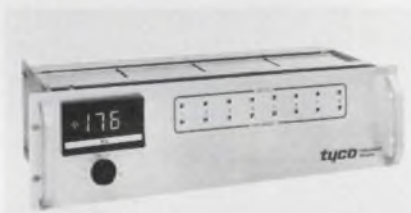

Tyco Instrument, 4 Hartwell Pl., Lexington, MA 02173. R. Minard (617) 861-7450.

Model DA data-acquisition system is a multichannel signal conditioner. It accommodates from four to ten information channels, providing signals for the digital indicator. An auxiliary output signal from each channel is available to drive remote devices. Each channel is provided with a single PC board that plugs into connectors, supplying transducer excitation and a continuous output of 0 to 1 V. Each board has zero and span adjustments. They also include a channel selector and a digital readout in percent of full load or appropriate engineering units.

CIRCLE NO. 391

Interface video with versatile patcher

Dynatech Data Systems, 900 Slaters Lane, Alexandria, VA 22314. Ed Siira (703) 548-3889.

The Model 153-112-22 video-patching unit interfaces video data terminals, allowing flexibility to rearrange the interconnections between terminals and controllers. It is available in 93 Ω and other coaxial-cable impedances. The system incorporates 22 video circuits in 3.5 in. of rack-panel height.

CIRCLE NO. 392

Acoustic coupler uses telephone handset

Anderson Jacobson, 521 Charcot Ave., San Jose, CA 95131. Wayne Seppler (408) 263-8520.

A Bell-compatible 103 and 202-mode acoustic coupler and modem in one unit, Model 1245 optimizes the transfer of low and medium speed data over normal voice-grade phone lines using an ordinary telephone handset. It will interface with any EIA terminal and communicate acoustically at 0 to 450 baud in 103 mode and 0 to 1200 baud in 202 mode. The user may switch-select between these two modes with the coupler automatically adjusting baud rate and interface protocol. It can also function as a slave unit to a remote 202 modem, and simultaneously provide a 103 half-duplex interface to the terminal at up to 1200 baud.

CIRCLE NO. 393

You can't get in without a card



Schlage Electronics, 1135 E. Arques Ave., Sunnyvale, CA 94086. (800) 538-1755.

Effective, reliable security without card slots or pushbuttons is possible with the Model-414 access control system. It operates by proximity. Credit-card-sized command cards activate access doors or gates when held within 4 in. of a concealed sensor. The system controls access for up to 8 locations, and includes control unit, sensors, system programmer, command keys, and optional printer. The programming unit's memory contains more than 1000 key codes. If a key card is lost, the 414 can be quickly reprogrammed to prevent a card's future use. The system's printer logs all accesses and attempted accesses by recording the key code, date, time of entry, and door number.

CIRCLE NO. 394

Opening new frontiers with electro optics

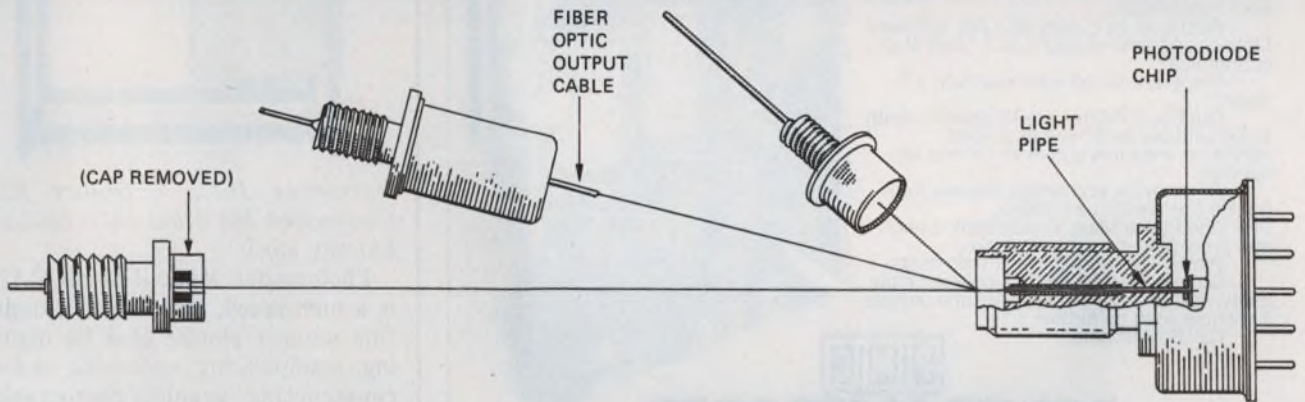

In optical communications, RCA helps you at both ends of the line.

Hi-speed IR emitters with removable caps for low-loss coupling.

With the cap off, you can bring your fiber or bundle right down into very close proximity to the 6-mil GaAlAs edge emitter to maximize coupling efficiency. Along with very high collection efficiency, you get 100 MHz min. analog bandwidth (C30119) or 40 MHz min. (C30123). Rated at up to 200 mA forward current for continuous operation and 1.5 A peak forward current for pulse operation, these devices are available from stock. Hermetically sealed version also available.

CIRCLE NUMBER 119

IR emitters with output "pigtailed." We've done the coupling for you.

Here we've made your job even easier. You can now couple your fiber or bundle to a fiber optic cable extending 5 inches from the source. At the source end, we've already made an extremely efficient internal optical connection. Like the C30119, the C30133 emitter gives you 100 MHz min. analog bandwidth. It's rated at up to 200 mA forward current for continuous operation, 1 A peak forward current for pulse operation.

CIRCLE NUMBER 120

Solid-state CW lasers: high power output for better coupling efficiency.

It takes less than a watt to get at least 5 mW of continuous lasing from these breakthrough solid-state lasers, which operate at room temperature. They have a rise time of less than 1 ns—allowing modulation rates well beyond 100 MHz. This plus small source size (13 x 2 μ m typical) and 820 nm wavelength make them especially well suited to single fibers as well as bundles. Choose either the C30130 (OP-12 package) or the C30127 (OP-4A package).

CIRCLE NUMBER 121

Avalanche detectors now with integral light pipes for efficient coupling.

At the receiving end too, we make efficient coupling easy. With our silicon avalanche photodiodes you secure the fiber or bundle through a hole in a mating connector (also available from RCA) and screw down the sleeve. Our detectors C30903E through C30908E give you a choice of light-pipe diameters, .25mm to 1.25mm, providing broad spectral response ranges, 400 to 1100 nm typical. All offer fast response time (0.5 to 2 ns typical) and high quantum efficiency (typically 77% to 85% at 830nm). Also available: detector preamp modules and temperature compensation units.

CIRCLE NUMBER 122

If electro optics can solve your problem, remember: EO and RCA are practically synonymous. No one offers a broader product spectrum. Or more success in meeting special needs. Call us for design help or product information. RCA Electro Optics, Lancaster, PA 17604. Phone 717-397-7661. Sunbury-on-Thames, Middlesex TW16 7HW, England; Ste. Anne-de-Bellevue, Quebec, Canada; Sao Paulo, Brazil; Hong Kong.

RCA

At Power/Mate, fast delivery of open frame power supplies is an open-and-shut case.

Power/Mate can deliver open frame supplies faster than anyone else in the business.

And that's a fact!

Our Econo/Mate II series is available in single, dual and triple output models with all the built-in reliability you've come to expect from Power/Mate.

But for all its quality features, a Power/Mate open frame supply is still, most of all, economical.

We wouldn't call it Econo/Mate if it wasn't.

Our Econo/Mates are stocked in-depth, along with our switching-regulated, miniature, modular, sub-modular and lab supplies.

All ready for immediate delivery from our East or West Coast plants.

And Power/Mate stands behind each and every power supply we make.

We've been doing it for fifteen years.

So if you're looking for a power supply today, from a company who will still be here tomorrow, look no further.

Call Power/Mate.

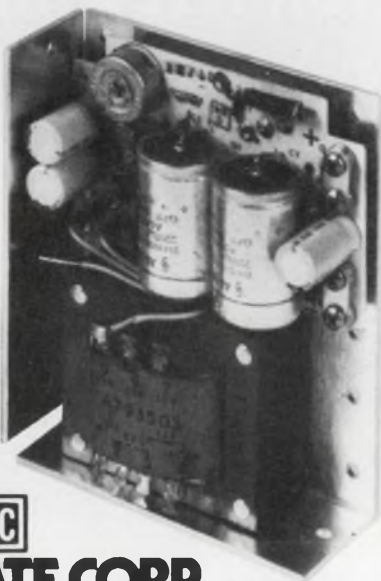

POWER/MATE CORP.

514 S. River St./Hackensack, New Jersey 07601/(201) 343-6294/TWX (710) 990-5023
17942 Skypark Circle/Irvine, California 92714/(714) 957-1606/TWX (910) 595-1766

The world's largest supplier of quality power supplies.

CIRCLE NUMBER 123

WATERS OFFERS the best answer to your servo feedback problem

Designed with computer programmed correction. Waters conductive plastic pots and elements are the answer to your most difficult servo feedback application. They offer long rotational life, low output smoothness, low static noise, and infinite resolution in rotaries from 1/2" to 2" diameters with accuracy to 0.1% terminal linearity. Elements are built to your specifications from 1/2" to 40" in length to almost any resistance value.

Waters customer service team includes an engineering services group which processes every customer inquiry and will consult with you to review existing applications and provide assistance on new ones.

Call Don Russell at (617) 358-2777.

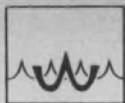

WATERS MANUFACTURING, INC.

Longfellow Center
Wayland, MA 01778 617-358-2777

CIRCLE NUMBER 124

DATA PROCESSING

Film scanner/plotter has large format



Optronics Int., 7 Stuart Rd., Chelmsford, MA 01824. (617) 256-4511. \$50,000; stock.

Photomation Mark II Model P-1700 is a high speed, large format, digital film scanner/plotter used for digitizing, manipulating, enhancing and reconstructing graphic/photographic imagery. It has an I/O terminal and a 17 x 22-in. format rotary-drum scanner/plotter that allows the operator to move, delete, crop, size, position and automatically align items. It can add rules, screens and other tonal effects including compensation for shade and contrast.

CIRCLE NO. 395

Dispersed processor uses two diskette drives

Datapoint, 9725 Datapoint Dr., San Antonio, TX 78284. Hal Morrow (512) 699-7059. \$5950.

The Model-1500 diskette-based dispersed processor has a typewriter-style keyboard, two diskette drives, high-speed video display and integral communications facilities. The keyboard provides 76 key positions, including a basic 55-key alphanumeric group, a 10-key numeric pad and five programmable function keys. The numeric pad allows high-speed entry of pure numeric material, while the function keys provide a means of generating program-control commands. Each of the two diskette drives provides storage capacity of 250,000 characters. The processor contains 32 kbytes of RAM, with an additional 4 k of system ROM. System memory provides complete support for communications I/O, display and keyboard logic, an optional serial printer, and diskette I/O.

CIRCLE NO. 396



The new Fluke 3041A programming station with the 3040A Logictester™ for μ P boards you haven't even designed yet!

Check one: Fluke's #1 #3 in digital board testers.

Correct on both counts.

More Fluke logic test systems are in production and service applications than anyone's. And more are shipped each month. Two ways of saying we're #1.

And, our customers spent less getting us there than they could have with anyone else. That makes us #3 on average cost.

But low front-end cost is only the start. You'll get lower programming, training and start-up costs than you thought possible. The highest test rates in the business, too, because boards run at rated speeds, including dynamic μ P boards at multi-MHz rates.

More importantly, you'll test with confidence. If your board passes our tester, it'll work in your system. It's

that simple. And reliable; more Fluke systems sold prove it.

The heart of our 3040A is a new merged sequence technique which lets you mix your test codes with automatically-generated sequences. And the best simulator around: your own known-good board. And dynamic LSI/fault isolation, automatic, manual or both!

Fluke hasn't forgotten about the bad boards either. After the tester nails the bad ones, we automate the troubleshooting. Our Autotrack™ computer-guided troubleshooting leads the operator to the fault. With the new 3041A programming station, you describe the board onto a floppy disk and the 3040A does the rest.

The 3040A, with up to 240-pin capability, is \$60,000 to \$95,000*, de-

pending on option configuration.

The 3020A logic test system, at about \$32,000*, is perfect for production test of all popular logic families.

For light production test or field service, our model 3010A has 128-pin capability for under \$15,000*.

Call (415) 965-0350, collect. Ask for the complete story on our high-ranking Logictester™ family, or the location of the closest Fluke office. Or, write: Fluke Trendar, a subsidiary of John Fluke Mfg. Co., Inc., 630 Clyde Ave., Mountain View, CA 94043.

In Europe, write: Fluke (Nederland) B.V., P.O. Box 5053, Tilburg, The Netherlands. Phone: (013) 673-973. Telex: 52237.

*U.S. price only.

Command Performance: Demand Fluke Logic Test.

CIRCLE 241 FOR LITERATURE



CIRCLE 242 FOR DEMONSTRATION

DATA PROCESSING

Controller runs CDC disc drives

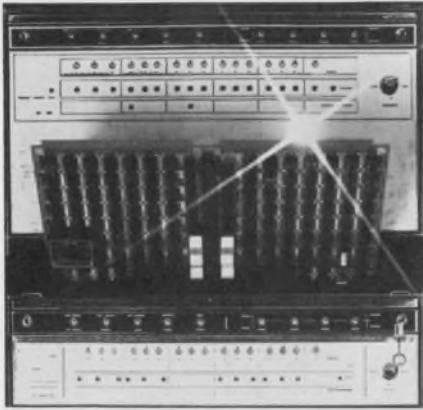

Datum, 1363 S. State College Blvd., Anaheim, CA 92806. Bob Cohen (714) 533-6333. 4 wk.

The Model 4091, an Embedded Storage Module Disc Controller, provides an interface to the Control Data storage module series (or equivalent) disc drive from a computer. A single board and occupying one CPU slot, the controller will operate using Data General software or Datum-supplied software drivers. The controller will handle two storage module series disc drives with the capability of mixing or matching drives. The μ P-based controller can monitor and control events, execute commands, perform alternate-track selection, and do on-the-fly CRC generation.

CIRCLE NO. 397

Terminal displays dual-intensity characters



Honeywell Information Systems, 200 Smith St., Waltham, MA 02154. (617) 890-8400. \$1980.

Asynchronous display terminal, VIP 7200, features a 1920-character, dual-intensity display capability. It is for use as a conversational teleprinter-compatible work station for use with Honeywell's Level-6 minis, and other Series-60 systems, for such applications as time-sharing with large Level-66 computers. In addition, it can communicate with Series-2000 and 6000 systems. Full cursor movement across 24 lines of display is provided. The keyboard includes 86 keys arranged in alphanumeric and numeric groups. They can generate 128 ASCII codes. Transmission rates vary at standard increments between 75 and 9600 bits/s. The terminal includes both 20-mA current-loop and RS232C interfaces.

CIRCLE NO. 398

Processor has floppy software for easy growth



NBI, 5595 E. Arapahoe Ave., Boulder, CO 80303. (303) 444-5710. \$11,990.

A software-based word processing system offers users application processing flexibility plus the performance of expensive hardware-based systems. The System I provides first-time users with an economical and easily upgradeable approach to automating the production of high-volume correspondence as well as document editing and production. It allows users to update applications by entering software changes on the system's standard diskette that stores approximately 250,000 characters, or about 50 pages of text. Hardware elements include a typewriter keyboard, a CRT display, and a high-speed "daisywheel" printer that operates at 30 char/s.

CIRCLE NO. 399

SHERLOCK OHMS & DR. WATTS

IN THE CASE OF THE EXPIRED ENGINEER

OR

DMM DE DMM DMM

by DUMONT



CIRCLE NUMBER 126



- TRUE RMS
- A4 TO 1 CREST FACTOR
- OPEN CIRCUIT OHMETER VOLTAGE LIMITED TO 2 VOLTS
- BATTERY \$18.00

JUST CALL US TOLL FREE (800) 631-1043. WITH YOUR CHARGECARD NUMBER FOR IMMEDIATE DELIVERY

DE FOREST

A Subsidiary of DUMONT OSCILLOSCOPE LABORATORIES, INC. 40 FAIRFIELD PLACE WEST CALDWELL, N.J. 07006

Increase Reliability and Performance with Custom Quartz Crystals.

McCoy Electronics offers a larger variety of Quartz Crystals than any other supplier. With a frequency range of 700 Hz to 250 MHz and a variety of housings available such as solder seal, glass, and cold weld, McCoy crystals have found broad uses in commercial, industrial, military, and high reliability applications.

McCoy specializes in applications where strict control of motional parameters is dictated, tight stabilities are needed, or in any program requiring experienced technological resources.

In addition, McCoy crystals are proven to be economical for the buyer in terms of consistent performance and high quality, thereby eliminating the costly burden of replacement.

We invite your use of McCoy's expert engineering and marketing staffs in developing specifications for custom crystals individually tailored to meet your needs.

Please write for our free catalog.



MCCOY
ELECTRONICS COMPANY

a subsidiary of **OAK Industries Inc.**

MT. HOLLY SPRINGS, PA. 17065 • 717-486-3411 - TWX: 510-650-3548

CIRCLE NUMBER 127

Memory Power

Eternacell® 10 year lithium primary battery for semiconductor memories

Don't risk memory failure. Eternacell® high reliability, lithium primary batteries are the ideal standby power source for all types of volatile memory applications. The reasons:

- Steady voltage (2.9 volts per cell) at low continuous current
- Shelf life of up to 10 years
- Highest energy per unit weight and volume
- No recharging
- Hermetically sealed
- Designed for pc board mounting

For complete information and pricing write:
Power Conversion, Inc.,
70 MacQuesten
Parkway South,
Mt. Vernon, N.Y. 10550.
Or call (914) 699-7333

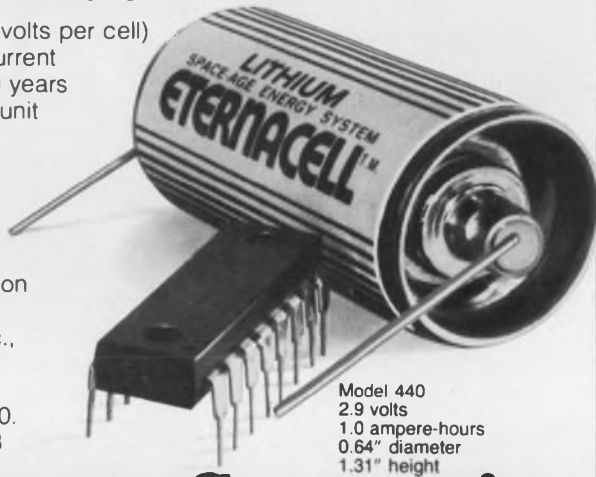

Model 440
2.9 volts
1.0 ampere-hours
0.64" diameter
1.31" height

Power Conversion

CIRCLE NUMBER 128

REED RELAYS — NO DELAYS



Quality since 1959

Choose from over 1,000 stock reed relay styles from our catalogs, or let us build to your specifications. Either way, you'll get delivery in 2 weeks for thousands, and sooner for smaller quantities. And at good prices.



Electronic Applications Company
4918 Santa Anita Avenue
El Monte, CA 91734

Telephone:
213/442-3212

CIRCLE NUMBER 129

POWER SOURCES

New power-supply package concept is hatched



Calex Mfg., 3305 Vincent Rd., Pleasant Hill, CA 94523. R.C. Kreps (415) 932-3911. \$55; stock.

The CM2.15.100, a ± 15 -V, 100-mA power supply, uses a new packaging concept—a recessed barrier strip that uses a minimum of space and also provides added protection against breakage and accidental shorting of leads. Another feature is the use of thru-holes for bolting the unit to a chassis as well as molded-in threaded inserts. Line and load regulation is 0.01%. Noise and ripple are less than 1-mV rms and the stability is better than $\pm 0.01\%/^{\circ}\text{C}$. Size is $3.7 \times 2.7 \times 1.4$ in.

CIRCLE NO. 403

High-power transformers suppress noise

Topaz Electronics, 3855 Ruffin Rd., San Diego, CA 92123. (714) 279-0831.

Isolation and noise-suppression transformers, and ac regulator systems having 98% efficiency, protect sensitive equipment against line noise, transients, spikes and voltage fluctuations. A box-shielded design is used to assure maximum attenuation of power-line interference caused by switching spikes, lightning strikes and other line transients. Transformers are available for 50/60-Hz operation in power ratings of 75, 100, and 130 kVA for all standard 3ϕ operating voltages. The regulators have a frequency range of 47 to 63 Hz, and less than 0.1% distortion. They are available in 50, 75, and 100-kVA ratings.

CIRCLE NO. 404

Finally! A low cost DC to 8MHz Up/Down Counter.

Ferranti Model ZN1040E features:

- 80mA per segment L.E.D. drive
- Multiplexed BCD and 7 segment outputs
- Cascadable
- Schmidt trigger input
- Switch-on reset
- Automatic zero suppression
- Single 5-V supply—TTL compatible



better by design

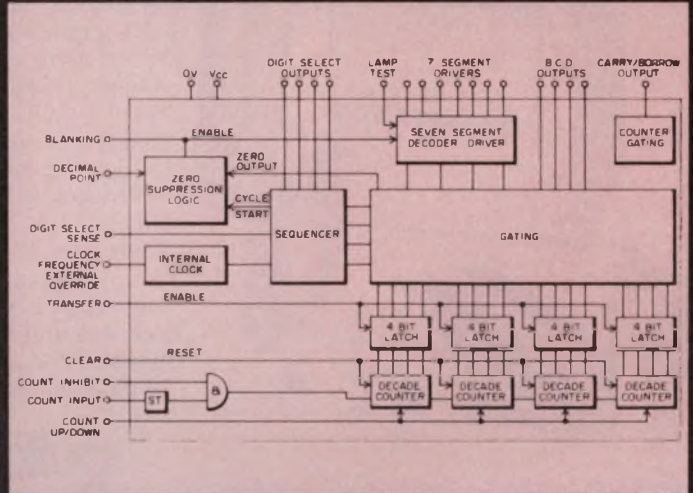

FOR COMPLETE SPECIFICATIONS, CONTACT: FERRANTI ELECTRIC, INC. / SEMICONDUCTOR PRODUCTS
EAST BETHPAGE ROAD, PLAINVIEW, NEW YORK 11803 PHONE: (516) 293-8383 / TWX: 510-224-6483

CIRCLE NUMBER 131

new from Hayden!

"... well-organized, extremely well written ... highly recommended for practicing engineers..."

IEEE Transactions

DIGITAL SIGNAL ANALYSIS

Samuel D. Stearns

This is an ideal master handbook on today's signal processing procedures and systems, containing recent advances, new design material, and a comparison between continual and digital systems that's extremely helpful to newcomers to the field. Featuring a foreword by Richard Hamming, the book contains a review of linear analysis; sample-data systems; analog-to-digital and digital-to-analog conversion; the discrete Fourier transform and the fast Fourier transform algorithm; spectral computations; non-recursive and recursive digital systems; computer simulation of continual systems; analog and digital filter designs, and more 288 pages

"Jacobi's book is great ... a new, original, readable, usable book on writing for business and professional people. . . ."

Jim Lufkin, Mgr. Professional Publications, Honeywell.

WRITING AT WORK: Dos, Dont's, and How Tos

Ernst Jacobi, Xerox Corporation.

This guide to better writing follows its own principles by being lively, informative, and easy to read. More than a collection of pat rules and formulas, the book is a storehouse of practical advice for business and professional people to make their writing sharper, more interesting, and more informative. It shows you how to overcome procrastination and change your entire attitude toward writing, making it easier and more enjoyable for you! 208 pages.



HAYDEN BOOK COMPANY, INC.
50 Essex Street, Rochelle Park, New Jersey 07662

Order today—15-day examination!

Please send me the following book(s) to read and use FREE for 15 days. At the end of that time I'll either send the amount indicated, plus postage and handling, or return the book(s) with no obligation

- DIGITAL SIGNAL ANALYSIS, #5828-4, \$19.95
- WRITING AT WORK, #5730-X, \$11.95

Name _____

Company/Institution _____

Address _____

City/State/Zip _____

SAVE MONEY! Payment Enclosed. Publisher will pay all shipping and handling charges. Same 15-day return privilege and full refund if not satisfied.

GULTON'S "fast change" artist

Lets you change or replace signal conditioners in seconds. Use your Gulton portable recorder to chart volts, amps, temperature, EKG, strain, ac to dc, log to dc and more . . . simply by plugging in appropriate signal conditioners.

Should any signal conditioner require testing or service, just slide it out and slide in a spare. It's as easy as it sounds.

Gulton portable recorders with plug-ins are available in 2, 4, 6 and 8 channel models. Write or call for 12 page portables catalog.

gulton[®]

Measurement & Control Systems Division
Gulton Industries Inc. East Greenwich, Rhode Island 02818
401-884-6800 • TWX 710-387-1500

CIRCLE NUMBER 132

MODULES & SUBASSEMBLIES

Hi-rel d/a's multiply 10 and 12 bits

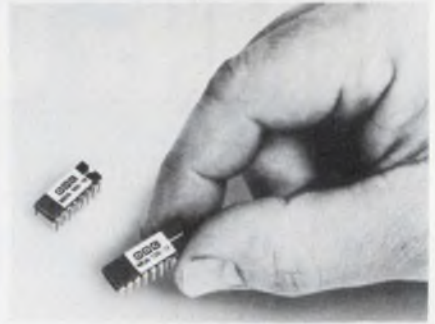

ILC Data Device, Airport International Plaza, Bohemia, NY 11716. Myron Anatole (516) 567-5600.

MDA100 and MDA120 are two high-reliability, four-quadrant, multiplying hybrid d/a converters. MDA100 is a true 10-bit unit with a full 10-bit linearity. MDA120 is a true 12-bit unit with a full 12-bit linearity. They have pull-up resistors for logic compatibility and a welded-lid package.

CIRCLE NO. 405

Sense rf power over wide band



Olektron, 6 Chase Ave., Dudley, MA 01570. (617) 943-7440. \$75; stock to 3 wk.

Model P3-PS4-1004 broadband rf power sensor has a frequency response of 30 to 400 MHz and an accuracy of power detection of $\pm 10\%$ of incident rf power, for a temperature span of -54 to $+70$ C. It produces a dc output that is proportional to the input power, and provides a dc output of 1 V across a 5-k termination for an input signal or reflected signal level of 15-W CW. It is available in octave and decade bandwidth, and its dc output can be used for feedback leveling systems. The insertion loss is 0.35 dB (max), VSWR is 1.1:1 and input/output impedance is 50 Ω .

CIRCLE NO. 406

ION IMPLANTED Tuning Diodes 2 to 500 pF

Design in Implion[®] hyperabrupt and abrupt tuning diodes which offer superior capacitance swings, reproducibility and reliability. Tailored for octave or linear tuning in communications and test equipment.

Send for our catalog including selection guide and electrical characteristics as well as information on PIN diodes and low voltage avalanche zener diodes or call 617-273-1730.

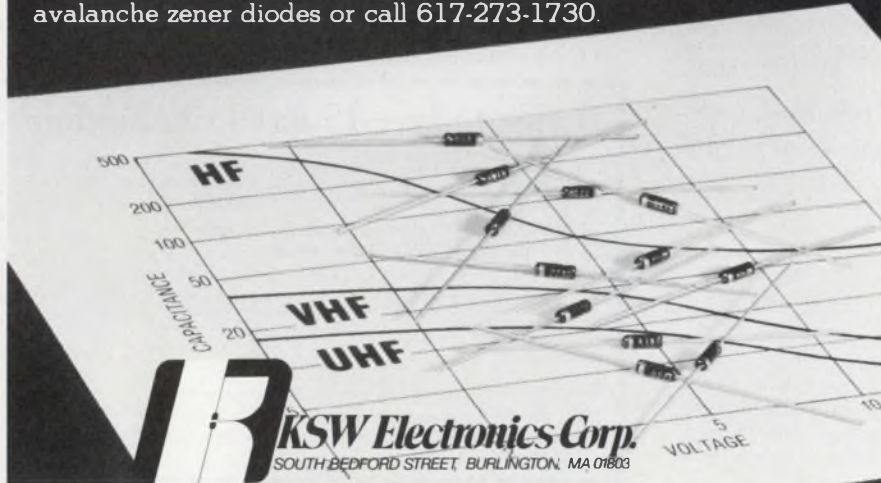

CIRCLE NUMBER 133

Superb characteristics and high-density processing

TDK has a whole range of materials for ferrite cores that go into high-performance transformers and filters for communications equipment. These cores help enhance the performance of the equipment, and make it more compact. Standard materials are available in 22 kinds, and you can find superb performances in permeability, in loss or in power. These materials are formed into various shapes including TDK-developed EP cores as well as quality products that conforms to IEC standards. And we use sophisticated processing technology to make the endproducts which use them more reliable and to give our materials a reputation on the market that allows them to live up to their name.

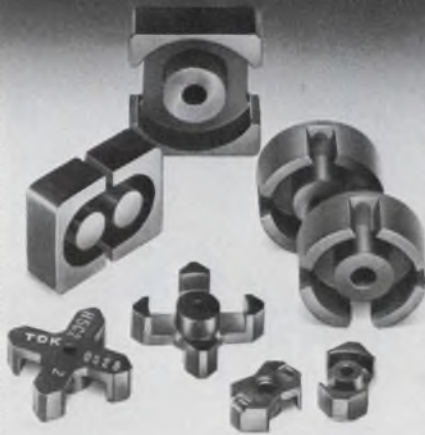

Ferrite cores for communications equipment. Just another part of our operations.

You might associate our name with ferrite cores that you find in communications equipment, in which case we'd be pleased. But we wouldn't jump up and down for joy unless you knew that they're just one of our many lines.

Yes, we make ferrite cores which are indispensable parts in televisions and radios, besides communications equipment. But we also make ferrite magnets for speakers and motors,

secondary products such as coils and transformers, as well as PTC thermistors (heat-sensitive elements) and microwave absorbers. We put our ferrite production know-how to work, too, in the manufacture of ceramic capacitors.

If you like music, you may know us for our magnetic tapes since we sell them all over the world. Most audiophiles have heard of our SD, ED and SA series of hi-fi cassette tapes. But

forming the basis even of these tapes is our magnetic material technology which first created our ferrites.

Our high-level magnetic material technology gives us a claim to world fame as a broad-line manufacturer of electronic parts and you'll find us on virtually all of the world's leading markets. You'll also find our products in automobiles, medical equipment, business machines, industrial equipment and many more.



TDK ELECTRONICS CO. LTD. 14-6 Uchizanda 2-chome Chiyoda-ku, Tokyo 100 Japan Phone: Tokyo (03) 257-2525
TDK CORPORATION OF AMERICA 3941 Rosecrans Avenue, Suite 365, El Segundo, California 90245 U.S.A. Phone: (213) 644-8625 **CHICAGO BRANCH** 2906 West Peterson Avenue, Chicago, Illinois 60659 U.S.A. Phone: (312) 973-1222
NEW YORK BRANCH 755 Eastgate Blvd., Garden City, N.Y. 11530 U.S.A. Phone: (516) 248-5230 **EL PASO BRANCH** 3501 Frutas Street, El Paso, Texas 79905 U.S.A. Phone: (915) 533-5799
TDK ELECTRONICS CORP. (Handles recording tapes only) 755 Eastgate Blvd., Garden City, N.Y. 11530 U.S.A. Phone: (516) 746-0880
TDK DE MEXICO S.A. de C.V. (Handles ferrite magnets only) Carr. Juárez-Parvení, Parque Ind. A. J. Bermúdez, Cd. Juárez, Chih., Mexico Phone: 3 88 27
MH&W INTERNATIONAL CORP. (Handles professional ferrites only) 14 Leighton Place, Mahwah, New Jersey 07430 U.S.A. Phone: (201) 891-8800 Telex: 134 484
MH&W INTERNATIONAL (CANADA) LTD. (Handles professional ferrites only) 6358 Viscount Road, Mississauga, Ontario, L4V 1H4 Phone: (416) 245-3606
MONTREAL 7575 Trans Canada Highway, Suite 305, St. Laurent, Quebec H4T 1V6 Phone: (514) 331-2827

CIRCLE NUMBER 134

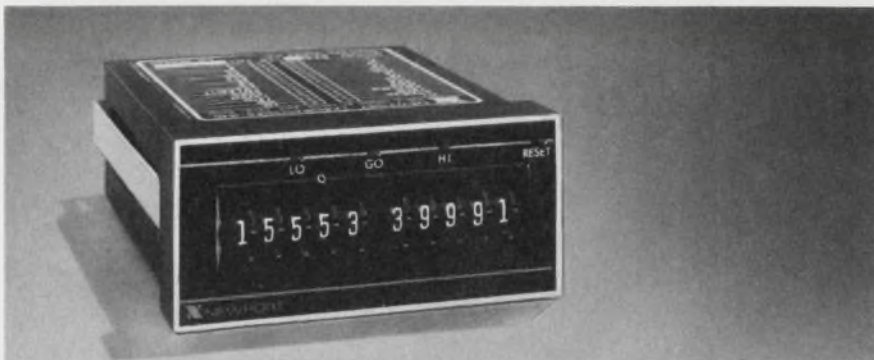

NEWPORT'S CONTROLLER CONVERTS YOUR DATA INTO ACTION . . .

- Single or dual switching points
- Comparison to ± 39999 or 99999
- Two position hysteresis control
- Form C relays with 2A rating
- Input data tracked or sampled
- Continuous or latched decisions
- DIN or NEMA case
- Priced from \$115.

The new series 870 Controllers compare BCD or binary inputs with thumb-wheel switch settings and provide logic level outputs and contact closures for process control. Controller status indicated by HI, LO, and GO LED colored lights. Control action is now ensured with digital voltmeters, pyrometers, counters, and process monitors.

For complete data call or write:

Newport Labs / 630 East Young Street
Santa Ana, California 92705
Phone (714) 540-4914
In Europe-Tele Amsterdam 20-452052

CIRCLE NUMBER 135

A "LIGHT" TOUCH



The optically encoded Series 5000. A fully custom keyboard priced for low volume users. And it's as reliable as a light beam.

You define the key codes, functions, interface, key locations and cap markings. If you can make do with a choice of only 2048 different codes, 360 keys or less, n-key lockout, 2-key rollover and logical or non-logical pairing, we'll make it up to you with fast delivery and no NRE or tooling charges.

Series 5000. The most sensible keyboard technology available today. Affordable in any quantity.

ADI APPLIED DYNAMICS INTERNATIONAL
KEYBOARD PRODUCTS DIVISION
3800 Stone School Road
Ann Arbor, Michigan 48104
Phone: 313-971-7840 Telex: 230238

CIRCLE NUMBER 136

MODULES & SUBASSEMBLIES

Cassette-tape transport uses ac capstan-motor

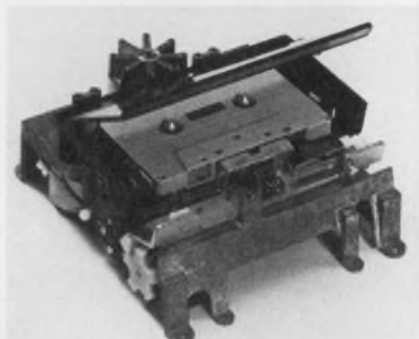

Triple I, 4605 N. Stiles, Oklahoma City, OK 73118. (405) 521-9000. \$149.

A fixed-speed cassette-transport with an ac capstan-motor features four-motor control, remote-control capability, fast start/stop, less than 30-s rewind, and speeds from 1 to 10 ips. Four separate motors control take-up, rewind, play or record, and head engagement. Flutter, wow, and jitter are minimized by the capstan drive. Control boards are TTL, DTL and CMOS compatible plus they contain all circuitry for proper control.

CIRCLE NO. 407

System element improves on isolation amps



Dynamic Measurements, 6 Lowell Ave., Winchester, MA 01890. (800) 225-1151. \$195; 2 wk.

IVFC, as an isolation element, provides common-mode rejection of 125 dB min along with isolation of 4kV, offset drifts of $1.5 \mu\text{V}/^\circ\text{C}$ (input) and $20 \mu\text{V}/^\circ\text{C}$ (output), and linearity within 0.1% max. Gain drift is 15 ppm/ $^\circ\text{C}$ max. The device is an inherently monotonic a/d converter with up to 13-bits accuracy, whose output is interpreted by digital hardware. The unit is encapsulated and shielded in a $4 \times 4 \times 0.75$ -in. module.

CIRCLE NO. 408

The Ansley "D" Connector...



Our new series of male and female "D" connectors offer you a cost effective external mass termination cable and connector system second to none. Its uniqueness begins with a one-piece "D" connector package that meets industry standards for size, pin spacing, and contact reliability. With no loose parts to match up, positive cable-to-contact alignment is assured. Conductors are mass terminated in seconds with our standard BLUE MACS™ hand or bench tools. The results? Faster installation, higher reliability.

Contact pins are spaced on .0545" centers — a perfect fit for any standard inter-cabinet "D" type connector application. Our new "D" connectors are designed to mate with standard .050" pitch flat cable as well as our new, improved jacketed cable — the only flexible flat cable engineered specifically for out-of-cabinet use.

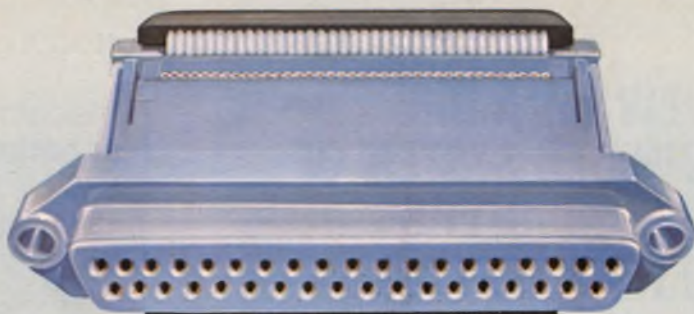

a new meaning to cost effectiveness.



The Ansley BLUE MACS™ jacketed cable is U.L. listed for external interconnection of electronic equipment. Electrically, it outperforms standard jacketed twisted pairs in typical I/O applications. And there's no special zipper lock tubing required — reducing the need for an extra cable accessory. Installation is faster, easier. And like all Ansley connectors, you can daisy chain our "D" types anywhere in the cable — along with our DIP socket, card edge, or pc board connectors.

Cable alignment and high contact reliability is assured — because both cable and connector are grooved for absolute alignment. Our patented TULIP™ 4-point insulation-displacing contacts are permanently fixed and sealed-in to provide a reliable, gas-tight, corrosion-free mass termination.

For the full reliability/cost effectiveness story and technical data, call or write:

T&B / Ansley

The mass termination company.

T&B/Ansley Corporation • Subsidiary
of Thomas & Betts Corporation
3208 Humboldt St. • Los Angeles, CA
90031 • Tel. (213) 223-2331 •
TWX 910-321-3938

Available through authorized
Ansley distributors

In Canada: T&B/Ansley, Ltd.
700 Thomas Ave.,
Industrial Park
Iberville, P.Q.

CIRCLE NUMBER 137

E-Z-MICRO HOOK ■ E-Z-MINI HOOK X100W AND XL1 ■ ADAPTORS ■ E-Z-PROBES XP AND XPL ■ TEST LEADS AND JUMPERS ■ E-Z-NAILCLIPS ■ BNC, UHF, SMA AND STACKING DOUBLE BANANA COAXIAL TEST CABLES ■ PATCH CORDS ■ COAXIAL JUMPERS ■ E-Z-PROBES 52 AND 53 ■

OUR NEW TAP-A-DIP™ AND COORDINATED SYSTEM OF TROUBLE SHOOTERS SIMPLIFY DIP TESTING

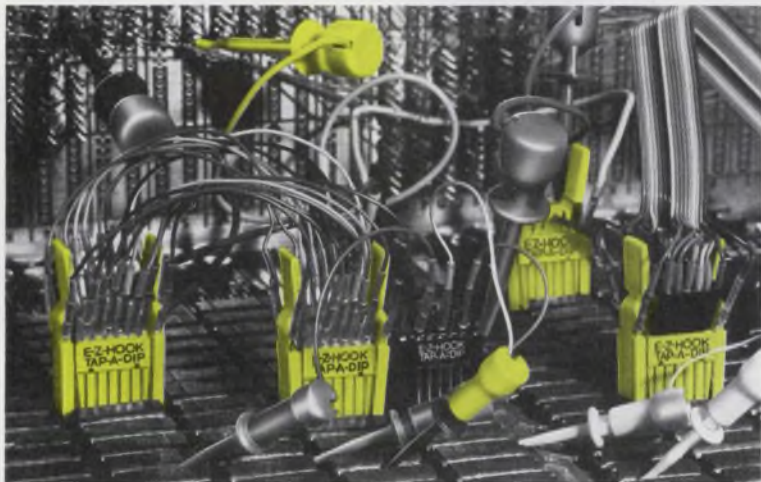

TAP-A-DIP 14 PIN MODEL—NO. 300-14 16 PIN MODEL— NO.300-16

POSITIVE LOCK-ON DESIGN—End contacts of TAP-A-DIP lock under each of the end leads on DIP...eliminates popping off and causing shorts.

NARROW PROFILE—Width is the same as DIP Mounting Socket. Ideal for high density boards since critical width does not change during insertion and removal.

WIPING ACTION— $.025''$ Square Gold-Plated Beryllium Copper Spring Contacts are shaped to provide wiping action during insertion...assures positive contact.

BARRIER STRIPS—Strong, Glass-Filled Injection Molded Body provides Barriers between each contact to prevent lead shorting.

COLOR-CODED—Model 300-14 coded Black, 300-16 coded Yellow.

CONTOURED GRIP—Handles compress easily to open jaws for attaching and locking TAP-A-DIP to the DIP...must be compressed again to remove from DIP.

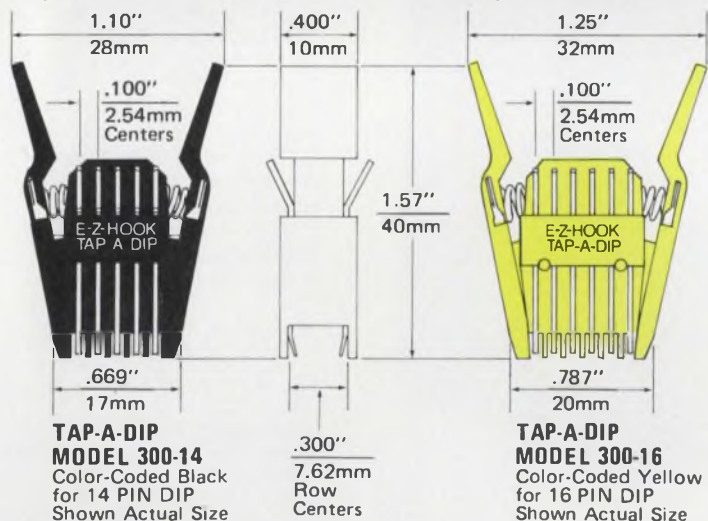

TAP-A-DIP'S INTERCONNECT WITH E-Z-HOOK TEST LEAD AND JUMPER ASSEMBLIES OF E-Z-MICRO-HOOK, E-Z-MINI-HOOK AND $.025''$ (.635mm) SQUARE SOCKETS...EACH AVAILABLE IN A WIDE SELECTION...TO LET YOU DESIGN YOUR SYSTEM TO SUIT YOUR SPECIFIC REQUIREMENTS.

SEND FOR COMPLETE NEW CATALOG AND PRICE LIST

E-Z-HOOK®
A DIVISION OF TEKTEST, INC.

114 EAST SAINT JOSEPH STREET
ARCADIA, CALIFORNIA 91006
(213) 446-6175 / TWX 910 582 1614

CIRCLE NUMBER 138

MODULES & SUBASSEMBLIES

Indicator lights go on as battery needs charge

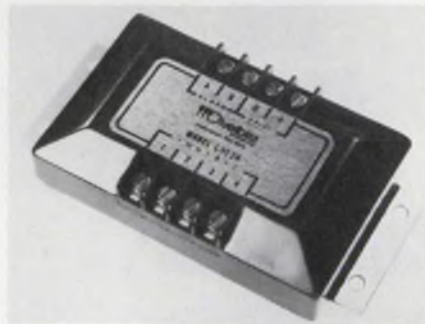

Divelbiss, Box 130, Fredericktown, OH 43019. Ralph Williams (614) 694-9015. \$49.

In the LVI low voltage indicator, a light indicates that a battery needs to be recharged. A second light warns of a dangerously low charge. Outputs are available to operate relays to sound an audible warning or lock out drive motors. Optional inhibits may be provided to prevent an alarm during heavy battery loads, so the LVI monitors voltage only when the battery is idle. The unit features easy connection to screw terminals, fully encapsulated solid-state circuitry, transient protection and stable setpoints.

CIRCLE NO. 409

Get 10 to 300-ns delay with variable delay line



Kappa Networks, 165 Roosevelt Ave., Carteret, NJ 07008. Mel Traum (800) 631-5653.

Minitrim variable delay line provides maximum delays from 10 to 300 ns, attenuation of less than 0.5 dB and resolution of less than 1 ns. Standard features include precious metal bifurcated contacts, an "O"-ring seal, stainless-steel shaft, epoxy-fiberglass case, two-point-terminal embedment and an internal PC board. Dimensions are $0.35 \times 0.7 \times$ either 2.25 or 4 in. long. The shorter units have delay time-to-rise time ratios of about 4:1; the longer units ratios are about 7:1.

CIRCLE NO. 410

AUGAT MAKES IT EASY TO BUY THE BEST.

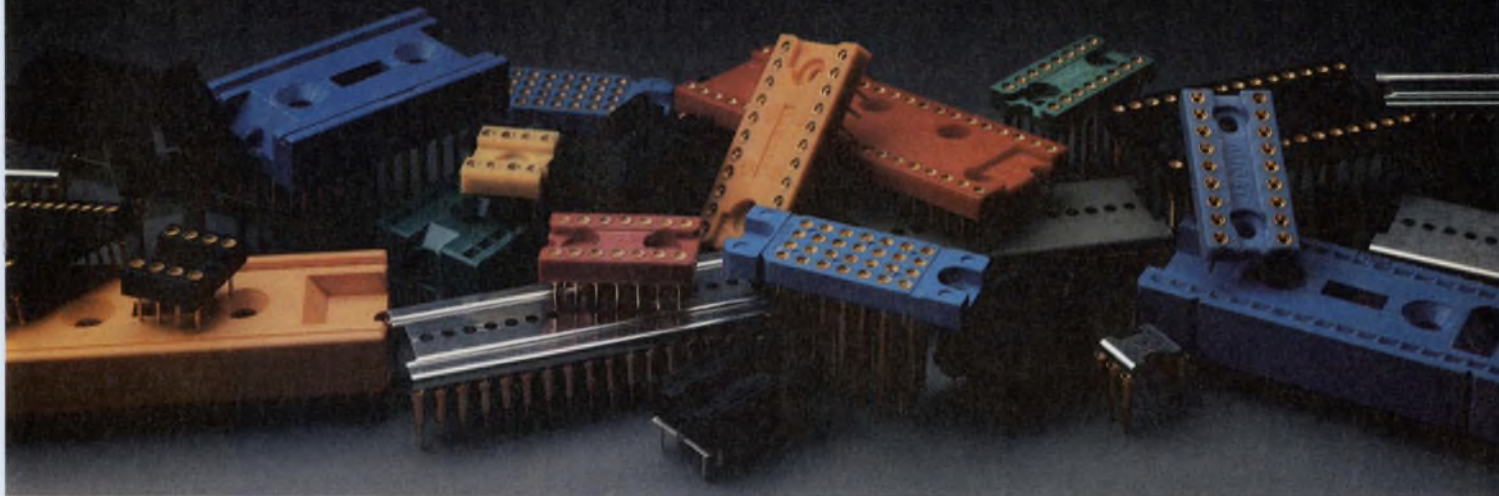

One of the biggest reasons Augat sockets outsell all others is that we make Augat sockets the easiest to buy. Augat offers IC sockets for off-the-shelf delivery from hundreds of worldwide distributor locations. So you have it easy when you buy the best. And here are some of the best you can buy.

Our Series 300 low-profile sockets excel over competitive types with their superior beryllium copper side-wipe contacts that handle all com-



300 Series low-profile

ponent lead sizes with better retention and longer contact life. They are available in all sizes from 8 to 40 contacts.

Our 300 Series wire wrap sockets are the best buy in the industry today. Their special pin taper locks them in place without bonding or soldering, and

they're very attractively priced.



300 Series wire wrap

Our 500 Series sockets are the industry's "premium grade", the ones to use when high reliability and exceptional performance (at a reasonable price) are a must. They come in 12 sizes between 8 and 40 contacts.

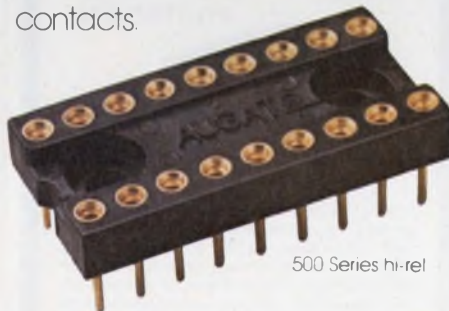

500 Series hi-rel

Our 700 Series lead socket carrier is a new concept of growing popularity. The metal carrier holds the individual contacts in place through assembly and soldering, and is then removed. Advantages: improved airflow and complete topside accessibility for inspection and solder rework. Available in 14 sizes.

Beyond that, of course, is our

broad selection of standard profile and test sockets, LED sockets, and numerous accessories.

So the next sockets you buy, make them Augat. They're not only the best you can get, but getting them is a breeze... just about anywhere. Write us for a condensed socket selection guide with prices and a list of our distributors.



700 Series lead socket carrier

Augat, Inc., 33 Perry Avenue, P.O. Box 779, Attleboro, Mass. 02703. Tel. (617) 222-2202

AUGAT[®]

Augat interconnection products, Isotronics microcircuit packaging, and Alco subminiature switches.

CIRCLE NUMBER 139

BUCKEYE flex-i-pak™ INSTRUMENT CASES

This is "THE" PACKAGE
for prototype or production!

Design your case interior with standard
accessories. 5 Heights — 3 Depths.

Write Today for
free catalog

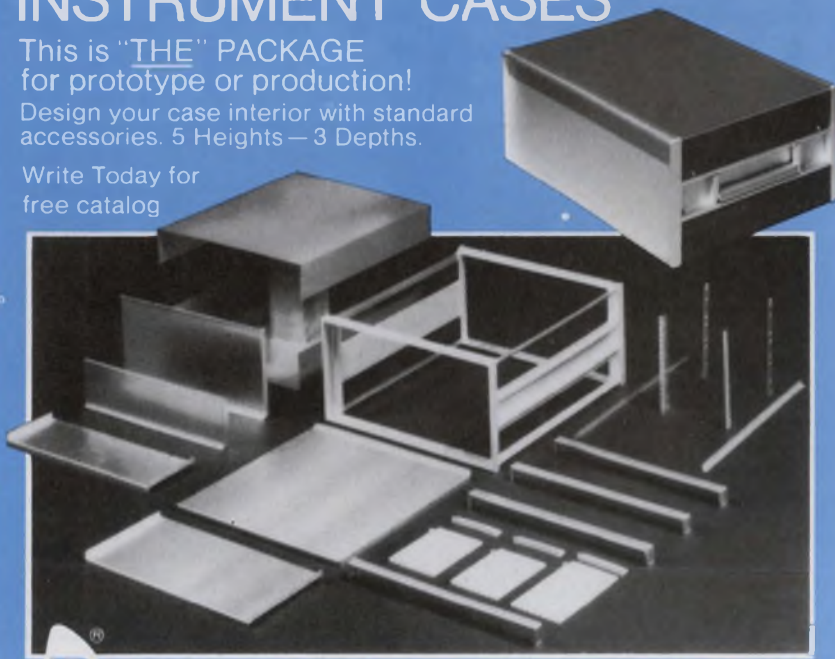

the BUCKEYE stamping co.

555 Marion Rd., Columbus, Ohio 43207 Ph 614-445-8433

CIRCLE NUMBER 140

STANDARD ELECTRONIC MODULES

Call Ed Skinner (714) 759-2411

Or send for new brochure:
500 Superior Ave., Newport Beach, CA 92663

HUGHES

HUGHES AIRCRAFT COMPANY
MICROELECTRONIC PRODUCTS DIVISION

CIRCLE NUMBER 179

CUSTOM CRYSTAL OSCILLATORS

Call Vic Gill (714) 759-2411

Or send for new brochure:
500 Superior Ave., Newport Beach, CA 92663

HUGHES

HUGHES AIRCRAFT COMPANY
MICROELECTRONIC PRODUCTS DIVISION

CIRCLE NUMBER 141

Circuit Savers

NEW
SIGNAL/DATA/TELEPHONE
PROTECTION



The SLP protectors were expressly designed to protect signal/data/telephone lines from transient overvoltages caused by lightning, heavy machinery, elevator motors, generators, etc. The SLP interfaces between the signal lines and the sensitive circuit to provide a sophisticated blend of high speed (nanoseconds) voltage limiting and brute force protection. The SLP's recoverer automatically to standby when the need for protection has passed.

Output Clamp Voltage Level $\pm 5V$ to $\pm 200V$
Input Voltage Level (max) to $\pm 35KV$ (1 Ous)
Energy Handling to 50 joules
and higher

BULLETIN 301

Full line of protection modules for every hi-lo voltage/current requirement. Write or call for data.

160 Brook Avenue, Deer Park, N.Y. 11729
Telephone: 516-586-5125

MCG Electronics

CIRCLE NUMBER 142

MODULES & SUBASSEMBLIES

Recorder stores 350,000 characters on one track



Columbia Data Products, 6655 Am-
berton Dr., Baltimore, MD 21227. Don
Knight (301) 796-2300. \$1295; 6 wk.

Write-only drive, Model 300W, uses
a data cartridge that can store over
350,000 characters in a single track.
Tapes can be written in 128 or 256-
character blocks with a 16-bit CRC-
check character as required by the
ANSI standard. Tapes generated can
be read with ANSI-compatible data
cartridge readers. Input buffers will
accept incremental 8-bit parallel data
or asynchronous serial data via RS232
or current loop. Max speed is 2500
characters/s with parallel data, and is
switch selectable up to 19.2 kbaud with
serial data.

CIRCLE NO. 411

8-channel FM recorder takes dc to 100-Hz data

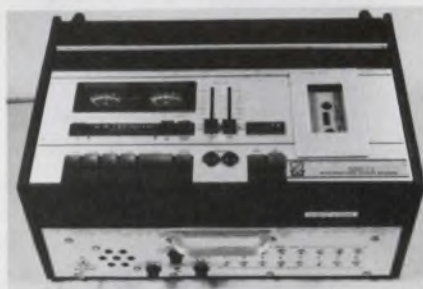

A.R. Vetter, P.O. Box 143, Rebersburg,
PA 16872. Art Vetter (814) 349-5461.
\$2300.

The Model C-8 FM recorder records
and plays eight channels of dc to 100-
Hz analog data on a standard Philips
cassette. The recorder uses the full
width of the cassette tape and operates
at 1-7/8 ips. The three-motor transport
features a closed-loop dual-capstan
drive, producing under 1% pk-pk flut-
ter noise. Also included is a voice-
override channel with microphone and
built-in speaker. A VU meter monitors
the voice channel and a pk-responding
meter monitors the FM channels.

CIRCLE NO. 412



ACCURACY

Electronic Design makes every effort to be accurate. If you spot a misstatement in either editorial or advertising matter, please bring it to our attention. Corrections are made promptly and appear in "Across the Desk."

If you find that an advertiser has made promises . . . then failed to deliver . . . we'll help you. Send us the details and we'll add our pressure to yours to help rectify the situation, or if it's an honest mistake, we'll try to find out why it happened.

Electronic Design refuses to run any advertisement deemed to be misleading or fraudulent. Our accuracy statement appears in every issue. Accuracy is everybody's business. To put teeth in our policy, we need your help and support.

Send comments to:

George Rostky

Editor-in-Chief

Electronic Design

50 Essex Street

Rochelle Park, New Jersey 07662

UNIVERSAL TWO CHANNEL SWEEP FREQUENCY RESPONSE ANALYZER



MODEL 916

- DISPLAYS & PLOTS AMP. RATIO (db) & PHASE SHIFT VS. LOG FREQUENCY
- OPEN LOOP RESULTS FROM CLOSED LOOP TESTS
- AUTOMATIC GAIN CONTROL - 80 db DYNAMIC RANGE IN EACH CHANNEL
- CONTINUOUS SWEEP OVER ANY PORTION OF 6% DECADE FREQUENCY RANGE

FREQUENCY RANGE

MODEL 916 - .005 Hz to 10,000 Hz.
MODEL 916H - .025 Hz to 50,000 Hz.

BAFCO, INC.

717 MEARNS ROAD • WARMINSTER, PA. 18974
TEL: (215) 674-1700 • TWX No. 510-665-6860

CIRCLE NUMBER 143

New Mini-Toggle Switch Line from SMK

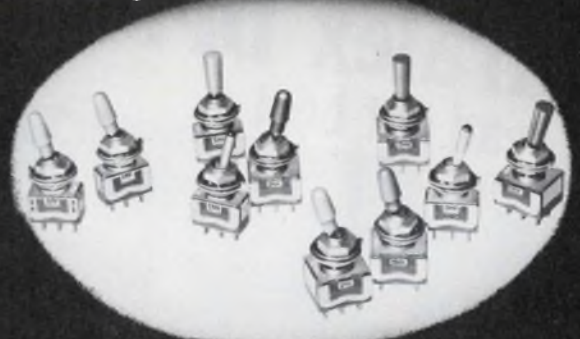

The **JU-4000 Series** complete line of UL Approved mini-toggle switches feature rugged construction with the terminals molded and secured into the housing to provide excellent shock and vibration characteristics.

Available in either SPDT or DPDT, the switches are rated at 6 amps at 125VAC or 12V DC resistive load and will operate from -10°C to $+60^{\circ}\text{C}$. Mechanical life is 100,000 cycles with no load and 20,000 cycles with rated resistance load.

Priced from \$1.18 in 100 piece quantity.

 SMK Electronics Corporation
of America

118 East Savarona Way Carson, California 90746

Tel: (213) 770-8915

CIRCLE NUMBER 144

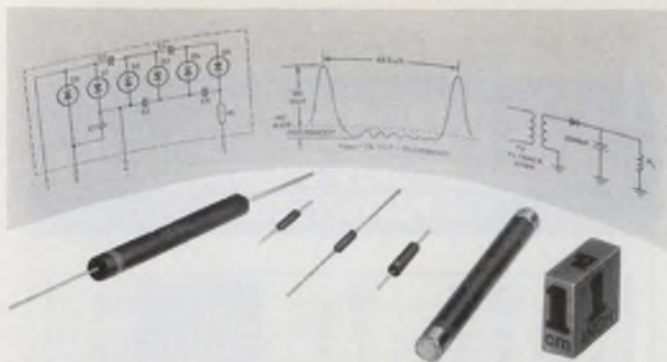

CRT RECTIFIERS

HIGH VOLTAGE SILICON DIODES FOR CRT'S AND MULTIPLIERS

Here's the complete, quality line of CRT and multiplier diodes and assemblies from the world's leader in television diodes.

TR SERIES—12,000, 15,000, 22,000, and 30,000 peak reverse voltages for 85°C ambient temperatures.

QR SERIES—High Temperature 12,000, and 18,000 PRV's, for 100°C ambient temperatures

TL12, QL12—Long lead versions

TVSL/TVS SERIES—22,000, 30,000, and 35,000 KV for B & W and small screen color.

Many other special features. Write or call for full information. **Free Samples:** Write, outlining your application for test samples.

Buy from the specialist.

edi electronic devices inc.
21 GRAY OAKS AVE., YONKERS, N.Y. 10710
(914) 965-4400. TWX 710 560-0021
CIRCLE NUMBER 145

digit for digit
Gralex DPM's
read out best

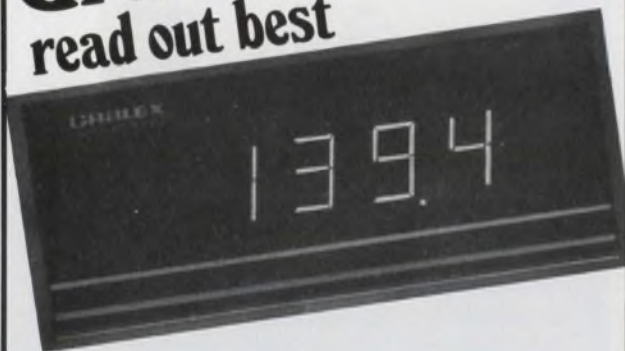

- Easy-to-read GAS DISCHARGE DISPLAY
- Accurate 3½ DIGIT performance
- Ultra-Reliability
- Low Cost
- NEMA Interchangeability

Send for specifications or see for yourself
Send for FREE 30 day evaluation unit.



GRALEX INDUSTRIES
DIVISION OF GENERAL MICROWAVE CORPORATION
155 Marine Street,
Farmingdale, N.Y. 11735
Tel. 516-694-3607
TWX 510-224-6406

CIRCLE 146 FOR LITERATURE
CIRCLE 147 FOR FREE EVALUATION UNIT

ENGELHARD

solutions for trouble-free electroplating!



Non-porous plating, exceptionally stable Engelhard electroplating solutions require less monitoring, inspire more confidence, because we don't put out a bath until we know it is trouble-free. Therefore, you can rely on high through-put, good economy and Mil-Spec adherence. For information on electroplating processes that require less maintenance, write today

ENGELHARD

ELECTRO METALLICS
ENGELHARD INDUSTRIES DIVISION
ENGELHARD MINERALS & CHEMICALS CORPORATION
2655 U. S. ROUTE 22, UNION, NEW JERSEY 07083
An Equal Opportunity Employer

947

CIRCLE NUMBER 148

Plastiglide

**INDUSTRIAL
PLASTIC
PARTS**



PLASTIGLIDE'S vast library of stock dies has established us as the leading supplier of injection molded industrial plastic components. We constantly create new parts through our **UNIQUE LOW COST TOOLING METHODS** which... solve our customer's problems...improve their products... and lower their costs. PLASTIGLIDE caters to your custom requirements. Our staff of experienced and imaginative engineers offer unmatched service in the design and development of new plastic parts...PLEASE REQUEST QUOTATIONS AND CATALOGS.

PLASTIGLIDE
MANUFACTURING CORPORATION
EXECUTIVE OFFICES: 2701 W. El Segundo Blvd., HAWTHORNE, CA. 90250
P.O. Box 427 (213) 777-8108 — Other Plants and Offices: WATERBURY, CT., CHICAGO, IL., HIGH POINT, N.C., TORONTO, ON.

CIRCLE NUMBER 149
ELECTRONIC DESIGN 24, November 22, 1977

Analog multiplexer takes 31 signals per channel

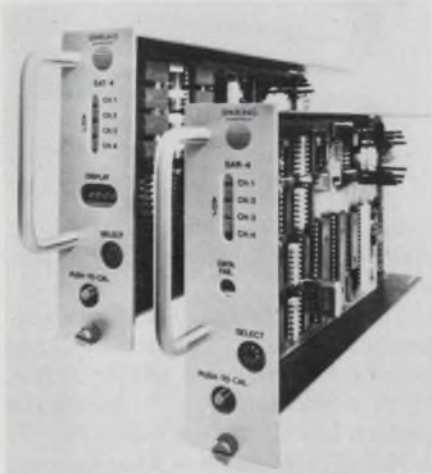

Sparling Div., Envirotech, 4097 N. Temple City Blvd., El Monte, CA 91731. (213) 444-0571. \$650 to \$1125; stock.

A μ P-based analog multiplexing system (SAM) can simultaneously accommodate up to 31 independent analog signals per voice channel. Program control permits the system to send or receive signals to or from telemetry instrumentation over a single tone-transmission voice channel. Accuracy of the analog output reproduced at the receiving station is 0.35% of full scale. Although the basic unit handles up to four analog signals, it can be expanded to handle 31 separate signals per voice channel.

CIRCLE NO. 413

13-bit a/d converter meets MIL STDs

Zeltex, 940 Detroit Ave., Concord, CA 94518. R. Terry (415) 686-6660. \$745 (100 qty); 30 days.

The 13-bit a/d converter, ZAD3213, meets the requirements of MIL-STD-883, Level B. The encapsulated-in-metal module is only 2.12 x 4 x 0.45 in. Four mounting ears permit attachment to bulkheads or PC boards. Features include a max conversion time of 100 μ s, max differential nonlinearity of $\pm 1/2$ LSB, input range is 0 to 10 V. Output coding is unipolar binary. Operating range is -25 to + 100 C; storage: -55 to +125 C. The converter withstands pk shock of 350 G's and vibration to 20 G's.

CIRCLE NO. 414

**Check the finest lighted display
PUSHBUTTON SWITCHES**

QPL Seismic qualified



Matrix System—

Four lamp message display. Square or rectangle. Up to 4PDT switching. Momentary, alternate, latch-down, or magnetic held action. Solder, wire wrap, PC, or crimp pin terminals. Full servicing from front of panel. Easy rear mount with flange or front mount with dress bezel.

Individual Mount—

Same pushbutton and switching options as Matrix System. Use for entire layout or to isolate function from matrix array with look-alike appearance. Quick and easy to mount. Relamp from front of panel.

Single Lamp—

Low cost military or industrial/commercial switches built to exacting specifications. 2PDT or 2 circuit switching. Momentary or alternate action. Solder or PC terminals. Wide selection of pushbutton sizes, colors, styles, and legend types. Bushing or snap-in bezel mount.

LOW PROFILE KEYBOARDS

LED Keyboards—

Lighted keys for visual indication of function status. 10, 12, or 16 station. Square or round keys. Attractive color selection. Clear, sharp keytop marking or two color overlay decal. Universal circuit and pin-out. Interfaces with most logic. Easy front mount.

Unlighted Keyboards—

Same design features as LED Keyboards except unlighted. Low cost, dependable, attractive. Wide choice of colors offers custom design at off-the-shelf prices.

Keyswitch Modules—

Single station modules, LED or unlighted. Square or round keys in choice of color with keytop marking. Mount on PC or pre-punched boards with holes on .100 centers.

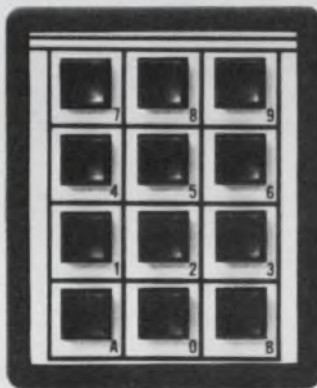

When you think switch... or keyboard... think STACOSWITCH.
Write today for free general catalog.



1139 BAKER STREET, COSTA MESA, CALIF. 92626
(714) 549 3041 TWX. 910/595-1507

Other STACO Company products:
Custom Transformers, STACO, INCORPORATED, Richmond, Indiana; Variable Transformers, STACO, INCORPORATED, Dayton, Ohio.

CIRCLE NUMBER 150

MODULES & SUBASSEMBLIES

Motor driver/controllers operate in six modes



Anaheim Automation, 922 Orangefair Ln., Anaheim, CA 92801. Tom Alcott (714) 992-6990. \$135-\$395; stock to 4 wks.

The M6128 and M6128PG motor drivers, and MC6128 and MCL6128 motor controllers, are all six function units in one. Each unit features multi-mode excitation allowing a choice of single, dual, or half-step excitation and is capable of driving 3 or 4 phase stepper motors. They include a 24-V-dc at 13-A power supply. The MCL6128 adds a control logic and an internal blower for cooling. The control logic provides for stop, forward/reverse, and speed adjustment.

CIRCLE NO. 415

Readout assembly uses fiber optics



Master Specialties, 1640 Monrovia Ave., Costa Mesa, CA 92627. (714) 642-2427.

Model 905-H Display Fiber Optic Readout Assembly meets MIL-STD-883 Level B, is nonencoded and features an internal decoder. Light-emitting diodes transmit through fiber-optic tubes to produce a 0.43 in. high character display on the 0.5 by 0.62-in. display screen. The screen is a 7-segment display with 0 to 9 numeric capability that also includes plus, minus, decimal point and limited alphabetical characters.

CIRCLE NO. 416

Dot-matrix printer goes at speed of 120 cps

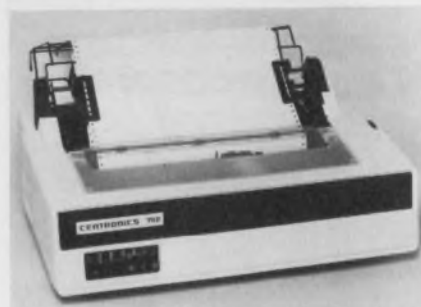

Centronics Data Computer, Hudson, NH 03051. Thomas Eifler (603) 883-0111.

The Model 702 is a 120-character-per-second, 132 column, bidirectional, logic seeking, impact, serial printer. It features a standard 7 x 7 dot-matrix pattern and offers four others (5 x 7, 9 x 7, 7 x 9, and 9 x 9) as options. Printed-data format consists of 10 characters-per-inch horizontally and operator selectable 6 or 8 line-per-in. vertical spacing with either a 2, 8, or 12-channel electronic vertical-format unit.

CIRCLE NO. 417

The original Test Clip and still the best.



Troubleshooting DIP ICs can be a pain in the probe if you can't get at their pins. But you can make the job faster and easier with Super-Grip™ IC Test Clips from A P. A P Test Clips are precision engineered to assure reliability. Our "contact comb" design prevents shorting while our superior gold-plated phosphor bronze terminals make contact. And this gutsy little spring clip is perfect as an IC puller, too. So use it for its connections or use it for its pull.

A P has a Super-Grip™ Clip for any DIP.

MODEL	ROW-TO-ROW DIMENSION	PART NUMBER	PRICE
TC-8	.3 in.	923695	\$ 7.35
TC-14	.3 in.	923698	\$ 4.50
TC-16	.3 in.	923700	\$ 4.75
TC-16LSI	.5/.6 in.	923702	\$ 8.95
TC-18	.3 in.	923703	\$10.00
TC-20	.3 in.	923704	\$11.55
TC-22	.4 in.	923705	\$11.55
TC-24	.5/.6 in.	923714	\$13.85
TC-28	.5/.6 in.	923718	\$15.25
TC-36	.5/.6 in.	923720	\$19.95
TC-40	.5/.6 in.	923722	\$21.00

Order from your A P distributor today. For the name of the distributor nearest you call Toll-Free 800-321-9668.

Send for our complete A P catalog, The Faster and Easier Book.

Faster and Easier is what we're all about.

**A P PRODUCTS
INCORPORATED**
Box 110 • 72 Corwin Drive
Painesville, Ohio 44077
216/354-2101 TWX: 810-425-2250





Cost efficiency you can put your finger on . . . CORTRON® SOLID STATE KEYBOARDS



Get your hands on a CORTRON Solid State Keyboard, and you'll soon find out why you can't judge all keyboards on initial price alone.

It's after installation that cost efficiency becomes most important. In life expectancy, ability to endure extreme environments, high speed operation without "misses," accuracy, downtime caused by beverage spillages, reliability, serviceability and human engineered features. That's where a CORTRON Solid State Keyboard really pays off.

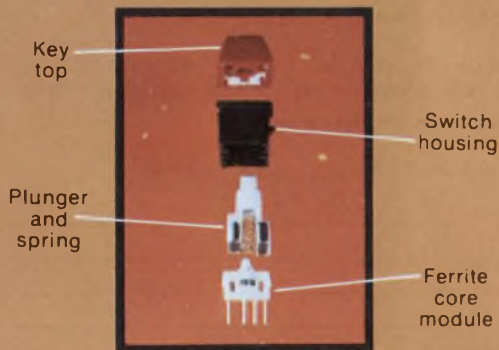

Unique contactless key switch makes the difference. Utilizing ferrite core switching technology, the CORTRON Key Switch is mechanically simple (only 4 basic parts!) and has an ultra reliable 100 million cycle life test rating. CORTRON Keyboard Professionals can translate what this can mean to you in cost efficiency terms of MTBF (mean time before

failure). CORTRON has actual customer experience of MTBF in excess of 40,000 hours.

They'll also explain other advantages you'll gain over competitive technologies such as Hall effect, reed switch, and capacitive switching. All in all, you'll find the CORTRON Key Switch offers unusual built-in protection against costly service calls and the hardship of downtime.

"**Human engineered**" keytops and key placement options give CORTRON low profile alpha numeric keyboards the familiar "typewriter feel" that promotes operator productivity and efficiency.

Nothing left to chance. CORTRON solid state keyboard materials, components, sub-assemblies, and final assembly are 100% inspected and tested to assure your specifications are met with plenty of room to spare.

These are just a few of the cost efficiency benefits CORTRON offers you and your customers.



Cost efficiency you can put your finger on. For a greater insight into the cost efficiencies attainable with a CORTRON Solid State Keyboard, write or call for details: CORTRON, A Division of Illinois Tool Works Inc., 6601 West Irving Park Road, Chicago, Illinois 60634. Phone (312) 282-4040. TWX 910-221-0275.



CORTRON
A DIVISION OF ILLINOIS TOOL WORKS INC.

THE KEYBOARD PROFESSIONALS

The New 1977-1978 **GOLD BOOK** Has Just Been Published



And Completely Outdates Last Year's Edition

If you were a subscriber on **ELECTRONIC DESIGN's** qualified circulation file in July 1977, you have been automatically sent your new **GOLD BOOK**. If you wish additional copies for other members of your company, you may order them now using the convenient coupon form below.

If you were not an **ELECTRONIC DESIGN** subscriber on our controlled circulation list, you may order your own multi-section set of the new **GOLD BOOK** by completing the form below. Shipment will be made promptly on receipt of your payment or company purchase order.

**HERE IS WHAT YOU AND YOUR COMPANY
WILL FIND IN THE UPDATED 1977-78**

GOLD BOOK

- **Three sections** containing 2,496 pages of information to quickly locate products used by the electronics industry.
- **A Product Directory** with 5,434 product categories.
- **A Trade Name Directory** of 9,814 listings.
- **A Manufacturers' Directory** listing 8,057 companies in the electronics industry.
- **Two Distributors' Directories** with 2,050 distributors listed.
- **A Giant Compendium of Manufacturers' Data Pages** with specifications.

MAIL TODAY WITH PURCHASE ORDER

Electronic Design's GOLD BOOK 449R
Hayden Publishing Co., Inc.
P.O. Box 13803, Philadelphia, Pa. 19101 U.S.A.

Here is our purchase order for _____ sets of the 1977-1978 GOLD BOOK at \$30,00 per set—for U.S., Canada and Mexico.
(All other countries: \$40,00 per set)

Check enclosed for \$ _____ . Bill us.

Name (Print) _____

Title _____

Company _____

Address _____

City/Province _____

State/Country _____

Zip or Postal Code No. _____

QUANTITIES ARE LIMITED. PLACE ORDER TODAY!

MODULES & SUBASSEMBLIES

Microhybrid device is two-quadrant divider



SGR, P.O. Box 391, Canton, MA 02021.
Ann Ripley (617) 828-7773. \$49 to \$160.

A series of microhybrid dividers that interface with μ P-based systems is comprised of a transconductance dividing element, stable reference, output amplifier with specified accuracy internally trimmed for feedthrough output zero and gain trim. The 503 through 506 divide in two quadrants with a transfer function of $-10X/Y$. They are specified for dividing errors of 1%, 0.5%, 0.25% and 0.1% at 25 C. The output provides ± 10 V at 5 mA. Small-signal bandwidth: 1 MHz, full-power bandwidth: 200 kHz, slew rate: 25 V/ μ s.

CIRCLE NO. 418

Data logger prints 10 channels, 4 1/2 digits



Datel Systems, 1020 Turnpike St., Canton, MA 02021. Gene Murphy (617) 828-8000. From \$1395; 4 to 8 wk.

The 10-channel 4 1/2-digit printing data-logger, PDL-10, is miniature and inkless. The device has a crystal-controlled conversion clock for high rejection of 50 or 60-Hz line noise. A relay multiplexer and selectable-gain amplifier offer individual range settings for each channel of ± 1.9999 or ± 19.999 V dc. Over-all sampling and printing occurs at 1 sample/s. The range-selecting switches may be set to skip selected channels to shorten the time needed to make scans and to limit the number of samples printed out.

CIRCLE NO. 419

Tickets—Labels—Multiple Forms VICTOR has the printer for you.



MODEL 5000-463

A low cost, reliable printer, backed by Victor's one year warranty, offers the solution to your printing problems. The Victor line of sprocket-feed printers for labels, tickets or pre-printed forms provides outstanding legibility combined with proven reliability.

The 5000-463 series offers you three choices of interface: parallel; RS232C or TTY current loop. This allows the printer to be connected directly to most computers or microprocessors.

The printer prints 64 ASCII alphanumeric and symbolic characters. By sending the proper command code, characters can be expanded, printed in red or both for highlighting or headlining.

There are no moving parts when the unit is not printing which keeps the noise level down and increases reliability since the printer is not wearing itself out while sitting idle.

The dot matrix printing mechanism in the sprocket feed printer is similar to those used in almost 500,000 Victor print mechanisms in use today.

If you print any of these applications:

- Pharmacy systems
- Inventory control
- Hospital supply systems
- Ticket Printing
- Label Printing

Then send this coupon today

John Tullio
Victor Business Products
3900 N. Rockwell Street
Chicago, Illinois 60618
312-539-8200

- Send Technical Literature
 Sprocket Feed Printers
 All Victor's Print Mechanisms

Name _____

Company _____

City/State _____

Zip _____ Phone _____

VICTOR

CIRCLE NUMBER 153

MODULES & SUBASSEMBLIES

Receiver takes dual-tone and gives BCD out

GTE Automatic Electric, P.O. Box 2059, Northlake, IL 60164. (312) 562-7100. \$105.

A touch-tone calling receiver, Model WA-1490-A, accepts inputs of two out of eight standard dual-tone multi-

frequency signals and provides binary-coded electronic outputs. Totally contained on an 18-pin standard-sized card, it is a stand-alone receiver, usable wherever detection of DTMF signals is required. All DTMF receiver functions are incorporated on the single PC card. Meeting standard telephone signaling requirements, the receiver can be used in computer terminals, remote control systems, or other applications using DTMF signaling.

CIRCLE NO. 420

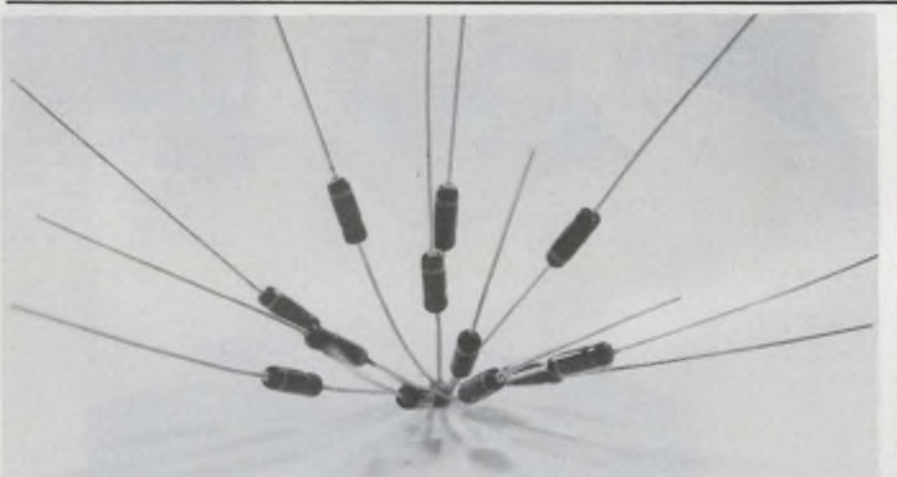

New CODI Precision Voltage Reference Diodes. Including a 2 mA alternative to the 7.5 mA Motorola MZ 605.

You're assured of prompt delivery of the CODI series of low noise, ultra-stable Precision Voltage Reference Diodes...including diodes equivalent to the Motorola MZ 605 (rated at 7.5 mA, stability 30 μ V/1000 hr, and 5 PPM/1000 hr).

The CODI PRD family of diodes is more than equivalent; it's available at either 7.5 mA or 2 mA for lower power consumption...but the price is the same. Other features of this series include guaranteed stability over one year, noise 1 PPM of output, and 1 PPM temperature coefficient (+25°C to +45°C).

When you're looking for extremely stable, low noise reference diodes, check CODI before you select. Ask for Bill Henderson.

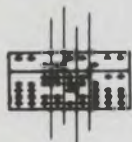

CODI CORPORATION

Semiconductor Products
Pollitt Drive South, Fair Lawn, N.J. 07410
201-797-3900 TWX: 710-988-2241

CIRCLE NUMBER 154

Scan 10 temp sensors with a/d converter

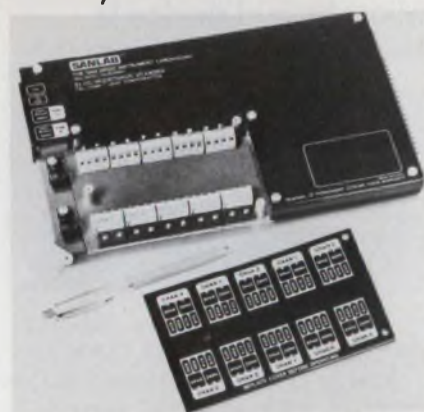

San Diego Instrument Lab, 7969 Engineer Rd., San Diego, CA 92111. (714) 292-0646. \$595 (10 qty).

A 10-channel modular RTD scanner in a card-mounted, shielded package, the SL115 connects 10 platinum-resistance thermometers directly to a user's high-level a/d converter. The scanner excites, lead compensates, continuity tests, linearizes, amplifies, and filters the signals. Segment-free linearization is for all platinum R-vs-T standards. Remote-calibration features give on-line calibration of the scanner at the ice point and, optionally, at any span point. DTL/TTL/CMOS compatible control logic receives commands from microprocessors, mini-computers, or toggle switches. Scan rates up to 20 channels/s are available.

CIRCLE NO. 421

Monitor prints-out time of power-line fault



Consultronics, 38 Le Page Ct., Downview, Ontario M3J 1Z9. (416) 630-0564.

Power Line Disturbance Monitor, Model FDM-2, monitors voltage and frequency on single or three-phase power lines and prints out exact time and duration of a fault. Features include: battery standby, adjustable thresholds, testpoints for oscilloscope display, and alarm. Also included are an optional clock display showing month, day, hour, minute and the alarm on-off and acknowledgement, nominal line-voltage selector and a self-check button to verify correct operation.

CIRCLE NO. 422

Now from Centralab . . .
Pioneers in Thick Film
Technology. . .

LOW COST CERBON™ NETWORKS



Networks Save Money

Networks are in big-volume demand for one simple reason. Compared with discretes, they save. They save on assembly costs. They save PC board space. They save on inventory. They save on inspection and testing. They save on ratio matching. And they can save installation errors.

Centralab knows networks. We pioneered thick film networks back in 1945. Since then we've produced millions. In fact, we've delivered more than 200,000,000 units.

Now, Save More With CERBON™

Centralab SIP thick film networks are now available with **CERBON™** — Centralab's patented resistor system. **CERBON** costs substantially less than cermet, yet it is measurably superior to carbon composition in critical areas. See chart below for some typical performance comparisons.

Compare CERBON Resistors With Carbon Discretes

Typical ¼ Watt Resistors

Measurement	Centralab CERBON	Carbon Composition (MIL-R-11F)
TCR (ppm/°C)	-250 @ - 55°C -350 @ +105°C	±800 @ - 55°C ±625 @ +105°C
Quantec Noise (0 db = 1µV/V)	-7 db max	0 to +10 db (not specified in MIL-R-11F)
Short Term Overload (%ΔR max.)	+0.1	±2.5

Give a Little — Get a Lot!

If you've wanted to use networks to enjoy their many benefits, but couldn't justify the cost, consider this: **CERBON** meets or exceeds the performance requirements of over 85% of all resistor applications. So, if you can give a little on the precise tolerances of cermet — which you may not need — **CERBON** networks from Centralab can get you all the cost-saving benefits of networks — at a price you can afford.

For More Information:

Whether your needs are for standard off-the-shelf SIP resistor or resistor/capacitor networks, or for custom hybrid designs, we will show you how you can save with **CERBON**. Talk to your Centralab Representative, or call (414) 228-2874, Centralab Circuit Product Sales.

*Products you need
from people who care.*



CENTRALAB

ELECTRONIC DIVISION
GLOBE-UNION INC.

5757 North Green Bay Avenue
Milwaukee, Wisconsin 53201

MODULES & SUBASSEMBLIES

F/v converters cover wide input range

Solid State Electronics, 15321 Rayen St., Sepulveda, CA 91343. Ed Politi (213) 894-2271.

Freqmeter is an encapsulated

solid-state unit that linearly converts frequency or repetition rate of input signals to proportional dc voltages. Four standard models span an input frequency range from 0 to 100 kHz. The output is insensitive to supply voltage, temperature, input amplitude or waveforms and will function when driven with sine, square and triangle waves or pulses. These converters respond to the average frequency of random signals.

CIRCLE NO. 423

Vhf crystal osc is stable to 1×10^{-9} /day

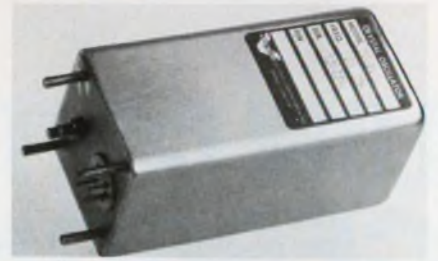

Vectron Lab, 121 Water St., Norwalk, CT 08854. Larry Jawitz (203) 853-4433.

The Model CO-220 vhf crystal oscillator provides long-term stability of 1×10^{-9} /day at any fixed frequency to 200 MHz. This stability is achieved by the use of a crystal in the 10-MHz area, followed by internal multiplication. The oscillator generates an output level of +7 dBm with +13 dBm optional. Temperature stability to $\pm 5 \times 10^{-9}$, from 0 to 50 C, is achieved by housing the oscillator in a proportionally controlled oven. Options include operation from -55 to +75 C and voltage frequency control to permit phase locking onto an external reference or for remote frequency control.

CIRCLE NO. 424



Bulletproof!

Babcock hi-rel relays meet their specifications in practice, not just on paper. Call us on it at (714) 540-1234.

Babcock Relays

An Esterline company, 3501 Harbor Blvd., Costa Mesa, CA 92626.

- Dry reed • Mercury wets • Military/aerospace
- Ultra hi-rel • Telephone • General purpose

CIRCLE NUMBER 156

Indicator monitors process signals



ElectroSyn, 480 Neponset St., Canton, MA 02021. Charles Earle (617) 828-2840.

Voltage or current signals from any process variable, such as pressure, flow, or level, can be monitored by the Model 9000. It remembers indefinitely the highest (peak) value obtained. Interrogation provides digital readout of the peak and present values. Peak value memory is equipped with 0 to 100% FS adjustable setpoint control.

CIRCLE NO. 425

Tiny fast pulser delivers 50 V

Avtech Electrosystems, P.O. Box 11426, Stn H, Ottawa, Ontario, Canada K2H 7V1. (613) 828-4823. \$398 to \$498; 4 to 6 wk.

Miniature pulse generators, in the AVI Series, provide high-amplitude flat-topped-pulse outputs up to 50 V when triggered by a low-level, slow-speed trigger pulse (TTL) and biased by a +15-V supply. The rise and fall times are 1 ns max. The pulse width is variable from 1 to 100 ns. An ultraminiature version is $2.25 \times 1.38 \times 1.13$ in.

CIRCLE NO. 426

Pocket pulser senses circuit logic state

Continental Specialties, 44 Kendall St., Box 1942, New Haven, CT 06509. (203) 624-3103. \$74.95 (suggested retail).

The DP-1 digital pulser senses circuit conditions and injects the proper pulse at a desired circuit node. The hand-held unit draws power from the circuit under test and the unit's automatic polarity pulse sensing detects the circuit's condition—high or low state—thus triggering the unit to produce an opposite polarity pulse. Trouble-shooting is accomplished by using the pulser to inject signals at key points in TTL/DTL, CMOS and other popular circuits. Testing with a single pulse or with 100 pulses per second is possible.

CIRCLE NO. 427

Thermal printhead prints 10 columns

Gulton Industries, 212 Durham Ave., Metuchen, NJ 08840. (201) 548-2800. From \$57.05; stock to 8 wk.

The DM-1050 thermal printhead features nonimpact printing with the only moving part being the advance mechanism. Printing 10 columns, character-line speeds through 7 lps are possible printing a full 5×7 matrix character on standard 90-C heat-sensitive paper. Printheads are furnished ready for mounting. They include a soldered ribbon-cable and the heat-sink mounting permits ganging to extend the number of columns.

CIRCLE NO. 428

Video L-C lines delay up to 2075 ns

Allen Avionics, 224 E. 2nd St., Mineola, NY 11501. Lester Jacobson (516) 248-8080. \$55 up; stock.

A series of 10 variable-delay units are passive L-C lines. The shortest delay is from 0 to 10.5 ns in 0.5-ns steps. The longest delay is from 0 to 2075 ns in 25-ns steps. Amplitude is flat to 5.5 MHz. The units come with toggle or rotary switches or terminals for strap-pable delay variations.

CIRCLE NO. 429

Cue three mag-tapes simultaneously

EECO, 1441 E. Chestnut Ave., Santa Ana, CA 92701. (714) 835-6000.

Microprocessor-based MQS-100 synchronizer systems can cue and synchronize any three video, audio or mag-film tape transports simultaneously. The SMPTE/EBU edit code, used for indexing of the tapes, need not be identical and tapes with drop-frame and nondrop-frame formats can be intermixed.

CIRCLE NO. 430



Call C.P. Clare
and ask them why they charge twice
our prices for mercury wetted relays.
If you don't like their answers—or
their prices—call us at (714) 540-1234.

Babcock Relays

An Esterline company, 3501 Harbor Blvd., Costa Mesa, CA 92626.

- Dry reed • Mercury wets • Military/aerospace
- Ultra hi-rel • Telephone • General purpose

CIRCLE NUMBER 157

let's calibrate



Model 82

PRECISION STANDARD for AC/DC Voltage and Current

- Tests a wide range of analog and digital meters
- AC and Bipolar DC voltage ranges of 100mV, 1V and 10V
- AC and Bipolar DC current ranges of 100uA, 1mA, 10mA and 100mA
- Nominal accuracies of 0.01% DC and 0.05% AC
- Percent error deviation dial
- Frequency variable from 40Hz to 1kHz
- Four fractional scale division ranges



Model 829G

Measure or supply with one instrument

- AC or DC voltages from 10 mV to 1400V
- Current from 10 uA to 14A
- 10 cardinal resistance values from 0.01 ohm to 10 megohms
- 5-digit readout



COMPLETE VOLTAGE, CURRENT & WATTMETER CALIBRATOR

- For calibration of wattmeters from 0.05 watt to 14 kilowatts
- Consists of two Model 829G's and a Model 5058A Wattmeter Calibration Module
- Available as individual units or, as shown, in an attractive customized enclosure with work table.



Call or write for full information
RFL Industries, Inc.
Instrumentation Division
Boonton, N.J. 07005

EST. 1922
Tel: (201) 334-3100 / TWX: 710-987-8352
Cable: RADAIRCO, N.J.

CIRCLE NUMBER 158

PACKAGING & MATERIALS

Use PVC sectionals for variety of outlet boxes



GTE Box & Fitting Div., 1 Stamford Forum, Stamford, CT 06904. (203) 357-2000.

A PVC sectional box can be used to make 14 different outlet box configurations. The middle section of the box, No. ES-00, mates with any two of five end sections to form a variety of combinations. Available end sections include units with one 1/2-in. opening, two 1/2-in. openings, one 3/4-in. opening, two 3/4-in. openings, and one blank unit. A complete box consists of a middle section and two end sections joined by PVC solvent-cement.

CIRCLE NO. 431

Use Teflon tubing for high temperatures



Cole-Flex, 91 Cabot St., West Babylon, NY 11704. (516) 249-6150.

TF250 tubing, made with FEP Teflon, is suited for applications that do not require 500-F operating temperature. But it still has a high enough rating (400 F) for most high temperature applications. The TF series is recommended for those jobs that require better clarity, higher dielectric strength, better cold-flow characteristics or longer continuous lengths. It is considered a Class-H insulation and is solder-iron resistant. Dielectric strength is 2100 V/mil.

CIRCLE NO. 432

Automatic tool speeds crimping of connectors

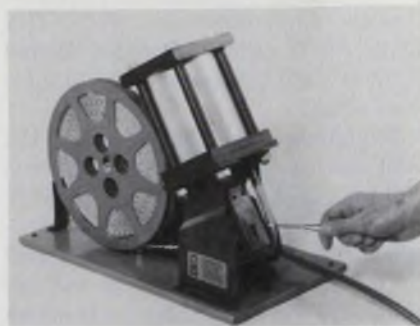

Thomas & Betts, 36 Butler St., Elizabeth, NJ 07207. (201) 354-4321.

A series of automatic strip-fed tools installs insulation-piercing magnet-wire connectors at production speeds. The tools crimp a stripped stranded lead wire to an unstripped film-coated magnet wire, or crimp two or more magnet wires together, without needing their coatings removed. The insulation-piercing connectors used in the tools are on a continuous reel-mounted strip, and are available for a range of copper magnet-wire sizes from #26 to #15 AWG. The magnet wire and lead wire are inserted in the tool which is then actuated, crimping the wires together in just one step.

CIRCLE NO. 433

Card-edge connector uses wire-wrap terminals



Elco Pacific, 2250 Park Pl., El Segundo, CA 90245. (213) 675-3311.

Series 6337 card-edge connectors contain contacts on 0.156-in.-center spacing with 0.025-in. square wire-wrappable terminals. The sizes offered cover 20, 44, 50, 56, 72 and 86-pin configurations. The insulator bodies are made of thermoplastic polyester per UL-94VO, and the contact material is phosphor bronze per QQ-W-321. Standard contact finish is gold over nickel. Current rating is 3 A max and contact resistance is 8 mΩ max. Insulation resistance is 5 kMΩ at 500 V dc and dielectric withstanding voltage is 1500 V ac between adjacent contacts at sea level.

CIRCLE NO. 434

Device-handler sorts bulk parts

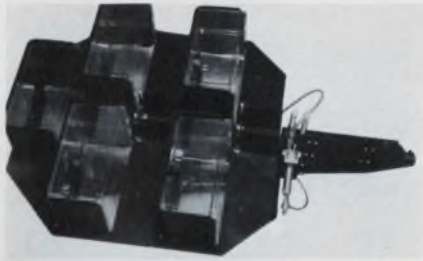

G.H.I., 1050 Independence Ave., Mountain View, CA 94043. Ron Hayes (415) 969-4750.

Any device which can be fed down a track by gravity can be handled by the 380 Opto-Switch device-handler. Devices are fed down the track to a bulk-sort at the output. The sort section is the same for all devices, but the input section is custom made to feed and probe a particular device. It is hand-fed, has a go/no-go section and discriminator for polarity where possible. Bowl or magazine feeding is optional.

CIRCLE NO. 435

Cable-jacket remover is fast and safe



P.K. Neuses, P.O. Box 100, Arlington Heights, IL 60006. (312) 253-6555.

N-2077 cable-jacket remover is fast, safe and versatile. It will cut wires and cables, remove plastic and rubber-like jackets from cables of all diameters. In addition, the N-2077 can easily cut off fillers, and is ideal for use on shielded and nonround cables. The special top edge serves for cutting wires and cables while the longer bottom blade serves as a cutting guide. Specially designed edges on the blade avoid possible damage to conductors and problems with varying jacket thicknesses.

CIRCLE NO. 436

Card-edge connector clips to flat cable



CW Industries, 550 Davisville Rd., Warminster, PA 18974. Herman Cohen (215) 355-7080.

Card-edge connector, CF-100, is for use with ribbon cable having 10, 20, 26, 34, 40 or 50 conductors on 0.05-in. centers. It provides a rapid means of connecting and disconnecting flat cable to 1/16-in. PC boards. A built-in strain relief is maintained within the connector profile and it can be permanently locked in place when a mounting flange is used. Specifications include: temperature rating of 105 C, a 1-A current rating and dielectric strength of over 500 V dc at sea level. It accepts 28-30 AWG solid or stranded conductors.

CIRCLE NO. 437

PYROFILM MAKES IT!

HIGH VOLTAGE RESISTORS

- Up to 40,000 Volts
- 10 sizes
- Up to 1,000M Ohms
- Temp. Coef. as low as 0 ± 100 PPM/°C
- Up to 5¼ Watts

Setting New Standards in Reliability

PYROFILM

60 S. Jefferson Road • Whippany, N. J. 07981 • (201) 887-8100

CIRCLE NUMBER 159

Edgeboard connector gives design versatility

Dale Electronics, E. Highway 50, Yankton, SD 57078. (605) 665-9301.

The EB8 line of MIL-C-21097C-type dual-readout edgeboard connectors are within the standard terminal grid pattern of 0.156 × 0.200 in. and provide a number of options for matching unit cost and uses. These options include a choice of three body materials—diallyl phthalate, phenolic and valox; plating options such as gold-plate, gold-flash and tin, contact choices including solder-eyelet, DIP-solar terminations in phosphor-bronze or beryllium-copper, and seven standard mounting methods. They are available in seven body sizes with 6, 10, 12, 15, 18, 22 or 25 contacts per side.

CIRCLE NO. 438

DIP socket has pins on IC side of board

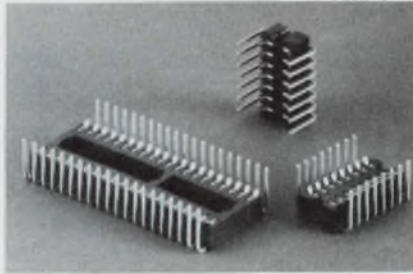

Robinson-Nugent, 800 E. 8th St., New Albany, IN 47150. (812) 945-0211.

Gone is the confusion of trying to match an IC lead to a wire-wrapping pin on the underside of a PC board. AS/U wire-wrapping DIP sockets save a great deal of time and trouble when breadboarding prototype circuits. AS/U socket pins are bent around to face the upper side of the socket. The sockets are available in 14, 16, 20, 24, 28 and 40-pin sizes.

CIRCLE NO. 439

Strain reliefs molded over flexible cables



Belden, 2000 S. Batavia Ave., Geneva, IL 60134. (312) 232-8900.

A semi-custom strain relief for molding over flexible cables ranges in diameter from 0.13 to 0.18 in. The vinyl relief, PH-693, accommodates two to six-conductor cables. Designed to fit a 1/4-in. split-mounting aperture, the strain relief is flat on one side to prevent rotation.

CIRCLE NO. 440

Biggest DVM news of the year

You name it, Systron-Donner has it! Bench, portable and systems models for every conceivable 4½-digit DVM application. Every model is brand new, packed with all the features you could possibly want. Do you need a battery pack or an analog meter? Do you need to make dBm measurements on tones? How about BCD outputs or complete IEEE-488 interface capability? Systron-Donner's new series of 4½-digit DVM's offers all these capabilities and much more.



Classy new portables.

These rugged performers for field or lab use come with all five functions (DCV, DCI, resistance, and true RMS ACV and ACI) plus autoranging. Choice of DC accuracy of ±0.05% or ±0.02%. Also with or without dBm. Options: Battery Pack and analog meter.

Model	DC Accuracies
7141A	± 0.05%; 7141B ± 0.02%
7142A	± 0.05% with dBm capability
7142B	± 0.02% with dBm capability

Plugs terminate flat ribbon-cable

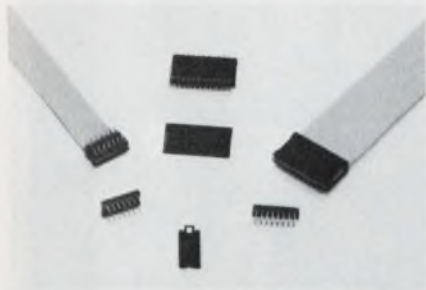

Circuit Assembly, 3169 Redhill Ave., Costa Mesa, CA 92626. Dick Foringer (714) 540-5490.

Insulation-displacement plugs terminate 0.05-in.-spaced laminated and extruded flat-ribbon cable. The plugs permit mass termination in one press operation and are offered in a selection of 14, 16 and 24-pin styles. A cover allows easy and quick removal for snap-on inspection or rework.

CIRCLE NO. 441

Pin-line headers are on 0.1-in. centers



Aries Electronics, P.O. Box 23, Frenchtown, NJ 08825. (201) 996-4096. 4¢ to 7¢/pin; stock.

Pin-line headers can be mounted side-by-side or end-to-end on 0.1-in. centers. Single rows of from 1-to-25 header positions in a glass-filled thermoplastic body are available with any of five styles of screw-machine terminals. Terminal pins can be either solder-tab or wire-wrap types with gold or tin plating.

CIRCLE NO. 442

RFI-shielded cases are in 14 sizes

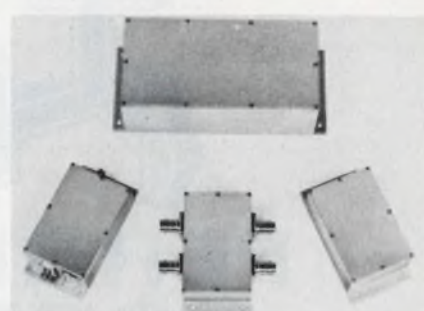

Compac, 279-I Skidmore Rd., Deer Park, NY 11729. (516) 667-3933. From \$12.65; stock.

Identified as the RFT series, cases are available in 14 basic sizes from 1½ in. square to 3 × 6 in. in five heights ranging from ¾ to 2½ in. Shielding effectiveness is enhanced by close spacing of screws tapped directly into extruded-aluminum sidewalls.

CIRCLE NO. 443

A 4½-digit DVM for every application!



Powerful bench instruments.

A workhorse series with all five functions, autoranging and a neat choice of options including BCD output, IEEE-488 bus, and rack mount. DC accuracy: ±0.02%.

Model Features

7241A 5 functions, 26 ranges
7244A with IEEE-488 capability



"Thin Line" for GPIB systems—under \$1,000 loaded.

Here's the first 4½-digit DVM designed around the IEEE-488 bus. Model 7344A is a full rack width, but only 1¾" high. Everything comes standard: IEEE-488 interface, DC volts, true RMS AC volts, and rack mount. DC accuracy: ±0.02%. There's nothing like it!

Get the full details on S-D's "think ahead" DVM's. Contact Scientific Devices or Systron-Donner at 10 Systron Drive, Concord, CA 94518. Phone (415) 676-5000.

CIRCLE NUMBER 160

SYSTRON  DONNER



FERRITE CORES

CUSTOM DESIGNED

**SHAPES
SIZES
MATERIALS**

**ENGINEERING AND
DESIGN ASSISTANCE
TO MAXIMIZE
FERRITE PERFORMANCE**

When It's Not In Anyone's Catalog...

CALL!!!

CERAMIC MAGNETICS, INC.

87 Fairfield Road, Fairfield, N. J. 07006 (201) 227-4222

CIRCLE NUMBER 801



3M Brand Light Control Film Improves Readout Readability.

Microlouvers within the film enhance contrast, screen out ambient light. Works equally well on LED and CRT displays. For information on how you can use 3M Light Control Film in your product write: Visual Products Division, Industrial Optics, 3M Center, St. Paul, MN 55101.



CIRCLE NUMBER 804

**Smallest
industrial
direct digital
readout
Elapsed Time
Indicator?**



The only big thing about it is its easily read 4-digit hourly display

Our Series 49200 Elapsed Time Indicator is the smallest industrial direct digital readout ETI we've ever made. It may be the smallest anyone has ever made. It measures a mere $3\frac{3}{64}$ " sq. x $1\frac{1}{4}$ " long—a real space-saving way to monitor operating time in business machines, computers, peripherals and other equipment where space is limited. Despite its small size, it's exceptionally accurate, and the .075" high 4-digit hourly display is readily legible. An automatic tamper-proof latching memory stores elapsed time indications that can't be lost in event of power failure. Where size is important, the Series 49200 can be one of your best values ever. It's powered by a 1W synchronous motor, 115V ac, 60 Hz. Front or side readout. Surface or through-panel mount.

Send for information today!

A. W. HAYDON CO. PRODUCTS

NORTH AMERICAN PHILIPS CONTROLS CORP.

Cheshire, Conn. 06410 • (203) 272-0301

FOR INFORMATION, CIRCLE 802

FOR IMMEDIATE, CIRCLE 803

WHO MAKES WHAT & WHERE TO FIND IT

Volume 1 of **Electronic Design's GOLD BOOK** tells all. And, when you look up an item in its **PRODUCT DIRECTORY** you'll find each manufacturer listed **COMPLETE WITH STREET ADDRESS, CITY, STATE, ZIP AND PHONE.** Save time. There's no need to refer elsewhere to find missing information.

**IT'S ALL THERE
in
Electronic Design
GOLD BOOK**

Copper-clad substrate is dimensionally stable

Mykroy Div., Synthane-Taylor, Orben Dr., Ledgewood, NJ 07852. Jack Liker (201) 398-7000. See text.

Mykroy-clad is a copper-clad glass-bonded-mica (ceramic) material for PC boards that is dimensionally stable from -270 to +750 F. The material neither outgases nor absorbs gases, because it is inorganic. It resists nuclear, X-ray and microwave radiation and is impervious to moisture with a low loss factor. It is available in standard panels 13 x 19 in. and in thicknesses of 1/16 and 1/8 in. One or two sides are clad with all standard copper foil thicknesses. The price of a 1/16-in. thick standard-sized panel (13 x 19 in.), 1-oz copper clad on one side is \$150.

CIRCLE NO. 444

Air-temp source conditions PCs or parts



Thermotron, Kallen Park Dr., Holland, MI 49423. (616) 392-1492.

The ETS-150 is a compact, portable, closed-loop air-temperature source that temperature conditions circuit boards or small components. The system is bench or relay-rack mounted and operates from a 115/1/60, 20-A receptacle. The air-flow rate is 148 cfm from -75 to +125 F with proportioning control better than ±2 C. A digital indicator with 3-position selector switch is provided for monitoring supply, return, or remote temperatures.

CIRCLE NO. 445

Connector uses crimp-pin to relieve strain



Amphenol, 900 Commerce Dr., Oak Brook, IL 60521. Bob Ashley (312) 986-2700.

Miniature "D"-shaped rear-release rack and panel connectors, Type 17, feature insulation-support crimp con-

tacts that secure both wire conductor and insulation in place, lessening chance of strain. The pin and socket contacts can accept any conductor size from 22 to 26 AWG, and have back-end tabs to crimp insulation up to a maximum OD of 0.050 in. Finger-tip pressure is all that is needed to snap contacts into connector housings. No special tools are required. The connectors are offered in 9, 15, 25, 37 and 50-contact configurations.

CIRCLE NO. 446

it's a small,
small
world . . .

. . . and
we're at
the CENTRE
with ceramic
capacitors

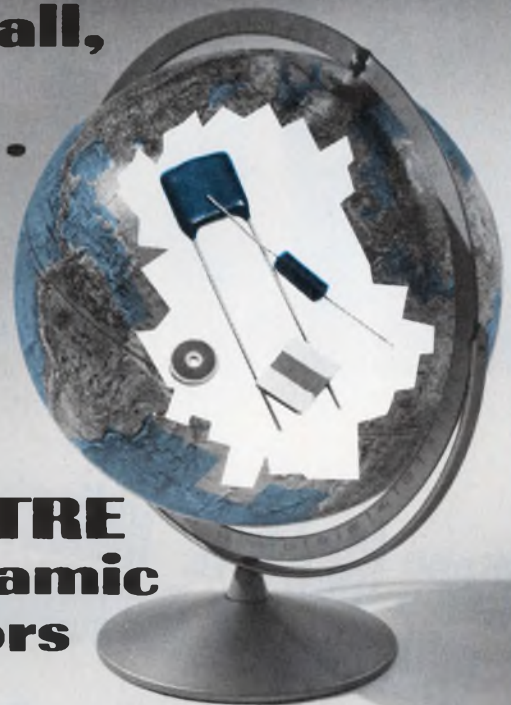

As the trend for miniaturization grows, the design engineers require smaller ceramic capacitors with maximum performance. The widest range of ceramic capacitors in the industry are available from Centre Engineering.

Sub-miniature ceramic capacitors as small as .050" x .040" up to .500" x .500" with a capacity range from 1 pf to 10 mfd are available to meet your requirements.

Our ultra-reliable subminiature ceramic chip capacitor both single and multi-layer are as small as .050" x .040" and designed for extreme

high capacitance-to-volume ratio.

Centre's conformal coated leaded devices are only .100" square for applications requiring accurate temperature compensation, high stability, high Q, tight capacitance-to-volume ratio.

The glass sealed multi-layer capacitors are available in reel form. The small, .170" x .100" DIA. capacitors are hermetically sealed, reliable, rugged, and are ideal for automatic insertion.

It's a small, small world and we're at the Centre. For complete information write for our free catalogue.

 CENTRE ENGINEERING

2820 E. COLLEGE AVE., STATE COLLEGE, PA 16801
814-237-0321 ■ TWX 510-670-3517

VICTORY SELECTIVITY

THERMISTORS

- New-Low cost SensiChips®
- Small size • From .020" sq. to .300" sq.
- Thickness from .005 to .070 in.
- Resistances from 5 K ohms to 1 meg.
- Typical response time 4 seconds.

VICTORY ENGINEERING CORP.
 Victory Rd. Springfield, N. J. 07081
 TWX: 710-988-4430 Tel: 201-379-5900



CIRCLE NUMBER 807

Micro-Mini BITE* Indicator with Internal Switching



Actual Size

Minelco's magnetic-latching BITE* Indicator MI70 is the latest in miniaturization and reliability, meeting all MIL-E-5400 requirements. It offers a dual-view, low-profile environmentally-sealed case for PC or panel, with outstanding vibration characteristics. Best of all: Minelco can provide internal means for isolated signal switching to eliminate latching relays, or switching for integral control of coil circuits, as well as suppression and steering diodes. The MI70 is available in 6 to 28 vdc, for temps -65°C to +105°C. Write or call for details.

*Built-In-Test-Equipment

MINELCO

a **TALLEY INDUSTRIES** Company
 135 South Main Street Thomaston, Conn. 06787
 Phone 203-283-8261

CIRCLE NUMBER 808



The world's only single-chip LSI Universal Printer Controller is here!

The very low-cost new 40-pin CY-480 controls ANY standard 5 x 7 dot matrix printer with print speeds up to 200 cps! The new CY-480 Universal Printer Controller from Cybernetic Micro Systems is the first—and only—40-pin LSI device which will control and interface any standard 5" x 7" dot matrix printer (including those from Victor, LRC, Practical Automation and Amperex) having a print speed up to 200 cps. It operates from a single +5V power supply and will interface a printer with any microcomputer or minicomputer system through standard 8-bit ports. The CY-480 accepts either serial (RS232C) or parallel ASCII input from the host system's data channel.

The CY-480 replaces bulky, expensive dedicated controllers. The small, single LSI package offers a 5 x 7 dot matrix character generator. The small, lower case ASCII 96-character font, and a 48-character (expandable to 96) internal line buffer storage. Standard are a 10, 12 or 16 characters/inch variable character density command, 2-color selectable print command, forward/backward printing command, and horizontal and vertical independently expanded print command. The CY-480 provides graphics capability and includes a "flip-print" operating mode for 180° viewing. Ready lines provide full asynchronous communications with handshaking, and an optional foreign language character generator is available.

Get full details on the inexpensive new Universal Printer Controller (\$92 a single unit, \$30 in 5,000 quantity) right now from

CYBERNETIC MICRO SYSTEMS
 2460 Embarcadero Way • Palo Alto, Calif. 94303
 Phone (415) 321-0410

CIRCLE NUMBER 809

AMPERITE Thermostatic DELAY RELAYS



Delays: 2 to 180 seconds*

LOW COST • LONG LIFE • MAXIMUM STABILITY

Hermetically sealed — not affected by altitude, moisture or climate changes... SPST only — normally open or closed... Compensated for ambient temperature changes from -55° to +80°C... Rugged, explosion-proof, long-lived... Standard radio octal and 9-pin miniatures.

*MINIATURES Delays: 2 to 120 seconds.

RELAY PRICES:

Standard or Miniature— Under \$4.00 Each.

PROBLEM: Send for BULLETIN No. TR-81

AMPERITE BALLAST REGULATORS

Automatically keeps current at a definite value. For AC or DC... Hermetically sealed, rugged vibration-resistant, compact, most inexpensive.

Price, under \$3.00 ea.

Write for Bulletins TR-81, LD-73 and AB-51



AMPERITE 600 PALISADE AVE., UNION CITY, N.J. 07087
 Telephone: 201 UNion 4-9503

Canada: Atlas Electronics, Ltd., 50 Wingold Ave., Toronto M6B 1P7

CIRCLE NUMBER 810
 ELECTRONIC DESIGN 24, November 22, 1977

PACKAGING & MATERIALS

Cable-tie mounts are adhesive backed

Panduit, 17301 Ridgeland Ave., Tinley Park, IL 60477. (312) 532-1800.

The ABM2S-A mount has a pressure-sensitive backing with peel-off paper. It secures small wire bundles from any of the four sides of the mount. Measuring 1 x 1 in., it supports ¼-lb weight. The mount can be used with all miniature, intermediate and standard cross-section cable ties.

CIRCLE NO. 447

Wire stripper self-adjusts



AMP, 449 Eisenhower Blvd., Harrisburg, PA 17105. (717) 564-0100.

A built-in wire sensor enables this hand tool to strip single or multiple-core cables with conductors up to 12 AWG without wire-size adjustments. Paired wires are simultaneously stripped and the front feed eases stripping of short wires. Strip length can be pre-set at up to 0.7 in. and an insulation-diameter adjustment accommodates extreme variations of insulation thickness. Stripping jaws are field replaceable, and a set of wire-cutting blades are incorporated into the tool.

CIRCLE NO. 448

Conductive epoxy resists high temps

Tra-Con, 55 North St., Medford, MA 02155. Jim Hart (617) 391-5550.

TRA-DUCT 2924 is an electrically conductive silver-epoxy adhesive for critical high-temperature (190 C) bonding and sealing. It is mixed and applied at room temperature and cures at 90 C. It can bond many dissimilar surfaces.

CIRCLE NO. 449

IC packaging panels give multi-interfaces



Gary Mfg., 1010 Jersey Ave., New Brunswick, NJ 08902. Harry Koppel (201) 545-2424. \$1.00 to \$2.50 per IC; 2 to 4 wk.

Universal IC-packaging panels, PS4108, provide a multiple-interface system with the flexibility of four I/O channels for segmenting logic functions. The panels contain 30 columns of 64 terminals per column on 0.1-in. centers. The IC-socket contacts feature low profiles and a closed-entry style.

CIRCLE NO. 450

Anyone can make Lighted Pushbutton Switches



Unimax makes them Status Symbols.

Single lamp, dual lamp or 4-lamp lighting. Momentary or alternate switching. Ratings from dry circuit to 10 amps. Unsealed or oil-tight. Each one is a Status Symbol. To see which one is right for you, call or write: Unimax Switch Corp., Ives Rd., Wallingford, Conn. 06492. Phone (203) 269-8701.

Unimax Switch

CIRCLE NUMBER 811



electrocube solutions...

POLYCARB

for **INSTANT RELIEF**



If capacitor performance and delivery are giving you problems, our reliable metallized polycarbonate Series 650 could be the solution. More than the 1100 miniature units, in 6 case styles, rated to 50 mfd and 600 VDC — all extremely stable over a wide temperature range. **And they're available in reel and un-reel packaging.** For instant relief, contact Electrocube, 1710 So. Del Mar Ave., San Gabriel, CA 91776; Tel.: (213) 573-3300.

CIRCLE NUMBER 812

Where can I get an AC-DC or DC-DC switching power supply in a modular, open frame or P.C.B. design, with a 5 year warranty at reasonable cost?

ETATECH



MODEL B5D10, 5V
@ 10A, 28 VDC INPUT
\$180, 1-99 PCS.



MODEL B5S10, 5V @ 10A,
115 VAC INPUT
\$145, 1-99 PCS.

187-M W. ORANGETHORPE, PLACENTIA, CA 92670

(714) 996-0981

CIRCLE NUMBER 813

PACKAGING & MATERIALS

Circuit tester whistles while it works



Stevron, P.O. Box 8656, Anaheim, CA 92802. \$29.95; stock.

"The Beeper" continuity tester measures circuit connections point-to-point on PC cards without removal of, or damage to, any component. The Model 100 uses an audio-response technique instead of an indicator scale. This technique minimizes the possibility of error and permits faster testing. It is a self-contained device and battery operation ensures electrical isolation from the equipment being tested. Output current is 20 μ A max, top output potential is 40 mV.

CIRCLE NO. 522

Wrapped-wire boards fit mini/micro units

Gary Mfg., 1010 Jersey Ave., New Brunswick, NJ 08902. Harry Koppel (201) 545-2424. See text.

Series CIP4 and CIP4/11 IC wrapped-wiring boards are for interfacing with the DEC LSI-11 microprocessor and DEC PDP8/11 mini-computers. The module boards plug directly into, and are bus-compatible with standard DEC Omnibus and Q-Bus systems. The boards provide 32 columns of 60 low-profile socket terminals per column with alternate rows of committed ground and voltage wrapped-wire terminals. They will accommodate up to 110 16-position IC chips or an equivalent mix of 14 to 40-position IC chips. Boards are available in dual, quad, and hex sizes. Prices are from \$1.50 to \$2.00 per IC position.

CIRCLE NO. 523

Application notes

4-bit bipolar μ P

A 12-page bulletin includes features, block diagrams and architecture of the IDM2901A 4-bit bipolar micro-processor. National Semiconductor, Santa Clara, CA

CIRCLE NO. 524

Lead-sulfide sensors

Performance data of lead-sulfide and lead-selenide sensors, packaging information, suggested circuits and environmental effects are covered in two application notes. Infrared Industries, Waltham, MA

CIRCLE NO. 525

Switching transistors

Using high-speed switching transistors in high-energy switching environments is the subject of a new 12-page app note, and parameter trade-offs in high-voltage, high-speed, switching power transistors are discussed in a reprint of a Powercon 1976 paper. General Semiconductor Industries, Tempe, AZ

CIRCLE NO. 526

Component burn-in

"A Guideline to Component Burn-in Technology," 38 pages, explains how to apply heat to semiconductor devices or other components for the purpose of reducing the effects of "infant-mortality" failure. Graphs, charts, tables, and photographs show quality-conditioning burn-in procedures. Wakefield-Systems, Wakefield, MA

CIRCLE NO. 527

Programmable calculators

The HP-19C and HP-29C programmable handheld calculators are described in a six-page brochure. Sections describe the advanced programming features of the two calculators, keyboard features, physical specifications, and the HP warranty. Hewlett-Packard, Palo Alto, CA

CIRCLE NO. 528

ENCLOSURES SHIPPED IN



Order a MarkHon cabinet* today at discount prices. If we aren't ready to ship in three days, we'll knock another 15% off the price.

Imagine.

Order any of our specially priced standard cabinets between now and December 31, 1977 and we *guarantee* your order will be ready for shipment within 72 hours. It's that simple.

If, for any reason, we can't deliver on our promise, we'll deduct another 15% and still produce our cabinets faster than any of our competitors.

It's the perfect solution if you need high quality cabinetry in a hurry. Large units or small. One unit or one thousand. Our 72-hour promise applies to any of the models shown here.

Order today.

To order (or for more detailed information) call or write Roger Miller at MarkHon.

Challenge us to keep our promise.

*72-hour promise and discounts apply to listed units only. Orders placed between now and December 31, 1977 are guaranteed to be on the loading dock of MarkHon plant and available for transit within 72 hours of receipt of order or an additional 15% discount will be extended to customer.

	Model 41H19	41J19	41K19
Frame Height (opening)	63.12"	70.12"	77.12"
Overall	67.5"	74.5"	81.5"
Width (opening)	19.06"	19.06"	19.06"
Overall	22"	22"	22"
Depth (opening)	19.06"	19.06"	19.06"
Overall	25.5"	25.5"	25.5"
Overall Height with caster base	72.4"	79.4"	86.4"

Frame includes: caster base, vented side and top panels, plain door (hinged right or left), door lock (optional).

Finish: frame, base, side and top panels are Gothic Black. Door, Caribbean Blue.



MarkHon

P.O. Box 547 • 200 Bond Street • Wabash, IN 46992
Phone (219) 563-2161

CIRCLE NUMBER 814

Murphy's Laws

Order now for
Christmas

8 x 10 \$4.95
5 x 7 \$3.95

All ten laws on a simulated blue printed circuit board with silver letters. Standard 8 x 10 and 5 x 7 sizes self-stand on desk or are suitable for framing.

Send check or money order to:

techno-mania
5821 Auburn Blvd., #5
Sacramento
California 95841
Tel. (916) 334-1850

Postage paid within U.S.A. and Canada · Calif. res. add 6% sales tax



CIRCLE NUMBER 815

AUTHOR'S GUIDE

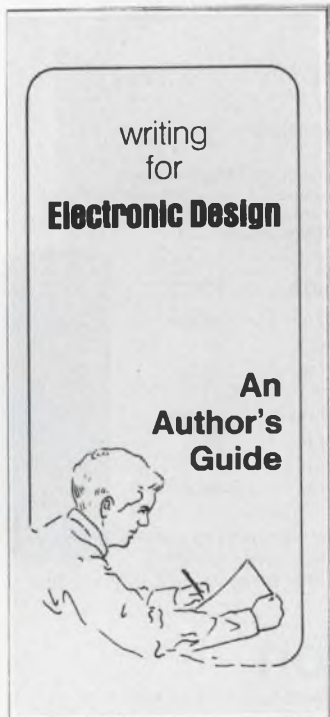

If you've solved a tricky design problem, if you have developed special expertise in a specific area, if you have information that will aid the design process... share it with your fellow engineer-readers of *Electronic Design*.

Articles you have authored not only raise your own professional status, but help build your company image as well. The readers benefit, your company benefits.

To help you prepare material that meets *Electronic Design's* high editorial standards, our editors have prepared a special author's guide entitled "Writing for *Electronic Design*." It covers criteria for acceptability, form, length, writing tips, illustrations, and payment for articles published. It's available without cost.

It's easy to write for *Electronic Design*, but it's often hard to get started. Send for your copy of our Author's Guide today.

**Circle No.
250**

New literature



Halogen-cycle lamps

Drawings, specifications and characteristics of halogen-cycle lamps are given in a 12-page catalog. General Electric, Miniature Lamp Products, Cleveland, OH

CIRCLE NO. 529

Circular connectors

Bayonet-type connectors are described in a 20-page catalog. There are more than two dozen drawings and photographs plus standard data on materials, finishes, shell styles and sizes, and charts on electrical data. ITT Cannon Electric, Santa Ana, CA

CIRCLE NO. 530

Breadboards

Over one hundred different breadboards are featured in a 32-page catalog. The catalog shows minicomputer-interface boards, which are compatible with DEC, Data General, Camac, Computer Automation, and S-100 hardware systems. Douglas Electronics, San Leandro, CA

CIRCLE NO. 531

Computing reference

The "Reference Book of Personal and Home Computing" provides a single source of information on stores and companies in the field, computer clubs and newsletters, magazines and professional societies. Its index of articles for the major publications sorts over 1200 articles by their content. People's Computer Co., Menlo Park, CA

CIRCLE NO. 532

At +125°C you can burn your fingers on some DAC's our 4058 stays cool

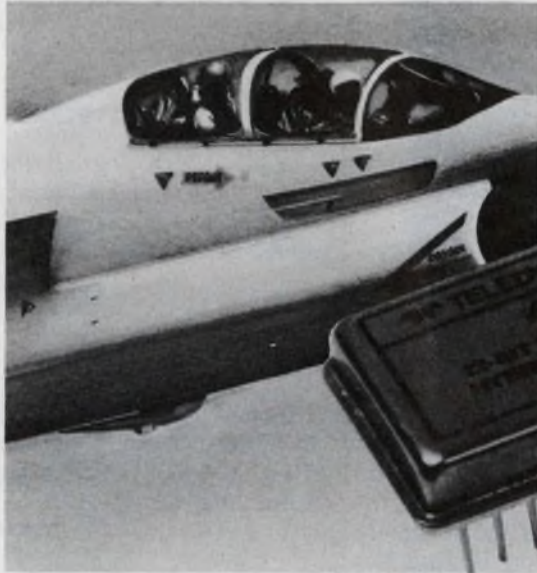

Because this new, hybrid 12 bit DAC was specifically designed for the temperature range -55 to $+125^{\circ}\text{C}$. It is not merely a top-end selection of commercial DAC's, where you don't know today what tomorrow's yield will be.

Your application may not need the full temperature range nor the hermetically sealed metal DIP. But for a lot of industrial applications these and other features of the new DAC offer you vital safety factors.

For example, it is produced to MIL Std 883 giving extremely high reliability. It has a very low temperature drift of $5\text{ ppm}/^{\circ}\text{C}$ gain, $10\text{ ppm}/^{\circ}\text{C}$ max. offset.

And if you want to fly with it, the 4058 is shock, vibration and acceleration tested - its already being used in the new MRCA.

 **TELEDYNE PHILBRICK**

Allied Drive at Route 128
Dedham, Massachusetts 02026
Tel: (617) 329-1600

TWX: (710) 348-6726
Telex: 92-4439
Cable: TELEPHIL

CIRCLE NUMBER 816

KEYBOARD SWITCHES for INSTRUMENT PANELS

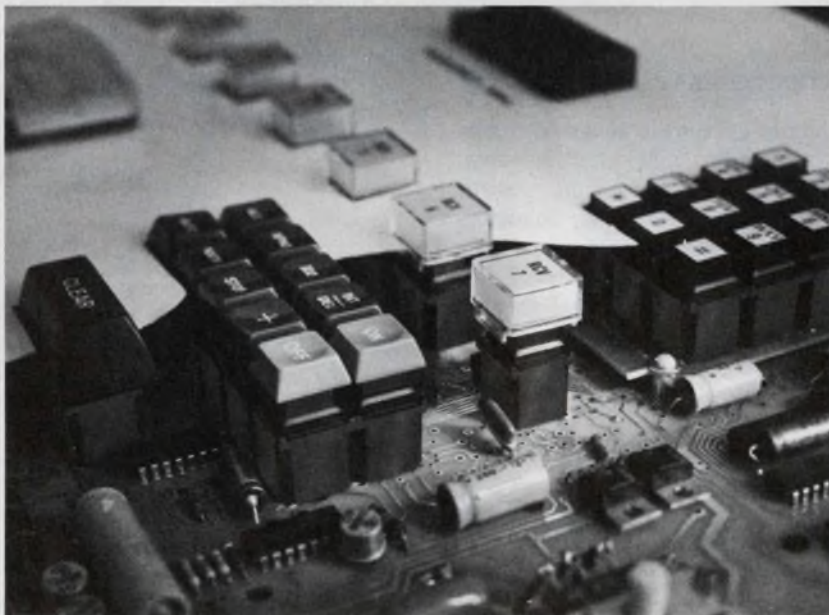

Now is the time to stop hand wiring to *expensive* panel-mounted switches.

Mechanical Enterprises' keyswitches are available at about *half-the-cost*. And, they are *self-supporting* on the PC board without the need for metal sub-plates.

Our switches feature —

- Sealed contacts or inexpensive gold bar mechanical contacts
- $3/4''$ or $5/8''$ spacing, or stand-alone
- Selection of legending systems including doubleshot keytops
- Lighted models in three lens styles, all relampable from front
- Single or double pole, NO or NC
- Momentary or alternate action
- Wave solderable
- 20 million cycle life at TTL loads with guaranteed low bounce

Please phone for a free sample with keytop.



Mechanical Enterprises, Inc.

8000 Forbes Place Springfield, Virginia 22151 (703) 321-8282 TWX 710-832-0942

Germany - NEUMULLER GMBH, MUNICH / U.K. - TEKDATA Ltd., STOKE-ON-TRENT / France - TEKELEC AIRTRONIC, SEVRES / Switzerland - DIMOS, AG ZURICH

CIRCLE NUMBER 817

MILITARY
APPLICATIONS

AD CONVERTERS

by

MSK

Accuracy

Speed

Size

Repairability

Military

Temp. Range
-55°C to +125°C



- 4 Bit/50 nSec; Low Cost
- Ideal for Radar Scan Converters
- Holds Absolute Accuracy Over Temperatures
- Tracks a 10 MHz Analog Input



- 9 Bit/200 nSec.
- < 2 Bit Drift Over Temperature
- Insensitive to Clock Frequency

For Further Information Call or Write
M.S. Kennedy Corp.
Pickard Drive, Syracuse, New York 13211
Tel. 315-455-7077

CIRCLE NUMBER 818

NEW LITERATURE

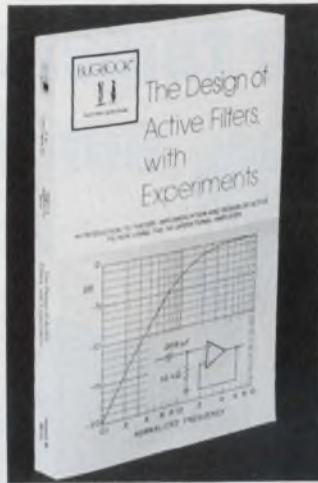

Active filter handbook

The Design of Active Filters and Experiments, a 285-page paperback textbook, provides an introduction to theory, implementation and design of active filters. Written by Howard M. Berlin, the book combines text and experiments permitting the reader to demonstrate the concepts covered. Subjects covered include the basics of operational amplifiers and filters, first-order low-pass and high-pass active filters and second and higher order active filters. Other topics described are bandpass and notch filters as well as the state-variable filter. The book costs \$8.50. E&L Instruments Inc., Derby, CT

CIRCLE NO. 533

Components

Details on a wide range of components, including wirewound and metal-film resistors, thick-film resistor networks, trimmer pots, inductors, transformers and connectors, are given in a catalog. Electrical and dimensional specifications are provided. Dale Electronics, Columbus, NE

CIRCLE NO. 534

Technical index

A six-page guide lists reprints, technical bulletins and applications data sheets available from the company. Topics include process analysis, water and air quality monitoring, source monitoring, vehicle emissions analysis, and safety monitoring programs. Beckman Instruments, Fullerton, CA

CIRCLE NO. 535

Terminal boards

An updated version of the terminal board, block and strip reference guide includes the thermoplastic series for PC, insulated feedthrough and conventional flat-mount applications. Kulka Electric, Mount Vernon, NY

CIRCLE NO. 536

Test-equipment rental

A 168-page catalog describes a broad line of test-equipment rental programs designed to fit a range of individual needs. Leasametric, Burlingame, CA

CIRCLE NO. 537

Mini-DIP switches

Dimensions, features, specifications and prices of mini-DIP switches are given in a four-page catalog. EEEO, Santa Ana, CA

CIRCLE NO. 538

Switches

Photos, line drawings, specifications and ordering information on over 300 different switches are included in a 24-page catalog. Chicago Switch, Chicago, IL

CIRCLE NO. 539

Solid-state amplifiers

A 32-page catalog covers solid-state amplifiers. The catalog includes selection charts, applications information, specifications, drawings, and a glossary of terms. Watkins-Johnson, Palo Alto, CA

CIRCLE NO. 540

Radio-link test set

A 24-page brochure describes the RM-4 radio-link precision test set for the two intermediate frequencies, 70 MHz and 140 MHz. Wandel and Golterman, Livingston, NJ

CIRCLE NO. 541

Pressure transducers

A 12-page brochure describes pressure transducers, carrier demodulators and multichannel signal-conditioning systems. Validyne Engineering, Northridge, CA

CIRCLE NO. 542

An 8½ inch Microprocessor Controlled Impact Printer for just \$345*

Now that's what we call
Practical!

Laugh all the way to the bank, OEM's. With both matrix impact print head and built-in microprocessor controller, our DMTP-6uP is a budget printer in price only. In practice, it's one of the greats.

You can print 80-96 columns of both data and text at a fast 110 cps. Turn out up to four copies at once on regular 8½ inch roll paper, even on fan-fold forms and labels. Not only are all needle drivers and diagnostic routines included with the microprocessor, but you can choose the interface function you want — parallel ASCII, RS-232C/I-Loop, or switch-selectable baud rates from 110 to 1200. You even get the economy of easily-replaceable ink rollers and a self-reversing 10-million character life ribbon.

* \$345 in 100 qts.; single units \$472



All that for \$345*? It's phenomenal...
and it's also very Practical.

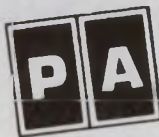

PRACTICAL AUTOMATION, INC.
Trap Falls Road, Shelton, CT. 06484
Tel: (203) 929-5381

CIRCLE NUMBER 819

Everything you've dreamed of in a scope...including a sensible price.



WO-527A \$479.00

See them at your VIZ distributor.

Whether it be for servicing or scientific research, the new WO-527A 15MHz 5" triggered-sweep oscilloscope is designed for a wide range of applications. With its host of useful functions and its advanced solid-state integrated circuits, it's hard to believe it's so reasonably priced.

- Easy-to-use pushbutton controls
- Triggered or automatic sweep; ac or dc triggered
- Unique trigger level control with LED polarity indicators
- 10mV to 20V/cm in 11 ranges
- 19 calibrated sweep ranges
- Preset, automatic TV sync separation circuits
- Built-in calibrated time-base
- Special line selector for TV line-by-line display
- 10 times sweep magnifier

**VIZ Test
Instruments Group
of VIZ Mfg. Co.**

335 E. Price St., Philadelphia, PA 19144

Formerly
RCA
Instruments

© VIZ
6883

CIRCLE NUMBER 820

CUSTOM HYBRIDS

Call Frank Albertson
(714) 759-2411

Or send for new brochure:
500 Superior Ave., Newport Beach, CA 92663

HUGHES

HUGHES AIRCRAFT COMPANY
MICROELECTRONIC PRODUCTS DIVISION

CIRCLE NUMBER 825

CUSTOM BIPOLAR LSI

Call Dennis Olson (714) 759-2411

Or send for new brochure:
500 Superior Ave., Newport Beach, CA 92663

HUGHES

HUGHES AIRCRAFT COMPANY
MICROELECTRONIC PRODUCTS DIVISION

CIRCLE NUMBER 821

Save on Calculators

HEWLETT-PACKARD

Model	Your Cost	Model	Your Cost
HP 67 224 step programming	\$25.95	HP 97 224 Program Step/Printer	\$596.95
HP 19C Comb. batw. HP25C/HP67/ptr	274.95	HP 29C Comb. bat. HP25C/HP67	154.95
HP 97 Bond Trader-Finance Printer	496.95	HP 25C Scient. ratans memory	127.95
HP 25 Scient. programmable	59.50	HP 27 Comb. Bus. Science-Stat	138.95
HP 80 R/E Bus-Fin 200 yr calendar	234.95	HP 81 Printer Scient. HP 45 spaces	259.95
HP 55 Scient. prog. Timer (was \$335)	139.95	HP 10 hand held Pir-mem. small	139.95
HP 21 Scient. slide rule	63.95	HP 22 R/E Business Finance	99.50
HP user lib. slide/book (40) each	2.00	HP accessories at discount prices	

We are an HP franchised dealer. Each unit comes complete with charger, batteries, case, manuals. One year guarantee by Hewlett-Packard. We will beat any deal. Try us.

TEXAS INSTRUMENTS

Model	Your Cost	Model	Your Cost
TI 59 960 prog. step—100 mems	\$25.95	TI 58 480 step prog. 80 memories	\$ 87.95
PC 100A printer for TI 59 58-56-52	146.95	TI 57 150 step prog. replaces SR56	63.95
HP 40 Scient. slide rule, parentheses	74.95	TI 30 Scient. slide rule, parentheses	17.95
Bus. Analyst R/E and Finance	28.95	Money Manager for R/E and Finance	18.95
SR 512 Super Slide Rule Conv.	48.95	TI 1750 Thin wall LCD 2M Hrs. mem.	19.95
Data Clip pencil thin LCD 1000 Hrs.	28.95	MBA Business-Finance-Stats	67.95
TI 1860 Instant Reply calcs	25.95	Little Prof. for kids 5 yr. up	12.95
TI 2550 3 Business Memory	25.95	Data Man (Big Prof.) educ.	21.95
TI 5040 Printer-Display Memory	58.95	TI 5015 Pn Grand Total-Percent	64.95
TI 5050M AC-DC printer memory	83.95	TI 5100 Desk Digital mem. percent	43.95
TI 1050 Mem. percent square root	12.95	TI 1025 Memory Percent—1/2 games	10.95
Literatures for TI 59 and TI 58	29.00	TI Digital Watches 5 func. from	9.95

We are a TI franchised dealer and carry TI accessories at discount prices. We will beat any deal. Try us. All TI calculators are guaranteed by Texas Instruments, Inc.

SPECIALS

Model	Your Cost	Model	Your Cost
Norelco #95 Dictating unit	\$145.00	Sony KV 1512 Color Trinitron 15"	\$361.00
Norelco #185 Dictating unit	89.95	Sony KV 1549 Color remote 15"	409.00
Norelco #88 Dictating unit	242.00	Sony KV 1724 Color Trinitron 17"	418.00
Norelco #186 Transcribing unit	245.00	Sony KV 1741R Color remote 17"	479.00
Norelco #N17 new dictating unit	164.00	Sony KV 1921 Color Trinitron 19"	461.00
Norelco #97 dictating or trans.	298.00	Sony KV 2101 Color Trinitron 21"	569.00
Norelco #98 dictating or trans.	409.00	Sony stereos-records and others. call us	
Norelco Min. Cassettes	2.95	Calc. Watch: mem by Hughes Aircraft 125 00	
Craig # 2625 select notebook	148.00	Alan comput. TV game incl. 1/2 games	169.95
Craig # 2706A dictating/trans.	189.95	RCA Televisions. All models. Call for best deal	
Smith Corona #2200 elec. type case	239.95	RCA new 4 hours video cassette recorder	
Olivetti Leshon 82 ball typewriter	249.00	revolutionary video recorder for less call us	
3M Dry photocopy machine #148	79.95	Zenith Televisions. All models.	
New TI Star Wars dig. watch (Oct)	14.95	Call us for the best deal	
Cherograph 15 func. LCD or LED	59.95	Phone Mate: Code A Phone Record a Call	
Sony KV 1204 Color Trinitron 12"	314.00	call us	

We carry: Royal—Olivetti—Smith Corona—Amana—Liton—Commodore—APF—Linnex—Canon—Casio—Sharp—Pansonic—Sanyo—Bally—JVC—HY Gain—Kosmos—Victor—Sincial—Pearcorider—Midea alarm—3M—Microm—Lloyds—Boshe—Rockwell—Sentry Sales—Walton Gym equip—RCA—Zenith—Sony—Alan—Phone Mate Record A Call-Code A Phone and many more. Over 20,000 units. 1 Try COFFEE PLUS at \$1.75 per one pound can by the case of 24 cans. Freight prepaid.

Prices are f.o.b. LA. Goods subject to availability. Ask for our famous catalog. We will beat any prices if the competition has the goods on hand. Add \$3.00 for shipping hand held calculators. CA residents add 8% sales tax.

OLYMPIC SALES COMPANY, INC.

216 South Oxford Ave., P.O. Box 74545
Los Angeles, CA 90004 • (213) 381-3911 • Telex 67-3477

CIRCLE NUMBER 822

NEW LITERATURE

Antenna testing system

Technical and application information for the series 2030 antenna data collection system are presented in a brochure. Scientific-Atlanta, Atlanta, GA

CIRCLE NO. 543

Linear and digital ICs

Linear and digital semi-custom integrated circuits are featured in a 16-page brochure. The characteristics of the various integrated components (bipolar transistors, resistors, diodes, and MOSFETs) are presented in tabular forms. Interdesign, Sunnyvale, CA

CIRCLE NO. 544

Image displays

"Screened Image Displays," 16-pages, provides a general overview of the SP-400 screened-on-glass, planar gas-discharge displays. Beckman Instruments, Scottsdale, AZ

CIRCLE NO. 545

Capacitors

Miniature aluminum electrolytic, metalized polyester film, Mylar, polystyrene film, ceramic and tantalum capacitors are featured in a 20-page catalog. TransCap, El Cajon, CA

CIRCLE NO. 546

Cabinet blower

Included in a two-page cabinet-blower data sheet are equipment specifications, in both English and metric measurements, diagrams of the equipment, air flow and acoustic charts. Rotron, Woodstock, NY

CIRCLE NO. 547

Bandpass filters

Microwave bandpass filters in the frequency range of 30 MHz to 12.4 GHz are covered in a 16-page catalog. A comparative summary, descriptions and performance data are provided. Lorch Electronics, Englewood, NJ

CIRCLE NO. 548

Bulletin board

Motorola's new power transistors—2N3055H, 2N3773, 2N6609 and MJ15015—combine the rugged Safe Operating Area (SOA) specified for single-diffused-base types, with the economy and complementary structures of epitaxial-base devices.

CIRCLE NO. 549

Burr-Brown's ADC85 and DAC85 a/d and d/a converter prices are slashed up to 30%.

CIRCLE NO. 550

Major enhancements to Honeywell's TDC 2000 process control system make complete centralized control with color-video displays a reality for both simple and complex industrial processes.

CIRCLE NO. 551

TRW Power Semiconductors has lowered the OEM prices of eight power-switching transistors and nine Darlington transistors an average of 25%.

CIRCLE NO. 552

Litronix has introduced five photo-transistor opto-isolators in the JEDEC series. Prices in 1000 qty are 4N25 and 4N25A, \$0.89; 4N26, \$0.83; 4N27, \$0.71, and 4N28, \$0.67.

CIRCLE NO. 553

Texas Instruments is offering the A78M00 and A79M00 voltage regulators in low-cost TO-202 packages.

CIRCLE NO. 554

General Electric has raised prices 4 to 9% for rechargeable nickel-cadmium batteries to original equipment manufacturers.

CIRCLE NO. 555

MFE Corp. has dropped prices up to 20% on parallel and serial I/O interfaces for a cassette transport.

CIRCLE NO. 556

Electronic Design

ELECTRONIC DESIGN's function is:

- To aid progress in the electronics manufacturing industry by promoting good design.
- To give the electronic design engineer concepts and ideas that make his job easier and more productive.
- To provide a central source of timely electronics information.
- To promote communication among members of the electronics engineering community.

Want a subscription? ELECTRONIC DESIGN is circulated free of charge to those individuals in the United States and Western Europe who function in design and development engineering in companies that incorporate electronics in their end product and government or military agencies involved in electronics activities. For a free subscription, use the application form bound in the magazine or write for an application form.

If you do not qualify, paid subscription rates are as follows: \$30.00 per year (26 issues) U.S./Canada/Mexico, \$40.00 per year (26 issues) all other countries. Single copies are \$2.50 U.S. and all other countries. The Gold Book (27th issue) may be purchased for \$30.00 U.S./Canada/Mexico, and \$40.00 all other countries.

If you change your address, send us an old mailing label and your new address; there is generally a postcard for this in the magazine. You will have to requalify to continue receiving ELECTRONIC DESIGN free.

The accuracy policy of ELECTRONIC DESIGN is:

- To make diligent efforts to ensure the accuracy of editorial matter.
- To publish prompt corrections whenever inaccuracies are brought to our attention. Corrections appear in "Across the Desk."
- To encourage our readers as responsible members of our business community to report to us misleading or fraudulent advertising.
- To refuse any advertisement deemed to be misleading or fraudulent.

Individual article reprints and microfilm copies of complete annual volumes are available. Reprints cost \$6.00 each, prepaid (\$.50 for each additional copy of the same article), no matter how long the article. Microfilmed volumes cost \$23 for 1976 (Vol. 24); \$30 for 1973-75 (Vols. 21-23), varied prices for 1952-72 (Vols. 1-20). Prices may change. For further details and to place orders, contact Customer Services Dept. University Microfilms, 300 N. Zeeb Rd., Ann Arbor, MI 48106. (313) 761-4700.

Want to contact us? If you have any comments or wish to submit a manuscript or article outline, address your correspondence to:

Editor
ELECTRONIC DESIGN
50 Essex St.
Rochelle Park, NJ 07662

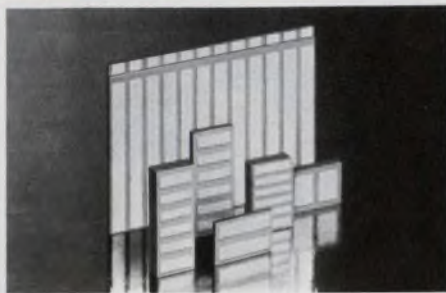

MULTIPLE CAPACITOR ARRAYS are single-plate multiple capacitance elements and serve as replacements of individually bonded chips in hybrid circuits. They are perfect for multiple circuit coupling, filtering, by-pass and high voltage meter multiplier circuits. They are easy to install and provide savings over the assembly of individual capacitors. Multiple capacitor arrays available in a variety of dielectric characteristics to meet specific requirements. JOHANSON DIELECTRICS, INC., Bx 6456, Burbank, Ca. 91510 213-848-4465.

CAPACITOR ARRAYS

181



LOW COST QUARTZ CRYSTALS Use Statek 10 to 300 kHz quartz crystals in TO-5s . . . they eliminate count down for oscillators, filters, tone generators, timers . . . They're rugged, accurate & resistant to high vibration and shock. Prices low as \$1.70 ea. in 1000 qty. Send your written application & we'll send you a sample. Call or write for literature. Details in Gold Book and EEM * STATEK CORP. * 512 N. Main, Orange, Ca. 92668 * (714) 639-7810 * Telex 67-8394

QUARTZ CRYSTALS

184

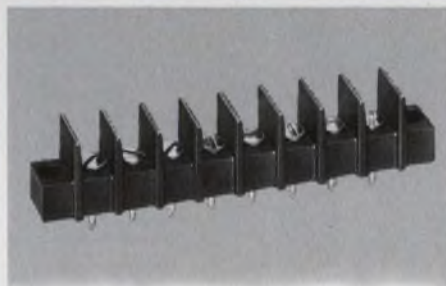

NEWLY DESIGNED "C" SERIES TERMINAL BLOCKS Your quality products deserve the best of the blocks—the Curtis Connection. Compact, break-resistant "C" blocks for control and electronic circuits are made from high-impact thermoplastic. Rigid, immovable molded-in insert prevents breaking of P.C. solder joints. High barrier design meets full 300 volt clearances required by UL 1059. 1 thru 26 terminals. Curtis Industries, Inc., 8000 W. Tower Ave., Milwaukee, WI 53223. Phone (414) 354-1500.

CURTIS INDUSTRIES

182



NEW DESKTOP TAPE READER—all you do is plug this Smart Box in. Up to 300 cps—RS232C, Current loop, parallel I/O—and quality built. State-of-the-art fiber optics, photo transistor read head, dual-sprocket drive. Outstanding for flexibility and simplicity. Low cost. Decitek, 250 Chandler Street, Worcester, MA 01602 (617) 798-8731.

NEW DESKTOP TAPE READER

185

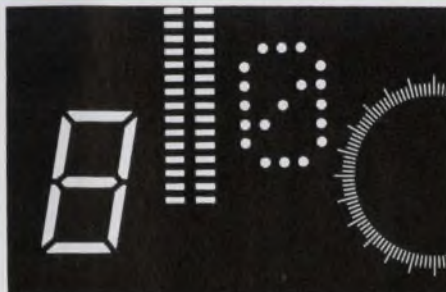

Power converters for gas discharge displays DC-to-DC power supplies convert low DC line voltages of 5, 9, 12 or 15 volts to nominal 200 or 250 volt DC levels required to activate gas discharge displays (multi-segment, matrix or bar graph). Ideal for battery powered applications. Ask about custom designs and cost-efficient models for high-volume users. For PC board mounting. ENDICOTT COIL CO., INC., 31 Charlotte Street, Binghamton, N. Y. 13905 (607) 797-1263.

DC-to-DC CONVERTER

183

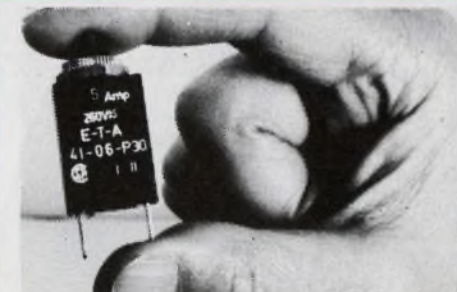

Overcurrent Protector, manual reset eliminates fuse replacement. Convenient panel mounting. 19 fractional ratings from 0.1 to 5 amp. Other models up to 400 amp. Trip-free and fool-proof, UL and CSA approved. High quality, low cost \$1.39 ea. in 1000 lots. E-T-A Products Co. of America, 7400 N. Croname Rd., Chicago, Ill. 60648. Tel: (312) 647-8303. Telex: 253780.

CIRCUIT BREAKER

186

quick ads

New and current products
for the electronic designer
presented by their manufacturers.

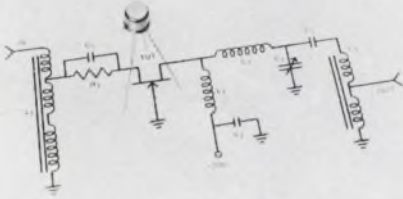

NEW BROADBAND RF FET SERIES New low noise, high dynamic range power RF FET's useful thru 500 MHz. CP640, 650, & 651 exhibit third order intermodulation intercept $> +40$ dbm, and 50 Ohm $< 1.5:1$ over 0.5 to 50 MHz range. CP-643 has a gm of 25,000 μ mhos @ 25 mA IDS. As IF preamp it presents near-perfect termination for double-balanced mixers with constant 50 Ohm input impedance over 1 to 108 MHz range. Teledyne Crystals, 147 Sherman St., Cambridge, MA 02140 (617) 491-1670

BROADBAND RF FET 187

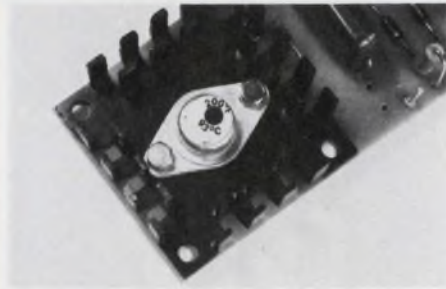

CELSIPOINT® temperature recording dots and strips do indicate by irreversible colour change (white→black) that a specific rated temperature was exceeded in the past of a component, equipment or any other item. Ideal for control of guarantee claims against overheating damages. Range from 100° F in 10° steps to 500°F. Accuracy $\pm 1\%$. Distributors required. Spirig-Signalarm, PO Box 3128, Springfield, Mass. 01101, (413) 788-0224. Internat: Spirig PO Box 160, CH8640 Rapperswil, Switzerland Tx 75400

TEMPERATURE INDICATORS 190

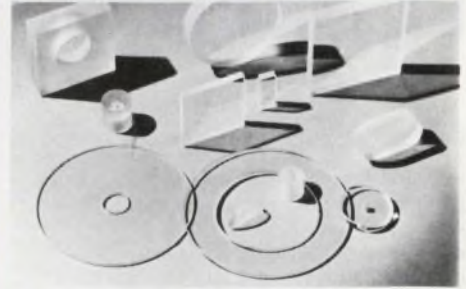

FREE 32 PAGE CATALOG. WINDOWS - PLATES - DISCS - OPTICS. Fused quartz, optical glasses, pyrex Ultra-low expansion materials, highly resistant to thermal shock. High UV and IR transmission. Chemically inert to most corrosive materials. Stocking center for lenses, prisms and laser accessories. Complete fabricating facilities. ESCO PRODUCTS, 181 Oak Ridge Rd., Oak Ridge, N.J. 07438. (201) 697-3700

LENSE, PRISM CATALOG 193



NEW PRODUCT: \$29 D.P.M. ANY QUANTITY *Fully Bipolar *Auto Zero *One Chip Design *1/2" LED Display 3 1/2 Digits *1000 Meg Zin *5V/115/230 Power *.1% ± 1 Digit Accuracy and Linearity *200pA Bias Current *Decimal Point Programmable *Same Panel Cut-out as Dattel's *\$29 Any Quantity to 500 *Plus \$3.50 Shipping and Handling to 25 Pieses Over 7,000 Other Models. Send for **FREE** Catalog to: IMC, 4016 E. Tennessee St., Tucson, AZ 85714. Tel: (602) 748-7900

\$29 DPM ANY QUANTITY 188



PROGRAMMING PROVERBS FOR FORTRAN PROGRAMMERS, H. F. Ledgard. These 26 unique "proverbs," or rules and guidelines, are specially designed to help FORTRAN programmers upgrade the quality of their work. Comes with many sample programs. #5820-9, 144 pages, \$6.95. Circle the Info Retrieval Number to order 15-day exam copy. When billed, remit or return book with no obligation. Hayden Book Co., 50 Essex Street, Rochelle Park, N.J. 07662.

PROGRAMMING PROVERBS 191



\$149 TV Camera has many features: Built in 9-30mm zoom lens, internal or line sync, 2:1 interlace, rugged solid state construction, light weight: 2.7 lbs, removable pistol grip: mounts anywhere, view finder, built in lens protector, low power consumption: 18VDC @ 350 na. Useful for security, CCTV, video recorders, process inspection. Close up and wide angle lenses available. Standard output: 1 volt negative sync 75 OHM impedance. Advanced Video Products, 5835 Herma St., San Jose, CA 95123 (408) 224-0606

LOW-COST TV CAMERA 194

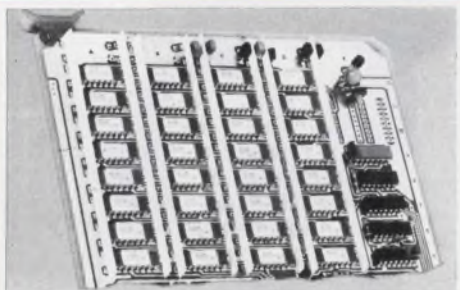

FOR MOS MEMORY CIRCUITS, Mini/Bus®, the off-board power distribution system, does things: saves PC board space and eliminates multi-layers; drastically reduces de-coupling capacitors; suppresses, reduces and isolates noise; makes PCB design easier. Full details on how and why Mini/Bus serves so well are in Rogers' Application Note No. 1976. For a copy, write or call Rogers Corporation, Chandler, AZ 85224. Phone: (602) 963-4584. (EUROPE: Mektron NV, Ghent, Belgium; JAPAN: Nippon Mektron, Tokyo)

MEMORY CIRCUIT FILTER BUS 189



A NEW 8080 μ P SYSTEMS ANALYZER — Tests 8080 μ P systems, buffered probe clips on instantly. Test and/or modify memory, I/O, and registers. Hardware breakpoint, qualified with read and/or write for any memory access, stack access or I/O transfer. Loop count and cycle delay trigger. System status and data display. Unique auto/exam breakpoint: on reg contents memory or I/O data and opcode. Also available AQ-6800 MPA. AQ Systems, Inc., 1736 Front Street, Yorktown Hts., N.Y. 10598. 914/962-4264

μ P SYSTEMS ANALYZER 192

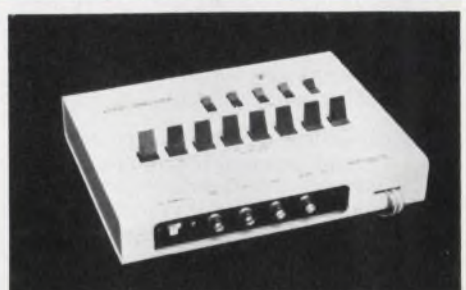

LOW COST LOGIC STATE ANALYZER. At \$295, the 8-channel Model 100A offers more features than any similar instrument: 16-word truth table display • Pre- & post-trigger data capture • Single/Repeat display modes • HEX or OCTAL formats • Operates with virtually any oscilloscope. Need 24 bits? Qualifiers? Program paging and loop analysis? Add the mating Model 10 Expander at any time for another \$295. Stocked throughout U.S. Kits available. Paratronics, Inc., 800 Charcot Ave., San Jose, CA 95131. (408) 263-2252.

LOGIC STATE ANALYZER 195



SWITCHER PROVIDES FOUR OUTPUTS FOR MICROCOMPUTERS. The versatile FS switching regulator power supply offers as many as four outputs totalling 375 watts from a package that is 5" x 8" x 12". Primary output is typically 5V @ 50 amps, with the second output 5 to 24 volts at 10 amps. The third and fourth output can be any combination of 5 to 24 volts @ 2 amps each. Stock to 4 weeks. SWITCHING POWER INC., 19 Daell Lane, Centereach, New York 11720 516-981-7231.

SWITCHING POWER SUPPLY

196



FREQUENCY STANDARD The AUSTRON Model 1250A Crystal Frequency Standard generates highly stable output frequencies at 5 MHz, 1 MHz, 100 KHz, and 1 MHz clock drive. • High frequency stability • Excellent waveform and spectral purity • Internal battery back-up • Automatic switchover on power source • Price: \$2450.00, single lot quantities. AUSTRON, INC., 1915 Kramer Lane, Austin, Texas 78758. Tel: 512-836-3523.

FREQUENCY STANDARD

199

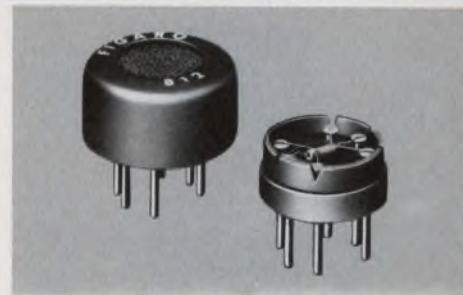

FIGARO GAS SENSOR TGS is a gas sensitive semiconductor. When combustible gas is absorbed on the sensor surface, a marked decrease of electrical resistance occurs. Major features of the sensor include high sensitivity, long term reliability and low cost. The applications are: GAS-LEAK ALARM, AUTOMATIC FAN CONTROL, FIRE ALARM, ALCOHOL DETECTOR, etc. Figaro Engineering Inc., North America Office-3303 Habor Boulevard, Suite D-8, Costa Mesa, Calif. 92626 Tel: (714) 751-4103 Telex: 678396

GAS SENSOR

202



THE '77-'78 GOLD BOOK IS NOW OFF THE PRESS. Contains 2,496 pages of up-to-the-minute information about the entire electronics industry. Complete with Product, Trade Name, Manufacturers, Distributors Directories and Catalogue Compendium. Price: \$30-U.S., Canada and Mexico. Other countries \$40-Overseas postage included. To order, send check or company purchase order to GOLD BOOK, Dept. #437-R, Hayden Publishing, 50 Essex St., Rochelle Park, NJ, 07662.

'77-'78 GOLD BOOK

197

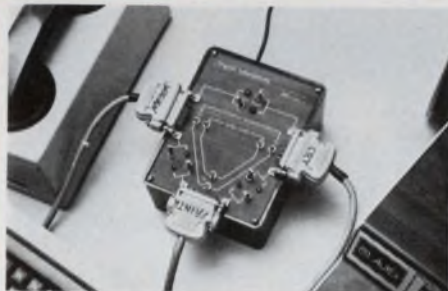

UNIVERSAL JUNCTION UNIT . . . for three devices, RS232C or current loop.

. . . Six switches provide all 63 interconnects that are possible between three I-O devices. LED's indicate data flow. . . . Designed to provide circuit compatibility and easy data routing between different manufacturer's devices. . . . \$350 (1-4) from DIGITAL LABORATORIES, 600 Pleasant St., Watertown, MA 02172 (617) 924-1680

3 PORT RS232 & 20 MA LOOP

200



ELECTRIC RESET "BITE" INDICATOR Meets M83827/02. Monitors systems or components. Pinpoints malfunctions by providing automatic and permanent (until reset) warning of fault condition. Miniature size. Can be compactly grouped. 3 to 28V dc. 40 ms response. Wire leads or turret terminals. North American Philips Controls Corp., Cheshire, Conn. 06410.

"BITE" INDICATOR

203



LEMO CONNECTORS are perfect for front panel applications. Superb design and craftsmanship complement any front panel design. The Quick Lock mechanism allows easy connection & disconnection. Panel space is saved because finger clearance is required on only two sides. The all metal shell is rugged and an effective strain relief grips the cable securely. Coax & multipin types from 2-18 pins are available from stock. Lemo U.S.A. Inc., 2015 2nd St., Berkeley, Ca 94710. Tel: 415/548-1966, Tx 335-393.

CONNECTORS

198



QUIK/STRIP BY ROGERS. Fast, low-cost system for connecting in-line pins on DIP socket boards and connector arrays. Shock and vibration resistant. 18 gauge current capacity. Can be used on pin densities as high as .100" x .100" and be stacked two or more high. Write or call for details. Rogers Corporation, Chandler, AZ 85224. Phone: (602) 963-4584. (EUROPE: Mektron NV, Gent, Belgium; JAPAN: Nippon Mektron, Tokyo.)

QUIK/STRIP

202

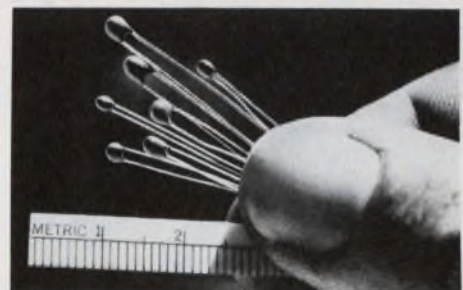

THERMISTORS with leads and coating are highly reliable low cost components in small dimensions more compatible with modern circuit design. R @ 25°C 100Ω to 1 meg Ω ±10% to ±1%. CURVE MATCHED INTERCHANGEABLES to ±.25°C. POINT MATCHED INTERCHANGEABLES to ±.2°C. Call or write for HP97 or TI SR52 THERMISTOR LINEARIZATION PROGRAM. WESTERN THERMISTOR CORPORATION, 354 Via Del Monte, Ocean-side, CA 92054. (714) 433-4484.

THERMISTOR

204



Free New '77 catalog contains over 34,500 quality power supplies from the world's largest manufacturer, Power/Mate Corp. Power Supplies for every application including submodulars, open frame, variorated, encapsulated, laboratory & system. All units UL approved and meet most military and commercial specs for industrial and computer uses. Power/Mate Corp., 514 S. River St., Hackensack, NJ 07601 (201) 343-6294

POWER SUPPLIES

205



Inexpensive DIGITAL IC TESTER performs 2²⁰ inspections per test in 1-5 secs. Covers 14/16-pin TTL, DTL and CMOS @ 5V. Employs fixed pattern functional test, requiring no "good" IC for comparison. 4-digit display gives absolute results. Can also check continuity of resistor network. Model 1248: \$750. Electro Scientific Industries, 13900 N.W. Science Park Dr., Portland, Oregon 97229. Sister instrument tests at two added voltages and also covers STL and offers automatic handler interface.

DIGITAL IC TESTER

208



FREE- The New Minicomputer Accessories Catalog. Hundreds of standard (but hard to find) minicomputer products. Disk Cartridges, Mag Tape, Floppy Disks, Binders, I/O Connectors, Cables, Racks. Much more. Packed with time and money saving ideas. All products fully guaranteed. Same day shipment. Write or call: (415) 969-5678. MCA Minicomputer Accessories, 1015 Corporation Way, PO Box 10056-M, Palo Alto, Ca. 94303

1977 CATALOG

211



PORTABLE MEGOHMMETERS. Measure leakage on semis, capacitors, wire/cable, printed circuit cards and other insulating materials. GenRad's megohmmeters provide a wide resistance range from 50 k Ω to 200 T Ω ($2 \times 10^{11} \Omega$) with up to 200 test voltages from 10 to 1090 V. Flip-tilt cover protects front panel when transported. The GR 1863 and GR 1864 can be your solution for precise high-resistance measurements. GenRad, 300 Baker Ave., Concord, MA 01742, Tel. (617) 369-8770

MEGOHMMETERS

206



3S-WICK® De-solder Braid. Spirig produces the vacuumized (pat. pend.) solder removal wick in unequalled technology to meet any standards worldwide. 3S-Wicks unique three dimension combination solves all electronics desoldering problems. 3S-Wick pat. pend. Spirig also produces pencil soldering irons. Dealers and distributor inquiries welcomed. USA: Spirig-Signalarm, PO Box 3128, Springfield, Mass. 01101, (413) 788-0224 Internat: Spirig, PO Box 160, CH-8640 Rapperswil, Switzerland TX 75400

3S-WICK DE-SOLDER BRAID

209



400 IDEAS FOR DESIGN, Volume 3, ed. by Morris Grossman. Brainstorm with the experts! Volume 3 of 400 IDEAS FOR DESIGN contains the best selections from *Electronic Design* that were published between 1971 and 1974. You'll find a wide range of ideas from very complicated to simple, but unique, approaches. #5111-5, 348 pp., \$13.95. Circle the Info Retrieval Number to order your 15-day exam copy. When billed, remit or return book with no obligation. Hayden Book Co., 50 Essex St., Rochelle Park, N.J. 07662.

IDEAS FOR DESIGN

212

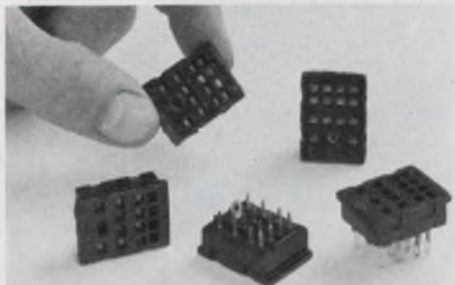

MINIATURE RELAY SOCKETS FROM METHODE are fully U/L listed for industrial relays. Models available for .062" or .125" printed circuit boards and for chassis mounting with optional spring clip. Rugged thermoset molded bodies with phosphor bronze tin plated contacts. Also available with "omit contacts" for custom relays. METHODE MANUFACTURING CORP., 1700 Hicks Road, Rolling Meadows, IL. 60008, (312) 392-3500

MINIATURE RELAY SOCKETS

207

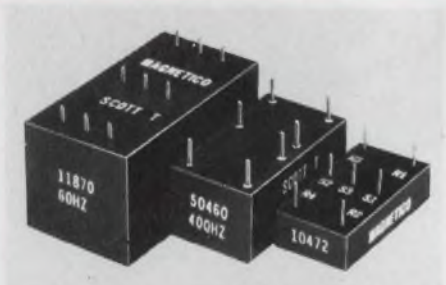

Scott T Transformer. 11870: 60HZ, 90v, L-L in. 1.1x2.1x1.1. 50460: 400 HZ, 90v, L-L in. 7/8x1.5/8x11/16. 50642: 400HZ, 11.8v, L-L in. 7/8x5/8-11/16. 10472: 400-HZ, 11.8v, L-L in. 3/4x1-1/2x3/8. All with 6v RMS sine & cosine output. MAGNETICO, INC., 182 Morris Ave., Holtsville, N.Y. 11742 516-654-1166.

TRANSFORMER

210

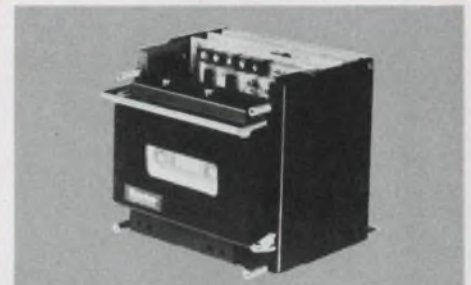

HIGH SPEED RECORDER FOR MICROPROCESSORS Model 764 has a patented constant speed tape drive using only 2 moving parts. No capstans, tachometers or clock tracks are necessary. Records up to 32,000 bits per second. Searches at 100 inches per second. Can store up to 5 megabits per 300 foot cassette. ANSI/ECMA compatible. Priced under \$500.00/OEM quantities. MEMODYNE CORPORATION, 385 Elliot Street, Newton Upper Falls, MA 02164. Telephone (617) 527-6600.

MICROPROCESSOR RECORDER

213

Electronic Design

Advertising Sales Staff

Susan G. Apolant
Sales Coordinator

Rochelle Park, NJ 07662

Robert W. Gascoigne
Thomas P. Barth
Stan Tessler
Constance McKinley
50 Essex St.
(201) 843-0550
TWX: 710-990-5071
(HAYDENPUB ROPK)

Philadelphia

Thomas P. Barth
(201) 843-0550

Boston 02178

Gene Pritchard
P.O. Box 379
Belmont, MA 02178
(617) 489-2340

Chicago 60611

Thomas P. Kavooras
Berry Conner, Jr.
200 East Ontario
(312) 337-0588

Cleveland

Thomas P. Kavooras
(312) 337-0588

Los Angeles 90045

Stanley I. Ehrenclou
Burt Underwood
8939 Sepulveda Blvd.
(213) 641-6544

Texas

Burt Underwood
(213) 641-6544

San Francisco

Robert A. Lukas
465 S. Mathilda, Suite 302
Sunnyvale, CA 94086
(408) 736-6667

England

Constance McKinley
50 Essex St.
Rochelle Park, N.J. 07662
Phone: (201) 843-0550

Europe

Sanders, W. J. M.
Raadhuisstraat 24
Graft-De Ryp, Holland
Phone: 02997-1303
Telegrams: Euradteam-Amsterdam
Telex: 13039-SIPAS

G. Nebut

Promotion Presse Internationale
7 ter Cour des Petites Ecuries
75010 Paris, France
Telephone: 5231917, 1918, 1919

Dieter Wollenberg

Erikastrasse 8
D-8011 Baldham/Muenchen
Germany
Telephone: 0 8106/4541

Tokyo

Haruki Hirayama
EMS, Inc.
5th Floor, Lila Bldg.,
4-9-8 Roppongi
Minato-ku, Tokyo, Japan
Phone: 402-4556
Cable: EMSINCPERIOD, Tokyo



HANDSOME, RUGGED ENCLOSURES
Custom-crafted laminated Formica®-Mahogany-Formica® construction, internally reinforced corners, rich wood grain or solid color exteriors. Superb workmanship, competitive prices, any quantity. W. A. Miller Co., Inc., 307 Mingo Loop, Oquossoc, Maine 04964. Phone: 207/864-3344

ENCLOSURES

214

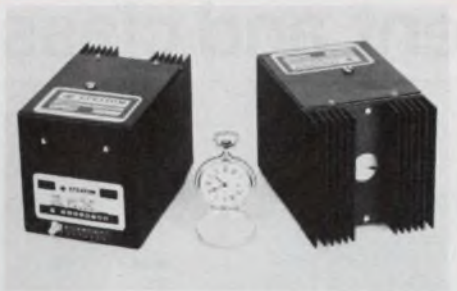

RUBIDIUM OSCILLATORS Series FRK are ultra stable, reliable, light (2.9 lb) small (4x4x4.5") and ideal for navigation/position location and communication systems. The unit provides 10 MHz; 5 and 1 MHz optional. Long-term stability 1×10^{-11} /month, short term 1×10^{-12} /100 sec. avg times and extremely low noise. Available commercial and MIL (radiation hardened) EFRATOM CALIFORNIA, INC., 18851 Bardeen Ave., Irvine, CA 92715 - (714) 752-2891

OSCILLATORS

217

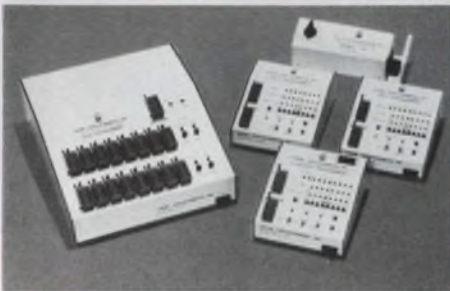

FREE PROM PROGRAMMER. Need to justify the advantages of your own private PROM PROGRAMMER? Take advantage of the offer from King of the Low Cost Programmings and evaluate their 2704/2708 Simulate/Write instrument for a 10 day evaluation. Units are in stock and priced at \$795.00. Look into the complete line of products and options. For information on how to qualify for the demo units contact PROM PROGRAMMERS, INC., 601 Nandell Lane, Los Altos, CA. 94022 (415) 948-0450.

FREE PROM PROGRAMMER

215



AVEL-LINDBERG toroidal transformer offers many electrical and mechanical advantages combined in attractive, uniform presentation in the range of standard power transformers. Toroids also have 50% less weight and volume; a lower height profile for slimline electronics and an incredible 8:1 lower radiated interference field. To order see Avel-Lindberg distributors listed in GOLD BOOK 77-78.

TOROIDAL TRANSFORMER

218



FREE HIGH VOLTAGE CAPACITOR CATALOG. Complete source listings for over 1000 power, pulse, high voltage, and special purpose capacitors and high voltage power supplies in glass, plastic and CP72 styles. Special low inductance types for laser and high energy applications. Many "custom" designs are standard with us. High reliability, long life, moderate cost, and fast delivery assured. To get your catalog, just drop us a line. Condenser Products Corporation, P.O. Box 997, Brooksville, FL 33512.

HIGH VOLTAGE CAPACITOR CATALOG 216



MAY I HELP SPEED LEAD BENDING OPERATIONS? Cut costs by 50%! Fast, exact, thumbwheel control adjusts to precise measurements. Match pointers with eyelet holes in circuit boards by adjusting knurled wheel with thumb, automatically spacing bends for insertion of component into boards. All axial lead components accommodated. From $1/2"$ x $1 1/2"$ long with max. distance between inside of bends of 1.725". Harwil Co., 1548 17th Street, Santa Monica, CA. 90404. (213) 829-2310

COMPONENT LEAD BENDER

219

★ABP

BPA

Electronic Design

recruitment and classified ads

PLACE YOUR AD AT ONLY \$45 PER COLUMN INCH IN

Electronic Design

— GET A REPEAT AD FREE!

With our 2 for 1 plan, your net cost in *Electronic Design* is only \$22.50 per column inch, lowest among all the national newspapers and electronics media. You get a total of 165,402 exposures to OEM engineers and engineering managers (not counting 10,600 more among general or corporate managers) at only 27¢ per thousand! You can't beat the price. You can't beat the coverage and you can't beat the quality.

YOU REACH ENGINEERS WITH TITLES LIKE THESE:

- Chief Engineer • Development Engineer • Design Engineer • Project Engineer • Electronic Engineer • Engineer-Supervisor • Section Leader • Staff Engineer • Systems Engineer • Test Engineer • Standards Engineer • Master Engineer

Electronic Design RECRUITMENT ADVERTISING RATES

15% commission to recognized agencies supplying offset film negatives. 2% 10 days. net 30 days. Four column makeup. Column width 1-3/4" x 10".

SPACE	DIMENSIONS		COST
	Wide	Deep	
One column inch	1-3/4" x 1"		\$45.
2 col. in	1-3/4" x 2"		\$90.
1/16 page (1/4 col.)	1-3/4" x 2-1/2"		\$112
1/8 page (1/2 col.)	1-3/4" x 5"		\$225
1/4 page (1 col.)	1-3/4" x 10" Vert.		\$450
	3-1/2" x 5" Hor.		
1/2 page (2 cols.)	3-1/2" x 10" Vert.		\$900
	7" x 5" Hor.		
3/4 page (3 cols.)	5-1/4" x 10"		\$1350.
1 page	7" x 10"		\$1800.

NOTE: EACH RECRUITMENT AD YOU PLACE WILL BE REPEATED FREE OF CHARGE!

LATE CLOSING DATES

Electronic Design is mailed every two weeks. Because of its timeliness, personnel recruitment advertising closes only two weeks before each issue's mailing date.

Mailing Date	Recruitment Closing Date	Issue Date on Cover
Nov. 18	Nov. 4	Dec. 6
Dec. 2	Nov. 18	Dec. 20
Jan. 4	Dec. 9	Dec. 23
Jan. 18	Dec. 23	Jan. 6
Feb. 1	Jan. 6	Jan. 20
Feb. 15	Jan. 20	Feb. 3
Mar. 1	Feb. 3	Feb. 17
Mar. 15	Feb. 17	Mar. 3



HOW TO PLACE YOUR AD

CALL THE RECRUITMENT HOT LINE 201-843-0550

Camera-ready film (right reading negatives, emulsion side down) or camera-ready mechanicals must be received by deadline. Or, if you wish us to set your ad (typesetting is free) simply pick up the phone and call our RECRUITMENT HOT LINE — (201) 843-0550. Ask for:

Constance McKinley
RECRUITMENT ADVERTISING MANAGER
ELECTRONIC DESIGN

50 Essex Street, Rochelle Park, New Jersey 07662

R & D ENGINEERS
\$20 - \$40K

- MICROPROCESSORS
- CPU'S
- PERIPHERALS
- RADAR
- NAVIGATION
- MICROWAVE
- PROCESS CONTROLS

Engineers - All Disciplines
National Listings
PATHFINDER
ENGINEERING AGENCY
P.O. Box 34 Commack NY 11725

TEXAS POSITIONS

Engineering, EDP & technical openings throughout Texas & the U.S. 100% fee paid. Send your resume in confidence to ENGINEERING/EDP SEARCH (Agency) 84 N.E. Loop 410, Suite 124E San Antonio, Texas 78216

WELLS ELECTRONIC SEARCH INC.

NATIONWIDE
SYS ARCHITECTURE - HARD/SOFTWARE
Mini/Micro Terms from Concept 38 000
SR SYS ENG/ANALYST - Elmt/Signal/Commt 29-35 000
BIOMED - Ultra Sound X-Ray CT Scanner Gamma Camera Pacemakers Implantables Sensors Fluid Handling Computer based Analyzers 16-32 000
PROJ LEADER - Business Machines 34 000
MGR FIRM HARDWARE DEV - Mini/Micro based Term Sys 32 000
CONTROLS ENGS - (1) 1/4 to 300 hp Motors (2) Lighting Sys Thyristor family 20-29 000
DES ENG - Digital Modems 24 000
TELEPHONY ENGS - Hard/Software 18-32 000
RAD & DESIGN - Video Games Analog Video Circuits Modems CRT displays Micro computer Syst 18-35 000
DIGITAL COMM DES ENGS - Signal Processing Info Theory Phase Locked Loops Digital Filters Coding Switching Syst 18-33 000
MINICOMPUTER Programmers Nationwide 18-32 000
CONTACT
D.L. Sweeney 212 949 8498 Dept F
WELLS RECRUITING SYSTEMS INC
545 5th Ave. NYC NY 10017 (AGENCY)

Our corporate goals have challenged us with very ambitious growth plans. You, as part of our team, can "make it happen" and be rewarded accordingly.

DIGITAL DESIGN ENGINEER . . . responsible for design and checkout of microcomputer controlled data collection systems. Should have BEE with three years of direct design experience with state-of-the-art digital circuits and preferably microcomputer design and debugging experience.

ANALOG DESIGN ENGINEER . . . perform new design of analog circuits related to industrial instrumentation, data acquisition systems and telemetry equipment for severe environment operation. Requires knowledge of instrumentation techniques, low level power transfer and some RF.

INSTRUMENTATION ENGINEER . . . responsible for system and circuit design of standard products used in the industrial telemetry field. Should have BEE or Physical Science Degree with experience in RF and analog, emphasizing wide temperature, worst-case design. Should be capable of analyzing and communicating in accordance with customer requirements. Potential management opportunity.

If you are motivated and seek a challenging career with tremendous growth potential and full benefits package, please send your resume in confidence with salary history to:

Recruiting Department
TESDATA / INMET, INC.

987 Pinetree Drive
Indian Harbour Beach, Florida 32937
(305) 773-2370

We Are An Equal Opportunity Employer

Tesdata
Inmet

A Subsidiary of
Tesdata Systems Corp.

Engineering

REED RELAYS

Application Engineering for Reed Switching devices. Background in manufacturing, research or design desirable. Reed switching experience more important than degree. Leads to Product Management. Chicago area relay manufacturer.

Magnacraft Electric Co.
5575 N. Lynch Avenue
Chicago, IL 60630
(312) 282-5500

Equal Opportunity Employer

PERSONNEL SEARCH

- CONFIDENTIAL
- PROFESSIONAL
- NATIONWIDE

Our clients are offering lucrative career positions for experienced circuit & logic designers. Our contacts with engr mgmt of growth cos can put you in hi-demand career oriented positions. All employment expenses paid by client cos. Contact D. Imperial. (215) 561-6300.

FOX-MORRIS

PERSONNEL CONSULTANTS
1500 Chestnut St. Phila. PA 19102
new york/fort lee/princeton/pittsburgh
cleveland/wilmington/baltimore
charlotte/atlanta

Electronic Design

BRINGS YOU THE HIGHEST NUMBER OF QUALIFIED EOEM ENGINEERS AND ENGINEERING MANAGERS ANYWHERE . . . AT THE LOWEST COST ANYWHERE!

MODCOMP[®]

HARDWARE DEVELOPMENT CAREER OPPORTUNITIES

We are seeking experienced professionals to join us and be a part of our rapid expansion in the booming mini-computer industry. There's never been a better time to consider the outstanding career opportunities with MODCOMP and the good life in sunny Ft. Lauderdale, Florida.

MANAGER, COMPUTER DEVELOPMENT

We are seeking an aggressive thinker to lead the entire computer design activity in an environment providing rapid advancement. Immediate responsibilities include, system conceptual design of all new processors and memory systems, technical management and guidance of a team of senior and junior computer designers and significant contribution to definition and development of a new distributed intelligence network system.

COMPUTER DEVELOPMENT ENGINEER

To explore new concepts in mini and midi-computer architectures and develop for the marketplace. This is an opportunity to participate in the specification design of multiprocessor networks. Requires design experience.

We offer highly competitive salaries, substantial fringe benefits, challenge and the opportunity to move out in front of the pack with a leader. If you are interested in finding out more about the exciting career openings with MODCOMP, please send your resume including salary history, or call (800) 327-8997.

Mr. Robert M. Coyner

MODULAR COMPUTER SYSTEMS, INC.

1650 West McNab Road

Ft. Lauderdale, Florida 33309

An Equal Opportunity Employer M/F

MODCOMP[®]

*"A Professional Approach to
your Career Growth"*

ENGINEERING SPECIALISTS

Gray-Kimball Associates specializes in engineering recruitment for nationwide clients committed to "State of the Art" progress. If you are planning to advance your career, Gray-Kimball will provide you with the selective exposure to companies offering excellent growth combined with outstanding salaries and benefit packages. All fees and expenses are paid by our clients. Our clients are equal opportunity employers.

If you are ready to start a new career, now is the time
Call to arrange a confidential interview with Lou Basso
Or send resume in confidence to:

 GRAY-KIMBALL ASSOCIATES INC.

660 BROADWAY, MASSAPEQUA, N.Y. 11758
(516) 799-5400

\$18K to \$40K

BEST & BRIGHTEST

Come to P n B first. Because, when we select you as a client we market you continuously to over 500 electronic, computer and aerospace companies until we find you what you want. You are our client but the companies pay all fees and expenses. So send your resume today! We'll be in touch with you.

P n B Consultants Inc.

Box 494D, Wayne, Pa. 19087

The Engineers Who Talk Your Language

Recruitment Ads Pull

ELECTRICAL ENGINEERS

Excellent opportunities for computer oriented engineers to join this expanding division of ITT in suburban Chicago and work on hardware design of computer related projects.

Activities will consist of development or peripheral controllers, analysis of semi-conductor memories utilizing 1K, 4K and 16K Ram devices. Work also consists of design of modem and peripheral equipment interfaces for a special purpose computer associated with central office switching systems. Requires one plus years design experience on computer projects.

If qualified send complete resume including salary history to: Tom Edminson, ITT Telecommunications, 2000 S. Wolf Road, Des Plaines, Illinois 60018.

TELECOMMUNICATIONS
Switching Center

ITT

An Equal Opportunity Employer, M/F

ENGINEERS

AVIONICS SYSTEMS & DEVELOPMENT

Florida and Gulf Coast opportunities
with a technology leader!

Smiths Industries, an international manufacturer of commercial, and military avionics systems, is expanding its research and development activities at the aviation division engineering center at Clearwater. We are looking for degreed engineers at all levels with state-of-the-art credentials in the following areas:

- Display Systems
- Electromechanical Flight Instruments
- Electronic Packaging
- Microprocessor Applications
- Analog/Digital Circuits
- Reliability/Maintainability

For confidential consideration, please forward your resume including salary history to:

Mrs. Brenda Jolly

Personnel Department

Smiths Industries, Incorporated

P.O. Box 5389

Clearwater, Florida 33518

An Equal Opportunity Employer M/F

PASSIVE COMPONENTS ENGINEER

For the evaluation and application of passive components, parts, and subassemblies. Should possess knowledge of keyboards switching circuits, and cooling devices and the manufacturing and application techniques of these devices. An ability to interface effectively with Engineering, Manufacturing, Purchasing, etc. is an important asset.

A technical degree and about 2 years Engineering experience will qualify you for consideration; the need is now and your reply will be given an early response.

P.O.S. TERMINAL DESIGN ENGINEER

To perform hardware design and some systems work on a next generation hospitality terminal including communications from the terminal to the CPU and peripherals. Some microprocessor architecture knowledge would be helpful.

A degree plus 2 or more years design experience will qualify.

SYSTEMS ENGINEER

You will perform and/or conduct system evaluation related to performance characteristics of computer based Point-of-Sale systems and subsystem elements (terminals, computers, peripherals, etc.). Candidates must be familiar with micro and minicomputer systems hardware and they should bring 2 or more years experience including exposure to isolating and solving problems related to RFJ-EMI.

LOGIC DESIGN ENGINEER

For digital implementation of algorithm required for video signal processing using TTL and/or microprocessor circuits. NCR's P.O.S. division is located in east central Ohio and offers an inviting work and family living environment.

Robert W. Donovan
Terminal Systems Division
NCR Corporation
Box 728
Cambridge, Ohio 43725
(614) 439-0293

NCR

An Equal Opportunity Employer



seeking new career opportunities?

- Circuit Design
- Computer Systems
- Digital Systems
- Systems Simulation
- Signal Processing
- Radar Systems
- ASW Systems
- Pattern Recognition
- Surface Ship Sonar
- Real Time Programmers
- Weapons Systems
- Command/Control
- Electro-Optical
- Reliability/Test
- Avionics Systems
- Electronic Warfare
- Communications
- Mini-Computers
- Submarine Systems
- Microprocessor Systems

We are a Professional Search Firm representing a number of prestigious employers throughout the United States. Our clients include research and development laboratories, defense contractors, government contract research centers, major commercial and industrial corporations and leading management consulting firms. Starting salaries range from \$15,000 to \$40,000 with our fees, and all interview and relocation expenses fully paid by our clients.

If you wish to be considered for current and future opportunities, please send your resume, including current salary and technical strengths, to L. J. Clavelli or R. Beach . . . today!

WALLACH
associates, inc.

1010 Rockville Pike, P.O. Box 2148
Rockville, MD 20852 (301) 762-1100

A licensed recruitment organization

Electronic Design

BRINGS YOU THE HIGHEST
NUMBER OF QUALIFIED OEM
ENGINEERS AND ENGINEERING
MANAGERS ANYWHERE
. . . AT THE LOWEST COST
ANYWHERE!

Constance McKinley
RECRUITMENT ADVERTISING MANAGER
ELECTRONIC DESIGN

50 Essex Street, Rochelle Park, New Jersey 07662
(201) 843-0550

I'm interested in placing recruitment
advertising in *Electronic Design*

Issue _____ Size of ad _____
 My copy is enclosed I need more information
 Name _____
 Title _____
 Company _____
 Address _____
 City _____ State _____ Zip _____
 Telephone _____

have a gripe?



let us know about it!

We'll help you put pressure on any company that makes promises in its ads . . . then fails to deliver.

Electronic Design refuses to run advertisements deemed to be misleading or fraudulent.

ACCURACY is everybody's business. So if you have a gripe about a misstatement or inaccuracy in either editorial or advertising material in *Electronic Design* . . . tell us about it. We'll do everything we can to find out what happened and see that it's corrected. Notify . . .

George Rostky

Editor-in-Chief

Electronic Design

50 Essex Street
Rochelle Park, New Jersey 07662

ELECTRONIC ENGINEERING

OPENINGS AT MANY LEVELS

"Achievements" is the key word in our dynamic Division. What we have accomplished in sophisticated systems and instrumentation speaks louder than adjectives, and gives us a recognized leadership place in our industry. Join us to contribute, as well as to advance your professional abilities and career.

SOFTWARE ENGINEERS

At least 6 months experience is needed in real-time assembly language programming — more will be advantageous. It should include one or more of these areas:

- E/W Computer Systems
- Firmware Coding
- Multi-Computer Systems Architecture
- Commercial Real-Time Systems

Take responsibility at various levels for software design, coding, testing, and integrating of software program into the hardware systems. BSEE is preferred, or equivalent in experience especially in Electrical Engineering, Physics, or Computer Science.

DESIGN ENGINEERS DIGITAL LOGIC

Minimum of 6 months experience (no upper limit) with mini-computer and/or microprocessor background especially helpful. Background in synchronous logic design of large systems utilizing MSI and LSI devices and related hardware will be valuable, and FORTRAN and assembly language programming experience will be an asset. BSEE or equivalent is desired, plus ability to work creatively and independently.

RF ENGINEERING AND DEVELOPMENT ALL LEVELS

At least 3 years design experience in active/passive devices is desired, implemented in stripline and microstrip at frequencies up to 3 GHz, perhaps including design of low level, low noise figure RF amplifiers, IF amplifiers, and frequency sources, receivers or filters. Responsibilities will include development of RF/IF subsystem designs into fully modularized integrated packages, including new MIC devices.

COMMERCIAL SYSTEMS

State-of-the-art electronics systems experience may have application and value in our environment, at various levels of experience. Openings will afford opportunity to broaden your expertise. Inquiries will be welcome — your qualifications will receive careful evaluation.

U.S. citizenship is essential for all positions. Initial salaries are excellent and will fully reflect experience and expertise. Comprehensive benefits include dental plan and investment-savings plan.

To arrange a convenient interview, call Charles Niederer (201) 284-2436 or send resume in confidence to: Charles Niederer, ITT Avionics Division, 390 Washington Avenue, Nutley, New Jersey 07110.

AVIONICS DIVISION **ITT**

An Equal Opportunity Employer M/F

Product index

Information Retrieval Service. New Products, Evaluation Samples (ES), Design Aids (DA), Application Notes (AN), and New Literature (NL) in this issue are listed here with page and Reader Service numbers. Reader requests will be promptly processed by computer and mailed to the manufacturer within three days.

Category	Page	RSN	Category	Page	RSN	Category	Page	RSN
Components			indicator, LED	205	366	printer	237	153
blower, centrifugal	206	369	indicators, LED	210	378	processor	218	396
cabinet blower (NL)	256	547	inductors	151	57	processor	220	399
capacitors	54	23	keyboard	200	355	processor, 16-bit	216	390
capacitors	133	161	keyboard	202	356	PROM programmers	62	180
capacitors	168	68	keyboard	226	136	security system	216	394
capacitors	176	74	keyboards	235	152	software system	146	54
capacitors	208	109	LED lamps	215	117	system, management	214	384
capacitors	211	113	LEDs	195	93	teletypewriters	95	35
capacitors	247	806	lead-sulfide sensors	251	525	terminal	212	381
capacitors	250	812	meter, digital-panel	200	354	terminal	220	398
capacitors (NL)	256	546	potentiometer	202	362	terminal, CRT	214	385
capacitors, mini film	206	371	potentiometer, precision	206	370	troubleshooter	216	389
circuit breaker	206	373	potentiometers	218	124			
circuit savers	230	142	pressure transducers					
components (NL)	254	534	(NL)	254	542	ICs & Semiconductors		
computing reference	252	532	quartz crystals	221	127	chip, digital-meter	196	343
contacts	134	47	relay	205	367	counter/timer	196	344
encoder	209	375	relay, hybrid	200	353	DACs, 10-bit	19	7
fan	202	361	relays	240	156	diodes	238	154
ferrite cores	246	801	relays	241	157	diodes, enclosed	198	349
filters, crystal	230	141	relays, delay	248	810	electro-optics	217	119
filters, RFI	206	372	relays, low-profile	210	380	formatter, LSI	194	341
heat sinks	202	357	relays, reed	174	73	interface couplers	189	87
			resistor, carbon-film	210	379	LEDs	187	85
			resistor networks	52	351	linear and digital		
			resistor networks	53	352	ICs (NL)	256	544
			resistor networks	74	231	log-amp, i-f	192	339
			resistor networks	239	155	LSI, bipolar	256	821
			resistor, precision	202	359	op-amp	192	338
			resistors	20	8	op-amps	194	342
			resistors	135	48	photodetectors	141	52
			resistors	243	159	prescaler, frequency	196	345
			resistors, film	205	365	programmable		
			switch, keyboard	204	364	multiplexer	199	98
			switch, keyboard	210	376	PROM	198	350
			switch, slide	202	358	RAM, 4-k	128	43
			switch, slide	210	377	rectifier, bridge	192	340
			switch, tilt	209	374	rectifiers, CRT	232	145
			switch, toggle	205	368	register, octal	198	348
			switches	61	25	ROM	198	347
			switches	254	538	ROM, N-channel	198	346
			switches, keyboard	253	817	SCRs and triacs	IV	232
			switches, PB	233	150	triac, optically coupled	192	337
			switches, PB	249	811	tuning diodes	224	133
			switches, toggle	231	144	VMOS	31	15
			switching transistors			4-bit bipolar μ P (AN)	251	524
			(AN)	251	526			
			thermistors	248	807	Instrumentation		
			transformer	204	363	analyzer, audio	180	316
			transformers, pulse	202	360	analyzer, logic	175	302
						antenna-testing system		
						(NL)	256	543
			Data Processing			calibrators	242	158
			CRT terminal	122	41	C-meters	177	75
			concentrator, data	212	383	component burn-in (AN)	251	527
			controller, disc-drive	220	397	controller, rf	176	306
			coupler, acoustic	216	393	counter, up/down	223	131
			emulator	214	386	counters	63	226
			film scanner	218	395	current sensor	178	308
			line printer	192	88	DMMs	182	80
			monitor, line	214	387	DMMs	203	101
			monitor, multichannel	216	391	DMMs	220	126
			multiplexer	216	388	DVM	245	160
			patcher	216	392	DVMs	28	12
			plotter, drum	212	382	DVOM	161	293

CUSTOM CRYSTAL FILTERS

Call Vic Gill (714) 759-2411

Or send for new brochure:
500 Superior Ave., Newport Beach, CA 92663

HUGHES

HUGHES AIRCRAFT COMPANY
MICROELECTRONIC PRODUCTS DIVISION
CIRCLE NUMBER 823

STANDARD ELECTRONIC MODULES

Call Ed Skinner (714) 759-2411

Or send for new brochure:
500 Superior Ave., Newport Beach, CA 92663

HUGHES

HUGHES AIRCRAFT COMPANY
MICROELECTRONIC PRODUCTS DIVISION
CIRCLE NUMBER 824

Category	Page	RSN	Category	Page	RSN	Category	Page	RSN
digital-board testers	III	241	system, floppy-disc	184	322	enclosures	251	814
digital latch	180	315	system, OEM	183	321	headers, pin-line	245	442
freq-response analyzers	231	143				instrument cases	226	135
generator, color	180	317	Modules & Subassemblies			light-control film	246	804
generator, pulse	176	304	active-filter handbook			mounts, cable-tie	249	447
indicator	246	802	(NL)	254	533	Murphy's-law plaque	252	815
indicators	248	808	amplifier, isolation	226	408	outlet boxes, plastic	242	431
instrumentation			amplifiers (NL)	254	540	panels, IC	249	450
recorders	123	42	bandpass filters (NL)	256	548	plastic parts	232	149
instruments	208	108	CMOS communication			plugs, ribbon-cable	245	441
logic analyzer	101	36	system	153	59	silicone resin	83	31
logic analyzers	209	111	controller	230	140	socket, DIP	244	439
logic analyzers	212	114	converter, a/d	198	97	sockets	181	79
meter, torque	176	305	converter, a/d, 13-bit	233	414	sockets	229	139
milli-ohmmeter	178	309	converter, f/v	240	423	soldering	208	110
modulation meter	185	83	converters, a/d	214	116	sorter, parts	243	435
multimeter, digital	176	307	converters, a/d	254	818	strain relief	244	440
multimeter, ratiometer	180	314	DACs	253	816	substrate, PC-board	247	444
multimeters	121	40	delay line, variable	228	410	Teflon tubing	242	432
oscilloscope, dual-trace	175	303	delay lines, video	241	429	temperature source	247	445
oscilloscopes	147	55	divider	237	418	tester, circuit	250	522
panel-meter, digital	175	301	driver, motor	234	415	tool, cable	243	436
probe	194	92	encoders	140	51	tool, crimping	242	433
pulse generators	103	38	filters, EMI/RFI	173	72	wire, cable and cord	32	400
pulse indicator	207	106	filters, EMI/RFI	180	78	wire stripper	249	448
recorders, strip-chart	206	105	generator, pulse	241	426			
scope	129	44	indicator, voltage	228	409	Power Sources		
scope	255	820	isolation amps	178	76	batteries	222	128
signal conditioners	224	132	logger, data	237	419	power supplies	7	6
signal generator	1	2	monitor, line-fault	238	422	power supplies	204	103
spectrum analyzers	188	86	monitor, process	240	425	power supplies	218	123
tape recorder/ reproduction	152	58	multiplier	224	405	power supply	222	403
tape recorders	210	112	multiplexer, analog	233	413	power supply	250	813
test clip	234	151	op amps	29	13	transformer	222	404
test lead, jumpers	228	138	oscillator, vhf	240	424			
test-set, radio	176	310	printer	234	417	new literature		
thermometers	172	236	printhead, thermal	241	428	active-filter handbook	254	533
timer/counter	197	96	pulser	241	427	amplifiers	254	540
			readout assembly	234	416	antenna-testing system	256	543
Micro/Mini Computing			receiver, touch-tone	238	420	bandpass filters	256	548
board, digital output	183	320	recorder, data	230	411	breadboards	252	531
boards, I/O	186	327	recorder, data	230	412	cabinet blower	256	547
calculators	256	822	scanner, sensor	238	421	capacitors	256	546
computer, desktop	184	323	sensor, rf power	224	406	components	254	534
computer terminal	186	325	synchronizer, tape	241	430	computing reference	252	532
computers	179	77	transport, cassette-tape	226	407	halogen-cycle lamps	252	529
controller, diskette	191	335				image displays	256	545
expansion-card, I/O	188	330	Packaging & Materials			linear and digital ICs	256	544
I/O system	186	328	adhesive, epoxy	249	449	pressure transducers	254	542
line adaptor	191	332	boards, wire-wrappable	250	523	radio-link test set	254	541
memory, static	183	318	breadboards (NL)	252	531	switches	254	539
microcomputer	191	336	cases, shielded	245	443	technical index	254	535
microcomputer, OEM	191	333	circular connectors (NL)	252	530	terminal boards	254	536
microcomputers	5	4	connectors, card-edge	242	434	test-equipment rental	254	537
microcomputers	139	50	connector, card-edge	243	437			
minicomputers	37	18	connector, crimp-pin	247	446	application notes		
monitor, control	191	334	connector, edgeboard	244	438	component burn-in	251	527
processors, PDP-8	188	331	connectors	55	24	lead sulfide sensors	251	525
programmable calculators (AN)	251	528	connectors	93	296	programmable calculators	251	528
programmer, kit	183	319	connectors	208	107	switching transistors	251	526
programs, leisure	186	326	connectors	227	137	4-bit bipolar μ P	251	524
storage systems	184	324	electroplating solutions	232	148			
synthesizer, speech	188	329	enclosures	194	91			
			enclosures	205	104			

Advertiser's index

Advertiser	Page	Advertiser	Page	Advertiser	Page
AMP, Incorporated.....	60, 61	Esco Products.....	258	Nichicon (America) Corporation.....	54
A P Products Incorporated.....	234	Etatech, Inc.....	250	Nitron.....	204H
A Q Systems, Inc.....	258	Fairchild Semiconductor, A Division of Fairchild Camera and Instrument Corporation.....	31	North American Philips Controls Corp.....	246, 259
Advanced Micro Devices.....	204B-C	Fairchild Systems Technology.....	189	Ohmite Manufacturing Company.....	42B-C
Advanced Video Products.....	258	Ferranti Electric Inc., Semiconductor Products.....	223	Olympia Sales Company, Inc.....	256
Allen Bradley Co.....	42D	Ferroxcube Corporation.....	42	Optima Enclosures, Scientific Atlanta, Inc.....	188
Amperite Co., Inc.....	248	Figaro Engineering, Inc.....	259	*Oscilloquartz SA.....	172C
Amphenol North America Division, Bunker Ramo Corporation.....	55	Fluke Manufacturing Company, Inc. John.....	63, 121, 203, 219	Paktron, Division Illinois Tool Works, Inc.....	196
Analog Devices, Inc.....	178	GenRad.....	260, 44, 45, 46, 47	Panasonic Electronic Components.....	Cover III
Anaren Microwave, Inc.....	193	General Electric Company.....	42A	Paratronics, Inc.....	258
Applied Dynamics International.....	226	General Scanning, Inc.....	206	*Philips Electronic Components and Materials.....	212, 231
Arnold Magnetics Corp.....	7	Gold Book, The.....	236, 246, 259	Plastic Capacitors.....	208
Arrow-M Corp.....	174	Gould, Inc., Instrument Systems Division.....	147	Plastiglide Manufacturing Corp.....	232
Augat, Inc.....	229	Gralex Industries.....	232	Power Conversion, Inc.....	222
Austron, Inc.....	259	Guildline Instruments, Inc.....	28	Power/Mate Corp.....	218, 260
Automotive Systems, Inc.....	158	Gulton Industries, Inc.....	224	Practical Automation Inc.....	255
Avel-Lindberg Ltd.....	261	Harris Semiconductor, A Division of Harris Corporation.....	153	Precision Monolithics, Incorporated.....	19
B P Instruments.....	212	Harwil Co.....	261	Processor Computer Systems, Inc.....	146
Babcock Relays, Division of Esterline Electronics.....	240, 241	Hayden Book Company, Inc.....	204D, 223, 258, 260	Prom Programmers Inc.....	261
Bafco, Inc.....	231	Heinemann Electric Company.....	40	Pyrofilm Corporation.....	243
Ballantine Laboratories, Inc.....	129	Hewlett-Packard.....	9 thru 18	RCA Electro Optics.....	*216, 217
Belden Corporation.....	32	Honeywell Test Instruments Division.....	123	RCA Solid State.....	Cover IV
Bell, Inc., F. W.....	194	Houston Instrument, The Recorder Company.....	192	RFL Industries, Inc.....	242
Berg Electronics.....	181	Hughes Aircraft Company, Connecting Devices.....	92, 93	Raytheon Company, Ocean Systems Center.....	184
Biomation.....	100, 101	Hughes Aircraft Company, Microelectronic Products Division.....	230, 256, 266	Raytheon Semiconductor.....	199
Bivar, Inc.....	23	IBM General Systems Division.....	71, 72, 73	Redac Interactive Graphics, Inc.....	84
Boonton Electronics Corporation.....	185	ITT Pomona Electronics.....	6	Rogers Corporation.....	258, 259
Bourns, Inc., Trimpot Products Division.....	Cover II	Instrument Specialties Company.....	163	*Rohde & Schwarz.....	172 I-J-K-L
Buckeye Stamping Company, Inc., The.....	230	Instrumentation Survey Card.....	236A-B	Rolm Corporation.....	179
Burr-Brown.....	94	Intel Corporation.....	4, 5	Rtron Corporation.....	180
CTS Corporation.....	74	International Microtronics Corp.....	258	SMK Electronics Corporation of America.....	231
Centralab, The Electronics Division of Globe-Union, Inc.....	239	Johanson/Dielectrics, Inc.....	257	Sangamo Data Recorder Division.....	152
Centralab/USCC.....	173	Johanson Manufacturing Corp.....	176	Sangamo Weston.....	75
Ceramic Magnetics, Inc.....	246	KSW Electronics Corp.....	224	Shugart Associates.....	30
Centre Engineering.....	247	Keithley Instruments, Inc.....	182, 183	Signetics Corporation.....	29
Codi Semiconductor Corp.....	238	Kennedy Corporation, M. S.....	254	Spirig Signalarm.....	258, 260
Computer Labs, Inc.....	200	Keystone Carbon Company.....	138	Sprague Electric Company.....	133, 157
Condenser Products Corporation.....	261	Kinetic Systems Corporation.....	194	Stacoswitch, A Staco Inc. Company.....	233
Continental Specialties Corporation.....	207	*Knurr, KG, Hans.....	223	Stanford Applied Engineering, Inc.....	134
Cortron, A Division of Illinois Tool Works, Inc.....	235	Krohn-Hite Corporation.....	85	Statek Corp.....	257
Curtis Industries, Inc.....	257	LSI Computer Systems, Inc.....	205	Switching Power Inc.....	259
Cybernetic Micro Systems.....	248	Lemo USA, Inc.....	259	Systron-Donner.....	103, 244, 245
Dale Electronics, Inc.....	52, 53	Litronix, Inc.....	204E	T & B/Ansley Corporation.....	227
Dana Laboratories, Inc.....	197	Litton Encoder Division.....	140	TDK Electronics.....	225
Data Display Products.....	215	3M Company.....	246	TEC, Incorporated.....	122
Data General Corporation.....	139	MCA Minicomputer Accessories.....	260	TRW/IRC Resistors, an operation of TRW Electronic Components.....	135
Data I/O Corporation.....	62	MCG Electronics.....	230	TRW/UTC Transformer, an Electronic Components Division of TRW, Inc.....	151
Data Precision Corporation.....	38, 39	Magnetic, Inc.....	260	Techo-Mania.....	252
Datel Systems, Inc.....	165, 167, 169	Mallory Capacitor Company.....	211	Tektronix, Inc.....	35
Decitek.....	257	Marconi Instruments, Division of Marconi Electronics Inc.....	213	Teledyne Crystalonics.....	258
De Forest.....	220	Mark Hon.....	251	Teledyne Philbrick.....	253
Delco Electronics Division of General Motors Corporation.....	112, 113	*Matsuo Electronics of America, Inc.....	223	Teletype Corporation.....	95
Dialight, A North American Philips Company.....	195	McCoy Electronics Company.....	221	Texas Instruments, Incorporated.....	36, 37, 102
Digital Equipment Corporation.....	26, 27	Mechanical Enterprises, Inc.....	253	Triplet Corporation.....	161
Digital Laboratories.....	259	*Mektron.....	28	Trompeter Electronics, Inc.....	208
Dow Corning Corporation.....	82, 83	Medyne Corporation.....	260	US Instrument Rentals Inc.....	201
Dranz Engineering Laboratories, Incorporated.....	204A	Mepco/Electra, Inc.....	20	Unimax Switch Corporation.....	249
Dylon Corporation, The.....	210	Methode Manufacturing Corp.....	260	United Systems Corporation.....	172
ECD Corporation.....	177	Micro Networks Corporation.....	198, 214	VIZ Manufacturing Company.....	255
E-H Research Laboratories, Inc.....	209	Micropac Industries, Inc.....	145	Vactec, Inc.....	141
EMM Semi, Inc.....	128	Microswitch, A Division of Honeywell.....	190, 191	Victor Electric Wire & Cable Corp.....	237
E-T-A Products Co. of America.....	257	Miller Co., Inc., W. A.....	261	Victory Engineering Corp.....	248
E-Z Hook, A Division of Tektest, Inc.....	228	Minelco Division, General Time.....	248	Viking Industries, Inc.....	170
Edmund Scientific Company.....	208	Mini-Circuits Laboratory, A Division of Scientific Components Corp.....	2	Vitramon North America Division of Vitramon Incorporation.....	168
Edsyn, Inc.....	208	Molex, Incorporated.....	204F-G	Waters Manufacturing, Inc.....	218
Efratom California, Inc.....	261	Monsanto Company.....	186, 187	Wavetek Indiana Incorporated.....	1
Electro Scientific Industries.....	180, 260	Mostek Corporation.....	24, 25	Western Thermistor Corporation.....	259
Electrocube Corp.....	250	*Mycom Electronic Co. Ltd.....	216	Wiltron Company.....	159
Electronic Applications Co.....	222	Newport Laboratories, Inc.....	226	Yokogawa Corporation of America.....	150
Electronic Design.....	231, 252				
Electronic Devices, Inc.....	232				
Electronic Measurements, Inc.....	204				
Endicott Coil Co.....	257				
Engelhard.....	232				

*Advertisers in non-U.S. edition

Panasonic ZNR[®] transient/surge absorbers go where others fear to tread.



Panasonic ZNRs provide a reliable, economical approach to the problem of protecting AC and DC circuits against repeated high voltage transients (positive or negative) and surges such as those produced by lightning, switching and noise spikes.

Just one of our ZNRs can replace the pair of back-to-back Zeners you may now be using in your circuit. And they're an excellent alternative to Varistors, RC circuits and spark gaps, too.

ZNRs are ideal for ground fault interrupter circuits, input line transient protection, microwave ovens, TVs, video displays, and just about any

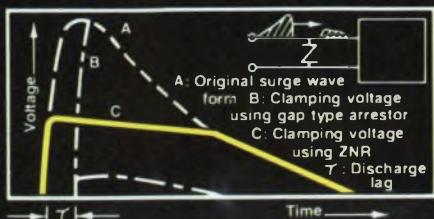

AC or DC circuit that is vulnerable to current surges and spikes.

Fast response time.

Panasonic ZNRs are zinc-oxide non-linear resistors whose ohmic value changes in less than 50 nsec when subjected to impulse surges. This eliminates the discharge lag inherent in gap-type arrestors.

Available from stock.

AC circuits ranging from 14V to 1000V, and DC circuits from 18V through 1465V, can be protected with Panasonic ZNRs. All line transient ZNRs are U.L. listed. For complete details, samples and prices, write or call Panasonic Electronic Components, One Panasonic Way, Secaucus, N.J. 07094. (201) 348-7282.

Panasonic[®]
just slightly ahead of our time

CIRCLE NUMBER 231

With new solid-state options ...

RCA helps you make discoveries in power design.

New devices. New packages. New parameters. All from the Powerhouse, your source for the widest choice in SCRs and Triacs. They offer you the latest ways to improve design, reduce costs and increase performance.

A new way to heat. Solid-state induction heating is now entirely feasible, thanks to our new 40A asymmetrical SCR (ASCR). The RCA S7310 gives you 40 kHz frequency, high voltage and current. Plus high di/dt and dv/dt capability. No need for 50/60 hertz transformers and other bulky parts.

A new way to switch. Now you can design-out some of the problems you've had with big dc relays—such as too much cable bulk in cars. Use our new plastic G4000 Series gate turn-off SCRs (GTOs)—they can switch up to 15 amps with as little as -6V gate turn-off voltage.

A new source for the C106. This popular 4A general purpose SCR and corresponding sensitive-gate triac are now available from RCA. In the economical, easily mounted 3-lead Versatab package.

New design flexibility for you. From RCA.

Family	V _{nom} (V)	I _T (A)	I _{GT} (mA)	Description	Pkg.
S7310	50-600	40	50-100	Fast Asymmetrical SCR	T0-48
G4000	50-400	15	3	Gate Turn-off SCR	T0-220
S860	50-600	100	200	Gen. purpose SCR	½" stud
S5800	100-600	5	50	Fast switching SCR	T0-220
C106	15-600	4.0	0.200	4-amp gen. purp. SCR	T0-202
T2320	50-400	2.5	3-40	Sensitive-gate triac	T0-202
T6000	50-600	15	10-50	Gen. purpose triac	T0-220

A new source for circuit ideas. "Power Options from the Powerhouse" is a new designer's guide to the selection of optimum RCA solid-state devices for power circuits. It's arranged by application, with over 40 circuits shown. This makes it easy for you to choose the type best suited to the job.

For your free copy, contact RCA Solid State headquarters in Somerville, NJ; Sunbury-on-Thames, Middlesex, England; Quickborn 2085, W. Germany; Ste.-Anne-de-Bellevue, Quebec, Canada; Sao Paulo, Brazil; Tokyo, Japan.

RCA Power experience is working for you.

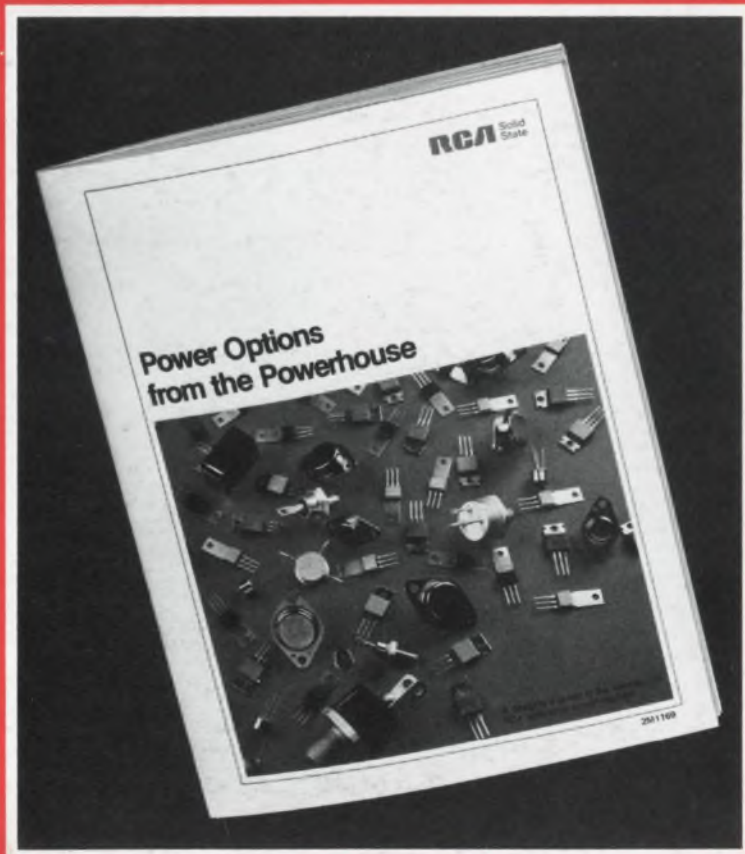

RCA