

# Electronic Design 21

VOL. 25 NO.

FOR ENGINEERS AND ENGINEERING MANAGERS

OCT. 11, 1977

**Selecting a processor** no longer requires wading through dozens of manuals. Electronic Design's  $\mu$ P Data Manual describes each processor's performance and the

available hardware and software support. Also included are spec summary tables, discussions of spec pitfalls and a primer for the  $\mu$ P beginner. Start on page 54.





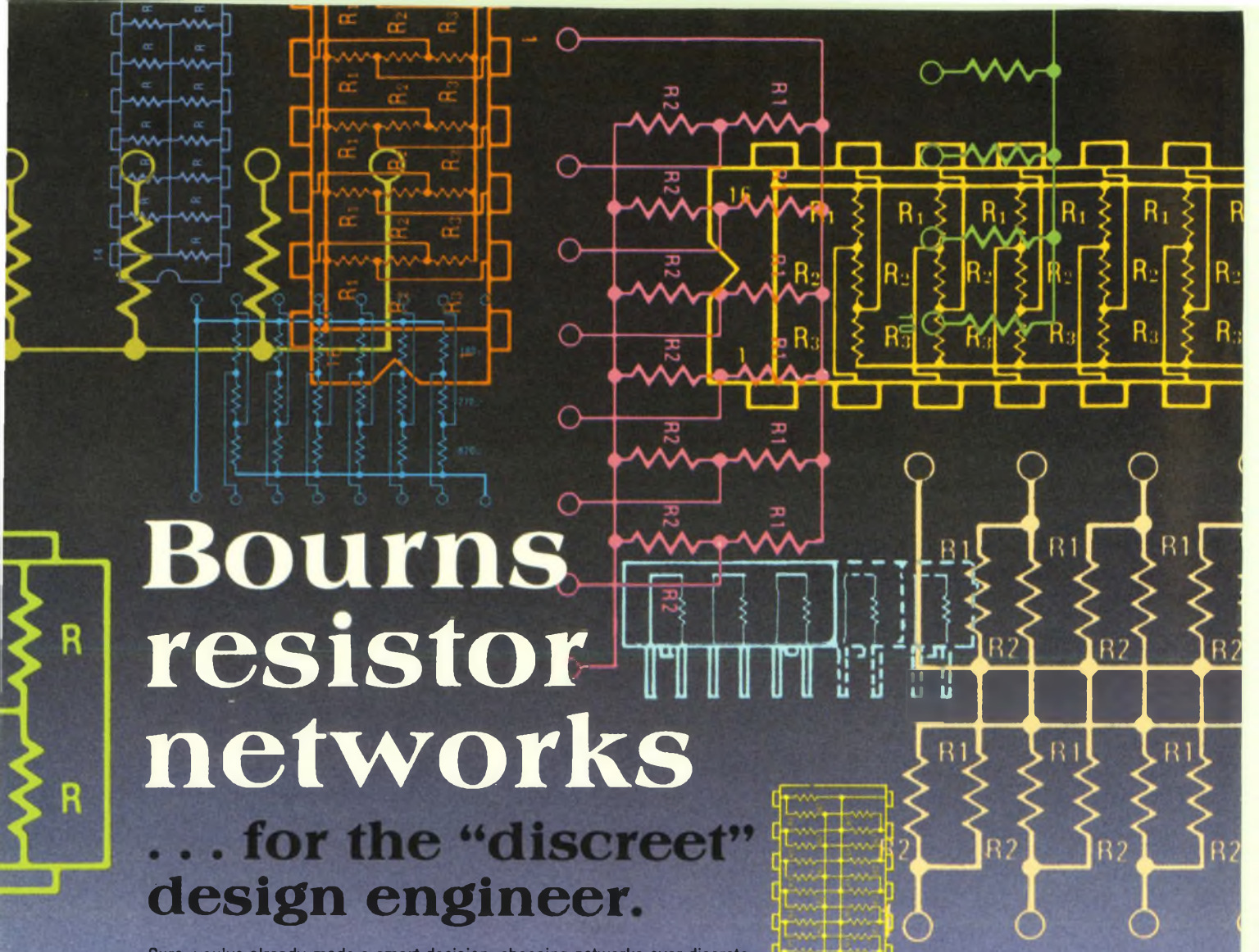

# Bourns resistor networks

... for the "discreet"  
design engineer.

Sure, you've already made a smart decision, choosing networks over discrete resistors. After all, the cost per resistor in a network package can be 40% less; they require only 10-15% of the P.C. board space needed by discretres; and component count is reduced as much as 95% with resistor networks.

But, when choosing a network supplier, you should also consider these points:

1. Bourns has the broadest network product line in the industry — over 1000 part numbers in all. And our standard DIP circuits range from simple pull-up configurations to Thevinin-equivalent ECL terminators and memory interface circuits.
2. Bourns Krimp-Joint™ offers both a mechanical and electrical bond that lap or butt joint construction doesn't provide. The lead is crimped onto the network element and a high-temp, reflow-resistant solder is used to prevent failure during wave soldering and in circuit thermal cycling and vibration.
3. Bourns was the first manufacturer to offer a complete line of off-the-shelf, super low profile SIPs with demonstrated automatic insertion capability.

These are the facts. So, now you can be even more "discreet". We're sure you'll specify Bourns Resistor Networks — direct or through your local distributor.

Send today for our new 1977 Resistor Networks Catalog.

TRIMPOT PRODUCTS DIVISION, BOURNS, INC., 1200 Columbia Avenue,  
Riverside, CA 92507, Telephone 714 781-5415 — TWX 910 332-1252.

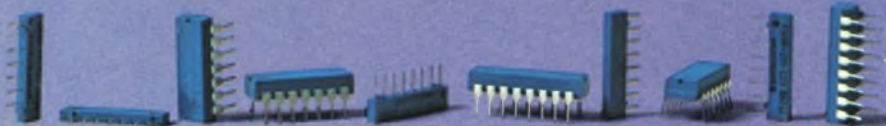

International Marketing Offices: European Headquarters — Switzerland 042/23 22 42 • Belgium 02/218 2005 • France 01/2039633 • Germany 0711/24 29 36 • Italy 02/32 56 88 • Netherlands 70/87 44 00 • United Kingdom 01/572 6531 • Norway 2/71 18 72 • Sweden 764/20 110 • Japan 075/921 9111 • Australia 02/55-0411 03/95-9566 • Israel 77 71 15/6/7

For Immediate Application — Circle 130  
For Future Application — Circle 230



# SURPRISE!



## Introducing HP's New Optically Coupled Line Receiver

Eliminate troublesome system ground loops and increase long distance communication noise immunity with HP's new easy-to-use optically coupled line receiver. An internal IC regulator serves as a line termination and allows direct connection to transmission lines without any additional components.

Use of a high-speed, high-gain output photo IC permits data rates in excess of 10 Mbits/second. An internal shield provides excellent common mode rejection even at these high data rates.

The HCPL-2602 is designed for high-speed data transmission applications such as computer-peripheral interface, instrumentation, and simplex/multiplex data transmission.

Priced at \$6.65\* in quantities of 1000, the HCPL-2602 is in stock at any franchised distributor. In the U.S., contact Hall-Mark, Wilshire or the Wyle Distribution Group (Liberty-Elmar) for immediate delivery.

In Canada, just call Zentronics, Ltd. \*U.S. Domestic price only

HEWLETT  PACKARD

1507 Page Mill Road, Palo Alto, California 94304



# TO-5 RELAY UPDATE

## The Relay of Tomorrow is here today: the Centigrad.

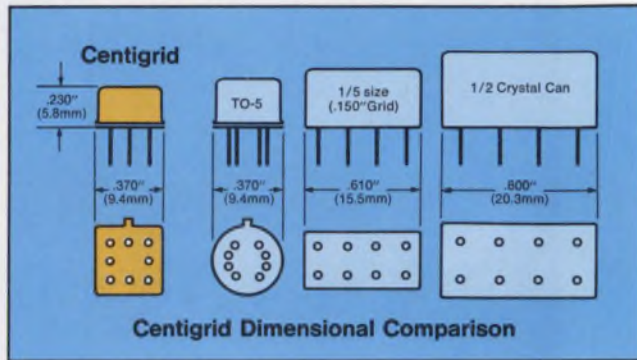

Out of Teledyne's TO-5 relay technology has evolved the Centigrad® — the ultimate subminiature relay. It combines the proven TO-5 relay design concept and internal construction into an even more compact package. Low profile height — just .230" (5.84mm) — with terminals spaced on a .100" (2.54mm) grid permitting direct pc board mounting without the need for lead spreading.

Add to this the same low coil power consumption as the TO-5 relay, with obvious thermal and power

supply advantages. And for RF switching, the Centigrad's low inter-contact capacitance and contact circuit losses provide high isolation and low insertion loss up through UHF frequencies.

To top it all off, the Centigrad is qualified to levels "L" and "M" of MIL-R-39016, including the internal diode suppressed versions.

For complete specification data on the Relay of Tomorrow, contact Teledyne Relays, the technology leader in the relay industry.

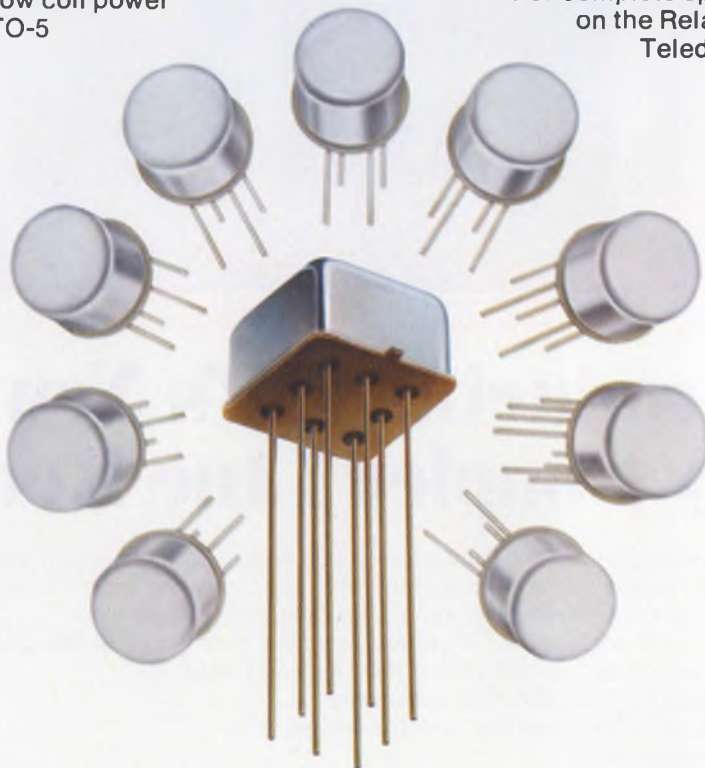

 **TELEDYNE RELAYS**

3155 West El Segundo Boulevard, Hawthorne, California 90250, Telephone (213) 973-4545

CIRCLE NUMBER 3



## NEWS

- 19 **News Scope**  
28 **Digital recording tape is denser** but standardization is no closer.  
32 **Spectrum analyzer on a chip?** Analog CCD module comes close.  
34 **Software distribution is a problem** in personal computing—with solutions.  
38 **Power transistor process** boosts performance.  
45 **Washington Report**

## TECHNOLOGY

### Microprocessor Data Manual

- 54 **Microprocessor Selection Guide:** Microprocessors offer the designer almost unlimited possibilities since they are general-purpose logic circuits. However, they are also extremely difficult to specify and test. Picking the right one from over 50 devices really tests the designer's skill.
- 74 **Learn microprocessor fundamentals.** Even if you are familiar with them, you may find this review of basic concepts useful and refreshing.
- 82 **Microprocessor data pages:** Summaries of each microprocessor's specifications help simplify the selection dilemma and cut the mass of data needed to start the selection process.
- 196 **FOCUS on floppy-disc drives.** Choosing a floppy involves the untangling of a dizzying assortment of mechanical and electrical specifications. This report helps to sort out the important details.
- 208 **Ideas for Design:**  
Circuit detects and remembers bipolar analog signals.  
Test digital circuits in step-by-step or continuous modes.  
Binary-to-BCD conversion for  $\mu$ Ps packs the units and tens into one byte.
- 216 **International Technology**

## PRODUCTS

- |     |                         |     |                       |
|-----|-------------------------|-----|-----------------------|
| 219 | Micro/Mini Computing    | 250 | ICs & Semiconductors  |
| 232 | Instrumentation         | 256 | Power Sources         |
| 235 | Components              | 258 | Packaging & Materials |
| 242 | Microwaves & Lasers     | 262 | Data Processing       |
| 244 | Modules & Subassemblies |     |                       |

## DEPARTMENTS

- |     |                                 |     |                            |
|-----|---------------------------------|-----|----------------------------|
| 51  | <b>Editorial:</b> The trademark |     |                            |
| 7   | Across the Desk                 | 270 | Bulletin Board             |
| 266 | Design Aids                     | 284 | Advertisers' Index         |
| 266 | Application Notes               | 286 | Product Index              |
| 268 | New Literature                  | 288 | Information Retrieval Card |

**Cover:** Photo by Art Director, Bill Kelly



**8-bit  
DAC's that  
think  
otherwise.**



**They come in 8-bit packages. They cost an 8-bit price. We keep telling everyone that they're 8-bit DAC's. There's only one problem: they don't think so. They think they're 12-bit DAC's.**

Advanced Micro Devices announces a new family of 8-bit, companding D/A Converters: Am6072/73 for telecommunications systems, and Am6070/71 for industrial control systems. (Am6070 and 6072 are built to  $\mu$ -law specifications; Am6071 and 6073, to A-law.)

Their logarithmic transfer function consists of 15 linear segments, or chords. A particular chord is identified with a sign bit input and three chord select input bits.

Each contains 16 uniformly spaced linear steps determined by four step select input bits. This gives you a dynamic range of 72db—the same as a 12-bit linear converter!

The new industrial converters, Am6070/71 can be used in servo controls, digital recording, microprocessor oriented control systems, data transceivers, data acquisition and control, industrial controls, measurement, automation and pollution monitoring. Wow!

Plus Advanced Micro Devices, being the helpful and thoughtful servant we are, supplies a complete package of supporting components for our companding converter systems. (Neat stuff like Sample/Hold LF398, successive approximation registers and comparators.) And, we're the only guys who do.

The Am6072/73. Perfect for your low-cost telephone system. The Am6070/71. Perfect for your industrial control problems. You pay for 8-bits, but you get 12-bit capability, plus everything else you need, all under one roof. Send for the applications note. Just ask for the 8-bit DAC's that think otherwise.

# Advanced Micro Devices

Bipolar LSI. N-channel, silicon gate MOS. Low-power Schottky.  
Multiple technologies. One product: excellence.



Advanced Micro Devices, Inc. • 901 Thompson Place, Sunnyvale, California 94086 • Telephone (408) 732-2400 •  
Distributed nationally by Hamilton/Avnet, Cramer and Schweber •  
Distributed regionally by Arrow, Bell, Century, Future, RAE and Sheridan.



# When You Buy a Power Supply, Why Not Get the Best?



**28 VDC to DC**  
(55,463 Hrs.)  
Model C95D

**28 VDC to 400 A**  
(61,387 Hrs.)  
Model S3D

**400 A to DC**  
(56,148 Hrs.)  
Model W5D

## Abbott's New Hi-Performance Modules

are designed to operate in the stringent environment required by aerospace systems — MIL-STD-810B and MIL-STD-461A for electromagnetic interference.

**RELIABILITY** — MTBF (mean time between failures) as calculated in the MIL-HDBK-217 handbook can be expected in excess of 50,000 hours at 100°C for all of these power modules. The hours listed under the photos above are the MTBF figures for each of the models shown. Additional information on typical MTBF's for our other models can be obtained by phoning or writing to us at the address below.

**QUALITY CONTROL** — High reliability can only be obtained through high quality control. Only the highest quality components are used in the construction of the Abbott power module. Each unit is tested no less than **41 times** as it passes through our factory during fabrication — tests which include the scru-

tinizing of the power module and all of its component parts by our experienced inspectors.

**NEW CATALOG**—Useful data is contained in the new Abbott Catalog. It includes a discussion of thermal considerations using heat sinks and air convection, a description of optional features, a discussion of environmental testing, electromagnetic interference and operating hints.

**WIDE RANGE OF OUTPUTS** — The Abbott line of power modules includes output voltages from 5.0 volts DC to 740 volts DC with output currents from 2 milliamperes to 20 amperes. Over 3000 models are listed *with prices* in the new Abbott Catalog with various inputs:

- 60A to DC
- 400A to DC
- 28 VDC to DC
- 28 VDC to 400A
- 12-28 VDC to 60 A

Please see pages 1037-1056 Volume 1 of your 1975-76 EEM (ELECTRONIC ENGINEERS MASTER Catalog) or pages 612-620 Volume 2 of your 1975-76 GOLD BOOK for complete information on Abbott Modules.

Send for our new 60 page FREE catalog.



**LABORATORIES, INCORPORATED**  
general offices eastern office

5200 W. Jefferson Blvd./Los Angeles 90016  
(213) 936-8185 Telex: 69-1398

1224 Anderson Ave./Fort Lee, N.J. 07024  
(201) 224-6900 Telex: 13-5332

CIRCLE NUMBER 4

**Sr. Vice President, Publisher**  
Peter Coley

### Editors

Editorial Offices  
50 Essex St.  
Rochelle Park, NJ 07662  
(201) 843-0550  
TWX: 710-990-5071  
(HAYDENPUB ROPK)  
Cable: Haydenpubs Rochellepark

**Editor-in-Chief** George Rostky

### Managing Editors:

Ralph Dobriner  
Michael Elphick

### Senior Associate Editor

Stanley Runyon

### Associate Editors:

Sid Adlerstein  
Dave Bursky  
Morris Grossman  
Gene Heftman  
Andy Santoni  
Max Schindler

### Contributing Editors:

Peter N. Budzilovich, Jules H. Gilder,  
Sidney Moskowitz, Nathan Sussman

### Editorial Field Offices

#### East

Jim McDermott, Eastern Editor  
P.O. Box 272  
Easthampton, MA 01027  
(413) 527-3632

#### West

Dick Hackmeister, Western Editor  
8939 S. Sepulveda Blvd., Suite 414  
Los Angeles, CA 90045  
(213) 641-6544  
TWX: 1-910-328-7240  
Dave Barnes, Western Editor  
465 S. Mathilda, Suite 302  
Sunnyvale, CA 94086  
(408) 736-6667

### Editorial Production

Marjorie A. Duffy, Production Editor  
James Keane, Copy Editor

### Art

**Art Director**, William Kelly  
Richard Luce, Anthony J. Fischetto

### Production

**Manager**, Dollie S. Viebig  
Helen De Polo, Nancy Hurey

### Circulation

**Director**, Barbara Freundlich

### Information Retrieval

Paula Greenleaf

### Advertising Promotion

Judith Nappo

### Reprints

Maxine Correal



# Across the desk

## Late WOM tester

We regret the delay in our publication of the April 1 announcement of the new Tektronix WOM tester. The system is intended for use with the Signuteks 9046 X N random-access write-only memory or equivalents. The system is unique in its testing neu devices (which enhance or deplete regardless of gate polarity).

The tester provides fast, clean pulses by use of Pushme-Pullyou Drivers. Quadra-state comparators allow flexibility in checking WOM outputs with only 12 clock phases.

The system uses TEKTEST IXX, Version 999.99, which is neither upward nor downward compatible with other test languages due to its unique language structure. Users can be freed of problems with hexadecimal, octal and other cumbersome languages, and revel in the simplicity of ones and zeros. No compilers, assemblers or translators are needed, so there is ample space for test programs.

The instruction set includes:

BH	Branch and Hang
IIB	Ignore Inquiry and Branch
TDB	Transfer and Drop Bits
DO	Divide and Overflow
SRZ	Subtract and Reset to Zero
PI	Punch Invalid
SSJ	Select Stacker and Jump
FSRA	Forms Skip and Run Away
RASC	Read and Shred Card
SRSD	Seek Record and Scar Disc
BST	Backspace and Stretch Tape
RIRG	Read Inter-Record Gap
UER	Update and Erase Record
SPSW	Scramble Program Status Word
EIOC	Execute Invalid Op Code
EROS	Erase Read-Only Storage
PBC	Print and Break Chain
CM	Circulate Memory
MLR	Move and Lose Record

CRN	Convert to Roman Numerals
DMPK	Destroy Memory Protect Key
DC	Divide and Conquer
EIP	Execute Programmer Immediate
LCC	Load and Clear Core
HCF	Halt and Catch Fire
IDC	Initiate Destruct Command

The address ports of the WOM are multiplexed with a negative frequency to achieve optimum resolution. The drain on the WOM is tested by monitoring a 5-gallon bucket.

Handlers are easily interfaced to this tester with only 500 signal lines. The system is capable of binning into two categories: one for NO-GO DIPs, the other for FAILED I<sup>2</sup>R. If the I<sup>2</sup>R mode occurs, it's time to call the power-distribution agency to find out how many substations went "WOM" as they exceeded maximum dissipation.

Depending on configuration, this machine will sell competitively from \$1.98 to something less than the national debt.

For more information **Circle 120**

## More resolution

Peter Simmons, marketing manager of EMI Technology's Instrumentation Division, now reminds us that his firm, too, markets a 6-1/2-digit voltmeter. In our March 1 story on Guildline Instruments' 7-1/2-digit instrument (ED No. 5, p. 18), we said that the highest-resolution DVM available in the United States was the 6-1/2-digit Dana/Keithley 6900. The Model SM215 from EMI and the DM-1000 from Julie Research, New York, also resolve 6-1/2 digits.

*(continued on page 272)*



## OPTRON OPTICALLY COUPLED ISOLATORS

NEW JAN 4N22A SERIES  
OFFERS  
HIGHEST RELIABILITY

You can't buy a more reliable optically coupled isolator than one of OPTRON's new JAN 4N22A series. The popular JAN 4N22A, 4N23A and 4N24A all feature fully qualified JANTX and JANTXV ratings.

These new OPTRON isolators consist of a high efficiency, solution grown gallium arsenide LED and a silicon N-P-N phototransistor in a hermetically sealed 6-pin TO-5 package. Minimum input-to-output isolation voltage for the series is 1000 volts and minimum current transfer ratios range from 25% for the 4N22A to 100% for the 4N24A.

New "A" version OPTRON isolators are a significant improvement over the older 4N22 series since the case is isolated from the sensor and LED to eliminate the need for an insulating spacer in many applications.

OPTRON also offers a new JEDEC registered series of high reliability isolators in a 4-pin TO-18 package. The 3N243 series includes three devices with the same reliability and similar characteristics as the JAN 4N22A TO-5 series, yet in a smaller package.



3N243

In addition, OPTRON's complete line of optically coupled isolators includes other immediately available standard devices in high-rel metal cans and low cost DIP and other plastic configurations for almost every application.

Detailed technical information on optically coupled isolators and other OPTRON optoelectronic products... chips, discrete components, limit switches, reflective transducers, and interrupter assemblies... is available from your nearest OPTRON sales representative or the factory direct.



**OPTRON, INC.**

1201 Tappan Circle  
Carrollton, Texas 75006, U.S.A.  
TWX-910-860-5958  
214/242-6571

Electronic Design welcomes the opinions of its readers on the issues raised in the magazine's editorial columns. Address letters to Managing Editor, Electronic Design, 50 Essex St., Rochelle Park, NJ 07662. Try to keep letters under 200 words. Letters must be signed. Names will be withheld upon request.



# Intel delivers the 8085, designers just

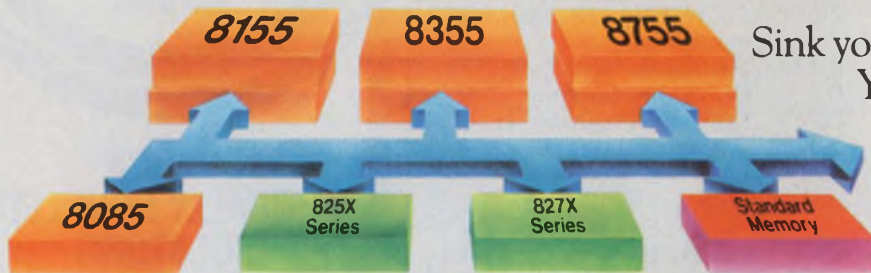

Sink your teeth into Intel's new 8085.

You'll find it's the only micro-computer that combines the performance, economic advantages and total support it takes to be recognized as

the new industry standard. So it's no surprise that there are already four announced sources for the 8085. In fact, the deeper you go, the better the 8085 gets.

The 8085, even more than the 8080 it succeeds, is a total design solution, not just a component. It delivers higher performance, for capabilities far beyond the 8080's. It has a higher level of integration, so you can design your products with fewer components, making them more competitive and more profitable.

And to help you get those products to market quicker we've given the 8085 the industry's broadest base of system and development support.

Yet the 8085 is fully compatible with the 8080. So your investment in existing designs is protected, and implementing new designs is simplified by the wealth of 8080 software and peripherals at your disposal.

It all adds up to a design solution you won't be able to resist. That's true for a broad range of applications. The 8085 can be designed in as an economical stand-alone three-chip system using the 8085 CPU, the 8155 256-byte RAM with I/O and timer, and the 8755 2K-byte EPROM with I/O or its interchangeable 8355 ROM with I/O.

You can expand this basic system for larger applications using additional RAM, ROM, EPROM and Intel's complete family of first and second generation peripheral controllers, including our four new programmable peripheral controller chips—the 8271\* Floppy Disc Controller, 8273\* Synchronous Data Link Controller, 8275 CRT Controller and 8279 Keyboard/Display Interface. All these components including 8755 EPROM operate from a single +5V supply.





# the new microcomputer can't resist.

A multiplexed data/address bus permits integration of many auxiliary system functions—such as clock generation, system control and multiple interrupts—onto the 8085 chip while maintaining 8080 compatibility and the same 40-pin package. And forward-thinking engineers will realize that it is also a link to Intel's future generation microcomputer products.

No microcomputer can match the 8085 as a total design solution because no microcomputer can come close to the 8085's support base. Support for the 8085 includes the Intellec<sup>®</sup> microcomputer development system with resident PL/M, the high level programming language that can cut months off your software development time. Intellec is the only development system with ICE-85,<sup>™</sup> providing in-system emulation for faster system development and debugging. Then there's application assistance, training classes and seminars worldwide. And a comprehensive development software library at your disposal.

The quickest way to get a taste of the 8085's power and versatility is with the SDK-85 System Design Kit. It's available now for only \$250. You can order SDK-85 and all MCS-85<sup>™</sup> components directly from your nearest Intel distributor: Almac/Stroum, Components Specialties, Cramer, Hamilton/Avnet, Harvey Electronics, Industrial Components, Pioneer, Sheridan, L.A. Varah, Wyle Liberty/Elmar or Zentronics.

Or, for more information on the 8085 and SDK-85, use the reader service card or write: Intel Corporation, 3065 Bowers Avenue, Santa Clara, California 95051. Telephone: (408) 246-7501.

## MCS-85<sup>™</sup> Microcomputer System Components Family

**8085 CPU** with system bus control, system clock generator, serial I/O and 4-level interrupt control.

**8155/8156 RAM, I/O & Timer.** 256-byte static RAM, 22 I/O lines. 14-bit programmable interval timer/event counter.

**8355 ROM & I/O.** 2048-byte masked ROM, 16 I/O lines. Interchangeable with 8755.

**8755 Erasable PROM & I/O.** 2048-byte UV erasable and electrically reprogrammable EPROM. Interchangeable with 8355.

## Compatible MCS-80<sup>™</sup>/MCS-85<sup>™</sup> Peripheral Components

### General Purpose

8251 Programmable Communications Interface

8253 Programmable Interval Timer

8255 Programmable Peripheral Interface

8257 Programmable DMA Controller

8259 Programmable Interrupt Controller

8205 High Speed 1 out of 8 Binary Decoder

8212 8-bit Input/Output Port (Latch/Buffer)

8216/8226 4-bit Parallel Bidirectional Bus Driver

### Dedicated Function

8271 Programmable Floppy Disk Controller

8273 SDLC Protocol Controller

8275 Programmable CRT Controller

8279 Programmable Keyboard/Display Interface

## Performance Matched Standard Memory

### Static RAM

2114 1024x4-bit, 450 nsec, 18 pin

2142 1024x4-bit, 450 nsec, 20 pin

8101A-4 256x4-bit, 450 nsec, separate I/O

8102A-4 1024x1-bit, 450 nsec, separate I/O

8111A-4 256x4-bit, 450 nsec, common I/O

### ROM/EPROM

2716 2048x8-bit Erasable PROM, 450 nsec

2708 1024x8-bit Erasable PROM, 450 nsec

2316E 2048x8-bit Masked ROM, 450 nsec

8308 1024x8-bit Masked ROM, 450 nsec

intel<sup>®</sup> delivers.



# When you're small you've got to be tough to last.

This rugged little 1/8-watt fixed resistor (.145 L x .062 D) is hard to beat in durability. It's the Type BB... part of a family that has passed nearly 800 million unit test hours without a single failure. It's small enough to be mounted on .300 by .100 hole centers, eight in the same space as one dual in-line package. It takes transient pulses that would knock out most any film resistor of similar dimensions. Performance is exceptionally consistent from one resistor to the next. We have the space-saving resistors you need. Our distributors have them when your need is now.

*Tough, high reliability*

Proved in nearly 800 million unit test hours without failure.

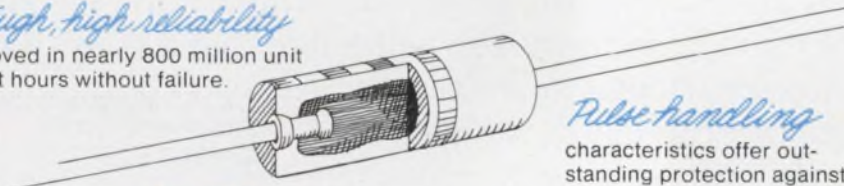

*Pulse handling*

characteristics offer outstanding protection against transient surges.

*Low TCR*

typically less than 200 PPM over normal operating temperature range of +15°C to +75°C.

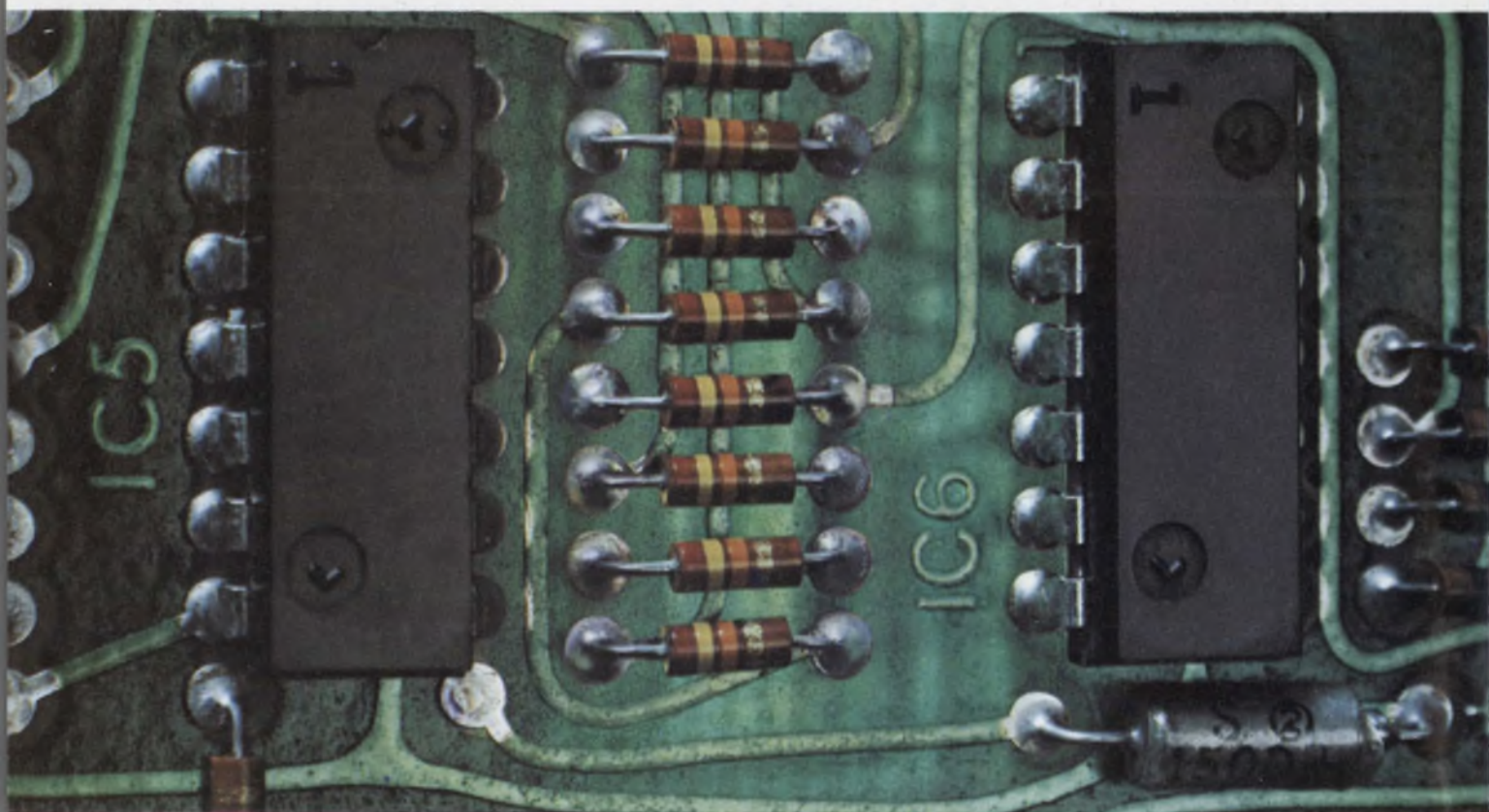

## Quality in the best tradition.



**ALLEN-BRADLEY**  
Milwaukee, Wisconsin 53204

CIRCLE NUMBER 7

CONTACT YOUR  
ALLEN-BRADLEY DISTRIBUTOR OR  
WRITE TO ELECTRONICS DIVISION

EC146



# Precision quad op amps. *Precision.*

PMI's new OP-09 and OP-11 are pin-compatible with the un-precision quads now on the market.

The quad op amp has finally come of age. With the introduction of the OP-09 and OP-11, PMI has made it a truly workable reality. Consider:

## Low $V_{OS}$ and other goodies.

Since quads can't be nulled—there aren't enough pins available—the user is at the mercy of whatever input offset voltage ( $V_{OS}$ ) he happens to get. PMI refined the manufacturing process to get  $V_{OS}$  under control. We came up with the lowest  $V_{OS}$  of any quad op amp made today.

At the same time, we gave the OP-09 and OP-11 the highest gain and the lowest drift of any quad op amp. We expanded bandwidth, reduced offset and supply current, and increased the slew rate. Here it is in black and white:

## OP-09/OP-11 Features

	TYP.	MIN./MAX.
• Low $V_{OS}$	0.30 mV	0.5 mV MAX.
• Low offset current	8.0 nA	20 nA MAX.
• Low supply current (Total for all 4)	3.5 mA	6 mA MAX.
• Voltage gain	250K	100K MIN.
• Slew rate	1.0 V/ $\mu$ S	0.7 V/ $\mu$ S MIN.
• Matched positive and negative slew rate for low distortion.		
• Bandwidth	2.0 MHz MIN.	

## We make them match.

Another important advantage: we guarantee that all four op amps will match in terms of  $V_{OS}$  and CMRR. Here's how we specify them:

## Matching Characteristics

Parameter	Symbol	OP-09A/E OP-11A/E			OP-09B/F OP-11B/F			Units
		Min	Typ	Max	Min	Typ	Max	
Input Offset Voltage Match	$\Delta V_{OS}$	—	0.5	0.75	—	0.8	2.0	mV
Common Mode Rejection Ratio Match	$\Delta CMRR$	—	1.0	20	—	1.0	20	$\mu$ V/V
		94	120	—	94	120	—	dB

(Match exists between all four amplifiers)

DUAL INSTRUMENTATION AMPLIFIER 2 OP AMP DESIGN  
(1/2 CIRCUIT SHOWN)

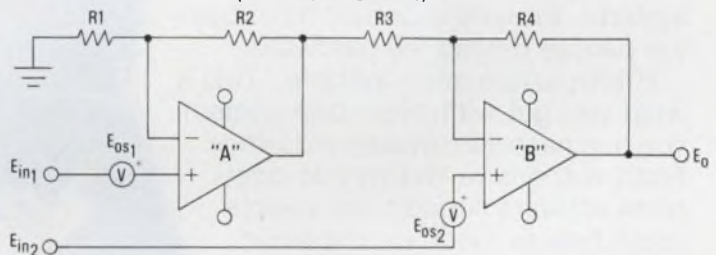

These matching dc characteristics should interest you. They reduce distortion, improve system performance, and simplify your design. But that's not all.

We've given all four op amps symmetrical positive and negative slew rates—an important thing to keep in mind for audio system design.

It's fair to say that the OP-09 and OP-11 are the most accurate, most advanced and the only precision quad op amps on the market. And they are on the market—available now, today.

Like to check one out? Be our guest. Just drop us a line on your company's stationery, telling us if you'd prefer an OP-09 (4136 pinout) or an OP-11 (148/474 pinout). We'll be glad to send literature and a sample.

Precision Monolithics Incorporated  
1500 Space Park Drive  
Santa Clara, California 95050  
(408) 246-9222.  
TWX: 910-338-9222  
Cable MONO.



CIRCLE NUMBER 8

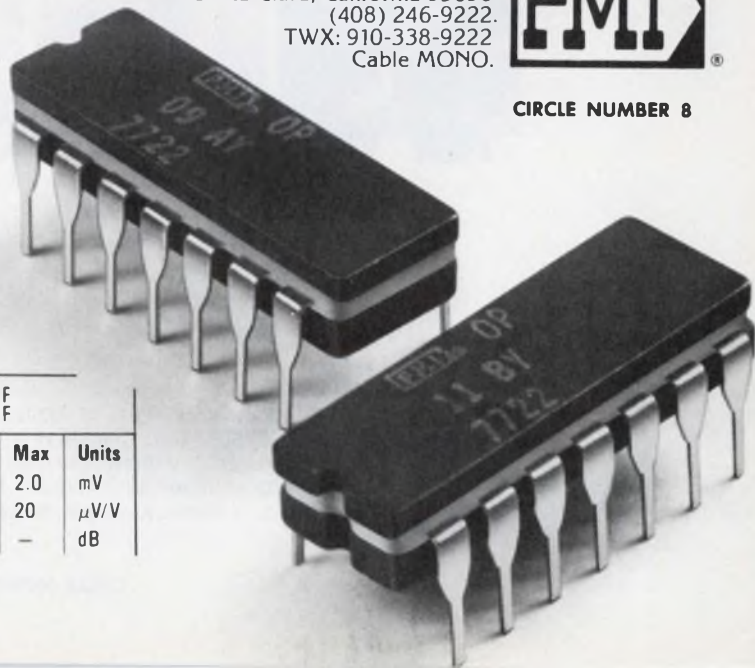



# When you buy disk systems from us, you get a lot more than just high-performance hardware...

At System Industries, we take great pride in translating the latest disk storage technologies into high-performance hardware. But by itself, superior hardware would not have made us the world's largest independent supplier of minicomputer disk systems. Equally important have been the people behind the hardware.

High-performance people. That's what you get with every disk system you purchase from System Industries. From responsive delivery to complete software support, our people know how to meet your specific requirements.

You can also add low price—the lowest in the industry for OEM-quantity purchases. Because we buy more disk drives than any other independent, we



can afford to pass the savings on to our customers.

We believe the best business relationship is a mutually profitable one. That's why we're ready to help our customers become self-sufficient in handling their future disk storage needs. And that's why our customer base continues to grow rapidly.

We'd like to tell you more about our high-performance people and products by sending you "The Bit" — our quarterly newsletter. To receive your free copies, simply drop us a short note with your business card. Or phone your request to the System Industries sales/service office nearest you.

We make good disk drives work better, and we think you should know why.

## ...you get the support of high-performance people.



**System Industries**

an equal opportunity employer

525 Oakmead Parkway  
P.O. Box 9025  
Sunnyvale, California 94086  
(408) 732-1650, Telex: 346-459

**Sales/Service Offices:**

**Boston:** (617) 492-1791. **New York:** (201) 461-3242; (201) 694-3334; (516) 751-8686; (716) 385-3021.

**Washington, D.C.:** (202) 337-1160. **Cincinnati:** (513) 661-9156. **Los Angeles:** (714) 752-8904.

**Houston:** (713) 465-2700. **Atlanta:** (404) 491-0161. **Sunnyvale HQ:** (408) 732-1650.

**Germany, Dusseldorf:** 0211-400606. **Sweden, Stockholm:** 08-236-640.

**United Kingdom, Woking:** (4862) 70725.





# It also comes assembled.

If you need dials, we have dials. If you need handsets, we have handsets. If you need Touch Calling keysets, we've got 'em by the thousands. Ringers and hook-switches, too. Or, if you need complete telephones, we have them for you in all the latest styles and colors.

You get communications components faster from GTE Automatic Electric because, outside of the Bell System, we're the largest manufacturer of telephone equipment in the U.S. If you need it, we have it.

Use the coupon below for a complete

catalog. Or if you're in a real hurry, call John Ashby at (312) 681-7632.

When it comes to quality components, call THE SOURCE: GTE Automatic Electric.



- Please send your catalog of communications components.
- Please send more information and prices on \_\_\_\_\_ of \_\_\_\_\_  
(Quantity) (Product)

Name \_\_\_\_\_ Title \_\_\_\_\_  
 Company \_\_\_\_\_  
 Address \_\_\_\_\_  
 City \_\_\_\_\_ State \_\_\_\_\_ Zip \_\_\_\_\_  
 Telephone \_\_\_\_\_

Mail to: Mr. J. D. Ashby, B-4, GTE Automatic Electric, Northlake, Illinois 60164.

**GTE AUTOMATIC ELECTRIC**



**Your New Microprocessor Power Supply will need to be custom designed... Right?**

**But it takes a long time to design and build a Power Supply for Microprocessors... and it costs a lot of money... Right?**

**Right.**

**Wrong.** At KELTEC FLORIDA we build high efficiency multiple-output power supplies to outlast and out-perform "off-the-shelf" units.

We've developed a proven series of power supplies ideal for microprocessor applications that can be easily tailored to your individual specs. Quickly... no lengthy development phase, at a great savings to you.

Plus, you're offered a choice of input voltages, output current levels, and packaging configurations.



**CHOOSE THE SPECS. YOU NEED:**

**INPUTS AVAILABLE**

115 VAC 47-400 Hz  
230 VAC 47-400 Hz  
24, 36 or 48 VDC

115 VAC  
w/Battery Backup

**OUTPUT CURRENTS AVAILABLE**

+ 5 VDC @ 2 to 10A  
- 5 VDC @ 0.5 to 3A  
+ 12 or + 15 VDC @ 0.5 to 2A  
- 12 or - 15 VDC @ 0.5 to 2A

**CONSTRUCTION:** Fully Enclosed, Open Frame, or PC Mount (depending on output power).

**EMI/RFI:** Input and Output filtering custom designed as required.

**REGULATION:** Typical specs. are 0.5% or 1% for +5 VDC; and 2% or 3% for -5, +12(15), and -12(15) outputs; line, load, and temp.

**RIPPLE & NOISE:** 1% P-P

**EFFICIENCY:** 65-75% depending on input and output power chosen.

**Aiken Industries**  
Keltec Florida Division

P. O. Drawer 1348  
Fort Walton Beach, Florida 32548  
(904) 651-1210 • TWX 510-730-7775

If you don't see what you need... specify it your way. Very powerful reasons for making the power supply for your next microprocessor application one of KELTEC FLORIDA's rugged, powerful, dependable and versatile units.

The right power supply for your needs.

Call Larry Thompson — the right man to help you with your needs.



MOTOR SHOWN ACTUAL SIZE

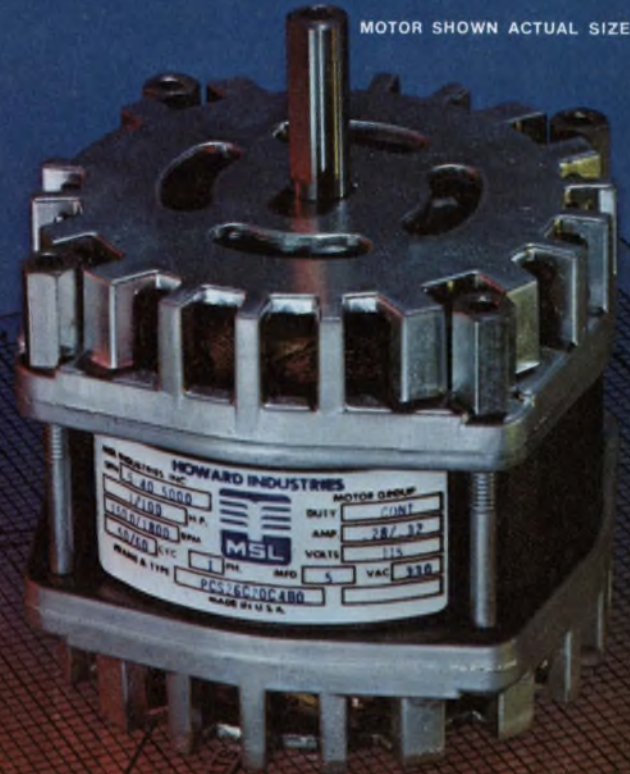

# NEW! high performance "floppy disc" motor

**SMALLER!  
INTERCHANGEABLE!  
AVAILABLE NOW!**

Howard has built a new "High Performance" FHP motor ideally suited for your "floppy disc" drives. It is 16.7% shorter than other motors of equal power — just 2¾" in height. Interchangeable with other motors and available right now! Specifications on this new reluctance synchronous motor: 1/100 HP, 115/230 VAC, 50-60 Hz; speeds, 1500 to 1800 RPM, voltage range, 90 to 127 volts.

Has UL and CSA approval pending. And you can get it from 1/100 HP to 1/10 HP in PC, capacitor start or split-phase models.

**GET ALL THE FACTS.** Write for full specifications, torque curves and other data today.



# HOWARD

**HOWARD INDUSTRIES** One North Dixie Highway, Milford, Ill. 60953. Phone: (815) 889-4105

CIRCLE NUMBER 12



# The new DAC standard. Analog Devices' complete 10-bit monolithic DAC.





# Less than a buck a bit.

You can pay at least twice as much for a 10-bit IC D/A converter and still not get the degree of accuracy and stability of our new AD561. Selling for less than \$10, the AD561 sets a new standard of price and performance for the other guys to shoot for.

As for accuracy, the AD561 is guaranteed to  $\pm 1/2$  LSB max of 10-bits (or even  $\pm 1/4$  LSB — and that's 11-bits). Monotonicity is guaranteed over the full operating temperature range. The excellent stability is made possible by a unique buried zener voltage reference and Analog Devices' proprietary thin film resistor process. And for settling time, there's nothing faster: less than 250ns for the worse case transition; that's fast enough to build a 5  $\mu$ sec ADC. Current-to-voltage conversion with an op amp is direct and simple: trimmed application resistors mean no calibration trimmers are needed.

How did we achieve this breakthrough? With the industry's most advanced monolithic processing and our pioneering technique of laser wafer trimming. The kind of advances that have quickly pushed us

to the top and made us the leading supplier of D/A and A/D converter components.

The AD561 joins another group of Analog Devices' pacesetters: a series of monolithic CMOS converters that also set new performance standards. At the same time they set a lot of microprocessor users free of analog interface problems. One is the 10-bit successive approximation AD7570 ADC. Another is the multiplying 10-bit DAC, AD7522, the only device that can be loaded in either parallel or serial modes.

And the AD561 joins the industry's 12-bit IC DAC standard, AD563.

Find out how you can cut in half the cost of your 10-bit IC D/A converters and still get true, 10-bit performance by writing for our data sheet. Contact Analog Devices, the real company in precision measurement and control.

 **ANALOG  
DEVICES**

The real IC converter company.

CIRCLE NUMBER 13



# You Can Do More with HP Microprocessor Power Supplies...

## BECAUSE YOU GET TRIPLE OUTPUT!



for the design stage...

of your microprocessor system, HP's compact, low cost lab power supplies offer more. For example, Models 6236B and 6237B offer three adjustable output voltages. Model 6236B covers 0 to 6V at up to 2.5A. Model 6237B is 0 to 18V at up to 1A. Both have plus and minus outputs of 0 to 20V that track within 1%, or you can switch

to a variable tracking mode which allows the negative output to be separately set lower than the positive providing three different output voltages. There are no turn-on/off voltage transients so your circuit is protected against damage. Both models are designed to make development work with microprocessors easier.



for the end product...

where you can feature a triple output OEM Modular Supply specifically designed for powering microprocessor systems. Model 62312D provides three isolated, independently adjustable outputs. The main output is rated at 4.75V to 5.25V at 3A. Two others each range from 4.75V at 0.38A to 12.6V at 0.6A. Other standard

features to help optimize your microprocessor design include an internal AC line fuse, fixed foldback current limit, over voltage protection on the main 5V output, remote programming terminals for margin testing and much more. Write for complete details or contact your nearby HP field sales office.

HEWLETT  PACKARD

1507 Page Mill Road, Palo Alto, California 94304

For assistance call: Washington (301) 948-6370, Chicago (312) 255-9800, Atlanta (404) 434-4000, Los Angeles (213) 877-1282

21701

CIRCLE NUMBER 14



## Codec converts with ladder of Cs, not Rs

The first telecommunications coder-decoder set to use switched capacitors instead of resistors in a/d and d/a conversions can maintain accuracies of one in 8000. The codec also takes advantage of fundamental CMOS properties. Furthermore this accuracy is obtained without the need for laser trimming.

Slated to be second-sourced by Nitron, Cupertino, CA, this single-line, logarithmic companding codec from Siliconix, Santa Clara, CA, has already proved useful to telephone companies converting to digital networks. They set the codec's performance specifications to fit their needs for PCM voice transmission. Moreover, "because of the large-volume demands of the telephone industry, the designer who builds single-line codecs into his equipment can be assured of a wide choice of types, and low prices from many viable suppliers," comments Fred Glynn, a telecommunications consultant with the San Francisco Research Group.

But the Siliconix codec may find uses in other audio fields as well, since it crams into 8-bit words the same high signal-to-noise ratio and speech quality of a 13-bit conventional a/d.

Requiring no external components, the codec consists of two CMOS chips in 14-pin DIPs. The DF 331 coder chip accepts a voice waveform, band-limited by filters to 4 kHz, does a/d conversions at 8-kHz under control of an external sample clock, and outputs an 8-bit PCM word for each sample. The DF 332 decoder accepts 8-bit words, performs d/a conversions, and outputs the reconstructed analog wave shape via an on-chip sample-and-hold amplifier.

In standard telephone applications, the output bits of 24 DF 331s are interleaved (multiplexed digitally) to form a single 1.544-Mbit/s PCM bit stream. Digital multiplexing is accomplished by tying the open-drain outputs of all 24 coders to the same pull-up resistor, and sequencing the

coders' sample clocks from separate taps of a shift register. The PCM bits are sent to the distant location, and distributed to 24 decoders.

Within the codec, logarithmically weighted groups of 256 identical 0.7-pF capacitors provide a 16-segment piecewise-linear transfer characteristic that assigns small quantizing steps to low-signal amplitudes and progressively larger steps to high-signal amplitudes.

Right now, the DF 331 and 332 follow the  $\mu$ -225 law, the standard companding characteristic in the United States. The European standard A-law will be incorporated into later codecs.

Siliconix is now shipping samples of the  $\mu$ -law codec, and plans to deliver in volume by year-end. Similar A-law codecs are scheduled for sampling by year-end and production in the first quarter of 1978. Both versions will be second-sourced by Nitron. Siliconix will provide masks, process information, and technical assistance to McDonnell Douglas division, which expects to be producing both  $\mu$ -law and A-law units in volume soon after Siliconix. Prices will be below \$10.

## Small 3½-digit multimeter: the lowest-cost of the low

At \$49.95, the PDM35 is not only the least expensive 3-1/2 digit multimeter but also half the price of the previous record holders. Measuring a scant  $6 \times 3 \times 1\text{-}1/2$  in., the Sinclair Radionics multimeter is styled much like the firm's handheld calculators.

Four ranges for ac and four ranges for dc voltage measurements are offered, as well as six direct-current ranges and five resistance ranges.

Part of the reason for the PDM35's very low price is that it has no circuitry to measure ac amperes, according to John T. Nicholls, head of Sinclair's instrument division. However, it does have LSI digital circuitry, discrete BiFet amplifiers instead of single-chip a/d converters, and thick-film re-

sistance ladder networks—all of which help bring down the cost, while hiking reliability.

Until now, the lowest-priced 3-1/2-digit instruments went for just under \$100 and came from, among other companies, B&K Precision, Chicago, and Sinclair, whose DM2 is priced at \$99.

The PDM35 is the first in a new series of DMMs Sinclair plans to introduce over the next six months. On tap is a 4-1/2-digit multimeter with automatic range selection and a price tag of around \$200.

The PDM35 operates either from throwaway 9-V batteries or from an optional ac adapter. Its rated accuracy is  $\pm(1\%$  of reading +1 count) on dc voltage and current ranges,  $\pm(1\%$  of reading +2 counts) on ac voltage ranges, and  $\pm(1.5\%$  of reading +1 count) on resistance ranges.

Resolution is 1 mV dc, 1 V ac, 1 nA dc, and 1  $\Omega$ . Polarity is selected automatically, and overrange (beyond 1999 counts) is indicated by horizontal bars on the most-significant digits and zeroes on the other digits.

Radionics has also introduced the first programmable calculator to use a single chip. Advanced mathematical and scientific capabilities are combined with a 36-step keyboard-entry program memory in a handheld unit about the size of a king-sized pack of cigarettes. At \$29.95, the Cambridge Programmable can handle programmed calculations in math, finance and statistics, physics and engineering, and electronics, as detailed in a four-book, 294-program library (\$9.95). Original programs can also be developed.

## Chip can interface micro with bus—all by itself

Making and using IEEE 488-compatible devices will soon be a lot easier.

A new chip can easily interface a microcomputer to the IEEE 488 bus without the expensive controllers currently used.

The 68488 from Motorola, Phoenix, AZ, is a semiconductor implementation of the talker/listener state diagram of the IEEE bus, and can be used alone as long as logic circuitry is available to control it. But a better way to use it, according to Motorola application engineer George Nelson, is to hook it up to a 6800 or 6802 microprocessor.

The 68488 provides a microprocessor with bus information when addressed. but if the chip recognizes that an ad-



dress is not its own, it ignores the address and leaves the micro undisturbed. Otherwise, it informs the micro that it is being addressed and tells it to go into a talk or listen mode.

The mode selected depends on the 7-bit address code sent. Five bits are actually used to supply address information, while the other two are used to designate the mode.

The 68488 decodes these two additional bits and uses the information to control bidirectional transceivers, which handle the flow of data to and from the bus.

The 68488 can be programmed for a particular address by entering binary data via external switches connected to three-state logic devices. When a read signal comes from the micro, the three-state devices are enabled and the data presented by the switches are read into the chip. This address information will remain in the 68488 memory until it is changed or until power is removed from the device.

The first applications of the new 488 interface IC will probably come from Motorola. Current plans call for the chip to be included in an updated version of the company's 6800 evaluation board. The chip will also be used in an IEEE-compatible DVM board and an IEEE-compatible DMM board.

The 68488 is currently being sampled and will be available off the shelf in December. The price in 100 quantities will be \$13.75.

## **$\mu$ P packs mini power but stays Z80-compatible**

A 16-bit microprocessor, optimized for compiler-generated code, will be able to match a PDP-11/70 minicomputer's processing power. Not only that, but the Z8000, being developed by Zilog, Cupertino, CA, will be assembly-language compatible with the Z80 8-bit microprocessor.

Programs that run on a Z80 will be able to run on the Z8000, providing the assembly code is available, states Ralph Ungerma, Vice President. A special translator program is being developed for code conversion.

The Z8000 will have an addressing range of millions of bytes—when used with a special auxiliary circuit. However, since it will be housed in a 40-pin DIP, the basic addressing range of the  $\mu$ P will be 65,536 words, assuming a 16-bit address bus.

But since the processor is designed to handle compiler generated code, the memory-expansion circuit will proba-

bly have to be used frequently. Compiler code tends to be quite lengthy and can easily require more memory than the basic addressing range can handle.

Instruction capabilities have not been fully defined as yet, but the shorter instructions are expected to execute in well under 1  $\mu$ s. Typical high-level instructions will include hardware multiply and divide.

## **Now you can watch two shows at once**



The latest advance in remotely operated color television receivers is a second channel-monitoring capability, which is being offered in sets just introduced by Barco Electronics of Belgium.

Using charge-coupled devices, Barco engineers have been able to design a system that inserts a miniature image of the program presented on a second channel in the top left-hand corner of the program being viewed. A viewer simply presses the CCD mode switch on the remote control unit and then punches in the number of the second channel to be monitored.

Two receiver sections are used to produce the individual video signals. The second video signal is then read into two charge-coupled devices, which reduce the bandwidth from 5 MHz to 1.6 MHz. By reading the signal out of the CCD at a three-times-faster rate, the 5-MHz bandwidth is restored.

Read-in and read-out operations to the CCD are synchronized by the field and sync pulses of the main video signal. As a result, the two video signals can be combined and displayed as one on the TV screen.

Another development from Barco is what is touted as the world's first worldwide color television receiver. Called the Seagull, the receiver can receive all color systems, including PAL, PAL M, PAL N, SECAM H, SECAM V, NTSC 4.43 and NTSC 3.58. The set's power supply accommodates 220-V, 50-Hz and 110-V, 60-Hz power sources.

In the works is a version of the Seagull that will automatically ex-

amine an incoming TV signal and activate the appropriate decoding circuitry.

## **Plastic insulation is safer than asbestos**

A new low-cost, high-temperature plastic insulation eliminates the hazards of handling asbestos-coated wire when fabricating and assembling the wiring for high-volume applications like electrical appliances.

EXL-150, a tough, cross-linked polyolefin insulation developed by Prestolite Wire Co., Port Huron, MI, can not only be handled more easily, but it also resists abrasion better than asbestos and another high-temperature insulation, silicone. EXL-150 is easier to terminate and mark than asbestos, which is soft and easily damaged, and difficult to mark for identification.

Prestolite wire insulated by EXL-150 costs only slightly more than asbestos-coated conductors, which are the lowest cost, but less than silicone-insulated wire which costs one and a half times as much as asbestos.

EXL-150 is rated at 150 C by Underwriters' Laboratories. To attain this rating it has passed accelerated aging tests at 180 C for five days followed by 158 C for 90 days.

## **Solar energy may power rendezvous with comet**

Solar energy may be the ultimate source of fuel for a space ship that will rendezvous with Halley's comet in 1986. If NASA scientists have their way, solar energy will be used to produce electricity to power mercury-ion engines, which will provide the actual motive force for the spaceship.

Ion rocket engines and solar-sail systems had been investigated for several years. But the former was finally chosen to be the source of power for interplanetary shuttles used in the 1980s and beyond. The ion drive was chosen primarily because it is less risky to use and has greater growth potential, according to Dr. Kenneth L. Atkins of the Jet Propulsion Laboratory in Pasadena, CA, and head of the propulsion study team.

The ion-drive spacecraft will be ready for launching from the Space Shuttle in late 1981 or early 1982, but probably won't be used for any major application until the anticipated rendezvous with Halley's comet.



# MINI-STIC



## HIGH VOLTAGE MULTI-JUNCTION RECTIFIERS FOR HIGH DENSITY PACKAGING

New Metoxilite MINI-STIC rectifiers are now available at competitive commercial prices. We have retained the superior technology and premium materials developed for aerospace programs. Stable electrical characteristics are maintained through Semtech's unique internal design. Ideal for high voltage high density packaging, these multi-junction devices are used successfully in single as well as polyphase high voltage rectifier circuits.

### Not epoxy! Our rectifiers are cased in Metoxilite.

To provide rugged minimum sized devices, metal oxides (Metoxilite) are fused directly to the junction pin assembly at high temperatures to form non-cavity hermetically sealed, monolithic rectifiers. Thermal expansion characteristics of Metoxilite are matched with the internal structure allowing

the rectifiers to withstand extreme thermal shock. Designed for use in encapsulated or oil environments.

### Used in CRT Power Supplies.

Our fast recovery multi-chip devices are especially designed for high voltage multipliers used in TV receivers and monitors.



Type: FM50, 75, 100 & 150  
PIV: 5,000, 7,500, 10,000 & 15,000V  
Average Rectified Current @25°C:  
25 & 10mA  
Static Forward Voltage, 10mA @25°C:  
10 & 20V  
Reverse Recovery Time (Max.): 300ns  
Case Size (Max.):  
FM50 & 75; .300"L x .120"D  
FM100 & 150; .400"L x .120"D

### X-Ray Equipment applications.

Our Sub-miniature High Voltage Rectifiers are used in X-Ray equipment. These devices form the building blocks for high voltage sticks such as the "X-WAY STIC" developed by Semtech.



Type: SH75 & SH100  
PIV @25°C: 7500 & 10,000V  
Average Rectified Current @55°C in Oil: 200mA  
Static Forward Voltage, 100mA @25°C: 12V  
D.C. Blocking Voltage @25°C: 7500 & 10,000V  
Case Size (Max.): .450"L x .160"D

1975 NATIONAL SBA SUBCONTRACTOR OF THE YEAR

 **SEMTECH**  
CORPORATION

652 Mitchell Road, Newbury Park, California 91320  
(805) 498-2111 • (213) 628-5392 • TWX: 910-336-1264  
CHICAGO: (312) 352-3227 • DALLAS: (214) 234-6523  
DAYTON: (513) 274-8356 • FLORIDA: (305) 644-5404  
MARYLAND: (301) 937-0070 • NEW JERSEY: (201) 654-4884  
SAN FRANCISCO: (415) 494-0113  
EUROPEAN SALES: Bourns AG Zug, Switzerland (042) 232-242



# Intel delivers PDP-11 memory for people who can't afford to wait.

When you're in a hurry for more semiconductor memory for your PDP-11, call Intel. We deliver memory for the full PDP-11 line. And because we're the largest manufacturer of semiconductor memory in the world, delivery is when you want it.

Why wait? Since you've chosen the leader to supply your minicomputer, it makes sense to go to the leader for memory, too. That's us.

Intel memory systems save you more than time. Our in-1670 add-on memory for the PDP-11/70 is one example. It gives you four times the capacity in the same frame compared to the DEC MJ11-A core memory. And built in Error Correction Code (ECC) and Error Logging improve up-time and reduce maintenance time by automatically correcting and recording single-bit failures and detecting and recording double-bit errors.

For PDP-11 add-in memory go with our in-4711 plug in boards. You'll get memory that's even faster than DEC's. 16K words per hex-wide board. With or without parity. To further expand PDP-11 memory and reduce UNIBUS™ loading choose our in-4011 add-on. With memory management you can expand to 128K words in 16K increments. And since the in-4011 requires only one UNIBUS load, you get added system flexibility.

Get more memory for your LSI-11 and PDP-11/03 in less space with our in-1611 add-in memory. You get up to 32K words, in 8K increments, on a single, two-wide, board. That's up to eight times the memory you get with a DEC board.

When you can't afford to wait call us at 800-538-8476. In California and Canada, call 408-734-8102, x575. We'll save you time, and much more.

**intel delivers.**

Intel Memory Systems  
1302 N. Mathilda Avenue  
Sunnyvale, California 94086

I can't wait! Must have delivery in  5 Days  30 Days  \_\_\_\_\_ Days

Please call me at \_\_\_\_\_ / \_\_\_\_\_ Ext. \_\_\_\_\_

Please send me information on semiconductor memory for the following:

LSI-11, PDP-11/03

PDP-11/04

PDP-11/05

PDP-11/34

PDP-11/35

PDP-11/40

PDP-11/45

PDP-11/55

PDP-11/70

Name/Title \_\_\_\_\_

Company \_\_\_\_\_ Mail Station \_\_\_\_\_

Address \_\_\_\_\_

City/State/Zip \_\_\_\_\_

UNIBUS is a trademark of Digital Equipment Corp. Maynard, Mass.



# You Don't Have To Beg, Borrow Or Buy...



## Rent'em From GE

Short or long-term instrument rentals give you flexibility and economy.

GE has over 9,000 instruments available for immediate shipment: □ Tek Scopes □ Biddle Megger Insulation Testers □ H-P Signal Generators □ Honeywell Oscillographs □ Complete Data Systems □ Esterline Angus Recorders □ GE Chart Recorders □ Modems □ Communication Terminals ... all calibrated to the manufacturer's specs.

We have over 100 Sales/Service Centers,

and one of them is near you. In addition to maintaining our Rental Inventory, they can also repair and calibrate your own equipment.

Don't borrow someone else's GE Rental Catalog. **Call collect (518) 372-9900** or your nearest Sales/Service Center.

**Quick-rental<sup>®</sup>  
instruments**

**ALA.** BIRMINGHAM (205) 925-3101 • **ARIZ.** PHOENIX (602) 278-8515 or 8516, TUCSON (602) 294-3139 • **CAL.** LOS ANGELES (213) 642-5350, SAN FRANCISCO (415) 436-9260 • **COL.** DENVER (303) 371-1260 • **CONN.** SOUTHINGTON (203) 621-4059 • **FLA.** JACKSONVILLE (904) 751-0610 • **GA.** ATLANTA (404) 457-5563 • **ILL.** CHICAGO (219) 933-4500 • **IND.** INDIANAPOLIS (317) 639-1565 • **KY.** LOUISVILLE (502) 452-3311 • **LA.** NEW ORLEANS (504) 367-6528 • **MD.** BALTIMORE (301) 332-4700 • **MASS.** BOSTON (617) 396-9600 Ext. 160, SPRINGFIELD (413) 781-1111 • **MICH.** DETROIT (313) 285-6700 Ext. 208 • **MINN.** MINNEAPOLIS (612) 522-4396 • **MO.** KANSAS CITY (816) 231-4377, ST. LOUIS (314) 965-7115 • **N.J.** CLIFTON (201) 471-6556 • **N.Y.** BUFFALO (716) 876-1200, SCHENECTADY (518) 385-2195 • **N.Y.C.** CLIFTON, N.J. (201) 471-6556 • **N.C.** CHARLOTTE (704) 525-0311 • **OH.** CINCINNATI (513) 874-8512, CLEVELAND (216) 523-6382, TOLEDO (419) 691-3501 • **OR.** PORTLAND (503) 221-5101 • **PA.** PHILADELPHIA (609) 424-4450, PITTSBURGH (412) 462-7400 • **TEX.** DALLAS (214) 357-7341, HOUSTON (713) 672-3570 • **VA.** RICHMOND (804) 232-6733 • **WASH.** SEATTLE (206) 854-0211 • **W.V.** CHARLESTON (304) 345-0920 • **WISC.** MILWAUKEE (414) 744-0110 • **PUERTO RICO** PONCE (809) 843-4225

GENERAL  ELECTRIC

CIRCLE NUMBER 17



# Now you can mass terminate with ribbon connectors...

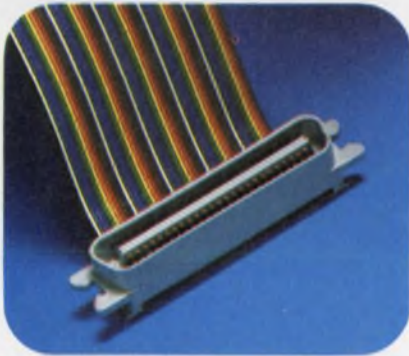

Here's another industry first from 3M that's good news for you: the Scotchflex brand Delta Ribbon Connector System for intra-system or I/O interconnections. In computer applications, in telecommunications, in any place or any way you want to use flat cable and ribbon connectors, this versatile system can do the job at sharply reduced assembly time and labor costs.

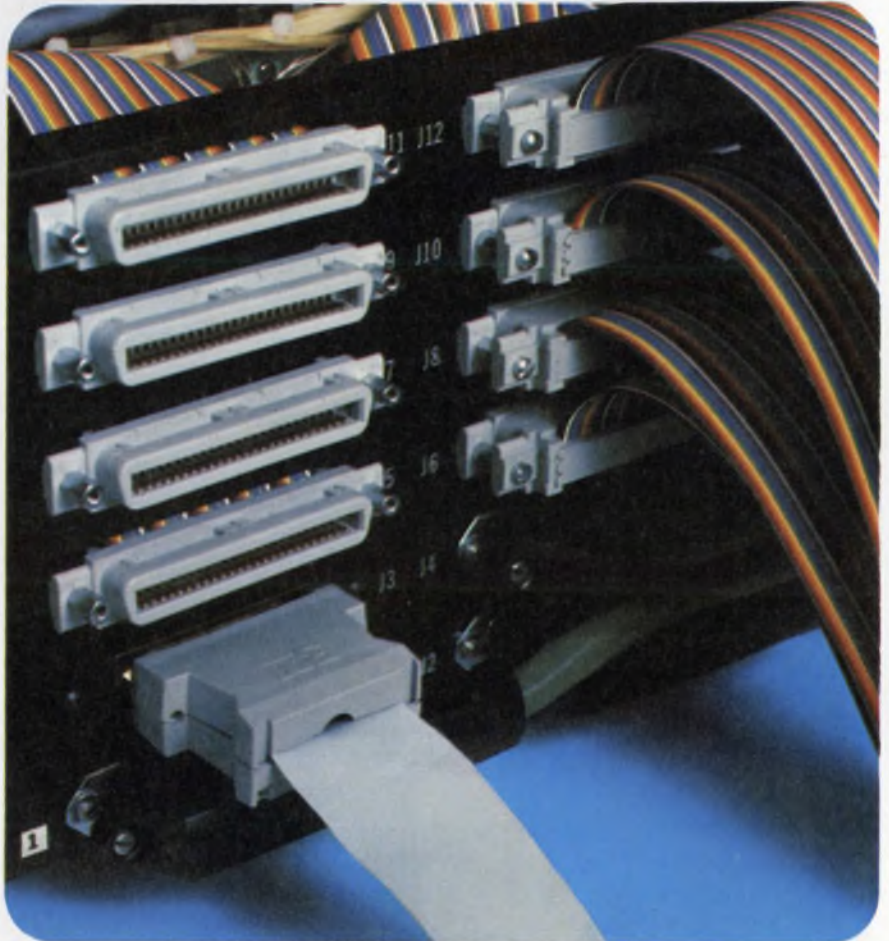

With Scotchflex Delta Ribbon Connectors, no stripping, soldering or other wire preparation is necessary. You can mass terminate a parallel-lay 50-conductor (25-pair) .0425" center-spaced flat cable in less than 30 seconds with one step. That's about ten times faster than other available methods. And thanks to 3M's field-proven, gold-plated beryllium copper U-contacts,

all connections are reliably corrosion-resistant and gas-tight.

After termination, there are more savings. You can buss from point to point without disassembling or breaking existing cables. And there's no need to redesign or rework first generation components. This Scotchflex system mates perfectly with all standard miniature ribbon connectors.



# ..in 30 seconds or less!



There's no costly investment to make in equipment or training. All you need are two locator plates and the Scotchflex manual or pneumatic assembly press. You can start mass terminating assemblies quickly and economically. No special operator skills are required. Rejects and reworking are greatly minimized.

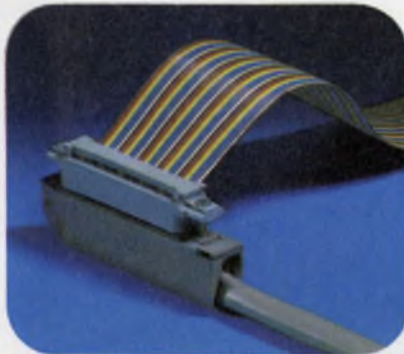

The Scotchflex Delta Ribbon system includes 50-position male and female connectors, plus appropriate bail mount, screw mount and jack screw kits, strain relief clips and dust covers. Color-coded flat cable is available in parallel-lay conductors #28 AWG stranded or #26 AWG solid.

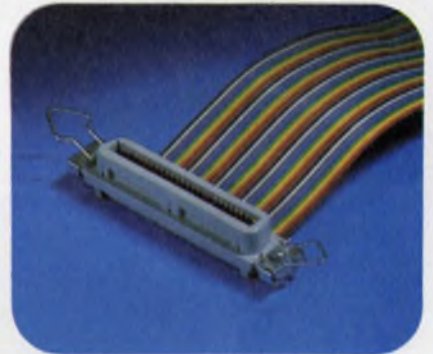

Only 3M offers you so broad a range of flat cable and system components. A nationwide network of stocking distributors. Best off-the-shelf availability. Proven performance. And the unmatched experience of the people who pioneered mass terminations.

"Scotchflex" is a registered trademark of 3M Co.

Scotchflex<sup>®</sup>  
systems  
from 3M.  
The source.



See our  
catalog in EEM,  
page 2256



# CENTRALAB MONOPANEL KEYBOARDS

## The TOUCH Switch System ...



## ...Now available from Centralab Distributors

You'll meet keyboard requirements faster, easier and at surprisingly low cost with MONOPANEL — Centralab's touch-sensitive keyboards. They help solve design problems, simplify and reduce cost in assembly and production and give your product a competitive edge in appearance, design and function. And now, 16 standard keyboards are in stock for immediate delivery from Centralab Distributors.

Don't confuse MONOPANEL with other keyboards. Even though they're priced about the same, MONOPANEL keyboards are superior in construction, reliability, quality and value. First of all, they're backed by Centralab's more than half-century of experience in switch manufacturing. They're 100% tested. They're tough — designed for long, trouble-free life; have no mechanical parts to wear out. And they've been proven in use. The basic Monopanel key switch has undergone more than 70,000,000 switching cycles without failure.

Your Centralab Distributor can furnish 16 standard keyboards. Select from 12 or 16 positions; with alpha-numeric or

telephone format numeric nomenclature; white or black bezel; with or without mounting flange. All units have .025" square terminals that are suitable for solder, wirewrapped or plug-on quick connects. One side common or X-Y switch interconnections are available.

For complete product and price information contact your Centralab Distributor. Or, for the name of your distributor, call Centralab Distributor Products, Milwaukee (414)228-2911.

### Products you need from people who care.

DISTRIBUTOR PRODUCTS



CENTRALAB

Electronics Division  
GLOBE-UNION INC

5757 NORTH GREEN BAY AVENUE  
MILWAUKEE, WISCONSIN 53201

### THIS IS HOW MONOPANEL WORKS

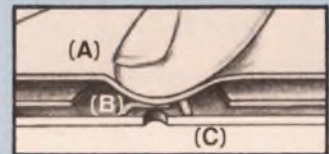

### To Give You Long-Life, Trouble-Free Keyboards.

MONOPANEL is a thin, light, flat, front panel subassembly with micro-motion touch switches already mounted and interconnected. Each MONOPANEL is a multilayer assembly containing (A) a flexible, tough, moistureproof polyester membrane with graphics and flexible conductors screened upon the rear surface; (B) a thin spacer with holes for each switch provides an .007" air-gap; (C) a circuit board with switch circuits on its face, joined by plated through-holes to interconnections on its back.

The basic switch closure is momentary, normally open. Light touch pressure (2 oz. typical) on the smooth, flexible front panel closes the contact. Releasing pressure allows the front panel membrane to return, opening the contact.



# Electronic Design's **GOLD BOOK** IS BEING USED AT LITTON



**"I KNOW OF NO OTHER PUBLICATION WHICH HAS THE AMOUNT OF NECESSARY INFORMATION SO CLOSE AT HAND."**

M.A. Richards is Component Engineer at Litton G/CS, Woodland Hills, California, a leading producer of inertial navigation systems. Richards is responsible for hybrid microcircuit activity including evaluation, selection of and vendor liason. His directory? *Electronic Design's GOLD BOOK*.

Richards estimates that he and his associates have purchased equipment and components worth \$500,000 through use of the GOLD BOOK.

**"The most useful feature is the directory of companies and their local representatives. I know of no other publication which has the amount of necessary information so close at hand. I find the rating of companies and the number of employees, dollar volume and list of key officials very useful. The GOLD BOOK is superior. I use it several times a day."**

The GOLD BOOK is working for advertisers because it's working for 90,000 engineers, engineering managers and specifiers — like Mr. Richards — throughout the U.S. and overseas.



**IF IT'S ELECTRONIC...IT'S IN THE GOLD BOOK**



## Digital tape recording is denser, but standardization isn't standard

Digital recording on tape, whatever its width, is getting denser. And then some. Quarter-inch-wide tape in cartridges has shot up to 6400 bits per inch. Half-inch reel-to-reel drives are running at 6250 bpi and full-inch tape for instrumentation is packing 33,000 bpi and 42 tracks across the head. But while density increases, the near-term likelihood of standardization decreases, particularly for quarter-inch cartridges.

Just as the American National Standards Institute was about to come up with a standard format for 3M quarter-inch-tape cartridges, IBM's introduction of the 5100 desktop computer upset the apple cart. The 5100 uses the 3M tape cartridge, but not the ANSI-proposed standard data format. So the tape industry's elation at having the "Giant of Armonk" ratify its standard was simultaneously dampened by the knowledge that IBM data formats almost automatically become industry standards.

Two other firms have introduced "nonstandard" 6400-bpi 3M tape drives. For example, the Model 3400 drive announced by Data Electronics of Pasadena, CA, "is used almost exclusively for backing up Winchester disc drives," according to marketing manager Sam Thompson. The unit reads and writes data at 30 inches per second and moves tape for rewind or search at 90 ips. A similar device is the Loadstar 6400-bpi drive from Microdata, Irvine, CA.

(The term "cartridge" was introduced by 3M to differentiate its belt-driven unit from Philips' "cassette," which uses a pinch roller. They both shuttle a length of tape from one reel to the other. The 3M cartridge should not be confused with those transport schemes based on an endless loop of

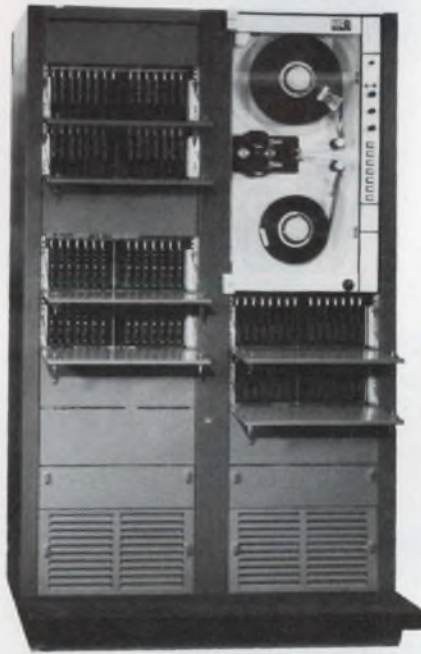

Besides this 28-track model, Bell & Howell's Data-tape Division, Pasadena, CA, supplies 42-track digital instrumentation recorders with packing densities of 33,000 bpi, data throughput rates of 150 Mbits/s, and error rates of one bit in 10-billion.

tape. These too can be called cartridges, as with Tri-Data's "Cartrifile" unit.)

### Half-inch goes full-cycle

Meanwhile, reel-to-reel half-inch tape drives are growing smarter and denser at the same time. Today, these tape drives, which used to run at 1600 bpi, can now run at 6250 bpi—and correct multiple-track errors without processor intervention. This involves adding an intelligent data formatter/checker at the front end.

For 6250-bpi recording, data are first accepted into the formatter's buffer memory, where partitioning and expanding take place, then divided into 4-byte subgroups and 8-byte full groups.

Each data byte gets a parity bit. Then an error checking and correction (ECC) byte is generated and imbedded in the data stream following each of the 4-byte subgroups. (The ECC is generated cyclically on the four associated data bytes plus parity.)

When reading, the formatter looks at an 8-byte full group and the two ECCs. Because of the mathematics involved, it can detect and correct both single and double-bit errors without the help of the processor.

This technique, called "group-coded recording" (GCR), comes from IBM, so of course it is IBM-compatible. And, not too surprisingly, it has been accepted as an ANSI standard.

The half-inch drives' increase from 1600 bpi to 6250 bpi makes phase-encoded recording unsuitable. Instead, the earlier nonreturn-to-zero (NRZ) recording technique must be used. Phase-encoded recording uses either one or two flux reversals per bit time. At 6250 bpi, flux-reversal density resulting from normal data streams exceeds the maximum density of the tape (see box). Today's magnetic tape can only support about 9500 flux reversals per inch before the signal-to-noise ratio degrades to the point where the tape cannot be read without excessive errors.

Even though 6250-bpi tape drives use NRZ recording, they retain the benefit of self-clocking by coding the data so that no more than two consecutive ZEROS are allowed in the data stream. The "read" clock need only adjust to three frequencies that correspond to a stream of ONES, alternating ONE-ZEROS or two ZEROS and a ONE.

Group-coded recording accommodates the consecutive-zero restriction and formats data so that multiple-track errors can be detected and corrected. This is a quantum jump over simple parity checking and other data integrity schemes that would demand the host processor's attention.





## microNOVA keeps on trackin'.

Southern Railway has a long track record of being one of the most profitable rail systems in the country. To help stay on that track, they decided to increase the speed and flexibility of their online distributed communications network. So Southern Railway is now changing dumb terminals into intelligent ones throughout its rail system, using microNOVA microcomputers.

Southern Railway found that only the Data General microNOVA microcomputers could help them cut costs and keep track of some 75,000 freight cars moving over 10,500 miles of track, and do it the way Southern Railway wanted to. Controlling rolling inventory like that takes a lot of flexibility. And that's the big advantage Data General microNOVA microcompu-

ters bring to any application. Whether in a chip, on a board, or as a packaged system.

With the speed, flexibility and software of a minicomputer and the economies of microprocessor technology, microNOVA microcomputers let you do things your way. That's why they're setting track records in all kinds of applications.

Mail to: Data General, Westboro, MA 01581

- Send microNOVA technical literature.  
 Send literature and have your sales representative call.

Name \_\_\_\_\_

Title \_\_\_\_\_

Company \_\_\_\_\_

Address \_\_\_\_\_ Tel. \_\_\_\_\_

City \_\_\_\_\_ State \_\_\_\_\_ Zip \_\_\_\_\_

NOVA is a registered trademark of Data General Corporation  
 © Data General Corporation, 1977

Data General, Westboro, MA 01581, (617) 366-8911. Data General (Canada) Ltd., Ontario. Data General Europe, 15 Rue Le Sueur, Paris 75116, France, 50-006-06. Data General Australia, Melbourne (03) 82-1361. ED1011

**Data General**  
 It's smart business.

CIRCLE NUMBER 21



## Flux Reversals

Flux reversals are the key to digital recording, no matter which recording method is used. Bits (ONES and ZEROs) are encoded with flux reversals on the tape as a function of the magnetic polarity (direction) of small, contiguous lengths of tape.

In earlier return-to-zero recording, a ONE was encoded as a period of flux reversal (opposite magnetization) against a background of all ZEROs. As the tape was moved across the fine coils of wire in the read head, flux reversals at the leading and trailing edges of the ONE would induce small voltages in the detector coils. One of these voltages would be amplified to a ONE.

Since with RZ recording the trailing edge of the flux-reversed seg-

ment was redundant, nonreturn-to-zero recording soon became popular. (Any flux reversal, in either direction, indicates a ONE; a ZERO manifests no indication.) But since there was no time reference, NRZ recording did not resolve the problem of dealing with a string of consecutive ZEROs—which Zero was which?

Phase-encoded recording solved the problem. At every bit time, at least one flux reversal occurs—one reversal indicates a ZERO, two reversals, indicate a ONE. The flux reversal is in one direction for a ZERO, another for a ONE. This scheme provides a self-clocking mechanism that can track a string of repetitive bits, no matter how long it is.

Still, the 6250-bpi drives are not all that popular.

"The cost of developing a 6250-bpi tape drive is over \$1-million," according to Steve Arnaudoff, marketing manager for Kennedy Tape Co., Altadena, CA. "And all that R&D would go out the window if semiconductor firms were to introduce LSI formatter chips." Meanwhile, all tape-drive eyes are on the Model 1900 6250-bpi GCR drive introduced by Storage Technology Corp. of Louisville, CO, at the NCC last June. If it is well received, a lot more 6250-bpi drives could hit the marketplace.

### New uses for 1-in. recorders

At the same time, full-inch digital instrumentation recorders, nudged forward by spaceborne and geophysical applications, now pack in up to 33,000 bpi and 42 tracks across the head. In one geophysical application, searching for oil, huge amounts of raw data need to be accumulated and burst into a host processor. Standard 1-in. instrumentation recorders exist with data-throughput rates up to 150 Mbits/s and error rates down to one bit in 10 billion—for an entire 2-mile reel of tape.

Data protocols and intelligent formatting are the key to these low error rates. The 1-in. recorders format the data somewhat like data-communications protocols—they use synchronizing words with particular bit patterns and differentiate them from raw data.

In Bell & Howell's high-density sys-

tem, for example, a sync word consists of 10 repeated ONE-ZEROs followed by ZERO-ONES. The double 00 line in the center is made unique, so it cannot be replicated by data because of parity differences.

At 33,000 bpi, each bit takes up a mere 30 microinches along the tape. Dynamic and static skew can be problems, so the Bell & Howell system uses the sync words to monitor and correct for it.

Because the short "data wavelengths" in the ferrite medium of data-recording tapes are substantially smaller than the thickness of Mylar backing, the problem of noise due to "print-through"—overlapping layers of tape magnetizing each other—is reduced to nil. Print-through is reduced even more because high-density systems do not saturate the ferrite medium as other technologies do. The B-H curve in the Bell & Howell system, for

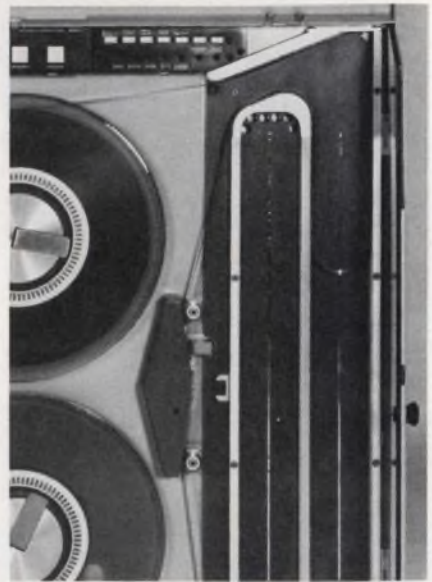

**Capacitive loop sensing** eliminates the "steps" that occur with photodiode sensing. A flexible, Mylar-backed conductive film is exposed to the back of the vacuum column (a thin vertical line). In this Model 9300, 125-ips, 6250-bpi tape drive from Kennedy, the magnetic tape, with atmospheric pressure on one side of the loop and a vacuum on the other, causes the conductive film to be deformed for a length equal to its position in the vacuum-buffer column. A servo control system responds to capacitance changes, which in turn indicate loop position.

example, is driven to no more than 10% of saturation.

Supporting bursts of very high-speed data from a satellite or from an unmanned geological monitoring site, requires a high rate of data throughput. Under certain conditions, time is compressed by high-density systems a factor of 80:1 or more.

If 150 Mbits/s is too fast for a host computer, data can be down-translated by a factor of 64 or less.■

### For more information . . .

Bell & Howell Co.  
300 Sierra Madre Villa  
Pasadena, CA 91109  
(213) 796-9381  
Bob Hawn

Data Electronics, Inc.  
370 N. Halstead Street  
Pasadena, CA 91107  
(213) 351-8991  
Sam Thompson

Kennedy Co.  
540 West Woodbury Rd.  
Altadena, CA 91001  
(213) 798-0953  
Steve Arnaudoff

Microdata, Inc.  
17481 Red Hill Ave.  
Irvine, CA 92714  
(714) 540-6730  
Bud Bleininger

Storage Technology Co.  
2270 S. 88th Street  
Louisville, CO 80027  
(303) 666-6581  
Erick Ringjob

Tri-Data, Inc.  
800 Maude Ave.  
Mountain View, CA 94043  
(415) 969-3700  
R. J. Hlava





The new Fluke 3041A programming station with the 3040A Logictester<sup>™</sup> for  $\mu$ P boards you haven't even designed yet!

# Check one: Fluke's #1 #3 in digital board testers.

Correct on both counts.

More Fluke logic test systems are in production and service applications than anyone's. And more are shipped each month. Two ways of saying we're #1.

And, our customers spent less getting us there than they could have with anyone else. That makes us #3 on average cost.

But low front-end cost is only the start. You'll get lower programming, training and start-up costs than you thought possible. The highest test rates in the business, too, because boards run at rated speeds, including dynamic  $\mu$ P boards at multi-MHz rates.

More importantly, you'll test with confidence. If your board passes our tester, it'll work in your system. It's

that simple. And reliable; more Fluke systems sold prove it.

The heart of our 3040A is a new merged sequence technique which lets you mix your test codes with automatically-generated sequences. And the best simulator around: your own known-good board. And dynamic LSI/fault isolation, automatic, manual or both!

Fluke hasn't forgotten about the bad boards either. After the tester nails the bad ones, we automate the troubleshooting. Our Autotrack<sup>™</sup> computer-guided troubleshooting leads the operator to the fault. With the new 3041A programming station, you describe the board onto a floppy disk and the 3040A does the rest.

The 3040A, with up to 240-pin capability, is \$60,000 to \$95,000\*, de-

pending on option configuration.

The 3020A logic test system, at about \$32,000\*, is perfect for production test of all popular logic families.

For light production test or field service, our model 3010A has 128-pin capability for under \$15,000\*.

Call (415) 965-0350, collect. Ask for the complete story on our high-ranking Logictester<sup>™</sup> family, or the location of the closest Fluke office. Or, write: Fluke Trender, a subsidiary of John Fluke Mfg. Co., Inc., 630 Clyde Ave., Mountain View, CA 94043.

In Europe, write: Fluke (Nederland) B.V., P.O. Box 5053, Tilburg, The Netherlands. Phone: (013) 673-973. Telex: 52237.

\*U.S. price only.

## Command Performance: Demand Fluke Logic Test.

For literature, Circle 283

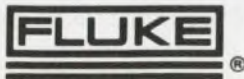

For demonstration, Circle 284



# Spectrum analyzer on a chip? Analog CCD module comes close

By computing Fourier spectra faster than a large-scale digital computer, a new analog CCD chip makes it practical to design spectrum analysis into bandwidth-compression and speech-recognition designs for commercial and consumer devices. So says John Rado, president of Reticon Corporation of Sunnyvale, CA. Reticon's Chirp Z-Transform (CZT) transversal filter chip, the R5601, is the first device available to the OEM that can compute Fourier transforms economically.

"Our CZT-CCD approach cuts size, weight, and power dramatically, perhaps in some cases by 50 to 1," Rado explains, pointing to a two-board spectrum analyzer module, built to demonstrate the use of the chirp chip. "This little module, taking up 80 square inches, gives you all the same answers as a digital Fourier analyzer that uses a dedicated minicomputer and half a rackful of other gear." And while the latter group takes only six microseconds per data point, Rado adds, the system costs \$40,000. The Reticon modules work just as fast, but for around \$800.

Performing many precise analog multiplications simultaneously in real time, the R5601 chip converts 512 time samples to 256 spectral lines. It does the convolution calculations for both discrete Fourier transforms (DFTs) and power spectral density plots (PSDs), starting from a sampled-data analog input with a dc-to-50-kHz bandwidth.

The chirp chip boasts a 70-dB dynamic range, peak-signal-to-rms noise, and can separate two adjacent-frequency signals that are 50 dB different in amplitude. Total harmonic distortion is less than 1%. Moreover, the average inefficiency of transferring the analog charge from one

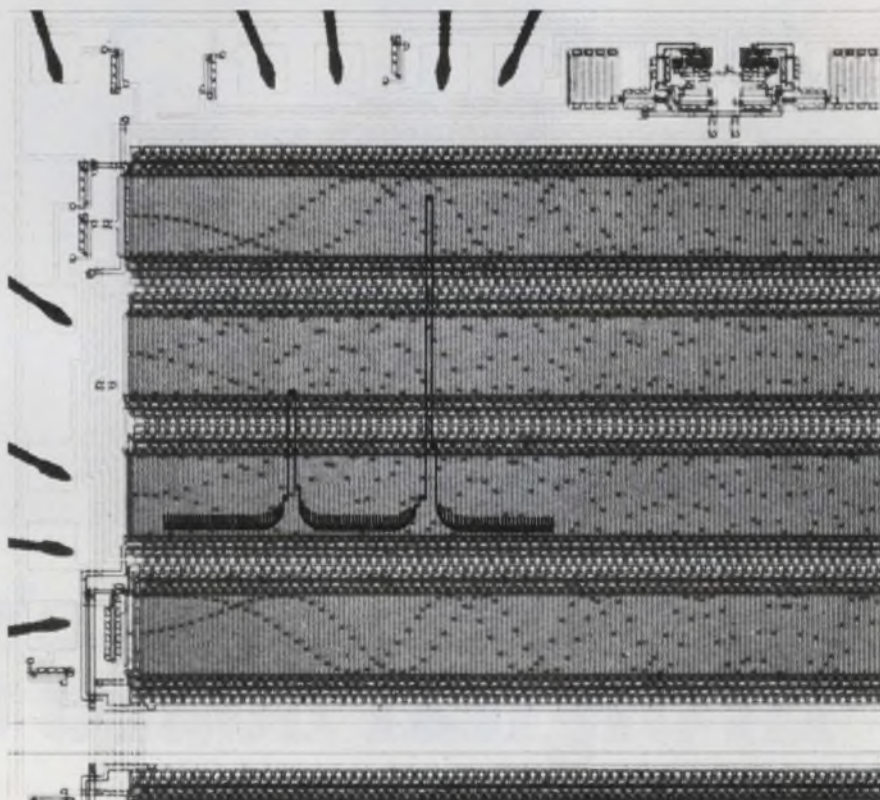

This photomicrograph of a quad CCD filter shows chirp (linear FM) waveform in metal mask. Output spectrum waveform is superimposed.

physical position in the CCD device to another is less than  $1 \times 10^{-4}$ .

## CZT algorithm shines in CCD

The CZT algorithm, developed at MIT in the late 1960s, is named for the chirp, a linear FM waveform that rapidly sweeps from low frequencies to high. The algorithm calls for pre-multiplying the signal by the chirp waveform, then circulating the product in the chirp filters, as shown in the block diagram. For PSD, the outputs of the filters are squared and summed. But for the actual Fourier coefficients for magnitude and phase, the outputs are postmultiplied by another chirp waveform.

The CZT algorithm alone has no

special advantage over other FFT methods for digital implementation, but the CZT-CCD approach is more accurate than conventional FFT methods, according to Charles Gopen, Reticon's marketing manager for analog products. In digital Fourier analysis, the errors in calculation increase as the square-root of N, the number of samples, he explains. But most of the CZT-CCD errors are independent of N.

"At 512 points," says Gopen, "this system with its 9-bit tap-weight precision is more accurate over-all than a digital FFT system with 13 bits."

Multiplying DACs do the pre-multiplication, getting their chirp-

(continued on page 34)



**Now, a new generation  
of semiconductor-grade  
molding compounds.**





# **Dow Corning 631 molding The advantages of silicone. The advantages of epoxy. And something more.**

At first it might appear pretentious to announce a new generation of semiconductor-grade molding compounds. "New generation" implies a product so outstanding, so totally unique, that it overshadows all existing technology. But that is precisely what we have developed. We've taken the best advantages of silicone. The best advantages of epoxy. And put them together in one very unique product. Dow Corning® 631 silicone/epoxy molding compound.

What this new generation of molding compound means to you is that now you have the best advantages of silicone and epoxy in one product specifically designed for integrated circuit applications. And it means something more. It means that now every other molding compound is second best.

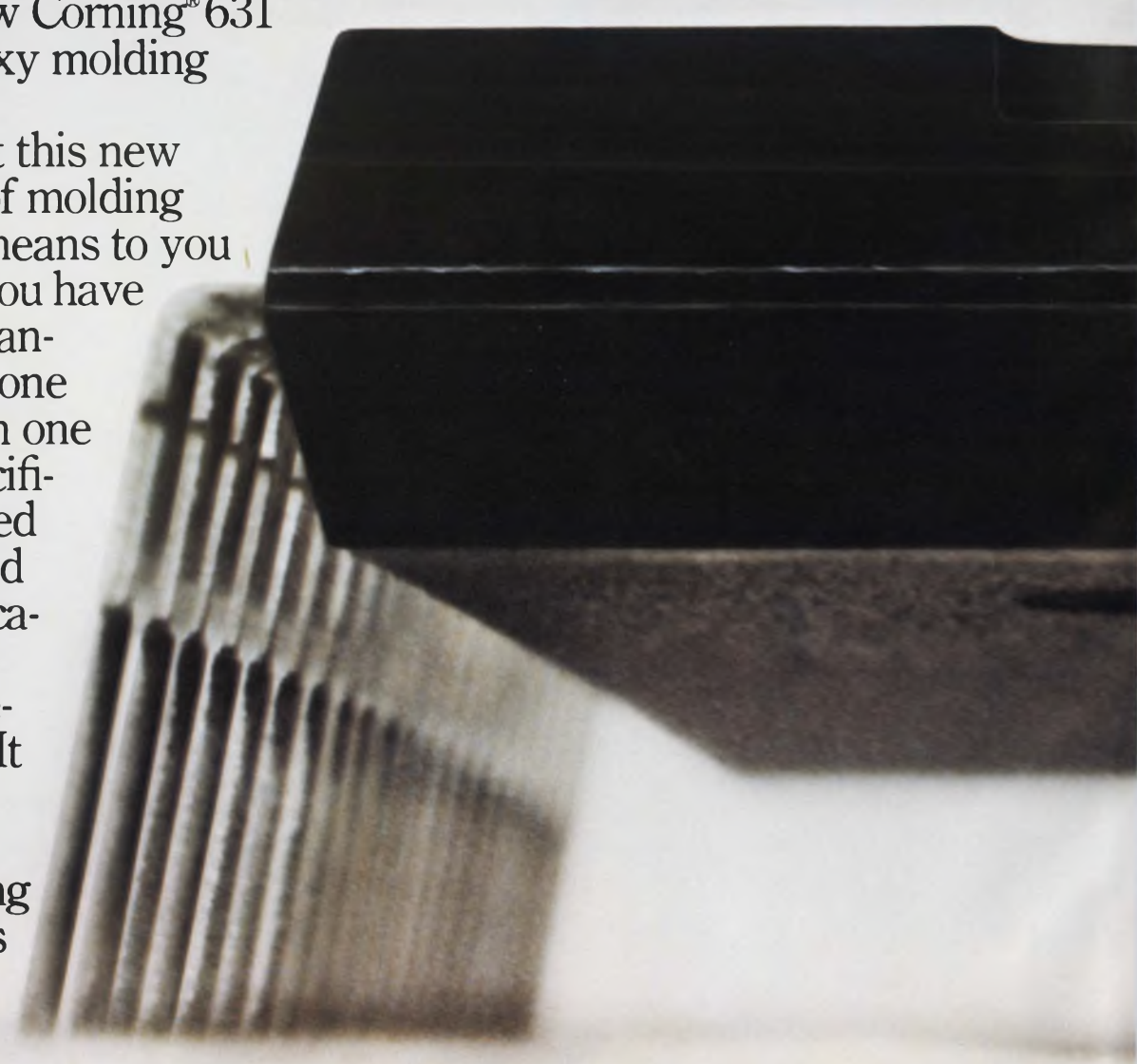



# compound.

## Dow Corning 631. Better than silicone.

Dow Corning 631 silicone/epoxy molding compound represents a breakthrough in a very real sense. It's the only molding compound that combines the compatibility and ease of molding of silicone compounds with the salt atmosphere resistance of epoxy compounds. The graph at right proves our point. After 600 hours' exposure to corrosive salt atmosphere, none of the devices that were molded in Dow Corning 631 silicone/epoxy compound failed. That's a major advantage over ordinary silicone molding compounds.

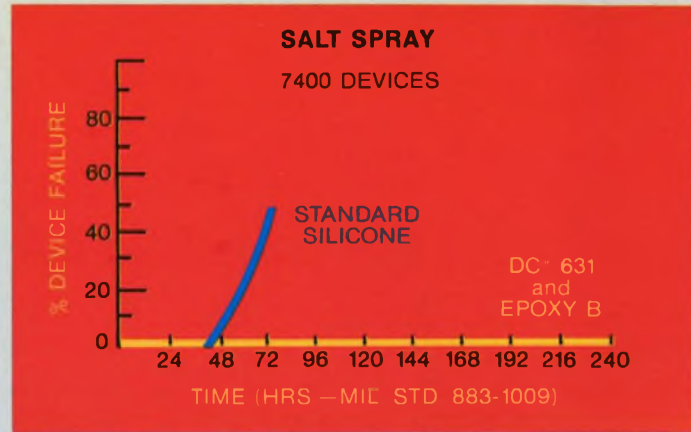

**Dow Corning 631. Better than epoxy.** Dow Corning 631's advantages over silicone are only half the story. It's also the only molding compound that combines the high strength and strong lead seal of epoxy with the

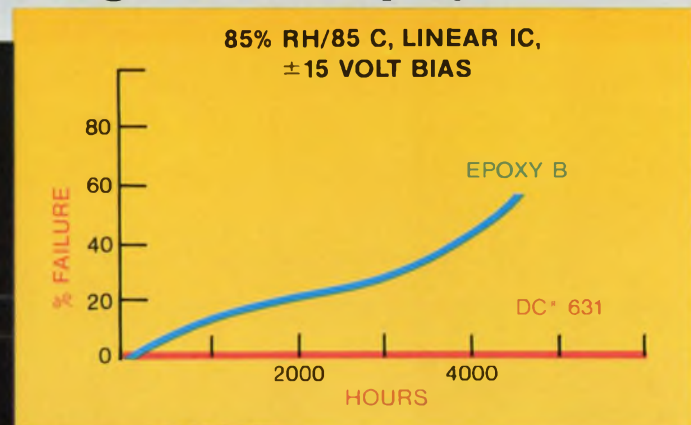

outstanding moisture resistance of silicone. The autoclave resistance of Dow Corning 631 is very nearly as high as that of an all-silicone molding compound. And look what happened on 85°C/85% R.H.-bias testing.



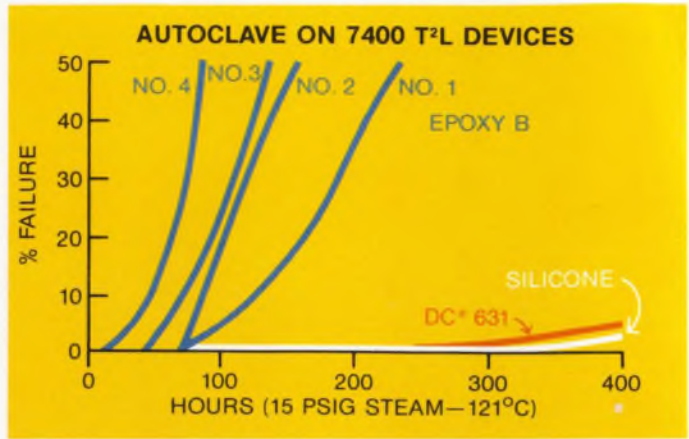
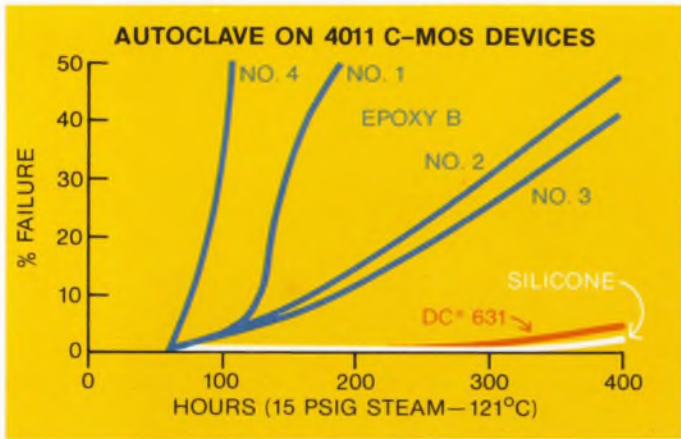

**Dow Corning 631. Unmatched design flexibility.** Dow Corning 631 silicone/epoxy molding compound gives you the compatibility, the moisture resistance and the unmatched ease of molding of silicone compounds. It gives you excellent 85/85-bias protection. It gives you the high strength, the strong lead seal, and the superb salt spray resistance of epoxy compounds. And it gives you all those advantages in one product. You can solve a problem with Dow Corning 631 that you wouldn't even approach with conventional molding compounds.

You have our word on how good Dow Corning 631 is. But we don't want you to just take our word for it. We want you to see for yourself. For samples and more information, write Dow Corning Corporation, Box 1767, Midland, Michigan 48640. Or, for immediate attention, call (517) 496-4682.

**Dow Corning 631 silicone/epoxy molding compound.  
Now everything else is second best.**

**Hong Kong**

Dow Corning Asia, Ltd.  
P&O Building, 9th Floor  
21 Des Voeux Road C  
Ph. 5-258035/7

**Brussels**

Dow Corning International, Ltd.  
Chaussee de la Hulpe, 177  
1170 Brussels, Belgium  
Ph. 02/673.80.60

**São Paulo**

Dow Corning do Brazil Ltda.  
Caixa Postal 4102-01000  
São Paulo, Brazil  
Ph. 52-2572, 52-8672

**Toronto**

6747 Campobello Road  
Mississauga, Ontario L5N 2M1  
416/826-9700

**Munich**

Dow Corning GmbH  
8 Munchen 50  
Pelkovenstrasse 152  
Ph. 89/14861

**Mexico City**

Dow Corning de Mexico, S.A.deC.V.  
Paseo de las Palmas 751, Piso 5  
Mexico 10, D.F., Mexico  
Ph. 905 5 40 31 10

**France**

Dow Corning SarL  
140 Avenue Paul Doumer  
92500-Rueil Malmaison, France  
Ph. 1/977.0040

**DOW CORNING**







# Your best source for SCRs is one you may never have heard of.

Would you believe Teccor? That's right. Teccor.

We're not a small components company. In fact, with over 1,000 employees, 3 plants, and over 16 million dollars in sales, we're not small at all.

Our reputation for dependable quality is known around the world. Has been for 13 years.

To give you the design flexibility you want, we offer the widest selection of SCR package designs in the industry.

At the same money you're paying now — maybe less.

Contact your local Teccor representative or call us at 817-267-2601. Tell us about your specific SCR applications. We'll get you the information or samples you need for evaluation.

You may not know us, but we figure it's only a matter of time.

Just think of us as the world's largest unknown source for SCRs.



**TECCOR**  
TECCOR ELECTRONICS, INC.  
P.O. Box 669 Euless, Texas 76039



(continued from page 32)

waveform values from ROM storage. All the pre and postprocessing circuits are available on the CZT prototype module.

Although the R5601 chip is designed for sampling rates from 500 Hz to 2 MHz, the CZT module is set up just for 100-kHz operation. Or it can be controlled by an external signal of up to 200 kHz.

### Quad-channel chirp chip

The R5601 chip itself is a surface-channel CCD split-electrode filter, in which analog charge packets are shifted along by a four-phase clock. It is packaged in a standard 22-pin DIP, and requires standard MOS-level clocks.

As with any CCD, digital or analog, mobile minority-charge carriers are stored in depletion regions under pulsed electrodes. The charges move in the direction dictated by the clocks, and the sampled signal moves down what amounts to an analog delay line.

Transversal filters, a fairly recent blossom in the CCD garden, are formed by splitting the pulsed electrodes. The location of the split is chosen to form capacitors whose size is correctly related to the tap-weight function. As the sampled analog signal moves down the line, each packet of charge introduces a current proportional to the product of its tap weight and its signal amplitude. The common connection between electrodes sums these currents, and the basic convolution calculation—summing many products—is accomplished.

Transversal filters can be made with some impressive specifications, such as

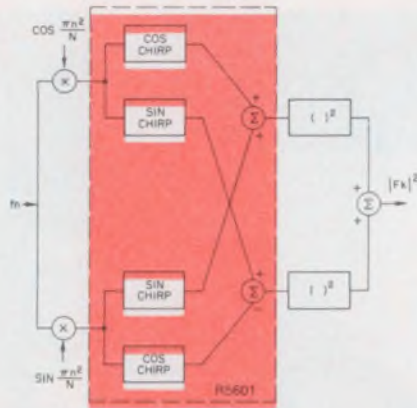

A CZT (chirped-Z transform) algorithm is implemented with external components in addition to the four transversal chirp filters of the R5601.

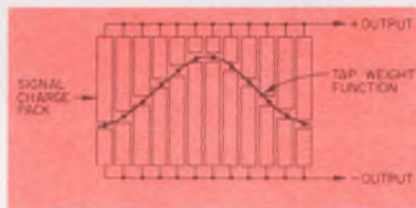

This split-electrode structure forms capacitors that hold the tap-weight function. Analog charges induce product currents that are summed and fed to differential amplifiers.

linear phase response, 1-MHz sampling rate, 100-dB/octave skirt steepness, and stopband rejection of 50 dB or more. For the CZT application, the tap-weight values are produced on the metal mask with an accuracy of  $\pm 8$  bits, and the complex convolution is performed by multiplying the input samples by these chirp-related tap weights.

Two types of chirp chips are available, the R5601-1 with linear-chirped

waveforms, and the R5601-2 with the same function multiplied by a Hanning window function. With the Hanning function, energy leakages into adjacent spectral lines are reduced. But this technique is used only in power spectral density applications, where phase information is not required. As a result, the 5601-1 can do either the total discrete Fourier transform or the PSD, while the 5601-2 can do only the PSD. Both devices, however, contain four 512-tap split-electrode transversal filters, with two sine chirps and two cosine chirps.

Each R5601 chip customer is required to buy at least one complete CZT module which requires only dc power to operate. The Reticon module is priced at \$600 including documentation, but without the CCD device. Either type of R5601 chirp chip costs \$675 in unit quantity, or \$265 in quantities of 100 and up. The availability of modules and chips is immediate, for sample quantities.

As new as the CZT-CCD capabilities are in the OEM market, the product is not an untried, unprecedented design. Reticon has been active for several years in producing related devices.

But the direct forerunner of the R5601 was developed by Texas Instruments under U.S. Navy contract. Technical contributions came also from GE, RCA, Bell Labs, and MIT (see *IEEE Journal of Solid-State Circuits*, Vol. SC-11, No. 1, Feb., 1976, pp. 75-84).

In addition, increasing the integration level of its CZT devices under Army and NASA contracts, TI has put the chirp multiplier DACs and clocks on a chip with its 500-point and 32-point CCD filters, and even includes the ROMs to feed the DACs on the 32-point chips. ■■

## Software distribution is a problem in personal computing—with solutions

With the ever increasing demand for computers by hobbyists and small businessmen, a problem that has been around for a long time but largely ignored is finally getting some attention—how to distribute software quickly and efficiently. Several solutions have been introduced, but so far

the least expensive way is to enter data into a computer from a series of bars, which are somewhat similar to the codes found on supermarket products. The width of the bars varies to represent a one or a zero, and seven bars can be used to represent one ASCII-coded character.

Other techniques include

- Magnetic tape cassettes.
- Floppy discs.
- Floppy ROMs.
- Magnetic cards.
- Semiconductor ROMs.

Actually, the simplest way is to print a listing of the program and send it out.



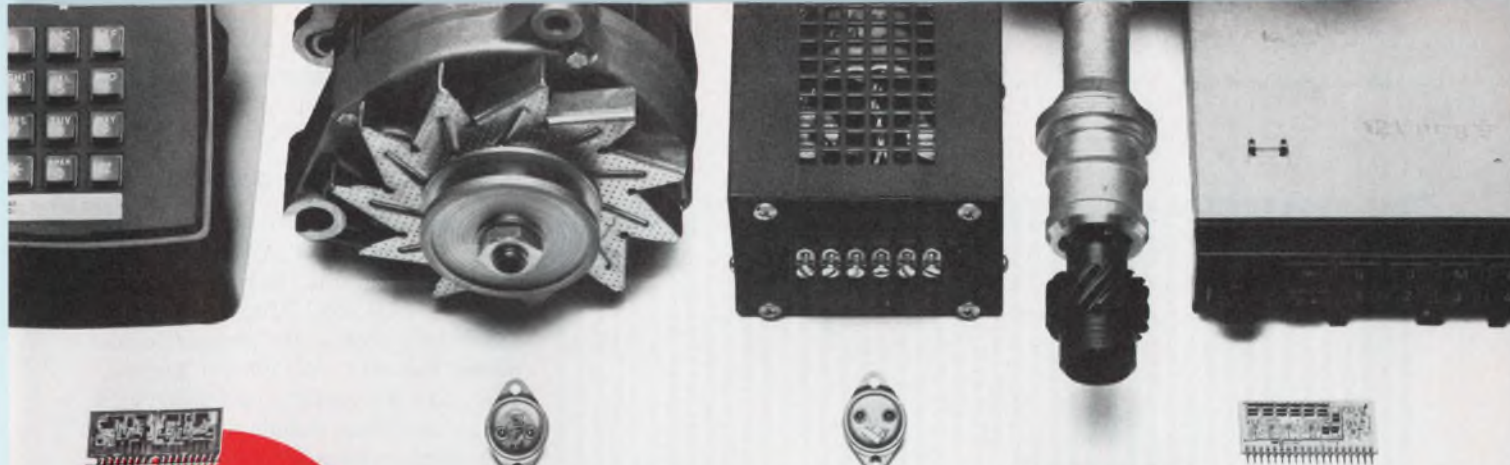

**HYBRID**

## **HYBRIDS RUSH IN WHERE MONOLITHICS FEAR TO TREAD.**

When you want to mix semiconductor technologies, maintain cost-effectiveness and avoid buying bulky subsystems, the only answer is hybrids. And when your requirements put equal emphasis on small size, high volume, high quality and low cost, Fairchild is the answer.

Although most people know us as one of the component giants of the western world, we also happen to be one of the world's largest suppliers of custom hybrids.

No other manufacturer can match our total hybrid capabilities. We custom-design and volume-produce hybrids for telecommunications, automotive, consumer electronics and industrial control applications. Our facilities in California and Hong Kong can turn out more reliable hybrid products in a day than most hybrid makers can produce in a week.

### **IF WE'RE SO GOOD, WHY AREN'T WE FAMOUS?**

Just about everything we make is custom. For example, we designed and now produce a hybrid ignition module for a major automobile manufacturer. We also make tuner control/station memory units for AM/FM radios and TV, products for telecommunications systems, and voltage regulators for industrial applications.

### **IT HELPS TO HAVE FRIENDS ON THE INSIDE.**

If we're known for anything, it's cost-effectiveness. There are two reasons. First, we're a volume manufacturer. Our ability to turn out hybrids in very large quantities translates into considerable cost savings for our customers. Second, Fairchild is one of the world's leading semiconductor manufacturers. We don't have to depend upon outside suppliers for the delivery, reliability or quality of the components we use. We also work directly with the people who design our components. So custom design time (and cost) is held to a minimum. The result is a better product at a lower cost to our customers.

### **READ OUR BROCHURE BEFORE YOU SEND US YOUR BREADBOARD.**

Get out your company letterhead and write to us about the kind of requirements you might have. We'll send you a comprehensive booklet on the world's most comprehensive hybrid facilities.

Your Fairchild sales office, distributor or representative could also help you get your hands on a copy. The phone number at the bottom of this ad is a direct line to our Hybrid Products people. Fairchild Camera and Instrument Corp., 464 Ellis Street, Mountain View, California 94042. Telephone: (415) 962-3771. TWX: 910-379-6435.

**FAIRCHILD**

**CALL US ON IT.  
(415) 962-3771**



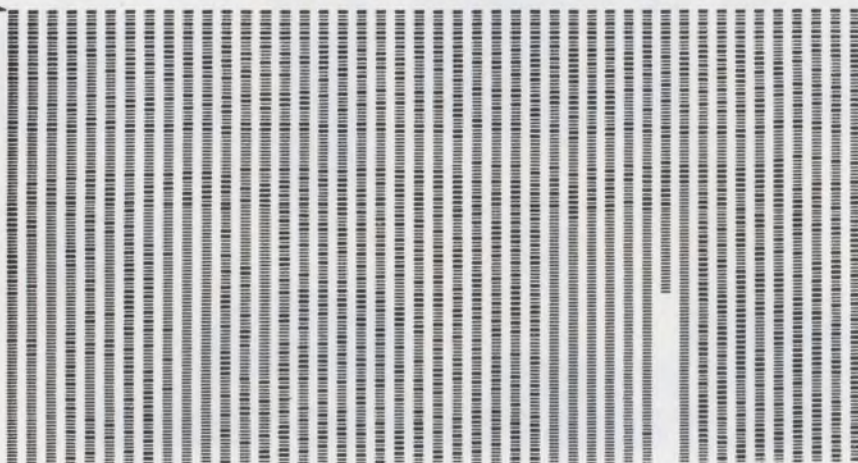

**Computer programs** printed in a bar-code format can be entered directly from a printed page into a computer with the aid of a scanner from Micro-Scan. Sensitivity is so good, that even photocopies of the bar code can be read.

But it is also the most inconvenient. Someone has to sit by a terminal and type the program in—which can be very time-consuming and inefficient if the program is long, as most useful ones are.

Punched paper tape, which reduces entry time drastically, can be read on most computer systems. But paper tape is awkward to handle and easily damaged. Reproduction is a problem, too, because paper tapes can only be reproduced one at a time. So if large quantities are needed, it takes a while to prepare the tapes.

But the bar-scanner technique developed by Walter Banks, head of the computer communications network group at the University of Waterloo in Canada, combines the mass production and low cost of the printed page with the ease of inputting data directly into a computer. To read the bar code, a simple hand-held scanner is used to scan a line of code. The output of the scanner is a TTL-compatible serial signal that is then fed into any parallel port of any computer. The signal is fed to the computer in the most significant bit position so it looks like a sign bit. A test is performed to see if it is a one or zero. Additional software converts the data to alphanumeric information. Only 256 bytes of machine language code are required to handle the input and interpretation of data entered from the bar-code scanner.

Several companies are preparing entries into the bar-code scanner arena. One scanner, just introduced by Micro-Scan Associates of Natick, MA, sells

for \$97, which is an order of magnitude cheaper than any available optical scanners. The expensive optics normally used have been eliminated, explains Frederick L. Merkwitz, designer of the unit. All the scanning head consists of is a rectangular aperture placed in front of a Texas Instruments TIL 139 LED-phototransistor pair. The lenses generally seen in scanners aren't needed, Merkwitz notes, because the rectangular aperture makes it possible to integrate light over the whole bar, while units that use lenses only look at a small circular portion of the bar.

This difference in reading also enables the Micro-Scan unit to read photocopies as well. No other scanner available can do that, Merkwitz claims.

Although the Micro-Scan is not yet in wide use, Merkwitz notes that there are several promising applications pending. Right now, computer programs can be entered directly from a book or magazine article. One hobby magazine has already started printing programs in machine-readable, as well as human-readable, form.

Minicomputer manufacturers have expressed interest in using bar codes and scanners to patch already released software, Merkwitz goes on, or to use them even to distribute small software packages. They might also be used with scientific calculators to enter programs.

Data density per printed page is about the same as that for conventional program listings and input speed to a

computer is comparable to that of paper tape.

## Magnetic tape has problems

Meanwhile, magnetic tape is widely used throughout the industry to store software programs. But there is no standard available. Efforts to standardize tape format for personal computing has met with limited success. There are still about a half dozen different recording techniques used.

Consumer-computer manufacturers like to use cassette tapes as a distribution medium because almost everyone has a reader—the conventional cassette recorder. The big problem for the software distributor, however is that cassettes are expensive and have to be produced one at a time. And for data-storage applications, high-quality tape and recording equipment are a must. In addition, several different recording formats must be provided to cover the whole market.

Floppy discs, which have become the darling of micro/mini users, have similar problems. They do have a much larger storage capacity, and are faster, but like cassettes, they have no standard. An IBM design is used by many manufacturers, but only for physical disc drives. Many IBM-compatible discs cannot be used on other IBM-compatible machines because the technique used for storing and retrieving data differs from unit to unit. And floppy discs are an expensive storage medium, typically \$8 per disc.

## Floppy ROM debuts

Another approach to the mass distribution of software is a flexible vinyl record that can be bound into a magazine. Known as a floppy ROM, it combines the convenience of cassette tapes with the low cost of records.

As with cassettes, most people already have a reader for the floppy ROM, their conventional hi-fi system. The floppy ROM itself can be mass-pressed like conventional records and made for only about 10¢ apiece. They can store about 4 kbytes of data. Interfacing to a computer is done via cassette-interface electronics.

A variation on the floppy ROM is the conventional phonograph record. With this approach, longer recording times become available—which means that either longer programs or multiple programs can be recorded or, as is currently being done, one program can be recorded with several different record-



# "Light-up" your customers

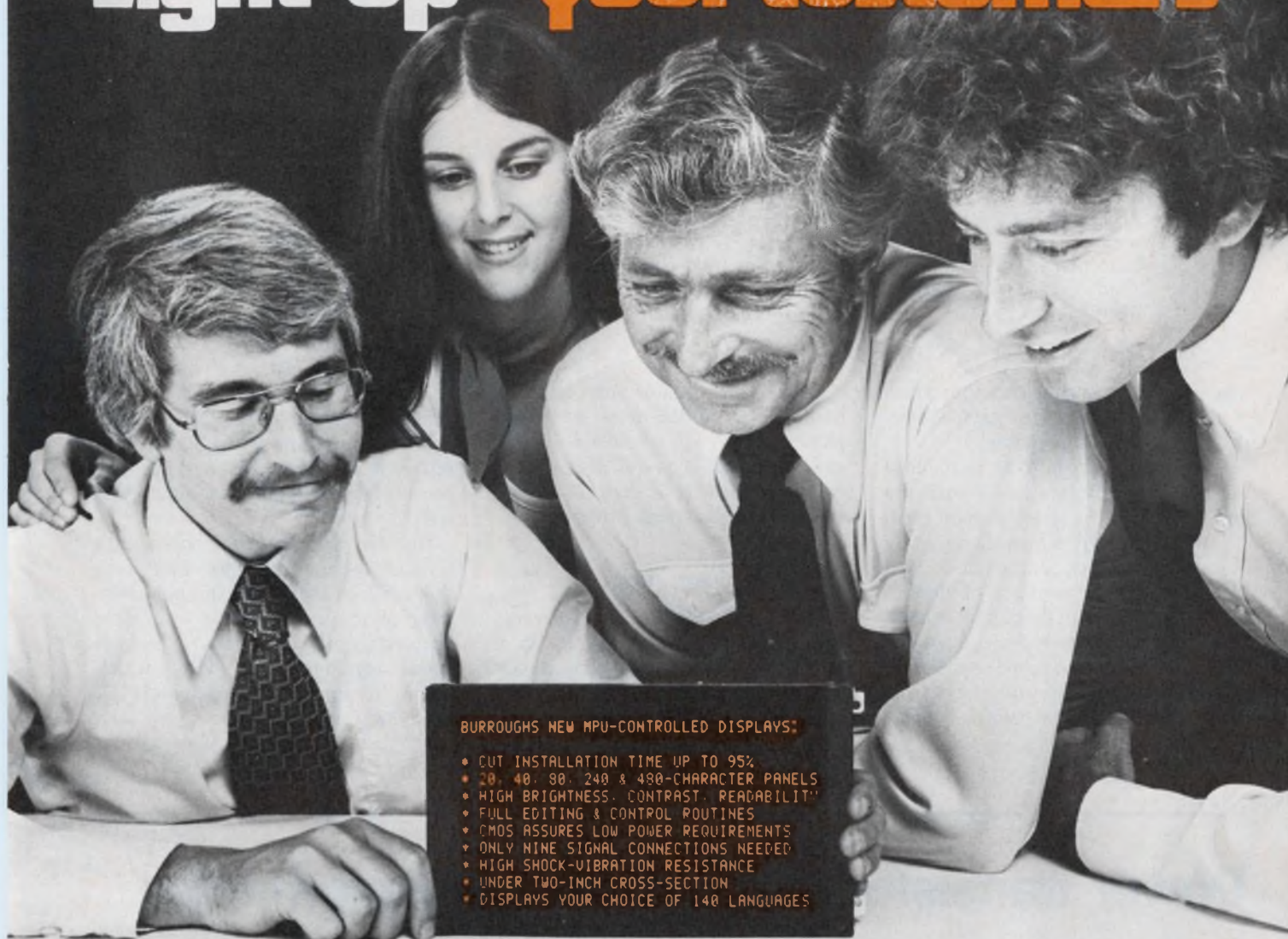

## BURROUGHS NEW MPU-CONTROLLED DISPLAYS:

- CUT INSTALLATION TIME UP TO 95%
- 20, 40, 80, 240 & 480-CHARACTER PANELS
- HIGH BRIGHTNESS, CONTRAST, READABILITY
- FULL EDITING & CONTROL ROUTINES
- CMOS ASSURES LOW POWER REQUIREMENTS
- ONLY NINE SIGNAL CONNECTIONS NEEDED
- HIGH SHOCK-VIBRATION RESISTANCE
- UNDER TWO-INCH CROSS-SECTION
- DISPLAYS YOUR CHOICE OF 140 LANGUAGES

## ...with Burroughs new microprocessor-controlled thin display systems!

Burroughs announces a major advance in its popular line of SELF-SCAN® gas plasma displays: *microprocessor-control and memory!* This means big savings plus the greatest operating and packaging flexibility ever in the flat panel display of alphanumeric information.

Your engineers will "light-up", too, as they discover operating advantages unmatched by any display. The new SELF-SCAN II displays are bright, crisp, easy-to-read. And, with Burroughs' unique new simplified control circuitry, the display panel — complete with electronics — is less than 2" thin for easy installation in compact designs.

The display's built-in microprocessor memory and control eliminate the need for you to design, develop and build circuitry to effect display operation. Just feed in appropriate 8-bit signals for the characters and control commands and you're in operation. Large system manufacturers save 95% of the engineering and development time formerly required and small system producers can now use displays since "design-in" cost is no longer a significant factor.

Adapting the Burroughs displays to your needs is as easy as a change in software. Their operation can be tailored for any product and changed for others with different display requirements.

The display subsystem operates off an 8-bit bi-directional buss or a TTL buss. Data can be entered at rates up to 1 MHz. and, with the addition of a keyboard and communication interface, it becomes a low-cost, compact data terminal!

The system's edit and control routine allows insertion, deletion and blinking of letters or lines, increasing or decreasing brightness, right-to-left data entry, etc.

Light up your customers and your engineers. And lighten your costs with Burroughs SELF-SCAN II microprocessor-controlled displays. For a copy of our SELF-SCAN Subsystems Brochure, write Burroughs Corporation, Electronic Components Division, P.O. Box 1226, Plainfield, New Jersey 07061 or call (201) 757-5000. Overseas, contact Burroughs ECD International, Buckingham House, The Broadway, Stanmore, Middlesex, England.

You can see the difference

# Burroughs



DISTRIBUTED BY HAMILTON AVNET AND CRAMER ELECTRONICS



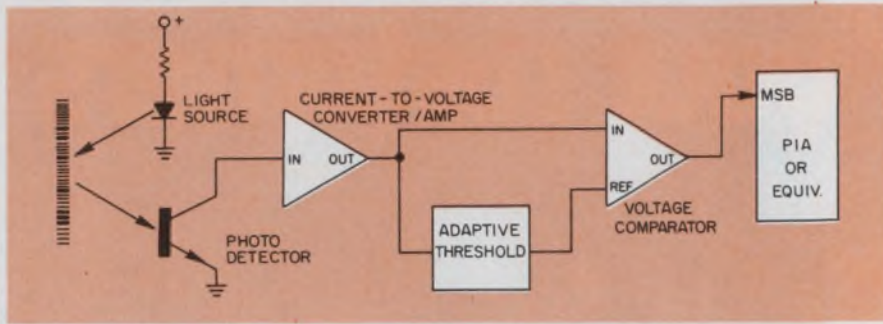

**Bar coded programs** are illuminated by a LED and sensed by a phototransistor. The pulse produced by the transistor is amplified and fed to a comparator. An adaptive threshold circuit that is used as a reference for the comparator helps eliminate noise. The output of the comparator then goes to a peripheral interface adapter (PIA) and then to the computer.

ing techniques so that it can interface with any of the cassette interface electronics currently available.

The latest medium to be introduced for the mass distribution of software is a card about the size of a credit card. The Kilobyte card is manufactured by Vertel Electronics. Although it is a magnetic-storage medium, it doesn't suffer from the high reproduction costs generally associated with magnetic storage. Cards can be produced in long strips and then cut up afterwards. They don't have to be recorded one at a time.

Each card contains four tracks of data that store 256 bytes, so that by passing it through a reader 4 times, it can yield 1024 bytes of data. This is equivalent to 30 to 50 lines of a conventional Basic language program.

#### Firmware being offered

For large, sophisticated programs, the PROM is gaining in popularity as a distribution medium. Software that has been placed in hardware is known as firmware. While this concept has been around for a long time, only the

recent low cost of semiconductor ROMs and PROMs has made it a feasible software-sharing technique.

A real-time operating system for the 6800 microprocessor is being offered as firmware by Microware in Des Moines, IA, and by AMI, a semiconductor manufacturer that produces the 6800.

Microware's RT-68 can easily be substituted into any system that uses Motorola's Mikbug ROM. The RT-68 has the same entry points as the Motorola device and is a real-time task scheduler that can handle 16 chores at one time.

#### Computer-to-computer exchange

The most sophisticated way of distributing software is by a computer to computer exchange. This has been done by large computers for a long time via different data networks, and has now become feasible for small computers as well.

One way is to equip computers with a cassette-tape interface and have them talk to each other through these interfaces. Another way is simple frequency-shift keying over conventional communication lines, which makes it possible for computers all over the world to converse with each other and exchange software. ■■

## Power transistor process boosts performance

A new breed of power transistors offers the rugged safe-operating area generally associated with single-diffused-base transistors and the economy and complementary structures of epitaxial-base devices.

Announced by Motorola Semiconductor, Phoenix, AZ, the transistors are fabricated with what Motorola calls a power-base process. This technique reduces the crowding of current into destructive hot spots, according to Ralph Greenburg, Motorola's manager of power products. A base-spreading resistance ring is used to produce a uniform current flow in the relatively thick epitaxial base region.

Base-spreading resistance should not be confused with base or emitter-ballast resistors that have been used in the past, says Greenburg. In an npn device, the base-spreading resistance takes the form of a ring structure that

surrounds the N+ emitter area in the center of the power-semi chip. This ring is fabricated by making an extra, deep P+ diffusion in the area surrounding the emitter.

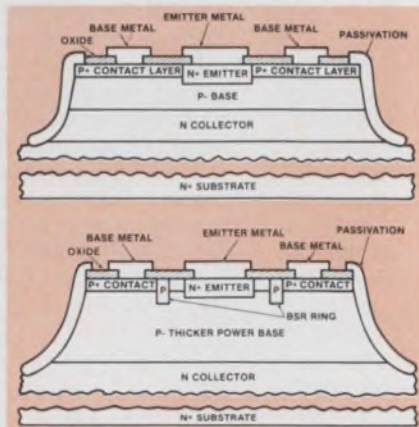

**Power-base transistors** (bottom) are constructed very much like conventional epitaxial devices (top).

Some additional changes are required in the standard epitaxial-base process to produce the new power-base devices. The epitaxial-base region and the collector-base are thicker than usual. And, since the thicker bases result in a lower gain, the concentration of impurities in the emitter is changed to bring the gain back up.

Comparing the new power-base devices with those currently available, Greenburg notes that they yield performance similar to that of single-diffused devices but with a much smaller chip. For example, a single-diffused device fabricated on a 180 x 180-mil chip can be replaced by a power-base device whose chip is only 120 x 120 mil. Not only does this size reduction cut costs, but also the modified epitaxial-base process is an inherently less expensive process than single-diffused. ■■



# Sprague... Prime source for SOURCE DRIVERS

## HIGH-VOLTAGE, HIGH-CURRENT INTERFACE ICs

Sprague Source Drivers are "high-performance" integrated circuits targeted for low-level logic applications requiring interface to solenoids, MUXed LEDs, lamps, vacuum fluorescent displays, stepping motors, telecommunications relays, triacs, SCRs, PIN diodes, and other high-level peripheral loads. Inductive-load drivers incorporate internal diodes for suppression of voltage transients. All types have input current-limiting resistors for compatibility with standard logic families.

● Type UDN-2956A and UDN-2957A 14-lead DIP designs are customarily used for switching the ground side of telecommunications relays (usually -48V). Positive input and "enable" levels activate the output load.

● Series UDN-2980A 18-lead DIP devices are 8-channel source ICs for general applications, including MUXed LEDs (segment-driver/common-cathode; digit-driver/common-anode), lamps, relays, solenoids, motors, triacs, etc. An appropriate logic "1" on the input switches the output "on"; an input inverter buffers the high supply voltage from the logic circuitry. A prime application is the replacement of current-sinking ICs which may experience logic malfunctions associated with high ground currents (IR buildup) or ground noise.

● Type UDN-6118A and UDN-6128A 18-lead DIP devices are intended for vacuum fluorescent display interface. A positive input signal causes the driver outputs to switch high. Internal pull-down resistors minimize component count as well as reduce circuit cost.



Application	Telecommunications Relays, PIN Diodes, & General-Purpose Power		LEDs, Relays, Motors, Lamps, Triacs, Solenoids, & General-Purpose Power		Vacuum Fluorescent Display Segment and Digit Driver	
	UDN-2956A	UDN-2957A	UDN-2981A/83A	UDN-2982A/84A	UDN-6118A	UDN-6128A
Type Number	UDN-2956A	UDN-2957A	UDN-2981A/83A	UDN-2982A/84A	UDN-6118A	UDN-6128A
Sustaining Voltage	80V	80V	50V (UDN-2981A) 80V (UDN-2983A)	50V (UDN-2982A) 80V (UDN-2984A)	85V	85V
Source Current	500mA	500mA	500mA	500mA	40mA	40mA
No. of Drivers	5	5	8	8	8	8
Input	6-15V	5V	5V	6-15V	5V	6-15V
Engineering Bulletin	29309		29310		29313	

For application engineering assistance on these or other interface circuits, standard or custom, write or call George Tully or Paul Emerald, Semiconductor Division, Sprague Electric Company, 115 Northeast Cutoff, Worcester, Mass. 01606. Telephone 617/853-5000.

For Engineering Bulletins and a 'Quick Guide to Interface Circuits', write to: Technical Literature Service, Sprague Electric Company, 347 Marshall Street, North Adams, Mass. 01247.

### FOR FAST INFORMATION, CALL YOUR NEAREST SPRAGUE SALES OFFICE:

ALABAMA, Sprague Electric Co. 205/883-0520 • ARIZONA, Sprague Electric Co. 602/279-5435 • CALIFORNIA, Sprague Electric Co. 213/649-2600 Wm. J. Purdy Co. 415/347-7701 NCF Corp. 714/278-7640 • COLORADO, Wm. J. Purdy Co. 303/777-1411 • CONNECTICUT, Sprague Electric Co. 203/261-2551 • DIST. OF COLUMBIA, Sprague Electric Co. (Govt. sales only) 202/337-7820 • FLORIDA, Sprague Electric Co. 305/831-3636 • ILLINOIS, Sprague Electric Co. 312/678-2262 • INDIANA, Sprague Electric Co. 317/253-4247 • MASSACHUSETTS, Sprague Electric Co. 617/859-9100 • MICHIGAN, Sprague Electric Co. 413/664-4411 • MINNESOTA, Sprague Electric Co. 517/787-3934 • MINNESOTA, HMR, Inc. 612/920-8200 • MISSOURI, Sprague Electric Co. 314/781-2420 • NEW JERSEY, Sprague Electric Co. 201/696-8200 • NEW MEXICO, Sprague Electric Co. 609/795-2299 Trimble Sales Inc. 805/795-4200 • NEW MEXICO, Wm. J. Purdy Co. 505/266-7959 • NEW YORK, Sprague Electric Co. 516/549-4141 Wm. Rutt Inc. 914/698-8600 Sprague Electric Co. 315/437-7311 Mar-Com Associates 315/437-2843 • NORTH CAROLINA, Electronic Marketing Associates 919/722-5151 • OHIO, Electronic Salesmasters, Inc. 800/362-2616 Sprague Electric Co. 513/278-0781 • PENNSYLVANIA, Sprague Electric Co. 215/467-5252 Trinkle Sales Inc. 215/922-2080 • TEXAS, Sprague Electric Co. 214/235-1256 • VERMONT, Ray Perron & Co. Inc. 617/762-8114 • VIRGINIA, Sprague Electric Co. 703/463-9161 WASHINGTON, Sprague Electric Co. 206/632-7761 • CANADA (Ontario), Sprague Electric of Canada Ltd. 416/766-6123 • CANADA (Quebec), Sprague Electric of Canada, Ltd. 514/683-9220



... and you thought we only make great capacitors.

CIRCLE NUMBER 27





# Check out TI's new 4K static RAMs.

They've got  
everything  
you ever liked  
about the 2102.

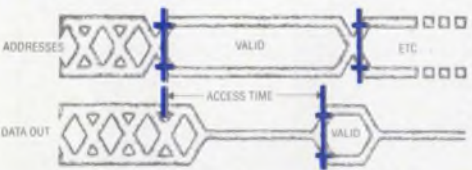
And more.

	2102 1K Static RAM	TI's New 4K Static RAMs	
<b>SIMPLE TO USE</b>	✓	✓	Like the popular 2102, TI's new 4K static RAMs are easy to use. Minimize system overhead; no refresh; simple addressing. It's easy!
<b>NO CLOCKS. NO TIMING STROBES.</b>  	✓	✓	No clocking needed for TI's fully static 4K RAMs. No edges. Just present an address to the selected device and data can be read at access time. That's it.

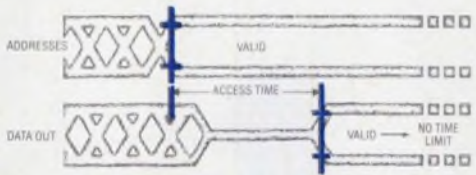
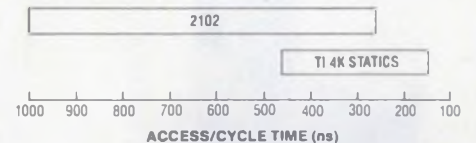

	2102 1K Static RAM	TI's New 4K Static RAMs																			
<b>FULLY STATIC. ACCESS TIME = CYCLE TIME.</b>	✓	✓	Fully static RAMs are totally asynchronous. Require no precharge or recovery time. Access and cycle times are always the same.																		
<b>DATA VALID - NO TIME LIMIT.</b> 	✓	✓	Fully static RAMs offer output data that are valid as long as the address is valid. Makes designing straightforward. No limit on output valid time. No extra circuitry.																		
<b>SINGLE +5 V SUPPLY. FULLY TTL COMPATIBLE.</b>	✓	✓	Just one +5 V supply needed. Full TTL compatibility on all inputs and outputs with full 400 mV guaranteed dc noise immunity.																		
<b>±10% TOLERANCE SUPPLY.</b>		✓	Improved power supply tolerance means less stringent regulation. Less cost.																		
<b>HIGH SPEED.</b>  <table border="1" data-bbox="109 1270 585 1417"> <thead> <tr> <th>Max Access</th> <th>4K x 1</th> <th>1K x 4</th> </tr> </thead> <tbody> <tr> <td>150 ns</td> <td>TMS 4044-15</td> <td>TMS 4045-15</td> </tr> <tr> <td>200 ns</td> <td>TMS 4044-20</td> <td>TMS 4045-20</td> </tr> <tr> <td>250 ns</td> <td>TMS 4044-25</td> <td>TMS 4045-25</td> </tr> <tr> <td>300 ns</td> <td>TMS 4044-30</td> <td>TMS 4045-30</td> </tr> <tr> <td>450 ns</td> <td>TMS 4044-45</td> <td>TMS 4045-45</td> </tr> </tbody> </table>	Max Access	4K x 1	1K x 4	150 ns	TMS 4044-15	TMS 4045-15	200 ns	TMS 4044-20	TMS 4045-20	250 ns	TMS 4044-25	TMS 4045-25	300 ns	TMS 4044-30	TMS 4045-30	450 ns	TMS 4044-45	TMS 4045-45		✓	TI's new 4K static RAMs take up where the 2102 left off. Offering a wide choice of speeds from 150 ns to 450 ns maximum access/minimum cycle. Plenty of performance to match today's and tomorrow's CPUs.
Max Access	4K x 1	1K x 4																			
150 ns	TMS 4044-15	TMS 4045-15																			
200 ns	TMS 4044-20	TMS 4045-20																			
250 ns	TMS 4044-25	TMS 4045-25																			
300 ns	TMS 4044-30	TMS 4045-30																			
450 ns	TMS 4044-45	TMS 4045-45																			
<b>LOW POWER.</b> <table border="1" data-bbox="109 1522 585 1711"> <thead> <tr> <th>Parameter</th> <th>Four Low Power 1K Static RAMs (2102AL-2)</th> <th>One TI 4K Static RAM (TMS 4044-25)</th> </tr> </thead> <tbody> <tr> <td>Max. Access</td> <td>250 ns</td> <td>250 ns</td> </tr> <tr> <td>Min. Cycle</td> <td>250 ns</td> <td>250 ns</td> </tr> <tr> <td>Operating Power (Max.)</td> <td>1368 mW</td> <td>500 mW</td> </tr> <tr> <td>Package(s)</td> <td>4 x 16 pin</td> <td>1 x 18 pin</td> </tr> <tr> <td>Board Area Ratio</td> <td>3.7</td> <td>1.0</td> </tr> </tbody> </table>	Parameter	Four Low Power 1K Static RAMs (2102AL-2)	One TI 4K Static RAM (TMS 4044-25)	Max. Access	250 ns	250 ns	Min. Cycle	250 ns	250 ns	Operating Power (Max.)	1368 mW	500 mW	Package(s)	4 x 16 pin	1 x 18 pin	Board Area Ratio	3.7	1.0		✓	Compare the power savings of the new 4K statics to the low power 21L02. For equivalent speed, the new TMS 4044 uses 63% less power. For super low standby-power/battery-backup operation, use the pin-compatible 20-pin TMS 4046/47 Series. Data is retained down to 10 mW.
Parameter	Four Low Power 1K Static RAMs (2102AL-2)	One TI 4K Static RAM (TMS 4044-25)																			
Max. Access	250 ns	250 ns																			
Min. Cycle	250 ns	250 ns																			
Operating Power (Max.)	1368 mW	500 mW																			
Package(s)	4 x 16 pin	1 x 18 pin																			
Board Area Ratio	3.7	1.0																			
<b>HIGH DENSITY 18-PIN PACKAGE.</b> 		✓	The new 4K statics come in industry-standard, 18-pin packages, plastic or ceramic. A density improvement of almost four-to-one over 2102s.																		

FOR DATA SHEETS, application reports, price and delivery, call your nearest authorized TI distributor or TI field sales office.

**TEXAS INSTRUMENTS**  
 INCORPORATED  
 CIRCLE NUMBER 28



# A little knowledge about computers can be expensive. A lot can be free.



1. The inside story on how our full **PRODUCT LINE** makes the difference to you.  
Reader Service #101



2. How **Commercial ECLIPSE** Systems answer the diverse demands business makes today on a data system.  
Reader Service #102



3. The secret of having computer power where your business needs it. Our book on **CS/40 SMALL BUSINESS SYSTEMS** tells.  
Reader Service #103



4. Describes seven important **SUPPORT SERVICES** that get systems up and running, then keep them there.  
Reader Service #104



5. Find out how our **Real-Time Disc Operating System SOFTWARE** can get you on-line fast, and keep you there.  
Reader Service #105



6. **IT'S SMART BUSINESS** to know how our way of doing business benefits our customers.  
Reader Service #106



7. How **OEM's** solve the dilemma of keeping their system costs down with our **NOVA 3 COMPUTER FAMILY**.  
Reader Service #107



8. What you need to know about getting everything for a **DATA ACQUISITION and CONTROL** system from one place.  
Reader Service #108



9. The last word in microprocessor-based **microNOVA** systems with full 16-bit **NOVA** architecture.  
Reader Service #109





10. The amazing story behind our unique heuristic MULTI-PROGRAMMING operating system.  
Reader Service #110



11. What to do when you need fast, fast access to MASS STORAGE.  
Reader Service #111



12. NOVA 3 systems, software and support let you customize a system to your application.  
Reader Service #112



13. A wealth of information about how our computers are being used in actual APPLICATIONS.  
Reader Service #113



14. Wonder what sets the benchmark for big performance computer systems? Wonder no more, it's ECLIPSE S/230.  
Reader Service #114



15. Is there a sensible way to use computers in DATA COMMUNICATIONS? The message comes through clear.  
Reader Service #115



16. What's the most you can expect to get from a mid-range mini today? What you get with an ECLIPSE S/130 — the standard setter.  
Reader Service #116



17. You want terminals that work the same way you do? You want the facts on our DASHER TERMINALS.  
Reader Service #117



18. Our whole SPARE PARTS catalog. They're too important to be kept a mystery.  
Reader Service #118



19. 1976 was a very good year. Our ANNUAL REPORT could be good for you.  
Reader Service #119

Mail to: Data General, Westboro, MA 01581

ED1011

Yes, I'd like to pick your brains. Please send me the brochures I have circled.

I'm in a hurry. Have your sales representative bring in the brochures I have circled.

Brochure numbers: 1 2 3 4 5 6 7 8 9 10 11 12 13 14 15 16 17 18 19

Name \_\_\_\_\_ Title \_\_\_\_\_

Company \_\_\_\_\_

Address \_\_\_\_\_ Tel. \_\_\_\_\_

City \_\_\_\_\_ State \_\_\_\_\_ Zip \_\_\_\_\_

Data General, Westboro, MA 01581, (617) 366-8911. Data General (Canada) Ltd., Ontario. Data General, Europe, 15 Rue Le Sueur, Paris 75116, France, 50-006-06. Data General Australia, Melbourne (03) 82-1361.

© Nova and ECLIPSE are registered trademarks of Data General Corp., 1977. DASHER is a trademark of Data General Corporation.

 **Data General**  
It's smart business.

© Data General Corporation, 1977



if you're designing ATE systems  
you really ought to talk to  
our power supplies

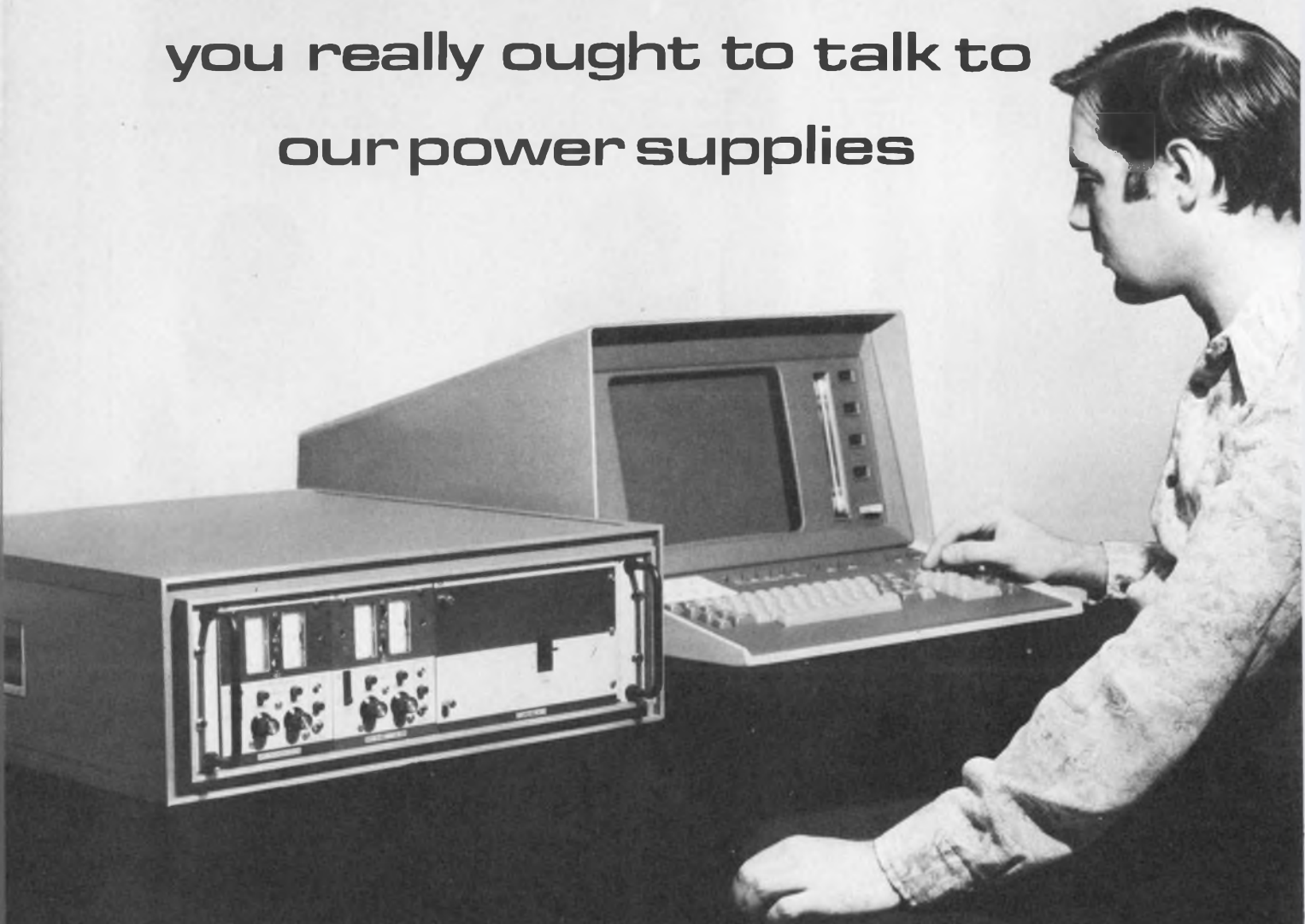

... hundreds of models  
interface the IEEE 488 BUS  
through the  
KEPCO SN-488 programming system

Write Dept. BYF-05 for all the details

**KEPCO**®

131-38 SANFORD AVENUE • FLUSHING, N.Y. 11352 U.S.A. • (212) 461-7000 • TWX # 710-582-2631 • Cable: KEPCOPOWER NEWYORK

CIRCLE NUMBER 30



# Washington report

---

## Space Shuttle instruments chosen

Five instruments have been chosen for the experimental payload of NASA's second orbital mission for the Space Shuttle. This flight, scheduled for 1979, will be the first with a predominantly scientific payload: The first mission will be devoted almost entirely to monitoring the performance of the spacecraft itself.

The instrument, an active radar of a type used in the Landsat earth-resources satellite program, is intended to operate in the microwave region of the spectrum. Landsat uses visible and near-infrared observations, and NASA considers active microwave sensors particularly valuable for mineral exploration and observations in areas usually covered by clouds. Another Landsat-type instrument, a multispectral IR radiometer, will test various combinations of near-IR bands not now used by Landsats.

Other instruments on the spacecraft will be used in experiments to measure the amount and circulation of carbon monoxide in the middle and upper troposphere; to find concentrations of chlorophyll in ocean water in an attempt to locate fish feeding grounds; and to examine the correlation between lightning and various types of severe storms. This last experiment will use a standard 16-mm movie camera rigged with a photocell to record lightning flashes as signals on a film sound track.

## Cruise missile price tag put at \$3.2-billion

Cruise missiles needed to fill the gap in strategic defenses left by the cancellation of the B-1 bomber will cost \$3.2-billion, the Pentagon now estimates. While the number of missiles needed has not been given, Navy Capt. Walter M. Locke, the Defense Department's cruise missile program manager, has estimated that the cruise missiles will cost up to \$1-million each when inflation is taken into account.

Testifying recently before the House Armed Services Committee, Locke stated that \$104.6-million in procurement funds will be needed for fiscal year 1978, which begins Oct. 1, and that another \$142.5-million will be earmarked for procurement in fiscal year 1979. These funds are above and beyond the \$218-million to be spent on cruise-missile development in fiscal 1978. According to Locke, the development funds will be used to prepare for the competitive flyoff in 1979 between Air Force and Navy Cruise missiles (ED No. 19, Sept. 13, 1977, p. 45) and to gear aircraft to accommodate cruise missiles.

## \$1.2-billion AWACS offer to Iran goes to Congress

Congress is considering a \$1.2-billion Defense Department proposal to sell an air defense system to Iran—seven E-3 Airborne Warning and Control System aircraft (\$718.7-million) plus maintenance, training and spare parts (\$510.2-million).

The offer had earlier been blocked by Congress on grounds that AWACS was more expensive than alternate systems and that selling the electronics-laden aircraft to Iran might cause top-secret cryptographic equipment to fall into the hands of the Soviet Union.

President Carter attempted to reassure Congress by promising that such



sensitive equipment as the KG-40 encipherment system, the Joint Tactical Information Distribution System, signal-intelligence equipment, electronic counter-countermeasures and a security mode of identification of friend and foe (IFF) would not be included in the deal.

Meanwhile, the Pentagon sought to override objections that there was a better alternative to AWACS by doing a comparative study of AWACS vs both the Navy's E-2C airborne warning aircraft and a ground-based radar system known as Seek Sentry. According to the Pentagon Study team, AWACS would be available in six and a quarter years at a total cost of \$2.25-billion, including 12 existing Westinghouse ADS-4 ground radars, while 21 E-2C aircraft and the same radars would cost \$1.95-billion and take six and a half years. However, the E-2C is a smaller aircraft and would not have the speed, range or on-station time of AWACS.

## **Air Force to develop anti-satellite weapons**

The Air Force is launching a program to develop anti-satellite weapons to match recent Soviet experiments with hunter-killer satellites that were tested against Russia's own satellites. Although a 1958 treaty bans weapons in space, it does not forbid a nation from testing them against its own satellites.

The top-secret Air Force effort, known as the Satellite Defense Technology Program, will study launching projectiles from both spacecraft and aircraft against hostile satellites. Anti-satellite weapons, which would be developed for the North American Air Defense Command, would fire small, lightweight projectiles from satellites orbited by Atlas or Titan boosters.

The studies will also consider high-flying aircraft that can go into a steep climb and fire projectiles into space from pods mounted under their wings. An Air Force F-15 fighter recently demonstrated that it could climb to an altitude of 96,000 feet in less than three and a half minutes.

## **NASA using IR to study air turbulence**

A new round of tests to improve measurements of clear-air turbulence (CAT) through infrared radiometry techniques is due to begin in mid-October under a joint program of the National Aeronautics and Space Administration and the National Oceanic and Atmospheric Administration. The tests will try to determine how much IR readings are affected by the direction the turbulence is approached and which IR wavelengths indicate the duration and intensity of the turbulence most reliably.

Earlier NOAA tests had achieved an 81% reliability in detecting CAT ahead of an aircraft, and NASA plans to check those results with an IR radiometer mounted in a Lear Jet. The radiometer will read the fluctuation in water vapor associated with CAT. An accelerometer will measure turbulence actually encountered.

**Capital Capsules:** The Air Force has ordered full-scale development of the Precision Location Strike System, **an array of airborne sensors to pinpoint and attack enemy air-defense radars.** Lockheed Missiles & Space Co. was chosen as the prime contractor in June and awarded a \$30-million contract, but actual payment was held up pending final approval. . . After a series of delays, the Sikorsky Aircraft Div. of United Technologies Corp. was chosen over the Boeing Vertol Div. to supply **the air frame for the Navy's Light Airborne Multi-Purpose System (LAMPS) Mark III anti-submarine-warfare helicopter.** At the same time, the Navy admitted that LAMPS prime contractor IBM had an 8% avionics "cost growth."



# New: The First Monolithic D/A Converter System.

**No one else can give you an 8-bit DAC with all peripheral functions on-chip. It's truly microprocessor-compatible and costs \$6.95!**

Single-chip D/A converter circuits have been around a long time. But so have the design problems that go along with them when interfacing with microprocessors—selection of op amps, voltage reference, latches and the various other active components you've had to add to use them.

Now, for the first time, you can simplify your system design by using the Signetics 5018 Monolithic D/A Converter System. It combines, on a single chip, the converter circuit and all the required peripheral functions—a voltage reference, input latches, and an output amplifier. It costs, in quantities of 100 and up, only \$6.95. That's one reason why it saves you money. **Reduce Parts Count and Assembly Costs.**

The 5018 is a system simplifier and cost reducer. You can forget about the costs associated with all those extra parts. Material control is simpler. Incoming test and inspection costs go down. Component handling and assembly expenses can be reduced as much as 75 percent.

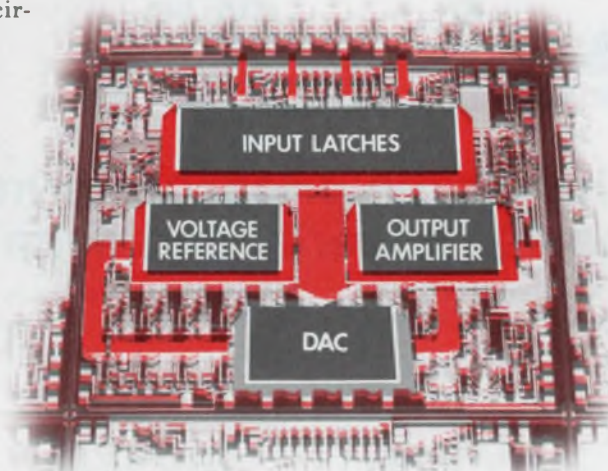

## Ideal Architecture for Computer-Based Systems.

The 5018 has built-in latches and extremely low input loading (1/100 TTL load per line). These features make it a good choice for multiple-peripheral, bus-oriented microprocessor or computer-based systems. The low input loading lets you drive many converters from a single bus. The latches then permit the bus to service several peripherals at its maximum throughput rate.

Temperature stability is an added plus. The reference voltage can be adjusted for correct full-scale value with minimal temperature effects. Temperature-related inaccuracies are also minimized because the precision, low-temperature coefficient resistors are on the chip. **Other Signetics DACs.**

The 5018 is our newest D/A conversion product. The coupon below will help you learn more about it. If you'd like other data sheets on our other D/A converters listed below, be sure to check the appropriate boxes or call your nearest Signetics distributor.

# signetics

a subsidiary of U.S. Philips Corporation

Signetics Corporation  
811 East Arques Avenue  
Sunnyvale, California 94086  
Telephone 408/739-7700

## SIGNETICS D/A CONVERTERS

5018—Monolithic D/A Converter System  
5007/5008—8-Bit, High Speed, Multiplying DAC ( $\pm 0.19\%$ )  
5009—8-Bit, High Speed, Multiplying DAC ( $\pm 0.1\%$ )  
MC 1408—8-Bit, Multiplying D/A Converter

To: Signetics Information Services, 811 E. Arques Ave.  
P.O. Box 9052, MS 27, Sunnyvale, CA 94086

Please send me information on the 5018 DAC System

I'm also interested in these other D/A conversion products:

5007/5008     5009     MC1408

I have an urgent requirement. Please have a D/A conversion specialist phone me at once: (    )    X

Name \_\_\_\_\_ Title \_\_\_\_\_

Company \_\_\_\_\_ Division \_\_\_\_\_

Address \_\_\_\_\_ MS \_\_\_\_\_

City \_\_\_\_\_ State \_\_\_\_\_ ZIP \_\_\_\_\_

ED1011

CIRCLE NUMBER 31



# Incredible performance... at unbelievable prices!



TRW hybrids shatter the price/performance barrier for RF output power, linearity and dynamic range!

You'll have to see it to believe it! And we're ready to show you proof. Take a look at some of our typical applications. Look at the gain quoted for each.

Then take a look at the price. Now, in your production units, you can get the performance you'd only expect from precision laboratory gear.

## TRANSMITTER DRIVERS:

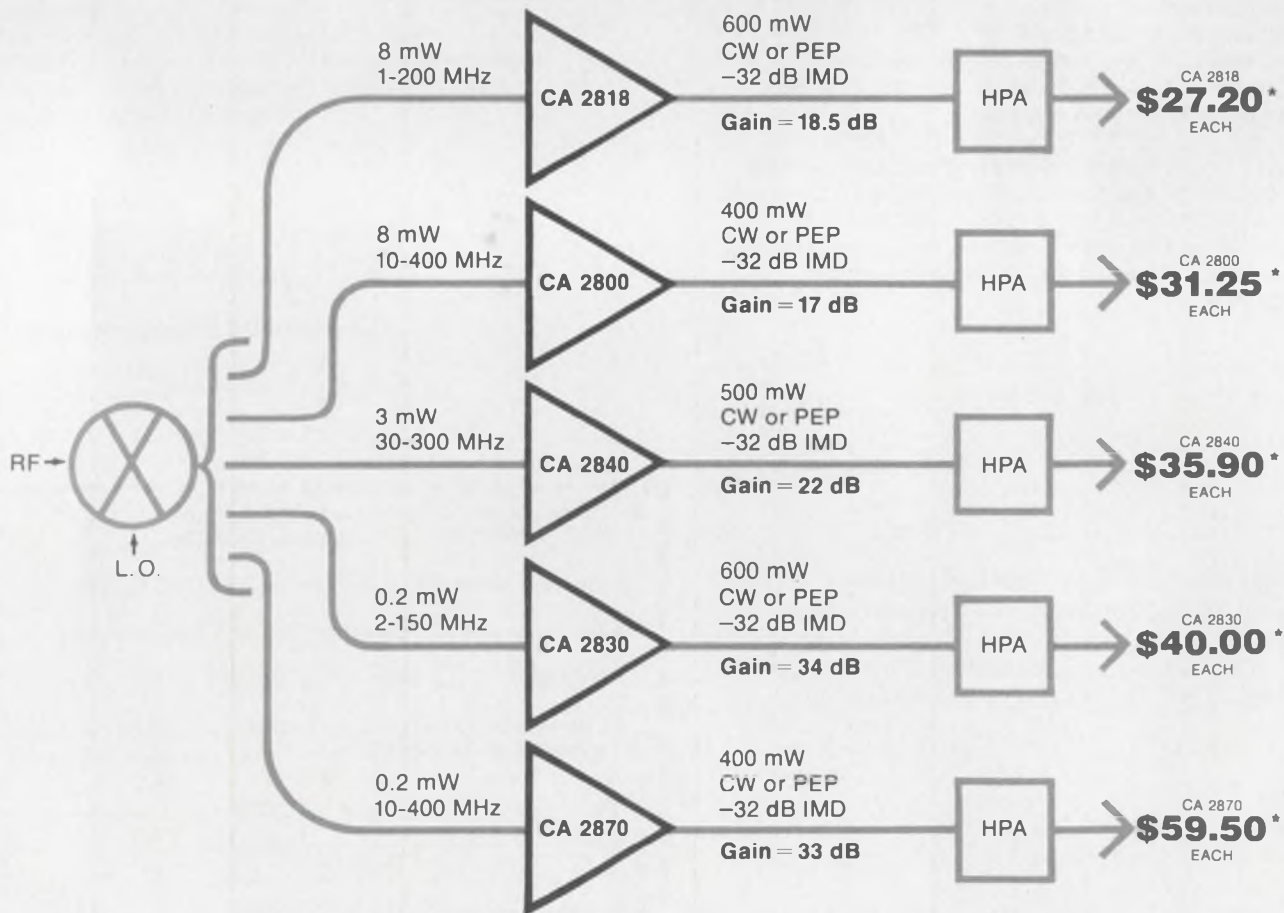



## RECEIVER APPLICATIONS:

40 MHz to 100 MHz IF amplifier.

### STANDARD IF

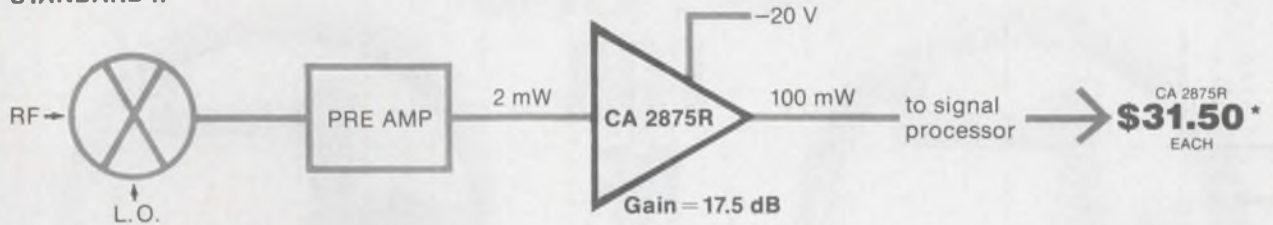

### HIGH PERFORMANCE IF

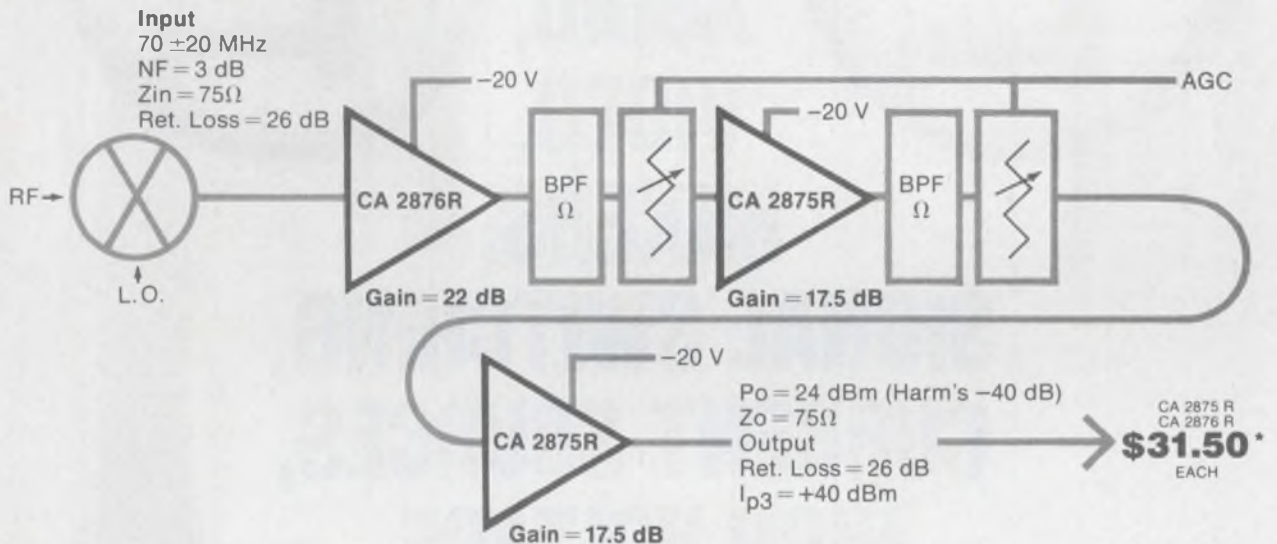

## INSTRUMENTATION APPLICATIONS:

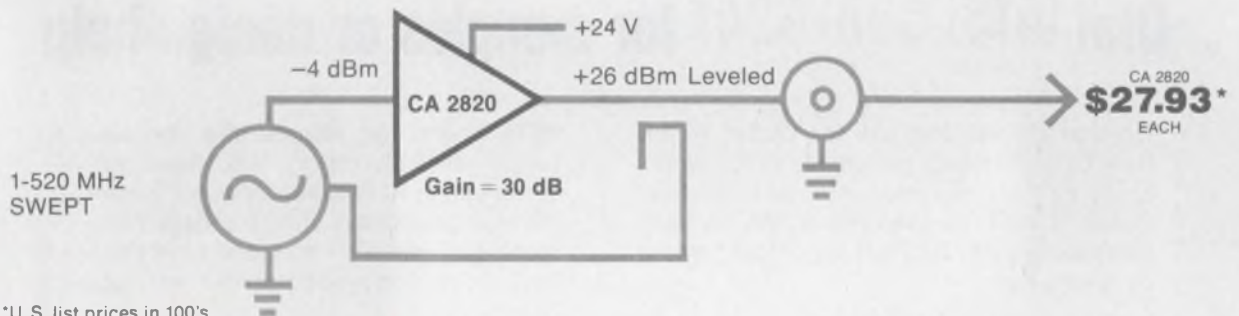

\*U. S. list prices in 100's

These applications are only the beginning. TRW RF linear hybrids can revolutionize design after design...with incredible performance at unbelievable prices. Let us prove it. To get complete data sheets, send us the coupon. **To find out how you can get a free sample and test fixture, call Don Feeney at (213) 679-4561.**

**TRW RF SEMICONDUCTORS**  
 ANOTHER PRODUCT OF A COMPANY CALLED TRW

#### TRW RF Semiconductors

An Electronic Components Division of TRW, Inc.  
 14520 Aviation Boulevard, Lawndale, California 90260

- Please send me your new RF linear catalog.  
 Please have an applications engineer contact me.

(Phone) \_\_\_\_\_

Name \_\_\_\_\_

Position \_\_\_\_\_

Company Name \_\_\_\_\_

Address \_\_\_\_\_

City \_\_\_\_\_

State \_\_\_\_\_

Zip \_\_\_\_\_

ED



# GET FETs

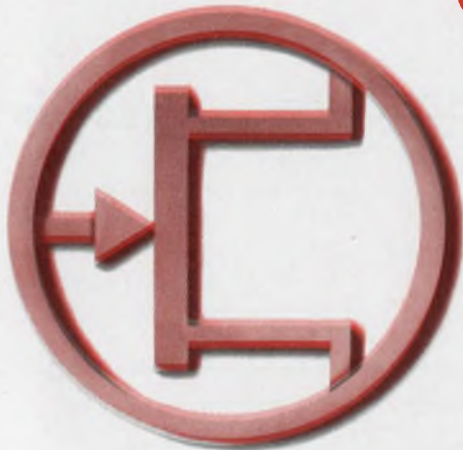

**FOR  
RF,  
AUDIO,  
VIDEO,  
MIXERS,  
SIGNAL SWITCHING,  
CURRENT SOURCES,  
HIGH VOLTAGE**

**Dial (415) 968-9241 for samples or design help**

It's that simple. Just ask for Walter Wong. He'll be glad to help you decide which of our broad FET line will meet your need and how to use it best. Or drop him a line on your company letterhead. He'll send your sample by return mail.

**FETs for all applications.** Whatever you're designing—if it's a function FETs can handle—you can be sure we'll have a FET with the precise characteristics to meet your need. You can be sure, too, that the performance of production orders will be consistent with the samples you test.

**Profit by our experience.** We've been making

FETs longer than anyone else. We have a longer reliability history (ask about our involvement in Hi Rel programs, for instance). We lead the industry in high voltage FETs; in monolithic duals for matched performance. And we're price-competitive across the board.

**Ask for applications help.** If you'd like design assistance in the best use of FETs for your specific application, just ask. If your need is more general, our FET Application Data Book is just off the press. It, too, is yours for the asking. So dial our number today and ask.

 **TELEDYNE SEMICONDUCTOR**

1300 Terra Bella Avenue, Mountain View, California 94043 Tel: (415) 968-9241 TWX: 910-379-6494 Telex: 34-8416

SALES OFFICES:

DOMESTIC: Salem, N.H. (603) 893-9551; Stony Brook, N.Y. (516) 751-5040; Des Plaines, IL (312) 299-6196;

Los Angeles, CA (213) 826-6639; Mountain View, CA (415) 968-9241 • INTERNATIONAL: Hounslow,

Middlesex, England (44) 01-897-2503; Tiengen, West Germany 7741-5066; Kowloon, Hong Kong 3-240122;

Tokyo, Japan 03-405-5738.



## The trademark

An attorney wrote the other day and insisted that I cease and desist from using his client's trademark as a generic term. Well, we're eager to protect people's trademarks, so we always capitalize the first letter. But in this case, I argued in my letter to the attorney, we didn't feel the word was a trademark, as it had seen widespread usage by other manufacturers and his client's leading competitor had been using it generically for years.

But I'm not a lawyer, I pointed out, so I would stop using the term until the squabble with his leading competitor was resolved. And it was.

The company whose lawyer had approached me—let's call it Company A—began legal action against the chief competitor—Company B. One day, one of the attorneys on Company B's side asked its president to sign some documents. When the president asked what it was all about, he was told, "This is in reference to Company A's suit against us." "Suit? What suit?" the president asked. And he was told—for the first time. "What!" he shouted. "Lead Arm' is going to sue us? That's ridiculous. That guy couldn't even throw a football straight when we were in school together. I'll take care of this right now."

So he telephoned "Lead Arm," Company A's president, and asked about the suit. The response went something like, "So you're still playing football without a helmet, 'Wrong Way.' What suit? What are you talking about?" And when "Wrong Way" told "Lead Arm" about the copyright-infringement litigation, "Lead Arm" said, "This is the first I've heard of it. That's absurd. I'll stop it right now." After an exchange of pleasantries and promises to buy lunch, "Lead Arm" called the head of his legal department and demanded, "Don't you guys have anything better to do with your time? Knock off this nonsense." And that was the end of the suit.

Well, it's nice to see a wrangle end amicably and sensibly. Perhaps it was fortunate, in this case, that the "contestants" were old college buddies. One wonders, though, how many other problems in management and engineering could be solved with a simpler, more direct approach. How many times do we tackle problems with a time-hallowed, absurd ritual? How often do we do things by formula, when some common sense and a departure from tradition would be simpler, less costly, and far more effective?



GEORGE ROSTKY  
Editor-in-Chief



# The 8080A diagram

At this writing, National Semiconductor is offering 60 support products for its 8080A microprocessor. (Most are off the shelf; all are compatible with National's standard MICROBUS,<sup>TM</sup> and with microprocessors of the future.)

## Micro Bus

### Digital I/O

Part No.	Description
8202	Tri-State 8-Bit Bus Driver
8203	Tri-State 8-Bit Bus Driver (Inverting)
82LS05	1 Out of 8 Binary Decoder
83C06	8-Bit I/O Latch
8208	8-Bit Bidirectional Bus Driver
8212	8-Bit Input/Output Port
8213	Bidirectional 8-Bit I/O Port
8216	4-Bit Bidirectional Bus Driver
8226	4-Bit Bidirectional Bus Driver (Inverting)

### Peripheral Control

Part No.	Description
8244*	90-Key Keyboard Encoder
8245	16-Key Keyboard Encoder
8246	20-Key Keyboard Encoder
8247*	4-Digit Display Controller
8248*	6-Digit Display Controller
8253*	Programmable Interval Timer
8254	Programmable Bit Addressable Interface
8255	Programmable Peripheral Interface
8257*	Programmable DMA Controller
8258*	Advanced Programmable DMA Controller
8259*	Programmable Interrupt Controller
8272*	Floppy Disk Formatter/Controller
8276*	CRT Controller
8285	Character Generator
8292	8-Bit A/D Converter with 16-Channel Analog Mux
8294	3-3/4-Digit DVM with Multiplexed BCD Outputs
8298*	LLL 8080A "Basic" Interpreter Plus Hex Debugger



# Intel couldn't run.

Intel offers only 29 support products.  
Which leaves us with 31 more ways we can help you  
get the job done.  
And that's kinda nice.

## 8080A Microprocessor

Part No.	Description
8224	Clock Generator and Driver for the 8080A CPU
8228	System Controller and Bus Driver for the 8080A CPU
8238	System Controller and Bus Driver for the 8080A CPU

## Communications

Part No.	Description
8250	Asynchronous Communications Element
8251	Programmable Communications Interface
8252*	Advanced Programmable Communications Interface
8261*	Programmable Communications Subsystem
8274*	Multi-Protocol Communications Controller-SDLC, ADCCP, Bisync, DDCMP
8283*	Advanced SDLC, ADCCP Protocol Controller

## Memory

Part No.	Description
8356	2048X8 ROM, 128X8 RAM I/O
8154	128X8 Static RAM with 16-Bit I/O
8364/	8192X8 MOS Mask ROM
8364E*	(E is 2708 Compatible)
8316A/E	2048X8 MOS Mask ROM
8332E	4096X8 MOS Mask ROM (2708 Compatible)
1702A	256X8 EPROM
8704	512X8 EPROM
2708/8708	1024X8 EPROM
8101A-4	256X4 Static RAM with Separate I/O
8111A-4	256X4 Static RAM with Common I/O
8102A	1024X1 Static RAM
74C920	256X4 CMOS Static RAM with Separate I/O
74C921	256X4 CMOS Static RAM with Common I/O
74C929	1024X1 CMOS Static RAM
2114	1024X4 Static RAM
MM257	4096X1 Static RAM
DM87S296*	512X8 Bipolar PROM
5290	16K Dynamic RAM
8316A/E	Mask ROM (2708 Compatible)
DM74S472*	512X8 Bipolar PROM/20-Pin DIP
MM5204	512X8 EPROM

\*Available soon.



# Microprocessor Data Manual

This manual has four sections to help you evaluate the microprocessors, microcomputers and bit slices available from over 30 manufacturers.

The first section of the Data Manual deals with microprocessor specifications and some of the pitfalls you should avoid as you try to narrow the choice to a specific model. Included are summary tables of many device specifications as well as cross references by model number and an alternate-source directory.

The second section features a primer article intended for the microprocessor novice or for those who want a refresher. The primer reviews most microprocessor fundamentals and contains a glossary of commonly

used microprocessor-related terms.

The third section contains a data page for each microprocessor or family of processors. Each page has a complete description of the processor, its family of support circuits with prices as of Aug. 1, 1977, a description of the architecture and a discussion of available software and the unit's instruction set.

The fourth section contains a Focus report on floppy-disc drives, the most popular bulk-storage device now in use with microprocessor-based equipment. Learning how to avoid specification pitfalls will be an important part of picking the best drive for your microcomputer system.

## Contents

Microprocessor selection guide..Dave Bursky, Associate Editor..	page 55
Microprocessor fundamentals....Ed Gellender, Consultant.....	page 74
Microprocessor data page.....Staff.....	page 82
Focus on Floppy-disc drives.....Dave Barnes, Western Editor...	page 196



# Microprocessor selection guide

Every microprocessor can do a job—but with its own language, architecture, support circuits and development aids. Knowing one particular microprocessor's language (instruction set) doesn't mean you can easily switch to another.

Selecting the best microprocessor, microcomputer or bit slice has become a nightmare. Once you've selected one, you face another bad dream—testing it. Because a  $\mu$ P is designed to be general-purpose, it can handle a virtually unlimited number of code combinations. Some manufacturers have calculated that, even when operating the processor at top speed, it would take over 10 years to check all code combinations.

To help sort out the various models, word sizes and performance ranges, *ELECTRONIC DESIGN* presents its Microprocessor Data Manual. In it you will find performance summaries of every available processor and summary tables to help you compare similar units. Also, to help you locate a processor by manufacturer or model number, we have included cross-reference tables and an alternate-source directory.

Three major classes of processor components are covered in this Manual:

1. **Microprocessor**—a general-purpose processor on one to three chips. It contains an arithmetic and logic unit (ALU), an address and data bus (sometimes multiplexed), a built-in instruction set, and the basic control logic.

2. **Microcomputer**—an all-in-one general-purpose processor that is similar to the microprocessor except that the chip contains the main control program in read-only memory (ROM) and possibly a clock oscillator, some input/output (I/O) capability, and some read-write random-access memory (RAM).

3. **Bit slice**—an enhanced subsection of the microprocessor's ALU. Besides the slice, which is available in two or four-bit sections, other circuits must be added to provide the basic control logic.

There are, of course, other classes of microprocessor components—dedicated controller chips that are either custom-designed or preprogrammed for specific applications. Calculator chips, floppy-disc controllers, microwave-oven controllers and many industrial process-control circuits are typical examples.

## Selection can start with data-word size

To start selecting, many companies recommend that you first decide on the word size and the type of instructions needed. Then you can determine the execution speed and I/O capability needed. Once these four basics are nailed down, you're free to look at price, power drain, technology and available support.

Instruction-compatible microprocessors are available in more than one technology to provide per-

formance demanded by some applications. You can pick and choose from bipolar technology (ECL, I<sup>2</sup>L, STTL or TTL) or MOS (CMOS, NMOS or PMOS).

If you plan to use an off-the-shelf processor, you can select data-word lengths of 1, 4, 8, 12 or 16 bits for microprocessor chips, 1, 4, 8 or 16 bits for microcomputer chips and 2 or 4 bits for bit slices. (An 8-bit ECL slice is expected next year from Fairchild.)

Performance summaries of the three processor types are provided in Tables 1, 2, and 3, respectively. While all performance specs have been normalized for easy comparison, you can still be misled by manufacturers if you don't read the fine print.

Computing speed is a case in point. Often, manufacturers use a basic cycle time or period—sometimes called a microcycle—to specify the instruction execution speed. But a microcycle is not necessarily the inverse of the clock frequency—it's often a multiple, possibly two or three times the clock frequency. Each instruction is then defined as requiring several microcycles for execution.

As a result, a three-microcycle instruction may actually require three, six or nine clock cycles. What's more, longer instructions such as multiply and divide can require tens or even hundreds of microcycles.

Clock speed can be misleading, too, if taken for a measure of processor speed. One microprocessor can perform basic operations—such as a register-to-register add—faster than another unit running at a higher clock because of variations in its internal architecture. In this instance a clock-rate spec is not very important.

Other speeds can give false indications of processor speed, including minimum instruction time, interrupt-response time, and addition time. Like cycle time and clock rate, these specs *don't* measure such important factors as the over-all time needed to perform critical routines in an application. Excluded, for instance, are the delays incurred when the processor must get data from memory. You can solve this dilemma by tailoring a program that compares the performance of several machines doing the same job.

Such a benchmark can help determine the power of the processor's instruction set, and circumvent another oft-abused spec—the number of instructions. Microprocessor comparisons based on this number abound, but don't make a choice based only on this number. Make sure you can use all the commands.

## Examine the instruction set carefully

A number won't tell you which instructions are put aside for data movement and manipulation, for decision and control and for input and output. Some microprocessors have many more I/O commands than



# Table 1. General-purpose microprocessors

Manufacturer	Processor	Process technology	Word size (data/instruction)	Direct addressing range (words)	Number of basic instructions	Maximum clock frequency (MHz)/phases	Instruction time shortest/longest? ( $\mu$ s)	TTL compatible	BCD arithmetic	On-chip interrupts/levels	Number of internal general-purpose registers	Number of stack registers	On-chip clock	DMA capability	Specialized memory & I/O circuits avail.	Prototyping system avail.	Package size (pins)	Voltages required (V)	Assembly language development system	High-level languages	Time-sharing cross software	Comments	Circle number
Motorola	MC14500	CMOS	1/4	0	16	1/1	1/1	Yes	No	Yes/1	1	0	Yes	No	No <sup>4</sup>	No	16	3 to 18	No	No	No	Needs external program counter	451
Intel	4004	PMOS	4/8	4k	46	0.74/2	10.8/21.6	No	Yes	Yes/1	16	3x12	No	No	Yes	No	16	15	Yes	Yes	Yes	Superseded by 4040	452
Intel	4040	PMOS	4/8	8k	60	0.74/2	10.8/21.6	No	Yes	Yes/1	24	7x12	No	No	Yes	Yes	24	15	Yes	Yes	Yes	General-purpose 4-bit $\mu$ P	453
NEC Microcomputers	$\mu$ PD541	PMOS	4/8	4k	69	0.5/2	6.4/38.4	Yes	Yes	Yes/8	4	8x12	No	Yes	Yes	Yes	42	5,-5	Yes	No	No	Intended for electronic cash registers, etc.	454
Fairchild	2 chip F8	NMOS	8/8	64k	69	2/1	2/13	Yes	Yes	Yes/1	64	RAM	Yes	Yes	Yes	Yes	40	5,12	Yes	Yes	Yes	Usually used with program storage unit	455
General Instrument	8000	PMOS	8/8	1k	48	0.8/2	1.25/3.75	No	Yes	Yes/1	48	0	No	No	Yes	Yes	40	5,-12	No	Yes	Yes	Predecessor of F8	457
Intel	8008	PMOS	8/8	16k	48	0.8/2	12.5/37.5	No	Yes	Yes/1	6	7x14	No	No	Yes	Yes	18	5,-9	Yes	Yes	Yes	Predecessor of 8080, still in wide use	458
Intel	8080A	PMOS	8/8	64k	78	2.6/2	1.5/3.75	Yes <sup>3</sup>	Yes	Yes/1	8	RAM	No	Yes	Yes	Yes	40	5,12,-5	Yes	Yes	Yes	By and large, still the most popular	459
Intel	8085	NMOS	8/8	64k	80	3/1	1.3/5.85	Yes	Yes	Yes/4	8	RAM	Yes	Yes	Yes	Yes	40	5	Yes	Yes	Yes	8080 code compatible, has built-in clock	460
MOS Technology	MCS-650X	NMOS	8/8	64k	56	4/1	0.5/3.5	Yes	Yes	Yes/1	0	RAM	Yes	No	Yes	Yes	40	5	Yes	Yes	Yes	Provides 13 addressing modes	461
MOS Technology	MCS-651X	NMOS	8/8	64k	56	4/2	0.5/3.5	Yes	Yes	Yes/1	0	RAM	No	No	Yes	Yes	40	5	Yes	Yes	Yes	Similar to 650X but needs 2 $\phi$ clock	462
Motorola	M6800	NMOS	8/8	64k	89	2/1	1/2.5	Yes	Yes	Yes/1	0	RAM	No	Yes	Yes	Yes	40	5	Yes	Yes	Yes	Available in new depletion-load version	463
Motorola	M6809	NMOS	8/8	64k	100+	2/1	2/5	Yes	Yes	Yes/1	0	RAM	Yes	Yes	Yes	Yes	40	5	Yes	Yes	Yes	Enhanced 6800 command set	464
Motorola	M6802	NMOS	8/8	64k	89	2/1	2/5	Yes	Yes	Yes/1	0	RAM	Yes	Yes	Yes	Yes	40	5	Yes	Yes	Yes	Has 128 x 8 on-chip RAM	465
National Semiconductor	SC/MP	PMOS NMOS	8/8	64k	46	4/1	5/10	NMOS only	Yes	Yes/1	0	RAM	Yes	Yes	No <sup>4</sup>	Yes	40	5,-7	Yes	Yes	Yes	Has handy daisy-chain capability	466
NEC Microcomputers	$\mu$ PD 8080A	NMOS	8/8	64k	78	2/2	1.92/8.16	Yes <sup>3</sup>	Yes	Yes/1	8	RAM	No	Yes	Yes	Yes	40	5,12,-5	Yes	Yes	Yes	Pin compatible but does BCD subtraction	467
RCA	1802	CMOS	8/8	64k	91	6.4/1	2.5/3.75	Yes	Yes	Yes/1	16	RAM	Yes	Yes	Yes	Yes	40	3 to 12	Yes	Yes	Yes	Superseded two-chip version	468
RCA	1803	CMOS	8/8	64k	91	6.4/1	2.5/3.75	Yes	Yes	Yes/1	16	RAM	Yes	Yes	Yes	Yes	28	3 to 12	Yes	Yes	Yes	Trimmed down version of 1802	469
Scientific Microsystems	SMS-300	Bi-polar	8/8	8k+	8	10/1		Yes	No	No	0	No	No	Yes		50		No	Yes	Yes	Yes	Very specialized instruction set	470
Signetics	2650	NMOS	8/8	32k	75	1.2/1	4.8/9.6	Yes	Yes	Yes/1	7	8x15	No	Yes	Yes	Yes	40	5	Yes	Yes	Yes	Has two higher speed versions	471
Zilog	280	NMOS	8/8	64k	150+	4/1	1/5.75	Yes	Yes	Yes/1	14	RAM	No	Yes	Yes	Yes	40	5	Yes	Yes	Yes	8080 instructions are a subset	472
Intersil	6100	CMOS	12/12	4k	81	4/1	2.5/5.5	Yes	No	Yes/1	0	RAM	Yes	Yes	Yes	Yes	40	4 to 11	Yes	Yes	Yes	Emulates PDP-8 instruction set	473
Toshiba	T3190	PMOS NMOS	12/12	4k	108	2.5/1	10/30	Yes	No	Yes/8	8	RAM	Yes	Yes	Yes	Yes	36	5,-5	Yes	Yes	Yes	Has multiply and divide inst.	474
Data General	mN601	NMOS	16/16	32k	42	8.33/2	1.2/29.5	Yes	No	Yes/1	4	RAM	Yes	Yes	Yes	No	40	5,10,14,-4.25	Yes	Yes	Yes	Emulates NOVA instruction set	475
Fairchild	9440	<sup>2</sup> L	16/16	64k	42	10/1		Yes	No	Yes/1	4	RAM	Yes	Yes	No <sup>4</sup>	No	40		No	No	No	Emulates NOVA instruction set	476
Ferranti	F100L	Bi-polar	16/16	32k	28	20/1	1.19/5.75	Yes	No	Yes/1	0	RAM	No	Yes	Yes	Yes	40	5	Yes	Yes	Yes	Can do double word operations	456
General Instrument	CP1600	NMOS	16/16	64k	87	4/2	1.6/4.8	Yes	No	Yes/1	8	RAM	No	Yes	Yes	Yes	40	5,12,-3	Yes	Yes	Yes	All internal registers can be accumulators	477
National Semiconductor	INS8900/PACE	NMOS/ PMOS	16/16	64k	45	2/2	2.5/5	No	Yes	Yes/6	4	10x16	No	Yes	Yes	Yes	40	5.8,-12	Yes	Yes	Yes	Architecture intended for data handling	478
Panafacom	MN1610	NMOS	16/16	64k	33	2/2	2/6	Yes <sup>3</sup>	No	Yes/3	5	RAM	No	Yes	Yes	No	40	5,12,-3	Yes	No	No		479
Texas Instruments	TMS9980	NMOS	16/16	16k	69	4/4	3.2/49.6	Yes <sup>3</sup>	No	Yes/4	16	RAM	Yes	Yes	Yes	No	40	5,12,-5	Yes	Yes	Yes	Small version of TMS 9900	480
Texas Instruments	TMS/SBP9900	NMOS <sup>2</sup> L	16/16	64k	69	4/4	2/31	Yes <sup>3</sup>	No	Yes/16	16	RAM	No	Yes	Yes	No	64	5,12,-5	Yes	Yes	Yes	Emulates 990 mini instructions	481
Western Digital	WD-16	NMOS	16/16	64k	116	3.3/4	2.1/780	Yes	Yes	Yes/16	6	RAM	No	Yes	Yes	Yes	40	5,12,-5	Yes	Yes	No	Very similar to DEC LSI-11	529

1. Has 8-bit external buses and 16-bit internal buses 2. With maximum clock 3. Except clock lines 4. Standard TTL or MOS circuits will suffice



others, and are thus tailored for a specific group of applications. Instructions that you want but are not included in the instruction set can be provided with programmed routines, although you'll probably sacrifice some speed to get the extra commands.

Examine a particular unit's programming manual carefully. The number of instructions claimed for a processor can increase from one page to another. Often, this increase stems from the different ways used to define instructions. Many instructions are available in different modes or operate on different bits of a data word. Each variation in the same basic instruction produces a different operation code—a different instruction.

For example, the programming manual for a Z80 microprocessor says there are 158 "different" instructions. But taking into account all the possible addressing modes and variations, the 158 instructions become 696 operation codes. (Just to go back to the testing problem, there are 696! possible combinations of instructions. Multiply each instruction by 1.5  $\mu$ s—assuming a 4-MHz clock—and then figure out how many years you'll need for a full test.)

Common addressing modes include direct, immediate and indirect, but many processors offer other modes, such as register, page 0, register indirect, extended, implied and relative.

Often, the most flexible instruction sets are available in 16-bit processors, since the units closely resemble minicomputers in both performance and design. For example, some 16-bit processors offer multiply and divide instructions that execute in tens of microseconds. Eight-bit processors can be programmed to do the same calculation, but take milliseconds to do the job. In general, processors with the same word length offer similar performance.

### Analyze the $\mu$ P's architecture

Chip vendors will tout the computer-like features of microprocessors every chance they get. These include the number and function of on-chip registers, the type and depth of the stack register, interrupt capability and the direct-memory-access feature. But when it comes to architecture, the chip vendors lose their voices to minicomputer manufacturers. They can't deliver as much performance.

The number of internal registers included in a processor is not really critical unless you are designing a minimal one or two-chip system. Essentially, the only register a processor needs is an accumulator. However, the accumulator must have access to memory, and an instruction set should permit immediate addressing and data manipulation between the memory and the accumulator. If indirect addressing is available, even special indexing registers can be imitated by using memory locations as registers.

The advantage of using on-chip registers instead of memory space is that the instructions are faster and the bits required are fewer. For example, not nearly

as many bits are required to specify one of several predefined working registers as to specify a memory location. And since the registers are on-chip, access times are much shorter than for normal memory.

The type and flexibility—not just the quantity—of these on-chip registers is also important. Not every "general purpose" register can be incremented, tested for zero, decremented, or have other operations performed. Not every register can be used for program-loop control or counting or even indexed addressing, without some fancy programming tricks or excessive time delays.

Even the source and destination points for these registers must be examined. A processor should be able to load registers directly from memory—and memory from registers—without having the data first go into its accumulator.

Microprocessors are split about 50-50 between those that have on-chip subroutine stack registers and those that don't. The units without use memory as a subroutine stack, so they can handle an almost unlimited number of program subroutines. However, their chips must have a stack-pointer register, which must be set by one of the initialization instructions to point at the area of memory reserved for the stack. When the stack is on the processor chip, there is a limit to the number of subroutine levels that can be stored in the stack.

If an application involves asynchronous or unpredictable events, an interrupt capability on the processor is essential. Most units claim some form of interrupt capability, but only a few of the newer units can handle several levels of prioritized interrupt. Most of the processors announced in the last year can handle single-line, multilevel and vectored interrupts. And all their registers are automatically saved in the stack when an interrupt comes along; after the interrupt is serviced, the register contents are automatically restored.

When large amounts of data must be transferred back and forth between a  $\mu$ P's memory and peripherals, your processor should be able to withdraw itself from the loop and permit direct-memory accesses (DMAs). Most of the newer units can do that and even have one or two pins dedicated to a DMA-control function. A DMA transfer can often be five to ten times faster than transferring data through the processor itself for I/O applications.

### Decide on the number of I/O lines

Most microprocessors provide the means to control input/output operations via specialized circuits. Minicomputers, on the other hand, usually have some of the I/O capability built in. If your application requires a fixed number of input lines and a fixed number of output lines, one of the all-in-one chips could be the answer, since they offer as many as 32 I/O lines in a single package. However, when your I/O requirements are subject to change, one of the



Table 2. All-in-one processors

Company	Device	Process technology	Word size in bits (data/instr.)	On-chip RAM size	On-chip ROM/PROM size (words)	Off-chip memory expansion	Number of basic instructions	Maximum clock frequency (MHz)	On-chip clock	Instruction time (shortest/longest) $\mu$ s	TTL compatible	BOD arithmetic	On-chip interrupts/levels	Subroutine nesting levels	General-purpose internal registers	Number of I/O lines	Additional special support circuits	Package size (DIP pins)	Voltages required (V)	Prototyping system avail.	Assembly language programming system	High-level language programming system	Time-sharing cross software	Comments	Circle number
General Instrument	SBA	NMOS	1/8	120 $\times$ 1	1024 $\times$ 8	No	8	800	Yes	1.25/1.25	Yes	No	No	16	RAM	31	No	40	5,12	Yes	No	No	No	Will have expandable version	482
Essex International	SX-200	PMOS	4/8	64 $\times$ 4	1024 $\times$ 8	Yes	41	400	Yes	20/20	No	Yes	Yes/1	1	RAM	16	No	28	10 to 20	Yes	Yes	Yes	Yes	Has touch switch interface	483
ITT Semiconductor	7150	PMOS	?	?	N.A. <sup>1</sup>	?	?	25	Yes	?	?	?	?	?	14	Yes	14/18/24	-15	No	No	No	No	Designed for washing machines	484	
National Semi	MM57109	PMOS	4/8	5 $\times$ 32	N.A.	Yes	70	400	No	1220/1 S	Yes	Yes	Yes/1	4	1	11	Yes	28	9	No	No	No	No	Has scientific calculation ability	485
	MM57140/57152	PMOS	4/8	55 $\times$ 4	630 $\times$ 8	No	35	280	Yes	16/16	Opt.	Yes	0	2	4	24	No	28	7.9 to 9.5	Yes	Yes	No	Yes	Drives LEDs or fluorescents	486
	MM5799	PMOS	4/8	96 $\times$ 4	1536 $\times$ 8	No	35	400	Yes	10/20	Opt.	Yes	0	2	5	23	Yes	28	7.9 to 9.5	Yes	Yes	No	Yes	Serial I/O and LED drive	487
	MM5781/82	PMOS	4/8	160 $\times$ 4	2048 $\times$ 8	Yes	35	400	No	10/20	Opt.	Yes	0	2	5	24	Yes	28	7.9 to 9.5	Yes	Yes	No	Yes	Two chip set	488
NEC Microcomputers	$\mu$ PD548	PMOS	4/10	96 $\times$ 4	1920 $\times$ 10	Yes	72	200	No	10/20	Yes	Yes	Yes/2	4	RAM	35	No	42	-10	Yes	Yes	No	No	Can interface to keyboard	489
	$\mu$ PD546	PMOS	4/8	96 $\times$ 4	2000 $\times$ 8	No	80	440	No	10/40	Yes	Yes	Yes/1	3	6	35	No	42	-10	Yes	Yes	No	Yes	Has 6-bit programmable timer	490
	$\mu$ PD547	PMOS	4/8	64 $\times$ 4	1000 $\times$ 8	No	58	440	No	10/40	Yes	Yes	Yes/1	1	RAM	35	No	42	-10	Yes	Yes	No	Yes	Instructions are 546 subset	491
	$\mu$ PD545	PMOS	4/8	32 $\times$ 4	640 $\times$ 8	No	58	440	No	10/40	Yes	Yes	Yes/1	1	RAM	21	No	28	-10	Yes	Yes	No	Yes	Can handle high voltages	492
Panasonic	MN1400	NMOS	4/8	64 $\times$ 4	1024 $\times$ 8	No	75	300	Yes	10/20	Yes	Yes	Yes/1	2	RAM	30	No	40	5	No	Yes	Yes	Yes	Complete all-in-one controller	532
	MN1402	NMOS	4/8	32 $\times$ 4	768 $\times$ 8	No	57	300	Yes	10/20	Yes	Yes	Yes/1	2	RAM	19	No	28	5	No	Yes	Yes	Yes	Smaller I/O version of 1400	533
	MN1498	NMOS	4/8	64 $\times$ 4	N.A.	Yes	68	300	Yes	10/20	Yes	Yes	Yes/1	2	RAM	18	No	40	5	No	Yes	Yes	Yes	Handles 1024 bytes of external memory	534
	MN1499	NMOS	4/8	64 $\times$ 4	N.A.	Yes	75	300	Yes	10/20	Yes	Yes	Yes/1	2	RAM	31	No	64	5	No	Yes	Yes	Yes	Handles 2048 bytes of external memory	535
Rockwell	PPS-4	PMOS	4/8	0	0	Yes	50	200/400	No	5/15	No	Yes	Yes/1	2	1	12+	Yes	42	-17/+5,-12	Yes	Yes	No	Yes	Combination ROM/RAM/I/O available	493
	PPS 4/2	PMOS	4/8	0	0	Yes	50	200/400	Yes	5/15	No	Yes	No	2	1	12+	Yes	42	-17/+5,-12	Yes	Yes	No	Yes	Same as PPS-4 but has internal clk	494
	PPS-4/1 MM77	PMOS	4/8	96 $\times$ 4	1344 $\times$ 8	RAM only	50	100/4	Yes	10/40	Yes	Yes	Yes/1	2	2+RAM	31	Yes	42	-15/+5,-10	Yes	Yes	No	Yes	I/O includes serial channel	495
	MM78	PMOS	4/8	128 $\times$ 4	2048 $\times$ 8	RAM only	50	100/4	Yes	10/40	Yes	Yes	Yes/1	2	2+RAM	31	Yes	42	-15/+5,-10	Yes	Yes	No	Yes	Software compatible with 77	496
	MM76	PMOS	4/8	48 $\times$ 4	640 $\times$ 8	RAM only	50	100/4	Yes	10/40	Yes	Yes	Yes/1	1	1+RAM	31	Yes	42	-15/+5,-10	Yes	Yes	No	Yes	Primarily used for keyboard display	497
	MM76/C	PMOS	4/8	48 $\times$ 4	640 $\times$ 8	RAM only	50	100/4	Yes	10/30	Yes	Yes	Yes/1	1	1+RAM	39	Yes	52	-15/+5,-10	Yes	Yes	No	Yes	Has high-speed counter	498
	MM76/D	PMOS	4/8	48 $\times$ 4	640 $\times$ 8	RAM only	50	100/4	Yes	10/30	Yes	Yes	Yes/1	1	1+RAM	37	Yes	52	-15/+5,-10	Yes	Yes	No	Yes	Has a/d converter on chip	499
	MM76/E	PMOS	4/8	48 $\times$ 4	1024 $\times$ 8	RAM only	50	100/4	Yes	10/30	Yes	Yes	Yes/1	1	1+RAM	31	Yes	42	-15/+5,-10	Yes	Yes	No	Yes	Larger ROM than MM76	500
	MM76/L	PMOS	4/8	48 $\times$ 4	640 $\times$ 8	RAM only	50	100/4	Yes	10/30	Yes	Yes	Yes/1	1	1+RAM	31	Yes	40	6 to 11	Yes	Yes	No	Yes	Low voltage version of 76	501
	MM75	PMOS	4/8	48 $\times$ 4	670 $\times$ 8	RAM only	50	100/4	Yes	10/40	Yes	Yes	Yes/1	1	1+RAM	22	Yes	28	-15/+5,-10	Yes	Yes	No	Yes	Reduced I/O version of 76	502
Texas Instruments	TMS-1000	PMOS/NMOS	4/8	64 $\times$ 4	1024 $\times$ 8	No	43	400	Yes	15/15	Yes	Yes	Yes/1	1	2	23/25	Yes	28/40	15	Yes	Yes	Yes	Yes	Also a 35 V family and a low voltage family TMS 1070/1270 and TMS 1100/1300	503
	TMS-1100	PMOS/NMOS	4/8	128 $\times$ 8	2048 $\times$ 8	No	40	400	Yes	15/15	Yes	Yes	Yes/1	1	2	23/28	Yes	28/40	15	Yes	Yes	Yes	Yes	Pin compatible with TMS-1000	504
	TMS-1018	PMOS	4/8	64 $\times$ 4	N.A.	No	43	400	Yes	15/15	Yes	Yes	No	N.A.	N.A.	4	No	28	15	Dedicated number cruncher				505	



Manufacturer	Part Number	Technology	Package	Address	Data	RAM	IO	IO Lines	IO Ports	IO Config	IO Support	IO Features	IO Notes							
Toshiba	TMS-1022	PMOS	4/8	64x4	1024x4	No	43	400	Yes	15/15	Yes	Yes/1	1	2	N.A.	No	28	15	Dedicated CB PLL controller	
	TMS-1117	PMOS	4/8	128x8	N.A.	No	43	400	Yes	15/15	Yes	No	N.A.	N.A.	19	Yes	28	15	Dedicated controller for microwave ovens	
	TMS-1121	PMOS	4/8	128x4	2048x8	No	42	400	Yes	15/15	Yes	Yes/1	RAM	RAM	N.A.	Yes	40	15	Dedicated multi-appliance timer/controller	
	TMS-1330	PMOS	4/8	128x4	2048x8	No	42	400	Yes	15/15	Yes	Yes/1	RAM	RAM	31	Yes	40	15	Has on chip 5-bit a/d converter	
Toshiba	T3444	NMOS	4/8	16x8	256x24	Yes	3	800	Yes	3	Yes	Yes/1	8	RAM	16	No	40	5	Intended for dedicated controllers	
	T3472	NMOS	4/8	16x4	256x24	Yes	67	1000	Yes	33/360	Yes	Yes/2	8	RAM	16	Yes	42	5	Designed for keyboard/display interfacing	
	1872	PMOS	4/10	4x32	512x10	No	37	150	Yes	6.25/12.5	Yes	Yes/1	1	RAM	27	No	40	12	RAM holds BCD numbers	
Western Digital	PIC-1650	NMOS	8/12	32x8	512x12	Yes	31	1000	Yes	4/8	Yes	Yes/1	2	RAM	32	No	40	5	Smaller I/O and larger ROMs avail	
	8041/8741	NMOS	8/8	64x8	1024x8	Yes	90	6000	Yes	2.5/5	Yes	Yes/1	RAM	RAM	18	Yes	40	5	Both a ROM and EPROM version are available	
Mostek 1 chip F.8	8048/8748	NMOS	8/8	64x8	1024x8	Yes	96	6000	Yes	2.5/5	Yes	Yes/1	8	RAM	27	Yes	40	5	8748 has UV PROM	
	3870	NMOS	8/8	64x8	2048x8	Yes	70+	4000	Yes	1/6.5	Yes	Yes/4	RAM	RAM	32	Yes	40	5	Software compatible with F8	
Motorola	6400	NMOS	8/8	32x8	1024x8	Yes	?	8000	Yes	?	Yes	?	?	RAM	?	Yes	?	5	1978	Intended for controller use
	6801	NMOS	8/8	?	?	Yes	?	2000	?	?	Yes	?	?	?	?	Yes	40	5	1978	Available 1978
Rockwell	PPS-8	PMOS	8/8	0	0	Yes	100	256/4	No	4/12	No	Yes/3	16	2	0+	Yes	42	5	1978	Combination RAM/ROM/I/O support
	PPS-8/2	PMOS	8/8	0	0	Yes	100	200/4	No	5/15	No	Yes/3	16	2	0+	Yes	42	5	1978	I/O chip includes clock
Zilog	Z8	NMOS	8/8	96x8	2048x8	Yes	?	4000	Yes	0.75/7	Yes	Yes/1	?	RAM	32	Yes	40	5	1978	Has two counter/timers
Texas Instruments	TMS 9940	NMOS	2	128x8	2048x8	No	68	5000	Yes	2/452	Yes	Yes/4	64	RAM	16	No	40	5	1978	Two versions available, one has a 2 k EPROM, the other a 2 k ROM

1 Not applicable      2 Externally 8 bits, internally 16 bits      3 User defined

more general-purpose units would probably be better. Ideally, when you pick a processor with I/O lines on the same chip, you'd like to be able to configure each line as you need it. With some processors, you can configure each line to act as either an input or an output. But many processors don't have this capability—and skimming the data sheet may not uncover this deficiency.

Often, the I/O lines are already dedicated—some fixed as outputs and the rest as inputs. And, even if they are programmable, they might be programmable only on a word basis. Individual lines cannot be set as input or output. Some all-in-one circuits can be expanded beyond their limited on-chip I/O capability, but by the time you add all the necessary expansion circuits, you'll be wishing that you had used a general-purpose chip instead.

While you're checking the capabilities of the I/O lines, check the capabilities of the I/O instructions. Processors with dedicated I/O lines usually have special instructions for manipulating bits, setting mask codes and even performing operations directly on the bits in the port. General-purpose processors usually don't have any I/O port lines, but there are many specially designed support circuits available to provide both serial and parallel I/O ports.

Serial I/O capability is available only on a few processor chips but if you need only one serial port along with some parallel I/O lines you should consider a processor with serial I/O to keep the chip count minimal. Controlling the serial port is done via the program so no extra hardware is needed, except for a buffer or level shifter.

For almost all processors, data sheets claim TTL compatibility—but don't expect most MOS processors to drive more than one normalized or low-power TTL load. Older processors can't even drive that much of a load without pull-up resistors or MOS-to-TTL level shifters and buffers.

Few microprocessor spec sheets deal with noise immunity—an important spec if your processor will be used in industrial environments. Comparing input levels for peripheral circuits with the address-output levels of a certain processor may reveal little or no protection against unwanted transients. If you don't have the needed noise immunity, you will quickly discover the need when you move the prototype from the lab bench to the factory floor.

However, some CMOS processors can provide noise immunity without much strain since the signal swings typically range from the supply to ground. Of course, you can get around the noise problem by using inexpensive level shifters and pull-up resistors, but they take up valuable board space and power.

### You can also roll your own processor

Now that bit-slice chips are available, you can design your own multichip processor. A bit-slice-based processor will be two to five times faster than NMOS



Table 3. Bit-slice families

Company	Series	Process technology	ALU part number	ALU word size (bits)	Number of ALU instructions	Can ALU do BCD arithmetic	Maximum ALU clock rate (MHz)	General-purpose registers in ALU	ALU package size (DIP pins)	Microprogram sequencer number	Number of address bits	Maximum sequencer clock rate (MHz)	Number of sequencer commands	Sequencer stack size	Sequencer package size (DIP pins)	Are parts TTL compatible	Voltages required (V)	Prototyping system available	Development software available	Specialized support circuits available	Comments	Circle Number
Advanced Micro Devices	2900	STTL	2901A	4	16	No	10	16	40	2909/11	4	10	12	4x4	28/20	Yes	5	Yes	Yes	Yes	Has widest number of second sources	517
		STTL	2903	4	25	No	10	16	48									Yes	Yes	Yes	ALU has nine more instructions than 2901, including multiply and divide.	827
Fairchild	Macrolagic	STTL/CMOS	9405/34705	4	64	No	10	8	24	9406	4	10	4	16x4	24	Yes	5	Yes	Yes	Yes	CMOS version (34705) operates at 2 MHz	518
	100k 8-bit	ECL	ADIU	8	27	Yes	20	1	*	*	*	*	*	*	*		-4.5,-2	1978	1978	1978	Only 8-bit slice	519
Intel	3000	STTL	3002	2	40	No	10	11	28	3001	9	10+	11	0	40	Yes	5	Yes	Yes	Yes	Only 2-bit ALU available	520
Monolithic Memories	5700/6700	STTL	57/6701	4	32	No	5	16	40	6710	9	10+	8	0	40	Yes	5	Yes	?	No	Has double-addressing capability	521
Motorola	10800	ECL	10800	4	100+	Yes	20	0	48	10801	4	20	16	4x4	48	No	-2,-5.2	Yes	Yes	Yes	Fastest bit slice available	522
National Semiconductor	IMP-4	PMOS	00A/520	4	8	No	5.714	20	24	44/521	4	5.714	100+	in ALU	24	Yes	+5,-12	Yes	Yes	No	Need external register file	523
	IMP-8	PMOS	00A/520	4	8	No	5.714	20	24	8A/521	8	5.714	100+	in ALU	24	Yes	+5,-12	Yes	Yes	No	Uses IMP-4 ALUs with big ROM	524
	IMP-16	PMOS	00A/520	4	8	No	5.714	20	24	16A/521	16	5.714	100+	in ALU	24	Yes	+5,-12	Yes	Yes	No	Two development systems available	525
Texas Instruments	SBP-0400A	i2L	SBP 0400	4	512	No	5	10	40	74S482	4	20	64	4x4	20	Yes	Current	Yes	No	No	Has pipeline register	526
	SBP-0401A	i2L	SBP 0401	4	512	No	5	10	40	74S482	4	20	64	4x4	20	Yes	Current	Yes	No	No	Does not have pipeline register	527
	74S481	STTL	74S481	4	24,780	No	10	0	48	74S482	4	20	64	4x4	20	Yes	5	Yes	No	Yes	Very flexible instruction set	528

\*In definition stage

processors since just about every slice is bipolar and takes under 100 ns to execute an instruction. Right?

Wrong. The 100 ns refers to a microinstruction—not a complete instruction as in microprocessors.

In a microprocessor, microprograms tell the logic circuits in the chip how to route data and set up the ALU to perform an operation. In a bit slice, you must program these instructions into the microprogram memory. (The microprogram memory consists of a ROM array that is not part of the addressable RAM or major program space.)

Normally, a programmed bit-slice processor may require anywhere from 100 to 1024 words of microprogram memory to control all the operations. Each word, in turn, can consist of many bits since it can be used to control more than just the processor slice. It can also control peripherals, memories and other processor subfunctions. Depending on the application, a microprogram-control word can be from about 10 to 60 bits long.

The advantages of microprogramming your own processor versus buying a programmed chip include the ability to write your own macroinstructions and thus customize for your application.

With microprogramming, you don't need as much control hardware either—software does more of the peripheral control than with a macroprogrammed processor. This proves invaluable in applications requiring in excess of tens of thousands of units. Microprogramming also presents a good alternative when a system must be emulated or when critical short routines must be executed rapidly.

However, microprogramming does have a drawback. Since the programmer works very closely with the timing relationships of the machine itself and on a machine-language level (the 1's and 0's), developing a program is difficult. Each application requires a different microprogram, with a different instruction set, so designs cannot be transferred readily. Nor can software design aids, most of which are geared for a fixed in-



struction set, be used with a bit-slice processor's alterable macroinstruction set.

### What's happening

Even in the short interval since *ELECTRONIC DESIGN* presented its microprocessor roundup (ED No. 14, July 5, 1977, p. 26), new microprocessors and microcomputers have been introduced.

For example, Texas Instruments claims a first with its TMS9940—the first 16-bit microcomputer chip. It is instruction compatible with the other TMS9900 products except for four instructions. The development version puts a 2048-byte erasable PROM and the processor on the same chip, while the production version puts a mask-programmed ROM on the chip.

Drifting down to the low-end microcontrollers: Both Toshiba and Panasonic (Matsushita) have introduced 4-bit processors for dedicated-control applications. Toshiba offers the T3444 and 3472 processors for high-speed data handling and man/machine interfacing, respectively. Preprogrammed versions of the T3444 are available as floppy-disc controllers and cassette controllers.

Panasonic's MN1400 family consists of four models, each with a different amount of on-board memory and different features. The MN1499 is the prototyping unit and has provisions for external memory and 75 instructions.

The other newcomer is the 4-bit S2000 developed by American Microsystems. It is a display-oriented microcomputer with a  $1\text{ k} \times 8$  on-chip ROM and drivers for either a LED or vacuum fluorescent display. Meanwhile, more details have finally come out about the 2903, an enhanced version of the 2901A bit slice from Advanced Micro Devices. The 2903 has nine additional instructions—unsigned multiply, two's complement multiply, increment by one or two, sign/magnitude two's complement, two's complement multiply correction, single length normalize, double length normalize and first divide op., two's complement divide, and two's complement divide, correction, and remainder. No other processor slice has multiplication or division routines.

Products that will appear in early 1978 include an 8-bit ECL processor slice currently being developed by Fairchild, the Z8 microcomputer from Zilog, and a  $2\text{-k} \times 8$  version of the 8048 from Intel.

More details of the Zilog Z8 all-in-one microcomputer have been released since the product was brought to light in the *ELECTRONIC DESIGN* roundup. The 8-bit processor chip includes a 96-byte RAM, where each byte can act as an accumulator. Data can be transferred back and forth to any RAM word by the I/O ports or ALU. Although the Z8's instruction set has fewer basic instructions than the Z80, more variations are possible. So the number of op codes increases.

Of the 32 I/O lines on the Z8, 16 are set up to be individual-line programmable as input or output,

eight lines are set to be byte-programmable as input, output or bidirectional, and eight can be divided into 4-bit sections, each of which can be either input, output or bidirectional lines. Software controls all the port I/O lines and the control commands can be either mask-programmed on the processor chip or stored in external memory.

External memory for the Z8 can be expanded so that the processor addresses both 65 kbytes of ROM and another 65 kbytes of RAM or ROM. The processor also has an on-chip prioritized interrupt structure that is software-controllable. Up to six interrupts can be handled without any support circuits.

The processor executes its instructions fairly fast—the shortest instruction can run in  $0.75\ \mu\text{s}$  and the longest in  $1.9\ \mu\text{s}$ .

Also on the Z8 chip are two software-controllable 8-bit counter/timers that can interrupt the processor. One timer has an 8-bit prescaler that is also software programmable so that large timing loops can be used.

Zilog is also readying the Z8000, an NMOS 16-bit microprocessor with the equivalent processing power of a minicomputer such as the 11/70 made by Digital Equipment Corp. (Maynard, MA). The Z8000 will have a RAM-addressing capability of millions of bytes (with the use of a special memory-expander chip) and have advanced instructions such as hardware multiply and divide.

The processor has been optimized to execute compiler-generated code, according to company officials. It can perform instructions in less than  $1\ \mu\text{s}$  (for the shortest instruction). Still, the processor instructions will be compatible with the assembly-level mnemonics already in use on the Z80. A translator program will also be available to transfer assembly-level Z80 programs into Z8000 op code.

Both the Z8 and Z8000 will not be available until 1978, with the Z8 scheduled for early 1978 and the Z8000 for late 1978.

This year has been a good one for alternate-source agreements. Even Intel has selected a few companies to whom it will provide masks for its 8048 and 8085 microprocessors. Monolithic Memories has finally found an alternate source—ITT—for its 5701/6701 bit slice just as it starts manufacturing the 2901A bit slice as an alternate source to AMD.

In the 4-bit area, Texas Instruments has quietly postponed its introduction of NMOS equivalents to its TMS-1000 family. But even more quietly, TI has announced a CMOS equivalent. The only 4-bit CMOS processor on the market, it should find a home in many portable and battery-operated items.

### Take a close look at some units

Most of this year's development activity has been in 8-bit microprocessors and microcomputers. The Mostek 3870 single-chip microcomputer is in a head-to-head confrontation with the Intel 8048. Both units have many of the same features, with the Mostek chip



# Processor alternate source directory

Generic type number	Data word size (bits)	Technology	Original source	Alternate sources	Data manual page number
1600, 1610	16	NMOS	General Instrument	EM&M Semiconductor	164
1650, 1655	8	NMOS	General Instrument	EM&M Semiconductor	106
1802, 1803	8	CMOS	RCA	Hughes & Solid State Scientific	130
1872	4	PMOS	Western Digital	None	116
2650	8	NMOS	Signetics	Advanced Memory Systems	144
2900	4	STTL	Advanced Micro Devices	National Semiconductor Fairchild, Monolithic Memories, Motorola, National Semiconductor, Raytheon, Sescosem, Signetics	180
3000	2	STTL	Intel	Signetics	176
3850	8	NMOS	Fairchild	Mostek, Motorola	132
3859	8	NMOS	Fairchild	Discontinued	—
3870	8	NMOS	Mostek	Fairchild, Motorola	110
4040/4004	4	PMOS	Intel	National Semiconductor	124
5701/6701	4	STTL	Monolithic Memories	ITT Semiconductor	182
6100	12	CMOS	Intersil	Harris Semiconductor	154
6400	8	NMOS	Motorola	None	—
65XX	8	NMOS	MOS Technology	Rockwell, Synertek	138
6800, 68A00, 68B00	8	NMOS	Motorola	American Microsystems, Fairchild, Fujitsu, Hitachi, Sescosem, Thompson CSF	140
6801	8	NMOS	Motorola	None*	—
6802	8	NMOS	Motorola	None	142
6809	8	NMOS	Motorola	None*	118
7150	4	PMOS	ITT Semiconductor	None	—
8000	8	PMOS	General Instrument	AEG, SGS-ATEs	112
8008	8	PMOS	Intel	None	148
8035, 8048, 8748	8	NMOS	Intel	Advanced Micro Devices, NEC and Signetics	108
8041, 8741	8	NMOS	Intel	None	120
8080A	8	NMOS	Intel	Advanced Micro Devices, NEC, National Semiconductor, Signetics, Texas Instruments	134
8085	8	NMOS	Intel	Advanced Micro Devices, NEC	136
8900	16	PMOS	National Semiconductor	None	166
9002	8	NMOS	Electronic Arrays	Discontinued	—
9080	8	NMOS	Advanced Micro Devices	Actually an alternate source for 8080	134
9405, 34705	4	STTL/CMOS	Fairchild (Macrologic)	Signetics	178
9440	16	I <sup>2</sup> L	Fairchild	None	160

\*This product is still in development

offering double the ROM capacity and the Intel device a larger instruction set.

Intel introduced the 8048 and 8085 processor families last year, with a flurry of industry firsts. A pin-compatible unit with the 8048, the 8748 has all the features of the 8048, but instead of containing 1024 bytes of mask-programmable ROM, the 8748 contains 1024 bytes of ultraviolet, erasable, programmable read-only memory. Not only is the PROM included on the chip, but the chip itself can operate from a single 5-V supply—another first.

Support for the 8048 and 8085 comes from a family of 8-bit auxiliary chips, including the 8155, a 256 ×

8 static RAM with programmable 14-bit timer and 22 lines of programmable I/O—all on one chip. There's also the 8355/8755, a 2048 × 8 ROM with 16 lines of programmable I/O, or a 2048 × 8 UV EPROM with 16 lines of programmable I/O. Both the 8155 and 8355/8755 also help simplify the interface between Intel's other new processor, the 8085, and the outside world.

The 8085 is a souped-up 8080A with two more instructions, some new control lines, an on-chip clock oscillator, and a faster instruction-execution speed. However, to get the additional control capability while keeping the processor in its 40-pin package, something



Generic type number	Data word size (bits)	Technology	Original source	Alternate sources	Data manual page number
9900	16	I <sup>2</sup> L/NMOS	Texas Instruments	American Microsystems (NMOS version)	170
9940	16	NMOS	Texas Instruments	None*	114
9980	16	NMOS	Texas Instruments	None	172
10800	4	ECL	Motorola	None	184
14500	1	CMOS	Motorola	None	122
8X300	8	STTL	Signetics	None	128
74S481	4	STTL	Texas Instruments	None	188
100 K	8	ECL	Fairchild	None*	98
COPS	4	PMOS	National Semiconductor	None	—
F8	8	NMOS	Fairchild	See 3850	158
F100L	16	Bipolar	Ferranti	None	190
IMP-4, 8, 16	4, 8, 16	PMOS	National Semiconductor	Rockwell	—
Macrologic	4	STTL/CMOS	Fairchild	See 9405, 34705	—
MCP-1600/WD-16	16	NMOS	Western Digital	None	174
Micromachine	8	NMOS	Fairchild	See 3859	—
mN601	16	NMOS	Data General	None	162
MN1400	4	NMOS	Panasonic	None	90
MN1610	16	NMOS	Panafacom	None	168
PACE	16	PMOS	National Semiconductor	Rockwell	—
PPS-4	4	PMOS	Rockwell	National Semiconductor	126
PPS-4/1	4	PMOS	Rockwell	None	104
PPS-4/2	4	PMOS	Rockwell	None	126
PPS-8	8	PMOS	Rockwell	National Semiconductor	152
PPS-8/2	8	PMOS	Rockwell	None	152
S2000	4	NMOS	American Microsystems	None	88
SBA	1	NMOS	General Instrument	None	84
SBP0400A/ 0401A	4	I <sup>2</sup> L	Texas Instruments	None	186
SC/MP, SC/MPII	8	NMOS/PMOS	National Semiconductor	Rockwell, Signetics, Western Digital	150
SMS-300	8	STTL	Scientific Microsystems	Signetics	—
SX200	4	PMOS	Essex International	None	96
T3190	12	PMOS, NMOS	Toshiba	None	156
T3444	4	NMOS	Toshiba	None	92
T3472	4	NMOS	Toshiba	None	94
TMS1000, 1100, 1200, 1300	4	CMOS, NMOS or PMOS	Texas Instruments	Motorola for CMOS version	86
uCOM 42	4	PMOS	NEC	None	100
uCOM 43, 44, 45	4	PMOS	NEC	None	102
Z8	8	NMOS	Zilog	None*	—
Z80	8	NMOS	Zilog	Mostek, Sharp	146

had to be forfeited.

So the 8080A's totally separate data and address buses had to go. The 8085 has the eight most-significant address bits brought out to their own pins, but the eight least-significant address bits are multiplexed on the eight data-bus lines. So that a complete system can be formed with only two chips, the 8355/8755 and the 8155 have internal address latches that can hold the first eight bits of the address.

The 8085 contains the equivalent of the bus controller and clock generator on its chip. All the 8080A's software is compatible with the 8085. The only changes you may have to make are in timing loops since the

time will change with the higher clock frequency. The processor chips, of course, are not pin-compatible, so upgrading the system really means redesigning the circuit board. However, all chips in the 8085 can operate from a single 5-V supply.

Mostek's 3870 doesn't have any new specialized support circuits, but it is compatible with all the older F8 processor circuits and software. So popular is the 3870, in fact, that Fairchild, the original developer of the F8, has scratched plans to market its own one-chip microcomputer, the 3859. Instead it will alternate-source the 3870, currently the only 8-bit microcomputer with 2048 bytes of on-chip storage.



**Table 4. Directory of  $\mu$ Ps by vendor**

Manufacturer	Microprocessor model number
AEG	Series 8000*
Advanced Micro Devices	2900, 8048*, 8080*, 8085*
Advanced Memory Systems (Intersil)	2650*
American Microsystems	6800*, 9900*, S2000
Data General	mN601 (microNova)
EM&M Semi	CP1600*, 1610*, 1650*, 1655*
Essex International	SX200
Fairchild	Macrologic (9405), 100K, 2900*, 3850(F8), 3870*, 6800*, 9440
Ferranti	F100-L
Fujitsu	6800*
General Instrument	CP1600, 1610, 1650, 1655, SBA
Harris Semiconductor	6100*
Hitachi	6800*
Hughes	1802*
Intel	3000, 4004/4040, 8008, 8048, 8080A, 8085
Intersil	IM6100
ITT	1600*, 5701/6701*, 7150
Monolithic Memories	2900*, 5701/6701
MOS Technology	65XX
Mostek	3850*, 3870, Z80*
Motorola	2900*, 3850*, 3870*, 6400, 6800, 6801, 6802, 6809, 10800, 14500
National Semiconductor	2650*, 2900*, 4004/4040*, 8080A* COPS, IMP-4, 8, 16, INS8900, PACE, PPS-4*, PPS-8*
NEC	8048*, 8080A*, $\mu$ COM 42, 43, 44, 45
Panafacom	MN1610
Panasonic	MN1400
Philips	8080A*
RCA	CDP1802
Raytheon	2900*
Rockwell	65XX*, PPS 4, 4/1, 4/2, 8, 8/2, SC/MP II*
SGS-ATES	Series 8000*
Scientific Microsystems	SMS-300
Sharp	Z80*
Siemens	8080A*
Signetics	8X300, 2650A, 2900*, 8048*, 8080A*, 8085*, 9405*, 34705*, SMS-300*
Solid State Scientific	1802*
Synertek	65XX*
Texas Instruments	74S481, 8080A*, SBP-0400A/0401A, TMS-1000, TMS-9900, 9940, 9980
Thomson CSF/Sescosem	2900*, 6800*
Toshiba	T3190, T3444, T3472
Western Digital	1872, MCP1600/WD-16, SC/MP II*
Zilog	Z8, Z80, Z8000

\*Alternate source product

Meanwhile, no 16-bit processor has captured a dominant market share. The biggest 16-bit trend is price reductions. General Instrument, for instance, recently introduced an \$8 version (100 qty) of its CP1600 16-bit microprocessor. The low-cost 1610 is totally pin and software-compatible. Performance, however, was traded off for low cost—the 1610 operates at a 2-MHz maximum clock instead of 4 MHz, and comes in a plastic—not ceramic—40-pin DIP.

National Semiconductor has upgraded its PMOS 16-bit microprocessor, the PACE, with an NMOS equivalent, the INS8900, which performs better for the same price. (National, however, isn't pushing the PACE any more and rumors indicate it will be discontinued in the near future.)

Ferranti's bipolar 16-bit processor, the F100L, is not well known in the U.S. But with its rapid clock speed, it can provide high performance, and since it's a bipolar device, it can operate over the full military temperature range.

The only other 16-bit bipolar processor is the SBP9900 from TI. The SBP9900 and its NMOS equivalent, the TMS9900, as well as a "shrink" (16-bit internal data bus, 8-bit external) version, the TMS9980, are all software-compatible with each other and with TI's 990 series of minicomputers. Software-development costs for the 9900 can be kept down since the 990 minicomputers have an extensive program library.

The same is true for the mN601 (microNova) from Data General. The 16-bit mN601 is software-compatible with the company's Nova series of minicomputers, so it has a vast repertoire of applications software. Also available are all the peripheral devices and interface circuits already designed for the Nova minicomputers.

Fairchild has announced a bipolar (I<sup>2</sup>L) 16-bit machine, the 9440, that emulates the Nova 1200 minicomputer-instruction set. However, due to patent-infringement lawsuits brought on by Data General (the developer of the Nova), the 9440 will not be available for a while.

Getting all the hardware together for a prototype system is probably the easier half of system design. The harder half is getting the software to control the system. Writing the code to control the microprocessor, microcomputer or bit slice can take about double the time you typically allot for it—and possibly cost as much as \$100,000. However, the software cost can be amortized by the number of systems produced since it is a one-shot expense.

#### Speed program development with design aids

Almost every manufacturer of a processor product—and several other manufacturers—offer some form of development system to help you develop both hardware and software for the processor. However, features vary considerably from one manufacturer's system to the next. Depending on the features each



system offers, be prepared to spend anywhere from \$6000 to \$15,000 for a system that permits you to program only one manufacturer's processor.

Only one or two systems can program more than one manufacturer's processor—that capability will cost you about \$25,000. But what do you get for the money? Typically you're buying a microcomputer with about 32 kwords of RAM, several kwords of ROM, a dual floppy-disc system, a CRT terminal and a printer, paper-tape reader/punch and possibly a PROM programmer. The floppy-disc memory and the ROMs contain most of the control programs needed to develop your own programs.

If you don't want to invest in major equipment such as a development system, you can use a computer (usually a large one) to develop your programs. But depending on how long it takes to develop your program, going this route could be more expensive in the long run.

Typical programs you would use during a program-development cycle include an assembler, editor and a compiler. There are also large programs written in Basic, variations of PL/1 and Fortran that are used first to develop programs in these higher-level languages, then to translate the instructions down to the actual operation code needed to control the processor. These languages, though, generate more code than is necessary. But that's the price you pay if you don't want to work in the assembly language of the processor itself.

An assembler is a program that translates assembly-language statements into machine code that your processor can execute. However, there are many types of assemblers, each with its idiosyncrasies.

Essentially, an assembler reads statements written in mnemonic or symbolic form and produces the op codes necessary to run the processor. Errors due to misuse of the assembly language can be detected by the better assemblers and pointed out before the code is programmed into the processor.

Most assemblers offered require two passes through the mnemonics to be assembled before they complete their job. Usually, on the first pass the assembler assigns addresses to all jump symbols and labels used in the program. On the second pass, all instructions are converted into binary, with all the correct jump locations inserted into the proper places.

More efficient assemblers require only one pass through the mnemonic listings to do the job completely, which cuts the time needed to obtain binary codes. Many of the assemblers also offer the convenience of transferring the binary codes directly to a paper tape or PROM, thus providing a permanent record of the program and putting it in a form easy for the processor to digest.

The more powerful assemblers often include another feature, called macro capability. This feature permits short, oft-used mnemonic routines to be represented by a new mnemonic that can then be substituted into the program under development. When

the final program is assembled, the macroassembler automatically substitutes the proper code sequence.

Editor programs permit you to write programs in assembly language and to change them at will with simple commands. They are available either on time-sharing systems or on most of the purchasable development systems. With editors, you can add documentation; store, combine and retrieve programs; and deliver programs to paper tape or printers.

The coding process is usually completed with a loader. Usually stored in ROM, a loader transfers the binary programs from paper tape into RAM, from ROM into RAM or from some form of magnetic storage into the computer. A relocating loader automatically readjusts program addresses and loads the resulting instructions into the computer. Another feature some loaders offer is a linking capability, which lets you use routines with undefined labels. Missing label definitions are filled in as the program is loaded.

Compiler programs let you develop your program in a higher-level language. Since many programmers are familiar with languages such as Fortran or PL or Basic, this capability cuts development time. The biggest factors in deciding whether or not to use a high-level language are turnaround time and memory size. (Code generated by high-level languages can require about 20 to 50% more memory space than assembly-language-generated programs.)

In addition to the basic development aids, simulators, emulators and debuggers are usually mandatory to track down errors that might still remain in the code. For the same reason hardware emulators and in-circuit emulation are handy capabilities to have in a development system.

### **Don't overlook the learning aids**

Anyone interested in designing  $\mu$ P-based equipment is immediately confronted with a bewildering variety of evaluation kits, learning aids, design aids, teaching aids and programming aids. Because the  $\mu$ P market has grown so rapidly, there are no exact definitions for the aids.

"Aids" currently range from under \$200 to well over \$20,000 depending on the features. But one subgroup, from \$100 to \$900, permits just about anyone to get "hands on" experience with a particular processor.

Almost all the inexpensive microprocessor design aids are aimed at 8-bit devices—there are no 4-bit microprocessor or microcomputer design aids. There are, however, several inexpensive evaluation kits for the two-bit Series 3000 bit slice and the 2900 4-bit slice.

For the 8-bit processors, Intel offers several kits as well as preassembled boards for its 8080A and 8085. Motorola offers several kits for its 6800. National Semiconductor offers a kit and some boards for the SC/MP. RCA offers a designer's kit for its 1802. Intersil offers a learning system for its 6100. MOS Technology offers a system for its 6502. Both Fairchild



and Mostek offer boards for the F8. Zilog offers a family of boards for the Z80. Signetics offers a board for the 2650 and another for its 8X300. American Microsystems offers several kits for the 6800. And the list of "offerings" keeps growing as more processors are developed.

Software for microprocessors can also be as confusing to select as design aids. Basically, software is available in resident and nonresident forms—and there are several hundred variations in each form. Resident software consists of programs written in the instructions of a specific microprocessor and ready to run on a system that uses that micro. Nonresident software consists of programs that run on one processor (typically, a minicomputer or larger processor) to help you develop the software of another processor (typically at  $\mu$ P).

Most microprocessor-development systems, which range from the \$100 kit to the \$20,000 work station, come with some form of resident software—if the system is designed to develop code for one type of microprocessor. Some development stations, though, don't have truly resident software. For example, the 8002 universal microprocessor development system from Tektronix (Beaverton, OR) uses the 2650 as the main controller, but it can also be used to develop code for the 8080A, 6800, Z80 and TMS9900 processors.

For less expensive systems, the software included is usually minimal and often stored in ROMs (sometimes referred to as firmware). The more expensive systems usually contain either a paper-tape reader or a floppy-disc drive to permit large programs to be entered and help you develop software.

Firmware on most of the smaller development systems usually consists of a monitor program that permits you to use either a TTY or CRT terminal with the board and write your programs in machine code. Such commands as examine a memory location, change its contents and examine the next location, start execution at a specific location, and establish breakpoints to allow selected program sections to be executed are available on most monitors.

However, if you want the convenience of working in assembly language, you'll have to use a fairly large development system, since most assembly-language programs require several thousand bytes of RAM. Extensive program-development systems are available from most processor vendors, but other alternatives are available from many companies. Future-data Computer Corp. (formerly Microkit) in Santa Monica offers a flexible system that provides assembly-language capability for the 8080, Z80 and the 6800. Other companies offering systems include muPro (Cupertino, CA) and Wintek (Lafayette, IN). The muPro System 80, intended for 8080A users, not only lets you develop programs for the 8080A, but also contains an in-circuit emulator, a field-test system, and an 8080 microcomputer. The system uses a language developed by muPro called BSAL-80, a non-

mnemonic language.

The Wintek systems use the 6800 and, since they are designed on a standard 44-pin circuit card (dual 22-pin), can be installed in a standard card rack.

Although not quite design aids, some of the newer microcomputer systems such as the PET made by Commodore (Palo Alto, CA) and the TRS-80 made by Radio Shack (Fort Worth, TX) come ready-to-use and let you write programs in Basic and load or store the programs on a magnetic-cassette transport. The 6502-based PET has an IEEE-488 interface bus, so it can figure in many instrumentation applications. What's more, the price for the processor with integral CRT, 12 k of ROM, 4 k of RAM, cassette deck and 70-key keyboard is only \$595.

The Z80-based Radio Shack system also includes 4 k of RAM and 4 k of ROM, but has a separate video monitor, cassette deck and keyboard/CPU as well.

### Don't want hardware? Try time-sharing

The accessibility of large computers and time-sharing services has sparked the processor manufacturers to develop higher-level programs that can run on the large machines and be shared by hundreds of users at the same time. Programs are now available in machine language, forms of PL/1, Fortran and Cobol to permit you not only to develop programs in higher languages but also to get processor-compatible code when you're done.

Such programs are usually not as efficient as assembly-language programs. However, some time-sharing companies have helped reduce the inefficiencies by developing their own software for program development. For instance, the Boston Systems Office uses large minicomputers in its time-sharing network, and develops its own software in the minicomputers' assembly language. What this means is more efficient use of the computer's time and thus smaller time-sharing bills.

Some of the other larger companies that offer  $\mu$ P-development programs include National CSS (Norwalk, CT), General Electric Information Services (Bethesda, MD), First Data (Waltham, MA), United Computer Systems (Kansas City, MO) and Tymshare (Cupertino, CA). Each company's original programs will offer different features, so you must get each company's manual and compare features to make sure you get what you need.

A high-level system often lets you develop the program for your system before the hardware can be prototyped—sometimes even before a dollar is spent for hardware—since complete simulators and emulators are available for many processors. Cross-assemblers are commonly available in Fortran, versions of PL/1 and assembly language. Some assemblers even provide more than one machine-code format for absolute and relocatable code listings.

Compiler and integrator programs are available in PL/M, PL/W, PL/Z, MPL, Fortran, Cobol, Forth. And



if that isn't enough alphabet soup, there are at least as many that have gone unnamed.

However, all isn't roses with time-sharing services—computer time is expensive. If you're concerned with CPU time, keep a careful watch over the use of a terminal with a time-shared computer. And CPU time isn't the only big expense. Storage space reserved, output time and communication links, and manpower will also cost you dearly.

Software costs can vary widely, depending on the design approach taken by the programmer. Some programmers can also keep the hardware cost down by transferring some of the hardware into software routines handled by the microcomputer. Often, the more functions you can assign to software, the more flexible the final system. Of course, you shouldn't burden the processor with so many little things that it can't do the job you originally wanted it for.

Software cost can get bothersome if you saddle capable programmers with a new and totally unfamiliar instruction set. The learning curve starts at the peak cost and must be given time to work its way back to average as the programmers become familiar with each processor's language. And with the approximately 40 languages that have appeared the last six years, it will take a while before they catch up.

When you start a microprocessor development program, don't just consider the circuit hardware and the programming language—look at the development system itself. One of the most overlooked items is some form of high-speed, hard-copy output device. Sure, the ASR-33 teletypewriter is the industry workhorse—but it's too slow for many program-development uses.

Say you've spent the day working on a program and you want to get a printout of your 2000-line program with all comment notes to check out. If you're using a 10 to 50 character-per-second printer, forget it. Assuming each line has about 50 characters and the printer chugs away at 10 cps, you'll have to wait about three hours for the listing. With a 50-cps printer the delay is less—only half an hour.

Does your system use a cassette, cartridge or disc-file system? Floppy-disc operating systems usually offer the fastest performance, but they're also the most expensive. But in a dual-disc system one disc holds main operating programs, while the other stores user programs. This method helps reduce access time, while providing a more flexible development system.

If there is an ideal development system, it hasn't been put on the market yet. Ideally, the basic hardware should include a universal CPU, a full complement of RAM and ROM-based bootstrap-loader programs, general-purpose interfaces for terminals, printers, disc drivers, PROM programmers, paper-tape readers/punches, etc., a CRT terminal with a few programmable keys and a high-speed printer capable of 50 to 100-cps hard-copy outputs. Of course, the floppy discs that come with the system should hold the development programs you'll need to write the software for your system. ■

## Need more information?

Listed below are the original-source microprocessor manufacturers and most of the alternate source vendors. For additional companies consult ELECTRONIC DESIGN's Gold Book under IC, Central Processing Unit and Computers, Digital, Micro.

- AEG, 6 Frankfurt 70, AEG Hochhaus, Federal Republic of Germany.  
Circle No. 405
- Advanced Memory Systems, 1215 Hammerwood Rd., Sunnyvale, CA 94086.  
(408) 734-4330.  
Circle No. 406
- Advanced Micro Devices, 901 Thompson Pl., Sunnyvale, CA 94086. (408)  
732-2400.  
Circle No. 407
- American Microsystems, 3800 Homestead Rd., Santa Clara, CA 95051. (408)  
246-0330.  
Circle No. 408
- Data General, Route 9, Southboro, MA 01772 (617) 485-9100  
Circle No. 409
- Electronic Memories & Magnetics, Semiconductor Div., 12621 Chadron Ave.,  
Hawthorne, CA 90250 (213) 644-9881.  
Circle No. 410
- Essex International, 564 Alpha Dr., Pittsburgh, PA 15238. (412) 963-9322.  
Circle No. 411
- Fairchild, 1725 Technology Dr., San Jose, CA 95110 (408) 998-0123. (MOS)  
Circle No. 412
- Fairchild Semiconductor, 464 Ellis St., Mountain View, CA 94042. (415)  
962-3816. (Bipolar).  
Circle No. 413
- Ferranti Ltd., Western Rd., Bracknell, Berkshire RG12 1RA, England.  
Circle No. 414
- Fujitsu Ltd., 6-1, Marunouchi 2 Chome, Chiyoda-ku, Tokyo, Japan  
Circle No. 415
- General Instrument, 600 W. John St., Hicksville, NY 11802. (516) 733-3130.  
Circle No. 416
- Harris Semiconductor, P.O. Box 883, Melbourne, FL 32901. (305) 727-5400.  
Circle No. 417
- Hitachi, Ltd., Nippon Building, No. 6-2, 2-Chome, Ohtemachie, Chiyoda-ku,  
Tokyo 100, Japan.  
Circle No. 418
- Hughes, Solid State Div., 2601 Campus Dr., Irvine, CA 92715. (714) 752-6396.  
Circle No. 419
- ITT Semiconductor, 74 Commerce Way, Woburn, MA 01801. (617) 935-7910.  
Circle No. 420
- Intel, 3065 Bowers Ave., Santa Clara, CA 95051 (408) 246-7501.  
Circle No. 421
- Intersil, 10900 N. Tantau Ave., Cupertino, CA 95014. (408) 996-5000.  
Circle No. 422
- MOS Technology, Valley Forge Corporate Center, 950 Rittenhouse Rd., Nor-  
ristown, PA 19401. (215) 666-7950.  
Circle No. 423
- Monolithic Memories, 1165 E. Arques Ave., Sunnyvale, CA 94086. (408)  
739-3535.  
Circle No. 424
- Mostek, 1215 W. Crosby Rd., Carrollton, TX 75006. (214) 242-0444.  
Circle No. 425
- Motorola Semiconductor, 3501 Ed Bluestein Blvd., Austin, TX 78721. (512)  
928-2600. (MOS)  
Circle No. 426
- Motorola Semiconductor, 5005 E. McDowell Rd., Phoenix, AZ 85008. (602)  
244-6900. (Bipolar).  
Circle No. 427
- NEC Microcomputers, 5 Militia Dr., Lexington, MA 02173. (617) 862-6410.  
Circle No. 428
- National Semiconductor, 2900 Semiconductor Dr., Santa Clara, CA 95050.  
(408) 737-5000  
Circle No. 429
- Panafacom Ltd., 2-10-16 Jiyuzaoka, Mezuro-ku Tokyo, Japan 152  
Circle No. 430
- Panasonic, 50 Meadowland Parkway, Secaucus, NJ 07094. (201) 348-7276.  
Circle No. 431
- Philips Industries, Electronic Components and Materials Div., P.O. Box 523,  
Eindhoven, the Netherlands.  
Circle No. 432
- RCA, Box 3200, Route 202, Somerville, NJ 08876. (201) 685-6423  
Circle No. 433
- Raytheon, 350 Ellis St., Mountain View, CA 94040. (415) 968-9211.  
Circle No. 434
- Rockwell International, P.O. Box 3669, RCOI-Dept. 720, Anaheim, CA 92803.  
(714) 632-2321  
Circle No. 435
- SGS-ATES, Via C Olivetti 1/20041, Agrate Brianza, Italy.  
Circle No. 436
- Scientific Microsystems, 520 Clyde St., Mountain View, CA 94043. (415)  
964-5700  
Circle No. 437
- Sharp, 22-22 Nagaike-Cho, Abeno-ku, Osaka, 545, Japan  
Circle No. 438
- Siemens AG, Central Information Dept., Oskar-von-Miller Ring 18, D-8000  
Munchen 2, Federal Republic of Germany.  
Circle No. 439
- Signetics, 811 E. Arques Ave., Sunnyvale, CA 94086. (408) 739-7700.  
Circle No. 440
- Solid State Scientific, Montgomeryville Industrial Park, Montgomeryville, PA  
18936 (215) 855-8400.  
Circle No. 441
- Synertek, 3050 Coronado Dr., Santa Clara, CA 95051 (408) 241-4300.  
Circle No. 442
- Texas Instruments, 13500 North Central Expressway, M/S 308, Dallas, TX  
75222. (214) 238-2011.  
Circle No. 443
- Thomson-CSF, Sescosem, 101 Boulevard Murat, 75781 Paris Cedex 16, France.  
Circle No. 444
- Toshiba Transistor Works, 1 Komukai Toshiba-cho, Kawasaki-shi Kanagana-  
ken, Japan.  
Circle No. 445
- Western Digital, 3128 Red Hill Ave., Newport Beach, CA 92663. (714) 557-3550.  
Circle No. 446
- Zilog Microcomputers, 10460 Bubb Rd., Cupertino, CA 95014. (408) 446-4666.  
Circle No. 447



# Doing high powered thinking

Everything  
you need to think  
CMOS microprocessing.  
Just choose your level.

**1.** Our free CMOS Data Book describes the Intersil IM6100 CMOS 12-bit Microprocessor and details the Intercept Prototyping System, the Intercept Jr. Tutorial System and our whole family of IM6100 CMOS components.



**2.** The least expensive microcomputer kit on the market. \$49. The fully-documented kit includes the IM6100 microprocessor, one IM6101 PIE, one IM6312 ROM, the IM6403 UART, and, three IM6561 1k RAMs. For an additional \$32.50, we'll include the PC board.



**3.** Learn to think CMOS. \$281. The Intercept Jr., one-card battery powered operating system helps you to learn (or teach) CMOS microprocessor programming. Fast. The Intercept Jr. package includes a multi-function keyboard, 8-digit LED display, 256 words of RAM memory, a resident microinterpreter, provisions for modular expansion...and, complete instructions. Options include: 1K x 12 CMOS RAM and battery backup; 2K x 12 PROM; Serial I/O; Audio Cassette Interface, and Tutorial Modules.

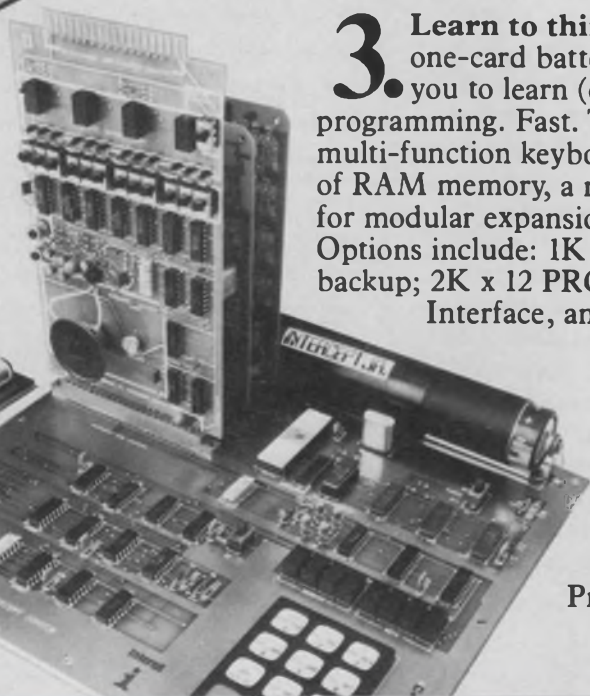

**4.** Prototype your systems in CMOS. \$2,850. With the Intercept Prototyping System. A complete microcomputer development system that includes 4K words of CMOS memory with on board battery backup. Prototype systems. Develop software.



# about low power CMOS? Call Intersil.

For quite a while, people have been telling you CMOS was on the way. At Intersil, it's here. Now. At prices that make CMOS thinking practical.

Evaluate the IM6100 in your range of applications. To help, we offer a full range of paper-tape software, which includes utility routines and diagnostic packages, editor and assembler software, floating point package, debugging programs and high level languages.

**5.** Add Floppy Disk for \$5,100. The Intersil 6970 floppy disk operating system includes all Intercept software and allows you to prototype systems. Fast. Typically, it allows you to develop complete software packages in about 1/10th of the normal time. If you're thinking CMOS, the 6970 could pay for itself in developing your first program.

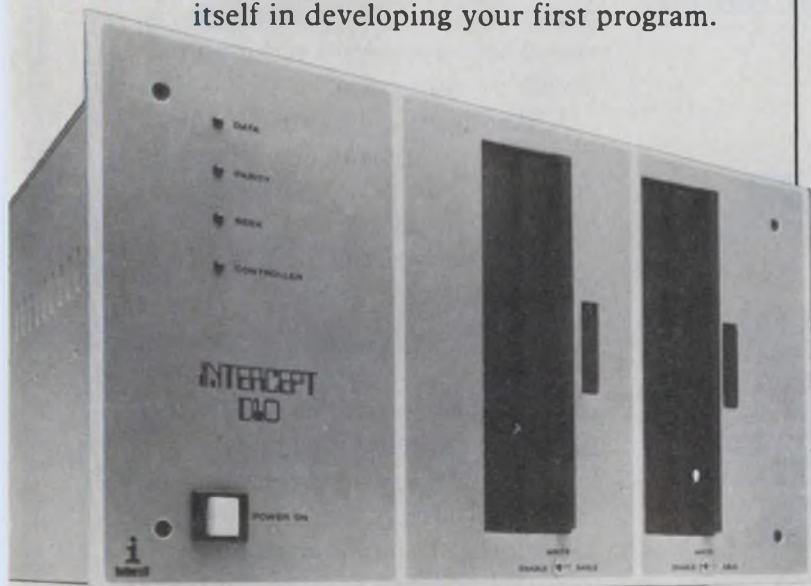

## PERIPHERALS THAT MAKE YOUR CMOS SYSTEM WORK

TYPE	DESCRIPTION	100
IM6100	CMOS 12-bit microprocessor	\$15.00
IM6101	CMOS Programmable Interface Element	8.65
IM6102	CMOS Memory Extender/ Interval Timer/DMA Controller	15.00
IM6312	CMOS 1024 x 12 ROM	*
IM6402	CMOS UART	4.00
IM6508	CMOS 1024 x 1 RAM	5.00
IM6512	CMOS 64 x 12 RAM	5.00
IM 6561	CMOS 256 x 4 RAM	5.00

\*Consult factory

## COMING SOON

Type	Description	When
IM6103	CMOS 20 Bit I/O Port	4th Qtr
IM6504	CMOS 4096 x 1 RAM	4th Qtr
IM6603	CMOS 1024 x 4 EPROM	4th Qtr

**YOUR INTERSIL DISTRIBUTOR HAS ALL INTERSIL CMOS PRODUCTS IN STOCK. NOW.**

# INTERSIL

10710 Tantau Avenue, Cupertino, CA 95014  
For CMOS information call: D. W. Sohn.

Marketing Manager, Digital Products.  
Telephone: (408) 996-5000 (800) 538-7930  
TWX: 910-338-0171

**ARIZONA**—Liberty Electronics, Kierulff Electronics. **CALIFORNIA**—Elmar Electronics, Intermark Electronics Inc., Kierulff Electronics, Liberty Electronics, Schweber Electronics. **COLORADO**—Century Electronics, Elmar Electronics, Kierulff Electronics. **CONNECTICUT**—Arrow Electronics, Schweber Electronics. **FLORIDA**—Arrow Electronics, Diplomat/Southland, Inc., Schweber Electronics. **GEORGIA**—Arrow Electronics, Schweber Electronics. **ILLINOIS**—Schweber Electronics, Kierulff Electronics. **INDIANA**—Advent Electronics, Inc., Sheridan Associates. **MARYLAND**—Arrow Electronics, Schweber Electronics. **MASSACHUSETTS**—Arrow Electronics, Kierulff Electronics, Schweber Electronics. **MICHIGAN**—Schweber Electronics, Sheridan Sales. **MINNESOTA**—Arrow

Electronics, Schweber Electronics. **MISSOURI**—LCOMP. **NEW JERSEY**—Arrow Electronics, Diplomat IPC, Corp., Schweber Electronics. **NEW HAMPSHIRE**—Arrow Electronics. **NEW MEXICO**—Century Electronics. **NEW YORK**—Arrow Electronics, Components Plus, Harvey Federal Electronics, Schweber Electronics. **NORTH CAROLINA**—RESCO. **OHIO**—Arrow Electronics, Schweber Electronics, Sheridan Associates, Sheridan Sales. **OKLAHOMA**—Component Specialties. **PENNSYLVANIA**—Schweber Electronics, Sheridan Sales. **TEXAS**—Component Specialties, Schweber Electronics. **UTAH**—Century Electronics. **WASHINGTON**—Kierulff Electronics, Liberty Electronics. **WISCONSIN**—Arrow Electronics. **CANADA**—CESCO, R.A.E. Ind. Elect. Ltd., Zentronics Ltd.



# How to save a million dollars and improve your product at the same time.

A million dollars is, actually, a conservative estimate.

If you are using a number of standard chips in your product, and come to us for a custom MOS/LSI circuit, you'll probably find that your savings are considerably higher.

Most of our customers have. Even those with production runs of less than 20,000 a year.

What's interesting is that when many of them came to us, savings were not uppermost in their minds. They wanted to make their products smaller, lighter, more versatile, or more reliable.

Our circuit achieved whatever aim they had in mind. And *the savings followed almost automatically.*

**Where the savings came from.** Obviously, switching from a number of IC circuits to a single MOS/LSI circuit eliminates the cost of all those other circuits.

But that's only the beginning. There's also the cost of quality control on all those circuits; the cost of inventorying and other in-plant handling costs; and the cost of wiring them all together.

And the cost of failures. With a number of IC's wired together, the failure rate has to be high. The more IC's, the higher the failure rate. And then, you've got to locate the cause of each failure, fix it, retest it, and, frequently, junk it. (And that's not even considering the cost of failures happening when seemingly good units

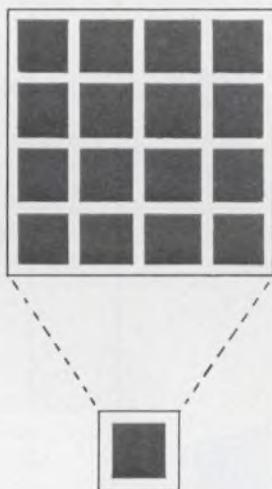

**LSI  
COMPUTER  
SYSTEMS  
INC.**

get out in the field.)

**And improve your product?**

Going to a custom MOS/LSI circuit from a number of standard IC's improves your product in a number of ways.

There's *always* an increase in reliability—generally a spectacular increase. There's always at least a small decrease in weight. There's always an opportunity to decrease size. There's always a reduction in power consumption.

And there's generally a way to make your product do things it could never do before—which increases its marketability.

And with all of these, go those tremendous cost savings.

**Deal only with qualified people.** To get the most of these benefits you must, of course, deal with people who are highly qualified in both the design and production of MOS/LSI circuits. And can give your job intense, personal attention.

At LSI Computer Systems you can deal *only* with such people.

And every job receives complete, personal attention from top-flight people from basic concept to delivery of packaged chips.

We've been helping companies realize the full benefits of custom MOS/LSI circuits for over eight years, now. We'd be glad to help you.

Call or write Ron Colino, VP Marketing, LSI Computer Systems, 1235 Walt Whitman Road, Melville, NY 11746. (516) 271-0400.



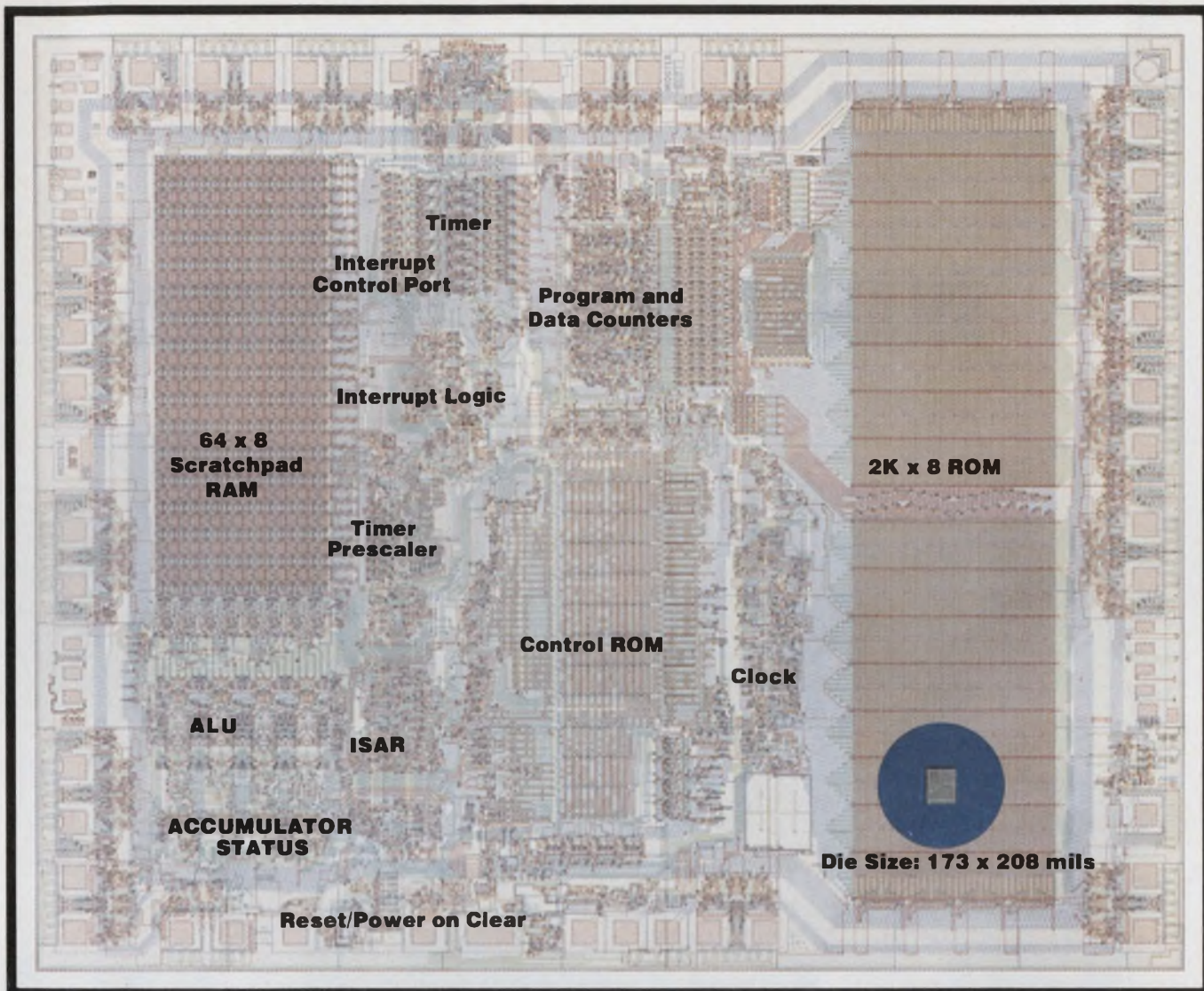

## Mostek 3870. Single and available. Under \$10.\*

Mostek's new MK 3870 single-chip microcomputer delivers more performance for less cost, and it's available now. The MK 3870 is the first microcomputer-on-a-chip designed with complete system capability and offering full compatibility with a multi-chip processor family. For less than \*\$10 the device offers important features to solve a wide range of control and logic replacement applications.

- 2K x 8 ROM • 64 x 8 RAM
- 32 bits I/O + Strobe • Programmable Timer • On-chip OSC/Clock
- 5V ± 10% Power Supply • Multi-chip Expandability • Low Power (typ. 300mW)

The MK 3870 provides twice the program storage of other single-chip devices and can execute the complete F8 instruction set of more than 70 commands, providing complete software compatibility with the versatile F8 multi-chip family.

The MK3870 is fully supported with a complete line of low-cost development aids. They include the Software Development Board (SDB 50/70), Application Interface Module (AIM 70), and the MK 3870 Emulator (EMU 70) for field prototyping.

**The MK 3870-based VAB-2 is a typical example of logic replacement.**

For customers desiring to evaluate the MK 3870 in an actual application, a pre-programmed version is available for \$50. This particular device has been designed to replace much of the logic normally required for sophisticated video terminal applications. The complete Video Adapter Board (VAB-2), is available through our distributors for \$195. Call or write today for a data sheet.

\*1000 piece quantity. Plastic DIP.

# MOSTEK

1215 West Crosby Road • Carrollton, Texas 75006 • (214) 242-0444  
 MOSTEK GmbH • West Germany • Telephone: (0711) 701096

CIRCLE NUMBER 35



# BRAND NEW MINICOMPUTERS

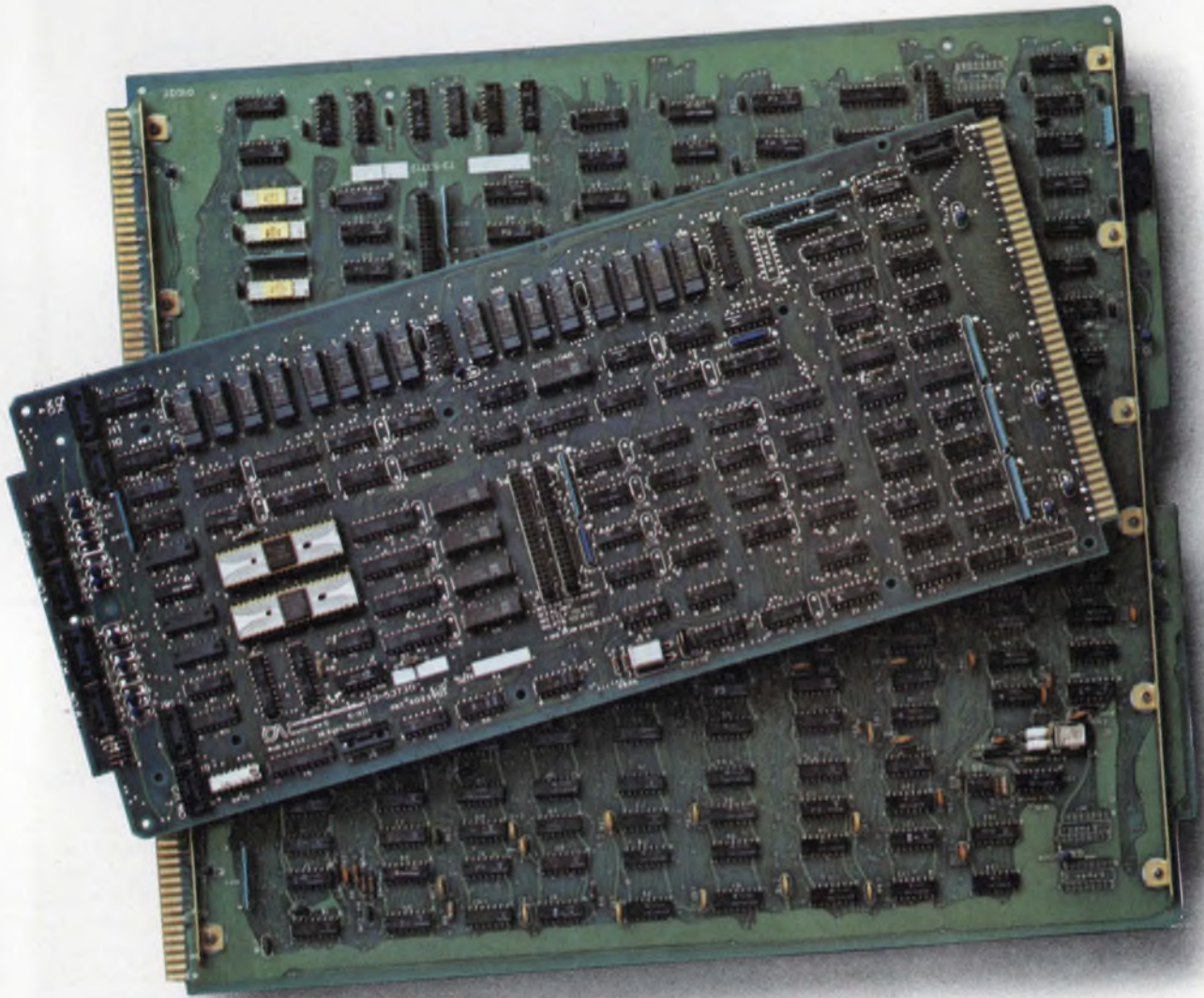



# BRAND NEW BROCHURE



Circle Reader Response No. 270

 **ComputerAutomation®**  
NAKED MINI® Division

18651 Von Karman, Irvine, California 92713  
Phone (714) 833-8830

©1977 Computer Automation, Inc.



# Learn microprocessor fundamentals.

Even if you are familiar with  $\mu$ Ps, you may find this review of basic concepts useful and refreshing.

As microprocessors ( $\mu$ Ps) become more and more acceptable as basic building blocks for all kinds of "intelligent" systems there is a tendency to assume that all engineers have a working knowledge of them. As a result, many  $\mu$ P articles that appear today—even many of the so-called "basics"—unexpectedly leave some readers in a dust cloud of vectored interrupts.

For those of you who missed the primer article about  $\mu$ P fundamentals that *ELECTRONIC DESIGN* ran back in 1975, the following article will introduce the basics. While no prior knowledge of  $\mu$ Ps is required, a little knowledge of computer programming and basic digital logic will help. A brief glossary of terms is included to summarize many of the buzz words.

A microprocessor can be thought of as a box with three sets of signal lines coming out of it (Fig. 1):

1. Address lines (often 16 of them), are all outputs and at any time may be at a logic 1 or 0, which indicates a binary number from 0 to 65,535 ("64 k").

2. "Data" lines (usually eight for an 8-bit  $\mu$ P) can act as inputs or outputs (bidirectional).

To find out what they are doing, look at

3. The control bus, whose most important segment is the read/write line. This output indicates whether the data lines are outputting (writing) or acting as inputs (reading).

At a given time, a  $\mu$ P will output an address between zero and 64 k, a read or write status, then will either output an 8-bit data word onto the data lines or accept data from the lines. The control bus also contains control lines for interrupts, resets, and other features, depending on the particular processor.

### The memory is organized like this...

There are 64-k possible memory addresses, typically organized in groups of 8 bits (Fig. 2). A group of bits in parallel is called a "word," but the 8-bit word occurs so frequently that it has its own name—a byte.

Each byte of memory is accessed by the address lines. Until its individual address is called, it appears open-circuited. The byte being addressed is either pulled from the memory location onto the data lines or changed to match the byte of data on the data lines,

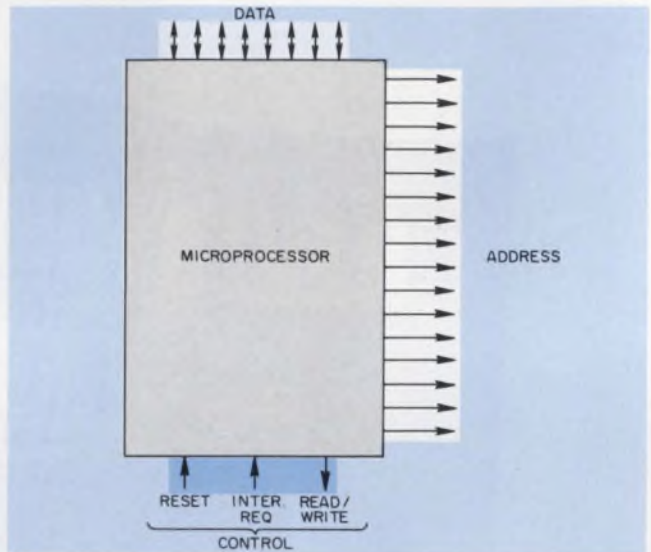

1. A microprocessor, in its simplest form, can be thought of as a black box with three sets of wires coming out of it.

depending on the status of the read/write line, shown in the block diagram of Fig. 3.

Rarely will all 64 kbytes of addressable memory be used. The capability is there, but only as much memory as is required by the application is ever used—sometimes less than 1024 bytes. Often in such systems, decoding is simplified by not using all 16 address bits.

To deal with large binary numbers, certain simplifications are extremely helpful. To this end, hexadecimal notation is often used (see box, p. 75).

A microprocessor's memory is generally organized into blocks of addresses that serve specific areas:

1. Program.
2. Scratchpad and data storage.
3. The "stack."
4. Input/output (I/O) ports.

The program is a series of instructions to direct processing. Each instruction can contain one or more bytes. The first byte of a multibyte instruction provides the basic information, including the number of additional bytes in the instruction. Steps within an instruction proceed serially byte by byte. And unless otherwise indicated, a  $\mu$ P will "look" at the instructions sequentially, starting with a specific memory address and incrementing the address.

Edward Gellender, Consultant, 26 Middle Neck Rd., Roslyn, NY 11576.



In most cases, a  $\mu$ P reads only from the program section of memory since programs are often stored in read-only memories (ROMs). In developmental systems, however, more flexible program storage is usually required. To this end, read/write random-access memories (RAMs) should be used. However, this permits the original program to be stored on a magnetic cassette, so that it can be entered each time the power is turned on. This inconvenience is compensated by ability to change the program at will and rerecord it on the cassette. The corrected tape can be

generated by one of several means—sometimes from a program already in the development systems, called a resident assembler, or from a “cross-assembler” program on a large computer. Or from a number of time-sharing services that have various cross-assemblers in their software arsenals. And simpler pad and pencil techniques can also be used quite successfully for short programs.

An intermediate programming step is to use EPROMs (erasable programmable read-only memories), which can be erased with ultraviolet light. Once programmed, however, they can retain their information indefinitely. With  $\mu$ Ps that serve to control routine operations, use of factory-programmed ROMs will minimize cost, but sacrifice flexibility.

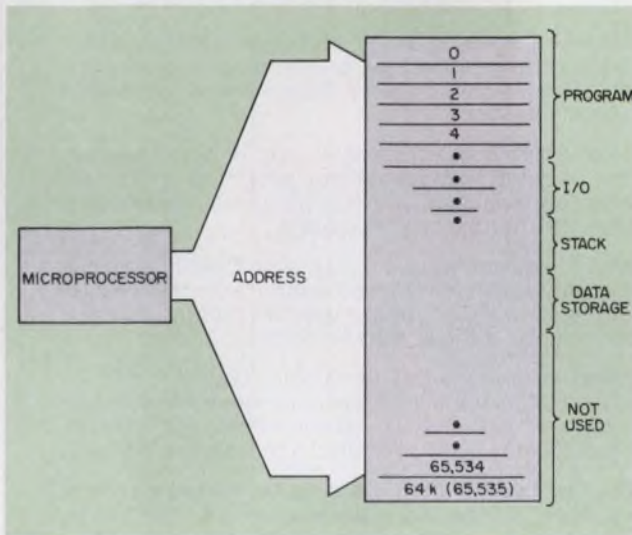

2. **Everything the microprocessor is hooked into** fits into the category of memory organized into specialized blocks.

### Examine a typical program sequence

Having come this far, consider a program sequence that illustrates a simple procedure. Suppose a byte of data were to be moved from one memory location to another. Assume that the address of the previous instruction is 0100 and that the contents of byte 24F1 are to be moved into 2407, neither address being in the program section of memory. Table 1 shows how it's done.

*Step 1.* The next consecutive address after 0100, 0101, is read. Its contents are 7A, which is interpreted as “Read data from the address given by the next two bytes.”

*Step 2.* The least significant byte (F1) is read.

*Step 3.* The most significant byte (24) is read.

*Step 4.* The consecutive-address sequence on the

## Hex notation explained

Hexadecimal notation groups together four binary digits to form one digit representing a count from zero to 15. Obviously, some one-digit characters are needed to represent the decimal two-digit numbers from 10 to 15. The six letters, A through F, are used for this.

Hexadecimal notation is very convenient for microprocessors since it gives good counting densities and works very well with the multiples-of-four binary words usually encountered in a  $\mu$ P.

To understand the hexadecimal notation, take a number like 107. In binary notation, this becomes 1101011. Breaking this number into two groups of four digits, you get 0110 and 1011. The first of these is equal to 6, while the second one is 11. In hexadecimal notation, 107 becomes 6B.

Note that the highest memory address in a micro is hexadecimal FFFF.

To convert from decimal to hexadecimal, or vice versa, you must first convert the number into binary and then into hexadecimal as previously illustrated.

## Decimal conversion guide

Decimal	Hex	Binary
0	0	0000
1	1	0001
2	2	0010
3	3	0011
4	4	0100
5	5	0101
6	6	0110
7	7	0111
8	8	1000
9	9	1001
10	A	1010
11	B	1011
12	C	1100
13	D	1101
14	E	1110
15	F	1111



# Glossary of some microprocessor related terms

## Category I: Basics

**Bit:** a minimum logic element. A binary number of either 0 or 1.

**Word:** any group of bits indicating a single number or expression.

**Byte:** a word consisting of eight bits.

**Address:** a specific memory location that is called out by the program counter.

**Hex:** short for hexadecimal: numbers calculated to the base 16.

**Register:** a device that stores one word of data, and often consists of several flip-flops.

**RAM** (random-access memory): a data-storage device that can retain and produce on demand any data placed in it.

**ROM** (read-only memory): a device that has data permanently entered into it to be outputted on demand.

**PROM:** a programmable ROM in which a program is entered by the user before installation into equipment, as opposed to a factory-programmed ROM.

**EPROM:** A PROM that can be erased and reused indefinitely. Most EPROMs are erased under ultraviolet light and can be recognized by the clear cover over the silicon "chip."

**Decoder:** usually a device that detects a certain specific address on the address bus.

**Bus:** a group of wires that carry related binary signals, usually a word, as in a 16-wire address bus. A bus can be bidirectional, as in the case of a data bus.

## Category II: Parts of a microprocessor

**Accumulator:** a register in the microprocessor that operates on data. It is so-called because these registers were first used to accumulate totals.

**ALU** (arithmetic and logic unit): the circuitry that performs the manipulations on data held in the accumulator.

**I/O** (input/output): hardware that interfaces a microprocessor system with the outside world.

**Port:** a place through which inputs and outputs—either data or instructions—are channeled. A  $\mu$ P can have more than one port or can address many. Port size, though, is often specified in bits, ranging from 4 to 16 bits.

**Processor Status Word (PSW):** a word of readily available status information provided to indicate the result of specific operations.

**Program Counter:** two 8-bit registers used to generate the 16-bit address. The registers are called PCH and PCL and are used for the higher-order and lower-order bytes, respectively.

**R/W** (read/write): a control output of the microprocessor that indicates if data are being transferred from the microprocessor to memory, or vice versa.

**Scratchpad:** an area of the main memory set aside for short and often done calculations.

**Stack:** storage for data during subroutines or interrupts.

**Stack Pointer:** two 8-byte registers containing the address of the top (most recent end) of the stack.

## Category III: Programming

**Assembly Language:** a compromise between the user's thoughts and the numerical notation of the microprocessor. Assembly language is the closest technique to the actual numerical codes that still retains some speaking-language characteristics.

**Branch:** depending on the status of a particular bit in the status register, the program will jump by the indicated amount if the condition is met, or merely increment if not.

**Cross-Assembler:** a program on a larger computer that allows a microprocessor programmer to use assembly language. The assembler reduces the program to the machine language.

**DMA** (direct memory access): a process in which a microprocessor is removed temporarily from a system to allow data to be transferred rapidly in or out of memory without microprocessor control.

**Interrupt:** an external signal that causes a microprocessor to jump to a specific subroutine. Interrupts are maskable or nonmaskable. A maskable interrupt may be delayed until a mask bit is lowered.

**Iterative Loop:** a programming technique whereby a process is repeated a specified number of times.

**Jump:** a programming instruction that breaks the consecutive-instruction programming sequence and resumes elsewhere in the program.

**Machine Language:** Numerical coding, representing instructions, usually in the form of groups of bytes, used by the microprocessor.

**Peripheral:** a unit operated with a microprocessor system such as a keyboard or a printer.

**Program:** a set of sequential instructions that a computer follows.

**Subroutine:** a program within a program that performs a specific, often-used function.

**Vector:** a specific address loaded into a microprocessor's program counter to force the  $\mu$ P to start processing at a specific address.

address bus is momentarily interrupted, and the contents of byte 24F1 are read. The contents are 7A — but now the 7A represents data, not an instruction as in Step 1.

*Step 5.* The consecutive-address count resumes at 0104. The next instruction, 4A, is interpreted as "Write the data stored in the processor into the address given by the next two bytes."

*Step 6.* The least significant byte (07) is read.

*Step 7.* The most significant byte (24) is read.

*Step 8.* The consecutive addresses are interrupted again, while 7A is placed into address 2407.



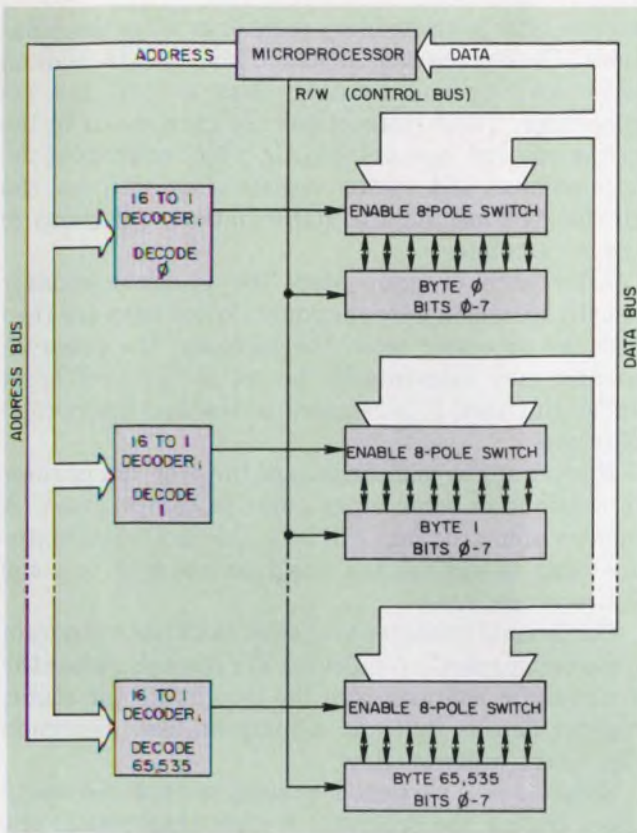

3. Microprocessor-to-memory connection via the buses can be thought of as shown above. Note that each 8-pole switch can be closed one pole at a time.

### A simple machine program

Step no.	Address bus	Data lines	R/W
1	0101	7A	R
2	0102	F1	R
3	0103	24	R
4	24F1	7A	R
5	0104	4A	R
6	0105	07	R
7	0106	24	R
8	2407	7A	W
9	0107	...	

Step 9. The consecutive addresses resume.

Note that the  $\mu P$  follows a rigid sequence to keep track of which bytes are instructions, which are data, which are addresses, and so on. Thus, the same byte (7A in the example) can be placed on the data lines at two different times and have two separate meanings.

Note also, that the least significant byte of an address is handled first, although it isn't crucial. Some processors do it this way while other processors do it the reverse. Just make sure to check which way it should be done when you start to program.

The *scratchpad* and *data storage* serve to store data temporarily. "Scratchpad memory" usually designates an area of memory used for many quick data transfers. It is the most frequently used memory segment. Some microprocessors have simplified instructions that can only be used in a certain small part of the memory (say, the first 256 bytes), where the most significant byte of the addresses is zero. The scratchpad is usually placed in such a location.

The data-storage area is similar to the scratchpad, except that just the usual processor instructions can be used. Thus data may be addressed slower than in the scratchpad area. Data storage is used for the bulk of the memory, and RAM is most often used for data storage.

The *stack* is a read/write block of memory used to "remember" the next consecutive address and associated data when the address lines are taken over by a sequence of nonconsecutive addresses, as in a subroutine. More will be said about the stack when subroutines are discussed.

*I/O ports* are simply a means for getting into and out of a  $\mu P$ , which is virtually a closed system with no way of communicating with the outside world. A typical port is an 8-bit register that can have data loaded into it or read out by means of external signals. It also has an address decoder to detect when the  $\mu P$  is addressing it. At such a time, either the contents of the data bus are put into the register (output port) or the contents of the register are placed on the data bus (input port).

If, for the program sequence of Table 1, address 2407 does not go to a RAM but is decoded and used to load the contents of the data lines (7A) into a register, the data are accessible at the outputs of the register (an output port) until the register is supplied with new data. Thus the data stored in memory at address 24F1 and accessible only by programming are now available to the outside world via an output port (Fig. 4a). If such a register's address is called with the outputs connected to the data lines, the register would be an input port (Fig. 4b).

### What goes on inside?

So far the microprocessor has been treated as a "black box" that always knows which words to place on the address and data lines. Look inside to see how the  $\mu P$  figures out what to do.

The simplest  $\mu P$  consists of a program counter, a controller and an accumulator (Fig. 5a). The program counter often consists of two cascaded 8-bit counters—the low and high-byte registers (or the least and most significant bytes). When power is applied, the program counter is forced to a particular starting address that holds the first line of the program. The first line is then read into and interpreted by the controller. The program counter is then increased by one count unless that line has information that drastically modifies the counter.



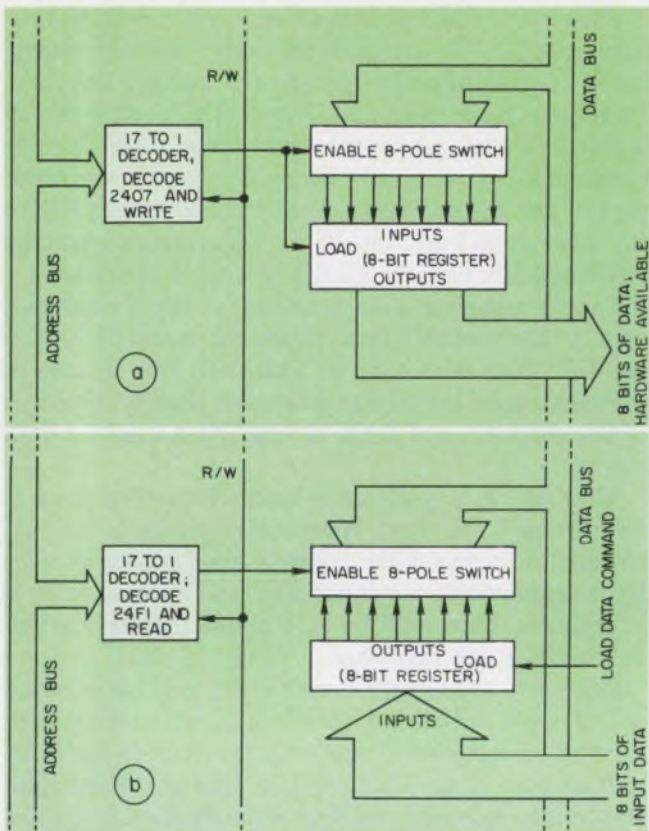

4. Output (a) and input (b) ports provide the means for communicating with the outside world. In "a," address 2407 and a WRITE command load the data bus into a register. In "b," data are loaded into the register. Address 24F1 places them onto the data bus.

Any data read in or out via data lines are read to or from the accumulator, which is also an 8-bit register. All logic and math manipulations occur in the accumulator. For example, a word can be read from memory and added to one already in the accumulator. The result is stored in the place of data used to generate it.

Fig. 5b depicts a more complex microprocessor. Certain tests on the accumulator such as checking for zero, a positive result, a negative result, or something else, are often needed, and indicators are provided by bits in the status register. A carry bit for additions indicates sums in excess of the accumulator capacity. Another bit indicates when the accumulator holds all zeros. Certain program instructions require the instruction decoder to monitor those status bits and a few others.

A number of auxiliary registers can be provided for modifying the program counter, additional accumulators, or readily available scratchpad memories.

### Control the $\mu P$ with a program

Having covered the basics, you are ready to learn about basic programming instructions to move and process data, and modify a program.

Data-move instructions transfer data from memory into the accumulator and vice versa, or from the

accumulator to an auxiliary register or other combinations. Data-processing instructions include adding, logic ANDing and rotating data around the accumulator. Those instructions are carried out in the arithmetic and logic unit (ALU), which consists of the accumulator and status register, as well as the circuitry performing the mathematical operations to the accumulator.

After each program step, the program counter usually increments by one count. When data are read into the processor from the memory, the program counter may momentarily be set to some different value. But then it is restored to the last instruction plus one.

If you want to, you can change the program counter to continue at some other point in the program. A number of instructions will help. Unconditional jumps are used to change the program counter to some entirely new value.

Conditional jumps, or branches, can force a program jump under specific conditions. For instance, when the accumulator contains zero the zero bit of the status register detects that and a jump on zero command can divert program flow.

Sometimes a particular process is repeated many times during the program. Rather than repeat the program section each time, the program can call a subroutine (a subservient program) whenever it is needed. This particular process is written in a separate part of program memory, usually after the main program. Getting to the subroutine is similar to the unconditional jump. Bear in mind, however, that the present location of the program sequence must be memorized for the program to return to where it left off after completing the subroutine.

The stack is used for this purpose. It is an area of memory reserved primarily, but not exclusively, for program addresses. A stack pointer, which refers to addresses placed in the stack, is initialized to a desired value at the beginning of the program to the starting point of the block of memory locations reserved for the stack. When a subroutine is called, the contents of the program counter are incremented and placed in two bytes of the stack memory (16 address bits in two bytes). The stack pointer is lowered by two counts. At the end of the subroutine, the two bytes are read from the stack into the program counter to call the next consecutive instruction as if no change had taken place. Of course, the stack pointer is brought back up to keep the bookkeeping up-to-date.

But suppose the contents of the accumulator, status register or other registers are needed later and cannot be kept in their present locations while the subroutine is being executed. The first instructions in the subroutine may also load these contents onto the stack. The last instruction in the subroutine will have to restore these registers to their original status. The stack pointer, of course, will be changed accordingly.

Another alternative is for subroutines to call other subroutines to be performed, then return first to the



original, or main subroutine, and finally to the main program. Calling subroutines within subroutines, or nesting, can continue indefinitely, as long as there is enough room in the stack. Each time an address is loaded onto the stack, the stack pointer is decremented by two bytes. The next address is then placed in the next two bytes, and the stack pointer is decremented again. Each time a return from subroutine is executed, the top address is taken from the stack and the stack pointer is incremented twice. When the main program is running again, the stack pointer will return to its initial value.

Sometimes, the program can be modified by data stored in a particular memory location. For instance, data stored in one place can indicate the address where some other data are to be sent. The programming steps described so far do not allow for this.

### Indirect addressing helps

Some sort of indirect addressing is included in a  $\mu\text{P}$ , to allow the data to provide some form of steering to the program. One technique is to place a byte of data into one byte of the program counter, and then have the  $\mu\text{P}$  read or write data between that composite address and the accumulator. At the end of that step, the old program counter contents (plus one) are reintroduced.

I/O ports are often used for data transfer into and out of the system. However, the  $\mu\text{P}$  must determine whether or not an input has occurred and data have been loaded into an input port.

One way to determine if data are present is to allow the processor program to test one bit of an input port periodically. If data are brought in, that bit can be set to 1 by external circuitry and reset to 0 via an output port after the data are entered. This approach is very slow, however, so a faster method is generally used.

The essence of the faster method is to provide a special input to a  $\mu\text{P}$ . It is called an interrupt input. During normal operation, the processor ignores all input ports. Should data be entered, an external signal is brought to the interrupt input, without going through the program.

Once the instruction in progress is completed, the processor acts as if a "call subroutine" is being read. The program counter and status-register contents are placed on the stack and the program counter is forced (or vectored) to the address where a program servicing the interrupt begins. The interrupt is serviced and a return from interrupt, similar to a return from subroutine, restores the program counter and status registers to the initial values.

In general, when one of several inputs causes an interrupt, the interrupt program scans the inputs to determine which one has new information. The most time-critical input is scanned first, then successively less critical inputs.

When a high-priority input is completed, scanning

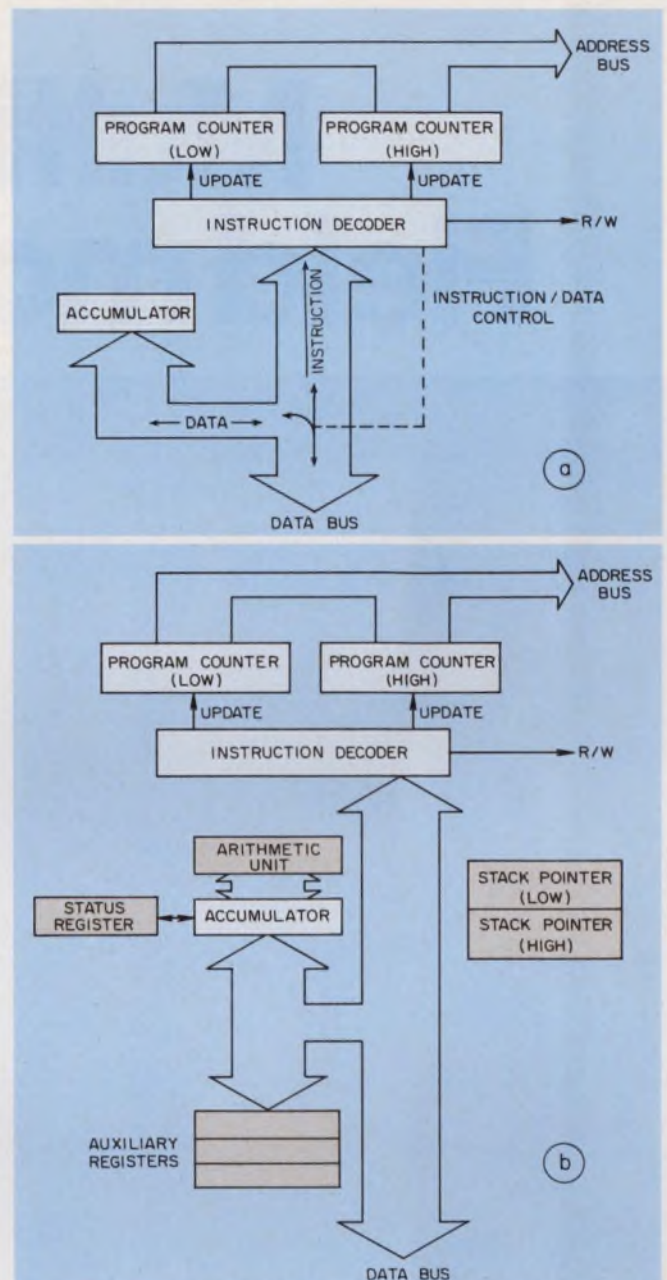

5. A simple microprocessor consists of just a few basic blocks (a). A more realistic  $\mu\text{P}$  (b) includes a few "frills" that make it operational.

resumes. Eventually, all the inputs are serviced according to their relative priority. High-priority interrupts can break in on lower-priority interrupts. As with subroutines, interrupts can be nested.

Interrupts can be either maskable or nonmaskable. A mask bit can delay servicing of an interrupt until the bit is lowered. Nonmaskable interrupts do not respond to a mask bit and are serviced immediately.

Sometimes, data or programs must be quickly loaded from memory into an external unit, or vice versa. These are jobs for direct memory access (DMA). DMA capability means that a  $\mu\text{P}$  can be effectively decoupled from the address, data, and read/write buses. An external device will control those lines to rapidly transfer blocks of data directly into memory, and bypass the  $\mu\text{P}$ . ■■



# Multiwire<sup>®</sup>: Field modifiable.

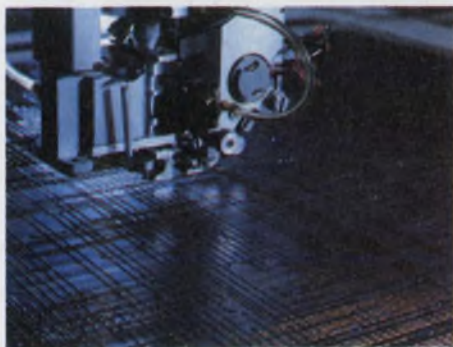
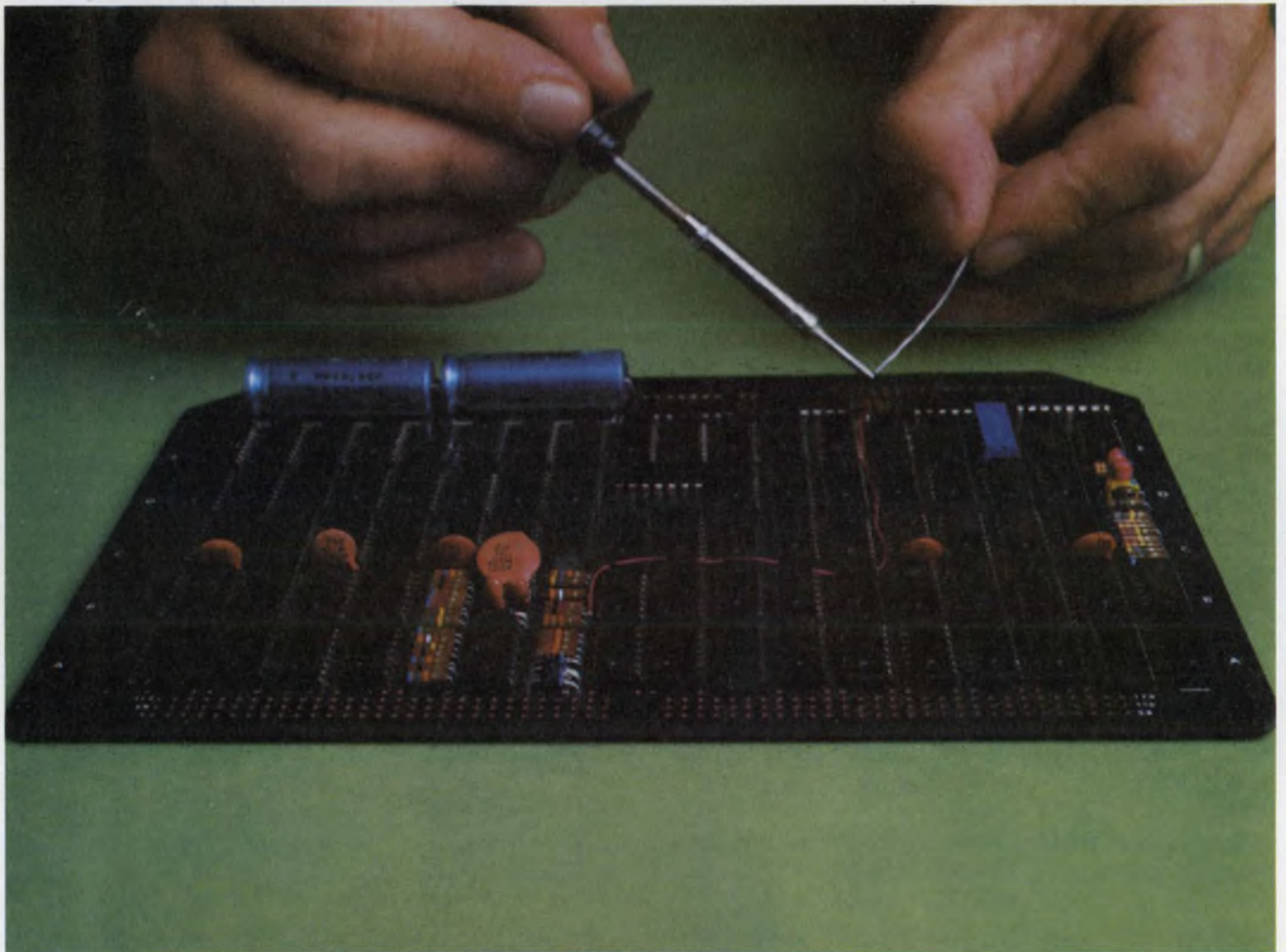

Of the many benefits offered by Multiwire, one of the most important is its simplicity of change and repair. Multiwire boards are normally easier to change after assembly or in the field than multilayer.

All wires are exposed in the typical Multiwire board. To make a change, use a blade to cut the conductor that you want to correct, and remove a portion of the wire to avoid bridging. Then, just solder in a jumper wire and

fasten down with epoxy or urethane.

Changes in Multiwire boards can easily be accomplished in minutes by field service technicians.

Multilayer changes, of course, are an entirely different story. Corrections are difficult at best and frequently impossible. As one engineer familiar with multilayer puts it: "Corrections . . . are something of a disaster."

With Multiwire, to replace a discrete or DIP that has failed, the component



# Multilayer: Field discardable.

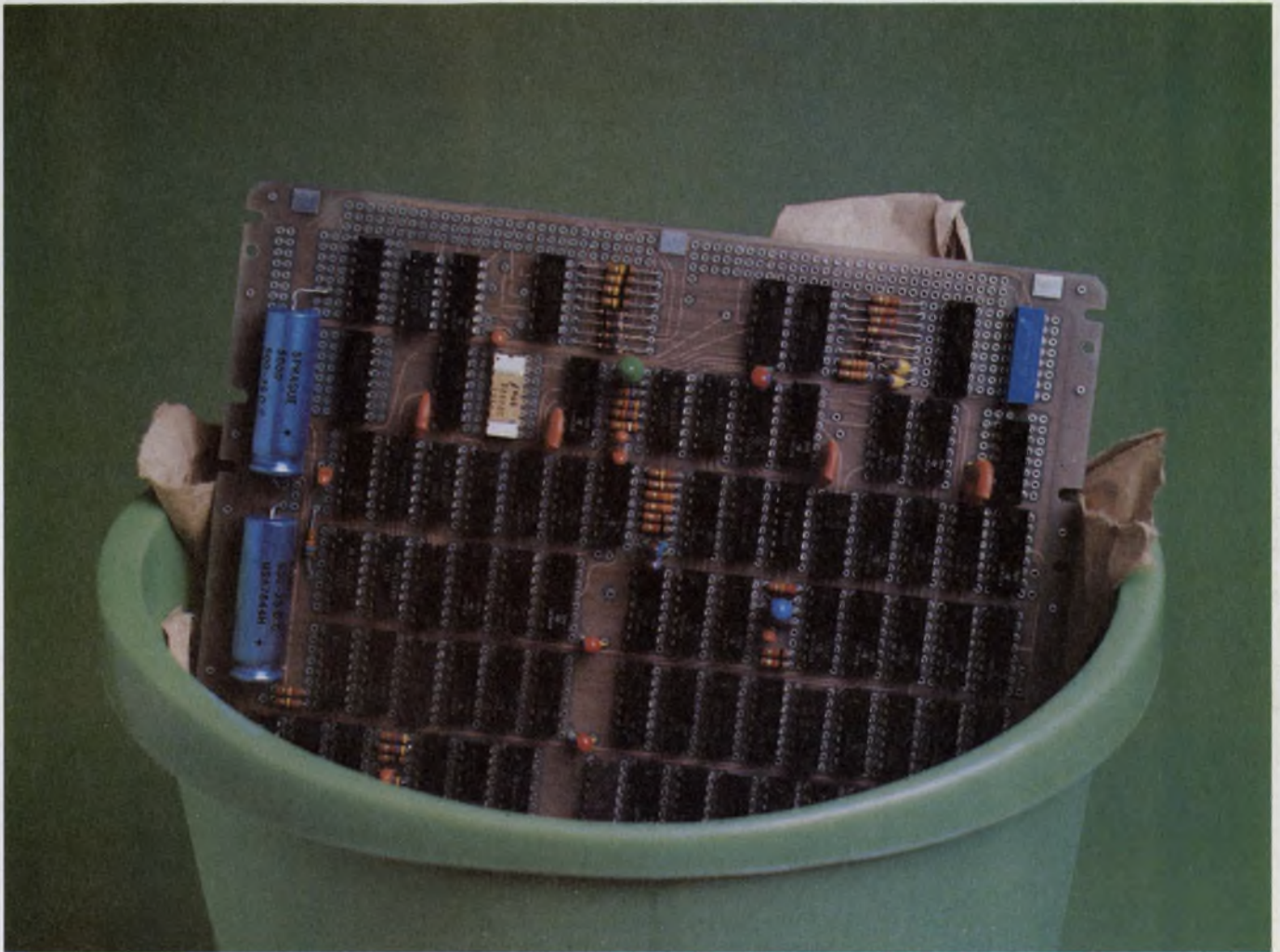

is simply unsoldered; the plated-through holes stand up just as well if not better than regular PC board holes. With multilayer, however, a soldering iron often lifts the land off the board, with many ensuing problems.

Of course, Multiwire will need fewer repairs to begin with. The Multiwire manufacturing method has far greater yield, usually better than 99% reliability at incoming inspection.

And now, consider some other key advantages of Multiwire: Shorter lead times. No artwork required except for basic ground planes and plug-in connections. Lower design and tooling costs. Much faster first-piece delivery.

To take advantage of Multiwire, all you supply us is an interconnection list from which we prepare the input data for our numerically controlled machines. Or you can prepare your

own input from our software. Since all of the logic is placed by N/C-controlled equipment made up from the wire running lists, changes in circuit design only require a change in your wire list.

For more information, write to Multiwire Marketing Department. Or call us at 516-448-1117. In New England, 603-889-0083. In California, 714-991-6030. For Texas, 214-234-2873.

## Multiwire<sup>®</sup> from Photocircuits.

Division of Kollmorgen Corporation, Glen Cove, New York 11542

CIRCLE NUMBER 36



## Using the Microprocessor Data Manual

The Data Manual microprocessor data pages are organized first by processor data-word size, then by generic family, by technology and finally by original source manufacturer (within each generic family processors are listed alphabetically by original manufacturer). Generic families included in the manual are:

Processor generic family	Manual pages	Processor generic family	Manual pages
1-bit microcomputer, NMOS	page 84	8-bit microprocessor, Bipolar	page 128
4-bit microcomputer, CMOS	page 86	8-bit microprocessor, CMOS	page 130
4-bit microcomputer, NMOS	page 88	8-bit microprocessor, NMOS	page 132
4-bit microcomputer, PMOS	page 96	8-bit microprocessor, PMOS	page 148
8-bit microcomputer, NMOS	page 106	12-bit microprocessor, CMOS	page 154
8-bit microcomputer, PMOS	page 112	12-bit microprocessor, PMOS	page 156
16-bit microcomputer, NMOS	page 114	16-bit microprocessor, Bipolar	page 158
4-bit microcontroller, PMOS	page 118	16-bit microprocessor, NMOS	page 162
8-bit microcontroller, NMOS	page 120	2-bit processor slice, STTL	page 176
1-bit microprocessor, CMOS	page 122	4-bit processor slice, Bipolar	page 178
4-bit microprocessor, PMOS	page 124	4-bit processor slice, PMOS	page 190

## Here's what's on a manual page

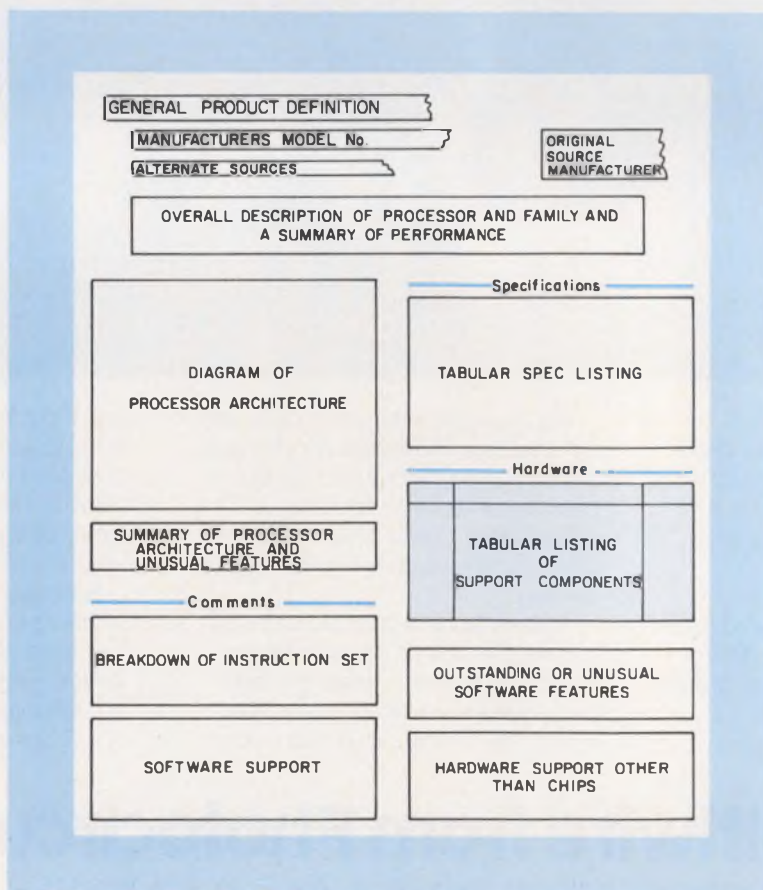



# New, High Performance Microelectronic Converters

## Datel has them...



### 16-Bit D/A Converters

#### DAC-HP16BMC & DAC-HP16DMC

- 16 Binary Bits—0.003% Linearity
- 4 BCD Digits—0.005% Linearity
- 15 ppm/°C max. Gain Tempco
- 0 to +10V or  $\pm 5V$  Output
- Price: \$119.00 (1-24), \$77.50 (100's)\*

When high resolution and stability are demanded, Datel's DAC-HP series provides the performance—applications such as precision signal reconstruction, automatic test systems, and ultra-linear ramp generation. DAC-HP's excellent performance results from special low tempco nichrome thin-film resistors, laser trimmed for optimum linearity, and a low tempco zener reference circuit. Models are available for -25 to +85 and -55 to +125C operation.



### 12-Bit A/D Converter with Sample-Hold ADC-HS12BGC

- 8  $\mu$ sec. Conversion Time
- 6  $\mu$ sec. Acquisition Time
- 5 Programmable Input Ranges
- 100 Megohm Input Impedance
- Price: \$149.00 (1-24), \$95.00 (100's)\*

Datel's ADC-HS12BGC is the first 12-bit A/D converter with a self-contained sample-hold. Particularly useful in 12-bit data acquisition systems, ADC-HS is ideal for the many systems applications where a sample-hold is required ahead of the A/D. Fabrication is with hybrid thin-film technology using laser-trimmed nichrome resistor networks. Models for -25 to +85C and -55 to +100C operation are available.

\*U.S.A. domestic prices only

**DATEL**  
SYSTEMS, INC.

1020 Turnpike St, Canton, MA 02021  
Tel: (617) 828-8000

Santa Ana, CA (714) 835-2751, (L.A.) (213) 933-7256 • Sunnyvale, CA (408) 733-2424 • Gaithersburg, MD (301) 840-9490 • Houston, TX (713) 932-1130  
OVERSEAS DATEL (UK) LTD—TEL: ANDOVER (0264) 51055 • DATEL SYSTEMS SARL 620-06-74 • DATELEK SYSTEMS GmbH (089) 78-40-45



# 1-bit microcomputer, NMOS

## SBA (Sequential Boolean Analyzer)

General Instrument Corp.  
600 West John St.  
Hicksville, NY 11802  
(516) 733-3107

Alternate sources: None.

A simple, low-cost single-bit processor, the SBA can directly evaluate a set of Boolean equations. Thirty programmable inputs and outputs as well as memory make the SBA a true 1-bit microcomputer. An n-channel, ion-implanted device, the SBA is designed for ease of use, in simple control applications.

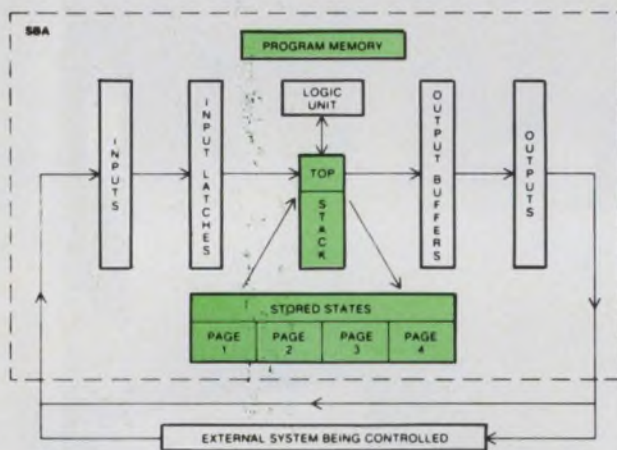

The Sequential Boolean Analyzer consists of a program memory that holds a set of Boolean functions that define system operation as well as 30 input buffers that are latched at the start of the evaluation of Boolean equations, and four pages of 30 stored-state flip-flops which can be grouped to emulate counters and shift registers. Also included are a logic unit that can perform the logic functions and a stack that holds a set of Boolean values used to evaluate the input equation.

### Comments

The results of Compare and Invert instructions are stored in either the stack, memory or output. Inputs for logic operations are from the stack or memory, or from inputs. The stack is 16 x 1 bit and the state store is 120 x 1 bit. There are 24 basic instructions, all of which execute in the same amount of time. The processor is designed to process Boolean equations based on the status of the 30 I/O lines.

An SBA Compiler produces optimized codes from Boolean equation inputs, and an SBA simulator provides software simulation of the SBA.

The programming for the SBA is via Boolean expressions. An 8-bit word provides the instruction code, five bits of the code provide an address for

### Specifications

Data word size:	1 bit
Address bus size:	None*
Direct addressing range:	None*
Instruction word size:	8 bits*
Number of basic instructions:	24
Shortest instruction/time (All):	1.25 $\mu$ s
Clock frequency (min/max):	10 kHz/ 800 kHz
Clock phases/voltage swing:	Internal
Dedicated I/O control lines:	30
Package:	40-pin DIP
Power requirements:	12 V/? mA 5 V/? mA

\* No external address lines are available but the SBA can address up to 1023 words of on-chip program memory.

### Hardware

Model	Description	Price
SBA	CPU	\$4 (2500 qty)
SBA-1	Same as SBA but uses external PROM/RAM	N/A

the inputs, outputs or stored states and, if two of the 32 available addresses are reserved for address-less instructions, the remaining three bits of the code enable a total of 24 instructions to be made available. Most of the instructions are AND, NAND, OR, Ex-OR, and stack or I/O operations.

Hardware support will be the SBA-1, a version with external RAM or PROM for prototyping, otherwise there are no prototyping systems available.



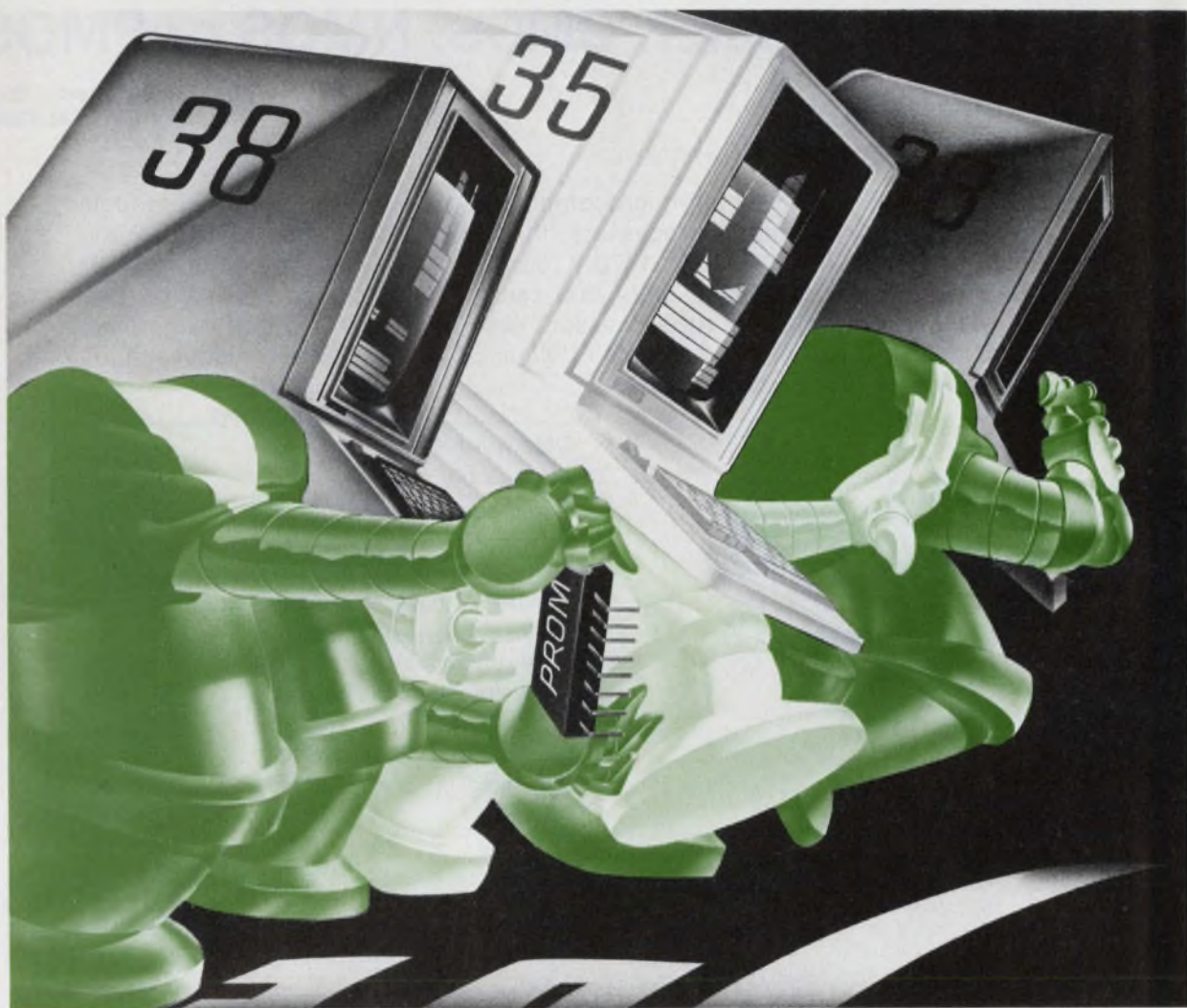

## The "hand-off." It's another plus from OMRON's triple threat.

The triple threat quarterback is OMRON's user-programmable intelligent terminal—the 8035.

8035 scores with up to a 28K memory and peripheral floppy discs for removable, virtual storage.

The running back is our 8038. It's equipped to make all the smart moves—on or off the line. 8038 can accept—and run with—hand-off PROM programs developed by the 8035—saving you up to 40-50% on-line time. 8038 is microprocessor-controlled, has storage capability and is operator-oriented.

If you'd like to use our hand-off option you can also count on 40-50% savings in hardware costs.

In addition to all the basic plays to control routine disc operations, the software system provides a resident monitor, a symbolic assembler, editor, debugger and utilities for systems generation, communications and copy operations. Device drivers are also provided for interfacing with CRT, communications adaptors and external peripherals. Discs provide memory storage and can be used in creating PROMs reflecting a user program. Final score: it's a winner!

Write or call Michael L. Squires for details and specifications, Information Products Division, Omron Electronics, Inc., 432 Toyama Drive, Sunnyvale, CA. 94086. (408) 734-8400.



for a universe of exceptionally reliable CRT systems.



# 4-bit microcomputer, CMOS, NMOS or PMOS

## TMS1000 family

Alternate sources: Motorola for CMOS version.

Texas Instruments Inc.  
P.O. Box 5012, M/S308  
Dallas, TX 75222  
(214) 238-2011

The TMS1000 family of single chip microcomputers is available in about 35 models—the unprogrammed evaluation processors (the TMS1099/SE1 and 1098/SE2), the general purpose family (the TMS1000, 1070, 1100, 1200, 1270, 1300 and other models) and some already preprogrammed units that can go right into an application (the TMS1018, 1022, 1117 and 1121). All processors have on-chip ROMs that range from 1024 × 8 to 2048 × 8 and on-board RAMs of either 64 × 4 or 128 × 4. Also, versions with up to 16 output lines can be had.

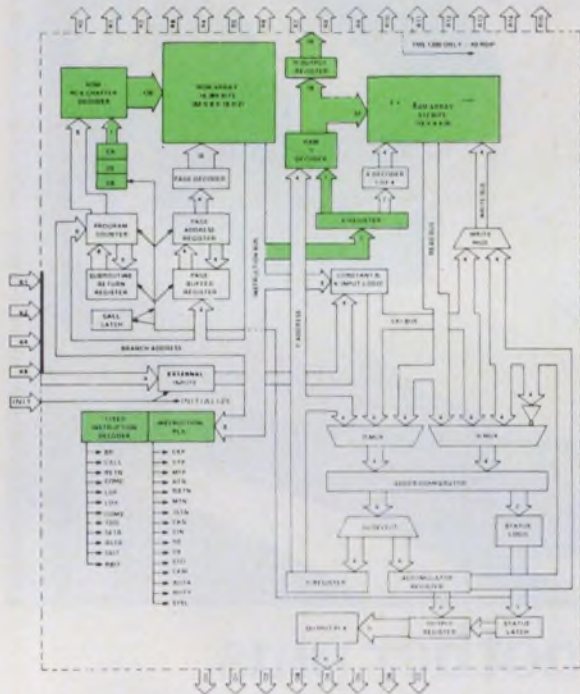

The architecture of all the TMS1000 products is very similar, with the main differences appearing in the size of the RAM and ROM and the number of I/O lines. All processors have an internal clock generator, but can accept a single-phase clock signal if timing must be generated externally. Just the single chip is needed to form a minimal working system.

### Comments

The instruction set contains a total of 54 commands that are divided into five basic groups: 12 register reference instructions, 27 arithmetic and logic operations, three bit-manipulation commands, five I/O instructions and seven memory addressing.

Software support for the TMS1000 family consists of an assembler, simulator, a high-level language compiler (TIML) and a variety of utility programs. There is no program library available.

Special features of the software include the wide variety of register and accumulator operations possible as well as the individual bit set, reset and test operations on the contents of a memory location.

Hardware support for the TMS1000 family starts

### Specifications

Data word size:	4 bits
Address bus size:	Internal
Direct addressing range:	2048 words, max
Instruction word size:	8 bits
Number of basic instructions:	54
Shortest instruction/time (All instructions):	6 $\mu$ s min.
Clock frequency (min/max):	50 kHz/1 MHz
Clock phase/voltage swing:	1/V <sub>supply</sub>
Dedicated I/O control lines:	16 max.
Package:	28 or 40-pin DIPS or 64-pin evaluator
Power requirements:	3 to 35 V at 1 to 10 mA, depending on model

### Hardware

Model	Description	Price (5000 qty)
TMS1000	28-pin microcomputer	Under \$4.
TMS1070	28-pin microcomputer	Under \$4.
TMS1100	28-pin microcomputer	Under \$4.
TMS1200	40-pin microcomputer	Under \$4.
TMS1270	40-pin microcomputer	Under \$4.
TMS1300	40-pin microcomputer	Under \$4.
TMS1098/SE1	64-pin evaluator	N/A
TMS1099/SE2	64-pin evaluator	N/A
TMS1330	Combo CPU, a/d converter and keyboard controller	\$7.
TMS1024	4 x 4 I/O expander	Under \$3.
TMS1025	4 x 7 I/O expander	Under \$3.
TMS1976	CPU to capacitive keyboard interface	Under \$3.

with the 64-pin system evaluator chips that permit external RAM and ROM interfaces and prototype boards for the evaluation chips. Also available is the AMPL development system which permits assembly and simulation and will soon permit in-circuit emulation.



# Coming through...

with a vital part in product design

It's what's up front that counts. That's why it pays off to involve Belden in the early stages of a project.

We know the codes, specs and electrical/environmental parameters you're faced with. We've come through with answers to some extraordinary new applications.

As much as any component, wire, cable and cord, can make a critical difference in your product's performance. And your costs. By drawing on thousands of high-quality standards—and a wealth of custom engineering knowhow—we can tailor an answer to fit your needs. Exactly.

We can even help you cope with the economics of wire processing, assembly and installation. Our problem solving experience ranges from innovative

packaging to total manufacturing analysis.

Whether you need cord sets, special harnesses, shielded cable construction, flat cable—or help putting it all together, involve a Belden Wire Specialist. He'll come through with everything we've got. For answers right now, phone:

317-966-6661 Electronic Division or mark 400 on reader service card.

312-986-1600 Electrical Division or mark 401 on reader service card.

312-887-1800 Transportation Division or mark 402 on reader service card.

Or write Belden Corporation, 2000 S. Batavia Ave., Geneva, IL 60134

## BELDEN



**Coming through...**  
with new ideas for moving electrical energy



# 4-bit microcomputer, NMOS

## S2000

American Microsystems Inc.  
3800 Homestead Rd.  
Santa Clara, CA 95051  
(408) 246-0330

Alternate sources: None.

A single-chip, 4-bit microcomputer built with silicon-gate, depletion-load NMOS technology, the S2000 includes, on-chip, a 1 k x 8-bit ROM, 64 x 4-bit RAM, 50/60-Hz timer and clock oscillator. Most of its 61 instructions are executed in 4  $\mu$ s. Among 29 I/O lines are LED drivers (and a 7-segment display decoder), as well as a touch-control interface. The device operates from a 9-V supply and has power-on reset circuitry.

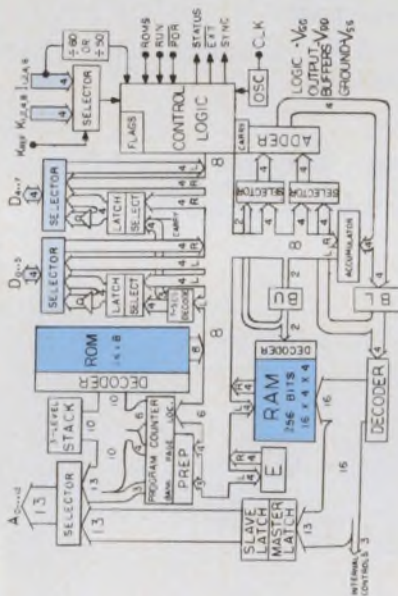

The architecture of the S2000 microcomputer includes I/O ports for almost every application—there are seven-segment display outputs, touch-control inputs, LED or vacuum-fluorescent drivers (S2000A), a voltage comparator, a 64 x 4 RAM, a three-level stack and an on-chip clock oscillator. All lines are TTL compatible and the eight D lines also have three-state capability.

### Comments

The instruction set for the S2000 processor consists of 61 commands that are divided into the following groups: 14 ROM and RAM instructions, 13 conditional skip commands, 12 arithmetic and logic operations, 11 I/O directives and 11 register instructions.

Software support includes a text editor, assembler, real-time debugger, floppy-disc operating system, software simulator, macroprogram library, self-diagnostic programs and many applications oriented programs. All these programs are designed

### Specifications

Data word size:	4 bits
Address bus size:	13 bits
Direct addressing range:	8192 words
Instruction word size:	8 bits
Number of basic instructions:	61
Shortest instruction/time (Most):	4 $\mu$ s
Longest instruction/time (Jump to subroutine):	8 $\mu$ s
Clock frequency (min/max):	Dc/1 MHz
Clock phases/voltage swing:	1/internal
Dedicated I/O control lines:	29
Package:	40-pin DIP
Power requirements:	9 V/26 mA

### Hardware

Model	Description	Price
S2000	4-bit microcomputer	\$3.50 (100-k qty)
	No special interface circuits are needed.	

to run on the MDC, a microcomputer development center.

Special features of the software include the fact that all but two instructions execute in one machine cycle and that some instructions can do several jobs simultaneously. For instance, the XCD command exchanges the accumulator contents with a RAM location, decrements register BL, modifies register BU and does a conditional jump.

Hardware support consists of the MDC microcomputer development center, which includes a CRT terminal, a dual-floppy-disc system, the DEV-2000 real-time debug breadboard, printer and logic analyzer (40 channels x 1024 events). There is also a single-board S2000 evaluator that uses a UV EPROM memory to permit program testing.





# We'll Put You On The Bus

(Without Taking You For A Ride.)



Our new  $\mu$ p-based interface couplers will link virtually any programmable instrument to the IEEE 488 bus even though their input and output is not bus compatible.

**RS-232 TO BUS** Here's a new, inexpensive way to convert your teletype to a 488 bus printer. For about \$900, the Model 4884 will provide a bi-directional data link between the parallel IEEE 488 bus and the RS-232 serial data path. And it's not limited to teletype. The 4884 will make any 20mA device such as printers and recorders bus-compatible.

**DVMs AND COUNTERS TO BUS** Building an ATE system? You may have a pool of older instruments, but the DVMs and counters aren't 488 compatible. For about \$800 you can buy a Model 4881 that will take data from any DVM, counter, or other instrument and put it on the bus.

**BUS TO FREQUENCY SYNTHESIZERS AND PULSE GENERATORS** Want to control stimulus devices? For the same \$800, a Model 4882 can control any programmable instrument from the bus. Or, use it to just output parallel data. It responds to a status request from the controller and passes all data without alteration.

**HOW ABOUT A BI-DIRECTIONAL COUPLER** For about \$900, the 4884 combines capability and operational features of the 4881 and 4882 in one unit. It can be used to control or take data from a measuring device, accept program commands from the bus, pass the commands on to a DVM's control inputs, initiate readings and output data when addressed. You can even reduce it to "talk-only" or "listen-only" by setting the mode switches.

**AND THERE'S MORE TO THE FAIRCHILD LINE** Fairchild also offers other instruments. The 6600 takes paper tape input and interfaces to CRTs, modems or remote CPUs. The 1700 takes BCD output and interfaces with TTys, CPUs modems and paper tape punches. Write: Fairchild Instrumentation, a unit of Fairchild Camera and Instrument Corp., 1725 Technology Drive, San Jose, CA 95110 Phone (408) 275-6600 or (408) 998-0123.

**FAIRCHILD**



# 4-bit microcomputers, NMOS

## MN1400 series

Alternate sources: None.

The MN1400 series of microcomputers consists of four models, each with different amounts of on-chip program memory. The "standard" model is the MN1400, with a 1k x 8 on-chip mask-programmed ROM and 75 instructions. A "shrink" version of the unit, dubbed the MN1402 offers 57 instructions and only a 768 x 8 program memory. Also available are two versions that have no on-chip memory. The MN1498 can address 1 k x 8 of external memory and offers 68 instructions. The largest processor is the MN1499, with an addressing capability of 2 k x 8 and 75 instructions. All processors have a two-level subroutine stack and on-board RAMs of 64 x 4 bits, except for the 1402, which has a 32 x 4 bit RAM.

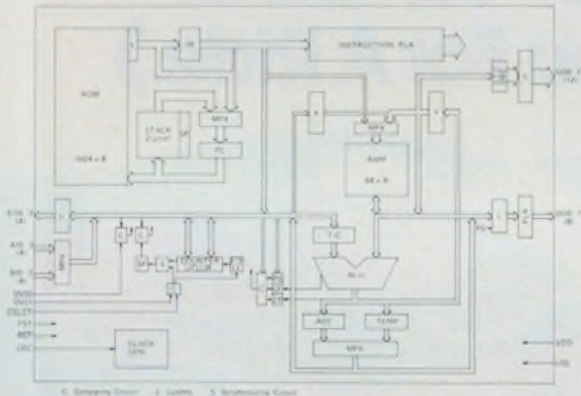

Complete all-in-one microcomputers on a chip, all parts in the MN1400 family have on-board clock generators, and up to 64 x 4 bits of RAM. All units have a two-level subroutine stack and different amounts of I/O capability. The MN1400 provides 12 individually settable latched output lines on one of its ports, eight simultaneously settable lines on another output port, four more lines on another output port and two sets of four lines each on two input ports. The 1402 has two 4-bit input ports, two 4-bit output ports and one 5-bit output port. The 1498 has fewer ports since the program memory must be externally addressed—it has one 4-bit input port, one 4-bit output port and one 9-bit output port. Lastly, the 1499 has all the ports of the 1400 and in addition has the interface necessary to handle external memory.

### Comments

Both the MN1400 and 1499 have a set of 75 instructions that are divided into four basic groups: 18 data transfer commands, 18 arithmetic and logic directions, nine I/O instructions, and 30 control commands. Both the 1402 and 1498 instruction sets are subsets of the 75 commands of the 1400.

Support software for the MN1400 family consists of a cross-assembler program for use on large computer systems. The cross-assembler contains error diagnostic and macro instructions, and is written in Fortran. Additional support is also available on minicomputers such as the PFL-16A made by Panafacom Ltd. Hardware simulation as well as editing and debug routines are available. There is

Panasonic Co.  
50 Meadowland Parkway  
Secaucus, NJ 07094  
(201) 348-7276

### Specifications

Data word size:	4 bits
Address bus size:	11 bits (max)
Direct addressing range:	2 k (max)
Instruction word size:	8 bits
Number of basic instructions:	57 to 75
Shortest instruction/time (several commands):	10 $\mu$ s
Longest instruction/time (Branch/Jump):	20 $\mu$ s
Clock frequency (min/max):	dc/300 kHz
Clock phases/voltage swing:	1/5 V
Dedicated I/O control lines:	20
Package:	28, 40 or 64-pin DIP
Power requirements:	5 V/100 mA

### Hardware

Model	Description	Price
MN1400	CPU, 40-pin, 75 instructions	approx. \$8 (1000 qty)
MN1402	CPU, 28-pin, 57 instructions	same.
MN1498	CPU, 40-pin, 68 instructions	consult factory
MN1499	CPU, 64-pin, 75 instructions	\$75. unit qty

no formal program library, but various application programs are available on request.

Special instructions in the MN1400 family include bit reset and bit set commands for data stored in memory as well as a wide choice of I/O commands. The built-in counter/timer is totally software controller—special instructions are used to preset the circuit or to enable or disable the counter.

Hardware support is performed by the MN1499, a system evaluator circuit. The 1499 requires external memory but to help debug programs it has a single-step control line that can be used to go through programs one line at a time.



# COULD A \$3 RESISTOR SAVE YOU A \$300 FIELD SERVICE CALL?

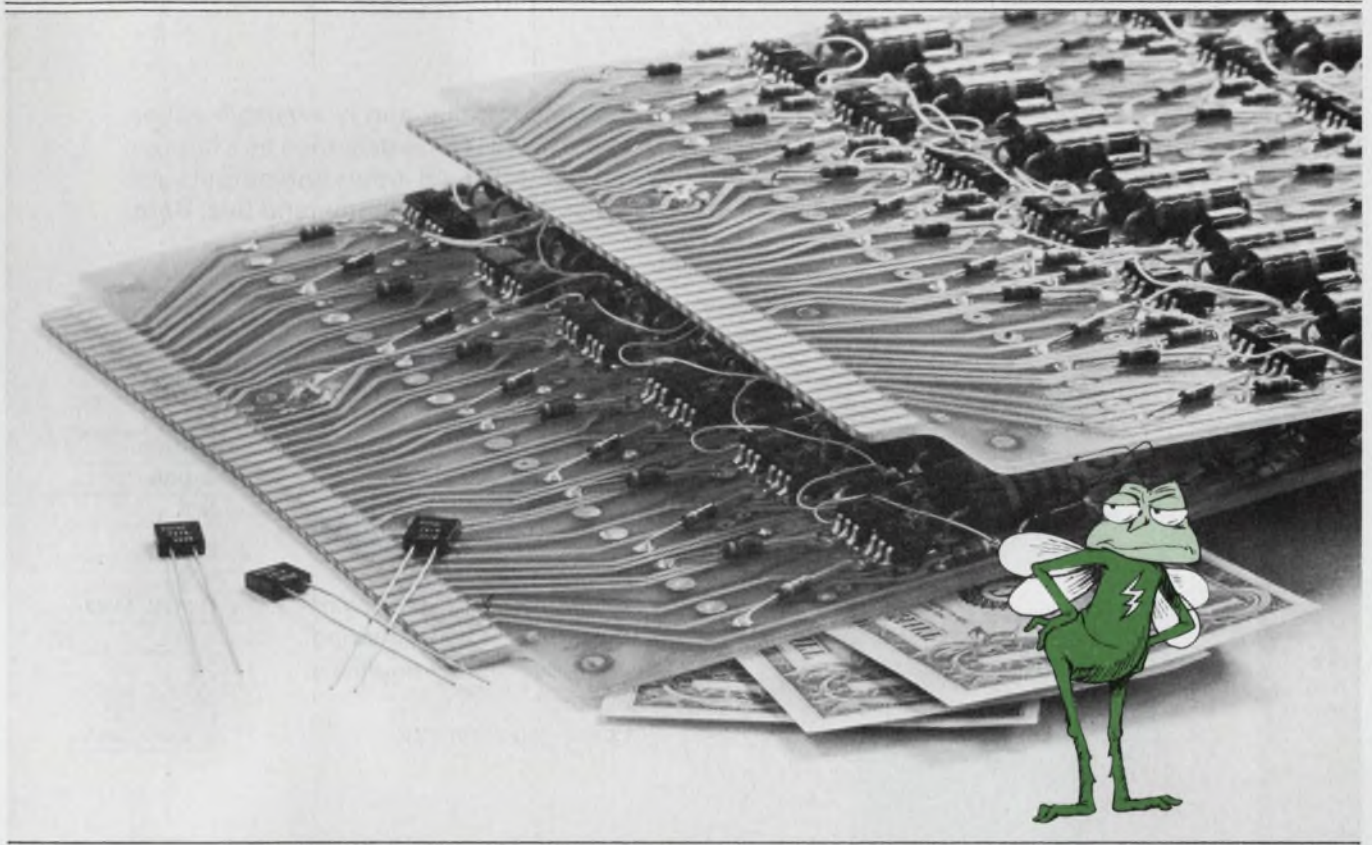

It sure could.

When the equipment you've built fails at the worst possible moment in the field, you may suddenly learn just how expensive a mere resistor can be. You may learn the hard way that the dollar or two you saved at the drawing board has cost you hundreds or even thousands in warranty service. And quite possibly even cost you a customer.

Not every resistance application cries out for Vishay quality. You may often do without this quality and still suffer no dire consequences.

But when you need a precision resistor or trimmer for rock-solid stability and reliability, think of this:

Some precision resistors offer you tight tolerance at the expense of poor frequency response. Others offer low inductance and fast rise at the expense of poor temperature characteristics. Only Vishay Bulk Metal® resistors offer you the *complete set* of top performance characteristics, including TCR as low as  $0 \pm 1 \text{ ppm}/^\circ\text{C}$ , a combination that will most often free your equipment from that tormenting bug.

And now Vishay offers you the chance to *make your own* custom bulk-metal resistors for breadboard, prototype, or even production use. Call or write for information on the simple calibration and encapsulation of Vishay resistors in your own plant. Vishay Resistive Systems Group, 63 Lincoln Highway, Malvern, PA 19355; phone (215) 644-1300; TWX 510-688-8944.



**Only Vishay resistors give you all six top performance specs.**

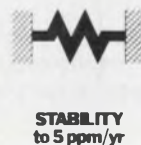
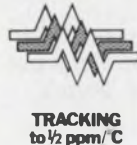
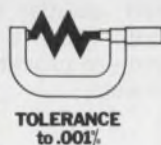







# Same great name. Same great color.

## And now a neat new way to definitive display performance.

# DOT MATRIX

Consider the new Noritake-Ise dot-matrix line-up—  
9, 10, 16, 20 and 40-character line displays.  
Variety aimed at giving you more design potential.  
Or consider our unique 400-dot graphics display  
with 17m/m depth and low 35V drive rating.  
It's aimed at helping you think low voltage,  
portability and economy all at the same time.

In short, consider Noritake-Ise period  
for dot matrix (or segmental) displays.  
Itrons always help you design more competitively.

*itron*<sup>®</sup>



**DC209A2**

Dimension: 41(H) x 208(W) x 10.5(D)mm Character Size: 9.0(H) x 6.3(W)mm

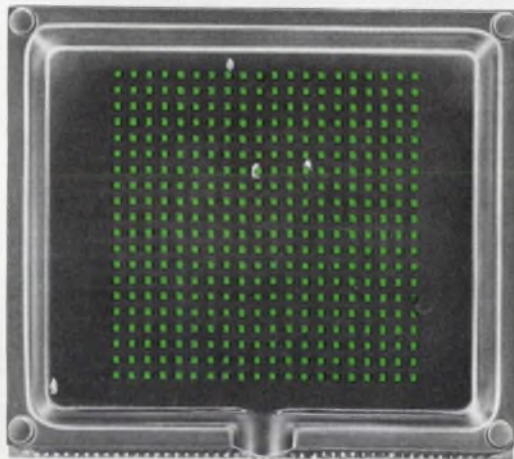

**DM400A1**

Dimension: 114(H) x 130(W) x 17(D)mm



**DC95A2**

Dimension:  
24(H) x 75(W) x 7.2(D)mm  
Character Size:  
5.05(H) x 3.55(W)mm



**FG48D6**

Dimension:  
25.5(H) x 56.5(W) x 7(D)mm  
Character Size:  
8.0(H) x 4.2(W)mm



**FG120S1**

Dimension: 39(H) x 138(W) x 12.5(D)mm



**FG209M2**

Dimension: 41(H) x 208(W) x 10.5(D)mm Character Size: 9.0(H) x 5.4(W)mm

## NORITAKE CO., LTD.

Electronics Division  
1-1, Noritake-Shinmachi,  
Nishi-ku, Nagoya-Shi,  
Japan  
Phone NAGOYA  
(052) 561-7111  
Telex: J59738 NORITAKE

Electronics Office (U.S.A.)  
22410 Hawthorne Blvd  
Torrance California 90505  
U.S.A.  
Phone: (213) 373-6704  
Telex: 230674910

F.R. Germany  
NEUMULLER GmbH  
München 2,  
Karlstrasse 55  
F.R. Germany  
Phone: 089 (599) 1230  
Telex: 522106

U.K.  
ITT Component Service  
Edinburgh Way, Harlow,  
Essex, U.K.  
Phone: 0279-3351  
Telex: 81146

Europavia France  
5-Avenue Leon Harmel 92167  
Antony Cedex - France  
Phone: 666-21-10  
Telex: 42204381

Hong Kong  
Room 1403 Shing Loon Bldg  
24-26 Stanley Street Hong Kong  
Phone: 5-237420 Telex: HX83151  
Taipei  
72-9 SEC 2, JEN AI RD, Taipei  
Phone: 351-0293 Telex: 11176

Manufacturer:  
**ISE ELECTRONICS CORP.**  
P.O. Box 46 Ise-shi  
Mie-Pref. Japan  
Phone: (0596) 39-1111  
Telex: 4969523



# 4-bit microprocessor, NMOS

## T3472

Toshiba Transistor Works  
1 Komukai Toshiba-cho Kawasaki-shi  
Kanagawa-ken, Japan  
044-511-3111

Alternate sources: None.

This microprogrammable 4-bit processor is intended to provide up to a 16-digit numeric display and handle a 64-key input. It is a silicon-gate NMOS device, operates from a single 5-V supply, and its data bus is three-state. A large instruction set (67) includes advanced instructions, like variable-length (1 to 16 digits) decimal/binary arithmetic operations. All inputs and outputs are TTL compatible. A two-level interrupt and 12-bit address bus are other features.

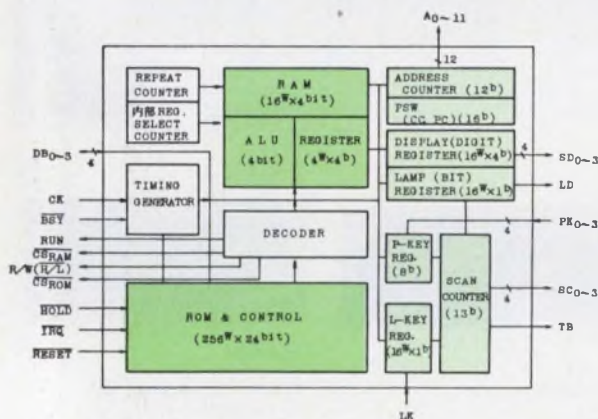

The architecture of the T3472 is oriented for binary and BCD data manipulation and display. All I/O lines are TTL compatible and the data bus has three-state capability. Display control logic and the clock as well as the keyboard scan control circuitry are included on the processor chip.

### Comments

The instruction set of the T3472 contains a total of 67 commands divided up as follows: 17 data transfer commands, 17 arithmetic instructions, 11 logic operations, four I/O commands, nine branch instructions and nine control operations.

Software support for the T3472 consists of a cross-assembler written in Fortran. There is no program library available.

Special features of the software include the capability of instructions to handle variable length data (from 1 to 16 digits), and the capability to handle both binary and BCD arithmetic operations.

### Specifications

Data word size:	4 bits
Address bus size:	12 bits
Direct addressing range:	4096 words
Instruction word size:	8 bits
Number of basic instructions:	67
Shortest instruction/time (Load immediate):	33 $\mu$ s
Longest instruction/time (Compare 16 bits):	360 $\mu$ s
Clock frequency (min/max):	Dc/1 MHz
Clock phases/voltage swing:	1/TTL
Dedicated I/O control lines:	16
Package:	42-pin DIP
Power requirements:	5 V/195 mA

### Hardware

Model	Description	Price (100 qty)
T3472	Microprocessor	\$13.00
T3473	Printer controller (for Seiko CR-101T)	\$6.50
T3538	Printer controller (for Seiko CR-330)	\$6.50
T3474	16 kbit mask-programmable ROM	\$9.50

Hardware support for the T3472 consists of the EX-4/01, a board containing 4096 words of RAM, 4096 words of PROM, a control panel with numeric display and a keyboard.



# MOLDED TANTALUMS:

KEMET Precision-Molded, Solid Tantalum Capacitors with axial leads are tailor-made for your high-speed, automatic insertion operations.

Their self-insulating epoxy cases are distinctively shaped for positive polarity identification, and provide unexcelled dimensional stability and lead concentricity.

You get extremely high capacitance-to-volume ratio, excellent performance characteristics from -55°C to +85°C, and solid KEMET quality throughout. At a surprisingly low in-place cost.

Specify the T320 Series for sub-miniature, extended-range units in three tubular case sizes, and CV range from 0.1 to 68  $\mu\text{F}$ , 6 to 50 volts. Or the KEMET "Bullet" T310 Series in four standard cases, and CV range from 0.1 to 330  $\mu\text{F}$ , 6 to 50 volts. Write for complete data.

Components Department, Union Carbide Corporation, P.O. Box 5928, Greenville, SC 29606; phone: (803) 963-6300; TWX: 810-287-2536; Telex: 57-0496.

Or see your local KEMET Capacitors Distributor.

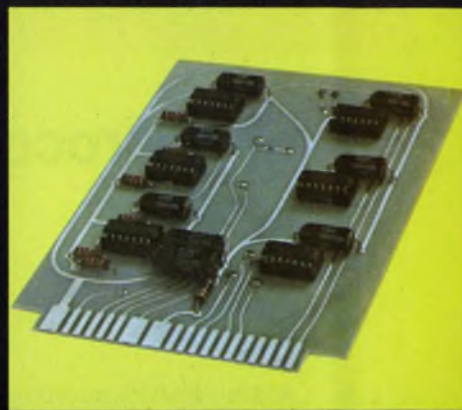

## KEMET® OFFERS YOU MORE.

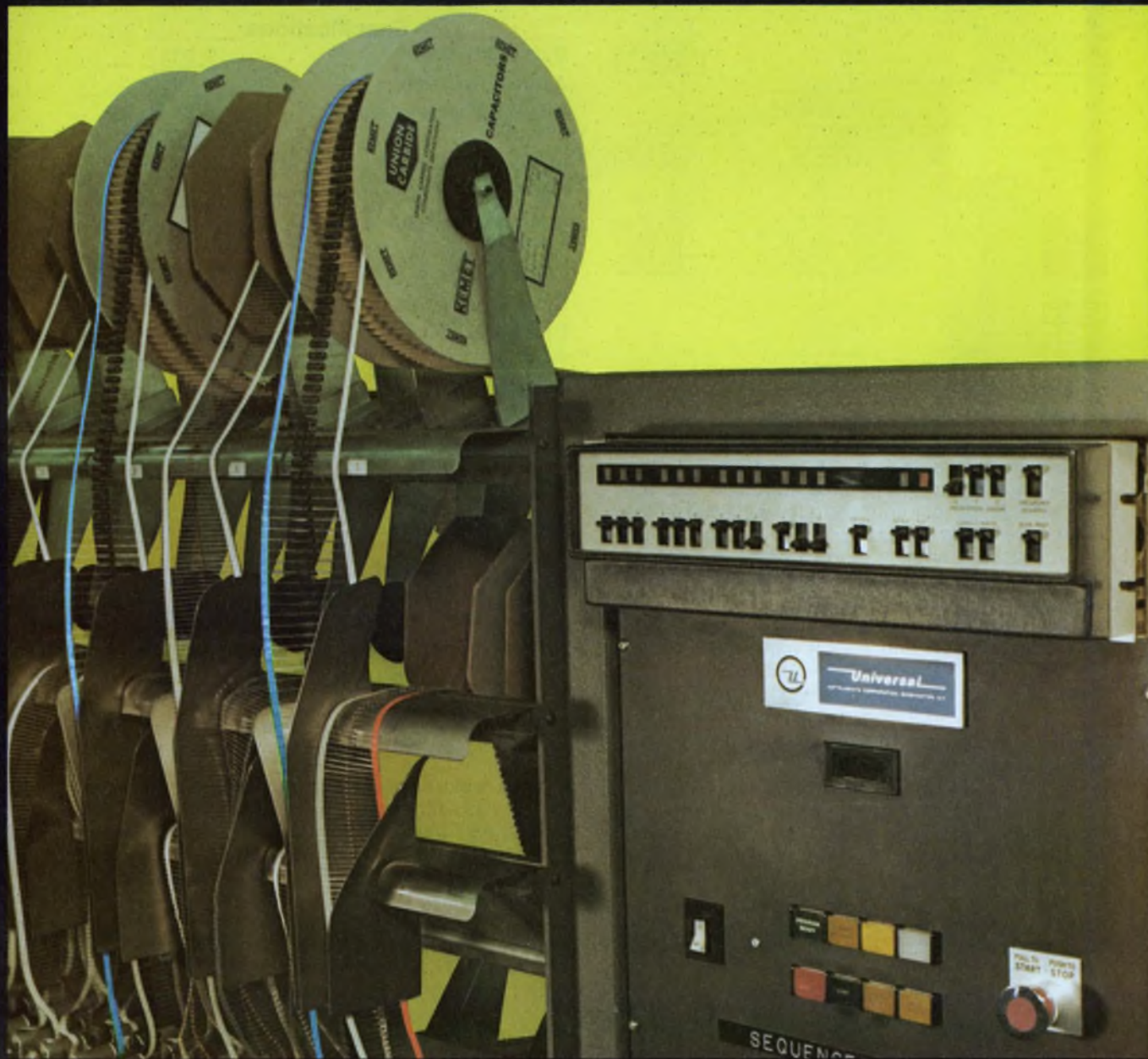

 **COMPONENTS DEPARTMENT**

KEMET is a registered trademark of Union Carbide Corporation

In Europe: Union Carbide Europe, S.A. 5, Rue Pedro-Meylan,  
Geneva 17, Switzerland Phone: 022/47 4411 Telex: 845-22253



# 4-bit microcomputer, PMOS

## SX 200

Essex Group Wire Assembly Division  
Semiconductor Operations  
564 Alpha Drive  
Pittsburgh, PA 15238  
(412) 963-9322

Alternate sources: None.

A 4-bit PMOS microcomputer in a single 28-pin package, the SX 200, combines CPU with  $1024 \times 8$  bits of ROM and  $64 \times 4$  bits of RAM. In addition to data storage, there are 16 individually settable, resettable and testable flag bits for program control. The outputs are mask programmable via a PLA; some outputs are individually settable and resettable under program control and others output parallel data. Direct input is provided for capacitive touchplates.

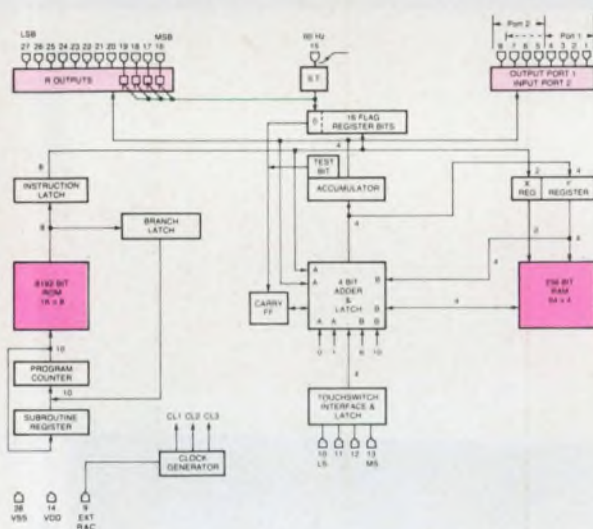

The architecture of the SX 200 processor is typical of the small all-in-one microcomputers—the on-chip ROM feeds instructions to the ALU and to the flag register while the RAM provides the workspace. The processor contains its own clock and touch-switch interface to make a complete system using capacitive touchplates to enter data. The output section contains three ports—a 12-bit output port, a 7-bit output port and a 4-bit input port.

### Comments

The instruction set contains 41 basic instructions that all execute in one cycle. The instructions can be split into the following groups: three branch instructions, eight constant operations, two bit-manipulation operations, 20 register, accumulator and RAM operations, and eight control and I/O instructions.

Software support is provided by the company for the SX 200 in the form of assembly and high-level assembler and simulator programs. There is no program library available.

### Specifications

Data word size:	4 bits
Address bus size:	4 bits
Direct addressing range:	1024 bytes (internal)
Instruction word size:	8 bits
Number of basic instructions:	41
Shortest instruction/time (Any):	20 $\mu$ s
Clock frequency (min/max):	Dc/400 kHz
Clock phases/voltage swing:	1/internal
Dedicated I/O control lines:	24
Package:	28-pin DIP
Power requirements:	10 to 18.5 V/25 mA

### Hardware

Model	Description	Price
SX 200	4-bit CPU There are no support circuits available.	N/A

Special features of the software start with the fact that all instructions require the same amount of time to execute. The 16 individually settable, resettable and testable flag bits greatly improve program control. Data can be input in BCD, thus simplifying many interfaces.

Hardware support consists of a programmable emulator that is used to verify the system and program design.



TEAR OUT

# OPTOELECTRONICS

**Selector  
Guide  
and  
Cross  
Reference**

**GENERAL  ELECTRIC**



## Authorized General Electric Semiconductor Distributors

### ALABAMA

Argo and Co., Birmingham 35201, 205/787-4652  
Forbes Distributing Co., Birmingham 35233, 205/251-4107  
Hamilton/Avnet, Huntsville 35805, 205/533-1170

### ARIZONA

Hamilton/Avnet, Phoenix 85034, 602/243-4151  
Kierulff Electronics, Phoenix 85040, 602/243-4101

### ARKANSAS

Carlton-Bates, Little Rock 72209, 501/562-9100

### CALIFORNIA

Brill Electronics, Oakland 94606, 415/834-5888  
Cramer Electronics, Irvine 92705, 213/771-8300  
Cramer Electronics, Sunnyvale 94086, 408/739-3011  
Elmar Electronics, Mt. View 94042, 415/961-3611  
Hamilton Electro Sales, Culver City 90230, 213/558-2011  
Hamilton/Avnet, Mt. View 94040, 415/961-0272  
Hamilton/Avnet, San Diego 92123, 714/279-2421  
Kierulff Electronics, Los Angeles 90022, 213/725-0325  
Kierulff Electronics, Palo Alto 94303, 415/868-6292  
Kierulff Electronics, San Diego 92123, 714/278-2112  
Marshall, G. S., Company, El Monte 91731, 213/686-0141  
Schweber Electronics (L.A. Div.) Costa Mesa 92626, 714/556-3880

### COLORADO

Electronic Parts, Denver 80210, 303/744-1992  
Hamilton/Avnet, Denver 80216, 303/534-1212

### CONNECTICUT

Bond Radio Supply, Waterbury 06702, 203/757-0546  
Cramer Electronics, N. Haven 06473, 203/239-5641  
Hamilton/Avnet (Georgetown), Wilton 06829, 203/762-0361  
Schweber Electronics, Danbury 06810, 203/792-3500

### FLORIDA

Cramer Electronics, Hollywood 33020, 305/923-8181  
Cramer Electronics, Orlando 32814, 305/894-1511  
Hamilton/Avnet, Hollywood 33021, 305/925-5401  
Schweber Electronics, Hollywood 33020, 305/927-0511

### GEORGIA

Cramer Electronics, Norcross 30071, 404/448-9050  
Hamilton/Avnet, Norcross 30071, 404/448-0800  
Lykes Electronics, Norcross 30071, 404/355-2223  
Schweber Electronics, Atlanta 30340, 404/449-9170

### ILLINOIS

Cramer Electronics, Mt. Prospect 60056, 312/593-8230  
Hamilton/Avnet, Schiller Park 60176, 312/671-6094  
Newark Electronics Corp., Chicago 60624, 312/638-4411  
Schweber Electronics, Elk Grove 60007, 312/593-2740  
Semiconductor Specialists, Chicago 60666, 312/279-1000

### INDIANA

Fort Wayne Electronics, Fort Wayne 46801, 219/423-3422  
Graham Electronics, Indianapolis 46204, 317/634-8202  
Hutch and Sons, Inc., Evansville 812/425-7201  
Pioneer Standard, Indianapolis 46250, 313/478-2700

### IOWA

Deeco, Inc., Cedar Rapids 52406, 319/365-7551

### KANSAS

Hamilton/Avnet, Lenexa 66215, 913/888-8900

### LOUISIANA

Lykes Electronics, Harvey 70059, 504/486-7441

### MARYLAND

Arrow Electronics, Baltimore 21227, 301/247-5200  
Cramer Electronics, Gaithersburg 20760, 301/948-0110  
Hamilton/Avnet, Hanover 21076, 301/796-5255  
Pioneer Standard (Washington), Gaithersburg 20760, 301/948-0710  
Schweber Electronics, Rockville 20852, 301/881-2973

### MASSACHUSETTS

Cramer Electronics, Newton Center 02159, 617/969-7700  
Cushing, T. F., Inc., Springfield 01101, 413/788-7341  
Gerber Radio, Dedham 02026, 617/329-2400  
Hamilton/Avnet, Woburn 01801, 617/273-2120  
Schweber Electronics, Waltham 02154, 617/890-7044

### MICHIGAN

Hamilton/Avnet, Livonia 48150, 313/522-4060  
Pioneer Standard, Livonia 48150, 313/525-1800  
R. S. Electronics, Livonia 48150, 313/491-1000  
Schweber Electronics, Troy 48084, 313/583-9242  
Semiconductor Specialists, Farmington 48024, 313/478-2700

### MINNESOTA

Cramer Electronics (Bonn), Edina 55435, 612/835-7811  
Gopher Electronics, St. Paul 55113, 612/645-0889  
Hamilton/Avnet (Minneapolis), Edina 55435, 612/941-3801  
Schweber Electronics, Eden Prairie 55343, 612/941-5280  
Semiconductor Specialists, Bloomington 55420, 612/854-8841

### MISSOURI

Hamilton/Avnet, Hazelwood 63042, 314/731-1144  
L. Comp., Kansas City 64120, 816/221-2400  
Olive Industrial Electric, University City 63130, 314/863-7800

### NEBRASKA

Scott Electronics, Lincoln 68504, 402/466-8221

### NEW JERSEY

Arrow Electronics, Moorestown 08057, 609/235-1900  
Arrow Electronics, Saddle Brook 07662, 201/797-5800  
Cramer Electronics, Little Falls 07424, 201/785-4300  
General Radio Supply, Camden 08102, 609/964-8560  
Hamilton/Avnet, Cedar Road 07009, 201/239-0800  
Hamilton/Avnet, Mt. Laurel 08057, 609/234-0483  
Schweber Electronics, Somerset 08873, 201/469-6008

### NEW MEXICO

Cramer Electronics, Albuquerque 87108, 505/265-5767  
Hamilton/Avnet, Albuquerque 87117, 505/765-1500

### NEW YORK

Arrow Electronics, Farmingdale 11735, 516/694-6800  
Cramer Electronics, East Syracuse 13057, 315/437-6671  
Cramer Electronics, Hauppauge 11787, 516/231-5600  
Cramer Electronics, Rochester 14623, 716/275-0300  
Hamilton/Avnet, East Syracuse 13057, 315/437-2641  
Hamilton/Avnet, Rochester 14623, 716/442-7820  
Hamilton/Avnet, Westbury 11590, 516/333-5800  
Rochester Radio Supply, Rochester 14614, 716/454-7800  
Rome Electronics, Rome 13440, 315/337-5400  
Schweber Electronics, Rochester 14623, 716/461-4000  
Schweber Electronics, Westbury 11590, 516/334-7590  
Standard Electronics, Cheektowaga 14225, 716/685-4220

### NORTH CAROLINA

Cramer Electronics, Winston-Salem 27102, 919/725-8711  
Dixie Radio Supply, Charlotte 28203, 704/377-5413  
Southeastern Radio Supply, Raleigh 27603, 919/828-2311

### OHIO

Electronic Marketing Corp., Columbus 43212, 614/299-4161  
Hamilton/Avnet, Cleveland 44143, 216/461-1400  
Hamilton/Avnet, Dayton 45459, 513/433-0610  
Hughes Peters, Inc., Cincinnati 45227, 513/351-2000  
Hughes Peters, Inc., Columbus 43211, 614/294-5351  
Pioneer Standard, Cleveland 44105, 216/587-3600  
Pioneer Standard, Dayton 45404, 513/299-7273  
REM Electronics, Warren 44482, 216/373-1300  
Schweber Electronics, Beachwood 44122, 216/464-2970

### OKLAHOMA

Oil Capitol Electronics, Tulsa 74145, 918/622-8520

### PENNSYLVANIA

Almo Electronics Corp., Philadelphia 19114, 215/698-4021  
Pioneer Standard, Horsham 19044, 215/674-5710  
Pioneer Standard, Pittsburgh 15238, 412/782-2300  
Rosen Electronics, York 17403, 717/843-3875  
Schweber Electronics, Horsham 19044, 215/441-0600

### RHODE ISLAND

Edwards, W. H. Company, Warwick 02888, 401/781-8000

### SOUTH CAROLINA

Dixie Radio Supply, Columbia 29202, 803/779-5332

### TEXAS

Hamilton/Avnet, Dallas 75240, 214/661-8661  
Hamilton/Avnet, Houston 77042, 713/526-4661  
Norvell Electronics, Dallas 75240, 214/233-0020  
Schweber Electronics, Dallas 75240, 214/661-5010  
Schweber Electronics, Houston 77036, 713/784-3600  
Sterling Electronics, Dallas 75220, 214/357-9131  
Sterling Electronics, Houston 77003, 713/627-9800

### TENNESSEE

Industrial Electronics, Knoxville 37920, 615/573-7135

### UTAH

Hamilton/Avnet, Salt Lake City 84119, 801/972-2800  
Newark Electronics Corp., Salt Lake City 84115, 801/486-1048

### VIRGINIA

Sterling/Meridian Electronics, Richmond 23220, 804/359-0221  
Virginia Radio Supply, Charlottesville 22901, 804/296-4184

### WASHINGTON

Almac/Stroum Electronics, Seattle 98108, 206/673-2300  
Hamilton/Avnet, Bellevue 98005, 206/746-8750

### WEST VIRGINIA

McJunkin Corporation, Nitro 24143, 304/348-4907

### WISCONSIN

Marsh Electronics, Milwaukee 53214, 414/475-6000  
Hamilton/Avnet, New Berlin 53151, 414/784-4510

GENERAL  ELECTRIC



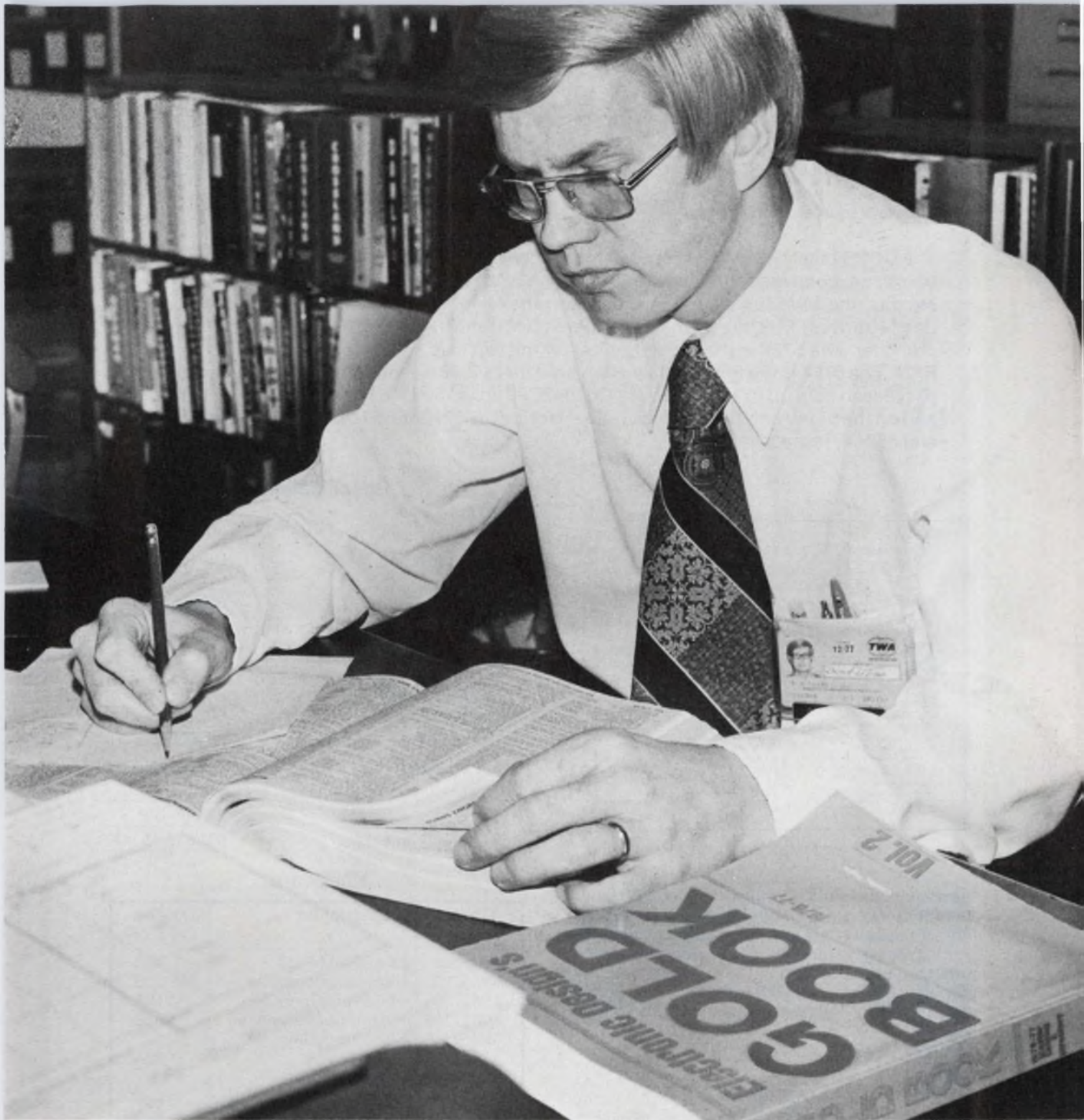

## **"I BELIEVE THE GOLD BOOK IS ONE OF THE MOST IMPORTANT BOOKS ON MY SHELF."**

Darrell D. Tilus is Master Engineer at TWA, Kansas City. He's in charge of design and/or purchase of equipment used to test aircraft "black boxes," and specifies the needed equipment and components. His directory? *Electronic Design's* GOLD BOOK.

Mr. Tilus estimates that he used the GOLD BOOK two or three times a week during the past year, rates it "extremely useful" and has purchased over \$10,000 worth of test equipment, components and devices through its pages.

**"I can count on the GOLD BOOK to give me and my fellow engineers the address and phone of all the electronic/electrical companies I need to contact. I think it's far superior to the others (especially the EEM) in the directory pages."**

If you're looking for electronic products — do what Mr. Tilus does — look *first* in the GOLD BOOK.

---

**IF IT'S ELECTRONIC...IT'S IN THE GOLD BOOK**

---



# 4-bit microcomputer, PMOS

## COPS series

Alternate sources: None.

National Semiconductor, Inc.  
2900 Semiconductor Dr.  
Santa Clara, CA 95051  
(408) 737-5000

The COPS family of PMOS processor chips consists of four different processor circuits or circuit combinations—the MM5781 and 5782 combination processor and ROM circuits, the MM5799 all-in-one processor, the MM57140/57152 single-chip processor (the 140 drives LEDs, the 152 handles fluorescents) and the MM57109 single-chip number cruncher. The 5782 is the processor half of the two chip set and contains a  $160 \times 4$  bit RAM. The 5781 is the ROM half and can hold up to  $2048 \times 8$  bits (an expansion chip, the 57129, can hold up to  $4096 \times 8$  bits). On the 5799 up to  $1500 \times 8$  bits of ROM are available and on the 57140 only  $630 \times 8$  bits. RAM space on the 5799 and 57140 decreases to  $96 \times 4$  and  $55 \times 4$ , respectively.

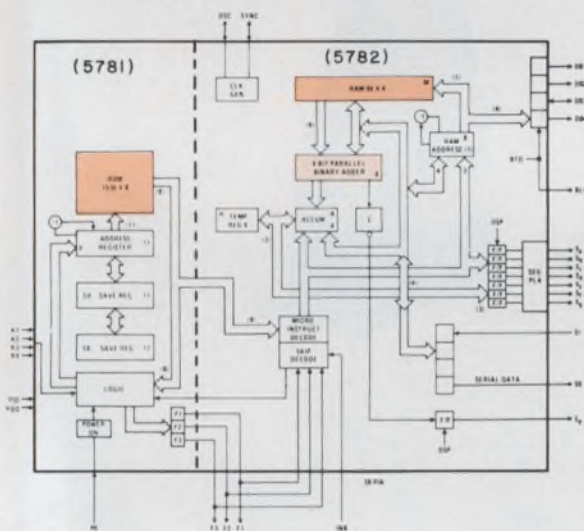

The architectures of the devices in the COPS family of processors are similar. Variations in memory size and I/O capability are the major differences. Most of the processors provide BCD or seven-segment outputs plus all can handle a direct keyboard interface. Only the MM5782 requires an external clock oscillator all other circuits have internal clocks.

### Comments

The instruction set between all four processor models is compatible—the instructions of the smaller processors are a subset of the larger chips. The largest processor MM5799 offers 41 instructions that can be broken down as follows: 18 control and ALU commands, 10 I/O directions and 13 memory operations. The other processors have 36 and 33 (for the 57140 and 5782, respectively). The 57109 has 70 pre-programmed commands to handle calculations.

Software support for the COPS series consists of a cross assembler and simulator program available on an IMP-16 computer system. No program library is available.

### Specifications

Data word size:	4 bits
Address bus size:	Internal
Direct addressing range:	Up to 4096 bytes
Instruction word size:	8 bits
Number of basic instructions:	33 to 41
Shortest instruction/time (Single word):	10 $\mu$ s
Longest instruction/time (Double word):	50 $\mu$ s
Clock frequency (min/max):	70/400 kHz
Clock phases/voltage swing:	4 internal
Dedicated I/O control lines:	11 to 24
Package:	28-pin DIP
Power requirements:	9 V/8 to 15 mA

### Hardware

Model	Description	Price (100 qty)
MM5781	2 k x 8 ROM & I/O	N/A
MM5782	4-bit microcomputer	\$14.35
MM5799	4-bit microcomputer	N/A
MM57109	4-bit number cruncher	12.00
MM57140	4-bit microcomputer, LED	N/A
MM57152	Same as 140 but fluoresc.	N/A
MM5785	Interface to RAMs	N/A
MM5788	Interface to printer	N/A
MM57129	4 k x 8 ROM & I/O	N/A

Special features of the software include simple BCD data handling and serial as well as parallel data handling instructions. All instructions require either one or two clock cycles.

Hardware support includes the IMP-16P micro-based hardware and software development system, including a ROM simulation capability. Chips without ROMs are also available so that external RAM and PROM can be used for program development.



# Mini-misers.



## Amphenol Micro-Miniature Connector Series. Minimum size at a miserly price.

Reduced size. And reduced weight. Those are just two good reasons for choosing your connectors from this economical trio:

**Amphenol 220 Series connectors.** For high-contact density rack-and-panel applications. Sturdy monoblock body, injection-molded polycarbonate, 52 or 104 contacts.

**Amphenol 221 Series multi-purpose strip connectors.** Polycarbonate or nylon, 4" and 6" strip lengths, on .100", .075" and .050" contact centers, in contact arrangements of 60, 53 and 80. Use as is, or cut the strips to lengths (or stack) as desired.

**Amphenol 223 Series connectors.** For circuit modules

potted-in or surface-mounted; also for rack-and-panel, cable-to-cable, and cable-to-panel. Polycarbonate or nylon bodies, 5, 9, 17, 25, or 33 contacts.

**More savings: new Econo-Tac™ contacts.** Gold-over-nickel plating. Stamped, crimp-removable contacts, supplied on 20,000-contact reels or loose. Ideal for high-volume production with the Amphenol semi-automatic termination equipment.

**Get most popular sizes immediately from your Amphenol Industrial Distributor.** Or for more information, call Harry Jaeger, (312) 986-3770. Or write Amphenol North America Division, Bunker Ramo Corporation, Dept. C17A, 900 Commerce Drive, Oak Brook, Illinois 60521.

The right idea  
at the  
right time.



**AMPHENOL**®

CIRCLE NUMBER 45



# 4-bit microcomputer, PMOS

## uCOM-42 (uPD548C)

Alternate sources: None.

NEC Microcomputers, Inc.  
5 Militia Dr.  
Lexington, MA 02173  
(617) 862-6410

The uCOM-42 is a 4-bit single-chip microcomputer designed for electronic cash register and vending applications. Containing an on-chip ROM of 1920 × 10 bits and a 96 × 4 bit RAM, the processor still has 35 lines available for I/O operations. The I/O lines can handle an 8 × 4 key keyboard as well as an eight-digit LED display and electronic printer without any additional support circuits.

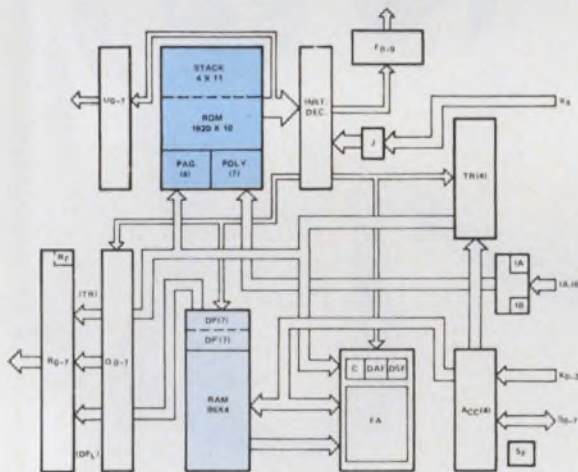

The architecture of the uCOM-42 is designed directly for the electronic cash register market and keyboard controllable appliances. The I/O structure handles an 8 × 4 keyboard, an 8-digit LED display and peripherals. The on-board RAM can also be expanded off the chip. All I/O lines are TTL compatible and all outputs can handle up to -35 V.

### Comments

The instruction set of the uCOM-42 processor contains 72 instructions divided as follows: 11 accumulator manipulation commands, five load/store directives, five data pointer manipulation directions, four register manipulation instructions, three bit manipulation operations, seven skip and jump instructions, three subroutine commands, four interrupt directives, nine I/O operations, 20 port manipulation instructions and one no-operation command.

Software support for the uCOM-42 consists of a cross assembler that runs on the company's 8080A-based PDA-80 program development system. Also available is the PDA editor program. There is no program library available.

### Specifications

Data word size:	4 bits
Address bus size:	11 bits (internal)
Direct addressing range:	1920 words (internal)
Instruction word size:	10 bits
Number of basic instructions:	72
Shortest instruction/time (Add):	10 μs
Longest instruction/time (Return from subroutine):	20 μs
Clock frequency (min/max):	100/200 kHz
Clock phases/voltage swing:	1/TTL
Dedicated I/O control lines:	15
Package:	42-pin DIP
Power requirements:	-10 V/-30 mA

### Hardware

Model	Description	Price
uCOM-42	Microcomputer (5000 qty) There are no specialized support circuits.	\$5.50

Important software features include the fact that all instructions require just a single cycle. And, many commands are multifunction and have auto increment and auto-decrement capability.

Hardware support comes in two forms—an evaluation chip or an evaluation kit. The chip is available so that external ROM or PROM can be used to prepare the program. It also has a hold line to stop operation so that instruction execution can be examined. The other aid is an evaluation kit that provides single-step, breakpoint and register display capabilities.



# AUGAT MAKES IT EASY TO BUY THE BEST.

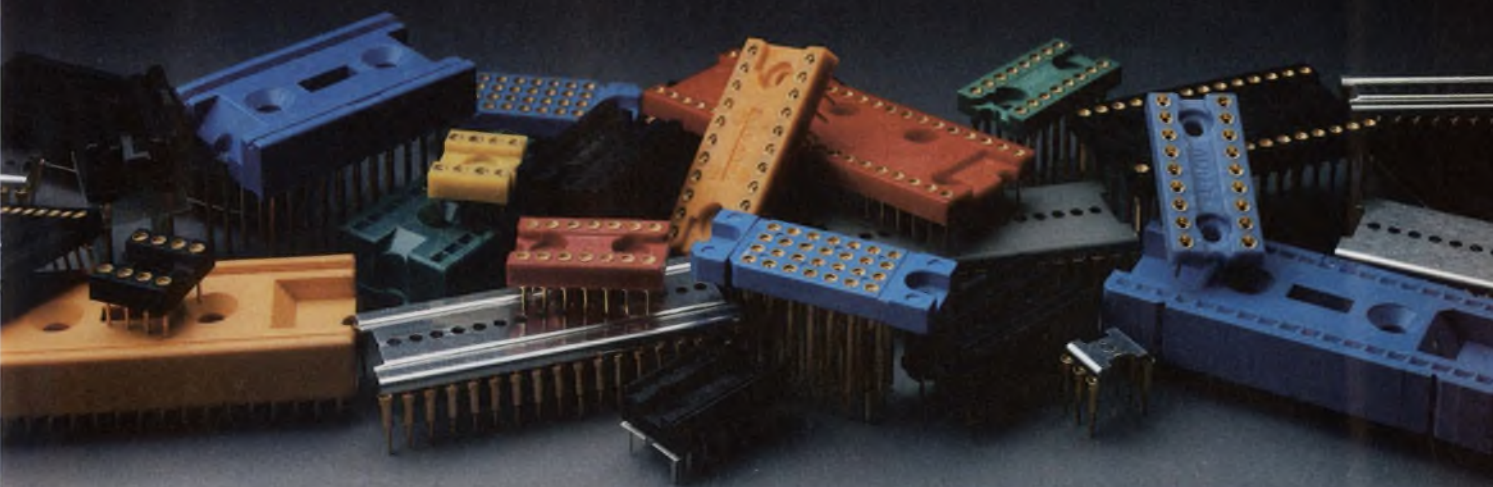

One of the biggest reasons Augat sockets outsell all others is that we make Augat sockets the easiest to buy. Augat offers IC sockets for off-the-shelf delivery from hundreds of worldwide distributor locations. So you have it easy when you buy the best. And here are some of the best you can buy.

Our Series 300 low-profile sockets excel over competitive types with their superior beryllium copper side-wipe contacts that handle all com-



300 Series low-profile

ponent lead sizes with better retention and longer contact life. They are available in all sizes from 8 to 40 contacts.

Our 300 Series wire wrap sockets are the best buy in the industry today. Their special pin taper locks them in place without bonding or soldering, and

they're very attractively priced.

Our 500 Series sockets are the industry's "premium grade", the ones to use when high reliability and exceptional performance (at a reasonable price) are a must. They come in 12 sizes between 8 and 40 contacts.



300 Series wire wrap



500 Series hi-rel

Our 700 Series lead socket carrier is a new concept of growing popularity. The metal carrier holds the individual contacts in place through assembly and soldering, and is then removed. Advantages: improved airflow and complete topside accessibility for inspection and solder rework. Available in 14 sizes.

Beyond that, of course, is our

broad selection of standard profile and test sockets, LED sockets, and numerous accessories.

So the next sockets you buy, make them Augat. They're not only the best you can get, but getting them is a breeze... just about anywhere. Write us for a condensed socket selection guide with prices and a list of our distributors.

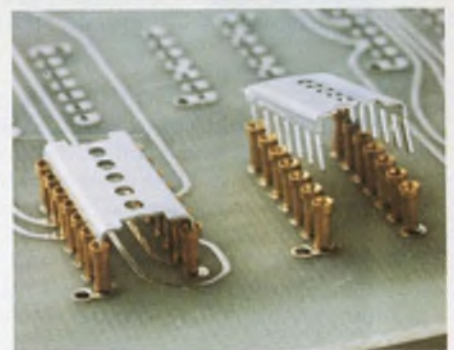

700 Series lead socket carrier

Augat, Inc., 33 Perry Avenue, P.O. Box 779, Attleboro, Mass. 02703. Tel. (617) 222-2202

## AUGAT<sup>®</sup>

Augat interconnection products, Isofonics microcircuit packaging, and Alco subminiature switches.

CIRCLE NUMBER 46



# 4-bit microcomputer, PMOS

NEC Microcomputers  
5 Militia Dr.  
Lexington, MA 02173  
(617) 862-6410

## uCOM-43, uCOM-44, uCOM-45 (uPD546C, 547C, 550C)

Alternate sources: None.

The uCOM-43, 44 and 45 family of all-in-one 4-bit microcomputers is designed for dedicated controller applications. The major differences between the different models is the amount of memory space available on each chip—the 43 is the largest with 2000 × 8 bits of ROM and 96 × 4 bits of RAM. Next step down is the 44 with 1000 × 8 of ROM and 64 × 4 of RAM. The smallest chip is the 45, with a 640 × 8 ROM and a 32 × 4 RAM. Other differences are in the number of I/O lines and a timer included on the uCOM-43 chip.

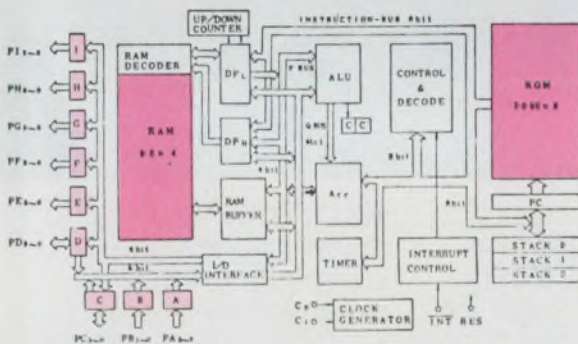

The architecture of the uCOM 43, 44 and 45 all-in-one processors is the same except for varying amounts of ROM and RAM. All chips have an on-board clock circuit and have TTL compatible I/O lines. The largest circuit, the 43, has an on-board programmable timer, a three-level stack, a flag register and six working registers. The I/O ports are divided as follows: two 4-bit input ports, two 4-bit I/O ports, four 4-bit outputs and one 3-bit output.

### Comments

The instruction set consists of 80 commands for the uCOM-43 and each of the instruction sets for the 44 and 45 are just subsets of the 80. The 44 and 45 have 58 instructions in their repertoire. The major instruction set is broken down as follows: six arithmetic, 11 jump, branch and skip, 11 I/O, two timer, 26 register and memory manipulation, three comparison and 10 register exchange operations.

**Software support** is provided by a cross assembler that runs on the company's 8080A-based PDA-80 hardware and software development system. Also available is the PDA-80 editor program and a Fortran IV cross assembler for a 16-bit host computer. There is no program library available.

**Special features of the software** start with the fact that 73 of the 80 instructions require just a single

### Specifications

Data word size:	4 bits
Address bus size:	Internal
Direct addressing range:	Up to 2000 bytes
Instruction word size:	8 bits
Number of basic instructions:	80 (max.)
Shortest instruction/time (Clear accumulator):	9.1 μs
Longest instruction/time (Return to subroutine):	36.4 μs
Clock frequency (min/max):	150/440 kHz
Clock phases/voltage swing:	1/Internal
Dedicated I/O control lines:	21 to 35
Package:	42-pin DIP
Power requirements:	-10 V/-30 mA

### Hardware

Model	Description	Price
uCOM-43	4-bit microcomputer	\$5.50
uCOM-44	4-bit microcomputer	3.40
uCOM-45	4-bit microcomputer	2.70
All prices are for 50,000 qty purchases.		
There are no support circuits available.		

byte. Six instructions provide multiple functions. There are also a total of 25 test-and-skip directions.

**Hardware support** for the uCOM-43, 44 and 45 starts with the uPD556D evaluation chip, which is the same as the uCOM-43 except that the address lines for the ROM are now available for external program memory. Also available is an evaluation kit that provides single-step, breakpoint and register display operations to aid program development.



## TYPE 192P PACER® FILM CAPACITORS



# BEAT THE SPACE/COST SQUEEZE

- Polyester-film dielectric, heat-shrinkable plastic sleeve . . . the kind of construction that saves both space and cost.
- Unique construction . . . all turns of extended foil electrodes terminated in metal end caps . . . assures best-possible non-inductive capacitor section.
- End caps provide controlled dimensions . . . suitable for automatic insertion on printed wiring boards.
- High humidity resistance . . . end caps over capacitor sections are effective moisture barriers.
- Voltage ratings from 80 to 600 WVDC. Capacitance values from .0001 to .39  $\mu$ F. Standard capacitance tolerances,  $\pm 5\%$ ,  $\pm 10\%$ ,  $\pm 20\%$ . Operating temperature range,  $-55^{\circ}\text{C}$  to  $+85^{\circ}\text{C}$ .

Write for Engineering Bulletin 2066C to Technical Literature Service, Sprague Electric Co., 347 Marshall St., North Adams, Mass. 01247.

THE BROAD-LINE PRODUCER OF ELECTRONIC PARTS



CIRCLE NUMBER 264

## TRIGATE® PULSE TRANSFORMERS



# THE INDUSTRY'S LOWEST-COST SCR TRIGGERS

- Dependable enough for industrial equipment, yet priced for high-volume commercial use.
- Balanced pulse characteristics and energy transfer, minimum saturation effect, fast pulse rise time, increased current capability, improved energy transfer efficiency.
- Variety of turns ratios available with line voltage ratings to 240 VAC or 550 VAC. Operating temperature range,  $-10^{\circ}\text{C}$  to  $+70^{\circ}\text{C}$ .
- Plug-in design, protected by thermoplastic sheath. Axial-lead and pre-molded designs also available.

Write for Engineering Bulletin 40003B to Technical Literature Service, Sprague Electric Co., 347 Marshall St., North Adams, Mass. 01247.

THE BROAD-LINE PRODUCER OF ELECTRONIC PARTS



CIRCLE NUMBER 265

## SERIES 207C300/207C400 MODULES



# ACTIVE FILTERS FOR USE WITH MODEMS

- Designed for low speed modem applications.
- Provide all necessary filtering for originate only, answer only, or answer/originate operation.
- Series 207C300 transmit modules feature 6-pole filter to suppress output sidebands, reduce harmonic distortion.
- Series 207C400 receive modules include 10-pole filter to eliminate noise and local carrier signals.
- Absolute max. ratings include supply voltages of  $+18\text{V}$  ( $V_{cc}$ ),  $-18\text{V}$  ( $V_{ee}$ ),  $5.5\text{V}$  ( $V_{DD}$ ). Operating temp. range is  $0^{\circ}$  to  $+70^{\circ}\text{C}$ . Storage temp. range is  $-40^{\circ}$  to  $+125^{\circ}\text{C}$ .

Write for Engineering Bulletin 22113 to Technical Literature Service, Sprague Electric Co., 347 Marshall St., North Adams, Mass. 01247.

THE BROAD-LINE PRODUCER OF ELECTRONIC PARTS



CIRCLE NUMBER 266

## TYPE 715P FILMITE® 'L' CAPACITORS



# LOW DISSIPATION FACTOR

- Polypropylene film dielectric . . . similar to polystyrene in high a-c current-carrying capability, but has added advantage of  $105^{\circ}\text{C}$  operation.
- Conformally coated with flame retardant epoxy.
- Ideal in solid-state TV vertical circuits, r-f generators, pulse-forming networks, plus other applications where high a-c current flow is found.
- Capacitance change with temperature less than 3% over operating temperature range of  $-55^{\circ}\text{C}$  to  $+85^{\circ}\text{C}$ .
- Capacitance values from .001 to .47  $\mu$ F, voltage ratings from 400 to 1600 WVDC.

Write for Engineering Bulletin 2090 to Technical Literature Service, Sprague Electric Co., 347 Marshall St., North Adams, Mass. 01247.

THE BROAD-LINE PRODUCER OF ELECTRONIC PARTS



CIRCLE NUMBER 267



# 4-bit microcomputer, PMOS

## PPS-4/1 family

Rockwell International  
P.O. Box 3669  
Anaheim, CA 92803  
(714) 632-3729

Alternate sources: AEG Telefunken.

A family of 4-bit, single-chip, microcomputers, the PPS-4/1 Models MM75, 76, 77 and 78 include CPU, RAM, ROM, I/O and clock circuitry on a single chip. On-board ROM ranges from 640 to 2048 bytes and on-chip RAM spans 48 to 128 4-bit words. Three special versions of the MM76 are also available—the E version with an expanded ROM, the D version with an a/d converter and the C model with a high-speed counter.

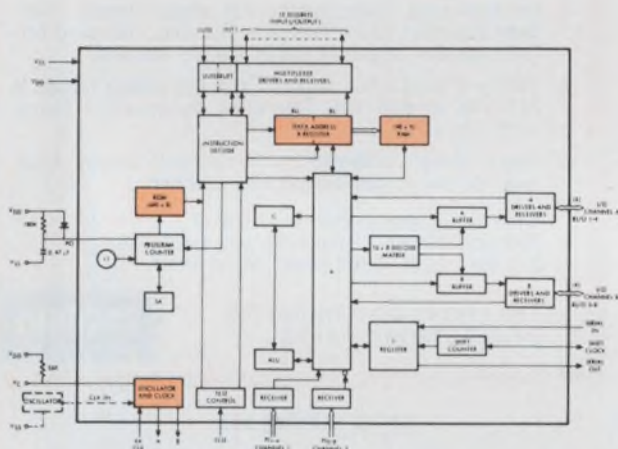

The architecture of the PPS-4/1 devices resembles that of a complete minicomputer—all the necessary circuits are included on a single chip. All chips except the MM77 and 78 have a 48 × 4 bit on-board RAM. The 77 and 78 contain 96 × 4 and 128 × 4 RAMs, respectively. All chips have one 8-bit bidirectional port as well as two conditional interrupt lines, except for the MM75 which has only one interrupt.

### Comments

The instruction set of the PPS-4/1 processors is divided into nine basic categories—RAM addressing commands, bit-manipulation directions, register-to-register operations, arithmetic instructions, ROM addressing commands, logic comparison instructions, I/O directions, conditional transfer operations and register/memory instructions.

Software support for the PPS-4/1 family consists of a Fortran IV cross assembler available either for direct purchase or on time-sharing networks (GE and Tymshare). Also available is the PPS MP Universal Assembler that contains supervisors, assemblers, and a text editor as well as debug routines.

Software features include specialized instructions for the software controllable converter and counter in the MM76D and C versions, as well as a large number of general-purpose I/O commands.

### Specifications

Data word size:	4 bits
Address bus size:	Internal
Direct addressing range:	Internal
Instruction word size:	8 bits
Number of basic instructions:	67 to 69
Shortest instruction/time (Most):	12.5 $\mu$ s
Clock frequency (min/max):	40/120 kHz
Clock phases/voltage swing:	Internal
Dedicated I/O control lines:	22 to 39
Package:	28 pin DIP or 42 and 52-pin QUILs
Power requirements:	15 V/5 mA

### Hardware

Model	Description	Price (1000 qty)
MM75	CPU with 640 bytes of ROM	\$6.10
MM76	CPU with 640 bytes of ROM	8.00
MM76C	CPU with counter	
MM76D	CPU with a/d converter	
MM76E	CPU (expanded MM76)	
MM77	CPU with 1344 bytes of ROM	9.50
MM78	CPU with 2048 bytes of ROM	10.75

Hardware support for the PPS-4/1 family consists of various processor modules that plug into the PPS MP Universal Assembler—the complete resident development system for the family. There are also a wide number of support modules for the Assembler—memory, I/O, personality and prototyping cards are available.



# THERE'S A Simpson<sup>®</sup> 260<sup>®</sup> VOM FOR EVERYONE

- Designers
- Engineers
- Technicians
- Electricians
- Inspectors
- Assemblers
- Scientists
- Environmentalists
- Experimenters
- Students
- Teachers
- Hobbyists

260-6.....\$79.50



260-6XL...\$93.00



**260-6M**  
with Mirror  
Scale  
\$82.50



**260-6P**  
Overload  
Protected  
\$119.00



**260-6PRT**  
Overload  
Protected  
in Roll Top  
Case  
\$129.00



**260-6RT**  
in Roll Top  
Case  
\$89.50



**260-6PM**  
Overload  
Protected  
with Mirror  
Scale  
\$122.00



**260-6MRT**  
with Mirror  
Scale  
in Roll Top  
Case  
\$92.50



**260-6XLM**  
with Mirror  
Scale  
\$96.00



**260-6XLP**  
Overload  
Protected  
\$128.00



**260-6XLPM**  
Overload  
Protected  
with Mirror  
Scale  
\$131.00

COMPLETE LINE OF PROBES,  
LEADS, CARRYING CASES AND  
OTHER ACCESSORIES AVAILABLE.

SEE THEM ALL AT YOUR LOCAL ELECTRONICS/ELECTRICAL DISTRIBUTOR or Write for Catalog 4500



## SIMPSON ELECTRIC COMPANY

853 Dundee Avenue, Elgin, Illinois 60120 • (312) 697-2260  
CABLE: SIMELCO • Telex: 72-2416

IN CANADA: Bach-Simpson, Ltd., London, Ontario

IN ENGLAND: Bach-Simpson (U.K.) Ltd., Wadebridge, Cornwall

IN INDIA: Ruttonsha-Simpson Private, Ltd., Vikhroli, Bombay

CIRCLE NUMBER 48

KATY INDUSTRIES



ELECTRICAL EQUIPMENT  
GROUP



# 8-bit microcomputer, NMOS

## PIC 1650/PIC 1655

Alternate sources: None.

General Instrument Corp.  
600 W. John St.  
Hicksville, NY 11802  
(516) 733-3000

Manufactured with ion-implant, n-channel processing, the PIC 1650 and PIC 1655 are byte-oriented, stand-alone processors that include 512-word user-defined ROMs for program storage and 32 eight-bit internal registers (RAM), all on-chip. The 1650 has 32 user-defined I/O lines and the 1655 has 20 lines.

### Specifications

Data word size:	8 bits
Address bus size:	Internal
Direct addressing range:	—
Instruction word size:	12 bits
Number of basic instructions:	30
Shortest instruction/time (Most):	4 $\mu$ s
Longest instruction/time (Program counter skips):	8 $\mu$ s
Clock frequency (min/max):	0.1/1 MHz
Clock phases/voltage swing:	Internal

Dedicated I/O control lines:	32 or 20
Package:	28-pin DIP(1655)
	40-pin DIP(1650)
Power requirements:	5 V/50 mA

### Hardware

Model	Description	Price
PIC 1650	CPU (2500 min order)	\$8.00
PIC 1655	CPU (2500 min order)	\$6.00
PIC 1664	CPU with ext. memory (for prog. dev.)	N/A

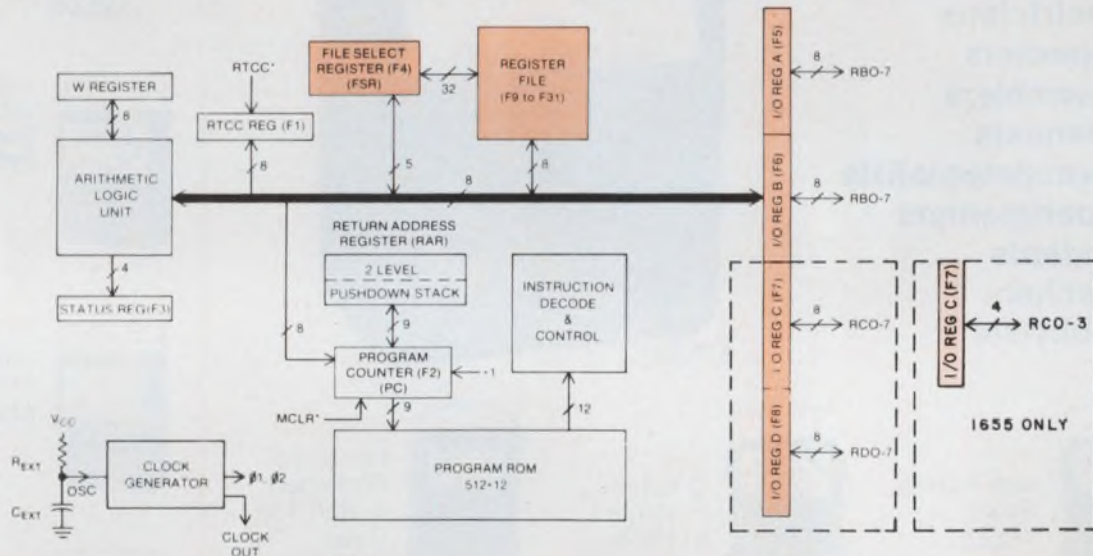

The PIC 1655 differs from the 1650 only in the number of I/O lines. All lines are TTL compatible. There are four 8-bit parallel ports on the 1650 as well

as 32 8-bit general-purpose registers and a built-in clock generator to supply all the timing signals. The 1655 has only two 8-bit and one 4-bit ports.

### Comments

**The instruction set of the PIC 1650/1655 contains 30 commands, including 18 for arithmetic and logic operations on the 32 internal registers. Another group of four operates on individual bits, while a third group of eight is for literals, subroutine stacking, and program control.**

**The software available** includes an assembler (PICAL), a debugger (PICBUG), and a software simulator (PICSIM) that are written to run on the Gemini 16-bit microcomputer system. A Fortran version of PICSIM is also available.

**Software features** of the PIC1650/1655 instruction set include individual bit set, reset and test operations as well as BCD arithmetic capability in the accumulator. The general purpose input/output lines can be programmed to scan keyboards, drive multiplexed displays, etc.

**Hardware support** is provided with the PIC Emulator, a single-board development tool with software debugger, Teletype interface, and in-circuit emulation. Also available is the PIC 1664 a version of the 1650 that uses external PROM or RAM for prototyping.





## HOLD DOWN PROM SOFTWARE DEVELOPMENT COSTS WITH DATA I/O SYSTEMS.

With Data I/O PROM programming systems you can develop and test PROM programs before committing a single PROM.

You simply load your program into the system using the Data I/O PROM Programmer keyboard or remote interface. The programmer system can emulate any commercially available PROM—including MOS.

You can then review the program as many times as you need to check against truth tables, edit or make changes. Once the program is perfect, you can begin programming with the assurance that the first PROM you program will work.

Data I/O Universal Programmers interface with all microprocessor developmental systems.



Programmers from \$1095.00

**HOW TO SELECT  
THE RIGHT PROM  
PROGRAMMER  
FOR YOUR NEEDS.**

### We'd like to tell you more.

This fact filled tabloid gives you valuable information about PROM programming technology. To get your copy, circle reader service number or contact Data I/O Corporation, P.O. Box 308, Issaquah, WA 98027. Phone 206/455-3990.

# DATA I/O

**THE PROM PROGRAMMER PEOPLE.**



# 8-bit microcomputer, NMOS

## MCS-48 (8035, 8048 and 8748)

Intel Corp.  
3065 Bowers Ave.  
Santa Clara, CA 95051  
(408) 246-7501

Alternate sources: Advanced Micro Devices, NEC and Signetics (Philips) are official second sources via mask exchange.

There are three versions of the basic processor available—the 8035, which is just a processor without any on-chip program memory; the 8048, which has the processor along with 1024 bytes of mask-programmable ROM on the same chip; and the 8748, which contains the processor and 1024 bytes of UV erasable PROM on the same chip. All three versions are made via an NMOS silicon-gate process and contain a 64 × 8 data RAM, 27 I/O lines, a counter/timer and an on-board clock generator in addition to the processor. And, all three versions of the processor are pin-compatible.

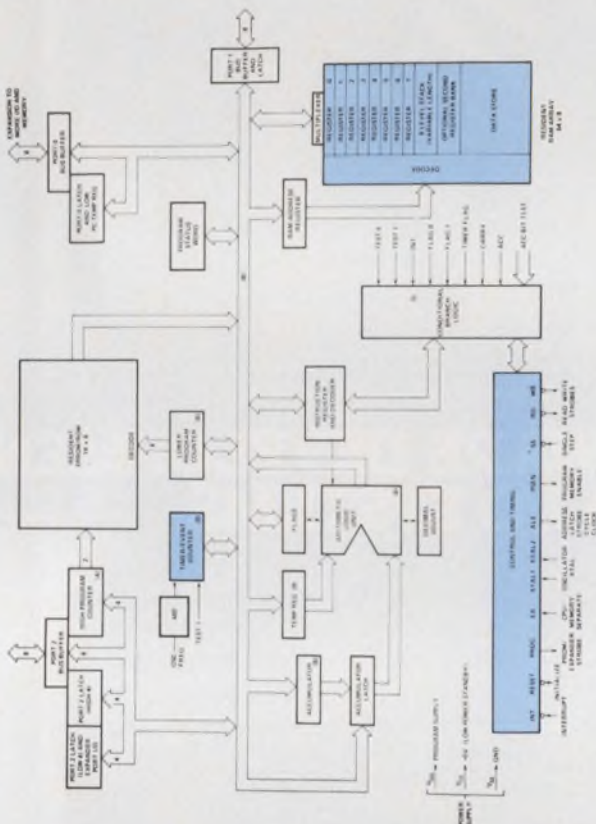

The basic architecture of the MCS-48 family is highly bus oriented, with almost every sub block tied into the bus. All three eight-bit ports provide latched outputs. If more program memory is needed than is on the chip, ports 0 and 2 can be used to output an address to external memory.

### Comments

The instruction set of the MCS-48 family consists of 96 instructions split into 24 register operations, 26 accumulator operations, 23 conditional and unconditional transfers, 13 I/O control instructions and 10 other system control instructions.

Software support for processors includes a macro-assembler on paper tape or floppy disc, a resident text editor in the MDS development system and Debug software as part of the ICE-48 in-circuit emulator system. Also, MCS-48 programs are available through the company's Insite program library, which contains over 350 programs.

### Specifications

Data word size:	8 bits
Address bus size:	12 bits
Direct addressing range:	4096 words
Instruction word size:	8 bits
Number of basic instructions:	96
Shortest instruction/time (50% of commands):	2.5 $\mu$ s
Longest instruction/time (remaining 50%):	5 $\mu$ s
Clock frequency (min/max):	1/6 MHz
Clock phases/voltage swing:	Internal/TTL
Dedicated I/O control lines:	27
Package:	40-pin DIP
Power requirements:	5 V/65 mA

### Hardware

Model	Description	Price (100 qty)
8035	CPU without ROM	\$13.55
8048	CPU with mask-programmed ROM	consult factory
8748	CPU with UV PROM	\$175.00
8155	RAM, I/O & timer	14.00
8205	1 of 8 binary decoder	2.80
8212	8-bit I/O port	2.90
8214	priority interrupt	4.65
8216	Bidirectional bus drive	2.75
8226	Inverting bus driver	2.75
8243	I/O expander	5.00
8253	Programmable timer	17.55
8259	Interrupt controller	17.20
8279	Keyboard/display interface	14.10
8355	ROM & I/O expander	c.f.
8755	UV PROM & I/O	125.00

Unique features of the software include AND and OR operations directly to the I/O ports for bit set and reset operations. Accumulator bit test operations and indirect fetch for table look-ups are also possible.

Hardware support includes the Prompt-48, a bench-top stand-alone development system and the Intel Microprocessor Development System (MDS), a full microcomputer based system with 16 k of RAM and 2 k of ROM and software and hardware interfaces for peripherals.



# The snap action switch

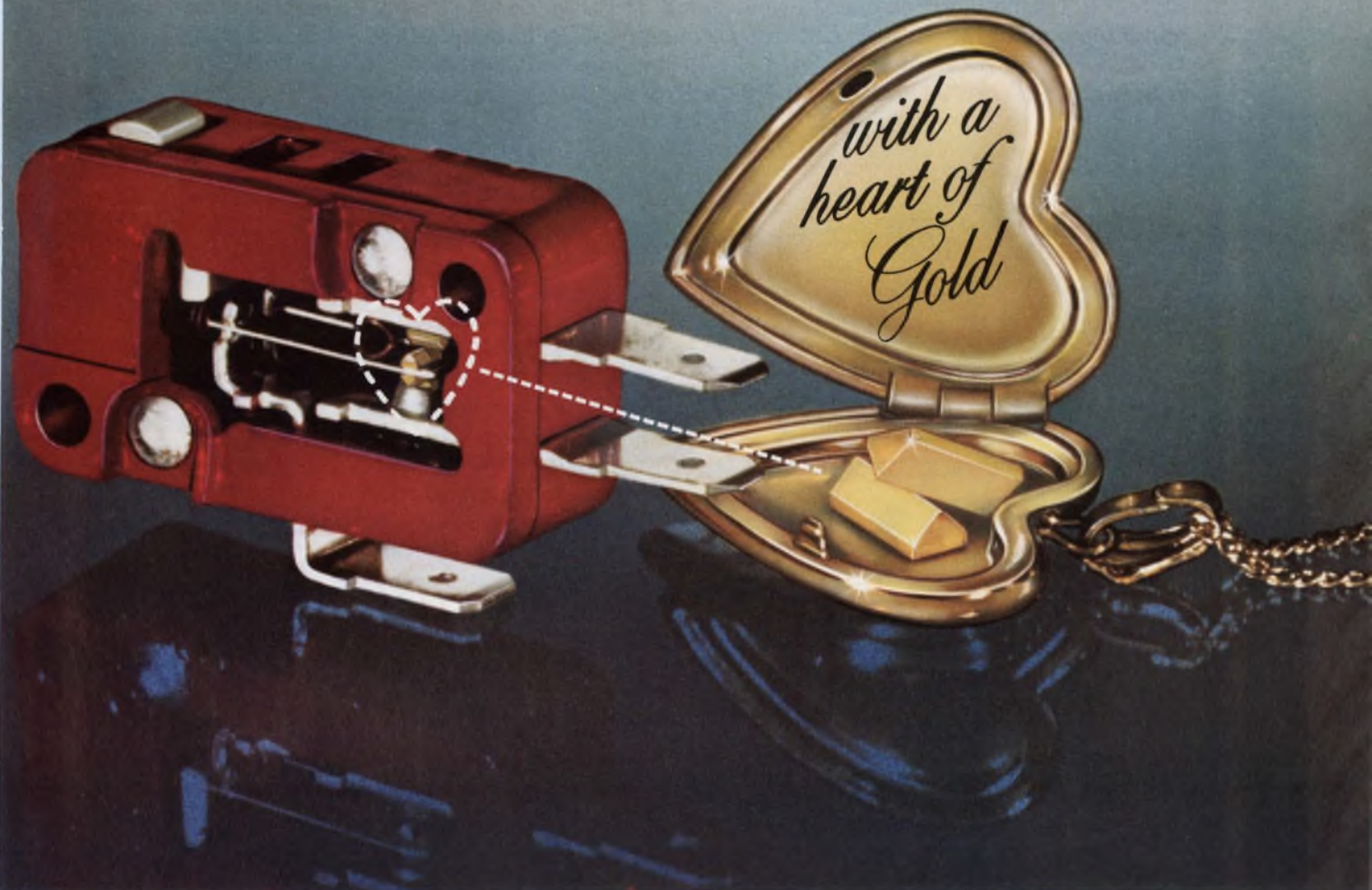

...for **POSITIVE** switching in low energy circuits

Now your 4 to 100 milliamperere, 4 to 30 volt circuits can have the same high reliability you've learned to love in Cherry snap action switches. Because, our "heart of gold" snap action switches have the same long life coil spring mechanism, the same large overtravel as all of our snap action switches.

**They also have gold crosspoint contacts.** A configuration with knife-edge contact area so small (9 millionths of a square inch)... with contact force so great (about 5,000 psi)... and gold alloy so pure and film-free... you are absolutely assured of positive contact every time. For 50 million operations and beyond.

Cherry Gold Crosspoint Contact Switches are available in virtually every snap action design in

Cherry's big catalog. And you *know* what a wide variety of switch types, sizes and mounts *that* is. Choose any switch design from a basic open or general purpose to a panel mount pushbutton, low torque, miniature, subminiature or subminiature module. Chances are 99 to 1 that the switch you have chosen is available with gold crosspoint contacts. Which will make designing low energy circuits a whole lot easier... and a whole lot *better*. (No love letters, please.)

**For free test sample and complete catalog,** just TWX 910-235-1572... or PHONE 312-689-7700.

# CHERRY

Cherry switches now available locally from distributors.

CHERRY ELECTRICAL PRODUCTS CORP., 3609 Sunset Avenue, Waukegan, IL 60085





# 8-bit microcomputer, NMOS

## MK3870

Mostek Corp.  
1215 W. Crosby Rd.  
Carrollton, TX 75006  
(214) 242-0444

Alternate sources: Fairchild and Motorola.

A complete microcomputer on a single chip, the MK3870, can execute the instruction set of the F8. The 8-bit device executes more than 70 instructions, allowing expansion into multichip configurations with software compatibility. Featured on-board are 2048 bytes of ROM and 64 bytes of scratchpad RAM. The processor operates from a single 5-V supply and contains 32 lines of bidirectional I/O and a programmable timer.

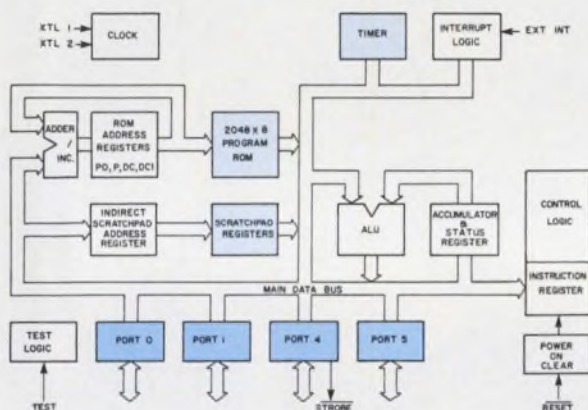

The architecture of the 3870 is identical to that of the original F8, with the extra features of ROM and RAM added to the original chip. Also included on the chip is an 8-bit timer and an 8-bit prescaler. The 3870 can form a complete processor system without any other additional circuits aside from the power supply. All lines are TTL compatible.

### Comments

The instruction set of the 3870 is compatible with that of the F8 processor. There are 76 basic instructions, divided as follows: 15 accumulator reference, eight memory reference, 12 branch and jump, 13 address modification, 15 scratchpad memory reference and 13 miscellaneous control instructions.

Software support for the 3870 processor includes resident debug, edit and assembly programs, non-resident Fortran-IV cross assembler for 16-bit and larger minicomputers, and many ROM-based software packages. There is no general program library, but the factory can be consulted for specific program needs.

Important features of the software include compact instruction codes (60% of the instructions require just one byte), auto-incrementing and auto-decrementing are possible, register and memory pointers are available, the processor can perform

### Specifications

Data word size:	8 bits
Address bus size:	11 bits (internal)
Direct addressing range:	2048 words
Instruction word size:	8, 16, or 32 bits
Number of basic instructions:	76
Shortest instruction/time (Register reference):	2 $\mu$ s
Longest instruction/time (Subroutine call):	13 $\mu$ s
Clock frequency (min/max):	1/4 MHz
Clock phases/voltage swing:	Internal
Dedicated I/O control lines:	32 I/O lines plus two control lines
Package:	40-pin DIP
Power requirements:	5 V/70 mA

### Hardware

Model	Description	Price (100 qty)
MK3870	8-bit microcomputer	\$19.00
MK3850N	F8 CPU	10.75
MK3853N	Static memory interface	9.50
MK3871N	Parallel I/O and timer	9.50

relative addressing and all I/O instructions require a single byte.

Hardware support for the 3870 includes the F8 evaluation kit with 1024 bytes of RAM, a TTY monitor with breakpoint capability and a Fortran cross assembler. An assembler, editor and debug routine are also available on the company's SDB-50/70 software development board. The largest system is the AIM-70, a complete real-time emulation system that provides snapshot software in ROM.



# Need ROM retention and RAM alterability?



## Design in Nitron Non-Volatile Memories.

Our Metal Nitride Oxide Silicon NVM are fully reprogrammable in-circuit. They offer long-duration storage security without battery backup or "power-on" auxiliaries.

### HIGH DATA RETENTION

Data is secure for a minimum of 10,000 hours and can be read  $10^{10}$  times between refresh cycles.

### PROGRAM VERSATILITY

Nitron NVMs offer entire memory or word alterability. And it can all be done in-circuit a minimum of  $10^5$  times. Millisecond write times are ideal for applications in the human-response range.

### SYSTEM COMPATIBILITY

We built in on-chip decoding, and TTL and CMOS compatibility. Plus, Nitron NVMs can be reprogrammed without additional power supplies or power supply switching.

### PRODUCT AVAILABILITY

Nitron NVMs are available off-the-shelf for parallel data applications in 64x4 and 256x4 configurations;

and for serial data applications in 21x16, 16x18 and 1024x1 configurations. If you don't see what you need, tell us about it. We custom design NVMs, too.

Unique Nitron process puts silicon nitride and silicon dioxide layers between MOS gate and substrate. When voltage is applied, trapped charge offsets threshold voltage. Charge remains after voltage is removed.

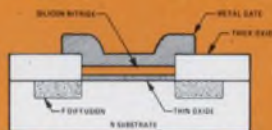

Need information fast? Call Nitron NVM Marketing at (408) 255-7550. Or fill in the coupon below for your NVM Fact Kit.



Mail to:  
NITRON NVM Marketing  
10420 Bubb Road  
Cupertino, CA 95014

TELL ME MORE!

I'm interested in (check box):

- |   |   |
|---|---|
| <input type="checkbox"/> 64x4<br>NC7040   | <input type="checkbox"/> 21x16<br>NC7033          |
| <input type="checkbox"/> 256x4<br>NC7050  | <input type="checkbox"/> 16x18<br>NC7035          |
| <input type="checkbox"/> 1024x1<br>NC7051 | <input type="checkbox"/> Complete<br>NVM Fact Kit |

Send to:

name & title

company

address

city

state

zip

ED-10



# 8-bit microcomputer, PMOS

## Series 8000

General Instrument Corp.  
600 West John Street  
Hicksville, NY 11802  
(516) 733-3000

Alternate sources: AEG and SGS-ATES.

The Series 8000 logic processor system is a multiple-chip set—the LP8000 processor chip, the LP6000 control memory and the LP1030 clock generator. Able to access 16 kwords over its all-MOS-level buses the Series 8000 system offers 24 bidirectional I/O lines. There are 48 general-purpose 8-bit registers on the LP8000 as well as an 8-bit bidirectional I/O port. The LP6000 control memory contains 16 lines of bidirectional I/O in addition to the 1 k × 8 control program.

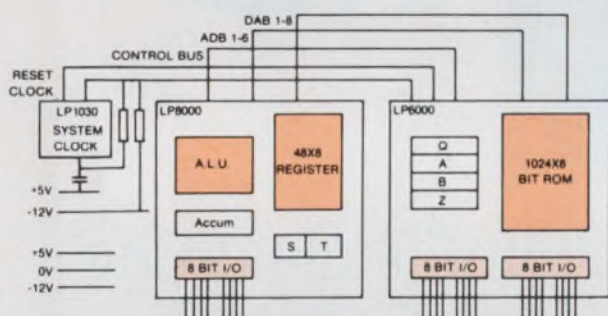

The architecture of the Series 8000 is based on a three-chip set—the CPU, ROM and clock generator. In the processor is an 8-bit ALU, a 48 × 8 register file, a four-word address stack and eight bidirectional I/O lines. The 8-bit data bus and 6-bit control bus combine to provide a 14-bit memory address.

### Specifications

Data word size:	8 bits
Address bus size:	Internal
Direct addressing range:	16,384 bytes
Instruction word size:	8 bits
Number of basic instructions	51
Shortest instruction/time (many):	5 μs
Longest instruction/time (Load accumulator from module indirect)	15 μs
Clock frequency (min/max):	500/800 kHz
Clock phases/voltage swing:	1/11 V
Dedicated I/O control lines:	24 (3-chip syst.)
Package:	40-pin DIP
Power requirements:	5 V/30 mA -12 V/70 mA (LP8000 only)

### Comments

The instruction set consists of 48 basic commands that are divided as follows: 11 register operations, nine jump instructions and 31 accumulator operations (including Binary and BCD Add, logic OR, AND and Exclusive-OR, and Compare).

Software support for the Series 8000 is composed of a Fortran IV cross assembler and simulator that can run on many minicomputer systems or is available from various time-sharing vendors. There is no program library available.

Special features of the software include the many accumulator operations and the multiple position bit shifts possible when handling BCD arithmetic.

Hardware support consists of several modules that permit ROM or PROM to be used to develop the

### Hardware

Model	Description	Price* (100 qty)
LP8000	8-bit processor chip	\$10.00
LP6000	1 k × 8 ROM & 16 I/O lines	10.00
LP1000	Memory interface	8.50
LP1010	I/O buffer	7.50
LP1030	800 kHz clock generator	2.50
	*Main market emphasis is in Europe.	

software. There is also a prototyping system available—the GIC 8000—that has resident hardware and software debug aids.





## T-METER™ MEANS TOUGH

This digital thermometer is virtually indestructible... drop proof, shock proof, water proof, chemical proof, you name it. We have hurled it against stone walls, immersed it in boiling water for an hour, and submerged it for a week in a salt water fish tank without harming it. Its electronics are cast in silicone. Its teflon-coated probes and cables resist chemicals. It is so rugged that we confidently offer a 3 Year Full Warranty.

Tough, accurate, and versatile, spanning  $-100^{\circ}\text{C}$  to  $200^{\circ}\text{C}$  and  $-150^{\circ}\text{F}$  to  $400^{\circ}\text{F}$ , the T-Meter (with standard probe) achieves  $\pm 0.5^{\circ}\text{C}$  ( $\pm 0.9^{\circ}\text{F}$ ) accuracy over  $-55^{\circ}\text{C}$  to  $125^{\circ}\text{C}$  ( $-67^{\circ}\text{F}$  to  $257^{\circ}\text{F}$ ). Optional high accuracy probes for special applications achieve  $\pm 0.1^{\circ}\text{C}$  ( $\pm 0.15^{\circ}\text{F}$ ), covering

the MIL range in  $20^{\circ}\text{C}$  increments. You can supplement the standard 3' probe with lengths of 10', 25', and 100'. And you can special order lengths to 3,000'!

Tough as nails and nuisance-free, this fully guaranteed pocket-sized time-saver will cut your costs in a host of practical applications. Our reps stock T-Meters at **\$239**. Standard probe, \$25. General purpose high accuracy probe, \$30. Others available.

ECD CORP.  
196 Broadway  
Cambridge, MA 02139  
(617) 661-4400



CIRCLE NUMBER 52

SALES OFFICES: AL, Huntsville (205) 533-5896; AZ, Scottsdale (602) 947-7841; CA, Costa Mesa (714) 540-7160; CA, Sunnyvale (408) 733-8690; CO, Denver (303) 750-1222; FL, Winter Haven (813) 294-5815; GA, Chamblee (404) 457-7117; IL, Elk Grove Vill (312) 593-0282; IN, Indianapolis (317) 293-9827; MD, Silver Spring (301) 622-4200; MA, Wakefield (617) 245-5940; MN, Minneapolis (612) 781-1611; MO, Kansas City (816) 358-7272; So. NJ/Philadelphia (215) 674-9600; NM, Albuquerque (505) 299-7658; NY, Great Neck (516) 482-3500; (212) 895-7177; Syracuse (315) 446-0220; NC, Raleigh (919) 787-5818; OH, Centerville (513) 433-8171; TX, Houston (713) 688-9971; TX, Richardson (214) 231-2573.



# 16-bit microcomputer, NMOS

## TMS 9940

Texas Instruments Inc.  
P. O. Box 5012, M/S 308  
Dallas, TX 75222  
(214) 238-2011

Alternate sources: None.

A 16-bit CPU, with RAM, EPROM and I/O circuitry contained in a single 40-pin package. The TMS 9940 also contains a timer/event counter, a flag register, and reconfigurable I/O. Instructions are compatible with the TMS 9900 and, in addition, include two new instructions for manipulating BCD data and a single LIIM instruction to load an interrupt mask. Memory-to-memory architecture features multiple register files, in RAM, for faster response to interrupts and greater programming flexibility. The processor implements four levels of interrupts including the internal decremter, which can be programmed as a timer or event counter.

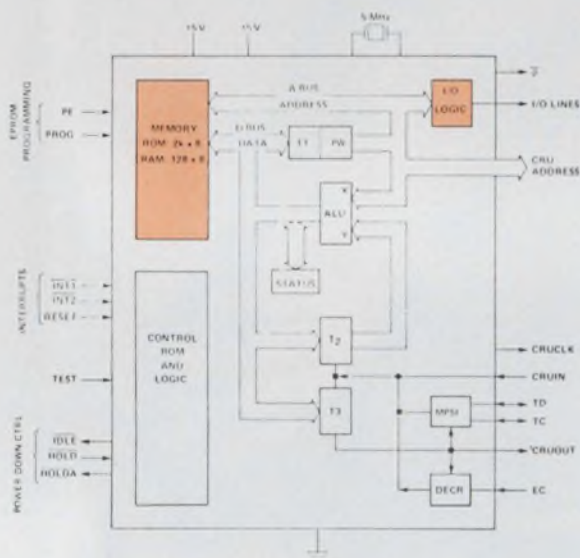

The TMS 9940 is a complete 16-bit computer system on a single chip. On the chip are 2048 bytes of ROM or UV PROM, 128 bytes of RAM, as well as an event counter/timer, a flag register and up to sixteen reconfigurable I/O lines. Even the clock generator is included on the chip. All lines are TTL compatible and the I/O lines are software configurable as either inputs or outputs.

### Comments

**Software for the TMS 9940** consists of all the instructions available on the TMS/SBP 9900 except for four commands that aren't applicable to the all-in-one configuration. Also, three new instructions have been added to simplify the manipulation of BCD coded data and to simplify masking operations. The 9940 can handle four levels of interrupt, and includes an internal decremter that can be programmed as a timer or event counter.

**Support software** for the TMS 9940 consists of assemblers, editors, simulators and debuggers. High-level languages will also be available shortly. There is also a program library available since most software is code compatible with the company's 990 series of minicomputers.

### Specifications

Data word size:	16 bits
Address bus size:	15 bits
Direct addressing range:	32,768 words
Instruction word size:	16 to 48 bits
Number of basic instructions:	68
Shortest instruction/time (Jump):	2 $\mu$ s
Longest instruction/time (Divide):	45.2 $\mu$ s
Clock frequency (min/max):	Dc/5 MHz
Clock phases/voltage swing:	1/TTL
Dedicated I/O control lines:	16
Package:	40-pin DIP
Power requirements:	5 V/160 mA

### Hardware

Model	Description	Price (100 qty)
TMS 9940	16-bit all-in-one CPU	N/A
TMS 9901	Programmable interface	\$8.75
TMS 9902	Asynchronous interface	7.50
TMS 9905	8:1 multiplexer	1.26
TMS 9906	8-bit latch	1.55
TMS 9907	8:3 priority encoder	1.01
TMS 9908	8:3 priority encoder	1.01

**The most outstanding features** of the software include the multiple register file capability and the flexibility it offers. The processor makes use of the minicomputer instruction set of the 990 series, including hardware multiply and divide commands. The software controllable counter/timer also provides a handy capability to implement timing loops.

**Hardware support** for the TMS 9940 includes all the support for the 9900—the TM 990 microcomputer modules, the PX 990 cassette-based prototyping system, and AMPL, a floppy-disc based development system. And, since most of the software is 990 code compatible, all the mini hardware is also at the designer's disposal.



# The Ansley "D" Connector...



Our new series of male and female "D" connectors offer you a cost effective external mass termination cable and connector system second to none. Its uniqueness begins with a one-piece "D" connector package that meets industry standards for size, pin spacing, and contact reliability. With no loose parts to match up, positive cable-to-contact alignment is assured. Conductors are mass terminated in seconds with our standard BLUE MACS™ hand or bench tools. The results? Faster installation, higher reliability.

Contact pins are spaced on .0545" centers — a perfect fit for any standard inter-cabinet "D" type connector application. Our new "D" connectors are designed to mate with standard .050" pitch flat cable as well as our new, improved jacketed cable — the only flexible flat cable engineered specifically for out-of-cabinet use.

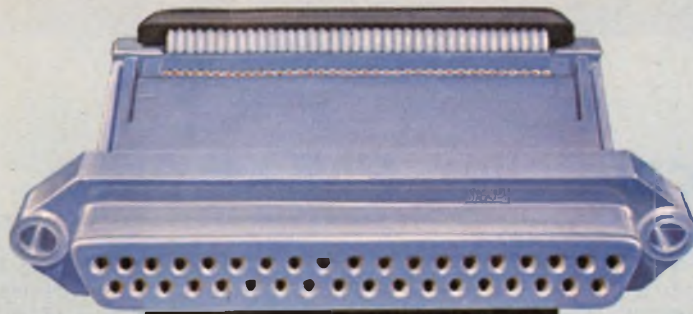

# a new meaning to cost effectiveness.

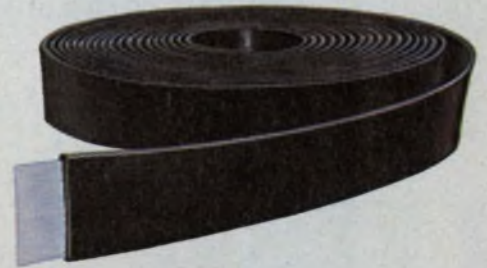

The Ansley BLUE MACS™ jacketed cable is U.L. listed for external interconnection of electronic equipment. Electrically, it outperforms standard jacketed twisted pairs in typical I/O applications. And there's no special zipper lock tubing required — reducing the need for an extra cable accessory. Installation is faster, easier. And like all Ansley connectors, you can daisy chain our "D" types anywhere in the cable — along with our DIP socket, card edge, or pc board connectors.

Cable alignment and high contact reliability is assured — because both cable and connector are grooved for absolute alignment. Our patented TULIP™ 4-point insulation-displacing contacts are permanently fixed and sealed-in to provide a reliable, gas-tight, corrosion-free mass termination.

For the full reliability/cost effectiveness story and technical data, call or write:

**T&B / Ansley**

The mass termination company.

**T&B/Ansley Corporation • Subsidiary  
of Thomas & Betts Corporation**  
3208 Humboldt St. • Los Angeles, CA  
90031 • Tel. (213) 223-2331 •  
TWX 910-321-3938

**Available through authorized  
Ansley distributors**

In Canada: T&B/Ansley, Ltd.  
700 Thomas Ave.,  
Industrial Park  
Iberville, P.Q.

CIRCLE NUMBER 53



# 4-bit microcontroller, PMOS

## CR1872

Western Digital  
3128 Red Hill Ave.  
P.O. Box 2180  
Newport Beach, CA 92663  
(714) 557-3550

Alternate sources: None.

A low-cost 4-bit microcontroller for dedicated control applications, the CR1872 includes a direct interface for keyboard or thumbwheel switches and decoded LED segment driver outputs. The on-chip ROM holds  $512 \times 10$  bits, and the on-chip RAM is  $32 \times 4$  bits.

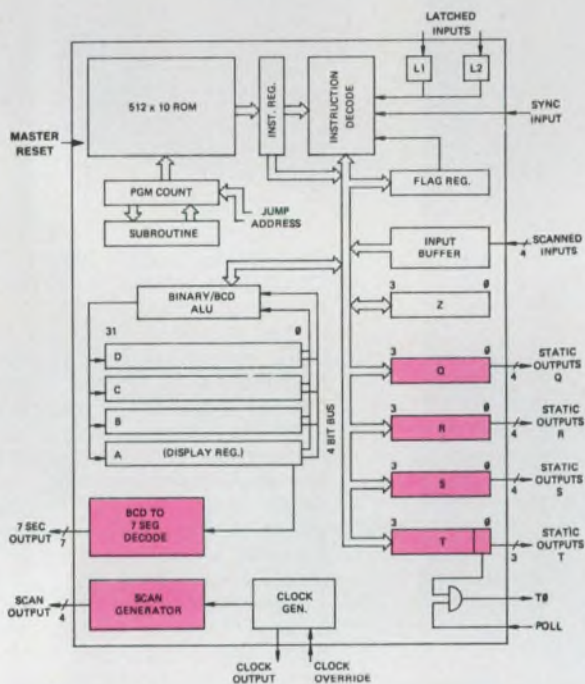

The stand-alone processor has scanned inputs and decoded outputs: seven input lines, 16 output lines, and LED segment driver outputs. All lines are compatible with TTL or CMOS logic families. In addition to the  $512 \times 10$  bit on chip ROM, the 1872 has a  $32 \times 4$  bit scratchpad RAM and on-board clock generator.

### Comments

The instructions set is broken into four groups: program control (6), conditions (14), I/O (5), and ALU (9). All instructions are optimized for dedicated control applications and BCD data handling and display.

Software support consists of Assembler, Editor, and Simulator programs which can run on PDP-11 minicomputers.

The software set used by this processor is optimized for dedicated controller applications. A version of the processor pre-programmed as a timer is available for evaluation.

### Specifications

Data word size:	4 bits
Address bus size:	None*
Direct addressing range:	None*
Instruction word size:	10 bits
Number of basic instructions:	34
Shortest instruction/time (Load Literal):	1 cycle
Longest instruction/time (BCD/ALU operations):	up to 32 cycles
Clock frequency (min/max):	5 kHz/150 kHz
Clock phases/voltage swing:	Internal or 1/5V
Dedicated I/O control lines:	30
Package:	40-pin DIP
Power requirements:	12 V/5 mA typ

\*The address bus is internal so the direct addressing range is limited to the 512 words of on-board ROM.

### Hardware

Model	Description	Price (100 qty)
CR1872	CPU No other support circuits available.	\$11.00

Hardware support includes a prototyping system that can be used in the SC/MP low-cost development system (LCDS) made by National Semiconductor. There is also a circuit card available that has a 64-pin version of the chip to permit external PROM connections for program development.



# Safety. Long life. Reliability. Pour it on.



Now there's an all-purpose encapsulant that gives you silicone performance at the price of organics. Dow Corning Sylgard® 170 A&B silicone elastomer. A two-part liquid encapsulant that cures at room temperature or can be heat accelerated to increase production rates.

Sylgard 170 carries the UL 94VO rating, the very highest rating for flame retardancy for this type of product.

Sylgard 170 offers excellent temperature stability. It is

reversion resistant at high temperatures. And that means greater reliability and longer product life under the most severe environmental conditions.

Sylgard 170 has great dielectric properties, too. So it's perfect for general potting and encapsulating jobs like modules, relays, power supplies, amplifiers, ferrite cores and connectors. At a price that'll let you keep a margin of profit in your product as you build in an extra margin of safety.

So add it up. Safety and reliability throughout the temperature range. Longer product life. Reasonable price. Sylgard 170 silicone elastomer. Pour it on.

Call your Dow Corning representative or write Dow Corning Corporation, Department A7-511, Midland, Michigan 48640.

## **DOW CORNING**





# 4-bit microcontroller, PMOS

## 7150

ITT Semiconductors  
74 Commerce Way  
Woburn, MA 01801  
(617) 935-7910

Alternate sources: None.

The 7150 microcontroller is designed for low-cost control of large appliances such as dishwashers and washing machines. It is a dedicated controller and does no calculations. There are 15 possible control input lines and 10 machine control output functions. The circuit is available in either an 18, 24 or 28-pin DIP, depending upon the number of control lines needed by the application. With the on-board ROMs, up to 10 machine control functions of up to 20 program steps each, can be defined.

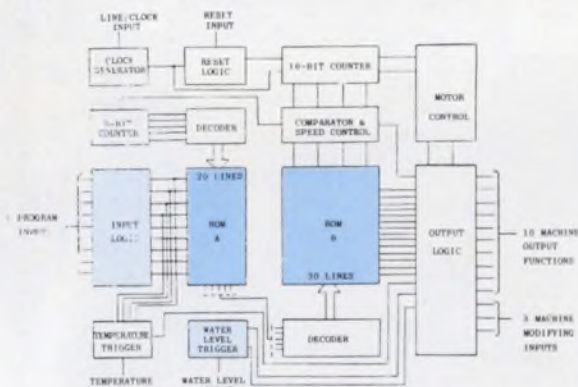

The architecture of the 7150 uses two ROMs to control the various output functions. There is no ALU since no data manipulation is required. However, there are two analog inputs to the processor that are used with an on-chip difference amplifier to form a temperature sensing circuit.

### Comments

**The instruction set** of the 7150 is strictly internal—all commands are predetermined by the manufacturer and the multiple program inputs determine the sequence of instruction execution.

**Software support** is nonexistent since the 7150 comes factory programmed.

**Unusual software features** include special sub-routines and a capability to speed up programs by a factor of 64.

### Specifications

Data word size:	Internal
Address bus size:	Internal
Direct addressing range:	Internal
Instruction word size:	Internal
Number of basic instructions:	N/A
Shortest instruction/time (Not applicable):	N/A
Longest instruction/time (Not applicable):	N/A
Clock frequency (min/max):	Dc/25 kHz
Clock phases/voltage swing:	1/10 V
Dedicated I/O control lines:	25 (max)
Package:	18, 24 or 28-pin DIP
Power requirements:	-15 V/30 mA

### Hardware

Model	Description	Price (100 qty)
7150	Microcontroller	N/A
7121	Program positioner	N/A
7122	Display driver	N/A

**Hardware support** is nonexistent. All that is available are the two support circuits for program position and numeric display.



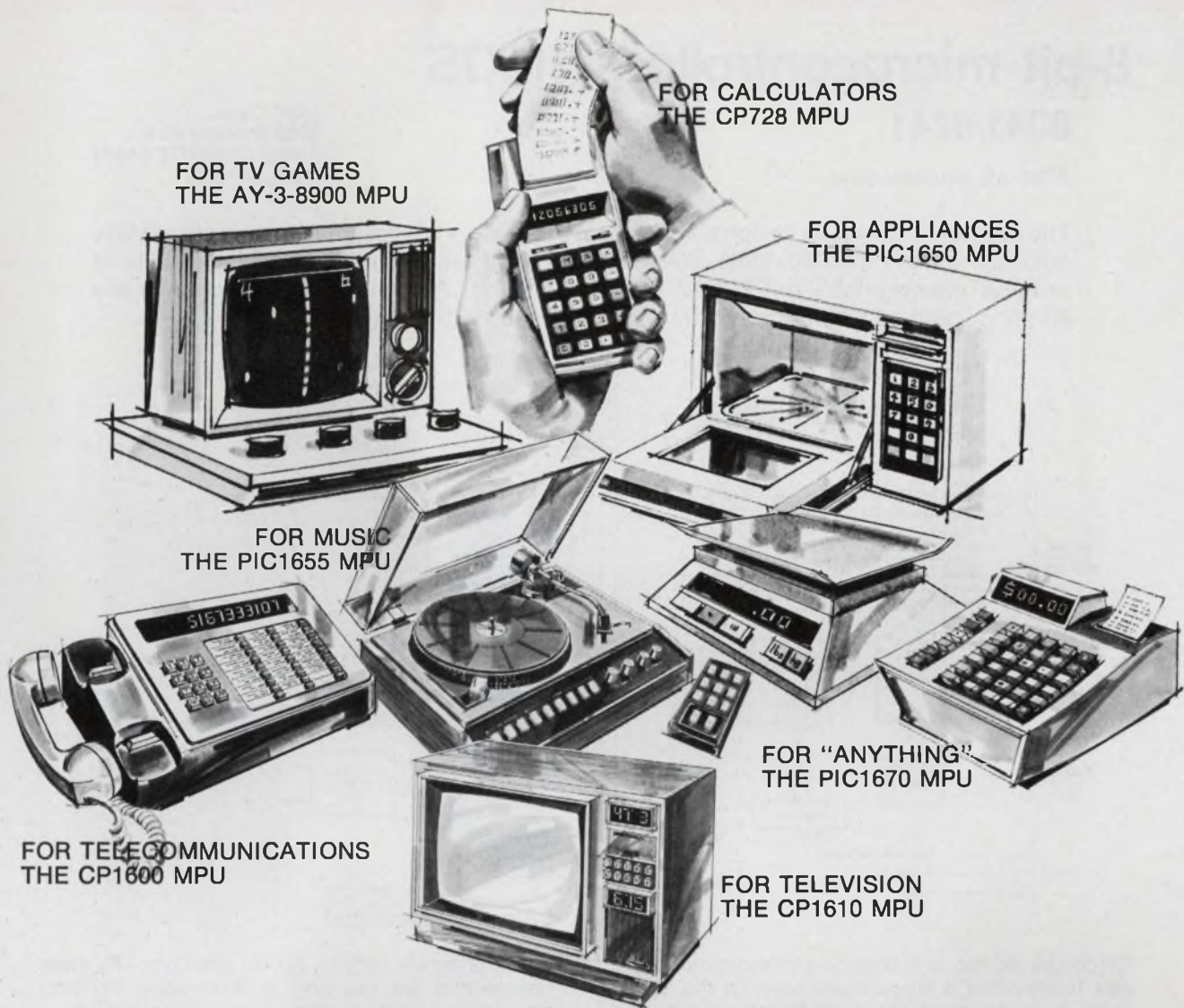

FOR TV GAMES  
THE AY-3-8900 MPU

FOR CALCULATORS  
THE CP728 MPU

FOR APPLIANCES  
THE PIC1650 MPU

FOR MUSIC  
THE PIC1655 MPU

FOR "ANYTHING"  
THE PIC1670 MPU

FOR TELECOMMUNICATIONS  
THE CP1600 MPU

FOR TELEVISION  
THE CP1610 MPU

# GI MICROPROCESSORS...

## "DEDICATED" TO HELP OUR CUSTOMERS COMPETE.

General Instrument standard microprocessors are *optimized* for the application they serve . . . a unique approach that *minimizes* interface circuit requirements and *eliminates* unnecessary costs. For example, the standard microprocessor designed as a numbers cruncher isn't the optimum vehicle for appliance control. It requires too many external circuits to interface it with the appliance and it carries along overhead hardware you simply don't need. In contrast, the GI "dedicated" approach provides the optimum interface LSI to best tailor the standard microprocessor to its application. And GI's "dedicated" solutions are drawn from our broad experience in the consumer and telecommunications markets.

*Standard microprocessors... dedicated to help our customers compete.*

**GENERAL INSTRUMENT CORPORATION  
MICROELECTRONICS**

600 WEST JOHN STREET, HICKSVILLE, NEW YORK 11802



CIRCLE NUMBER 55



# 8-bit microcontroller, NMOS

## 8041/8741

Alternate sources: None.

Intel Corp.  
3065 Bowers Ave.  
Santa Clara, CA 95051  
(408) 246-7501

The 8041/8741 Universal peripheral interface processors are designed to operate as slave microcomputers in 8080, 8085, 8048 or other 8-bit systems. They contain 1 kbyte of program memory (ROM or EPROM), I/O ports, an 8-bit CPU, clock and timer/counter in a 40-pin package. The interface processor also has a built-in single-step mode.

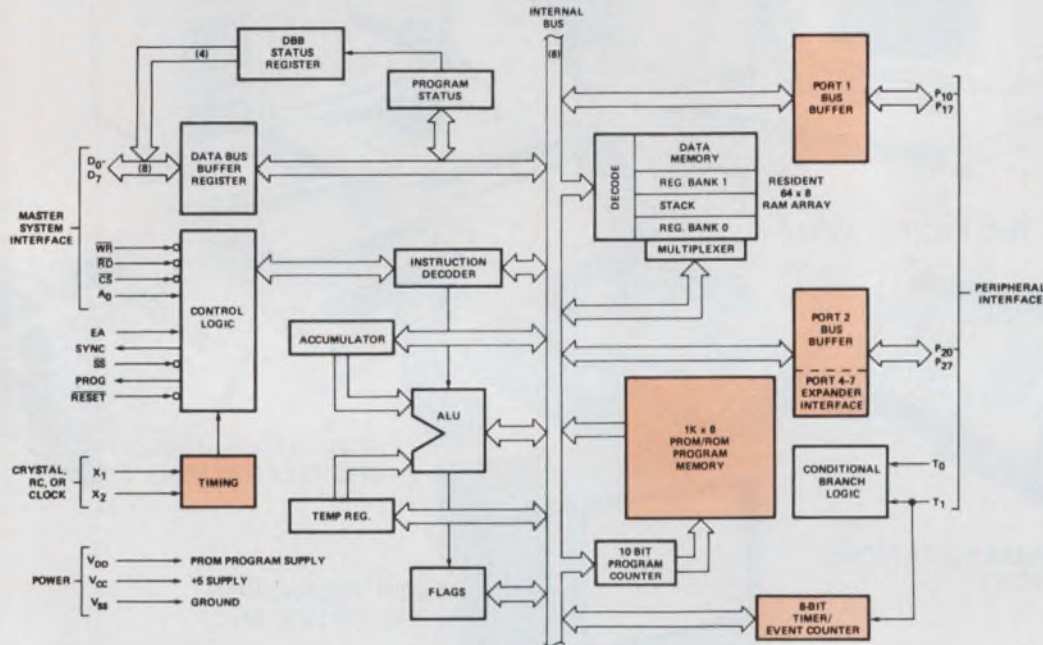

Since the device is a complete microcomputer, it can function as a stand alone unit. Of the 18 I/O lines, 2 are for input only, and 16 are input-output

under program control. All I/O lines are TTL compatible and the bus port is three-state. An 8-bit timer/counter and a clock are on the chip.

### Specifications

Data word size:	8 bits
Address bus size:	10 bits
Direct addressing range:	1024 words
Instruction word size:	8 bits
Number of basic instructions:	90
Shortest instruction/time (Many instructions*):	2.5 $\mu$ s
Longest instruction/time (Many instructions):	5 $\mu$ s
Clock frequency (min/max):	1 MHz/6 MHz
Clock phases/voltage swing:	1/TTL
Dedicated I/O control lines:	18
Package:	40-pin DIP
Power requirements:	5 V/65 mA

\* The instruction set is divided about 50/50 between 2.5 and 5  $\mu$ s instructions.

### Comments

Included in the set of 90 instructions are 14 data moves, 28 accumulator and register operations, six flag, 20 branch and subroutine call, 12 timer and control and 10 I/O commands. All instructions are either one or two bytes and are executed in one or two machine cycles.

### Hardware

Model	Description	Price (100 qty)
8041	ROM version of UPI	N/A
8741	UV PROM version of UPI	\$156.
8243	I/O expander	

**Support software** consists of a macro assembler that can be used on the company's Intellec Microprocessor Development System.

**Software features** allow asynchronous data, commands and status to be transferred to an external (master) processor. Both 8-bit I/O ports are software configurable to act as inputs or outputs on a line by line basis. The internal counter/timer is software controllable.

**Essentially the same hardware support** offered for 8080 systems is used with the 8041/8741. This includes the Intellec Microcomputer Development System (MDS) and the ICE-41 in-circuit emulator. When used as a slave unit in an 8080 based system, the device can perform keyboard scanning, printer control and display multiplexing.



Even in today's digital world, there are hundreds of applications where the infinite resolution and graphic indication of a linear slide control work best.

**Duncan Series 400 Slideline® instrumentation pots** are already in use in rapid transit speed controllers, X-ray and blood analysis equipment, petrochemical plant servo-controls, office copiers, solar energy instrumentation and many other unique applications.

Duncan linears can be set instantly and accurately. And reset perhaps 50 million times without significantly changing their characteristics (thanks to our special RESOLON® conductive

plastic element). Even lay people find their operation self-explanatory.

You can order Series 400 Slidelines with single or dual elements, in values from 600 to 250k ohms, with 70 or 108mm stroke lengths and linear, audio, or balance tapers with your choice of tolerance. There's even an exclusive *dual-slider* version that's perfect for setting both upper and lower limits.

So next time you're designing a control system, stop and think about the advantages of going analog. Then grab onto a Slideline and take control! Write us for complete literature.



## Series 400 puts you in control.



1. X-ray equipment controller
2. Reproducing machine tone control
3. People mover speed controller
4. Rapid transit system speed/brake controller
5. Medical instrumentation for cardiac diagnostic machine
6. Controller for blood analyzer

**DUNCAN ELECTRONICS**  
SUBSIDIARY

**SYSTRON S+ DONNER**

2865 FAIRVIEW ROAD • COSTA MESA, CALIFORNIA 92626  
PHONE: (714) 545-8261 TWX 910-595-1128

CIRCLE NUMBER 56



# 1-bit microprocessor, CMOS

## MC14500B ICU

Alternate sources: None.

Motorola  
5005 E. McDowell Rd.  
Phoenix, AZ 85036  
(602) 244-3716

Designed as a programmable logic controller, the single chip, 1-bit CMOS industrial control unit replaces multi-bit processors or hardwired logic in decision-oriented tasks. Housed in a 16-pin package, the device accepts 16 four-bit instructions. Each instruction performs logical operations on data appearing on a 1-bit bi-directional data line. The main attribute of the device is its simplicity in control system applications.

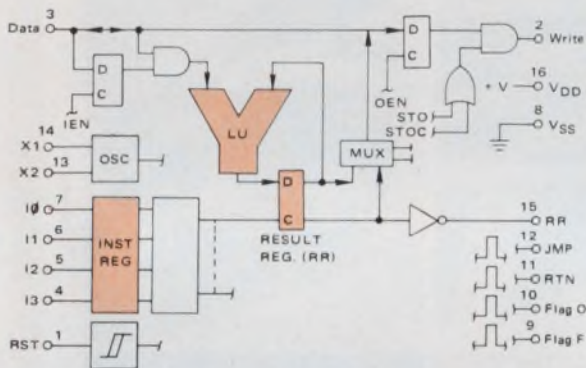

A minimum system consists of the processor, an external memory, program counter, 8-channel data selector and an 8-bit addressable latch. Instruction lines are TTL compatible and the 1-bit bi-directional data line has three-state capability. On-chip there are three 1-bit registers that are directly addressable, and the clock oscillator.

### Comments

**Sixteen 4-bit instructions** comprise the entire set. There are seven logic instructions, five program control, two output and two no operation. All operations are performed at the bit level. Looping control structure is used, where the program counter feeding the external memory that inputs instructions to the processor wraps around after reaching its highest value and repeats the program.

**The idea of this processor is not to require the use of any additional software support.** Designed primarily as an industrial controller, the device is oriented towards a simple, repetitive control function.

**Time invariant software is the important feature** of this processor. This means that the processor can effect a conditional jump without parallel loading the program counter with the jump address. Whole blocks of instructions can be either turned on or off. This leads to the looping control structure in which the same sequence of commands are encountered with certain blocks of code being selectively

### Specifications

Data word size:	1 bit
Address bus size:	Variable
Direct addressing range:	As determined by address bus
Instruction word size:	4 bits
Number of basic instructions:	16
Shortest instruction/time (All are performed in same time):	1 $\mu$ s
Clock frequency (min/max):	dc/1 MHz
Clock phases/voltage swing:	1/supply voltage
Dedicated I/O control lines:	4
Package:	16-pin DIP
Power requirements:	3 to 18 V/2 mA

### Hardware

Model	Description	Price (100 qty)
MC14500B	1-bit processor	\$4.88
MC14099	8-bit addressable latch	2.22
MC14599	8-bit read/write addressable latch with master reset	2.81
MC14512	8-channel data select	0.98

enabled or disabled. In conventional systems the execution time of the program varies with the state of the input signals.

**No prototyping hardware** is available for this circuit. The design cycle for implementing a working system is intended to be so short as not to require any additional hardware or software. Particular emphasis is made of the fact that this processor is much easier to use than 4, 8 or 16-bit models.



# Satisfy Your 8080 Microcomputer Design, Test and Service Needs



## MUPRO 80 The complete solution

### MUPRO FEATURES

- Real-Time Execution from emulator or users' system memory
- Multi-User/Multi-Task Disk Operating System (MUTE)
- Block Structured Assembly Language (BSAL) and user oriented software packages
- Transparent Control/Display Console
- Compact and ruggedized system packaging

### YOUR BENEFITS

- More thorough and flexible system test capability
- More efficient use of software personnel permits simultaneous use by up to four programmers
- Saves software development and maintenance time while retaining the size, speed and flexibility of assembly language programs
- Provides total use of microprocessor. No memory, I/O or interrupt restrictions
- Single system provides total solution to development, test and field service needs

MANUFACTURED BY:

## MUPRO

424 Oakmead Parkway  
Sunnyvale, California 94086  
(408) 737-0500  
TWX 910-339-9251



WORLDWIDE SALES AND SERVICE BY:

## DATA I/O



P.O. Box 308 / 1297 N.W. Mall  
Issaquah, WA 98027(206) 455-3990  
Telex 320290

Circle 268 for demo and technical data

Circle 269 for technical data



# 4-bit microprocessor, PMOS

## MCS-40 (4004 and 4040)

Intel Corp.  
3065 Bowers Ave.  
Santa Clara, CA 95051  
(408) 246-7501

Alternate sources: National Semiconductor.

The MCS-40 microcomputer family includes the 4040 and 4004 central processing circuits and a comprehensive line of support chips. Both circuits are PMOS and are instruction compatible, but the 4040 is an enhanced device, with 14 more instructions than the 4004 for a total of 60 commands. Other differences between the CPUs include a larger address stack in the 4040 (seven levels instead of three), a larger scratchpad in the 4040 (24 instead of 16), and the 4040 also has interrupt and single-step capability.

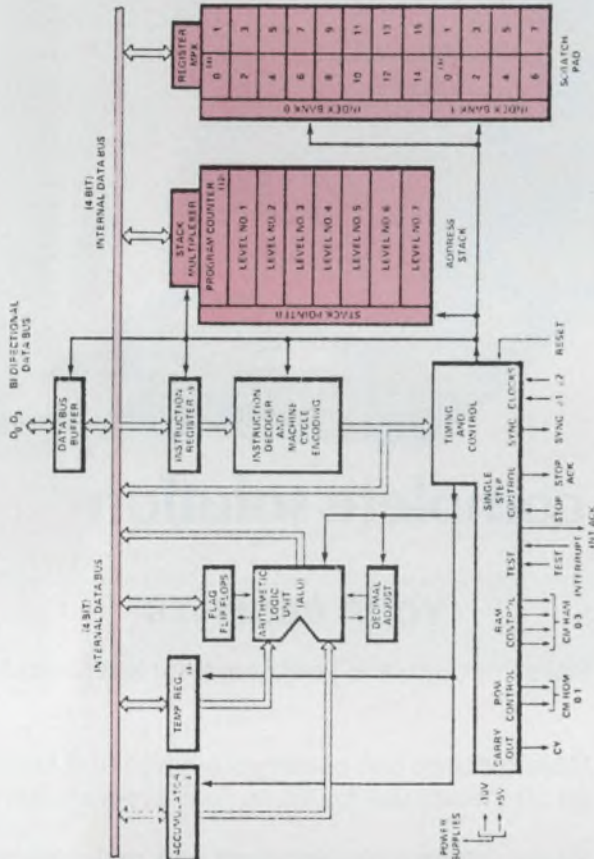

The architecture of the MCS-40 processors is almost identical except for the expanded stack and scratchpad areas of the 4040 as compared to the 4004. A minimal system typically requires three chips—the CPU, a clock generator and a memory circuit.

### Comments

The instruction set of 60 commands for the 4040 and 46 instructions for the 4004 are compatible—all 4004 instructions can run on the 4040. Instructions are broken into three groups—basic operations, machine-only instructions, and I/O and RAM commands.

Software support for the MCS-40 family consists of the MAC40 cross assembler and a 4004/4040 cross simulator (Interp/40) that are available on time-sharing systems and for in-house computer systems. There is also a program library containing over 50 programs.

### Specifications

Data word size:	4 bits
Address bus size:	12 bits
Direct addressing range:	8192 words
Instruction word size:	8 bits
Number of basic instructions:	60 (4004: 46)
Shortest instruction/time (Add):	10 $\mu$ s
Longest instruction/time (Jump):	20 $\mu$ s
Clock frequency (min/max):	0.5/0.75 MHz
Clock phases/voltage swing:	2/15 V
Dedicated I/O control lines:	8
Package:	24-pin DIP (4004: 16-pin DIP)
Power requirements:	15 V/40 mA

### Hardware

Model	Description	Price (100 qty)
4004	4-bit CPU	\$5.00
4040	Enhanced 4-bit CPU	5.50
4003	10-bit shift register	2.75
4265	Programmable general-purpose I/O	3.85
4269	Programmable kbd/disp.	7.75
4201A	Clock generator	3.25
4008/9	Memory interface ckts.	6.50 ea
4289	Standard memory interface	8.20
4002	320-bit RAM & 4 I/O lines	4.45
4001	256 $\times$ 8 ROM & I/O	10.00
4308	1024 $\times$ 8 ROM & I/O	8.50
4316	2048 $\times$ 8 ROM	16.90
4702A	256 $\times$ 8 EPROM	11.70

Important software features include the BCD adjust instruction for decimal arithmetic and a register bank switch command for data save operations.

Hardware support for the MCS-40 family consists of the Intellec 4/Mod 40 hardware and software development system, with PROM resident monitor and peripheral interfaces. Also available are RAM memory boards and a designers kit.



# 4-bit, one-chip micro- computers

Brainy enough  
for anything  
from TV games  
to industrial  
controls.

Block diagram of MN1400  
with on-chip, 1024x8-bit ROM.

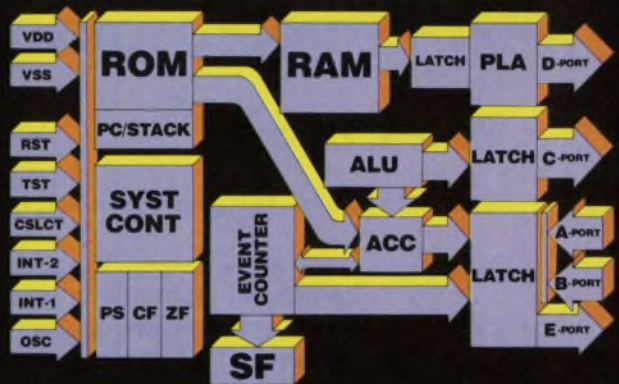

Now Panasonic offers you a whole family of TTL compatible, one-chip microcomputers. So you can choose the combination of features and capabilities that are most cost-effective for your application. From appliances to gas pumps and electronic scales, to copiers, POS and intelligent terminals, tractor controls and countless others.

### Why pay for costly I/O interfacing when Panasonic puts it all on the chip?

Our MN1400 family is ideally suited for control functions with its extensive array of on-chip I/O facilities. There's an 8-bit presetable counter/timer, a clock generator, an arithmetic logic unit, and several input and output ports. Units are available with a self-contained 1024x8-bit ROM and a 64x4-bit RAM memory.

### Still more flexibility and efficiency from Panasonic.

For flexibility, our instruction set contains up to 75 instructions. To give you TTL compatibility, all our family members operate on +5V. And for extra computing speed, we've utilized N-channel E/D MOS construction.

### Panasonic can help you cut development time and costs.

Our Evaluator, the MN1499, can help you design, evaluate and debug programs quickly. In addition, software is available for a number of applications.

### The Panasonic family of one-chip microcomputers.

Package	MN1400 40-Pin Plastic DIP	MN1402 28-Pin Plastic DIP	MN1498 40-Pin Plastic DIP	MN1499 64-Pin Ceramic DIP
Power Supply	+5V	+5V	+5V	+5V
Instruction Cycle Time	10 $\mu$ s	10 $\mu$ s	10 $\mu$ s	10 $\mu$ s
Instruction Set	75	57	68	75
Instruction Memory	Internal 1024 x 8 bits (8192 bits)	Internal 768 x 8 bits (6144 bits)	External 1024 x 8 bits (8192 bits)	External 2048 x 8 bits (16384 bits)
Total on Chip RAM	64 x 4 bits (256 bits)	32 x 4 bits (128 bits)	64 x 4 bits (256 bits)	64 x 4 bits (256 bits)

### 16-bit microprocessors, too.

They're ideally suited for a wide variety of computer peripheral and business machine applications. Designed with minicomputer architecture LOCOS MOS N-channel construction for optimum speed and thruput efficiency.

For complete information and prices, write to Panasonic Electronic Components, One Panasonic Way, Secaucus, N.J. 07094; or call (201) 348-7269.

**Panasonic**<sup>®</sup>  
just slightly ahead of our time



# 4-bit microprocessor, PMOS

## PPS-4, PPS-4/2

Rockwell International Microelectronic Devices  
P.O. Box 3669  
Anaheim, CA 92803

Alternate sources: AEG Telefunken and National Semi. (714) 632-3729

Forming either a three or two-chip processor, the PPS-4 and PPS-4/2 central processor chips provide over 50 instructions and 12 dedicated I/O lines. The 4/2 CPU is a newer version of the 4 and can operate with an inexpensive 3.58 MHz crystal. The PPS-4 requires an external clock. Both processors, though, are totally instruction compatible and have 8-bit instruction/data buses and 11-bit address buses. The one major difference is that the PPS-4/2 CPU automatically floats all output lines when power is turned on; the PPS-4 doesn't. And, the 4/2 can directly drive low-power LED display segments.

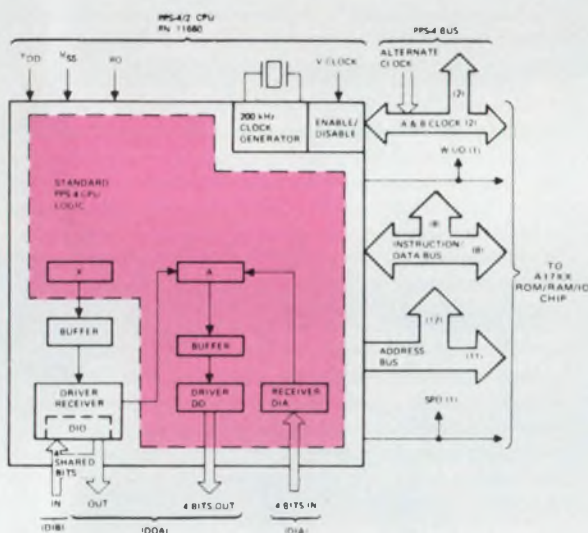

The straightforward architecture of the PPS-4 and 4/2 revolves around the 4-bit accumulator and the three four-bit I/O buses. All lines are designed for direct MOS-level interfaces so to connect to other logic families buffer circuits must be used. The PPS-4 requires an external clock while the 4/2 just needs an external crystal.

### Comments

**The instruction set** contains a total of 50 commands that can be grouped as follows: 10 arithmetic and logic, 24 data transfer, six transfer, five skip, four I/O and one special address generation instruction.

**Software support** for the PPS-4 and 4/2 includes a Fortran IV simulator and cross assembler for use on in-house computer systems and time-share networks as well as resident assemblers, supervisors, text editors and debug routines for use on the PPS MP Universal Assembler hardware and software development system.

**Special features** of the software include the capability to perform an automatic memory address

### Specifications

Data word size:	4 bits
Address bus size:	12 bits
Direct addressing range:	4096 words
Instruction word size:	8 bits
Number of basic instructions:	50
Shortest instruction/time (Transfer):	5 $\mu$ s
Longest instruction/time (Load B long):	10 $\mu$ s
Clock frequency (min/max):	199 kHz
Clock phases/voltage swing:	4/12 V (PPS-4); Internal (PPS-4/2)
Dedicated I/O control lines:	12
Package:	42-pin QUIL
Power requirements:	17 V/26 mA

### Hardware

Model	Description	Price (100 qty)
PPS-4	CPU	\$18.15*
PPS-4/2	CPU	10.00*
10706	Clock generator	7.45
10738	Bus interface	4.50
11049	Interval timer	8.50
10696	General purpose I/O	8.50
10930	Serial data controller	15.00

\*Price as of Oct. 1. Peripheral chip prices were also cut on Oct. 1. Consult distributors for current cost.

modification in addition to the basic data transfer instruction, and software controllable interrupts.

**Hardware support** for the PPS-4 and 4/2 starts with simple CPU modules designed to plug into the PPS MP Universal Assembler. Other modules available as plug-ins include memory boards, I/O boards and prototyping modules.





## SAY HELLO TO OUR MODEL 101. AND GOODBYE TO CALIBRATION HASSLES.

Meet a new kind of instrumentation portable, one so self-contained that all the calibration equipment you'll ever need is built right in.

Just press AUTO TEST and Honeywell's new Model 101 checks itself and tells you what, if anything, needs adjustment. You can do a complete calibration in about half the usual time, and do it with only a screwdriver or simple tweaking tool.

But don't think of the 101 as just a more portable portable. Because it's also a more advanced lab system.



One that comes with up to 32 data channels — wideband or intermediateband, speeds from 15/16 to 120 ips, programmable selective track sequencing, and large reels for up to 32 hours of recording time.

Compare the Model 101 with your present tape system and see what a difference a microprocessor makes. For details, or for a demonstration of the Model 101, contact:

Darrell Petersen, Honeywell Test Instruments Division, Box 5227, Denver, CO 80217. (303) 771-4700.

## WE'LL SHOW YOU A BETTER WAY.

# Honeywell

CIRCLE NUMBER 59



# 8-bit microcontroller, bipolar (STTL)

## 8X300

Alternate sources: None.

Signetics  
811 E. Arques Ave.  
Sunnyvale, CA 94086  
(408) 735-8055

Featuring control-oriented instructions, the 8X300 is a fixed instruction microcontroller. Each of the eight 16-bit control instructions can be executed in 250 ns. The single-chip device handles 8-bit data and can execute data formats of one to eight bits at equal speed. Processor timing can be set via an external crystal or clock source.

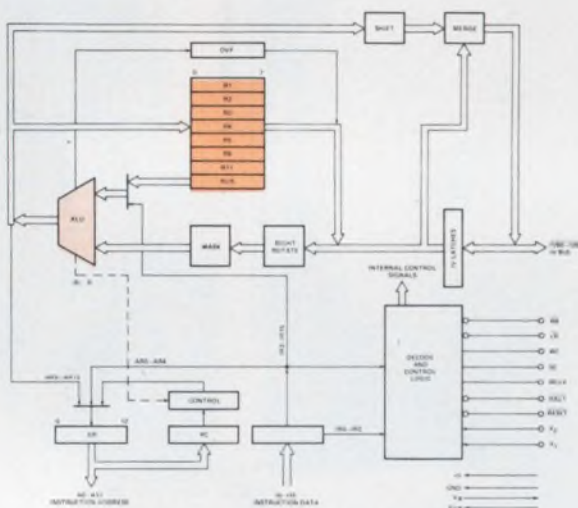

The architecture of the 8X300 is designed so that several operations can take place simultaneously—shift, merge, rotate and mask. A minimal system contains the 8X300, some memories and several 8-bit I/O ports. All lines are TTL compatible and the 8-bit interface bus has three-state capability.

### Comments

**The instruction set** contains only eight instructions—Move, Add, AND, XOR, Execute, Nonzero transfer, Transmit and Jump. Input data can be rotated and masked while output data are shifted and merged—all within a 250 ns cycle time.

**Software support** for the 8X300 consists of a cross assembler. There is no program library available.

**Unusual software features** include the simplicity of operation and the identical 250 ns execution speed for each instruction. The circuit uses addressed I/O so the instructions can address up to 512 8-bit I/O ports directly from data bus.

### Specifications

Data word size:	8 bits
Address bus size:	13 bits
Direct addressing range:	8192 words
Instruction word size:	16 bits
Number of basic instructions:	8
Shortest instruction/time (All instructions):	250 ns
Clock frequency (min/max):	Dc/4 MHz
Clock phases/voltage swing:	Internal or external TTL
Dedicated I/O control lines:	8
Package:	50-pin DIP
Power requirements:	5 V/450 mA

### Hardware

Model	Description	Price (100 qty)
8X300	8-bit microcontroller	\$48.75
8T32	8-bit programmable I/O port	3.50
8T33	8-bit programmable I/O port	3.50
8T35	8-bit programmable I/O port	3.50
8T36	8-bit programmable I/O port	3.50
8T39	Bus extender	5.40

**Hardware support** consists of the 8X300KT100SK, a designers kit and McSim, a development system produced by Scientific Microsystems, Mountain View, CA. McSim has an in-circuit emulation capability.



AN OPEN CHALLENGE:

**“We defy you  
to find a  
more reliable  
DIP socket  
or a less  
expensive one.”**

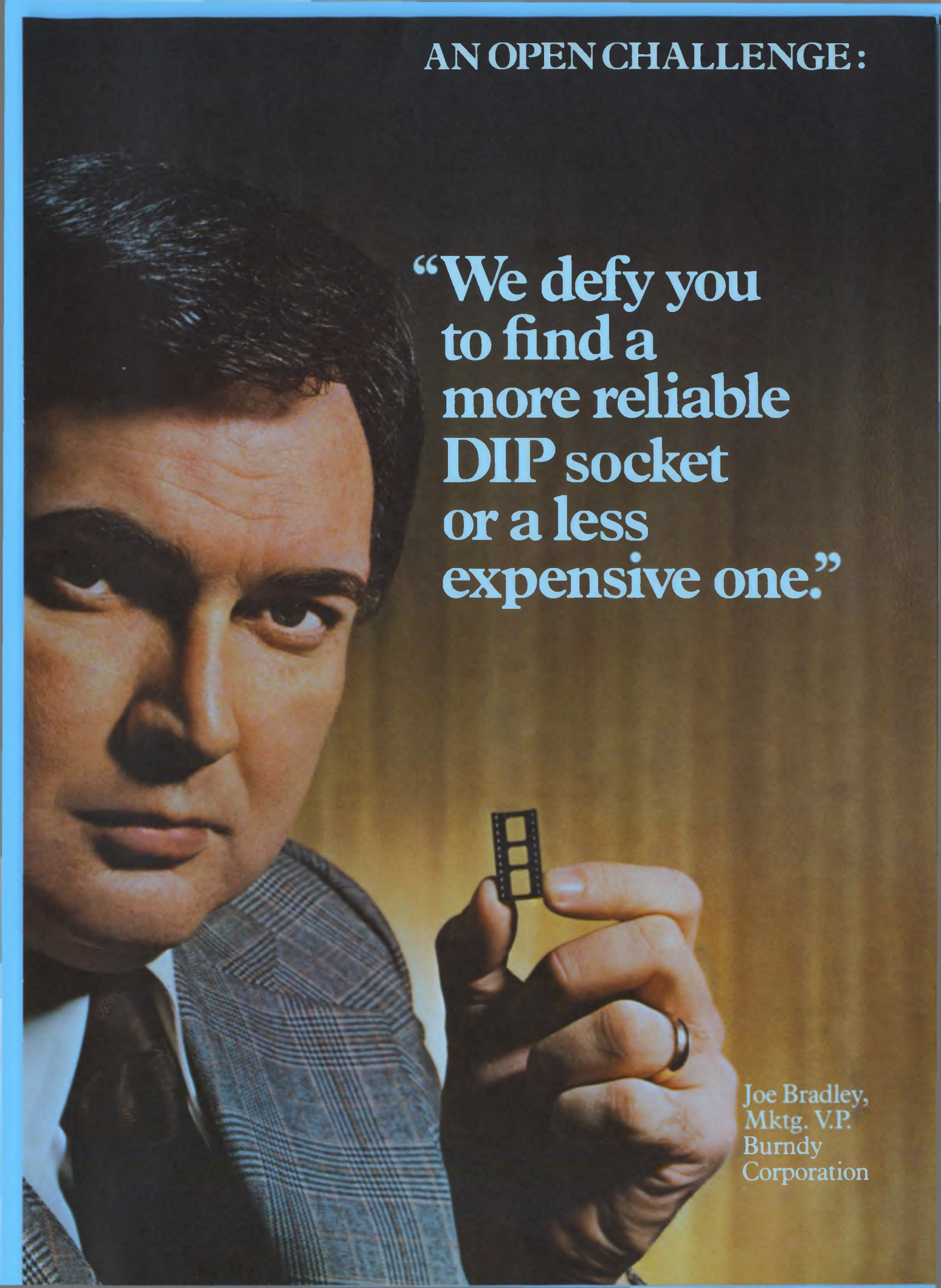
A close-up photograph of a man with dark hair, wearing a grey plaid suit jacket, a white shirt, and a dark tie. He is looking directly at the camera with a serious expression. He is holding a small, black, rectangular DIP socket between his fingers. The background is a plain, light-colored wall.

Joe Bradley,  
Mktg. V.P.  
Burndy  
Corporation



# “Here’s proof!”

## Burndy DIP sockets outperform the others in economy and reliability.

Forget everything you’ve ever known — or thought you knew — about DIP sockets. And especially about DIP socket costs.

Burndy’s new low-cost, high-reliability GTH DIP sockets have changed everything for the better. Now, for just pennies you can use DIP sockets where you never dreamed of using them before — to enhance your product without pricing it out of the market.

*And in most cases, using our DIP sockets adds nothing to overall costs. It can even result in a net cost reduction in many applications by simplifying design. Speeding installation.*

*Improving quality control and reducing your reject ratios.*

In short, you enjoy all the advantages of IC pluggability (field serviceability, simplified design, faster installation, improved quality control and fewer rejects) without sacrificing reliability or adding significantly to costs. If you think that’s promising a lot — it is! And we’re ready to deliver on everything we promise. For proof, use the convenient Quick Response Card. Or write: Burndy Corporation, Norwalk, Connecticut 06856. And see how fast we get back to you.

### Laboratory Proof

TESTS CONDUCTED PER MIL-S-83734A(USAF) REPORT NO. F7608-762 SUMMARY				COMPARATIVE TEST DATA (Durability and Moisture)												
TEST PERFORMED	MIN.	MAX.	AVG.	Milliohms												
				5	10	15	20	25	30	35	40	45	50	55	60	65
<b>GROUP 1</b> Mating Force (lbs./contact)	0.600	0.730	0.643	Burndy GTH Contacts	6.11	CHANGE IN MAXIMUM CONTACT RESISTANCE (with identical target areas) AFTER: • 10 cycles of Mate-Unmate • 10 cycles of Moisture Resistance per MIL-STD 202; Method 106 (-25°C +65°C 95% RH)										
Contact Withdrawal Force (oz. w/.008" blade)	2.500	8.100	4.940	Brand A Type 1 Tin Contacts	8.19											
Insulation Resistance (600 VAC for 1 min.)	2x10 <sup>6</sup>	2x10 <sup>6</sup>	2x10 <sup>6</sup>	Brand B Tin Contacts	13.55											
Contact Resistance	2.950	5.860	4.650	Brand C Tin Contacts	14.14											
<b>GROUP 2</b> Vibr. & Mech. Shock	5.050	5.930	5.420	Brand D Type 1 Gold Contacts	16.32											
Durability (50 cycles)	5.050	6.750	5.520	Brand E Tin Contacts	20.90											
<b>GROUP 3</b> Insulation Resistance (5,000 megohms min.)	>2x10 <sup>6</sup>	>2x10 <sup>6</sup>	>2x10 <sup>6</sup>	Brand F Gold Contacts	24.05											
Ins. Res. after Moist. Res. (5,000 megohms min.)	>2x10 <sup>6</sup>	>2x10 <sup>6</sup>	>2x10 <sup>6</sup>	Brand A Type 2 Tin Contacts	25.39											
<b>GROUP 4</b> Contact Resistance	5.200	6.350	5.545	Brand C Gold Contacts	96.54											
after Corrosive Atmos.	4.850	6.350	5.519	Brand G Gold Contacts	211											
				Brand D Type 2 Gold Contacts	693											
				Brand G Tin Contacts	911											
				Brand E Gold Contacts	9,400											
				Brand H Tin Contacts	15,000											

## Low-cost DIP sockets for all types of applications

Burndy DIP Sockets are currently being used in a wide variety of applications where high reliability and economy are required.



Burndy DIP Sockets are used in the Dictaphone Thought Center 293, a multiple-cassette, central dictation system for word processing applications.



Burndy DIP Sockets have been specified for the Model 1430 print-plus-display calculator by Monroe, The Calculator Company.



Burndy DIP Sockets have helped simplify design for Fairchild's popular Video Entertainment System.



Exclusive GTH contacts deliver gold-like reliability at base metal costs.

Polarized body design assures proper installation.

Body design provides easy access for logic monitor testing.

Self-aligning contacts speed package installation.

High temperature, self-extinguishing thermoplastic body meets UL 94 V-O rating.

Unique contact design prevents wicking during soldering to avoid rejects.

Narrow body permits 15% greater package densities.



**“MAKE ME PROVE IT.**

Use this Quick Response Card and I'll send you data worth its weight in gold.”

Dear Joe: I like what you're saying but you've got to prove it to me in my own application. Here are my requirements:

Product Application \_\_\_\_\_

Operating Temperature \_\_\_\_\_

Mating Cycles \_\_\_\_\_

Name \_\_\_\_\_ Title \_\_\_\_\_

Firm \_\_\_\_\_

Address \_\_\_\_\_

City \_\_\_\_\_ State \_\_\_\_\_ Zip \_\_\_\_\_



# Leaded or leadless Burndy leads the way in DIP Socket Design

Leaded or leadless. Solder tail or surface mount. Standard or hybrid. Top, bottom or side pad. Any required shape or size. Burndy makes DIP sockets to fit virtually every application need, any performance level. And they all have two things in common. Low cost and high reliability. That's because they all feature our patented GTH contact design that delivers good-as-gold connections without the cost of gold. And that's why you find our DIP sockets in such a wide variety of applications from highly sophisticated computers to TV receivers, from automotive applications to complex process control systems.

Burndy Corporation, Norwalk,  
Connecticut 06856.



FIRST CLASS  
Permit No. 100  
Norwalk, Ct.

## Business Reply Mail

No Postage Necessary if Mailed in The United States

Postage will be paid by —

**BURNDY CORPORATION**  
**Norwalk, Connecticut 06856**

Attention: MS-100

## AVAILABLE NOW THROUGH THESE BURNDY DISTRIBUTORS

- ARIZONA, Phoenix**  
Kierulff Electronics, 602-243-4101
- CALIFORNIA, Irvine**  
Cramer Electronics, 714-979-3000
- Los Angeles**  
Kierulff Electronics, 213-685-5511
- Palo Alto**  
Kierulff Electronics, 415-968-6292
- San Carlos**  
Sterling Electronics, 415-592-2353
- San Diego**  
Cramer Electronics, 714-565-1881  
Kierulff Electronics, 714-278-2112
- COLORADO, Denver**  
Kierulff Electronics, 303-371-6500
- CONNECTICUT, Hamden**  
Arrow Electronics, 203-248-3801
- New Haven**  
Cramer Electronics, 203-239-5641
- DISTRICT OF COLUMBIA**  
Cramer Electronics, 301-948-0110
- FLORIDA, Ft. Lauderdale**  
Arrow Electronics, 305-776-7790
- Hollywood**  
Cramer Electronics, 305-923-8181
- Orlando**  
Cramer Electronics, 305-894-1511
- GEORGIA, Norcross**  
Cramer Electronics, 404-448-9050  
Lykes Electronics, 404-449-9400
- ILLINOIS, Elk Grove Village**  
Kierulff Electronics, 312-640-0200
- Mt. Prospect**  
Cramer Electronics, 312-593-8230
- MARYLAND, Baltimore**  
Arrow Electronics, 301-247-5200
- MASSACHUSETTS, Lexington**  
Harvey Electronics, 617-861-9200
- Newton**  
Cramer Electronics, 617-969-7700
- MICHIGAN, Kentwood**  
R-M Electronics, 616-531-9300
- MINNESOTA, Bloomington**  
Arrow Electronics, 612-888-5522
- Edina**  
Cramer Electronics, 612-835-7811
- MISSOURI, St. Charles**  
Electronix, Inc., 800-325-3348
- NEW JERSEY, Moorestown**  
Arrow Electronics, 609-235-1900
- Rutherford**  
Kierulff Electronics, 201-935-2120
- Saddlebrook**  
Arrow Electronics, 201-797-5800
- NEW YORK, Binghamton**  
Harvey Electronics, 607-748-8211
- Farmingdale**  
Arrow Electronics, 212-995-2100
- Iris Electronics, 516-420-8400**
- Rochester**  
Cramer Electronics, 716-275-0300
- Syracuse**  
Cramer Electronics, 315-437-6671
- NORTH CAROLINA, Winston Salem**  
Cramer Electronics, 919-725-8711
- OHIO, Cleveland**  
Cramer Electronics, 216-248-8400  
Arrow Electronics, 216-464-2000
- Dayton**  
Arrow Electronics, 513-253-9176
- PENNSYLVANIA, Montgomeryville**  
Pyttronic Industries, 215-643-2850
- TEXAS, Dallas**  
Cramer Electronics, 214-661-9300  
Sterling Electronics, 214-357-9131
- WASHINGTON, Tuckwila**  
Kierulff Electronics, 206-575-4420
- WISCONSIN, New Berlin**  
Arrow Electronics, 414-782-2801

For more information on how Burndy low-cost, high-reliability DIP sockets can help you improve your product without pricing it out of the market, send us your particular requirements.



# The New 1977-1978 **GOLD BOOK** Has Just Been Published

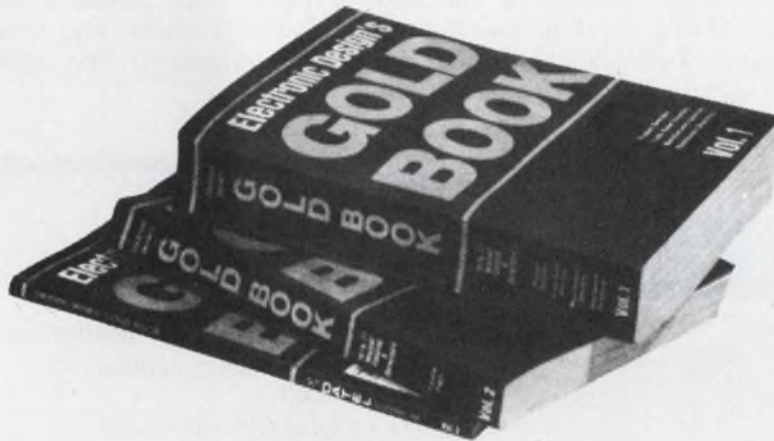

## And Completely Outdates Last Year's Edition

If you are currently a subscriber on **ELECTRONIC DESIGN's** qualified circulation file, you need do nothing. You will receive your new **GOLD BOOK** automatically. If you wish additional copies for other members of your company, you may order them now using the convenient coupon form below.

If you are not currently an **ELECTRONIC DESIGN** subscriber on our controlled circulation list, you may order your own multi-section set of the new **GOLD BOOK** by completing the form below. Shipment will be made promptly on receipt of your payment or company purchase order.

**HERE IS WHAT YOU AND YOUR COMPANY  
WILL FIND IN THE UPDATED 1977-78**

### **GOLD BOOK**

- **Three sections** containing 2,496 pages of information to quickly locate products used by the electronics industry.
- **A Product Directory** with 5,434 product categories.
- **A Trade Name Directory** of 9,814 listings.
- **A Manufacturers' Directory** listing 8,057 companies in the electronics industry.
- **Two Distributors' Directories** with 2,050 distributors listed.
- **A Giant Compendium of Manufacturers' Data Pages** with specifications.

### **MAIL TODAY WITH PURCHASE ORDER**

Electronic Design's **GOLD BOOK** 449R  
Hayden Publishing Co., Inc.  
P.O. Box 13803, Philadelphia, Pa. 19101 U.S.A.

Here is our purchase order for \_\_\_\_\_ sets of the 1977-1978 **GOLD BOOK** at \$30.00 per set—for U.S., Canada and Mexico.  
(All other countries: \$40.00 per set)

Check enclosed for \$ \_\_\_\_\_,  Bill us.

Name (Print) \_\_\_\_\_

Title \_\_\_\_\_

Company \_\_\_\_\_

Address \_\_\_\_\_

City/Province \_\_\_\_\_

State/Country \_\_\_\_\_

Zip or Postal Code No. \_\_\_\_\_

**QUANTITIES ARE LIMITED. PLACE ORDER TODAY!**



# 8-bit microprocessor, CMOS

## CDP 1802

RCA Solid State Division  
 Box 3200  
 Somerville, NJ 08876  
 (201) 685-6731

Alternate sources: Hughes Solid State Products, Solid State Scientific Inc.

Fabricated using CMOS technology, the 1802 offers static operation, high noise immunity, wide voltage tolerances and speeds faster than possible with NMOS construction. The device's architecture features register orientation and on-chip direct memory access and clock to lower the cost of memory and systems. The 1802 is still the only 8-bit CMOS microprocessor available.

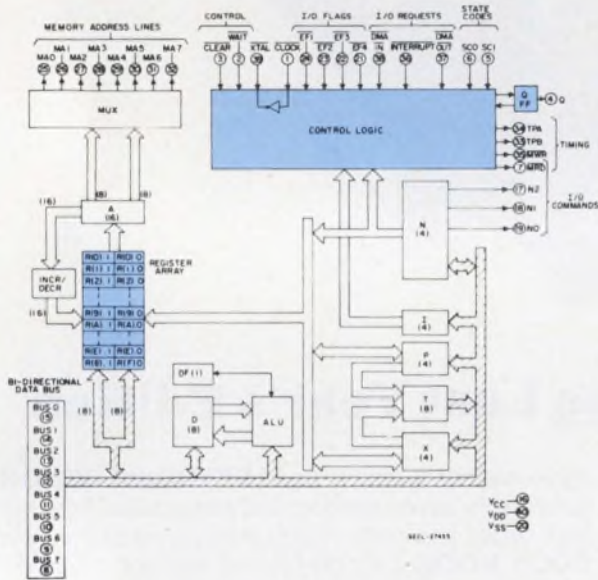

### Specifications

Data word size:	8 bits
Address bus size:	16 bits
Direct addressing range:	65,536 words
Instruction word size:	1 to 3 bytes
Number of basic instructions	91
Shortest instruction/time (Most):	2.5 $\mu$ s
Longest instruction/time (Long Branch):	3.75 $\mu$ s
Clock frequency (min/max):	Dc/6.4 MHz
Clock phases/voltage swing:	1/supply voltage
Dedicated I/O control lines:	9
Package:	40-pin DIP
Power requirements:	4 to 12 V/1.6 mA (5 V)

The architecture of the 1802 revolves around the 16 x 16 bit register file that is used to simplify addressing and memory reference commands. Because of the on-chip register file and the built-in clock, a minimal system can be built around the processor and a single ROM.

### Comments

The 91 basic instructions include 10 for control, seven for memory reference, seven for register operation, 12 for logic operations, 12 for arithmetic operations, 20 short branch instructions, eight long branch instructions, nine skip instructions, and 14 I/O instructions. On-chip program storage includes a 16 x 16-bit scratchpad RAM.

**Software support** includes arithmetic, resident editor and assembler, cross assembler/simulator, and firmware debug packages as well as a full floppy-disc based program development system. Also available is a high-level interpretive language.

**Features of the software** include simple 1, 2, or 3-byte instructions and simple timing loops for debugging. There is also a wide variety of branch and skip instructions from which to choose to permit rapid

### Hardware

Model	Description	Price (100 qty)
1802	Commercial CPU	\$15.90
	Industrial CPU	19.50
1852	8-bit I/O port	6.50
1853	N-bit decoder	
1854	UART	10.55
1856/57	Memory & I/O bus Buffers/separators	4.25
1858/59	Memory latches decoders	4.45
1861	TV interface	N/A

selection of a subroutine or program jump. A programmable serial port is also included on the chip to permit simple serial I/O without any specialized communications circuits.

**Hardware support** includes the Microtutor II learning tool, the COSMAC Development System for software development, and an evaluation kit for prototyping and breadboarding.



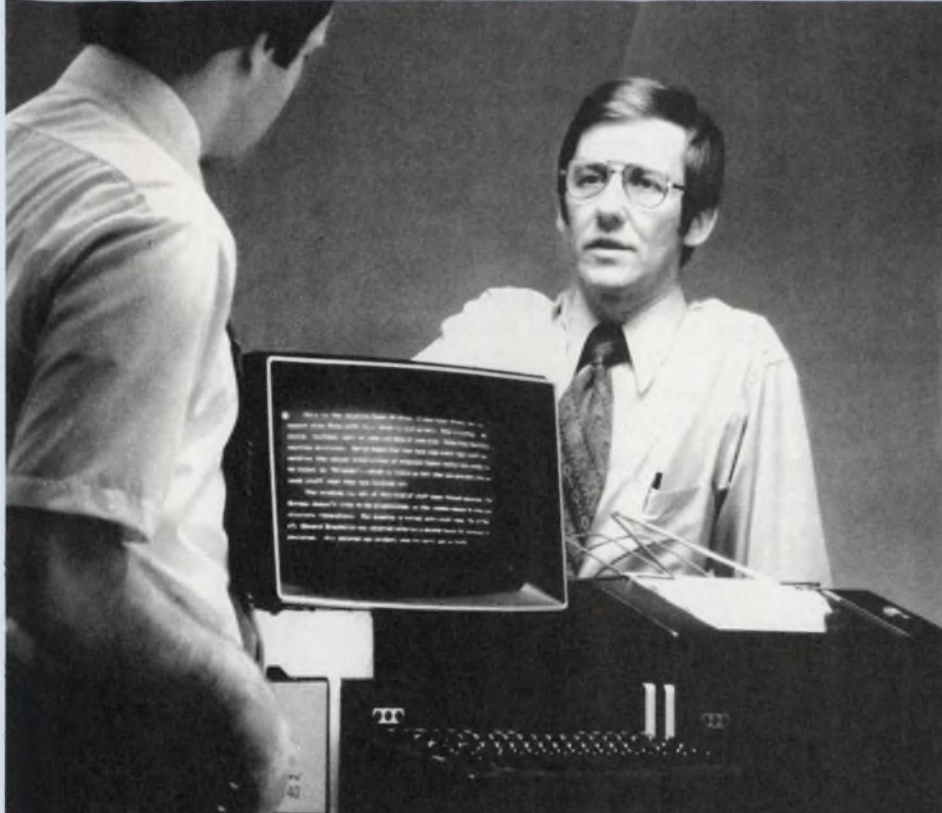

## IF THE TELETYPE MODEL 40 SYSTEM EVER MALFUNCTIONS, IT'S DESIGNED TO TELL YOU WHAT'S WRONG.

Even though we probably go to more trouble to insure uninterrupted reliability than anyone else, we're still realistic enough to admit that sometime something's going to go wrong.

So instead of burying our heads in the sand and pretending it won't, we've concentrated our efforts on what can be done to make downtime as short and painless as possible.

For starters, we gave the model 40 product line its own diagnostic capability. To tell you quickly what's wrong. Then, to make it easy to fix, we used a modular design concept. The result is an average mean-time-to-repair of only 3/4 hour.

We also made sure that when something does go wrong, you'll never be alone. We've got a nationwide service network standing behind every product with the Teletype name on it. We offer on-call repair service, maintenance contracts, and even an exchange repair service on components and parts.

The way we look at it, building something the best way humanly possible is only half our job. The other half is being ready for the unexpected.

For more information about the Teletype model 40 product line, write: Teletype, 5555 Touhy Ave., Skokie, IL 60076. Or call: 312/982-2000.



Teletype is a trademark and service mark registered in the United States Patent and Trademark Office.

CIRCLE NUMBER 61

Built-in diagnostics pinpoint trouble

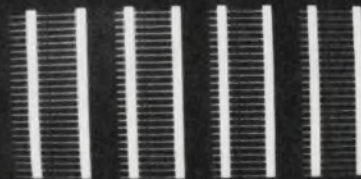

Average repairs take only 3/4 hour



Exchange repair of major assemblies

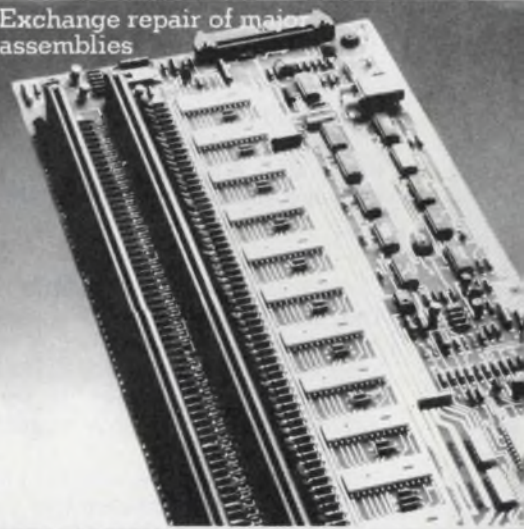

Nationwide service





# 8-bit microprocessor, NMOS

## 3850

Fairchild Semiconductor  
464 Ellis St.  
Mountain View, CA 94042  
(415) 962-3816

Alternate sources: Mostek, Motorola and SGS-ATES.

The multichip F8 microcomputer family is designed to handle I/O intensive applications. The minimal system typically consists of the 3850 CPU and one or more 3851, 56 or 57 program storage units, which can hold up to 2048 bytes of instructions and provide I/O lines and a programmable timer.

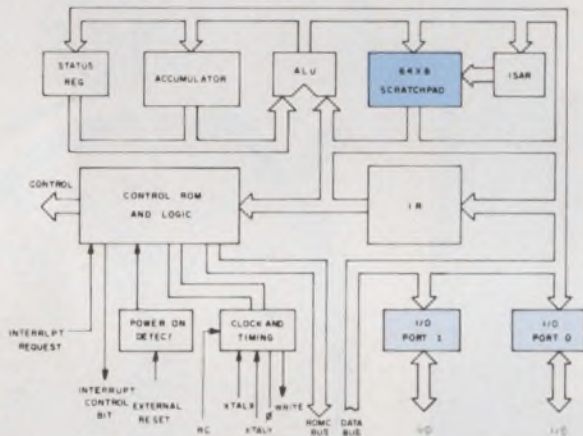

The architecture of the 3850 CPU provides a distributed format, thus permitting simple system expansions. The processor contains a 64 byte scratchpad RAM and 16 I/O lines. Any program storage unit added to the system brings 16 I/O lines, a counter/timer and other features depending on the version. All I/O lines are TTL compatible and the data and address buses have three-state capability.

### Comments

**The instruction set** contains a total of 76 basic instructions split as follows: 15 accumulator reference, eight memory reference, 12 branch and jump, 13 address modification, 15 scratchpad register reference and 13 control instructions.

**Software support** is available in many forms; there is a Fortran IV cross assembler that can run on 16-bit minicomputers, there are editor, assembler and debugger routines in the resident development system and ROM based programs, such as Fairbug, which has load, dump, display and store features.

**Outstanding software features** start with the fact that 60% of the instructions are one byte, thus providing compact code. I/O instructions are only one byte and both register and memory locations can be automatically incremented or decremented by some instructions.

**Hardware support** starts with the F8 evaluation kit that contains 1024 bytes of RAM, a TTY monitor routine with breakpoint capability and a Fortran

### Specifications

Data word size:	8 bits
Address bus size:	16 bits
Direct addressing range:	65,536 bytes
Instruction word size:	1 to 3 bytes
Number of basic instructions:	76
Shortest instruction/time (Add from scratchpad):	2 $\mu$ s
Longest instruction/time (Call to subroutine):	13 $\mu$ s
Clock frequency (min/max):	0.1/2 MHz
Clock phases/voltage swing:	Internal
Dedicated I/O control lines:	16
Package:	40-pin DIP
Power requirements:	5 V/80 mA
	12 V/25 mA

### Hardware

Model	Description	Price (100 qty)
F3850	CPU, Commercial	\$9.95
F3850	CPU, Industrial	12.95
F3850	CPU, Military	40.00
F3851	1 k ROM, I/O & timer	9.95
F3852	Dynamic memory interface	7.45
F3853	Static memory interface, I/O and timer	7.45
F3854	Direct memory interface	5.95
F3856	2 k version 3851	14.95
F3857	2 k ROM plus F3851	14.95
F3861	Peripheral I/O with timer	6.45
F3871	Same as 3861 but also does pulse width measurement	9.50

cross assembler. Other hardware includes the SDB-50/70 software development board that has, in ROM, an editor, assembler and debugger. For in-circuit emulation the AIM-S1 system provides complete real-time device emulation.



A single, double, or  
triple pole, compact,  
printed-circuit-mounted,  
immersion-proof, .310 high,  
IC and  $\mu$ P compatible,  
off-the-shelf, reed relay.

The MIP\*

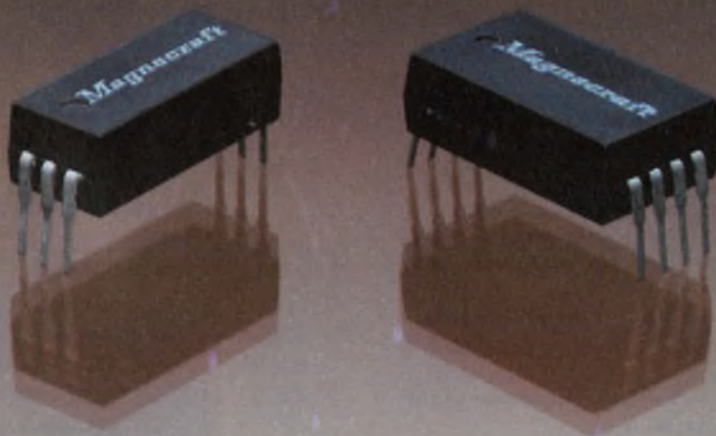

It's available in a variety of standard contact combinations . . .  
single pole: 1 Form A, 1 Form B, and 1 Form C . . .  
double pole: 2 Form A and 2 Form C . . . triple pole: 3 Form A.  
And, both .1 and .150 pin spacing is offered.

The modular MIP is epoxy molded and completely immune to  
standard printed circuit board cleaning processes.

Complete information and specifications are available in our  
MIP Catalog. Write or call Magnecraft Electric Company,  
5575 North Lynch, Chicago, Illinois 60630. 312/282-5500.

**Magnecraft**<sup>®</sup>  
ELECTRIC COMPANY

\*Molded In-Line Package

CIRCLE NUMBER 62



# 8-bit microprocessor, NMOS

## MCS-80 (8080A)

Alternate sources: Advanced Micro Devices, Mitsubishi, National Semiconductor, NEC Microcomputers, Siemens, Signetics (Philips) and Texas Instruments.

Intel Corp.  
3065 Bowers Ave.  
Santa Clara, CA 95051  
(408) 246-7501

The 8080A is an 8-bit parallel processor designed for use in general-purpose computing applications. Fabricated with silicon-gate NMOS technology, the 8080A contains six general-purpose 8-bit registers, and 8-bit accumulator, four testable flag bits, an 8-bit parallel-processing arithmetic and logic unit, a 16-bit stack pointer and a 16-bit program counter. The processor can handle vectored interrupts and can directly address up to 512 I/O ports. Arithmetic and logic instructions can set or reset four flags and a fifth flag is used for decimal arithmetic only.

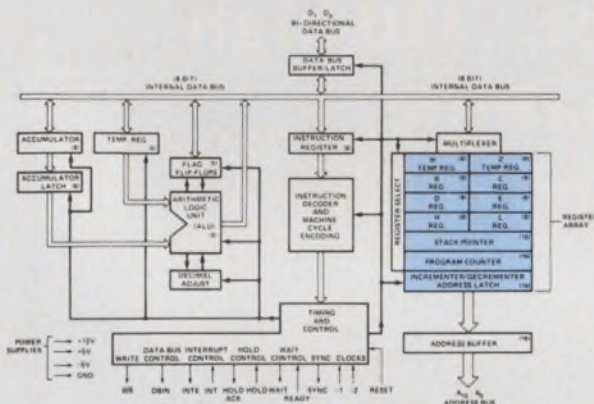

The typical 8080A system consists of a processor, a clock, a bus controller, some memory and a memory decoder. Both the data and address buses are TTL compatible and have three-state capability. All but the clock lines are TTL-compatible.

### Comments

The 8080A has 78 basic instructions divided into five groups: Data transfer, Arithmetic, Logic, Branch and Stack, and I/O and Machine control. There are also four addressing modes—direct, indirect, register and immediate. The move, load and store instruction groups can transfer either 8 or 16 bit data words between memory, the six working registers and the accumulator.

Software support for the 8080A includes a relocating macroassembler, a text editor and PL/M—all available on the company's own development system. There is also a program library (Insite) available to Intel customers that contains well over 200 programs submitted by users.

The basic software of the 8080A is designed for rapid stack manipulation and flexible jumps from the main program to subroutines. The ability to increment or decrement memory locations, the six general-purpose registers or the accumulator as well as register pairs or the stack pointer provides simple program looping capability.

Hardware support is available in several forms—from the low cost SDK-80 prototyping kit to the larger Microprocessor Development Systems in the Intellec family. Also available is a large range of 8080A-based computer boards from general-

### Specifications

Data word size:	8 bits
Address bus size:	16 bits
Direct addressing range:	65,536 words
Instruction word size:	8 to 24 bits
Number of basic instructions:	78
Shortest instruction/time (Add reg. to accum.):	2μs, typ.
Longest instruction/time (Swap H&L with top of stack):	9μs, typ.
Clock frequency (min/max):	0.5/3 MHz
Clock phases/voltage swing:	2/9 V
Dedicated I/O control lines:	None
Package:	40-pin DIP
Power requirements:	12 V/40 mA 5 V/60 mA -5 V/10 μA

### Hardware

Model	Description	Price (100 qty)
8080A	CPU (commercial)	\$13.10
8080A	CPU (MIL level C)	31.60
8205	1-of-8 decoder	2.80
8212	8-bit latch/buffer	2.90
8214	Priority Interrupt controller	4.65
8216	4-bit bidirectional bus driver	2.75
8224	Clock driver	
8226	Inverting version, 8216	2.75
8228	Bus controller	
8251	USART	
8253	Counter/timer	17.55
8255	Parallel I/O	7.40
8257	DMA controller	
8259	Interrupt controller	17.20
8279	Keyboard/disp. control	14.10

purpose CPU boards to multichannel analog-input boards. The large prototyping and development system, the Intellec-MDS offers the most flexibility—the system comes with a CPU, 16 k of RAM, 2 k of ROM, and software and hardware interfaces for terminals, printers and other equipment.



# Trimmer Breakthrough...



**Mepco/Electra's**  
New Series 8014 Single  
Turn Miniature Cermet  
Trimmer is the smallest  
size professional trimmer  
of its type available



today. A major breakthrough in the design of high performance

high reliability potentiometers combining an exceptionally low

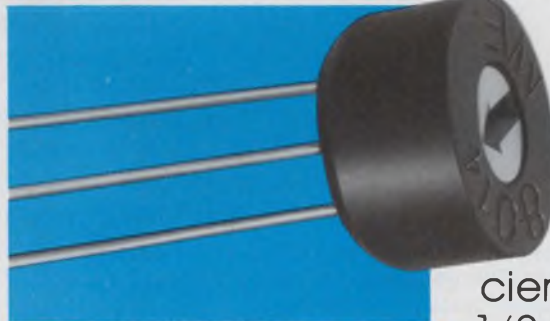

profile with equally low prices.

- Size — maximum height .150" x 1/4" diameter
- Linearity — index of determination > 0.9997 • CRV — typically less than 0.25% average and 1% typical maximum
- Sealed against deterioration from moisture absorption, solder-bath

vapors and thermal shock during automatic soldering

- Three popular terminal styles • A low  $\pm 100$  PPM standard temperature coefficient • Power rating 1/2 watt.

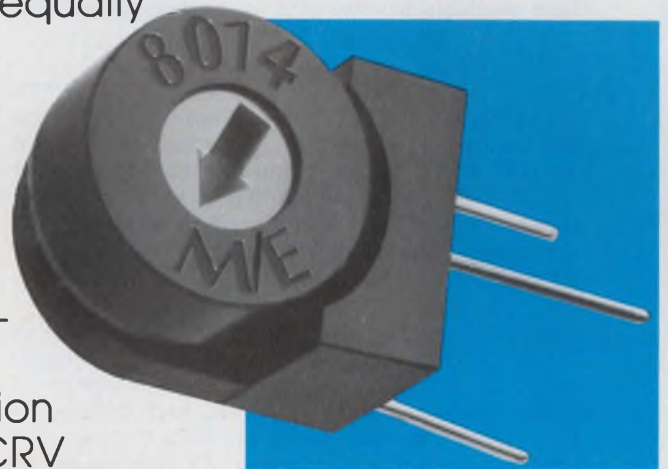

For information and samples, write or "Call M/E," **Mepco/Electra, Inc.**  
P.O. Box 82927,  
San Diego,  
California 92138,  
(714) 453-0353.



CIRCLE NUMBER 63



# 8-bit microprocessor, NMOS

Intel Corp.  
3065 Bowers Ave.  
Santa Clara, CA 95051  
(408) 246-7501

## MCS-85 (8085)

Alternate sources: Siemens, NEC and Advanced Micro Devices all by mask exchange.

The 8085 processor is a software-compatible upgrade of the 8080A processor. It offers two more instructions and has many of the peripheral circuits originally needed built right onto the same chip as the processor. With five levels of vectored interrupt, a serial I/O line and a clock speed of 3 MHz, the 8085 offers 8080A users a simple way to upgrade existing systems without losing any software. And, since the clock is on chip, all signal lines are TTL compatible, with the address and data buses having three-state capability.

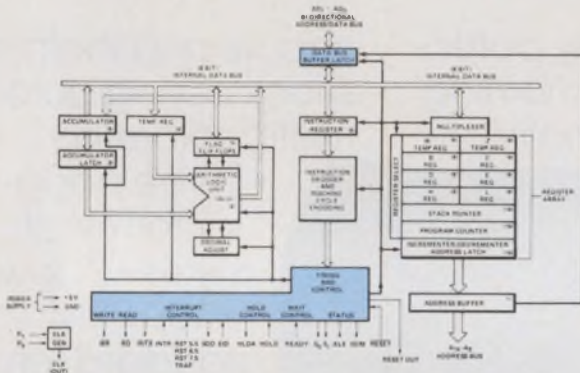

The basic architecture of the 8085 is the same as that of the 8080A. The only differences are the built-in clock generator, the built-in system control circuit and the multiplexed address/data bus structure to make available several pins for additional control.

### Comments

The **instruction set** of the 8085 contains all of the 8080A's instructions plus two more—RIM (read interrupt mask) and SIM (set interrupt mask)—for a total of 80 basic commands. The RIM and SIM instructions are used in conjunction with the interrupt capability built into the 8085 to provide four vectored interrupts, three of which are maskable.

**Available software support** for the 8085 includes all the existing 8080A software available through Insite—the company's user's software program library—and the many companies and private organizations that offer 8080A and 8085 software. An 8085 macroassembler can also be purchased, as well as PL/M when an MDS system with floppy disc is used.

**Special features** of the two new instructions permit the 8085 to handle serial inputs and outputs, and set up special masking bits to set or reset flags for the levels of vectored interrupts. Otherwise, all 8080A instructions can run on the 8085 without modification. The only adjustment that may have to be made is in any timing loops that use the 2 MHz clock frequency of the 8080A to compensate for the new 3 MHz clock.

**Hardware support** for the 8085 includes the ICE-85, an in-circuit emulator; the SDK-85 low-cost prototyping system; and the UPP 855 and EPROM

### Specifications

Data word size:	8 bits
Address bus size:	16 bits*
Direct addressing range:	65,536 bytes
Instruction word size:	8 bits
Number of basic instructions:	80
Shortest instruction/time (Move data):	1.3 $\mu$ s
Longest instruction/time (Double add):	5.2 $\mu$ s
Clock frequency (min/max):	0.5/3 MHz
Clock phases/voltage swing:	1/TTL
Dedicated I/O control lines:	None
Package:	40-pin DIP
Power requirements:	5 V/170 mA

\* 8085 uses partially multiplexed address bus—eight lines are direct and eight are shared with the data bus.

### Hardware

Model	Description	Price (100 qty)
P8085	CPU (commercial temp)	\$19.00
D8085	CPU (industrial temp)	24.00
P8155	256 byte RAM, I/O & timer	18.00
P8156	Same as 8155	18.00
P8355	2 kbyte ROM & 16 line I/O	consult factory
P8755-8	2 k UV EPROM & 16 line I/O	125.00
8205	1 of 8 binary decoder	2.80
8212	8-bit I/O port	2.90
8214	Priority interrupt	4.65
8216	Bidirectional bus driver	2.75
8226	Inverting version, 8216	2.75
8253	Programmable timer	17.55
8259	Interrupt controller	17.20
8279	Kbd/display interface	14.10

programmer. Also, most of the development hardware available for the 8080A can be used to develop 8085 circuits and programs. The entire Intellec MDS microprocessor development system can be used, with just a few changes.



# We're now an analog for Analog.

Analog Devices has named us the second source for these linear CMOS circuits:

The broadest selection of linear CMOS switches, multiplexers and converters used to be available from only one company—Analog Devices. Now you can get identical CMOS components from us.

We've become the second source for Analog Devices for a lot of good reasons. Like specs, functions and package options you can't find anywhere else. And CMOS—our brand of High-Density CMOS—which insures the lowest power dissipation available in linear ICs.

## Multiplexers

- 7501 8 channels
- 7502 4 channels (differential)
- 7503 8 channels (inverted Enable)
- 7506 16 channels (DG506 replacement)
- 7507 8 channels (DG507 replacement)

So let's begin a dialogue about Analog today. Simply circle the R.S. number, and we'll send you more information about the circuits listed here. We'll also give you an opportunity to request detailed data sheets for the specific devices which interest you.

If your need is urgent, contact Linear Marketing at (408) 247-5350.



3100 Alfred Street, Santa Clara CA 95050  
CIRCLE NUMBER 64

## Switches

- 7510DI Quad SPST (protected)
- 7511DI Quad SPST (protected)
- 7512DI Dual SPDT (protected)
- 7513 Dual SPST (DG200 replacement)
- 7516 Quad SPST (CD4016A replacement)
- 7519 Quad SPDT (current steering)

If you've used Analog CMOS in the past, you'll find

it easy to order pin-for-pin replacements from us. Our numerical model numbers are identical, and our OEM prices are comparable. And of course, we offer the same reliability and product performance you've come to expect from Analog.

Check the tables for the linear CMOS you can get from us today. Soon, more unique circuits will join the roster. Whether you're a veteran user of linear CMOS, or just now contemplating its merits, you should know more about our responsive second-source capability.

## Converters

### Digital-to-Analog

- 7520 10-bit, Multiplying
- 7521 12-bit, Multiplying
- 7522 10-bit, Multiplying (buffered)

### Analog-to-Digital

- 7550 13-bit (2's complement)
- 7570 10-bit (successive approximation)



# 8-bit microprocessor, NMOS

## MCS 650X, 651X

MOS Technology  
950 Rittenhouse Rd.  
Norristown, PA 19401  
(215) 666-7950

Alternate sources: Rockwell Microelectronic Devices and Synertek.

The 8-bit pipelined microprocessor is available in nine variants (10 from Rockwell). The 6502 family has an on-board one-phase clock while the 6512 family works with an external two-phase clock (for systems that need maximum timing control). Both families include models that can address 4, 8, and 65 kbytes (6502, 6515). Maximum operating frequencies are 1 MHz or 2 MHz (suffix A).

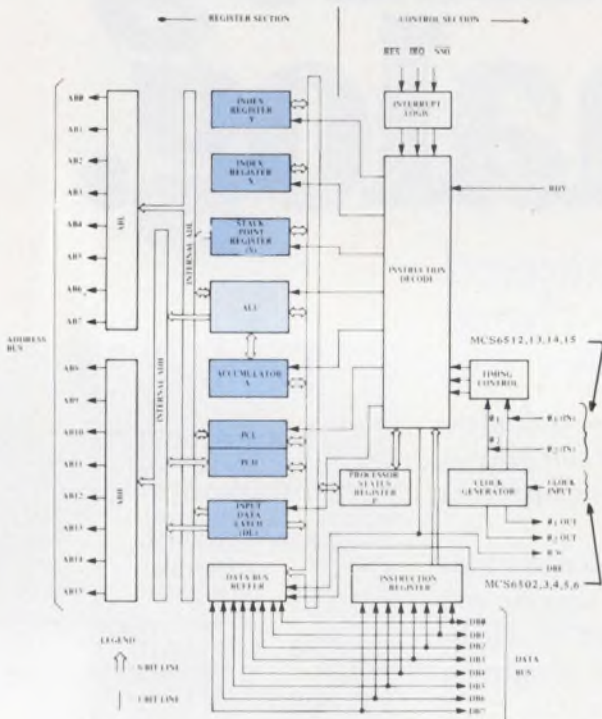

Note: 1. Clock Generator is not included on MCS6512, 13, 14, 15.  
2. Addressing Capabilities and control options vary with each of the MCS6500 Products.

The architecture of the MCS6500 permits all registers to accept data from the data bus and transfer data back and forth since they are all connected to the same internal bus. A minimal system consists of the CPU and some memory (for a 651X system you also need a clock generator).

### Comments

The instruction set is memory-oriented with emphasis on convenient addressing of data in memory tables. The 56 instructions have the following addressing modes: accumulator immediate and absolute addressing, zero page indexed zero page, and indexed absolute addressing; implied and relative addressing; indexed indirect, indirect indexed, and absolute indirect addressing.

Software support includes a cross-assembler for PDP-8, 10, 11; a text editor, a debugger, a resident assembler, a math package, a Fortran compiler, a cross-emulator and Basic (cross and host).

Outstanding software features include: add and subtract in decimal mode with automatic correc-

### Specifications

Data word size:	8 bits
Address bus size:	16 bits
Direct addressing range:	65,536 bytes
Instruction word size:	8 to 24 bits
Number of basic instructions:	56
Shortest instruction/time (Decrement register):	1 $\mu$ s
Longest instruction/time (Rotate memory):	3 $\mu$ s
Clock frequency (min/max):	20 kHz/2 MHz
Clock phases/voltage swing:	1/TTL or 2/5 V
Dedicated I/O control lines:	3
Package:	28 or 40-pin DIP
Power requirements:	5 V/140 mA

### Hardware

Model	Description	Price (100 qty)
6502	On-bd clock, 65 k, 40 pin $\mu$ P	\$10.90
6503	On-bd clock, 4 k, 28 pin	8.50
6504	On-bd clock, 8 k, 28 pin	8.50
6505	On-bd clock, 4 k, 28 pin	8.50
6506	On-bd clock, 4 k, 28 pin	8.50
6507	Rockw, only, 8 k, 28 pin	9.65
6512	Ext. clock, 65 k, 40 pin	10.90
6513	Ext. clock, 4 k, 28 pin	8.50
6514	Ext. clock, 8 k, 28 pin	8.50
6515	Ext. clock, 4 k, 28 pin	8.50
6520	Peripheral interface adaptor (40-pin)	6.55
6522	6520 plus 2 timers (16-bit)	6.75
6530	16 I/O, 8 k ROM, 65 $\times$ 8 RAM, timer	13.00
6532	like 6530, but 128 $\times$ 8 static RAM	\$12.75

tion, powerful addressing modes (indexed indirect and indirect indexed) and a Basic interpreter.

Hardware support consists of the KIM-1 board (including a  $\mu$ P, hex keyboard, 6-digit display, 1 k  $\times$  8 RAM, 16 I/O lines and control program); KIM-2 (4 k RAM expansion); KIM-3 (8 k RAM expansion); KIM-4 (motherboard), TIM (a 6530 with monitor software for interfacing serial terminals). Also available is the MDT 650 development terminal.



# When you need LED readout displays or more than LED readout displays...

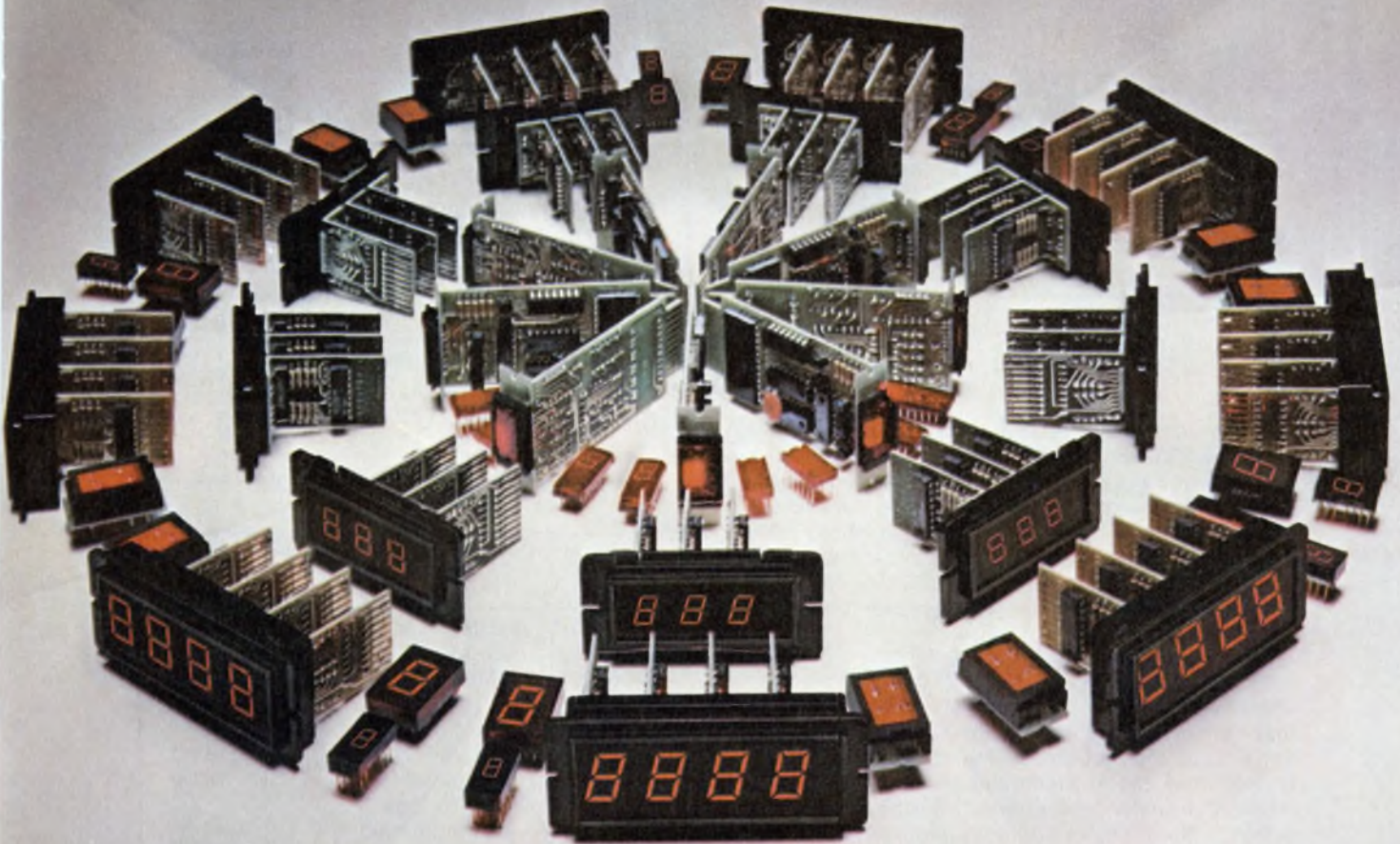

Come to Dialight. For built-in circuitry for example. If that's the type of convenience you're considering, then Dialight's the first place to look . . . because Dialight's the first in value-added LED readout displays.

For many years now we've been offering not only the latest technology, but also the latest in time and labor-saving pre-engineered displays. These can be ordered any way you wish: with or without on-board decoder/driver, with or without code generator, in any

number of digits in an assembly, complete with bezel for instant panel mounting.

We also offer high brightness, low cost design flexibility with a choice of discrete and assembly displays with character heights of .270", .300" and .600".

For your free copy of our new Readout Product Selector Guide, call or write to us at Dialight today.

**DIALIGHT**  
A North American Philips Company

## Dialight meets your needs.

Dialight, 203 Harrison Place, Brooklyn, N.Y. 11237 (212) 497-7600

CIRCLE NUMBER 65



# 8-bit microprocessor, NMOS

## MC6800

Alternate sources: American Microsystems, Fairchild, Fujitsu, Hitachi and Sescosem/Thomson CSF.

Motorola, IC Div.  
3501 Ed Bluestein Blvd.  
Austin, TX 78721  
(512) 928-2600

Designed as a general-purpose central processor, the MC6800 provides 8-bit computational capability with an instruction set of 72 commands. The processor has a bidirectional data bus, a full 16-bit address bus and can operate from a 5 V supply. There are three versions of the MC6800 available—the original MC6800 with a 1 MHz clock rate, the MC68A00 with a 1.5 MHz clock, and the MC68B00 with a 2 MHz clock. All versions are pin compatible.

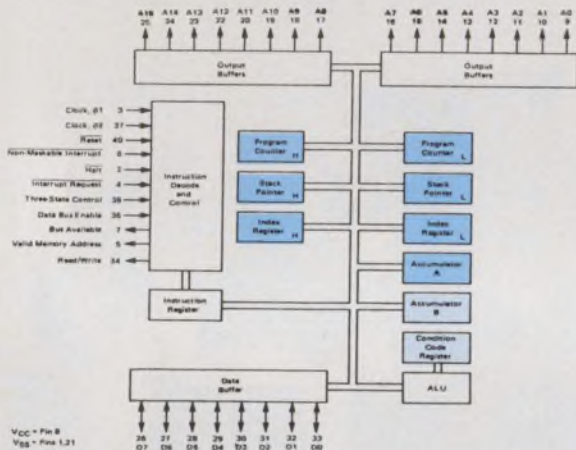

A minimum system for the MC6800 will typically consist of the processor, some ROM and RAM, a clock circuit and some I/O circuits. All lines except the clock lines are TTL compatible and the address bus, data bus and R/W line also have three-state capability. The 6800 has two accumulators, but all stack space is in the user-supplied RAM—there are no auxiliary registers on the processor chip.

### Comments

**The basic instruction set** consists of 72 commands that contain binary and decimal arithmetic operations, logic instructions shift and rotate functions, branch and stack manipulation commands and memory transfer operations. I/O commands are stored in the memory address space. Most instructions operate on both the ALU and memory.

**The basic software support** includes an assembler, editor, macro-assembler, a disc-based operating system and several high-level languages—Basic and Fortran. The user program library contains more than 65 programs.

**Software features** include direct page memory addressing and relative branches that allow position independent code to be written. A read/modify/write instruction can be used to modify the contents of a memory location without bringing the contents into the accumulator.

**Hardware support** for the MC6800 comes in several forms. For the circuit designer there are several evaluation board systems available from Motorola and the alternate sources. And, for the program

### Specifications

Data word size:	8 bits
Address bus size:	16 bits
Direct addressing range:	65,536 words
Instruction word size:	8 bits
Number of basic instructions:	72
Shortest instruction/time (Load accumulator A):	1 $\mu$ s
Longest instruction/time (Software interrupt):	6 $\mu$ s
Clock frequency (min/max):	Dc/2 MHz
Clock phases/voltage swing:	2/ Vcc - 0.6 to Vss + 0.4 V
Dedicated I/O control lines:	9
Package:	40-pin DIP
Power requirements:	5 V/100 mA

### Hardware

Model	Description	Price (100 qty)
MC6800	CPU (commercial), 25-up	\$17.95
MC6800	CPU (industrial), 25-up	49.00
MC6800	CPU (military), 25-up	76.00
MC6820	Peripheral interface adapter	6.60
MC6840	Programmable timer	13.00
MC6850	Asynchronous communications adapter	7.80
MC6854	Data link controller	17.00
MC6860	600 bps modem	8.00
MC6862	2400 bps demodulator	13.15
MC68488	General purpose interface adapter	14.00
MC6843	Floppy-disc controller, 25-up	25.00
MC6844	DMA controller, 25-up	23.50
MC6845	CRT controller, 25-up	25.00

development engineer, the EXORciser system, consisting of a CPU board, a 2-k static RAM board, a 16-k dynamic RAM board, a baud-rate board, serial and parallel interfaces, a PROM programmer and a PROM/EPROM board can be used with the floppy-disc operating system. Also available is a user system evaluator (USE) that can help with the early prototyping efforts.



# How fast can you measure rise time, fall time and pulse width?

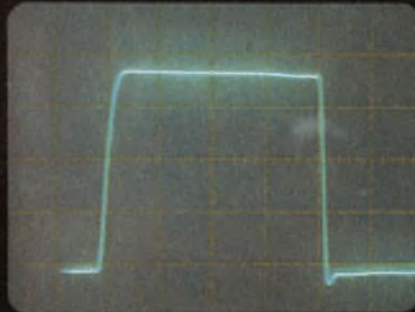

## Your way.



(About 5 minutes.)

1. Connect signal to scope.
2. Adjust trace intensity.
3. Adjust focus. 4. Select VOLTS/DIV range.
5. Select TIME/DIV range. 6. Adjust vertical gain to fill screen for location of 10% & 90% points. 7. Locate 10% point. 8. Locate 90% point. 9. Determine horizontal displacement between 10% & 90% points. 10. Multiply displacement by horizontal scale factor.

That's RISE TIME. Only 9 more steps and you've got PULSE WIDTH and FALL TIME.

## Our way.

(About 5 seconds.)

1. Connect signal.
2. Push  button for RISE TIME. 3. Push  button for PULSE WIDTH. 4. Push  button for FALL TIME.

The rest is automatic.

## Your move.

Give us a call and we'll tell you how the Dana 9000 Microprocessing Timer/Counter can solve your measurement problem the easy way.

# DANA<sup>®</sup>

**Others measure by us.**

Dana Laboratories, Inc., 2401 Campus Drive, Irvine, CA 92715  
Phone: 714/833-1234



# 8-bit microprocessor, NMOS

## MC6802

Alternate sources: Fairchild and Hitachi.

Motorola, Inc.  
Integrated Circuit Div.  
3501 Ed Bluestein Blvd.  
Austin, TX 78721  
(512) 928-2600

A general-purpose central processor for the M6800 family, the MC6802 includes a crystal-controlled clock oscillator and 128 bytes of on-chip RAM, 32 bytes of which can be retained during power-off by using battery backup. Like the earlier MC6800, it operates from a 5-V supply, and has a bidirectional data bus, a 16-bit address bus and 72 instructions. Maximum clock rate is 4 MHz.

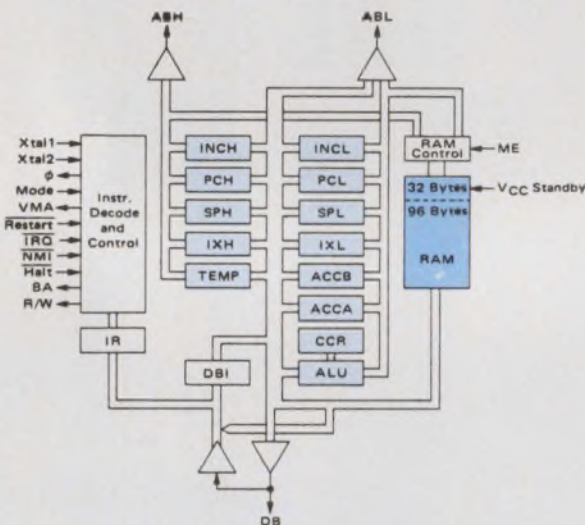

The architecture of the MC6802 resembles that of the MC6800 except that the 6802 includes the stack and the clock oscillator on the chip. A minimum system requires just two chips—the MC6802 MPU and the MC6846, a combination ROM and I/O timer.

### Comments

**The instruction set** contains 72 commands, including binary and decimal arithmetic operations, logic instructions, shift and rotate functions, branching commands and memory transfer operations. I/O commands are stored in the memory address space.

**Software support** offered includes an assembler, editor, macro assembler, a disc-based operating system and several high-level languages such as Basic and Fortran. The user program library contains over 65 programs.

**Software features** include direct page addressing of memory for shorter coding, and relative branches that allow position-independent coding. Read/modify/write instructions operate on memory without passing data through an accumulator.

**Hardware support** comes in several forms. Several evaluation-board systems are available from Motorola and other sources. A user system evaluator (USE) can aid prototyping. For program development, the EXORciser system can be used with a

### Specifications

Data word size:	8 bits
Address bus size:	16 bits
Direct addressing range:	65,536 words
Instruction word size:	8, 16 or 24 bits
Number of basic instructions:	72
Shortest instruction/time (Load accumulator A):	2 $\mu$ s
Longest instruction/time (Software interrupt):	12 $\mu$ s
Clock frequency (min/max):	1 MHz/4 MHz
Clock phases/voltage swing:	Internal
Dedicated I/O control lines:	9
Package:	40-pin DIP
Power requirements:	5 V

### Hardware

Model	Description	Price (100 qty)
MC6802	CPU (commercial), 25-up	\$22.00
MC6802	CPU (industrial), 25-up	45.00
MC6846	Combined ROM/timer	N/A
MC6820	Peripheral interface adapter	6.60
MC6840	Programmable timer	13.00
MC6850	Asynchronous communications adapter	7.80
MC6854	Data link controller	17.00
MC6860	600-bps modem	8.00
MC6862	2400-bps demodulator	13.15
MC68488	General purpose interface adapter	14.00
MC6843	Floppy-disc controller, 25-up	25.00
MC6844	DMA controller, 25-up	23.50
MC6845	CRT controller, 25-up	25.00

floppy-disc operating system. The EXORciser system includes a CPU board, a 2-k static RAM board, a 16-k dynamic RAM board, a baud-rate board, serial and parallel interfaces, a PROM programmer and a PROM/EPROM board.



# STAMP OUT "almost right" Trimmer Capacitors

—specify non-rotating pistons  
that guarantee precision performance

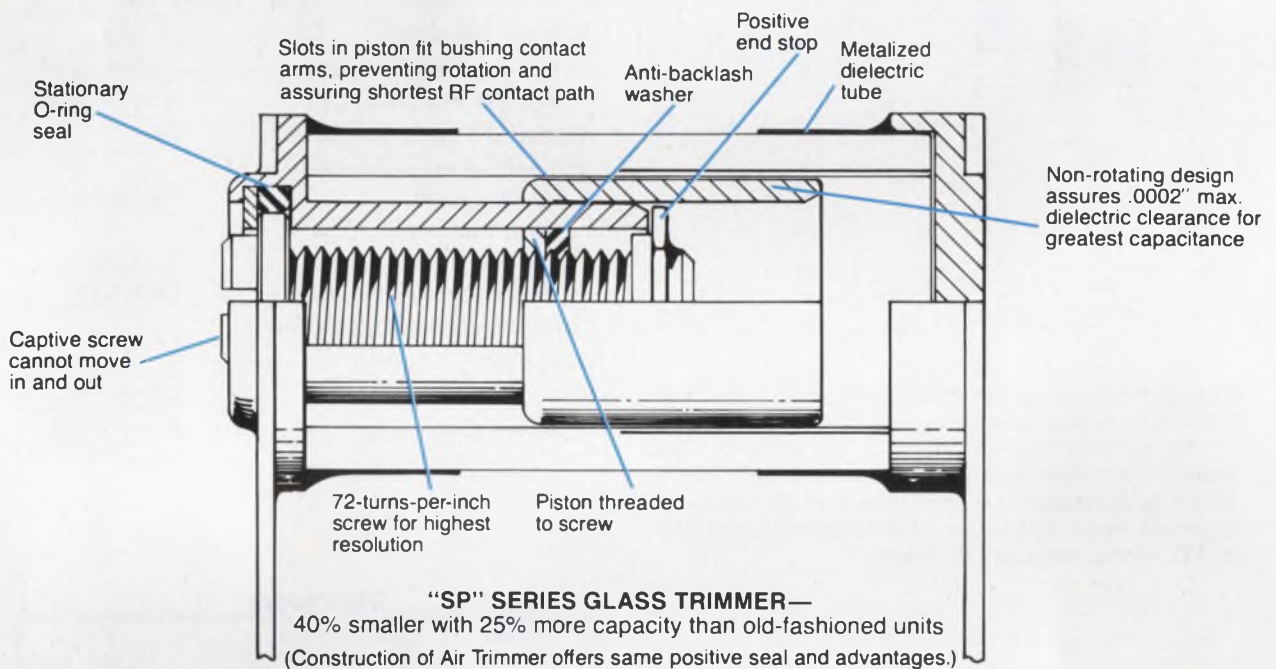

When high Q and stable performance are a *must*, you can't settle for a trimmer capacitor that is "almost right". Only Voltronics, with its unique, patented, non-rotating piston, eliminates the problems of conventional capacitors.

This totally unique principle is available in both glass and air units. The non-rotating piston provides  $\pm 1\%$  linearity, and no chance of reversals—unlike rotating pistons, where linearity is limited to  $\pm 10\%$  due to unavoidable turning eccentricity.

What's more, the Voltronics trimmer screw does not move in and out with the piston. This means, for the first time, you can get a sealed unit that *really* is sealed. (When a trimmer screw moves in and out, in old-fashioned units, the O-ring turns, slides, distorts, and can't be fully compressed. The Voltronics O-ring is stationary, providing a positive, trouble-free seal.) And, through this non-rotating design, Voltronics units are smaller, and lighter, and can be provided with extended shafts.

And there are still more reasons to specify Voltronics—the screw is not in the RF circuit, assuring low losses and low, constant self-inductance; you get 72 turns-per-inch resolution; and even vibration does not cause a change in value, let alone FM modulation.

Want proof? We have the data and complete literature on our entire line ready for you. Just circle our number on the Reader Service Card, or write directly to us at Dept. ED-1.



# Voltronics

West Street, East Hanover, N.J. 07936 telephone: 201-887-1517 twx: 710-986-8253

CIRCLE NUMBER 67







# RF TRANSFORMERS

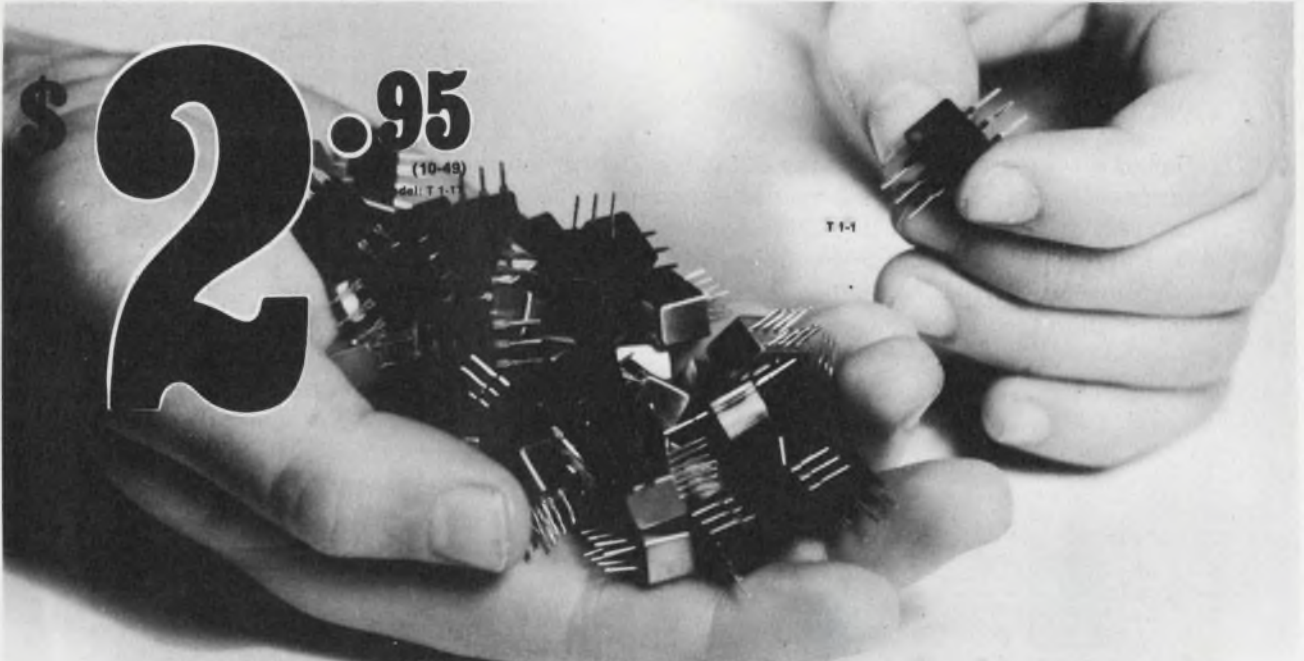

## Have it your way! 36 models to choose from, 10KHz-800MHz

It costs less to buy Mini-Circuits wideband RF transformers. The T-series (plastic case) and TMO series (hermetically sealed metal case) RF transformers

operate with impedance levels from 12.5 ohms to 800 ohms and have low insertion loss, 0.5 dB typ. High reliability is associated with every transformer. Every

production run is 100% tested, and every unit must pass our rigid inspection and high quality standards. Of course, our one-year guarantee applies to these units.

DC ISOLATED PRIMARY & SECONDARY							
Model	TMO 1-1	TMO 1.3-1	TMO 2.5-4	TMO 4-4	TMO 9-1	TMO 16-1	
Metal Case	T 1-1	T 1.3-1	T 2.5-4	T 4-4	T 9-1	T 16-1	
Plastic Case	T 1-1	T 1.3-1	T 2.5-4	T 4-4	T 9-1	T 16-1	
Freq Range, MHz	15-400	1-300	.01-100	0.2-200	.15-200	.3-120	
Impedance Ratio	1	1.5	2.5	4	9	16	
Max Insertion Loss	MHz	MHz	MHz	MHz	MHz	MHz	
3 dB	15-400	1-300	.01-100	0.2-200	.15-200	.3-120	
2 dB	.35-200	.2-150	.02-50	0.5-150	.3-150	7-80	
1 dB	2-50	1-80	0.05-20	1-100	2-40	5-20	
Price, Model TMO	\$4.95	\$6.25	\$5.95	\$5.95	\$5.45	\$5.95	
(10-49) Model T	\$2.95	\$3.95	\$3.95	\$3.95	\$3.45	\$3.95	

UNBALANCED PRIMARY & SECONDARY						
Model	TMO 2-1	TMO 3-1	TMO 4-2	TMO 8-1	TMO 14-1	
Metal Case	T 2-1	T 3-1	T 4-2	T 8-1	T 14-1	
Plastic Case	T 2-1	T 3-1	T 4-2	T 8-1	T 14-1	
Freq Range, MHz	0.15-800	5-800	5-600	15-250	2-150	
Impedance Ratio	2	3	4	8	14	
Max Insertion Loss	MHz	MHz	MHz	MHz	MHz	
3 dB	0.15-800	5-800	2-800	15-250	2-150	
2 dB	.02-400	2-400	5-500	25-200	5-100	
1 dB	0.5-200		2-250	2-100	2-50	
Price, Model TMO	\$5.45	\$6.25	\$5.45	\$5.45	\$6.25	
(10-49) Model T	\$3.45	\$4.25	\$3.45	\$3.45	\$4.25	

DC ISOLATED PRIMARY & SECONDARY CENTER-TAP SECONDARY									
Model	TMO 1-1T	TMO 2-1T	TMO 2.5-4T	TMO 3-1T	TMO 4-1	TMO 8-1T	TMO 13-1T		
Metal Case	T 1-1T	T 2-1T	T 2.5-4T	T 3-1T	T 4-1	T 8-1T	T 13-1T		
Plastic Case	T 1-1T	T 2-1T	T 2.5-4T	T 3-1T	T 4-1	T 8-1T	T 13-1T		
Freq Range, MHz	05-200	07-200	01-100	05-250	2-350	3-300	3-120		
Impedance Ratio	1	2	2.5	3	4	5	13		
Max Insertion Loss	MHz	MHz	MHz	MHz	MHz	MHz	MHz		
3 dB	05-200	07-200	01-100	05-250	2-350	3-300	3-120		
2 dB	08-150	1-100	02-50	1-200	35-300	8-200	7-80		
1 dB	2-80	5-50	05-20	5-70	2-100	5-100	5-20		
Maximum Amplitude Unbalance MHz									
1 dB	5-80	1-50	1-20	1-70	5-100	10-100	5-20		
.5 dB	05-200	07-200	01-100	05-250	2-350	3-300	3-120		
Maximum Phase Unbalance Degree MHz									
1°	5-80	1-50	1-20	1-70	5-100	10-100	5-20		
5°	05-200	07-200	01-100	05-250	2-350	3-300	3-120		
Price (10-49)									
Model TMO	\$5.95	\$6.25	\$6.25	\$5.95	\$4.85	\$6.25	\$6.25		
Model T	\$3.95	\$4.25	\$4.25	\$3.95	\$2.95	\$4.25	\$4.25		
Primary Impedance:	50 ohms	TMO-series	T-series						
Total Input Power:	1/2 watt	25 cu. inches	02 cu. inches						
		.07 ounces	.01 ounces						

### Designers Kit Available

(TK-1) — 2 transformers of each type T1-1, T2-1, T4-1, T9-1, T16-1 **\$32.00**  
 (TK-2) — 2 transformers of each type TMO1-1, TMO2-1, TMO4-1, TMO9-1, TMO16-1 **\$49.50**

World's largest manufacturer of Double Balanced Mixers

**Mini-Circuits**  
 MINI-CIRCUITS LABORATORY  
 A Division of Scientific Components Corp

OUR NEW ADDRESS  
 AND PHONE NO IS

2625 East 14th Street Brooklyn, New York 11235 (212) 769-0200  
 Domestic and International Telex 125460 International Telex 620156

### WE'VE GROWN

Customer acceptance of our products has been so overwhelming, we've been forced to move to larger facilities — THANKS.

International Representatives: **AFRICA:** Altra (PTY) Ltd, P.O. Box 9813, Johannesburg 2000, S Africa **AUSTRALIA:** General Electronic Services, 99 Alexander Street, New South Wales Australia 2065 **ENGLAND:** Dale Electronics, Dale House, Wharf Road, Frimley Green, Camberley Surrey **EASTERN CANADA:** B.D. Hummel, 2224 Maynard Avenue, Utica NY 13502 (315) 736-7821 **FRANCE:** SCIE, D I M E S, 31 Rue George, Sand 91120 Palaiseau France **GERMANY, AUSTRIA, SWITZERLAND, DENMARK:** Industrial Electronics GMBH 6000 Frankfurt/Main Klüberstrasse 14 West Germany **INDIA:** Gaekwar Enterprise, Kama Mahal, M.L. Dananukar Marg, Bombay 400 026, India **ISRAEL:** Vectronics Ltd, 69 Gordon Street, Tel-Aviv, Israel **NETHERLANDS, BELGIUM, LUXEMBOURG:** Coimes, Veidweg II, Hattem, Holland

**NORWAY:** Datamatik AS, Ostensjoveien 62, Oslo 6, Norway **SINGAPORE & MALAYSIA:** Electronics Trading Co. (PTE) Ltd, 87 Bukit Timah Road, Singapore 9, Malay Peninsula **SWEDEN:** Integrad Elektronik AB, Box 43, S-18251, Djursholm, Sweden

**U.S. Distributors:** **NORTHERN CALIFORNIA:** PENN-STOCK Co., Foothill Office Center, 105 Fremont Avenue, Los Altos, CA 94022 (415) 948-6533 **SOUTHERN CALIFORNIA, ARIZONA:** Crown Electronics, 11440 Collins Street, No Hollywood, CA 91601 (213) 877-3550 **NEW YORK:** NEW YORK MICROWAVE DISTRIBUTORS COMPANY, 61 Mall Drive, Commack, NY 11725, 516 543-4776



# 8-bit microprocessor, NMOS

## Z80-CPU

Alternate sources: Mostek, NEC and Sharp.

Zilog Inc.  
10460 Bubb Rd.  
Cupertino, CA 95014  
(408) 446-4666

Based on the architecture of the 8080, the Z80 can perform the 78 instructions of that processor plus 80 additional instructions. The ion-implanted NMOS device is offered in two versions — the Z80 with 2.8 MHz maximum clock and the Z80A with a 4.5 MHz clock. Operating from a single 5-V supply and a single-phase external clock, the processor contains 17 internal registers and built-in dynamic RAM refresh circuitry and has three modes of interrupt response.

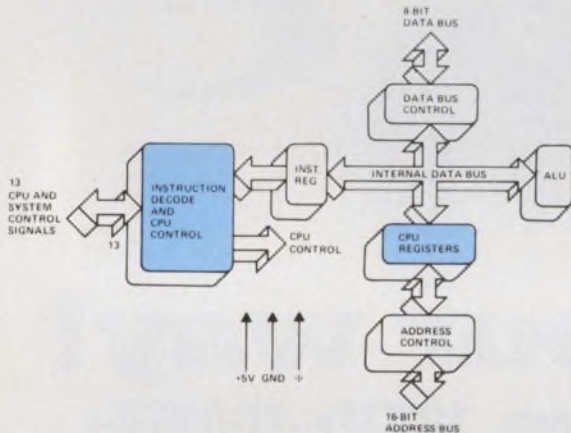

The architecture of the Z80 resembles that of the 8080A, except that there is a second bank of eight 8-bit registers that mirrors the eight registers in the 8080A. All timing generation is on the processor chip except the oscillator, and the Address bus is structured so that refresh addresses appear on the lower half of the bus to refresh dynamic RAMs. A minimal system consists of the processor, a clock source and some memory.

### Comments

**The instruction set of the Z80** contains all 78 op codes of the 8080A's instruction set as well as another 80 codes. Of the 158 total instructions, there are 21 8-bit Load commands, 20 16-bit Load commands, 14 Exchange, Block transfer and Search instructions, 17 Arithmetic and Logic commands for 8-bit operations, 11 instructions for 16-bit arithmetic and logic operations, 12 general-purpose arithmetic commands, 16 shift and rotate functions, nine Bit set, Reset and Test commands, 11 Jump instructions, seven Call/Return directives and 12 I/O operations.

**Software support** includes a macroassembler that can generate relocatable code, a linker that can link together program modules and generate a load module with absolute addresses, and several high-level languages—PL/M, PL/Z and Basic. Also available is a text editor and a file maintenance and debug routine that supports the floppy-disc based program development system.

**Special features of the instruction set** include the block-move operations that permit large sections of data held in memory to automatically be relocated.

### Specifications

Data word size:	8 bits
Address bus size:	16 bits
Direct addressing range:	65,536 words
Instruction word size:	One to three bytes
Number of basic instructions:	158
Shortest instruction/time (Load register to register):	1 $\mu$ s
Longest instruction/time (Set bit at address IX+d):	5.75 $\mu$ s
Clock frequency (min/max):	5 kHz/4.5 MHz
Clock phases/voltage swing:	1/5 V
Dedicated I/O control lines:	5
Package:	40-pin DIP
Power requirements:	5 V/90 mA (Z80A)
	5 V/60 mA (Z80)

### Hardware

Model	Description	Price (100 qty)
Z80	CPU (commercial)	\$ 24.50
Z80	CPU (military)	165.00
Z80A	8-bit-commercial	29.50
Z80A	8-bit-Mil	N/A
Z80-PIO	2-port parallel I/O	10.00
Z80A-PIO	Higher speed version	14.00
Z80-CTC	Quad counter/timer	16.00
Z80A-CTC	Higher speed version	20.00
Z80-DMA	Two port direct memory access	38.00
Z80A-DMA	Higher speed version	N/A
Z80-SIO	Dual full-duplex serial I/O channels	N/A
Z80A-SIO	Higher speed version	N/A

**Hardware support** provided for the Z80 includes a development system with in-circuit emulation capability, real-time debug and program storage modules. The system has a dual floppy-disc operating system and can be expanded to handle up to 64 kbytes of RAM and many interface options for terminals and printers.



Make us your headquarters for

# EMI/RFI FILTERS



## Passive Filter Headquarters:

Centralab Los Angeles is a one-stop source for reliable miniature ceramic low pass Feed Thru's/Filters. They're cost effective from 30 KHz to beyond 1 GHz. Threaded or solder mount for easy installation. Proven in AC as well as DC applications. Monolithic and multi-element. Standard products or computerized custom designs, including multi-circuit custom packages. Call Rich Colburn at (213) 240-4880.

## Active Filter Headquarters:

That's Centralab Milwaukee. Solve design problems and cut costs with our thick film hybrids. Band pass, low pass, high pass and band reject. Cost effective for low to medium frequencies. Let us put our design and manufacturing expertise to work for you. Call Don Weiland at (414) 228-2872.



**CENTRALAB**

Electronics • GLOBE-UNION INC.

4561 Colorado Blvd., Los Angeles, California 90039  
5757 North Green Bay Ave., Milwaukee, Wisconsin 53201

CERAMIC CAPACITORS • FILTERS • POTENTIOMETERS • SWITCHES  
THICK FILM CIRCUITS • TRIMMER RESISTORS

SEE OUR COMPLETE CATALOG IN EEM; PAGES 317 to 335; AND GOLD BOOK PAGES 103 to 121; OR CONTACT US DIRECTLY.



# 8-bit microprocessor, PMOS

## 8008, 8008-1

Alternate sources: None.  
 Not recommended for new designs.

Intel Corp.  
 3065 Bowers Ave.  
 Santa Clara, CA 95051  
 (408) 246-7501

The 8008 and 8008-1 were the first 8-bit single-chip microprocessors. There are currently just the two versions available—the 8008 has a 20  $\mu$ s instruction time while the 8008-1 has a 12.5  $\mu$ s cycle time. Either unit is a complete 8-bit parallel processor that can address up to 16 kbytes of memory, handle up to seven levels of subroutine nesting and respond to external interrupts. Most of the 48 instructions are oriented for data handling although addition, subtraction and logic operations are available.

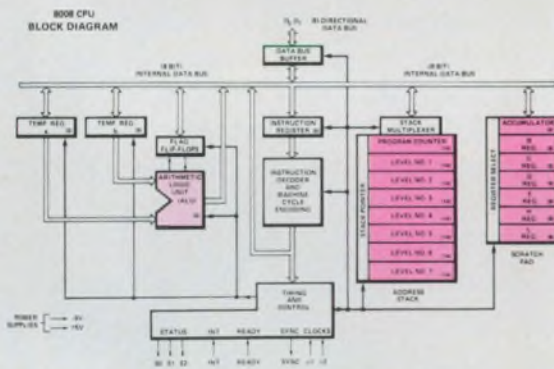

The architecture of the 8008 family parts is similar to the 8080 which has superseded it. On the 8008 chip are a 7-word x 14-bit stack register, a 6-word x 8-bit scratchpad register and a parallel 8-bit ALU. An external clock is required along with some RAM or ROM to form a minimal operating system.

### Comments

The instruction set for the 8008 family has 48 basic instructions that can be divided as follows: seven index register commands, 12 accumulator directions, 16 arithmetic, logic and shift commands, and 13 program counter, stack, I/O and machine instructions.

Software support for the 8008 family consists of the MCS-8 cross assembler, which is written in Fortran IV and can run on most 32-bit computer systems. Also available is an 8008 simulator that is written in Fortran IV.

Software features include the ability to access up to 16 kbytes of RAM or ROM with just an 8-bit data bus, the ability to handle up to seven nesting levels

### Specifications

Data word size:	8 bits
Address bus size:	Multiplexed (8 bits and 6 bits)
Direct addressing range:	16,384 bytes
Instruction word size:	1, 2 or 3 bytes
Number of basic instructions:	48
Shortest instruction/time (Return):	1.25 $\mu$ s (8008-1)
Longest instruction/time (Call):	37.5 $\mu$ s (8008-1)
Clock frequency (min/max):	333/500 kHz
Clock phases/voltage swing:	2/11 V
Dedicated I/O control lines:	4
Package:	18-pin DIP
Power requirements:	5 V/20 mA -9 V/40 mA

### Hardware

Model	Description	Price (100 qty)
8008	8-bit microprocessor	\$24.25
8008-1	8-bit microprocessor	26.90

of subroutines and the capability to respond to externally generated interrupts.

Hardware support for the 8008 family is nonexistent since it is not recommended for new designs.



# Introducing push-button microprocessor system debugging.

HP's 1611A Logic State Analyzer ... Dedicated to all 8080 or 6800 based systems.\*

**View program flow in mnemonics.** With CRT data and addresses selectable in either hexadecimal or octal formats and external lines in 1's and 0's.

**Maintain testing control.** LED indicators show status at all times. You can monitor system operation at normal speed or stop the microprocessor and give control to the 1611A for single or multiple keyed steps.

**Enter data quickly and easily.** The hexadecimal keyboard makes trigger and qualifier data entry as easy as operating a calculator. And the CRT display gives you a quick visual check on your entries.



Offering the 8080, 6800, Z80 and the F8 modules. More module introductions coming soon.

Choose your display. Either mnemonic or absolute (op codes). Roll the display to view any 16-line slice of the 64-byte memory.

**Pinpoint virtually any specific event.** Trigger on address, data, or external signals... or on any combination of the three. You can also qualify the trigger by bracketing the address and opting to trigger on the nth occurrence of the trigger word. TRIGGER ENABLE and DISABLE keys act as arm and disarm circuits providing unparalleled pinpointing flexibility.

**Move the display window.** Delay up to 65,472 qualified clocks or memory transactions from the trigger word. Or, pre-trigger to see up to 63 bytes leading up to the trigger word (negative time).

**Obtain program and timing data.** Qualify the display with TRACE TRIGGER and see only those bytes that match your trigger inputs... all write instructions, for example. Press COUNT TRIGGERS and the 1611A displays the number of trigger occurrences between the TRIGGER ENABLE and TRIGGER DISABLE entries. Push TIME INTERVAL and you get a display of actual elapsed time between selected points in your program on your hardware.

The 1611A should be on hand when you start up your microprocessor-based system. Imagine the time you'll save with push-button operation and an unparalleled view of your system's operation; viewing things dynamically that you never could see before. And there's more... self test; trigger outputs to drive external equipment; error messages to warn of improper operation or setup; and the choice of two initial "μP personality modules" that let you tailor the 1611A to either 8080 or 6800 based systems.



Let HP's 1611A, priced at \$5,000\*\*, help you speed development, production-line testing or service. Ask your local HP field engineer for all the details. Ask him about HP's digital seminars too. He can tell you when one will be held in your area and how you can attend.

\*and more modules for other microprocessors to come.  
\*\*Domestic U.S.A. price only.

**HEWLETT hp PACKARD**

Sales and service from 172 offices in 65 countries.  
1501 Page Mill Road, Palo Alto, California 94304  
For assistance call: Washington (301) 948-6370, Chicago (312) 677-0400  
Atlanta (404) 434-4000, Los Angeles (213) 877-1282

**Managing the data domain.**



# 8-bit microprocessor, PMOS (SC/MP) or NMOS (SC/MP II)

National Semiconductor  
2900 Semiconductor Drive  
Santa Clara, CA 95051  
(408) 737-5000

## SC/MP and SC/MP II

Alternate sources: Rockwell, Signetics and Western Digital for SC/MP II, none for SC/MP.

Both the SC/MP and SC/MP II are low cost 8-bit microprocessors intended primarily for simple control applications. The PMOS SC/MP costs under \$10 but is limited to a 1-MHz maximum clock rate. The higher performance SC/MP II can operate at 4-MHz clock rates. Both versions have on-chip clock oscillators and timing generators.

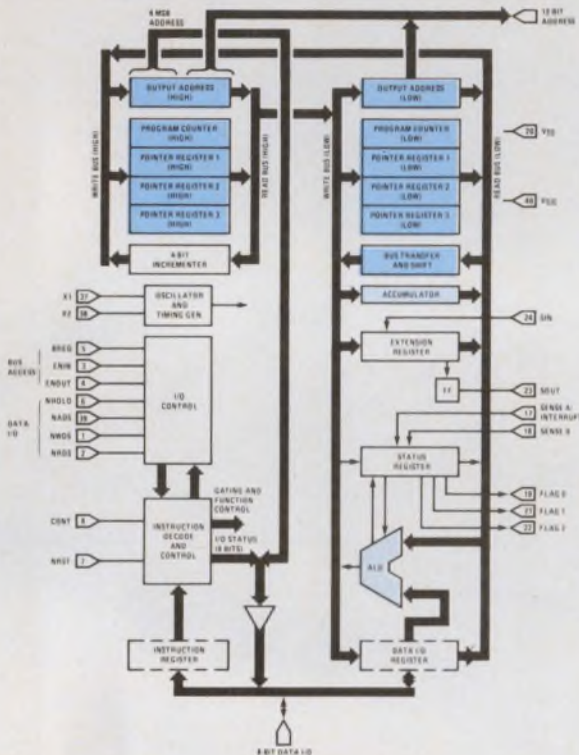

The architecture of the SC/MP provides the processor with DMA capability as well as a simple cascadable structure that is handy for multiprocessing applications. On the chip is the clock circuit to simplify the timing requirements.

### Comments

The instruction set of 46 commands breaks down into 24 single-byte instructions and 22 double-byte instructions. Single-byte instructions include those for an extension register, the pointer register, and for shift, rotate and serial I/O. Double-byte instructions include all memory operations.

Software support offered includes a high-level interpretive language, NIBL, written especially for the industrial user. Also available are conversational cross-assemblers that run on minicomputers. A Fortran cross-assembler is available on GE and National CSS time-sharing networks.

Software features include the ability to directly address up to 65 kwords with a 12-bit address bus and four bits siphoned from the data bus. SC/MP chips can be cascaded to simplify multiprocessing.

### Specifications

Data word size:	8 bits
Address bus size:	12 bits
Direct addressing range:	65,536 words
Instruction word size:	8 and 16 bits
Number of basic instructions:	46
Shortest instruction/time (Shift, rotate, I/O):	5 $\mu$ s (NMOS)*
Longest instruction/time (Decimal add):	23 $\mu$ s (NMOS)*
Clock frequency (min/max):	Dc/1 MHz (PMOS); dc/4 MHz (NMOS)
Clock phases/voltage swing:	Internal
Dedicated I/O control lines:	14
Package:	40-pin DIP
Power requirements:	5 V/125 mA
*PMOS version requires double the time.	-7 V/135 mA

### Hardware

Model	Description	Price (100 qty)
SC/MP	8-bit CPU (PMOS)	\$9.00
SC/MP II	8-bit CPU (NMOS)	N/A
DM8334	8-bit bit-addressable latch	3.20
DM8131	6-bit unified bus comparator	2.56
DM8546	Three-state, 8-bit, I/O shift register	3.84
MM5307	Baud-rate generator/programmable real-time clock	12.00
DS8692, 8693, 8694	Seiko-printer interface set	N/A

Hardware support for the SC/MPs comes in several forms. For low cost, the SC/MP kit provides a minimal system with a TTY interface. A portable terminal, the SC/MP keyboard kit, permits simple program entry and development. More extensive support comes from application cards (CPU, RAM and ROM/PROM) and a complete stand-alone development system (LCDS).



# 100 Hz TO 1000 MHz



## ONLY S-D'S NEW SIGNAL GENERATOR GIVES YOU SUCH WIDE COVERAGE—IN ONE RANGE— WITH 100 Hz RESOLUTION!

Many of today's test requirements go well beyond 520 MHz. That's why Systron-Donner's new Model 1702 AM/FM Signal Generator covers 100 Hz to 1,000 MHz in one range with the stability and accuracy of a synthesizer.

**Output accuracy 1 dB.** Obviously output level accuracy of a signal generator is critical; a small variation makes a big difference. Systron-Donner's attenuator accuracy of 1 dB is significantly better than other signal generators costing much more

than our price of \$4,150 (U.S. only).

Model 1702 is a synthesized generator with external reference capability and digital display of amplitude and frequency modulation. Modulation may be controlled internally, externally or a combination of internal and external.

Why pay more for an obsolescent signal generator? Please contact Scientific Devices or Systron-Donner at 10 Systron Drive, Concord, CA 94518. Phone (415) 676-5000.

SYSTRON  DONNER

CIRCLE NUMBER 71



# 8-bit microprocessor, PMOS

## PPS-8, PPS-8/2 (P/N 11806)

Rockwell International  
P.O. Box 3669  
Anaheim, CA 92803  
(714) 632-3729

Alternate sources: AEG Telefunken.

Eight-bit parallel processing systems, the PPS-8 and PPS-8/2 form minimum micro-computers with five and two-chip sets, respectively, and are software compatible. The CPU chip can handle both prioritized interrupts and direct memory accesses.

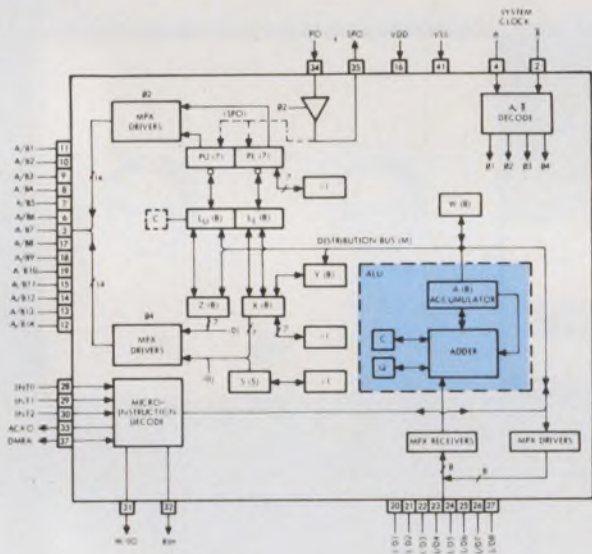

The architecture of the PPS-8 processor is designed to handle both binary and BCD arithmetic. An external two-phase clock must be used, but inside the chip the clock is expanded into four-phase dynamic logic. A minimal system configuration consists of the CPU, a clock and the necessary memory and I/O circuits.

### Comments

The instruction set of the PPS-8 family consists of 24 data transfer commands, 10 stack operations, 13 arithmetic and logic instructions, six increment/decrement operations, 23 branch/skip commands, 21 register operations, four I/O instructions and eight bit-manipulation directions.

**Software support** for the PPS-8 family consists of a Fortran IV cross assembler and a Fortran IV simulator. There is also a software development system, the PPS MP Universal Assembler, that does program assembly, debug, emulation and even incoming device testing.

**Software features** include BCD arithmetic capability as well as dedicated I/O instructions. Software controlled DMA transfers of up to eight prioritized

### Specifications

Data word size:	8 bits
Address bus size:	14 bits
Direct addressing range:	16,384 bytes
Instruction word size:	8, 16, 24 bits
Number of basic instructions:	109
Shortest instruction/time (Many):	4 $\mu$ s
Longest instruction/time (Some):	15 $\mu$ s
Clock frequency (min/max):	199/256 kHz
Clock phases/voltage swing:	2/MOS
Dedicated I/O control lines:	15
Package:	42-pin QUIL
Power requirements:	17 V/35 mA

### Hardware

Model	Description	Price (100 qty)
PPS-8	CPU	\$20.00*
PPS-8/2	CPU	\$11.25*
10706	Clock generator	\$ 7.45
10738	Bus interface	\$ 4.50
11049	Interval timer	\$ 8.50
10817	DMA controller	\$18.75
10453	Parallel data controller	\$15.00
10936	Floppy disc controller	\$40.00
10696	General purpose I/O	\$ 8.50
10930	Serial data controller	\$15.00

\*Price as of Oct. 1. Peripheral circuit prices have been cut as well. Consult distributors.

channels at 256 kbytes/s are possible. There is also a 5-bit stack pointer available to address the sub-routine stack.

**Hardware support** includes a floppy-disc based program/hardware development system, the PPS MP Universal Assembler. There are also many peripheral interface cards and memory support products available.



# 1976:

## Shugart introduces minifloppy,<sup>®</sup> the first miniature floppy.

# 1977:

## Shugart reduces minifloppy prices by 15%.

Experience pays. When Shugart introduced the first miniature floppy, OEM's and end-users gained floppy access speed and reliability at a cost competitive with cassettes. The value was obvious to OEM's. Wang Laboratories. North Star. ICOM (Pertec). Southwest Technical. Intelligent Systems. All are buying quantities of Shugart minifloppy drives and going after new markets. Now, with minifloppy deliveries approaching 10,000 units, Shugart does it again. High volume production expertise allows the impossible—a 15% reduction in price.

What's coming next from Number 1? Now you can reach data in milliseconds with our field-proven spiral cam actuator. Depend on a reliability of 8000 Power-On-Hours MTBF. Gain a two orders of magnitude improvement in error rate compared to cassettes. And record your data safely with the industry accepted high margin 35 track format.

Only Shugart has it all. Drives proven in one year of customer operation. ministreaker™ controllers that control up to three minifloppy drives. Floppy expertise, comprehensive systems design support, technical service, documentation and applications help. All this, and the best price in the business.

So come to the people who started the minifloppy revolution. Shugart.

10000

15

1  
**The Leader  
In Low Cost  
Disk Storage**

 **Shugart Associates**

415 Oakmead Parkway, Sunnyvale, California 94086  
Telephone: (408) 733-0100  
West Coast Sales/Service  
Telephone: (408) 252-6860  
East Coast Sales/Service:  
Telephone (617) 890-0808  
Europe Sales/Service:  
3, Place Gustave Eiffel, Silic 311  
94588 Rungis, France Telephone: (1) 686-00-85  
<sup>™</sup> ministreaker is a Shugart trademark





# 12-bit microprocessor, CMOS

## IM 6100

Alternate sources: Harris Semiconductor.

Intersil, Inc.  
10900 N. Tantau Ave.  
Cupertino, CA 95014  
(408) 996-5000

Able to emulate the Digital Equipment Corp. PDP-8 minicomputer's instruction set, the IM 6100 processor provides the user with a wealth of readily available software. The CMOS processor can also operate from a single supply and, since it draws only about 2 mA (at 5 V and 4 MHz) it is ideal for portable equipment design. The processor's architecture is also very similar to that of the PDP-8, with the only major difference in the bus—the IM 6100 doesn't use the DEC patented Unibus structure and timing.

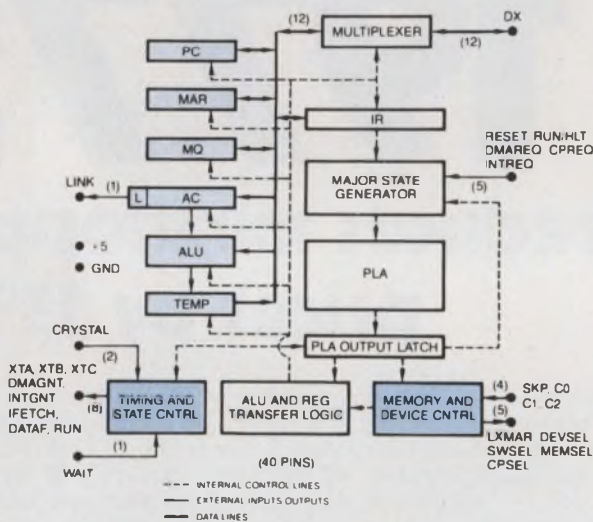

The architecture of the IM 6100 resembles that of the PDP-8 minicomputer. Signals are available that can help create a front panel so that the processor can be manually controlled. The processor's on-board crystal-controlled clock can be driven by an external source.

### Comments

The instruction set of the IM 6100 is divided into three groups—Memory reference instructions, Operate instructions, and Output transfer instructions. There are six memory reference instructions, with three addressing modes each. Another 62 commands are Operate instructions and the remaining 12 instructions are I/O transfer commands.

Software support offered includes an extended software package containing loaders, editors, assemblers, debuggers and a floating point arithmetic program. Also available is FOPAL, a Fortran cross assembler, FOCAL, a high-level interpreter and the DECUS program library with over 1000 programs.

The most important software features include the code-compatibility with the PDP-8 and the flexible addressing modes. And, some of the Operate instructions can be combined with other Operate commands to make multifunction instructions.

Hardware support for the IM 6100 ranges from a single-board learning system—the Intercept Jr.—to

### Specifications

Data word size:	12 bits
Address bus size:	12 bits
Direct addressing range:	256 words
Instruction word size:	12 bits
Number of basic instructions:	80
Shortest instruction/time (AND, OR, Jump, etc.):	2.5 $\mu$ s
Longest instruction/time (Autoindexed increment and skip if zero):	5.5 $\mu$ s
Clock frequency (min/max):	Dc/8 MHz (10 V)
Clock phases/voltage swing:	1/CMOS or TTL
Dedicated I/O control lines:	24
Package:	40-pin DIP
Power requirements:	5 V/2.5 mA or 10 V/10 mA

### Hardware

Model	Description	Price (100 qty)
IM 6100	12-bit CPU (commercial)	\$15.00
IM 6100	Industrial grade CPU	16.50
IM 6100	Military grade CPU	52.80
IM 6101	Programmable parallel interface element	8.65
IM 6102	Memory extender/DMA controller/timer	15.00
IM 6103	Multimode latched port	10.00
IM 6402	CMOS UART (16x clock)	4.00
IM 6403	CMOS UART (xtal clock)	4.00
IM 6312	1 k x 12 mask ROM	27.90
IM 6512	64 x 12 CMOS RAM	5.00
IM 6603	1 k x 4 CMOS UV EPROM	25.00

a dual floppy-disc based development system—the Intercept. Plug-in boards, including 1 k RAM, 2 k PROM, Serial I/O, cassette interface, and parallel I/O circuits are available.



# MICRO

DIP SWITCH

# MINI

DIP SWITCH

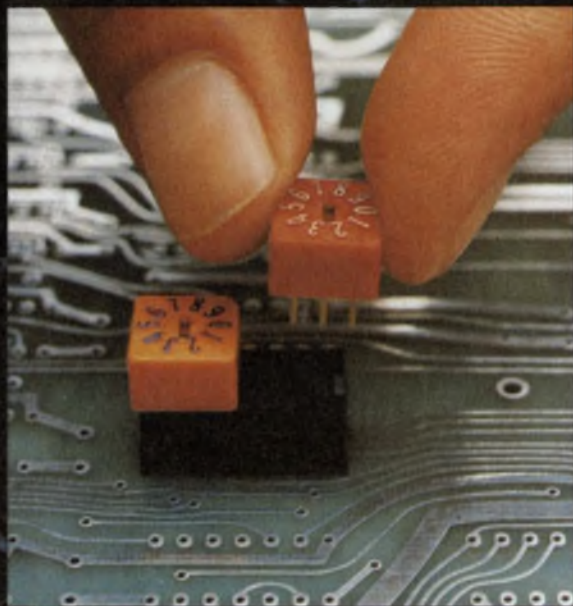

MICRO-DIP... 10 and 16 position miniature binary coded DIP switch designed to be mounted directly to PC Boards. Ideal for address encoding, pre-setting, PCB programming... every area of digital electronics.

Packaged in a color coded, glass-filled nylon housing with terminals on .100 x .300 centers. It occupies only one half of a standard 14-pin DIP socket.

Screwdriver slot is rotated in either direction to desired setting. Gold contacts protected by dust-seal design.

Positive detenting 10 position BCD, 16 position binary with separate common to not true bits, repeating 1 and 2 pole codes. Guaranteed life of 10,000 detent operations. Operating temperature range of  $-10^{\circ}\text{C}$  to  $+85^{\circ}\text{C}$ , contact resistance of 25 milliohms max. initial.

One year warranty

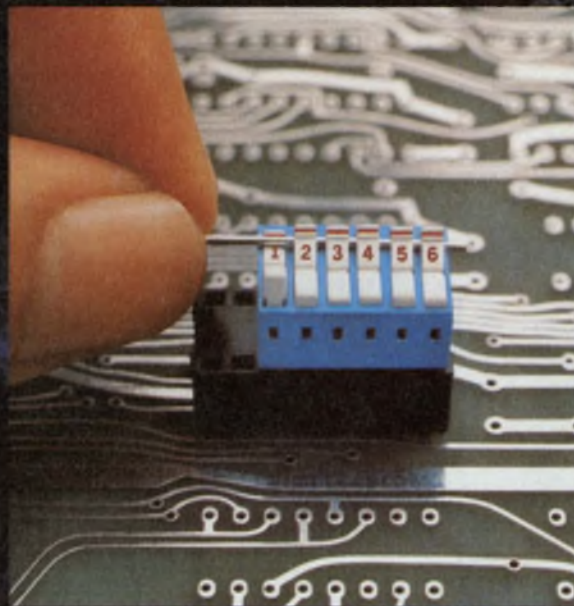

MINI-DIP... new from EECO. Form A and C contact arrangements ideal for positive on/off switching and programming.

Easily actuated, positive wiping, gold contacts are packaged in a dust free glass-filled nylon housing.

Interference-fit of terminal pins and one piece housing prevent contamination. Larger cross section pins allow positive insertion into sockets and PC Boards.

New locking design in which .035 diameter locking rod is inserted through rockers, insures against accidental actuations.

Guaranteed life of 50,000 cycles. Operating temperature range  $-10^{\circ}\text{C}$  to  $+85^{\circ}\text{C}$ , contact resistance 25 milliohms max. initial.

Standard .100 x .300 centers allows retrofitting of other major brands of DIP switches. Available in 2-10 station Form A, 1-5 station Form C contacts.

One year warranty

# EECO

1441 East Chestnut Avenue, Santa Ana, California 92701 - Phone 714-835-6000. Distributed in U.S. by Marshall Industries, Hall-Mark, and Schweber. In Canada by R.A.E. and Perryn. Agents throughout the world.

CIRCLE NUMBER 73



# 12-bit microprocessor, PMOS

## T3190

Alternate sources: None.

Toshiba Transistor Works  
1 Komukai Toshiba-cho Kawasaki-shi  
Kanagawa-ken, Japan  
044-511-3111

The 12-bit microprogrammed parallel processor has machine instructions such as multiply and divide. Other features include asynchronous read/write, DMA capability, eight-level prioritized interrupt and seven addressing modes.

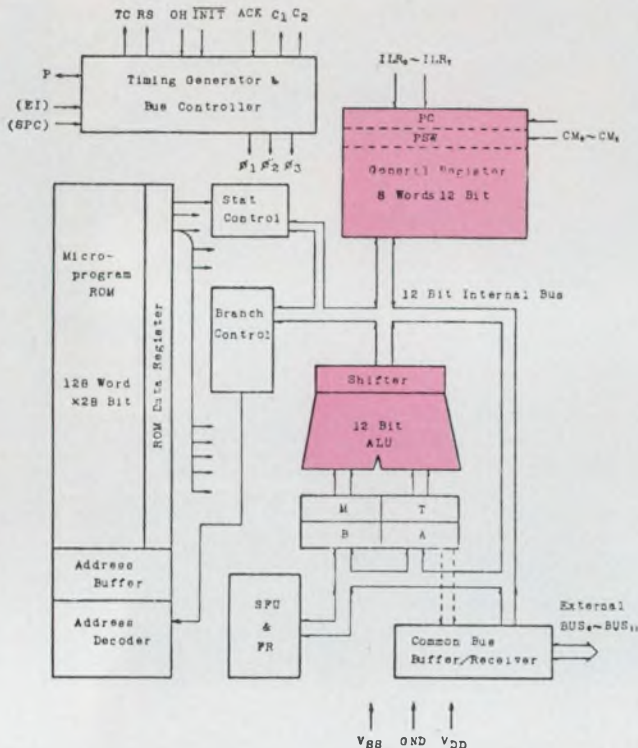

The T3190 has a three-state data/address bus and an eight-word register stack. The minimum system requires a processor, the MM111C RAM, TMM121C PROM, T3416 memory control unit, T3418 I/O control unit, and a 3220 general-purpose I/O register.

### Comments

The instruction set consists of three data transfer instructions, nine logical instructions, seven arithmetic instructions including multiply and divide, and two branch instructions.

**Software support** consists of a cross-assembler and simulator written in Fortran VI, a self-assembler and a software package including debug and PROM program. Floating-point arithmetic package and over 50 other programs are available.

**Software features** of the T3190 include hardware multiply and divide capability as well as multi-bit rotates.

### Specifications

Data word size:	12 bits
Address bus size:	12 bits
Direct addressing range:	4096 words
Instruction word size:	12 bits
Number of basic instructions:	21
Shortest instruction/time (Load register):	6.6 $\mu$ s
Longest instruction/time (Divide):	104 $\mu$ s
Clock frequency (min/max):	0.63/2 MHz
Clock phases/voltage swing:	3/Internal
Dedicated I/O control lines:	None
Package:	36-pin DIP
Power requirements:	5 V/140 mA -5 V/35 mA

### Hardware

Model	Description	Price (100 qty)
T3190	12-bit $\mu$ P	\$47.00
T3219	Interrupt latch unit	13.00
T3220	Gen-purp. I/O register	15.00
T3269	Bidirectional driver	12.00
T3416	Memory control unit	16.00
T3418	I/O control unit	13.00
T3445	DMA control unit	28.00
TMM111C	128 $\times$ 4 static RAM	8.50

**Hardware support** includes EX-0 (a single-board computer containing 512 words of RAM, 3.5 kwords of PROM and a control panel); EX-1 (a single board with 4 k RAM or PROM, TTY interface and a control panel); EX-12/5 (a single board with 2 k of RAM, 2 k of PROM and a control panel); and EX-12/10 (a single board with 2 k of RAM, 2 k of PROM, a TTY interface, a DMA controller and a control panel).



# Gould OS4000

## Unlimited storage, plus hard copy option



The OS4000 dual trace storage oscilloscope gives you unlimited storage time, providing a unique capability for examining waveforms. It is ideal for displaying and recording transient waveforms for medical, electrical, vibration, dynamic testing and pulse testing applications. In addition you get the full capability of a conventional DC to 10MHz dual trace oscilloscope.

Digital storage provides non-flicker viewing of ultra-low frequencies plus simultaneous viewing of stored and real-time signals, and allows examination of single events prior to as well as after the trigger point. By using the 4001 manual or 4002 automatic output options you can have hard copy output on any X-Y or T-Y recorder. Digital output also provided.

For full details on the OS4000 and the 4001/2 Output Options write: Gould Inc., Instruments Systems Division 3631 Perkins Avenue, Cleveland Ohio 44114. Or call the number below. **FOR BROCHURE CALL TOLL FREE AT (800) 325 - 6400 EXTENSION 77** In Missouri: (800) 342 - 6600



## Gould Oscilloscopes

### They have a name for reliability



# 16-bit microprocessor, bipolar

## F100-L

Alternate sources: None.

Ferranti Limited  
Western Road, Bracknell  
Berkshire RG12 1RA, England  
(0344)3232

The F100-L and its support chips use bipolar CDI technology and was developed to meet defense specifications and operate over the full MIL temp range. Its features include an 8 MHz cycle speed via a single-phase clock; multiple direct memory access capability; vectored priority interrupts; and the ability to call external hardware, such as a multiply/divide chip (under development). The 29 basic instructions yield 110 variants.

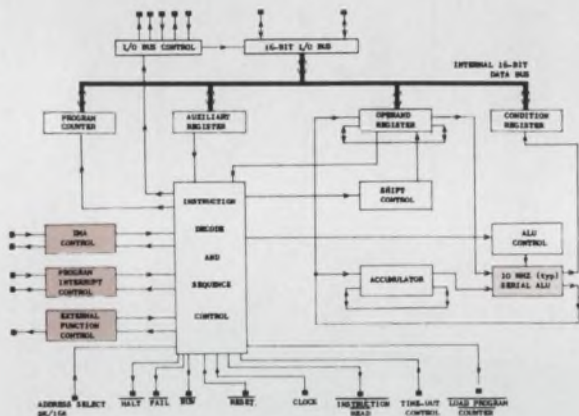

The architecture of the F100-L uses a multiplexed data and address bus. However, to simplify the handling of data many of the bus control functions are handled by support chips. The processor performs all of its ALU operations in a serial mode—the ALU is only 1 bit wide. An external clock is required and a clock rate of up to 20 MHz is possible. All lines are TTL compatible.

### Comments

The **Instruction set** of the F100-L contains 29 commands that are divided into the following groups: load and store (2), arithmetic and logic (7), shifts (6), bit manipulation (2), jumps (10), and machine control (2). The processor also has four addressing modes—direct, pointer indirect, immediate data and immediate indirect.

**Software support** for the F100-L is available on many levels. Programs can be written in F100-L assembly language or in a real-time high-level language called Coral 66. There are several cross-software products—a simulator, an assembler and a linking editor—all written in Fortran IV and available on time-sharing networks or for in-house use.

**Special features of the software** include the ability to transfer control to another "slave" processing

### Specifications

Data word size:	16 bits
Address bus size:	16 bits
Direct addressing range:	32,796 words
Instruction word size:	16 bits
Number of basic instructions:	29
Shortest instruction/time (Uncond. jump):	0.94 $\mu$ s
Longest instruction/time (Jump using stack):	5.75 $\mu$ s
Clock frequency (min/max):	Dc/8 MHz
Clock phases/voltage swing:	1/TTL
Dedicated I/O control lines:	10
Package:	40-pin DIP
Power requirements:	5 V/75 mA

### Hardware

Model	Description	Price
F100-L	Microprocessor (MIL temp range)	N/A
F111-L	Control interface	N/A
F112-L	Data interface	N/A
F101-L	Multiply-divide (under development)	N/A

chip, individual bit set and reset instructions and the indirect addressing modes.

**Hardware support** consists of several chips to simplify direct memory accesses and control of peripheral devices. There are also some micro-computer systems available that can be used for prototyping or the final system. Available are a 13-slot card cage with power supply, a processor card, RAM cards, ROM cards, specialized interfaces and prototyping cards.



# THE FIRST MULTI-PROTOCOL MOS/LSI DEVICE FOR SDLC AND HDLC NOW IN STOCK

Standard Microsystems' new COM 5025 multi-protocol communications controller, is a 40-pin monolithic IC using the COPLAMOS® n-channel silicon gate process. It replaces hundreds of IC's and operates at speeds up to 2 M baud.

The device is a universal synchronous receiver/transmitter for dedicated control and implementation of all major protocols, including bit-oriented types such as SDLC, HDLC, and ADCCP, and byte-oriented BISYNC and DDCMP. It is the first programmable chip controller approved for these protocols and the only one that processes both SDLC and HDLC protocols.

The COM 5025 is processor compatible (8 or 16 bit), and direct TTL compatible, and contains selectable protocols and a tri-state input/output bus. The data, status, and control registers are double buffered. Full or half duplex operation is provided by means of independent transmitter and receiver clocks.

Data lengths are individually selectable for receiver and transmitter from 1 to 8 bits. Data, status and control registers are linked to a master reset which initializes them to the SDLC protocol on power-up. This device also has a built in maintenance feature to test the operation of the chip by performing data loop-around internally.

The controller of the device is responsible for all higher level decisions and interpretation of some fields within message frames. The degree to which this occurs is dependent on the protocol being implemented. The receiver and transmitter logic operate as two totally independent sections with a minimum of common logic.

For bit-oriented protocols such as SDLC, HDLC and ADCCP, the COM 5025 provides bit stuffing and stripping, automatic frame character detection and generation, and residue handling. Messages which terminate with a partial data byte are accompanied by the number of valid data bits available.

Options for bit protocols include variable length data (1 to 8 bit), error checking—16 bit polynomial CRC (or CCITT), primary or secondary station address mode, APA all parties address, extendable address field to any number of bytes, extendable control field to 2 bytes, and idle mode to transmit flag characters or mark the line.

For byte-oriented protocols the COM 5025 features automatic detection and generation of SYNC characters, and options such as variable length data, variable SYNC characters (5, 6, 7, or 8 bits), error checking—16 bit polynomial CRC (or CCITT) or odd/even parity, deletion of leading SYNC characters after synchronization, and an idle mode to transmit SYNC characters or to mark the line.

COM 5025 devices are now available in quantity from SMC and their distributors.

 **STANDARD MICROSYSTEMS  
CORPORATION**  
The largest manufacturer of data communication circuits  
35 Marcus Boulevard, Hauppauge, N.Y. 11787  
(516) 273-3100 TWX-510-227-8898

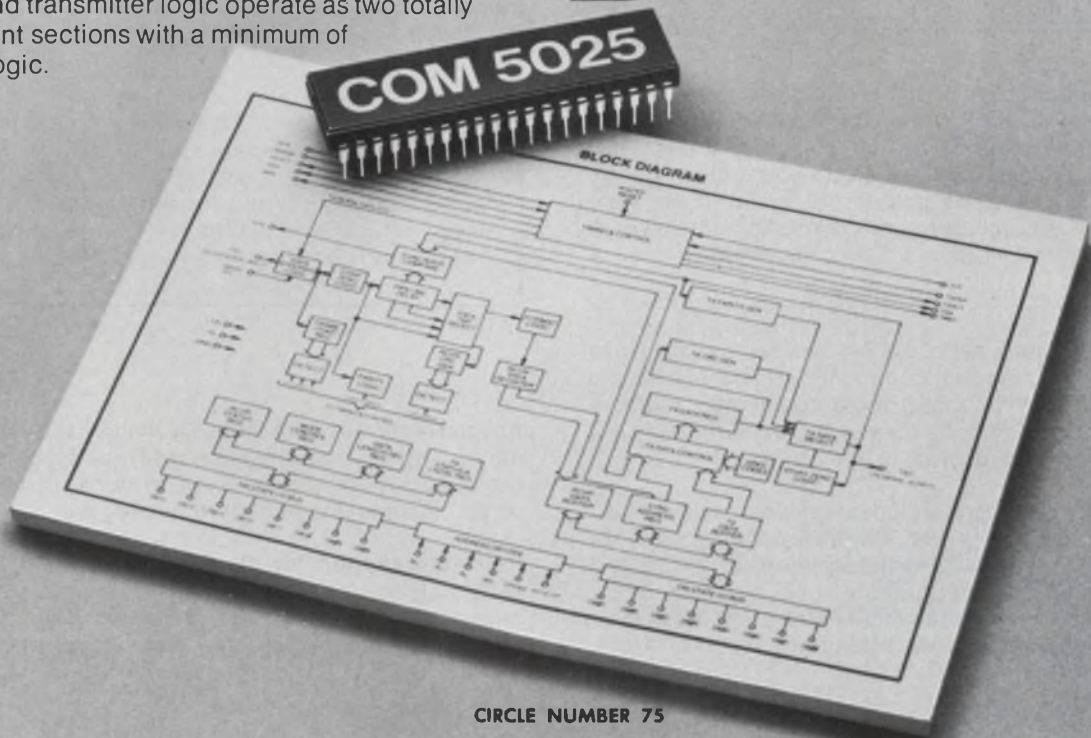



# 16-bit microprocessor, I<sup>3</sup>L

## 9440

Fairchild Camera and Instrument Corp.  
464 Ellis Street  
Mountain View, CA 94042  
(415) 962-5011

Alternate sources: None.

The 9440 is a 16-bit microprocessor fabricated with the company's proprietary Isoplanar I<sup>2</sup>L process (I<sup>3</sup>L). Housed in a 40-pin DIP, the processor requires less than a watt. All of the 9440's software is instruction compatible with the Nova minicomputer series made by Data General Corp. Up to 63 peripheral I/O devices can be serviced via the programmed or interrupt driven I/O.

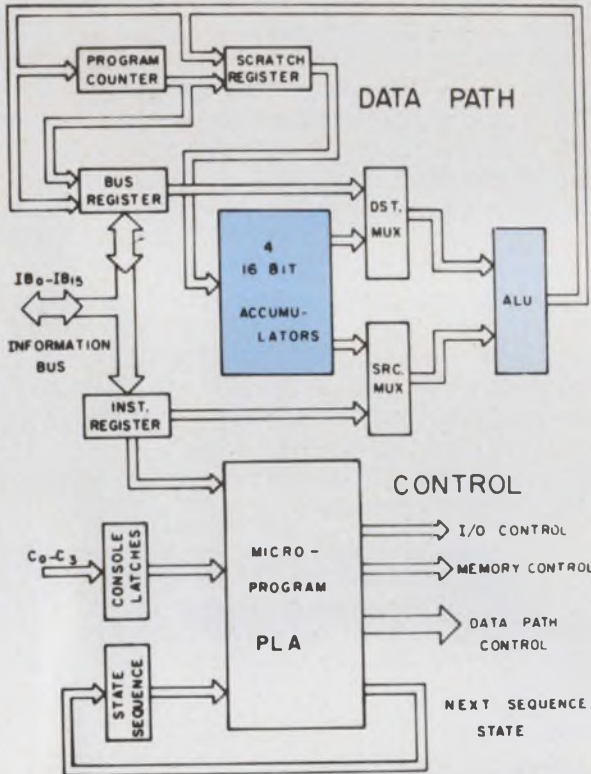

The architecture of the 9440 varies considerably from that of the Nova although the  $\mu$ P can perform the same instructions. The 9440 uses a 4-bit ALU to process data and has an on-board clock generator that just needs an external crystal. Three-state outputs are included on the data/address bus, otherwise all lines are TTL compatible.

### Comments

**The instruction set** of the 9440 contains all the Nova 1200 minicomputer commands. Basic operations include arithmetic and logic commands, memory reference operations, flag or bit test directions, I/O instructions and branch operations.

**Software support** includes resident diagnostics, assemblers, compilers, editors, operating systems, high-level languages such as Basic and Fortran, and stand-alone software. There is no program library available from Fairchild, but many companies offer code-compatible Nova software.

### Specifications

Data word size:	16 bits
Address bus size:	15 bits
Direct addressing range:	32,768
Instruction word size:	16 bits
Number of basic instructions:	
Shortest instruction/time (Jump to subroutine):	1.12 $\mu$ s
Longest instruction/time (Increment and skip if zero):	3 $\mu$ s
Clock frequency (min/max):	Dc/10 MHz
Clock phases/voltage swing:	1/TTL
Dedicated I/O control lines:	4
Package:	40-pin DIP
Power requirements:	5 V/150 mA 1 V/200 mA

### Hardware

Model	Description	Price (100 qty)
9440	16-bit microprocessor There are currently no special support circuits available.	N/A
9441	Memory control unit	N/A
9442	I/O control unit	N/A
9443	Hardware multiply/divide	N/A

**Special features of the software** include the various addressing modes—absolute addressing of page zero, and three relative addressing modes using one of the multiple accumulators or program counter.

**Hardware support** for the 9440 has not yet been defined. However, expected aids will consist of full development systems and hardware debugging tools. Many companies offer Nova hardware.



**Who can fill all your needs for  
KJL-Series I and KJ-Series II  
connectors designed to MIL-C-38999?**



**Cannon can!**

Six decades on the leading edge of interconnect technology.

**CANNON ITT**



# Your complete source for both KJL-Series I and KJ-Series II Connectors

## KJL-SERIES I AND KJ SERIES II (SCOOP PROOF, LOW PROFILE) CONNECTORS...DESIGNED TO MIL-C-38999 WITH CANNON'S NEW HIGH STRENGTH RETENTION SYSTEM "SUPER CAESAR"™

- High contact density
- Lightweight/low-profile/scoop proof
- Environment-resistant
- Operating temperature range from  $-85^{\circ}\text{F}$  to  $+392^{\circ}\text{F}$
- Crimp snap-in contacts in the *NEW SUPER CAESAR*™ rear release contact retention assembly.

ITT Cannon's KJL and KJ miniature circular connectors are environment-resistant and designed to meet the critical performance and design requirements of MIL-C-38999. Engineered for high density circuitry capabilities, these connectors are designed to operate at temperatures ranging from  $-85^{\circ}\text{F}$  to  $+392^{\circ}\text{F}$ . They are readily adaptable to both commercial and space age requirements where size, weight, low-profile/scoop proof design and high reliability are key factors. KJL/KJ connectors are offered in nine shell sizes. A total of 59 contact arrangements are available that will accommodate from 3 to 128 contacts using AWG wire sizes 16 through 28. Contacts are of high conductivity copper alloy with gold plated finish.

The KJL-Series of connectors are designed with a "scoop-proof" feature which provides a safety factor in blind mating applications.

Contact retention is provided by the newly developed SUPER CAESAR™ rear release contact assembly. SUPER CAESAR more than meets the MIL Specs, for contact retention. The assembly features a multiple-tine metal retaining clip housed in a monobloc plastic insert. Contacts are inserted, released, and extracted from the rear of the connector, offering lower installation and maintenance costs to the user.

Monobloc (one-piece) inserts are made of strong, durable plastic. Pin contact cavities in the insert are constructed with a closed-down effect. This feature offers superior pin stability and positive axial alignment of the contacts. Lead-in chamfers in the socket front insert face provide for positive contact mating. The shells also feature five-keyway shell polarization to assure alignment during engagement. A three-point bayonet lock coupling provides fast connect and disconnect. Complete environmental sealing is accomplished by an interfacial seal, with individual raised tapered sealing barriers around each pin contact: a peripheral seal, and a multiple-ripple wire sealing grommet. Hermetic shell styles are also available.

For further information, please contact your nearest ITT Cannon sales office or write to 666 East Dyer Road, Santa Ana, CA 92702. Telephone (714) 557-4700.

### KJL SERIES I

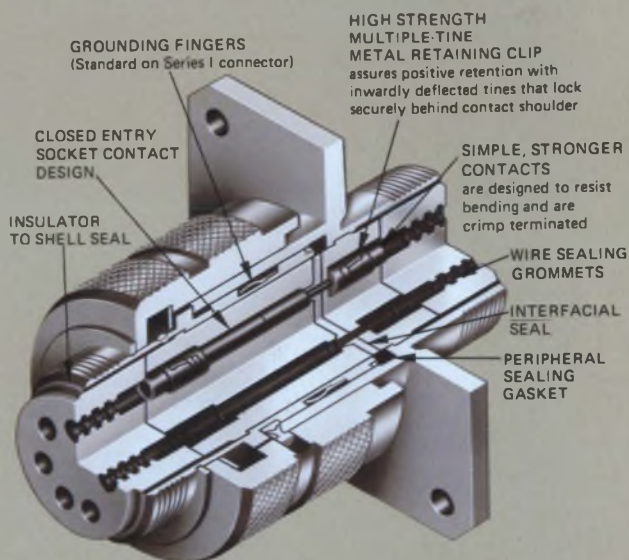

### KJ-SERIES II

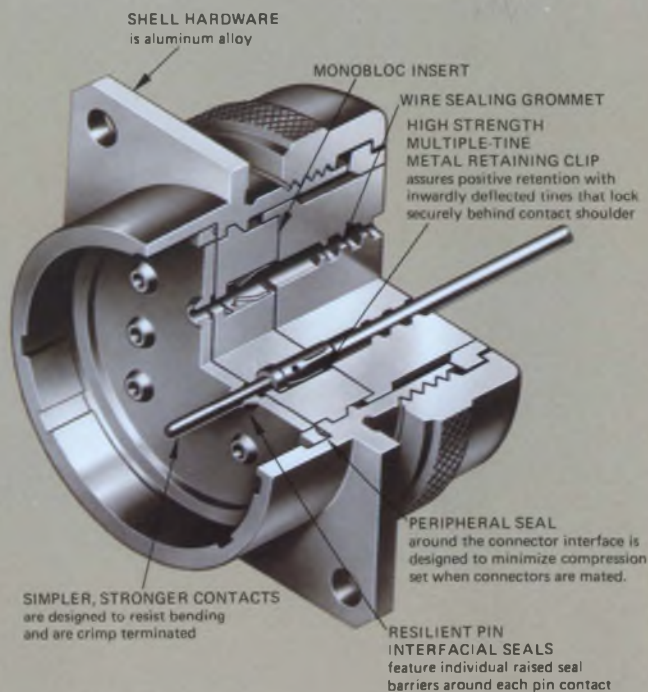



## CONTACT ARRANGEMENTS KJL-SERIES I (ENGAGING VIEW PIN INSERT)

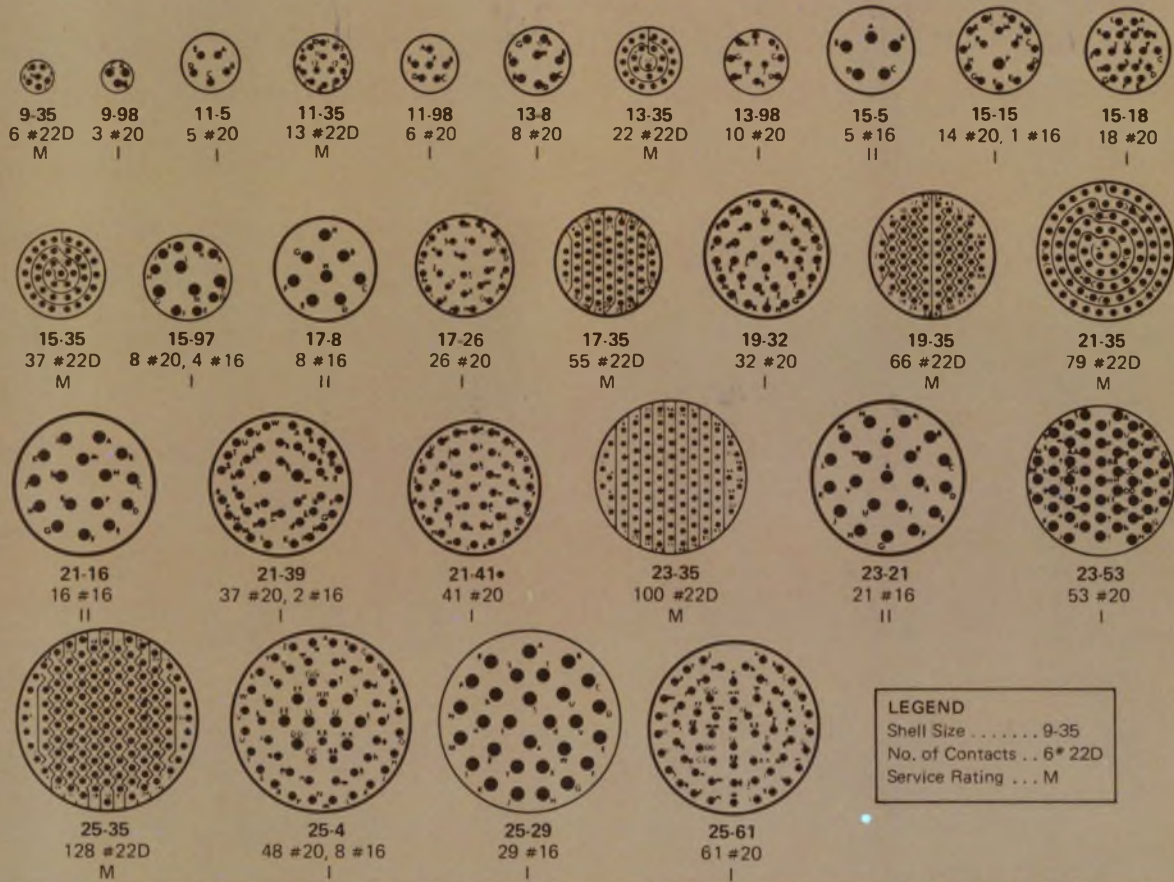

## CONTACT ARRANGEMENTS KJ SERIES II (ENGAGING VIEW PIN INSERT)

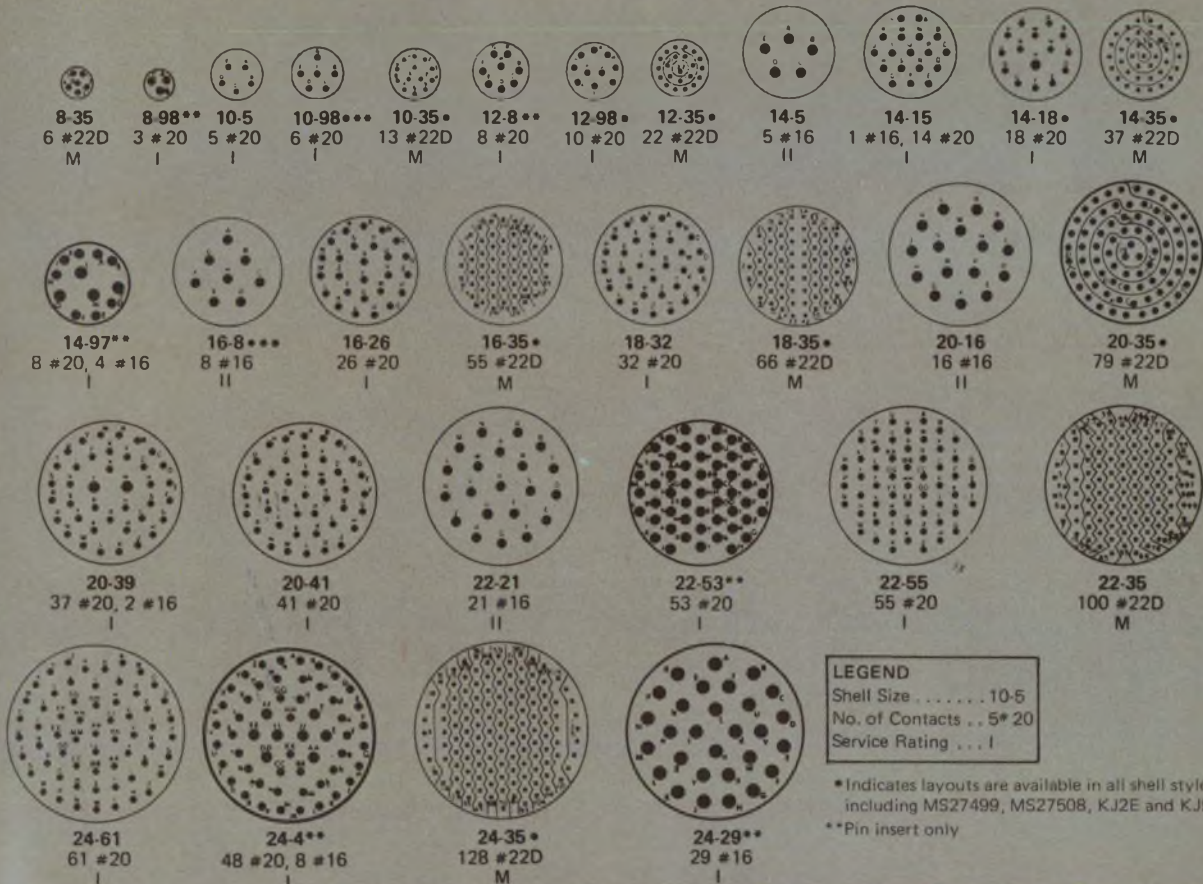



## CONFIGURATIONS KJL AND KJ SERIES I AND II

### Wall mounting receptacles



Available in shell sizes

8 10 12 14 16 18 20 22 24 (KJ Series II)  
9 11 13 15 17 19 21 23 25 (KJL Series I)

### Box mounting receptacles

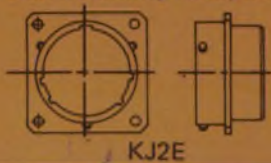

KJ2E

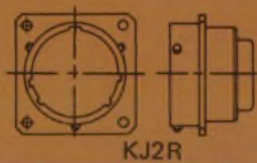

KJ2R

### Back panel configurations

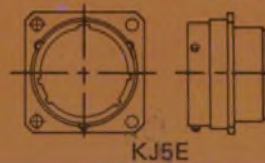

KJ5E

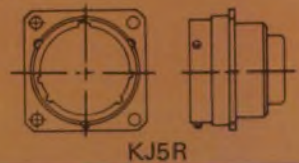

KJ5R

### Straight plugs (RFI grounding spring, std. on KJL 6 and KJG6 plugs.



KJ6 Less Grounding Spring



KJG6

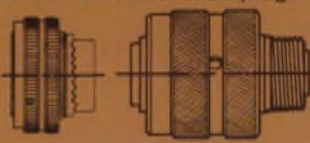

KJL6

### Jam nut receptacles



KJL7



KJ7

### Hermetic receptacles

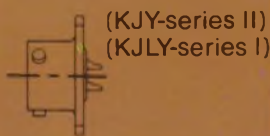

(KJY-series II)  
(KJLY-series I)

### Filter receptacles

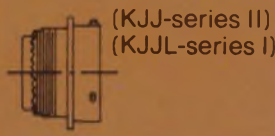

(KJJ-series II)  
(KJJL-series I)

### Backshell accessories



Type E

Type F

Type P

## ACCESSORIES

Shown here are accessories for the new KJL and KJ series. The clean design of the crimp snap-in contacts meets MIL spec requirements. The contacts are made of high conductivity copper alloy and are available in sizes 16 thru 22D. Contact size 16 will accommodate AWG wire sizes 16, 18 & 20. Contact size 20 will accommodate AWG wire sizes 20, 22 & 24. Contact size 22D will accommodate AWG wire sizes 22, 24, 26 & 28.

Wire sealing plugs meet MS27488 standards. The plugs are color coded according to size for easy identification. Both contacts and wire sealing plugs may be ordered separately.

## TOOLS

A complete line of MS and ITT Cannon crimping, insertion and extraction tools are available for the KJL and KJ connectors. All of the tools are precision instruments produced from the finest materials and are designed for long life and trouble-free service.

Insertion and extraction tools may be ordered for both series. These rugged tools are maintenance-free and are color coded for quick contact size identification.

The insertion tools have a single color band to indicate tool size. Extraction tools are coded with two color bands, one to indicate tool size, and one to indicate removal tool.

## AVAILABILITY **Cannon's got it**

ITT Cannon Electric products and engineering services are available throughout the world. Distributors across the United States maintain comprehensive inventories for immediate off-the-shelf delivery; most are Cannon Authorized Plug Specialists (CAPS®). CAPS distributors operate local assembly centers set to our factory standards. More specialized orders are expedited at the factory level.

## Contacts



Series	Cannon Contact	Size	Description	MS Contact*
KJL	021-1251-001	16	Socket	MS27490-16
KJL	031-1250-001	20	Socket	MS27490-20
KJL	031-1147-007	22D	Socket	MS27490-22D
KJ	031-1123-016	16	Socket	MS27491-16
KJ	031-1124-020	20	Socket	MS27491-20
KJ	031-1147-000	22D	Socket	MS27491-22D
KJL/KJ	030-1995-016	16	Pin	MS27493-16
KJL/KJ	030-1997-020	20	Pin	MS27493-20
KJL/KJ	030-2042-000	22D	Pin	MS27493-22D

\*Specification MIL-C-39029/56;/57;/58.

For full details on the KJL/KJ series connectors contact product manager Circulars Division, ITT Cannon Electric, 666 East Dyer Road, Santa Ana, Calif. 92702. Toll-free, 24-hr. (800) 854-3573; in Calif., (800) 432-7063.

See EEM for all your Cannon connector needs.

## Cannon can!

Six decades on the leading edge of interconnect technology.

# CANNON ITT





## **I PREFER THE GOLD BOOK OVER EEM...**

**IT'S EASIER TO HANDLE...EASIER TO LOCATE PRODUCTS AND PHONE NUMBERS ARE LISTED EACH TIME A COMPANY'S NAME APPEARS**

Lillian Herold is Purchasing Manager, Kantz Electronics Industries, Clifton, New Jersey. Kantz designs and prepares prototype circuitry for printed circuit boards and provides manufacturing facilities for PC board production. Her directory? *Electronic Design's* GOLD BOOK.

**"I prefer the GOLD BOOK over EEM because it's easier to handle. The print is easier to read, too, and it's better organized. You can scan quickly to find what you need.**

**"Another great feature of the GOLD BOOK is that phone numbers are listed with each company's name and address in the Product Directory. With EEM I have to take the extra step to refer back to the Manufacturers Directory for the phone listing."**

Ms. Herold uses the GOLD BOOK about 15 times a week. Among other purchases, she has recently ordered 300,000 resistors, 20,000 sockets, solder bars, a wave soldering machine and an axial forming machine through its use.

*Electronic Design's* GOLD BOOK is working for advertisers because it's working for 90,000 engineers, engineering managers, specifiers and buyers — like Ms. Herold — throughout the U.S. and overseas. Is your company represented in its pages?

---

**IF IT'S ELECTRONIC...IT'S IN THE GOLD BOOK!**

---



# 16-bit microprocessor, NMOS

## mN601 (microNova)

Alternate sources: None.

Data General Corp.  
Route 9  
Southboro, MA 01772  
(617) 485-9100

Full Nova minicomputer 16-bit architecture and instruction set is included in a single 40-pin silicon-gate NMOS chip. Subroutine calls can be handled with Save and Return instructions. The processor performs 16-bit hardware multiply and divide, and is provided with hardware stack and frame pointers with stack overflow protection. System memory support can control up to 32 kwords of RAM/PROM, with integral hidden refresh and control logic for dynamic RAMs.

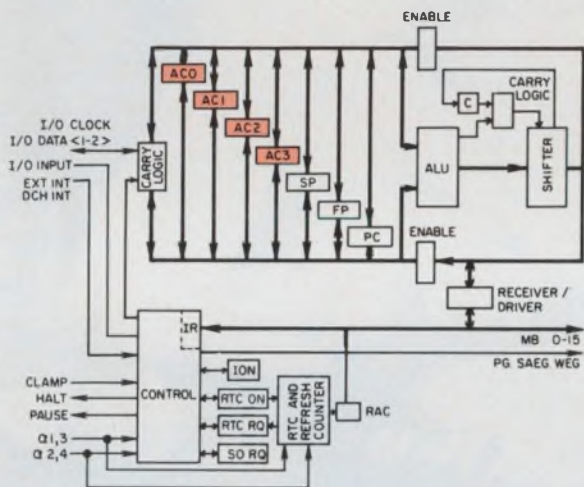

Included in the basic chip set are the mN601 microprocessor, mN640 clock driver and the mN629 I/O transceiver. All I/O lines are decoded for I/O interfacing and are not available for control purposes. The lines are open-collector TTL compatible. Four 16-bit registers in the CPU can act as source or destination accumulator.

### Comments

There are 72 basic instructions that are broken into six groups: Memory-reference, six instructions; Arithmetic and logic, 10 instructions; Input/output, 11 instructions; Stack manipulation, 12 instructions and Central processor control, nine instructions. The microNova instructions are code-compatible with existing Nova minicomputers, thus permitting simple processor upgrades.

The choice of available software is very wide since most Nova software will run on microNova systems. For program development, assemblers, text editors, library file editors and relocatable loaders are available. For disc-based development systems, high-level languages such as Basic and Fortran IV are available in addition to the disc-operating system. Most disc-based systems come with a program library that includes logarithmic, exponential, trig, array handling and character-formatting routines.

Software features include 16-level interrupt and Save and Return instructions for subroutine calls, and 16-bit hardware multiply and divide. Stack capability control is handled with hardware stack

### Specifications

Data word size:	16 bits
Address bus size:	15 bits
Direct addressing range:	32,768 words
Instruction word size:	16 bits
Number of basic instructions:	72
Shortest instruction/time (Add):	2.4 $\mu$ s
Longest instruction/time (Divide):	59.04 $\mu$ s
Clock frequency (min/max):	dc/8.3 MHz
Clock phases/voltage swing:	2/14 V
Dedicated I/O control lines:	None
Package:	40-pin DIP
Power requirements:	5 V/20 mA
	10 V/60 mA
	14 V/30 mA
	4.25 V/0.25 mA

### Hardware

Model	Description	Price (100 qty)
mN601	CPU	\$114.95
mN603	I/O controller	\$70.00
mN606	4-k dynamic RAM	\$13.00
mN629	CPU I/O Transceiver	\$30.00
mN634	Octal bus transceiver	\$10.00
mN506	Quad sense amp	\$12.00
mN636	I/O controller transceiver	\$10.00
mN638	Memory clock driver	\$7.00
mN640	I/O & CPU clock driver	\$7.00

and frame pointer registers. The processor can also handle direct memory accesses via a control line.

Memory support hardware is provided by the following units: Models 8567 to 8570, PROM boards (512 to 4 kwords); Model 8572 (4 k RAM); and Model 8573 (8 k RAM). A PROM programmer board, Model 8574 is also available. Diskette subsystems include the single-drive Model 6038 and the dual-drive Model 6039. Interfacing is provided by the 4210 general purpose interface board and the 4207 asynchronous interface board.



# Datel's 8080 A/D-D/A Advantage

## SINETRAC 800

- ▶ 32 channel A/D - D/A input card slides directly into Intel's MDS-800 or SBC-80/10/20 Microcomputers.
- ▶ Only 2 cards needed for 80 single-ended or 64 differential A/D channels!
- ▶ Super-software supplied on paper tape with full listings in manuals.
- ▶ On-board channel counters and scan-timers reduce CPU housekeeping for fastest speed: True 40 kHz total I/O rate using DMA.
- ▶ Expandable in increments of 48 A/D or 8 D/A channels up to 256 channels each.

COVERED BY GSA CONTRACT

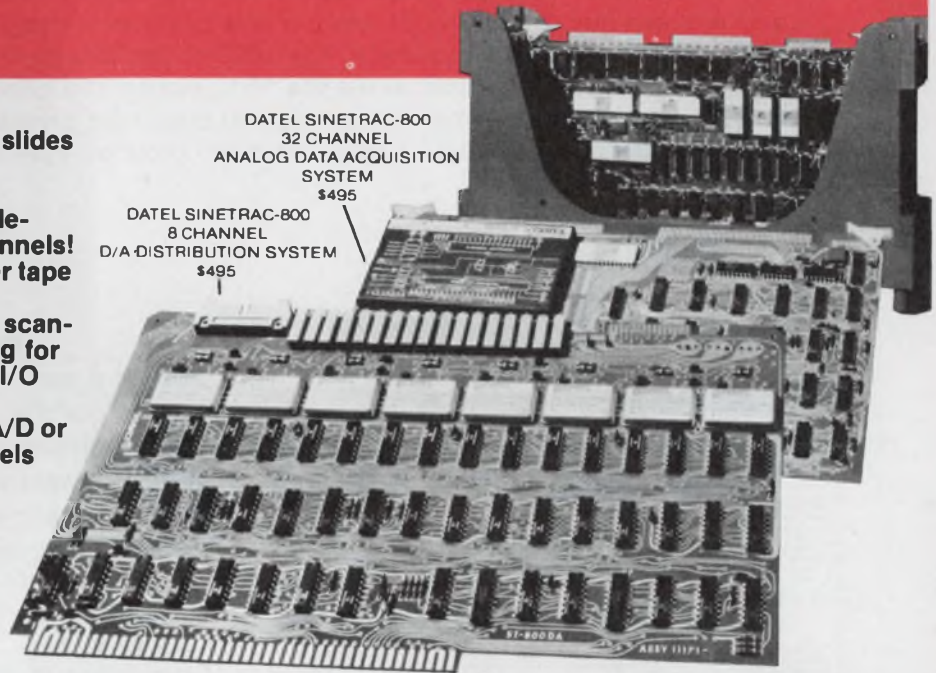

You'll find complete specifications on this product and more than 300 data conversion circuits and systems in Gold Book.

Just check Gold Book's Volume 3. That's Datel's complete Engineering Product Handbook, in its own separate volume. More than 290 pages of D/A & A/D Converters, Multiplexers, Sample-Holds, Op Amps, Power Supplies, Digital Panel Meters, and Printers, Digital Calibrators, Data Loggers, Digital Cassette Recorders, and Data Acquisition Systems. Each fully detailed on individual data sheets.



**DATEL**  
SYSTEMS, INC.

1020 Turnpike St., Canton, MA 02021  
Phone: (617) 828-8000

See Electronic Design's  
1977-78 "GOLD BOOK"-Vol. 3, page 141

Santa Ana, CA (714) 835-2751, (L.A.) (213) 933-7256 • Sunnyvale, CA (408) 733-2424 • Gaithersburg, MD (301) 840-9490 • Houston, TX (713) 932-1130  
OVERSEAS: DATEL (UK) LTD—TEL: ANDOVER (0264) 51055 • DATEL SYSTEMS SARL 620-06-74 • DATELEK SYSTEMS GmbH (089) 78-40-45

CIRCLE NUMBER 77



# 16-bit microprocessor, NMOS

## CP1600, CP1610

General Instrument Corp.  
600 W. John Street  
Hicksville, NY 11802  
(516) 733-3000

Alternate sources: EM&M Semiconductor and ITT Semiconductor.

The CP1600 and 1610 are 16-bit NMOS microprocessors that use a multiplexed data and address bus. Both circuits are pin and instruction compatible and only differ in package and operating frequency. The 1600 comes in a ceramic DIP and operates at clock frequencies to 5 MHz, while the 1610 comes in a plastic DIP and operates to 2 MHz. Either processor can do conditional branching on status word or 16 external conditions as well as handle almost unlimited program interrupts and DMA requests.

### Specifications

Data word size:	16 bits
Address bus size:	16 bits
Direct addressing range:	65,536 words
Instruction word size:	10 bits
Number of basic instructions:	87
Shortest instruction/time (Control group):	1.6 $\mu$ s (5 MHz)
Longest instruction/time (Jump group):	4.8 $\mu$ s (5 MHz)
Clock frequency (min/max):	Dc/5 MHz
Clock phases/voltage swing:	2/10 V (nominal)
Dedicated I/O control lines:	10
Package:	40-pin DIP
Power requirements:	5 V/12 mA 12 V/70 mA -3 V/0.2 mA

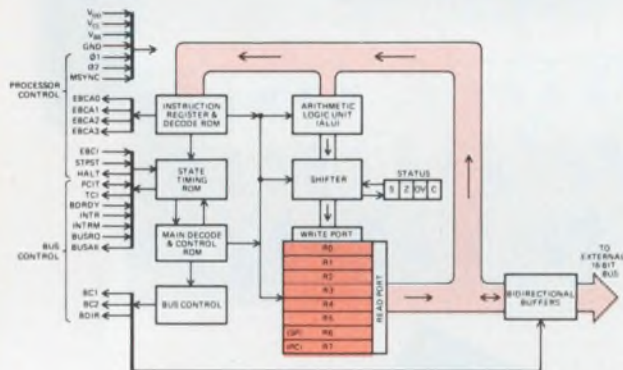

The architecture of the CP1600 family processors starts with a 16-bit parallel ALU and an eight-word general-purpose register file that is directly accessible by the processor. All lines are TTL compatible except for the clock lines, and the 16-line bus has three-state capability.

### Comments

The instruction set for the CP1600 and 1610 contains 87 commands that provide four addressing modes and conditional branching on the contents of the status word. Instructions include: 20 arithmetic and logic operations, eight I/O instructions (also including all four addressing modes), 18 conditional branch commands, six Jump operations, 28 internal register operations and seven control instructions.

Software support for the CP1600 family consists of an assembler, a "super assembler," a text editor, a relocating linking loader, diagnostic routines, an object module linker, and a cross software package written in Fortran IV. There is also an extensive program library available.

Strong points of the software include the large number of conditional branches possible as well as unlimited interrupt capability.

### Hardware

Model	Description	Price (100 qty)
CP1600	16-bit CPU, 3.3 MHz	\$38.50*
CP1600A	16-bit CPU, 5 MHz	N/A
CP1610	16-bit CPU, 2 MHz	\$8.00
DAC1610	Dual d/a converter	4.00
IOB1610	Input/output buffer	4.60
MUX1610	18-channel analog mux	2.95
RO-3-5120	512x10 bit ROM	8.17*
RO-3-20480	2048x10 bit ROM	16.50
	* 1000 qty price	

Hardware support consists of a wide array of circuit boards, cage assemblies and even complete systems. Memory, interface, I/O, CPU and console modules are available for the Gemini micro-computer.



# Datel's A/D-D/A I/O Peripheral Boards for the M6800 Microcomputers

## MODEL ST-6800

- ▶ Slides directly into Motorola's M6800 EXORciser Microcomputer
- ▶ Includes 32 Single-ended or 16 Differential A/D Channels plus 2 D/A Channels on one board
- ▶ Expandable up to 128 A/D and/or D/A Channels
- ▶ Powerful paper tape diagnostic software included!
- ▶ Comprehensive systems manual included!
- ▶ Prices from \$335

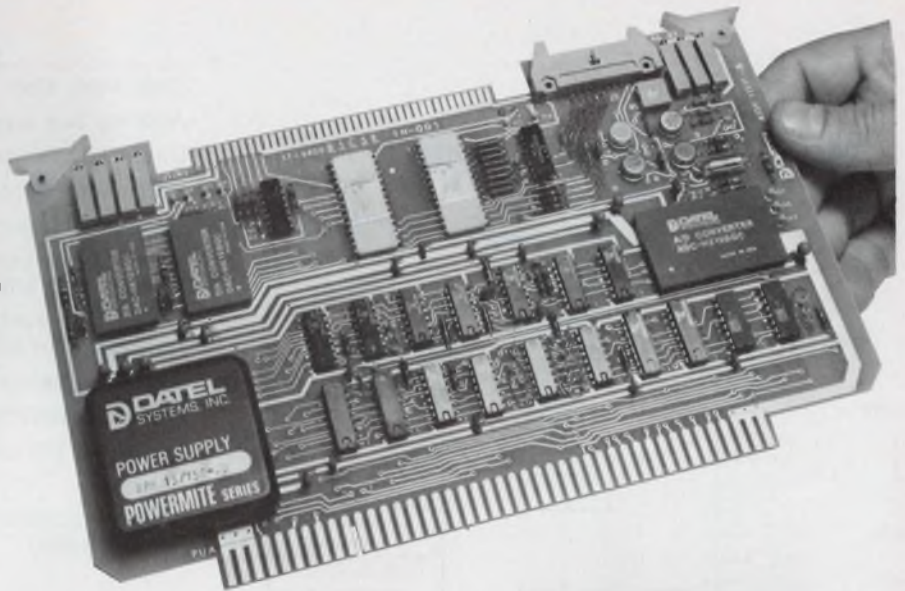

You'll find more specifications on this product and more than 300 data conversion circuits and systems in Gold Book.

Just check Gold Book's Volume 3. That's Datel's complete Engineering Product Handbook, in its own separate volume. More than 290 pages of D/A & A/D Converters, Multiplexers, Sample-Holds, Op Amps, Power Supplies, Digital Panel Meters and Printers, Digital Panel Instruments, Data Loggers, Digital Cassette Recorders, and Data Acquisition Systems. Each fully detailed on individual data sheets. And it's available to you in Gold Book.



**DATEL**  
SYSTEMS, INC.

1020 Turnpike St., Canton, MA 02021  
Phone: (617) 828-8000

See Electronic Design's  
1977-78 "Gold Book"-Vol. 3, page 146

Santa Ana, CA (714) 835-2751. (L.A.) (213) 933-7256 • Sunnyvale, CA (408) 733-2424 • Gaithersburg, MD (301) 840-9490 • Houston, TX (713) 932-1130  
OVERSEAS: DATEL (UK) LTD—TEL: ANDOVER (0264) 51055 • DATEL SYSTEMS SARL 620-06-74 • DATELEK SYSTEMS GmbH (089) 78-40-45

CIRCLE NUMBER 78



# 16-bit microprocessor, NMOS or PMOS

## INS8900 (successor to PACE)

National Semiconductor  
2900 Semiconductor Dr.  
Santa Clara, CA 95051  
(408) 737-5000

Alternate sources: None.

Architecturally similar to the PACE PMOS microprocessor, the INS8900 is intended to supersede the PACE. The 16-bit word size and flexible instruction set give the processor minicomputer-like computational power. Features include an on-chip 10 word stack, indirect addressing, a choice of 8 or 16-bit word operation and memory-mapped I/O.

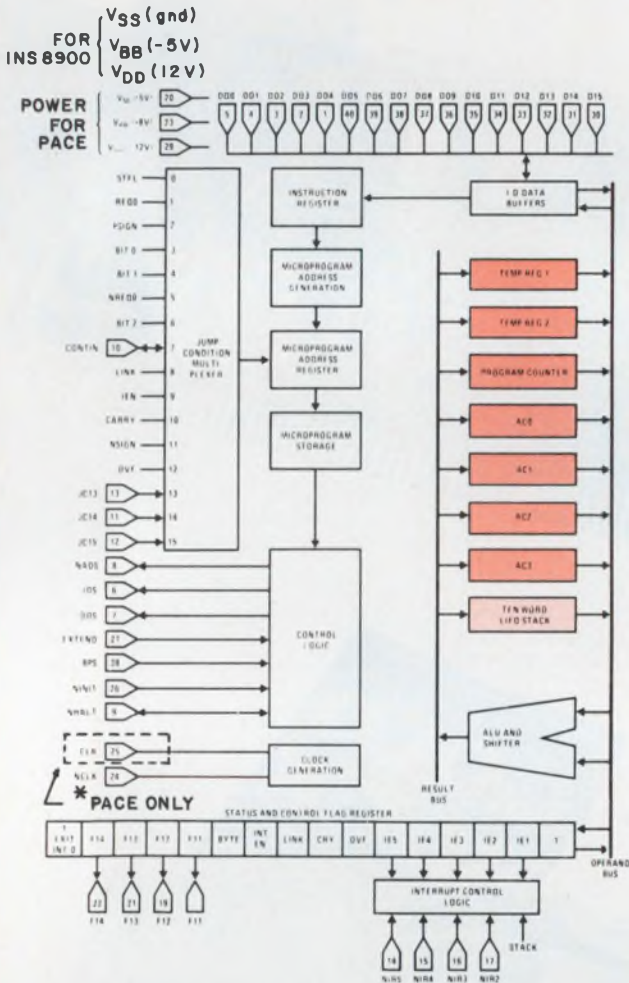

\* ON INS 8900 THIS PIN IS  $V_{CC}(5V)$

The architecture of the INS8900 and the PACE provides a 10-word stack as well as four general-purpose registers and an independent 16-bit status and control flag register. There is also a six-level vectored priority interrupt system built into the chip. However, an external single-phase clock must be supplied. A minimal system consists of the CPU, a clock and some memory.

### Comments

The instruction set of the INS8900 contains 45 commands that can be divided into 12 arithmetic and logic operations, 10 memory reference commands, 13 branch and skip instructions and 10 register operations.

### Specifications

Data word size:	8 or 16 bits
Address bus size:	16 bits
Direct addressing range:	65,536
Instruction word size:	8 or 16 bits
Number of basic instructions:	45
Shortest instruction/time (Load and store):	8 $\mu$ s
Longest instruction/time (Decrement and skip if zero):	16 $\mu$ s
Clock frequency (min/max):	1.5/2 MHz
Clock phases/voltage swing:	1/12 V
Dedicated I/O control lines:	7
Package:	40
Power requirements: for INS8900	5 V/10 mA 12 V/50 mA -5 V/0.2 mA -12 V/40 mA -8 V/0.1 mA 5 V/85 $\mu$ A
for PACE:	

### Hardware

Model	Description	Price (100 qty)
INS8900	Microprocessor	\$19.95
PACE	Microprocessor	19.95

There are no specially designed interface circuits.

Software support for the INS8900 includes conversational assemblers, a Fortran cross assembler, a Basic interpreter and a floppy-disc operating system. There is also a user's group that has a library of over 50 programs.

Software features include multilevel priority interrupts, four separate flag outputs, three jump inputs and simple stack manipulation commands. Software also determines whether the processor performs the operations on either 8 or 16-bit data.

Hardware support for the INS8900 includes CPU card, a floppy-disc operating system, a low-cost development system and an in-circuit emulator to simplify hardware debugging.



# Datel's New Low Priced Digital Panel Meter

MODEL DM-3100

## FEATURES

- ▶ Miniature case with 0.5" LED display
- ▶ Bipolar, differential  $\pm 2$ VFS input
- ▶ 3½ Digit resolution with Autozeroing
- ▶ LCD display available at additional cost
- ▶ Additional ranges — customer programmable
- ▶ 4½ digit resolution also available—\$59 (100's)
- ▶ Additional current and ohmmeter capability — customer programmable

# \$29\*

\$35 (1-99) \$29 (100-499)



You'll find complete specifications on this product and more than 300 data conversion circuits and systems in Gold Book.

Just check Gold Book's Volume 3. That's Datel's complete Engineering Product Handbook, in its own separate volume. More than 290 pages of D/A & A/D Converters, Multiplexers, Sample-Holds, Op Amps, Power Supplies, Digital Panel Meters, and Printers, Digital Panel Instruments, Data Loggers, Digital Cassette Recorders, and Data Acquisition Systems. Each fully detailed on individual data sheets.

And it's available to you in Gold Book.



1020 Turnpike St., Canton, MA 02021  
Phone: (617) 828-8000



See Electronic Design's 1977-78  
"GOLD BOOK"—Vol. 3, page 226

Santa Ana, CA (714) 835-2751, (L.A.) (213) 933-7256 • Sunnyvale, CA (408) 733-2424 • Gaithersburg, MD (301) 840-9490 • Houston, TX (713) 932-1130  
OVERSEAS: DATEL (UK) LTD—TEL: ANDOVER (0264) 51055 • DATEL SYSTEMS SARL 620-06-74 • DATELEK SYSTEMS GmbH (089) 78-40-45

CIRCLE NUMBER 79



# 16-bit microprocessor, NMOS

## MN1610

Alternate sources: None.

Panafacom  
6-17-15 Shinbashi Minatoku  
Tokyo, Japan  
03-438-0311

A high-speed 16-bit parallel processor, the MN1610 has 33 basic instructions. Also included are five arithmetic registers, two of which may be used as index registers. The processor has six addressing modes, a three-level multi-interrupt control, and a bus priority control function for DMA.

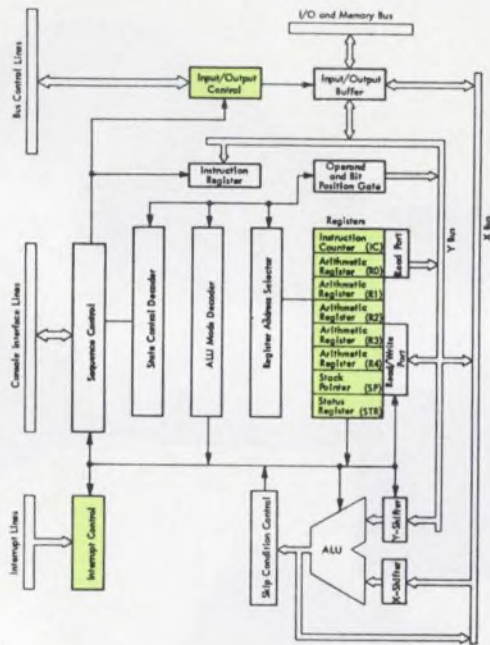

Included in the basic chip set are the MN1610 CPU, the MN1640 real-time controller, and memory—typically 4 kbits of RAM and 8 kbits of ROM. The six I/O lines include four that are output-only and 2 that are input-only. All lines are TTL compatible except the clock input, which is MOS, and the 16 bidirectional data/address bus lines are three-state.

### Comments

The 33 basic instructions built into the processor include six register-to-memory commands, 12 register-to-register commands, 12 register change operations and three I/O and register command instructions. Over 345 possible operation codes are possible using combinations of the addressing modes with various operands. I/O addressing is used, thus permitting up to 256 I/O addresses.

Support software packages include Assembler language processors, Linkage Loaders, and utilities such as Editors, Tracer, and self-debugger. Simulator, ROM support, and channel connection support software programs are also available. Also available are many cross-software programs that can run on large mainframe systems.

Software features include five addressing modes that provide the processors with a flexible programming structure. There are also three levels of mul-

### Specifications

Data word size:	16 bits
Address bus size:	16 bits
Direct addressing range:	65,536 words
Instruction word size:	16 bits
Number of basic instructions:	33
Shortest instruction/time (Add):	3 $\mu$ s
Longest instruction/time (Increment memory and skip):	12 $\mu$ s
Clock frequency (min/max):	100 kHz/2 MHz
Clock phases/voltage swing:	2/12 V
Dedicated I/O control lines:	6
Package:	40-pin DIP
Power requirements:	5 V/60 mA 12 V/55 mA -3 V/200 mA

### Hardware

Model	Description	Price (100 qty)
MN1610	CPU	\$35.00
MN1630	8-bit subchannel adapter	15.00
MN1640	Real-time controller	15.00
MN1650	DMA channel controller	20.00

iple interrupt possible by using information held in the program status word. The register to register operations permit many byte manipulation and byte comparison operations. And, bit manipulation instructions permit individual bits in a word to be set, reset or tested.

Hardware support for the MN1610 ranges from small circuit cards that contain the processor, memory and I/O functions to full blown minicomputer-like systems with front panels and complete machine control. Also available are memory cards, I/O cards, Process control cards, and DMA control cards. The complete system with programmers panel, the L-16A, is available in a 6 or 12-card cabinet.



# Now you can get 3 different types of solid-state relays from P&B.

## That's P&B solid-statesmanship.

Specify P&B solid-state relays for wide choice, top performance, fast delivery. Three designs—103 ratings and voltages—now available from your local distributor. Get P&B experience—nearly two decades of designing solid-state devices.

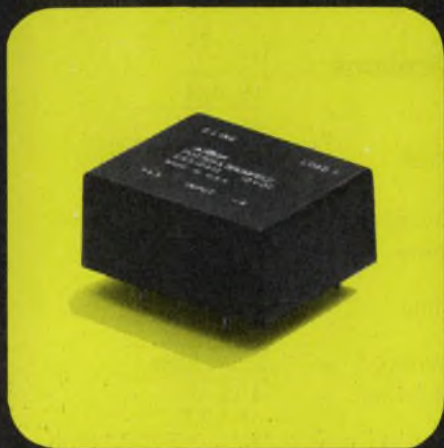

### **New EAX Series. Solid-state 1.2 ampere AC relay. Transformer coupled. Zero current turn-off.**

Low cost, solid-state relays that can be driven directly by logic circuitry (TTL, MOS, HTL, and others). For switching solenoids, fractional hp motors, heating elements, contactors and small lamp loads.

Thyristor switch controlled and isolated by a pulse transformer circuit. Terminals for printed circuit board mounting (0.1" grid).

Expected life of over 100 million operations. Temp. range: storage, -40°C to +85°C. Operating ambient, -10°C to +55°C.



### **EOM/EOT Series. 0.1 to 20 amperes. All solid-state opto-coupled AC relays.**

Medium power, 120/240 VAC 50/60 Hz switches. Controlled and isolated by opto-electronic coupler. For use as ON/OFF switch for loads through 20 amperes. EMI and RFI are greatly reduced due to zero voltage turn-on and zero current turn-off.

An ideal component for interfacing between the logic output of TTL, HTL, or MOS circuitry and such AC loads as solenoids, motors, lamps and transformers.

Expected life greater than 100 million operations. Temp. range: storage, -40°C to +85°C. Operating ambient, -10°C to +55°C.

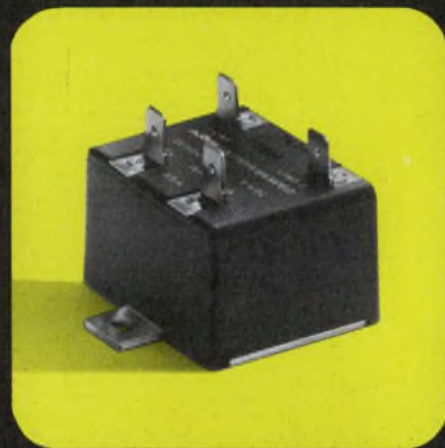

### **ECT Series. Solid-state Hybrid relay. Reed triggered triac. 0.1 to 32 amperes.**

Medium power, 120/240 VAC 50/60Hz solid-state switches controlled and isolated by a reed relay, packaged for direct chassis mounting. Intended for switching AC loads such as solenoids, motors, lamps and transformers through 32 amperes. AC and DC actuation available.

Advantages: long life, high inrush switching capacity and input/output isolation provided by the reed relay.

Expected life greater than 10 million operations. Operating ambient, -10°C to +55°C.

Standard models have .250" quick-connect terminals. .187" and .205" also available.

Ideal applications for P&B solid-state relays include process controls, instrumentation, life support equipment, alarm devices, machine tools, vending machines, dryers, photocopiers, lighting and traffic controls.

See your P&B representative or authorized P&B distributor for specifications on his 103 off-the-shelf solid-state and hybrid relays. Or, write Potter & Brumfield Division AMF Incorporated, 200 Richland Creek Drive, Princeton, Indiana 47671. 812/386-1000.

**AMF**  
**Potter & Brumfield**

# Potter & Brumfield



# 16-bit microprocessor, NMOS 16-bit microprocessor, I<sup>2</sup>L (bipolar)

For NMOS version:  
Texas Instruments  
P.O. Box 1443, MS-653  
Houston, TX 77001  
(713) 494-5115

For I<sup>2</sup>L version:  
Texas Instruments  
P.O. Box 5012, MS-308  
Dallas, TX 75222  
(214) 238-2011

## TMS-9900/SBP-9900

Alternate sources: American Microsystems for the TMS-9900, none for the SBP-9900.

Both the TMS-9900 and SBP-9900 are 16-bit microprocessors with separate data and address buses. The TMS version is a silicon-gate NMOS device that can operate at speeds of up to 3 MHz and requires a four-phase clock input. It's twin, the SBP unit, is an I<sup>2</sup>L equivalent that can operate at 2 MHz clock rates, but it requires just a single-phase clock input. The I<sup>2</sup>L unit also permits the supply current to be adjusted so that power consumption can be reduced in noncritical applications.

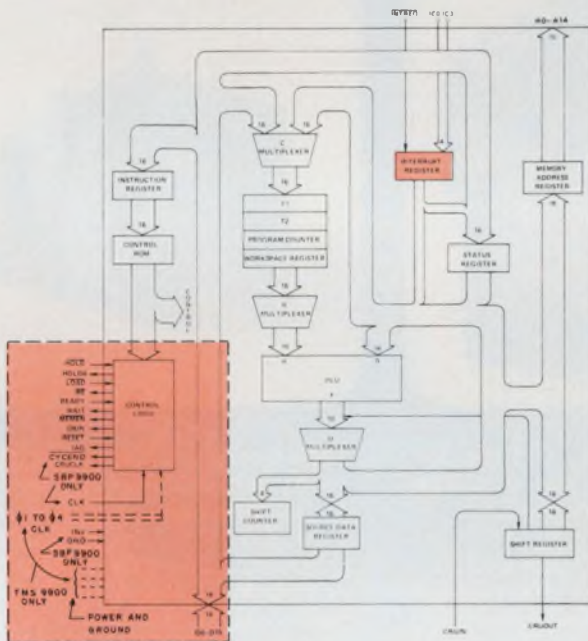

The 16-bit memory-to-memory architecture of the 9900  $\mu$ Ps permits flexible register files to be set up in memory. A minimal system consists of the CPU, a clock generator and the necessary memory.

### Comments

The minicomputer-like instruction set of 69 commands provides 26 arithmetic, logic and data manipulation instructions; 14 internal register to memory operations; five data transfer commands; and 24 control functions. Instructions include binary multiply and divide as well as provisions for 16 prioritized interrupts and programmed and DMA I/O capability.

**Support software** for the 9900-series  $\mu$ Ps includes assemblers, editors, simulators, debuggers and high-level languages such as PL/9900, Basic and Fortran. There is also a program library available since all software is code compatible with the larger 990 minicomputer systems.

**The most outstanding features** of the software include the multiple register file capability and the flexibility offered by the dual bus structure. The

### Specifications

Data word size:	16 bits
Address bus size:	15 bits
Direct addressing range:	32,768 words
Instruction word size:	16 to 48 bits
Number of basic instructions:	69
Shortest instruction/time (Branch):	2 $\mu$ s
Longest instruction/time (Divide):	31 $\mu$ s
Clock frequency (min/max):	0.5/4 MHz
Clock phases/voltage swing:	4/12 V or 1/TTL
Dedicated I/O control lines:	3
Package:	64-pin DIP
Power requirements:	5 V/75 mA -5 V/0.1 mA 12 V/40 mA or variable for I <sup>2</sup> L version

### Hardware

Model	Description	Price (100 qty)
TMS9900	16-bit CPU (NMOS)	\$70.58
SBP9900	EJ version (-40 to +84) C range)	193.00
SBP9900	MJ version (-55 to +125 C range)	386.00
SBP9900	NJ version (MIL 883)	424.60
TMS9901	Programmable interface	8.75
TMS9902	Asynchronous interface	7.50
TMS9904	Clock driver	5.42

processors use addressed I/O and has three software controlled lines—a Hold/Hold Acknowledge, a Ready/Wait, and an Interrupt line.

**Hardware support** for the processors includes a series of 990 modules containing central processor cards and memory cards, the PX990 cassette-based development system and AMPL, a floppy-disc based software and hardware development system.



# METSHIELD™ Fabric. The first major advance in magnetic shielding in 50 years.



## Now in 40" widths

METSHIELD™ Fabric can help you achieve EMC in field repairs, prototype design, production equipment, and shielded rooms.

Now you have such a shielding. METSHIELD™ magnetic shielding fabric—a wholly new flexible product made from Allied Chemical's METGLAS® amorphous metal alloys.

Because of its exceptional strength and flexibility, METSHIELD fabric retains its full shielding effectiveness during fabrication and use.

This reliability of performance—plus the ease with which METSHIELD fabric can be fabricated—enables you to use magnetic shielding as a preferred method to achieve electromagnetically compatible system designs. And METSHIELD fabric now comes in 40" (1 meter) widths for even greater design flexibility.

Discover how this remarkable material can help meet your shielding needs. Phone John Dismukes at 201-455-4031 or Jack Thorp at 201-455-3306. Or return the coupon.

This is the magnetic shielding product whose time has come.

Increased sales of electronic equipment, a trend toward miniaturization and intensified regulatory considerations have put increased emphasis on EMC.

Consequently, electronics manufacturers need cost-effective magnetic shielding not plagued by fabrication problems and use limitations associated with conventional nickel alloys.

-----  
Check boxes for information on METGLAS® alloys and METSHIELD™ fabric.

- Technical data
- Fabrication
- Grounding and contacting
- Other (specify) \_\_\_\_\_
- Send me sample of METSHIELD fabric

Name/Title \_\_\_\_\_

Company \_\_\_\_\_

City/State/Zip \_\_\_\_\_

Mail to: Metglas Products, Allied Chemical Corporation  
7 Vreeland Road, Florham Park, NJ 07932

-----  
 **Allied  
Chemical**  
Metglas Products



# 16-bit microprocessor, NMOS

## TMS 9980

Alternate sources: None.

Texas Instruments Inc.  
P.O. Box 5012, M/S 308  
Dallas, TX 75222  
(214) 238-2011

Software compatible with the TMS 9900 series of microprocessors, the 9980 incorporates a 16-bit CPU with an 8-bit data bus and an on-chip clock in a single 40-pin package. The separate bus structure simplifies system designs, and memory-to-memory architecture features multiple register files, in memory, for faster response to interrupts. Adding memory forms a working minimum system.

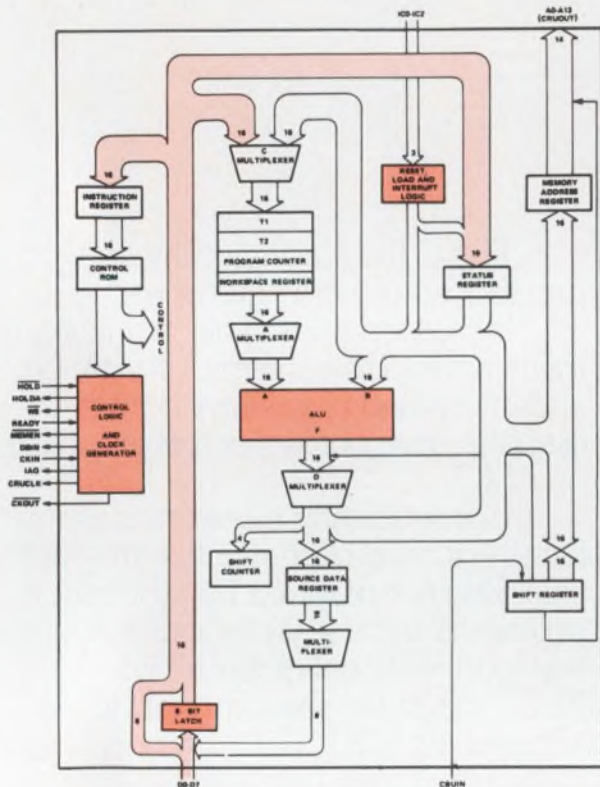

The TMS 9980 is almost identical in architecture to the TMS/SBP 9900. The only difference is that the 9980 uses an 8-bit data bus instead of a 16-bit, a 14-bit address bus instead of a 15 bit and has fewer levels of prioritized interrupt. And, the 9980 has its clock generator built onto the same chip.

### Comments

The minicomputer-like instruction set of the TMS 9980 is identical to that of the TMS/SBP 9900 processors. Included are 26 arithmetic, logic and data manipulation instructions, 14 internal register to memory operations, five data transfer commands and 24 control functions. Instructions include binary multiple and divide as well as provisions for four levels of prioritized interrupt. The processor also has programmed DMA and I/O capability.

**Software support** for the TMS 9980 consists of assemblers, editors, simulators, debuggers and high-level languages such as PL/9900, Basic and Fortran. There is also a program library available.

### Specifications

Data word size:	16 bits*
Address bus size:	14 bits
Direct addressing range:	8192 words
Instruction word size:	16 to 48 bits
Number of basic instructions:	69
Shortest instruction/time (Branch):	4.8 $\mu$ s
Longest instruction/time (Divide):	54.4 $\mu$ s
Clock frequency (min/max):	1 MHz/2.5 MHz
Clock phases/voltage swing:	1/TTL
Dedicated I/O control lines:	11
Package:	40-pin DIP
Power requirements:	12 V/50 mA 5 V/50 mA

\*Memory is organized in byte format; two sequential bytes form one data word.

### Hardware

Model	Description	Price (100 qty)
TMS 9980	CPU	\$30.62
TMS 9901	Programmable interface	8.75
TMS 9902	Asynchronous interface	7.50
TMS 9905	8:1 multiplexer	1.26
TMS 9906	8-bit latch	1.55
TMS 9907	8:3 priority encoder	1.01
TMS 9908	8:3 priority encoder	1.01

The most outstanding features of the software include the multiple register file capability and the flexibility offered by the dual bus structure. The processor uses addressed I/O and has several lines that control I/O operations—the Hold, Hold Acknowledge, Ready, Wait, Interrupt Control and Control Register lines.

**Hardware support** for TMS 9980 development includes all the support for the 9900—the TM 990 microcomputer modules, the PX 990 cassette-based prototyping system and AMPL, a floppy-disc based development system.



# Specifier's QPL Shopping List.

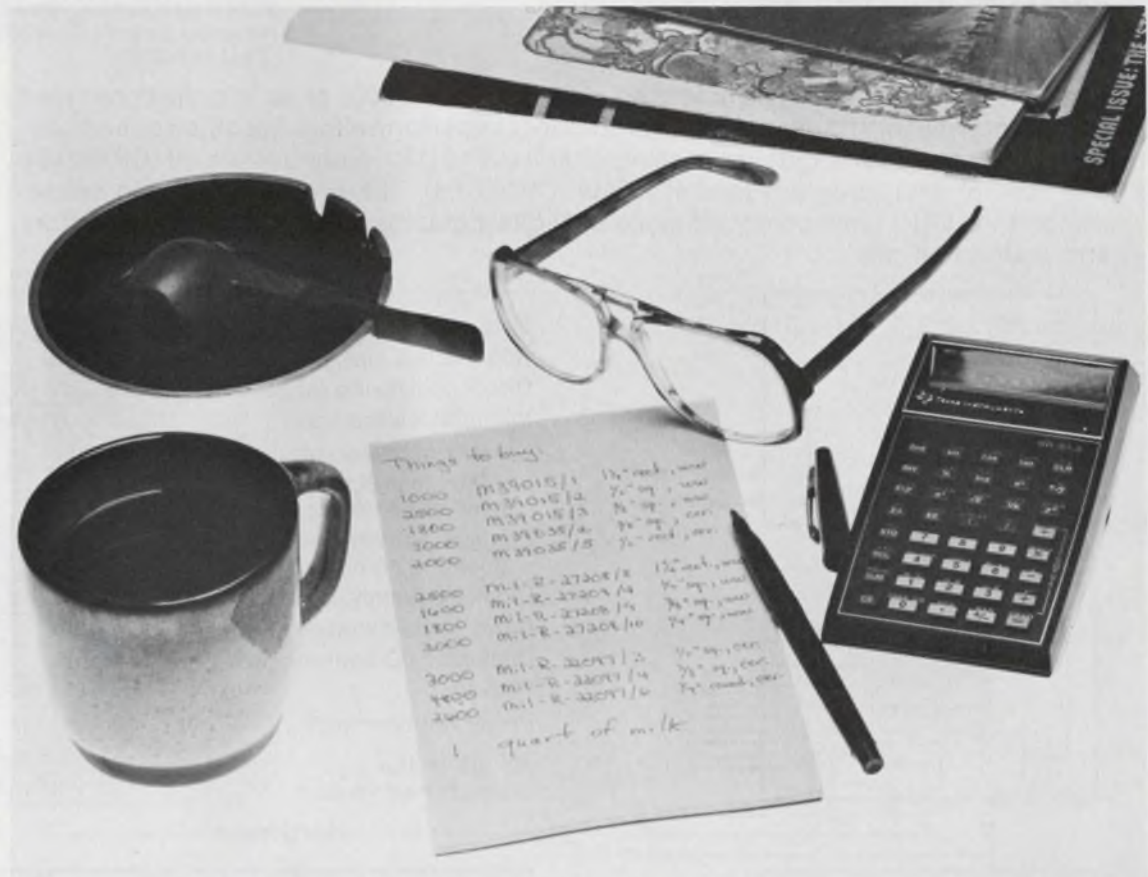

Shop the Weston Mil-Qualified Trimmer Supermarket for great selection and quality!

WESTON MIL-QUALIFIED TRIMMERS			
Type	Mil Spec.	Term.	Description
RTR12	M39015/1	L.P.Y	1/4" Rectangular. Wirewound
RTR22	M39015/2	L.P.W.X	1/2" Square. Wirewound
RTR24	M39015/3	L.P.W.X	3/8" Square. Wirewound
RJR24C.F	M39035/2	P.W.X	3/8" Square. Cermet
RJR28C	M39035/5	P	1/2" Rectangular. Cermet
RT12C2	Mil-R-27208/8	L.P.Y	1/4" Rectangular. Wirewound
RT22C2	Mil-R-27208/4	L.P.W.X	1/2" Square. Wirewound
RT24C2	Mil-R-27208/9	L.P.W.X	3/8" Square. Wirewound
RT26C2	Mil-R-27208/10	P.W.X	1/4" Square. Wirewound
RJ22C	Mil-R-22097/3	L.P.W.X	1/2" Square. Cermet
RJ24C.F	Mil-R-22097/4	L.P.W.X	3/8" Square. Cermet
RJ50C	Mil-R-22097/6	P	1/4" Round. Cermet

Weston Mil-Qualified Trimmers will meet all your most demanding applications because they're designed and manufactured to the highest government standards for consistently superb performance. For model specifications, check our chart. With 12 Mil-Qualified Trimmers to choose from, we're sure you'll find just what your shopping list calls for. And on the way home, don't forget to stop for that milk!

**SANGAMO WESTON**  
**Schlumberger**

WESTON COMPONENTS & CONTROLS  
A Division of Sangamo Weston, Inc.  
Archbald, Pa. 18403  
Tel. (717) 876-1500  
TWX 510 656-2902  
Telex 83-1873



RTR12

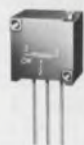

RTR22



RTR24



RT22C2



RT26C2



RJ50C

CIRCLE NUMBER 82



# 16-bit processor set, NMOS

## MCP-1600/WD-16

Alternate sources: None.

Western Digital Corp.  
3128 Red Hill Ave., Box 2180  
Newport Beach, CA 92663  
(714) 557-3550

Available as either an unprogrammed chip set (MCP-1600) or as a preprogrammed processor (WD-16), the multiple-chip processor can perform either 8 or 16-bit operations. Both sets consist of a data-processing circuit (CP1611B), a control circuit (CP1621B), and several microprogram-control ROMs (CP1631Bs). The programmed chip set resembles the LSI-11 minicomputer made by Digital Equipment Corp. in both architecture and instruction set.

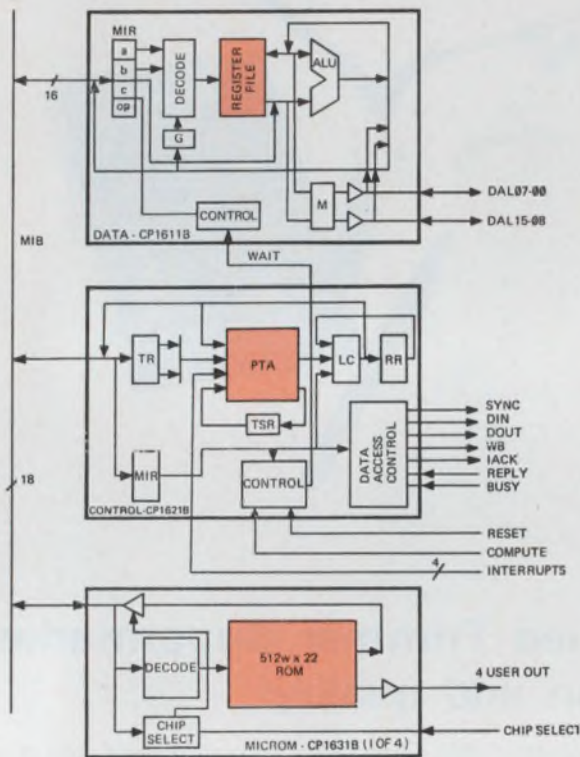

The basic chip set consists of a data-manipulation chip containing an 8-bit ALU and 26 8-bit registers. The 16 registers can be set up to act as program counter, stack pointer, accumulator and general-purpose 8 or 16-bit registers. A typical minimal system consists of a data chip, a control chip, two to four ROM chips, a clock generator and buffers.

### Comments

The **WD-16 instruction set** consists of 16 branch commands, 16 register-only operations, five floating-point arithmetic instructions, eight block-move directions, three supervisory commands, 16 single-operand word operations, 16 single-operand byte operations, 12 double-operand instructions (word and byte), and eight different addressing modes. There are no dedicated I/O instructions since the processor uses memory-mapped I/O. Software includes vectored interrupts with a 16-bit priority mask, hardware multiply/divide, floating-point arithmetic and up to 16 Mbyte addressing.

**Available software** includes an assembler, editor, simulator, and debugger that are intended to run on a disc-based PDP-11/05 system from DEC. Single-

### Specifications

Data word size:	8 or 16 bits
Address bus size:	16 bits
Direct addressing range:	65,536 words
Instruction word size:	2 to 6 bytes
Number of basic instructions:	116*
Shortest instruction/time (load condition codes):	2.1 $\mu$ s
Longest instruction/time (Floating point div.):	780 $\mu$ s
Clock frequency (min/max):	2/3.3 MHz
Clock phases/voltage swing:	4/12 V
Dedicated I/O control lines:	None
Package:	40-pin DIP
Power requirements:	5 V/50 mA
	-5 V/0.5 mA
	12 V/35 mA

\*Or 99 in the programmed version

### Hardware

Model	Description	Price (100 qty)
WD-16	CPU chip set	N/A
FD1771	Floppy-disc controller	\$60.00
TR1602	UART	7.00
TR1863	UART (5-V only)	8.55
BR1941L	Baud-rate generator	7.50
UC1671	Astro (mux'd address)	30.00
UC1971	Astro (chip select)	N/A
TR1953	USART (Intel 8251 equiv)	10.00
TR1923	BOART (async only)	8.00
SD1933	Synchronous data-link controller (1 to 9)	55.00
DM1883	DMA controller	N/A
FR1502	FIFO buffer (40 x 9)	16.00
CG1921J	Clock generator (4 $\phi$ )	7.50

user software, floppy-disc based, without higher-level languages, is available in source form.

**Software features** include hardware register-save/restore, vectored-interrupt overhead consisting of two op codes, and program-counter-relative addressing. Supervisory calls automatically save registers or do a tabled jump. The floating-point format uses an 8-bit exponent and a 40-bit mantissa.

**Prototyping hardware** includes a two-board CPU set that is S-100 bus compatible, as well as a single-board floppy-disc controller (also S-100 bus compatible) that has on-board PROM-based software and a DMA controller. A microprogramming development system consisting of a CPU, writable control store and memory boards is available.



# First in the Industry!

## LEDs with PHOTOCONDUCTORS

### in DIP OPTO-ISOLATORS

Clairex has developed these four LED/photoconductive cell isolators in the conventional dual-in-line package. They are truly an industry first! The inherent slower speed response of a photoconductive cell, as compared to a silicon detector, provides an ideal unit for

noise and transient immunity.

All four units have a photoconductive cell output capability of 250 volts PAC along with an isolation voltage of 1500 PAC. They also feature a minimum  $R_{OFF}$  of one megohm and guaranteed  $R_{ON}$  maximums

at  $I_f$  biases of 16 ma and 1 ma respectively.

The CLM 50 and CLM 51 incorporate a GaP LED with a photoconductive cell for both linear and logic functions. The CLM 60 and CLM 61 feature two GaP LEDs connected in inverse parallel in their input cir-

cuits to facilitate an a-c input signal to the isolator.

For complete details or any other assistance with your opto-electronic problems, call 914-664-6602 or write Clairex®, 560 South Third Avenue, Mount Vernon, New York 10550.

**LED- PHOTOCONDUCTOR DIP ISOLATORS**

The CLM50 and CLM51 incorporate a GaP LED connected with a photoconductive cell to provide a 1500 PAC isolation voltage for both linear and logic functions. The unit provides low voltage output capability of 250V PAC, isolation voltage of 1500V PAC and a minimum  $R_{OFF}$  resistance of 1 Meg. Controlled resistances are featured at 16mA and 1mA respectively. Typical and maximum resistances are listed at four operating voltages.

**TECHNICAL DATA**

LED	CHARACTERISTICS	TEST CONDITIONS	Min.	CLM50 Typ	CLM51 Max	UNITS
$I_f$ max.	Maximum forward current			2.0	40	mA
$V_f$	Forward voltage	$I_f = 16 \text{ mA}$		2.0	2.5	VOLTS
$I_r$	Reverse current	$V_r = 3 \text{ V}$		250	250	100% DC of PAC
PHOTOCELL $V_{max}$	Cell voltage			50	50	volts
$P$	Power dissipation	25° C		1.5W	1.75W	watts
PHOTOMOD $R_{ON}$	On resistance	$I_f = 1 \text{ mA}$ $I_f = 16 \text{ mA}$		1 Meg	1 Meg	ohms
$R_{OFF}$	Off resistance	5 sec after $I_f = 0$ & VDC on cell		500	500	ohms
$t_r$	Rise time	Time to 63% of final condition at $I_f = 16 \text{ mA}$		50	60	microseconds
$t_d$	Decay time	Time to 100K		1500	1500	microseconds
$V_{iso}$	Isolation			1	1	with DC or PAC
$\alpha_{TCS}$	Cell temperature coefficient	$I_f = 1 \text{ mA}$				%/°C

**CLM50-CLM51**

**DUAL LED PHOTOCONDUCTOR DIP ISOLATORS**

The CLM60 and CLM61 incorporate two GaP LEDs connected in inverse parallel and coupled to a photoconductive cell. Inverse parallel A-C signal input capability. The photoconductive cell outputs feature 250V PAC values and both units have 1500V PAC isolation levels, along with 1 Meg. minimum  $R_{OFF}$  resistances. Controlled resistances are featured at 16mA and 1mA respectively.

**TECHNICAL DATA**

LED	CHARACTERISTICS	TEST CONDITIONS	Min.	CLM60 Typ	CLM61 Max	UNITS
$I_f$ max.	Maximum forward current			2.0	2.5	mA
$V_f$	Forward voltage	$I_f = 16 \text{ mA}$		2.0	2.5	VOLTS
PHOTOCELL $V_{max}$	Cell voltage			50	50	100% DC of PAC
$P$	Power dissipation	25° C		1.5W	1.75W	watts
PHOTOMOD $R_{ON}$	On resistance	$I_f = 1 \text{ mA}$ $I_f = 16 \text{ mA}$		1 Meg	1 Meg	ohms
$R_{OFF}$	Off resistance	5 sec after $I_f = 0$ & VDC on cell		500	500	ohms
$t_r$	Rise time	Time to 63% of final condition at $I_f = 16 \text{ mA}$		50	60	microseconds
$t_d$	Decay time	Time to 100K		1500	1500	microseconds
$V_{iso}$	Isolation			1	1	with DC or PAC
$\alpha_{TCS}$	Cell temperature coefficient	$I_f = 1 \text{ mA}$				%/°C

**CLM60-CLM61**

**CLAIREX ELECTRONICS**  
A DIVISION OF CLAIREX CORPORATION  
560 South Third Avenue, Mount Vernon, N.Y. 10550 (914) 664-6602

# CLAIREX ELECTRONICS

A Division of Clairex Corporation

CIRCLE NUMBER 83



# 2-bit processor slice, Schottky-TTL

## Series 3000

Alternate sources: Signetics.

Intel Corp.  
3065 Bower Ave.  
Santa Clara, CA 95051  
(408) 246-7501

The Series 3000 bipolar bit slices are two-bit microprogrammable processor sections that contain a multifunction arithmetic and logic unit, some working registers and the necessary control logic. The processor chip, the 3002, can be cascaded to form an  $n \times 2$  bit system. The multiple buses that act as inputs and outputs make the processor readily adaptable to many high-speed controller applications.

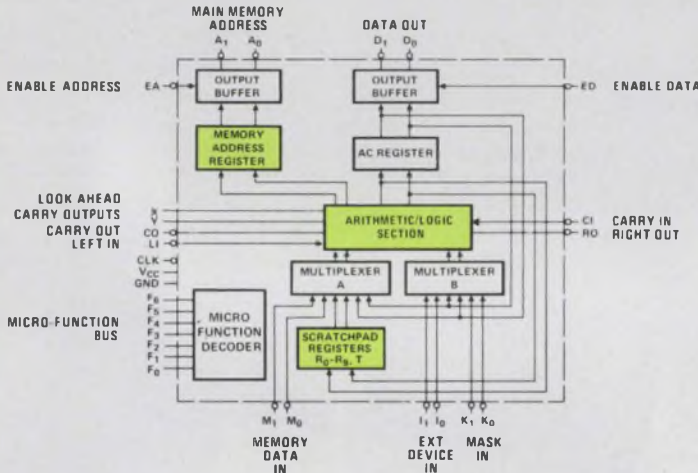

A minimal system for the Series 3000 is hard to define since the user determines the processor word length and the amount of microprogram storage needed. A typical 16-bit machine application, though, might require about 25 to 35 devices. The processor's architecture revolves about the ALU and 11 general-purpose registers. All operations are controlled by the function bus, which accepts the microprogram control words and selects both operands and the ALU operation to be performed.

### Comments

The instruction set of the 3002 central processing element consists of over 40 Boolean and binary operations, all controlled by the 7-bit input to the function bus. Each 3002 has five independent two-line buses that accept data from external memory (M bus), transfers data from an I/O device (I bus), function as a microprogrammed mask (K bus), act as a memory address bus (A bus) and function as a data bus (D bus).

Software support for the Series 3000 consists of CROMIS, a cross microassembler written in Fortran IV and available for use on a 16-bit or larger computer system. There is no general program library available for the family.

### Specifications

Data word size:	2 bits
Address bus size:	On micro-program controller
Direct addressing range:	512 words on 3001
Instruction word size:	7 bits
Number of basic instructions:	Over 40
Basic ALU instruction execution time:	150 ns
Clock frequency (min/max):	Dc/6.67 MHz
Clock phases/voltage swing:	1/TTL
Dedicated I/O control lines:	User defined
Package:	28-pin DIP
Power requirements:	5 V/190 mA

### Hardware

Model	Description	Price (qty.)
D3002	2-bit processor slice	\$13.35
D3002M	MIL version of slice	48.15
D3001	Microprogram controller	8.80
D3001	MIL version	26.75
D3003	Look-ahead carry gen.	6.60
P3212	Hex buffer	2.90
P3214	interrupt controller	4.65
P3216	Hex bus driver	2.75
P3226	Hex bus driver	2.75

Software features put the various I/O buses to good use. For instance, output buses A and D often present address and data to external main memory during the same microcycle. Also, operations such as byte swapping can be done in fewer cycles than with other processors by taking advantage of the D and M bus manipulation commands.

Hardware support for the series 3000 consists of the Intellec MDS 800 system with the following options: ICE 30, an in-circuit emulator; ROM SIM, a ROM simulator; and a PROM programmer. There is also a chip set available for the designer to begin breadboarding his circuit.





**Series 97-520\***  
A smaller size Sticky Fingers for high shielding effectiveness in less space.

**Series 97-560**  
Newest series, 1/2" wide double-twist, ideal for panel divider bar cabinets.



**Series 97-555**  
Single Twist series for use when space is at a premium. Measures a scant 3/8" wide.



# stickn fingers®

## RFI/EMI SHIELDING from Instrument Specialties attaches faster, shields better than anything else!

Instrument Specialties line of Sticky-Fingers beryllium copper gaskets provides *the* answer for just about every RFI/EMI problem.

Each strip is backed with a strong, *really* sticky self-adhesive that attaches quickly, grips and holds securely. There's no need to drill holes, no need for metal fasteners. You merely cut the strip to the desired length, peel the backing, and apply.

What's more, you get shielding effectiveness of up to 126 dB at 10 GHz plane wave, or greater than 90 dB at 1 MHz magnetic. Whether you want to keep interference in or out—in new installations or retrofits—with standard or narrow flanges—there's a Sticky Fingers contact strip to do your job *better!*

Our complete catalog of RF shielding strips and rings is available free. Write today to Dept. ED-85.

**INSTRUMENT SPECIALTIES CO., INC.**

Little Falls, New Jersey 07424

telephone: 201-256-3500 twx: 710-988-5732

**Specialists in beryllium copper since 1938**



**Series 97-500\***  
The original, 3/4" wide Sticky Fingers with superior shielding effectiveness.

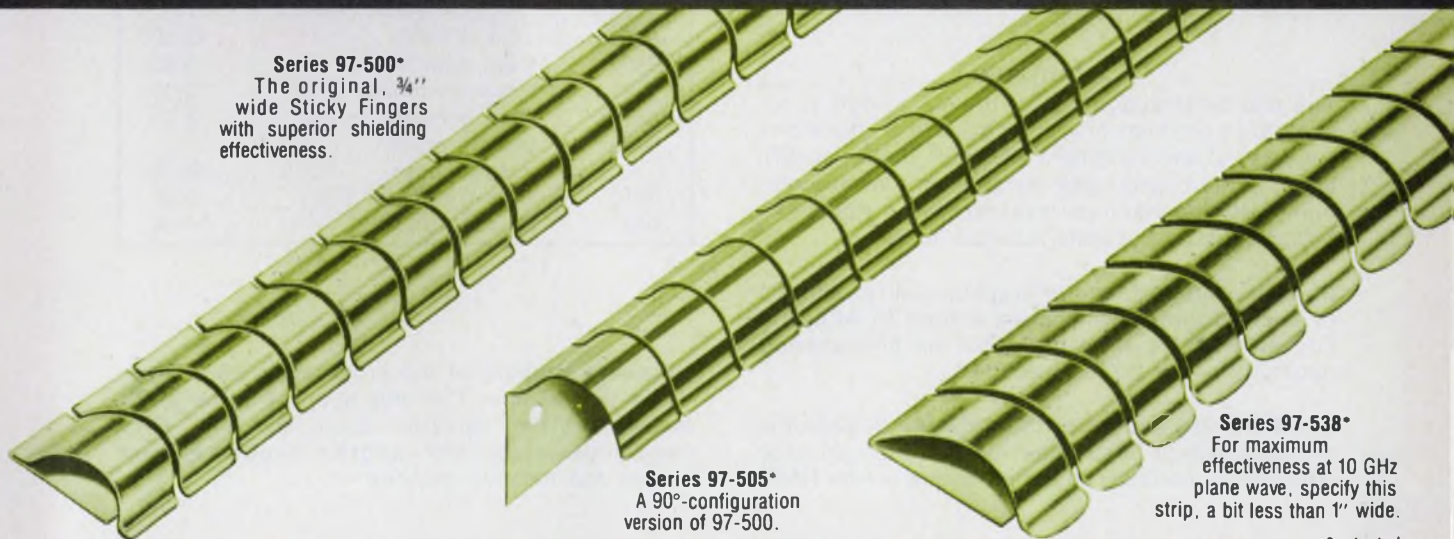

**Series 97-505\***  
A 90°-configuration version of 97-500.

**Series 97-538\***  
For maximum effectiveness at 10 GHz plane wave, specify this strip, a bit less than 1" wide.

\*patented



# 4-bit processor slice, CMOS or STTL

## Macrologic (9405A, or 34705)

Fairchild Camera and Instrument Corp.  
464 Ellis Street  
Mountain View, CA 94042  
(415) 962-3955

Alternate sources: Signetics.

The Macrologic 4-bit processor slice is available in either CMOS or Schottky-TTL technologies. The ALU sections, 9405A for STTL and 34705 for CMOS, can be cascaded and then microprogrammed to form a complete digital processor. Containing an eight instruction ALU and an 8 × 4 bit RAM bank, the processor slice can operate at microinstruction rates of 10 MHz. A total of 64 microinstructions are possible via the six instruction code lines. The processor comes in a 24-pin "skinny" DIP (400 mils wide).

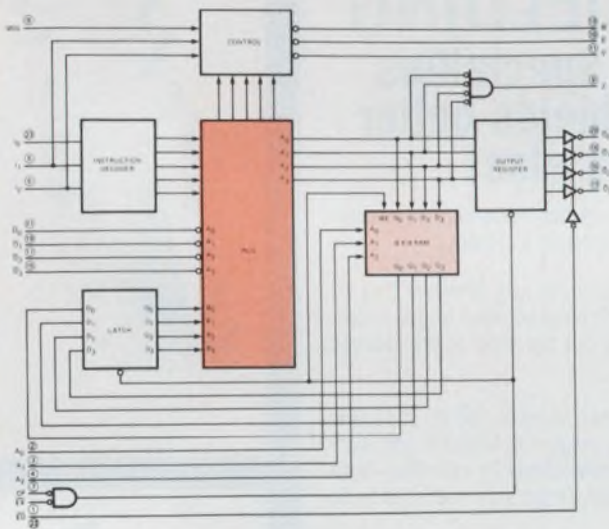

The architecture of the Macrologic slices is such that the chips can be cascaded to make an  $n \times 4$  bit processor. Carry outputs are provided for carry-lookahead operation and three status signals are also available—accumulator zero, negative or overflow. The four data output lines have three-state capability. A minimal system is hard to define, but a typical organization might use 30 to 50 chips.

### Comments

The microinstruction set for the Macrologic processor slice contains only eight basic ALU operations—Add, Add and increment, AND, OR, Exclusive-OR, Load, Output, and Load complement. When combined with the eight address instruction inputs, the processor's instructions increase to 64.

Software support for the processor slice consists of microprogram assemblers written in APL and Fortran that are available either on time-sharing networks or for direct purchase.

Outstanding features of the software include the relatively simple instruction organization and the addressing flexibility of the on-chip 8 × 4 bit RAM.

### Specifications

Data word size:	4 bits
Address bus size:	4-bit expandable
Direct addressing range:	User defined
Instruction word size:	6 bits (ALU)
Number of basic instructions:	8 (ALU only)
Shortest instruction/time (any microinstruction):	100 ns
Clock frequency (min/max):	Dc/12 MHz
Clock phases/voltage swing:	1/TTL
Dedicated I/O control lines:	User defined
Package:	24-pin DIP
Power requirements:	5 V/160 mA

### Hardware

Model	Description	Price (100 qty)
9405A	4-bit processor slice from—	\$12.00
34705	CMOS version of 9405A	15.31
9401	Cyclic redundancy check generator	7.80
9403	16 × 4 FIFO	13.00
9404	Data path switch	3.90
9406	Program stack	12.00
9407	Data access register	8.75
9408	Microprogram sequencer	34.75
9410	16 × 4 register file	5.50
9423	64 × 4 FIFO	N/A

Hardware support for the processor slice is practically nonexistent. The only support is the availability of the circuits such as the CRC checker/generator, the program sequencer and specialized memory devices.



**Need miniature audio transformers  
in most popular configurations  
in any of three sizes?**

**TRW/UTC has a stock answer.**

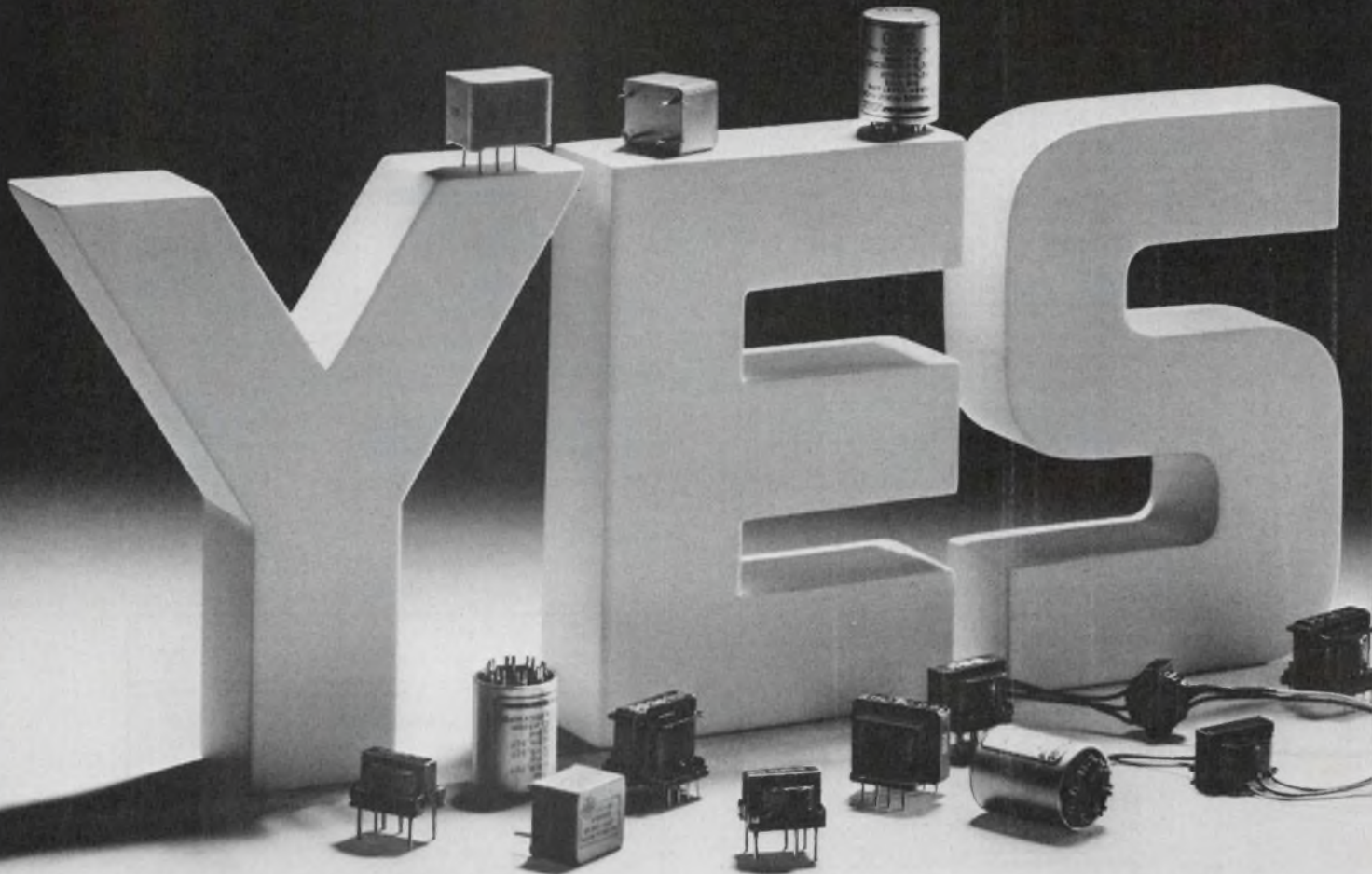

TRW/UTC has a line of miniature industrial audio or signal transformers that come in three wattage ratings. And, they're available in four different configurations.

To find the unit you need, check the table below.

	Ouncer	Subouncer	Sub-Subouncer
P.C. Board Mounting	PC-O Series	PC-SO Series	PC-SSO Series
Flexible Leads		SO Series	SSO Series
Molded		SO#P Series	SSO#P Series
Alarm Housing	O Series		

Because our miniatures come in 4 styles, you have a choice. Now you can design our unit into your circuit in the manner most convenient for you.

For immediate off-the-shelf delivery check your authorized TRW/UTC local distributor. Or for more information on standards that are something special, contact TRW/UTC Transformers, an Operation of TRW Electronic Components, 150 Varick Street, New York, N.Y. 10013. Area Code: 212-255-3500.

CIRCLE NUMBER 85

**TRW UTC TRANSFORMERS**

ANOTHER PRODUCT OF A COMPANY CALLED TRW



# 4-bit processor slice, Schottky TTL

## Am2901A

Advanced Micro Devices  
901 Thompson Place  
Sunnyvale, CA 94086  
(408) 732-2400

Alternate sources: Fairchild, Monolithic Memories, Motorola, National Semiconductor, Raytheon, Sescosem, and Signetics

The Am2901A has become the "industry standard" 4-bit bipolar processor slice. It consists of a 16 word  $\times$  4 bit two-port RAM, a high-speed arithmetic and logic unit and the necessary shifting, decoding and multiplexing circuitry. Any number of 2901A slices can be cascaded to make a processor with a word length of  $n \times 4$ . There are many support circuits available, and also the widest number of second sources for any bit-slice device.

\*Coming soon from AMD is an enhanced version of the 4-bit slice, the 2903, which will have additional instructions such as multiply and divide.

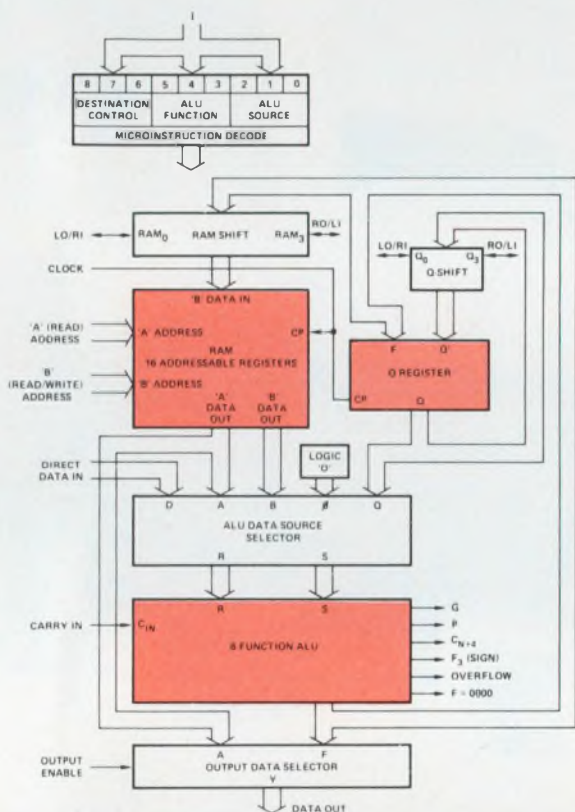

A minimal system is hard to pin down since the word size can be set to any size. However a typical number of circuits would be between 40 and 60. The high-speed ALU in the 2901A can perform its operations on two 4-bit input words, one from a two-input multiplexer and the other from a three-input mux.

### Comments

The instruction set of the 2901A bit slice permits many variations, as determined by the way the nine-bit instruction word is set up. The ALU itself only has eight possible basic operations, but there are also eight source operands and another eight destination codes, for 256 operations.

**Software support** for the 2901A bit slice consists of three programs—AMDASM/TS, a time-shared microprogram assembler; AMDASM/80, a microprogram assembler that can run on the Intel Microprocessor development system; and AMDASM/29, a resident assembler for the System 29 microprogram development system made by AMD.

**Software features** include the two register or-

### Specifications

Data word size:	4 bits
Address bus size:	User defined
Direct addressing range:	User defined
Instruction word size:	9 bits
Number of basic instructions:	8
Basic ALU instruction execution time:	110 ns typ.
Clock frequency (min/max):	dc/15 MHz
Clock phases/voltage swing:	1/TTL
Dedicated I/O control lines:	4 flag lines
Package:	40-pin DIP
Power requirements:	5 V/160 mA

### Hardware

Model	Description	Price (100 qty)
Am2901A	4-bit processor slice	\$14.70
Am2901A	MIL version	71.40
Am2902	Carry look-ahead	2.65
Am2905	Bus interface ckt. O.C.	5.40
Am2906	Bus interface ckt. O.C.	7.45
Am2907	Bus interface ckt. O.C.	4.75
Am2909	Microprogram sequencer	5.95
Am2910	Microprogram controller	N/A
Am2911	Microprogram sequencer mini version	3.95
Am2913	Interrupt expander	2.53
Am2914	Vectored interrupt controller	29.95
Am2918	One-by-two-port register	3.08
Am29LS18	Low power Am2918	2.60
Am2919	Another version, 2918	3.10
Am2930, 31 & 32	Program control units	N/A
Am29803	16-way branch control	4.95
Am29811	Instruction controller	3.25

ganization of the 2901A, making possible a wide number of instruction combinations. There are four status flags—carry, overflow, zero and sign—that can function as outputs and there is also a left or right shift operation available that is independent of the ALU.

**Development hardware** includes the Am2900K1, a learning and evaluation kit. Also available is the System 29 microprogramming system.



# Here in Wabash James Pobst can sell his eggs for less because he grows his own feed. We make relays the same way – sort of.

We make our own switches. That not only helps lower the cost of our relays, it does something else that's important.

Since James Pobst knows what's gone into his chickens, he knows what kind of eggs he's going to get. Same way with us. We know what our relays with our switches in them are going to do. And just to make sure – we run over 3 billion test cycles a day.

That's what you get in a Wabash relay – performance you can count on – no matter which of over 6000 variations you select. Of course all meet proposed NARM and EIA standards.

But as we say – the best news is our price. Why not call us for a quote on a dry reed relay now. Look at it this way. If you found out later you could have purchased a better relay at a lower price from us – you'd have egg on your face.

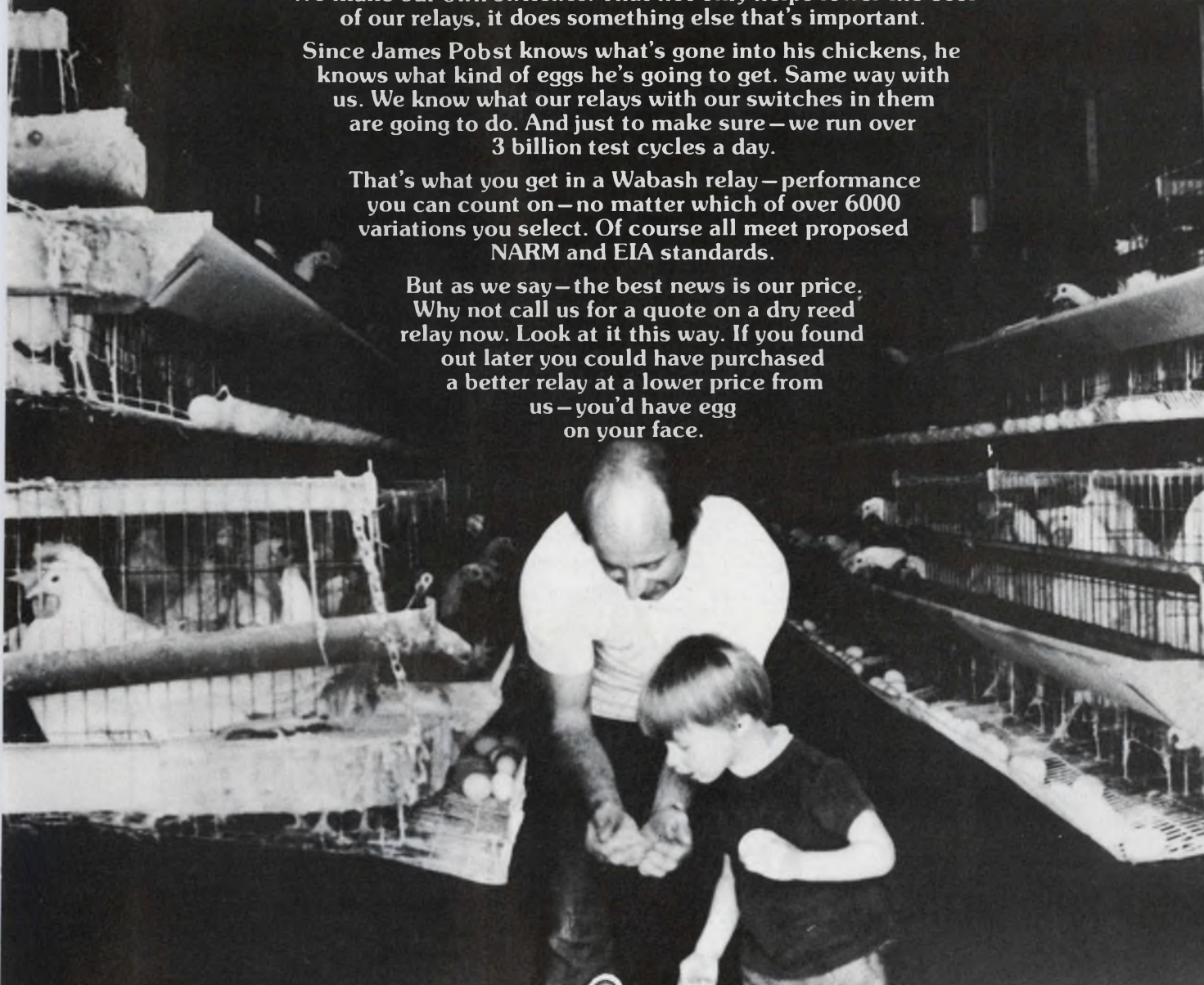

*Coils, Relays & Transformers*  
**wabash**  
of  
**Wabash, Indiana**  
and Huntington, Indiana; Farmington, Missouri;  
Tipton, Iowa and South Boston, Virginia  
For information and quotes write or call:  
Wabash, Inc., Dept. RC-5, 810 N. Cass St., Wabash, Ind. 46992 Tel: 219/563-2191 TWX 810-290-2722  
CIRCLE NUMBER 86



The Econo-Miser. The most automatically manufactured dry reed relay available. 1 and 2 pole standard types. Less than one dollar in quantity.



# 4-bit processor slice, bipolar (STTL)

## 5701/6701

Monolithic Memories, Inc.  
1165 E. Arques Ave.  
Sunnyvale, CA 94086  
(408) 739-3535

Alternate sources: ITT Semiconductor.

A 4-bit slice of a digital processor on a single chip, the 5701/6701 provides 36 instructions and has 16 directly addressable, two-port accumulators, a separate scratchpad register bank and a 175 ns cycle time. The slices can be cascaded with full carry look-ahead and they have a low fan-in input bus and a three-state output bus.

### Specifications

Data word size:	4 bits
Address bus size:	User defined
Direct addressing range:	User defined
Instruction word size:	8 bits (internal)
Number of basic instructions:	36
Shortest instruction/time (5701 or 6701):	175 or 230 ns
Clock frequency (min/max):	Dc/5.2 MHz
Clock phases/voltage swing:	1/TTL
Dedicated I/O control lines:	User defined
Package:	40-pin DIP
Power requirements:	5 V/280 mA

### Hardware

Model	Description	Price (100 qty)
5701	4-bit slice (MIL)	\$ 56.50
6701	4-bit slice (commercial)	26.15
57110	Microprogram controller (MIL version)	28.00
67110	Microprogram controller (commercial version)	14.00

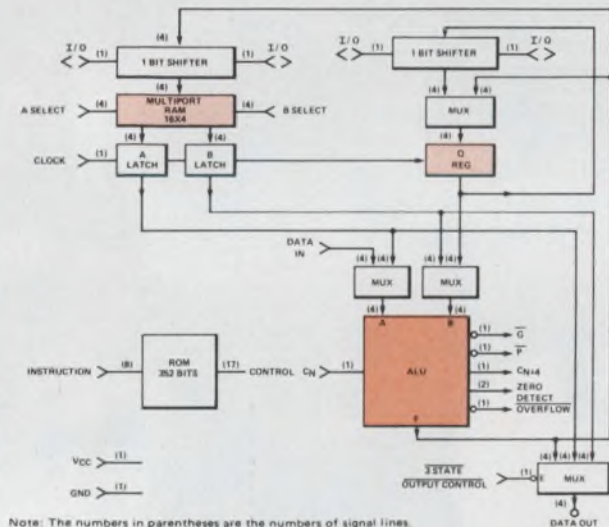

Note: The numbers in parentheses are the numbers of signal lines.

The architecture of the 5701/6701 bit slice includes a 16 word x 4 bit dual-port RAM as well as a 36 instruction ALU and a single 4-bit working register that can be used as a second accumulator or as an extension to permit an 8-bit result. On the chip are also some microprogrammed ROMs that determine the operation of the ALU for each incoming instruction.

### Comments

**The microprogram instruction set** of the 5701/6701 processor slices contains 36 instructions. The instructions include addition, subtraction, transfer or decrement or increment, AND, OR, Exclusive-OR, Invert and 2's complement, all with various combinations of internal registers.

**Software support** consists of a Fortran IV cross assembler that is designed to run on 16 and 32-bit minicomputers and mainframes. There is no program library available.

**Special features of the software** include overflow detection and the logic shifting capability. The slices can perform multiple nanosecond instruc-

tions such as subtract, shift and store in just one clock cycle.

**Hardware support** for the processor is minimal—the only products are the microprogram controller, which can address 512 words of microprogram storage, and standard memory circuits such as PROMs and multiport RAMs.



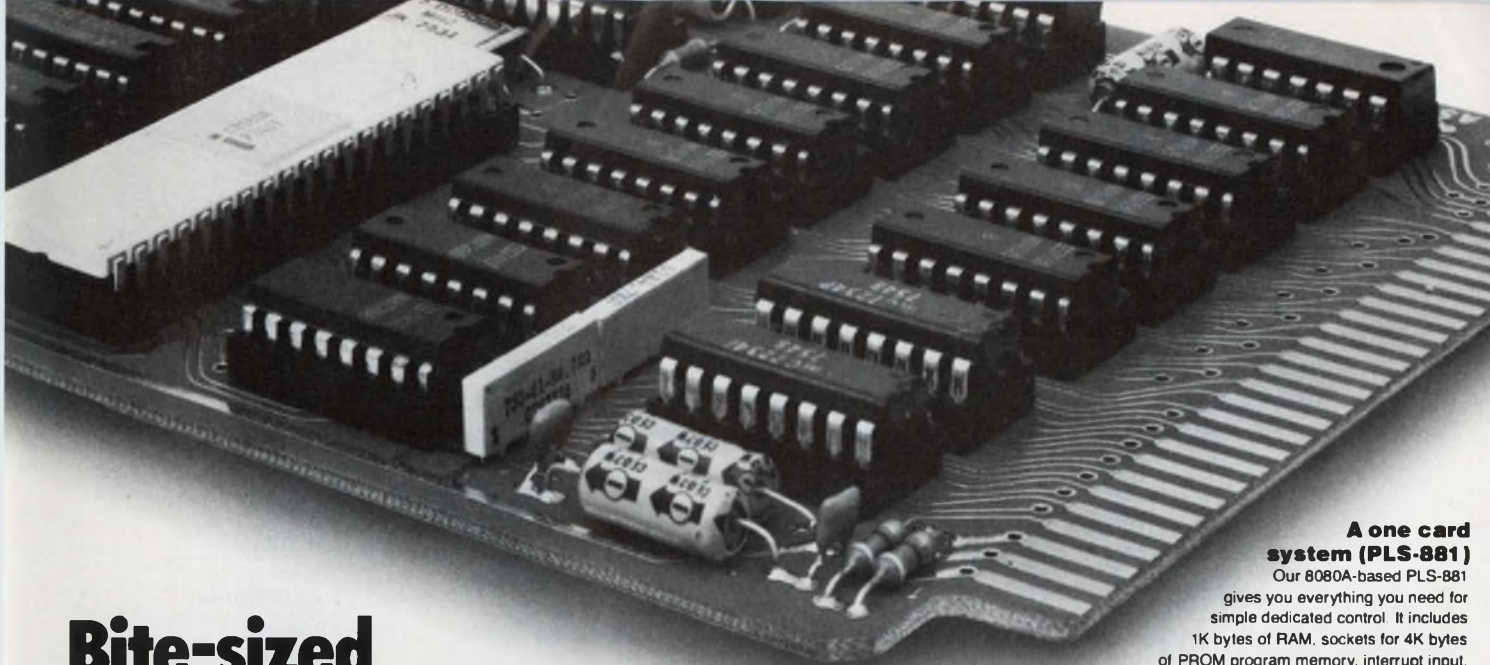

**A one card system (PLS-881)**

Our 8080A-based PLS-881 gives you everything you need for simple dedicated control. It includes 1K bytes of RAM, sockets for 4K bytes of PROM program memory, interrupt input, crystal clock, power-on and external reset, three 8-bit output ports, and two 8-bit input ports. It costs only \$115 in 100 piece quantities.

#165

# Bite-sized 8080A systems make big boards hard to swallow.

**Simple, flexible, standardized Pro-Log 8-bit microprocessor systems a best buy for OEM's.**

We sell 8080A and 6800 microprocessor cards two ways; as single and multicard systems, or as individual CPU and support cards so you can build a system of your own.

Our cards are all standard 4.5" by 6.5" with 56 pin edge connectors. They fit into standard card racks. To keep you from being tied to a specific semiconductor manufacturer for parts, delivery and pricing, our 8080A and 6800-based systems use only second-sourced parts.

Buy 250 of any particular card and we throw in free its manufacturing and assembly plans and non-exclusive rights to manufacture it, allowing you to build your own hardware, relying on us as an established and dependable second source.

**We've got 4-bit systems, instruments, education and literature, too.**

4-bit 4040 and 4004 systems; 4- and 8-bit microprocessor system analyzers; PROM programmers; a half-day economics seminar for decision makers; a three-day hands on design course for engineers; manuals and support documentation.

Call or write for data sheets or a free copy of The Microprocessor User's Guide.

*Check our new low prices!*

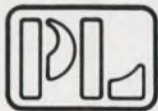

**PRO-LOG CORPORATION**  
2411 Garden Road  
Monterey, CA 93940  
Telephone (408) 372-4593  
TWX 910-360-7082

CIRCLE NUMBER 87

#160

**An expandable plug-in CPU card (8821)**

Our "buffered bus" 8821 processor card implements the 8080A as a fully TTL buffered microprocessor. Add one I/O card and it becomes a complete two-card system. Or expand it to use full 8080A memory and I/O capability—it's compatible with all the Pro-Log ROM, RAM and I/O modules shown here plus many more. The 8821 costs only \$110 in 100-piece quantities. We also have equivalent cards implementing the 6800 microprocessor.

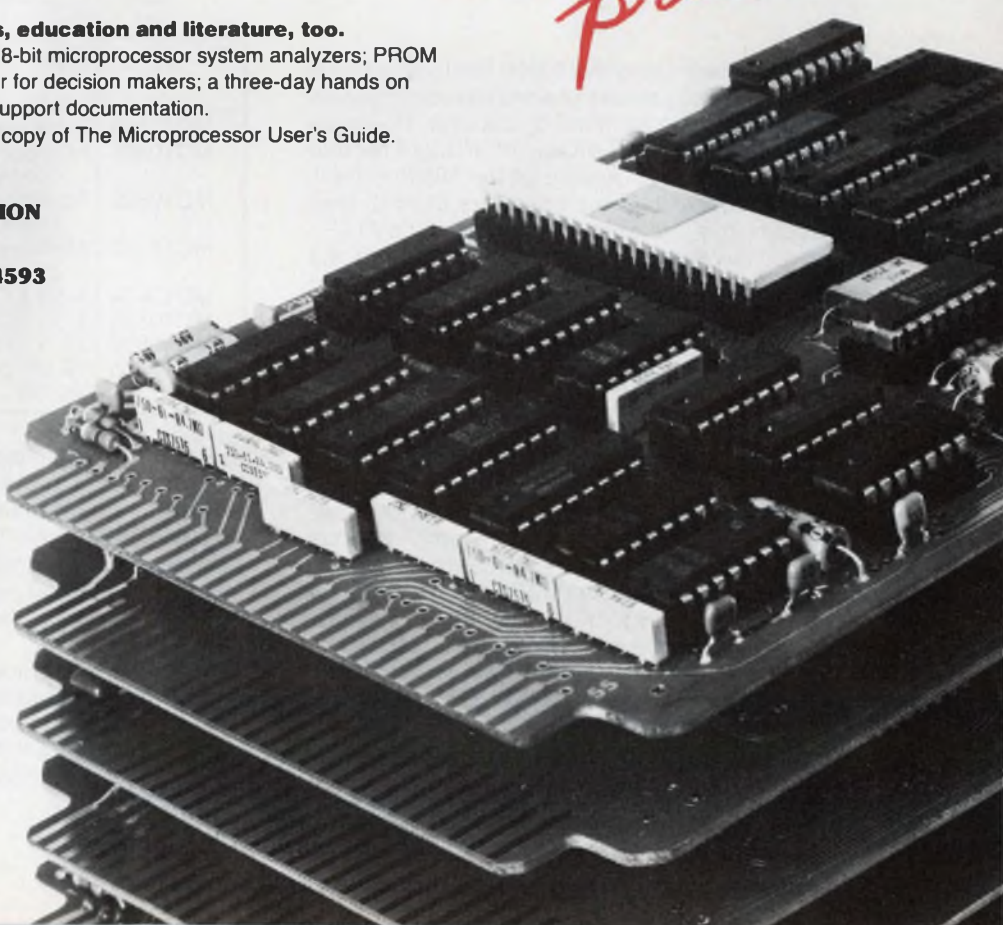



# 4-bit processor slice, ECL

## MC10800

Alternate sources: None.

Motorola Semiconductor  
5005 E. McDowell Rd.  
Phoenix, AZ 85036  
(602) 244-6900

The MC10800 family of ECL processor circuits offers the highest speed processing of digital data in LSI form. With a full family of support devices and ECL logic elements, high-performance digital processors with  $n \times 4$  bit word lengths can be designed around the family of parts. Most of the devices in the family are housed in a special 48-pin quad in-line package to get the density desired without using large packages.

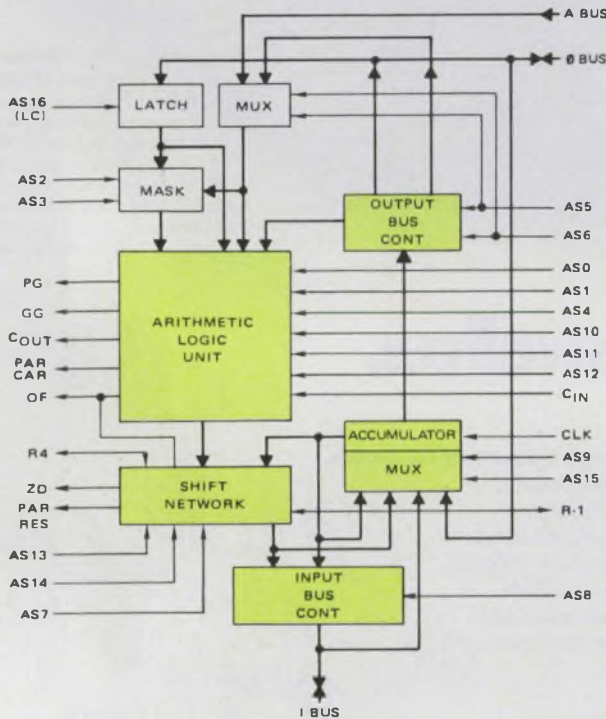

A minimal system using the 10800 family of circuits is difficult to specify since the word size and memory requirements are determined by the user. However, a typical system for a 16-bit machine might require 25 to 40 devices. Architecture of the 10800 slice is very straightforward. Three buses are used to feed information into and out of the processor's ALU—the A bus, the Ø bus and the I bus—of which the A bus is input only. And, there are no on chip registers aside from the accumulator and latches for the Ø bus, so external registers must be used.

### Comments

The instruction set of the 10800 processor chip can perform logic operations, binary arithmetic, and BCD arithmetic on combinations of one, two or three variables. These variables are the A bus, the output bus latch and the accumulator. Various select lines on the processor also control the routing of data within the chip. Simple instructions typically execute in 25 to 50 ns—about twice as fast as the other available bit-slice processors.

At this time there is no support software for the 10800 family except for a programming handbook that shows how to develop a microprogram. And, there is no library of user programs yet available. The 10800 family of bit slice processors is the only one to include BCD arithmetic capability as well

### Specifications

Data word size:	4 bits
Address bus size:	User determined
Direct addressing range:	User determined
Instruction word size:	User determined
Number of basic instructions:	About 10*
Basic ALU instruction execution time:	30 to 50 ns
Clock frequency (min/max):	Dc/10 MHz
Clock phases/voltage swing:	2/MECL 10,000
Dedicated I/O control lines:	User determined
Package:	48-pin QUIL
Power requirements:	-5.2 V/ 240 mA -2 V/199 mA

\*for ALU only

### Hardware

Model	Description	Price (100 qty)
MC10800	4-bit processor slice	\$30.00
MC10801	Microprogram controller	50.00
MC10802	Multiphase clock source	15.00
MC10803	Memory interface circuit	40.00
MC10804	4-bit ECL/TTL shifter	4.00
MC10805	5-bit ECL/TTL shifter	4.75
MC10806	32 x 9 bit register	62.00
MC10808	16-bit programmable shifter	25.00

as normal binary. It also includes a 9's complement circuit to simplify the BCD calculations. The overall instruction set of the 10800 bit slice has so many variations since the 10 basic ALU operations can be performed on combinations of one, two or three inputs, that the total number of possible instructions is more than 1000 variations.

At this time there are no prototyping systems or program development aids available for use with the 10800 family. However, boards compatible with the company's EXORciser (the M6800 microprocessor development system) will be available shortly.



# Omnigraphic® Series 2000 X-Y recorders

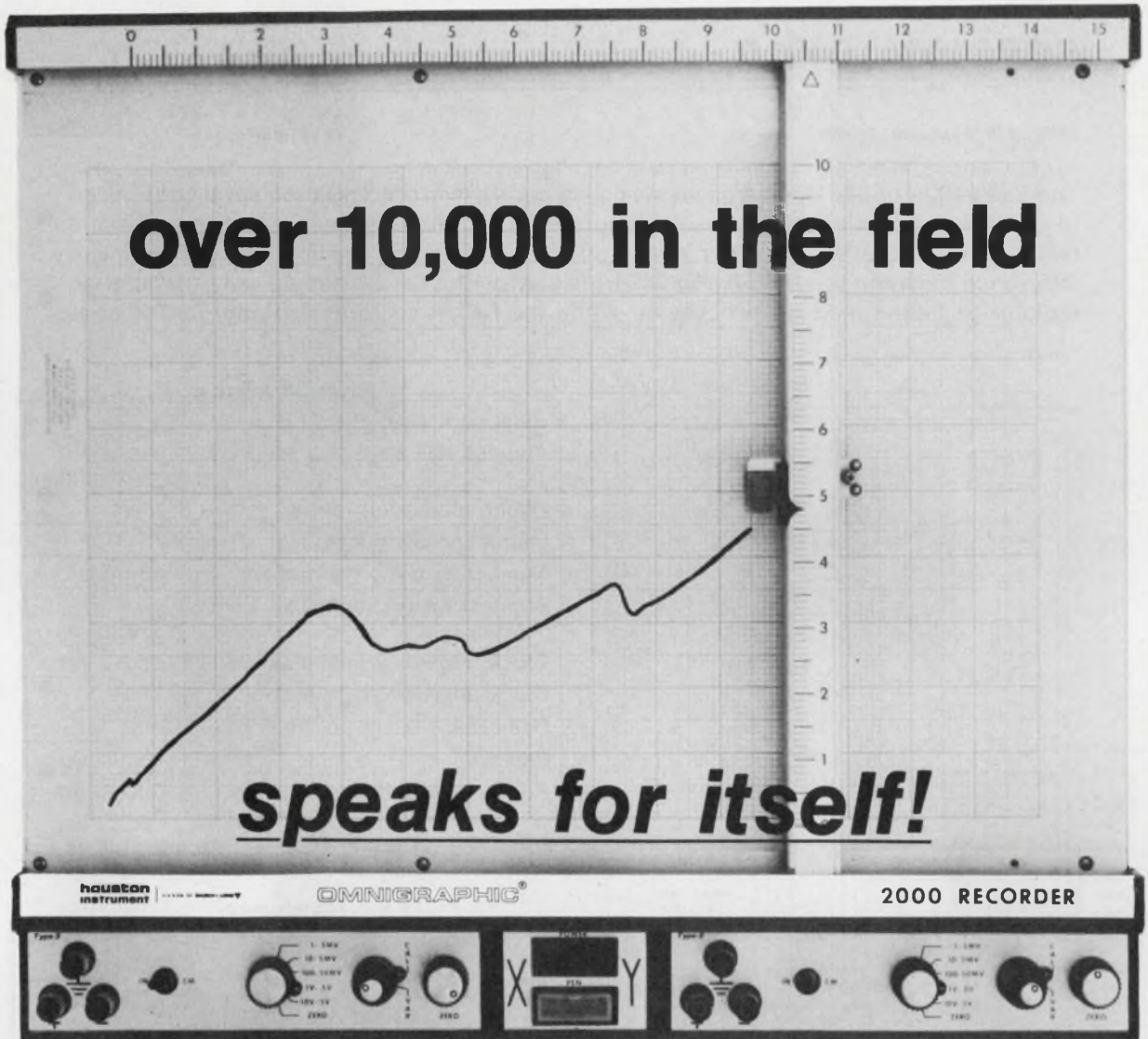

**over 10,000 in the field**

**speaks for itself!**

**You get the best price/performance possible**

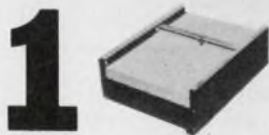

**Start with the versatile main frame**

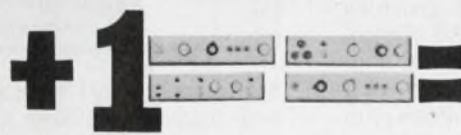

**Add your "Designers Choice" from 18 input modules**



**You get an X-Y Recorder with the best price/performance available.**

**Send for FREE "Designers Choice" catalog today**

® A registered trademark of Houston Instrument

**houston instrument**

**THE RECORDER COMPANY**

DIVISION OF BAUSCH & LOMB

ONE HOUSTON SQUARE  
(512) 837-2820

1st 8500 Cameron Road  
TWX 910-874-2022

AUSTIN, TEXAS 78753  
cable HOINCO

EUROPEAN HEADQUARTERS

Phone 059/277445 Telex Bausch 81399



# 4-bit processor slice, bipolar (I<sup>2</sup>L)

## SBP0400A, 0401A

Texas Instruments  
P.O. Box 5012, M/S 308  
Dallas, TX 75222  
(214) 238-2011

Alternate sources: None.

The SBP0400A or 0401A 4-bit processor slice can be microprogrammed and configured to build any size digital processor. Integrated injection logic technology permits the user to define the speed/power consumption by adjusting the injector current. The difference between the 0400A and 0401A is slight—the 0400A has an on-chip pipeline register to help speed up processing while the 0401A requires an external register.

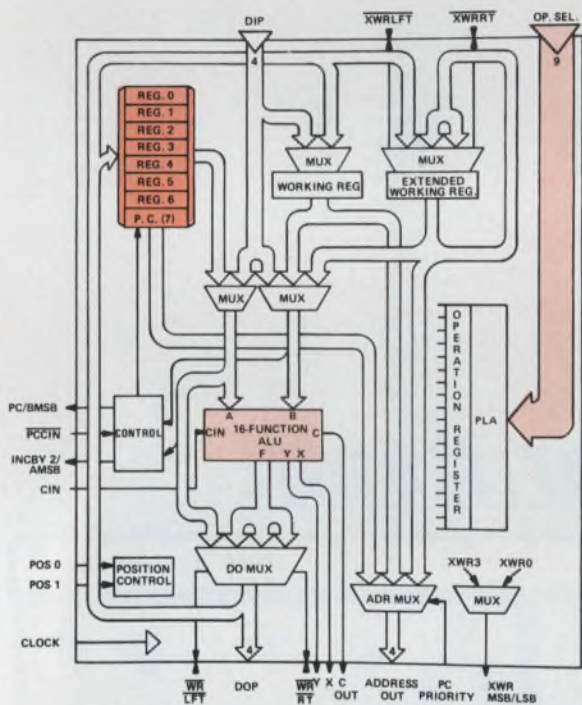

The architecture of the processor slice provides separate data in, data out, address out and control ports, as well as a 16 function ALU. On the chip are an eight-word general register file, two 4-bit working registers, dual scaled-shifters (with on chip handling of end conditions) and a factory programmable logic array that generates on-chip control signals. A minimal system is hard to specify since it depends on word size and control options. A typical system might contain 30 to 50 chips.

### Comments

The micro-instruction set of the SBP0400A/0401A can execute any of the 512 possible micro-instructions within a single clock cycle. Operand modifications or combinations via eight arithmetic or logic operations are possible in the ALU as well as combinations of ALU instructions with other commands.

### Specifications

Data word size:	4 bits
Address bus size:	4 bits (expandable)
Direct addressing range:	N.A.*
Instruction word size:	13
Number of basic instructions:	16 (ALU)
Shortest instruction/time (All):	350 ns
Clock frequency (min/max):	Dc/3.3 MHz
Clock phases/voltage swing:	1/TTL
Dedicated I/O control lines:	5
Package:	40-pin DIP
Power requirements:	5 V/40 mA (typical)

\*Depends on the number of cascaded slices

### Hardware

Model	Description	Price (100 qty)
SBP0400A	4-bit slice (pipelined)	\$14.62
SBP0400A	MIL temp version	43.85
SBP0401A	4 bit slice (unpipelined)	14.62
SBP0401A	MIL version	43.85
	No special interface circuits are needed	

**Software support** is practically nonexistent. The only material available as an aid to programming is the "Bipolar Microcomputer Components Data-Book," in which SBP0400A/0401A programming is explained. There is no program library available.

**Outstanding software features** include the availability of pipelined or unpipelined architecture to suit the design. The slices have an independent program counter with unjammable access controls and a relative position control to define the slice rank in n-bit applications.

**Hardware support** for the SBP0400A/0401A consists of the LCM-1000 series of microprogrammable prototyping modules as well as standard TTL and MOS circuits.



# BEST SELLER

for people  
who like to stay  
up to date on  
threaded  
fasteners

*Read any lately? Here's one you shouldn't miss. The Fastener Reference Guide has an incredible mix of "characters" (from machine screws to sems), a believable plot and some highly colorful sets and locations. One of the features that makes it a Best Seller is the fact that it can save you money, too.*



IF WE  
DON'T MAKE  
THE FASTENERS  
YOU NEED  
(UNLIKELY!),  
WE'LL CUSTOM-MAKE  
THEM FOR YOU

  
**accurate**  
THREADED FASTENERS, INC.  
Division of Beatrice Foods Co.  
3550 West Pratt Avenue  
Chicago, Illinois 60645  
(312) 583-5300

*Send for a copy for your own business library.*



# 4 bit processor slice, bipolar (STTL)

## SN74S481

Alternate sources: None.

Texas Instruments  
P.O. Box 5012  
Dallas, TX 75222  
(214) 238-2011

The SN74S481 4-bit microprogrammable processor slice is available in either Schottky-TTL or low-power Schottky-TTL technology. It can be used to build a processor with almost any word size. Both versions have fully parallel I/O ports and memory address ports as well as on-chip circuits that define the slice rank and perform sign-bit protection and fill in.

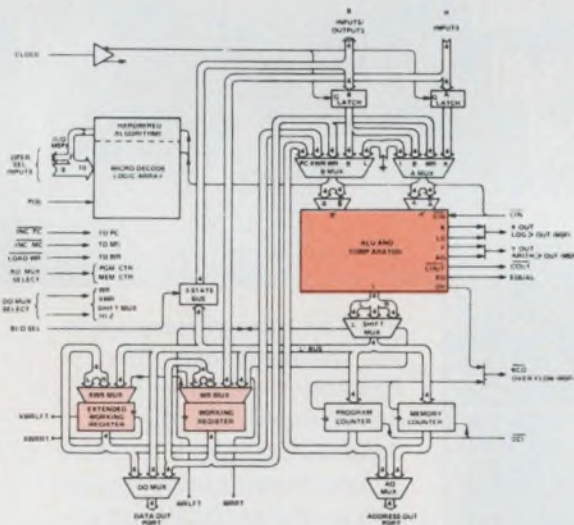

Architecture features of the 74S481 include fully parallel dual input and output ports, a full function ALU with look-ahead carry, magnitude and overflow decision capabilities, a double-length accumulator and dual memory address generators on chip. A typical system consists of 30 to 50 circuits.

### Comments

The instruction set of the processor's ALU consists of only 16 arithmetic and logic commands. But also included in the chip are macroprogrammable multiply and divide algorithms and multidirectional data flow control. There are 24,780 unique operations possible, including automatic CRC update.

Software support for the 74S481 family is minimal. There are no programming languages or aids to the designer except for the company's "Bipolar Microcomputer Components Data Book," which describes how to work with the processor slices.

Important software features include the preprogrammed multiply and divide operations for double precision signed or unsigned numbers, cyclic redundancy character accumulation instructions to help in error prevention, and simultaneous one clock compound operations.

### Specifications

Data word size:	4 bits
Address bus size	4 bits (expandable)
Direct addressing range:	N.A.*
Instruction word size:	N.A.
Number of basic instructions:	16 (ALU)
Shortest instruction/time (microinstruction):	67 ns
Longest instruction/time (signed integer divide):	200 to 250 ns
Clock frequency (min/max):	Dc/15 MHz
Clock phases/voltage swing:	1/TTL
Dedicated I/O control lines:	8
Package:	48-pin QUIL
Power requirements:	5 V/200 mA

\*Depends on the number of cascaded slices.

### Hardware

Model	Description	Price (100 qty)
74S481	4-bit slice (plastic)	\$19.60
74S481	4-bit slice (ceramic)	29.25
74S481	4-bit slice (MIL)	87.75
SN74S482N	4-bit controller	6.30
SN74S330N	12-In, 50-Term, 6-Out FPLA	9.00
SN74S225N	16-word-by-5-bit FIFO	4.50
SN74S226N	Quad bus transceiver	2.25
SN74S182N	Carry look-ahead	2.91
SN74S240N	Octal inv/buffer	4.20
SN74S241N	Octal buffer/driver	4.20
SN74S373N	Octal transparent latch	4.72
SN74S374N	Octal D-type register	4.72

Hardware support is minimal at present. In 1978, evaluation processor modules that duplicate the TI 990 minicomputer's instruction set will be available.





# Relax

**It's amazing how an easy mind eases your swing.**

We're the easy mind people. TRW Capacitors.

You'll never have to worry about reliability, for example. Our X675HV polyester capacitor line is proof of that, it's a true high voltage capacitor with a range from 2,000v to 16,000v DC. MTBF (90% lower confidence limit) is better than 260,000 hours at 85° C and full rated voltage.

And can they perform! IR is 30,000 megohms x MFD. DF is less than 1% at 1,000 Hz. Capacitance values are .68 mfd and smaller. For applications such as voltage multi-

pliers and filters in high density, high voltage power supplies, instrumentation, data displays, pulse modulators and copiers. TRW can take a big load off your mind.

Our engineering services and field support will also put your mind at ease. Just give us a call. Or write: TRW Capacitors, An Electronic Components Division of TRW, Inc., 301 W. "O" St., Ogallala, Nebraska 69153 • Tel: (308) 284-3611.



**TRW** CAPACITORS  
ANOTHER PRODUCT OF A COMPANY CALLED TRW  
CIRCLE NUMBER 90



# 4-bit processor slice, PMOS

## IMP-8, 16 (00A/520)

Alternate sources: None.

National Semiconductor  
2900 Semiconductor Drive  
Santa Clara, CA 95051  
(408) 737-5000

The IMP series of 4, 8 and 16-bit processors is built around a 4-bit PMOS slice (P/N 00A/520) that can be cascaded. The slice, called a register and arithmetic unit (RALU), combines with control ROM circuits (CROMs) to form a complete microcomputer. Contained in the RALU are a seven-word  $\times$  4-bit general register bank, a status register, and a 16-word  $\times$  4-bit last-in first-out stack, as well as a multifunction ALU.

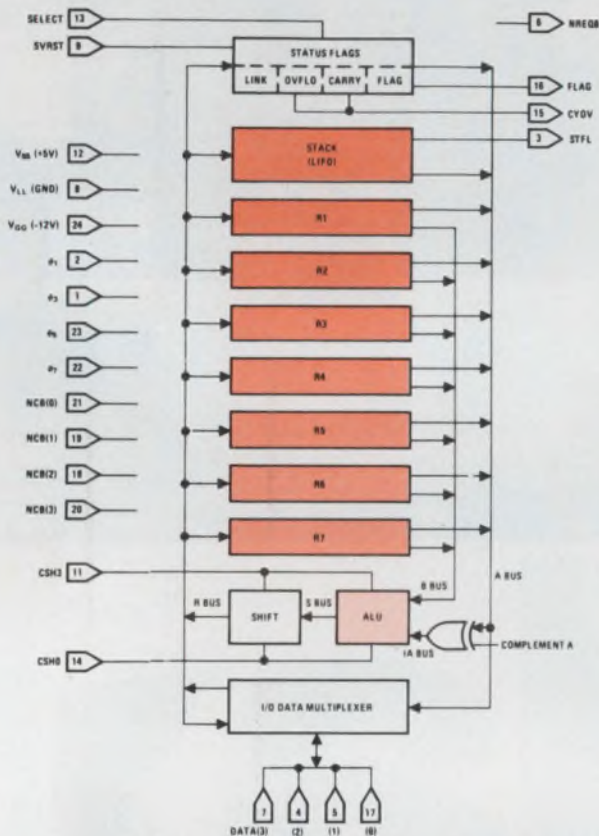

The architecture of the IMP processor family is split into three basic chips. On the RALU are all the RAM registers, counters and control logic (including the ALU). The CROM holds the microprogram for the macroinstructions while the interface logic circuit provides the flags, condition-jump controller, program counter and program-counter stack. All circuits interface directly via MOS level buses and require a four-phase nonoverlapping clock.

### Comments

The macroinstruction set of the IMP processor slice contains 42 commands including 16 register operations, two flag instructions, 13 memory reference operations, five branch commands and six increment/decrement and I/O instructions. The IMP-16L processor has 17 optional instructions including multiply and divide and bit operations.

Software support for the IMP family consists of resident and cross assemblers. Resident software can run on any of the IMP systems since all process-

### Specifications

Data word size:	4 bits (ALU)
Address bus size:	4, 8 or 16 bits
Direct addressing range:	Up to 65,536 words
Instruction word size:	23 bits (CROM)
Number of basic instructions:	42
Shortest instruction/time (nonmemory reference):	12 $\mu$ s (average)
Longest instruction/time (memory reference):	20 $\mu$ s (average)
Clock frequency:	5.17 MHz max.
Clock phases/voltage swing:	4/16 V
Dedicated I/O control lines:	4
Package:	24-pin DIP (RALU)
Power requirements:	5 V/40 mA -12 V/40 mA

### Hardware

Model	Description	Price (100 qty)
00A/520	4-bit RALU	\$22.00
8A/521D	8-bit wide control CROM	40.00
16A/521D	16-bit wide control CROM	27.50
IMP-16A/523D	Power I/O CROM (25-up)	40.50
IMP-16A/524D	Arithmetic CROM (25-up)	40.50

ors share the same set of commands. The cross software is written in Fortran IV and can run on many 32-bit computers. Also available are diagnostic, loader and debug programs.

Software features include the compatibility of instructions from the smaller processors to the largest and the flexibility of defining your own instruction set by the control program in the CROM.

Hardware support for the IMP processor family consists of several processor cards built around the RALU and CROMs as well as full microcomputer systems—the IMP-16L or IMP-16P. Memory cards, I/O cards and card cages are available.



# Our 8X300 Bipolar Microprocessor handles 4 million operations/second with an optimized fixed-instruction set.

**That kind of speed even makes sense for slow systems because it reduces parts count. This Guide explains why.**

Our new Evaluation Guide was written to help you analyze the system design economics of microprocessor speed. It describes how a typical application can be implemented four different ways. Use of the Signetics 8X300 is compared with three other alternatives.

This Guide explains how microprocessor speed can shrink system cost by reducing parts count. You need it if you're sincerely interested in an apples-to-apples comparison of popular design techniques. Chances are, it may also convince you that you need the 8X300.

**Learn the Hidden Economics of Speed.** Regardless of a system's overall speed requirement, microprocessor speed affects the most important selection criteria you can apply—operations/second/dollar.

The 8X300 has the raw speed—4,000,000 operations per second—combined with a surprisingly low price. Speed also buys you much more than high processing throughput and greater I/O capability. You get lower system cost because you can eliminate the extra parts a slower microprocessor might force upon you. And quite often, because of the 8X300's speed, you don't have to hassle with interrupts.

## 8X300 HONOR ROLL:

- First NASA-qualified bipolar microprocessor
- "Product of the Year" Award/*Electronic Products*

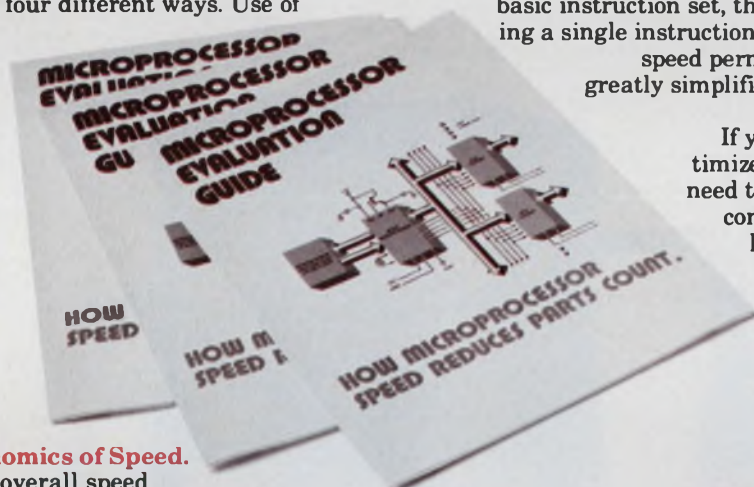

## Fixed Instructions: Optimized for Control.

The 8X300 is the only single-chip bipolar microprocessor available with both a fixed instruction set and a reasonable price. This small, powerful instruction set took more than 3 man-years to develop.

That's work you don't have to do.

You have just 8 basic instructions to learn. There are no separate instructions for rotate, merge and mask. Because these operations are integral to the basic instruction set, they're routinely executed during a single instruction cycle. Moreover, the 8X300's speed permits line-by-line control. This greatly simplifies the I/O for handling serial or parallel data.

If you need a microprocessor optimized for high-speed control, you need to know about the 8X300. For convenience. For simplicity. For lower cost. Contact your local Signetics distributor—or use the coupon below to send for your Microprocessor Evaluation Guide today. For peace of mind.

# signetics

a subsidiary of U.S. Philips Corporation

Signetics Corporation  
811 East Arques Avenue  
Sunnyvale, California 94086  
Telephone 408/739-7700

To: Signetics Information Services, 811 E. Arques Ave.,  
P.O. Box 9052, MS 27, Sunnyvale, CA 94086.

Please send me your free "Microprocessor Evaluation Guide."

My needs are urgent. Please have an 8X300 applications specialist phone me at once: ( ) \_\_\_\_\_ X \_\_\_\_\_

Name \_\_\_\_\_ Title \_\_\_\_\_

Company \_\_\_\_\_ Division \_\_\_\_\_

Address \_\_\_\_\_ MS \_\_\_\_\_

City \_\_\_\_\_ State \_\_\_\_\_ ZIP \_\_\_\_\_

ED1011



# Brawn for your brainchild.

**Computer Grade Aluminum Electrolytics.** No one needs to tell you how vital capacitors are to the operating competence of a computer. A single surge or cut-back in power can potentially cause an entire system to malfunction. That's why Nichicon makes Computer Grade Capacitors under the strictest quality control procedures. We supply the brawny reliability to make sure that your brainchild works properly.

**Nichicon has the right capacitor** for every computer design need. These include our NKB Compact

Series, NSB Standard Series and NHB High-Ripple Series. Nichicon computer grade capacitors feature top quality pressure sensitive safety vent construction with PVC insulating sleeves.

**Long life reliability** is built into every unit. In an operating temperature range of  $-25^{\circ}\text{C}$  through  $+85^{\circ}\text{C}$ , these aluminum electrolytics offer a dependable low-leakage current, high-ripple capabilities and low ESR.

Computer Grade Capacitors are excellent examples of Nichicon's continuing emphasis on reliability as the dominant design criterion. We also manufacture every other type of capacitor including all types of aluminum electrolytics, ceramic discs, film, oil filled—without PCB's, metallized paper and wax paper capacitors for standard or specialized applications.

Send for your free catalog and engineering samples today. Simply write to us on your company letterhead. You'll hear from us soon.



The pulse of the industry.

**nichicon**



NICHICON (AMERICA) CORPORATION • 6435 N. Proesel Ave. • Chicago, IL 60645 • (312) 679-6530  
Division of NICHICON CAPACITOR, LTD., Kyoto, Japan

CIRCLE NUMBER 92



# MINIATURIZED POWER SUPPLIES

## For Logic and Op Amps

With Screw Terminals



Nominal Output Voltage	Output Current Amps.	Regulation		Ripple mv RMS	Price	Model	Case Size
		Load $\pm\%$	Line $\pm\%$				
5	.500	.15	.05	1	\$ 55	5EB50	EB-10
5	1.0	.25	.05	1	75	5EB100	EB-13
5	1.5	.35	.1	1	105	5EB150	EB-13
5	2.0	.25	.05	1	115	5EB200	EB-20
5	2.5	.25	.05	1	130	5EB250	EB-20
$\pm 12$	.100	.05	.05	1	55	DB12-10	EB-10
$\pm 12$	.150	.05	.05	1	65	DB12-15	EB-10
$\pm 12$	.200	.05	.05	1	75	DB12-20	EB-10
$\pm 12$	.300	.05	.05	1	105	DB12-30	EB-13
$\pm 12$	.350	.05	.05	1	110	DB12-35	EB-13
$\pm 12$	.500	.1	.05	1	135	DB12-50	EB-20
$\pm 15$	.100	.05	.05	1	55	DB15-10	EB-10
$\pm 15$	.150	.05	.05	1	65	DB15-15	EB-10
$\pm 15$	.200	.05	.05	1	75	DB15-20	EB-10
$\pm 15$	.300	.05	.05	1	105	DB15-30	EB-13
$\pm 15$	.350	.05	.05	1	110	DB15-35	EB-13
$\pm 15$	.500	.1	.05	1	135	DB15-50	EB-20

PCB Mounting

Nominal Output Voltage	Output Current Amps.	Regulation		Ripple mv RMS	Price	Model	Case Size
		Load $\pm\%$	Line $\pm\%$				
5	.250	.05	.05	0.5	\$ 39	5E25	ES-10
5	.500	.1	.05	1	49	5E50A	EL-10
5	1.0	.2	.05	1	69	5E100	EL-13
5	1.5	.3	.1	1	98	5E150	EL-13
5	2.0	.15	.05	1	110	5E200	EL-20
5	2.5	.15	.05	1	125	5E250	EL-20
$\pm 12$	.025	.1	.05	1	24	D12-03	ES-10
$\pm 12$	.050	.1	.05	1	39	D12-05	ES-10
$\pm 12$	.100	.05	.05	1	49	D12-10A	EL-10
$\pm 12$	.150	.05	.05	1	59	D12-15A	EL-10
$\pm 12$	.200	.05	.05	1	69	D12-20	EL-10
$\pm 12$	.300	.05	.05	1	98	D12-30	EL-13
$\pm 12$	.350	.05	.05	1	105	D12-35	EL-13
$\pm 12$	.500	.1	.05	1	130	D12-50	EL-20
$\pm 15$	.025	.1	.05	1	24	D15-03	ES-10
$\pm 15$	.050	.1	.05	1	39	D15-05	ES-10
$\pm 15$	.100	.05	.05	1	49	D15-10A	EL-10
$\pm 15$	.150	.05	.05	1	59	D15-15A	EL-10
$\pm 15$	.200	.05	.05	1	69	D15-20	EL-10
$\pm 15$	.300	.05	.05	1	98	D15-30	EL-13
$\pm 15$	.350	.05	.05	1	105	D15-35	EL-13
$\pm 15$	.500	.1	.05	1	130	D15-50	EL-20

**Input Voltage:** 105-125 Vac, 47 to 420 Hz, single phase.

**Output Voltage Setting:** Single output models are factory preset to within  $\pm 2\%$  of nominal output voltage, and may be more precisely trimmed to the nominal voltage rating with an external trim resistor. Dual models are set to within  $\pm 1\%$  of their nominal ratings, and are not trimable.

**Polarity:** Either positive or negative terminal of a single output module may be grounded. Dual output modules have a positive/common/negative output terminal configuration.

**Ambient Operating Temperature:**  $-20$  to  $+71^\circ\text{C}$ . (Model 5E150 and 5EB150, 0 to  $+71^\circ\text{C}$ .) No derating required.

**Temperature Coefficient:** 5-volt models,  $.03\%/^\circ\text{C}$ ; dual output models,  $.015\%/^\circ\text{C}$ .

**Impedance:** 0.07 ohm at 1 kHz, 0.2 ohm at 10 kHz (approx.).

**Optional 230 Volt Input:** To order, add suffix "-230" to model number and \$10.00 to price.

**Case Sizes and Weight:**

EB-10: 3.5" x 2.5" x 1.375" (1 lb)

EB-13: 3.5" x 2.5" x 1.625" (1 lb 5 oz)

EB-20: 3.5" x 2.5" x 2.375" (2 lb 1 oz)

EL-10: 3.5" x 2.5" x 1" (15 oz)

EL-13: 3.5" x 2.5" x 1.25" (1 lb 3 oz)

EL-20: 3.5" x 2.5" x 2" (2 lb)

ES-10: 2.3" x 1.8" x 1" (7 oz)

**Other models available from 1 to 75 volts. Send for complete information.**



Corp., Easton, Pa. 18042 Tel: (215) 258-5441



# NEC JUST MADE INTEL'S 8080A TWICE THE MICROPROCESSOR IT USED TO BE.

Introducing the  $\mu$ PD8080AF.  
From NEC Microcomputers.

Now you can get a microprocessor  
that's absolutely identical to Intel's  
8080A.

And we can prove it.

In three separate tests using  
standard Intel programs, conducted  
by three independent laboratories,  
the  $\mu$ PD8080AF was demonstrated  
to be, both parametrically and func-  
tionally, exactly the same as the  
8080A. (The certified results of the  
tests are available upon request).

Which means that now there's a  
microprocessor that's pin for pin and  
program compatible to the Intel 8080A.  
And available in plastic or ceramic.

Of course, we continue to offer

our original  $\mu$ PD8080A—a microproc-  
essor with enhanced arithmetic capa-  
bility and logical flags.

With either an  $\mu$ PD8080AF or  
 $\mu$ PD8080A comes our complete line  
of standard peripheral chips. Plus  
state-of-the-art support chips like the  
8K Electrically Erasable PROM  
( $\mu$ PD458), a Universal Synchronous  
Receiver/Transmitter Data Commu-  
nications Controller ( $\mu$ PD379), a  
450ns 32K ROM ( $\mu$ PD2332) and a  
Floppy Disc Controller ( $\mu$ PD372)

that can control up to four IBM 3740-  
compatible drives, and a complete  
line of the most reliable memories  
you can buy.

All backed up by applications sup-  
port available nationwide.

The  $\mu$ PD8080AF from us. And  
the 8080A from them.

Even with a program, you won't  
be able to tell them apart.

NEC Microcomputers, Inc., Five  
Militia Drive, Lexington, MA 02173.  
(617) 862-6410.

**NEC microcomputers, inc.**

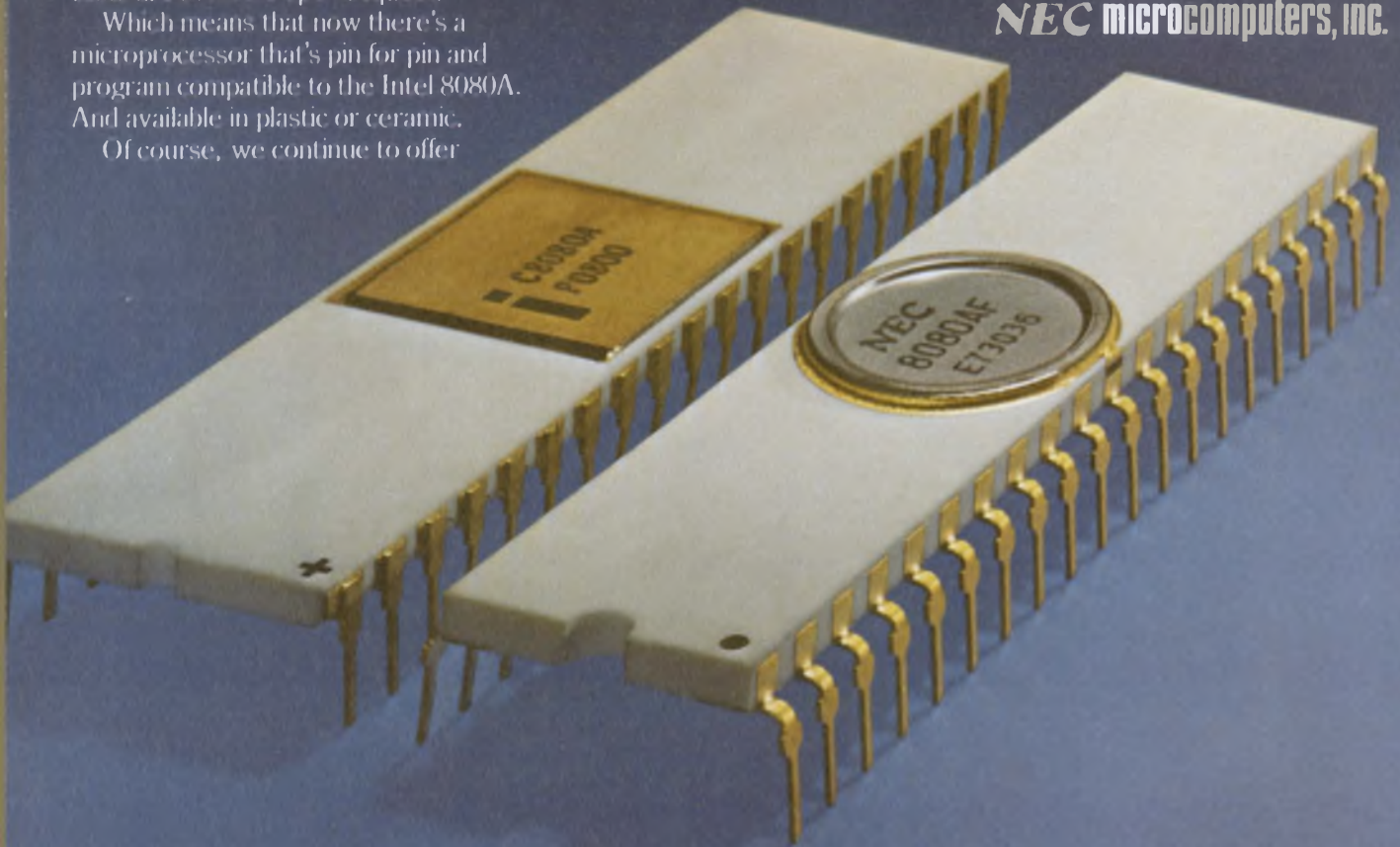

REPS: East—C&D Sales 301-296-4306, Contact Sales 617-273-1520, Harry Nash Assoc. 215-657-2213, Rome 516-249-0011, Tech-Mark 607-748-7473, 716-223-1252, 315-652-6229, Trionic Assoc. 516-466-2300, South—Perrott Assoc. 305-792-2211, 813-585-3327, 305-275-1132, 20th Century Mktg. 205-772-9237, Wolffs Sales Serv. Co. 919-781-0164, Midwest—Electronic Innovators 612-884-7471, W. Pat Fralia Co. 817-640-9101, 817-649-8981, 713-772-1572, Imtech 216-826-3400, 513-278-6507, K-MAR Eng. & Sales 816-763-5385, R.C. Nordstrom & Co. 313-559-7373, 616-429-8560, Technology Sales 312-438-3300, West—Cercro 714-560-9143, D/Z Assoc. 303-534-3649, Electronic Component Mktg. 714-879-9460, Summit Sales 602-994-4587, Trident Assoc. 408-734-5900, Trn Tronix 206-232-4993, 505-265-8409; Canada—R.F.O. Ltd. 416-626-1445, 514-626-8324.

DISTRIBUTORS: ASI Electronics (Baltimore), Bell Ind. (Bellevue WA), Century Electronics (Albuquerque, Salt Lake City, Wheatridge CO), Diplomat (Chicopee Falls MA, Clearwater FL, Elk Grove Village IL, Farmington MI, Minneapolis, MI, Laurel NJ, Salt Lake City, St. Louis, Sunnyvale, Totowa NJ, Woodbury NY), Future Electronics (Montreal, Ottawa, Rexdale Canada), Harvey Electronics (Fairfield NJ, Lexington MA, Norwalk CT, Woodbury NY), Intermark Electronics (San Diego, Santa Ana, Sunnyvale), G.S. Marshall (Sunnyvale), Mirco Electronics (Phoenix), Resco (Raleigh), R-M Electronic (Kentwood MI, Madison Hgts MI), Semicomp (Costa Mesa CA), Semiconductor Specialists (Burlington MA, Chicago, Dallas, Dayton, Farmington MI, Hazelwood MO, Indianapolis, Kansas City, Milwaukee, Minneapolis, Pittsburgh, Malton Canada), Sterling Electronics (Albuquerque, Dallas, Houston, New Orleans, Phoenix, San Diego, Seattle, Sun Valley CA, Watertown MA), Summit Distributors (Buffalo), Summit Electric (Rochester), Technico (Columbia MD, Roanoke VA), Western Microtechnology Sales (Sunnyvale), Zeus Components (Elmsford NY).



# FOR RENT...

the truly universal PROM Programmers from Data I/O that enable you to program any of the more than 200 PROMs now available.

A single Data I/O programmer—the Model V or Model IX—can be used to program every single commercially available PROM.

Data I/O programmers are universal. You can use them to program any PROM, and more than 200 PROMs are currently available. This means you don't have to get a separate programmer to accommodate different PROMs. With either the Model V or Model IX and the appropriate personality card, you can program any PROM or its second source equivalent. Moreover, one personality module can be used to program all PROMs within a generic family and keep your yield at the maximum.

ROM emulation and editing capabilities are built-in, making software development a breeze and virtually eliminating PROM waste.

All the Data I/O programmers save lab time and slash your development expense. These are

portable, rugged, human-engineered and easy to use units. They're ideal for field service. Both the Model V and Model IX offer a direct display readout of PROM or RAM data at any address and offer unlimited data editing capabilities. Operation is totally automatic, and you can enter data manually through the keyboard or load it automatically from a preprogrammed master PROM. There are built-in error checking routines to insure accurate and correct data transfers, and serial or parallel I/O are standard. These unique PROM programmers and their personality cards are available now.

## Rental Electronics, Inc.

Another of the **AMERICAL** companies

More than 11,642  
electronic instruments...  
off-the-shelf, throughout North America.

<input type="checkbox"/> Tell me more about the Data I/O PROM Programmers now! Call me at _____	<input type="checkbox"/> Send me a copy of your free illustrated Rental Catalog.
<input type="checkbox"/> Send me your Equipment Sales Catalog—I might be interested in buying some of your great "previously owned" equipment on a money-back guarantee.	Name _____
<input type="checkbox"/> I have a pressing need right now for the following: _____	Title _____
	Company _____
	Address _____
	City _____
	State _____ Zip _____
	Phone No. _____ Ext. _____
Please phone me immediately at _____	GSA #GS-04S-21963 Neg ©1977 Rental Electronics, Inc.

Complete this coupon and return it today to the world's oldest and largest electronic equipment rental firm, REI, 19347 Londelius St., Northridge, California 91324

Anaheim, CA (714) 879-0561 • Mountain View, CA (415) 968-8848  
Fort Lauderdale, FL (305) 771-3500 • Des Plaines, IL (312) 827-6670  
Burlington, MA (617) 273-2770 • Gaithersburg, MD (301) 948-0620  
Oakland, NJ (201) 337-3757 • Cleveland, OH (216) 442-8080  
Dallas, TX (214) 661-8082 • Houston, TX (713) 780-7218  
Seattle, WA (206) 641-6444 • Rexdale, Ontario, Canada (416) 675-7513  
Montreal, Quebec, Canada (514) 681-9246 • Northridge, CA (213) 993-RENT (7368)



# TEST DATA

## low profile

**“...TWO contacts are not more reliable than ONE!”**

Surprisingly, a low profile (.150" high) DIP socket is a different breed of cat when it comes to engineering in contact reliability. Most standard DIP sockets have dual contacts. (R-N's dual "side-wipe" contacts are among the most reliable in the industry.) But, when you shorten the contact length to achieve the "low profile" you lose a great deal of contact force and IC retention strength. So, to achieve effective low profile socket reliability you must redesign the contacts and make them out of the strongest contact material available.



Low .150" profile of ICL socket reduces board density by 26%.

AVERAGE  
3.5 oz.  
minimum  
withdrawal  
force

Fat-Skinny **TESTS PROVE\*** that R-N "back fold side-wipe" SINGLE CONTACT design for low profile sockets provides—  
**4 TIMES BETTER IC RETENTION FORCE** than competitive low profile dual-leaf sockets

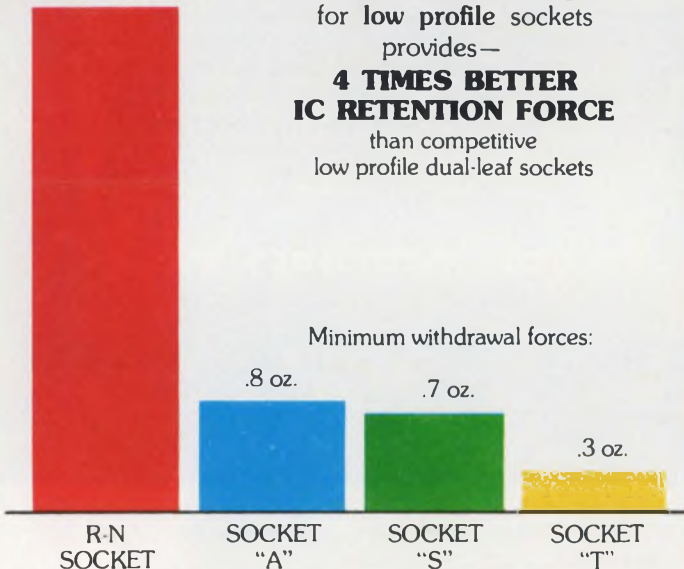

\* In "Fat-Skinny test," withdrawal forces are measured using the smallest size (.008") lead after insertion of largest size (.012") lead.

### Representative NORMAL FORCE Test Scores for 10 R-N ICL low profile sockets

TEST SOCKET	NORMAL FORCE *
1	410 grams
2	465 grams
3	480 grams
4	465 grams
5	395 grams
6	425 grams
7	465 grams
8	395 grams
9	410 grams
10	425 grams

AVERAGE — 430 grams

This force is 4 to 5 times greater than average dual contact socket NORMAL FORCE

\* NORMAL FORCE means force perpendicular or at right angles to IC lead. The single ICL contact exerts this kind of force against the IC lead when inserted into the socket.

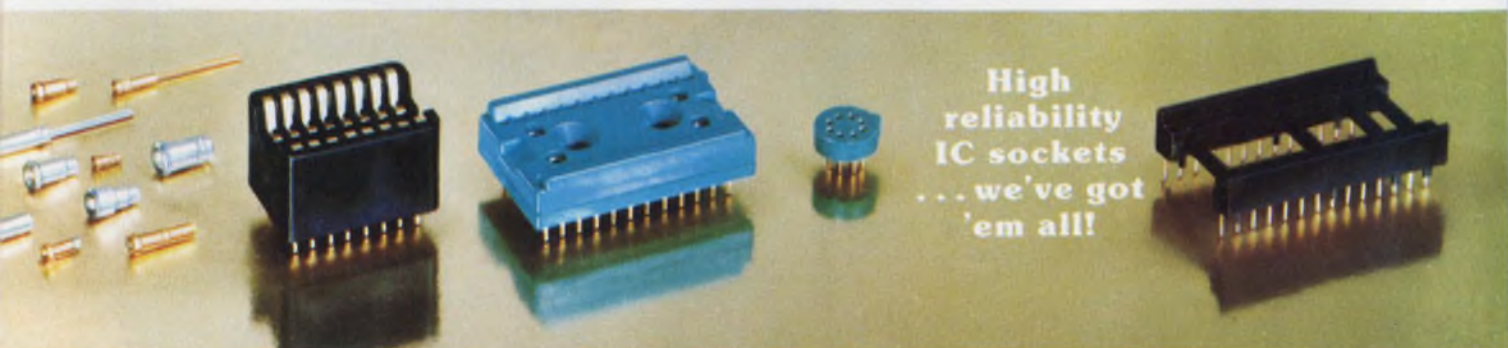

High  
reliability  
IC sockets  
... we've got  
'em all!



# DEBUNKS

## DIP socket MYTH



### UNIQUE R-N SINGLE CONTACT DESIGN PROVES SUPERIOR

Tests prove that R-N "back fold side-wipe" single contacts exert up to 4 times greater holding force on your IC leads than competitive low profile dual leaf contacts.

In a tough, 50-G shock test of 25 ICL sockets — not a single IC package came loose from the socket! More convincing proof that vibration problems are ended with R-N's new low profile ICL sockets. Socket density in multi-layer board can now be increased **without** sacrificing reliability.

... and this **FULL LINE** of low-profile R-N ICL sockets is priced very, very competitively.

Beryllium copper for 36% greater contact strength than other commonly used contact alloys.

Self-lock leads hold socket firmly during high speed wave soldering. Also, this "bump" restricts solder flow and prevents solder wicking.

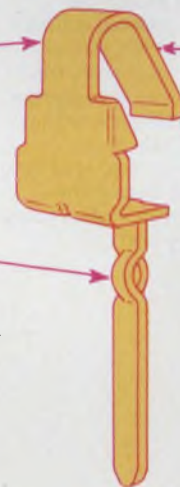

"Back fold" contact design provides longer spring contact for maximum pressure against IC lead.

"Side-wipe" design meets flat, smooth side of IC lead for perfect contact.

Check into the low-profile ICL sockets that deliver the high density dependability you need. New R-N catalog contains complete test data on insertion-withdrawal forces. **Write today.**



# RN ROBINSON NUGENT, INC.

800 East Eighth Street, New Albany, Indiana 47150 • Phone: (812) 945-0211 — TWX: 810-540-4082

CIRCLE NUMBER 273

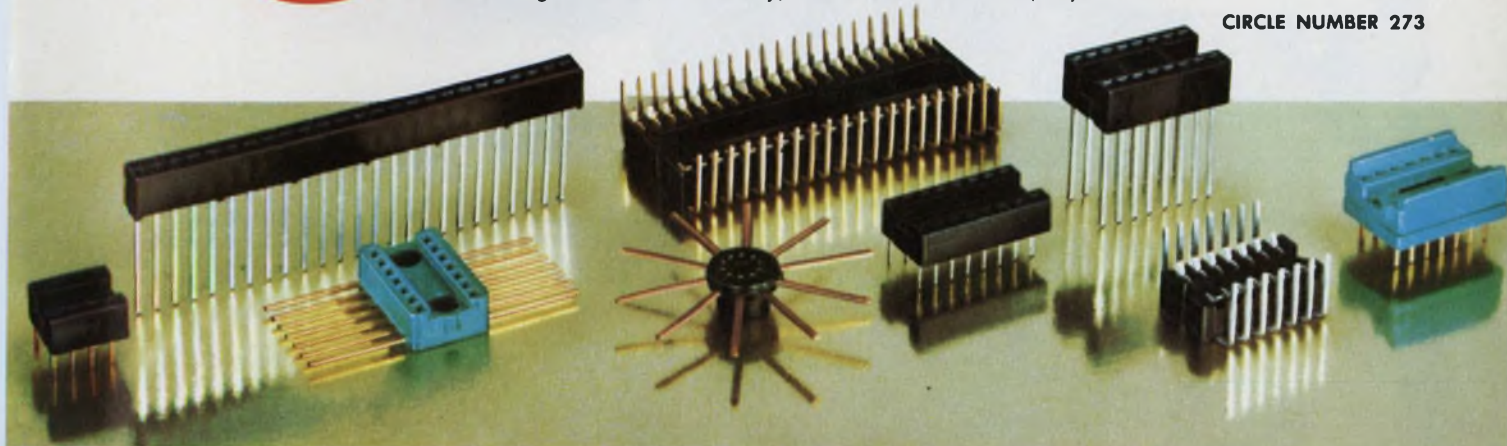



# Rent the Tek 8002 Microprocessor Lab today.

## And get Leasametric's total support package.

### The System

The new Tektronix 8002 Microprocessor Lab is the most advanced microprocessor development system available today. Each system is delivered complete with software support for two microprocessors plus hardware support for one microprocessor—all of your choice.

With the real-time prototype analyzer (including its 8-channel external ability), CRT console and 180 CPS line printer, your design team will enjoy the most productive design tool in existence.

In addition, the 8002's universality enables it to support several microprocessors—the 8080, 6800, Z-80 and 9900 with more to follow—thus freeing the designer to select a microprocessor solely on the basis of capability and cost-effectiveness.

### The Training

With the advent of the microprocessor, your design team now faces a new kind of development process, a process which brings with it an unprecedented opportunity for design flexibility. It also brings a process where proper training on the equipment and hardware / software integration techniques are of vital importance.

As part of Leasametric's total support package, we offer you **Tektronix-qualified** training, consisting of two full days of specialized on-site sessions for up to three members of your design team. There's no need to send your designers across the country to attend costly and time-consuming seminars. Upon completion of the training, you get immediate design productivity since your design team can now concentrate on the design task at hand and not on system operation.

### The Service

In the unlikely event that repairs should be necessary on the development system, Leasametric will initiate either in-house service or a replacement system within 24 hours—at no additional cost.

Leasametric will also make available a special hot line telephone number to assist you in solving any operational problems.

Our 18 fully-stocked Inventory Centers across the U.S. and Canada will provide on-going technical assistance and dedicated service whenever needed.

Call your nearest Leasametric Rental Inventory Center listed below for immediate shipment of the Tek 8002 or further details.



**Leasametric**

Division of Metric Resources Corporation  
822 Airport Blvd., Burlingame, CA 94010

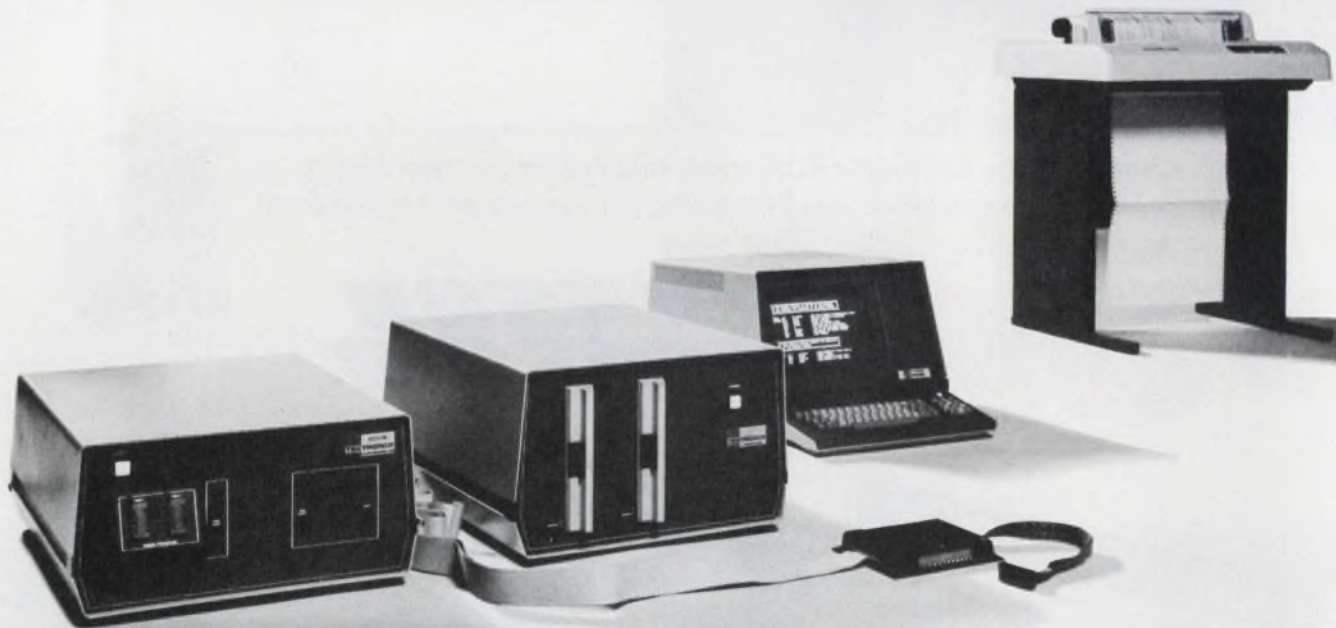

**INVENTORY CENTERS:** San Francisco, CA (415) 342-7111; Los Angeles, CA (213) 768-4200; Anaheim, CA (714) 634-9525; San Diego, CA (714) 565-7475; Houston, TX (713) 477-9911; Chicago, IL (312) 595-2700; Boston, MA (617) 244-9400; Midland Park, NJ (201) 444-0662; Long Island, NY (516) 293-5881; Washington, D.C. (301) 881-6700; Orlando, FL (305) 857-3500; Dayton, OH (513) 898-1707; Philadelphia, PA (215) 583-2000; Denver, CO (303) 429-7900; Minneapolis, MN (612) 854-3426; Dallas, TX (214) 661-9193; Atlanta, GA (404) 491-1155; Toronto, Ontario (416) 676-1897.

**TOLL FREE NUMBERS:** Outside California 800-227-0280; Outside New Jersey 800-631-7030; Outside Maryland 800-638-0838; Outside Illinois 800-323-2513.

CIRCLE NUMBER 274



# Group portrait: The Class of '77



**Guardian solenoids are made in all sizes and shapes: Box frame, U-frame, laminated and tubular . . . push 'n pull . . . AC 'n DC. But, it's the WAY they're made that puts them in a class by themselves.**

**Example: Uni-Guard® II molded bobbin and coil covers are now standard on our box frame and U-frame solenoids. This one design feature alone gives you cost savings of up to 25% . . . with at least 25% longer life.**

**Example: Our tubular solenoids are made in two basic versions . . . and hundreds of variations. There are the built-to-take it traditional tubulars. Plus, long-life tubulars that survive 100 million operations.**

**Example: We have more types available from stock than anyone else:** A special? You spec it and Guardian's ready to produce it. Return springs, special plunger configurations, terminations, mountings, coil finishes, thermal cutouts, dual windings, external switches . . .

**Let your Guardian Angel show you why Guardian is No. 1 in its solenoid class.**



 Recognized under the component program of Underwriters Laboratories, Inc.

## GUARDIAN®

GUARDIAN ELECTRIC MANUFACTURING CO. • 1572 West Carroll Ave. • Chicago, Illinois 60607 • 312/243-1100

CIRCLE NUMBER 275



# If your Christmas delivery of indicator lights arrived in time for Valentine's Day, you need Littelfuse.



**It can happen any time of the year.**  
Broken delivery dates. Long lead  
times. Production downtime.

But not with Littelfuse! Our indicator  
lights are more than just top quality—  
they're available—fast. From a  
nationwide network of Littelfuse  
Littelite distributors or from Littelfuse  
direct in large volume orders.

All Littelites are U.L. Recognized  
and Certified by C.S.A. And they sell at  
better than competitive prices.

Quality. Attractive Pricing.  
Unmatched delivery. We think



CIRCLE NUMBER 276

you'll find Littelites offer an unbeatable  
combination. For more information,  
send for our Littelites Product Guide  
or give us a call—today!

**LITTELFUSE®**  
SUBSIDIARY OF  
**Tracor**

800 EAST NORTHWEST HIGHWAY  
DES PLAINES, ILLINOIS 60016 • 312/824-1188





HAYDEN

# in personal computing books!

## See for yourself the reasons why:

**1. MICROPROCESSORS: New Directions for Designers** by Edward A. Torrero, #5777-6, paper, 1975, 144 pp., 8½ x 11, illus., \$10.95.

**2. GAME PLAYING WITH COMPUTERS** Rev. 2nd Ed., by Donald D. Spencer, #5103-4, cloth, 1976, 320 pp., 6 x 9, illus. \$16.95.

**3. FUNDAMENTALS AND APPLICATIONS OF DIGITAL LOGIC CIRCUITS** by Sol Libes, #5505-6, paper, (\$6.95), #5506-4, cloth, (\$9.95), 1975, 192 pp., 6 x 9, illus.

**4. COMPUTERS IN ACTION: How Computers Work** by Donald D. Spencer, #5861-6, paper, 1974, 160 pp., 6 x 9, illus., \$5.50.

**5. COMPUTERS IN SOCIETY: The Wheres, Whys and Hows of Computer Use** by Donald D. Spencer, #5915-9, paper, (\$5.50), #5916-7, cloth, (\$7.50), 1974, 208 pp., 6 x 9, illus.

**6. PROGRAMMING PROVERBS** by Henry F. Ledgard, #5522-6, paper, 1975, 144 pp., 6 x 9, illus, \$6.95.

**7. PROGRAMMING PROVERBS FOR FORTRAN PROGRAMMERS** by Henry F. Ledgard, #5820-9, paper, 1975, 144 pp., 6 x 9, illus., \$6.95.

**8. COBOL WITH STYLE: Programming Proverbs** by Louis J. Chmura, Jr., and Henry F. Ledgard, #5781-4, paper, 1976, 144 pp., 6 x 9, illus. \$6.95.

**9. MINICOMPUTERS: Structure and Programming**, by T.G. Lewis and J.W. Doerr, #5642-7, cloth, 1976, 288 pp., 6 x 9, illus., \$13.95.

**10. PATTERN RECOGNITION** by M. Bongard, #9165, cloth, 1970, 256 pp., 6 x 9 illus., \$14.90.

**11. DIGITAL SIGNAL ANALYSIS** by Samuel D. Stearns, #5828-4, cloth, 1975, 288 pp., 6 x 9, illus., \$19.95.

**12. BASIC BASIC: An Introduction to Computer Programming in BASIC LANGUAGE** by James S. Coan, #5872-1, paper, (\$7.95), #5873-X, cloth, (\$9.95), 1970, 256 pp., 6 x 9, illus.

**13. ADVANCED BASIC: Applications and Problems**, by James S. Coan, #5856-X, cloth, (\$8.95), #5855-1, paper, (\$6.95), 1976, 192 pp., 6 x 9, illus.

**14. FORTRAN FUNDAMENTALS: A Short Course** by Jack Steingraber, #5860-8, paper, 1975, 96 pp., 6 x 9, illus., \$4.95.

**15. DIGITAL TROUBLESHOOTING: Practical Digital Theory and Troubleshooting Tips** by Richard E. Gasperini, #5708-3, paper, 1976, 180 pp., 8½ x 11, illus., \$9.95.

**16. DIGITAL EXPERIMENTS** by Richard E. Gasperini, #5713-X, paper, 1976, 192 pp., 8½ x 11, illus., \$8.95.

## Write for 15-day examination copies of any of these books!

*At the end of 15 days, please remit payment plus postage and handling, or return the books and owe nothing. Prices subject to change without notice. If payment*

*accompanies order, we pay postage and handling. Outside USA, cash must accompany order — include \$2.00 per book for shipping and handling.*



## Hayden Book Company, Inc.

50 Essex Street, Rochelle Park, New Jersey 07662

phone: (201) 843-0550





# For a whole range of capabilities

## Ask CYBERNET<sup>®</sup> Services.

Get advanced programs that can cut time and costs, increase reliability in electronic design/analysis/testing. Easy-to-use through batch or interactive terminals. And available now with technical support just about anywhere in the U.S.

**CIRCUIT ANALYSIS—SYSCAP II**  
SYSCAP simulates circuit design on an interactive terminal. And it's reliable enough to let you go from schematic to simulation to production without ever building a physical breadboard. Circuits are modeled as a system of nodes interconnected by circuit elements, driven by signal sources and power supplies. A data bank for conventional parts is built into the program. Special functions can be easily formulated in FORTRAN. A single, free-format, easy-to-use language enables you to submit the same circuit file with only minor alterations to any type of analysis — AC, DC,

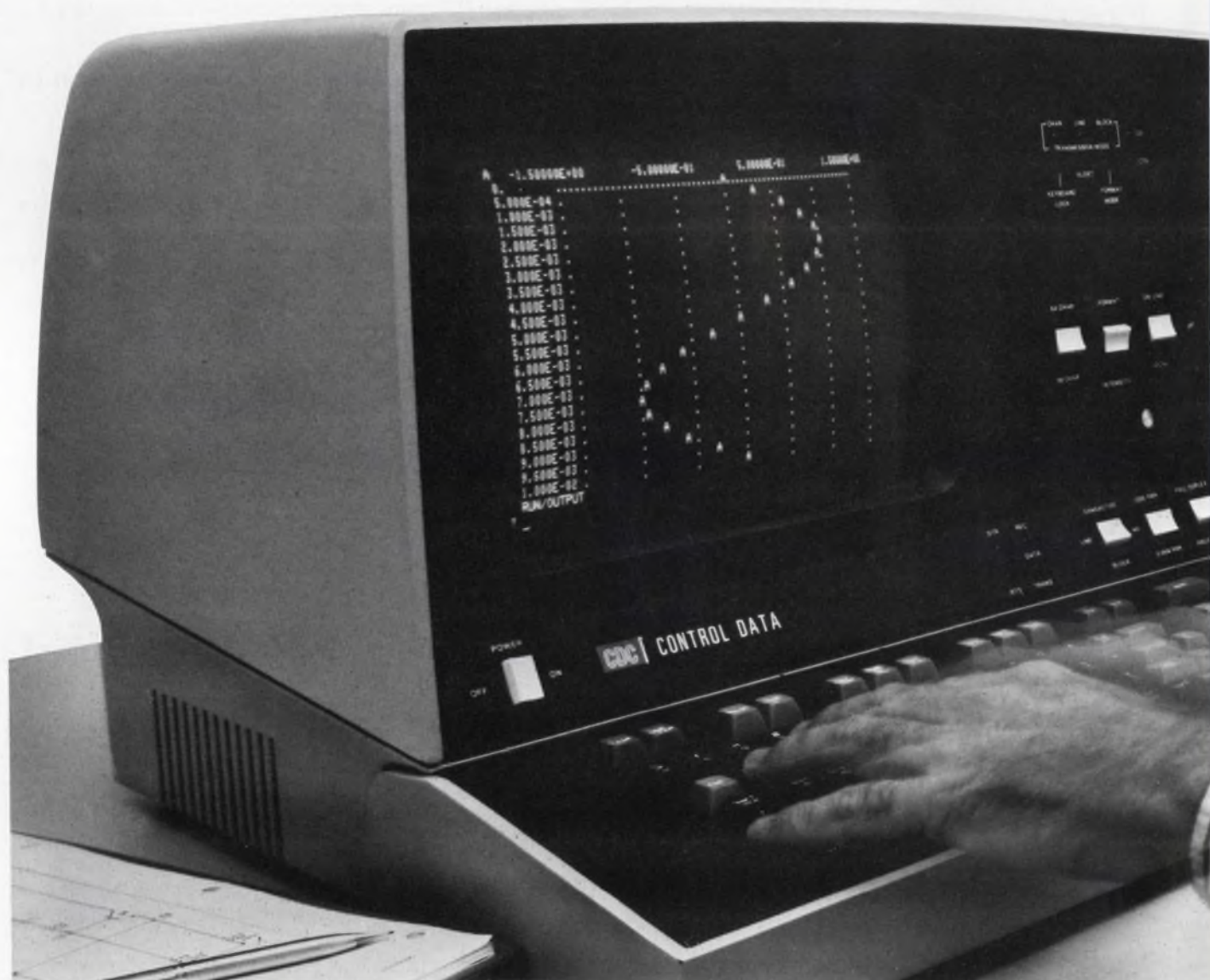



# in computer-aided design...

transient — in either mode — batch or interactive.

SYSCAP is easy to learn, efficient, economical and completely supported.

## CIRCUIT AND SYSTEM ANALYSIS — TESS

TESS is a flexible modeling tool which can be used not only in circuit design, but in combinational analysis (electromechanical, digital-analog, electro-optical) — virtually any system which can be represented by a set of coupled linear or non-linear differential equations. Data for approximately 1200 semiconductor devices is available with the program. A single input language makes it easy to use TESS's wide range of capabilities.

## LOGIC SIMULATION/TEST GENERATION — CC-TEGAS3

CC-TEGAS3 enables you to perform the three fundamental functions required in digital logic simulation — design verification, fault simulation, and test generation — with a single input language. TEGAS can be used through either batch or interactive terminals. A stand-alone preprocessor allows you to check out and correct input before submitting it to analysis. Combining all three applications into one system makes it possible for the designer to file test patterns for subsequent use by a test engineer in fault detection tests.

## MICROPROCESSOR PROGRAMMING — MICROLIB

MICROLIB is a library of assemblers and simulators for writing and verifying programs for the leading microprocessors and their second sources. It allows you to simply and easily evaluate chips for your particular requirements prior to purchase. And, programming is simpler and easier using an assembler instead of machine language. Simulators let you verify the program by observing how well it works, how efficient it is, if there are any errors, and what output it generates at different points. With MICROLIB, you get fast turnaround, efficient programs, support when you need it, and a broad selection of microprocessor software — with no development or maintenance costs.

## CYBERNET SERVICES TOTAL CAPABILITIES

CYBERNET Services offers a unique combination of comprehensive programs, computer power, technical support and a full selection of processing modes — for better, faster, more economical designs.

For information, call your nearby CYBERNET Service Center, circle the number below, or call our hotline, collect: 612/853-7600.

 CONTROL DATA CORPORATION

CIRCLE NUMBER 94





# Floppy-Disc Drives

In a floppy-disc drive, the medium spins while the head stays put. But dive into the specs on the 30 available models, and your head may end up spinning.

To select the right floppy drive for your job, you have to choose from a wide range of capacities and transfer rates, decide on a hard-sectored or soft-sectored format, satisfy yourself of the reliability of the unit you choose, and match it with an appropriate controller, interface, and software. You also must consider your company's requirements for tomorrow.

You face a choice between 8-in. and 5-1/4-in. diskettes, single and double density, single and double-sided recording, tunnel or straddle erase, and (soon) single and double-track density. You have to pick a head that's crowned or flat, ceramic or ferrite, single or double, and that's moved by a voice coil, a traditional lead screw or the newer metal band.

Is your head spinning yet? You're still not out of the woods. There are many conflicting manufacturer's claims to evaluate. You may find three "fastest" actuators, four "best" heads, maybe eight "smartest" door interlock systems.

Then come the not-so-technical headaches. Keeping in mind cost and vendor reliability. Second-guessing the next IBM move and its impact on what's available. Comparing drive mechanical details: "If this snap-action switch got designed out of two other brands after a few months of field use, do I want it in mine? Does it really harm the diskette envelope? Why did two manufacturers replace the switch with a LED-photodiode assembly?"

With so many different floppy designs, the performance picture hasn't stabilized by a long shot. For

example, a half-dozen vendors have followed Shugart with two-headed standard floppies that double the on-line capacity of their units. More changes can be expected as soon as IBM tips its hand on double-track

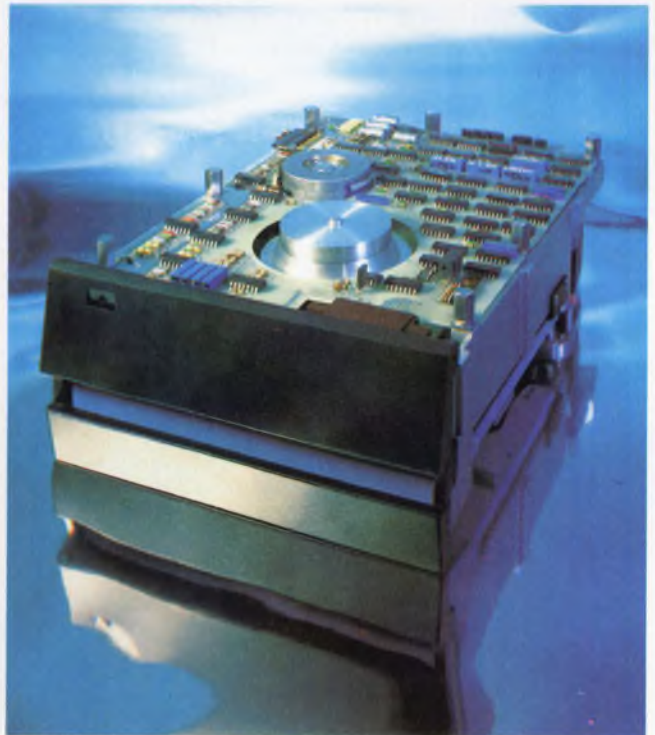

**This double-sided, double-density IBM-compatible Mayflower 700 from MFE measures 30% smaller than competition, and multiplies media life by four. Dc-motored 750 version claims a high 10,000-h MTBF and low power—30 W. The 700 and the 750 are the first floppy products of MFE, an established cassette builder.**



density in January, 1978.

Right now, many drives have built-in provisions for double track. They use two (in one case, three) stepper increments to do a one-track move. There is no guarantee that this will completely satisfy the new IBM format. But there's hope. Although many drives are used to record non-IBM-compatible formats, IBM compatibility is still the watchword for factors as basic as the track geometry itself.

As if waiting for double-track standards weren't enough, rumor now has it that IBM will soon bring out a 3-1/2-in. micro-sized floppy. Indeed, no part of floppy-disc technology is standing still. Look at the frame—a component that few electronic designers normally consider very exciting. Manufacturers have been stamping them out of aluminum or steel for years—drilling a few holes, and going on from there.

Now Memorex has introduced a plastic chassis. It's molded in one piece of extra-rugged fiberglass-reinforced polyester (FRP), which gives you lighter weight and tolerances that may be unachievable with aluminum or steel.

FRP can also save money, since the molding process incorporates a large number of inserts, holes, bosses and gussets without any per-unit labor expense.

But along with the new benefits, are there any new problems? Will the electrical shielding of the old metal chassis be missed? Or the magnetic shielding of the steel one?

The floppy disc field is only five years old. But the typical design you'll look at is one or two years old at the most, and may have been redone to correct the faults or limitations of the first-generation design.

### A child of diversity

But aren't all floppy drives based on an IBM standard format, and therefore alike? In format, yes. In construction, dependability, and performance, no.

Innovations and variations in design have come from a dozen noncaptive manufacturers, which are still manufacturing floppy drives for OEM use, from three or four that have stopped manufacturing floppies, and from suppliers like IBM, Burroughs and Sycor, which build floppies for only their own products.

What was a single, well-defined product five years ago has been superseded by a broad spectrum of competing products, each bringing something a little different to your search party. Tables 1, 2, and 3 tell the growth story.

Before you can simply run a finger down the charts and pick a winner, you have to examine the whole range of available products. You should also be aware of spec tricks and be ready to visit and grill every prospective supplier.

Table 1 shows the tremendous range of floppy-disc drives with integration levels defined along the horizontal axis of the chart, and data capacities along

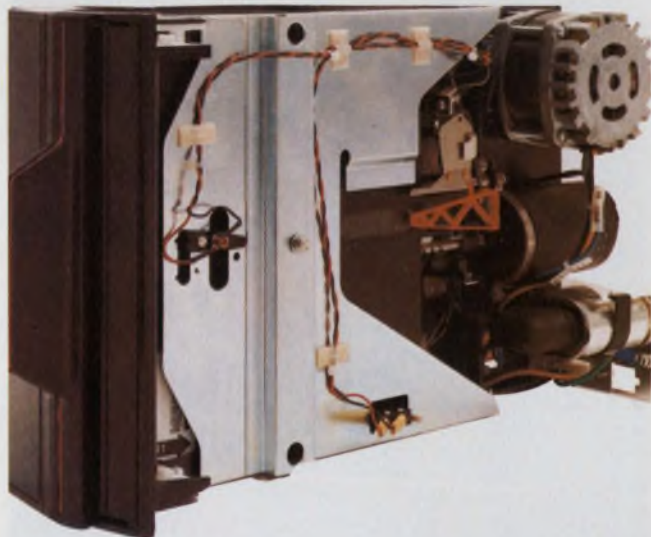

The light, rigid chassis of the Model 550 from Memorex, molded from fiberglass-reinforced polyester, meets tight tolerances that steel and aluminum can't. Its design permits factory upgrading to the recently introduced dual-head 552 version.

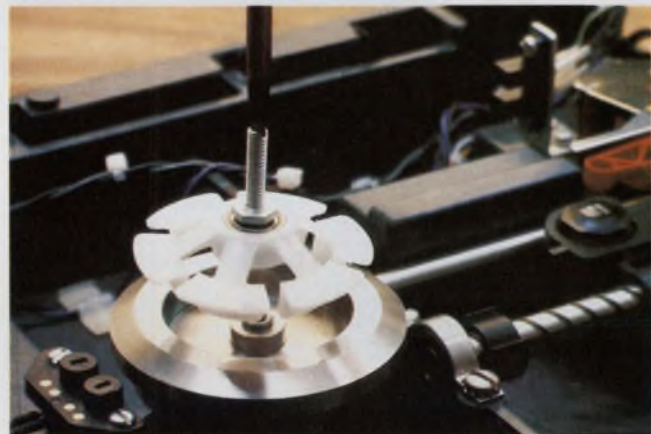

To reduce the usual disc-damage problems, Memorex 550/552 drives use a "balanced-velocity" clamping design (top) that cuts slippage during diskette engagement, and a door-controlled latch/eject mechanism (bottom) that pops media in and out and is interlocked to prevent the door from closing on a diskette that's not fully in.





Seeking guaranteed interchangeability of diskette media, Tri Data departs from industry standards with its floppy drives for the Flexifile 10 (left) and 11 (right). Track width



is triple the industry standard, though the 8-in. medium affords only 32 tracks, 98 kbytes of storage and 40 kbytes/s transfer with 100-rpm operation.



Dual-index and file-protect sensors permit recording of data on both sides of a microdiskette on the Wangco Model 82 Micro-Floppy. Up to four units can be daisy-chained on a single bus.

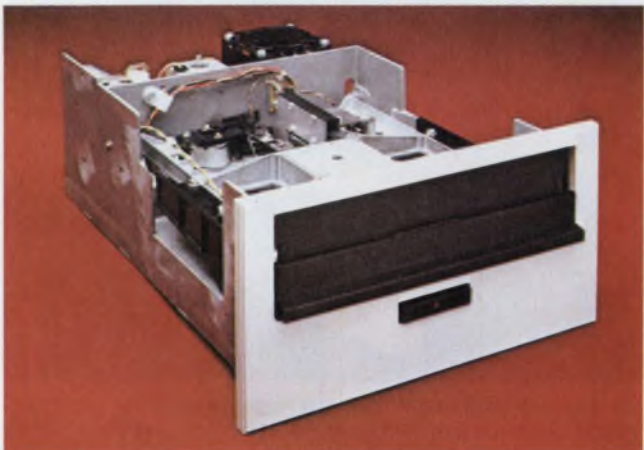

A double-sided, double-density floppy-disc drive, the SA 850 from Shugart Associates is plug-compatible with the company's standard 800.

the vertical axis. At the right-hand side of the chart are some of the quasistandard specs for most of the products in each capacity level. The arrow at the left reminds you that it all began with the standard floppy, from which came the smaller-capacity minifloppy as well as the larger-capacity combinations of double-density, double-head, and (soon) double-track.

Examine the integration levels. No doubt if you're designing for volume production, you will end up buying basic floppy-disc drives with read-write and motion-control electronics and little else (level 1 or 2). These days, you'll probably evaluate several existing controllers before seriously thinking about building your own.

Perhaps, however, you can get your project off the ground six months sooner by buying a complete ready-to-go floppy-storage subsystem. It can "front" for you in system-level tests, while you engineer your production version to be functionally similar but much more cost-effective. To determine if this two-pronged approach makes sense, you may want to look at complete, packaged floppy subsystems as well as bare drives. Talk with the system builders. They're old hands at evaluating and comparing basic drives.

Use Tables 2 and 3 to complete the overview of available products. Get in touch with vendors early in the design and stay plugged in on spec changes and new product announcements.

Now to the specs.

### Digging into the data sheets

One question you'll surely ask: How long do diskettes last? Most manufacturers specify track life as 3-million to 5-million passes (rotations) per track, and their accompanying literature smoothly assures you



that the early problems with media life have been solved for the most part.

But once you do the arithmetic and discover that even a low diskette speed of 360 rpm (low compared with the 1800 to 3600 rpm of fixed-head discs) translates to more than a half-million passes per day, you don't feel so assured.

A track can wear out in as little as six 24-hour days.

No problem, if the wear is distributed among the 77 tracks of a standard floppy, and if no diskette spends too much time on the system, and if the heads aren't loaded against the medium when data aren't being accessed.

But some designs locate frequently used information, such as the software-operating system and key subroutines, on a few heavily used tracks of the disc. And heavy usage of a few tracks and light usage of others is determined by software, and seldom by the hardware design engineer.

Diskettes themselves can be dented, damaged, or devoured by media sensors and faulty clamping mechanisms, and made vulnerable to damage by doors that either aren't locked or aren't interlocked. Improved designs have been triumphantly announced—only to be recalled as quietly as possible when unexpected bugs developed. Don't count on the data sheet to show you that the mechanical arrangements are foolproof.

Many data sheets crow about "the unit's superior head design" which is said to give "the extremely low head/media wear." But few mention the head-loading force, let alone specify that it is a controlled quantity.

Shugart's design improvements in the 850/851 two-head band design allow the company to lower head loading from 15 to 8 grams. The result? A longer media and head life. The vendor should specify the force at which his heads are set, and guarantee it over all units. How much, for example, will that force vary on a single-sided unit as the head-load pad wears out?

### Your pad or mine?

Even though data sheets say "no maintenance required," head load pads on a single-sided unit need to be replaced after 1000 to 2000 hours. And while dual-head designs eliminate the little pad holding the medium against the head, some new designs use big "squeegee" pads to help clean the disc and put the medium in tension. Check how often the pad must be replaced.

Check access times, too. Be sure to ask for maximums. Find out also if the "average" access includes settling time—it usually doesn't. The "average" is usually a third (not a half) of the maximum access time, although average latency is half the maximum rotational period. Vendors are inconsistent, but at least the numbers not shown on the data sheets are readily available.

Remember to question "hours" at every appearance on a data sheet. Head life and service life are stated

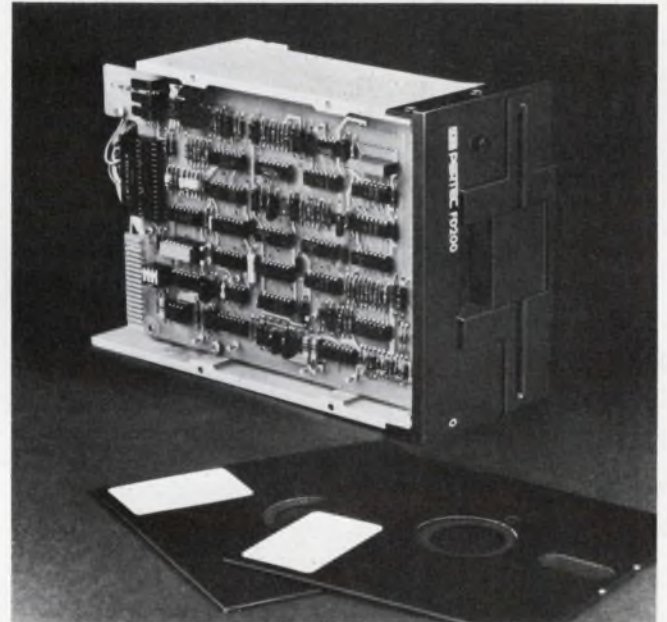
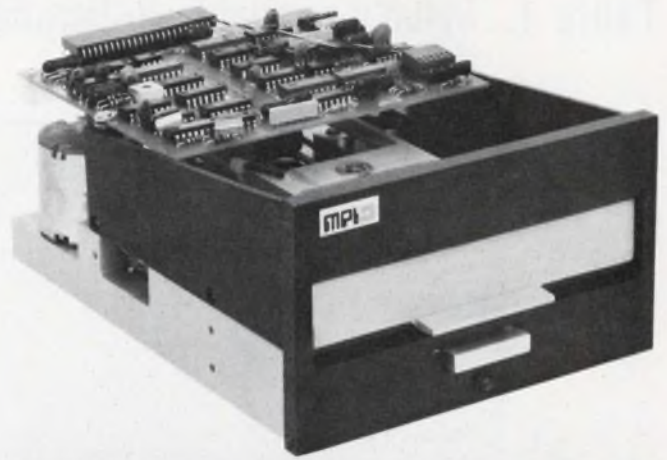

A micro-sized drive (top) from MPI is the only minifloppy to use a metal-band actuator. Its track-to-track time is 5 ms. Pertec's micro-sized floppy (bottom) boasts the same dimensions, mounting holes, interface signals, and voltage requirements as the Shugart SA400.

in hours. What is meant? During power-on hours (POH), the drive is active only a small fraction of the time. What fraction is the manufacturer assuming?

Whether or not the drive manufacturer sells formatter/controllers specialized to his unit, ask him who else does. Ask how his electronics mates with the Western Digital 1771 controller chip, the NEC 372D, the SMSFDO 300, the Motorola MC 6843, the Intel 8271 or whichever ones pertain to your work. Request design examples and ask him to put you in touch with people who are using those controllers with his drives.

The controller determines how you'll handle double density—but the drive capabilities have to match. The encoding and decoding for modified frequency modulation (MFM) or modified modified frequency modulation (M<sup>2</sup>FM) or group-coded recording (GCR) are normally done in the controller. Discussion abounds as to which scheme is theoretically the best. Find out who's successful with each method for each drive



# Table 1. What's available in floppies

		← Integration Levels →					
		Diskette media only	Drive with electronics	Dual with electronics	Level 1 or 2 drive, plus controller	Level 3 drive, plus interface	Level 4 hardware, plus software
		Level 0	Level 1	Level 2	Level 3	Level 4	Level 5
Larger capacity ↑  ORIGINAL FLOPPY →  ↓ Smaller capacity	Double-sided & double-density floppy disk	See "Need More Info (Media)"	See Table 2	Example: PerSci 277 and 297 dual drives are comparable in size to most single drives; four 2-diskette duals fit vertically across 19" rack.	Available from many vendors, Tables 2, 3.	Available from some vendors of each group	See "Need More Info (Systems)"
	"Flippy"® or double-sided floppy disk						
	Single-sided double-density floppy disk						
	Standard floppy disk						
	Mini-floppy® or Micro-floppy® disk						

DD — Double-density (MFM, M<sup>2</sup>FM or GCR) FO — Flip-over: 2-side recording with 1 head 2 HD — Two-head: 2-side recording with 1 head on each side, full capacity on-line.

you're considering. The bandwidth of the heads and electronics also affect your choice.

### Don't forget dirt

A well-known and valuable feature of the floppy is that it doesn't have to operate in a "clean room." But how much dirt is acceptable? Data sheets list temperature and humidity limits but fail to consider the amount of dirt in the air. So beware.

Unless you can find it in print, the manufacturer isn't promising a floppy that will tolerate dirt. At least one vendor, Innovex, does have an enclosed filtered-air environment.

Until recently, most floppy applications have had no major dirt/dust problems, since the diskette stayed wrapped in an envelope lined with a dirt-removing material. Constant burnishing by the freshly cleaned medium cleans the heads, too.

But now a new component that is potentially dirt-sensitive has been introduced in some drives. Several vendors are offering metal-band actuator designs as the least expensive way to reduce track-to-track motion times. A metal band wrapped around a capstan replaces the traditional lead screw as the element transferring the motion from the stepping motor to the head assembly.

However, dirt buildup on the metal band may affect reliability by changing the effective radius of the capstan. So, more dirt means more head motion when the capstan rotates—and more track separation. Even a few-thousandths buildup across the 77 tracks of a standard floppy can cause real problems, some experts warn.

Memorex and General Systems International have so far avoided a dirt hassle—no band. They have stayed with the lead screw, and made it play at 3 ms, the same as most metal-band actuators.

In the current Shugart product line, the single-head Models 800 and 801 use a lead screw. The dual-head Models 850 and 851 use a metal band and feature a decrease from 8 ms to 3 ms of track-to-track time. But too many changes are involved to upgrade an existing single-head model to dual-head.

Both Memorex and General Systems International claim to have a higher commonality of parts between their single-head and dual-head models than Shugart. Memorex will upgrade its single-head Model 550s to Model 552s for dual-head double-sided recording at the factory. GSI discourages such modifications because too many changes are needed, including head-loading hardware as well as the head carrier, but points to an 85% commonality of spare parts between its single-head FDD110s and double-head FDD220s.



← Typical Storage Specs →

Capacity vs. Sectoring	No. of Tracks	Transfer Rate	Media Size
Kilobytes	Count	Kilobytes/sec.	Package
1600 Hard 972 Soft (DD + FO or ZHD)	77 per side	500	8" x 8" envelope
800 Hard 486 Soft (FO or ZHD)	77 per side	250	
800 Hard 486 Soft (DD)	77	500	
400 Hard 243 Soft	77	250	↓
498.8 if DD & FO 218.8/249.4 if DD or FO 124.7 if 40 tk 109.4 basic	35 (40 opt.)	125 (250 if DD)	5 1/4" x 5 1/4" envelope

Speaking of upgrades, how well can you foresee those your product may need later? And what do the manufacturers promise? Will you have to discard your floppies or merely modify them when double-track or some other change comes out? Data sheets seldom clear up such questions.

**Get thee to a factory**

For this reason and because many of the floppy-drive designs—and companies—are new, visits to the vendors' plants are valuable. Go with the idea of extensively questioning and examining the field performance of the unit you're considering, and the modes of failure. Down-to-earth discussions with satisfied—and dissatisfied—users of the products are also a must.

Put tough questions to every manufacturer you are considering, such as: "Is your mean-time-between-failures spec measured or calculated? If it is not based on field data, just how is it calculated?" Several data sheets candidly state that MTBF figures are calculated; that is, they are theoretical figures derived on paper from formulas—not factual data based on the real longevity of drives used in the field. Other manufacturers are not so candid; they omit the word "calculated." One even heralds "our MTBF rating," as

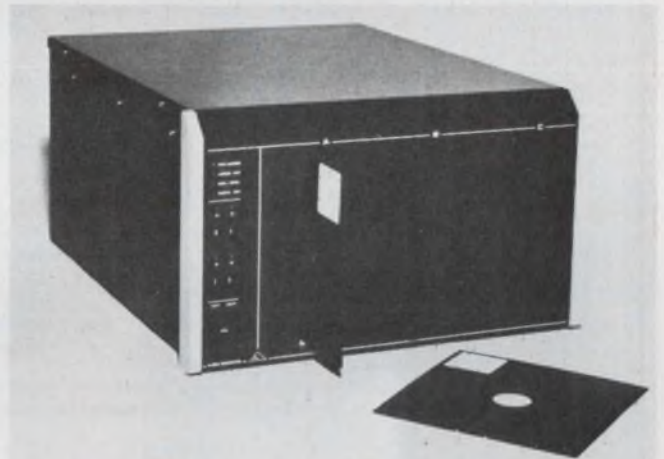
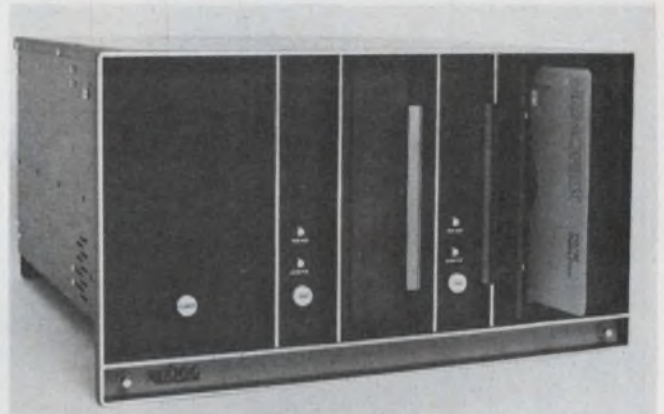
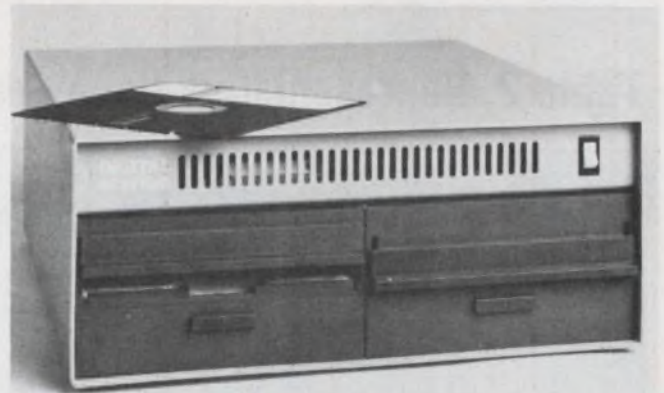

**Complete floppy-disc systems** offer both hardware and software systems. Digital Systems' FDS-1 (top) includes one or two Shugart drives, an IBM-compatible controller, an Altair-IMSAI S-100 interface, and cables for connecting with Z80/8080 systems. Various Xebec models (middle) interface PerSci, Shugart, and Memorex drives to PDP8, PDP11, LSI 11, Nova, and Eclipse computers. Advanced Electronics Design (bottom) ties Memorex, Shugart (shown) and Pertec units to those five computers.

if some outside authority had bestowed the 9000-hour figure after it was earned.

Keep your questions coming: "May I see the data that are the basis of your 0.5-hour mean-time-to-repair (MTTR) specification? What are the main failure modes of the model I am considering? If I sat down at your bench right now, how long would it take you to train me to repair all the kinds of failures that come up?"

*(continued on page 202)*



## Table 2. Representative floppy drives

Notes: accept 8-inch square diskettes, access to 1.6 megabytes.

Company	Model No.	Model Designation	Capacity level and options (see Table 1)	Integration level (see Table 1)	Motor type	Head actuator	MTBF (hrs)	MTTR (min)	No. of Heads	Head life (wks)	Track Life (days)	Read errors recoverable	Read errors unrecoverable	Seek error rate	Motion times (ms.)					Units in rack width	Weight (lb.)	Special features	
															latency (av.)	headload	access, 1k-1k	access, (av.)	settling				
Calcomp	142M	Floppy Disk Drive	1.2	1	AC	V leadscrew	note 1 7000	<30	1	note 2 DES 5 yr. or 30,000h	note 7 ?	10 <sup>-9</sup>	10 <sup>-12</sup>	10 <sup>-6</sup>	83	30	6	—	10	3E	16	Daisy chain, good read margins.	
	143M	" " "	4MFM	1(3)	AC	"	"	"	2	"	?	"	"	"	83	30	6	—	10	3E	16	Unique flat heads, opt'l. 1143M controller.	
Control Data	9400	" " "	1	1(3)	AC	Leadscrew	4000	30	1	SVC 5 yrs or 30,000h	—	10 <sup>-9</sup>	10 <sup>-12</sup>	10 <sup>-6</sup>	83	60	10	270	10	3	12	9474 subsystem interfaces 9404 & 6's with 8080.	
	9404	" " "	1.2	1(3)	AC	"	4000	30	1	"	—	"	"	"	"	60	10	270	10	3	12	"	
	9406	" " "	4	1(3)	AC	Band (note 9)	8000	30	2	"	—	"	"	"	"	40	3	91	10	3	12	"	
General Systems Int'l.	GSI-110	Flexible Disk drive	2	1(3)	AC	Leadscrew	6000	20	1	SVC 5 yrs or 30Kh	7	10 <sup>-9</sup>	10 <sup>-12</sup>	10 <sup>-6</sup>	83	35	6	156	14	4	13	>55% read resolution on track 76.	
	FDD-200	Flexible Disk drive	4MFM, M <sup>2</sup> FM	1(3)	AC	Leadscrew	6000	<20	2	SVC 5 yrs or 30Kh	7	10 <sup>-9</sup>	10 <sup>-12</sup>	10 <sup>-6</sup>	83	35	3	128	14	4	11	3-bearing stepper, shielded pc	
Innovex Corp	200, 400 Series	Floppy disk drive	1.2		AC	Leadscrew	>8500	<30	1	>15Kh typ.	7	10 <sup>-9</sup>	10 <sup>-12</sup> est.	10 <sup>-6</sup>	83	30	8	—	8	4E	14	Filtered air, 35% better read margins.	
	600 Series	Double-sided disk drive	4		( In development )				2	—	—	—	—	—	—	—	—	—	—	—	—	—	
MFE	500 Series	Mayflower single-sided drive	1.2		( In development )				1														
	700 Series	Mayflower Double sided drive	4MFM, M <sup>2</sup> FM	1	AC or DC models	Band	>10,000 if DC motor	—	2	4x10 <sup>7</sup> passes (note 5)	>10	<10 <sup>-9</sup>	<10 <sup>-12</sup>	<10 <sup>-6</sup>	83	35	3	—	15	4	10	Smallest, lowest power in DC version.	
Memorex Corp.	550	OEM floppy	1.2	1	AC	Leadscrew	9000	30	1	—	10	10 <sup>-9</sup>	10 <sup>-12</sup>	—	83	35	6	—	10	4	10.7	FRP frame, power saver on stepper.	
	552	OEM dual-head floppy	4MFM, M <sup>2</sup> FM	1	AC	Leadscrew	9000	30	2	—	10	10 <sup>-9</sup>	10 <sup>-12</sup>	—	83	35	3	—	10	4	10.7	Factory can upgrade 550 to 552	
Micro Peripherals Inc.	882	Flexible disk drive	1.2, 4	1	AC or DC	Band	8000	30	2	DES 5 yr (note 2)	7	10 <sup>-9</sup>	10 <sup>-12</sup>	10 <sup>-6</sup>	83	35	3	91	15	3	10	Compatible with Shugart, 30% less parts.	
Per Sci. Inc.	70	Single floppy	1.2	1(3)	DC	Voice-coil	6000	20	1	DES 5 yrs or 15Kh	7	10 <sup>-9</sup>	10 <sup>-12</sup>	10 <sup>-6</sup>	83	40	10	33	0	4	15	1070 controller available (all models)	
	277	Dual floppy	1.2	2(3) (note 8)	"	"	"	"	2	"	"	"	"	"	"	"	"	33	0	4	20	Holds 2 independent diskettes.	
	297	Two-sided dual floppy	4	2(3) (note 8)	"	"	"	"	4	"	"	"	"	"	"	35	"	33	0	4	22	All models have motor to insert disk & push-button to eject	
Pertec, Inc.	FD400	Flexible disk	1	1	DC	Leadscrew	>10,000	—	1	20Kh	10	10 <sup>-9</sup>	10 <sup>-12</sup>	—	83	40	10	—	20	4	14	3 steps/tk., ferrite heads.	
	FD5X0	"	1(2)	1	AC	"	"	—	1	"	10	"	"	—	83	40	10	—	20	4	14	Steel chassis, DD optional.	
	FD511	"	1.2	1	AC	"	"	—	1	"	10	"	"	—	83	40	10	—	20	4	14	Daisy chain, and extra control lines.	



Company	Model No	Model Designation	Capacity level and options (see Table 1)		Motor type	Head actuator	MTBF (hrs.)	MTTR (min.)	No. of Heads	Head life (wks)	Track Life (days)	Read errors, recoverable	Read errors, unrecoverable	Seek error rate	Motion times (ms.)					Special features		
			Integration level (see Table 1)												latency (av)	headload	access, lk-lk	access, (av)	settling		Units in rack width	Weight (lb.)
Remex	RFD1000	"	1.2MFM	1(3-5)	AC	Stylus ball	—	—	1	>30Kh	>10	<10 <sup>-9</sup>	<10 <sup>-12</sup>	—	83	50	6	176	24	3E	15	PDP 8/11 interfaces available
Shugart Associates	SA800	Diskette storage drive	1.2	1(3)	AC	Leadscrew	5000HD 8000TYP	30	1	15Kh	7	10 <sup>-9</sup>	10 <sup>-12</sup>	10 <sup>-6</sup>	83	35	8	260	8	3E	13.0	Industry std Controllers available
	SA850	" " "	4M <sup>2</sup> FM	1(3)	AC	Band	"	30	2	"	7	10 <sup>-9</sup>	10 <sup>-12</sup>	10 <sup>-6</sup>	83	35	3	91	15	3E	13.0	8 gm head load force, down from 15
Wangco, Inc.	76	Diskette drive	1.2	1(3)	AC	Uni-ball	5000	30	1	DES 5 yrs	N.A.	10 <sup>-10</sup>	10 <sup>-12</sup>	10 <sup>-6</sup>	83	16	6	168	14	3E	13	
	276	Dual head diskette drive	4	1	AC	Uni-ball	8000	30	2	DES 5 yrs	N.A.	10 <sup>-9</sup>	10 <sup>-12</sup>	10 <sup>-6</sup>	83	35	3	90	15	3E	13	

**Table 3. Representative micro/mini/floppies**

**Note:** accept 5.25-inch-square diskettes, hold 109.4 kilobytes on 35 tracks, one side up to 498.8 kilobytes if options incl. 40, DD, FO } double for DD (double-density) (MFM, M<sup>2</sup>FM) and/or double (again) if FO (flip-over recording)

Company	Model No	Model Designation	Capacity level and options (see Table 1)		Motor type	Head actuator	MTBF (hrs.)	MTTR (min.)	No. of Heads	Head life (wks)	Track Life (days)	Read errors, recoverable	Read errors, unrecoverable	Seek error rate	Motion times (ms.)					Special features		
			Integration level (see Table 1)												latency (av)	headload	access, lk-lk	access, (av)	settling		Units in rack width	Weight (lb.)
Pertec, Inc.	FD200	Micro-sized	0.40, DD, FO	1(5)	DC servo	Cam	—	—	1	20Kh	6	—	—	—	100	35	25	?	10	—	3.2	
Shugart Associates	SA400	Minifloppy	0	1(3)	DC	Cam	8000 (note 6)	30	1	?	6	10 <sup>-9</sup>	10 <sup>-11</sup>	10 <sup>-6</sup>	100	75	40	463	10	—	3	note
Micro Peripherals Inc.	B51	Micro-sized	0.40, DD	1	DC servo	Band	10,000	30	1	DES 5 yrs	6	10 <sup>-8</sup>	10 <sup>-10</sup>	10 <sup>-6</sup>	100	35	5	75	15	—	3.0	Patented disk clamp, eject. band
Wangco, Inc.	Model 82	MicroFloppy™	0.40, DD, FO	1(3)	DC servo	Leadscrew	8500	30	1	Des. 5 yrs	N.A.	10 <sup>-9</sup>	10 <sup>-12</sup>	10 <sup>-6</sup>	100	60	30	370	20	—	3.5	8201 micro-controller available.

**Notes:**

1. MTBF figures are sometimes labeled "calculated" or "normal operations".
2. If head life is not stated, "DES" (design life) or "SVC" (service life) spec is quoted in this column.
3. "E" means estimated, where not stated by manufacturer. If H= 4.38, 4-wide is assumed.
4. Weight is "nominal", according to Shugart.
5. MFE quotes head life as >40x10<sup>6</sup> wear revolutions (>80 days of 24 hrs with heads loaded — absolute worst case, this is >11 weeks). Normal usage makes heads last much longer, since heads contact media a small fraction of POH (power-on hours). But all manufacturers leave "normal usage" undefined.
6. MTBF is 8000 power-on hours, but spindle motor is assumed to be on only 25% of those hours.
7. ED has quoted media life per track in terms of worst-case 24-hour days. Thus 3.5x10<sup>6</sup> wear passes becomes 7 days. Normal usage makes media last much longer, if duty cycles are low.
8. PerSci 277 and 297 are about the same size as most single-diskette drives, but each holds two independent diskettes, usable simultaneously.
9. CDC9406 was shown at NCC with leadscrew, but band is used in production units.

(continued on page 204)



(continued from page 203)

"How many repair people have you trained this way? How many are within service distance of my customers' locations? What tools and equipment will such a serviceman need, and how big a stock of parts? How do I test to ensure that I am reading  $10^9$  bits per soft error and  $10^{12}$  bits per hard error? Can I test every unit to this spec? If not, how and when do I apply the spec?"

In a standard-density floppy, the data transfer rate is 250 kilobits per second. Figuring 10 bits per byte, reading or writing  $10^9$  bits takes 400 seconds or 6-2/3 minutes and  $10^{12}$  bits takes 111 hours.

But suppose soft errors start cropping up more often than every 6 minutes—and hard errors more often than every 111 hours. Certainly, the burden of proof will be on you to show that you are maintaining and operating the unit correctly.

But what kinds of records will the manufacturer expect to see before he will even consider that it is *his* problem? How will you demonstrate to him that the "bug" is in the heads or electronics that he supplied, not in some infrequent glitch in your digital controller? Must you prove that you have never

operated his floppy drive outside the temperature and humidity ranges he specified?

Does his spec apply only when you are using diskette media carrying his brand name? Or only when the diskette is recorded on his make of drive? Or only when it is recorded on the same drive that's reading it?

Find out if the manufacturer will work with you to correct any failures of *his* floppy drive in *your* system. He may plan to defend his unit by excluding your system as an unknown situation, and proving his drive meets specs in the environment at his factory. Perhaps previous customers have charged that the units were not meeting the MTBF, MTTR, or reliability specifications. How were these challenges resolved?

Apply hard questioning to burn-in and production testing as well. Does the manufacturer do margin testing? If so, how? In one method, specially prepared diskettes at Shugart contain track segments that are radially displaced by 1 to 10 mils, in 1-mil increments. Units that cannot read tracks displaced by  $\pm 0.008$  in. don't get shipped. This provides an effective margin test on the read electronics. ■■

## Need more information?

The products cited in this report don't represent the manufacturers' full lines. For additional details, circle the appropriate number on the Reader Service Card. For data sheets and more vendors, consult ELECTRONIC DESIGN's GOLD BOOK.

### Floppy drives

- Calcomp, 2411 W. LaPalma, Anaheim, CA 92801. (714) 821-2011. (Joel Levine)  
Circle No. 361
- Control Data, P.O. Box 12313, Oklahoma City, OK 73112. (405) 946-5421.  
(Terry Hardie) Circle No. 362
- General Systems International, 1440 Allec St., Anaheim, CA 92085. (714)  
956-7183. (Mike Krunic) Circle No. 363
- Innovex Corp., 75 Wiggins Ave., Bedford, MA 01730. (617) 275-2110. (Gary  
Bloch) Circle No. 364
- MFE, Keewaydin Dr., Salem, NH 03079. (603) 893-1921. (Jim Bartley)  
Circle No. 365
- Memorex Corp., San Tomas & Central, Santa Clara, CA 95052. (408) 987-1396.  
(Bob Erdman) Circle No. 366
- Micro Peripherals, 8724 Woodley Ave., Sepulveda, CA 91343. (213) 894-4076.  
(Keith Ullal) Circle No. 367
- PerSci, Inc., 4087 Glencoe Ave., Marina Del Rey, CA 90291. (213) 820-3764.  
Circle No. 368
- Pertec, 9600 Irandale Ave., Chatsworth, CA 91311. (213) 999-2020. (Bob Conti)  
Circle No. 369
- Remex (Ex-Cell-O), 1733 E. Alton St., Irvine, CA 92714. (714) 557-6860. (David  
Kolstrom) Circle No. 370
- Shugart, 415 Oakmead Pkwy., Sunnyvale, CA 94086. (408) 733-0100. (George  
Soliman) Circle No. 371
- Wangco, 5404 Jandy Place, Los Angeles, CA 90066. (213) 390-8081. (George  
Toor) Circle No. 372

### Systems

- Advanced Electronics Design, Inc., 440 Potrero Ave., Sunnyvale, CA 94086.  
(408) 735-3555. (Jerry Kennedy) Circle No. 373
- Charles River Data Systems, Inc., 235 Bear Hill Rd., Waltham, MA 02154. (617)  
890-1700. (Wm Nirnee) Circle No. 374
- DTC (Data Terminals & Communications), 1190 Dell Ave., Campbell, CA 95008.  
(408) 378-1112. (Herb Martin) Circle No. 375

- Data Systems Design, Inc., 3130 Coronado Dr., Santa Clara, CA 95051. (408)  
249-9353. (George Fink) Circle No. 376
- Digital Systems, 6017 Margarido Dr., Oakland, CA 94618. (415) 428-0950.  
(John Torode) Circle No. 377
- Echo Science Corp., 485 E. Middlefield Rd., Mountain View, CA 94043. (415)  
961-7145. (Bill Nichols) Circle No. 378
- Gnat Computers, Inc., 7895 Convoy Court, Unit 6, San Diego, CA 92111. (714)  
560-0433. Circle No. 379
- Mupro, Inc., 424 Oakmead Pkwy., Sunnyvale, CA 94086. (408) 737-0500.  
(Donald Pantle) Circle No. 380
- North Star Computers, Inc., 2465 Fourth St., Berkeley, CA 94710. (415)  
549-0858. Circle No. 381
- Peripheral Vision, P. O. Box 6267, Denver, CO 80206. (303) 777-4292. (John  
Taylor) Circle No. 382
- Scientific Micro Systems, 777 E. Middlefield Rd., Mountain View, CA 94043.  
(408) 964-5700. Circle No. 383
- Sykes Datatronics, Inc., 375 Orchard St., Rochester, NY 14606. (716) 458-8000.  
Circle No. 384
- Tri-Data, 800 Maude Ave., Mountain View, CA 94043. (415) 969-3700. (Herm  
Levin) Circle No. 385
- Western Telematic, Inc., 2435 Anne St., Santa Ana, CA 92704. (714) 979-0363.  
Circle No. 386
- Xebec Systems Inc., 2985 Kifer Rd., Santa Clara, CA 95051. (408) 988-2550.  
(Bob Sigal) Circle No. 387

### Media

- BASF Systems, Crosby Dr., Bedford, MA 07130. (617) 271-4000. (John Healion)  
Circle No. 388
- Control Data Corp., 11615 "I" St., Omaha, NE 68137. (402) 333-0850. (J. D.  
Grimshaw) Circle No. 389
- Dysan Corp., 2388 Walsh Ave., Santa Clara, CA 95050. (408) 247-4109. (Wm.  
Harry) Circle No. 390
- EM&M Media Products, 1020 Timothy Dr., Santa Clara, CA 95133. (408)  
298-7090. (Jack Smyth) Circle No. 391
- IBM Information Records Div., Rt. 522, Ridge Rd., Princeton, NJ 08540. (201)  
329-1000. Circle No. 392
- ITC (Information Terminals Corp.), 322 Soquel Way, Sunnyvale, CA 94086.  
(408) 245-4400. (Bob Katzive) Circle No. 393
- K-Tronic Inc., 3260 Scott Blvd., Santa Clara, CA 95051. (408) 246-6830. (Ron  
Rader) Circle No. 394
- Memorex Corp., San Tomas and Central Expwy., Santa Clara, CA 95052. (408)  
987-1000. Circle No. 395
- 3M Co. Headquarters, 3M Center, St. Paul, MN 55101. (612) 733-1100.  
Circle No. 396



# Here's your golden opportunity to meet our better half.

Texas Instruments Incorporated  
Mail Station 2-16, Attleboro, MA 02703

I'd like to meet TI's better half. Please send information on your new H4 Series .156" x .200" Edgeboard Connector.

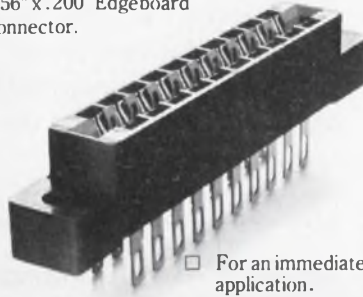

- For an immediate application.  
 Please contact me directly.  
 For reference.

Name \_\_\_\_\_

Title \_\_\_\_\_

Company \_\_\_\_\_

Area code \_\_\_\_\_ Phone \_\_\_\_\_ Ext \_\_\_\_\_

Address \_\_\_\_\_ Mail Station \_\_\_\_\_

City \_\_\_\_\_ State \_\_\_\_\_ Zip \_\_\_\_\_

ED

## Our better half.

TI's new H4 Series edgeboard connector half of a PC board/edgeboard connector system. It's today's best connector value because we made it better in so many ways.

Better functional and dimensional interchangeability, better design and construction, better porosity and wear characteristics, and better price and delivery advantages.

But we've done ourselves even one better. Specifically, our better half uses more gold to

get more performance and reliability. And yet there is a substantial cost savings. The reason is our proprietary clad metal technology.

Cladding permits gold to be concentrated only where it is needed — at the contact mating surface — the area critical to contact reliability.

Therefore, significant cost savings can be realized in terms of labor and precious metal consumption. This savings is being passed on to you in the form of a lower price. Or if you prefer, a bigger value.

After all, TI pioneered gold inlay. And we also make extremely high performance connectors. So it was only natural to put them together in our better half.

If you haven't met our better half yet, don't miss out on this truly golden opportunity. Return the coupon above or call Texas Instruments Connector Systems Marketing today. (617) 222-2800, Extension 268 or 269.



**TEXAS INSTRUMENTS**  
INCORPORATED



# INTRODUCING DELCO ELECTRONICS' MONOLITHIC OPERATIONAL AMPLIFIER

If you're now using discrete power output transistors, we've got an alternative that gives you design versatility.

It's the DA-101—Delco's Monolithic Operational Amplifier—with all the circuitry you need in one compact package.

The Monolithic Operational Amplifier (MOA) has two separate gain and power stages contained in a modified dual-in-line package.

The DA-101 operates from a 10- to 16-volt DC supply and can be used in an audio bridge configuration with floating speaker output, or as two separate amplifier-speaker systems.

The MOA means weight savings in more ways than one. Besides reducing the total number of components you need, the MOA has a copper mounting surface to assure ample heat transfer to the convector. The tab negative or ground connection eliminates the need for mica insulation.

In fact, the design of one power megaphone showed a components weight savings of 65 per cent.

Our new MOA means added design application flexibility, too. In automotive and home entertainment systems, two-way communication systems, power megaphones, motor controls, various H switch applications, and more.

Another advantage of our Monolithic Operational Amplifier is its durability. It has integral protective circuitry for not only overvoltage, but

temperature, current conditions and shorted outputs as well.

And it can be mounted by either direct soldering to a printed circuit board or through the use of a suitable socket.

For more information, contact an authorized Delco distributor, your nearest Delco sales office, or return the coupon on the right.

## ABSOLUTE MAXIMUM RATINGS

Supply Voltage	24V
Operating Voltage	16V
Peak Current	3A
Storage Temperature	-55°C to 150°C
Power Dissipation	22W

## ELECTRICAL CHARACTERISTICS

	TYPICAL
$V_{CC} = 14V$ dc	
$I_{in} P_{out} = 0W$	40mA
Differential Input Bias Current	0.80 $\mu A$
Open Loop Gain	90dB
Power Out @ 5% Distortion	
4 $\Omega$ Bridge	6W
4 $\Omega$ Non-bridge	3.5W

## THERMAL CHARACTERISTICS

Thermal Resistance, $R_{\theta JC}$ (Typical)	4° C/W
---	--------

## AUDIO BRIDGE CIRCUIT

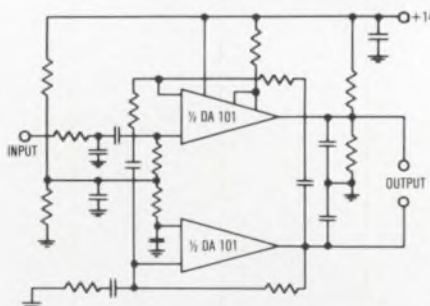

## TWO SEPARATE AMPLIFIERS CIRCUIT

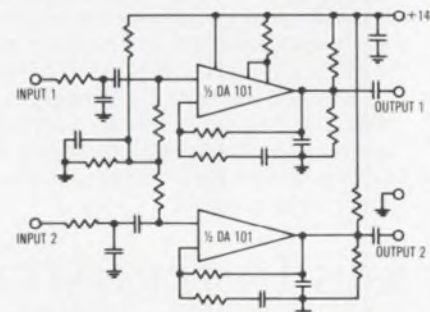

## DERATING CURVE

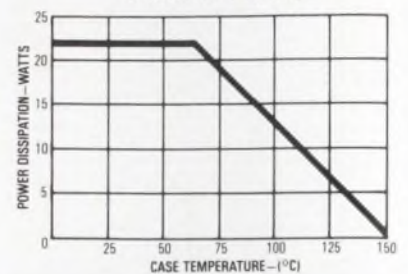

## DIMENSIONS AND CONNECTIONS

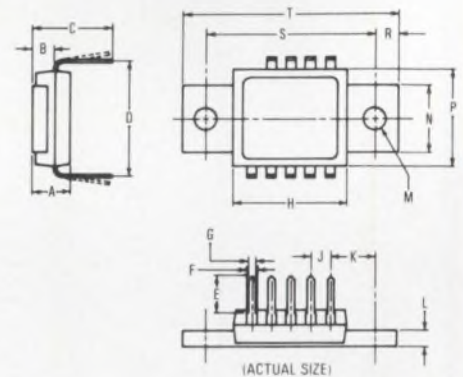

SYMBOL	INCHES		MILLIMETERS	
	MIN	MAX	MIN	MAX
A		.220		5.59
B	.127	.133	3.22	3.38
C	.423	.443	10.746	11.254
D	.628	.632	15.95	16.05
E	.215	.225	5.463	5.717
F	.044	.048	1.13	1.21
G	.015	.019	0.39	0.47
H	.644	.650	16.37	16.52
J	.095	.105	2.413	2.667
K	.275	.285	6.983	7.237
L	.086	.096	2.183	2.437
M	1.220	1.280	3.100	3.250
N	.369	.379	9.373	9.627
P	.539	.549	13.693	13.947
R	.120	.130	3.053	3.307
S	.955	.965	24.253	24.507
T	1.199	1.219	30.446	30.954



**NOW AVAILABLE FROM THESE DISTRIBUTORS  
IN PRODUCTION QUANTITIES.**

**ALABAMA**

HUNTSVILLE  
Powell Electronics  
(205) 539-2731

**ARIZONA**

PHOENIX  
Sterling Electronics, Inc.  
(602) 258-4531

**CALIFORNIA**

GARDENA  
Bell Industries  
Electronics Distributors Div.  
(213) 321-5802

GOLETA  
R.P.S. Electronics, Inc.  
(805) 964-6823

LOS ANGELES  
Kierulff Electronics, Inc.  
(213) 725-0325

R.P.S. Electronics, Inc.  
(213) 748-1271

PALO ALTO  
Kierulff Electronics, Inc.  
(415) 968-6292

SAN DIEGO  
Kierulff Electronics, Inc.  
(714) 278-2112

R.P.S. Electronics, Inc.  
(714) 292-5611

SUNNYVALE  
Bell Industries  
(408) 734-8570

**COLORADO**

DENVER  
Kierulff Electronics, Inc.  
(303) 371-6500

**CONNECTICUT**

NORWALK  
Harvey Electronics  
(203) 853-1515

**FLORIDA**

CLEARWATER  
Diplomat/Southland  
(813) 443-4514

MIAMI SPRINGS  
Powell Electronics/Florida  
(305) 592-3260

**ILLINOIS**

ELK GROVE VILLAGE  
Kierulff Electronics, Inc.  
(312) 640-0200

SKOKIE  
Bell Industries  
Electronics Distributors Div.  
(312) 282-5400

**INDIANA**

INDIANAPOLIS  
Graham Electronics  
Supply, Inc.  
(317) 634-8202

**MARYLAND**

BALTIMORE  
RESCO/Baltimore  
(301) 823-0070

**MASSACHUSETTS**

BILLERICA  
Kierulff Electronics, Inc.  
(617) 935-5134  
(617) 667-8331

NEWTON  
The Greene-Shaw Co., Inc.  
(617) 969-8900

**MICHIGAN**

LIVONIA  
Pioneer/Michigan  
(313) 525-1800

**MINNESOTA**

MINNEAPOLIS  
Stark Electronics Supply Co.  
(612) 332-1325

**MISSOURI**

KANSAS CITY  
Walters Radio Supply, Inc.  
(816) 531-7015

ST. LOUIS  
LCOMP-St. Louis  
(314) 291-6200

**NEW JERSEY**

CINNAMINSON  
Wilshire Electronics/  
Philadelphia  
(609) 786-8990  
(215) 627-1920

CLIFTON  
Wilshire Electronics/  
New Jersey  
(201) 340-1900  
(212) 244-8930

**NEW MEXICO**

ALBUQUERQUE  
Sterling Electronics  
(505) 345-6601

**NEW YORK**

BINGHAMTON  
Harvey Electronics  
(607) 748-8211

BUFFALO  
Summit Distributors, Inc.  
(716) 884-3450

FARMINGDALE  
Wilshire Electronics/  
Long Island  
(516) 293-5775

FREEPORT  
Milgray/New York  
(516) 546-6000

WOODBURY  
Harvey Electronics  
(516) 921-8700  
(212) 895-9260

**OHIO**

CINCINNATI  
United Radio, Inc.  
(513) 761-4030

CLEVELAND  
Pattison Supply Co.  
Industrial Electronics Div.  
(216) 441-3000

DAYTON  
Pioneer/Dayton  
(513) 236-9900

**PENNSYLVANIA**

PHILADELPHIA  
Almo Electronics  
(215) 698-4000

PITTSBURGH  
CAM/RPC Electronics  
(412) 782-3770

**SOUTH CAROLINA**

COLUMBIA  
Dixie Radio Supply Co., Inc.  
(803) 779-5333

**TEXAS**

DALLAS  
Sterling Electronics  
(214) 357-9131

HOUSTON  
Harrison Equipment  
Co., Inc.  
(713) 652-4700  
Sterling Electronics  
(713) 627-9800

**WASHINGTON**

SEATTLE  
Kierulff Electronics, Inc.  
(206) 575-4420

**IN CANADA:**

Zentronics Ltd.  
Toronto (416) 635-2822  
Ottawa (613) 238-6411  
Montreal (514) 735-5361

**OVERSEAS:  
EUROPEAN  
INQUIRIES:**

European Parts &  
Accessories Marketing  
Group  
General Motors Continental  
Plant 2, Noorderlaan,  
Postbus 9  
B-2030, Antwerp, Belgium

**ALL OTHER  
OVERSEAS  
INQUIRIES:**

General Motors Overseas  
Operations  
Parts & Accessories Dept.  
767 Fifth Avenue  
New York, N.Y. 10022  
(212) 486-4412

**DELCO ELECTRONICS  
REGIONAL SALES  
OFFICES**

Charlotte, North Carolina  
28209  
4600 Park Road  
(704) 371-5160  
Van Nuys, California 91404  
Box 2968  
(213) 988-7550

**GENERAL SALES  
OFFICE**

700 E. Firmin, Kokomo,  
Ind. 46901  
(317) 459-2175

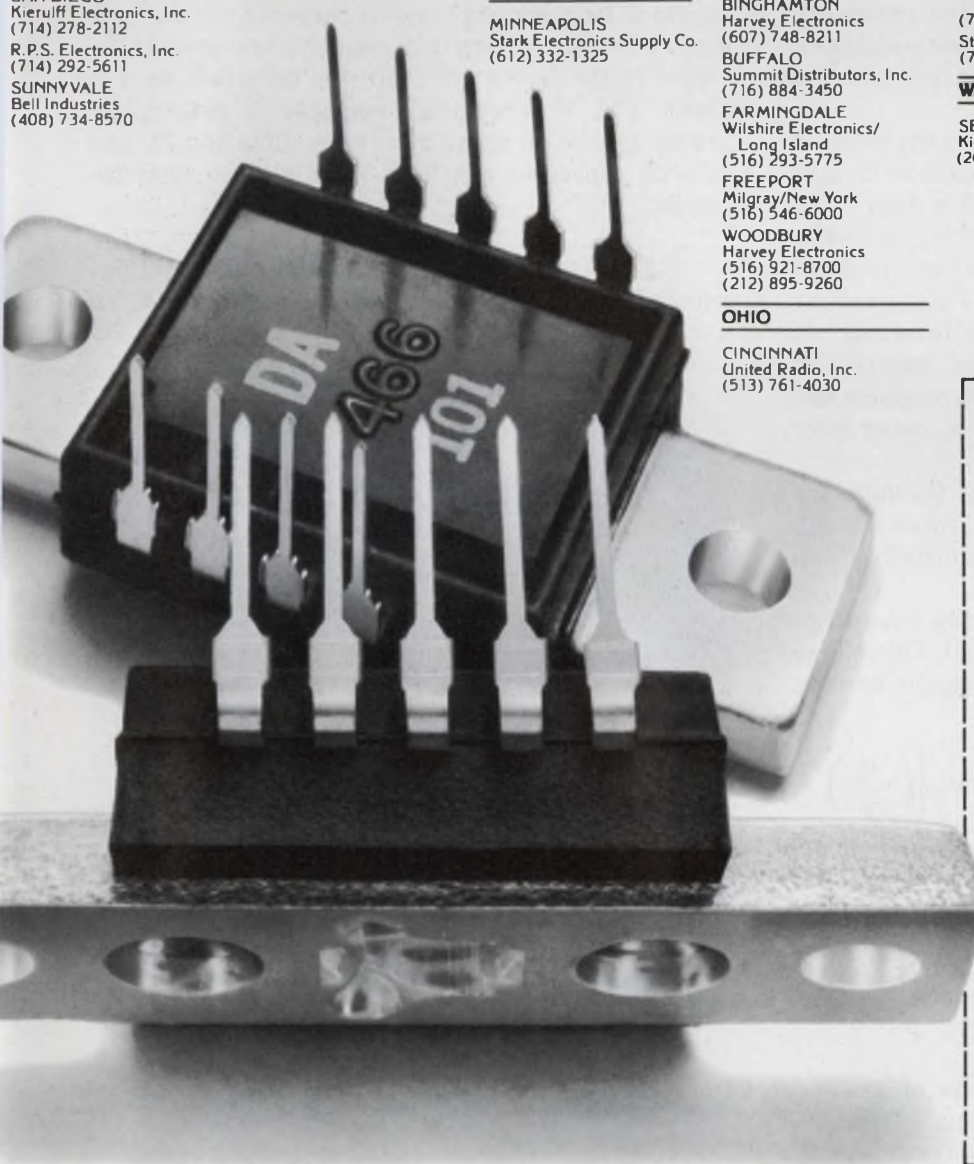

**FOR MORE INFORMATION ABOUT  
DELCO'S NEW MONOLITHIC  
OPERATIONAL AMPLIFIER, MAIL  
THIS COUPON TO:**

**Delco Electronics Division  
General Motors Corporation  
Marketing Services MS A-213  
700 E. Firmin Street  
Kokomo, Indiana 46901**

NAME \_\_\_\_\_

TITLE \_\_\_\_\_

COMPANY \_\_\_\_\_

ADDRESS \_\_\_\_\_

CITY \_\_\_\_\_ STATE \_\_\_\_\_ ZIP \_\_\_\_\_

PHONE \_\_\_\_\_

01 **Delco Electronics** ED10/11





## Circuit detects and remembers bipolar analog signals

The circuit in the figure can detect an analog signal of either polarity, then remember that the event occurred. It is also simple to design, easy to reset and TTL-compatible.

With no input signal, diodes  $D_1$  and  $D_2$  of the circuit conduct. Approximately  $+0.6$  V and  $-0.6$  V are applied, respectively, to the inverting and noninverting connections of an op amp. Either voltage is sufficient to saturate the op amp, which then provides a negative output.

If a positive-input signal is applied to the detector circuit, the signal current through resistor  $R_A$  and diode  $D_1$  doesn't appreciably change  $D_1$ 's drop of 0.6 V. The signal current through  $R_{A1}$  and  $R_{B1}$ , however, causes  $D_2$  to stop conducting. When the positive-input signal rises sufficiently, the op amp's noninverting input becomes more positive than the inverting. At this point the op amp switches from negative to positive saturation. Simultaneously,  $D_3$  conducts and holds the op amp in positive saturation, even after the input signal is removed.

The detector circuit performs almost the same for negative-signal inputs, except that  $D_1$  turns off and the inverting input then becomes more negative than the noninverting.

When the input signal is removed, the circuit can be reset by grounding the Reset terminal. The following expression determines the input-signal level at which the detector changes state:

$$\left| e_{in} \right| = \left| V_d \right| \left( 1 + \frac{R_a}{R_b} \right) + \left| V_{cc} \right| \left( \frac{R_a}{R_b} \right),$$

where  $V_d$  = diode-voltage drop,  
 $V_{cc}$  = power-supply voltage,  
 and

$$\frac{R_a}{R_b} = \frac{R_A}{R_B} = \frac{R_{A1}}{R_{B1}}.$$

The expression ignores the effects of op-amp offset voltage and current, assumes that  $V_d$  remains constant with variation in the level of input signal,

and also that the signal-source impedance is very low. Particularly if  $|V_{cc}|$  is large relative to  $|V_d|$ , the effects of diode variations are minimized.

If the op amp is supplied with  $+5$  V and  $-12$  V, only a series output resistor is needed to provide direct interfacing with TTL logic. The series resistor should be large enough to safely current limit the logic input when the op amp is negatively saturated. If the values in the figure are used, the detection level is about  $\pm 7.7$  V. Frequency response is determined mainly by the op amp's slew rate. Shunting  $D_1$  and  $D_2$  with capacitors can limit the high-frequency response.

*C.E. Musser, Jr., Design Engineer, General Electric Co., P.O. Box 5000, Binghamton, NY 13902.*

CIRCLE NO. 311

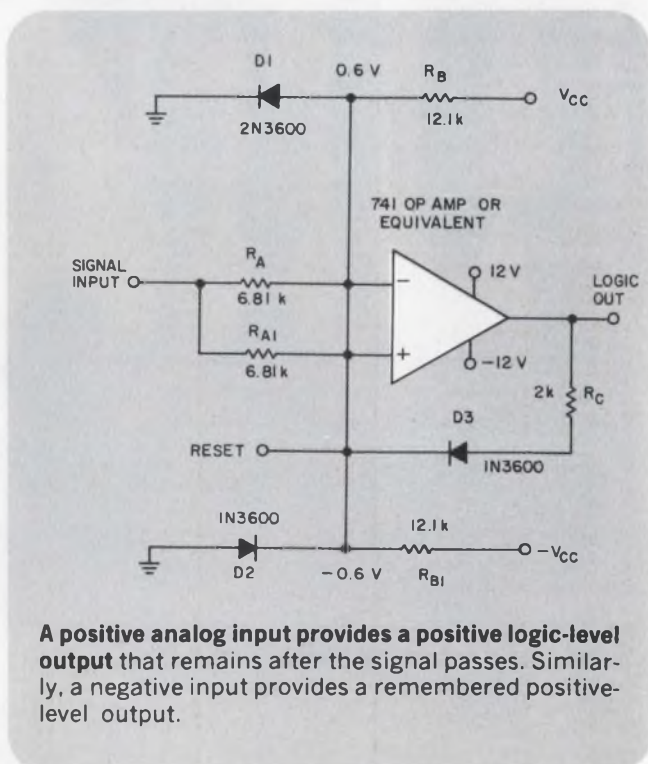



If you need panel instruments with **custom** dials, cases, accuracy, tracking, resistance, response time, or practically any combination of unusual specs...

Buy  
**Triplett's**  
designed-for-you  
**Panel**  
Instruments

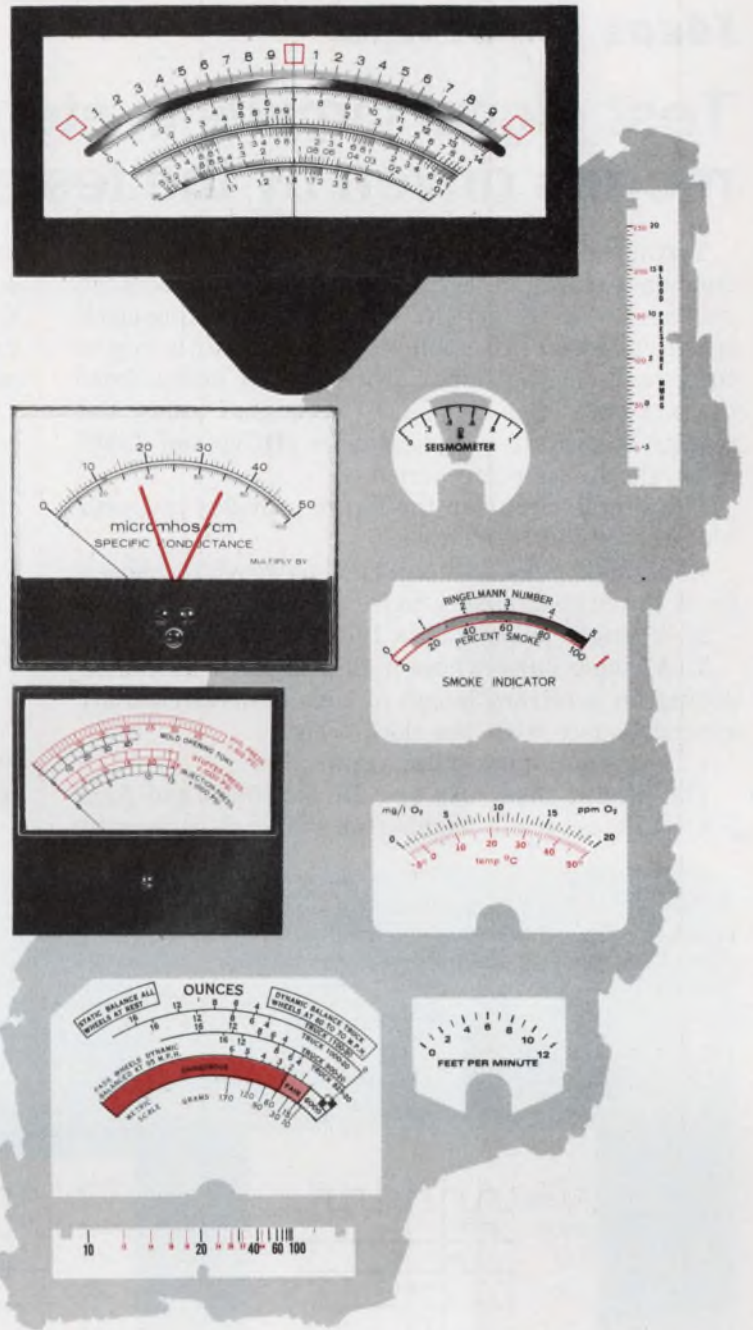

Although we stock some 1369 different styles, sizes and types of standard panel instruments, a very large proportion of our customers buy custom instruments.

Because they need:

**custom dials**

reading in such units as pH, roentgens, mm Hg, rpm, %, inches.

**custom cases**

square, round, rectangular, edge-wise (horizontal and vertical), wide, narrow, shallow.

**custom accuracy**

to within 1/2% with mirror scales and knife-edge pointers.

**custom tracking**

to match the specific needs of existing or new instrument designs.

**custom resistance**

for low circuit loading with tolerances as low as  $\pm 1\%$ .

**custom damping**

to meet stringent electrical and vibration requirements.

For instance, one of our customers had us design and manufacture a custom instrument to replace — in every detail of physical and electrical specifications — one which he was using on a delicate piece of medical instrumentation. Rejects from his previous source had risen to over 20%. He rejected only 3 of the first hundred we shipped — with almost negligible rejections from the many hundreds we've shipped since.

What custom panel instrument specifications do you need to make your

**CIRCLE NUMBER 281 FOR INFORMATION**

**CIRCLE NUMBER 282 FOR FREE DEMONSTRATION**

product more reliable, more accurate, more rugged and — in the long run — less expensive? For quick, dependable delivery of small quantities of Triplett's "designed-for-you" panel instruments, contact your Triplett Sales/Service/Modification Center. For prototypes or production quantities, contact your Triplett representative. He'll put you in touch with our Instrument Designers/Engineers who'll help you analyze the problem and suggest the optimum cost/result solution.

**TRIPLETT**  
BLUFFTON, OHIO 46817

Manufacturers of the World's  
most complete line of V-O-M's



## Ideas for design

# Test digital circuits in step-by-step or continuous modes driven by the tested system's clock

Testing complex logic circuits with continuous low-frequency clock pulses is usually inadequate, because you can't stop the action and normal operating-clock specifications aren't employed. A better way is to give the circuit one pulse out of a string of pulses from the system's high-frequency clock, and study the results step-by-step during both HIGH and LOW intervals of the pulse period.

The simple circuit in the figure provides you with four test modes:

1. A single pulse with a normal pulse width, chosen from the system's clock-pulse train.
2. A single pulse with a full-period width.
3. A single pulse whose high polarity is sustained during an arbitrary length of time and switched off synchronously with the clock train.
4. A normal clock-pulse train.

The circuit uses just two JK flip-flops and four NAND gates. When pushbutton switch  $S_1$  is pressed

and released,  $FF_1$  sets. At the next clock pulse,  $FF_2$  sets since  $J_2$  is HIGH and  $K_2$  is either 0 or 1. Output  $Q_2$  resets  $FF_1$  via  $FF_1$ 's clear input. This sequence is common to all modes. The sequence, thereafter, depends on the positions of switches  $S_2$  and  $S_3$ .

If  $S_2$  and  $S_3$  are set as shown, the output  $Q_2$  is NANDed with the clock pulses to obtain Mode 1. Since  $J_2 = 0$  after  $FF_1$  resets, and  $S_2 = 1$ ,  $FF_2$  will be reset after one pulse. If  $S_3$  is switched the opposite way, the output pulse has a pulse with a full-period width (Mode 2). With both  $S_2$  and  $S_3$  opposite the positions shown,  $FF_2$  stays in the set condition with the output HIGH until  $S_2$  is set back. At the next clock pulse,  $FF_2$  resets (Mode 3).

Mode 4 is obtained with  $S_3$  as shown and  $S_2$  opposite.

*C. van Holten, Senior Engineer, Dept. of Applied Physics, University of Technology, Delft 2208, The Netherlands.*

CIRCLE NO. 312

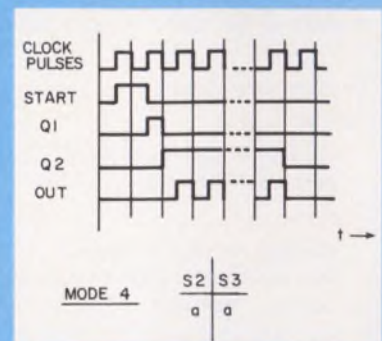
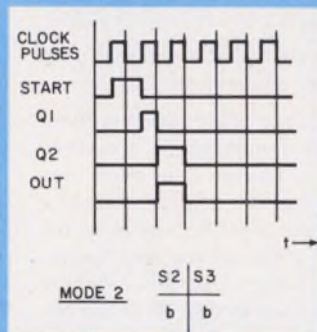
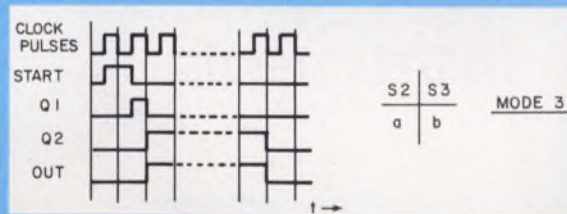
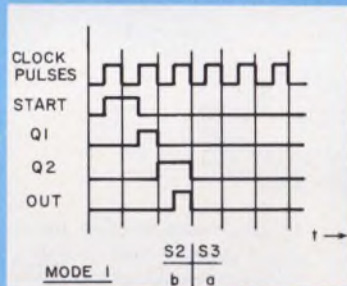
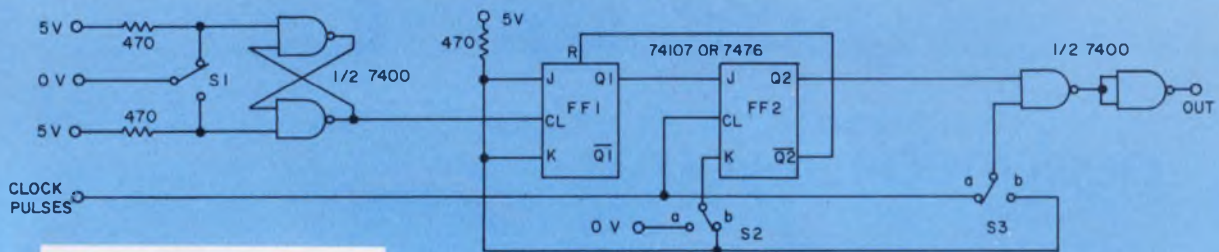

Four modes of testing can be obtained by setting switches  $S_2$  and  $S_3$  in the four possible position

combinations. Pushbutton switch  $S_1$  starts the test cycle, which is then driven by the system clock.



# New Concept in Digital Filtering Multiplier-Accumulator

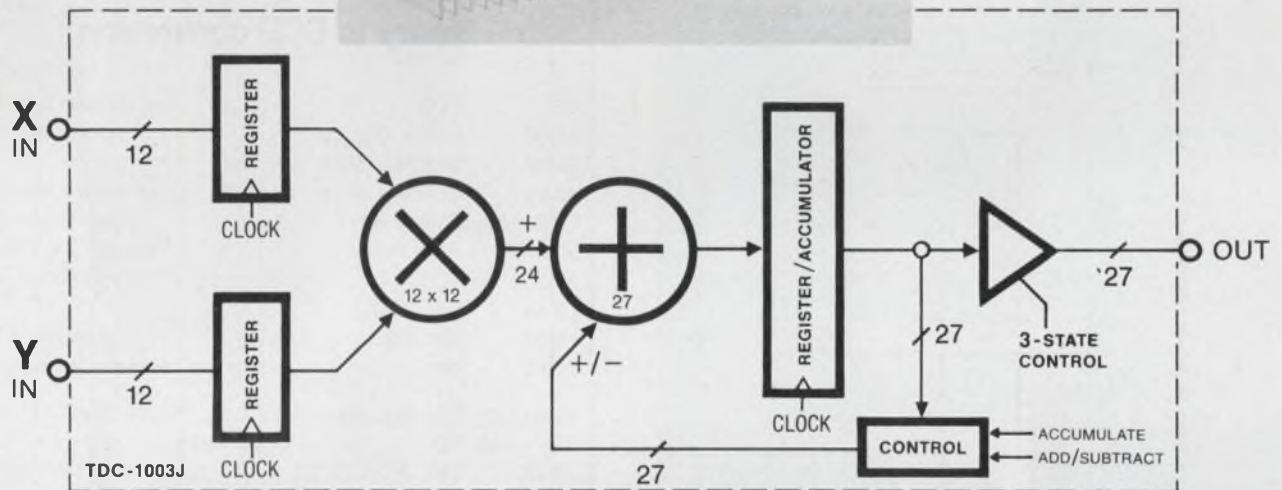
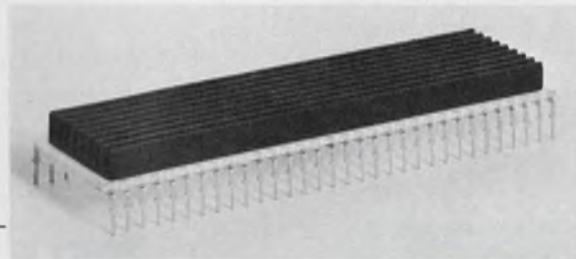

**175 ns, 12 bits - \$140 in 100's**

IDEAL FOR

- FFT Processing
- Digital Filter - Recursive
- Digital Filter - Non-Recursive
- Sum of Products
- Complex Multiplication
- General Signal Processing Applications

12 x 12 Bit Parallel Multiplier with a 27 Bit Accumulator/ Subtractor - Single Chip, Bipolar, TTL.

The new TDC-1003J features controllable accumulation and subtraction. It requires much lower power than equivalent MSI multiplication-accumulation systems, yet features much faster speed.

Let us show you how you can add functions, simplify the design... and reduce total circuit cost. Contact your local TRW Electronic Components field sales office or call us at (213) 535-1831, or send the coupon.

**TRW LSI Products**

An Electronic Components Division of TRW, Inc.,  
P. O. Box 1125  
Redondo Beach, California 90278

**Please send data sheets on the new 12x12 bit parallel Multiplier / Accumulator.**

NAME \_\_\_\_\_

COMPANY \_\_\_\_\_

DIV/DEPT \_\_\_\_\_ MAIL CODE \_\_\_\_\_

ADDRESS \_\_\_\_\_

CITY \_\_\_\_\_

STATE \_\_\_\_\_ ZIP ED-10 \_\_\_\_\_

**TRW LSI PRODUCTS**

... from a company called TRW

CIRCLE NUMBER 99



# Binary-to-BCD conversion for $\mu$ Ps packs the units and tens into one byte

An assembly and machine-language program written for MOS Technology's 6502  $\mu$ P converts 8-bit binary numbers into two BCD numbers. Also it stores the BCD tens and ones digits within one 8-bit byte of memory.

The general flow chart shown is applicable to most microprocessors. The first operation checks the binary number's value. If the number is 100 (64 hexadecimal) or larger, then 100 is subtracted from the binary number, and memory location  $M_2$  is incremented by 1. This process repeats until the result falls below 100. If the maximum binary number never exceeds 99, this operation can be omitted.

If the binary number is less than 100, or becomes less than 100 in the first step, the program stores it in memory location  $M_1$ . This location is incremented by six for every 10 bits of the binary number. Upon completing the program loops,  $M_1$  holds the tens and ones digits as two BCD numbers within one byte of memory, while  $M_2$  contains the hundreds digit.

*Bert G.H. Penhollow, Manager of Electrical Engineering, Colt Industries, Quincy Compressor Div., 217 Maine St., Quincy, IL 62301.*

CIRCLE NO. 313

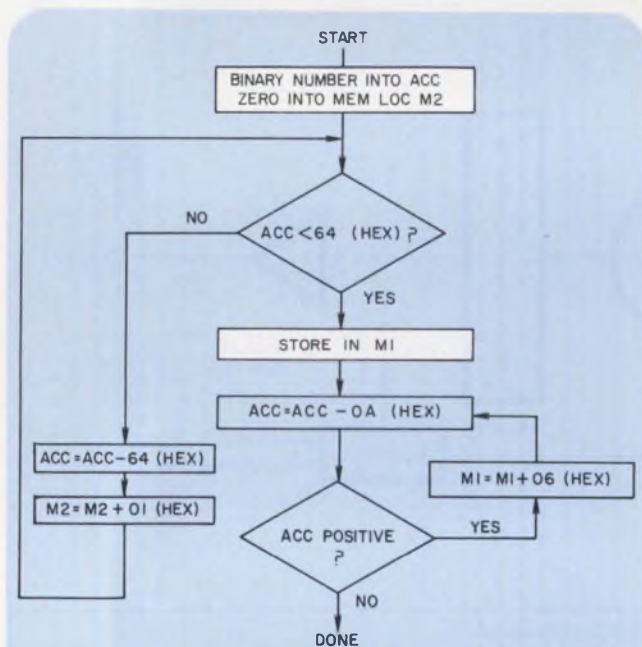

When the binary-to-BCD conversion is complete,  $M_1$  contains the tens and ones digits within a single byte in BCD, while  $M_2$  contains the hundreds digit.

## Binary to BCD conversion

D8	CLD.....	Set Binary Addition
A2 00	LDX # 00.....	Clear M2
86 02	STX M2 (Mem. Loc. 02)	
A5 00	LDA Bin (Mem. Loc. 00).	Load Binary Number
C9 64	Hund CMP # 64.....	Less Than 100?
90 07	BCC Tens.....	Yes, Go To "Tens"
38	SEC.....	No, Subtract 100
E9 64	SBC # 64	
E6 02	INC M2.....	Increment M2
D0 F5	BNE Hund.....	Go To "Hund", Recompare
85 01	Tens STA M1 (Mem. Loc. 01)..	Store "Bin" In "M1"
38	AGN SEC.....	Subtract 10 From "Bin"
E9 0A	SBC # 0A.....	Is "Bin" Negative?
30 0B	BM1 Done.....	Yes, Go To "Done"
AA	TAX.....	No
A5 01	LDA M1	
18	CLC	
69 06	ADC # 06.....	Add 6 To "M1"
85 01	STA M1	
8A	TXA	
D0 F0	BNE AGN.....	Loop Back To "AGN"
60	Done RTS	

### IFD Winner for June 7, 1977

**John Okolowicz**, Senior Electrical Engineer, Honeywell Inc., 1100 Virginia Dr., Fort Washington, PA 19034. His idea "Timing Circuit Burps Battery to Improve Charging Efficiency" has been voted the most valuable of Issue Award.

**Vote for the Best Idea in this issue** by circling the number of your selection on the Reader Service Card at the back of this issue.

**SEND US YOUR IDEAS FOR DESIGN.** You may win a grand total of \$1050 (cash)! Here's how. Submit your IFD describing a new or important circuit or design technique, the clever use of a new component or test equipment, packaging tips, cost-saving ideas to our Ideas for Design editor. Ideas can only be considered for publication if they are submitted exclusively to ELECTRONIC DESIGN. You will receive \$20 for each published idea. \$30 more if it is voted best of issue by our readers. The best-of-issue winners become eligible for the Idea of the Year award of \$1000.



# More than just the ABC's...

Now we give you the nitty-gritty on design for eight of the currently popular micro's!

## Microprocessor Basics

Edited by  
Michael S. Elphick

Two unique features make it different from the rest:

1. Unlike most books which either talk in general terms or cover only a single type of microprocessor, this book provides detailed coverage of these important models: 8080, 6800, F8, PACE, IMP, 2650, 1802, and 6100.
2. The first three sections of the book offer the beginner a foundation and the experienced designer a useful review of the general information that applies to all microprocessors.

### For each microprocessor:

- The major advantages are highlighted to speed selection for a specific application.
- A detailed analysis of hardware and software features, support circuits, and design aids are given.
- All instructions are tabulated so you can easily follow the application examples and move rapidly to writing your own assembly language programs.

#5763-6, 224 pages,  
paper, \$10.95



For a good overview...

## Microprocessors: New Directions for Designers

Edited by Edward A. Torrero

This popular collection of articles from recent issues of *Electronic Design* magazine provides an exceptionally well-rounded view of the micro world. It offers practical information, data, and advice on:

- how to select circuits
  - how to interpret their capabilities
  - how to extend their useful range
- how to apply them effectively
- Applications run from traffic control systems to small accounting equipment and from computer terminals to industrial-process controllers.

#5777-6, 144 pages,  
paper, \$10.95

**SEND NO MONEY!  
EXAMINE FREE FOR 15 DAYS!**



**Hayden Book Company, Inc.**

50 Essex Street, Rochelle Park, N.J. 07662

Please send me the book(s) checked below on 15-day exam. At the end of that time I will remit payment, plus postage and handling, or return the book(s) and owe nothing. Prices subject to change without notice. Offer good in U.S.A. and Canada only.

- Microprocessor Basics #5763-0** . . . \$10.95
- Microprocessors #5777-6** . . . . . 10.95

NAME \_\_\_\_\_

FIRM \_\_\_\_\_

ADDRESS \_\_\_\_\_

CITY/STATE/ZIP \_\_\_\_\_

**I want to save money!** Payment enclosed. Publisher pays postage. Same 15-day return guarantee.

**For more versatility  
in micro design - turn to Hayden Book Co.!**



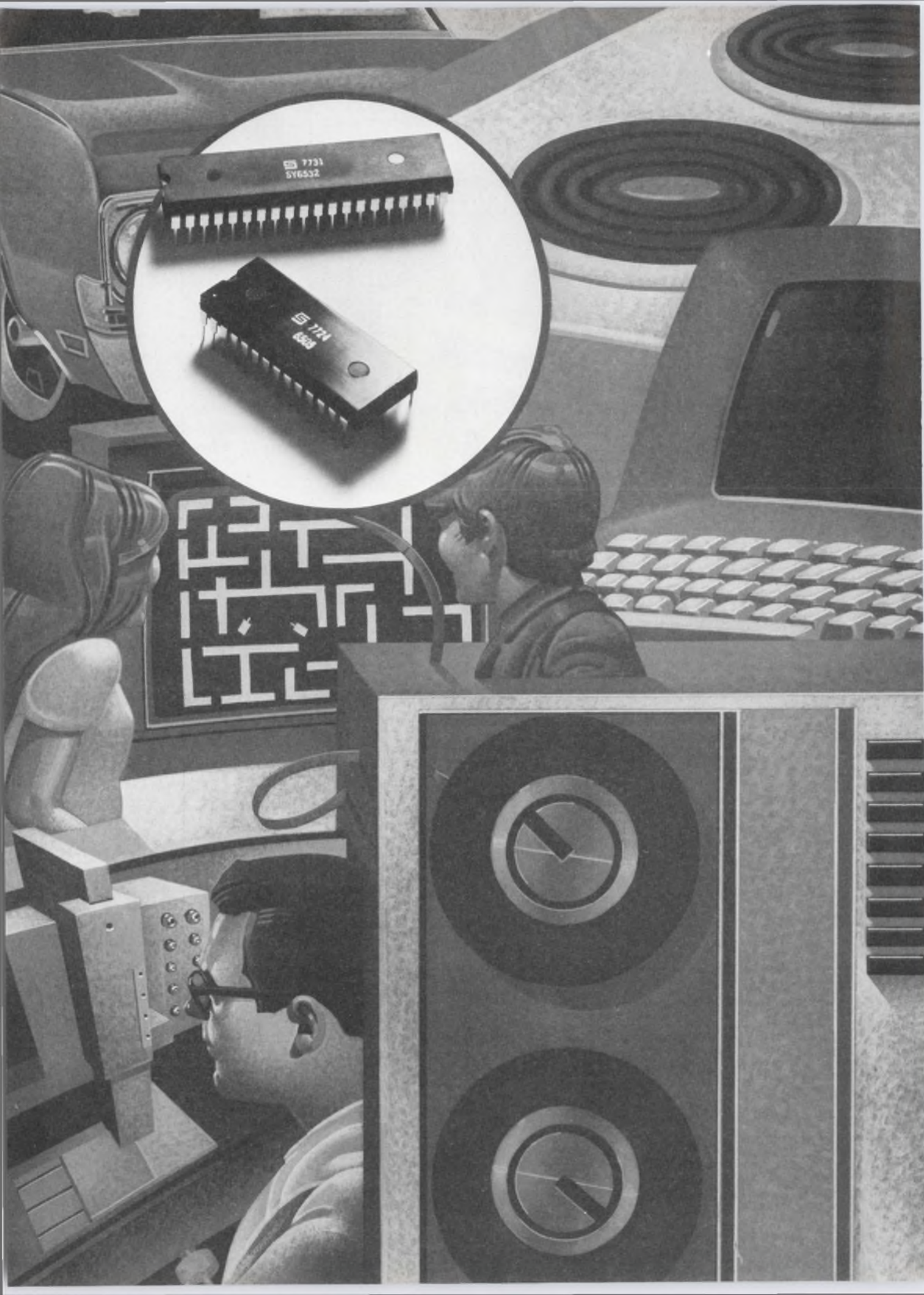



# When the chips are down

# The lowest cost, highest performance microprocessor wins.

## And here it is: the 6500.

A full family of nine software compatible microprocessors, with comprehensive interface circuits and all the supplementary memory you could need. The technology is N-Channel Silicon Gate with Depletion Load implementation and Ion Implantation. This means the smallest real estate coupled with high speeds and a host of performance benefits.

## Low Cost.

The 6500 is already established as the most popular third generation microprocessor family. We will ship 300,000 microprocessors this year, for good reason. More capability at remarkably low cost, for the chips themselves, and for the overall system.

## The microprocessor itself is low cost because:

- Smaller die than the 6800 or 8080.
- 28 pin versions available (pick the one that's right for you — pay only for what you need).
- In high volume production — the more we make the better we get and the learning curve advantages derived are passed on to the customer.

## Your system will be low cost because:

- Less ROM required for programming code due to the flexibility provided by having 13 different addressing modes!!
- Minimum system requires only 2 chips. Select one of our microprocessors, add a 6530 (RAM:ROM:I/O:Timer) and you have a microcomputer system.
- Lower component costs.

## High Performance.

### A fast 2MHz standard.

At 2MHz, the 6500 has a potential throughput equal to a 6800 or 8080

running at 4MHz — if they could. All our microprocessors are software compatible within the group and bus compatible with the 6800. Makes it easy to improve performance and costs in existing 6800 applications.

## True Pipeline Architecture.

Unusual in a low cost microprocessor, but even as the 6500 microprocessor is interpreting one instruction, it is accessing the next memory location. By doing its tasks in parallel, the 6500 attains tremendous system throughput, and overall performance you'd expect to cost much more.

## Thirteen Addressing Modes and a Host of Other Advantages.

Our thirteen different addressing modes include zero page and indirect indexed, features you'd not normally look for in a low cost microprocessor, but we have them. The flexibility of these addressing modes allows you to write your programs using an average of 20-40% less code. This means a savings in the amount of ROM required.

With a choice of internal or external clocks and drivers, you can optimize the costs vs. timing control requirements.

The 6500 family operates from a single 5 Volt power supply; it has true indexing capability, two interrupt modes and addressable memory range up to 65K bytes. It offers both decimal and binary arithmetic.

## Outstanding Interface Chips.

Our interface chips combine functions which required several packages in first generation microprocessor systems. All feature 8-bit bidirectional data bus for interface to the microprocessor. The SY6530 has a 1K byte ROM, 64 byte RAM, interval timer and I/O. The SY6532 has 128 bytes of RAM, interval timer and I/O. The SY6520 Peripheral Adapter has

two 8-bit bidirectional data ports, four peripheral control/interrupt lines and is available at either 1 or 2MHz. It is a high performance replacement for the 6820 Peripheral Adapter. The SY6522 Versatile Interface Adapter offers all of the features of the 6520 plus latching inputs, two fully-programmable interval timers/and an 8 bit shift register for serial interface.

## Compatible RAMs and ROMs.

Where the application requires additional memory, we offer fully compatible 4K Static RAMs (2114) and 16K Static ROMs (2316A, 2316B). Our mask programmable ROMs are available in two week prototype turnaround, and we're geared for rapid shipments in production volumes.

## Multiple Sources, of course.

Rockwell and MOS Technology are shipping identical parts on all members of the 6500 microprocessor family and interface circuits. New designs are cross-fed among all three as part of the cross-licensing agreements. In addition to price and performance, you're assured of availability, too.

## Complete Information is Free.

We want you to know all about this low cost, high performance microprocessor family. For data sheets on any or all of our products, or more detailed information, call or write to: Jerry Demsky, Synertek, 3050 Coronado Drive, Santa Clara, CA 95051. (408) 984-8900. Twx: 910-338-0135.

# Synertek



## GaAs high-frequency performance gets a boost

A gallium-arsenide FET with substantially improved high-frequency performance has been developed by Hitachi's Central Research Laboratory in Kokobunji, Japan.

The high-frequency performance of a FET greatly depends on how small its gate length is. Earlier Hitachi GaAs FETs with submicrometer gate lengths operate with low noise at X-band frequencies. But the researchers who developed those FETs have upped the frequency with a technique called intentional side etching.

A gallium-arsenide FET with a gate length of only 0.5  $\mu\text{m}$ , has an unusually low noise figure of 2.1 dB at 12 GHz, with 7.6 dB gain. So the device is suitable for operation at frequencies above X-band.

The new FET is formed on a high-purity, p-type buffer layer upon which is created, by vapor-phase epitaxy, an n-type active layer with a typical carrier concentration of  $2$  to  $3 \times 10^{17} \text{ cm}^{-3}$ . Source and drain ohmic contacts are

formed on the n-type layer, and a gate region is etched. A titanium layer 0.15- $\mu\text{m}$  thick is then evaporated and a layer of gold 0.4  $\mu\text{m}$  thick is added.

A stream of argon ions then mill the gold layer, leaving only a gate pattern of gold, 1  $\mu\text{m}$  long and 300  $\mu\text{m}$  wide.

The titanium layer, whose milling rate is half that of the molybdenum used for the earlier devices, protects the GaAs layer from damage from the ion beam. The gate pattern is then protected by photoresist. The titanium layer is etched with hydrogen fluoride and nitric acid.

The effective gate length is determined by intentionally etching the side of the titanium layer. The etching rate is about 0.4  $\mu\text{m}/\text{min}$ . The usual difficulties of etching titanium, which rapidly accumulates layers of surface oxide, are eliminated by the ion-milling process, which leaves the titanium with a clean surface. Consequently, the etching is easy to control, and 0.5  $\mu\text{m}$  patterns can be reproducibly obtained.

changes as the temperature rises. Temperature differentials of 30 C are sufficient to produce easily distinguishable color differences.

Multicolored traces can be generated simultaneously by applying current pulses of differing periods to the writing points.

## I<sup>2</sup>L chip 'sees' light

Measuring light intensity will soon be easier than it is now with an integrated injection logic chip that contains a photosensitive, 11-stage ring oscillator.

Light shines on the oscillator of the chip from Siemens, West Germany, through a window in the package. The frequency of oscillation varies with the intensity of the light. Oscillator output then goes to an internal divide-by-16 circuit to produce an output pulse that can last as long as 10 minutes.

## Data lines and points traced with thermal head

With a thermal writing head, a new system of producing chart-recorder traces can form data points and lines like those of pen recorders, but without the problems plaguing pen-and-ink mechanisms. The method results from a four-year development program at the Industrial Instruments Div. of Smith Industries, Ltd. in London. It can be adapted to microprocessor outputs that drive chart recorders capable of printing alphanumeric characters as well as conventional traces.

The thermal head is combined with thermally sensitive chart paper to produce multicolor traces. The head, a thin, multisegment line, is formed on a thick-film circuit and held in contact

with the heat-sensitive paper by a free-floating roller.

The head is 256 mm (10 in.) long, with 250 writing segments on 1-mm centers. As a result, 250 points are produced along the writing axis of the recorder. Current pulses address the individual segments to raise the temperature of the paper at those points.

Color shades depend on how much thermal energy is coupled into the paper at the writing points. The chart paper is treated with a color-forming chemical and an acid coating. When a resistive writing point is addressed for a few milliseconds, the temperature rise mixes the chemicals and changes the color at that point. The color

## Trade Shows

**U.S. Electronics Production and Test Equipment and Electronic Components Catalog Exhibition**—Vienna, Austria, Nov. 14-18.

**U.S. Electronic Production Machinery, Test Instrumentation and Materials Catalog Exhibition (Interelectronic)**—Brussels, Belgium, Nov. 26-Dec. 3.

**Sponsor:** U.S. Dept. of Commerce. Contact: Peter C. Van Allen, Catalog Exhibition Sect., Special Activities Div., Office of International Marketing, U.S. Dept. of Commerce, Domestic and International Business Administration, Washington, DC 20230.

**Electronic Components '77**—U.S. Trade Center, London, Nov. 7-11.

**Sponsor:** U.S. Dept. of Commerce. Contact: Robert Connan, project officer, U.K. Office of International Marketing, Room 4217, U.S. Dept. of Commerce, Washington, DC 20230.



# Introducing the PMUX

The world's first programmable multiplexer

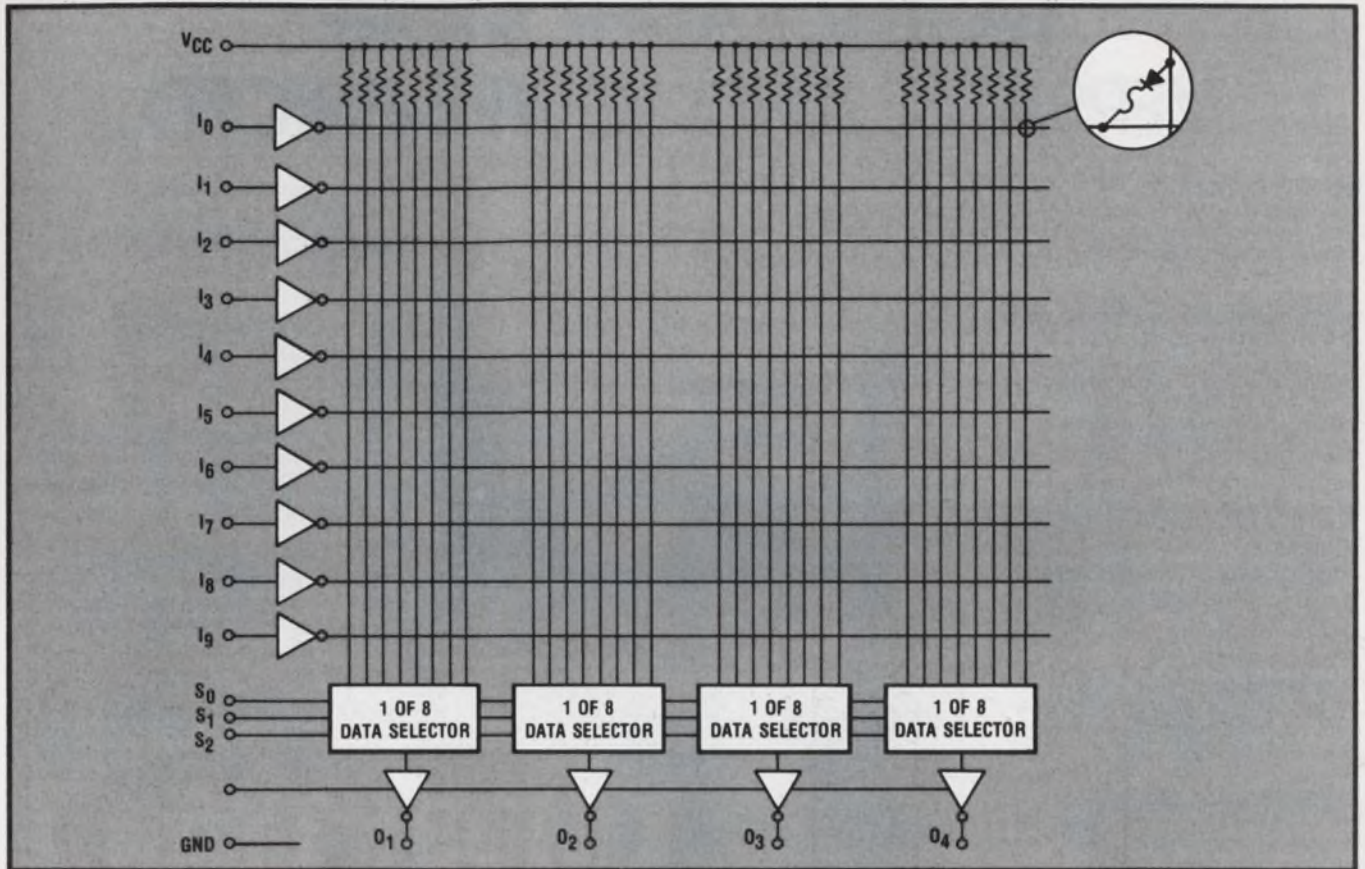

## THE 29693 IS:

- A poor man's FPLA
- A sign extender
- A programmable data flow control
- A buffered programmable diode matrix
- A digital crosspoint array
- Easily programmed
- Fast, only 30nS typical ( $I_x$  to  $O_N$ )
- Economical, only \$4.25 at 100 pieces

Another first from

**"The Specialists in Bipolar Microcomputer Components"**

**Field Sales Offices**

California: Irvine (714) 833-9042, Mountain View (415) 969-3475.

Florida: St. Petersburg (813) 576-2221. Illinois: Des Plaines (312) 297-5540. Massachusetts: Newton (617) 527-0030.

Minnesota: Minneapolis (612) 920-7935. New Jersey: Cherry Hill (609) 663-4066. New York: Melville (516) 420-0700.



**SEMICONDUCTOR DIVISION**

**Tell me more ...**

- Full data and applications on your PMUX
- Your full Semiconductor Selection Guide

Name \_\_\_\_\_

Title \_\_\_\_\_

Company \_\_\_\_\_

Address \_\_\_\_\_

City \_\_\_\_\_

State \_\_\_\_\_ Zip \_\_\_\_\_

My phone number is \_\_\_\_\_

Mail to: Raytheon Company, Semiconductor Division  
350 Ellis Street, Mt. View, CA 94042



# IF YOU'RE WAITING FOR SOLDERLESS BREADBOARDS TO BE FASTER, EASIER, MORE VERSATILE AND LOWER-PRICED...

**Incredibly inexpensive.** EXPERIMENTOR solderless sockets begin at \$5.50\* (\$4.00\* for the 40 tie-point quad bus strip). A spool of solder costs more.

**Mix and match.** Use large and small chips in the same circuit without problems. There are two sizes of EXPERIMENTOR sockets with 0.3" and 0.6" centers.

**Full fan-out. A CSC exclusive.** The only solderless breadboard sockets with full fan-out capabilities for **micro-processors** and other larger (0.6") DIP's.

**Microprocessors and other complex circuits are easy to develop.** Each EXPERIMENTOR quad bus gives you four bus lines. By combining quads, 8-, 12- and 16-line address and data buses can be created, simplifying complex data/address circuits.

**Infinitely flexible.** Circuits can go in any direction, up to any size. All EXPERIMENTOR sockets feature positive interlocking connectors that snap together. Horizontally and/or vertically. And un-snap to change a circuit whenever you wish.

**Easy Mounting.** Use 4-40 screws from the front or 6-32 self-tapping screws from the rear. Insulated backing lets you mount on any surface.

**EXPERIMENTOR 350. \$5.50\*** 46 five-point terminals plus two 20-point bus strips. 0.3" centers; 3/8 x 3 1/2 x 2".

**EXPERIMENTOR 650. \$6.25\*** 46 five-point terminals plus two 20-point bus strips. 0.6" centers; 3/8 x 3 1/2 x 2 1/4".

**EXPERIMENTOR QUAD BUS STRIP \$4.00\*** Four 40-point bus strips. 3/8 x 6 x 3/4".

**Designated tie-points.** Simplify translation from breadboard to PC-boards or wiring tables.

**EXPERIMENTOR 600. \$10.95\*** 94 five-point terminals plus two 40-point bus strips. 0.6" centers; 3/8 x 6 x 2 1/4".

**Accepts all standard components.** EXPERIMENTOR sockets conform to an 0.1" grid and are DIP compatible. Also accept IC's, transistors, diodes, LED's, resistors, capacitors, transformers, pots, etc.

**Easy hookup.** Components push in and pull out instantly. Use #22-30 solid AWG wire for jumpers.

**Rugged, dependable construction.** Sockets are constructed from abrasion resistant materials and withstand 100°C. Each one features non-corrosive nickel-silver contacts.

**EXPERIMENTOR 300. \$9.95\*** 94 five-point terminals plus two 40-point bus strips. 0.3" centers; 3/8 x 6 x 2".

## WHAT ARE YOU WAITING FOR?

Discover today how solderless breadboarding can save time and money on every circuit you build. Get acquainted with EXPERIMENTOR™ sockets\* and how they simplify circuit design, assembly and testing. Eliminate the hassles and component damage of soldering. No special hardware or jumper cables required, either. And the price is so low, it's hard to believe.

**See your CSC dealer today. Or call 203-624-3103 (East Coast) or 415-421-8872 (West Coast) for the name of your local stocking distributor and a full-line catalog.**

CONTINENTAL SPECIALTIES CORPORATION

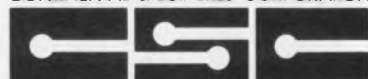

44 Kendall Street, Box 1942, New Haven, CT 06509, 203-624-3103 TWX 710-465-1227  
WEST COAST: 351 California St., San Francisco, CA 94104, 415-421-8872 TWX 910-372-7992  
GREAT BRITAIN: CSC UK LTD., Spur Road, North Feltham Trading Estate,  
Feltham, Middlesex, England, 01-890-8782 Int'l Telex: 851-881-3669  
MEXICO: ELPRO, S.A., Mexico City 5-23-30-04/CANADA: Len Finkler Ltd.; Ontario

\*Manufacturer's recommended resale.  
© 1977 Continental Specialties Corporation

U.S. Patent No. D235,554

CIRCLE NUMBER 123



# New products

## EPROM programmer is accessory for MMD-1

*E & L Instruments, 61 First St., Derby, CT 06418. Richard Vuillequez (203) 735-8774. \$222 assembled, \$166 kit form.*

A programmer, MMD-PP, for the 1702A electrically-programmable and UV-erasable ROM is an accessory for the Mini-Micro Designer (MMD-1) training and development micro-computer. By sharing MMD-1 circuitry under the control of its PROM, the MMD-PP can program a 2048-bit EPROM in about 4 min. A 1702A EPROM inserted in an MMD-PP socket will accept data from any block of MMD-1 memory as well as any PROM designated as master. For convenience and speed, the data stored in any master can be transferred to a section of RAM within the MMD-1 for modification or editing before it is used to program a new EPROM.

CIRCLE NO. 301

## Central processing unit needs no support logic

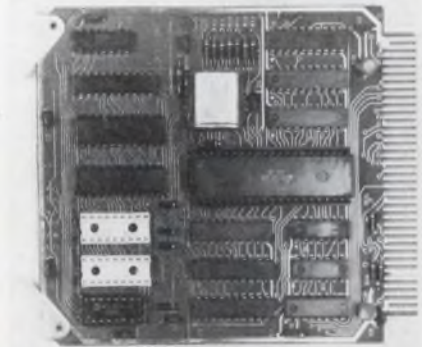

*MilerTronics, 303 Airport Rd., Greenville, SC 29607. Michael Webb (803) 242-9232. \$275; 4 wks.*

Model PDC-100 is a SC/MP II central processing unit. It is self-contained and has on-board RAM and PROM and is able to run without any supporting logic or cards. It can also control memory and I/O cards in bus-type systems. Features are: SC/MP II CPU chip, 256 bytes of RAM, up to 1024 bytes of bipolar PROM, address decoder for system control, crystal controlled clock, 600 ns/microcycle, and 15-card fanout.

CIRCLE NO. 302

## Paper-tape reader has large capacity

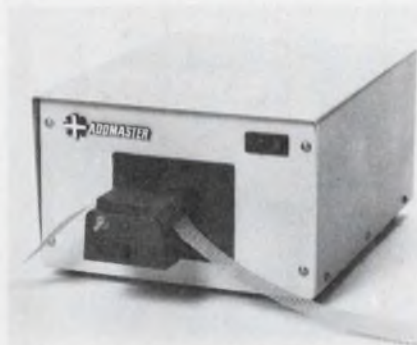

*Addmaster, 416 Junipero Serra Dr., San Gabriel, CA 91776. (213) 285-1121. \$625-\$725.*

Model 612, a stand-alone paper-tape reader, has greater capacity than earlier models. Ability to read 5 to 8-level tape and to transmit 7 to 11 frames per character at 50 to 9600 baud are among the features. Others include starting and stopping on character at all speeds, choice of manual control or X-on, X-off, and even, odd or no parity. RS232, current loop or parallel outputs are available, as is a choice of desk-top or rack mounting.

CIRCLE NO. 303

## Interactive computing done in a small system



*PolyMorphic Systems, 460 Ward Dr., Santa Barbara, CA 93111. Toby Bradley (805) 967-0468. From \$3250.*

System 8813 is a compact complete disk-based microcomputer. The central unit includes 16 kbytes of RAM and room for three mini-floppy disk drives. Included in the package is a video monitor, keyboard with cable, and complete system software on diskette. Software allows the system to work immediately, running applications in either assembly language or in fully extended Basic. The high-speed video display exhibits produces graphics and alphanumeric.

CIRCLE NO. 304

## Read/write amps go with cassette transports

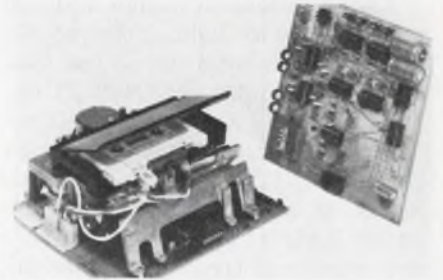

*Triple I, 4605 N. Stiles, Oklahoma City, OK 73118. (405) 521-9000. \$119.50.*

Digital read/write amplifiers are available for the family of remote-controlled Phi-Deck cassette transports. They come in one or two channel versions, as well as read/write, read only, and write only. Reading or writing of 1600 flux reversals per inch densities can be done at tape speeds to 20 in/s. This allows data transfer rates of 16 kbit/s.

CIRCLE NO. 305

## Slave $\mu$ C boosts processing power

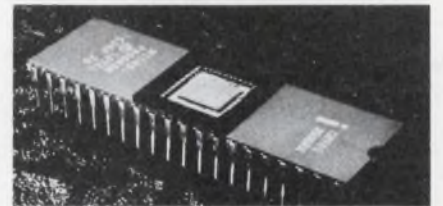

*Intel, 3065 Bowers Ave., Santa Clara, CA 95051. Rob Walker (408) 246-7501. See text.*

Universal Peripheral Interface components, UPI-41, are single-chip slave microcomputers used to boost the processing power and control flexibility of 8-bit microprocessors such as the 8080A, 8085 and 8048. They are offered in two interchangeable versions along with an I/O expander. The 8041 UPI contains a mask-programmed ROM. The 8741 UPI contains an EPROM in place of the 8041's ROM, and is used to expedite system development. Each 8243 I/O expander unit contains 16 I/O lines. The 8741 is available from stock at a single unit price of \$250, and the 8243 is \$8 for a single unit in a plastic package. The 8041 is custom manufactured.

CIRCLE NO. 306



## MICRO/MINI COMPUTING

### Gang module programs eight 2708-type EPROMs

Pro-Log, 2411 Garden Rd., Monterey, CA 93940. (408) 372-4593. \$895; stock.

A gang personality module is able to program up to eight 2708-type 8-k EPROMs simultaneously in less than 3 min. Called the PM 9051, it can program, duplicate, list and verify the EPROMs. It works with both Pro-Log's Series-90 PROM programmer and Series 92 PROM programmer/Duplicator control units. These units are now capable of accepting regular, generic and gang modules.

CIRCLE NO. 307

### Multiple port board has four serial interfaces

Intel, 3065 Bowers Ave., Santa Clara, CA 95051. Rob Walker (408) 246-7501. \$650 (unit qty); stock.

Complete computer hardware systems with multiple communications channels can be built with two circuit boards. It's possible with the SBC 534 four-channel communications expansion board. The board adds four programmable serial data channels plus 16 lines of parallel I/O that interface a Bell Model 801 automatic calling unit or other RS-232C-compatible devices. The board measures 6.75 x 12 in. and plugs into a 0.5 in. SBC chassis card slot. All basic functions are software-programmable. Each data channel provides half or full-duplex operation and contains a programmable baud rate generator, programmable USART, RS-232C interface and sockets for optically isolated, 20-mA current loop interfaces. Operating modes (synchronous or asynchronous), data formats and other functions are also individually programmable. In addition, baud rates can be selected and changed with software. The rates are derived from an on-board crystal oscillator. Any frequency from 18.75 Hz to 614.4 kHz can be obtained by using the interval timers. Typical baud rates range from 4850 to 38,400 in the USART synchronous operating mode and from 75 to 9600 baud in the asynchronous mode. The board requires +5, +12, and -12 V supplies and draws 1.9 A, 275 mA and 250 mA, respectively.

CIRCLE NO. 308

### Programmable calculator has full program editing



Hewlett-Packard, 1501 Page Mill Rd., Palo Alto, CA 94304. (415) 493-1501. P&A: see text.

The HP-29C, a handheld calculator, features 98 fully merged program steps, which typically hold 175 separate operations. It also has full program editing functions and continuous memory. Priced at \$195 it offers three subroutine levels, 10 addressable labels, indirect addressing, and insert/delete editing. The 29C also is equipped with the standard programming functions of backstep, single step, pause, and a total of 10 decision tests. The continuous memory feature makes possible virtually permanent storage of the user's program. CMOS memory chips allow programs and data to be retained in memory for long periods after the calculator has been turned off, with little battery drain. The HP-29C comes with a 204-page owner's handbook, as well as a separate 164-page applications book.

CIRCLE NO. 309

### Develop and debug Z80 programs for $\mu$ Cs

Zilog, 10460 Bubb Rd., Cupertino, CA 95014. Dave West (408) 446-4666. \$2850.

The Z80-PDS program development system provides complete support for developing and debugging Z80 micro-computer programs. The standard unit includes a floppy-disc drive with up to 300 kbyte of on-line data storage, internal memory of 3 kbyte of PROM and 16 kbyte of RAM, and serial I/O with RS-232 or strappable current loop interface. It is expandable via options to provide additional I/O or terminal capability and can also be used as a general-purpose computer.

CIRCLE NO. 310

## Call your nearest ISC sales representative.

If your state is not listed call 800/241-9888.

**ALABAMA:** Huntsville

W. A. Brown Inst. Inc. 205/539-4411

**ARIZONA:** Phoenix

Thorson Co. 602/956-5300

**CALIFORNIA:** Goleta

Thorson Co. 805/964-8751

**CALIFORNIA:** Los Angeles

Thorson Co. 213/476-1241

**CALIFORNIA:** Mountain View

Thorson Co. 415/964-9300

**CALIFORNIA:** San Diego

Thorson Co. 714/298-8385

**CALIFORNIA:** Tustin

Thorson Co. 714/544-5121

**COLORADO:** Denver

Thorson Co. 303/759-0809

**FLORIDA:** Ft. Lauderdale

W. A. Brown Inst. Inc. 305/776-4800

**FLORIDA:** Melbourne

W. A. Brown Inst. Inc. 305/723-0766

**FLORIDA:** Orlando

W. A. Brown Inst. Inc. 305/425-5505

**FLORIDA:** Valparaiso

W. A. Brown Inst. Inc. 904/678-7932

**GEORGIA:** Atlanta

W. A. Brown Inst. Inc. 404/939-1674

**LOUISIANA:** Gretna

W. A. Brown Inst. Inc. 504/366-5766

**MARYLAND:** Bethesda

Bartlett Assoc. 301/656-3061

**MASSACHUSETTS:** Framingham

Bartlett Assoc. 617/879-7530

**MICHIGAN:** Madison Hts.

WKM Associates 313/588-2300

**NEW MEXICO:** Albuquerque

Thorson Co. 505/265-5655

**NEW YORK:** White Plains

Bartlett Assoc. 914/949-6476

**NORTH CAROLINA:** Durham

W. A. Brown Inst. Inc. 919/682-2383

**OHIO:** Cleveland

WKM Associates 216/267-0445

**OKLAHOMA:** Norman

Data Marketing Assoc. 405/364-8320

**PENNSYLVANIA:** Pittsburgh

WKM Associates 412/892-2953

**PENNSYLVANIA:** Wayne

Bartlett Assoc. 215/688-7325

**SOUTH CAROLINA:** Columbia

W. A. Brown Inst. Inc. 803/798-3297

**TENNESSEE:** Knoxville

McCoin Elec. Equip. 615/584-8411

**TEXAS:** Austin

Data Marketing Assoc. 512/451-5174

**TEXAS:** Dallas

Data Marketing Assoc. 214/661-0300

**TEXAS:** Houston

Data Marketing Assoc. 713/780-2511

**TEXAS:** San Antonio

Data Marketing Assoc. 512/828-0937

**WASHINGTON:** Bellevue

Thorson Co. 206/455-9180

**AUSTRALIA:** Mt. Waverly, Victoria

Anderson Digital Elec. 03-543-2077

**CANADA:** Montreal

Cantec Rep. 514/620-3121

**CANADA:** Ottawa

Cantec Rep. 613/225-0363

**CANADA:** Toronto

Cantec Rep. 416/624-9696

**EUROPE:** England

Techex, Ltd. 0202-293-115

**EUROPE:** France

Peritec 749-40-37

**EUROPE:** Switzerland

Interest, AG 031-224481

**JAPAN:** Tokyo

Munzing International 586-2701



**Intelligent Systems Corp.**



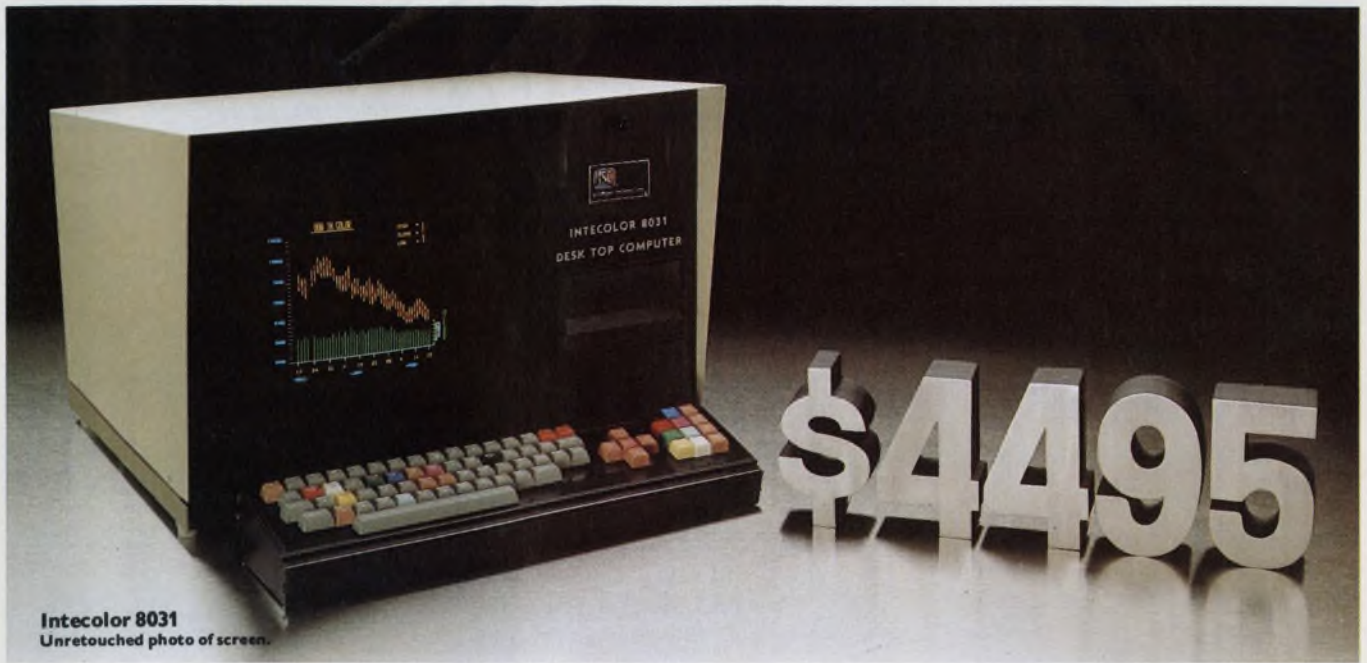

**Intecolor 8031**  
Unretouched photo of screen.

## Two very sophisticated desk top computers with two very unsophisticated price tags.

We're Intelligent Systems Corporation and we've developed two brand-new stand-alone desk top systems. Both are capable of handling an incredibly diverse range of business, control, research and financial applications—in color. Both have a better price/performance ratio than any other compact computer system on the market.

Take a look at the Intecolor 8031. A compact 13-inch 8-color CRT, it comes complete with graphics hardware and software, a built-in mini disk drive for extra storage, plus "File Handling BASIC" which lets you create, delete, and retrieve program segments from storage, by name.

Now take a look at the Intecolor 8051. Perfect if your needs call for a large-screen format. It comes with the same standard features as the 8031, but it has a

big 19-inch diagonal screen and external mini disk drive.

We also have a variety of options available for both units, including a convenient bi-directional desk top printer and a new 2708/2716 PROM programmer.

Contact the ISC representative nearest you for a working demonstration of these two highly sophisticated, versatile and dependable desk top systems. Prices are based on a one unit, cash-with-order basis. Guaranteed 30-day delivery or your money back.



**Intelligent Systems Corp.**

5965 Peachtree Corners East  
Norcross, Georgia 30071

Telephone 404-449-5961 TWX: 810-766-1581



**Intecolor 8051**  
Unretouched photo of screen.



# How to defend against attack by air,

Series I panel sealed lighted pushbuttons are qualified under MIL-S-22885.

FW solid state self-contained proximity controls provide high reliability and long life.

Panel sealed solid state keyboards in a variety of arrays.

TL toggles offer environment-proof sealing and many circuit options. TW provides switching versatility in a smaller size.

SE and XE miniature basic switches are environment-proof. HM version provides hermetic sealing and larger-sized HT withstands extreme temperatures.

EN is environment-proof limit switch with variety of actuators, circuitries, and electrical ratings. HE is hermetically-sealed version.

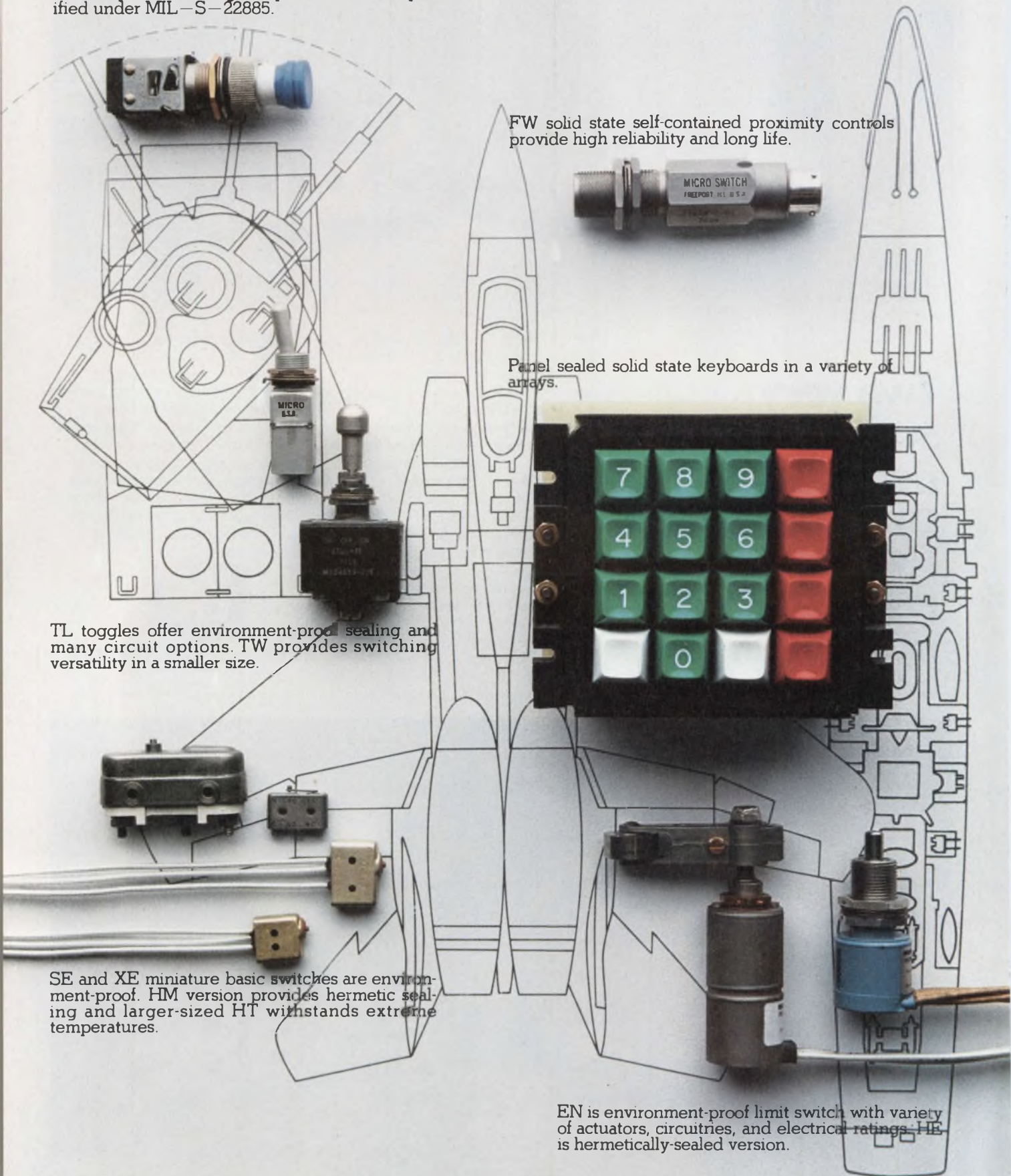



# sea or dust.

For use in extraordinary conditions, MICRO SWITCH builds some pretty extraordinary devices. Sealed to keep the environment out and keep on working in a wide variety of aerospace, transportation, ordnance and marine uses.

Uses where they simply can't afford to fail.

HE and HM switches offer true hermetic sealing, with metal-to-metal, glass-to-metal construction.

There's the FW solid state proximity control for high reliability in severe environments. For high temperature uses up to +1,000°F, there's the HT line. The SE and XE basic switches are the smallest environment-proof basic switches offered by MICRO SWITCH.

MICRO SWITCH also makes toggles with a variety of locking configurations and different-shaped levers, including colored tab levers. Integrated Wire Termination System is also available.

And there's also a complete line of Series 1 lighted pushbuttons. They're built to last hundreds of thousands of operations, and offer round or square buttons, momentary or alternate action and solid state options.

Every bit as rugged as the buttons, switches and toggles, MICRO SWITCH keyboards offer panel sealing plus solid state Hall-effect technology for reliability.

MICRO SWITCH will provide you with factory-trained field engineers for application assistance and a network of Authorized Distributors for local availability. For complete information, write us for details or call 815/235-6600.

## MICRO SWITCH

FREEMONT, ILLINOIS 61032

A DIVISION OF HONEYWELL

MICRO SWITCH products are available worldwide through Honeywell International.

## MICRO/MINI COMPUTING

### Two engineers can work on dual microcomputer



*Futuredata Computer, 11205 S. La Cienega Blvd., Los Angeles, CA 90045. Bob Scharf (213) 641-7700. \$5850; 4 wk.*

Microsystem 10/10 consists of two complete tape-based systems including two high-speed CRTs, two keyboards, two dual-tape units, operating software and manual. Each operator has full access to the system's editing, debugging and assembling capability. One half of the system can be dedicated to 8080; the other to 6800 or Z80 and either operator can switch processors by changing PC boards. The system provides two 8-in. floppy-disc based systems, each with 16 kbyte of RAM.

CIRCLE NO. 314

### Portable terminal system has built-in LINC tape



*Computer Operations, 9700 B Palmer Highway, Lanham, MD 20801. Michael Keating (301) 459-2100. \$3850 (unit qty); stock.*

The Serial Box, a portable, interactive terminal, can interface to any mini/microcomputer via an RS-232 or current loop port at selectable data transmission speeds from 110 to 9600 baud. The Model CO-4420 consists of a 1 Mbyte direct-access LINC tape drive, a full ASCII keyboard, a 40-character plasma display, an RS-232 port and a microprocessor controller, all contained in a 23-lb case. Also available without display or keyboard the unit adds direct-access mass storage capability to any system via a second RS-232 or current-loop port.

CIRCLE NO. 315

### 4-bit microcomputers are for consumer products

*NEC Microcomputers, 5 Militia Dr., Lexington, MA 02173. (617) 862-6410. \$2 to \$8 (large qty); stock.*

There are 4 members in the uCOM-4 family of 4-bit LSI microcomputers. Each member includes an ALU, user-specified masked ROM, RAM, and multiple I/O lines. ROM capacity ranges from 640 x 8 bits to 1920 x 10 bits. Each type has a powerful applications-oriented instruction set with multi-function instructions.

CIRCLE NO. 316

### Microprocessor analyzer handles 8080 and 6800 $\mu$ Ps



*Yucca International, 14415 N. Scottsdale Rd., Scottsdale, AZ 85260. (602) 991-1491. \$875; 30 days.*

The YA-20, a  $\mu$ P logic analyzer, is intended to help debug systems using 8-bit processors like the 6800 and 8080. Up to 128 30-bit data words can be trapped and stored at any address, data or user input in the program. The YA-20's selective trapping feature permits "write only" selection and VMA selection for 6800  $\mu$ Ps; DBI for 8080s. A stepping switch and forward-reverse switch allow instructions to be read a data word at a time (32 words back, 96 words ahead) on hexadecimal LED displays. User inputs and MPU status are reported by LED indicators. Data trapping can be delayed up to 256 times past trigger point using the units pass counter feature. Trigger can be generated by a selected address on the bus, by a selected data word, by any combination of address, data or external inputs, or an external trigger can be used. "Don't care" selection switches are provided for all address, data and user inputs. A BNC connector allows optional scope display synchronized by the analyzer. A clip-on probe, provided for either 6800 or 8080  $\mu$ Ps at no extra cost, has a 10-M $\Omega$  input impedance. Probes for other  $\mu$ Ps are available. Housed in an 18 x 9 x 4 in. metal cabinet, the VA-20 needs only 115 V ac to operate.

CIRCLE NO. 317



# Alternate Timebase Display

Gives you the whole picture  
for \$1395.\*

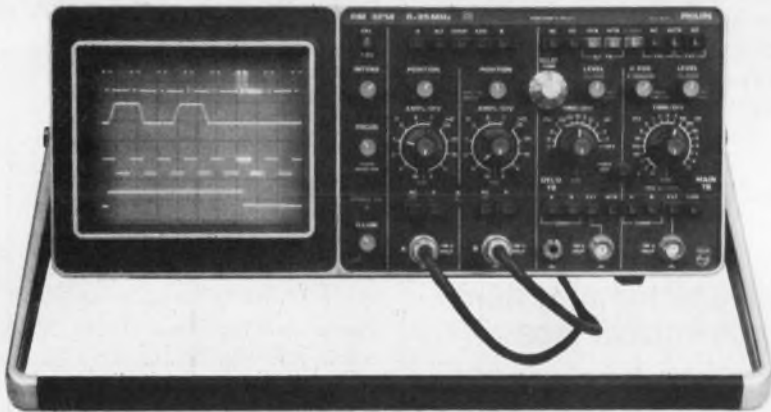

Continuous indication of where DELAYED T.B. measurements are taken.

- Eliminate BACK-AND-FORTH SWITCHING
- Forget MIXED-SWEEP limitations

The PM 3214 is the latest addition to the Philips oscilloscope family. At 25 MHz and 2mV sensitivity, the PM 3214 incorporates all the triggering facilities found on the latest, most expensive oscilloscopes available: AC, DC, TV and an auto position that derives its trigger from the peak to peak signal input. Trigger selection from either channel, line and external sources as well as composite triggering for ASYNCHRONOUS signals.

Composite triggering in A-B display derives its source from the differential signal, allowing measurement of signals riding on high AC or DC components.

The 18.5 lb. portable is double insulated and even has an internal battery option. Supplied with two probes and a protective front cover, the PM 3214 is a money saving solution to many oscilloscope requirements.

If you don't need DELAYED TIMEBASE the economy priced PM 3212 has all the triggering and overall performance of the PM 3214 at only \$1,155.00\*.

For immediate detailed information utilize our toll-free Hotline number: 800 631-7172 (New Jersey residents call collect), or contact: Philips Test & Measuring

In the U.S.:  
85 Mc Kee Drive  
Mahwah, New Jersey 07430  
Tel. (201) 529-3800

In Canada:  
6 Leswyn Road  
Toronto, Ontario, Canada M6A 1K2  
Tel. (416) 789-7188

\* U.S. Domestic Price Only



## PHILIPS

CIRCLE NUMBER 125

## MICRO/MINI COMPUTING

### Memory emulation unit programs and debugs

M&E Assoc., 10439 N. Stelling Rd.,  
Cupertino, CA 95014. Michael Maples  
(408) 739-5168. \$5995; 30-60 days.

A Z80 based development system combines the power of a special assembler with a memory emulation module. The assembler allows the insertion of any instruction mnemonic, including multibyte instructions, like those of the Z80. The assembler's symbol table can be set for an 8080, F80, 6800, F8 and 6502, to generate the appropriate code. The object code is loaded into the emulator memory space where it can be executed by the target processor. Any target microcomputer system with a standard 2708 EPROM can be programmed and debugged using breakpoints. Once a program is debugged the EPROM can be debugged via an RS232 link.

CIRCLE NO. 318

### Cassette storage system handles over 1 Mbyte

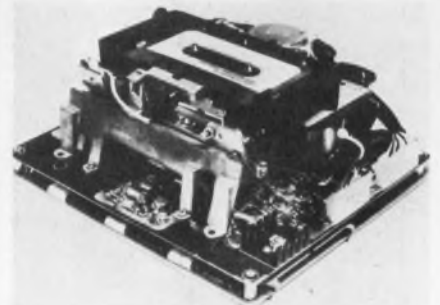

Triple I, 4605 North Stiles, P.O. Box  
18209, Oklahoma City, OK 73118. Jack  
Morrow (405) 521-9000. For one trans-  
port and controller: \$375 (unit qty);  
stock.

The GCR cassette system is a magnetic tape data storage and retrieval system. It can control up to four of the company's Phi-Deck cassette transports and access any of over one million 8-bit bytes within 20 seconds. Each deck is fully controlled to prevent tape breakage. A 4 to 5 bit translation scheme, called Group Coded Recording, allows higher packing densities with a soft error rate of less than one bit in  $10^8$ . This system operates at 1600 flux changes per inch, yielding a data transfer rate of 800 bytes per second at a tape speed of five inches per second.

CIRCLE NO. 319



## Electrostatic printer also does graphics

Axiom, 5932 San Fernando Rd., Glendale, CA 91202. Simon Harrison (213) 245-9244. \$795 (unit qty); 30 days.

The EX-810, a full-graphics plotter, can print 8192 dots per second with up to 512 dots per row. It can also function as an 80 column alphanumeric printer with a speed of 160 characters per second. Specifically designed to be driven by an 8-bit  $\mu$ P with a minimum software overhead, the unit is equipped with a TTL compatible controller which takes care of all the internal timing functions necessary to drive the printhead and advance the paper. Printout is initiated by a single input command, which causes an 8-track nonimpact printhead to move across the printing field in about 240 ms with a speed uniformity better than 0.1%. Margin and printhead position marker signals are fed back to the user's micro-computer and may be used to synchronize an 8-bit scanning raster to the printhead driver input. The uniform speed of the printhead also allows the user to vary the horizontal dot resolution by generating an external timing cycle for the input raster. A complete self-contained unit with case, power supply, paper holder, infrared low-paper detector and bell, the EX-810 measures just  $9.625 \times 4 \times 10.875$  in. and weighs 12 lb (with 240 ft roll of 5 in. wide electrosensitive paper).

CIRCLE NO. 320

## Prototyping tool makes development easy

RCA, Box 3200, Somerville, NJ 08876. (201) 685-6423. \$2900.

An interactive prototyping tool, CDP18S005, facilitates the development of software and hardware using the RCA 1800 family of micro-processors. The system uses a CPU and includes a RAM resident editor and assembler. Space is available for additional I/O devices. Also included are power supplies, clock, controls, display, and seven plug-in PC modules containing a CPU, control, address latch and bank select, 4-kbyte RAM, ROM/RAM, I/O decode and terminal interface. Only a data terminal is needed to make the system operational.

CIRCLE NO. 321

# OUR NAME TELLS YOU HOW WE EXPRESS PACKAGES, DOOR-TO-DOOR.

## \$12.11 TELLS YOU HOW MUCH.



We're Airborne Freight and we deliver small, critical packages all over the country, fast. We pick up and deliver any average size package fitting into one of our Express Packs and weighing 2 pounds or less, for just \$12.11. You tell us when and where you want delivery and we'll get it there.

We use an air express system that includes the flights of over 200 airlines, jet taxis, plus our exclusive Charter Express to link together key cities providing you with delivery service no one can match.

We also provide you with something else: Free "hard" or "soft" Express Packs. Our "soft pack" is tearproof, waterproof and big enough for parts, briefs, bids, film, tape, etc. Our "hard pack" is a rigid box designed for protecting fragile items such as photos, art work, instruments, prototypes, and other delicate pieces. For your own Express Packs call your Airborne Customer Service Representative. The same person you call when you've got something large to ship, fast.

Then just tell us when and where. We'll get it there.

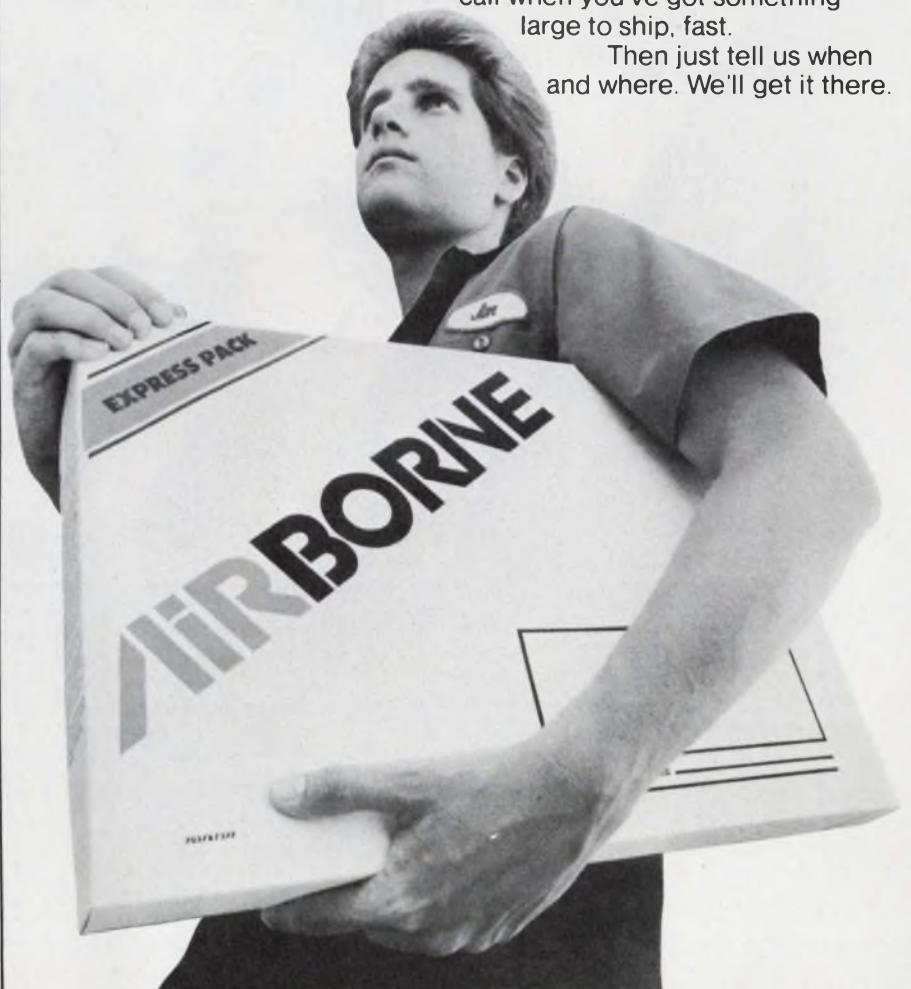

CIRCLE NUMBER 126



# How to get more mileage from discrete components.

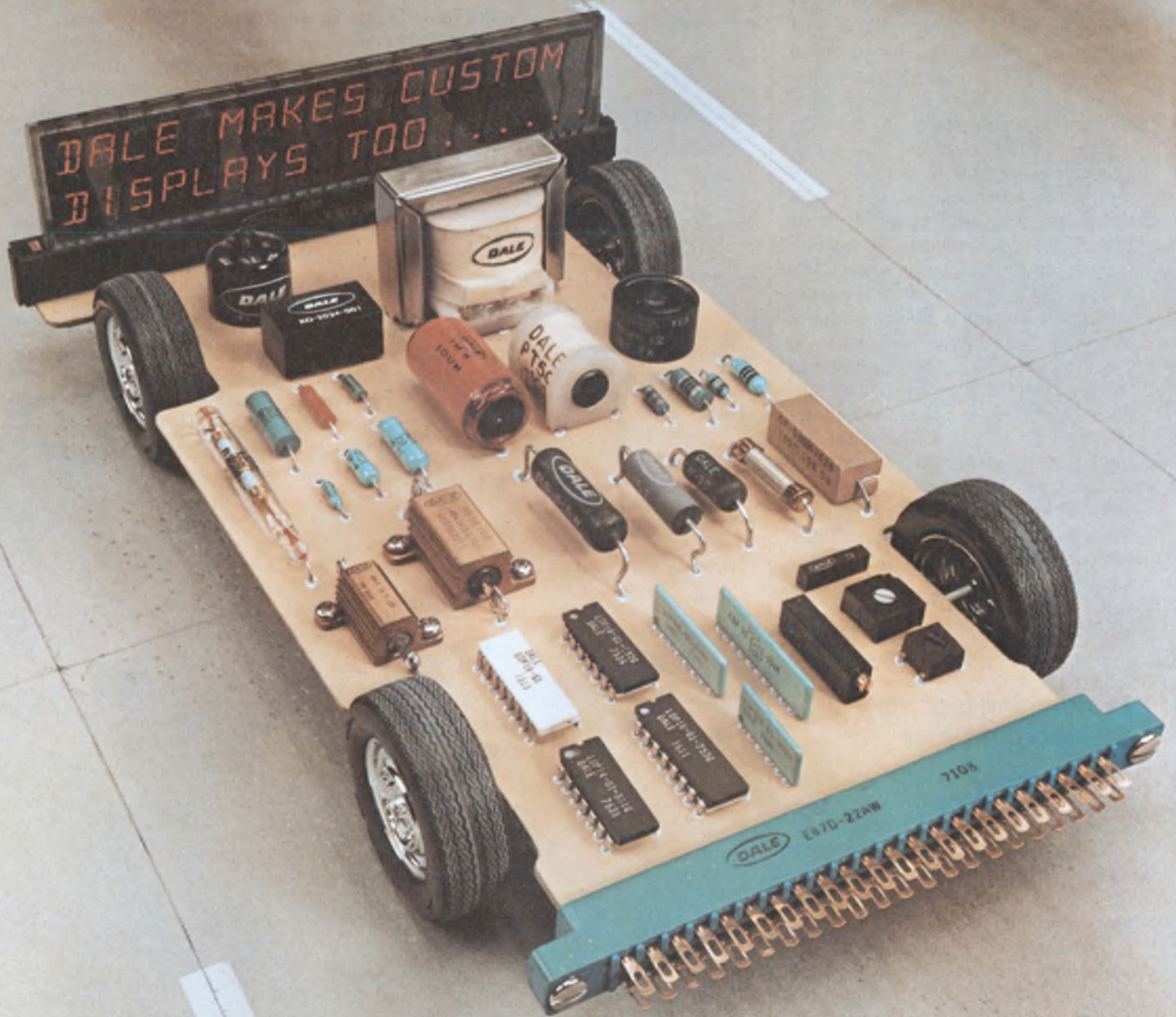



# Start with Dale...

because we're making a lot more of the discretes you need on and around your board. And we're geared to save you time, energy and money with this growing family of products.

## RESISTORS

The industry's broadest line to meet commercial, industrial and military requirements...including everything from the most stripped-down wirewound to glass-enclosed metal film.

## RESISTOR NETWORKS

Space-saving SIP and DIP models, including the first DIP qualified to MIL-R-83401. Very competitive prices plus one-week delivery from stock.

## TRIMMERS

Dale's low profile 700 Series and single turn 100 Series (3/8" square) interchange with all popular competitive models and give you performance advantages in a wide choice of pin spacings.

## INDUCTORS

Expanded production makes Dale a major supplier of roll-coated chokes. And,

we're gaining steady acceptance as a source of filter inductors and low power laminated transformers.

## CONNECTORS

Get excellent price and delivery on .156" edgeboards and 2-piece rack and panel styles plus board interchangeability with a wide range of other styles.

## ARRESTERS

Dale offers overvoltage protection for everything from lightning to transients within a circuit. Exclusive patented design with Mil. qualification.

## CRYSTALS

Our newest line. Includes compact, low-cost clock oscillators for DIP applications plus temperature compensated oscillators, voltage controlled oscillators and a broad range of filter designs.

It's a fact. Dale has more of the discretes you need. More standard parts from a strong distributor network...more capability to meet your special needs...more of the quality you've come to expect from Dale. It adds up to more mileage for your efforts and your budget when you call your man who sells Dale.



### Dale makes your basics better.

DALE ELECTRONICS, INC.  
1300 28th Avenue, Columbus, Nebraska 68601  
A Subsidiary of The Lionel Corporation  
IN CANADA: Dale Electronics Canada Ltd.  
IN EUROPE: Dale Electronics GmbH,  
8 Munchen 60, Falkweg 51,  
West Germany

CIRCLE NUMBER 127





# Bliley

first name in frequency control

We have a reputation that can mean as much to you as it does to us. Here's why.

By manufacturing our own crystals and growing and sweeping our own quartz, we control product quality from raw material to finished unit.

Next, we specialize in the design and production of units whose level of precision is difficult—if not impossible—to find elsewhere.

Finally, our total commitment to quality makes us the preferred supplier to the more sophisticated levels of electronics.

If that's *your* level, you've found your peer in Bliley. Tell us about your present requirements or, simply request our catalog of complete product information and call later when you need us.

QUARTZ CRYSTALS • CRYSTAL OSCILLATORS

## BLILEY ELECTRIC COMPANY

2545 West Grandview Boulevard,  
P.O. Box 3428, Erie, PA. 16508  
Tel. (814) 838-3571 TWX 510-696-6886



CIRCLE NUMBER 128

# A "LIGHT" TOUCH

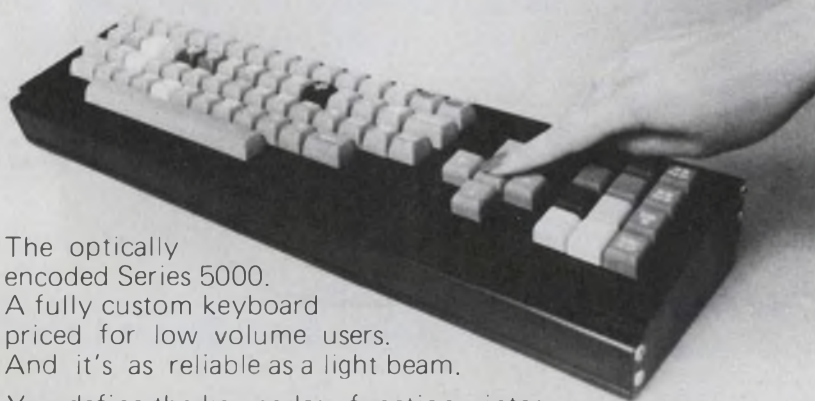

The optically encoded Series 5000. A fully custom keyboard priced for low volume users. And it's as reliable as a light beam.

You define the key codes, functions, interface, key locations and cap markings. If you can make do with a choice of only 2048 different codes, 360 keys or less, n-key lockout, 2-key rollover and logical or non-logical pairing, we'll make it up to you with fast delivery and no NRE or tooling charges.

Series 5000. The most sensible keyboard technology available today. Affordable in any quantity.

# ADI

APPLIED DYNAMICS INTERNATIONAL  
KEYBOARD PRODUCTS DIVISION  
3800 Stone School Road  
Ann Arbor, Michigan 48104  
Phone: 313-971-7840 Telex: 230238

CIRCLE NUMBER 129

## MICRO/MINI COMPUTING

### Printer controller handles 15 column copy

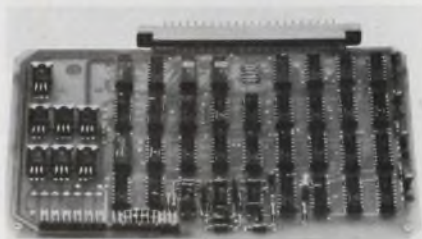

Sheldon Sodeco Printer Corp., 4 Westchester Plaza, Elmsford, NY 10523. Peter Engstrom (914) 592-4400. \$180 for the controller (unit qty), \$104 for the PR1501 (100 qty); stock.

A printer control interface, Model 4-621-9200, is designed for use with the company's PR1501-01 alphanumeric impact printer. The printer can produce 15 columns, in two colors, at speeds up to 90 lines per minute. The interface, assembled on a 5.5 x 7.5 printed-circuit board accepts an ASCII input code and provides a 15-column line buffer, ROM character generator, timing control, and solenoid drive circuits to completely control the PR1501 printing mechanism. Input commands for start load, load data, busy, start print, paper feed and ribbon shift are provided by the interface. Units are supplied with an edge connector and complete documentation.

CIRCLE NO. 322

### Mass memory system holds up to 14 Mbits

Monolithic Systems, 14 Inverness Dr. East, Englewood, CO 80110. Robert Billhimer (303) 770-7400. P&A: See text.

A 14 Mbit semiconductor RAM memory, contained in a 5.25 in. high RETMA rackmount chassis is designed around 16 k dynamic RAMs. The MSC 2601 contains its own power supplies, forced air cooling, and cards for timing and control, address buffer, and termination and register. Bit lengths of the memory array cards can be arranged to meet the requirements of the user. Addressing, data input and data output buses are arranged to permit addressing up to eight, 768 kword modules. The MSC 2601 is priced at less than 0.25¢/bit in OEM quantities and delivery with a custom-designed I/O is 45 days.

CIRCLE NO. 323



## Micro system needs no professional programmer

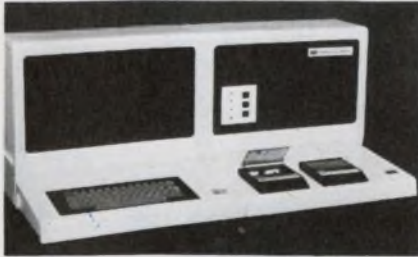

Information Control, 9610 Bellanca Ave., Los Angeles, CA 90045. (213) 641-8520. \$4875-\$6950.

A system designer's task is simplified by the use of the Micro-Command system. Unique features are: complete hardware/software package for development of either 8080 or Z80 based systems without CPU change; light pen for interactive I/O; "menu-oriented" software. The lower-cost option has dual-cassette tape storage.

CIRCLE NO. 324

## Controllers for diskette drives handle 2 Mbytes

Intel, 3065 Bowers Ave., Santa Clara, CA 95051. Rob Walker (408) 246-7501. \$1290 (unit qty); stock.

A self-contained, programmable controller, the SBC 202, handles up to 2 Mbytes of floppy-disc mass storage. The controller interfaces SBC 80 Single Board Computers and System 80 packaged OEM computers with most types of double-density diskette drives. Multiple SBC 80 and System 80 computers can share mass storage resources and process concurrently. Moreover, multiple controllers can be used on the Multibus. Major features of the SBC 202 include: direct memory access, complete cyclic redundancy checking, recording in a high-density, soft-sectored format, and pre-programmed to simplify computer programming. The recording format allows up to 500 kbytes to be stored on each diskette and the controller can handle up to four drives. Two 6.75 x 12-in. boards are needed to build the controller: A channel board, containing an 8-bit bipolar processor, decodes commands, fetches parameters from system memory, and controls the operations. And an interface board handles communications between the drives and central processor, and implements all DMA and CRC operations.

CIRCLE NO. 325

## Hand-held terminal interfaces $\mu$ Cs

RCA, Box 3200, Somerville, NJ 08876. (201) 685-6423. \$140.

Packaged in the size and shape of a pocket calculator, the Microterminal CDP18S021 is a low-power, nonhard-copy alternative to the conventional teletypewriter data terminal. It pro-

vides a convenient means of controlling a COSMAC microprocessor-based system, reading and modifying memory, and providing hexadecimal I/O capability. It is suited for use with the COSMAC evaluation kit CDP18S021 or the development system, CDP18S005. But it can be designed into user-built systems to provide control, communications and debugging functions.

CIRCLE NO. 326



# Bulletproof!

Babcock hi-rel relays meet their specifications in practice, not just on paper. Call us on it at (714) 540-1234.

## Babcock Relays

An Esterline company, 3501 Harbor Blvd., Costa Mesa, CA 92626.

- Dry reed • Mercury wets • Military/aerospace
- Ultra hi-rel • Telephone • General purpose

CIRCLE NUMBER 131



## GULTON'S "fast change" artist

Lets you change or replace signal conditioners in seconds. Use your Gulton portable recorder to chart volts, amps, temperature, EKG, strain, ac to dc, log to dc and more . . . simply by plugging in appropriate signal conditioners.

Should any signal conditioner require testing or service, just slide it out and slide in a spare. It's as easy as it sounds. Gulton portable recorders with plug-ins are available in 2, 4, 6 and 8 channel models. Write or call for 12 page portables catalog.

**gulton**®

Measurement & Control Systems Division  
Gulton Industries Inc. East Greenwich Rhode Island 02818  
401 884-6800 • TWX 710-387-1500

CIRCLE NUMBER 132

## 16-gang programmer can verify PROMs



PROM Programmers, 601 Nandell Lane, Los Altos, CA 94022. (415) 948-0450. \$2995; 30 days.

A 16-gang programmer programs and verifies PROMs of the 2708 or 2716 families. It will program the first tier of eight sockets while loading the second row and then program the second row while unloading and loading the first. A toggle switch allows all 16 sockets to be programmed at the same time.

CIRCLE NO. 327

## NEW Micro-Clip heat sinks let you operate your MPUs at 2x their rated power... or 1/2 their case temperature.

IERC's two-piece Micro-Clip heat dissipators adjust to fit all double DIP, CMOS, MOS-FET, and micro-processor packages in the 20- to 40-pin range. *Result: fewer stocking problems.* Spring-finger design lets units make good, solid contact with top and bottom of an MPU. *Result: heat transfer increases up to 100% over that of glued-down devices.* Staggered-finger design maximizes heat radiation under natural convection and through increased turbulence in forced air modes. *Result: higher heat transfer efficiency.* Two

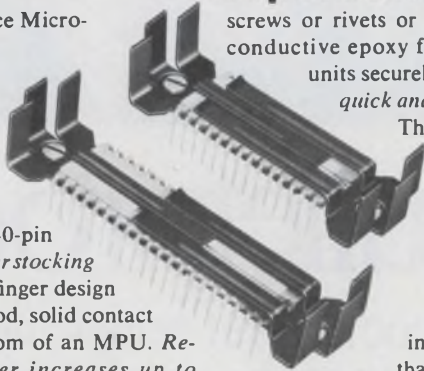

screws or rivets or dots of thermally conductive epoxy fasten Micro-Clip units securely in place. *Result: quick and easy installation.*

Three finger heights:

1/4, 1/2 and

3/4 in. *Material: black anodized aluminum.* Weight:

4 grams. Space required: only .6 sq.

in. more board space than the device itself.

Call today for more details. Ask for Bulletin 186. International Electronic Research Corporation/A subsidiary of Dynamics Corporation of America/ 135 West Magnolia Blvd., Burbank, California 91502 (213) 849-2481.

**IERC**



HEAT SINKS/DISSIPATORS  
CIRCLE NUMBER 133

## Fortran compiler is made for minifloppy/μC



GNAT Computers, 7895 Convoy Ct., San Diego, CA 92111. Frank Adams (714) 560-0433. \$3990 (system); stock to 30 days.

A Fortran compiler is available for the GNAT minifloppy/microcomputer system. The compiler includes all ANSI standard Fortran, X3.9-1966, except for double precision and complex numbers. A relocating assembler, a linking loader, and the Fortran library are included. The Fortran functions are implemented with 32-bit floating-point arithmetic. Integers are implemented with 16-bit numbers. The system includes a 1.3-μs CPU, 32-k RAM, 2-k PROM on 16-k ROM module, serial/parallel I/O, disk interface and control, front panel, and minifloppy disk drive.

CIRCLE NO. 328



## $\mu$ P controller allows high speed plotting

Zeta Research, 1043 Stuart St., Lafayette, CA 94549. Ralph Manildi (415) 284-5200. \$2500; 30-45 days.

A microprocessor interface (MPI) controller, model MPI-DGV, plugs directly into a minicomputer's backplane and does much of the computer's work using Zeta's Graphic Machine Language (GML) software. The combined effort of this distributed computing allows high speed plotting, with minimal host CPU time at the computer's lowest priority, with any Zeta plotter.

CIRCLE NO. 329

## Analog boards for SBC-80 systems need just 5 V



Intel, 3065 Bowers Ave., Santa Clara, CA 95051. (408) 246-7501. From \$395 to \$1125; stock.

Three analog I/O subsystems and an optically isolated digital I/O subsystem have been added to the SBC-80 single board computer family. The SBC 732 analog combination I/O board, contains 8 differential/16 single-ended analog inputs (expandable to 16/32 inputs) and two digital-to-analog conversion channels; the SBC 711 analog input-only board, has the same number of inputs as the SBC 732's input section; the SBC 724 analog output-only board, offers four d/a converter channels; and the SBC 556 optically isolated I/O board, contains digital interfaces for 48 I/O lines and sockets for the user's choice of opto-isolators, drivers and terminators. All plug-in boards are 6.75 x 12 in. and operate from a +5-V power supply.

CIRCLE NO. 330

## Process control system is $\mu$ P based

Digitek, 5950 6th Ave. S., Seattle, WA 98108. Frank Mauger (206) 762-3933. \$15,000; 12 to 16 wk.

A microprocessor-based process control system includes a complete software package for supporting up to 16

control loops and 16 additional inputs with alarm limits. Programming is done in Basic with some subroutines written in assembly language. Features include manual or automatic mode operation, flow totalization, cascade effect, high and low alarms for limit detection and trend logging and display.

CIRCLE NO. 331



# What to do with your TO-5 relays:

Once you find out that our .100"-grid BR44 relays occupy 30% less real estate and switch loads twice as high, you may find other uses for the TO-5 relay. For a few suggestions, call us at (714) 540-1234.

## Babcock Relays

An Esterline company, 3501 Harbor Blvd., Costa Mesa, CA 92626.

- Dry reed • Mercury wets • Military/aerospace
- Ultra hi-rel • Telephone • General purpose

CIRCLE NUMBER 134



# Join the IMC Book Club\*



Floppy Disc Motor

Free 100 page Motor Catalog contains thousands of choices of AC and DC Motors.

This catalog is devoted to technical information and illustrations along with sections on connection diagrams and dimensional drawings. Motors from .750 inch outer diameter to 5.375 inches in outer diameter are described in various models having power outputs ranging from subfractional to three horsepower.

For immediate service please call Gene Egan, V.P. Sales 516/334-7070.

\*Product Literature Broadside and request card will be sent to you along with this catalog.

SERVING INDUSTRY OVER 25 YEARS

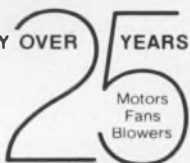

**IMC MAGNETICS CORP.**

EASTERN DIVISION

570 MAIN STREET, WESTBURY, NEW YORK 11590

CIRCLE NUMBER 135



electrocube solutions...

**POLYCARB**

for **INSTANT RELIEF**

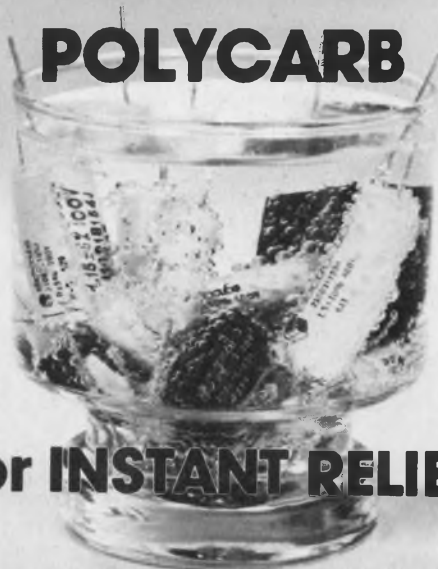

If capacitor performance and delivery are giving you problems, our reliable metallized polycarbonate Series 650 could be the solution. More than the 1100 miniature units, in 6 case styles, rated to 50 mfd and 600 VDC — all extremely stable over a wide temperature range. **And they're available in reel and un-reel packaging.** For instant relief, contact Electrocube, 1710 So. Del Mar Ave., San Gabriel, CA 91776; Tel.: (213) 573-3300.

CIRCLE NUMBER 136

## INSTRUMENTATION

### Color-pattern generator provides all TV signals

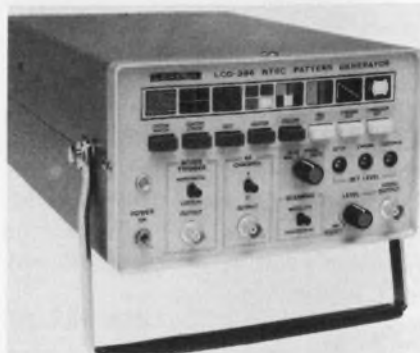

Leader Instruments, 151 Dupont St., Plainview, NY 11803. Pat Redko (516) 822-9322. \$900.

The LCG-396 color-Lar generator provides all signals necessary for testing or aligning any TV equipment. It provides full-field and IQW insertion as well as on/off control of chrome and luminance. Both fixed and variable-video outputs are available and it generates eight precision color bars as well as dot, crosshatch, centerline single crosshatch and white, red, blue, green rasters.

CIRCLE NO. 332

### Probe voltage tester needs no ground



Mono-Probe, 5471 Huntington Dr., Los Angeles, CA 90032. Dan Tucker (213) 222-7222. \$39.95.

Hand-held, with a single probe, the Trouble Shooter tester detects 120, 240 and 480 V and produces both light and sound signals. An auxiliary probe allows continuity testing.

CIRCLE NO. 333



## Resistance box offers 0.005- $\Omega$ resolution

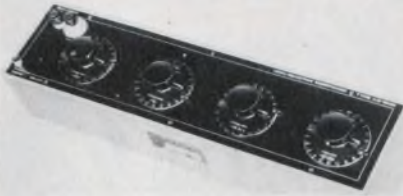

James G. Biddle, Plymouth Meeting, PA 19462. (215) 646-9200. \$280-\$345.

High resolution of 0.005  $\Omega$  is obtained with the ac/dc decade resistance box. Features include: silver-faced contacts with laminated-copper brushes, very low self-inductance and capacitance, and full shielding. Seven models are available, two with steps of 0.005  $\Omega$ .

CIRCLE NO. 334

## Hf receiver tunes the 5-kHz to 30-MHz range

Watkins-Johnson, 700 Quince Orchard Rd., Gaithersburg, MD 20760. (301) 948-7550.

Featuring a seven-digit LED-readout display, the WJ-8718 hf receiver tunes across the 5-kHz to 30-MHz range in four switch-selectable steps. A built-in frequency synthesizer provides 10 Hz of resolution over the entire range. It can detect AM, FM, CW, ISB, LSB, and USB emissions. Five i-f bandwidths cover 0.3 to 16 kHz and are front-panel selectable.

CIRCLE NO. 335

## Rf field measures silicon-wafer resistance



ADE, 127 Coolidge Hill Rd., Watertown, MA 02172. Virginia Regal (617) 923-2180. \$5360; stock.

Slice resistivity of silicon semiconductor wafers are measured by the 6035 MicRhoSense, a noncontact gauging system using an rf field. Readout is metric or English and separate high/low LEDs can be set for production sorting. Resistivity range is 0.001 to 99.9  $\Omega$ -cm.

CIRCLE NO. 336

## Power meter provides accurate rf measurement



Narda Microwave, Plainview, NY 11803. (516) 433-9000. \$425.

Having a 30-dB dynamic range, the hand-held, battery-operated power meter makes accurate measurements in the 10-MHz to 13.7-GHz range. The Model 8401 is available with interchangeable 50- $\Omega$  mounts covering a full-scale power range of 0.1 to 100 mW. Also available is a 75- $\Omega$  mount for CATV use with a range of 1 to 10 mW. Full scale accuracy is  $\pm 3\%$ .

CIRCLE NO. 337



# Call C. P. Clare

and ask them why they charge twice our prices for mercury wetted relays. If you don't like their answers—or their prices—call us at (714) 540-1234.

## Babcock Relays

An Esterline company, 3501 Harbor Blvd., Costa Mesa, CA 92626.

- Dry reed • Mercury wets • Military/aerospace
- Ultra hi-rel • Telephone • General purpose

CIRCLE NUMBER 137





**AMP's tin plated  
interconnection  
system performs  
reliably.  
Even in dry  
circuit applications.**

Because our Commercial Interconnection System (CIS) features a unique, high pressure, redundant, metal-to-metal contact design, tin plating can be used instead of gold. A choice of fork-type-contacts provides mating forces from 400 to 1,000 grams for maximum application flexibility. And the posts assure positive wiping action for clean contacts and extended stability.

AMP CIS also helps you save on materials other than gold. You can use wider tolerance pc boards because CIS is a two-piece system that assures reliable connections even when boards are warped or bowed.

Receptacle assemblies are designed for fast, easy soldering to boards without need for tooling. And boards can be mated from top, bottom or sides for full packaging versatility. Posts, straight or right-angled, are available for gang insertion, for machine application and in pin headers, to serve any volume efficiently.

The entire System is available on 0.100" and 0.150" centers, with or without polarization features, for full compatibility with today's new generation of components. And that can mean lower costs from initial design right through final production.

There are more reasons for using AMP's tin plated Commercial Interconnection System, including AMP backup, whenever you need it. So why not call AMP Customer Service and find out more about CIS. Just dial (717) 564-0100 or write AMP Incorporated, Harrisburg, PA 17105.

**AMP has a better way.**

**AMP**  
INCORPORATED

CIRCLE NUMBER 138



## AMP EUROPE

**Austria** — AMP Austria. Branch of AMP Deutschland GmbH. Markgraf-Ruediger Str. 6-8, 1150 Vienna. Phone: 924191/92

**Belgium** — AMP Belgium. Branch of AMP-Holland B.V., Rue de Brabant 62-66, Brussels. Phone: 322.17.55.17

**Finland** — AMP Finland OY Postilokero 3, 00401 Helsinki 40 Phone: 90/584122

**France** — AMP of France. 29 Chaussée Jules-César. Boite Postale No. 39. 95301 Pantaise France. Phone: 030 82 20, 030 92 30

**Germany** — AMP Deutschland GmbH. Ampèrestrasse 7-11, 607 Langen, B. FFM., West Germany. Phone: (06103) 7091

**Great Britain** — AMP of Great Britain Limited, Terminal House, Stanmore, Middlesex, England. Phone: 01-954-2356

**Holland** — AMP Holland B.V., Papierstraat 2-4 5223 AW 's-Hertogenbosch, Holland. Phone: (073) 125221

**Italy** — AMP Italia S.p.A., Via Fratelli Cervi 15, 10093 Collegno (Torino), Italy. Phone: 785-656

**Spain** — AMP Española, S.A., Apartado 5294. Pedro IV, 491, 495, Barcelona 5, Spain. Phone: 307-75-50

**Sweden** — AMP Scandinavia AB, Datavägen 5, 17500 Jakobsberg, Sweden, Mailing Address: Fack S-175 20 JARFALLA 1, Sweden. Phone: 0758/10400

**Switzerland** — AMP AG, Haldenstrasse 11, 6006 Luzern, Switzerland. Phone: (414) 235421, 235422, 235423

## AMP NORTH AMERICA

**Canada** — AMP OF CANADA LTD., 20 Esna Park Drive, Markham, Ontario, Ph: 416-499-1251

**Mexico** — AMP de Mexico, S.A., Apartado Postal 179, Naucalpan de Juarez, Edo. de Mexico, Phone: Mexico City 576-41-55

**Puerto Rico** — AMP OF CANADA LTD., 677 Calle de Diego, Rio Piedras, Puerto Rico 00924, Phone: (809) 766-2346

**United States** — AMP Incorporated, Harrisburg, Pa. 17105, Phone: 717-564-0100

## AMP SOUTH AMERICA

**Argentina** — AMP S.A. Argentina 4 de Febrero, 76 Villa Zagla — SAN MARTIN, Buenos Aires, Argentina, Phone: 752-4612

**Brazil** — AMP do Brasil Ltda., AV Comendador Martinelli 185, Lapa, Sao Paulo, Phone: 262-4353

## AMP PACIFIC

**Australia** — Australian AMP Pty. Limited, 155 Briens Road, Northmead, N. S.W. 2152 Australia, Mailing Address: P.O. Box 194, Baulkham Hills, N. S.W. 2153 Aus. Ph: 630-7377

**Japan** — AMP (Japan), Ltd., No. 15-14, 7-Chome, Roppongi Minato-Ku, Tokyo, Japan, Ph: 404-7171

Products and services for many specialized industries are provided by the AMPLIVERSAL Division. In the United States, this division is known as AMP Special Industries.

For Amp products and services in other countries, write: AMP International Division, Harrisburg, PA 17105, USA.

## COMPONENTS

### Hall-effect switch replaces mechanicals

*Texas Instruments, P.O. Box 5012, Dallas, TX 75222. Dale Pippenger (214) 238-3527.\$0.36; stock.*

A bipolar magnetically activated switch, the TL170 uses the Hall effect for sensing a magnetic field. It performs electrical switching with hysteresis. Operation is with an input magnetic field of 700 Gauss and it provides a switching hysteresis of 200 Gauss. Action is bipolar with minimum field density of  $\pm 350$  Gauss over 0 to 70 C.

CIRCLE NO. 338

### Freq-sensitive relay accepts any waveshapes



*Solid State Electronics, 15321 Rayen St., Sepulveda, CA 91343. Edward Politi (213) 785-4473.*

Contacts on the Model-471 frequency-sensitive relay will pull in when the input frequency is within  $\pm 5\%$  of the specified value, regardless of wave shape. Sine, square, triangular waves, and pulses will actuate the device, which comes in versions from 50 Hz to 100 kHz. The contacts are an isolated spdt, form-C reed relay rated at 0.25 A, 28 V dc, 3 W max. A screwdriver adjustment is provided for fine setting of the closure frequency. Power-supply requirements are 28 V dc at 20 mA, and the operating temperature range is from  $-30$  to  $+80$  C. Hermetic sealing of the can allows the unit to operate in 100% relative humidity environments up to 90 C. The relay was designed to meet the requirements of MIL-E-5272.

CIRCLE NO. 339

### Ecologically sensitive? Use this capacitor



*Sprague Electric, North Adams, MA 01247. (413) 664-4411.*

Commutating capacitors, designed for ecologically sensitive applications, use a nontoxic biodegradable impregnant having a flash point of 430 F. The 365P paper capacitors are rated at 200 and 300 V ac and the 366P dual-dielectric, paper-polypropylene types are rated at 400, 500, 700 and 800 V ac.

CIRCLE NO. 340

### Look-alike keyboard matches Bell models



*Chomerics, 77 Dragon St., Woburn, MA 01801. Rick Seeger (617) 935-4850. \$2.00 (OEM-qty).*

Western Electric's standard Touch-Tone keyboard is duplicated by the model-LT telephone keyboard. Key centers of 0.66 in., 10-12 oz. operating force and 0.125 in. key travel exactly match Bell System models. The units also feature built-in overtravel and mechanical hysteresis. Available with single-pole or Touch-Tone row/column encoding, matrix encoding can be provided with either one or two commons, or with none. Termination is by means of a flexible tail, or cylindrical pins that accept a variety of connectors and allow soldering.

CIRCLE NO. 341





## Thermal head prints analog, graphic data

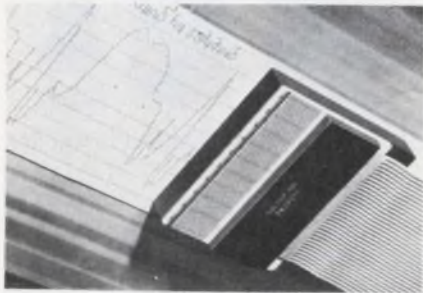

*Gulton Ind., 212 Durham Ave., Metuchen, NJ 08840. (201) 548-2800. \$75.75 (100-499 qty); stock-8 wks.*

Thick-film, dot-matrix thermal printheads allow simultaneous printing of analog, graphic and alphanumeric data. Each printhead in the DM10101 contains 101 dot elements, with the 101st dot used for applications requiring both a zero and 100th data point. The DM1099 contains 99 dot elements and is used with the DM10101 for data expansion. Fixed-head operation makes possible the design of graphic printers with higher speed and simpler mechanisms than conventional moving head printers. The units are supplied with a soldered cable and are mounted onto a standard Gulton heatsink for ganged operation.

CIRCLE NO. 342

## Light-pipe digit LEDs visible over wide angle

*Litronix, 19000 Homestead Rd., Cupertino, CA 95014. Dick Tetschlag (408) 257-7910. \$1.25/digit (1000-qty); stock.*

Using light-pipe digits, the DL-700 LED displays are visible over a viewing angle of nearly 180°. Available in 1, 1-½ and 2-digit DIPs, the units use 0.5-in. LED digits. Also available are 2 to 6-digit modules with PC board edge connectors. All displays operate from 5-V dc, feature a decimal point after each digit, and have common-anode or common-cathode terminals. DIP-packaged digits can be butted end to end to create displays of any length with equal spacing between digits. Units come with either a red plastic cap or a clear plastic cap suitable for use behind a transparent red window.

CIRCLE NO. 343

## LED-matrix display is easily readable

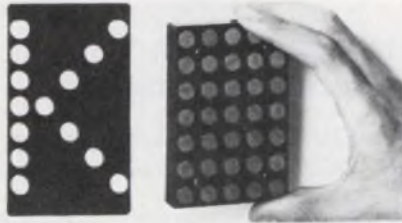

*Chicago Miniature Lamp, 4433 N. Ravenswood Ave., Chicago, IL 60640. George Neeno (312) 784-1020. \$60/1, \$40/100; stock.*

The Datablox display generates 4 × 3-in. alphanumeric digits and uses 35 high-intensity LEDs mounted in individual reflectors. The digits have a brightness and visibility, with wide-angle viewing, which make them readable at distances of 200 ft in normal office lighting. Compatible with solid-state drives, they are capable of generating the full 64-character ASCII set. They are offered in red and yellow.

CIRCLE NO. 344

## Easily soldered relay comes in 16-pin DIP

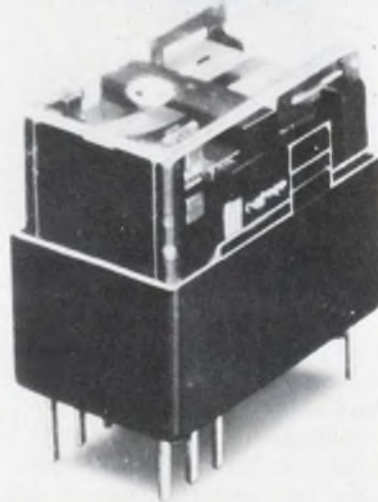

*Arrow-M, 250 Sheffield St., Mountainside, NJ 07092. (201) 232-4260. \$0.75 (1000-qty); stock-90 days.*

Molded construction in the HB-series miniature relays prevents solder-flux inflow to the mechanism. Packaged in a DIP-matching 16-pin IC socket, the mechanism contains only 7 parts. Operating power ranges from 230 to 360 mW in units containing a 1C contact arrangement, and from 370 to 576 mW for 2C contact units. The devices are rated 125-V ac, 30-V dc and can switch a maximum of 2A. Mechanical life of the silver-nickel contacts is rated at 10-million operations.

CIRCLE NO. 345

## TI Distributors

Get the TM 990/100  $\mu$ P module from these distributors.

- ALABAMA:** Huntsville. Hall-Mark/Huntsville (205) 837-8700
- ARIZONA:** Phoenix. Kierulff Electronics (602) 243-4101. R. V. Weatherford (602) 272-7144. Tempe. G. S. Marshall (602) 968-6181
- CALIFORNIA:** Anaheim. R. V. Weatherford (714) 633-9633. Canoga Park. G. S. Marshall (213) 999-5001. El Monte. G. S. Marshall (213) 686-0141. El Segundo. TI Supply (213) 973-2571. Glendale. R. V. Weatherford (213) 849-3451. Goleta. RPS, Inc. (805) 964-6823. Irvine. Cramer/Los Angeles (714) 979-3000. (213) 771-8300. G. S. Marshall (714) 556-6400. Los Angeles. Kierulff Electronics (213) 685-5511. RPS, Inc. (213) 748-1271. Mountain View. Time Electronics (408) 965-8000. Palo Alto. Kierulff Electronics (415) 968-6292. Pomona. R. V. Weatherford (714) 623-1261. San Diego. Cramer/San Diego (714) 565-1881. Kierulff Electronics (714) 278-2112. G. S. Marshall (714) 278-6350. RPS, Inc. (714) 292-5611. R. V. Weatherford (714) 278-7400. Sunnyvale. Cramer/San Francisco (408) 739-3011. G. S. Marshall (408) 732-1100. TI Supply (408) 732-5555. Torrance. Time Electronics (213) 320-0880. Woodland Hills. Semiconductor Concepts (213) 884-4560.
- COLORADO:** Denver. Cramer/Denver (303) 758-2100. Kierulff Electronics (303) 371-6500. Englewood. R. V. Weatherford (303) 761-5432
- CONNECTICUT:** Hamden. Arrow Electronics (203) 248-3801. North Haven. Cramer/Connecticut (203) 239-5641. Orange. Milgray/Connecticut (203) 795-0714
- FLORIDA:** Clearwater. Diplomat/Southland (813) 443-4514. Ft. Lauderdale. Arrow Electronics (305) 776-7790. Hall-Mark/Miami (305) 971-9280. Hollywood. Cramer/Hollywood (305) 923-8181. Orlando. Cramer/Orlando (305) 894-1511. Hall-Mark/Orlando (305) 855-4020. Winter Park. Milgray Electronics (305) 647-5747
- GEORGIA:** Norcross. Cramer/Atlanta (404) 448-9050
- ILLINOIS:** Arlington Heights. TI Supply (312) 593-7660. Elk Grove. Hall-Mark/Chicago (312) 437-8800. Kierulff Electronics (312) 640-0200. Chicago. Newark Electronics (312) 638-4411. Mt. Prospect. Cramer/Chicago (312) 593-8230
- INDIANA:** Ft. Wayne. Ft. Wayne Electronics (219) 423-3422. Indianapolis. Graham Electronics (317) 634-8202
- IOWA:** Cedar Rapids. Decco (319) 365-7551
- KANSAS:** Shawnee Mission. Hall-Mark/Kansas City (913) 888-4747
- MASSACHUSETTS:** Billerica. Kierulff Electronics (617) 667-8331. Newton. Cramer/Newton (617) 969-7700. Waltham. TI Supply (617) 890-0510. Woburn. Arrow Electronics (617) 933-8130
- MARYLAND:** Baltimore. Arrow Electronics (202) 737-1700. Hall-Mark/Baltimore (301) 796-9300. Columbia. Technico (301) 461-2200. Gaithersburg. Cramer/Washington (301) 948-0110. Kierulff Electronics (301) 948-0250. Hyattsville. Milgray/Washington (301) 459-2222
- MICHIGAN:** Detroit. Newark Electronics (313) 967-0600. Wyoming. Newark Electronics (616) 241-6681
- MINNESOTA:** Bloomington. Arrow Electronics (612) 888-5522. Edina. Cramer/Minnesota (612) 835-7811
- MISSOURI:** Earth City. Hall-Mark/St. Louis (314) 291-5350. Kansas City. LCOMP-Kansas City (816) 221-2400. St. Louis. LCOMP-St. Louis (314) 647-5505
- NEW HAMPSHIRE:** Manchester. Arrow Electronics (603) 668-6968
- NEW JERSEY:** Camden. General Radio Supply (609) 964-8560. Cherry Hill. Cramer/Pennsylvania (215) 923-5950. (609) 424-5993. Milgray/Delaware Valley (609) 424-1300. (215) 228-2000. Clark. TI Supply (201) 382-6400. Clifton. Wilshire Electronics (201) 340-1900. Moonachie. Cramer/New Jersey (201) 935-5600. Moorestown. Arrow Electronics (609) 235-1900. Rutherford. Kierulff Electronics (201) 935-2120. Saddlebrook. Arrow Electronics (201) 797-5800
- NEW MEXICO:** Albuquerque. Cramer/New Mexico (505) 265-5767
- NEW YORK:** East Syracuse. Cramer/Syracuse (315) 437-6671. Endwell. Wilshire Electronics (607) 754-1570. Farmingdale. Arrow Electronics (516) 694-6800. Hicksville. Kierulff Electronics (516) 433-5530. Fishkill. Arrow Electronics (914) 896-7530. Freeport. Milgray Electronics (516) 546-6000. (201) 432-4300. Hauppauge. Cramer/Long Island (516) 231-5600. Semiconductor Concepts (516) 273-1234. Rochester. Cramer/Rochester (716) 275-0300. Rochester Radio Supply (716) 454-7800. Wilshire Electronics (716) 442-9560
- NORTH CAROLINA:** Raleigh. Hall-Mark/Raleigh (919) 832-4465. Winston-Salem. Cramer/Winston-Salem (919) 725-8711
- OHIO:** Cleveland. Arrow Electronics (216) 464-2000. Cramer/Cleveland (216) 248-8400. Columbus. Hall-Mark/Ohio (614) 846-1882. Dayton. ESCO Electronics (513) 226-1133. Kettering. Arrow Electronics (513) 253-9176
- OKLAHOMA:** Tulsa. Hall-Mark/Tulsa (918) 835-8458. TI Supply (918) 582-8272
- PENNSYLVANIA:** Huntingdon Valley. Hall-Mark/Philadelphia (215) 355-7300
- TEXAS:** Austin. Hall-Mark/Austin (512) 837-2814. Dallas. Hall-Mark/Dallas (214) 231-6111. TI Supply (214) 238-6821. Houston. Harrison Equipment (713) 652-4700. TI Supply (713) 776-6511. R. V. Weatherford (713) 688-7406
- UTAH:** Salt Lake City. Diplomat/Altland (801) 486-7227. Standard Supply (801) 486-3371
- VIRGINIA:** Roanoke. Technico (703) 563-4975
- WASHINGTON:** Seattle. Almac/Strom Electronics (206) 763-2300. Cramer/Seattle (206) 575-0907. Kierulff Electronics (206) 575-4420
- WISCONSIN:** Oak Creek. Arrow Electronics (414) 764-6600. West Allis. Hall-Mark/Milwaukee (414) 476-1270
- CANADA:** Calgary. Cam Gard Supply (403) 287-0520. Downsview. CESCO Electronics (416) 661-0220. Zentronics (416) 635-2822. Edmonton. Cam Gard Supply (403) 426-1805. Halifax. Cam Gard Supply (902) 454-8581. Kamloops. Cam Gard Supply (604) 372-3338. Moncton. Cam Gard Supply (506) 855-2200. Montreal. CESCO Electronics (514) 735-5511. Future Electronics (514) 735-5775. Zentronics (514) 735-5361. Ottawa. CESCO Electronics (613) 729-5118. Future Electronics (613) 232-7757. Zentronics (613) 238-6411. Quebec City. CESCO Electronics (418) 524-4641. Regina. Cam Gard Supply (306) 525-1317. Reddeale. Future Electronics (416) 677-7820. Saskatoon. Cam Gard Supply (306) 652-6424. Vancouver. Cam Gard Supply (604) 291-1441. Winnipeg. Cam Gard Supply (204) 786-8481



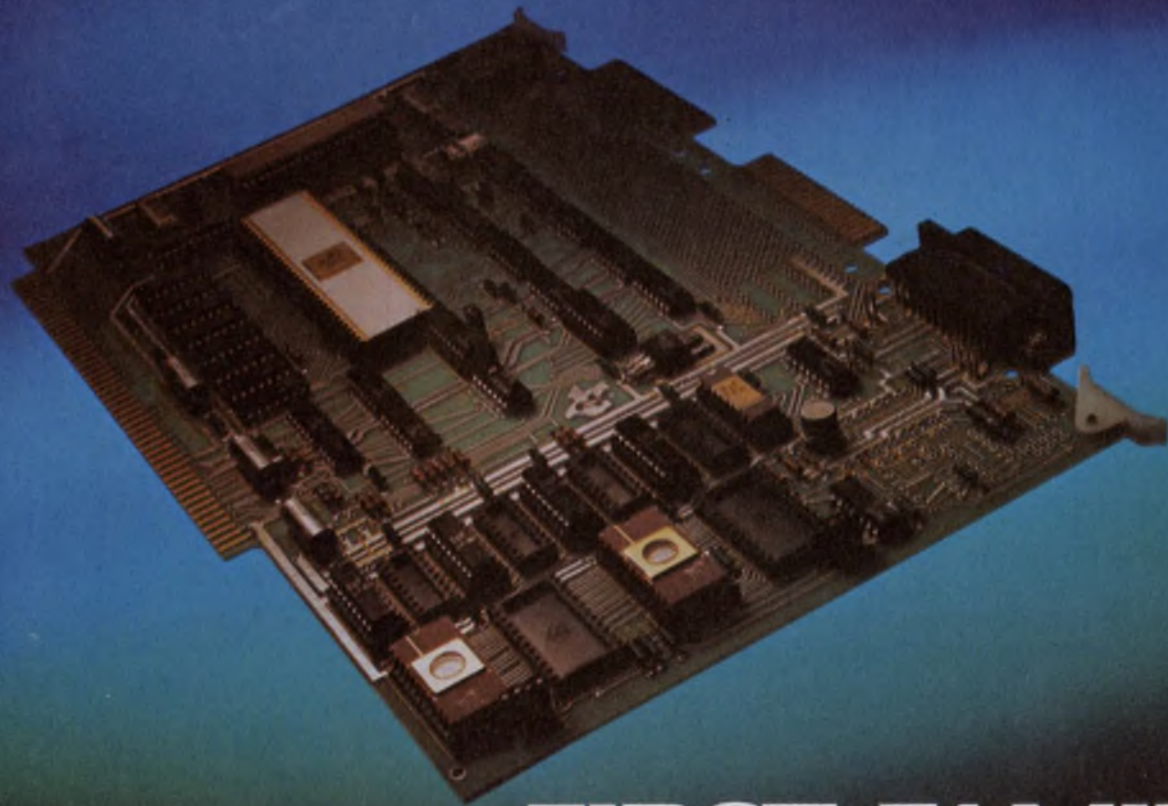

## FIRST FAMILY

# First low-cost, 16-bit $\mu$ P modules. For OEMs. From Texas Instruments.

The new TM 990 Series from Texas Instruments. Fastest, easiest way to get a microprocessor-based design to market. Ideal for  $\mu$ P evaluation. And a cost-effective production alternative.

First in TI's new series: TM 990/100M. A TMS 9900 microprocessor, I/O circuits, 1K x 16-bit EPROM and 256 x 16-bit RAM on a single 7½" x 11" board. Pretested and ready to go.

The EPROM, which includes a self-contained software monitor (TIBUG™), is expandable to 4K x 16 bits. The RAM to 512 x 16 bits. Also on board: 16 lines of programmable parallel I/O, TTY current loop or RS 232 terminal interface. Two programmable interval tim-

ers; 15 external hardware interrupts. Plus a user prototyping area. All control, address and data lines are fully available to facilitate expansion to extremely large systems.

### Leadership price

At a single unit price of \$450.00, the TM 990/100M is an economical means for checking out what TI's 9900 microprocessor can do. And at a 50-piece price of \$315.00, it is attractive for production runs.

### More modules coming

A TMS 9980-based CPU module. A ROM/RAM memory expansion module. An I/O expansion module. A microterminal for data entry/

display. A line-by-line assembler in EPROM.

### 9900 First Family compatibility

The TM 990 Series modules are supported by the new advanced AMPL™ software development system. And are fully compatible with all members of TI's 9900 First Family. So you can move to the TMS 9900 components level. Or to TI's 990/4 microcomputer. Easily. Economically.

Order the TM 990/100M today from your TI distributor. Or for details, write Texas Instruments Incorporated, P.O. Box 1443, M/S 653, Houston, Texas 77001.



## TEXAS INSTRUMENTS

INCORPORATED  
CIRCLE NUMBER 139





## Design Engineering Headquarters for Solder Clad Information

If you're designing with clad metals ... or if you are thinking of designing with clad metals, you've arrived at the right place.

TMI wants you to know all there is to know about Solder Clads.

These unique clads are opening up bright new opportunities for design engineers in the semi-conductor and electronic industries, as well as for manufacturers of telephone equipment, connectors, automotive parts, data processing equipment, computer parts, etc.

Direct benefits of using Solder Clads are:

- Reduced labor costs
- Increased flexibility in design
- Elimination of multiple handling and inspection of stamped parts
- Improved and consistent quality of the end product
- Permanent solderability providing increased shelf life

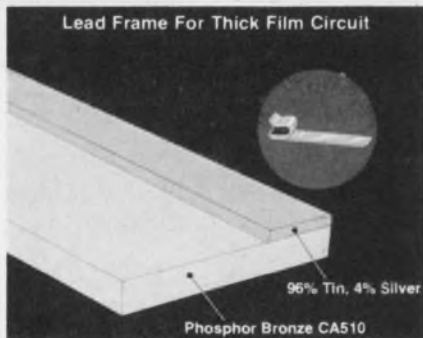
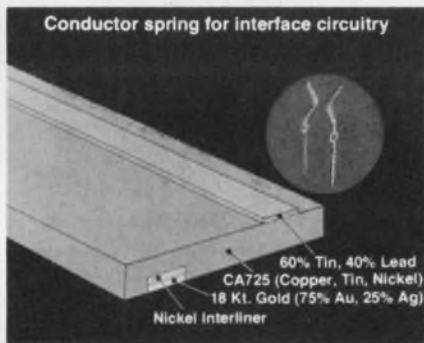
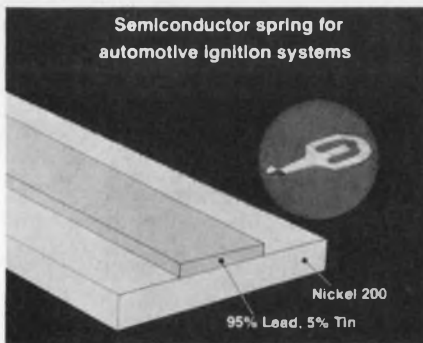

To get the most from Solder Clads, come to the people with the most to give you.



**TECHNICAL MATERIALS, INC.**

5 Wellington Rd., Lincoln, Rhode Island 02865  
Telephone: (401) 333-1700

CIRCLE NUMBER 140

## COMPONENTS

### Synchronous motor drives program time switch



Zenith Controls, 830 W. 40th St., Chicago, IL 60609. (312) 247-6400.

The synchronous-motor-driven 2400 program time switch provides 24-h on-off control for electrical equipment. A 24-h dial includes 96 self-contained clips for on-off operation in 15-min increments, or multiples thereof. The UL listed timer has an spdt snap-action contact rated at 20 A, noninductive to 480 V ac. Available is a time delay option which provides a 0-2 min. adjustable delay for staggered starting of heavy loads. A snap-in bracket is supplied for panel mounting, or in an enclosure. Dimensions are 6-1/2 in. (W), 9-3/8 in. (H), and 3-3/4 in. (D).

CIRCLE NO. 346

### Photoelectric controls offer plug-in functions

Autotron, 3629 N. Vermilion, Danville, IL 61832. (217) 446-0650.

Compact self-contained LED photoelectric controls, the R series, feature a variety of plug-in function cards to control or alter logic functions. Also available as a plug-in is a 10-A DPDT relay. The complete retroreflective control unit with recessed glass lens is housed in a 57-in<sup>3</sup> package. Shielding from electrical noise is provided by a die-cast aluminum case that is gasket sealed. The units can operate over a distance of 35 ft and transmit a modulated infrared beam that is immune to sunlight or other ambient light.

CIRCLE NO. 347



## Ferrite E cores have round center legs



Siemens, 186 Wood Ave. S., Iselin, NJ 08830. Martin Weitzner (201) 494-1000. See text; stock.

A line of round-center-leg ferrite E cores are available for use in switch-mode power supplies. They are in the EC35, EC41, EC52 and EC70 configurations. The cores may be obtained with glass-fiber-reinforced-plastic bobbins. The bobbins have pins inserted for either vertical or horizontal mounting. Prices in OEM quantities range from about \$.50 to \$1.60.

CIRCLE NO. 348

## Counter subtracts from 5 predetermined digits

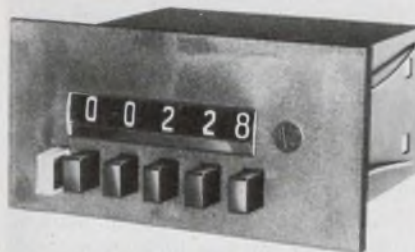

IVO Industries, P.O. Box 36, Neptune, NJ 07753. James Tannar (201) 922-3600.

Set up a predetermined count with pushbuttons and the spdt switch operates when the count reaches zero. The count speed of the FS228/FS229 series is 10 cps and the power rating is 4 W. Reset is pushbutton or, optionally, pushbutton plus electrical. Automatic recycling can also be provided. Operation is on 24 V dc and 24, 115 and 220 V ac.

CIRCLE NO. 349

## FM broadcast tube has 25-kW rating

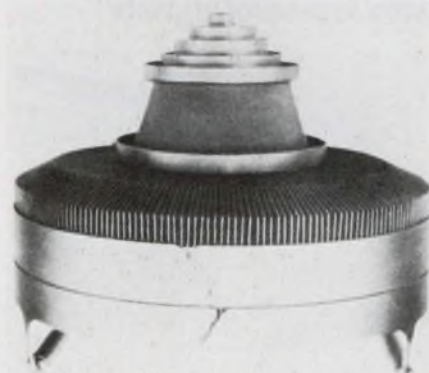

RCA, New Holland Ave., Lancaster, PA 17604. (717) 397-7661. \$900; 8 wk.

For use in high-gain, high-efficiency FM service, the 4695 beam-power tube gives 25 kW of useful power output at 20-dB gain and 80% over-all plate efficiency. A plate supply of 10 kV and only 300 cfm of cooling air is required. Rated for full output to 230 MHz.

CIRCLE NO. 350

# NSITY • HI-DENSITY • HI-DENSITY • HI-DE

These two-piece, Hi-Density connectors offer the best combination of cost and performance available. They are ideal for use on single sided, double sided and multilayer boards and are well suited for applications where shock and vibration are a factor (tests show better than 200 Hz at 20 g.).

- Easy contact removeability to replace worn or broken pins
- Polarization with or without loss of contact.
- Shrouded male plug prevents accidental damage to pins.

For Full Details & Information, contact your local VERO representative or write to us directly at:



171 Bridge Road, Hauppauge, N.Y. 11787  
(516) 234-0400 TWX: 510-227-8890

CIRCLE NUMBER 141





## COMPONENTS

### Wet switch is compatible with low-level signals



Signal Systems Int., Monmouth County Airport, Farmingdale, NJ 07727. Angelo Ghio (201) 938-3535. \$2.00; stock.

Hermetically sealed in a steel case, the WS101 switch is compatible with low-level solid-state circuits. Contacts are mercury film and there are no interfaces between closed contacts. Nanowatt signals are transmitted without loss or distortion. When required, the switch can control loads to 20 W. Operation can be by a magnet or the field of an electromagnetic coil.

CIRCLE NO. 356

### Dual-primary transformer meets US, European specs

Dale Electronics, East Highway 50, Yankton, SD 57078. (605) 665-9301. \$2.95 (100-qty); stock.

Rated at 4.5-W, the PL-23 miniature dual-primary transformer can be operated from 115 or 230-V ac, 50/60 Hz, to meet both US and European requirements. The PC-board-mounted device provides isolation from the power line and is available in both voltage step-up or step-down models. Output voltages range from 8 to 230-V ac with series-connected secondaries and 4 to 115-V ac when parallel connected. Designed to operate over the temperature range from -55 to 105 C, the unit produces a maximum temperature rise of 25 C at rated operating voltages and loads. In addition to the basic plug-in mounting style, models are available with mounting frames for tab and screw attachment to the PC board.

CIRCLE NO. 357

### Use compact counter in small panel cut out



Veeder-Root, 70 Sargeant St., Hartford, CT 06102. A. Patricelli (203) 527-7201. \$16.20 (7 digit), (1-qty).

Requiring a panel cut out of only 1.63 x 1.14 in., the series 7286 electric counter is designed for warranty recording, metering and other tamper-proof applications. The non resettable totalizers are available in either 12 or 24-V-dc models, and record impulses at up to 600 counts per min. Power may be applied continuously, with 2.5-W dissipation. The units come with either six or seven white-on-black figures and operate over a temperature range of 0 to 40 C. The case, of modified polyphenylene oxide, is ultrasonically welded around the counter frame and component parts.

CIRCLE NO. 358

## SIMPLE AS 1-2-3-4 money-saving...highly reliable Filmatic® Capacitors

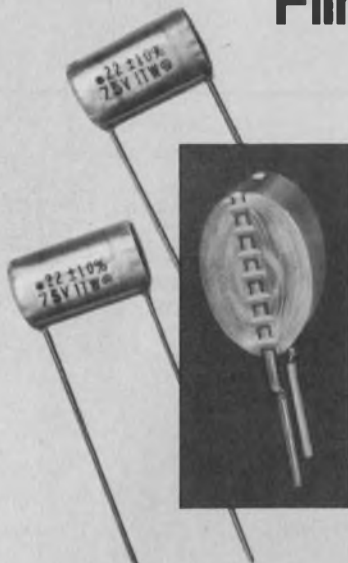

- 1 Uniform, rugged, self-encased Rippleweld® construction
- 2 Impregnated with wax for environmental protection
- 3 Trim and small size .001 to 1.0 mfd
- 4 Proven reliability to meet a wide range of electronic equipment needs

Available through your local distributor.

Request full details and catalog.



### PAKTRON

A DIVISION OF ILLINOIS TOOL WORKS INC.  
900 Follin Lane, S.E., Vienna, Virginia 22180  
Phone: (703) 281-2810 TWX 710-833-0682

In Europe—ITW Electronics  
Franz Pruller Str. 15  
8000 Munich 80 West Germany  
Telephone—089/483021/22  
Telex 910 322 1130

The Innovative Electronic Components Group of ITW . . . PAKTRON and EMCON  
© Illinois Tool Works Inc. 1977

CIRCLE NUMBER 142



## Ratchet actuator system in multiturn trimmer

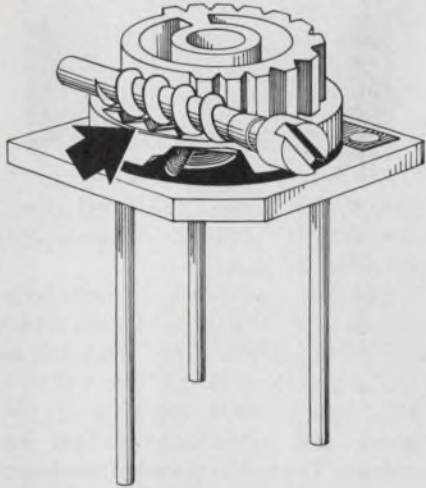

Bourns, 1200 Columbia Ave., Riverside, CA 92507. (714) 781-5122. \$7.48 (prod. qty); stock.

Using a simplified worm-gear actuator drive, the RJR26 trimpot offers extended life operation by reducing wear on internal parts. A specially designed set of ratchet teeth drops the rotor into an idling position at the element end-point. Setability is enhanced, since minimal backlash occurs when reversing the direction of the worm gear. The trimmer uses a cermet element covering a standard resistance range of 10  $\Omega$  to 1 M  $\Omega$ ,  $\pm 10\%$ , with closer tolerances available. Power rating is  $\frac{1}{4}$ W at 85 C, and the operating temperature range is from -65 to 150 C. The device has been qualified to MIL-R-39035, and an industrial model, the 3262 is also available.

CIRCLE NO. 359

## Temperature switches use ceramic elements

Midwest Components, Port City & Keating Blvds., Muskegon, MI 49443. (616) 777-2605.

Miniature temperature switches use an electro-ceramic element instead of a bimetallic switch. The hermetically sealed sensors are corrosion and explosion proof. Switches may be specified as normally open, normally closed or a combination of both in an SPDT switch configuration. Fast response time is achieved by packaging the devices in a small (0.25x0.5 in.) case. At full rated load, the switches can perform 3-million operations. Switch temperatures from -5C and up are available.

CIRCLE NO. 360

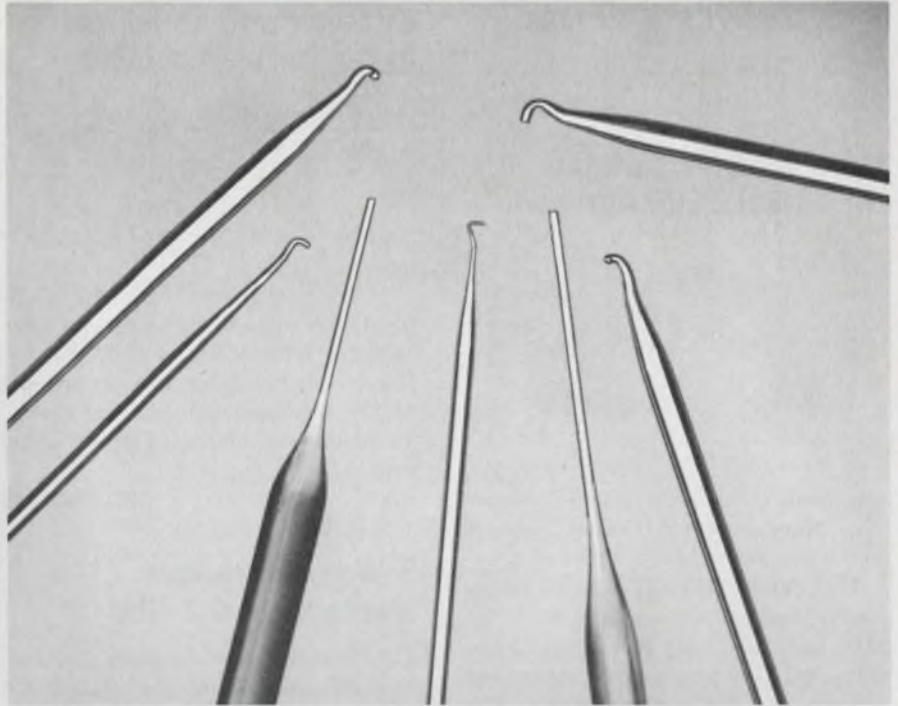

## New micro-glass pipette has nozzle I.D. tolerance of .0001" That's .0001" Consistently.

Thinner, stiffer and more durable than metal, the pipette's special formula glass enables closer tolerances than are possible with conventional glass tubing or other materials.

It's used for drilling holes .004" to .080"... electro-chemically... round, shaped, angled, deep... in super-tough alloys.

Its precision brings new opportunities to product designers and engineers for other micro applications.

Its custom-designed uniformity makes it ideal for any production line.

It is available only from TRW. So is the application engineering, design of equipment and tooling, and consulting service. Let's talk about your problem.

Call or write Clyde W. Bargar, TRW Equipment, Electronic Machining Laboratory, 31020 Industrial Road, Livonia, Michigan 48150. Phone 313-427-2450.

### STANDARD TOLERANCES—PLUS OR MINUS

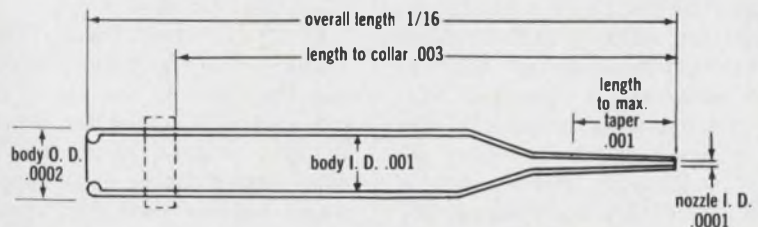

All tolerances can be tightened if required.

All dimensions can be varied to fit specific applications.

# TRW EQUIPMENT

CIRCLE NUMBER 143



### Up-converter suitable for digital, FDM signals



California Microwave, 455 W. Maude Ave., Sunnyvale, CA 94086. C. Starnes (408) 732-4000.

The Model CV-3473 up-converter converts signals from a 70-MHz or 700-MHz band to an output between 7.9 and 8.4 GHz. Low phase noise makes the converter suitable for systems with digital and/or FDM signals. Equalized filters minimize group delay distortion in FM and pulse modulated systems. The CV-3473 has a self-contained frequency synthesizer, eliminating mechanical adjustments. The synthesizer's 10-Hz tunability reduces the search requirements of modems.

CIRCLE NO. 355

### Fiber-optics receiver boasts 1-ns rise time



EG&G Inc., 35 Congress St., Salem, MA 01970. E Danahy (617) 745-3200. Stock.

In the FOD-100 fiber-optics receiver, designed for optical communications and data transmission, high light-collection efficiency is combined with maximum operating bandwidth. The receiver has a convenient fiber interface, a 5.1-mm<sup>2</sup> receiver area, a responsivity of 0.65 A/W min at 904 nm, a spectral range of 350-1100 nm, and a rise time of 1 ns max. It uses a high-speed, high-sensitivity silicon photodiode, the FND-100, which is also available separately.

CIRCLE NO. 397

### Octave-band equalizer in featherweight class

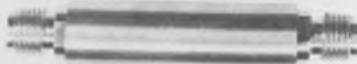

Cascade Microwave, 3125 S. 208th St., Seattle, WA 98188. (206) 842-2100. 6 wks.

This miniature equalizer with 0.8 dB band-edge loss covers an octave, up to 18 GHz, with a max VSWR of 1.3:1. Nominal attenuation is 3 dB at band center, but other values are available. The equalizer weighs 0.5 oz and measures 0.34 in. dia × 1.7 in.

CIRCLE NO. 398

### 5-W power output available at 4.2 GHz

California Eastern Laboratories, Inc., One Edwards Court, Burlingame, CA 94010. (415) 342-7744. From \$150 (10-99 qty).

A series of microwave power transistors with a "stepped electrode" structure provides high power, gain, efficiency and reliability. The NE4200 Series consists of three devices, the NE4201 (1.5 W, 8 dB gain at 4.2 GHz); the NE4203 (3 W, 5 dB gain at 4.2 GHz); and the NEM4205 (5 W, 4 dB gain at 4.2 GHz). The NE4201, NE4203 are available with or without internal matching, while the NEM4205 requires external matching.

CIRCLE NO. 399

### 'Sugar cube' mixer sweetens MW problems



RHG Electronics, 161 E. Industry Court, Deer Park, NY 11729. S. Wolin (516) 242-1100. \$295; stock.

The 1/8 in<sup>3</sup> Model DMM1-18 double-balanced mixer is the smallest possible size that permits the use of flange-mounted SMA connectors. Because of its light weight (1/3 oz) the "sugar-cube" mixer can be cable supported, which reduces mechanical problems and simplifies system packaging. Conversion loss for the 1 to 18 GHz mixer is typically 7 dB with +8 dBm LO power and i-f response from dc to 350 MHz.

CIRCLE NO. 403

### Frequency-agile source sports eight outputs



Zeta Laboratories, 3265 Scott Blvd., Santa Clara, CA 95051. C. Dudley (408) 246-6001. 12 wks.

The 6641 uses direct synthesis techniques to provide up to 24 steps across the 1.6 to 1.8-GHz range. They can be set in less than 25 ms (selected with TTL logic), while maintaining low phase and amplitude-transient responses. The source also contains seven other output frequencies for COHO, 2nd LOs, clock, and chirp driver, which provide all the signals needed in a frequency-agile radar system. Each output has at least 20 mW of power.

CIRCLE NO. 404

### Infrared detector has built-in refrigeration



Sanders Associates, Daniel Webster Highway S., Nashua, NH 03061. J. Joyce (603) 885-2810. \$200; 3 wks.

Thermoelectrically cooled lead-sulfide infrared detectors provide high sensitivity and long-term stability for such applications as smoke and moisture detectors. The TO-5-TE lead-sulfide detectors are packaged in standard transistor cans and are hermetically sealed. Because the lead sulfide is cooled to about -20 C, a detectivity (D\*) of 2.5 to 5.0 × 10<sup>11</sup> cm-Hz<sup>1/2</sup> -W<sup>-1</sup> and a responsivity of 1 × 10<sup>6</sup> V/W are possible. Each unit incorporates a calibrated monitoring thermistor.

CIRCLE NO. 448



# now, coax and waveguide ferrite circulators from one source

...it's the winning combination from Merrimac

## HIGH POWER COAXIAL FERRITE CIRCULATORS AND ISOLATORS 140 MHz TO 3 GHz

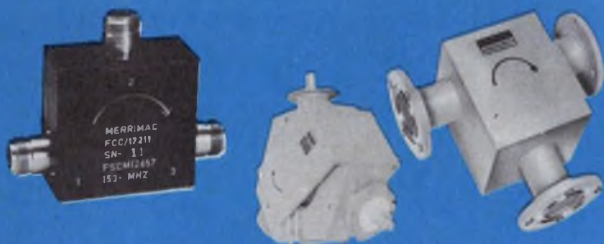

The winning combination is 39 different, standard, 3 port coaxial junction circulators and isolators capable of handling high average and peak powers, with low insertion loss.

Models with various connectors such as N, HN, 7/8", 1 5/8" and 3 1/8" EIA are available.

Following are 4 coaxial circulators, illustrating Merrimac's capability in high power ferrite components.

MODEL NO.	FREQUENCY RANGE	AVERAGE POWER	PEAK POWER (WATTS)	CONNECTORS
FCC-11230	205-225 MHz	4.5KW	70KW	1 5/8" EIA
FCC-1203-460	450-470 MHz	350 W	---	N FEMALE
FCC-1115	890-940 MHz	3 KW	100KW	1 5/8" EIA
FCC-1109	1.7-2.4 GHz	1.2KW	CW	1 5/8" EIA

## HIGH POWER WAVEGUIDE FERRITE CIRCULATORS AND ISOLATORS 1 TO 18 GHz

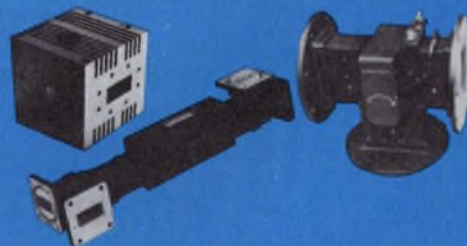

The winning combination is 60 different 3 port junction and 4 port differential phase shift circulators capable of handling extremely high average and peak powers with low insertion loss.

A wide variety of waveguide types/flanges are available and are suited for the proper waveguide cut-off frequencies.

Following are 4 standard high power waveguide circulators popular in the fields of industrial heating, earth stations and radar systems.

MODEL NO.	FREQUENCY RANGE(GHz)	AVERAGE POWER	PEAK POWER	NO. OF PORTS
FCW-1521	2.425-2.475	6 KW	CW	3
FCW-1528	5.9-6.4	3 KW	CW	3
FCW-1914	7.9-8.4	3 KW	CW	4
FCW-1937	8.5-9.6	1.2 KW	1.2 MW	4



### SPORTS ILLUSTRATIONS SUITABLE FOR FRAMING.

Football, Basketball, Soccer and Hockey,  
Two Color reproductions FREE on request.

CIRCLE 263

For additional detailed information on Merrimac's high power ferrites or other IF and microwave components, please request the following Merrimac catalogs.

- M-129-High Power Ferrite Catalog; CIRCLE 261
- M77-3-Condensed Catalog of all Merrimac Signal Processing Components. CIRCLE 262



now there is one...in signal processing

EXPORT REPRESENTATIVES DAGE CORP.  
STAMFORD, CONNECTICUT 06902  
(203) 324-3123 TWX 710-474-2490 Telex: 96-5928

**Merrimac**  
INDUSTRIES, INCORPORATED  
POST OFFICE BOX 986, 41 FAIRFIELD PL., W. CALDWELL, N.J. 07006  
• 201 575-1300 • TWX 710-734-4314



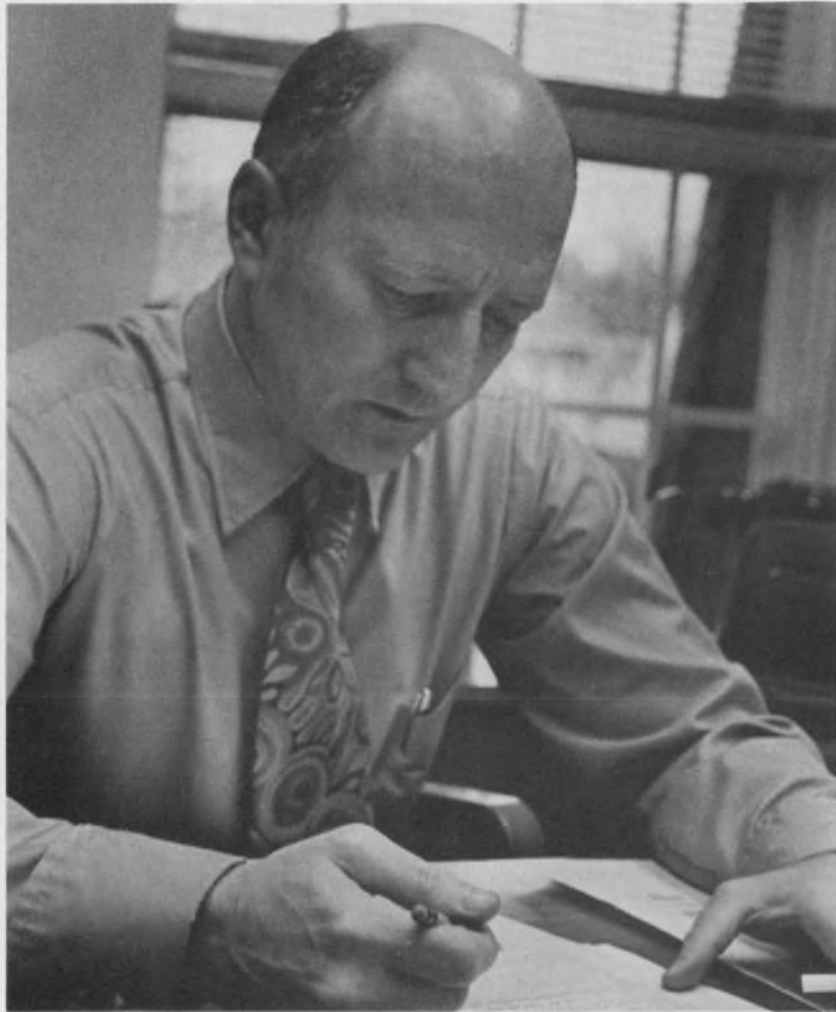

George Rostky, Editor-in-Chief, *Electronic Design*

## Electronic Design WANTS YOU

If you have solved a tricky or unusual design problem... if you have experience in a special area that will aid the design process... if you have simplified a circuit or developed a practical design aid *why not share it with your fellow engineer-readers of *Electronic Design*?*

Each man has his own motivation for writing an article. Here are just a few:

- To help other engineers do their jobs better.
- To help build your company's image.
- To encourage authors to submit material to us, and to make it easier, we've prepared a special AUTHOR'S GUIDE that's yours for the asking. Contents include:
  - Why write?
  - Why write for *Electronic Design*?
  - Which articles will *Electronic Design* accept?
  - How long should it be?
  - What form should it take?
  - Tips on structure.
- To raise your professional status and speed your advancement.
- To increase your own knowledge.
- Tips on writing.
- Tips on getting it done.
- 7 Tests you can apply to your article.
- What happens to your article?
- Where to send it.

Why not get started today? Payment can range as high as \$200 for an article contributed in a single issue.



**FOR FREE**  
**Electronic Design**  
**AUTHOR'S GUIDE**  
**CIRCLE NUMBER 300**

## MODULES & SUBASSEMBLIES

### Photon counting done at high speed



*Pacific Photometric Instruments, 5675 Landregan St., Emeryville, CA 94608. Fred Weekes (415) 654-6585. \$685; 3 wk.*

An amplifier/discriminator for use in photon counting (Model AD6) couples a photomultiplier tube to a high-speed counter. The unit has a gain of 100 and 5-ns rise time. Variable-threshold and simultaneous positive (TTL-compatible) and negative (NIM-compatible) outputs are provided. 1.3 lb—3 × 11¼ × 1½ in.

CIRCLE NO. 449

### Teletypewriter control stops spurious prints



*Digital Laboratories, 600 Pleasant St., Watertown, MA 02172. W. Kahn (617) 924-1680. \$175.*

Model TR 20, a smart motor control, allows a teletypewriter to print and punch paper tape without producing junk characters during an on-off cycle. The unit stores six-characters and so provides a 0.6-s delay for the motor to speed up and print. No programming changes or lead-in characters are required. The module mounts by magnet to the pedestal and connects to the motor through a fuse-plug. A bypass switch permits standard-keyboard operation. An adjustable timer provides up to 20-s turn-off delay. In the event of an unexpected delay between transmitted characters no data is lost. 6 × 3.5 × 3 in.

CIRCLE NO. 450



## Board for custom logic supplies mini signals

Interconnection Technology, P.O. Box 126, Accord, MA 02018. (617) 749-5605. See text 2 to 3 wks.

Three interface modules: N 102-P (\$475), N 103-P (\$550) and N 104-P (\$690) for Data general, DDC and Keronix minicomputers provide the handshake logic required to interface custom circuitry to the computer. In addition, each unit provides wire-wrap pins for mounting up to 114 IC sockets or the ICs themselves. The single-card unit fits into a mainframe slot. Combinations of devices with from 14 to 40 pins are accommodated. You also get up to 100 I/O connections via a ribbon-cable connector. The 102 is the basic model, the 103 has I/O registers and the 104 adds data-channel-control logic to the 103.

CIRCLE NO. 541

## Bridge sensor outputs directly to processor

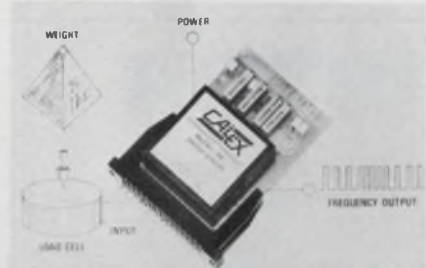

Calex Mfg., 3305 Vincent Rd., Pleasant Hill, CA 94523. Ron Kreps (415) 932-3911. \$98 (1-9 qty); stock.

A complete bridge instrumentation system is contained in the Model 166 frequency-output, strain-gauge amplifier. The small (2 x 2 x 0.6) module has an adjustable bridge power supply, differential instrumentation amplifier, v/f converter and optically isolated output stage. To implement a complete weighing system all that must be added is an external power source and a load cell. The output of the module can be fed directly to a microprocessor or digital display. Gain of the differential amplifier is adjustable from 10 to 1000 and input impedance is 10 MΩ. The input stability of the amplifier is typically ±0.5 μV/°C and the output is rated at ±10 V at 5 mA, while the frequency output ranges from 0 to 10 kHz.

CIRCLE NO. 542

# GE miniature lamps offer you gigantic design advantages.

### With 11 new wedge base GE lamps, you have more choices than ever.



Enjoy new design freedom with this expanded line of GE all-glass wedge base lamps. And keep enjoying the inherent benefits of the line: savings in weight, space, time and costs. GE now offers more than 30 wedge base lamps in three sizes: miniature lamps T-3¼ (10 mm diam.) and T-5 (15 mm diam.); subminiature lamp T-1¼ (6 mm diam.). Voltages range from 2.5 V to 28 V. Candlepower from 0.03 to 21 cd.

Use GE wedge base lamps with confidence for indicator, marker and general illumination applications, especially where space is at a premium. You may enjoy lower systems cost than with metal-based lamps and LED's. They're easy to insert and remove; have no soldered connections to corrode or break; and the filament is always oriented the same in relation to the base.

To start saving with GE wedge base lamps now, send for the latest bulletin on GE's expanded line. Order #3-5259R2. It's free.



## For whiter, brighter light use GE halogen-cycle lamps.

GE halogen-cycle lamps offer you very high light output from a very small package. They can provide better light efficiency because the bulb doesn't blacken and because of accurate filament placement. Many have uniform bulb tops (no tip).

You get a whiter light than from comparable incandescent lamps because of higher color temperature operation. And they maintain their high initial output level for virtually the life of the lamp.

Because of their lower electrical power requirements, you also save on operating costs vs. comparable incandescent lamps. Some halogen lamps have long design life for low maintenance costs, too.

You can use GE halogen-cycle lamps with confidence when your design needs call for a lot of light in restricted space. For greatly expanded information on GE halogen-cycle lamps, send for your free copy of the new GE bulletin #3-5257-R.

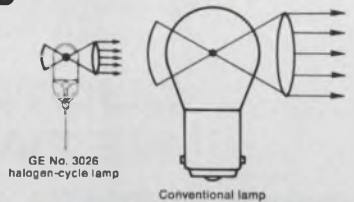

## How to order lamp samples and important new free catalogs.

For catalogs and information on how to get lamp samples, call your local GE Miniature Lamp Products Representative or write: General Electric, Miniature Lamp Products Department #3382, Nela Park, Cleveland, Ohio 44112.

GENERAL  ELECTRIC

CIRCLE NUMBER 145



### Miniature filter passes 6 to 18 GHz at low loss



Microphase, P.O. Box 1166, Greenwich, CT 06830. Craig Snyder (203) 661-6200. \$450; 12 wk.

High-pass filter module, Model R3372, passes 6 to 18 GHz with less than 1-dB insertion loss and a nominal VSWR of 1.6:1. Skirt selectivity is greater than 50 dB within 8% of the cut-off frequency. The unit can be PC or stripline mounted and is 0.9 × 0.8 × 0.25 in.

CIRCLE NO. 543

### Controller board fits into the computer

Rianda Electronics, 2535 Via Palma, Anaheim, CA 92801. (714) 995-6552. \$2950; 30 days.

The 260X controller crams eight asynchronous communication channels, a parallel line-printer interface, a real-time clock and a TTY port onto one PC board. The controller occupies one slot in a Data General computer chassis. The unit comes with a cable set for the communication channels, TTY and line printer. The communication channels are software compatible with the Data General 4060 asynchronous multiplexer; the line printer is software compatible with the Data General 4034/4193 printer controller; the real-time clock and TTY are software compatible with the Data General 4008 and 4010 respectively. The asynchronous multiplexer permits baud-rate selection, word-length selection, parity determination and RS232-C or 20-mA I/O on a per channel basis. The line-printer controller interfaces to many popular line printers.

CIRCLE NO. 544

### Isolation amp drives multichannel system

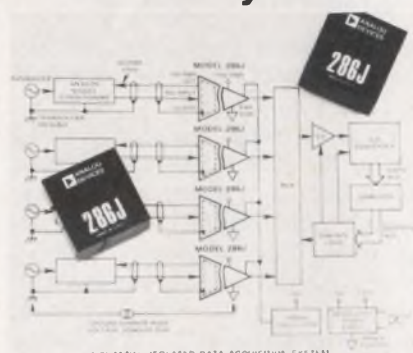

4 CHANNEL ISOLATED DATA ACQUISITION SYSTEM

Analog Devices, Route 1 Industrial Park, Norwood, MA 02062. Joseph Codispoti (617) 329-4700. \$59; stock.

Up to eight of the 286J isolation amplifiers can be driven by one synchronizing oscillator. Total ground-loop isolation and protection from common-mode potentials of 2500 V is provided. Nonlinearity of ±0.05% at 10-V pk-pk output makes the device suitable for systems requiring 10-bit accuracy. Input drift is less than ±10 μV/°C at a gain of 100 and gain stability is 0.001%/1000 h and 0.01%/°C.

CIRCLE NO. 545

# THICK FILM RESISTOR

## CUSTOM DIP NETWORKS

Our computer controlled laser has solved thousands of custom designed dip and sip networks ... use it to solve yours!

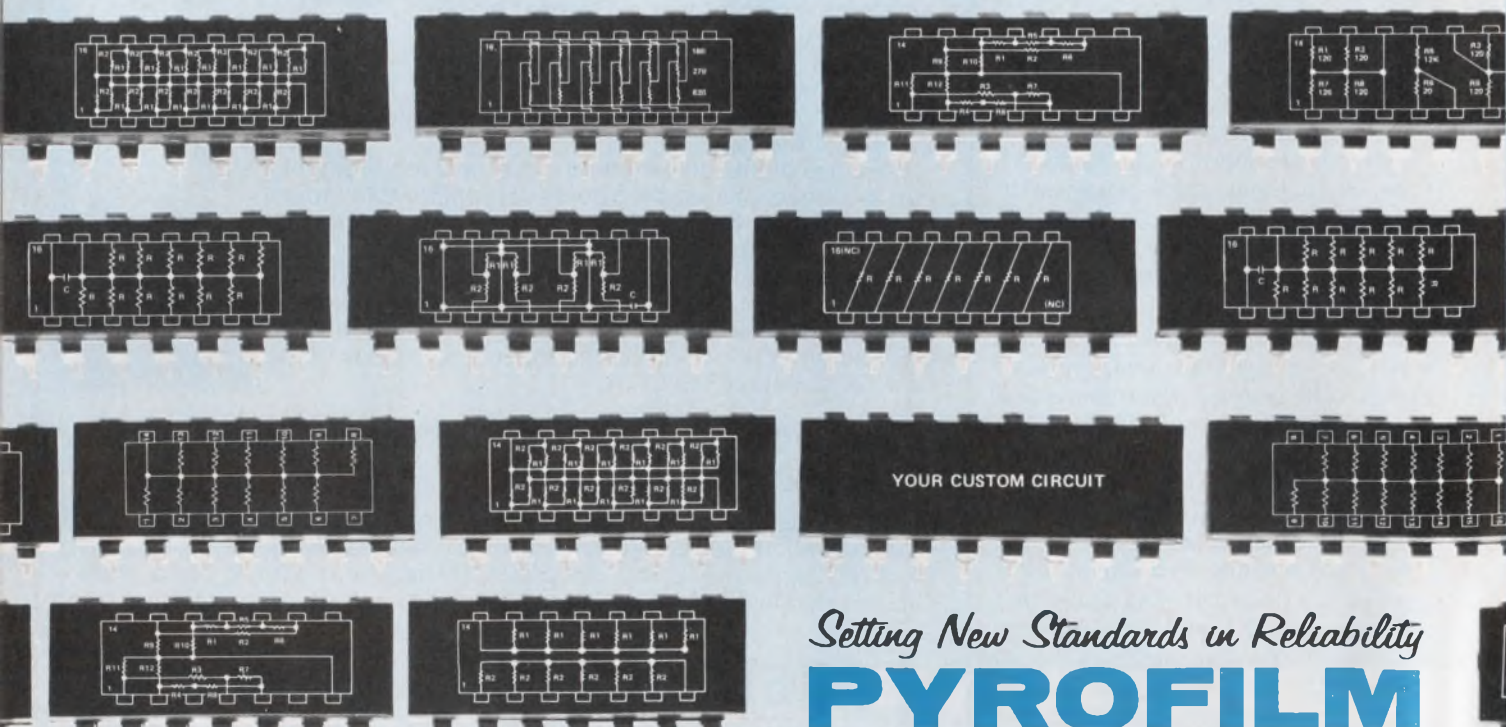

YOUR CUSTOM CIRCUIT

Setting New Standards in Reliability

# PYROFILM

60 S. Jefferson Road • Whippany, N. J. 07981 • (201) 887-8100

CIRCLE NUMBER 146



## Speed controls match dc motors

Minarik Electric, 232 E. Fourth St., Los Angeles, CA 90013

Series SLF adjustable speed controls are precisely matched to the operating characteristics of Bodine's popular 130-V-dc PM motors (frames 32D3-, 32D5-, 42D3- and 42D5BEPM). Features of the controls include choke and capacitor filtering; temperature, IR and line-voltage compensation; line starting and stopping; max and min-speed adjustment; smooth motor acceleration; full-wave field and armature supply (permits operating shunt motors); and current limiting. Speed regulation is 2% typ. The controls use 115-V-ac 50/60-Hz input. The 1/8-hp model draws 3 A and delivers 0 to 130 V dc at 1.2 A to the armature and 100 V dc at 0.5 A to the field. Ratings for the 1/4-hp models are identical except that they draw 4.5 A and deliver 2.2 A to the armature.

CIRCLE NO. 546

## Fast d/a converter multiplies 12 bits

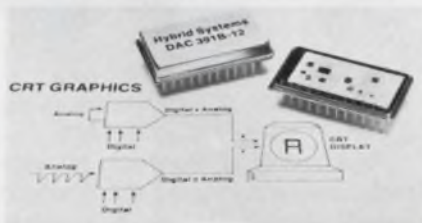

Hybrid Systems, Crosby Dr. Bedford Research Park, Bedford, MA 01730. L. Lauenger (617) 275-1570. From \$129 (1-9 qty); stock to 4 wks.

Setting time of 200 ns to 0.01% of full scale is featured in the DAC391 Series of two-quadrant 12-bit multiplying d/a converters. Differential linearity of 0.0125% of full scale and transfer linearity of  $\pm 1/2$  LSB are also noteworthy in the hybrid unit. The devices accept TTL or DTL logic levels and deliver current outputs of 0 to +5 mA for binary-coded inputs and  $\pm 2.5$  mA for offset-binary-coded inputs. The output compliance potential is 0 to +1.0 V (unipolar) and  $\pm 1$  V (bipolar). For applications requiring outputs of 0 to -10 V and  $\pm 5$  V, provisions are included for connection of an external op amp. Commercially processed versions operate from 0 to 70 C or -25 to +85 C. Mil versions operate from -55 to +100 C. Metal, 24-pin, DIP.

CIRCLE NO. 547

# MEET OUR family of shielded "black BOXES"

Almost 10 years ago (1966 to be exact) we introduced our first two series of shielded electronic enclosures. They became an overnight success. Since then the demand for different sizes, shapes and applications has increased our family to ten series of models, each with a noise rejection greater than 70db. Sizes range from 1.50" x 1.13" x 0.88" to 4.13" x 2.68" x 6.0"; in blank versions or with a complete choice of coaxial connectors; painted or unpainted; with or without printed circuit card guides; with mounting flanges or bottom mounting plates. All models supplied with aluminum covers and mounting screws.

AVAILABLE THROUGH YOUR  
FAVORITE ELECTRONIC  
PARTS DISTRIBUTOR

## ITT POMONA ELECTRONICS

1500 East Ninth St., Pomona, Calif. 91766  
Telephone (714) 623-3463. TWX: 910-581-3822



CIRCLE NUMBER 147



### Thirteen components in single IC panel meter

International Microtronics, 4016 E. Tennessee St., Tucson, AZ 85714. Otto Fest (602) 748-7900. \$39 (100-qty) 5-V units.

A 3-1/2 digit DPM, B500, contains a

single IC, seven passive components and the display—for a total of thirteen parts. The meter is bipolar, differential, autozero, accepts 200-mV to 1000-V inputs and operates from either 5-V-dc or 115/230-V-ac power sources. A 0.5-in.-high red LED is used in the display. Power consumption is 200 to 800 mW. The B500 units are successors to the Series 500, the first \$49 digital panel meters. Models containing a liquid crystal display will be available in the near future.

CIRCLE NO. 548

### Instrumentation amp hardly drifts

Dynamic Measurements, 6 Lowell Ave., Winchester, MA 01890. (800) 225-1151 From \$79; stock

Max input-offset drifts of only 15-pA/°C and 0.25-μV/°C are features of the 1313 instrumentation amp. Also, offset voltage changes only 50 mV over the 1-to-1000-gain range, and maximum gain nonlinearity is 0.01%. The amp delivers ±10 mA at ±11 V, and the min output-slew rate is 1 V/μs. Bandwidth is 75 kHz at 1000 gain. Input range: ±10V; min common-mode impedance: 10<sup>10</sup>Ω. Input bootstrapping produces a min common-mode rejection of 114 dB at 120 Hz, and virtually eliminates power-supply variation problems. The 1.5 × 1.5 × 0.375 in. metal package is pincompatible with both Datel's 201C and DMC's 351 and 1308 families.

CIRCLE NO. 549

### Cassette transports are for audio applications



Triple I, 4605 N. Stiles, Oklahoma City, OK 73118. (405) 521-9000. \$124.

Five models of electronic cassette-tape transports are available. Features include four-motor control, remote control, fast start/stop, rewind in less than 30 s and speeds from 0.4 to 20 ips. Options such as tab sensing, counter for position reference, and cassette-in-place sensing can be provided.

CIRCLE NO. 550

### 150-W transient voltages suppressed by zener

Unitrode, 580 Pleasant St., Watertown, MA 02172. Roy Selinger (617) 926-0404. See text; 4-6 wk.

The UZ306 series of zener transient-voltage suppressors can dissipate 3 W (steady-state) and 150 W (transient) for 1 ms. Standard voltages include the 6.8 to 400-V range. All devices feature low leakage and clamping-voltage ratios. Transient-response time is 1 × 10<sup>-12</sup> s. At 1-k quantity, prices range from \$0.70 to \$1.05; at the 10-k level, prices are \$0.36 to \$0.55.

CIRCLE NO. 551

# Pinlite® displays.

## Almost an endless variety.

Every day the variety of high-contrast Pinlite incandescent digital displays gets more endless as we add new, feature-packed models to meet the needs of military, avionics, marine, and business machine applications. And we're adding complementary connectors and connector/diode assemblies to make them easier to package, too.

Even though we've expanded our line, every Pinlite display still incorporates all those outstanding features you need, including 9,000 foot lambert brightness, 120° viewing angle, per-segment life of over 100,000 hours, wide operating temperature range, and direct compatibility with standard TTL driving networks and multiplex circuits. Every one of our 3/16" to 5/8" characters is enhanced by our patented cross-over filament arrangement which eliminates open corners for improved readability.

With Pinlite displays now more available right from stock, it will pay you to check them out. Write or call today for the whole story.



**REFAC**

electronics corporation.

P.O. Box 809, Winsted, CT 06098 (203) 379-2731

CIRCLE NUMBER 148



# the only one of its kind

...AN ALTERNATIVE TO NICKEL CADMIUM



**6 volt 1/2 ampere hour**  
 1.92" length  
 1.00" width  
 2.00" height  
 4.8 ounces

**THE NEW  
 IMMOBILIZED  
 ELECTROLYTE  
 TECHNOLOGY THAT'S  
 MORE RELIABLE THAN GEL**

- No memory conditioning required
- No cell reversal
- Less expensive
- Better float life
- Entirely maintenance-free
- Spill-proof and rechargeable

Also available in 30 other sizes from 1/2 to 40 ampere hours

**EAGLE P ICHER**

SINCE 1843

**EAGLE-PICHER INDUSTRIES, INC.**  
 Commercial Products Department ED  
 P.O. Box 130, Seneca, Mo. 64865  
 Telephone (417) 776-2258

CIRCLE NUMBER 149

## SWITCHES FOR KEYBOARDS

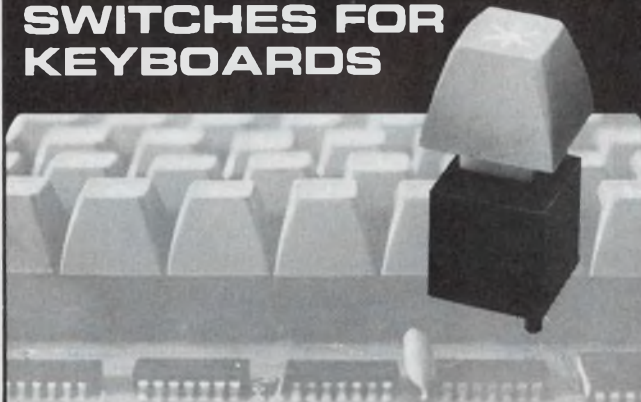

We offer the following for OEM's producing their own keyboards.

- Keyswitch sizes for 5/8" or 3/4" centers
- Gold Bar mechanical contacts or sealed contacts
- Front panel relampable lighted models
- Single and double pole contacts including NC
- Alternate action models
- Doubleshot molded keytops for 3/4" or 5/8" mounting
- Easy change legend systems
- 100,000 pc. quantity prices as low as \$0.21 each

Letterhead request or phone call brings free sample switch w/keytop.

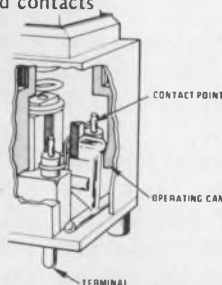

**MECHANICAL ENTERPRISES, INC.**  
 8000 Forbes Place Springfield, Virginia 22151  
 (703) 321-8282 TWX 710-832-0942

In Germany - NEUMÜLLER GMBH, MUNICH  
 In U. K. - TEKDATA Ltd., STOKE-ON-TRENT

CIRCLE NUMBER 152

ELECTRONIC DESIGN 21, October 11, 1977

## 50 Million operations

With TTL loads, our new reed relay offers maximum contact resistance of 0.12 ohms, after more than 50 million operations. And a contact resistance delta

of 0.01 ohms, maximum. Sticking and missed operations are essentially eliminated.

Call or write for information on the RX-1.

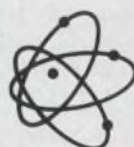

**EAC** Electronic Applications Company

4918 Santa Anita Ave., El Monte, CA 91734  
 213/442-3212 TWX 910/587-3351

CIRCLE NUMBER 153



Now the simplicity,  
efficiency, and economy  
you want in

## Ferroresonant Power Supplies.

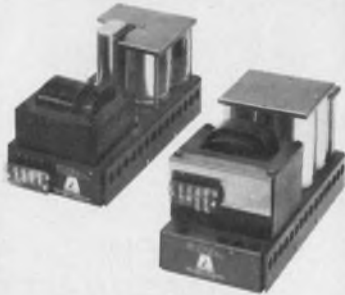

- Minimum MTBF of 150,000 hours.
- Inherent overcurrent, shortcircuit, and overvoltage protection.
- High efficiency rating of 70 to 90%.
- Ideally suited for series or parallel banking to fulfill bulk power demands.
- UL listed; 100% tested.
- Inexpensive to buy, simple and economical to operate.
- Common specifications: Regulation:  $\pm 2\%$ ; Ripple: 1% RMS; AC Input: 100-130 VAC, 60Hz.

### Model Specifications

Model No.	Current @ 50°C.	Unit Price*
<b>12 Volt Models</b>		
AFR 12-10	10 A	\$140.00
AFR 12-15	15 A	170.00
<b>24 Volt Models</b>		
AFR 24-6.5	6.5 A	\$155.00
AFR 24-10	10 A	175.00
AFR 24-15	15 A	230.00
AFR 24-25	25 A	290.00
<b>28 Volt Models</b>		
AFR 28-8	8 A	\$175.00
AFR 28-15	15 A	230.00
AFR 28-25	25 A	290.00
<b>48 Volt Models</b>		
AFR 48-10	10 A	\$265.00
AFR 48-20	20 A	340.00

\*OEM prices available

Send for our master catalog, which includes open frame and encapsulated power supplies and unique solid state programmable loads.



Phone (716) 968-2400 / Telex 91-6451  
TWX 510-245-2700

**Acme Electric Corporation**

Cuba, N.Y. 14727

CIRCLE NUMBER 154

## ICs & SEMICONDUCTORS

### Static 4-k RAMs access in less than 55 ns

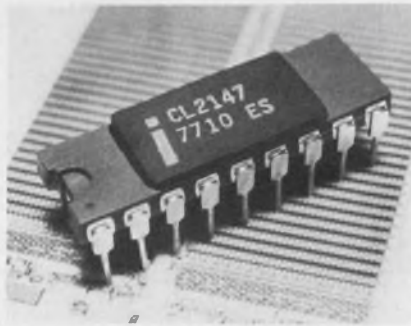

Intel, 3065 Bowers Ave., Santa Clara, CA 95051. Rob Walker (408) 246-7501. From \$37.50 (100 qty); stock.

The 2147 family of high-speed, 4096-bit static RAMs has a typical access time of 45 ns. And, a low-power standby mode automatically reduces average device power consumption to a fraction of the active power. The low-power mode is unique in that it does not reduce RAM operating speed, data throughput, and does not require clocking or complex power-switching techniques. The basic 2147 design has a typical access time of 45 ns but guaranteed times are 55 ns for the 2147-3 and 70 ns for the 2147. These speeds are guaranteed over 0 to 70 C and the standard power supply tolerance of 5 V  $\pm 5\%$ . Typical active dissipation is 500 mW for the 2147 and 600 mW for the 2147-3, and worst-case is 800 and 900 mW, respectively. The standby mode reduces typical dissipation to 50 and 75 mW, respectively. The 2147s come in 18-pin DIPs and the three-state data outputs typically sink 25 mA and source 15 mA at TTL levels.

CIRCLE NO. 552

### Low-offset FET op amps slew at 45 V/ $\mu$ s

Precision Monolithics, 1500 Space Park Dr., Santa Clara, CA 95050. Shelby Givens (408) 246-9222. From \$2.50 (100 qty); stock.

With a 45 V/ $\mu$ s minimum slew rate the OP-17 BiFet op amp has a maximum input offset of just 500  $\mu$ V. Offset drift is 5  $\mu$ V/ $^{\circ}$ C. Input bias currents are 11nA, max and settling time of the output is 400 ns to 0.1%. The OP-17 comes in an 8-lead T0-99 case and is pin-compatible with the LF157A series of op amps.

CIRCLE NO. 553

### Octal latch and register interfaces $\mu$ Ps

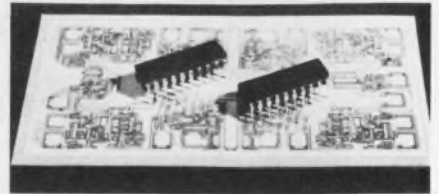

Monolithic Memories, 1165 E. Arques Ave., Sunnyvale, CA 94086. Ray Gouldsberry (407) 739-3535. \$4.60; stock.

Two bipolar parts, a latch (SN74S373) and a register (SN74S374) feature three-state outputs to drive the high capacitance and low impedance of long buses connecting processor, controller and I/O subsystems. Either device can be used with a 4-bit micro-processor slice, and a pair of them will work with a 16-bit processor system.

CIRCLE NO. 554

### Quad memory drivers handle 600 mA/output

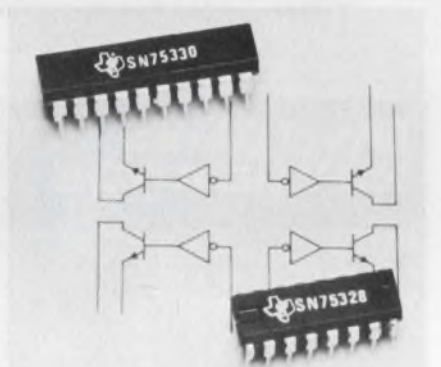

Texas Instruments, P.O. Box 5012, Dallas, TX 75222. Dale Pippenger (214) 238-2011. From \$2.47 (100 qty); stock.

The SN75328 and SN75330 each contain four 600-mA memory drivers that can handle core or bubble memories. They operate from two power supplies—one a 5 V, the other can be 4.75 to 24 V. The drivers can function individually as either source or sink. The SN75328 driver comes in 16-pin plastic or ceramic DIP packages while the 75330 comes in a 20-pin package. In the 75328 the base drive of all four of its output transistors is provided by connecting an external resistor between the second supply and Node R on the chip. On the SN75330 the base drive of each individual output transistor can be separately set. Both devices operate from 0 to 70 C.

CIRCLE NO. 555



PROGRAMMABLE CONNECTIONS

# Sealectro molded Shorting Plugs & Jacks

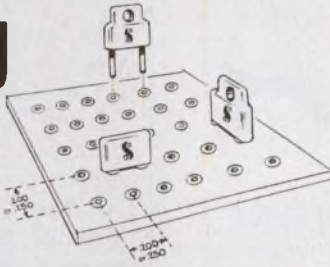

Perfect for programmable connections between two mating receptacles. Mates with pin jacks when arranged on .200 or .250 center-to-center arrangement. Molded units with eye handle or plain handle units. Also female receptacle to accept .040 pins. Available as "U" shaped metal connectors. Send for free Circuit Component Catalog.

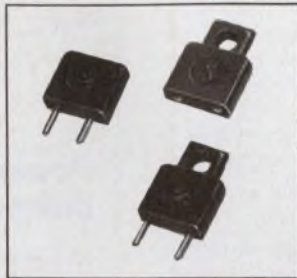

CIRCUIT COMPONENTS DIVISION  
**SEALECTRO CORPORATION**  
 MAMARONECK, N.Y. 10843  
 PHONE 914 688-5600 TWX 710-588-1110  
 SEALECTRO UNIT  
 14811 Rensselaer Blvd. Suite 212, Sherman Oaks, Ca. 91423 (818) 888-8131  
 1901 Die Middlefield Rd. Suite 118, Menlo Park, Ca. 94023 (415) 965-1212  
 SEALECTRO LTD., Parklands Road, Englewood  
 SEALECTRO S.R.L. Zone Industriale Teulada Est. 03007 Teulada Capua, France  
 CIRCUIT COMPONENTS ■ R.F. COMPONENTS ■ PROGRAMMING DEVICES

CIRCLE NUMBER 155

## CHOCKED FULL OF TECHNOLOGY!!

Model D-72C  
 Two Element X-Y, T  
 Recorder



**Features**

1. Two element time axis  
 Model D-72C permits time recording by two systems; mechanical recording chart feed and time axis sweep by time.
2. High performance chart attraction  
 Troubles due to faulty attraction of the chart due to friction during chart feed has been completely eliminated regardless of the temperature or feed rate.
3. Automatic chart replacement in XY recording  
 The chart can be automatically fed and stopped at the end of chart replacement with one touch by loading roll chart.
4. Remote control terminals  
 • Pen up-down • X-axis electronic time sweep trigger • Mechanical time feed recording chart start/stop • XY chart automatic replacement feed trigger
5. Easy-to-install optional chart take-up device (Optional)
6. Felt tip pen (Optional)
7. High input impedance 10MΩ fixed (Optional)

• For further information, please contact:

*Riken Denshi Co., Ltd.*

5-5-2, Yutenji, Meguro-ku, Tokyo, Japan. TELEX: 0246 8107

**PAYTON ASSOCIATES INC.**

244 Delaware Avenue, Buffalo, New York 14202 Phone: (716) 852-6213, 855-1314

CIRCLE NUMBER 156

ELECTRONIC DESIGN 21, October 11, 1977



Three ways  
 to get a  
 good CRT yoke



Call  
**Syntronic**  
 (312) 543-6444



Write  
**Syntronic**

Use  
 our Yoke  
 Selection Guide

It shows a simplified way to specify the best yoke for your CRT display. Our engineers have developed a unique concept—the yoke energy constant—as a way to estimate yoke inductance and current. From there, it's an easy step to specify a yoke "by the numbers". Try it. Call or write for your copy.\* See for yourself how Syntronic's years of experience can add up to getting a better yoke for your display.



Syntronic Instruments, Inc.  
 100 Industrial Road, Addison, IL 60101  
 (312) 543-6444

\*Or see Pages 405 to 408 in EEM

CIRCLE NUMBER 157



# COST CUTTER FOR OEM PARTS

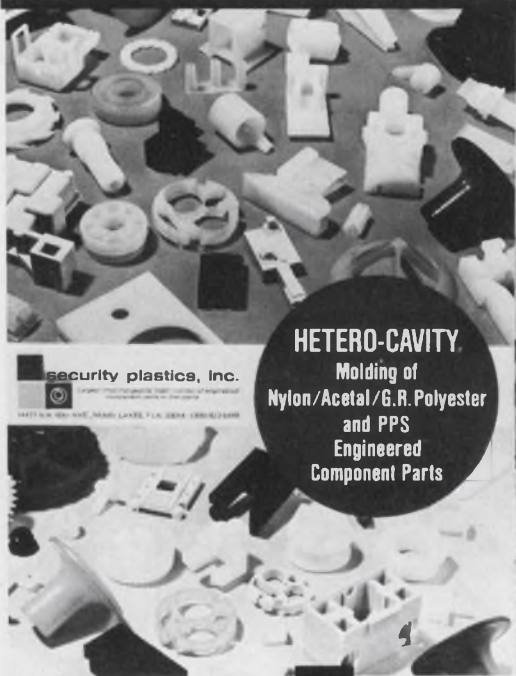

**HETERO-CAVITY**  
Molding of  
Nylon/Acetal/G.R. Polyester  
and PPS  
Engineered  
Component Parts

security plastics, inc.  
Largest interchangeable insert molder of engineered component parts in the world

What it is...

How to design for it...



## FREE DESIGN GUIDE

gives full details on lower tooling costs and lower unit costs, plus TIME-saving advantages of Hetero-cavity® molding of nylon/ acetal/GR polyester/PPS engineered component parts.

Now molding OVER TWO BILLION parts a year. Security can save YOU time and money on your small parts needs. Call or write for free copy of newly-revised full-color brochure today!

**security plastics, inc.**



14427 N.W. 60th Avenue,  
Miami Lakes, FL 33014 / (305) 823-5440

Largest interchangeable insert molder of engineered component parts in the world  
CIRCLE NUMBER 158

## Set the Pace with Synchron



### "600" SERIES AC TIMING MOTORS

These motors are designed both for timing and drive applications. Speeds from 600 RPM down to one revolution per week and output torque up to 40 oz. in. rated @ 1 RPM. Available in reversible and double power configurations. For immediate service please call us at-812/385-3415.

## JOIN OUR BOOK CLUB

SYNCHRON® MOTOR CATALOG gives general specifications on AC timing motors, AC clock movements, DC motors and related products manufactured by Hansen Manufacturing Company, Inc. Product Literature Broadside and request card will be sent to you along with this catalog.



## Hansen Manufacturing Company, Inc.

SUBSIDIARY OF IMC MAGNETICS CORP.  
PRINCETON, INDIANA 47670

CIRCLE NUMBER 159

## ICs & SEMICONDUCTORS

### Analog shift-registers provide 185-bit delays

American Microsystems, 3800 Homestead Rd., Santa Clara, CA 95051. (408) 246-0330. \$7.05 (100-999).

Requiring a two-phase symmetrical clock input, the S10110 analog shift register provides a delay depending on the clock frequency. The S10111 part is similar, but saves outboard circuitry by requiring only a one-phase clock input.

CIRCLE NO. 556

### Power Schottky diodes deliver up to 75 A

Motorola, P.O. Box 20912, Phoenix, AZ 85036. Cliff Peterson (602) 244-6900. From \$3.45 (100-qty); stock.

Designed specifically for high-current switching applications, the MBR7520 series of Schottky rectifiers covers a forward current range from 25 to 75 A, with reverse voltage ratings up to 45 V. There are 17 devices in the series and they can operate at junction temperatures of 150 C. For most devices in the series, the dV/dt ratings are 1000 V/μs. Units on test at a forward current of 70 A, a voltage of 45 V and a case temperature of 100 C have been hit with 8.3 ms pulses of 1300 A (one every minute) with no failures. DO-4 or DO-5 stud packages.

CIRCLE NO. 557

### Schottky paramp varactor is used in X to K-band

Alpha Ind., 20 Sylvan Rd., Woburn, MA 01801. Jerry Hill (617) 935-5150. \$300-\$500 (1 to 9).

GaAs Schottky paramp varactors, DVS 6680, are for use in low-noise parametric amplifiers from X to K-band. These varactors have  $f_{CO} > 800$  and  $C_{J0} / C_{J3} > 1.85$ .  $C_J$  is typically 0.15 pF. Only 20 mW of pump power is needed. Diodes are offered in the 290, 324, and 328 low-parasitic package styles. Diode series resonance is approximately 50 GHz and parallel resonance is to 100 GHz in the 328 package outline.

CIRCLE NO. 558



## 3-1/2 digit a/d's have LCD or LED drive outputs

*Intersil, 10710 N. Tantau Ave., Cupertino, CA 95014. S. Osgood (408) 996-5000. 100-qty prices: \$9.80 (7106), \$9.25 (7107). Also evaluation kits are available: \$24.95 (LED), \$29.95 (LCD); stock.*

Two low power CMOS a/d converters provide outputs for a 3-1/2 digit display. Both units provide parallel, seven-segment outputs/ and are housed in 40-pin DIPS. The ICL 7106 is designed to directly drive an LCD, including backplane drive, while the ICL 7107 will directly drive instrument size, LED displays without buffering. Only seven additional passive components, a display and a power supply are needed to form a complete digital voltmeter with automatic zero correction and automatic polarity. True ratio-metric readings can be done over a full scale input range from under 200 mV up to 2 V.

CIRCLE NO. 559

## Replace hi-fi discretes with IC power driver

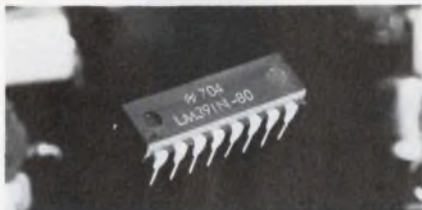

*National Semiconductor, 2900 Semiconductor Dr., Santa Clara, CA 95051. Bill Gross (408) 737-5621. \$2; stock.*

The LM391 monolithic IC can drive external power transistors in 10 to 75-W power amplifiers. It is capable of direct operation from a  $\pm 40$ -V supply. Total harmonic distortion is less than 0.05% over the entire audio band. Wideband noise is 3  $\mu$ V at the input.

CIRCLE NO. 560

## 8-kbit erasable PROM cuts $\mu$ C power drain

*Intel, 3065 Bowers Ave., Santa Clara, CA 95051. Rob Walker (408) 246-7501. \$26.60; stock.*

Operating on a 5-V TTL power supply, the 2758 EPROM avoids the need for special MOS supplies. It reduces active power dissipation by more than 50% and a standby mode can be used to reduce dissipation by more than 80%. Storage is 1 kbyte and access time is 450 ns.

CIRCLE NO. 561

## Precision v/f converter also converts f/v

*Teledyne Semiconductor, 1300 Terra Bella Ave., Mountain View, CA 94043. Michael Paiva (415) 968-9241. \$3.70/(1000 qty); stock.*

The 9400 is a low-cost v/f converter which also functions as an f/v converter. It combines bipolar and CMOS technology on a singlechip, interfaces

with all logic families, and comes in a 14-pin plastic or ceramic DIP. Operation is from 10 Hz to 100 kHz in v/f applications, with 0.01% typical linearity to 10 kHz. Both pulse and square-wave outputs are provided. The device operates on a single or dual power supply and draws only 1.6 mA. In the f/v mode, the 9400 operates from dc to 100 kHz, with 0.1% typical linearity over the full range.

CIRCLE NO. 562



## CTS matches crystal specs to your microprocessor.

And no waiting. CTS Industrial Distributors supply a perfectly matched crystal at the same time you buy the microprocessor, because CTS carefully checks the crystal requirements with each semiconductor manufacturer before writing crystal specs.

CTS now has a full line of standard crystals for microprocessors and clock IC's. CTS Knights crystals feature low start-up resistance, reliable CTS mil-approved manufacturing processes and gold and silver frequency calibration for long term stability. Available in 17 standard frequencies, 1.0 to 22.1184 MHz. Other frequencies available on special order.

CTS Knights crystals are available **off the shelf** at these typical 100-piece prices: from \$5.50 each (1.0 MHz) to \$2.75 each (18.432 MHz).

See your nearest CTS distributor for full information, or write **CTS Knights, Inc.**, 400 Reimann Ave., Sandwich, IL 60548, phone: (815) 786-8411.

**CTS Knights.**  
The frequency specialists.

**CTS CORPORATION**  
Elkhart, Indiana



CIRCLE NUMBER 160



## ICs & SEMICONDUCTORS

### Zener diodes now come with 2.5 and 5-W ratings

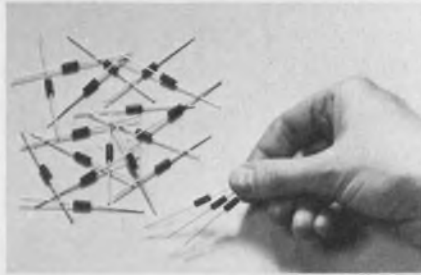

American Power Devices, 7 Andover St., Andover, MA 01810. Robert Dimodana (617) 475-4074. For 1000 qty lots: \$0.24 (2.5 W) \$0.30 (5 W), 3 wks.

Zeners with power ratings of 2.5 W—the 1N5008 series—are available in 42 voltage ratings from 3.3 to 82 V with 5% and 10% tolerances. Also available is a 5-W series—the 1N5333—with 43 voltage ratings from 3.3 to 82 V in 5%, 10%, and 20% tolerance versions. The silicon-oxide-passivated diodes are encased in axial-leaded transfer-molded packages.

CIRCLE NO. 563

### Bipolar transistor has 2.8-dB NF at 4 GHz

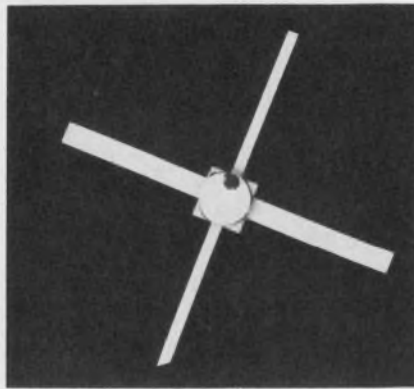

Avantek, 3175 Bowers Ave., Santa Clara, CA 95051. William Berridge (408) 249-0700. Stock.

The AT-4680 bipolar microwave transistor is optimized for low noise-figure, small-signal amplification at frequencies up to 6 GHz. NF is 2.8 dB, with 8.5-dB associated gain, at 4 GHz. At 2 GHz the typical NF and gain are 1.8 dB and 13.6 dB, respectively, and at 1 GHz they are 1.4 dB and 17.7 dB. The device is housed in a 70-mil square, metal/ceramic strip-line package.

CIRCLE NO. 564

### Volt-controlled filter has 4 tracking sections

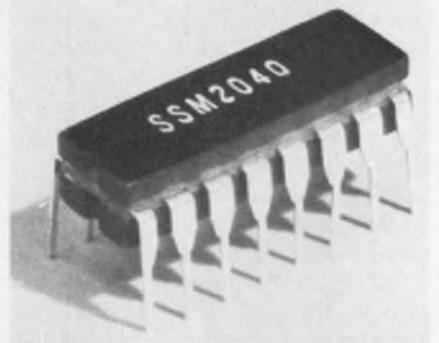

Solid State Music, 2102A Walsh Ave., Santa Clara, CA 95050. John Burgoon (408) 246-2707. \$10; stock.

The SSM2040 monolithic voltage-controlled filter contains an exponential generator, four voltage-controlled amplifiers and four high-impedance buffers. The combination provides four flexible tracking filter sections. It operates from  $\pm 15$  V. Signal-to-noise ratio is better than 75 dB and distortion is less than 0.1%. The control rejection characteristic is guaranteed over the filter's 10,000:1 sweep range.

CIRCLE NO. 565

## WE KNOW A LOT ABOUT A LITTLE.

### Photoetched parts. Lead frames and magnetic head frets, for instance.

For openers, we're big enough to take on any photoetch job, regardless of quantity. And we have the expertise to etch all standard materials. In short, we're a one-stop shop, geared to save you time and money. We compound, melt and roll our own metal alloys. So if you call for a special composition or thickness, we have the capability—in house—to meet your exacting specs. Need artwork? We do that, too. Want your magnetic head frets stacked and bonded? Our process will give you absolute uniformity and precise thickness batch after batch. Put us to the test—send your drawings and let us quote. Write Magnetics, Components Division, Butler PA 16001.

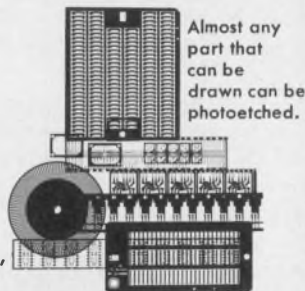

Almost any part that can be drawn can be photoetched.

**Very special specialists in photoetched parts.**

**MAGNETICS**  
A DIVISION OF SPANG INDUSTRIES INC.

CIRCLE NUMBER 161

## WE KNOW A LOT ABOUT A LITTLE.

### Silicon-iron alloys, for instance.

Magnetics offers you fast delivery on silicon-iron alloy coils in 1- to 7-mil thicknesses, either coated or uncoated. And we're the only source for 5- and 7-mil nonoriented types. You can count on them for uniformity in magnetic properties—in fact, we make and use them for our own magnetic devices, so they have to be right. In widths to 15".

Our Magnesil catalog tells more. For a copy, write Magnetics, Metals Division, Butler PA 16001.



Magnesil materials provide low core losses.

**Very special specialists in specialty alloys.**

**MAGNETICS**  
A DIVISION OF SPANG INDUSTRIES INC.

CIRCLE NUMBER 162

ELECTRONIC DESIGN 21, October 11, 1977



## One-chip converter drives and converts for DPM

National Semiconductor, 2900 Semiconductor Dr., Santa Clara, CA 95051. Jerry Zis (408) 737-5225. See text.

A single CMOS chip, the ADD3501, includes all conversion and drive circuitry for a 3½ digit DPM. The device, in a 28-pin dual-in-line package, uses a pulse modulation analog-to-digital technique, integrating the input signal to obtain a high immunity to noise. Accuracy is  $\pm 0.05\%$  +0-1 count for a 0-to-70-C temperature range. The output can drive 0.5 and 0.7-in. LED displays. Overflow indication is provided. 100 qty prices: \$9.95 (plastic package), \$10.95 (ceramic).

CIRCLE NO. 566

## AM/FM receiver circuits need few external parts

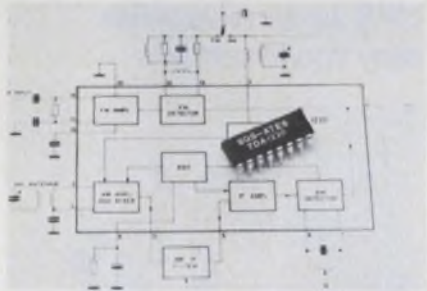

SGS-ATES Semiconductor, 70 Massachusetts St., Waltham, MA 02154. Ruben Sonnino (617) 891-3710. 1 to 99 qty: \$1.95 (1220), \$3.50 (1230); samples from stock.

The TDA1220 and TDA1230 are radio receiver circuits. Available in a 16-pin DIP, the TDA1220 is a complete AM-FM system for portable radios. It includes i-f FM amplifier, limiter and fm detector in the FM section and rf-AM amplifier, mixer, local oscillator, i-f amplifier and detector in the AM section. The supply voltage can vary between 4 and 18 V and AM-FM selection is done with a dc switch. In the FM mode, the circuit has a 30  $\mu$ V sensitivity, an AM rejection of 60 dB and a signal-to-noise ratio of over 60 dB. In the AM mode less than 1% distortion is present and an AGC range exceeding 80 dB is available. The TDA1230 is intended for monophonic AM/FM radios and includes a complete sub-system for amplification and detection of FM i-f signals. Also included is a 4 W power amplifier. The TDA1230 comes in a fin-DIP package.

CIRCLE NO. 567

# ENCLOSURES SHIPPED IN



Order a MarkHon cabinet\* today at discount prices. If we aren't ready to ship in three days, we'll knock another 15% off the price.

Imagine.

Order any of our specially priced standard cabinets between now and December 1, 1977 and we *guarantee* your order will be ready for shipment within 72 hours. It's that simple.

If, for any reason, we can't deliver on our promise, we'll deduct another 15% and still produce our cabinets faster than any of our competitors.

It's the perfect solution if you need high quality cabinetry in a hurry. Large units or small. One unit or one thousand. Our 72-hour promise applies to any of the models shown here.

Order today.

To order (or for more detailed information) call or write Roger Miller at MarkHon.

Challenge us to keep our promise.

\*72-hour promise and discounts apply to listed units only. Orders placed between now and December 1, 1977 are guaranteed to be on the loading dock of MarkHon plant and available for transit within 72 hours of receipt of order or an additional 15% discount will be extended to customer.

	Model 41H19	41J19	41K19
Frame Height (opening)	63.12"	70.12"	77.12"
Overall	67.5"	74.5"	81.5"
Width (opening)	19.06"	19.06"	19.06"
Overall	22"	22"	22"
Depth (opening)	19.06"	19.06"	19.06"
Overall	25.5"	25.5"	25.5"
Overall Height with caster base	72.4"	79.4"	86.4"

Frame includes: caster base, vented side and top panels, plain door (hinged right or left), door lock (optional)  
Finish: frame, base, side and top panels are Gothic Black. Door, Caribbean Blue



## MarkHon

P.O. Box 547 • 200 Bond Street • Wabash, IN 46992  
Phone (219) 563-2161

CIRCLE NUMBER 163



A "special" offer from Bud.

Win a trip to Super Bowl XII... FREE.

Use the reader service card and we'll mail you an entry form for our Super Bowl sweepstakes! Here's what you can win: Four days and three nights in New Orleans for the 1978 Super Bowl! Great seats at the game! Air fare and hotel accommodations! All free! For two! And no purchase is necessary to enter.

**Bud's ready to make you something special!**

In particular, a special enclosure.

We can build that special in one of two ways: (1) We can take any one of our 2700 standard enclosures and by modifying it, convert it into a special. We use existing tooling and dies. You save money! Or (2), we can build a custom-made enclosure. In fact, we'll help you design it.

The point is, we're the "pros" who've built thousands of special enclosures for hundreds of firms who know Bud; rely on Bud.

Why not! We're Number One!

**You've got our number!** Dial it now -- toll free -- if you want to talk about special enclosures. (800) 321-1764; in Ohio, (800) 362-2265.

**BUD**

BUD INDUSTRIES, INC.  
4605 East 355th Street  
Willoughby, Ohio 44094

BUD WEST, INC.  
3838 North 36th Avenue  
Phoenix, Arizona 85019

© 1978 BR

CIRCLE NUMBER 164

## POWER SOURCES

Low-cost supplies cover wide range

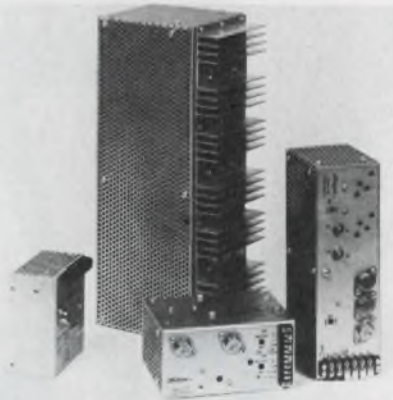

Deltron Inc., Wissachickon Ave., North Wales, PA 19454. (215) 699-9261. See text, 6 wks.

Prices range from \$40 to \$233 in 10-piece qty for 78 single and multiple-output supplies with nominal ratings of 5 to 32 V at from 1 to 35 A. Units in the OEM series deliver up to 277 W. Other features include: a heavy-duty barrier block for input and output connections, remote sensing and programming capabilities. Overvoltage protection is standard on certain models and an option for all others. All units are said to be, drop-in electrical and mechanical replacements for the corresponding supplies from ACDC.

CIRCLE NO. 568

Small solar cells boast passivation



Dionics, 65 Rushmore St., Westbury, NY 11590. Manny Sussman (516) 997-7474. See text; stock.

Miniature silicon solar cells, types PK104/PK105/PK106, have protected junctions (oxide-passivated) with both contacts on the top surface. They are provided as individual chips which may be assembled into arrays. The open-circuit output is 0.5 V with output currents ranging from 0.47 to 1.8 mA depending on type. Prices are from \$.18 to \$.50 each, depending on type and quantity.

CIRCLE NO. 569

Protect 3 $\phi$  lines with plug-in monitor



Amtron, P.O. Box 2783, Norman, OK 73069. David Donaghe (405) 364-6143. \$38-\$49.50; stock.

Continuously monitoring 3 $\phi$  power lines, the plug-in unit opens contacts when it senses a lost phase, low voltage, phase reversal or phase-angle shift. It is offered in three adjustable-voltage ranges: 85 to 125 V (3P120); 160 to 240 V (3P240); 340 to 480 V (3P480). A failure indicator lamp is provided.

CIRCLE NO. 570

UPS system supplies only the essentials



Trio Labs, 80 Dupont St., Plainview, NY 11803. P.Bauer (516) 681-0400.

Model 692 is a switching power supply, with partial UPS capabilities, that allows a system to stay on at reduced capacity until the ac input returns. Operating with ac-line power the supply provides the following typical outputs: 5 V at 100, 5 V at 18 A and 12 to 15 V at 6.5 A. When the ac input is removed, a battery takes over and supplies the input for the two lowest power outputs. Specifications include:  $\pm 0.2\%$  static regulation for the worst combination of ac or dc inputs and load;  $\pm 2\%$  dynamic regulation for a 50% load change; 50-mV pk-pk ripple; overvoltage crowbars; overcurrent foldback; line-dropout immunity; and power-fail signal. 8 x 5.25 x 23 in.

CIRCLE NO. 571



**Smallest  
industrial  
direct digital  
readout  
Elapsed Time  
Indicator?**

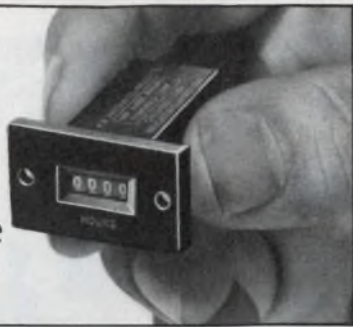

**The only big thing about it is its  
easily read 4-digit hourly display**

Our Series 49200 Elapsed Time Indicator is the smallest industrial direct digital readout ETI we've ever made. It may be the smallest anyone has ever made. It measures a mere  $3\frac{3}{4}$ " sq. x  $1\frac{1}{4}$ " long—a real space-saving way to monitor operating time in business machines, computers, peripherals and other equipment where space is limited. Despite its small size, it's exceptionally accurate, and the .075" high 4-digit hourly display is readily legible. An automatic tamper-proof latching memory stores elapsed time indications that can't be lost in event of power failure. Where size is important, the Series 49200 can be one of your best values ever. It's powered by a 1W synchronous motor, 115V ac, 60 Hz. Front or side readout. Surface or through-panel mount.

**Send for information today!**

A. W. HAYDON CO. PRODUCTS

**NORTH AMERICAN PHILIPS CONTROLS CORP.**

Cheshire, Conn. 06410 • (203) 272-0301

**FOR INFORMATION, CIRCLE 166**

**FOR IMMEDIATE, CIRCLE 167**

**DIP Switch  
Line  
from  
SMK**

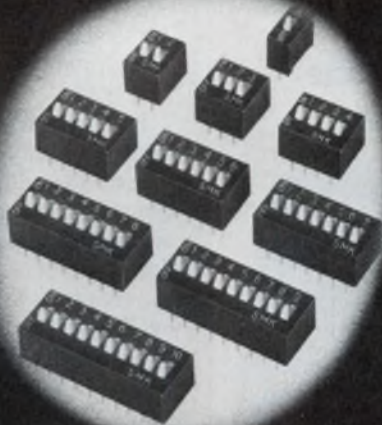

**The JS-8722 Series** is a complete line of DIP Switches, from 1 to 10 positions, featuring sealed construction to prevent flux contamination during wave soldering. A clip-type wiper design assures positive 2-sided contact to provide excellent shock and vibration characteristics.

Available in SPST configuration, the switches are rated at 24V DC at 300mA switching, resistive load, and will operate from  $-20^{\circ}\text{C}$  to  $+60^{\circ}\text{C}$ .

Typical price for a 4 position DIP Switch in 100 piece quantity would be \$1.16 each.



**SMK Electronics Corporation  
of America**

118 East Savarona Way Carson, California 90746

Tel: (213) 770-8915

**CIRCLE NUMBER 60**

ELECTRONIC DESIGN 21, October 11, 1977

# We're Second only to the N.B.S.

**SOURCES — REFERENCES  
CALIBRATORS — STANDARDS**

**DC Voltage  
and Currents  
Standards in  
12 models from**



$\pm 10$  nV to  $\pm 1100$  Vdc. Differential Voltmeter optional. Current 10 nA to 10 Amps. Prices from \$695. Circle # 208

**Programmable  
DC Standards**  
from  $\pm 0.1$   $\mu\text{V}$   
to  $\pm 200$  Vdc,  
current from  
10 nA to 100 mA dc. Accuracy  $\pm 0.005\%$ .  
Prices from \$1595. Circle # 209



**AC Voltage and Current Sources** 10  $\mu\text{V}$  to  
1100 Vac @ 50 VA burden. Current 1  $\mu\text{A}$  to  
10 Amp ac.

Frequency 50  
Hz to 1000 Hz.

Price \$3695.  
Circle # 210



Circa 1982

**Electronic Development Corp.**

11 Hamlin Street, Boston, Mass. 02127  
(617) 268-9696



# RF Power Amplifiers?

## One unit may be all you'll ever need.



If you have the ENI Model 440LA ultra-wideband solid state power amplifier, all you need is a laboratory signal generator and you've got the ultimate in linear power for such applications as RFI/EMI testing, NMR/ENDOR, RF transmission, ultrasonics and more.

Capable of supplying more than 40 watts of RF power into any load impedance, the 440LA covers the frequency range of 150 kHz to 300 MHz.

We could mention unconditional stability, instantaneous failsafe provisions and absolute protection from overloads and transients, but that's what you expect from any ENI power amplifier, and the 440LA is no exception!

Our catalog contains complete specifications on the 440LA as well as the entire line of ENI amplifiers, and is available without obligation, of course.

For further information or a demonstration, contact ENI, 3000 Winton Road South, Rochester, New York 14623. Call 716-473-6900, or Telex 97-8283 ENI ROC.

# ENI

**The World's Leader  
in Power Amplifiers**

CIRCLE NUMBER 211

## PACKAGING & MATERIALS

### Glass-silicone bobbins withstand 180 C

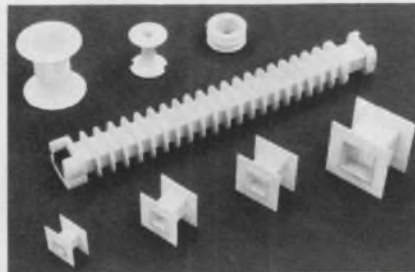

Stevens Products Inc., 128 N. Park St., East Orange, NJ 07019. (201) 672-2140.

Open-stock tooling is available for thousands of sizes of bonded glass-silicone, Class-180-C coil bobbins. Bobbin cores are cut to length from 18-in. long, convolutely wrapped tubes, molded in thicknesses from 0.02 in. and then sandblasted outside. Tubing meets MIL-P-997B specs. Flanges are fabricated from NEMA Grade G7 glass-silicone sheet stock, sanded on both sides and tap fitted over the ends of the core with a 0.015-in. offset for bonding of both sides.

CIRCLE NO. 800

### Crimp 1200 contacts per hour

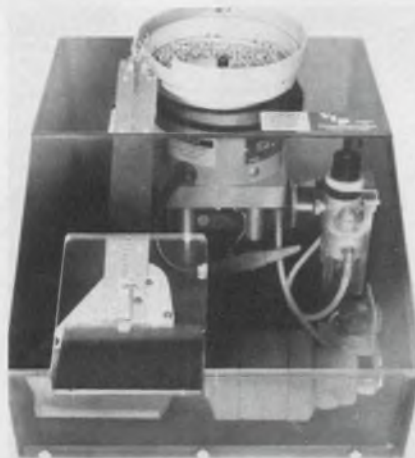

VIP Industries, 246 Knickerbocker Ave., Paterson, NJ 07503. Ed Nemeth (201) 345-5800.

An automated contact and eyelet crimper produces more than 1200 crimped wires per hour. It orients, positions, feeds and crimps a variety of eyelets, contacts, pins and receptacles onto stripped wire. The system accepts wire gauges from #26 to #10.

CIRCLE NO. 801

### Lead terminator does 3000 per hour



Cannon Electric, 29000 Aurora Rd., Solon, OH 44139. Allen Gath (216) 248-8800. 12 wk.

Open or closed-barrel terminals can be automatically put onto leads at speeds up to 3000/h with the Model ATS/1000. Lead lengths from 3½ to 199 in. can be handled. When connected to the Artos CS6-CTO wire-cutting/stripping machine, it measures, cuts, strips and terminates the wires automatically. Wire sizes from #22 to #10 are accommodated.

CIRCLE NO. 802

### High capacity dip board speeds $\mu$ P system design

Vector Electronic Co., 12460 Gladstone Ave., Sylmar, CA 91342. (213) 365-9661. See text.

Four new high capacity DIP circuit cards provide a combination of board sizes, convenient power-bus and ground-plane organization and edge connector configurations that speed development of microprocessor, memory, or interface systems. Unlike other cards with restrictive bus patterns, the new Vectorcards accept all DIP sockets with 0.1 in. by 0.3, 0.4, 0.6, and 0.9-in. lead spacing, and with up to 64 pins. Two 4.5 in. wide  $\times$  6.5 in. long boards, designated 4493 and 4494 accommodate any combination of DIPs up to a maximum of 42. For more extensive systems the model 4493-1 and 4494-1 boards which are 4.5 in. wide and 9.6 in. long can be used. These boards accept up to 60 ICs. A full ground plane is provided on the component side and a power plane is provided on the wiring side. Power supply conductors are placed less than one quarter inch from any DIP lead. The board design provides an optional area for mounting either DIPs or a low-profile heat sink and two regulators in TO-220 packages.

CIRCLE NO. 803



# MDB SYSTEMS presents... The LSI-11 Connection

GP Logic Modules • Peripheral Controllers • Communications Interfaces • Special Purpose Modules • Accessory Hardware  
 Plus: DEC's own LSI-11 Micro-processor Module.



Here are some MDB Systems connections to LSI-11 microprocessors:

- General Purpose Interfaces: Parallel for programmed I/O and DMA.  
Do-it-yourself dual and quad wire wrap for any DIP design.
- Device Controllers for most major manufacturer's Printers  
Card equipment  
Paper tape equipment  
Plotters
- Communications/Terminal Modules  
Asynchronous Serial Line  
Synchronous Serial Line

- MDB Backplane/Card Guide Assembly (8 Quad slots)  
Rack mount chassis 5 1/4" front panel.
- Special Purpose Modules and Accessories  
System monitoring unit provides front panel switch addressing, power on/off sequencing; line frequency clock.

- Bus extenders/terminators.  
E-PROM and PROM modules.  
Bus connectors for backplane assemblies.

MDB Systems products always equal and usually exceed the host manufacturer's specifications and performance for a similar interface. MDB interfaces are software and diagnostic transparent to the host computer. MDB products are competitively priced; delivery is usually within 14 days ARO or sooner.

MDB also supplies interface modules for DEC PDP-11 Data General NOVA\* and Interdata minicomputers.

## MDB

MDB SYSTEMS, INC.

1995 N. Batavia St., Orange, California 92665  
 714/998-6900 TWX: 910-593-1339

\*TMs Digital Equipment Corp. & Data General Corp.

CIRCLE NO. 285 FOR LSI-11: 286 FOR PDP-11: 287 FOR NOVA: FOR INTERDATA 288  
 "See us at Systems '77 Munich."

## New Mini Lo-Power BITE Indicator for Computers

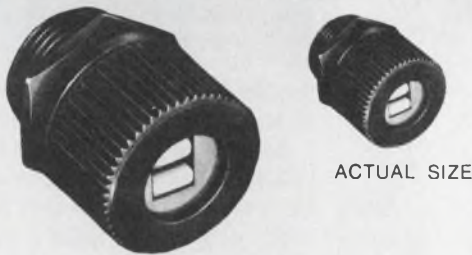

Qualified to MIL-I-83287/04. This patented manually-resettable magnetic latching indicator requires only 50 milliwatts pulse power to operate. It is ideal for direct interface with TTL logic. The indicator changes from all-black to red or white display upon application of a pulse width of 25 milliseconds, latches and holds until reset by rotating the knob 60°. The Minelco MI51LP is available in 1.5 to 28v dc. Operating temperature range is -60°C to +125°C. Write or call for details.

135 South Main Street  
 Thomaston, Conn. 06787  
 Phone 203-283-8261



TALLEY INDUSTRIES COMPANY

# Minelco

CIRCLE NUMBER 212

ELECTRONIC DESIGN 21, October 11, 1977

## The fabulous Phi-Deck® family of 5 cassette transports under \$100 in quantities of 10

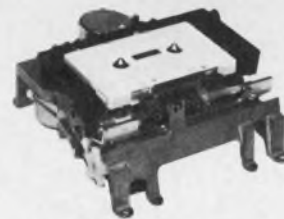

Featuring:

- Die-cast frames
- Remote controllable
- Precise, fast head engage/disengage
- Quick braking
- Search FF/rewind 120 ips
- Speed ranges from .4 to 20 ips

Electronic packages and mag heads for most applications

For application in:

- |                                   |                                       |
|-----------------------------------|---------------------------------------|
| 1. Micro processing               | 7. Security/automatic warning systems |
| 2. Data recording/logging/storage | 8. Test applications                  |
| 3. Programming                    | 9. Audio visual/education             |
| 4. Instrumentation                | 10. Telephone interconnect            |
| 5. Industrial Control             | 11. Hi-Fi                             |
| 6. RS-232 Data storage            | 12. Point of sale                     |



Title I Incorporated

4605 N. Stiles P.O. Box 18209  
 Oklahoma City, Oklahoma 73118 (405) 521-9000

- I am interested in application no. \_\_\_\_\_  
 Have Representative call  Send application notes

Name \_\_\_\_\_ Title \_\_\_\_\_  
 Company Name \_\_\_\_\_  
 Address \_\_\_\_\_  
 City \_\_\_\_\_ State \_\_\_\_\_ Zip \_\_\_\_\_  
 Phone Number \_\_\_\_\_

CIRCLE NUMBER 213



Custom designs  
or off-the-shelf...

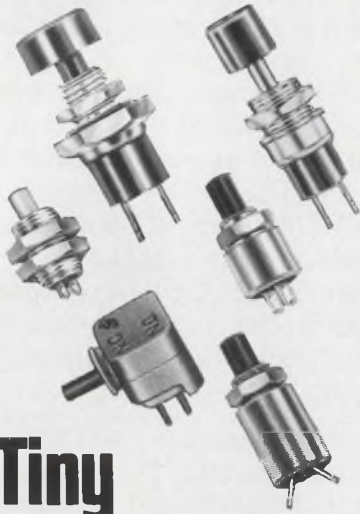

## Tiny but tough... Grayhill push-button switches

from logic levels  
to UL-listed  
power switching

- As small as .250" diameter, .675" over-all length
- Wiping or butt contacts; momentary or alternate action; SPST, SPDT, DPDT
- Bezel, bushing, or sub-panel mounting, variety of button colors and shapes

There's a wide range of options in the Grayhill miniature push-button switch line, but all offer high reliability over a long life span. Off-the-shelf availability of standard types is augmented by a superior custom design capability for unusual circuitry, environmental usage, or size requirements. For details, consult EEM or write for free literature from Grayhill, Inc., 561 Hillgrove Avenue, La Grange, Illinois 60525, Phone (312) 354-1040



CIRCLE NUMBER 214

## PACKAGING & MATERIALS

### Thermal paste also good insulator



Wakefield Engineering, 77 Audubon Rd., Wakefield, MA 01880. (617) 245-5900. See Text.

An easy-to-spread thixotropic paste, Delta Bond 155, provides high heat transfer, low shrinkage and a coefficient of thermal expansion comparable to that of copper and aluminum. It bonds to a wide variety of substrates and resists severe temperature cycling. When used to form thermally conductive joints between heat sinks and power devices, the paste also serves as an electrical insulator. Kits containing resin and hardener are priced at \$3.95 in quantities of 1 to 9.

CIRCLE NO. 804

### Mini-connectors disconnect fast

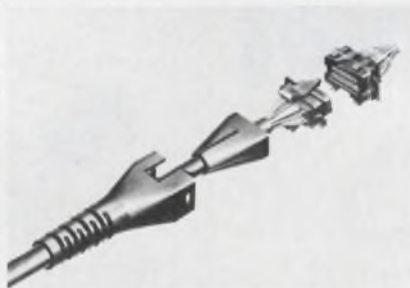

TRW Cinch, 1501 Morse Ave., Elk Grove Village, IL 60007. Oscar Rothchild (312) 439-8800. \$3 (10,000 qty.).

A miniature, high-reliability, quick-disconnect system, Dura-Lok, can have up to 24 contacts in a cross-section of 0.95 x 0.65 in. Primarily for cable-to-panel use, the connector also connects cable-to-cable. It accepts cable of 22 to 26 AWG, solid or stranded wire. The replaceable crimp-type contacts snap into the insulator. The connector halves mate with a positive, audible action. Rating is 5 A.

CIRCLE NO. 805

### Assembly pliers install strain-relief bushings



Heyman Mfg., P.O. Box 160, Kenilworth, NJ 07033. (201) 245-2345.

Installation of larger-size strain-relief bushings can be done with the #30 pliers. It provides a leverage ratio of 10:1 and is adjustable for the sizes that assemble into mounting holes with diameters from 7/8 to 1-13/16 in.

CIRCLE NO. 806

### Wide variety offered by cut-to-length connectors

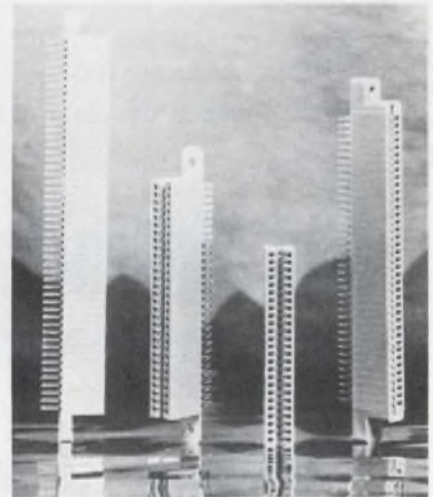

Amphenol, 2875 S. 25th Ave., Broadview, IL 60153. (312) 345-9000.

A mix-and-match capability that keeps pace with manufacturers' needs for a variety of connectors is possible with new cut-to-length connectors being offered by Amphenol. From 15 basic components a total of 40,800 different connectors can be produced. The connectors provide as many as 85 contacts on each side. The contacts can be single or double sided with spacings of 0.1 in. and 0.156 in. They are made of a high tensile material and come with one of three gold plating thicknesses—0.5 microns, 0.76 microns and 1.2 microns. Five tail styles and four contact configurations are available for each spacing version.

CIRCLE NO. 807



# MINICOMPUTER BREADBOARDS

## FOR DESIGNERS

UTILIZING

DEC

DATA GENERAL

CAMAC

COMPUTER AUTOMATION

S-100

SYSTEMS

PLUS

GENERAL PURPOSE BREADBOARDS

AND

PROTOTYPE PACKAGING

*Plus a complete line of general purpose breadboards and accessories. Send for our free 32 page catalog.*

**DOUGLAS ELECTRONICS**

718 MARINA BLVD / SAN LEANDRO CA 94577

PHONE (415) 483-8770

CIRCLE NUMBER 215

# Heyco Nylon Bushing Labkits



Here, in five complete LabKits you'll find all the specialized nylon bushings, plugs and cable clamps you need for product development and prototype work. Ideal for product design groups and experimental labs. Each compartmentalized box has an assortment of the most popular sizes. Each box has data and usage information mounted on the lid. Order any of these individual LabKits for \$10 each, four LabKits for \$30.00 and five for \$37.00.

- No. 1 Strain Relief Bushings, 185 pieces.
- No. 2 Insulating Bushings, 241 pieces.
- No. 3 Hole Plug Assortment, 255 pieces.
- No. 4 Knock-Out Hole Size Assortment, 125 pieces.
- No. 5 Nylon Cable Clamps, 285 pieces.

Strain Relief Assembly Pliers for kits 1 and 4, \$12.50.

### HEYMAN MANUFACTURING COMPANY

KENILWORTH, NEW JERSEY 07033 WAUKESHA, WISCONSIN 53186  
(201) 245-2345 • TWX: 710-996-5986 (414) 542-7155 • TWX: 910-265-3668

Call Toll-Free (800) 558-0917 except from Wisconsin.  
If calling from Wisconsin use (800) 242-0985



CIRCLE NUMBER 216

ELECTRONIC DESIGN 21, October 11, 1977

**If you're trying to do  
— some other way —  
what these power amps  
are designed to do,  
your system probably  
costs too much.**

In the DC to 30KHz range, Crown power amps are practically unbeatable. They're rugged, reliable, and can handle almost any load — right or wrong. Their performance has been proven in many different kinds of systems, under wildly different conditions. Designed for 19" rack mount and quick, simple hook-up. And they are almost always cheaper than whatever you think is an alternative. For more information, write or call the Crown Industrial department.

### The Better Way Amps

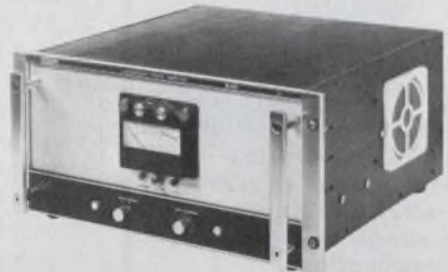

**M-600** Single-channel, 750 watts into 8 ohms, 1000 watts into 4 ohms.



**DC-300A**  
Two-channel, 190 watts/ch into 8 ohms, 340 watts/ch into 4 ohms, (switch convertible to single-channel, 650 watts into 8 ohms).



**D-150A**  
Two-channel, 75 watts/ch into 8 ohms, (switch convertible to single channel, 250 watts into 8 ohms).



1718 Mishawaka Rd., Elkhart, Indiana 46514 • 219/294-5571

CIRCLE NUMBER 217



# Zeltex

# 14 BIT

## HIGH PERFORMANCE

# A TO D

# CONVERTERS ONLY \$199\*



You could pay that or more for just 12 bits. But with the ZAD3014, you get 14-bits—a cost-effective solution for a wide range of high performance applications.

The ZAD3014 delivers 14-bit resolution at conversion times of less than 100 $\mu$ sec. With four input ranges (+10V, +5V, 0 to 10V and 0 to 5V) and three output codes (unipolar binary, offset binary and 2's complement) to give you all the flexibility you need in a space-saving 3.5 cu. in. case.

Thin film resistors with low temperature coefficients insure that no codes are missed over the 0 to 70°C operating range. External zero and full scale adjustments are provided.

Is that all there is? No. Zeltex quality and reliability are built-in. As always.

\*(100 unit qty.)

## Zeltex INC.

The Conversion Product Specialists  
940 Detroit Avenue, Concord,  
California 94518.  
(415) 686-6660/TWX 910-481-9477

CIRCLE NUMBER 218

## DATA PROCESSING

### Plug-in generates data at top speed

*Tau-Tron Inc., 11 Esquire Rd., North Billerica, MA 01862. (617) 667-3874. \$3300; 8-10 wks.*

The MG-15 is a quarter-size plug-in module providing a serial data output at clock rates up to 500 megabits. Front-panel toggle switches program the 15 or 16 bit word. The 1-V output may be selected as RZ or NRZ.

CIRCLE NO. 808

### Desk-top printer handles 1200-baud data



*Scope Data, 3728 Silver Star Rd., Orlando, FL 32808. Walt Plyter (305) 298-0500.*

An electrosensitive nonimpact high-speed printer, the COMM 1200 handles 1200-baud data transmissions continuously and operates asynchronously at speeds up to 300 cps. The desk-top or pedestal-mounted unit is 19 x 14 x 6 in. and weighs 25 lb. Roll-type electrosensitive paper 8½-in. wide and 300-ft long is used. ASCII coding is standard with APL, EBCDIC and BAUDOT optional.

CIRCLE NO. 809

### Indexed tables enhance disc-storage accuracy

*Mohawk Data Sciences, 1599 Littleton Rd., Parsippany, NJ 07054. J. Santoro (201) 540-9080. No charge.*

A software enhancement for the System 1200/2400 product line permits users to create and store on disc index-sequential tables as large as 17.5 megabytes. The new feature allows users to create and store off-line as many as 64 tables with entries of up to 122 characters. Indexed tables improve accuracy because any field can be verified simultaneously against as many as four separate tables.

CIRCLE NO. 810

### Cartridge recorder is ANSI/ECMA compatible

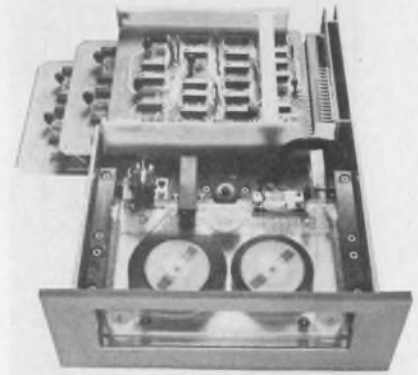

*Raymond Engineering, 217 Smith St., Middletown, CT 06457. Charles Gould (203) 632-1000. \$1250-\$1400.*

Used with ¼-in. data cartridges, the model 64/3 Raycorder tape drive is fully ANSI/ECMA compatible. It provides automatic search to load point on command, and external program capability for drive-select codes when up to four drives are operated from a single controller. Data format is serial NRZ, at 48 kbits/s. Block detection allows block count/search operations. An optional PC card provides 8-bit parallel data transfer over a bidirectional data bus. Error detection during both read and read-while-write is also provided, as is complete status reporting.

CIRCLE NO. 811

### Comparator indicates 6 levels of alarm



*United Systems, 918 Woodley Rd., Dayton, OH 45403. Mike Elovitz (513) 254-6251. \$895; stock.*

Providing six distinct levels of alarm indication, the 6806 Data Sentinel is half-rack size and weighs 6 lb. Each of the six setpoints has its own thumb-wheel switch to assign alarm levels from 00000 to  $\pm 19999$ . A front-panel indicator shows when a limit is exceeded. Each alarm output is through spdt contacts having 2-A (resistive) ratings.

CIRCLE NO. 812



# Diskettes.



A complete family of diskettes,  
all Verbatim™ quality.

Double sided. Single sided. Double and single density. And minidisks™ in every format. All 100% certified on every track to eliminate dropouts. Verbatim diskettes give you the cleanest data and longest life you've ever seen. We're sure, because we make them ourselves.

Ask about our standard disk line or our newest Verbatim disks. And while you're at it, write or call for the name of your local Verbatim distributor.



**Information Terminals Corp.**  
323 Soquel Way  
Sunnyvale, CA 94086  
(408) 245-4400

**Information Terminals S. A.**  
Case Postale 296  
1215 Genève 15  
Switzerland  
Tel: (022) 32-32-39  
Telex: 22647 ITGE CH

**ITC—Far East**  
404 Roppongi Skyheights  
3-2-21 Roppongi, Minatoku  
Tokyo, Japan  
Tel: (03) 583-1981  
Telex: J 47879

CIRCLE NUMBER 219

COOL  
COMPUTERS  
ELECTRONICS  
MACHINE  
TOOL  
SYSTEMS

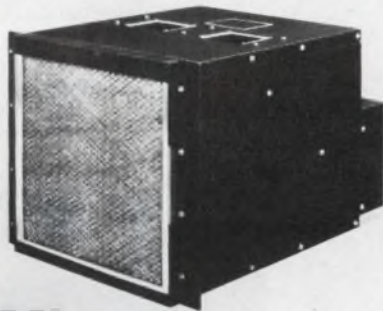

## McLEAN 6000 BTU AIR CONDITIONER

This compact 19" rack-mounted "LOBOY" provides longer life, more reliability and better performance for electronic equipment. Easy to install. Operates on 115 volts, 60 Hz, draws 12 amps max., weighs only 135 lbs. Centrifugal blowers circulate cool air over entire coil/fin surface for uniform airflow. Constant clean air in contact with electronics. 20,000 hours continuous duty assured in ambients to 125°F.

SEND FOR CATALOG

**McLEAN McLEAN**

ENGINEERING LABORATORIES

ENGINEERING MIDWEST

Princeton Junction, NJ 08550  
609-799-0100 • Telex 84-3422

9560 Eighty-Fifth Ave. N.  
Maple Grove, MN 55369 • 612-425-4747

CIRCLE NUMBER 220

ELECTRONIC DESIGN 21, October 11, 1977

# Buzzzzz.

(Write for new catalog.)



Solid state electronic MICRO-BUZZER from CITIZEN: High reliability, competitively priced with immediate delivery.

A complete range: **SMB** 1.5, 6, 12, 24, VDC  
**RMB** 3, 6, 12, 24, VDC  
**IMB** (Intermittent) 6, 12, VDC

## CITIZEN

CITIZEN AMERICA CORPORATION  
1710 - 22nd St.  
Santa Monica,  
CA 90404

Toll Free (800) 421-6516  
In Calif. (213) 829-3541  
TWX: (910) 343-6450

Name \_\_\_\_\_  
Company \_\_\_\_\_  
Address \_\_\_\_\_  
City \_\_\_\_\_ State \_\_\_\_\_  
Zip \_\_\_\_\_ Phone \_\_\_\_\_

CIRCLE NUMBER 221



# strip chart recorders

- OEM MODULES
- LOW PROFILE
- PACKAGED UNITS
- PORTABLE DC

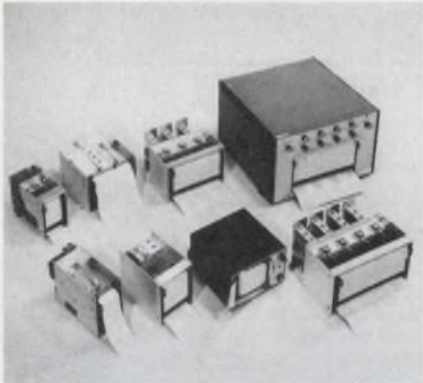

General Scannings thermal writing Strip Chart Recorders are available in a wide range of configurations and performance characteristics to meet virtually every recorder need.

You can select open-loop, velocity feedback or closed-loop operation; continuous roll or fan-feed paper; one to eight channels in channel widths of 20, 40, 50, 80 or 100mm; a variety of chart speeds; and either AC or DC operation.

Recorders can be furnished as modules for use by OEM's or fully packaged.



For complete details, circle readers' service number or write today for our full line Strip Chart Recorder Catalog.

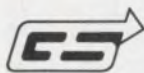

**GENERAL SCANNING INC.**  
150 Coolidge Avenue  
Watertown, MA 02172  
TEL: (617) 924-1010

CIRCLE NUMBER 222

## DATA PROCESSING

### Programmable processor has high throughput rate

*Stein Associates, 28 Bear Hill Rd., Waltham, MA 02154. Ralph Jackson (617) 891-4700.*

Modular-multiprocessor design enables the AR-10 high-speed processor to operate with high throughput rates and system bandwidth. The FFT-execution time (1024-point complex) ranges from 1.45 to 8.5 ms. Sub-processors operate in parallel and are interconnected by the AR/BUS which performs DMA transfers without cycle stealing. A cross-assembler and linker written in ANSI Fortran, combined with hidden pipeline operations allows programming with the ease of a mini-computer. The processor has an AR/SCAN panel, which allows operational analysis and program debugging by trapping and displaying data, addresses or other program parameters in any of the subprocessors while the program operates at full speed.

CIRCLE NO. 813

### Instrumentation printer has serial interface



*Master Digital, 1308-F Logan Ave., Costa Mesa, CA 92626. Michael Campo (714) 751-8271. \$595; stock to 4 wks.*

RS 232 and 20-ma current loop serial interfaces are available for the MDC 300 Series instrumentation printers. The general-purpose printers are packaged for bench-top or rack mounting. Up to 21 columns of numeric and limited alphabetical data can be printed at 3 lines/s. Features include two-color impact printing, low noise, 100% duty cycle and a printing mechanism with a life of five million lines. Options include: Date/time clock, event counter and low-paper indicator.

CIRCLE NO. 814

### 32-k byte add-in memory is totally transparent

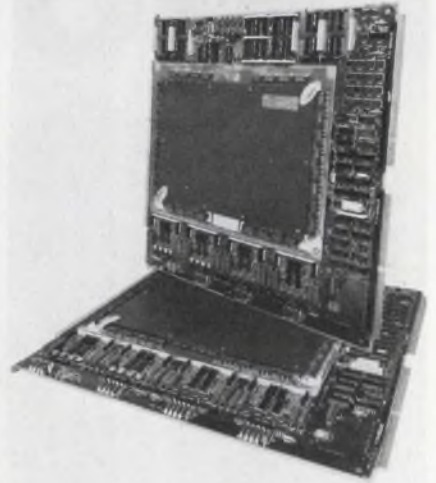

*Amplex, 200 N. Nash St., El Segundo, CA 90245. Clyde Cornwell (213) 640-0150. \$1725; stock.*

A 32-k byte add-in memory, the ARM-3, is totally transparent and pin-compatible with the Data General Nova 3 computers. It offers 800-ns full-cycle operation in 16-k modules. Temperature-independent cores provide more uniform performance and wider operating margins over the temperature ranges found in industrial environments. The module operates in any address field and is completely software and hardware compatible with all models of DG's Nova 3.

CIRCLE NO. 815

### Triple processor board runs published software

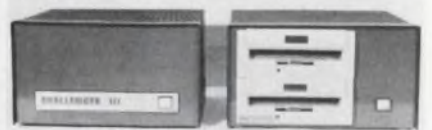

*Ohio Scientific, 11681 Hayden, Hiram OH 44234. (216) 569-7905.*

Challenger III is a triple-processor-CPU board that runs almost all published software for microprocessors, including the 6800, 6502, 8080 and Z-80 programs. It uses the OS-65D disc operating system, and a 74-Mbyte-disc option makes mass data storage possible. Another option is a software-processor-status switch for writing multiple programs. Also included is a 1-Mbyte pager and user-programmable vectors for both the 6502 and 6800 that allow real-time multitasking.

CIRCLE NO. 816



**Rogan knobs  
look better  
and are built better,**



**and we'll prove it  
with a free sample.**

After you receive our catalog, send us a note outlining your specific requirement and the quantity involved.

Or furnish us with our competitor's part number and we will cross-reference it.

Our samples and quotation will be returned promptly.



3455 Woodhead Drive, Northbrook, Illinois 60062 (312) 498-2300

CIRCLE NUMBER 224

## WHO MAKES WHAT & WHERE TO FIND IT

Volume 1 of **Electronic Design's GOLD BOOK** tells all. And, when you look up an item in its **PRODUCT DIRECTORY** you'll find each manufacturer listed **COMPLETE WITH STREET ADDRESS, CITY, STATE, ZIP AND PHONE.** Save time. There's no need to refer elsewhere to find missing information.

**IT'S ALL THERE  
in  
Electronic Design  
GOLD BOOK**

### A CAMBION Double "QQ" Product Line

Whether you want micro-miniature types 1/10th the size of a TO-5 transistor, fixed chokes, L-C filters, balun transformers or toroids, Cambion makes high "Q" standard coils for industrial, commercial and defense-related applications in a wide variety of package and mounting styles. We also have large families of coils with overlapping inductance ranges, variable units and shielded or unshielded units for chassis or printed circuit mounting.

If your design requires a custom coil, Cambion can engineer and produce it. So the choice is yours. Whether it's a standard or custom Cambion inductive device, you're assured of repeatable operating characteristics, no matter how many you require. That's the Cambion double "QQ" approach – the Quality stands up as the Quantity goes on. You'll find them all in our latest catalog. Cambridge Thermionic Corporation, 445 Concord Avenue, Cambridge, Mass. 02138. Phone: 617-491-5400. In Los Angeles: 2733 Pacific Coast Highway, Torrance, CA 90505. Phone: 213-326-7822.

## Cambion's cure for the common coil.

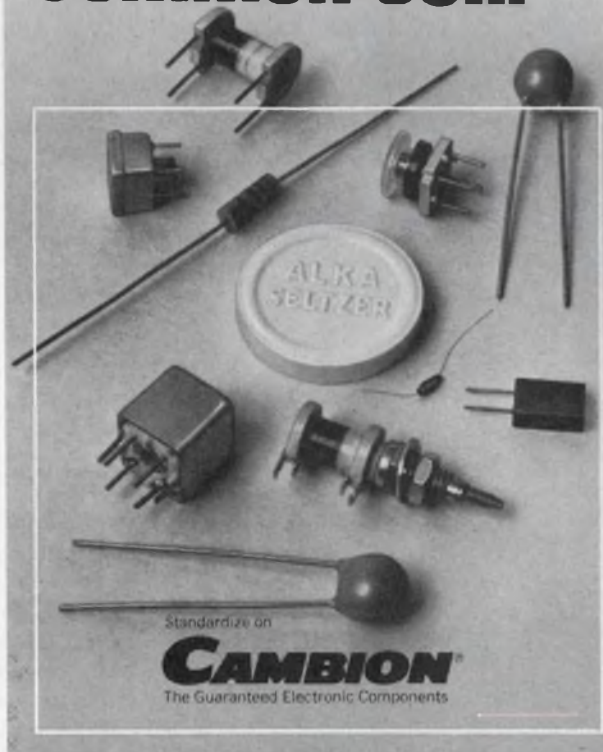



# NEW! Systems Integration through Switching!

How do you reconfigure four data acquisition channels and 500-600 transducer leads from each of eight test stations — frequently, reliably, quickly, without distorting low level analog signals? Easy. Integrate your system with a matrix switch using 60-circuit T-Bar "Pluggables" that mate directly with wrappable connectors.

T-Bar makes high density multi-pole switches and relays — designs and fabricates special switching systems — reliably and economically. That's all we do. And we've been doing it for 15 years. If you switch a lot of lines — all at once or a few at a time — write or phone today for T-Bar's new Series 6900 Pluggable Switching Catalog.

**T-Bar** INCORPORATED  
SWITCHING COMPONENTS DIV.  
141 Danbury Road Wilton, CT 06897  
Phone: 203/762-8351

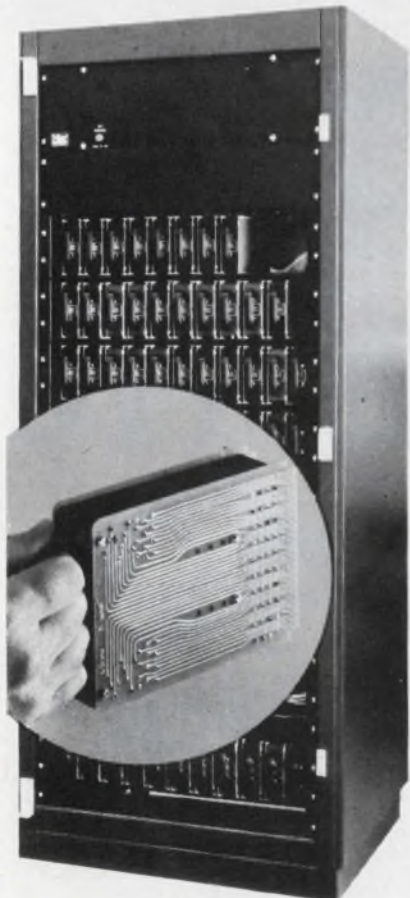

CIRCLE NUMBER 226

## Design aids

### Data communications

A wall-mountable chart provides circuit and operational details for both RS-232C and current-loop data communication. Termiflex.

CIRCLE NO. 817

### Stepping-motor technology

For those who like to hear it, there's a 15-minute cassette tape to go with a 52-page "Design Engineers' Guide to DC Stepping and AC Synchronous Motors." The package costs \$5. Superior Electric, Briston, CT 06010.

CIRCLE NO. 818

### Slide rule

The metric/inch gear computer, a pocket slide rule, indicates 18 different gear functions, inch gear data on one side and metric on the other. PIC Design Div., Benrus Corp.

CIRCLE NO. 819

### Process control tables

Conversion tables and engineering data useful in process control are found in a 20-page handbook. The Foxboro Co.

CIRCLE NO. 820

### Motor controls

"Selection Guide to Solid State Motor Speed Controls" details each model, giving a full description, dimensions, ratings (amps and voltage), type of mounting, standard and optional features, and typical applications. KB Electronics.

CIRCLE NO. 821

### Intelligent terminals

A guide presents the company's intelligent-terminal line in summary form. Included are two charts. The first details the relationship among the standard intelligent terminals in its stored-program-display (SPD) product line. The second chart gives the basic hardware and software characteristics. Incoterm.

CIRCLE NO. 822

## Application notes

### Linear LSI products

A 176-page handbook, "Siliconix LSI Design Catalog," provides PC-board layouts, parts lists and construction tips for building prototype systems. Included are application notes, which describe IC functions, operating characteristics and design considerations. Siliconix, Santa Clara, CA

CIRCLE NO. 823

### X-Y recorders

How to evaluate X-Y recorders based upon acceleration and slewing-speed specs is shown in a four-page note. Hewlett-Packard, Palo Alto, CA

CIRCLE NO. 824

### Data processing

"Distributed Data Processing: The Practical Alternative" describes the advantages of the newest computer phenomenon and how DEC Data-systems can match resources to evolving needs. Digital Equipment, Northboro, MA

CIRCLE NO. 825

### Instrumentation

Four application notes are available from Fluke. For the 40-page "System Use of the Fluke Model 8500A," CIRCLE NO. 828; for the four-page "A Practical Comparison of Average vs True Rms Ac Measurements," CIRCLE NO. 829; for the 12-page "Models 6010A & 6011A Signal Generators," CIRCLE NO. 831; and for the 12-page "80T-150 Temperature Probe," CIRCLE NO. 830. John Fluke Mfg. Co., Mountlake Terrace, WA

### 8085-based $\mu$ Cs

A 288-page manual covers operation, specifications and applications of the 8085 and other basic MCS-85 components, general-purpose and dedicated-function peripherals, and standard RAM and ROM components used to expand the system. Copies are \$5. Send check or money order to Intel, Literature Dept., 3065 Bowers Ave., Santa Clara, CA 95051

INQUIRE DIRECT



# 150 watts of power for Floppy Disk Subsystems

Introducing the field-proven AED 101. A high-efficiency power supply designed to provide the special DC power range required to operate floppy disk subsystems with one to four drives. Extremely compact and lightweight in design, the AED 101 provides the highest power output available for floppy disks. Triple output (5V @12 Amps, -12V @ 7 Amps, +24V @ 3.5 Amps) for four drives, drive electronics, formatter and interface circuitry. Other features include OVP, foldback current limiting, 5V switching regulator, and superior cost/efficiency ratio. Contact us today for detailed specifications and our low prices. Immediate delivery from stock, \$150 in production quantities.

**ADVANCED ELECTRONICS DESIGN, INC.**

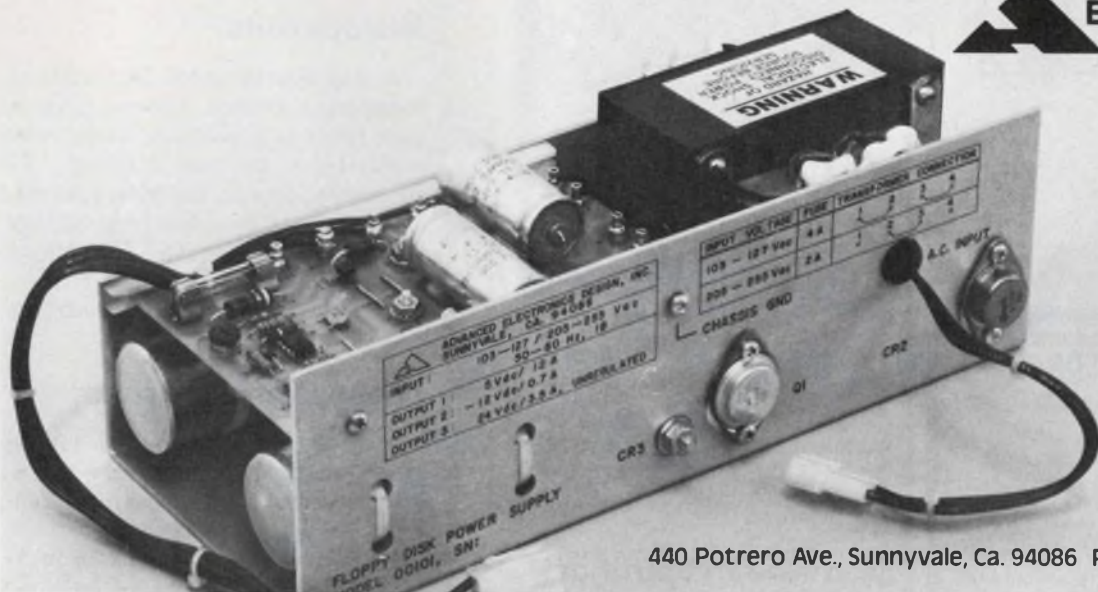

440 Potrero Ave., Sunnyvale, Ca. 94086 Phone 408-733-3555

CIRCLE NUMBER 227

## NEW 1-PC NYLATCH<sup>®</sup>

PATENTS PENDING

The Lowest Installed Cost-Positive Latching Systems!

Multi-Purpose Blind Fastener/HN4-2 Model

- Designed to increase wide range of Nylatch<sup>®</sup> fastener applications to ultra-high speed assembly operations
- Installation, captivation and latching require only single mallet tap on plunger head
- Following captivation of grommet, connecting web shears, allowing plunger to continue inward to latch
- Thereafter, plunger is pulled to release, pushed to latch, cycling over 10,000 times!



### Split Second Installation

The HN4-2 One-Piece Nylatch<sup>®</sup> is available in the nominal 1/4" dia. size with mini-grip (shown) and tamper proof handles.

Design is ideal for applications requiring quick access to panels and doors. **Write today for specifications and FREE sample!**

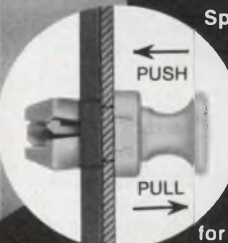

Latching Specialists Since 1939

**THE HARTWELL CORPORATION**  
900 S. Richfield Rd., Placentia, Calif. 92670  
(714) 993-4200. Branch Offices & Warehouses  
Chicago, Ill. (312) 253-7820. Fort Worth, Tex.  
(817) 535-0824. Hackensack, N.J. (201) 342-2964



CIRCLE NUMBER 228

ELECTRONIC DESIGN 21, October 11, 1977

## Noise sensitivity problems go away - we guarantee it!

Topaz Ultra-Isolation Transformers provide an inexpensive and reliable way to supply clean, noise-free AC power to sensitive equipment such as computers, instrumentation, communication and process control equipment.

Ultra-Isolation Transformers offer the industry's best noise attenuation:

- Common-mode noise rejection greater than 145 dB.
- Transverse-mode noise rejection greater than 125 dB at 1 kHz.
- Standard models 125 VA to 130 kVA.
- Priced from \$120.



**Our guarantee:** A Topaz Ultra-Isolation Transformer will solve your noise sensitivity problems to your complete satisfaction or we'll take it back—no questions asked.

**TOPAZ** SOLUTIONS TO POWER PROBLEMS  
ELECTRONICS

3855 RUFFIN ROAD, SAN DIEGO, CA. 92123 • (714)279-0831 • TWX (910)335-1526

CIRCLE NUMBER 229



# Available Now!

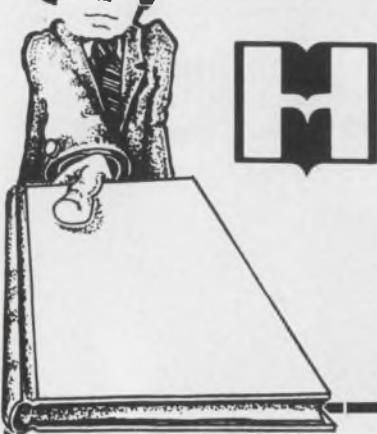

## MICROPROCESSOR

**BASICS**, edited by Michael S. Elphick. Here's the nitty-gritty on design selected from *Electronic Design* for the eight currently popular microprocessors: 8080, 6800, F8, PACE, IMP, 2650, 1802, and 6100. Each chapter discusses one model, detailing its advantages, disadvantages, architecture, capabilities, and includes many illustrations of its applications. #5763-6 paper 224 pp., \$10.95

## ORGANIZING AND DOCUMENTING DATA PROCESSING INFORMATION,

by Thomas R. Gildersleeve. Write sharp, precise DP documents that command attention. This book will show you how to... prepare a first draft... shape your sentences for reading ease... organize a document for quick study. Filled with examples of great DP writing and scores of exercises for practice. #5739-3 paper, 160 pp., \$7.95

Please send the book(s) checked on 15-day examination. At the end of that time, I will send payment, plus postage and handling, or return the book(s) and owe nothing. On all prepaid orders, publisher pays postage. Prices are subject to change without notice. Offer good in U.S.A. and Canada only.

NAME \_\_\_\_\_

COMPANY \_\_\_\_\_

ADDRESS \_\_\_\_\_

CITY \_\_\_\_\_

STATE/ZIP \_\_\_\_\_

Send to:

Hayden Book Company, Inc.  
50 Essex Street, Rochelle Park  
New Jersey 07662

\*77-62

## New literature



### Test instruments

A 68-page catalog provides detailed descriptions of many of the more than 12,000 electrical and electronic test instruments available for rent. General Electric, Schenectady, NY

CIRCLE NO. 832

### Microwave control devices

A 43-page microwave solid-state control-devices catalog features switches, attenuators, limiter and video filters. There are also sections on processing and testing and design-oriented application notes for making rf and video tradeoffs. Crown Microwave, N. Billerica, MA

CIRCLE NO. 833

### Connector caps

Product information is available on connector caps for power resistors, with spring fingers made of beryllium-copper and available with or without straps. Carborundum, Niagara Falls, NY

CIRCLE NO. 834

### Logic-circuit testing

A 350-page handbook includes chapters on microprocessor testing and field-service testing, describes available programming testing and fault-isolation techniques, and explains how to calculate the optimum comprehensiveness for test programs, how to assign priorities for boards to be programmed, and how to prepare financial analyses. \$95 to \$165. Omnicomp, Phoenix, AZ

INQUIRE DIRECT

### Keyboard modules

Sloped and stepped Hall-effect keyboard modules that may be used as single units, panel arrays or as keyboards are described in an eight-page product sheet that also lists features and typical applications. Honeywell, Freeport, IL

CIRCLE NO. 835

### Microcircuits

A step-by-step guide for OEMs to incorporate custom microcircuits in such fields as appliances, autos, communications, business machines, instruments, process controls, and machine tools is provided in a 24-page illustrated brochure. American Microsystems, Santa Clara, CA

CIRCLE NO. 836

### Photoelectric sensors

A four-page short-form catalog briefly outlines subminiature photoelectric sensors with electronic controls, including special systems and bar-code reading equipment. Skan-A-Matic, Elbridge, NY

CIRCLE NO. 837

### Power relays

Hermetically sealed power relays are described in a two-page bulletin that features diagrams of the internal wiring, operating characteristics and specs as well as ordering information and module dimensions. Struthers-Dunn, Pitman, NJ

CIRCLE NO. 838

### Flat cable

Basic data on the advantages of using flat-cable systems, as well as information on types of flat cable and terminations available are offered in a flat-cable design guide. Institute of Printed Circuits, Evanston, IL

CIRCLE NO. 839

### FETs and linear ICs

A 42-page selector guide offers specs, prices and competitive substitution information for JFETs, MOSFETs, some linear ICs, a smoke-detector circuit and new MOS power FETs. Siliconix, Santa Clara, CA

CIRCLE NO. 840



# Our love affair with LSI-11\*



**LOOK...this gal has POWER!**

And you double your speed when we help pedal with:  
Power Supplies; Packaging; RAM, EPROM & Multi-Access  
Memory Floppy Disk; D.M.A.; SYNCH & ASYNCH Ports;  
Peripheral Interfaces, CAMAC Interface; Prototype Modules  
and many, many others.

Write or call (415) 657-7555

**STANDARD ENGINEERING CORPORATION**  
4400 Industrial Drive • Fremont, Calif 94538 • 415 657-7555

\*Trademark Digital Equipment Corporation

CIRCLE NUMBER 239

# 1st In Micro Processor Crystals

Crystek has been first in Micro  
Processor Crystals from the be-  
ginning. This means . . .

- More experience to satisfy your needs
- Less engineering & delivery time
- Dependability through stringent quality control
- Low costs through volume production

Since 1958, Crystek has been a supplier for all types of  
crystals.

Send for descriptive literature

**CRYTEK CRYSTALS CORPORATION**  
1000 Crystal Drive • Ft. Myers, FL 33901  
813-936-2109 TWX 510-951-7448 FOMY



CIRCLE NUMBER 240

ELECTRONIC DESIGN 21, October 11, 1977

# Multiple choice

1,700 answers  
to electrical enclosure needs  
by Hoffman.

Quick answers too. Hoffman offers you "off-the-  
shelf" shipment on most of over 1,700 standard  
electrical/electronic enclosures.

Each of them is built to meet the quality standards  
that made Hoffman's reputation. They include:

1. NEMA 1, 3, 4, 9  
and 12 enclosures

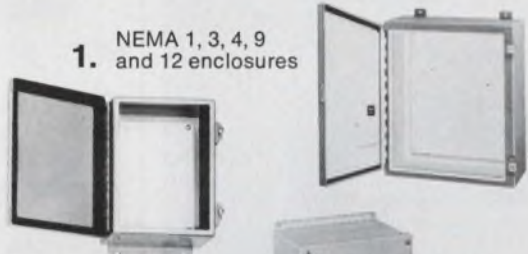

2. JIC-type boxes



3. Pushbutton  
enclosures



4. Wireways



5. Consoles and  
consolets

6. Fiberglass  
enclosures



7. Cutout and  
pull boxes



8. Transformer  
cabinets

If you have a need that isn't met by one of our over  
1,700 standard enclosures, we can modify them or  
custom engineer and fabricate per your specifica-  
tions. Our free catalog gives details on quality  
Hoffman enclosures and is available on request.  
Put Hoffman to the test.

**Hoffman** **ELECTRICAL  
ENCLOSURES**

HOFFMAN ENGINEERING COMPANY  
Division of Federal Cartridge Corporation  
ANOKA MN 55303 DEPT ED524

CIRCLE NUMBER 241



# Designers Choice In Low-Cost 8-Bit A/Ds

## 3 New Series In Dual In-Line Packages

Provide choice of

- Input ranges  
+10V, -10V,  $\pm 5V$ ,  $\pm 10V$
- Power supplies  
 $\pm 12V$  or  $\pm 15V$
- Conversion time  
2.5 or 6  $\mu\text{sec}$  max.
- Operating temperature  
-0° to 70°C  
-55° to +125°C
- Mil-Std 883  
processing



**MN 5120 \*\$49**

( $\pm 15V$  6  $\mu\text{sec}$ )

**MN 5130 \*\$59**

( $\pm 15V$  2.5  $\mu\text{sec}$ )

**MN 5140 \*\$59**

( $\pm 12V$  2.5  $\mu\text{sec}$ )

\* (1 to 24 units)



Micro Networks Corporation  
324 Clark Street, Worcester, MA 01601  
(617) 852-5400 TWX 710-340-0064

CIRCLE NUMBER 242

## NEW LITERATURE



### Semi products

A 148-page cross-reference and product guide lists and describes transistors, complementary-pair transistors, zener diodes, diodes, color-TV crystals, integrated circuits and field-effect transistors. P.R. Mallory, Indianapolis, IN

CIRCLE NO. 841

### Recording instruments

A 16-page illustrated catalog describes a line of analog and digital recording instruments and systems. It includes key performance specifications for industrial, scientific and biophysical measurements. Gould, Cleveland, OH

CIRCLE NO. 842

### Electronic hardware

A short-form catalog contains detailed specifications, ordering data and prices on cable plugs, socket and terminal strips, transistor and IC sockets, and adapter plugs and covers. SAM-TEC, New Albany, IN

CIRCLE NO. 843

### Analyzing instruments

Instruments and systems for analyzing audio-frequency spectra, distortion, frequency response and very-low-frequency phenomena are illustrated in a 16-page brochure. Spectral Dynamics, San Diego, CA

CIRCLE NO. 289

### Metal tubing

Information on available sizes, materials and types of small metal tubing is available in Spec Sheet 100. Handy & Harman, Norristown, PA

CIRCLE NO. 290

# Bulletin board

United Systems has reduced the price of its DigiTec 8320 high-resolution, time-interval counter to \$4500.

CIRCLE NO. 295

Fairchild has signed an agreement to second-source Mostek's 3870 single-chip microcomputer and the 3871 peripheral input/output circuit.

CIRCLE NO. 296

Intel's 8748 single-chip microcomputer system is available from its distributors, along with the 8035  $\mu\text{C}$  and the 8243 I/O expander.

CIRCLE NO. 297

Burr-Brown has cut the price of its Model 4341 true-rms-to-dc converter up to 20%.

CIRCLE NO. 298

Solitron Devices has reduced prices on its npn power-transistor families. The 10,000-qty prices are: 2N3054, \$0.35; 2N3055, \$0.49; 2N3771, \$0.82; 2N3772, \$0.74 and 2N3773, \$1.50

CIRCLE NO. 299

Raytheon Data Systems has added IBM 360/20 remote job-entry enhancement to its PTS-1200 distributed-systems line.

CIRCLE NO. 351

Hewlett-Packard has reduced prices up to 39% on its light-emitting-diode lamps.

CIRCLE NO. 352

Silicon General's 7800A series of positive fixed-voltage regulators are interchangeable with the industry-standard SG7800, SG140/340 devices. Using on-chip trimming of output voltage, accuracy can be held to within 1.5%.

CIRCLE NO. 353

With its support capability for the TMS 9900  $\mu\text{P}$ , the Tektronix 8002 microprocessor lab adds the first 16-bit device to the growing family of  $\mu\text{Ps}$  for which it provides complete software/hardware design, emulation and debug capabilities.

CIRCLE NO. 354



# PROM ERASER



Designed specifically to deliver a calibrated dose of ultraviolet at the correct wavelength and intensity to assure long-term data retention. Tested by leading manufacturers of EPROMs, it meets data-sheet requirements of Intel, National, AMD, AMI, Mostek and others.

- SAFE - Operator protected against uv and ozone
- SMALL - 7 in. wide, front loading
- AUTOMATIC lamp start and timer
- CONVENIENT - Metal-tray loading
- FLEXIBLE - One to 60 PROMS per cycle
- AVAILABLE from current stock

Write or call for further data, or to order

**TURNER DESIGNS**  
 2247A Old Middlefield Telephone  
  
 Mountain View, CA 94043  
 415/965-9800

CIRCLE NUMBER 243

## MICROPAC

AVAILABLE FROM STOCK  
**HYBRID VOLTAGE REGULATORS**



4 TO 10 amp  
 output current

- 5 to 37 fixed voltage range
- Positive & Negative voltages
- 120 Watts power dissipation
- Internal short circuit protection
- Available to MIL-S-883 B
- External components not required
- Standard TO-3 Package
- Available from stock
- Economically priced

Write for Micropac Capabilities Brochure  
 on Custom Thick & Thin Hybrid Microcircuits

**mii**

**MICROPAC INDUSTRIES, INC.**

905 E. WALNUT ST. GARLAND, TEXAS 75040 Tel. 214-272-3571  
 TWX 910-860-5186

CIRCLE NUMBER 244

ELECTRONIC DESIGN 21, October 11, 1977

**Here's Preston's answer to  
 "do-it-yourself" card-module ADCs:**

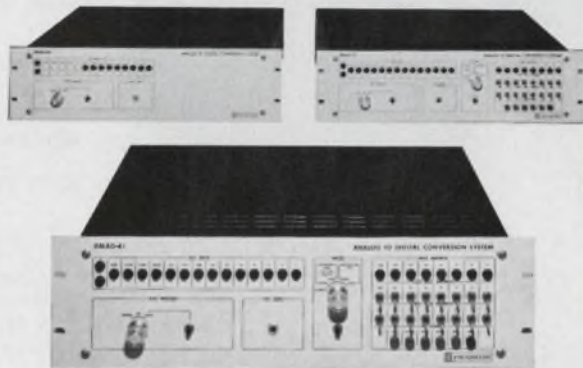

**"Preston's new lower-cost ADCs  
 with high speed 15 bit accuracy  
 and built-in system flexibility!"**

Preston's new GMAD-4 Analog-to-Digital Converters give you a choice of three resolutions—9, 11 or 14 bits—(plus sign, of course)—and a 'quick-step' conversion time of only 25 microseconds!

These new ADCs are delivered complete with front panel controls and back-panel system interfacing signals that make it easy for you and your data acquisition system to control all of the built-in operating modes.

Everything is included in this low-profile chassis—the ADC, all the timing and address controls, a Sample-and-Hold Amplifier (if you need it) and the central power supply—and there's still room for as many as 256 analog multiplexer channels!

And when it's time to expand your GMAD-4 ADC system, you can add 1000 or more multiplexer channels for less than \$20 per channel!

For complete specifications on the GMAD-4, plus detailed timing and interconnection data, ask for your copy of Preston's 12 page GMAD-4 brochure. And if you need information on the other GM Series ADCs that cover the range of conversion speeds from 10 microseconds to 100 nanoseconds, we'll send it along, too.

Just write to Preston Scientific, Inc., 805 E. Cerritos Ave., Anaheim, California 92805—or call us at (714) 776-6400.

We'll put all our years of experience on the line!



 **PRESTON**

CIRCLE NUMBER 245



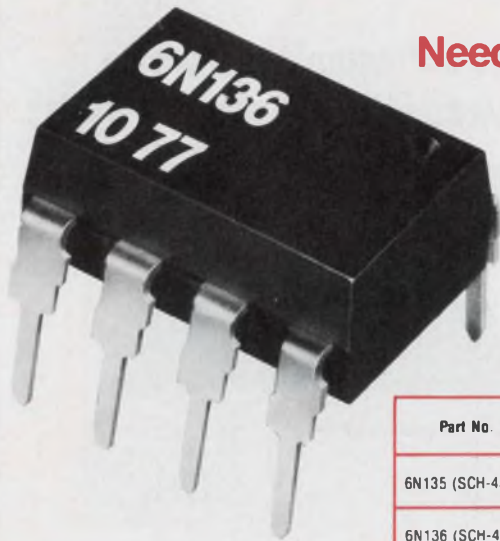

## Need a second source on high-speed optically coupled isolators?

Spectronics 6N135-6N139 are pin-for-pin replacements for respective HP6N135-139 devices.

3000 VDC Isolation!

Now there's a second-source for those hard-to-find high speed optically coupled isolators. Spectronics, Inc., leading manufacturer of quality optoelectronic products, is offering advanced technology optical isolators in 8-pin DIPs. (See chart at right for performance features.)

For more details and delivery information, contact our Corporate Office at 830 E. Arapaho Road, Richardson, Texas 75081, (214) 234-4271.

Part No.	Input Current	Data Rate	CTR
6N135 (SCH-4350)	16 ma	1 Mbit/sec	7% (min)
6N136 (SCH-4351)	16 ma	1 Mbit/sec	19% (min)
6N137 (SCH-4360)	5 ma	10 Mbit/sec	700% (typ)
6N138 (SCH-4370)	1.6 ma	300 Kbit/sec	300% (min)
6N139 (SCH-4371)	0.5 ma	300 Kbit/sec	400% (min)



**Spectronics**  
INCORPORATED

CIRCLE NUMBER 246

## MICROPROCESSOR CASE

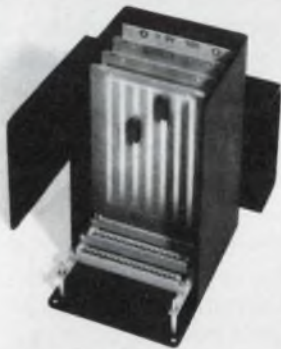

A new pc card case with optional heat sinking and/or blower accommodation. "TEKARD" cases receive standard 4.5" wide pc cards, as made by many manufacturers. The connector rails have up to 37 mounting positions, spaced on .200". Five extruded shapes are available in three lengths, allowing 45 "off the shelf" kits.

"TEKARD" case basic unit prices range from \$17.97 to \$39.77.

**DESTEK** P.O. Box 24163  
INDUSTRIES L.A. CA 90024  
(213) 474-5093

CIRCLE NUMBER 247

## MOVING?



If you've recently moved or plan to in the near future, tell us, and we'll send your issues to you at your new office.

For fast, accurate service:

1. Detach the Change of Address Form bound into the back of this issue.
2. Remove the mailing label from the front cover of this issue and affix it to the designated area on the card.
3. Print your new address in the grid provided.
4. Write date that the change becomes effective. (Please allow 6-8 weeks for processing).
5. Affix proper postage to card and mail today!

## Across the desk

(continued from page 7)



Sure you'll be a great designer someday. Engineers don't dress so conservatively any more.

Sorry. That's Michelangelo Merisi's (Caravaggio) "The Fortune Teller," which hangs in the Louvre in Paris.

## More capabilities than you think

The second paragraph of your article on "Bit-oriented Protocols..." (ED No. 12, June 7, 1977, p. 36) contained a serious misrepresentation of the capabilities of Digital Equipment Corporation's DDCMP protocol.

While it is true that DDCMP is a byte-oriented protocol, it has all the advantages listed for SDLC, and then some.

To be more specific,

1. DDCMP is independent of line characteristics. It runs on full duplex lines quite as successfully as on half-duplex. It also runs on asynchronous lines as well as synchronous—something the bit stuffing SDLC protocol cannot do.

2. DDCMP does lend itself to LSI implementation, and is in fact totally implemented in the microcode of Digital's standard DMC-11 line controller.

3. There are no line turnarounds with DDCMP on full-duplex links. In fact the multiacknowledge feature (one ACK message can acknowledge many data messages), coupled with an ability to acknowledge messages received within control headers of messages being transmitted, makes DDCMP ideal for use over satellite links, where long-line turnaround delays have traditionally been a problem.



4. Error checking is ensured by a CRC16 polynomial, transmitted with both the control information and the user data. The chances are that successful aliasing (an undetected error) on a 9600-baud link would not have occurred had DDCMP been running on it continuously since the start of this century.

In conclusion, future communications probably will not all be "bit-oriented." Rather, it will all be independent of line characteristics, as DDCMP and, to a lesser extent, SDLC are today.

*Ron Kleinman*

Digital Equipment Corp.  
2656 Walsh Ave.  
Santa Clara, CA 95050

## Give and take

You really know how to hurt a guy! Not too long ago, I found your "Dear Deer," editorial (ED No. 11, May 24, 1977, p. 51) helpful in driving a salesman out of my office. He had made many claims for the quality of his product, one of which was that his foundry was "OSHA-approved." This really has little to do with the quality of the product. When he repeated it for the third time, I quickly rummaged through my stack of ELECTRONIC DESIGNS, found your editorial and handed it to him. Our meeting drew rapidly to a close.

But in "Time for Decisions" (ED No. 13, June 21, 1977, p. 51), you take poor little me to task. Thanks for the advice. I will try to do better.

*Roy E. Crocker*

CBC Inc.  
167 Hamakua Dr.  
Kailua, Oahu, HI 96734

## A big wow

I read George Rostky's editorials faithfully and have been meaning to write for some time. But "Time for Decisions" (ED No. 13, June 21, 1977, p. 51):

WHOOPS

It's pasted on the wall to the left of my desk. Right where I can see it—every morning. Lest I forget.

*John S. Simonton, Jr.*  
President

PAIA Electronics, Inc.  
P.O. Box 14359  
Oklahoma City, OK 73114

## New Books

**Displays for Man-Machine Systems**—IEE Conference Publication, April 1977, The Institution of Electrical Engineers, PO Box 8, Southgate House Stevenage, Herts. SG1 1HQ, England. UK £8.30, 1441 p. overseas £9.70.

CIRCLE NO. 251

**6800 Programming for Logic Design**—A. Osborne, Osborne & Associates, Inc., P. O. Box 2036, Berkely, CA 94702, 314 p. \$7.50

CIRCLE NO. 233

**Electronic Communications**—D. Roddy and J. Coolen, Prentice-Hall Inc., Englewood Cliffs, NJ 07632, 706 p. \$19.95

CIRCLE NO. 256

**Introduction to Circuit Synthesis and Design**—G. C. Temes and J. W. LaPatra, McGraw-Hill Book Co., 1221 Avenue of the Americas, New York, N.Y. 10020, 598 p. \$21.50

CIRCLE NO. 257

**A User's Handbook of Semiconductor Memories**—E. R. Hnatek, John Wiley & Sons, Inc., 605 Third Ave., New York, NY 10016, 652 p. \$29.50

CIRCLE NO. 258

**Digital Filters**—R. W. Hamming, Prentice-Hall Inc., Englewood Cliffs, NJ 07662, 226 p. \$17.95

CIRCLE NO. 259

**Applying Microprocessors**—edited by L. Altman, S. E. Scrupski, McGraw-Hill Book Co., 1221 Avenue of the Americas, New York, NY 10020, 191 p. \$15

CIRCLE NO. 277

**MOS/LSI Databook—National Semiconductor**, 2900 Semiconductor Drive, Santa Clara, CA 95051, 714 p. \$4

CIRCLE NO. 278

**Logical Design Using Integrated Circuits**—W. D. Becher, Hayden Book Co., 50 Essex St., Rochelle Park, NJ 07662, 320 p. \$17.95

CIRCLE NO. 279

**Power Transistor and TTL Integrated-Circuit Applications**—Texas Instruments, P. O. Box 5012, Dallas, TX 75222, 248 p. \$16.50

CIRCLE NO. 280

**Microprocessor Basics**—edited by M. Elphick, Hayden Publishing Co., 50 Essex St., Rochelle Park NJ 07662, 215 p. \$9.95

CIRCLE NO. 293

# Quad Output Power Sources...

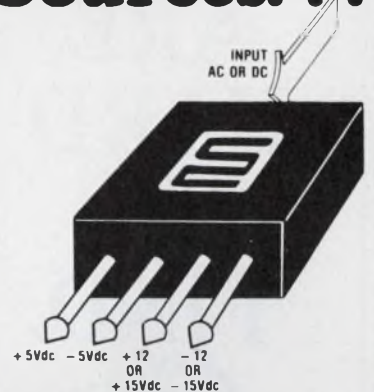

## QUADRUPLE YOUR DESIGN POWER DENSITY!!

Now... Up to FOUR dc outputs from a compact, cool-running package... AC/DC and DC/DC models for powering  $\mu$ P's, A/D/A's, DAS's and op amps.

### Take Your Choice . . .

#### OUTPUTS . . .

$\pm 5$ ,  $\pm 12$ ,  $\pm 15$ V  
... To 25 Watts

#### INPUTS . . .

AC  
105-125Vac  
210-250Vac (K2 Option)  
50-440Hz (All Models)

#### DC

4.5-90V  
INPUT RANGE UP TO 4:1  
Over/under voltage protection available

#### PERFORMANCE . . .

Reg. to 0.15%

#### RELIABILITY . . .

MTBF's > 100,000Hrs.

#### PRICE . . .\*

From \$133.00 (unit)

\*LIBERAL OEM DISCOUNTS

To get complete data and our NEW 1977 Catalog, circle the number below. Your No. 1 SOURCE is ready to serve you.



**SEMICONDUCTOR  
CIRCUITS, INC.**  
POWER SOURCES DIVISION

306 RIVER ST., HAVERHILL, MA 01830  
TEL (617) 373-9104, TWX 710 347 0269

CIRCLE NUMBER 248



# GOOD BOOKS ARE HARD TO FIND.



# WHY HIDE YOURS?

We are always looking for well-written manuscripts, or book proposals, for works on topics of interest to professional engineers that will advance their understanding of the state of their art.

What have you been working on?

What can we do for each other?

Let me know.

**S. WILLIAM COOK**  
EDITORIAL DIRECTOR



**Hayden Book Co., Inc.**

50 ESSEX STREET  
ROCHELLE PARK, N.J. 07662

## Electronic Design

### Advertising Sales Staff

Susan G. Apolant  
Sales Coordinator

### Rochelle Park, NJ 07662

Robert W. Gascoigne  
Thomas P. Barth  
Stan Tessler  
Constance McKinley  
50 Essex St.  
(201) 843-0550  
TWX: 710-990-5071  
(HAYDENPUB ROPK)

### Philadelphia

Thomas P. Barth  
(201) 843-0550

### Boston 02178

Gene Pritchard  
P.O. Box 379  
Belmont, MA 02178  
(617) 489-2340

### Chicago 60611

Thomas P. Kavooras  
Berry Conner, Jr.  
200 East Ontario  
(312) 337-0588

### Cleveland

Thomas P. Kavooras  
(312) 337-0588

### Los Angeles 90045

Stanley I. Ehrenclou  
Burt Underwood  
8939 Sepulveda Blvd.  
(213) 641-6544

### Texas

Burt Underwood  
(213) 641-6544

### San Francisco

Robert A. Lukas  
465 S. Mathilda, Suite 302  
Sunnyvale, CA 94086  
(408) 736-6667

### England

Constance McKinley  
50 Essex St.  
Rochelle Park, N.J. 07662  
Phone: (201) 843-0550

### Europe

Sanders, W. J. M.  
Raadhuisstraat 24  
Graff-De Ryp, Holland  
Phone: 02997-1303  
Telegrams: Euradteam-Amsterdam  
Telex: 13039-SIPAS

### G. Nebut

Promotion Presse Internationale  
7 ter Cour des Petites Ecuries  
75010 Paris, France  
Telephone: 5231917, 1918, 1919

### Dieter Wollenberg

Erikastrasse 8  
D-8011 Baldham/Muenchen  
Germany  
Telephone: 0 8106/4541

### Tokyo

Haruki Hirayama  
EMS, Inc.  
5th Floor, Lila Bldg.,  
4-9-8 Roppongi  
Minato-ku, Tokyo, Japan  
Phone: 402-4556  
Cable: EMSINCPERIOD, Tokyo



## Electronic Design

ELECTRONIC DESIGN's function is:

- To aid progress in the electronics manufacturing industry by promoting good design.
- To give the electronic design engineer concepts and ideas that make his job easier and more productive.
- To provide a central source of timely electronics information.
- To promote communication among members of the electronics engineering community.

**Want a subscription?** ELECTRONIC DESIGN is circulated free of charge to those individuals in the United States and Western Europe who function in design and development engineering in companies that incorporate electronics in their end product and government or military agencies involved in electronics activities. For a free subscription, use the application form bound in the magazine or write for an application form.

If you do not qualify, paid subscription rates are as follows: \$30.00 per year (26 issues) U.S./Canada/Mexico, \$40.00 per year (26 issues) all other countries. Single copies are \$2.50 U.S. and all other countries. The Gold Book (27th issue) may be purchased for \$30.00 U.S./Canada/Mexico, and \$40.00 all other countries.

**If you change your address.** send us an old mailing label and your new address; there is generally a postcard for this in the magazine. You will have to requalify to continue receiving ELECTRONIC DESIGN free.

**The accuracy policy** of ELECTRONIC DESIGN is:

- To make diligent efforts to ensure the accuracy of editorial matter.
- To publish prompt corrections whenever inaccuracies are brought to our attention. Corrections appear in "Across the Desk."
- To encourage our readers as responsible members of our business community to report to us misleading or fraudulent advertising.
- To refuse any advertisement deemed to be misleading or fraudulent.

Individual article reprints and microfilm copies of complete annual volumes are available. Reprints cost \$6.00 each, prepaid (\$5.00 for each additional copy of the same article), no matter how long the article. Microfilmed volumes cost \$23 for 1976 (Vol. 24); \$30 for 1973-75 (Vols. 21-23), varied prices for 1952-72 (Vols. 1-20). Prices may change. For further details and to place orders, contact Customer Services Dept. University Microfilms, 300 N. Zeeb Rd., Ann Arbor, MI 48106. (313) 761-4700.

**Want to contact us?** If you have any comments or wish to submit a manuscript or article outline, address your correspondence to:

Editor  
ELECTRONIC DESIGN  
50 Essex St.  
Rochelle Park, NJ 07662





**MINIATURE CERAMIC TRIMMER CAPACITORS** 9371 series of ceramic trimmer capacitors are compact, economical and rugged. They are 50% smaller than other trimmers of this type yet provide high capacitance values. Available in 4 capacitance ranges, 1.5 to 4, 3.0 to 10, 3.5 to 18 and 5.0 to 25 pf with Q's > 300 at 10 MHz. They have an overall diameter of .225" with .215" above board height. **JOHANSON MANUFACTURING CORPORATION**, Rockaway Valley Road, Boonton, N.J. 07005 201-334-2676

TRIMMER CAPACITORS

181

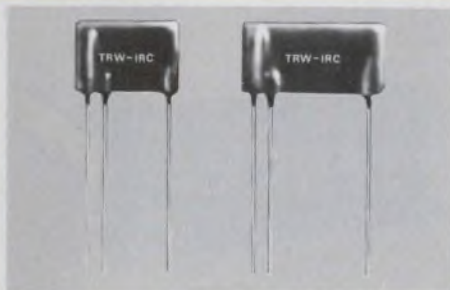

**Thick-Film High Voltage Dividers** are the latest line of high-voltage resistors from TRW. Each device consists of a high-voltage thick-film resistor circuit deposited on a high alumina ceramic substrate. The circuit can be encapsulated in a high-temperature epoxy coating with printed circuit leads or it can be made as a substrate for customer assembly into an integral high-voltage function. Available in various sizes and configurations. **TRW/IRC Resistors**, 401 N. Broad St., Phila, Pa. 19108. (215) 922-8900.

HIGH VOLTAGE RESISTORS

184

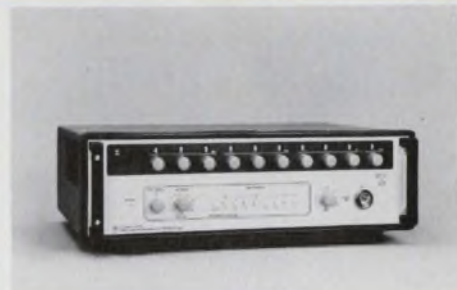

**FREQUENCY SYNTHESIZERS.** GenRad offers the best combination of low-phase noise, fast switching speed and price. Frequency range is dc to 500 MHz. Important features: non-harmonic spurs > 80 dB down; a-m, fm and pm capabilities; built-in search sweep; programmable (BCD parallel) frequency control; and optional resolution to 0.1 Hz. **GenRad**, 300 Baker Ave., Concord, MA 01742, (617) 369-8770.

FREQUENCY SYNTHESIZERS

187



**MAGNETIC SHIELDING** Take advantage of Eagle's 23-year background in shield design and production. Custom and standard models. Full service includes design, engineering, fabrication, heat treating, finishing, testing. Also wide selection of sheet and foil so you can form your own shields. For helpful design and cost data, request Bulletin E-77. **Eagle Magnetic Co., Inc.**, Box 24283, Indianapolis, IN 46224, 317-297-1030.

MAGNETIC SHIELDING

182



**EASY READERS!** Burroughs Bar Graphs are ready for your application. These devices provide instant visual readout of analog information with digital accuracy. They're currently in wide use in automobiles, aircraft, process control systems and instrumentation. Models include dual linear with 1/2 or 1% scales, a dual resettable, for measuring performance against preset ranges, as well as a 120 element circular design. Circle the reader service number for complete information or call Hamilton/Avnet or Cramer Electronics.

BAR GRAPHS

185

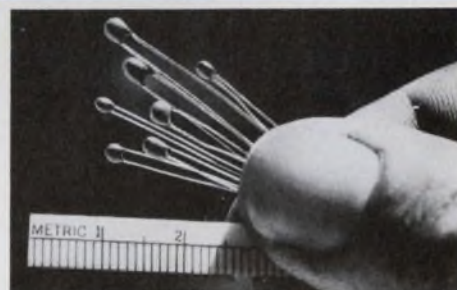

**THERMISTORS** with leads and coating are highly reliable low cost components in small dimensions more compatible with modern circuit design. R @ 25°C 100Ω to 1 meg Ω ±10% to ±1%. **CURVE MATCHED INTERCHANGEABLES** to ±.25°C. **POINT MATCHED INTERCHANGEABLES** to ±.2°C. Call or write for HP97 or TI SR52 THERMISTOR LINEARIZATION PROGRAM. **WESTERN THERMISTOR CORPORATION**, 403 Via El Centro, Ocean-side, CA 92054- (714) 433-4484.

THERMISTOR

188



**OMRON TWO-CIRCUIT LIMIT SWITCHES** Rugged industrial limit switches designed to cover a wide range of applications with a variety of actuators, i.e., high precision, over-travel, operation indicator, solid state, sealed internal, low temperature, heat resistant and corrosion resistant. Switching current: 10A to 480 VAC (resistive). Operating force: 142 gm to 4,082 gm with service life of more than 1.5 million mechanical operations. **OMRON ELECTRONICS, INC.**, 233 S. Wacker Drive, Chicago, IL 60606. (312) 876-0800.

WL TWO-CIRCUIT LIMIT SWITCHES

183



**OMRON PHOTOELECTRIC SWITCHES** Self-contained, pulse-modulated, die-cast aluminum housing for heavy industry, these switches feature bi-color LED indicators for easy installation and system maintenance and IC design for high-reliability in regular reflection and diffuse reflex models. They operate in ambient light to 30,000 lx. Lens separately attached on sidefacing unit housing permits 90 degree increment positioning. **Omron Electronics, Inc.**, 233 S. Wacker Drive, Chicago, IL 60606. (312) 876-0800.

E3N PHOTOELECTRIC SWITCHES

186



**OMRON PROXIMITY SWITCHES** Self-contained oscillation-type heavy-duty industrial switches featuring die-cast aluminum housings and high-reliability solid state ICs which interface easily with electronic control systems. Good noise and temperature immunity. Current-output, voltage-output and AC switching types available. LED operation indicator. Switching response time faster than conventional snap-action or limit switches. **Omron Electronics, Inc.**, 233 S. Wacker Drive, Chicago, IL 60606. (312) 876-0800

E2M PROXIMITY SWITCHES

189



# quick ads

New and current products  
for the electronic designer  
presented by their manufacturers.

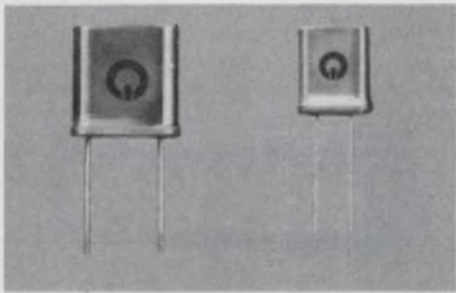

**HIGH STABILITY LOW COST QUARTZ CRYSTAL** for  $\mu$ -processor and clock oscillator. Accuracy is  $\pm 0.002\%$  at  $25^\circ\text{C}$ . Frequency change over  $-10$  to  $+55^\circ\text{C}$  is within  $\pm 20\text{ppm}$ . 1.000, 1.8432, 2.000, 2.097152, 2.4576, 3.2768, 4.0000, 5.0000, 5.0688, 5.1850, 5.7143, 6.5536, 10.0000, 18.0000, 18.4320, 20.0000, 22.1184 Immed. Divy. \$1.85 ea. 10 MHz up in HC-18/u; (Min. 100 pcs.) Q-MATIC CORP., 3194-D Airport Loop Dr., Costa Mesa, CA 92626, (714) 545-8233, Telex 678389

CRYSTAL 190



**Digital AC line monitor Model 37DLM** is designed to measure voltages associated with AC power lines or systems. It offers accuracy of  $1/2\%$  and ease of readability at distances to 20 feet. Ranges are 200 or 400 volts with 0.1 volt resolution or 600 volts with 1 volt resolution at frequencies from 45 Hz to 20 kHz. Prices start at \$164 (discounts to OEM). Availability 3-4 weeks. GRALEX INDUSTRIES, 155 Marine Street, Farmingdale, N.Y. 11735 (516) 694-3607

DIGITAL PANEL METERS 193



**CMOS Crystal Oscillators in Low profile TO-5.** Frequency range is 10 kHz to 300 kHz (divided outputs to 1 kHz, low as one cycle per month available). Low milli-amp current consumption. Accuracy  $\pm 0.01\%$ . Shock 1000 g. Hybrid thick and thin film chip and wire design is rugged and ideally suited for portable equipment. Details in Gold Book & EEM \* STATEK CORP \* 512 N. Main, Orange, Ca. 92668 \* (714) 639-7810 \* Telex 67-8394.

CRYSTAL OSCILLATOR 196



Off-the-shelf, in any quantity, toroidal line transformers are available with 75 most commonly used (6 to 40V) secondaries, 2 x 115V primaries, in 15, 30, 50, 90 and 130VA ratings. Toroids can solve your problems — they have an 8:1 smaller hum field — are 50% lighter — with 50% smaller volume over electrical equivalents — and fully encapsulated in resin filled tough thermoplastic shells. High efficiency saves power, cuts temperature. Green-Shaw Co. Inc., 70 Bridge Street, Newton, MA. 02195 Tel: (617) 969-8900.

TOROIDAL TRANSFORMERS 191



**PROGRAMMING PROVERBS FOR FORTRAN PROGRAMMERS**, H. F. Ledgard. These 26 unique "proverbs," or rules and guidelines, are specially designed to help FORTRAN programmers upgrade the quality of their work. Comes with many sample programs. #5820-9, 144 pages, \$6.95. Circle the Info Retrieval Number to order 15-day exam copy. When billed, remit or return book with no obligation. Hayden Book Co., 50 Essex Street, Rochelle Park, N.J. 07662.

PROGRAMMING PROVERBS 194



**THE '77-'78 GOLD BOOK IS NOW OFF THE PRESS.** Contains 2,496 pages of up-to-the-minute information about the entire electronics industry. Complete with Product, Trade Name, Manufacturers, Distributors Directories and Catalogue Compendium. Price: \$30-U.S., Canada and Mexico. Other countries \$40—Overseas postage included. To order, send check or company purchase order to GOLD BOOK, Dept. #437-R, Hayden Publishing, 50 Essex St., Rochelle Park, NJ, 07662.

'77-'78 GOLD BOOK 197

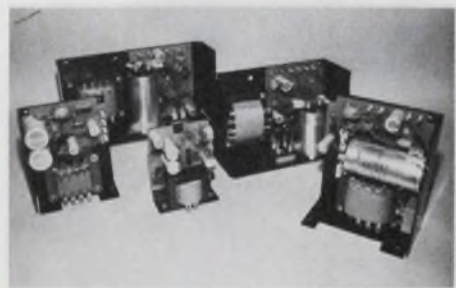

**45 different Open Frame Power Supply models** are available with outputs ranging from 5Vdc to 24Vdc and 500 mA to 15 Amps. Regulation is  $\pm 0.05\%$  for line and  $\pm 0.15\%$  for load. Ripple and noise is less than 5mV max P-P. Standard on all models is a 110/220Vac transformer. Units have a 5 year warranty. COMPUTER POWER SOURCE, INC., 370 Park Ave., Worcester, MA 01610. Contact: Steve Banks 617-752-8972

POWER SUPPLIES 192

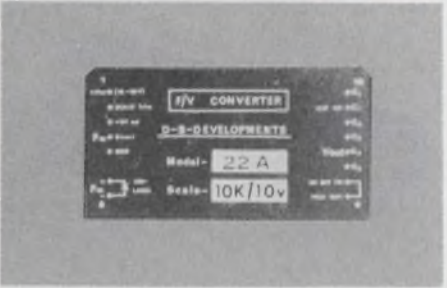

**NEW, RIPPLE-FREE F/V CONVERTER.** A new Design Technique combines ripple-free conversion with fast response. Self-contained (models 22A,B) 10 KHz modules offer linearities to 0.005%, slew rates of 2.5volts/millisecond, and a residual ripple of less than  $1/2$  mv peak to peak. Single (10-16v) and dual ( $\pm 15v$ ) supply operation available. Four decade dynamic frequency range —  $2'' \times 1 \frac{1}{2}'' \times 1 \frac{1}{2}''$ . A basic F/V building block that works. D-B-Developments, 7709 Kilbourne Rd, Rome, NY 13440 (315) 339-1265

RIPPLE-FREE F/V CONVERTER 195



**Overcurrent Protector**, manual reset eliminates fuse replacement. Convenient panel mounting. 19 fractional ratings from 0.1 to 5 amp. Other models up to 400 amp. Trip-free and fool-proof, UL and CSA approved. High quality, low cost \$1.39 ea. in 1000 lots. E-T-A Products Co. of America, 7400 N. Croname Rd., Chicago, Ill. 60648. Tel: (312) 647-8303. Telex: 253780.

CIRCUIT BREAKER 198



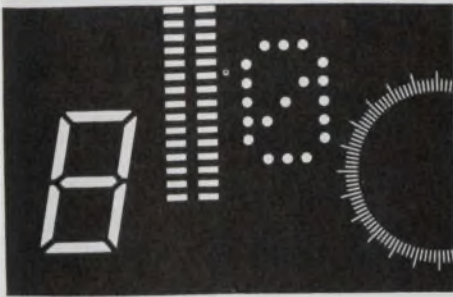

**Power converters for gas discharge displays** DC-to-DC power supplies convert low DC line voltages of 5, 9, 12 or 15 volts to nominal 200 or 250 volt DC levels required to activate gas discharge displays (multi-segment, matrix or bar graph). Ideal for battery powered applications. Ask about custom designs and cost-efficient models for high-volume users. For PC board mounting. ENDICOTT COIL CO., INC., 31 Charlotte Street, Binghamton, N. Y. 13905 (607) 797-1263.

DC-to-DC CONVERTER

199



**QUIK/STRIP BY ROGERS.** Fast, low-cost system for connecting in-line pins on DIP socket boards and connector arrays. Shock and vibration resistant. 18 gauge current capacity. Can be used on pin densities as high as .100" x .100" and be stacked two or more high. Write or call for details. Rogers Corporation, Chandler, AZ 85224. Phone: (602) 963-4584. (EUROPE: Mektron NV, Gent, Belgium; JAPAN: Nippon Mektron, Tokyo.)

QUIK/STRIP

202

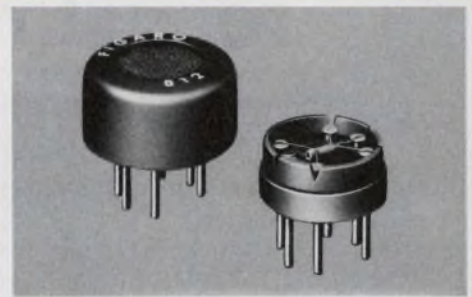

**FIGARO GAS SENSOR TGS** is a gas sensitive semiconductor. When combustible gas is absorbed on the sensor surface, a marked decrease of electrical resistance occurs. Major features of the sensor include high sensitivity, long term reliability and low cost. The applications are: GAS LEAK ALARM, AUTOMATIC FAN CONTROL, FIRE ALARM, ALCOHOL DETECTOR, etc. Figaro Engineering Inc., North America Office-3303 Harbor Boulevard, Suite D-8, Costa Mesa, Calif. 92626 Tel: (714) 751-4103 Telex: 678396

GAS SENSOR

205



**DUAL PRESET UP/DOWN COUNTER** Two presets, large LED display, and operation from a variety of electromechanical and electronic sensors highlight Vorne's Model 215-DUAL. Plug-in relay or solid state output options are available with the 2-5/8 h x 3-1/8 w x 4-1/4" d, 115 VAC operated unit. Priced from \$208 (25 quantity). Vorne Industries, Inc., 5023 West Belmont, Chicago, IL 60641 (312) 725-3077.

INDUSTRIAL PRESET COUNTER

200

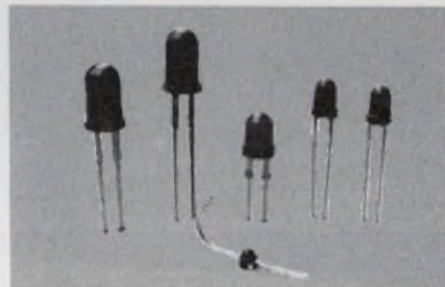

Ultra high Brightness in LED has been achieved in a new and unique process developed by "STANLEY ELECTRIC" of Japan in which continuous liquid growth of Multilayers of Ga Al As compound is deposited on Ga As substrate in the crystal growing phase. Ultra bright LED's made of this material exhibit 60 to 80 mcd at IF 20ma. Samples and literature available from A.C. INTERFACE, INC., 2925 College Ave., #A-1, Costa Mesa, California 92626, (714) 979-9830.

ULTRA BRIGHT LED's

203



**Free New '77 catalog** contains over 34,500 quality power supplies from the world's largest manufacturer, Power/Mate Corp. Power Supplies for every application including submodulars, open frame, variorated, encapsulated, laboratory & system. All units UL approved and meet most military and commercial specs for industrial and computer uses. Power/Mate Corp., 514 S. River St., Hackensack, NJ 07601 (201) 343-6294

POWER SUPPLIES

206



**DIGITAL DISPLAY ELECTRONIC SWEEP Generator WS8-10D.** Three stepless noise-free ramp functions. Eight sweep rates (.5 minutes to 100 minutes std.), two continuously adjustable ranges (0 to  $\pm 2V$ , 0 to  $\pm 2V$ ), automatic sweep centering. "Hold" feature. Digital readout of output or %, either range. Digital signals for computer analyzer, analog signals for recorder. X-Y recorder drive independent of range setting. Remote or cabinet-mounted. Write Walker Scientific, Inc., Rockdale Street, Worcester, MA 01606.

SWEEP GENERATOR

201



**NEW PCB-JACKS**, designed for PC-board mounting, are 1/2 the size of conventional Bantam jacks, 1/3 the size of Long-frame jacks. Solder them directly to the PC-board and eliminate connecting wires and mounting hardware. Compatible with Bantam plugs. ADC Products, 4900 W. 78th, Minneapolis, MN 55435. (612) 835-6800.

PC-BOARD JACKS

204



**Synchro to Linear DC Converter:** Infinite Resolution. Full ( $\pm 180^\circ$ ) or Limited Angle DC Output ( $\pm 90^\circ$ ),  $\pm 6$  or  $\pm 15$  minute accuracy at input rates up to  $1440^\circ/\text{sec.}$ , 60 or 400 Hz input. Custom Output scaling available. Module 2.6" x 3.1" x .82" H. Price from \$350 in quantity. Other CCC Products are Synchro to Digital, Digital or DC to Synchro, Solid State C.T.'s or CDX's, and Absolute Encoders. Send for Free Catalog & Application Notes. Computer Conversions Corp., East Northport, N.Y. 11731—(516-261-3300).

SYNCHRO TO LINEAR DC

207



# Electronic Design

## recruitment and classified ads

PLACE YOUR AD AT ONLY \$45 PER COLUMN INCH IN

### Electronic Design

— GET A REPEAT AD FREE!

With our 2 for 1 plan, your net cost in *Electronic Design* is only \$22.50 per column inch, lowest among all the national newspapers and electronics media. You get a total of 165,402 exposures to OEM engineers and engineering managers (not counting 10,600 more among general or corporate managers) at only 27¢ per thousand! You can't beat the price. You can't beat the coverage and you can't beat the quality.

YOU REACH ENGINEERS WITH TITLES LIKE THESE:

• Chief Engineer • Development Engineer • Design Engineer • Project Engineer • Electronic Engineer • Engineer-Supervisor • Section Leader • Staff Engineer • Systems Engineer • Test Engineer • Standards Engineer • Master Engineer

### Electronic Design RECRUITMENT ADVERTISING RATES

15% commission to recognized agencies supplying offset film negatives. 2% 10 days, net 30 days. Four column makeup. Column width 1-3/4" x 10".

SPACE	DIMENSIONS		COST
	Wide	Deep	
One column inch	1-3/4" x 1"		\$45.
2 col. in.	1-3/4" x 2"		\$90
1/16 page (1/4 col.)	1-3/4" x 2-1/2"		\$112.
1/8 page (1/2 col.)	1-3/4" x 5"		\$225.
1/4 page (1 col.)	1-3/4" x 10" Vert.		\$450.
	3-1/2" x 5" Hor.		
1/2 page (2 cols.)	3-1/2" x 10" Vert.		\$900.
	7" x 5" Hor.		
3/4 page (3 cols.)	5-1/4" x 10"		\$1350.
1 page	7" x 10"		\$1800.

NOTE: EACH RECRUITMENT AD YOU PLACE WILL BE REPEATED FREE OF CHARGE!

### LATE CLOSING DATES

*Electronic Design* is mailed every two weeks. Because of its timeliness, personnel recruitment advertising closes only two weeks before each issue's mailing date.

1977 Mailing Date	Recruitment Closing Date	Issue Date on Cover
Oct. 7	Sept. 23	Oct. 25
Oct. 21	Oct. 7	Nov. 8
Nov. 4	Oct. 21	Nov. 22
Nov. 18	Nov. 4	Dec. 6
Dec. 2	Nov. 18	Dec. 20



### HOW TO PLACE YOUR AD

CALL THE RECRUITMENT  
HOT LINE 201-843-0550

Camera-ready film (right reading negatives, emulsion side down) or camera-ready mechanicals must be received by deadline. Or, if you wish us to set your ad (typesetting is free) simply pick up the phone and call our RECRUITMENT HOT LINE — (201) 843-0550. Ask for:

Constance McKinley  
RECRUITMENT ADVERTISING MANAGER  
ELECTRONIC DESIGN  
50 Essex Street, Rochelle Park, New Jersey 07662

### R&D ENGINEERS

#### MICRO/MINI/COMPUTER

Computer Memory	\$18-28K
Minicom Arch	\$26-31K
Minicom CPU	\$19-28K
Minicom Progmg	\$18-30K
Intel 8080 or M6800	\$18-30K
Non Impact Printers	\$18-25K
ASSEMBLER/FORTRAN	\$16-26K
Microprocessor Apps	\$20-26K
Microprogramming	\$20-26K
A&D Circuit Design	\$20-27K
TV Receiver Design	\$20-26K

Partial List  
Openings in 35 States

Call toll free 1-800-821-2270 X605  
(IN Mo. 1-800-892-7655) or send resume

RALPH STEVENSON Partner

**JIM KING**  
438 GULF LIFE TOWER  
JACKSONVILLE, FLA 32207

#### MANAGER ADVANCED PRODUCT DEVELOPMENT

Outstanding opportunity for creative supervisor of Commercial Business Equipment Development Group. Microprocessor experience and electromechanical paper handling devices appropriate. Salary starts to \$5k.

**Brucks Personnel Corp.**  
2541 Monroe Ave., Rochester, N.Y. 14618  
716-442-5400

#### TEXAS POSITIONS

Engineering, EDP & technical openings throughout Texas & the U.S. 100% fee paid. Send your resume in confidence to ENGINEERING/EDP SEARCH (Agency)  
84 N.E. Loop 410, Suite 124E  
San Antonio, Texas 78216

## Manager Electronic Technology

Are you ready to lead one of the most advanced operations in the telecommunications industry?

If you are, Stromberg-Carlson will offer you the chance to direct a highly skilled engineering team involved in applying the latest semiconductor, power and related electronic technologies to innovative, new telecommunications systems.

As our Manager of Electronic Technology you'll make visible contributions to an important part of our System CENTURY® — a family of digital switching products meeting the exploding demand for state-of-the-art telecommunications systems.

Position requires BSEE or MSEE and 3-5 years experience in analog or digital circuit design. You should also have in-depth knowledge of such areas as microprocessor selection — both evaluation and application, solid-state component characteristics and selection; and analog to digital conversion circuit design.

We offer commensurate salary and excellent benefits. Location is in Rochester, N.Y., an area noted for its broad variety of cultural, recreational and educational attractions. Send resume, including salary history, to: Mr. Steve Peters, Stromberg-Carlson, 100 Carlson Road, Rochester, N.Y. 14603.

## Stromberg-Carlson

A SUBSIDIARY OF GENERAL DYNAMICS CORPORATION

An equal opportunity employer m/f  
U.S. Citizenship or permanent visa required.

### ENGINEERS



Needed for FEE-PAID positions THROUGHOUT THE U.S. Over 1,000 client companies. Send resume and salary history or request confidential application today.

**ATOMIC PERSONNEL, INC.**  
Suite D-2, 1518 Walnut St. Phila., Pa. 19102  
Empl. Agcy. - All Technical Fields - Est. 1959

### DESIGN ENGINEERS

SALARY RANGE: 18,000 -  
Several current openings in digital telecommunications. M.S.E.E. preferred. 3+ years' experience in digital logic and circuit design in areas of modems, multiplexes & digital communication systems required. Send resume in confidence to:

**DATABIT INCORPORATED**  
50 DAVIDS DRIVE HAUPPAUGE NY 11787  
An Equal Opportunity Employer M/F

### SWITCHING POWER SUPPLIES

Outstanding opportunity for Senior Electrical Engineer to work in Magnetic Circuits, pot cores, solenoids and switching power supplies for high speed mechanisms in Matrix Printer development. To 23K

**BRUCKS PERSONNEL CORPORATION**  
2541 Monroe Ave., Rochester, NY 14618  
(716) 442-5400

## PROJECT ENGINEER

A nationally-known, highly regarded manufacturer of electrical/mechanical automotive switches is seeking men to build prototype samples of new products and related assignments. Plant located in northern Indiana college and resort town, boating - fishing abundant. Liberal financial and fringe package. Reply to:

**BOX 000**  
Equal Opportunity Employer M/F  
Please send box replies to:

**ERIC C. BAUM & ASSOC.**  
510 N. Dearborn, Chicago, IL. 60610  
Attn: Mr. Kenneth Alpers, Vice Pres.





# Advanced Software Design

**Talk With Us About The Career Challenges  
In Telecommunications**

**CALL COLLECT  
(312) 681-7731**

**Today thru Friday, from 8 am to 5 pm cst**

Telecommunications is one of the most rapidly growing segments of the software frontier. We have major projects underway now . . . forerunners of our long-term commitment to significantly advancing the state-of-the-art. We're working from definition and design through development and implementation in areas such as CAD, Data Base Systems, Simulation, Fault Recovery, Diagnostics and many areas of software design in an on-line, real-time environment.

## **SOFTWARE DESIGN**

We're looking for an indepth background in the development of systems software and a minimum of 3 years' experience in structured design, testing and documentation of programs running on large data base, multi-file systems in real-time. Familiarity with HIPO design documentation, TSO usage and software simulation techniques as well as PL1, Fortran and assembler languages for the 8080 and PDP 11 programming is also important.

## **DATA BASE DESIGN**

This position requires a minimum of 5 years' experience in the planning development, design and implementation of data base software, including data base management systems administration. Your primary responsibilities will be the development of data base system for a large on-going project including the implementation, support and administration of systems.

## **COMPUTER AIDED DESIGN**

We are looking for an extensive background in the design of CAD/CAM systems and the development of Interactive access by the users of CAD/CAM functions. Required is 5-10 years' experience in both hardware and software aspects; DA systems operations, and design, and systems engineering. Your initial responsibilities will include evaluation of existing systems, and working with a project team in the Architectural Planning of a major new system.

## **MINI-COMPUTER PROGRAMMERS**

We have specific assignments available on project development teams responsible for the design implementation of various telecommunication processing systems utilizing mini-computers as the processing element. Responsibilities will include the development of software programs for real-time operating systems as well as unique hardware elements incorporated into the systems.

If you have in-depth expertise in one or more of these areas, a BS, MS or PhD in Electrical Engineering, Computer Science, Math or other appropriate engineering discipline and have an interest in moving forward with one of the challenging new frontiers in computer technology, talk with us.

**If unable to call, please send your resume to:  
Manager of Technical Employment, Dept. 471A6**

**GTE AUTOMATIC  
ELECTRIC LABORATORIES**

400 N. Wolf Road  
Northlake, Illinois 60164

An Equal Opportunity Employer M/F



## DESIGN DRAFTSMAN

Well-known, highly regarded national manufacturer of electrical/mechanical automotive switches is seeking an innovative electrical/mechanical design draftsman. Plant located in northern Indiana college and resort town - boating - fishing. Liberal financial and fringe package. Reply to:

**BOX 000**

Equal Opportunity Employer M/F

Please send all box replies to:

**ERIC C. BAUM & ASSOC.**

510 N. Dearborn, Chicago, IL. 60610  
Attn: Mr. Kenneth Alpers, Vice Pres.

## ENGINEERS FOR MARKETING

We have immediate needs for engineers familiar with component technology to provide technical support in marketing. The work will involve technical promotion sales training, publicity, some applications and supervision of technical writers. Salaries are \$27-30,000 and \$16-20,000 depending on experience.

## MICROPROCESSOR ENGINEER

Will play a major role in introducing this technology for a leading manufacturer of materials characterization instrumentation. Must be experienced in state of the art microprocessor technology.

For more information on these positions contact Dennis Fitzgerald or Steve Ford at (617) 426-4180 or send resume including salary history to *Technical Department*.

**ROGERS AND SANDS INC.**  
100 FEDERAL ST.  
BOSTON MASS. 02110

## PLUG INTO A NATIONAL NETWORK

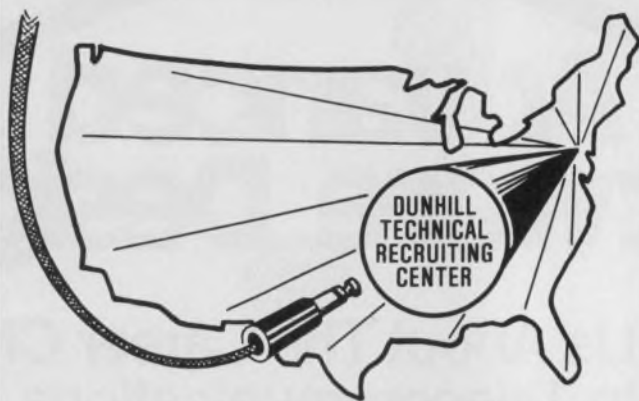

### HARDWARE AND SOFTWARE

- DESIGN ENGINEERS (Digital, Microprocessor, RF, Video, Analog)
- LOGIC
- COMPUTER ARCHITECTURE
- SYSTEMS ENGINEERS
- REAL TIME PROGRAMMERS (Assembler and/or Fortran)
- SOFTWARE DEVELOPMENT
- I C DESIGNERS

### AEROSPACE, INDUSTRIAL, SOLID STATE

Wherever you are or want to go Dunhill Technical Recruiters have growth opportunities. We will prepare a professional presentation of your background and confidentially present it to growth oriented electronic companies searching for talent such as yours. We will do this directly or through one of 200 offices nationwide. Client companies assume all fees including relocation expenses.

Contact: Allen I. Frank

### DUNHILL TECHNICAL RECRUITING CENTER

1009 W. 9th AVENUE - Suite F  
King of Prussia, PA 19406  
215-337-3355 (agency)

### WELLS ELECTRONIC SEARCH, INC. NATIONWIDE

SYS ARCHITECTURE - HARD/SOFTWARE  
Mini, Micro Terms: From Concept 38,000  
SR SYS ENG/ANALYST - Elmt, Sgnt, Comm 25-35,000  
BIOMED - Ultra Sound, X-Ray, CT Scanner  
Gamma Camera, Pacemakers, Implantables,  
Sensors, Fluid Handling, Computer based  
Analyzers 18-32,000  
ADV-DEV - PhD, MS Programmable  
Controller 18-32,000  
SR SOFTWARE ENG - Process Control  
75-35,000  
DIR - DIAGNOSTIC ENGR - programming/  
design automation 43,000  
R&D & DESIGN - Video Games - Analog,  
Video circuits, Modems, CRT displays,  
Micro computer Syst. 18-35,000  
DIGITAL COMM DES ENGRS - Signal  
Processing, Info Theory, Phase Locked  
Loops, Digital filters, Coding, Switching  
Syst. 18-33,000  
MINICOMPUTER - Programmers  
Nationwide 18-32,000  
CONTACT:  
D.L. Sweeney 212 949 8400 Dept. F  
WELLS RECRUITING SYSTEMS, INC.  
545 5th Ave. NYC NY 10017 (AGENCY)

## KEEP Electronic Design's GOLD BOOK HANDY



### When You Call

Save time when you contact suppliers. Check their catalog pages first in *Electronic Design's GOLD BOOK*. Maybe the information you need is right at your fingertips.

## ENGINEERING EXECUTIVE

### SYSTEMS ENGINEERING & ANALYSIS

Requires PhD in Engineering, or Sciences and 10-15 yrs. experience in Systems Engineering and Analysis. Technical expertise will probably be in sophisticated aero-space systems technology, or the design of complex petrochemical processes via computer techniques. Individual must have strong managerial credentials. Successful candidate will plan, staff and direct a new department for their NYSE client engaged in commercial products. Compensation \$40-50K (perhaps more), plus unparalleled benefits and professional growth. All search expenses are paid by our client. In complete confidence, contact C. B. Baker, Executive Search Div., CORPORATE STAFFING, Professional Recruiters, Executive Plaza, Ft. Washington, Pa. 19034. (215) 643-3310.

PLACE YOUR AD AT ONLY \$45 PER COLUMN INCH IN

## Electronic Design

— GET A REPEAT AD FREE!

## ENGINEERS SEEKING A FUTURE IN THE FAST GROWING VIDEO FIELD

Sony Corporation of America, the largest supplier of video equipment in the world, is expanding its technical staff to service broadcast and industrial users of state-of-the-art video equipment. We are looking for engineers with strong technical backgrounds and maintenance experience with video products such as VTRs, studio color cameras, time-base correctors, and related signal-processing equipment.

Job openings as follows:  
**MANAGER OF INSTALLATION AND SERVICE:** Direct a staff of product engineers in providing full support of all broadcast product lines. Formulate procedures to ensure that all installations are carried out according to spec and provide technical guidance to see that field people are properly trained and equipped in maintain the product with a high degree of efficiency. Candidate should possess an EE degree, have proven ability to manage a technical group and have several years of direct involvement in servicing broadcast customers.

Location — NYC area

**VTR PRODUCT ENGINEERS:** Assume complete product support responsibility for specialized video tape recorders. Evaluate field problems, prepare service literature in rough form for engineering change notices, field modifications and service bulletins. Train regional engineers to understand and maintain new products. Candidates should possess an EE degree and have thorough technical knowledge of studio-type recorders and maintenance procedures with at least three years of direct maintenance experience.

Location — NYC area

**COLOR CAMERA PRODUCT ENGINEERS:** Assume complete product support responsibility for state-of-the-art ENG cameras. This includes follow-up on field and application problems, training of field people and the generation of technical support literature such as service/modification bulletins and engineering change notices. Candidates should possess an EE degree and have in-depth knowledge of modern multiple pick-up tube cameras and alignment techniques with a minimum of three years experience in direct maintenance.

Location — NYC area

**VIDEO ENGINEERS:** Work with customers to service video equipment at customer's location and on the bench in regional service labs. Provide on-site training for customer technicians. Candidates should possess an associate degree or equivalent, have an in-depth knowledge of video and VTR systems, and have a minimum of three years direct maintenance experience.

Locations — NYC, Los Angeles, Chicago, Dallas, Atlanta

All positions offer excellent salaries and growth potential. Employment benefits are fully paid by the company and include family coverage, hospitalization, pension plan, profit sharing, life insurance and tuition refund.

This may be your opportunity to join a technically-oriented team in which the opportunities to move forward professionally are better than can be found in most areas of the profession today.

Send your resume in complete confidence to Mr. Jerry McGinty at:

## SONY

### CORPORATION OF AMERICA

47-47 Van Dam Street, Long Island City, N.Y. 11101

an equal opportunity employer m/f



# Engineers... are you pigeonholed?

We won't keep you pigeonholed in the same old assignment, year after year. After all, variety is the spice of a life's work. And we have a commitment to it. We make our living selling variety: command and control systems, complete air defense systems, radar systems, sonar systems, computer systems and much more. We're part of a company of 36,000 people, active in more than 550 major product areas in 80 technologies. Plenty of room for developing interests, plenty of room for growth.

Our Systems Division engineers enjoy technical diversity because of our program variety, and growth opportunities that we're steadily expanding. They benefit from the technically oriented management which put us on our strong growth curve. And they enjoy a good professional environment, where many of our people wear 10, 15, and 20 year service pins.

**Any more good news? Well, yes. We're hiring now.**

**For quick action, reach for your phone instead of your resume ... call M. F. Duggins collect (714) 871-4080, Ext. 5410 between 8 A.M. and 4 P.M. Monday through Friday. Or send your resume to: Professional Employment—Ground Systems Group C, 1901 W. Malvern, Fullerton, CA 92634.**

U.S. citizenship required • Equal opportunity M/F/H/C employer

**HUGHES**

HUGHES AIRCRAFT COMPANY

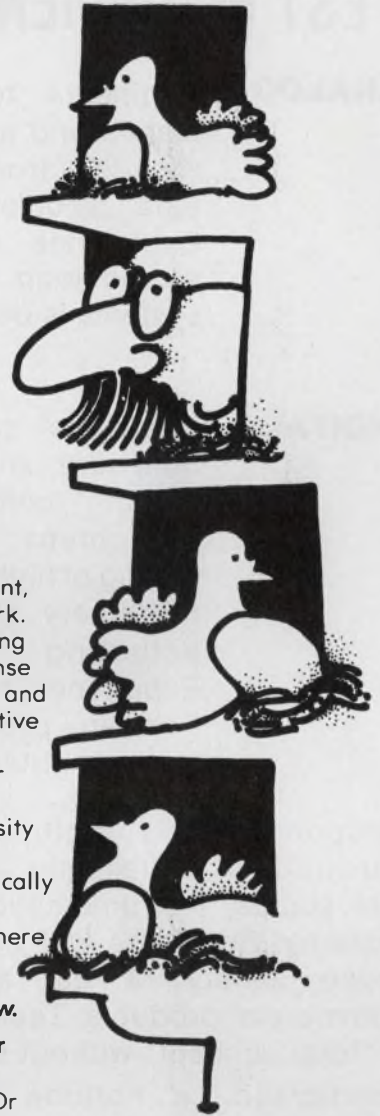

**Communications System Engineers.** Must understand hardware/software interaction, signal processing, spread spectrum.

**Senior Systems Engineers.** Tactical, strategic system application of radar, sonar communications, electro-optical software, data processing and command and control technologies.

**Communication Analysts.** Lead/direct application of systems theory, applied math, estimation, probability to communication system problems.

**Data Processing and Software Analysts.** System level data processing architecture analysis, design, performance evaluation for multisensor systems.

**Display System Engineers.** Long term opportunity to lead display product definition/selection for military C&C Systems.

**Radar Systems Engineers.** Lead/direct radar system conceptual design/analysis. Integration of radar, weapon, command and control systems.

**Senior Air Defense Engineers.** BSEE, Math or Physics, project management experience in real-time hardware software systems.

**Hardware System Engineers.** Large scale data processing, peripheral, display systems design, specification, integration checkout.

**Systems Analysts.** Systems Theory, applied math background. Variety of problems requiring modern analysis techniques.



# ELECTRICAL ENGINEERS TEST EQUIPMENT DESIGN

**ANALOG** - Engineers to design test stands and associated electrical/electronic controls and data acquisition systems. Experience in solid state closed loop analog control systems is desired.

**DIGITAL** - Engineers to design the hardware and software of digital computer based equipment used in the testing of high speed rotating machinery and mechanical actuating equipment. Experience in Assembly and Fortran programming of minicomputers is required.

Responsibilities include the design, construction, installation and checkout of test stands, instrumentation and control systems. Engineers will be exposed to a broad variety of our aerospace and commercial products. Technical exposure is "total concept" without specialization.

Sundstrand, a Fortune 500 advanced technology company, designs, manufactures and markets a variety of aircraft accessory products. Sundstrand offers an excellent benefits package including 14 paid holidays plus vacation and an extensive medical and dental plan. Our headquarters are in Rockford, Illinois, located 90 miles from Chicago.

Send Resumes to:

**SUNDSTRAND CORPORATION**  
**Peter L. Arthurs**  
**4751 Harrison Avenue**  
**Rockford, Illinois 61101**

An Equal Opportunity Employer  
M/F

## ELECTRICAL ENGINEERS

with  
Arnold Research Organization, Inc., contractor operator of the Arnold Engineering Development Center, located in Middle Tennessee.

### Electronic Instrumentation Engineer

Solve engineering problems involved with the performance testing of precision measuring equipment. Develop procedures and techniques for routine servicing and calibration of instruments, particularly in the areas of acceleration/vibration and dynamic pressure. Design and implement digital control circuitry for automation of laboratory processes. Requires BSEE with an interest in physics and up to five years of experience. Fortran programming ability is desirable.

### Electrical Design Engineer

Electrical design for power distribution, process control, communication, building services and lighting systems typical of heavy industrial plants. Requires BSEE and 1-3 years experience.

Please send resume including salary history or request application by contacting:

R. F. Shanks

ARO, Inc.

Arnold Air Force Station, TN 37389

(615) 455-2611, extension 529  
An Equal Opportunity Employer

## Electronic Design

BRINGS YOU THE HIGHEST  
NUMBER OF QUALIFIED OEM  
ENGINEERS AND ENGINEERING  
MANAGERS ANYWHERE  
... AT THE LOWEST COST  
ANYWHERE!

# SPECIAL

## 2 RECRUITMENT ADS FOR THE PRICE OF 1!

Double the coverage . . .  
double the effectiveness  
of every ad you place!

**Constance McKinley**  
**RECRUITMENT ADVERTISING MANAGER**  
**ELECTRONIC DESIGN**  
50 Essex Street, Rochelle Park, New Jersey 07662  
(201) 843-0550

I'm interested in placing recruitment  
advertising in *Electronic Design*

Issue \_\_\_\_\_ Size of ad \_\_\_\_\_  
 My copy is enclosed  I need more information  
Name \_\_\_\_\_  
Title \_\_\_\_\_  
Company \_\_\_\_\_  
Address \_\_\_\_\_  
City \_\_\_\_\_ State \_\_\_\_\_ Zip \_\_\_\_\_  
Telephone \_\_\_\_\_



# How they work on the job is the ultimate test

Use these fine books for 15 days  
without charge!



## INTEGRITY AND RECOVERY IN COMPUTER SYSTEMS

by T. K. Gibbons. Places at your fingertips in step-by-step fashion all the techniques and strategies you need for locating and correcting errors and failures and for reestablishing complete system integrity and reliability as quickly as possible. #5454-8, cloth, 144 pages, \$9.95

## COMPUTER DESIGN DEVELOPMENT: Principal Papers

edited by Earl E. Swartzlander. Gathers together the original papers that heralded the major achievements in logic design, arithmetic algorithms, and computer arithmetic. The coverage progresses from basic design concepts to small subsystems to complete computing systems. #5988-4, cloth, 320 pages, \$13.95

## I/O DESIGN: Data Management in Operating Systems

by Donald E. Freeman and Olney R. Perry. Details the many I/O system and subsystem designs in use today allowing you to design your systems with more confidence and accuracy. #5789-X, cloth, 384 pages, \$17.50

## LARGE SCALE COMPUTER ARCHITECTURE: Parallel and Associative Processors

by Kenneth J. Thurber. A rare and comprehensive reference covering both general theory and practical applications of the main systems currently in operation. #5775-X, cloth, 352 pages, \$18.95

## ORDER FORM

### 15-Day money-back guarantee

Please send me the books checked below to read and use FREE for 15 days. At the end of that time, I will send payment, plus handling and postage, or return the book(s) and owe nothing. On all prepaid orders, publisher pays postage. Prices are subject to change without notice. Offer good in U.S.A. and Canada only.

- #5454-8 **Integrity and Recovery in Computer Systems** ..... \$ 9.95
- #5789-X **I/O Design** ..... 17.50
- #5775-X **Large Scale Computer Architecture** ..... 18.95
- #5988-4 **Computer Design Development** ..... 13.95

NAME \_\_\_\_\_

COMPANY \_\_\_\_\_

ADDRESS \_\_\_\_\_

CITY/STATE/ZIP \_\_\_\_\_

Send to: **Hayden Book Company, Inc.**  
50 Essex Street  
Rochelle Park, New Jersey 07662



77-6

**You'll learn a lot from HAYDEN —  
your computer science publisher**







Advertiser	Page
NEC Microcomputers, Inc.	192B
National Semiconductor Corporation	52, 53
Nichicon America Corporation	187
Nitron, a division of McDonnell Douglas	111
Noritake Co. Ltd.	93
North American Philips Controls Corp.	257
Omron Electrics, Inc.	85, 275
Optron, Inc.	7
Paktron, Division Illinois Tool Works, Inc.	240
Panasonic Electronic Components	125
*Philips Electronic Components and Materials	16, 17
Philips Test & Measuring Instruments, Inc.	224
*Plessey Semiconductors	26, 27
Potter & Brumfield, Division of AMF, Incorporated	169
Power-Mate Corp.	277
Precision Monolithics, Incorporated	11
Preston Scientific, Inc.	271
Pro-Log Corporation	183
Pryofilm Corporation	246
Q-Matic Corp.	276
RCA Solid State	Cover IV
Raytheon Semiconductor	217
Reader Service Card	288 A-B
Refac Electronics Corporation	248
Rental Electronics, Inc.	192C
Riken Denshi Co., Ltd.	251
Robinson Nugent, Incorporated	192 D-E
Rogan Corporation	265
Rogers Corporation	277
*SGS Ates Semiconductor Corporation	13
SMK Electronics Corporation of America	257
Sangamo Weston, EMR Telemetry Division	173
Sealectro Corporation	251
Security Plastics	252
Semiconductor Circuits, Inc.	273
Semtech Corporation	21
Shugart Associates	153
Signetics Corporation	47, 191
Simpson Electric Company	105
Sony Corporation of America	280
Spectronics, Incorporated	272

Advertiser	Page
Sprague Electric Company	39, 103
Standard Engineering Corp.	269
Standard Microsystems	159
Statek Corp.	276
Stromberg-Carlson	278
Sundstrand Corporation	282
Synertek	214, 215
Syntronic Instruments, Inc.	251
System Industries	12
Systron-Donner	151
T & B/Ansley Corporation	115
T-Bar, Incorporated	264
TRW Capacitors, an Electronic Components Division of TRW, Inc.	189
TRW Equipment	241
TRW/IRC Resistors, an Electronic Components Division of TRW, Inc.	275
TRW/IRC Resistors, an operation of TRW Electronic Components	Cover III
TRW LSI Products	211
TRW RF Semiconductors, an Electronic Components Division of TRW, Inc.	48, 49
TRW/UTC Transformer, an Electronic Components Division of TRW, Inc.	179
Teccor Electronics Inc.	33
Technical Materials, Inc.	268
Teledyne Relays, A Teledyne Company	2
Teledyne Semiconductor	50
Teletype Corporation	131
Texas Instruments, Incorporated	40, 41, 205, 236, 237
Topaz Electronics	267
Triple I, A division of the Economy Co.	259
Triplett Corporation	209
Turner Designs	271
*U.S. Department of Commerce, Union Carbide, Components Department	14, 95
Vero Electronics, Inc.	239
Vishay Resistive Systems Group	91
Voltronics Corporation	143
Vorne Industries Inc.	277
Wabash, Inc.	181
Walker Scientific, Inc.	277
Western Thermistor Corporation	275
Zeltex, Inc.	262

\*Advertisers in non-U.S. edition

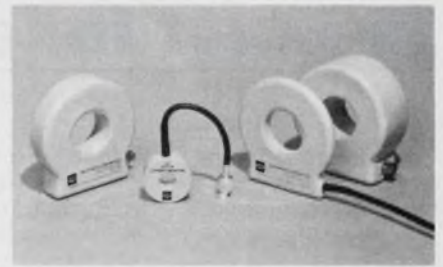

## CURRENT MONITORS

With our monitor and your oscilloscope, read fast pulsed currents (nsec to millisec) of any conductor. Prices range from \$66 to \$286 for standard, in-stock models. Sensitivities from 1 V/A to .01 V/A; no physical connection required; readings without ground loops; BNC standard; specials upon request.

For further information write or call: Ion Physics Company, P.O. Box 416, Burlington, Mass. 01803. Tel. 617-272-2800.



**ION PHYSICS COMPANY**  
A DIVISION OF HIGH VOLTAGE ENGINEERING CORPORATION

CIRCLE NUMBER 252

## MINIATURE FREQUENCY STANDARD

UNDER \$50  
(1000 UNITS)



± 3X10<sup>-7</sup>/MONTH  
(1.2 CUBIC INCHES)  
CALL OR WRITE



**Greenray  
Industries, Inc.**

840 West Church Rd.  
Mechanicsburg, PA 17055  
Phone 717-766-0223

CIRCLE NUMBER 253



# Product index

**Information Retrieval Service.** New Products, Evaluation Samples (ES), Design Aids (DA), Application Notes (AN), and New Literature (NL) in this issue are listed here with page and Reader Service numbers. Reader requests will be promptly processed by computer and mailed to the manufacturer within three days.

Category	Page	RSN	Category	Page	RSN	Category	Page	RSN
<b>Components</b>			switches and relays	266	<b>226</b>	<b>Instrumentation</b>		
capacitor	235	<b>340</b>	switches, DIP	155	<b>73</b>	analyzing instruments	270	<b>289</b>
capacitors	95	<b>43</b>	switches, DIP	257	<b>209</b>	calibrator, portable	127	<b>59</b>
capacitors	103	<b>264</b>	switches, PB	260	<b>214</b>	display, time-base	224	<b>125</b>
capacitors	189	<b>90</b>	transformers	211	<b>99</b>	generator, color	232	<b>332</b>
capacitors	232	<b>136</b>	transformers	240	<b>357</b>	monitor	285	<b>252</b>
capacitors	240	<b>142</b>	trimmers	135	<b>63</b>	oscilloscopes	157	<b>74</b>
capacitors, trimmer	143	<b>67</b>	trimpots	241	<b>359</b>	panel instruments	209	<b>282</b>
coils	265	<b>225</b>	tube, broadcast	239	<b>350</b>	power meter, rf	233	<b>337</b>
coils, relays,			yokes, CRT	251	<b>157</b>	receiver, hf	233	<b>335</b>
transformers	149	<b>70</b>				recorder, portable	230	<b>132</b>
communications			<b>Data Processing</b>			recorder, X-Y	251	<b>156</b>
components	13	<b>10</b>	board, CPU	264	<b>816</b>	recorders, strip-chart	264	<b>222</b>
controllers	238	<b>346</b>	cartridge recorder	262	<b>811</b>	recorders, X-Y	161	<b>292</b>
controls, photoelectric	238	<b>347</b>	comparator	262	<b>812</b>	recorders, X-Y (AN)	266	<b>824</b>
cores, ferrite	239	<b>348</b>	data generator	262	<b>808</b>	recording instruments		
counter	239	<b>349</b>	disc operating system	123	<b>269</b>	(NL)	270	<b>842</b>
counter, electrical	240	<b>358</b>	disc systems	12	<b>9</b>	rental instruments	23	<b>17</b>
crystals	228	<b>128</b>	diskettes	263	<b>219</b>	rental instruments	192C	<b>272</b>
crystals	253	<b>160</b>	intelligent terminal	85	<b>38</b>	rental instruments	192F	<b>274</b>
crystals	269	<b>240</b>	intelligent terminals			resistance tester	233	<b>336</b>
data communications	266	<b>817</b>	(DA)	266	<b>822</b>	signal generator	151	<b>71</b>
discrete components	227	<b>127</b>	keyboards	26	<b>19</b>	slide rule (DA)	266	<b>819</b>
display, LED	236	<b>344</b>	memory, add-in	264	<b>815</b>	test instruments (NL)	268	<b>832</b>
displays	93	<b>42</b>	printer	262	<b>809</b>	tester, voltage	232	<b>333</b>
displays	248	<b>148</b>	printer	264	<b>814</b>	thermometer, digital	113	<b>52</b>
displays, readout	139	<b>65</b>	processor	264	<b>813</b>	VOMs	105	<b>48</b>
electrolytics	192	<b>92</b>	PROM programming	107	<b>180</b>			
indicator lights	192H	<b>276</b>	system software	262	<b>810</b>			
indicators	257	<b>166</b>	teletypewriter	131	<b>61</b>			
indicators	259	<b>212</b>				<b>Micro/Mini Computing</b>		
intelligent terminals	266	<b>822</b>	<b>ICs &amp; Semiconductors</b>			amplifier, read/write	219	<b>305</b>
isolators	7	<b>5</b>	converter, a/d	255	<b>566</b>	analyzer, $\mu$ P	223	<b>317</b>
isolators	272	<b>246</b>	converter, v/f	253	<b>562</b>	board, communications	220	<b>308</b>
keyboard	228	<b>129</b>	converters, 3 $\frac{1}{2}$ digit	253	<b>559</b>	boards, analog	231	<b>330</b>
keyboard modules (NL)	268	<b>835</b>	diodes, zener	254	<b>563</b>	calculator, program	220	<b>309</b>
keyboards	249	<b>152</b>	driver, audio	253	<b>560</b>	compiler, Fortran	230	<b>328</b>
latching system	267	<b>228</b>	drivers, memory	250	<b>555</b>	computers	53	<b>101</b>
LEDs	236	<b>343</b>	FETs	50	<b>33</b>	controller, diskette	229	<b>325</b>
motors	15	<b>12</b>	FETs & linear ICs	268	<b>840</b>	controller, plotter	231	<b>329</b>
motors	232	<b>135</b>	filter	254	<b>565</b>	controller, printer	228	<b>322</b>
motors, timing	252	<b>159</b>	interface couplers	89	<b>40</b>	desk-top computer	221	<b>124</b>
panel instruments	209	<b>282</b>	line receiver	1	<b>2</b>	interface, peripheral	219	<b>306</b>
potentiometers	121	<b>56</b>	linear CMOS circuit	137	<b>64</b>	memory, mass	228	<b>323</b>
power relays	268	<b>838</b>	linear LSI products	266	<b>823</b>	microcomputer	219	<b>302</b>
printers	236	<b>342</b>	memories	22	<b>16</b>	microcomputer	219	<b>304</b>
relays	2	<b>3</b>	memories	253	<b>561</b>	microcomputer, 4-bit	223	<b>316</b>
relays	169	<b>80</b>	memories, static	250	<b>552</b>	microcomputer, 4-bit	125	<b>58</b>
relays	236	<b>345</b>	microcircuits	268	<b>836</b>	microprocessors	119	<b>55</b>
relays, freq sens	235	<b>339</b>	MOS/LSI circuits	185	<b>88</b>	microprocessors	215	<b>121</b>
relays, hi-rel	229	<b>131</b>	multiplier-accumulator	179	<b>85</b>	miniature floppy	153	<b>72</b>
relays, reed	249	<b>149</b>	op amps	11	<b>8</b>	minicomputers	73	<b>270</b>
relays, reed	287	<b>254</b>	op amps, BiFet	250	<b>553</b>	module, personality	220	<b>307</b>
relays, TO-5	231	<b>134</b>	opto-isolators	175	<b>83</b>	printer/plotter	225	<b>320</b>
resistor networks	II	<b>130</b>	receivers, AM/FM	255	<b>567</b>	processor	231	<b>331</b>
resistors	III	<b>231</b>	rectifiers	21	<b>15</b>	programmer, PROM	219	<b>301</b>
resistors	10	<b>7</b>	rectifiers, Schottky	252	<b>557</b>	programmer, PROM	230	<b>327</b>
resistors	91	<b>41</b>	register, shift	252	<b>556</b>	reader, paper tape	219	<b>303</b>
resistors, thick-film	246	<b>146</b>	register	250	<b>554</b>	system cassette	224	<b>319</b>
stepping-motor			SCRs	187	<b>89</b>	system, development	220	<b>310</b>
technology	266	<b>818</b>	SCRs, triacs	IV	<b>232</b>	system, development	224	<b>318</b>
switch, solid state	235	<b>338</b>	semi products	270	<b>841</b>	system, microcomputer	223	<b>314</b>
switch, wet	240	<b>356</b>	semiconductors	49	<b>32</b>	system, microcomputer	229	<b>324</b>
switches	109	<b>50</b>	transistor, rf	254	<b>564</b>	terminal	229	<b>326</b>
switches	241	<b>360</b>	varactor, GaAs	252	<b>558</b>	terminal, portable	223	<b>315</b>
						tool, development	225	<b>321</b>



Category	Page	RSN
$\mu$ P, bipolar	191	91
$\mu$ P cards	183	87
<b>Microwaves &amp; Lasers</b>		
circulators	243	261
detector, infrared	242	448
equalizer	242	398
frequency source	242	404
mixer, dble-balanced	242	403
receiver, optical	242	397
power transistor	242	399
up-converter	242	396
<b>Modules &amp; Subassemblies</b>		
amp, instrumentation	248	549
amplifier/discriminator	244	449
amplifier, isolation	246	545
amplifier, read/write	219	305
bridge, measurement	245	542
controller, interface	246	544
converter, d/a	17	13
converters, a/d	270	242
d/a converter, 12-bit	247	547
filter, microwave	246	543
frequency standard	285	253
interface, computer	245	541
keyboard, phone	235	341
latching system	267	228
panel meters	248	548
photoelectric sensors	268	837
power amplifiers	258	211
power amps	261	217
speed control	247	546
suppressor, transient	248	551
teletypewriter	244	450
timer/counter	141	152
transport, cassette	248	550
<b>Packaging &amp; Materials</b>		
air freight	225	126
alloys, silicon-iron	254	162
bobbin coil covers	192G	275
breadboards	213	100
breadboards	261	215
circuit boards	258	803
clad metals	238	140
coil bobbins	258	800
connections	259	285
connector	260	807
connector caps	268	834
connector, miniature	260	805
connectors	115	53
connectors	239	141
connectors, ribbon	25	18
crimper, automatic	258	801
enclosures	247	147
enclosures	255	163
enclosures	256	164
enclosures	269	241
fasteners, threaded	33	24
gaskets, beryllium	177	84
heat sinks	230	133
interconnection system	234	138
lead terminator	258	802
magnetic shielding	171	81

Category	Page	RSN
metal tubing	270	290
nylon bushings	261	216
PC board	81	36
PC card case	272	247
photoetched parts	254	161
pliers, assembly	260	806
plugs and jacks	251	155
polyester parts	252	158
precision fabrication	241	143
silicone elastomer	117	54
sockets	101	46
sockets	192E	273
thermally conductive paste	260	804
wire, cable and cord	87	400
<b>Power Sources</b>		
batteries	245	153
crowbar, dc	287	255
monitor, voltage	256	570
power modules	192A	271
power sources	273	249
power supplies	44	30
power supplies	250	154
power supplies	257	210
power supplies	269	239
power supplies, dc	256	568
power supplies, $\mu$ P	18	14
power supply	6	4
regulators, HV	271	245
solar cell	256	569
transformers	267	229
UPS, partial	256	571
<b>new literature</b>		
analyzing instruments	270	289
connector caps	268	834
electronic hardware	270	843
FETs & linear ICs	268	840
flat cable	268	839
keyboard modules	268	835
metal tubing	270	290
microcircuits	268	836
microwave control devices	268	833
photoelectric sensors	268	837
power relays	268	838
recording instruments	270	842
semi products	270	842
test instruments	268	832
<b>application notes</b>		
data processing	266	825
instrumentation	266	828
linear LSI products	266	823
recorders, X-Y	266	824
<b>design aids</b>		
data communications	266	817
intelligent terminals	266	822
motor controls	266	821
process control tables	266	820
slide rule	266	819
stepping-motor technology	266	818

# Smallest 2A Reed Relay!



## COTO'S NEW **Reed** MICRO-MINIATURE **Relays**

- Wide variety contacts 1A, 2A, 1C, or 1A (Hg. wet)
- Uses only .17 sq. in. pc board space: Package dimen. .210" x .225" x .810"
- Choice of coil resistances at 5 or 12 VDC
- Encapsulated in epoxy-coated metal can
- Electrostatic or coaxial shielding for R.F. switching

Write or Call for Bulletin 14.1



**COTO-COIL COMPANY, INC.**  
59 Pavilion Avenue  
Providence, R. I. 02905  
Phone (401) 467-4777

CIRCLE NUMBER 254

# Circuit Savers



**\$3.00**  
1000 pcs

DC  
**CROWBAR**



Here's positive low cost protection for your IC's, transistors, power supplies and pc cards.

The LVC-1A crowbar switches to a short circuit whenever the voltage across it exceeds a specified level.

Any trip voltage level between 4.7V and 200V  $\pm$  10% can be selected. The unit will handle a peak current of 50 Amps (8ms) and 3A continuously. MIL Temperature range. Call Mike Coyle for applications assistance.

Full line of protection modules for every hi-lo voltage/current requirement. Write or call for Catalog 749.

160 Brook Ave.  
Deer Park, N.Y. 11729  
Telephone: 516-586-5125

# MCG Electronics

CIRCLE NUMBER 255





## **“THE GOLD BOOK IS ONE SOURCE I CAN COUNT ON NOT TO WASTE MY TIME.”**

Mark A. Edwards is President of Edwards Industries, Reno, Nevada. His company designs and manufactures CATV-telephone equipment and provides consulting services. In addition to corporate management, Mr. Edwards is design supervisor. His directory? *Electronic Design's* GOLD BOOK.

**“The GOLD BOOK is the most comprehensive and accurate publication of its kind. The great number of headings and listings along with the in-depth cross referencing make it a pleasure to use. As a matter of policy, Edwards Industries does not endorse products or services. In this case, however, an exception is warranted. I've used the GOLD BOOK countless times. It's without question the finest directory I've used.”**

Mr. Edwards has specified relays, transformers, ICs, transistors and design aids for purchase directly from the GOLD BOOK.

The GOLD BOOK is working for advertisers because it's working for 90,000 engineers, engineering managers and specifiers — like Mr. Edwards, throughout the U.S. and overseas.

# **IF IT'S ELECTRONIC...IT'S IN THE GOLD BOOK**



What's TRW up to now?

# Wirewounds that save.

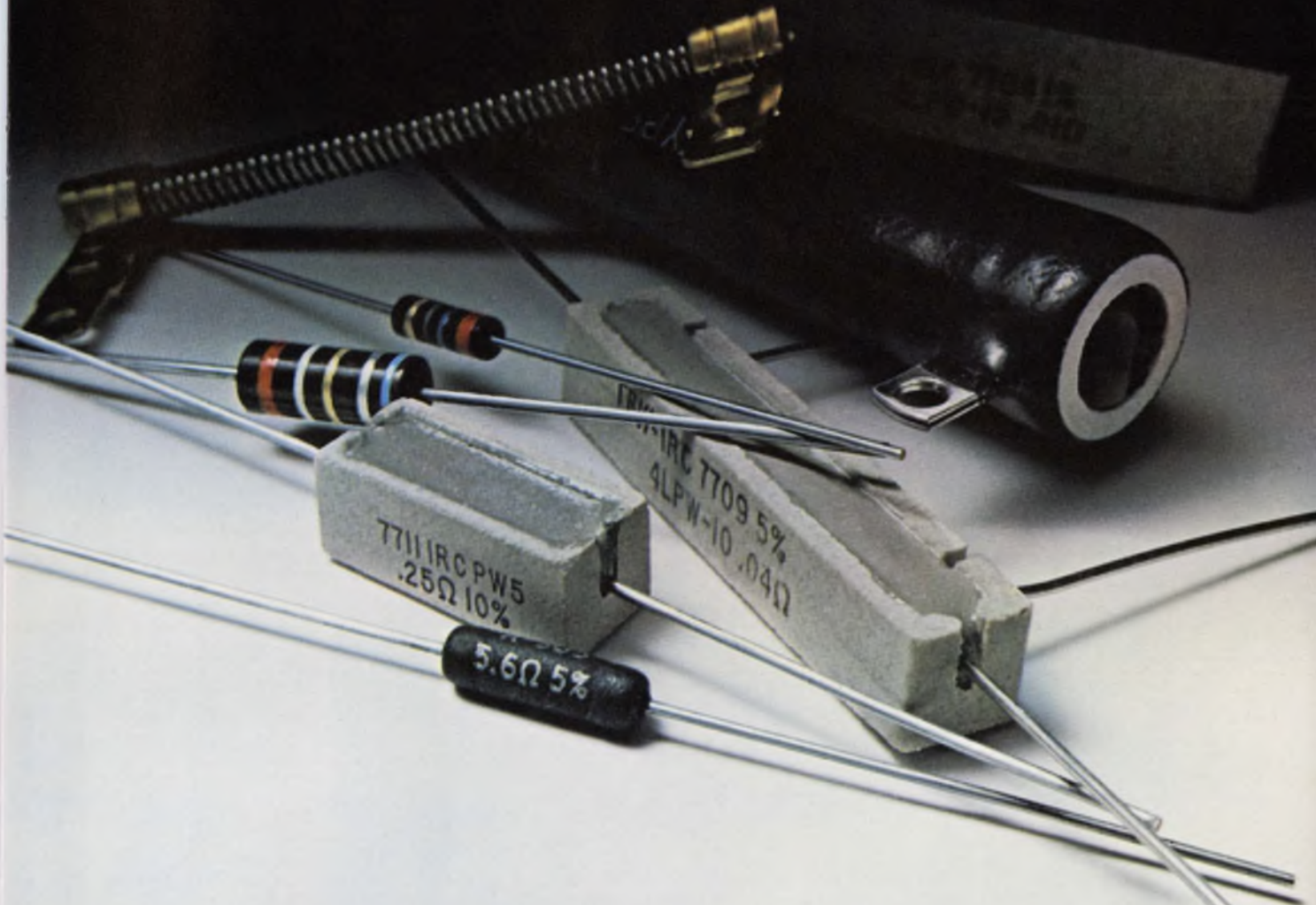

For pennies you can buy circuit protection with our BWF series resistors, perhaps saving your company a bundle later. U.L. approved, they will fail safe under specified overload conditions.

And when it comes to cost and reliability, our molded BW and ceramic PW series are standards for 1-22W general purpose applications.

For higher power we've introduced new PW styles in 30, 40 and 50W ratings. Integral mounting

brackets boost power dissipation up to 30%.

And, if it's good sense you're after, our 4LPW series is designed for current sensing and feedback circuits. Available in 5 ratings from 3 to 15W, with 2 or 4 leads, and resistance values as low as .01Ω.

For standards in all types of resistors, contact your local TRW distributor. Or TRW/IRC Resistors, 401 N. Broad St., Philadelphia, Pa. 19108. (215) 922-8900, Dept. W.

## **TRW** IRC RESISTORS

ANOTHER PRODUCT OF A COMPANY CALLED TRW

CIRCLE NUMBER 231



With new solid-state options ...

# RCA helps you make discoveries in power design.

New devices. New packages. New parameters. All from the Powerhouse, your source for the widest choice in SCRs and Triacs. They offer you the latest ways to improve design, reduce costs and increase performance.

**A new way to heat.** Solid-state induction heating is now entirely feasible, thanks to our new 40A asymmetrical SCR (ASCR). The RCA S7310 gives you 40 kHz frequency, high voltage and current. Plus high di/dt and dv/dt capability. No need for 50/60 hertz transformers and other bulky parts.

**A new way to switch.** Now you can design-out some of the problems you've had with big dc relays—such as too much cable bulk in cars. Use our new plastic G4000 Series gate turn-off SCRs (GTOs)—they can switch up to 15 amps with as little as -6V gate turn-off voltage.

**A new source for the C106.** This popular 4A general purpose SCR and corresponding sensitive-gate triac are now available from RCA. In the economical, easily mounted 3-lead Versatab package.

## New design flexibility for you. From RCA.

Family	Vonom (V)	IT (A)	IGT (mA)	Description	Pkg.
S7310	50-600	40	50-100	Fast Asymmetrical SCR	T0-48
G4000	50-400	15	3	Gate Turn-off SCR	T0-220
S860	50-600	100	200	Gen purpose SCR	1/2" stud
S5800	100-600	5	50	Fast switching SCR	T0-220
C106	15-600	4.0	0.200	4-amp gen. purp. SCR	T0-202
T2320	50-400	2.5	3-40	Sensitive-gate triac	T0-202
T6000	50-600	15	10-50	Gen. purpose triac	T0-220

**A new source for circuit ideas.** "Power Options from the Powerhouse" is a new designer's guide to the selection of optimum RCA solid-state devices for power circuits. It's arranged by application, with over 40 circuits shown. This makes it easy for you to choose the type best suited to the job.

For your free copy, contact RCA Solid State headquarters in Somerville, NJ; Sunbury-on-Thames, Middlesex, England; Quickborn 2085, West Germany; Ste.-Anne-de-Bellevue, Quebec, Canada; Sao Paulo, Brazil; Tokyo, Japan.

**RCA Power experience is working for you.**

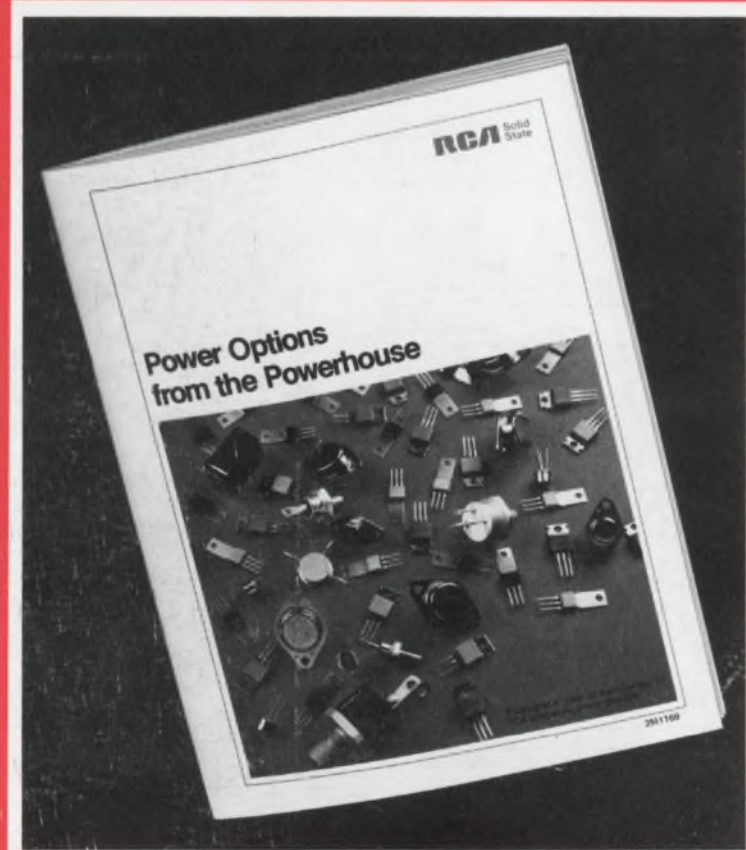

# RCA