

The growing choice of software development aids for μ Ps can confuse even the experienced programmer. Moreover, the range of features differs widely even

for similarly named aids. Cost, time and available memory size are yardsticks that simplify your selection decision. For a look at what's available turn to p. 20.

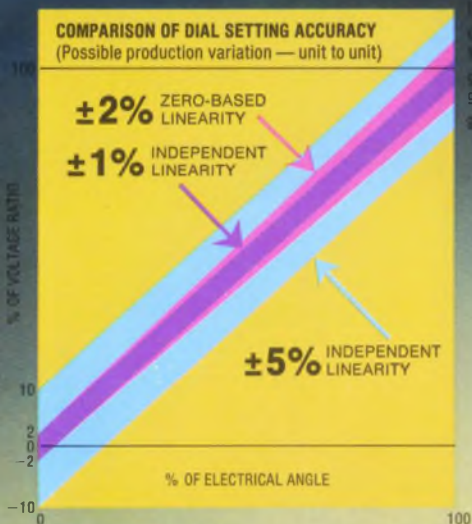

The \$2 Pot with the \$5 Linearity...

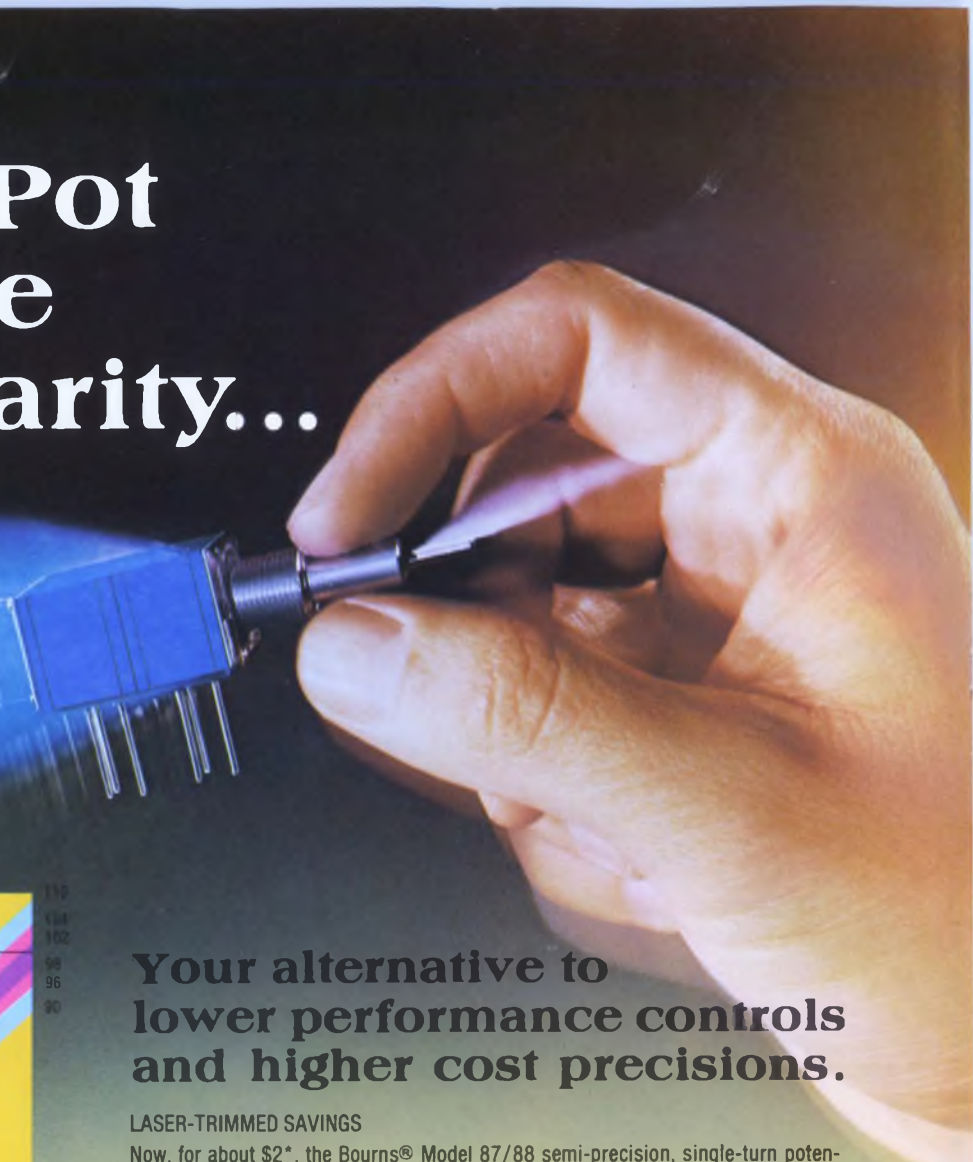

Your alternative to lower performance controls and higher cost precisions.

LASER-TRIMMED SAVINGS

Now, for about \$2*, the Bourns® Model 87/88 semi-precision, single-turn potentiometer delivers $\pm 2\%$ zero-based linearity. Compare the accuracy to the \$5 precision pot with $\pm 1\%$ independent linearity that you're buying now . . . especially the performance at the low end setting, where dial setting accuracy is most critical. Laser trimming and advanced element design† deliver performance and savings in a $\frac{5}{8}$ " square modular package.

MOVE UP FROM INDUSTRIAL GRADE CONTROLS

Again, for about \$2, the Model 87/88 offers 200-300% greater panel setting accuracy over industrial grade controls. They're perfect for applications requiring close, consistent calibration of output-to-panel setting and versatility of design.

MODEL 87/88 — THE ALTERNATIVE

Don't compromise your application with lower performance controls or pay a premium for precision pots. Specify the alternative — Bourns Model 87/88. Write or call today for complete technical information.

\$2 SEMI-PRECISION MODULAR POTS . . . BEAUTIFUL!

TRIMPOT PRODUCTS DIVISION, BOURNS, INC., 1200 Columbia Avenue, Riverside, California 92507, Telephone (714) 781-5122 — TWX 910 332-1252.

PERFORMANCE/COST COMPARISON			
Type	Element	Linearity	Approx. Cost
HIGHER COST PRECISION POTS	Conductive Plastic	$\pm 1\%$ Independent	\$5.00
BOURNS 87/88 SEMI-PRECISION POTENTIOMETERS	Conductive Plastic	$\pm 2\%$ Zero-Based	\$2.00
	Cermet	$\pm 2.5\%$ Zero-Based	
LOWER COST CONTROLS	Conductive Plastic/Cermet	$\pm 5 - 10\%$ Independent	\$1.00

* Production quantities, Domestic U.S.A. price only
† Patent Pending



Int'l Mktg. Offices: European Hdqtrs. — Switzerland 042/23 22 42 • Belgium 02/218 2005 • France 01/2039633 • Germany 0711/24 29 36
• Italy 02/32 56 88 • Netherlands 70/87 44 00 • United Kingdom 01/572 6531 • Japan 075/921 9111 • Australia 02/55-0411 03/95-9566

CIRCLE NUMBER 262

Here are three electromagnetic X-Y display scopes that have a lot in common: each has a big 12-inch diagonal CRT, is economically priced, and is ideal for applications requiring continuous monitoring of response signals with bandwidths up to 15 kHz.

The one in front is specifically for use in OEM systems. With the Model 1951, you can have controls mounted on the rear panel, or they can be pre-set on an easily accessible PC board. And the unit's power supply can be removed and installed

elsewhere in your system. The 1951 is particularly well suited to medical electronic systems.

The scope on the left is our Model 1901C which can be used with our (or anybody's) RF or microwave sweepers. The unit has a sensitivity of 1 mV per division which is ideal for low-level detection requirements. Features such as Z axis intensity modulation, Y marker adders and a blanking protection circuit contribute to the unit's versatility.

Finally, the scope at right is our

Model 1910. It's basically the same as the 1901C except that it provides dual trace capability.

So just decide which of these low-priced scopes has the most in common with your operation. We'll be happy to ship as many as you want. WAVETEK INDIANA, P.O. Box 190, Beech Grove, Indiana 46107, Telephone (317) 783-3221, TWX 810-341-3226.

WAVETEK®

CIRCLE NUMBER 2

Scope City!

Model 1901C: \$545.00

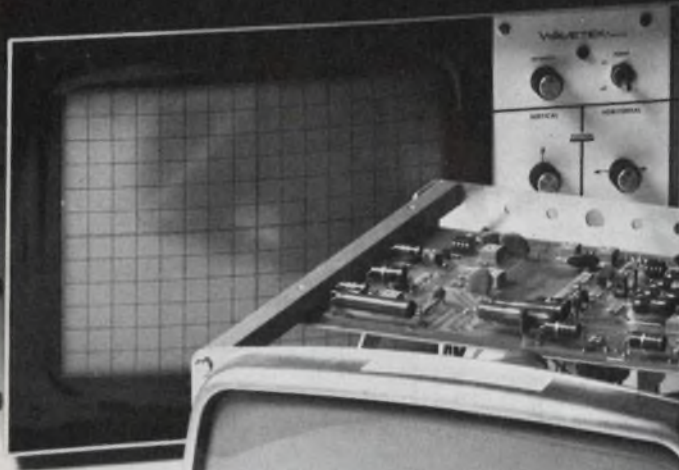

Model 1910: \$675

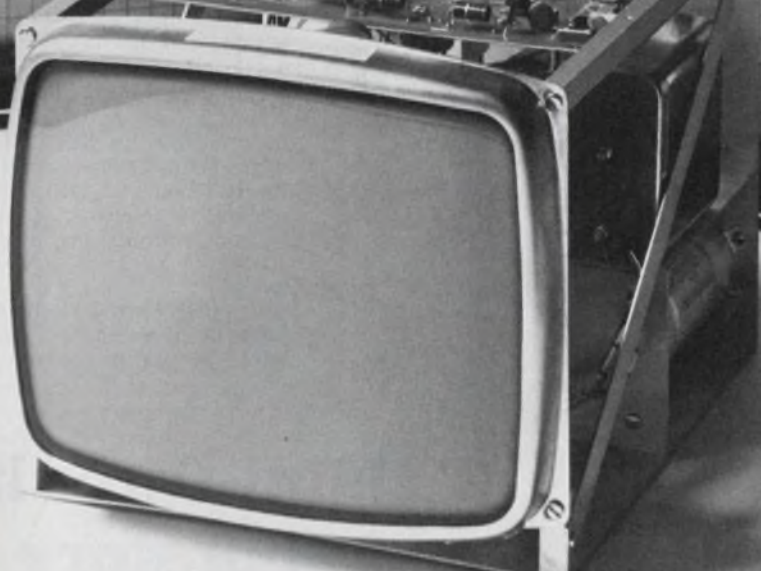

Model 1951: \$450 (in small quantities)



Tough... Tougher!

NEW

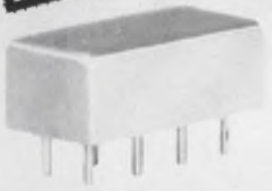

DOUBLE BALANCED MIXERS



Model SBL-1

\$2.95
500 pieces
\$3.95 (10-49)

For demanding industrial and commercial applications, where low-cost and high-performance are critical, model SBL-1 will fill your need.

Don't let the low price mislead you. Only well-matched, hot-carrier diodes and ruggedly constructed transmission-line transformers are used. Every SBL-1 is RF tested four times, and every solder connection is 100 percent inspected under a high-power microscope. Internally, every component is bonded to the header and metal case for excellent protection against shock.

Of course, our one-year guarantee applies to these ruggedly constructed units.

Model SBL-1		Frequency Range MHz	Model SRA-1	
LO	1-500		LO	0.5-500
RF	1-500		RF	0.5-500
IF	DC-500		IF	DC-500
Typ.	Max.	Conversion Loss dB	Typ.	Max.
5.5	7.5	One Octave from Band Edge	5.5	7
6.5	8.5	Total Range	6.5	8.5
+1dBm		Signal 1dB Compression Level	+1dBm	
Typ.	Min.	Isolation, dB	Typ.	Min.
50	35	Lower Band Edge to One Decade Higher	LO-RF	50 45
45	30	Mid Range	LO-IF	45 35
45	30	Upper Band Edge to One Octave Lower	LO-RF	45 30
40	25	Impedance, All Ports	LO-IF	40 25
35	25	Phase Detection	LO-RF	35 25
30	20	DC Offset DC Polarity	LO-IF	30 20
50 ohms		Electronic Attenuation	50 ohms	
1mV typical		Minimum Attenuation (20mA)	3dB	
Negative			3dB	

Model SRA-1

\$7.95
500 pieces
\$9.95 (1-49)

For stringent military, space or commercial applications, model SRA-1 has become the industry standard. Packaged within an RFI shielded metal enclosure and hermetically-sealed header, these high-performance units are specified by branches of the Dept. of Defense, NASA, FAA and major communications firms. Each Schottky diode is preconditioned by the HTRB technique, (with the diode operated for 168 hours at 150°C with one-volt reverse bias applied), to accelerate aging and to screen out potentially unreliable units.

Our SRA-1 is the only double-balanced mixer in the industry with a two-year guarantee.

International Representatives: □ **AUSTRALIA:** General Electronic Services, 99 Alexander Street, New South Wales, Australia 2065 □ **ENGLAND:** Dale Electronics, Dale House, Wharf Road, Framley Green, Camberley Surrey □ **FRANCE:** S.G.I.T. D.I.M.E.S. 31 Rue Giscard, Sand 91120 Palaiseau France □ **GERMANY, AUSTRIA, SWITZERLAND:** Brohnschal Elektronik GmbH, Kugelstrass 14, 6000 Pfullen, Pfullen/Main, Germany □ **ISRAEL:** Vechronix Ltd, 69 Gideon Street, Tel-Aviv, Israel □ **JAPAN:** Densho Kaisha Ltd, Eguchi Building 8-1-1 Chome Hamamatsucho Minato-ku, Tokyo □ **EASTERN CANADA:** B.D. Hummel, 2224 Maynard Avenue, Utica NY 13502 (315) 736-7821 □ **NETHERLANDS, BELGIUM, LUXEMBOURG:** Comex Veldweg 11 Hattem, Holland □ **NORWAY:** Datamatik AS, Ostensjovveien 62 Oslo 6, Norway

U.S. Distributors: □ **NORTHERN CALIFORNIA:** Carr, White & Co., Foothill Office Center, 105 Fremont Avenue, Los Altos, CA 94022 (415) 948-6533 □ **SOUTHERN CALIFORNIA, ARIZONA:** Crown Electronics, 11440 Collins Street, No. Hollywood, CA 91601 (213) 877-3550

World's largest manufacturer of Double-Balanced Mixers

Mini-Circuits Laboratory
MCL
A Division Scientific Components Corp
837-843 Utica Avenue, Brooklyn, NY 11203
(212) 342-2500 Int'l Telex 620156 Domestic Telex 125460

NEWS

- 15 **News Scope**
- 20 **It's getting easier for the designer to program microprocessors with the new software design aids—A special report.**
- 30 **Schottky diode mixer** enables imaging system to operate at 90 GHz.
- 32 **Temperature, not current switches** p-n-p-n element.
- 35 **Washington Report**

TECHNOLOGY

- 41 **Microprocessor Design**
- 54 **Solve software problems step by step**—just as you would approach hardware problems. 'Top-down' design is a procedure you can follow consistently.
- 62 **Develop systems around the SC/MP.** Two versions permit performance selection, and the versatile instructions allow simple addressing of the 65-k memory.
- 74 **Control an intelligent teletypewriter** with a simple μ P system. Pack all control and communication functions into the software instead of the hardware.
- 82 **Marry your μ P to monolithic a/ds.** Size, price and power compatibility team up with simple interfaces to give you an efficient on-line system.
- 90 **Ideas for Design:**
Control 10 to 10,000 Hz digitally and get complementary output frequencies.
Watchdog circuit guards μ P systems against looping.
Circuit allows program-halt and single-instruction mode on μ P.
Simple solid-state relay circuit can be built with few components.
- 98 **International Technology**

PRODUCTS

- 101 **Integrated Circuits:** Programmable gate arrays add flexibility and cut complexity.
- 104 **Instrumentation:** Data logger changes role with drop-in card modules.
- 108 **Microwaves & Lasers**
- 112 **Power Sources**
- 114 **Data Processing**
- 118 **Packaging & Materials**
- 122 **Modules & Subassemblies**
- 128 **Discrete Semiconductors**
- 130 **Components**

DEPARTMENTS

- 51 **Editorial:** Are all men brothers?
- 7 **Across the Desk**
- 132 **Application Notes**
- 134 **New Literature**
- 136 **Bulletin Board**
- 137 **Vendors Report**
- 142 **Advertisers' Index**
- 144 **Product Index**
- 144 **Information Retrieval Card**

Cover: Photo by Lennie Zbiegien, courtesy of Motorola, Phoenix, AZ.

ELECTRONIC DESIGN is published biweekly by Hayden Publishing Company, Inc., 50 Essex St. Rochelle Park, NJ 07662. James S. Mulholland Jr., President. Printed at Brown Printing Co., Waseca, MN. Controlled circulation postage paid at Waseca, MN and New York, NY, postage pending Rochelle Park, NJ. Copyright © 1977. Hayden Publishing Company, Inc. All rights reserved. POSTMASTER: Please send form 3579 to ELECTRONIC DESIGN, P.O. Box 13803, Philadelphia, PA 19101.

**Buy one
ROM.
Get two
fasts.**

1. Fast performance.

You probably always knew
Advanced Micro Devices had 8K

and 16K ROM's. But did you know
they're the fastest in the business?

Device	Size	Supply Voltages	Worst Case Access Time (nanoseconds)	Comments
Am9214	512 x 8	+5	500	Plug in replacement for 3514
Am8308	1024 x 8	$\pm 5, +12$	450	
Am9208	1024 x 8	+5, +12	250	Plug in replacement for 8308
Am8316A	2048 x 8	+5	850	
Am9217	2048 x 8	+5	450	Plug in replacement for 8316A
Am8316E	2048 x 8	+5	450	
Am9218	2048 x 8	+5	350	Plug in replacement for 8316E.
Am9216	2048 x 8	+5, +12	300	

All Advanced Micro Devices' ROMs are available in military (-55 C° to +125°C) and commercial (0°C to +70°C) temperature range. And we only make them one way: MIL-STD-883 for free.

2. Fast delivery.

5 weeks maximum to prototype.
And we don't mean 5 weeks and
three days or 5 weeks if the
weather's good. We mean 5 weeks.

Advanced Micro Devices'
ROM's. If you want to know more,
call, write or wire. We'll get back
to you. Fast.

Advanced Micro Devices

Bipolar LSI. N-channel, silicon gate MOS. Low-power Schottky.
Multiple technologies. One product: excellence.



Advanced Micro Devices, 901 Thompson Place,
Sunnyvale, California 94086. Telephone (408) 732-2400.

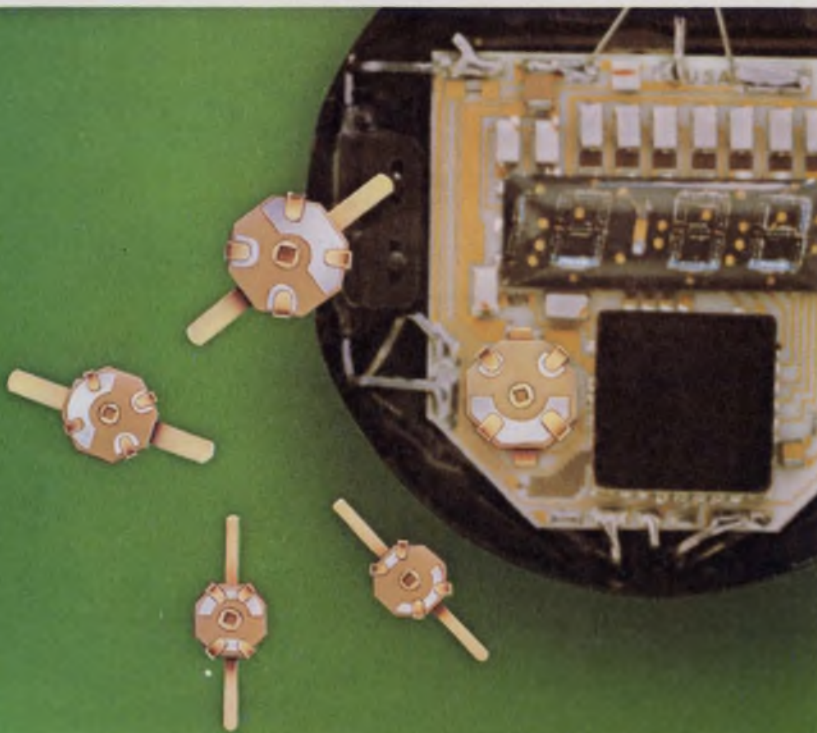

Thin-Trim[®] capacitors

Tucked in the corner of this Pulsar Watch is a miniature capacitor which is used to trim the crystal. This Thin-Trim capacitor is one of our 9410 series, has an adjustable range of 7 to 45 pf, and is .200" x .200" x .050" thick.

The Thin-Trim concept provides a variable device to replace fixed tuning techniques and cut-and-try methods of adjustment. Thin-Trim capacitors are available in a variety of lead configurations making them easy to mount.

A smaller version of the 9410 is the 9402 series with a maximum capacitance value of 25 pf. These are perfect for applications in sub-miniature circuits such as ladies' electronic wrist watches and phased array MIC's.

Johanson Manufacturing Corporation
Rockaway Valley Road
Boonton, New Jersey 07005
(201) 334-2676 TWX 710-987-8367

CIRCLE NUMBER 5

Sr. Vice President, Publisher
Peter Coley

Editors

Editorial Offices
50 Essex St.
Rochelle Park, NJ 07662
(201) 843-0550
TWX: 710-990-5071
Cable: Haydenpubs Rochellepark

Editor-in-Chief George Rostky

Managing Editors:
Ralph Dobriner
Michael Elphick

Senior Associate Editor
Stanley Runyon

Associate Editors:
Sid Adlerstein
Dave Bursky
Morris Grossman
John F. Mason
Max Schindler

Contributing Editors:
Peter N. Budzilovich, John Kessler
Alberto Socolovsky, Nathan Sussman

Editorial Field Offices

East

Jim McDermott, Eastern Editor
P.O. Box 272
Easthampton, MA 01027
(413) 527-3632

West

Dick Hackmeister, Western Editor
8939 S. Sepulveda Blvd., Suite 510
Los Angeles, CA 90045
(213) 641-6544
TWX: 1-910-328-7240
Dave Barnes
844 Duncardine Way
Sunnyvale, CA 94087
(408) 736-6667

Editorial Production

Marjorie A. Duffy, Production Editor
James Keane, Copy Editor

Art

Art Director, William Kelly
Richard Luce, Anthony J. Fischetto

Production

Manager, Dollie S. Viebig
Helen De Polo, Anne Molfetas

Circulation

Director, Barbara Freundlich
Trish Edelmann

Information Retrieval

Paula Greenleaf

Advertising Promotion

Susan G. Apolant

Across the Desk

Murphy vs Wolfe

On page 7 of the November 22 issue of Electronic Design, we compared Murphy's Law with Wolfe's Law. Murphy won. We identified Jim Wolfe as general manager of Centralab Electronics, which is correct, and as vice president of Gould Inc., which is wrong. Mr. Wolfe is vice president of Globe-Union.

Watch for the glitch

The frequency-division techniques presented by Cornelis van Holten and Jan Obdralék (ED No. 18, Sept. 1, 1976, p. 104) are most useful. When they are implemented, however, the problem of "glitches" immediately arises. The authors' Fig. 1 shows a $\times 3/4$ multiplier that can be implemented as follows:

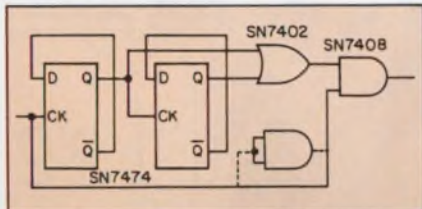

The propagation delays introduced by the second flip-flop produce the waveform shown:

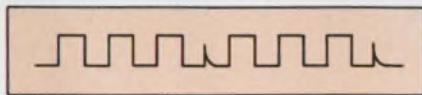

The glitch is marginally recognized as an additional pulse that stops frequency division under some conditions. Inserting another AND gate as shown delays the clock pulse until the output of the OR gate reaches its true value, thereby producing a "glitch-free" output.

The $\times 3/5$ multiplier shown in the authors' Fig. 2 is perhaps not so obvious in its implementation. A satisfactory way to do it is shown below:

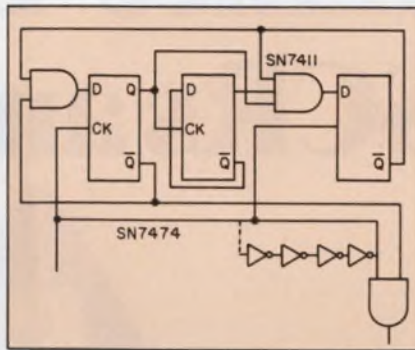

In this case the output contains a severe glitch that can be removed by inserting four inverters, as shown. Internal to the multiplier is a glitch at the D input to the third stage divider. Since it occurs after the clock pulse on that divider stage, it is ignored.

Stanley Wood

Star Route
Box 176
Inyokern, CA 93527

Misplaced Caption Dept.



I knew we should have checked out that radar set before we left.

Sorry. That's Theodore Gericault's "The Raft of the Medusa," which hangs in The Louvre in Paris.

(continued on page 10)

Electronic Design welcomes the opinions of its readers on the issues raised in the magazine's editorial columns. Address letters to Managing Editor, Electronic Design, 50 Essex St., Rochelle Park, NJ 07662. Try to keep letters under 200 words. Letters must be signed. Names will be withheld on request.

Bypass the middleman!

Save more than 55%
with unsurpassed quality
and performance!

Delivery from stock!



Deltron Slashes the Price of μ Processor Power Supplies

MPS-1: \$77
MPS-2: \$88

In any quantity!

Full one year
guarantee.
Designed for U.L.



MPS-1



MPS-2

Automatic
overload and
adjustable
overvoltage
protection. Dual
input voltage,
0.1% regulation,
1.5 mV ripple
and noise.

The MPS-1 or
MPS-2 powers
virtually any
Microprocessor
available. For that
rare exception,
talk to us about
a custom unit.

MODEL	VOLTS	AMPS			PRICE ANY QUANTITY
		40°C	50°C	60°C	
MPS-1	5 \pm 5% Adj.	3.0	2.5	2.0	\$77
	7 \pm 4%	0.6	0.5	0.4	
	12 \pm 5% Adj.	0.6	0.5	0.4	
	x 2% 9 to 12V Adj. or 5V	0.3B	0.3B	0.3B	
MPS-2	5 \pm 5% Adj.	7.0	6.0	5.0	\$88
	9 \pm 4%	1.0	0.9	0.8	
	12 \pm 5% Adj.	1.2	1.1	1.0	
	x 2% 9V or 5V	0.75	0.65	0.55	

Why buy brand A?
Deltron's got them
spec for spec
at half the price.

Next time get the best
for a lot less...
write or call collect to:



Deltron, Inc.

Wissahickon Avenue North Wales, Pa. 19454
215-699-9261, TWX 510-661-8061

CIRCLE NUMBER 6

Join Motorola's New Age of Buck-Saving, Performance-Busting TO-220 SCRs and Triacs!



Can Metal Can!

Motorola TO-220 First to Save 30%

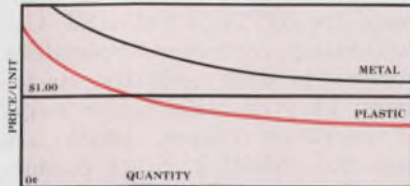

Save $\frac{1}{3}$ out of your next thyristor buck by specifying Motorola TO-220 SCRs and Triacs.

And get better performance!

These 25 A SCRs and 15 A Triacs actually cost $\frac{1}{3}$ less than comparable RCA and GE metal studs in almost any quantity.

The 2N6504-09 SCR is a natural-born replacement for those goodie-but-oldie 2N681-series sockets where you're operating to max limits set by data sheet ratings . . . motor and heating controls, power supplies, battery chargers, crowbars, ad infinitum.

It's got super low, 1.8 V max V_F at 50 A peak or just 26 W P_O at full rated current. You can heat sink to 85°C case with lower thermal excursions and potentially longer life.

Use MAC15/15A Triacs for full-wave designs and realize the same $\frac{1}{3}$ saving! Like the SCR, it blocks to 800 V and operates from -40°C to 125°C.

Motorola TO-220 First to Defy 300 A Peaks

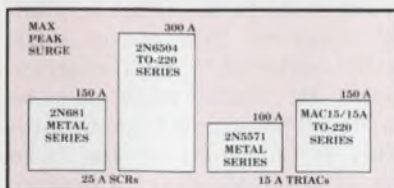

Whoever heard of a TO-220 SCR with 300 A peak surge ratings? You did - exclusively from Motorola.



That's *twice* the performance available from 2N681 metal studs in less than half the space.

We've maximized the technology in TO-220 to state-of-the-art levels by enlarging the active die area approximately 15% in each package - SCR and Triac - so much more capability is available than from any other comparable plastic OR metal package.

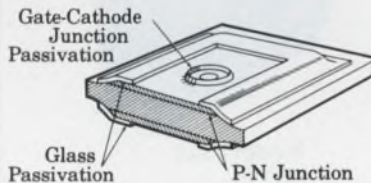

And who else but the industry's technology leader would offer the only truly upgraded thyristor process technology to come down the road since glassivation began - Photo-Glass.

Result? Total assurance that voids, moisture and impurity penetration don't exist - but excellent reliability does.

Motorola TO-220 First to Raise Reliability

Our TO-220s can take almost anything you can throw at them.

Like worst-case, full-on, full-off power cycling with package temps reaching 'way beyond your design limits . . . 95°C excursions.

Our plastic packages survived 43 MILLION of these power cycles with just 15 failures. An MTTF of 3 MILLION cycles!

Or blocking life tests at rated ambients. Our TO-220s survived 279,000 hours with zero failures.

Or 100 days at MIL-S-750 conditions - 92% to 98% relative humidity with units alternately drenched, then dried, during 24-hour cycles. Just one failure.

Motorola TO-220s can take it. Our brochure proves it.

Motorola Thyristors First in Price, Quality, Availability

There is nobody else with more to offer in SCRs and Triacs to 40 Amps than Motorola. Check it out.



And the best costs even less now through Motorola's unmatched volume production capability.

We won't be undersold. By anyone.

Try us. Contact an authorized distributor, sales rep or Box 20912, Phoenix, AZ 85036 for Guide to Thyristors and Everything You Always Wanted To Know About Reliability.

See the Plastic SCR and Triac world for what it really is. Motorola's.



MOTOROLA Semiconductors

MEET OUR family of dip clips



Model 3916
14/16 Pin



Model 4124
24 Pin

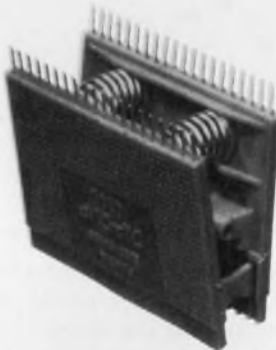

Model 4140
40 Pin



Model 4236
14/16 Pin
For Ultra Dense
Packaging



Model 4324
24 Pin
For Ultra Dense
Packaging



Model 4340
40 Pin
For Ultra Dense
Packaging

Count on Pomona Electronics to keep pace with the industry's trend toward higher density Dual In-Line packaging. We introduced the first Model 3916 in 1972. Now there are six improved models, including three designed for ultra dense packaging.

DIP CLIPS are designed for hands-free testing of integrated circuit packages. Lower contacts are .050 wide for improved surface contact with I.C. packages. Test contacts are .025 square, and are serrated for improved connection of test clips. Molded barrier between contacts minimizes accidental shorting. Can also be used as insertion and removal tool for DIPs.

Available Through Your Favorite Electronic Parts Distributor

ITT POMONA ELECTRONICS

1500 East Ninth St., Pomona, Calif. 91766
Telephone (714) 623-3463, TWX: 910-581-3822



CIRCLE NUMBER 12

ACROSS THE DESK

(continued from page 7)

The response was great, but they don't sell it

In the list of suppliers that followed your article on conductive elastomers (ED No. 23, Nov. 8, 1976, p. 60), you included our client, Instrument Specialties Company, Inc., of Little Falls, NJ. Unfortunately, Instrument Specialties does *not* produce conductive elastomers. They do make finger strips of beryllium copper, which are used for shielding. Since conductive elastomers are also used for this purpose, perhaps the confusion occurred in this connection.

You should know that Instrument Specialties and its reps have received many phone calls and letters from prospective customers for conductive elastomers. When the reps tell the callers that Instrument Specialties does not make this product, the callers frequently become irate, and accuse the rep of being stupid and not knowing what his company manufactures—since, after all, "ELECTRONIC DESIGN says you do make it."

David Levy
President

Levy Advertising Associates, Inc.
1 Rockefeller Plaza
New York, NY 10020

What was the point?

I read with interest Editor-in-Chief George Rostky's editorial on planning ahead (ED No. 15, July 19, 1976, p. 61). As an admirer of the various management techniques, I have also at times wondered if all the "paper work" they call for is worth the effort in practical situations. However, on reading the editorial, I can't conclude whether Mr. Rostky wants us to be Charlie (who worried about producing instruments) or Joe (who worried about planning to produce instruments).

R. Venkatraman
Deputy Manager

Bharat Electronics Ltd.
Jalahali, Bangalore -560013
India

Ed. note: It depends on whether you want to produce instruments or paper.

"As the first interactive small plotter, it was the only intelligent choice."

Problem: Until now, no small plotter could carry on an intelligent conversation.

Because most B-sized plotters have been pretty much the same: slow, unreliable, and dumb. Even with large off-line plotters you can wait hours, even days, for results... and if there's a mistake—start over.

Solution: Tektronix' new microprocessor-based 4662. For interactive plotting, page scaling, digitizing, and camera-ready output. Just \$3995.†

The 4662 is the first smart buy among 11"x17" flatbed plotters. Its digital design and vector generation offer exceptional accuracy and repeatability without drift or slidewire dirt build-up. Its 1600-byte buffer lets the host work while the 4662 plots... at speeds up to 22 ips.

It's the first B-sized plotter with graphic input. Digitizing capability and built-in joystick mean you can input corrections in seconds, experiment with designs, and run off camera-ready copies practically as fast as you load paper.

It's plug-to-plug compatible with virtually any RS-232 system... from minis to mainframes. You can plot circles around any other B-sized plotter, for about the same price as the competition. For a demonstration, call your local Tektronix Sales Engineer, or write:



The 4662 contains its own character generator, alpha rotation, and page scaling, thus minimizing support software. Proven graphic and plotter software is provided by Tektronix.

Tektronix, Inc.
Information Display Group
P.O. Box 500
Beaverton, Oregon 97077
Tektronix Datatek NV
P.O. Box 159
Badhoevedorp, The Netherlands



The 4662. Plug it in. It speaks for itself.

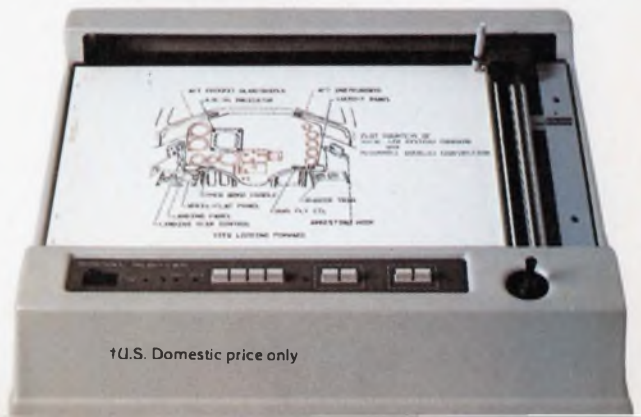

At long last! A that doesn't do

microprocessor very much.

All it does is process numbers.

Other microprocessors do almost anything you tell them to. And that's proven to be an industry-shaking advantage. But in certain cases there's a hitch. Programming can be kind of hairy, and in many applications general-purpose microprocessors can be cost ineffective.

Our new MM 57109 dedicated microprocessor (the Number Cruncher) is our answer.

It's pre-programmed to do a wide variety of math functions (including log, trig and functions of x), and do it more efficiently, reliably and cheaply.

Use it as a stand-alone or as a satellite to your general purpose microprocessor.

And the price tag?

In quantities of a hundred, a mere \$12.

And that's a number you should be able to process very nicely.

National Semiconductor
2900 Semiconductor Drive
Santa Clara, CA 95051

ED 117

Gentlemen:

I don't have very much for a microprocessor to do, so send me details on your microprocessor that doesn't do very much.

NAME _____ TITLE _____

COMPANY _____

ADDRESS _____

CITY _____ STATE _____ ZIP _____

 **National Semiconductor**

Touch & Trigger

Automatic displays to 25 MHz at 2 mV

As illustrated, the PM 3212 has an impressive combination of features that add up to unbeatable all-round performance.

Bandwidth, sensitivity, triggering facilities, weight and dimensions are all what you expect for \$ 1155.00*

* US domestic price only

"Auto" triggering on the PM 3212 is more than a trace finder - much more. In this mode not only is a zero line displayed when there is no input signal, but in the presence of a signal the trigger level is derived from the peak-to-peak amplitude of the signal. This gives instant and unambiguous triggering for a wide variety of measurement conditions.

But we give you more. A brighter trace, a sharper display, a double insulated supply, battery operation and versatile X-Y facilities. And the usual Philips plus: the unbeatable front panel layout.

For further information contact, Philips Test & Measuring Instruments, Inc.

Automatic TV triggering at the touch of a button. Frame triggering occurs in the lower sweep speeds, changing over automatically to line from 200 μ s/div upwards.

Level control can be used instead of "Auto" when the instrument needs to be triggered at an exact point in the input signal.

DC coupled triggering without which variable duty cycle waveforms cannot be handled. This is a vital feature for digital measurements.

Composite triggering when both buttons are depressed. When used in the alternate mode this gives a stable display of two unrelated signals.

Continuously variable timebase for easier measurements of phase, for timing comparisons and to avoid "double writing" problems in digital applications.

High light output displays through 10 kV tube. Small spot size. Continuously variable illumination of fine-line internal graticule.

PM 3212 has compact dimensions of 445 x 300 x 145 mm (l x w x h). Weight approx. 7.9 kg (17.4 lb)

Double-insulated power supply eliminates need for earth connection (i.e. 2-wire line cord).

Any of the selected trigger sources can be switched to the horizontal channel.

Separate source triggering for unambiguous, stable displays without the inconvenience of changing probes.

Carrying handle automatically protects crt and controls.

Philips Test & Measuring Instruments, Inc.

In the United States:
400 Crossways Park Drive
Woodbury, N.Y. 11797
Tel: (516) 921-8880

In Canada:
6 Laswyn Road
Toronto, Ontario Canada M6A 1K2
Tel: (416) 789-7188

Use our toll free hot line number, 800 645-3043.

New York State residents call (516) 921-8880 collect.



Test & Measuring
Instruments

PHILIPS

JANUARY 18, 1977

Put your product in space and see what happens

Ever wonder what would happen to your firm's product if it were sent into space? How it would react to intense solar radiation, bombardment with micrometeorites and charged particles, or exposure to high vacuum and low gravity. The National Aeronautics and Space Administration is providing the first opportunity to find out—for free.

The opportunity is a project called the University Space Experiments (USE), which is open to the electronics industry for comparative studies of shieldings, coatings and circuitry implemented in various technologies, such as TTL, MOS and SOS.

Beginning in 1979, NASA will put into orbit its long-duration exposure facility (LDEF) satellite for six months at a time. An open aluminum frame cylinder 30 ft long and 14 ft in diameter, the satellite can expose more than 70 different experimental packages directly to the solar winds.

Colonization of the moon and other planets will require commercial equipment that stands up to the rigors of outer space," says Dr. M. H. Davis, program director of LDEF/USE. "We are particularly interested in encouraging potential experimenters who haven't had previous experience in space research."

The experiments can either utilize the orbital environment or study it. Housed in NASA-supplied trays, 50 in. long, 38 in. wide and up to 12 in. deep, the experiments will be mounted around the periphery of the satellite, facing outward. The cylinder will maintain a constant attitude toward earth. An experimenter can request a particular location on the satellite for his experiment.

Simple experiments are particularly well-suited to the LDEF mission because no essential power

source or telemetry can be provided. Consequently, each experiment must be self-sufficient—that is, it must be electromagnetically passive and draw power either from solar cells or a battery pack. The satellite's payload is limited to 175 lb of equipment in each tray. However, a large experiment can be mounted inside the structure. And power facilities may become available on subsequent flights.

The LDEF satellite will be borne aloft by a space shuttle and left in near-circular orbit whose period will last 90 min. and whose altitude will be 300 nautical miles (556 km). After the six-month period, the shuttle will retrieve it.

The LDEF program is being coordinated by the Universities Space Research Association (USRA), which is a consortium of some 50 universities and a branch of NASA. "Our program has no deadlines and is noncompetitive, but industry applicants should be able to relate their experiments to an academic institution in order to qualify for the 'no cost' status. USRA will assist them in doing this."

Firms interested in participating in the LDEF/USE program should write to USRA, P.O. Box 3006, Boulder, CO 80307, or telephone (303) 449-3414.

Elephant with μ P brain skates in Rose Parade

One of the more unusual sights during the 1977 Tournament of Roses Parade was a panic-stricken mother elephant with a mouse on her trunk, pulling a baby elephant in his red wagon. The "mother" had roller skates on its feet and a microprocessor for a brain.

Designed and built by engineering students at California State

Polytechnic University, the 16-ft tall model pachyderm's animation is built around a Rockwell PPS-4 microprocessor and 4 kbits of PROM, 4 kbits of RAM and 40 channels of I/O.

The I/O channels monitor and control the position of the big elephant's legs, trunk, head and eyes. Potentiometers inputted to a/d converters detect the positions of the float's animated parts instantaneously. The progress of all the motions is monitored by a PROM-resident supervisor program in the μ P-based control system.

A control panel enables the float's crew of four to modify and enhance the sequence of actions to obtain the most dramatic effect. And since the float's actual animation sequence is stored on cassette tape and loaded into RAM, the μ P system is flexible enough to be used in other floats and displays.

"This is the first Rose Parade float to use a microprocessor," says Doug Dubrall, Electronics chairman of Cal Poly's Rose Bowl Committee.

The animation includes side-to-side roller skating by the mother elephant, up and down swaying of her trunk, rolling head, blinking eyes and bending knees. The baby elephant in the wagon holds a pinwheel that spins. For safety, limit switches are located at the extreme ends of motion.



Artists sketch of μ P-controlled elephant float in Rose Bowl parade.

New standard to improve computer security

A new federal data encryption standard to be released by the Commerce Dept. is aimed at im-

proving the security of computer data.

Registered as FIPS PUB 46, the standard will be "the first publicly available standard that can be used to provide a high level of protection for computer data," says Ruth M. Davis, director of the Institute for Computer Sciences and Technology at the National Bureau of Standards.

Hardware is used to encrypt (reduce to cipher) and decrypt (decipher) digital information. Encryption is accomplished by electronic devices that implement the mathematical algorithm specified in the standard.

In addition to government agencies, the standard will be available to private organizations and individuals. It will be unveiled at a conference to be held Feb. 15 at the Gaithersburg, MD, headquarters of NBS.

The hardware devices have been patented by IBM, which has agreed to grant nonexclusive, royalty-free licenses to users.

Ultrasonic system turns the lights on and off

A guest leaves his hotel room, and a minute and a half later all the lights he's left on, including the television set, switch off. When he returns and enters the room, all the appliances turn on.

This discrete economy move is accomplished by an ultrasonic transmitter-receiver system that is set to sense the entrance or exit of any bulk the size of a human being moving at from 1 to 2 ft/s. Small animals don't trigger the system because they're the wrong size and usually don't move at the right speed.

Called EASE, for Energy Activation Systems Equipment, the system contains an oscillator that consists of transmitters and receivers recessed in the ceiling. Each device commands a radius of approximately 10 feet. The transmitter consists of an oscillator that generates ultrasonic emissions at 42 kHz.

The sensor contains a microphone transducer, an AGC circuit, and a circuit that makes comparative analysis between a reference signal and the ultrasonic sound in

the space being monitored. If, for example, a frequency above or below 42 kHz is received, it means a doppler shift has been created by movement in the room.

The circuit is similar in design to that of an ultrasonic burglar alarm. A switching module causes the relay to open or close, thus turning the appliances on or off.

EASE is being manufactured by Elcobar, a joint venture formed by Barnum Enterprises, Leonia, NJ, and Elco, Ltd. of Israel. The system is marketed by MRCA, Inc., Leonia, NJ.

ITT head gets patent on wrist pulse monitor

Besides serving as chairman and chief executive of the International Telephone and Telegraph Corp., Harold S. Geneen has been granted a patent on a "wristwatch" pulse-rate indicator that warns a jogger when to slow down.

Besides its usefulness for joggers who would like to know if they're exceeding their own safe limits of cardiovascular activity without having to stop and take their pulse, the indicator could also prove helpful during sedentary situations for people whose emotions tend to boost their heart rates.

The device displays the wearer's heart rate in three forms: digital, color (green for rest, amber for safe exercise level, and red for

danger), and by an audible beep in conjunction with the red light.

The device consists of a contact-type pulse-detector worn over the radial artery in the vicinity of the user's wrist or as a headband. The detector may comprise a thin silicon-metal piezoelectric transducer or a piezoelectric strain gauge.

The sensor produces an electric output signal which is played to a programmable IC within the unit's housing. The signal is amplified and peak detected in the shaper circuit. The shaper circuit is made variable to conform to the individual's physiological characteristics.

The shaped output pulse is applied to a counter. At the end of a predetermined period, which may consist of 15 seconds or one minute, the count is transferred through transfer gates to storage circuits.

At the end of a predetermined number of counts, an averaging circuit determines the average rest pulse rate over a predetermined period. This average is applied to a comparator circuit and displayed.

The averaging circuit also includes a set element to fix or set the average of the pulse rate so that this figure remains constant during jogging. If, however, an individual knows his rest pulse rate, he can set it into the averaging circuit by hand.

How soon, and even whether, ITT will produce the pulse rate indicator is still under consideration.

News Briefs

Detection and identification of single atoms of various elements are now possible with a laser technique developed at Oak Ridge National Laboratory. Among potential applications, the technique promises to provide a more sensitive method for identifying and measuring chemical pollutants in the environment.

Prototypes of a nickel-zinc battery, which will have three times the energy output of a lead acid battery, are now under development at Gould Inc. William Ylvisaker, chairman, believes that by the late 1970s and early 1980s commercial versions of the battery will enable electric cars to attain speeds of 60 mph and a

range of 125 miles.

The first commercial bubble memory chips will be introduced by Plessey Microsystems, Irvine, CA, during the second quarter of 1977. The 64-kbit chip, which will have a price tag in the \$20-to-\$30 range, will be used in serial memory devices.

Production of capacitors containing PCB materials (polychlorinated biphenyl) will be discontinued by Sprague Electric by July 1—10 months sooner than originally planned. Sprague's Clorinol family of oil-paper capacitors will be replaced by a new series of Eccol capacitors which use a biodegradable synthetic-oil impregnant.

Now from Amperex— a group of high-performance, 4- and 5-GHz PNP's at prices between \$2.40 and \$3.15.

The ever-growing Amperex line of high-performance, economical, small-signal GHz transistors now opens up still more design possibilities in the GHz region. These six new low-noise PNP's offer the key to both new and retrofit/upgraded circuits for portable pagers and transceivers...for high bit rate communications gear...for high frequency spectrum analyzers and oscilloscopes...for counters...and for CATV/MATV amplifiers.

Like their NPN complements, the six new PNP's have f_T of 4- or 5-GHz at I_C 's from 14 to 30 mA and offer high linearity and low noise; they provide maximum available gain as high as 19 dB. Two of them, the BFR92 and the BRF93 are in the new SOT-23 microminiature plastic

package for high frequency hybrid circuit applications.



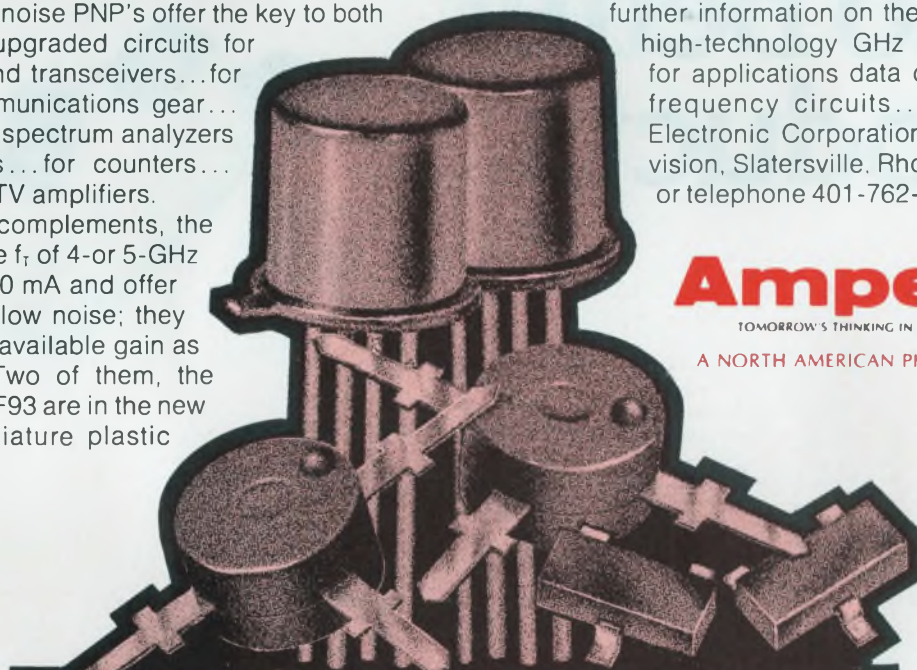



There's simply nothing else like them available at anything like our prices anywhere else today. For further information on the Amperex line of high-technology GHz transistors...and for applications data on PNP's in high frequency circuits...write Amperex Electronic Corporation, Slatersville Division, Slatersville, Rhode Island 02876, or telephone 401-762-9000.



Amperex®

TOMORROW'S THINKING IN TODAY'S PRODUCTS

A NORTH AMERICAN PHILIPS COMPANY

COMPLEMENTARY PAIRS FOR GHz APPLICATIONS				
New PNP Types			Complementary NPN Types	
TYPE	FEATURES	PRICE*	TYPE	PRICE*
A440 (TO-72) 	f_T ... 5 GHz @ 14 mA NF ... 2.3 dB @ 200 MHz G_{max} ... 18 dB @ 500 MHz	\$2.40	A400 (TO-72)	\$1.65
A441 (TO-72) 	f_T ... 5 GHz @ 30 mA NF ... 2.4 dB @ 200 MHz G_{max} ... 14 dB @ 500 MHz	\$2.65	A401 (TO-72)	\$1.75
ON586 (SOT-37) 	f_T ... 5 GHz @ 14 mA NF ... 2.5 dB @ 500 MHz G_{max} ... 19 dB @ 500 MHz	\$2.85	BFR90 (SOT-37)	\$2.25
BFQ23 (SOT-37) 	f_T ... 5 GHz @ 30 mA NF ... 2.4 dB @ 500 MHz G_{max} ... 15 dB @ 500 MHz	\$3.15	BFR91 (SOT-37)	\$2.45
BFT92 (SOT-23) 	f_T ... 4 GHz @ 14 mA NF ... 2.7 dB @ 500 MHz G_{max} ... 17.5 dB @ 500 MHz	\$2.53	BFR92 (SOT-23)	\$2.30
BFT93 (SOT-23) 	f_T ... 4 GHz @ 30 mA NF ... 2.4 dB @ 500 MHz G_{max} ... 15.5 dB @ 500 MHz	\$2.70	BFR93 (SOT-23)	\$2.45

*In 1000 piece quantities

**Why Rockwell
microcomputers
turn your good ideas
into better
products.**

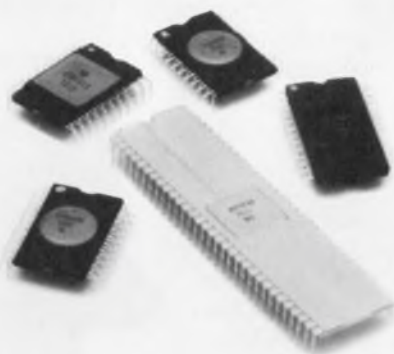

Rockwell's broad line of microprocessor systems are making all kinds of new products possible as well as practical because they fit the application so precisely. You get the right functional capability at the right price—and the Rockwell in-house capability to make sure your product idea becomes a reality.

The Rockwell advantage — a 5-family approach.

Rockwell offers five compatible microcomputer families, from low-cost one chippers through multi-chip 8-bit systems. You select the most cost-effective microprocessor system for your immediate design requirements, then expand models up or down with our compatible systems. You don't need to redo your total program.

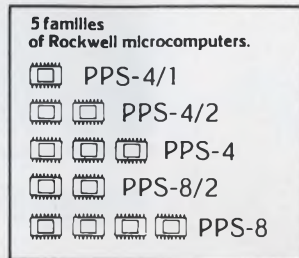

Our one-chip PPS-4/1 family with CPU, ROM, RAM, and 31 or more I/O ports cover a wide range of applications at lowest possible cost.

The two-chip PPS-4/2 and the multi-chip PPS-4 systems offer more power at low cost. Both have fast execution speeds, high throughput, and are expandable with dozens of LSI I/O peripheral controllers and memory options.

Rockwell's 8-bit systems include the PPS-8/2 (two chip microcomputer with I/O) and the fully compatible multi-chip PPS-8 system. Both use the same multi-function 109 instruction set and accept the same broad range of provided LSI memory and I/O controller options.

And Rockwell backs its microcomputers with all needed design aids and a worldwide network of applications centers, representatives and distributors.

Better products like these are made possible with Rockwell cost-effective systems.

Cash registers and P-O-S terminals—Inside some of the most popular machines on the market today are Rockwell microcomputers. At the low end, PPS-4/1 one-chippers. In P-O-S terminals, two-chip microcomputers combine with any of dozens of available LSI I/O and memory options.

Home and commercial products—Weighing scales, security systems, copiers, scanning

radios, hi-fi record changers and appliances are now being controlled or automated with Rockwell microcomputers.

High-speed printer—The functional ability and low cost of a six-chip PPS-8 Rockwell microcomputer is why it was selected to control a matrix printer which zip-prints at 200 characters/second and tabs at 550.

Hand held computer terminals—Two and a half hours of paperwork for meter readers and sales clerks are reduced to 30 seconds. The reason—a Rockwell PPS-4/2 microcomputer in a hand-held terminal that records transactions and interfaces directly with central computers.

Electronic games and pinball machines—Rockwell's compatible microcomputers are reducing manufacturing costs and shortening design time in all kinds of exciting new games. We have supplied custom design services for makers of these games.

Heart-monitoring bicycle exerciser—This unique but functionally complex idea was made economically possible with a Rockwell PPS-4/2 microcomputer. Rockwell is producing the microcomputer as a cost-saving subassembly.

Automobile computers—A 1977 production car has the first digital computer to control spark firing—based on a custom Rockwell two-chip system.

Stationary and mobile telephones—Our versatile one, two and multi-chip systems have expanded telephone usage with features like credit verification and automated mobile service. Other types of communications equipment, like auto-dialers and facsimile machines, now also use Rockwell microcomputers.

Get the full story. Write on your company letterhead to: Marketing Services, D/727-B Microelectronic Device Division, Rockwell International, P.O. Box 3669, Anaheim, CA 92803, U.S.A. or phone (714) 632-3729.



Rockwell International

It's getting easier to program μ Ps with the new software design aids

While grateful for the circuit simplification microprocessors permit, the designer is not so pleased with the difficulty and high cost of programming them. Designers have almost learned to live with the programmer's rule of thumb: Three to five lines of valid code represent a good day's work.

The meager output is understandable, however: With over 40 available μ P types—and each with a different instruction set—the designer/programmer can't be an expert in them all. Changing from one to another requires preparation and time.

To remedy the costly bottleneck many companies that make or use μ Ps offer myriad forms of programming aids—from simple programs that help you develop your own to full libraries of working programs for use on your system.

Software support is available in four basic levels and in almost as many forms:

- If you're familiar with machine language, you can work directly with the microprocessor in hexadecimal notation. For large programs, however, working in hex can be extremely cumbersome.

- If numbers bother you, go one step away from machine language and do the programs in assembly language—mnemonic equivalents of the hex codes. Once the program is written, however, you'll have to convert it back to hex.

- If you don't like mnemonics, go down one more level to a more English-like language (such as Basic) with special operators or even a more simplified form called Tiny Basic. However, complex languages like Basic require more



Low-cost cassette tapes and CRT monitors can be used by such development systems as this one from Microkit, Santa Monica, CA. Important to any software-development system, however, is the support literature for the programs.

memory support and are not often as efficient (with more lines of machine code to do a specific task) in the long run.

- If you're most familiar with programming large computers in such languages as Fortran, PL/1, or Cobol, you can also use these languages as the fastest route to a program. However, these languages are the most inefficient.

Software in many forms

You can purchase the software, for use on in-house computer systems, in the form of firmware ROMs, paper-tapes, mag-tapes, floppy discs, card decks or source listings. And, if no in-house computer is available, a terminal and any one of the many time-sharing services offer viable alternatives with high-level languages, simulators and emulators.

For short microprocessor pro-



The 6100-based dual-floppy disc system from Intersil offers a file system, monitor, text editor, assembler, binary loader, octal debugger, high-level interpreter and utilities.

grams, say 200 lines or less, you can readily put the program together by hand. A pencil and paper are the only tools absolutely necessary to hand-assemble and compile a program. Almost every μ P vendor offers pads of specially lined

paper to permit you to keep track of all points by setting up columns for instructions, address data and comments. Even non- μ P vendors have picked up on this method, and some companies, like Walton Electronics in Bethany, OK, offer pads of coding forms.

But aside from some demonstration routines, few programs are less than 200 lines long. Typical lengths range from 200 to 4000 lines (often equatable with 500 to 8 kbytes of memory). For programs longer than 200 lines you'll end up whittling a lot of pencils unless you're sharp in hex notation. Vendors who have foreseen this problem offer a wide variety of assemblers, debuggers, compilers and disassemblers to help you.

Software for microprocessor-program development can be split into two major groups—resident and nonresident. Resident software consists of programs written in the instructions of a specific microprocessor and designed to run on a system that uses that microprocessor. Nonresident software consists of programs that run on one processor (typically, a minicomputer or larger) for the benefit of developing the software of another processor (typically, a μ P).

Most of the microprocessor-development systems, from the \$100 kit to the \$10,000 work station, come with some form of resident software. (For more about development hardware see ED No. 25, December 6, 1976, p. 30). In the lower-cost systems, the software, usually minimal, appears in the form of ROMs—often referred to as firmware. The more expensive development systems usually contain either mag-tape or floppy-disc drives, which permit large support programs.

Three basic programs permit software development: resident assemblers, editors and debuggers. Another program usually included in most utility packages is some form of communications routine that permits the microcomputer to communicate with a teletypewriter or other I/O device.

Each of the various μ P manufacturers offers his own version of an assembler, editor, debugger or other program—and the available features and capabilities vary widely. For example, the Kitbug ROM included in the SC/MP kit from

National Semiconductor, Santa Clara, CA, requires 512 bytes of memory and enables you to:

- Initiate execution of your program at any point desired.
- Establish breakpoints within your program to allow execution of selected program segments.
- Examine memory contents and SC/MP registers to determine if your program is producing the desired results.
- Change the contents of any memory location.
- Alter the contents of SC/MP registers to set up conditions.
- Communicate with the SC/MP via a teletypewriter control routine.

Motorola, Phoenix, AZ; Fairchild, Mountain View, CA; RCA,

that uses the asynchronous interface adapter to do the RS-232 interface, are available with the Evaluation Module 1 and the Evaluation Kit 1, respectively. A five-command program known as Mikbug comes with the Evaluation Module 1.

The most complex program is EXbug, which provides 34 commands and requires 3 kbytes of ROM. Of the 34 commands, 26 are used for interactive debugging.

Only the EXbug and Mikbug ROMs are available by themselves, for \$200 and \$18.15 respectively.

Included on the MOS Technology Kim microcomputer board is the Kim monitor, which resides in two 6530 ROM/RAM and I/O circuits. The monitor program, called TIM

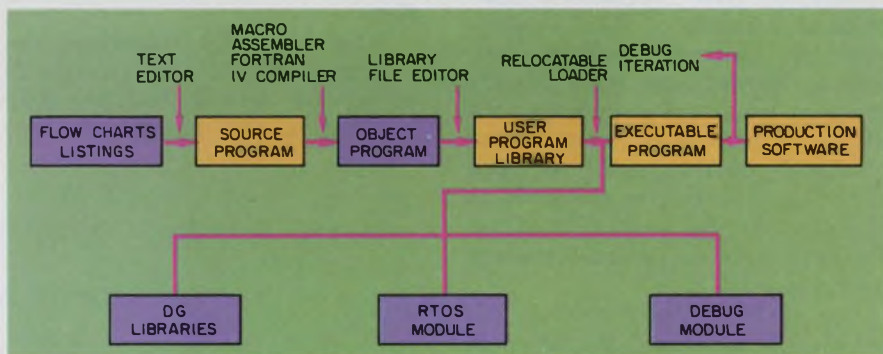

A general program-development cycle, as suggested by Data General, can be a long and tedious process. However, for microNova users, real-time operating systems, large software libraries and debug aids can speed programming.

Somerville, NJ; Intel, Santa Clara, CA; Signetics, Sunnyvale, CA; and MOS Technology, Norristown, PA, all offer similar ROMs in their evaluation boards. But in most cases, you can't buy just the ROM—it comes with the entire package.

The ROMs from Motorola appear to offer the widest range of capabilities. Seven ROM-based programs are available. The smallest is the monitor included with the Educator 2. It has six commands that are intended to handle binary-entered instructions and data. Jbug, which comes with the two-board Evaluation Kit 2, offers eight commands and is designed to handle data from a hex keyboard. Available with the Micromodule μ P board is Microbug, a monitor and assembler with 13 commands and an RS-232 interface routine.

Two versions of Minibug, one that uses the peripheral interface adapter as an RS-232 port and one

(terminal interface monitor), communicates with you over a full-duplex port and adjusts the data speed to that of your terminal. I/O routines similar to SC/MP also come with TIM. Coming soon are ROM-based line editors, assemblers and even a mathematics package.

Even nonmicroprocessor manufacturers are developing firmware that helps you cut μ P-program development time. Wintek, Lafayette, IN, for instance, has ROM programs called Fantom I and Fantom II designed to support the 6800 μ P. Fantom I is similar to Motorola's Mikbug, and has five basic commands that let you load, examine, print and display data and instructions as well as initiate programs. Fantom II is a 1-kbyte loader and diagnostic program that, in addition to the commands used in Fantom I, permits you to operate the μ P in the single-instruction step mode, examine instructions in

memory, dump memory to console, and examine/modify the A, B, condition-code and, index registers and program counter.

ROMs limit programming ease

Most of the ROMs in the small systems permit you to work only in hexadecimal—a severe limitation when you have to develop a lengthy program. The next step up is to get a system that offers a program that can assemble and then compile assembly language listings.

The program necessary to do the assembly usually requires several kbytes of memory. Resident programs in Motorola's EXORciser, Intel's Intellec-MDS, Zilog's development system, Fairchild's Formulator and RCA's development system are often sold with a minimum of 4 kbytes of RAM in addition to the resident ROM programs. Resident-assembler/editor/compiler programs require up to 4 kbytes of ROM and up to 1 kbyte of RAM working space to store variables. The rest of the RAM is allocated by the monitor program for your own workspace (program development).

One of the largest program development systems available is Intel's 8080-based MDS-800. The minimum system consists of 16 kbytes of RAM, 2 k of ROM, an 8080-based microcomputer, hardware interfaces and software drivers for TTY, CRT, floppy discs, line printer, high-speed paper-tape reader/punch, and PROM programmer. A system monitor is included in the resident ROM for program loading, debugging and execution.

A resident assembler, written in Intel's PL/M, a high-level system programming language, occupies 12 kbytes of RAM and translates symbolic 8080 assembly-language instructions into machine-operation codes. Also available is a text editor that permits manipulation of entire lines of text or individual characters within a line. The text editor requires 8 kbytes of RAM and is also written in PL/M.

A resident PL/M compiler program that is designed to operate on the dual floppy disc-based MDS system has been introduced recently by Intel. However, a full 65-kbyte memory is necessary to support the \$10,000 system. Specially developed



Development programs for M6800 microprocessors are available in just about every format from Motorola.

routines in the disc control system permit up to 200 files to be packed onto the disc. To provide maximum code storage, the disc-monitor program keeps track of the empty space and the location of files.

Zilog's recently introduced development system uses a single Z-80 μ P for driving both the user hardware and the resident monitor.

The system monitor permits programs to be entered into memory, then edited, assembled and loaded for execution.

A debug ROM module allows user-designated operations to be stored in an independent memory and the user to specify an operation that can stop processing and cause the system to go into the monitor mode. In addition, all oper-

PL/M-80 COMPILER FACTORIAL GENERATOR - PROCEDURE

```

SUBJECT(:F1:FACT.OB2)
SDEBUG
SXREF
$TITLE('FACTORIAL GENERATOR - PROCEDURE')
$PAGEWIDTH(90)

1      FACT:
      DO;

2      1      DECLARE NUMCH BYTE PUBLIC;

3      1      FACTORIAL: PROCEDURE (NUM, PTR) PUBLIC;
4      2      DECLARE NUM BYTE, PTR ADDRESS;
5      2      DECLARE DIGITS BASED PTR (161) BYTE;
6      2      DECLARE (I, C, M) BYTE;

7      2      NUMCH=1; DIGITS(1)=1;
9      2      DO M = 1 TO NUM;
10     3      C=0;
11     3      DO I = 1 TO NUMCH;
12     4      DIGITS(I) = DIGITS(I) * M + C;
13     4      C = DIGITS(I)/10;
14     4      DIGITS(I) = DIGITS(I) - 10 * C;
15     4      END;

16     3      IF C <> 0 THEN
17     3      DO;
18     4      NUMCH = NUMCH+1; DIGITS(NUMCH) = C;
20     4      C = DIGITS(NUMCH)/10;
21     4      DIGITS(NU4CH) = DIGITS(NUMCH) - 10 * C;
22     4      END;
23     3      END;

24     2      END FACTORIAL;

25     1      END;

```

Programming in PL/M, Intel's high-level language, can slash the time needed to develop 8080 software. English-like commands replace many lines of hard-to-write assembly-language statements. A PL/M compiler in the Intellec development system can cut the cost of time-shared program development costs.

**Need electric wave filters for
critical, complex situations?
TRW / UTC has a stock answer.**

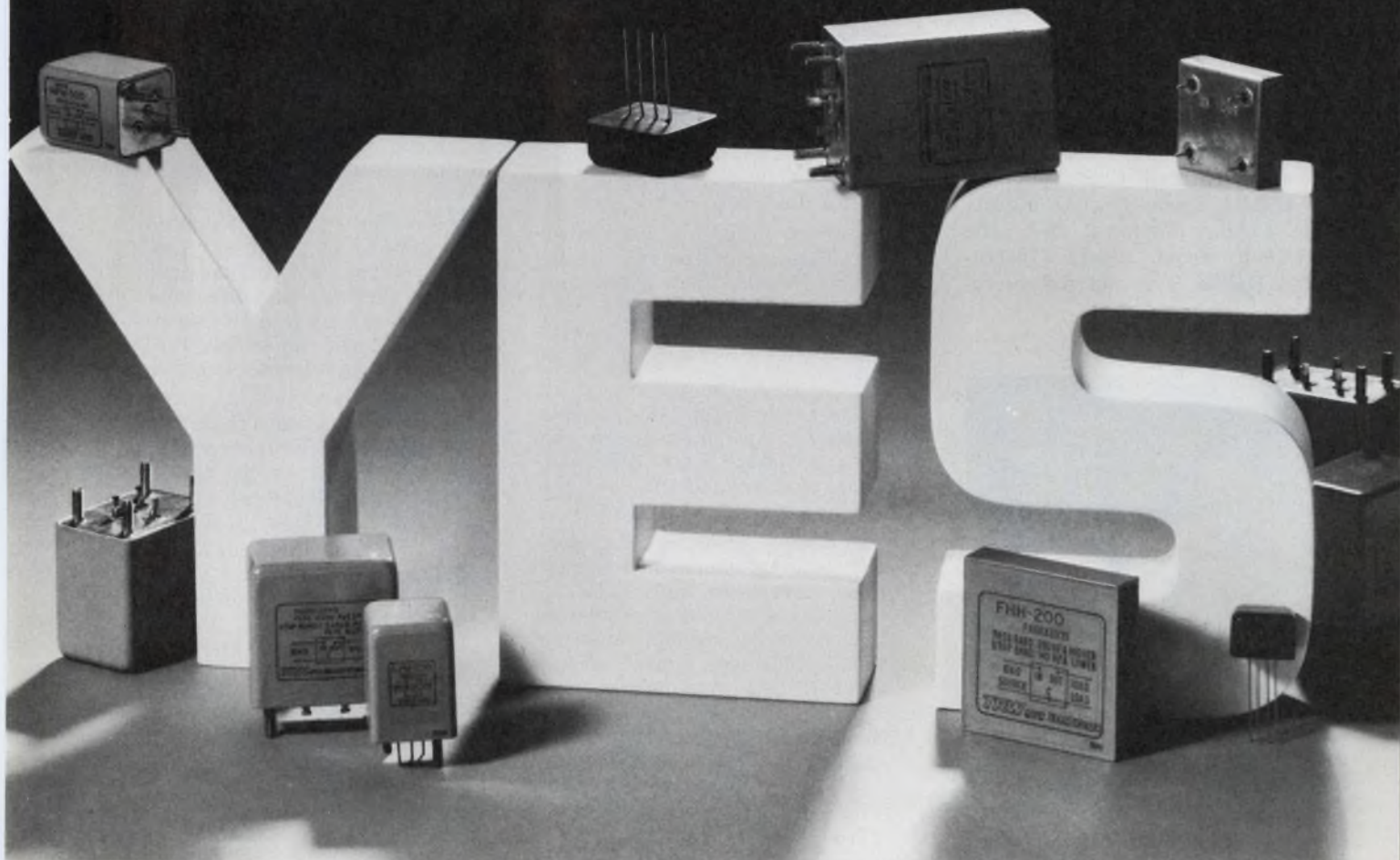

The more complex the equipment or system, the greater the demand for an electric wave filter you can count on.

Almost 40 years of specialization in selective networks, from image parameter design to modern network synthesis, results in the superior performance, miniaturization, stability, and reliability of TRW/UTC electric wave filters produced today.

TRW/UTC Filters are miniaturized, lightweight, temperature stable, and manufactured to MIL-F-18327 for

critical applications such as telemetering, fire control and medical instrumentation. Available in flat configuration with heights as low as 3/8", and with straight pin terminals for mounting on PC boards. Operating temperature range from -55°C to +105°C.

Check your authorized TRW/UTC local distributor for immediate off-the-shelf delivery or contact TRW/UTC Transformers, an Operation of TRW Electronic Components, 150 Varick Street, New York, N.Y. 10013. Area Code: 212 255-3500.

TRW UTC TRANSFORMERS

ANOTHER PRODUCT OF A COMPANY CALLED TRW

CIRCLE NUMBER 45

ations preceding the suspension are stored in an independent memory and can be examined to find errors.

With two 2650 μ Ps to speed program development, the Twin system from Signetics can offer many advantages. Software includes an operating system, a file-management system, debugging software, a text editor and a resident macro-assembler.

The dual- μ P structure provides a common (user) memory space and a master processor/operator system that is independent of the user system.

Mini-like micros have software

For the μ Ps that approximate full minicomputers, such as the 6100 from Intersil, Cupertino, CA, the LSI-11 from Digital Equipment Corp., Maynard, MA, the TMS-9900 from Texas Instruments, Dallas, TX, and the micro-



A resident Fortran compiler for 8080 software development is available on a floppy-disc system offered by Realistic Controls.

Nova from Data General, Southboro, MA, a wealth of available software and programming aids already exists.

Data General, for example, has a diskette-based disc-operating system for the microNova with such utilities as an editor, assembler, relocatable loader and symbolic debugger. A real-time Fortran IC program also can run on the microNova.

Digital Equipment Corp.'s user library, DECUS, provides many programs that can be used on the 6100 since the 6100 emulates, to a great extent, the PDP-8 minicomputer originally developed by DEC. And for LSI-11 program develop-

ment, DEC offers a wide range of compatible PDP-16 software.

A new language, developed by RCA and Forth, Manhattan Beach, CA, is designed to run on the Cosmac development system. Dubbed microForth, this language is an interactive program that can compile assembly-language statements directly into RAM. An 8 kbyte system is recommended to hold microForth. About 2 k of RAM workspace is available.

Other new languages are being developed by outside (non-IC manufacturers) companies and individuals to make programming easier. One such program is a string-oriented language called SLP that

Software Definitions

Machine code: commands for the μ P system, often written in binary or hexadecimal format. Machine code is often referred to as machine language or object code.

Assembly language: commands for the μ P system written in mnemonic form. Typically, three letter abbreviations, called mnemonics, are used to represent each instruction, and each mnemonic can usually be equated to one machine-code instruction.

High-level: commands for computer systems where each instruction is actually equated to many machine-code instructions strung together.

Monitors: programs that control the operation of the entire computer system. They often contain routines that tell the computer how to communicate with the outside world and how to allocate resources.

Editors: programs that permit data or instructions to be manipulated and displayed. Their most common use is in the preparation of new programs.

Assemblers: programs that permit you to represent instructions, addresses and data in symbolic form (character strings that represent machine instructions, addresses, data, among others). An assembler automatically translates symbols into their corresponding numerical values. It permits symbolic ad-

ressing by assigning values to labels used to indicate program-jump locations.

Compilers: programs that usually translate an assembled program into a complete machine-code listing. No matter how many times a section of code is used in the assembled program, it will be translated only once and put in its proper place.

Interpreters: programs that, much like the compiler, translate an assembled program into a complete machine-code listing on a line-by-line basis. If a statement is used in a program 10 times, it will be translated 10 times.

Disassemblers: programs that do the opposite of compiler programs. Given a machine-code program listing, the disassembler turns it back into an assembly listing, with mnemonic representations, for troubleshooting purposes.

Debuggers: programs that help track down and eliminate errors that occur in the normal course of program development.

Cross-assemblers and cross-compilers: programs that are usually designed to run on a large computer for the purpose of translating instructions for use on another processor, usually a μ P.

Simulators: programs that help to evaluate a μ P by duplicating all logic operations within the software of a large computer.

permits large arrays of instructions to be assembled with fast and compact listing.

Scelbal, developed by Scelbi Computer Consulting, Milford, CT, and originally intended to run on the older 8008 μ P, is similar to Basic in capabilities. The language operates in an interpretive mode—both the user and the resident programs must be held in RAM. When a run command is given, the resident program converts each line of high-level language program into executable code.

Slam, a symbolic language adapter for microcomputers, works on 8080-based equipment. Developed by Penn Micro, Lancaster, PA,



HYBRID

FAIRCHILD JUST CANNED A WHOLE FAMILY OF 5-AMP REGULATORS.

Introducing the very first family of 5-amp Power Voltage Regulators in TO-3 cans.

These new Fairchild hybrids include three fixed voltage devices at 5, 12 and 15 volts and one adjustable regulator with output selection from 5 to 20 volts. All pin-for-pin compatible with the industry standard 7800 Series monolithic Voltage Regulators in TO-3 packages. But with more power and better performance.

IT TAKES LESS TO DO MORE.

Our new 5-amp regulators save you a considerable amount of time. You won't have to fool around with extra components, trying to make 1-amp and 3-amp regulators add up to 5. And you'll be able to short-cut your approach to short-circuit current limiting and thermal shut-down requirements.



In brief, you'll have better specs than previous high-current regulators gave you (50-watt power dissipation, low drop-out voltage, etc.) with none of the design disadvantages.

COME AND GET THEM.

Your very favorite Fairchild distributor can fill your palm with 5-amp regulators whenever you're ready.

Device	Volts	Price (100 Quantity)
μ A78H05KC	5	\$7.00 ea.
μ A78H12KC	12	\$7.00 ea.
μ A78H15KC	15	\$7.00 ea.
μ A78HGKC	5-20	\$7.50 ea.

At these prices, how can you not be ready?

If you have lower current

requirements, don't forget Fairchild's μ A7800 and μ A7900 1-amp Series. Our μ A78M00 and μ A79M00 0.5-amp Series. And our μ A78L00 100 mA Series.

For more information, write or call your Fairchild sales office, distributor or representative today. Use the direct line at the bottom of this ad to call our Hybrid Products people. Fairchild Camera & Instrument Corp., 464 Ellis Street, Mountain View, CA 94042. Tel: (415) 962-3641. TWX: 910-379-6435.

FAIRCHILD

**CALL US ON IT.
(415) 962-3641**

Slam is an interpreter-type language with editing capability and English-like instructions.

Pull apart programs to debug

Not only is there a wide variety of languages that assemble assembly-language listings, but there is also a specialized group of programs called disassemblers that rip apart an assembled listing to help in the debugging. MOS Technology's MDT development system has such a program. Tranti Systems, North Billerica, MA, has a similar program in its Model 8000 universal programming system.

The MDT system's assembler assembles from a source tape or RAM, has six character labels and symbols, permits free-form entry of the source statement, delivers a symbol table, puts error flags on listings and delivers an assembled program in executable code. Once

the assembler has done an assembly, the disassembler can pull the listing apart and give back the mnemonics from the hex code. Of course, the disassembler does even more, such as setting program traps, goes forward or backward one instruction, shows next or last cycle of operation and more.

A text-editor program comes with the MDT. Available text-manipulating routines include load text buffer, insert or delete a line or character, step forward or backward one character or one blank, go to top or bottom of text index up or down one line, find a specified string of characters and provide output to printer/punch.

Time-sharing cuts capital costs

Because of the accessibility of large computers or time-sharing services, many of the μ P vendors have developed programs written in

PL/1, Fortran, Cobol and other languages that will deliver micro-processor-compatible machine code. National CSS, Norwalk, CT; General Electric Information Services, Bethesda, MD; First Data, Waltham, MA; United Computer Systems, Kansas City, MO; and Tymeshare, Cupertino, CA, are just some of the firms that offer a wide variety of μ P-development software.

All the programs offered on time-sharing systems are designed to run on large computers—the IBM 360/370, the GE Mark 111a, and even the DECsystem 10s. Cross-assemblers, cross-compilers, debuggers, simulators and other programs are available for μ Ps and bit-slice processors. Each company's programs offer slightly different features, so make sure you know the capability of the various time-sharing programs before you hook up.

The familiarity of engineers with Fortran and PL/1 makes these two languages the most popular choices, although Cobol is favored by most programmers. Cross software typically operates faster than resident software and often has more commands or a library of available routines to select from.

A high-level system often permits you to develop the program for a μ P before the actual hardware can be prototyped—sometimes even before a dollar is spent for hardware, since complete simulators are available for some μ Ps. Cross-assemblers are commonly available in Fortran, versions of PL/1, and assembly language. Some assemblers can even produce more than one machine-code format to allow for absolute and relocatable code listings.

Compilers and integrator programs in PL/M, PL/W, PL/Z, MPL, Forth, Cobol and Fortran are available, and there are probably others still to be found. Programs in PL/M, PL/W, PL/Z and MPL are all optimized by the IC vendors to work only for their μ Ps.

The last type of program just starting to appear is a resident form of Fortran. Motorola has available a condensed form of Fortran that runs on the EXORciser system and is available on floppy disc. However, it will burn up quite a bit of RAM—about 16 k is needed to hold the program. ■■

LEVEL I ASSEMBLY LANGUAGE

FL LOC	COSMAC CODE	LNNO	SOURCE LINE
0000		1	.. THIS SAMPLE CALCULATES THE ARITHMETIC
0000		2	.. AVERAGE OF TWO NUMBERS. THE NUMBERS ARE
0000		3	.. STORED IN TWO ADJACENT LOCATIONS
0000		4	.. POINTED TO BY REGISTER R2. THE
0000		5	.. RESULT IS STORED IN THE HIGH ORDER BYTE
0000		6	.. OF REGISTER 3.
0000		7	.. -----
0000	42	8	LDA R2
0001	E2	9	SEX R2
0002	F4	10	ADD
0003	F6	11	SHR
0004	B3	12	PHI R3
0005		13	.. -----

LEVEL II ASSEMBLY LANGUAGE

FL LOC	COSMAC CODE	LNNO	SOURCE LINE
0000		1	.. THIS SAMPLE CALCULATES THE ARITHMETIC
0000		2	.. AVERAGE OF TWO NUMBERS. THE NUMBERS ARE
0000		3	.. STORED IN TWO ADJACENT LOCATIONS
0000		4	.. POINTED TO BY REGISTER R2. THE
0000		5	.. RESULT IS STORED IN THE HIGH ORDER BYTE
0000		6	.. OF REGISTER 3.
0000		7	.. -----
0000	42E2F4F6B3	8	@R2!+@'R2/2->R3.1
0005		9	.. -----

FORTH LANGUAGE

THE EXAMPLE BELOW CALCULATES THE AVERAGE OF ANY TWO NUMBERS.
THE NUMBERS ARE ENTERED FROM THE TERMINAL AT EXECUTION TIME.
THE FIRST LINE STATES THE FORTH DEFINITION.
THE SECOND LINE IS AN EXAMPLE OF ITS EXECUTION AND PRINT OUT.

```

: AVR + 2 /
12 46 AVR . 29

```

Programming the Cosmac μ P from RCA can require knowledge of assembly language, a higher symbolic assembly language, or an interactive language called microForth—depending on the money spent for software development.



UNIVERSAL MODEMS

Making data move is the name of the game in today's switched or dedicated-line networks. If you're moving it at any speed up to 2400 BPS, Universal Data Systems has the proper modem for reliability, economy and efficiency in your system.

UDS has more than 30,000 modems in active field service, and the total is growing by more than 1,000 units per month. Our product line includes CMOS 201s, plus 103s, 202s, ACUs and the new 12•12, which permits full-duplex 1200 BPS communication over only two wires. UDS also offers the multiple modem RM-16, which contains up to 16 units in any configuration mix you desire.

In addition to our products, we're extremely proud of our customer service. Check us out: Call us on the telephone. You'll like what you hear.



universal data systems

member of
IDCMA

4900 Bradford Drive • Huntsville, Alabama 35805 • Telephone (205) 837-8100 • TWX 810-726-2100

Created by Hall & McLenzie Advertising, Winter Park, Florida

CIRCLE NUMBER 15

Intel 8080 peripherals

Now you can get microcomputer based products out of the lab and into production faster than ever before. Intel® 8080 programmable LSI peripherals give you the competitive advantage by helping you reduce design time, component count and manufacturing and inventory costs. Most of all they'll help you get to market first.

Intel 8080 programmable peripherals are software controlled LSI replacements for hardwired SSI/MSI logic assemblies. You simply attach the appropriate peripherals to the system bus and the +5V supply. Then, with system software, you personalize device operating configurations to suit your applications. Reconfiguration and design changes are made with software. No expensive and time consuming hardware redesigns are necessary.

One peripheral, the 8253 Programmable Interval Timer, is the first LSI solution to system timing problems. It counts out I/O servicing delays, eliminating software timing loops and increasing CPU throughput. It also saves hardware when you need event counters, rate generators or real-time clocks. Each 8253 contains three 16-bit timer/counters.

Our 8257 Programmable DMA Controller is the lowest cost way to handle applications that require high speed data transfer such as disks, magnetic tape, analog interfaces and high speed communication controllers. The four channel 8257 contains all the logic necessary for bus acquisition, cycle counting and priority resolving of the channel requests.

The 8259 Priority Interrupt Controller replaces complex TTL arrays and minimizes component costs. The CPU can change interrupt structure "on the fly" to suit changes in the operating environment, such as time of day or process control parameters. The 8259 handles up to eight vectored priority interrupts. Multiple 8259's can control up to 64 interrupt levels.

Use the 8251 Programmable Communication Controller for "serial I/O." The first true USART in a single chip, the 8251 implements all popular com-

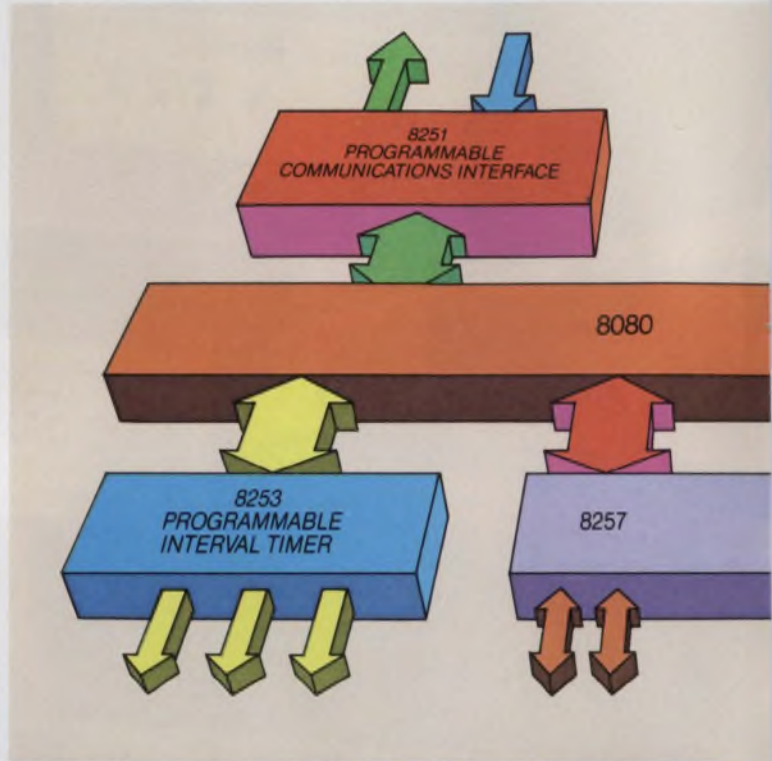

get you to market first.

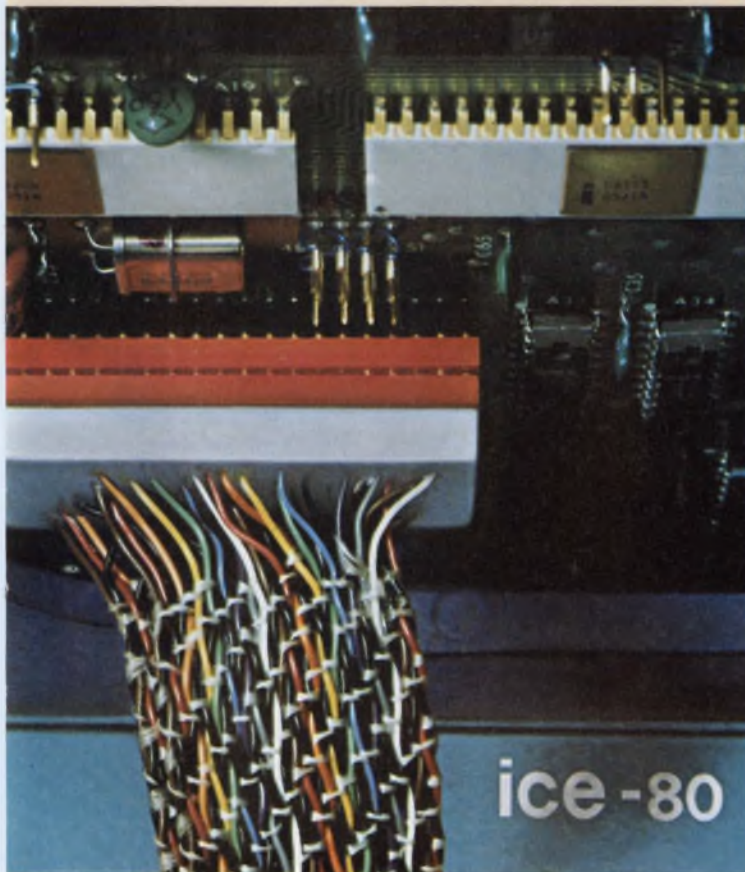
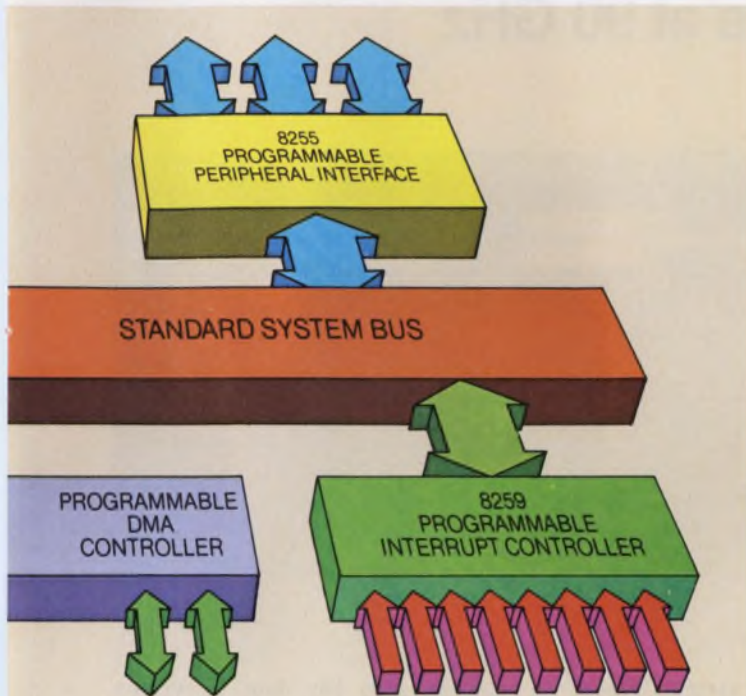

munication protocols, including IBM Bi-Sync. For "parallel I/O," each 8255 Programmable Peripheral Interface gives you 24 versatile I/O lines to interface relays, motor drives, printers, keyboard/display and other parallel equipment.

Once you've selected the peripherals to fit your application, use the Intel[®] Microcomputer Development System for both software and hardware development. Using the Intel[®] CRT terminal, call up the resident text editor. Write the source program to initialize the peripheral and the subroutines for peripheral/system operation. Then you assemble or compile the source programs into an object file using resident macroassembler or resident PL/M compiler—and store the object file on the Intel[®] diskette. With the relocation and linkage capability of the Intel[®] ISIS II diskette operating system, these routines can be added to a system library and called from user programs as needed. Once the main system program is written, the new peripheral device routines are easily linked in. The entire program is now ready to be run on your prototype via the Intel[®] ICE-80™ in-circuit emulation module. ICE-80 lets you debug your software and hardware in your actual prototype environment. Move from system integration and debugging to production in a fraction of the time previously required.

Intel also provides applications assistance, training programs, the largest user's program library, and volume production support. Intel's 8080 programmable peripherals give you the competitive advantage from start to finish. Be first to market.

To order the new peripherals, contact our franchised distributors: Almac/Stroum, Components Specialties, Components Plus, Cramer, Elmar, Hamilton/Avnet, Industrial Components, Liberty, Pioneer, Sheridan or L.A. Varah. For your copy of our 8080 System brochure write: Intel Corporation, 3065 Bowers Avenue, Santa Clara, California 95051.

intel[®]
Microcomputers. First from the beginning.

Schottky diode mixer enables imaging system to operate at 90 GHz

A GaAs Schottky diode-mixer with a conversion loss of less than 8 dB sharpens the resolution of radiometric imaging systems by a factor greater than 2. Developed by Aerospace Corp., El Segundo, CA, the diode mixer's low conversion loss permits an operating frequency of 90 GHz—the maximum operating frequency of previous imaging systems had been 35 GHz.

The 8-dB conversion loss overcomes the main impediment to increasing the frequency—hence, the resolution—of radiometric imaging systems, an inefficient mixer stage.

The advantage to 90-GHz operation is twofold. For a given-sized antenna, the system's resolution increases directly with frequency to permit the use of smaller antennas. And terrain signatures peculiar to 90 GHz can be observed.

Variations in ground temperature cause corresponding variations in the amplitude of a wide spectrum of emitted radiation. This electromagnetic radiation is detected and used to construct an image of the terrain below: Each detected frequency provides a different signature.

Developed in a cooperative effort with NASA and Naval Research Labs the diode mixer was built into a radiometer and then tested in an aircraft flown over Virginia's Chesapeake Bay area.

The radiometer's output was fed into an on-board data processor, which provided both a real-time TV image and a tape recording.

"The real-time monitor gave us a dramatic view of the terrain below, even though it was obscured by 2000 feet of opaque cloud cover," notes Howard King, head of

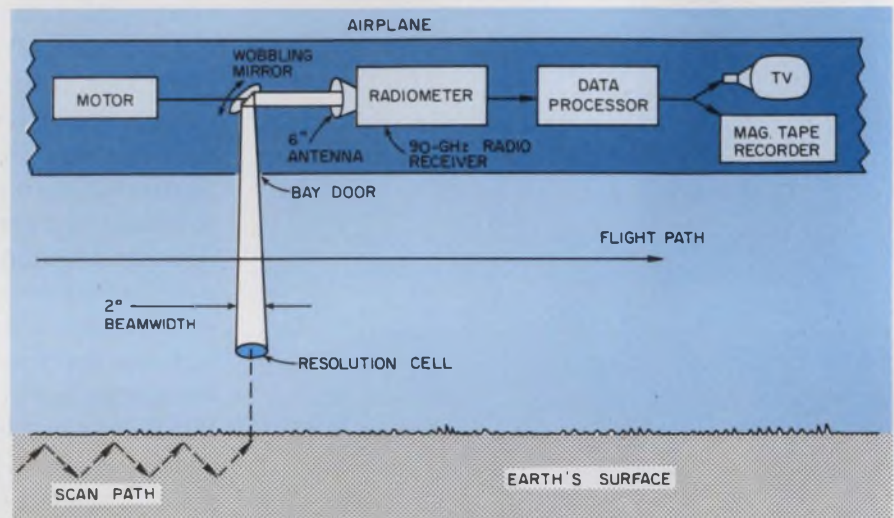

Radiometric imaging system "looks" through an open bay door to receive electromagnetic radiation from Earth's terrain. A wobbling mirror causes receiving antenna to scan both sides of flight path. The radiometer selects frequency of interest and provides input raster to data processor. The system is entirely passive; no radio transmission takes place.



This high-resolution radiometer needs only the small, cylindrical antenna at left to "see" Earth terrain signatures at 90 GHz. A new GaAs Schottky diode-mixer stage permits an 88-GHz local oscillator to be mixed with the 90-GHz reflections from the ground.

the Antenna and Propagation Department at Aerospace.

The 90-GHz imaging system can replicate ground features matching geological survey maps of the ground below. Flights were conducted at various altitudes during the field test, and the imaging system was able to identify natural terrain features and man-made ob-

jects smaller than 30 feet across, as well as bridges, rivers, islands, marshes, aircraft at rest and ships at sea and their wakes.

A wobbling mirror is used to focus the radiometer's 6-in. antenna toward the ground and scan 32 degrees to each side of the flight path. At a forward speed of 173 mph and a scan rate of 0.1 s per

Dick Hackmeister
Western Editor

If the 2900 isn't already the industry standard TTL processor family, this'll do it.

Motorola introduces

m2900

M2900 is Motorola's second source for the popular Am2900 low power Schottky TTL four-bit processor family. It's a contractual, mask-exchange second source, and the key family devices are available now.

Key M2900 devices available now

MC2901 is the expandable four-bit microprocessor slice with a high-speed eight-function ALU, a 16-word by four-bit two-port RAM, and shifting, decoding and multiplexing circuitry.

MC2909 is the expandable four-bit wide microprogram sequencer, an address controller for sequencing through a series of microprograms stored in ROM or PROM. It includes a register to hold a reference address, a microprogram counter and a four-word deep push-pop stack for subroutine linkage. It can jump to any address.

MC2902, the look-ahead carry generator, generates carries for three MC2901s from the Generate and Propagate outputs, producing them in 8 ns from the G and P inputs.

M2900 prices are right on the money

All three introduced M2900 Family devices are available now from authorized Motorola distributors and Motorola sales offices, at prices you'll find right on the money. In 100-up quantities, the MC2901LC is \$21.00, the MC2909LC is just \$12.98, and the MC2902LC is \$3.78.

Eight more in the M2900 Family from now to May

Device	Function	Available
MC2905	Quad Bus Transceiver	May '77
MC2906	Quad Bus Transceiver	May '77
MC2907	Quad Bus Transceiver	May '77
MC2911	Microprogram Sequencer	Feb. '77
MC2915	Quad Bus Transceiver	May '77
MC2916	Quad Bus Transceiver	May '77
MC2917	Quad Bus Transceiver	May '77
MC2918	4-Bit Register	Feb. '77

For data, circle the reader service number, or write to Motorola Semiconductor Products, Inc., P.O. Box 20912, Phoenix, AZ 85036.



MOTOROLA Semiconductors

—and you thought we were just a production house

CIRCLE NUMBER 17

RCL

OFFERS A
LOW COST
REPLACEMENT
FOR "OBSOLETE"*
OPEN DECK
WAFER SWITCHES

*Not all, but most... ask us!



RCL's

ENCLOSED,
LOW PROFILE
PC SWITCH...
FROM
STOCK!

Send For New '77 Catalog or Call
our Hotline For Name Of Your
Local Representative Or Stocking
Distributor.

(201) 374-3311

AMF

RCL Electronics

General Sales Office:
700 So. 21st Street
Irvington, N. J. 07111

CIRCLE NUMBER 18

NEWS

excursion, the differential temperature resolution of the system is 2.8 K, which can be enhanced with longer dwell times.

For example, the Navy is planning to put a similar radiometric imaging system aboard an Earth satellite to monitor America's proposed 200-mile fishing limit. The Navy is using the new imaging

system onboard aircraft to provide electromagnetic maps of the globe. Correlated radiometric images at different frequencies (including 90 GHz) are revealing such natural and man-made surface features as land masses, icebergs, fault lines, cities and underwater vessels. These are now being catalogued for a wide variety of purposes. ■■

Temperature, not current switches p-n-p-n element

A simple temperature-sensitive switching device is similar in design to a thyristor but can be triggered by temperature instead of gate current.

Called Thermosenstor and developed by the Mitsubishi Electric Corp., Itami, Japan, the three-terminal device is said to have the following advantages over conventional solid-state temperature-sensitive devices:

- It combines temperature-sensitive and switching functions, so its circuitry is less complicated than a thermistor-based switching circuit. For example, it does not require a differential amplifier and a Schmitt circuit.

- The turn-on temperature can be remote-controlled through the gate terminal.

- Once the Thermosenstor is turned on, conduction is maintained until on-state current is reduced to almost zero—even though the temperature falls below the switching temperature.

- Below the turn-on temperature, the Thermosenstor can be switched by gate current as in a thyristor.

The Japanese device is constructed with a silicon p-n-p-n structure (see Fig.). The chip is 0.5 mm square and 0.2 mm thick.

The minimum rated off-state voltage is 50 V; the rated average on-state current is 100 mA, at an ambient of 87 C.

High gain at low temperatures

To obtain low turn-on temperature without increasing the applied voltage requires high current gains at low temperature. This reduced

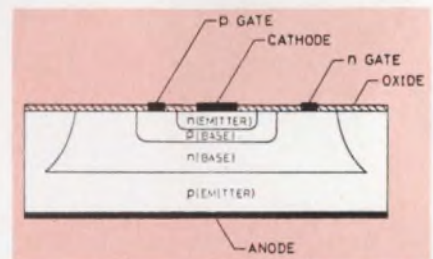

Thermosenstor is a new temperature switch from Mitsubishi Electric.

temperature is accomplished in the device by reducing the width of the base layers and increasing the leakage current of the collector junction.

The turn-on temperature is regulated by connecting a shunt resistance from one of the gates to either the cathode-emitter junction or the anode-emitter junction. This gate-shunt resistance shifts the turn-on temperature upward under an applied forward voltage. The temperature can be shifted from 50 to 150 C.

Like conventional thyristors, once the Thermosenstor is turned on in a dc circuit, its conduction is maintained until the on-state current is reduced to almost zero—even though temperature decreases below the turn-on temperature.

When operating in an ac circuit, the device will, of course, turn off at the zero value after each positive half cycle if the junction temperature falls below the turn-off temperature. But this turn-off temperature is not always identical to the turn-on temperature. The difference between temperatures is caused by the effects of the dv/dt of the reapplied off-state voltage following the termination of conduction. ■■

By sealing out liquids,
this Amphenol® connector
keeps you out
of hot water.

While it
saves you some
cold cash.

It's the Amphenol 44 Series connector. It lets you save money and still get a connection that's waterproof. And resistant to lubricants, fuel, abrasion, ozone. It even withstands salt spray, vibration, and shock.

You can use it almost anywhere. Anywhere you want a connector that's both easy to service and trouble-free. That's because 44 Series connectors are self-sealing. They're molded of a resilient material that stays tough. They're simple to mate and unmate. And you can't mis-mate them, either. Rating for 44 Series connectors is 250 VDC, 200 VAC, 8 amps continuous.

There's an insert arrangement right for you. Five different ones—with 2, 3, 4, 5, or 6 easy-to-use crimp Poke-Home® contacts. A complete line of tools for crimping and contact insertion by machine or hand minimizes installation costs.

Available in quantity. Available now. Just call your Amphenol Industrial Distributor to find out that low price and to get fast delivery. For further information, see *EEM Catalog* 76-77. Catalog Volume, pp. 588-589. Or write or call: Ray Hayer, Amphenol Connector Systems, Bunker Ramo Corporation, 900 Commerce Drive, Oak Brook, Illinois 60521. (312) 986-3749.

The right idea
at the
right time.

AMPHENOL Connector Systems **BUNKER RAMO**®

CIRCLE NUMBER 19

AMP component sockets are sealed with silicone rubber. And can be inserted at up to 7,000 an hour. You can't beat that.

AMP component sockets. They're the ones that come in strip form. You can insert them at high speed and cut your costs. Use a bench press or, for really fast loading, a N/C machine. AMP can furnish the applicator and interface module for compatibility with most N/C machines.

And AMP keeps your product out of trouble by sealing its component sockets with silicone rubber. Which ends solder flux contamination and solder flooding.

Of course, they provide easy pluggability with either rectangular integrated circuit leads or .016 inch-.019 inch diameter leads. Their small head diameters permit .100 inch center-to-center mounting. Our sockets help you save on board costs too, as they seat securely in wide tolerance holes.

For more data on AMP component sockets, ask your AMP Sales Engineer. He's ready to help you in any way possible.

Or write or call AMP Incorporated,
Harrisburg, PA 17105.
(717) 564-0100.

CIRCLE NUMBER 20

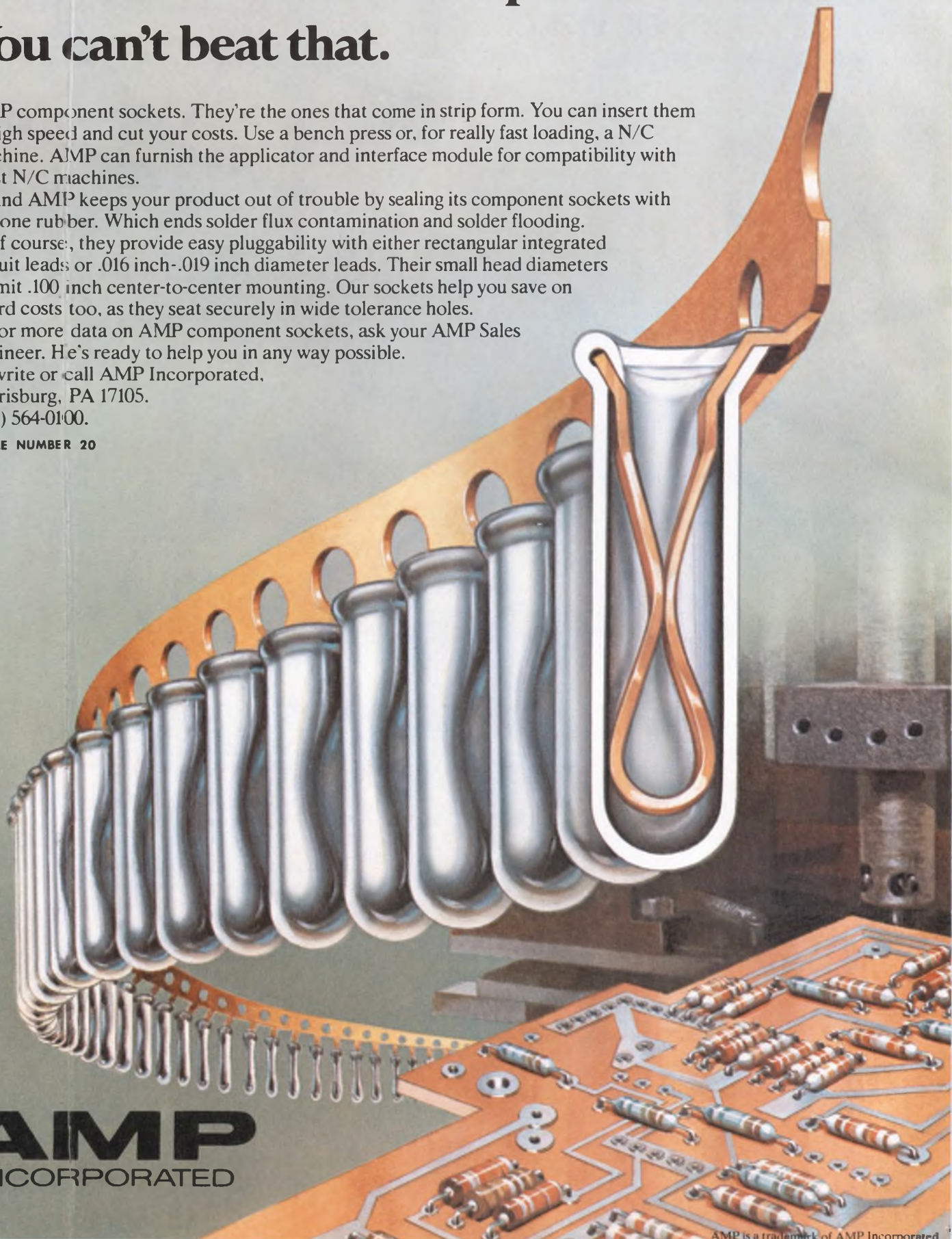

AMP
INCORPORATED

AMP is a trademark of AMP Incorporated.

Washington Report

FAA adds altitude warning feature to ground radars

A safety feature known as Minimum Safe Altitude Warning (MSAW) has been added by the Federal Aviation Administration to Dulles International Airport, Washington, DC, and Los Angeles International Airport. Four more airports will get the feature in February.

Produced by Sperry Univac, St. Paul, MN, MSAW works in conjunction with the automated radar terminal systems (ARTS III) to monitor aircraft altitudes automatically and compare them to an altitude table programmed into the ARTS III computer. Monitoring begins as soon as the aircraft approaches the terminal area and is picked up by the ARTS III radar. The aircraft must be equipped with a 4096-code transponder and altitude encoder. When the computer detects a potentially unsafe altitude condition, an alarm sounds and the words "LOW ALT" appear above the aircraft's symbol on the air-traffic controller's radar scope.

Defense contractor shifts keyed to foreign sales

Major shifts among the top defense contractors are reflected in the Pentagon's latest list of its 100 major suppliers. The reason—expanded foreign military sales.

McDonnell Douglas vaulted into first place for the fiscal year ended last June 30, as its sales rose from \$1.4 billion the previous year to \$2.5 billion in fiscal 1976. McDonnell Douglas, which was in fourth place in fiscal 1975, is supplying 25 F-15 fighters to Israel, which wants to buy 25 more.

The biggest gainer was Northrop, which rose from 12th place the year before with \$620 million in DOD contracts to third place with \$1.4 billion. The firm recently completed its 3000th F-5 fighter—most of them sold abroad.

The Pentagon awarded \$42 billion in prime contracts last year, and the top 100 received \$29.9 billion, or 69% of the total.

Army to fund helicopter avionics system

The Army expects to select two parallel development contractors about the first week of March for a new day-and-night target-designation system to be used in its future helicopters.

Known as the Target Acquisition and Designation System/Pilot Night Vision System (TADS/PNVS), it will contain internal forward looking infrared (FLIR) sensors, television units and laser subsystems that can lock onto a target about 2 meters square from as far away as 5 to 6 km.

The TADS/PNVS will be installed initially in the Army's new Advanced

Attack Helicopter (AAH), which is being developed by the Hughes Helicopters Division of Summa Corp., to direct the laser-guided Hellfire missile to ranges that will be twice that of the present TOW missile fired from Cobra helicopter gunships.

The target tracking system is also being considered for the Army's proposed Advanced Scout Helicopter (ASH). (Congress disallowed a program to develop a similar system for the ASH last year, but did provide sufficient funds for a TADS/PNVIS to be used by both helicopters.)

Seven firms have submitted proposals on the new system to the Army Aviation Systems Command in St. Louis: Ford Aerospace & Communications, General Electric, General Motors' Delco Division, Hughes Aircraft Corp., Martin Marietta's Orlando Division, Northrop and Texas Instruments. While the Army hopes to fund two of the companies for at least a year of engineering development, it may be able to fund only one because of a rumored shortage of money.

The winning contractor will outfit the 536 projected AAH helicopters, plus an undetermined number of ASH helicopters if Congress approves that program this year.

TWTA problems afflict NASA Mariner spacecraft

A variety of minor problems have cropped up during tests with the Watkins-Johnson traveling-wave-tube (TWTA) amplifiers for NASA's two Mariner Jupiter/Saturn spacecraft to be launched in August and September. The problems are serious enough for NASA to consider backup units from Ford Aerospace & Communications and Hughes.

Both the X-band and S-band units have been afflicted, according to Mariner program manager Rodney A. Mills. As a result, costs have been driven up and deliveries delayed about nine months. The life testing still has to be done.

NASA will have to decide by April if a substitution is necessary. The first flight spacecraft is already in assembly at Jet Propulsion Laboratory (JPL). The second will begin in January.

The possible X-band replacement is a Hughes unit used in the NATO communications satellites. It has the same output as the Watkins-Johnson TWTA, 20 W, but is less efficient. The Hughes substitute requires 100-W input, the TWTA 70 watts. For an S-band replacement, NASA will consider a device by Ford Aerospace that is comparable in efficiency, but lower in power—about 20 W vs the TWTA's 29 W.

Under subcontract to JPL, Motorola will integrate the TWTAs into the spacecraft's radio subsystem.

Capital Capsules: The Army plans to build a 5000-m test range at Fort A. P. Hill, VA, to accommodate high-energy research being relocated from Fort Monmouth, NJ. . . . The Army's Patriot anti-aircraft missile (formerly SAM-D) has successfully knocked down a drone target while being jammed by airborne electronic countermeasures during tests at White Sands Missile Range, NM. . . . The Navy's controversial Seafarer extremely-low frequency (ELF) system for communicating with submerged submarines has received a qualified blessing from the National Research Council. NRC's preliminary report said the 0.07 volt per meter radiated by the communications grid would cause no biological damage but did raise questions about the 15 V/m around the terminal points. The system of underground antennas is being considered for Michigan's Upper Peninsula, where local residents have opposed it. A final report from NRC, an affiliate of the National Academy of Sciences, is due this spring.

Save Space. Save Weight. Increase Reliability.

Paralleling transistors doesn't pay —not when an inherently rugged single device can do the job far more reliably, using much less space, weight, and at lower total system cost. That's why PowerTech's unique single-chip NPN silicon high-power transistor is the one way to go.

Used alone, our space-saving single-chip device eliminates multiple failure sources while reducing the environmental testing costs inherent in parallel arrays. Because of their simplicity they're available off-the-shelf pre-rated, pre-tested and inventoried to meet virtually any hi-rel JAN and JAN-TX hi-current requirements without custom prices and long custom waits.

For information, application assistance, and free design guide call Sales Engineering. PowerTech, Inc., 0-02 Fair Lawn Avenue, Fair Lawn, New Jersey 07410; Tel. (201) 791-5050.

Type #	(pk.) I_c	V_{ce0}	($h_{fe} = 10$) $V_{ce} (sat) @ I_c$
JAN-TX 2N5926	90A	120V	0.6V @ 50A
PT-7511	90A	200V	0.6V @ 50A
JAN-TX 2N5927	120A	120V	0.6V @ 70A
PT-6502	200A	80V	0.7V @ 100A
PT-9502*	500A	80V	0.5V @ 300A

350 Watt Power Rating
*625 Watt Power Rating
Guaranteed SOAR

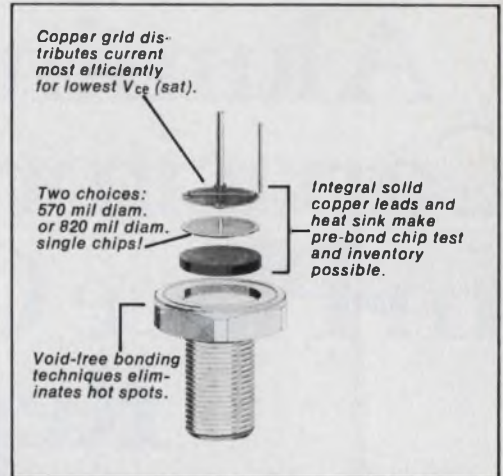

TO UNPARALLEL IS TO SAVE:

Silicon transistors
to 500 amps with
lowest $V_{CE} (sat)$



PowerTech, Inc.
"BIG IDEAS IN
BIG POWER"

New Sangamo Type 300 Aluminum Electrolytic Capacitors Slash Space and In-Place Cost in Switching Regulator PC Boards.

Now you can specify economical Sangamo Type 300 Premium-Grade Aluminum Electrolytic Capacitors for printed circuit board mounting in

switching regulator power supplies and other applications from 10 to 100 kHz.

Type 300 Capacitors give you low ESR, low inductance, high capacitance and long life—in a unique package that dramatically reduces size, weight and in-place cost.

The basic unit has three radial leads arranged in an isosceles triangle. Just plug in and wave-solder. No fumbling. No reversing. No screw terminals. You can even parallel them.

Or choose the Type 301 with two radial leads. Or the



Sangamo Type 300 Capacitors (actual size)

horizontal Type 301A with the dummy lead on the bottom for rigid mounting without using a strap.

If you're now using stacked foil, four-terminal or wet tantalum capacitors, look into the new, economical alternatives—Sangamo Type 300 Aluminum Electrolytic Capacitors.

Write for specs and engineering samples. Sangamo Capacitor Division, Box 128, Pickens, SC 29671; phone: (803) 878-6311; TWX: 810-397-2496; Telex: 57-0441.

Type 300 Capacitors Electrical/Mechanical Specifications

Capacitance Range	130 uF to 16,500 uF
ESR Values at 10 kHz	From .012 ohms
Impedance Value at 100 kHz	From .015 ohms
Typical Inductance	12 to 15 nanohenries
Max. Ripple Current Capability at 10 kHz*	15.9 amps at 65°C; 11.6 amps at 85°C
Operating Temperature Range	-55°C to +105°C
Voltages Available	6.3 to 100 VDC
Nominal Case Sizes	.750" x 1.625" (19.05 mm x 41.27 mm) to 1.000" x 3.625" (25.40 mm x 92.08 mm)

*For high ripple current applications, units may be installed in parallel.

SANGAMO WESTON
Schlumberger

Put the pressure on...

If you're using compression-type SCR's and diodes, there is a Wakefield mounting clamp that is perfect for your application. Used with a variety of heat sink extrusions, these clamps provide clamping pressures from 800 lbs. to 10,000 lbs., and have mounting spaces from .66 to 8.50 inches ...enough space to accommodate 4 devices.

We have been developing and improving clamps for over 10 years to meet the changing needs of semiconductors. This experience has resulted in significant product advancements.

For example, all Wakefield clamps include a built-in force indicator which gives high accuracy readings of the clamping force. Minimum insulation of .02" conformal epoxy coats the crossbar and studs up to the thread. This coating is rated class B for 40,000 hours at 130°C with specified working voltage of 2500V AC RMS.

Another good thing about these clamps is their price... as low as \$2.24 to \$23.00 in 100 quantity. For full details, send for catalog of our standard clamps available from stock.



WAKEFIELD ENGINEERING INC.

77 AUDUBON ROAD, WAKEFIELD, MA 01880 (617) 245-5900. TWX 710-348-6713

AN  COMPANY

CIRCLE NUMBER 23

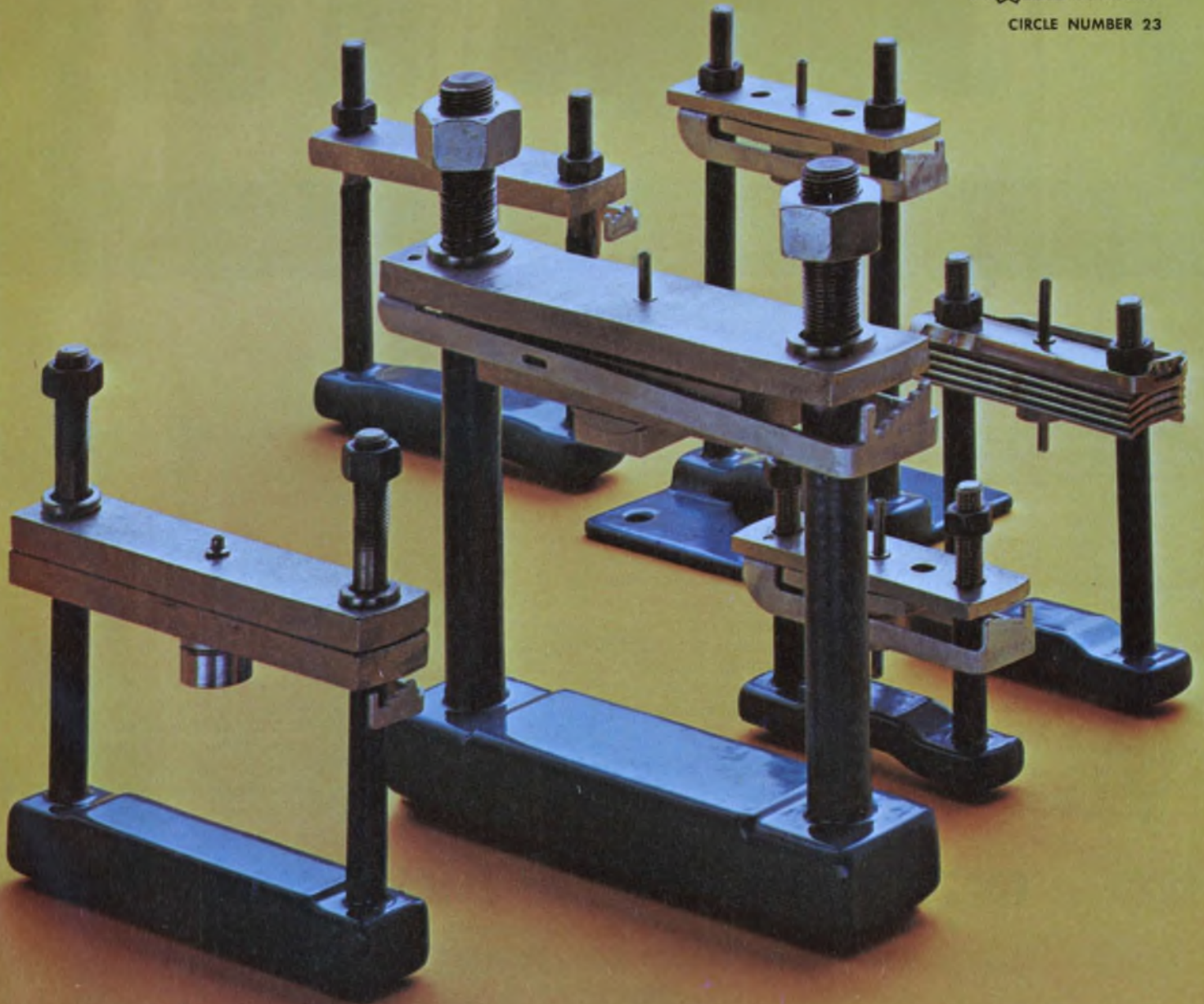

Gotcha, DEC!

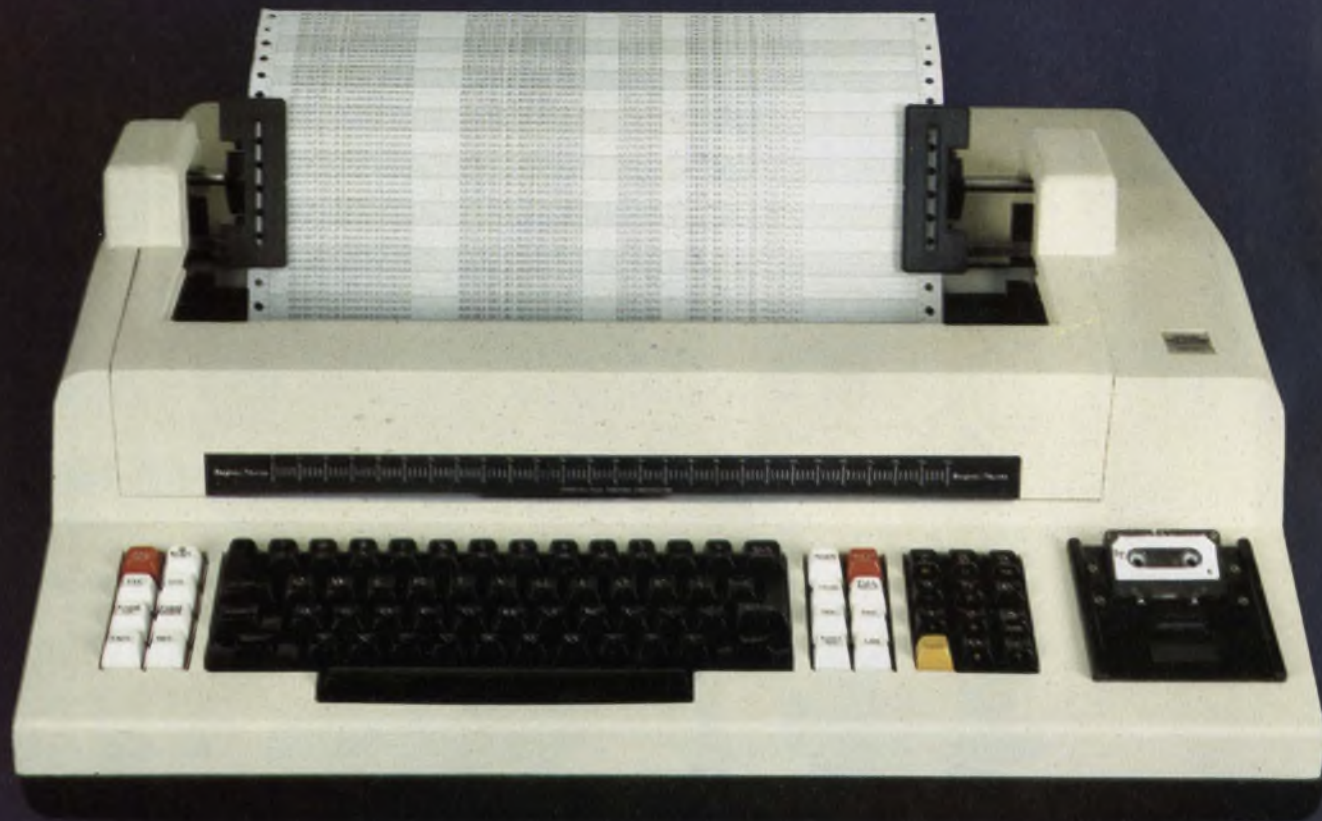

SuperTerm

Yes, we gotcha DECwriter II and we did it with such standard features as: matrix impact printing (no thermal paper!), 132 column print width, microprocessor electronics, portability (SuperTerm weighs less than 45 lbs), high speed (10, 15, 30, 45 and 60 characters per second are standard with 120 and 180 cps being optional), an IBM Selectric configured keyboard, a 33 key alphanumeric "gear shifted" key pad and a quick loading cartridge ribbon system.

In addition, SuperTerm's unique "anvil" printhead design is warranted for the life of the terminal! This means that should you ever encounter defects in printhead workmanship, Intertec will replace or repair the defective component(s).

OEM's will be pleased to learn that the Intertec SuperTerm provides all of this capability and more at an OEM price of only \$1,400.

Low cost options available on every SuperTerm include: Super and sub-scripting, horizontal and vertical tabs, variable vertical pitch, forms control, pagination, direct X/Y addressing, adjustable left and right margins, reverse printing, double width characters, automatic CR on end of line, and a font programmable character set.

If your application calls for APL/ASCII, SuperTerm has that too. In fact, SuperTerm has got just about everything—except competition.

Want more? You've got it! A built-in micro-cassette (Supercette) is available to end users at only \$700 in single quantities with OEM discounts available.

In addition to unparalleled price and performance, every SuperTerm is backed by Intertec's nationwide factory trained service network with over 160 service centers strategically located coast to coast.

For more information on the total performance and unparalleled low price that make the Intertec SuperTerm the very best buy for your terminal dollar, just call Intertec Data Systems, the only company with international sales, service and revolutionary SuperTerm.

INTERTEC DATA SYSTEMS

1851 Interstate 85 South • Charlotte, North Carolina 28208

Telephone (704) 377-0300 • TWX: 810-621-7831

CIRCLE NUMBER 24

Microprocessor Design

The 8080As are not all alike; you should know the differences

While the various 8080A chips are pin-compatible and essentially alike, there are several logic differences in the flag flip-flops that are set and reset by arithmetic and logic instructions—as well as differences in speed, power and noise immunity.

The 8080A, which has rendered the 8080 obsolete, is now available from Intel, Advanced Micro Devices (AMD), National Semiconductor, Nippon Electric Corp. (NEC), and Texas Instruments.

“Many companies use the different vendors’ 8080As interchangeably, once they understand about the auxiliary carry flag,” says one industry engineer. “But there are usually some problems in incoming inspection because of the flag differences. The tester shows up the fact that

the chips from different manufacturers treat these flags differently.”

Furthermore, he believes, the 8080A, for all its popularity, doesn’t quite have the status of a production device. “When you go to multiple-sourcing, you can’t just turn the problem over to purchasing. You have to involve engineering and the incoming-inspection people, too.”

Andrew Allison, AMD’s MOS μ P marketing manager, agrees. “The Intel 8080A and the National device, which appears to be an exact copy of it, have what we think is an internal design error. Intel’s design allows logic operations to disturb the contents of the auxiliary carry-flag register. We developed our chip design

(continued on page 42)

Eliminate microprocessor bugs with system analyzer

Designed to develop and debug microcomputer systems built around 6800 μ P, the AQ6800 system analyzer from AQ Systems connects to the microprocessor via a buffered, 40-pin clip-on probe. It also displays all address and status data.

The system analyzer is interactive, and can transmit or receive data from all 6800 internal registers; modify the contents of any RAM location; examine any memory location; and send and receive data from selected I/O ports.

Front-panel controls permit getting to the memory and internal registers, controlling the microprocessor, setting the breakpoints and monitoring specific memory locations. An optional sequence recorder can record up to 128 instruction addresses to help simplify program tracing and debugging.

All circuitry is mounted on one motherboard. The entire system measures 19 × 10.5 × 1.875 in. and requires 5 V at 3 A.

Base price of the analyzer is \$875 and delivery takes as long as six weeks. Although the analyzer is made by AQ Systems of Yorktown Heights, NY, it can be ordered from E & L Instruments.

E & L Instruments, 61 First St., Derby, CT 06418. (203) 735 8774.



MICROPROCESSOR DESIGN

(continued from page 41)

independently, as did NEC, and neither of us made that error.

"To sidestep this problem, you save the carry bit *before* a logic operation and reload it into the carry-flag register afterwards. Any program that does this will work the same with all 8080As. The logic differences among the versions become insignificant."

Dave Millet, a μ P product manager at NEC, adds: "We included a decimal subtract flag in the NEC 8080A that allows people to do decimal subtraction more efficiently. This saves program steps by storing the fact that the last operation was a subtraction."

Other differences in the available 8080As may make a particular version the best for a particular application. The AMD 9080A dissipates only two-thirds as much power as the Intel chip, and handles 3.2 mA on all outputs—Intel handles 1.9 mA. So the 9080A can drive two TTL loads instead of one. This capability can save two or three buffer ICs and reduce circuit delays. AMD's minimum voltage for a logic ONE is 3.0 V, Intel's 3.3 V. This means better noise immunity.

The NEC 8080A also specifies an input voltage of 3 V for a logic ONE, uses fewer clock cycles for some operations, and eliminates one 80-ns data-setup time requirement. To simplify interfacing to CMOS, the NEC 8080A has no internal pull-up resistors on the chip inputs. Moreover, this unit operates over a temperature range of -10 to 70 C, compared to Intel's 0-to-70-C range.

Atmospheric-measurement system uses μ Ps to preprocess data

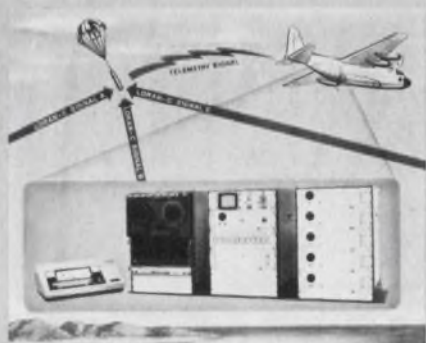

Providing detailed atmospheric profile measurements, the WL-3DS Environmental System developed by Beukers Laboratories, Bohemia, NY, uses five 6800 microprocessors. The μ Ps are used to preprocess meteorological parameters sent in by five dropsondes—free falling sensors—before the data are logged on tape and processed by a Nova minicomputer.

The system continuously samples wind speed, direction, temperature, humidity and pressure via the dropsondes. Dropsondes can provide readings starting at altitudes as high as 30,000 ft and dropping down to sea level.

Usually the dropsondes are released at five-minute intervals from an aircraft over the measurement area. Using the retransmission of Loran-C long-range, navigational-aid signals, the Beukers system determines dropsonde position, speed and direction. The Loran-C signals are processed by an on-board minicomputer and then logged with the data.

Bipolar microprocessor kit permits system evaluation



Dubbed the 8X300KT100SK, this evaluation kit allows designers to assess the 8X300 bipolar μ P developed by Signetics. The single-board kit includes all components necessary to get a minimal system up and running: one 250-ns, instruction-cycle-time CPU, four I/O ports, 256 bytes of RAM and a preprogrammed monitor system in ROM.

Controls in the evaluation kit for diagnostic and instructional purposes include a wait mode for single stepping, the ability to change program flow and to change or examine internal registers, and one-shot or repeated-instruction jamming. The board layout permits simple system modification and expansion.

(continued on page 44)

DUAL COIL CIRCUIT BREAKER

reacts to both
voltage and current.



Smaller, Lighter, Less Expensive. The Airpax Dual Coil Circuit Breaker is a single pole magnetic circuit protector that reacts like a two pole breaker but is smaller, lighter, and less expensive.

Wide Variety of Applications. In addition to conventional circuit protection, the Airpax Dual Coil Circuit Breaker can be used in conjunction with a temperature transducer to protect heat-sensitive equipment such as power supplies. By connecting a sensing device to the voltage coil, it can be used in interlock circuits or can react to pressure, flow, weight, or fluid level.

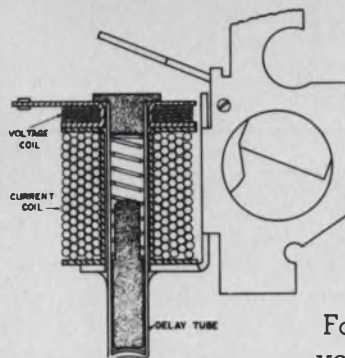

Current Coil Ratings. The current coil ratings are from 0.050 to 30 amperes at 65V dc or 250V ac maximum, 60 or 400 Hz. (Other models to 100 amperes.)

For more detailed information, call your local Airpax representative or contact Airpax Electronics, Cambridge Division, Cambridge, Md. 21613. Phone (301) 228-4600. Telex: 8-7715. TWX: 865-9655. Other factories in Europe and Japan. European Sales Headquarters: Airpax S.A.R.L., 3 Rue de la Haise, 78370 Plaisir, France.

AIRPAX™
THE PRO IN PROTECTION

MICROPROCESSOR DESIGN

(continued from page 42)

All signals from the μ P can be brought off the board. A bare section permits custom interfaces to be built.

One of the few fixed-instruction bipolar microprocessors, the 8X300 has a 13-bit address bus and a separate 16-bit instruction bus. An 8-bit interface vector bus, which is supported by four additional control lines, and a clock perform data handling and I/O-device addressing.

The evaluation kit costs \$299 and is available from stock.

Signetics, 811 E. Arques Ave., Sunnyvale, CA 94086. Robert Lanford (408) 739-7700.

CIRCLE NO. 509

Compact software development system emulates the EA9002



Designed to speed up software development for the EA9002 microprocessor, the EASE 2000 emulator includes an Editor program and 2 kbytes of workspace. The self-contained development/debug system from Electronic Arrays also has its own hexadecimal keyboard, 14 special-function keys and an 8-digit hexadecimal LED display.

There are two basic operating modes, Execute and Edit, and a resident assembler is optionally available.

In the Execute mode, the program can run at normal clock speeds, or it may be stepped one instruction at a time. In the Edit mode, both internal and external memory can be examined or modified.

Specialized function keys include reset, jump, read, write, step, edit, continue, memory-select, register-select, scratchpad select, TTY-select and breakpoint-select. Programs can be loaded via the hex keyboard or with paper tape through a TTY port.

The entire EASE 2000 system is housed in a case almost as big as a large printing calculator. All power supplies are built in, and all I/O lines fully buffered. Base price is \$995, and the optional resident assembler package costs an additional \$250. Delivery takes 30 days.

Electronic Arrays, 50 E. Middlefield Rd., Mountain View, CA 94043. Richard Eiler, (415) 964-4321.

CIRCLE NO. 510

Micro Capsules

A simplified version of Basic, developed for industrial users, is being readied by National Semiconductor, Santa Clara, CA. Called NIBL (National Industrial Basic Language), the program will fit in less than 4-k words of ROM and require 2-k words of RAM workspace. . . . **The Intelligent Breadboard**, soon to be released by IMSAI, San Leandro, CA, connects directly to the bus on the company's 8080-based microcomputer. Two forms of the breadboard will be available—a kit for \$435 and a completely assembled unit for \$625. . . . A **low-cost intelligent terminal**, being developed by Southwest Technical Products, San Antonio, TX, promises to be a boon to companies that need intelligence but can't justify paying several thousand dollars for a terminal. The terminal will be available in kit form for under \$300, less monitor. . . . **The First West Coast Computer Fair**, reportedly the first west coast convention exclusively devoted to personal, home and hobby computing, is scheduled for April 15 to 17, 1977 at San Francisco's Civic Auditorium. Additional details can be obtained by contacting Jim Warren at (415) 851-7075 or writing to him at Star Route Box 111, Woodside, CA 94062.



Designing Inverters?

Here
comes
help

NEW SHAPE—Now there's a new, low cost ferrite shape that combines the advantages of E Cores and Pot Cores. This low cost component reduces copper loss and leakage inductance while maintaining high efficiency and moderate shielding.

NEW PERFORMANCE—We've added this new shape to our **Inverter-Rated™** line. It's available now in our special ferrite materials designed for inverter operation with guaranteed inverter specs, three temperature ranges and a choice of performance cost options.

OLD EXPERTS—We can improve your inverter performance and efficiency. We can decrease your component cost. Sometimes, we can even do both. Check the Bingo Card for a copy of our new design guide. Or call Application Engineering—(201) 826-5100 for specific help.

EMM indiana general

a division of Electronic Memories & Magnetics Corp.

Keasbey, N.J. 08832 • (201) 826-5100

CIRCLE NUMBER 26

CB servicing is PROFITABLE with the B&K-PRECISION 40-channel CB Test Bench



MODEL 1040
\$250

The B&K-PRECISION CB servicemaster is designed for rapid programmed testing and trouble shooting of any CB transceiver—even 40-channel models!

When used with a scope and signal generator, you can:

- Measure signal-to-noise ratio of CB receiver
- Measure audio output power
- Measure audio distortion percentage
- Measure receiver sensitivity
- Check AGC
- Measure effectiveness of CB noise limiter or blanker (when used with an impulse noise generator)
- Measure squelch threshold
- Measure adjacent channel rejection on any channel
- Measure transmitter AM power output—even mobile!
- Measure SSB power output with TRUE peak-reading RF Wattmeter
- Check AM modulation
- Check SSB modulation with a two-tone test—the only accurate way!
- Measure antenna SWR—even mobile!
- Check the transceiver in the car to determine if the problem is in the antenna system or the transceiver

You can save \$500—\$1,500 in equipment costs because the CB Servicemaster eliminates many of the test instruments you would otherwise need for CB servicing. These instruments, or their functions, are built into the unit:

- Audio wattmeter • Audio generator • Distortion meter • RF wattmeter/dummy load • DB meter • SWR bridge

These instruments—which you should have, if you don't own them already, are all you need to get the maximum use from your CB Servicemaster. And the B&K-PRECISION CB Servicemaster is compatible with most oscilloscopes, frequency counters, signal generators and power supplies on the market today.



MODEL 1403A—3", 5 MHz
Recurrent Sweep Oscilloscope

Checks CB modulation and provides viewing of 27MHz CB envelope when used with the Model 1040. Small, compact and inexpensive, it frees other scopes for more effective use. **\$209**



MODEL 1640—Regulated Power Supply

Designed especially for CB and other mobile equipment, the 1640 eliminates changes in supply voltage due to load variations. A stable power supply is essential to precise testing of the transceivers. Less than 0.8% variation from zero to full load, 3 amps continuous, 5 amps surge. Adjustable to any output from 11 to 15 VDC. Suppressed zero scale for greater accuracy. Overload protected. **\$100**



MODEL 1801—
Digital Frequency Counter

To quickly determine the exact frequency of a CB channel, the 1801 automatically displays it for you in large, easy-to-read digits. You can tune oscillators precisely, conduct audio frequency analysis tests. Six digit display is updated five times per second. Accuracy guaranteed to 40MHz; 60MHz typical. **\$240**



MODEL 2040—40-Channel CB Signal Generator

Covers all 40 channels, AM and SSB with built-in capability. Ultra-stable crystal-controlled, phase-locked-loop frequency generation. Has 5 ppm accuracy. Output attenuator and vernier provide calibrated outputs from 100,000 μ V to 0.1 μ V for receiver sensitivity measurements. Includes EIA standard noise test signal generator to check receiver noise suppression. Internal 400, 1000 and 2500 Hz modulating frequencies—can also be externally modulated. Internal protection against 5W RF input. **\$475**

B&K PRECISION

DYNASCAN CORPORATION
Makers of Cobra CB Equipment

6460 W. Cortland Avenue, Chicago, Illinois 60635 • 312/889-9087
In Canada: Atlas Electronics, Ontario

For additional information, contact your B&K-PRECISION distributor for our comprehensive brochure describing the operation of the Model 1040 CB Servicemaster and the CB Service Center—or write us for your free copy.

CIRCLE NUMBER 27

A revolutionary idea. Stackpole "top-hat" networks prove you can get more resistance on less real estate.

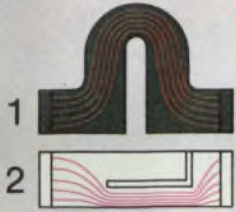

1
2
Compare (1) our "top hat" to (2) a standard "L"-cut and you see why ours dissipates more heat, faster. On a much longer resistance path.

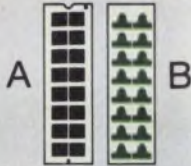

(A) Standard thick-film networks have more hot spots, current crowding higher capacitance than (B) our "top-hat" network.

Flip our network's lid and you can see why. It's revolutionary.

The more our unit is trimmed, the better your resistance. So ratings of 200 watts/in² are very realistic.

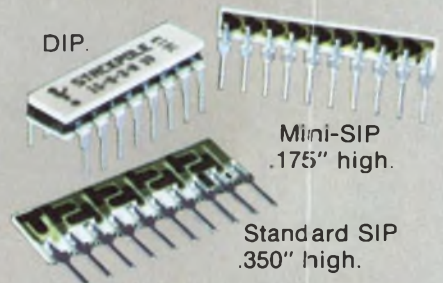

The secret is in the simple laser cut in the middle of each "hat." In this and its horizontal geometry you get lower capacitance without hot spots, current crowding, or the other power-robbing things built into conventional networks.

Now you can get equal resistance in less space. Or greater resistor network performance in the same space.

We're out to tip our "hat" to you. With a full range of values, tolerances, sizes. In single or dual in-line networks, custom designs and even mini-SIPs that are only .175 inch high.

Ask for a free sample of a revolutionary idea. Stackpole Components Company, P.O. Box 14466, Raleigh, N.C. 27610. (919) 828-6201.

 **STACKPOLE**
The revolutionary resistor people.

CIRCLE NUMBER 28



More and more major companies The future

More than 200
deep discharge
cycles.

Great versatility
in charging methods.

Wide temperature range
from -40°C to
 $+50^{\circ}\text{C}$.

More packaging
flexibility than
you might
have thought possible.

Easy
recharge,
plus a wide
range of
discharge rates.



use Gates. in energy cells.

Fewer design problems,
fewer operating problems.

A watt-hour
per dollar value
that would warm
a comptroller's heart.

Thermal
runaway problems
are a memory.

Tough,
sealed construction
for rugged, safe
performance.

FREE!

I would like to know a
lot more about Gates' energy
cells. Please send your **FREE**,
no-obligation brochure containing
battery features, application information,
ratings and specifications.

ED-46

Name _____

Title _____

Company _____

Address _____

City/State/Zip _____

Please mail coupon to: Gates Energy Products, Inc.,
1050 S. Broadway, Denver, CO 80217.

CIRCLE NUMBER 29



Energy Products

Hand us your interconnection design problem.

We'll hand you back the solution.

At Fabri-Tek's National Connector Division, we do more than just sell connectors out of the book. We'll custom-tailor a complete interconnection system from our wide line of plate, molded, backpanel, and special connector products. And we'll handle your job from start to finish:

- Design engineering and artwork
- Stamping and molding, numerically controlled drilling, selective plating, automatic subassembly, quality assurance
- Field service, applications engineering

Many "blue chip" companies rely on us to solve their special interconnection problems. Give us a chance to solve yours. Call Peter Van Wyngereen at (612) 533-3533.

- Integrated backpanel systems
- Metal backplanes and plate connectors
- Special molded connectors
- Standard card edge connectors
- Card cages
- I/O connectors
- Telephone and military connectors

Single and Multilayer P.C. Backpanels #201
Aluminum Backpanels #202
Edge Card Connectors #203
Special Molded Connectors #204
Commercial #205
Military #206



FABRI-TEK

NATIONAL CONNECTOR DIVISION

9210 Science Ctr. Drive

Minneapolis, MN 55428

(612) 533-3533

Are all men brothers?

I've always been deeply moved by the line, "All men are brothers," in the "Ode to Joy" at the conclusion of Beethoven's magnificent Ninth Symphony. In this choral setting of Johann Schiller's poem, Beethoven emphasized the brotherhood of man in receiving the blessings of joy.

But I've always felt that in almost all other ways as well, men are much the same all over the world. The men I know in Europe and Asia share with men in the States the same interests—mainly women. After that, all people seem to prefer good food, good wine, good entertainment, good books, good everything.

I thought of this some weeks ago at a Motorola bowling party during the Electronica Show in Munich. After an hour of beering and bowling, I noticed that my buddies included a chap from England, one from France, one from Finland, one from Sweden and three from Germany. What distinguished us were the facts that I, alone, could speak only English; my bowling skill was worse than anyone else's; and our Englishman could hoist and put to proper use an enormous mug of beer. Beyond that, we were indistinguishable.

A few nights later, I was dining with Dr. Friedrich Baur, a delightful gentleman who runs the Components Div. of Siemens. And he shook me up. "Why," he challenged, "do people in different parts of the world buy so differently?" Taking time out to appreciate some delicate smoked trout and some hearty venison, we talked of national differences that affect all engineers designing for world markets.

In the States, most people buy cars with automatic transmission; in Europe, relatively few do. In the States, "instant-picture" cameras are enormously popular; in Europe, they're not. In Europe, most full-size television receivers are sold with remote control. In the States, almost nobody buys remote control. Why?

Well, we kicked around some possible answers. It's because the European demands quality, one of us suggested, and he's willing to pay for it. But that's really no answer; it's the doorstep to another question.

There's no clear answer, we agreed. But is there, at least, a plausible theory? I wonder if readers of ELECTRONIC DESIGN can offer one. Ideas anyone?



George Rostky

GEORGE ROSTKY
Editor-in-Chief

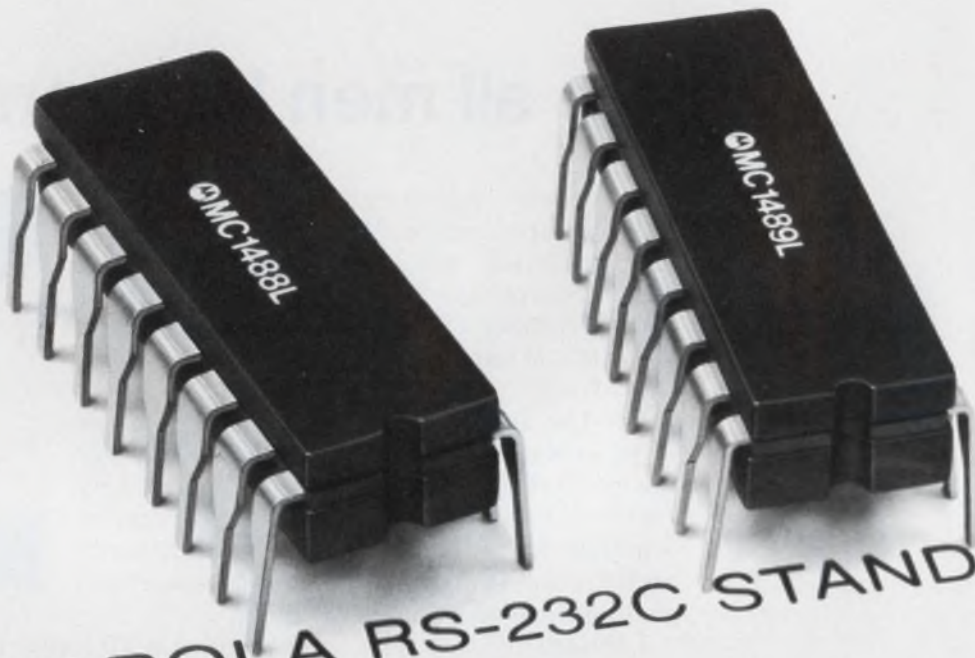

MOTOROLA RS-232C STANDARD

Once A Linear Winner,

The quads everybody copied. Motorola-originated MC1488/1489 Line Drivers/Receivers set the RS-232 data comm standard since their introduction in 1969.



MOTOROLA

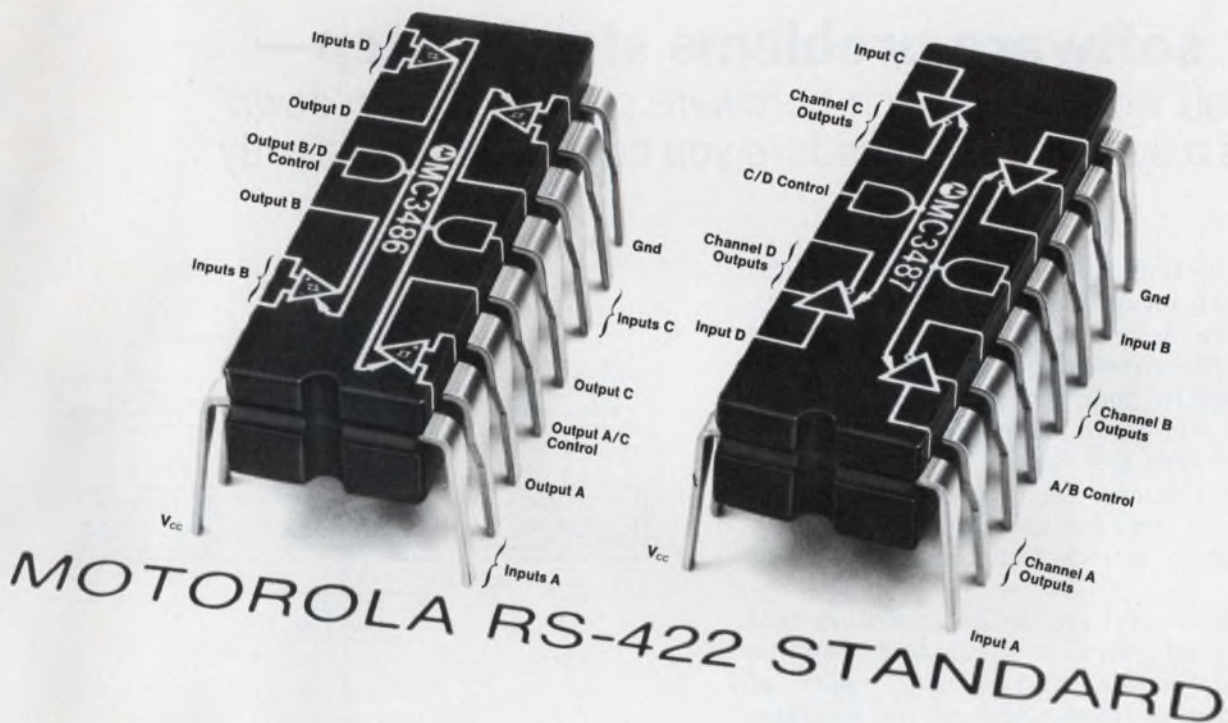

MOTOROLA RS-422 STANDARD

Always A Linear Winner.

Now there's a new IC standard for RS-422/3 data comm. And Motorola's got it†. . . the MC3486/87 quad line-drivers/receivers that will be the 10 megabaud benchmarks for new generations of fast-data-rate, two-wire systems. They feature four independent driver/receiver chains and are three-state structured which are forced to high impedance states when the appropriate output control pin reaches a logic zero. They're MOS, TTL and PIA-compatible and offer PNP-buffered inputs to minimize loading.

The Driver...

Power up/power down protection is ensured with the MC3487 in addition to typically fast propagation time of 15 ns. It works off single 5 V supplies and meets RS-422 standards.

The Receiver...

Each MC3486 chain has internal hysteresis circuitry to improve noise margin and discourage output instability for slowly changing input waveforms. It too offers fast propagation time and works off 5 V supplies. It meets RS-422 and -423 standards.

The Winner...

You . . . if you're into RS-422 with MC3486/87 units because the prices couldn't be better: \$2.25 in plastic and \$2.50 in ceramic for either. That's real communication in anybody's language.

†With a second source—National.

We were first in RS-232. Now we're first in RS-422/3. Contact Motorola Semiconductor Products, Box 20912, Phoenix, AZ 85036 for data.

Once a winner, always a winner.

Semiconductors
—and you thought we were just a production house



CIRCLE NUMBER 32



Solve software problems step by step— just as you would approach hardware problems. 'Top-down' design is a systematic procedure you can follow consistently.

Is there a secret to good software design? Judging by the incantations that used to accompany software design in the past, you might think so. But the secret simply is to be systematic and consistent in your design. Once you have established a step-by-step procedure that works, stick with it, even for "trivial" tasks. You will find your programming faster, more efficient and less error prone. And you can pay more attention to the economic factors that separate success from failure.

To establish a software design procedure that works, you must learn to distinguish between strategy and tactics. The strategy part of software design is independent of the language and the computer to be used. To develop the strategy you look at the big picture, objectively state the problem, and break it down into manageable functional blocks that can be analyzed individually.

Systematic software design strategy is often called top-down design, because it follows the procedure outlined in Fig. 1.

Once your strategy is established, you can tackle the tactics—namely, the ways to implement the solution on a specific machine with a specific language. Consistent tactics for good program design require the discipline of structured programming, which will be discussed later.

Step 1: Define the problem

Before you can solve any software problems, you have to decide exactly what the finished software system must do. Defining the system's operational characteristics is called the "functional specification." Writing a functional specification can be easy for small problems that require specific solutions. But a large and complex problem may require judgment, conceptual design decisions, and hardware/software tradeoffs. Simple systems can be specified in a few pages, while

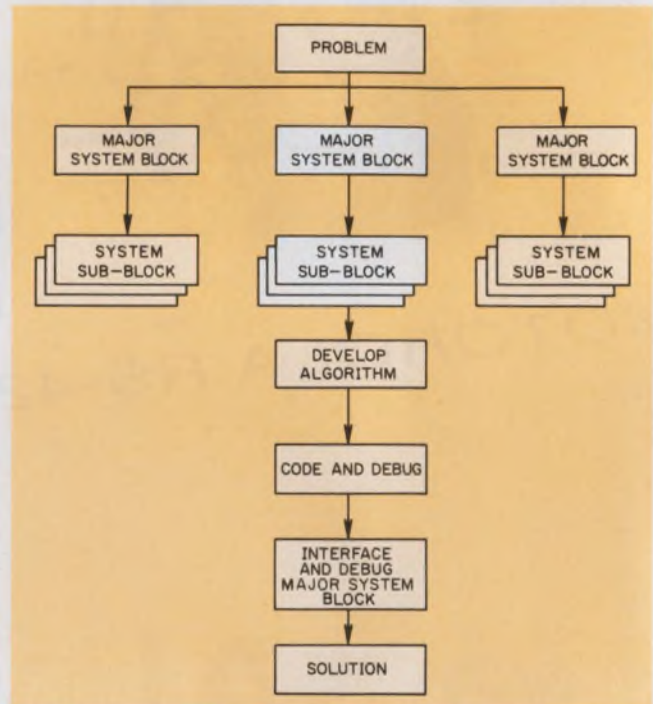

1. Solving problems systematically is the secret to good software design. This flow chart illustrates the sequence of events for the "top-down" design approach.

complex systems can require hundreds. So, the following information should always be present in any functional specification:

- Problem statement—one short paragraph that concisely describes the problem the system must solve.

- Hardware—a list of all hardware required, including the characteristics of each input and output signal or device.

- Software interfaces—when new programs co-exist with other programs, the details of the interfaces must be included in the specifications. They may have a significant effect on the new design.

- User's description—the largest section of the functional spec. It includes a complete description of the system from the outside world's point of view. It should also describe user interaction, data required, output produced, special features,

error-condition handling, and so forth.

A thorough specification is the key to a successful project. It is well worth spending the time to specify the problem carefully and completely at the beginning. Otherwise you will interrupt yourself constantly, fill in the blanks of the problem definition.

Once you have a completely functional specification, stick with it. If you don't, you are likely to run into that dreaded software disease known as "creeping features." This infection occurs when an inadequate problem specification permits organisms known as "neat features" to creep in, after you've started to work on the solution.

As a result, changes that are easily accommodated in the planning stage may require massive redesign efforts during the implementation stage. The farther the work progresses, the worse the problem becomes. The disease is often well advanced before detected, and has proven fatal to many software projects. Marketing people who are frequently the carriers have been known to infect entire engineering departments. While you certainly should incorporate advanced product features, they must be designed in from the top, not added from the side. If you do fall prey to creeping features, then you probably should have spent more time brainstorming during the specification stage.

Step 2: Partition the problem

Once the functional specification is complete, divide the whole problem into smaller functional blocks that can be analyzed and implemented individually. These blocks can be as complex as a complete floating-point arithmetic package or as simple as a few data-conversion instructions.

During program execution, control passes from one functional block to another, so that the functional block diagram can be considered the highest level of system flow chart. You continue partitioning the problem to as many levels of blocks and sub-blocks until algorithm development for each block becomes straightforward. If you are new to the game, do not hesitate to partition

down to blocks that are almost trivial. You will often find that the algorithm for each detailed block becomes very simple. The partitioning process is quite flexible and allows you to adjust the level of block detail to the complexity of each part of the problem.

The initial system blocks can usually be determined from the functional specification. You only have to identify major system structures without being concerned how they operate. Some common initial blocks are: input operations; output operations; program functions (such as data transfers, memory searches, arithmetic operations); system timing and control; and major data structures such as tables and lists.

Once the initial blocks are defined, they are

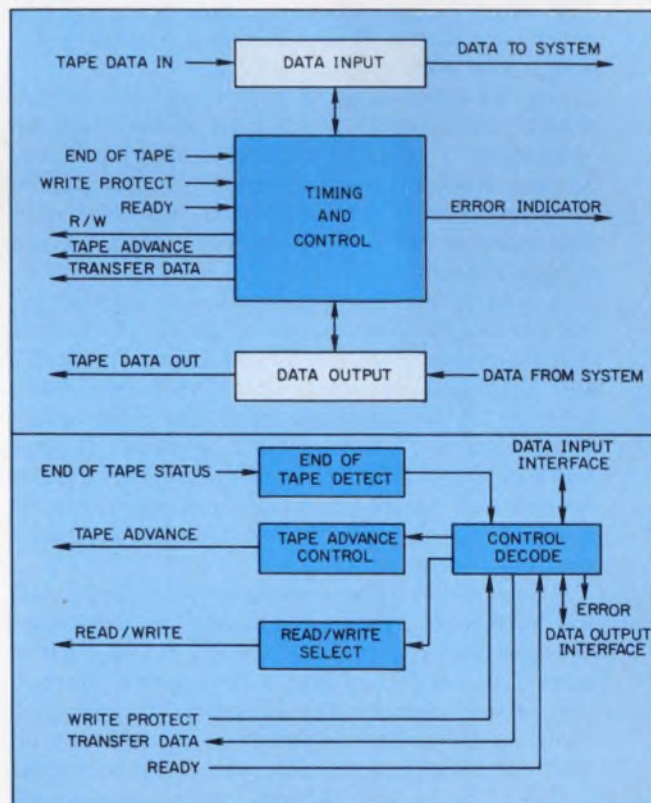

2. The block diagram for a tape I/O system contains the major functional blocks (top). A major block, i.e., "timing and control" can usually be broken down into sub-blocks (bottom).

The economics of software vs hardware

Microprocessor-based systems tend to be either hardware or software intensive because few engineers are equally familiar with hardware and software design. Almost any computer function can be performed in either hardware or software, but the choice should be based on economics, not personal preference. The most valuable tradeoffs between hardware and software can be made at the block diagram stage of the "top-down" design procedure.

The total cost of a new product is the sum of fixed costs and variable costs. Fixed costs include all expenses independent of the number of units manufactured—hardware design, tooling, software design, system debug, documentation, and most overhead costs. Variable costs are directly proportional to the number of units manufactured and include the cost of components, materials, direct labor, the remaining overhead, and (usually inexpensive) copies of the software.

Evaluate the effect of fixed and variable costs on profits, with a break-even chart. By plotting costs vs the number of units sold, you can determine how many units you have to sell before loss turns into profit. Clearly, if you intend to sell 100,000 systems, you must minimize the variable cost of each system. You can spend \$100,000 on development for every dollar per system saved in production. So, fancier software is much less costly than additional hardware for every unit sold.

On the other hand, if your production run is small, you shouldn't spend a lot on software development. Using the breakeven chart and the system block diagram together, you can decide whether to implement each functional block with hardware or software at an early stage of the design process.

A well known hardware/software tradeoff involves the decision to use a UART (Universal Asynchronous Receiver Transmitter) for serial interface to a terminal. The UART chip takes care of all the protocol for serial communications with a TTY or a CRT terminal. It provides all the timing, control logic, and data paths needed for parallel-to-serial conversion, start-and-stop-bit formatting for transmitting, and receiving serial data.

All of the functions performed by the UART in hardware can be replaced by software routines that require only a single bit of a hardware I/O port. Increased software development cost, more memory for program storage, and tying up the processor during serial I/O may or may not be less costly than using the hardware UART. The answer depends on the number of units produced and whether the processor can

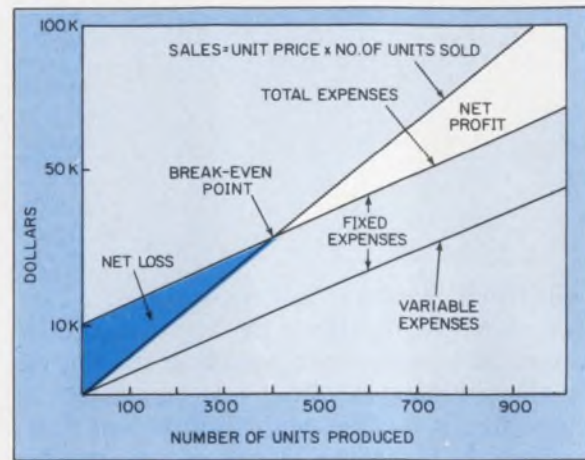

be used to perform other tasks during serial I/O.

One of the thorniest tradeoffs involves system speed, memory size, and software. High-speed operations are usually equivalent to high-cost operations in the microprocessor world. Most single-chip microprocessors have clock rates in the 2-MHz range, and it takes a bunch of clock cycles to execute a string of instructions. Any operation you want the computer to perform that takes less than 100 microseconds, or must be repeated more often than every 100 microseconds, may tax the microprocessor's ability to respond. You can often overcome speed problems by using a TTL microprocessor, adding buffer memories, adding special-purpose hardware I/O devices and optimizing critical paths.

To develop your microcomputer system, you need a software development system. You can either use a time-share service, or buy your own. Time-sharing offers faster software development because a large, high-speed computer and powerful editing programs are available. On the other hand, you can connect your own hardware-development system to your I/O devices and terminals, and use it for real-time interfacing and debugging during prototype design. It can be a tough choice.

To better understand this tradeoff, assume that time-sharing costs about \$15 per hour for connect time, plus about \$200 per minute for CPU time, plus about \$25 per month per 100 k-bytes of storage. With these rates, you can calculate the approximate cost of time-sharing for your projected usage. Don't be surprised if it comes out in the range of \$2000 to \$10,000 per month. Buying your own development system can cost you between \$4000 and \$15,000 up front for reasonable systems. If you plan to do a lot of program development over many months, plan to have your own system.

interconnected to form the system's block diagram. You must make sure that this block diagram is complete. It should contain blocks to implement all the features of the functional specification. The blocks must also be detailed enough for you to develop algorithms for them. If some blocks seem vague or ill-defined, add sub-blocks until they clearly and completely represent the functional specifications.

For example, examine the block diagram for a magnetic tape I/O driver program shown in Fig. 2. The major system blocks are at the top. The bottom section shows the second level of blocking for the most complex major block.

So far, you have not decided whether to implement a block with hardware, software or any combination of the two. Economic considerations should determine the optimum combination. The economics of hardware/software tradeoffs is a complex subject, which is discussed in the box.

Step 3: Develop the algorithms

Having defined the problem, you can begin to seek solutions in the form of algorithms for each functional block. Each algorithm contains the fundamental logic required for each block, but remains independent of any specific computer or language.

When you develop the detailed logic of an algorithm, your most useful tool is the flow chart. It provides a convenient notation that is easy to document and check for logic errors. Flow charts may be used at any level of detail, but are especially valuable at a level that is more detailed than the block diagram but not so detailed that every line of code has its own block. To keep the design procedure consistent, and help others understand your work, you should adhere to the standard set of flow chart symbols shown in Fig. 3.

Algorithm development is the most creative part of software design, and experience plays a big part in your ability to develop creative algorithms. But some general procedures can help you to translate a logical system block into an algorithm:

- Decide what the block should do. You have done this to specify the problem, but now you are dealing with a particular program segment instead of the whole system.

- Determine how to obtain the raw data. Are they read into the system? Passed from another block? Looked up in a table? You need operational blocks in your flow chart to input the required data.

- Determine if the data require any pre-processing before they can be used. Do they have to be complemented? Rotated? Masked? Scaled? If so, insert the proper data-transformation blocks in

the flow chart.

- Decide how to transform the raw data into the required outputs. This step requires process blocks, data, and decision blocks.

- Decide what to do with the processed data. Should they be re-formatted? Saved? Passed back to the calling routine? Add the blocks that prepare the data for output.

- Examine your flow chart. Make it your goal to keep it simple, straightforward, logical and clear. Be particularly careful about entering and exiting routines.

If at first you don't succeed . . .

Algorithm development accounts for the largest portion of your work. It is an iterative process and may require several tries before it is complete and correct. Start by writing down the sequence of operations in the order they will be performed. For example, "read data in, test for control characters, then test for lower case characters," and so on. After you determine the general steps to be performed, add the process and decision blocks that actually perform these operations to your flow chart.

Test your preliminary algorithm on paper with actual data to make sure that it works. Consider the extreme cases and try to imagine every

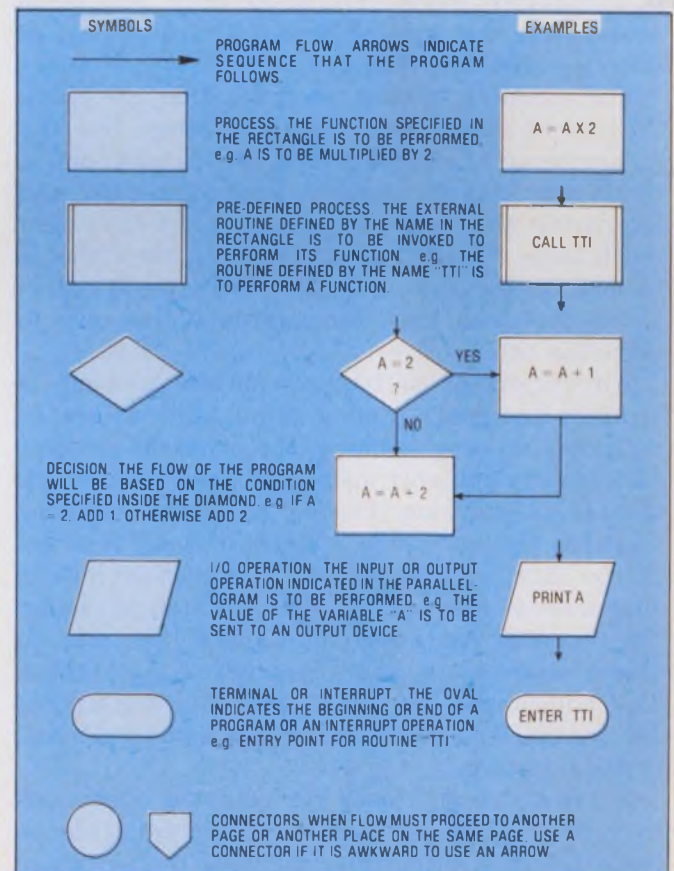

3. Standard flow-chart symbols help clarify the sequence of events in a program or algorithm, not only for the designer but also for other engineers.

possible data condition. Does the algorithm still work? Be patient and thorough, or your algorithm will cost you extra debug time later.

When your algorithm is complete you should have a logic flow chart that looks something like the example in Fig. 4. This chart solves the problem of reading a tape without reference to any specific hardware. Each block of the flow chart may require several instructions when translated into a specific language.

When you have developed algorithms for each program block, the complete strategy for solving the problem is established. What's left is tactics. You now need to know what machine will be used to solve the problem and what language will be used to implement the solution.

Dig for gold—in your software

Not only hardware/software tradeoffs (see box) but also software/software tradeoffs may reduce your costs. One important consideration is the speed of execution.

Within the constraints of your microprocessor's clock rate, there are many ways to trade speed for memory size without impacting the other hardware. The best way to speed up a "slow" program is to find a more efficient algorithm. Selecting or designing a better algorithm is invariably more rewarding than efforts to squeeze the last byte of code out of a sloppy, or ill-considered, algorithm.

For example, take a program that calculates the sine of an angle to a given accuracy. Normally, an iterative algorithm evaluates a polynomial, but it may take an excessive time to execute. And improving the code will probably not save very much time. An alternate, and faster, algorithm is to look up the sine in a table. Now the question is whether you have the additional memory to store the table.

An important software/software tradeoff is straight-line programming versus subroutines. In straight-line programming, the program executes each instruction only once as it proceeds through the entire program. During execution you may find that the same code is repeated several times. If you sacrifice a little speed, you may be able to save a lot of memory by writing a subroutine for the repeated operation and calling that subroutine from the main program each time it is needed. The additional "overhead" housekeeping chores for the call and return process is usually a small penalty to pay.

Subroutines and loops for repeated operations may hide more pay dirt. When subroutines or loops are used often in a program, the processor may spend 80% of its time to execute 20% of the code. So, if you have a speed problem, you should first try to optimize the code that is repeated

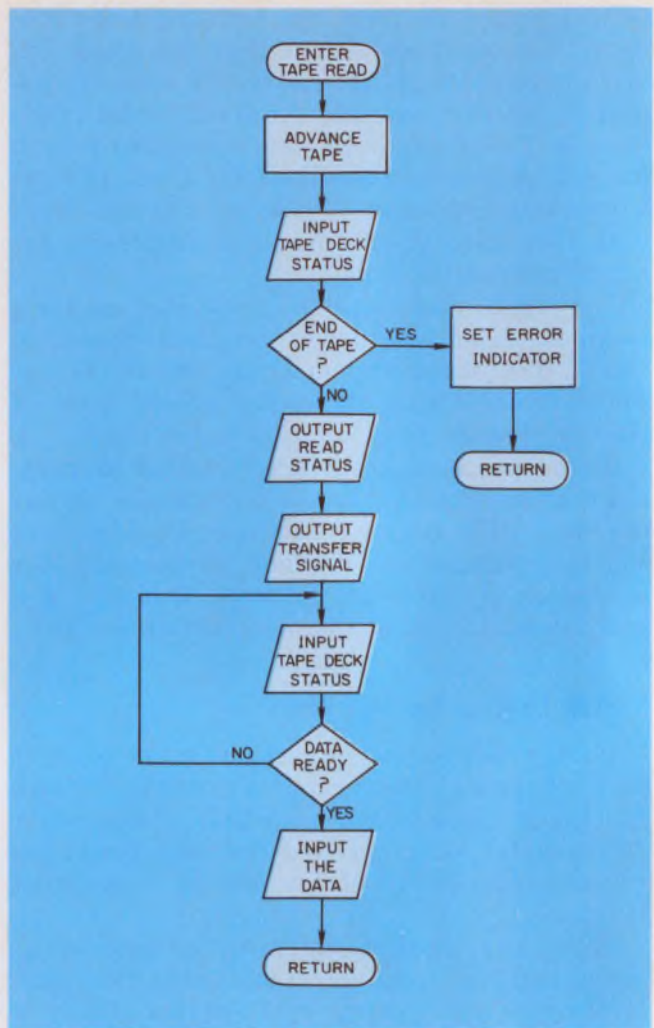

4. This flow chart for reading a tape deck is derived from the block diagram shown in Fig. 2. Each flow chart symbol may correspond to several computer instructions.

most often. If you can save one byte in a loop or subroutine that is executed 100 times, you will save 100 times more than if you save a byte in the main program.

Your choice of language to develop your programs can also affect system cost greatly. Most higher level language processors produce at least 1.5 to 2 times as much machine code as programs written directly in assembly language, which means that 1.5 to 2 times as much memory is required to store the program. Also the program will take longer to execute. On the other hand, development time will be less because you can write and debug your programs much faster in a higher level language. And studies show that assembly language is usually more cost-effective for high-volume products, where minimum memory space and fast execution are most important.

Hardware/software tradeoffs and your programming strategy are vital steps in the over-all design process. But the tactics you employ to implement your strategy can be equally important, and will be discussed in the next part of this series. ■■

INTERFACE ACE



For High-Voltage, High-Current Interface with PMOS, CMOS, TTL, DTL . . . Sprague Darlington Transistor Arrays Have No Equal

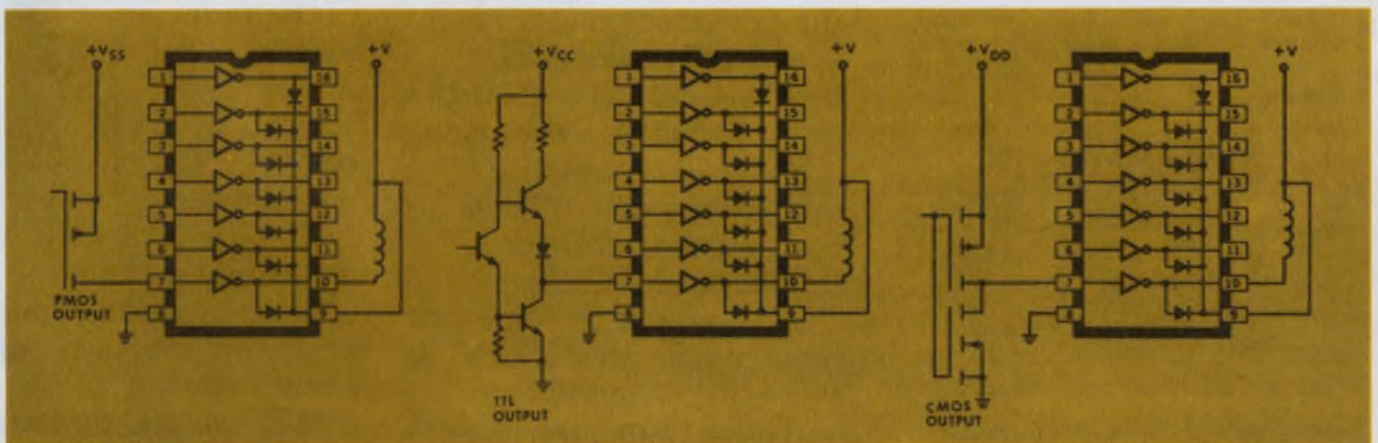

A new exclusive Sprague development, Series 2000 Transistor Arrays are high-voltage, high-current integrated circuits comprised of seven silicon NPN Darlington pairs on a common monolithic substrate. They feature open collector outputs and integral suppression diodes for inductive loads.

Supplied in 16-pin dual in-line plastic, these devices greatly reduce the number of discrete components used to

interface between digital logic and high-voltage and/or high-current loads. In some applications, all discrete components can be replaced by a single DIP, resulting in substantial space and cost reduction.

With broad commercial/industrial application, these unique arrays are an excellent choice for interfacing to LEDs, solenoids, relays, lamps, and small stepping motors in printing calculators,

cash registers, and control equipment.

Type ULN-2001A is a general-purpose array, pinned with inputs opposite outputs to facilitate circuit board layout. Type ULN-2002A is designed for use with 14 to 25 V PMOS inputs. Type ULN-2003A and ULN-2005A interface with TTL, low-power Schottky TTL, DTL, or CMOS operating at a 5V supply voltage. ULN-2004A has series input resistor to allow operation directly from CMOS and PMOS outputs utilizing 6V to 15V supplies.

For more information, write or call George Tully, Semiconductor Division, Sprague Electric Co., 115 Northeast Cutoff, Worcester, Mass. 01606. Tel. 617/853-5000.

For Engineering Bulletin 29304, write to Technical Literature Service, Sprague Electric Co., 347 Marshall St., North Adams, Mass. 01247.

For the name of your nearest Sprague Semiconductor Distributor, write or call Roger Lemere, Sprague Products Company, North Adams, Mass. 01247. Tel. 413/664-4481.

THE BROAD-LINE PRODUCER OF ELECTRONIC PARTS

CIRCLE NUMBER 33



DELCO'S NEW 25-AMPERE HIGH VOLTAGE DARLINGTONS WITH THE SPEED AND ENERGY CAPABILITY YOU ASKED FOR.

Good news for motor speed control designers who have expressed a need to upgrade horsepower ratings. The 25-ampere gain of these new Darlington permits increased horsepower ratings of existing AC motor speed control systems and a reduction in paralleling in new designs. However, grouping of t_{off} is available for current sharing in designs

MAJOR PARAMETER LIMITS

Type	hFE @ 25A	hFE @ 10A	VCEO (sus)	VCE (sat) @ 20A	ICEO @ 600V
DTS-4066	5	75	350V	3.5V	0.25mA
DTS-4067	10	150	350V	2.0V	0.25mA
DTS-4074	5	75	350V	3.5V	0.25mA
DTS-4075	10	150	350V	2.0V	0.25mA

TYPICAL SWITCHING

	DTS-4066 DTS-4067	DTS-4074 DTS-4075
t_r	0.5 μ s	0.5 μ s
t_s	5.0 μ s	3.2 μ s
t_f	4.5 μ s	1.0 μ s

NPN triple diffused silicon Darlington are packaged in solid copper cases conforming to JEDEC TO-3 outline dimensions.

SAFE OPERATING CURVES

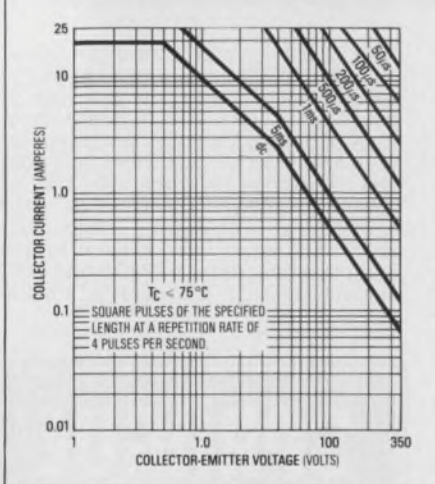

with parallel Darlington. A speed-up diode is built into the DTS-4074 and DTS-4075 permitting data sheet t_f typicals of 1.0 μ s. Drive circuit techniques involving $I_{B2} \geq 2 A$ and a Baker clamp produce t_f typicals in the 0.4-0.6 μ s range for the DTS-4066, DTS-4067, DTS-4074, and DTS-4075.

Our experience with tolerances, faults, transients, and start-stall conditions in most systems convinces us that these Darlington have the right trade-off between speed and peak power handling capability. Note the greater than 10 kVA region of the reverse bias safe operating graph. All this, and you still get Delco's traditional solid copper TO-3 hermetic package that has a conservative 0.75°C/W thermal resistance.

These Darlington are already in high volume production and are available on distributor shelves. Prices, applications literature, and data sheets from your nearest Delco sales office or Delco distributor can complete the story on these new Darlington.



Features of Delco's new DTS-4066, 4067, 4074, 4075 Darlington.

- Upgrade existing motor speed control horsepower ratings.
- Reduce need for paralleling in new systems.
- Offer switching speed improvements over our earlier types.
- Achieve greater than 10 kVA peak power dissipation.
- Available with t_{off} grouping
- Delco hermetic copper package with 0.75°C/W.
- Currently in high volume production.

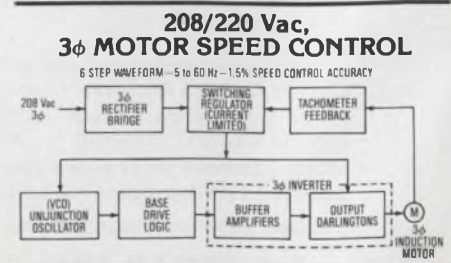

NOW AVAILABLE FROM THESE DISTRIBUTORS IN PRODUCTION QUANTITIES.

ALABAMA

BIRMINGHAM
Forbes Distributing Co., Inc.
(205) 251-4104
HUNTSVILLE
Powell Electronics
(205) 539-2731

ARIZONA

PHOENIX
Sterling
Electronics, Inc.
(602) 258-4531

CALIFORNIA

GARDENA
Electronics
Distributors Div.
Bell Industries
(213) 321-5802
GOLETA
R.P.S. Electronics, Inc.
(805) 964-6823
LOS ANGELES
Kierulff Electronics, Inc.
(213) 685-5511
R.P.S. Electronics, Inc.
(213) 748-1271
PALO ALTO
Kierulff Electronics, Inc.
(415) 968-6292
SAN DIEGO
Kierulff Electronics, Inc.
(714) 278-2112
R.P.S. Electronics, Inc.
(714) 292-5611
SUNNYVALE
Bell Industries
(408) 734-8570

COLORADO

DENVER
Kierulff Electronics, Inc.
(303) 371-6500

CONNECTICUT

NORWALK
Harvey Electronics
(203) 853-1515

FLORIDA

CLEARWATER
Diplomat/Southland
(813) 443-4514

MIAMI SPRINGS
Powell Electronics/Florida
(305) 592-3260

ILLINOIS

ELK GROVE VILLAGE
Kierulff Electronics, Inc.
(312) 640-0200
SKOKIE
Bell Industries
Electronics Distributors Div.
(312) 282-5400

INDIANA

INDIANAPOLIS
Graham Electronics
Supply, Inc.
(317) 634-8202

MARYLAND

BALTIMORE
RESCO/Baltimore
(301)823-0070

MASSACHUSETTS

BILLERICA
Kierulff Electronics, Inc.
(617) 935-5134
(617) 667-8331
NEWTON
The Greene-Shaw Co., Inc.
(617) 969-8900

MICHIGAN

LIVONIA
Pioneer/Michigan
(313) 525-1800

MINNESOTA

MINNEAPOLIS
Stark Electronics Supply Co.
(612) 332-1325

MISSOURI

KANSAS CITY
Walters Radio Supply, Inc.
(816) 531-7015
ST. LOUIS
LCOMP-St. Louis
(314) 647-5505

NEW JERSEY

CINNAMINSON
Wilshire Electronics/
Philadelphia
(609) 786-8990
(215) 627-1920
CLIFTON
Wilshire Electronics/
New Jersey
(201) 340-1900
(212) 244-8930

NEW MEXICO

ALBUQUERQUE
Sterling Electronics
(505) 345-6601

NEW YORK

BINGHAMTON
Harvey Electronics
(607) 748-8211
BUFFALO
Summit Distributors, Inc.
(716) 884-3450
FARMINGDALE
Wilshire Electronics/
Long Island
(516) 293-5775
FREEPORT
Milgray/New York
(516) 546-6000
WOODBURY
Harvey Electronics
(516) 921-8700
(212) 895-9260

OHIO

CINCINNATI
United Radio, Inc.
(513) 761-4030
CLEVELAND
Pattison Supply Co.
Industrial Electronics Div.
(216) 441-3000
DAYTON
Pioneer/Dayton
(513) 236-9900

OREGON

PORTLAND
Almac/Stroum Electronics
(503) 292-3534

PENNSYLVANIA

PHILADELPHIA
Almo Electronics
(215) 698-4000
PITTSBURGH
CAM/RPC Electronics
(412) 782-3770

SOUTH CAROLINA

COLUMBIA
Dixie Radio Supply Co., Inc.
(803) 779-5333

TEXAS

DALLAS
Sterling Electronics
(214) 357-9131

HOUSTON
Harrison Equipment
Co., Inc.
(713) 652-4700
Sterling Electronics
(713) 627-9800

WASHINGTON

SEATTLE
Almac/Stroum Electronics
(206) 763-2300
Kierulff Electronics, Inc.
(206) 763-1550
SPOKANE
Almac/Stroum Electronics
(509) 928-0679

IN CANADA:

Zenitronics Ltd.
Toronto (416) 787-1271
Ottawa (613) 238-6411
Montreal (514) 735-5361

OVERSEAS: EUROPEAN INQUIRIES:

European Parts &
Accessories Marketing
Group
General Motors Continental
Plant 2, Noorderlaan,
Postbus 9
B-2030, Antwerp, Belgium

ALL OTHER OVERSEAS INQUIRIES:

General Motors Overseas
Operations
Parts & Accessories Dept.
767 Fifth Avenue
New York, N.Y. 10022
(212) 486-4412

DELCO ELECTRONICS REGIONAL SALES OFFICES

Charlotte, North Carolina
28209
4600 Park Road
(704) 527-4444
Van Nuys, California 91404
Box 2968
(213) 988-7550

GENERAL SALES OFFICE

700 E. Firmin, Kokomo,
Ind. 46901
(317) 459-2175

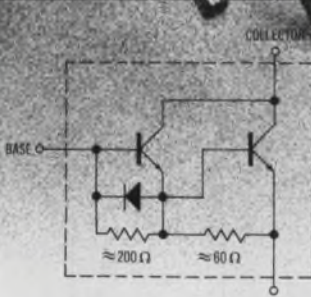

SPEED-UP DIODE USED ON DTS-4074/4075 ONLY

3 ϕ DARLINGTON INVERTER DTS-4066-4067

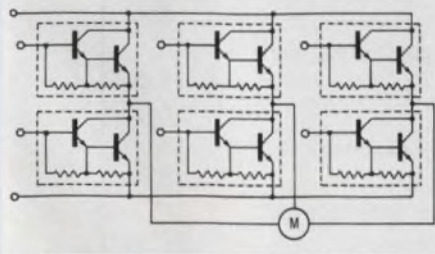

CLAMPED INDUCTIVE SWITCHING PERFORMANCE

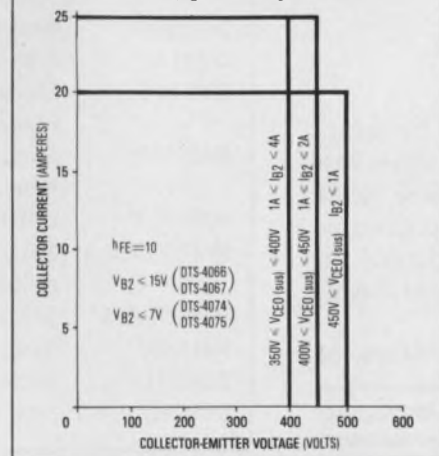

CIRCLE NUMBER 34



Develop systems around the SC/MP.

Two versions permit performance selection, and the versatile instructions allow simple addressing of the 65-k memory.

Available in either PMOS or NMOS, the SC/MP (simple, cost-effective microprocessor) enables you to choose an 8-bit μ P by performance. And the multiprocessing capability of the μ P, combined with its low cost, lets you put computing power where it's needed.

The SC/MP comes in a 40-pin dual in-line package with a set of 46 instructions. Both the p and n-channel parts are pin-compatible (except for three minor signal reversals), so system upgrades are simple—just pull out the p-channel unit, plug in the n-channel version and modify the ground and power lines. The NMOS μ P can operate at clock rates of up to 4 MHz while the PMOS version is limited to 1 MHz rates.

Both the SC/MP and its development tools are easy to use. All necessary timing and clock signals are generated by SC/MP's built-in clock that can be either crystal-controlled or capacitively tuned. Like the 6100 μ P, the SC/MP uses a 12-bit address bus. But it also uses four bits siphoned from the data bus to make a 16-bit address and thus address 65-k words of memory.

Of the 40 pins on the SC/MP, 20 are needed for data and address, two for power, two for clock generation, two for a serial I/O, three for flag lines and the remaining 11 for system control (Fig. 1a). All data transfers between memory and the μ P are controlled by just two timing signals—negative address strobe and negative write or read data strobe (Fig. 1b).

Systems assemble easily

Input/output procedures and memory interfacing are straightforward. A minimal system can be built from the SC/MP, along with some ROM and RAM (Fig. 2). For applications that require just a few words of RAM, pointer registers inside the μ P can be used instead of external RAM. Then a two-chip system is possible.

Systems that require more than 4-k words of

Table 1. SC/MP hardware support

Product	Description	Price (100-up)
SC/MP	8 bit CPU chip	\$ 9.00
MM2102-1	1024 \times 1 500-ns static RAM	2.45
MM2101-1	256 \times 4 500-ns static RAM	3.20
MM2111-1	256 \times 4 500-ns static RAM	3.20
MM74C89	16 \times 4 CMOS static RAM	4.50
MM74C920	256 \times 4 CMOS static RAM	12.15
MM1702A	256 \times 8 erasable ROM	25.25
MM5203	256 \times 8 (512 \times 4) erasable ROM	25.25
MM5213	256 \times 8 maskable 5203 ROM	12.50
MM5204	512 \times 8 erasable ROM	29.50
MM5214	512 \times 8 maskable 5214 ROM	17.50
MM2708	1024 \times 8 erasable ROM	*
MM5242	1024 \times 8 MOS ROM	12.50
MM5246	2048 \times 8 MOS ROM	21.25
DM8597	256 \times 8 bipolar ROM	15.85
DM8596	512 \times 8 bipolar ROM	27.00
DM85S28	1024 \times 8 bipolar ROM	27.00
DM74S287	256 \times 4 bipolar PROM	3.22
DM74S471	256 \times 8 bipolar PROM	8.25
DM74S570	512 \times 4 bipolar PROM	6.98
DM81LS95-98	Three-state octal buffers	1.35
DM8542	Quad I/O register	4.50
DM74LS374	Three-state octal register	1.75
DS8833	Three-state quad bus transceiver	1.90
DM8334	8-bit bit-addressable latch	3.20
DM8131	6-bit unified bus comparator	2.56
DM8546	Three-state 8-bit I/O shift register	3.84
MM5307	Baud rate gen./prog. real time clock	12.00
MM5303	UART	6.00
MM74C922,3	16 & 20-key keyboard encoders	3.80
DS8692,3,4	Seiko printer interface set	*
MM5357	8-bit a/d converter	7.95
CD4051	8-channel analog mux/demux	1.17
DP8212	8-bit I/O port	*

* To be announced

Dan Moss, Design Engineer, and Hash Patel, Microprocessor Product Marketing Manager, National Semiconductor, 2900 Semiconductor Dr., Santa Clara, CA 95051.

RAM must use an external quad latch connected to the data bus (the four lower-order bits) to hold the block number of the 16, 4-k memory blocks.

No nonstandard peripheral circuits are required to support the SC/MP, so common latch circuits and RAMs and ROMs work with no interfacing problems (Table 1). All lines of the SC/MP are TTL compatible and can each handle one TTL load. When larger loads must be serviced, standard unidirectional and bidirectional buffers can be used to drive the bus. Both the address and data-bus outputs from the SC/MP use three-state logic to present minimal loading on the buses.

Several lines on the μP permit a few SC/MPs to be cascaded—all with direct interface to the address and data buses (Fig. 3). If the SC/MP is the only bus controller, the bus access control line can be hard-wired in the active state. All that's needed for using the SC/MPs in a multi-processing mode are three control lines—enable in, enable out and bus request.

To power up the SC/MP, you can choose from several options. The PMOS units operate from +5 and -7 V supplies (Fig. 4a and b). The NMOS version of the SC/MP requires just a 5-V supply and can interface directly to most 5-V logic families (Fig. 4c).

Three signals control data flow

Before the μP can transfer data to or receive data from memories or peripherals, it must have access to the system-address and control bus. Bus access is controlled by three signals—the bus-request (BREQ), the enable-input (ENIN), and the enable-output (ENOUT). For simple systems with a single μP , the BREQ and ENOUT lines need not be used and the ENIN line can be permanently enabled.

(continued on page 64)

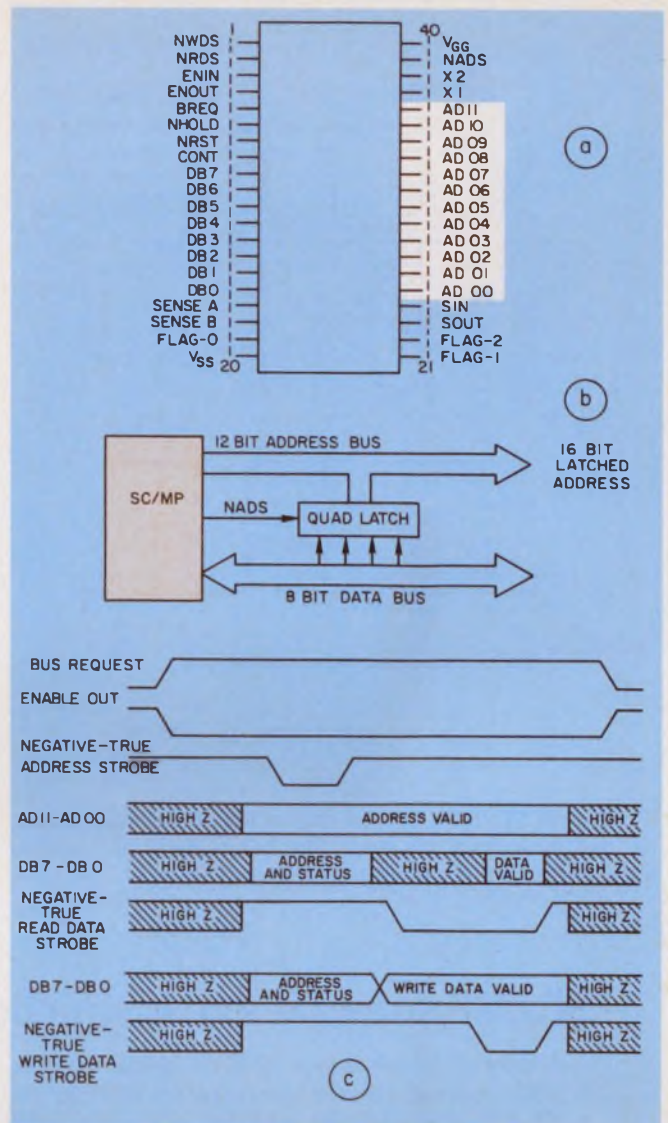

1. Because the SC/MP is crowded into a 40-pin package (a), only a 12-bit address bus is used. To get full 65-k addressing capability, four bits of the data bus are used in addition to the 12 address lines (b). Only two lines, at the most, are necessary to control all the I/O timing (c): negative-true address strobe and negative-true read (or write) data strobe.

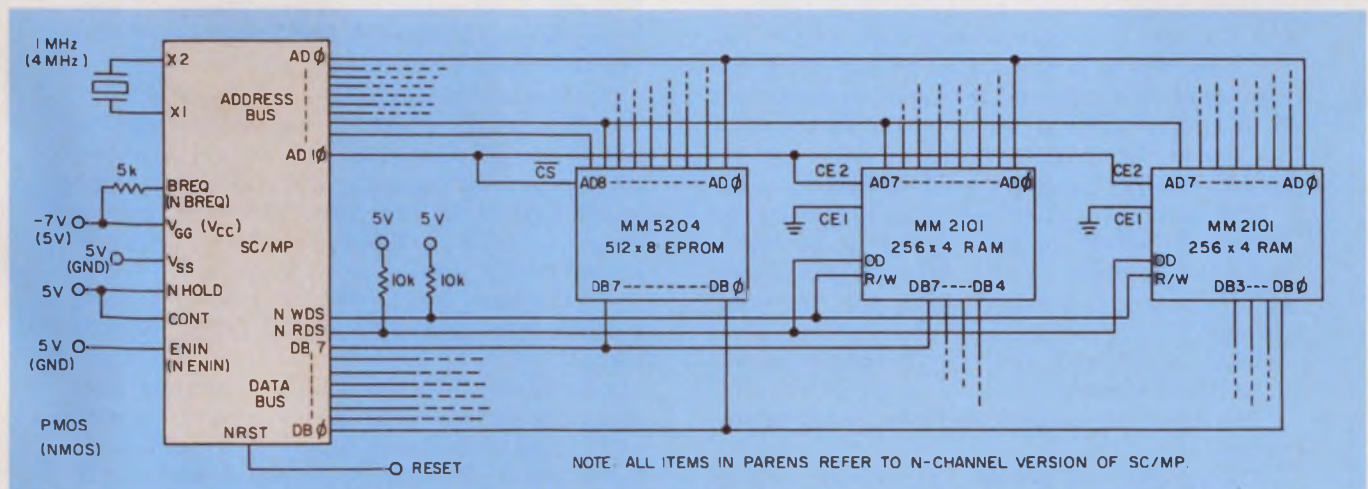

2. Building a minimal operating system with the SC/MP requires few external circuits. If little RAM is needed, the

on-chip oscillator and pointer registers permit even smaller systems than the one shown.

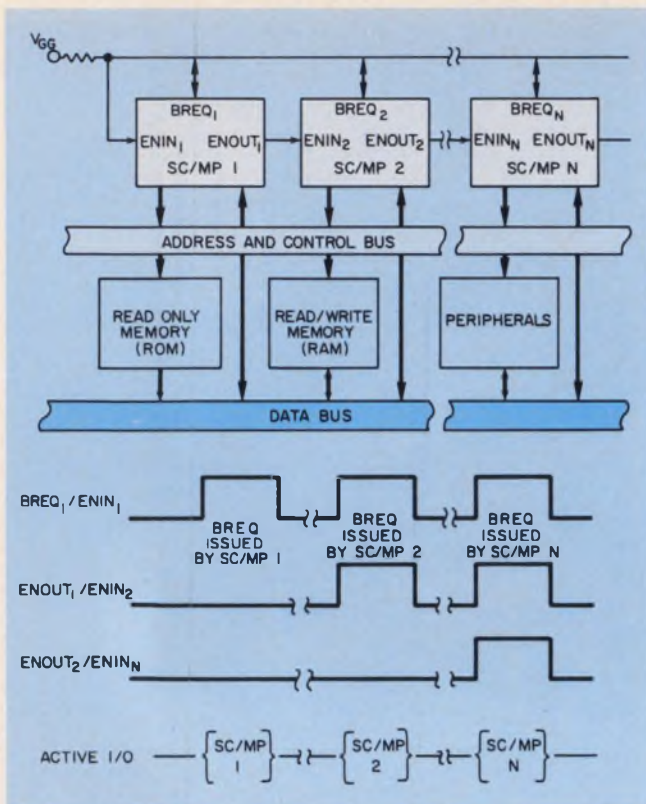

3. Several SC/MPs can be connected to common buses for multiprocessor systems. The bus-request and enable lines permit simple control of the various μ Ps.

In large systems, especially those with peripherals that transfer data at high speed, direct-memory access (DMA) can be implemented without involving the SC/MP. When a DMA is externally requested, the SC/MP requests bus access by bringing the BREQ line high. This signal alerts the DMA controller, and if the bus is idle (no peripheral is currently transmitting or receiving data) the ENIN line goes high and grants the bus access.

When the DMA transfer is completed, the BREQ line goes low and bus access is terminated. Peripherals can also request a DMA operation by using the peripheral-request and peripheral-enable lines on the user-designed DMA controller circuit.

The SC/MP can use readily available memories. For slow memory systems the SC/MP has several features that can circumvent the long access times. For example, its NHOLD (negative-true hold) input line lengthens the input/output cycle. When low, it holds the I/O cycle by delaying the rising edge of the NRDS or NWDS (negative-true read or write data strobe) pulses.

The NHOLD signal can also be used to add a simple debugging circuit to a SC/MP system. All the bus signals remain valid while NHOLD is low, so if LEDs are connected to each buffered

SC/MP software and instruction set

Although it only has a 12-bit address bus, the SC/MP microprocessor can directly address up to 65-k words with the addition of just a quad latch. The μ P handles both serial and parallel data transfers, has DMA capability, five flexible addressing modes, and can operate in multiprocessor systems. The software set has 46 commands, including some special instructions.

Three instructions, increment and load (ILD), decrement and load (DLD) and delay (DLY) provide some unusual capability. For instance, the ILD and DLD commands are useful for loop counters. These two instructions can fetch the loop count from memory, increment or decrement it and store the new value in the accumulator (AC) and the RAM. A "jump if AC = 0" instruction (JZ) completes the loop-count test.

The DLY instruction can delay processing by a variable length of time, which is computed from the contents of the AC, and the second style of the instruction with the following formula:

$$DLY = 12 + 2 (AC) + 2 (\text{displacement}) + 2^9 (\text{displacement}).$$

The delay can range from 13 to 131,593 microcycles.

The SC/MP can address any byte in memory with only a two-word instruction: It uses one of the pointer registers and an offset value speci-

fied in the second byte of the instruction.

The SC/MP instruction set contains single and double-byte instructions. A single-byte instruction consists of an 8-bit operation code that defines an operation the SC/MP will execute. The double-byte instruction consists of an 8-bit op code and an 8-bit data or displacement field. When the second byte represents a data field, the data are processed by the μ P during execution of the instruction. If the second byte represents a displacement value, the byte is used to calculate a memory address that will be accessed during execution of the instruction.

The five addressing modes include:

- PC-relative, which forms an address by adding the current contents of the program counter to a displacement value specified in the second byte of the instruction. The displacement range is from -128_{10} to $+127_{10}$ locations around the PC value.

- Immediate, during which the second byte of a double-byte instruction is used as the operand (data).

- Indexed, which permits any memory location to be addressed. It uses a pointer register (PTR) and a displacement value, but otherwise works like the PC-relative method. A double-byte instruction specifies both the PTR and an 8-bit displacement to that pointer.

address and data line, they will show step-by-step program execution.

Serial-data transfers under program control are also possible with the μ P. The serial-input and output pins (SIN and SOUT, respectively) work in conjunction with the extension register built into the SC/MP. A serial input/output (SIO) instruction shifts the contents of the extension register one bit position. The contents of bit position 0 are shifted into a built-in output flip-flop that holds the bit for the SOUT line. At the same time, data present at the SIN line are shifted into bit position 7 of the extension register.

Transfers on the data bus don't have to be synchronized to any particular timing sequence; devices with widely different data rates can all connect to the common bus.

System timing starts with the clock

The SC/MP's built-in clock can operate at frequencies of up to 1 MHz for the PMOS version and 4 MHz for the NMOS model. For both models, either an external crystal with an equivalent series resistance of 600 Ω can be used for precision timing, or a capacitor can be connected across the clock terminals.

All necessary timing signals are generated by

- Auto-indexed, which provides the same capabilities as the indexed mode, along with the ability to increment or decrement the designated PTR by the value of the displacement. In the indexed mode, the value of the PTR remains unchanged. However, in the auto-indexed mode the PTR value changes. If the displacement is less than zero, the PTR is decremented by that value before the contents of the effective address are fetched or stored. When the displacement is equal to or greater than zero, the PTR is incremented by that value after the contents or the specified location are fetched.

- Implied, which specifies only internal registers. For example, the copy status register-to-accumulator (CSA) command defines the status register as the originating operand and the accumulator as the destination operand.

The SC/MP can handle interrupts. When one occurs, the contents of PTR 3 are automatically exchanged with the PC to do a subroutine jump to the interrupt service routine. A jump-to-subroutine command also follows the same exchange procedure, except that any PTR can be used. For subroutine jumps, however, the PTR should be set to a value one less than the subroutine-starting address: The PC is incremented prior to the instruction fetch cycle.

the on-chip clock and timing generator. If desired, the on-chip oscillator can be disabled and the μ P's timing generator driven by an externally generated clock.

Inside the μ P, instructions are executed in multiples of microcycles. In the PMOS unit, 1 microcycle is twice the period of the oscillator; in the NMOS unit, the microcycle equals four times the clock period.

To start up the μ P first bring the reset input (NRST) low to clear the internal status and all registers on the SC/MP. When NRST goes high, the first instruction is fetched from location 0001. The continue (CONT) input permits the SC/MP to be halted without losing any internal data on status info. Bringing CONT high for one microcycle allows a single instruction to be executed.

The CONT line, since it is an asynchronous input, provides a simple way to step through a program. If an interrupt is requested while CONT is low, the first instruction of the user-

Double-byte instructions			
Mnemonic	Description	Format	
Memory reference instructions		7 6 5 4 3 2 1 0 7 6 5 4 3 2 1 0	
LD	Load	1 1 0 0 0	0 ptr disp
ST	Store	1 1 0 0 1	
AND	AND	1 1 0 1 0	
OR	OR	1 1 0 1 1	
XOR	Exclusive-OR	1 1 1 0 0	
DAD	Decimal add	1 1 1 0 1	
ADD	Add	1 1 1 1 0	
CAD	Complement and add	1 1 1 1 1	
Memory increment/decrement instructions		7 6 5 4 3 2 1 0 7 6 5 4 3 2 1 0	
ILD	Increment and load	1 0 1 0 1	0 ptr disp
DLD	Decrement and load	1 0 1 1 0	
Immediate instructions		7 6 5 4 3 2 1 0 7 6 5 4 3 2 1 0	
LDI	Load immediate	1 1 0 0 0	1 0 0 data
ANI	AND immediate	1 1 0 1 0	1 0 0
ORI	OR immediate	1 1 0 1 1	1 0 0
XRI	Exclusive-OR immediate	1 1 1 0 0	1 0 0
DAI	Decimal add immediate	1 1 1 0 1	1 0 0
ADI	Add immediate	1 1 1 1 0	1 0 0
CAI	Complement and add immediate	1 1 1 1 1	1 0 0
Transfer instructions		7 6 5 4 3 2 1 0 7 6 5 4 3 2 1 0	
JMP	Jump	1 0 0 1 0	0 ptr disp
JP	Jump if positive	1 0 0 1 0	1
JZ	Jump if zero	1 0 0 1 1	0
JNZ	Jump if not zero	1 0 0 1 1	1
Miscellaneous instructions		7 6 5 4 3 2 1 0 7 6 5 4 3 2 1 0	
DLY	Delay	1 0 0 0 1	1 1 1 1 disp
Single-byte instructions			
Extension register instructions		7 6 5 4 3 2 1 0	
LDE	Load AC from extension	0 1 0 0 0	0 0 0 0
XAE	Exchange AC and extension	0 0 0 0 0	0 0 0 1
ANE	AND extension	0 1 0 1 0	0 0 0 0
ORE	OR extension	0 1 0 1 1	0 0 0 0
XRE	Exclusive-OR extension	0 1 1 0 0	0 0 0 0
DAE	Decimal add extension	0 1 1 0 1	0 0 0 0
ADE	Add extension	0 1 1 1 0	0 0 0 0
CAE	Complement and add extension	0 1 1 1 1	0 0 0 0
Pointer register move instructions		7 6 5 4 3 2 1 0	
XPAL	Exchange pointer low	0 0 1 1 0	0 ptr
XPAH	Exchange pointer high	0 0 1 1 0	1
XPPC	Exchange pointer with PC	0 0 1 1 1	
Shift, rotate, serial I/O instructions		7 6 5 4 3 2 1 0	
SIO	Serial input/output	0 0 0 1 1	0 0 0 1
SR	Shift right	0 0 0 1 1	0 0 0
SRL	Shift right with link	0 0 0 1 1	0 1 0
RR	Rotate right	0 0 0 1 1	1 1 0
RRL	Rotate right with link	0 0 0 1 1	1 1 1
Single-byte miscellaneous instructions		7 6 5 4 3 2 1 0	
HALT	Halt	0 0 0 0 0	0 0 0 0
CCL	Clear carry/link	0 0 0 0 0	0 1 0
SCL	Set carry/link	0 0 0 0 0	1 1 0
DINT	Disable interrupt	0 0 0 0 0	1 0 0
IEN	Enable interrupt	0 0 0 0 0	1 0 1
CSA	Copy status to AC	0 0 0 0 0	1 1 0
CAS	Copy AC to status	0 0 0 0 0	1 1 1
NOP	No operation	0 0 0 0 0	1 0 0 0

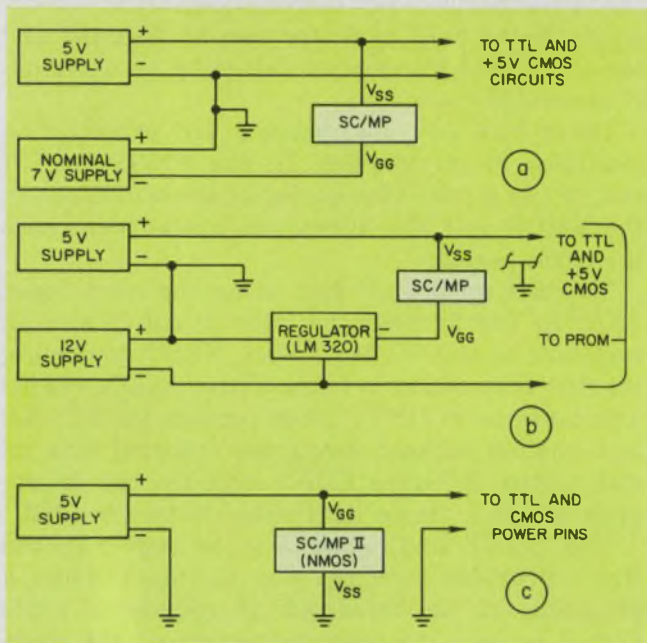

4. No ground pin is available on the PMOS SC/MP (a and b), but operation is possible with a +5 and -7 V supply. On the NMOS version the V_{ss} pin is used as the ground and the V_{cc} line to +5 V (c).

generated-interrupt service routine is automatically executed.

The first operation performed by the μP for each I/O cycle loads the 12 least significant address bits onto the address bus and the four most significant address bits, along with four special status-flag bits onto the data bus. While all the bits are loaded, the NADS (negative-true address strobe) output is brought low to indicate that address and status information are valid.

The four status bits, R, I, D and H-flag, indicate the following: RFLG—when high, the current I/O cycle is a read cycle; when low, a write cycle. IFLG—when high, the instruction op code (single-byte instruction or first byte of double byte instruction) will be output from memory after a NADS signal. DFLG—when high, a delay instruction is being executed. HFLG—when high, the processor is held in the halt mode.

Systems based on the SC/MP can handle externally generated or program-initiated interrupts. When set, the internal-interrupt enable (IE) flag lets the sense-A line serve as an interrupt-request input (Fig. 5). When reset, the IE flag stops the SC/MP from detecting any interrupts.

While the IE flag is set, the sense-A input gets tested prior to the fetch phase of each instruction. Upon detection of an interrupt request, the IE flag gets reset, the contents of the program counter are exchanged with the contents of pointer register 3, and the contents of the program counter are incremented by 1 to address the first instruction of the user-generated service routine, thus handling the interrupt.

The various addressing modes of the SC/MP (see software box, p. 64) allow the μP to rapidly access any location in memory. The pointer registers are considered very powerful because all memory-reference instructions specify either a pointer-register or the program counter. An example might help illustrate the μP 's versatility.

An example illustrates the pointer

The example lets the SC/MP load a number from a RAM location into the accumulator (AC), add it to the value in the extension register (E), push the result onto a software stack and, finally, call a subroutine.

To set up the program, first make some pointer-register assignments:

- P1 = RAM address pointer.
- P2 = Stack pointer.
- P3 = Subroutine pointer.

Next, write the program (the indexed addressing mode should be used):

```
LD 5(P1) ; Load data stored at (pointer
           register 1) +5 into AC
ADE      ; Add value previously stored
           in E to AC
ST @-1(P2) ; Push onto stack with auto-
           increment (@) addressing
XPPC P3 ; Jump to subroutine
           To pull the value dumped onto the stack, use
           LD @ 1(P2).
```

However, since P2 always points to the top of the stack, make sure that no other operations take place to change P2 before you access the stack.

If possible, the three pointer registers should be assigned so that each points to an important block of RAM or ROM, such as a subroutine, RAM variable list, a table, stack or I/O device.

For example, if all I/O devices are within a 255-word block of memory, one pointer can access all devices by using indexed addressing. A pointer must be loaded in two parts. The following list shows P2 being loaded from "lower" and "upper" RAM locations, which use P1 as their base pointer:

```
LD lower (P1) ; Load lower 8 bits into AC
XPAL P2 ; Exchange AC with lower
           half of P2
LD upper (P1) ; Load upper 8 bits into AC
XPAH P2 ; Exchange AC with upper
           half of P2
```

Load immediate (LDI) instructions can be used if data are in the program, not in RAM.

System support comes in all forms

Since the SC/MP is designed with low system cost in mind, a variety of low-cost development aids are available to you (Table 2). The cheapest

What goes on inside the SC/MP microprocessor?

The SC/MP microprocessor, in either its p or n-channel versions, forms an almost complete minimal microcomputer system. The chip has all the registers, the arithmetic and logic unit (ALU), an oscillator and enough buffers to drive one TTL load on every pin.

There are seven major registers in the SC/MP μ P: a 16-bit program counter (PC), an 8-bit accumulator (AC), three 16-bit pointer registers (PTR), an 8-bit extension register (E) and an 8-bit status register (SR). Like other microprocessors, the PC holds the address of the instruction being executed. However, the PC's output is divided into a 4-bit, high-order address and a 12-bit, low-order address. When incremented, only the 12 low-order bits act as a counter; no carry is generated to the four high-order bits.

For systems that require more memory than the 12 low-order bits can address (4 kwords), the four high-order memory-address bits can be loaded into a 4-bit latch fed by the data bus when the address strobe line is low. They can also select any one of 16, 4-k blocks.

The AC is the main working register of the μ P and is used for storing the results of ALU operations, as well as for data transfers, shifts and rotates.

Three pointer registers can be used as temporary memory storage, memory address-base pointers and subroutine address pointers but their primary use is in memory references. Either the upper or lower eight bits of a PTR can be exchanged with the contents of the AC, which permits the PTRs to be used as either address-storage or data-storage registers.

The E register, similar to the accumulator in function, can be used three ways:

1. As an 8-bit extension of the accumulator and to store a computation's partial result.
2. To hold an address displacement value if the second byte of a memory-reference instruction is equal to -128_{10} . (This feature applies to PC-relative, indexed and auto-indexed addressing modes described in the box discussion on software, p. 64.)
3. As a serial input/output port under software control.

The last major register is the SR, whose eight bits are used for various indicator and sensing functions. Bits 0, 1 and 2 are software controll-

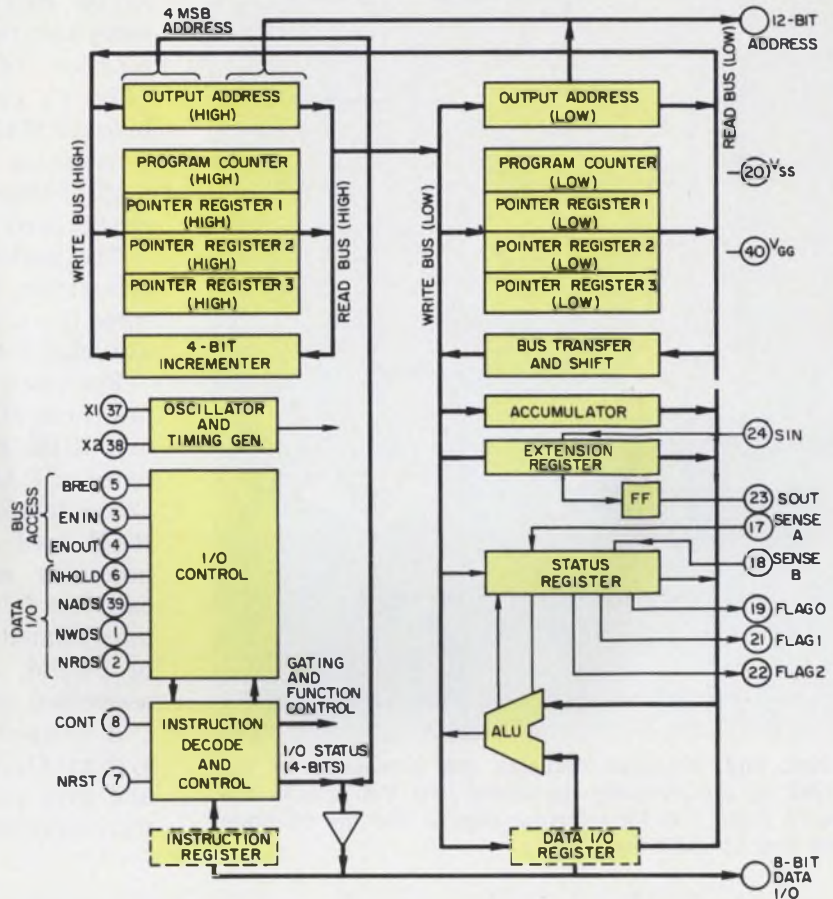

able flag bits (F0, F1 and F2). The next bit, bit 3 (interrupt enable), can also be set or reset under software control. When set, the μ P will recognize an interrupt request on the sense-A input line (interrupt input).

Both the sense-A and sense-B bits (bits 4 and 5) are inputs and can be tested by copying the SR into the AC. When the interrupt-enable bit is set and sense A goes high, an interrupt occurs. The sense-B input doesn't have the interrupt capability, but otherwise performs like the sense-A input. The sense-A and sense-B bits in the SR are read-only indicators and are not affected if the AC is copied into the SR.

Bit 6 represents an overflow and is set if an arithmetic overflow occurs during an add—ADD, ADI or ADE—or complement-and-add—CAD, CAI or CAE—instruction. It is not affected by decimal-add instructions—DAD, DAI or DAE. (For mnemonic explanations see software discussion, p. 64.)

The last bit of the SR is a carry/link bit, which gets set if a carry from the most significant bit occurs during an add, complement-and-add or decimal-add instruction. It is used in the link form with such AC shift instructions as shift right with link (SRL) and rotate right with link (RRL).

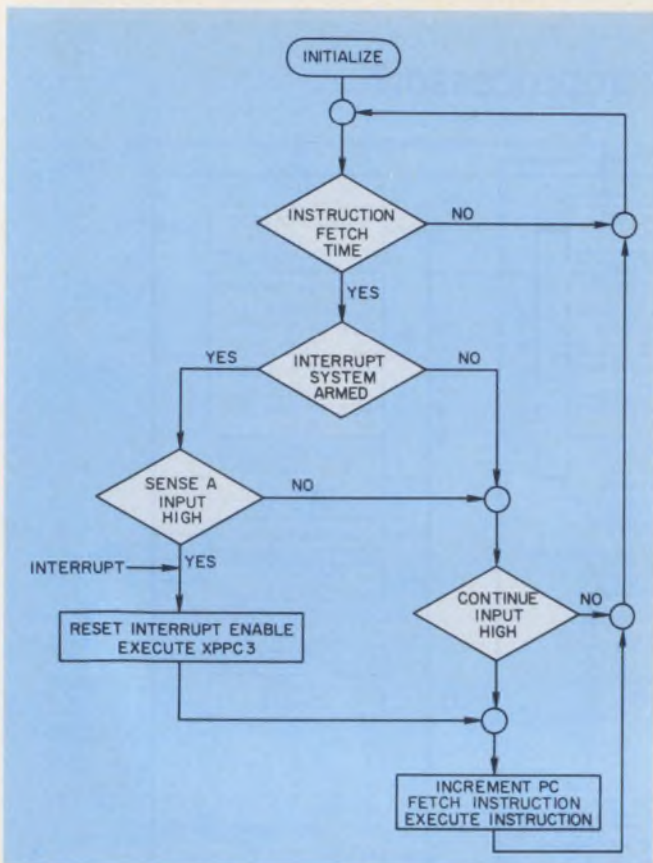

5. Halt and interrupt requests are processed in the SC/MP by a continually monitored loop that checks the sense-A input line for interrupt signals and the continue input line for halt signals.

is the SC/MP kit, which is a minimal system with a teletypewriter interface.

A recently introduced portable terminal, known as the SC/MP keyboard kit, permits program entry and register and address display. The combination of the SC/MP and keyboard kits (Fig. 6) provides you with a SC/MP μ P, 256 bytes of RAM, 512 bytes of preprogrammed ROM (containing Kitbug—a debug and I/O program), a teletypewriter interface, a voltage regulator, a circuit card and all required discrete components.

The keyboard kit, which can replace the teletypewriter, links with the SC/MP via a cable and some interface circuitry. The SC/MP kit is also available completely assembled and tested.

For more extensive system development there are three SC/MP application cards—CPU, RAM and ROM/PROM. The CPU card contains 256 bytes of RAM and space for 512 bytes of PROM, and can address the full 64-k of memory. The RAM card contains 2-k bytes of RAM and all necessary address decoding. The ROM/PROM card has full address decoding built in and comes unpopulated, but has space for 4-k bytes of ROM or PROM. All application cards come factory-assembled and tested.

A complete, stand-alone, low-cost development system (LCDS) can hold the application cards and give you detailed system control and software-debugging capabilities. With a 6-digit hexa-

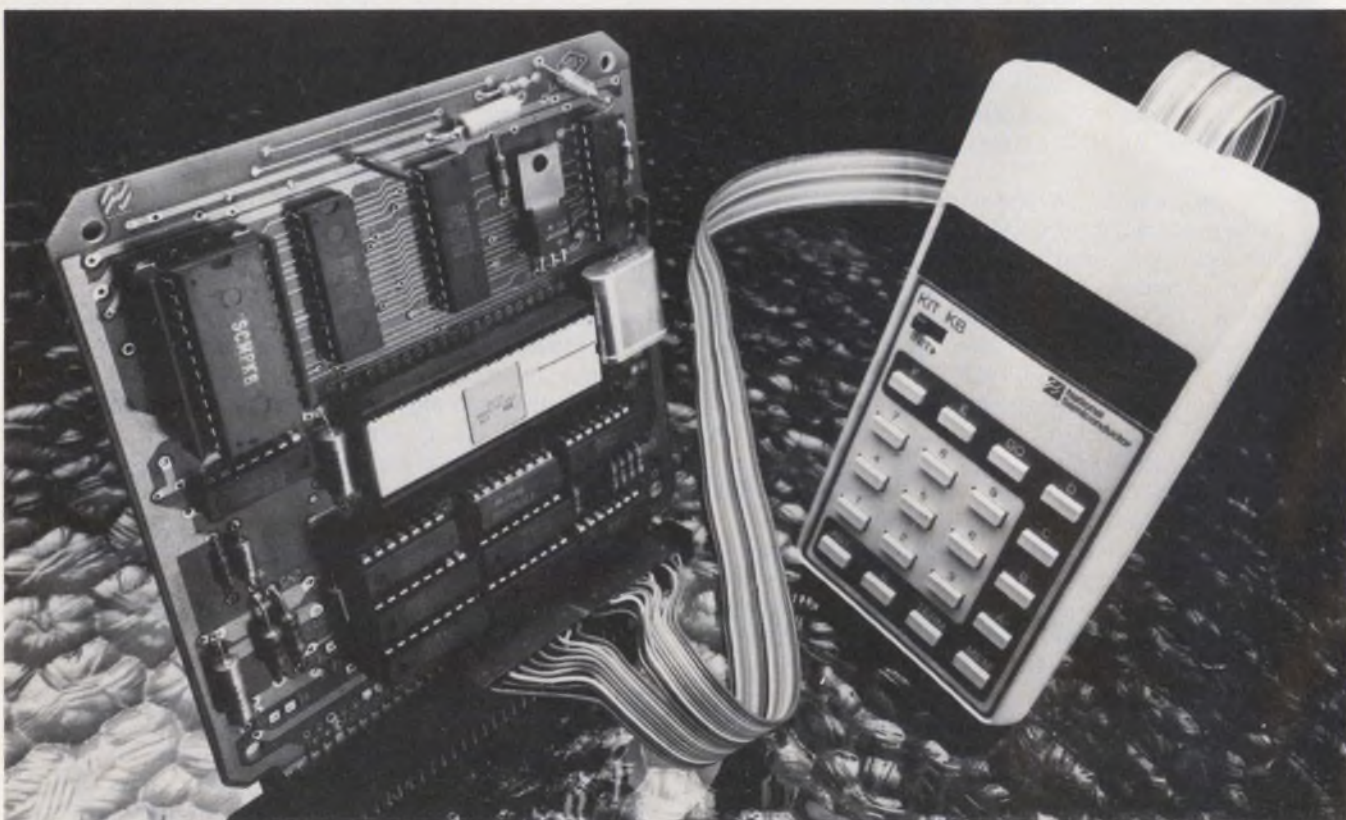

6. The SC/MP kit and keyboard kit combine to make a low-cost minimal operating system. All that's needed for

operation is a power supply. The keyboard's built-in display shows addresses and data.

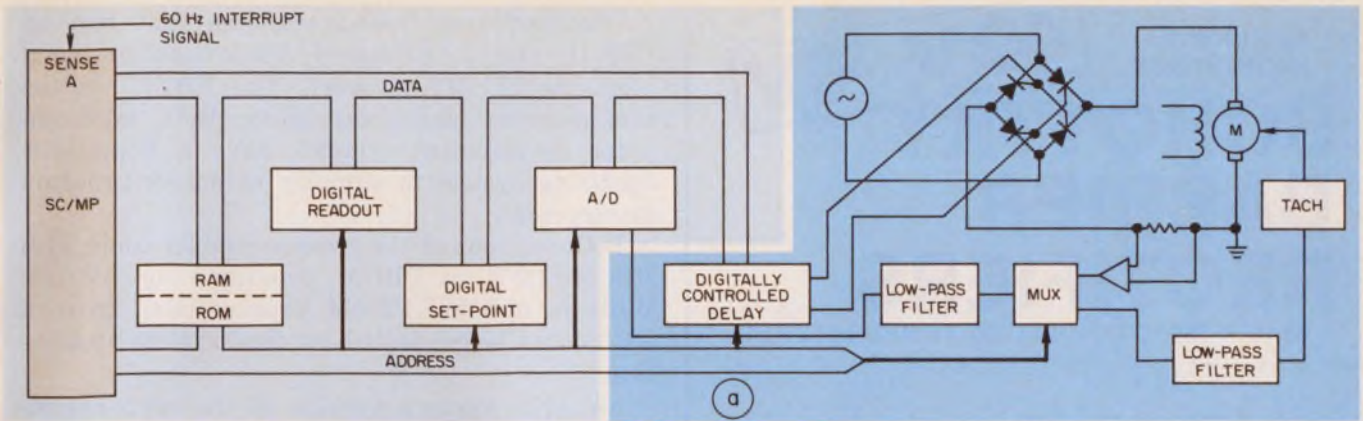

(a)

7. A typical industrial application may use the SC/MP to control the speed of a dc motor (a). The controller senses the motor speed via a tachometer and feeds it to the SC/MP through an a/d converter. The SC/MP in turn sends back a digital control to the SCR bridge. The entire process, outlined in flow-chart form, shows one possible approach to the control (b).

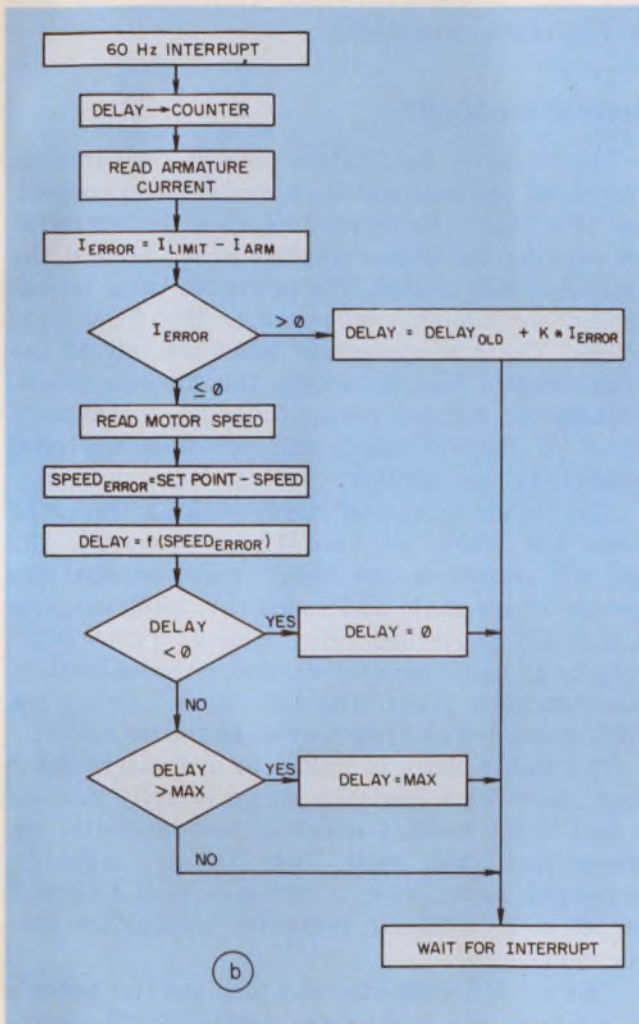

(b)

Table 2. SC/MP system support

Product	Description	Price (1-24)
SC/MP kits and development systems		
ISP-8K/200	SC/MP kit	\$ 99
ISP-8K/220	SC/MP kit assembled	125
ISP-8P/301	SC/MP low cost development system (LCDS)	499
ISP-8K/400	SC/MP kit keyboard	95
SC/MP application cards		
ISP-8C/002	SC/MP RAM card (2-k x 8)	160
ISP-8C/004	SC/MP ROM/PROM card (4-k x 8), with sockets for eight MM5204/MM5214	125
ISP-8C/100	SC/MP CPU card (includes 256 x 8 RAM and sockets for 512 x 8 of ROM/PROM)	250
SC/MP cross assembler software packages		
ISP-8S/100C,Q	SC/MP (IMP-16 based) 4-k cross assembler (object paper tapes/punched cards, and listing)	150
ISP-8S/101C,Q	SC/MP (IMP-16 based) 8-k cross assembler (object paper tapes/punched cards, and listing)	150
ISP-8S/103C	SC/MP (Pace based) cross assembler	150
ISP-8S/102P	SC/MP (ANS Fortran) cross assembler	495
NIBL	National Industrial Basic	25

decimal display and a control keyboard, you can display and alter the contents of the SC/MP's program counter, register and accumulator, as well as any memory location. You can also initiate program execution at any memory address, set software breakpoints, load IMP-16 or Fortran cross-assembler-generated paper tapes, and dump programs onto the paper tapes.

LCDS I/O is switch-selectable between the front-panel keyboard and a user-supplied teletypewriter. Although all features on the LCDS are available through the TTY, the TTY's paper-

tape reader and punch are needed to do cross-assembler memory loads and dumps.

Software available for the SC/MP includes a high-level interpretive language written especially for the industrial user, National Industrial Basic Language (NIBL), which requires no intermediate files or paper tapes. NIBL fits into 4-k of ROM and uses 2-k of RAM for program and variable storage.

AVAILABLE
FROM STOCK

40V PIV

SCHOTTKY BARRIER RECTIFIERS

- 65 to + 150°C OPERATING TEMPERATURES

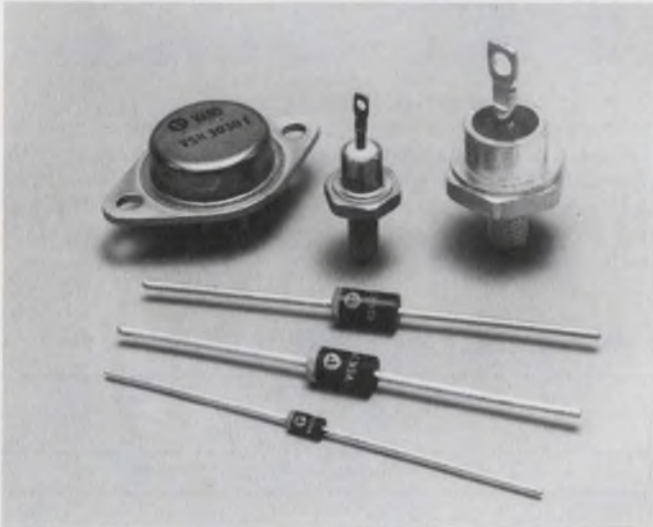

Varo Schottky Barrier Rectifiers offer you many significant advantages:

VERY LOW FORWARD VOLTAGE DROP (V_F)

Because of the large metal-barrier-to-silicon junction, V_F ranges are from 550 mV, $I_F = 1$ A, to 620 mV, $I_F = 40$ A. This results in less heat dissipation, low power loss, and greatly improved efficiency.

EXTREMELY FAST RECOVERY TIMES (t_{rr})

Typically ≤ 10 nsec. Schottkys are ideally suited for low-voltage power supplies, free-wheeling diode and flyback diode applications, and polarity protection in high-speed switching circuits.

MAJORITY CARRIER CONDUCTION

In addition to fast recovery, Schottky barrier construction results in high surge capacity and low stored charge. Schottkys are not subject to conventional P-N diode forward and reverse recovery transients caused by minority carriers.

OTHER VARO SCHOTTKY FEATURES ARE:

- -65 to + 150°C junction operating temperatures
- 1 A, 3A, 5A, 15A, 30A and 40A (I_G) ratings
- 20V, 30V, and 40V (V_{RRM}) ratings
- Low reverse leakage
- Epoxy axial lead, DO-4, DO-5, and TO-3 package configurations
- Competitive pricing

Try one in your circuit; you will see for yourself these advantages and more.

For more information and data sheets on all Varo Schottky Barrier Rectifiers call Mike Hawkins, 214/272-4551



Design us in . . . we'll stay there

VARO SEMICONDUCTOR, INC.

P.O. BOX 676, 1000 N. SHILOH, GARLAND, TEX. 75040
(214) 272-4551 TWX 910-860-5178

EUROPEAN OFFICE: UK: VARO SEMICONDUCTOR INTERNATIONAL, INC.
Deerpene House, Bellgrave Road, Welling, Kent, England DA163PY, 01-304-6519/0

CIRCLE NUMBER 36

Conversational cross-assemblers that run on IMP-16 and PACE-based minicomputers complete the SC/MP support. The PACE version also provides macro capability. Both minicomputer development systems have a floppy-disc operating system to simplify extensive program development.

Both versions of the cross-assembler come with PROM-SOFT, a PROM programming routine. With an optional PROM programming card, a PROM can be generated for final system application.

An ANS Fortran version of the cross-assembler, on GE Timeshare and National CSS networks, is also available.

Applying the SC/MP

The following application puts SC/MP into an industrial environment as a motor-speed controller (Fig. 7a). The dc motor's speed is controlled by varying the power applied to it through the full-wave SCR bridge. The power, in turn, is controlled by timing, or phasing, the SCR gate pulses. The microprocessor generates all of the phase-control timing, senses the motor's speed, adjusts the applied power to bring the motor's speed to the set point, and provides a digital readout to the operator.

The circuit operation starts with an interrupt from the 60-Hz ac line. Upon interrupt, the SC/MP computes the delay required for the proper phase angle and sends this 8-bit value to a digitally controlled delay circuit. This circuit may be an oscillator and counter, or some form of programmable timer. The delay circuit drives the SCR gates, which apply power to the dc motor.

The motor shaft is linked to a dc tachometer that generates a feedback signal directly proportional to the motor's speed. A low-pass filter removes any brush noise. This feedback signal is presented, along with a motor-current feedback signal, to an 8-bit a/d converter through an analog multiplexer.

The SC/MP computes and displays the motor's speed from the tachometer feedback, then compares the motor speed with the digital set point and corrects the phase angle accordingly. The loop starts over again. (The flow chart for the actual program is shown in Fig. 7b.)

A SC/MP subroutine can give the desired motor start-up, including corrections for back EMF. The SC/MP can drive the digital readout with a minimum of external hardware and receive digital set-point information from a keyboard or computer. Computations or conversions on the incoming data can also be done. For example, if the motor is driving a conveyor belt, the SC/MP can compute and display the speed of the belt in ft/min. ■■

There you are at 30,000 feet.
And whom do
you turn to?
Us.



The entertainment console in the armrest of your passenger seat was most likely made by us. We've supplied at least 85% of all of the entertainment consoles used in today's wide-bodied commercial jet aircraft. So you've had EECO experience all this time without knowing it.

We're telling you now because we thought it's time you knew that we do more than make thumbwheel switches, tape readers, and packaging hardware.

EECO is part of your life.

EECO

1441 East Chestnut Avenue, Santa Ana, California 92701
Phone 714/835-6000

What makes The faster and easier?

...Rapidograph, Rapidometric, Rapidograph SL

Finest precision, highest quality Technical Pens offer the most complete range of line widths. Points available in hard chromed stainless steel, sapphire jewel and tungsten carbide.



...Pelikan and Koh-I-Noor Drawing Inks

Specially formulated for the most exacting requirements.



...Rapiddraw Drafting Film

A virtually indestructible film with a fine-toothed surface for maximum precision and reproducibility in engineering drawings.

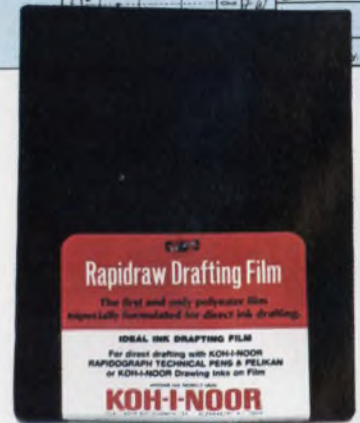
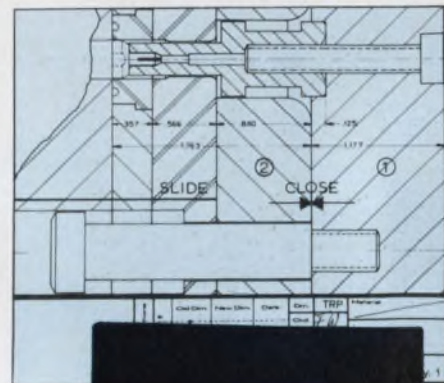

"RAPIDRAW" System

To learn how The "Rapidraw" System can help you save money and achieve highest quality engineering drawings, call Koh-I-Noor on our toll-free number 800-631-7646 or collect 201-479-4124.

...Koh-I-Noor Ink Erasing System

Erasures can be made on the film with confidence and ease without marring the film surface, as often as required.

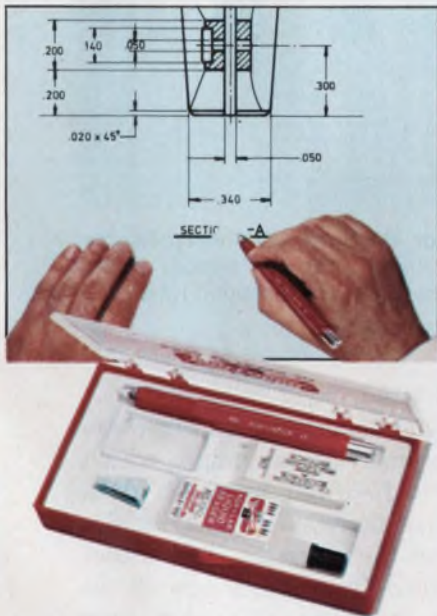

...System accessories

Designed to make drafting with ink on film even easier than you might suppose.



What makes us the authority?

Koh-I-Noor has developed Rapiddraw, a System of totally integrated instruments and materials, providing a remarkable simplification of drafting techniques. This System makes direct ink drafting on film the most practical method to achieve precision engineering drawings, as confirmed by leading industries. We would like to give you a free manual completely describing our System.

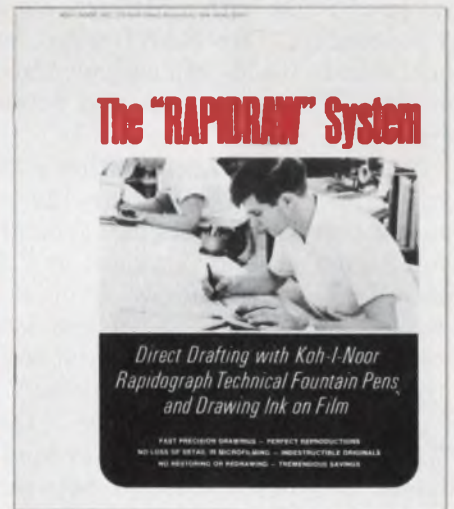

YOU GET MORE FROM
KOH-I-NOOR[®]
The "Breakthrough" Company

Koh-I-Noor Rapidograph, Inc., 100 North Street, Bloomsbury, N.J. 08804
In Canada: Koh-I-Noor/Canada/Ltd., 4180 Ave. de Courtrai, Montreal, Quebec H3S 1C3.

CIRCLE NUMBER 150

Control an intelligent teletypewriter with a simple μP system. Pack all control and communication functions into the system's software instead of the hardware.

Low-cost, intelligent teletypewriters that require text storage and the printing of a few hundred characters can benefit from a μP -based controller. Not only can this type of controller satisfy the requirements with minimal hardware, but it also can supervise the storage with software-based commands that are easily changed or added as required.

Just five ICs complement the controller's microprocessor. And since the μP 's power isn't exhausted, it can do things that might otherwise have to be done by extra single-function chips:

- Handle serial-input and output data communication.
- Recognize and execute typed commands.
- Control text storage in the controller's RAMs.

The system uses only six chips

The intelligent-teletypewriter controller (ITC) uses the Signetics 2650 μP (Figs. 1 and 2). Two static RAMs can hold up to 250 typed characters, and one PROM with a 512-byte capacity holds the μP 's program. Two NAND gates, in a package of four, decode RAM-chip selects; the other two buffer the μP 's serial input and output lines to the terminal.

The ITC connects with either a 20-mA current-loop or lines capable of swinging ± 7.5 V around the teletypewriter's signal ground (V_s , Out-). That signal ground is biased at 7.5 V above the controller's power-supply ground so that the driver's high state (15 V) and low state (0 V) look like ± 7.5 V to the external receiver.

Since the current-loop is usually noisy because of mechanical-relay switching in the terminal, the TTY-In line is pulled below ground by a voltage-divider network connected between -15 V and $+5$ V.

A dual one-shot chip generates the system clock. The 1-MHz clock signal drives the μP and controls the serial baud rate. Changing a one-shot timing resistor varies the character-transmission

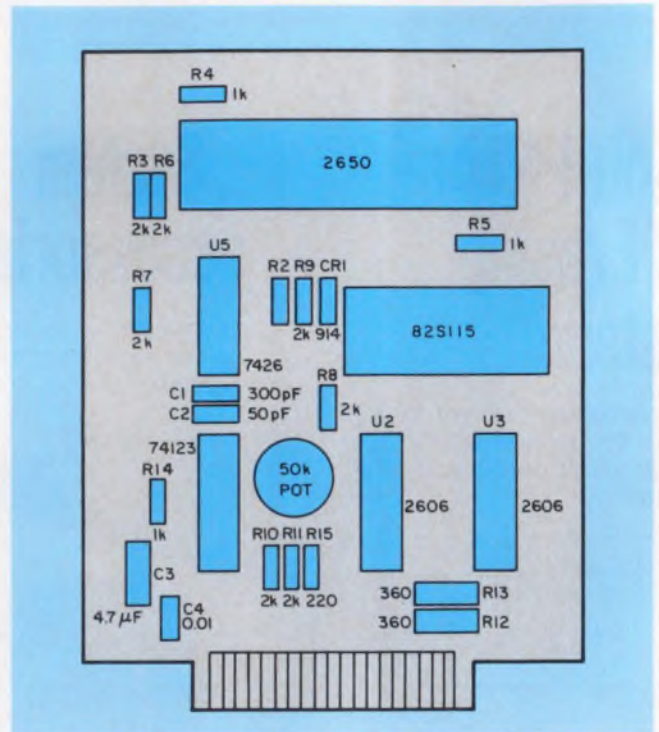

1. The PC-board layout of the intelligent-teletypewriter controller includes a pot that varies the system clock, which indirectly changes the serial transmission rate.

rates from 110 to 300 baud.

Input and output serial-asynchronous lines carry the standard teletypewriter language, which begins with a start bit followed by seven data bits, and ends with one or more stop bits (Fig. 3). The μP synchronizes on the start bit. The subsequent bits are assembled into characters in an internal register. An incoming character may command the ITC to perform an operation, or it may be a data character that must be stored in memory. The six commands that control ITC responses are listed in Fig. 4.

The ITC program (Fig. 5) is designed with structured programming techniques that require self-contained subroutine modules to be written for each function. The Out subroutine, for example, formats the bits that go to the terminal. Each subroutine is called by the main program, which functions as a central switching center.

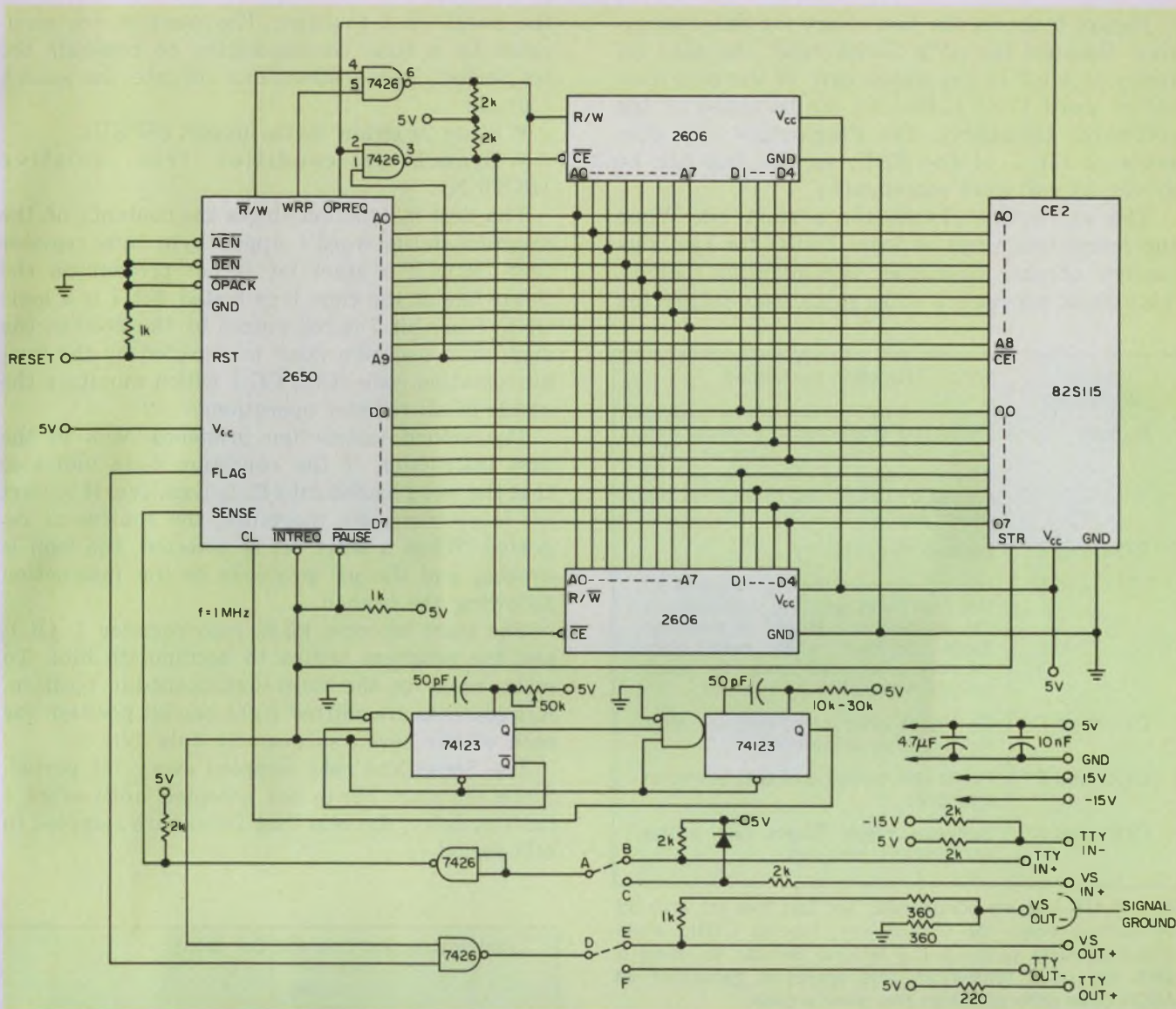

2. The controller schematic shows the μ P, with PROM, RAM and support circuits. Standard 74-series TTL gates drive and receive the serial lines.

Adding or changing modules requires very little modification of the main program. If more teletypewriter commands are needed they can be programmed into additional PROMs. For example, a command may be added to delete a line and push the remaining lines together.

At power up, the main program branches to an initialization routine that performs necessary housekeeping tasks. Then control returns to the main program, and the ITC enters a "do forever" loop that includes several subroutines.

The In subroutine takes the serial data

The subroutine, called In, loads a character into one of the μ P's registers. When the character is accepted, the program executes the appropriate operation, then returns to the start-bit search routine.

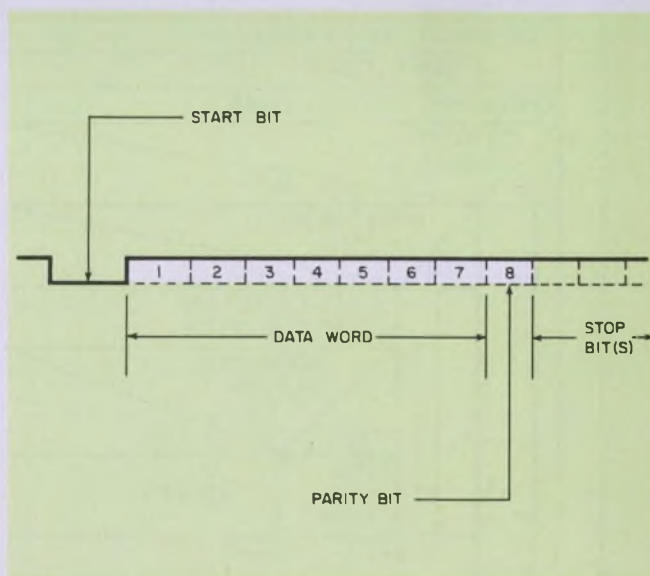

3. The serial-data format between controller and teletypewriter is standard. Communication starts when the start bit, always a logic ZERO, is received.

Figure 6 shows the flow chart for this subroutine. Because the μP 's Sense-input line goes directly to bit 7 in the upper byte of the program-status word (PSU), this bit can be tested by the software. (Similarly, the Flag-output line connects to bit 6 of the PSU, so the flag can be driven by software commands.)

The subroutine checks for a start bit. When the Sense line stays at logic ZERO for two successive checks, character accumulation begins. This check prevents a noise spike from triggering

the serial-input routines. The samples are separated by a time corresponding to one-half the bit period. Two instructions initiate the search routine:

- Store program status upper (SPSU).
- Branch on condition true, relative (BCTR,N).

The first instruction stores the contents of the program-status word's upper byte into register zero (R_0). If a start bit is not present on the Sense line at the time it is tested, bit 7 is a logic ONE. Since bit 7 is recognized by the 2650 as the sign bit, a negative value is reflected by the two-bit condition code (CC_0, CC_1) which monitors the status of all register operations.

The second instruction branches back to the first instruction if the condition code indicates that the word loaded into R_0 is negative. If a start bit is not detected, therefore, the routine is repeated. When a start bit is detected, the loop is broken, and the μP proceeds to the instruction following the branch.

The start bit now loads into register 1 (R_1), and the program begins to accumulate bits. To make room in the most-significant-bit position, R_1 's contents are shifted right one bit position for each of the seven subsequent data bits.

The Sense line gets sampled every bit period. Since the start bit is not accepted until after a half-bit delay, the bits that follow are sampled in mid-period.

Keys depressed	Function performed
Rubout	Erase last character in memory and echo the erased character. Additional preceding characters can be erased by continuing to depress the delete key.
CTRL and E	Erase entire memory.
CTRL and B	Used to indicate the beginning of an inserted message. The command is not printed, but stored in memory. Stops printout when read from memory. Required once for each unique information entry point.
CTRL and C	Continues printout of memory after entry of unique information.
CTRL and P	Prints out contents of text stored in memory.
CTRL and R	Software reset. Clears text buffer and restarts program.

4. The ITC has six commands. The last five are entered by holding down the control key, labeled CTRL, while simultaneously pushing the letters. Similar to using a shift key on a typewriter, this operation generates an ASCII code different from the letter's code.

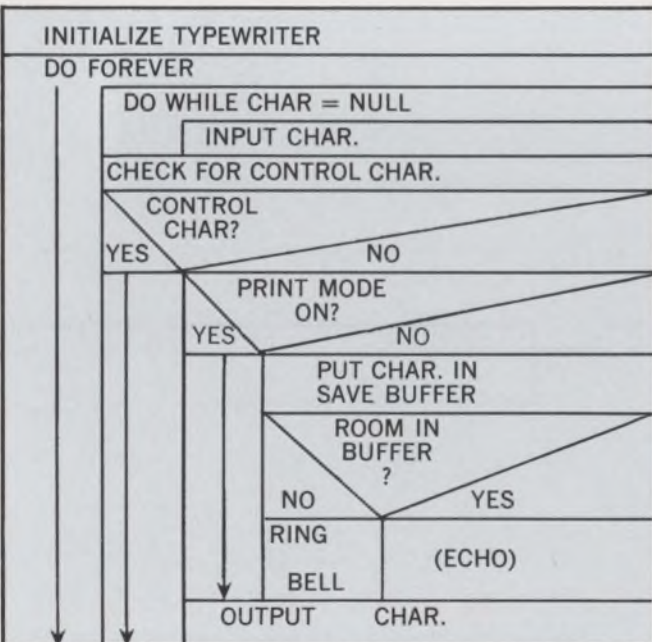

5. The structured flow chart of the main program (left) and instructions (right) shows the order in which the subroutines are called.

Label	Instruction	Operand (sub-routine name)	Comments
MAIN	BSTA, UN	INIT	Unconditional branch to initialize subroutine.
LOOP	BSTA, UN	IN	Unconditional branch to input char: subroutine (put char in R_1).
	COMI, R_1	NULL	Compare R_1 with ASCII for null (00).
	BCTR, EQ	LOOP	If a null. Go back and look again.
	BSTA, UN	CNTL	If not a null check for control char.
	BCTR, Z	LOOP	If a control char. go back and get next char.
	LODA, R_0	PMOD	If not a control char check to see if print mode.
	BCTR, N	LOP1	If print mode set don't save char, just echo.
	BSTA, UN	SAVE	If not set, save in buffer.
	BCFR, Z	LOOP	If no room in buffer go back to find next char.
LOP1	BSTA, UN	OUT	Print out char either saved or printed.
	BCTR, UN	LOOP	Go back and find next char.

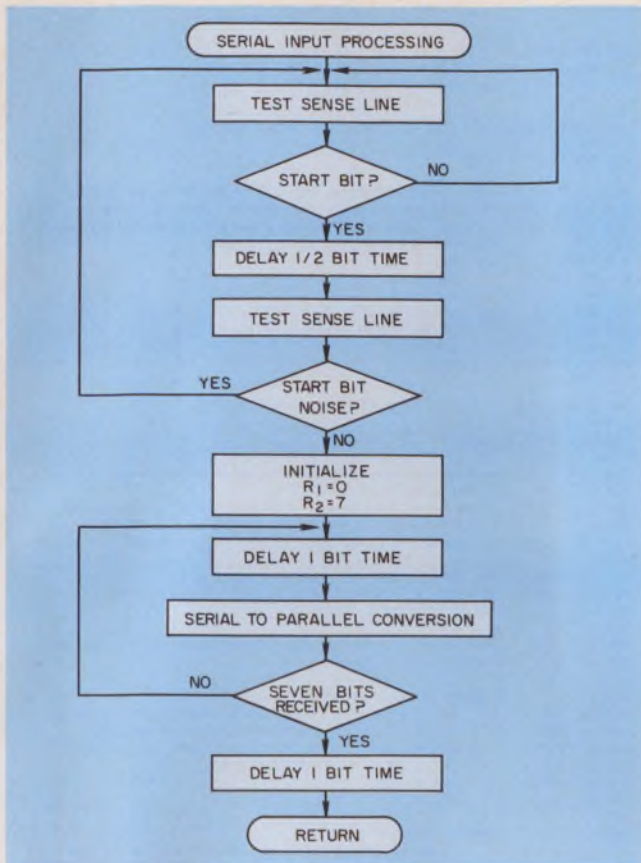

6. The flow chart for the subroutine In shows how serial data are entered into R₁. Register 2 serves as a seven-bit counter, allowing only the seven data bits to fill up R₁.

Register 2 (R₂) is initially loaded with a binary 7. For each bit transferred, R₂ counts down. When all seven bits are accumulated (R₂ = 0), control returns to the main program.

Now the main program must decide what to do with the character. So the program branches to subroutines that compare the contents of R₁ against a list of possible character types. Subroutine Null determines if the character has the ASCII code, 00 (hex). If it does, the program ignores the character and looks again.

Other subroutines match R₁'s contents against a known list of control characters. An identified control function is serviced by its subroutine.

If the character isn't a control or null, then it must be a data character. The program then proceeds to store it in RAM. The main program gets a pointer that indicates the first RAM location available for storing the data. That pointer is first compared with a RAM location containing the number of available buffer locations. If that number isn't 0—the buffer isn't full—the character is stored in RAM. The pointer is incremented, and the buffer-number indicating buffer size is decremented. A final instruction sets a condition code that indicates if the memory has room for more characters.

If the buffer is already full, the program branches to a subroutine that directs a bell on the terminal to ring. The bell also rings if the operator requests printing when there are no stored characters, or if he wants to delete more characters than are stored.

When a print command from the teletypewriter sets a print-mode flag, all characters in the ITC's memory are printed until a stop command is received. The print flag is reset at the end of the routine that transfers characters from the save buffer to an output-holding register.

The character-output subroutine called (Out) is similar to the In subroutine, except that it is reverse order. The eight bits of data in the output register go through the μ P's Flag line to the serial-output line.

Before starting an output routine, the program first ensures that two stop bits have been sent after the last output subroutine. This delay gives the terminal time to complete such mechanical functions as moving a hammer to the print head.

A start bit is first sent out by clearing the flag bit in the PSU. The flag output now stays low for one bit period. The first bit of the ASCII character is then shifted to the MSB of R₁. If it is a logic ZERO, the flag line stays low. If it is a logic ONE, the flag is set high, and a one-bit delay is performed before transferring the next bit. When all seven bits are output, the main program again takes control. ■■

Table 1. Program listing for the intelligent teletypewriter controller

LINE ADDR	OBJECT	SOURCE	MC	EDU	H'00'	PSL
0002		*****				
0002		* INTELLIGENT TYPEWRITER SYSTEM - MODEL C - VERSION 6				
0004		*****				
0005		* PROCESSOR SYMBOLS				
0006 0000	R0	EDU 0	PSU	- SENSE		
0007 0001	R1	EDU 1	PSU	- FLAG		
0008 0002	R2	EDU 2	PSU	- INTERRUPT INITIAT		
0009 0003	R3	EDU 3	PSU	- STACK POINTER		
0010 0000	SENSE	EDU H'00'	PSU	- SENSE		
0011 0000	FLAG	EDU H'40'	PSU	- FLAG		
0012 0020	II	EDU H'20'	PSU	- INTERRUPT INITIAT		
0013 0007	SP	EDU H'07'	PSU	- STACK POINTER		
0014 00C0	CC	EDU H'C0'	PSL	- CONDITION CODE		
0015 0020	IDC	EDU H'20'	PSL	- INTERDIGIT CARRY		
0016 0010	RS	EDU H'10'	PSL	- REGISTER BANK SELECT		
0017 0008	WC	EDU H'08'	PSL	- 1-WITH CARRY, 0-WITHOUT		
0018 0004	OVF	EDU H'04'	PSL	- OVERFLOW		
0019 0002	COM	EDU H'02'	PSL	- LOGICAL COMPARE, 0-ARITHMETIC COMP		
0020 0001	C	EDU H'01'	PSL	- CARRY, BORROW		
0021 0000	Z	EDU 0	BRANCH CONDITIONS	- ZERO		
0022 0001	P	EDU 1		POSITIVE		
0023 0002	N	EDU 2		NEGATIVE		
0024 0000	EO	EDU 0		EQUAL		
0025 0001	GT	EDU 1		GREATER THAN		
0026 0002	LT	EDU 2		LESS THAN		
0027 0003	UN	EDU 3		UNCONDITIONAL		
0028						
0029						
0030 0000	NULL	EDU H'00'				
0031 0000	CR	EDU H'00'				CARRIAGE RETURN
0032 000A	LF	EDU H'0A'				LINE FEED
0033 0020	SPAC	EDU H'20'				SPACE KEY
0034 007F	DELE	EDU H'7F'				DELETE KEY

(continued on page 78)

```

0025 0002 CTLC EQU M'03' CONTROL+C KEYS
0026 0005 CTLE EQU M'05' CONTROL+E KEYS
0027 0010 CTLP EQU M'10' CONTROL+P KEYS
0028 0012 CTLR EQU M'12' CONTROL+R KEYS
0029 0013 CTLS EQU M'13' CONTROL+S KEYS
0040 0007 BELL EQU M'07' OUTPUT CHAR TO BELL
0041 0009 (RLN EQU 8 KBD/PTR CHARACTER LENGTH INCL PARITY BIT
0042
0043
0044
*****
0045 0000 * ORG M'700' RAM PORTION OF PROGRAM
0046 * VARIABLE STORAGE IS DEFINED AT LOC M'700'
0047 * FOR PROTOTYPING SYSTEM CHECKOUT ONLY ITS
0048 * PERMANENT ADDRESS WILL BE M'200'
0049 * VARIABLE STORAGE
0050 0700 VSTR EQU 0 START OF VARIABLE STORAGE
0051 * GLOBAL VARIABLE
0052 0700 PPOD RES 1 PRINT MODE SWITCH=0 IF OFF, =M'FF' IF ON
0053 * SAVE BUFFER MODULE VARIABLES
0054 0701 SOPT RES 1 POINTER FOR FILLING SAVE BUFFER
0055 0702 SIPT RES 1 POINTER FOR PRINTING SAVE BUFFER
0056 0703 SEBU RES 250 SAVE BUFFER FOR LATER PRINTING

```

TWIN ASSEMBLER VER 2.0 ITS66 - 2650 INTELLIGENT TYPEWRITER PAGE 0002

```

LINE ADDR OBJECT E SOURCE
0057 07FD SEND EQU 0 END OF SAVE BUFFER
0058 07FD VEND EQU 0 END OF VARIABLE STORAGE AREA

```

TWIN ASSEMBLER VER 2.0 ITS66 - 2650 INTELLIGENT TYPEWRITER PAGE 0003

```

LINE ADDR OBJECT E SOURCE
0060 07FD * ORG 0 PROMOTION PORTION OF PROGRAM
0061 *
0062 0000 1F000 PSET BCTLN MAIN RESET ENTRANCE - MAIN PROGRAM
0063 *
*****
0064 * MAIN PROGRAM - INTELLIGENT TYPEWRITER SYSTEM
0065 *
0066 MAIN BCTLN INIT INITIALIZE TYPEWRITER
0067 0002 2F002 LOOP BCTLN IN GET INPUT CHAR INTO P1
0068 0006 3F003 COM1.P1 NULL IF ITS A NULL
0069 0009 E500 BCTR.E0 LOOP THEN GET NEXT CHARACTER
0070 0008 1879 BSTR.UN CNTL IF CONTROL FUNCTION - EXECUTE FCN
0071 0000 3F007 BCTR.Z LOOP AND GET NEXT CHARACTER
0072 0010 1874 LOPR.P0 PPOD IF PRINT MODE ON
0073 0012 0C0700 BCTR.N LOP1 THEN (NOT SAVE CHAR - ECHO CHAR ONLY
0074 0015 1A05 BSTR.UN SAVE ELSE PLACE CHAR IN SAVE BUF IF ROOM
0075 0017 3F009 BCTR.Z LOOP IF NO ROOM. (NOT ECHO CHAR
0076 001A 50E8 LOP1 BSTR.UN OUT ELSE ECHO LITERAL CHARACTER
0077 001C 2F009 BCTR.UN LOOP AND GET NEXT CHARACTER
0078 001F 1B65
0079
*****
0080 * INITIALIZE SYSTEM
0081 INIT PPSU I1 INHIBIT INTERRUPTS
0082 0021 7620 CPSEL MCARS SELECT B&B REGS + ARITH/ROTATE W/O CARRY
0083 0023 7518 PPSL COM SELECT LOGICAL COMPARE
0084 0025 7702 LOP1.P2 VEND-VSTR R2=LENGTH OF VARIABLE STORAGE
0085 0027 07FD EOR2 P0
0086 0029 20 STRA.P0 VSTR.P2 - ZERO VARIABLE STORAGE AREA
0087 002A CF4700 BAMP.R3 IN11
0088 002C 5070 BSTR.UN IN11 INITIALIZE INPUT DEVICES
0089 002F 3F006 BSTR.UN ITOT INITIALIZE OUTPUT DEVICES
0090 0032 3F006 RETC.UN EXIT
0091 0035 17
0092 * END OF INITIALIZATION MODULE

```

TWIN ASSEMBLER VER 2.0 ITS66 - 2650 INTELLIGENT TYPEWRITER PAGE 0004

```

LINE ADDR OBJECT E SOURCE
0094 *****
0095 * INPUT CONTROL MODULE
0096 * THE FOLLOWING SUBROUTINES WOULD NORMALLY SWITCH INPUT CONTROL
0097 * BETWEEN THE VARIOUS INPUT DEVICES SINCE THERE IS ONLY ONE INPUT
0098 * DEVICE THESE ROUTINES ARE EQUATED DIRECTLY TO THE KEYBOARD ROUTINE
0099 *
0100 0026 1F00C ITIN BCTLN ITXV ROUTINE TO INITIALIZE THE INPUT DEVICE
0101 0029 1F00D IN BCTLN IYIN ROUTINE TO GET AN INPUT CHARACTER
0102 * END OF INPUT CONTROL MODULE
0103
*****
0104 * KEYBOARD PROCESSING MODULE
0105 *
0106 * NO KEYBOARD INITIALIZATION NECESSARY
0107 ITKY RETC.UN
0108 003C 17
0109 *
0110 * GET A KEYBOARD CHARACTER
0111 *
0112 * THIS ROUTINE SERIALY INPUTS A CHARACTER FROM THE KBD THRU THE
0113 * SENSE BIT THE ROUTINE DOES NOT INPUT THE PARITY BIT
0114 002D 0500 KYIN LOP1.P1 0 P1 WILL HOLD CHAR UN EXIT
0115 002F 0507 LOP1.P2 CRU+1 R2=CHARACTER LENGTH-PARITY BIT
0116 0041 12 KY11 SPSU GET SENSE BIT (-BIT ?)
0117 0042 1A7D BCTR.N KY11 IF NOT A START BIT-LOOP UNTIL IT COMES
0118 0044 20 EOR2 P0 DELAY 1/2 BIT TIME TO MIDDLE OF START BIT
0119 0045 3F005F BSTR.UN IYAF IF NOT STILL A START BIT
0120 0048 12 SPSU THEN IT WAS NOISE,SO KEEP LOOKING
0121 0049 1A76 BCTR.N KY11 DELAY 1 BIT TIME TO MIDDLE OF NEXT BIT
0122 004B 3F005A KY12 BSTR.UN DELAY
0123 004E 12 SPSU GET SENSE BIT
0124 004F 4400 AND1.P0 SENS
0125 0051 61 IOR2 P1 AND SHIFT IT INTO P1
0126 0052 C1 STRZ R1
0127 0053 51 PRR.P1
0128 0054 FA75 BDRP.R2 KY12 IF ALL BITS ARENT IN-COMTINUE AT KY12

```

```

0129 0056 3F005A BSTR.UN DELAY DELAY 1+1/2 BIT TIMES TO END OF PARITY BIT
0130 0059 17 RETC.UN
0131 * END OF KEYBOARD PROCESSING MODULE

```

TWIN ASSEMBLER VER 2.0 ITS66 - 2650 INTELLIGENT TYPEWRITER PAGE 0005

```

LINE ADDR OBJECT E SOURCE
0133 * DELAY ROUTINE - TO PROVIDE TIMING FOR 110 BAUD SERIAL INPUT/OUTPUT
0134 * BASED ON A 1MHz INPUT CLOCK ENTRY AT DELAY PROVIDES A ONE BIT
0135 * DELAY ENTRY AT IYAF PROVIDES A HALF BIT DELAY AND REQUIRES THAT
0136 * P0 BE PREVIOUSLY SET TO 0
0137 005A 20 DELAY EOR2 P0
0138 005B FB7E BDRP.P0 0
0139 005D FB7E SCAP.P0 0
0140 005F FB7E IYAF BDRP.P0 0
0141 0061 04E5 LOP1.P0 M'ES'
0142 0063 FB7E BDRP.P0 0
0143 0065 17 RETC.UN

```

TWIN ASSEMBLER VER 2.0 ITS66 - 2650 INTELLIGENT TYPEWRITER PAGE 0006

```

LINE ADDR OBJECT E SOURCE
0145 *****
0146 * OUTPUT CONTROL MODULE
0147 * THESE ROUTINES WOULD NORMALLY SWITCH OUTPUT CONTROL BETWEEN THE VARIOU
0148 * OUTPUT DEVICES SINCE THERE IS ONLY ONE OUTPUT DEVICE THESE
0149 * ROUTINES ARE EQUATED DIRECTLY TO THE PRINTER ROUTINES
0150 *
0151 0066 1F006C ITOT BCTLN ITPR INITIALIZE OUTPUT DEVICE
0152 0069 1F0079 OUT BCTLN IYOT WRITE A CHARACTER TO OUTPUT DEVICE
0153 * END OF OUTPUT CONTROL MODULE
0154
*****
0155 * PRINTER PROCESSING MODULE
0156 *
0157 * PRINTER INITIALIZATION ROUTINE
0158 ITTP PPSU FLAG ASSURE STOP BITS ARE BEING SENT TO PRINTER
0159 006C 7640 LOP1.P1 CP OUTPUT (CARRIAGE RETURN AND LINE FEED)
0160 006E 0500 BSTR.UN IYOT CALL OUT DIRECTLY SINCE THIS IS PRINTER
0161 0070 2F0079 LOP1.P1 LF PECULIAR INITIALIZATION
0162 0073 050A BSTR.UN IYOT
0163 0075 2F0079 BSTR.UN IYOT
0164 0079 17 EXIT
0165 *
0166 * PRINTER OUTPUT ROUTINE
0167 * THIS ROUTINE SERIALY OUTPUTS THE CHARACTER IN P1 THRU THE FLAG
0168 * BIT TO THE PRINTER
0169 BOUT LOP1.P2 CRUN CHARACTER LENGTH TO P2 FOR COUNTER
0170 007B 0600 BSTR.UN DELAY ASSURE 2 STOP BITS ARE OUTPUT
0171 007E 2F005A BSTR.UN DELAY
0172 0081 7440 CPSU FLAG SEND START BIT
0173 0083 2F005A POUT BSTR.UN DELAY DELAY 1 BIT TIME
0174 0086 51 PRR.P1 SHIFT NEXT BIT OUT TO MSB POSITION TO TEST
0175 0087 1A04 BCTR.N IYOT IF ITS A 1 THEN BRANCH
0176 0089 7440 CPSU FLAG OUTPUT A ZERO BIT
0177 008B 1B82 BCTR.UN IYOT
0178 008D 7640 POUT PPSU FLAG OUTPUT A 1 BIT
0179 008F FA72 BDRP.P2 IYOT IF ALL BITS OF P1 NOT SENT CONTINUE AT POUT1
0180 0091 2F005A BSTR.UN DELAY DELAY 1 BIT TIME
0181 0094 7640 PPSU FLAG OUTPUT STOP BIT
0182 0096 17 RETC.UN
0183 * END OF PRINTER PROCESSING MODULE
0184

```

TWIN ASSEMBLER VER 2.0 ITS66 - 2650 INTELLIGENT TYPEWRITER PAGE 0007

```

LINE ADDR OBJECT E SOURCE
0186 *****
0187 * INPUT CHARACTER DECODE MODULE
0188 *
0189 * CONTROL FUNCTION ROUTINE - CHARACTER IS IN P1 UN ON ENTRY
0190 * IF CHARACTER NOT A CONTROL CHARACTER, RETURN CC NOT=0 ELSE CC=0
0191 0097 E57F CNTL COM1.P1 (ELE IF DELETE CHARACTER)
0192 0099 3000 BCTR.E0 CNT1
0193 009B 3F00FE BSTR.UN IYCF THEN DELETE LAST CHAR FROM SAVE BUFFER
0194 009E 3F0069 BSTR.UN IYOT ECHO DELETED CHAR (OR BELL IF BUF FULL)
0195 00A1 1821 BCTR.UN CEX1
0196 00A3 E505 CNT1 COM1.P1 CTLE IF ERASE FUNCTION
0197 00A5 3005 BCTR.E0 CNT2
0198 00A7 3F00E1 BSTR.UN EPR5 THEN ERASE ENTIRE SAVE BUFFER AND RESET PTR
0199 00A9 1B10 BCTR.UN CEX1
0200 00AC E510 CNT2 COM1.P1 CTLP IF PRINT FUNCTION
0201 00AE 3005 BCTR.E0 CNT3
0202 00B0 3F010A BSTR.UN IYPT THEN PRINT SAVE BUFFER FROM THE TOP
0203 00B2 1B0F BCTR.UN CEX1
0204 00B5 E503 CNT3 COM1.P1 CTLC IF CONTINUE FUNCTION
0205 00B7 3005 BCTR.E0 CNT6
0206 00B9 3F0125 BSTR.UN IYCT THEN PRINT SAVE BUFFER FROM LAST STOP
0207 00BC 1B06 BCTR.UN CEX1
0208 00BE E512 CNT6 COM1.P1 CTLR IF RESET FUNCTION
0209 00C0 300A BCTR.E0 CNT7
0210 00C2 3000 ZBRP PSET EXECUTE SOFTWARE RESET
0211 00C4 20 CEX1 EOR2 R0 SET CC=0 TO INDICATE CHAR WAS A CNTL FCN
0212 00C5 17 RETC.UN
0213 00C6 0AFF LOP1.P0 M'FF' SET CC NOT= 0 TO INDICATE NOT A CNTL CHAR
0214 00C9 17 RETC.UN
0215 * END OF INPUT CHARACTER DECODE MODULE
0216

```

TWIN ASSEMBLER VER 2.0 ITS66 - 2650 INTELLIGENT TYPEWRITER PAGE 0008

```

LINE ADDR OBJECT E SOURCE
0218 *****

```



```

0219 * SAVE BUFFER MODULE
0220 *
0221 * SAVE BUFFER ROUTINE
0222 * THIS ROUTINE SAVES LITERAL CHARACTERS AND OUTPUT CONTROL
0223 * FUNCTIONS FOR LATER PRINTING WHEN THE PRINT COMMAND IS INPUT
0224 * ON EXIT CC=0 IF ROOM FOR CHAR IN BUFFER, CC NOT=0 IF BUFF FULL
SAVE  L00A.P2  SORT      GET SAVE BUFFER POINTER
0225 00C9 0F0701 COM1.P2 SEND-SBUF IF BUFFER FULL
0226 00CC E7FA BCTR.E0 SFUL THEN BRANCH
0227 00CE 1809 L002 P1 PLACE CHAR FROM P1 INTO SAVE BUFFER
0228 00C0 01 STRA.P0 SBUF-1.P2 *
0229 00D1 CF2702 STRA.P2 SORT      SAVE NEW BUFFER POINTER
0230 00C4 CF0701 EORZ P0 CC=0
0231 0007 20 PTC.UN
0232 0000 17
0233 00D9 0507 SFUL L001.P1 BELL RING BELL - BUFFER IS FULL
0234 0000 2F0069 BSTR.UN OUT
0235 000E 04FF L001.P0 M'FF' CC NOT= 0 TO SHOW BUFFER FULL
0236 00E0 17 PTC.UN EXIT
0237 *
0238 * ERASE ROUTINE
0239 * THIS ROUTINE ERASES THE ENTIRE SAVE BUFFER AND RESETS BOTH POINTER
ERAS  L001.P2 SEND-SBUF ZERO SAVE BUFFER
0240 00E1 07FA EOPZ P0
0241 00E2 20 EPAL STRA.P0 SBUF.P2 -
0242 00E4 CF4702 BSTR.P2 EPAL
0243 00E7 5078 STRA.P2 SIPT ZERO SAVE BUFFER PRINT POINTER
0244 00E9 CF0702 STRA.P2 SORT ZERO SAVE BUFFER LOAD POINTER
0245 00EC CF0701 STRA.P0 P'00' DESELECT PRINT MODE
0246 00EE CF0700 PTC.UN
0247 00F2 17
0248 *
0249 * DELETE CHARACTER ROUTINE
0250 * THIS ROUTINE DELETES THE LAST CHARACTER IN THE SAVE BUFFER
0251 * AND RETURNS THE CHARACTER IN P1 IF THE BUFFER IS EMPTY.
0252 * IT RETURNS WITH THE BELL CODE IN P1
LCHP  L00A.P2 SORT      GET BUFFER POINTER
0253 00F3 0F0701 COM1.P2 0 IF BUFFER EMPTY
0254 00F6 E700 BCTR.E0 DCHL THEN BRANCH
0255 00F8 1800 L00A.P0 SBUF.P2 - ELSE GET LAST CHAR AND DECREMENT POINTER
0256 00FA 0F4702 STR2 P1 CHAR TO P1
0257 00FD C1 MULL AND REPLACE IT WITH A NULL
0258 00FE 0400 STRA.P0 SBUF.P2
0259 0100 CF0702 STRA.P2 SORT      SAVE NEW POINTER
0260 0102 CF0701 PTC.UN
0261 0106 17
0262 0107 0507 DCHL L001.P1 BELL OUTPUT BELL FOR IMPROPER REQUEST
0263 0109 17 PTC.UN
0264 *
0265 * PRINT SAVE BUFFER ROUTINE
0266 * THIS ROUTINE PRINTS THE SAVE BUFFER STARTING AT THE BEGINNING
0267 * UNTIL THE END OF DATA OR A STOP CODE IS REACHED
PRNT  L001.P2 0 SET POINTER TO START OF BUFFER
0268 010A 0700 L00A.P0 SBUF.P2 GET NEXT PRINT CHAR BUT CONT INCR INDEX
0269 010C 0F6702 COM1.P0 MULL IF BUFFER EMPTY
0270 010F E400 BCTR.E0 PEEL THEN BRANCH
0271 0111 180C L00A.P0 M'FF' TURN ON PRINT MODE SWITCH
0272 0113 04FF

```

TWIN ASSEMBLER VER 2.0 TIME: 0050 INTELLECTUAL PROPERTY PRICE: 0000

```

LINE ADDR OBJECT E SOURCE
0273 0115 C0B700 STRA.P0 P'00'
0274 0119 2F0142 BSTR.UN MOV# MOVE CHARACTERS TO OUTPUT BUFFER
0275 011B CF0702 STRA.P2 SIPT SAVE NEW PRINT POINTER
0276 011E 17 PTC.UN
0277 011F 0507 PEEL L001.P1 BELL OUTPUT BELL FOR IMPROPER REQUEST
0278 0121 2F0069 BSTR.UN OUT
0279 0124 17 PTC.UN
0280 *
0281 * CONTINUE PRINTING ROUTINE
0282 * THIS ROUTINE CONTINUES PRINTING THE SAVE BUFFER FROM WHERE THE
0283 * THE LAST PRINT OR CONTINUE REQUEST LEFT OFF, UNTIL THE END OF
0284 * DATA OR A STOP CODE IS REACHED
CONT  L00A.P2 SIPT GET PRINT POINTER
0285 0125 0F0702 COM1.P2 0 IF SAVE BUFFER EMPTY
0286 0129 E700 BCTR.E0 CBEL THEN BRANCH
0287 012A 0810 COM1.P2 SEND-SBUF IF POINTER AT END OF BUFFER
0288 012C E7FA BCTR.E0 CBEL THEN BRANCH
0289 012E 180C L00A.P0 SBUF.P2 GET NEXT PRINT CHAR BUT CONT INCR INDEX
0290 0130 0F6702 BCTR.E0 CBEL IF ITS A NULL (END OF DATA) BRANCH
0291 0132 1807 BSTR.UN MOV# MOVE CHARACTERS TO OUTPUT BUFFER
0292 0135 2F0142 STRA.P2 SIPT SAVE NEW PRINT POINTER
0293 0138 CF0702 PTC.UN
0294 013E 17
0295 013C 0507 CBEL L001.P1 BELL OUTPUT BELL FOR IMPROPER REQUEST
0296 013E 2F0069 BSTR.UN OUT
0297 0141 17 PTC.UN
0298 *
0299 * MOVE ROUTINE
0300 * THIS ROUTINE TRANSFERS CHARACTERS FROM THE SAVE BUFFER TO THE
0301 * OUTPUT BUFFER. IT EXPECTS P2 TO BE SET UP AS THE STARTING INDEX
0302 * TO THE SAVE BUFFER. TRANSFERS WILL STOP WHEN A STOP CODE OR THE
0303 * END OF DATA IS REACHED
MOV#  COM1.P2 SEND-SBUF IF END OF BUFFER REACHED
0304 0142 E7FA BCTR.E0 MOV2 THEN EXIT
0305 0144 1812 L00A.P0 SBUF-1.P2 * GET NEXT CHAR FROM SAVE BUFFER
0306 0146 0F2702 COM1.P0 MULL IF END OF DATA REACHED
0307 0149 E400 BCTR.E0 MOV1 THEN EXIT
0308 014B 1809 COM1.P0 OTLS IF STOP CODE IN BUFFER
0309 014D E412 COM1.P0 THEN EXIT
0310 014F 14 STR2 P1 CHAR TO P1
0311 0150 C1 BSTR.UN OUT AND OUTPUT IT
0312 0151 2F0069 BCTR.UN MOV# CONTINUE MOVES
0313 0154 180C MOV1 SUB1.P2 1 MOVE INDEX BACK TO NULL CHARACTER
0314 0156 A701 MOV2 EORZ P0 TURN OFF PRINT MODE
0315 0158 20 STRA.P0 P'00'
0316 0159 C0B700 PTC.UN
0317 015C 17
0318 *
0319 * END SAVE BUFFER MODULE
0320 *****
0321 0007 END MAIN
TOTAL ASSEMBLY ERRORS = 0000

```

QUIK/STRIP

SOLDERLESS BUS CONNECTOR

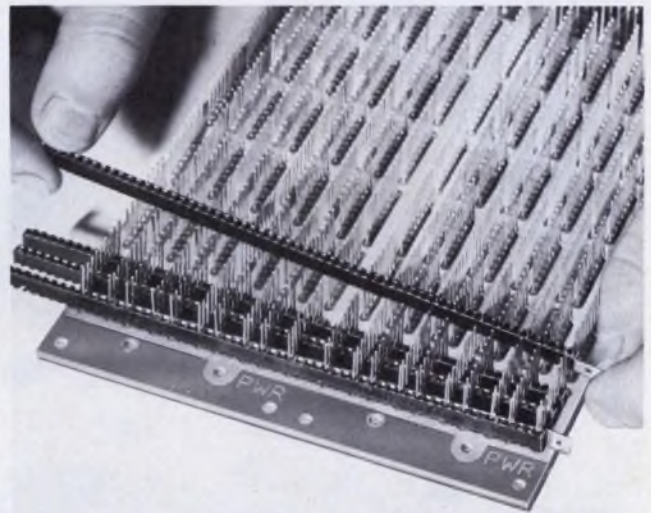

for fast, low cost connection of in-line pins on DIP socket boards and connector arrays.

- low installed cost*
- fully insulated contacts
- extremely reliable — shock and vibration resistant
- 18 gauge current capacity
- strips can be stacked for increased capacity

* Installed cost runs between 2.5¢ and 11¢ per connection.

Write on company letterhead for free sample. For more information, contact product specialist.



ROGERS CORPORATION
Chandler, AZ 85224
Phone: (602) 963-4584

EUROPE: Mektron NV, Ghent, Belgium. JAPAN: Nippon Mektron, Tokyo.

ITT CANNON FOUND OUT...



Electronic Design IS BEST READ BY ITS CUSTOMERS AND PROSPECTS

Theodore Knudson, an American dedicated to assisting the European aerospace community at ESTEC, Noordwijk, Holland, states: "I usually read each issue of *Electronic Design* for its unique features. I also find E.D. useful in the form of a resource material depicting recent state-of-the-art advances that is not totally theoretical and therefore can be suggested for application in our real life designing and procurement processes."

If you read *Electronic Design*, you're in good company. Almost 90% of those firms who have taken the trouble to find out which magazines their customers read, rank *Electronic Design* in first position.

For example: ITT Cannon mailed 1,000 questionnaires to a portion of their prospect list (respondents to advertising and publicity releases in many publications).

The survey asked: "Designate in order of importance those publications which you are now receiving and read on a regular basis." Here are the top winners:

PUBLICATION	READ REGULARLY (ITT Cannon Prospect List)	
	REPLIES	RANK
ELECTRONIC DESIGN	732	1
EDN	668	2
ELECTRONICS	416	3

PASS THE WORD

Maybe your advertising brass doesn't know as much about the power of *Electronic Design* as you do. If your company wants to reach engineers and engineering managers . . . *pass the word*. Tell your sales, marketing and advertising people which publication will bring highest readership among the engineers who make the wheels go round in this industry . . . *Electronic Design*.

Electronic Design

BEST READ ELECTRONICS PUBLICATION IN THE WORLD



How to turn a computer into a disk jockey. The μ PD372 Floppy Disk Controller.

Now you can turn almost any micro or minicomputer into a genuine floppy disk jockey with the help of just one small chip.

Our μ PD372 Floppy Disk Controller. Or if your computer prefers playing tapes, we also have the μ PD371 Tape Cassette Controller.

Either one can take the place of from 50 to 60 TTL packages to save you space as well as money. The 372 is

completely compatible with IBM, Minifloppy,^{TM*} and other formats and controls up to 4 floppy disk drives. The 371 controls up to 2 tape cassette drives. They come with complete documentation and — best of all — they're available now.

The μ PD372 and 371 are just part of our complete family of micro-processor products including 8080As, dynamic and static RAMs, ROMs,

Electrically Erasable PROMs, and 8212, 8214, 8216, 8224, 8228/38, 8251, 8255 and other support chips. All backed by full documentation, applications support, and software.

The μ PD372. The μ PD371.

And the hits just keep on comin'.

NEC Microcomputers, Inc.
Five Militia Drive, Lexington, MA.
02173. 617-862-6410

^{*}TM Shugart Associates

NEC microcomputers, inc.

REPS: East — C & D Sales 301-296-4306. Contact Sales 617-273-1520, Harry Nash Assoc. 215-657-2213, Trionic Assoc. 516-466-2300; South — Merino Sales Co. 214-233-6002, Perrott Assoc. 305-792-2211, 813-585-3327, 305-275-1132, Wolfs Sales Serv. Co. 919-781-0164; Midwest — Electronic Innovators 612-884-7471, K-MAR Eng. & Sales 816-763-5385, McFadden Sales 614-221-3363, R. C. Nordstrom & Co. 313-559-7373, 616-429-8560, Technology Sales 312-438-3300; West — Mike Duffy Assoc. 303-934-7392, Electronic Component Marketing 714-524-9899, 213-649-5374, Spedden Assoc. 714-295-6122, Summit Sales 602-994-4587, Trident Assoc. 408-734-5900, Tri-Tronix 206-232-4993, 505-265-8409; Canada — R. F. Q. Ltd. 416-626-1445, 514-626-8324.

DISTRIBUTORS: Century Electronics (Albuquerque, Salt Lake City, Wheatridge CO), Diplomat (Chicopee Falls, Clearwater FL, Dayton, Elk Grove Village IL, Farmington MI, Little Falls NJ, Minneapolis, Mt. Laurel NJ, Salt Lake City, St. Louis, Sunnysvale, Woodbury NY), Future Electronics (Montreal, Ottawa, Rexdale, Canada), Harvey Electronics (Fairfield NJ, Lexington MA, Norwalk CT, Woodbury NY), Intermark Electronics (San Diego, Santa Ana, Seattle, Sunnysvale) Lionex (Burlington MA), G. S. Marshall (Sunnysvale), Mirco Electronics (Phoenix), Resco (Raleigh), R-M Electronic (Kentwood MI, Madison Hgts MI), Semicomp (Newport Beach CA) Semiconductor Specialists (Burlington MA, Chicago, Dallas, Dayton, Farmington MI, Hazelwood MO, Indianapolis, Kansas City, Los Angeles, Milwaukee, Minneapolis, Pittsburgh; Malton Canada), Sterling Electronics (Albuquerque, Dallas, Houston, Los Angeles, New Orleans, Phoenix, San Diego, Seattle, Watertown MA), Technico (Columbia MD, Roanoke VA), Zeus Components (Elmsford NY).

Marry your μ P to monolithic a/ds.

Size, price and power compatibility team up with simple interfaces to give you an efficient on-line system.

Interfacing microprocessors to the world of analog data requires a new approach. The hundreds of data-acquisition systems and modules that have served minicomputers well are inappropriate for micros. They're too expensive, too power-consuming or too large.

The new monolithic a/d converters stand apart with their combination of cost, efficiency and size (under \$10, in hundreds, for an 8-bit, 20-mW DIP). With monolithic converters in your micro-based system, you get the size and cost that have prompted you to go to the μ P in the first place.

But the monolithics are slow—1.8 ms is a typical conversion speed for an 8-bit unit. So, instead of treating the a/d as a memory location as you would for μ s-conversion devices,¹ interface your micro to a monolithic a/d as you would to a slow peripheral. Assign the converter an input/output (I/O) address, decode the address in the interface, and let the μ P go about its other business while a conversion takes place. After the conversion, when the resulting data are in the converter's output latches, request an interrupt. When the processor is ready to service the interrupt, have it address the converter's I/O port to read the data.

For multiple-input channels, don't tolerate the errors and complexity of multiplexing into a single faster converter. Assign each one a dedicated monolithic a/d. If priorities are necessary, implement them in the software. Eliminate reading stale data with simple storage and comparison circuitry in the interface.

The converter/ μ P system

Obviously, you need both circuitry and service routines to integrate monolithic converters into your μ P-based system. Fortunately, the hardware is not complex, and the software is equally simple. Consider, for example, Teledyne Semiconductor's 8-bit 8700 a/d in an 8080A-based system.

Dave Guzman, President, Iasis, 815 W. Maude Ave., Sunnyvale, CA 94086.

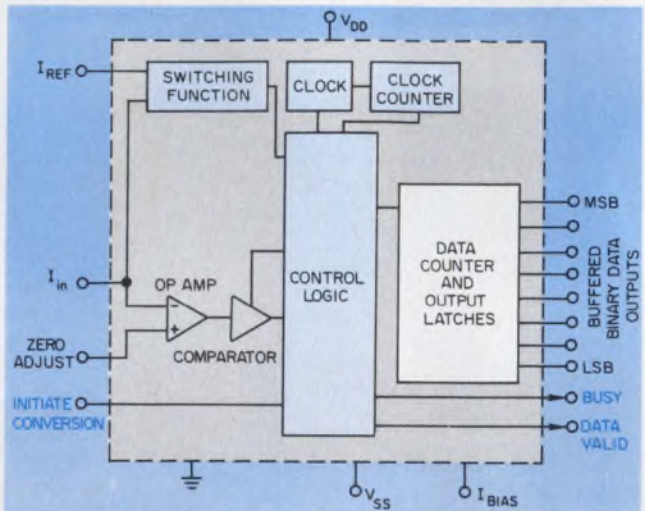

1. **Busy, Data Valid and Initiate Conversion** control signals link the 8700 a/d converter to a microprocessor. The a/d stores its binary outputs in latches.

The 8700 a/d converter is an 8-bit monolithic CMOS device. An integrating converter (Fig. 1), it accepts an unlimited voltage input, which is changed to a current input by a scaling resistor, and produces latched parallel-binary output.

In addition to the buffered data output lines, three handshaking (control) signals pass between the converter and the host μ P:

- **Initiate Conversion**, an input to the converter that starts the conversion cycle. A positive-going pulse of at least 500-ns duration causes the conversion to begin. With this input tied high, conversions occur in a free-running mode at approximately 50 per second.

- **Busy**, an output that, when high, informs the μ P that a conversion is in progress.

- **Data Valid**, an output that, when high, informs the μ P that the converter's output latches contain valid data. Normally, Data Valid is high for the entire cycle except for about 5 μ s before the end of the conversion, when data in the latches are updated.

Control of the a/d is simple. Pulsing Initiate Conversion starts the cycle. Data Valid and Busy give the processor the converter's status.

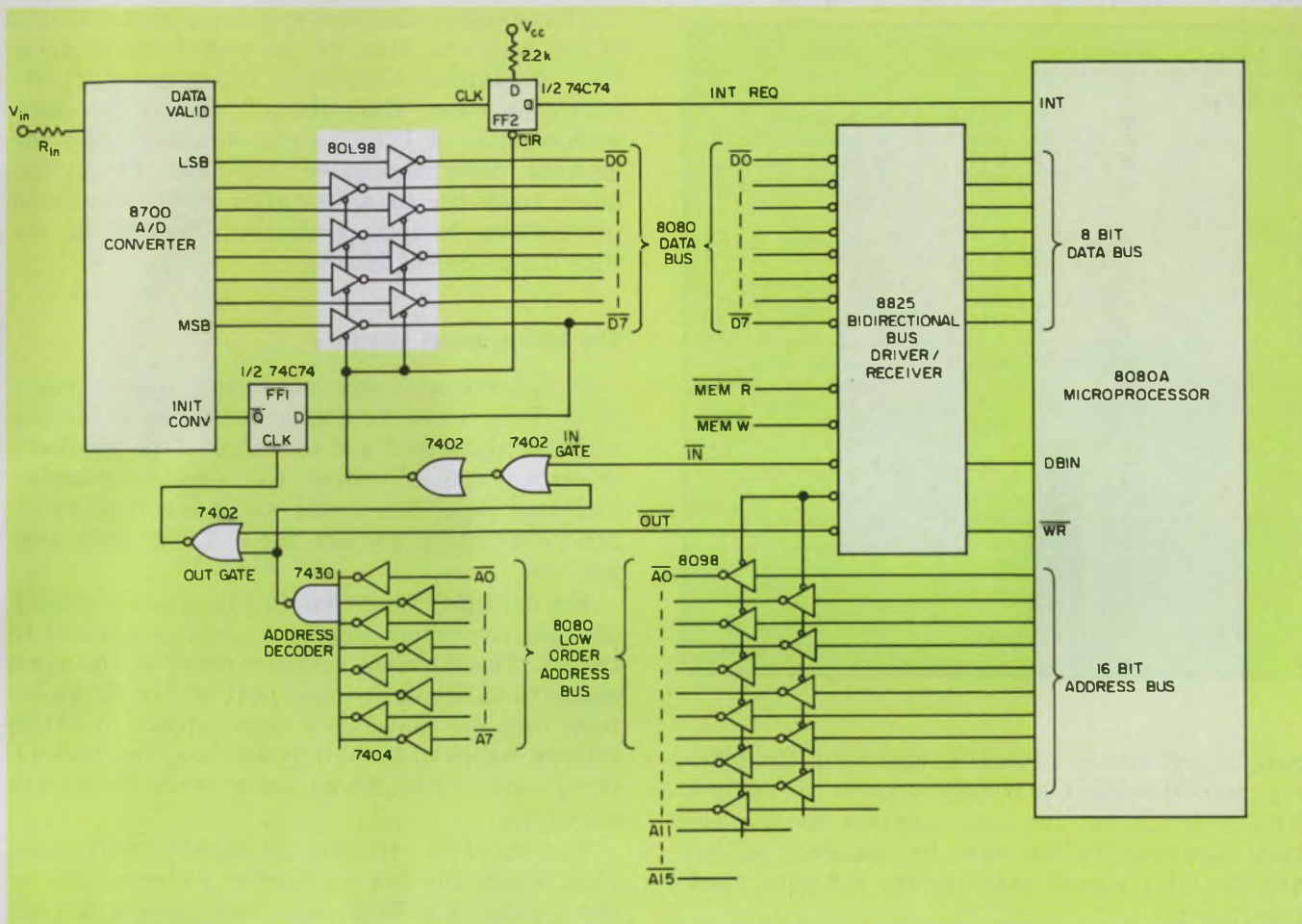

2. The basic interface for a monolithic converter/ μ P system decodes the micro's address bus to access the a/d.

Data pass from the converter port to the processor on the data bus, which the μ P services with interrupts.

The 8080A is an 8-bit μ P with two internal buses.² One carries 16-bit memory addresses, and the other 8-bit data. During each machine cycle, the address bus transports the number in the program counter to the memory, which receives the address and returns the contents of the selected memory location via the data bus. During an instruction-fetch cycle, the returning data are interpreted as an instruction.

The μ P system plugs into the outside world by means of I/O ports that are addressed on the address bus. The I/O instructions use 8-bit addresses, which are duplicated on both the low and high-order address lines of the 16-bit address bus.

With a set of control signals, the μ P also communicates with its memory and I/O ports. Two control lines, $\overline{\text{DBIN}}$ and $\overline{\text{WR}}$, enable the I/O ports. A ZERO on $\overline{\text{DBIN}}$ enables the addressed port to input to the μ P. $\overline{\text{WR}}$ functions similarly for outputs from the microprocessor.

The basic interface

Conversion starts on command from the μ P to the Initiate Conversion input of the converter.

The interface logic for a single-channel data-acquisition system is shown in Fig. 2.

When the conversion is complete, the converter requests an interrupt via its Data Valid output. In the μ P, an interrupt service routine transfers the current data from the working registers to the stack memory, and the a/d input port is read. A control signal is then sent to the Initiate Conversion input to restart the conversion, and the main-program activity is resumed.

If the data bus is shared by many devices, include inverting drivers/receivers (such as the 8228) in the 8080A system to service this bus. Use 80L98 buffers at the a/d to drive an inverted input over the data bus, and provide the three-state function. Where inverted signals are not needed, use the version of the 8700 that has three-state outputs.

For selection, assign each port an address and decode the address bus accordingly. For the input port (Fig. 2) to the μ P, the 80L98s are enabled by the low output of the address decoder. This output is low only when all the decoder's inputs are high, as a result of address FF₁₁.

To initiate a conversion in the a/d, employ the

Table 1. Interrupt service routine

Label	Mnemonic	Operand	Explanation
Initiation	MVI	A, 80H	The conversion is initiated by sending a brief pulse to port FF
	OUT	0FFH	
	MVI	A, 0	
	OUT	0FFH	
Interrupt	PUSH	B	The processor registers and status are saved in the stack, and the data are read and stored in reg. B. The conversion is initiated and the data are processed.
	PUSH	D	
	PUSH	H	
	PUSH	PSW	
	IN	0FFH	
	MOV	B, A	
	MVI	A, 80H	
	OUT	0FFH	
	MVI	A, 0	
	OUT	0FFH	
	.		
	.		
	.		
	.		
POP	PSW	When complete, the registers are restored, the interrupts enabled and program control returned to the main program.	
POP	H		
POP	D		
POP	B		
RET			

output port whose address is also FF_H. By defining both the input and output ports as address FF_H, you can use the same address decoder for both functions. In this case, the decoder's output and the OUT signal, gated by the out gate, clock flip-flop 1.

The D input of the flip-flop is tied to the D₁ line of the data bus, so in effect, the flip-flop is a one-bit output port. Sending the data word, 80_H, to port FF_H with an output (OUT) instruction sets flip-flop 1, and thereby supplies an Initiate Conversion signal to the a/d. Send 00_H to the same port with a second output instruction. This process resets flip-flop 1 and removes the Initiate Conversion signal. After beginning the conversion, the μP is free to perform other operations.

After completing its conversion cycle, the a/d latches the results onto its internal output latches. Its Data Valid output goes high. This output triggers flip-flop 2 and clocks a ONE from the D input (tied high) onto the μP's Interrupt Request line.

Consequently, the microprocessor is interrupted when the conversion is complete. The interrupt service routine shown in Table 1 saves the CPU's working-register contents by pushing them onto the stack, and then reads the output of the a/d.

To read the converter port, simultaneously put FF_H on the address bus and send out a ZERO on the DBIN control line. Use the combination of the address decoder and in gate to supply a ZERO to the enabling input of the three-state input-port buffers on the outputs of the converter. Send the same ZERO to the Clear input of flip-flop 2 on the Interrupt line. In this way, you put counter data on the data bus and remove the interrupt

request, after it is serviced.

After reading the converter data, save it in one of the registers. Then let the system again pulse the a/d's Initiate Conversion input and start the next conversion. Have the μP restore its stack with a series of POP instructions, and reset the internal interrupt-enable flip-flop. Thus, the micro reads the converter after newly converted information becomes available. The rest of the time the processor is free.

The multichannel interface

In systems with multiple analog inputs, many older designs use an analog multiplexer feeding a single, high-speed a/d converter. This approach is error-prone, of course, and requires complex interface logic. Now, with small low-cost monolithic converters, you can use a/d's for each analog line.

For example, the system in Fig. 3 has a battery of eight converters supplying data in parallel to the μP. The interface contains many of the same elements as the basic input port of Fig. 2. As before, feed the converter's data outputs to 80L98 buffers, which in turn drive the bus. The buffers' three-state feature allows you to make them inert selectively.

The decoding circuitry is slightly more complex. Apply the five high-order address lines as the inputs to a 7430 gate that enables a 7442 BCD-to-decimal decoder. To perform the final port-selection decoding with a 7442, select the appropriate a/d when an INPUT instruction is executed to one of the output ports, F8_H to FF_H. Also, tie the converter's Initiate Conversion inputs high, so that the devices operate in the free-running mode.

Construct each of the eight interrupt-input ports of a flip-flop (1/2 74L74) with its D input wired high. Clock each flip-flop independently with the appropriate converter's Data Valid output. Gate the output of each flip-flop onto the line that requests the μP to interrupt (INT). Thus, you can request an interrupt whenever an a/d completes its cycle. Buffer the flip-flop outputs with an 8098 AND-tied to the data bus; enable this buffer, with the 7430 and 7400 gates, to respond to the input instruction at address 7F_H. In this way, let the μP determine which flip-flop has caused an interrupt and which converter has completed its cycle.

Use an interrupt service routine (see Table 2) to save the contents of the working registers with a series of PUSH instructions. Then determine which port causes the interrupt with an input instruction to address 7F_H. This instruction loads the status of each converter's Data Valid output from the 8098 into the accumulator. At this point, have the μP test the word, bit by bit, until it finds

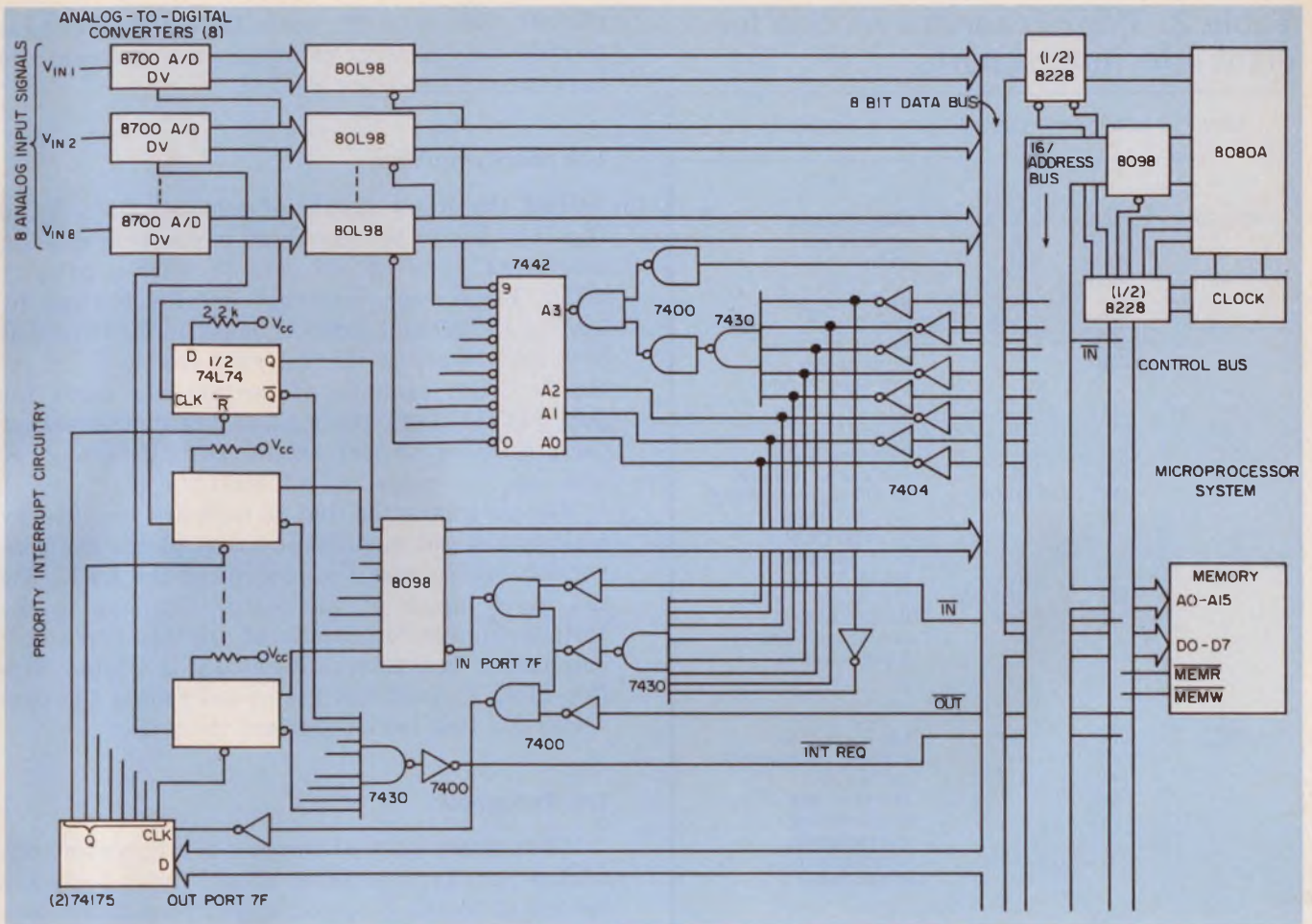

3. This eight-port a/d converter system is derived from the basic single-port interface. The maskable priority in-

terrupt feature lets you program the microprocessor's servicing sequence for interrupt requests.

a ONE. Thus, the μP determines the address of the correct a/d input port and reads that port by means of an INPUT instruction. At the conclusion of the service routine, reset the flip-flop by sending a ZERO to the appropriate bit position of output port 7F_{II}. Finally, restore the stack and reset the internal interrupt-enable flip-flop.

With this arrangement, then, the flip-flop tied to the second port can be set when one of the converters completes its cycle while another a/d port is being read. The second completed conversion generates an additional interrupt request signal—but the μP will not respond.

The μP 's internal interrupt-enable flip-flop is automatically disabled by the first interrupt received—which locks out any further interrupts. You must reset the flip-flop with an EI instruction. End the first interrupt service routine by resetting the Status flip-flop and enabling the internal interrupt-enable flip-flop. Consequently you remove the source of the first interrupt. Then the second Status flip-flop causes a new interrupt which must be serviced in turn. Thus the μP will respond to each input port, even when several conversions are completed in a short time.

So far, the a/d ports have been equally im-

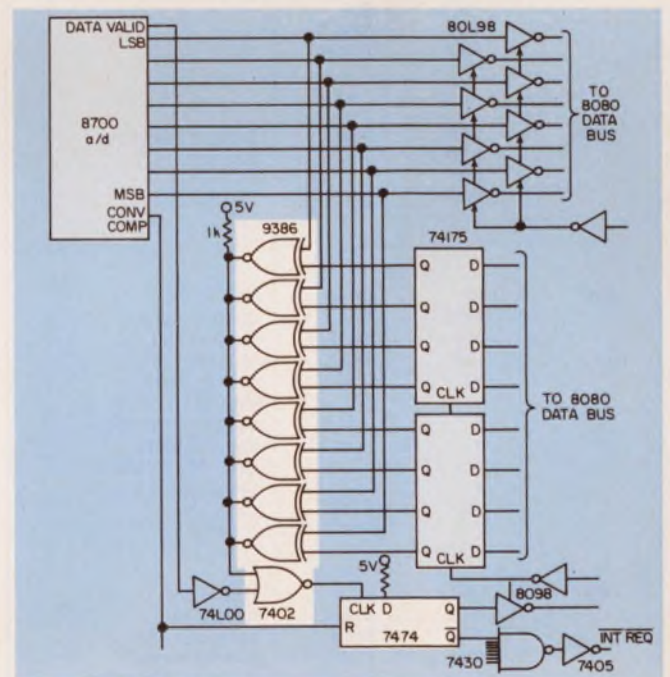

4. To avoid wasting processor time, monitor a slowly changing channel with this comparison scheme. Previously read data are latched into the 74175s by the μP . An interrupt request for this port is generated only when the converted data are different from those stored.

Table 2. Priority service routine for eight interrupting ports

Label	Instruction	Operand	Explanation
POLLED:	PUSH PUSH PUSH PUSH IN MVI STC CMC	B D H PSW 7FH D, 0	Save processor registers and status. Read input port to find which caused interrupt. Set D to zero and Carry to zero.
LOOP 1:	RAL INR JNC LXI LXI	D LOOP1 H, STABL B, 3	Determine which port caused interrupt by rotating accumulator left and testing for presence of Carry. Increment D each time. Load H and L with starting address of jump table and B and C with 3.
LOOP 2:	DAD DCR JNZ PCHL	B D LOOP2	Add B and C to H and L, decrement D and test for zero. Exit loop by transferring to appropriate jump command in jump table.
STABL:	JMP JMP JMP JMP JMP JMP JMP	ONE TWO THREE FOUR FIVE SIX SEVEN EIGHT	Jump table consisting of 3-byte jump instructions.
RSTR:	POP POP POP POP RET	PSW H D B	Restore registers and exit.
ONE:	IN MOV MVI OUT EI • • • • • JMP	0F8H B, A 0FEH 7FH RSTR	This is the service routine for port #1. It loads the priority mask with 1111 1110, enables interrupts and processes data. At conclusion, the program jumps to RSTR.
TWO:	IN MOV MVI OUT EI • • • • • JMP	0F9H B, A 0FCH 7FH RSTR	This is the routine for port #2. The priority mask is 1111 1100 which keeps port #1 from interrupting.

portant. To assign the ports priorities, you have to make only a slight change in the program; no hardware changes are needed.

The priority problem

Hold the Reset inputs of selected Data Valid flip-flops low to prevent those ports from causing interrupts. Load output port 7F with a priority mask. Begin each interrupt service routine by loading a different priority mask into the output port and resetting the internal enable-interrupt flip-flop. For example, if the priority mask for port 3 is 11111100, ports 1 and 2 cannot interrupt the processing of port-3 data; ports 4 through 8, however, can cause more interrupts.

You can guarantee that no data are ever lost by making a slight modification that places the conversion cycle under the control of the CPU. Tie the Reset inputs of the Status flip-flops to the Initiate Conversion inputs of the flip-flop's corresponding converters. Resetting a Status flip-flop after its port has been read causes the converter for that port to restart its cycle.

The throughput

When either your μ P processes a large amount of data or a large number of a/d input ports are connected to the bus, you might feed more data to the system than it can process. But if the analog inputs on some of the ports change slowly, you can add logic that increases the effective capacity of the system. Add a latching output port with the same address as its corresponding a/d input port (see Fig. 4). Then, after you read the input port, generate an output instruction to the same address. The data are thereby duplicated in the 74175 latches. A pair of 9386 quad, exclusive-NOR circuits with open-collector outputs compares the output word from the a/d with the word stored in the 74175 latches. The open-collector feature of the 9386 allows it to be collector-ORed; ONEs at all 9386 outputs signify that the data in the a/d latches match the data in the output ports. This condition means that there has been no change in the analog-input voltage, so there is no need to reprocess the data. When the a/d bits do not match the corresponding bits in the 74175, the output of the 9386s goes to ZERO. This output clocks the 7474 Status flip-flop, which in turn interrupts the μ P. From this point the operation is unchanged. ■■

References

- Schmid, H. and Mrozowski, G., "Mating Microprocessors with Converters," *Electronic Design*, Sept. 1, 1975, p. 76.
- Nichols, A. J. and McKenzie, K., "Build a Compact Microcomputer," *Electronic Design*, May 10, 1976, p. 84.

Here's a miniature 3½ digit portable multimeter that delivers extraordinary performance and value for only \$189.



Data Precision proudly presents a 0.1% accuracy multimeter that brings the same high performance and value to 3½ digit portable instruments that our Model 245 brought to 4½ digit multimeters. The same levels of reliability, the same small size, the same great convenience and flexibility. The Model 175 has it all... and more for just \$189.00.*

High performance

The Model 175 gives you 32 ranges of measurement capability, six functions, 0.1% DCV accuracy guaranteed for one year, and 100 microvolts resolution. You can measure DCV from ±100 microvolts to ±1000V, ACV from 100 microvolts to 500V with a frequency response of 30Hz to 50kHz, DC Current from ±100 nanoAmps to ±2A, AC Current from 100 nanoAmps to 2A with a frequency response of 30Hz to 50kHz, Resistance from 100 milliohms to 20 Megohms in two excitation voltages.



*Price U.S.A.

Real miniature portability

Here is true miniature portability that delivers lab performance wherever you take it. And you can take it anywhere. The 175 operates from AC line, or rechargeable NiCad batteries for 6 hours of in-spec operation. Add this to the remarkably small size 1¾"H x 5½"W x 3½"D, 34 cu. in., weight 22 oz. (4.45 x 13.97 x 8.89cm, 552cc, .63kg.) exceptional operating temperature characteristics, rugged construction... and you can see that this is real portability.



Right at home in the lab

Connect the 175 to an AC line and you have a great bench instrument. It's always recharging when line connected and ready to go into the field whenever you need it.

And the Model 175 gives you a lot more.

• **Easy to Read, Big, Bright Display:** 0.43" LED display for easy reading in dim light or bright light.



• **Hi/Lo Resistance Measurement:** Measure resistance in two modes. Hi excitation 2.5V (exceeds semiconductor forward threshold) and Lo excitation 300mV (below silicon junction threshold), for in-circuit resistance measurement without turning on semiconductor junction. No need to unsolder resistor.

- Automatic Zero
- 100% Overrange
- Overload Protected
- Overload Indication
- Recharging Indication
- A Complete Package: accessories supplied include: rechargeable NiCad battery module, line cord recharger, test leads carrying case and documentation.

Data Precision Corporation, Audubon Road, Wakefield, MA. 01880, USA
617 (246) 1600 Telex (0650) 949341.



Actual size, front view.

FOR A DEMONSTRATION, CIRCLE 224

FOR ADDITIONAL INFORMATION, CIRCLE 225

DATA PRECISION
...years ahead



HAYDEN

in personal computing books!

See for yourself the reasons why:

- 1. MICROPROCESSORS: New Directions for Designers** by Edward A. Torrero, #5777-6, paper, 1975, 144 pp., 8½ x 11, illus., \$10.95.
- 2. GAME PLAYING WITH COMPUTERS** Rev. 2nd Ed., by Donald D. Spencer, #5103-4, cloth, 1976, 320 pp., 6 x 9, illus. \$16.95.
- 3. FUNDAMENTALS AND APPLICATIONS OF DIGITAL LOGIC CIRCUITS** by Sol Libes, #5505-6, paper, (\$6.95), #5506-4, cloth, (\$9.95), 1975, 192 pp., 6 x 9, illus.
- 4. COMPUTERS IN ACTION: How Computers Work** by Donald D. Spencer, #5861-6, paper, 1974, 160 pp., 6 x 9, illus., \$5.50.
- 5. COMPUTERS IN SOCIETY: The Wheres, Whys and Hows of Computer Use** by Donald D. Spencer, #5915-9, paper, (\$5.50), #5916-7, cloth, (\$7.50), 1974, 208 pp., 6 x 9, illus.
- 6. PROGRAMMING PROVERBS** by Henry F. Ledgard, #5522-6, paper, 1975, 144 pp., 6 x 9, illus, \$6.50.
- 7. PROGRAMMING PROVERBS FOR FORTRAN PROGRAMMERS** by Henry F. Ledgard, #5820-9, paper, 1975, 144 pp., 6 x 9, illus., \$6.50.
- 8. COBOL WITH STYLE: Programming Proverbs** by Louis J. Chmura, Jr., and Henry F. Ledgard, #5781-4, paper, 1976, 144 pp., 6 x 9, illus. \$5.45.
- 9. MINICOMPUTERS: Structure and Programming**, by T.G. Lewis and J.W. Doerr, #5642-7, cloth, 1976, 288 pp., 6 x 9, illus., \$12.95.
- 10. PATTERN RECOGNITION** by M. Bongard, #9165, cloth, 1970, 256 pp., 6 x 9 illus., \$14.90.
- 11. DIGITAL SIGNAL ANALYSIS** by Samuel D. Stearns, #5828-4, cloth, 1975, 288 pp., 6 x 9, illus., \$19.95.
- 12. BASIC BASIC: An Introduction to Computer Programming in BASIC LANGUAGE** by James S. Coan, #5872-1, paper, (\$7.95), #5873-X, cloth, (\$9.95), 1970, 256 pp., 6 x 9, illus.
- 13. ADVANCED BASIC: Applications and Problems**, by James S. Coan, #5856-X, cloth, (\$8.95), #5855-1, paper, (\$6.95), 1976, 192 pp., 6 x 9, illus.
- 14. FORTRAN FUNDAMENTALS: A Short Course** by Jack Steingraber, #5860-8, paper, 1975, 96 pp., 6 x 9, illus., \$4.95.
- 15. DIGITAL TROUBLESHOOTING: Practical Digital Theory and Troubleshooting Tips** by Richard E. Gasperini, #5708-3, paper, 1976, 180 pp., 8½ x 11, illus., \$9.95.
- 16. DIGITAL EXPERIMENTS** by Richard E. Gasperini, #5713-X, paper, 1976, 192 pp., 8½ x 11, illus., \$8.95.

Write for 15-day examination copies of any of these books!

At the end of 15 days, please remit payment plus postage and handling, or return the books and owe nothing. Prices subject to change without notice. If payment

accompanies order, we pay postage and handling. Outside USA, cash must accompany order — include \$2.00 per book for shipping and handling.



Hayden Book Company, Inc.

50 Essex Street, Rochelle Park, New Jersey 07662
phone: (201) 843-0550



TI introduces the Face Gripper.



TI, the world leader in dual-in-line sockets, brings you a new version of an old idea: Face Grip Sockets. Tin or gold contact surface, extremely reliable, redundant contact points, chamfered entry design, low insertion force, high retention, built-in anti-wicking feature, U.L. approved 94V-0 insulator material, 8 to 40 position availability, and priced to sell. Which means we now can offer you a full line of dual-in-line wire wrap and solder tail sockets for your next application.

For free samples of our new Face Gripper,* specs and literature, write to Texas Instruments Incorporated, Mail Station W-1, Attleboro, MA 02703. Or call Connector Systems Marketing, (617) 222-2800, Ext. 268 or 269.

*Patent Pending



TEXAS INSTRUMENTS
INCORPORATED
CIRCLE NUMBER 43

Control 10 to 10,000 Hz digitally and get complementary output frequencies

A digital-to-frequency converter (see figure) provides two output frequencies that are frequency "complements" of each other. One frequency output is proportional to a 10-bit digital input number, N , while the frequency of the other output is proportional to the number, $1023-N$. Excellent linearity is obtained over three decades, from 10 Hz to 10,000 Hz, for digital-number inputs 1 to 1000. A 556 dual timer provides either pulse or sawtooth output waveforms.

An AD7520 d/a converter provides an output current, I_1 , proportional to N , and another current, I_2 , proportional to $1023-N$. The transistors Q_1 and Q_2 and op amps A_1 and A_2 not only charge capacitors C_1 and C_2 , but also maintain a zero-voltage sink to absorb the d/a converter outputs. The timer circuits discharge the capacitors to $1/3 V_{cc}$ whenever the voltage reaches $2/3 V_{cc}$ at a frequency proportional to the currents I_1 and I_2 . Since the charging current is proportional to the digital input, linear digital-to-frequency operation is achieved.

D. R. Morgan, Senior Engineer, General Electric Co., Electronic Laboratory, Syracuse, NY 13201.
CIRCLE NO. 311

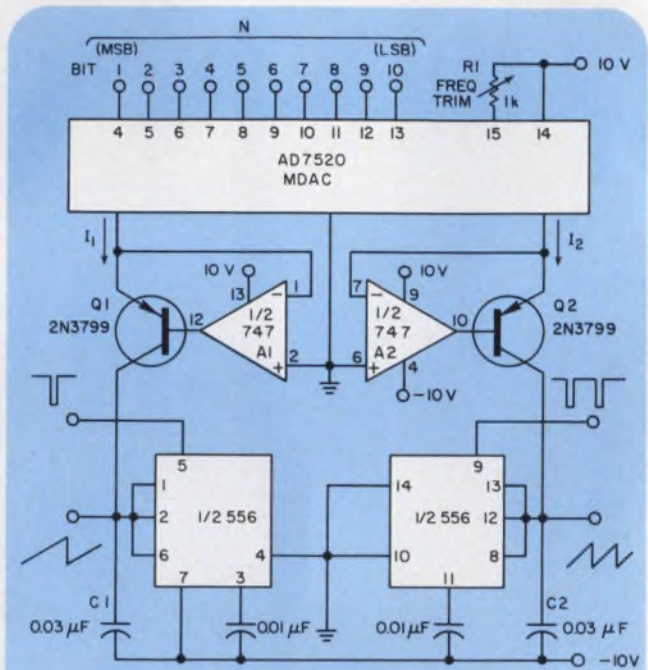

Complementary frequencies proportional to digital inputs are provided with only three DIP IC packages and two transistors.

Watchdog circuit guards μP systems against looping

Lightning discharges or even man-made EMI can totally scramble commands and produce a looping condition within a mini or microcomputer's program. Component or peripheral equipment failure can cause the microprocessor system to hang up in a loop. And even though all due caution is exercised during program development, bugs may reside for years without being discovered.

Therefore, an automatic "watchdog" circuit is imperative in unattended systems and is quite useful in most other systems.

The watchdog circuit (Fig. 1) is built around an LM555 timer. Applied to National Semiconductor's PACE microprocessor, the timer is periodically reset by the μP 's F-12 flag signal via capacitor C_1 and transistor Q_1 . Should the flag signal fail to appear within the 555's timeout period, an output labeled EXINIT is generated. And should the system fail from other causes with F-12 high, coupling capacitor C_1 prevents a system lockup.

EXINIT "pulls down" C_2 and fires the Schmitt

(continued on page 92)

Our KH series. Nobody satisfies your 4PDT relay needs any better.

P&B gives you more contact, terminal, socket, rating, enclosure choices than anyone else.

With all the available options, you can virtually design your own KH relay. Need bifurcated crossbar terminals for low-level switching? PC board terminals? Push-to-test button? No problem. These options and dozens more are tooled, ready for production.

KH relays are rated up to 3 amperes at 30V DC or 120V AC, resistive. Contact arrangements include DPDT and 4PDT. KHU relays are UL recognized and CSA certified. KHX relays are UL recognized for opposite polarity ratings.

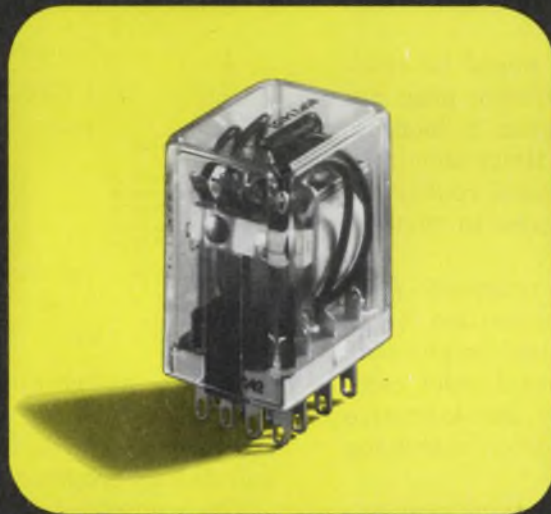

This is an original Potter & Brumfield design. No wonder we've made more, with more variations for special applications, than anyone. KHU and KHS (hermetically sealed) relays are available from authorized P&B distributors.

Complete specifying information is available from your local P&B representative or call Potter & Brumfield, 200 Richland Creek Drive, Princeton, Indiana 47671. 812/386-1000.

 AMF
Potter & Brumfield

Potter & Brumfield

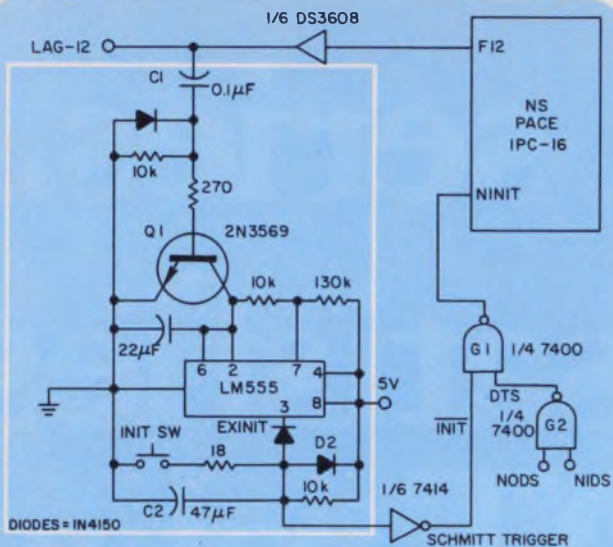

1. Watchdog circuit monitors subroutine time. Should an F-12 signal fail to appear within a predetermined limit, looping is indicated and the system is reinitialized.

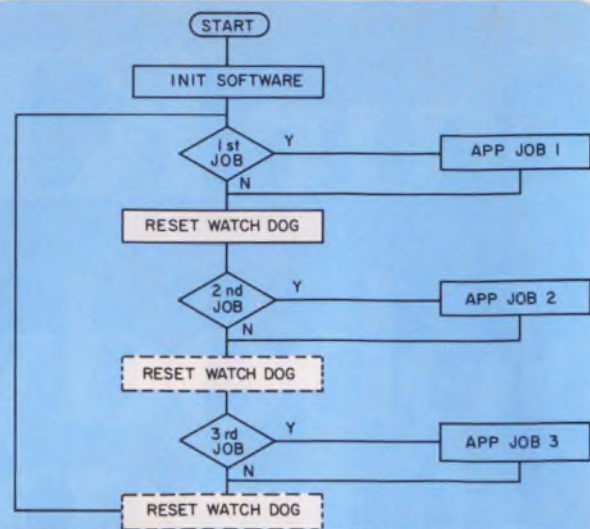

2. A typical top-down structured program incorporates watchdog reset commands within the executive program. To accommodate the timing of different job loops, multiple watchdog resets (shown dotted) may be required. Tree-oriented logic requires watchdog resets at major branch points.

trigger as does the manual switch, INIT. Inverted by G₁, INIT, reinitializes the processor via the μ P input, NINIT; DTS (data transfer strobe) to G₁ prevents an initialization during a data transfer, which prevents a short write cycle from producing errors.

With "top-down" programming, the resetting command for the watchdog is located in the executive program between subroutine junctions (Fig. 2).

The watchdog's timeout period might be critical, depending on how long the system user can wait before deciding that the system is looping. As a rule of thumb, the watchdog timer should be set 20% longer than the longest legal routine. A greater safety margin may be needed in systems not having crystal-clock timing.

In a large system with many relatively fast-response modules, the longest legal routine might take as long as 500 ms. But each loop might take only 10 ms to execute. Here, several reset commands can be distributed within the executive routine to allow an over-all shorter watchdog time.

Locating the watchdog reset command and setting the timeout period in "tree-oriented" program logic are more difficult and more critical. Parallel subroutines and greater programming difficulty allow a high probability of error and inadvertent program looping. In limited programs, the watchdog reset commands are located at the main branch points. On more extensive programs, the reset commands are integrated into several branch points located within the tree structure.

An ancillary software or hardware counting

circuit, set for a predetermined number of NINIT-signal counts is a valuable checkout tool. If, say, three counts occur during a fixed time-period, a high possibility exists that the system is malfunctioning. Visual and aural indications can then be given, and the equipment shut down, especially when malfunctioning, can be dangerous.

Coding, of course, depends upon the device and program concept. For a PACE, the coding is:

```

1          *TITLE WDRST.* WATCHDOG RESET V1R0 TPXVSI01876A'
2
3          ; DEMONSTRATION OF CODE TO RESET WATCHDOG
4          ; TIMER USING F12 AS RESET SIGNAL
5
6          START:
7          000C          F12=F12          ? ASSEMBLER ASSIGNMENT
8
9          0000 3C00 A          PFLG F12          ; TO RESET F12 IF HIGH
10         0001 5C00 A          NOP                    ; TIMING
11         0002 3C80 A          SFLG F12          ; STARTS RESET PULSE
12         0003 5C00 A          NOP                    ; TIMING
13         0004 3C00 A          PFLG F12          ; ENDS RESET PULSE
14
15         0000          *END START
START 0000 T          F12 000C A
NO ERROR LINES
SOURCE CHECKSUM = 5622

```

Ensure that nothing in the executive or any of the subroutines can alter the flag chosen as the reset signal. The designer may use both the editor and de-debug programs.

The watchdog circuit is useful also in system checkout. Routines and subroutines can progress automatically, with the watchdog calling attention to the loops as they develop. Time is saved not only when the watchdog reinitializes the system on random disturbances, but also when component failure or hidden faults are exposed in the operating program.

Victor E. Shiff and Richard H. Parr, Engineering Department, Teleplex Corp., 33 Danbury Road, Wilton, CT 06897.

CIRCLE NO. 312

The Naked DIP Handler. Ambient or Environmental.

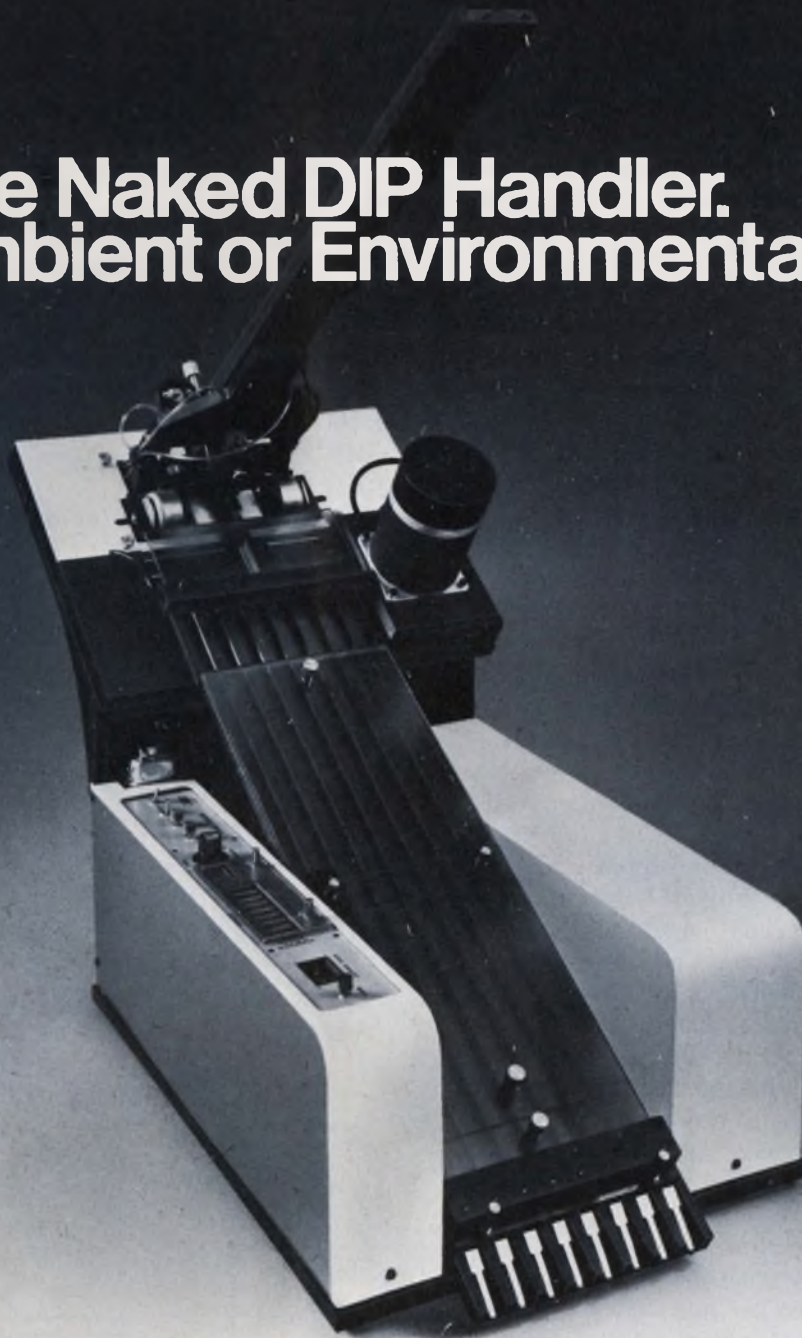

Increased throughput with fewer operators means lower test cost. The 2608 Naked DIP handler hands it to you at the rate of 10,000 devices per hour at zero test time. And even with continuous operation at this high speed, the 2608's simple, functional engineering makes it a most reliable handler. Compatible with virtually any IC tester, the 2608 handles 8 to 40 pin DIP's with minimum hardware changes, and sorts tested DIP's into as many as 8 categories. What more could anyone ask for?

Environmental test capability? You've got it. With the 2608E. The handler allows for testing in temperatures ranging from ambient to $+125^{\circ}\text{C}$. It includes an input storage tray with capacity for up to 400 fourteen-pin devices. Best of all, the basic 2608 can be upgraded to a 2608E whenever your test requirements dictate. For detailed information, please contact: Siemens Corporation, Computest Products, 3 Computer Drive, Cherry Hill, New Jersey 08034 (609) 424-2400.

The 2608 is manufactured by Micro Component Technology, Inc. Siemens Corporation is the sole worldwide distributor.

SIEMENS

Circuit allows program-halt and single-instruction mode on μP

The ability to halt program execution and then to proceed one instruction at a time is a valuable capability of any computer system. In a micro-processor system, this capability is normally implemented by controlling its run/halt input.

The Fairchild F8 μP , unlike most other 8-bit μP s, doesn't have a run/halt input. Nevertheless, the circuit in Fig. 1 provides such a run/halt and single instruction capability for the F8.

With the circuit's switch, S_1 , in the Run position, the F8 executes normally. When it is in the Halt position, instruction execution is effectively "halted." Then the momentary-contact switch, S_2 , can be used to initiate a single CPU (central processor unit) instruction and then to return the μP to the halt state.

Although the processor can't directly halt execution, the system can be "halted" by forcing the CPU to execute a sequence of no-ops. And because the program counter is not contained within the F8 CPU chip, the counter isn't advanced during this no-op situation.

To halt the F8, an instruction-fetch request from the μP 's output ROMC control bus is detected and translated by the control circuit into a system no-op. At the same time, a processor no-op instruction (2B hexadecimal) is placed on the data bus. The F8 CPU reads the data bus and executes the no-op instruction. After executing the no-op, the CPU's fetch-request for another instruction again translates to a no-op, and so on.

The instruction-fetch code of all ZEROS on the F8's ROMC output lines is detected with a simple NOR gate, G_1 .

After appropriate synchronization, the control circuit translates the instruction fetch into a system no-op code (1C hexadecimal) with the use of the three OR gates, G_2 , G_3 and G_4 . Also, a processor no-op code (2B hexadecimal) is placed on the data bus by the control circuit's 74S241 three-state buffer, IC_1 .

The control circuit's pulse synchronizer, IC_{2a} and IC_{2b} , provides all the necessary synchronization. If S_1 is in the Run mode, IC_{2b} passes pulses. The CPU clock occurs during a Write pulse, so IC_{2b} is continually clocked LOW, thus clearing the Xlate signal to allow normal operation. When S_1 is placed in the Halt mode, IC_{2b} continues to pass pulses until a negative transition of the reset input G_5 occurs.

A reset occurs when an instruction fetch is detected by G_1 . When IC_{2b} stops passing pulses, IC_{2a} is clocked HIGH, thus setting Xlate and halting the processor.

When the processor is halted, switch S_2 can single step the system. With S_2 pressed, IC_{2a} passes one pulse, which resets IC_{3a} . Since IC_{3a} is reset, IC_{2b} passes the next Write pulse, which causes the F8 to begin normal execution. Execution continues until another instruction-fetch cycle is detected.

The Reset input of IC_{2a} should be connected to the F8 CPU reset line to ensure proper system reset.

Terry Dollhoff, Director of Computer Science, Acuity Systems Inc., 11413 Isaac Newton Square, Reston, VA 22090. CIRCLE NO. 314

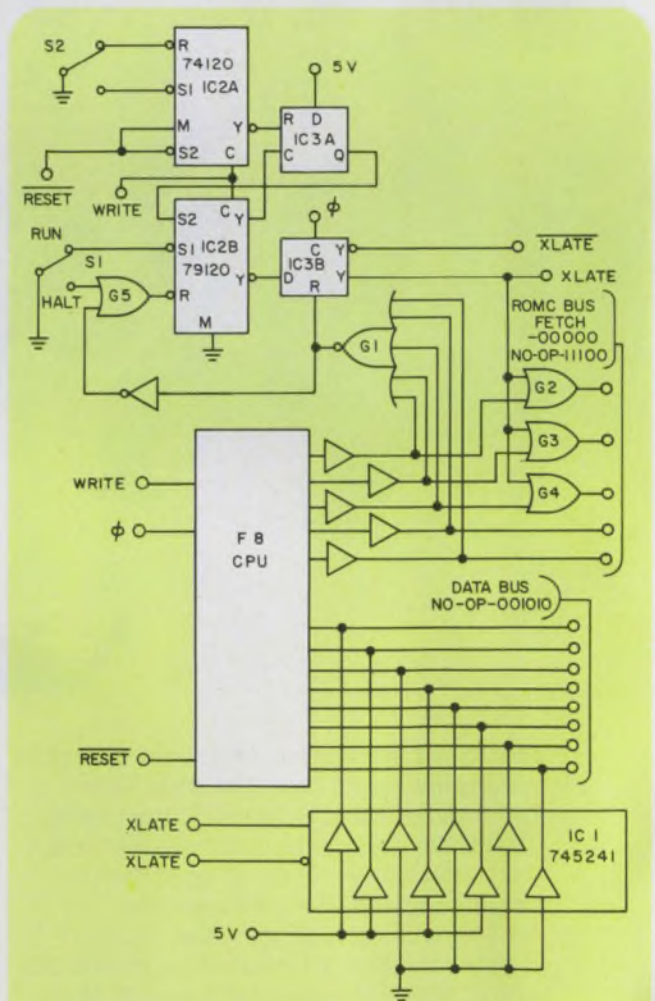

1. A control circuit translates the instruction-fetch code into a sequence of no-op's to obtain a μP -system "halt" and to allow single-instruction action.

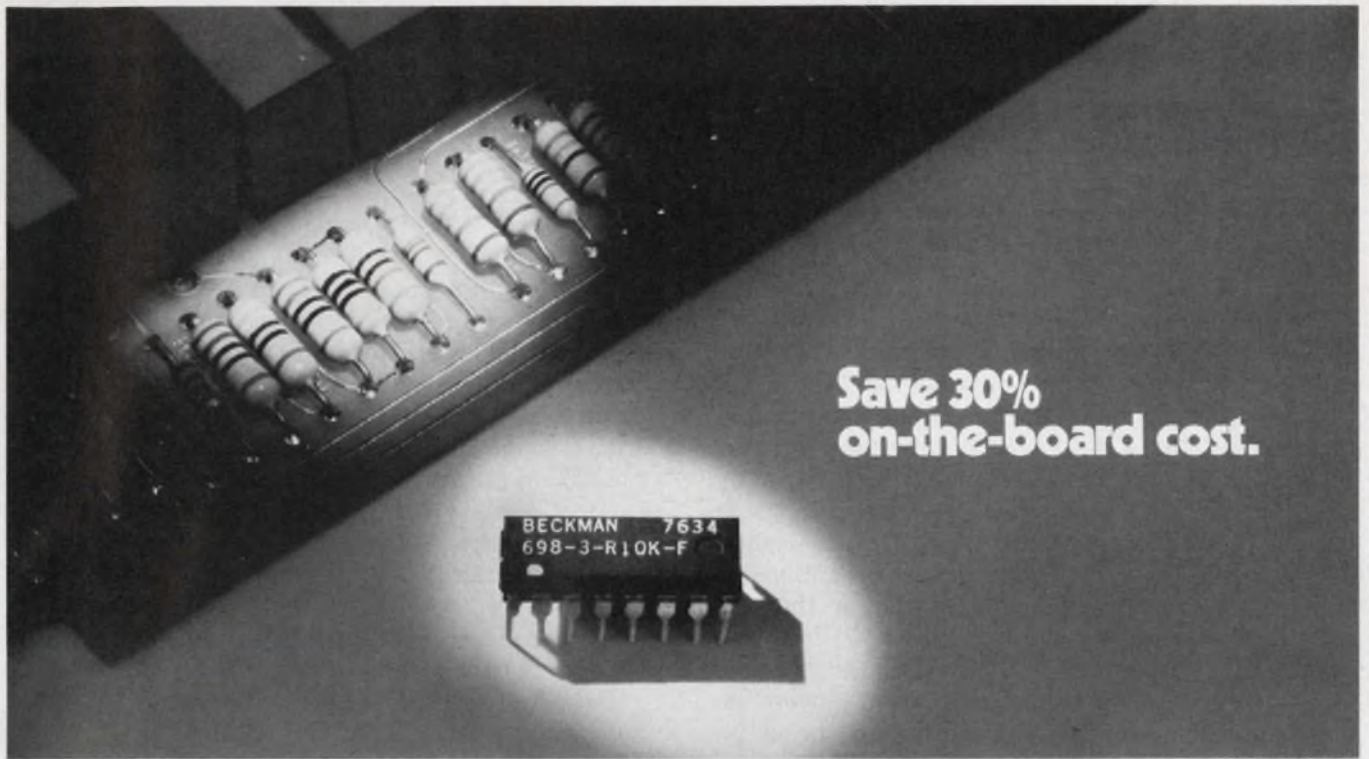

Save 30%
on-the-board cost.

Now, an alternative in the precision resistor world.

Beckman introduces precision film networks.

The board geography savings are obvious.

But our standard, 16-pin Series 698 Precision Film Resistor Networks mean much more. First, they're competitive in purchase cost with thin film discrete resistors. And, when you consider inventory and handling costs, lead bending, QC and other factors, they mean about a 30% savings in "on-the-board" costs.

That isn't all. Beckman precision networks have better performance and stability than unmatched discrettes. With ± 5 ppm/ $^{\circ}$ C tracking, the matched resistors in our dual in-line packages feature (1) absolute 1% resistance tolerance ratioed to 0.5%, and (2) ± 50 ppm/ $^{\circ}$ C tempo.

The two models (see schematics) are standard size and pin-spaced for automatic insertion. Series 698-1 comes in 17 stock resistance

values; Series 698-3 in 20 stock values. And these parts can be coupled, in series or parallel, to obtain other values in gain-setting, summing and feedback circuit applications.

The 1,000-piece price: just 65¢ for the 698-3 (8 resistors), 81¢ for the 698-1 (15 resistors). Compare with discrettes!

And remember: they're standard... for quick delivery, off the shelf through our widespread distribution.

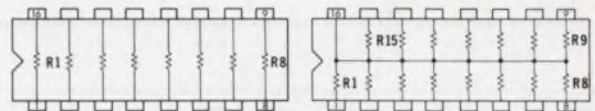

Get into the world of precision resistor networks. For more data, and applications information, contact your local distributor or Beckman Helipot today at (714) 871-4848, Extension 1776.

BECKMAN®

HELIPOT DIVISION

CIRCLE NUMBER 46

Simple solid-state relay circuit can be built with few components

A sensitive-gate triac such as the 2N6071B makes possible the construction of a simple, inexpensive solid-state relay where the triac gate is driven directly by an opto-isolator. No amplifier is necessary, nor is the circuit complicated by the need for a dc power supply (see figure).

Current to trigger the triac flows directly from the line through capacitor C_1 and resistor R_1 . The capacitor introduces a leading phase shift into the gate current to make the current maximum near the zero-voltage crossing of the line voltage. Resistor R_1 and varistor RV_1 limit the voltage applied across the opto-isolator transistor, and also protect the isolator from power-line transients and surges, especially any occurring when power is first applied. Varistor RV_1 can be

any general-purpose type that limits voltage peaks to about 20 V.

Bridge diodes D_1 through D_4 (low-cost general-purpose types) route the gate current in the proper direction through the opto-isolator transistor. And components R_1 , C_1 , C_2 , and C_3 prevent the triac from triggering for a half-cycle when power is first turned on. These components can be omitted if the half-cycle of power to the load can be tolerated.

The circuit can control ac circuits that draw about 2 A (nominal), although with proper heat sinking the triac can handle 4 A.

Dale Hileman, Sphymetrics, Inc., 6311 J DeSoto Ave., Woodland Hills, CA 91367.

CIRCLE NO. 313

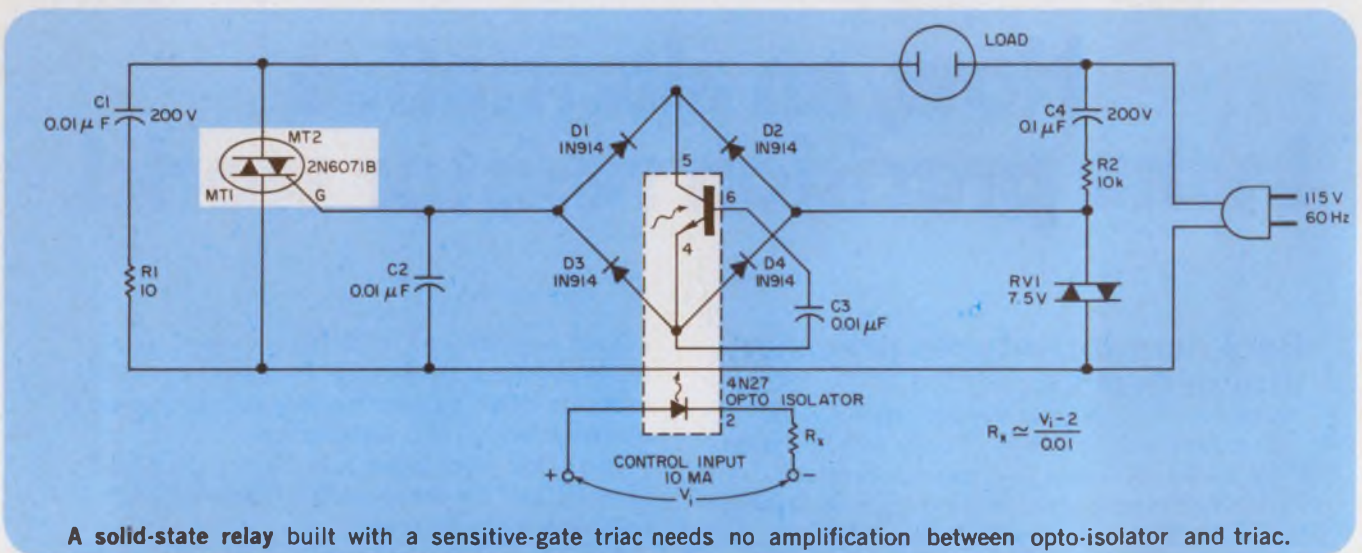

IFD Winner of September 13, 1976

J. E. Buchanan, Westinghouse Electric Corp., Defense & Electronics Systems Center, Friendship International Airport, P.O. Box 746, Baltimore, MD 21203. His idea "Build a Voltage-Controlled Oscillator with only One TTL-Inverter Package" has been voted the Most Valuable of Issue Award.

Vote for the Best Idea in this issue by circling the number for your selection on the Reader Service Card at the back of this issue.

SEND US YOUR IDEAS FOR DESIGN. You may win a grand total of \$1050 (cash)! Here's how. Submit your IFD describing a new or important circuit or design technique, the clever use of a new component or test equipment, packaging tips, cost-saving ideas to our Ideas for Design editor. Ideas can only be considered for publication if they are submitted exclusively to ELECTRONIC DESIGN. You will receive \$20 for each published idea, \$30 more if it is voted best of issue by our readers. The best-of-issue winners become eligible for the Idea of the Year award of \$1000.

NEW



FROM

THE

HOBBY~WRAP

COMPLETE WITH BIT AND SLEEVE

ONLY \$34⁹⁵



Now you, the hobbyist, can do wire-wrapping professionally with our easy to use Hobby-Wrap gun.

Model BW-630

OK MACHINE & TOOL CORPORATION

3455 Conner St., Bronx, N.Y. 10475 / (212) 994-6600 / Telex 125091

.025 sq. post,
AWG 30 wire
(batteries not included)

CIRCLE NUMBER 47

WE KNOW A LOT ABOUT A LITTLE.

Magnetic shielding materials, for instance.

If you have the problem of shielding electronic devices from stray magnetic fields, we supply a wide variety of highly effective shielding materials, vacuum-melted to assure product purity and repeatable properties, with performance guaranteed lot to lot. Our Mu Guard[®] 80 and Permalloy 80, for example, are excellent for critical applications. For medium shielding effectiveness, we offer Alloy 48 and Mu Guard 48.

In fact, we can tailor alloys to meet your specific needs—annealed for forming or fully annealed. For more about our single-source capability, write Magnetics, Metals Division, Butler PA 16001.

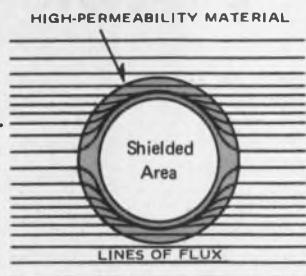

Very special specialists in shielding materials.



CIRCLE NUMBER 48

ELECTRONIC DESIGN 2, January 18, 1977

WE KNOW A LOT ABOUT A LITTLE.

Photoetched parts. Lead frames and magnetic head frets, for instance.

For openers, we're big enough to take on any photoetch job, regardless of quantity. And we have the expertise to etch all standard materials. In short, we're a one-stop shop, geared to save you time and money. We compound, melt and roll our own metal alloys. So if you call for a special composition or thickness, we have the capability—in house—to meet your exacting specs. Need artwork? We do that, too. Want your magnetic head frets stacked and bonded? Our process will give you absolute uniformity and precise thickness batch after batch. Put us to the test—send your drawings and let us quote. Write Magnetics, Components Division, Butler PA 16001.

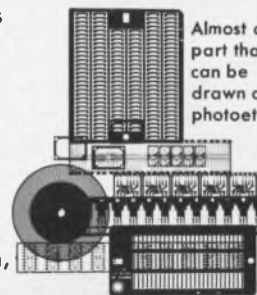

Almost any part that can be drawn can be photoetched.

Very special specialists in photoetched parts.



CIRCLE NUMBER 49

New method speeds μ P software development

A radical technique that speeds up microprocessor software development has been introduced by Quarndon Electronics of Derby, England.

Known as direct assembly, the British technique combines the two separate, basic programs used in the conventional method of generating μ P software:

- The Assembler, which converts mnemonic instructions and symbolic addresses into absolute machine code.

- The Editor, which allows assembly-language programs to be modified without re-entering the entire program.

In their place, a single Direct Assembler simultaneously converts each mnemonic instruction or each

symbolic address to machine code as it is entered, and checks for syntax errors. Errors can be corrected on the spot before entering additional mnemonics. Standard monitor functions, such as breakpoints are also included.

Direct Assembler programs have been developed by Quarndon for the 8080 and 2650 systems run on Nova minicomputers. A resident 8080 Direct Assembler has also been developed that occupies only 3 kbytes of PROM.

Quarndon's resident Direct Assembler is used with a single-board 8080 microcomputer that doubles as the development system. Work is now in progress to produce resident Direct Assemblers for 2650 and 9900 systems.

conventional dynamic stereo microscope cannot tilt the specimen, but must deflect the two incident electron beams before the specimen can be viewed from different angles. But as a result, the resolution drops about 10,000 times to about 1000 Å.

Hitachi's instrument can even measure and display heights of less than one micrometer, such as scratches on a polished surface.

Schottky-barrier anode device doesn't suffer

A planar, gallium-arsenide, Gunn-effect device by Fujitsu Laboratories, Kawasaki, Japan, does not suffer from the usual high electric-field layer near the anode that causes current saturation at high bias and incoherent oscillation. A Schottky-barrier anode contact in Fujitsu's device eliminates the high field.

The device is formed by n-GaAs layers—grown on (100) crystalline-oriented surfaces of chromium-doped, semi-insulating substrates—whose carrier concentrations are 8 to $15 \times 10^{15} \text{ cm}^{-3}$ with thicknesses of 3 to 5 μm . The cathode contact is formed from an alloyed gold-germanium-nickel film; the anode contact is an evaporated aluminum film. Straight, bar-shaped active areas, 35- μm long, are formed by mesa etching.

Measurements of the current/voltage (I/V) characteristic under dc-biased conditions show that the I/V curve is linear over a range of more than 15 V—better than the 5 V recorded for the earlier devices with ohmic-anode contacts.

While the earlier devices produce only noisy waveforms, the Schottky-barrier anode devices produce coherent waveforms with a typical period of 750 ps.

Because of its stable operation, Fujitsu's Gunn-effect device looks promising for very-high-speed logic applications.

Demand for 3-D semi observation is answered

Observing, measuring and displaying three-dimensional semiconductors are now possible with a stereoscopic observation and measuring instrument that connects to a scanning electron microscope.

Developed by the Central Research Laboratory of Hitachi, Ltd., Tokyo, the instrument measures three-dimensional (3-D) images, magnified up to 500,000 times, to a maximum height of 300 Å and a maximum length and width of 30 Å.

The instrument has two 3-D-image memory devices, a time-sequential television with a PLZT electro-optical shutter, and a measuring unit. (PLZT is a piezoelectric material composed of lead

lanthanum, zirconium and titanium.)

An object can be observed three-dimensionally with the scanning electron microscope because each eye views the object from a different angle. The specimen is tilted in the microscope column, and electron beams are directed at it from two different angles. As a result, two images are stored in the image-memory devices and shown on a television monitor. Each image is presented alternately at 1/60th of a second and synchronized by the PLZT shutter.

The 3-D measuring unit computes distances automatically and gives digital readings.

Unlike Hitachi's instrument, a

WHEN IT'S FINALLY ON THE SCREEN, YOU DESERVE FAST HARD COPY.

Gould's electrostatic printer/plotter is the fastest graphic hard copy peripheral available today for your Tektronix 4000 Series interactive graphic terminal. You get permanent graphics direct from the

terminal in as little as 4 seconds, regardless of image complexity. In an on-line CPU configuration, you can plot at up to 3.25 paper in./sec. and print at up to 1600 lines per minute.

Yet Gould's hard copy still possesses exceptional resolution and extremely high contrast. Only Gould offers you both unmatched speed and unsurpassed image quality.

And Gould lets you select a 0° or 90° image orientation at will. In 90° mode, images are enlarged

up to 72%. You are able to select 1024 or 2048 point sampling and high or low speed graphic operation, letting you optimize image size, resolution and speed.

As with all Gould systems, your software is all-Gould. You never need worry about third party variables.

Gould images don't deteriorate. The system requires no warm-up. Gould paper costs a fraction of silver paper. Up to 2 interfaces are accommodated in the plotter, allowing you to use it with up to 8 Tektronix terminals or 4 terminals and a minicomputer, or 2 mini-computer CPU's.

Your CRT work deserves the best hard copy you can get. You get it from Gould.



For more information and a sample graphic output, contact Gould Inc., Instrument Systems Division, 3631 Perkins Ave., Cleveland, Ohio 44114. Or Gould Advance Ltd., Raynham Road, Bishop Stortford, Herts, United Kingdom.

FOR FREE BROCHURE CALL GOULD
TOLL-FREE AT (800) 325-6400 Ext. 77.
In Missouri: (800) 342-6600

 **GOULD**
The product development company

Arrow-M Amber Relays

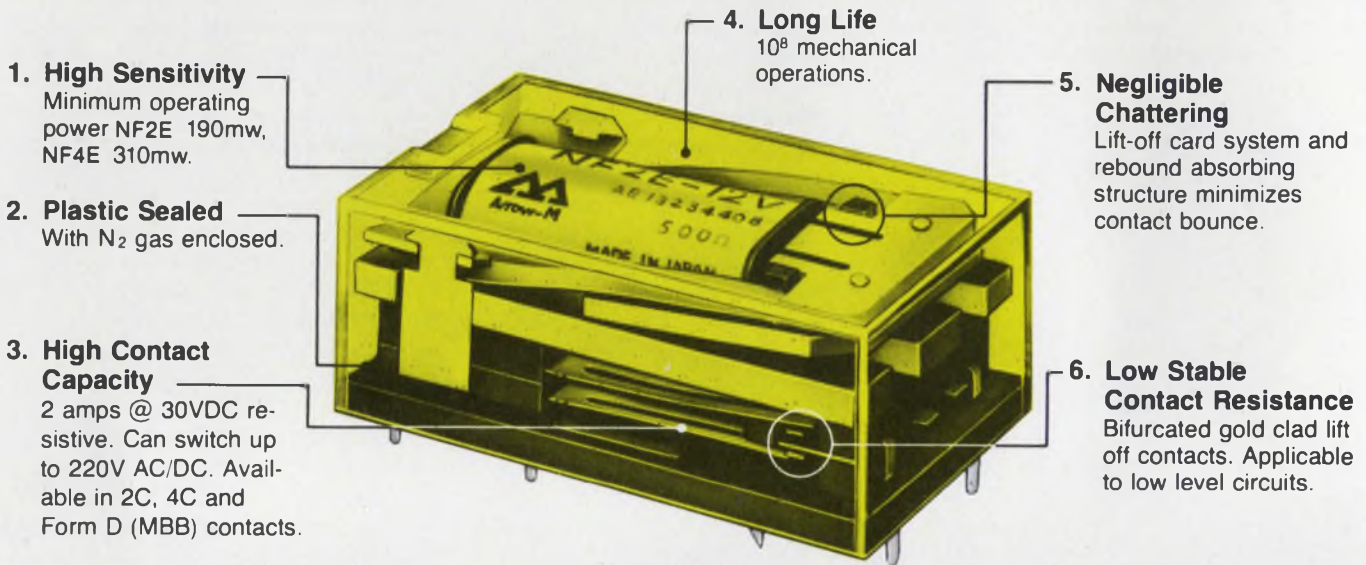

Sound advice for the alarm industry.

You know better components make a better alarm system. So it pays to install the most reliable relays available today: Arrow-M NFE Amber Relays . . . supported by our unique and advanced manufacturing techniques. They offer you:

Reliability — The secret is a unique automated modular assembly coupled with lift off bifurcated contacts and a rebound absorbing mechanism. Installed in a sensitive alarm, it can go unused for long periods of time and still work when needed.

Sensitivity — NFE Amber Relays use only half the power of ordinary relays.

Automatic Wave Soldering — NFE Amber Relays are plastic sealed with N₂ gas.

High Packaging Density PC Board Mounting — flatpack NFE Amber Relays are only 0.425 inches high.

The proven dependability and sensitivity of Arrow-M Amber Relays is based on more than 50 years of meeting the advancing needs of modern technology. So for relays that make it easier to make a better alarm, rely on Arrow-M NFE Amber Relays.

For evaluation samples, or for more information on exact specifications, write or call your nearest Arrow-M office.

Arrow-M Corporation
250 Sheffield Street
Mountainside, N.J. 07092
(201)232-4260

Western Office:
22010 S. Wilmington Ave.
Suites 300 & 301
Carson, Calif. 90745
(213) 775-3512



Arrow-M

Member of Matsushita Group

Relays for Advanced Technology

CIRCLE NUMBER 52

Programmable gate arrays add flexibility, cut complexity

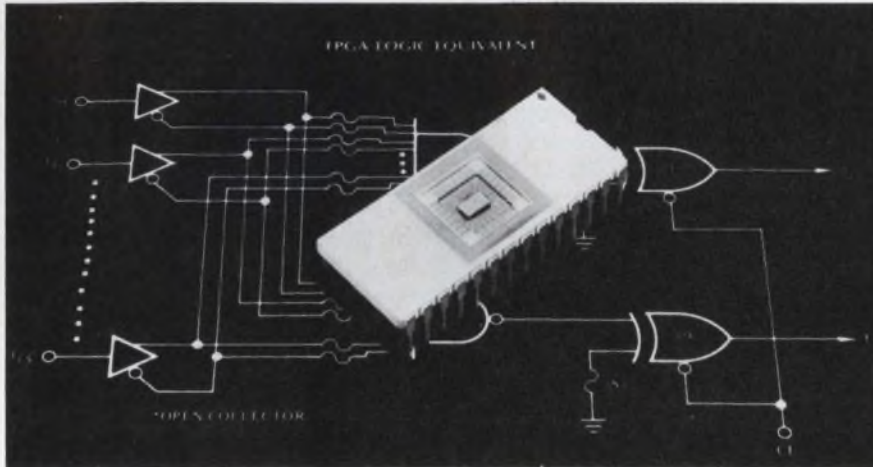

Signetics, 811 E. Arques Ave., Sunnyvale, CA 94086. Napoleone Cavalan (408) 739-7700. P&A: See text.

In addition to read-only memories and programmable logic arrays now used as low cost replacements for discrete logic, a new tool has become available to the logic designer—the programmable gate array (PGA). Developed by Signetics, this circuit contains nine 16-input AND/NAND gates, each with its own output.

Although the PGA and PLA seem alike at first glance, there are some major differences. The PGA is a one-level gate array that performs AND or NAND combinations, while the PLA is a more complex two-level array that performs AND/OR, NAND/OR and other dual combinations.

Each of the nine PGA gates has 16 inputs, but each of the 16 inputs can appear in either its true or complement form. And, any or all of the 16 inputs for each gate can be programmed for don't-care conditions by electrically disconnecting them from the gate input.

The output of each NAND gate goes into an Exclusive-OR gate, which can be programmed to behave as inverter to convert the

NAND output to an AND. If the Exclusive-OR gate is left unprogrammed, the NAND gate output remains unchanged. Programming is done in much the same way as in PROMs and PLAs—zapping nichrome fuse links that were deposited on the chip during fabrication.

There are two versions of the PGA available—the 82S102 and the 82S103. The 82S102 has open collector outputs, and the 82S103 three-state outputs. Both versions have an output-enable control line that permits output strobing.

Two operating temperature ranges are also available. Units with an N prefix operate over a 0-to-75-C range while units having an S prefix function over -55 to +125 C. N-series units have a maximum propagation delay, input-to-output, of 30 ns, and a maximum input loading of -100 μ A. S-series PGAs have a maximum delay of 40 ns and a maximum input current limit of -150 μ A. Typical power dissipation for all units is about 600 mW.

All PGAs operate from a 5-V TTL power supply and are fully TTL-compatible on all inputs and outputs. For gate programming,

however, the supply voltage must increase to 8.75 V and the output voltages must be brought to about 17 V. Fusing current must be limited to about 175 mA.

Available in plastic or ceramic 28-pin, 600-mil-wide DIPs, the arrays cost \$7 each and up for the commercial plastic version in 100-unit quantities. Delivery is from stock.

CIRCLE NO. 303

LED flashing circuit doubles battery voltages

Lithic Systems, P.O. Box 869, Cupertino, CA 95014. Robert Hirschfeld, (408) 257-2004. Less than \$0.50 (lge. qty.); stock.

The LS3909 monolithic LED flasher circuit is a direct second-source for the LM3909 from National Semiconductor. The flasher can blink 1.6-V LEDs from a battery voltage as low as 1.1 V, by use of a voltage-doubling technique. The LS3909 is available in 8-pin mini-DIPs, TO-100s, and individual chips.

CIRCLE NO. 304

Motor controller handles brushless ac motors

Photo-Therm, 110 Sewell Ave., Trenton, NJ 08610. Roman Kuzyk (609) 396-1456. \$6 (1000-up); 4 wks.

Control the loading of any brushless ac motor with the power controller. The circuit, housed in a 14-pin DIP, can turn off the motor upon overload (settable to 1% of load), provides line voltage operation, has zero-crossover firing for inductive loads and contains two delay circuits, one for overcoming starting surge and a second to override short-term overloads. A patented technique that measures the power factor of the motor is used by the IC.

CIRCLE NO. 305

SEMIPACK[®] is the answer

What was your question?



SEMIPACK is the standard multi-function power semiconductor building block for controlled and non-controlled systems. Standard circuit configurations are:

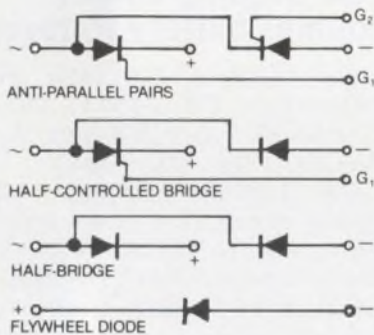

SEMIPACK is a modular concept, electrically isolated and mechanically compatible for simple assembly into single and three-phase bridges such as . . .

- HALF CONTROLLED
- FULLY CONTROLLED
- DIODE BRIDGES
- AC CONTROLLERS (2 to 4 wire)

Module rating: 25 to 90A per device to 1600 PIV. Typical applications include: phase and inverter motor controllers, electrical heating and lighting controls . . .

For further information or technical literature write or call . . .

Tel: 617 337-7220

SEMIKRON INTERNATIONAL INC.

A MAJOR DESIGNER AND MANUFACTURER OF POWER SCRs, DIODES, AND MULTIFUNCTION ASSEMBLIES OF SEMICONDUCTORS

P.O. BOX 59
South Weymouth, MA 02190

CIRCLE NUMBER 53

INTEGRATED CIRCUITS

IC does both f/v & v/f conversions to 100 kHz

Intech/FMI, 282 Brokaw Rd., Santa Clara, CA 95050. (408) 244-0500. From \$6.50 (100-up); stock to 4 wks.

Capable of operating over a near-dc-to-100-kHz range, the A-8402 voltage-to-frequency or frequency-to-voltage converter requires only a 4-to-18-V supply. An analog input voltage of 0 to 10 V can be converted into a pulse train of 100 kHz, maximum. Key specifications include a $\pm 0.05\%$ maximum nonlinearity at 10 kHz, a ± 200 ppm maximum tempco on gain, and a digital output compatible with DTL, TTL, and CMOS. The A-8402 operates over 0 to 70 C and an extended temperature range version (A-8402 ET1) is available for -25 to $+100$ C operation. The v/f/v converter is housed in a 14-pin ceramic DIP.

CIRCLE NO. 306

Monolithic tachometers switch at desired speed

National Semiconductor, 2900 Semiconductor Dr., Santa Clara, CA 95051. (408) 737-5000. \$1.65 (100-up); stock.

By combining a frequency-to-voltage converter, a high-gain op amp and a comparator on a single chip, National Semiconductor has developed the LM2907 and 2917 monolithic tachometer speed switches. When the circuits are used with a floating transistor as an output, either a supply-referred load of 50 mA or a swing-to-ground for zero frequency can be handled. Both circuits are specifically designed to operate relays, lamps, and other components when the input frequency reaches or exceeds a selected rate. The main difference between the two devices is that the LM2917 includes an active shunt regulator to clamp the supply. The regulator is not included in the LM2907. The tachometer circuits are also available as 8-pin models (2908 and 2918). Models 2907 and 2917 have 14 pins. All units operate from 12 V and have a maximum frequency input of 10 kHz. Nonlinearity for a 10-kHz input is 1% maximum.

CIRCLE NO. 307

FIFO memories operate at rates to 20 MHz

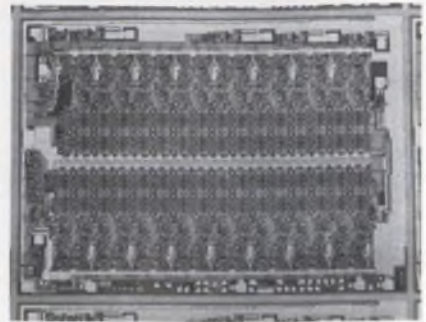

Monolithic Memories, 1165 E. Arques Ave., Sunnyvale, CA 94086. John Kosek (408) 739-3535. \$28 (100-up); stock.

A first-in, first-out memory, the 67401, is organized 4-bits wide and 64 words long. It is pin compatible with the Fairchild MOS 3341 FIFO, but at its typical speed of 20 MHz is about 20 times faster. The 67401 is suitable for synchronous or asynchronous operation, uses a standard 5-V power supply and is TTL compatible on all inputs and outputs. The memory is available in a standard, 16-pin, side-brazed package.

CIRCLE NO. 415

Multidecade latched counter handles 8 digits

LSI Computer Systems, 1235 Walt Whitman Rd., Melville, NY 11746. Alvin Kaplan (516) 293-3850. \$8.15 (100-up); stock to 6 wks.

A six-decade, dc-to-5-MHz up-counter, the LS7031, has a built-in 8-digit multiplexer. All counter outputs are latched and data are available in multiplexed BCD format. Two additional on-chip quad latches, in the two LSD positions, allow the latching of BCD data from off-chip prescalers, thus permitting a count rate well above 5 MHz. Digit strobes are guardbanded so they occur totally within valid BCD data. The multiplex scan counter is driven by an external clock or an on-chip oscillator whose frequency is determined by an external capacitor. Maximum multiplex frequency is 500 kHz. The MSB of decades 6, 7 and 8 are available for overflow and carry functions. The circuit operates from a single power supply, between $+5$ and $+15$ V dc and comes in a 40-pin DIP.

CIRCLE NO. 416

High voltage display drivers handle 200 V

Dionics, 65 Rushmore St., Westbury, NY 11590. (516) 997-7474. From \$2.06 (1000-up); stock.

The DI-300 and DI-500 families of monolithic high voltage display drivers offer programmable constant-current outputs. For example, the DI-302 level-shifted segment driver is a pin-for-pin replacement for the Sprague UDN-7183A, 7184A and 7186A but it also offers a programmable constant-current output of 0.1 to 2.5 mA. The DI-300 has the same programmable constant-current output. Both are housed in 18-pin DIPs and are designed for eight-channel displays. The level shifter portion of the DI-300 circuit has an operating voltage capability of 200 V; the DI-302 is rated for 125 V. The DI-500/505/510 series of level-shifted digit drivers feature full 200-V level shift capability. The DI-502/507/512 drivers have a 125 V capability. These devices are direct pin-for-pin replacements for the Sprague UDN6144A, 6164A and 6184A circuits, respectively. They also functionally replace the Signetics 585 Series. All DI-500 family types are available in 4, 6 and 8-line versions.

CIRCLE NO. 308

ICs for remote control provide 31 functions

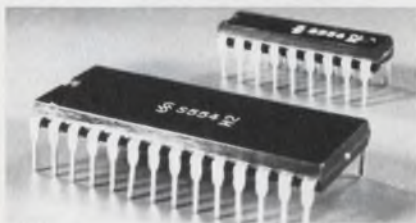

Siemens AG, Zentralstelle für Information, Postfach 3240, D-8520, Erlangen 2, Federal Republic of Germany. Joachim Ullmann.

Two MOS ICs, the S556 and S554, can be used to form an infrared remote control system. The S556, when used with two to four LEDs, functions as the transmitter and the S554, with a photodiode, serves as the receiver. Up to 31 control functions are possible and binary coded outputs can easily be decoded. The 18-pin S556 draws only 10 μ A; the receiver circuit comes in a 28-pin DIP.

CIRCLE NO. 309

A NEW GENERATION OF IMAGE SENSORS

SIMPLICITY OF USE

Requiring less than a dollars worth of circuitry to drive—and barely more than that for video processing—is just one of the key features of our new “G” series image sensors. Compare the non-critical single TTL clock needed for the “G” device to the complex multi-phase clocks prescribed by others.

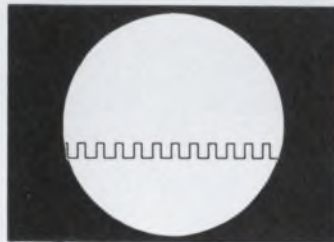

You need only this for Reticon

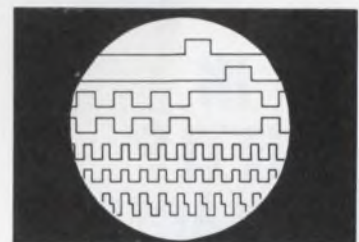

You need all these for others

HALF THE PRICE

Or even less will bring you 256, 512, 768, or 1024 sensor elements on 25 μ centers or up to 1728 elements on 15 μ centers in our “H” series.

SUPERIOR PERFORMANCE

Low dark current allowing low light level operation, on-chip noise cancellation, and smooth spectral response from visible through infrared makes this new generation the unquestionable choice.

APPLICATIONS

Page readers, facsimile, OCR, point of sale readers, non-contact measurements and inspection and many others.

RETICON®

910 Benicia Avenue, Sunnyvale, California 94086
PHONE: (408) 738-4266 TWX: 910-339-9343

CIRCLE NUMBER 54

BIG POWER SUPPLIES



IN LITTLE PACKAGES

**AC-DC and DC-DC
miniaturized power converters
that deliver 3.9 watts
per cubic inch.**

- AC inputs: 115-220 VAC, 47-500 Hz.
- DC inputs: 12, 28, 48, 115 & 150 VDC.
- 1 to 6 isolated and regulated DC outputs from 4.2 to 300 VDC.
- Line and load regulation to 0.1%.
- Up to 800 watts per output.
- Efficiencies to 85%.
- Design-As-You-Order construction from standard sub-modules . . . over 1200 possible configurations.
- Completed converters provided in tested and encapsulated, conduction cooled packages in just days.

See for yourself how we've packed the power and performance in . . . request our actual size "little black box" punch out kit and catalog today!

Call us collect . . . ask for Jim Dunn.



**ARNOLD MAGNETICS
CORPORATION**

11520 W. Jefferson Blvd.
Culver City, Ca. 90230 ● (213) 870-7014

CIRCLE NUMBER 55

INSTRUMENTATION

Data logger changes role with drop-in card modules



*Digitec/United Systems Corp., 918
Woodley Rd., Dayton, OH 45403.
(513) 254-6251. See text.*

It's rare today to get more for less, but that's what the Digitec Datalogger 1000 gives you—more data logging capability for about 10% less dollars than its closest competitor, the Doric Scientific 200.

At \$1995, the 1000 comes with 10 channels, field-interchangeable modules for multiparameter measurements (one at a time), an internal crystal clock that reads out real or elapsed time and a 20,000-count (4-1/2 digits) display. These features are just a sprinkling of what the 1000 offers.

By contrast, the 12-channel Doric 200 sells for \$2290 with an optional clock, and displays just 3-1/2 digits. The 200 also appears to be less accurate than the Digitec unit.

The signal-conditioning modules

(PC boards) of the 1000 aren't found on other units. The Digitec approach lets you go from dc to ac voltage, to true-rms, to dc auto-ranging or to temperature measurements (RTD, thermistor or thermocouple) at will. Extra modules range from \$130 to \$275 (temperature modules cost \$175).

If you need more channels, the Digitec lets you expand up to 100; the Doric to only 24. Program time intervals are switch selectable on the 1000. Nine intervals are available, ranging from 1 min to 5 h, and you can choose from manual, continuous and automatic-cycle modes.

Single-point, repeat printing is also standard in the Digitec unit. This feature selects a data point of interest, continuously interrogates that point and displays and records—at a selected interval—all pertinent information. The displays of time, channel number and measured data are simultaneous—not time-shared as in other units.

Resolution of the 1000 is 1 μ V dc, 10 μ V ac and 0.01° for temperature. Systems dc accuracy—at 23 C and < 85% relative humidity—is $\pm 0.01\%$ of reading $\pm 0.005\%$ of full scale on the higher ranges; it gets slightly worse on the more sensitive scales.

With autoranging, another feature not found on the Doric unit, the 1000's accuracy again suffers slightly. Note that "systems" accuracy doesn't include items like thermal EMF or offset voltages contributed by scanning cards. Accuracy of the Doric 200 is listed as $\pm 0.1\%$ of full scale $\pm 5 \mu$ V, with an additional tempo of $\pm 0.0025\%$ of reading/°C.

The Digitec's 60-Hz CMR isn't very high—only 80 dB versus the Doric's 59-Hz spec of 120 dB. However, Digitec specs CMR at 1000- Ω imbalance, the most accepted way, while Doric uses a 100- Ω value.

Optional features—alarms, BCD

(continued on page 106)

Ise introduces five new ways to make the competition turn green.

Your competition probably already thinks they're using the perfect display in whatever it is they make. Let them keep thinking it. While you prove them wrong with a new Itron display. They're designed to make the competition turn green. Which also happens to be the color of the segments.

All 17 of them on the 17-digit Itron. All 5 on the FG-512A1. Next comes an Alfa-Numerical Itron. A Linear-Analog Itron. And a Digital Clock Itron. Five ways to be heartless if you put a little heart into it.

itron[®]

Alfa-Numerical Display



FG209M2

ef = 10V
ec = eb = 40Vp-p
ic = 10mA-p
ib = 8mA-p
Wd. 205mm
Lg. 40mm
Segment 9mm

Instruments & Large Calculator Display



FG179F2

ef = 7V
ec = eb = 35Vp-p
ic = 7mA-p
ib = 5.5mA-p
Wd. 170mm
Lg. 40mm
Segment 9.5mm

Instruments & Terminal Units Display

FG512A1
ef = 3.5V
ec = eb = 24Vp-p
ic = 4mA-p
ib = 3mA-p
Wd. 100mm
Lg. 40mm
Segment 12mm



Digital Clock Display



FG425A1

ef = 5.5V
ec = eb = 35Vp-p
ic = 8mA-p
ib = 6.5mA-p
Wd. 140mm
Lg. 59mm
Segment 25mm

Linear Analog Display



FG120S1

ef = 5.5V
ec = eb = 35Vp-p
ic = 4mA-p
ib = 0.2mA-p
Wd. 140mm
Lg. 40mm
Segment 8mm

NORITAKE CO., LTD.

Electronics Office (U.S.A.)
22410 Hawthorne Blvd. Torrance California 90505.
U.S.A.
Phone: (213) 373-6704.
Telex: "230674910"

Electronics Division
1-1. Noritake-Shinmachi, Nishi-ku, Nagoya-City,
Japan.
Phone: NAGOYA (052) 561-7111.
Telex: J59738 NORITAKE

ISE ELECTRONICS CORP.

London Office
c/o NORITAKE (U.K.) LTD
Noritake House 2, York Street W1H 1 Be, England
Phone: (01) 935 7543 Cable: "LUCTUAL" LONDON
Munich Office
c/o NEUMULLER GmbH 8 Muenchen 2, Karlstrasse 55
West Germany. Phone 592 421 Telex 522106

Hong Kong Office
Room 1403 Shing Loon Bldg
24-26 Stanley Street, Hong Kong
Phone: 5 232420 Telex: HX8315
Taipei Office
72-9 SEC 2, JEN AI RD, Taipei
Phone: 351-0293 Telex: 11176

CIRCLE NUMBER 56

NEW! Systems Integration through Switching!

How do you reconfigure four data acquisition channels and 500-600 transducer leads from each of eight test stations — frequently, reliably, quickly, without distorting low level analog signals? Easy. Integrate your system with a matrix switch using 60-circuit T-Bar "Pluggables" that mate directly with wrappable connectors.

T-Bar makes high density multi-pole switches and relays — designs and fabricates special switching systems — reliably and economically. That's all we do. And we've been doing it for 15 years. If you switch a lot of lines — all at once or a few at a time — write or phone today for T-Bar's new Series 6900 Pluggable Switching Catalog.

T-Bar INCORPORATED
SWITCHING COMPONENTS DIV.
141 Danbury Road Wilton, CT 06897
Phone: 203/762-8351

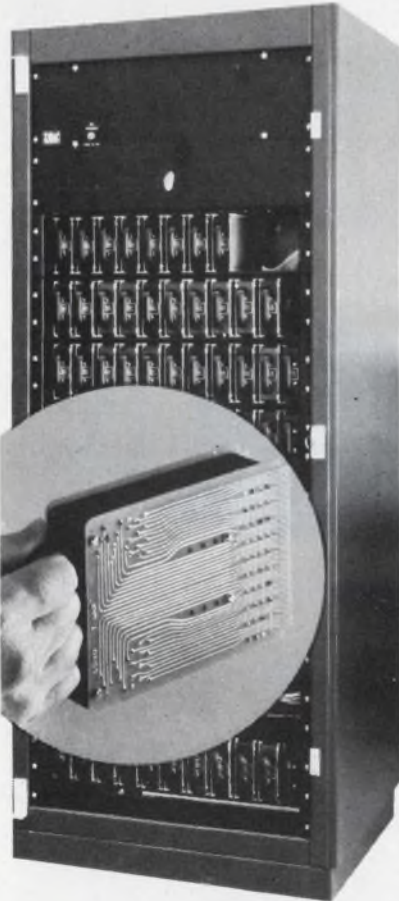

See us at the EDN Caravan in your area.

CIRCLE NUMBER 57

INSTRUMENTATION

(continued from page 104)

outputs and more—further expand the 1000's capabilities. For its performance, the 1000 is surprisingly compact. The unit measures 8-1/2 × 11 × 14 in., and weighs but 22-1/2 lb. Delivery takes two weeks, starting Feb. 15.

For Digitec
For Doric

CIRCLE NO. 301

CIRCLE NO. 302

Unit scales or corrects errors in count source



Durant, 901 S. 12th St., Watertown, WI 53074. (414) 261-4070. From \$400; stock-8 wks.

Series 1100 scaler/error corrector alters a count received from a signal source (transducer) and compensates for error factors in the measuring system. The 1100 provides a metric output even though the input supplies American units. Series 1100 is not a counter itself, but is used to interface between the count source and a counter to scale pulses into usable engineering units, such as inches, feet or meters. Standard units have count speed to 6 kHz, five digits of preset for correction setting and are available in desk or panel mounting.

CIRCLE NO. 310

Filler

We hear from Bob Pease of National Semiconductor that a National spy has just returned from Signetics with one of its secret processes. He says that, by making a NOR gate with Insulated Gate transistors, you get an IG-NORE gate which, of course, is the key to the Signetics Write-Only Memory.

Now that we have the secret, Pease confides, we can second-source the WOM and make more than twice the profits that Signetics did.

Miniature DMM reads true rms

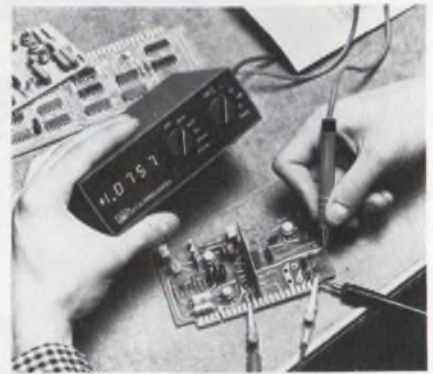

Data Precision, Audubon Rd., Wakefield, MA 01880. (617) 246-1600. \$345.

Model 248 provides true-rms measurement of ac volts and current. Measuring only 1-3/4 × 5-1/2 × 3-1/2-in. deep, the unit offers 4-1/2-digit resolution on all parameters, and it features 10-μV sensitivity dc and ac. Basic one-year accuracy is ±0.05% of input. Maximum crest factor is 5 at full scale ac voltage and current range input, and 2-1/2 at the 100% over-range level. The rms-to-dc conversion is accomplished with a calculating converter LSI module.

CIRCLE NO. 417

Unit analyzes for electrical safety



Bio-Tek Instruments, 500 Shelburne Rd., Shelburne, VT 05482. (802) 985-8014. \$497; 4-8 wks.

Model 250MA electrical safety analyzer performs all safety tests as described in the National Electrical Code, the NFPA 76BT and in AAMI Safe Current Limits. With simple pushbutton control, you can perform leakage-current testing, potential-difference testing, voltage measurement, ground-wire resistance measurement and power conduct-to-chassis resistance. Model 250MA also measures current consumption at the push of a button.

CIRCLE NO. 418

Two models join generator line

Marconi, 100 Stonehurst Ct., Northvale, NJ 07647. (201) 767-7250. 2015/1, \$2250; 2015/2, \$2250; 60-90 days.

Two new AM/FM signal generators, based on the Model 2015, cover 10 to 520 MHz to meet the specialized modulation requirements of telemetry systems and narrowband mobile radios. Model 2015/1 is particularly suitable for use in the production and servicing of narrowband transceivers. It has full-scale deviation ranges of 2.5, 5 and 25 kHz. Model 2015/2 is a wide deviation version suitable for tests on wideband telemetry receivers. It features full-scale deviation ranges of 20, 100, and 500 kHz.

CIRCLE NO. 320

Graphics package tells user what to do



Julie Research Laboratories, 211 W. 61 St., New York, NY 10023. (212) 245-2727. \$10,000.

Computer graphics has been added to the company's LOCOST automated test systems. The graphics software uses pictures and alphanumeric display to direct the interconnection of cables and equipment; identify and direct the adjustment of internal controls; identify and direct the use of each panel control; describe in English any necessary keyboard action; and explain when and how to make any pertinent observations. The system uses alphanumeric and line art—including simplified three-dimensional drawings and flashing graphics elements—to show the operator what to do next.

CIRCLE NO. 321

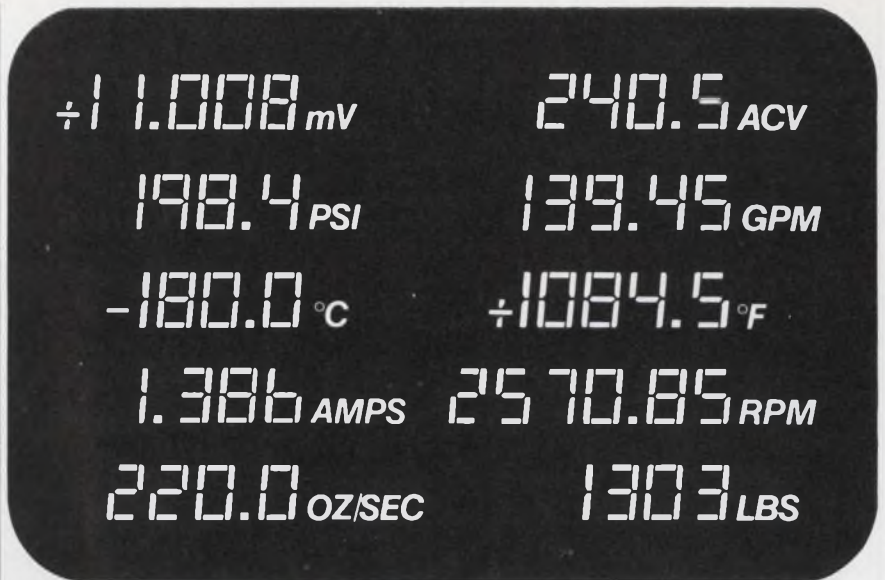

United Systems' Indicators Will:

- MEASURE voltage and current; ac, true rms or dc.
- CONVERT the output of any transducer/transmitter to display in engineering units.
- DISPLAY temperature (C or F) directly from thermocouple, RTD, or thermistor sensors.
- INTERFACE readily into your system by optional "single line enable" parallel BCD output.
- INDICATE when a predetermined limit is exceeded, through relay closure or logic level output from optional internal comparator alarm.

And with United Systems' exclusive adaptors these indicators change, in the field, to perform any measurement listed above and more!

For additional information contact your United Systems Representative or call the factory (513) 254-6251.

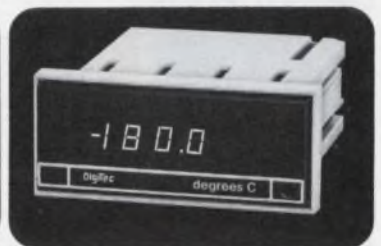

DigiTec.

UNITED SYSTEMS CORPORATION

918 Woodley Road, Dayton, Ohio 45403
(513) 254-6251 TWX (810) 459-1728

United Systems Corp: Precision measurements to count on

FOR INFORMATION ONLY CIRCLE #168

FOR DEMONSTRATION ONLY CIRCLE #210

let's calibrate



Model 82

PRECISION STANDARD for AC/DC Voltage and Current

- Tests a wide range of analog and digital meters
- AC and Bipolar DC voltage ranges of 100mV, 1V and 10V
- AC and Bipolar DC current ranges of 100uA, 1mA, 10mA and 100mA
- Nominal accuracies of 0.01% DC and 0.05% AC
- Percent error deviation dial
- Frequency variable from 40Hz to 1kHz
- Four fractional scale division ranges



Model 829G

Measure or supply with one instrument

- AC or DC voltages from 10 mV to 1400V
- Current from 10 uA to 14A
- 10 cardinal resistance values from 0.01 ohm to 10 megohms
- 5-digit readout



COMPLETE VOLTAGE, CURRENT & WATTMETER CALIBRATOR

- For calibration of wattmeters from 0.05 watt to 14 kilowatts
- Consists of two Model 829G's and a Model 5058A Wattmeter Calibration Module
- Available as individual units or, as shown, in an attractive customized enclosure with work table.



Call or write for full information
RFL Industries, Inc.
Instrumentation Division
Boonton, N.J. 07005

EST 1922
Tel: (201) 334-3100 / TWX: 710-987-8352
Cable: RADAIRCO, N.J.

CIRCLE NUMBER 59

MICROWAVES & LASERS

Laser beam modulated by acoustic signal

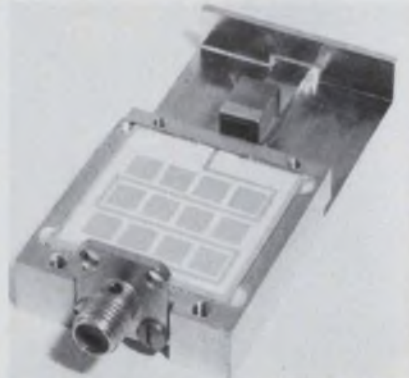

Thomson-CSF Electron Tubes, 750 Bloomfield Ave., Clifton, NJ 07015. (201) 779-1004. \$4325; 20 wks.

What your microfiche or optical memory system needs is an opto-acoustic deflector and modulator. These devices use the optical interference between an acoustic wave and a laser beam on a lead-molybdate substrate. The result is a frequency-modulated light beam, which is also deflected in proportion to the acoustic frequency. Modulation efficiency up to 90% in the 150-to-300-MHz band has been attained.

CIRCLE NO. 322

Divide your power and conquer



Sage Laboratories, 3 Huron Dr., Natick, MA 01760. (617) 653-0844. \$225; 45 days.

If your problem is to divide 3.7- to 4.2-GHz power eight ways, you can conquer with the Model FP-2036. It features isolation of 25 dB min (30 dB typ), insertion loss of 0.6 dB max (0.4 dB typ) and unbalance of 0.25 dB max. The unit can handle 1 W, and is equipped with type N female receptacles.

CIRCLE NO. 323



The Accuracy Policy of Electronic Design Is:

- To make diligent efforts to ensure the accuracy of editorial matter.
- To publish prompt corrections whenever inaccuracies are brought to our attention. Corrections appear in "Across the Desk."
- To encourage our readers as responsible members of our business community to report to us misleading or fraudulent advertising.
- To refuse any advertisement deemed to be misleading or fraudulent.

This statement of accuracy appears in every issue of *Electronic Design*. Staff members are imbued with it, from their very first day.

Electronic Design

50 Essex Street
Rochelle Park, New Jersey 07662
(201) 843-0550

CIRCLE NUMBER 60

ELECTRONIC DESIGN 2, January 18, 1977

Track with a Staloc! A what?

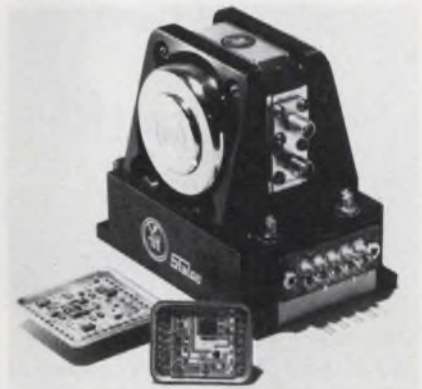

Yig-Tek Corp., 1725 De La Cruz Blvd., Santa Clara, CA 95050. (408) 244-3240. From \$2400; 120 days.

A self-tracking automatic lock-on circuit, that's what. The Model L183 automatically centers any YIG bandpass or band-reject filter at the desired frequency differential from a cw reference, over the 2-to-18-GHz range. The new technique is similar to a phase-lock loop, and can be used for preselectors or remote tuning up to decade ranges. YIG driver and loop circuits are included. Drivers are also available separately for \$400, 60 day delivery.

CIRCLE NO. 324

HeCd laser radiates deep blue yonder

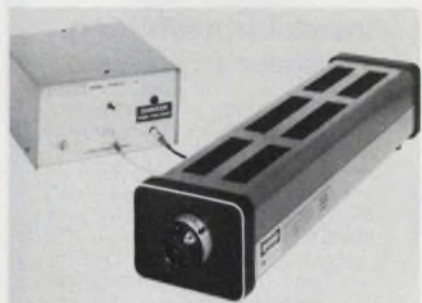

Liconix, 1400 Stierlin Rd., Mountain View, CA 94043. (415) 964-3062. \$3000; 30 days.

The deep blue, 442-nm, light of the Model 4110 HeCd laser is ideally matched to silver-halide films and photoconducting materials. This lower-priced version of the 4100 lacks feedback control, but has extended tube life and very good environmental stability. A number of options are available. Inquire for volume discounts.

CIRCLE NO. 325

CLAIREX OPTO-ISOLATORS 5 darlington, 10 transistor, 4 with a-c input

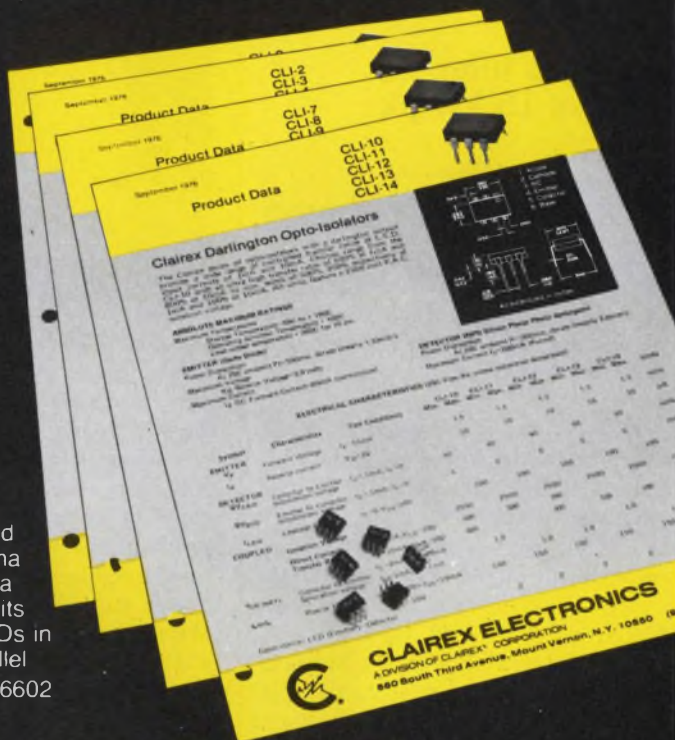

- For logic functions
 - 2500V PAC isolation
 - Characterized CTRs @ 1 ma and/or 10 ma
 - A-C input units utilize 2 IREDs in inverse parallel
- Call (914) 664-6602

CLAIREX ELECTRONICS

A Division of Clairex Corporation

CIRCLE NUMBER 61

Hot Semis? Get relief fast!



IERC



Heat Sinks

INTERNATIONAL ELECTRONIC RESEARCH CORPORATION / A SUBSIDIARY OF DYNAMICS CORPORATION OF AMERICA / 135 WEST MAGNOLIA AVENUE, BURBANK, CALIFORNIA 91502

CIRCLE NUMBER 62

Low-pass filter handles 15 kW pk



Sage Laboratories, Inc., 3 Huron Dr., Natick, MA 01760. Tony Cieri (617) 653-0844. \$800; 30 to 60 days.

Can you use a low-pass rf filter with 50-dB min rejection from 1.28 to 11.0 GHz? The Model FF1922 measures 7/8 x 14-1/2 in., including HN connectors. It handles power levels of 15 kW pk, 500 W av in the transmission bands of 1026.5 to 1033.5 and 1085 to 1095 MHz. Passband VSWR is 1.25 max. Maximum insertion loss is 0.5 dB in the lower and 1 dB in the higher channel.

CIRCLE NO. 326

Telemetry preamp for L-band sports 2.5-dB NF

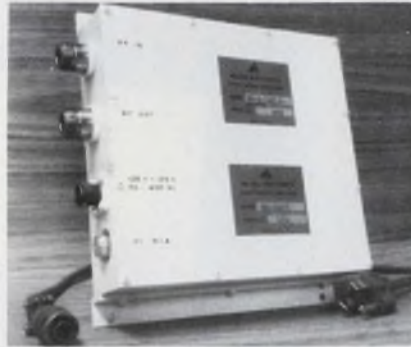

Mu-Del Electronics, 2426 Linden Lane, Silver Spring, MD 20910. Irv Kuzminsky (301) 587-6087. \$1095; 60 days.

Packaged for an outdoor environment, the Model MDA-1415E consists of a low-noise solid-state preamplifier with a low-loss comb-line preselector bandpass, and a power supply. In the 1435-to-1540-MHz range it provides 29-dB gain with a 2.5-dB noise figure. Output is 10 dBm, and the unit measures 7 x 7 x 2 in. Higher gain and other frequencies are available.

CIRCLE NO. 327

L-band Xistor amplifier gives 45 W swimmingly

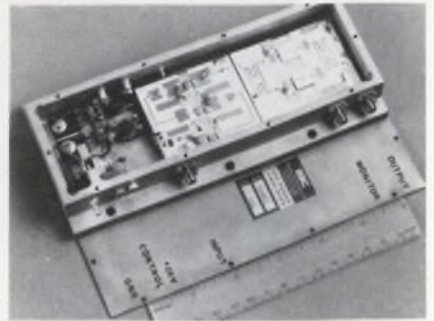

Microwave Semiconductor Corp., 100 School House Rd., Somerset, NJ 08873. Richard B. Moffet (201) 469-3311. See text; 90 days.

For your seaworthy houseboat, the Model MSC91045 amplifier can provide communications via the Marisat system. With 45-W min (cw) from 1.62 to 1.66 GHz, the AM/PM conversion is still under 8°/dB. Small signal gain is 25 dB and over-all efficiency is 35%. The 7.5 x 3.4 x 1-in. unit is designed for marine environments. Price depends on a number of design alternatives.

CIRCLE NO. 328

HIGH ANALOG TECHNOLOGY #1

OUR ANALOG PRODUCTS DELIVER HIGH VOLTAGE.

Ideal for all markets—games, automotive, medical, appliances, audio. Our digit drivers, NE584 & 585, MOS and TTL compatible. Plus our power amplifier, NE541.

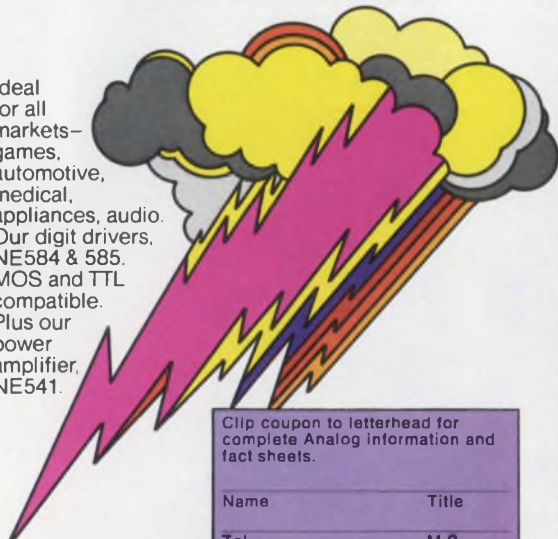

Clip coupon to letterhead for complete Analog information and fact sheets.

Name	Title
Tel.	M.S.
811 E. ARQUES, SUNNYVALE, CA 94086	

THINK signetics

a subsidiary of U.S. Philips Corporation

©1976.

CIRCLE NUMBER 63

OEM DESIGNERS Get this FREE Design File
on our new modular switching power supplies



These compact, modular power supply switchers simplify design in 300-600 watt applications and keep costs down too. (They're priced at less than 90¢ per watt!) Benefits to the end user include **low EMI noise levels** (we are designed to meet VDE STD 0875) and **highly reliable operation** plus convenient maintenance and easy add-on capability up to 1200 watts in a single, 19 in. rack. Get specs, prices and feature details today from:

Jim Daly
phone (612) 830-5800
TWX 910 576 2978
or write: 7801
Computer Ave. So.
Minneapolis, MN 55435.

GD CONTROL DATA CORPORATION

CIRCLE NUMBER 64

ELECTRONIC DESIGN 2, January 18, 1977

Flat broadband coupler is small and rugged



Narda Microwave Corp., Plainview, NY 11803. (516) 433-9000. \$175; stock.

Available in 6 and 10 dB values, the Model 4246 covers 6.5-18 GHz with ± 0.3 dB flatness. It uses the patented Narda Multi-Section coupling structure and handles power levels of 50 W cw, 3 kW peak. Operation to 105 C and storage to 125 C without degradation are guaranteed. The precision SMA female connectors mate in compliance with MIL-C-39012.

CIRCLE NO. 329

X-band FET amplifier plugs into 110 V ac

Aercom Industries, 1050F E. Duane Ave., Sunnyvale, CA 94086. Dick Hassett (408) 736-7600. \$3650 (1 to 4); 45 days.

The Model AT-12001-P offers small-signal gain of 30-dB min from 8 to 12.4 GHz with a noise figure of 7.5-dB max. The $2.65 \times 6.1 \times 2$ in. FET amplifier gives +7-dBm min output, and plugs into 110 V ac, 50 to 400 Hz.

CIRCLE NO. 330

Lightweight dummy load is leakproof

Coaxial Dynamics, Inc., 12110 Enterprise Ave., Cleveland, OH 44135. (216) 671-3550. \$148; stock.

The Model 4260 dry coaxial load handles 200 W with less than VSWR typ., from dc through 512 MHz. Peak power capability of 1000 W, no need for cooling fluid and a weight of 6 lb make the unit especially suitable for field use.

CIRCLE NO. 331

Gunn source aims at klystron oscillators



PRD Electronics, 6801 Jericho Tpke., Syosset, NY 11791. Wally Weissman (516) 364-0400. See text; 90 days.

The Model 917 Gunn oscillator provides 50 mW min of rf power, and is mechanically tunable over the industrial/medical 10.5 ± 0.2 GHz band. Together with the Model-821 power-supply modulator, the oscillator serves as a general-purpose signal source, and can be substituted for klystron oscillators. The Model 821 provides 9 to 10 V dc at 900 mA, and an adjustable square-wave signal of 1000 ± 100 Hz. The oscillator costs \$350; the power supply, \$325.

CIRCLE NO. 332

ALCOSWITCH®

Offers your best choice in compact 7/8" diameter Oil-Tight Controls including; Pushbuttons, Turn to Lock or Unlock, Wobble, Rotary Lever, Keylock, Joy Stick, etc. Easy Snap-In contact blocks with choice of options provide a 10A - 300 VAC rating. Also in 600 VAC types, too. Meets requirement per NEMA, U.L., etc. Call or write for full particulars.

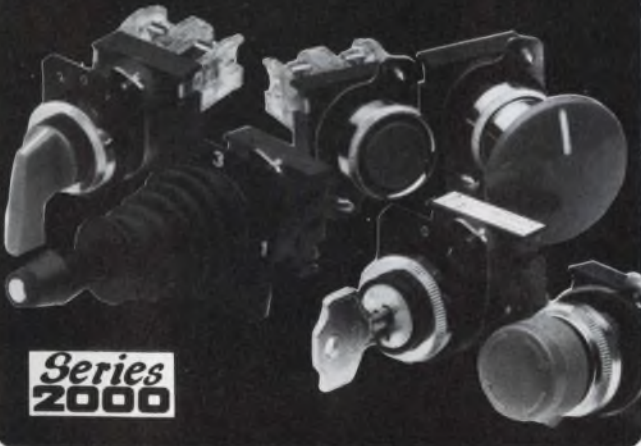

Series 2000

Call (617) 685-4371

ALCO ELECTRONIC PRODUCTS, INC.
1561 OSFOOD STREET, NORTH ANDOVER, MA 01845 U.S.A.

TEL: (617) 685-4371 TWX: 710 342-0552

A SUBSIDIARY OF **AUGAT** INC.

CIRCLE NUMBER 65

ELECTRONIC DESIGN 2, January 18, 1977

HIGH ANALOG TECHNOLOGY #2

OUR ANALOG PRODUCTS ARE LEADERS IN HIGH SPEED.

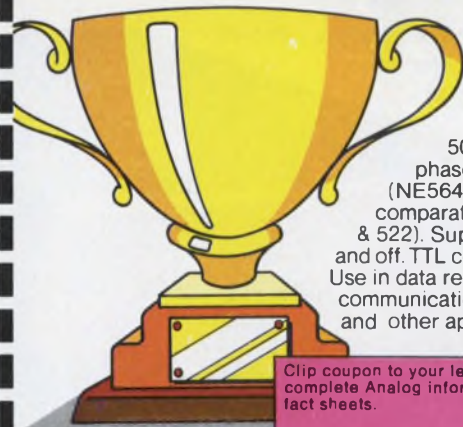

The first 50 MHz digital phase locked loop (NE564) and dual comparators (NE521 & 522). Super fast on and off. TTL compatible. Use in data recording communications and other applications.

Clip coupon to your letterhead for complete Analog information and fact sheets.

Name _____ Title _____
Tel. _____ M.S. _____
811 E. ARQUES, SUNNYVALE, CA. 94086

THINK **Signetics**

a subsidiary of U.S. Philips Corporation

© 1976.

CIRCLE NUMBER 66

111

Buy One. Get Five Free.

New for 8080 users.

Buy a μ Pro-80 and you get-

- 8080 microcomputer
- High level language
- Software development system
- In-circuit emulator
- Field test system.

All five in one modular, portable package!

What a value. The μ Pro-80 Control/Display Module provides all the functions found in a minicomputer front panel—and more. Like breakpoint and program trace functions. And a push button keyboard and hexadecimal displays so you can examine or modify memory and CPU down to the status bit and register level. This tiny module also eliminates bulky terminals in test and field service environments.

Want more value? Add up your software development costs and see how much you can save with our BSAL-80 programming language. Developed especially for the 8080, this unique language can save programming hours because it uses a non-mnemonic syntax that reads the way programmers and engineers think. Also relocatability, parametric macros and automatic memory allocation save coding time. And assembly language efficiency minimizes execution time and program memory size.

You don't have to buy a μ Pro-80 to get a free brochure. Why not send for one today?

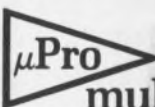

muPro Inc.

10340 Bubb Road ■ Cupertino, California 95014 ■ (408) 996-1137

CIRCLE NUMBER 67

POWER SOURCES

Broad inverter line has been improved

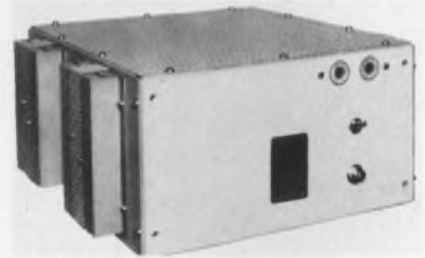

Nova Electric, 263 Hillside Ave., Nutley, NJ 07110. Ken Niovitch, (201) 661-3434. From \$375; stock.

The full line of more than 150 Nova inverters boasts three improved key specifications. Frequency regulation, from no-load to full-load is upgraded from 0.25 to 0.15%; voltage regulation, which was $\pm 2\%$ is now $\pm 1\%$; and distortion has dropped from 6 to 5%. The line of inverters provides outputs of 115, 220 or 240 V ac, at 50, 60 or 400 Hz.

CIRCLE NO. 333

Bipolar dc supply tracks over 12-15 V

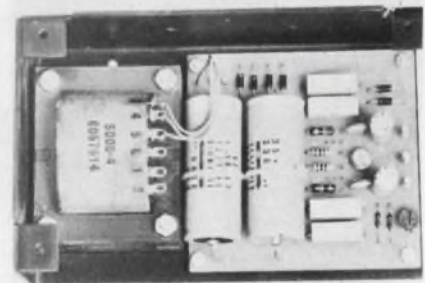

Century Electronics, 2688 S. La Cienega Blvd., Los Angeles, CA 90034. (213) 870-1083. From \$32.95 (100 units).

Bipolar dc supplies of the LBA series provide automatic tracking with balance errors as low as 1%. Of the over 200 standard models, the 15 LBA-1 is shown. It has 2% max tracking error, and is adjustable from ± 12 to ± 15 V with a single control. A model with less than 1% tracking error (15LBA-1A) is also available. The tracking supplies are rated for 1-A load current to 50-C ambient without derating. Other specs include 105 to 125 V, 47-to-63-Hz input, $\pm 0.05\%$ line/load regulation, 0.5-mV rms typical output ripple, and a temperature coefficient of $\pm 0.02\%/^{\circ}\text{C}$.

CIRCLE NO. 334

Convection cooled UPS is quiet



Clary Corp., 320 W. Clary Ave., San Gabriel, CA 91776. (213) 287-6111. From \$1650.

The Mini-UPS uninterruptible power system features a solid-state, convection-cooled design that cuts size and weight and eliminates audible noise generated by fans and blowers. The system is immune to input voltage variations of $\pm 15\%$. Standard models have single-phase outputs and are available in 625-VA, 1.25, 2.5 and 5-kVA ratings. The unit mounts in a standard 19 in. rack or can be supplied in a stand-alone cabinet. A static-bypass switch and battery packs are available as options.

CIRCLE NO. 335

Strappable switcher spans wide outputs



Trio Laboratories, 80 Dupont St., Plainview, NY 11803. (516) 681-0400. From \$355; stock.

The 672 features a strappable input of 115 or 208-V nominal at 45 to 400 Hz and delivers 2 to 48 V dc. In this single-output 175-W switching-supply efficiency runs as high as 80% and the MTBF exceeds 40,000 h with only self-cooling. Overvoltage and overload protection are standard features along with remote sensing and adjustable output voltage.

CIRCLE NO. 336

Sub-C cell capacity has been increased

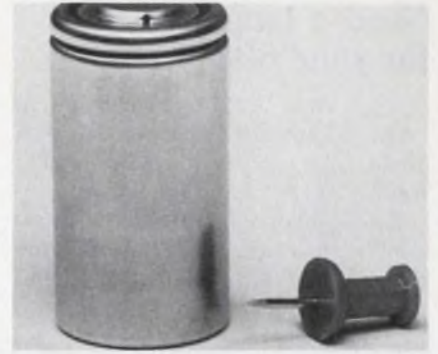

General Electric, P.O. Box 861, Gainesville, FL 32602. T. Traeger (904) 462-4746. See text; stock to 8 wks.

The Super sub-C, rechargeable cell delivers 1.4 A-h at 1.25 V. This addition to the company's 1.2 and 1.0-A-h line of sub-C, wound NiCd cells is priced at \$1.47 per cell (10,000 qty). The 1.2 and 1.0 A-h units are priced at \$1.25 and \$1.15 for like quantities. The 1.62-in. high sub-C's have 0.875-in. diameters.

CIRCLE NO. 337

Introducing the efficient little 82900 stepper motor

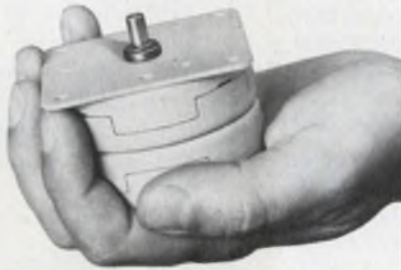

It gives you an edge on compactness, torque and price.

It's new. It's bidirectional. It has a 7.5° step angle. It gives you maximum pull-in/pull-out torque of 23 oz-in @ 200 pps. It's rated at 12.38w @ 5vdc and runs at lower than average temperatures.

The 82900 has a lot to offer, particularly in impact and non-impact printers, small X-Y plotters and computer peripherals. It's powerful, compact and moderately priced. And it's reliable. So reliable — in fact — that it can also be used to control pumps and valves in medical instruments and similar devices. In many applications it can replace larger, bulkier steppers at much lower cost.

Standard construction provides 2-phase operation (requiring simplified, low-cost circuitry), a 7.5° step angle and roller bearings. However, 4-phase operation, a 15° step angle or sleeve bearings can be furnished as options.

Write for information today!

A. W. HAYDON CO. PRODUCTS

NORTH AMERICAN PHILIPS CONTROLS CORP.

For Immediate Need Cheshire, Conn. 06410 • (203) 272-0301 For Information Only Circle #207

CIRCLE NUMBER 68

ELECTRONIC DESIGN 2, January 18, 1977

HIGH ANALOG TECHNOLOGY #3 OUR ANALOG PRODUCTS ARE HIGH ON CURRENT.



First, our NE544 servo-amplifier fills consumer and industrial servo needs. All functions integrated into one.

Our new addition to the standard 7800 voltage regulator line, the new 78HV high voltage regulator offers high breakdown voltage for better reliability.

Clip coupon to letterhead for complete Analog information and fact sheets.

Name _____ Title _____
Tel. _____ M.S. _____
811 E. ARQUES, SUNNYVALE, CA. 94086

THINK
Signetics

a subsidiary of U.S. Philips Corporation

© 1976.

CIRCLE NUMBER 69

DATA PROCESSING

Need a language tutor for your 8080 μ P?

muPro Inc., 424 Oakmead Parkway, Sunnyvale, CA 94086. Jim Moon (408) 737-0500. From \$975; stock.

BSAL-80, a block-structured assembly language program for the 8080 family of μ Ps, is an assem-

bler with a relocating or linking loader. It permits the user to write programs in high-level language syntax while retaining the flexibility and execution speed of assembly code. BSAL 80 comes in 8080-resident or standard Fortran-4 cross-assembler versions. Text manipulation is facilitated by an optional editor with automatic line numbering and a special command set (\$275).

CIRCLE NO. 338

Floppy-disc-storage drive has rugged parts

Industrial Micro Systems, 633 W. Katella Ave., Orange, CA 92667. (714) 633-0355. \$2350 (1-24).

A floppy-disc-storage drive, the Model 61-0010, has a die-cast cartridge guide and base plate. The drive comes in a fully enclosed, portable or rack-mounted case. The unit stores 3.2 megabits per disc. The controller supports up to three drives. Communication goes through a three-wire, full duplex, 9600-baud communication interface. The signal levels are RS-232 or 20-mA current-loop levels. Power requirements are 115 V \pm 10% at 1.5 A.

CIRCLE NO. 339

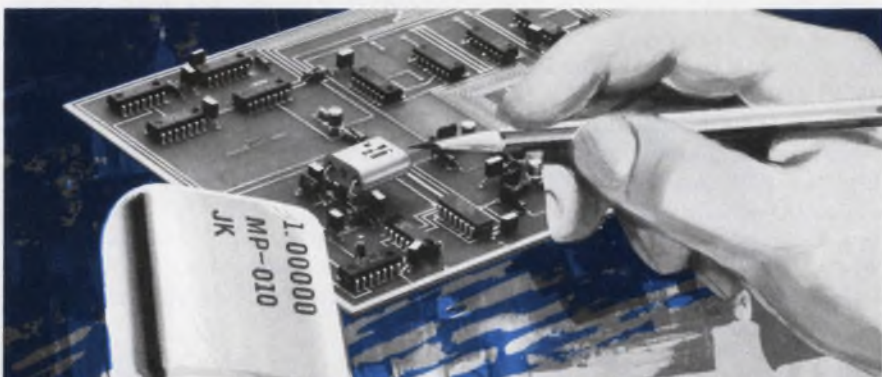

CTS matches crystal specs to your microprocessor.

And no waiting. CTS Industrial Distributors supply a perfectly matched crystal at the same time you buy the microprocessor, because CTS carefully checks the crystal requirements with each semiconductor manufacturer before writing crystal specs.

CTS now has a full line of standard crystals for microprocessors and clock IC's. CTS Knights crystals feature low start-up resistance, reliable CTS mil-approved manufacturing processes and gold frequency calibration for long term stability. Available in 17 standard frequencies, 1.0 to 22.1184 MHz. Other frequencies available on special order.

CTS Knights crystals are available **off the shelf** at these typical 100-piece prices: from \$5.50 each (1.0 MHz) to \$2.75 each (18.432 MHz).

See your nearest CTS distributor for full information, or write **CTS Knights, Inc.**, 400 Reimann Ave., Sandwich, IL 60548, phone: (815) 786-8411.

CTS Knights.
The frequency specialists.

CTS CORPORATION
Elkhart, Indiana



CIRCLE NUMBER 70

Spectrum analyzer system comes with mini

EMR Telemetry Div., Sangamo-Weston, P.O. Box 3041, Sarasota, FL 33578. (813) 371-0811. \$19,000.

The Model 1510 digital real-time spectrum analyzer system comes with a DEC PDP-11/04 minicomputer. The analyzer operates on signals up to 25.6 kHz. The included software package computes octave and 1/3-octave spectrum analysis with ANSI Class III filter characteristics. The Model 1510 also does power-density analysis with automatic gain control. The hardware consists of a spectrum analyzer, computer and teletypewriter.

CIRCLE NO. 340

Bug-killer offered for IBM System/3 programs

Informatics Inc., 21031 Ventura Blvd., Woodland Hills, CA 91364. Janet Wharton (213) 887-9040. \$199; stock.

Called XREF, this enhancement program for Models 4, 6, 8, or 10 of the IBM System/3 generates an alphabetical list of field names, file names and indicators during compilation. XREF is completely compatible with Auto Report, Total, and other RPG software enhancements, and even runs on systems that use only disc source libraries.

CIRCLE NO. 341

Self-sharpening cleaner picks up debris and bugs



Data Devices International, 6301 De Soto Ave., Woodland Hills, CA 91364. Warren Sproul (213) 884-5500. From \$9295; 8 wks.

With the Century 22 automatic cleaner/evaluator you can remove loose oxide and debris from 1/2-in. mag tape (IBM hub) and check it for errors at the same time. Cleaning is accomplished with a self-sharpening, rotating cylinder and two self-sharpening grids, at speeds up to 360 in/s (forward or reverse). An interlock provides fail-safe operation. The head is guaranteed for 2000 h or 1 yr.

CIRCLE NO. 342

Hard-disc drives operate with floppies



Data General, Southboro, MA 01772. (617) 485-9100. See text.

A series of cartridge-disc systems can be mixed with flexible-disc drives supervised by one controller. The series consists of Models 6045 (10 Mbyte), 6046 (20 Mbyte), 6047 (30 Mbyte) and 6048 (40 Mbyte). The Model 6045 consisting of cartridge-disc drive, integrated power supply, controller and cabling costs \$9950. The unit needs a rack height of 10.5 in.

CIRCLE NO. 343

Now you see the keyboard—now you don't



Applied Digital Data Systems, 100 Marcus Blvd., Hauppauge, NY 11787. (516) 231-5400. \$25 premium.

If you need a CRT display terminal with a movable keyboard, the D-option of the Consul series provides this flexibility. Separation from the screen up to 2 ft is possible. Yet, when attached, the D-option adds only 1 in. to the depth of the standard TTY-compatible Consul terminals (Models 520, 580, 920 and 980.)

CIRCLE NO. 344

New! Model 640 Low Cost* Loader Reads 350 Characters per Second

All solid state photo-electronic components. Reads all standard 5,6,7 or 8 level tapes. Smooth, quiet, AC drive.

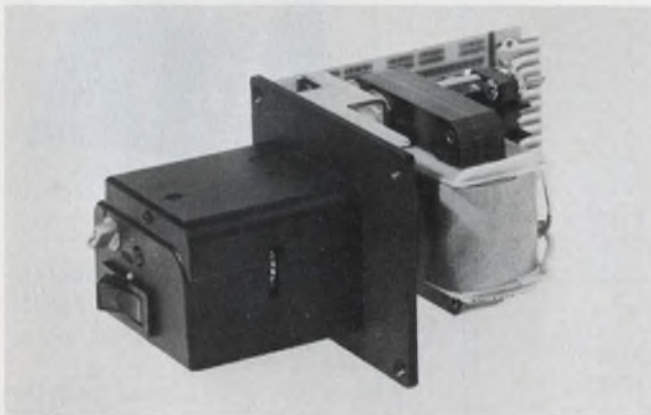

Provides reliable, high speed data entry. Data amplifiers and "character ready" output available for CMOS or TTL interfaces. Fanfold box available.

The Model 640 is the newest addition to the Addmaster line of quality paper tape equipment.

*only \$151! (1-49 units; substantial quantity discounts available.)

Addmaster Corporation, 416 Junipero Serra Drive, San Gabriel, California 91776. Telephone: (213) 285-1121.

CIRCLE NUMBER 71

ELECTRONIC DESIGN 2, January 18, 1977

HIGH ANALOG TECHNOLOGY #4
**OUR ANALOG PRODUCTS
 PAY OFF
 WITH HIGH PERFORMANCE.**

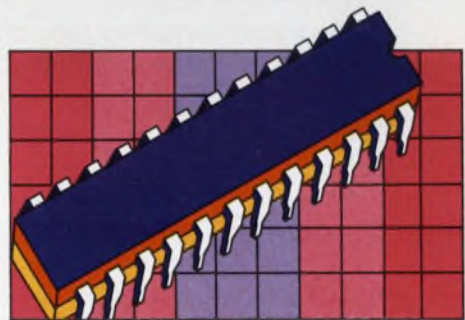

New heights in Analog performance. Our SE & NE535 op-amps with high slew rate, low offset voltage and bias current. SD5301 Analog multiplexer with all control logic on one chip. SE & NE558 & 559 quad-timers and NE570 & 571 Compressor/Expander Audio Amplifier.

Clip coupon to letterhead for complete Analog information and fact sheets.

Name	Title
Tel.	M.S.
811 E. ARQUES, SUNNYVALE, CA. 94086	

**THINK
 Signetics**

a subsidiary of U.S. Philips Corporation

CIRCLE NUMBER 72

© 1976



salon international des
**composants
electroniques 77**

International Electronic Components Show

March 31 to April 6, 1977, Paris

The world's first electronic event in 1977



- Electronic Components
- Measuring Instruments
- Materials and Products
- Equipment and Methods
- Press and Publications

The electronic meeting point of the world
An ever increasing number of visitor:

1974 :	57000	} permanent cards
1975 :	61000	
1976 :	72000	

Concurrently:

THE INTERNATIONAL SYMPOSIUM "ELECTRONIC + 5"
from March 28 to April 1.

Yes, I would like to receive more information on:

- The International Electronic Components Show
- The Special travel arrangements to these events
- The Symposium "Electronic + 5"

Name _____

Company _____

Address _____

City _____ State _____ Zip _____

"INTERNATIONAL TRADE SHOWS IN FRANCE"
1350 Avenue of the Americas New York, N.Y. 10019
☎ (212) 582.4960 - ☐ 237 757 Fren Ur

CIRCLE NUMBER 73

DATA PROCESSING

Disc-memory system connects to minis



Data Systems Design Inc., 1122 University Ave., Berkeley, CA 94702. (415) 849-1102. \$2795-up; 2-4 wk.

The DSD-210 diskette-memory system works with DEC's PDP-8 PDP-11 and LSI-11 minicomputers. The system is compatible with DEC's instruction set and IBM's 3740 disc-recording format. An 8-bit bipolar μ P controls all data transfers, monitors read/write head positionings, and performs data-error checks. A self-test microcode verifies the system. The DSD-210 comes with single, double, or triple diskette drives.

CIRCLE NO. 345

Digital cassette unit features remote control



Techtran Industries, Inc., 580 Jefferson Rd., Rochester, NY 14623. (716) 271-7953. \$950 (single qty); 45 days.

The Model 815 digital cassette recorder features remote control of read, write, rewind, fast-forward and edit functions. It also has switch-selectable data rates of 110 and 300 baud, dual RS-232C plug-in interfaces, and a 20-mA terminal interface. The unit stores 145,000 characters on one Philips-style cassette. The 815 weighs 6 lb and measures 5 x 7.25 x 11 in.

CIRCLE NO. 346

Portable terminals speak ASCII and APL



Computer Devices, Inc., 9 Ray Ave., P.O. Box 421, Burlington, MA 01803. K. Stofer (617) 273-1550. From \$1635 (see text).

As an extra-cost option, the APL character set is available on several Miniterm models, in addition to the normal upper/lower case ASCII and numerics. Prices range from \$1635 (\$87 per month, if leased) for the read-only Model 1201, to \$2435 (\$135 per month) for the portable time-sharing terminal, Model 1203, with built-in coupler.

CIRCLE NO. 347

Paper tape reader has only one moving part

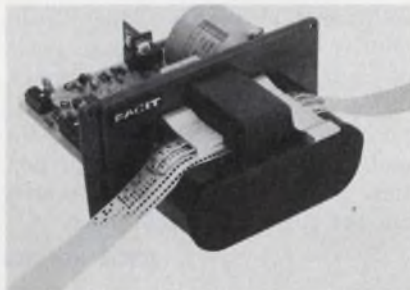

Facit-Addo, Inc., 66 Field Point Rd., Greenwich, CT 06830. Odd Bjerkmann (203) 622-9150. \$325 (unit qty); stock.

The Model-4030 paper-tape reader combines a small read-head with a simple design: only one part moves. With LED light sources the head handles up to 60% tape transmissivity. The basic unit contains control electronics, and is also available in a two-module (3-1/2 in.) rack panel. Another option includes a power supply and parallel SP-1 interface.

CIRCLE NO. 348

Drum memory beats other drums' price

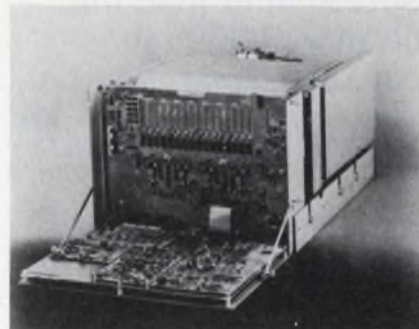

Vermont Research, Precision Park, North Springfield, VT 05150. Edward W. Hinkley (802) 886-2256.

Reduced cost and small size (12-1/4-in. high in a 19-in. rack) are the main attractions of the Model-4016 fixed-head drum memory. In addition to 4.2 megabytes of storage and 8.5-ms access time, the drum features speed detection and noncontact start/stop heads. All electronic circuits are external to the media enclosure. A wide choice of controllers is available.

CIRCLE NO. 349

new data system

For production/traffic/experimental studies

NEW Count/Time Data System (C/TDS) counts switch closings, totalizes ON/OFF time on up to 248 channels. With it and your own switches you have everything you need for a sophisticated production or statistical activity monitoring system — with on-board printout, plus tape records, calculator or computer feeds. Even provides time-of-event data on selected channels!

Keyboard sets all channel inputs, crystal clock timing, reset intervals, channel scale, outputs and more. Counts 10 events/channel/sec. The C/TDS is like a giant event recorder, but with output tabulated by channel the way you want it. It's a low cost way to replace a roomful of counters, recorders, timers, and man-hours. Request Bulletin B130 from Esterline Angus Instrument Corporation, P.O. Box 24000, Indianapolis, IN 46224. Tel. 317-244-7611



CIRCLE NUMBER 74

ELECTRONIC DESIGN 2, January 18, 1977

HIGH ANALOG TECHNOLOGY #5

OUR ANALOG PRODUCTS TUNE IN ON CONSUMER NEEDS.

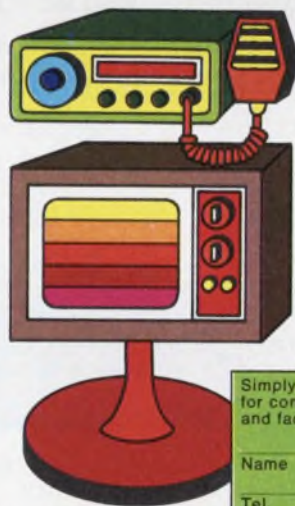

Offering all the benefits of designing with Analog for consumer products. Games, automotive control and entertainment systems, TV, CB, just to name a few.

Simply clip coupon to letterhead for complete Analog information and fact sheets.

Name _____ Title _____
Tel. _____ M.S. _____
811 E. ARQUES, SUNNYVALE, CA. 94086

THINK
Signetics

a subsidiary of U.S. Philips Corporation

CIRCLE NUMBER 75

© 1976.

PACKAGING & MATERIALS

Spread your gold ink down to 0.0003 in.

Engelhard Industries, Electro Metallics Dept., 1 Central Ave., East Newark, NJ 07029. Sanford Cole (201) 589-5000. From \$150/oz; 2 wks.

Four new gold inks, designated A2763, A3319, A3360 and A3362,

yield a fired thickness of only 0.3 mil, thus covering up to 375 square inches per oz. The new inks also permit well-defined metallizing widths of 5 to 10 mils, as a result of their high-shear flow characteristics. The four inks differ only in printing and firing requirements, and some secondary final properties. Price depends on quantity and, of course, the gold price.

CIRCLE NO. 350

CHEAP AIN'T CHEAP

Price is a lousy way to buy keyboards. Because the low-price buy can turn into a costly nightmare. You've got to look for reliability...On the job...100% testing at every step. And you need a keyboard with the **right** features for your product: Standard ROM that lets you use any code for any key. 28 unassigned keys for even more built-in flexibility. N-key rollover for error-free high throughput.

When you find a keyboard like this, you've found a real bargain, a custom keyboard off-the-shelf. The Datanetics 75 Key, Model 70/75. Then start talking price.*



*From \$88 each in quantities of 1,000, or 1 for \$120.

Datanetics

Affordable reliability.

18065 EUCLID ST., FOUNTAIN VALLEY, CA. 92708
(714) 549-1191 TWX: 910-596-1301

CIRCLE NUMBER 76

SMA feedthrough has uniform impedance

Cablewave Systems Inc., 60 Dodge Ave., North Haven, CT. 06473. (203) 239-3311. \$6.27 (500-up); stock.

The SMA bulkhead feedthrough adaptor, type 705627-101, has a uniform impedance of 50 Ω throughout its length. The solder-in glass seal has the same impedance as the rest of the connector. This contrasts with other connectors that have a glass seal of about 44 Ω . The hermetic unit has a leak rate of 1×10^{-8} cc/s at 1 atm. The center pin of the connector is attached to the glass seal by welding. The hermetic SMA bulkhead feedthrough adaptor has a max VSWR of 1.25:1, from 2 to 18 GHz. Both connector ends have female matings.

CIRCLE NO. 351

Tool kit comes in small-sized case

Specialized Products Co., 2324 Shorecrest, Dallas, TX 75235. (214) 358-4663. \$77 (single qty).

The Model SPC-199 contains more than 40 tools mounted in a simulated-leather black-zippered case measuring 11.5 \times 10 in. The tools include several varieties of screwdrivers, nut drivers, wrenches, pliers, files, instrument oilers and alignment tools. Also included is a soldering iron.

CIRCLE NO. 352

Conductive-plastic tray prevents static

Wescorp, 1601 Stierlin Rd., Mountain View, CA 94040. (415) 969-7717. \$10 (1-24); 3 wk.

A plastic parts tray, Model W5024-3, protects microcircuits from static electricity during a manufacturing operation. Called SCAT, for a sectioned, conductive anti-static parts tray, it is curved to fit a "lazy Susan" parts table. The tray has an outer semicircular length of 18 in. The inner length is 9 in. It is divided into three equal-sized compartments. The tray is made of opaque polystyrene mixed with graphite and is black in color.

CIRCLE NO. 353

Christmas tree replaces screws?

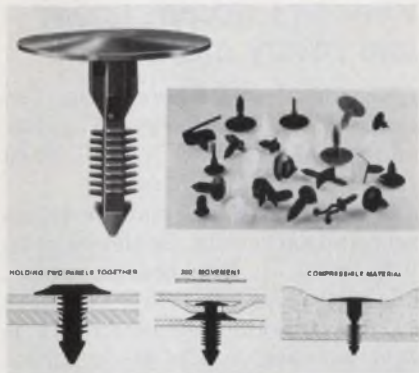

Illinois Tool Works, Inc., Fastex Div., 195 Algonquin Rd., Des Plaines, IL 60016. LeRoy Rysell (312) 299-2222. See text; stock.

The versatile "Christmas tree clips" have molded flexible ribs that deflect as the clip is pressed into a hole, and spring back on the other side of the panel. These fasteners come in a wide range of sizes and shapes, for insertion in hard as well as pliable materials, and just about any kind of hole. Price depends on the specific model.

CIRCLE NO. 354

Backplane holds twice the cards for LSI-11



MDB Systems, Inc., 1995 N. Bavaria St., Orange, CA 92665. (714) 998-6900. \$295; 14 days.

A backplane assembly holds twice as many cards as the version from DEC, for its LSI-11 μ C. The backplane holds eight quad modules or 16 dual modules. The unit has 10 power-supply terminal posts. It also has full-length card guides and a prewired multilayer PC-backplane board.

CIRCLE NO. 355

Radiant solder system outshines other units

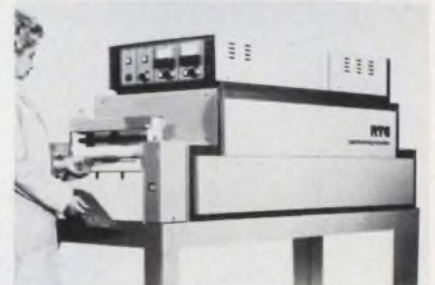

Radiant Technology Corp., 13906 Bettencourt St., Cerritos, CA 90701. Joe Romance (213) 926-6518. \$6000.

If you work with printed-circuit boards, but have no access to a large soldering machine, the Model F750 infrared solder system may be your answer. It fits on a table top and is relatively inexpensive, yet completely automates the process of fusing tin-lead to the copper conductors of printed-circuit boards, with widths up to 15 in. The operator simply places the prefluxed board on the conveyor at one end, and picks up the finished product at the other end.

CIRCLE NO. 356

Noise sensitivity problems go away—we guarantee it!

Topaz Ultra-Isolation Transformers provide an inexpensive and reliable way to supply clean, noise-free AC power to sensitive equipment such as computers, instrumentation, communication and process control equipment.

Ultra-Isolation Transformers offer the industry's best noise attenuation:

- Common-mode noise rejection greater than 145 dB.
- Transverse-mode noise rejection greater than 125 dB at 1 kHz.
- Standard models 125 VA to 130 kVA.
- Priced from \$64.



Our guarantee: A Topaz Ultra-Isolation Transformer will solve your noise sensitivity problems to your complete satisfaction or we'll take it back—no questions asked.

TOPAZ SOLUTIONS TO POWER PROBLEMS
ELECTRONICS

3855 RUFFIN ROAD, SAN DIEGO, CA. 92123 • (714)279-0831 • TWX (910)335-1526

CIRCLE NUMBER 77

ELECTRONIC DESIGN 2, January 18, 1977

HIGH ANALOG TECHNOLOGY #6 OUR ANALOG PRODUCTS KEEP DATA PROCESSING HUMMING.

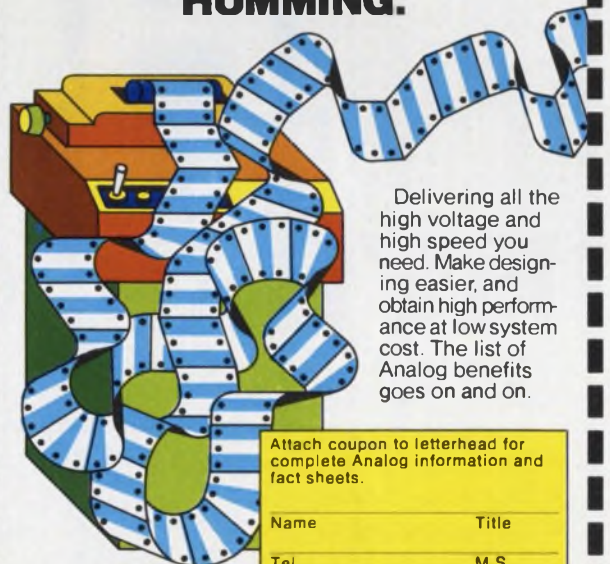

Delivering all the high voltage and high speed you need. Make designing easier, and obtain high performance at low system cost. The list of Analog benefits goes on and on.

Attach coupon to letterhead for complete Analog information and fact sheets.

Name _____ Title _____
Tel. _____ M.S. _____
811 E. ARQUES, SUNNYVALE, CA. 94086

THINK
Signetics

a subsidiary of U.S. Philips Corporation

©1976

CIRCLE NUMBER 78

Our attenuators can be

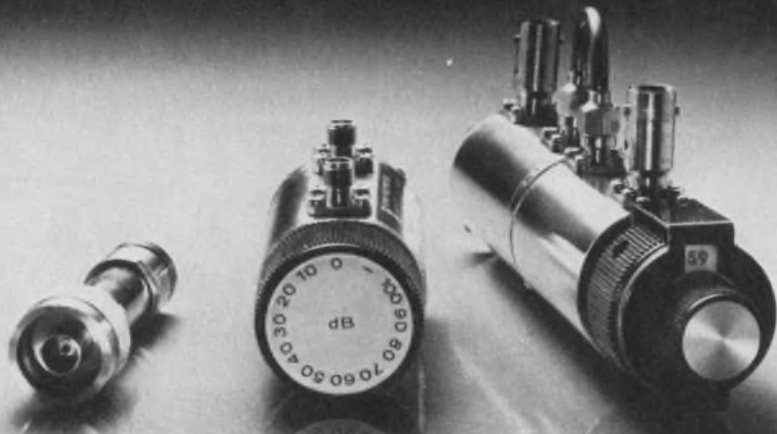

Fixed Rotated Ganged

If your design calls for any type of attenuator in the DC to 4 GHz range, talk to Telonic first. We have 'em for handling .1 dB all the way to 130 dB. The solid-state, thick film resistors we use give longer service life, higher accuracies and power capabilities of 3 watts or better. Prices start at \$28.00, even lower in quantities. Our attenuator catalog is yours on request. Write, or call toll free.

TelonicAltair  2825 Laguna Canyon Rd. · Box 277
Laguna Beach, California 92652
Tel: 714 494-9401 or toll free, 800-854-2436
TWX: 910 596-1320 · Cable: TELENG

Telonic—the name for attenuators

CIRCLE NUMBER 79

IS FOR HYBRICON

Hybricon means:

- Direct, hy-density mounting of discrete components
- Plated through holes
- Four power busses
- Two ground planes
- Complete documentation
- Component mounting without carriers

Hybricon is:

A manufacturer and supplier of a unique wire-wrap panel, designed by users who really understand your problems. It's not another "me-too" panel. For more information contact the Hybricon Corporation, 410 Great Rd., P.O. Box 513, Littleton, Ma. 01460. Telephone: (617) 861-6692.

Wire-wrap is a Gardner-Denver trade mark.

HYBRICON

CIRCLE NUMBER 80

PACKAGING & MATERIALS

Bearings accept linear and rotary motion

Linear-Rotary Bearings, Inc., 99 Urban Ave., Westbury, NY 11590. (516) 333-6678. 1-9 prices: \$5.05 (LR-4) to \$217 (LR-64).

The LR series of rotary bearings accepts shafts with diameters from 0.25 to 4.0 in. The bearing design allows the shaft to rotate and move in the direction of length. It is said to have a life of 10-million inches of relative motion, compared to competitive models' life of 2 to 4-million in. The Model LR-4 can accept a 0.25-in.-dia. shaft rotating at 3600 rev/min with a 14-lb load.

CIRCLE NO. 357

A series of plastics conduct electricity

Emerson & Cuming, Inc., 809 Washington St., Canton, MA 02021. (617) 828-3300. Sheets: \$84-\$239, bars: \$8.40-\$30.00.

A series of five plastics, called Eccosorb HF, has a volume resistivity ranging from 10^3 to 10^7 Ω -cm. The plastics come in sheets measuring up to 12 x 12 x 1 in. Or they come in bars with cross-sections measuring up to 1 x 1 x 12 in. They can be used at frequencies from dc through microwave.

CIRCLE NO. 358

Silicone tubing shrinks on exposure to air

Insulation Systems Inc., 1233 Reamwood Ave., Sunnyvale, CA 94086. (401) 734-5190. See text.

A line of silicone tubing, called No Heat, shrinks down when it is exposed to air. The tubing comes packaged in air-tight pouches or cans, and will start to shrink 5 min after exposure. It reaches its final diameter in 30 min. The silicone tubing is nonflammable and has a continuous operating range of -75 C to +175 C. The tubing is available with shrunk inside diameters of 0.062 to 1 in. One type, which costs \$1.89/ft (500-up), shrinks to an inside diameter of 0.25 in.

CIRCLE NO. 359

Inexpensive fixture speeds PC assembly

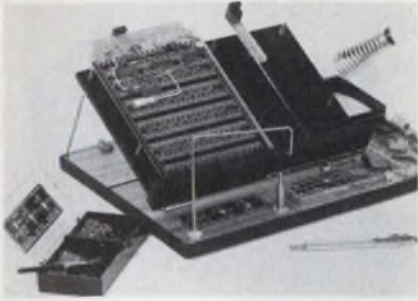

Cir-Pax Systems, 11535 Leo Rd., Fort Wayne, IN 46825. Andrew S. Gall (219) 627-3607. From \$49.50; stock-2 wks.

For prototype IC systems, this compact work station not only keeps your desk or bench neat, it speeds up assembly, too. The terminals provided fit holes with diameters of 0.055, 0.073, and 0.093 in. and the gripping fingers of the terminals hold component leads in the proper position. The assembly can then be turned over, and either hand or flow-soldered.

CIRCLE NO. 360

Inexpensive connector snaps into PC boards

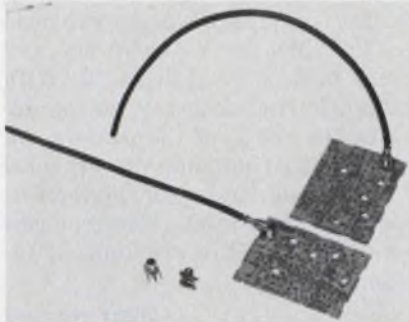

Connector Corp., 6025 N. Keystone Ave., Chicago, IL 60646. Bill Paradise (312) 539-3108. 10¢ (small qty); stock to 5 wks.

The Model 107E65-4 rf/audio connector snaps instantly into PC boards, and allows both parallel and right-angle connection. The clever design of the 107E65-4 prevents flux or solder from entering the contact area, and provides rigid mounting with three lugs. The connector protrudes less than 1/2 in. above the board.

CIRCLE NO. 361

Neat epoxy adhesive sticks—up to 190 C



Tra-Con, Inc., 55 North St., Medford, MA 02155. (617) 391-5550. From \$25; 1 wk.

Tra-Bond 2248 is a high temperature epoxy adhesive for bonding and staking applications. It comes in pre-dispensed "Bipax" packages that end the mess of mixing two-component systems. The dark brown, 100%-solids epoxy bonds to metal, glass, ceramics and plastics. After curing at elevated temperatures, the 2248 resists water and many solvents, and retains its mechanical and electrical properties up to 190 C.

CIRCLE NO. 362

Full circle.

**HEYCO
Universal
Bushings
come in
these
6 sizes.**

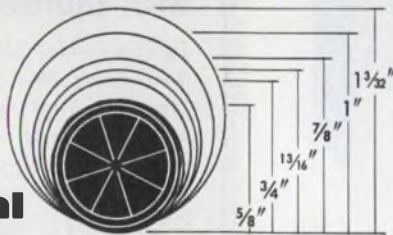

Heyco Nylon Universal Bushings snap lock into these 6 hole sizes and solve most of your insulation problems quickly, efficiently and inexpensively. U.L. recognized, C.S.A. approved.

FREE Test Pack
is yours for the asking.
Send for it today.

HEYMAN MANUFACTURING COMPANY

KENILWORTH, NEW JERSEY 07033 WAUKESHA, WISCONSIN 53186
(201) 245-2345 • TWX: 710-996-5986 (414) 542-7155 • TWX: 910-265-3668

CALL TOLL-FREE (800) 558-0917 • IN WISCONSIN CALL (800) 242-0985



CIRCLE NUMBER 81

ELECTRONIC DESIGN 2, January 18, 1977

HIGH ANALOG TECHNOLOGY #7

OUR ANALOG PRODUCTS MAKE INSTRUMENTATION MEASURE UP.



The high voltage, high speed and high current advantages of Analog fit right into your instrumentation requirements. Scientific, medical, processing instruments keep on beam with Analog.



Clip coupon to letterhead for complete Analog information and fact sheets.

Name _____ Title _____
Tel. _____ M.S. _____
811 E. ARQUES, SUNNYVALE, CA. 94086

THINK
Signetics

a subsidiary of U.S. Philips Corporation

©1976.

CIRCLE NUMBER 82

121

MODULES & SUBASSEMBLIES

True-rms converter handles dc to 2 MHz

National Semiconductor, 2900 Semiconductor Dr., Santa Clara, CA 95051. Brent Welling (408) 737-5000. From \$22.50; stock to 6 wks.

The LH0091, a true-rms converter, computes the root-mean-square value of virtually any combination of ac or dc input signal from dc to

2 MHz. Performance is guaranteed to better than 0.2% accuracy to 30 kHz, with crest factors as high as 5. The frequency can be extended to 200 kHz for 1% accuracy and crest factors as high as 10. With external trim, accuracy can be adjusted to 0.05% of the reading. An uncommitted amplifier is provided for filtering, gain, or high-crest-factor configuration. The true-rms converter comes in two kinds of 16-lead DIPs.

CIRCLE NO. 363

Accelerometers cover wide range



Schaevitz Engineering, P.O. Box 505, Camden, NJ 08101. (609) 662-8000. From \$539; stock.

Five models of ASB-series closed-loop-servo angular accelerometers measure from $\pm 50 \text{ rad/s}^2$ to $\pm 1500 \text{ rad/s}^2$ full scale, with linearity to $\pm 0.1\%$ of full scale, hysteresis to $\pm 0.02\%$ of full scale, and resolution to $\pm 0.0005\%$ of full scale. These units are intended for measuring angular acceleration of roll, pitch or yaw in aircraft or aerospace control systems. They operate from standard dc supply voltage. Available options are 0.2-to-4.8-V telemetry output, and output-to-input isolation. An output-bias option permits operation around a nonzero level. Other output variations are: unipolar, limiting, bipolar (with single supply voltage) and low-impedance. These devices are $2.6 \times 1.1 \times 1.68$ in.

CIRCLE NO. 364

Q: Is there a recorder just for spectrum analyzers?

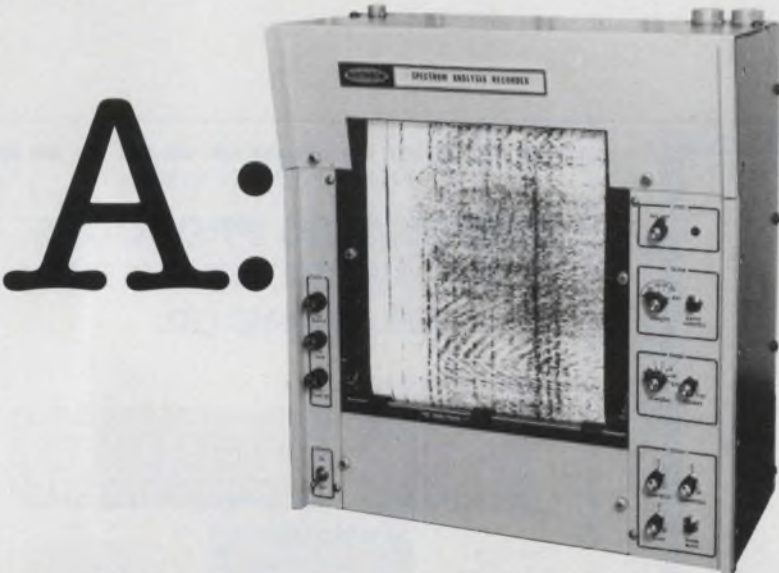

The new 19" rack-mounting SPECTRUM ANALYSIS RECORDER from Raytheon. It's the first dry paper line scanning recorder specifically developed for direct plug-in operation with commercially available spectrum analyzers.

Any new or existing spectrum analyzer equipped with the SAR-097 will have a lot more going for it. Like infinitely variable 100:1 speed range - 5 sec/scan to 50 milliscan... stylus position encoder... automatic recorder synchronization... computer/analyzer compatibility... high resolution and dynamic range... all-electronic drive. And more.

If you design and build - or buy and use - spectrum analyzers, you don't have to settle for multi-purpose recorders any more. The SAR-097 is here. For full details write the Marketing Manager, Raytheon Company, Ocean Systems Center, Portsmouth, Rhode Island, 02871. U.S.A. (401) 847-8000.

RAYTHEON

CIRCLE NUMBER 83

Set relay's delay with thumbwheels

International Microtronics, 4018 E. Tennessee St., Tucson, AZ 85714. Dr. Otto Fest (802) 748-7900. \$79; stock-to-4 wks.

You set this solid-state time-delay relay with direct-reading thumbwheel switches. Series 280 Digilay times on-or-off delay modes from 1 ms to 999 s with accuracy and repeatability of $\pm 0.5\%$. Power turn-on time is 30 ms and power-recycle time is 10 ms. An external frequency-modulation feature permits fine tuning of the oscillator's base frequency, or you can modulate the time delay with an external waveform. SPDT-relay, SPDT-reed-relay, and SPDT-triac options provide switching times ranging from 10 μs to 1 ms. The device operates from 12-V $\pm 10\%$ input power.

CIRCLE NO. 365

Video sample-and-hold works faster

ILC Data Device, Airport International Plaza, Bohemia, NY 11716. (516) 567-5600. From \$395; stock.

The Model VADC-150 is the fastest video sample-and-hold unit available. It features a 100-MHz small-signal bandwidth, 500-V/ μ s slew rate and 20-MHz sample rate and is intended for video a/d and pulse processing. The module's acquisition time can vary from 12 to 25 ns, depending on signal change; aperture time or aperture jitter is ± 60 ps. The VADC-150 is a system-oriented modular device that provides TTL-compatible control inputs and a FET input impedance for video. Feedthrough attenuation is 50 dB at 10 MHz, linearity is 0.1% and the drift rate is 0.2 mV/ μ s. The unit meets the requirements of MIL-STD-202D. The modules are offered in two types, each having its own temperature range, the VADC-150-1 for -55 to $+85$ C, and the VADC-150-3 for 0 to $+70$ C.

CIRCLE NO. 366

FET op amp delivers high output

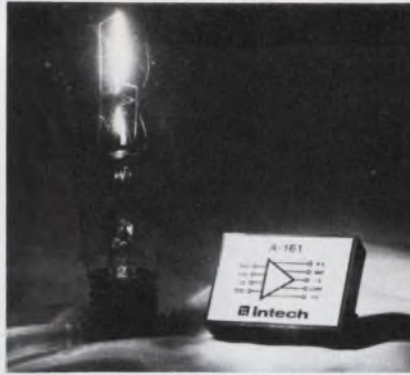

Intech/FMI, 282 Brokaw Rd., Santa Clara, CA 95050. (408) 244-0500. \$95 (1-29); stock to 4 wks.

FET inputs and a rated output of ± 35 V at 150 mA are features of the A-161 modular op amp. It also boasts a min slew rate of 15 V/ μ s and bias current of less than 20 pA. The unit operates over a supply range from ± 12 to ± 40 V. In addition, the amplifier, connected as a unity-gain follower, can operate into a capacitive load of up to 1000 pF.

CIRCLE NO. 367

Control small motors without spiking

G.K. Heller, 7 Mayflower Pl., Floral Park, NY 11001. (516) 775-7170. \$62 (singles); 3 to 4 wks.

The TSX controller maintains the preset-speed of 1/40-HP permanent-magnet or shunt-wound dc motors with power transistors instead of triacs and SCRs. Therefore, you can use this controller close to sensitive electronic equipment without causing rf interference. The unit provides speed regulation within 1% for fluctuations in torque within the motor's rated limits, or variations in ac-line voltage from 100 to 130 V. The device is said to give you a wider range of smooth rotational-speeds than can be attained with SCR controllers. Standard features include full-wave field-voltage supply, full-wave-filtered armature supply, protection against transient voltages on both the input line and the dc output, a line-voltage correction circuit, and trimming adjustments for max and min speeds.

CIRCLE NO. 368

FREE!

THE ALL-NEW NEWARK ELECTRONICS CATALOG 103

688 PAGES!
100,000 ITEMS.
ALL PRODUCTS LISTED ARE STOCKED.
150 TOP BRAND NAME LINES



FEATURING Sola Power Supplies

Sola offers dual and triple output power supplies for microprocessors and accessories: RAM's, PROM's, FPROM's, clocks, and IO devices.

Fully isolated independent outputs for either positive or negative operation.

Series or parallel operation.

Plus remote sensing programming, and complete serviceability.



All available from your nearest Newark branch.

WRITE OR PHONE TODAY FOR YOUR PERSONAL COPY!



NEWARK ELECTRONICS

500 N. PULASKI • CHICAGO, IL 60624
PHONE (312) 638-4411 • TELEX 25-3218

CIRCLE NUMBER 84

ELECTRONIC DESIGN 2, January 18, 1977

HIGH ANALOG TECHNOLOGY #8

OUR ANALOG PRODUCTS ANSWER COMMUNICATION NEEDS.

Encode, decode, display, switch, digitize with analog for highest voltage, speed and current. Products on hand to keep telecommunications and communications systems talking.

Clip coupon to letterhead for complete Analog information and fact sheets.

Name _____ Title _____

Tel. _____ M.S. _____

811 E. ARQUES, SUNNYVALE, CA. 94086

THINK Signetics

a subsidiary of U.S. Philips Corporation

© 1976

CIRCLE NUMBER 85

How to get high

HIGH VOLTAGE

HIGH SPEED

HIGH CURRENT

HIGH PERFORMANCE



Signetics' high technology products fit all markets.

We have a lot of things to talk about. From our broad line of analog products available to fill consumer, data processing, instrumentation and communication requirements—including new products, exclusive products, interface products, industrial products, military products, you name it. Right down to our special applications assistance which includes detailed literature and our experienced engineering staff that's always on-call to help you on a one-to-one basis.

Then there are the specific benefits offered by our analog products. In fact, when you see the high voltage, high current, high speed and high performance...you'll see why Signetics is "high on analog."

And, see how easy it is for you to take advantage of all the benefits for yourself.

So where do we begin?

High voltage. Just for example, there's the Signetics NE541 Class AB monolithic power driver that offers an operation up to 80 volts, low standby current, and a wide power bandwidth. Perfect for driving large audio output stages and similar applications. Signetics has many other analog products rated at high voltages to meet your latest requirements.

High speed. Signetics analog devices act faster to provide better performance when computer logic

on analog.

DIGIT DRIVERS (NE584 & 585)	POWER AMPLIFIER (NE541)	DIGITAL PHASE LOCKED LOOP (NE564)	DUAL COMPARATORS (NE521 & 522)	SERVO-AMPLIFIER (NE544)	HIGH VOLTAGE REGULATOR (78HV)	OP-AMPS (SE & NE535)	MULTIPLEXER (SD5301)	QUAD-TIMERS (SE & NE558 & 559)	COMPRESSOR/EXPANDERS (NE570 & 571)
yes	yes				yes				
		yes	yes			yes			
	yes			yes	yes			yes	
yes	yes	yes	yes	yes	yes	yes	yes	yes	yes

and memory function faster with low signal levels. Signetics sense amps, dual comparators and other products turn on and off faster. Perfect for data recording and communication applications.

High current. Examine the NE544 servo-amplifier that is a linear one-shot, all purpose servo driver with all functions integrated into one, and you will see it is truly unequalled. You'll also see why Signetics is "high on current."

High performance. There's a whole list of high performance analog products available from Signetics. Multiplexers, quad-timers, compressor/expanders, operational amps. They feature low input offset voltage, low input bias current, TTL compatibility, all logic on a single chip, economy, everything to make designing easier.

The more you know about analog, the higher you get on it. Don't wait. Start now by mailing the coupon.

Attach this to your letterhead for fast response.

- Send me the complete analog information and fact sheets.
- Have a Field Applications Engineer call me for a one-to-one appointment.

My application is _____

Name _____ Title _____

Telephone _____ Mail Stop _____

THINK **Signetics**

811 E. Arques Ave., Sunnyvale, Ca. 94086

© 1976.

A subsidiary of U.S. Philips Corporation

33% more power to the people.

Power/Mate presents Econo/Mate II.

The open frame power supply.

Now Power/Mate brings you 33% more power in the same package size with the second generation of our Econo/Mate series.

The size is the same, the basic components are the same for easy interchangeability. But that's where the similarity ends.

Econo/Mate II adds features like dual AC primary and a plug-in IC regulator for improved regulation.

And Econo/Mate II is tough. Computer design, quality control, and Power/Mate's experience helps insure 100,000 hr. MTBF even at this higher power output.

But for all its features, Econo/Mate II is still, most of all, economical.

We wouldn't call it Econo/Mate if it wasn't.

Econo/Mate II is in stock, ready for delivery. Send for our free brochure.

Prices start at \$19.95.

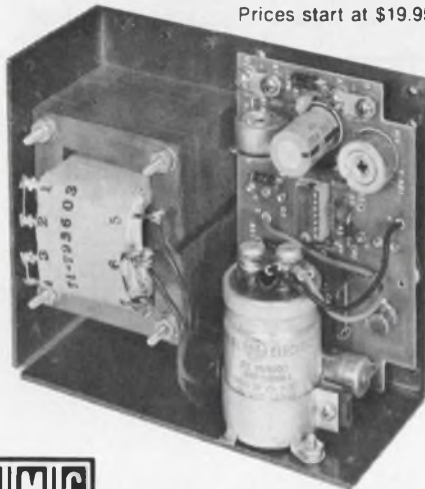

POWER/MATE CORP.

World's largest manufacturer of quality power supplies.

514 South River Street/Hackensack, N.J. 07601/Phone (201) 343-6294 TWX 710-990-5023

CIRCLE NUMBER 87

MODULES & SUBASSEMBLIES

Amp lets you select gain and bandwidth



Preston Scientific, Inc., 805 E. Cerritos Ave., Anaheim, CA 92805. (714) 776-6400. See text; stock to 30 days.

Gain of the DX-series Model-A instrumentation amplifier can be set at any of seven levels by a front-panel rotary switch. Fixed gains of 10, 20, 50, 100, 200, 500 and 1000 are standard. A continuous fine-control lets you adjust gain-settings between selector levels, with a gain of 3000 max. A six-position front-panel switch lets you select bandwidths of 1 Hz, 10 Hz, 100 Hz, 1 kHz, 10 kHz or "wideband." A critically damped 12-dB/octave filter determines the frequency response. In small quantities, the amplifier is priced at \$295. Dual outputs (one filtered, one unfiltered) are optional at \$35. The amplifier boasts the following characteristics: 0.05% accuracy; 0.005% linearity; 1 μ V max one-sigma input noise. Tempco over the 0-to-50-C range is 1 μ V referred to the input; 30-day stability is $\pm 3 \mu$ V referred to input and $\pm 100 \mu$ V referred to the output. Additional specifications include: output amplitude of ± 5 or ± 10 V with 100-mA max current on both ranges; output impedance of 1 Ω ; common-mode rejection (at 1000 gain) of 130 dB at dc, 120 dB at 60 Hz and 60 dB at 60 kHz; common-mode voltage of 10-V pk; slew rate of 1 V/ μ s; and settling time to $\pm 0.01\%$ of final value of 50 μ s.

CIRCLE NO. 369

Nothing is Faster and Easier than ACE for circuit breadboarding.

Used to be you'd get a circuit idea, lay out a pc board, print it, solder everything together, troubleshoot, change your layout, try a new board, and spend absolutely too much time breadboarding. Now A P ACE All Circuit Evaluators let you breadboard in a fraction of the time. Make your changes immediately. Keep full leads on your components. Avoid the heat damage possible with repeated soldering and desoldering. And have a pattern for your board—if you need a board—sitting in front of you. In about as long as it takes to sketch a schematic. Get cooking with ACE. ACE. The All Circuit Evaluator from A P Products.



Part No	ACE Model No	Tie Points	DIP Capacity	No Buses	No Posts	Board Size (inches)	Price Each
923333	200-K (kit)	728	8 (16's)	2	2	4-9/16x5-9/16	\$18.95
923332	208 (assem)	872	8 (16's)	8	2	4-9/16x5-9/16	28.95
923334	201-K (kit)	1032	12 (14's)	2	2	4-9/16x7	24.95
923331	212 (assem)	1224	12 (14's)	8	2	4-9/16x7	34.95
923326	218 (assem)	1760	18 (14's)	10	2	6-1/2x7-1/8	46.95
923325	227 (assem)	2712	27 (14's)	28	4	8x9-1/4	59.95
923324	236 (assem)	3648	36 (14's)	36	4	10-1/4x9-1/4	79.95

Order from your A P distributor today.
Our distributor list is growing daily.
For the name of the distributor nearest you
call Toll-Free 800-321-9668.



Send for our complete A P catalog.
The Faster and Easier Book.

A P PRODUCTS INCORPORATED

Box 110-F Painesville, OH 44077 (216) 354-2101 TWX: 810-425-2250

CIRCLE NUMBER 88

1 Relay Miss every 2-Billion Cycles



Series E Relay
(actual size)

We tested 129 of our new Series E Relays at loads from dry circuits to 3 Amps. After 35-billion operations, only 10 single-cycle misses were monitored.

Series E Relays offer:

- Indefinite life
- No contact bounce
- Operation in all positions
- Contacts stable to ± 0.015 ohms over life
- Reliability at dry circuit or power loads
- Self-healing contacts
- Hermetically sealed contacts
- 1250V rms contact breakdown
- Low cost

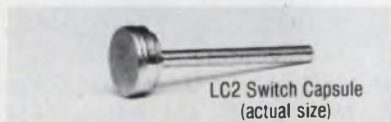

LC2 Switch Capsule
(actual size)

Series E Relay uses a rugged LC2 welded capsule rather than a fragile glass reed switch. This patented design holds a film of mercury securely to the metal walls of the capsule. With every operation, the mercury film renews the switch contacts. You get the reliability of mercury relays, but with complete freedom of mounting orientation. LC2 welded capsule reliability is proven by hundreds-of-thousands of units in the field, as well as billions of cycles under stringent laboratory conditions.

Send for a FREE SAMPLE of the LC2 welded capsule on your letterhead. Circle the reader service card number for Series E Relay information.

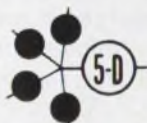

Fifth Dimension, Inc.

P.O. Box 483
Princeton, N.J. 08540
Tel: (609) 452-1200

CIRCLE NUMBER 89

ELECTRONIC DESIGN 2, January 18, 1977

Data-acquisition unit needs no baby sitter

CSP, 209 Middlesex Tpk., Burlington, MA 01803. (617) 272-6020. From \$4000; 120 days.

Series-500 Analog Data Acquisition Modules (ADAMs) provide for crystal-controlled sampling (4.8 MHz) and processing of up to eight analog signals, without supervision from a host computer. All of the hardware (including up to eight sample-holds) and software necessary to accomplish data-acquisition and a/d conversion are incorporated within the ADAM. These modules digitize input signals into a normalized 16-bit floating-point format using the company's MAP's SNAP II Fortran-compatible language. Processing rate for standard units is 125 kHz with 12-bit resolution, while a higher-speed model offers a 250-kHz digitization rate with 10-bit resolution.

CIRCLE NO. 370

Stable oscillator takes the punches

Frequency & Time Systems, 182 Conant St., Danvers, MA 10923. (617) 777-1255. \$2400 (1 up) stock.

The Model 1000 quartz-crystal oscillator gives you stability: better than 1×10^{-12} for averaging times of 1 to 1000 s, and better than 1×10^{-10} per day for 30-day averaging. It boasts ruggedness: meeting MIL-STD-810C, method 514.2, for ground-launched missiles, cat.E, proc.4 and withstanding random vibration of 23.9 g rms from 20 to 2 kHz and peak-shock with a pyrotechnic spectrum of 2300 g at 1850 Hz. The unit has spectral purity: less than 118 dB of phase noise 1-Hz from the 5-MHz output. The oscillator's spectral purity and stability point to its use as a stand-alone basic-frequency source for multiplication up through the millimeter band. Modules can be specially ordered with lower phase noise, up to four TTL-compatible outputs and with output frequencies other than 5 MHz. Radiation hardened models are available. The $3 \times 3 \times 6.9$ in. unit weighs 1.9 lb.

CIRCLE NO. 371

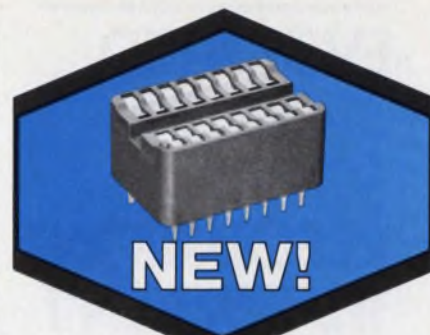

"LOW SIDE" DIP SOCKETS

Unique TEXTOOL design offers high reliability... maximum socket density

The new TEXTOOL "Low Side" DIP socket series is designed for test and aging applications requiring both high reliability and maximum socket density.

Lower sidewall construction of the new socket leaves a device body exposed for better heat dissipation and more uniform airflow during extended tests at elevated temperatures. The sidewall is high enough, however, to act as a guide to the tapered contact entry designed to accept bent or distorted leads.



The compact TEXTOOL "Low Side" DIP socket requires up to 15% less P.C. board area than similar sockets, yet still combines a minimum profile with low insertion force contacts for easy loading and unloading without damage to device leads. Since the contacts do not extend above the top of the socket, they are protected from possible bending or breaking.

A center slot on the socket accepts all currently available loading and unloading tools. Its solid wall construction design significantly reduces damage caused by misalignment of a loading tool.

New TEXTOOL "Low Side" DIP sockets are available in a choice of 14 or 16 pin versions in materials capable of 300°C operation. Both models have mounting holes in the socket body for applications requiring other than P.C. board mounting.

Detailed information on these and other products from TEXTOOL... IC, MSI and LSI sockets and carriers, power semiconductor test sockets, and custom versions... is available from your nearest TEXTOOL sales representative or the factory direct.



PRODUCTS, INC.

1410 W. Pioneer Drive • Irving, Texas 75061
214/259-2676

CIRCLE NUMBER 90

EVER NEED STORAGE 'SCOPE RESOLUTION THAT WASN'T THERE?



In a storage 'scope you need better, not lower, resolution because what you capture will be all you'll see if the signal occurs just once.

Nicolet's EXPLORER general purpose storage oscilloscope provides 20 times better resolution than the next best storage 'scope. You can electronically zoom in on any detail of interest. Quickly and easily, whether the signal is stored or live.

To learn what hundreds of happy EXPLORER users already know about resolution, write-through storage, "hiding" a waveform, automatic persistence, simple signal capture and storing a week-long signal, call or write for our new four-page ad reprint and descriptive brochure.



NTC NICOLET INSTRUMENT CORPORATION

5225 Verona Road
Madison, Wisconsin 53711
Telephone: 608/271-3333

CIRCLE NUMBER 91

DISCRETE SEMICONDUCTORS

Microwave transistors deliver low noise

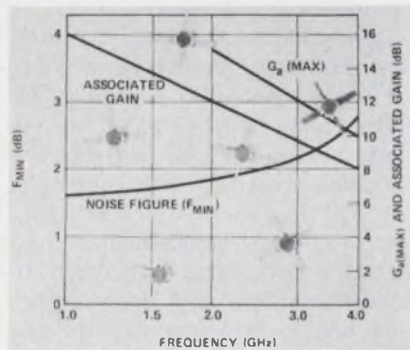

Hewlett-Packard, 1501 Page Mill Rd., Palo Alto, CA 94304. (415) 493-1501. \$49: HTXR-5103, \$105: HTXR-6104 (10-24); stock.

Two silicon bipolar transistors are suitable for low-noise amplifiers in the 1-to-4-GHz range. Model HXTR-6103, with a 2.2-dB (max) noise figure at 2 GHz and a 110 dB (min) associated gain, can replace the Fairchild FMT 4005. Model HXTR-6104 has a 1.6-dB (max) noise figure at 1.5 GHz and associated gain of 13 dB (min). Both devices are manufactured with ion-implantation techniques and titanium-platinum-gold metallization. Packaged in the hermetic HPAC-100 metal/ceramic packages, both devices can meet the requirements of MIL-S-19500 and the test requirements of MIL-STD-750/883.

CIRCLE NO. 372

Pnp power transistor complement of 2N3373

Motorola Semiconductor Products, Inc., P.O. Box 20912, Phoenix, AZ 85036. (602) 244-3465. \$2.59 (100-999); stock.

A pnp power transistor, the 2N6609, rated at 16-A continuous maximum collector current and a V_{CE0} of 140 V dc minimum, is a complement to the popular 2N3373 npn. The transistor features a dc safe operating area of 1.5 A at a V_{CE} of 100 V. This 150-W capability is over three-times greater than the power-dissipation capabilities of earlier 16-A, 140-V pnp's. This performance has been achieved by including base ballasting with Motorola's standard epitaxial-base process.

CIRCLE NO. 373

LED numerical displays 0.5 and 0.3-in. high

Spectronics Inc., 830 E. Arapaho Rd., Richardson, TX 75080. (214) 234-4271. \$1.25: SPX-300, \$1.45: SPX-500 (1000 up); 30 days.

Two series of red, seven-segment LED displays feature 0.3-in. high (SPX-300) and 0.5-in. high (SPX-500) characters. The new devices offer wide viewing angles, continuous uniform segments and high contrast. And they are categorized for uniformity of luminous intensity. They are available in both common-cathode and common-anode configurations.

CIRCLE NO. 374

Power Darlingtons rated to 1000 V at 125 W

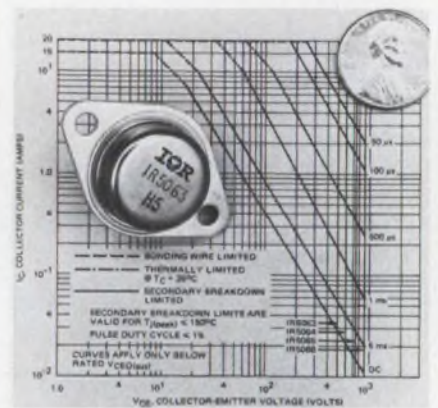

International Rectifier, 233 Kansas St., El Segundo, CA 90245. (213) 322-3331. \$11.75 to \$18 (100-999); stock.

Very high-voltage monolithic Darlingtons with power ratings to 125 W, designated the IR5063 through IR5066 series, have collector-to-base ratings to 1000 V and collector-to-emitter ratings to 900 V. Peak collector current for all units in the line is 20 A. Hard-glass passivation of the silicon chip provides exceptional stability at high operating junction temperatures. Processing is triple diffused for high voltage with a wide safe operating area and fast switching. Small-signal current gain for all the Darlingtons is 8 at 0.5 A, 10 V. Thermal resistance, junction-to-case, is 1 C/W. Maximum power dissipation for all units is 125 W. Packaging is in a standard JEDEC TO-3 case.

CIRCLE NO. 375

Short Story

EMC's New Short Contact for Short Leads



IC's jarring loose? EMC's brand new short contact grabs and **holds** IC leads even less than .10" long! We designed it into our patented Nurl-Loc[®] terminal to provide the precise insertion and withdrawal forces you need. And Nurl-Loc[®] gives you 5 times the gripping surface to prevent twist and spread the stress to eliminate warping. Short contacts are available now in EMC's Wire-Wrap[®] Panels . . . and in our full line of DIP and Transistor Sockets. Call Allan Klepper (401) 769-3800 for the longer story, or write Electronic Molding Corp., 96 Mill Street, Woonsocket, R.I. 02895.

Wire-Wrap[®] Gardner-Deser Co.



Interconnection Specialists

CIRCLE NUMBER 92

ELECTRONIC DESIGN 2, January 18, 1977

it's so simple

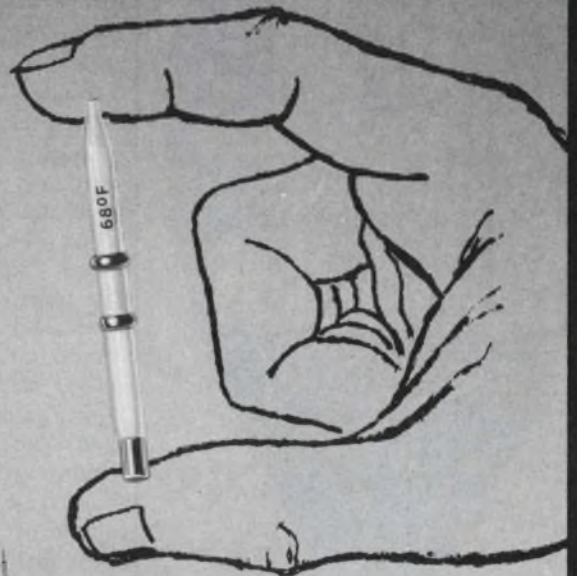

why
didn't I
think
of this
thermostat?



More and more engineers are asking themselves that question when they see and learn of the advantages of using P.S.G.'s Mercury and Lead State Thermostats.

ACCURACY	$\pm .05^{\circ}$ C to 2° C
DIFFERENTIAL	$.05^{\circ}$ C to 10° C
SHOCK	100 G
VIBRATION	20G at 2000 cycles per second
LOAD	5 M.A. to 5 amps
SIZE	length 5/16 and up - diameter 3/32 and larger

All types of mountings. Simple, no moving parts and they are low cost, ranging from \$2.10 each up (depending on model and quantity).

We find it simple to solve temperature control problems. Let us have yours.



PSG Industries, Inc.

MANUFACTURER OF PRECISION THERMO AND ELECTRONIC CONTROLS
1225 Tunnel Road, Perkasie, Pa. 18944



CIRCLE NUMBER 93

ALONE AGAIN

in low cost 1-watt
Zener Diodes

SCHAUER

"Z" SERIES ZENERS

DO-41 epoxy
molded case

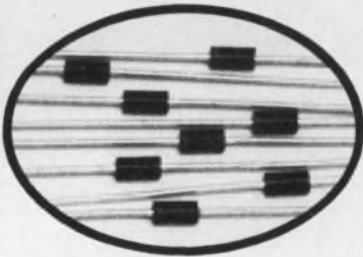

ANY VOLTAGE

2.6 to 34.0

ANY TOLERANCE

1% 2% 5% 10%

At Any Test Current

Compare These Prices

On 1% Tolerance Diodes

Quantity	Price each
1-99	91¢
100-499	83¢
500-999	77¢
1000 up	73¢

**LARGE STOCK
GOOD DELIVERIES**

Send for complete rating data
and other tolerance prices.

Semiconductor Division

SCHAUER

MANUFACTURING CORP.

4511 Alpine Ave., Cincinnati, OH 45242
Telephone 513-791-3030 Telex 21-4576

CIRCLE NUMBER 95

COMPONENTS

Snap-action thermostats sealed hermetically

Protective Controls Inc., Husky Park, Frederick, MD 21701. (301) 663-5141. \$6 to \$6.50 (OEM qty); 2 to 8 wks.

Series 5100 thermostats are hermetically sealed immersion-type snap-action bimetallic disc units. A new single-break switch design gives improved reliability as well as improved shock and vibration characteristics. The devices withstand 20 g's up to 2000 Hz and meet MIL-STD-202, condition D. Ratings are 3 A, 120 V ac; 1.5 A, 240 V ac; or 5 A, 30 V dc—100,000 cycles with SPST single-break (NC or NO) contacts. Quick-disconnect, spade or screw-type terminals are provided. The thermostats are factory calibrated within an operating range of -20 to 350 F.

CIRCLE NO. 376

PB switches assemble with contact blocks



Alco Electronic Products, Inc., 1551 Osgood St., North Andover, MA 01845. (617) 685-4371. \$3.85; operator, \$2 to \$3.85; blocks (1-9); stock to 6 wks.

Called the Series 2000, these oil-tight pushbutton control switches mount in 7/8-in. dia panel holes popular in the industry. The switches use Snap-Bloc contact blocks that require no tools to assemble and have UL and CSA ratings of 10 A at 300 V ac nominal (3500 VA make; 360 VA break). Virtually, any combination of NO and NC contact blocks is available.

CIRCLE NO. 377

PB lighted switches wipe gold contacts

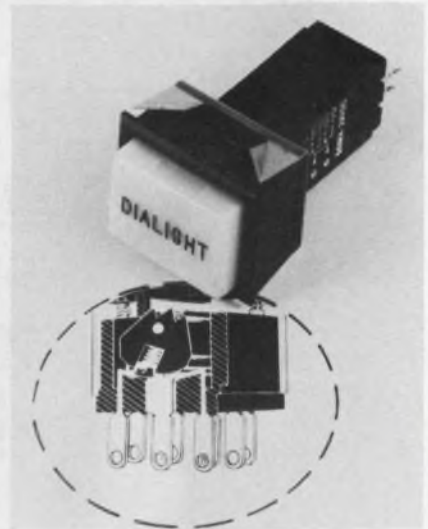

Dialight, 203 Harrison Pl., Brooklyn, NY 11237. (212) 497-7600. \$1.65 (1000 up); 2 to 3 wks.

Wiping-action with gold contacts provides reliable switching at low levels under a wide range of operating environments. The switches are part of Dialight's 554 series of low-cost computer-grade illuminated pushbutton switches and incorporate the same features as the 554 Series snap-action switches. Applications are typically for 1-to-100-mA (resistive) switched current at 1 to 30 V dc. A choice of momentary or tease-proof alternate action with SPDT or DPDT arrangement and solder-blade, quick-connect or PC-board terminals is available. T-1-3/4 incandescent lamps are used.

CIRCLE NO. 378

Miniature crystals operate at 2 to 3 MHz

Valtec, 75 S. St., Hopkinton, MA 01748. (617) 435-6831. \$3.50 to \$15; 6 to 10 wks.

A series of miniature quartz crystals, the VM6 series, can operate in the 2-to-3-MHz range with a typical series resistance of under 200 Ω . The crystals are packaged in an HC-18/U holder with maximum dimensions of 0.53 \times 0.435 \times 0.183 in. This construction, previously only used for high-frequency crystals, permits use of the crystals in high-density mounting on PC boards.

CIRCLE NO. 379

do you need a
**120 dB/OCTAVE LOW
 PASS FILTER?**

that has

- Cutoff frequencies from 1 Hz to 15 kHz
- Pass band ripple $\pm \frac{1}{2}$ dB typical
- Remote computer compatibility
- Cutoff frequencies switched in 10 μ s.
- Single channel price of \$850.00 (LP 120)
- A 2 to 16 channel version (LP-120 k)



Then consider the
UNIGON SUPER FILTER Model LP-120
 Get rid of noise, aliasing and unwanted signals.

Also consider our Model HP-120 high pass filter and our BP 120 band pass filter with similar characteristics.

**IF YOU WANT A FILTER OR A COMPLETE
 FFT PROCESSING SYSTEM, CONTACT US TODAY -**

UNIGON Industries, Inc.
 1 Park Ave., Mt. Vernon, N.Y. 10550 / (914) 699-7545

CIRCLE NUMBER 96

**WHO
 MAKES WHAT
 & WHERE TO
 FIND IT**

Volume 1 of **Electronic Design's GOLD BOOK** tells all. And, when you look up an item in its **PRODUCT DIRECTORY** you'll find each manufacturer listed **COMPLETE WITH STREET ADDRESS, CITY, STATE, ZIP AND PHONE.** Save time. There's no need to refer elsewhere to find missing information.

**IT'S ALL THERE
 in
 Electronic Design
 GOLD BOOK**

Dialight LED Displays

The widest choice for your every application.

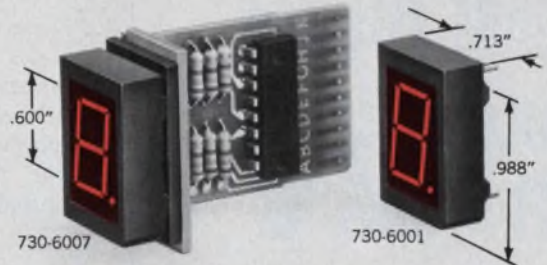

730 SERIES A new 0.600" LED character in super bright red, seven-segmented readout . . . low power . . . draws 10mA/segment or less . . . operates with standard IC power supply levels. Very high contrast ratio . . . visible from 40'. Available with or without on-board decoder/driver, plus or minus bar, and with bezel mounting. In 1000-lot quantities each LED **730-6007 \$6.95. 730-6001 \$2.55.**

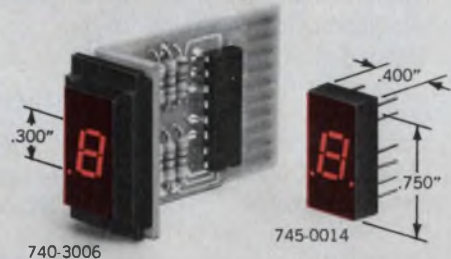

745 SERIES A new 0.300" LED character in a very bright red, seven-segmented readout . . . low power requirements. Standard 14-pin DIP . . . available with left and right decimal with ± 1 , and with and without on-board decoder/driver. Compatible with most TTL and DTL circuits. In 1000-lot quantities each **740-3006 \$6.43. 745-0014 \$2.10.**



Dialight, the company with the widest choice in switches, LEDs, indicator lights and readouts, looks for needs . . . your needs . . . and then they develop solutions for your every application. No other company offers you one-stop shopping in all these product areas. And no other company has more experience in the visual display field. Dialight helps you do more with these products than any other company in the business, because we are specialists that have done more with them. Talk to the specialists at Dialight first. You won't have to talk to anyone else. Send for your free new copy of Dialight's current catalog.

DIALIGHT

Dialight, A North American Philips Company
 203 Harrison Place, Brooklyn, N. Y. 11237
 (212) 497-7600

See Dialight.

CIRCLE NUMBER 97



subminiature EMI filters excel in IR@125°C

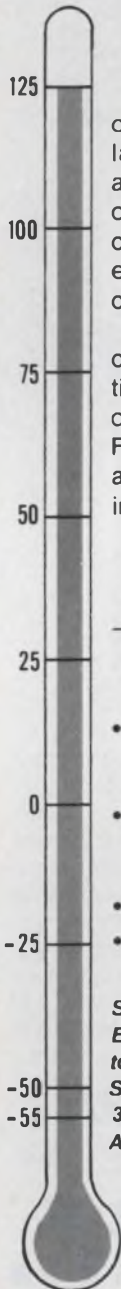

Astute users and specifiers of EMI Filters know that insulation resistance at high ambient temperatures is one of the most significant indicators of the quality and life expectancy of this type of component.

By utilizing Monolithic[®] ceramic layer-built construction in the capacitor elements of Sprague Subminiature EMI Filters, insulation resistance at 125°C is substantially improved.

Industry Standard (at 125°C)	Sprague Standard (at 125°C)
5-50 megohms	50-500 megohms

- **JX2000 SERIES**
Up to 15 amperes and 200 VDC @ 125°C
- **JX3000 SERIES**
Up to 15 amperes @ 125 VAC/400 Hz/125°C
- **M15733/23 QUALIFIED**
- **M15733/26 QUALIFIED**

For complete information on Sprague EMI Filters, write for Engineering Bulletin Series 8132 to: Technical Literature Service, Sprague Electric Company, 347 Marshall Street, North Adams, Mass. 01247.

45F-6141

CIRCLE NUMBER 98

Application Notes

Spectrum analysis

"Notes on Spectrum Analysis" discusses the important design and operational features concerning the use of all spectrum analyzers. A simple-to-follow question-and-answer format is used. Ailtech, Farmingdale, NY

CIRCLE NO. 380

Optically coupled isolators

How isolators can be applied in circuits using thermocouples and transducers in equipment for patient monitoring, adaptive control systems and high-voltage current monitoring is covered in a four-page application note. Hewlett-Packard, Palo Alto, CA

CIRCLE NO. 381

Machine controls

Machine Controls in the Manufacturing System discusses effective use of modern machine controls as significant factors in increased production, and describes how computer-numerical-control and programmable-control machines can be applied in automatic manufacturing systems. Allen-Bradley, Milwaukee, WI

CIRCLE NO. 382

Ultra-isolation transformers

The protection of sensitive electronic equipment from ac line noise and transients is the subject of the *Noise-Suppression Reference Manual for Ultra-Isolation Transformers*. Topaz Electronics, San Diego, CA

CIRCLE NO. 383

μP/display interface

Techniques for interfacing microprocessors to alphanumeric displays are described in a six-page application note. Burroughs, Electronic Components Div., Plainfield, NJ

CIRCLE NO. 384

We squeeze time

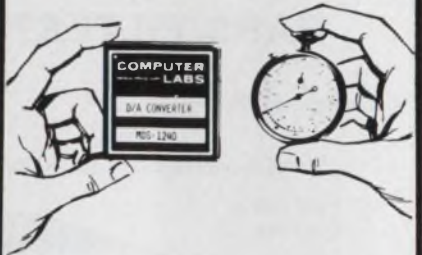

...in our new...



12-bit D/A!



MDS-1240 D/A CONVERTER

12-Bits, 40NS

\$149

COMPUTER LABS

505 EDWARDIA DRIVE
GREENSBORO, N. C. 27409
(919) 292-6427

CIRCLE NUMBER 99

ELECTRONIC DESIGN 2, January 18, 1977

Semiconductor testing

A 16-page semiconductor testing handbook tells what preconditioning and testing can accomplish, the cost and risk factors, and guidelines as to the degree of testing that various ICs require to ensure against system failures. Microelectronic Testing Laboratories, Irvine, CA

CIRCLE NO. 385

Data processing

An Executive Guide to Dispersed Data Processing describes in nontechnical language the dispersed processing concept and its significance for the business executive. The 20-page brochure includes explanatory illustrations of functioning networks. Datapoint, San Antonio, TX

CIRCLE NO. 386

Minicomputers

The advantages of using a minicomputer for small-business applications is described in nontechnical language in a 12-page brochure. Cincinnati Milacron, Lebanon, OH

CIRCLE NO. 387

Surge-suppression circuits

A six-page application note shows how to design surge-suppression circuits to protect thyristors from load-induced faults. Westinghouse Electric, Semiconductor Div., Youngwood, PA

CIRCLE NO. 388

Dry plasma

The use of dry-plasma methods for failure analysis of semiconductor devices is described in an application note. Tegal, Richmond, CA

CIRCLE NO. 389

Reinforced thermoplastics

Wear and friction properties of internally lubricated reinforced thermoplastics for applications involving moving parts are covered in a 20-page study. LNP Corp., Malvern, PA

CIRCLE NO. 390

better temp control

Fast, dependable, automatic snap-action . . . at a reasonable cost. Elmwood thermostats fill your high limit or control needs with the right temperature range, differential, tolerance, terminals, bracket or custom package. All are 100% pre-tested, with U.L., C.S.A. and European listings available for world trade, and conform to DIN norms. Ask for prototypes. Elmwood Sensors, Inc., 1675 Elmwood Ave., Cranston, R. I. 02907. Phone (401) 781-6500. In Europe: Elmwood Sensors, Ltd., North Shields, Tyne and Wear, NE29 8SA, England. Phone (089) 45-82821.



Elmwood thermo- stats

CIRCLE NUMBER 101

LSI-11 Micro- computer Data Acquisition System

The ADAC Model 600-LSI-11 is the first data acquisition system available for use with the DEC LSI-11/PDP-11/03 microcomputers.

Both software and hardware compatible, the Model 600-LSI-11 A/D system plugs directly into the bus of the LSI-11/PDP-11/03 systems.

Features include a 12 bit A/D converter, high speed sample and hold circuit, from 16 to 64 channels of MUX., DC/DC power converter and bus interfacing. A/D system throughput rate is 35 KHz.

Optionally available are: one or two 12 bit D/As and programmable gain amplifier with auto zeroing circuit.

Basic system price in single quantity is \$895.

Send for full technical data on the Model 600-LSI-11 and other ADAC minicomputer data acquisition and control systems and modules.

ADAC Corporation,
15 Cummings Park, Woburn,
MA 01801. (617) 935-6668.

GSA Contract Group 66.

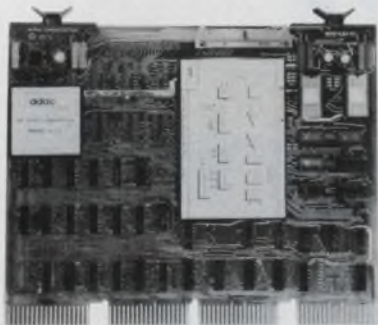

CIRCLE NUMBER 102

New Literature

CATALOG NO. 501

TRW RF SEMICONDUCTORS



Semiconductors

Complete data for hybrids and discretes for rf linear applications are covered in a 12-page catalog. It includes specifications, application block diagrams and reliability notes. TRW RF Semiconductors, Lawndale, CA

CIRCLE NO. 391

Software directory

Datapro Directory of Software provides current, comprehensive and objectively prepared profiles on thousands of software products and their vendors and applications, along with an extensive survey of software users. Sample pages of the directory are available on request. Datapro Research, Delran, NJ

CIRCLE NO. 392

Semi screening report

The third quarter *Screening Report Summary* on integrated circuits, transistors and diodes includes both a tabulation of detailed data on each lot processed by device type and part number. Continental Testing Laboratories, Fern Park, FL

CIRCLE NO. 393

Data communications

Illustrations and descriptions of data communications products can be found in a six-page brochure. Tele-Dynamics, Fort Washington, PA

CIRCLE NO. 394

Semiconductor packaging

Custom transistor and hybrid requirements are described in a four-page brochure. Transistor Specialties, Peabody, MA

CIRCLE NO. 395

Antennas

Technical, system design and product information for antenna and transmission line systems are covered in a 128-page catalog. Andrew Corp., Orland Park, IL

CIRCLE NO. 396

Keytops

Included in a 16-page brochure describing keytops is an application guide and many photographs. Key Tronic, Spokane, WA

CIRCLE NO. 397

Circuit boards

Sub-elements for making instant circuit boards, pre-etched general-purpose prototype and wire-wrap socket boards, and PC drafting aids for making circuit-board master artwork are described in a six-page catalog. Circuit-Stik/Centron Engineering, Torrance, CA

CIRCLE NO. 398

Power-supply periodical

A periodical, *WATTS UP AT SCI*, provides information about power-supply concepts, applications and new-product developments. Semiconductor Circuits, Haverhill, MA

CIRCLE NO. 399

Power supplies

Specifications, outline drawings and pricing of single, dual and triple-output miniaturized power supplies are given in a 20-page catalog. Acopian, Easton, PA

CIRCLE NO. 400

8 Bit A to D/D to A Converter - the first priced at only \$4.50*

The Ferranti Model ZN425E—an 8 bit dual mode analog to digital/digital to analog converter features:

- Single chip monolithic construction
- Typical settling time 1.0 μ s for 1 L.S.B. step
- 8 bit binary counter, R-2R ladder network and switches
- On-chip precision voltage reference
- Self-contained, precision ramp generator
- TTL and CMOS compatible



better by design

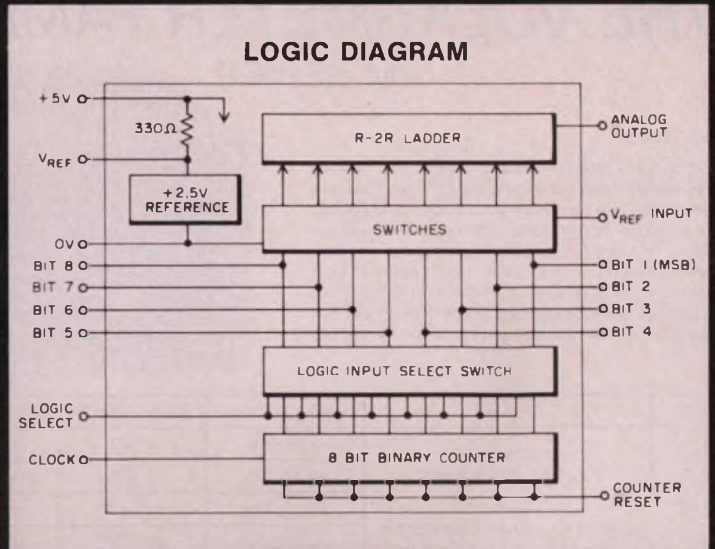

*1000 piece price

FOR COMPLETE SPECIFICATIONS, CONTACT: FERRANTI ELECTRIC, INC. / SEMICONDUCTOR PRODUCTS
EAST BETHPAGE ROAD, PLAINVIEW, NEW YORK 11803 PHONE: (516) 293-8383 / TWX: 510-224-6483

CIRCLE NUMBER 103

FILTERS LC & CRYSTAL

COMSTRON ■ SEG's on-time delivery of "impossible" filters, from engineering conception to mathematical synthesis, through quality oriented production, satisfies our most demanding customers.

Whatever your needs . . . from spectral shaping and phase correction to time-domain synthesis . . . you can rely on the filter experts at COMSTRON ■ SEG. Computer-optimized custom designs from DC to 120 MHz with sharp roll offs, phase correction, and narrow bandwidths, all in production quantities with competitive pricing.

NAME IT AND COMSTRON ■ SEG WILL DELIVER IT ON SCHEDULE!

Call or write today for information or applications assistance on all your LC and Crystal Filter requirements.

200 EAST SUNRISE HIGHWAY ■ FREEPORT, NEW YORK ■ 11520
(516) 546-9700

COMSTRON · SEG



CIRCLE NUMBER 104

ELECTRONIC DESIGN 2, January 18, 1977

DO YOU NEED A RUGGED CONTROL SYSTEM SHAFT ENCODER?

BEI HAS IT!



BEI Series 3700 optical shaft, incremental encoders will meet machine tool specifications. . .

- rugged- 3.5" dia. construction, sealed and protected against severe environments.
 - rugged- industrial grade solid state light source.
 - rugged- high shaft loads, 40 lbs.
- . . . plus dual inch/metric resolutions...plus direction sensed counts to 12,700 per revolution...plus noise immune, low impedance TTL line driver outputs.

For best performance, best reliability in your digital control system phone or write BEI today.



BEI Electronics Inc.

CONTROLS AND INSTRUMENTS DIVISION
1101 McAlmont Street, Little Rock, Ark. 72203
Telephone: 501-372-7351 TWX: 910-722-7384

CIRCLE NUMBER 105

DIGITAL MULTIMETERS

NLS proves NLS' DMMs have more capability at lower prices.

NLS' Silver Jubilee Year

THE VOLKSMETER FAMILY LM SERIES

Features Include:

- Super Rugged - ideal for field service use.
- Battery powered with batteries and charger unit included.
- Exclusive NLS fuseless protection in kΩ mode - up to 500 vdc or rms ac may be applied without damage.
- Overload indication.
- Automatic zeroing and polarity.
- Operating temperature - 0° to 45°C.
- Large 0.3" LED display.
- Small size: 1.9" H x 2.7" W x 4.0" D.
- Six optional shunts for current measurement - LM-3.5 includes three shunts in values of 10 mA, 100 mA and 1A.



MODEL	RANGES	DC ACCURACY	RESOLUTION	DIGITS	PRICE
LM-3	VDC & VAC	±1% Rdg	1 mV	3	\$125
LM-3.5	1V, 10V, 100V & 1000V	±0.5% Rdg	1 mV	3-1/2	\$147
LM-40	OHMS	±0.1% Rdg	100 μV	4	\$190
LM-4	1 kΩ, 10 kΩ, 100 kΩ, 1 MΩ & 10 MΩ	±0.03% Rdg	100 μV	4	\$227



Non-Linear Systems, Inc.

Originator of the digital voltmeter.

Box N, Del Mar, California 92014 Telephone (714) 755-1134

CIRCLE NUMBER 106

See your local distributor!

Distributor Inquiries Invited.

NEW! INSTANT FREQUENCY DIFFERENCE!



Tracor Model 527A measures frequency difference instantly, precisely. For precisely \$2,950. Front-panel meter reads directly to parts per 10¹¹. Allows adjustment of two oscillators to the same frequency, adjustment to a specific offset, determination of offset — all instantly. Plus both short-term and long-term stability analysis. Internal oscilloscope extends precision to 1 x 10⁻¹². Reference and signal frequencies need not be the same. Write or call for full technical and application information.

Tracor Industrial Instruments

6500 Tracor Lane • Austin, Texas 78721 • AC 512/926-2800

CIRCLE NUMBER 107

Bulletin Board

Wintek has scheduled its three-day "Hands-On Microprocessor Short Course with Take Home Microcomputer" at nine locations in February and March, 1977. Tuition is \$495. Course locations include Boston, Chicago, Dayton, Huntsville, Los Angeles, St. Petersburg Beach, Palo Alto, Philadelphia and Washington, DC.

CIRCLE NO. 401

Mostek and Fairchild have announced that Fairchild's MOS/CCD Products Div. will second-source the Mostek MK 4027, a 16-pin 4096-bit dynamic RAM, which has an access time of 150 ns.

CIRCLE NO. 402

Texas Instruments has lowered prices of programmable control system components. The single-unit price of an input module drops from \$11 to \$10, an output module from \$13 to \$12 and an interface module from \$80 to \$70.

CIRCLE NO. 403

Hundreds of microcomputer programs are available on paper tape and in listing form through a new expanded user's library announced by the Microcomputer Systems Div. of Intel.

CIRCLE NO. 404

Motorola is second-sourcing the 2900 four-bit μP slice family originated by Advanced Micro Devices.

CIRCLE NO. 405

Users of MSCS, PMS or CMSC network analysis programs for planning and control calculations can now obtain graphic reports (time-scaled networks, Gantt bar-charts and cost/resource graphs) automatically generated by Systonetics' EZPERT on a "pay-as-you-use" basis. This service is available throughout the U.S. via the McDonnell Douglas Automation (MCAUTO) computer network.

CIRCLE NO. 406

Vendors Report

Annual and interim reports can provide much more than financial position information. They often include the first public disclosure of new products, new techniques and new directions of our vendors and customers. Further, they often contain superb analyses of segments of industry that a company serves.

Selected companies with recent reports are listed here with their main electronic products or services. For a copy, circle the indicated number.

Bunker Ramo. Information systems; electronic intelligence and ocean surveillance systems; connection and interconnection devices.

CIRCLE NO. 407

Reynolds Metals. Aluminum products.

CIRCLE NO. 408

Control Data Corp. Computer services.

CIRCLE NO. 409

Hazeltine. Electronic display systems; anti-submarine warfare systems; computer terminals and equipment; electronic identification and communications equipment; transportation control systems and color-analysis equipment.

CIRCLE NO. 410

General Electric. Products for generation, transmission, distribution, control and use of electricity.

CIRCLE NO. 411

CTS. Resistors and resistor networks, switches, microcircuits, quartz crystal products, loudspeakers, metal and plastic specialties.

CIRCLE NO. 412

Basic Inc. Refractory materials and chemical and electronic products.

CIRCLE NO. 413

Burroughs. Products that record, store, compute, process and communicate data.

CIRCLE NO. 414

NOW!...Spectronics large numeric displays in single and multi-digits

Spectronics has the VLEDS you need for large numeric display applications . . . in red single and multi-digits.

Single-Digits SPX 300 and 500 series single-digit numeric displays feature wide viewing angles, continuous uniform segments and high contrast. Plus, they are categorized for uniformity of luminous intensity and are available in both common cathode and common anode configurations.



SPX 300 characters are .3 inches high; SPX 500 characters are .5 inches high. Plus and minus — left and right decimal points offered.

Multi-Digits For multi-digit applications, Spectronics offers the SPX 766 and SPX 767. Both displays feature .7 inch-high characters, colon, plus and minus. SPX 766 is common cathode, direct drive, 24 hour; SPX 767 is common cathode, direct drive, 12 hour. Contact Spectronics today for price and delivery information.

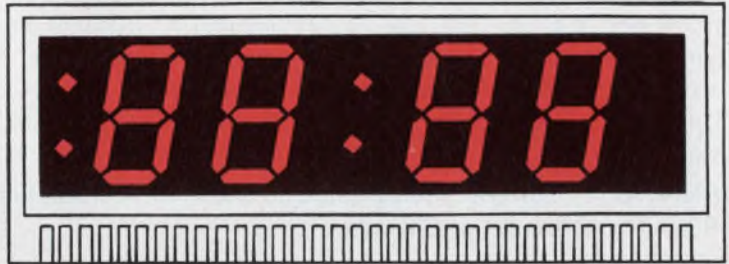

We make optoelectronics work for you with superior quality, competitive pricing, fast deliveries!



Spectronics
INCORPORATED

830 East Arapaho Road Richardson, Texas 75080
(214) 234-4271 Telex 73-0890

The
Quality
Leader

CIRCLE NUMBER 108



Total Reliability in Elapsed Time Indicators and Event Counters

Most dependable sub-miniature indicators you can buy . . . for critical HOW-LONG/HOW-MANY records for aerospace, military and industrial applications. ETI's conform to MIL-M-7793D, operate in ambients -65°C to $+125^{\circ}\text{C}$, with digit or dial readouts.

Event Counters meet MIL specs, operate in ambients up to 425°F , with 4, 5 or 6 digits. AC and DC models, hermetically sealed, with wide choice of mountings, housings and other modifications to suit.

Write or Call for full catalog



MINELCO DIVISION OF
GENERAL TIME
A TALLEY INDUSTRIES COMPANY

135 South Main St., Thomaston, Conn. 06787 Phone (203) 283-8261

CIRCLE NUMBER 109

ELECTRICAL ENGINEERS TEST EQUIPMENT DESIGN

ANALOG — Engineers to design test stands and associated electrical/electronic controls and data acquisition systems. Experience in solid state closed loop analog control systems is desired.

DIGITAL — Engineers to design the hardware and software of digital computer based equipment used in the testing of high speed rotating machinery and mechanical actuating equipment. Experience in Assembly and Fortran programming of minicomputers is required.

Responsibilities include the design, construction, installation and checkout of test stands, instrumentation and control systems. Engineers will be exposed to a broad variety of our aerospace and commercial products. Technical exposure is "total concept" without specialization.

SUNDSTRAND is a Fortune 500 company located in Rockford, Illinois, about 90 miles northwest of Chicago.

Send Resumes to:

SUNDSTRAND CORPORATION

Peter L. Arthurs
4751 Harrison Avenue
Rockford, Illinois 61101
An Equal Opportunity Employer M/F

AUTHOR'S GUIDE

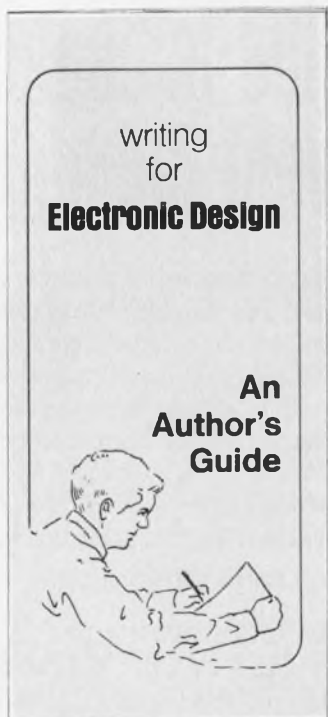

If you've solved a tricky design problem, if you have developed special expertise in a specific area, if you have information that will aid the design process... share it with your fellow engineer-readers of *Electronic Design*.

Articles you have authored not only raise your own professional status, but help build your company image as well. The readers benefit, your company benefits.

To help you prepare material that meets *Electronic Design's* high editorial standards, our editors have prepared a special author's guide entitled "Writing for *Electronic Design*." It covers criteria for acceptability, form, length, writing tips, illustrations, and payment for articles published. It's available without cost.

It's easy to write for *Electronic Design*, but it's often hard to get started. Send for your copy of our Author's Guide today.

Circle No.
250

Electronic Design

ELECTRONIC DESIGN's function is:

- To aid progress in the electronics manufacturing industry by promoting good design.
- To give the electronic design engineer concepts and ideas that make his job easier and more productive.
- To provide a central source of timely electronics information.
- To promote communication among members of the electronics engineering community.

Want a subscription? ELECTRONIC DESIGN is sent free to qualified engineers and engineering managers doing design work, supervising design or setting standards in the United States and Western Europe. For a free subscription, use the application form bound in the magazine. If none is included, write to us direct for an application form.

If you do not qualify, paid subscription rates are as follows: \$30.00 per year (26 issues) U.S., \$40.00 per year (26 issues) all other countries. Single copies are \$2.00 U.S., \$3.00 all other countries. The Gold Book (27th issue) may be purchased for \$30.00 U.S. and \$40.00 all other countries.

If you change your address, send us an old mailing label and your new address; there is generally a postcard for this bound in the magazine. You will have to requalify to continue receiving ELECTRONIC DESIGN free.

The accuracy policy of ELECTRONIC DESIGN is:

- To make diligent efforts to ensure the accuracy of editorial matter.
- To publish prompt corrections whenever inaccuracies are brought to our attention. Corrections appear in "Across the Desk."
- To encourage our readers as responsible members of our business community to report to us misleading or fraudulent advertising.
- To refuse any advertisement deemed to be misleading or fraudulent.

Microfilm copies are available of complete volumes of ELECTRONIC DESIGN at \$19 per volume, beginning with Volume 1, 1952 through Volume 20. Reprints of individual articles may be obtained for \$3.00 each, prepaid (\$3.50 for each additional copy of the same article) no matter how long the article. For further details and to place orders, contact the Customer Services Department, University Microfilms, 300 North Zeeb Road, Ann Arbor, Michigan 48106 telephone (313) 761-4700.

Want to contact us? If you have any comments or wish to submit a manuscript or article outline, address your correspondence to:

Editor
ELECTRONIC DESIGN
50 Essex Street
Rochelle Park, N.J. 07662

Step-by-step coverage of defense radar system design . . .

INTRODUCTION TO DEFENSE RADAR SYSTEMS ENGINEERING

James N. Constant

This all-inclusive handbook covers virtually every facet of radar technology that must be mastered in order to design a complete defense radar system. In fact, it concludes with a *step-by-step procedure for specifying and designing a complete radar system for a given application*. Separate chapters cover target characteristics; radar detection; radar receivers; radar system error model; flight of a ballistic missile; ballistic reentry trajectories; trajectory prediction; radar data processing; reflector antennas; and array antennas. Order your 15-day examination copy today! #9194, 344 pages, cloth, illustrated, \$22.95



15-DAY FREE EXAMINATION!



Hayden Book Company, Inc.
50 Essex Street
Rochelle Park, N.J. 07662

Please send me my copy of INTRODUCTION TO DEFENSE RADAR SYSTEMS ENGINEERING to read and use for 15 days. At the end of that time, I'll send a check or money order for \$22.95, plus postage and handling, or return the book and owe absolutely nothing.

I want to save money! I have enclosed full amount. Publisher pays postage and handling. I get a complete 15-day money-back guarantee.

Name _____
Firm _____
Address _____
City/State/Zip _____

76-15

Electronic Design

ELECTRONIC DESIGN's function is:

Advertising Sales Staff
Tom W. Carr, Sales Director
Jean Bunfield, Sales Coordinator

Rochelle Park, NJ 07662
Robert W. Gascoigne
Daniel J. Rowland
Thomas P. Barth
50 Essex St.
(201) 843-0550
TWX: 710-990-5071

Philadelphia
Thomas P. Barth
(201) 843-0550

Boston 02178
Gene Pritchard
P.O. Box 379
Belmont, MA 02178
(617) 489-2340

Chicago 60611
Thomas P. Kavooras
Berry Conner, Jr.
200 East Ontario
(312) 337-0588

Cleveland
Thomas P. Kavooras
(312) 337-0588

Los Angeles 90045
Stanley I. Ehrenclou
Burt Underwood
Neil Canavin
8939 Sepulveda Blvd.
(213) 641-6544

Texas
Burt Underwood
(213) 641-6544

San Francisco
Robert A. Lukas
3579 Cambridge Lane
Mountain View, CA 94040
(415) 965-2636

London
Constance McKinley
50 Essex St.
Rochelle Park, N.J. 07662
Phone: (201) 843-0550

Amsterdam, Tokyo, Seoul
Sanders, W. J. M.
Raadhuisstraat 24
Graft-De Ryp, Holland
Phone: 02997-1303
Telegrams: Euradteam-Amsterdam
Telex: 13039-SIPAS

Haruki Hirayama
Electronic Media Service
5th Floor, Lila Bldg.,
4-9-8 Roppongi
Minato-ku, Tokyo, Japan
Phone: 402-4556
Cable: Electronicmedia, Tokyo
Mr. O-kyu Park, President
Dongbo Intl Corp.—
World Marketing
C.P.O. Box 4010
Seoul, Korea
Tel. 76-3910/3911
Cable: DONGBO SEOUL
Telex: EBKOREA K27286

★ABP

BPA

Smallest 2A Reed Relay!



COTO'S NEW MICRO-MINIATURE Reed Relays

- Wide variety contacts 1A, 2A, 1C, or 1A (Hg. wet)
- Uses only .17 sq. in. pc board space: Package dimen. .210" x .225" x .810"
- Choice of coil resistances at 5 or 12 VDC
- Encapsulated in epoxy-coated metal can
- Electrostatic or coaxial shielding for R.F. switching

Write or Call for Bulletin 14.1



COTO-COIL COMPANY, INC.
59 Pavilion Avenue
Providence, R. I. 02905
Phone (401) 467-4777

CIRCLE NUMBER 111

KEEP

Electronic Design's

GOLD BOOK

HANDY



When You Call

Save time when you contact suppliers. Check their catalog pages first in *Electronic Design's* GOLD BOOK. Maybe the information you need is right at your fingertips.



CERAMIC CHIP CAPACITORS. SPLIT-CHIP, is a new concept in ceramic chip capacitor technology. These new units have two broad electrodes on one face and eliminate conventional wrap-around end terminations. This new concept provides lower cost and easier assembly. SPLIT-CHIPS are available in five standard sizes from .040" x .030" to .130" x .090" and .015" thick and in all popular dielectrics and capacitance ranges. JOHANSON DIELECTRICS, INC., Box 6456, Burbank, Ca. 91510 213-848-4465

CERAMIC CHIP CAPACITORS 181

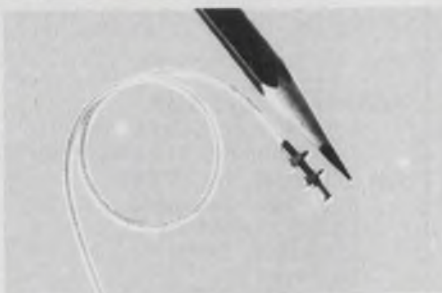

World's Smallest Displacement Transducer. Make precision, noncontacting displacement measurements at points never before possible. This new transducer, 0.080" OD, gives accuracy of <math>< 100 \mu\text{in.}</math> in a range up to 0.020". Temperature stable. Repeatability and resolution is better than 10 $\mu\text{in.}$ Price \$485, including associated electronics. Kaman Sciences Corporation, P. O. Box 7463, Colorado Springs, CO 80933. (303) 599-1500.

TRANSDUCER 184

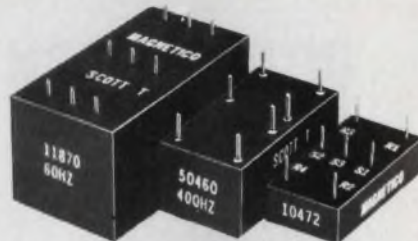

Scott T Transformer. 11870: 60HZ, 90v, L-L in. 1.1x2.1x1.1. 50460: 400 HZ, 90v, L-L in. 7/8x1.5/8x11/16. 50642: 400HZ, 11.8v, L-L in. 7/8x5/8-11/16. 10472: 400-HZ, 11.8v, L-L in. 3/4x1-1/2x3/8. All with 6v RMS sine & cosine output. MAGNETICO, INC., 182 Morris Ave., Holtsville, N.Y. 11742 516-654-1166.

TRANSFORMER 187



MEMODYNE INCREMENTAL LOW POWER DATA LOGGER Model 2221, is ideal for remote or unattended collection of sporadic measurements. Features 16 channels, 0 to +10 volt analog input, 12 bit resolution, over 2 megabit capacity per 300 foot cassette. Standby current is less than 50 microamps. Available for line or battery operation. Unit price is \$1670.00. Memodyne Corporation, 385 Elliott Street, Newton Upper Falls, Massachusetts, 02164. (617) 527-6600.

LOW POWER DATA LOGGER 182



ANTI-STATIC SYSTEMS FOR PRINTERS, OCR COM and other machines. Static causes rapidly moving paper and film to jam. . . cause arc tracks on undeveloped film. . . attract and hold dust to photographic negatives causing imperfections on printed circuit boards. Numerous products, of interest to both OEM and user, are detailed in new 32 page catalog to solve these problems quickly, reliably and economically. Chapman Anti-Static Div., Portland Co., 58 Fore St., Bx 427, Portland, ME 04112. (207) 773-4726

ANTI-STATIC SYSTEMS 185



MAGNETIC SHIELDING Take advantage of Eagle's 23-year background in shield design and production. Custom and standard models. Full service includes design, engineering, fabrication, heat treating, finishing, testing. Also wide selection of sheet and foil so you can form your own shields. For helpful design and cost data, request Bulletin E-77. Eagle Magnetic Co., Inc., Box 24283, Indianapolis, IN 46224. 317-297-1030.

MAGNETIC SHIELDING 188

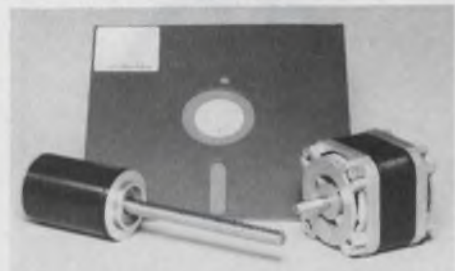

FLOPPY DRIVE TEAM! Now, drive motors and stepping motors specifically for flexible disc systems—both from EAD. The drive motor has excellent torque, precise repeatable speeds, 1/100 hp, 1500 rpm @ 50 Hz, 1800 rpm @ 60 Hz. Stepping motors are Size 18 and 20, with single or multiple start lead screw, 3- or 4-phase, 15° per step. Write or call: Eastern Air Devices, Holtzer-Cabot motors, Dover N.H. 03820, (603) 742-3330, TWX (510) 297-4454. Syn & Ind Motors • Gear Motors • Fans • Blowers.

DRIVE & STEPPING MOTORS 183



VIDEO CHARACTER GENERATOR. Converts up to 16 parallel BCD digits at TTL levels into video signals for display on monitors or for insertion into a video signal. Fifteen fixed alpha-numeric characters can also be included. Horizontal and vertical positioning controls. Many formats available. Chrono-log Corporation, 2 West Park Road, Havertown, Pa. 19083 (215) 853-1130.

VIDEO DISPLAY GENERATOR 186



Free 32 Page Catalog

FREE 32 PAGE CATALOG. WINDOWS - PLATES - DISCS - OPTICS. Fused quartz, optical glasses, pyrex Ultra-low expansion materials, highly resistant to thermal shock. High UV and IR transmission. Chemically inert to most corrosive materials. Stocking center for lenses, prisms and laser accessories. Complete fabricating facilities. ESCO PRODUCTS, 181 Oak Ridge Rd., Oak Ridge, N.J. 07438. (201) 697-3700

LENSE, PRISM CATALOG 189

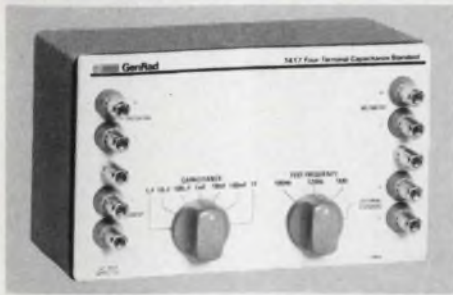

New Capacitance Standard. The GR 1417 is a four-terminal capacitance standard with direct reading accuracy of 0.025% at capacitance values of 1, 10 and 100 μ F, 1, 10 and 100 mF and 1F. This standard is calibrated for use at frequencies of 100 Hz, 120 Hz and 1 kHz but may be used over a frequency range from below 50 Hz to over 10 kHz. The GR 1417 also acts as a standard for dissipation factor. Gen-Rad, 300 Baker Ave., Concord, MA 01742 (617) 369-8770.

CAPACITANCE STANDARD

190



Free New '77 catalog contains over 34,500 quality power supplies from the world's largest manufacturer, Power/Mate Corp. Power Supplies for every application including submodulars, open frame, variorated, encapsulated, laboratory & system. All units UL approved and meet most military and commercial specs for industrial and computer uses. Power/Mate Corp., 514 S. River St., Hackensack, NJ 07601 (201) 343-6294

POWER SUPPLIES

193

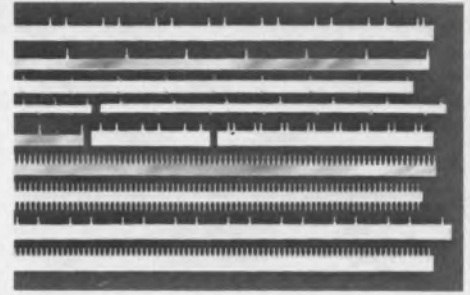

MINI/BUS® BY ROGERS, low-cost, low-inductance, high capacitance printed circuit board bus bars for noise reducing voltage distribution, are available in a variety of ready-to-ship designs. Prototype kits are also available from stock. Call or write Mini/Bus product specialist for a complete list. Rogers Corporation, Chandler, AZ 85224. Phone: (602) 963-4584. (EUROPE: Mektron NV, Gent, Belgium; JAPAN: Nippon Mektron, Tokyo.)

BUS BARS

196

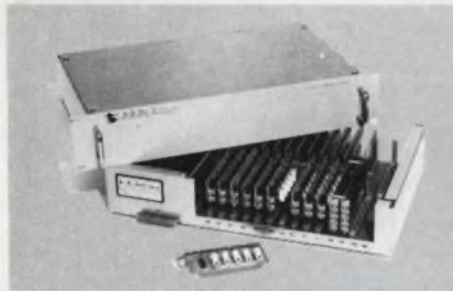

DATA SWITCHING SYSTEMS Whether you want a Multiplexer or Matrix to switch Low Level or High Frequency by Manual or Computer control we have a switch to meet your specifications. The systems are built up from a basic control unit into which can be plugged many different switching modules in the configuration you require. IEEE 488 interface available. For further information and a complete solution to your switching problems contact A.D. DATA SYSTEMS INC. P.O. Bx 9209, Rochester, NY 14625 (716) 381-2370

MATRICES

191

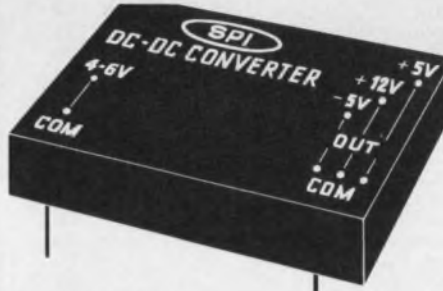

LOW COST TRIPLE OUTPUT DC-DC CONVERTER FOR MICROPROCESSOR FIELD. Provides regulated +12V, +5V, and -5V from unregulated 4 to 6V input. Will operate from 4 cells for battery-operated applications. Over 80% efficient. Other outputs also available. Input filtered. Low output noise. 100% burn-in. Optional power strobing. Encapsulated in rigid case. Small (only 3.1" x 2.1" x 0.4"). Scientific Programming, Inc., 1499 Bayshore Hwy., Burlingame, Ca. 94010. (415) 692-1600.

MINIATURE DC POWER SOURCES

194



FLUORESCENT PHOTOELECTRICS. TRAN-BAL INVERTER BALLAST; allows designer to utilize fluorescent lamp for long photoelectric light source by eliminating flicker associated with 60 Hz Operation. Models available for all lamps through 40 watts. Input voltage 12 to 48 v.d.c. The Bodine Co., 236 Mt. Pleasant Road, Collierville, TN (901) 853-7211

FLUORESCENT PHOTOELECTRONICS

197

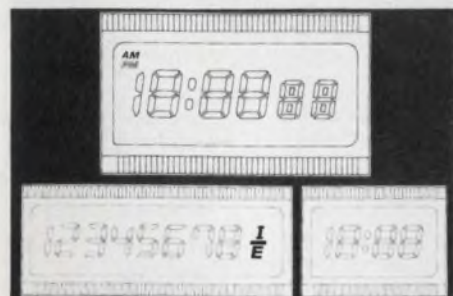

SHARP LIQUID CRYSTAL DISPLAY. We have a wide range of standard displays and can special design for a low design cost. Quick delivery on all displays. Contact:—Sharp Corporation, Semi Conductor Division, Overseas Marketing, 2613-3, Ichinomoto Tenri, Nara, Japan. Tel: (07436) 5-1321 Telex: 5522364 SHAPEL J

STANDARD/SPECIAL DISPLAYS

192



NEW MOTOR CONTROLS COST LESS! KBGE AC Voltage Controls for motors, heaters and lamp loads. KBGE modules use high reliability triacs. Phase-controlled circuitry is rugged and compact (3" x 2" x 1"). Versatile for power on voltage control; many features. Samples: 120 VAC, \$18.; 240 VAC, \$20. Free data sheet D-162. KB ELECTRONICS, INC., 5801 Foster Ave., Brooklyn, N.Y. 11234 (212) 968-8000.

MOTOR CONTROLS

195



Overcurrent Protector, manual reset eliminates fuse replacement. Convenient panel mounting. 19 fractional ratings from 0.1 to 5 amp. Other models up to 400 amp. Trip-free and fool-proof, UL and CSA approved. High quality, low cost \$1.39 ea. in 1000 lots. E-T-A Products Co. of America, 7400 N. Croname Rd., Chicago, Ill. 60648. Tel: (312) 647-8303. Telex: 253780.

CIRCUIT BREAKER

198

Advertiser's Index

Advertiser	Page	Advertiser	Page	Advertiser	Page
A. D. Data Systems, Inc.	141	Ferranti Electric Inc. Semiconductor Products	135	*Oscilloquartz SA	81
A P Products Incorporated	126	Fifth Dimension, Inc.	127	PSG Industries, Inc.	129
AMP, Incorporated	34	Gates Energy Products, Inc.	48, 49	*Philips Electronic Components and Materials	14
Adac Corporation	134	Gen Rad	141	Philips Test & Measuring Instruments Inc.	14, 88
Addmaster Corporation	115	Gold Book, The	131, 139, 143	Portland Co., Inc.	141
Advanced Micro Devices	4, 5	Gould Inc., Instrument Systems Division	99	Potter & Brumfield, Division of AMF, Incorporated	91
Airpax Electronics, Cambridge Division	43	Hayden Book Company, Inc.	88, 93, 96A-B, 139	Power/Mate Corp.	126, 141
Alco Electronic Products, Inc.	111	Heyman Manufacturing Company	121	PowerTech, Inc.	37
Amperex Electronics Corporation	17	Hybricor Corporation	120	RCA Solid State	Cover IV
Arnold Magnetics Corp.	104	IERC. A Subsidiary of Dynamics Corporation of American	109	RCL Electronics, Inc.	32
Arrow-M Corp.	100	ISE Electronics Corporation	105	RFL Industries, Inc.	108
B & K Products of Dynascan Corporation	46	ITT Pomona Electronics	10	Raytheon Company, Ocean Systems Center	122
BEI Electronics Inc.	135	Indiana General	45	Reticon	103
Beckman Instruments, Inc., Helipot Division	95	Intel Corporation	28, 29	Rockwell International	18, 19
Bodine Electric Company	141	Intertec	40	Rogers Corporation	79, 141
Bourns, Inc., Trimpot Products Division	Cover II	Johanson Dielectrics, Inc.	140	S.D.S.A.	116
Bunker Ramo Connector Division	33	Johnson Company, E. F.	6	Sangamo Capacitor Division, Division of Sangamo Weston, Inc.	38
CTS Corporation	114	K B Electronics	141	Scientific Programming	141
Chrono-Log Corp.	141	Kaman Sciences Corp.	140	Schauer Manufacturing Corp.	130
Clairex Electronics, A Division of Clairex Corporation	109	Koh-I-Noor Radiograph, Inc.	72, 73	Semikron International Inc.	102
Computer Labs, Inc.	132	Magnetic, Inc.	140	Sharp Corporation	141
Comstron-SEG	135	Magnetics, Inc.	97	Siemens Corporation	93
Control Data Corporation, Magnetic Components Division	110	Memodyne Corporation	140	Signetics Corporation	110, 111, 113, 115, 117, 119, 121, 123, 124, 125
Coto Oil Company, Inc.	139	Minelco Division, General Time	137	Spectronics, Incorporated	137
Data Precision Corporation	87	Mini-Circuits Laboratory, A Division of Scientific Components Corp.	2	Sprague Electric Company	59, 132
Datanetics	118	Molex, Incorporated	Cover III	Stackpole Carbon Company	47
Delco Electronics, Division of General Motors	60, 61	Motorola Semiconductor Products, Inc.	8, 9, 31, 52, 53	T-Bar, Incorporated	106
Deltron, Inc.	7	Mu Pro Inc.	112	TRW/UTC Transformer, an Electronic Components Division of TRW, Inc.	23
Dialight, A North American Philips Company	131	NEC Microcomputers, Inc.	81	Tektronix, Inc.	11
EECO	71	National Semiconductor Corporation	12, 13	Telonic Altair	120
*FMI SE Labs	95	Newark Electronics	123	Texas Instruments, Incorporated	89
E-T-A Products Co. of America	141	Nicolet Instrument Corp.	128	Textool Products, Inc.	127
Eagle Magnetic Co.	141	Non-Linear Systems, Inc.	136	Topaz Electronics	119
Eastern Air Devices	140	North American Philips Controls Corp.	113	Tracor, Inc.	136
Electronic Design	80, 138	O. K. Machine & Tool Corporation	97	Unigon Industries Inc.	131
Electronic Molding Corporation	129			United Systems Corporation	107
Elmwood Sensors, Inc.	133			Universal Data Systems	27
Esco Products	140			Varo Semiconductor, Inc.	70
Esterline Angus Instrument Corporation	117			Wakefield Engineering, Inc.	39
Fabri-Tek, National Connector Division	50			Wavetek Indiana Incorporated	1
Fairchild Semiconductor, A Division of Fairchild Camera and Instrument Corporation	25				

*Advertisers in non-U.S. Edition

IT'S WORKING FOR ME

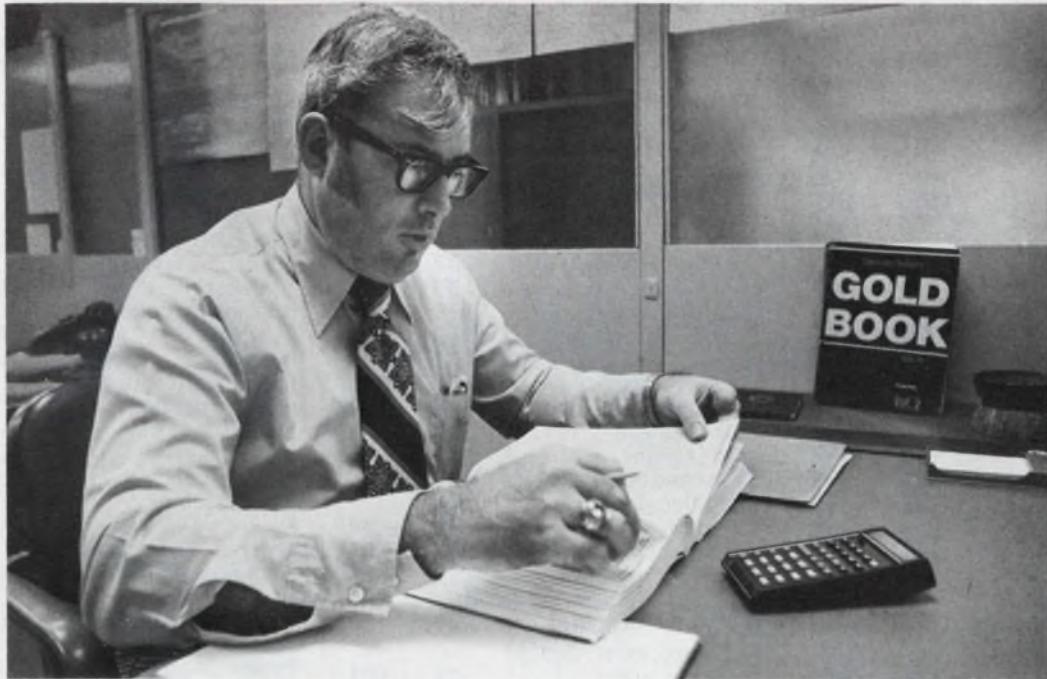

Electronic Design's GOLD BOOK is very convenient and always on my desk. I don't have to go somewhere else to use it.

Mr. W. T. Noel is Senior Engineer at the Naval Air Systems Command, Arlington, Virginia. He is involved with infrared avionics development and procurement for the Navy Department. Mr. Noel states:

"I refer to the GOLD BOOK often and find it quite useful in my work. It's very convenient and always on my desk. I don't have to go somewhere else to use it.

"Navy avionics procurements are largely to specification. The performance sheets and vendor sources provided by the GOLD BOOK are quite useful in the preparation of these specifications."

This is the *Electronic Design* audience working for you. (The GOLD BOOK goes essentially to *Electronic Design's* audience of engineer/specifiers.) Mr. Noel, like 78,000 electronics engineers and engineering managers, purchasing agents and distributors throughout the U.S. (plus 13,000 abroad) has his own personal copy of the GOLD BOOK.

The GOLD BOOK is *there*, at hand, ready when the need arises.

**THIS IS THE ELECTRONIC DESIGN AUDIENCE
WORKING FOR YOU**

Electronic Design / GOLD BOOK

HAYDEN PUBLISHING COMPANY, INC.

50 Essex Street, Rochelle Park, New Jersey 07662 • Tel: 201-843-0550

Product Index

Information Retrieval Service. New Products, Evaluation Samples (ES), Design Aids (DA), Application Notes (AN), and New Literature (NL) in this issue are listed here with page and Information Retrieval numbers. Reader requests will be promptly processed by computer and mailed to the manufacturer within three days.

Category	Page	IRN	Category	Page	IRN	Category	Page	IRN
Components			Integrated Circuits			breadboards		
circuit breakers	43	25	analog multiplexer	115	72	bus connector	126	88
components catalog	123	84	array, programmable	101	303	bushings, universal	79	38
crystals	114	70	chips	125	86	clips, DIP	121	81
crystals, quartz	130	379	communication chips	123	85	connector sockets	106	57
Darlingtons, power	128	375	consumer chips	117	75	connector	34	20
ferrite cores	45	26	controller motor	101	305	connector, rf	121	361
keyboards	118	76	converter, v/f/v	102	306	connector systems	118	351
LED displays	128	374	converters, a/d, d/a	135	103	contacts	33	19
potentiometers	11	262	data processing chips	119	78	drafting supplies	129	92
relays	91	44	drivers and amps	110	63	fastener	73	37
relays	100	52	drivers, display	103	308	heat sinks	119	354
relays	127	89	flasher, LED	101	304	heat sinks	109	62
resistor networks	47	28	instrumentation chips	121	82	hobby-wrap gun	99	51
resistors, precision	95	46	LED displays	131	97	interconnections	81	40
stepper motor	113	68	opto-isolators	109	61	metallizing ink	118	350
switch, PC	32	18	PLLs and comparators	111	66	parts tray	118	353
switches, pushbutton	130	377	quad-line-drivers/ receivers	53	32	plastic, conductive	120	358
switches, pushbutton	130	378	remote control	103	309	shrink tubing	120	359
thermostats	130	376	ROMs	5	4	sockets, DIP	127	90
transistor, power	128	373	switches, speed	102	307	sockets, face-grip	89	43
Data Processing			transistor arrays	59	33	soldering machine	119	356
cassette recorder			Microprocessor Design			tool kit	118	352
digital	116	346	analyzer, μ P	41	508	wire-wrap panels	120	80
computer program	114	341	microprocessor, bipolar	42	509	Power Sources		
count/time data system	134	102	system, development	44	510	energy cells	49	29
data-acquisition system	134	102	Microwaves & Lasers			power-batteries	113	337
data terminals	117	347	amplifier, L-bd	110	328	power supplies	104	55
hard disc drives	115	343	amplifier, X-bd	111	330	power supply, bipolar	112	334
magnetic tape	115	342	coaxial load	111	331	power supply, inverter	112	333
memory drum	117	349	direct coupler	111	329	power supply, switcher	113	336
memory system diskette	116	345	filter, low pass	110	326	power supply, UPS	113	335
modems	27	15	He-cd laser	109	325	transformers	119	77
paper-tape equipment	115	71	opto-acoustic module	108	322	new literature		
paper-tape reader	117	348	power divider, 8-way	108	323	antennas	134	396
printer/plotter	99	51	pn _p 's, 4 and 5-GHz	17	10	circuit boards	134	398
spectrum analyzer			preamplifier, L-bd	110	327	data communications	134	394
digital	114	340	signal generator	111	332	keytops	134	397
μ P program	114	338	tracking filter	109	324	power supplies	134	400
Discrete Semiconductors			Modules & Subassemblies			power-supply periodical	134	399
Darlingtons, high-speed	61	34	accelerometer	122	364	semiconductor		
Schottky-barrier			amp instrumentation	126	369	packaging	134	395
rectifiers	70	36	controller motor	123	368	semiconductors	134	391
SCRs and triacs	9	6	controls, oil-tight	111	65	semi screening report	134	393
silicon transistors	37	21	converter, true-rms	122	363	software directory	134	392
zeners	130	95	data acquisition	127	370	application notes		
Instrumentation			displays	105	56	data processing	133	386
CB test bench	46	46	elapsed time indicators	137	109	dry plasma	133	389
computer graphics	107	321	filters	93	45	machine controls	132	382
count scaler	160	310	filters, EMI	132	98	minicomputers	133	387
data logger	104	301	filters, LC and crystal	135	104	optically-coupled		
display scopes	1	2	image sensors	103	54	isolators	132	381
displays	137	108	op amp	123	367	reinforced thermo-		
DMMs	136	106	oscillator	127	371	plastics	133	390
entertainment console	71	37	relay-time delay	122	365	semiconductor testing	133	385
frequency-difference			sample and hold	112	366	spectrum analysis	132	380
meter	136	107	servo amplifier	113	69	surge suppression		
indicators	107	168	thermostats	129	93	circuits	133	388
oscilloscope	14	260	thermostats	133	101	ultra-isolation		
precision standard	108	59	Packaging & Materials			transformers	132	383
spectrum analysis			adhesive, high temp	121	362	μ P/display interface	132	384
recorder	122	83	assembly center	121	360			
storage scope	128	91	backplane assembly	119	355			
			bearings	120	357			

eliminate assembly problems & save 60¢ per connector*

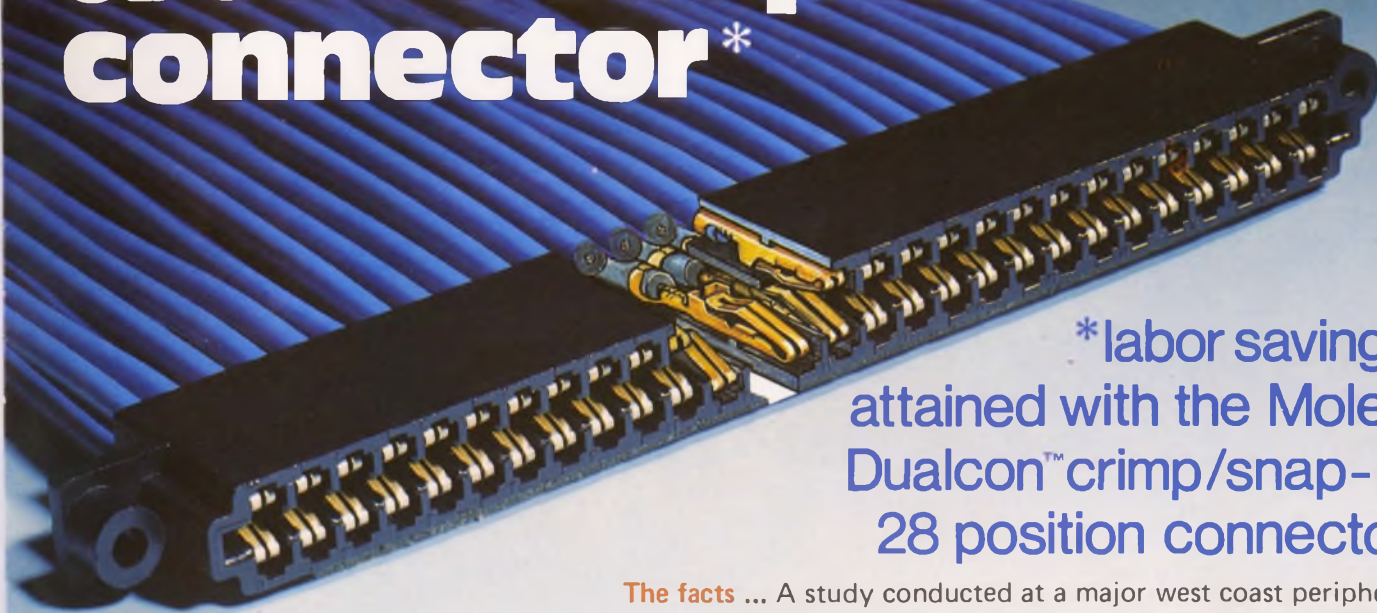

*labor savings
attained with the Molex
Dualcon™ crimp/snap-in
28 position connector

The facts ... A study conducted at a major west coast peripheral manufacturer clearly shows the labor and cost savings between the Molex 4338 crimp/snap-in connector versus a solder eyelet P.C. Connector. The evaluation was made on a fully loaded 28 position dual connector.

OPERATION	SOLDERING METHOD	MOLEX 4338 CRIMP/STYLE
STRIP INSULATION	5:37	5:37
SHRINK TUBING ON WIRE	4:40	N/A
SELECT TERMINAL AND ATTACH WIRE	10:17	N/A
SOLDER WIRE TO TERMINAL	3:44	N/A
POSITION SHRINK TUBING	1:53	N/A
HEAT SHRINK TUBING ON FIRST SIDE	1:00	N/A
HEAT SHRINK TUBING ON SECOND SIDE	0:16	N/A
CRIMP WIRE TO TERMINAL *	N/A	2:12
SELECTIVELY LOAD TERMINAL	N/A	7:27
TOTAL OPERATION TIME	27:27	15:16

Using a \$3.00 per hour labor rate ... it costs \$1.38 per connector using the soldering method, versus 78¢ per connector, using the Molex crimp/style snap-in. A savings of 60¢ per connector ... or a 44% SAVINGS.

*Based on 1200 crimps per hour

The designer and manufacturing engineers answer to eliminating assembly operations, saving time and lowering cost

... The Molex Dualcon.

The 4338 Series Dualcon is a new .156 crimp/snap-in dual readout edge connector for .062 P.C. cards. The snap-in type contact allows greater production flexibility and at the same time reduced labor/assembly man-hours because you use only the contacts you need.

Literature and Information — How much can you save on your present or future application? Ask your Molex Sales Engineer. For more information on the 4338 call or write MOLEX INCORPORATED, 2222 Wellington Court, Lisle, IL 60532. (Phone: 312/969-4550)

Options: The 5 Amp rated terminals are available with pre-tin gold over nickel, or selective gold plating and will accommodate 18–24, and 24–30 AWG. Solder loop and split eyelet type terminals are available. Inter-contact and on-contact polarizing keys are optional.

The connector housing is available with or without mounting flanges in 6, 8, 10, 12, 15, 18, 22, 24, 25, and 28 dual row positions.

Application tooling is available for hand termination, semi-automatic bench machines (available on lease or purchase terms) and fully automatic units for extremely high speed production.



23 Part I approvals in 13 months ...

Acceptance of High Rel COS/MOS is climbing fast.

In rapid succession, 23 RCA COS/MOS circuits have become the first CMOS devices to pass the rigorous environmental and life-test requirements for QPL-38510, Part I Qualification. That's just more evidence of the inherent reliability of COS/MOS.

It means you can buy with even greater confidence. And if you buy for military or other high-reliability applications, you have a wide range of options. The approved list includes gates, multi-vibrators, binary ripple and synchronous counters, and multiplexers/demultiplexers.

It also means you have the assurance of a dependable High Rel source. With a disciplined organization. Tightly controlled environments and processes. And a wholehearted commitment to High Rel COS/MOS.



You'll see the results of this commitment in our latest High Rel data book (SSD-230), just off the press. Contact your local RCA Solid State distributor. Or RCA.

RCA No.	MIL-M-38510/	RCA No.	MIL-M-38510/
CD4000A	05201	CD4017A	05601
CD4001A	05202	CD4018A	05602
CD4002A	05203	CD4019A	05303
CD4007A	05301	CD4020A	05603
CD4009A	05501	CD4021A	05704
CD4010A	05502	CD4022A	05604
CD4011A	05001	CD4023A	05003
CD4012A	05002	CD4024A	05605
CD4013A	05101	CD4025A	05204
CD4014A	05702	CD4027A	05102
CD4015A	05703	CD4049A	05503
		CD4050A	05504

Write: RCA Solid State, Box 3200, Somerville, N.J. 08876; Sunbury-on-Thames, Middlesex TW16 7HW, England; Ste. Anne de Bellevue H9X 3L3, Canada; Fuji Building, Tokyo, Japan.

RCA

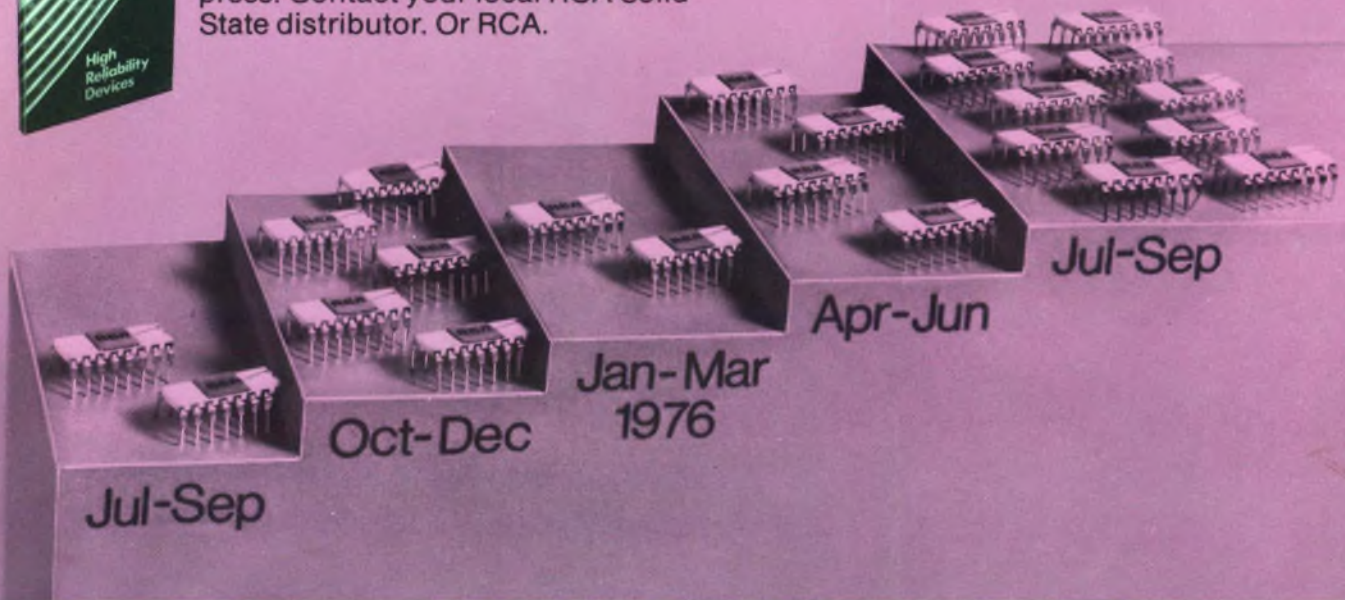

RCA. First house in CMOS.