

Electronic Design.26

VOL. 24 NO.

FOR ENGINEERS AND ENGINEERING MANAGERS

DEC. 20, 1976

Solid-state relays fight for sales with winning punches. But load specs are often feints, not true performance. And transients and heat can deliver knock-out blows.

However, SSRs can be winners with silent operation, long life and zero-voltage turn-on. Make sure you're in the right corner. Get a ringside view on p. 48.

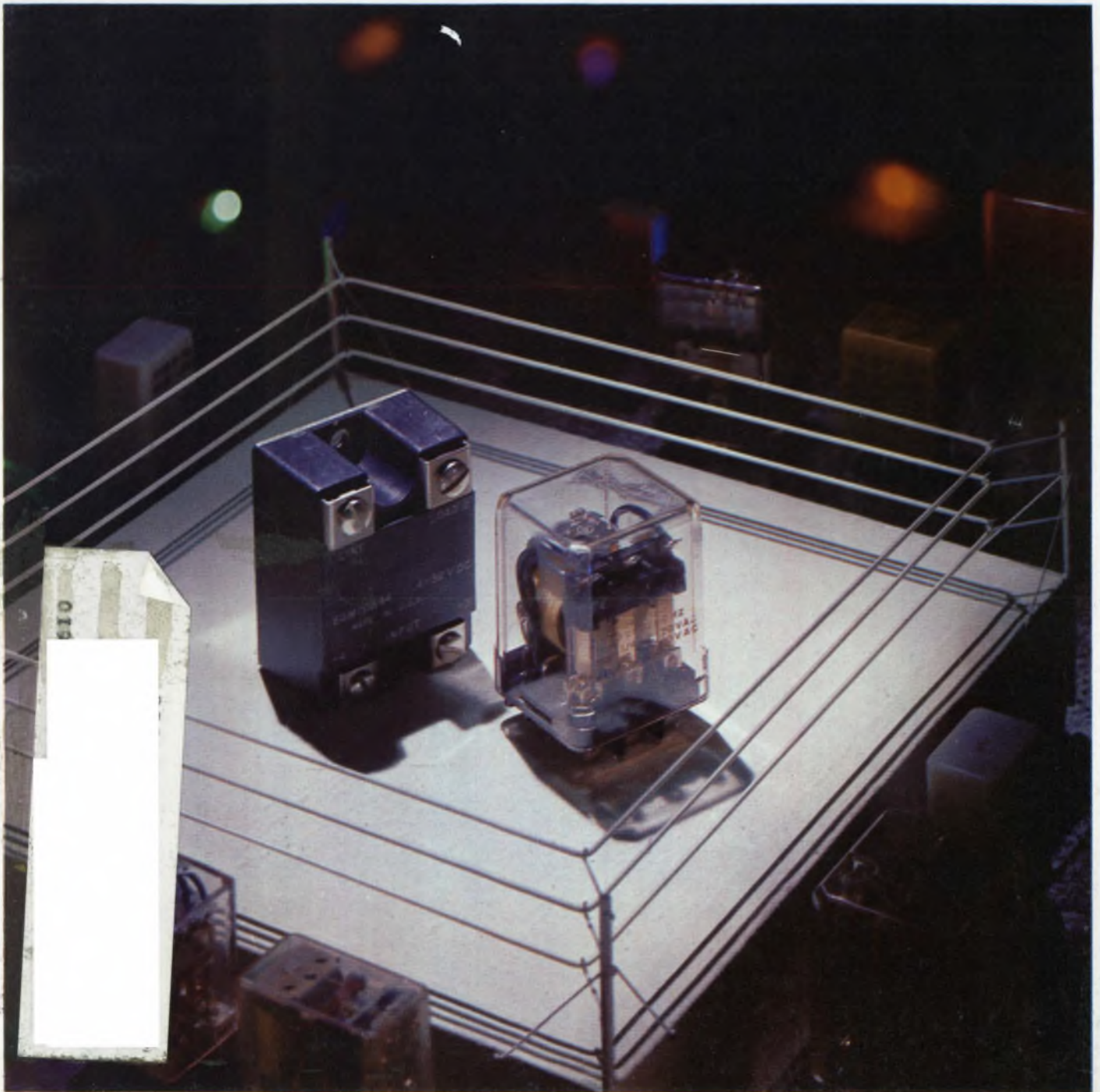



FEEL
the pot . . .



CLICK
the switch . . .



GANG
the modules . . .

and add
"feel appeal" to your product.

FEEL THE POT . . . a smooth, quality feel, only from Bourns® 81/82 Model Potentiometers. Rotational torque range, only .3 to 2.0 oz. inch, is consistent for one, two, three or four cup assemblies.

Independent linearity of $\pm 5\%$ and low 1% CRV provide exceptional setability in both cermet and conductive plastic element types.

CLICK THE SWITCH* . . . one that really clicks, with positive action detent at either CW or CCW end. The Bourns Model 85/86 potentiometer/switch combination is rated at 2 amps in DPST style and 1 amp in DPDT. Contacts are constructed of fine silver with gold overlay. This provides exceptionally low contact resistance, for reliable operation at low level analog or logic signal levels — or any application requiring an "on-off" function.

GANG THE MODULES . . . potentiometers and switches. Up to 4 modules can be ganged on the same single or dual concentric shaft, without sacrifice to the satin-smooth feel or the sure-fire click. Other options include a wide choice of bushing and shaft styles, P.C. pins or solder lugs. Think of the possibilities! Now you can specify custom pots and switches assembled from "off-the-shelf" modules — at standard cost and leadtime.

Add "feel appeal" to your equipment with BOURNS Model 80 Family of Modular Potentiometers and Switches. Write or call today for complete technical information, direct or through your Bourns distributor.

FEEL, CLICK, GANG . . . BEAUTIFUL!

TRIMPOT PRODUCTS DIVISION, BOURNS, INC., 1200 Columbia Avenue, Riverside, California 92507, Telephone (714) 781-5122 — TWX 910 332-1252.

*Patent pending



Int'l Sales Offices: European Hdqtrs. — Switzerland, 042/23 22 42 • Belgium 02/218 2005 • France 01/2039633 • Germany 0711/24 29 36
• Italy 02/32 56 88 • Netherlands 070/88 93 18 • United Kingdom 01/572 6531 • Japan 075 92 1121 • Australia 86 9410 • Brazil 257-3535

CIRCLE NUMBER 252

You probably remember our Model 3000 (shown at left)—the AM/FM phase-locked signal generator that covers the 1 to 520 MHz frequency range? Well, now we've got a companion model that's even better. The new Model 3001 is identical to the 3000 except: (1) FM accuracy is now 0.001%; (2) A ± 5 kHz frequency vernier is provided in all modes; (3) You can lock the 3001 to an external frequency standard (optional at \$150); and (4) An internal reference frequency standard (with 5×10^{-9} /day stability) is also an available option at just \$500.

At just \$2,600, the Model 3001 is a downright bargain when you consider its accuracy, stability, programmability, and ease of operation.

We'll gladly send you detailed specifications on our competitive new signal generator. When we're competing with ourselves, we know everything about the competition.

Model 3001 Specifications:

Frequency Range: 1-520 MHz
 Frequency Accuracy: $\pm 0.001\%$
 (all operating modes)
 Resolution: 1 kHz
 Stability: 0.2 ppm per hour
 Output Range: +13 dBm to

-137 dBm
 Flatness: ± 0.75 dB
 AM Modulation Range: 0-90%
 FM Deviation Ranges: 0-10 kHz
 and 0-100 kHz
 Internal Modulation Rates:
 400 Hz and 1 kHz
 Dimensions:

12" wide x 5½" high x 13¾" deep
 WAVETEK Indiana Incorporated,
 P.O. Box 190, 66 North First Avenue,
 Beech Grove, Indiana 46107,
 Phone (317) 783-3221,
 TWX 810-341-3226.

WAVETEK®

CIRCLE NUMBER 2

The signal generator competition never showed up. So we're it.



The Model 3000.

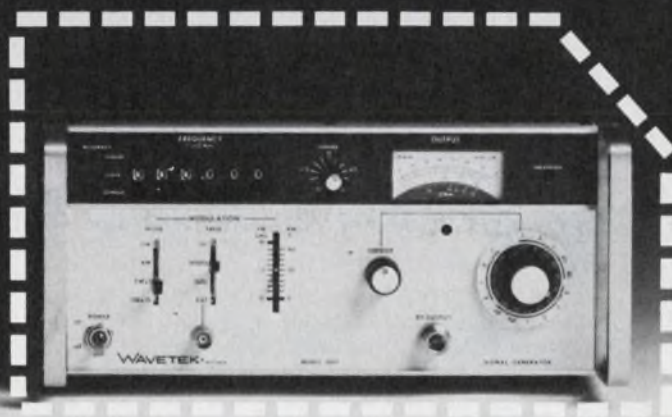

The New Model 3001

The only Double-Balanced Mixers with a 2-YEAR GUARANTEE*

featuring Hi-Rel tested diodes-

still only

\$7.95
(500 pieces)
\$9.95 (1-49)

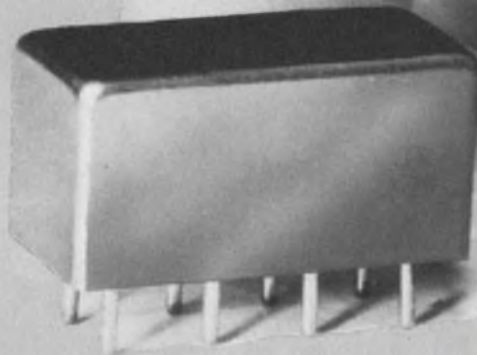

*including diodes!

Yes, a two-year guarantee for DBM's is now a reality . . . made possible by an accelerated-life diode screening program adopted at Mini-Circuits.

Each Schottky diode used in Mini-Circuits' SRA-1 mixers is now preconditioned by the HTRB (High Temperature Reverse Bias) technique, previously reserved almost exclusively for semiconductors assigned to space applications. With HTRB testing, each diode is operated for 168 hours at 150°C with one volt reverse bias applied.

To screen out "infant mortality", the diodes are deliberately stressed to accelerate aging and to force time-related failure modes to take their toll. In conventional testing or "baking", the diode does not experience anywhere near the stress encountered with the HTRB program. Hence, the ability at Mini-Circuits' to locate the potentially-unreliable diodes before they are assembled into SRA-1 units And, with double-balanced mixers, the overall reliability hinges almost entirely on the diodes used.

Yes, the HTRB procedure costs us more and screens out more devices. But our goal is to improve reliability to a level unmatched for off-the-shelf DBM's at no increase in cost to our customers. You — our customers by your overwhelming confidence in our product line have made us the number one supplier of DBM's in the world.

To earn your continuing support, we are now employing HTRB Hi-Rel testing for every diode used in the SRA-1, at no increase in cost to you. So, for the same low price of \$7.95, you can purchase our SRA-1, with a two-year guarantee, including diodes.

To ensure highest system reliability demand highest quality diodes on your source-control drawings and purchase orders. Specify SRA-1 mixers, with HTRB tested diodes from Mini-Circuits'... where low price now goes hand-in-hand with unmatched quality.

MODEL SRA-1

Freq. range (MHz) LD - 0.5-500, RF 0.5-500, IF dc-500

Conversion loss (dB)

One octave from band edge

Total range

Isolation (dB)

Lower band edge to

one decade higher

Mid range

Upper band edge to

one octave lower

Min Electronic attenuation (20 mA) 3 dB

Signal, 1 dB compression level + 1 dBm

Impedance all ports 50 ohms

Typ. Max.

5.5 7.5

6.5 8.5

Typ. Min.

LO-RF 50 35

LD-RF 45 30

LO-RF 45 30

LO-IF 40 25

LO-RF 35 25

LO-IF 30 20



Mini-Circuits Laboratory

A Division Scientific Components Corp

837-843 Utica Avenue, Brooklyn, NY 11203

(212) 342-2500 Int'l Telex 620156

Domestic Telex 125460

International Representatives: AUSTRALIA General Electronics Services, 99 Alexander Street, New South Wales, Australia 2065 ENGLAND Dale Electronics, Dale House, Wharf Road, Frimley Green, Camberley Surrey FRANCE S. C. I. E. D. I. M. E. S., 31 Rue George Sand, 91120 Palaiseau, France GERMANY, AUSTRIA, SWITZERLAND Industrial Electronics GMBH, Klüberstrasse 14, 6000 Frankfurt/Main, Germany; ISRAEL Vectronics, Ltd., 69 Gordon Street, Tel Aviv, Israel; JAPAN Denso Kaisha, Ltd., Eguchi Building, 8-1-1 Chome Hamamatsucho Minato-ku, Tokyo; EASTERN CANADA B. D. Hummel, 2224 Maynard Avenue, Utica, NY 13502 (315) 736-7821; NETHERLANDS, BELGIUM, LUXEMBOURG Cormex, Veldweg 11, Hattem, Holland; NORWAY Datamatik AS, Ostensioveien 62, Oslo 6, Norway

US DISTRIBUTORS: NORTHERN CALIFORNIA Cain White & Co., Foothill Office Center, 105 Fremont Avenue, Los Altos, CA 94022 (415) 948-6533; SOUTHERN CALIFORNIA, ARIZONA Crown Electronics, 11440 Collins Street, No. Hollywood, CA 91601 (213) 877-3550

For complete product specifications and U.S. Rep listing see MicroWaves "Product Data Directory," Electronic Designs "Gold Book" or Electronic Engineers Master "EEM"

NEWS

- 19 **News Scope**
- 24 **Army Communications**—A special report. The switch to digital design is accelerating in radios, phones and satellites.
- 30 **Smart industrial robot** can 'see' whatever it's supposed to do.
- 35 **Washington Report**

TECHNOLOGY

- 39 **Microprocessor Design**
- 48 **FOCUS on solid-state relays:** Load ratings for SSRs are full of traps. Avoid them, and SSRs can live long, uneventful and quiet lives.
- 60 **Gate-turn-off SCRs** provide fast and efficient alternatives to power transistors. Pulse input signals can switch high dc currents and voltages both on and off.
- 66 **Design flyback converters** for best performance. Analyzing the two basic operating modes gives the relationships between the important parameters.
- 72 **Stabilize optical-sensing systems** with automatic light-intensity control. Negative feedback via the light path maintains the switching threshold accurately.
- 78 **Ideas for Design:**
Transient-free pulsed acoustic sinusoids generated with phased-array speakers. Diodes act as temperature sensor in remote temperature-measuring circuit. Heart-beat monitoring circuit provides steady output and a missed-beat alarm.
- 86 **International Technology**

PRODUCTS

- 89 **Packaging & Materials:** Connector mass-terminates flat-conductor, flat cable.
- 91 **Instrumentation**
- 94 **Components**
- 96 **Data Processing**
- 98 **Integrated Circuits**
- 100 **Modules & Subassemblies**
- 103 **Power Sources**

DEPARTMENTS

- 45 **Editorial:** The importance of being important
 - 7 **Across the Desk**
 - 106 **New Literature**
 - 110 **Advertisers' Index**
 - 112 **Product Index**
 - 112 **Information Retrieval Card**
- Cover:** by Business Arts, courtesy of Potter and Brumfield, Princeton, IN

The only microcomputer with the power of a PDP-11. The PDP-11/03.

If you've been looking for a microcomputer with minicomputer power at a micro price, join the hundreds of OEMs who've already found it with the DIGITAL microcomputer. The PDP-11/03.

The 11/03 gives you everything you could ask for in a small computer. High performance. High reliability. And a low price — just \$1,357 in quantities of 50. And that micro price buys you mini features that quickly translate into benefits OEMs appreciate. Features like full PDP-11 instructions with eight general purpose

registers for fast program development. RAM (MOS or Core) and PROM memories that let you match the memory with the application. Hardware vectored interrupts with stack processing for real computer power. And multiple-sourced components for sure delivery.

Buying our 11/03 also buys you the chance to start small without staying small. Because you can add up to 32K words of memory, fast floating point instructions, and more. Whenever you and your customers are ready.

Besides growing bigger in size, the 11/03 lets you grow bigger in scope. It's software compatible with every other PDP-11 we offer. From our LSI-11 all the way up to our medium scale PDP-11/70. That means you can take full advantage of Digital PDP-11 software and services.

You can also take advantage of Digital's OEM Referral program — your chance to take on an international marketing and support team without hiring them. The OEM Referral program can help you locate new custom-



ers and new markets around town and around the world. And it can all start with the PDP-11/03.

So if you're looking for a

proven microcomputer with proven power and performance, get the micro with all the power and performance of a PDP-11.

Digital's PDP-11/03. Call your nearest Digital sales office. Or send the coupon to Digital Equipment Corporation, Maynard, Massachusetts 01754. (617) 897-5111. European headquarters: 81 Route de l'Aire, 1211 Geneva 26. In Canada: Digital Equipment of Canada, Ltd.

Digital Equipment Corporation, Maynard, Massachusetts

- I'm interested. Please send information.
 I'm more than interested. Please have your nearest Digital sales representative contact me.

Name _____ Title _____

Company _____

Address _____ Phone _____

City _____ State _____ Zip _____

ED126

digital

50,000 computers saving managers millions.

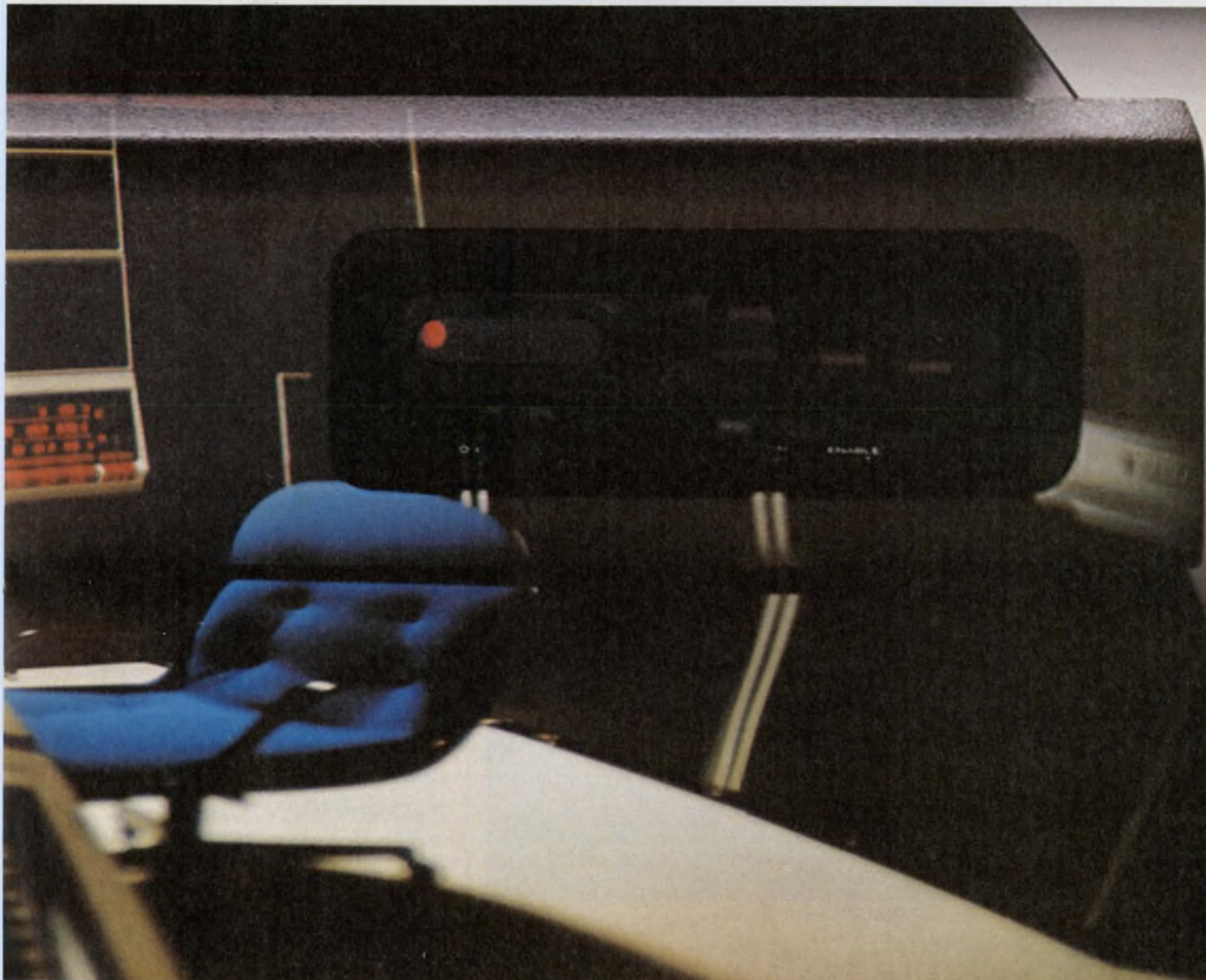

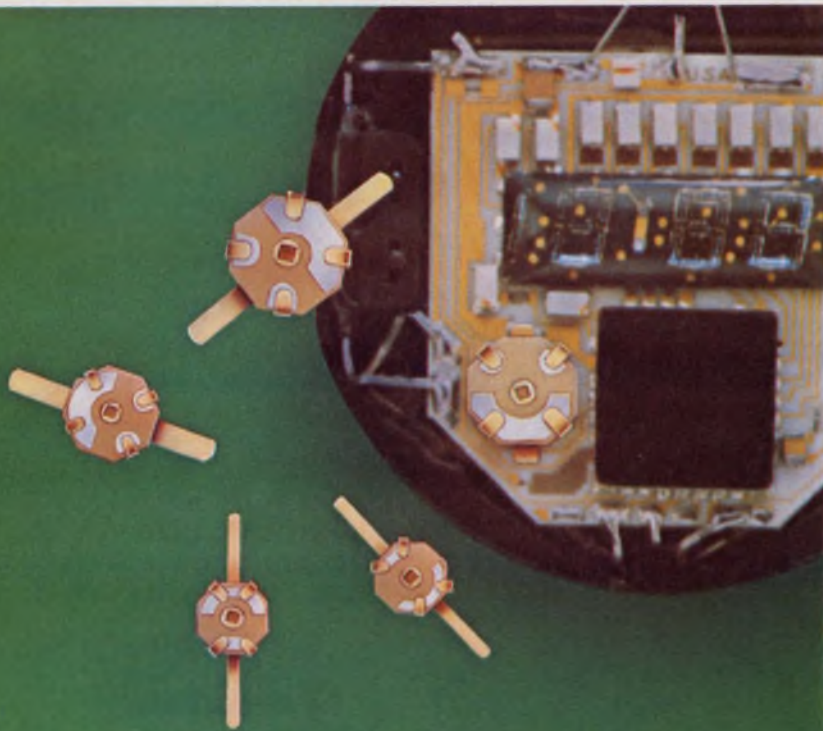

Thin-Trim capacitors

Tucked in the corner of this Pulsar Watch is a miniature capacitor which is used to trim the crystal. This Thin-Trim capacitor is one of our 9410 series, has an adjustable range of 7 to 45 pf, and is .200" x .200" x .050" thick.

The Thin-Trim concept provides a variable device to replace fixed tuning techniques and cut-and-try methods of adjustment. Thin-Trim capacitors are available in a variety of lead configurations making them easy to mount.

A smaller version of the 9410 is the 9402 series with a maximum capacitance value of 25 pf. These are perfect for applications in sub-miniature circuits such as ladies' electronic wrist watches and phased array MIC's.

The logo for Johanson Manufacturing Corporation, featuring the name "Johanson" in a stylized, cursive script font enclosed within an oval border.

Johanson Manufacturing Corporation
Rockaway Valley Road
Boonton, New Jersey 07005
(201) 334-2676 TWX 710-987-8367

CIRCLE NUMBER 4

Sr. Vice President, Publisher
Peter Coley

Editors

Editorial Offices
50 Essex St.
Rochelle Park, NJ 07662
(201) 843-0550
TWX: 710-990-5071
Cable: Haydenpubs Rochellepark

Editor-in-Chief George Rostky

Managing Editors:
Ralph Dobriner
Michael Elphick

Senior Associate Editor
Stanley Runyon

Associate Editors:
Sid Adlerstein
Dave Bursky
Samuel Derman
Morris Grossman
John F. Mason
Max Schindler
Michael Shunfenthal

Contributing Editors:
Peter N. Budzilovich, John Kessler
Alberto Socolovsky, Nathan Sussman

Editorial Field Offices

East

Jim McDermott, Eastern Editor
P.O. Box 272
Easthampton, MA 01027
(413) 527-3632

West

Dick Hackmeister, Western Editor
8939 S. Sepulveda Blvd., Suite 510
Los Angeles, CA 90045
(213) 641-6544
TWX: 1-910-328-7240

Editorial Production

Marjorie A. Duffy, Production Editor
James Keane, Copy Editor

Art

Art Director, William Kelly
Richard Luce, Anthony J. Fischetto

Production

Manager, Dollie S. Viebig
Helen De Polo, Anne Molfetas

Circulation

Director, Barbara Freundlich
Trish Edelmann

Information Retrieval

Paula Greenleaf

Advertising Promotion

Susan G. Apolant

Across the Desk

Guess what's hiding in the calculator?

Anyone using Texas Instruments' SR-52 might be interested to know that up to 28 "software" data registers are "hidden" within the calculator. It doesn't mention these registers in its user's manual. Program memory can be automatically partitioned into these 28 additional registers, each of which has a length of eight storage locations.

Keyboard addresses of these registers range from 70 (location 000) to 97 (location 216), inclusive, and are accessed via STO and RCL operations. Even though these software registers are not cleared by the CMs key, they do prove useful in the storage of both program codes and data for transfer to magnetic cards.

The user must keep careful track of the program-address space; however, the remainder of memory can be used to store data in register locations lying above the program. Data are automatically formatted for either scientific or fixed and floating notation. A microprogram performs the address conversion and data formatting.

J. M. Davidson
Research Engineer

Applied Automation, Inc.
Pawhuska Rd., RB2 106
Bartlesville, OK 74004

Forget us not

Having read Stanley Runyon's "Focus on Network Analyzers" (ED No. 16, August 2, 1976, p. 50), I was quite surprised to find that EMR's Model 1172 Frequency Response Analyzer had been deleted from the article, particularly

since our primary competitor, Bafco, was included, and EMR was included in the vendors' list at the end of the article.

Marshal Fram
Product Line Manager
Dynamic Analysis Instrumentation
EMR Telemetry
Weston Instruments, Inc.
P.O. Box 3041
Sarasota, FL 33578

What's in a name . . .

In our News Briefs section of the November 8, 1976 issue (Vol. 24, No. 23, p. 16), we accidentally referred to American Microsystems, Inc., as *American Micro Devices*. Our apologies. *Moreover, the company doesn't make an all-solid-state telephone—just the circuits.*

Loved the article, but . . .

Thank you for "FCC Swamped with Complaints as Sources of RFI/EMI Increase" (ED No. 20, September 27, 1976, p. 24). The article is well written, presents the problem in a readily understandable manner and is one of the best general articles on the subject of interference and its control that I have read.

There are a few minor inaccuracies. In the section, "Battle lines drawn," you refer to the Citizen's Radio Station of EIA. This should be Citizen's Radio Section. In the same paragraph, you refer to John Sadowsky as EIA staff vice president of communications. His name is John Sololski and his title is Staff Vice President, Communications Div. On page 34, paragraph 2, you say that the FCC proposes to discard its 1948 maximum-emission

(continued on page 13)

Electronic Design welcomes the opinions of its readers on the issues raised in the magazine's editorial columns. Address letters to Managing Editor, Electronic Design, 50 Essex St. Rochelle Park, N.J. 07662. Try to keep letters under 200 words. Letters must be signed. Names will be withheld on request.

The smallest*



re-lampable indicators are



Illuminated Products' QT Series incandescent, neon, and LED indicators

- Long-life reliability
- Simplified press-in panel mounting
- All popular lens colors and styles
- Distributor on-shelf availability now

*Actual size shown

Lighten your decisions
contact . . .

ILLUMINATED PRODUCTS INC.

A subsidiary of OAK Industries Inc.
2620 South Susan St., P.O. Box 11930
Santa Ana, California 92711
Tel: (714) 540-9471 • TWX 910-595-1504



COMPONENTS GROUP

CIRCLE NUMBER 5

Dance It's the Tri-

for joy! Safe™ PROM.

And who could blame you for dancing?
It isn't every day a Bi-Polar PROM like this
comes along.

It virtually eliminates fuses being blown
incorrectly by out of calibration programmers, because
3 distinct and separate circuit conditions must be
effected to blow the fuse.

So what?

So typical programming yields of 98%, that's what.

And we've got the reliability data to prove it.

As if that weren't enough, our titanium-tungsten
fuse material provides greater reliability after
programming.

Tri-Safe™ PROMS come in 1K, 2K and 4K capacity,
and are Schottky-clamped for high speed operation.

So get your pen out.

And your dancing shoes.

National Semiconductor ED 1220
2900 Semiconductor Drive, Santa Clara, CA 95051

Gentlemen:

Please send me an invitation to the Tri-Safe PROM... data sheets,
application note, reliability data, process info, the works.

Name _____ Title _____

Company _____

Address _____

City _____ State _____ Zip _____

 National Semiconductor

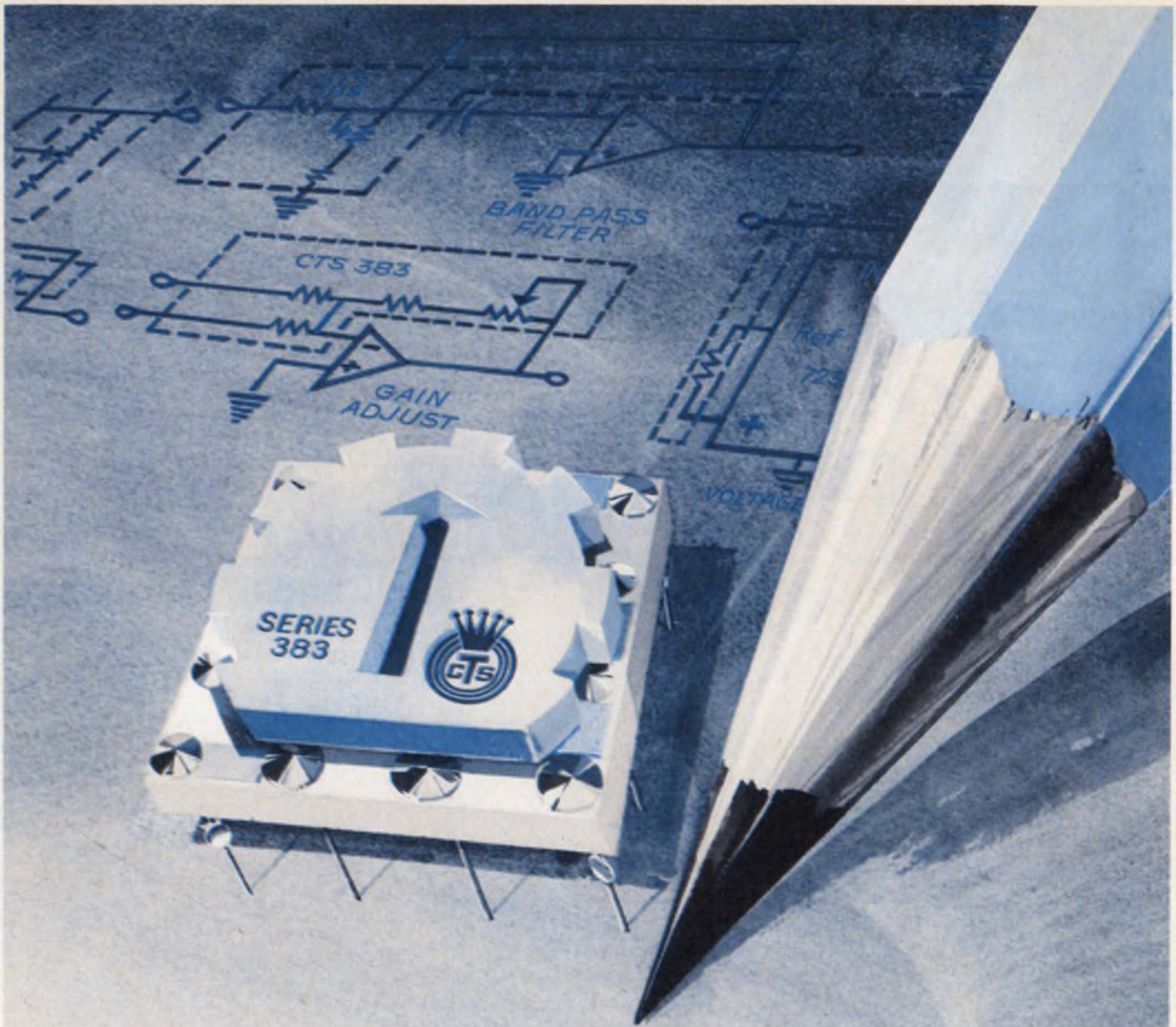

Specifying both resistors and trimmers? Here's a single solution from CTS.

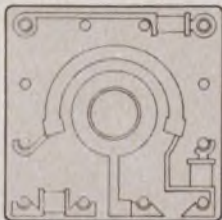

CTS proudly presents a single solution to many of the problems you face in specifying resistors and trimmers ... the Series 380 thru 384 Cermet Resistor/Trimmer combinations.

Have Board Space Problems? The Series 384 offers you up to eight fixed resistors plus a trimmer in a .46" square (.275" high) package.

Need Hefty Power Capability? All units in this Series can handle one watt at 70°C and ¾ watt at 85°C.

Need Cermet Stability? ± 250 ppm/°C is the standard temperature coefficient in this Series with ± 100 ppm available for your critical needs.

Want Rock Bottom Prices? The Series 383 (shown above) provides you combinations of three fixed resistors plus a trimmer for only 35¢ in production quantities. The Series 380 trimmer only is priced under 25¢. This economical space saving form factor is available as a trimmer only, in resistor/trimmer networks, and as resistor networks only. Let the Application Engineer from CTS Microelectronics help you decide which Series is best for your design.

CTS MICROELECTRONICS, INC., 1201 Cumberland Avenue, West Lafayette, Indiana 47906. Phone (317) 463-2565.

CTS CORPORATION

Elkhart, Indiana

A world leader in cermet and variable resistor technology.



Meet the cost cutter

New wire-wrap relay socket cuts costs up to 50% per connection

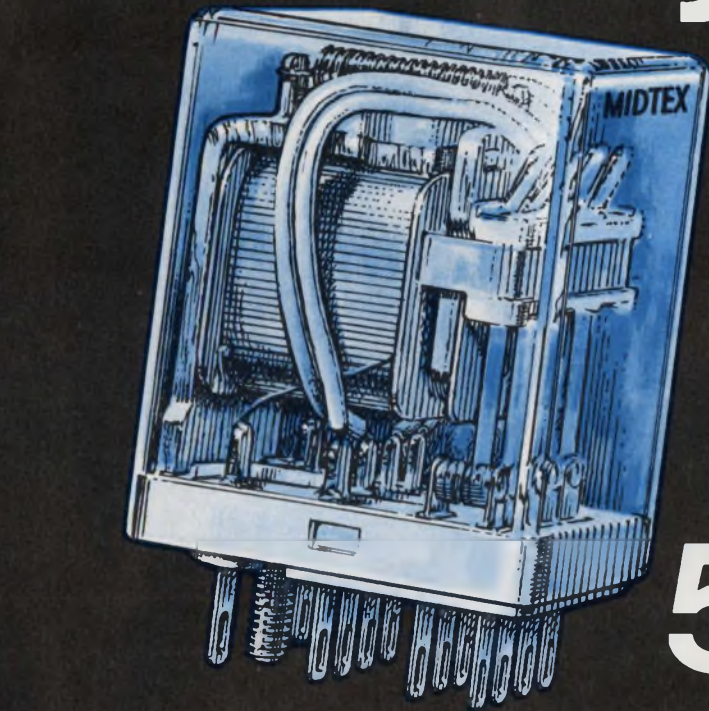

Here is the first wire-wrap[®] socket in the industry for a standard industrial relay. It can cut your connection costs in half because now you can wire-wrap industrial relays, too! It's another new idea from Midtex.

Wrapped wire connections cut costs because they're faster. Less than half the time it takes to solder.

Wrapped wire connections cut costs because they're cleaner. No solder splatter or wire clippings to short.

Wrapped wire connections cut costs through standardization. PCBs and relays *all* can be wire-wrapped . . . at once.

Designed for our Type 156 4PDT 3 amp relay, the Midtex wire-wrap socket provides 14 mating terminals, .031" x .062" x .75", and will accept solid wire wrapped or stranded Termi-point connections ranging in size from 20 AWG to 26 AWG. Terminals will provide for three separate connections. Socket dimensions: .75" x 1.55"; two .160" diameter mounting holes are 1.3" center-to-center. Socket body is U/L approved G.P. Phenolic.

Our job is to help you make your job more profitable through relays and relay assemblies. Midtex, The Total Relay Company.

® Trademark of Gardner-Denver Co.

MIDTEX 
INCORPORATED

1650 TOWER BLVD., N. MANKATO, MN 56001
PHONE 507 625-6521 TWX 910-565-2244

You get variety, unique design, economy and more when you specify AMP's DIP sockets.

You get more performance.

And that's what all the features of AMP's DIP and microprocessor sockets add up to.

Take variety. You can choose from standard and low profile housings, a wide range of sizes, tin or gold plated contacts, in widths of .300", .400" or .600". And that's only the beginning.

There's design and economy. DIP socket contacts include a unique retention feature. It makes sure that every socket you insert into a pc board will stay there, even during the soldering process.

The design also prevents solder wicking problems. And with AMP automatic insertion equipment,

the sockets can be installed at rates to meet your production needs.

And don't forget AMP's solid backup. You can count on it with the kind of personal attention your product line deserves.

So why not get AMP quality when you need DIP and microprocessor sockets. Just call Customer Service at (717) 564-0100. Or write AMP Incorporated, Harrisburg, PA 17105.

AMP

INCORPORATED

CIRCLE NUMBER 8

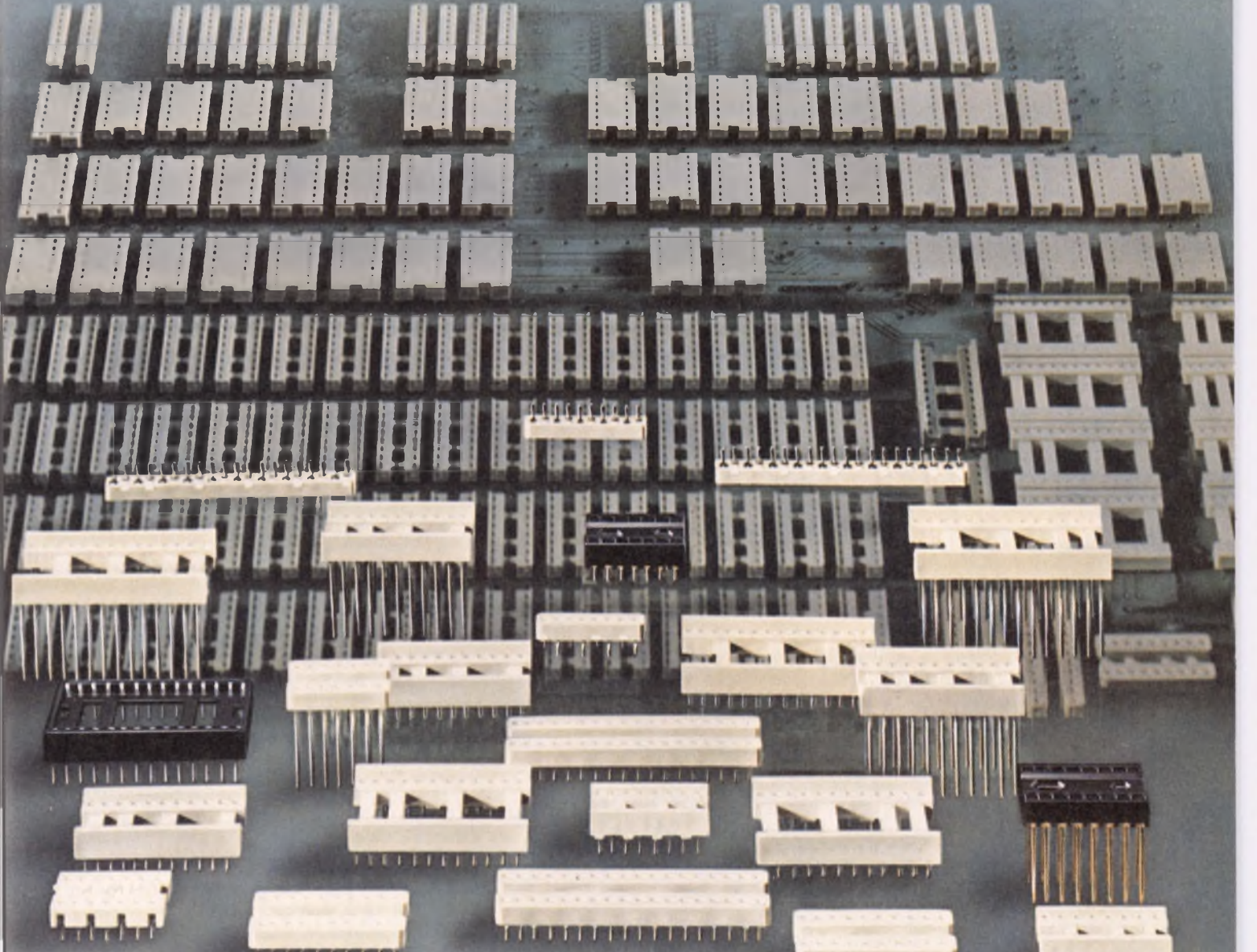

AMP is a trademark of AMP Incorporated.



AMP EUROPE

Austria — AMP Austria. Branch of AMP Deutschland GmbH. Markgraf-Ruediger Str. 6-8, 1150 Vienna. Phone: 924191/92

Belgium — AMP Belgium. Branch of AMP-Holland B.V., Rue de Brabant 62-66, Brussels. Phone: 322.17.55.17

France — AMP de France. 29 Chaussée Jules-César. Boite Postale No. 39. 95301 Pantaise France. Phone: 030 82 20, 030 92 30

Germany — AMP Deutschland GmbH. Ampérstrasse 7-11, 607 Langen, B. FFM., West Germany. Phone: (06103) 7091

Great Britain — AMP of Great Britain Limited, Terminal House, Stanmore, Middlesex, England. Phone: 01-954-2356

Holland — AMP Holland B.V., Papierstraat 2-4 's-Hertogenbosch, Holland. Phone: (04100) 25221

Italy — AMP Italia S.p.A., Via Fratelli Cervi 15, 10093 Collegno (Torino), Italy. Phone: 785-656

Spain — AMP Española, S.A., Apartado 5294. Pedro IV, 491, 495, Barcelona 5, Spain. Phone: 307-75-50

Sweden — AMP Scandinavia AB, Datavägen 5, 17500 Jakobsberg, Sweden, Mailing Address: Fack S-175 20 JARFALLA 1, Sweden. Phone: 0758/10400

Switzerland — AMP AG, Haldenstrasse 11, 6006 Luzern, Switzerland, Phone: (414) 235421, 235422, 235423

AMP NORTH AMERICA

Canada — AMP OF CANADA LTD., 20 Esna Park Drive, Markham, Ontario, Ph: 416-495-6222

Mexico — AMP de Mexico, S.A., Apartado Postal 179, Naucalpan de Juárez, Eda, de Mexico, Phone: Mexico City 576-41-55

Puerto Rico — AMP OF CANADA LTD., 677 Calle de Diego, Rio Piedras, Puerto Rico 00924, Phone: (809) 766-2346

United States — AMP Incorporated, Harrisburg, Pa. 17105, Phone: 717-564-0100

AMP SOUTH AMERICA

Argentina — AMP S.A. Argentina 4 de Febrero, 76 Villa Zagla — SAN MARTIN, Buenos Aires, Argentina, Phone: 752-4612

Brazil — AMP do Brasil Ltda., AV Comendador Martinelli 185, Lapa, Sao Paulo, Phone: 262-4353

AMP PACIFIC

Australia — Australian AMP Pty. Limited, 155 Briens Road, Northmead, N.S.W. 2152 Australia, Mailing Address: P.O. Box 194, Baulkham Hills, N.S.W. 2153 Aus. Ph: 630-7377

Japan — AMP (Japan), Ltd., No. 15-14, 7-Chome, Roppongi Minato-Ku, Tokyo, Japan, Ph: 404-7171

Products and services for many specialized industries are provided by the AMPLIVERSAL Division. In the United States, this division is known as AMP Special Industries.

For AMP products and services in other countries, write: AMP International Division, Harrisburg, PA 17105, USA.

ACROSS THE DESK

(continued from page 7)

standard of $15 \mu\text{V}/\text{m}$ at $\lambda/2\pi$. Actually, this standard was first adopted in 1938 and has been in effect under various rule numbers since that date.

*Herman Garlan, Chief
RF Devices & Experimental
Branch*

Federal Communications
Commission
Washington, DC 20554

Misplaced Caption Dept.



This new geiger counter runs for three years on a single D cell. Then you need a sword to cut through the corrosion when you change the battery.

Sorry. That's Francisco Goya's "General Jose de Urrutia," which hangs in the Prado Museum in Madrid.

Don't start a trend we are trying to avoid

In your article on CRTs (ED No. 17, August 16, 1976, p. 26), you state:

"A widespread misconception about CRTs is that if you don't buy a standard item, you will pay more for the device. That may be true in some cases, but in most instances a tube design can be fit to an application with no engineering charge by putting together

existing gun, screen and envelope designs."

For some time, we and some of our customers have been striving to achieve a higher degree of standardization of CRT types and CRT parts. Your comment encourages a counter trend.

Many manufacturers in our industry are plagued by short runs of a large variety of sophisticated tube types. This greatly reduces the effectiveness of our engineers, deteriorates the profit margins in our industry and reduces the effectiveness of our products.

Our customers are unable or unwilling to support the costs of retooling and preparing new processes for revised types. The changes, which often appear to be simple, embody subtle problems that result in schedule delays as well as excess cost to the user and the manufacturer.

Unless our industry can return to a higher degree of use of common tube types, the deterioration of the quality and potential of the industry will continue, and a very essential aspect of the U.S. display industry will be further compromised.

*William N. Moody
President*

Tubes & Devices Corp.
DuMont Electron
DuMont Div.
750 Bloomfield Ave.
Clifton, NJ 07015

Whose 2909, 2911?

You'd never know it from the article, "Bipolar Controllers—They're Fast, Cheap and Easy to Use" (ED No. 22, October 25, 1976, pp. 106-110), but two leading bipolar microprogram sequencers, the 2909 and 2911, were pioneered by Advanced Micro Devices of Sunnyvale, CA.

Interested now?

CIRCLE NO. 88

Second glance at naked model

In our June 7, 1976 Computer '76 Issue (ED Vol. 24, No. 12, p. 88) Computer Automation was incorrectly mentioned as offering the Naked Milli LSI-3/04. The correct model number is the Naked Milli LSI-3/05.

TEN-FOUR, CB-LAND, DO YOU COPY?



... Hammer up and lay an eyeball on this copy for a minute. We don't want to overmodulate, but we've got four handbooks that, for not much lettuce, can have you doing your thing in the left lane in no time.

How to get your license from Uncle Charley. How to select and set up a rig. How it works. How to fix your set when something's dusting your ears. Do you copy ... it's all here!

Whether you're a green apple or a trucking guy, even if you drive a pregnant roller skate and want help the next time you get bubble trouble, here's the information, tips and techniques you need.

Use the coupon and put down your handle (name) and 10-20 (address) to order the book(s) you want. They come with a 15-day money back guarantee. And keep the wheels spinning and the beavers grinning.



HAYDEN BOOK COMPANY, INC., 50 Essex St., Rochelle Park, N. J. 07662

MOST OFTEN ASKED QUESTIONS AND ANSWERS ABOUT CB RADIO
CB Magazine Staff

Everything from "WHAT DOES CB MEAN?" to "HOW DO RG-58 and RG-59 CABLE DIFFER?" Over 160 questions sent in to *CB Magazine* cover all you need to know to really enjoy your rig. 5747-4, \$3.95.

PRACTICAL CB RADIO SERVICING Revised 2nd Edition
R. R. Freeland

How to handle just about every problem you'll ever face. Step-by-step instructions, including spot-testing and troubleshooting. Filled with charts, diagrams, illustrations. 0869-4, \$6.95.

CITIZENS BAND RADIO Revised 2nd Edition
Allan Lytel

Compares different types of equipment ... how they work ... maintenance and repair ... the FCC and you. 5737-7, \$4.90.

CBers' HOW-TO BOOK
Leo G. Sands

How to select and install equipment, including mobile and base stations ... codes and channels ... how to modify your rig for greater convenience and performance. 0718-3, \$4.95.

Please send the books checked on 15-day examination. Enclosed is my check for \$_____. Include your state sales tax (NJ-5%, CA-6%, FLA-4%) and 65¢ per book for postage & handling. I understand that I may return the book(s) within 15 days for a complete refund if not satisfied.

Name _____

Address _____

City _____

State/Zip _____

76-47

THIRTEEN JUST BECAME YOUR LUCKY NUMBER



NEW! 1390 and 1395 DPDT



Two new 1300 series relays give you the most complete line of miniature enclosed relays to meet your most exacting specifications.

Your Guardian Angel calls these relays the 1300 series. You'll call them miraculous. Check these specs for proof:

1310 AC and 1315 DC relays, 4 PDT, 5 amp in your choice of .107" solder lug or .059" printed circuit termination.

1330AC and 1335DC relays, DPDT, 5 amp with .098" solder lug or .059" printed circuit termination.

NEW! 1345DC relay, SPST-NO, SPST-NC, or SPDT, 10 amp. Termination is standard .055" x .030" printed circuit. Just over a cubic inch small, yet specifically designed for low cost, high reliability.

NEW! 1390AC and 1395DC relays, DPDT, 13 amp. Dual type .187" or solder lug termination. Space saving, compact. Give large control capacity in about half the size of competitive relays that do the same job. Small price, too.

1360AC and 1365DC relays, DPDT, 5 amp with .060" diameter, 13/64" long terminal pins on .1" grid spacing for PC board. Also available in SPST and SPDT up to 50 amps.

Mounting sockets and hardware. A complete line of solder lug, PC and wire wrap sockets. Plus, side mounting/permanent stud hardware that allows you to mount these relays in any position.

NEW! 1345 SPST-NO, SPST-NC, SPDT



Send for the free book that tells it all:

Guardian's 48 page relays catalog. Full of facts and specs to make selecting a relay a snap.



This mark indicates recognition under the component program of Underwriters Laboratories, Inc.



GUARDIAN®

GUARDIAN ELECTRIC MANUFACTURING CO. • 1572 W. Carroll Ave., Chicago, Ill. 60607

CIRCLE NUMBER 10

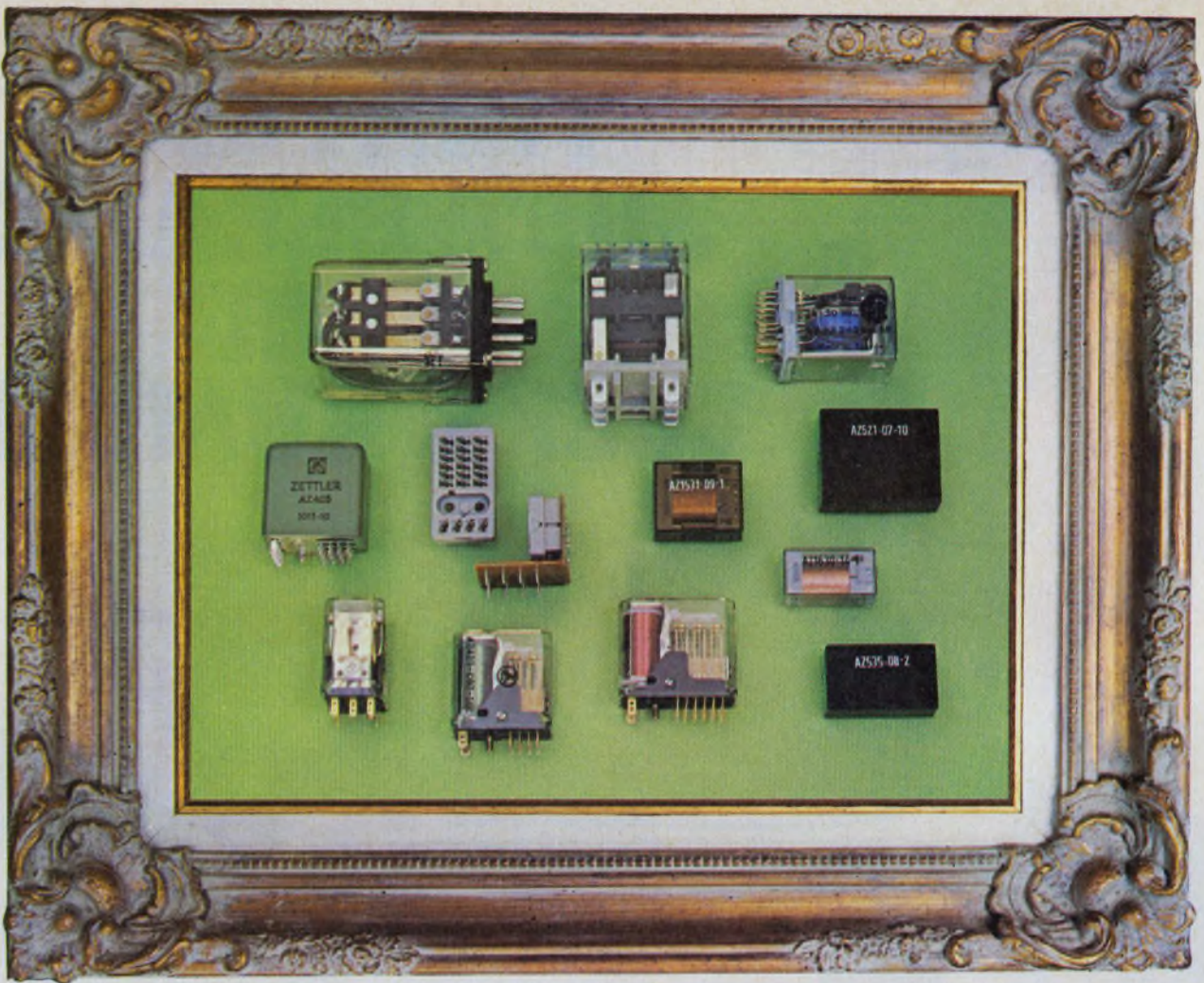

Masterworks Circa 1977



American Zettler takes genuine pride in offering to you its beautifully crafted relays.

There's a very real heritage of technical competence and consistent quality behind the Zettler name. Although we are an *American manufacturer*, the design and fabrication of our relays reflect the 100-year-old tradition of Zettler... now one of the world's largest makers of precision electromechanical products.

American Zettler invites you to examine its relays carefully. You'll find elegant design, true precision construction, generous use of high-quality materials, and workmanship that meets tight specifications... all at most attractive prices. Compare our products with those of our biggest competitors and you'll agree that Zettler relays are Masterworks.

The full American Zettler line includes hundreds of configurations in the most popular and important electromechanical relay styles.

MINIATURE GENERAL PURPOSE RELAYS

DPDT through 6PDT models • AC/DC coils • dry circuit to 5 amp contacts • UL and CSA approved • hermetically sealed versions also available

LOW-PROFILE THINPAK® RELAYS

Unsealed and sealed styles • Less than 0.5 inch high • SPDT through 4PDT models • DC coils • dry circuit to 5 amp contacts • UL approved • magnetic latching versions also available

GENERAL PURPOSE HEAVY DUTY RELAYS

SPDT through 4PDT models • AC/DC coils • 5 to 10 amp contacts • octal/11-pin or quick-connect versions • UL and CSA approved

Over 40 American Zettler representatives and distributors in the U.S. and Canada stand ready to help you with your applications or order. Contact us today for a full-line catalog, the location of your nearest representative, and evaluation samples.

"It's a Better Relay"



AMERICAN ZETTLER, INC.

16881 Hale Avenue • Irvine, California 92714 • Phone (714) 540-4190 • Telex 67-8472

CIRCLE NUMBER 11



From the originators of the photo-isolated solid-state power relays that have become the industry standard . . .

8 AMP SERIES 2 FOR HEATSINK OR PANEL MOUNT

Two models, S218 (120 Vac) and S228 (240 Vac), feature standard 0.187" terminals for push-on connectors or bare-wire solder connection, positioned to provide maximum isolation between signal and power circuits. Offset positioning of the terminals permits side-by-side gang mounting for high packaging density. Occupying less than 1.0 cubic inch, they provide a full 8 ampere (rms) current rating and a high surge current capacity suitable for control of the toughest loads. The S218 units are \$5.90 in 1,000-piece lots.

**A QUANTUM STEP
IN SIZE
AND PRICE
REDUCTION!**



**TWO NEW CRYDOM
CHALLENGER
SOLID-STATE RELAYS!**

The new Crydom Series 2 and 3 SSRs combine small size and low price, challenging all comparably rated SSRs, hybrid relays, and in-house designs on a size/cost/performance basis. They provide photo isolation, zero voltage switching, high current rating and rugged packaging — first established by the original Crydom Series 1, now the world's leading SSR design. Designed for UL/CSA approval, they offer the advantages of long life, RFI-free switching, logic level control, and excellent electrical and mechanical isolation of signal and power circuits.

The application of SSRs is no longer limited by size and cost. Crydom Challengers have knocked down these barriers. SSR control of motors, heaters, lamps, transformers, solenoids, valves and contactors now becomes practical in many new applications.

Think about it for your product . . . and join the Challengers!

INTERNATIONAL RECTIFIER

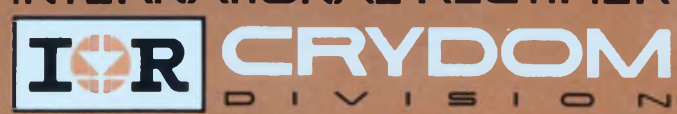

1521 Grand Avenue, El Segundo, CA 90245 (213) 322-4987

2 AMP SERIES 3 FOR PC BOARD MOUNT

Two models, S312 (120 Vac) and S322 (240 Vac), provide a higher power handling capability than any SSR of equal size. Occupying less than 0.4 cubic inch, Series 3 SSRs achieve a full 2 ampere free-air rating in a 40° ambient. A low 3/8" profile allows 1/2" spacing of rack mounted printed-circuit boards. The S312 units are \$4.90 in 1000-piece lots.



...the pacesetters!

CIRCLE NUMBER 121

DELCO'S NEW 25-AMPERE HIGH VOLTAGE DARLINGTONS WITH THE SPEED AND ENERGY CAPABILITY YOU ASKED FOR.

Good news for motor speed control designers who have expressed a need to upgrade horsepower ratings. The 25-ampere gain of these new Darlings permits increased horsepower ratings of existing AC motor speed control systems and a reduction in paralleling in new designs. However, grouping of t_{off} is available for current sharing in designs with parallel Darlings. A speed-up diode is built into the DTS-4074 and DTS-4075 permitting data sheet t_r typicals of $1.0 \mu s$. Drive circuit techniques involving $1_{B2} \geq 2A$ and a Baker clamp produce t_r typicals in the $0.4-0.6 \mu s$ range for the DTS-4066, DTS-4067, DTS-4074, and DTS-4075.

Our experience with tolerances, faults, transients, and start-

stall conditions in most systems convinces us that these Darlings have the right trade-off between speed and peak power handling capability. Note the greater than $10kVA$ region of the reverse bias safe operating graph. All this, and you still get Delco's traditional solid copper TO-3 hermetic package that has a conservative $0.75^\circ C/W$ thermal resistance.

These Darlings are already in high volume production and are available on distributor shelves. For prices, applications literature and data sheets, visit your nearest Delco sales office or Delco distributor, or mail in the coupon on the right.

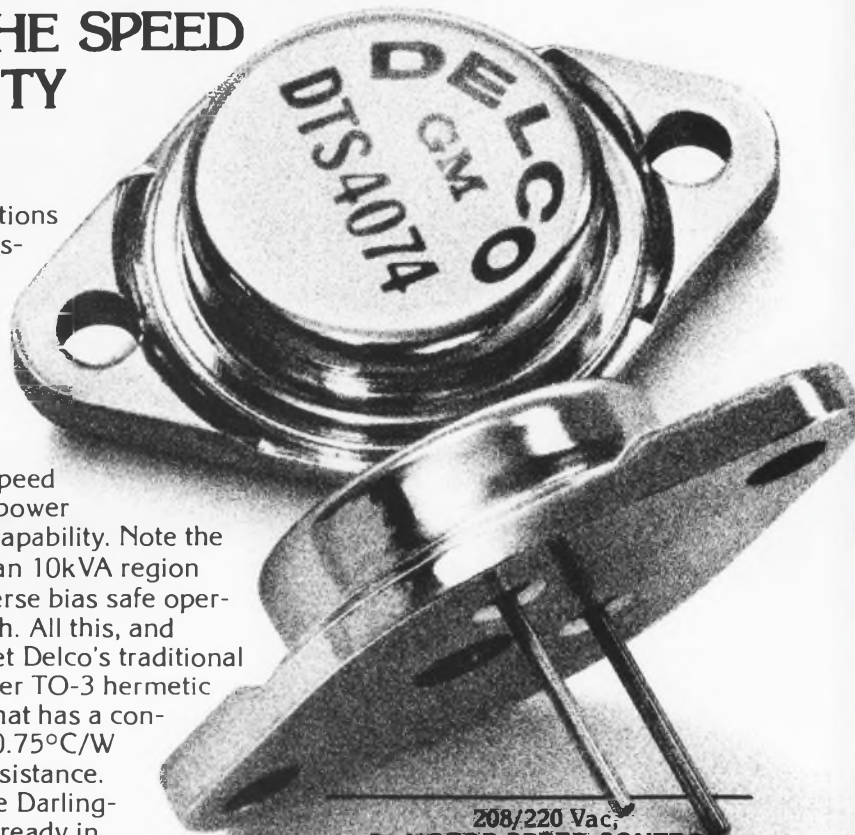

MAJOR PARAMETER LIMITS

Type	h_{FE} @ 25A	h_{FE} @ 10A	V_{CEO} (sus)	V_{CE} (sat) @ 20A	I_{CEO} @ 600V
DTS-4066	5	75	350V	3.5V	0.25mA
DTS-4067	10	150	350V	2.0V	0.25mA
DTS-4074	5	75	350V	3.5V	0.25mA
DTS-4075	10	150	350V	2.0V	0.25mA

TYPICAL SWITCHING

	DTS-4066 DTS-4067	DTS-4074 DTS-4075
t_r	$0.5 \mu s$	$0.5 \mu s$
t_s	$5.0 \mu s$	$3.2 \mu s$
t_f	$4.5 \mu s$	$1.0 \mu s$

NPN triple diffused silicon Darlings are packaged in solid copper cases conforming to JEDEC TO-3 outline dimensions.

SAFE OPERATING CURVES

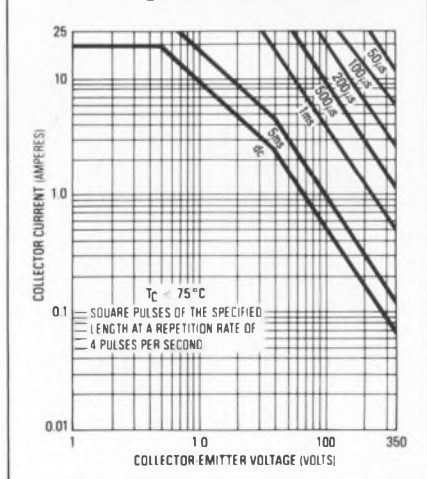

CLAMPED INDUCTIVE SWITCHING PERFORMANCE

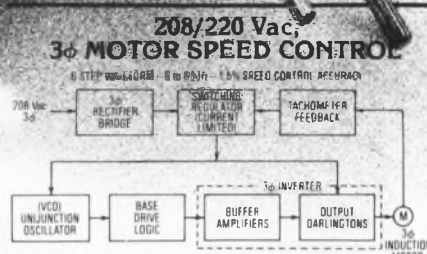
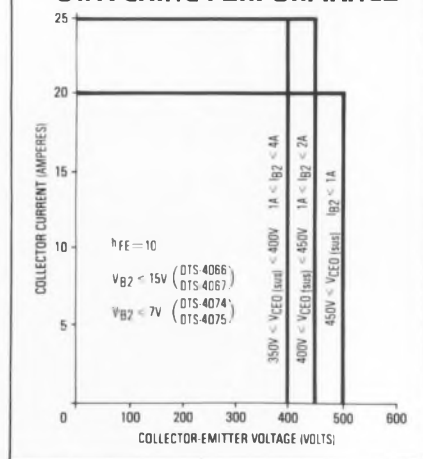

FOR MORE INFORMATION ABOUT DELCO'S NEW 25-AMPERE HIGH VOLTAGE DARLINGTONS, MAIL THIS COUPON TO:

Delco Electronics Division
General Motors Corporation
Marketing Services MS A-213
700 E. Firmin Street
Kokomo, Indiana 46901

NAME _____ TITLE _____
 COMPANY _____
 ADDRESS _____
 CITY _____ STATE _____ ZIP _____
 PHONE _____

**Delco
Electronics**



DELCO ELECTRONICS SALES OFFICES
Kokomo, Indiana (317) 459-2175
Charlotte, North Carolina (704) 527-4444
Van Nuys, California (213) 988-7550

CIRCLE NUMBER 122

48-pin IC Tester: Total programming flexibility and no program boards put the IT-200 in a class by itself.

Here is an extremely flexible integrated circuit tester that can handle virtually *all* digital devices.

Its 100 kHz functional capability, coupled with a powerful DC parametric capability, allows testing of CMOS, NMOS, PMOS, ECL, and TTL devices of any complexity. The particularly powerful DC parametric test capacity provides current ranges from ± 200 na to ± 200 ma, and voltage ranges up to ± 20 V.

The versatile IT-200 operates under ROM or RAM program control (software load) and readily interfaces with handlers, probers and other instrumentation.

Check out the IT-200. You'll find the specs are truly in a class by themselves and the price is surprisingly low. For complete details, write or call: Siemens Corporation, Computest Products, 3 Computer Drive, Cherry Hill, New Jersey 08034 (609) 424-2400.



IT-200 is manufactured by Imperial Technology and marketed by Siemens.

SIEMENS

ITT CANNON FOUND OUT...



Electronic Design IS BEST READ BY ITS CUSTOMERS AND PROSPECTS

Theodore Knudson, an American dedicated to assisting the European aerospace community at ESTEC, Noordwijk, Holland, states: "I usually read each issue of *Electronic Design* for its unique features. I also find E.D. useful in the form of a resource material depicting recent state-of-the-art advances that is not totally theoretical and therefore can be suggested for application in our real life designing and procurement processes."

If you read *Electronic Design*, you're in good company. Almost 90% of those firms who have taken the trouble to find out which magazines their customers read, rank *Electronic Design* in first position.

For example: ITT Cannon mailed 1,000 questionnaires to a portion of their prospect list (respondents to advertising and publicity releases in many publications).

The survey asked: "Designate in order of importance those publications which you are now receiving and read on a regular basis." Here are the top winners:

PUBLICATION	READ REGULARLY (ITT Cannon Prospect List)	
	REPLIES	RANK
ELECTRONIC DESIGN	732	1
EDN	668	2
ELECTRONICS	416	3

PASS THE WORD

Maybe your advertising brass doesn't know as much about the power of *Electronic Design* as you do. If your company wants to reach engineers and engineering managers . . . *pass the word*. Tell your sales, marketing and advertising people which publication will bring highest readership among the engineers who make the wheels go round in this industry . . . *Electronic Design*.

Electronic Design

BEST READ ELECTRONICS PUBLICATION IN THE WORLD

Sharpen your competitive edge.

Use an HP computing calculator for design, analysis, control, and test.

In the highly competitive, high-technology electronics business, everthing counts: keeping costs in line, exploring promising design alternatives, shortening lead times, product and prototype testing, increasing productivity. That's where HP computing calculators, software, peripherals, and interfacing capabilities come in. They can help you get and maintain a competitive edge.

Three computing calculators and plenty of peripherals: It's your choice. Three different models—the low-cost HP 9815, the powerful HP 9825 and the all-purpose HP 9830—offer a range of computing power.

HP peripherals include paper tape punch and readers, printers, storage devices, a digitizer, a CRT, and an X-Y plotter. You choose the model and I/O options to configure a system just right for you.

Software, specialized and generalized, helps you look at more alternatives.

HP engineers developed software to optimize designs and analyze engineering problems quickly. There's a State Variable package for control system analysis. There's CNAP for circuit design and analysis, BAMP for microwave design and analysis, and Digital Simulation for state and timing analysis.

You can add other programs, too—commonly needed math routines and statistical programs to name but two. Programs are also available for accounting applications, report generation, and financial analysis.

Automate your instruments. We make the connection friendly. From simple data logging to complex integration, our programming commands and interface cards make instrument interfacing easy. Whether your instruments require BCD, bit-parallel, RS-232-C, or HP-IB (HP's implementation of IEEE Standard 488-1975), you plug the correct interface into the calculator and connect the cable to your instrument. It's the friendly connection.

HP computing calculators: from initial design to final test. Whether you're in research, design, production, or test—or all four—we can provide the computing power and programs to help you increase productivity and sharpen your competitive edge. Our new brochure for electronic engineers will show you how. Get a copy from your HP representative, or circle our reader service number in this magazine.



HP desktop computing systems put the power where the problems are.

HEWLETT  PACKARD

Sales and service from 172 offices in 65 countries.

P.O. Box 301, Loveland, Colorado 80537
 For assistance call: Washington (301) 948-6370, Chicago (312) 677-0400,
 Atlanta (404) 434-4000, Los Angeles (213) 877-1282, Toronto (416) 678-9430

FOR INFORMATION OEM APPLICATIONS

CIRCLE NUMBER 102

CIRCLE NUMBER 101

SSR UPDATE

We've got 87 answers to your AC solid state relay needs.

Teledyne Relays can handle virtually any AC solid state relay switching application. The reason? A family of AC SSRs with 87 models — and more on the way. We offer a broad range of voltage ratings up to 600V peak, with current ratings from 0.5 to 40 Amps. Add to that a variety of packages for pc board, chassis, or heat sink mounting and you have the industry's most complete line of AC SSRs.

But hardware isn't the only answer. You need assurance of the best available applications engineering support.

And we've got it — backed by seven years as a pioneer and leader in SSR technology to enable you to use our SSRs to their maximum advantage.

That know-how, for example, is reflected in Teledyne's new 970 Series MOV transient suppressors designed specifically to protect our AC solid state relays against high voltage transients.

Contact your local Teledyne Relays people. You'll find we have the experience, technical support and products to meet your SSR needs.



- A. **601 Series***
5 and 10A (to 600V peak). Optically isolated, zero voltage turn-on. Screw terminals, quick disconnects, and pcb pin options.
- B. **611 Series***
10, 15, 25 and 40A (to 600V peak). Optically isolated, zero voltage turn-on. Dual purpose screw/quick disconnect terminals.
- C. **675 Series***
Low profile (0.5" max.) pc board SSRs. Output rating 3A, up to 600V peak. Optically isolated, zero voltage turn-on.
- D. **671 Series**
I/O Converter Modules. Special purpose SSRs for use in programmable controllers, machine tool controls, etc. Mounting panel available.
- E. **SerenDIP® Series***
TO-116 DIP package. Output rating 1A/280VRMS. Logic compatible 3.8 to 10VDC input.
- F. **970 Series MOVs**
High voltage transient suppressors designed specifically for use with all Teledyne AC SSRs.

*UL recognized/CSA certified.

 **TELEDYNE RELAYS**

3155 West El Segundo Boulevard, Hawthorne, California 90250
Telephone (213) 973-4545

DECEMBER 20, 1976

Popular μ P bit slice has an even better twin

A pin-compatible version of the 2901, the most widely used μ P bit slice, is 20 to 30% faster, 30% cheaper, and 50% stiffer in Y-output drive currents, yet uses 25% less power. The 2901A will also be available next month from Advanced Micro Devices, Sunnyvale, CA.

Functionally, the 2901A chip is identical to the 2901. But plugging in the 2901A in place of the 2901 cuts the typical time for a read/modify/write cycle from 105 to 75 ns and the I_{CC} from 280 to 200 mA (at V_{max} and 125 C). The 2901A also boosts I_{OL} on the Y output from 16 to 24 mA and improves noise immunity by increasing V_{IL} from 0.7 to 0.8 V max.

Die size is cut from 33,000 to 20,000 square mils. Cost in 100s drops from \$21 for the 2901 to \$14.70 for the 2901A.

The 2901A's improvements are the result of two-layer metallization and internal logic simplifications.

The 2901A's improved speed will not affect the throughput in every application: Its impact depends on the microcode-sequencer architecture used with the bit slice. AMD plans to offer other aids to improve throughput, including a 2930 program control chip that can relieve the 2901A of program counting.

Although several other manufacturers may soon announce similar devices, AMD's 2901 remains the leading bit-slice part and the fastest TTL slice available. The 74S481 from Texas Instruments is not yet out, although its introduction had been planned for the fall of 1976. (See "Bipolar bit slice μ P's shrink the size and cost of minis and controllers," ED 10, May 10, 1976, p. 34.) Raytheon and Motorola are alternate sources for the 2901.

Since 2901 users have had to develop microcoding capability,

Motorola, an alternate 2901 source, now offers training courses on the 2901 hardware and microprogramming. A 2901-2901A microprogram assembler will soon be available on Computer Sciences Corp.'s Infonet time-sharing service.

The availability of the microcoded 2901 has led several computer manufacturers to design universal device controllers, identical hardware units, for such peripheral devices as printers, tapes and discs. At system-generation time, the central processor specializes each controller by loading its RAM with a microcode-program design for the peripheral device it controls.

CIRCLE NO. 318

Solderless interconnect system shown by Augat

A new interconnection packaging method that allows components to be plugged directly into printed wiring boards without the need for soldering has been introduced by Augat Interconnection Products, Attleboro, MA.

Called Holtite, the interconnection system is based on precision-machined contacts that are pressed into a printed wiring board, plated-through hole.

Until recently, plated-through holes for socket applications have been used as soldered receptacles to mount standard style sockets, according to Richard Holt, Augat product manager. These sockets are mounted above the top surface of the board with an average profile height of 0.16 in.

The Holtite system is the first solderless method to use the existing space within the board as the contact receptacle, says Holt. As a result, the socket offers a very low profile that permits card rack spacing as close as 0.4 in.—equal to

that of boards with soldered components.

The tapered entry contact is recessed into the board to provide a large contact target area (0.044 in. diameter), which makes it ideal for automatic component insertion, Holt observes.

Holtite contacts can be installed in boards at a rate of 30,000 per hour by means of a specially designed, mass-loading machine that features a vibratory feed and vacuum system.

CIRCLE NO. 319

Undersea communicator sharpens speech clarity

An underwater voice communicator that uses enhanced speech-processing techniques to improve the intelligibility of subsurface communication has been developed by Sound Wave Systems, Costa Mesa, CA. Called the "WetPhone," the device also features specially developed transducer encapsulating material and a 31-kHz, amplitude-modulated carrier signal.

"Reverberations caused by speaking into a small face mask as well as breathing and gurgling noises have been the main problems with previous undersea voice systems," observes Dennis Johnson, president of Sound Wave Systems. The WetPhone filters out these noises along with those components of human speech below 650 Hz—including breathing sounds.

Because 65% of voice intelligibility is contained in speech components above 1000 Hz, the unit employs two high-pass filters and a very sensitive receiver. The receiver is equipped with an automatic gain control whose dynamic range covers 85 dB.

The WetPhone communicator delivers 1 W of acoustic power into the water and has a range of a quarter mile. Its operating cycle runs six to seven hours with replaceable alkaline batteries or an optional, rechargeable battery pack.

Two other options are available. One is an alarm, called Auto-Alarm, that is activated automatically when the WetPhone detects that the diver isn't breathing. This alarm can alert any underwater companions as well as a surface rescue unit. It can also be

used as a tracer signal for search and rescue operations. A separate acoustic direction finder is also available for use in such an emergency.

The other option, called VOX, is a voice detector that can be placed against the larynx to automatically switch the WetPhone from "receive" to "transmit" without manual intervention.

Solar μ wave repeater saves power and money

A solar-powered microwave communications repeater that uses only 4 W of power and can operate at temperatures as high as 140 F has been developed by GTE Lenkurt Inc., San Carlos, CA. The repeater, called the 700F1 can be installed at about one-fourth the cost of existing repeater systems.

The first commercial installation of the solid-state repeater begins operation this month to provide telephone service to a remote Navajo Indian outpost near the community of Mexican Hat in southeastern Utah.

Currently, the 700F1 can transmit 36 simultaneous telephone conversations, but a system with "much greater capacity" is planned for next year, according to Herbert Krenzel, GTE Lenkurt's president.

Power is supplied to the repeater as well as to a bank of four storage batteries by 36 silicon solar cells mounted on two panels. The batteries allow the system to operate for up to 10 days of total darkness.

Ability to operate at high temperatures (over a range nearly three times higher than repeaters currently in use) eliminates the need for costly, high-power air conditioning to cool the electronics.

'Recombination' laser readied for space use

A recombination argon-gas laser that should be useful to communications and power transmission in space has been proved feasible at Princeton University in NJ. The laser produces energy in the 4700-to-5100-Å ultraviolet spectrum. But ultimately, this use of doubly ionized helium may result in a laser operating in the soft

X-ray region around 1500 Å, according to Dr. Edward M. Campbell, the first to demonstrate the argon plasma-dynamic recombination lasing.

Short-wavelength lasers of this nature can be useful in space communications because unlike the radiation from the sun in the infrared spectrum, the radiation in the ultraviolet is relatively low, according to Campbell. For this reason, background noise that may interfere with UV receivers is lowered substantially. Consequently, the system design of such a receiver will be simpler and laser-power requirements minimized.

Minicomputer system to be the first OEM for IBM

A general-purpose computing system with both communications and sensor-based capabilities represents IBM's first venture into the OEM minicomputer business.

Developed and being manufactured at IBM's General Systems Div., Boca Raton, FL, the Series/1

will enable users to attach many different input and output devices, including custom-made equipment for special applications.

Formerly known by the code name "Peachtree," the Series/1 is expected to replace some large computer systems in organizations that wish to decentralize their operations. IBM's first two sales are to Citibank in New York and to an automobile parts distributor, Middleton, Delaware, which will use three units for inventory control, accounts receivable and automatic ordering.

Offered for sale—not for leasing—Series/1 models will range in price from \$10,000 to \$100,000. The 19-in., rack-mounted units are available in 16,384-byte increments of memory, from 16,384 to 65,536 bytes, in Model 3 and from 16,384 to 131,072 bytes in Model 5. Model 3 has a storage cycle-time of 800 ns, and Model 5 660 ns.

Not only are the IBM minicomputers competition for DEC, Data General and Hewlett-Packard, but for IBM itself. The firm's 370 sales force is reportedly concerned.

News Briefs

The first family of CMOS programmable ROMs requiring one hundredth the power of their bipolar counterparts has been introduced by Harris Semiconductor. The power cut will keep systems running cooler and make them more power efficient. However, since the PROMs are CMOS, they will not operate at bipolar speeds—access times will be about 200 ns instead of 60 to 100 ns. . . . Users of specialized digital communications circuits, called ASTRO (asynchronous transmitter/receiver), developed by financially-troubled Western Digital, will soon have a second source. A pin-compatible replacement is due from SMC Microsystems, Hauppauge, NY, in the first quarter of 1977. . . . A Motorola single-bit controller cir-

cuit, built with CMOS technology and scheduled for introduction early in 1977, will find its way into a number of control applications in industrial processes and in such appliances as blenders and washing machines. The circuit will reduce both manufacturing cost and the size of the finished product by eliminating large numbers of discrete components—transistors, small-scale integrated logic and (possibly) medium-scale ICs. . . . The Defense Dept.'s Autodin communications system in Europe will soon acquire a new switching system capable of handling both analog and digital transmissions. Specifications will be published in 1977. A full digital system won't be installed before 1985, according to a EOD spokesman.

Intro- ducing the amaz- ing EECO

machine: in one end you put your raw, un-annotated logic diagram, and out of the other comes your fully wire wrapped socket board/frame/drawer/system—your choice. Together with a *Final Exception Report*, a *Final String List*,

an IC Location List, *lists for IC Type and Socket Size*, *a Wire Loop List*, *a Pin Assignment List*, *an Unused Circuit Elements and Pins List*, *a Pin by Pin Wire List*, and your diagram back, fully annotated.

This machine uses a computer, and people, and hardware all under the same roof, and gives you a chance to correct or change your circuitry before we go to hardware. We deliver in as little as two weeks, including time for you to review. We've been doing this for more than five years, almost in secret. Now we're telling you and the world because it's about time. Write or phone the keeper of the EECO machine, Dick Hunter.



EECO

PACKAGING/SWITCHES/READERS

1441 East Chestnut Avenue, Santa Ana, California 92701
Phone 714/835-6000

CIRCLE NUMBER 14

ATTENTION ALL ENGINEERS!

Design yourself a free vacation for two!

Yes, you can win an all-expense-paid Caribbean vacation plus \$1,000 cash — or one of 99 other valuable prizes!

There's nothing to buy, nothing to write, no slogans or gimmicks.

All you have to do is pick the ten advertisements that our readers will best recall having seen in the January 4 issue.

It's *Electronic Design's* popular TOP TEN CONTEST — the contest that can pay off handsomely for you *and* for your company.

Win a free vacation for yourself

Think of it! Clear sky... warm sun... expanses of blue water. The Caribbean is at its best when viewed from the deck of a sailing ship.

Top prize is a fabulous week's Windjammer Cruise for two. You can choose trips among the Bahama Out Islands, the U.S. and British Virgin Islands, or the exotic Windwards and Leewards.

Visit colorful ports with their old world charm and duty-free shops. Swim, fish, snorkel, relax, or lend a hand with the ship.

And it's all free! The prepaid cruise is worth many hundreds of dollars — not to mention the \$1,000 cash for travel and incidentals.

Win for your company

More and more companies are urging their engineers to enter this contest. Why? Because a large sample of *Electronic Design* subscribers will determine the top-scoring ads. The ten best will be rerun free of charge. Your company can win one of these reruns, worth up to several thousand dollars! (To receive this prize, your company must have an ad in the contest issue.)

Separate contest for advertisers and their agencies

The TOP TEN CONTEST is actually two contests with separate sets of prizes (1) for engineers and engineering managers (readers) and (2) for company executives, marketing and advertising personnel and their advertising agencies. Urge your top brass to enter. Xerox this page and pass it on to them. Maybe they can pick the top ten ads and walk off with one of the separate prizes.



Here's all you have to do to enter

First, read the rules contained in the January 4 issue. Then:

(1) Examine the contest issue with extra care.

(2) Pick the ten ads that you think *Electronic Design* subscribers will best recall having seen. List these ten ads by company name and reader service number on the entry card. Mail before February 15, 1977.

Your selections will be checked against Reader Recall, *Electronic Design's* method of measuring readership.

100 reader prizes in all

Watch for the January 4 Top Ten issue, then try your skill. This year, maybe *you* can sail away with the top prize.



PRIZES READER CONTEST

1st PRIZE
A WINDJAMMER CRUISE (FOR TWO)
IN THE CARIBBEAN
(Choice of itineraries and dates)

PLUS
\$1,000 CASH FOR TRANSPORTATION
AND INCIDENTALS

2nd PRIZE
GTE SYLVANIA PORTABLE COLOR TV SET
(\$325 value)

3rd, 4th & 5th PRIZES
DIGITAL WRISTWATCH
(\$100 value)

6th through 100th PRIZES
TECHNICAL BOOKS
(title to be announced)

PRIZES ADVERTISER CONTEST

1st PRIZE
WINDJAMMER CRUISE (FOR TWO)
IN THE CARIBBEAN
(Choice of itineraries and dates)

PLUS
\$1,000 CASH FOR TRANSPORTATION
AND INCIDENTALS

2nd PRIZE
GTE SYLVANIA PORTABLE COLOR TV SET
(\$325 value)

3rd PRIZE
DIGITAL WRISTWATCH
(\$100 value)



NOTE TO ENGINEERING MANAGERS

Urge your staff to enter.
The winning ads will receive
free reruns worth \$ thousands
for your company.

WATCH FOR THE
**TOP TEN
CONTEST
(JAN. 4
ISSUE)**



The switch to digital accelerates in radios, phones and satellites

Never before has the Army communicator or the design engineer who develops his equipment known in such detail what battlefield communications would be like 20 years hence and the steps their evolution would take.

Hybrid capability, both analog and digital, which has been part of the Army's tactical communications since 1972, will accelerate.

By 1982, the balance will start leaning toward the digital side. By 1992, everything that can be digital will be—even telephones, if one can be built cheaply enough.

Electronic switching equipment will be found even in the forward combat areas.

Voice communications probably won't go out of style, but more and more data will be transmitted: maps, handwritten messages and photographs shot back and forth by facsimile—even to the fronts. High-speed facsimile will be transmitted on a new vhf family of radios on a time-shared basis with voice users. The facsimile device will transmit an 8 × 10-in. page of 240 words in approximately 30 seconds. Today's teletypewriter takes four minutes.

Conventional hf-radio teletypewriter assemblages may be eliminated in favor of high-speed, automatic teletypewriter terminals that print out at 12 s/page. These machines will be smart and will enable the operator to type, store, edit and display before transmitting over satellite and uhf radios.

At the brigade and division levels, the conventional multichannel radio system will be replaced by a fully automatic radiotelephone



The Army version of the Marine Corps SB-3614 switchboard provides fully automatic queuing, ring and disconnect. It is built by Sylvania.

switching system known as the Mobile Subscriber Equipment (MSE) subsystem.

Multichannel tactical satellite terminals and automatic voice and teletypewriter switching will improve the grade and speed of service even further.

High-frequency radio will retreat from the field as the satellite communications advance—even for short-haul links.

Equipment will be secure or securable. If it isn't built secure, it will be designed to accommodate a secure module, or adapter, later.

And all systems will be as interoperable and standard throughout the Defense Dept. as possible. To ensure this conformity, a special Defense Dept. office called Tri-Tac (Joint Tactical Communications) has been established to

pass on every tactical-communications development proposed by any service.

The future is known for the Army because of a study called Intacs (Integrated Tactical Communications Systems), carried out in its early stages by the Army Signal School at Fort Gordon, GA, and completed by the Aerospace Division of Martin Marietta Corp., Baltimore, MD. The input for the study includes some 46,000 communications-support requirements turned in by combat arms and other tactical Army users of communications equipment.

When Intacs is implemented, it is hoped that 30,000 less signal personnel and 5000 fewer vehicles will be needed to support the 24-division Army projected for 1980. "This is the first time in the his-

tory of the Signal Corps that we have been able to cover the gamut of tactical communications in a single study," says Colonel William E. Wilson, director of the U.S. Army Signal School Combat Development Directorate at Fort Gordon.

Much of the equipment required to implement the concept is either being developed or planned for development by such Defense agencies as Tri-Tac and the Army's Tactical Satellite Communications and Single-Channel Ground and Airborne Radio Subsystem (Sincgars) programs.

A new family of radios

The Sincgars family of vhf/FM radios, which will probably go into the battalion level and below, will be smaller and lighter than the currently used VRC-12 family as well as securable and hardened against electromagnetic pulse.

All Sincgars radios—manpack, vehicular and airborne—will be essentially identical, with special modules for different applications.

The radios will be optimized for 16-kbs digital data: They will have to perform with the same functions and interoperate with the current Army inventory of vhf/FM equipment in both the secure and non-secure modes, and they will have to provide at least 920—and preferably more—usable channels. At least four of these will be preset frequency/crypto-net channels.

A lightweight family of antennas is required that are simple to operate, need no physical tuning adjustment, and minimize the targeting of the operator.

The secure manpack radio will not exceed 20 lb, including batteries. The batteries, some of which will be lithium organic, will provide power for 24 hours of continuous operation for normal duty cycles.

The minimum acceptable MTBF will be 1250 hours, with the best operational capability set at 3300 hours for the manpack and 1500 for the vehicular and airborne units. The scheduled organizational maintenance time will be no more than 30 min/week.

Improved filter technology will be required—"more than likely in the active filters rather than in the passive," says Theodore A. Pfeiffer, chief, Communications

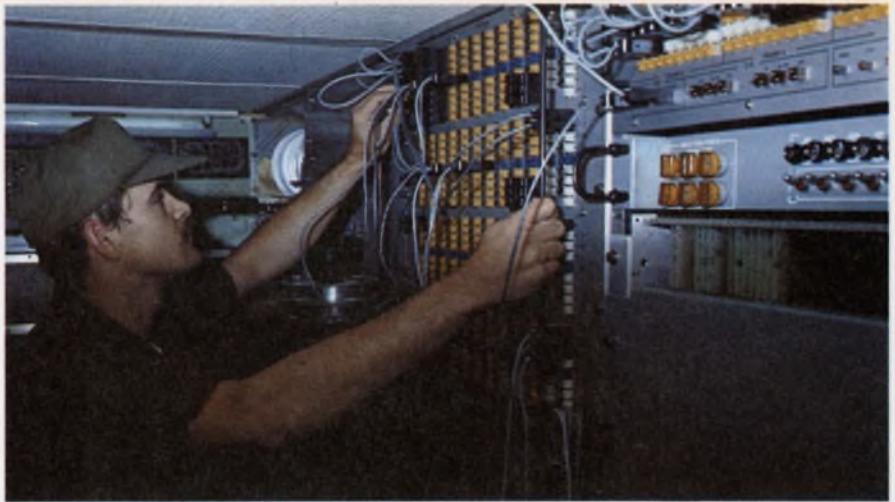

The AN/TTC-38 tactical-automatic-telephone central office, built by Sylvania, switches up to 300 analog, nonsecure voice circuits.



Technical Control Facility, AN/TSQ-84A, built by the Army, interconnects, monitors and tests up to 432 full duplex channels.

Electronics Systems Integration Office, Army Electronics Command at Fort Monmouth, NJ. "And we're probably going to a higher level of microprocessor technology where practical. This will reduce power consumption, physical size and weight, as well as other phenomena such as transient problems."

Switching for the future

Designed to tie the present to the future the AN/TTC-39 is an automatic communications central office switch—a telephone switchboard that accommodates both analog and digital transmissions. Actually, the TTC-39 has two switches: a circuit switch for voice and data, and a message switch for

data exclusively. Both switches can operate with a wide range of transmission systems, such as satellite communications, tropospheric scatter and microwave, cable, data terminals and voice telephones.

The circuit switch can be equipped with a mix of both analog (space-division) and digital (time-division) matrices controlled by the same central processor. This combination provides a hybrid switch that can interface with both current and future analog and digital systems.

Both the circuit switch's hardware and software are modular to provide a family of compatible switching combinations.

Circuit-switching modularity is provided by a basic switching mod-



The 82nd Airborne Div.'s AN/VSC-2 radio-teletypewriter terminal is air-droppable, lightweight and long-range. Mounted in a jeep, it uses an AN/GRC-106 single-channel, hf, SSB radio with a frequency-shift modem.

ule that is expandable in increments of 150 terminations and may be expanded in the field to 3000 terminations.

A continuously variable-slope-delta (CVSD) technique is used to convert the analog input into digital signals.

The message switch is a means for data-terminal equipment with dissimilar characteristics to communicate with each other. Its hardware and software permit it to understand, and be understood by, any military data terminal.

The switch can process up to 81-million characters per day, with a one-second peak throughput up to 9000 characters. Single messages may be as long as 44,000 characters.

In the TTC-39, LSI is used as much as possible along with multi-layer PC cards. CMOS is used primarily to keep power consumption down, but where necessary, low-power Schottky TTL medium-scale integration is used.

The TTC-39 system is being built by GTE Sylvania's Electronic Systems Group's eastern division, Needham Heights, MA.

Telephone network on the move

Probably the most advanced equipment under development for Intacs is a mobile radio-telephone subscriber system, known as the Mobile Subscriber Equipment



The TD-1069 Time Division Multiplexer (TDDM) multiplexes and demultiplexes up to 24 separate digital and teletypewriter dc signals into a bit stream of 32 Kbp/s.

(MSE), which will provide secure automatic radio telephone service to subscribers who require access while in transit.

The Army wants to get away from the multichannel line-of-sight equipment now used. It takes too long to set up; and it requires large antennas, retransmission stations, and too much cable. And its limited mobility is no longer acceptable. "The multichannel equipment takes too long to wire up our command posts," Colonel Wilson says. "It's just not good enough for the future battlefield."

With the MSE, each subscriber has a unique address that can be reached at distances up to 45 km with the help of one or more relay centrals. Direct calls without a central should be possible up to 10 km.

Switching will be automatic. If a call doesn't get through by direct link, it switches over to a central. The concept is a significant emulation of the old, now defunct, Random Access Discrete Address system under development in the 1960s.

The MSE subsystem will be operational some time in 1987.

Tactical satellites step forward

The Tactical Satellite Communication System is being upgraded, says Colonel Fred M. Knipp, commanding officer of the Army Satellite Communications Agency, Fort Monmouth, NJ. "We're putting in new digital terminals and converting existing terminals. The first one went in earlier this year, and by 1980 we'll be all digital."

Satellite communications can be used over a wide range of point-to-point distances. "You can use them from one valley to the next or for distances up to 9000 miles," Col. Knipp says.

The satellite network has three satellites operating at shf that are shared by the Strategic Satellite system: one for the Atlantic, one for the Pacific, and one for NATO forces. A second NATO satellite is soon to be launched. The tactical system also uses several classified satellites operating in the uhf region plus two Marisat relay craft, also uhf.

Uhf is used for vehicular and manpack terminals. Shf is used with 8-foot antennas installed on trucks. Collins is manufacturing the uhf equipment, and RCA, the shf. The manpacks, which will use whip antennas, are being built by Cincinnati Electronics.

The satellite-communications system is moving to Time Division Multiple Access modulation, Col. Knipp says, because the spectrum is so tight. With TDMA, each channel is divided into a number of discrete time slots, with 30 ns the lowest practical limit.

Each terminal in the communication system will be assigned a time slot on a given channel and will transmit in a burst mode. With burst transmissions, each channel will be able to accommodate many more subscribers with no loss in communications capability per terminal.

Uninterrupted voice communica-

Coming through...



with wire, cable and cord
that delivers quality,
performance, economy...

Belden has it: a total service capability. Extensive design and application know-how. What it takes to deliver complex cable configurations, special harnesses, cords, lead wires, and even special packages to fit your requirements.

Our specialists and engineers will meet with your people at your plant to discuss problems in processing, assembly, installation, ordering, human engineering, color coordination, physical and electrical parameters, opportunities for cost reduction. And when we can't help you using standard products, we'll innovate a solution to your problem.

Talk to a Belden specialist about your new applications, product ideas, processing problems—all your wire, cable and cord needs. He has thousands of standard items to draw from. And standard or special, he'll come through with the best wire buy around. For answers right now, phone:

317-966-6661 Electronic Div. or mark No. 400 on reader service card
312-986-1600 Electrical Div. or mark No. 401 on reader service card
312-887-1800 Transportation Div. or mark No. 402 on reader service card,
or write Belden Corporation, 2000 S. Batavia Ave., Geneva, IL 60134.

BELDEN 

Coming through...

with new ideas for moving electrical energy

tions can be expected in this mode, just as with a straight-through channel, since the time slots are so small and so frequent that no loss of communication can be perceived.

Millimeter waves are in the future, according to Col. Knipp: 30 GHz up to the satellite, and 20 GHz down.

Technology leads the way

The Army wants fundamental technology change in *all* future communications inventory. For example:

"We're trying to get away from punched paper tape as a recording medium," says Pfeiffer at Fort Monmouth. The goal is to cut what is considered the biggest time waster at the communications center, message handling.

To get away from the problems inherent in electromechanical devices keyboard technology will be as solid-state as possible. Fort Monmouth is looking at a number of possibilities including piezoelectric technology.

For video display, CRT is being considered, of course, because it's the most prevalent. But the field is open. Liquid crystals (LCD) and plasma are both possible.

Many battlefield transmitters that all send data may one day be combined: sensors, IFF, wideband data links from aircraft to ground terminals and position beacons, says Pfeiffer. "Maybe someday we'll be smart enough to build modular transceivers that can do all these things."

For possible answers, Pfeiffer's group is looking at Time Division Multiple Access techniques, which have already been selected for the satellite program.

The Army currently uses PCM to multiplex, which, of course, is digital: "The Army is probably more digital today than any other service," Pfeiffer observes.

TDMA will eventually join the Army in the field via the Joint Tactical Information Distribution System, which the Air Force is handling for all the services. An outgrowth of the basic communication system proposed for the Air Force's airborne warning and command system aircraft, AWACS, the system can be applied to a communications network serving a large



High-Speed Data Buffer TD-1065 is being developed for digital access of high-speed data and wideband, secure voice traffic at rates of 32,000 and 16,000 bits/s into the Army's tactical trunking system.



The AN/PRC-77 manpack radio, which still uses some germanium transistors, will be used until Sincgars radios come into inventory.

community of users who share the same general data interests and can share the same transmission, explains Grady Banister, Deputy Project Manager of Army Tactical Data Systems at Fort Monmouth.

For example, an air-defense sensor can send out a message describing an enemy position via the TDMA system to all system members. Also, each participant has a time slot for transmitting his own data, which can be received only by the addressees.

"I believe TDMA will dramatically change the way we communicate," says Banister. "It has a high bit rate and serves a large number of data subscribers."

A digital multiplexer joining the Army's inventory will permit the digital access of high-speed data and wideband, secure voice traffic

with rates of 32 k and 16 kbits/s to be fed into the Army's tactical communication transmission system. The 1065 will sense analog or digital signals and process them accordingly. Digital telephones are now under development. In such an instrument the a/d converter will be right in the telephone.

"Perhaps the continuously variable slope delta modulated (CVSDM) chips being used in the satellite program, the TTC-39 and in other Defense Dept. programs could be used in the digital telephone," Pfeiffer suggests.

A problem with digital telephones is that of loop length. "We're told now that the digital telephones are limited to 3.2 km over a pair of field wires," according to Col. Wilson at Fort Gordon. "And since we don't want repeaters that have to be powered by an outside source, we've got to have one that can operate on a couple of flashlight batteries for an extended period of time."

Fort Monmouth recognizes the benefits of multilayer printed-circuit boards. Some of the security equipment now being built contains cards 14 layers thick. "A 14-layer PC card has such high density that it can't be repaired easily, so they've got to be reliable," Pfeiffer observes.

For memory technology, the Army will use whatever is available—bubbles, if they are ready, because they save power; but definitely solid-state memories, cassette tapes and discs. ■■

Who provides the industry's broadest line of electronic packaging hardware ... including Card Files?

SAE does! In either kit form or fully assembled, VARIFILE's® exclusive snap-together construction lets you assemble a card file in just minutes—without tedious component stringing.

Designed on a modular basis, SAE card files contain only five basic parts: end plates; support bars; card guides; nylon snap locking tabs; and connector mounting feet. Also available is a complete line of accessories including identification tabs, card pullers, circuit card ejectors, circuit card ejector/retainers, printed circuit board edge connectors, and cable connector hoods.

Stanford Applied Engineering has the complete capability for the design and production of special card files in both New York and California that will accommodate mixed cards and connectors with such features as front/rear panels, divider plates, front panel hinges, chassis slides, etc. Your request for quotation will receive immediate attention!

Our new 128 page packaging handbook gives complete details, and also describes our entire line of electronic packaging and interconnection hardware.

® Stanford Applied Engineering, Inc.

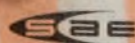

Stanford Applied Engineering, Inc.

340 Martin Ave., Santa Clara, CA 95050
(408) 243-9200 TWX 910-338-0132

CIRCLE NUMBER 56

For an immediate reply, call the following toll-free
"ZIP QUOTE" number at the factory ... 800-538-6843

CIRCLE NUMBER 16

RCL

is

#1

in the Hi Rel Wire-Wound Resistor Field!

RCL has more military approvals on power and precision fixed wire-wound resistors than any other manufacturer.

AMF

RCL Electronics

195 McGregor St.
Manchester, N.H. 03102
(603) 627-3831

CIRCLE NUMBER 17

NEWS

Smart industrial robot sees whatever it's supposed to do

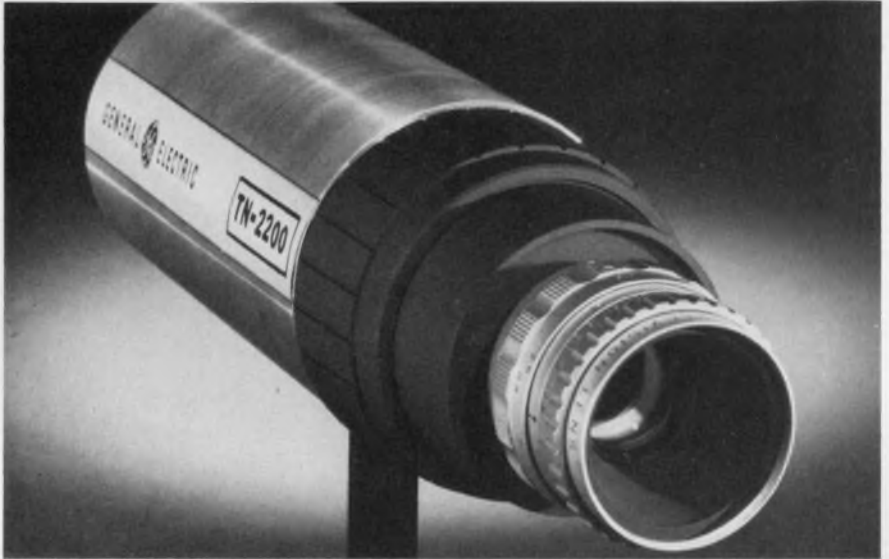

The robot's video camera, similar to the TN-2200, can inspect and measure piece parts, recognize printed material and collect data in real time.

Industrial robots are well known for grabbing small parts as they ease down an assembly line, whirling around and screwing them on to another part a few feet away—all without being able to see.

But now a robot from Auto-Place Inc., Troy, MI, has been given "eyes," an automatic camera, and even a "brain," a microprocessor. Opto-Sense, a small black box with an air-powered arm that can lift up to 30 lb, can watch products move down the line, much like a shepherd watching sheep file through a mountain pass. It can also pick up all the round ones—if that's what it's been told to do—and throw out the rest.

If, say, five different-sized products have to be grouped into one package, the brainy, sighted robot can be instructed to do so. For more complicated tasks, two robots can be used, each handling as many decisions as it can.

Opto-Sense's possibilities are infinite, as demonstrated at the recent North American Industrial Robot Conference in Chicago. With a GE TN-2000, an automated standard TV camera modified for sequential scanning, Opto-Sense picked up playing cards, inspected

them and sorted them according to suit.

The camera was developed by GE originally for the Air Force to guide "smart" bombs.

"Using conventional analytical circuitry, we gave the TN-2000 camera the ability to make a number of decisions," says Frederick A. Sachs, marketing manager for GE's Optoelectronic Systems operation, Syracuse, NY. "If the robot presented the wrong side of the card to the camera, the circuitry told the robot arm, to turn it over."

The camera then focused on the small number and suit symbol in the corner of the card, determined the suit by area analysis and told the robot which pile to put it in.

"End of the game" was the final decision for which the camera was programmed. If there were no more cards, the camera waited until a new game began.

The GE camera's charge-injection area sensor, which consists of 244 rows with 188 elements per row, produces 46,000 pixels (picture elements). The output signal conforms to the EIA RS 170 signal-structure standard—which means the camera can interface with any monitor built to U.S. standards. ■

TEAMWORK.

P&B pro teamwork keeps your control assembly costs down...simplifies 'make or buy' decisions.

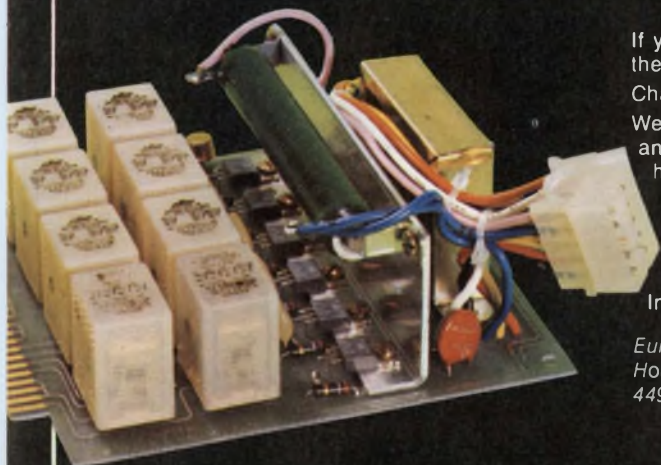

If your equipment requires a control assembly, compare a quote from us with the investment you'll make for in-house production.

Chances are, the bottom line will convince you to go with the P&B Pro Team. We're set up to do the complete job for you. Specialized production equipment and assembly tools. Test equipment. Skilled personnel. Floor space. Engineering help. All the major investments you won't have to make.

And we'll deliver your assemblies to your pre-determined schedule, 100% functionally tested.

For complete information on control assemblies, see your Potter & Brumfield sales representative or contact Potter & Brumfield Division AMF Inc., Princeton, Indiana 47671. Telephone: 812-385-5251

European address: Electrical Products Group, AMF International Limited, AMF House, Whitby Road, Bristol BS4 4AZ, England. Telephone: (0272) 778383. Telex: 449481, AMMAFOCO, BRISTL.

Go with the Pros and you can't go wrong.

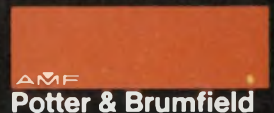

IT'S WORKING FOR ME



Electronic Design's GOLD BOOK is very convenient and always on my desk. I don't have to go somewhere else to use it.

Mr. W. T. Noel is Senior Engineer at the Naval Air Systems Command, Arlington, Virginia. He is involved with infrared avionics development and procurement for the Navy Department. Mr. Noel states:

"I refer to the GOLD BOOK often and find it quite useful in my work. It's very convenient and always on my desk. I don't have to go somewhere else to use it.

"Navy avionics procurements are largely to specification. The performance sheets and vendor sources provided by the GOLD BOOK are quite useful in the preparation of these specifications."

This is the *Electronic Design* audience working for you. (The GOLD BOOK goes essentially to *Electronic Design's* audience of engineer/specifiers.) Mr. Noel, like 78,000 electronics engineers and engineering managers, purchasing agents and distributors throughout the U.S. (plus 13,000 abroad) has his own personal copy of the GOLD BOOK.

The GOLD BOOK is *there*, at hand, ready when the need arises.

**THIS IS THE ELECTRONIC DESIGN AUDIENCE
WORKING FOR YOU**

Electronic Design / GOLD BOOK

HAYDEN PUBLISHING COMPANY, INC.

50 Essex Street, Rochelle Park, New Jersey 07662 • Tel: 201-843-0550

VACTEC Photodetectors

The Industry's Broadest Line Provides More Semiconductor Detectors for More Design Applications

Vactec serves manufacturers of a wide range of modern electronic products. Pictured are a few examples. All these devices are both made and sold by Vactec, including complete lines of LDR's (photoconductive cells, CdS and CdSe); silicon solar cells, as well as silicon high speed and blue enhanced cells; NPN phototransistors and darlington's; opto-couplers (LED/LDR, lamp/LDR and neon/LDR); selenium photovoltaic cells; silicon photodiodes, blue enhanced and PIN; and custom C-MOS and bi-polar IC's. Write for technical bulletins on the types that suit your requirements. Or send your application, and Vactec will recommend the right cell for the job.



Vactec, Inc.

2423 Northline Industrial Blvd.
Maryland Heights, Mo. 63043
(314) 872-8300



Electronic Organs

LED or lamp/LDR Vactrols for audio, and CdS cells for swell pedal controls.

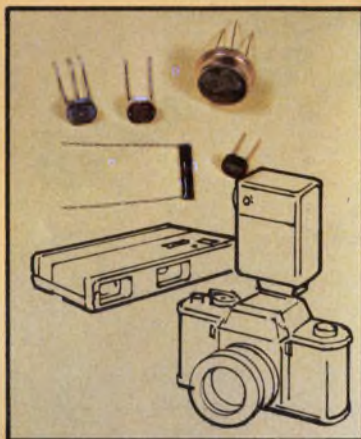

Cameras and Projectors

CdS or blue enhanced silicon photodiodes for automatic shutter timing; aperture servo systems for automatic projector focus; and slave flash controls.

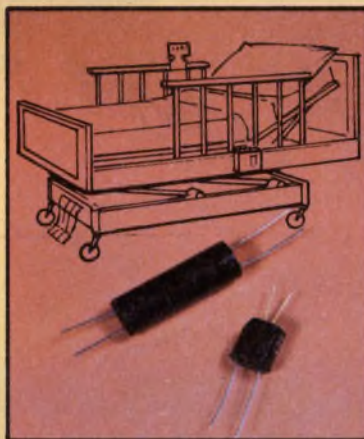

Triac Motor Controls

A special Vactrol gates a triac for forward and reverse motor operation as in hospital beds.

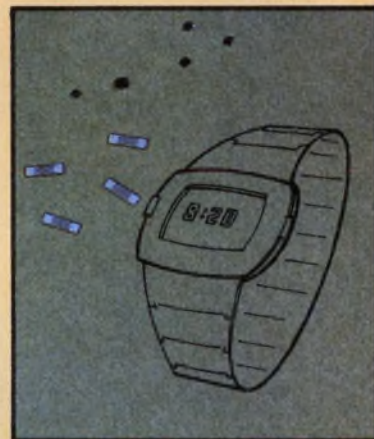

LED Watches

Photoconductive or phototransistor chip controls LED brightness.

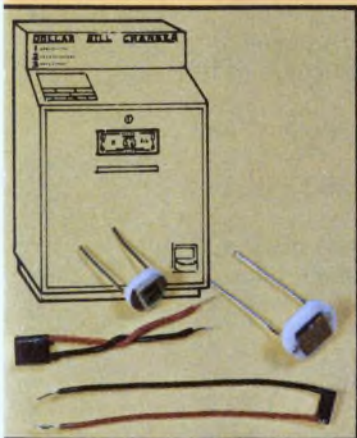

Dollar Bill Changers

Silicon photovoltaic cells analyze optical characteristics.

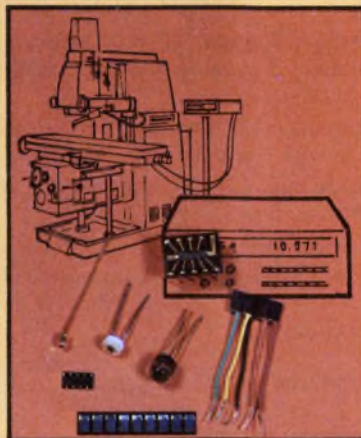

Machine Tool Controls

High-speed photovoltaic cells or transistor arrays help computer control repetitive operations, non-contact sensing, and counting and weighing.

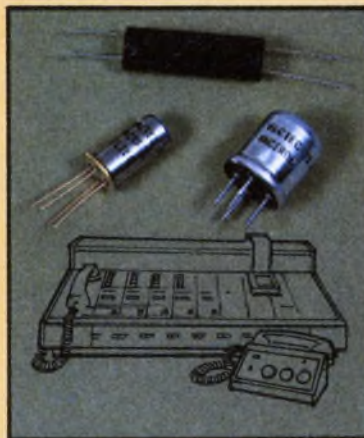

Telephone Equipment

Neon/LDR Vactrols sense ringing. Direct a-c coupling, slow LDR response isolates electronics from noise.

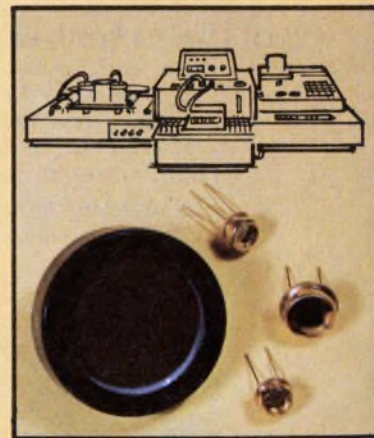

Scientific Instruments

Blue enhanced silicon or selenium photovoltaic cells detect solutions densitometrically for precise blood chemistry and other analyses.

LED SUPERSTARS

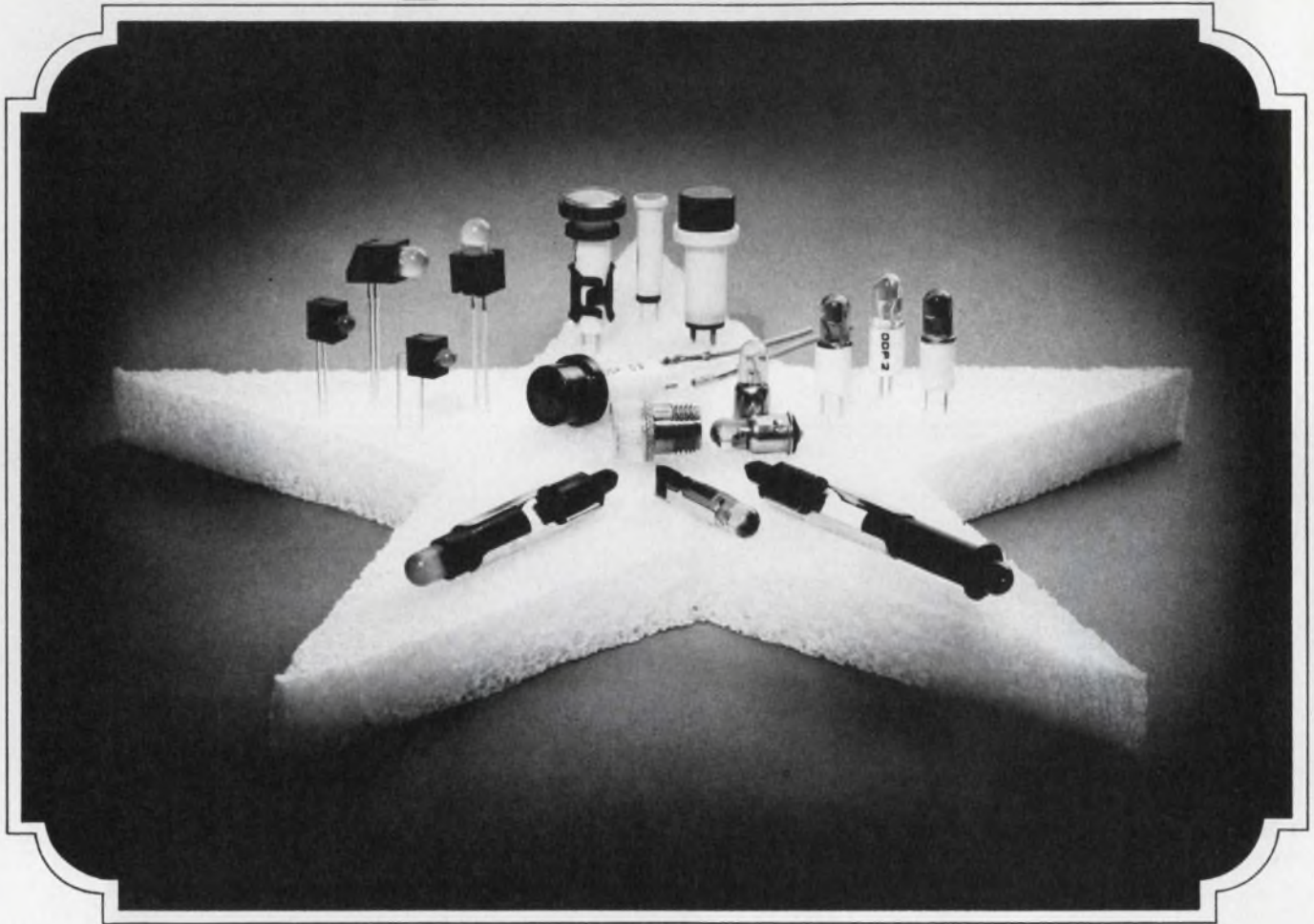

As bright as many incandescents!

Meet the LED Superstars . . . red, amber and green superbright panel and PCB lights. Their high brightness 50 MCD @ 20 MA (typical clear red) make them the perfect cost and power saving replacements for incandescents. Available with built-in resistors for all popular voltages.

Subminiature Panel LED's (also suitable for PCB mounting)—available in hundreds of sizes, shapes and styles.

PCB LED's—Horizontal or vertical viewing . . . optional built-in resistor for 5V applications.

Bi-Pin (T1-3/4) LED's—Ideal for dead front panel applications, e.g. DEC's PDP Series computers.

Midget-Flanged (T1-3/4) LED's—Direct replacements for incandescents in panel light and switch applications.

Replacement Lenses—Specifically designed for use with Midget-Flanged LED's.

Slide Base LED's—Direct replacements for incandescent types.

There's lots more too, and they're all Superstars! Send for our Catalog today: Data Display Products, P.O. Box 91072, Los Angeles, Ca. 90009, (213) 641-1232.

Produced by the original "little light" people.

••• Data DISPLAY PRODUCTS **•••**

Washington Report

Air Force, Canada seek new air-warning system

The Air Force, in a joint program with Canada, is asking for industry proposals by January 7 on a network of seven military air-traffic control centers to be known as the Joint Surveillance System (JSS). The system will replace the existing Semi-Automatic Ground Environment (SAGE) and Back Up Intercept Computer (BUIC) systems installed in the late 1950s and early 1960s, which have become too expensive to operate.

The JSS, which is expected to cost \$300-million, will be managed by the Air Force's Electronic Systems Div., Bedford, MA. Canada is putting up about \$45-million of the total cost, and Canadian subcontractors are expected to receive a comparable share of the business.

The Air Force expects to award parallel-development contracts to two firms in September and then choose a single prime contractor to produce the entire system around January, 1979.

Boeing, Hughes Aircraft and Burroughs are the likely contenders for the prime contract. Boeing has teamed with IBM (builder of the original SAGE system) to propose a land-based version of its Airborne Warning and Control System (AWACS). Hughes and Burroughs (builder of the BUIC) are bidding alone. Ford Aerospace & Communications (formerly Aeronutronic Ford) and GTE Sylvania, which had indicated an interest in the prime contract, are no longer expected to bid.

Navy seeks ion implantation, electron-beam ideas

The Navy is interested in pushing the state of the art of IC fabrication by seeking ideas from industry on new ion-implantation and electron-beam imaging systems to be operated in an IC process line.

The ion-implantation system should be capable of processing at least 100 wafers per hour. Other requirements include high beam currents of more than 1 milliamp for most encountered dopants, low-energy implants of 5 to 30 KEV and reproducibility to within 1% accuracy across a 3-in.-diameter silicon wafer.

The electron-beam imaging system should be fully automated and capable of producing at least 60 wafers per hour with sub-micron resolution and alignment accuracy. Current single-beam, pattern-generation systems that serially scan each pattern are too slow for production applications, according to the Navy.

Interest has not reached the request-for-proposals stage yet, but if the Navy sees something it likes it might award hardware contracts later. The project is being handled by the Naval Regional Procurement Office at Long Beach, CA.

DOD criticized for keeping R&D from industry

The Defense Dept. continues to keep development work within its own research establishment that should be contracted out to industry, according to a declassified study prepared for Congress by the General Accounting Office (GAO). The study focuses on Mitre Corp. of Bedford, MA, and its relationship with the Air Force's Electronic Systems Division. Mitre is one of nine federal contract research centers, commonly called "think tanks."

The GAO investigators reviewed three Air Force programs, managed by Mitre—the Pave Paws phased-array radar, the AN/GPN-XX air-traffic-control radar and the Tactical Loran C/D navigation system—and found that industry would have bid on the same technical management tasks if they'd had the opportunity. In the case of Pave Paws, for example, 10 radar producers were asked if they would have bid on the technical management contract even if it involved a hardware-exclusion clause. All 10 firms said they could have done all or part of the work, and five would have signed a hardware exclusion clause to get the job, according to GAO.

Defense Dept. regulations prohibit the federally sponsored centers from doing such work unless they can prove that private industry cannot do it. Mitre and the Air Force failed to provide such evidence for the three programs reviewed, according to the GAO study.

NBS to calibrate diagnostic X-ray units

A calibration service for high-voltage dividers used with diagnostic X-ray units has been established by the National Bureau of Standards as part of an effort to reduce unnecessary exposure to X-rays.

Diagnostic dividers, consisting of a number of resistors, are hooked into the high-voltage points of X-ray units to divide the voltage and reduce it to a point low enough to be measured. By ensuring that the peak voltage is consistent from one X-ray unit to another and from day to day within the same unit, a calibrated divider enables patient dosage to be reduced. Consistency also reduces the number of retakes required by cutting the number of nonuniform film exposures.

The calibration service, which has been tested for the past year by the Dept. of Health, Education and Welfare's Bureau of Radiological Health, is now being made available to the X-ray industry on a cost-reimbursable basis.

Capital Capsules: The Federal Aviation Administration is considering making it mandatory for all commercial aircraft to carry FAA approved equipment for transmitting and receiving information about adverse weather. . . . The Defense Dept. plans to increase its funding to industry to apply new manufacturing-technology methods to increase productivity. This year's funding level of \$114-million is due to rise to \$132-million in the new budget to be submitted to Congress in January. The eventual goal is \$200-million a year to support more automation and other productivity-related investment. . . . The Army Mobility Equipment R&D Command, Fort Belvoir, VA, is seeking a new infrared aiming device with a laser diode for rifles to illuminate targets at night. The system should be effective at 100 meters and work with current Army night-vision goggles. Average power output of the diode should be 150 microwatts in the near-IR spectrum of about 850 nanometers.

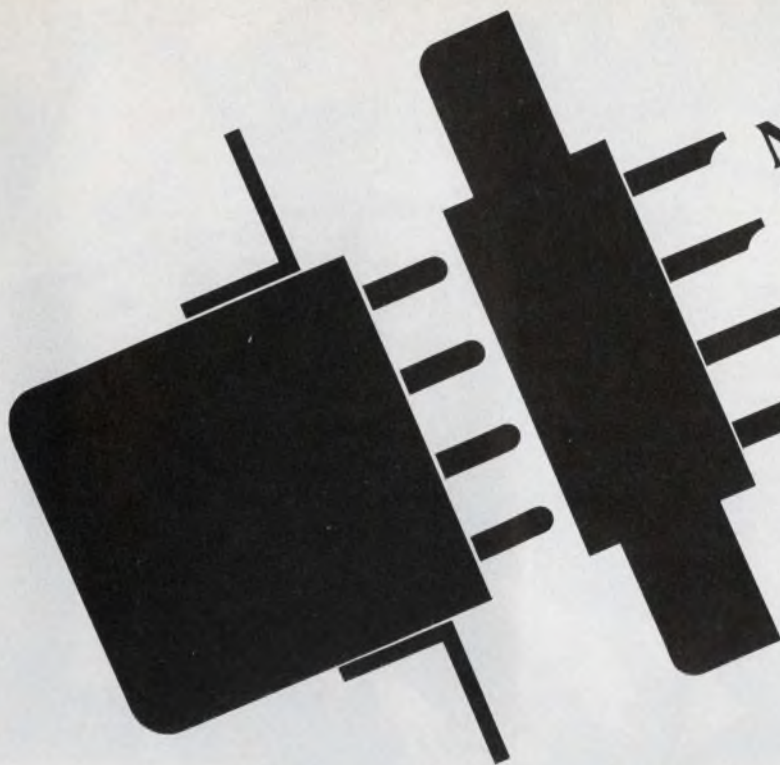

Now!
There's one simple
answer to all of
your relay socket
needs.

Us.

We have sockets for just about every crystal can relay made, including those by:

Babcock
 C. P. Clare
 Deutsch
 Electronic Specialty
 Hi-G
 Leach
 Struthers-Dunn
 Wabco

and more. We have them for relays meeting MIL-R-5757, MIL-R-6106, MS, Buweps, Buord, Navair, BAC... and other specifications in Electronics, Aerospace, and the Military.

Fact is, you'd have to use a very rare relay to miss our line.

How to order.

Our distributor nearest to you has on his shelf the popular sockets that mate with relays of the leading relay manufacturers. Tell him the relay you're using — he'll know the Viking socket that fits.

Quality is tops, of course. So is delivery time. So, call him. And make your life a little easier.

Or send for our detailed 16 page brochure. A copy is yours for the asking.

O.K. Send me your brochure on Viking Relay Sockets.

NAME _____

TITLE _____

COMPANY _____ M/S _____

ADDRESS _____

CITY _____

STATE _____ ZIP _____

TELEPHONE _____

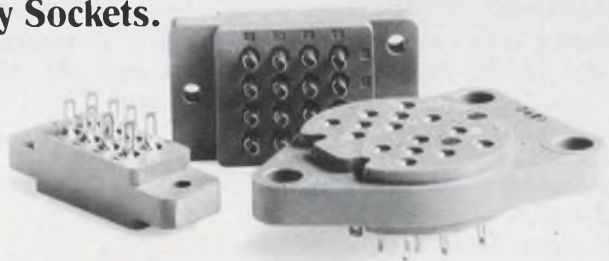

 **Viking**
CONNECTORS

Viking Industries, Inc. /MilCom Division/9324 Topanga Canyon Boulevard/Chatsworth, Ca. 91311, U. S. A. / (213) 882-6275



Tom and Barbara Herrold just bought their spacious Wabash, Indiana home for \$31,500.

What do you think relays are going for around here?

Ten rooms, 8 fireplaces, 6 porches, 11 foot ceilings, oak paneling, choice neighborhood, mint condition—all for \$31,500. That's Wabash value. And that's why our relays are in such demand. They are made right here—switches and all—to rigid specifications in a hospital-clean environment where heat, humidity and dust are controlled so quality can be assured. Just to be certain, 3 billion test cycles are run every day.

When you purchase Wabash relays you get the kind of quality the Herrold's got in their home. And at a price that gets you the kind of value the Herrold's got. We've got over 6,000 variations of dry reed relays for sale. Contact us. When you see the asking price, you will know you found a new home for your relay requirements.



The Econo-Miser. The most automatically manufactured dry reed relay available. 1 and 2 pole standard types. Less than one dollar in quantity.

Coils, Relays & Transformers

wabash

of
Wabash, Indiana

and Huntington, Indiana; Farmington, Missouri;
Tipton, Iowa and South Boston, Virginia

For information and quotes write or call:
Wabash, Inc., Dept. RA-1, 810 N. Cass St., Wabash, Ind. 46992 Tel: 219/563-2191 TWX 810-290-2722
CIRCLE NUMBER 23

Microprocessor Design

N-channel SC/MP-II doubles speed but cuts power by four times

By going to n-channel processing, designers at National Semiconductor have boosted performance, slashed power and cut costs to come up with a "super" version of the already popular SC/MP 8-bit microprocessor. The SC/MP-II requires only a +5-V power supply, not the +5 and -7 required by the original SC/MP.

With the power requirement cut to only 225 mW—one-quarter that of the p-channel version—the SC/MP-II can be housed in an inexpensive plastic package. And, being an NMOS device, the super μ P can operate at clock frequencies as high as 4 MHz—double that of the PMOS version. Thus, low-cost, 3.58-MHz timing crystals can be used for the clock source.

The SC/MP-II can slip into the same socket as the SC/MP if the negative supply is eliminated and the pin is grounded. However, there are three minor software changes: The bus-request, enable-in and enable-out lines, which are active-high in the SC/MP, are

(continued on page 40)

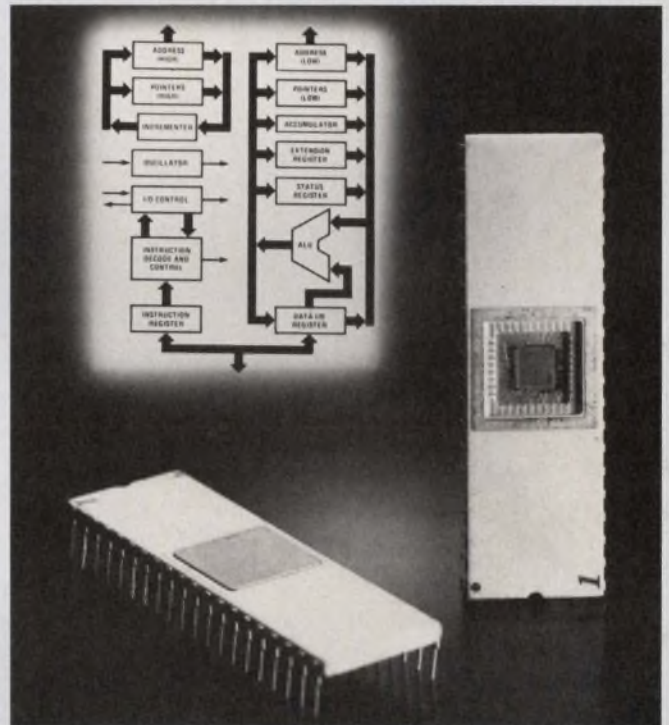

Satellite-borne μ P system can repair itself

A powerful μ P-based system designed to operate reliably in space for seven years is being developed by Hawker Siddeley Dynamics of Stevenage, England. A custom μ P will be used in communication satellites from 1980 on and will have two unique features: direct, high-level language programming and sophisticated self-repair facilities.

Normal μ P design procedure has been reversed to design the space microprocessor around its own real-time, high-level programming language, which provides a one-to-one compilation into assembly language instructions.

To improve reliability, two μ Ps, with specially developed firmware to detect failures, will be used in the satellite system. Although it will have seven types of NMOS LSI devices, the complete Siddeley system will contain about 20 chips, some of which will be doubly redundant.

The μ P is currently in the chip-fabrication stage and, following successful simulation trials, is scheduled for flight trials in 1978. The device is being produced with a low-power NMOS process that features "semi-dynamic" techniques. For example, the memories will need no refresh cycle but will be powered up briefly during access and write cycles.

MICROPROCESSOR DESIGN

(continued from page 39)

active low in the SC/MP-II. And minor hardware adjustments must be made.

Like its predecessor, the super μ P has a three-state data bus, separate serial-data input and output ports, full TTL compatibility on all

lines and an addressing capability of 65 kwords. And, by use of their special delay instruction, either microprocessor can interface with memories or peripherals operating at any speed.

Available from stock, the SC/MP-II sells for less than \$10 in quantities of 1000 or more. *National Semiconductor, 2900 Semiconductor Dr., Santa Clara, CA 95051. H. Patel, (408) 737-5000.*

CIRCLE NO. 508

Dual μ Ps simplify interactive terminal operation



The first interactive graphic display system to incorporate two programmable microprocessors—the Sanders Associates Graphic 7—can either independently operate or be interfaced with most 16-bit computers. The dual intelligence of the Nashua, NH, firm's system provides a "universal" interface and minimizes the cost of special interface hardware and programming.

The basic system has terminal control circuitry, a 21-in. CRT display, such input devices as a keyboard, and such optional features as a light pen and a trackball.

The terminal controller includes two " μ Ps," one a display processor the other a graphic controller. Both are actually built from 6700-series bipolar bit slices from Monolithic Memories.

The display processor, a general-purpose unit, operates with 8 and 16-bit words. It has eight general-purpose registers and an 8-k read-write memory, expandable in 8-k increments.

The graphic controller is a 16-bit parallel μ P with 40 display instructions, 13 display registers and four general registers, and provides the refresh functions. A 4-k \times 16 ROM contains the graphic control program, which handles communications between the terminal and a host computer, controls and data-entry devices, manages the display-image refresh and performs other functions usually done in a host computer.

The CRT screen has 2048 \times 2048 addressable locations with 1024 \times 1024 reserved for viewing.

The standard character set is 96 ASCII elements. Up to 32 user-defined characters are optionally available, and each can be rotated 90 degrees counterclockwise and presented in four different sizes. However, 2.4 μ s are required to present a typical character. Eight brightness levels are available.

The firmware-committed, graphic control program makes terminal operation transparent and minimizes host-computer involvement in display functions. It also frees the system programmer from having to support the graphics terminal and allows him to concentrate on the application software.

Software development package plugs into a microcomputer

By plugging four EPROMs, the RDP2 package, into Intel's SBC 80/10 single board computer, and adding power supplies and a teletypewriter, it is possible to give a system program editing, assembly, and debugging capabilities.

The programs are subsets of Intel's versions supplied for the MDS development system.

(continued on page 42)

Someone has developed a more efficient resistor.



THE new Dale resistors are more efficient to buy. A network of computer terminals throughout our resistor plants gives you a wealth of useful information. In seconds we can tell you if an order can be shipped from stock...or give you its exact production status...and instantly mark it for expediting if needed. That's resistor efficiency you can use. It's part of an expansion program that has increased our resistor facilities to more than 400,000 square feet. And much of this is automated. Multi-station winders give you wirewound stability and power at a lower cost than ever...and batteries of laser spirallers turn out RN-style metal film parts at machine-gun speed. We're making the most efficient resistors you can buy—and we're ready to prove it.

OUR COMPLETE PRODUCT LINE CAN BE FOUND IN ELECTRONIC DESIGN'S GOLD BOOK.

The new Dale resistors are more efficient to use. Today, one out of every 10 Dale employees is directly involved with quality control. Tangible results include: More than 100 separate QPL listings for wirewound and metal film resistors and the world's most reliable wirewound resistor (proven failure rate .000021% per 1000 hours). As a result, we're certain the new Dale resistors will give you less trouble—before and after purchase—than any others you can buy—and that's efficiency! Call 402-564-3131 for wirewound and 402-371-0080 for metal film.

DALE ELECTRONICS, INC.

1300 28th Avenue, Columbus, Nebraska 68601

A subsidiary of The Lionel Corporation

In Canada:

Dale Electronics Canada Ltd.

In Europe:

Dale Electronics GmbH

8 Munchen 60, Falkweg 51,

West Germany



CIRCLE NUMBER 24

Dale!



MICROPROCESSOR DESIGN

(continued from page 40)

The assembler, for example, will not create macros—user generated subprograms—or use operand expressions.

The editor prepares assembly-language paper tapes for the assembler. In one pass the assembler generates up to 500 lines of code and puts it into the SBC 80/10 memory. Because source code only has to be read once, the RDP2 is two to three times faster than other multipass assemblers.

The monitor contains functions for software debugging, including tape dumping and loading, storage and register modifications, and selective program execution.

The package price of \$995 includes complete documentation, periodic software updates, and a warranty. RDP2 is available for immediate delivery.

Extensys Corp., 592 Weddell Dr., Suite 3, Sunnyvale, CA 94086. (408) 734-1525.

CIRCLE NO. 509

Microprocessor development system has resident compiler



A combined resident-compiler and modular-programming system from Intel can support the 8080, the SBC80 single-board computers and other 8080-based products.

Residing in the Intellec microcomputer, the software system consists of an advanced version of the PLM-80 compiler for the 8080A, and a new diskette operating system, the ISIS-II. The compiler is supplied on diskettes and costs \$975.

The PL/M compiler supports modular software designs and generates linkable and relocatable object code modules. These modules can be automatically connected not only to each other, but also to object-code modules produced by a new relocating micro-assembler contained in the ISIS-II package.

Since the Intellec resident compiler does away with having to access large, expensive computer or time-sharing systems, development costs come down.

ISIS-II includes all other subsystems required for modular programming: macro-assembler, linker, locator and library manager. A text editor with string search, substitution, insertion and deletion commands is also included.

Intel, 3065 Bowers Ave., Santa Clara, CA 95051. (408) 246-7501.

CIRCLE NO. 510

Micro Capsules

Both a commercial temperature-range series and a plastic-encased series of microprocessors have been added, with related support circuits, to the 6800 family by Motorola, Austin, TX. Identified by a "C" suffix, the commercial circuits have a temp range of -40 to $+85$ C and cost 60 to 80% more than standard 6800 parts. The plastic units are intended for operation over the 0-to-70-C range and will probably cost 15 to 20% less than the ceramic-cased models. . . . In a few years, one 300-mil-square chip should contain not only the CPU, but all the ROM, RAM and interface circuitry. Volume production of the large chips should be economically feasible by 1981, predicts National Semiconductor's William Baker, Group Director for Microprocessors. . . . MicroForth, a high-level language developed by Forth Inc. of Manhattan Beach, CA, permits the user to work on a resident or direct basis to develop programs on the RCA 1802 μ P. The new language executes 10 to 100 times faster than Basic and requires only 8 kbytes of memory, including a 2-k work space. . . . A small, hand-held terminal will be introduced soon by the microprocessor-development group at RCA, Somerville, NJ. With a built-in keyboard and LED display, the terminal is expected to cost about \$300.

INTERFACE ACE



For High-Voltage, High-Current Interface with PMOS, CMOS, TTL . . . Sprague Darlington Transistor Arrays Have No Equal

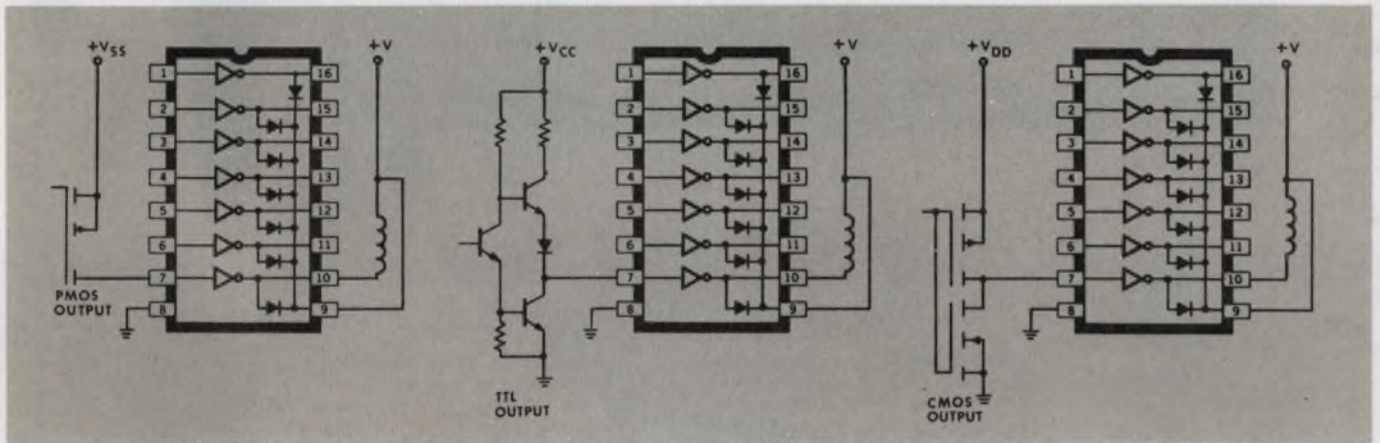

A new exclusive Sprague development, Series 2000 Transistor Arrays are high-voltage, high-current integrated circuits comprised of seven silicon NPN Darlington pairs on a common monolithic substrate. They feature open collector outputs and integral suppression diodes for inductive loads.

Supplied in 16-pin dual in-line plastic, these devices greatly reduce the number of discrete components used to

interface between digital logic and high-voltage and/or high-current loads. In some applications, all discrete components can be replaced by a single DIP, resulting in substantial space and cost reduction.

With broad commercial/industrial application, these unique arrays are an excellent choice for interfacing to LEDs, solenoids, relays, lamps, and small stepping motors in printing calculators,

cash registers, and control equipment.

Type ULN-2001A is a general-purpose array, pinned with inputs opposite outputs to facilitate circuit board layout. Type ULN-2002A is designed for use with 14 to 25V PMOS inputs. Type ULN-2003A and ULN-2005A interface with TTL, low-power Schottky TTL, DTL, or CMOS operating at a 5V supply voltage. ULN-2004A has series input resistor to allow operation directly from CMOS and PMOS outputs utilizing 6V to 15V supplies.

For more information, write or call George Tully, Semiconductor Division, Sprague Electric Co., 115 Northeast Cutoff, Worcester, Mass. 01606. Tel. 617/853-5000.

For Engineering Bulletin 29304, write to Technical Literature Service, Sprague Electric Co., 347 Marshall St., North Adams, Mass. 01247.

For the name of your nearest Sprague Semiconductor Distributor, write or call Roger Lemere, Sprague Products Company, North Adams, Mass. 01247. Tel. 413/664-4481.

THE BROAD-LINE PRODUCER OF ELECTRONIC PARTS

CIRCLE NUMBER 25



A miniature 0.005% Digital Voltage Source...



SHOWN ACTUAL SIZE

ONLY \$295

(SINGLES)

Datel's Digital Voltage Calibrator, DVC-8500 comes in a mini-benchtop package, at a mini-price (\$295 in singles*), but provides very big performance. DVC-8500 offers 4½-digit resolution and a ±19.999 volt full scale output range with ±1 millivolt accuracy (±0.005% of full scale.)

Use your DVC-8500 to calibrate A/D and D/A converters, DPM's, DVM's, Op Amps, V/F converters, and Data Acquisition Systems. A short-proof, buffered output gives up to ±25mA output current with an LED overload warning signal. The ±1.5 millivolt front panel vernier allows fine tuning of A/D and D/A bit steps.

Options include a panel-mounting kit, rear PC sense terminal, and a choice of 115, 110, or 230 VAC power inputs.

Contact Datel, or your nearest Datel Representative listed in Gold Book or EEM.

* U.S.A. Domestic Price only.

 **DATEL**
SYSTEMS, INC.

1020 Turnpike St., Canton, Mass. 02021
Phone (617) 828-8000

- Santa Ana, Calif. (714) 835-2751
- Santa Ana (L.A. Exchange)
(213) 933-7256
- Sunnyvale, Calif. (408) 733-2424
- Gaithersburg, Md. (301) 840-9490

The importance of being important

Joe's new X-21 was a winner. Every day he'd get a dozen calls about it from potential customers who seemed almost as excited about it as he was. Then one day the calls stopped coming. Abruptly.

Joe began to sweat. He had expected the calls to taper off eventually, after the novelty of the product wore off. But this was too sudden. So he spent lots of time worrying about the product. Had a competitor suddenly introduced a more exciting unit? Did customers see flaws that he had missed? Had marketing priced his product too high? He checked with the fellows in marketing, but they were stymied, too. Something very strange had happened.

Well, because the situation seemed hopeless anyway, Joe began to forget about it. Trying to help him forget, Charlie one day told Joe to size up Sally, the new switchboard operator—"a real knockout."

"Sally?" Joe gulped. "What happened to Mary?"

"Not to worry," Charlie calmed him. "Mary just has a mild case of pregnancy. She'll be all right in a few months. Before she left she broke in Sally thoroughly. Told her everything about the switchboard and the company."

Well, not quite everything, Joe discovered. Mary had prepared a chart listing everybody's extension number. And she'd told Sally that Joe was the chief engineer, Charlie the sales manager, Jack the president, and Ted the company wolf. But she had neglected to tell Sally that if a caller wanted information on the X-21 (or almost anything else), then Joe was to get the call. So, very courteously, Sally told such callers that she didn't know what they were talking about. She needed a person's name.

That was unfortunate because the X-21 was important. All the *important* people in the company knew about it. Had Sally been important, she would have known about it, too.



RECOGNIZED BY
AMERICAN REVOLUTION
BICENTENNIAL
ADMINISTRATION

ELECTRONIC DESIGN is deeply honored to have received official recognition as a participant in the American Revolution Bicentennial Celebration, with authority to display the Bicentennial Symbol.

GEORGE ROSTKY
Editor-in-Chief

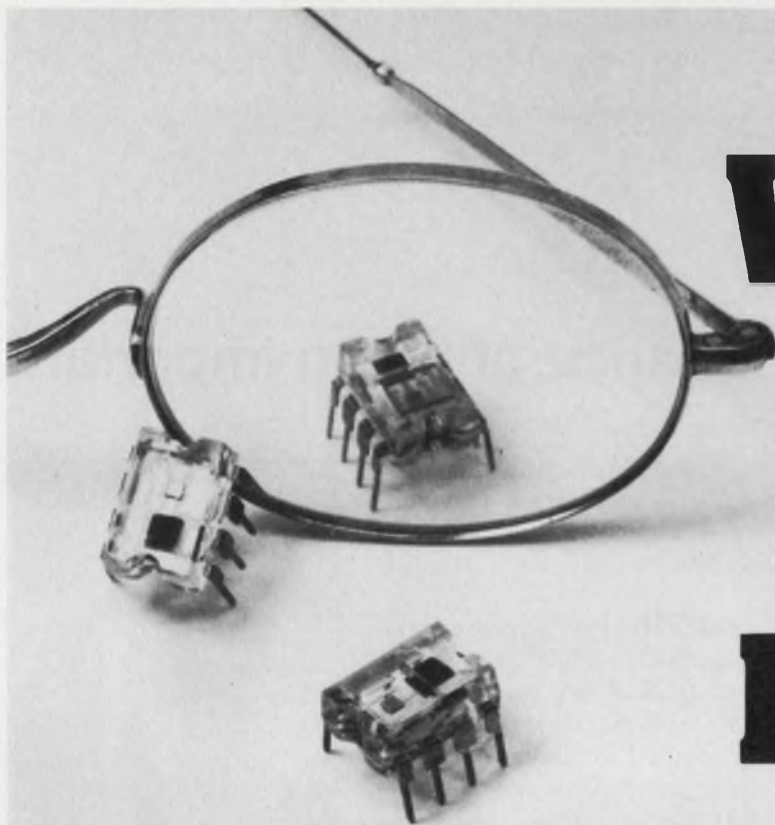

WHAT CAN YOU DO

with these SEEING-IC™ Photo Sensitive Circuits?

They're the first photo-sensitive IC's in a transparent, mini-dip package incorporating BOTH the silicon detector diode and the integrated control circuit in a single, high reliability package.

We're supplying similar circuits for use in the new Kodak Instant Cameras. They monitor all exposure functions including aperture selection and shutter speeds as well as computing battery condition on command and activating the low-light signal. MCC-400 Series circuits typically include (in addition to the Photo-Detector and Amplifier) a voltage-operated Schmitt Trigger and an Internal Voltage Reference.

These devices are also being used in advanced smoke detection systems and other industrial and consumer products. Optical Filters permit limiting response to specific wavelengths for industrial process or other controls.

We'll send you complete engineering and performance data on the MCC-400 Series SEEING-IC™ opto-electronic devices. We're prepared to discuss your application ideas now and to deliver IN ANY VOLUME. Call our Sales Department at (401) 463-6000; or write:



MICRO COMPONENTS CORPORATION

99 Bald Hill Road, Cranston, Rhode Island 02920 • (401) 463-6000 • TWX 710-381-1757

State of the art leadership in mass terminations ...that's what the BLUE MACS™ System is all about!

LEADERSHIP IN MASS TERMINATION DESIGN FLEXIBILITY begins with a complete package of BLUE MACS connector styles and sizes to meet your varied interconnect requirements. An expanded standard cable package that includes round conductor cable for intra-cabinet wiring, flat conductor cable for high flex life applications, and U.L. listed jacketed cable for external interconnect requirements. A tool package that includes hand and bench versions, cable cutters and separators, discrete wire fixtures and accessories.

LEADERSHIP IN MASS TERMINATION CONTACT RELIABILITY starts with our exclusive patented TULIP™ contact that provides 4 points of electrical contact per conductor for gas-tight, corrosion-free ter-

minations. Comprehensive test information is available upon request.

LEADERSHIP IN LOWER INSTALLED COSTS begins with a one piece connector design that eliminates unnecessary handling to reduce installation time by as much as 65%. This one piece design incorporates mating grooves which assures positive cable to connector alignment, and it eliminates the operator variable when assembling the cable to the connector. Insulation displacing TULIP contacts let you simultaneously mass terminate up to 60 conductors in seconds —without wire stripping or soldering.

A colorful reference guide tells the full reliability story about our complete systems package. Ask your local Ansley distributor for a free copy of the BLUE MACS Wall Chart. Or write us, direct.

T&B / Ansley

The mass termination company.

T&B/Ansley Corporation
Subsidiary of Thomas & Betts Corporation
3208 Humboldt St., Los Angeles, CA 90031
Tel. (213) 223-2331 • TWX 910-321-3938



Stocked and sold through authorized Ansley distributors.

International Offices: AUSTRALIA, Brookvale, (02) 938-1713 ● CANADA, Iberville, Quebec, (514) 658-6611 ● SOUTH AFRICA, Benrose, 24-8134 ● ENGLAND, Luton, (0582) 597-271 ● WEST GERMANY, Dreieichenhain bei Frankfurt, 06103-8 20 21 ● FRANCE, Rungis, 687-23-85 ● JAPAN, Tokyo, 03-354-9661 ● SWEDEN, Breddenvagen, 0760-86140 ● ITALY, Milano, 02-431216.



FOCUS

on
Solid-State
Relays

Question a solid-state relay manufacturer about his specs, and he is likely to come back with several questions that you must answer first—a sure sign that the spec sheet shouldn't be taken simply at face value.

For example an SSR's output-current capability appears simple to specify. Not so! Although the "maximum" current is boldly flaunted, contingent conditions, such as temperature and the need for a heat sink hide in footnotes and derating curves.

Designers more accustomed to working with electromechanical relays (EMRs) tend to forget about temperature—the SSR's greatest enemy—because EMRs are hardly affected by heat.

Heat can sink an SSR

Up front, the spec list may simply say, "Maximum load current: 15 A rms." But buried at the bottom is a typical fine-print footnote: "Above 5 A rms, the relay must be mounted on a 6 × 6 × 1/8-in. aluminum plate held in a vertical position. Use silicone grease to seal the relay tightly to the plate."

The relay itself may occupy a surface of only 1-3/4 × 2-1/4 in., so you may find yourself squeezing in a much larger heat sink after your layout has been completed. Worse, a burnout may be the first indication that you have forgotten the heat sink. And that's not all.

Not only will the SSR usually not handle the listed maximum current without a sizable heat sink, but many specs state (and some make you guess) that the ambient must be at room temperature—about 25 C. Sound reasonable? No, it isn't. Rarely do you find air at room temperature

in the immediate vicinity of power-handling electronic components. Temperatures over the range of 40 to 80 C are more realistic.

Even with the recommended heat sink, that "15-A" relay can probably carry only 10 A safely, because the ambient is 60 C, not 25 C. But you find this out only after you carefully study the derating curves, which aren't always supplied with the spec sheet.

The typical 15-A relay's derating curve might be flat to 25 C, then rapidly slope to 10 A at 60 C. But be careful: When you operate on the slope, a slight increase in ambient temperature or load can often lead to regenerative behavior, and to the SSR's destruction.

Some derating curves can fool you even further, so examine them very closely. Are the curves plotted for ambient temperature? Often, manufacturers plot allowable load current against the SSR's case temperature, not the ambient, even though the curve's title boldly states, "Permissible Load Current vs Ambient Temperature." Sometimes there's no label: You are left to guess. Case temperatures can run 20 to 40 C higher than the corresponding allowable ambient, and so make the spec look better than it is.

Another point: Thermal derating curves of SSRs designed for use without heat sinks can define the general derating conditions, but curves that call for a specific type of heat sink can't. Those for the rather frequently cited 6 × 6-in. aluminum plate are of limited value, because you can use such a plate only rarely. Moreover, even if a standard heat sink is specified, the specific unit listed may not fit your packaging concept. Then the heat-sink curves are at best useful only as guidelines.

Some manufacturers specify an allowed thermal resistance between the SSR's case and am-

bient. With a thermal resistance, you can easily select a heat sink to fit your specific application. This is the preferred method.

A case of high heat

If thermal resistance is not provided, you can use a rough relationship to obtain the temperature rise of the SSR's case above the ambient under free convection conditions. The relation is

$$T \approx 133 (W/A),$$

where W/A is the dissipated watts per square inch. So, for a 15-A load, an ON-state forward-voltage drop of 0.7 V and 6×6 -in. heat sink, the case temperature of an SSR reaches almost 40 C above the ambient temperature.

With a PC-mounted SSR, only the sink's top side is exposed to the free flow of air. Thus, the value of 36 in.² is used in the example—only one side of the plate.

Of course, a heat sink can't extend an SSR's rating beyond the maximum allowed ambient operating temperature. A typical spec might list an operating ambient range of -30 to 100 C. But take note: The relay is useless at or near 100 C because it is derated to carry zero current as 100 C is approached. Also, the -30-C end of the range limits operation, though not as severely

as the high end. Minimum allowed load current rises sharply near the low limit.

At the low end of an SSR's "operating" temperature range, the relay can fail to turn on reliably, especially if the load current is low. At normal operating temperatures, SSRs with SCRs or triacs as output devices require a minimum load current—typically about 5% of the rating. Between -20 and 80 C, the minimum-current requirement rises only slightly as the temperature drops. But at temperatures colder than -20 C, the minimum-current requirement increases very rapidly; at -30 C, the current can rise to about 30% of rated.

SSR leaks can sink a design

Besides being temperature-dependent, SSRs can leak in the OFF state—seldom a problem with EMRs.

Although leakage in SSRs is not important in most power circuits, occasionally it can be troublesome, such as when a null is required in a servo-motor drive or when lightly loaded solenoids must drop out. And even when low, leakage does add substantially to the power the relay must dissipate, since in the OFF state, the full voltage is across the SSR.

The SSR's ON-to-leakage current ratio is

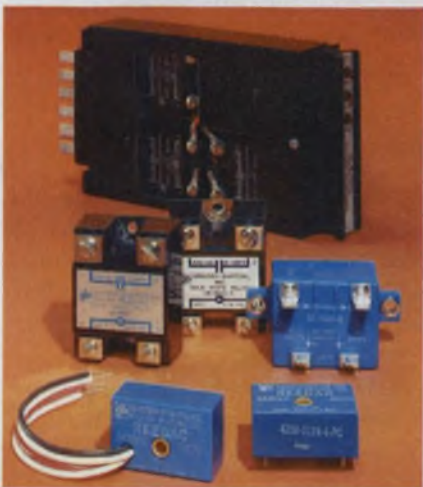
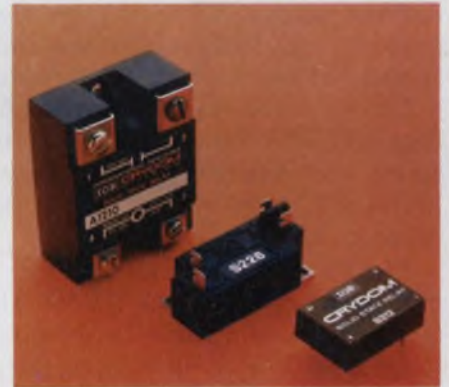

The four-screw terminal-block style of housing has become a widely used package for solid-state power relays. The same sized package (about 1-3/4 W x 2-1/2 L x 1 H in.) serves loads from 2 to 40 A rms. But be very careful: Above about a 2-A load, the relays must be mounted on a sizable heat sink for safe operation. Many manufacturers such as Grigsby-Barton, Magnecraft, Electrol, Crydom and North American Philips (from lower left, clockwise) package their SSRs in these block-style plastic cases.



generally over 1000:1. A 10-A SSR typically exhibits a 5-to-10-mA leakage proportional to the load voltage—5 mA at 120 V and 10 mA at 240 V.

Not all the leakage comes from the SSR's semiconductor output device: An RC snubber network—used to limit the rate of output voltage rise—as well as internal control and biasing circuits, can easily contribute at least half.

Broad turn-on voltage range featured

Interestingly, although specifying the load of an SSR leads to many complications, an SSR's input presents few difficulties. EMRs generally operate over a relatively narrow input-voltage range with a single coil. Coil changes or even different relay styles may be needed to cover the same range handled by one SSR. Typical SSRs easily turn on positively and safely over a range as wide as 3 to 32 V dc, and in some cases as wide as 3 to 300 V dc—and even ac over the same voltage range. Furthermore, SSR inputs are no more temperature-sensitive than EMRs.

The more sophisticated SSR designs incorporate a current regulator to maintain a relatively constant input current over most of the rated ON input-voltage range.

Hybrid SSRs have reed-relay inputs and are probably the most limited in input-voltage range—determined by the reed's pick-up and drop-out characteristics and the coil's resistance. But a reed input is simple, low-cost, and effective in many applications. Most applications need only a narrow range of inputs, and the life of a reed that can run into hundreds of millions of operations is often more than adequate.

Opto-isolated-input and transformer/oscillator coupled SSRs, however, are preferable where the speed and mechanical life of a reed may be a limitation; they allow wide, versatile input conditions.

Pickup and dropout ratings for SSRs are handled very much like EMRs. The low end of an SSR's input-control voltage range is analogous to an EMR's pick-up voltage rating and often referred to confusingly as "maximum pick-up" voltage. A less ambiguous name is "must-operate" voltage. Of course, the high-end, must-operate voltage should not be exceeded, or the relay may be damaged.

Similarly, turn-off voltage—the highest input voltage at which the relay in the ON state can return dependably to the OFF state—is often called "minimum drop-out" voltage. The term, "must-release" voltage, is less confusing. Must-release voltage is generally less than half the must-operate voltage.

The difference between the must-operate and must-release voltages gives the SSR a control

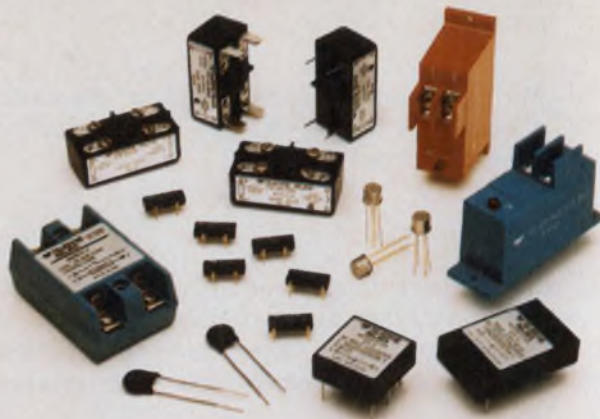

Some companies use a wide range of packaging styles. Teledyne's SSRs come in all sizes from DIPs and TO-5 cans to the terminal-block style for power-sized loads.

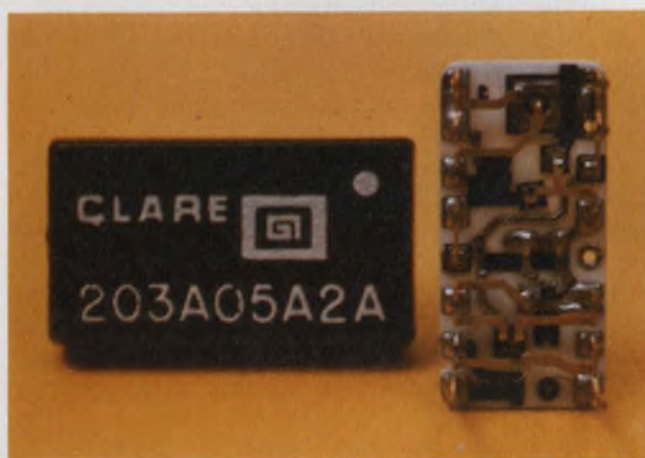

Compatible with TTL/DTL logic both in input control voltage and in its DIP packaging, C.P. Clare's 203 series of SSRs handles 750 mA for voltages to 240 V rms at 45-C ambient temperature in free air. Although the package is tiny, thick-film circuitry allows even zero-crossover switching to be squeezed into this opto-isolated unit.

hysteresis—a desirable (usually) characteristic that promotes clean switching. Uncertain, or fuzzy, ON/OFF action can be caused by control-voltage fluctuations, noise pick-up in the control circuit and transients coupled from the power line, among other things.

A relay is a four-terminal device

Since a relay, by definition, is a four-terminal device, the degree of input/output isolation is important. The three specs that define input/output isolation—insulation resistance, dielectric strength, input-output capacitance—are usually unambiguous.

The insulation resistance between input and output (and to a metal case, if any), usually measured at 500 V dc, is typically in the neighborhood of $10^9 \Omega$.

The dielectric strength, typically about 1500 V rms, can be as high as 5000 V rms in some special designs. And the input-to-output capacitance, though not always given, can range from 5 to 10 pF in small units, though 10 to 20 pF is usually low enough to ensure little noise coupling from load back to the input.

Hybrid SSRs have input/output isolation characteristics determined mostly by the properties of the input reed relay. Hybrids probably have the most rugged inputs—more tolerant of input transients than all-solid-state designs, because the input relays require a substantial amount of energy to operate.

The solid-state-input SSR needs little input energy. But when the SSR operates on short pulses, the pulses must contain a minimum amount of energy for reliable turn-on. The pulse height may exceed the SSR's trigger level, but the width must last long enough to supply the needed energy.

Such a minimum-energy spec is hardly ever provided. You must ask for it.

Of course, maximum input-voltage specs (almost always provided) should never be exceeded. Solid-state input circuits can be damaged by high, narrow spikes even though they don't last long enough to turn the SSR on.

Many SSR designs have built-in input protection circuits. Units for dc input are often protected against accidental reversal of the input polarity. Where necessary, external circuits—low-pass filters, clippers and special signal conditioners can remove most transients without materially affecting the desired performance.

Also, special input circuits can be provided to match impedances, shift levels and accept balanced signals with high, common-mode voltages. Naturally, inputs compatible with TTL, CMOS and other popular logic families are a common feature of SSRs.

Let the dynamic response fit the load

Between its input and output, the SSR allows a wide choice of dynamic responses, many not possible with EMRs. Compared with EMRs, the SSR can turn on almost instantaneously—1 μ s in some fast units vs 1 to 50 ms for EMRs.

Random turn-on SSRs are generally recommended for resistive loads only, because there are no current surges or inductive kickbacks to worry about.

Of course, if you want fast turn-on, choose a transformer or optically coupled unit. The hybrid is slower, limited by the reed relay to about 1 ms, but still 10 times faster than any EMR of comparable load rating.

Zero-voltage turn-on—closure of the output circuit synchronized with a zero crossing of the

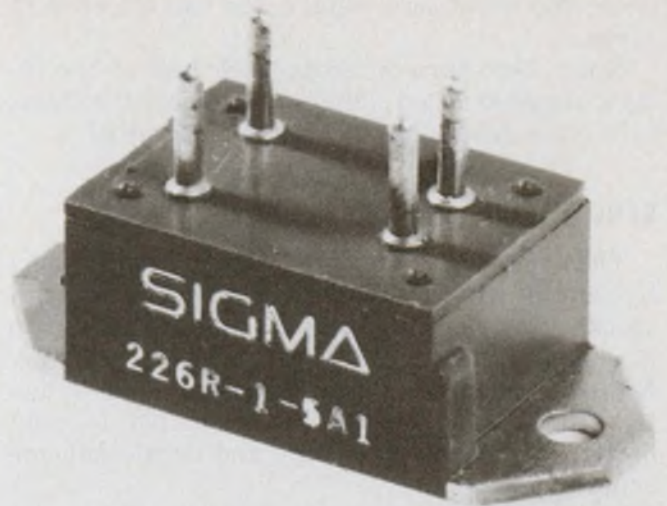

Many companies concentrate on a single package for their SSRs. Sigma's Series 226 units handle 50 mA to 7 A in one housing. However, the unit needs a heat sink above 1.5 A and above 30 C. The unit fits TO-3 transistor heat sinks. This low-cost relay provides only random turn-on operation.

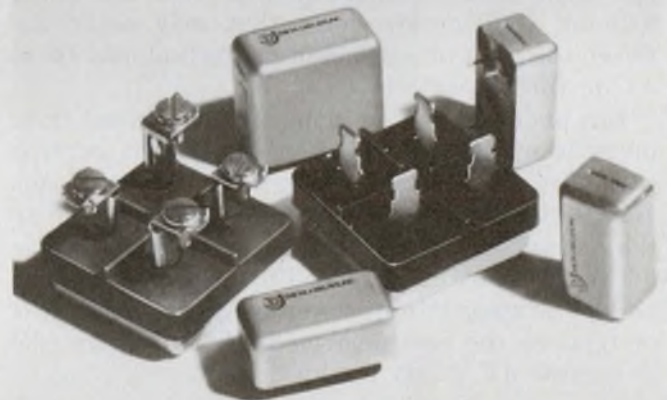

This family group of SSRs manufactured by Theta-J Relays covers a range of load capabilities from 0.75 to 25 A at up to 280 V rms. As with most SSR ratings, the ambient temperature must be carefully considered. To its credit, Theta-J has chosen 40-C ambient as its rating criterion vs 25 to 30 C for most other vendors.

ac line voltage—is highly desirable for high input-current surge loads like lamps and capacitors. In addition to protecting the SSR against huge current surges, zero-voltage turn-on keeps electromagnetic interference to a minimum. Note that zero turn-on response has an inherent delay, which may be as much as a half cycle, or 8.33 ms on 60-Hz power.

Be aware that an SSR doesn't necessarily have zero turn-on, merely because the manufacturer claims "internal transient protection" for an SSR. He may be referring only to an internal snubber network that, though helpful (especially for inductive loads) can't do the job of zero turn-on.

If you decide you need zero-crossover turn-on, ask about the worst-case, zero-switching voltage. Very few spec sheets include this information. The

lower the worst-case voltage, the less the current surge.

Note: Zero turn-on SSRs work best at the relay's nominal rated voltage; at reduced voltage, turn-on is delayed, and the output distorted.

SSRs turn off softly

The abrupt interruption of current in an inductive circuit can cause very high transient voltages (kickbacks) reaching several thousand volts. The attendant arcing and EMI can be very damaging. EMRs must be particularly rugged with inductive loads, since protection is limited to only partially effective snubbers and semiconductor suppressors.

With SSRs on ac systems, SCR or triac output devices inherently turn-off only when the circuit current falls close to zero, regardless of when the OFF command occurs. The result: no current, no kickback and no EMI. The inherent 2-to-5- μ s delay that the SCR or triac introduces at turn-off has little effect compared with the maximum 8.33-ms (half-cycle) delay that may occur between the turn-off command and actual load turn-off in a 60-Hz system.

But another problem pops up. The output triac or SCR may turn off when the output current goes through zero; however, with reactive loads (capacitive or inductive), the supply voltage to the output device may be near its peak (close to 90 degrees out of phase with the current). The result: a steeply rising voltage across the SCR or triac as the device turns off. This voltage rise is termed dV/dt on the spec sheet.

Turned off by turn-off specs?

Here is where the output-to-input capacity spec becomes important. The dV/dt generated across the SSR uses the I/O capacitive path—along with any stray wiring capacitance—to find its way back to the triac's or SCR's input control gate. The result is a commutation failure—the circuit refires (false fires) repeatedly and hangs up the circuit in an ON condition.

Transients originating in remote sources can enter the load wiring to the SSR and also cause false firing, but last usually only half a cycle. Such random false triggering may not be detected when you switch lamps or heater loads, and usually can be tolerated with such loads. However, with inductive loads, fast and repetitive false triggering can degrade and eventually destroy the SSR.

Thus, an SSR's dV/dt rating is an important output characteristic. Many manufacturers list a maximum dV/dt . Some don't. Of course, it's better to have a high maximum dV/dt .

But be careful: dV/dt ratings come in two

categories, commutating and OFF-state, with the latter much higher in value than the former. An OFF-state dV/dt of 100 V/ μ s minimum is usually considered satisfactory for most applications. The corresponding commutating dV/dt value generally is only about 5 V/ μ s.

Sometimes a spec sheet lists only one value without identification: If the value is 100 V/ μ s or more, it's the OFF-state value.

Another problem: dV/dt ratings should be determined under realistic test conditions. Both the load and source impedance must be defined. A 50- Ω resistance has been proposed as an industry standard to be included in the NARM (National Association of Relay Manufacturers) SSR specifications. Clearly, this resistance can be set arbitrarily high to produce a seemingly better (higher), but unrealistic, dV/dt rating. Spec sheets rarely mention the test conditions for the given values: It's better to ask than be surprised.

Finally, if an SSR's built-in transient tolerance and dV/dt rating are insufficient you can add an external snubber circuit across the load to help suppress the transients.

High on/off rates can hurt

When an SSR is fully ON, its load-switching element may carry a high current, but the voltage

What's a solid-state relay?

A relay is defined as a four-terminal device whose input can control—but is dc-isolated from—its output. A solid-state relay, in addition to passive components, contains mostly semiconductor active devices. Unlike electromagnetic relays, most solid-state units are specifically designed to carry either ac or dc loads; the same SSR usually can't switch both.

Popular SSR load voltages include such ranges as 6 to 48 V and 90 to 150 V dc, or 80 to 140 V, 90 to 280 V and 200 to 480 V ac (rms). Higher voltages to the limits of modern semiconductors—about 1000-V peak—are also obtainable. The low limit is established by the minimum voltage needed for reliable turn-on of the load-switching semiconductor. Most manufacturers specify a range of 47 to 63 Hz for ac SSRs; 400-Hz units are available on special order.

Both SCRs and triacs are used for ac switching—SCRs tend to be more resistant to false turn-on than triacs. Power transistors are usually used for dc. However, some manufacturers make a back-to-back transistor bidirectional unit that can handle either dc or ac loads.

Isolation of the input from the output is usually done at the input circuit. Three methods are commonly used: optical, transformer/oscillator and reed relay.

drop across the element is low (typically 0.7 to 1.7 V). When the SSR is fully OFF, the current is low (milliamps of leakage), even though the voltage is high. In both cases, consequently, the power dissipated by the switching device is modest—between, say, 2 and 15 W for medium-sized SSRs. Generally, this power dissipation is included in published SSR specs, if not always adequately.

However, during the interval the SSR switches on or off (the breakover state), both high current and high voltage are present, and substantial power peaks are generated, peaks that must be dissipated.

Some SSR-design experts advise that the power-switching semiconductor should be built with glassivated junctions. Properly glassivated junctions produce devices with sharp breakover "knees." The "softer" the knee the longer the high-leakage interval during switching and the greater the heating, especially at chip edges where surface impurities can cause hot spots.

Switching time is short (microseconds), so when switching rates of the SSR are low—or even moderately high—the heat generated during switching contributes little above that of the static ON/OFF states. However, when switching occurs very rapidly, the heat generated during switching can become substantial. A marginal

Optical isolation is all solid state

Some manufacturers, like C.P. Clare, use LEDs optically coupled to a phototransistor or photo-SCR. This approach is said to provide a fast or snap-action transfer characteristic desirable for triggering a triac or SCR. Other manufacturers, like Theta-J and Sigma, prefer a photocell or photoresistor sensor for greater light sensitivity, increased immunity to noise, higher voltage rating and lower cost.

However, the photocell is slow and produces a "soft" trigger for the output semiconductor, which may shorten the semiconductor's life. Photocoupled SSRs have a high parts count when compared with reed-relay inputs, and especially with zero turn-on characteristics. Therefore photo SSRs are relatively high in cost.

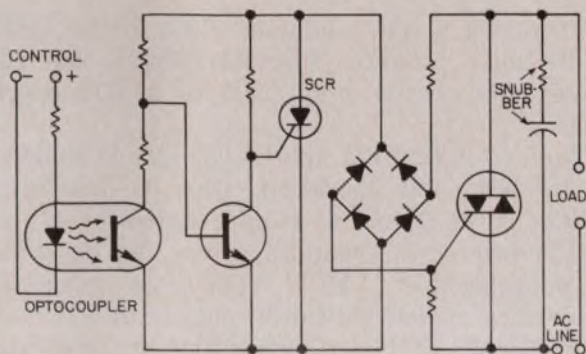

Transformer isolation is fast

SSRs for dc often use a modulated-oscillator input and a small toroid transformer for isolation. This approach, used by Theta-J and Teledyne in some models, can have a very fast turn-on time—as fast as $1 \mu\text{s}$ —and low contact off-sets—as low as $150 \mu\text{V}$.

The transformer should have electrostatic shielding against capacitive coupling of transients from the load to the input, which can damage the input gate. Another caveat: Since the switched output current depends on the input current, any attempt to switch more load current than the input circuit can make available may damage the output semiconductor.

Also, the oscillator can produce rf noise in the load—from a few microvolts to as much as 200 mV at 3 to 9 MHz. This noise, of course, can be bypassed.

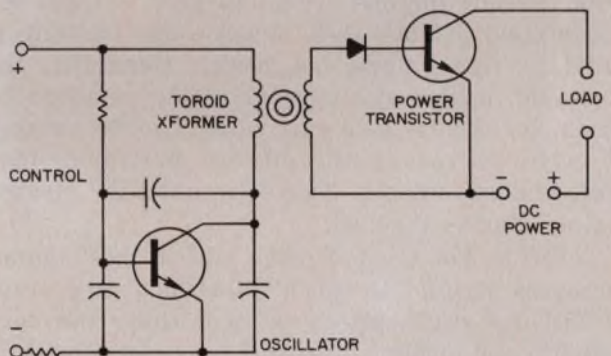

Reed-relay isolation is low cost

Many SSR users have balked at using a reed-relay-input hybrid SSR, because it's a departure from the use of all-solid-state components. But low-cost, reliable performance and good trigger action, especially for triacs, have won over many users to reed-relay isolated types, such as Gordos' Reedac series. The over-100-million operation life is adequate for many applications.

Some disadvantages include sensitivity to shock, vibration and magnetic fields. Furthermore, a reed relay can stick when closed—not a fail-safe condition. Optocouplers generally fail in the open condition.

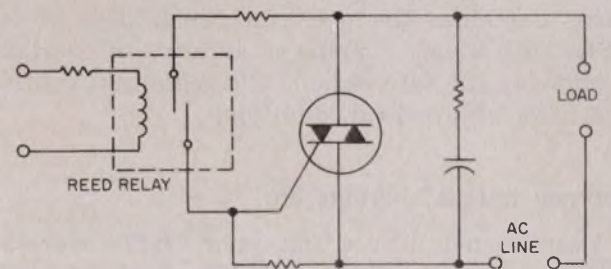

heat-sink design can then cause a unit to be short-lived. An SSR must be derated for such duty.

Then why are almost all SSR specs silent on this subject? For applications involving high switching rates (for which SSRs are superior to EMRs), you are practically forced to consult the SSR manufacturer.

Curb that surge

One series of specs that is almost never missing from even the most abbreviated spec sheet is the current-overload, or surge, maximums.

Exceeding those surge-current ratings can permanently damage an SSR. The rapid rise of the output semiconductor's junction temperature on a current surge ultimately limits the current rating. Most semiconductor junction temperatures should not exceed about 100 C maximum.

Overload ratings often appear in two ways: peak current for one cycle and peak current for one second. (Note that steady-state current is rated in rms values, not peak). Generally, the one-cycle, peak-surge current rating is about 10 times the steady-state rms value. As the number of cycles increases, the allowed maximum current, understandably, decreases, until the steady-state rating is reached.

Careful: Though not often stated, most manufacturers assume an initial junction temperature of 25 C for peak surges—a value that's not very realistic for either surge ratings or steady-state loads.

Some manufacturers supply a plot of allowable surge data in the form of a derating curve. Typically, a 10-A, steady-state-rated relay can have a one-cycle, 90-A rating. For one second (or for 60 cycles on 60 Hz), the allowed current can drop to 20 A. And at 120 cycles, the curve can approach the steady-state value.

A disturbing phenomenon frequently observed but seldom reported by manufacturers occurs when the overload exceeds certain levels of current and time. The SSR can lose its ON/OFF control for several seconds and lock into the ON state until the junction cools. Recommendation: Use slow blow fuses or circuit breakers, since this lock-ON condition can damage both controlled equipment and the SSR. At least one manufacturer describes the overload capabilities of its SSRs with a plot of amps vs duration of overload—showing the safe regions and regions of control loss after an overload condition.

Thermal fatigue shortens life

Despite such curves and other "safe" overload criteria, avoid operation near specified extremes and near overloads. Working at maximum load or



A nylon case covers the innards of this SSR. The relay is mounted on an isolated metal base to provide good heat conduction to an external heat sink. Guardian Electric rates these units for loads of 7 to 10 A and up to 280 V rms.

repeated overload produces a cumulatively destructive effect on an SSR.

Thermal fatigue of SCRs and triacs is a subject dealt with gingerly by manufacturers of power semiconductors—and totally avoided by SSR makers.

Virtually all SSRs use SCRs and triacs made with soft-soldered chips. Solderable chips switched at maximum ratings undergo substantial temperature excursions that stress the solder interface.

Operating a semiconductor close to the limits of its specs produces thermal fatigue that can cause failure after only 5000 to 10,000 operations.

The life of a SSR's input LED also is shortened by heat and operation near its maximum rating. A LED has a definite half-life—a fact well known to LED manufacturers, but not widely publicized. A LED's brightness gradually diminishes to half its initial output in hundreds of thousands of hours, depending on how hard it's driven. A well designed SSR with optocou-



SSR current ratings are based upon the maximum junction temperature of the output semiconductor device. Opto-22 recommends a safe value of 100 C for its units.

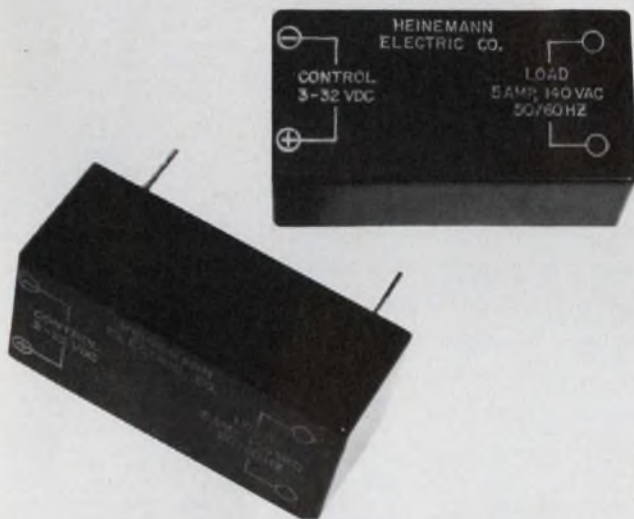

A choice of PC-mounting, quick-on or screw connectors is available for Heinemann's line of SSRs. The units feature fail-safe fusible links to prevent short-circuit damage.

pling operates the LED conservatively—say, at 20% of maximum brightness—to achieve long life in a generally hot (60 to 80 C) environment.

Don't snub the snubber

Many manufacturers build snubbers into their SSRs; some units don't have the room. Don't overlook the need for an external snubber when driving inductive loads.

While a snubber can ensure that an SSR's dV/dt ratings are not exceeded, it can have some undesirable side effects as well. Its capacitor can resonate with the load inductance and in some cases develop voltages that exceed the line voltage and the SSR's voltage rating.

A similar phenomenon occurs when switching load capacitors. For example, when switching the capacitor in a reversing motor, the voltage across the SSR can rise as much as 100 V above a 120-V line.

One way to protect the SSR against overvoltage is to install a metal-oxide varistor (MOV)

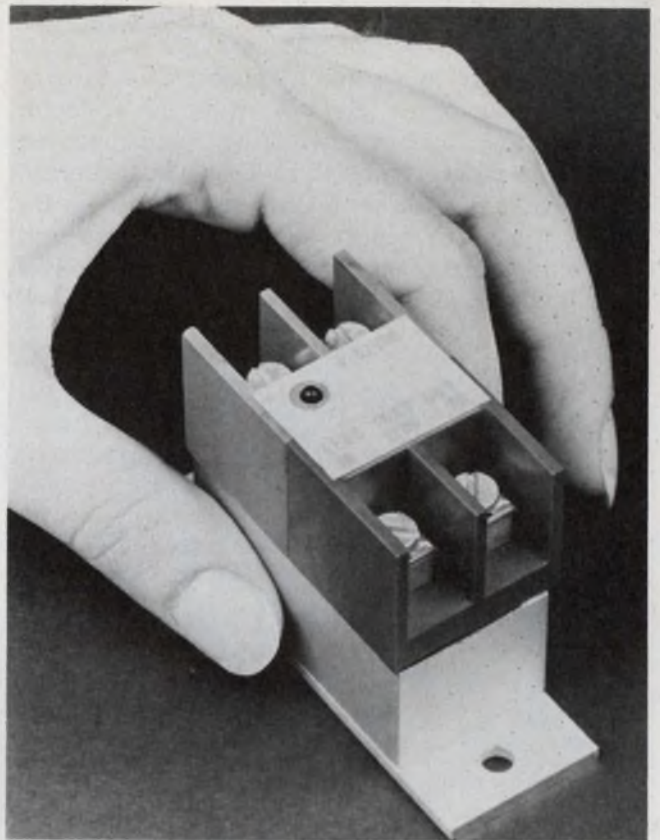

Here's one SSR that comes with a "built-on" heat sink. Made by Electronic Instrument and Specialty Co., this relay can therefore handle the load specified; however, the spec sheet still warns, "electrical specs at 25 C, unless otherwise specified."

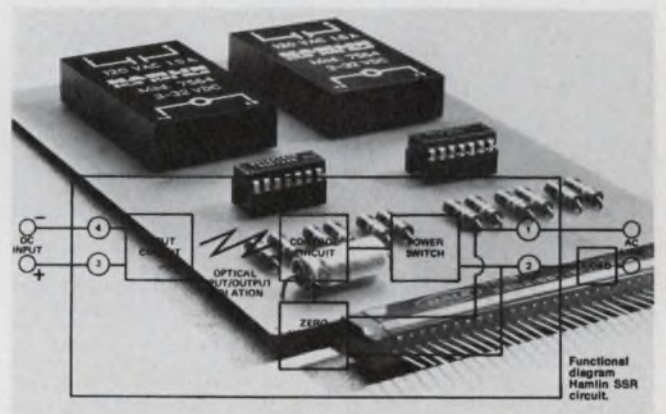

Printed-circuit-board mounted SSRs, such as these Hamlin units, provide a convenient and logic-circuit compatible way to control ac-power loads to about 1.5 A.

across the output terminals. But be careful: The MOV should be not only in a fully conductive state at a voltage less than the peak voltage rating of the SSR, but also in a high-impedance state below the maximum line voltage.

Therefore, to allow "room" for the MOV to operate properly, the SSR's rating should be well above the maximum line voltage. If a 200-V-peak SSR is used for a 120-V rms line without an

MOV, choose the next highest rated SSR—possibly a 400-V unit—with an MOV.

SSRs for dc loads are as susceptible to over-voltage as ac types. But dV/dt is not a factor, because the output switching semiconductor (usually a power transistor) is a nontriggerable device; thus, dV/dt snubbers are not needed. But MOVs, diodes or zeners should be used to limit overvoltages. And the constraint of using an SSR rated well above the line voltage applies for both

ac and dc units. In some cases, it may be necessary to use transient suppression across both SSR and load.

Another way to suppress transients in dc switching circuits is to employ a controlled-response circuit. Controlling the rise and fall rates of the switched load current can substantially reduce the kickback in inductive loads. But, of course, external transients must still be controlled by voltage-limiting devices. ■■

Need more information?

For further information on solid-state relays, readers may consult the manufacturers listed here by circling the appropriate numbers on the reader service card. More vendors and information may be found in ELECTRONIC DESIGN'S GOLD BOOK.

Action Instruments Inc., 8601 Aero Dr., San Diego, CA 92123. (714) 279-5726. **Circle No. 421**

Adams & Westlake Co., 1000 N. Michigan St., Elkhart, IN 46514. (219) 264-1141. **Circle No. 422**

Aerolite Electronics Corp., 2207 Summit Ave., Union City, NJ 07087. (201) 863-2955. **Circle No. 423**

Allen Bradley Co., 1201 S. 2nd St., Milwaukee, WI 53204. (414) 671-2000. **Circle No. 424**

American Zettler Inc., 16881 Hale Ave., Irvine, CA 92714. (714) 540-4190. **Circle No. 425**

Applied Electro Tech, Inc., 2220 S. Anne St., Santa Ana, CA 92704. (714) 556-6570. **Circle No. 426**

Automatic Switch Co., 50-56 Hanover Rd., Florham Park, NJ 07932. (201) 966-2000. **Circle No. 427**

Autronics Corp., 180 N. Vinedo Ave., Pasadena, CA 91107. (213) 681-3545. **Circle No. 428**

Barber-Colman Co., Industrial Instrus. Div., 1317 Rock St., Rockford, IL 61101. (815) 877-0241. **Circle No. 429**

Basler Electric Co., Box 269, Highland, IL 62249. (618) 654-2341. **Circle No. 430**

Branson Corp., Vanderhoff Ave., Denville, NJ 07860. (201) 625-0600. **Circle No. 431**

B-W Controls Inc., 2200 E. Maple, Birmingham, MI 48012. (313) 643-8800. **Circle No. 432**

Cardinal Control Co., Inc., 32 Kensington Rd., Kensington, CT 06037. (203) 828-6379. **Circle No. 433**

C. P. Clare & Co., a subsidiary of General Instruments Corp., 3101 W. Pratt Ave., Chicago, IL 60645. (312) 262-7700. **Circle No. 434**

Computer Components, 88-06 Van Wyck Expressway, Jamaica, NY 11419. (212) 291-3500. **Circle No. 435**

Cutler-Hammer, 4201 N. 27th St., Milwaukee, WI 53216. (414) 442-7800. **Circle No. 436**

Delaval/Gems Sensors Div., Spring Lane, Farmington, CT 06032. (203) 677-1311. **Circle No. 437**

Deltronic Controls Corp., 2745 S. 19th St., Milwaukee, WI 53219. (414) 671-6800. **Circle No. 438**

Elec-Trol Inc., 26477 N. Golden Valley Rd., Saugus, CA 91350. (805) 252-8330. **Circle No. 439**

Electronic Instruments & Specialty Corp., 42C Pleasant St., Stoneham, MA 02180. (617) 438-5300. **Circle No. 440**

Electronic Relays, Inc., 7106-08 W. Touhy Ave., Niles, IL 60648. (312) 647-7727. **Circle No. 493**

Electronic Specialty Div., Datron Systems Inc., 18900 NE Sandby Blvd., Portland, OR 97220. (503) 665-0121. **Circle No. 441**

Essex Controls Div., 121 Godfrey, Logansport, IN 46947. (219) 753-7521. **Circle No. 442**

Essex International Inc., 1601 Wall St., Fort Wayne, IN 46804. (219) 743-0311. **Circle No. 443**

General Automatic Corp., 235 W. 1st St., Bayonne, NJ 07002. (201) 437-7500. **Circle No. 444**

General Electric Co., Electronic Components Sales, Electronics Pk., Building 1, Rm 3, Liverpool, NY 13088. (315) 956-0123. **Circle No. 445**

Gordos/Grigsby-Barton Inc., 1000 N. 2nd St., Rogers, AR 72756. (501) 636-5000. **Circle No. 446**

Gould Inc., Allied Control Div., 100 Relay Rd., Plantsville, CT 06479. (203) 628-9654. **Circle No. 447**

Grayhill Inc., 565 Hillgrove Ave., La Grange, IL 60525. (312) 354-1040. **Circle No. 448**

Guardian Electric Manufacturing Co., 4030 W. Spencer St., Torrance, CA 90503. (213) 542-8651. **Circle No. 449**

Hamlin Inc., Lake & Grove Sts., Lake Mills, WI 53551. (414) 648-2361. **Circle No. 450**

Hartman Electrical Mfg Div., A-T-O Inc., 175 N. Diamond St., Mansfield, OH 44902. (419) 524-1411. **Circle No. 451**

H-B Instruments Co., 4316 N. American St., Philadelphia, PA 19140. (215) 329-9125. **Circle No. 452**

Heinemann Electric Co., Brunswick Pike, Route 1, Trenton, NJ 08602. (609) 882-4800. **Circle No. 453**

Hi-G Inc., 580 Spring St., Windsor Locks, CT 05096. (203) 623-2481. **Circle No. 454**

Hope Elecs, 20 Newark Pompton Turnpike, Wayne, NJ 07470. (201) 777-3522. **Circle No. 455**

International Rectifier, Crydom Div., 1521 Grand Ave., El Segundo, CA 90245. (213) 322-4987. **Circle No. 456**

Walter Kidde, Douglas Randall Div., 6 Pawcatuck Ave., Pawcatuck, CT 02891. (203) 599-1750. **Circle No. 457**

Kratos, 403 S. Raymond Ave., Pasadena, CA 91109. (213) 449-3090. **Circle No. 458**

LaMarche Manufacturing Co., 106 Bradrock Dr., Des Plaines, IL 60018. (312) 299-1188. **Circle No. 459**

Lark Elecs Inc., Box 390, New York, NY 10040. (212) 925-9060. **Circle No. 460**

Leach Corp., Relay Div., 5915 Avalon Blvd., Los Angeles, CA 90003. (213) 232-8221. **Circle No. 461**

Logitek Inc., 42 Central Ave., Farmingdale, NY 11735. (516) 694-3080. **Circle No. 462**

LRC Inc., 101 Digital Dr., Hudson, NH 03051. (603) 883-8001. **Circle No. 463**

Madison Labs, 83 Bradley Rd., Madison, CT 06443. (203) 245-4280. **Circle No. 464**

Magnecraft Electric Co., 5575 N. Lynch, Chicago, IL 60630. (312) 282-5500. **Circle No. 465**

Master Electronic Controls, 1651 19th St., Santa Monica, CA 90025. (213) 393-3177. **Circle No. 466**

Midtex Inc., 1650 Tower Blvd., North Mankato, MN 56001. (507) 388-6286. **Circle No. 467**

MKC Elecs Corp., 454 E. Donovan, Kansas City, KS 66115. (913) 371-1351. **Circle No. 468**

Monsanto Electronics Div., 3400 Hillview Ave., Palo Alto, CA 94304. (415) 493-3300. **Circle No. 469**

North American Philips Controls Corp., Frederick Div., Husky Pk., Frederick, MD 21701. (301) 663-5141. **Circle No. 470**

Ohmite Manufacturing, 3601 Howard, Skokie, IL 60076. (312) 675-2600. **Circle No. 471**

Opto 22, 5842 Research Dr., Huntington Beach, CA 92649. (714) 892-3313. **Circle No. 492**

Potter & Brumfield Inc., 1200 E. Broadway, Princeton, IN 47671. (812) 386-1000. **Circle No. 472**

Regent Controls Inc., 169 Harvard Ave., Stamford, CT 06902. (203) 348-7734. **Circle No. 473**

Ripley Co., Inc., 46 Nooks Hill Rd., Cromwell, CT 06416. (203) 346-6677. **Circle No. 474**

R K Electric Co., Inc., 11315 Williamson, Cincinnati, OH 45241. (513) 793-4060. **Circle No. 475**

Sensor Corp., 303 Scottdale Ave., Scottsdale, PA 15683. (412) 887-4080. **Circle No. 476**

Shigoto Ind. Ltd., 350 5th Ave., New York, NY 10001. (212) 695-0200. **Circle No. 477**

Sigma Instruments Inc., 170 Pearl St., Braintree, MA 02184. (617) 843-5000. **Circle No. 478**

Solid State Electronics, 15321 Rayen St., Sepulveda, CA 91343. (213) 894-2271. **Circle No. 479**

Square D Co., Executive Plaza, Park Ridge, IL 60068. (312) 774-9200. **Circle No. 480**

Sterer Engraving & Manufacturing Co., 4690 Colorado Blvd., Los Angeles, CA 90039. (213) 245-7161. **Circle No. 481**

Struthers-Dunn Inc., Lambs Rd., Pitman, NJ 08071. (609) 589-7500. **Circle No. 482**

TDR Electronics, Foot of John St., Lowell, MA 01852. (617) 459-0151. **Circle No. 483**

Teledyne Relays, 3155 W. El Segundo Blvd., Hawthorne, CA 90250. (213) 973-4545. **Circle No. 484**

Texas Instruments Inc., P.O. Box 5012, Mail Station 84, Dallas, TX 75222. (214) 238-3333. **Circle No. 485**

Theta-J Relays, Inc., 2 Linden St., Reading, MA 01867. (617) 942-0390. **Circle No. 486**

Utec Corp., 871 Allwood Rd., Clifton, NJ 07012. (201) 779-0430. **Circle No. 487**

Vectrol Inc., 1010 Westmore Ave., Rockville, MD 20853. (301) 424-6900. **Circle No. 488**

Versitron, 6310 Chillum Pl. NW, Washington, DC 20011. (202) 882-8464. **Circle No. 490**

Wabash Relay & Electronics, First & Webster St., Wabash, IN 46992. (219) 563-2191. **Circle No. 491**

Magnecraft's line of 1200 stock relays just increased . . . by another series.

WHY WAIT FOR SOLID STATE? Our family of 24 solid state relays provides current ratings from 2.5 to 40 amps, with switching capacity up to 480 VAC. All models incorporate optoisolation between input and output, and zero-voltage switching. Screw type clamps and Faston "Quick-Connect" terminals are available on packages which are interchangeable with others.

Output switching reflects the latest state-of-the-art technology. Both the high-reliability dual SCR approach and the more economical triac approach are available.

Magnecraft is committed to providing design engineers with the best solution for their switching applications. It is with a complete understanding of the areas where solid state relays provide the most reliable and economical switching solution, that we've included this family in our line of stock relays.

For complete information and specifications, WRITE FOR OUR SOLID STATE RELAY PRODUCT BULLETIN. Magnecraft Electric Co., 5575 N. Lynch Ave., Chicago, IL 60630

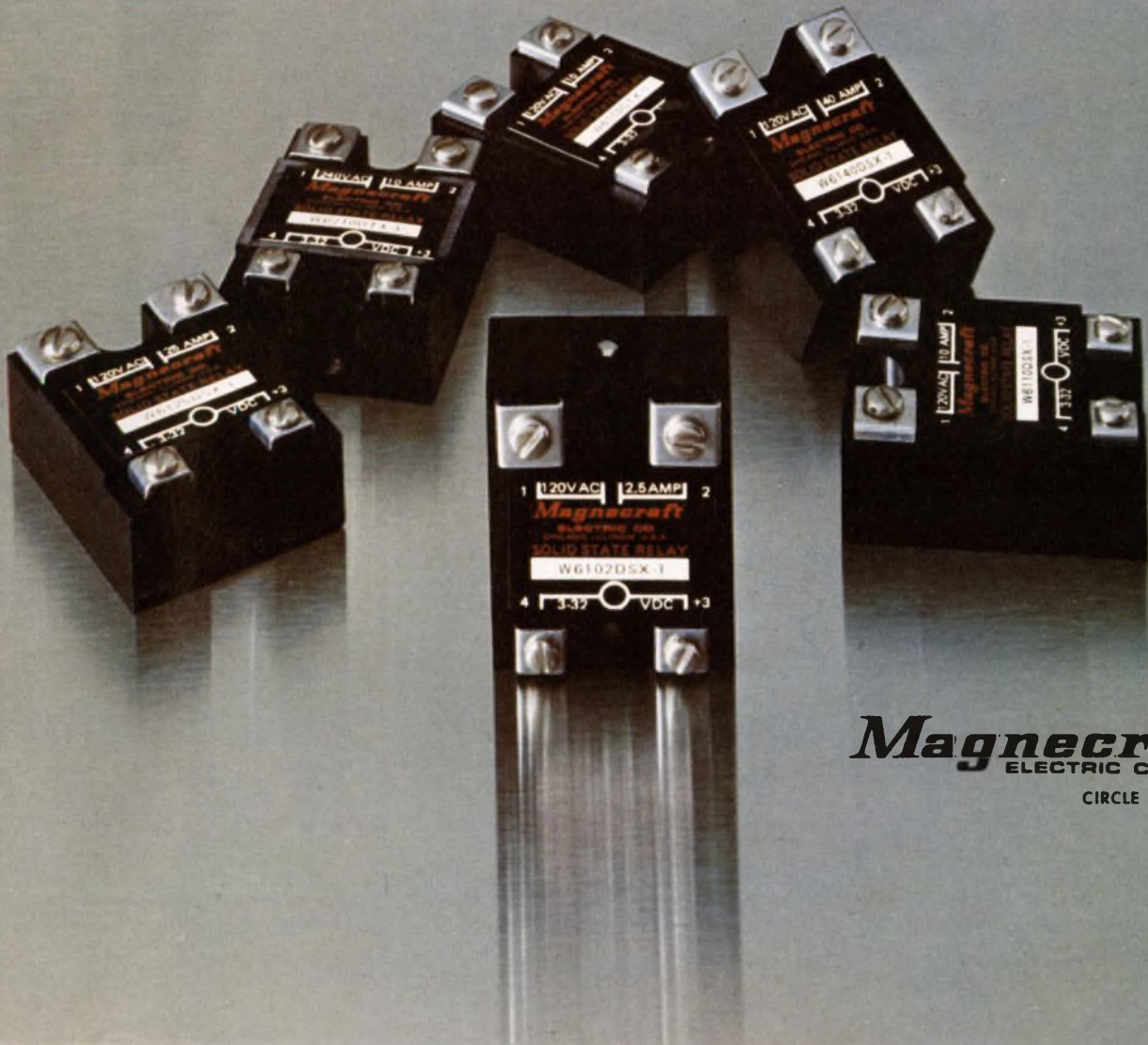

Magnecraft
ELECTRIC COMPANY

CIRCLE NUMBER 29

**NEW FROM KEITHLEY:
TWO "BEST BUY" DMMs.
4½ DIGITS. 30000 COUNTS.
UNDER \$500.**



Model 173



Model 172

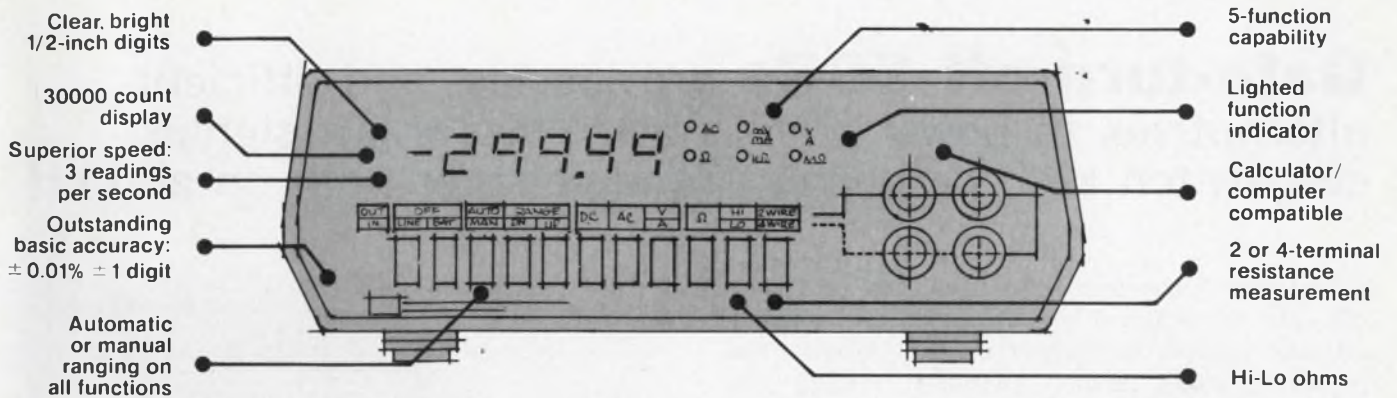

Take a look at the remarkable features of the new Keithley Digital Multimeters. They're unmatched in the industry.

Now consider price. At \$499 we think you'll agree the Keithley 172 is the best buy in a general purpose 4½-digit DMM.

There isn't another 4½ that matches the price-performance value of the 172. Except for its higher-rated companion, the Keithley 173.

For \$499: the exceptional 172.

To begin with, you get a dependable, durable, portable, easy-to-use, autoranging instrument with five functions. Designed for research, engineering or production applications.

Measure from 10 microvolts to 1200 volts dc, 10 microvolts to 1000 volts ac, 10 milliohms to 300 megohms, 10 microamps to 2 amps, ac or dc. DC accuracy is 0.01% ± 1 digit.

There's more: 3 month recal cycle. No-nonsense, full-year guarantee on parts, workmanship, and specs. 30000-count display yields maximum accuracy for 15, 18, 24 and 28-volt measurements.

For \$625: the even more exceptional 173.

The Keithley 173 is our top-rated 4½-digit DMM. It gives you all the performance and accuracy of the 172 plus superior autoranging current measurements from 10 nanoamps to 3 amps. This makes the 173 the most complete and versatile general purpose 4½-digit DMM in the world — at any price.

More versatility. Now or later.

Options and accessories expand the 172 or 173 to your specific needs: Rechargeable battery pack you can buy now or add later. Digital output/control. RF probe. 50-amp shunt. Clamp-

on ammeter. High-voltage probe. Rack mount kits. Test lead sets. Carrying case. IEEE 488 interface.

Make this easy decision.

For most 4½-digit DMM applications, the new Keithley 172 is your best buy. When you require more current measuring capability, the 173 is.

For convincing proof, send for detailed specs or request a demonstration. Or if you're already convinced, send your order to: Keithley Instruments, 28775 Aurora Road, Cleveland, Ohio 44139. (216) 248-0400. Europe: Heiglhofstrasse 5, D-8000 München 70, West Germany. (089) 7144065.

DMMs for all your needs.

We know you have a variety of measurement requirements. So we offer a growing family of DMMs — 3½ to 6½ digits — to satisfy your application. And your budget.

3½ digits	4½ digits	5½ & 6½ digits
<p>Model 168 General purpose Low cost.</p> <p>Model 160B 1 μV and 10 pA sensitivity.</p> <p>Model 616 Super-sensitive. 0.1 pA full-scale</p>	<p>Models 172 and 173 Two "Best-Buys!"</p> <p>Model 171 1 μV sensitivity. 5-functions.</p> <p>Model 174 0.1 μV sensitivity. (coming soon)</p> <p>Model 180 30 nV sensitivity.</p>	<p>Model 190 Multi-function. Low cost.</p> <p>Model 5900 0.001% accuracy. High stability.</p> <p>Model 6900 Accuracy, stability and sensitivity measured in ppm.</p>

New guide available: "How to get more from your DMM." Send for yours today.

KEITHLEY
The measurement engineers.

Gate-turn-off SCRs provide fast and efficient alternatives to power transistors. Pulse input signals can switch high dc currents and voltages both on and off.

Ordinary thyristors once fired, can be turned off only by removal of the anode voltage—not an easy task in dc high-voltage, high-power applications. Gate turn-off switches (GTS), however, have the advantage that they can be turned off with relatively little effort by a negative pulse to the gate.

GTS thyristors can be used where only transistors (and sometimes electromechanical devices) could do the job before—in solid-state relays for the control of high-voltage and high-current dc; in the control of dc traction motors, stepping motors and powerful dc solenoids; and in power inverters and many other applications.

Further, GTS thyristors can do a better job than transistors. They are more efficient (especially for high power), operate with low-control power (need only pulses to turn ON or OFF) and can act faster and provide higher blocking voltage (to 800 V) and higher current switching (to 30 A average) for a given size.

GTS construction similar to ordinary SCR

The GTS thyristor is a four-layer pnpn device constructed similarly to a conventional thyristor (Fig. 1a). However, a new factor, turn-off gain (G_{off}), is introduced, and defined as equal to the anode current, I_A , divided by the amount of reverse gate current, I_G , required to turn off the anode current,

$$G_{off} = \frac{I_A}{I_G}$$

Fig. 1b shows an approximate equivalent circuit of a GTS. The device acts as if it contained two transistors and one zener diode and the gate (G) to cathode (K) path presents a voltage/current characteristic similar to a zener diode (Fig. 1c).

A positive pulse to gate, G, turns Q_2 ON, which then turns Q_1 ON. The regenerative feedback via paths I_1 and I_2 keeps the Q_1/Q_2 combination con-

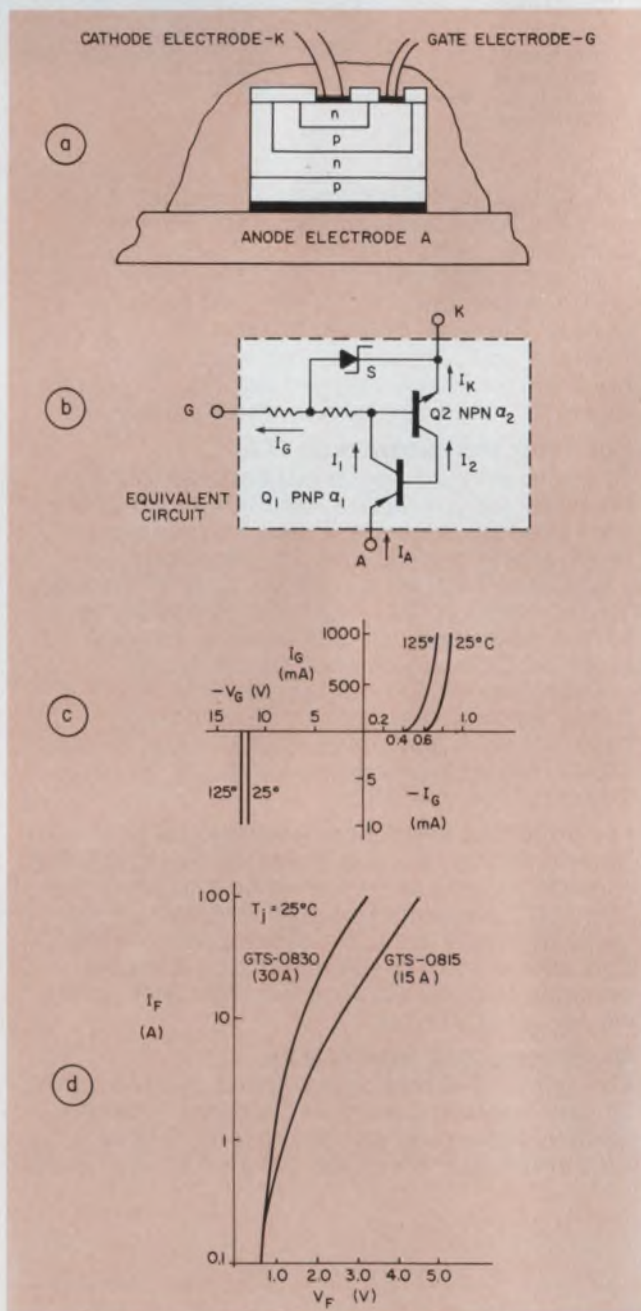

1. A gate turn-off thyristor is very similar in construction (a) to an ordinary SCR and has a similar equivalent representation (b). Between the control gate and cathode terminals, the GTS exhibits the properties of a zener (c). And the forward drop from anode to cathode (d), when the GTS conducts, is low and varies little—between 0.7 and 2 V—over a large current range.

K. P. Ohka, Vice President of Engineering, and E. D. Lucas Jr., Consultant, Sabor Corp., 12597 Crenshaw Blvd., Hawthorne, CA 90250.

ducting after removal of the pulse, provided the current gains a_1 and a_2 of Q_1 and Q_2 , respectively, are adequate. This behavior is exactly as for ordinary SCRs. But because of design compromises to achieve a fast gate turn-off capability in GTS thyristors, the high regenerative gain inherent in conventional SCRs is reduced in GTS design.

GTSs are specially configured so that a negative current flow to G can turn off the device by drawing off current from I_a sufficiently to "break" the regenerative loop. Although a large G_{off} would

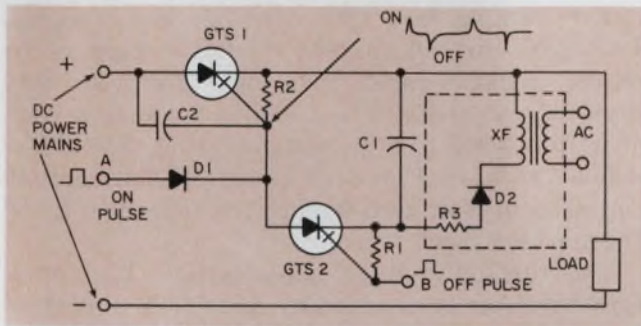

2. One of the first successful turn-off circuits uses a separate small power supply to charge a capacitor that supplies the extinguishing-current surge to the GTS's gate. With only milliamps of input, amperes of dc current can be turned on and off.

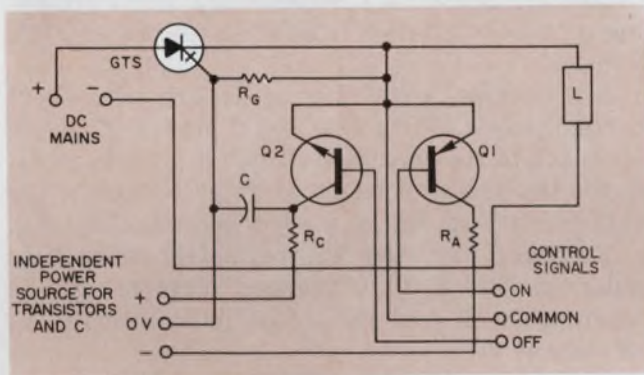

3. Medium-sized transistors can be used to control high-volt, high-current GTS units.

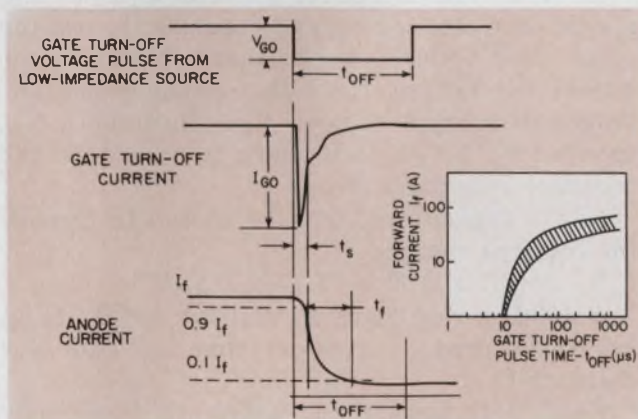

4. The gate turn-off peak pulse, I_{GO} , lasts only a short period, t_s —roughly 10% of the total turn-off time, t_{off} .

make turning off the GTS easier, a limit is reached for a G_{off} between 15 and 20. Above this gain range, GTS fabrication requirements produce an increase in forward-voltage drop, V_f (see Fig. 1d for typical values), and a decrease in reverse blocking voltage. Therefore, especially for high-power devices, G_{off} must be traded at the expense of providing a higher turn-off current, I_G , from the external control circuit.

Dc can turn off a GTS, but a sharp pulse is best, especially in rapidly repeated on/off application. The reasons for this conclusion can be understood by referring to the equivalent circuit, Fig. 1b.

■ If the reverse gate current is gradually increased, then near the turn-off point, transistors Q_1 and Q_2 only slowly release from saturated states, as I_a decreases. During this interval, the voltage rises between the anode (A) and cathode (K) and the relatively high current and voltage will produce high power consumption, and hence, loss of efficiency.

■ Further, with the negative voltage still applied to the gate after the gate has turned OFF, the zener can conduct, and the loss of power into the gate can also be very high.

Fig. 2 is the first of several successful circuits used for controlling a GTS thyristor. With only 20 mA, about 30-A-dc current can be turned on, but a sizable, 10-to-15-A, 5- μ s pulse is needed to turn it off. Thyristor GTS_1 is the main power-control unit and GTS_2 acts as a turn-off trigger for GTS_1 .

A capacitor supplies the turn-off pulse

A positive pulse to terminal A turns GTS_1 on. Capacitor C_1 is charged by an independent power supply, shown in the dotted box enclosing R_3 , D_2 and a small transformer, XF.

To turn off GTS_1 , a positive pulse is applied to terminal B. GTS_2 fires and discharges a current pulse from C_2 through resistor R_3 . This pulse applies a negative voltage to the gate of GTS_1 , for a period sufficiently long to turn off GTS_1 . GTS_2 also turns off automatically when the current from C_1 drops below GTS_1 's hold-on current— R_3 limits C_1 charging current below the hold-on current. With GTS_2 OFF, C_1 recharges.

A similar control circuit (Fig. 3) uses transistor, Q_1 , to turn on the GTS and another, Q_2 , to discharge a capacitor, C, to turn off the device. Note that again, separate power sources are needed. They supply the transistor voltages and charge C.

Resistor R_A controls the forward gate turn-on current of the GTS, and R_C the charging current of C. And, acting in series, resistors R_A and R_C determine the amount of power drawn from the separate power supplies.

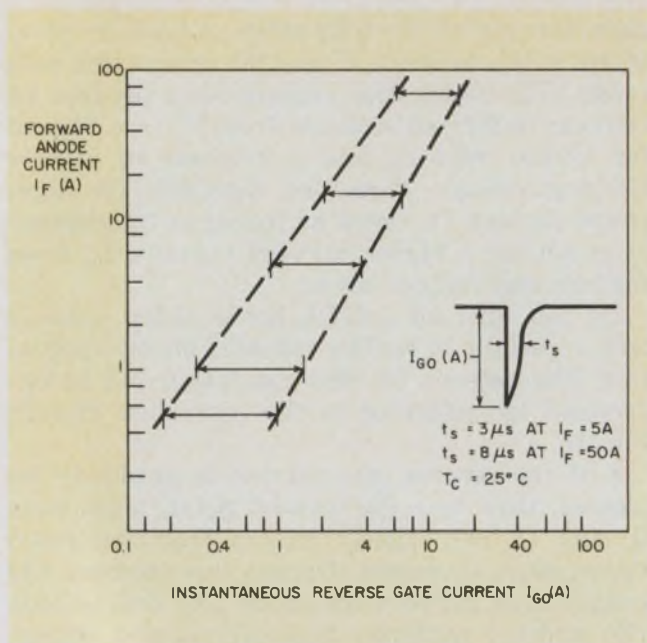

5. The peak current needed to turn off a GTS depends upon the forward anode current.

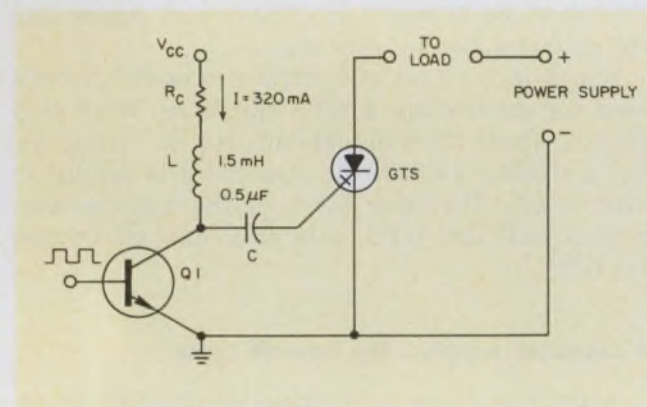

6. An inductor in the turn-off circuit allows the use of a reduced voltage source, V_{cc} , to charge the turn-off capacitor, C , sufficiently to extinguish the GTS.

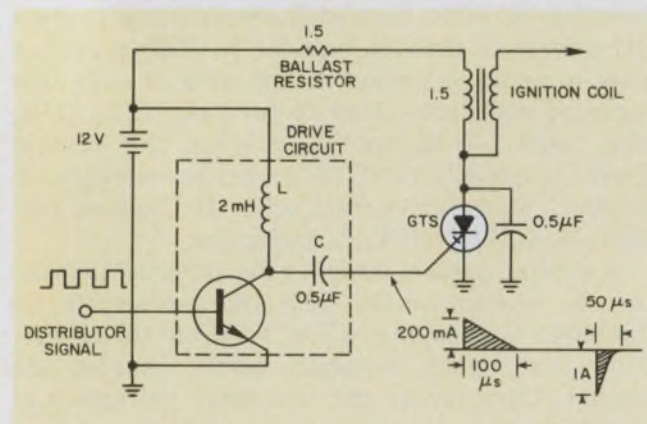

7. Ignition signals from an automobile distributor control the on/off timing of a GTS thyristor. High-voltage developed in the ignition-coil secondary, when the GTS turns off, produces a spark across the gap of a spark plug. The GTS turns on within $100 \mu s$ and off in about $50 \mu s$ and needs about 1-A peak to extinguish.

Clearly, turning off the GTS requires a bit more ingenuity than turning it on. The turn-off pulse must be applied for several tens of microseconds, t_{off} , but fortunately the amperes of peak current that may be required need persist for only a few microseconds, t_s , of the interval, t_{off} (Fig. 4). A very rough rule of thumb calls for an instantaneous peak pulse current, I_{GO} , of about one-half the anode current at the time of turn off. Fig. 5 provides a more accurate range of peak-current values for a typical GTS, than this rule of thumb. New GTS developments may strongly reduce the peak-current requirement.

For example, for a GTS carrying 20 A, roughly 10-A peak turn-off current should be supplied to ensure reliable rapid turn off. However, this high current needs to be supplied for only a very short time— 0.5 to $5 \mu s$, depending on the GTS—defined as t_s in Fig. 4. Thereafter, the current can drop to near zero during the fall time, t_f , of the anode current.

The turn-off voltage specification, V_{GO} , of a GTS thyristor is assumed by most GTS manufacturers to be derived from a low-impedance constant-voltage source. The V_{GO} for the device of Figs. 4 and 5 is specified as 14 V.

Amp- μs : A better way to spec turn off

But this is not very helpful data when designing a capacitor turn-off circuit as shown in Figs. 2 and 3.

A more meaningful way of dealing with short current pulses, which also would provide a simple approach to the capacitor-circuit design, is to describe the pulses in terms of ampere-seconds (or rather A- μs) of charge needed to turn off a GTS.

Therefore, for the approximately triangular pulse, in Fig. 4, the "average" current can be taken as $I_{GO}/3$. And for a $5\text{-}\mu s$ pulse interval, t_s , the charge is

$$Q \approx \frac{10 \times 5}{3} \approx 17 \text{ A-}\mu s.$$

To assure the required high initial current and still retain some charge for the total t_{off} time, and also to overcome wiring and capacitor losses, the open-circuit voltage used to charge the capacitor may be two to three times the recommended low-impedance-sourced voltage, V_{GO} . Thus for a V_{GO} specified at 14 V, a 35-V charging source for the capacitor is appropriate.

Now a capacitor, C , can be chosen to provide the required charge:

$$C = Q/V \approx 17/35 \approx 0.5 \mu F.$$

A $100\text{-}\Omega$ series charging resistor for R_c (Fig. 3) would produce a $50\text{-}\mu s$ time constant for charging C .

Note: With capacitor C sufficiently large, only part of its charge is drained off during the initial t_s surge, because the impedance of the GTS gate

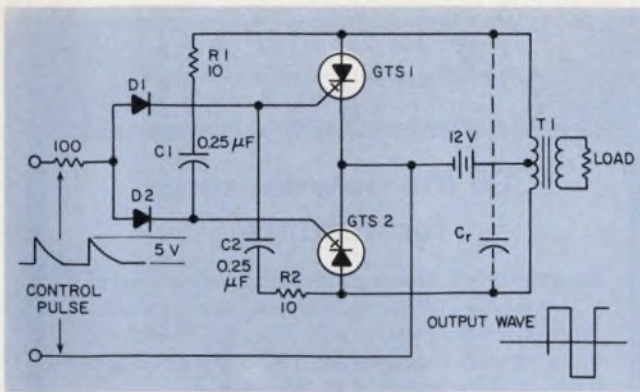

8. In this dc-to-ac converter, input-control pulses turn the two GTS thyristors on alternately. When one GTS goes on, the other is automatically turned off by the charge stored in C_1 or C_2 . Thus, alternate half-cycle pulses in the primary of the transformer become ac in the secondary. Low-loss and high-current capabilities of GTSs provide efficient power conversion.

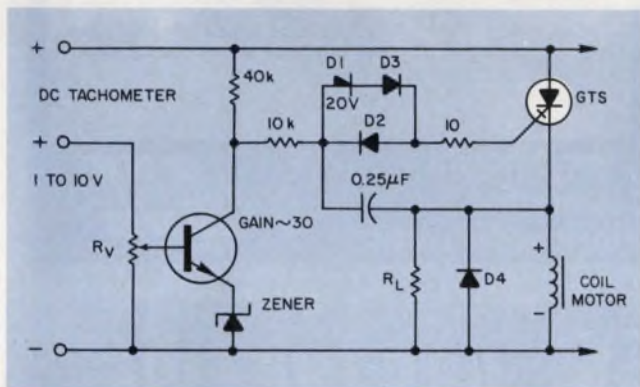

9. For use as a dc-motor speed control, a dc tachometer turns transistor Q on or off as the motor speed and tachometer voltage rises above or drops below a reference level set by resistor R_v and the zener diode. At low speeds, Q turns off and its collector voltage rises to turn the GTS on via a 20-V Shockley diode. When the speed, and thus, the tachometer's voltage rises above the reference level, Q turns on and the GTS gate becomes negative with respect to its cathode, turning the GTS off. The Shockley diode produces a sharp turn-on point when it "breaks" into conduction, and also, it introduces some desirable hysteresis into the circuit. The circuit can also be used as a solid-state relay operating from a wide variety of input sources for driving motors, solenoids, mechanical counters and many other devices.

becomes high once the OFF state is achieved in the first 0.5 to 5 μ s.

An interesting variation of GTS control combines an inductor with the capacitor and allows the use of a lower source voltage (Fig. 6). Energy stored in the inductor, when the transistor is conducting, is converted to voltage to increase the voltage on the capacitor, when the transistor opens. The voltage, V_L , that is added to V_{cc} to make a total voltage V_c across the capacitor can be determined approximately by assuming that all of the coil energy eventually is stored in the

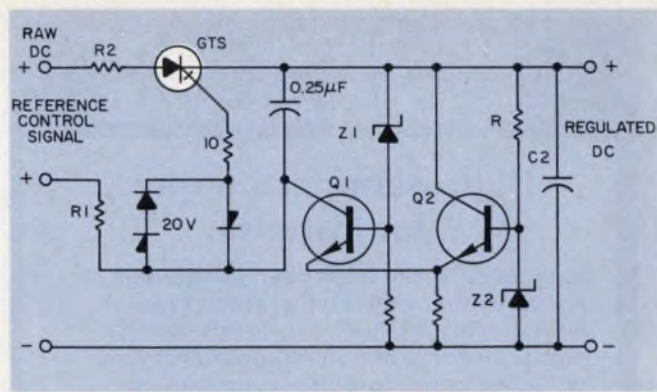

10. In this voltage regulator, a positive reference control level turns the GTS on. When the regulated voltage stabilizes, transistor Q_2 stays on, which keeps Q_1 off, to allow GTS to conduct and supply power to the regulated-voltage load. A rise in regulated voltage above the level established by the reference turns Q_1 on, which extinguishes the GTS temporarily, until the output voltage falls to the controlled level.

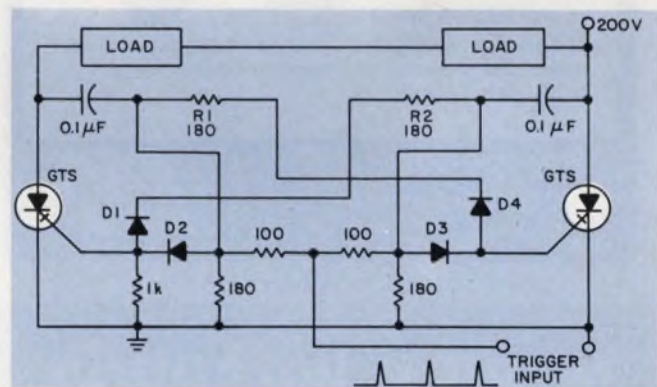

11. To switch high voltage and current between two loads under the control of low-voltage trigger pulses, two GTS devices serve as power switches in this flip-flop.

capacitor; therefore,

$$(\text{energy in coil}) \frac{1}{2} LI^2 \approx \frac{1}{2} CV_L^2 \quad (\text{energy in capacitor})$$

$$V_L = I \sqrt{\frac{L}{C}}$$

$$V_c = V_{cc} + V_L$$

In Fig. 6, with the values of L and C shown, for a current of 320 mA, limited by R_c , V_L when taken together with about 18 V on V_{cc} can charge C to about 35 V.

The A- μ s approach is, admittedly, very "rough," but it gets practical results.

As is so often the case with other solid-state nonlinear devices, design engineers can often best learn to use the GTS by studying the circuits of some representative application examples. A drive for an ignition circuit (Fig. 7), a dc-to-ac converter circuit (Fig. 8), a dc motor-speed control (Fig. 9), a dc voltage regulator (Fig. 10) and a high-voltage flip-flop (Fig. 11) show the diversity of possible uses for GTS. Each circuit is explained by its caption. ■■

WE KNOW A LOT ABOUT A LITTLE.

High-perm ferrite cores, for instance.

Magnetics' ferrite cores offer you greater resistivity than metal alloys. Their high-permeability and high-flux levels provide high inductance in a small space. Our type W 10,000 perm material has an extremely high Curie temperature (140°C). In transformer applications ferrite cores make an excellent substitute for laminated cores, reducing cost and simplifying packaging. For more information on our 14 different ferrite materials, write Magnetics, Components Division, Butler PA 16001.

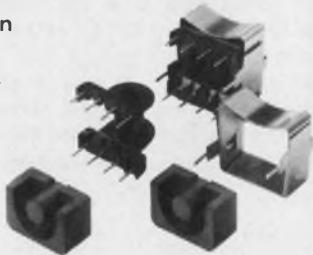

Available in EP, RM and toroid geometry shapes.

Very special specialists in ferrites.



CIRCLE NUMBER 30

WE KNOW A LOT ABOUT A LITTLE.

300 Mu powder cores, for instance.

Magnetics' exclusive patented process offers you the only 300-perm low loss core on the market. To give you greater design flexibility, these cores are available in 20 different sizes from .250" to 2.250" OD. We also offer nine other permeabilities and nine temperature characteristics. Samples are available upon request. Write Magnetics, Components Division, Butler PA 16001.



300 Mu cores include either temperature stabilized or unstabilized types.

Very special specialists in powder cores.



CIRCLE NUMBER 31

IN WIRE-WRAPPING HAS THE LINE... HOBBY-WRAP-30 FOR AWG 30 WIRE ON (.025 SQUARE POST)

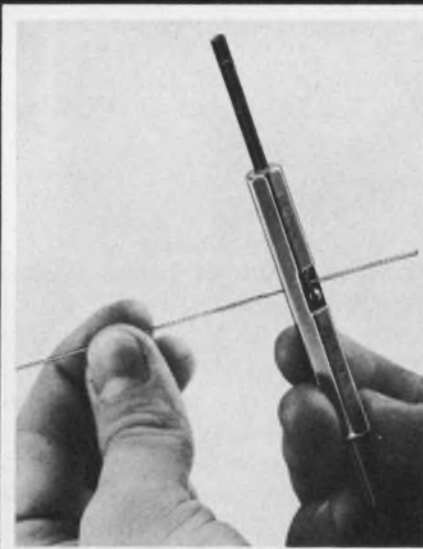

STRIP



WRAP



UNWRAP

\$5⁹⁵

OK MACHINE & TOOL CORPORATION

3485 CONNER STREET, BRONX, NEW YORK, N.Y. 10475 U.S.A. • PHONE (212) 994-8600

TELEX: 125091 TELEX: 232395

three
The ~~one~~ and only...

Three Series of Amphenol® connectors are now qualified to MIL-C-26482, MIL-C-38999 and MIL-C-83723.

One company offers connectors qualified to all three specs—Amphenol Connector Systems, Bunker Ramo Corporation.

These three connector series are preferred under military standard MIL-STD-1353A. They're designed for general-purpose and high-density applications in ground-support and airborne equipment.

Polymer retention is a big plus. Each of these Amphenol connectors uses a one-piece, molded polymer retention disc. (It's an advanced design we pioneered. For a closer look at how it works, see the cross-sectional view at lower left.) Polymer retention eliminates as many as 128 troublesome metal clips. And you know the fewer parts there are, the less can go wrong.

To learn more, call or write. Ask about the wide range of shell sizes, insert arrangements and termination tooling available for the Amphenol Connector 118, 418 and 518 Series. And ask for a free catalog, too. Call Vince Pusateri, (312) 986-3761. Or write: Amphenol Connector Systems, Bunker Ramo Corporation, 900 Commerce Drive, Oak Brook, Illinois 60521.

MIL-C-83723/Series III
Amphenol Connector 518 Series

MIL-C-38999/Series I & II
Amphenol Connector 418 Series

MIL-C-26482/Series 2
Amphenol Connector 118 Series



The right idea
at the
right time.

AMPHENOL Connector Systems **BUNKER RAMO**®

CIRCLE NUMBER 85

Design flyback converters for best performance. Analyzing the two basic operating modes gives the relationships between the important parameters.

Knowing how the output parameters of a flyback converter vary with voltage and load, you can optimize the converter for various requirements, such as maximum current limits or minimum transformer volume.

To analyze what happens in the choke, assume an ideal switch and linear operation for the inductance. The power stage and the time variation of currents and voltages at the transformer input and output are shown in Fig. 1.

The principle behind flyback converters is based on the storage of energy in a choke during a time period, t_1 , and the discharging of the energy to a load during a second period, t_2 . If isolation is necessary between the battery—the primary source of power—and the load, the primary of a transformer can play the part of the storage choke in addition to its normal role.

Analysis boils down to two modes

Although there are many different flyback-converter designs, just two basic modes of operation exist. In one mode (A), the energy stored in the choke is yielded totally to the load before the next cycle begins. In the other mode (B), the choke begins to recharge before discharge is completed.

In mode A, during t_1 , the input current increases linearly until it reaches a maximum value, I_{pM} , given by:

$$I_{pM} = \frac{E}{L_p} t_1, \quad (1)$$

where E is the battery voltage, and L_p the primary inductance. During t_2 , the current in the secondary decreases from a maximum of I_{sM} given by:

$$I_{sM} = \frac{V_s \text{ (off)}}{L_s} t_2, \quad (2)$$

where V_s is the voltage across the secondary, and L_s the secondary inductance.

The energy stored in the primary during t_1 , expressed by $1/2 L_p I_{pM}^2$, is transferred to the secondary with efficiency η_{tr} , a number that indi-

cates the quality of the transformer. From the relationship, $1/2 L_s I_{sM}^2 = \eta_{tr} 1/2 L_p I_{pM}^2$, comes:

$$I_{sM} = \sqrt{\eta_{tr} \frac{n_p}{n_s}} I_{pM}, \quad (3)$$

where n_p is the primary turns and n_s the secondary turns. Find the load current by integrating the secondary current for the period T and getting this result:

$$I_L = \frac{1}{2} I_{sM} \frac{t_2}{T}. \quad (4)$$

Since the rectifier loses power, a rectifying efficiency, η_R (significant for low output voltages) must be introduced. Thus:

$$\eta_R = \frac{V_L}{V_s \text{ (off)}}. \quad (5)$$

Using the notation, $\tau = t_1/T$, and introducing the over-all efficiency, $\eta = \eta_{tr} \eta_R$, the power delivered to the load can be deduced from Equations 1 through 5:

$$P_L = \left(\frac{1}{2} \eta \tau^2 \right) \frac{E^2}{f L_p}. \quad (6)$$

The value of t_2 as a function of the load can also be found:

$$t_2 = \sqrt{\frac{2 \eta_R L_s}{f R_L}}. \quad (7)$$

Expressions 4 and 5 can be reshaped for easier use in design. Thus:

$$I_L = \frac{1}{2} \left(\frac{n_p}{n_s} \sqrt{\eta_{tr}} \right) \frac{\tau (1 - \tau) E}{f L_p}; \quad (8a)$$

$$V_L = \eta_R \sqrt{\eta_{tr}} \left(\frac{n_s}{n_p} \right) \left(\frac{\tau}{1 - \tau} \right) E. \quad (8b)$$

What the equations show

Analyzing the equations reveals a number of things about converters working in mode A:

1. The maximum input current I_{pM} does not depend on load variations.

2. The power delivered to the load does not depend on the load value R_L . The converter provides a constant power, and the battery is isolated from the load for any output conditions, including no-load. For the no-load condition, the output voltage increases until the dissipation of the leakage resistances equals the constant power of the converter. At that point, t_2 is very short.

3. The power delivered by the converter de-

Vladimir Brunstein, Design Engineer, Nova Electric, 263 Hillside Ave., Nutley, NJ 07110.

depends on the product, fL_p , for a given duty cycle and battery voltage, E . In other words, for a given power, an increase in the frequency decreases the inductance, L_p , and, hence, the size of the ferrite core.

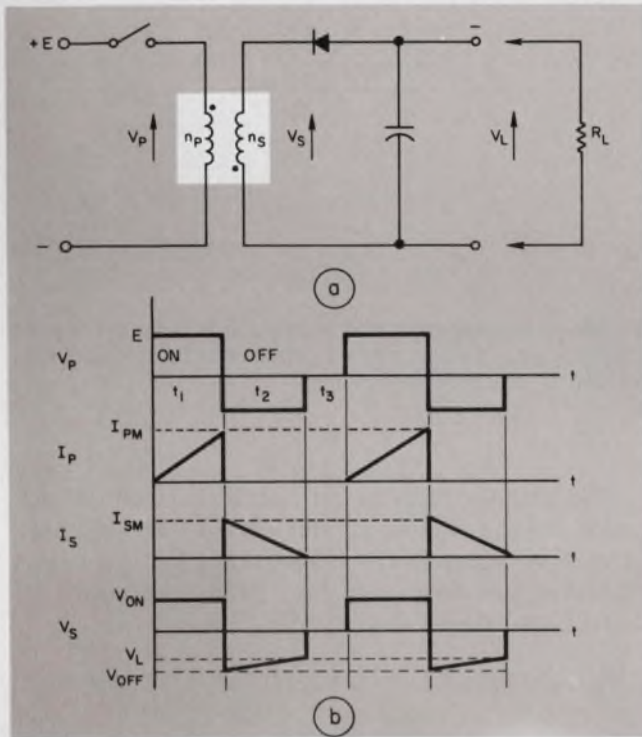

1. The power stage of a flyback converter can be idealized into an ideal switch and a linear transformer for analysis (a). The primary and secondary voltages and currents of the ideal converter (if all energy is discharged at each cycle) are shown in (b).

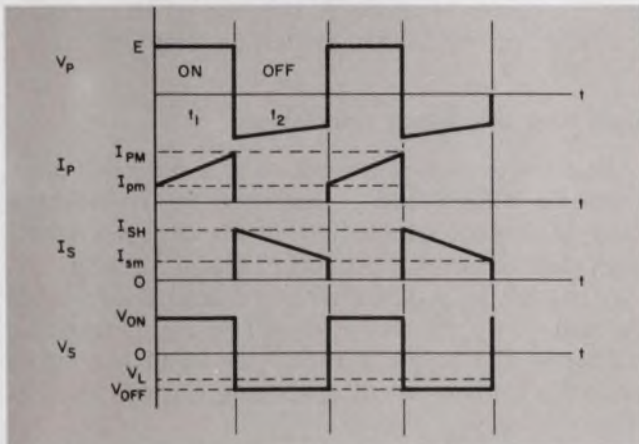

2. If all energy isn't discharged before the next cycle begins, then the flyback currents and voltages are somewhat different from those for complete discharge. Energy is stored during interval t_1 .

4. The values of τ or f , or both, can be modified through a feedback loop (usually the frequency is kept constant and only τ is varied) to stabilize values I_L or V_L with load variations.

In mode B, the primary and secondary currents and voltages are similar to mode A (Fig. 2). During t_1 , energy is stored by a linear growth of the current in the winding from a minimum value, I_{pm} (residual from the previous cycle), to a maximum, I_{pM} , where:

$$I_{pM} - I_{pm} = \frac{E}{L_p} t_1. \quad (9)$$

During t_2 , current appears only in the secondary and decreases linearly from a maximum of I_{sM} to a minimum of I_{sm} as follows:

$$I_{sM} - I_{sm} = \frac{V_s(\text{off})}{L_s} t_2. \quad (10)$$

Since switching occurs before the secondary current drops to zero, energy remains stored in the choke and is transferred back to the primary through the current I_{pm} . The relationship between the currents—similar to the one in mode A—is given by:

$$I_{sM} - I_{sm} = \frac{n_p}{n_s} (I_{pM} - I_{pm}), \quad (11)$$

and the load current is:

$$I_L = \frac{I_{sM} + I_{sm}}{2} \left(\frac{t_2}{T} \right). \quad (12)$$

Using the same notations as in mode A results in the following:

$$I_L = \frac{1}{2} \left(\sqrt{\eta_{lr}} \frac{n_p}{n_s} \right) \tau (1 - \tau) \frac{E}{f L_p} + \sqrt{\eta_{lr}} \frac{n_p}{n_s} (1 - \tau) I_{pm}. \quad (13)$$

$$V_L = \eta_R \sqrt{\eta_{lr}} \frac{n_s}{n_p} \left(E \frac{\tau}{1 - \tau} \right). \quad (14)$$

$$P_L = \frac{1}{2} \eta \tau^2 \frac{E^2}{f L_p} + \eta \tau E I_{pm}. \quad (15)$$

The values of I_{pm} and I_{pM} are given by:

$$I_{pM} = I_{pm} - \frac{1}{2} \frac{E \tau}{f L_p}; \quad (16)$$

$$I_{pm} = \frac{\eta_R}{\tau} \left(\frac{\tau}{1 - \tau} \right)^2 \left(\frac{n_s}{n_p} \right)^2 \frac{E}{R_L}. \quad (17)$$

In mode B, therefore;

1. The output voltage is not dependent on the load or the frequency. However, a weak dependency exists between V_L and the load through the efficiency, which depends on R_L .

2. The power delivered by the converter is a function of R_L , so protection against overload is necessary.

3. Voltage V_L can be stabilized against variations in E only by varying τ .

4. Eq. 16 shows that I_{pm} varies with the load

and, at a certain moment, can be zeroed. At that moment, a change in the working mode occurs since the increase of resistance R_L leads to mode-A operation.

5. For the condition, $I_{pm} = 0$, the equations for mode B become the same as those for A, where $t_3 = 0$, and $t_1 + t_2 = 1/f$. This case corresponds to a blocking-oscillator mode (self-oscillating fly-back). The limiting value for R_L can be obtained from any of the cited conditions.

For R_L in the blocking-oscillator mode, the frequency and the duty cycle vary according to:

$$R_L = \eta_r \frac{n_s^2}{n_p} \left[\frac{2 f L_p}{(1 - \tau)^2} \right]. \quad (18)$$

To illustrate the advantages and disadvantages of both modes, compare two converters with the same load, the same τ , and the same power delivered from a battery E.

How the modes stack up

Begin by comparing the regulation of the output parameters (voltage or current). Notice that the load current is inversely proportional to $\sqrt{R_L}$ in mode A and inversely proportional to R_L in mode B.

Consequently mode A is advisable for those converters with constant output current (for instance, remotely supplied amplifiers in cable-communication equipment), because the current variation to be stabilized for a given R_L is small. On the other hand, mode B is better for a converter of constant output voltage, because V_L is only mildly dependent on load variations (Eq. 14).

Comparing the maximum currents is important when the restricting element is the current limit of the semiconductor being used as the switch. From Equations 6 and 15, the output powers are:

$$P = \frac{1}{2} \tau E \eta I_{pM}, \text{ for mode A;} \quad (19)$$

$$P = \frac{1}{2} \tau E \eta (I_{pM} + I_{pm}), \text{ for mode B.} \quad (20)$$

Equating Eq. 19 to Eq. 20:

$$I_{pM} (\text{mode A}) = I_{pM} (\text{mode B}) [1 + k], \quad (21)$$

where $k = \frac{I_{pm}}{I_{pM} (\text{mode B})}$, and $0 < k < 1$.

So to obtain the same output power in mode B, the maximum current should be smaller and approach a limit that is half the value required in mode A. Specifically, k ranges between 1/2 and 2/3.

The primary inductance for both cases follows from Equations 1, 9 and 21:

$$L_{pB} = L_{pA} \frac{1 + k}{1 - k}.$$

Hence, for the same core, the turns ratio is:

$$\frac{N_B}{N_A} = \sqrt{\frac{1 + k}{1 - k}}. \quad (22)$$

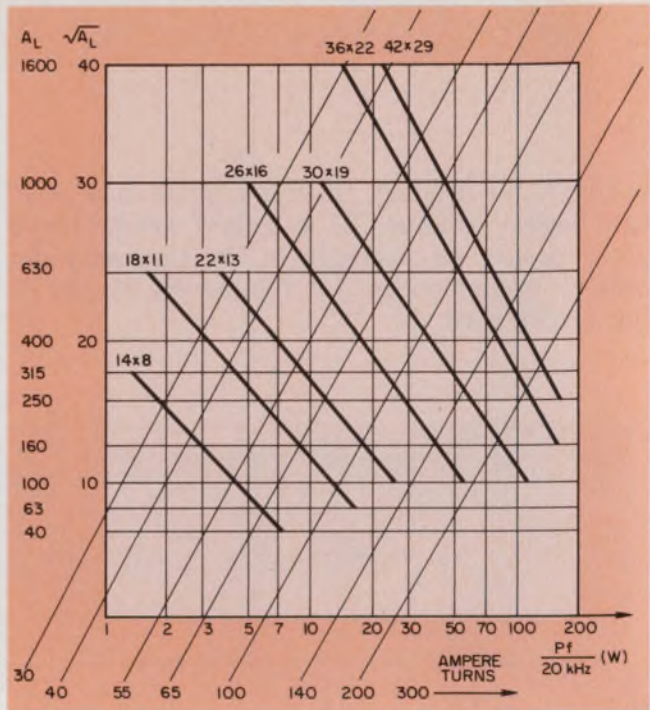

3. Taking the approximated straight line from the Hanna diagram, you can plot a more convenient family of curves for use in practical designs.

The greater number of turns in mode B depends on the factor, k , you choose. The number of ampere turns in the choke leads to the correct choice of the core's air gap. From Equations 21 and 22, it follows that:

$$N_B I_{pM} (\text{mode B}) = N_A I_{pM} (\text{mode A}) \left[\frac{1}{\sqrt{1 - k^2}} \right] \quad (23)$$

Hence, for the same core in mode A, ferrite saturation occurs later and additional power can be supplied.

A continued comparison shows that diminishing the number of turns in mode A decreases copper losses and that the ripple induced in the supply is greater in mode A because of the greater variation in mode A's switching current.

Designing the output transformer

The major difference between a flyback transformer's design and a feedthrough converter's is a dc-current component in the flyback windings that requires a properly chosen air gap.

With the help of Equations 6 and 8 for mode A, and 13 to 15 for mode B, you can find the values of the primary inductance and the turns ratio for a given set of specs and a given switching frequency.

Knowing L_p and L_s , you must then find the optimum core for the required power. That is, you can opt for either minimum volume or maximum efficiency (resulting in a lower temperature

increase in the core). The conventional procedure uses the well known Hanna curves, a family of core curves using the air gap or the A_L (inductance) factor as a parameter for each type of core.

Some data books provide a single Hanna diagram for all types of cores, but the values on the X or Y axis are normalized to volume or weight. In either case, using the diagrams is difficult when the starting point is the value of the output power. However, the curves can be redrawn.

Bear in mind that the Y axis on the Hanna curves represents the energy stored in the choke for a given ampere-turn product. In a flyback converter, this energy is transferred to the load at a rate of f times a second. Knowing that the product, $1/2LI^2f$, gives the output power of the converter (without the losses), and taking as a reference $f = 20$ kHz, you can compute the power values for each significant point on the Hanna curves.

Knowing that the saturation points for each A_L lie along an approximately straight line, you can plot a new family of curves for each group of cores (for instance, pot cores). The new family represents the saturation points, with A_L as a parameter and the output power and ampere turns, respectively, on the X and Y axes.

Replot the Hanna curves

A convenient diagram is shown in Fig. 3, in which $\sqrt{A_L}$ is plotted on the Y axis and $Pf/20$ is on the X axis (f is in kHz).

The diagram in Fig. 3 stems from Hanna curves found in the 1975 MBLE ferrite catalog (available from Philips, Eindhoven, the Netherlands). The straight lines represent only the core's nonsaturable mode. The relationships that govern the characteristics are as follows:

$$\frac{1}{2} LI^2 = k_1 NI + k_2,$$

which approximates linearly the nonsaturating portions of the Hanna curves, and

$$P = \frac{1}{2} LI^2 f,$$

$$A_L = \frac{L}{N^2}.$$

To design a transformer, start with the value of the output power. Divide it by the estimated efficiency to get the power the transformer should handle. Then choose the switching frequency and locate that point on the X axis. A vertical line from the X point intersects the curves at the values of A_L at which the cores will saturate. Since the inductance factor, A_L , has standard values, choose either the value below the intersecting point or a higher value on a larger pot core.

For the best transformer design, the copper and ferrite losses should be equal. This happens for A_L values between 160 and 250.

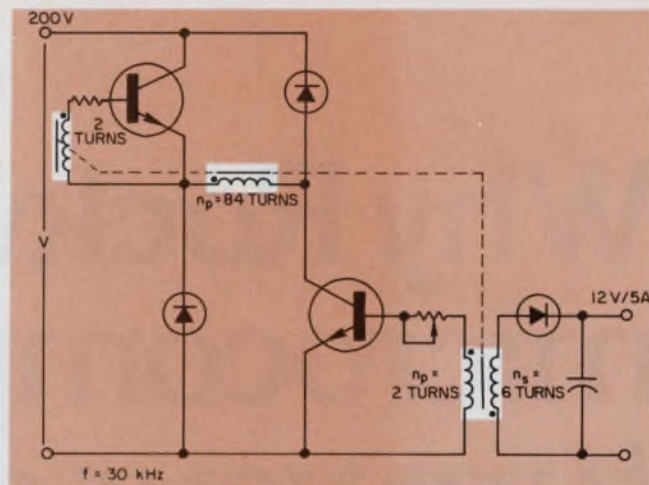

4. Practical flyback-transformer design starts with the values of the output power, frequency, and input and output voltages. Cores are selected from the modified Hanna curves, and the number of turns from the given equations. The switching transistor is selected to handle the calculated maximum current and the peak voltage.

The skin effect shouldn't be overlooked in evaluating the transformer's efficiency. At 20 kHz, efficiency can be increased with stranded wire. If you use solid wire, the diameter should not exceed double the penetration depth, or approximately 0.5 mm at 20 kHz.

Suppose you want a flyback, self-oscillating converter with the following values: $V_{in} = 200$ V; $V_{out} = 12$ V; $P_{out} = 60$ W; $f = 30$ kHz. With an assumed efficiency of 0.8, the input power equals 75 W.

From the diagram in Fig. 3, the 50-W point (for 20 kHz) corresponds to 75 W at $f = 30$ kHz. Following the vertical line from this point, you can see that this power can be handled by a couple of cores: $\phi 26 \times 16$, with $A_L = 100$; $\phi 30 \times 19$, with $A_L = 250$; and $\phi 36 \times 22$, with $A_L = 630$.

The optimum core is $\phi 30 \times 19$ since for the $\phi 26 \times 16$ core the copper losses exceed the core losses; for the $\phi 36 \times 22$ core, the core losses exceed the copper losses.

For a self-oscillating converter, the formulas for mode A are identical with those for mode B ($t_1 + t_2 = T$ for A, and $I_{pm} = 0$ for B). From Eq. 6 or Eq. 15, determine the value of L_p , assuming a maximum duty cycle (for $\tau = 1/2$, we obtain the value $L_p = 1.77$ mH). With $A_L = 250$, the number of primary turns is found from $N_p^2 = A_L/L_p = 84$. The number of secondary turns (six) is found from Eq. 8 or 14. To choose the switching transistor, calculate the maximum current for the inductance L_p . From Eq. 1 or Eq. 9, with $I_{pm} = 0$ and $t_1 = T/2$, $I_{pm} = 1.88$ A.

The feedback windings are designed conventionally, with the feedback voltage double the V_{RE} (Fig. 4). You can provide the converter with additional feedback control circuits for a regulated output. ■■

**Why Rockwell
microcomputers
turn your good ideas
into better
products.**

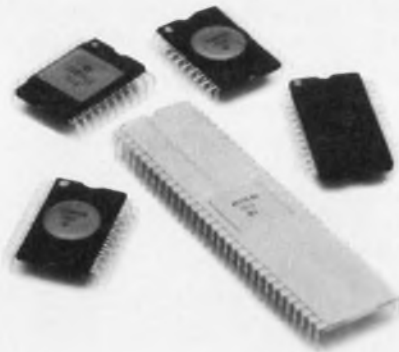

Rockwell's broad line of microprocessor systems are making all kinds of new products possible as well as practical because they fit the application so precisely. You get the right functional capability at the right price—and the Rockwell in-house capability to make sure your product idea becomes a reality.

The Rockwell advantage—a 5-family approach.

Rockwell offers five compatible microcomputer families, from low-cost one-chippers through multi-chip 8-bit systems. You select the most cost-effective microprocessor system for your immediate design requirements, then expand models up or down with our compatible systems. You don't need to redo your total program.

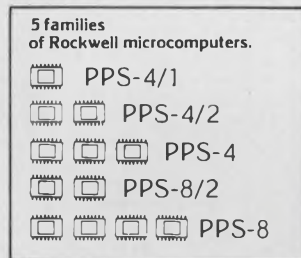

Our one-chip PPS-4/1 family with CPU, ROM, RAM, and 31 or more I/O ports cover a wide range of applications at lowest possible cost.

The two-chip PPS-4/2 and the multi-chip PPS-4 systems offer more power at low cost. Both have fast execution speeds, high throughput, and are expandable with dozens of LSI I/O peripheral controllers and memory options.

Rockwell's 8-bit systems include the PPS-8/2 (two chip microcomputer with I/O) and the fully compatible multi-chip PPS-8 system. Both use the same multi-function 109 instruction set and accept the same broad range of provided LSI memory and I/O controller options.

And Rockwell backs its microcomputers with all needed design aids and a worldwide network of applications centers, representatives and distributors.

Better products like these are made possible with Rockwell cost-effective systems.

Cash registers and P-O-S terminals—Inside some of the most popular machines on the market today are Rockwell microcomputers. At the low end, PPS-4/1 one-chippers. In P-O-S terminals, two-chip microcomputers combine with any of dozens of available LSI I/O and memory options.

Home and commercial products—Weighing scales, security systems, copiers, scanning

radios, hi-fi record changers and appliances are now being controlled or automated with Rockwell microcomputers.

High-speed printer—The functional ability and low cost of a six-chip PPS-8 Rockwell microcomputer is why it was selected to control a matrix printer which zip-prints at 200 characters/second and tabs at 550.

Hand held computer terminals—Two and a half hours of paperwork for meter readers and sales clerks are reduced to 30 seconds. The reason—a Rockwell PPS-4/2 microcomputer in a hand-held terminal that records transactions and interfaces directly with central computers.

Electronic games and pinball machines—Rockwell's compatible microcomputers are reducing manufacturing costs and shortening design time in all kinds of exciting new games. We have supplied custom design services for makers of these games.

Heart-monitoring bicycle exerciser—This unique but functionally complex idea was made economically possible with a Rockwell PPS-4/2 microcomputer. Rockwell is producing the microcomputer as a cost-saving subassembly.

Automobile computers—A 1977 production car has the first digital computer to control spark firing—based on a custom Rockwell two-chip system.

Stationary and mobile telephones—Our versatile one, two and multi-chip systems have expanded telephone usage with features like credit verification and automated mobile service. Other types of communications equipment, like auto-dialers and facsimile machines, now also use Rockwell microcomputers.

Get the full story. Write on your company letterhead to: Marketing Services, D/727-B Microelectronic Device Division, Rockwell International, P.O. Box 3669, Anaheim, CA 92803, U.S.A. or phone (714) 632-3729.



Rockwell International

Stabilize optical-sensing systems

with automatic light-intensity control. Negative feedback via the light path maintains the switching threshold accurately.

Anyone familiar with optical control and sensing systems knows how difficult it is to adjust and maintain light intensity and the alignment of the light path. And, adjusting multiple electro-optical channels is particularly difficult, especially when a system is called upon to sense less-than-perfect marks on colored or soiled documents.

If the documents are fully opaque and no dust accumulation occurs on the optical devices, choosing a safe, fixed switching level to differentiate "white" from "black" will not be a problem.

However, relatively thin documents may easily transmit 20% of the incident light, and a grease spot may let up to 30% of the light pass through. Even a small amount of dust on the light source or sensor window can cut the light transmission substantially. These problems, taken together with unavoidable tolerances, can make unattended reliable sensing for long periods almost impossible with the use of fixed switching levels.

Automatic light-intensity control (ALIC), however, has proven itself on both see-through and reflective systems, such as for sensing through translucent documents in a dusty environment and low-contrast marks on documents of varying reflectivity.

A servo-loop serves the system

A typical (but simplified) two-level ALIC system (Fig. 1), shows a closed-loop feedback system consisting of a differential control amplifier, A_1 , and driver circuit, D_1 and Q_L . A LED light source, LD, and phototransistor, PS, close the loop via the sensing path. A second differential amplifier, A_2 , with its driver, D_2 , produces a black/white logic-level output, V_o .

A white-light level on the document (maximum light), transmitted from the LED to PS, produces an input voltage of $V_B = 1.82$ V to the two differential amplifiers. With R_2 equal to 30 k Ω , I_p is about 62 μ A and automatically kept there by the negative feedback loop.

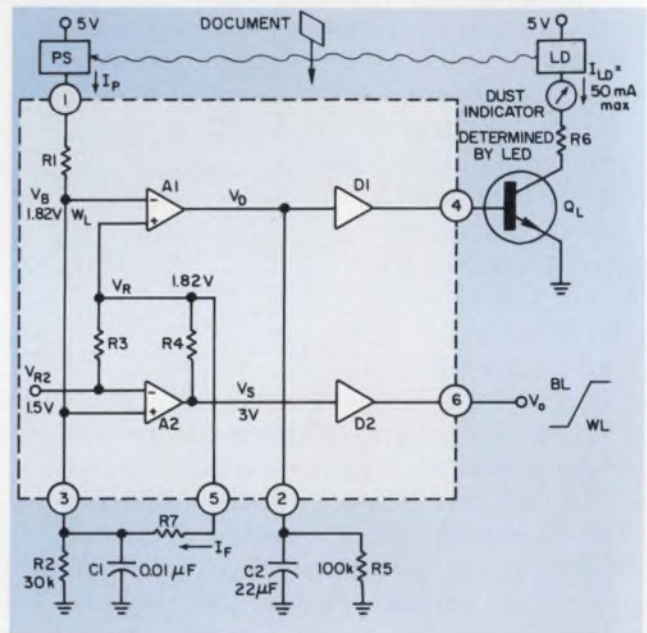

1. In this simplified diagram of an automatic light-intensity control, the differential control amplifier, A_1 , with its drivers, D_1 and Q_L , controls the LED light source; the differential switching amplifier, A_2 , with its output driver, D_2 , provides a logic output. The logic switching point is determined by the internal reference voltage V_{R2} , which—along with R_3 , R_4 and the voltage swing at V_S —establishes the reference voltage, V_R , for the differential amplifier, A_1 .

Capacitor C_2 (22 μ F) provides heavy damping to prevent oscillations or overshoot and also slows the loop's response. Therefore, only slowly changing light intensities are compensated. The C_2 and R_5 combination limits the LED-current rate of change to about 6 dB in 50 to 100 ms—much too slow to respond to small marks on a document. Rapid response to obtain the logic level outputs is provided by a separate path via A_2 and D_2 .

If V_B rapidly drops to, or below, A_2 's reference-voltage level of 1.5 V, when a black mark is sensed, V_o switches to the black level. At the same time, the A_1 reference voltage, V_R , drops from 1.82 V (WL) to 1.24 V, but the rapid change doesn't affect the LED current.

However, note that for extended black periods V_B stabilizes at a level equal to 1.24 V (BL) and

I_p at $42 \mu\text{A}$ (Fig. 2). Thus the ALIC has a two-level threshold reference—BL after the input signal has been “black” for an extended period and WL after the signal has been at the “white” level. Also, note the fast compensation of overshoot in the white directions when compared with the slow response to a black excursion. Both the two-level threshold and a special discharge-path circuit for capacitor C_2 under “high” input-current conditions, which produces this black/white re-

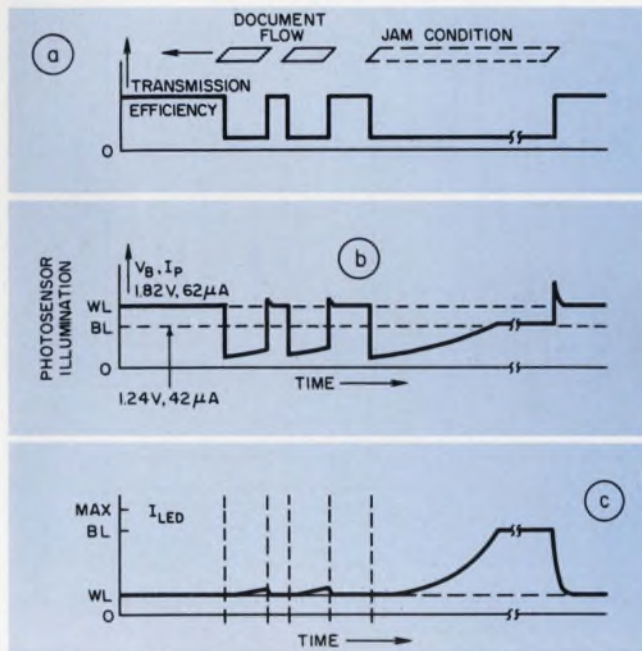

2. In a typical see-through, document-sense application, the transmission efficiency, I_p/I_{LD} , shown in curve A, is a measure of the light reaching the photosensor, if I_{LD} is constant. Curve B represents the actual I_p in an ALIC system, if translucent documents let about 20% of the impinging light pass through. In curve C, note particularly that the LED current rises slowly to the BL level when the illumination is low, and falls quickly to the WL level from a fully illuminated condition.

sponse discrimination, is discussed in detail for a single-chip implementation of the circuit (Fig. 3).

A single-chip implementation of the ALIC

Although the ALIC circuit can be built with discrete components and IC differential amplifiers and drivers, integrating most of the circuit into a single IC package (Fig. 3) provides money and space-saving ways to handle multiple-channel optical systems. Two such circuits have been built on an 82-mil-square silicon chip.

Transistors 1 through 8 and an external damping network (the equivalent of R_5 and C_2 in Fig. 1) form the automatic LED control circuit and provide a minimum open-loop gain of 126 dB. The reference voltage, V_R , is either 1.82 or

1.24 V, depending on the state of switching transistor 23. Transistors 9, 10, 11, 16 and 23 provide the output logic function equivalent to A_2 (Fig. 1), and transistors 17, 18, 19 and 20, equivalent to D_2 , act as the output driver. Transistor-diodes 12 through 15 establish voltage-reference levels, with diode 15 serving in the constant-current circuits of transistors 4, 8, 11, 16 and 18.

As in Fig. 1, with the so-called full white condition ($I_p = 62 \mu\text{A}$ and $V_B = 1.82 \text{ V}$), transistors 9 and 23 are fully ON and holding the output V_o at its down-level state and V_R at 1.82 V.

Switching occurs when a signal causes the input current to drop at least 20%—from 62 to 50 μA or less—which decreases the input voltage, V_B , below the switching reference voltage, V_{R2} . Transistors 9 and 23 turn OFF, which switches the output to HIGH and the V_R to the black value—nominally 1.24 V. Current I_p is now regulated toward 42 μA for this new V_B of 1.24 V through control of the LED current.

The fast white-level restore function previously mentioned is provided by transistor-diode 3 in combination with transistor 1 and diode 15. As the input voltage rises above 2 V, diode 3 bypasses constant-current source transistor 4 and allows the collector current to transistor 1 to increase to 1.2 mA (limited by $R_2 = 1 \text{ k}\Omega$). This action produces a discharge rate for C_2 that is 50-times faster than the 24- μA , black-level charge current (limited by $R_3 = 100 \text{ k}\Omega$).

Threshold and hysteresis are adjustable

The circuit's built-in switching level and threshold values are determined by resistors R_{10} and R_{11} (equivalent to R_3 and R_4 in Fig. 1). These resistors can be chosen to provide almost any desired combination of values for the WL and BL thresholds. And for fast, reliable snap-action, a small switching hysteresis—about 3%—is built into the circuit of Fig. 3.

When transistors 17 and 23 turn off, current through diode chain 12 to 15 increases. Consequently, the switching reference voltage, V_{R2} , rises from 1.46 V to about 1.50 V to produce the built-in hysteresis with terminals 5 and 6 open.

As much as a 40% hysteresis can be achieved with a resistor (30 $\text{k}\Omega$ minimum) between terminals 3 and 5 (equivalent to R_7 in Fig. 1). However, because resistor R_7 provides positive feedback from the reference voltage V_R to the input V_B , not only the hysteresis, but also the switching thresholds are affected by a change in R_7 . This interaction is normally desirable, because both hysteresis and switching levels increase together, providing higher noise immunity for lower sensitivity setting.

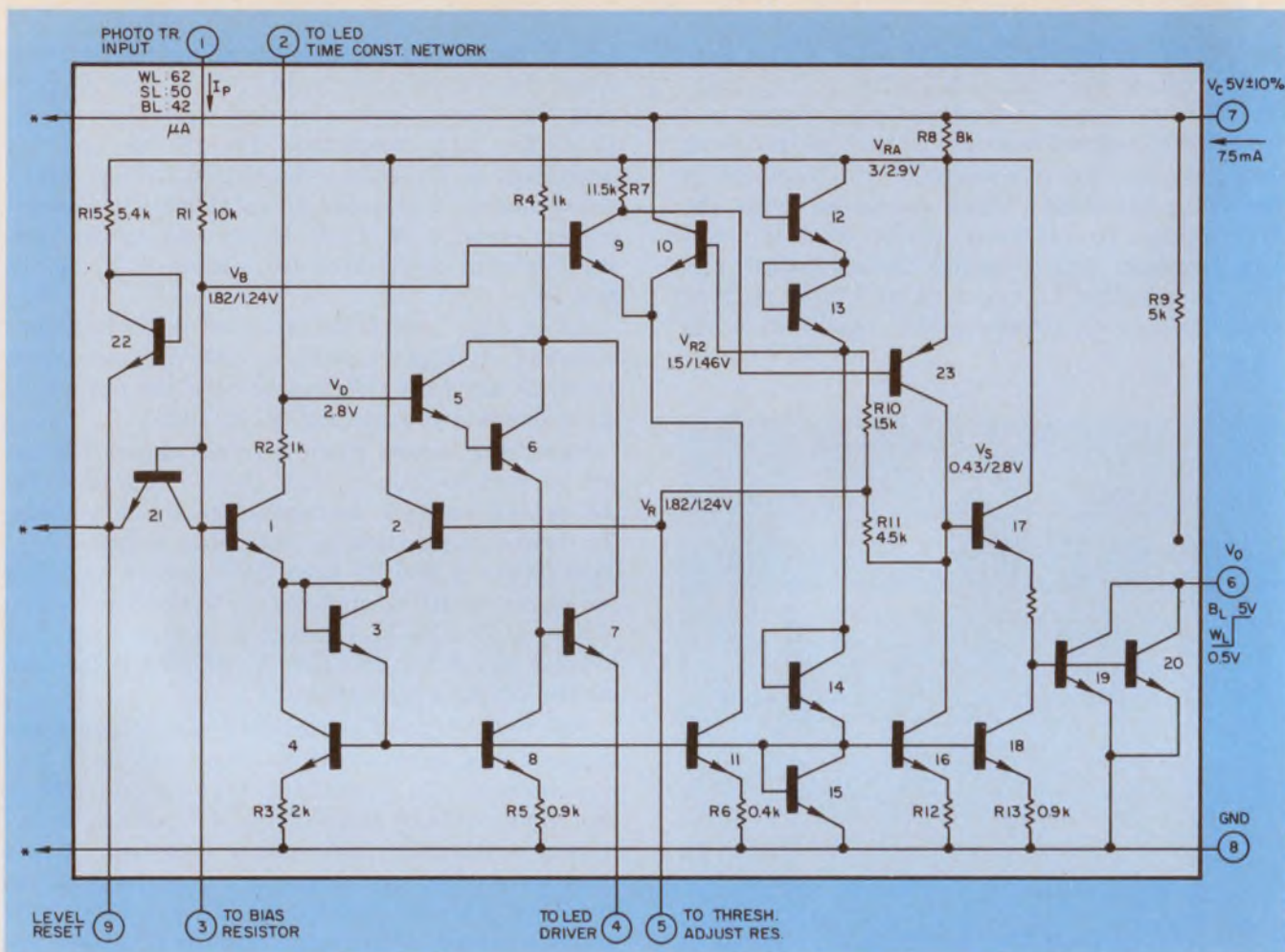

3. Two ALIC circuits can be integrated on an 82-mil-square IC chip. Only one of the two circuits per chip is

shown. The circuits are connected together at the asterisk-marked points.

The IC version includes a reset feature provided by a diode network that connects reset terminal 9 to the positive voltage source, V_c . The reset feature is used for both testing and initializing the circuit to the WL state.

Initialization is the reset feature's main function. When the power to the circuit is first turned on, the circuit normally assumes the BL state, because capacitor C_2 charges slowly. The circuit, however, changes to the correct state—BL or WL—automatically only after the first signal transition. Some cases, however, require an initial WL condition—for example, to correctly identify the leading edge of the first document.

A voltage less than 0.6 V applied to terminal 9 forward-biases diode 21 and forces V_b below its BL reference voltage of 1.24 V. This applied voltage simulates an extreme black signal; thus, all currents and voltages assume their BL values, and I_p , V_d and I_{LD} rise toward their maximum saturation levels. When terminal 9 opens, or a voltage above 1.2 V is applied, at the end of this down signal, the circuit automatically assumes the WL state, provided a white optical condition exists. The downward reset signal should be at least 50 ms wide.

The ALIC circuit design allows loose component tolerances as well as a large range of input conditions. Even the black and white threshold levels, which are normally the only critical values, depend only on resistance ratios— R_3/R_4 in Fig. 1, and R_{10}/R_{11} in Fig. 3—rather than absolute values. For different applications, these ratios and the components that determine the maximum LED current, input current, time-constant, high-frequency response and the adjustable portion of the switching threshold and switching hysteresis can all be changed over a wide range.

Both parts and temperature are uncritical

Temperature influences the threshold levels less than $\pm 5\%$ between 10 and 60 C, and a $\pm 10\%$ power-supply variation has negligible influence because of built-in voltage regulation (Fig. 3). A total threshold tolerance of $\pm 10\%$ can easily be achieved with ordinary IC-component tolerances and low-tolerance discrete components.

Exposure to high-frequency noise is not a serious problem, despite the low current and high impedance of the circuit's input, even with the

photosensor at a large distance from the amplifier. The signal frequency is low; thus, a filter capacitor, C_1 , as large as $0.01 \mu\text{F}$ can be used across the amplifier input to suppress noise above 20 kHz without affecting signals with rise times of 0.1 ms or greater. For faster rise times, C_1 may be reduced; for extremely high-speed applications, photodiodes should be used with a pre-amplifier mounted near the sensor.

Dust indicator: a circuit feature

In many applications, an early warning of the system's dust-accumulation status minimizes the need for frequent routine cleaning. Also, early warning can be a valuable diagnostic tool for identifying deteriorated or nonaligned components.

Normally, the LED current increases with dust accumulation and other degrading influences, which cause the collector voltage of the LED driver, Q_L (Fig. 1), to decrease proportionally. Once saturation of Q_L occurs, the circuit has reached its operational limit. To the point of saturation, the collector voltage of Q_L directly indicates the system's remaining safety margin, and indirectly indicates the amount of dust accumulated in the optical path.

The ALIC's ability to overcome the dust problem in optical sensing is of equal importance with the circuit's insensitivity both to loose tolerances and a wide range of input conditions. Consequently, the ALIC principle can work with fluorescent, neon or incandescent lamps and almost any optical sensor, and, the principle can even extend to work with ultrasonic and magnetic sensing, among others.

The need for only low average light intensity is an important side benefit of the ALIC concept: Decreased power dissipation allows a long life for the light source.

Unfortunately, since each sensor in the ALIC system must have its own light source, sensor arrays with a common light source can use the ALIC principle only in a compromised form. But this problem should be readily solvable with the wide variety of available small LEDs that allow the use of closely spaced arrays of individual light sources to replace single sources. Also, the IC design of the ALIC circuit allows low-cost use of many circuits.

However, large arrays may suffer from optical crosstalk. Optical crosstalk between the LEDs and sensors in an array can become troublesome, especially where a common glass covers the LEDs and sensors. Internal reflections in the glass can mix the signals. Such reflections increase rapidly with even a thin layer of dust on the outside surface. But crosstalk is easily avoided with care in design of the optical paths. ■■

SCHOTTKY BARRIER RECTIFIERS

AVAILABLE FROM STOCK

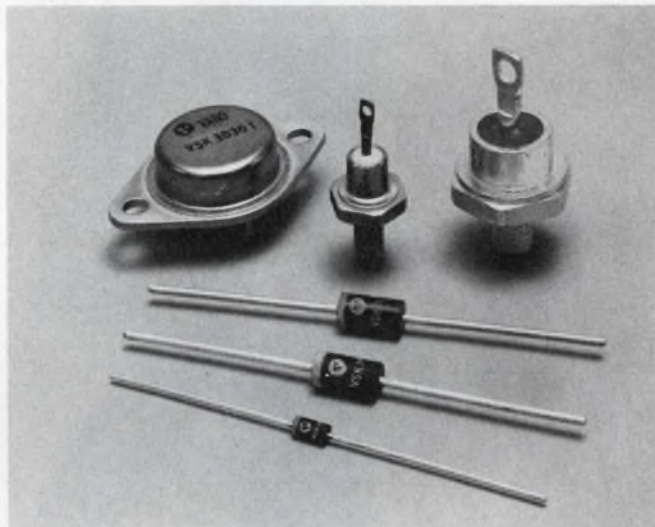

Varo Schottky Barrier Rectifiers offer you many significant advantages:

VERY LOW FORWARD VOLTAGE DROP (V_F)

Because of the large metal-barrier-to-silicon junction, V_F ranges are from 550 mV, $I_F = 1 \text{ A}$, to 620 mV, $I_F = 40 \text{ A}$. This results in less heat dissipation, low power loss, and greatly improved efficiency.

EXTREMELY FAST RECOVERY TIMES (t_{rr})

Typically $\leq 10 \text{ nsec}$. Schottkys are ideally suited for low-voltage power supplies, free-wheeling diode and flyback diode applications, and polarity protection in high-speed switching circuits.

MAJORITY CARRIER CONDUCTION

In addition to fast recovery, Schottky barrier construction results in high surge capacity and low stored charge. Schottkys are not subject to conventional P-N diode forward and reverse recovery transients caused by minority carriers.

OTHER VARO SCHOTTKY FEATURES ARE:

- -65 to $+150^\circ\text{C}$ junction operating temperatures
- 1 A, 3 A, 5 A, 15 A, 30 A and 40 A (I_O) ratings
- 20V, 30V, and 40V (V_{RRM}) ratings
- Low reverse leakage
- Epoxy axial lead, DO-4, DO-5, and TO-3 package configurations
- Competitive pricing

Try one in your circuit; you will see for yourself these advantages and more.

For more information and data sheets on all Varo Schottky Barrier Rectifiers call Mike Hawkins, 214/272-4551



Design us in . . . we'll stay there **VARO SEMICONDUCTOR, INC.**

P.O. BOX 676, 1000 N. SHILOH, GARLAND, TEX. 75040

(214) 272-4551 TWX 910-860-5178

EUROPEAN OFFICE: UK: VARO SEMICONDUCTOR INTERNATIONAL, INC.
Deepdene House, Bellegrave Road, Welling, Kent, England DA163PY, 01-304-6519/0

CIRCLE NUMBER 34

CMOS and PMOS compatible 9668. All four are available in a 16-pin plastic package with optional copper lead frame which increases power dissipation to 2 Watts.

8-BIT D-TO-A CONVERTERS

Our new industry standard 8-bit DACs include the μ A0801 pin-for-pin replacement for PMI DAC-08, and the μ A0802 pin-for-pin replacement for Motorola's MC1408 and 1508. Both devices will interface directly with most other logic families. They provide lower power dissipation and more speed than competitive products. They're available in a cost-effective plastic package for industrial applications.

ALL YOUR FAVORITES, TOO

Following is a summary of the Fairchild Interface product line. Most devices are available in commercial and military temperature ranges, molded and hermetic packages and processing to Class B or MIL STD 883A. They're also available right now at the right price.

FAIRCHILD INTERFACE PRODUCTS				
Memory Drivers/Sense Amps				
9643	9647/A*	55/7534/35	55/75224/225	55/75325
9644	9648/A*	55/7538/39	55/75232/233	55/75326
9645*	55/7524/25	55/75207	55/75234/235	55/75327
9646*	55/7528/29	55/75208	55/75238/239	
Peripheral Drivers				
9665	55/75430	55/75450A/B	55/75460	55/75471
9666	55/75431	55/75451A/B	55/75461	55/75472
9667	55/75432	55/75452A/B	55/75462	55/75473
9668	55/75433	55/75453A/B	55/75463	55/75474
	55/75434	55/75454A/B	55/75464	
Line Drivers/Receivers				
9612	9621	9634*	55/75107A	55/75121/8T13
9613	9622	9636	55/75107B	55/75122/8T14
9614	9626*	9637	55/75108A	55/75123/8T23
9615	9627	9638	55/75108B	55/75124/8T24
9616	9628*	9640*	55/75109	75150
9617	9629*	9641*	55/75110	55/75154
9620	9630*	9642*	55/75112*	1488*
				1489/A*
Display Drivers/Other				
9624	9664A	55/75491	55/75491B	55/75492A
9625	9664B	55/75491A	55/75492	55/75492B
9664				

*TO BE ANNOUNCED

If you don't see what you need, or you need more information on what you've seen, call or write your Fairchild sales office, distributor or representative today and ask for a line card. Fairchild Camera and Instrument Corp., Linear IC Division, 464 Ellis Street, Mountain View, CA 94042. TWX: 910-379-6435.

FAIRCHILD

**CALL US ON IT.
(415) 962-2444**

Transient-free pulsed acoustic sinusoids generated with phased-array speakers

When testing an acoustical-to-electrical transducer such as a microphone, it is often necessary to drive it with bursts of acoustic sinusoidal signals. But speakers are notorious for their poor transient responses. Thus, difficulties occur in deciding whether questionable characteristics of the test data result from the unit under test or from a poor acoustical-input signal.

The circuit (Fig. 1), with the use of principles known for years by rf-antenna designers, can provide a microphone with a distortion-free burst of acoustic sinusoids in free space. The circuit doesn't use the obvious approach of driving a speaker with a gated sinusoidal signal. Instead, two speakers in a phased-array configuration (Fig. 2) provide the bursts. Both are fed an identical, continuous sinusoidal signal. Almost any two speakers will do.

The microphone is placed, as shown, between the two speakers. The circuit sequentially changes the phase of the signal to one of the two speakers by 180 degrees (Fig. 3). The signal "seen" by the microphone is then either a sum or a cancellation of the two speakers' outputs. Moving the test microphone around allows you to obtain virtually any ratio of high-to-low ampli-

tude for pulse testing.

The secret of the circuit lies in ensuring that the phase of the one speaker changes at the right time. Otherwise, the original transient-distortion problem will be still there. The phase should only change when the sinusoid is at a positive or negative peak, when the speaker diaphragm travels at zero velocity. At this point, a phase change merely causes the speaker to remain stationary a little longer.

In the circuit, the clock signal starts at twice the desired output frequency and is divided in half by IC_{5A}. Then, after passage through a low-pass filter, it is amplified and drives one of the speakers, S₁. The low-pass filter suppresses the higher harmonics of the digital signal, E. Of course, the better the filter, the more sinusoidal the signal out of speaker S₁. For most applications, a simple two-pole active or passive filter is sufficient.

The TTL-level input labeled Gate controls the phase relationship between the two speakers. This signal can be provided by a switch, pulse generator or any TTL-logic source. Signal A (Fig. 3), a retimed version of the gate signal, is converted to pulses, C, which cause IC_{5B} to "skip"

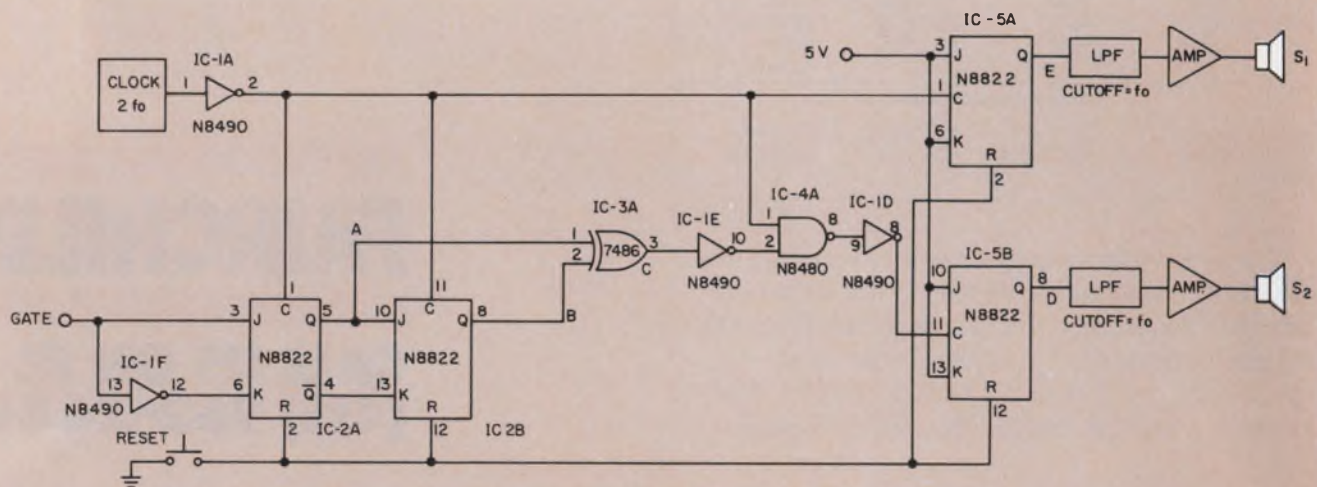

1. The phase of the signal to speaker S₂ is switched 180 degrees, sequentially, at the peak signal

amplitudes to produce ON/OFF bursts of transient-free pulsed acoustical signals.

Amphenol® 17-Series rear-release connectors, contacts, and crimpers.

A family that
works together
to save
together.

Cut your assembly costs with a total termination systems approach. Our 17 Series has everything you need for rear-release, input/output connections for data transmission. You get the lowest possible installed cost.

First, the connectors: 50% less costly to assemble. These rear-release connectors permit fingertip contact insertion. Without insertion tools. You can snap several of our crimp Poke-Home® contacts in place in the time normally required for a single contact inserted with a tool. So you can cut labor costs in half—at least. And no special skills or training are needed either.

Some important electrical improvements, too. Our 17 Series connectors have a shrouded rear-release insert to prevent shorting and arc-over. No potting or sleeving is required. These connectors meet EIA Standard RS-232C for data-communication input/output connectors and have an insulation resistance greater than 5000 megohms, per MIL-STD-202A, Method 302.

Second, the contacts: big savings for volume users. With our 15,000-contact capacity reels, you can save a bundle over loose contacts.

Finally, the crimpers: high-speed for lowered costs. Our new hand crimp tool makes accurate, identical crimps—time after time. And our semi-automatic crimping machine can turn out up to 2000 terminations per hour.

Get them all—connectors, reeled contacts, crimpers. And get them now. Five basic contact configurations in 17 Series connectors are now available. So is all termination equipment, backshells, and accessories. For more details, contact: Bob Ashley, Amphenol Connector Systems, Bunker Ramo Corporation, 900 Commerce Drive, Oak Brook, Illinois 60521.

The right idea
at the
right time.

AMPHENOL Connector Systems **BUNKER RAMO**®

CIRCLE NUMBER 36

Hand crimpers
and semi-automatic
crimping machine.



IDEAS FOR DESIGN

(continued from page 78)

a clock pulse corresponding to the beginning and end of each gate signal.

Whenever IC_{5B} misses a clock pulse, signal D remains in its previous state until the next clock pulse. The result is a 180-degree phase change with respect to signal E.

Signal D is low-pass filtered and amplified, as in the case of signal E, and then fed to the speaker, S_2 . A reset switch ensures that both speakers start out in phase. The sum of signals from the two speakers ($S_1 + S_2$) is "seen" by the microphone in the median-plane between the two speakers.

Of course, an anechoic chamber is the ideal environment in which to use this system. However, good results are easy to get with two small speakers separated about a foot, with the test microphone only a few feet away between them. On-to-off amplitude ratios of 30 dB can be obtained in almost any room. The relative positions of the speakers and microphone are not critical. With reasonable care, experimental repeatability is no problem.

*William F. Lawrence, Electronic Engineer,
707 Kingston Rd., Towson, MD 21212.*

CIRCLE No. 311

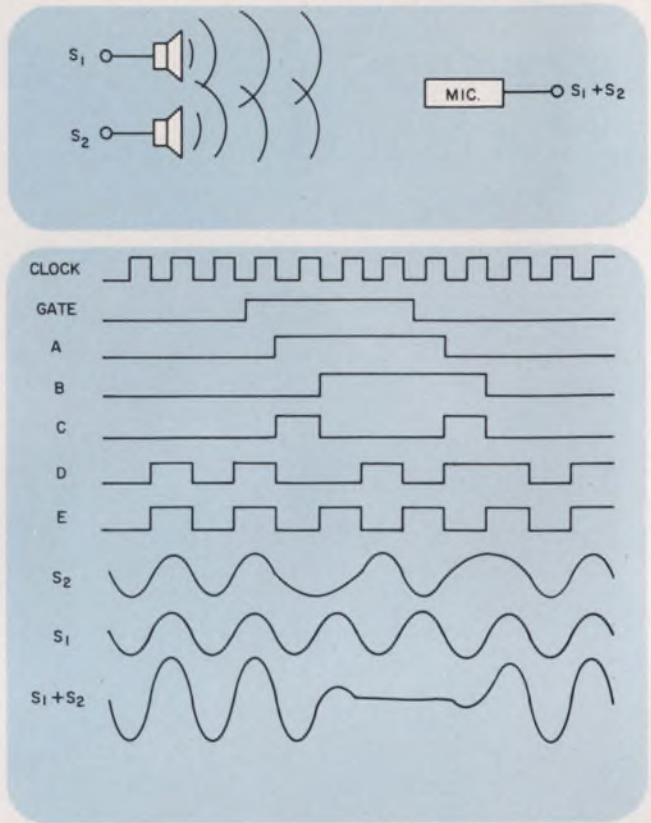

When it's time to swit

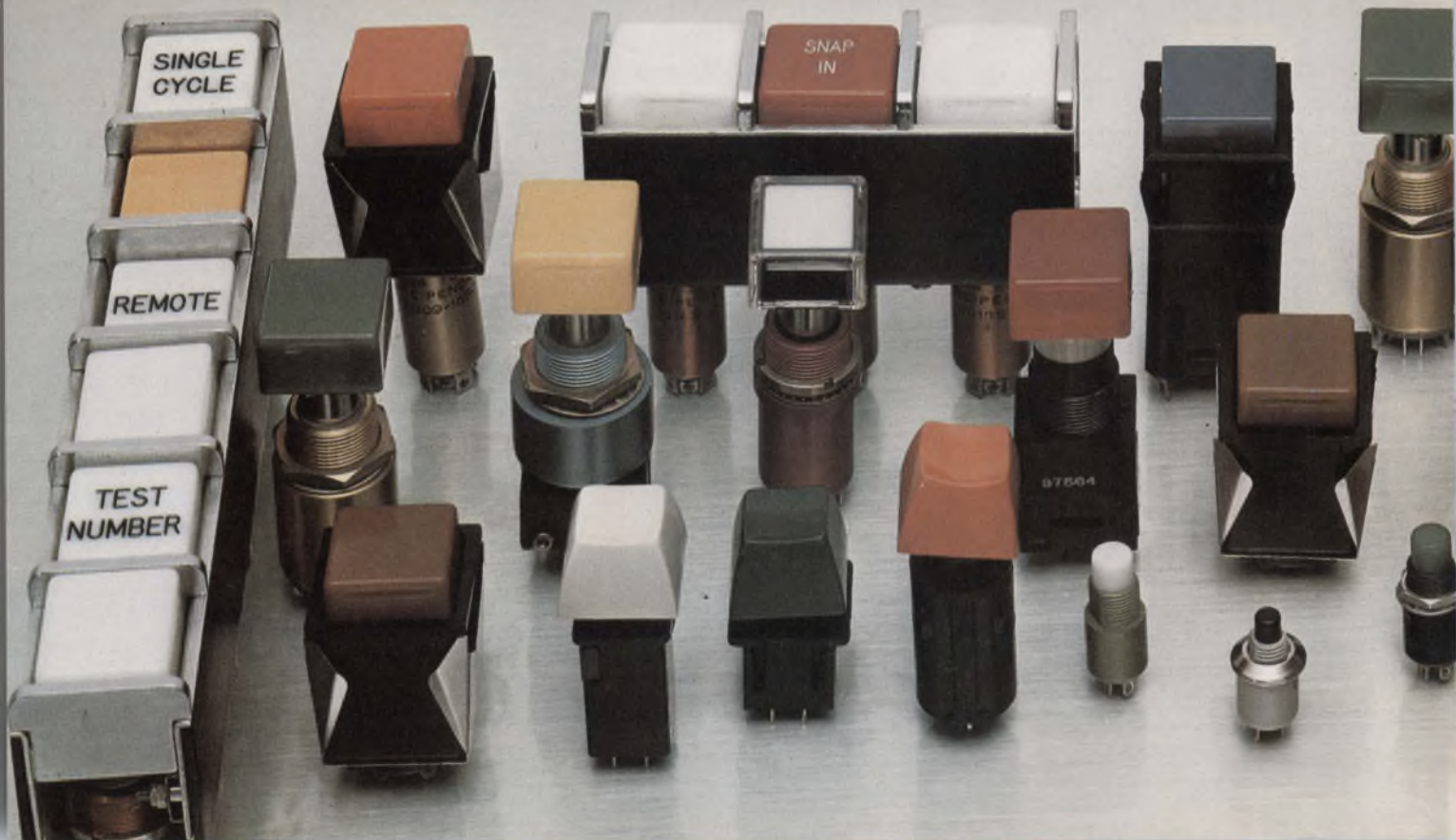

Diodes act as temperature sensor in remote temperature-measuring circuit

A remote temperature probe can be built from ordinary diodes. The probe senses temperature by the change of voltage drop across several forward-biased silicon diodes. With such a probe outside temperature can be measured from inside a building. Even the water temperature at the bottom of a lake can be remotely measured with the sensor.

The circuit (Fig. 1) compares the voltage across the diode sensor with a voltage set with potentiometer R_L . As the temperature increases, the voltage across the sensor decreases at the rate of $2 \text{ mV}/^\circ\text{C}$ for each diode in the probe.

The circuit shown uses four diodes. Over a $25\text{-}^\circ\text{C}$ temperature range, the voltage change across the diodes is 200 mV . This voltage change causes a $50\text{-}\mu\text{A}$ current change into a $4\text{-k}\Omega$ impedance.

With the probe exposed to the lowest temperature of interest, the meter is set to zero with the $5\text{-k}\Omega$ potentiometer, R_L . The meter is adjusted to full scale with R_H , the series $2\text{-k}\Omega$ resistance, when the probe is exposed to the highest temperature of interest. The zener diode and transistor regulate the voltage to the probe, so that

readings are relatively independent of battery-voltage fluctuations.

Donald C. Elmore, Principal Engineer, Electronic Communications, Inc., P.O. Box 12248, M/S 22, St. Petersburg, FL 33733.

CIRCLE NO. 312

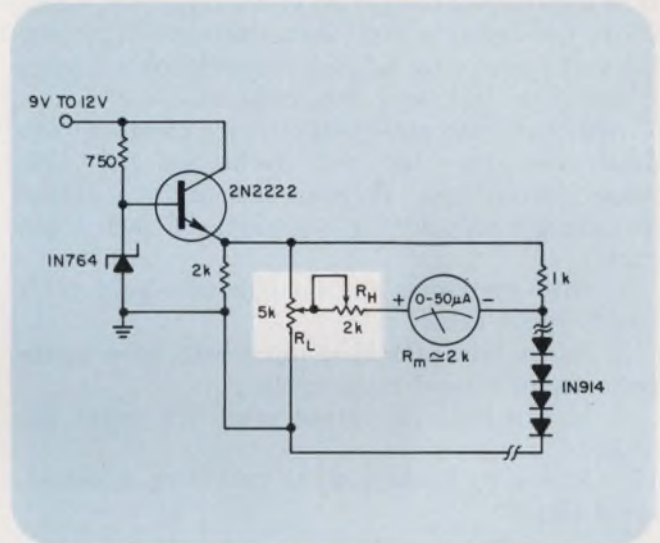

ch...switch to CLARE.



There's an outstanding CLARE SWITCHING DEVICE waiting for your application.

From switchlights to indicators. Interlocked gangswitch assemblies to advanced key switch designs. All backed by a quarter century of Clare-Pendar quality and reliability . . . combined with the proven service capabilities of C. P. Clare.

Ready for a switch? Contact your local distributor. Or, C. P. Clare & Company, 3101 W. Pratt Avenue, Chicago, Illinois 60645. Phone (312) 262-7700.

**C. P. CLARE & COMPANY
GENERAL INSTRUMENT CORPORATION**



CIRCLE NUMBER 46

Heart-beat monitoring circuit provides steady output and a missed-beat alarm

A new technique¹ called rate matching neatly circumvents the problems of pulse-averaging methods commonly used in frequency-meter circuits for applications like heart-rate monitoring. With pulse averaging, since the desired response time approaches the period of the measured waveform, the designer must either accept output ripple and a wavering ratemeter needle, or use more filtering to slow down the response.

Although rate matching is more complex than pulse-averaging, the new technique has four major advantages. Because the circuit's output can change only at the beginning of each input cycle:

1. Rate matching has a ripple-free output for steady input rates;
2. It can track the base input rate, even in the presence of missed input cycles;
3. It can hold its output after the input has ceased;
4. It readily lends itself to providing a missed-cycle alarm.

The rate-matching circuit (Fig. 1) uses negative feedback to match a ramp rate to the input rate. The input signal passes through a pulse former that generates a short pulse at the beginning of each input cycle. The pulses then drive an analog switch labelled reference/reset.

An integrator, A₁, with no input resistor, presents a virtual ground that fully discharges capacitors C₁ and C₂ transferring the algebraic sum of their charges to C₃ each time an input cycle causes the analog switch to "operate." Capacitor C₄ merely absorbs switching transients; its value is not critical.

After each discharge, a new ramp voltage starting from zero builds up across C₁ at a rate proportional to V_o, the output of A₁.

If reference voltage V_r charges C₂ to be equal and opposite to the charge on C₁, then their combined discharge into the integrator has no effect on V_o. However if the rate of ramp build-up across C₁ is slow, the C₁ charge doesn't balance

(continued on page 84)

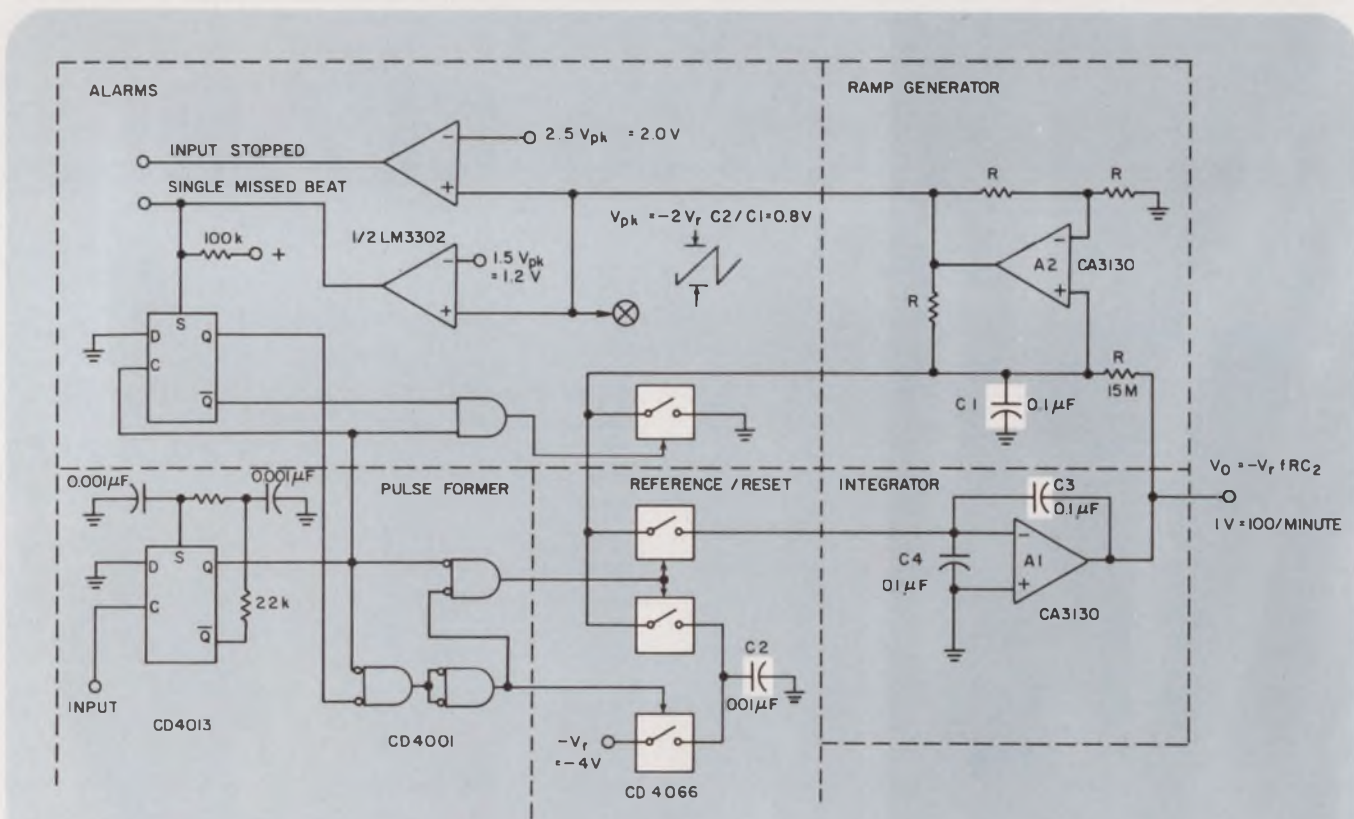

1. A heart-beat monitoring circuit uses a CMOS quad 4066 analog switch to control transference of

charge from C₁ and C₂ into the integrator-circuit's storage capacitor, C₃.

Opening new frontiers with electro optics

PMTs with GaP dynode give scientists outstanding PHR.

If you're a nuclear or plasma scientist, you should know about RCA photomultipliers with gallium-phosphide first dynodes. They provide a gain of 30 to 50, vs. the usual 4 to 8 using conventional dynode materials. This high gain provides a PHR (Pulse Height Resolution) capability that permits the discrimination of up to 5 photoelectron events — impossible with conventional PMTs. Our 8850 PMT and larger 8854 have these GaP first dynodes. They're part of RCA's line of alkali and S-11 types for the nuclear physicist.

Let us help you choose the PMT best suited to your needs.

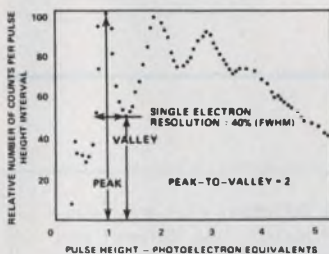
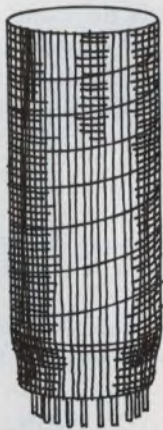

Circle 201

Timesaver for spectroscopists: PMT circuit in a socket.

No longer do you have to design circuitry to get the right voltages for photomultipliers. We've done it for you. Just plug the PMT into one of our compact solid state power supplies, apply 12 volts dc, and here's what you get: regulated —500 to —1250 V controlled by resistance or voltage programming (Model PF1042) or —100 to —1250 V that varies directly with input voltage (PF1043). Both power supplies work with most side-on PMTs in RCA's broad line, covering UV to near IR (165 to 1200 nm). Some have broad range, others focus on the visible region. Ask for in-depth applications help from RCA.



Circle 202

RCA announces a new SI Imaging Device. Better performance, lower price.

Using buried channel techniques, we've improved horizontal resolution in our new Silicon Imaging Device (SID). And we're subjecting units to more stringent blemish criteria. RCA's "Big SID" is a 512 x 320 array, 163,840 pixel, charge-coupled device that produces a standard interlaced 525-line TV picture with ultra low blooming and no lag or microphonics. SID52501, priced under \$1000 is available with 30-day delivery. Or get Big SID in our TC1160 camera for less than \$2000.

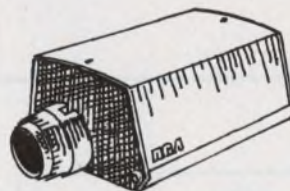
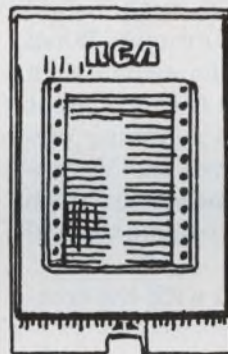

Circle 203

Hi-speed IR emitters for fiber-optic communications.

The speeds are right: 100 MHz min. analog bandwidth (C30119) or 40 MHz min. (C30123). And so is the size: A 6-mil edge emitter in an OP-18 package with removable cap that assures good collection efficiency with single fibers or bundles. (Also available in hermetically sealed package.) These IR emitters are rated at up to 200 mA forward current for continuous operation and 1.5 A peak forward current for pulse operation. Competitively priced, they're available from stock.

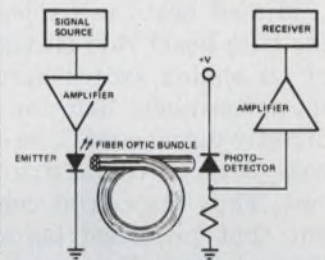

Circle 204

If electro optics can solve your problem, remember: EO and RCA are practically synonymous. No one offers a broader product spectrum. Or more success in meeting special needs. Call on us for design help or product information. RCA Electro Optics, Lancaster, PA 17604. Phone 717-397-7661. Sunbury-on-Thames, Middlesex TW16 7HW, England; Ste. Anne de Bellevue H9X 3L3, Canada; Belo Horizonte, Brazil; Hong Kong.

RCA

IDEAS FOR DESIGN

(continued from page 82)

the C_2 charge and the difference causes an increase in the output of V_o . An increase in V_o then increases the ramp rate. Conversely, V_o is decreased if the ramp rate is too high to match C_2 at the time of the input signal causes the analog switch to operate.

Thus, the circuit's negative feedback forces the ramp rate to match the rate of the input signal. And output V_o is kept proportional to the input signal's rate—a responsive measure of the input frequency. V_o is ripple free once it has adjusted to reflect the input rate.

The ramp voltage at point X in Fig. 1 is used to trigger a missed-beat alarm. During normal operation, the signal at X is a sawtooth with a peak amplitude, V_{pk} , equal to $-2V_1C_2/C_1$ independent of input rate. However, if one beat is missing from the input stream, the ramp voltage continues to rise to approximately twice the normal peak voltage; two missed beats result in a triple-height peak, and so on. Thus, the comparator set to trigger at 1.5 times the nominal peak height will detect a single miss; another set to 2.5 times the nominal peak height will detect more serious interruptions.

Missed beats are reported without disturbing the base heart-rate measurement, V_o , with the aid of an analog switch across C_1 to ground. When the missed-beat detector is ON, this switch then directly discharges C_1 to ground on the next input beat without connecting it to the summing circuit. Thus the circuit can carry over the V_o output that prevailed before the emergency, even through several missed beats, and resume normal operation thereafter.

The response time of the circuit with the components shown in Fig. 2 is

$$t_3 = RC_3 = 1.5 \text{ s.}$$

As the input frequency, f , approaches $1/t_3$, the

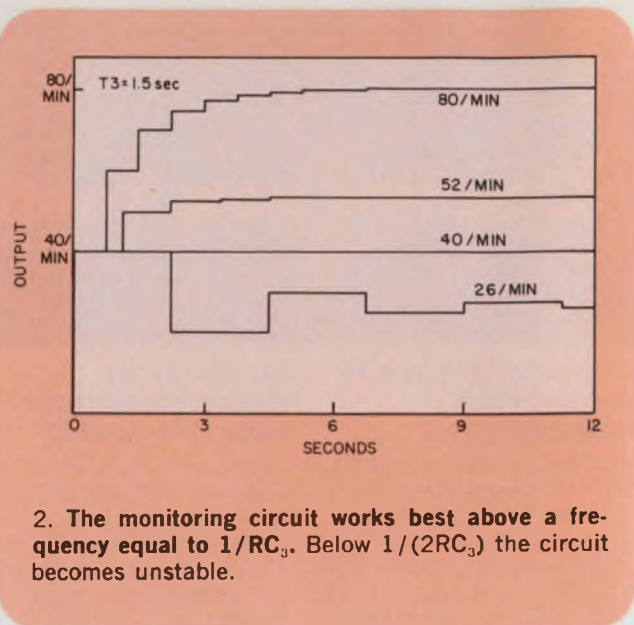

2. The monitoring circuit works best above a frequency equal to $1/RC_3$. Below $1/(2RC_3)$ the circuit becomes unstable.

circuit's response at first improves. When f exactly equals $1/t_3$ (40 pulses/min), the first correction fed back within the circuit is exact and the output is steady and correct thereafter; below frequencies of $1/t_3$, corrections increasingly overshoot. Nevertheless, convergence to the correct output value eventually occurs as long as f remains greater than $1/2t_3$. Below $1/2t_3$, the error doesn't converge; the circuit is unstable.

The CMOS pulse former and control logic may be powered by a ± 5 -V supply. The 4-V reference, V_r , can be derived from the -5 -V supply with a potentiometer. Adjustment of V_r also provides calibration.

Note

1. A patent assigned to the University of Washington, Seattle 98195, has been granted for a circuit based on this technique, Patent 3,968,431.

Dr. Philip A. Ekstrom, Affiliate Assistant Professor, Dept. of Physics, University of Washington, Seattle, WA 98915.

CIRCLE NO. 313

IFD Winner of August 16, 1976

Burt Sandberg, Engineer, Fermi National Accelerator Laboratory, P.O. Box 500, Batavia, IL 60510. His idea "State Diagrams for a 555 Timer Aid Development of New Applications" has been voted the Most Valuable of Issue Award.

Vote for the Best Idea in this issue by circling the number for your selection on the Reader Service Card at the back of this issue.

SEND US YOUR IDEAS FOR DESIGN. You may win a grand total of \$1050 (cash)! Here's how. Submit your IFD describing a new or important circuit or design technique, the clever use of a new component or test equipment, packaging tips, cost-saving ideas to our Ideas for Design editor. Ideas can only be considered for publication if they are submitted exclusively to ELECTRONIC DESIGN. You will receive \$20 for each published idea, \$30 more if it is voted best of issue by our readers. The best-of-issue winners become eligible for the Idea of the Year award of \$1000.

ELECTRONIC DESIGN cannot assume responsibility for circuits shown nor represent freedom from patent infringement.



Use CLARE Solid State relays across the board...

**There's a CLARE SOLID STATE RELAY
for every PCB application.**

For heavy duty AC applications—computer peripheral, process control, inductive load. For DC control applications—motor and servo controllers for process control and machine tools.

From popular modules to DIP for 0.5" PCB mounting centers. Or from wire wrap to quick disconnect for non-PCB use. If you need the speed and reliability of solid state, Clare has the right relay for you.

All Clare solid state relays offer complete input-output isolation, zero-crossing synchronous switching, and a

productive life of over 10 billion operations.

For solid answers on solid state relays, contact your Clare Representative, or C. P. Clare & Company, 3101 W. Pratt Avenue, Chicago, Illinois 60645. Phone (312) 262-7700.

QUALITY, SERVICE, RELIABILITY

**C. P. CLARE & COMPANY
GENERAL INSTRUMENT CORPORATION**



CIRCLE NUMBER 39

and then some.

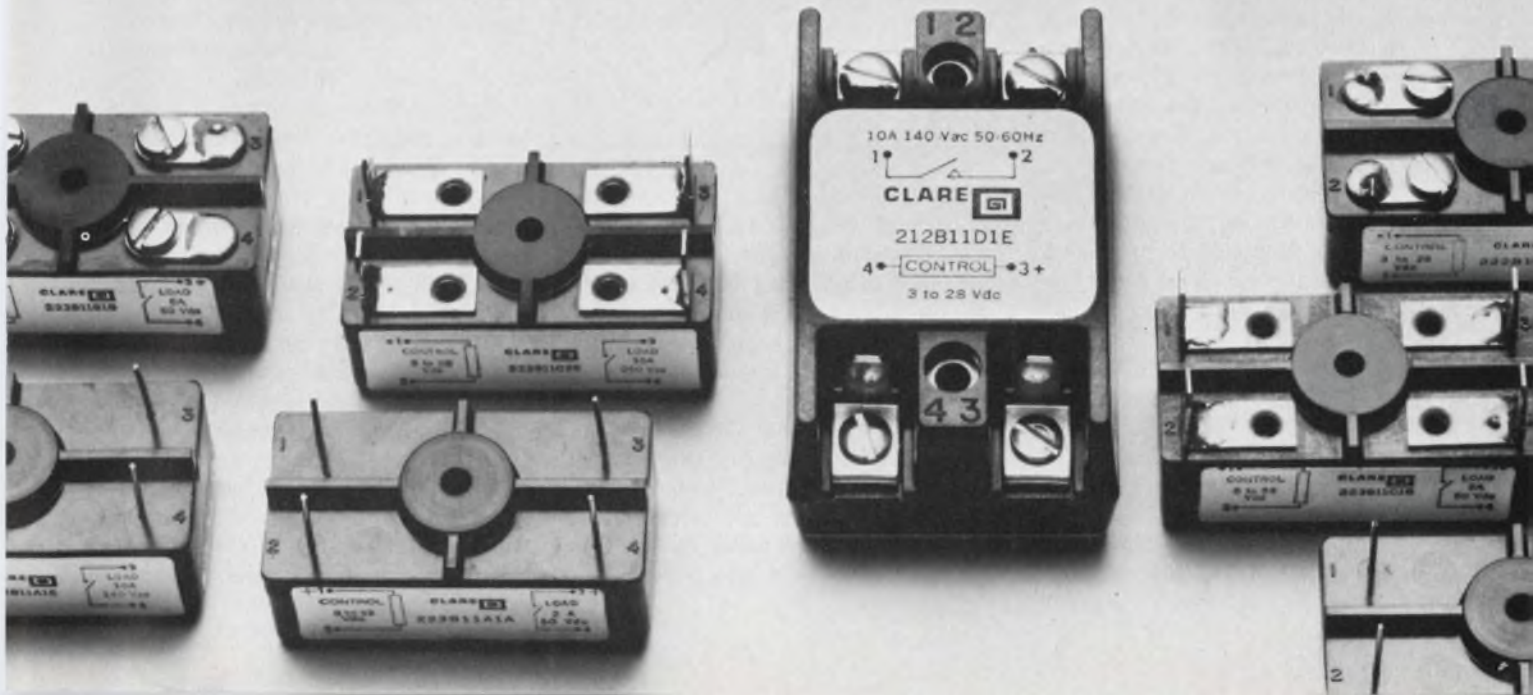

Liquid crystals increase laser-beam deflection

An electrically controlled optical beam bender that uses liquid crystals to deflect a laser beam substantially has been developed at the Royal Radar Establishment in Malvern, England. Angular deflections to $\pm 20^\circ$ have been obtained with a liquid-crystal layer 1 mm thick. The Kerr cell, the Malvern device's potential major competitor, deflects laser beams only a fraction of a degree, and competing acousto-optic methods less than 1° .

The molecular orientation of liquid crystals is modified electrically to produce a spatially varying refractive index that causes light to follow a curved path through the liquid crystal. The Malvern device, which deflects light in a single plane, consists of a cell, 1 to 2 mm thick and 3 to 4 mm wide, that contains a positive nematic liquid crystal and electrodes at the top and bottom of the front and rear cell walls.

The crystal molecules are aligned parallel to the cell walls by applying equal and opposite voltages to the top and bottom electrodes (Fig. 1). In this state the device acts like a crystal with its straight optical axis parallel to the cell walls. A polarized beam, applied at right angles, passes through undeflected.

If the electrode-potential relationships are varied, the molecular alignment is modified to produce a curved optical axis. The light follows the curved path through the cell.

The angle through which the beam is deflected depends on the dimensions of the cell, the optical anisotropy of the liquid crystal, and the ratios of the electrode potentials. The absolute values of the electrode voltages determine the speed of deflection only. Since the op-

tical-path length does not vary linearly across the cell, the angle of deflection varies with the location at which the beam is applied.

Although the device may be used for beam scanning, the region that produces maximum deflection is one in which switching produces turbulence in the crystals. So continuous scanning is not compatible with maximum deflection. Continuous scanning can be achieved, however, if the beam is focused outside the turbid region.

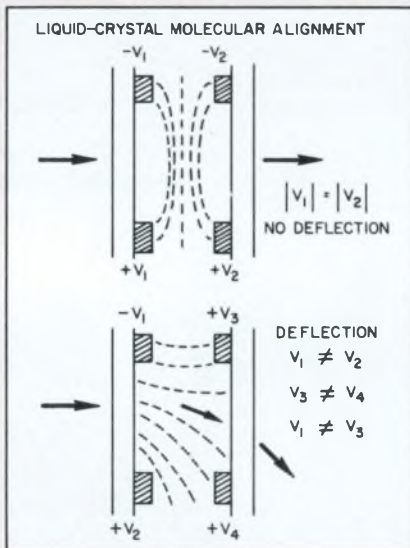

At 1 kV, the beam deflects full-scale and returns in less than 1 ms. At present, the transmission loss due to absorption and scattering is typically greater than 50%. Scattering is combated by specially treating the cell walls and by operating the device at high fields.

An eight-electrode device, capable of deflecting a beam in two dimensions, has also been constructed. With this device, x-y addressing, such as for use in holographic storage systems, becomes a possibility.

Japanese keyboard lowers mechanical parts

A thin, light-action electronic keyboard with a piezoelectric sheet has been produced at the Musashino Electrical Communication Laboratory in Tokyo.

The 0.3-mm thick piezoelectric sheet lies on top of a PC board, which detects key depression and carries out the first stage of key encoding. This arrangement minimizes the number of mechanical parts and permits the use of low-profile keys. The sheet is formed by blending a base material of polyfluoric vinylidene resin with particles of zirconate-titanate lead.

The keyboard also consists of a key mechanism, a MOSFET wave-shaping circuit and final-encoding circuitry.

Thin-film matrix on glass will lead to flat TV

A low-cost, flat TV screen with either electroluminescent or liquid-crystal display elements may be commercially feasible in three years, says Dr. A. Fischer of the University of Dortmund, West Germany. He has developed an automated production system that allows thin-film transistor matrices to be deposited on glass.

Shift-register circuitry for the screen requires five components per stage. Depositing the register matrix on glass is a seven-mask process. The masks and their support frames are housed in a bell jar. Each mask can be drawn out or pushed back by means of magnetic drives that operate through the walls. The glass substrates can also be raised or lowered so that the masks can be properly mated with the substrates in the bell jar.

Films are deposited from vapors generated by electron-beam heating. Film growth rate is monitored by preprogrammed controllers.

DON'T FIGHT THE RELAY MAZE

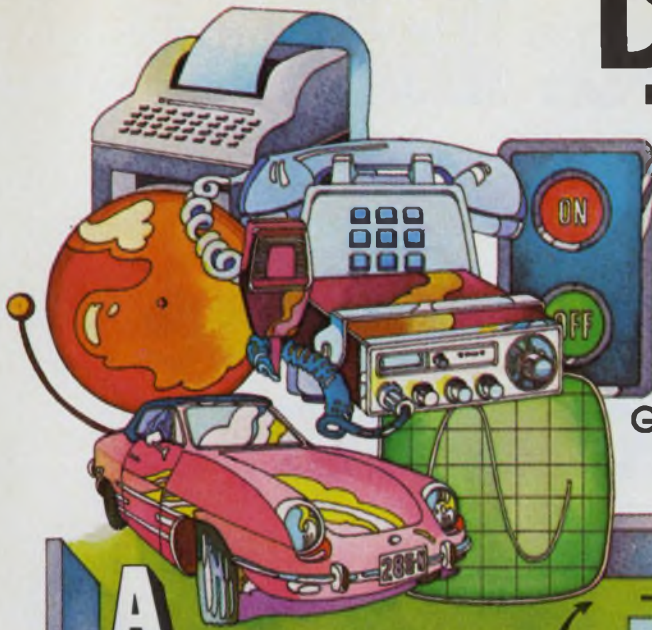

PROBLEM:

Go directly from relay requirement "A" to optimum relay specification "B" for any application.

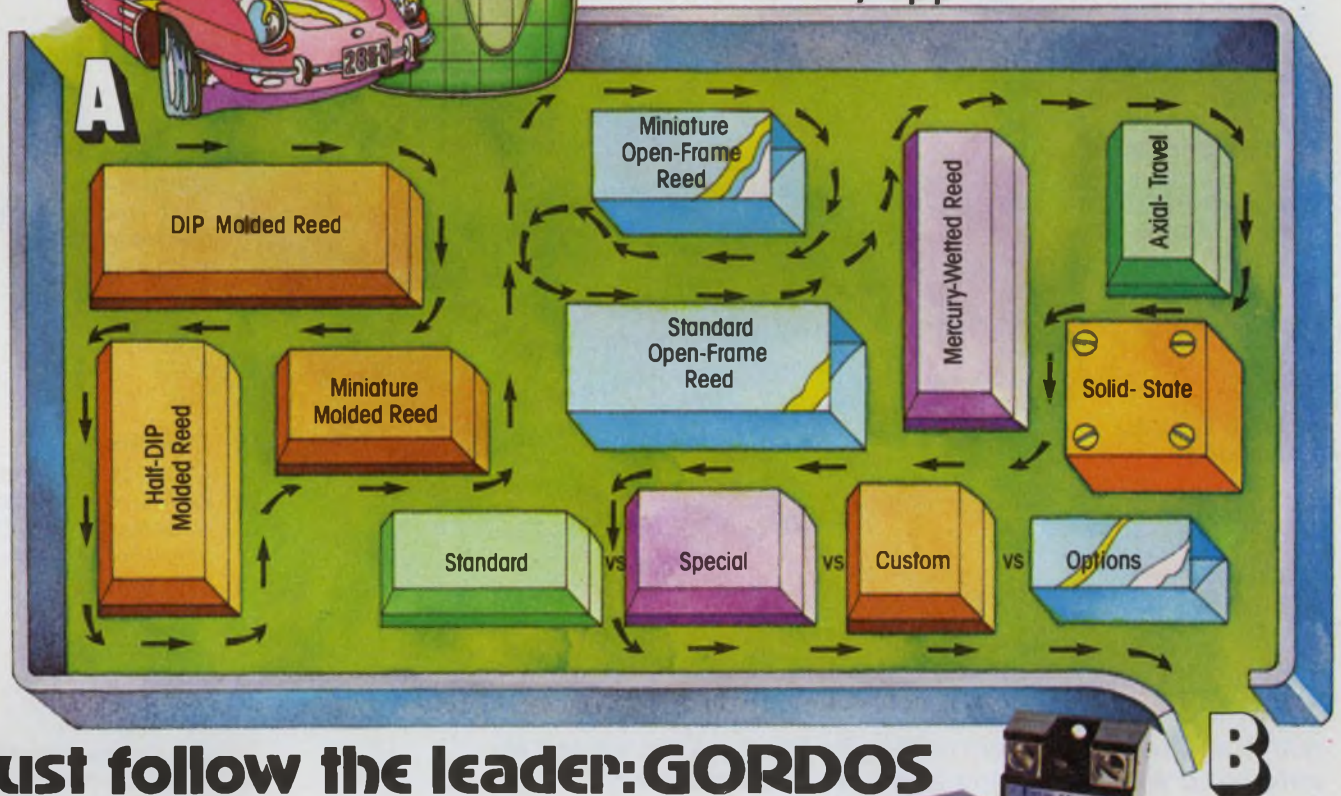

Just follow the leader: GORDOS

Because we're the only relay company that makes all its own switches, we know relays from the inside out — and make more than anyone else. More types... more versions of each type.

And, we accept single responsibility for maintaining high standards of quality for every one. So, when matching the optimum relay to an application, we help keep tradeoffs down. We offer a broad perspective unmatched by suppliers with fewer alternatives... a greater product base from which to select special-purpose relay solutions others just don't have... plus the technological expertise to avoid high custom-design costs often by simply modifying a standard solid-state, axial-travel, or reed relay design.

The fact is: there's really no reed or solid-state relay problem Gordos can't handle... usually right off the shelf. So, don't fight your way through the relay maze — call Gordos.



For Data On	Ask For Bulletin
Molded-Epoxy DIP Reed Relays	RR407
Miniature Molded-Epoxy Reed Relays	RR408
Mercury-Wetted Reed Relays	RR409
Open-Frame Reed Relays	RR406
Axial-Travel Relays	ATR601
Solid-State Relays	SS502

GORDOS

Gordos Corporation, 250 Glenwood Ave., Bloomfield, N.J. 07003 • Telephone: (201) 743-6800 • TWX: 710-994-4787
Gordos/Grigsby-Barton Inc., 1000 N. Second St., Rogers, Arkansas 72756 • Phone: (501) 636-5000 • TWX: 910-720-7998

CIRCLE NUMBER 37

Arrow-M Amber Relays

An important communication for the telecommunications industry.

- 1. High Sensitivity**
Minimum operating power NF2E 190mw, NF4E 310mw.
- 2. Plastic Sealed**
With N₂ gas enclosed.
- 3. High Contact Capacity**
2 amps @ 30VDC resistive. Can switch up to 220V AC/DC. Available in 2C, 4C and Form D (MBB) contacts.

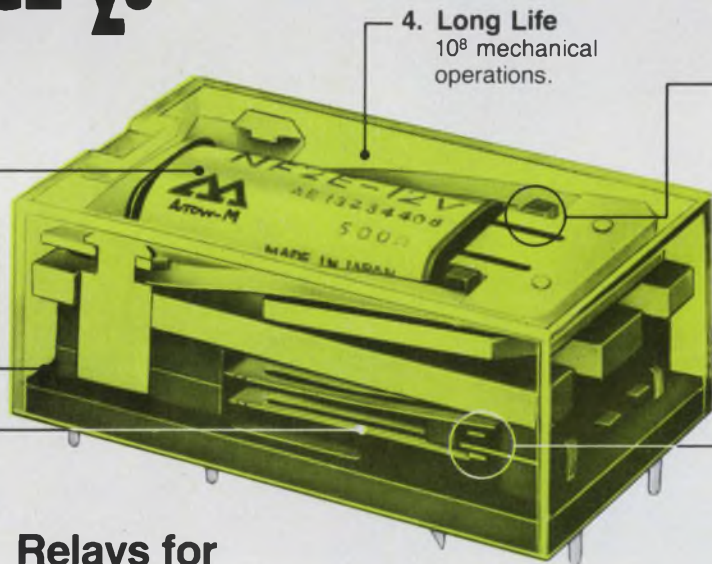

- 4. Long Life**
10⁸ mechanical operations.
- 5. Negligible Chattering**
Lift-off card system and rebound absorbing structure minimizes contact bounce.
- 6. Low Stable Contact Resistance**
Bifurcated gold clad lift off contacts. Applicable to low level circuits.

Relays for advanced technology.

Arrow-M NFE Amber relays give you high sensitivity with half the power drain... N₂ gas-filled plastic sealed for automatic wave soldering and ultrasonic cleaning.

The low power requirements of most telecommunications computer installations demand critical sensitivity and reliability in the relay systems.

Arrow-M Flatpack NFE relays offer maximum reliability and sensitivity using half the power of ordinary relays. The Flatpack design, only .425 inches high, is ideal for high density PC board packaging. The unique automated modular assembly insures extra long life and total reliability. And the gas-filled plastic sealed construction allows for economical automatic wave soldering and ultrasonic cleaning.

For NFE relays providing maximum sensitivity and reliability with minimum power drain, look to Arrow-M, the Company with over 50 years of meeting and advancing needs of modern technology.

For more information on exact specifications, write or call your nearest Arrow-M office.

Arrow-M Corporation
250 Sheffield St.
Mountainside, N.J. 07092
(201) 232-4260

Western Office:
22010 South Wilmington Ave.
Suites 300 & 301
Carson, California 90745
(213) 775-3512



Connector mass terminates flat-conductor, flat cable

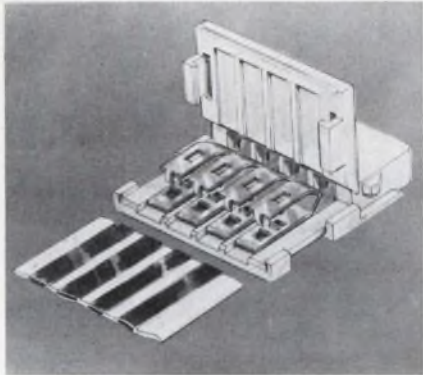

Berg Electronics, Div. of E. I. DuPont De Nemours & Co., New Cumberland, PA 17070. (717) 938-6711. See text.

Housing five to 33 contacts, a new connector, the Clincher, simultaneously terminates all conductors in a flat-conductor, flat cable. Crimping the connector to the cable is done faster and with less expensive tooling than is possible with the only other flat-conductor connector, one from AMP, Harrisburg, PA.

In production, Berg's crimping machine simultaneously presses down on all the contacts, forces them to pierce the plastic surrounding each conductor, then squeezes around the copper to hold it securely. Additional ridges in the contacts pierce the copper to make a low-resistance connection, said to be a maximum of 10 m Ω .

The Clincher system cuts total assembly time for an 18-conductor connector to under 10 seconds—more than 20 seconds faster than the AMP system, whose crimping machine does one contact at a time at a rate of two per second. Then, the operator must snap the assembly into a separate housing. The AMP crimping machine must be rented for \$300 a month, while Berg's machine sells for \$800.

However, AMP does make a

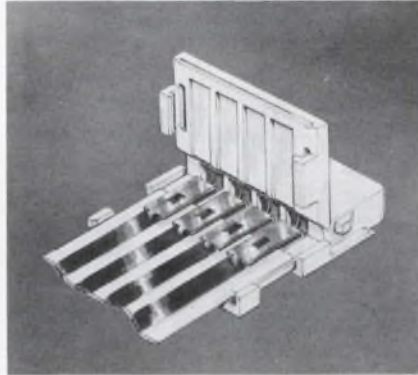

variety of contact types and housings, while Berg makes only a single-row, 5-to-33 contact female connector series with 30 μ in. of gold, or solder plating that mates with 0.025-in-square posts. AMP offers male, female, or solder-tab contacts and eight kinds of plating. Housings hold 9 to 33 contacts in single rows, or 18 to 70 in double rows.

Both connectors accept cable having conductor spacings of 0.1 in. The width of the conductor can measure from 0.04 to 0.062 in. The connectors can be installed on a cable end or in the middle to produce a daisy-chained connection. Both connectors carry about 3 A; the maximum for the copper conductors.

The Clincher's housing comes with an opened lid so that the cable can be slipped into place between the contacts. The lid flips down after the contacts are crimped, which insulates the connection and provides strain relief for the cable.

The contacts are made of two different metals, one supplying spring retention and the other supplying high conductivity. The spring material is made of a beryllium-copper alloy, which provides high forces to the opposing contact. A copper-nickel alloy provides high conductivity. The housing material

is made of polyester, rated up to 105 C.

The over-all height of the housing allows stacked connectors to be spaced in increments of 0.1 in.

Whether one method is cheaper than the other is unclear. The Clincher costs 7 to 9¢ per contact, with either 30 μ in. of gold plating or solder-plated contacts 10-K quantities. AMP's cost per contact—including housing and the same gold plating as the Clincher's—is 4 to 10¢ in quantities of 5-K to 100-K.

Berg Electronics
AMP, Inc.

CIRCLE NO. 301
CIRCLE NO. 302

Operator station solders and desolders

Cooper Group Deutschland GmbH, 7122 Besigheim/Wurt, West Germany. 07143 7063.

The Weller DS100P station solders and desolders components on PC boards. The unit consists of two solder pencils and stands, and a vacuum pump. The pencils are transformer-powered, low-voltage temperature-controlled types. One pencil has a standard soldering tip. The other pencil is fitted with a solder-suction nozzle and a transparent solder collector. Air vacuum or pressure is supplied from the built-in pump, a factory air line or a compressed air cylinder. When employed with air systems other than the vacuum pump, a transducer must be used to convert the compressed air into a vacuum. Solder is removed when a foot switch is depressed. The system will operate on air pressures between 30 and 120 lb/in².

CIRCLE NO. 303



AMPERITE
THERMOSTATIC
DELAY RELAYS

For **LOW COST,**
LONG LIFE,
Maximum Stability

Delays: 2 to 180 Sec.*

Hermetically sealed — not affected by altitude, moisture, or climate changes... SPST only — normally open or normally closed... Compensated for ambient temperature changes from -55° to +80°C... Rugged, explosion-proof, long-lived... Standard radio octal and 9-pin miniatures.

Price, standard or min., under \$4.00 ea.

*Miniatures delays: 2 to 120 seconds.

PROBLEM? Send for Bulletin No. TR-81

New! LONG DELAYS

240 & 300 Sec.

Same rugged construction, hermetic sealing and stability as the shorter Delay Relays described above... For delays beyond 300 seconds, these Relays may be used in series.

Price, under \$6.00 ea.
Write for Bulletin No. LD-73.



DIFFERENTIAL RELAYS

For automatic overload, over-voltage or under-voltage protection... Made only to specifications for 70V, 80V, 90V and 100V.

Price, under \$6.00 ea.

AMPERITE
BALLAST REGULATORS

Automatically keeps current and voltage at a definite value. For AC or DC... Hermetically sealed, rugged, vibration-resistant, compact, most inexpensive.

Price, under \$3.00 ea.
Write for 4-p. Bulletin No. AB-51.



AMPERITE

600 PALISADE AVE., UNION CITY, N.J. 07087

Telephone: 201 UNion 4-9503

In Canada: Atlas Electronics, Ltd.,
50 Wingold Ave., Toronto 19

OUR COMPLETE PRODUCT LINE CAN BE FOUND
IN ELECTRONIC DESIGN'S GOLD BOOK.

CIRCLE NUMBER 44

PACKAGING & MATERIALS

Double-walled bushing insulates wires



Heyman Manufacturing Co., North Michigan Ave., Kenilworth, NJ 07033. (201) 376-7300. \$3.05 (500-2000); stock.

A panel bushing, Model S-87, provides a double wall of insulation for wires going through its center. The bushing's outside surface is rounded to minimize sharp bends in the wire. The S-87 mounts using fingertip pressure, into a hole with a diameter of 0.875 in. It locks into panel thicknesses up to 0.062 in. The inside diameter is 0.5 in.

CIRCLE NO. 304

Adjustable latch allows wide closure tolerances

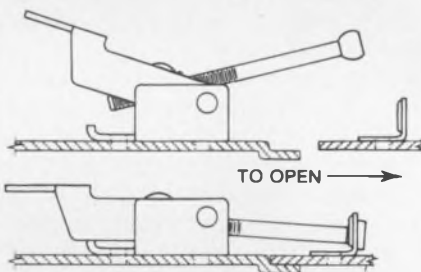

Southco Inc., Brinton Lake Rd., Concordville, PA 19331. (215) 459-4000. \$2.63 (1-50); stock.

An adjustable latch, Model A1-10-501-10, allows gaskets of differing thicknesses to fit between a case and a lid. The thickness may vary 0.342 in. The unit comes in two parts, a latch and a keeper, both of zinc-plated steel with a chromate dip. It has an over-all length of 2.5 in. There are four mounting holes: two in the case and two on the lid. Rivets, bolts, or screws can be used to fasten the latch body to the case and the keeper to the lid.

CIRCLE NO. 305

Breadboard has contacts of conductive elastomer

Lareine Microelectronique, 53 Rue N.D. de Nazareth, 75003 Paris, France.

The Wonderboard solderless breadboard has electrical contacts made of conductive-elastomer slugs molded into an insulating substrate. The board measures 3.19 × 1.4 × 0.16 in. It has six rows of contacts, with spacings between row pairs of 0.3 in. On each row, contact-to-contact spacing is 0.1 in. The contacts accept wire diameters from 19 to 31 AWG and contact resistance is 1 mΩ. Insertion force is 750 grams.

CIRCLE NO. 306

Silicone grease conducts heat well

Emerson & Cuming, Inc., Canton, MA 02021. (617) 828-3300. \$6 (12 oz-up); stock.

A thermally conductive, electrically insulating, silicone grease, Eccotherm TC-5, is filled with inert metal oxides. The material features a thermal conductivity of 0.0062 (cal)(cm)/(s)(cm²)(C), a volume resistivity of 10¹⁴ ohm-cm and a dielectric strength of 500 V/mil. Eccotherm TC-5 does not harden or run on prolonged exposure to temperatures up to 200 C.

CIRCLE NO. 307

Conductive paints spray on, shield

Tecknit, 129 Dermody St., Cranford, NJ 07016. (201) 272-5500. 1 lb, 1-up prices: \$55 (Acrylic 1), \$44 (Acrylic 10).

Two acrylic conductive paints, Acrylic 1 and 10, have surface resistivities, after application, of 1 Ω/sq. and 10 Ω/sq. The paints provide a minimum of 25-dB insertion-loss shielding to electric and plane-wave fields. Both have the consistency of regular paint and can be applied in one operation with industrial sprayers. The paints stick to structural foam and molded plastics. They are colored silvered gray (Acrylic 1) or gray (Acrylic 10) and come in 1 and 7-lb containers. The operating temperature ranges from -65 F to +180 F.

CIRCLE NO. 308

INSTRUMENTATION

Generator delivers 3-kV pulses



Monroe Electronics, 100 Housel Ave., Lyndonville, NY 14098. (716) 765-2254. \$995; stock.

Model 241 ± 3 -kV reference supply/pulse generator is designed as a calibration supply for high input-resistance instruments. It can be used as a high-voltage dc supply, 0.05% accuracy, or as a high-voltage pulse generator providing an output pulse of up to 3 kV with less than 1-ms rise time. Output pulse may be set for single-shot or repetitive operation at a 2-Hz rate. Pulse width and slope are variable by a front-panel control.

CIRCLE NO. 309

Unit takes test results and provides reports

Fairchild Systems Technology, 1725 Technology Dr., San Jose, CA 95110. (415) 962-3816. \$125,000 to \$250,000; 60 days.

A new concept in semiconductor test-system architecture correlates total test results into a meaningful management information system. The system, called the Integrator, is aimed at both manufacturers and volume users of complex LSI circuits. The system integrates raw data from on-line test systems to tell managers at every level what is happening in various process stages from silicon to finished product to the end system. The Integrator separates the data processing and software support functions from the product testing function. Essentially, the system consists of test locations, a communications network, and a centralized data storage and data processing system. Data are collected through the network into a disc file to create a central data base.

CIRCLE NO. 310

VICTOREEN WRAPS HIGH VOLTAGE PERFORMANCE IN SLIM-MOX PACKAGES.

Victoreen's SLIM-MOX is the small, flat substrate, high voltage resistor that saves you space with no sacrifice in performance.

That's because small size is only one of many SLIM-MOX features.



Designed into your high voltage circuits, SLIM-MOX will deliver better long term stability. You will appreciate its small temperature co-

efficients over a wide temperature range.

Switch to SLIM-MOX, the rugged and highly stable resistor now available in an expanded resistance range — 1 to 5,000 M. Tolerances to 1%.

Standard values are available from stock. And at any value, Victoreen quality is a built-in SLIM-MOX virtue. Find out for yourself by using SLIM-MOX wherever you need to save space in high voltage circuitry. Wherever stability and reliability are key performance characteristics.

**Victoreen Instrument Division,
Sheller-Globe Corporation,**



SHELLER-GLOBE CORPORATION

**10101
Woodland
Avenue,
Cleveland,
Ohio 44104**

RESISTOR SPECIFICATIONS

Model	SLIM-MOX 204	SLIM-MOX 208	SLIM-MOX 308
Resistance Range	1M-5,000M	2M-5,000M	5M-5,000M
Critical Resistance	50M	56.25M	64.8M
Power Rating at 70° C	2W	4W	5W
Maximum Operating Volts	10,000V	15,000V	18,000V
Available Tolerance	1% 5% 15%	1% 5% 15%	1% ^a 5% 15%
Max. Surface Temp.	150°C	150°C	150°C

^aApplicable above critical resistance

MAXIMUM DIMENSIONS (inches)

Model	204	208	308
A	1.08	2.08	2.08
B	.59	.59	.89
C	.145	.145	.145
D	.860	1.885	1.885

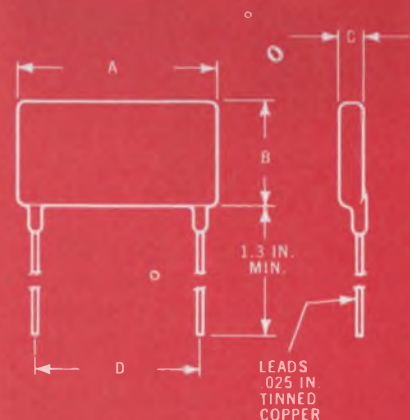

Standard interface bus boosts test speed

Hewlett-Packard, 1501 Page Mill Rd., Palo Alto, CA 94304. (415) 493-1501. 5390A, \$22,500; 8950A, \$58,500; 14 weeks, either system.

Two test systems owe their performance to the HPIB (HP's implementation of IEEE-488). The first, the 5390A frequency-stability analyzer, makes fast phase-noise measurements to within 0.01 Hz of a carrier. The second, the 8950A transceiver test system, needs just three minutes to check out a typical 2-channel mobile FM transceiver, CB radio, handi-talkie or AM transceiver. Both test systems are calculator controlled, and both are built up of mostly off-the-shelf instruments interconnected via the standard bus.

Transceiver tester CIRCLE NO. 320
Stability analyzer CIRCLE NO. 321

CB signal generator covers 50 channels

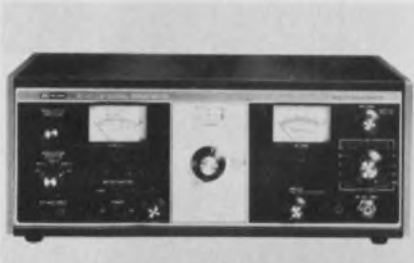

B&K Precision, 6460 W. Cortland Ave., Chicago, IL 60635. (312) 889-9087. \$475; stock.

Model 2040 CB signal generator covers 50 channels, including all 40 authorized channels. Frequency calibration and stability are accurate to ± 5 ppm (0.0005%) after a 15-min warmup. Phase-locked loop circuitry, referenced to a high-accuracy crystal, and powered by a well-regulated power supply, maintains performance standards under all normal operating conditions. A microvolt output meter and calibrated attenuators combine to provide accurate generator output measurements, down to 0.1 μ V.

CIRCLE NO. 324

DPM monitors ac power lines



Gralex Industries, 155 Marine St., Farmingdale, NY 11735. (516) 694-3607. \$164; 90 days.

Series 37DLM DPM measures voltages associated with ac power lines or systems. Capable of replacing large 4-1/4-in. switchboard meters, the series offers 1/2% accuracy and readability at distances up to 20 ft. Other features include gas-discharge display, NEMA standard case and universal ac line powering. Standard units are available in ranges of 200 or 400 V with 0.1-V resolution or 600 V with 1-V resolution. The meters are accurate at frequencies from 45 to 2000 Hz and usable with reduced accuracy to 20 kHz.

CIRCLE NO. 322

Distortion meter works automatically



Marconi Instruments, 100 Stonehurst Ct., Northvale, NJ 07647. (201) 767-7250. \$850; 30 days.

Model 2337A automatic distortion meter enables rapid measurements to be made of both level and distortion of audio-frequency test signals. There's no need to set a reference level or to precisely tune a fundamental rejection filter. The only controls are pushbutton switches for selection of input voltage range, distortion range and fundamental frequency. Distortion down to 0.01% can be measured with an input signal of 100 mV.

CIRCLE NO. 325

Probe makes any DVM a digital thermometer



John Fluke, P.O. Box 43210, Mountlake Terrace, WA 98043. (206) 774-2211. \$125.

The 80T-series is a small, self-powered temperature probe. Intended to be a universal accessory to DMMs, the probes are available in both Celsius (-50 to $+150$ C) and Fahrenheit (-58 to $+302$ F) versions. Probe output is in mV/degree and basic accuracy is ± 2 C or F. Battery life is rated in 1000 h of continuous use. DMM compatibility is not critical, and any instrument with $\pm 0.25\%$ accuracy, minimum 1-M Ω input resistance and adequate sensitivity will do.

CIRCLE NO. 323

Microwave counters measure pulsed carriers



Eldorado, 2495 Estand Way, Pleasant Hill, CA 94523. (415) 682-2100. 988G, \$5500; 989G: \$6500; 17 wks.

A new 18-GHz pulsed microwave counter, Model 989G, and a similar 12.4-GHz instrument (Model 988G) measure carrier frequencies during pulse-modulation conditions. Frequency measurements to a resolution of 10 kHz (7 digits) are automatically provided, and rf pulses as narrow as 100 ns can be measured. Models 989G/988G also offer a CW mode providing resolution to 1 Hz (11 digits). Complete systems compatibility is available, including remote programming and data output in BCD or IEEE GPIB format.

CIRCLE NO. 326

New Transducer modules measure electric power

NEW!



These new power transducers compute instantaneous ac electrical power. Simple design and high quality yield excellent reliability at an **unprecedented price**. New capabilities meet the needs of hundreds of previously difficult or uneconomical applications. These include, $\pm 0.50\%$ accuracy, 50 Hz to 10 kHz frequency range, one and three phase operation, accurate operation with non-sinusoidal waveforms, better than $\pm 0.25\%$ power factor influence and a 100 μ s response time.

Each transducer is encased in a small, tough nylon case for easy installation. Use the inquiry card to get complete technical data.

4949 Freeway Drive E
Columbus, Oh 43229
614/888-7501
TWX: 810-337-2851



A subsidiary of The Arnold Engineering Company

CIRCLE NUMBER 42

4 SWITCHED ON 4 ADVANTAGES!

DIPSWITCH was the industry's first rotary switch for DIP sockets. It offers the designer the versatility and reliability only experience can bring. Here are four reasons you should consider **DIPSWITCH** for your switching needs.

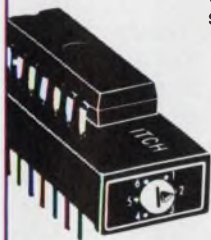

- 1 if savings board space is important, you can piggyback an IC right onto **DIPSWITCH**.
- 2 if you need additional switch closures, **DIPSWITCH** can be tandem coupled using extended shafts.
- 3 if multilayered boards are part of your design, **DIPSWITCH**'s .230" profile is about half anybody else's. You can stack as close as 1/4".
- 4 if you need special switch closure programming, **DIPSWITCH**'s six independent cams can be factory assembled to perform your programming.

DIPSWITCH is a Registered Trademark of the McGraw-Edison Company. Pat. No. 3621157



EDISON ELECTRONICS
a McGraw-Edison Company Division

Greater Field Municipal Airport, Manchester, New Hampshire 03103 603-669-0940

CIRCLE NUMBER 41

ELECTRONIC DESIGN 26, December 20, 1976

Want A Safer Product And Lower Manufacturing Costs Too?

On the one
hand choose the
MICROTEMP®
thermal cutoff

On the other
hand, don't
overlook the new
PICOTEMP
thermal cutoff



A reliable, accurate easy to install, "one shot" thermal limiter.

- temperature tolerance— $\pm 1.7^\circ\text{C}$.
- temperature ratings— 58° to 242°C . (136° to 468°F .)
- current capacity—up to 30 amps at 240 VAC.
- compact—diameter, .157"; length, .457" (exclusive of leads).
- economical
- easy to install—assorted terminations, mounting packages and insulations available.
- Recognized under the Component Program of Underwriters' Laboratories, Inc. UL File #E40667A. CSA approved. BSI Certificate #5041 approved. Recognized by MITI and VDE. Military approval.

Used where installation or space restrictions rule out MICROTEMP® thermal cutoffs.

- temperature tolerance— $+0^\circ\text{C}$.— -3.3°C .
- temperature ratings— 63° to 150°C . (146° to 300°F .)
- current capacity—to 5 amps. at 120 VAC. Will hold this rating up to and including 240 VAC.
- compact—.236" x .389" x .087".104" (exclusive of leads).
- economical
- Package is completely insulated, leads are 26 gauge silver plated wire.
- Recognized under the Component Program of Underwriters' Laboratories, Inc. UL File #40667A. MITI approved. CSA approved.

Both devices are completely sealed against the atmosphere. Because of their unique design and construction, they won't derate. And they're unaffected by age or extended use. You not only get positive, yet low cost protection against malfunctions in circuits and components caused by equipment failure or user abuse, but you eliminate costly and unnecessary service calls caused by nuisance tripping.

PICOTEMP or MICROTEMP? Which is best? Depends on your needs. Tell us about them.



MICRO DEVICES



DIVISION OF EMERSON ELECTRIC CO.
1881 SOUTHTOWN BLVD
DAYTON OH 45439 513-294-0581

CIRCLE NUMBER 49

1 Relay Miss every 2-Billion Cycles

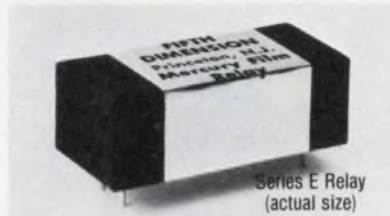

We tested 129 of our new Series E Relays at loads from dry circuits to 3 Amps. After 35-billion operations, only 10 single-cycle misses were monitored.

Series E Relays offer:

- Indefinite life
- No contact bounce
- Operation in all positions
- Contacts stable to ± 0.015 ohms over life
- Reliability at dry circuit or power loads
- Self-healing contacts
- Hermetically sealed contacts
- 1250V rms contact breakdown
- Low cost



Series E Relay uses a rugged LC2 welded capsule rather than a fragile glass reed switch. This patented design holds a film of mercury securely to the metal walls of the capsule. With every operation, the mercury film renews the switch contacts. You get the reliability of mercury relays, but with complete freedom of mounting orientation. LC2 welded capsule reliability is proven by hundreds-of-thousands of units in the field, as well as billions of cycles under stringent laboratory conditions.

Send for a FREE SAMPLE of the LC2 welded capsule on your letterhead. Circle the reader service card number for Series E Relay information.



Fifth Dimension, Inc.

P.O. Box 483
Princeton, N.J. 08540
Tel: (609) 452-1200

CIRCLE NUMBER 27

COMPONENTS

DIP combines LED with TTL circuit

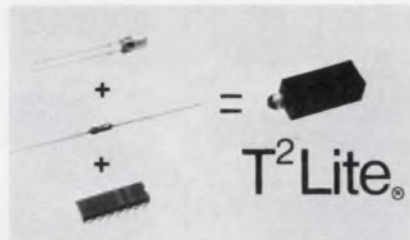

Data Display Products, Box 91072, Los Angeles, CA 90009. (213) 641-1232. \$1.50 (100 up); 3 to 5 wks.

A new concept in PC-board indicator lights combines a visual indicator, using super or standard brightness LEDs and a TTL IC in a standard DIP package, thus saving the unnecessary cost and space of connecting separate components. This T² Lite is available with most 74-series ICs and either a super-bright or standard-bright LED in four colors. Current limiting resistors are built-in for 10, 20 or 30-mA LED current. LEDs are available either with tinted or clear encapsulation for narrow-beam, high-intensity units, or tinted or diffused encapsulation for wide-angle units.

CIRCLE NO. 327

New piezoceramic builds into stable filters

Channel Products Inc., 16722 Park Circle Drive W., Chagrin Falls, OH 44022. (216) 543-8137.

A new piezoceramic filter material, FGH, is said to have time and temperature stability that is greatly improved over currently available materials. The material has a frequency stability with time of +0.1% for 5 yr. Temperature stability is better than 0.1% from 0 to 50 C and 0.2% from -40 to 85 C. Present uses of the new material include filter resonators for AM radios and transceivers. For example, an FGH-01 filter resonator built with the material can be used for emitter bypass applications to improve selectivity and markedly simplify i-f alignment. The FGH-01 can also be used as a basic building-block resonator for complex bandpass-filter designs at 455 kHz.

CIRCLE NO. 328

Power transformers suppress line noise

Topaz Electronics, 3855 Ruffin Rd., San Diego, CA 92123. (714) 279-0831. From \$95 (unit qty).

A line of noise-suppression transformers protects data-processing and other sensitive equipment from power-line transients. Some models are available with line cords and receptacles built-in for ease of installation. The transformers use a triple-box shielding technique to attain an extremely low primary-to-secondary winding coupling of less than 0.0005 pF. A low-impedance path for line noise to ground results in noise attenuation of more than 146 dB. Single-phase models are available in power ratings from 125 VA to 20 kVA. Three-phase models are rated from 3 kVA to 130 kVA.

CIRCLE NO. 329

Rotary switch provides coded outputs



AMP Inc., Harrisburg, PA 17105. (717) 564-0100.

AMP 3500 Series rotary switches use bidirectional rotating coded PC boards with fixed cantilever brush contacts to provide a variety of output codes that include BCD, a direct seven-segment numerical code and a number of special synthesizing codes. Switch modules have 18-to-50 detent positions. As many as seven modules can be ganged for multilayer operation from a single shaft without increasing mounting surface dimensions. Rated for 2.5-A nonswitching and 125-mA switching, the units have a dielectric withstanding voltage of 250 V dc min. Life expectancy is over 25,000 bidirectional rotations at rated load.

CIRCLE NO. 330

21-column head prints in two colors



Master Digital Corp., 1308-F Logan Ave., Costa Mesa, CA 92626. (714) 751-8271. \$102 (100 up); stock.

Two-color printing is achieved in Model 308-21, a 21-column numeric print head, by using an ink-ribbon cassette that features no-ribbon replacement. The print head can be operated with a 100% duty cycle at a print rate of 3 line/s. Life is 5-million printed lines. The print head can be mounted so the paper exits from either the top or front to allow flexibility in packaging. Dimensions of the head are 3.5 H x 5 W x 4.1 D in. and the unit weighs 3 lb.

CIRCLE NO. 331

EM transducer replaces precision potentiometers

Astrosystems Inc., 6 Nevada Dr., Lake Success, NY 11040. (516) 328-1600. \$295 (1-9); stock to 2 wks.

A wiperless high-accuracy electromagnetic position transducer provides a replacement for precision potentiometers. Proven rotational life is in excess of 100,000,000 rotations. An electromagnetic rotary transducer with solid-state excitation and conditioning electronics provides a smooth continuous dc-voltage output proportional to shaft rotation. The shaft is capable of continuous rotation. The transducer has infinite resolution with a dead band of less than 0.02°, a starting torque of less than 0.1 oz-in, and an accuracy and linearity of 0.05%. Available output voltages are 0 to +10 V dc, -5 to +5 V dc or 0 to +10 V dc from an internal or external reference. Ripple voltage is less than 3 mV rms. The unit is approximately 1.5 in. in diameter by 1.3 in. long.

CIRCLE NO. 332

Polyester-film caps offer high cap/volume

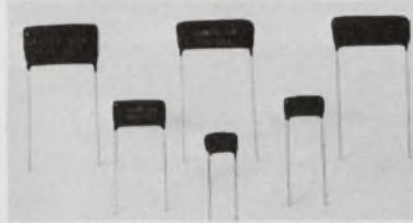

Cornell-Dubilier, 150 Avenue L, Newark, NJ 07101. (201) 589-7500.

Type DMT polyester-film dipped capacitors provide very high volumetric efficiency and moisture resistance (95 to 100% relative humidity at 40 C for 240 h). A combination plastic coating with a firm bonding of epoxy around the leads prevent the entrance of moisture. The capacitors operate to 125 C without derating and with good stability, and at up to twice the rated voltage at 85 C.

CIRCLE NO. 362

Anatomy of Value in a Voltage-Tuned Oscillator

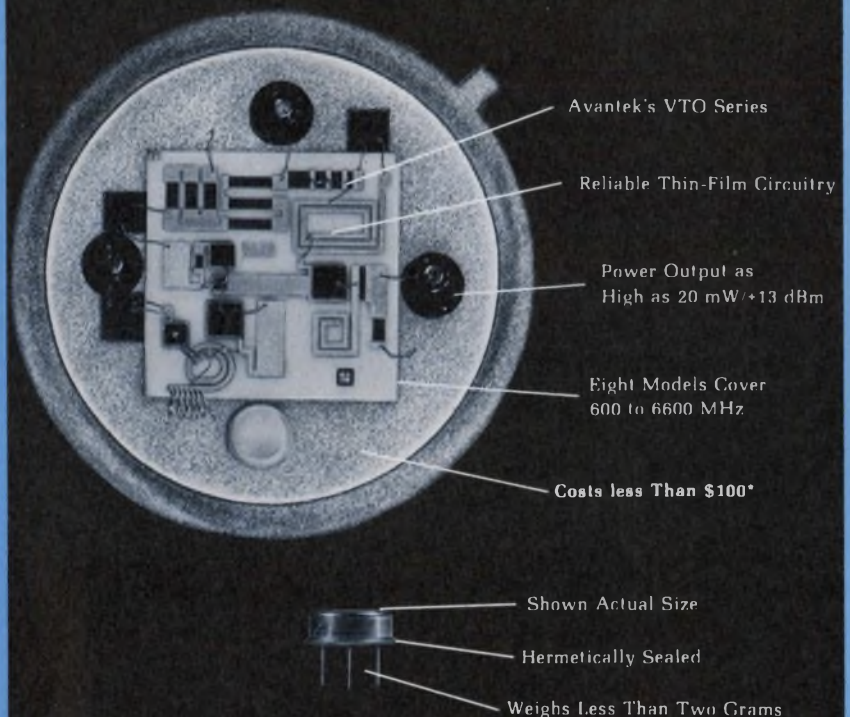

*in breadboard quantities

If you're designing a synthesizer or other instrument, why worry about designing voltage-tuned oscillators? Avantek VTO's represent an outstanding value as a cost-effective alternative to in-house discrete designs. Contact Avantek for an applications brochure describing the VTO Series in detail.

Avantek

3175 Bowers Ave., Santa Clara CA 95051 Phone (408) 249-0700

CIRCLE NUMBER 48

Telonic wrote the book on filters

For 15 years Telonic's been considered an authority on filter design. Look at the prime, successful customers who use them. So why shouldn't they produce the most authentic, comprehensive catalog in the business?

This 40-page volume covers specifications on several hundred designs (standard and special) with graphic data on attenuation, insertion loss, connectors and more. You'll find a broad range of tubulars in low and band pass types, cavities, combine, miniature, and tunable—all backed by a 5-year warranty. It's No. 1 on our best-seller list—since it's free. Write or call our Product Manager for your autographed copy.



TelonicAltair 

2825 Laguna Canyon Rd., Box 277,
Laguna Beach, CA 92652. Telephone
714/494-9401, or toll-free
(outside California) 800/854-2436.

CIRCLE NUMBER 50

DATA PROCESSING

Memory system adds 1 Mbyte to IBM's 370

Intel Memory Systems, 1302 N. Mathilda Ave., Sunnyvale, CA 94086. (408) 734-8102. \$4567/mo.

An add-on memory system, Model 7125, expands the 96 kbytes of IBM's standard memory size for the 370/125 to 1 Mbyte. The Model 7125 semiconductor memory system uses 16 kbit RAMs for data storage. When parts of the memory fail, backup memory is automatically switched in. System access time runs 280 ns, and the cycle period is 480 ns.

CIRCLE NO. 333

Color-TV display accepts computer data

Comtal Corp., 169 N. Halstead St., Pasadena, CA 91107. (213) 793-2134. See text: 90 days.

The Model 2000 computer-output memory and buffer produces a full-color continuously refreshed, flicker-free display. The unit operates on-line with a host processor such as a 16-bit minicomputer (\$17,950 with interface controller). Or the 2000 takes data from a magnetic-tape drive (\$19,950 including 9-track drive). The unit displays 480 lines with 512 picture elements per line. The display is refreshed 30 times per second.

CIRCLE NO. 334

16-k × 20 RAM board accesses in 280 ns

National Semiconductor, 2900 Semiconductor Dr., Santa Clara, CA 95051. (408) 737-5000. \$1050 (large qty).

The Model NS3000-1 RAM board holds 16-k × 16, 18 or 20 bits, according to user requirements. The timing specifications are: access, 280 ns; read or write cycle, 430 ns; and read-modify-write cycle, 610 ns. Options include parity generation and check and data-available reset. The latter option permits the NS3000-1 to control a shared-data bus. The card measures 11.75 × 15.40 in. The NS3000-1 is rated for operation between 0 and 50 C.

CIRCLE NO. 335

BUCKEYE KNOBS

Buckeye precision-molded ABS knobs will enhance all types of instrumentation at an affordable cost. Many styles, types, sizes and colors are available. Skirts and custom markings are Buckeye specialties. ASK today for free literature, prices and samples.

the BUCKEYE stamping co.
555 Marion Road
Columbus OH 43207
Phone 614/445-8433

Quality Products Since 1902

CIRCLE NUMBER 51

Keyboard terminal drives a video monitor



Computer Conversor Corp., 1961 Old Middlefield Way, Mountain View, CA 94043. (415) 969-3213. \$695.

The Conversor-8000 terminal has a keyboard and generates composite-video output for an 80-character by 24-line TV display. The terminal talks to a computer over RS232 lines at a 110 or 300 baud rate. The 8000 has automatic display scrolling. It weighs 6.5 lb, and measures 6 x 11 x 14 in. Options include an integral acoustic coupler (\$110), video monitor (\$120) and software-controlled beeper (\$30).

CIRCLE NO. 336

Printer includes control electronics



LRC, Inc., Technical Research Park, Riverton, WY 82501. (307) 856-6524. \$495 (single qty).

A 40-column printer comes with control electronics. Designated the Model 140, it uses a dot-matrix printer. The system contains a MOS chip that has a 48-character buffer, a character generator, and control logic. Software commands alter character width, height and density. Extra-cost options include RS-232C or current-loop lines, a pin-feed platen, a high-speed paper feed, label printing and front-feed document printing.

CIRCLE NO. 337

Floppy-disc terminal searches for data



Techtran Industries, 530 Jefferson Rd., Rochester, NY 14623. (716) 271-7953. \$2595 (single qty); 60 days.

The 9512 floppy-disc drive and terminal can search its disc for a 14-character sequence and alter or read out the associated data. Other disc-based terminals require the track and sector location of the data be entered to alter it; the 9512 will also do that. The unit stores data on the disc in an IBM-compatible format. The 9512 has two 110-9600 baud serial lines. One line could connect to a keyboard, the other to a computer.

CIRCLE NO. 338

iCOM's PROM Programmer

MAKES IT EASY FOR YOUR 2708's AND 2704's TO CHANGE THEIR MINDS.

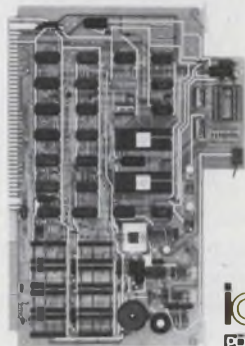

Now you can program 2708's & 2704's in just 100 seconds including automatic verify using iCOM's PROM Programmer/Memory Expander which occupies a single card slot in either Intel's* SBC 80/10 or Inteltec* MDS-800. The PP80 card also provides sockets for 8 additional 2708/2704 type devices for memory expansion.

Just \$395 including 1K ROM resident programming firmware.

* Intel and Inteltec are trademarks of Intel Corp.

iCOM MICROPERIPHERALS™
PERTEC a division of Perfec Computer Corporation

6741 Variel Ave., Canoga Park, CA 91303 (213) 348-1391 TWX 910-494-2788

MILITARY
APPLICATIONS

A/D CONVERTERS

by
MSK

Accuracy

Speed

Size

Repairability

Military

Temp. Range
-55°C to +125°C



- 4 Bit/50 nSec; Low Cost
- Ideal for Radar Scan Converters
- Holds Absolute Accuracy Over Temperatures
- Tracks a 10 MHz Analog Input



- 9 Bit/ 200 nSec.
- < 2 Bit Drift Over Temperature
- Insensitive to Clock Frequency

For Further Information Call or Write
M.S. Kennedy Corp.
Pickard Drive, Syracuse, New York 13211
Tel. 315-455-7077

CIRCLE NUMBER 53

INTEGRATED CIRCUITS

Bipolar PROMs hold 8 k and access in 100 ns

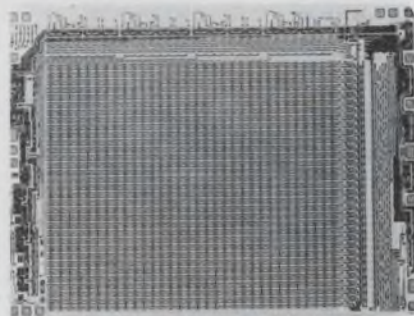

Signetics, 811 E. Arques Ave., Sunnyvale, CA 94086. (408) 739-7700. \$31 (100-up); stock.

Developed with either open collector or three-state outputs, the 82S184 and 82S185 field-programmable bipolar ROMs are available in a 2048 × 4 organization. The ROMs have an address access time of 100 ns maximum and a typical power dissipation of 50 μW/bit. Both devices are available in 18-pin ceramic DIPs with performance guaranteed over the commercial temperature range. Military temp range devices will be available in the near future.

CIRCLE NO. 339

JFET-input amplifiers come in many models

Texas Instruments, P.O. Box 5012, Dallas, TX 75222. (214) 238-2011. From \$1.60 (100-up); stock.

The LF155 series of JFET input op amps offers input-bias currents of under 50 pA (LF156A). There are three basic model groupings available: the LF155, 155A, 255, 355 and 355A are intended for low current drain applications; the LF156, 156A, 256, 356 and 356A are designed for wideband uses; the last group, the LF157, 157A, 257, 357, 357A are intended for wideband decompensated uses. The 155 series units are rated over the full military temperature range, the 255 series over a -25 to +85-C range and the 355 series over the 0 to 70-C range. The op amps are available in 8-pin ceramic or plastic DIPs and in TO-99, 8-pin metal cans. All units are pin-compatible with the LF155 series of op amps from National Semiconductor.

CIRCLE NO. 340

HiNIL counters deliver decimal or hexadecimal

Teledyne Semiconductor, 1300 Terra Bella Ave., Mountain View, CA 94043. (415) 968-9241. From \$3.06 (1000-up); stock.

Two up-down (reversible) counters, the HiNIL 373 and 374, offer a choice of decimal or hexadecimal outputs. Each unit has two clock inputs; pulsing one clock input causes the device to count up; pulsing the other causes it to count down. Other features include a noise immunity of 3.5 V, minimum, carry and borrow outputs for N-bit cascading, a clear input independent of count and load, individual presets to each flip-flop, and synchronous operation. The circuits operate at maximum counting frequencies of 1 MHz.

CIRCLE NO. 341

Speedy shift register handles ECL and TTL

TRW Defense and Space Systems, One Space Park, Redondo Beach, CA 90278. (213) 536-1500. \$80 (1 to 99); 30 days.

A 128-bit bipolar shift register, the SR128, has both ECL and TTL compatible inputs and outputs. Its 60-MHz operating speed is guaranteed when the ECL connections are used. ECL outputs are complementary open-emitter, thus permitting hard-wire OR connections. In the 60-MHz ECL configuration, the SR128 can source 20 mA. The TTL mode operates at a guaranteed 40 MHz, and its output is single-ended with a 6-mA sink capability. TTL and ECL inputs are either single ended or differential and can be multiplexed with an ECL level control. The inputs and outputs can be interfaced with single-ended inputs by connecting the complementary input to one of the two on-chip reference voltages. In the differential mode, inputs can be used as analog comparators with the ECL inputs for high level signals and the TTL for lower level signals. The SR128 operates from a single power supply of 5 V for TTL or -5.2 V for ECL. Open-emitter ECL outputs may terminate in 50 Ω by connecting load resistors to a -2.2-V supply.

CIRCLE NO. 342

μ P support circuits do control or bus driving

AMD, 901 Thompson Pl., Sunnyvale, CA 94086. (408) 732-2400. From \$6.50 (100-up); stock.

A pair of system controllers and bus drivers, the Am8228 and Am8238, are designed for operation with 9080A/8080A microprocessor systems. They provide eight-bit, bi-directional bus drive and are controlled by signals from a gating array. These circuits, pin-compatible with like-numbered devices from Intel, provide multibyte instruction interrupt acknowledge and a selectable single level vectored interrupt. The Am8238 has an extended memory write pulse width enhancing its application in large system timing controls. Both devices are available in molded and hermetic DIPs and are specified for operation over the commercial or military temperature ranges.

CIRCLE NO. 343

Telephone-tone decoder uses digital filtering



Collins Commercial Telecommunications, Division of Rockwell International, Newport Beach, CA 92663. (714) 833-4638. See text; stock.

Using a unique digital filtering technique, the CRC-8030 provides a low-cost solution for DTMF decoding. The circuit, which costs only \$29 in hundreds, when used in conjunction with a front-end band-split filter/limiter, forms a complete telephone-tone receiver. Valid tones are detected and converted to binary or 2-of-8 coded outputs within 22 to 39 ms, depending upon the front-end filter. The CRC-8030 is an ion-implanted depletion-mode, p-channel MOS/LSI device. It can operate from a +5-V supply and requires only a standard external 3.579545-MHz crystal for clock generation. It is housed in a 28-pin ceramic DIP.

CIRCLE NO. 344

8080 programming problems?

IF you need to know how to:

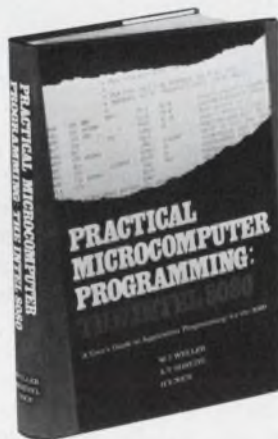

- service interrupts
- do multi-precision arithmetic
- convert number bases
- handle arrays and tables
- control complex peripherals
- use the stack pointer
- debug your programs

THEN . . . Practical Microcomputer Programming:

The Intel 8080 is the book you've been waiting for. Written by application programming people for application programmers, this is not a book of theory, but a book of step by step solutions to real problems. In eighteen chapters and more than 100 example programs it shows you exactly how to do all of the things listed above and many, many more with 8080 assembly language. A complete programmer's guide to using the 8080, it also contains the full source text of a mini-computer cross assembler and a debug program for 8080 based systems. This could be the best programming information bargain you will ever see.

Northern Technology Books

Box 62, Evanston, Illinois 60204

Please send my copy of Practical Microcomputer Programming: The Intel 8080 at \$21.95.

check enclosed money order enclosed

Illinois residents add \$1.10 state sales tax. No C.O.D. please.

Please type or print

Name _____

Company _____

Address _____

City _____ State _____ Zip _____

CIRCLE NUMBER 54

What makes GENERAL SCANNING OEM RECORDER MODULES



A better selection of standard 'specs' to easily fit particular applications. We developed our complete line of strip chart recorder modules — with OEM needs in mind. Needs like reliability, accuracy, compactness, flexibility and, of course, low cost.

Chances are General Scanning has a standard off-the-shelf recorder module just right for your application. If we don't, our modular construction method makes it simple to fill the most unique requirements. A sample of 'specs' to choose from:

- **Number of Channels**
single through eight
- **Channel Widths**
20, 40, 50, 80 & 100 mm
- **Paper Feed**
roll
fan fold
- **Chart Speeds**
multi-speed, electrically selectable
- **Pen Motor Operation**
open loop
velocity feedback
closed loop
- **Inkless Thermal Writing**

We offer packaged recorders for your lab, portable DC recorders and precision pen motors, too. Make "the designer's choice", call or write for full details. The general awaits your orders.



GENERAL SCANNING INC.
150 Coolidge Avenue
Watertown, MA 02172
TEL: (617) 924-1010

CIRCLE NUMBER 55

MODULES & SUBASSEMBLIES

Industrial multiplexer cuts the wire-mire

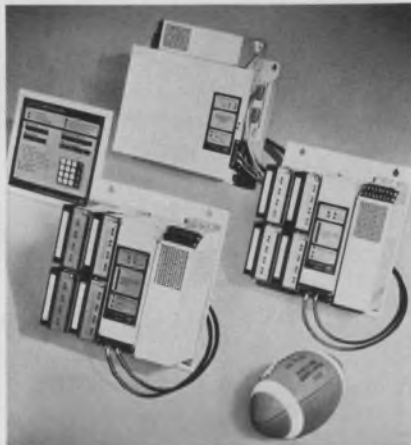

Cutler-Hammer, 4201 N. 27th St., Milwaukee, WI 53216. (414) 442-7800. From \$6000; 20 wk.

Directrol is a multiplex system that permits industrial control devices to communicate over a two-wire loop. The manufacturer estimates that multiplexing can save up to 50% in wiring costs when compared with conventional point-to-point wiring networks. A system can handle up to 4096 input and/or output devices. Up to 4096 individual digital or 2048 analog signals, or a combination of the two, can be transmitted from as many as 128 separate locations via time-division-multiplexing at a throughput rate of 3 ms. The system transmits analog measurements between terminal stations and to the communications station, where they can be displayed on an optional monitoring panel or made available for a computer. This stand-alone system does not need a computer. However, it is compatible with many computers. A standard feature automatically bypasses a malfunctioning station without disturbing continuous-flow processes. A redundancy option, using two pairs of wires, reconfigures a new communications loop when wires break. Bipolar 12-V, non-return-to-zero pulses at a 500 kHz rate, bi-phase modulated (Manchester code) give the system a data rate of 190 k bits per s. Each 8-bit data word is redundant and undergoes a geometric parity-check. The systems meet or exceeds NEMA ICS 2-230 for noise.

CIRCLE NO. 345

Stable ladders resolve 15 bits

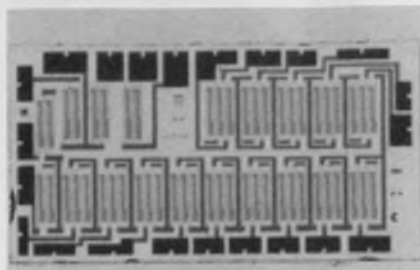

HyComp, 146 Main St., Box 250, Maynard, MA 01754. (617) 897-4578. \$47 (100 qty).

The series HC 1500 is a family of six R-2R ladder networks, each with 15-bit resolution. These nichrome thin-film devices have tracking tempcos of 1 ppm typical, 2 ppm maximum, and absolute tempcos of ± 50 ppm. Standard impedance level is $25 \text{ k}\Omega \pm 5\%$, but laser-trimmed ladders with $\pm 1\%$ tolerances are available. Ratio accuracies range from 0.005% to 0.05%. Maximum accumulated positive and negative deviation error is less than the specified ratio-accuracy. The networks are available in a 24-pin DIP or flatpack; the passivated chip itself is 0.19×0.1 in.

CIRCLE NO. 346

8-bit a/d settles in 800 ns or less



Intech Inc., 282 Brokaw Rd., Santa Clara, CA 95050. (408) 244-0500. \$199 (1-24); stock to 4 wks.

The A-857A-8 features an 800-ns conversion time, and can be short-cycled for 2-to-7-bit operation with proportionately shorter conversion times. At its input, the A-857A-8 accommodates ± 10 V, ± 5 V, and 0 to +10 V; digital outputs are provided in both parallel and serial formats. A low temperature coefficient guarantees no missing codes over the rated 0-to-70-C temperature range.

CIRCLE NO. 347

KING Q

At Vanguard, when it comes to high Q hybrid chip inductors, we definitely don't monkey around. From field-proven fixed chip inductors like the Magna Q Mini or Micro to the world's smallest variable chip inductor to complete tuned circuits, we've got all your inductive needs covered.

With every VE chip inductor, you get high Q, low DCR and high



SRF in an all-welded, transfer-molded miniature device that's compatible with automatic insertion equipment, and meets and exceeds MIL-C-15305.

For specs, application assistance or to place an order, call (213) 678-7161, TWX 910-328-6126 or write 930 Hyde Park Blvd., Inglewood, CA 90302.

VANGUARD ELECTRONICS COMPANY, INC.
King of high Q hybrid chip inductors

CIRCLE NUMBER 56

NOW—A FAIL-SAFE SOLID-STATE RELAY

A unique combination of dv/dt snubber, fusible-link protection in the trigger circuit, plus an oversized triac—all combine to protect against catastrophic system failure should the triac fail to turn on.

Either zero-voltage or non-zero-voltage switching, both types rated for maximum ac load currents of 5A or 10A. Any control voltage from 3 to 32V dc; all models compatible with TTL, DTL, CMOS logic. Solder-pin, quick-on, or screw terminals.

Call (609-882-4800) or write for further information. Heinemann Electric Company, Brunswick Pike, Trenton, NJ 08602.

HEINEMANN

We keep you out of trouble.

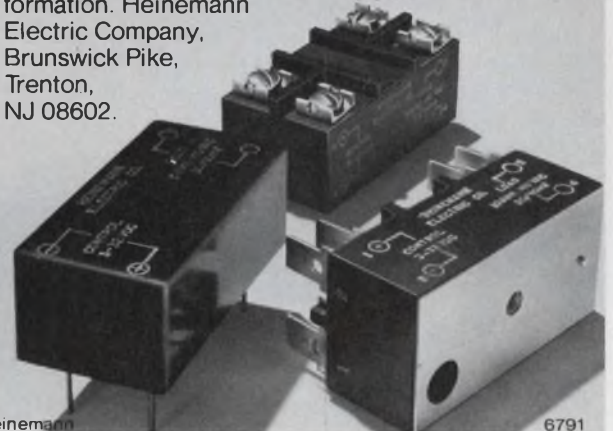

CIRCLE NUMBER 58

MODEL SP-G11

SPEEDEX RECORDER

Model SP-G11 is equipped with a built-in A/D converter in addition to common analog recorder functions. Since output terminals are also provided. It can be readily used in computation and for connection to a printer or paper tape punch.

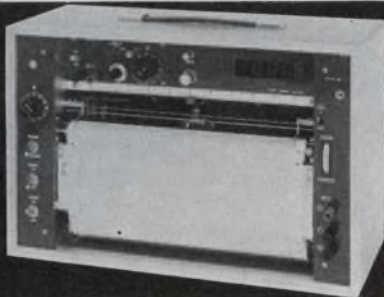

● **FEATURES**

1. Digital output terminal (10-bit binary or 3-digit BCD)
2. External clock terminal permits chart drive by external clock.

● **SPECIFICATIONS**

1. Chart width 250mm
2. Pen speed 0.8 secs full scale
3. Measurement voltage..... 0.5, 1, 5, 10, 50, 100mV, 1, 5, 10, 50, 100V full scale
4. Chart speed 10, 20, 50, 100, 300, 600mm/hr
20, 50, 100, 300, 600mm/min
5. Digital output (A or B) A...10-bit binary full scale at 1000 digit
1 digit 0.1%
B...3-digits BCD $10^2 \cdot 10^1 \cdot 10^0$ full scale 999

● Please write us on your letterhead for detailed information.

Riken Denshi Co., Ltd.
5-5-2, Yutenji, Meguro-ku, Tokyo, Japan.
TEL: 711-6656 TELEX: 0246-8107

CIRCLE NUMBER 57

TOUCH-TONE*



Telenetics 7603 is a complete Touch-Tone generator and automatic dialer sub-system packaged in a 1/2 cubic inch 32 pin DIP. Telephone standard 2-of-8 tones are transmitted in the conventional manner from manual keyboard entries, or automatically from either internal or external stored program sources. Key entry codes may be 1-of-16, 2-of-8 or binary. Timed output control leads provide line seizing and handset transmitter/receiver muting functions suitable for both telephone and 2-way radio system operation.

Signal purity is assured through a (patent pending) digital synthesis technique that yields less than 1% THD with a worst case (16th order) harmonic product that is 40 dB down from the fundamental. Operating voltage range is 5.5 to 28 volts DC (single supply). Standby current drain 1/2 MA. Typical. Temperature range -30 to 70° C.

- 7507 Analog Switches
- 7508 Multiplexers
- 7509 Solid State Switches
- 7511 Address Selector
- 7516 Touch Tone Decoder
- 7635 Keypswitch Assemblies

Call or write today for catalogs, prices and applications assistance.

Telenetics Telenetics, Inc., 4120 Birch Street, Newport Beach, California 92660 Phone: (714) 752-6363

*R- Registered trademark of AT&T

CIRCLE NUMBER 59

CRITICAL CRYSTALS

come from M-tron

M-Tron specializes in providing quality crystals and design assistance with maximum economy. Complete facilities for production of AT Cut crystals for commercial and military applications from 800 KHz to 200 MHz. Computer-aided design program speeds sample delivery for all types of precision, industrial and commercial applications.

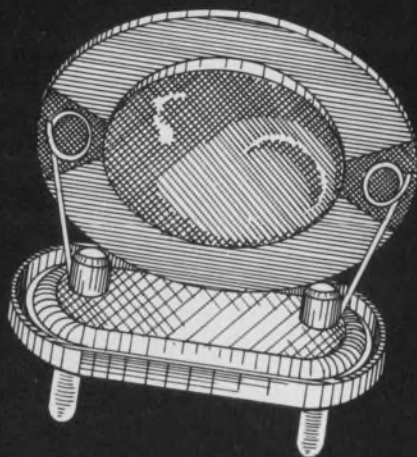

Phone 800-843-6842 or write

M-tron INDUSTRIES, INC.

Box 630, Yankton, South Dakota 57078 A Div. of Lynch Corp.

CIRCLE NUMBER 60

TAKE YOUR PICK!!

NLS' DPMs fill every need and the prices are pleasing.

NLS' Silver Jubilee Year

PM SERIES DC OR AC VOLTS

Features Include:

- Operates from a +5-volt separate power supply.
- MOS/LSI construction. • Smallest package available anywhere - 1" H x 2.5" W x 3.25" D. • Automatic zeroing. • Programmable decimal. • Overload indication. • Protected input. • Low power consumption. • Large 0.3" LED display.



PM-4 PANEL METER

MODEL	RANGES	ACCURACY	AUTO POLARITY	MUX BCD OUTPUT	RATIO OPERATION	DIGITS	PRICE
PM-3	VDC 1V, 10V, 100V, or 1000V	±0.1% F.S.	No	Optional	Optional	3	\$ 85
PM-3/OL	(PM-3, 5 has 100% over- range - 1200V maximum)	±0.1% F.S.	Standard	Optional	Optional	3	\$ 89
PM-3.5		±0.05% F.S.	Standard	Standard	Standard	3-1/2	\$ 99
PM-4		±0.02% F.S.	Standard	Optional	Optional	4	\$170
PM-3.5AC	VAC - 2V, 20V, 200V or 1000V	±0.5% F.S.	N/A	Standard	Standard	3-1/2	\$136



Non-Linear Systems, Inc.

Originator of the digital voltmeter.

Box N, Del Mar, California 92014 Telephone (714) 755-1134

See your local distributor!

Distributor Inquiries invited.

PM SERIES VDC CIRCLE #161

PM-3.5AC CIRCLE #162

MODULES & SUBASSEMBLIES

D/a converters get MIL-883 testing

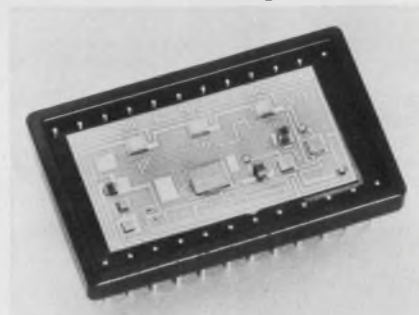

Micro Networks Corp., 324 Clark St., Worcester, MA 10606. (617) 852-5400. From \$69 (1-24).

DAC-85 series 12-bit d/a converters are routinely tested to MIL-883 Class C specs, at no extra cost. In quantities of 1 to 24, the Model DAC-85-C (0 to 70 C) starts at \$69, while the DAC-85-CBI and CCD (-25 to +85 C) are priced at \$89. These, as well as BCD and binary versions, come in sealed 24-pin DIPs, and offer guaranteed monotonicity within the -25 to +85 C range. Both voltage and current output models provide programmable ranges, TTL-compatible inputs, and work from standard +5 and ±15-V supplies.

CIRCLE NO. 348

Low-cost oscillators span 20-MHz range



Dale Electronics, 930 W. 23 St., Tempe, AZ 85282. (602) 967-7874. See text.

For \$5.50 (1000 qty.) the XO-2000 series of crystal-controlled oscillators gives you an output frequency in the 3.7-to-25-MHz range. The frequency's stability is ±1000 ppm from 0 to 60 C. Stabilities of ±50, ±100 and ±500 ppm are available at higher costs. Fan-out is ten TTL inputs from the 14-pin DIP-type, 0.8 × 0.5 × 0.4 in., encapsulated unit. As an option, the height can be shrunk from 0.4 to 0.3 in.

CIRCLE NO. 349

Programmer ties supplies to HP-IB

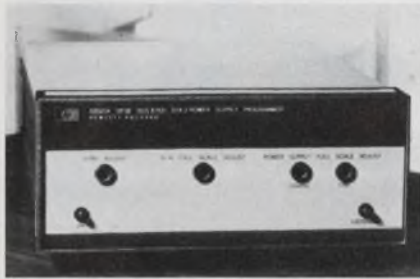

Hewlett-Packard, 1501 Page Mill Rd., Palo Alto, CA 94304. (415) 493-1501. \$500; 2 wk.

With this power-supply programmer you can control more than 80 models of HP unipolar and bipolar power supplies via the Hewlett-Packard Interface Bus (HP-IB). The Model 59501A controls a wide range of dc voltages and currents at power levels up to 10 kW. Output voltage (or current) of HP remotely programmable power-supplies is controlled by voltage programming from the unit, with gain provided by the power-supply control circuits. The programmer contains an adjustable resistance network that matches its output to various HP power-supply programming coefficients and full-scale output ratings. The device offers isolation rated at 600 V dc between bus input lines and the output terminals. The instrument also can be used as a low-level dc voltage source with two manually selected output modes. One mode is unipolar, from 0 to 9.99 V in 10-mV steps with an accuracy of 0.1% of output plus 5 mV. The other mode is bipolar, from -10 to +9.98 V in 20 mV steps with an accuracy of 0.1% of output plus 10 mV. Resolution for both modes is 0.1%. A bus-programmable 0.1-times range provides increased resolution and accuracy over the lower 10% of both output modes. Output current up to 10 mA is available. Internal conversion circuitry enables the 59501A to produce a full-scale d/a voltage change in less than 150 μ s from the time the digital data are received until the programmed analog voltage is reached.

CIRCLE NO. 350

HAMLIN SOLID-STATE RELAYS...

...save board space.

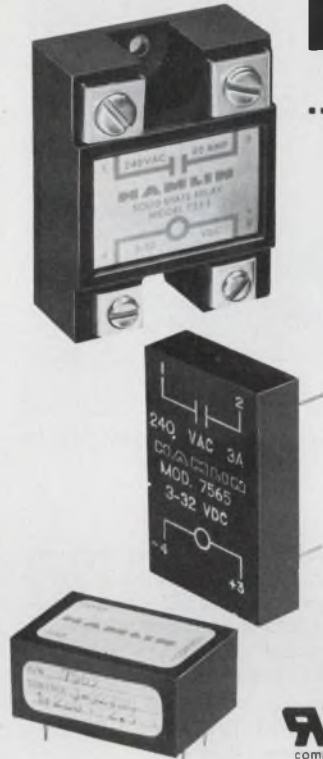

New Solid-State relays for PCB mounting offer designers the field-proven circuitry of the 7521 chassis mounted units. You get the same opto-coupled, zero-voltage synchronous switching, 1500 Vac isolation, 120 or 240 Vac switching capability. And they occupy only 1/3 the space.

For technical and pricing information call your Hamlin distributor or representative. Hamlin, Inc., 614 Lake St., Lake Mills, WI 53551 • 414/648-2361 • TWX 910/260-3740.

LINE VOLTAGE (47-63 Hz)	FULL LOAD CURRENT RATING (AMPS)					BLOCKING VOLTAGE VDC
	2.5	3	10	25	40	
120 Vac	7561	7564	7521	7531	7551	200
240 Vac	7562	7565	7522	7532	7552	400
	7563	7566	7523	7533	7553	600
INPUT:	3-32 Vdc		3-32 Vdc, 80-140 Vdc, 90-280 Vac			

 This mark indicates recognition under the component program of Underwriters Laboratories, Inc.

HAMLIN

CIRCLE NUMBER 62

New "MM" Series Switchers pack up to 2.26 watts per cubic inch; cost less than 60¢ per watt!

- 21 models — one, two, three, four, five and six outputs.
- Most watts/in.³ — more than 2 times denser than competitive switchers.
- Up to 80% efficient.
- Smallest sizes — 750 watt model measures only 5" x 5" x 12.75".
- Lightest weight — up to 62 watts/lb.
- Most reliable — all models carry 2-year guarantee.
- All models designed to meet UL 478.
- DC inputs and other options available.
- Almost 20,000 LH high power switchers now in use.

Write for 8-page catalog.

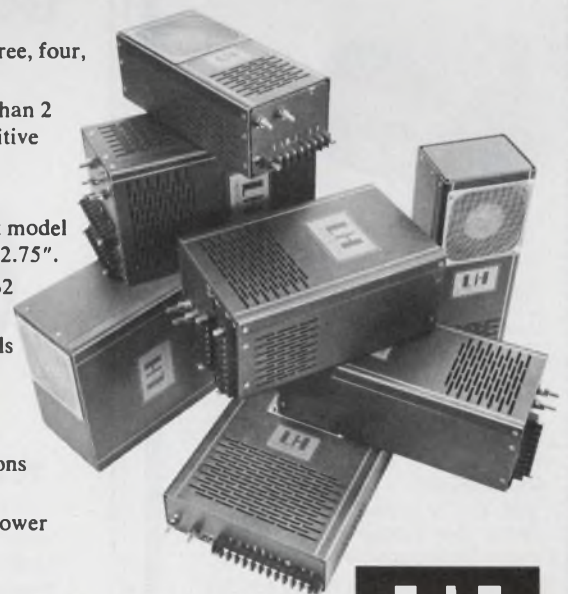

LH Research, Inc. • 1821 Langley Avenue, Irvine, CA 92714 • 714/546-5279

CIRCLE NUMBER 63

NINE ENCLOSURES FOR \$89.11

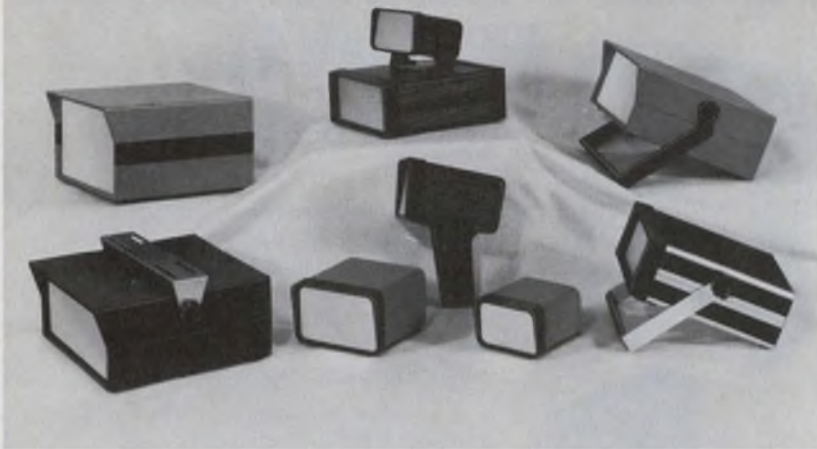

To order, mail a check for \$89.11 plus \$5.00 shipping and handling. Ohio residents add 4% sales tax. Descriptive literature is available.

For a limited time you can buy the pictured evaluation package at the 1000 piece price, nine (9) enclosures for \$89.11. This offer expires February 14, 1977.

Tracewell enclosures are opening many previously uneconomical product areas with high quality enclosures at low prices. Two exciting new series have just been added to the successful line. These are all included in the evaluation package.

Tracewell is a young growing company, committed to producing quality enclosures at a realistic price. Whatever your enclosure needs, contact us for a quotation. You will be pleasantly surprised. Prices range from \$7 to \$19.

TRACEWELL ENCLOSURES, INC.
200 Montrose Way
Columbus, Ohio 43214
phone: (614) 263-3702

CIRCLE NUMBER 64

Circuit Savers

NEW

AC POWER LINE PROTECTOR



Protects
110, 220, 380,
440 VAC line
1 ϕ , 3 ϕ - 50/60/400 Hz

The **Series P** operates rapidly to prevent damage to equipment operating on the AC power lines, by switching rapidly to a clamping state whenever a transient exceeds the clamping threshold. The units operate on overvoltages of either polarity, on 1 ϕ and 3 ϕ lines and recover automatically when the transient expires. Severe transient conditions cause the protector to switch to a crowbar mode and cause an external fuse or circuit breaker to operate.

CATALOG 801

Full line of protection modules for every hi-lo voltage/current requirement. Write or call for data.

279 Skidmore Rd., Deer Park, N. Y. 11729
Telephone: 516-586-5125

MCG Electronics

CIRCLE NUMBER 65

KEEP

Electronic Design's

GOLD BOOK

HANDY



When You Call

Save time when you contact suppliers. Check their catalog pages first in *Electronic Design's GOLD BOOK*. Maybe the information you need is right at your fingertips.

POWER SOURCES

Supplies for boards offer high regulation



Standard Power, 1400 S. Village Way, Santa Ana, CA 92705. John Mittelbach, (714) 558-8512. \$29-\$115; stock.

Circuit-board mountable ESPD and ESPT dc power supplies provide either two or three outputs with no-load to full-load regulation of 0.02%. You can select any combination and polarity of 15, 12, or 5-V outputs, at total currents from 25 mA to 2 A.

CIRCLE NO. 351

Dial-a-voltage with 0.005% fs accuracy



Datel Systems, Inc., 1020 Turnpike St., Canton, MA 02021. (617) 828-8000. \$295 (1-9 units); 4-6 wks.

The DVC-8500 low-cost miniature voltage generator supplies a bipolar output up to ± 19.999 V at 25 mA, in 1-mV switch-selected steps, accurate to 0.005% full scale, or ± 1 mV of setting. For precise zeroing, a vernier varies the output by 0 to 1.5 mV. The manufacturer claims a 90-day stability of 27-ppm fs drift, and 5- μ V zero drift, with less than 1 mV absolute error over a 0-to-50-C operating range. Powered by 115 or 230 V ac $\pm 10\%$, 47 to 440 Hz, the instrument has a short-circuit protected output accessible both in front and back. Panel mounting kit available.

CIRCLE NO. 352

**Low cost, high performance
3A SPDT relay
really saves
PC board space**

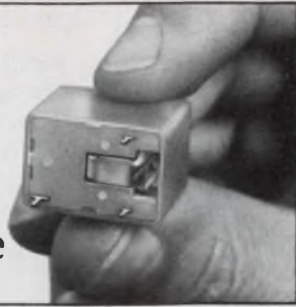

**Mounts on .69" centers...
satisfies thousands of application needs**

Where size and space are important, the Series 27 relay can be just the low cost answer you've been looking for. It provides 3 amps of switching in a 0.526" cube and mounts on .69" centers, assuring high density PC board mounting. The cost is \$1.05 each in 1,000 piece lots for 3, 6 and 12V dc units...slightly higher for 24V dc.

You'll find the Series 27 relay suitable for hundreds of control applications. For instance: timing controls; gas pilot light controls; anti-theft devices for CB radios; automotive controls; emergency lighting equipment; and medical equipment, to name a few.

The relay has a 450 mW pick-up sensitivity (180 mW available). Contact rating is 3A res @ 28V dc. 120V ac. Contact resistance is 0.10 ohm.

Write for information today!

NORTH AMERICAN PHILIPS CONTROLS CORP.

Frederick, Md. 21701 • (301) 663-5141

CIRCLE NUMBER 66

**Borrow my calculator...
but never my C-Meter.**



**It's so handy, you'll
measure capacitors
instead of resistors.**

- Hand Held
- Pushbutton Speed
- Accuracy: .1%
- Range: .1pf to .2 farads
- Rep Stocked

**Try one. You won't be
able to keep your hands off it. \$289**

ECD ECD CORP.
196 BRIDGEWAY, CAMBRIDGE, MASS. 02139
(617) 661-4400

SALES OFFICES: AL, Huntsville (205) 533-5896; AZ, Scottsdale (602) 947-7841; CA, Costa Mesa (714) 540-7160; CA, Sunnyvale (408) 733-8690; CO, Denver (303) 750-1222; FL, Winter Haven (813) 294-5815; GA, Chamblee (404) 457-7117; IL, Elk Grove Vill (312) 593-0282; IN, Indianapolis (317) 293-9827; MD, Silver Spring (301) 622-4200; MA, Burlington (617) 273-0198; MN, Minneapolis (612) 781-1611; NJ, Camden (215) 925-8711; NM, Albuquerque (505) 299-7658; NY, Great Neck (516) 482-3500, (212) 895-7177; Syracuse (315) 446-0220; NC, Raleigh (919) 787-5818; OH, Centerville (513) 433-8171; TX, Houston (713) 688-9971; TX, Richardson (214) 231-2573.

CIRCLE NUMBER 67

BASIC DESIGN — CUSTOM BUILT

Model 90



ROTARY CERAMIC SWITCHES

**for RF and Power
Applications**

R.S.C. switches are available
in various models that can be
customized to meet your
particular requirements.

Model 88

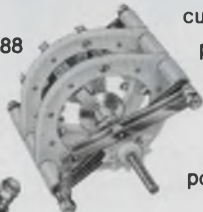

All switches have
heavily silver plated
current carrying components
for long life and
minimum maintenance.

Model 86



Types include shorting and
non-shorting, single and multi-
deck, 10 to 100 amp capacity,
20° - 90° detents, and
2,000 to 24,000 volt peak
flashover.

Model 80

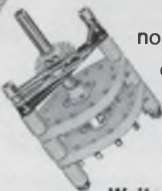

Write for catalog No. 960



RADIO SWITCH CORPORATION
RT. 79, MARLBORO, N.J. 07746
PHONE: 201-462-6100

49 REASONS TO GET UGLY

- | | | |
|---------------------|----------------------|----------------------------------|
| 1. Intel 4004 | 18. Motorola 6800 | 35. Toshiba TLCS-12 |
| 2. Intel 4040 | 19. AMI 6800 | 36. National IMP-16 |
| 3. National 4040 | 20. National SCAMP | 37. National PACE |
| 4. Rockwell PPS-4 | 21. RCA 1801 | 38. PanaFacom PFL-1600A |
| 5. National PPS-4 | 22. RCA 1802 | 39. Texas Instruments TM-9900 |
| 6. Rockwell PPS-4/2 | 23. Rockwell PPS-8 | 40. Advanced Micro Devices 2901 |
| 7. Rockwell PPS-4/1 | 24. National PPS-8 | 41. MOS Technology 6502 |
| 8. Fairchild F-8 | 25. Rockwell PPS-8/2 | 42. Texas Instruments EA 9002 |
| 9. Mostek F-8 | 26. Signetics 2650 | 43. Electronic Arrays EA 9002 |
| 10. Intel 8008-1 | 27. Motorola 2901 | 44. Scientific Micro Systems 300 |
| 11. Intel 8080 A | 28. Raytheon 2901 | 45. General Instruments CP 1600 |
| 12. AMD 8080 A | 29. Fairchild 9400 | 46. Western Digital MCP-1600 |
| 13. T. I. 8080 A | 30. Intel 3002 | 47. Monolithic Memories 6701 |
| 14. NEC 8080 A | 31. Signetics 3002 | 48. Motorola 10800 |
| 15. Siemens 8080 A | 32. Zilog Z-80 | 49. Texas Instruments SBP0400 |
| 16. Intel 8048 | 33. Intersil 6100 | |
| 17. Mostek 5065 | 34. Harris 6100 | |

By now, you've probably got the idea:

If you've got a microprocessor chip, kit or system,
one of our UGLY dc supplies was made for you.

They've got the right voltages. The right currents. The
right specifications.

And definitely the right price, because we've concentrated
on making them perform instead of making them
pretty. It all adds up to the prettiest
price/performance ratio you've ever seen.

And another couple of reasons
to get UGLY Now.

ELPAC
©Elpac Electronics, Inc.

Elaxon: the ugliest dc supplies on earth.

Get UGLY at Cramer, Newark, MIL-COMM, QPL, Ultronics, Technico,
Shap Electronics, Integrated Electronics. Or call 714/979-4440 today.

CIRCLE NUMBER 68

New Literature



Digital instruments

Specifications on over 150 digital instruments, such as DMMs, thermometers, calibrators, data-acquisition systems, are contained in a 20-page catalog. United Systems, Dayton, OH

CIRCLE NO. 355

Remote terminal

The Model 78 remote processing system is described in an eight-page brochure. Several typical applications along with all hardware and software elements are also described. Data 100, Minnetonka, MN

CIRCLE NO. 356

Test sockets, carriers

Versatile test sockets and carriers for integrated and hybrid circuits, MSI and LSI, rectifiers and other semiconductor devices are covered in an eight-page catalog. Textool Products, Irving, TX

CIRCLE NO. 357

Ordnance systems

Specialized capabilities and resources for the development, design, manufacture and support of electronic and electromechanical weapon control systems are described in a 12-page brochure. General Electric Ordnance Systems, Pittsfield, MA

CIRCLE NO. 358

Optoelectronic displays

Multidigit optoelectronic displays are described in a four-page catalog. Texas Instruments, Dallas, TX

CIRCLE NO. 359

Miniature switches

Detailed descriptions, specifications and prices covering over 1200 miniature switch items are listed in a 72-page catalog. Alco Electronic Products, North Andover, MA

CIRCLE NO. 360

Display devices

Display devices for a variety of demanding industrial and military applications are covered in a 22-page catalog. The illustrated catalog is divided into the following product sections: CRTs, display storage tubes and a developmental electroluminescent (EL) flat-panel display. Westinghouse Electric, Industrial & Government Tube Div., Horseheads, NY

CIRCLE NO. 361

C&K's Pushbutton Switches with Snap-in Bezels make the screwdriver obsolete.

specify
8161J82ZQ

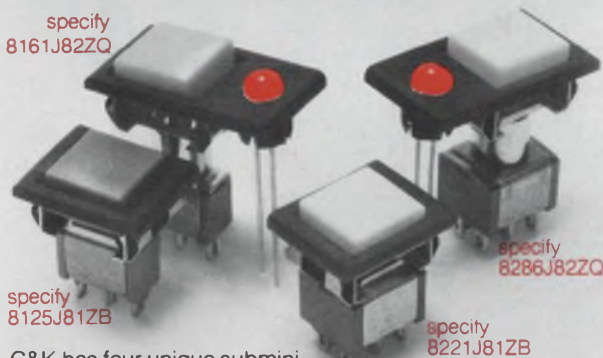

specify
8125J81ZB

specify
8286J82ZQ

specify
8221J81ZB

C&K has four unique submini pushbutton switches with snap-in bezels that make a screwdriver unnecessary in panel assembly. These time-and-money saving switches simply snap into a panel hole and a nickel-plated steel mounting spring holds the switch firmly in place. The switches are available in 1-amp and 6-amp models in SPDT and DPDT configurations. Also .4VA for low energy circuits. LED illumination is available on certain models. For specifics, write or call today. With these new switches, the next time you pick up a screwdriver will be in your local tavern.

C&K Components, Inc., 103 Morse Street,
Watertown, MA 02172 Tel: (617) 926-0800
TWX: 710-327-0460 TELEX: 92 2546
Free Engineering Sample on Request.

CIRCLE NUMBER 69

Terminal Boards

READI-MADE

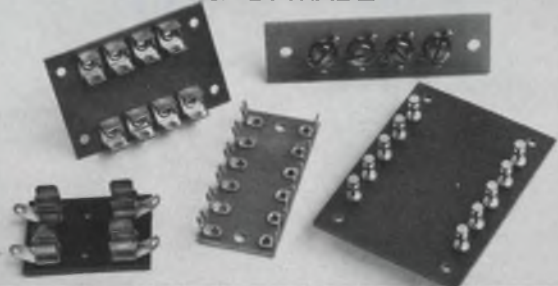

CUSTOM FABRICATED

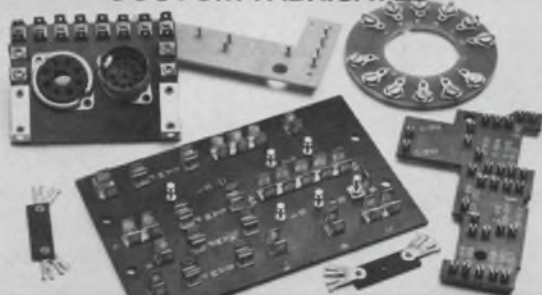

NEW FREE CATALOG ON REQUEST

KEYSTONE
ELECTRONICS CORP.

49 BLEECKER ST., NEW YORK, N.Y. 10012 • (212) 475-4600

CIRCLE NUMBER 70

ELECTRONIC DESIGN 26, December 20, 1976

low cost data system

Easiest to use: Monitoring Processes, Logging Data, Tracking Tests & Studies

Gather analog or digital data from up to 248 channels—thermocouples, transducers, etc.—print out results, tape them, feed your computer. It's all under your keyboard control with a microprocessor in the proven PD 2064 System. You easily set or change all functions: crystal clock timing, scan intervals, channel signal conditioning, alarms, auto-programming with new multi-program bank and program printout, plus timesaver subroutines like true integration and averaging if you want. We believe it's the most powerful, versatile, and lowest cost standardized way to reduce more data per dollar in industry, lab, or field applications. Some units stocked for quick shipment. Request Bulletin B110 from Esterline Angus Instrument Corporation, P.O. Box 24000, Indianapolis, IN 46224. Tel. 317-244-7611.



CIRCLE NUMBER 71

New Space Saver coolers for TO-3 cases meet competition spec for spec — at 1/2 the price.

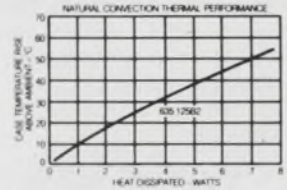

It's true. Wakefield's new Series 635 Space Saver Cooler is directly interchangeable with Thermalloy's 6013 series and replaces other TO-3 heat sinks—yet costs only 11¢ each in 5,000 quantity.

If you're looking for lightweight, one-piece TO-3 heat sinks, you should discover Series 635. We also offer the 635 with hole patterns for TO-66 and TO-220 packages.

Try one free:

See for yourself. Indicate your specs, then cut out and mail for a free sample.

Height: 50" 75" 1.00" 1.25"
 Finish: Plain Black Anodize
 Configuration: TO-3 Standard TO-3 (8 pin)
 TO-66 TO-220



WAKEFIELD ENGINEERING INC.

77 AUDUBON ROAD, WAKEFIELD, MA 01880 (617) 245-5900
 TWX 710-348-6713 AN EGI COMPANY

CIRCLE NUMBER 72

AUTHOR'S GUIDE

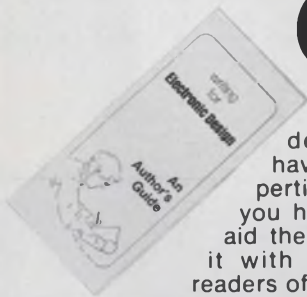

If you've solved a tricky design problem, if you have developed special expertise in a specific area, if you have information that will aid the design process... share it with your fellow engineer-readers of *Electronic Design*.

Articles you have authored not only raise your own professional status, but help build your company image as well. The readers benefit, your company benefits.

To help you prepare material that meets *Electronic Design's* high editorial standards, our editors have prepared a special author's guide entitled "Writing for *Electronic Design*." It covers criteria for acceptability, form, length, writing tips, illustrations, and payment for articles published. It's available without cost.

It's easy to write for *Electronic Design*, but it's often hard to get started. Send for your copy of our Author's Guide today.

**Circle No.
250**

New Mini-Toggle Switch Line from SMK

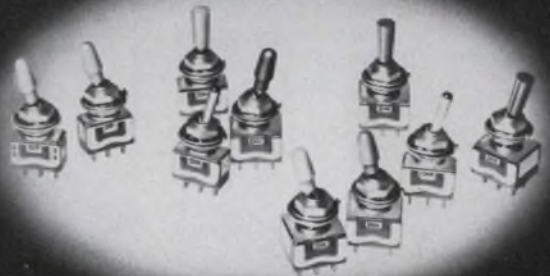

The **JT-3000 Series** complete line of UL Approved mini-toggle switches feature rugged construction with the terminals molded and secured into the housing to provide excellent shock and vibration characteristics.

Available in either SPDT or DPDT, the switches are rated at 6 amps at 125V AC or 12V DC resistive load and will operate from -10°C to +60°C. Mechanical life is 100,000 cycles with no load and 20,000 cycles with rated resistance load.

Priced from \$.90 in 100 piece quantity.



SMK Electronics Corporation of America

118 East Savarona Way Carson, California 90746
 Tel: (213) 770-8915

CIRCLE NUMBER 73

Electronic Design

ELECTRONIC DESIGN's function is:

- To aid progress in the electronics manufacturing industry by promoting good design.
- To give the electronic design engineer concepts and ideas that make his job easier and more productive.
- To provide a central source of timely electronics information.
- To promote communication among members of the electronics engineering community.

Want a subscription? ELECTRONIC DESIGN is sent free to qualified engineers and engineering managers doing design work, supervising design or setting standards in the United States and Western Europe. For a free subscription, use the application form bound in the magazine. If none is included, write to us direct for an application form.

If you do not qualify, paid subscription rates are as follows: \$30.00 per year (26 issues) U.S., \$40.00 per year (26 issues) all other countries. Single copies are \$2.00 U.S., \$3.00 all other countries. The Gold Book (27th issue) may be purchased for \$30.00 U.S. and \$40.00 all other countries.

If you change your address, send us an old mailing label and your new address; there is generally a postcard for this bound in the magazine. You will have to requalify to continue receiving ELECTRONIC DESIGN free.

The accuracy policy of ELECTRONIC DESIGN is:

- To make diligent efforts to ensure the accuracy of editorial matter.
- To publish prompt corrections whenever inaccuracies are brought to our attention. Corrections appear in "Across the Desk."
- To encourage our readers as responsible members of our business community to report to us misleading or fraudulent advertising.
- To refuse any advertisement deemed to be misleading or fraudulent.

Microfilm copies are available of complete volumes of ELECTRONIC DESIGN at \$19 per volume, beginning with Volume 1, 1952 through Volume 20. Reprints of individual articles may be obtained for \$3.00 each, prepaid (\$.50 for each additional copy of the same article) no matter how long the article. For further details and to place orders, contact the Customer Services Department, University Microfilms, 300 North Zeeb Road, Ann Arbor, Michigan 48106 telephone (313) 761-4700.

Want to contact us? If you have any comments or wish to submit a manuscript or article outline, address your correspondence to:

Editor
ELECTRONIC DESIGN
50 Essex Street
Rochelle Park, N.J. 07662

quick ads

New and current products for the electronic designer presented by their manufacturers.

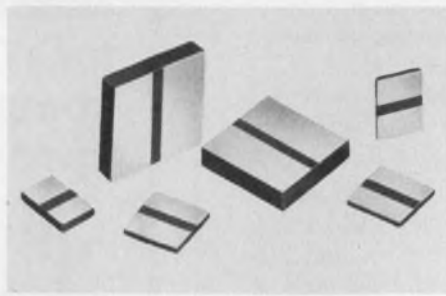

CERAMIC CHIP CAPACITORS. SPLIT-CHIP, is a new concept in ceramic chip capacitor technology. These new units have two broad electrodes on one face and eliminate conventional wrap-around end terminations. This new concept provides lower cost and easier assembly. SPLIT-CHIPS are available in five standard sizes from .040" x .030" to .130" x .090" and .015" thick and in all popular dielectrics and capacitance ranges. JOHANSON DIELECTRICS, INC., Box 6456, Burbank, Ca. 91510 213-848-4465

CERAMIC CHIP CAPACITORS

181

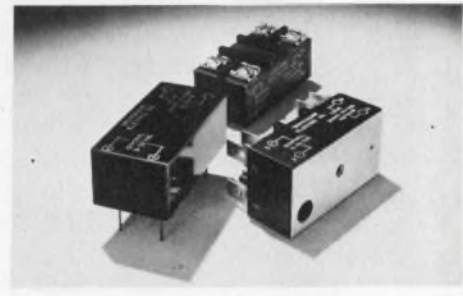

Fail-safe Heinemann solid-state relays combine dv/dt snubber, fusible link in the trigger circuit, and an oversized triac, all of which act to prevent catastrophic system failure should the triac fail to turn on. 5A and 10A ac output, load voltage from 25V ac to 270V ac. TTL and CMOS control compatible (3 to 32V dc input), choice of zero-voltage and non-zero-voltage switching. Solder-pin, quick-on, or screw terminals. Heinemann Electric Company, Brunswick Pike, Trenton, NJ 08602; phone (609) 882-4800.

SOLID-STATE RELAYS

184



Low-cost tape reader is fast—up to 300 cps—and quality-built. Dual sprocket drive, a state-of-the-art fiber optic light source and photo transistor read head. Simplicity of design makes it easy to adapt to specific OEM requirements. Decitek, 250 Chandler Street, Worcester, MA 01602 (617) 798-8731

SAM® TAPE READER

182



Basic Electricity & Basic Electronics by Van Valkenburgh, Nooger & Neville, Inc. Derived from the COMMON-CORE Training Program initially developed for the U.S. Navy. Thorough, comprehensive coverage. Available in separate paperbacks or cloth volume. Write for FREE brochure. Hayden Book Co., Inc., 50 Essex St., Rochelle Pk, N.J. 07662 (201) 843-0550.

TRAINING TEXT

185

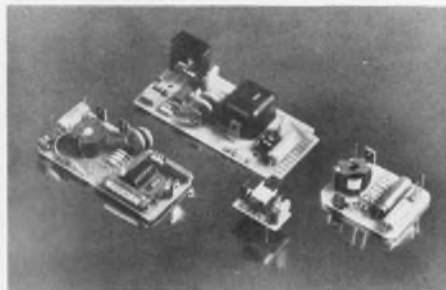

Activate gas discharge readouts! Custom designed and produced DC-to-DC power supplies to activate gas discharge displays, or for other applications. Regulation I/O options, packaging (encapsulated, aluminum shell or open frame), size and configuration, heat dissipation, mounting (PC board pins, edge connectors), etc., can be tailored to meet individual specifications. Price and delivery discussed after specifications are submitted. Endicott Coil Co., Inc., 31 Charlotte Street, Binghamton, N.Y. 13905 (607) 797-1263.

CUSTOM DESIGNED POWER SUPPLIES

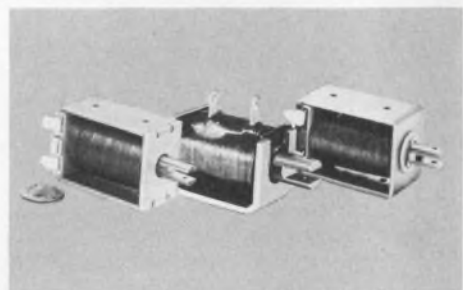

Potter & Brumfield Solenoids. Famous P&B reliability now in new solenoid series. All with .87 quick disconnect terminals, acetate yarn coil finish to meet Class A 105° C. requirements. Pull-on-operate action standard, push optional. **S11:** general purpose D-frame solenoid in 6, 12, & 24 VDC and 24, 120 VAC. **S11L:** heavy-duty general purpose D-frame with shock dampener; in 6, 12, & 24 VDC ratings. **S34:** genl. purpose C-frame with standard 6, 12, 24 VDC + 24, 120 VAC. Potter & Brumfield Div. AMF Inc., Princeton, IN 47671. 812-386-1000.

SOLENOIDS

186

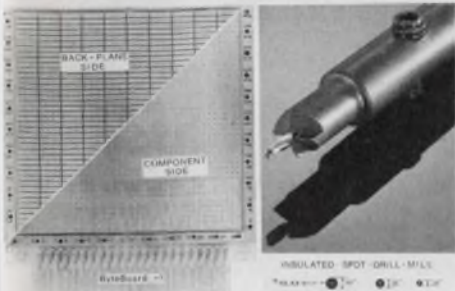

THE BREADBOARDING SYSTEM - BYTE BOARD - 1 + INSULATED - SPOT - DRILL - MILL. A unique board with 4 common connections per pad **MINIMIZES/ELIMINATES** interconnect wiring - point-to-point or wire-wrap. Specifically designed for Insulated Spot - Drill - Mill to cut clearance spots in component side ground plane and drill mounting holes. Drill-Mill with #60 Carbide Drill, IS6003C, \$27.50 set of 3, Byte Board-1, BB-1, \$75 doz. A.F. STAHLER COMPANY, P. O. 354, Cupertino, CA 95014 (408) 252-4219

BREADBOARDING SYSTEM

187

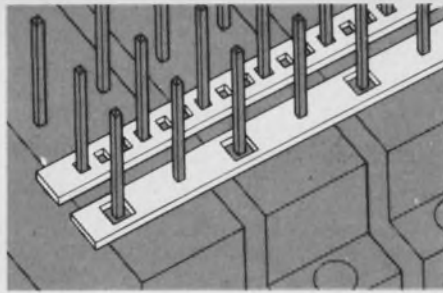

STRIP/BUS BY ROGERS. Low Cost Bus-ing Systems; easy installation, reliable solder joints; greater pin exposure. Write or call for details. Rogers Corporation, Chandler, AZ 85224. Phone (602) 963-4584. (EUROPE: Mektron NV, Ghent, Belgium; JAPAN: Nippon Mektron, Tokyo)

STRIP/BUS

190



Free New '76 catalog contains over 34,500 quality power supplies from the world's largest manufacturer, Power/Mate Corp. Power Supplies for every application including submodulars, open frame, var-iated, encapsulated, laboratory & system. All units UL approved and meet most military and commercial specs for in-dustrial and computer uses. Power/Mate Corp., 514 S. River St., Hackensack, NJ 07601 (201) 343-6294

POWER SUPPLIES

188

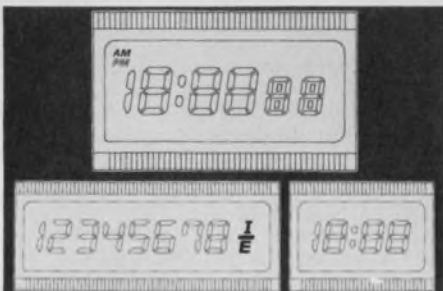

SHARP LIQUID CRYSTAL DISPLAY. We have a wide range of standard displays and can special design for a low design cost. Quick delivery on all displays. Contact:—Sharp Corporation, Semi Conductor Division, Overseas Marketing, 2613-3, Ichinomoto Tenri, Nara, Japan. Tel: (07436) 5-1321 Telex: 5522364 SHAPEL J

STANDARD/SPECIAL DISPLAYS

191



PRECISION DC VOLTAGE CHECK AT A GLANCE. The ISE Voltage Sentry will instantly alert you of a module failure and save hours of costly down-time. Its "tight" on/off status eliminates ordinary LED ambiguity and its draws less than 60mW from monitored source. Available in 5, 10, 12, 15, 16, 24, 28 and 40 voltage ranges with a typical trip value of .5V below the voltage range. Also available for rack mounting in a 19" panel. Unit price: \$9.75. ISE, Inc., 811 2nd St., Ronkon-koma, N.Y. 11779

VOLTAGE SENTRY

189



DIGITAL TO SYNCHRO CONVERTERS— 14, 12 or 10 bit input, 11.8/90V, 400 or 60Hz transformer isolated output, accuracy ± 4 , ± 15 or ± 30 min. Driving 1VA, 2VA (2.6" x 3.1" x .82"H module) or 5 VA loads (4 1/2" x 9 1/4" PC card). Price from \$350 in qty. Other CCC products are Synchro to Digital or DC, and DC to Synchro Converters, Solid State C.T.'s or CDX's, and Absolute Encoders. Send for Free Catalog & Application Notes. Computer Conversions Corp., East Northport, N.Y. 11731 (516) 261-3300.

DIGITAL TO SYNCHRO

192

Advertising Sales Staff

Tom W. Carr, Sales Director
Jean Bunfield, Sales Coordinator

Rochelle Park, NJ 07662

Robert W. Gascoigne
Daniel J. Rowland
Thomas P. Barth
50 Essex St.
(201) 843-0550
TWX: 710-990-5071

Philadelphia

Thomas P. Barth
(201) 843-0550

Boston 02178

Gene Pritchard
P.O. Box 379
Belmont, MA 02178
(617) 489-2340

Chicago 60611

Thomas P. Kavooras
Berry Conner, Jr.
200 East Ontario
(312) 337-0588

Cleveland

Thomas P. Kavooras
(312) 337-0588

Los Angeles 90045

Stanley I. Ehrenclou
Burt Underwood
8939 Sepulveda Blvd.
(213) 641-6544

Texas

Burt Underwood
(213) 641-6544

San Francisco

Robert A. Lukas
3579 Cambridge Lane
Mountain View, CA 94040
(415) 965-2636

London

Constance McKinley
50 Essex St.
Rochelle Park, N.J. 07662
Phone: (201) 843-0550

Amsterdam, Tokyo, Seoul

Sanders, W. J. M.
Raadhuisstraat 24
Graft-De Ryp, Holland
Phone: 02997-1303
Telegrams: Euradteam-Amster-dam

Haruki Hirayama

Electronic Media Service
5th Floor, Lila Bldg.,
4-9-8 Roppongi
Minato-ku, Tokyo, Japan
Phone: 402-4556
Cable: Electronicmedia, Tokyo

Mr. O-kyu Park, President Dongbo Intl Corp.—

World Marketing
C.P.O. Box 4010
Seoul, Korea
Tel. 76-3910/3911
Cable: DONGBO SEOUL
Telex: EBKOREA K27286

Step-by-step coverage of defense radar system design . . .

INTRODUCTION TO DEFENSE RADAR SYSTEMS ENGINEERING

James N. Constant

This all-inclusive handbook covers virtually every facet of radar technology that must be mastered in order to design a complete defense radar system. In fact, it concludes with a *step-by-step procedure for specifying and designing a complete radar system for a given application*. Separate chapters cover target characteristics; radar detection; radar receivers; radar system error model; flight of a ballistic missile; ballistic reentry trajectories; trajectory prediction; radar data processing; reflector antennas; and array antennas. Order your 15-day examination copy today! #9194, 344 pages, cloth, illustrated, \$22.95



15-DAY FREE EXAMINATION!

 Hayden Book Company, Inc.
50 Essex Street
Rochelle Park, N.J. 07662

Please send me my copy of INTRODUCTION TO DEFENSE RADAR SYSTEMS ENGINEERING to read and use for 15 days. At the end of that time, I'll send a check or money order for \$22.95, plus postage and handling, or return the book and owe absolutely nothing.

I want to save money! I have enclosed full amount. Publisher pays postage and handling. I get a complete 15-day money-back guarantee.

Name _____
Firm _____
Address _____
City/State/Zip _____

76-15

Advertiser's Index

Advertiser	Page	Advertiser	Page
AMP, Incorporated	12, 13	Keithley Instruments, Inc.	58, 59
American Zettler, Inc.	16	Kennedy Corporation, M. S.	98
Amperite Co., Inc.	90	Keystone Electronics Corporation ..	106
Ansley Electronics Corp.	47		
Arrow-M Corp.	88	LH Research, Inc.	103
Avantek, Inc.	95		
		M-Tron Industries Inc.	102
Belden Corporation	27	MCG Electronics	104, 112
Bell, Inc., F. W.	93	Magnecraft Electric Company	57
Bourns, Inc., Trimpot		Magnetics, Inc.	64
Products Division	Cover II	Micro Components Corporation	46
Buckeye Stamping Company,		Micro Devices Corp.	93
Inc., The	96	Midtex, Inc.	11
Bunker Ramo Connector Division	65, 79	Mini-Circuits Laboratory, A Division	
		of Scientific Components Corp.	2
C & K Components, Inc.	106	National Semiconductor	
CTS Corporation	10	Corporation	8, 9
Clare & Co., C. P.	80, 81, 85	Non-Linear Systems, Inc.	102
Computer Conversions Corp.	109	North American Philips Controls	
		Corp.	105
		Northern Technology Books	99
Dale Electronics, Inc.	41		
Data Display Products	34	O.K. Machine & Tool Corporation ..	64
Datak Corporation, The	111		
Datel Systems, Inc.	44	*Philips Electronic Components and	
Decitek	108	Materials Division	14, 15, 81, 85
Delco Electronics, Division of		Potter & Brumfield, Division of	
General Motors Corporation	16B	AMF, Incorporated	31, 108
Dialight, A North American		Power/Mate Corp.	109
Philips Company	Cover III		
Digital Equipment Corporation	4, 5	RCA Electro Optics	83
		RCA Solid State	Cover IV
ECD Corporation	105	RCL Electronics, Inc.	30
EECO	21	Radio Switch Corporation	105
Edison Electronics, A McGraw		Reader Service Card	112A-B
Edison Company Division	87, 111	Regent Controls Inc.	111
Electronic Design	16D, 22, 23, 107	Relay Survey Card	64A-B
Elxon Power Systems	105	Riken Denshi Co., Ltd.	101
Endicott Coil Co., Inc.	108	Rockwell International	70, 71
Esterline Angus Instrument		Rogers Corporation	109
Corporation	107		
		SMK Electronics Corporation of	
Fairchild Semiconductor, A Division		America	107
of Fairchild Camera and		Sharp Corporation	109
Instrument Corporation	76, 77	Siemens Corporation	16C
Fifth Dimension, Inc.	94	Sprague Electric Company	43
		Stahler Company, A.F.	109
		Stanford Applied Engineering, Inc. ..	29
General Scanning, Inc.	100		
Gold Book, The	32, 104	Teledyne Relays, A Teledyne	
Gordos Corporation	87	Company	18
Inc.	14, *160, 108, 110	Telenetics Inc.	101
Guardian Electric Manufacturing		Telonic Altair	96
Company	15	Tracewell Enclosures, Inc.	104
Hamlin, Inc.	103	U. S. Components, Inc.	112
Hayden Book Company,		*U. S. Department of Commerce.....	80
Inc.	14, *16C, 108, 110		
Heinemann Electric Company ..	101, 108	Vactec, Inc.	33
Hewlett-Packard	17	Vanguard Electronics	
		Company, Inc.	101
Icom Microperipherals	97	Varo Semiconductor, Inc.	75
ISE, Inc.	109	Victoreen Instrument Division,	
Idec Systems & Controls		Shellar-Globe Corporation	91
Corporation	111	Viking Industries, Inc.	37
Illuminated Products Co.	7		
International Rectifier, Crydom		Wabash Inc.	38
Division	16A	Wakefield Engineering, Inc.	107
		Wavetek Indiana Incorporated	1
Johanson Dielectrics, Inc.	108		
Johanson Manufacturing Corp.	6		

*Advertisers in non-U.S. edition

Regent ER651 all-solid-state relays are designed for direct **interchangeability** with conventional electromechanical relays. With familiar control panel layout, front-straight-through wiring, and captive saddle clamping terminals your production and maintenance personnel understand.

multiple pole all-solid-state machine tool relays



Available in up to 4-pole models, NO and NC, ER651's are ideal for controlling such loads as: solenoids, clutches, electromechanical relays, timers, motors, brakes, counters, lights, and contactors or motor starters through NEMA II.

They're fast, **compact** (occupy only 6 sq. in. of panel space), epoxied for rugged service. Complete isolation between line, load, and control circuits assures reliable performance. The ER651's are the only solid-state relays to comply with IEEE's Surge Withstand Test 472-1974.

Most of all, they're designed and manufactured to be **reliable**. Only Regent guarantees every solid-state relay for 500 million operations or 5 years' life.

Phone or write for descriptive literature, including our technical bulletin that takes the guesswork out of conversion from electromechanical to Regent solid state.

REGENT

REGENT CONTROLS, Inc.

181 Harvard Ave., Stamford, Conn. 06902
203-348-7734

CIRCLE NUMBER 74

4 SWITCHED ON ADVANTAGES!

DIPSWITCH was the industry's first rotary switch for DIP sockets. It offers the designer the versatility and reliability only experience can bring. Here are four reasons you should consider **DIPSWITCH** for your switching needs.



1 if multilayered boards are part of your design, **DIPSWITCH**'s .230" profile is about half anybody else's. You can stack as close as 1/4".

2 if you need additional switch closures, **DIPSWITCH** can be tandem coupled using extended shafts.

3 if savings board space is important, you can piggyback an IC right onto **DIPSWITCH**.

4 if you need special switch closure programming, **DIPSWITCH**'s six independent cams can be factory assembled to perform your programming.

DIPSWITCH is a Registered Trademark of the McGraw-Edison Company. Pat. No. 3621157



EDISON ELECTRONICS

a McGraw-Edison Company Division

Greiner Field Municipal Airport, Manchester, New Hampshire 03103 (603) 668-0940

CIRCLE NUMBER 76

COMPARE!

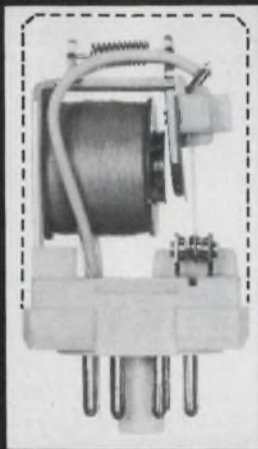

OURS
U. S. Patented

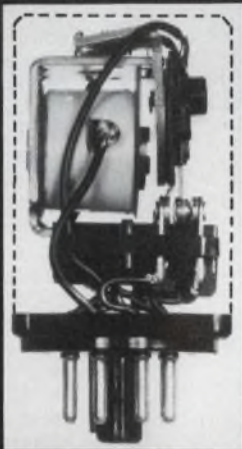

THEIRS

As evidenced by the photographs, Idec's relays have far less wiring and soldering than any other relay in the market today. Thus, less contact resistance is attained. For trouble free application, use Idec Relays.

U. L. Recognized CSA Approved

For Catalog and Information, please contact
IDEC SYSTEMS & CONTROLS CORPORATION
3553 Ryder St., Santa Clara, California 95051
Tel: (408) 738-4332 • Telex: 340601 • Cable: IDEC, SANTA CLARA

IDEC

CIRCLE NUMBER 75

ELECTRONIC DESIGN 26, December 20, 1976

PHOTO ETCHTM PRINTED CIRCUIT KIT

Makes circuits **THREE WAYS**

- 1 FULL SCALE ARTWORK MASTER**
- 2 MAGAZINE ART ILLUSTRATION** → **FILM POSITIVE** → **NEGATIVE** → **DEVELOPED PHOTO RESIST IMAGE ON COPPER CLAD CIRCUIT BOARD** → **ETCHED CIRCUIT BOARD**
- 3 DIRECT ETCH DRY TRANSFERS APPLIED TO COPPER CLAD BOARD**

NO CAMERA
DARKROOM
FILM CUTTING
TRACING

USES DATAK'S POS-NEG PROCESS
The revolutionary photographic way
that makes **PERFECT** printed circuits
from original art or a printed page.

KIT CONTAINS: 5" x 6" steel printing frame, 4 sheets 5" x 6" photocopy film, yellow filter, chemicals for 1 print film developer and 1 print film fixer, 5" x 6" copper clad board, 3" x 4" copper clad board, spray can of photo etch resist, 1 print resist developer, 2 sheets 8 1/2" x 11" layout film, 1 roll 1/16" printed circuit tape, 1 roll 1/32" printed circuit tape, 8 sheets dry transfer direct etch PC patterns including pads, transistors, round can and flat pack ICs, DIP ICs, edge card connectors, lines, circles, logs, etc. 1 lb anhydrous ferric chloride to make 1 pint etchant, instructions.

ER-4 COMPLETE PHOTO ETCH SET	\$26.95
ER-2 PC patterns and tapes — refill	3.95
ER-3 1/2 pound dry etchant — refill	1.49
ER-5 6 sheets photocopy film — refill	3.95
ER-6 Film process chemicals — refill	1.95
ER-7 Photo resist spray, 2.5 oz. — refill	2.95
ER-8 Resist developer, 16 oz. can — refill	2.95

AT YOUR DISTRIBUTOR OR DIRECT

the **DATAK** corp.
65 71st St. • Guttenberg, N. J. 07093

CIRCLE NUMBER 77

USC UPCC/REPC CONNECTORS

Draw Pull and Screwlocking. Built to MIL-C-55302 and Commercial Specifications Printed Circuit and Related Applications. REPC Connectors are Removable, Re-Entrancy, Crimp Contact Types.

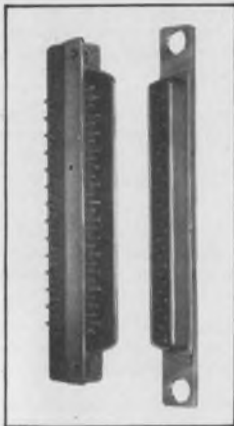

1 of over 20,000 Connector Types Manufactured. Send today for UPCC-REPC-A Series 32-page Catalog.

U.S. COMPONENTS, INC.

Leader in advanced engineering design

1320 Zerega Avenue, Bronx, N.Y. 10462
(212) 824-1600 TWX 710-593-2141
Cable: COMPONENTS, NYK

CIRCLE NUMBER 79

Circuit Savers

NEW SIGNAL/DATA/TELEPHONE PROTECTION



The SLP protectors were expressly designed to protect signal/data/telephone lines from transient overvoltages caused by lightning, heavy machinery, elevator motors, generators, etc. The SLP interfaces between the signal lines and the sensitive circuit to provide a sophisticated blend of high speed (nanoseconds) voltage limiting and brute force protection. The SLP's recover automatically to standby when the need for protection has passed.

Output Clamp Voltage Level $\pm 5V$ to $\pm 200V$
Input Voltage Level (max) to $\pm 35KV$ (10 US)
Energy Handling to 50 joules and higher

CATALOG 801

Full line of protection modules for every hi-lo voltage/current requirement. Write or call for data.

279 Skidmore Rd., Deer Park, N.Y. 11729
Telephone: 516-586-5125

MCG Electronics

CIRCLE NUMBER 80

Product Index

Information Retrieval Service. New Products, Evaluation Samples (ES), Design Aids (DA), Application Notes (AN), and New Literature (NL) in this issue are listed here with page and Information Retrieval numbers. Reader requests will be promptly processed by computer and mailed to the manufacturer within three days.

Category	Page	IRN	Category	Page	IRN
Components			temperature probe	92	323
ac power-line protector	104	65	Integrated Circuits		
capacitors	6	4	amplifiers, JFET input	98	340
capacitors	95	362	counters, HiNIL	98	341
chip inductors	101	56	decoder, tone	99	344
coils, relays and transformers	38	23	oscillator	95	48
crystals	102	60	PROMs, 8-k	98	339
ferrite cores	64	30	shift register, fast	98	342
indicators	7	5	support, microprocessor	99	343
LED/TTL DIP IC	94	327	Microprocessor Design		
photodetectors	33	20	microprocessor, NMOS	39	508
piezoceramic material	94	328	microprocessor systems	71	33
powder cores	64	31	PROM programmer	97	52
printing head	95	331	software, μC	42	509
relay, delay	90	44	system, development	42	510
relay, solid-state	101	58	Modules & Subassemblies		
relays	15	10	circuit savers	112	78
relays	16	11	control assemblies	31	18
relays	87	37	converters, a/d	98	53
relays	88	43	converter, a/d	100	347
relays	94	47	converter, d/a	102	348
relays	105	65	electro-optics	83	201
relays	111	75	encoder, touch-tone	101	59
relays, solid-state	18	13	filters	96	50
relays, solid-state	57	29	multiplexer	100	345
relays, solid-state	85	39	oscillator	102	349
relays, solid-state	103	62	resistor network	100	346
resistors, HV	91	45	transistor arrays	43	25
resistors	41	24	Packaging & Materials		
rotary switches	94	330	breadboards, IC	90	306
switch, rotary	93	41	bushing	90	304
switchers	103	63	connectors	89	301
switches	III	253	connectors	112	77
thermal cutoffs	93	49	cooler	107	72
transformers, power	94	329	conductive paint	90	308
transducer, electromagnetic	95	332	electronic packaging		
transducers	93	42	hardware	29	16
Data Processing			enclosures	104	64
calculator, computing	17	101	knobs	96	51
color display, digital	96	334	latch door	90	305
data system	107	69	mass terminations	47	28
floppy-disc terminal	97	338	relay sockets	37	22
memory card, RAM	96	335	silicone grease	90	307
memory, IBM compatible	96	333	socket board	21	14
printer, dot matrix	97	337	sockets	12	8
terminal	97	336	soldering station	89	303
Discrete Semiconductors			terminal boards	106	70
LEDs	34	21	wire, cable and cord	27	400
rectifier, Schottky barrier	75	34	wrapped-wire socket	11	7
Instrumentation			tool, wrapped wire	64	32
automatic testers	92	320	Power Sources		
counters	92	326	calibrated source	104	352
DPM	92	322	power supply, dc	104	351
DPMs	102	161	programmer, supply	103	350
distortion meter	92	325	new literature		
LSI tester	91	310	digital instruments	106	355
OEM recorder module	100	55	miniature switches	106	360
pulse generator	91	309	optoelectronic displays	106	359
recorder	101	57	remote terminal	106	356
signal generator	1	2			
signal generator	92	324			

Dialight Switches

A switch for all reasons.

Reason 1: Dialight offers three switch configurations to meet all your needs—*snap-action switches with silver contacts* for moderate-level applications, *snap-action switches*

with gold contacts for intermediate-level applications, and *wiping-action switches with gold contacts* for low-level applications. Each of these ranges is served by two switching actions—momentary (life: 750,000 operations) and alternate (life: 250,000 operations).

Reason 2: Dialight's snap-action and wiping-action switches come in a new modular design concept . . . a common switch body for either high or low current operation. All 554 series switches and matching indicators have the same rear-panel projection dimensions.

The snap-action switching mechanism guarantees a fast closing and opening rate. This insures that contact force and contact resistance

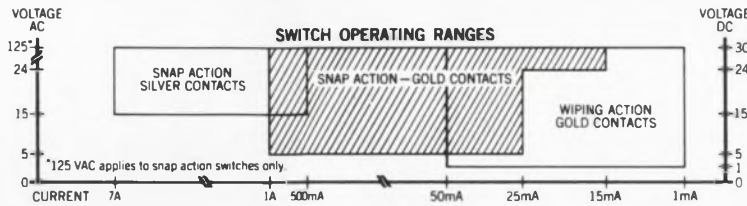

Reason 3: Dialight offers a wide variety of panel and snap-in bezel mounting switches with momentary and alternate action configurations in SPDT and DPDT

types. There are over 240 switch variations to choose from.

The 554 illuminated switch, designed for front of panel lamp replacement, gives you a choice of five different bezel sizes . . . $\frac{3}{4}$ " x 1", $\frac{5}{8}$ " x $\frac{3}{4}$ ", $\frac{3}{4}$ " square, $\frac{5}{8}$ " square, and $\frac{1}{2}$ " square. The first four sizes are also available with barriers. You also get a choice of six cap colors . . . white, blue, amber, red, green, and light yellow . . . four different underlying filter colors . . . red, green, amber, and blue and a variety of engraved or hot-stamped legends . . . over 300 cap styles . . . over 100,000 combinations.

There is also a variety of terminal connections . . . solder blade, quick connect, and for PC board insertions.

Reason 4: Dialight's 554 series is designed as a *low cost switch with computer-grade quality.*

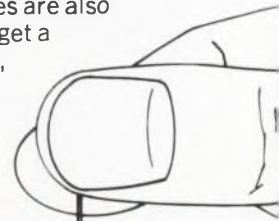
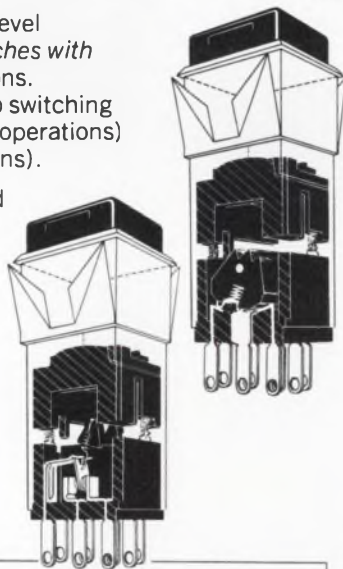

\$1.65 EACH
P/N 554 - 1121
(1K PRICING)
See Dialight

PRODUCT SELECTOR GUIDE						
SWITCHING ACTIONS	Snap-Silver contacts		Snap-Gold contacts		Wiping-Gold contacts	
	SPDT	DPDT	SPDT	DPDT	SPDT	DPDT
MOMENTARY	<input type="checkbox"/>	<input type="checkbox"/>	<input type="checkbox"/>	<input type="checkbox"/>	<input type="checkbox"/>	<input type="checkbox"/>
ALTERNATE	<input type="checkbox"/>	<input type="checkbox"/>	<input type="checkbox"/>	<input type="checkbox"/>	<input type="checkbox"/>	<input type="checkbox"/>
OPTIONS						
	PUSH BUTTON CAP SIZES					
	$\frac{1}{2}$ " Sq.	$\frac{5}{8}$ " Sq.	$\frac{5}{8}$ " x $\frac{3}{4}$ "	$\frac{3}{4}$ " Sq.	$\frac{3}{4}$ " x 1"	
BEZEL MOUNTING TO ACCOMMODATE	<input type="checkbox"/>	<input type="checkbox"/>	<input type="checkbox"/>	<input type="checkbox"/>	<input type="checkbox"/>	
BEZEL MOUNTING WITH BARRIERS TO ACCOMMODATE		<input type="checkbox"/>		<input type="checkbox"/>	<input type="checkbox"/>	
PANEL MOUNTING TO ACCOMMODATE	<input type="checkbox"/>	<input type="checkbox"/>	<input type="checkbox"/>	<input type="checkbox"/>	<input type="checkbox"/>	
MATCHING INDICATORS	<input type="checkbox"/>	<input type="checkbox"/>	<input type="checkbox"/>	<input type="checkbox"/>	<input type="checkbox"/>	

are independent of the switch's actuation speed.

In the wiping-action switch, the contacts are under constant pressure (A unique Dialight design). This insures long life with a minimum build-up of contact resistance.

Both switch types are tease-proof.

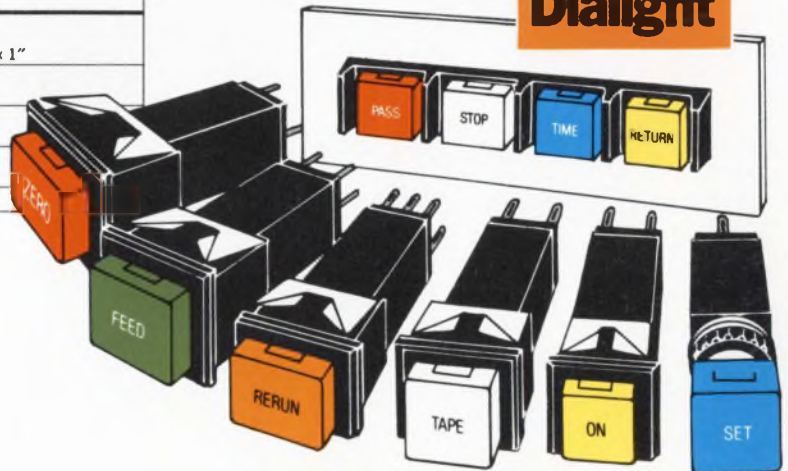

DIALIGHT

A North American Philips Company
203 Harrison Place, Brooklyn, N.Y. 11237
(212) 497-7600

What's new in solid state ...

RCA BiMOS op amps. They mix technologies to match circuit needs.



BiMOS was born with our CA3100. On a single chip we combined Bipolar with PMOS—for a more cost-effective wide-bandwidth op amp.

Next, the versatile 3130. With FET, Bipolar and CMOS, it can do a tremendous variety of jobs well.

Latest arrival: our 3140. The most useful op amp since the 741. Able to fill the great mass of op amp sockets, thanks to MOS/FET input and Bipolar output.

Low-cost, no-compromise circuits

BiMOS gives you the best from each technology without the drawbacks. So you can select op amps with exactly the characteristics you need. A single op amp can often do jobs that ordinarily require many more parts. And that ability opens up new cost-saving ways to meet circuit needs.

Why pay more than you have to for your circuit? Check into BiMOS. Contact your RCA Solid State distributor. Or RCA.

Write: RCA Solid State, Box 3200, Somerville, N.J. 08876; Sunbury-on-Thames, Middlesex TW16 7HW, England; Ste. Anne de Bellevue H9X 3L3, Canada; Fuji Bldg., Tokyo, Japan.

Op amp category	What BiMOS contributes	RCA device
General Purpose	Wide applicability Low cost.	CA3140 CA3130
FET Input	Lower device cost. Reduced circuit cost. Large input voltage range: capability of swinging to 0.5 V below rail	CA3140 CA3130
Wideband 4.5 to 70 MHz	High slew rate with low ringing.	CA3140 CA3130 CA3100
Micropower down to 1.5 mW	Strobability.	CA3130
High Current up to 22mA	Eliminates driver stage Low device cost Rail-to-rail output swing	CA3130

RCA



RCA. Full house in Linear ICs.