

Electronic Design.25

VOL. 24 NO.

FOR ENGINEERS AND ENGINEERING MANAGERS

DEC. 6, 1976

Hardware design aids for μ Ps make an engineer's life easier. These development tools help take the bugs out of breadboard systems. You can also use them

to learn the rudiments of LSI computers. Design aids vary in price from several hundred to several thousand dollars. Help to find the right aid is on p. 30.

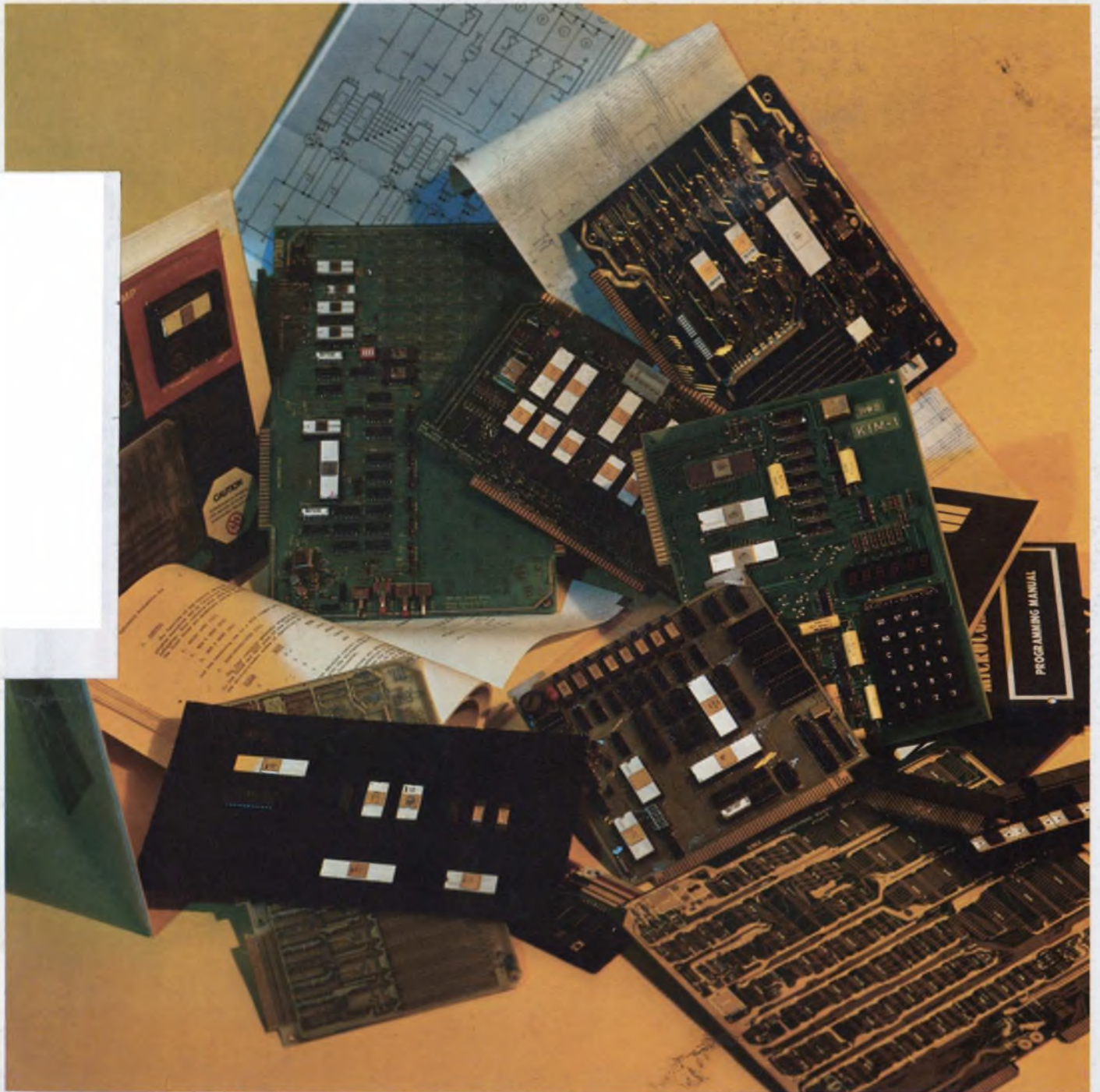

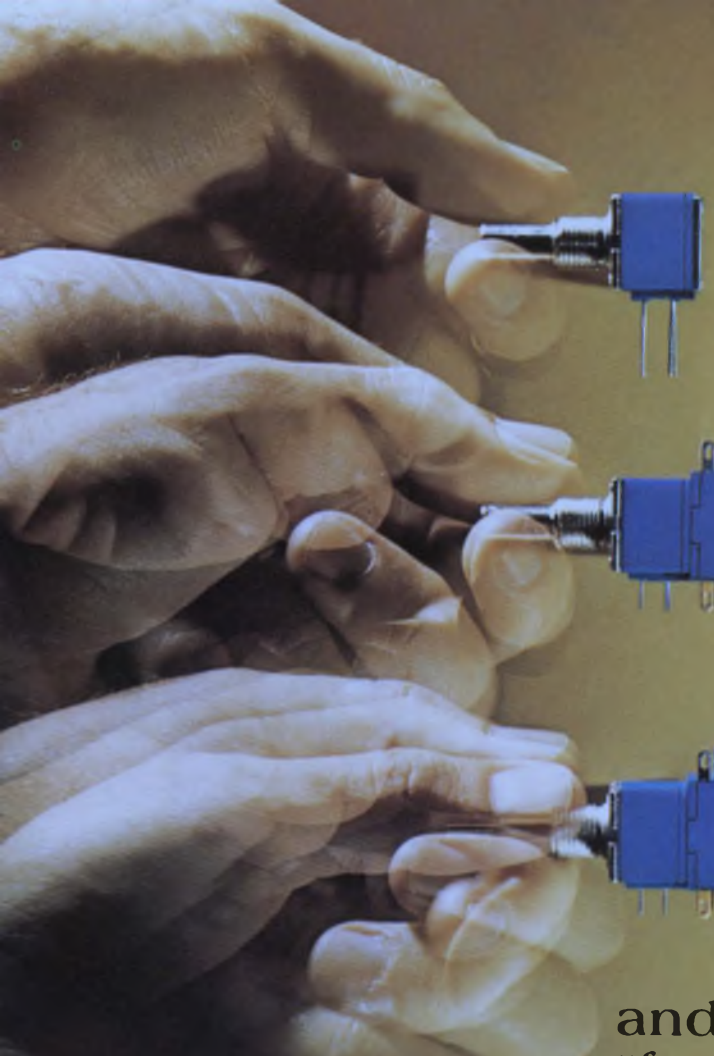

FEEL
the pot . . .

CLICK
the switch . . .

GANG
the modules . . .

and add
"feel appeal" to your product.

FEEL THE POT . . . a smooth, quality feel, only from Bourns® 81/82 Model Potentiometers. Rotational torque range, only .3 to 2.0 oz. inch, is consistent for one, two, three or four cup assemblies.

Independent linearity of $\pm 5\%$ and low 1% CRV provide exceptional setability in both cermet and conductive plastic element types.

CLICK THE SWITCH* . . . one that really clicks, with positive action detent at either CW or CCW end. The Bourns Model 85/86 potentiometer/switch combination is rated at 2 amps in DPST style and 1 amp in DPDT. Contacts are constructed of fine silver with gold overlay. This provides exceptionally low contact resistance, for reliable operation at low level analog or logic signal levels — or any application requiring an "on-off" function.

GANG THE MODULES . . . potentiometers and switches. Up to 4 modules can be ganged on the same single or dual concentric shaft, without sacrifice to the satin-smooth feel or the sure-fire click. Other options include a wide choice of bushing and shaft styles, P.C. pins or solder lugs. Think of the possibilities! Now you can specify custom pots and switches assembled from "off-the-shelf" modules — at standard cost and leadtime.

Add "feel appeal" to your equipment with BOURNS Model 80 Family of Modular Potentiometers and Switches. Write or call today for complete technical information, direct or through your Bourns distributor.

FEEL, CLICK, GANG . . . BEAUTIFUL!

TRIMPOT PRODUCTS DIVISION, BOURNS, INC., 1200 Columbia Avenue, Riverside, California 92507, Telephone (714) 781-5122 — TWX 910 332-1252.

*Patent pending

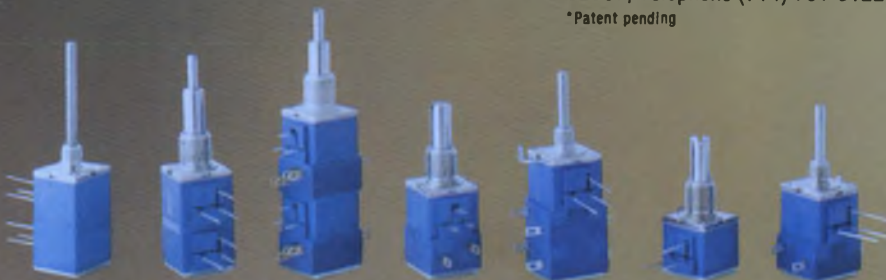

Int'l Sales Offices: European Hdqtrs. — Switzerland, 042/23 22 42 • Belgium 02/218 2005 • France 01/2039633 • Germany 0711/24 29 36
• Italy 02/32 56 88 • Netherlands 070/88 93 18 • United Kingdom 01/572 6531 • Japan 075 92 1121 • Australia 86 9410 • Brazil 257-3535

CIRCLE NUMBER 262

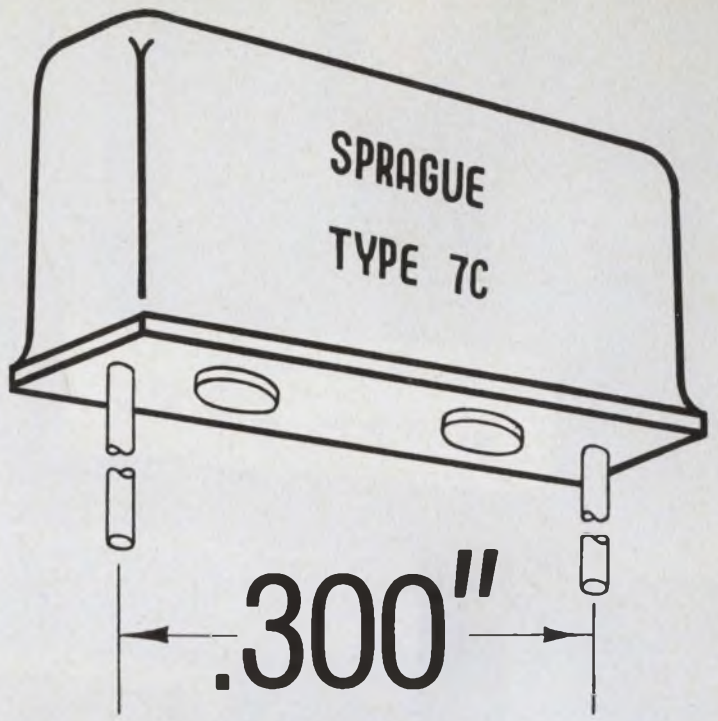
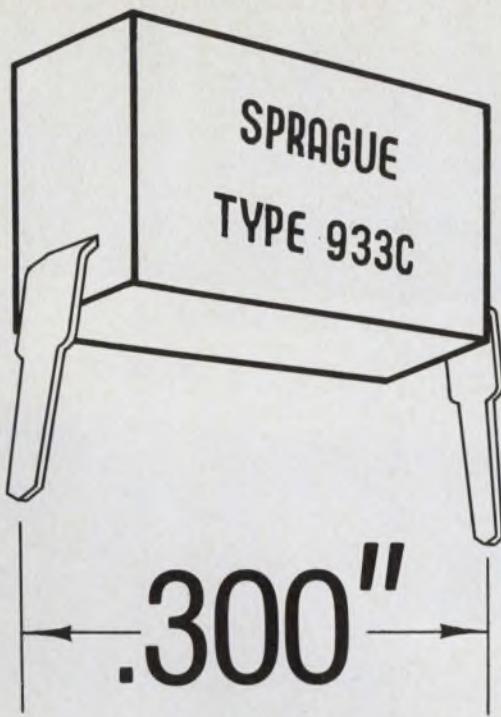

COMPATIBILITY

SPRAGUE GIVES YOU A CHOICE OF 2 MONOLYTHIC[®] CERAMIC CAPACITORS THAT GO HAND IN HAND WITH ALL TYPES OF STANDARD DIP COMPONENTS

Type 933C DIP-Style* Molded-Case

Moisture-proof case offers excellent mechanical protection during hand or automatic insertion. Made by alternately depositing thin layers of metallic electrodes and ceramic dielectric until desired capacitance is obtained, then firing into a homogenous block. Capacitance range: 18 pF to .1 μ F @ 100 WVDC; to .22 μ F @ 50V; to .47 μ F @ 25V.

Type 7C Saddle-Base Resin-Coated

Tough resin case, with outer epoxy varnish coating, protects against damage from handling as well as moisture. Phenolic base plate insures accurate lead spacing and eliminates resin run-down on leads. Capacitor sections made with proven layer-built construction. Capacitance range: 51 pF to 1 μ F. Voltage ratings: 50 and 100 WVDC.

For more information on these and other Monolythic[®] Ceramic Capacitors, write for Short-Form Catalog MC-108 to: Technical Literature Service, Sprague Electric Company, 347 Marshall Street, North Adams, Mass. 01247.

***Sprague puts more component families into dual in-line packages than any other manufacturer.**



CIRCLE NUMBER 2



UNIVERSAL MODEMS

Making data move is the name of the game in today's switched or dedicated-line networks. If you're moving it at any speed up to 2400 BPS, Universal Data Systems has the proper modem for reliability, economy and efficiency in your system.

UDS has more than 30,000 modems in active field service, and the total is growing by more than 1,000 units per month. Our product line includes CMOS 201s, plus 103s, 202s, ACUs and the new 12-12, which permits full-duplex 1200 BPS communication over only two wires. UDS also offers the multiple modem RM-16, which contains up to 16 units in any configuration mix you desire.

In addition to our products, we're extremely proud of our customer service. Check us out: Call us on the telephone. You'll like what you hear.



universal data systems

4900 Bradford Drive • Huntsville, Alabama 35805 • Telephone (205) 837-8100 • TWX 810-726-2100

Created by Hall & McRenzie Advertising, Winter Park, Florida

CIRCLE NUMBER 3

member of
IDCMA

NEWS

- 21 **News Scope**
- 30 **Design aids are keeping pace with the explosive growth in microprocessors**—An Electronic Design special report.
- 36 **Optical modulator developed** for high-power IR lasers.
- 38 **Programmable SAW delay line** developed for data communications.
- 45 **Washington Report**

TECHNOLOGY

- 53 **Microprocessor Design**
- 64 **Keep the PACE up and running** without complicated circuitry. The 16-bit μ P has a compact instruction set yet delivers minicomputer performance.
- 74 **Starting μ P software:** You can get going without front panels or extra hardware. The key lies in vector points residing in R/W memory.
- 78 **Convert all your synchro channels** to digital with a single μ P-based system. For low speeds, you get an accurate, inexpensive, efficient and small unit.
- 86 **Inexpensive digital storage media:** Cassettes, discs and cartridges all have advantages. Let the application decide which one does your job.
- 92 **Speed up your linear circuits** with broadbanded op amps. They're fast yet inexpensive, use little power and come in quads—but you can't ignore stability.
- 100 **Al Cookson of ITT** speaks on boosting R&D output.
- 108 **Ideas for Design:**
 - Display letters and symbols on a seven-segment numerical display.
 - Zero-crossover tone-burst circuit delivers integral number of sine waves.
 - Simple circuit interfaces TTL to CMOS with use of only a single 12-V supply.
- 114 **International Technology**

PRODUCTS

- 144 **Packaging & Materials:** CRT enclosures use plastic for low cost.
- 117 Data Processing
- 120 Integrated Circuits
- 125 Power Sources
- 129 Components
- 132 Instrumentation
- 136 Modules & Subassemblies
- 148 Discrete Semiconductors
- 151 Microwaves & Lasers

DEPARTMENTS

- 61 **Editorial:** Company policy
- 7 Across the Desk
- 154 New Literature
- 157 Vendors Report
- 160 Advertisers' Index
- 162 Product Index
- 162 Information Retrieval Card

Cover: Cover photo by art director, Bill Kelly. Microprocessor evaluation kits courtesy of American Microsystems, Inc., Fairchild Semiconductor, Intel, MOS Technology, National Semiconductor, RCA, Signetics and Zilog.

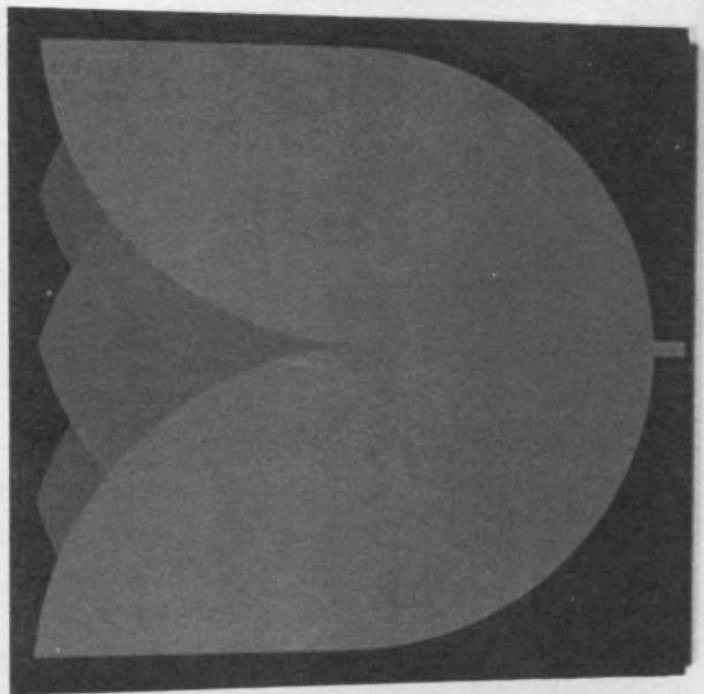

Five tough questions to ask our 8080A competitors.

1. Do you have an 8K Electrically Erasable PROM? You know, like NEC Microcomputer's μ PD458 that's compatible with 2708's but can be erased in 1 minute, programmed in 80 seconds, only needs two voltages for reading and programming, has conventional packaging, a guaranteed data retention time of 10 years, and an access time of 450/650ns, making it the first practical non-volatile RAM storage.

2. Do you have a Universal Synchronous Receiver/Transmitter Data Communications Controller? You know, like NEC's μ PD379 with SDLC capacity up to 50K baud.

3. Do you have a 450ns 16K ROM? You know, like NEC's μ PD2316A that's pin compatible with other 2316As but has the speed to match the 8080A.

4. Do you have a Floppy Disk

Controller? You know, like NEC's μ PD372 that can control up to four IBM 3740-compatible drives.

5. Do you have a Tape Cassette Controller? You know, like NEC's μ PD371 that can control up to two cassette drives with International Standard Data Format.

Go ahead, ask any competitor you like. What you'll find is that if you want these super 8080A peripherals, you'll simply have to come to NEC.

And when you do, you'll also be dealing with an 8080A supplier with complete applications support — plus the full range of 8080A products listed.

Any more tough questions?

Your NEC rep or distributor is waiting to put you at ease.

NEC Microcomputers, Inc.,
Five Militia Drive, Lexington, MA
02173. 617-862-6410.

μ PD8080A	2.0 MHz MPU
μ PD8080A-E	1.25 MHz MPU
μ PD8080A-2	2.5 MHz MPU
μ PD8080A-1	3.0 MHz MPU
μ PD411	4K DYN-RAM
μ PD5101-E	1K STATIC RAM
μ PD2101AL	1K STATIC RAM
μ PD2102AL	1K STATIC RAM
μ PD454	2K EE PROM
μ PD2308	8K Mask ROM
μ PD369	UART
μ PD758	Seiko Printer Controller
μ PB8212	I/O Port
μ PB8214	Priority Interrupt Controller
μ PB8216	Bus Driver
μ PB8224	Clock
μ PB8228	Generator/Driver
μ PD8251	System Controller
μ PD8255	Prog. Comm. Interface
	Peripheral Interface

NEC microcomputers, inc.

REPS: East — C & D Sales 301-296-4306, Contact Sales 617-273-1520, Trionic Assoc. 516-466-2300; South — Merino Sales 214-233-6002, Perrott Assoc. 305-275-1132, 305-792-2211, 813-585-3327, Wolffs Sales Serv. 919-781-0164; Midwest — Electronic Innovators 612-884-7471, K-MAR Eng. & Sales 314-567-1829, 816-763-5385, McFadden Sales 614-221-3363, R.C. Nordstrom 313-559-7373, 616-429-8560, R.F. Specialists 312-698-2044; West — Mike Duffy Assoc. 303-934-7392, Electronic Component Mktg. 213-340-1745, 714-295-6122, 714-524-9899, Summit Sales 602-994-4587, Trident Assoc. 408-734-5900, Tri-Tronix 505-265-8409; Canada — R.F.Q. Ltd. 416-626-1445, 514-626-8324

DISTRIBUTORS: Century Electronics (Albuquerque, Denver, Salt Lake City) Diplomat (Chicago, Chicago Falls, Clearwater, Dayton, Detroit, Little Falls, Minneapolis, Mount Laurel, Newport Beach, St. Louis, Salt Lake City, Sunnyvale, Woodbury) Harvey Electronics (Boston, Fairfield, Norwalk, Woodbury) Intermark Electronics (San Diego, Santa Ana, Seattle, Sunnyvale) Lionex Corp. (Boston) G.S. Marshall (Sunnyvale) Mirco Electronics (Phoenix) R-M Electronic (Detroit) Semiconductor Specialists (Boston, Chicago, Dallas, Dayton, Detroit, Indianapolis, Kansas City, Los Angeles, Milwaukee, Minneapolis, Pittsburgh, St. Louis, Malton, Canada) Technico, Inc. (Baltimore)



TAKE THE GAMBLE OUT OF SPECIFYING POWER SUPPLIES

When you specify power supplies manufactured by Abbott Transistor Laboratories, you minimize your risks and maximize your return.

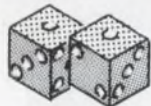

No "SNAKE EYES" with Abbott, only winning performance

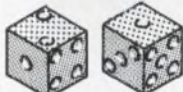

Abbott power supplies are reliable, they won't "CRAP OUT" on you



No "LITTLE JOE'S," Abbott units are big on performance



No "BOX CARS" either — Abbott units are compact

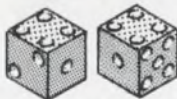

Don't go the "HARD WAY," specify Abbott, the easy way to solve your power supply requirements

Abbott makes a wide variety of industrial/commercial, OEM, military and aerospace power supplies. Each and every unit is subjected to rigorous quality control and electrical testing before shipment to insure that when you put it on the line, it will pass every time.

So when you want a reliable power supply, come to Abbott, the winner for price and performance.

Please see pages 1836-1848 of your 1976-77 EEM (ELECTRONIC ENGINEERS MASTER Catalog) or pages 672-682 Volume 2 of your 1976-77 GOLD BOOK for information on Abbott Modules.

Send for our new 60 page FREE catalog.

abbott transistor
LABORATORIES, INCORPORATED

GENERAL OFFICES
5200 W. Jefferson Blvd.
Los Angeles, CA 90016
(213) 936-8185
Telex 69-1398

EASTERN OFFICES
1224 Anderson Ave.
Fort Lee, NJ 07024
(201) 224-6900
Telex 13-5332

Sr. Vice President, Publisher
Peter Coley

Editors

Editorial Offices
50 Essex St.
Rochelle Park, NJ 07662
(201) 843-0550
TWX: 710-990-5071
Cable: Haydenpubs Rochellepark

Editor-in-Chief George Rostky

Managing Editors:
Ralph Dobriner
Michael Elphick

Senior Associate Editor
Stanley Runyon

Associate Editors:
Sid Adlerstein
Dave Bursky
Samuel Derman
Morris Grossman
John F. Mason
Max Schindler
Michael Shunfenthal

Contributing Editors:
Peter N. Budzilovich, John Kessler
Alberto Socolovsky, Nathan Sussman

Editorial Field Offices

East

Jim McDermott, Eastern Editor
P.O. Box 272
Easthampton, MA 01027
(413) 527-3632

West

Dick Hackmeister, Western Editor
8939 S. Sepulveda Blvd., Suite 510
Los Angeles, CA 90045
(213) 641-6544
TWX: 1-910-328-7240

Editorial Production

Marjorie A. Duffy, Production Editor
James Keane, Copy Editor

Art

Art Director, William Kelly
Richard Luce, Anthony J. Fischetto

Production

Manager, Dollie S. Viebig
Helen De Polo, Anne Molfetas

Circulation

Director, Barbara Freundlich
Trish Edelmann

Information Retrieval

Paula Greenleaf

Advertising Promotion

Susan G. Apolant

Across the Desk

New squelch circuit is not very funny

Bob Pease of National Semiconductor in his letter (ED No. 15, July 19, 1976, p. 11) writes in a jocular manner about a new squelch circuit for disabling a transmitter. Well, this is no joke! There is a need for a reverse-squelch circuit chip or noise editor for many communications systems. In particular, Omega VLF receivers, Loran C and others often need to have some kind of a noise blanker circuit. It sure would be nice if these high-powered scientific types would spend some time supplying useful devices as well as writing letters to the editor.

Ralph W. Burhans

*Research Engineer & Lecturer
Avionics Engineering Center*

Ohio University
E.E. Dept.
Athens, OH 45701

Marine test bedding isn't all that new

I read with interest your news item, "Marines Test Ground-Unit Concept before Buying" (ED No. 15, July 19, 1976, p. 21). The information was technically correct regarding the function of the MTACCS Test Bed and its resident computer systems. Whether intentional or not, however, the article definitely conveys the impression that the Test Bed is something new and the test/evaluation process has just started. As one of the "founding fathers" of the MTACCS Test Bed, I can tell you this is definitely not the case. In fact, the Test Bed has been doing its job since June, 1971, when we were the first installation of

several to occupy the Stuart Mesa area at the Marine Corps Base, Camp Pendleton, CA.

Richard C. Reynolds

Lieutenant Colonel, USMC

Marine Corps Electronics Div.
Naval Electronics Systems
Command
Washington, DC 20360

Wrong number

In the editorial "We Want to Be Better" in the Aug. 16 issue, we wrote that we have been publishing an accuracy-policy statement for 17 years. That's true, the first statement appeared in the issue of Oct. 28, 1959, Vol. 7, No. 22.

On page 124 of the Aug. 16 issue we published a small advertisement stating that we've been publishing the accuracy policy statement for 24 years. That's wrong. We've been publishing the magazine for 24 years and have maintained the accuracy policy for all that time. But we only began publishing the policy statement in October, 1959.

The screwup came about because one guy wrote the editorial and another guy wrote the ad. Neither knew what the other was doing.

We do that sometimes, too.

Postscript to 'Sin'

Reference: Editorial, "Sin," ELECTRONIC DESIGN Vol. 24, No. 8, April 12, 1976.

I feel the following to be an appropriate postscript to your editorial on our upside down world of morality.

"Woe unto them that call evil good, and good evil; that put dark-

(continued on page 8)

Electronic Design welcomes the opinions of its readers on the issues raised in the magazine's editorial columns. Address letters to Managing Editor, Electronic Design, 50 Essex St. Rochelle Park, N.J. 07662. Try to keep letters under 200 words. Letters must be signed. Names will be withheld on request.

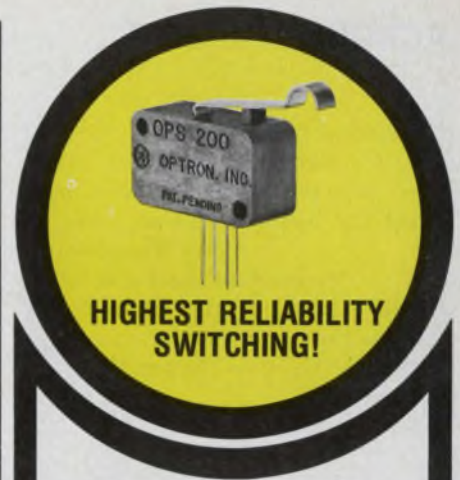

**HIGHEST RELIABILITY
SWITCHING!**

OPTICALLY COUPLED LIMIT SWITCHES

**OPTRON OPS 200 SERIES
SWITCHES MEET SPECS
AFTER 100,000 HOURS
OF OPERATION**

Even after 100,000 hours of operation at rated currents, OPTRON's new high reliability OPS 200 series optical limit switches will still meet specifications.

New OPS 200 and OPS 200A limit switches combine the non-contact switching feature of popular optically coupled interrupter modules with the convenient mounting and actuating features of conventional mechanical switches to provide solid-state reliability in a mechanical switch package.

An optical shutter controlled by a snap-action mechanism interrupts the light path between a gallium arsenide infrared LED and a silicon photosensor. The condition of the photosensor, either illuminated or dark, determines the ON (closed) or OFF (open) state of the switch.

There is no contact bounce or contact contamination. Interfacing with high speed logic circuitry is possible without the buffering stage required with conventional switches. Both the OPS 200 and OPS 200A eliminate arcing and are unaffected by magnetic fields.

The OPS 200 has a high gain N-P-N phototransistor output. In the closed condition with a LED drive current of 30 mA, a minimum output of 1.6 mA at 0.4 volts assures TTL compatibility. In the OPS 200A, a photodiode sensor followed by a Schmitt trigger circuit with 140 mA output sink capability eliminates the need for amplifiers in most applications.

Both new limit switches are available from stock in either normally open or normally closed conditions.

Detailed technical data on OPS 200 series limit switches and other OPTRON optoelectronic products... chips, discrete components, reflective transducers, isolators and interrupter assemblies... is available from your nearest OPTRON sales representative or the factory direct.



OPTRON, INC.

1201 Tappan Circle
Carrollton, Texas 75006, U.S.A.
TWX-910-860-5958
214/242-6571

ACROSS THE DESK

(continued from page 7)

ness for light, and light for darkness; that put bitter for sweet, and sweet for bitter."—Isaiah 5:20

Peter Kushkowsky

Process Computer Engineer

Engineering Computer Services
Process Computer Section
Northeast Utilities Service Co.
P.O. Box 270
Hartford, CT 06101

Ambiguous abbreviation raises reader's wrath

A headline in News Scope of your July 5th issue (ED No. 14) points up the danger of abusing S I units in the drive for new abbreviations.

It says " μ W generator produces most powerful pulses." A tricky microwatt generator? No, μ W just refers to microwave.

Such usage, of course, follows from the abominable μ P for microprocessor. So let's call a halt to this nonsense now and keep the S I prefixes for the arithmetic use they were meant for.

Daniel Waxler

207 Park Heights Ave.
Dover, NJ 07801

About this case . . .



Help! We're trying to locate the manufacturer of the two-piece molded or vacuum-formed plastic case shown in the photo.

We got a couple of sample cases last spring as a result of a phone conversation, so there is no record on our purchase order file. Now we're ready to go with a new product and we can't find the case manufacturer—about 30 letters and phone calls to various case makers have failed to unearth this one.

Any help you can give will be greatly appreciated.

Ron Tipton
President

TDL Electronics
P.O. Box 45
Prairie Grove, AR 72753

Misplaced Caption Dept.



The accounting department is parceling out this year's engineering raises—twenty-five cents to R&D, a dime to design, fifteen to production . . .

Sorry. That's Quentin Metsys' "The Banker and his Wife," which hangs in The Louvre in Paris.

Sponsor was right, but the message was wrong

The News Scope article entitled, "Performance of Military Systems Monitored by μ Ps" (ED No. 18, Sept. 1, 1976, p. 21) erroneously stated that I was with the Naval Electronics Laboratory Center in San Diego, CA. The Naval Electronics Laboratory Center was the sponsoring activity for the program, but I am with the Naval Avionics Facility in Indianapolis, IN, where the system was designed and constructed.

Donald R. Weidner
Applied Research Dept.

Naval Avionics Facility
Indianapolis, IN 46218

False alarm, CBers: Start worrying again

The basis for the Commerce Dept.'s declaration concerning long-range communication (ED No. 17, Aug. 16, 1976, p. 45) is totally wrong. In fact, we are near sun-

spot-cycle minimum at this time. The world's scientists are currently mulling over whether we have just passed the point of least solar activity or are just approaching it. The effect of sunspots on CB radios will be increasingly felt beginning in early 1977 and will peak in 1980-82.

Robert G. Beaudet

30 Rocky Crest Rd.
Cumberland, RI 02864

Don't blame the tools because of a few fools

The straightforward, storytelling approach of your editorials makes it easy for a simple-minded person such as myself to quickly grasp the main point of your messages. You should know that at least one reader appreciates your column. However:

While the theme of "Scientific Management" (ED No. 18, Sept. 1, 1976, p. 61) came through loud and clear, it merely served to reinforce stereotyped images of old and new schools of management that have been thrust upon us by movies and television. The portrayal is usually that of a lovable, personable, "traditional" supervisor who has always maintained an adequate level of production, but is now being replaced by a hardnosed, unapproachable, "modern" manager who is only concerned with high productivity.

Actually, if one uses the latest management tools properly, his company most likely will run as efficiently as possible. These tools include equal emphasis on cost control and profit maximization, leadership and motivation techniques, effective communication within an organization, and other skills your Clarence seemed to lack. Courses in management stress the value of being considerate of employees as well as production-oriented.

Modern management techniques have evolved because of dissatisfaction with the old, and the best tools are available. Perhaps, in certain cases, the wrong people are handling them.

James S. Burrill
Staff Engineer

Martin Marietta Aerospace
Orlando Div.
P.O. Box 5837
Orlando, FL 32805

hp MEASUREMENT COMPUTATION NEWS

product advances from Hewlett-Packard

NOVEMBER 1976

in this issue

Full ASCII code in new matrix LED display

Recorders and CRT displays for the OEM

14.9 Mbytes of memory for HP 9825A



A new data acquisition system can measure parameters in the form of ac, dc and resistance, analyze the information and make decisions, process the information, present results in graphic or printed format, interact with a process and provide alarm and switching functions.

NEW data acquisition system reads up to 19 channels/sec with 1 μ V resolution

With capabilities found in many larger computer-based systems, the HP 3052A Automatic Data Acquisition system is a lower cost alternative for fast process monitoring and control, component and product test, environmental and energy use monitoring, stimulus/response testing and signal analysis.

Under control of the HP 9825A desktop computing controller, the HP 3052A uses two digital voltmeters to cover its wide measurement range and speed—the HP 3455A, a high resolution, high accuracy digital voltmeter and the HP 3437A, a high speed dc systems voltmeter. Inputs to both DVM's may be switched by the HP 3495A scanner. The 9825A takes over system control interfacing and data processing.

Dc measurements up to 19 channels/sec are possible with 1 μ V resolution on the 100 mV range.

Excellent noise rejection and low thermal uncertainty make the 3052A suited for accurate, repeatable, low-level measurements even in the presence of noise. The > 120 dB effective common-mode rejection of the 3455A/3495A effectively cancels out unwanted offsets or super-imposed signals.

Consider the wide range of problem solutions offered in the 3052A System:

- Signal digitizing
- High-speed scanning
- System timing
- Two-level interrupt system
- High-speed data access and storage
- Alphanumeric display for easy interaction with the operator.

For more information on data collection, processing and control solutions, check D on the HP Reply Card.

The HP 1000 for computing, instrumentation control and operations management



An HP 1000 can be dedicated to a specific application, or be part of a computer network linking "islands of automation" within a plant. Several users performing different tasks simultaneously will all think that *only they* are using the computer.

Hewlett-Packard introduces its new series HP 1000 computer systems—powerful, flexible tools that can be applied in a multitude of ways to help you optimize the use of your always limited resources.

Dynamic microcycle timing. A singular HP technical concept, allows the processor to execute most instructions in 175 ns while taking 280 ns for the occasional slower functions.

Processor growth power. A new microprogramming package including a symbolic microassembler and debug-editor allows you to increase the speed of time-critical tasks. New, fast, low cost, semi-conductor, main memory capacity of up to 608K bytes is twice that of comparable systems.

HP-pioneered mini-cartridges. The standard console is the fast new 9600 baud, high-resolution HP 2645 CRT terminal. Programmers on multiple terminals now can plug-in, modify, and then walk away with their own programs stored on pocket-size mini-cartridges. The 2645's "Soft-keys" can be programmed to automatically enter multiple keystroke sequences. With a single stroke of a user-defined "Soft-key", you can load or compile a program, query a data base, or monitor the status of multiple tasks.

HP software. The RTE operating system orchestrates interactive program development from multiple terminals concurrently with batch processing. Multi-lingual programming—in FORTRAN, ALGOL, HP Assembly and multi-user BASIC—allows users to communicate with the system in the most suitable language.

Rapid access disc. The fastest disc cartridge on the market, the HP 7905, employs the latest track-follower disc technology and a micro-processor based control unit. Disc storage capacity of up to 120M bytes allows the construction of a data base for most small to medium-sized organizations.

Hewlett-Packard Interface Bus. With an HP-IB kit, the HP 1000 can control multiple clusters of instruments in a very broad range of automated electronic or electrical testing measurement and control applications.

IMAGE/1000. Hewlett-Packard's data base management can define, build, and maintain a data base that can be used by many of your people for a wide variety of purposes. Non-programmers can access the data base with QUERY, an easy-to-use inquiry language in order to quickly retrieve meaningful information. IMAGE automatically links together related in-

formation and reduces redundant data. Users can have multi-terminal access to the data base for concurrent and interactive retrieval and reporting of information.

Computer networks. If you use more than one computer within your organization, HP's networking software will provide cost benefits that include sharing peripheral devices such as line printers, magnetic tape and disc memory systems. In addition to placing HP 1000 "power centers" where they are most needed, you can disperse terminals throughout your organization to feed timely data into the data base.

Choice of cabinet enclosures. The Models 30 and 80 are offered as attractive "deskcomputer" work centers; Models 31 and 81 are traditional cabinet-mounted versions.

This well-balanced combination of HP 1000 computer system power and IMAGE/1000 information handling usefulness makes dynamic, user-oriented information handling a reality at an exceptionally low cost.

If you would like more information on how the HP 1000 can be dedicated to a demanding application or distributed throughout an entire network, check A on the HP Reply Card.



Put the HP 1000 to work anywhere you need to combine computers and electronic instruments for faster and easier measurement and testing.

Memory of 9825A desktop system can be expanded in multiples of 468,480 bytes



With its live keyboard, vectored priority interrupt, direct memory access, and built-in tape storage, the 9825A can control and acquire data from several instruments while it performs calculations, prints or plots results, and reviews programs—all through simple keyboard commands and with apparent simultaneity.

Two fast, low-cost flexible disk drives expand the usefulness of the HP 9825A programmable desktop computing system.

The new disk drives, the 9885M (master) and 9885S (slave), have a memory capacity of up to 468,480 bytes per disk.

The master, in addition to containing the built-in power supply, contains the controller for managing the operations of the slave units. Up to eight 9885M master drives can be connected to a 9825A, and up to three slave drives can be connected to each master—a total of 32 separate disks with 14,991,360 bytes of user available memory. The flexible disks provide virtually unlimited economical off-line storage for both programs and data.

Fast transfer rates are achieved through the direct memory access (DMA) feature. Instantaneous transfer rate of information between the disk drive and the calculator is 62,500 bytes/sec; continuous throughput rate is 23,000 bytes/sec. Average access time to any place on the disk is 260 msec.

Double density read/write on the disk enhances the access rate in addition to increasing the total storage

capacity. The 9885M is controlled by a high-level command system that organizes the data into named files on the disk. A directory keeps track of the names of the files, where they are located, and the size and type of the files.

Write-verify automatically ensures that the information recorded on the disk is identical to the source information in the memory. Additional features include the ability to sort and print the directory or catalog information, recover data after a check sum error, and copy files, portions of files, or complete disks to other disks. Data can be organized serially or randomly for optimum data access.

The new 9878A Expander increases the usable I/O channels from three to nine. The addition of two expanders to the 9825A, in combination with the HP Interface Bus, makes it possible for the 9825A to interface with as many as 210 instruments and/or peripherals.

For more information on this computing and controlling capability, check K on the HP Reply Card.

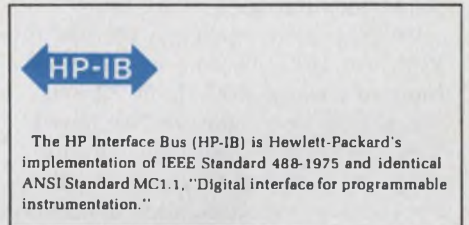

The HP Interface Bus (HP-IB) is Hewlett-Packard's implementation of IEEE Standard 488-1975 and identical ANSI Standard MC1.1, "Digital interface for programmable instrumentation."

Presenting...computer product solutions from HP



Hewlett-Packard can meet information processing needs at many levels. A free 12-page brochure describes our product range from hand-held units to full-scale computer systems.

Illustrated are examples of how such diverse organizations as Eastman Kodak, General Motors, The Travelers Insurance, Yale University, Walter Reed Hospital and Bell Labs are using our computer products.

Check Q on the HP Reply Card.

New telephone line analyzer simplifies high-speed data line measurements

The new HP 3770B analyzer is designed for audio data line characterization to CCITT M.1020 and M.1060 standards. In a single, portable unit, it provides all the routine maintenance measurements recommended by CCITT for high-speed data lines.

It measures group delay, attenuation distortion, and absolute level in the frequency range 200 Hz to 20 kHz. The 3770B also measures weighted noise, noise-with-tone, and impulse noise. An optional slave facility for group delay and attenuation distortion measurements allows the results, for both directions of transmission on a 4-wire circuit, to be displayed and recorded at one end of the circuit.

The sender and receiver are combined in a single, rugged unit. With automatic ranging, zeroing, synchronization and simultaneous LED readout of measurement result and frequency, the 3770B is an easy-to-use, portable test set.

Linked to an HP X-Y recorder, a permanent swept record of the measurement can be obtained. Pre-printed graph paper showing CCITT limits for group delay and attenuation distortion measurements is available.

Pertinent specifications include:

- Group delay (0 to ± 10 ms)
- Attenuation distortion (0 to ± 40 dB)
- Absolute level (+10 to -50 dBm)
- Noise (0 to -85 dBm)
- Noise-with-tone (0 to -80 dBm)
- Impulse noise
- Slave facility



Select the capabilities you need from a wide range of options available for this new rugged, portable line analyzer.

For more information on solving your data line problems, check E on the HP Reply Card.

Now, HP's new digital IC troubleshooting probe, pulser, current tracer and clip are in kits



The HP 5023A shown here contains all five new IC troubleshooters from Hewlett Packard. Three kits are now available, each packaged in a convenient zippered vinyl case.

Recently, HP introduced four new multi-family IC troubleshooters: the HP 545A logic probe, 546A logic pulser, 548A logic clip, and the revolutionary 547A current tracer.

Now, these troubleshooting tools are available in three convenient kits. You'll save time and money when you purchase them, and again, when you use them in your circuits. That's because the kits cost less than our stand-alones, and also because they provide great troubleshooting benefits—packaged as easy-to-use, hand-held instruments.

Instruments	Kits		
	5021A	5022A	5023A
545A Logic Probe	X	X	X
546A Logic Pulser	X	X	X
547A Current Tracer		X	X
548A Logic Clip	X	X	X
10529A Logic Comparator			X

The new **5022A** kit provides all the capability you're likely to require for nodal and gate troubleshooting. It contains the probe, pulser, current tracer and clip plus handy vinyl carrying case and most of the connectors you'll need to connect up to any TTL, DTL, HTL, or CMOS circuit.

The addition of the 10529A logic comparator in the **5023A** kit provides the ability to do multi-pin static and dynamic testing.

The economically-priced **5021A** kit contains probe, pulser and clip, essential tools for most gate-to-gate troubleshooting problems.

For a data sheet on all kits, check G on the HP Reply Card.

Comprehensive new Application Note on precise time interval measurements

Just published is a new application note, AN 191, a thorough presentation of precision time interval measure-

ments using an electronic counter. Among the topics discussed are resolution, time interval averaging, trigger circuit operation, and error evaluation. Applications presented include phase measurements, ATC ranging, and remote operation via the Hewlett-Packard Interface Bus.

For your copy, check P on the HP Reply Card.

A wide range of DC power supplies are now HP-IB programmable

New RF test sets offer convenience and precision



Utilizing the new 59501A programmer, you now may select from more than 80 HP power supply models for use in HP-IB test systems.

A new isolated D/A converter / power supply programmer, the HP 59501A, provides a convenient interface between the Hewlett-Packard Interface Bus and over 80 models of HP power supplies. Output voltage (or current) control of remotely programmable power supplies is accomplished by voltage programming from the 59501A, with gain provided by the power supply control circuits.

Isolation is rated at 600 Vdc between the input HP-IB data lines and output terminals to keep all power supply circuits separated from the controller and bus-connected instruments.

Output from the programmer is from 0 to 9.99 volts in 10 mV steps. Accu-

racy is 0.1% plus 5 mV. Increased resolution and accuracy are available over the lower 10% of output using the HP-IB programmable 0.1 X range. A network in the 59501A programmer may be adjusted to match the various power supply programming coefficients and full scale output ratings. In addition, the programmer output may be manually switched to a bipolar mode required for controlling power supply/amplifiers.

The 59501A may also be used as a low level DC voltage source with a conversion time of $< 150 \mu\text{s}$ and output current up to 10 mA.

For additional details, check H on the HP Reply Card.

New application note for testing active RF devices

Measuring the gain characteristics of active microwave devices—primarily amplifiers and transistors—has traditionally been a time consuming procedure because many tests had to be performed at discrete (i.e., CW) frequencies. Now a new HP Application Note (AN 155-1) describes how to make swept-frequency measurements of such important parameters as:

1. Gain and Power Output
2. Gain Compression
3. Harmonic Content

(CW Gain vs. Power Output is also described; a more convenient test than the traditional Gain vs. Power Input).

These applications are keyed to the HP 8755 Frequency Response Test Set, a versatile dual-channel detection and display system with ratio-ing capability and 60 dB dynamic range. Frequency coverage of the 8755 is from 15 MHz to 18 GHz. Operating instructions and accuracy considerations are included in this eight-page note.

Send for your copy today. Check O on the HP Reply Card.

Two precision RF test sets, designed for use with the HP 8505A Network Analyzer (500 kHz to 1.3 GHz), are available separately so they can be used with such other RF instrumentation as the popular HP 8405A vector voltmeter (1-1000 MHz), HP 8407A 110 MHz network analyzer system, and HP 8755 frequency response test set (two-channel, magnitude-only detection and display system).

Model 8502 transmission reflection test set contains both a precision power splitter and a high directivity directional bridge permitting simultaneous measurement of transmission and reflection coefficients of the device under test. Also included in the test signal channel is an RF attenuator with 70 dB range in 10 dB steps, which means sensitive devices can be tested at very low test signal levels. The test device can be biased through a dc bias network incorporated within the set. This test set is available with test port impedance of either 50 ohms (8502A) or 75 ohms (8502B). The 75 ohm version is configured to allow measurements in 75 ohm systems using 50-ohm instrumentation.

The HP 11850 three-way power splitter is an extremely flat, well-matched signal divider useful for such transmission measurements as gain or loss, matched pair gain or loss, and comparison tests. The three output ports can be either 50 ohms (11850A) or 75 ohms (11850B).

For more details, check J on the HP Reply Card.



Precision test sets for measuring 50 and 75 ohm networks in the 500 kHz to 1.3 GHz frequency range: (left) HP 8502A/B transmission/reflection tests sets with built-in 70 dB attenuator, and (right) HP 11850 A/B three-way power splitters.

New low-cost Schottky diode for general purpose switching

With a low forward voltage of 410 mV, the HSCH-1001 (IN6263) is a functional replacement for many germanium diodes. It also offers 15 mA forward current and a 60V breakdown voltage for efficient switching in the picosecond range. With an operating range of -65°C to $+200^{\circ}\text{C}$, it is suitable for harsh environments.

The HSCH-1001 is ideal for waveform clipping, clamping and sampling, transistor speed-up, and rf signal detection and power monitoring.

For details, check M on the HP Reply Card.

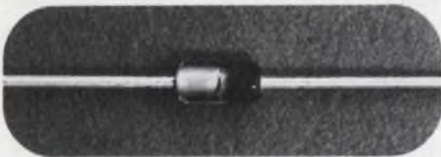

The HSCH-1001 is offered in the low-cost DO-35 hermetic package. It is rugged enough for automatic insertion equipment and can be supplied in tape or reel.

New low noise transistor

A new microwave bipolar transistor, the HXTR-6102, has a guaranteed noise figure of only 2.7 dB maximum at 4 GHz, with 2.5 dB typical. Associated gain is 9 dB.

The HXTR-6101, with a guaranteed noise figure of 3.0 dB, has been reduced in price up to 33%.

Check N on the HP Reply Card for further specifications.



The HXTR-6102 is supplied in the HPAC-70GT, a rugged metal/ceramic hermetic package capable of meeting tough environmental and test requirements.

New compact alphanumeric display with on-board IC's reduces system complexity

Compared with the external circuitry required for earlier and more expensive alphanumeric LED displays, the HDSP-2000 reduces the parts count for a typical display system by a factor of 36:1.

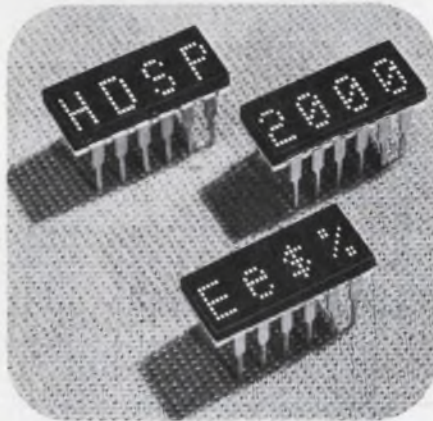

HP introduces a compact LED alphanumeric display, complete with on-board electronics. The HDSP-2000 is a 3.8mm (.150") high alphanumeric available in a standard DIP package. Packages are end-stackable to any message length. On board are shift registers and constant current drivers, reducing the parts count for a typical 32-character system by a factor of 36:1. These low voltage LED displays are directly TTL or CMOS compatible and are readily microprocessor controlled.

The internal circuitry accepts decoded 5×7 matrix data in a serial format. In operation, one column of data for each character in the display string is first clocked into the on-board shift registers from an external character generator and parallel-to-serial converter. The appropriate column of the HDSP-2000 is then strobed using an external column drive transistor.

Because of their small package size and on-board circuitry, HDSP-2000 alphanumeric displays are expected to open new application possibilities in-

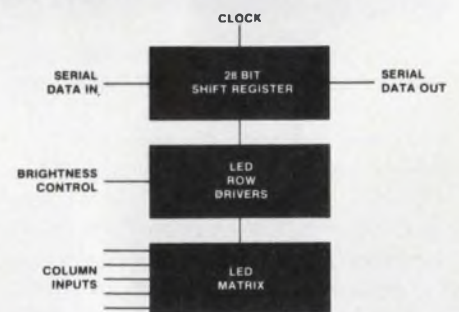

Only 12 pins are needed to address each 4-character set. On-board electronics includes shift registers and externally programmable constant-current drivers.

cluding interactive point-of-sale devices, compact mobile communications sets, 'smart' microprocessor-based instruments or control systems, medical instruments, and portable business terminals. The miniature package makes many hand-held applications feasible. Rugged solid state construction and ability to operate at temperatures from -20°C to $+70^{\circ}\text{C}$ allows these displays to be used in harsh industrial environments and many military designs.

Each HDSP-2000 character is formed with a 5×7 dot matrix capable of displaying the full ASCII character set, upper and lower-case letters, punctuation marks, mathematical symbols as well as numerals. The 35-dot matrix allows flexibility of character font design. Character height is optimized for hand-held, desk-top, or viewing distances of 1 to 3 meters.

For detailed specifications, check L on the HP Reply Card.

OEM

NEWS

At Hewlett-Packard, your OEM dollar buys more than just hardware

When you purchase OEM equipment from Hewlett-Packard, you are assured of product performance, service and applications assistance from a company that recognizes your reputation and success depend partly on the support you receive from your OEM supplier.

Confidence can be yours with the knowledge that HP is ready to respond to your needs with over 3,000 sales, service and technical personnel located in 172 offices in 65 countries.

A highly competitive OEM discount structure is offered across a wide selection of instruments. In addition, many instruments can be custom tailored to meet your specific needs.

Confidence is yours when an HP recorder is part of your OEM system



HP instrumentation tape recorders, including the eight-channel shown above, are designed and packaged for versatility, portability and durability.

With the addition to the OEM recorder line of eight and four-channel instrumentation tape recorders, the HP 3968A and 3964A respectively, high performance data collection is realizable for the systems you manufacture.

Both recorders use economical ¼-inch tape. A combination of FM and direct electronics permits recording from DC to 64 kHz. These compact, rugged recorders provide laboratory quality performance even in tough field environments. Standard features include TTL remote control, a push button built-in calibration source, tape servo, flutter compensation and voice annotation. Six tape speeds from 15/32 ips to 15 ips give you a 32:1 tape base compression or expansion for flexibil-

ity and easy data analysis.

Designed to serve the broadest possible range of OEM applications, HP also offers an extensive line of analog and graphic recorders including:

- **X-Y** Available in two basic configurations: 11×17" (DIN A3) and 8½×11" (DIN A4).

- **Strip Chart** Choose from four categories: single span, compact desk-top unit, "slim line" models, and a battery powered portable.

- **Graphic Plotters** Paper up to 11×17" (DIN A3) can be used in three models for use with communications terminals and computers.

An OEM catalog describing all these models is available. For your copy, check F on the HP Reply Card.

An HP display will enhance your system's image

End users of your system will judge capability by the information displayed. HP's CRT Displays are excellent choices for many applications.

The 1332A, 1333A and 1335A displays all have a very small spot size that focuses uniformly over the complete viewing area, regardless of writing speeds or intensity level. Fine image detail with excellent contrast and uniformity make them particularly well suited for applications involving complex graphics, especially when combined with alphanumeric data.

If you need a larger viewing area, and a brighter image at fast scan rates,



consider the **1332A** with a 9.6×11.9 cm viewing area.

For photographic recording of displayed data over the 8×10 cm area, the **1333A** offers an extremely small spot size (.20 mm).

The **1335A**, a variable-persistence, storage and non-storage display has a totally new CRT design. For maximum flexibility, any operating mode—erase, store, write, conventional or variable persistence—can be selected with manual front panel controls, re-

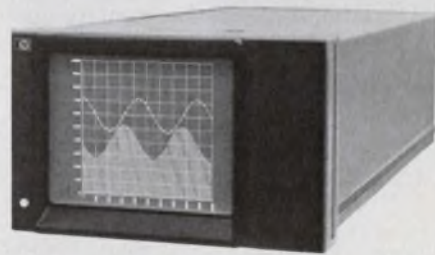

mote program inputs, or both.

HP also offers five large screen graphic displays for OEM computer graphic and instrumentation applications. These large displays have linear writing speed of 25.5 cm/μs and X/Y settling times of ≤500 ns.

For details on large displays, check B on the HP Reply Card. For smaller displays, check C on the HP Reply Card.

New 1 GHz pulse generator for testing your fastest circuits

With transition times down to 300 ps and repetition rates to 1 GHz, the HP 8080 pulse/word generator system provides powerful new stimulus capabilities for testing the fastest of pulse circuits. Giving you a choice of high performance modules from 300 MHz and 1 GHz families, a system can be configured as either a pulse generator or a word generator whose features you can tailor to exactly match your testing requirements.

The 1 GHz repetition rate generator, delay generator/frequency divider, and output amplifier modules form a versatile dual channel pulse generator. With 300 ps transition times, 1.2V pulse amplitude, and precise 100 ps delay increments, the system tests the fastest available IC logic families. Frequency division and inter-channel delay are designed into the system so you can economically, and simply, generate the dual channel waveforms necessary for flip-flop and dual input device testing. Previously requiring 2 pulsers, these signals are produced using only a single system.

The 300 MHz module family consisting of a repetition rate generator, word generator, and output amplifier forms a serial 64-bit data source extremely useful in fiber optics and telecommunications applications. The system features 800 ps transition times, 2V amplitudes, and word lengths variable to 16, 32, or 64 bits. RZ and NRZ data formats and complementary out-

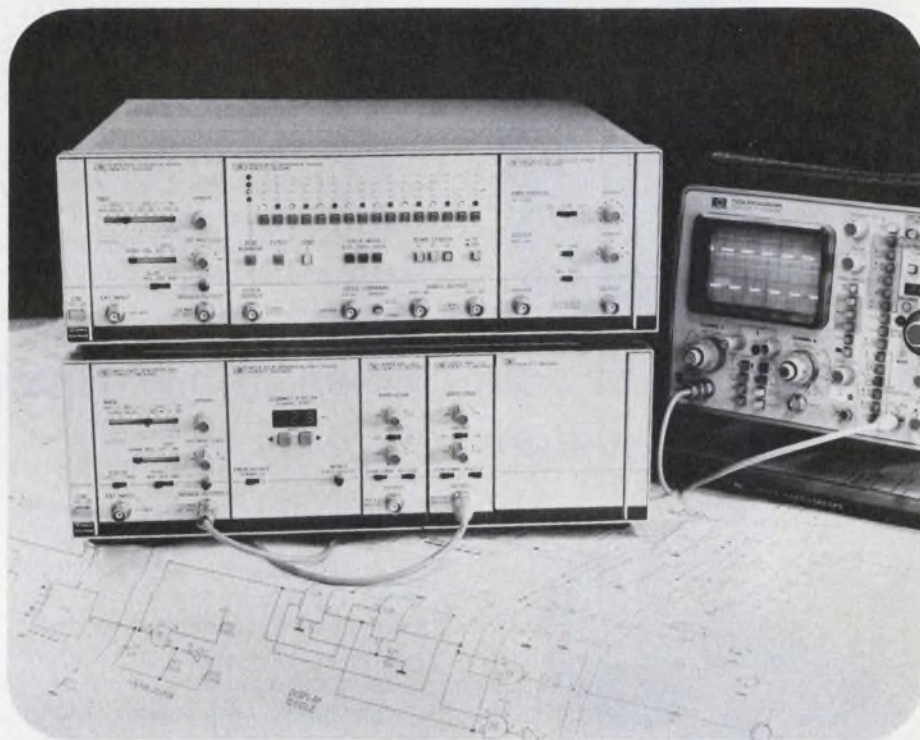

The 8080 series is a powerful new pulse and word generator system for subnanosecond risetime applications. The modular construction of the series enables you to configure pulse stimulus systems to exactly match your high frequency testing requirements, either at 300 MHz or 1 GHz operation.

puts provide flexibility for applications requiring fast serial data streams.

Other combinations of these fully compatible modules provide still further testing capabilities. Modularity protects your investment, letting you easily reconfigure or expand your system to meet changing requirements.

For more information on choosing the modules for assembling your system, check I on the HP Reply Card.

East-4 Choke Cherry Road, Rockville, MD 20850

Ph. (301) 948-6370.

South-P.O. Box 10505, Atlanta, GA 30348

Ph. (404) 434-4000.

Midwest-5500 Howard Street, Skokie, IL 60076,

Ph. (312) 677-0400.

West-3939 Lankershim Blvd, North Hollywood, CA

91604, Ph. (213) 877-1282.

Europe-7, rue du Bois-du-lan, P.O. Box, CH-1217, Meyrin-2,

Geneva, Switzerland, Ph. (022) 41 54 00.

Canada-6877 Coreway Drive, Mississauga, Ontario,

L4V 1M8, Ph. (416) 678-9430.

Japan-Yokogawa-Hewlett-Packard Ltd., Ohashi

Bldg., 1-59-1 Yoyogi, Shibuya-ku,

Tokyo 151, Ph. 03-370-2281/92.

HEWLETT  **PACKARD**

Sales and service from 172 offices in 65 countries.

MEASUREMENT **news**
COMPUTATION
product advances from Hewlett-Packard

November/December 1976

New product information from

HEWLETT-PACKARD

Editor: Iona M. Smith

Editorial Offices:

1507 Page Mill Road
Palo Alto, California, 94304 U.S.A.

*If you buy
a prom programmer
before you read this
you're making a
big mistake!*

You can spend a lot of money and get practically nothing if you aren't careful.

Here's what to test for:

1. Is the programmer universal? Does it equip you for "tomorrow?" Will it program every available PROM type? (At last count there were over 165.)

2. Are programming techniques approved by the semiconductor manufacturers?

3. Can the programmer be calibrated? By you? Can performance be verified to PROM manufacturers' current specifications?

4. Is the programmer supported by direct sales, installation, training and service?

If the programmer is from Data I/O, it passes the test. Today, more than 1500 companies use Data I/O programmers. We build a complete range of machines including the Programmer V which has outsold every other automatic programmer in the

world (including the former world champ, the Data I/O Programmer I).



Data I/O total three point service.

1. Every Data I/O customer receives a quarterly update on currently available PROMs.

2. Through our direct (computerized) mailing program, Data I/O customers are kept constantly up-to-date on PROM specification changes and technological innovations.

3. Nine field offices in the U.S.A. and 22 distributors worldwide provide our customers with direct sales support, installations, operator training and service.

Get the facts

If you would like to know more about our products, or want copies of our quarterly PROM Comparison Chart and PROMBiTS (our periodic technical bulletin on PROM applications and innovations), mail this coupon or call one of our offices. Data I/O Corporation, P.O. Box 308, Issaquah, Washington 98027.

Name _____

Title _____

Company _____

Address _____

City/State/Zip _____



Data I/O

CIRCLE NUMBER 6

**You can buy
this Spectrum Analyzer
and take a big chunk
out of your budget.**

**You can rent
this Spectrum Analyzer
and get more
equipment out of
your budget.**



Even the best equipment budget can only go so far. And at the price you pay for electronic test equipment nowadays, that's not very far at all.

Unless you rent your equipment from REI.

When you rent from us, there's no large cash outlay. You pay only for the time you have your instruments, and you return them when you're through. So you never have to spend your money on idle equipment.

Getting more for your money is just one reason for renting from REI. Immediate delivery is another. We have over \$10 million in inventory in fully stocked centers around the country. And, when you have short-term needs, you can rent equipment for just as long as you need it, and make it pay for itself.

REI stocks over 8,000 fully checked-out test instruments, and they're ready whenever you are. For the full story on renting, as well as our low prices, send in the coupon for prompt delivery of our free illustrated catalog... or call us now for your immediate requirements.

Rental Electronics, Inc.
99 Hartwell Avenue, Lexington, Mass. 02173
Please send me your free instrument rental catalog:

Name _____ Title _____

Company _____

Address _____

City _____ State _____ Zip _____

Tel. Number _____

Rental Electronics, Inc. 

A **DEPSICO** LEASING COMPANY

Burlington, MA (617) 273-2770 • Gaithersburg, MD (301) 948-0620 • Oakland, NJ (201) 337-3757 • Ft. Lauderdale, FL (305) 771-3500
• Des Plaines, IL (312) 827-6670 • Dallas, TX (214) 661-8082 • Mountain View, CA (415) 968-8845 • Anaheim, CA (714) 879-0561
• Rexdale, Ontario (PLC Leasing Ltd.) (416) 677-7513

CIRCLE NUMBER 7

DECEMBER 6, 1976

Optical transistor doubles as amplifier or switch

An optical transistor that can function as either an analog optical amplifier or a digital optical switch has been developed by researchers at the Massachusetts Institute of Technology.

The MIT device has a weak ($5.3\ \mu\text{m}$) laser-input signal that directly controls a powerful $10.6\text{-}\mu\text{m}$ CO_2 laser beam. Incremental power gains greater than 100 can be realized—much better than those of an optical transistor reported last year by Bell Laboratories. Based on an interferometer containing sodium vapor as the active medium, the Bell transistor recorded a gain of only 2 because of a resonance mechanism in the modulated interferometer cavity.

The MIT transistor, however, is a totally new approach. It optically modulates the refractive index of a nonlinear crystal in which the low-power signal and high-power, or pump, laser-input beams are mixed. A refractive index change, on the order of one part in 10,000, in crystals sensitive to this effect—tellurium, in this case, can produce 100% modulation.

A nonlinear crystal such as tellurium acts as an optical frequency doubler, according to Dr. George Pratt Jr., a professor in MIT's Dept. of Electrical Engineering and Computer Science. In the optical transistor, a high-power CO_2 laser beam (see fig.) is applied to the crystal at what is called the "phase-matching" angle. The crystal is cut especially for this angle.

The $10.6\text{-}\mu\text{m}$ beam is frequency-doubled within the crystal whose output contains two components, a diminished CO_2 beam and a second harmonic $5.3\text{-}\mu\text{m}$ beam. The energy in the $5.3\text{-}\mu\text{m}$ output is extracted from the $10.6\text{-}\mu\text{m}$ CO_2 beam.

For the second harmonic to ex-

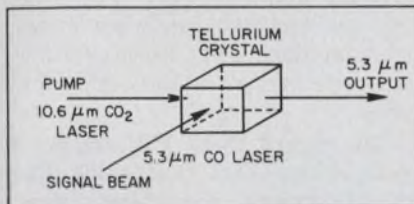

tract significant power from the pump beam, the diminished CO_2 beam must travel through the crystal with the same velocity as the pump beam. This means that the crystal's index of refraction is the same for energy at both frequencies. Called index (or phase) matching, this phenomenon is the key to the operation of the optical transistor. If the fundamental and harmonic beams remain in phase through the crystal, 100% of the fundamental energy can be converted into the second harmonic. But if the beams get slightly out of step because of index mismatch, the second harmonic output is drastically reduced.

The $5.3\text{-}\mu\text{m}$ CO -laser's signal beam—it has a fraction of the CO_2 beam power—varies the crystal's refractive index. This variation may either help phase matching and produce maximum second-harmonic output, or destroy the phase match and cut off the $5.3\text{-}\mu\text{m}$ output.

For analog applications, the CO -laser signal's magnitude can be varied between maximum output and cutoff limits.

The MIT optical transistor potentially can handle tens of GHz worth of channels, which can be applied by simultaneous modulation of the signal beam, according to MIT researchers. These channels appear independently amplified in the second harmonic output.

Index-sensitive crystals like tellurium can be cut along special

crystallographic axes so that with an input pump beam (but without a signal beam) there is no phase match and consequently no second-harmonic output. Adding the signal beam produces maximum output. Work is being done on this type device, which provides an AND gate for digital application.

The signal beam does not necessarily have to be at the $5.3\text{-}\mu\text{m}$ second-harmonic frequency, Pratt points out. The only requirement is that it be capable of interacting within the crystal to produce the refractive index change.

Computer net concept shown by Sperry Univac

A communications concept that links several computers and their terminals together in a network and an intelligent communications system that uses this new architecture have both been introduced by Sperry Univac. The Distributed Communications Architecture (DCA) can also link up "foreign host" IBM 370s.

A computer twice as powerful but only one-third as large as the company's 1100/40—and with less heat dissipation and lower power requirement—has also been introduced by Sperry Univac, the 1100/80.

Not a product in itself, DCA serves as a set of procedures to direct the development of communications networks. It defines logical structure, the relationship of the host terminals and major processing components within the network, and establishes protocols and interfaces.

Telcon, the communications network, provides basic hardware, software and peripherals for the large-communication user. Its major components are the Sperry Univac Distributed Communications Processor and the Telcon network software.

The processor, a 16-bit computer with 8-bit addressability, includes storage interface, 32 general and 6 specific registers, a ROM, an arithmetic section and function-control sections. Internal data transfers are communicated with a single parallel bus that connects all logical units and the general register.

Sperry Univac's 1100/80 com-

puter has been built with emitter-coupled logic (ECL) and multilayer packaging. ECL was used because it is fast, requires fewer components than other logic families, and permits size reduction, explains Frank B. Holst, vice-president of the program management.

The computer's semiconductor memory has a main storage of 524-k words (2 Mbytes), which can be expanded to 4194-k words (16 Mbytes). A CPU can be added for multiprocessing applications and a second I/O unit for expanding I/O channels sizably.

Sperry Univac's introduction of DCA and Telcon comes one week after IBM had announced a new function for its system network architecture that will permit two or more computers to be tied together in the same data-processing network instead of just one.

Convinced that distributed systems are the way to go, Sperry Univac plans to move forward to gradually include intelligent components like μ Ps in terminals, remote concentrators and host front-end computers.

A minicomputer that thinks like a mainframe

A minicomputer on a board that not only features capabilities usually considered optional in minis but also packs the power of a large-scale computer has been introduced as part of a new family of minicomputers by Varian Data Machines, Irvine, CA.

The "optional" capabilities that are standard in the V77-200 are a real-time clock, hardware multiply and divide, and a virtual console built onto the board. The powerful mini also features an 8-register CPU; a 32-bit arithmetic capability, which permits 8, 16 or 32-bit data to be handled; and a working set of 187 instructions, which are implemented by microinstructions stored in a block of 512×24 -bit read-only memory (ROM) devices.

The speed of the V77-200's arithmetic functions distinguishes the mini from conventional OEM systems. For example, a LOAD A instruction that takes three or four cycles in conventional machines requires only 2 cycles in the V77-200.

Signed multiplication functions are typically performed in 4.9 μ s, divide function in 8 μ s.

These speeds are not much slower than the 4.8- μ s multiply, and 6- μ s divide times of the V75 computer. But the V75 costs \$40,000, while a V77-200 processor board sells for \$1200, and a chassis-mounted model with 32-k of memory costs \$7600.

The V77-200 is a member of a new family of minicomputers aimed at manufacturers of systems requiring a high level of computation software and hardware. The V77-200, 400 and 600 can work either as stand-alone computers or function together as a network hierarchy.

"We regard these V77 machines as minicomputers that think like mainframes," says Jim Orris, Varian's vice president for marketing. "As a family, more than one unit can be coupled into communications and data network configurations, shared memory systems, or distributed network configurations without special conversion interfaces."

Features of the V77-400 (\$10,100) include memory protect and dual-port memory capability for shared memory applications. Dual-port memory permits shared-memory multiprocessor networks, in which two V77 processors share one or more memory modules. Thus, the 400 can directly access memories serving other V77 computers without being routed through processor or I/O channels.

Aimed at the end user, the V77-

600 (\$22,450) has 64-k \times 16 bits of memory and features high-speed cache memory with a cycle time as fast as 370 ns.

CIRCLE NO. 318

Midget d/a delivers 18-bit performance

An 18-bit digital-to-analog converter that brings rack-sized precision to pocket-sized modules has been developed by Analog Devices, Norwood, MA. Squeezed into a $2 \times 4 \times 0.4$ -in. package, the DAC1138 doesn't use any technology breakthroughs to get its performance, but its component-selection criteria, board layout and even board material have been fine-tuned for top specs.

The converter is expected to be available in 17 and 18-bit-accuracy models, both with 18-bit resolution. The 18-bit converter's accuracy, a tight 0.00038%, applies over a limited ± 10 -C range. However, the ± 10 -C range can be set to fall anywhere within the full 0-to-70-C operating range.

Not only does the d/a converter match most of the specs usually considered available only from units housed in 19-in.-wide rack cases, but it does so at a comparatively low price—\$950 each. The 17-bit unit is expected to cost only \$750 each.

The DAC-1138 is pin-compatible with Analog's older DAC-QM series of 16-bit converters.

CIRCLE NO. 319

News Briefs

Motorola expects to be in full production early in 1977 with the **first U.S.-produced SOT-23 plastic-encased transistor**. Dubbed the Miniblock, the ultra-small (approximately $0.05 \times 0.114 \times 0.033$ in.) devices are now built overseas by Siemens, TI, Amperex and NEC. . . . **Fairchild Semiconductor is readying for market a 16-bit μ P using I²L technology**. Although the company has not released any specs, the new device is expected to be housed in a 40-pin DIP. The only other I²L processors are made by Texas Instruments—the SBP-9900 16-bit μ P and the SBP-0400A bit slice. In general, I²L means greater speed

than the NMOS μ Ps available today. . . . The most effective and economical way to search in space for signals from other civilizations is to **put into earth orbit a 2-mile-diameter hemispheric antenna**, according to a study conducted for NASA by the Stanford Research Institute, Palo Alto, CA. . . . **Sewage sludge is being disinfected by high-energy electrons** at the Deer Island sewage-treatment plant in Boston Harbor. Using a 50-kW electron generator, built by the High Voltage Engineering Corp., Burlington, MA, a beam of electrons sweeps back and forth across a stream of sludge at the rate of more than six feet/s.



Intro- ducing our new thumbwheel switch

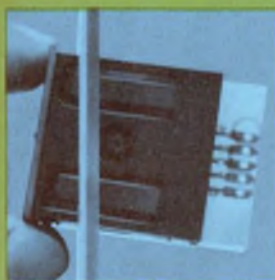

for 8-mm thumbs. It's a skinny switch that we call the 1800 Series. It has many of the features of our notorious 1776 Series —but simpler, more standardized, and cheaper. For example, just \$2.50 for one, less for more, with a choice of five codes, gloss or matte finish, with or without stops, and readable by 20/20 eyes from 10 feet away.

It's got PC board terminations for plug-in or solder connections, and it snaps into a panel for mounting (no tools needed). It mounts singly or ganged (up to 20 stations), and will give at least 500,000 detent operations before it tires.

So now we've left you with no excuse for not choosing EECO when you need a thumbwheel switch. We've got more versions for more applications than any other switch maker in the country. And more offices to buy from (87 in the U.S. and Canada). For any thumbwheel switch, see us first.

WE'VE GOT YOUR SWITCH.

EECO
SWITCHES/PACKAGING/READERS

1441 East Chestnut Avenue, Santa Ana, California 92701 Phone 714/835-6000
Distributed in the U.S. by Hall-Mark, G. S. Marshall, and Schweber. In Canada by R.A.E.

CIRCLE NUMBER 8

It pays to look into Metal Glaze™ from all angles.

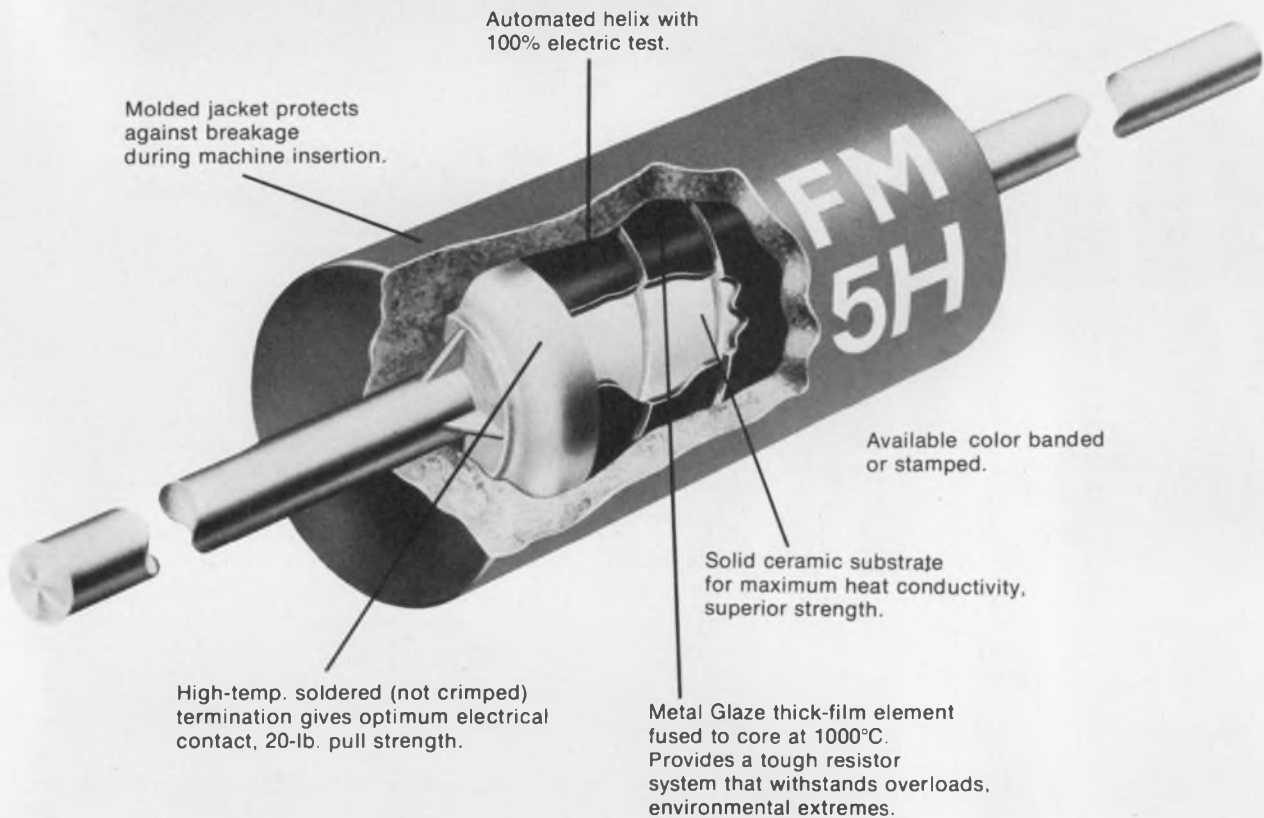

™Metal Glaze is TRW trademark for its thick-film resistors.

We have designs on you. Especially if you're designing any type of low-power circuitry and need resistors with excellent load life stability and cost effectiveness.

TRW/IRC Metal Glaze resistors can take the heat. For instance, their thermal characteristics are outstanding, resulting in lower operating temperatures, greater reliability.

Another advantage, you can often double-rate our Metal Glaze resistors so you can use smaller resistors, saving board space.

The ability and toughness of Metal Glaze to withstand heat with minimum drift has been proven billions of times in all types of electronic equipment, worldwide. And they're available in ratings ≤ 3 watts, $\geq 1\%$ tolerance, with ranges as low as 1 ohm.

For complete resistor choice including Metal Glaze, carbon comp., thin-film, wirewound and networks, contact your local TRW authorized distributor or sales representative. Or TRW/IRC Resistors, an Electronic Components Division of TRW, Inc., 410 N. Broad St., Philadelphia, Pa. 19108, (215) 922-8900.

**RG PULSE OR SURGE POWER RATING:
MAXIMUM APPLIED POWER/PULSE ON TIME**

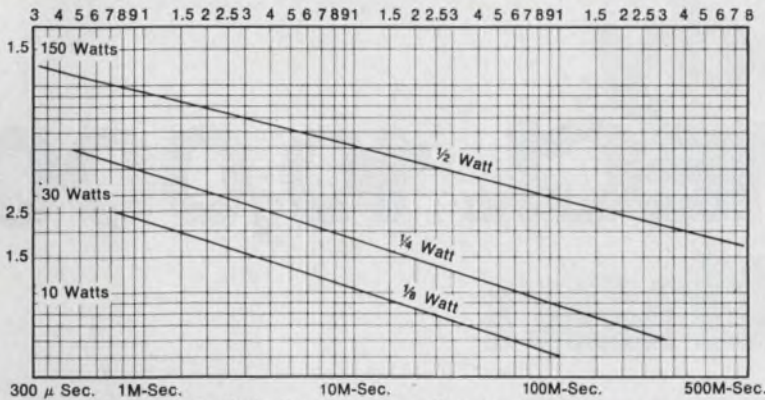

Note: Average power dissipation not to exceed component rating.

Overload Protection

Rugged Metal Glaze construction provides excellent power surge capability. A 1/4w unit will conservatively operate within specifications when exposed to 18w, 10msec pulses, provided average power, and max voltage ratings are not exceeded. Ask us about your applications, including those requiring steady state conditions exceeding mil rated power.

TYPICAL TO-55 DESIGN TOLERANCE

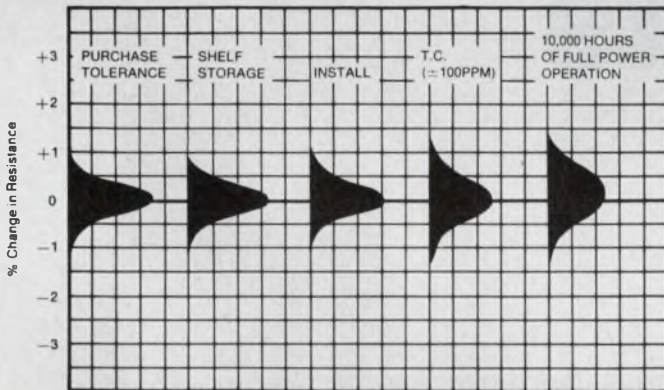

Minimum Design Tolerance

(Design tolerance = a statistical summation of various parameters including load life, TCR, installation, and moisture resistance) All the features of Metal Glaze Resistors result in tight, predictable design tolerances which can be as low as ±1.5%, depending upon your application.

TYPICAL DISTRIBUTION OF TEMPERATURE COEFFICIENT OF RESISTANCE

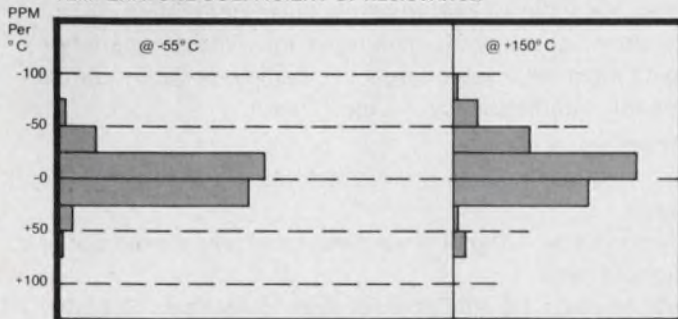

Absolute, Linear TCR

T.C.'s of 50, 100, or 200ppm are specified across the entire resistance range from 1Ω to 1MΩ. Our TC characteristic is essentially linear with temperature, and is a normal distribution centered near zero.

AVERAGE RESISTOR TEMPERATURE RISE VS. APPLIED POWER

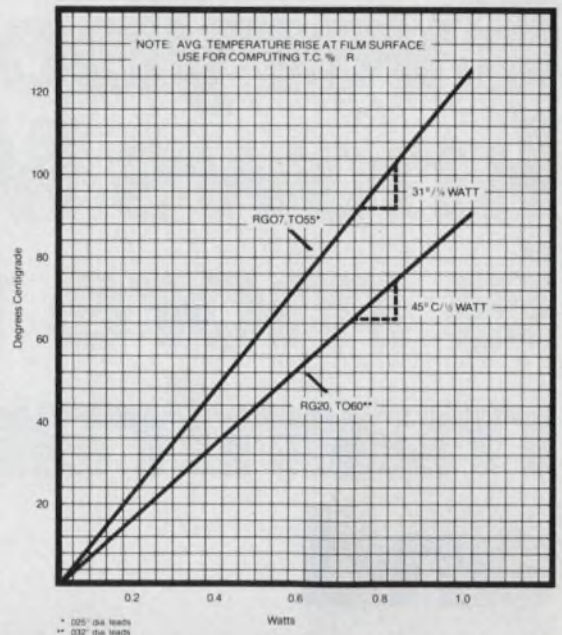

High Thermal Conductivity

A solid alumina substrate and other design features efficiently transfer heat from the resistor element. As an example, a 1/4w unit at full load has a hot spot temp rise of only 30°C, half the rise experienced in some other types. Cooler operation means stability and reliability are optimized.



Capless Terminations

All Metal Glaze resistors have our exclusive high temperature soldered terminations. This capless construction means excellent pull strength and prevents substrate damage during assembly. With the additional protection of a molded jacket, 1/4w Metal Glaze resistors withstand a 20lb pull test.

TRW IRC RESISTORS
ANOTHER PRODUCT OF A COMPANY CALLED TRW

CIRCLE NUMBER 9

Everybody knows MECL 10,000 is more than mainframes and instruments

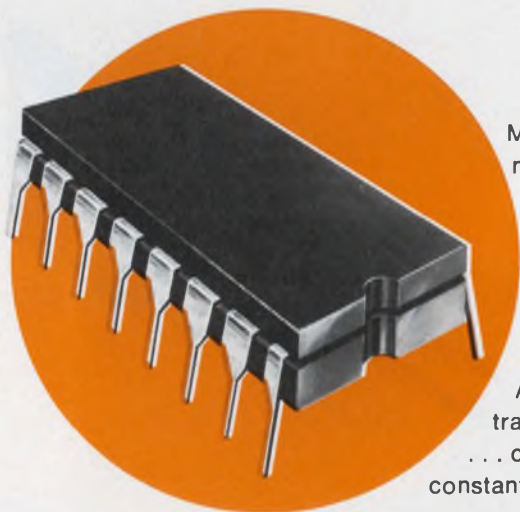

More people now use MECL 10,000 in general logic designs than in mainframes and instruments.

It was bound to happen.

Oh, it's still #1 with the 2 nanosecond mainframe and instrument boys alright.

But others have discovered it's the most versatile, functional, high-performance logic form around for a variety of high-speed commercial industrial designs.

And the reasons: insignificant power supply noise generation . . . transmission line drive capability . . . high input/low output impedance . . . compatibility with most other logic forms . . . complementary outputs . . . constant power dissipation with frequency . . . etc.

Maybe they know something you don't.

That MECL 10,000 raises performance, cuts power dissipation and package count and lowers equipment costs.

That MECL 10,000 offers more than 120 individual functions from simple gates to 1K RAMs for every throughput need.

That MECL 10,000 production costs are similar to, or even lower than, Schottky T²L.

That MECL 10,000 is more than number crunchers and counters.

It's everything else, too.

MECL 10,000.

Get smart.



Just ask 'em.

- **NATIONAL MEMORY** . . . uses MECL 10,000 in add-on memory
- **COLLINS**[†] . . . uses MECL 10,000 in peripheral controller
- **TRW** . . . uses MECL 10,000 in space shuttle
- **CINCINNATI MILACRON** . . . uses MECL 10,000 in small business systems
- **TERADYNE** . . . uses MECL 10,000 in IC test system
- **BURROUGHS** . . . uses MECL 10,000 in radar data processor
- **NETWORK SYSTEMS** . . . uses MECL 10,000 in data interface
- **AMS** . . . uses MECL 10,000 in add-on memory
- **KING RADIO** . . . uses MECL 10,000 in avionics
- **GENERAL DYNAMICS** . . . uses MECL 10,000 in missiles and F-16 support
- **RAYTHEON** . . . uses MECL 10,000 in ECM systems
- **DIGITAL COMMUNICATIONS** . . . uses MECL 10,000 in satellites
- **CDC** . . . uses MECL 10,000 in military magnetic disk drive
- **BUNKER-RAMO** . . . uses MECL 10,000 in Army systems
- **ELECTRONIC MEMORIES** . . . uses MECL 10,000 in add-on memory
- **STORAGE TECHNOLOGY** . . . uses MECL 10,000 in disk controller
- **CUBIC CORP** . . . uses MECL 10,000 in multi-band translator
- **DIGITAL EQUIPMENT CORP.** . . . uses MECL 10,000 in small computers

[†]DIVISION OF ROCKWELL INTERNATIONAL

MOTOROLA Semiconductors
—and you thought we were just a production house

Motorola Semiconductor Products, Inc., Box 20912, Phoenix, AZ 85036

CIRCLE NUMBER 10

MEMORY AT WORK

Replacing four 2102s

If you're designing the 2102 into any application, stop. Look at our new SEMI 4804A.

It will quadruple your density, cut your power per bit in half. One SEMI 4804A static

1K x 4 RAM replaces four 2102s (or 2112s). It operates on 5V (but will protect data down to 1.5 V_{DD}), reads and cycles in 450 nsec., and is packaged in an 18-pin DIP.

The SEMI 4804A is second-sourced, and is available now from your local EMM SEMI distributor. (If you need 4K x 1 organization, ask about our new SEMI 4801. That's available immediately, too.)

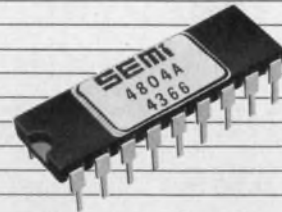

Write or call today
for full details.

EMM SEMI
A subsidiary of

Electronic Memories & Magnetics Corp.
3883 N. 28th Ave., Phoenix, Ariz. 85017
(602) 263-0202

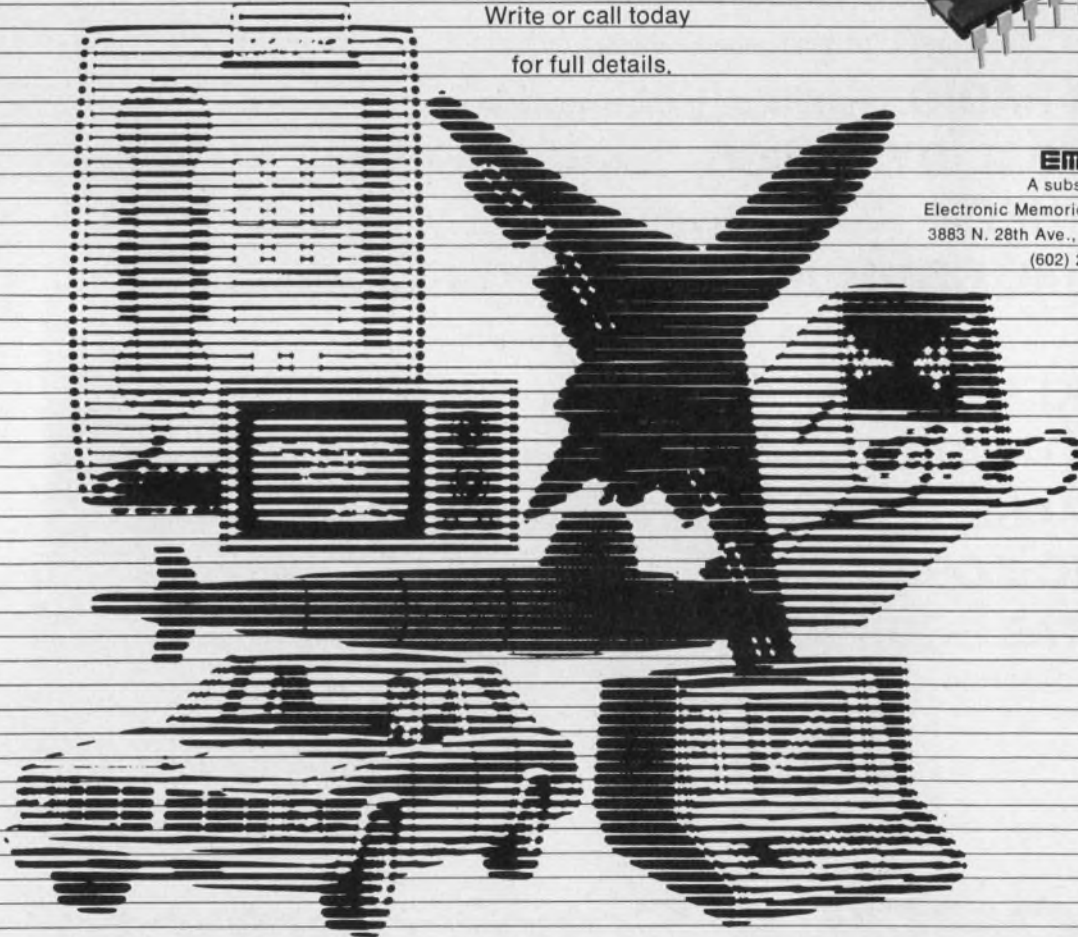

DAK

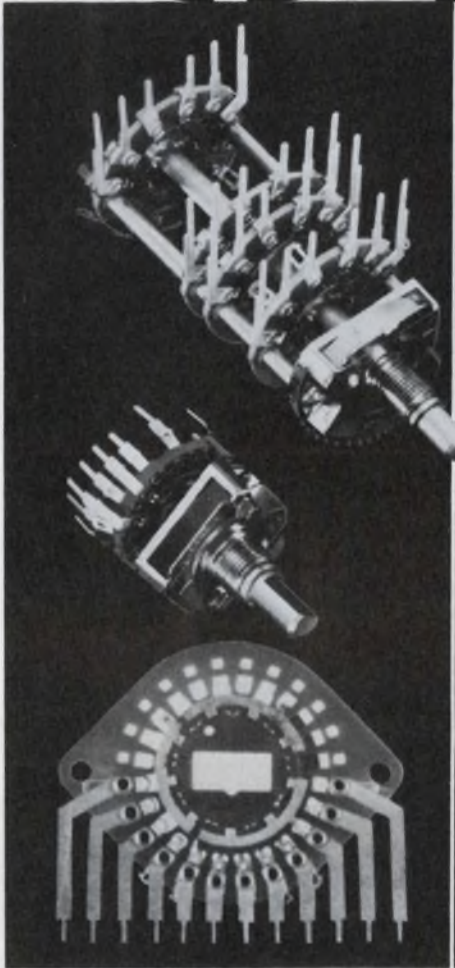

Headquarters
for every kind of
printed circuit
rotary switch

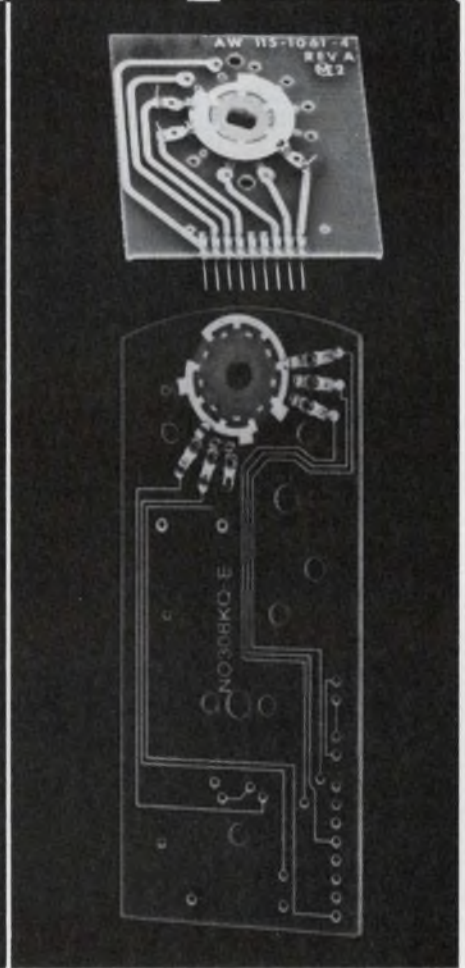
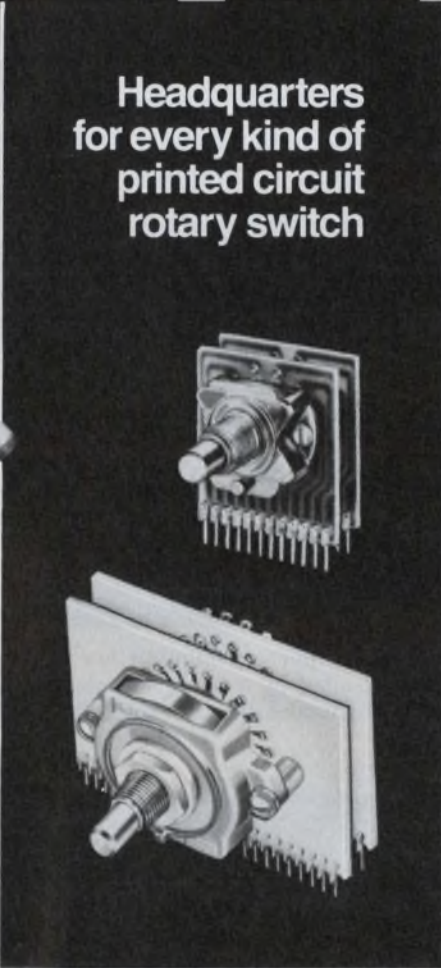

Simplify your equipment design and reduce assembly costs with this broad selection.

1. PCB Terminations can be provided on any conventional Oak rotary switch—the most extensive line in the industry—($\frac{1}{2}$ " to $2\frac{5}{8}$ " diameter sections).

2. Standard PC Board section switches, 12 and 24 position, with PCB terminations are tooled for volume production.

3. Custom designs to meet special applications, including switching built directly into the PC board are readily supplied.

A NEW CATALOG

Detailing Oak PCB switch products and capabilities has just been published. Write for your free copy.

DAK Industries Inc.

SWITCH DIVISION / CRYSTAL LAKE, ILLINOIS 60014

TELEPHONE: 815 • 459 • 5000 ■ TWX: 910 • 634 • 3353 ■ TELEX 72 • 2447

CIRCLE NUMBER 12

Low-cost design aids keep pace with growing microprocessor field

The explosive proliferation of the microprocessor industry is more than matched now by a rapid increase in the number of μ P design aids.

Anyone interested in designing μ P-based equipment is immediately confronted with a bewildering variety of teaching aids, learning aids, design aids, development aids, evaluation kits, software and hardware-development aids and kits and on and on.

And because the microprocessor field is both new and growing, exact definitions of these aids simply don't exist.

Aids currently range from tiny devices, whose simple circuitry (less than \$200) is controlled by a few switches and mounted on a single printed circuit (PC) board, to highly sophisticated, computer-based behemoths, bearing a price tag that often runs to tens of thousands of dollars.

Particularly important are the hardware design aids—mainly one or two PC boards—on which the designer can put together a breadboard version of his μ P-based system. The price range, approximately \$100 to \$900, is low enough to permit just about anyone to join the μ P generation.

Although at first glance it might seem that the cost of a particular design aid should bear a direct relation to its complexity and to the amount of memory it provides, such is not always the case. The amount of memory is certainly a factor, but there are other contributors:

- Speed. Cheaper units run at a



Input/output capability at low cost for National Semiconductor's SC/MP kit is provided by a hand-held hexadecimal keyboard and display. A 21-wire flat cable supplies the connection to the μ P board.



The EVK 300 from AMI is one of a series of four PC boards for designing 6800-based systems.



Designing with the 16-bit CP1600 μ P is made easier by General Instrument's Gimini microcomputer.

1-MHz rate rather than at 2 MHz or faster.

- Documentation. The greater the amount of material provided, the higher the price, in general.

- The desired market. Equipment aimed mainly for the hobbyist or experimenter usually is made with low-quality components. The

result is a low price. Some large semiconductor manufacturers, however, unwilling to compromise their reputation, produce only quality kits—for anybody—that sell for a relatively higher price.

Other semiconductor firms shooting primarily for large-volume sales of their particular μ Ps may

Samuel Derman
Associate Editor

offer design aids at zero profit, or even below cost, to encourage engineers to design with their product.

Consequently, classifying hardware-design aids simply by selling price can be misleading. Categorizing them by the μ P they support avoids such a pitfall.

Getting started with the 6800

A simple and inexpensive tool for designing systems based on the 8-bit M6800 μ P is the MEK68002 evaluation kit from Motorola, Austin, TX. Except for the power supply, all parts needed to complete the μ P-based system and get "on line" are provided.

Consisting of two PC boards, the \$225 kit is configured to allow programs to be entered manually through a 24-key hexadecimal keyboard or via an asynchronous interface adapter for an audio-cassette tape recorder. By avoiding an expensive teletypewriter terminal, the designer can get started at a minimal cost. A 6-digit LED display monitors both the data and address buses. Four other 6800 prototyping kits, all from American Microsystems in Santa Clara, CA, range in price from a low \$152 to a hefty \$950. The EVK 99, 100, 200 and 300 all have the same basic 10-1/2 in. \times 12-in. PC board.

For anyone willing to buy or borrow his own TTL buffers, clock generators and power supply, the EVK 99 can get them off and designing with the 6800. In addition to the 6800 MPU, the EVK 99 comes equipped with four 128 \times 8 RAMs, a peripheral interface adapter (PIA), a 1 k \times 8 ROM and an asynchronous communications-interface adapter (ACIA). The ACIA allows the system to communicate bidirectionally with such serial-data I/O peripherals as a standard teletypewriter.

The EVK 100 (\$295) provides 2 kbytes of ROM, 512 bytes of RAM, and totally buffered MPU lines. Built on a PC card with two edge connectors, one for the MPU bus and one for I/O, the EVK 100 can even be expanded to the EVK 300.

Programming the S6834's 512 \times 8 erasable and electrically programmable memory (EPROM) is available in the higher-priced EVK 200 (\$512). A 1 kbyte random-access memory gives the EVK 200 greater design capability.

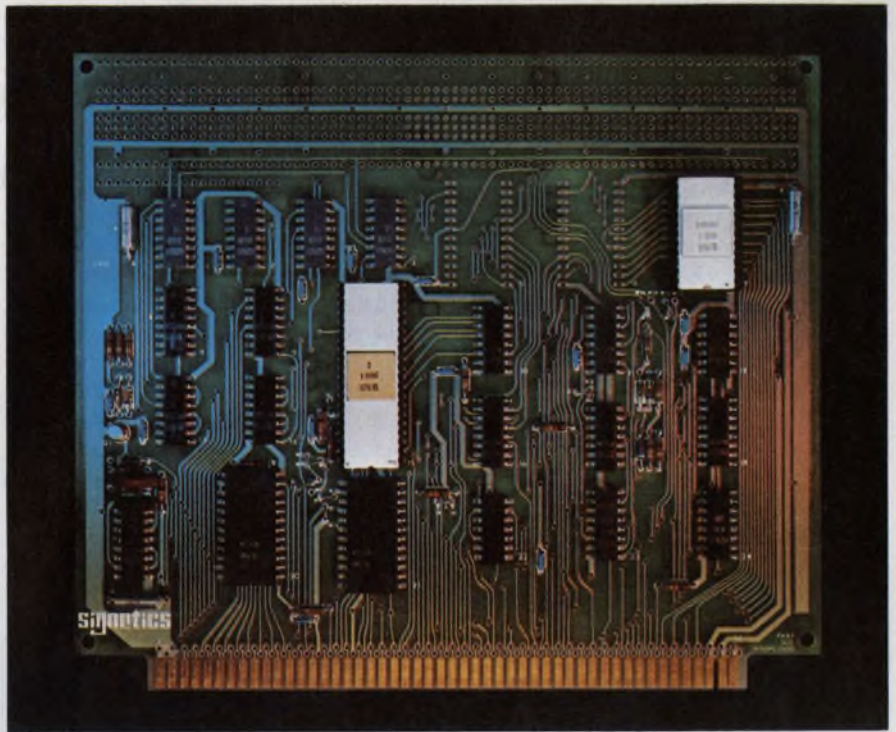

Signetics' Adaptable Board Computer provides a system of jumper wires for changing the board configuration. Additional components may be added.

The EVK Model 300 (\$950) features 2 kbytes of ROM (with an S 6831), 512 bytes of EPROM, 1 kbyte of RAM, and three PIAs (58 input/output lines). A ROM-subroutine program library and a selectable DMA mode augment the system's versatility.

However, none of the EVK units comes configured with a keyboard. Since external terminals are required to read the program in, their cost must be added to the "get started" expenses.

Although low-cost keyboard entry permits aspiring designers to get started with a small initial investment, a penalty must be paid. The size of the programs that can be entered via a manual keyboard is limited, and the maximum number of program steps is about 150.

Still more μ P support

An evaluation kit from RCA in Somerville, NJ, for its 8-bit CDP-1802 COSMAC μ P comes with a PC board, byte-input and output ports, a terminal interface, a ROM containing a utility program of commonly required functions, and a RAM for storing the user's program.

With a user-supplied terminal and a single 5-V power supply, the CDP18S020 Evaluation Kit be-

comes a compact computer system for the evaluation of COSMAC programs and prototyping systems. The kit costs \$249. A pocket-sized miniterminal, soon to be available as an add-on for the board, contains both keyboard and digital display and should sell for under \$300.

The difference between higher-priced development systems with higher capability and the low-cost hardware designs is clearly illustrated by RCA's more expensive (\$3000) CDP18S004 COSMAC Development System. It has 11 plug-in PC cards; fits onto a 19-in. rack; and features editor, assembler and debug programs—and permits complete software development.

An SC/MP kit (\$99) from National Semiconductor, Santa Clara, CA, comes supplied with PC board, parts and documentation. However, an external teletypewriter is required for inputting and outputting information.

A recently introduced portable keyboard from National interfaces with the SC/MP kit. The handheld keyboard (\$95) avoids the teletypewriter, so the user's initial financial outlay stays low.

Besides a hexadecimal, six-digit display, the keyboard provides keys for inputting commands and hexa-

decimal data. A 21-wire flat cable connects the keyboard with the PC board.

ABC for the beginner

Two different design aids from Signetics, Sunnyvale, CA, fit into the low-cost category.

For \$190, the novice designer can assemble the Adaptable Board Computer (ABC), a flexible prototyping system based on the 8-bit 2650 μ P.

ABC includes 512 bytes of read/write memory, two latched I/O ports and three-state buffers on data, address, and control lines. The basic board configuration can be altered by a system of jumper wires and by adding more com-

ponents to the board.

For those beginners designing with the Signetics 8×300 bipolar μ P, an evaluation kit, designated the 8×300 KT 100 SK, is available for \$299. The kit's single board includes a 250-ns, 8-bit- μ P central processing unit (CPU), four input/output (I/O) ports for interfacing external devices, and 256 bytes of working data storage. The 8×300 can be used with any bipolar or TTL-compatible integrated circuits.

A complete single-board system, including CPU, memory, and I/O, is available from Intel, Santa Clara, for designing with the 8-bit 8080 μ P. Intel's SDK-80 kit interfaces directly with most terminals (75 to 4800 baud), and boasts 2- μ s

instruction-cycle time. The board comes with 2 kbytes of ROM (expandable to 4 k) and 256 bytes of RAM (expandable to 1 k).

Although it's a full microcomputer on a single board, the Apple Computer developed by Apple Electronics in Palo Alto includes a large breadboard area for the engineer to develop his own interface circuitry.

The Apple uses the 8-bit MOS Technology 6502 μ P, and comes not only with up to 8 kbytes of RAM, but also with all the electronics needed to interface directly with a video terminal.

A peculiar price of \$666.66 may put Apple close to the upper edge of the low-cost spectrum, but it also gives the purchaser a video link that operates six times faster than a standard teletypewriter. The Apple system is formatted to display 960 characters in 24 rows of 40 characters each. Since Apple's video-display section contains its own 1 kbyte of memory, all 8 kbytes of RAM are available to the user for programming.

Two design aids, the SE1 and 2 from Texas Instruments in Houston, allow the 4-bit TMS 1000 μ P family's on-chip mask programmable ROM to be replaced with external PROM. Consequently, the designer can develop and modify programs before committing them to final hardware.

Both devices are 64-pin dual in-line packages (DIPs). For \$43.66 (\$26.95 in quantities over 100), the SE1 provides a 64×4 RAM on chip and offers access to 1024×8 bits of external ROM. For \$61.12 (\$37.33 for 100 or more), the SE2 provides twice the ROM and RAM density of the SE1.

To supply data and control functions, the designer connects a CRT or teletypewriter.

Complete systems

Other systems are complete microcomputers that don't need the breadboarding space. The PC board (or boards) is complete as it stands. To simulate his system, the designer connects his particular I/O devices, including any necessary supplies, or clocks, then programs the μ P to accommodate this hardware.

A complete, factory-assembled system for evaluating the IM6100

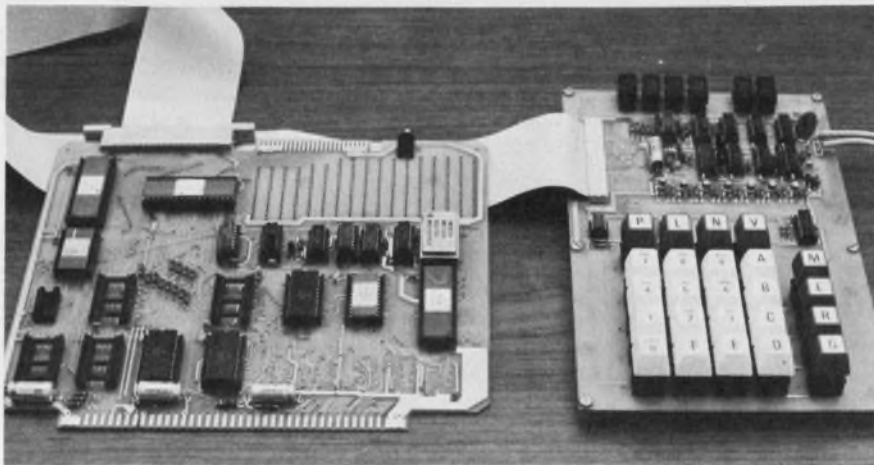

A design aid for the MC 6800 μ P is Motorola's MEK6800D2. Programs can be entered through the system's keyboard or via audio cassette interface.

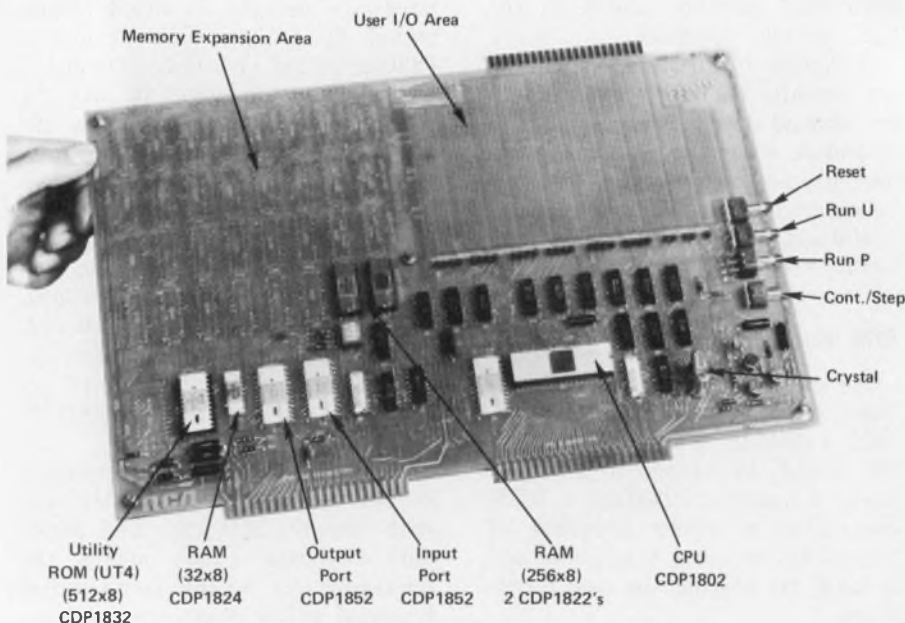

Low-cost design support for RCA's COSMAC is provided by the CDP 18SO20. This unit comes with a 512-byte ROM and a 256-byte program RAM.

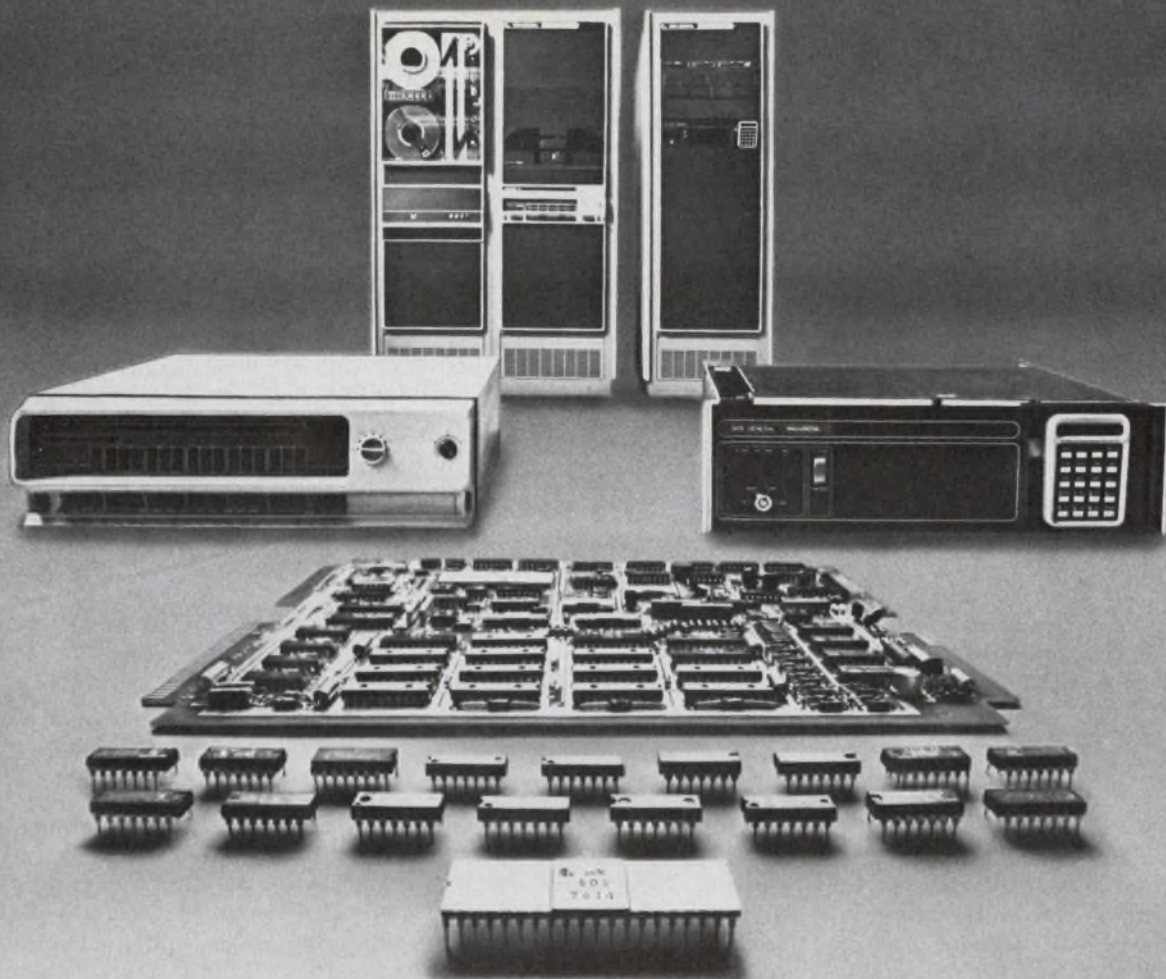

With a line of minis and micros like ours, we don't have to push any one of them.

With other companies, you might set out to buy a microprocessor chip and end up with the whole chassis. Or get a box when all you need is a board.

But Data General doesn't work that way. We don't have to push you into buying something you weren't really looking for. Because we can let you choose from microprocessor chip sets, microcomputer boards, completely packaged MOS minis and full-blown NOVA 3 systems. All four are compatible. And they give you a range of performance with a range of prices.

So, if you're a component user, there are both high-performance microNOVA chip sets and microcomputer boards that feature Data General's mN601 microprocessor. The mN601 is a full 16-bit NOVA-on-a-chip. And the microcomputer is a full 4K-word computer-on-a-board. You package them yourself, for greatest economy. (Speaking of economy, the board costs only \$589 in OEM quantities of 100.)

And if you're not ready for components yet, there's our fully-packaged microNOVA MOS minicomputer. It's available with up to 32K words of MOS memory and peripherals like

our diskette subsystem. And it's supported by our Real-Time Operating System and diskette-based Disc Operating System. You can get our mini with 4K words of MOS memory for only \$1995. Or as a complete development system with the diskette.

If you need bigger systems capabilities, take a look at our NOVA 3 computer. It's compatible with our microNOVA family. And it runs with high-performance peripherals, sophisticated software like Real-Time Disc Operating System, high-level languages like FORTRAN 5 and BASIC, and memory expansion to a full 128K words.

We've got it all. But we won't try to sell it all. Unless it's what you really need. If you don't believe that line, call us. Dial 800-225-9497 (in Massachusetts, 1-617-485-9100, extension 2509) and ask for information on microNOVA and on the free half-day microNOVA seminars that happen this fall all over the country.

Or write for our microNOVA and NOVA 3 brochures. And see for yourself.

DataGeneral

Data General, Route 9, Southboro, Mass. 01772 (617) 485-9100. Data General (Canada) Ltd., Ontario.
Data General Europe, 15 Rue Le Sueur, Paris 75116, France. Data General Australia, Melbourne (03) 82-1361
NOVA is a registered trademark of Data General Corp.



Intel's SDK-80 is a complete 8080 microcomputer on a single PC board. Instruction-cycle time is 2 μ s.

CMOS μ P comes from Intersil, Cupertino, CA. Intercept Jr., which is called a tutorial system by its manufacturer, features one PC board (10 in. \times 11 in.) that mounts all components, including batteries.

A single, 12-key keyboard on the unit is used for both operation entries and numerical entries. In fact, each key can enter either a single numerical value or one of three different program operations.

There is no ambiguity. The operator simply keys in his instructions and the numerical data, and a program built into a ROM decides that the entry is to be interpreted either as a numeric or an instruction or a command.

The Intercept Jr. is also the first low-cost (\$281) design aid to provide op-coded control functions right on the keyboard, according to Gopal Ramachandran, Intersil's application engineer. The microcomputer comes configured with a 1024 \times 12 CMOS ROM (the IM6312) and a 256 \times 12 CMOS RAM. Memory addresses as well as data are displayed simultaneously in octal language on two, 4-digit LED displays.

Four standard "D" cells supply the required voltage. To compensate for aging batteries the microcomputer is designed to function at supply voltages as low as 4-1/2 V. A receptacle can be added to permit operation from a standard 110-V-ac-to-6-V-dc adapter.

SC/MP, FB and Z80 support

For SC/MP design capability more advanced than the SC/MP kit permits, National Semiconduc-

And still more aids

The wide range of equipment discussed here does not include digital logic analyzers. This separate, versatile class of machines enables designers to probe into the very heart of logic circuits, including μ Ps, and permits the capture and display of control and data signals at any point in their path.

Such logic analyzers are readily available from companies like Biomation, Hewlett-Packard and Tektronix, to name just a few. But the present high price of these devices (\$1000 and up) puts them out of reach of many smaller firms.

Logic analyzers will be dis-

cussed fully in a later issue (ED, Feb. 1, 1977).

There exists yet another class of devices on the market, a group of μ P tools that must be relegated to the category of learning and programming aids. These are systems basically to help the user learn and develop software.

One example of such a device is a combined microcomputer and textbook—all within the covers of a single looseleaf binder—available from Iasis, Sunnyvale, CA. RCA's COSMAC based Microtutor is another example. Software aids will not be discussed here.

tor supplies a Low Cost Development System (LCDS) with a single chassis. The chassis contains six-digit hex display, PC board, control switches and circuitry—all controlled by a 16-key dual-function keyboard.

For \$499, the LCDS includes the following capabilities:

- Displaying the contents of the SC/MP program counter, registers and accumulator.
- Altering the components of the SC/MP program counter, registers and accumulator.
- Displaying the contents of any memory location.
- Interrupting the execution of the user-generated program at any point.

Anyone designing with the 8-bit F8 μ P can be helped by the F8 Micro Pro from Fairchild in San Jose, or by the F8 Survival Kit from Mostek, Carrollton, TX. Both aids include a user-operating system for loading, debugging and modifying software, 1 k of RAM, four 8-bit I/O ports, teletypewriter interface, timer and Fortran IV cross assembler. The designer operates the two systems by attaching either a 100 or 300-baud ASCII terminal and a +5 and a +12-V supply. Both Micro Pro and Survival Kit come assembled for \$185. (An unassembled version from Mostek is available for \$147).

There is a major difference, however. The Survival Kit begins its

1000-byte debug program in memory location zero, which may interfere with the designer's program. On the other hand, the Micro Pro's debug program starts at some high location in memory to avoid such a problem.

A compact, one-board development system with 8 kbytes of memory for the Z80 8-bit μ P is available from Zilog in Cupertino, CA. The Z80-MCB comes with the following features:

- A timer chip with four programmable timer-counter circuits for varying the baud rate so that the Z80-MCB-system speed can be matched to that of peripheral, electromechanical devices.
- A programmable, serial I/O port with RS-232 or current loop interface for hooking up to a teletypewriter or cathode ray tube (CRT).
- 4 kbytes of RAM.
- A PC board, smaller than that of most design aids of this type (only 7.7 in. \times 7.5 in.).

The Z80-MCB sells for \$475 in quantities of 1 to 9, \$435 in quantities of 10 to 24, and \$400 for quantities of 25 and over.

Two plug-in accessory boards for mating with the Z80-MCB are also available from Zilog. A floppy-disc controller card, the MCD (\$745 in 1 to 9 qty), controls up to four floppy discs, contains 12 kbytes of RAM, two ports for parallel I/O, and a ZDOS operating system.

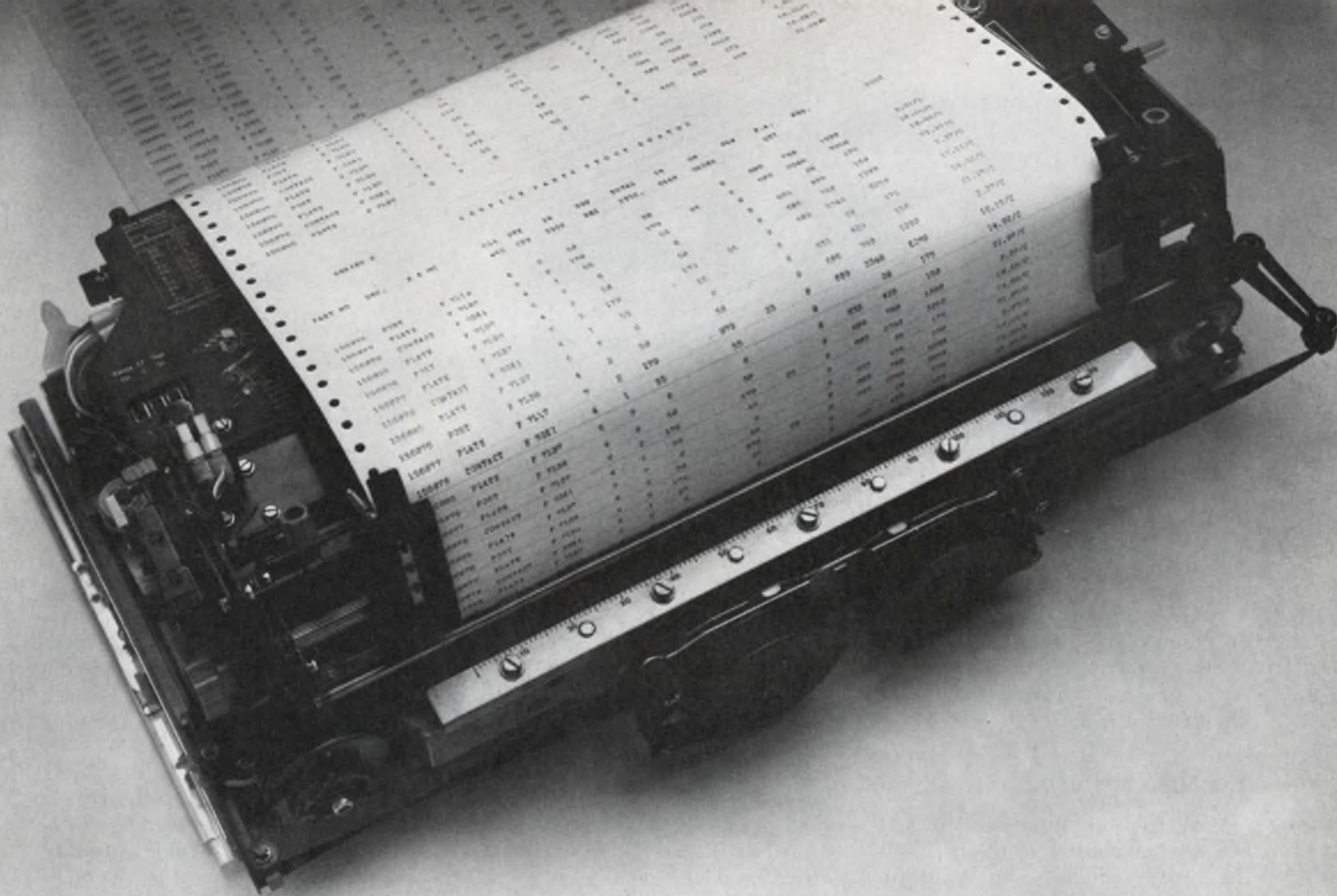

**The Teletype® model 40 OEM printer.
When you look at it from price and performance,
you'll find it difficult to look at anything else.**

The fact of the matter is simply this:
We don't think any other printer can even come close to the model 40.

And that's no idle boast. Not when you consider the facts.

Consider: Where else can you get a 132-column, heavy-duty impact printer that delivers over 300 lines per minute for less than \$2000, or an 80-column printer for under \$1400?

The big reason behind the model 40's price/performance advantage is our unique design.

Even though it operates at speeds of more than 300 lpm, wear and tear is less than you'd find in a conventional printer operating at considerably slower speed. Fewer moving parts and solid-state components add up to greater reliability and reduced maintenance.

Here's something else to consider: Where else can you get a printer that delivers the kind of flexibility and reliability the model 40 offers?

For complete information, please contact our Sales Headquarters at: 5555 Touhy Ave., Skokie, Ill. 60076. Or call Terminal Central at: (312) 982-2000.



**The Teletype model 40 OEM printer.
Nothing even comes close.**

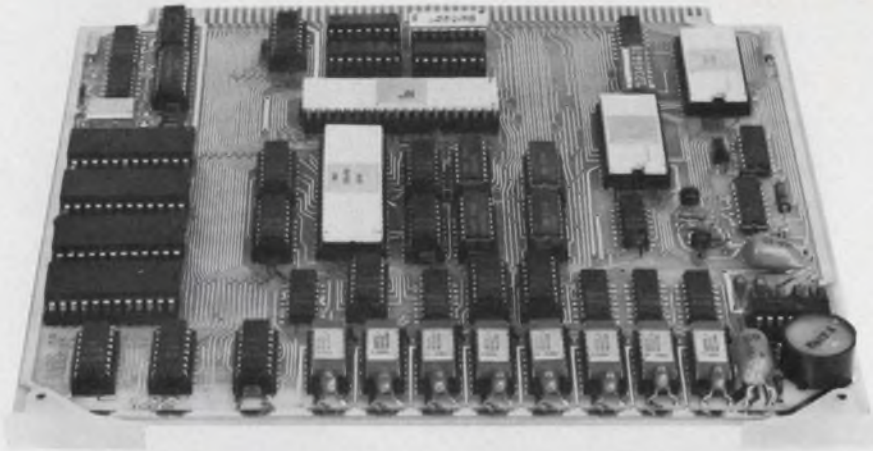

Measuring only 7.7 in. x 5 in. Zilog's Z80-MCB provides 4 kbytes of RAM with capacity up to 4 kbytes of ROM. A single 5-V source powers it.

A RAM memory card containing 16 kbytes of memory, the Z80-MCB (\$750), can support up to four such cards for a total of 64 kbytes of RAM.

The 8080 and 6502 revisited

Both the 8080 and the 6502 μ Ps are also supported by design aids that come complete on a board. Two single-board 8080 μ P-based computers from Intel, the SBC 80/10 and the SBC 80/20, provide programmable synchronous/asynchronous interfacing with the RS 232 or a teletypewriter. The 80/10 requires an optional adapter for the teletypewriter. A 1-kbyte memory is provided with the 80/10 and 2k with the 80/20.

The keyboard-controlled, single-card KIM-1 from MOS Technology, Norristown, PA, is a complete microcomputer for designing with

the 6502 μ P. Besides its 23-key keyboard, the MOS design aid (\$245) contains the electronics needed to interface with either an audio-cassette tape recorder or a teletypewriter terminal. With control from the keyboard, KIM-1 can generate hard-copy printout and read or punch paper tapes. A six-digit LED display provides on-board readout.

The memory, which consists of 2048 bytes of ROM and 128 of RAM, can be expanded to 65 k.

Every extra bit helps

Sixteen-bit μ Ps provide advantages not offered by the 8-bit devices. For example, more precise calculations can be made at higher speeds (see "16-Bit μ Ps Speed Things Up in Precision Computing," ED No. 14, July 5, 1976, p. 35). But such a capability requires

complex support equipment and, ultimately, more money. Although the high cost of such equipment places them out of the low-cost category they must be included as a necessary adjunct to 16-bit μ P design.

For example, the sophisticated, 16-bit "Gimini" from General Instrument Corp., Hicksville, NY, costs \$3500. Built around GI's CP-1600 N-channel MOS μ P, the Gimini provides a host of capabilities, including:

- Separate data, address and control buses.
- Direct addressing up to 65 k words of memory.
- Nested interrupt system.

Although Gimini comes housed in a cabinet, its ICs and other circuitry are mounted on PC plug-in boards. A card cage behind the front panel holds four PC boards, with space and connectors for nine more.

All control and timing signals as well as data and address buses are fully buffered and available to expand the memory. A cable assembly allows interfacing to a teletypewriter or to a paper tape reader/punch.

Another 16-bit μ P, National Semiconductor's PACE, is supported by the PACER, manufactured by Project Support Engineering, Sunnyvale, CA.

For \$1195, PACER provides such sophisticated features as the ability to examine and modify the contents of any computer register or memory location, hexadecimal to decimal conversion, and full alphanumeric display. ■■

Optical modulator developed for high-power IR lasers

A piezoelectric-driven prism modulator for high-power carbon monoxide and similar infrared lasers has been developed by Martin Marietta Aerospace, Orlando, FL.

Based on frustrated total internal reflection (FTIR), the modulator incorporates several advances:

- The IR modulator can turn

the 5- μ m CO laser beam on and off with either a random-pulsed input or a coded pulse train, at 250 W and greater.

- The prisms constituting the modulator assembly have an unusually broad aperture of 2 cm, suitable for the relatively large CO beams and CO₂ lasers.

- The prisms, composed of

barium fluoride, withstand the laser beam energy without suffering the optical degradation or undesirable thermal effects encountered by other materials and optical elements.

- The system is simply aligned with a helium-neon laser because the prisms are of clear material.

(continued on page 38)

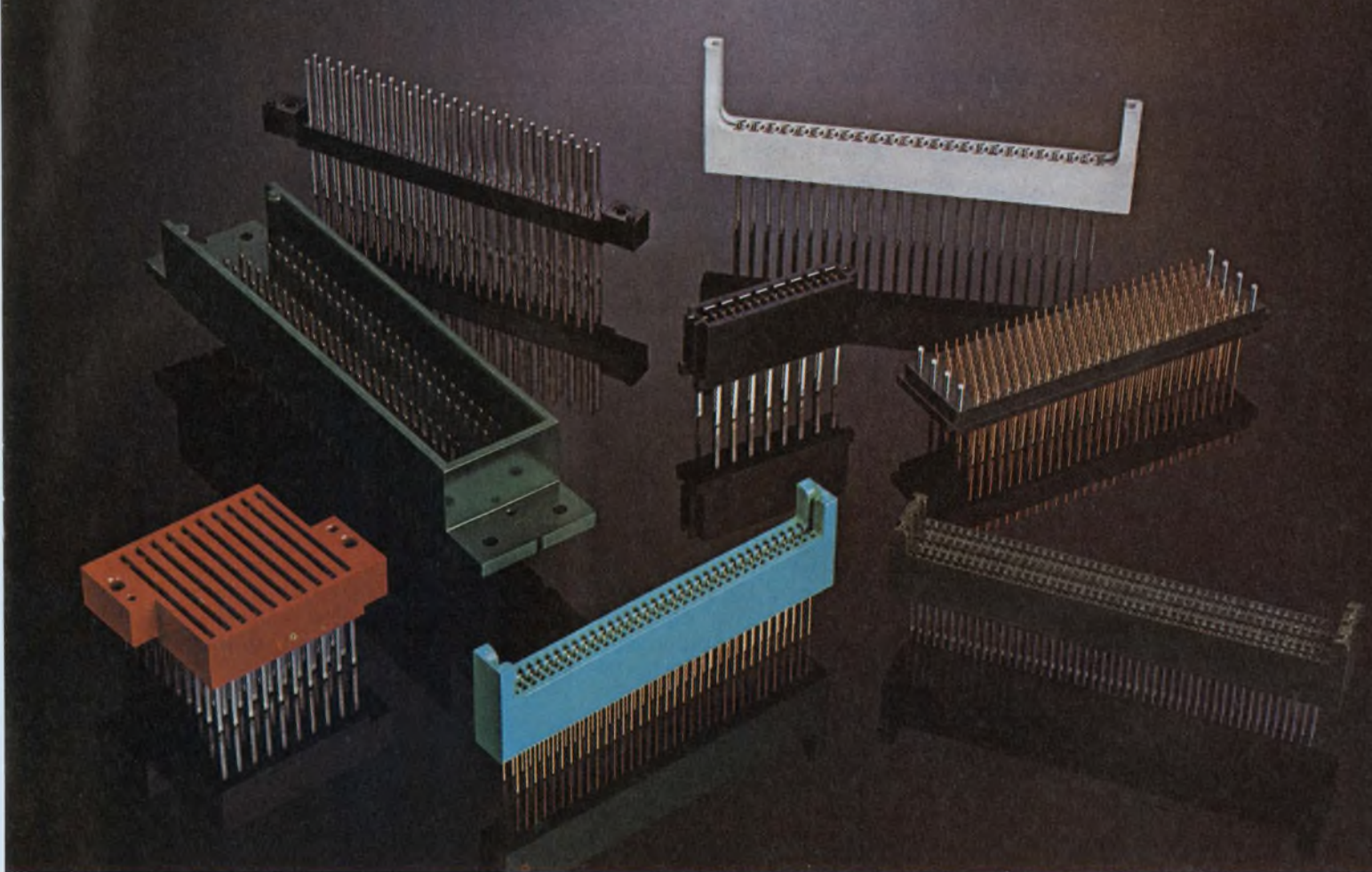

Special connectors are an old family custom.

We've been designing and manufacturing connectors for special custom applications for a long time. In fact, that's how we started in the business.

Over the years we've built up the special tooling skills and design expertise needed to produce the best connector at competitive prices.

Our in-house manufacturing capability makes for tight quality control. We can produce every part in-house—from the plastic body to the gold dot on the contact.

And we know our gold dots. We're the people who developed the most reliable system on the market.

We're not limited to any one design or manufacturing approach, either. We've made them all—bifurcated bellows, cantilever, single-beam contacts, thermoplastic or thermoset plastic.

But don't wait until after you've firmed up your design to call us. Our engineers and toolmakers show you ways to save money while getting a more reliable product.

They might even be able to fill your needs with a member of our off-the-shelf connector family.

Contact GTE Sylvania, CPO, Titusville, Pa. 16354. Phone 814-589-7071.

Good connections run in our family.

GTE SYLVANIA



Test setup to measure the optical response of a laser prism modulator is adjusted by Martin researcher.

■ The energy transmission through the prisms is independent of beam polarization.

The Martin system, which contains the driving electronics, produces a square-wave pulsed laser output at from 100 to over 150 Hz, with a duty cycle adjustable from less than 20 to greater than 80%.

The ratio of maximum to minimum laser output—better than 50:1, with at least 85% switching efficiency—permits an average throughput greater than 100 W with a 50% duty cycle, says Ronald Selleck, a senior engineer at Martin.

FTIR is considered by Martin the best way to realize its long-term objective: a technique to modulate high-power infrared lasers at relatively high frequencies. If light strikes a prism sur-

face at an angle greater than the critical angle, the surface experiences total internal reflection (see Fig. 1). If the two surfaces of the same refractive index come very close to contact, the reflection is frustrated, and the radiation passes on through.

The distance between the two prism surfaces ranges from about $0.2 \mu\text{m}$ for maximum transmission to $4 \mu\text{m}$ for minimum. When the surfaces are nearest each other, the energy is coupled across the gap between the prism faces by "evanescent" waves. The effect is somewhat similar to tunneling in quantum physics.

The prism modulator's optical-transmission response is a complex function of the refractive index of the prisms, the gap spacing, the wavelength of radiation and the angle of incidence to the prism

modulator's interface.

The piezoelectric driving elements are two 1-cm stacks of six elements, electrically in series but mechanically in parallel. The stacks are set in notches in the prisms and bonded in place with epoxy. Applying about 1300 V to the stacks gives the $4\text{-}\mu\text{m}$ separation that provides the desired modulation depth.

The stacks are driven by two SCRs: One applies the voltage, while the other turns it off. The modulator's present upper-frequency response limit of 150 Hz is established by the slow recovery time of the SCRs used in the feasibility study conducted for the Air Force.

However, high-voltage SCRs with substantially faster turn-off are now available that should raise the response eventually to the kilohertz region. ■■

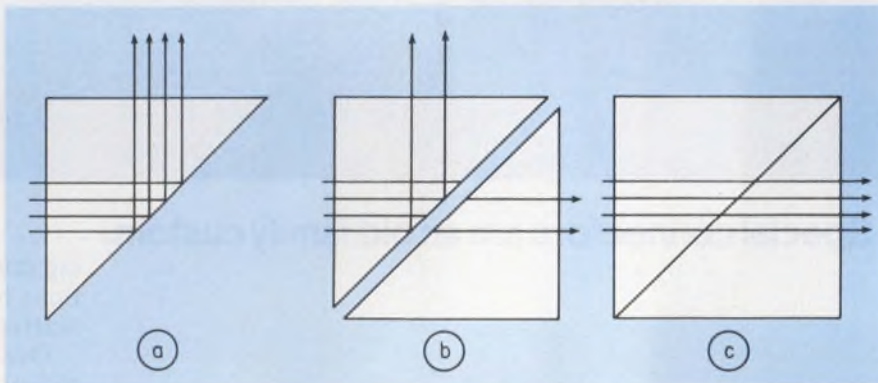

The principle of frustrated total internal reflection is used in the Martin laser modulator. When two prism faces are close, some energy is reflected and some transmitted through the second prism (B). When prisms are brought together, all energy is transmitted through both prisms.

Programmable SAW delay line developed for data communications

Programmable surface-acoustic-wave (SAW) delay lines have been combined with micro-electronic diode and resistor arrays in devices that may find wide use in portable, low-power, phase-shift-keyed (PSK) data communications systems and radar.

The new devices produced by United Technologies Research Center, East Hartford, CT, are electronically programmable, broadband PSK signal encoders and decoders or correlators. They are key

elements in multisubscriber aircraft-navigation data systems where a main ground station communicates with many airborne receivers, each having its own code.

Another broad application is in a secure communications system where the codes can be changed in microseconds or nanoseconds. In airborne or portable radars, for example, they can function as a correlation-matched filter that compresses long pulse returns.

Two types of devices have been

produced by United Technologies for the Navy Electronics Command: 64-tap and 128-tap. The latter unit incorporates a parallel-cascade delay channel fabricated on the SAW-delay-line substrate so that the unit can be cascaded.

SAW line is lithium niobate

The United Technologies correlator is essentially a hybrid circuit that incorporates a lithium-niobate, tap SAW delay line inter-

Introducing Model 9300

Quality that's Quick & Quiet

Model 9300 Vacuum Column digital tape transport has characteristics common to all Kennedy recorders — and a few new ones. It's quick (125ips); quiet (noise level of less than 70db), and it has the built-in quality of all Kennedy products.

Utilizing side-by-side vacuum columns and a capacitive tape-location detector for improved tape life; air bearings and Tribaloy coated read-after-write heads to reduce tape wear and improve data integrity, Model 9300 is ideal for minicomputer and data collection applications requiring complete reliability at high tape speeds.

Model 9300 comes complete with all the operational features of the 9000 Series. Performance is guaranteed by crystal controlled timing, read threshold scanning, our

read-after-write shortened skew gage and other exclusive Kennedy features. Operation is simplified by such operator-oriented features as a front-accessible test panel, quick-release hubs and simplified tape loading.

Model 9300 has a standard tape speed of 125ips, with data densities of 200/556cpi or 556/800 on the 7-track unit and 800cpi, 1600cpi or 800/1600cpi on the 9-track transport. The format is NRZI/PE.

Model 9300 is not only quick and quiet — it's very competitive. That's quite a lot, considering the Kennedy quality.

KENNEDY CO.

540 W. WOODBURY RD., ALTADENA, CALIF. 91001
(213) 798-0953



KENNEDY · QUALITY · COUNT ON IT

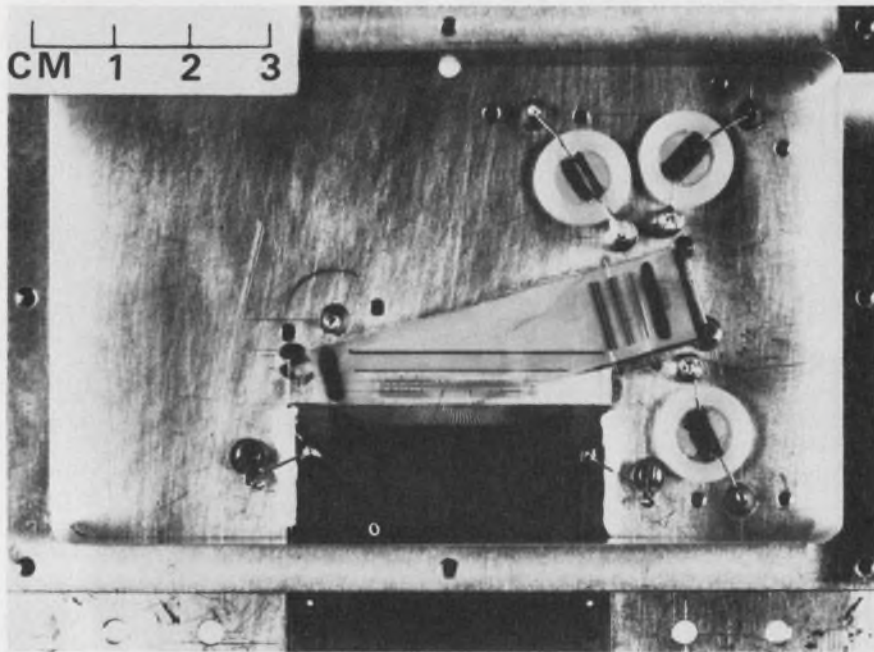

The 64-tap programmable PSK correlator is a hybrid combination of piezoelectric tapped delay line and attached silicon-on-sapphire integrated circuit diode and resistor array. The correlator, by United Technologies, uses surface acoustic wave effects.

connected with an array of twin diodes and their bias resistors. The diode array is fabricated with silicon-on-sapphire technology, which provides high diode isolation and simplifies thin-film resistor fabrication.

These PSK correlators have important advantages over competing SAW devices. These include:

- High "chip" rates (a chip is an rf signal that is a selected number of cycles long). Each PSK sequence is composed of several chips. The Technologies devices work at a nominal 10 MHz chip rate, but can operate as high as 100 MHz.
- Simpler design. It requires only two diodes per delay-line tap, whereas competing approaches need four to eight.
- Diode power on the order of microwatts, compared to milliwatts for other units.
- A dynamic range of 60 to 75 dB, against 20 to 40 dB for similar SAW devices.
- Long code processing of 256 chips, which can be achieved by cascading two 128-tap devices. Potentially, they can be cascaded to process codes of 1024 chips.

PSK signal processing is accomplished by converting an input frequency (F_1) into an acoustic wave

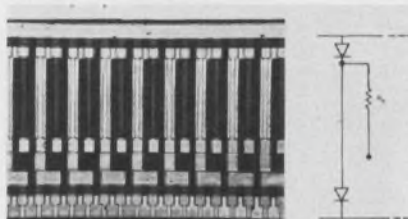

The active switching elements of the PSK correlator are provided by an IC array of diode pairs and their bias resistors.

that propagates across the delay-line surface towards a series of equally spaced acousto-electric taps. Diode pairs connected back to back are located at each tap (see photo with schematic).

A second CW surface wave launched at the input end of the line (F_2) produces CW-reference (local oscillator) signals at each tap.

Propagation losses reduced

The taps are not in line with the F_1 and F_2 surface wave as in other diode correlators, but are slanted at an angle (see photo). This configuration substantially reduces high intertap-reflection and wave-propagation losses. Since the taps intercept only a fraction of the beam width, lower propagation loss-

es are somewhat offset by increased input-transducer losses. Nevertheless the over-all correlation-insertion loss is still lower than that of an equivalent in-line geometry.

Intertap reflections are minimized with an input signal, $F_1 = 71.1$ MHz, and a reference (or local oscillator) signal, $F_2 = 100.5$ MHz. The tap spacing of 0.014 in. is an odd multiple of a quarter-wavelength at these frequencies. Split-finger tap electrodes also serve to reduce reflections further.

The F_1 and F_2 voltages excited at each tap are applied to the diode pairs, which function as product mixers. They produce what is essentially an i-f output, $F_3 = F_2 \pm F_1$. The output-difference frequency of 29.4 MHz is used in the Technologies correlators.

The correlation output at the difference frequency is received at the output (or common) electrode that sums up the outputs of the diode taps. The delay-line tap spacing is suitable for processing PSK sequences with chip rates equal to, or a multiple of, 9.8 MHz.

The Technologies devices are programmed by applying positive or negative bias currents to the taps of the diode array. This produces the desired phase-coded sequence—that is, the difference signals (29.4 MHz) produced at successive diodes taps are programmed to be in-phase or 180 degrees out of phase, depending on the sign of the bias current.

These programmable SAW units are used two ways: to generate a PSK code, or to decode or correlate a received PSK signal.

To generate a code, 100-ns pulses of the 71.1-MHz signal are applied, along with the 100.5-MHz CW reference signal to the SAW coder. The 100-ns pulse is equal to tap-to-tap propagation time and to the chip period.

At 71.1 MHz this pulse is equal to seven cycles per chip. The total burst length of the 128-tap device is 128 times the chip period, or 12.8 microseconds.

As a 100-ns pulse propagates through the delay line, it reads out the programmed phase of each tap in sequence. The contributions of all taps are summed at the output, which is a 29.4-MHz PSK-encoded signal. At this frequency there are three cycles per chip. ■■

The Unitrode approach to power Darlingtons in plastic.

TO-202's up to 10A.

Introducing classic Unitrode quality and reliability in a brand-new line of inexpensive power Darlingtons in TO-202 plastic packages. These new fast switching Darlingtons are available in ranges from 3 to 10 amps and 60 to 300 volts.

And the 5 amp, 300 volt package is the only high voltage, high current, fast switching plastic Darlington now on the market.

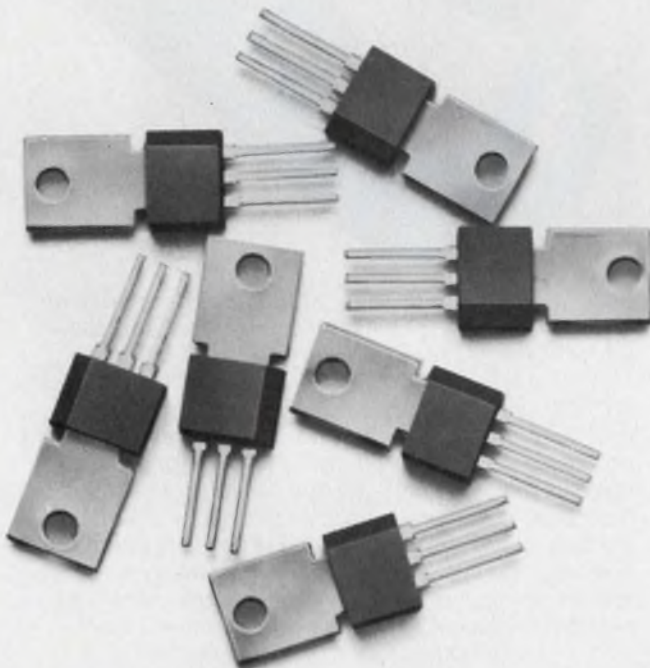

The first 3A in a TO-92.

We've also come out with the industry's first 3 amp, 100 volt power Darlington in a TO-92 plastic package. So for applications where you don't need a high power package, you no longer have to pay for it. The 3A TO-92 is less than 40¢ in volume and can be used with automatic insertion equipment.

Unitrode's new line of plastic power Darlingtons. Never before has so much performance been offered for so little money. The perfect answer for computer peripheral, POS, and industrial control applications.

For complete details, contact:
Unitrode Corporation,
580 Pleasant St.,
Watertown, MA 02172,
617-926-0404.



UNITRODE

CIRCLE NUMBER 18



**You'll like
Burr-Brown's
one word price story...
Down.**

You've always expected high quality from Burr-Brown. Now you can expect Burr-Brown to keep your costs down, too. Take a look at the prices of these high quality Burr-Brown units:

ADC 80: Lowest priced hybrid 12 bit A/D on the market. ADC 80 is complete with clock, comparator and reference, and is especially applicable in designs where space is crucial. With a conversion speed of 25 μ sec, price is only \$47.50 (in 100's).

DAC 80: 12 bit DAC's price cut by half. The DAC 80 is a truly self-contained D/A converter with guaranteed monotonicity. It includes internal reference source, output buffer amplifier, maximum non-linearity of $\pm 1/2$ LSB, and a price of only \$19.50 (in 100's).

3650/3652 Isolation Amp: Breakthrough in price and size. Thanks to a new optical coupling technique, you now have a low cost alternative. Under one cubic inch in volume, the 3650HG, with 0.3% gain non-linearity and 1500V continuous isolation is only \$26.50 (in 100's).

3626 Instrumentation Amp: Modular performance at lower cost. The laser-trimmed 3626 family offers the performance you need. Input offset drift as low as 1μ V/ $^{\circ}$ C at $G = 1000$, $< 2 \mu$ V/ $^{\circ}$ C at $G = 5$, gain non-linearity is 0.01%. Prices start at \$13.00 (in 100's).

4127 Log Amp: Low-cost solution to signal processing problems. 4127 is the first hybrid log amp to accept inputs of either polarity — up to 4 decades of voltage or 6 decades of current input. It functions as a logarithmic, log ratio, or antilog amplifier, and is only \$26.00 (in 100's). Five circuits — typical examples of Burr-Brown's commitment to cost savings. Over the past year, Burr-Brown has cut prices on a substantial number of products, some by more than 50%.

To find out more on how Burr-Brown can help you meet those crucial cost vs. performance specifications, write or call: Burr-Brown, International Airport Industrial Park, Tucson, Arizona 85734. (602) 294-1431.



**Still at the top,
except in price**

Things that run long and hard deserve more than crummy bridges that don't

Most bridges that cost as little as two-bits* don't run quite as good as this one.

Matter of fact, some don't run at all. You get 'em in and instead of single-phase, full-wave, you've got no-phase, short-wave.

These are different. And EIA registered. 3N246/253.

So different they meet stringent MIL and Motorola quality standards others will just surrender to unconditionally.

Like 1,000-hour HTRB at 600 volts, 150° ambient with no failures.

Or 5,000 cycles of power cycling at 2.2 amps (10% over rated current) with a ΔT_J of 100°C and no failures.

Or 1,000 hours of high-temperature storage with no failures.

Or solder heat, solderability and moisture resistance testing to MIL standards /202B and /202D with no failures.

Like 1% AQL.

And so on. And on. And on. With no failures.

Even Underwriter's Laboratories recognizes them.

And you know how *they* are.

Electrically, the series consists of 1 and 2 A, 50 to 1,000 V, single-phase, full-wave bridges with 30 A and 60 A surge capability, respectively, with the 2 A units operating to +165°C T_J .

Physically, their slimline cases save considerable board space requiring only in-line sockets instead of symmetrical pin spacing.

And economically, their very aggressive prices will give even the cheapest bridge a real run for its crummy money.

Our volume production is running long and hard to give you what you want in a bridge — top quality at a low price.

You deserve it.

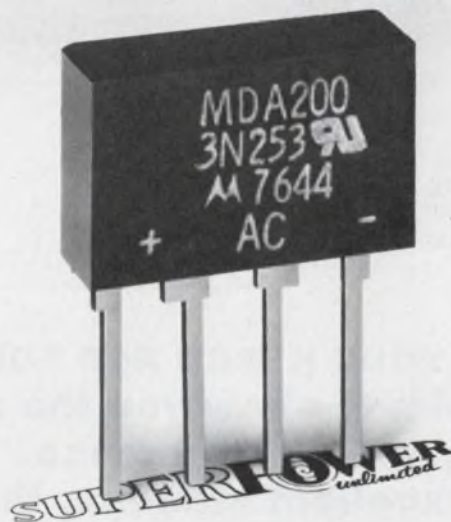

MOTOROLA Semiconductors

Motorola Semiconductor Products, Inc., Box 20912, Phoenix, AZ. 85036

*1 A, 50 V unit, 25,000 up.

from **KEPCO** by **TDK**

the series

RMK

25 KHz SWITCH-MODE POWER SUPPLIES

- 75% efficiency
- 90-130V a-c input (brownout protection)
- d-c input
- $\pm 10\%$ output adjustment
- adjustable current limit
- adjustable overvoltage
- logic level on-off
- 1 millisecond recovery
- $< 2\%$ envelope, (load, line and temperature)
- 50°C rating (uprating for lower temperature)

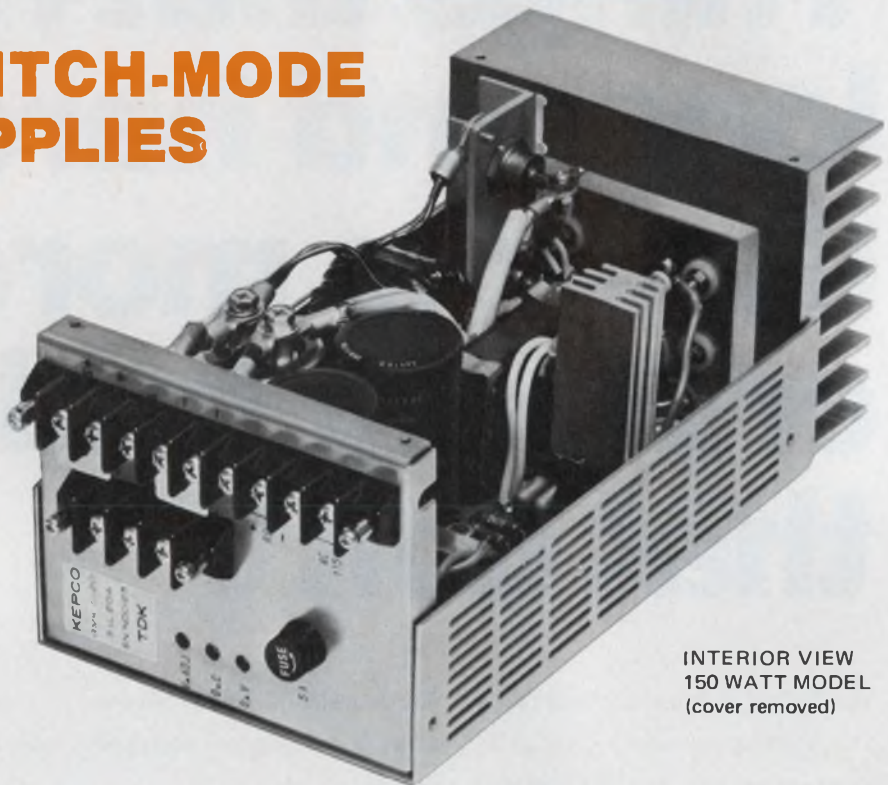

INTERIOR VIEW
150 WATT MODEL
(cover removed)

BLOCK DIAGRAM OF
THE RMK SWITCH-MODE
POWER SUPPLY

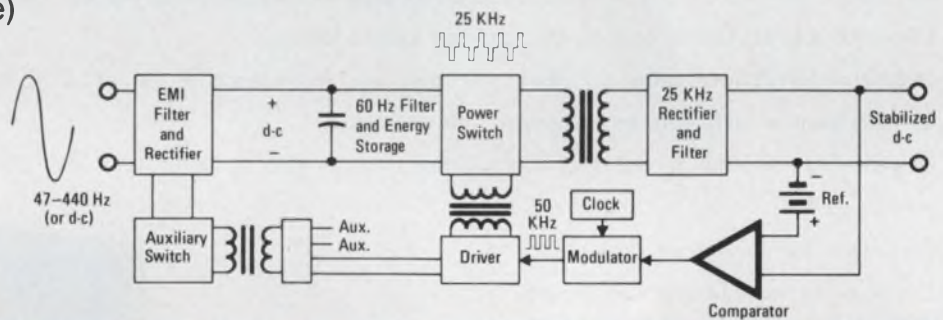

AVAILABLE OUTPUT
RATINGS FOR THE
KEPCO RMK MODELS

Volts	5V	9V	12V	15V	24V	SIZE	WGT.	PRICE
Amps	10A	6A	5A	4A	2A	2 3/16" x 5 1/8" x 7 1/2"	3.0 lbs.	\$210.00
Amps	20A	10A	8A	8A	4A	3 3/32" x 5 1/8" x 8 3/4"	4.75 lbs.	299.00
Amps	30A	16A	12A	12A	6A	4 1/16" x 5 1/8" x 8 3/4"	5.25 lbs.	399.00

CALL YOUR KEPCO REP FOR AN IMMEDIATE DEMONSTRATION
ask him to show you the clean layout, the cool operation,
the silent performance. Put an RMK to *your* test, check
the excellent stability, the low noise, the rapid response.
Compare Kepco's 5-year warranty.

Call or write Department FL-05
for a 4-page Specification Folder.

KEPCO®

KEPCO, INC. • 131-38 SANFORD AVENUE • FLUSHING, N.Y. 11352 U.S.A. • (212) 461-7000 • TWX #710-582-2631 • Cable: KEPCOPOWER NEWYORK

CIRCLE NUMBER 21

ELECTRONIC DESIGN 25, December 6, 1976

Washington Report

U.S., Soviets push pulsed-power technology

The United States and the Soviet Union are running neck and neck in the development of pulsed power for high-energy laser weapons, nuclear-blast simulation and other advanced applications, says Dr. Malcolm Currie, director of defense and research at the Pentagon.

The Soviet effort is "the largest investment in fundamental research in the world at the present time," according to Currie, speaking at the IEEE International Pulsed-Power Conference at Lubbock, TX. The Russians have also taken a "significant lead" in inductive storage, magnetohydrodynamics and explosive flux compression, added Currie. Soviet scientists attended the conference.

Meanwhile, three pulsed-power facilities have been opened by the U.S. Nuclear Defense Agency to simulate nuclear events. The largest of these, known as Aurora, stores megajoules of energy and can discharge it in 100 ns to produce an electron-beam output of 20 terrawatts, roughly equal to the annual electric-power output of the entire United States. Aurora is used to simulate the ionizing effects of gamma and X-rays on electronics.

The other two facilities are Casino, which is used to study radiation effects on semiconductors, and Ares, which provides an electromagnetic-pulse environment to test missiles, aircraft and spacecraft.

R&D spending policies criticized in Congress

Federal research and development spending, which is expected to reach \$23.5-billion for the current fiscal year ending Sept. 30, suffers from a lack of criteria to measure its effectiveness, according to a study prepared for Sen. William Proxmire (D-WI), chairman of the Joint Economic Committee.

The study cites, for example, the high concentration of R&D funds in military and space programs—\$14.9 billion this year, or 63% of the total.

The study calls for more state and local participation in formulating national R&D policies.

Communications bill looms in new Congress

Look for legislation curbing the operations of specialized common carriers—and supported by AT&T and other telephone-operating companies—to be reintroduced early in the new Congress, says the Electronic Industries Association.

Sponsored by Rep. Teno Roncalio (D-WY), the bill will reverse the Fed-

eral Communications Commission ruling that permits the independent companies to compete by taking jurisdiction away from the government agency and turning it over to state governments.

The bill will also prevent the specialized firms from providing any services already furnished by the telephone companies. Other versions of the bill will make telephone companies immune from anti-trust action if they have acquired any assets of the independent firms.

The EIA has been following the controversial legislation through lengthy hearings in the fall before the Communications Subcommittee of the House Interstate and Foreign Commerce Committee.

Air Force, NASA plan ND/YAG space laser tests

The Air Force and NASA are both preparing spaceborne-laser experiments using neodymium-doped yttrium garnet (ND/YAG) lasers to be flight tested in the early 1980s.

Under its Space Test Program, the Air Force plans to orbit a ND/YAG laser operating at the frequency-doubled wavelength (0.53 micron) to demonstrate a 1-gigabit data-transfer rate. Although the initial experiment will involve a downlink from the spacecraft to the Air Force Electro-Optical Facility at Cloudcroft, NM, the ultimate application is data transfer among spacecraft. Launch is planned for 1980.

NASA, meanwhile, is preparing an ND/YAG experiment at its Goddard Space Flight Center that may be able to detect earthquakes. The laser will be orbited in a Space Shuttle in 1981 and used to measure very precisely—on the order of “a few centimeters”—the distance between small optical cube reflectors spaced 25 kilometers apart. Theoretically, even these small movements in the earth's crust signal impending earthquakes.

This experiment will be essentially the reverse of current laser measurements being conducted by NASA with ground-based lasers and the reflectors on the orbiting Laser Geodetic Earth Orbiting Satellite (LAGEOS). That program has demonstrated accuracies of 2 to 5 centimeters, so NASA is confident that laser ranging will work equally well from space. NASA will use both the frequency-doubled wavelength and the inherent ND/YAG wavelength (1.6 micron) to achieve a self-calibrating capability.

Capital Capsules: The Air Force's Rome (NY) Air Development Center, working with Texas Instruments, has developed a voice-recognition system for use in controlled-access areas. The system uses a computer to store four pre-selected phrases (for example, “Ben swam north”) and has been 99% effective in tests. . . . Sales of CB radios, which slumped last summer because of public confusion over the FCC allocation of 17 additional channels (effective Jan. 1), are expected to shoot up during the Christmas season, the EIA projects. Prices have dropped to attractive levels, and the present 23 channels are seen as adequate for less congested areas. . . . A ring-laser gyro-guidance system, originally developed by Honeywell for the Navy's studies of a long-range, air-to-ground standoff missile, is now being considered by the Army. The firm will deliver five units, designated the H-700, for tests next year as part of the Army's Simplified Inertial Guidance Demonstration (SIG-D) program. . . . The Air Force plans early next year to test the Northrop Laser Augmented Target Acquisition Recognition (LATAR) system with an F-4E aircraft. LATAR works with a pilot's helmet-mounted display and is being considered for future fighter aircraft.

Situation Wanted:

Name—Amphenol® 97 Series connector. For consumer, industrial, business equipment. And more. Here's the old pro of standard circular power connectors. It's for service from 250 to 4200 VDC (200 to 3000 VAC, RMS) and wire gauges from 4 to 16. So 97 Series connectors are ideal for all kinds of equipment—TV, computers, machine tools, communications, you-name-it.

And still more qualifications. Including MIL-C-5015. And our pre-aligned non-rotating contacts that mean quick, easy soldering. The 97 Series is also built strong to work hard. With diallyl phthalate insert material (it's highly stable at high temperatures). Molded barriers between contacts for higher voltage ratings. And a few more features you'll want to find out about.

Literally hundreds of configurations. Take your pick of inserts—for a number of wires, all of the same gauge. Or for lots of wire, all of different gauges. And choose the receptacle you want: wall, cable, or box. And the plug you want: straight, quick-disconnect, angle, or panel-mount.

Availability: Whenever you're ready. Amphenol 97 Series connectors are available now for off-the-shelf delivery from your Amphenol Industrial Distributor. Call him soon. Or to find out how Amphenol 97 Series connectors can be tailor-made to match your specific application, just write or call: Bob Ashley, Amphenol Connector Systems, Bunker Ramo Corporation, 900 Commerce Drive, Oak Brook, Illinois 60521. (312) 986-3763.



**HEAVY EXPERIENCE
SEEKS CHALLENGE
REASONABLY PRICED**

The right idea
at the
right time.

AMPHENOL Connector Systems **BUNKER RAMO®**

LARGEST LINE OF

SOLDERLESS WIRE-WRAPPED TERMINATION PRINTED CIRCUIT CONNECTORS

**.025" and .045"
Square Contact Terminations
for Wire-Wrapping**

Various sizes from 12 to 120
terminals with a choice of
.100", .125", .156" or .200"
contact centers. Accept
.054"-.071" printed circuit
board (1/16").

**WRITE OR PHONE
FOR COMPLETE
PRINTED CIRCUIT
CATALOGS:
(212) 899-4422**



For the Sales Representative Nearest You, See Our Listings in EEM and GOLD BOOK Directories.

CONTINENTAL CONNECTORS

CONTINENTAL CONNECTOR CORPORATION ■ WOODSIDE, NEW YORK 11377

CIRCLE NUMBER 23

STOP

WAITING ON OUTPUT FROM YOUR μP DEVELOPMENT SYSTEMS

You Are Wasting More In Program Development
Costs Than This **LINE PRINTER** Sells For

2400 LPM – 80 COL.
MODEL 8210 – \$3000*

1400 LPM – 132 COL.
MODEL 8230 – \$3785*

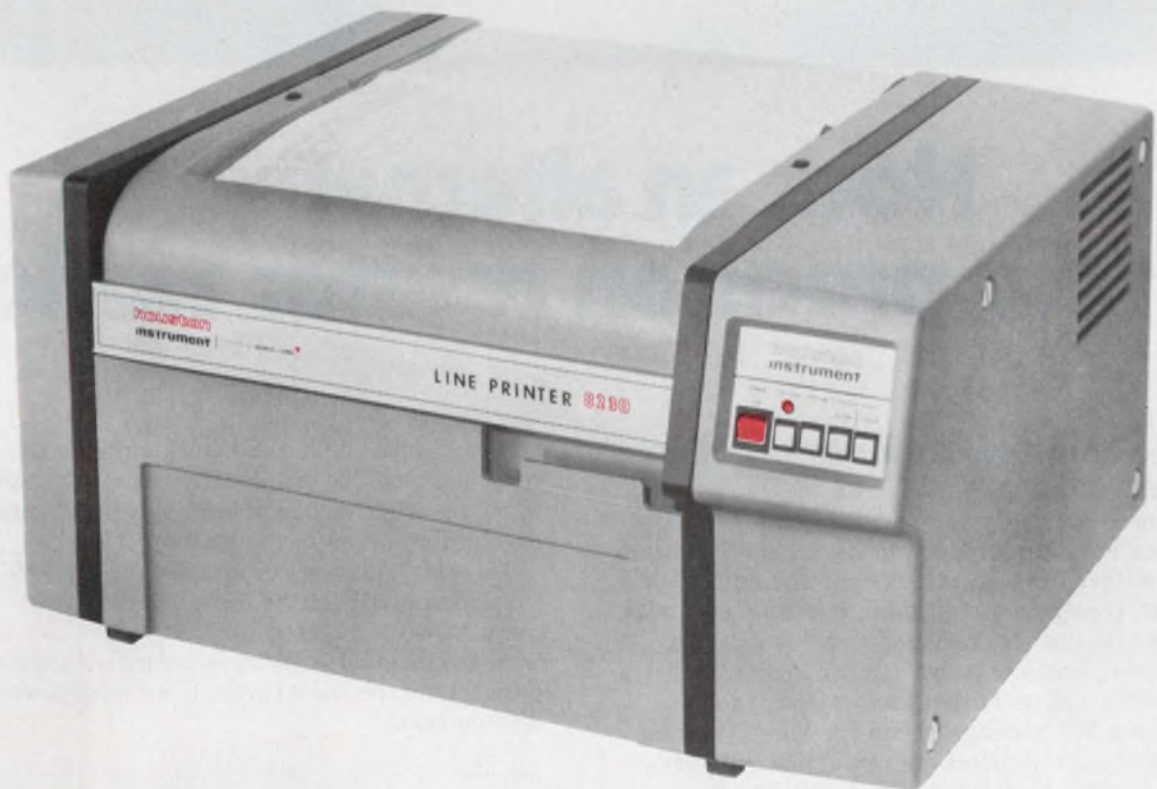

POWERFUL – A 65K byte dump
may be done in 30 secs.

QUIET – The rustle of paper and
the cooling motor hum are the
loudest noises you'll hear.

FOR ORDERING
INFORMATION
CALL OR
WRITE

houston
instrument

DIVISION OF **BAUSCH & LOMB** 

ONE HOUSTON SQUARE (at 8500 Cameron Road) AUSTIN, TEXAS 78753
(512) 837-2820 TWX 910-874-2022 cable HOINCO

EUROPEAN HEADQUARTERS Rochesterlaan 6 8240 Gistel Belgium
Phone 059/277445 Telex Bausch 81399

* Domestic USA Prices, Qty 1, End User

CIRCLE NUMBER 24

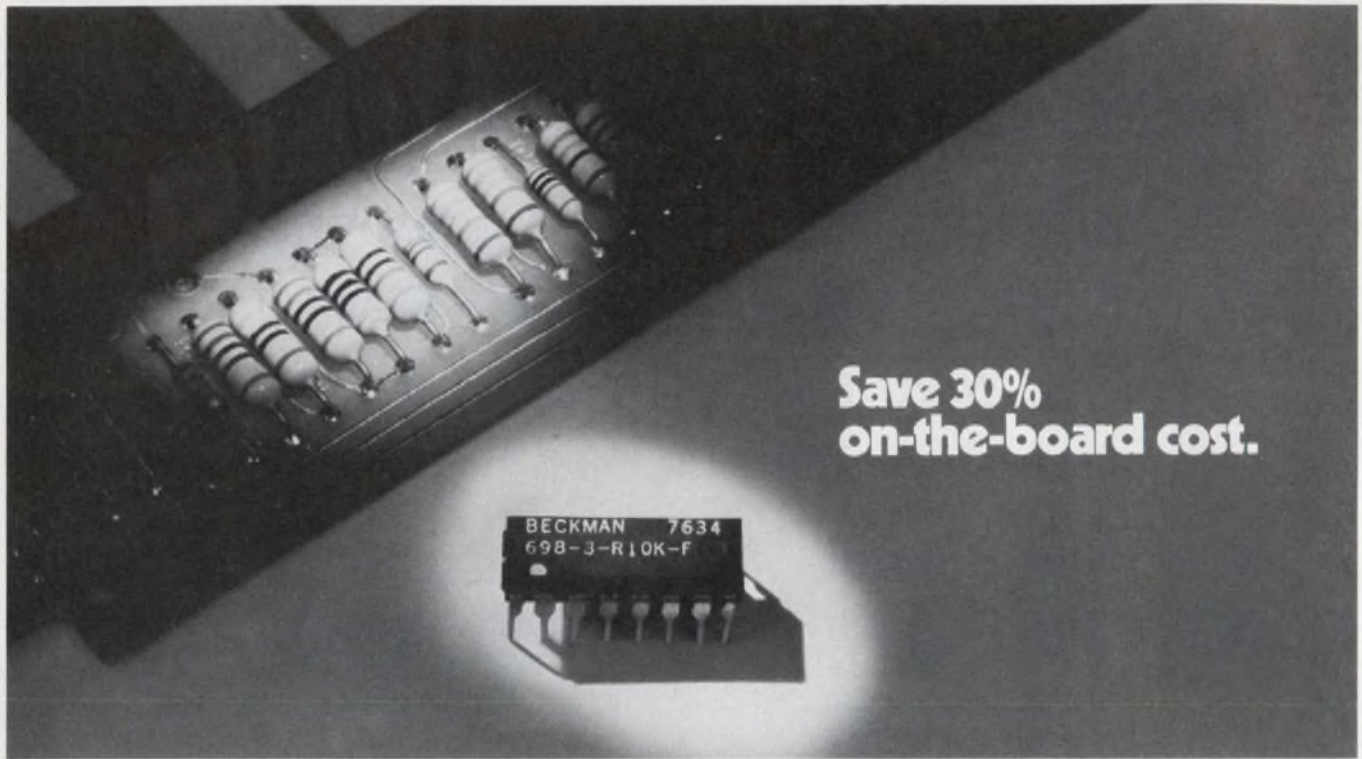

**Save 30%
on-the-board cost.**

Now, an alternative in the precision resistor world.

Beckman introduces precision film networks.

The board geography savings are obvious.

But our standard, 16-pin Series 698 Precision Film Resistor Networks mean much more. First, they're competitive in purchase cost with thin film discrete resistors. And, when you consider inventory and handling costs, lead bending, QC and other factors, they mean about a 30% savings in "on-the-board" costs.

That isn't all. Beckman precision networks have better performance and stability than unmatched discretes. With ± 5 ppm/ $^{\circ}$ C tracking, the matched resistors in our dual in-line packages feature (1) absolute 1% resistance tolerance ratioed to 0.5%, and (2) ± 50 ppm/ $^{\circ}$ C tempo.

The two models (see schematics) are standard size and pin-spaced for automatic insertion. Series 698-1 comes in 17 stock resistance

values; Series 698-3 in 20 stock values. And these parts can be coupled, in series or parallel, to obtain other values in gain-setting, summing and feedback circuit applications.

The 1,000-piece price: just 65¢ for the 698-3 (8 resistors), 81¢ for the 698-1 (15 resistors). Compare with discretes!

And remember: they're standard... for quick delivery, off the shelf through our widespread distribution.

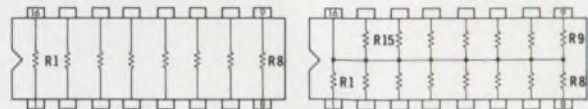

Get into the world of precision resistor networks. For more data, and applications information, contact your local distributor or Beckman Helipot today at (714) 871-4848, Extension 1776.

BECKMAN®

HELIPOT DIVISION

CIRCLE NUMBER 25

Automatic Frequency Counting and Display to 60MHz with 1Hz Resolution



B&K PRECISION MODEL 1801, \$240

For laboratory, production line or maintenance applications, the Model 1801 will meet most requirements for sensitivity, ruggedness and dependability. With the Model 1801 you can watch oscillator adjustments, monitor RF and audio frequencies precisely, do fast production testing, check critical countdown chains, calibrate signal generators and check CB frequencies.

Automatic ranging 20Hz—40MHz is guaranteed. Ranging to 60MHz is typical. Reliable TTL circuitry updates the six-digit display five times per second. Resolution to 1Hz is obtained by switching to the 1SEC mode that suppresses the leading digits above 1MHz.

Specified accuracy better than 10PPM, 0-50° C. Maximum aging rate 10PPM/year.

The 1801 is compatible with prescalers that will extend its usability into the UHF range.

For detailed specifications and a no obligation, 10-day free trial, contact your local electronic distributor or B&K Precision.

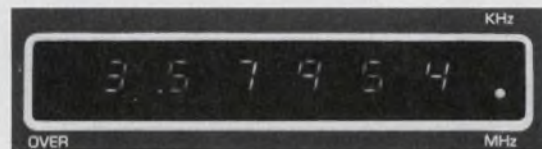

MHz display of 3.579548 MHz input (AUTO mode)

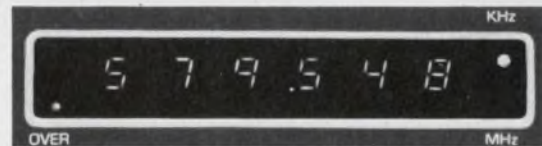

KHz display of overflow of 3.579548 MHz input (1SEC mode)

B&K PRECISION
PRODUCTS OF DYNASCAN

6460 W. Cortland Avenue
Chicago, IL 60635 312/889-9087
In Canada: Atlas Electronics, Toronto

The Most POWERFUL 8080 or 6800 Microcomputer Development System at any price . . . \$3,850⁰⁰ COMPLETE.



Only a truly powerful microcomputer development system allows you to accomplish your design task quickly, efficiently, and at a minimum cost. MICROKIT has the powerful microcomputer development system you need.

OTHER SYSTEMS OBSOLETE

The MICROKIT-8/16 has a unique CRT display refreshed directly from the microcomputer memory so it can write the full 960 character screen at 20,000 cps, faster than the blink-of-an-eye. Using the fast CRT, our interactive debugger gives you full screen hexadecimal memory dump displays instantaneously. With this kind of fast system response, debugging is a snap.

To match our fast debugger we have a screen based editor that is quickly learned and easy to use, because it lets you see the changes you make instantly and in full context on the CRT display. Rounding out our outstanding software package is a complete microcomputer resident assembler.

Any system without a display as fast as ours and without software like ours cannot possibly match the powerful debugging and editing features we offer.

EVERYTHING FOR \$3,850

But how is it that the MICROKIT-8/16 has everything (keyboard, display, tape units, and software) included in the basic price? We keep your cost low by using a standard television set for the high-speed display, and by using audio cassette units for mass storage. And with MICROKIT's proprietary recording technique, you get data reliability comparable to digital cassette units while data is transferred to the cassettes at the rate of 2000 bps — 20 times faster than TTY paper tape.

BOTH 8080 AND 6800

The MICROKIT-8/16 can be ordered as either an 8080 or a 6800 based system. At \$3,850 either system is the best buy in microcomputer development systems today because they both include the 8K memory, the display and keyboard, the two audio cassette units, and the full complement of development software — debugger/monitor, editor, and assembler. Furthermore, either system can be easily switched to the other processor with our conversion packages that consist of a plug-in processor module and software.

FULL LINE OF ENHANCEMENTS

Rest assured that we also back you up with a complete line of enhancements including In-Circuit Emulators, EPROM programmers, add-on RAM or EPROM memories, line printers, "semiconductor disk" memory resident operating systems, and single or dual drive floppy disks with a super disk operating system.

MICROKIT-8/16'S ARRIVE READY TO GO TO WORK FOR YOU

But don't be misled by our name, our system comes fully assembled, fully tested, fully warranted, and ready to begin helping you with microcomputer development the very day it arrives. The MICROKIT-8/16 is a proven and reliable system which over the past year has received enthusiastic customer acceptance.

Our unbeatable features make the MICROKIT-8/16 an obvious choice for the designer requiring a microcomputer development system. Write or call MICROKIT INC. today, (213) 828-8539, to see just how well the MICROKIT-8/16 fits your microcomputer development requirements.

MICROKIT INCORPORATED

2180 COLORADO AVENUE □ SANTA MONICA, CALIFORNIA 90404 □ (213) 828-8539

CIRCLE NUMBER 27

Microprocessor Design

Enhanced 8080 cuts component count while new support circuits add flexibility

Combining all the features of the 8080 and then some, Intel's new microprocessor, the 8085, is fully compatible with existing 8080-based systems.

On a single chip, the 8085 combines the 8080, the clock circuitry and the equivalent of an 8228 system controller. This third-generation microprocessor uses a 6-MHz crystal to generate a 3-MHz system clock, which is available from a divide-by-2 output on the 8085. Even with all this additional circuitry built in, the 8085 still comes in a 40-pin DIP and requires a single +5-V supply.

A partially multiplexed address bus used in the 8085 makes room for the new features on the chip. The address bus delivers the eight MSBs, while the eight-bit data bus delivers the eight LSBs of the address.

By eliminating two supply lines and eight address lines, Intel has made available 4 interrupt lines and an S1 and S0 line. These lines encode the status of the machine cycle

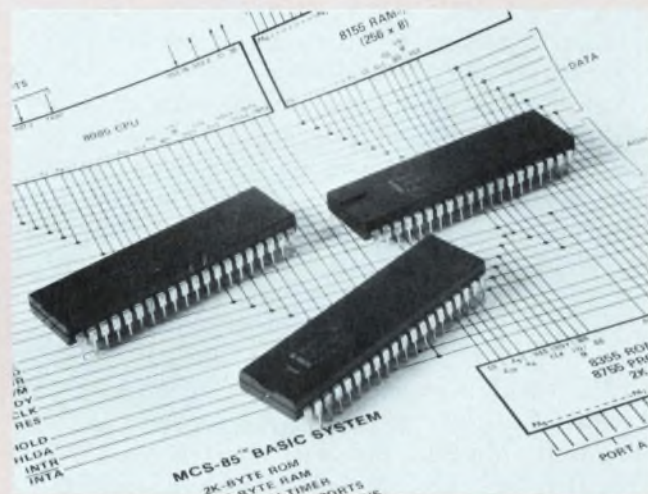

to permit bus arbitration and memory refresh.

The interrupt lines are internally prioritized on the chip, with three of them also maskable on the chip. The fourth is not maskable and

(continued on page 54)

Microprocessor-controlled prober has self-diagnostics



Based on an 8080 microprocessor, the CP-3300 semi-automatic wafer prober places each wafer into the measurement check and performs all probing operations automatically, except for fine alignment. Even maintenance is simplified—the μ P checks all functions by running a diagnostic routine.

System-alignment speed is 1.6 in./s (40 mm/s). Resolution is either 0.5 mil (10 pitch) or 1 mil (5 pitch) and determined by software or lead-screw changes. (Metric equivalents are 10 microns/10 pitch, 20 microns/5 pitch.)

The overdrive of the profiler assembly (edge sensor) is automatically controlled, which ensures that the probe card's tips touch with constant pressure. Should the profiler be damaged, automatic probing stops.

Separate inking or contact inking on one channel (two with option) is available. The CP-3300 requires 115/230 V, 50/60-Hz power, costs \$20,000 and is available in 12 to 14 weeks.

Computervision Corp., Cobilt Div., 2727 Augustine Dr., Santa Clara, CA 95051. (408) 984-2500.

CIRCLE NO. 499

MICROPROCESSOR DESIGN

(continued from page 53)

is used for power-fail applications. The main interrupt input, included on the 8080, is also prioritized on the chip.

Two lines have been added to perform a serial I/O function. They form a "slow" serial port that can be used in teletypewriter-interface applications. Memory-timing requirements are relaxed enough to permit the use of RAMs with 450-ns access times. A special control line, the address latch enable, controls the external latch or peripheral support-circuit latches to help demultiplex the address.

The 8085 is totally compatible with the 8080 instruction set. In addition, two op codes not used by the 8080 are used on the 8085 to provide RIM (read interrupt mask) and SIM (set interrupt mask) instructions. These permit the 8085's new interrupt mask register to be set, altered and read.

The μ P is totally TTL-compatible—each line can sink 1.9 mA and source 400 μ A.

Like the Z80 made by Zilog (Cupertino, CA), the 8085 has the controller circuitry built in; but unlike the Z80, the 8085 has the clock circuitry, too. And, although Intel has added only two instructions to the 8080 set, the 8085 offers more control options than most other available microprocessors.

Three specialized n-channel support circuits

have been designed specifically for 8085 systems. The 8155 contains a 256×8 RAM, two 8-bit I/O ports, one 6-bit I/O port and a 14-bit programmable interval timer. The 8355 is a mask-programmable I/O chip with $2 \text{ k} \times 8$ ROM storage and two 8-bit I/O ports. The 8755, an ultraviolet-erasable PROM with a $2 \text{ k} \times 8$ storage capacity and two 8-bit I/O ports, is pin-compatible with the 8355. Each of the three support circuits also contains the 8-bit latch necessary to demultiplex the address signals coming from the 8085.

All three support circuits come in 40-pin DIPs and operate from only +5 V. Their I/O ports are all software programmable. The I/O ports on the ROM chips are programmable down to the individual bit level of each port: Each of the 8-bits can act as an input or output.

Up to five 8155 RAM I/O circuits can be connected to a system bus.

System component prices are expected to start at \$36 in 100-up quantities for the 8055, \$39 for the 8155 and reach \$170 for the 8755 in the same quantities. Delivery of sample quantities will be in the first quarter of 1977. Also available shortly will be the 8048, an 8-bit μ P with 64 bytes of RAM and 1 kbyte of PROM—all on a single chip.

Intel Corp., 3065 Bowers Ave., Santa Clara, CA 95051. (408) 246-7501.

CIRCLE NO. 500

Computer system has dual cassettes and a video monitor



A 6800- μ P-based computer system, dubbed Jupiter IIC, provides a video terminal and two audio cassette recorders, along with an ASCII keyboard, for displaying, storing and inputting data. With the hardware, you also get a simple operating system, program development software, and a Basic interpreter.

The video terminal and cassette recorders are supplied with the assembled system (\$3800), but not in the kit version (\$2850). Interfaces are provided for the devices, however, in the kit version.

The video terminal displays either characters or dot graphics. Both upper and lower-case ASCII characters, and the Greek alphabet are displayed in a 32 line by 64 char./line format. In the graphics mode, the video screen has a resolution of 128 dots horizontally, and 96 dots vertically. The video interface refreshes the display from a 2-k dual-port RAM, independent of μ P operation.

Operation of the two cassette units are controlled through a cassette interface, including tape-motor start and stop. Data are stored according to a "Kansas City" standard that uses 1200 and 2400 Hz tones to record one and zero bits. Data may be stored so that they read out of the cassette at 300, 600 or 1200-baud rates.

Along with the hardware, you also get a small operating system, a monitor/debugger/assembler, programmed into 3-k bytes of EPROM that is plugged into the Jupiter IIC. With it, you command: loading data from or to the cassettes, starting execution of a

(continued on page 56)

And now minis too! All from a catalog, at discount prices.

Digital's Direct Sales Catalog — the first catalog to offer computer products by mail with off-the-shelf delivery — was such a success, we've come out with an expanded second edition that includes the PDP-8A, the newest member of the world's most popular mini-computer family.

We've also added the LA180 line printer and expanded the sections on microcomputers,

logic modules, terminals, cabinets, connectors, accessories, and supplies from the first edition.

Of course, you still get our 5% catalog discount, plus another 4% for cash with your order. You also get a 10-day free trial period, plus our standard 90-warranty. (Since we're selling by mail, you do have to install the equipment yourself.)

If you were among the thou-

sands who ordered our original catalog, you'll get the new one automatically by mail.

If you weren't, why not sign up now?

For your free copy, call 800-225-9480 (Mass. 617-481-7400 ext. 6608). Or write: Components Group, Digital Equipment Corp., MR2-2/M59, One Iron Way, Marlborough, MA 01752. (Catalog sales to U.S. only.)



MICROPROCESSOR DESIGN

(continued from page 54)

program, and examining and changing memory. The debugger sets a breakpoint in memory which stops program execution when it reaches that location.

As if that weren't enough, you also get a Basic interpreter, macro text editor and a two-pass assembler, recorded on three cassettes. The Basic interpreter when loaded into the system, occupies 6-k of the system's 8-k of RAM. The remaining 2-k is used for the user's program, typically enough for 100 lines.

The editor may be used to prepare assembly language programs. The assembler accepts 6800-assembly-language statements and generates machine code which may be loaded onto a cassette.

Wave Mate, 1015 W. 190 St., Gardena, CA 90248. (213) 329-8941.

CIRCLE NO. 501

Micro manufacturer makes a mini-like computer system

A μ P, first integrated into the SBC80/10 single board computer, has, in turn, been put into a box containing power supply and support circuitry so that it looks like a minicomputer. The unit, dubbed the System 80/10, contains in addition to the 8080- μ P board and a power supply, a card-cage assembly, cooling fans, and cabling, all in a cabinet measuring $3.5 \times 19 \times 19$ in.

The card cage and power supply will accommodate three additional system-expansion boards. The boards may contain additional RAM (16-k bytes), additional EPROM/ROM (16-k bytes) or more I/O lines.

A system monitor comes on the SBC80/10 board that enables loading, executing and debugging applications programs. It will work with paper-tape or CRT-based systems.

The System 80/10 sells for \$1495 in single quantities.
Intel Corp., 3065 Bowers Ave., Santa Clara, CA 95051. (408) 246-7501.

CIRCLE NO. 502

Application notes tell how to troubleshoot μ P systems

If you have Hewlett-Packard's logic-state-analyzer system, Models 1600A and 1607A, a new set of application notes will help you troubleshoot the operation of the most popular μ Ps. Individual notes explain execution of a typical instruction on the 6800, 8080, 8080, 4004, 4040, F8, IMP, and SC/MP μ Ps.

The notes also tell you where to hook up probes on the chip, how to set the controls and how to interpret the resulting analyzer waveforms, while the μ P runs at its normal clock rate.

The application notes also show the device pinouts and the definitions of the signal names.

Hewlett-Packard, 1501 Page Mill Rd., Palo Alto, CA 94304. (415) 493-1501.

6800	CIRCLE NO. 503	8080	CIRCLE NO. 505	F8	CIRCLE NO. 507	SC/MP	CIRCLE NO. 509
8008	CIRCLE NO. 504	4004	CIRCLE NO. 506	4040	CIRCLE NO. 508	IMP	CIRCLE NO. 510

Micro Capsules

A \$169 microcomputer system, the Educator 2, is being readied for early 1977 introduction by Motorola in Phoenix, AZ. It contains the 6800, several PIAs, an ACIA, a ROM monitor and 265 bytes of RAM. . . . A CMOS version of the 8080, developed by Intersil of Cupertino, CA, may be introduced during 1977. Operating power of the pin-compatible unit will be just a few milliwatts. . . . A high-speed version of the 6701 bipolar bit slice is coming soon from Monolithic Memories of Sunnyvale, CA. The souped-up bit slice is expected to have a 90-ns microinstruction cycle time. . . . The Motorola MC6800 microprocessor family will be manufactured and marketed by Fairchild Semiconductor, Mountain View, CA, using photomasks and other technical aids provided by Motorola. In exchange, Motorola will manufacture the one-chip F8 microcomputer now under development by Fairchild.

Big 0.6" double and single digits.

Our new super bright orange double- and single-digit displays are available in both common cathode and common anode configurations. These 0.6" digits (with overflow) incorporate our latest rounded-corner solid segment font to give you a display that's easy to read and easy to like.

The package is new, too. It has a colored face for optimum ON/OFF contrast. It's just under an inch in length and packs densely to provide digits on .50" centers.

The light emitting material is our new GaAsP:N on GaP, so you get all the benefits of this new high brightness technology—including direct MOS drive—plus all the inherent shock resistance and long life of solid state. Not bad.

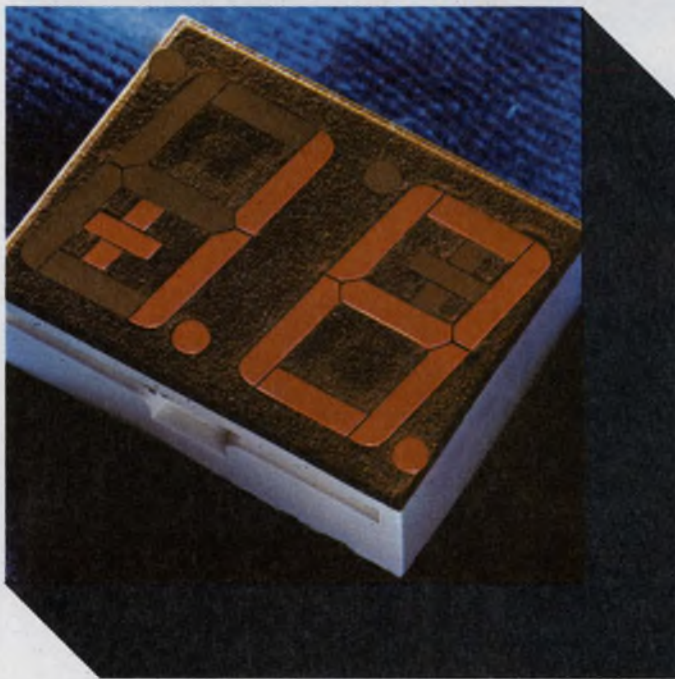

Model Number	Description	Color	Luminous Intensity*
MAN 6610	2 Digit; Common Anode, RHDP	Orange	510 μ cd
MAN 6630	1½ Digit; Common Anode, Overflow (± 1.8), RHDP	Orange	510 μ cd
MAN 6640	2 Digit; Common Cathode, RHDP	Orange	510 μ cd
MAN 6650	1½ Digit; Common Cathode, Overflow (± 1.8), RHDP	Orange	510 μ cd
MAN 6660	Single Digit; Common Anode, RHDP	Orange	510 μ cd
MAN 6680	Single Digit; Common Cathode, RHDP	Orange	510 μ cd
MAN 6710	2 Digit; Common Anode, RHDP	Red	125 μ cd
MAN 6730	1½ Digit; Common Anode, Overflow (± 1.8), RHDP	Red	125 μ cd
MAN 6740	2 Digit; Common Cathode, RHDP	Red	125 μ cd
MAN 6750	1½ Digit; Common Cathode, Overflow (± 1.8), RHDP	Red	125 μ cd

*Minimum digit average @ 10mA, DC per segment

So if it's bright you want, and your application calls for 0.6" displays, call your Monsanto man in and have a look at the MAN6600 and MAN6700 series. They're terrific.

Monsanto:
the science
company.

IN EUROPE CONTACT: Monsanto Europe S.A.,
Electronics Division, Avenue de Tervuren 270-272,
B-1150, Brussels, Belgium

Please send me a data sheet on your MAN6600 and MAN6700 series digits.

Name

Title

Company

Street

City

State Zip

Mail to Monsanto Electronics Division,
Dept. MCD, 3400 Hillview Ave., Palo Alto,
CA 94304. Phone (415) 493-3300.

© Monsanto Company Electronics Division, 1976

CIRCLE NUMBER 29

25-bit words:

Biomation's 16+8+1 answer to μ Processor analysis.

The first microprocessor analyzer that really analyzes.

Biomation has developed a new instrument to solve a new problem: How to get inside the mind of your microprocessor. The instrument is our 168-D. The Mind Reader.

In the process, we've invented a new word. 25 bits long. Contains 16 bits of address, 8 bits of data, and one bit that tells you whether your machine is reading or writing. All in hex characters, just like your program listing.

The Mind Reader starts by capturing up to 256 of those 25-bit words at synchronous rates as fast as 10MHz. That's fast enough for anybody. You can dial in a hardware breakpoint and step your system through its program. Or you can monitor your system as it runs free. But that's just the beginning. Now watch:

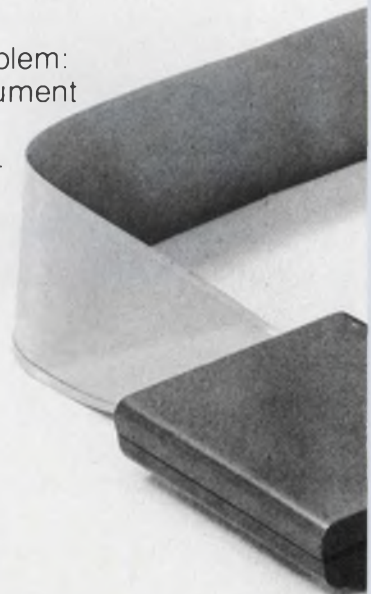

First, the Big Picture

The Mind Reader takes a first macro-bite out of the territory you're investigating. 256 big words. In Memory Mode you can see the areas of memory where the action occurred. (You're writing into ROM, for heaven's sake!?)

Then zoom in!

The 168-D gives you a movable cursor that locks onto a location and stays with it through the analysis modes. Once you spot the action you've been looking for, stake it out with the cursor and switch to Page Mode. That gives you the address, data, and read/write information.

Now: A whole new perspective . . .

You've found the program, now switch to Sequential Mode and find out **how it got there**. Where were you coming from, and where did you go from there? Study all time relationships. A powerful new way to analyze the problem!

By switching to the List Mode you display the twenty words surrounding the cursor location you selected in the Page Mode. Address and data are presented in hex along with the R/W bit to let you compare the sequence to your program listing.

In summary: The 168-D lets you record with respect to time and analyze with respect to location.

It's the first microprocessor analyzer that really analyzes. You can put it to work today on **8080A** and **6800** problems. Personality modules for other μP 's are currently under development.

So if you're working with microprocessors and want to know whether your software or hardware is giving you problems, Biomation's 168-D Mind Reader will tell all: What happened . . . where . . . and when. You've got to get the data sheet. Circle the number below. Better yet, call Biomation for a demo. Biomation, 10411 Bubb Road, Cupertino, CA 95014, (408) 255-9500. TWX: 910-338-0226.

biomation
Creating tools for technology

CIRCLE NUMBER 30

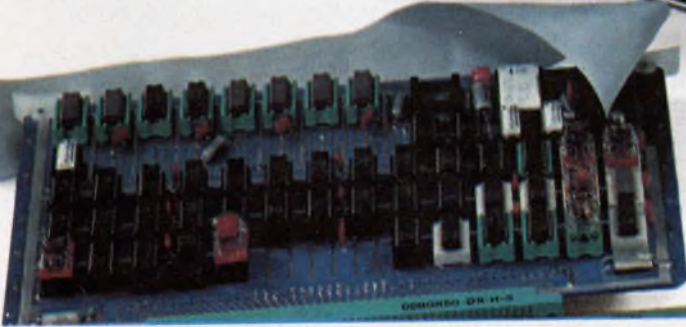



There is no more accurate 12-bit A/D converter on the market ... and it's monolithic.

Differential and overall linearity within $\frac{1}{2}$ LSB. Inherently monotonic operation (and no missing codes). Immunity to noise transients. They all add up to unusually high accuracy for our 8702, a single chip, 12-bit CMOS A/D converter.

The 8702 has some other important advantages, too. CMOS technology means very low power dissipation — typically less than 20 mW. It is easy to use; no active auxiliary components are needed. And its latched parallel outputs are



ideal for inputting to microprocessors.

Compared to modules, the 8702 offers immediate significant cost savings plus the prospect of even greater future economies due to its monolithic construction. And the savings in PCB real estate go without saying.

The 8702 comes in a 24-pin ceramic DIP. Other versions include 8 and 10 bit devices in ceramic, and an 8 bit unit in plastic for commercial environments. Call or write for full details.

TELEDYNE SEMICONDUCTOR

1300 Terra Bella Avenue, Mountain View, California 94043 Tel: (415) 968-9241 TWX: 910-379-6494 Telex: 34-8416

SALES OFFICES:

DOMESTIC: Salem, N.H. (603) 893-9551; Stony Brook, N.Y. (516) 751-5640; Des Plaines, IL (312) 299-6196; Los Angeles, CA (213) 826-6639; Mountain View, CA (415) 968-9241 • INTERNATIONAL: Hounslow, Middlesex, England (44) 01-897-2503; Tiengen, West Germany 7741-5066; Wiesbaden, West Germany 06121-39171; Kowloon, Hong Kong 3-240122; Tokyo, Japan 03-405-5738

CIRCLE NUMBER 31

COMPANY POLICY

Charlie started a company some years ago. He was a sharp engineer who knew his markets and worked hard, so the company's success was never in doubt. And since Charlie knew that "undoubted" success called for devoting all his efforts to building the company's products, sales and reputation, he didn't bother to "manage" the company.

In the early days, Charlie's small band of employees was so excited at helping him build up this young company that 50, 60 and 70-hour work weeks were common. When Sally needed a day off for some serious dental work, and Charlie urged her to take off a few more days to rest, she declined because she was needed. In fact, *everybody* was needed. And everybody knew it.

So the company grew. But as it grew, management experts warned Charlie of the calamities that would result if the company were not properly "managed." "Not only do you not have an organization chart," they berated him, "you don't even have an organization." And because Charlie was "merely" an engineer, uneducated in the esoteric art of management, he was persuaded to allow professional managers to "help."

They knew their jobs. Very quickly, there were formalized working hours and formalized policies on overtime, vacations, medical benefits, sick days, holidays and retirement benefits. For the engineers, there were additional policies on design planning, design procedures and procurement. A resistor is a resistor, the managers decided, because the small difference in performance cannot justify the increased paperwork necessary to define qualitative matters.

But paperwork—loads of it—was justified everywhere else. *Now* when Sally needed time to visit her dentist, she had to fill out six forms. And *now* if she didn't feel too good, she took off a few days because she wasn't urgently needed. Nobody was. And everybody knew it.

For some strange reason, Charlie's by now abundant group of employees couldn't be counted on to work even 40 hours—let alone 50, 60 or 70—without some prodding. So more regulations had to be issued. The rules grew to be so important that they became company policy, then COMPANY POLICY.

Pretty soon, COMPANY POLICY was becoming more important than products, sales and reputation—all of which were slipping, along with the profits. Charlie was still an unsophisticated guy who couldn't understand management techniques. But he could recognize reality when it stared him in the face. So, he eliminated the management experts, eliminated most of the COMPANY POLICY, company policy and just plain rules, and went back to building products, sales and reputation.

Guess whose company is growing again.



RECOGNIZED BY
AMERICAN REVOLUTION
BICENTENNIAL
ADMINISTRATION

ELECTRONIC DESIGN is deeply honored to have received official recognition as a participant in the American Revolution Bicentennial Celebration, with authority to display the Bicentennial Symbol.

GEORGE ROSTKY
Editor-in-Chief

BECAUSE

Electronic Design

WORKS FOR YOU...



**IT
WILL
WORK FOR
YOUR
COMPANY!**

You and your fellow engineer subscribers to *Electronic Design* now number 93,500 — worldwide.

If you are a typical engineering manager reader, chances are you have been a subscriber for 5 years or more, and you read every issue. You also, (92.6%) keep *Electronic Design* on file in whole or part for 15 months.

Chances are, too, that you prefer *Electronic Design* above all other industry publications.

You're part of a highly skilled very active audience that responds with almost 1,500,000 inquiries per year to our editorial

and advertising items. (You may not know it, but this is the greatest number of inquiries produced by any industrial magazine in the world!)

If you are like the thousands upon thousands of readers who find *Electronic Design* works for you, then remember *Electronic Design* can work for your company, too.

Tell your top marketing and advertising brass which magazine will be their best advertising medium. We reach the engineers who make things happen in this industry.

Electronic Design

BEST READ ELECTRONICS PUBLICATION IN THE WORLD!



Hughes hybrid microcircuitry saves the DC-10 enough weight to carry two pro linebackers.

How can anything that small add up to that much in weight savings?

Simple. A Hughes multiplex system uses time-sharing techniques to carry many signals over a single coaxial transmission line.

And that means eliminating hundreds of feet of copper wire going to some 250 passenger seat stations. Or over 500 pounds.

Multiplexing technology made it possible, sure. But Hughes hybrid microcircuitry made it practical.

Maybe you don't need to save the weight of two football players. But using hybrid circuits can cut the fat out of a lot of equipment. It can

sideline high assembly time and heavy production costs and substitute high reliability.

Let us tackle your problem. We'll analyze your present circuitry, then design the hybrid circuits, develop the prototype, manufacture the custom components, assemble, test and guarantee the total hybrid package.

Write for our illustrated brochure. To:

Hughes Microelectronic Products Division, 500 Superior Ave., Newport Beach, CA 92663. Or telephone: (714) 548-0671.

HUGHES

HUGHES AIRCRAFT COMPANY
MICROELECTRONIC
PRODUCTS DIVISION

Keep the PACE up and running without complicated circuitry. The 16-bit microprocessor has a compact set of 45 instructions yet delivers minicomputer performance.

The PACE microprocessor is one of the few 16-bit μ Ps available, and the only one made with a low-cost PMOS process. It can operate with just a single-phase clock (both true and complement signals) and still deliver much of the performance formerly requiring a minicomputer.

A hardware stack, six vectored interrupts and six addressing modes work together to make the PACE easy to apply. The support circuits available (Table 1) also help during system design. A system timing element (STE) and three bi-directional transceiver elements (BTE) combine to provide a fully buffered and clocked processor (Fig. 1). The 16-bit data and address bus can drive 30 TTL loads, as can all the flag and strobe lines when buffered with BTEs.

Data flow easily on the bus

All data transfers between the PACE and external memories or peripherals take place over the 16 data lines. The transfers are synchronized by the NADS (negative true address strobe) IDS (input data strobe), ODS (output data strobe) and EXTEND (extended data transfer) signals.

Timing for address or data signals on the bus is shown in Fig. 2a. Where the signal timing is referenced to the clock signals, the reference is to valid logic ONE or ZERO clock levels. Cross-hatched areas indicate either uncertainty of output transitions or don't-care states for data inputs. Address data become valid one clock phase prior to the NADS signal and remain valid for one clock phase afterwards. Typically, the NADS signal strobes the address data into a set of latches that are either internal or external to the memory chips, or clocks decoded peripheral addresses into a control flip-flop.

PACE-address drivers go into a high-impedance state during the data-input interval (see Fig. 2a). The IDS signal can disable the output sense amplifiers and enable the three-state input buffers. Typically, this timing permits maximum

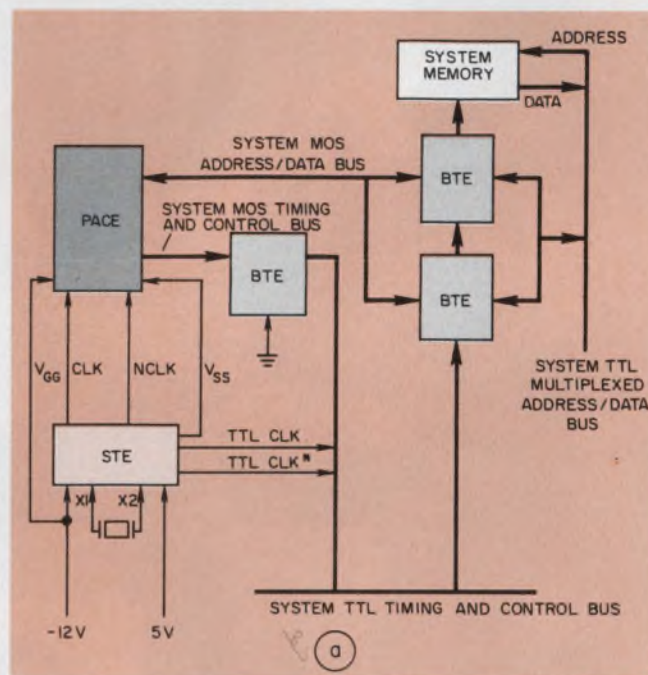

1. A minimal operating system can be built from the PACE, three BTEs, one STE and any amount of RAM or ROM (a). All input/output lines of the system can handle 30 TTL loads. A simple development system (b) uses three BTEs and simple TTL. Either the self-contained keyboard or a teletypewriter can be used.

Frank Lynch, PACE Product Manager, National Semiconductor, 2900 Semiconductor Dr., Santa Clara, CA 95051.

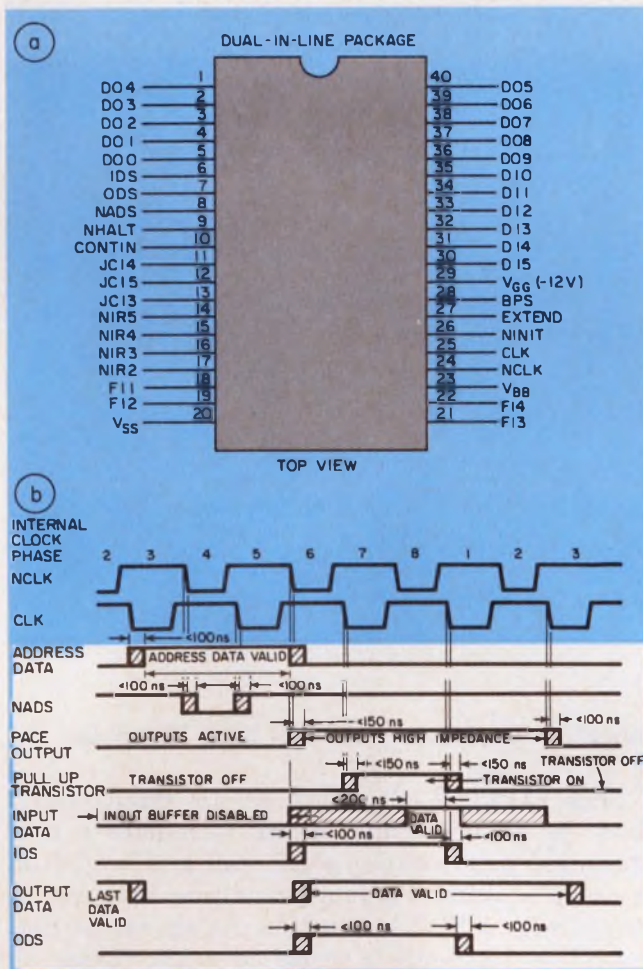

2. The PACE μP (a) uses a multiplexed data and address bus and has six vectored interrupts. The two non-overlapping clock phases, provided by the STE, control the PACE μP (b). TTL-level clock signals (not shown) are also generated by the STE.

speed of the μP in a system only if the memory access is less than two clock periods. The fastest commercial PACE has a 500-ns cycle time, so memories that access in $1\ \mu\text{s}$ or faster work fine. To use memories that have a longer access time, either the clock frequency can be reduced or the input/output (I/O)-cycle extend feature can be used.

Four serial inputs and four serial outputs are available via the flag, jump and continue lines. In all, there are 12 control lines on the PACE

Table 1. PACE support circuits

Model number	Pins	Description	Cost (100-up)
IPC-16A/500D	40	PACE CPU, 500-ns cycle time	\$60.00
IPC-16A/520D	40	PACE CPU, 750-ns cycle time	\$40.00
DP 8302D	16	System timing element	\$6.50
DP 8300N	24	Bidirectional transceiver element	\$5.10
DP 8301N	28	Multidirectional interface latch element	to be announced
MM 2101	22	256×4 static MOS RAM, 500-to-1000-ns access	\$3.20
MM 2102	16	$1\text{ k} \times 1$ static MOS RAM, 500-to-1000-ns access	\$2.30
MM 2112	16	256×4 static MOS RAM, 650-to-1000-ns access	\$3.20
MM 5269	22	256×4 static MOS RAM, with address latches, 1000-ns access	\$3.20
MM 5271	18	$4\text{ k} \times 1$ dynamic MOS RAM, 250-ns access TTL compatible	\$12.00
MM 5281	22	$4\text{ k} \times 1$ dynamic MOS RAM, 250-ns access TTL compatible	\$15.00
MM 5214	24	512×8 MOS ROM, 1000-ns access	*
MM 5242	24	$1\text{ k} \times 8$ MOS ROM, 500-ns access	*
MM 5246	24	$2\text{ k} \times 8$ MOS ROM, 500-ns access	*
MM 5204	24	512×8 electrically programmable MOS ROM, 1000-ns access	\$29.50

* consult factory

(not including the flag and jump lines) that can simplify many of the possible interface applications. The Extend input, employed by slow memories or peripherals to temporarily increase the time duration of data I/O transfers, can also be used to suspend I/O operations if applied at the end of an ODS or IDS pulse.

The three Jump Condition inputs (JC13, 14, 15) are user-specified inputs that can be tested with the Branch-on-Condition (BOC) instructions. These JC inputs are useful for testing external device status or receiving serial data. Four flag outputs (F11, 12, 13, 14), which can be either set by a Set-Flag instruction or pulsed or reset by a Pulse-Flag instruction, can provide direct con-

Internal architecture of the PACE microprocessor

The PACE central processor, a single PMOS IC, uses a shared data and address bus to manipulate 16-bit wide data and instructions. All 45 instructions use a single-word, 16-bit format that keeps memory accesses and program-storage requirements to a minimum.

Data transfers between the PACE μ P and the memory or peripheral devices take place on the 16-bit parallel address/data bus. Inside the chip, the data bus interfaces through a set of buffers to the operand bus and the instruction register. Connected to the operand bus are seven registers and a 10-word last-in, first-out stack. Four of the registers, AC0 to AC3, are available as general purpose accumulators. The other three registers include the program counter and two scratch pad registers, temp reg. 1 and temp reg. 2.

The contents of the registers or stack are routed to either the A or B inputs of the arithmetic and logic unit (ALU) and shifter. The ALU output can then be returned to any of the registers or stack by way of the result bus. Aside from performing the arithmetic, the ALU also sets the status flags, in accordance with the data length (8 or 16 bits) selected by the state of the byte-status flag. All status information is stored in a 16-bit status-and-control-flag register that can also be loaded onto or from the operand bus. The 14 status and control flags can be individually set, pulsed or reset under software control.

Instructions are stored in the instruction register as they are to be executed and are inter-

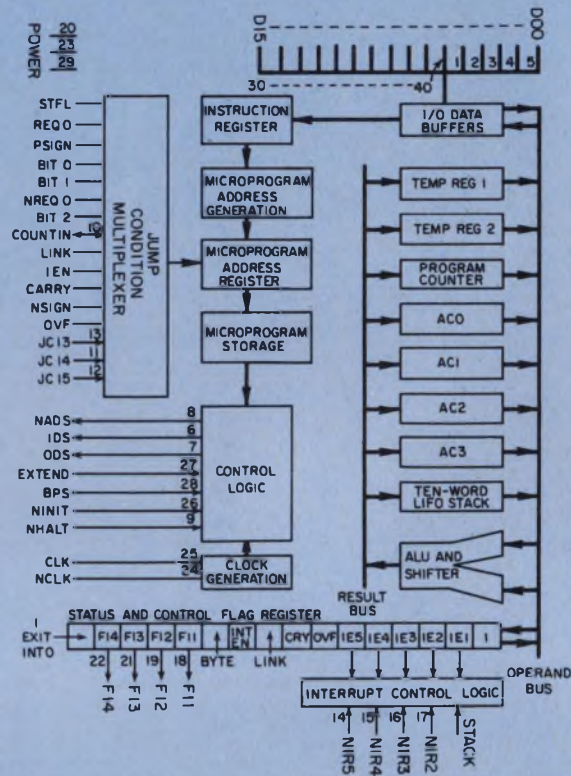

preted and executed by a microprogram stored in a 75-word- \times -20-bit ROM. Actual execution time is determined by the particular instruction and clock frequency.

trol of a system function or serve as individual serial output ports.

A dozen control lines do everything

Four lines are used as Negative-True Interrupt Request lines (NIR2, 3, 4, 5). Holding these lines LOW for one clock period (minimum) sets the associated internal-interrupt-request latch—but only if the corresponding interrupt enable has been set by the user's program. The interrupt is serviced after the current instruction is completed if the Master Interrupt Enable is set. The four interrupt lines are given differing priorities with NIR5 having the lowest priority.

The NHALT (Negative-True Halt) line, acting as an input or output signal, can be driven LOW by external logic to "stall" the μ P or initiate a Level-0 interrupt, depending on the timing of the CONTIN (continue) signal. When not controlled by external logic, NHALT can be driven LOW by the PACE software for 7/8 duty cycle while a programmed halt condition exists. A programmed halt initiated by the Halt instruction can be ter-

minated by using external logic to pulse the CONTIN line.

The CONTIN also acts as an input/output line. As an input line, it can terminate a programmed halt, exercise a μ P stall and level-0 interrupt or initiate a jump condition that can be tested with a BOC instruction. As an output line, CONTIN transmits a pulse to acknowledge an active interrupt input.

Two other input lines, the BPS (Base-Page Select) and the NINIT (Negative-True Initialize), are also available. The BPS signal enables one of two base-page addressing schemes. When BPS is LOW, the first 256 words of memory constitute the base page (page zero). When BPS is HIGH, however, the first 128 memory words and the last 128 memory words constitute the base page.

When the NINIT signal is LOW, all μ P operation is suspended, and IDS/ODS signals are set to an inactive state. After NINIT completes a LOW-to-HIGH transition, the program counter is set to zero, the internal stack pointer is cleared and all flags and interrupt enables except the

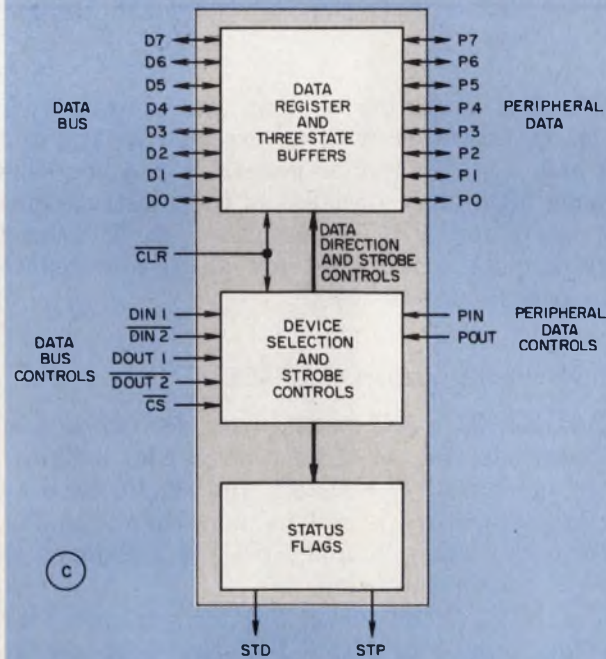
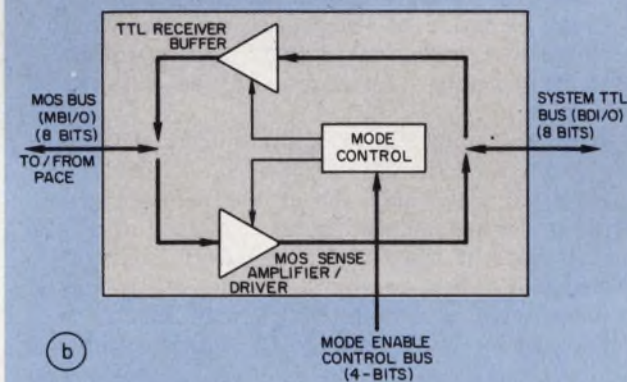
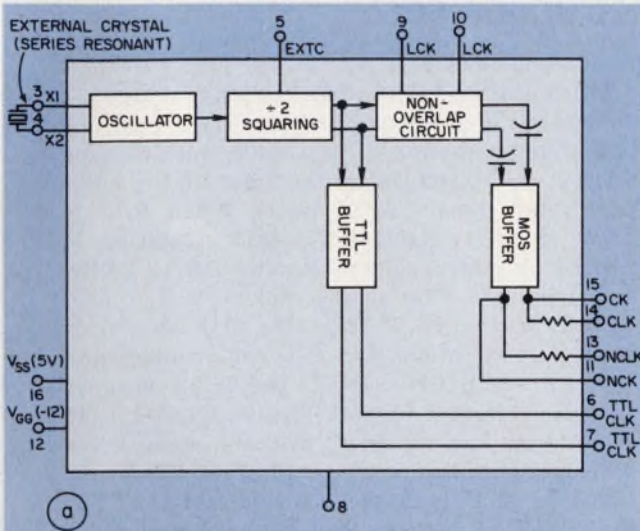

3. Providing all system timing, the STE delivers both MOS and TTL clocks (a). To buffer both incoming and outgoing data, the BTE can drive up to 30 TTL loads and has three-state outputs to the TTL bus (b). The MILE 8-bit latch element (c) provides the address or data storage for memories and peripheral devices while the μ P bus switches from the address mode to the data mode of operation.

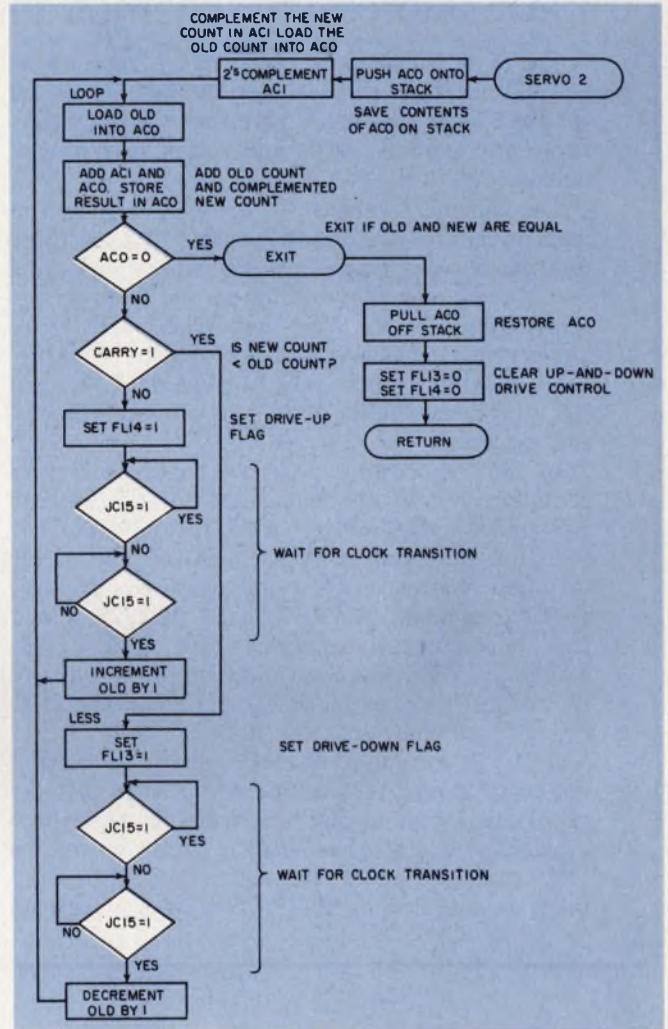

1			DIGITAL SERVO	
2	0000	AC0	=	0
3	0001	AC1	=	1
4	000A	CRY	=	10
5	000D	FL13	=	13
6	000E	FL14	=	14
7	000F	JC15	=	15
8	0000	6000	A	SERVO: PUSH AC0 ;SAVE AC0 ON STACK
9	0001	7101	A	CAI AC1.1 ;2S COMPLEMENT NEW COUNT
10	0002	C113	A	LOOP: LD AC0,OLD ;LOAD OLD COUNT INTO AC0
11	0003	6840	A	RADD AC1,AC0 ;(AC0) - (AC1) -> (AC0)
12	0004	4100	A	BOC 1,EXIT ;EXIT IF NEW = OLD
13	0005	4A06	A	BOC CRY,LESS ;BRANCH IF NEW < OLD
14				NEW COUNT GREATER THAN OLD COUNT
15	0006	3E80	A	SFLG FL14 ;SET DRIVE UP FLAG
16	0007	4FFF	A	BOC JC15,+0 ;WAIT FOR CLOCK TO GO LO
17	0008	4F01	A	BOC JC15,+2 ;WAIT FOR CLOCK TO GO HI
18	0009	19FE	A	JMP -1
19	000A	8D0B	A	ISZ OLD ;INCREMENT OLD BY 1
20	000B	19F6	A	JMP LOOP ;CONTINUE ASSUME NO SKIP
21				NEW COUNT LESS THAN OLD COUNT
22	000C	3D80	A	LESS: SFLG FL13 ;SET DRIVE DOWN FLAG
23	000D	4FFF	A	BOC JC15,+0 ;WAIT FOR CLOCK TO GO LO
24	000E	4F01	A	BOC JC15,+2 ;WAIT FOR CLOCK TO GO HI
25	000F	19FE	A	JMP -1
26	0010	AD05	A	DSZ OLD ;DECREMENT OLD BY 1
27	0011	19F0	A	JMP LOOP ;CONTINUE IF OLD NOT 0
28	0012	6400	A	EXIT: PULL AC0 ;RESTORE AC0
29	0013	3D00	A	PFLG FL13 ;CLEAR DRIVE DOWN FLAG
30	0014	3E00	A	PFLG FL14 ;CLEAR DRIVE UP FLAG
31	0015	8000	A	RTS ;RETURN
32	0016	0000	A	OLD: WORD 0 ;OLD COUNT
33		0000		END

4. To make the PACE μ P simulate a servo, use one of the JC inputs and two of the flag lines and some of the accumulators (top). The actual simulation program (bottom) requires only about 30 lines of code.

PACE addressing schemes and instruction set

The PACE microprocessor has a mix of 45 general-purpose instructions that can be sorted into five basic groups: branch and skip, memory-reference, register, shift and rotate, and miscellaneous.

The memory-reference instructions use a memory-addressing scheme that provides three floating-memory pages of 256 words each and one fixed-memory page of 256 words. The register instructions let the user manipulate data without accessing memory, and data-transfer instructions provide an easy way to move data between the functional blocks of the PACE microprocessor system.

In the PACE microprocessor, data are represented in the two's-complement number system. The most-significant-bit position indicates the sign of the number, 0 for positive and 1 for negative. With a single 16-bit word, the greatest positive number is $7FFF_{(16)}$ or $32,767_{(10)}$, and the most negative number is $8000_{(16)}$ or $32,768_{(10)}$. When the 8-bit data length is selected, the largest number is $7F_{(16)}$ or $127_{(10)}$, the most negative number, $80_{(16)}$ or $128_{(10)}$.

Both direct and indirect memory addressing instructions are included in the PACE instruction set. Direct-memory addressing has three available modes: base-page; program-counter (PC) relative; and indexed. The addressing mode is specified by the xr field of the instruc-

tion as shown in Fig. A.

When the xr field is 00, base-page (page 0) addressing is specified. However, two types of base-page addressing are available, and the type selected is determined by the state of the base-page select-signal (BPS) input. When BPS is LOW (ZERO), the 16-bit memory address is formed by setting bits 8 through 15 to ZERO and using the 8-bit displacement (DISP) field for bits 0 through 7. Thus, the first 256 words of memory (locations 0 to 255) can be addressed.

If BPS is HIGH (ONE), the 16-bit memory address is formed by setting bits 8 through 15 equal to bit 7 of the DISP field and using DISP for bits 0 through 7. Thus, the first 128 words (0000 to 007F) and the last 128 words (FF80 to FFFF) of memory can be addressed. This technique is useful for splitting the base page between RAM and ROM or between memory and peripheral devices. Consequently, base-page addressing permits easy access of the data or peripherals.

When the xr field is 01, addressing relative to the contents of the PC is specified. During the PC-relative addressing mode, the memory address is formed by adding the contents of PC to the value of the DISP field, which is interpreted as a signed number. (The 8-bit DISP field is interpreted as a 16-bit value with the bit 7 value used for bits 8 through 15, which permits

Level-0 interrupt enable are set LOW. The Level 0 is set HIGH. All other registers can contain arbitrary values.

With its six-level priority interrupt structure, the PACE μP keeps the circuitry for interrupt-driven systems simple. Each level of interrupt has its own Interrupt Enable (IEN). A master IEN is provided for all five lower-priority levels at once. The master IEN is an input to the μP 's internal jump-condition multiplexer. The state of the interrupt is tested by the PACE during the instruction-fetch routine (internal to the PACE) executed after each instruction is completed. Thus, an interrupt that is HIGH is automatically serviced.

During the interrupt sequence, an address is formed by the output of the priority encoder. This address is used to access the interrupt pointer, which in turn gives the highest priority interrupt request. The pointer specifies the starting address of the interrupt service routine for the particular interrupt level, except for a Level-0 interrupt (IR0), which is used primarily for alarm interrupts and control panel displays.

Surrounding the PACE are four circuits (Fig. 3), at the most, that need be used to make

a complete operating system. The 24-pin STE (Fig. 3a), together with an external crystal and +5 and -12 V supplies generates the nonoverlapping MOS clock signals and the substrate bias necessary for PACE operation. A TTL-level clock and its complement are also generated to ease over-all system design.

Simple circuits support the PACE

On the STE, a MOS buffer provides two sets of clock signals. One set (CLK and NCLK) is damped by on-chip 43Ω resistors and should be used for printed-circuit runs of no more than 2 in. The other output set (CK and NCK) is undamped to permit user-optimization.

The BTE circuit (Fig. 3b) in a 24-pin DIP provides input and output buffering between the PACE MOS I/O lines and the TTL world. Each BTE line has a fanout of up to 30 TTL loads. The four BTE mode-control function lines decode input control signals and, in turn, produce signals that set the TTL receiver/buffer and the MOS sense amplifier/driver into one of three operating modes: it can act as a driver, receiver or appear as a high impedance.

representation of numbers ranging from -128 through 127.)

After the memory address is formed, the PC is incremented and contains an address value that is one greater than the location of the current instruction. Thus, memory addresses that can be referenced range from 127 locations below through 128 locations above the address of the current instruction.

The indexed (or accumulator-relative) mode of addressing permits any memory location within the 65,536 word address space to be referenced. The DISP field, as in PC-relative addressing, is interpreted as a signed value ranging from -128 through 127. The memory address is formed by adding DISP to the contents of either accumulator AC2 (when $xr = 10$) or accumulator AC3 (when $xr = 11$).

Indirect addressing consists of first establishing an address in the same manner as direct addressing (by either the base-page, PC relative, or indexed mode). The contents of the memory location at the selected address are then used as the operand address.

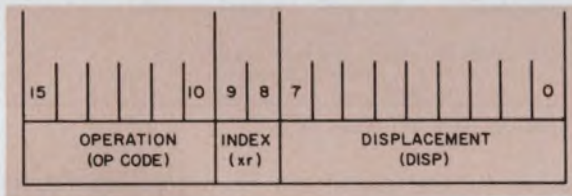

The PACE is also supported by the multidirectional interface latch element (MILE), a bidirectional 8-bit wide latch. The MILE comes in a 28 pin DIP and requires only a single supply due to its CMOS structure. On the chip are four select lines and a strobe that permit up to 16 MILEs to be put on a single bus. Outputs of the MILE are three state and can drive eight TTL loads. Also included are several status flag lines to provide handshaking.

With the MILE, almost any memory can be used with the PACE. But for a minimal system, the MM5269—a 256×4 static RAM with built-in latches—fits in very nicely. The MM5269 has an access time of $1 \mu s$ and is housed in a 22-pin DIP; three are needed for a minimal system.

System support: The choice is wide

Supporting the PACE μP are a wide range of hardware and software products (Table 2). For simple hardware integration and basic program development, the PACE LCDS provides an inexpensive starting point. The LCDS system comes with a keyboard, display and a fully expandable common bus. Machine-language routines can be

Mnemonic	Format			Description
	15	8, 7	disp 01	
Branch and skip instructions				
BOC	0100	cc	disp	Branch-on condition
JMP	000110	xr	disp	Jump
JMP	100110	xr	disp	Jump indirect
JSR	000101	xr	disp	Jump to subroutine
JSR@	100101	xr	disp	Jump to subroutine indirect
RTS	100000	00	disp	Return from subroutine
RTI	011111	00	disp	Return from interrupt
SKNE	1111 r	xr	disp	Skip if not equal
SKG	100111	xr	disp	Skip if greater
SKAZ	101110	xr	disp	Skip if AND is zero
ISZ	100011	xr	disp	Increment and skip if zero
DSZ	101011	xr	disp	Decrement and skip if zero
AISZ	011110	r	disp	Add immediate, skip if zero
Memory data-transfer and operate instructions				
LD	1100 r	xr	disp	Load
LD@	101000	xr	disp	Load indirect
ST	1101 r	xr	disp	Store
ST@	101100	xr	disp	Store indirect
LSEX	101111	xr	disp	Load with sign extended
AND	101010	xr	disp	logic AND
OR	101001	xr	disp	logic OR
ADD	1110 r	xr	disp	Add
SUBB	100100	xr	disp	Subtract with borrow
DECA	100010	xr	disp	Decimal add
Register data-transfer and operate instructions				
LI	010100	r	disp	Load immediate
RCPY	010111	dr sr	000000	Register copy
RXCH	011011	dr sr	000000	Register exchange
XCHRS	000111	r 00	000000	Exchange register and stack
CFR	000001	r 00	000000	Copy flags into register
CRF	000010	r 00	000000	Copy register into flags
PUSH	011000	r 00	000000	Push register onto stack
PULL	011001	r 00	000000	Pull stack into register
PUSHF	000011	00 00	000000	Push flags onto stack
PULLF	000100	00 00	000000	Pull stack into flags
RADD	011010	dr sr	000000	Register add
RADC	011101	dr sr	000000	Register add with carry
RAND	010101	dr sr	000000	Register AND
RXOR	010110	dr sr	000000	Register EXCLUSIVE OR
CAI	011100	r	disp	Complement and add immediate
Shift and rotate instructions				
SHL	001010	r	n l	Shift left
SHR	001011	r	n l	Shift right
ROL	001000	r	n l	Rotate left
ROR	001001	r	n l	Rotate right
Miscellaneous instructions				
HALT	000000	000	0000000	Halt
SFLG	0011	fc 1	0000000	Set flag
PFLG	0011	fc 0	0000000	Pulse flag

developed easily for it without a teletypewriter.

In all, three major levels of design support are available to PACE users:

- A program written in National's extended Basic language quickly checks the feasibility of any design scheme and provides assembly-language subroutine calls and direct I/O control.

- The PACE Resident Software Package provides a full set of utility programs, including a macro-assembler.

- A full disc-operating system permits easy handling of large programs.

Hardware support includes a full range of peripherals, memory cards, cables and utility boards, as well as a source-statement translator that can convert older IMP-16 software to PACE software and reduce development time.

Designing with PACE is simple

A good example of a PACE design is an all-digital servo that would typically require four 4-bit up/down counters (74193) and four 4-bit comparators (7485) as well as some control logic to be simulated by a short subroutine.

The logic part of a servo includes a 16-bit position input that is initialized to a zero reference. An external servo element provides one clock pulse for each increment of motion in either the up or down direction. With "normal" operation the $A > B$, $A < B$ and $A = B$ outputs serve to drive the servo element to the position indicated by the 16-bit position input.

If, for example, the position input has a greater value than the output of the counter, the $A < B$ output lets the servo be driven in the up direction by the incoming counter pulses. When the counter has reached its position value, the $A < B$ output goes LOW and the $A = B$ output goes HIGH to stop the servo simulation. The servo will hold its current position until the value of the position input is increased or decreased.

For the flow chart and program listing based on this example (Fig. 4), the following assumptions are made:

- Specified memory locations are dedicated for the storage of the current and desired servo positions.

- Accumulator AC1 is used both as an input-data register for desired servo position value and as a working register (along with AC0) to determine when the servo is at the desired position.

- Input and output assignments are as follows: Clock = JC15, $A > B$ = flag 13 set (drive servo down), $A < B$ = flag 14 (drive servo up) and $A = B$ = flag 14 set and 14 reset (stop servo).

The comparison function is accomplished by taking the two's complement of AC1 after AC0 is

Table 2. System-level support

Model number	Description	Cost (unit qty)
IPC-16P/108	PACE development system with 8 k × 16 memory	\$4910.00
IPC-16P/840	PACE disc operating system	\$4500.00
IPC-16P/301	PACE low-cost development system with keyboard and display	\$ 585.00
IPC-16C/100	PACE CPU card 500-ns cycle	\$ 300.00
IPC-16C/001	PACE 1 k × 16 RAM card	\$ 170.00
IPC-16C/011	PACE 1 k × 16 RAM common bus card	\$ 170.00
IPC-16C/002	PACE 2 k × 16 ROM/PROM card	\$ 495.00
IPC-16C/012	PACE 2 k × 16 ROM/PROM common bus card	\$ 495.00
IPC-16C/801	Utility wrapped-wire card	\$ 32.00
IPC-16P/802	Bus extender cable card	\$ 120.00
IPC-16S/101	PACE/IMP cross-assembler	\$ 100.00
IPC-16S/102P	PACE Fortran cross-assembler	\$ 495.00
IPC-16S/901	PACE resident software package including assemblers, editor, loaders, debugger and diagnostics	from \$100.
IPC-16S/902	PACE disc resident software package including assemblers, editor, loader, debugger and diagnostics	\$ 200.00
IPC-16S/201	PACE Basic interpreter	\$ 100.00
IPC-16A/928	PACE system design manual	*
IPC-16A/927	PACE logic designers guide to TTL equivalents	*
IPC-16S/969Y	PACE assembly-language programming manual	*

* available from local sales office

stored in the stack and then loading OLD into AC0 and adding the contents of AC0 and AC1. In effect, this comparison function is a standard binary subtraction that does not alter the contents of AC1. If the subtraction's result is zero, the servo is in the desired position. If not, the state of the carry flag indicates whether the servo needs to be driven up (carry = flag reset) or down (carry = flag set).

When the servo must be driven, flag 13 or 14 must be set and the JC15 input tested to detect the positive going clock edge of the pulse input. Upon detection of the positive-going edge, the contents of OLD are incremented or decremented, as appropriate, and the subroutine returns to the loop address. This compare-and-count loop then gets repeated until the servo arrives at the desired position (the contents of OLD are the same as NEW).

When the servo does arrive, bit 0 of AC0 is HIGH, and the compare-and-count loop is terminated by the branch to the EXIT address. The original contents of AC0 then get restored from the stack and flags 13 and 14 get reset to terminate servo action. An RTS instruction can return to the main program. ■■

Previous articles in this series covered the 8080, F-8, 6800, 2650, CDP-1802 and the 6100. The next article will discuss the SC/MP.

The price of tin plated DIP sockets just took a big dip.

We've just snipped a big 20% off the price of our entire line of tin plated wire wrap DIP sockets. But we didn't cut any of the features. For example, you still get a 200 microinch minimum plating of tin. Universal mounting and packaging. Stand-off tabs on the base for solder flush. 94 V-O U.L. rated insulation material. Individually removable pins. And redundant contact points for low contact resistance, high reliability, and repetitive insertion.

The sockets are designed for automatic wire wrapping. And they're available in pin arrays from 8 to 40, including our new 20 pin configuration.

A lot of our other prices are low too.

We'd like to send you some free samples of our tin plated DIP sockets. We'll include literature and specs, of course. And just for good measure, we'll throw in our latest price list on everything we make. We think you'll find some surprises. Because a lot of our prices are lower than you think.

Just mail this coupon to Texas Instruments Incorporated, Attleboro, Massachusetts 02703. Or call Connector Systems Marketing, (617) 222-2800, Ext. 268 or 269. Reduced prices effective in U.S. and Canada only.

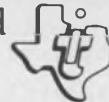

Texas Instruments Incorporated
Connector Systems Marketing
MS W-1, Attleboro, Mass. 02703

Name _____

Title _____

Company _____

Address _____

City _____

State _____ Zip _____

Please have a TI Field Engineer call

ED 12/76

TEXAS INSTRUMENTS
INCORPORATED

CIRCLE NUMBER 34

CORTRON IS WRITING THE SOLID STATE KEYBOARD SUCCESS STORY

A new name in keyboards, CORTRON actually has a history dating back to 1968, when Illinois Tool Works Inc. made news with the introduction of its first solid state keyboard through its Licon Division. ITW has emerged as a major producer of solid state keyboard products and has supplied thousands upon thousands of custom-designed keyboards to meet specific customer requirements.

CORTRON DIVISION FORMED BY ITW

With a strong market demand and a promising future for keyboard products, ITW formed a new division, CORTRON, to handle full responsibilities for electronic keyboards and key switches. Following a proven ITW strategy, CORTRON concentrates a special division team of experienced Licon design, manufacturing and marketing people on this new major business opportunity.

KEYBOARD MARKET DIVERSIFIED

Typical applications for CORTRON™ Keyboards include data and word processing, computerized accounting, production and inventory control systems, retail point-of-sale and remote banking terminals, airline reservation and seat assignment stations, typesetting and text editing systems. And new applications are continually surfacing.

PROVEN PRODUCT RELIABILITY

The CORTRON Division offers proven keyboard products with an

established reputation for excellence and reliability. The

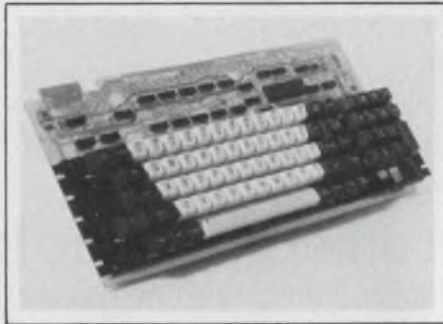

CORTRON Series 555 Solid State Keyboard is a sophisticated electronic device. Its high reliability protects against costly service calls and the hardship of downtime. The low profile alpha numeric keyboard has the human engineered "feel" required by your marketplace. This promotes speed, accuracy and greater operator productivity.

CORTRON KEY SWITCH MAKES THE DIFFERENCE

The CORTRON Contactless Key Switch is the heart of the solid state keyboard. The CORTRON

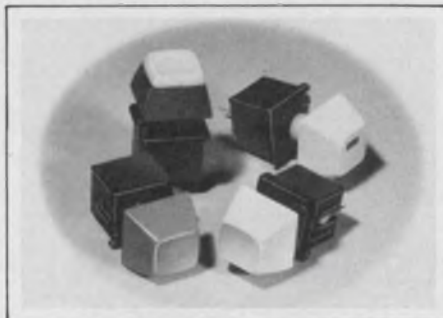

Key Switch is respected throughout the industry for its ultra reliable 100 million cycle life rating. Utilizing a ferrite core switching technology, the key switch is mechanically simple with only four basic parts.

CORTRON RESPONDS TO CUSTOMER NEEDS

Since keyboard products are CORTRON's only business, the ITW Division is highly responsive to individual customer needs and requirements. CORTRON offers expert application engineering assistance, and has the high volume keyboard production capability so essential to large customer demands. Further, the division is backed by the resources of ITW, a worldwide corporation. Whether you want to buy keyboards or build them, CORTRON can supply the key elements necessary to success. For complete details, contact CORTRON, A Division of Illinois Tool Works Inc., 6601 West Irving Park Road, Chicago, Illinois 60634. Phone: (312) 282-4040. TWX: 910-221-0275.

CORTRON is writing the solid state keyboard success story.

TO BE CONTINUED...



CORTRON

A DIVISION OF ILLINOIS TOOL WORKS INC.

**THE KEYBOARD
PROFESSIONALS**



The keyboard switch with a heart of gold

...keeps your product WORKING year after year...after year.

In your keyboard or ours, Cherry key switches just don't fail. The knife-edge contact area is so small (9 millionths of a square inch) ... the contact pressure so great (about 5,000 psi) ... the gold alloy so pure and film-free ... that you are assured of positive contact every time. For 50 million operations and beyond. (Which is probably beyond the life expectancy of your product!)

Cherry "heart of gold" keyboard switches are available individually or with two-shot molded keycaps. Hopefully, you want keycaps. Because, we *have* keycaps ... in more legends, sizes, type faces than you're likely to find anywhere else. Sculptured keycaps? We've got 'em. Gloss or matte finish? We've got *both*. Colors? Lighted? Specials? Sure! Some "off the shelf" ... all at prices that make it obvious why the *Cherry* way is the *economical* way to put a heart of gold in any keyboard.



For free test sample switch and catalog, just TWX 910-235-1572 ... or PHONE 312-689-7700.



CHERRY ELECTRICAL PRODUCTS CORP., 3609 Sunset Avenue, Waukegan, IL 60085

Starting μ P software: You can get going without front panels or extra hardware. The key lies in vector points residing in R/W memory.

You've put your microcomputer together and checked it out. You're ready to run programs. Or are you? Do you first have to build a front panel, backed by extensive starting hardware? You'd like to avoid that, of course.

You'd like to develop schemes to start the microcomputer without fuss. But you don't want to sacrifice flexibility, especially where software is frequently changed or where starting schemes must handle dedicated systems that also need flexibility.

In the 8080—the μ P that's finding widest use—the first page of memory, or the first 256 locations, contains some special locations that need defining (Table 1). In the following examples, assume the high address is always 000 (octal), unless otherwise noted.

One of the easiest ways to start software is to use read/write (R/W) memory, starting at location 0. A front panel is used to load a starting address and a Jump instruction. When the 8080 is reset, control then jumps to the start of any program anywhere in the available memory. This method is flexible since you can use the vectors at locations 10 to 70 if you wish. The use of R/W memory doesn't dedicate these points to a particular application.

It can be a bother, however, to use a front panel. And you can't assume that users will immediately understand how to get information into the computer with the switches and controls.

If you use a read-only-memory (ROM) or programmable-read-only-memory (PROM) for the first page of memory, the Jump instruction at locations 0, 1 and 2 will always point to the same place—a very useful feature if a Monitor, Bootstrap or Debug software routine is always resident in the computer.

Using ROM or PROM also means that before you program, you must decide upon some use for the vector addresses 10 to 70. Those addresses then become committed, and you can't help but lose some flexibility.

A useful variation of the ROM method permits the starting address to exist in PROM and the vector addresses to exist in R/W memory. How can this be possible? Just as you program the Start PROM to jump to the starting address of the Bootstrap, you also program the vector addresses to jump to free locations in R/W memory (Fig. 1).

Now whenever you reset the 8080, the system

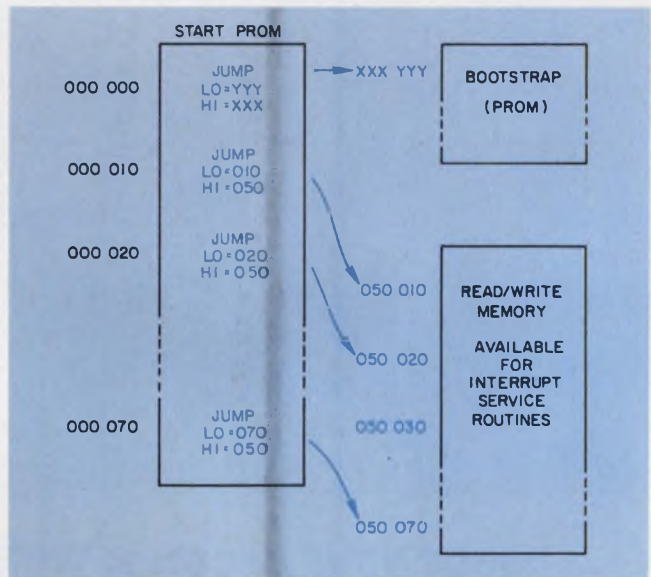

1. By using a PROM, you can jump to a Bootstrap routine or relocate the 8080's interrupt-service routine. The pre-empted position can hold a "start" program.

Table 1. 8080 locations available for start-up

Locations	Use
0	This is the RESET, or starting address. When the 8080 chip is reset, it executes the program that starts at location 000 000.
10, 20, 30 40, 50, 60 and 70	These are the RESTART instructions' vector points. They are the starting addresses of interrupt service routines. If interrupts or restart instructions aren't used, you can use these locations in any way you wish.

Jonathan A. Titus, President, Tychon Inc., P.O. Box 242, Blacksburg, VA 24060.

will immediately execute the Jump to the Bootstrap. If a vector or a restart instruction is to be used, the servicing software must be put at a high address of 050 and a low address corresponding to the low address of the vector point. This means that an interrupt—which will point the computer to 000 010—will be “jumped” to 050 010, where the necessary software resides in R/W memory. The jump is very useful when you use a Debug

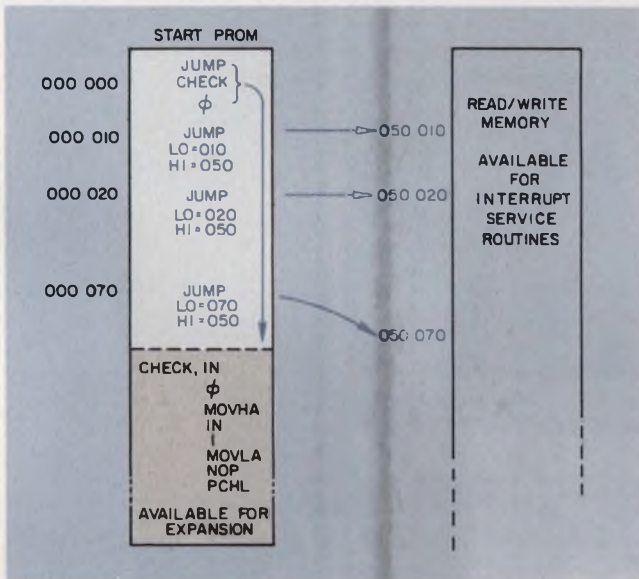

2. Starting addresses can be specified without a front panel. A Check routine placed in PROM uses input data as an address to which to jump.

Table 2. Routine to use input data to generate JUMP address

CHECK IN	INPUT HI ADDRESS BYTE FROM 000
MOV H,A	MOVE IT TO REGISTER H
IN	INPUT LO ADDRESS BYTE FROM 001
MOV L,A	MOVE IT TO REGISTER L
NOP	NO OPERATION
PCHL	MOVE H&L TO PROGRAM COUNTER & START EXECUTING FROM THAT ADDRESS

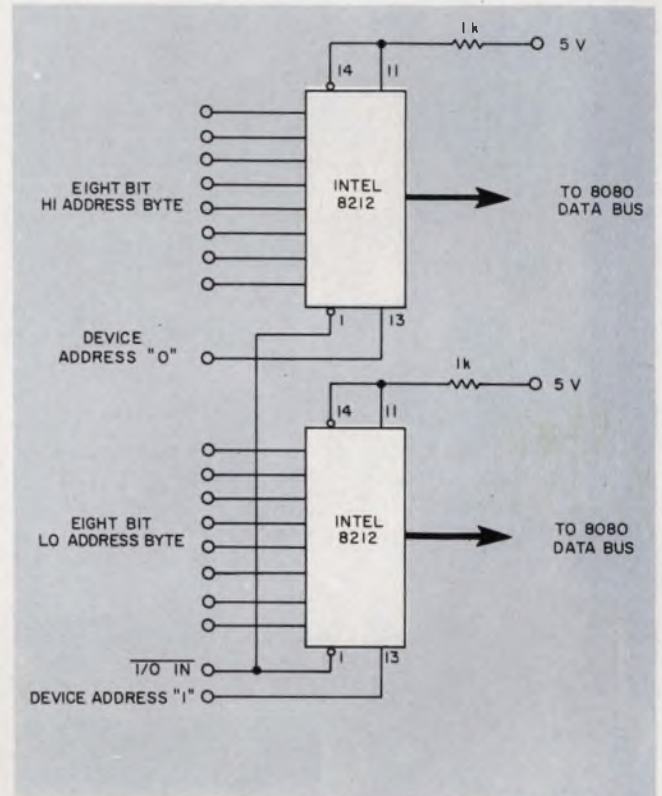

3. Software-controlled address input: Three-state devices are used at the input.

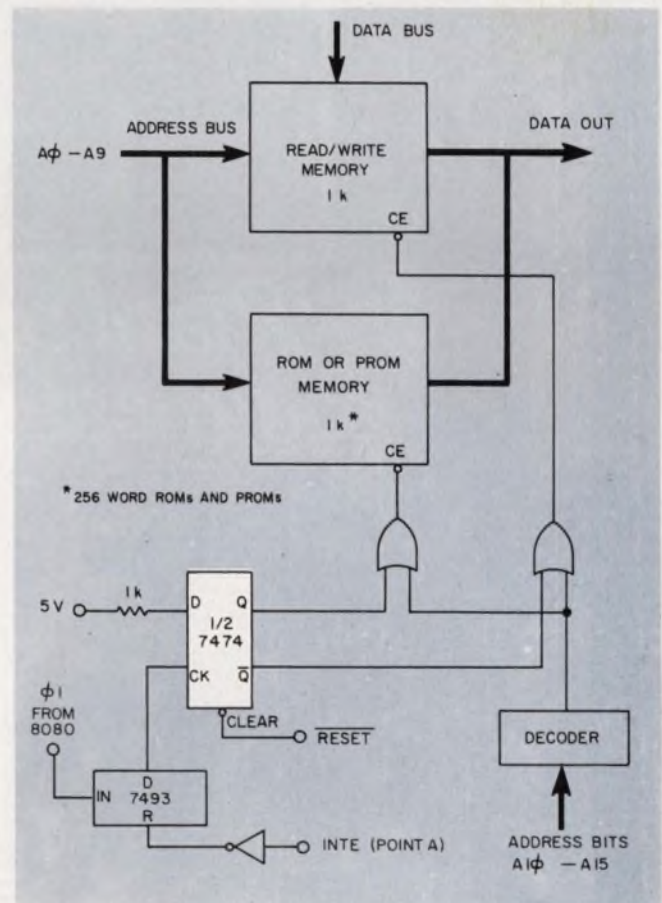

4. Software-switched memory can be used when all 256 initial locations are already committed. A flip-flop switches the chip enables.

Specifying custom pots for demanding applications was no bed of roses — until Duncan designers grew our New Breed of Hybrids. That's because they came up with a way to make hybrid versions of our entire line of precision pots — at very little extra cost! □ So if you need the precise linearity and low tempco of a wirewound pot *and* the infinite resolution and long life of conductive plastic, talk to Duncan now. With the industry's broadest line of hybrids, we're sure to have exactly what you're

looking for. □ We've got rotary, straight-line, and multi-turn types (including our famous 7/8" 10-turn Pixiepot®), with a huge variety of sizes—all available in either linear or non-linear functions. Standard specs like 0.1% output smoothness and ± 70 ppm/°C tempco — even better on special order. **All single and multi-turn Mil-R-39023 styles are QPL approved.** □ Duncan's New Breed is ready to solve

your toughest application problems now. We'd be happy to send you details.

Duncan's New Breed of Hybrids



*Plant one in your
toughest application.*

DUNCAN ELECTRONICS

SUBSIDIARY

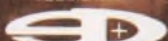
SYSTRON  DONNER

2865 FAIRVIEW ROAD, COSTA MESA, CALIFORNIA 92626

(714) 545-8261 • TWX: 910-595-1128

Actual photo of Hybrid Red Rovers
grown especially for this ad

package to test a system before production.

Although the Jump scheme preserves the flexibility of the vector points in R/W memory, you can have only one starting address at locations 0, 1 and 2 for each Start PROM. Of course, you can always work with a collection of PROMs with various starting addresses for various programs. But this is a waste, and switching the PROMs takes time.

Another method can be used to specify any starting address and still give the use of the vector points, but without a front panel. You still use a PROM to move the vector points to R/W memory with jumps. Instead of jumping from address 0 to the Bootstrap, you jump to a routine that delivers and uses the starting address in a jump instruction. Here, you simulate the front panel with thumbwheel or DIP switches (Fig. 2).

The Check routine is simple: it takes the data from two 8-bit input ports and uses the data as the address to which to jump (Table 2). The hardware for this method is also simple, as shown in Fig. 3. Besides the I/O decoding, only two 8212 I/O chips (Intel) are needed. This is a neat solution since you don't need a front panel, vectors are preserved in R/W memory, and any starting address can be specified.

Existing software may need modification since the actual locations of the interrupt or restart service software have been changed, in this case from 000 0X0 to 050 0X0. The Check routine could fit between locations 0 and 10, but remember, you have moved it elsewhere in PROM to leave room for expansion.

Flip-flop selects the right chip

In some systems, the first 256 memory locations are already committed. But you still would like a flexible starting method without having to change software. You can use software to "switch" back and forth between ROM and R/W memory. Set up a bank of ROM and R/W memory (1 kwords) with the same address, but use a flip-flop to switch the chip enables (Fig. 4).

The PROM in Fig. 4 contains the Check routine, and you add an enable interrupt (EI) in place of the NOP instruction. Use the interrupt enabled signal (INTE) to switch the flip-flop and the chip enable signals, but only after eight $\phi 1$ TTL clock pulses occur. The pulses are accumulated by a 7493 binary counter, which clocks one half of a 7474 flip-flop.

The time delay of eight clock pulses occurring after the interrupt is enabled allows you to operate on the PCHL instruction before switching memory banks. This example uses the interrupt-enable output from the 8080 chip but sometimes you may not want the interrupt enabled when starting execution of software. ■■

Dialight LEDs

The widest choice for your every application.

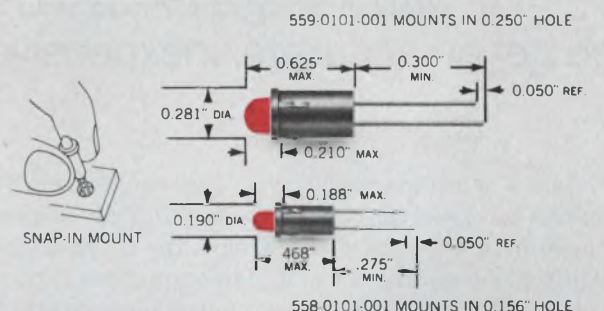

559-0101-001 MOUNTS IN 0.250" HOLE

558 and 559 SERIES Available in red, green or yellow LEDs, with and without integral current limiting resistors. Snap-in mounting requires no additional hardware. Straight terminals suited for wire-wrapping and/or soldering. Low power requirements—15 to 20mA. In 1000-lot quantities each

558-0101-001 . . \$33. 559-0101-001 . . \$33.

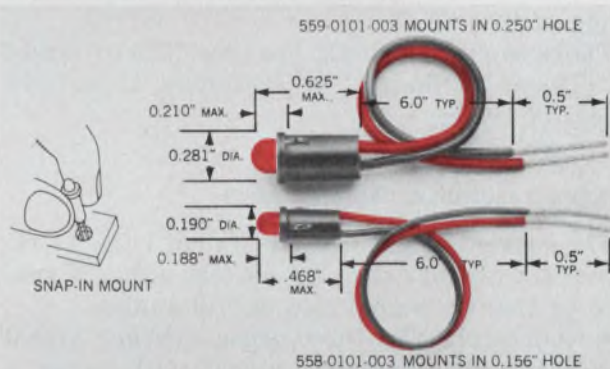

558-0101-003 MOUNTS IN 0.250" HOLE

558 and 559 SERIES Available with 6" wire leads, these red, green or yellow LEDs are designed for quick positive insertion in 0.031" to 0.062" panels. Compact design allows high density packaging. In 1000-lot quantities each

558-0101-003 . . \$75. 559-0101-003 . . \$71.



Dialight, the company with the widest choice in switches, LEDs, indicator lights and readouts, looks for needs . . . your needs . . . and then they develop solutions for your every application. No other company offers you one-stop shopping in all these product areas. And no other company has more experience in the visual display field. Dialight helps you do more with these products than any other company in the business, because we are specialists that have done more with them. Talk to the specialists at Dialight first. You won't have to talk to anyone else. Send for your free new copy of Dialight's current catalog.

DIALIGHT

Dialight, A North American Philips Company
203 Harrison Place, Brooklyn, N. Y. 11237
(212) 497-7600

See Dialight.

CIRCLE NUMBER 38

Convert all your synchro channels

to digital with a single μ P-based system. For low speeds, you get an accurate, inexpensive, efficient and small unit.

Using a microprocessor, you can convert eight synchro or resolver channels to digital angles with four-arc-minutes accuracy in a package roughly the same size as a single-channel converter system—with only a bit more power consumption and at nearly the same cost. For example, in a complete modular system, the MN7200 from Micro Networks, a microprocessor controls sequencing and performs data conversions. The result is a converter capable of handling up to eight synchro or resolver inputs, whose accuracy is guaranteed over the full operating temperature range of 0 to 70 C.

There is one drawback, however. The μ P-based instrument is limited to maximum transducer speeds of 10 deg/s.

Synchro/resolver converter basics

The conventional converter system (Fig. 1) requires six distinct steps to convert either a synchro or resolver signal into digital angles:

- Converting the three-phase synchro signal into a two-phase resolver signal with either a Scott-T transformer or op amps. One phase of the resolver signal is proportional to the angle's sine, and the other phase to the angle's cosine.

- Demodulating both these signals with respect to the synchro's ac reference signal with an ac/dc converter, to get dc levels proportional to the sine and cosine of the input angle.

- Detecting, from the dc signal, the quadrant or octant in which the input angle lies, and digitizing the angle. Table 1 shows the bit weights for a binary sequence of angles.

- Feeding the binary-angle information to an up-down counter.

- Multiplying the counter's output by the dc signals with two multiplying d/a converters—one for the sine signal and one for the cosine signal—to get two results: $\sin \theta \cos \phi$, and $\cos \theta \sin \phi$, where θ is the angle in the counter and ϕ the input angle.

Binary weights of angles in the coding method employed in the MN7200

Bit number	Degrees	Degrees, minutes	Radians
1	180	180 0	3.141593
2	90	90 0	1.570796
3	45	45 0	0.785398
4	22.5	22 30	0.392699
5	11.25	11 15	0.196349
6	5.625	5 37.5	0.098175
7	2.8125	2 48.75	0.049087
8	1.40625	1 24.38	0.024544
9	0.70312	0 42.19	0.012272
10	0.35156	0 21.09	0.006136
11	0.17578	0 10.55	0.003068
12	0.08789	0 5.27	0.001534
13	0.04395	0 2.64	0.000767
14	0.02197	0 1.32	0.000383
15	0.01099	0 0.66	0.000192
16	0.00549	0 0.33	0.000096

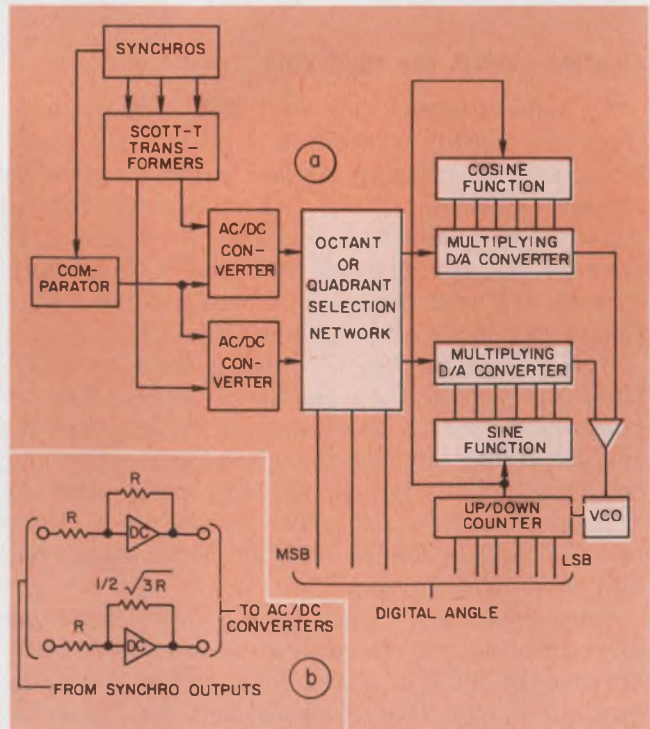

1. Conventional multichannel converters (a) use many linear components. You can replace the Scott-T transformer with an electronic Scott-T converter (b).

Arthur Berg, Project Engineer, Micro Networks, Worcester, MA 01606.

▪ Subtracting, in an op amp, to get the difference between the two converter outputs, and adjusting the frequency of a gated voltage-controlled oscillator (VCO) with the result. The VCO's output pulses the up-down counter to the correct digital angle—the digital equivalent of nulling in an analog system. When the counter contains the exact input angle, the subtraction result is zero, and the process is complete.

The disadvantages inherent in this six-step process are obvious. Too much circuitry is re-

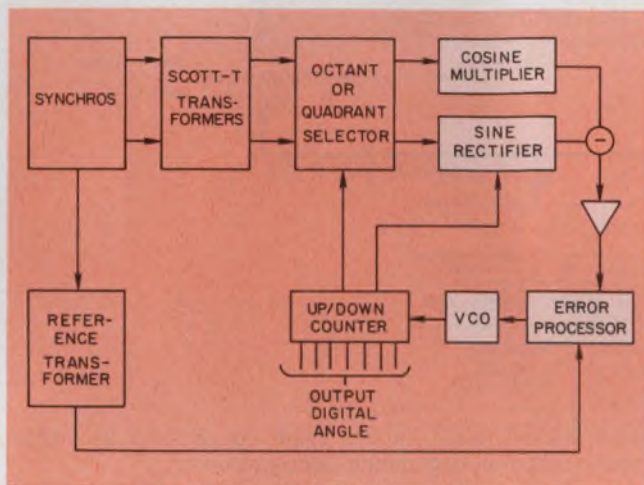

2. The popular tracking converters are accurate but limited to converting only a few channels. Successive-approximation sampling converters are useful for converting several channels in a multiplexed system, but have serious accuracy problems.

quired, principally for quadrant or octant selection and angle determination, and analog signals are carried too far—right up to the final counter.

Now there are three

The new μP technique competes with two other methods for converting synchro and resolver signals to digital angle data that, hitherto, have been used. These older types are the tracking converter and the successive-approximation sampling converter.

The tracking converter (Fig. 2) is noted for its high accuracy even with noisy signals. Noise cancels out because of ratio rather than amplitude detection. But, even though some recently available s/d and r/d tracking converters have improved operating speeds, most tracking converters can't track a synchro or resolver rotating at more than four rev/s. On the other hand, the successive-approximation sampling converter, although a higher-speed circuit than the tracking converter, becomes inaccurate with noise or distortion.

Tracking converters are used primarily when a limited number of channels is to be converted ac-

curately, and sampling converters when six or more multiplexed channels are to be converted at high speed.

The third method for s/d conversion, the microprocessor-based system, as used in the MN7200 is intended for multichannel applications. Accuracy (even in the presence of noise), low cost, small size and low power consumption make the μP -based system attractive for many applications, in spite of its low speed.

The new circuit (Fig. 3) is made up of eight dual ac/dc converters, a 16-channel data-acquisition system, and a microprocessor.

The microprocessor, a Fairchild Semiconductor F8, is a two-chip unit that consists of the CPU, and the Program Storage Unit (PSU). Besides being μP -based, the MN7200 circuitry differs from conventional s/d and r/d circuits because it has a minimum number of custom-linear circuits and, thus, is cheaper. Octant selection (0 to 45 degrees) is performed digitally with the microprocessor. And the hybrid circuits used, such as the ac/dc demodulators, multiplexers, and a/d converters are all standard products.

The system converts eight resolver (or with the addition of Scott-T transformers, synchro) channels into 14-bit digital form.

Multiplexing the inputs

While conventional multichannel converters typically require an a/d for each channel, only a single a/d is used in this circuit: It accepts up to eight pairs of sequential inputs from the multiplexer.

Synchro outputs from the Scott-T transformers or resolver outputs V_x ac and V_y ac are converted to dc voltages V_x and V_y by two ac/dc demodulators—one each for sine and cosine (Fig. 3). A multiplexer connects these dc signals sequentially—one per conversion period (approximately 2 ms)—to the a/d converter that converts them into the binary signals X and Y. After conversion, the binary X and Y signals are stored in RAM. The microprocessor then executes the conversion equation,

$$\theta = \tan^{-1} \frac{Y}{X},$$

and the result is placed on the output-data lines and stored in RAM. Up to 8 channels are thus converted and stored in 16 RAM locations. A conversion cycle takes 2 ms.

A fetch cycle takes 50 μs from the time the data-output line is triggered. The system has two externally controlled channel-selection modes. In the sequential mode, a counter is incremented after each channel is converted. In the random mode, each channel may be selected by the channel-select inputs and triggered by the load line.

The circuit differs from conventional s/d and

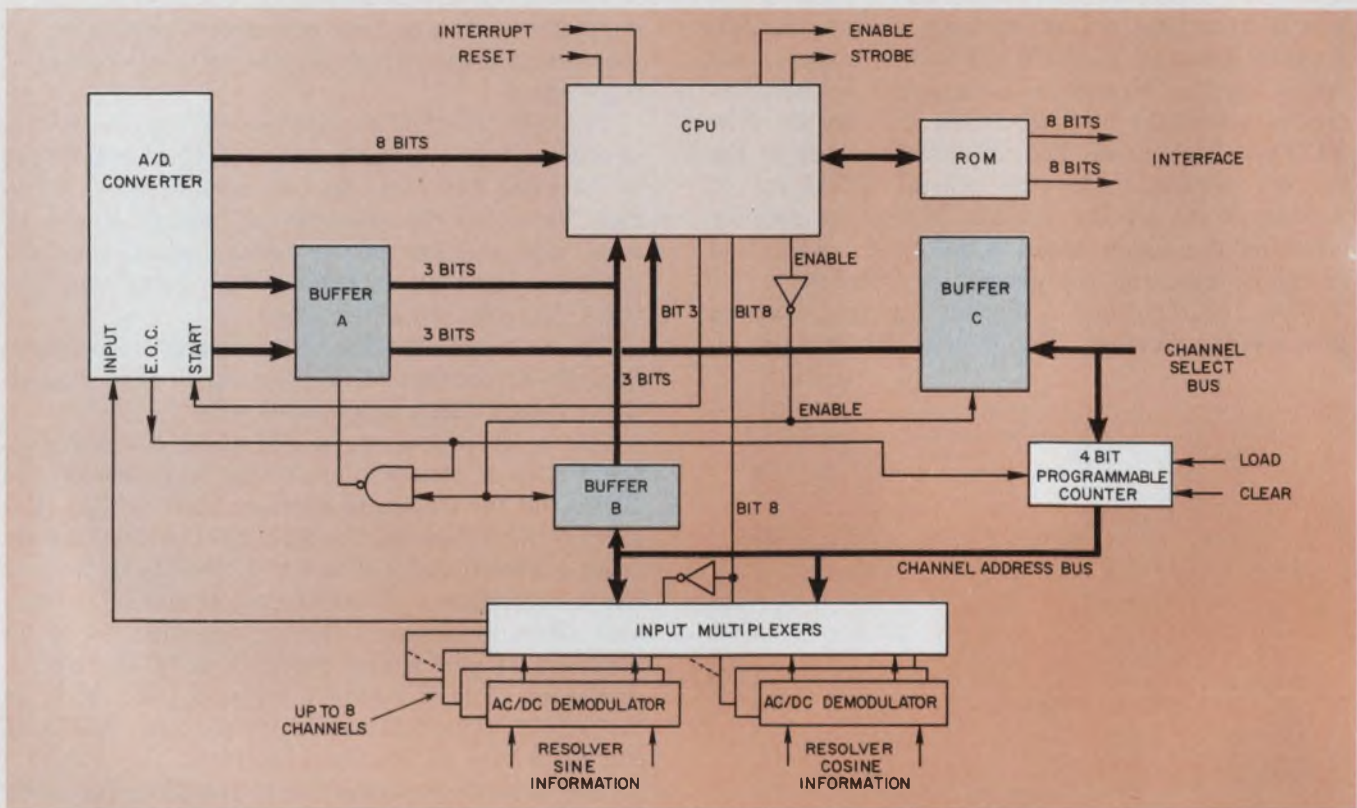

3. The MN7200 resolver-to-digital converter circuit differs from conventional ones in that it allows for low-cost

multichannel (eight, in this case) conversions in a compact, low-power-dissipating configuration.

r/d converters in that all its data are converted to digital form at the input a/d converters, whereas much of the information in conventional designs remains subject to error in analog form, right up to the final digital counter.

This arrangement allows simple interfacing with either 16-bit minicomputers or 8-bit microcomputers.

Canceling nonlinearities

The 12-bit a/d converter in the circuit (Fig. 3) performs both sine-proportional and cosine-proportional signal conversions, so errors caused by using separate a/d's are eliminated. By ratioing, the microprocessor eliminates the potential error source due to amplitude changes of the sine or cosine-input signals.

After the synchro or resolver angle is computed, the microprocessor system stores the resulting 14-bit word in the registers of the PSU's two I/O ports, until the word is replaced by a new result.

Two data I/O ports connect the 12-bit a/d converter's output and the microprocessor's CPU. Two 8-bit ports deliver 12 bits to the CPU in 2 bytes. One port inputs eight bits, the other only four.

The 4-bit programmable counter, which addresses the input multiplexers sequentially, is connected to the channel-select bus to receive direct-set inputs from an external channel-selector circuit. The 3-bit, channel-address bus links the input multiplexers to the programmable counter and the CPU via buffer B.

With buffer A on and buffers B and C off, a/d data goes to the CPU. With buffers A & C off and B on, the address of the channel being converted is sent to the CPU. When operating in the interrupt or data-fetch modes with C on and A and B off, an external address can be sent to the CPU to address the memory for data.

It all starts with reset input

In addition to the data bus that links the PSU and the CPU, two other 8-bit I/O ports are used as a single 14-bit output port, with all eight bits active in one and only six active in the other.

Operation begins when a reset input initializes the CPU. The system is clocked by bit 7 of the CPU's I/O port, which drives the start input of the a/d. The a/d then outputs EOC (end of clock), which drives the programmable address counter. Bit 8 enables the input multiplexers to pass the channel addressed by the programmable counter. In all, 6 bits are used for data entry to the CPU.

The multiplexer's sine inputs are enabled by bit 8. Its complement, bit 8, enables the cosine inputs so only one set of inputs, either sine or cosine, is active at a given time.

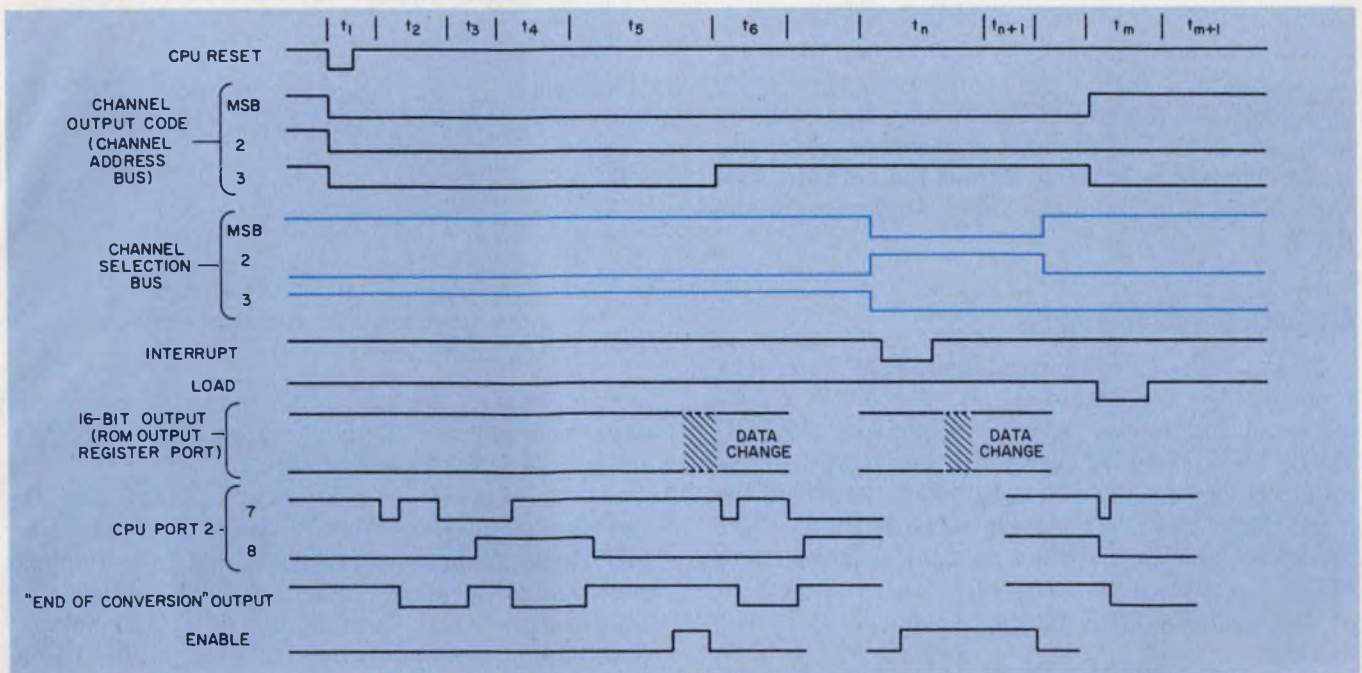

4. The converter's six timing states are repeated as it cycles through each of eight channels. For fewer than

eight channels, the last active channel is followed by channel 0 and the sequence repeats.

The CPU's enable-output line indicates that an interrupt signal has been received or data are changing. Normally, this line (low) disables buffers B and C. Buffer A is enabled after the a/d conversion is finished (EOC high). (An enabled buffer A permits data transfer from the a/d converter to the microprocessor's CPU.)

After an interrupt signal, the enable goes high, which activates buffers B and C and disables buffer A. The interrupt stops the normal operation of the microprocessor and requests that stored data from the addressed channel be transferred to the output lines.

The reset line to the CPU resets the program counter in the PSU. The load line allows the programmable counter to be set to the channel chosen by the channel-select data bus. The clear line resets the programmable counter.

Look at the timing diagram

Operation starts at t_1 with a pulse on the CPU's reset line (and the programmable counter's clear line). This pulse clears both the program counter in the ROM and the programmable counter to ZERO (see Fig. 4). The ROM's program counter is started by CPU clock signals. The channel-select line is still inactive, and all three bits on the channel-address bus are ZEROS.

The sine input of channel 0 then passes from its dedicated demodulator through the input multiplexer into the a/d converter.

At t_2 , the a/d converter's start line and the programmable counter's clock line are pulsed, which starts conversion in the a/d converter and

blocks buffer stage A. During t_2 , the EOC line clocks the programmable counter, but does not change the address to the multiplexers. This line changes only the LSB, which is not on the channel-address bus.

When the counter first accesses a channel, the address LSB is always ZERO. The multiplexer, therefore, always samples the selected channel's sine input first. The LSB is then toggled to a ONE, and the cosine input sampled. The LSB is then retoggled to ZERO. This time the 3-bit address is incremented, which accesses the next channel, starting with its sine input.

Also during t_2 , the PSU's internal timer is set for a time interval slightly longer than the conversion time needed by the a/d. This timer stops the program counter in the CPU and restarts it at the end of the preset time interval. Meanwhile, the a/d converter completes its conversion cycle, and the EOC enables buffer A.

The a/d converter's 12 bits are routed in two parts—eight bits through data-port 1, and four bits through data-port 2. The first bit (MSB) indicates signal polarity. The remaining three bits are amplitude data and are stored in RAM by a program in ROM.

At t_3 , bit 8 changes state, which both disables the sine multiplexer and enables the cosine multiplexer.

At t_4 , conversion starts in the a/d and the EOC output blocks buffer stage A. The multiplexer connects the dc analog of the cosine input to the a/d converter, and an all-ZERO address is again connected to the multiplexer. The ROM's internal timer starts again, and the a/d converts the

cosine analog of input-channel 0 to digital form. At the conversion's end, EOC reverses the state of the buffers so that the cosine is at the CPU's I/O ports. At the end of the timer's interval, the program is restarted, and the cosine goes into RAM. Therefore, after t_1 , values for both the sine and cosine of a channel's input angle are in the RAM.

A branch point can occur

Next, the μP computes the angle (answer) from its sine and cosine values. The MSBs of the sine and the answer are the same. For a ZERO MSB, the answer is between 0 and 180 degrees, and here the program has a branch point. If the sine's MSB is ZERO (sine positive), the cosine's MSB becomes the answer's next bit. For the sine's MSB, a ONE (sine negative), the complement of the cosine's MSB is the second MSB in the answer.

The answer's third MSB is determined by subtracting the sine's 11 amplitude bits from the cosine's. A positive result makes the third MSB a ONE, a negative result ZERO.

Now the μP can divide the larger 11-bit number into the smaller to get the angle's tangent. The ROM contains a tangent-to-angle table. To minimize the size of this table, only 64 values and the slopes to the next value are provided for the tangent function. Therefore, only the tangent's six MSBs are used to address the table; the remaining five bits are multiplied by the slope.

The final answer is the sum of two values; the first an 11-bit word that the tangent's six MSBs fetch from ROM. The second summed value is the product of the five remaining bits multiplied by a slope value that is also accessed by the six MSBs.

The enable line is held high to indicate changing output data. Buffers B and C are enabled, buffer A is disabled. The channel address, along with the program's instructions, select a pair of RAM addresses in which to store the 14-bit answer. The 14-bit answer also remains at the ROM's output register port.

At t_2 , the programmable counter is clocked, which changes the second LSB of the three-bit address. The multiplexers pass to the next channel. The a/d converter starts, which begins the sequence for the next input channel. This process continues until the digital angles for all inputs are in storage, when the CPU's main program counter and the programmable counter are zeroed and started over again. Words stored in RAM are replaced by updated words as new information is processed and received.

The digital-angle data are in binary-angle form rather than in degrees. The MSB indicates which half-circle the angle is in, the next MSB indicates

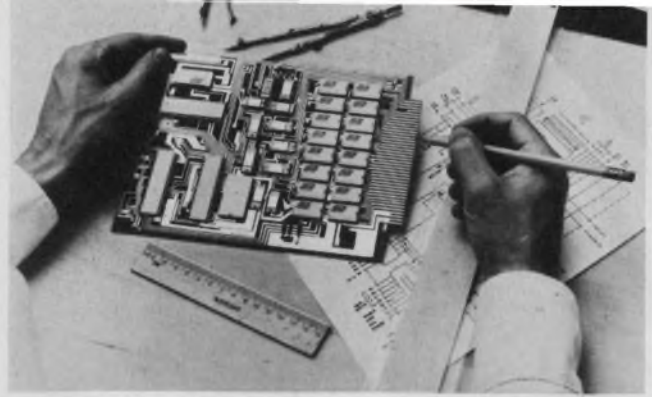

5. The entire μP -based r/d converter consists of 32 DIPs on a 6 x 8-in. board.

which quarter, the next MSB indicates which octant, and so on. Code conversion, say, to binary or degrees is easily added here.

At t_3 (Fig. 4), an interrupt signal inhibits buffer A, enables buffers B and C, and stops the ROM's program counter. The three bits that are now manually entered onto the channel-select bus address the RAM through buffer C and port 2. This 3-bit code addresses one of eight 14-bit angles in the RAM. The addressed angle appears at the ROM's output-register port. At the end of the interrupt, the main program counter picks up again, and the program continues from where it was interrupted.

At t_4 , a load signal jams the address on the channel-select bus into the programmable counter. The CPU's reset line then resets the CPU and clears the main program counter to ZERO. The program then picks up by using the channel selected on the channel-select bus as the first channel, and proceeds in sequence thereafter.

Interrupt, therefore, provides the latest stored data for a selected channel, while load and reset cause new data to be processed starting with the selected channel.

The Scott-T transformers and ac/dc demodulators in the input circuit are conventional components. So are the IC multiplexers. The 12-bit a/d converter needs only a parallel output, something available in a variety of commercial components. Three-state buffers A, B, and C are merely used as on-off switches in the data paths to permit time-sharing of the CPU I/O ports. While the programmable counter is shown in Fig. 3 as a 4-bit unit, a 3-bit unit is adequate. The fourth bit is used to divide by 2, thereby maintaining the same channel address as the sine and cosine input multiplexers are successively enabled.

In the two-chip F8 microprocessor, one chip houses the CPU (including the control logic for RAM and ALU) and clock-generating circuitry, and the other chip, the PSU, houses the ROM. For a description of the F8 μP see "Microprocessor Basics, Part 3" (ED, No. 12, June 7, 1976, p. 126). A look-up table, for converting the tangent function to angular data, is burned into the microprocessor's nonvolatile ROM. ■■

Burndy's GTH™ connectors deliver good-as-gold reliability at a fraction of the cost.

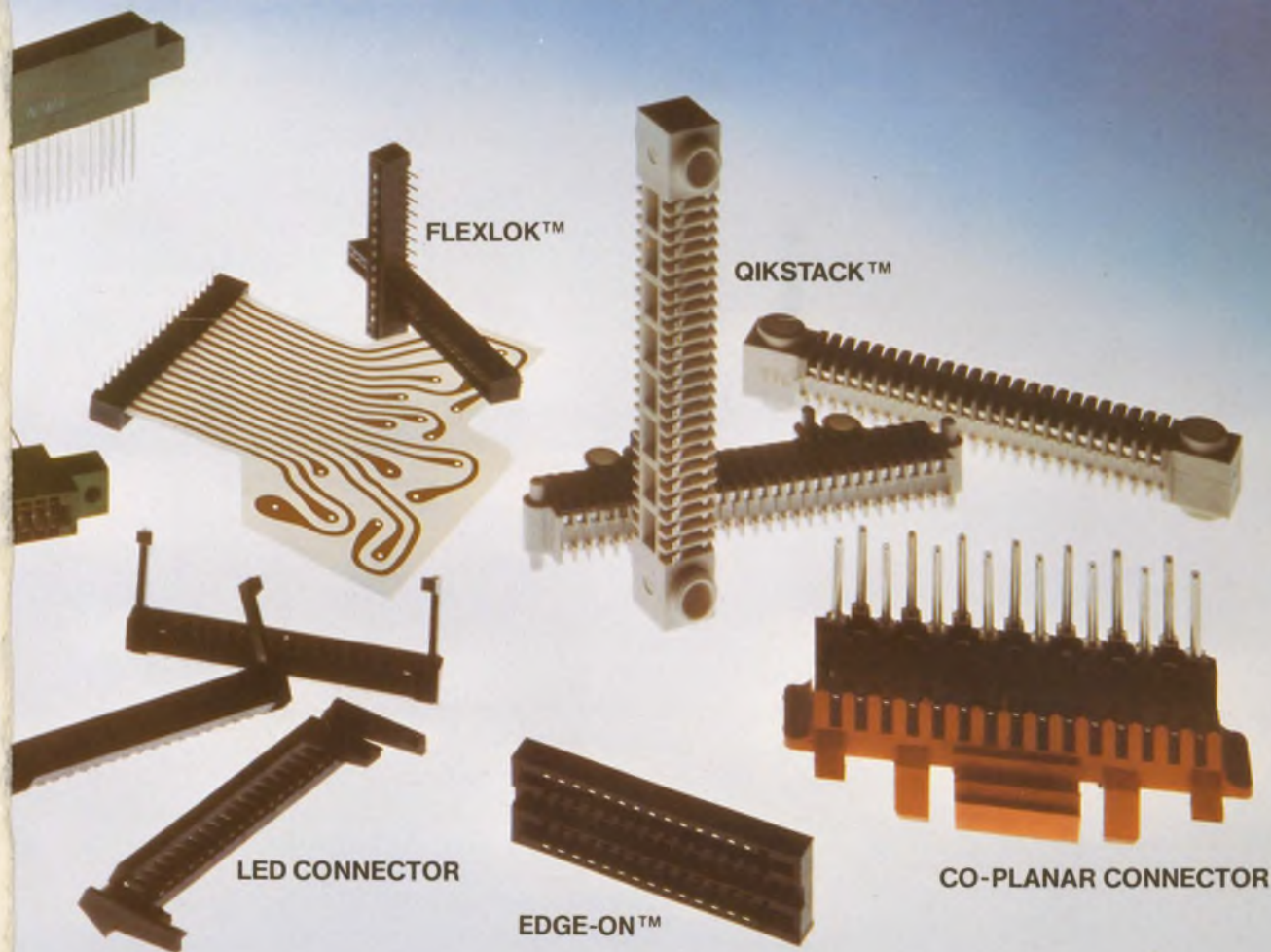

FIELD PROOF



For high reliability and economy, GTH QIKSTACK connectors are used in Honeywell's new Series 60, Level 6 minicomputer.

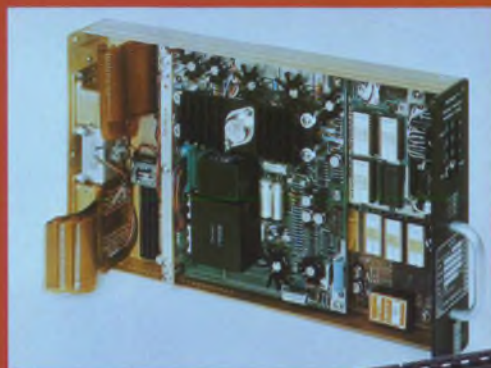

For design flexibility and reliability, GTH FLEXLOK connectors are used by Aero Products Division of Litton Industries in the DIGIPROX™ ground proximity warning system.



For closer packaging density and high reliability, the GTH chassis Co-Planar connectors are used in Quasar's remote control television.

With Burndy GTH connectors, you enjoy the performance characteristics of gold—without suffering its high cost. If that's too hard to believe, just study the performance comparison chart.

The secret behind the amazing performance of GTH is the use of high pressure plastic deformation to achieve a gas-tight, corrosion-free contact, and a contact geometry that provides an ingenious mechanical interlock to insure good metal-to-metal contact despite vibration or thermal expansion.

Burndy GTH contacts not only eliminate the need for gold in the connector, they eliminate gold in the mating component as well. You save both ways—without sacrificing performance or reliability.

Here's

Burndy's exclusive GTH gas-tight, corrosion-free

High-pressure plastic deformation forms gas-tight, corrosion-free contact without the use of gold.

ADVANTAGES OF GTH CONNECTIONS

- **Low cost, high reliability:** Helps you cut interconnection costs up to 33% and more—without sacrificing reliability.
- **Interchangeability:** May be used with existing gold, tin or solder-plated components with no loss in reliability.
- **Design Flexibility:** Compact design for close packaging densities, simplified handling, installation and field serviceability.
- **Ease of Installation:** Requires no special tooling or operator training. Installs like any ordinary connector.

Unbelievable? Send for more proof. Simply check the convenient Quick Response Card and we'll send you documented test data.

proof!

concept insures high-pressure, contact without the use of gold.

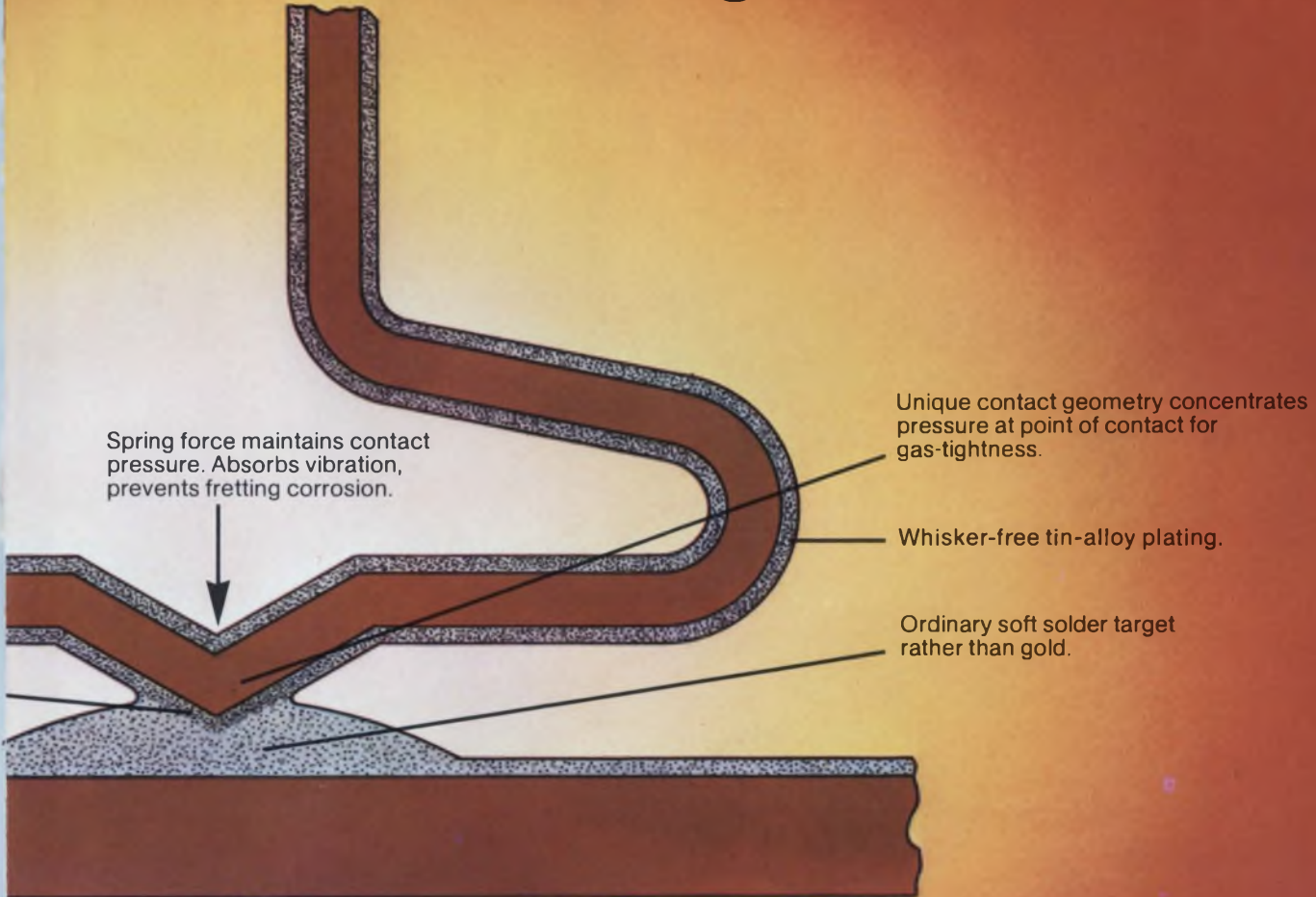

LABORATORY PROOF

TYPICAL CONTACT RESISTANCE VALUES (Milliohms)

After Environmental Test, at Dry Circuit Levels
(Range of Values Within 99.9% Confidence Level)

Environmental Test	GTH Contacts	Conventional Geometry Contacts			
	Tin-Alloy Plate	15 Microinch Gold Flash	30 Microinch Gold Plate	50-100 Microinch Gold Plate	Tin or Tin-Alloy Plate
Initial	4.0 - 6.0	4.5 - 13.3	4.5 - 8.6	4.4 - 8.3	4.1 - 12.0
Thermal Shock	4.0 - 8.6	6.0 - 15.0	5.0 - 8.0	5.2 - 7.2	6.0 - 15.0
Humidity	4.5 - 7.0	10.1 - 31.8	5.0 - 9.0	4.9 - 8.8	5.3 - 75.1
Industrial Atmosphere	4.0 - 6.0	10.9 - 20.3	5.0 - 20.0	5.0 - 13.0	28.7 Open Circuit
Gas Tightness	4.0 - 6.5	Not Applicable	Not Applicable	Not Applicable	4.0 Open Circuit
Thermal Cycling	4.0 - 7.0	8.5 - 15.5	5.0 - 10	4.6 - 9.0	4.0 Open Circuit
Durability	4.0 - 5.5 100 cycles	10.1 - 12.2 100 cycles	5.0 - 9.0 100 cycles	5.3 - 9.3 500 cycles	13.9 - 57.9 100 cycles
Vibration	4.0 - 5.5 5-500-5 Hz	9.0 - 15.0 10-55-10 Hz	4.0 - 8.0 10-2000-10 Hz	5.3 - 9.3 10-2000-10 Hz	4.0 - 15.0 10-55-10 Hz

IMMUNITY TO FRETTING CORROSION

Relative Lifetimes Under Accelerated Fretting Conditions
Without Lubrication

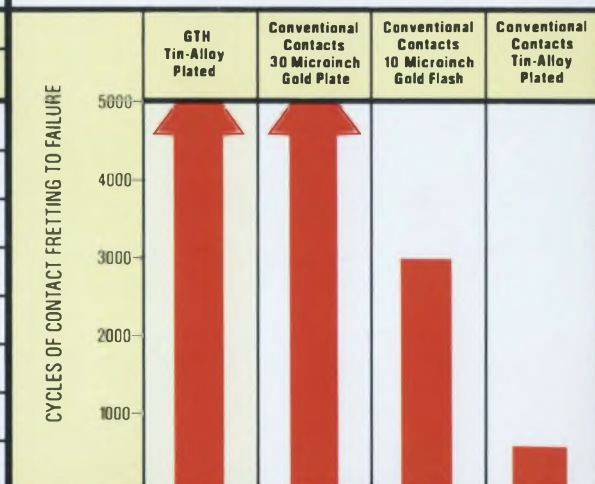

Burndy GTH connectors: Your golden opportunity to cut connector costs up to 33%.

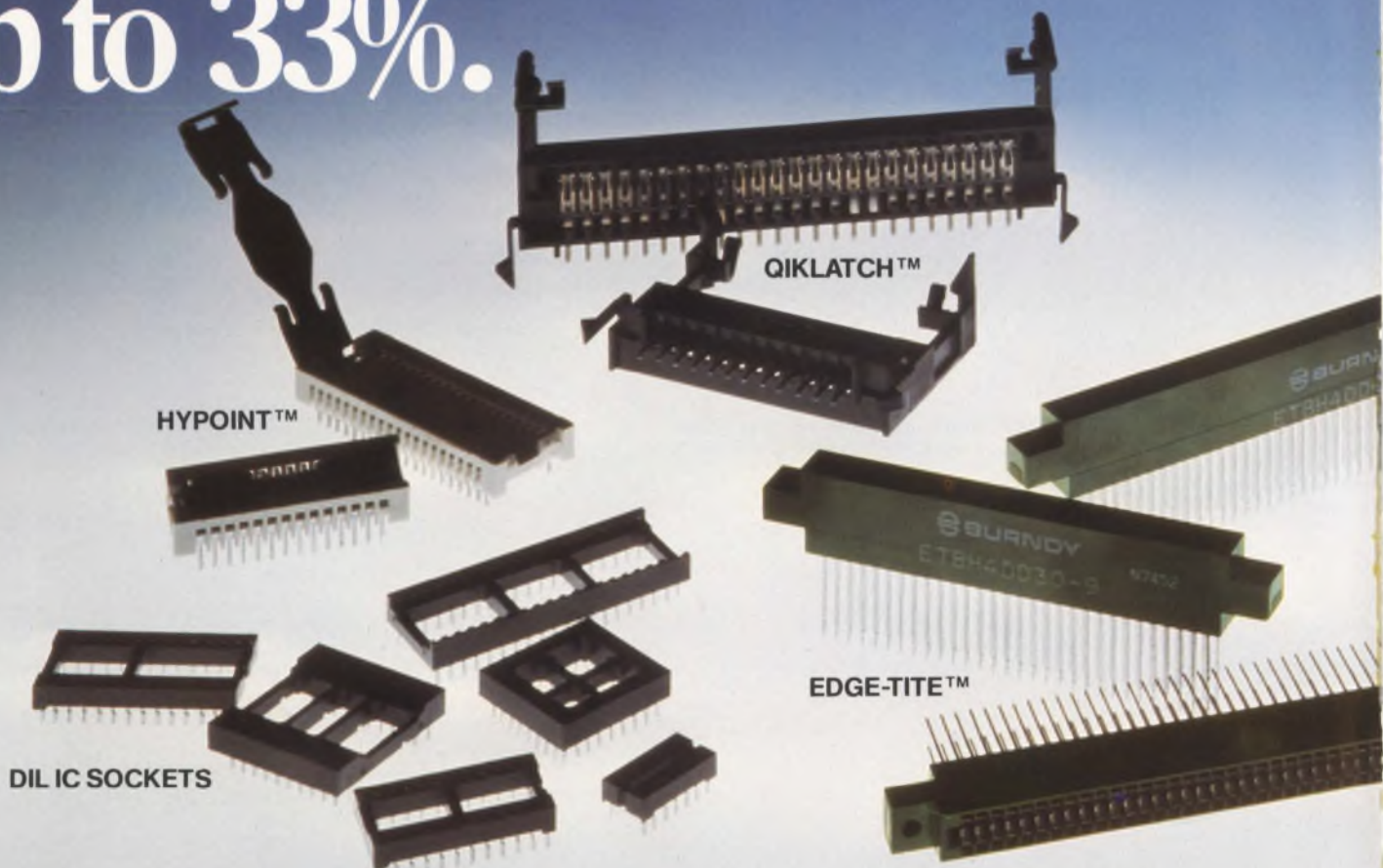

Burndy GTH connectors are available in all types of designs for all types of applications. All of them are currently being used to help control connector costs by some of the best known names in the electronics field. Names like Quasar Electronics, Litton Industries, Honeywell, National Semiconductor, Dictaphone, and Wang Laboratories to name just a few. Use the convenient Quick Response card for more information on how GTH can help you keep your competitive edge. We'll send you data that's worth its weight in gold.

QIKLATCH™ zero-entry Mother/Daughter PC connectors in sizes from 8 through 24 positions on .156" centers.

EDGE-TITE™ PC connectors in sizes from 10 through 50 positions on .100" centers.

QIKSTACK™ feed-thru connector. Board-to-board spacing from .250" to .625". Up to 30 contact positions.

EDGE-ON™ board-to-board receptacle. Up to 15 positions on .100" centers.

DIL IC SOCKETS for leaded packages, in sizes from 8 through 42 positions.

LED CONNECTOR board-mounted PC receptacle in a wide range of sizes and viewing angles on .100" centers.

FLEXLOK™ connectors for flexible circuitry and flat conductors in sizes from 6 through 21 positions on .100" centers.

CO-PLANAR solderless-wrap chassis connector in 15 positions on .156" centers.

HYPOINT™ leadless IC receptacles in sizes from 24 through 48 positions.

 **BURNDY**
Norwalk, Connecticut 06856

Now from IR the power people...

97 new High Energy Epi Base Power Transistors built to last!

We see no reason why power transistors shouldn't live longer.

That is why we're introducing 97 high energy, epi base power transistors and Darlington's, rated 40 to 140 Volts V_{CE0} sus, and to 170 Volts V_{CEX} sus, using the same tough, hard-glass passivation as our high voltage line.

Hard glass passivation reduces high temperature leakage current to just 1/10 that of others. You benefit from our years of development of glass passivation processing, by getting the added high temperature stability for nothing. We've learned, as a successful manufacturer of power semiconductors for nearly 30 years, that extra quality is good for both of us in the long run.

These new transistors have higher switching speeds, and lower V_{CE} saturation levels than single diffused types, plus a wide safe operating area. They also have high gains at 150°C junction temperature.

Delivery is off the shelf. Contact your nearest IR Salesman for price, spec sheets and samples, or write to: International Rectifier, 233 Kansas St., El Segundo, CA 90245, (213) 322-3331.

97 Types Now Available from IR

VOLTS	PNP	NPN	VOLTS	PNP	NPN
5 AMPERES			12 AMPERES		
100V	2N6226	2N5758	60V	2N6050*	2N6057*
120V	2N6227	2N5759	80V	2N6051*	2N6058*
140V	2N6228	2N5760	100V	2N6052*	2N6059*
8 AMPERES			15 AMPERES		
60V	2N6053*	2N6055*	40V	2N6469	2N6470
	1R900*	1R1000*	60V	2N5879	2N3055
80V	2N6054*	2N6056*		2N6246	2N5881
	1R901*	2N6534*			2N6471
		1R1001*	80V	2N5880	2N5882
100V		2N6535*		2N6247	2N6472
		2N6536*	100V	2N6029	2N5629
120V		2N6537*	120V	2N6030	2N5630
10 AMPERES					1R3773
40V		2N6383*	140V	2N6031	1R6302
60V	2N3789	2N3713			2N5631
	2N5791	2N5715	20 AMPERES		
	2N5875	2N5877	60V	2N5745	1R3772
	1R2500*	2N6384*		2N6285*	2N6282*
	1R645*	1R1010*	80V	2N6286*	2N5303
		1R1020*			2N6283*
		1R3000*	100V	2N6287*	2N6284*
		1R640*	25 AMPERES		
80V	2N3790	2N3714	60V	2N5883	2N5885
	2N3792	2N3716	80V	2N5884	2N5886
	2N5876	2N5878	30 AMPERES		
	1R2501*	2N6385*	40V	2N4398	1R3771
	1R646*	1R3001*			2N5301
		1R641*	60V	2N4399	2N5302
100V	2N6229	2N5632*	90V	1R4502	1R802
	2N6248	1R642*			
	1R647*				
120V	2N6230	2N5633			
140V	2N6231	2N5634			

*Darlington

International Rectifier

... the innovative semiconductor people



IMSAI PRESENTS THE INTELLIGENT BREADBOARD SYSTEM

IMSAI, one of the world's largest manufacturers of microcomputer

systems—the high-performance IMSAI 8080, has achieved another breakthrough—The IMSAI Intelligent Breadboard System.

What you can do with the IMSAI Intelligent Breadboard is enough to qualify you and your IMSAI 8080 computer as a microprocessor R&D department.

Our Intelligent Breadboard is a complete system for development of discrete logic circuits and microprocessor

software circuits. It connects directly to the IMSAI 8080, communicating with the 8080's bus and 48 TTL level I/O lines.

Use the Intelligent Breadboard to implement circuits in hardware and transfer them to software in a step-by-step fashion. Because the computer and Intelligent Breadboard communicate, hardware-software tradeoffs may be studied and new circuit designs tested extensively. It is a flexible, easy-to-use instructional tool ready to serve your development ideas under conditions of total control.

Circuits can be built using the bus logic

of the 8080 while remaining outside the computer chassis. Think of that for ease of construction and analysis!

There are dozens of uses for this new and unique laboratory tool. Examples:

- As a learning tool to teach replacement of discrete devices in digital logic circuits with microprocessors and computer software.

- A sophisticated classroom laboratory for logic design courses.

- To simulate hardware circuits in software.

- To develop new I/O interfaces and memory systems that connect directly to, yet are physically outside, the computer. And much, much more.

Best news of all, pricewise the IMSAI Intelligent Breadboard, like the IMSAI 8080, is as affordable as it is useful: \$435 kit; \$625 assembled. Immediate delivery. Call or write for a complete illustrated brochure describing the IMSAI 8080, options, peripherals, software, prices and specifications, plus everything you want to know about the IMSAI Intelligent Breadboard.

Call for the name of your nearest IMSAI dealer. Why not the very best? Dealer inquiries invited.



IMSAI

IMS Associates, Inc.

14860 Wicks Blvd., San Leandro, CA. 94577 • (415) 483-2093 • TWX 910-366-7287

SWAP MEET

CUSTOM "SWAP" CHIP ADVANTAGES

1

Reduced IC's per system

2

Savings on IC direct material costs

3

Savings on PCB's and hardware

4

Full compatibility with DTL, TTL, and CMOS

5

Simplified inventory control, procurement, documentation, system check-out, and repair

6

Savings on system power supplies

7

Better system reliability

8

Reduced manufacturing costs

Now you can trade in your SSI and MSI circuits for all these custom I²L "SWAP" chip advantages!

Now with "SWAP"—Stewart Warner Array Programming—you can have all these custom chip benefits without paying the usual custom chip penalties. No large tooling costs and huge entry fees. No gigantic production order requirements. No long waits for

deliveries. For as low as \$1800, you have delivery of your first custom I²L "SWAP" prototypes in four weeks.

"SWAP" is the major price breakthrough in custom logic circuits that makes it easy for you to take that first step. To climb aboard the bandwagon

with your buddies in the industry, all you need is \$25. That buys you your new SWAP Kit including the Design Manual, vellum work sheets, and 15 sample I²L devices illustrating some of the functional blocks that can be used in a SWAP design. Send for yours!

Okay, here's my \$25.00 (or P.O. No. _____). Rush me my I²L SWAP Design Kit.

I need more information, please have a representative call me.

Tell me about your standard off-the-shelf DTL, TTL, and CMOS circuits. (We have these in stock.)



SYMBOL OF
STEWART-WARNER MICROCIRCUITS DIVISION
STEWART-WARNER CORPORATION
730 E. Evelyn Ave • Sunnyvale, Ca 94086 • (408) 245 9200

Name _____

Company _____

Phone _____

Address _____

City _____ State _____ Zip _____

CIRCLE NUMBER 41

Inexpensive digital storage media:

Cassettes, discs and cartridges all have advantages. Let the application decide which one does your job.

Because computer costs have plunged, the pressure is on to reduce the cost of storage. Fortunately, cartridges, cassettes and diskettes all offer inexpensive mass memory with unique capabilities.

Each of these storage media comes with trade-offs. For example, cassettes and cartridges both store much more data than diskettes, but diskettes provide the quickest access time. Then there are other things to consider, such as media cost per byte, drive cost and reliability.

A specific application, with its special considerations, calls for a specific data-storage medium. But before a cassette, cartridge or diskette can be selected over the other two, the advantages and disadvantages of each must be examined.

Cassette technology is mature

The cassette is the oldest of the three storage media, and recording standards such as ANSI, ECMA and ISO are widely accepted. The cassette stores a large amount of data (1 to 5 megabits), yet is economical (\$6 to \$10).

The package is easiest of the three to handle, store and mail because it is small and rugged. So, it is often used in hostile environments, including airborne and other remote data-collection applications.

The drive mechanism for the cassette is smaller than a diskette drive and about the same size as the quarter-inch-cartridge drive. The cassette drive requires no standby power, and operates on dc, unlike the diskette drive.

While providing some protection for the tape against the environment, the cassette's plastic case does limit performance. The access speed for data is limited because of the more complicated servos required for tension control and the mechanical limitations in the roller and guidance systems. These prevent the tape from being spooled past the head too quickly. Moreover, the case contains more parts than a diskette, so the cas-

sette tends to be less reliable.

The mini-cassette, an offshoot, is smaller and lower in cost than the standard cassette and requires a lower-powered drive, but provides less storage capacity. About one-third the size of a standard cassette, the mini holds approximately 20% of the data.

The diskette is still evolving

Diskettes represent the newest technology and, as such, are still being improved. Their strongest advantage over the others is that data may be accessed in under a second. The diskette is easy to file because it is flat, and smaller than an 8-1/2- \times -11-inch piece of paper.

Recently developed diskettes have increased storage capacity, lower cost and smaller size. The increased capacity comes from recording on both diskette surfaces, doubling the bit-recording density and increasing the track density. Heads on both sides of the disc drive, as with the IBM Diskette 2, lower the access period.

The disc drive and controller are larger and more complex than the cassette's or cartridge's. Lower cost single-chip controllers are becoming available to make the disc drive more competitive with the others.

Lower disc-drive cost and even smaller size are a feature of the mini-diskette drives announced by Shugart and GSI. These are roughly the size of typical cassette drives and cost approximately the same. Other manufacturers plan to join this market soon.

The quarter-inch cartridge packs a lot of data

The quarter-inch cartridge has four times the storage capacity of the cassette and comes in a more rugged case.

The cartridge housing protects the tape better than the cassette because it has a tape-head access door that is held closed until the cartridge is inserted into the drive. This door prevents contaminants from reaching the tape when the cartridge is outside the drive. The cassette housing, in contrast, has one side open across its front

A. Bruce Manildi, Vice President of Engineering and Quality Assurance, Information Terminals Corp., 323 Soquel Way, Sunnyvale, CA 94086.

that always exposes the tape (unless it is stored in its box).

When data must be located on tape, the strong cartridge housing allows the tape to be pulled past its recording head faster than the tape in a cassette drive. The cartridge uses an aluminum

Storage formats: IBM dictates

The first group of high-density, low-cost media was 1/2 in.-wide tape disc packs and disc cartridges introduced by IBM for its own computers. Because IBM has such a large share of the computer market, those media were practically guaranteed popularity.

The need developed for media that carried less data, but cost less. The cassette, pioneered by Philips for audio recording, was initially adapted eight years ago for digital use and became quite popular without IBM's help.

However, nagging reliability problems cropped up. So 3M developed the 1/4-in. cartridge. This holds more data, and costs less per stored bit than the cartridge. However, since it is a completely new format, not second-sourced until recently, and not adopted by IBM before its 5100 minicomputer, it has not been as widely accepted as the cassette.

Meanwhile, IBM introduced the reliable diskette technology, which stored and transferred data as quickly as the cartridge.

plate with steel shafts for the rotating elements that allow a 90-in./s search speed.

The cartridge drive can be made more cheaply than a cassette drive because only one drive motor need be used, with the belt inside the cartridge providing tape tensioning. A cassette drive requires at least two motors; one each for the take-up and supply reels, and one more if a capstan drive is used.

Recently introduced cartridges pack increased bit density (6400 bit/in. and higher); more than previous cartridges.

The quarter-inch cartridge costs two to three times as much as a cassette or diskettes. However, the cartridge's cost per byte is lower than theirs because it stores considerably more.

While the mini-cartridge drive is smaller and cheaper than its full-sized parent, that cost advantage must be weighed against the mini-cartridge's higher cost per byte.

In general, a designer must be careful when comparing the cost per byte of different magnetic media. The number of bytes actually stored on the media in a particular application, not its maximum storage capacity determines the cost per byte. Only when the maximum storage capacity is used is the vendor-quoted cost per byte a minimum value.

Table 1 shows costs, capacities, transfer rates and access times of some magnetic and, for comparison purposes, paper-storage media.

Word processors require rugged media

One of the most demanding uses of storage is in word-processing systems. The storage medium must be easy to store and load into its drive, since few operators are experienced with computer-controlled devices.

Searching for data when editing requires rapid accessibility. The operator asks the word processor to find a certain word or block of data and tells it to relocate these data. Then new words and paragraphs are added and reorganized.

With cassettes, two drives are almost mandatory so that new data can be merged, and old data rearranged by taking the old data set from one drive, modifying and adding to it, then recording the new data set on the second drive.

The diskette offers two advantages: Both new and old data sets can be contained on the same diskette, and data can be accessed faster than on other media (less than 1 s). A cassette requires considerably longer searching time—from several seconds to more than a minute. However, the diskette might be less desirable than a cassette if more data must be stored (20 pages) than the diskette can handle.

Data transfer rates to and from storage are not so important in a word-processing system. The keyboard data-entry rate runs less than 15 char/s, even for high-speed bursts. The data from the media go to a CRT (maximum speed 1200 baud) or to a low-speed printer (30 to 120 characters per second). Any of the three storage devices can handle these speeds.

Since word processing is done typically in an office environment, controller size and power requirements are not so important, either.

Data acquisition requires all three types

Data acquisition covers a considerable number of different applications, from remote, automatic data acquisition to key-data entry. Since these

Table 1. A comparison of low cost recording media

Media type	Cost/byte (cents)	Typical unit capacities (byte) Note 1	Typical transfer rates (Byte/s)	Average access time (s)
Typing paper (One page, single spaced)	0.0005	2,000	15	300
Punched card (80 columns at 600 card/min)	0.001	80	800	150 Note 2
Punched paper tape (1000 ft reel or Z fold)	0.003	120,000	30 to 120	500
Magnetic card	0.008	5,000	200	10
Cassette (incremental format, 290 ft)	0.0021	360,000	3,600	20 to 100
Cassette (blocked format, 290 ft)	0.0014	540,000	3,600	20 to 100
Mini-cassette (blocked format, 50 ft)	0.006	64,000	200	150 to 320
Flexible disc (77 tracks, one side) (two sides)	0.002 0.0014	240,000 480,000	31,250	0.45
1/4-in. cartridge (blocked format, 300 ft)	0.0009	2,160,000	6,000	20 to 60
Mini-cartridge (blocked format, 150 ft, 2 tracks)	0.0055	270,000	4,000	15

Note 1. One Byte = 8 bits

Note 2. Selecting one character out of 3000 cards

applications require data to be stored and read out sequentially, random-access media are not required. Any of the different types will do.

The standard-sized cassettes lend themselves to applications requiring large storage capacity and remote automatic data collection in environmental conditions more stringent than other media can handle. Such applications include sonobuoy recorders, power-line monitors, legal stenotype recording, and traffic counters.

For portable applications like warehousing, forestry, and other field applications, the small, low-powered mini-cassette has the advantage. The drive requires less than 1 W when operating and no power when standing by. The data-storage requirements are low, and many days' worth of information can be collected on a single mini-cassette.

For very large storage capacity, the cartridge should be used. However, the environmental extremes must not exceed the device's range of use.

In automatic data-collection systems requiring high data-transfer rates, either the cartridge or

Table 2. Some manufacturers of magnetic recording media

Manufacturer and address	media
Athana Incorporated 2730 Monterey St. Torrance, CA 90501	diskettes
BASF Systems Crosby Dr., Bedford, MA 01730	cassettes, diskettes
Data Packaging Corp. 205 Broadway, Cambridge, MA 02139	cassettes
Dysan 2388 Walsh Ave., Santa Clara, CA 95050	diskettes
Eastman Kodak Co. 343 State St., Rochester, NY 14650	diskettes
Fuji Photo Film Empire State Bldg., New York, NY 10001	cassettes
IBM Corp. Industrial Products Marketing, 201 E. 42 St., New York, NY 10017	diskettes
Information Terminals Corp. 323 Soquel Way, Sunnyvale, CA 94086	1/4-in. cartridges cassettes, diskettes
K/Tronic 3260 Scott Blvd., Santa Clara, CA 95050	cassette, diskettes
Kybe Corp. 132 Calvary St., Waltham, MA 02154	cassettes
3M Co. St. Paul, MN 55101	1/4-in. cartridges, cassettes, diskettes
Maxell Corp. of America 130 W. Commercial Ave., Moonachie, NJ 07074	cassettes, diskettes
Memorex Corp. Santa Clara, CA 95052	diskettes
TDK Electronics Tokyo, Japan	cassettes

the diskette suffices. The choice depends on the required access period.

Storage media for minicomputers vary widely

Cassettes, cartridges and diskettes may be applied in small business and scientific systems using minicomputers. Cassettes and cartridges should be used for on-line storage of large volumes of data (equivalent to 1/2-in. tape on large systems). Because the cartridge can store more than the cassette, most of its capacity should be used for the lowest cost per byte of stored data. The cartridge should be even better if a 9-track version becomes available and a standard computer interface is developed.

The diskette is best for manipulating on-line data and updating small files, if the required storage capacity isn't too high. ■■

Inherently rugged, these triple-diffused devices permit circuit operation directly from rectified 117V or 220V line—eliminating transformers. Ideally suited for inverters, converters, switching regulators, motor controls and wherever there's hi-rel applications. The exploded view demonstrates our single chip design and packaging

TYPE #	(pk.) I _c	V _{CE}	h _{FE} @ I _c	Switching Speed (Typ.)
PT-3512	70A	325	10 @ 30A	t _r = .5 μs
PT-3513	70A	400	10 @ 30A	t _s = 1.2 μs
PT-3522	90A	325	10 @ 50A	t _r = .5 μs
PT-3523	90A	400	10 @ 50A	
350 Watt Power Rating		Guaranteed SOAR		

concept which makes high-voltage, high-current transistors off-the-shelf availability possible. Pre-rating and pre-testing techniques of chip allows choice of solid copper packages. For further information

and application assistance, call Sales Engineering, PowerTech, Inc., 0-02 Fair Lawn Ave., Fair Lawn, N.J. 07410; Tel. (201) 791-5050.

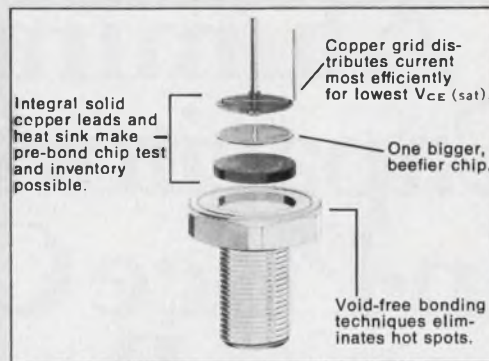

PowerTech, Inc.

"BIG IDEAS IN
BIG POWER"

400v90 AMP



NPN Silicon
Power Transistor
Switch — Highest KVA
at lower cost,
weight & space.

New Sangamo Type 300 Aluminum Electrolytic Capacitors Slash Space and In-Place Cost in Switching Regulator PC Boards.

Now you can specify economical Sangamo Type 300 Premium-Grade Aluminum Electrolytic Capacitors for printed circuit board mounting in switching regulator power supplies and other applications from 10 to 100 kHz.

Type 300 Capacitors give you low ESR, low inductance, high capacitance and long life—in a unique package that dramatically reduces size, weight and in-place cost.

The basic unit has three radial leads arranged in an isosceles triangle. Just plug in and wave-solder. No fumbling. No reversing. No screw terminals. You can even parallel them.

Or choose the Type 301 with two radial leads. Or the



Sangamo Type 300 Capacitors (actual size)

horizontal Type 301A with the dummy lead on the bottom for rigid mounting without using a strap.

If you're now using stacked foil, four-terminal or wet tantalum capacitors, look into the new, economical alternatives—Sangamo Type 300 Aluminum Electrolytic Capacitors.

Write for specs and engineering samples. Sangamo Capacitor Division, Box 128, Pickens, SC 29671; phone: (803) 878-6311; TWX: 810-397-2496; Telex: 57-0441.

Type 300 Capacitors Electrical/Mechanical Specifications

Capacitance Range	130 uF to 16,500 uF
ESR Values at 10 kHz	From .012 ohms
Impedance Value at 100 kHz	From .015 ohms
Typical Inductance	12 to 15 nanohenries
Max. Ripple Current Capability at 10 kHz*	15.9 amps at 65°C; 11.6 amps at 85°C
Operating Temperature Range	-55°C to +105°C
Voltages Available	6.3 to 100 VDC
Nominal Case Sizes	.750" x 1.625" (19.05 mm x 41.27 mm) to 1.000" x 3.625" (25.40 mm x 92.08 mm)

*For high ripple current applications, units may be installed in parallel.

SANGAMO WESTON
Schlumberger

Power supplies.

The HE200 Series Power Supplies offer the design engineer a low-cost, highly efficient alternative to the size, weight and heat generation problems normally associated with series-pass regulated supplies. Using state-of-the-art switching techniques and CMOS logic, the HE200 Series Supplies achieve 75% efficiency at full load.

All models in the HE200 Series have the "footprint" and mounting dimensions of the Lambda package size "B" supplies...a feature that allows the engineer to experiment with high-efficiency techniques in existing designs. In new designs, the engineer can take advantage of

the small size (1.2 watts per cubic inch) and light weight ($\frac{1}{2}$ ounce per watt) of the HE200 Series Supplies.

The highly reliable HE200 Series Supplies are all short-circuit proof, over-voltage protected, available in 115 and 230 VAC input models, and backed by a full two-year warranty.

Finally, the HE200 Series offers the design engineer considerable savings: 5 volts, 10 amps for \$195; 5 volts, 20 amps for \$295; and ± 15 volts, 1.5 amps for \$195 in single quantities.

 **Computer Products, inc.**

Distributors: Los Angeles 213-877-5518/
Dallas: 214-341-8311 - Houston: 713-780-2220

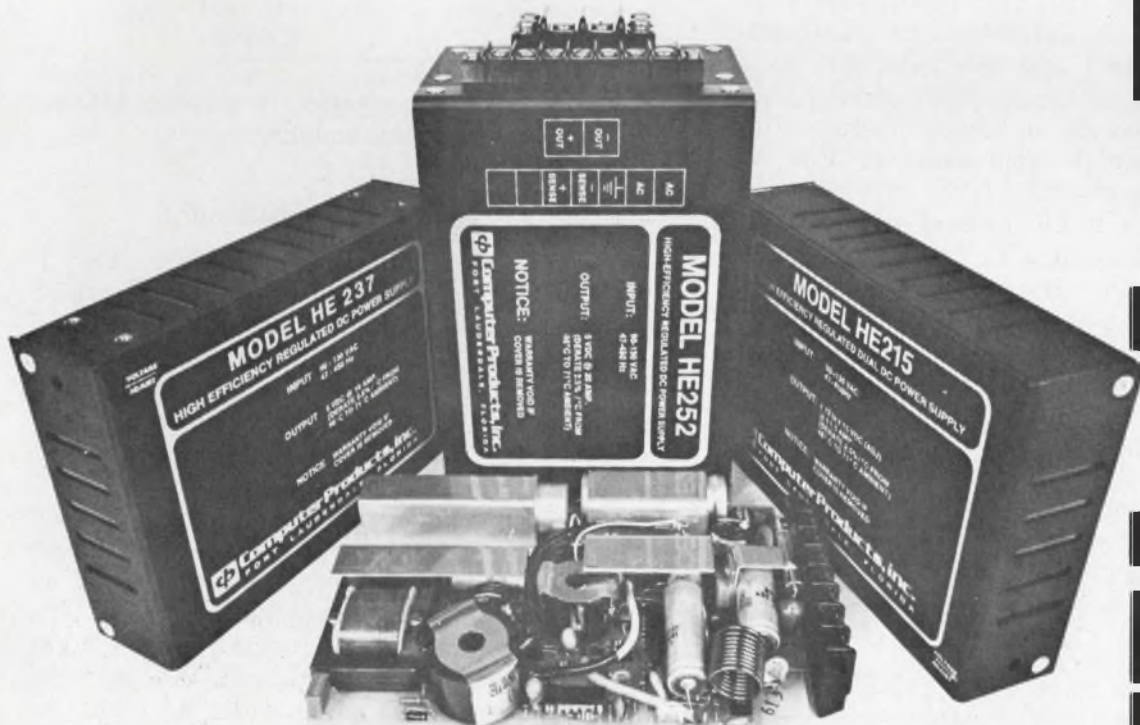

1400 N.W. 70th Street, Fort Lauderdale, Florida 33309 (305) 974-5500, TWX (510) 956-9895

CIRCLE NUMBER 44

High-Efficiency

Speed up your linear circuits with broadband op amps. They're fast, inexpensive, efficient and available as quads—but you can't ignore stability.

Broadbanded op amps are a good choice to meet the speed, price, size and power restrictions you face when designing today's analog systems. Broadbands can improve multiple op-amp filters and, with compensation, can operate as fast unity-gain inverters or voltage followers.

But you can't use them like the 741, with its built-in, 65-degree phase margin: broadbands can oscillate. Fortunately, however, broadbanded op amps can be compensated without too much difficulty.

Unity-gain-stable op amps have been the workhorses in active filters. But while the best of those produced by the new integrated circuit technology are low low-priced, their speeds are only medium-range, and their power dissipation prevents dense packaging. Therefore, look to the broadbanded op amps now available in quad packages for your new linear systems.

What is a broadbanded op-amp?

A broadbanded op amp is a general-purpose operational amplifier with a lower-than-optimum internal-compensation capacitance. Its gain-bandwidth product (GBW) and slew rate (Sr) have been increased, but at the expense of unity-gain stability (the device can no longer operate with its output and negative input shorted). For example, take an op amp with a GBW of 4 MHz and Sr of 10 V/μs and a 10-pF internal compensation capacitor (C_c). Decreasing C_c by a factor of 5 increases the device's GBW and Sr by the same factor—and creates a new, fast op amp (GBW = 20 MHz Sr=50 V/μs), which is the broadbanded version of the original amplifier. This new device will tolerate a maximum feedback factor of 0.2 (i.e., minimum inverting gain of 4 or noninverting gain of 5).

Broadbanding neither increases the op amp's power consumption nor degrades any of its dc characteristics. Stability is traded for more speed. The open-loop gain is described as follows:

$$A(s) \approx \frac{g_m}{sC_c} = \frac{\text{GBW}}{s}$$

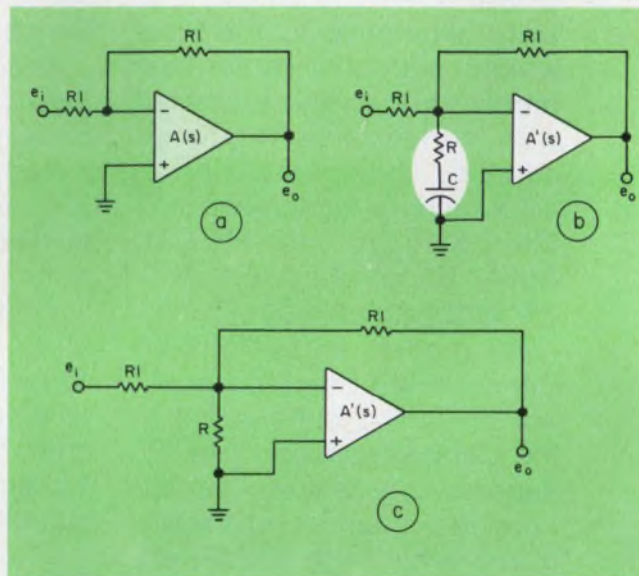

1. The basic inverter using unity-gain-stable op amps needs no external compensation (a). Inverters using broadbanded op amps (b) can be stabilized with an R-C circuit across the device's inputs. Broadbanded inverters (c) can be compensated with a resistor, $R = 0.33R_1$.

for the unity-gain stable circuit, and

$$A'(s) \approx \frac{g_m}{s(0.2C_c)} = \frac{5 \text{ GBW}}{s},$$

for the broadbanded version. In these equations, g_m is the op amps' transconductance.¹

Can unity-gain inverters be broadband?

Three op-amp inverters are shown in Fig. 1. Two use broadbanded op amps while the third circuit (Fig. 1a) uses an internally stabilized op amp.

Fig. 1a shows the well-known inverter using an op amp that is stable at unity gain. This basic inverter's characteristics are described in the first column of Fig. 2.

Fig. 3b shows the circuit for a broadbanded inverter using R-C compensation at the op amp's input. In this diagram, A is the conventional op amp, while A' is its broadbanded version. The R-C network across the A' inputs provides high-frequency compensation (Fig. 2). At low frequencies, it has a high impedance. At high frequencies, where the op amp loses gain and develops phase shift, capacitor C acts as a short-circuit so that a voltage is developed across R.

Nello Sevastopoulos, Senior Linear Applications Engineer, National Semiconductor, 2900 Semiconductor Dr., Santa Clara, CA 95051.

	Basic inverter	Broadbanded inverter with RC compensation	Broadbanded inverter with single R compensation
Closed loop gain = e_o/e_i	$\frac{1}{1 + 2/A}$ $\approx (1 - 2/A)$ (Note 1, 3)	$\frac{1}{1 + 0.4/A}$ $\approx (1 - 0.4/A)$ (Note 1, 2, 3)	$\frac{1}{1 + 1/A}$ $\approx (1 - 1/A)$ (Note 1, 3)
Output offset voltage	$2 V_{os}$ (in)	$2 V_{os}$ (in)	$5 V_{os}$ (in)
Slew rate	Sr	5 Sr	5 Sr
Power bandwidth	PBW	5 PBW	5 PBW
Gain bandwidth	GBW/2	GBW	GBW
Input Z	$\approx R_1$	$\approx R_1$	$\approx R_1$
Output noise	$2 \times e_n$ (in)	$2 e_n$ (in) for $f < 10 f_{lead}$ and $5 e_n$ (in) for $f > f_{lead}$	$5 \times e_n$ (in)

Note 1: The approximation holds for frequencies where A is much greater than 2.

Note 2: True for frequencies less than $0.1 f_{lead}$. For frequencies above f_{lead} the closed-loop gain expression is identical to the gain using R-compensation.

Note 3: A, the open loop gain, is a complex number. So when computing the closed loop gain error (at a particular frequency) take the absolute value of

$$\frac{e_o}{e_{in}} \text{ i.e. } \left| \frac{e_o}{e_{in}} \right| \text{ or } \left| \frac{1}{1 + 2/A} \right|$$

2. A comparison of three inverter circuits, one using unity-gain-stable op amps, the other two using broadbanded op amps compensated by either R-C or R methods, shows that the broadbands increase speed (GBW, PBW and Sr) with hardly any sacrifice of dc characteristics. But noise and offset voltage are increased somewhat.

The closed-loop gain is greater than unity, so the circuit is stable. The feedback factor of the circuit is

$$\beta = 0.5 \frac{1 + sRC}{1 + sC(R + 0.5 R_1)}$$

β has a phase lag of 45° at the frequency:

$$f_{lag} = \frac{1}{2\pi(R + 0.5 R_1)C}$$

The frequency at which β shows a phase lead of 45° is given in this equation:

$$f_{lead} = \frac{1}{2\pi RC}$$

To choose the values of R and C, simply set f_{lead} equal to the frequency where the device starts showing excessive phase shift—that is, a decade before its gain becomes unity. At this frequency, the impedance between the two inputs must equal $0.33 R_1$ to ensure a feedback factor

of 0.2. In other words:

$$\left[R^2 + \left(\frac{1}{2\pi C f_{lead}} \right)^2 \right]^{1/2} = \frac{R_1}{3}$$

This implies that:

$$R = \frac{R_1}{4.24}$$

$$C = \frac{2.12}{\pi R_1 f_{lead}} \text{ and}$$

$$f_{lag} = 0.32 f_{lead}$$

Using the broadbanded op amp whose GBW is 20 MHz, set f_{lead} equal to 2 MHz and R_1 equal to 10 k Ω . These yield: $R = 2.35$ k Ω , $C = 33$ pF.

An alternate compensation method uses only a resistor between the op-amp's inputs. Set this resistor equal to $0.33 R_1$, as shown in Fig. 1c. The pertinent characteristics of compensated broadbanded inverters (Figs. 1b and 1c) are compared to those of the classical unity-gain-stable inverter (Fig. 1a) in Fig. 2. As you can see, an R-C network improves the inverter's speed without degrading its dc characteristics.

Can broadbanding make followers fast?

A broadbanded op amp, compensated as shown in Fig. 3b, works as a unity-gain voltage follower. The lead-lag input compensation keeps the circuit stable. By the same reasoning as for the inverter circuit:

$$R = \frac{R_f + R_s}{5.6}$$

$$C = \frac{2.8}{\pi(R_f + R_s)} \times \frac{1}{f_{lead}}, \text{ and}$$

$$f_{lag} = 0.15 f_{lead}$$

For example, if $R_s = 51 \Omega$,

$$R_f = 10 \text{ k}\Omega,$$

$$\text{and } f_{lead} = 2 \text{ MHz},$$

$$\text{then } R = 1.78 \text{ k}\Omega,$$

$$\text{and } C = 45 \text{ pF}.$$

The capacitor can be shorted, but only with a slight degradation of V_{os} for the voltage follower. In this case, R is given by:

$$R = 0.25 (R_f + R_s).$$

The performance of these voltage-follower circuits is described in Fig. 4. As with the inverter, a resistor and a capacitor at the op amp's input improves its Sr and power bandwidth (PBW) by a factor of 5 while leaving the remaining features of the basic circuit relatively unaffected. Note that the broadbanded voltage follower's input impedance is lowered when only a resistor is used for compensation. However, you can get a high-input impedance with a FET-input, broadbanded op amp by plugging in a large value for R.

Example: With $A = 100,000$ and V_{os} zeroed, if $R_f = 1 \text{ M}\Omega$ and R_s is much smaller than R, then $R = 250 \text{ k}\Omega$. This R yields a dc R_{in} of $2.5 \times 10^{11} \Omega$ and an input current equal to the bias current of the op amp plus 40 pA/V of input voltage.

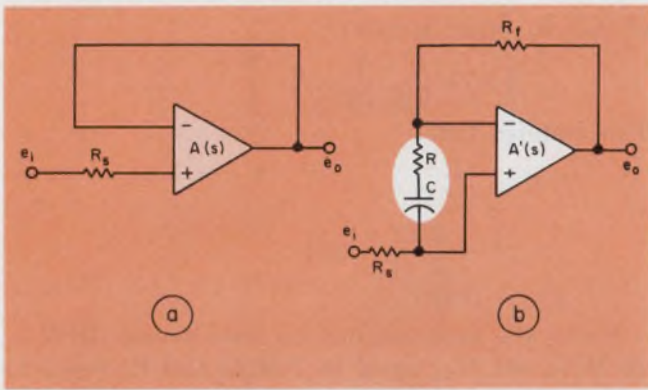

3. The basic voltage-follower circuit uses a unity-gain-stable op amp without any external compensation (a). Broadbanded op amps (b) can operate as voltage followers with external R-C compensation.

Because of their increased gain-bandwidth product, broadbanded op amps can improve the sensitivity of active filters, and keep power consumption low, to boot. However, the need for nonunity-gain stability creates a bigger problem in active filters than in the unity-gain inverter and follower. Since the integrator is the basic filter element, today's most popular active filter circuits use unity-gain-stable operational amplifiers so that their component values are practical. Because of circuit feedback loops, these operational amplifiers need excellent phase margin to maintain over-all stability.

Externally compensated, broadbanded op amps can be used as integrators, but, as we have seen, this use requires a capacitor between the inputs for the device to have an ac gain of 4 or more. This increase in parts (two additional capacitors per second-order filter) and the resulting higher noise input make broadbanded op amps impractical for the state-variable filter² shown in Fig. 5. In this circuit, both integrators (A_1 , A_3) require external compensation.

Can the Vogle filter be broadbanded?

Broadbanded op amps are well-suited for the Vogle filter.³ This filter uses two cascaded integrators, one inverting, the other noninverting. As seen in Fig. 6, the noninverting integrator consists of two op amps, A_1 and A_2 . The inverter, A_2 , is connected inside the noninverting integrator's feedback loop.

This circuit boasts a distinct advantage over the state variable filter—its Q sensitivity with respect to the variation of the op amp's GBW is close to zero, provided that K is equal to 1. Obviously, then, the Vogle filter has a low Q drift with temperature.

Center-frequency drift, however, is a more practical concern. The center-frequency sensitivities of the Vogle and state-variable filters are

	Basic follower	Broadbanded follower with RC compensation	Modified follower with single R compensation
Closed loop gain	$= \frac{1}{1 + 1/A}$ $\approx (1 - 1/A)$ (Note 1)	$= \frac{1}{1 + 0.2/A}$ $\approx (1 - 0.2/A)$ (Note 1)	$= \frac{1}{1 + 1/A}$ $\approx (1 - 1/A)$ (Note 1)
Output offset voltage	$V_{os} \text{ (in)}$	$V_{os} \text{ (in)}$	$5 V_{os} \text{ (in)}$
Slew rate	S_r	$5 S_r$	$5 S_r$
Power bandwidth	PBW	5 PBW	5 PBW
Gain bandwidth	GBW	GBW	GBW
Input impedance (Note 2)	$(A + 1) R_{in}$	$\approx (A + 1) R_{in}$, $f < 10 f_{lead}$ $\approx (A + 1) R$, $f > f_{lead}$	$(A + 1) R$
Input current	I_{bias}	I_{bias}	$I_{bias} + \frac{e_i}{(A + 1)R} \pm \frac{V_{os}}{R}$
Output noise	$e_n \text{ (in)}$	$e_n \text{ (in)}$ for $f < 10 f_{lead}$ $5 \times e_n \text{ (in)}$ for $f > f_{lead}$	$5 e_n \text{ (in)}$

Note 1: The approximation holds for frequencies where A is much greater than 2.

Note 2: R_{in} is the differential input impedance of the compensated amplifier.

4. Broadbanding improves the voltage follower's S_r and PBW, while noise, input current and impedance, and offset are degraded somewhat.

equivalent. The center frequency, f_r , is given by:

$$f_r \approx \frac{f_o}{1 + \epsilon} \quad (1)$$

where f_o is the theoretical center frequency, and ϵ is an error term that depends mainly on the ratio f_o divided by GBW. This same ϵ is the center-frequency sensitivity¹ of the filter and, of course, should be minimized.

The Vogle filter's design equations are extremely simple:

$$f_o = \frac{1}{2\pi RC \sqrt{K}},$$

$$Q_o = \frac{R_n}{R \sqrt{K}},$$

$$H_{oBP} = \frac{v_{oBP}}{v_{in}} = \frac{R_q}{R_{in}}, \quad (2)$$

$$H_{oLP} = \frac{v_{oLP}}{v_{in}} = \frac{R}{R_{in}}$$

The center-frequency sensitivity is:

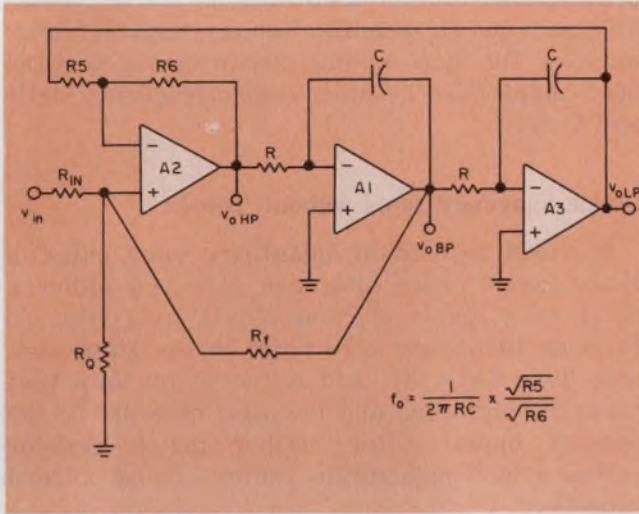

5. State-variable filters, of this form, cannot efficiently use broadbanded op amps without increasing the parts count and degrading their noise figure.

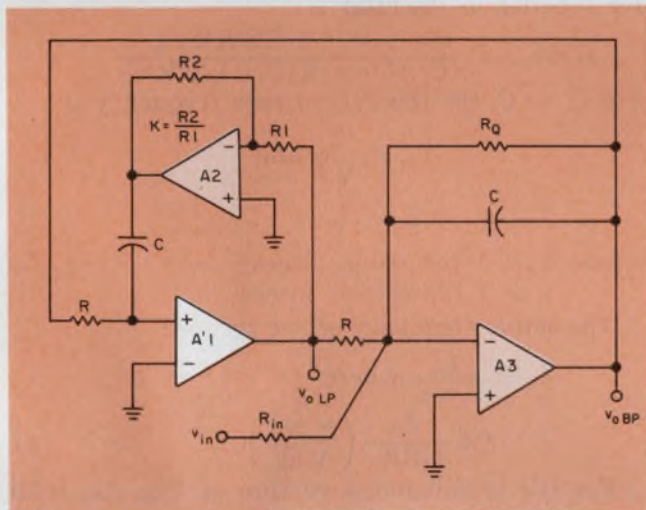

6. Q_o -drift of the Vogle noninverting-integrator filter is improved by using inverter A_2 inside the feedback loop of broadbanded integrator A_1' .

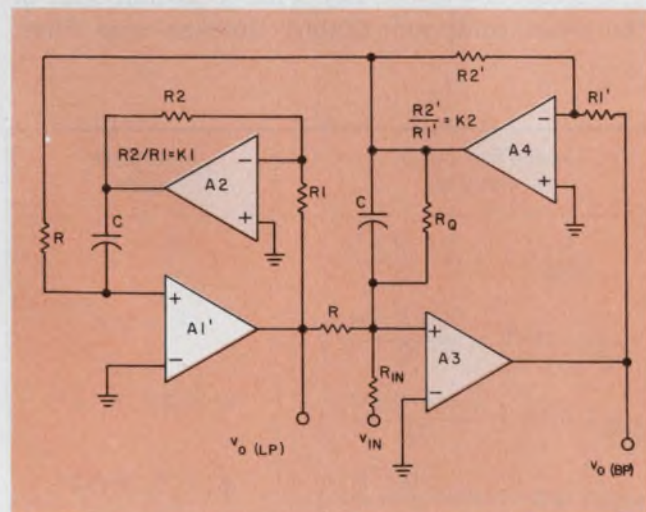

7. The noninverting-integrator filter's frequency sensitivity is improved by the addition of A_4 .

$$\epsilon \approx 0.5 \left[\frac{f_o}{GBW_1} \left(\frac{1}{\sqrt{K}} + \frac{1}{Q_o K} \right) + \frac{f_o}{GBW_3} \left(\sqrt{K} + \frac{1+H_o}{Q_o} \right) \right] \quad (3)$$

Here we can see that for a Vogle filter with infinite GBW op amps, $f_1 = f_o$. The expression for ϵ contains no GBW_2 terms. Therefore, the circuit shows no sensitivity of f_1 with respect to inverter A_2 's GBW variations: GBW_2 , however, should be large enough to prevent loop instability. Also, a fast but low phase-margin device introduces excessive phase shift, and the loop formed by A_1 and A_2 oscillates. So the inverter must use a unity-gain-stable op amp or a broadbanded op amp with input compensation. For $GBW_1 = GBW_3$, the denominator of Eq. 3 has a minimum for $K = 1$. That is: For equal GBW op amps such as quads, $K = 1$ yields the lowest possible f_1 drift.

The Vogle filter's f_1 sensitivity can be minimized further by using a broadbanded op amp for the noninverting integrator, A_1 . Assuming again, that the GBW of A_1 is five times the GBW_3 of A_3 , ϵ of Eq. 3 becomes:

$$\epsilon \approx \frac{0.5 f_o}{GBW} \left[\frac{K+0.2}{\sqrt{K}} + \frac{1}{Q_o} \left(1 + H_o + \frac{0.2}{K} \right) \right],$$

which has a minimum for $K = 0.2$.

This circuit is stable— A_1 's ac gain is 5. A_2 minimizes frequency error and compensates A_1 .

To optimize Eq. 3 even more, insert an op amp, A_4 , into the feedback loop of the inverting integrator, A_3 , as in Fig. 7. The resulting four-op-amp filter consists of two cascaded, noninverting integrators. Over-all negative feedback is still needed, so close the loop from the output of inverter A_4 , rather than from A_3 . Thus, the frequency sensitivity becomes:

$$\epsilon \approx 0.5 \frac{f_o}{GBW} \times \left[\frac{0.2 K_2 + K_1}{K_2 \sqrt{K_1}} + \frac{1}{Q_o} \left(\frac{0.2}{K_1} + \frac{1}{K_2} \right) + H_o \right].$$

Unfortunately, for stability reasons, you cannot make K_2 , inverter A_4 's gain, greater than 5 without adding external compensation. The new filter's design equations are the same as Equation 2 except that for the new filter:

$$H_{oBP} = \frac{R_Q}{K_2 R_{IN}}$$

How does slew rate affect stability?

For large amplitude signals, an op amp's slow slew rate often causes filter oscillations: slew limiting introduces additional phase shift.

The filter in Fig. 6 can be unstable with large input signals, as seen in the following equation:

$$f_o \geq \frac{Sr}{\pi V_{in} H_o}$$

where V_{in} is the peak input voltage. Here again, broadbanded op amps can help, this time because

of their high slew rates. A quad of broadbanded op amps can be used as a noninverting integrator filter (Fig. 8).

For stability broadbanded integrators A_1' and A_2' require that: $K_1=K_2 \leq 0.2$. The inverters, A_2' and A_1' , are stabilized by the resistors between the two inputs of each op amp. With $K_1 = K_2 = 0.15$, f_r is less sensitive with respect to GBW variations than the original Vogle filter circuit of Fig. 6; and the new filter has the advantage of an increased slew rate.

Expressions for the sensitivities of multiple op-amp filters are summarized in Fig. 9. For medium to low Q applications (Q of 10 or less), the filters of Figs. 6 and 7 give the lowest frequency sensitivity as well as a low Q drift. The

broadbanded four op-amp filter is attractive for high gain and H_o stability. For very high Q filters, however, the three-op-amp circuit of Fig. 6 is the best compromise between center-frequency drift and Q drift.

Create imaginary zeros without 'tweaks'

Modified to contain imaginary zero pairs, a basic second order filter can give you either a notch or a highly efficient elliptic response. To form an imaginary zero pair² in the state-variable filter (Fig. 5), add a fourth op amp that sums the high-pass and low-pass outputs. In the popular biquad filter,⁵ either match resistor ratios—and complicate the tuning—or use a third capacitor.⁴

With the noninverting-integrator-type filters, use a third capacitor, C' (Fig. 10). Trimming R_{in} tunes the zero's frequency, so the addition of C' doesn't complicate the adjustment. The transfer function of the filter is:

$$G(s) = -\frac{C'}{C} \frac{s^2 + 1/CC'KR_{in}R}{s^2 + s/R_0C + 1/KR^2C^2}$$

For $C' = C$, the theoretical zero frequency is:

$$f_{zo} = \frac{f_o}{\sqrt{a}} \text{ and } a = \frac{R_{in}}{R}$$

where $a = 1$ for notch filters;
 $a < 1$ for elliptic filters.

The actual frequency of the zero is:

$$f_{zr} = \frac{f_o}{1 + \epsilon'} \text{ where } \epsilon' = 0.5 \frac{f_{zo}}{GBW_1} \left(\frac{a + 1}{\sqrt{ak}} \right) \quad (4)$$

For the broadbanded version of Fig. 10, with K equal to 0.2, the frequency sensitivity of the zero is:

$$\epsilon' = 0.22 \frac{f_{zo}}{GBW} \left(\frac{a + 1}{\sqrt{a}} \right)$$

The frequency sensitivity with C' is half that of the basic, unity-gain-stable, three-op-amp filter.

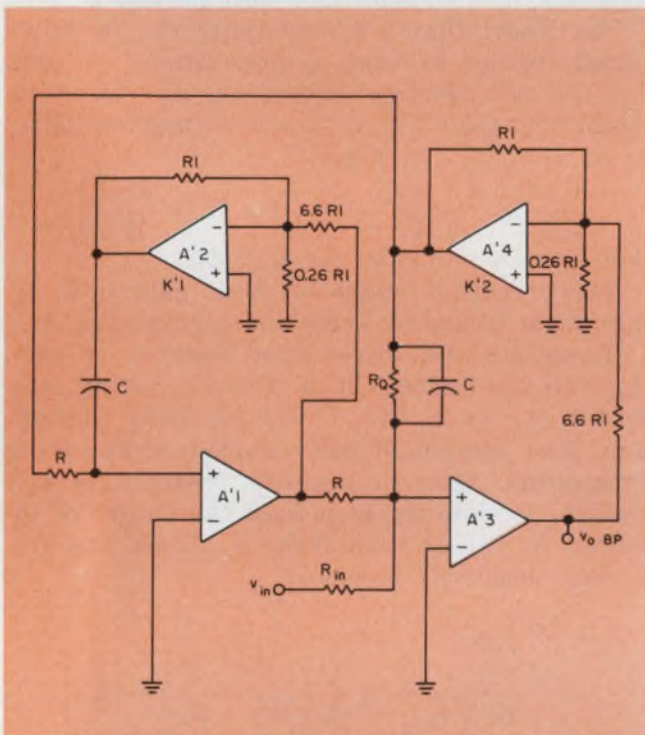

8. Broadbanding all four op amps with a quad improves the slew rate of a modified Vogle filter.

Applicable figures	Unity gain stable op amps	Broadbanded op amps	Center frequency sensitivity	Inverter(s) gain
5, 6	3	0	$\frac{f_o}{GBW} \left(1 + \frac{1 + 0.5 H_o}{Q_o} \right)$	$K = 1$
6	2	1	$\frac{f_o}{GBW} \left(0.45 + \frac{1 + 0.5 H_o}{Q_o} \right)$	$K = 0.2$
7	or $\begin{cases} 3 \\ 2 \end{cases}$	$\begin{cases} 1 \\ 2 \end{cases}$	$\frac{f_o}{GBW} \left(0.27 + \frac{0.6 + 0.5 H_o}{Q_o} \right)$	$K_1 = 0.2, K_2 = 5$
8	0	4	$\frac{f_o}{GBW} \left(0.5 + \frac{1.2 + 0.1 H_o}{Q_o} \right)$	$K_1 = K_2 = 0.15$

9. Broadbanding improves the center-frequency sensitivity of multiple op-amp filters.

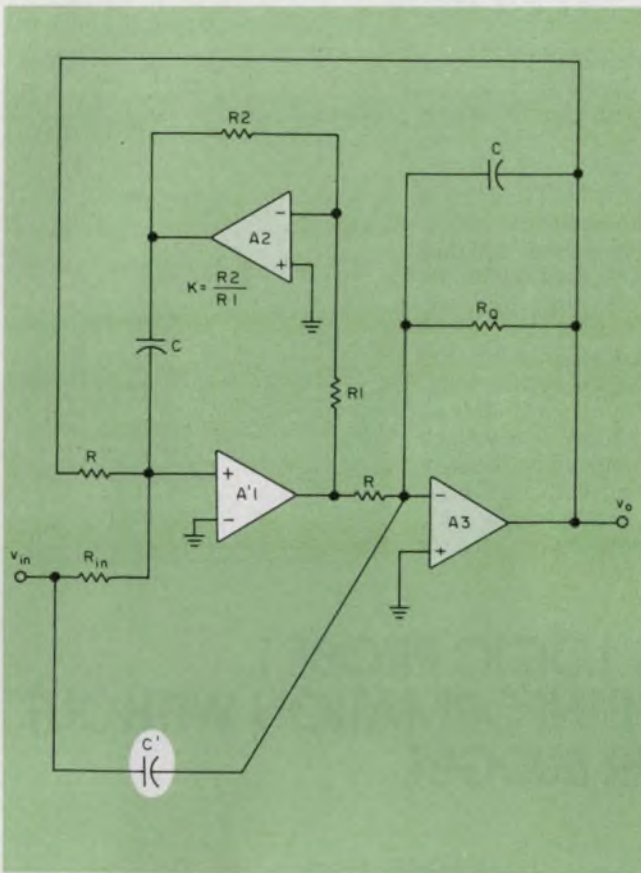

10. Modification of the Vogle filter's input structure with C' lets you generate the imaginary zero pairs needed in notch and elliptic filters.

As a result, broadbanding lowers the zero's frequency sensitivity.

For the widely used Sallen-Key type filters, you first must determine if compensation is needed. So, calculate the feedback factor's value at the frequency where the broadbanded op amp starts showing phase shift. This task is cumbersome, but you do get a stability indication. An input R-C compensation network, as discussed for unity gain inverters and followers, desensitizes the op amp at the filter's center frequency, thereby preventing high-frequency oscillations. Also, the filter's sensitivity with respect to GBW variations improves. ■■

References

1. Solomon, J., "The Monolithic Op Amp; A Tutorial Study," *IEEE Journal of Solid State Circuits*, Vol. SC-9, #6, December, 74.
2. "AF100 Universal Active Filter," National Semiconductor Inc., Santa Clara, CA.
3. Vogle, P. W., "Method for Phase Correction in Active RC Circuits Using Two Integrators," *Electronics Letters*, May 20, 1971, pp. 273-75.
4. Akerberg, D., and Mossberg, K., "A Versatile Active RC Building Block with Inherent Compensation for the Finite Bandwidth of the Amplifier," *IEEE Transactions on Circuits and Systems*, Vol. CAS-21, No. 1, January, 1974.
5. Fleischer, P. E. and Tow, J., "Design Formulas for Biquad Active Filters Using Three Operational Amplifiers," *Proceedings of the IEEE*, May, 1973.

it's so simple

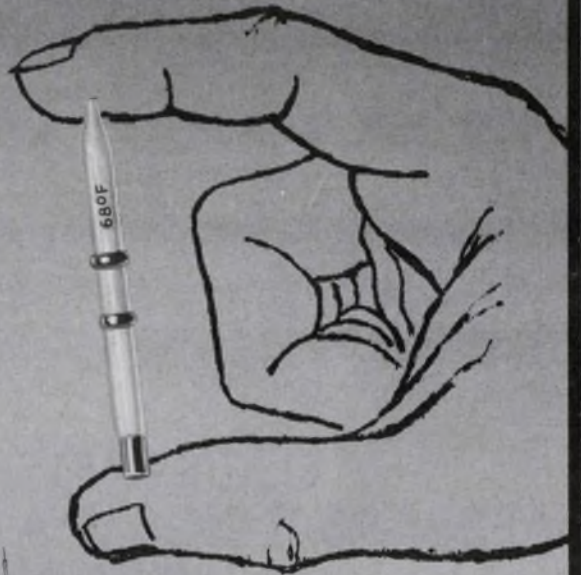

why
didn't I
think
of this
thermostat?

More and more engineers are asking themselves that question when they see and learn of the advantages of using P.S.G.'s Mercury and Solid State Thermostats.

ACCURACY	$\pm .05^{\circ} \text{C}$ to 2°C
DIFFERENTIAL	$.05^{\circ} \text{C}$ to 10°C
SHOCK	100 G
VIBRATION	20G at 2000 cycles per second
LOAD	5 M.A. to 5 amps
SIZE	length 5/16 and up - diameter 3/32 and larger

All types of mountings. Simple, no moving parts and they are low cost, ranging from \$2.10 each up (depending on model and quantity).

We find it simple to solve temperature control problems. Let us have yours.



PSG Industries, Inc.
MANUFACTURER OF PRECISION THERMO AND ELECTRONIC CONTROLS
1225 Tunnel Road, Perkasio, Pa. 18944



Logic Probe 1 is a compact, enormously versatile design, test and troubleshooting tool for all types of digital applications. By simply connecting the clip leads to the circuit's power supply, setting a switch to the proper logic family and touching the probe tip to the node under test, you get an instant picture of circuit conditions.

LP-1's unique circuitry—which combines the functions of level detector, pulse detector, pulse stretcher and memory—makes one-shot, low-rep-rate, narrow pulses—nearly impossible to see, even with a fast scope—easily detectable and visible. HI LED indicates logic "1", LO LED, logic "0", and all pulse transitions—positive and negative as narrow as 50 nanoseconds—are stretched to 1/3 second and displayed on the PULSE LED.

By setting the PULSE/MEMORY switch to MEMORY, single-shot events as well as low-rep-rate events can be stored indefinitely.

While high-frequency (5-10MHz) signals cause the "pulse" LED to blink at a 3Hz rate, there is an additional indication with unsymmetrical pulses: with duty cycles of less than 30%, the LO LED will light, while duty cycles over 70% will light the HI LED.

In all modes, high input impedance (100K) virtually eliminates loading problems, and impedance is constant for all states. LP-1 also features over-voltage and reverse-polarity protection. Housed in a rugged, high-impact plastic case with strain-relieved power cables, it's built to provide reliable day-in, day-out service for years to come.

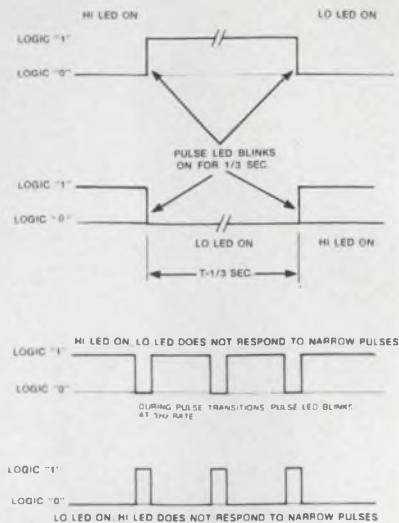

CSC'S MULTI-FAMILY LOGIC PROBE 1. AT \$44.95, IT DIGS UP A LOT OF INFORMATION WITHOUT BURYING YOUR BUDGET.

HI/LO LED's—Display level (HI-logic "1", LO-logic "0") of signal activity at node under test

PULSE LED—Lets you know what's going on—and off. Indicates positive and negative pulse and level transitions. LP-1 stretches pulses as narrow as 50 nanoseconds to full 1/3 sec. (3Hz pulse rate)

PULSE/MEMORY Switch—PULSE position detects and stretches pulses as narrow as 50 nanoseconds to 1/3 sec. Switch to MEMORY and it stores single shot and low-rep-rate events indefinitely; HI/LO LED's remain active

Logic Family Switch—TTL/DTL or CMOS matches Logic "1" and "0" levels, for greater versatility. High Input Impedance—100K virtually eliminates circuit loading problems and is constant in both "0" and "1" states. CMOS position also compatible with HTL, HiNIL and MOS logic

Non-corrosive nickel-plated probe tip and clip leads—For reliable contacts and maximum life

Rugged high impact plastic case—Built to take it... in the lab or in the field

Protected—Features built-in reverse polarity and over-voltage protection; strain-relieved power cable

\$44.95 Price tag—Costs so little it can be your personal property

© 1976 Continental Specialties Corp



For more information, see your distributor or write for our catalog and distributor list.
44 Kendall St., Box 1942 New Haven, CT 06509 • 203-624-3103 TWX: 710-465-1227 West Coast office:
Box 7809, San Francisco, CA 94119 • 415-421-8872 TWX: 910-372-7992 Canada: Len Finkler Ltd., Ontario

Eye-Pleasing GREEN.

NEC is the world's largest vacuum fluorescent display producer.



Last year, NEC produced 15 million displays for calculators. We expect a 30% increase this year. Reliability/price advantages are optimum. Another decisively attractive feature is the color—green. The human eye is most sensitive to green which opens up wide new applications—POS terminals, clocks, car dashboards, microwave ovens and instruments. A wide range of other OEMs are also turning to us.

Choosing the right display can decide how well your product sells. Contact NEC, the world's largest "green" display producer.



NEC America, Inc., Sunnyvale Office

505 West, Olive Ave., Suite 310, Sunnyvale,
Calif. 94086, U.S.A. Tel: 408-738-2181,
Telex: NECAM SUVL 35-7475

NEC Electronics (Europe) GmbH

4000 Düsseldorf, Immermannstrasse
22, West Germany Tel: Düsseldorf
357088, 357089, 357080
Telex: NECD 8587419

NEC

Nippon Electric Co., Ltd.

NEC Building, 33-1, Shiba-Gochome,
Minato-ku, Tokyo 108, Japan
Tel: 03-454-1111
Cable: MICROPHONE TOKYO
Telex: NECTOK J22686

Al Cookson of ITT Speaks On Boosting R&D Output



Companies live or die based on their success in research and development. Yet, statistically, there is more likelihood of failure than success in R&D efforts. A recent Harvard study suggests that almost three-fourths of the \$20-billion or so spent annually in the United States for R&D is unproductive. That's staggering. We waste \$15-billion.

If these estimates are right, 25 percent of an average company's R&D expenditure yields a product that a company can sell at a profit. That's discouraging. Intuitively, you've got to think you can operate at an efficiency higher than that. I think 75 percent is a reasonable figure. A good company should get pretty close to that.

Why do we have this relatively low productivity? Is R&D management so difficult that the best you can hope for is 25% efficiency? Or is industrial R&D often poorly managed? In my opinion, the latter is the case. The low probability of success in R&D is due primarily to inept or sloppy R&D management, which is prevalent in many companies.

Is R&D management that complex? I don't think so. Successful R&D management is, above

all, hard work, but beyond that it requires only the dedicated application of certain fundamental principles:

1. Professional market research.
2. Detailed product planning.
3. Driving program management.
4. The flexibility and guts to adjust quickly to changing technology or market conditions.

To any professional R&D manager, these points are obvious, but let me comment on them.

I can't overemphasize the first point that the cornerstone of successful R&D is good market research. Not understanding the marketplace is probably the major contributor to the 75% failure rate of R&D activity.

The second step in successful R&D is the conversion of market research into detailed quantitative product plans. This is a ponderous paperwork exercise that must precede any significant product-development activity.

Once you know the market and have defined your specific products, you need driving program management to bring the products out within cost targets and on schedule. A major factor in

the 75% failure rate of R&D is the tendency to fall behind schedule, and to bring products to market too late.

A good R&D program manager should have the tender disposition of World War II's famous George Patton.

Finally, no matter how well you follow the first three principles, you get enormous R&D waste if you get locked into something because you don't want to admit that you were wrong six months ago. There's a human tendency to keep plowing ahead long after you see that you've made one helluva mistake.

The mistake might be a result of changes in the external environment beyond your foresight and control. It's a sad truism that the biggest waste of R&D funds often occurs *after* it's obvious that a program is doomed.

So an important part of cutting that 75-percent waste is to have the flexibility and guts to redirect programs quickly to changing technology or market conditions, even to the extent of canceling large projects in midstream and writing off an R&D investment.

I often wonder what the difference would have been if GE and RCA in computers or Lockheed on the 1011 had bitten the bullet and taken their write-offs when they saw the storm warnings.

Several years ago, at an ITT Technical Directors' Conference, I had to give a keynote speech on R&D management. On the plane I wrote what I termed, "Some fundamentals of R&D management." Like many other things you do in a hurry, my hastily composed list expressed my thoughts more clearly than anything I have put together on the subject since. Here's what I wrote:

1. Understand your market and your customers in depth or you will design great products for someone else's market and customers.

2. Know and specify exactly what you are looking for and how you will accomplish your design before you spend significant R&D funds.

3. Remember that most companies succeed or fail based on the *cost* of their products. At least 50% of all R&D expenditures should go into cost reduction of existing products.

4. R&D should be scheduled and managed with the same exactness and toughness as production. Any R&D man who will not submit to this discipline should be fired as he is a liability.

5. Beware of transient inventors and intuitive promoters of inventions. The chances of their having anything worthwhile is negligible.

6. Successful R&D is much more often the result of good planning and hard work than of brilliant invention.

7. Most companies find more products come from their manufacturing companies' engineering departments than from their laboratories.

This indicates that the closer an engineer is to the manufacturing floor and the customer, the better design job he does.

8. Defect prevention is the result of professional engineering which, in turn, is a product of dedicated engineering management.

In my mind the most critical is Point 3—cost and cost reduction in R&D activities.

Most R&D managers give lip service to product cost and cost reduction, but many do not appreciate that it is the fundamental factor that determines the very existence of almost every manufacturing company.

It is very difficult to find a manufacturing company that's not in a cutthroat price competition with competent, entrenched competitors. Now everyone knows that final product cost is a build-up of many factors—basic design, manufacturing volume and efficiency, and overheads. However, you start with product design and all costs build on that.

So the pilot responsibility for cost reduction generally rests with the R&D department. We have a technique at ITT, Single Product Cost Leadership, which is a formula approach for annually taking 10 to 20% out of the cost of a product. The profit-and-loss rewards of this simple program have been enormous.

Point 7, the desirability of physical proximity between R&D departments and manufacturing and marketing groups represents a philosophy I have developed empirically over the years.

One great danger for R&D groups is to become insulated from the mainstream of the business and to lose the stimulation of the day-to-day tempo of operations. Unfortunately, many managements encourage this isolation and pay the price in decreased efficiency in R&D operations.

I am not opposed, *per se*, to companies having independent laboratories. We have many at ITT and, most are quite productive. However, any time we set up a laboratory independent of our manufacturing groups, we must accept the need for much more management attention to make the laboratory efficient than would be necessary if the lab were co-located and organizationally integrated into a manufacturing division.

So far, I've said a lot about planning and operations but nothing about invention. This was deliberate because I see invention as the great illusion of modern management.

Many company managements, correctly seeing the importance of technology to their future, develop the mistake that if they isolate some good R&D people, and give them enough money and freedom, they will make wonderful "inventions"

and "breakthroughs" that will ensure a bright future for their corporation.

Nothing could be further from the truth. R&D people, funded and managed this way will, 99 times out of 100, waste large sums of money and frustrate themselves and their managements.

The route to technological breakthroughs is the studied approach to R&D management: careful market research, product planning and skilled R&D program management. If these are done right, and everyone in the organization starts early and works late, every once in a while you will hit a technological breakthrough that will speed you along your planned and deliberate path to success. It's like the lucky shot in golf from the sand trap into the hole. It's real nice when it happens but you don't plan your game around it.

These points are pretty much the essence of our corporate philosophy in regard to research, development and engineering. Let me show you how we organize to implement them.

To put this in context, let me comment on ITT. We are now the twelfth largest company in the world, with sales of about \$12 billion and we employ over 400,000 people. We spent about \$485 million on all engineering activities in 1975, about half in product development—what is normally classified as R&D in most manufacturing companies.

In our engineering organization, we have over 20,000 people dispersed in 67 laboratories and major development centers in 28 countries. We cover a broader product line than practically any other corporation.

To manage \$485 million in research, development and engineering every year means that you must have a large and complex (but hopefully not bureaucratic) management organization.

In our case we have a staff of about 150 people at headquarters in New York who assume responsibility that this \$485 million R&D operation runs efficiently. The primary mechanism we use to assure a strong correlation between our corporate policies and business objectives is a document called the "Business Plan." Our business plans are more than planning documents at ITT, though they certainly are that. They also become essentially a way of life that ties together every function in the corporation—technical, finance, manufacturing, personnel, marketing, etc.

Everything that goes on in the operations of the company—every R&D program every capital program, every organizational change—is geared to meeting the objectives of the business plans.

The business planning cycle at ITT begins with the setting of our corporate objectives, or guidelines, early in each calendar year. These objective-setting milestones form the basis for the

Who is Al Cookson?

The youngest of six children, Albert Cookson became interested in engineering by hanging around his father's electrical contracting business. Other influences were "the chemistry-set routine," model airplanes and ham radio.

"You learn a lot more about electronics as a hobbyist than you do as a professional," he says. "You have time to explore all sorts of side avenues and nuances instead of just learning from the book. No communications engineer knows radio propagation like a radio amateur, and no one understands the weather like a private pilot."

In 1939 Cookson entered Northeastern University, where he earned a BSEE in a crash, war-accelerated program. After that he served as a radar officer on two cruisers in the Navy in World War II before going to work at MIT's Research Laboratory of Electronics in 1947. While at MIT he completed requirements for a master's degree (his thesis was on a microwave blind-landing system for aircraft) and became group leader in the development of early guided-missile systems. He also met Constance Buckley, the personnel director of a Boston department store, and married her.

When the MIT lab developed a prototype air-to-air missile, Cookson went looking for a contractor to package and manufacture it. He finally settled on ITT Federal Laboratories, Nutley, NJ, and in the process of completing the arrangements, was offered a chance to head the program for ITT. He accepted.

In 1968, 17 years and many assignments later, Cookson became general technical director of the ITT system. He became senior vice president a year later, and now supervises the technical activities of more than 250 ITT companies and more than 20,000 engineers and scientists.

In spite of that responsibility, Cookson says office pressure doesn't bother him. Not only did he grow into his present position a step at a time, but "ITT is a fascinating, dynamic company and the technical fields are all interesting," he says. "If you've been around a long time you get to know and enjoy the people, too, so this is more than a job to me."

He catches movies on airplanes, manages in his travels to keep up with the theater seasons in both New York and London, and often plays tennis and golf with his wife (his handicap is 17; hers is 21). Since he lives on Long Island Sound he does "a modest amount" of boating and fishing. Presently he is taking up flying again after a number of years of raising a family. He includes reading among his quieter pleasures. One recent book he particularly enjoyed is Richard Adams' *Watership Down*.

The Cooksons have two children; William, 23, a newly minted electrical engineer like his father, and Constance, 25, a Latin-American-studies major, now serving overseas with the Peace Corps.

following year's business plans. These are prepared during May and August at the unit (or divisional) level and presented for corporate management review in the fall. The agreed-upon business plan results in detailed plans and budgets for the following year for all units and functions of the corporation.

Three kinds of engineering activity are planned and budgeted in each year's business plans.

Research and Development. This encompasses the development of new products, processes or systems, or the improvement of existing products (including cost reduction and quality/reliability improvement).

Contract Engineering. This includes engineering defined and paid for by an outside customer. It's most common in our space and defense activities, but it occurs elsewhere.

Engineering Support. This includes all engineering support for other functions within the corporation, such as marketing, manufacturing, test, installation, quality control. This cost is generally borne by the user organization.

These three kinds of engineering activity can be funded at the unit level (termed local development), at the corporate level (called general development), or even by an outside customer, as in the case of contract engineering. However, in line with the ITT concept of centralized management, all engineering activity, regardless of the source of funds, must be approved by the Headquarters Technical Department.

The approval of all R&D projects in excess of \$5000 involves a coordinated preparation effort by the commercial, technical and executive elements of the unit that will execute the project, followed by a review-and-approval cycle by the counterpart functional organizations at the group and corporate level.

The document we use to authorize the expenditure of R&D funds is called a local or general development case (local if the funding comes from the unit, general if the funding is from headquarters). The R&D case serves as a standard planning and control document for all development activity in the corporation.

At any given time there are about 2300 active R&D cases throughout our divisions and laboratories. In reviewing and authorizing these 2300 cases each year, my headquarters technical staff and its commercial counterpart (called product-line managers) must be satisfied that four crucial questions are substantially answered by the case write-up and commercial support documentation (the product plan). The four questions in simple form are as follows:

What? What is the objective of the case?

Why? This is the most difficult and probably most important question. Its answer establishes the economic issue, the commercial/marketing justification, the important "who needs it" consideration.

How? How shall we do the work? How much manpower and funds will be required to complete the job? Are the necessary skills (people) and resources (equipment) available?

When? This is the all-important question of time. It always includes a schedule with milestones showing the phases of the program and when each phase will be completed.

The planning and approval of any R&D case cannot be a one-shot activity because all of the factors influencing the project are in a constant state of change. So the case must be periodically updated to reflect new realities of the environment. This involves periodic reviews by the same members of the management team (technical, commercial, financial, etc.) who were initially responsible for the case preparation. In addition, members of the headquarters technical staff continually visit units on an *ad hoc* basis to check the status of all important on-going projects.

In describing our over-all R&D, there are two other areas I should touch on. The first is the role of our laboratories in the total ITT R&D complex. In addition to the engineering-development teams in each of 52 major manufacturing divisions, we operate 16 laboratories in eight countries. Some function within a narrow technology or product specialty (like chemical cellulose, food products, automotive), while others—our central laboratories—serve all units of the corporation in a wide range of technologies.

In every case, however, we make a major effort to ensure that all laboratories are end-product, results-oriented activities that are focused on bridging the gap between concept and reality, theoretical design and practical product, research and production.

There is one final element I should mention. Because of the size and organizational and geographical dispersion of technical activities, we have formed semi-permanent Technical Committees and Technical Task forces to promote inter-unit cooperation and synergism within a common technology or product area of mutual interest.

For example we have Task Force 3 on our telephone-switching activities, Task Force 6 on space/defense activities, Task Force 9 on energy-related activity and Task Force 10 on electronic components. These task forces cut across organizational and geographical lines and periodically bring together all key people working in certain specialty areas. The task forces have been so successful that they have often been used as *de facto* policy-determining groups in certain product lines. They work. ■■

these two Panel Meters . . .
can become 93 different measuring instruments . . .

count'em.

DC and AC Volts	23 models
DC and AC Current	20 models
DC Autoranging	2 models
True rms	8 models
Thermocouple C or F	16 models
RTD C or F	4 models
Thermistor C or F	8 models
Offset and Scaled	4 models
Process Monitors	8 models

and the best part is . . .

You can change to any one of these models anytime. It is as simple as reprogramming the rear connector or adding one of DigiTec's exclusive adapters. Call or write for complete specifications.

These instruments are available under GSA Contract, GS-00S-27741.



DigiTec: Precision Measurements to count on



918 Woodley Road, Dayton, Ohio 45403
(513) 254-6251, TWX (810) 459-1728

INFORMATION ONLY, CIRCLE 271

DEMONSTRATION ONLY, CIRCLE 281

ENGINEERS and SCIENTISTS

EG&G has expanded opportunities for professionals that offer exceptional interest and potential. We now have the operating contract of Idaho National Engineering Laboratory (INEL) for ERDA.

Continual growth in on-going programs in the area of nuclear safety and development of other energy sources have created immediate openings in all the aspects of:

ELECTRICAL DESIGN AND DEVELOPMENT
INSTRUMENTATION
MECHANICAL DESIGN AND DEVELOPMENT
MEASUREMENTS
THERMAL ANALYSIS

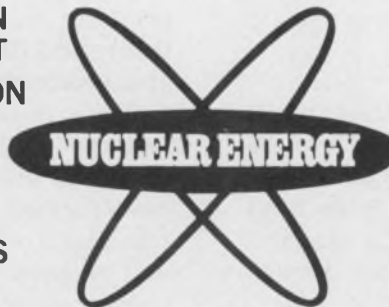

QUALITY ENGINEERING
FLUID FLOW
NUCLEAR WASTE MANAGEMENT
CONSTRUCTION MANAGEMENT
MATERIALS ENGINEERING
And Other Technical Areas.

Tired of the city hassle? Our location provides a virtually unmatched concentration of nuclear R&D facilities, in a vast "park." The surrounding country offers a Western recreation area with skiing, hunting, fishing, camping and other outdoor activities in country where skies and mountain vistas are breathtaking.



Please send resume indicating your interest (openings cover a range of experience levels), in confidence, to:

TECHNICAL EMPLOYMENT—ED

EG&G E G & G Idaho, Inc.

550 Second Street
Idaho Falls, Idaho 83401

U. S. citizenship required

We are an equal opportunity employer and we welcome responses from minorities, females and handicapped.

The GOULD/Brush 2000 Series.

The most significant advance in direct writing recorders in the past decade.

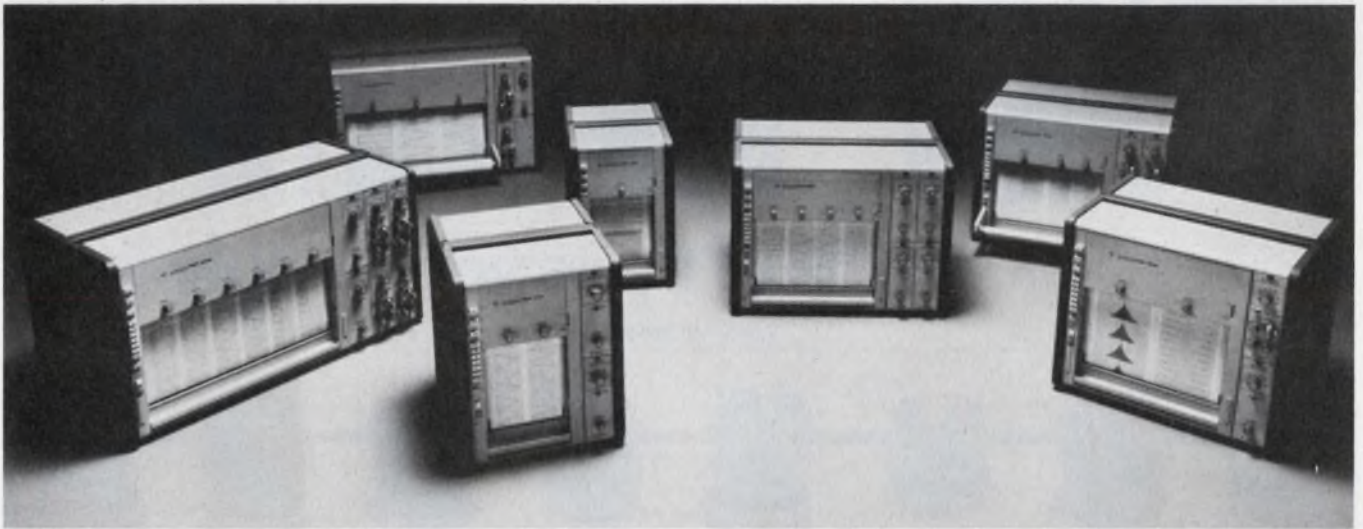

The new GOULD/Brush 2000. We can modestly say it's the best in performance, versatility and reliability. And if you take a look at all it has to offer, we know you'll agree.

Let's start with frequency response that's unexcelled in performance. An exceptional 30 Hz at 100mm, 50 Hz at 50mm, and up to 125 Hz at reduced amplitude.

Superior resolution is assured through a high-stiffness servo penmotor that enforces 99.65% linearity over the entire channel width.

Traces are uniform in width at all writing speeds. And

they're clear and crisp, with no smudges, smears or puddles. The pressurized fluid writing system is completely closed, allowing the recorder to be operated in any position—even upside down.

Then take flexibility. Our plug-in signal conditioners fit every model in the 2000 Series, and record virtually any function you could possibly want.

Thanks to its modular design, it's as versatile as your needs. Channel choices range from 1 to 8. In combinations of 100mm or 50mm channels.

There's a lot more the GOULD/Brush 2000 Series can

give you ranging from easy use and easy servicing to a cost that's downright economical. For details on the oscillographic recorders you should be using, write Gould Inc., Instrument Systems Division, 3631 Perkins Ave., Cleveland, Ohio 44114. Or Gould Allco S.A., 57 rue St. Sauveur, 91160 Ballainvilliers, France. Or call the number below.

**FOR BROCHURE CALL
TOLL FREE AT (800) 325-6400.
EXTENSION 77.**

In Missouri: (800) 342-6600.

**The GOULD/Brush 2000 Series,
Winner of 1976 1-R 100 Competition.**

 **GOULD**
The product development company

CIRCLE NUMBER 50

Power to the μ P



Sola offers **DUAL** and **TRIPLE OUTPUT POWER SUPPLIES** for **MICROPROCESSORS** and accessories: **RAM's, PROM's, ROM's, FEPROM's, CLOCKS** and **IO devices.**

All available from your local electronic distributor. At competitive pricing. From a name you can count on—Sola.

Our versatile power supplies offer fully isolated independent outputs for either positive or negative operation. Series or parallel operation. Plus, remote sensing/programming, and complete serviceability. Just call or write for Catalog 648.

For added protection, consider our minicomputer regulators, UPS, and Standby units. Everything you need for MPU power and protection.

Sola Electric, 1717 Busse Road, Elk Grove Village, Ill. 60007 (312) 439-2800.

SOLA ELECTRIC



Think of us as your supply line.

CIRCLE NUMBER 51

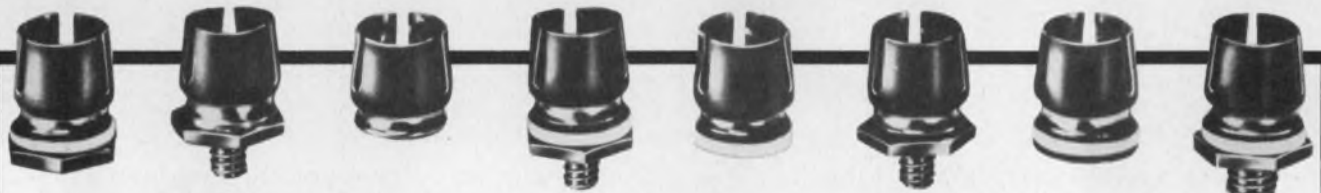

Keep Transistors Cool and Snug

Now your TO-5 and TO-18 case style transistors can be held more securely while improving thermal resistance at the same time.

Wakefield's Series 260 Cup Clips have a unique one piece construction that gives greater surface contact between the case and the clip. Results are greater holding strength and cooler operation.

These popular semi-conductor retainers are more economical than competitive makes, too. Only 10¢ apiece in quantity. Non-insulated, epoxy insulated or beryllium insulated, all types feature a flared lip for easy component insertion.

Call or write for full details and free samples.



WAKEFIELD ENGINEERING INC.

77 AUDUBON ROAD WAKEFIELD MA 01880 (617) 245-5900
TWX 710-348-6713

AN **EG&G** COMPANY



CIRCLE NUMBER 52

Ise introduces five new ways to make the competition turn green.

Your competition probably already thinks they're using the perfect display in whatever it is they make. Let them keep thinking it. While you prove them wrong with a new Itron display. They're designed to make the competition turn green. Which also happens to be the color of the segments

All 17 of them on the 17-digit Itron. All 5 on the FG-512A1. Next comes an Alfa-Numerical Itron. A Linear-Analog Itron. And a Digital Clock Itron. Five ways to be heartless if you put a little heart into it

itron[®]

Alfa-Numerical Display



FG209M2

ef = 10V
ec = eb = 40Vp-p
ic = 10 mA p-p
ib = 8 mA p-p
Wd. 205 mm
Lg. 40 mm
Segment 9 mm

Instruments & Large Calculator Display



FG179F2

ef = 7V
ec = eb = 35Vp-p
ic = 7 mA p-p
ib = 5.5 mA p-p
Wd. 170 mm
Lg. 40 mm
Segment 9.5 mm

Instruments & Terminal Units Display

FG512A1
ef = 3.5V
ec = eb = 24Vp-p
ic = 4 mA p-p
ib = 3 mA p-p
Wd. 100 mm
Lg. 40 mm
Segment 12 mm



Digital Clock Display



FG425A1

ef = 5.5V
ec = eb = 35Vp-p
ic = 8 mA p-p
ib = 6.5 mA p-p
Wd. 140 mm
Lg. 59 mm
Segment 25 mm

Linear Analog Display

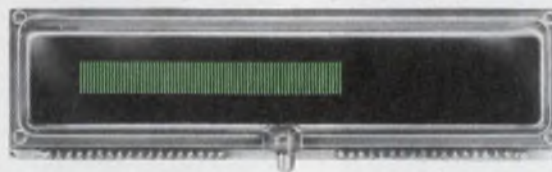

FG120S1

ef = 5.5V
ec = eb = 35Vp-p
ic = 4 mA p-p
ib = 0.2 mA p-p
Wd. 140 mm
Lg. 40 mm
Segment 8 mm

NORITAKE CO., LTD.

Electronics Office (U.S.A.)
22410 Hawthorne Blvd. Torrance California 90505
U.S.A.
Phone: (213) 373-6704
Telex: "230674910"

Electronics Division

1-1, Noritake Shinmachi, Nishi-ku, Nagoya-City, Japan
Phone: NAGOYA (052) 561-7111
Telex: J59738 NORITAKE

ISE ELECTRONICS CORP.

London Office
c/o NORITAKE (U.K.) LTD.
Noritake House 2, York Street W1H 1 Be, England
Phone: (01) 935 7543 Cable: LUCTUAL LONDON
Munachen Office
c/o NEUMULLER GmbH, 8 Muenchen 2, Karlstrasse 55
West Germany. Phone: 592 421 Telex: 522106

Hong Kong Office
Room 1403 Shing Loon Bldg
24-26 Stanley Street, Hong Kong
Phone: 5-232420 Telex: HK83151
Taipei Office
72-9 SEC. 2, JEN AI RD, Taipei
Phone: 351 0293 Telex: 11176

CIRCLE NUMBER 53

Display letters and symbols on a 7-segment numerical display

Although the 7-segment LED display and its associated decoder/drivers have been designed primarily to display the numbers 0 to 9, the circuit in Fig. 1 can extend the numeric display to selected letters and symbols (Fig. 2). Or, with a different diode matrix, the characters can be inverted for upside-down reading.

The commonly used binary-code input—0000 to 1111—allows a choice of 16 characters. The full use of all the 16 codes to represent 10 numerics and 6 other commonly recognizable characters has been extensively studied and either PROMs¹ or decoders² have been used to obtain hexadecimal displays.

However, these hexadecimal displays generally lack uniformity: The six characters generated are usually a mixture of upper and lower-case letters. The special symbols directly obtained on a 7-segment display for codes from 10 to 16 (1010 to 1111) have proved to be difficult to remember.

The circuit in Fig. 1 extends the display with the use of a 74154 1-of-16 decoder in parallel with the 7448 7-segment decoder/driver. A control signal, designated N/C, selects between numbers and characters.

When N/C is HIGH, the 7-segment decoder is enabled and the 1-of-16 decoder is disabled. When

N/C is LOW, the 7-segment decoder operates in a test mode with all seven segments ON, and the 1-of-16 decoder is enabled.

The 1-of-16 decoder provides a LOW at only one of its addressed outputs. A corresponding buffer then sinks those segments of the display selected by a diode matrix to form one of the 16 characters in Fig. 2.

The possible characters or their sequence is not limited to those in the list. Other characters or symbols can be programmed in any sequence desired. The matrix also can be programmed to invert numbers or letters and avoid more complicated circuits.³

References

1. Withrow, III, F. E., "PROM Converts Binary Code for Hexadecimal Display," *Electronics*, July 8, 1976, p. 106.
2. Starr, R. F., "Decoders Convert Binary Code for Hexadecimal Display," *Electronics*, July 8, 1976, p. 107.
3. Ramamoorthy, V. and Murugesan, S., "Display Inverter Circuit Eliminates Upside-down Readout Problems," *Electronic Design*, Mar. 1, 1975, pp. 68-70.

Stamatios V. Kartalopoulos, The University of Toledo, College of Engineering, 2801 W. Bancroft St., Toledo, OH 43606.

CIRCLE No. 311

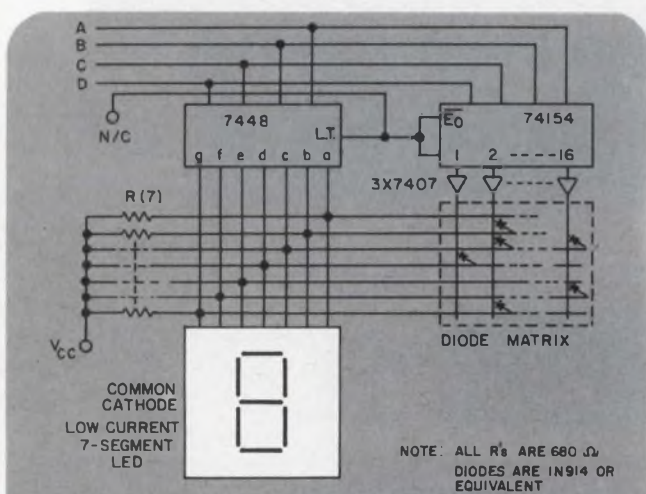

1. Letters and other symbols can be displayed on a 7-segment numerical display, in addition to the usual numbers.

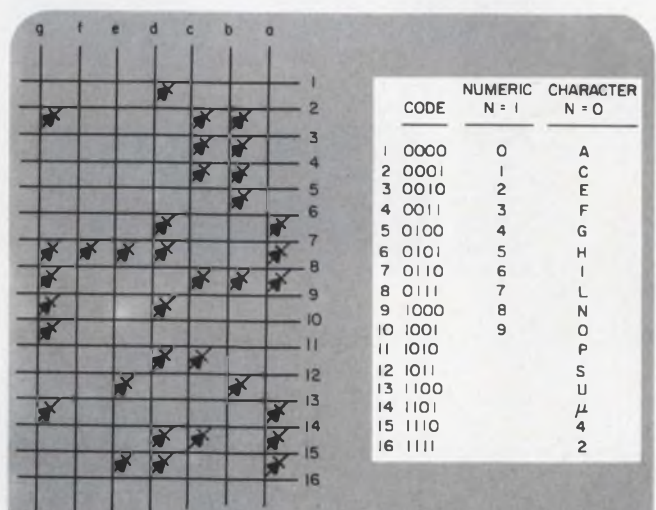

2. A diode matrix selects the LED-display segments that are sunk by the 7407 buffer, addressed by the 74154 1-of-16 decoder. The list of alphanumeric characters has been found useful, but other selections are possible.

If you need
top-quality
panel
instruments
 with a clean,
 modern look...

Buy
Triplett's
 Series GL
 or GL/B

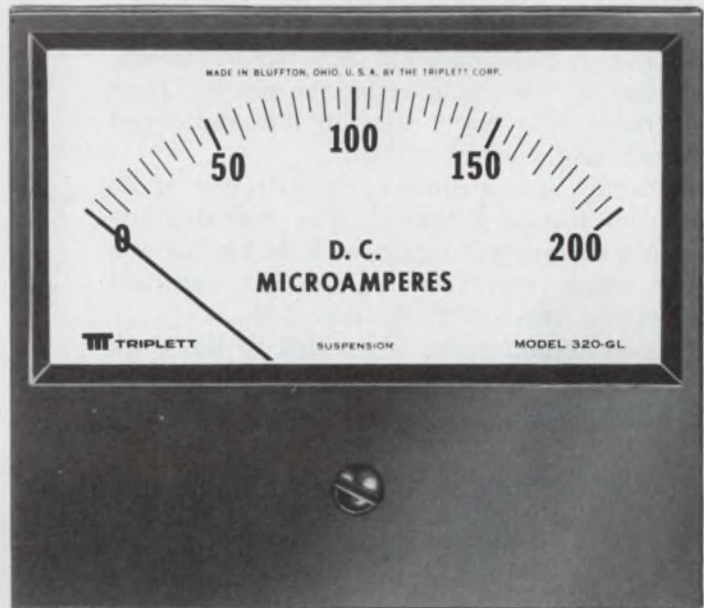

GL



GL/B (mounted appearance)

Triplett's newest panel instruments, the Series GL and GL/B, feature glass windows, matte-finish phenolic cases and a dial design that can readily accommodate multiple scales. They are available in 3½", 4½" and 5½" sizes.

The GL Series features a standard 2-stud mount with 3- and 4-stud mounts available.

The feature of the GL/B Series is behind-the-panel mounting with a bezel which is an integral part of the case.

There's a choice of more than 275 stock sizes and ranges — in DC microammeters, milliammeters, ammeters, millivoltmeters and voltmeters; AC milliammeters, ammeters, and voltmeters; RF thermoammeters; dB meters and VU meters. For those who need special instruments . . . custom dials, pointers, scales, accuracy, tracking, resistance, response time or practically any combination of unusual specs can be put into these new cases. For quick, dependable delivery

of small quantities of these adaptable new instruments, contact your Triplett Sales/Service/Modification Center or distributor. For prototypes or production quantities, contact your Triplett representative. Triplett Corporation, Bluffton, Ohio 45817.

TRIPLETT
 BLUFFTON, OHIO 45817
 Manufacturers of the World's
 most complete line of V-O-M's

CIRCLE #286 FOR INFORMATION

CIRCLE #287 FOR FREE DEMONSTRATION

Zero-crossover tone-burst circuit delivers integral number of sine waves

An integral number of sine-wave cycles that start and end at zero are generated by the circuit in Fig. 1. Nonsinusoidal, but "well-behaved" waves, can also be handled by the circuit. Such gated trains find many uses in automatic test equipment and control systems.

The circuit uses a comparator with one of its differential inputs grounded. The comparator's output is a rectangular signal with its leading and trailing edges corresponding to the zero-volt crossovers of the input sine wave, E_{in} .

This rectangular wave is applied to the clock input CK of a J-K flip-flop via an Exclusive-OR gate, which inverts its own output phase when its P control input is programmed with a ONE.

When the gating-input signal, T, which must be wider than two CK pulses, drives the J terminal of the J-K flip-flop both the leading and trailing edges of the flip-flop's output signal at Q coincide with a positive-going clock pulse at CK. The Q signal turns ON the analog switch, S, which is connected in the inverting input of op-amp A.

When S is ON, the output $E_o = - [R_2/R_1] E_{in}$. This output exists as long as Q remains low.

(continued on p. 112)

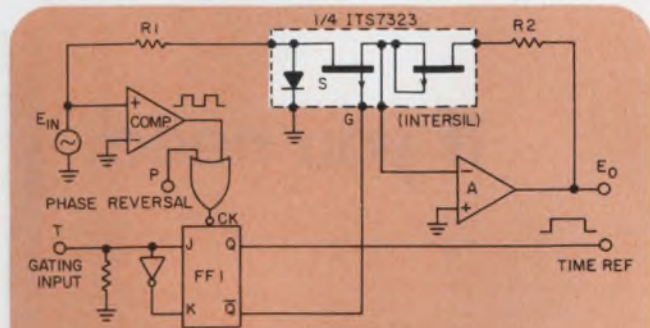

1. In this zero-crossover tone-burst circuit the analog switch, S, is designed to directly interface with +5-V CMOS logic. Output voltage, E_o , is determined by the ratio R_2/R_1 .

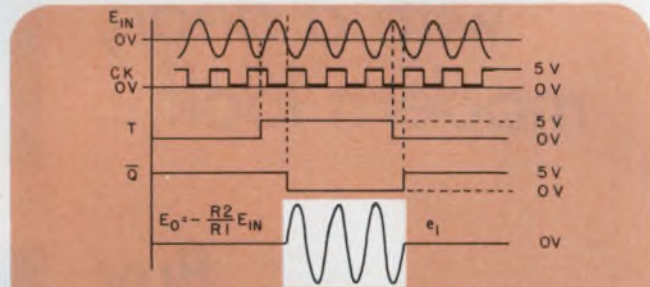

2. There is no time correlation between the signals at T and CK, but Q-signal edges are synchronous with positive-going clock signals.

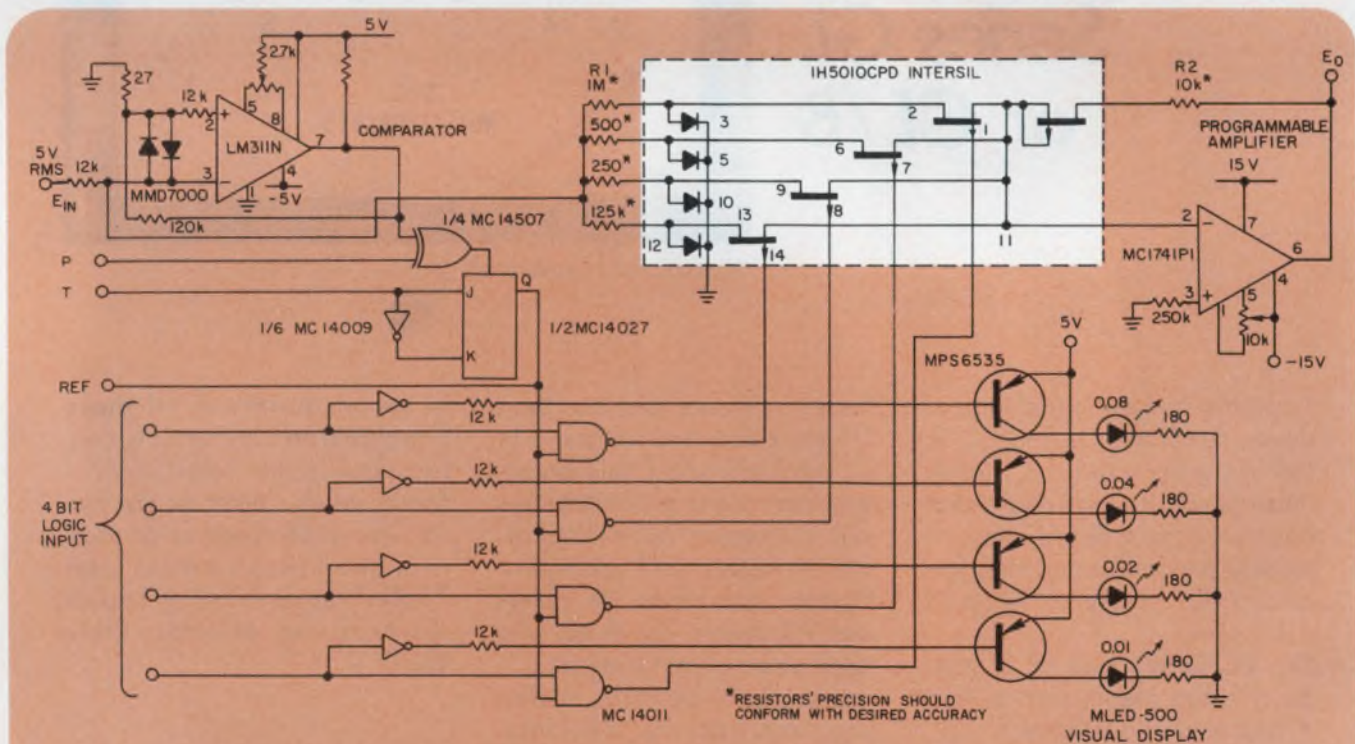

3. Gain can be controlled to provide 50-to-750-mV rms output in 50-mV steps when E_{in} is 5-V rms. With the addition of two more quad gates—for a total 12-bit program logic input—the range can be

extended to cover 50 mV to 8.325 V rms. Of course, E_{in} must be kept stable; signals under 50-mV output should be avoided because of possible noise interference.

When your show must go on,

In an industry where aspiring new IC's emerge daily, it helps to know there's an old pro **D/A converter** you can count on to carry the show.

Our DAC-100, introduced in 1970 as the **AIM DAC**, is an established performer. Proven in a multitude of applications ranging from avionics to commercial monitoring equipment, it's available in over 50 varieties. There are 4 nonlinearity specs, 2 full scale output options, 4 T.C. choices. Temp ranges include $-55^{\circ}\text{C}/+125^{\circ}\text{C}$, $-25^{\circ}\text{C}/+85^{\circ}\text{C}$, and $0^{\circ}\text{C}/+70^{\circ}\text{C}$.

The DAC-100 cuts heat and cost dramatically without sacrificing speed or performance. Its fast settling time will give you more data per second. So our DAC-100 doesn't need to prove itself a star. It has already played the circuit.

Free App. Notes

We have a great bunch of Applications Notes supporting the Old Pro. We'll be glad to send them to you. Just write, phone or TWX us. The numbers are below.

call in our Old Pro.



Precision Monolithics, Incorporated
1500 Space Park Drive, Santa Clara, CA 95050
(408) 246-9222. TWX: 910-338-0528
Cable MONO.

CIRCLE NUMBER 55



Both the starting and ending time of the sine-wave output train are in phase with positive transitions of the clock signal, CK, and therefore also with the zero-crossing points of the continuous sine wave. An integral number of sine waves are delivered (Fig. 2). Sine waves start in a positive or negative direction depending upon the logic signal on the P input to the Exclusive-OR gate.

The frequency response of the circuit is limited by the gain-bandwidth product of the op-amp and the 0.5- μ s response time of the analog switch. With an MC1741S op amp the circuit can achieve frequencies to 10 kHz with gains to 10 and with a distortion of less than 0.03%. Voltage outputs can be as high as 20 V peak-to-peak, and with $R_1 = R_2 = 10 \text{ k}\Omega \pm 0.05\%$, unity gain is readily obtained with only a 0.1% worst-case

precision for frequencies under 1 kHz. For higher frequencies and gains, the circuit requires faster amplifiers, such as the Harris HA-3235-5.

The Q output of the flip-flop provides a convenient time reference for any attached subsystems. Since there is no time correlation between input-signal T and clock-signal CK, the leading edge of Q may be delayed two clock pulses.

Fig. 3 shows an implementation of the circuit that provides four channels having gains of 0.01, 0.02, 0.04 and 0.08. With an input of 5-V rms, the output can be programmed from 50 to 750 mV rms in 50-mV steps. A row of LEDs indicates which channels are ON.

Gil Lorman, Principal Engineer, Motorola, Inc., P.O. Box 20855, Scottsdale, AZ 85088.

CIRCLE No. 312

Simple circuit interfaces TTL to CMOS with use of only a single 12-V supply

Unlike 34104 and 75367 interface chips, the circuit in Fig. 1 doesn't require both 5 and 12-V power supplies to interface a TTL signal to a higher-voltage CMOS circuit.

The R_1/R_2 voltage divider matches the interface circuit to the 2-V TTL logic threshold and the resistance R_1 controls the circuit's power-consumption. The pull-up resistor, R_3 , can be selected for nearly any output speed and power requirements.

IC manufacturers should consider offering a packaged version of this circuit. All that would be required for a flexible, simple-to-design-and-make interface chip would be to substitute a suitable current source for R_1 .

Roger H. Lsaelius, Electronic Engineer, Branch of Electromagnetism and Geomagnetism, U. S. Geological Survey, U. S. Dept. of the Interior, Box 25046, MS-964, Denver Federal Center, Denver, CO 80225.

CIRCLE No. 313

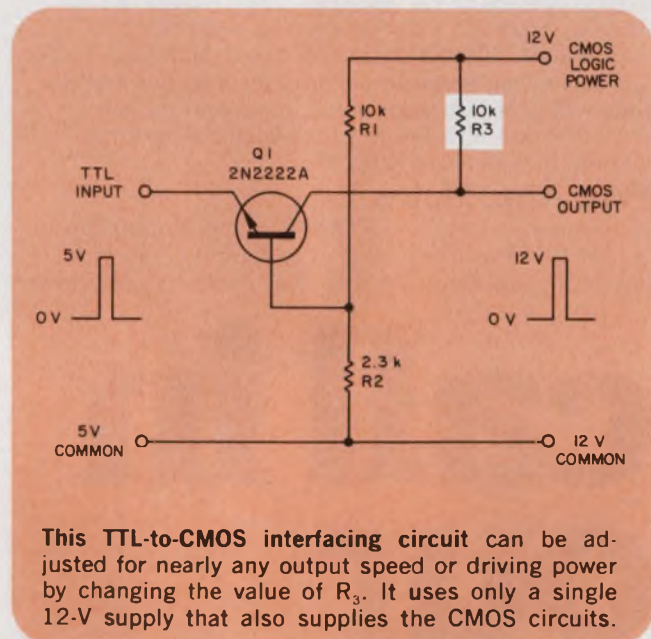

This TTL-to-CMOS interfacing circuit can be adjusted for nearly any output speed or driving power by changing the value of R_3 . It uses only a single 12-V supply that also supplies the CMOS circuits.

IFD Winner of August 2, 1976

Andrew M. Hudor Jr., Cosmic Ray Physics Group, Department of Physics, University of Arizona, Tucson, AZ 85721. His idea "Party-Line Intercom System Needs Only Three Wires" has been voted the Most Valuable of Issue Award.

Vote For the Best Idea in this issue by circling the number of your selection in the Reader Service Card at the back of this issue.

SEND US YOUR IDEAS FOR DESIGN. You may win a grand total of \$1050 (cash)! Here's how. Submit your IFD describing a new or important circuit or design technique, the clever use of a new component or test equipment, packaging tips, cost-saving ideas to our Ideas for Design editor. Ideas can only be considered for publication if they are submitted exclusively to ELECTRONIC DESIGN. You will receive \$20 for each published idea, \$30 more if it is voted best of issue by our readers. The best-of-issue winners become eligible for the Idea of the Year award of \$1000.

Is Modular Sensorialization the Answer to Efficient Microprocessor Testing?

by Richard C. McCaskill, Manager, Applications Services



With the development of LSI technology have come testing problems every bit as complex as the new circuits themselves. Consequently, a serious question has arisen. Do we continue with traditional "gate" test methods such as "path sensitization" or look to newer perhaps more well suited methods?

New Methods

Modular sensorialization, one of these new methods, is designed to test a module or a subsystem — instead of concentrating on each of the hundreds of MPU gates. And since a single chip MPU consists of relatively few modules, the procedure is relatively simple. Here is a brief description of that method.

Circuit Architecture

The first step in modular sensorialization is the investigation of the architecture of the MPU and the consequent partitioning of the MPU into modules. Each module should be accessible on the I/O bus by executing a proper set of

microprocessor instructions in order to propagate its results directly or indirectly to the I/O bus for sensing externally by executing a defined set of instruction sequences in the microprocessors own language. When dealing with each particular module, every effort should be made to run a worst-case test pattern, subject to the instruction executability. Once the first module is fully tested, then the procedure applies to each module until all modules within the MPU are covered. As a result of this, the entire MPU will be fully tested from the hardware viewpoint.

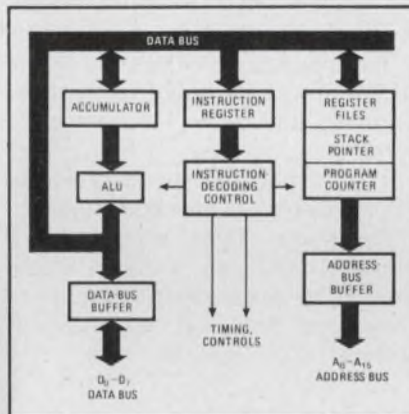

On the bus. Microprocessors may be viewed as assemblies of independent functional blocks that can be tested separately. Address and data buses tie the blocks together and provide access to each.

Software Architecture

Software is tested in a similar manner. A set of MPU instructions should be executed when testing the first module. Then, on the second module, another set of new MPU instructions (the same instruction could be executed previously) can be executed. This same procedure applies to all modules and hence all sets of instructions until

all specific MPU instructions are executed one or more times.

This approach provides two-fold diagnostic information. First, from a hardware viewpoint, any faulty module on the MPU will be isolated. Due to the fact that this approach is a modularity procedure, a break point is inherent in the test flow of each module to facilitate the modular diagnosis. Secondly, in conjunction with each module, a set of MPU instructions will be executed and thus any malfunction on a specific instruction or a specific set of instructions can be identified.

Systems to Solve Your Problems

Because of the ever increasing pace of technology, Macrodata recognizes there can be no one answer to every testing problem. That's why we are continuing to update and broaden the capability of our LSI test systems and our library of test programs and software to stay abreast of industry needs.

For more information on this or other LSI test subjects, consult Jack Salvador, vice president of engineering and marketing.



MACRODATA

Macrodata Corporation,
P.O. Box 1900, Woodland Hills,
Calif. 91365, Phone: (213) 887-5550,
Telex: 69-8489

New bubble memory is a real package deal

A 16-kbit bubble memory that contains its bubble chip and bias and driving circuitry in a single dual-in-line package has been produced by Plessey Memories in Towcester, England. A 236-k, bubble-memory system has been developed that uses these 16-k packages, organized as 32-k \times 8 bits.

Each bubble chip is a single, 16-kbit, nonvolatile shift register, in a 30 \times 17 \times 10-mm package. The bubbles, 6 μ m in diameter, are contained in a 6- μ m-thick single crystal film of yttrium iron garnet (YIG), which is doped with samarium and gallium to give the optimum properties.

The YIG film is deposited onto a nonmagnetic substrate of gadolinium gallium garnet. The multi-chip wafer includes, in a simple two-mask process, gold interconnectors for the READ, WRITE and ERASE functions and permalloy in the typical bar and T pattern for the shift-register elements.

Data are stored at the chips as

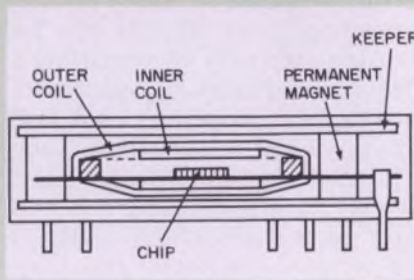

magnetic domains (bubbles). Each storage cell is 26 \times 26 μ m, which gives a storage density of 1550 bits/mm². The bubble chip is mounted on a ceramic lead frame. Coils furnishing a rotating field are wound onto the same frame. A steady-bias field is provided at a normal angle to the magnetic circuit by two small permanent magnets and two soft magnetic keepers.

The bubble systems built to date have a 0-to-50-C operating temperature range. Data rate is 100-k words/s, with an average access time of 80 ms. Laboratory devices have been produced that can operate at 120 C and 300 kHz.

Millisecond switch for fiber optic systems

Fiber-optic systems for communications and data processing will require switches that connect and disconnect signal paths in a few milliseconds as well as the much-publicized, faster nanosecond switches currently being developed in many research laboratories.

The faster switches will be needed for modulation in telecommunications systems or for on/off switching in digital systems, but the slower switches will be required, for example, to switch channels in telephone systems.

A prototype, millisecond optical switch consisting of three fibers held in a square glass tube has been developed by researchers at the University of Oxford. The fiber carrying the incoming signal is moved a distance of about one core diameter (10 μ m for single-mode fibers, 100 μ m for multi-mode fibers) to line up with one of two outgoing fibers.

Although prototypes built to date employ direct mechanical control of the fiber movement, work is now being directed towards

magnetic activation. A nickel sleeve is deposited on the outside of the fiber, and an electromagnetic coil surrounds the glass sleeve.

'Buried' laser used as video-disc pickup

A Japanese semiconductor-laser pickup for video-disc systems features relatively low cost, easy adjustment and maintenance, and a low voltage power supply—at 1/20th the size of competing helium-neon laser pickups. Produced by the Central Research Laboratory of Hitachi, Ltd., in Tokyo, the pickup is a buried-heterostructure injection laser whose optical system is substantially simpler than the complex assembly of mirrors and lenses in helium-neon laser pickups.

A small (2 μ m) spot size improves signal resolution, and a low operating current, 10 mA, produces an output of 0.5 mW. With the 0.5-mW output, images can be reproduced from a video disc with a signal-to-noise (S/N) ratio of over 40 dB, the same as that of a standard color-TV signal.

The laser's optical system has been simplified by aligning automatic-focus laser beams, video-track following and video-signal pickup all on one axis. A helium-neon pickup uses separate beams for each purpose, so its optical system is more complicated.

Interference between the auto-focusing and tracking signals, caused by the single beam, is alleviated electrically.

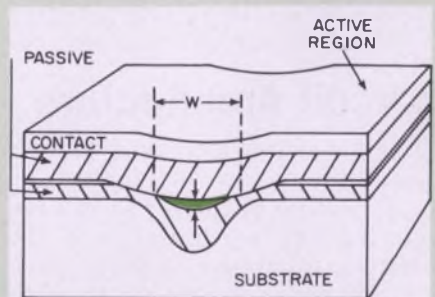

Buried-channel laser structure shows active region (about 10 μ m wide).

The Solid State Memory

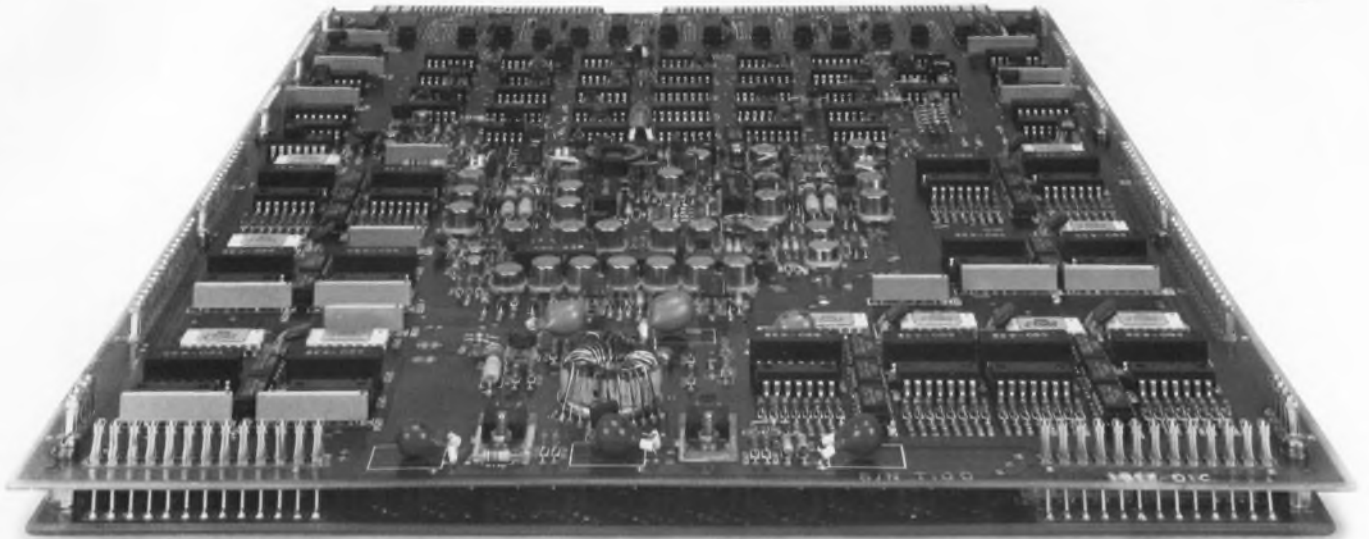

That Works

Here's a new solid state memory that works wherever a reliable, non-volatile, high capacity, fast access digital memory is needed.

Ampex 3220 Series core memories are modular. Individual modules store 32K words of up to 20 bits each, and you can combine as many as 16 modules for a total memory capacity of 512,000 words.

New 3220 Series memories are fast, too. Data access within 275 nanoseconds and full cycle in 650 nanoseconds. And power supply options offer a choice of +5/+15 volts or +5/+15/-15 volts.

Size is no problem. Ampex 3220 Series memory modules measure *less* than 1 by 12 by 16 inches. And you can get a complete system from Ampex, too, complete with cage space for 4, 8 or 16 modules plus power supply, blowers and logic interface.

Versatility is another advantage of Ampex 3220 Series memories. They're physically and electrically compatible with Ampex 1600 Series and with Micro 3000 Series products. And you'll get far wider operating margins, thanks to temperature independent core formulation.

Solid design. Solid performance. Solid reliability. Solid value. Ampex Core. The solid state memory that works.

AMPEX

Ampex Memory Products Division
200 N. Nash Street, El Segundo, California 90245
(213) 640-0150

Intel 8080 peripherals

Now you can get microcomputer based products out of the lab and into production faster than ever before. Intel® 8080 programmable LSI peripherals give you the competitive advantage by helping you reduce design time, component count and manufacturing and inventory costs. Most of all they'll help you get to market first.

Intel 8080 programmable peripherals are software controlled LSI replacements for hardwired SSI/MSI logic assemblies. You simply attach the appropriate peripherals to the system bus and the +5V supply. Then, with system software, you personalize device operating configurations to suit your applications. Reconfiguration and design changes are made with software. No expensive and time consuming hardware redesigns are necessary.

One peripheral, the 8253 Programmable Interval Timer, is the first LSI solution to system timing problems. It counts out I/O servicing delays, eliminating software timing loops and increasing CPU throughput. It also saves hardware when you need event counters, rate generators or real-time clocks. Each 8253 contains three 16-bit timer/counters.

Our 8257 Programmable DMA Controller is the lowest cost way to handle applications that require high speed data transfer such as disks, magnetic tape, analog interfaces and high speed communication controllers. The four channel 8257 contains all the logic necessary for bus acquisition, cycle counting and priority resolving of the channel requests.

The 8259 Priority Interrupt Controller replaces complex TTL arrays and minimizes component costs. The CPU can change interrupt structure "on the fly" to suit changes in the operating environment, such as time of day or process control parameters. The 8259 handles up to eight vectored priority interrupts. Multiple 8259's can control up to 64 interrupt levels.

Use the 8251 Programmable Communication Controller for "serial I/O." The first true USART in a single chip, the 8251 implements all popular com-

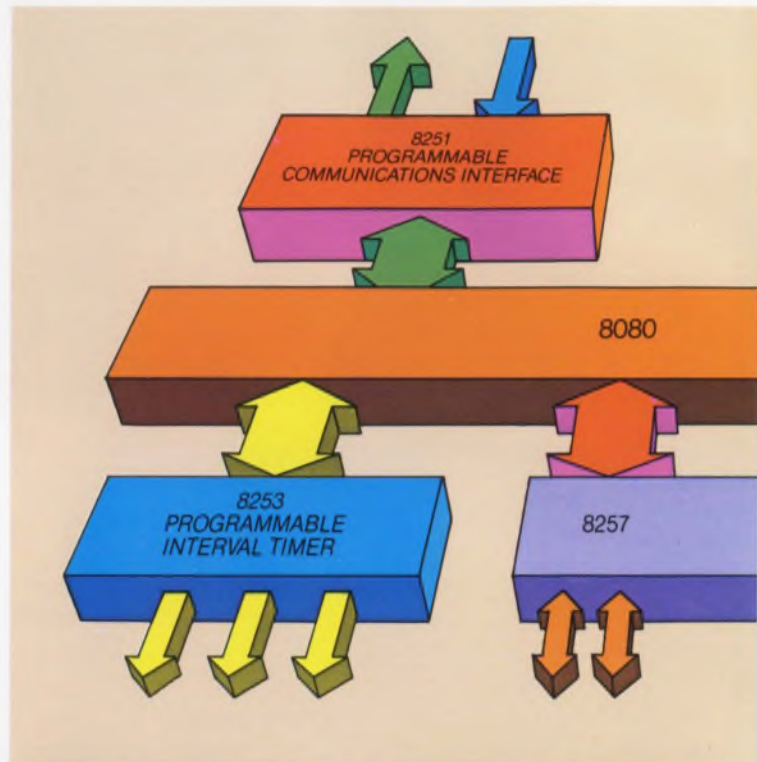

get you to market first.

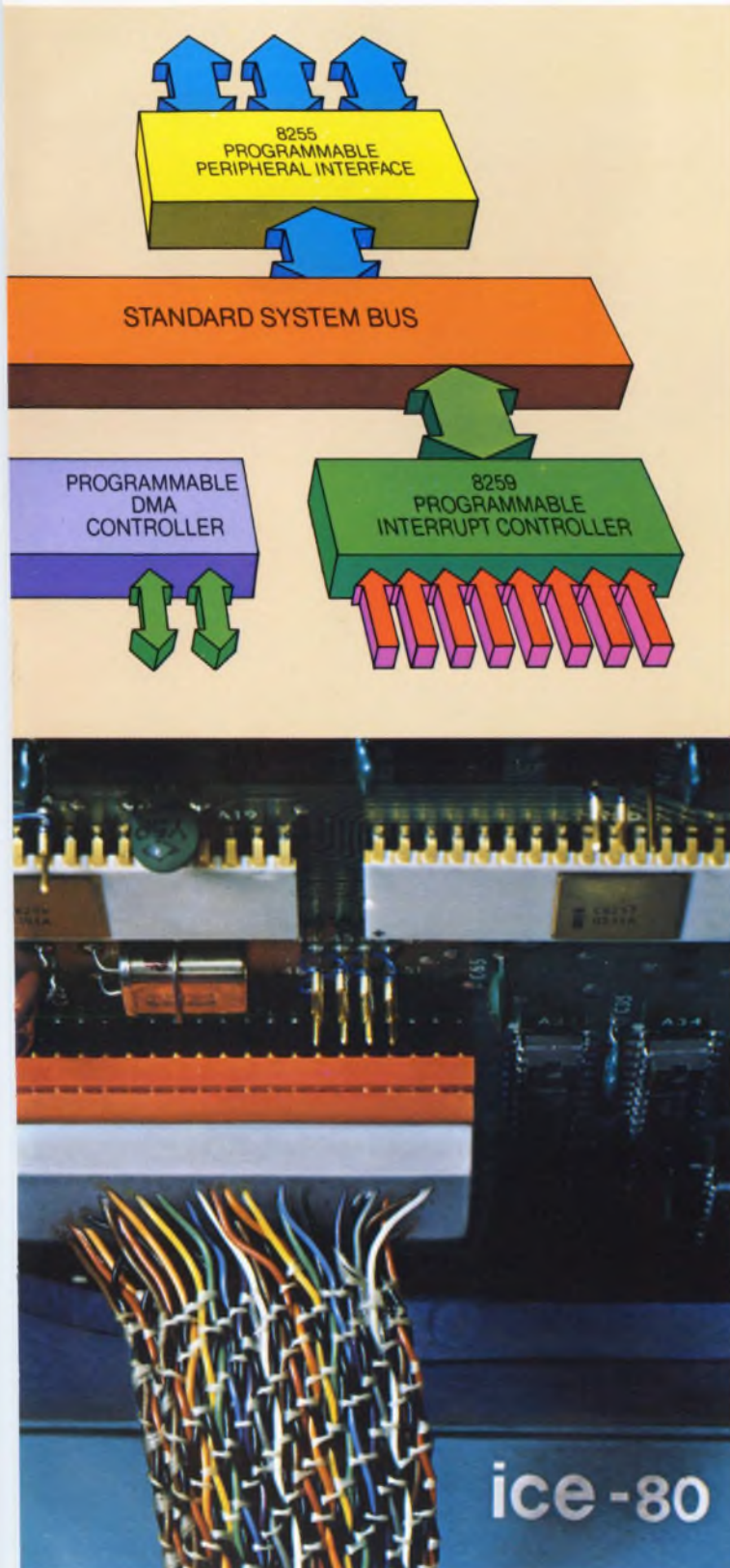

munication protocols, including IBM Bi-Sync. For "parallel I/O," each 8255 Programmable Peripheral Interface gives you 24 versatile I/O lines to interface relays, motor drives, printers, keyboard/display and other parallel equipment.

Once you've selected the peripherals to fit your application, use the Intel[®] Microcomputer Development System for both software and hardware development. Using the Intel[®] CRT terminal, call up the resident text editor. Write the source program to initialize the peripheral and the subroutines for peripheral/system operation. Then you assemble or compile the source programs into an object file using resident macroassembler or resident PL/M compiler—and store the object file on the Intel[®] diskette. With the relocation and linkage capability of the Intel[®] ISIS II diskette operating system, these routines can be added to a system library and called from user programs as needed. Once the main system program is written, the new peripheral device routines are easily linked in. The entire program is now ready to be run on your prototype via the Intel[®] ICE-80™ in-circuit emulation module. ICE-80 lets you debug your software and hardware in your actual prototype environment. Move from system integration and debugging to production in a fraction of the time previously required.

Intel also provides applications assistance, training programs, the largest user's program library, and volume production support. Intel's 8080 programmable peripherals give you the competitive advantage from start to finish. Be first to market.

To order the new peripherals, contact our franchised distributors: Almac/Stroum, Components Specialties, Components Plus, Cramer, Elmar, Hamilton/Avnet, Industrial Components, Liberty, Pioneer, Sheridan or L.A. Varah. For your copy of our 8080 System brochure write: Intel Corporation, 3065 Bowers Avenue, Santa Clara, California 95051.

intel[®]

Microcomputers. First from the beginning.

17 days from now this trace will look the same as it does today. Now that's storage!

The Gould OS-4000 Digital Storage Oscilloscope . . .

will store any signal up to 450 kHz for as long as you need, while providing the performance of a conventional 10 MHz scope as well. The OS-4000 opens the door for entirely new viewing possibilities involving low frequency measurements. It is ideal for displaying and recording transient waveforms for medical, electrical, vibration, dynamic testing and pulse testing applications.

The digital storage capability provides a non-flickering, full trace at low frequencies and a unique "Dot Joining" technique.

The OS-4000 will allow you to simultaneously view stored and real time signals. These may even be superimposed to reveal small changes.

The OS-4000 also allows you to examine a single event trace prior to, as well as after, a trigger point; and it's stored indefinitely as long as power is supplied to the unit.

If you'd like a hard copy of a stored trace, you can record it in either analog or digital form on your recorder by using the Gould 4001 Output Unit.

Find out how the unique Gould OS-4000 Digital Storage Oscilloscope and the companion 4001 Output Unit can make your work more efficient and easier. Call your nearest Gould Sales Engineer for details. Or write Gould Inc., Instrument Systems Division, 3631 Perkins Avenue, Cleveland, Ohio 44114.

PHONE TOLL FREE FOR BROCHURE (800) 325-6400.
(In Missouri (800) 342-6600)



 **GOULD**
The product development company

CIRCLE NUMBER 133

If you're working RF linear:

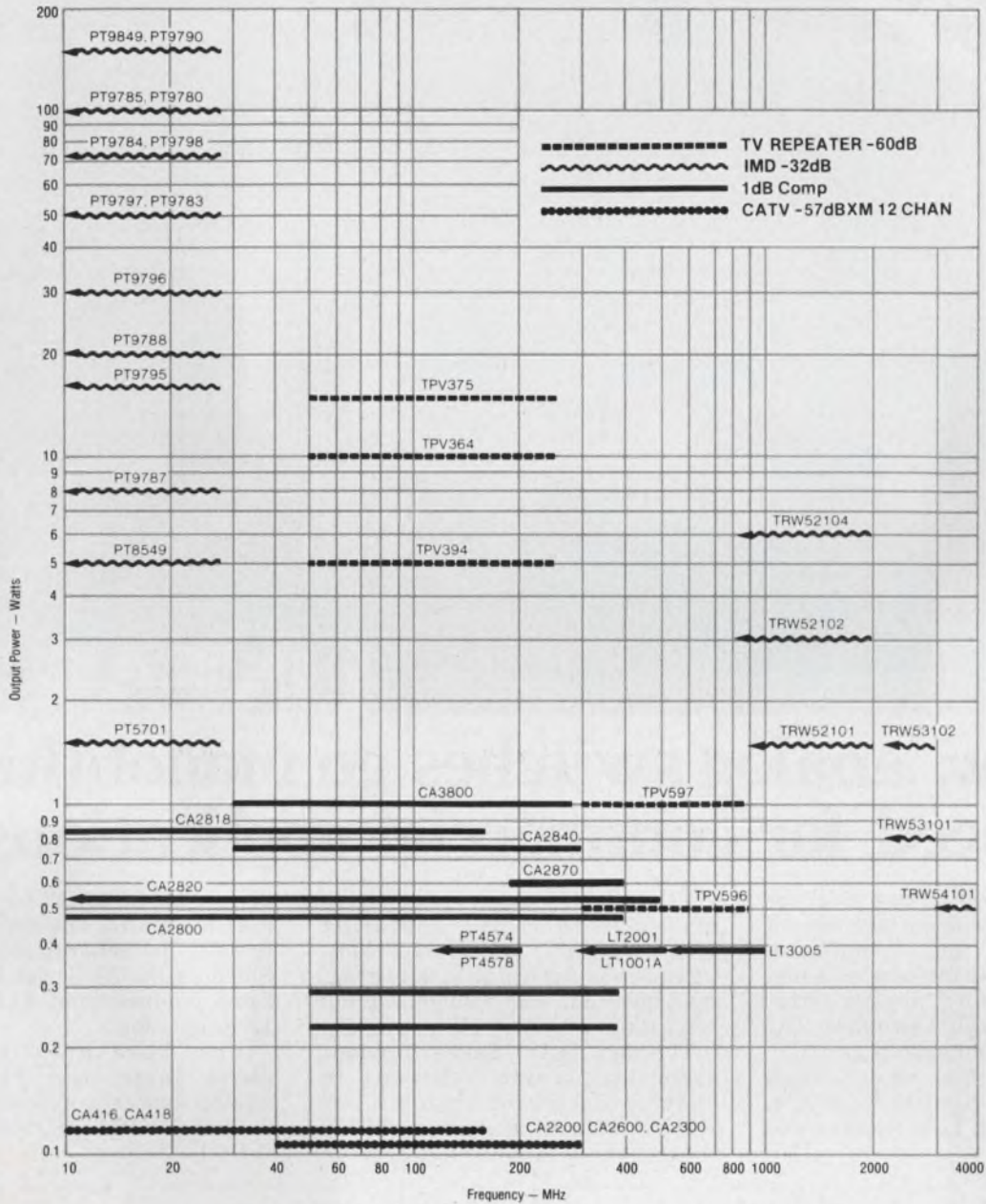

New TRW RF catalog tells all!

This valuable booklet covers hybrids and discretes for RF linear applications from microwatts to kilowatts of output from 1MHz to 4GHz.

You'll find complete product specs, application block diagrams, reliability criteria and a good measure of advanced theory.

And it's yours, FREE. To get your personal copy, use the coupon or bingo number below — or call Warren Gould at (213) 679-4561.



TRW RF Semiconductors
An Electronic Components Division of TRW, Inc.
14520 Aviation Boulevard, Lawndale, California 90260
Please send me your new RF Linear catalog.

Name _____

Company Name _____

Address _____

City _____ State _____ Zip _____ Ed _____

TRW RF SEMICONDUCTORS

ANOTHER PRODUCT OF A COMPANY CALLED TRW

CIRCLE NUMBER 57

**LINEAR INNOVATIONS
FROM TI**

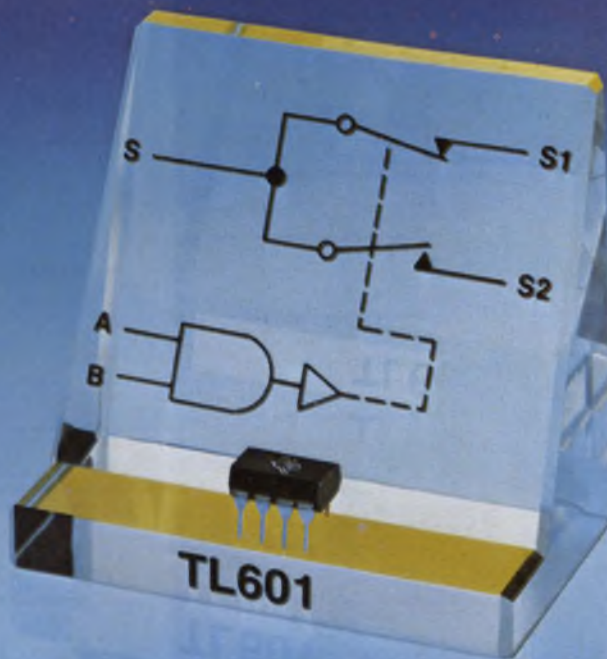
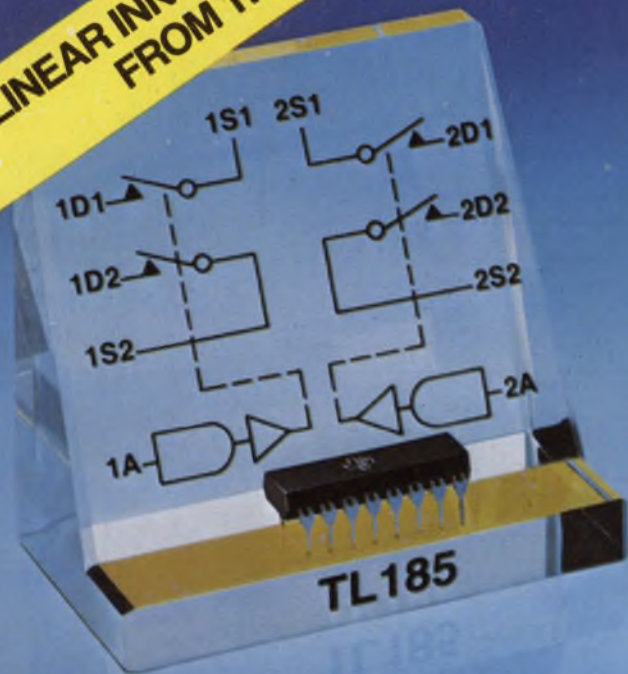

LINEAR ICs

Now, analog switches go monolithic. Priced for commercial applications.

Expensive hybrid analog switches are out. TI's pioneering use of BIMOS, BIFET, and ion implantation technologies introduces a major innovation: single-chip, monolithic analog switches. At less than \$1.00 per switch.

You also get fast speeds. High reliability. TTL compatible inputs. Easy triggering. Low leakage. No latch-up.

TI's new TL600 Series is a general-purpose family featuring high r_{off}/r_{on} ratio and no offset voltage. Ideal for signal switching, multiplexing, and controlling op amp gain. \$0.88 in 1K quantities.

TI's new TL181 Series provides symmetrical on-state resistance to allow switching of precision AC signals without distortion. JFET control input allows series to be

driven by TTL, ECL, CMOS, or PMOS circuits. The series is functionally interchangeable with the Siliconix DG181 Series having the same pinouts. Just \$1.88 each in 1K quantities.

For more details about these new TI analog switches priced for widespread use, return the coupon.

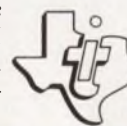

TI Analog Switches

AVAILABLE NOW

Series	Channel	Type	Typical On-State Resistance (Ohms)
TL601	1	SPDT	75
TL604	1	Dual SPST (Complement)	75
TL607	1	SPDT (with inhibit)	75
TL610	1	SPST	40
TL182	2	SPST	50
TL185	2	DPST	75
TL188	1	Dual SPST (Complement)	50
TL191	2	Dual SPST (Complement)	75

Texas Instruments
P. O. Box 5012, M/S 964
Dallas, Texas 75222

Please send information on the following:

- | | |
|--|---|
| <input type="checkbox"/> TL600 Series | <input type="checkbox"/> Switching Regulators |
| <input type="checkbox"/> TL181 Series | <input type="checkbox"/> BIFET Op Amps |
| <input type="checkbox"/> Voltage Regulators | <input type="checkbox"/> New Linear Control Catalog |
| <input type="checkbox"/> Please have salesman call | |

NAME _____ TITLE _____

COMPANY _____

ADDRESS _____

CITY _____ STATE _____ ZIP _____

TEXAS INSTRUMENTS
INCORPORATED

New Products

Plug-in modules sense 24 temperatures



Bentley Nevada, P.O. Box 157, Minden, NV 89423. (702) 782-2255. See text; 8 wk.

The 9000-series system monitors the temperatures of from two to 24 points and displays one temperature on a digital or analog readout. The system consists of dual-temperature modules, a rack holding either 2, 4 or 12 of the modules, and a power supply. The modules use resistance temperature detectors (RTD monitors No. 90200; \$450, single qty) or thermocouple transducers (TC monitors No. 90225, \$550). Any combination of RTD or TC monitors plug into the rack. The 12-module-rack, No. 90060, costs \$190, and the power supply with readout, No. 90050, runs \$495.

CIRCLE NO. 301

Four cassette drives fit into one box

Hewlett-Packard, 1501 Page Mill Rd., Palo Alto, CA 94304. (415) 493-1501. \$2340 (single drive); \$3065 (two drives); \$4330 (four drives).

The 9877A contains up to four tape-cartridge drives for the manufacturer's 9825 desktop computing system. Each cartridge holds 250 kbytes. The 9877 can also duplicate a tape from one drive to another under software or switch control. Data transfers at a rate of 2750 byte/s. The search and rewind speed is 90 in./s, and the read/write speed is 22 in./s. The average access time is six seconds for any file from any tape in the unit.

CIRCLE NO. 302

Cassette-tape reader plays back in 3 min.



Memodyne Corp., 385 Elliot St., Newton Upper Falls, MA 02164. (617) 527-6600. \$1495; 2-3 wk.

A tape reader Model 3722 plays back cassettes written on the manufacturer's 200, 300 or 500 series of digital recorders. A standard 300 ft Philips cassette reads out in less than three min. The data transfer from the unit in parallel words of 8, 12 or 16 bits. The 3722 reads tapes at a speed of 20 in./s and rewinds at 100 in./s.

CIRCLE NO. 303

20-Mbyte disc drive replaces 2.4 Mbyte

Wango, Inc., 5404 Jandy Pl., Los Angeles, CA 90066. (213) 390-8081. OEM qty prices: \$3100 (5 Mbytes), \$3575 (10 Mbyte), \$4470 (20 Mbyte); 50 days.

A series of cartridge disc drives stores 10 or 20 Mbyte of data in the space usually required for 2.4 Mbyte drives. The units measure $7.75 \times 19 \times 22$ in. Called the Super Generation series, the new drives are available in either top-load or front-load models. The Super T top-load version uses an IBM 5540-type cartridge in combination with a fixed disc. It offers data densities up to 4400 bits per in. with up to 200 tracks per in., for a total capacity of 20 Mbytes per drive. Data transfer at a rate of 5 Mbyte/s. The Super F front-load version uses the IBM 2315-type cartridges. It stores 10 Mbyte and transfers data at a rate of 2.5 Mbyte/s. The unit uses side-throw voice-coil positioning. A magnesium positioner reduces access time to 33 ms random-average seek, 20-ms track-to-track, and 60-ms full stroke.

CIRCLE NO. 304

Tape drives come with a smart formatter



Pertec Computer Corp., 9600 Irondale Ave., Chatsworth, CA 91311. (213) 882-0030. 1-up prices: \$3275 (FT7000), \$4195 (FT8000), \$4700 (FT9000).

A series of tape drives, Models FT7000, 8000 and 9000, includes a formatter that offers both non-return to zero and phase-encoded tape-recording methods on a single circuit board. Tape speeds from 12.5 to 75 in./s can be switch selected. The board measures 8×15 in. The formatter allows each drive to search for files and includes a crystal oscillator for timing. Three additional drives may be added in a master/slave configuration.

CIRCLE NO. 305

Multiport memory talks to 14 processors

Interdata, Inc., 2 Crescent Pl., Oceanport, NJ 07757. (201) 229-4040. See text.

A multiport core-memory system can be accessed by as many as 14 of the manufacturer's 32-bit processors. The simplest system contains 64 kbytes, with two processor ports, and costs \$18,600. Another version that contains 128 kbytes, also with two ports, costs \$54,500. In addition to the processors, custom devices and peripherals can connect to a separate port. Each processor in a network accesses the shared memory and its own memory. The total memory space for each processor cannot exceed its 1-Mbyte direct-addressing capacity.

CIRCLE NO. 306

from *Electronic Measurements* . . .

SCR 1~~Ø~~ & 3~~Ø~~ DC Power Supplies

We are pleased to report that we now produce the industry's largest selection of SCR phase-controlled power supplies.

How did we do it?

Slowly.

We didn't acquire the largest selection without selling a lot of power supplies along the way. Our way, for 35 years, has been giving the user what he wants; and in a watts/dollar ratio that gives him no choice but E/M.



Type	SINGLE PHASE				THREE PHASE			
Watts	500	800	1600	2400	2500	5000	10 KW	To 60 KW
Volts	0 to 7.5 V up to 600 V DC							
Amperes	0 to 0.75 A up to 3000 A DC							
Height (in.)	3.50	3.50	5.25	7.00	7.00	8.75	12.25	To 4'
Price (\$)	450 to 500	575 to 650	800 to 895	1000 to 1100	1200 to 1600	1500 to 2300	2300 to 2900	To 9500

Over 100 standard models. Thousands of optional combinations.

To order, or for any technical information, call
TOLL FREE (800) 631-4298



ELECTRONIC MEASUREMENTS INC.

405 Essex Road, Neptune, N.J. 07753
Phone (New Jersey) 201-922-9300 (Toll free) 800-631-4298

Specialists in Power Conversion Equipment

DATA PROCESSING

16 k × 18 RAM boards
plug into the PDP-11

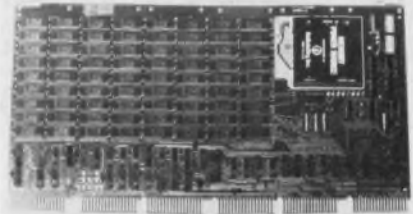

Fabri-Tek, Inc., 5901 County Rd. 18, Minneapolis, MN 55436. (612) 926-2721. \$1250 (16 k × 18); 10 days.

The Add-In 11 semiconductor memory board plugs into DEC PDP-11 minicomputers. The board is compatible with the following PDP-11 models: 04, 05, 10, 34, 35, 40, 45, 50, and 55. The Add-In 11 comes in 16 k × 18 bit and 16 k × 16 bit configurations. Dynamic 4-k bit MOS chips are used.

CIRCLE NO. 307

Timer programs from
0.1 s to 99 h

Shumway Brothers, Inc., 391 Laundale Dr., Salt Lake City, UT 84115. (801) 486-5653. 1-up prices: \$475 (SBI-054), \$520 (SBI-057), \$550 (SBI-059); 45 days.

The 05X programmable-sequencer series has four, seven, or nine timers. The Model SBI-054 has four timers, the SBI-057 has seven, and the SBI-059 has nine. Each timer programs from 0.1 s to 99 h using digital thumbwheel switches. Panel-mounted LEDs indicate which time period is active. A numeric readout indicates the running time of each period in the sequence. The timers operate sequentially. Each timer can start when the previous one ends. Or, the unit can advance to the next time period before the selected time period has expired. Also, a sequence may be stopped in the middle of a time period and then started again. Individual open-collector transistor-driver or optional relay-contact outputs come from corresponding time sequences. Optional rear-panel selection switches combine any number of time sequences to one output.

CIRCLE NO. 308

Scientific calculator solves equations simply

Texas Instruments, Inc., P.O. Box 5012/MS308, Dallas, TX 75222. (214) 238-2011. \$39.95; stock.

The SR-40 scientific calculator features an algebraic operating system which allows complex equations to be entered the way they are stated. The unit holds up to 15 sets of parentheses and four pending operations. If the calculator has not been used for 25 to 50 s, it displays a single moving decimal point. It turns off completely after 7 to 14 min. Operations that involve memory include store, recall and sum. There is also a key that exchanges memory contents with the displayed value.

CIRCLE NO. 309

Multiplexer boards fit into minicomputers

Custom Systems, Inc., 2415 Annapolis Lane, Minneapolis, MN 55441. (612) 553-1112. From \$1250; stock.

Four or eight channel communications multiplexer boards, Models 260-4 or 260-8, plug into Data General and Digital Computer Controls minicomputers. Each board measures 15 x 15 in. Up to 64 channels on eight 260-8 boards can be installed. Data format and baud rate are jumper selectable for each channel.

CIRCLE NO. 310

Smart cable connects mini to IEEE-type units

Computer Automation, 18651 Von Karman, Irvine, CA 92713. (714) 833-8830. \$300.

An interface, called the IEEE Intelligent Cable, connects up to 14 IEEE 488-1975 bus-interface-compatible instruments to the manufacturer's LSI family of minicomputers. The cable is 16 ft long. It has a microprogrammed controller to select instruments and monitor the data transfer and device status. Data transfer at a rate up to 100 kbyte/s into the company's four or eight-channel I/O distributor cards. Peripheral devices may be interconnected using daisy-chained cables.

CIRCLE NO. 320

For Sale



70 million optimized filters (in one small box)

For analog or digital signal conditioning, alias-free signal processing, and every kind of spectrum shaping, our Models 452 and 852 wide-range-adjustable dual analog filters are the best choice . . . and the best buy.

Why best? Because these are *truly* optimized filters — designed without the tradeoffs and compromises that limit the effectiveness and the applications range of other designs. To begin with, both the Model 452 (4-pole) and the Model 852 (8-pole) provide dual, completely independent channels, with *near-ideal* flat-amplitude and linear-phase responses (pushbutton selectable).

But that's not all you should look for in an *optimized* filter. You have a right to expect *negligible* offset and offset drift.

Negligible feedthrough coupling. *Very* high input impedance. *Very* low output impedance. *Negligible* noise. *Precise* and uniform range-to-range calibration. The *highest* possible time and temperature stability. The *widest* possible dynamic range. *Complete* modal flexibility — high-pass, low-pass, bandpass, band-reject, notch . . . and freedom to cascade independent channels, as well.

In the 452/852 designs, we deliver *all* of those features — at *no higher cost than conventional, heavily compromised designs*.

As for applications range, check these parameters: any cutoff frequency from 0.1Hz to 111 kilohertz, (optionally, down to 0.01Hz). Pushbuttons select

High-Pass or Low-Pass; 0dB or 20dB gain; Flat-Amplitude (Butterworth) or Flat-Delay (linear-phase) response. Model 452 gives you 24dB/octave; Model 852, 48dB/octave. Cascade channels to *double* the rolloff. Altogether, there are over 70 million combinations of settings and modes (count them).

BUDGET TIGHT? Get the facts and figures on Models 432/442 — similar range, performance, and flexibility but lower resolution . . . at *much* lower cost.



HOW & WHY optimized filters can enhance the performance of your analog and digital systems is explained in great detail in this new 24-page Handbook. Get it — *free* by using the inquiry number or write:

THE APPLICATION OF FILTERS TO ANALOG & DIGITAL SIGNAL PROCESSING

ROCKLAND

Rockland Systems Corporation
230 W. Nyack Road
W. Nyack, N.Y. 10994
TEL: (914) 623-6666
TWX: 710-575-2631

ADVANCED SIGNAL TECHNOLOGY

ROCKLAND

SYNTHESIS • PROCESSING • ANALYSIS

Our Second Decade of Leadership

CIRCLE NUMBER 60

Switch Access From Racked PC Boards

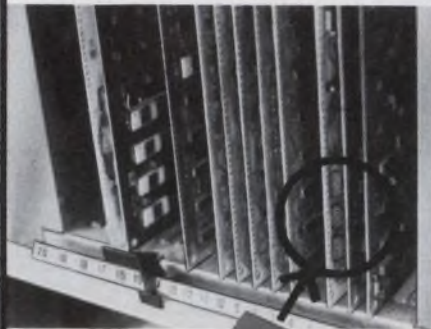

Grayhill Piano-DIP™ Side-Actuated Rocker DIP Switches

SPST circuitry under each rocker... Dimensionally compatible with SPST, SPDT, and DPDT Rocker DIP switches and standard sockets.

- Positive identification of rocker position from the side of the mounted switch.
- Low profile... can be readily edge mounted on racked PC boards.
- Grayhill's reliable spring loaded, sliding ball contact system... life rated at 50,000 operations with positive wiping action and immunity to normal shock and vibration.

Here's the latest entry to the comprehensive and innovative Grayhill DIP switch line... a new switch that can be actuated without removing the PC board from its rack. Because of its distinctive shape and side actuation, Grayhill calls this the PIANO-DIP™. It's ideal for mounting on the exposed edge of a racked PC board, allowing engineer or technician easy programming access. PIANO-DIP™ switches are now offered with 7 rockers; future versions will include 4 to 10 switch stations. Complete information is contained in Bulletin 260R321, available free on request from Grayhill, Inc., 561 Hillgrove Avenue, La Grange, Illinois 60525; phone: (312) 354-1040.



CIRCLE NUMBER 61

INTEGRATED CIRCUITS

Bipolar PROMs come with three-state outputs

National Semiconductor, 2900 Semiconductor Dr., Santa Clara, CA 95051. \$3.22 (100-up); stock.

The DM74S387/287 field-programmable bipolar ROM can be programmed with low voltages. The PROMs are available in either open collector output (DM74S387) or three-state outputs (DM74S-287). Both are organized as 256 × 4 bits and use titanium-tungsten fuses. The PROMs require three coincident events for programming to occur. This eliminates the problem of random programming due to noise. Available as ROMs as well as PROMs, the DM74S387/287s have pnp inputs to reduce input loading. Because of the high speed (50-ns address access time, 25-ns enable access) the units are ideal for controllers and minicomputers as well as code converters and logic replacement.

CIRCLE NO. 321

Touch switch circuits handle up to 32 switches

American Microsystems, 3800 Homestead Rd., Santa Clara, CA 95051. (408) 246-0330. From \$5.85 (100-up); stock.

A family of circuits designed to interface to a variety of touch switches, the S9260 to S9266, can control up to 32 switches. The S9260 and 9261 are housed in 22-pin DIPs, interface with seven switches and drive seven corresponding outputs. The S9262 uses a 2 × 7 multiplexed switch matrix to operate 14 switches. It is housed in a 22-pin DIP and delivers binary-coded outputs for each switch closure from four pins. Three circuits, the S9263, 64 and 65, are supplied in 40-pin DIPs and can handle 16 touch switches and drive 16 corresponding outputs. Also in a 40-pin DIP is the 9266, which controls 32 switches using a 2 × 16 multiplexed switch array. A 5-bit binary-coded output is also available. A design kit that includes the S9263 and a PC board that contains 16 switches and all interconnects is available for \$19.

CIRCLE NO. 322

Digital multipliers handle 8 × 8-bit inputs

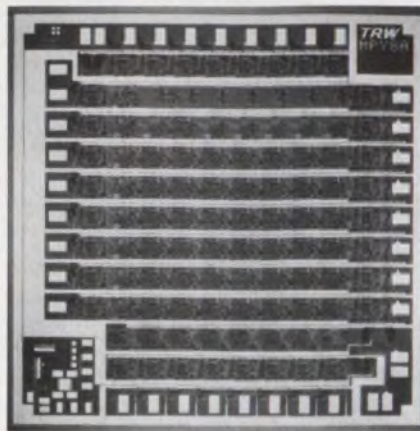

TRW Defense and Space Systems, One Space Park, Redondo Beach, CA 90278. (213) 536-1500. \$100 (1 to 9); 30 days.

The MPY-8 can perform a complete 8 × 8-bit parallel multiplication in 130 ns, typical. It is a monolithic bipolar circuit on a 190 × 190-mil chip. Inputs and outputs are fully TTL-compatible, and the outputs have three-state control. A single 5-V power supply is required. Inside the circuit emitter-follower logic is used to achieve high speed and low power consumption (1.8 W). The multiplier is organized as a four-port device and is packaged in a 40-lead ceramic DIP. Four independent D-type registers are used for input loading and storage of the output product. If desired, a single 8-bit bus can be used for both loading and transmitting the product using a sequential mode on the control signals. The multiplier is a 2's complement device and the sign bit occupies the most significant bit position.

CIRCLE NO. 323

Quad JFET op amps come in 14-pin DIPs

Texas Instruments, P.O. Box 5012, Dallas, TX 75222. (214) 238-2011. \$4.95 (100-up); stock.

The TL084, a monolithic quad JFET-input op amp, has been developed by Texas Instruments. The quad is claimed to have a high slew rate and very low power consumption. It requires no frequency compensation and is available in a plastic 14-pin DIP specified for the 0-to-70°C operating range.

CIRCLE NO. 324

TEN-FOUR, CB-LAND, DO YOU COPY?



... Hammer up and lay an eyeball on this copy for a minute. We don't want to overmodulate, but we've got four handbooks that, for not much lettuce, can have you doing your thing in the left lane in no time.

How to get your license from Uncle Charley. How to select and set up a rig. How it works. How to fix your set when something's dusting your ears. Do you copy ... it's all here!

Whether you're a green apple or a trucking guy, even if you drive a pregnant roller skate and want help the next time you get bubble trouble, here's the information, tips and techniques you need.

Use the coupon and put down your handle (name) and 10-20 (address) to order the book(s) you want. They come with a 15-day money back guarantee. And keep the wheels spinning and the beavers grinning.



HAYDEN BOOK COMPANY, INC., 50 Essex St., Rochelle Park, N.J. 07662

MOST OFTEN ASKED QUESTIONS AND ANSWERS ABOUT CB RADIO

CB Magazine Staff

Everything from "WHAT DOES CB MEAN?" to "HOW DO RG-58 and RG-59 CABLE DIFFER?" Over 160 questions sent in to *CB Magazine* cover all you need to know to really enjoy your rig. 5747-4, \$3.95.

PRACTICAL CB RADIO SERVICING Revised 2nd Edition

R. R. Freeland

How to handle just about every problem you'll ever face. Step-by-step instructions, including spot-testing and troubleshooting. Filled with charts, diagrams, illustrations. 0869-4, \$6.95.

CITIZENS BAND RADIO Revised 2nd Edition

Allan Lytel

Compares different types of equipment ... how they work ... maintenance and repair ... the FCC and you. 5737-7, \$4.90.

CBers' HOW-TO BOOK

Leo G. Sands

How to select and install equipment, including mobile and base stations ... codes and channels ... how to modify your rig for greater convenience and performance. 0718-3, \$4.95.

Please send the books checked on 15-day examination. Enclosed is my check for \$_____—Include your state sales tax (NJ-5%, CA-6%, FLA-4%) and 65¢ per book for postage & handling. I understand that I may return the book(s) within 15 days for a complete refund if not satisfied.

Name _____

Address _____

City _____

State/Zip _____

76-47

Premier Electronic Cabinets and Cases

- ESTHETICS KEYED TO MODERN SYSTEMS
- RUGGED-FUNCTIONAL CONSTRUCTION
- ECONOMICAL PRICING
- PROMPT SERVICE & AVAILABILITY

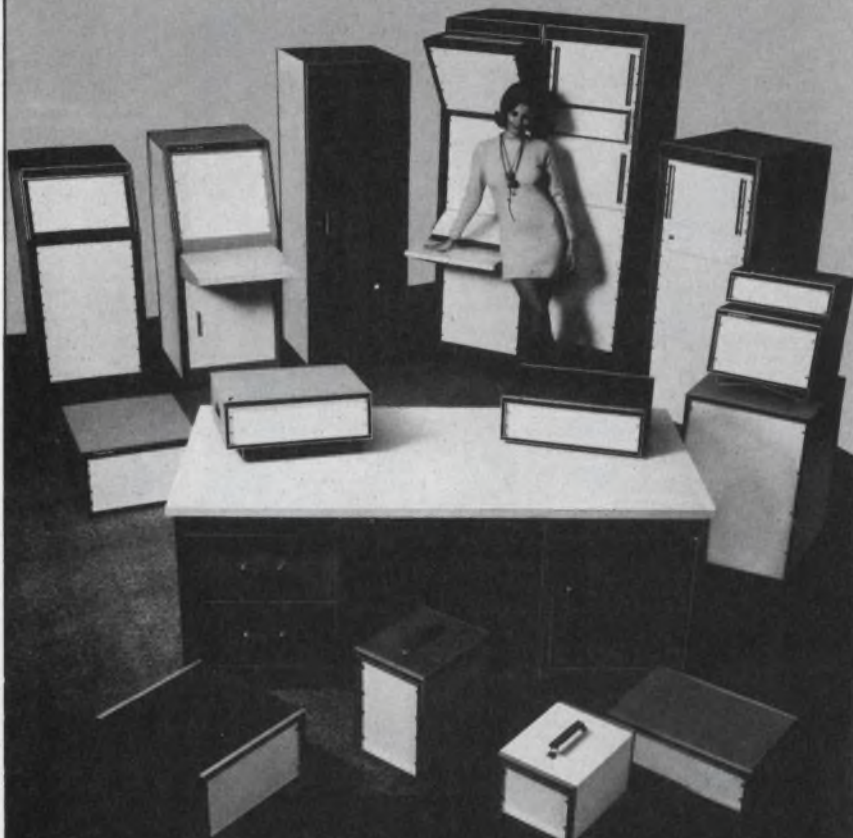

INSTRUMENT CASES—TIC SERIES

TVA Series Vertical Assembly—
Construction Details
(1 Frame, 2 End Panels, Rear Door)

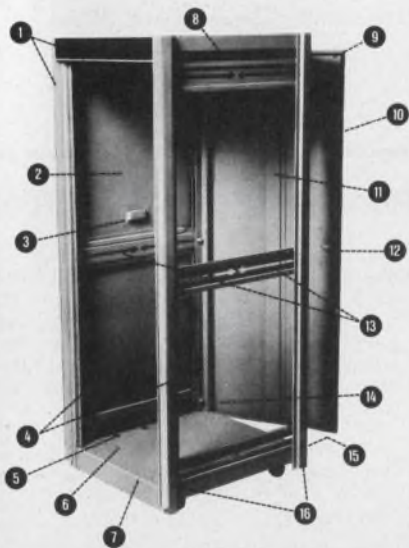

1. Trim: extruded anodized aluminum with textured vinyl inlays
2. Outside removable flush end panels (16 ga.)
3. Recessed hand grip for panel removal
4. 2 pr. panel mounting angles, fully adjustable front to rear with tapped 10-32 holes on EIA & WE Standards spacing (12 ga.)
5. 1" dia. holes for cable entry beneath base
6. Recessed caster mounting holes
7. 1 piece formed steel base provides for heavy equipment mounting area and concealed caster mounting (14 ga.)
8. 1 piece solid top for extra rigidity and squareness (14 ga.)
9. Foam gasketing (3 sides)
10. Magnetic closure gasket
11. Door stiffener channel
12. Keyed latch and brushed aluminum pull handle
13. Horizontal cross-brace and panel mounting angle supports
14. Quick release, spring loaded door hinges (top and bottom)
15. 1 1/8" dia. knock-outs for rear cable entry underneath rear door
16. Formed steel uprights (14 ga.) provide 1/2" recess to panel mounting angles

All features shown are standard in the Trimline TVA Series
Welded, formed steel construction

Complete catalog and prices on request



PREMIER METAL PRODUCTS COMPANY
381 Canal Place, Bronx, N.Y. 10451/(212) 993-9200

CIRCLE NUMBER 63

INTEGRATED CIRCUITS

Chopper-stabilized amp has offset of 80 μ V max

Texas Instruments, P.O. Box 5012, Dallas, TX 75222. (214) 238-2011. \$14.50 (100-up); stock.

Combining MOSFETs and bipolar devices on a single chip, the TL089 chopper-stabilized op amp offers a drift of only 0.2 μ V/ $^{\circ}$ C, typical. The TL089 has a maximum input offset voltage of 80 μ V over a -25-to-85-C range. Input bias current over the full temperature range (-25-to-85-C range for the TL089C) is 10 nA, maximum and 15 nA for the restricted range (0 to 75 C, TL089C) version. The amplifier has a common-mode input range of \pm 10 V and a large signal voltage gain of 100 dB, minimum. The common-mode rejection ratio is a minimum of 100 dB and the unity gain bandwidth is 3 MHz. Pinout of the TL089 is identical to that of the Harris HA-2904 and 2905 amplifiers.

CIRCLE NO. 325

Digital correlator operates at 20 MHz

TRW Defense and Space Systems, One Space Park, Redondo Beach, CA 90278. \$250 (1 to 24); 30 days.

Parallel digital-signal correlation with analog outputs is possible with the 64BCIV bipolar correlator LSI IC. The circuit operates at 20 MHz. Correlation takes place when two binary words are serially shifted into two independently clocked shift registers. The two words are continually compared bit-for-bit by Exclusive-OR circuits to provide the required function of multiplication. Each Exclusive-OR circuit controls a current source digital-to-analog converter. The outputs of the d/a circuits are summed to produce the correlation function. The 64-BCIV is fully TTL compatible: two standard TTL clocks are required for bit synchronization. Power consumption is less than 32 mW per correlation bit. Total device consumption is 2 W. Packaged in a 40-pin, ceramic DIP, the 64-BCIV is available in both military and commercial temperature range version.

CIRCLE NO. 326

Quad NOR circuits offer 2 and 3-input gates

Teledyne Semiconductor, 1300 Terra Bella Ave., Mountain View, CA 94043. (415) 968-9241. From \$0.81 (100-up); stock.

The HiNIL 306 and 307 both contain two 2-input NOR gates and two 3-input NOR gates. However, the 306 has active pullup outputs and a 10-mA output drive current, which permits it to drive lines of up to 10 ft without loss of noise immunity. The 307 has open collector outputs to permit wired-OR connections. Both circuits operate from 10-to-16-V supplies and are pin-compatible with the company's HiNIL 325. Either unit is available in either a plastic or ceramic 16-pin DIP and has an operating temperature range of -30 to 70 C.

CIRCLE NO. 327

Peripheral drivers need little input current

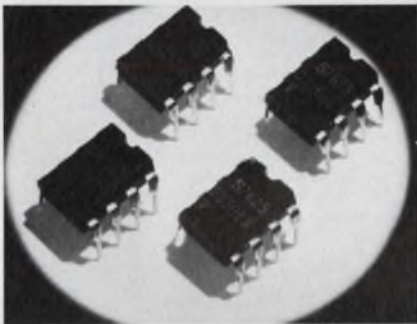

Signetics, 811 E. Arques Ave., Sunnyvale, CA 94086. (408) 739-7700. Under \$1.00 (OEM qty.); stock.

The DS3611 to 3614 series of peripheral-driver ICs has one-tenth the input power requirement of competitive units. The drivers are rated for an 80-V breakdown in the OFF-state and a current rating to 300 mA per driver in the ON state. All units have high-voltage pnp inputs compatible with PMOS, CMOS, TTL or DTL circuits. Required input current for the series is just 40 μ A for a logic ONE input of 2.4 V input. Clamping diodes are included for circuit protection. All units in the series are dual drivers; DS3611 is a dual AND, DS3612 is a dual NAND, DS3613 is a dual OR and DS3614 is a dual NOR. The pinout arrangement for the 3611 to 3614 series is identical to industry standard 75451 through 75454 drivers.

CIRCLE NO. 328

Power drivers operate at CMOS input levels

National Semiconductor, 2900 Semiconductor Dr., Santa Clara, CA 95051. (408) 737-5000. \$1.40 (100-up); stock.

A series of CMOS-compatible dual peripheral power drivers, including the DS1631/3631, DS1632/3632, DS1633/3633, and DS1634/3634, has a V_{OC} operating range of 4.5 to 15 V. Pinouts and logic

functions are the same as the DS-75451, DS75461 and DS3611 series of peripheral drivers, so present CMOS systems can convert to the DS1631 series circuits for power drive applications. The circuits have a breakdown voltage of 56 V (at 250 μ A), and an output current capability of 300-mA maximum. Power dissipation of the dual drivers is 28 mW with both outputs ON.

CIRCLE NO. 329

Here's why our Model 175 is the best 3 $\frac{1}{2}$ digit portable multimeter on the market... and why you should own one!

	Data Precision Model 175	HP 3435	HP 3176B	Fluke 8000A	Fluke 8030
Digits	3 $\frac{1}{2}$	3 $\frac{1}{2}$	3 $\frac{1}{2}$	3 $\frac{1}{2}$	3 $\frac{1}{2}$
Size	34 cu. in.	395 cu. in.	123 cu. in.	212.5 cu. in.	69.8 cu. in.
Display Size	0.43" LED	0.30" LED	0.25" LED	0.25" LED	0.33" LED
Basic Accuracy for 1 Year ± 1 Digit	0.1%	0.1%	0.3%	0.1%	0.1%
DCV Sensitivity	100 μ V	100 μ V	100 μ V	100 μ V	100 μ V
AC Frequency Response	30Hz-50kHz	30Hz-100kHz	45Hz-10kHz	45Hz-20kHz	45Hz-10kHz*
Functions	6	5	5	5	6
Ranges	32	27	19	26	26
Hi/Lo Excitation	Yes	No	No	No	No
Calibration Accuracy Guaranteed	1 year	1 year	1 year	1 year	1 year
Overrange	100%	100%	10%	100%	100%
Ranging	Manual	Manual & Auto (except current)	Auto	Manual	Manual
Rechargeable	Yes	Yes	Yes	Optional (\$50.00)	Optional (\$40.00)
Recharges Batteries While Operating	Yes	Yes	No	Optional	Optional
Full Scale Voltage Drop Measuring Current	100 millivolts (EIA STANDARD)	220-400 millivolts	100 millivolts	100 millivolts	250 millivolts
Price With Batteries	\$189.00	\$400.00	\$275.00	\$349.00	\$275.00

*with true RMS

For complete information or a demonstration, contact your local Data Precision representative or Data Precision Corporation, Audubon Road, Wakefield, MA. 01880, (617) 246-1600. TELEX (0650) 949341.

The Data Precision Model 175, 3 $\frac{1}{2}$ digit miniature portable multimeter. Only \$189. The facts speak for themselves.



DATA PRECISION
...years ahead

FOR DEMONSTRATION CIRCLE 145

FOR ADDITIONAL INFORMATION CIRCLE 146

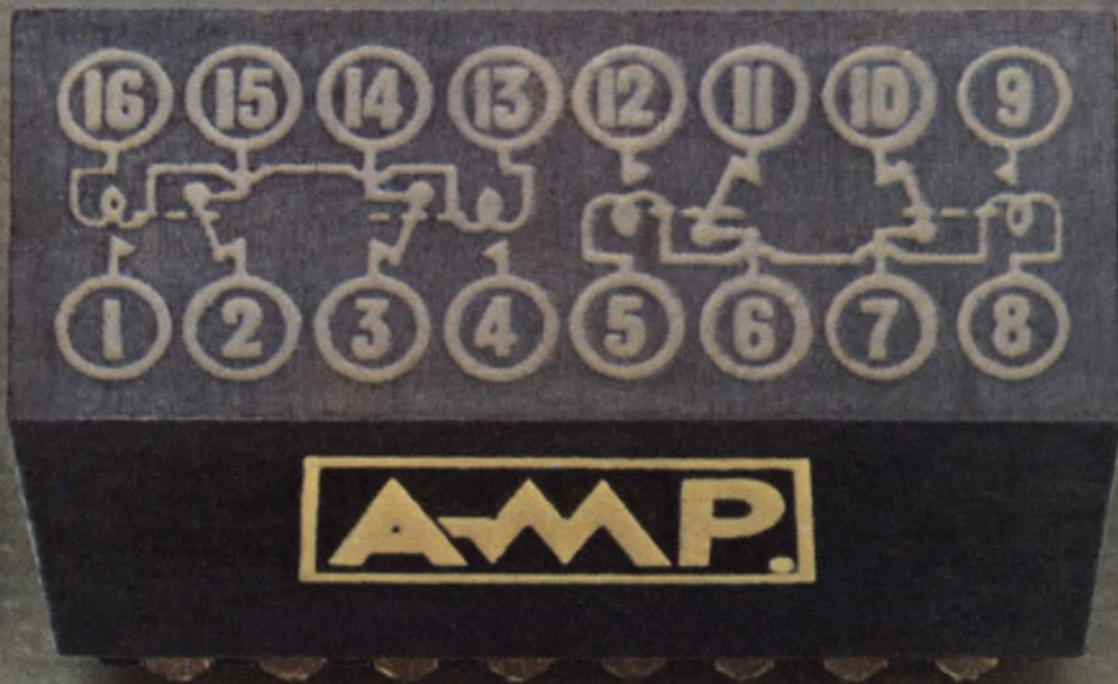

Function for function you still can't beat AMP's Dual-DIP relay for low level switching.

Its 16-lead, pluggable package contains two independent DPDT electromechanical relays. Providing a total of eight switching functions, with maximum operating time of only 5 ms. And maximum release time of just 4 ms.

Low-resistance, gold-plated contacts are ideal for "dry circuit" as well as general use.

AMP Dual-DIP relays can be "plugged" in with a variety of AMP standard or low-profile DIP headers, or standard or miniature spring-type receptacles, some posted, for automatic wiring. Or soldered directly to pc boards.

If you have a low-level switching application—and limited board space—the AMP Dual-DIP relay is your logical choice. Function-for-function.

For more information, call Customer Service at (717) 564-0100. Or write AMP Incorporated, Harrisburg, PA 17105.



AMP EUROPE

Austria — AMP Austria. Branch of AMP Deutschland GmbH, Markgraf-Ruediger Str. 6-8, 1150 Vienna. Phone: 924191/92

Belgium — AMP Belgium. Branch of AMP-Holland B.V., Rue de Brabant 62-66, Brussels. Phone: 322.17.55.17

France — AMP de France, 29 Chaussée Jules-César, Boite Postale No. 39, 95301 Pontoise France. Phone: 030 82 20, 030 92 30

Germany — AMP Deutschland GmbH, Ampéressasse 7-11, 607 Langen, B. FFM., West Germany. Phone: (06103) 7091

Great Britain — AMP of Great Britain Limited, Terminal House, Stanmore, Middlesex, England. Phone: 01-954-2356

Holland — AMP Holland B.V., Papierstraat 2-4 's-Hertogenbosch, Holland. Phone: (04100) 25221

Italy — AMP Italia S.p.A., Via Fratelli Cervi 15, 10093 Collegno (Torino), Italy. Phone: 785-656

Spain — AMP Española, S.A., Apartado 5294, Pedro IV, 491, 495, Barcelona 5, Spain. Phone: 307-75-50

Sweden — AMP Scandinavia AB, Datavägen 5, 17500 Jakobsberg, Sweden, Mailing Address: Fack S-175 20 JARFALLA 1, Sweden. Phone: 0758/10400

Switzerland — AMP AG, Haldenstrasse 11, 6006 Luzern, Switzerland, Phone: (414) 235421, 235422, 235423

AMP NORTH AMERICA

Canada — AMP OF CANADA LTD., 20 Esna Park Drive, Markham, Ontario, Ph: 416-499-1251

Mexico — AMP de Mexico, S.A., Apartado Postal 179, Naucalpan de Juarez, Edo. de Mexico, Phone: Mexico City 576-41-55

Puerto Rico — AMP OF CANADA LTD., 677 Calé de Diego, Rio Piedras, Puerto Rico 00924, Phone: (809) 766-2346

United States — AMP Incorporated, Harrisburg, Pa. 17105, Phone: 717-564-0100

AMP SOUTH AMERICA

Argentina — AMP S.A., Argentina 4 de Febrero, 76 Villa Zagla — SAN MARTIN, Buenos Aires, Argentina, Phone: 752-4612

Brazil — AMP do Brasil Ltda., AV Comendador Martinelli 185, Lapa, Sao Paulo, Phone: 262-4353

AMP PACIFIC

Australia — Australian AMP Pty. Limited, 155 Briens Road, Northmead, N.S.W. 2152 Australia, Mailing Address: P.O. Box 194, Baulkham Hills, N.S.W. 2153 Aus. Ph: 630-7377

Japan — AMP (Japan), Ltd., No. 15-14, 7-Chome, Roppongi Minato-Ku, Tokyo, Japan, Ph: 404-7171

Products and services for many specialized industries are provided by the AMPLIVERSAL Division. In the United States, this division is known as AMP Special Industries.

For AMP products and services in other countries, write: AMP International Division, Harrisburg, PA 17105, USA.

POWER SOURCES

Sealed lead-acid cells have wound plates



General Electric, P.O. Box 992, Gainesville, FL 32602. (904) 462-4746. See text; stock.

A line of rechargeable sealed-lead-acid (SLA) cells to compete with those from Gates features the same type of wound-plate construction used in GE's nickel-cadmium batteries. The "D" SLA cells provide 2.5 Ah at a 250-mA discharge rate. The new SLA cells are capable of delivering continuous current up to 40 A or momentary currents of 75 A for 1 s. Internal resistance is 10 mΩ—this low value makes high-charge-and-discharge rates possible with minimum danger of overheating. In discharge, cell temperature limits are -40 to +65 C. Charging limits are nominally -20 to +50 C. Although storage temperature limits range from -40 to +65 C, room temperature storage is recommended. The cells weigh 6.4 oz and measure 2.67 × 1.34 in. The outer metal case is electrically isolated from the cell plates by a polypropylene inner container; both positive and negative contacts are made at the top of the cell. A resealable safety vent is provided to prevent cell bursting under extreme abusive use, but in normal service it will never be needed. The cells can be used in any position. The SLA devices are priced from \$2.49 to \$4.80 per cell ("D" size), depending on quantity ordered. On the standard batteries, pricing will be \$8.12 to \$13.90 for the 6-V unit and \$15.59 to \$26.68 for the 12-V unit.

CIRCLE NO. 330

POWER SUPPLY MAGIC



There's no trick! Get a full house everytime with Deltron's dual and triple power supplies.

U.L. recognized. One year warranty.



Socketed semiconductors. Barrier block interface.

MODEL	RATINGS volts/amps	PRICE		
		1	100	250
QD12/15-0.6	±12 to ±15/0.6	\$42	\$36	\$35
QD12/15-1.7	±12 to ±15/1.7	\$62	\$54	\$49
QD12/15-3.0	±12 to ±15/3.0	\$79	\$67	\$64
QT-1	5/3.0 ±12 to ±15/0.5	\$69	\$66	\$65
QT-2	5/6.0 ±12 to ±15/1.0	\$89	\$82	\$79

Deltron inc.

Wissahickon Avenue
North Wales, PA 19454
Tel: 215/699-9261 Twx: 510/661-8061
AC 12

CIRCLE NUMBER 66



now you have
a choice!

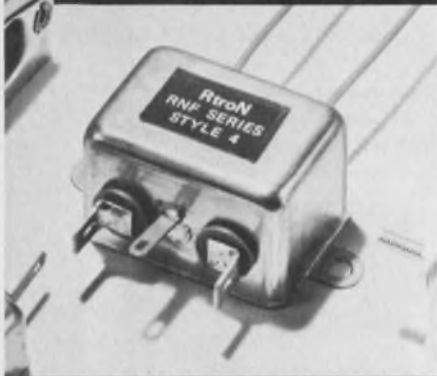

RFI/EMI FILTERS

For Data Processing,
Industrial Control and
Instrument Application

Rtron's RNF Type Filters represent three series of the most widely used, low cost filters available. Over 100 combinations of current and case style to choose from. "L" Series - low cost for general applications to combat line to ground noise. "P" Series - for suppression of line to line as well as line to ground interference. "T" Series - most effective for low impedance load applications. All types are U.L. Recognized and meet C.S.A. requirements. Rated at 115/250 VAC. Low leakage current insures safety.

For complete catalog and
details, write

Rtron corporation.

P.O. Box 743, Skokie, Illinois 60076
(312) 679-7180

CIRCLE NUMBER 67

POWER SOURCES

Solar power module lives forever

Sensor Technology, 21012 Lassen St., Chatsworth, CA 91311. (213) 882-4100. \$108; 2 wk.

When operated between -65 and $+125$ C and protected from mechanical forces, the life of the MOD-2118 solar-power module is claimed to be almost limitless. Under irradiation, the 17×6.5 in. module produces 3.6 W at 7.2 V. A unit is composed of 18 2-in. silicon solar cells potted in silicone. The cells are connected in series on a finned-aluminum-substrate. Single units can be easily interconnected for use as an array to produce higher voltages or currents. A built-in Schottky blocking-diode is optional.

CIRCLE NO. 331

Dc-to-dc power supply packaged in DIP



Reliability, Inc., 5325 Glenmont, Houston, TX 77036. (713) 666-3261. \$38.20 (1-9); stock.

Regulated dual-output dc-dc power sources, designated V-Pac provide the designer with ± 12 V (V5R 12-12) or $+12$ and -5 V (V5R 12-5) from a 5-V input at a maximum power of 1 W. Both units are available with 12-V inputs. Output ripple and noise is only 30 mV peak-to-peak over a bandwidth of 20 Hz to 20 MHz. Line and load regulation is 0.3% and output voltage tolerance is $\pm 5\%$. The operating temperature range is 0 to 70 C in still air, and efficiency is typically 65%. The units are packaged in 24-pin DIPs and occupy only 0.3 in³. Pins are spaced so that they may be plugged into standard IC sockets or soldered into PC cards with standard 0.1-in. spacing.

CIRCLE NO. 332



use pressure sensitive
TEMP-R-TAPE of fiberglass
for quick relief.

Excellent electrical properties plus most anything else you want in fiberglass tapes like high tensile and tear strength, dimensional stability, good conformability, thermal endurance, abrasion resistance, non-corrosiveness, Temperature to 180°C. Available with several adhesive systems. Low unit cost.

Find your nearest Distributor in the Yellow Pages under "Tapes, Industrial" or in Industrial Directories or write for complete specification kit and sample offer. The Connecticut Hard Rubber Company, New Haven, Conn. 06509

CHR

an ARMCO company

CIRCLE NUMBER 68

ELECTRONIC DESIGN 25, December 6, 1976

External μ P supply avoids UL listing



Dynamic Instrument Corp., 933 L. I. Motor Parkway, Hauppauge, NY 11787. (516) 234-2900.

Designed in two configurations, desktop and wall plug-in, these power supplies convert 120 V ac into low-voltage regulated dc for use by μ Ps. Since no high voltage enters the μ P enclosure, the housing can be smaller and less costly because of the elimination of shielding and heat problems. With an external power supply, UL listing is not required for the customer's product enclosure. However, the power supply itself is UL and CSA listed. UL listing is particularly important in familiarization kits and μ Ps designed for the hobby market or for use in schools or homes. The most versatile power supply produces simultaneous outputs of 5 V dc at 500 mA, 12 V dc at 150 mA, and -12 V dc at 150 mA. Line regulation is 3%, load regulation, 2%. Ripple and noise are 3.5 mV rms.

CIRCLE NO. 333

Switcher in 500-W box delivers 750 W

Trio Labs Inc., 80 Dupont St., Plainview, NY 11803. (516) 681-0400.

The Model 682 has the outline dimensions of a popular 500-W supply but delivers 750 W. It measures 5 x 8 x 11 in. and weighs 15 lb. The unit is over 75% efficient and accepts inputs of either 110 or 220 V ac. The single output ranges from 2 to 48 V dc. Over-voltage, overtemperature, and overload protection along with remote sensing and adjustable output voltage are standard features. This switcher has UL recognition.

CIRCLE NO. 334

better temp control

Fast, dependable, automatic snap-action . . . at a reasonable cost. Elmwood thermostats fill your high limit or control needs with the right temperature range, differential, tolerance, terminals, bracket or custom package. All are 100% pre-tested, with U.L., C.S.A. and European listings available for world trade, and conform to DIN norms. Ask for prototypes. Elmwood Sensors, Inc., 1675 Elmwood Ave., Cranston, R. I. 02907. Phone (401) 781-6500. In Europe: Elmwood Sensors, Ltd., North Shields, Tyne and Wear, NE29 8SA, England. Phone (089) 45-82821.



Elmwood thermo- stats

CIRCLE NUMBER 69

ALONE AGAIN

in low cost 1-watt
Zener Diodes

SCHAUER

"Z" SERIES ZENERS

DO-41 epoxy
molded case

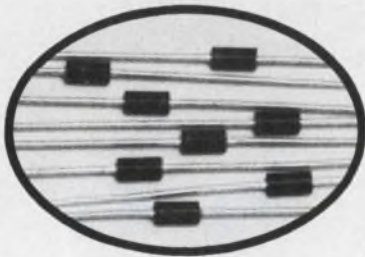

ANY VOLTAGE
2.6 to 34.0

ANY TOLERANCE
1% 2% 5% 10%

At Any Test Current

**Compare These Prices
On 1% Tolerance Diodes**

Quantity	Price each
1-99	91¢
100-499	83¢
500-999	77¢
1000 up	73¢

**LARGE STOCK
GOOD DELIVERIES**

Send for complete rating data
and other tolerance prices.

Semiconductor Division

SCHAUER

MANUFACTURING CORP.

4511 Alpine Ave., Cincinnati, OH 45242
Telephone 513-791-3030 Telex 21-4576

CIRCLE NUMBER 70

POWER SOURCES

Modular supply has 75% efficiency

Computer Products, 1400 N.W. 70th St., P.O. Box 23849, Fort Lauderdale, FL 33307. (305) 974-5500. \$295; stock to 45 days.

The HE252 dc power supply boasts a 75% efficiency at full load and is contained in a 5.5 × 4.5 × 3.2-in. package weighing 3.25 lb. This unit has the same footprint and mounting hole configuration as Lambda's B-package supplies. It is overvoltage protected and short-circuit proof. Its basic specifications are: output of 5 V, 20 A at 45 C; input of 90 to 130 V ac (180-to-260-V-ac Model HE252E) at 47 to 450 Hz; line and load regulation of ±0.1% max for a 10% change in line from no-load to full-load; input isolation of 50 MΩ, 900 V rms min breakdown; ripple and noise of 50 mV pk-pk max; typical tempo of 0.01%; and derating of 2.5%/°C from 45 to 71 C.

CIRCLE NO. 336

Small switcher gives you 750 W

LH Research, Inc., 1821 Langley Ave., Irvine, CA 92714. (714) 546-5279. \$775 (1-9); 8 wks.

A new five-output, switching regulator delivers up to 750 W total output power, and comes in a 5.1 × 7 × 12.75-in. package. Primary output of Model MM-450 is 5 V at up to 150 A. The second, third, fourth, and fifth outputs can be any one of the following: 5 V at up to 5 A, 12 V at up to 5 A, 15 V at up to 5 A, 18 V at up to 4 A, and 24 V at up to 3 A. Combined max power of all five outputs is 750 W. This newest addition to the Mighty-Mite series is up to 80% efficient and features 1% or 50 mV pk-pk ripple and noise, line regulation of 0.4% over the entire input range, and load regulation of 0.4% from no-load to full-load. Response time is 200 μs to 1% after 25% load change. Operating temperature is 0 to 70 C. Full rating is maintained to 40 C, derated to 60% at 70 C. The unit contains a fan, and is designed to meet UL 478.

CIRCLE NO. 335

RF detectors fast delivery

**Quantities to 200
from stock**

You get fast delivery on WILTRON's quality RF detectors whether your needs are large or small.

And with discounts of up to 15% in quantity.

These are WILTRON's time-proved quality detectors with field-replaceable diodes. Diodes are field-replaceable even in 18.5 GHz models.

Call Walt Baxter at WILTRON now for details.



Model	Range	Connectors In	Out	Flatness	Price \$
71B50	100 kHz-3 GHz	BNC Male	BNC Fem.	±0.5 dB	70
73N50	100 kHz-4 GHz	N Male	BNC Fem.	±0.2 dB	75
74N50	10 MHz-12.4 GHz	N Male	BNC Fem.	±0.5 dB	145
74S50	10 MHz-12.4 GHz	SMA Male	BNC Fem.	±0.5 dB	165
75A50	10 MHz-18.5 GHz	APC-7	BNC Fem.	±1 dB	190
75N50	10 MHz-18.5 GHz	N Male	BNC Fem.	±1 dB	170
75S50	10 MHz-18.5 GHz	SMA Male	BNC Fem.	±1 dB	170



930 E. Meadow Drive • Palo Alto, Ca. 94303 • (415) 494-6666 • TWX 910-373-1156

CIRCLE NUMBER 71

COMPONENTS

Snap-action switches sport open design

Cherry Electrical Products Corp., 3600 Sunset Ave., Waukegan, IL 60085. (312) 689-7702. \$0.48 (2000 up); samples in stock, 10 to 12 wks production.

Snap-action switch S38-20H has an open design for easy insertion into a PC board by simply plugging it in. No additional mounting hardware is necessary. Compact, the switch allows a large number of switching functions in a limited amount of space. The contacts are rated at 2 A, 250 V ac. When mounted on a PC board, the top of the switch is about 1/2 in. above the board surface.

CIRCLE NO. 337

Liquid-crystal displays use low power

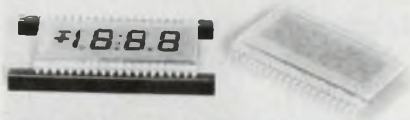

Industrial Electronic Engineer Inc., 7720-40 Lemona Ave., Van Nuys, CA 91405. (213) 787-0311. \$10: 4 digits (100 up).

The IEE-Polaris line of 3-1/2, 4, 4-1/2, 5, 6 and 8-digit numerical, 12-h clock and 16-segment alpha-numeric field-effect liquid-crystal displays are available in a choice of either reflective (for ambient lighting) or transmissive (for backlighting) models. Uniformly spaced terminal clips solder directly to PC boards, or the clips may be inserted into low-cost strip sockets on 0.1-in. centers. Exceptionally low-power requirements (2.5 to 24 μ W typical for all segments) are suited for portable and battery-powered devices. The displays are compatible with CMOS and MOS ICs. They offer wide viewing angles (up to 110°), 20:1 contrast ratio, and an average operating life of 50,000 h at temperature ranges from -20 to 60 C. The segmented characters are available in five-character heights from 0.4 to 1.0 in.

CIRCLE NO. 338

Capacitor switch senses finger on remote plate

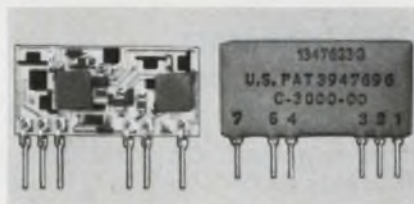

Centralab, 5757 N. Green Bay Ave., Milwaukee, WI 53201. (414) 228-

2751. \$6.20 (1000 up); 6 to 8 wks.

A capacitor touch switch senses the contact of a person's finger on a remotely located touch surface. The touch surface may be up to 25 ft from the switch module. The all-solid-state design in a thick-film hybrid package features bounce-free momentary or latching action and TTL or CMOS compatibility.

CIRCLE NO. 339

Reliable AC line filters

Advanced engineering of inductors combined with the unique ceramic capacitor technology acquired from Allen-Bradley offers the reliability your equipment demands. Spectrum power line filters are designed for:

125 240VAC @ 125°C 0-400 HERTZ

Proven Reliability

Controlled thermal characteristics

Limited AC voltage rise

Volumetric efficiency

Available in C, Pi, L, T

Mil-F-15733

TYPICAL PARTS	I Amps	Volts AC	Insertion Loss —Db		
			150KHz	10MHz	1GHz
54-367-006	15	125	12	53	65
51-353-112	3	125	13	70	70
51-320-023	1	240	24	70	70

For other ratings — see EFM 1-576 to 1-583

AVAILABLE from stocking distributors

HALL-Mark ELECTRONICS 215-355-7300 MOLFONICS 213-773-6521
METUCHEN CAPACITOR 201-442-0500 ROSE ELECTRONICS 415-697-0224

ELECTRO 76 Boston Booths 2624/2626
IEEF-EMC Symposium Wash. D.C. Booths 31/32



SPECTRUM CONTROL INC.
152 EAST MAIN ST · FAIRVIEW, PENNSYLVANIA 16415



SPECIALISTS IN ELECTRO-MAGNETIC COMPATABILITY

For a complete EMC solution let us test and analyze your equipment.

CIRCLE NUMBER 72

a little A-300 goes a long way.



In high frequency transmission. RF power generation for industrial and research processes. RFI/EMI and general laboratory applications, too.

The Model A-300 is a totally solid state power amplifier, covering the frequency range of 0.3 to 35MHz with a gain of 55dB. Capable of delivering 300 watts of linear Class A power and up to 500 watts in the CW and pulse mode, the A-300 is the ultimate in reliability.

Although the unit is perfectly matched to a 50 ohm load, it will deliver its full output power to any load (from an open to a short circuit) without oscillation or damage.

Complete with power supply, RF output meter and rack mount, the A-300 weighs a mere 89 pounds and operates from ordinary single phase power.

For further information or a demonstration, contact ENI, 3000 Winton Road South, Rochester, New York 14623. Call 716-473-6900 or TELEX 97-8283 ENI ROC

ENI
THE WORLD'S LEADER
IN POWER AMPLIFIERS

The World's Leader
in Power Amplifiers

CIRCLE NUMBER 73

COMPONENTS

Chip inductors claimed to be smallest

Electronics Co., Inc., 930 W. Hyde Park, Inglewood, CA 90302. (213) 678-7161. \$1.25 (1000 up); stock to 8 wks.

Chip inductors, the smallest in the industry, according to Vanguard Electronics, and designated Magna-Q-Micro and Magna-Q-Mini, cover an inductive range of 0.010, 1000 μ h. Typical Q at 150 MHz is 65 for a 0.010- μ h chip. These units are used in paging, telemetry, radar, guidance, medical and industrial applications.

CIRCLE NO. 340

Motor starter redesign first in 15 years

Allen-Bradley, 1201 S. Second St., Milwaukee, WI 53204. (414) 671-2000.

Motor starters, Bulletins 500/505/509 AC, the first complete redesign in 15 years, are available in sizes 0, 1 and 2. They include contactors, and reversing, nonreversing and multispeed starters. A-B will continue to manufacture and sell its Series K starters. Like its predecessors, the new units feature a single vertical moving armature and gravity dropout. The user has a choice of top or feed-through power wiring. Load terminals are located either at the top or bottom of the contactor with line terminals always at the top. Up to eight auxiliary contacts may be added in the field. Four pockets on the controller allow either single or double-circuit auxiliaries to be easily snapped into place without screws or other mounting hardware. Each is held firmly to guard against dislodging by vibration. All auxiliaries carry a heavy duty pilot rating. Power poles may also be added in the field. They have the same electrical ratings as main contactor poles, and are designed to provide the same life. New faster acting Type W heater tripping elements are included in the design. The new Bulletin 509 starter is considerably narrower, which means more panel space is available.

CIRCLE NO. 341

Keystone VERSATILE THERMISTOR PROBES



Get quick response for sensing temperatures of gases, liquids and surfaces with 23 thermistor probe styles and configurations. Probes with stainless steel tips can be ordered in lengths from 1" to 4", giving you an extra dimension to customize certain standard probes. Other features include:

Sensitivity . . . highly sensitive to minute temperature changes . . . fast response.

Temperature range . . . can withstand temperatures from -50°C to 260°C .

Resistance values . . . from 1K to 1 meg at 25°C . . . also miniature discs and rods of 100 ohms to 1 meg at 25°C are available.

Tolerance on resistance . . . $\pm 20\%$ at 25°C is standard; $\pm 10\%$ and $\pm 5\%$ or tighter tolerances if desired.

Low-cost series . . . three inexpensive probes to answer many requirements.

Catalog TP-739
. . . gives details
on 23 probe styles
and ordering infor-
mation. Circle
reader service
card.



Keystone

CARBON COMPANY
Thermistor Division
St. Marys, PA 15857
814/781-1591 • Telex 91-4517

CIRCLE NUMBER 74

Solid-state relay needs no heat sink



North American Philips Controls Corp., Cheshire Industrial Park, Cheshire, CT 06410. (203) 272-0301. \$5.85 (1000 up); 6 to 8 wks.

The small (less than 0.75 in.³) Series 501 solid-state relay has a load rating of 2 A at 115 V, 60 Hz. Typical control voltage is 5 V dc at only 7 mA. The relay is compatible with TTL, DTL and CMOS logic circuits. The relay is PC-board mounted and require no heat sink. Desensitized to input transients, the typical turn-on time is 8 ms. Epoxy encapsulation protects the relay.

CIRCLE NO. 342

Induction motors feature short design



Bodine Electric Co., 2500 W. Bradley Pl., Chicago, IL 60618. (312) 478-3515. Selected items in stock.

A new line of NEMA 48-frame totally enclosed, fan-cooled (TEFC) induction motors and companion parallel and right-angle shaft gear-motors is shorter than many current 48-frame models of equivalent horsepower. Standard continuous duty, four-pole ratings range from 1/10 through 1/2 hp, which doubles the maximum ac horsepower previously offered by Bodine. Over-all frame length of the motor varies between 6.8 and 7.8 in., excluding the shaft. The motors are available as synchronous or nonsynchronous types with permanent split capacitor, split-phase and polyphase windings. Also a torque-motor design is available.

CIRCLE NO. 343

These custom IC's are not for sale!



But the technology that created them is...

along with all the other capabilities you'll need for custom LSI from design through production.

Silicon Systems specializes in custom LSI... it's not a sideline. We're interested when others aren't because we've lowered the volume at which custom IC's become cost effective.

Over the years we have developed the world's most advanced IC design capability. A proprietary system, created in our own computer lab, helps us solve design problems in any technology—TTL, SCHOTTKY, ECL, I²L, LINEAR, PMOS, NMOS, CMOS, whatever is best for you.

Our custom IC's are used in talking calculators, traffic controllers, code generators, garage door openers, automotive instrumentation, etc.

Are your products ready for state-of-the-art custom LSI?

For more information, phone or write Jim Meyer, (714) 979-0941 at 16692 Hale Ave., Irvine, California 92714.



Silicon Systems
incorporated

BIG POWER SUPPLIES



IN LITTLE PACKAGES

**AC-DC and DC-DC
miniaturized power converters
that deliver 3.9 watts
per cubic inch.**

- AC inputs: 115-220 VAC, 47-500 Hz.
- DC inputs: 12, 28, 48, 115 & 150 VDC.
- 1 to 6 isolated and regulated DC outputs from 4.2 to 300 VDC.
- Line and load regulation to 0.1%.
- Up to 800 watts per output.
- Efficiencies to 85%.
- Design-As-You-Order construction from standard sub-modules . . . over 1200 possible configurations.
- Completed converters provided in tested and encapsulated, conduction cooled packages in just days.

See for yourself how we've packed the power and performance in . . . request our actual size "little black box" punch out kit and catalog today!

Call us collect . . . ask for Jim Dunn.



ARNOLD MAGNETICS CORPORATION

11520 W. Jefferson Blvd.
Culver City, Ca. 90230 ● (213) 870-7014

CIRCLE NUMBER 76

INSTRUMENTATION

Microwave counters get facelift

EIP Inc., 3230 Scott Blvd., Santa Clara, CA 95051. (408) 244-7975. 350D, \$5500; 351D, \$5800; 4-6 wks.

Models 350D/351D microwave frequency counters now offer several major product improvements. Maximum input without damage is increased from +20 to +33 dBm (2 W); minimum sensitivity is increased 5 dBm across the microwave band as follows: 825 MHz to 1.1 GHz; -25 dBm; 1.1 to 12.4 GHz; -30 dBm; 12.4 to 18 GHz; -25 dBm. Previously optional, automatic input level control will now be incorporated in all 350D/351D counters.

CIRCLE NO. 344

Wattmeter spans broad power-freq ranges



Electric Wattmeter Co., 2275 Sixth St., Sarasota, FL 33577. (813) 959-5905. \$750; stock.

The CLA 1173 solid-state wattmeter has an accuracy of 1-to-2% with nine ranges, covering 10 mW to 316 kW. It operates down to virtually zero power-factor, as required in core-loss testing, with the unit's three-position power-factor switch. A switch-position logic computer in the test set actuates a LED display that indicates which of the nine wattmeter ranges is in use for each of the 42 voltage/current range combinations. Two auxiliary meters indicate proper voltage and current limits of operation consistent with spec accuracy and crest factor maxima. Spectrum bandwidth is 20 Hz to 20 kHz. The instrument operates to 200 kHz at reduced accuracy.

CIRCLE NO. 345

Disc certifier speeds testing



G. P. Systems, 1430 Koll Circle, Suite 103, San Jose, CA 95112. (408) 294-0288. From \$50,000.

This computer-disc certifier tests both sides of a single disc in 30 s. The Model 348 single-disc certifier tests for dropouts, extra pulses, positive and negative modulation, and amplitude in a single, continuous pass from the outside diameter to the inside diameter of the disc. It performs all of the tests that take up to 3 min per disc with other certifiers. Model 348 features control-panel switches for setting clipping level, noise pulse count, correctable burst length, correctable and noncorrectable error counts, and head location. In the automatic mode, the operator only needs to load and clean the disc: the Model 348 completes the test program automatically. In the manual mode, the operator has complete control of the head position.

CIRCLE NO. 346

Logic probe covers wide test ground



AVR Electronics, P.O. Box 45167, San Diego, CA 92145. (714) 566-1570. \$24.95.

Catch-a-pulse logic probe is compatible with RTL, DTL, TTL, CMOS, MOS and μ Ps using a 3.5-to-15-V power supply. Thresholds are automatically programmed for multilogic family operation. An automatic resetting memory allows single or multipulse detection. No adjustment is required. LEDs show HI, LO, band level or open-circuit logic or pulses (60 ns).

CIRCLE NO. 347

POWER FOR YOUR μ PROCESSOR



Single, dual, and triple output power supplies in a broad selection of output voltage combinations. Output current ratings from 30 ma to 60 amps. Various package styles suitable for virtually every application. Any module you select will be shipped within 3 days; rack mounting models, within 9 days.



Corp., Easton, Pa. 18042 Tel: (215) 258-5441

CIRCLE NUMBER 77

IMMEDIATE DELIVERY

23 ¢ ea.

IN QUANTITIES OF 500 OR MORE



MODEL 401

Model 401 has a black finish and will dissipate 7° C/W. This efficient cooler can be ordered with one of five standard hole patterns. Series 400 offers this style HEAT SINK in three other heights: .75", 1.00" and 1.50".

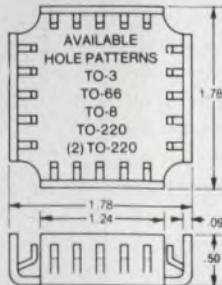

AHAM

HEAT SINKS

968 W Foothill Blvd. P.O. Box 909, Azusa, California 91702
(213) 334-5135 TWX-910-584-4859

CIRCLE NUMBER 78

ELECTRONIC DESIGN 25, December 6, 1976

Socket Center

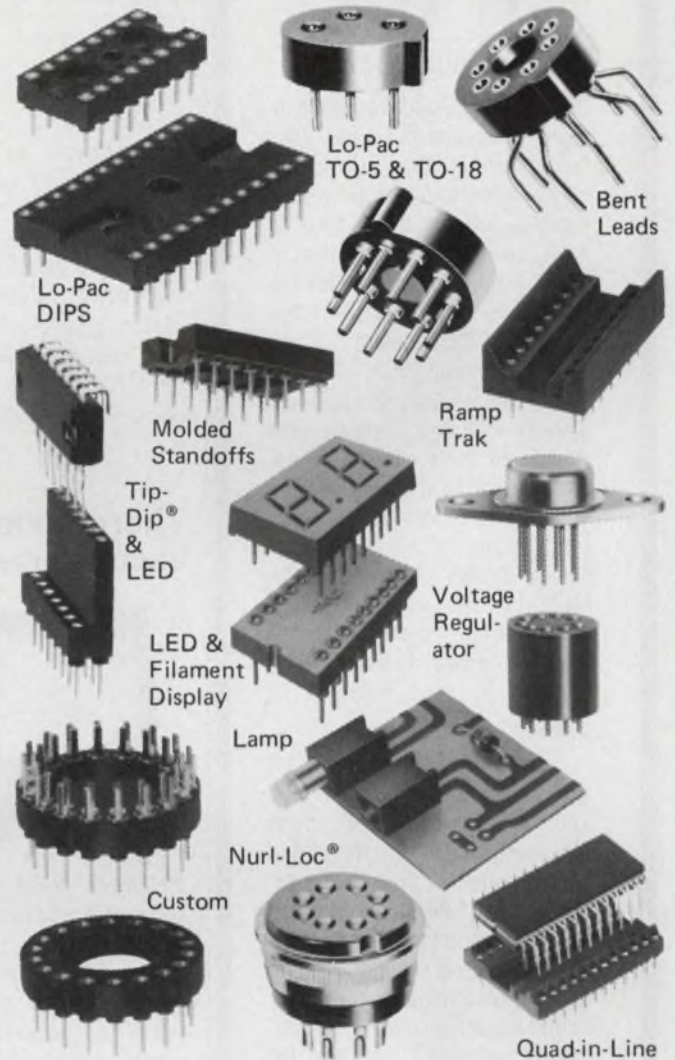

EMC HAS IT ALL!

Seeking sockets? EMC stocks the widest variety with the most options you can buy! 6 to 48 pins. Short, long or extra long terminals. Straight or bent leads. Thermoset molded materials. Platings. Standoffs. Short or standard contacts. Solder or Wire-Wrap® terminals. Special sockets custom-molded . . . even fabricated if you need it. All of the finest, highest quality workmanship, at the lowest prices, in any quantity. EMC does have it all. For you. Today. Call or write for new Catalog '76. Electronic Molding Corp., 96 Mill Street, Woonsocket, R.I. 02895. Phone (401) 769-3800.

Wire-Wrap® Registered Service Co.



CIRCLE NUMBER 79

the
State
of the
Art

TAKE A MONOLITHIC TO LUNCH

Every day, thousands of people, in countries around the world, take our monolithic filters to lunch, or maybe home to dinner (in paging receivers which can call them to a fire, an emergency operation, or a poker game). Size, ruggedness, and low cost are important in this application. Our standard 10.7 and 21.4 MHz monolithics offer all three. Many paging receivers operate in urban, dense signal areas, and there our VHF monolithic filters can simplify front-end design and reduce intermodulation. If you're thinking about paging, or any other production application of monolithic filters, call for PTL — the standard in monolithic crystal filters.

STRAIGHT STORY . . .

. . . about linear phase (constant group delay) monolithic filters. Three new four-pole models in our low-priced Comline® series offer a delay variation of 10 μ s. max. over the specified 3 dB. bandwidth (± 6 kHz.) for land mobile radio applications requiring data transmission or improved impulse response. Center frequency is 10.7 MHz. Spec sheet available. Just ask for models 5182, 5261, and 5262.

What's your application? Whether it's one of the above or something brand-new we'll be glad to work with you. Just give us a call, or a brief note outlining your requirements. We'll take it from there.

PTI

Piezo Technology Inc.

2525 Shader Road Orlando, FL 32804
(305) 298-2000

The Standard in monolithic crystal filters.

CIRCLE NUMBER 80

INSTRUMENTATION

Lightweight printer works quietly

Panasonic Div. of Matsushita Electric Corp., 1 Panasonic Way, Secaucus, NJ 07094. (201) 348-7282. \$75.

These quiet, nonimpact electro-sensitive printers use a 7×5 dot matrix and offer a choice of 15, 21, 32, or 40 characters per line. The units print alphanumerals, symbols and graphs at about 2 lines per second on 60-mm (2.36 in.) metalized recording paper. Added versatility is built into the EUY-10E models because there is also a choice of scanning direction and character generators (for LSD or MSD). Just 24 V at 300 mA is needed to operate the units.

CIRCLE NO. 348

Thermopile gauge fills vacuum range gap



Teledyne Hastings-Raydist, Hampton, VA 23661. (804) 723-6531. \$355; stock.

A new thermopile type vacuum gauge, Model NV-8, for the range between ionization gauges and the normal thermocouple gauge range, spans the range of 10^{-5} to 10^{-2} torr. The compact instrument uses a Hastings thermopile as the pressure-sensing element in the gauge tube. The instrument has all of its circuitry behind the indicating meter for panel mounting. As an option, it is also available in an instrument cabinet. A gauge tube cable and a power cable are attached. The NV-8 is also available calibrated in pascals with a direct reading dial face for the range of 0 to 1.3 pascals. Units operate from either 115 or 230 V, 50/60-Hz input power. A type DV-8 vacuum gauge tube is included as standard equipment.

CIRCLE NO. 349

POLA™: THE ULTIMATE IN VERSATILITY IN EMI/RFI PRESSURE-SEAL GASKETING

In strip form, it's Polastrip®. For magnetic-field shielding, Pola-H™. When you cut it out yourself, it's Polasheet®. With pressure-sensitive adhesive backing, Polastick®. Whatever form you specify, it's the first family of composite EMI/RFI pressure-seal gasketing—a silicone elastomer matrix with embedded conductive wires that provides high-resilience shielding/sealing efficiency with maximum conductivity between mating surfaces.

More? Metex also makes annular Polaring® in a wide variety of standard and custom sizes. Or, factory-fabricated gaskets are made of Polasheet® or Polastick® gasketing for standard AN, RF or other popular connectors. And, for the optimum in EMI-RFI shielding with pressure seal, Xecon® Polastrip offers a wide variety of hollow, channeled or user-defined cross-sections produced from silicone containing a uniformly dispersed conductive filler.

For full data, samples and application engineering consultation on Pola and other composite shielding/pressure seal solutions, call or write: Metex Corporation, Edison, N. J. 08817, (201) 287-0800; or Cal-Metex Corp., Inglewood, CA. 90301, (213) 641-8000.

POLA

METEX
ELECTRONIC SHIELDING GROUP

CIRCLE NUMBER 81 ►

Scope features storage and more for just \$2250



Hewlett-Packard, 1501 Page Mill Rd., Palo Alto, CA 94304. (415) 493-1501. \$2250; 60 days.

A new variable persistence/storage scope, the Model 1223A, includes a burn-resistant CRT and automatic storage control to make it easy to capture low rep-rate and single-shot waveforms for stored display. Other features include 15-MHz bandwidth and 2-mV sensitivity. Maximum writing speed is 1 cm/ μ s in the storage mode. An auto-erase mode provides repetitive, single-shot displays while also making it easy to set up the instrument for capturing single-shot events. An auto-store mode allows the scope to wait for an event and capture it when it occurs.

CIRCLE NO. 350

Unit extends analyzer logic display modes

Biomation, 10411 Bubb Rd., Cupertino, CA 95014. (408) 255-9500. \$1150; 30-60 days.

Model 116 display control accessory for the company's 16-channel logic analyzer, Model 1650-D, extends the unit into a single instrument for both data domain and time domain analysis. A user can choose between timing diagram, truth table, or map presentation from one logic analyzer. The display control also provides the capability to retain 16 words of data from the memory of the logic analyzer for comparison to other portions of the analyzer's memory or to subsequently recorded data.

CIRCLE NO. 351

LORLIN IMPACT II

The only automatic semiconductor test system that does it all



Multidevice Packages



10pA Leakage MOSFETs



100W Power FETs



100A Diodes



2000V Bipolars



Opto Isolators



Op Amps

... not to mention SCRs, TRIACs, DIACs, PUTs, UJTs and just about any other semiconductor you have to test. Available with many terminal and peripheral options. Fully expandable, including a long menu of software and hardware additions to customize for your requirement. Easily reconfigured to meet changing needs. Write or phone LORLIN today for a system brochure.



LORLIN industries, inc.

Precision Road, Danbury, CT 06810
Tel: 203/744-0096 • TWX: 710/456-5030

Western Area: 1287 North Lawrence Station Road, Sunnyvale, CA 94086.
Telephone: (408) 734-3521. TWX: 910-339-9386

CIRCLE NUMBER 82

Low Cost Reliability

Applications for sub-miniature ceramic capacitors requiring stringent specifications in critical frequency areas for accuracy and stability have made Centre Engineering an excellent source of supply.

Technological advancements have enabled Centre Engineering to manufacture ceramic capacitors in high volume for low cost applications. The processes are the same as used in manufacturing ultra-high reliable sub-miniature ceramic capacitors.

The widest range of ceramic capacitors in the industry are available from Centre, including multi-layer or single layer chip capacitors, polymer coated leaded devices and glass sealed devices. Over 40 different formulations to meet your requirements with a capacity range of 1pF to 10mF. Catalog available upon request.

CENTRE ENGINEERING

2820 E. COLLEGE AVE., STATE COLLEGE, PA. 16801
814-237-0321 ■ TWX 510-670-3517

CIRCLE NUMBER 83

THINKING ABOUT YOUR OWN COMPUTER?

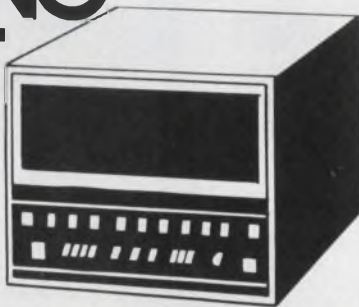

Join over 50,000 avid readers of BYTE, the magazine with rich, professionally edited articles on micro-computers . . . for building, expanding and having downright fun with your own system. You'll reread super articles on . . .

- detailed hardware/software designs by successful experimenters and hobbyists
- editorials on the fun of computers . . . electronic music, video games, hobbyist control systems, ideas for ham radio, model railroading and lots more
- reviews of upcoming general purpose systems
- tutorial background and sources full of ideas for home computers and computer science
- ads by firms with computer products you want
- club information and social activities

SUBSCRIBE TO BYTE NOW! IT'S FUN . . . AND GLITCH-PROOF!

Send this coupon for a trial subscription to BYTE. Get your first issue by return mail. Read it from cover-to-cover. If it isn't everything you want, just write "CANCEL" on the bill and return it to us. The first copy is yours to keep.

BYTE PETERBOROUGH, NH 03458

Please enter my trial subscription to BYTE . . .
 \$12 One Year \$22 Two Years \$30 Three Years
 I understand you will send the first issue by return mail and bill me later. If I don't like BYTE, I just write "CANCEL" across the invoice and return it. I will not be charged.
 Name (Please Print) _____
 Address _____
 City _____ State _____ Zip _____

CIRCLE NUMBER 84

MODULES & SUBASSEMBLIES

Drive synchros with mini-Scott-T

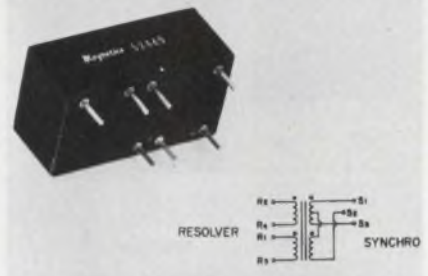

Magneto Inc., 182 Morris Ave., Holtsville, NY 11742. (516) 654-1166. \$17 (500 qty); stock to 6 wk.

Now you can mount a synchro driver on your converter board. The 53449 resolver-to-synchro converter (Scott-T transformer) can deliver 3 VA to a 2.5 kΩ 90-V line-to-line 400-Hz synchro or control transformer. The PC mountable unit is 1 × 1.63 × 0.69 in. From an input of 6 V rms sine and cosine resolver information, the unit delivers 3 arc-minutes accuracy without adjustment, selection, or trimming, and maintains this for any load, up to 2.5 kΩ, and temperature condition from -55 to 105 C.

CIRCLE NO. 352

DIP delay line offers 5% increments

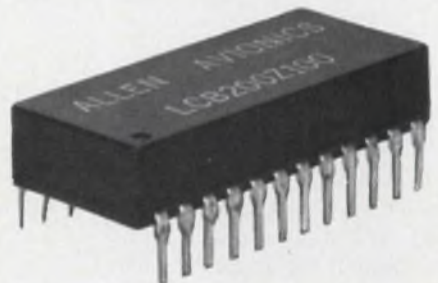

Allen Avionics, Inc., 224 E. 2nd St., Mineola, NY 11501. (516) 248-8080. \$45 up; 3 wk.

LC Dip 20 is a dual-in-line 24-pin tapped lumped-constant delay line that gives you 20 equal delay increments. Featuring time-delay to rise-time ratios of 10 to 1, these units provide high bandwidths and low rise times in a small package. Total delay tolerance is 5% or 1 ns (whichever is greater). Devices are compatible with TTL and DTL.

CIRCLE NO. 353



Phase converter spans wide range

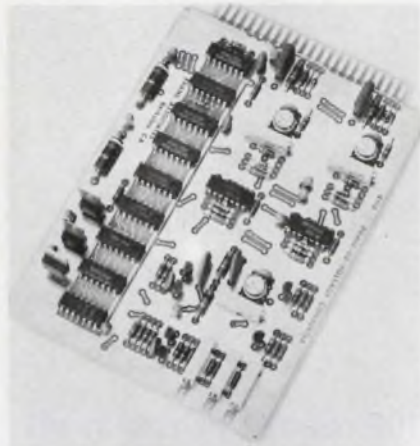

Evans Associates, P.O. Box 5055, Berkeley, CA 94705. (415) 848-6839. \$145; 2 to 4 wk.

Model 4118 phase-to-voltage converter provides precise and unambiguous 0-360 deg phase measurements over a frequency range of 0.01 Hz to 3 MHz. This analog function card accepts inputs ranging from 3 mV to 30 V rms. Linearity departure is within $\pm 0.1^\circ$. tempco is within $\pm 1\%$. On-board potentiometers provide calibration and zero adjustments. The converter handles signals containing harmonics, or substantial amounts of noise. Also its gating feature permits phase measurements to be made on half cycles, full cycles, or tone bursts, when used with the company's Model 4130 gated integrator. The module is contained on a 4.5×6.5 in. board that mates to a standard 22-pin double-read-out edge-connector.

CIRCLE NO. 354

Save \$270 on amplifier design kit

Alpha Industries, 20 Sylvan Rd., Woburn, MA 01801. (617) 935-5150. \$155 (1 kit); stock.

Just to prove that Optimax off-the-shelf components are economical, A. I. offers a sampler kit until 12-31-76. It consists of a low-noise, 2.5 dB max, amplifier (AH-522), a power amplifier with a 1 dB compression point at +23 dBm (AH-60), a high gain interstage amplifier with a typical gain of 32 dB (AH-555), and a matched voltage-controlled attenuator with a 15 dB range (ATN-4001). All components operate in the 5 to 500 MHz range.

CIRCLE NO. 355

Isolation amplifier claims more for less

Analog Devices, Route 1 Industrial Park, Norwood, MA 02062. (617) 329-4700. \$59 (unit qty); stock.

According to the manufacturer, the Model 284J is the industry's lowest cost, smallest size isolation amplifier. In quantities over 100, the price for the $1.5 \times 1.5 \times 0.62$ -in. unit drops to \$41. The 284J features 5000-V pulse, or 2500-V continuous common-mode rejection.

Defibrillator pulses or high process-control voltages therefore pose no problems. The gain is adjustable from 1 to 10 and the $8\text{-}\mu\text{V}$ pk-pk (0.05 to 100 Hz) input noise assures resolution of low level signals. Dual isolated power of ± 8.5 V at ± 5 mA for external transducers, and single-battery operation make the Model 284J attractive for hand-held instruments. For medical applications, the $1.2\ \mu\text{V}$ rms maximum leakage current at 60 Hz is especially important.

CIRCLE NO. 356



CTS matches crystal specs to your microprocessor.

And no waiting. CTS Industrial Distributors supply a perfectly matched crystal at the same time you buy the microprocessor, because CTS carefully checks the crystal requirements with each semiconductor manufacturer before writing crystal specs.

CTS now has a full line of standard crystals for microprocessors and clock IC's. CTS Knights crystals feature low start-up resistance, reliable CTS mil-approved manufacturing processes and gold frequency calibration for long term stability. Available in 17 standard frequencies, 1.0 to 22.1184 MHz. Other frequencies available on special order.

CTS Knights crystals are available **off the shelf** at these typical 100-piece prices: from \$5.50 each (1.0 MHz) to \$2.75 each (18.432 MHz).

See your nearest CTS distributor for full information, or write **CTS Knights, Inc.**, 400 Reimann Ave., Sandwich, IL 60548, phone: (815) 786-8411.

CTS Knights.
The frequency specialists.

CTS CORPORATION
Elkhart, Indiana



CIRCLE NUMBER 85

ATTENTION ALL ENGINEERS!

Design yourself a free vacation for two!

Yes, you can win an all-expense-paid Caribbean vacation plus \$1,000 cash — or one of 99 other valuable prizes!

There's nothing to buy, nothing to write, no slogans or gimmicks.

All you have to do is pick the ten advertisements that our readers will best recall having seen in the January 4 issue.

It's *Electronic Design's* popular TOP TEN CONTEST — the contest that can pay off handsomely for you *and* for your company.

Win a free vacation for yourself

Think of it! Clear sky... warm sun... expanses of blue water. The Caribbean is at its best when viewed from the deck of a sailing ship.

Top prize is a fabulous week's Windjammer Cruise for two. You can choose trips among the Bahama Out Islands, the U.S. and British Virgin Islands, or the exotic Windwards and Leewards.

Visit colorful ports with their old world charm and duty-free shops. Swim, fish, snorkel, relax, or lend a hand with the ship.

And it's all free! The prepaid cruise is worth many hundreds of dollars — not to mention the \$1,000 cash for travel and incidentals.

Win for your company

More and more companies are urging their engineers to enter this contest. Why? Because a large sample of *Electronic Design* subscribers will determine the top-scoring ads. The ten best will be rerun free of charge. Your company can win one of these reruns, worth up to several thousand dollars! (To receive this prize, your company must have an ad in the contest issue.)

Separate contest for advertisers and their agencies

The TOP TEN CONTEST is actually two contests with separate sets of prizes (1) for engineers and engineering managers (readers) and (2) for company executives, marketing and advertising personnel and their advertising agencies. Urge your top brass to enter. Xerox this page and pass it on to them. Maybe they can pick the top ten ads and walk off with one of the separate prizes.



Here's all you have to do to enter

First, read the rules contained in the January 4 issue. Then:

(1) Examine the contest issue with extra care.

(2) Pick the ten ads that you think *Electronic Design* subscribers will best recall having seen. List these ten ads by company name and reader service number on the entry card. Mail before February 15, 1977.

Your selections will be checked against Reader Recall, *Electronic Design's* method of measuring readership.

100 reader prizes in all

Watch for the January 4 Top Ten issue, then try your skill. This year, maybe *you* can sail away with the top prize.



PRIZES READER CONTEST

1st PRIZE
A WINDJAMMER CRUISE (FOR TWO)
IN THE CARIBBEAN
(Choice of itineraries and dates)
PLUS
\$1,000 CASH FOR TRANSPORTATION
AND INCIDENTALS

2nd PRIZE
GTE SYLVANIA PORTABLE COLOR TV SET
(\$325 value)

3rd, 4th & 5th PRIZES
DIGITAL WRISTWATCH
(\$100 value)

6th through 100th PRIZES
TECHNICAL BOOKS
(title to be announced)

PRIZES ADVERTISER CONTEST

1st PRIZE
WINDJAMMER CRUISE (FOR TWO)
IN THE CARIBBEAN
(Choice of itineraries and dates)
PLUS
\$1,000 CASH FOR TRANSPORTATION
AND INCIDENTALS

2nd PRIZE
GTE SYLVANIA PORTABLE COLOR TV SET
(\$325 value)

3rd PRIZE
DIGITAL WRISTWATCH
(\$100 value)

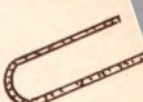

NOTE TO ENGINEERING MANAGERS

Urge your staff to enter.
The winning ads will receive
free reruns worth \$ thousands
for your company.

WATCH FOR THE
**TOP TEN
CONTEST
(JAN. 4
ISSUE)**



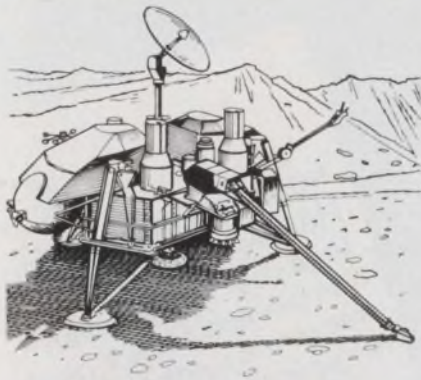

ALNICO 9 Nb™ where performance is super-critical!

Like on the Viking Mars Landers! And on such other space projects as the Lunar Excursion Module of the Apollo Program, Alnico 9 magnets have performed faultlessly with proven stability since the development and introduction of the alloy by Thomas & Skinner over ten years ago.

Alnico 9 offers a high coercive force and high energy product... with a typical peak energy product of 10.5-12.5 m.g.o. ... approaching that of the rare earth materials. It has low temperature coefficients and extreme mechanical stability*. It is easy to magnetize and stabilize. It has a lot of things going for it. So it makes sense to "Redesign with Alnico 9".

If you've got a magnet problem . . . come to the magneticians!

T & S has been in the permanent magnet business for over 75 years, and has been a leader in developing and pioneering new magnetic alloys and concepts . . . and in producing reliable products. T & S made the



permanent magnet in the earth inductor compass used on Col. Charles A. Lindbergh's pioneer flight . . . New York to Paris Non-Stop . . . in the "Spirit of St. Louis." Even 50 years ago in 1927, T & S products have had the reputation for quality and performance that is so necessary in today's world.

BEFORE YOU DESIGN . . . Send for Bulletin M-304 CR which gives details on all T & S metallic alloy permanent magnets. Or better yet, call on T & S experts to help solve your magnet design problems . . . large or small . . . unique or ordinary.

*Alnico 9 has the highest stability of all known permanent magnet materials.

Thomas & Skinner Inc.
MAGNETICIANS



P.O. BOX 150-B, 1120 EAST 23RD ST.
INDIANAPOLIS, IND. 46208
PHONE: (317) 923-2501

CIRCLE NUMBER 86

MODULES & SUBASSEMBLIES

Tiny modem suits Ma Bell

Cermetek Microelectronics, 660 National Ave., Mountain View, CA 94043. (415) 969-9433. From \$39.50 (1000 qty).

This addition to the "mini-Modem" line adds logic, carrier detection, and control circuitry to the basic modem function of earlier models. It provides full 101-type Bell specification compliance, with 70% reduction in external parts. The hybrid IC units conveniently mount on your PC board. A variant with only the four basic functions (modulator, demodulator, two filters) is available at \$39.50 in quantities of 1000; with added logic and control the price is \$49.

CIRCLE NO. 357

Interface mimics memory to μ P

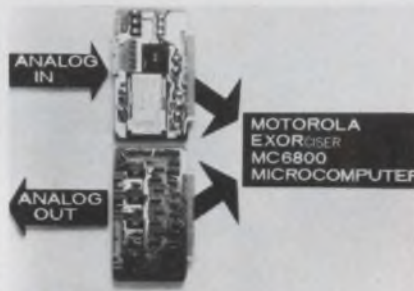

Burr-Brown, International Airport Industrial Park, Tucson, AZ 85734. (602) 294-1431. From \$295 (100 up); 4-6 wks.

If you want to interface analog inputs and outputs with Motorola's EXORciser, Burr-Brown's plug-compatible units ease the task. The MP7208 with an eight-channel differential input, and the MP7216 with a 16-channel single-ended input have ranges from ± 10 mV to ± 10 V. Analog signals are multiplexed and converted to 12-bit digital equivalents for output on the EXORciser data bus. The four-channel, MP7104, output system accepts 12-bit inputs from the data bus and delivers up to ± 10 V at 5 mA. Software implementation is simple, because all boards look like memory to the microprocessor.

CIRCLE NO. 358

Active filter separates high/low audio tones

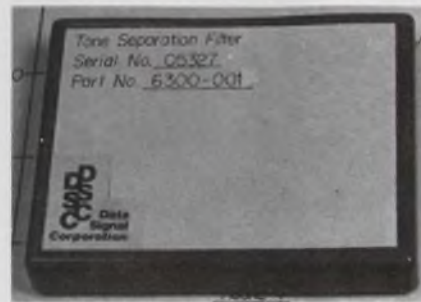

Data Signal, 40-44 Hunt St., Watertown, MA 02172. (617) 926-5080. \$76.50 (10 to 24); stock to 3 wk.

The Model 6300-001 tone separation filter is a pretuned active filter that separates composite low (200 to 940 Hz) and high (1209 to 3000 Hz) frequencies into independent low-and-high-tone outputs. Intended for dual-tone detection uses e.g., data transmission, alarm-status reporting, supervisory control, radio-paging, and tone-telecommunication, its specifications include 30 dB min separation between high and low-group tones, 1.5 dB max in-band deviation, 0 to 70 C operating range and -25 to $+100$ C storage. The epoxy encapsulated hybrid module is $2 \times 2 \times 0.437$ in.

CIRCLE NO. 359

3-1/2-digit a/d features fancy specs, plain price



Intech Inc., 282 Brokaw Rd., Santa Clara, CA 95050. (408) 244-0500. \$39 (100 up); stock.

The Model 103 integrating a/d converter, with automatic zero correction, transforms a 0-to-10-V input into a 3-1/2-digit output. Key features are $\pm 0.01\%$ max non-linearity, ± 5 ppm/ $^{\circ}$ C max offset drift and ± 10 ppm/ $^{\circ}$ C max scale-factor drift. Clock and timing outputs are provided, as well as internal reference and ratiometric operation.

CIRCLE NO. 360

Hi-Strength Aerospace Epoxy now available HYSOL EPOXI-PATCH[®] KITS

BOND, SEAL, REPAIR.....ANYTHING

There's no such thing as a single miracle adhesive or sealing compound that works everywhere, all the time. It takes different formulations for different applications. That's why Hysol offers 10 kinds of Epoxi-Patch Kits (no one else does).

These kits will solve literally thousands of production line, maintenance or repair problems. We have a Selector Chart just to explain briefly what they can do for you. For your copy and the name of your nearest distributor, write

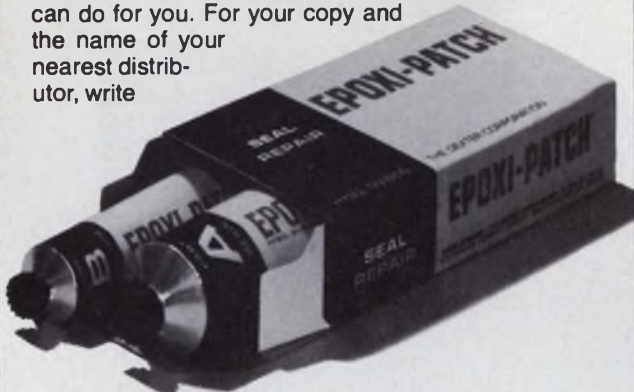

HYSOL DIVISION
THE DEXTER CORPORATION
Division Headquarters: 15051 E. Don Julian Road,
Industry, Ca. 91749. Phone: (213) 968-6511

CIRCLE NUMBER 87

FOR ELECTRONIC
EQUIPMENT ENCLOSURES

MACHINE TOOLS,
COMPUTERS, ELECTRONICS
6,000 & 8,000 BTU

McLEAN INDUSTRIAL AIR CONDITIONERS



For "closed loop enclosures". Recirculates and cools internal air. Constant clean air in contact with electronics. Highest quality refrigeration and electrical components. 20,000 hours continuous duty in ambients to 125°F. High velocity cooling for maximum heat removal. Std. cabinet mounting. Quick installation. Factory-installed gaskets seal against induction of ambient, contaminated, or polluted air. 115 or 230 volts.

SEND FOR CATALOG

McLEAN ENGINEERING
LABORATORIES
PO BOX 147D PRINCETON JUNCTION, NEW JERSEY 08550
PHONE 609-799-0100 • TELEX 84-3422

CIRCLE NUMBER 88

ELECTRONIC DESIGN 25, December 6, 1976

POWER

Power you can count
Power you can count on



AILTECH's Model 446 RF Power Signal

Source has an easy-to-read 5 digit frequency counter, with accuracy as high as .002%, power output to 50 watts, full AM-FM capability, and covers a frequency range from 10KHz to 2500MHz with plug-in head versatility. It's just part of a complete line extending up to 8GHz. The very versatile Model 446 is universally used for both dedicated production line testing and research applications such as EMC testing, wattmeter calibration, component evaluation, high-power solid-state amplifier design, biological studies and plasma investigations.

Model 446 features easy operation and direct indication of forward and reflected power. For truly tunable precision RF power, consider Model 446. Don't take our word for it, though. With Model 446 you can count it yourself.

We've
Got The
Power

plus a complete line of Noise Figure Instrumentation, Spectrum Analyzers, System Noise Monitors and Frequency Synthesizers.

AILTECH 
A CUTLER-HAMMER COMPANY CONTROL

WEST COAST • CITY OF INDUSTRY, CA. 91748 • (213) 965-4911
EAST COAST • FARMINGDALE, NEW YORK 11735 • (516) 595-6471
FRANCE • LA GARENNE-COLOMBES • TELEPHONE (01) 780-73-73
UNITED KINGDOM • CROWTHORNE • TELEPHONE 5777
GERMANY • MUNICH • TELEPHONE (089) 5233023
JAPAN • TOKYO • TELEPHONE (404) 8701

For Data Circle #212
For Demonstration Circle #213

Electronic Design's 1976-77 GOLD BOOK



**THE INDUSTRY'S
BEST DIRECTORY
GETS EVEN
BETTER!**

MOST COMPREHENSIVE ELECTRONICS DIRECTORY IN THE WORLD

THE GOLD BOOK HAS

5,280

PRODUCT HEADINGS
AND CROSS-REFERENCES

(EEM HAS ONLY 3,281)

THE GOLD BOOK LISTS

7,648

MANUFACTURERS

(EEM LISTS ONLY 4,195)

THE GOLD BOOK LISTS

83,930

SALES OUTLETS

(Sales offices, reps, export offices
and distributors under manufacturers)

(EEM LISTS ONLY 40,268)

THE GOLD BOOK LISTS

2,198

DISTRIBUTORS

(EEM HAS DROPPED ITS
DISTRIBUTOR DIRECTORY THIS YEAR)

THE GOLD BOOK LISTS

7,812

TRADE NAMES

(EEM HAS DROPPED ITS TRADE
NAME DIRECTORY THIS YEAR)

THE GOLD BOOK KEEPS
ON GROWING

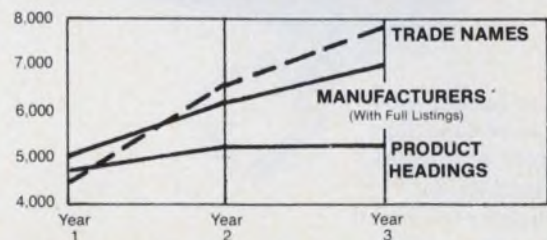

SPEED YOUR FIRST-STEP SEARCH FOR PRODUCTS

SIMPLIFY CONTACT WITH SUPPLIERS

OBTAIN IMMEDIATE SPECIFYING INFORMATION AND DATA

IF IT'S ELECTRONICS...IT'S IN THE GOLD BOOK

Prototype CRT enclosures use plastic for low cost

Enclosure Dynamics, P.O. Box 6276, Bridgewater, NJ 08807. (201) 725-7982. See text.

Cutting corners to make heavy-duty but inexpensive cabinets, Enclosure Dynamics uses 0.25-in.-thick molded Noryl plastic in its line of CRT terminal enclosures. The cabinets are said to be about 40% cheaper than the closest competing metal cabinets.

The largest available cabinet is a full CRT terminal enclosure, the VTE 101, that combines a base (19-in. wide \times 21-in. deep \times 4-in. high) with a cover shroud (17-in. wide \times 12.5-in. deep \times 11.25-in. high) and weighs 13 lb. The base has a sloping front section large enough to hold a keyboard and auxiliary controls, a rear opening for a fan, two ventilation grills and a pattern of ribs and bosses for a mounting plate.

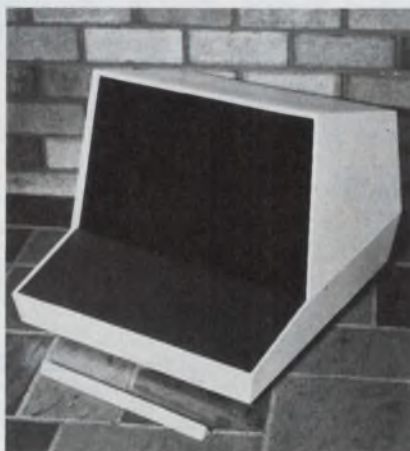

The CRT-display shroud has a smoke-gray plexiglass screen that measures 11.25 \times 17 in. The sloping keyboard panel is 7.25 in. deep, with a tapered width that is 18 in. at the front and 18.5 in. at the rear. The keyboard panel can be removed easily for machining.

Two other terminal cabinets are also available. The TVTE 101 is similar to the VTE 101 except that it has a raised cover plate that measures about 17 \times 12.5 in. instead of the CRT shroud. The TVTE 101 is lighter (9 lb.). A CRT monitor can be seated on the cover. The other model, the KBE 101, is a cabinet designed just for the keyboard and associated circuitry. This version weighs only 3 lb.

All three cabinets are available in three different colors: light blue, light beige or dark blue. Prices range from \$22.25 for the KBE 101 to \$77.75 for the VTE 101 in single-unit quantities. An unfinished version of the VTE 101 is available for \$69.95. Delivery takes up to four weeks. For custom-panel cutouts, \$1000 is a typical tooling charge.

CIRCLE NO. 361

**Borrow my calculator...
but never my G-Meter.**



It's so handy, you'll measure capacitors instead of resistors.

- Hand Held
- Pushbutton Speed
- Accuracy: .1%
- Range: .1pf to .2 farads
- Rep Stocked

Try one. You won't be able to keep your hands off it. **\$289**



SALES OFFICES: AL, Huntsville (205) 533-5896; AZ, Scottsdale (602) 947-7841; CA, Costa Mesa (714) 540-7160; CA, Sunnyvale (408) 733-8690; CO, Denver (303) 750-1222; FL, Winter Haven (813) 294-5815; GA, Chamblee (404) 457-7177; IL, Elk Grove VIII (312) 593-0282; IN, Indianapolis (317) 293-9827; MD, Silver Spring (301) 622-4200; MA, Burlington (617) 273-0198; MN, Minneapolis (612) 781-1611; NJ, Camden (215) 925-8711; NM, Albuquerque (505) 299-7658; NY, Great Neck (516) 482-3500; (212) 895-7177; Syracuse (315) 446-0220; NC, Raleigh (919) 787-5818; OH, Centerville (513) 433-8171; TX, Houston (713) 688-9971; TX, Richardson (214) 231-2573

CIRCLE NUMBER 90

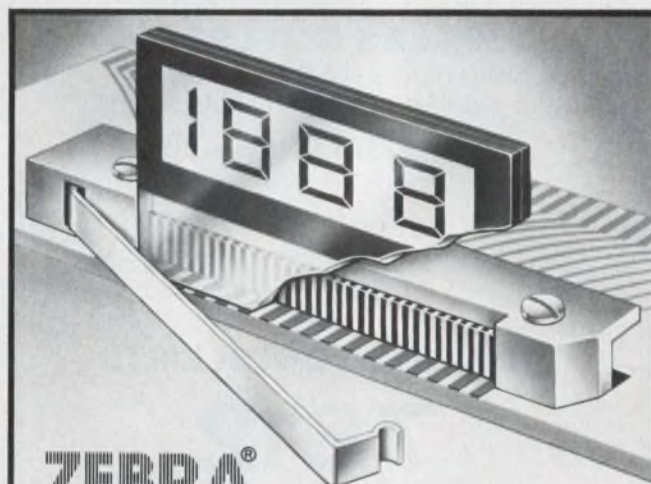

ZEBRA®

LCD CONNECTOR
90° EDGE MOUNT
CONDUCTIVE ELASTOMERIC CONNECTOR

- A unique design of a solderless connector and holder for 90° edge mount LCD's.
- Provides vibration and shock protection
- Gas-tight seal is created
- Zero insertion force
- Easily installed and replaced
- Standard configurations available from stock.

Send for Connector Catalog.



TECKNIT®

Eastern Division • 129 Dermody St., Cranford, N.J. 07010 • (201) 272-5500
Western Division • 427 Olive St., Santa Barbara, Ca. 93101 • (805) 903-1867

CIRCLE NUMBER 91

ELECTRONIC DESIGN 25, December 6, 1976

Pressure-sensitive glue applies like ink

Metron Optics, Box 690, Solana Beach, CA 92075. (714) 755-4477. \$2.95 (1-up).

A pressure-sensitive adhesive is applied with a pen just like ink. The adhesive, Liquid 2-Way Tape, provides a permanently high-tack surface. The bonded materials can be separated and rebonded again, as often as needed. Liquid 2-Way Tape remains tacky and does not harden nor become brittle with age. The glue will adhere to any dry, non-oily surface, even Teflon. It will bond nonporous surfaces such as plastic films, glass, ceramics, metal and plastics. Liquid 2-Way Tape becomes water resistant after hardening, in about 30 min., but may be removed with most solvents.

CIRCLE NO. 362

5 x 5-in. PC boards can carry 24 ICs

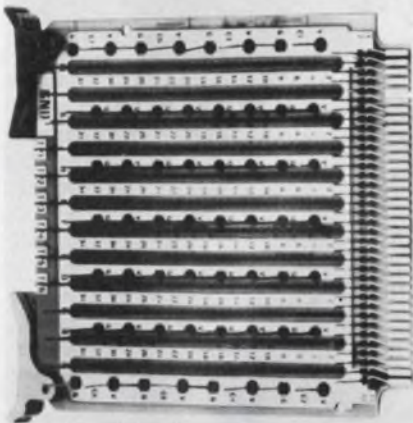

Garry Manufacturing Co., 1010 Jersey Ave., New Brunswick, NJ 08902. (201) 545-2424. \$1.00 to \$1.50 per IC position; 2-4 wk.

A line of IC plug-in boards is designated the ECM 72 series. The cards measure 4.86 x 4.38 in. and hold 12, 18, or 24 ICs. A universal version has 12 columns of 35 socket terminals on centers of 0.1 in. A high-density version has from 16 to 20 universal columns and 12 test terminals. All versions have a card-edge connector. The ECM 72 series can be obtained with either 14 or 16 pins per IC position, and with or without voltage and ground sockets. Wrapped-wire posts accept one, two, or three levels of wraps.

CIRCLE NO. 363

MEET OUR family of GRABBERS



MODEL 4233 MICRO GRABBER
Tests high density packaging



MODEL 3925 MINI GRABBER
Tests conventional packaging



MODEL 4011 THREADED GRABBER
Accepts 6-32 threaded leads



MODELS 3780 - 3789 GRABBER LEADS
10 choices of connectors other end



MODEL 4225 MAXI GRABBER
Tests high rise packaging

All Grabbers shown actual size

Our Grabber family is five years old now, and we're adding new members to keep pace with the complexities of state-of-the-art electronic packaging. Grabber is our name for a series of test clips designed to simplify testing of electronic packages from conventional components to maximum density DIP's. They're rugged, dependable, versatile, and very easy to use. Write for our catalog and get the complete story on the whole family of Grabbers. Find out why they are your best solution to your electronic testing problems.

**AVAILABLE THROUGH YOUR
FAVORITE ELECTRONIC
PARTS DISTRIBUTOR**

ITT POMONA ELECTRONICS

1500 East Ninth St., Pomona, Calif. 91766
Telephone (714) 623-3463, TWX: 910-581-3822



CIRCLE NUMBER 92

A Paper Tape Combo for your Terminal

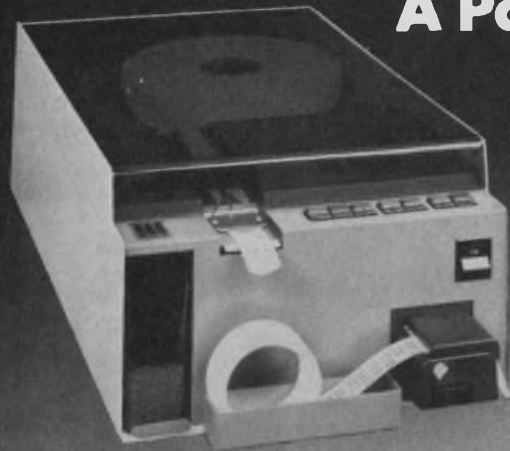

DATA SPECIALTIES' SRP-300 connects, without modification, to any 300 baud teleprinter or CRT terminal thru the RS-232 connector and provides all the features of a conventional ASR. In addition, the Combo may be used as a stand-alone computer peripheral. This whisper quiet (58 dB) unit is provided with full/half duplex, line/local, search/edit control, backspace, tape feed, remote control selection and switch selectable baud rates as standard features.

The Combo employs a photo electric/LED reader and the revolutionary MODUPERF™ tape punch mechanism. The unit will reliably read and punch without readjustment or modification paper, MYLAR, rolled or folded tapes.

DSI, 3455 Commercial, Northbrook, IL, 60062-Tel: (312) 564-1800

ds i DATA SPECIALTIES

CIRCLE NUMBER 93

PC board connectors meet military standards

Eby Co., 4701 Germantown Ave., Philadelphia, PA 19144. (215) 841-3000. See text.

Two series of card-edge connectors meet military standard MIL-C-2109. One, designated the CM Series, has contact spacing of 0.100 in. The other, the CH Series, has contact spacing of 0.156 in. Both have contacts made of phosphor bronze with a gold-over-nickel finish. The insulator material is thermoplastic polyester. The CM Series mounts on a PC board or accepts wrapped wires. The CH Series accepts soldered wires or mounts on a PC board. Both types have 15, 22, 36 or 43 dual positions. In quantities of 100 to 249 and with 36 dual positions, the CM series costs \$2.90 and the CH series costs \$2.71.

CIRCLE NO. 364

Wrapped-wire board has decoupled busses



Interdyne, 14761 Califa St., Van Nuys, CA 91411. (213) 787-6800. \$1-\$1.50 per IC position; stock.

The Proto-Wrap-Kit series contains a chassis with either 14, 16, or 24-contact sockets, one 48-in. jumper cable, three discrete-component platforms, clips and solder preforms. The sockets are mounted to a plated-steel chassis with decoupled power and ground planes. The planes have up to 25 pF of distributed capacitance per in². The platforms accommodate jumper cables and discrete components.

CIRCLE NO. 365

Here is a case in point!



You need a good looking tool case that will be at home anywhere in the field or office. The new SPC 88 MD tool kit comes in an ABS heavy duty case molded with fiberglass reinforced corners for durability. It's stocked with 100 carefully selected quality tools in an easy to find arrangement. The SPC 88 MD tool kit is designed for the field service engineer but we also make kits for the medical technician or any other professional.

Individual tools or a complete kit — we can deliver! A case in point for calling Specialized Products Company. (214) 358-4663.

Send for free brochure and product information.

2324 Shorecrest Drive/Dallas, Texas 75235

SPECIALIZED PRODUCTS COMPANY

CIRCLE NUMBER 94

Tool slits insulation on wires up to 1 in.

Lumia Products, 221 Ruth Ave., Venice, CA 90291. (213) 396-9719. \$1.25 (single qty); stock.

The Model LP-8 removes insulation from wire and cable with diameters up to 1 in. The tool slits the insulation lengthwise as well as circumferentially. A V-notch in the LP-8 guides the blade lengthwise along the centerline of the cable. A semicircular notch guides the blade around the cable. The LP-8 uses a single-edge razor blade and the body is made of ABS plastic. The blade is adjustable for various insulation thicknesses.

CIRCLE NO. 366

Ground plane holds 16 120-pin PC boards

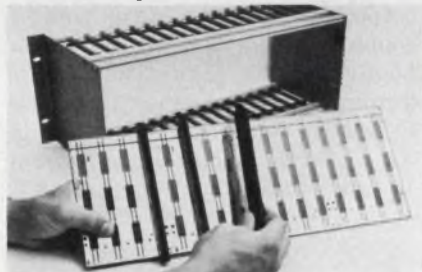

EECO, 1441 E. Chestnut Ave., Santa Ana, CA 92701. (714) 835-6000. \$59.50 (single qty); stock.

The Model 3D8007 holds sixteen 120-pin card connectors on centers of 1.0 in. The wrapped-wire ground plane measures 6.2 x 16 in. It has 2-oz copper cladding on both sides. The board has 16 tantalum capacitors with provision for an additional 24. Supply voltage and ground connections have the same pin numbers for all connector positions.

CIRCLE NO. 367

Hand tool cuts and swages component leads

Micro Electronic Systems Inc., 8 Kevin Dr., Danbury, CT 06810. (203) 746-2525. \$28.42.

A hand tool, Model 2658TQ, cuts off a component lead then flattens the remaining end. This prevents the component from falling out of a printed-circuit board prior to soldering. The tool measures 5 in. long and weighs 90 g. The tool cuts copper wire 1.5 mm in diameter and steel wire 1.0 mm thick.

CIRCLE NO. 368

Tool cuts and strips wires for wrapping

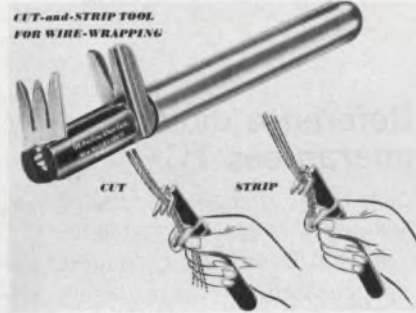

OK Machine and Tool Corp., 3455 Conner St., Bronx, NY 10475. (212) 994-6600. \$11.50

The ST-100 strips and cuts wires to the correct length for wrapped wiring. To operate, place one to four wires in the stripping slot with the wires extended beyond the cutter blades. Press and pull the tool end. The ST-100 uses hardened-steel cutting blades and an insulated handle. The stripping blade is replaceable.

CIRCLE NO. 369

5½ DIGIT ACCURACY. 4½ DIGIT PRICE.

The 4600 is our brand new 4½ digit multimeter. It gives you the accuracy and resolution of typical 5½ digit multimeters. At half the cost.

And the 4600 stays accurate longer than other DVM's. DC accuracy stays within 0.01% ± one digit for six months at a time. We guarantee it.

80dB normal mode noise rejection produces a 10,000:1 reduction of excess noise. A full decade better than the 1,000:1 reduction of comparable instruments.

Loading errors are virtually eliminated by the 4600's 10,000MΩ input impedance on the two lowest DC voltage ranges.

There's a lot more. Send for a free catalog on our new 4½ digit 4600 multimeter. And find out how to get 5½ digit accuracy without paying for it.

Dana Laboratories, Inc.,
2401 Campus Drive, Irvine,
California 92715. 714/833-1234.



DANA

Others measure by us.

FOR PRODUCT DEMONSTRATION
CIRCLE # 141

FOR LITERATURE ONLY
CIRCLE # 142

PULL!

The only barrier strips with non-twist, non-pull-out terminals.

The interconnection company that innovates to serve you better.

BEAU



Beau Products Division
Vernitron
Electrical Components

P.O. Box 10, Laconia, N.H. 03246/N.H. tel.: 524-5101
CALL TOLL FREE: (800)258-0370

CIRCLE NUMBER 97

FAST!

We're geared for special connectors—and react to your needs!

The interconnection company that innovates to serve you better.

BEAU



Beau Products Division
Vernitron
Electrical Components

P.O. Box 10, Laconia, N.H. 03246/N.H. tel.: 524-5101
CALL TOLL FREE: (800)258-0370

CIRCLE NUMBER 98

DISCRETE SEMICONDUCTORS

Reference diode guarantees TC

Codi Corp., Pollitt Dr., Fair Lawn, NJ 07410. (201) 797-3900.

The full series of temperature-compensated reference diodes, 1N-3611A, B, C through 1N4613A, B, C, has a guaranteed maximum temperature coefficient for a wide range of current, as well as at a given current. Operating current range is 1 to 3 mA for the 1N4611 family, 8 to 7 mA for the 1N4612 family and 7 to 15 mA for the 1N4613 family. All have been screened for 1 μ V maximum noise and are encapsulated in a hermetically sealed DO7 package.

CIRCLE NO. 370

Power-switching Xistor is radiation hardened



RCA/Solid State Div., Route 202, Somerville, NJ 08876. (201) 685-6423. Sample qty available.

A radiation-hardened power-switching transistor, TA 9107, is designed for aerospace applications where the device may be exposed to extreme nuclear environments. The device withstands radiation environments with cumulative neutron fluence levels to 1×10^{14} neutrons/cm² and gamma intensity to 2×10^8 rad(si)/s. The TA 9107 has a sustaining voltage of 80 V, a gain of 50 at 8 A and a dissipation rating of 87 W. In addition, the transistor features extremely fast rise and fall times (typically less than 100 ns at 10 A).

CIRCLE NO. 371

Optoisolator drives 10 TTL unit loads

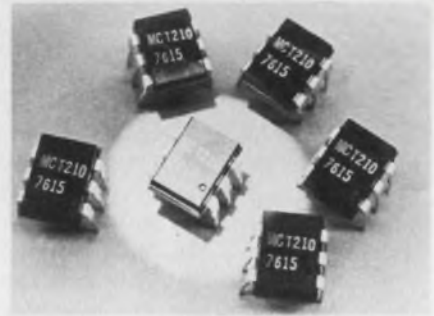

Monsanto Commercial Products Co., 3400 Hillview Ave., Palo Alto, CA 94304. (415) 493-3300. \$1.55 (100-999); stock.

Designated the MCT210, a new optoisolator has a specified minimum current transfer ratio (CTR) of 50% saturated, and 150% unsaturated, over a temperature range of 0 to 70 C. The device incorporates a GaAs diode emitter coupled to an npn silicon planar phototransistor. The saturated collector-to-emitter voltage is typically 0.2 V (specified maximum of 0.4 V) with a collector current of 16 mA and an input current of 32 mA.

CIRCLE NO. 372

Zener suppresses 1500-W peak power



TRW Capacitors, 301 West O St., Ogallala, NE 69153. (308) 284-3611. \$1.35 (100 up); 6 to 8 wks.

A series of zener transient-voltage suppressors, TVP1500, rapidly changes impedance values from very high at standby to very-low conducting values, when subjected to high energy transients. The zeners shunt potentially damaging effects by clamping the voltage at some predetermined level. The devices feature 1500-W peak pulse power (1.5 joules), a voltage-breakdown range of 8.2 through 200 V and a fast recovery time of approximately 1×10^{-12} s. Reverse standoff voltage range is 6.6 through 171 V.

CIRCLE NO. 373

*Bodine has doubled
its AC horsepower*



AVAILABLE FROM STOCK

And our new 48-frame TEFC parallel shaft and right angle gearmotor designs are shorter, too. Proven gearheads with ratios from 5:1 through 60:1. Speeds from 340 through 28 Rpm. And torques through 330 Lb-in. Available in all popular AC windings and voltages. In a wide range of mounting configurations. You can get continuous duty ratings through 1/3 Hp—with gearhead or without. But get all the facts. Write for Catalog S.

ADE (After Delivery Economies)
make Bodine a better flp buy



Bodine Electric Company, 2500 W. Bradley Place, Chicago, IL 60618.

CIRCLE NUMBER 99

MICROPAC

LOW-COST OFF-THE-SHELF

HYBRID VOLTAGE REGULATORS



4 TO 10 amp
output current

- 5 to 36 fixed voltage range
- Positive & Negative voltages
- 120 Watts power dissipation
- Internal short circuit protection
- External components not required
- Standard TO-3 Package
- Available from stock
- Economically priced

CUSTOM PRODUCTS ALSO AVAILABLE
WRITE FOR OUR FREE FACILITIES BROCHURE



MICROPAC INDUSTRIES, INC.

905 E. WALNUT ST. GARLAND, TEXAS 75040 Tel. 214-272-3571
TWX 910-860-5186

CIRCLE NUMBER 100

ELECTRONIC DESIGN 25, December 6, 1976



There Goes Your Reputation --Up In Smoke.

**Here's how to protect
your product, your cus-
tomer—and yourself!**

Just add MICROTEMP® safety thermal cutoffs to your plans. The millions already in use are your assurance of positive, yet low cost protection against overheating caused by malfunctions in electrical circuits and components.

MICROTEMP is a reliable, accurate, easy to install, "one shot" thermal limiter. Because of its patented design and construction, it won't derate. And, it's unaffected by age or extended use.

Compare this data:

- opening tolerance — $\pm 3^\circ$ F.
- temperature range — 58 to 242° C. (136 to 468° F.)

- compact — diameter, .157"; length, .457" (exclusive of leads)
- economical
- proved reliable in millions of on-the-job applications
- installation ease — assorted terminations, mounting packages and insulations are available

Recognized under the Component Program of Underwriters' Laboratories, Inc. UL File #E40667A. CSA and BSI Certificate #5041 approved. Recognized by MITI and VDE. Military approval.

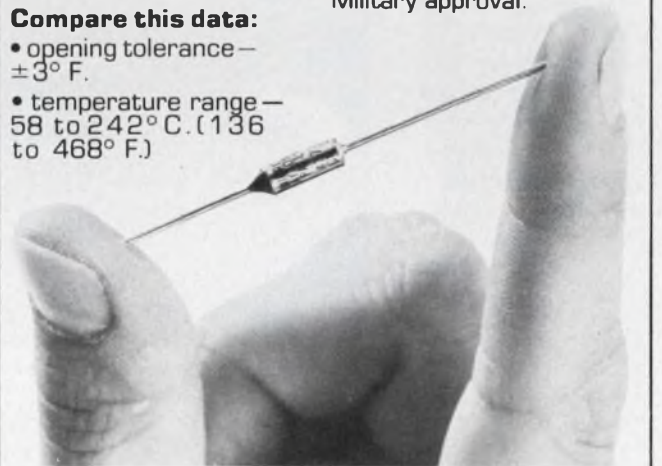

MICRO DEVICES



DIVISION OF EMERSON ELECTRIC CO.
1881 SOUTHTOWN BLVD.
DAYTON OH 45439 513-294-0581

CIRCLE NUMBER 101

Cut your jumper assembly time to zero while you cut your costs by as much as 50%.

Meet Great Jumpers™ and Great Daisy Jumpers™ from A P Products. They come from our factory fully pre-assembled and fully pre-tested, complete with molded-on connectors featuring integral strain relief and complete line-by-line probeability, yet can cost half as much as the jumpers you're using now.

Just name your jump and watch us hop to it. We offer the three most popular connectors, the five most popular flat cable widths, solid or stranded Electric Pink or rainbow cable, single ended, double ended or daisy chained. And Great Jumpers are directly-interchangeable replacements for the jumpers you're using now.

Connect with the A P rep nearest you.

(203) 868-7748	(219) 447-9623	(314) 434-6242	(512) 443-9687	(617) 272-8163
(206) 822-8223	(301) 484-5400	(315) 437-8343	(513) 433-0966	(713) 691-3961
(212) 682-5844	(303) 420-4646	(414) 421-2300	(602) 946-4437	(714) 560-6266
(214) 238-0408	(305) 894-3351	(415) 328-3232	(602) 949-8424	(714) 833-1802
(215) 923-5195	(312) 298-4830	(416) 638-1322	(605) 429-4013	(816) 765-2998
(216) 333-4120	(313) 356-2161	(503) 223-3374	(612) 922-7011	

Faster and easier is what we're all about.



A P PRODUCTS INCORPORATED

BOX 110-F Painesville, OH 44077 (216) 354-2101 TWX: 810-425-2250

CIRCLE NUMBER 102

Balco

DIVISION

Capacitors for
Time Circuits
Delay Lines
R. C. Oscillators
Integrators

- Smallest Size
- Exceptional Performance
- Low Cost
- Fast Delivery
- Long Term Stability

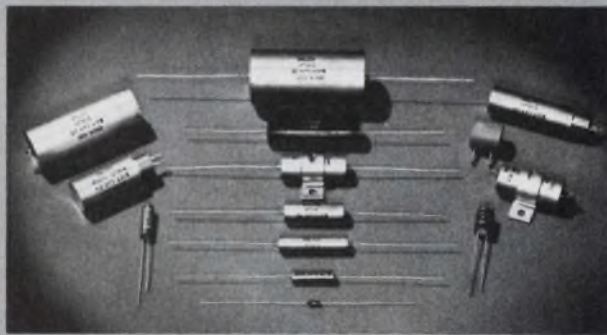

	featuring Clear and Metalized Teflon® types.	
	Extended Foil (RTWGX)	Metalized Film (RTWGMX)
Capacitance Range (μF)	0.0005 to 2.0	0.05 to 4.0
Working Voltage (Vdc)	50 to 600	50 to 600
Temperature Coefficient	± 1.5%	- 90 PPM/°C ± 40
DF at 25°C and 1 kHz (%)	0.05	0.1
Operating Temperature Range (°C)	- 55 to + 175	- 55 to + 175
Dielectric Absorption (%)	< 0.05	< 0.05
IR (Ohms)	> 1 x 10 ¹²	> 1 x 10 ¹¹

Contact Custom for capacitors to suit your applications. Write for Brochure



CUSTOM ELECTRONICS, Inc.

Balco Division
4 Browne Street, Oneonta, N.Y. 13820
Ph: 607-432-3880 TWX: 510-241-8292

CIRCLE NUMBER 103

DISCRETE SEMICONDUCTORS

Numerical LED displays can be stacked

National Semiconductor, 2900 Semiconductor Dr., Santa Clara, CA 95051. (408) 737-5000. \$1.80 to \$2 (100 up); stock.

A series of LED 2 (NSN) and 4-digit (NSB) GaAsP reflective displays in 0.3, 0.5 and 0.7-in. formats can be stacked on end. When combined with the options for overflow, polarity and other indications, virtually all display requirements can be satisfied. Common-anode or common cathode and direct-drive or multiplex versions are available. PC-board terminals on the edges of the display provide electrical contact. The series features a typical light intensity at 10 mA of 1.6 mcd.

CIRCLE NO. 374

Low forward-volt diodes stable as silicon units

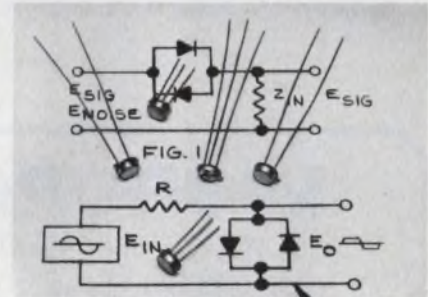

Solid State Devices, Inc., 14830 Valley View Ave., La Mirada, CA 90638. (213) 921-9660. \$0.98 to \$3 (100 up); stock.

Three diode families, HSA/46, HSB/46 and HSC/46, provide forward threshold voltages (225 to 450 mV at 1 mA) up to 50% lower than germanium devices and still retain the stable temperature characteristics associated with silicon devices. The diodes are manufactured with SSDI's proprietary Epion ion-implantation process claimed to provide an order of magnitude faster turn-on and recovery times, low power dissipation and a high-current pulse-handling capability to 800 MHz. The diodes are supplied in two or three-lead TO46 hermetically sealed packages. Operating temperature is -65 to 175 C; storage temperature ranges are -65 to 200 C.

CIRCLE NO. 375

MICROWAVES & LASERS

Portable power meter accepts 1 MHz to 18 GHz



Pacific Measurements, 470 San Antonio Rd., Palo Alto, CA 94306. (415) 494-2900. \$725; stock to 30 days.

The Model 1034A microwave power meter can take measurements over a frequency range of 1 MHz to 18 GHz. Its measurement accuracy will hold over a 0-to-50-C operating span. The power meter is a battery-operated instrument and has a self-check feature to guarantee performance. The instrument has full scale power range from +10 dBm to -50 dBm. An additional feature is the 1034A's extra meter scale that presents a full 50-dB dynamic range of the instrument in one meter sweep. Although totally portable and in a moisture-proof carrying case, the 1034A has a maximum sensitivity of 10 nW full scale and is usable to 3 nW (-55 dBm). The detectors for the instrument are field repairable and are available for either 50 or 75 Ω with adapters.

CIRCLE NO. 376

PET amplifier is sensitive and quiet

AIL Div. of Cutler-Hammer, Deer Park, NY 11729. (516) 595-4434. \$15,000; 90-120 days.

The PET is a portable earth terminal, and the amplifier is the Model C867. It listens to NASA spacecraft at a cool 160 K max. The frequency range is 11.6 to 12.15 GHz. The C867 and its variants can be used in conjunction with the communications technology satellite (CTS) launched earlier this year.

CIRCLE NO. 377

Measure 1.006 VSWR from 10 MHz to 18 GHz

Wiltron Co., 930 E. Meadow Dr., Palo Alto, CA 94303. (415) 494-6666. 6 wks.

A whole new family of ultra-precision test components working from 10 MHz to 18 GHz include terminations, air lines, adaptors,

and SWR bridges. Accurate SWR measurements as low as 1.006:1 are possible. Components are available in 75 Ω versions with GR900 connectors, as well as for 50 Ω with GR900 or APC-7 connectors. Using these components, the 4-port SWR bridge measures with an effective directivity in excess of 50 dB across the band.

CIRCLE NO. 378

CONTEMPO DESK TOP PANEL CABINETS

CONTEMPO SLOPE FRONT CABINETS

TERMINAL DESK WORK STATIONS

INTEGRA CABINETS

INTEGRA SLOPE PANEL CABINETS

MOD-CAB DESK CABINETS

Just a few examples of Par.Metal's packaging systems...

an extensive line of modern electronic cabinets, racks, terminal desk work stations, instrument cabinets, accessories and hardware.

SEND FOR THE LATEST CATALOG ...

Par.Metal PRODUCTS, INC.

1260 Atlantic Ave., Brooklyn, N.Y. 11216
(212) 772-5800

CIRCLE NUMBER 104

an investment in capitol buys rugged switch design and long, trouble-free life

For Example!
Our Extremely
Dependable,
Multiple-Position
Push Button Strip
Switches



Basic frames are anodized aluminum. Plungers are 5/32" square brass with a nylon actuator molded on them. Hence, they will not bend or warp.

Mechanical linking of all switch positions prevents operation of more than one position at a time. A released button will return to the "up" position before the next button can be actuated. These switches can be illuminated either by an external circuit or directly from the switch. Lamps do not travel when positions are engaged, eliminating shock to the bulb.

Capitol switches are tested with 2 to 3 million operations to assure life-long, trouble-free performance.

Our 28-page catalog will give you all the "specs" on CAPITOL's entire line of quality switches.



CAPITOL manufactures a complete, high-quality line of push button and lever switches — illuminated if desired — standard and custom designs to fit your every need.

CAPITOL

The Capitol Machine and Switch Co.
87 Newtown Road, Danbury, Conn. 06810
Phone: 203-744-3300

CIRCLE NUMBER 105

MICROWAVES & LASERS

'Canned' cplrs, hybrids simplify installation



Merrimac Industries, 41 Fairfield Pl., Caldwell, NJ 07006. (201) 228-3890. \$15 (coupler), \$35 (hybrid); stock.

Lower installation cost and small size (0.375 in. dia., 0.3 in. high) characterize these low-cost quadrature hybrids and directional couplers. Packaged with TO-5 headers, the hermetically sealed units need less drilling and soldering than flatpacks. The devices meet requirements of MIL-E-16400 F, Class 1, and MIL-E-5400L, Class 2, and are tested to MIL-STD-202 from -55 to +100 C. Models C-114 (10-dB coupling) and C-115 (20-dB) directional couplers are ideal for i-f signal processing in the 5-to-500-MHz range, when space and weight are critical—they weigh only 2 g. For both models, coupling deviation is ± 1 dB, frequency sensitivity ± 0.5 dB (10 to 200 MHz) and ± 0.7 dB (5 to 500 MHz). VSWR is 1.3:1 (10 to 200 MHz), 1.5:1 (5 to 500 MHz) at 50 Ω . Min. directivity is 20 and 15 dB, insertion loss 0.6 dB and 1 dB, respectively, for partial and full band. Main line power rating is 1 W. The quadrature hybrid Model Q116 is used where two quadrature, isolated outputs are needed from one input signal. It can also be used to combine quadrature phased inputs. Model Q116 operates over a 10% bandwidth at 30 MHz. Other center frequencies up to 300 MHz are available. Specifications include -3 dB min isolation and 0.25-dB max insertion loss. Phase quadrature is 90 ± 3 degrees, amplitude equality is 0.8 dB, max, VSWR is 1.3:1 at 50 Ω and average power is 1 W.

CIRCLE NO. 379

Nd:YAG Q-switched laser runs on 115 V ac, 24 V dc



Int'l Laser Systems, 3404 N. Orange Blossom Trail, Orlando, FL 32804. (305) 295-4010. \$22,950; 90 days.

The Model NC-10P3 is a multi-purpose, low-energy laser with a power supply that operates from 115 V, 50-60 Hz, or from 24 V dc. The laser head contains a neodymium-doped, yttrium-aluminum garnet laser, Q-switched with a Pockels cell. The head weighs only 8 lb, and measures 12 in. Output ranges from 10 to 60 mJ/pulse, and can be modified by a range of accessories.

CIRCLE NO. 380

Power dividers cover ultra-wide bands



Norsal Industries, 34 Grand Blvd., Brentwood, NY 11717. (516) 231-4040. \$200 up; stock to 4 wks.

A new line of ultra-wide band two-way and four-way isolated power dividers covers the bands of 0.75 to 12.4 GHz, 2 to 18 GHz, 4 to 18 GHz, and 7 to 18 GHz. Amplitude balance is ± 0.5 dB, and phase balance is ± 5 degrees. The units have SMA female connectors and offer typical isolation and VSWR of 20 dB and 1.4:1, respectively. Also available are six new models each of two-way and four-way units, priced at \$75 up. They cover the range of 0.5 to 18 GHz, in standard bands. Amplitude unbalance is ± 0.1 dB, phase balance is ± 2 degrees for most two-way units. All models have 20-dB min. isolation.

CIRCLE NO. 381

Discover...



The Versatility of Repco's Modular RF links.

Repco's Modular RF links are designed for voice, low-speed digital, or tone operation. Frequencies available are 25-50 Mhz, 72-76 Mhz, 132-174 Mhz, and 450-470 Mhz ranges (66-88 Mhz for overseas usage). All units are built to stringent FCC & EIA specifications. Join the Geniuses who have discovered Repco's RF links. Write or call for free specs brochure.

Repco inc.

A subsidiary of Scope, Inc. 1940 Lockwood Way
 (305) 843-8484 TWX 810-850-0120 Orlando, FL 32804
 CIRCLE NUMBER 106

CLIPLITE™

COMBINATION LENS AND MOUNTING DEVICE FOR T 1 3/4 LED

REQUIRES NO TOOLS AND....

INSTALLS IN 6 SECONDS

THE CLIPLITE COMBINES THE BENEFITS OF THE PRESENT LED DISPLAY PANEL MOUNTING METHODS AND ELIMINATES THEIR DEFICIENCIES

SIMPLE TWO-STEP INSTALLATION

SNAP CLIPLITE

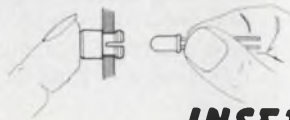

INSERT LED

AVAILABLE IN TRANSPARENT RED - GREEN - AMBER - CLEAR & YELLOW
 ORDER YOUR TRIAL SAMPLE TODAY
 Special Pricing for Trial Order Only

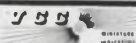

VISUAL COMMUNICATIONS COMPANY

P.O. BOX 986 EL SEGUNDO, CALIFORNIA 90245 (213) 822-4727

PLEASE SHIP: 100 CLIPLITES \$10.00 LITERATURE

NAME _____ COMPANY _____

ADDRESS _____

CITY _____ STATE _____ ZIP _____

CIRCLE NUMBER 107

ELECTRONIC DESIGN 25, December 6, 1976

The M-600 amp works harder at 2.5 ohms

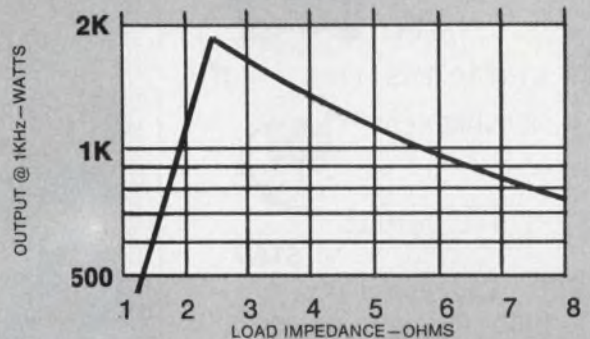

So each watt costs less

You get more watts per dollar from the Crown M-600 power amp if your circuit design lets it look at a 2.5Ω load.

The M-600 provides power from DC to 20KHz with complete protection against shorts, open circuits, mismatch, RF burnout and thermal overload. The M-600 will even drive a purely reactive load without overheating. Designed for continuous operation at full rated power, at any rated frequency.

One M-600 will cost you \$1,795. A copy of the spec sheet is free. Write today.

We'd also like to hear from you if you have any special amplification problems in the DC-20KHz range. We've already solved some tough, unique problems. We'd like to consider yours.

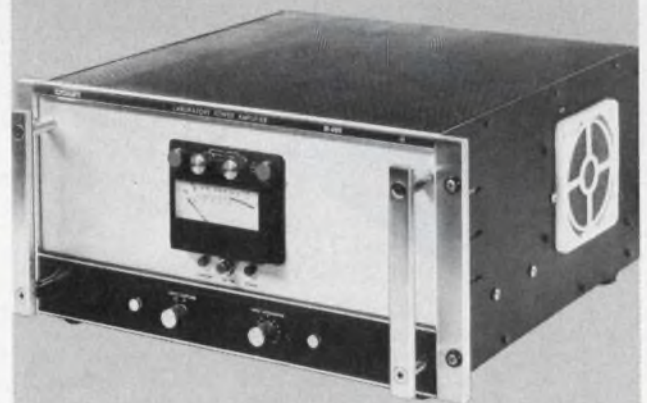

CROWN INDUSTRIAL

1718 W. Mishawaka Road, Elkhart, Indiana 46514

219 / 294-5571

CIRCLE NUMBER 108

**GO Digital WITH
Siltran LINEAR
POSITION INDICATORS**

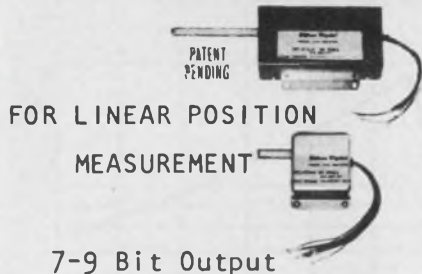

FOR LINEAR POSITION
MEASUREMENT

7-9 Bit Output

\$169

$\pm .005''$ LSB Accuracy
Digital word output
Solid state electronics
Low power requirements
Single voltage input
TTL compatible outputs



LED READOUT

Siltran Digital

PHONE (714) 649-2704
SILVERADO, CALIFORNIA 92676

CIRCLE NUMBER 114

for Low-Level Data Scanning

Ultra Low-Thermal
EMF Reed
Relays

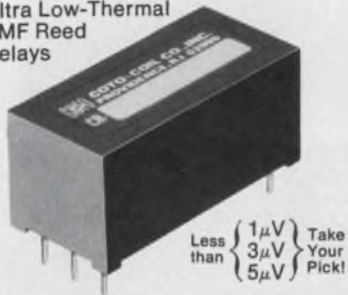

Perfect for low-level scanners and multi-plexers! Coto's new CR-3250 ultra low-thermal EMF reed relays include 2 low thermal contacts plus a third for guard switching... all specially conditioned and tested for reliable low-level switching. Relays are graded and priced according to magnitude of thermal offset; you pay for no more accuracy than you need! Write for new Bulletin MR-10.3.



**COTO-COIL
COMPANY, INC.**
59 Pavilion Avenue
Providence, R. I. 02905
Tel: (401) 467-4777

CIRCLE NUMBER 115

New Literature



Variable capacitors

A handbook and catalog on variable capacitors begins with a detailed application/selection guide and then describes virtually every type of capacitor. Specifications, operational charts, performance graphs as well as applicable MIL-SPEC data are included. Johanson Manufacturing, Boonton, NJ

CIRCLE NO. 382

Ultraviolet eraser

The Model 30 TD PROM eraser, designed to deliver a calibrated dose of UV at the correct wavelength and intensity for the safe effective processing of 60 or less erasable PROMs per loading, is described in a two-page bulletin. Turner Designs, Mountain View, CA

CIRCLE NO. 383

Linear/conversion ICs

A 282-page catalog, *1976 Linear and Conversion IC Products*, includes 63 pages of application notes, selection guides, an industry cross-reference and complete data sheets for all PMI products. For a copy write on company letterhead to Precision Monolithics, 1500 Space Park Dr., Santa Clara, CA 95050.

INQUIRE DIRECT

μ P analyzer

The Model AO6800 μ P analyzer, a high-performance development tool for 6800 microprocessor systems, is described in a four-page catalog. AO Systems, Yorktown Heights, NY

CIRCLE NO. 384

Microcomputer glossary

The LSI-11 Microcomputer Glossary, a 44-page pocket-sized book, contains more than 200 μ C-related terms spanning both equipment and programming aspects of microcomputers. Digital Equipment, Components Group, Marlborough, MA

CIRCLE NO. 385

Elastomers

Conductive silver/silicone elastomers are described in a data sheet. Tecknit, Cranford, NJ

CIRCLE NO. 386

Power transistors

Technical information on a complete line of power transistors appears in a comprehensive handbook. Manufacturing processes are illustrated in the data book along with reliability information, selection guides, industry cross-references, information on unpackaged dice and listings of standard terms and symbols. Letterhead requests only. Fairchild, Transistor Div., 464 Ellis St., Mountain View, CA 94042

INQUIRE DIRECT

Synchro converters

A 30-page catalog describes synchro converters, displays and encoders. Digital angle conversion and metric-to-English-unit conversion charts are included. Computer Conversions, East Northport, NY

CIRCLE NO. 387

Microwave instruments

A 68-page catalog covers thermoelectric power meters, p-i-n diode switches, attenuators and modulators, radiation hazard meters and solid-state signal sources. General Microwave, Farmingdale, NY

CIRCLE NO. 388

**IS A
DETECTOR WITH
SUB NANOSECOND
RISE-TIME OF VALUE
TO YOU?**

IF YES-

Can you live with an S-1, S-5,
S-13, S-20, or S-25 cathode?

IF YES-

Will you pay \$190 for it?
Or \$520 in a housing?

IF YES-

Write, or call me personally
(Ralph Eno) and let's talk about it.

IF NO-

But you do need quality detectors
such as Photomultipliers,
Vidicons, Silicon Detectors, InAs,
InSb, and others ranging in price
from \$1 to \$6,000, send for our
full catalog.

**HAMAMATSU
CORPORATION**
120 Wood Avenue
Middlesex, New Jersey 08846
(201) 469-6640

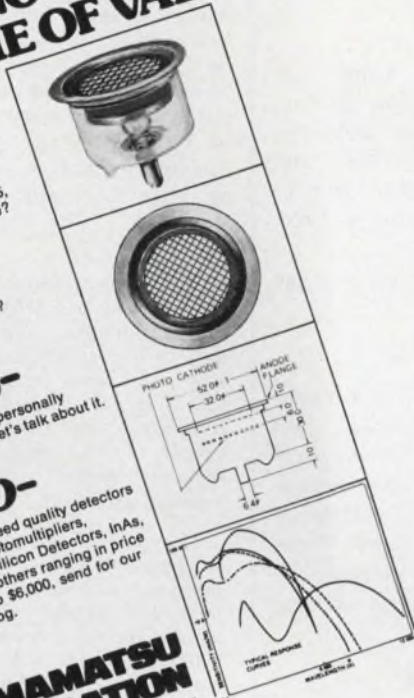

CIRCLE NUMBER 109

**Fast start/stop...
positive
directional
stability**



**It's great on torque and price, too!
The compact 81700 synchronous motor.**

High torque-to-frame size ratio, superior performance characteristics and attractive low price make the 81700 synchronous motor ideal for computer peripherals, business machines and home entertainment equipment. Included are turntables, remote tuners, credit card readers and facsimile transmission equipment.

The motor's inherent reliability and 6 oz. in. @ 300 rpm are key factors. Instantaneous start/stop eliminates clutching and prestarting. Directional stability and low cost are other important advantages. A permanently lubricated bearing prolongs motor life and minimizes maintenance.

Write for information today!

NORTH AMERICAN PHILIPS CONTROLS CORP.

Cheshire, Conn. 06410 • (203) 272-0301

CIRCLE NUMBER 110

ELECTRONIC DESIGN 25, December 6, 1976

**This counter
is different.**



What makes Systron-Donner's new 6202B different from other low cost counters? The fact that it can *accurately* measure most of the signals encountered in low frequency applications. Here's why:

- Three-position attenuator: x1, x10, x100. (avoids false counting)
- Offset control allows measurement of *non-sinusoidal* waveforms
- Four selectable gate times from 0.1 Hz to 100 Hz
- 25 mV rms sensitivity
- Advanced input circuitry to assure error-free measurements
- 10 MHz frequency range
- Rugged and reliable
- Only \$295 (U.S. price).

In short, it's a super workhorse counter. It's the one low cost counter you can depend on. Find out more.

SYSTRON DONNER

10 Systron Drive

Concord, CA 94518. Phone (415) 676-5000

CIRCLE NUMBER 111

**POWER TOGGLE
SWITCHES**

STV
SERIES



The STV Series switches are designed to meet the latest international dimensional and electrical specifications. Features an all-

plastic bushing and actuator for utmost safety at 250VAC. Solid silver contacts provide a 5 amp rating. Choice of five attractive colors; supplied with matching dress nuts.

Call (617) 685-4371 for more information, prices and samples.

CIRCLE NUMBER 112

**MAGNET/REED
PROXIMITY**



RS-11
SERIES

Miniature Proximity Switch and Magnet assembly includes a basic dry reed switch and an enclosed Alnico-5 mag-

net. The reed switch is activated within a distance of .39". Supplied either Normally Open or Normally Closed. Permanent 9" lead.

Call (617) 685-4371 for more detailed information and prices.

ALCO ELECTRONIC PRODUCTS, INC.

NO ANDOVER, MASS 01845 U.S.A.
Tel: (617) 685-4371 FAX: 730 382 0552

A SUBSIDIARY OF AUGAT INC.

CIRCLE NUMBER 113

High-Accuracy

Phase Meters

0.5 Hz to 2 MHz

Digital or meter readouts

As low as \$1150



930 E. Meadow Dr. • Palo Alto, CA 94303
(415) 494-6666

CIRCLE NUMBER 119

classified ads

MICROCOMPUTER RENTALS
DEVELOPMENT HARDWARE SPECIALISTS
PROM Programmers
Intellex 8's and 4's
EXORclers
Pro-Log Analyzers

1562 Devonshire Ave.
Westlake Village, CA. 91361
Phone (213) 991-1704

Protect Your Heart
HAVE REGULAR MEDICAL
CHECK UPS



Give Heart Fund 

NEW LITERATURE

Power transistors

Germanium power transistors are described in a 16-page catalog. Included are a selector guide, a replacement cross-reference and case and hardware outline dimensions. Lansdale Transistor & Electronics, Tempe, AZ

CIRCLE NO. 389

Wirewound resistors

Wirewound Resistive Components is full of electrical and mechanical specifications for precision wirewound resistors. Standard values, nonstandard resistance ranges and prices are shown. General Resistance, Mount Vernon, NY

CIRCLE NO. 390

Linear hybrid amps

Wide bandwidth linear hybrid amplifiers, CA2800, CA2810 and CA818, are described in three data sheets. Maximum ratings, electrical characteristics and schematics are included. TRW RF Semiconductors, Lawndale, CA

CIRCLE NO. 391

Analog panel meters

Ordering information, dimensional drawings and easy-to-read price listings for analog panel meters are contained in a 44-page catalog. General Electric, Schenectady, NY

CIRCLE NO. 392

IEEE standards

The *IEEE Standards Catalog* lists over 350 standards publications in numerical sequence and also provides a subject index to the standards. IEEE Standards Office, New York, NY

CIRCLE NO. 393

Processor storage system

The multimemory/158 processor storage system is covered in an illustrated brochure. Electronic Memories & Magnetics, Hawthorne, CA

CIRCLE NO. 394

Electronic Design

ELECTRONIC DESIGN's function is:

- To aid progress in the electronics manufacturing industry by promoting good design.
- To give the electronic design engineer concepts and ideas that make his job easier and more productive.
- To provide a central source of timely electronics information.
- To promote communication among members of the electronics engineering community.

Want a subscription? ELECTRONIC DESIGN is sent free to qualified engineers and engineering managers doing design work, supervising design or setting standards in the United States and Western Europe. For a free subscription, use the application form bound in the magazine. If none is included, write to us direct for an application form.

If you do not qualify, paid subscription rates are as follows: \$30.00 per year (26 issues) U.S., \$40.00 per year (26 issues) all other countries. Single copies are \$2.00 U.S., \$3.00 all other countries. The Gold Book (27th issue) may be purchased for \$30.00 U.S. and \$40.00 all other countries.

If you change your address, send us an old mailing label and your new address; there is generally a postcard for this bound in the magazine. You will have to requalify to continue receiving ELECTRONIC DESIGN free.

The accuracy policy of ELECTRONIC DESIGN is:

- To make diligent efforts to ensure the accuracy of editorial matter.
- To publish prompt corrections whenever inaccuracies are brought to our attention. Corrections appear in "Across the Desk."
- To encourage our readers as responsible members of our business community to report to us misleading or fraudulent advertising.
- To refuse any advertisement deemed to be misleading or fraudulent.

Microfilm copies are available of complete volumes of ELECTRONIC DESIGN at \$19 per volume, beginning with Volume 1, 1952 through Volume 20. Reprints of individual articles may be obtained for \$3.00 each, prepaid (\$.50 for each additional copy of the same article) no matter how long the article. For further details and to place orders, contact the Customer Services Department, University Microfilms, 300 North Zeeb Road, Ann Arbor, Michigan 48106 telephone (313) 761-4700.

Want to contact us? If you have any comments or wish to submit a manuscript or article outline, address your correspondence to:

Editor
ELECTRONIC DESIGN
50 Essex Street
Rochelle Park, N.J. 07662

Electronic Design

Advertising Sales Staff

Tom W. Carr, Sales Director
Jean Bunfield, Sales Coordinator

Rochelle Park, NJ 07662

Robert W. Gascoigne
Daniel J. Rowland
Thomas P. Barth
50 Essex St.
(201) 843-0550
TWX: 710-990-5071

Philadelphia

Thomas P. Barth
(201) 843-0550

Boston 02178

Gene Pritchard
P.O. Box 379
Belmont, MA 02178
(617) 489-2340

Chicago 60611

Thomas P. Kavooras
Berry Conner, Jr.
200 East Ontario
(312) 337-0588

Cleveland

Thomas P. Kavooras
(312) 337-0588

Los Angeles 90045

Stanley I. Ehrenclou
Burt Underwood
8939 Sepulveda Blvd.
(213) 641-6544

Texas

Burt Underwood
(213) 641-6544

San Francisco

Robert A. Lukas
3579 Cambridge Lane
Mountain View, CA 94040
(415) 965-2636

London

Constance McKinley
50 Essex St.
Rochelle Park, N.J. 07662
Phone: (201) 843-0550

Amsterdam, Tokyo, Seoul

Sanders, W. J. M.
Raadhuisstraat 24
Graft-De Ryp, Holland
Phone: 02997-1303
Telegrams: Euradteam-Amsterdam

Haruki Hirayama

Electronic Media Service
5th Floor, Lila Bldg.,
4-9-8 Roppongi
Minato-ku, Tokyo, Japan
Phone: 402-4556
Cable: Electronicmedia, Tokyo

Mr. O-kyu Park, President

Dongbo Intl Corp.—
World Marketing
C.P.O. Box 4010
Seoul, Korea
Tel. 76-3910/3911
Cable: DONGBO SEOUL
Telex: EBKOREA K27286

Vendors Report

Annual and interim reports can provide much more than financial position information. They often include the first public disclosure of new products, new techniques and new directions of our vendors and customers. Further, they often contain superb analyses of segments of industry that a company serves.

Selected companies with recent reports are listed here with their main electronic products or services. For a copy, circle the indicated number.

Tally. Printers and data-communications systems.

CIRCLE NO. 395

The Foxboro Co. Instruments and systems for process management and control.

CIRCLE NO. 396

ITT. Telecommunications; insurance/financial services and natural resources.

CIRCLE NO. 397

Sprague Electric. Electronic and electrical circuit components.

CIRCLE NO. 398

GenRad (formerly General Radio). Measuring, testing and analyzing instruments and instrumentation systems.

CIRCLE NO. 399

Cubic Corp. Measuring devices and systems; telemetry equipment; data-processing and peripheral equipment; computer services and software, and medical electronics.

CIRCLE NO. 400

Codura. Electronic books.

CIRCLE NO. 401

Marathon Mfg. Co. Batteries.

CIRCLE NO. 402

ASARCO. Metals and minerals.

CIRCLE NO. 403

TRW. Electronics and computer-based services; spacecraft and propulsion products, fasteners, tools and bearings; energy products and services.

CIRCLE NO. 404

Build a Microcomputer System With This Applications Handbook.



At last, a proven, practical approach to building an operational microcomputer for a bargain price of \$7.95. This handbook explores, in detail, the various design approaches of 8080 based systems in 144 pages of text, diagrams and tables. You will be guided through all phases of the entire design process including development systems OEM systems, and writing a resident program. Plus, this handbook makes you aware of all important decisions, tradeoffs and pitfalls in designing your system.

Also included, are hardware information, 8080 architecture charts, 8080 instruction sets, and much more. Send for your own copy today.

P.S. If this handbook isn't everything we say it is, return it within 15 days for a full refund.

Order before Jan. 15, 1977 and we'll ship your handbook post-paid.

Here's my check or money order for \$7.95. Add \$.50 for postage and handling if ordered after Jan. 15, 1977 (California residents, please add \$.52 state sales tax). RUSH my Microcomputer Applications Handbook to the address below. HURRY!

Charge my order to the credit card number below:
BankAmericard No. _____
Master Charge No. _____
For Master Charge, add 4-digit number above name.
It is _____

Signature _____

Credit card expiration date _____

FIRM _____

M/S _____

NAME _____

ADDRESS _____

CITY _____

STATE/ZIP _____

Mail to: Iasis, Inc. 815 W. Maude Ave. Suite 20, Sunnyvale, CA 94086

ABP

BPA



MINIATURE CERAMIC TRIMMER CAPACITORS 9371 series of ceramic trimmer capacitors are compact, economical and rugged. They are 50% smaller than other trimmers of this type yet provide high capacitance values. Available in 4 capacitance ranges, 1.5 to 4, 3.0 to 10, 3.5 to 18 and 5.0 to 25 pf with Q's > 300 at 10 MHz. They have an overall diameter of .225" with .215" above board height. JOHANSON MANUFACTURING CORPORATION, Rockaway Valley Road, Boonton, N.J. 07005 201-334-2676

TRIMMER CAPACITORS

181



MAGNETIC SHIELDING Take advantage of Eagle's 23-year background in shield design and production. Custom and standard models. Full service includes design, engineering, fabrication, heat treating, finishing, testing. Also wide selection of sheet and foil so you can form your own shields. For helpful design and cost data, request Bulletin E-77. Eagle Magnetic Co., Inc., Box 24283, Indianapolis, IN 46224, 317-297-1030.

MAGNETIC SHIELDING

184

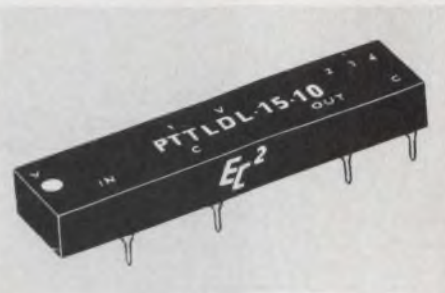

EC²'s new Digitally Programmable T²L Logic Delay lines feature Schottky T²L input and output; 15 models with time delays to a max of 255ns; 16 delay steps available with 1ns, 2ns, 3ns, 5 ns, 10 ns or 16ns resolution; propagation delays fully compensated; 32-pin dip package (.250 high); 4ns max rise time on all delays; 10 T-L fanout; programming by remote switching or automatically by computer-generated data. Engineered Components Company, P.O. Box Y, San Luis Obispo, Ca. 93406 (805) 544-3800

LOGIC DELAY LINE

187

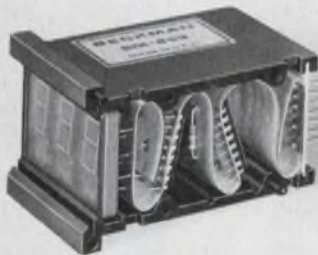

New way to pack added security into your design. R/flex circuits do several jobs at once and accordion fold to fit. Eliminate multiple circuit boards and jumpers; mount components directly on circuit. Made in 1 to 6 layers, various sizes and shapes, with or without plated-through holes. Rogers Corp., Chandler, AZ 85224 (602) 963-4584. (EUROPE: Mektron NV, Ghent, Belgium; JAPAN: Nippon Mektron, Tokyo)

FLEXIBLE CIRCUITS

182



DIGITAL SIGNAL ANALYSIS, S. Stearns. Contains the most recent advances, brand-new design material, and a comparison between continuous and digital systems, making it an ideal master reference to today's signal processing techniques and systems. #5828 4, 288 pages, \$18.95. Circle the Info Retrieval Number to order 15-day exam copy. When billed, remit or return book with no obligation. Hayden Book Co., 50 Essex Street, Rochelle Park, N.J. 07662.

DIGITAL SIGNAL ANALYSIS

185

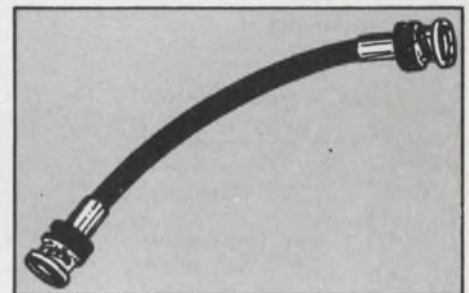

COAXIAL CABLE ASSEMBLIES. \$3.99 each at 15 pieces, \$2.99 at 1000 pieces. BNC Male to BNC Male, 50 Ohm RG-58 Series. Model No. PE3067-12, 12"; PE3067-24, 24"; PE3067-36, 36"; PE3067-48, 48"; PE3067-60, 60". Shipped same day order received. Types BNC, TNC, SMA, N. UHF are available in both flexible and semi-rigid cable. Custom made cable assemblies at competitive prices. For complete catalog: PASTERNAK ENTERPRISES, 8538 Hamilton Ave., Huntington Beach, CA 92646 (714) 536-7511.

COAXIAL CABLE ASSEMBLIES

188



ANTI-STATIC SYSTEMS FOR PRINTERS, OCR COM and other machines. Static causes rapidly moving paper and film to jam. . . cause arc tracks on undeveloped film. . . attract and hold dust to photographic negatives causing imperfections on printed circuit boards. Numerous products, of interest to both OEM and user, are detailed in new 32 page catalog to solve these problems quickly, reliably and economically. Chapman Anti-Static Div., Portland Co., 58 Fore St., Bx 427, Portland, ME 04112. (207) 773-4726

ANTI-STATIC SYSTEMS

183

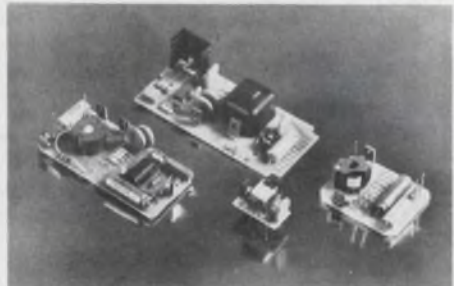

Activate gas discharge readouts! Custom designed and produced DC-to-DC power supplies to activate gas discharge displays, or for other applications. Regulation I/O options, packaging (encapsulated, aluminum shell or open frame), size and configuration, heat dissipation, mounting (PC board pins, edge connectors), etc., can be tailored to meet individual specifications. Price and delivery discussed after specifications are submitted. Endicott Coil Co., Inc., 31 Charlotte Street, Binghamton, N.Y. 13905 (607) 797-1263.

CUSTOM DESIGNED POWER SUPPLIES

186



PRACTICAL DESIGN FOR ELECTROMAGNETIC COMPATIBILITY, ed. by R. Ficchi. A complete guide to elec. compatibility for electronic systems and equipment, including semiconductor, microelectronic, and digital computer equipment. Numerous charts, graphs, and nomographs. #5685-0, 272 pages, \$17.20. Circle the Info Retrieval Number to order 15-day exam copy. When billed, remit or return book with no obligation. Hayden Book Co., 50 Essex Street, Rochelle Park, N.J. 07662.

DESIGN GUIDE

189

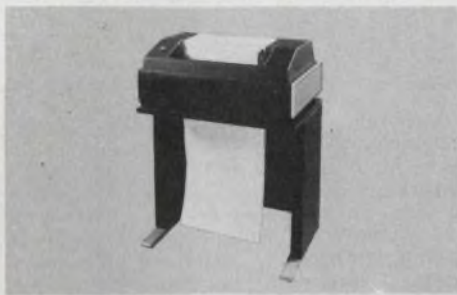

Need a hi-quality, low cost lineprinter for your DEC, Hewlett-Packard, Data General, Wang or other manufacturers computer system? Data Engineering can provide the Model 3100 with a price/performance ratio that is hard to beat. Greater than 300 lines per minute for around \$6500. OEM discounts are available. For further information please call or write to Data Engineering/ Box 84/ Vernon Hills, IL/ 60061/ (312) 566-0055

LINEPRINTER

190

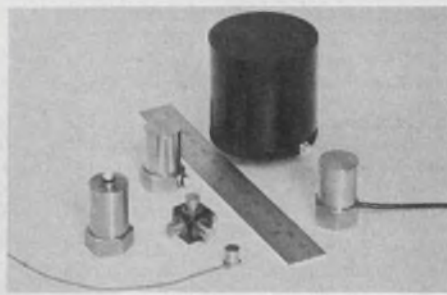

Piezoelectric Accelerometers for Vibration Measurement and Analysis. Internal pre-amplifier drives long cables without need for charge amplifier . . . internal pre-amplifier protected from effects of dropping by exclusive 500 V overvoltage protection . . . units as light as 8 grams . . . sensitivities from 8 mV/g . . . measurement resolution greater than 0.001 g's . . . frequency response to 20 kHz. BBN Instruments Co., A Division of Bolt Beranek and Newman, Inc., 50 Moulton St., Cambridge, Mass. 02138 617-491-0091.

PIEZOELECTRIC ACCELEROMETERS 193

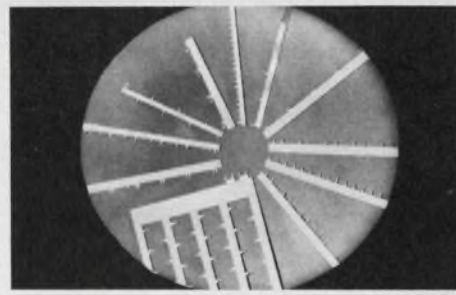

Mini/Bus® Evaluation Kit, \$25, in stock. Lets you try Rogers' low-cost, noise attenuating, high packaging density power distribution system for PC boards. Millions in use. Standard parts on 2 weeks delivery, or less! Customer parts 4 to 6 weeks delivery. Rogers Corporation, Chandler, AZ 85224. Phone (602) 963-4584. (EUROPE: Mektron NV, Ghent Belgium; JAPAN: Nippon Mektron, Tokyo)

MINI/BUS

196



PROGRAMMING PROVERBS, H. F. Ledger. A unique collection of "proverbs", or rules and guidelines, for upgrading the quality of your work, improving your skills in *program organization and logical thinking*. Sample programs in PL/1, ALGOL, and others. #5522-6, 144 pages, \$5.95. Circle the Info Retrieval Number to order 15-day exam copy. When billed, remit or return book with no obligation. Hayden Book Co., 50 Essex Street, Rochelle Park, N.J. 07662.

PROGRAMMING PROVERBS

191

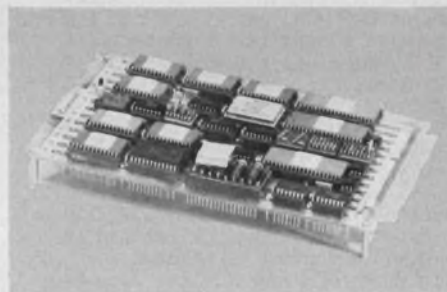

MICROPROCESSOR BOARD FOR MOTOROLA M6800 EVALUATION CHIP SET. \$197.50 from CAMBION distributors. Pre-wired board saves hours interconnecting M6800 evaluation kit. Wire-Wrap® tool and precut wires for circuit changes included plus circuitry and components to interface with teletype machine, pre-wired sockets for three more MC6810L, connections for 12 more IC's, instructions and hardware. Cambridge Thermionic Corp., 445 Concord Ave., Cambridge, MA 02138.

MICROPROCESSOR BOARD

194



Free New '76 catalog contains over 34,500 quality power supplies from the world's largest manufacturer, Power/Mate Corp. Power Supplies for every application including submodulars, open frame, variorated, encapsulated, laboratory & system. All units UL approved and meet most military and commercial specs for industrial and computer uses. Power/Mate Corp., 514 S. River St., Hackensack, NJ 07601 (201) 343-6294

POWER SUPPLIES

197



SAMTEC "ORDER NOW" DIP SOCKET CATALOG—with all prices included. Here, at last, is a do-it-now catalog with all specs, part numbers and prices. It features SAMTEC's new KEL Series DIP Sockets—the first low cost sockets that offer premium quality reliability. Catalog also features KEL Socket Strips - TS Test Sockets - and IC Series DIP Sockets for your most demanding applications. Send today for this "QUICK-ORDER" Catalog—SAMTEC 2652 Charlestown Road, New Albany, Indiana, 47150.

DIP SOCKET CATALOG

192



Basic Electricity & Basic Electronics by Van Valkenburgh, Nooger & Neville, Inc. Derived from the COMMON-CORE Training Program initially developed for the U.S. Navy. Thorough, comprehensive coverage. Available in separate paperbacks or cloth volume. Write for FREE brochure. Hayden Book Co., Inc., 50 Essex St., Rochelle Pk, N.J. 07662 (201) 843-0550.

TRAINING TEXT

195



Overcurrent Protector, manual reset eliminates fuse replacement. Convenient panel mounting. 19 fractional ratings from 0.1 to 5 amp. Other models up to 400 amp. Trip-free and fool-proof, UL and CSA approved. High quality, low cost \$1.33 ea. in 1000 lots. E-T-A Products Co. of America, 7400 N. Croname Rd., Chicago, Ill. 60648. Tel: (312) 647-8303. Telex: 253780.

CIRCUIT BREAKER

198

Advertiser's Index

Advertiser	Page	Advertiser	Page	Advertiser	Page
A P Products Incorporated.....	150	Data Precision Corporation	123	Intel Corporation	114B-C
AMP, Incorporated	124, 125	Data Specialties, Inc.	146	International Rectifier	83
Abbott Transistor Laboratories, Inc. 6		Datak Corporation, The	161	Johanson Manufacturing Corp.	158
Acopian Corp.	133	Deltron, Inc.	125	Kennedy Co.	39
Aham Electronics	133	*Densiton Corporation	42	Kepeco, Inc.	44
Ailtech, A Cutler-Hammer Company	141	Dialight, A North American Philips Company	77	Keystone Carbon Company	130
Alco Electronic Products, Inc.	155	Digital Equipment Corporation	55	Lorlin Industries, Inc.	135
Ampex Memory Products Division	114A	Duncan Electronics, Subsidiary of Systron-Donner	76	Macrodata Corporation	113
Arnold Magnetics Corp.	132	ECD Corp.	144	McLean Engineering Laboratories ..	141
B & K Products of Dynascan Corporation	51	EECO	23	*Membrain Ltd.	4
BBN Instruments Co.	159	E G & G Idaho, Inc.	104	Metex Corporation	134
Beckman Instruments, Inc. Helipot Division	50	*EMI, SE Labs	20	Microkit Incorporated	52
Biomation	58, 59	EMM Semi, a Subsidiary of Electronic Memories & Magnetics Corp.	28	Micropac Industries, Inc.	149
Bodine Electric Company	149	E-T-A Products Co. of America	159	Microwave Devices Corp.	149
Bourns, Inc., Trimpot Products Division	Cover II	Eagle Magnetics Co. Inc.	158	Monsanto Company	57
Bunker Ramo, Connector Division....	47	Edmund Scientific Company	160	Motorola Semiconductor Products, Inc.	26, 27, 43
Burndy Corporation	82A-F	Electronic Design	62, 138, 139, 161	MuRata Corporation of America....	161
Burr-Brown Research Corporation	42, *47	Electronic Measurements, Inc.	118	NEC Microcomputers, Inc.	4, 5
Byte Publications, Inc.	136	Electronic Molding Corporation	133	Nippon Electric Company, Ltd.	99
CTS Corporation	137	Electronic Navigation Industries	130	North American Philips Controls Corp.	155
Cambridge Thermionic Corporation	159	Elmwood Sensors, Inc.	127	Oak Industries, Inc.	29
Capitol Machine & Switch Co., Inc., The	152	Endicott Coil Co., Inc.	158	Optron, Inc.	7
Centre Engineering	136	Engineered Components Company..	158	PSG Industries, Inc.	97
Cherry Electrical Products Corp.....	73	GTE Sylvania, Parts Division.....	37	Par-Metal Products Inc.	151
Computer Products, Inc.	91	Gold Book, The	142, 143	Pasternak Enterprises	158
Connecticut Hard Rubber Company, The	126	Gould Inc., Instrument Systems Division	105, 114D	*Philips Electronic Components and Materials	50
Continental Connector Corporation 48		Grayhill, Inc.	120	Piezo Technology, Inc.	134
Continental Specialties Corporation..	98	Hamamatsu Corporation	155	Poly Paks Inc.	161
Cortrion, A Division of Illinois Tool Works Inc.	72	Hayden Book Company, Inc.	121, 158, 159	Portland Co., Inc.	158
Coto Coil Company, Inc.	154	Hewlett-Packard	9 thru 18	Power/Mate Corp.	159
Crown International	153	Houston Instruments, A Division of Bausch & Lomb	49	PowerTech, Inc.	89
Crown International	153	Hughes Aircraft Company, Microelectronic Products Division 63		Precision Monolithics, Incorporated..	111
Custom Electronics, Inc.	150	Hysol, a division of the Dexter Corporation	141	Premier Metal Products Company....	122
Dana Laboratories, Inc.	147	IMS Associates, Inc.	84	RCA Solid State	Cover IV
Data Engineering	159	ISE Electronics Corporation	107	Rental Electronics, Inc.	20
Data General Corporation	33	ITT Pomona Electronics	145	Repco, Incorporated	153
Data I/O Corporation	19	Iasis, Inc.	157	Rockland Systems Corporation	119

Design Data from Manufacturers

Advertisements of booklets, brochures, catalogs and data sheets. To order use Reader-Service Card (Advertisement)

GIANT FREE CATALOG



New 164-page catalog! Packed with 1,000's of hard-to-find buys in Optics, Science, Electronics. Loaded with optical, scientific, electronic equipment available from stock. Rare surplus buys. Many "one-of-a-kinds". Ingenious scientific tools. Components galore: lenses, prisms, wedges, mirrors, mounts, accessories. 100's of instruments: pollution test equipment, lasers, comparators, magnifiers, microscopes, projectors, telescopes, binoculars, photo attachments, alternate energy sources. Shop, save by mail! Request free Catalog "DA".

CIRCLE NUMBER 171

Edmund Scientific Co.

America's Largest Science-Optics-Electronics Mart
300 Edscorp Bldg., Barrington, New Jersey 08007 (609) 547-3488

Specialized Products Company	146
Spectrum Control, Inc.	129
Sprague Electric Company	1
Stanford Applied Engineering, Inc.	Cover III
Stewart-Warner Corporation	85
Systron-Donner	155
TRW/IRC Resistors, an Electronic Components Division of TRW, Inc.	24, 25
TRW Semiconductors, an Electronic Components Division of TRW, Inc.	115
Tecknit	144
Teledyne Semiconductor	60
Teletype Corporation	35
Texas Instruments, Incorporated	71, 116
Thomas & Skinner Inc.	140
Triplet Corporation	109
*U. S. Department of Commerce....	42
United Systems Corporation	104
Unitrode Corporation	41
Universal Data Systems	2
Vernitron Electrical Components ..	148
Visual Communications Company ..	153
Wakefield Engineering, Inc.	106
Wiltron Company	128, 156

*Advertisers in non-U.S. Edition

POLY PAKS®
ONE CENT
'HONEST
ABE' SALE

BUY 1 AT OUR SALE PRICE
 GET 2 FOR 1¢ MORE

TTLs Order by Cat. No. 12D1983 & Type No. Below!

Type	Sale	2 for	Type	2 for	Type	2 for
SN7400	.22	.23	SN74125	1.29 1.30	SN74173	1.69 1.70
SN7401	.22	.23	SN74126	1.29 1.30	SN74174	1.42 1.43
SN7402	.22	.23	SN74132	1.95 1.96	SN74175	1.45 1.46
SN7403	.22	.23	SN74141	1.12 1.13	SN74176	1.59 1.60
SN7404	.24	.25	SN74145	1.69 1.70	SN74177	1.59 1.60
SN7406	.36	.37	SN74148	3.25 3.26	SN74181	3.75 3.76
SN7407	.46	.47	SN74150	1.12 1.13	SN74184	2.19 2.20
SN7408	.22	.23	SN74153	1.10 1.11	SN74190	2.75 2.76
SN7409	.52	.53	SN74154	1.53 1.54	SN74191	2.75 2.76
SN7410	.22	.23	SN74157	1.09 1.10	SN74193	1.29 1.30
SN7411	.27	.28	SN74158	1.55 1.56	SN74195	.89 .90
SN7417	.62	.63	SN74160	1.59 1.60	SN74196	2.19 2.20
SN7420	.22	.23	SN74163	1.50 1.51	SN74198	2.25 2.26
SN7421	.55	.56	SN74164	1.79 1.80	SN74199	2.25 2.26
SN7423	.47	.48	SN74165	1.79 1.80		
SN7425	.37	.38				
SN7430	.22	.23				
SN7432	.36	.37				
SN7440	.22	.23				
SN7442	.97	.98				
SN7445	.97	.98				
SN7446	1.10	1.11				
SN7447	1.10	1.11				
SN7448	1.10	1.11				
SN7450	.22	.23				
SN7451	.27	.28				
SN7473	.44	.45				
SN7475	1.00	1.01				
SN7483	.99	1.00				
SN7485	1.41	1.42				
SN7486	.47	.48				
SN7489	2.25	2.26				
SN7490	1.00	1.01				
SN7491	.91	.92				
SN7494	.82	.83				
SN7495	.86	.87				
SN7496	.86	.87				

MEMORIES

Cat. No.	Type	Sale	2 for
12D2310	8008	\$19.95	\$19.96
12D2585	8080	49.95	49.96
12D2855	2102	3.50	3.51
12D2856	2102-1	3.50	3.51
12D2847	1101	1.50	1.51
12D1989	1103	2.95	2.96
12D2853	5262	3.95	3.96
12D2155-A	MM5203	12.50	12.51
12D2155-B	MM5202	9.95	9.96
12D2854	1702-A	12.50	12.51

Terms: Add postage. Rated: net 30
 Phone: Wakefield, Mass. (617) 245-3829
 Retail: 16-18 Del Carmine St., Wakefield, Mass.
POLY PAKS® **FREE CATALOG**
BOX 942D LYNNFIELD, MASS. 01940

C.O.D.'s MAY BE PHONED

© Poly Paks Inc., Wakefield, Mass., U.S.A. 1976 **MINIMUM ORDER — \$6.00**

CIRCLE NUMBER 116

together-ness!

Murata's new Piezoelectric Tuning Forks and Companion Hybrid I.C.'s for Precision Signaling and Control!

There's a new dimension in solid state tone signaling and control with Murata's microminiature EFM-GA/GC piezoelectric tuning forks and companion hybrid I.C. systems. Vastly improved temperature stability, reliability, resistance to shock and vibration, and greatly increased flexibility through the frequency independence of components combine to provide a "plug-in" encoding and decoding capability second to none. Find out how these new systems can be put to work for you. Write for complete technical details.

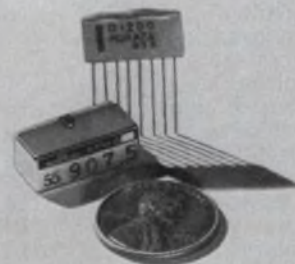

muRata
 CORPORATION OF AMERICA
 1148 FRANKLIN ROAD, S.E., MARIETTA, GEORGIA 30067
 Tel: 404-422-9777 Telex: 54-2329 TWX: 810-763-4723

CIRCLE NUMBER 117

AUTHOR'S GUIDE

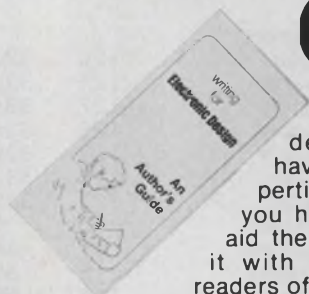

If you've solved a tricky design problem, if you have developed special expertise in a specific area, if you have information that will aid the design process... share it with your fellow engineer-readers of *Electronic Design*.

Articles you have authored not only raise your own professional status, but help build your company image as well. The readers benefit, your company benefits.

To help you prepare material that meets *Electronic Design's* high editorial standards, our editors have prepared a special author's guide entitled "Writing for *Electronic Design*." It covers criteria for acceptability, form, length, writing tips, illustrations, and payment for articles published. It's available without cost.

It's easy to write for *Electronic Design*, but it's often hard to get started. Send for your copy of our Author's Guide today.

Circle No.
250

PHOTO ETCH PRINTED CIRCUIT KIT

Makes circuits **THREE WAYS**

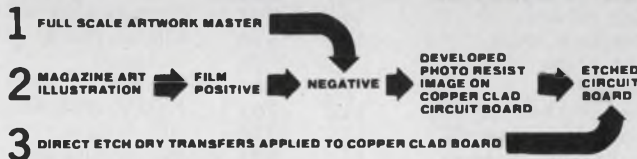

NO CAMERA DARKROOM FILM CUTTING TRACING **USES DATAK'S POS-NEG PROCESS**
 The revolutionary photographic way that makes **PERFECT** printed circuits from original art or a printed page.

KIT CONTAINS: 5" x 8" steel printing frame 4 sheets 5" x 8" photocopy film yellow liter chem-cats for 1-gal film developer and 1-gal film fixer 5" x 8" copper clad board 3" x 4"; copper clad board spray can of photo etch resist 1-gal resist developer 2 sheets 8 1/2" x 11" layout film 1 roll 1/16" printed circuit tape 1 roll 1/32" printed circuit tape 8 sheets dry transfer direct etch PC patterns including pads transistors round can and flat pack IC's DIP IC's edge card connectors lines circles tags etc 1/2 lb anhydrous ferric chloride to make 1-gal etchant instructions

- ER-4 COMPLETE PHOTO ETCH SET \$26.95
- ER-2 PC patterns and tapes—refill 3.95
- ER-3 1/4 pound dry etchant—refill 1.49
- ER-5 6 sheets photocopy film—refill 3.95
- ER-6 Film process chemicals—refill 1.95
- ER-7 Photo resist spray, 2.5 oz.—refill 2.95
- ER-8 Resist developer, 16 oz. can—refill 2.95

AT YOUR DISTRIBUTOR OR DIRECT

the **DATAK** corp.
 65 71st St. • Guttenberg, N. J. 07093

CIRCLE NUMBER 118

Product Index

Information Retrieval Service. New Products, Evaluation Samples (ES), Design Aids (DA), Application Notes (AN), and New Literature (NL) in this issue are listed here with page and Information Retrieval numbers. Reader requests will be promptly processed by computer and mailed to the manufacturer within three days.

Category	Page	IRN	Category	Page	IRN	Category	Page	IRN
Components			Instrumentation			Power Sources		
capacitor, ceramic	1	2	C-meter	144	90	power, solar	126	331
capacitors	90	43	computer-disc tester	132	346	power source	125	330
capacitors	136	83	counter	51	26	power supply	127	334
capacitors	150	103	counters	132	344	power supply	128	335
crystal filters	134	80	display control	135	351	power supply	128	336
detectors	155	109	gauge thermoplug	134	349	power supply, DIP	126	332
displays, liquid crystal	129	338	logic probe	132	347	power supply, μ P	127	333
hybrid pots	76	37	panel instruments	109	286	power supplies	6	5
indicators	154	114	panel meters	104	271	power supplies	91	44
inductor chips	130	340	phase meters	156	116	power supplies	118	59
keyboards	72	35	printer	134	348	power supplies	125	66
line filters, ac	129	72	probes	135	350	power supplies	132	76
magnets	140	86	rental instruments	20	7	power supplies	132	77
matched crystal	137	85	rf signal source	141	212	new literature		
motor starters	130	341	wattmeter	132	345	analog panel meters	154	385
motors, induction	131	343	μ P analyzer (NL)	154	384	elastomers	154	386
precision film networks	50	25	Integrated Circuits			IEEE standards	156	393
relay, solid state	131	342	amp, chopper-stabilized	122	325	linear hybrid amps	156	391
relays	121	62	amp, JFET quad	120	324	microcomputer glossary	154	385
relays	124	65	correlator, digital	122	326	power transistors	156	389
relays, reed	154	115	drivers, peripheral	123	328	processor storage	156	394
resistors	25	9	drivers, power	123	329	system	156	394
switch, capacitive	129	339	gates, HiNIL	123	327	variable capacitors	154	382
switches	152	105	IC technology	131	75	wirewound resistors	156	390
switches, DIP	120	61	LSI test subjects	113	56	μ P analyzer	154	384
switches, magnet/reed	155	113	microcircuitry	63	33			
switches, rotary	29	12	multiplier, digital	120	323			
switches, snap-action	129	337	PROMs, bipolar	120	321			
switches, toggle	155	42	semiconductor test					
synchronous motor	155	110	system	135	82			
thermal cutoffs	149	101	switches, touch-control	120	322			
thermistor probes	130	74	Microprocessor Design					
thermostats	127	69	application notes, μ P	56	503			
tuning forks	161	120	breadboard system	84	40			
Data Processing			computer magazine	136	84			
cassette drive	117	302	microcomputer system	56	501			
cassette-tape reader	117	303	microprocessor	53	500			
disc drives	117	304	minicomputer micro-					
interface, mini	119	320	based	56	502			
line printer	49	24	prober, μ P controlled	53	499			
memories	28	11	PROM programmer	19	6			
memory boards, IC	118	307	μ P analyzer	59	30			
multiplexer boards	119	310	μ C development system	52	27			
multi-port memory	117	306	Modules & Subassemblies					
OEM printer	35	14	amplifier, isolation	137	356			
paper-tape reader	146	93	amplifier kit	137	355			
scientific calculator	119	309	converter, a/d	140	360			
tape drives	117	305	delay line	136	353			
tape transport	39	16	digital interface	140	358			
temperature monitor	117	301	displays	99	47			
timer, programmable	118	308	filter tone	140	359			
Discrete Semiconductors			modem, telephone	140	357			
bridges	43	20	phase to voltage	137	354			
diodes	150	375	power amp	153	108			
diodes, reference	148	370	power amplifiers	130	73			
display, LED	150	374	transformer, Scott-T	136	352			
displays	57	29	Microwave & Lasers					
LEDs	77	38	amplifier, low-noise	151	377			
opto-isolator	148	372	couplers & hybrids	152	379			
power Darlingtons	39	16	laser, portable	152	380			
transistor, power	148	371	meter, power	151	376			
zener diodes	128	70						
zeners	148	373						

Who provides the industry's broadest line of electronic packaging hardware ... including IC Sockets?

SAE does! And in most cases, we'll deliver right off the shelf, because SAE makes all kinds of IC sockets to satisfy a wide variety of applications.

You can choose side or edge wipe styles; dual-in-lines or single-row strips. Standard or low-profile configurations (.150" high). One, two or three-level wrap terminals; dip-solder types in 8 through 40 pin sizes, all on .100" contact centers. Or if you prefer, select individual contacts or carrier strips; and even discrete assemblies.

Plating thicknesses range from 10 to 50 mils gold; and all the low-profile components have an anti-wicking feature that eliminates solder wicking entirely. So for your next requirement ... whether prototype or by the thousands ... give us a call. We'll deliver! Our new 128 page packaging handbook gives complete details, and also describes our entire line of electronic packaging and interconnection hardware.

For an immediate reply, call the following toll-free "ZIP QUOTE" number at the factory ... 800-538-6843.



Stanford Applied Engineering, Inc.

340 Martin Ave., Santa Clara, CA 95050
(408) 243-9200 TWX 910-338-0132

CIRCLE NUMBER 263

New RCA kit makes it easy ...

Evaluate CMOS microprocessing for yourself.

Here's a microprocessor kit that lets you prove how cost-effective the all-CMOS RCA 1800 system can be.

You'll quickly see how the RCA COSMAC architecture and a repertoire of 91 powerful instructions give you maximum performance with minimal memory. And how you can take advantage of CMOS low power dissipation, single wide-range power supply, full operating temperature range, high noise immunity, and single-phase clock.

Multi-purpose Tool

Build this inexpensive kit to evaluate not only the benefits of its CMOS CPU, but also CMOS memory and CMOS I/O. Use it for easy prototyping and debugging. Exercise it with start, stop, and single-step controls. And, via the utility ROM,

generate, evaluate, and verify software.

The CDP18S020 Evaluation Kit comes complete with the RCA CDP1802 COSMAC CPU plus clock and control, display, memory and I/O sections, and all passive components needed for a low-cost microcomputer system. For just \$249. Build it in four to eight hours. Add a power supply and I/O terminal and you're into CMOS microprocessing. With built-in room to expand.

To get your kit or more information, contact RCA or your local RCA representative.

Write: RCA Solid State, Box 3200, Somerville, N.J. 08876; Sunbury-on-Thames, Middlesex TW16 7HW, England; Ste. Anne de Bellevue H9X 3L3, Canada; Fuji Building, Tokyo, Japan.



RCA 1800. Cost-effective microprocessing.