

Passive microwave components come in all shapes and sizes. The most popular transmission media are waveguide, coax cable stripline and microstrip. The

hardest components to specify are filters, attenuators, couplers, switches and ferrite isolators and circulators. To simplify selection, and trim your VSWR, see p. 58.

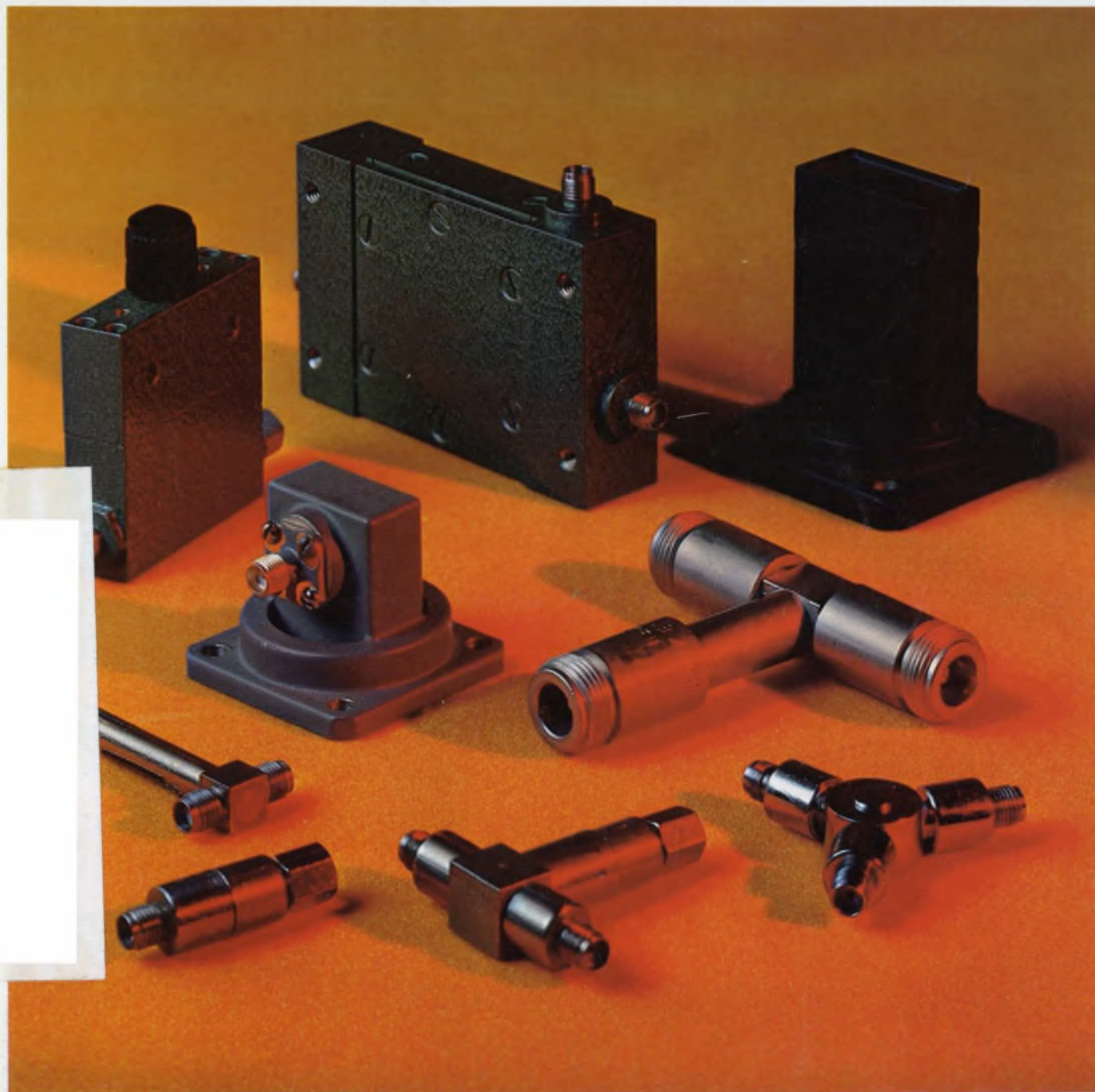

New Hybrid Potentiometer Combines the Best of Wirewound and Conductive Plastic— \$5³³*

New HYBRITRON™
resistance element . . .
conductive plastic
material on wirewound
mandrel.

The new BOURNS®
HYBRITRON™ resist-
ance element brings
you the best of both
worlds . . . the long life and
infinite resolution of con-
ductive plastic . . . plus the
tight linearity and low tem-
perature coefficient of a wire-
wound . . . at a new, low price.

You'll find this new element in
BOURNS® Model 3541 ten-turn
precision potentiometer . . . a new
member of BOURNS popular 3540
family of compact ($\frac{7}{8}$ " dia., $\frac{3}{4}$ " deep),
low-cost multi-turn potentiometers.

Significant specifications of the Model
3541: service life of 5,000,000 shaft rev-
olutions; linearity 0.25%; temperature coef-
ficient of ± 100 ppm/°C maximum; reliable
SILVERWELD® direct terminal-to-element
bond; output smoothness of 0.015%; essentially
infinite resolution; rugged, mechanically locked
construction (no rear lid "pop-off"); special heat
resistant insert around terminals to prevent damage
during soldering.

If a low-cost wirewound satisfies your control requirement
. . . you can't do better than our Model 3540 ten-turn at \$3.97*.
Same quality construction features, same 0.25% linearity . . . with
rotational life of 1,000,000 revolutions. A wide range of standard and
custom options are available, including three- and five-turn versions.

FREE SAMPLE:

Write or phone the BOURNS PANEL POWER PEOPLE and tell us about your
application. We'll send you the Model 3540/41 that best suits your needs.

Available off-the-shelf from extensive factory stock and nearly 100 local distributor
inventories. TRIMPOT PRODUCTS DIVISION, BOURNS, INC., 1200 Columbia Avenue,
Riverside, California 92507. Telephone 714 684-1700. TWX 910 332-1252.

*1,000 pieces, same R.C., U.S. Dollars, F.O.B. Riverside, California



We planned to do a hard-hitting, gutsy comparison ad. Their specs versus ours. Sort of a "High Noon" for signal generators.

Then we began checking out the competition, if you can call it that. Our new Model 3000 signal generator sells for \$2,265.

Among other things, it features 0.001% accuracy, phase-lock stability, AM and FM modulation, 20 milliwatts leveled output power, and pro-

grammable frequency capability (at no added cost).

There are other signal generators in the 1 to 520 MHz frequency range that match our accuracy. But the cheapest one is \$4,300. Hardly competition.

And although you can pay up to \$6,400 for other VHF signal generators, none of them offers programmable frequency.

How can we do a comparison ad when we're stuck with a product this good? Not possible. So we'll just have to be content with running non-comparison ads. And taking orders. WAVETEK Indiana, Incorporated, P.O. Box 190, 66 North First Avenue, Beech Grove, Indiana 46107, Phone (317) 783-3221, TWX 810-341-3226.

WAVETEK®
INFORMATION RETRIEVAL NUMBER 2

**We'll compare our
signal generator with
the competition.
Just as soon as
there is any.**



The largest selection of "OFF-THE-SHELF" POWER SPLITTERS/COMBINERS Available!

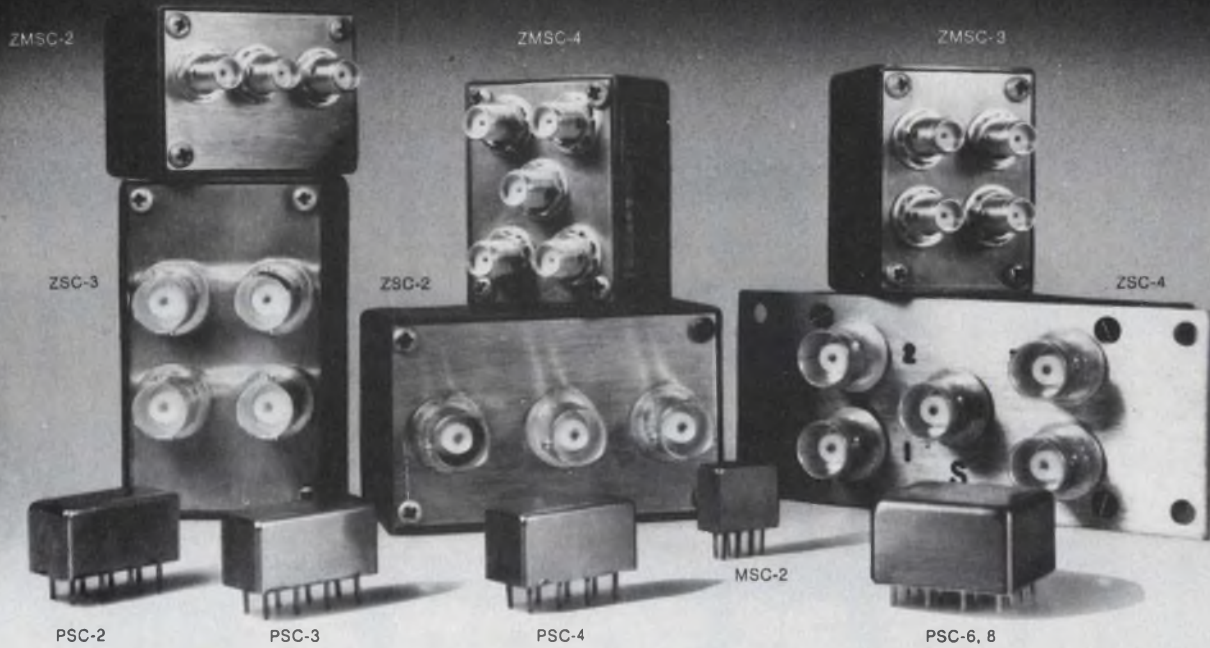

TWO-WAY, THREE-WAY, FOUR-WAY, SIX-WAY AND EIGHT-WAY POWER SPLITTER/COMBINERS

Model No.	Freq. range (MHz)	Isolation between outputs (dB) typical	Insertion loss (dB) (typical)	Unbalance		Price (Quantity)	Model No.	Freq. range (MHz)	Isolation between outputs (dB) typical	Insertion loss (dB) (typical)	Unbalance		Price (Quantity)
				φ (deg)	Amp (dB)						φ (deg)	Amp (dB)	
Two-way 0°							Three-way 0°						
PSC 2-1	0.1-400	25	0.4 above	1	0.1	\$ 9.95 (6-49)	PSC 3-1	1-200	30	0.4 above	2	0.1	\$19.95 (6-49)
ZSC 2-1			3dB split			\$24.95 (4-24)	ZSC 3-1			4.8 split			\$34.95 (4-24)
ZMSC 2-1						\$34.95 (4-24)	ZMSC 3-1						\$44.95 (4-24)
PSC 2-2	0.002-60	40	0.3 above	1	0.1	\$19.95 (6-49)	PSC 3-2	0.01-30	40	0.25 above	2	0.1	\$29.95 (6-49)
ZSC 2-2			3dB split			\$34.95 (4-24)	ZSC 3-2			4.8 split			\$44.95 (4-24)
ZMSC 2-2						\$44.95 (4-24)	ZMSC 3-2						\$54.95 (4-24)
PSC 2-1W	1-650	25	0.5 above	3	0.20	\$14.95 (6-49)	Four-way 0°						
ZSC 2-1W			3dB split			\$29.95 (6-49)	PSC 4-1	0.1-200	30	0.5 above	2	0.1	\$26.95 (6-49)
ZMSC 2-1W						\$39.95 (6-49)	ZSC 4-1			6dB split			\$41.95 (4-24)
PSC 2-1-75*	0.25-300	25	0.4 above	1	0.05	\$11.95 (6-49)	ZMSC 4-1						\$51.95 (4-24)
MSC 2-1	0.1-450	30	0.4 above	1	0.1	\$16.95 (6-24)	ZSC 4-2	0.002-20	33	0.45 above	2	0.1	\$64.95 (4-24)
Two-way 180°							ZMSC 4-2			6dB split			\$74.95 (4-24)
PSCJ 2-1**	1-200	33	0.6 above	2.5	.15	\$19.95 (5-49)	PSC 4-3	0.25-250	30	0.5 above	2	0.1	\$23.95 (6-49)
ZSCJ 2-1			3dB split			\$34.95 (4-24)	ZSC 4-3			6dB split			\$38.95 (4-24)
							ZMSC 4-3						\$48.95 (4-24)
Two-way 90°							Six-way 0°						
PSCQ 2-90	55-90	30	average of coupled outputs less 3dB	3	1.0	\$19.95 (5-49)	PSC 6-1	1-175	30	0.75 above	4	0.2	\$59.95 (1-5)
			0.3							7.8dB split			
Two-way 180°							Eight-way 0°						
							PSC 8-1	0.5-175	30	0.8 above	3	0.2	\$59.95 (1-5)
										9dB split			

COMMON SPECIFICATIONS FOR ALL MODELS: Impedance all ports, 50 ohms. *Except 75 suffix denotes 75 ohms VSWR:1.1-1.2 typical Nominal phase difference between output ports, 0° **Except J suffix denotes 180° Q denotes 90° Delivery from stock; One week max.

For complete product specifications and U.S. Rep. listing see MicroWaves' "Product Data Directory," Electronic Designs' "Gold Book" or Electronic Engineers Master "EEM"

World's largest supplier of double balanced mixers

Mini-Circuits Laboratory

A Division Scientific Components Corp

837-843 Utica Avenue, Brooklyn, NY 11203

(212) 342-2500 Int'l Telex 620156 Domestic Telex 125460

International Representatives: AUSTRALIA General Electronic Services, 99 Alexander Street, New South Wales, Australia 2065; ENGLAND Dale Electronics, Dale House, Wharf Road, Frimley Green, Camberley Surrey; FRANCE S. C. I. E. - D. I. M. E. S., 31 Rue George - Sand, 91120 Palaiseau, France; GERMANY, AUSTRIA, SWITZERLAND Industrial Electronics GMBH, Klüberstrasse 14, 6000 Frankfurt/Main, Germany; ISRAEL Vectronics, Ltd., 69 Gordon Street, Tel-Aviv, Israel; JAPAN Densho Kaisha, Ltd., Eguchi Building, 8-1-1 Chome Hamamatsucho Minato-ku, Tokyo; EASTERN CANADA B. D. Hummel, 2224 Maynard Avenue, Utica, NY 13502 (315) 736-7821; NETHERLANDS, BELGIUM, LUXEMBOURG: Coimex, Veldweg 11, Hatterem, Holland; NORWAY Datamatik AS, Ostensjoveien 62, Oslo 6, Norway

US Distributors: NORTHERN CALIFORNIA Cain-White & Co., Foothill Office Center, 105 Fremont Avenue, Los Altos, CA 94022 (415) 948-6533; SOUTHERN CALIFORNIA, ARIZONA Crown Electronics, 11440 Collins Street, No. Hollywood, CA 91601 (213) 877-3550

NEWS

- 21 **News Scope**
- 26 **Home television receiver** to double as computer terminal and information and game center.
- 30 **Cathodochromic cathode-ray tube display** stores images indefinitely and erases them easily.
- 34 **First flight tests planned** of full fiber-optic interface display.
- 37 **Washington Report**

TECHNOLOGY

- 43 **MICROPROCESSOR DESIGN**
- 58 **FOCUS on passive microwave components:** A proliferation of new types has made it tougher than ever to specify these important system building blocks. The price of miniaturization is often a loss of performance.
- 68 **Consider low-cost lasers** for your light-source application. The coherent sources offer minimal spot size and high spectral purity. Here are tips in selecting them.
- 74 **Quartz-crystal timing accuracy** is hard to beat. Crystals don't wear out; they improve with age. But Qs must be high for good stability and settability.
- 82 **Ideas for Design:**
Programmable divide-by-n counter provides symmetrical outputs for all divisors. Digital probe shows voltage, duty cycle and signal quality. Line drivers made from 555 timers provide inverted or noninverted outputs.
- 88 **International Technology**

PRODUCTS

- 91 **Modules & Subassemblies:** Hybrid isolation amplifier avoids transformers but maintains isolation.
- 93 Components
- 100 Integrated Circuits
- 102 Instrumentation
- 104 Data Processing
- 106 Packaging & Materials
- 110 Discrete Semiconductors
- 111 Power Sources

DEPARTMENTS

- 55 **Editorial:** Naughty words.
- 7 Across the Desk
- 114 New Literature
- 120 Advertisers' Index
- 122 Product Index
- 122 Information Retrieval Card

Cover: Photo by Oravetz Studio, courtesy of Microlab/FXR.

What our bottom-of-the-line

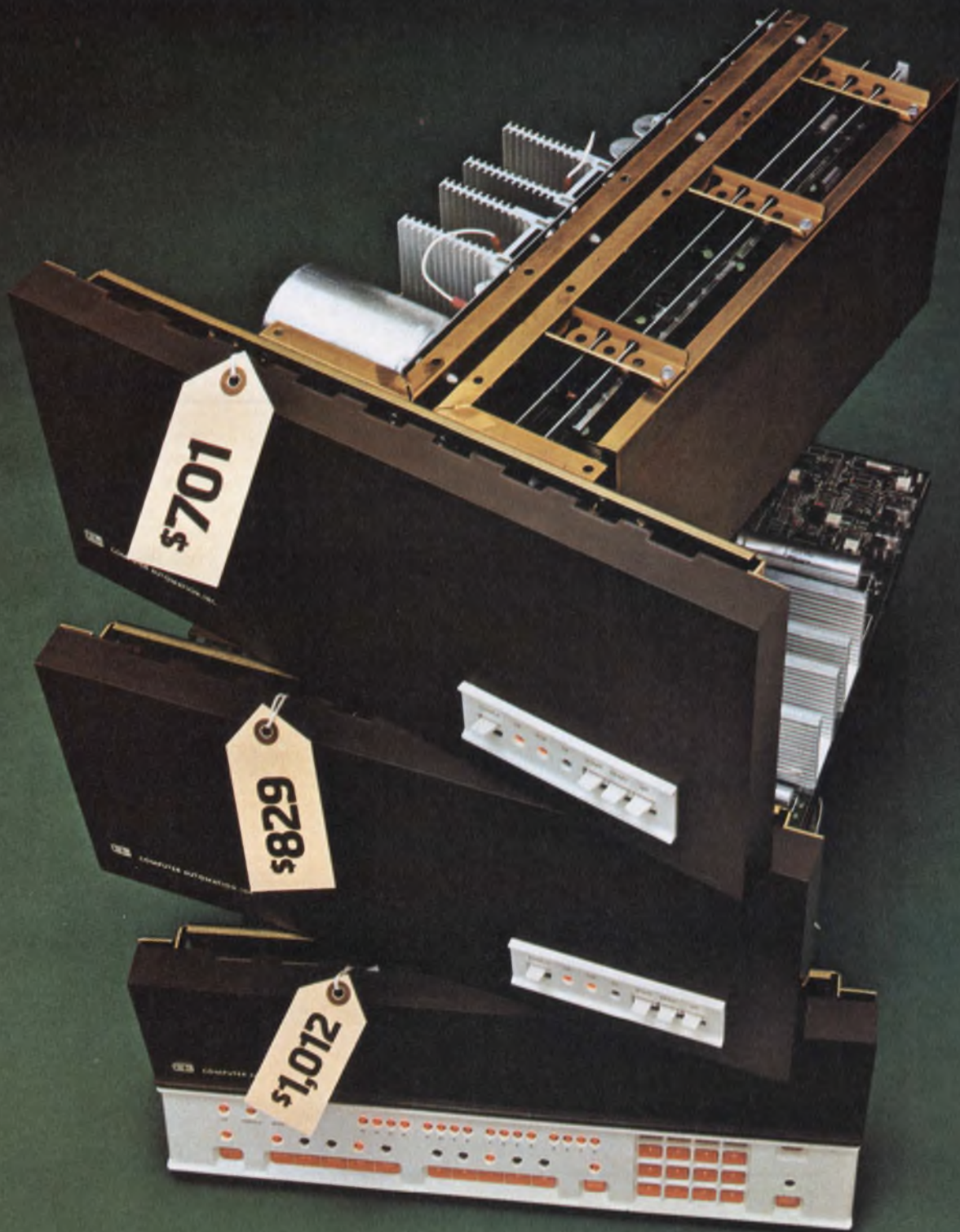

The New ALPHA™ LSI-3/05

Introducing the lowest priced, 16-bit, full-scale, fully compatible, packaged computers in the world.

can do for your bottom line.

Stack the new ALPHA LSI-3/05 millicomputer up against any other low-end computer.

Preferably while you're sitting down, because on price alone, you're bound to be astounded.

Ready? \$701 total packaged price. And that's complete with 256 words of MOS RAM, and a CPU that offers a really powerful instruction set, Power Fail Restart, Real-Time Clock and Autoload capability.

Try to buy an equivalent computer at twice the price.

Have it your way.

You also get the capability to configure your computer pretty well the way you want it. A choice of packaging, of course, that includes either the Operator's or the Programmer's Console, power supplies and so on.

A choice of two standard I/O options.

And a choice of optional memory configurations that



Maxi-Bus compatible ALPHA LSI-3/05 achieves unprecedented cost-effectiveness with ComputerAutomation's new Distributed I/O System.

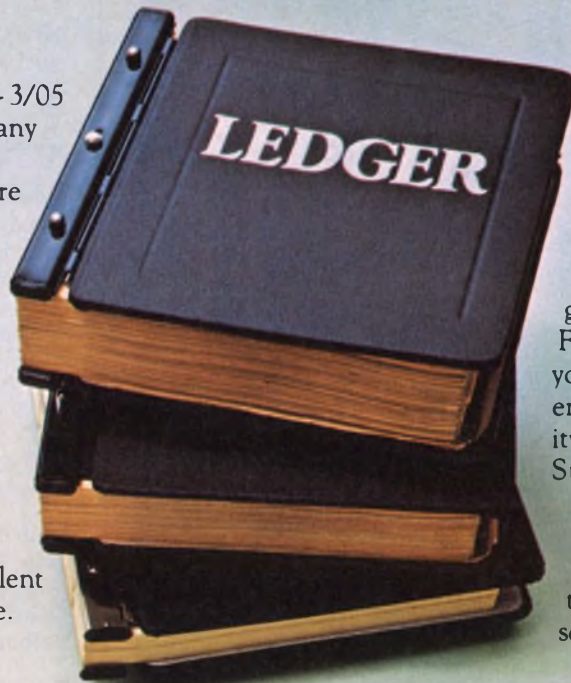

include RAM/ROM, RAM/EPROM and RAM-only in sizes from 256 words all the way up to 32K words. Totally addressable.

Family connections save you still more money.

So far, what we've been talking about could easily add another five or six figures to the bottom line of your ledger.

But there's more. Really big savings on off-the-shelf software, peripheral controllers and I/O interfaces.

The reason is that the ALPHA LSI-3/05 millicomputer is a full-fledged member of ComputerAutomation's LSI Family... Maxi-Bus compatibility and the whole works. So, every piece of Family hardware we've ever developed will work like it was made for the ALPHA LSI-3/05. Including ComputerAutomation's exclusive new Distributed I/O System... just like you see it in the picture.

With this versatile interface system, you can interface virtually any kind or combination of peripherals. Parallel or serial. Just by plugging them in.

Your cost? Probably less than \$200 per interface.

The pros know.

Computer-wise OEM's will tell you that product requirements sooner or later get ahead of the hardware. For instance, the computer you buy today may not have enough I/O or memory capacity for tomorrow's Mark II Super Widget.

Then you'll have to scrap all your software and your interface designs, because they're not about to work on some other machine.

You lose.

Of course, with our LSI Family of compatible computers you don't.

You can switch to a different CPU or a different memory anytime. Faster, slower, bigger, smaller. The electrical interface will still be the same; the original programming will still work.

You win.

From the people who brought you the NAKED MINI®

And the NAKED™ MILLI. And the Distributed I/O System. And the PICOPROCESSOR.

And now the ALPHA LSI-3/05 millicomputer.

One cost breakthrough after another. Breakthroughs that didn't just happen... a lot of profits got plowed back into R&D.

But then, that's the price of leadership.

 **ComputerAutomation**
NAKED MINI Division

U.S.A. 18651 Von Karman, Irvine, CA 92664
(714) 833-8830

EUROPE 31/35 Clarendon Road, Watford,
Hertfordshire, WD1. 1JA England (0923) 39627

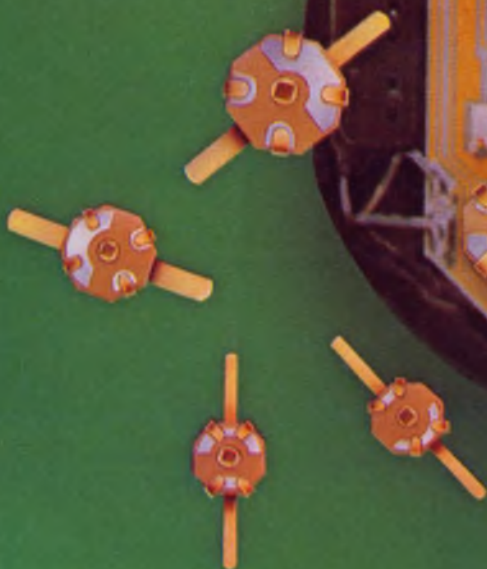

Thin-Trim[®] capacitors

Tucked in the corner of this Pulsar Watch is a miniature capacitor which is used to trim the crystal. This Thin-Trim capacitor is one of our 9410 series, has an adjustable range of 7 to 45 pf, and is .200" x .200" x .050" thick.

The Thin-Trim concept provides a variable device to replace fixed tuning techniques and cut-and-try methods of adjustment. Thin-Trim capacitors are available in a variety of lead configurations making them easy to mount.

A smaller version of the 9410 is the 9402 series with a maximum capacitance value of 25 pf. These are perfect for applications in sub-miniature circuits such as ladies' electronic wrist watches and phased array MIC's.

The logo for Johanson Manufacturing Corporation, featuring the name "Johanson" in a stylized, cursive script font enclosed within an oval border.

Johanson Manufacturing Corporation
Rockaway Valley Road
Boonton, New Jersey 07005
(201) 334-2676 TWX 710-987-8367

Sr. Vice President, Publisher
Peter Coley

Editors

Editorial Offices
50 Essex St.
Rochelle Park, NJ 07662
(201) 843-0550
TWX: 710-990-5071
Cable: Haydenpubs Rochellepark

Editor-in-Chief George Rostky

Managing Editors:

Ralph Dobriner
Michael Elphick

Associate Editors:

Dave Bursky
Samuel Derman
Morris Grossman
John F. Mason
Stanley Runyon
Edward A. Torrero

Contributing Editors:

Peter N. Budzilovich
John Kessler
Alberto Socolovsky
Nathan Sussman

Editorial Field Offices

East

Jim McDermott, Eastern Editor
P.O. Box 272
Easthampton, MA 01027
(413) 527-3632

West

David N. Kaye, Senior Western Editor
8939 S. Sepulveda Blvd.
Suite 510
Los Angeles, CA 90045
(213) 641-6544
TWX: 1-910-328-7240

Editorial Production

Marjorie A. Duffy, Production Editor
Tom Collins, Copy Editor

Art

Art Director, William Kelly
Richard Luce
Anthony J. Fischetto

Production

Manager, Dollie S. Viebig
Helen De Polo
Anne Molfetas

Circulation

Manager, Evan Phoutrides

Information Retrieval

Peggy Long

Promotion, Creative Layouts

Manager, Albert B. Stempel
Maxine Correal
Nancy Gordon (Reprints)

Reader sharpens Focus on Displays

In "Focus on Displays" (ED No. 19, Sept. 13, 1975, p. 52), you say LCDs were "formerly rejected by many engineers because of early deficiencies, some of which have since been cured or modified." True. But misinformation and myths have been other reasons for the rejection, and regrettably your Focus does little to make the picture clearer.

In several places in the article you state that multiplexing is difficult—or impossible (you don't seem sure which)—particularly in the case of dynamic-scattering (DS) displays, because of the slow responses of LCDs. You then go on to say that Hitachi has developed a 600-alphanumeric-character panel (dynamic-scattering, incidentally). So how did Hitachi do it?

The slow response of LCDs limits the update rate but has nothing to do with the supposed difficulty of multiplexing them. The techniques (of which the Hitachi system is only one of a great many) are less than obvious because LCDs respond to rms voltages—not peak voltages—of either polarity, and because they respond to high-frequency signals in various odd ways that are a function of the physics of the LC material rather than of the parallel-plate capacitor nature of the cell. Full-selected matrix intersections cannot therefore be differentiated from part or nonselected intersections by voltage or cur-

rent polarity (as can, for example, LEDs), and the Fourier spectra of the multiplex waveforms must be matched to the LCD parameters.

I am not certain how that 600-character panel is organized, but Hitachi has demonstrated a 210-character panel organized as a 70×148 X-Y matrix, which proves that multiplexing a DS display with a duty ratio down to 1-in-70 at least is possible. While this achievement is at the frontier of the technology, any competent engineer can design a multiplex circuit for, say, 5 to 10 characters. Indeed one IC manufacturer now offers an IC that will multiplex 4-1/2 digits onto just 12 lines.

Incidentally, at present, DS displays are easier to multiplex than are twisted-nematic (TN) displays—not, as your Focus states, harder.

As for the statement that "Schiffs-Base LC (display) types are very sensitive to moisture"—well, yes and perhaps. The LC material certainly is; the display may or may not be—it depends upon how well the LC material is sealed in. Some manufacturers apply MIL-STD-883 leak tests or similar.

The Focus article says: "Until now, the fabrication of large-area LCDs has been unsuccessful because of the long time lag between the application of voltage and the change in transparency of the liquid-crystal material." How's that again? The long time lag occurs at turn-off, not at turn-on. Also, a little earlier you mentioned that

(continued on page 12)

Switches-

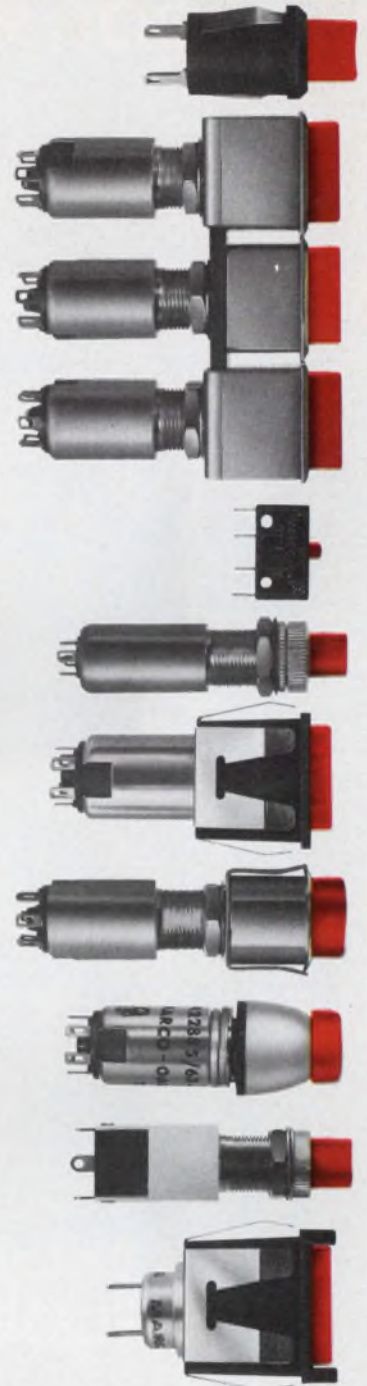

We've got them all

Lighten your decisions
contact . . .

ILLUMINATED PRODUCTS INC.

(formerly MARCO-OAK)
A Subsidiary of OAK Industries Inc.

207 S. Helena St., P.O. Box 4011
Anaheim, CA 92803
Tel: (714) 535-6037 TWX 910-591-1185

INFORMATION RETRIEVAL NUMBER 6

Electronic Design welcomes the opinions of its readers on the issues raised in the magazine's editorial columns. Address letters to Managing Editor, Electronic Design, 50 Essex St. Rochelle Park, N.J. 07662. Try to keep letters under 200 words. Letters must be signed. Names will be withheld on request.

A beautiful put-up
can wrap up a great saving

BELDEN 

...new ideas for moving electrical energy



To us, put-ups are more than shipping containers that get our wire, cable, and cords to you in performance shape.

Put-ups are also a potential source of cost reduction at your end. The "right" put-up usually pays off via reduced assembly time, longer runs, storage efficiencies, or less spoilage.

For example, there's our new cost-cutting UNREEL™ put-up.* A packaged wire dispenser. Wire flows freely stops instantly when pulling stops. No reel inertia to overcome. No snarls or backlash. No need for tensioning devices. No reels or spools to return or dispose of. Saves man hours.

With Belden, put-up analysis is part of our total engineering approach to the applica-

tion of wire, cable and cords.

When you're ready to explore the potential cost reduction of put-ups with Belden, you can benefit from our comprehensive applications support. We not only have the capability to provide all the standard forms where they work best, we also have developed proprietary techniques to meet a variety of usage needs. And if we can't optimize a put-up from standard and proprietary methods, we'll innovate one for you. For answers right now, phone:

(317) 966-6681, Electronic Division

(312) 887-1800, Transportation Division

(312) 986-1600, Electrical Division

Or write Belden Corporation, 2000 South Batavia Ave., Geneva, Illinois 60134.

*Available on a widening selection of Belden wire, cable and cordage.

H-3-4A



The EC series is ACDC's new line of power supplies designed for OEM applications. No bells and whistles, no fancy frills or extras. Just solid, reliable power supplies designed and built by ACDC Electronics... a name synonymous with quality.

The EC series is mechanically and electrically interchangeable in form, fit and function with other open frame power supplies that meet accepted industry standard. There are over 50 models to choose from in a wide range of voltages and currents so you can order the exact power supply for your application. Power supplies with a maximum of reliability at minimum cost.

STOCK DELIVERY
2 YEAR GUARANTEE
18 WORLD-WIDE SERVICE CENTERS

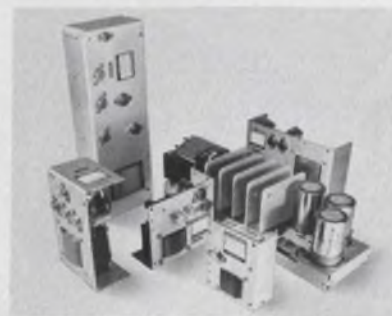

INTRODUCING THE EC SERIES - A NEW LINE OF LOW COST POWER SUPPLIES

SINGLE OUTPUT POWER SUPPLIES

Nominal Output Voltage	Max. Current (amps)	Model Number	Price		
			1	100	250
2 V.	3.0	EC2N3	\$ 31.00	\$ 24.95	\$ 22.95
	6.0	EC2N6	51.00	41.50	39.00
	9.5	EC2N9.5	63.00	51.00	48.50
	12.0	EC2N12	80.00	65.50	62.00
	17.0	EC2N17	101.00	82.00	78.00
	25.0	EC2N25	137.00	112.00	106.00
5 V.	3.0	EC5N3	31.00	24.95	22.95
	6.0	EC5N6	51.00	41.50	39.00
	9.5	EC5N9.5	63.00	51.00	48.50
	12.0	EC5N12	80.00	65.50	62.00
	17.0	EC5N17	101.00	82.00	78.00
	25.0	EC5N25	137.00	112.00	106.00
6 V.	2.6	EC6N2.6	31.00	24.95	22.95
	5.4	EC6N5.4	51.00	41.50	39.00
	8.5	EC6N8.5	63.00	51.00	48.50
	11.0	EC6N11	80.00	65.50	62.00
	15.0	EC6N15	101.00	82.00	78.00
	23.0	EC6N23	137.00	112.00	106.00
12 V.	2.2	EC12N2.2	31.00	24.95	22.95
	3.5	EC12N3.5	51.00	41.50	39.00
	6.0	EC12N6	63.00	51.00	48.50
	7.5	EC12N7.5	80.00	65.50	62.00
	10.0	EC12N10	101.00	82.00	78.00
	16.0	EC12N16	137.00	112.00	106.00
15 V.	1.8	EC15N1.8	31.00	24.95	22.95
	3.0	EC15N3	51.00	41.50	39.00
	5.0	EC15N5	63.00	51.00	48.50
	6.5	EC15N6.5	80.00	65.50	62.00
	9.5	EC15N9.5	101.00	82.00	78.00
	14.0	EC15N14	137.00	112.00	106.00
20 V.	1.5	EC20N1.5	31.00	24.95	22.95
	2.5	EC20N2.5	51.00	41.50	39.00
	4.2	EC20N4.2	63.00	51.00	48.50
	5.3	EC20N5.3	80.00	65.50	62.00
	8.0	EC20N8	101.00	82.00	78.00
	11.0	EC20N11	137.00	112.00	106.00

Nominal Output Voltage	Max. Current (amps)	Model Number	Price		
			1	100	250
24 V.	1.3	EC24N1.3	31.00	24.95	22.95
	2.4	EC24N2.4	51.00	41.50	39.00
	4.0	EC24N4	63.00	51.00	48.50
	5.0	EC24N5	80.00	65.50	62.00
	7.5	EC24N7.5	101.00	82.00	78.00
	10.0	EC24N10	137.00	112.00	106.00

DUAL OUTPUT POWER SUPPLIES

Nominal Output Voltage	Max. Current (amps)	Model Number	Price		
			1	100	250
± 12/15	0.5	EC12D0.5	\$ 45.00	\$ 38.00	\$ 35.00
± 12/15	1.5	EC12D1.5	69.00	57.00	53.00
± 12	3.0	EC12D3	89.00	72.00	67.00
± 15	3.0	EC15D3	89.00	72.00	67.00
± 12	5.0	EC12D5	122.00	99.00	92.00
± 15	5.0	EC15D5	122.00	99.00	92.00

TRIPLE OUTPUT POWER SUPPLIES

Nominal Output Voltage	Max. Current (amps)	Model Number	Price		
			1	100	250
5V	6.0	ET401	\$113.00	\$ 92.00	\$ 85.00
± 12/15	1.0				
5V	12	ET601	165.00	135.00	125.00
± 12	3				
5V	12	ET602	165.00	135.00	125.00
± 15	3				

OVERVOLTAGE PROTECTION OPTION

Rated output current of power supply	Price		
	1	100	250
0 to 12 Amps	\$ 8.00	\$ 7.50	\$ 6.50
12 to 25 Amps	12.00	10.50	10.00

acdc electronics

ACDC Electronics, 401 Jones Road, Oceanside, CA 92054 • West Coast (714) 757-1880; East Coast (201) 687-6633

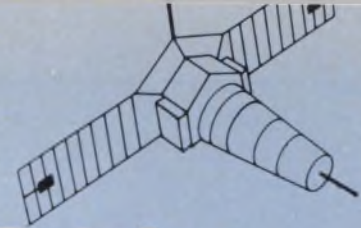
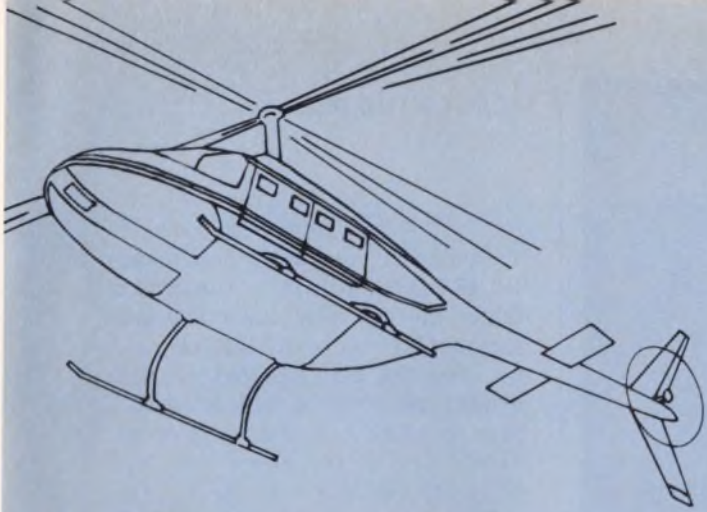

LogiMetrics.

In RF subsystems and test equipment the word gets around.

The fact is, LogiMetrics manufactures a greater variety of RF signal generators and TWT amplifiers for the communications market than any other U.S. company. And our new frequency synthesizers are making a tremendous impact, too.

The reasons are clear. We've developed some of the most dramatic techniques in the industry. Like direct digital calibration for unprecedented accuracy, resolution and reliability in our signal generators.

What's more, all of our products are specifically designed for the systems application in which they're used. So there's no need to settle for the wrong size equipment or less than the right specs, even if cost is a consideration. And our standard designs offer additional cost advantages, too.

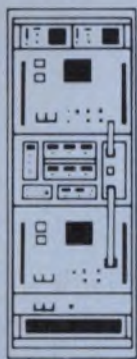

Consider, too, that we're very responsive. Our worldwide organization knows the RF communications and test equipment field so well that we can probably help you solve most problems. We'll help you before you buy to make sure you get exactly what you need. And we're ready to help after you take delivery, too. So, if you decide what RF subsystems and test equipment to buy, don't do it without calling LogiMetrics.

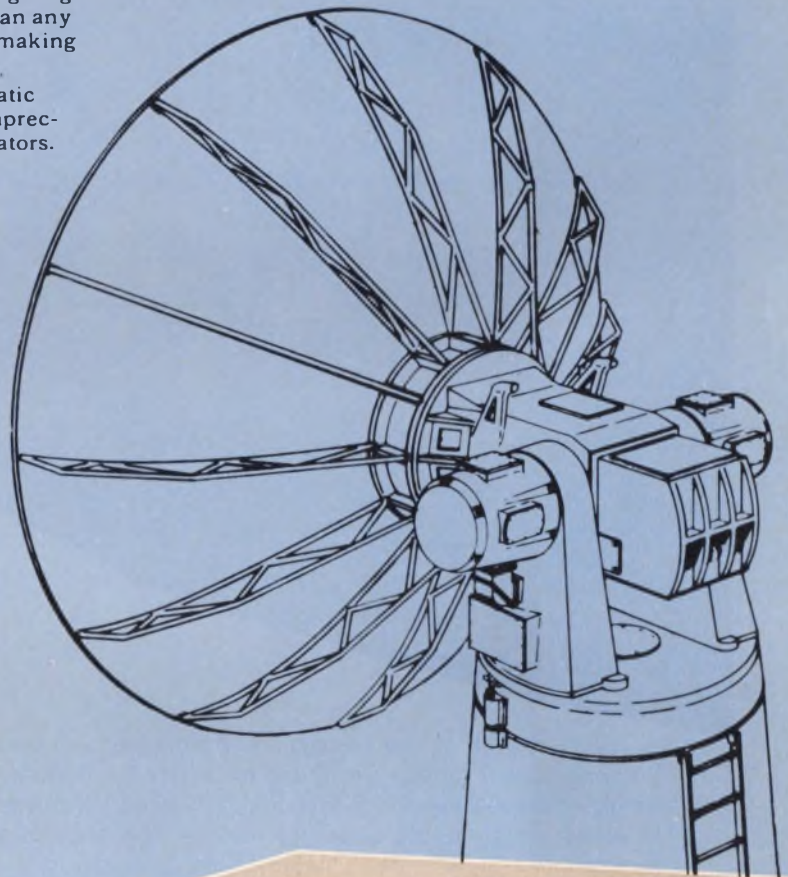

LogiMetrics

121-03 Dupont Street, Plainview, New York, 11803 (516) 681-4700

A year ago we introduced 7 new JCM miniature RF coaxial connectors that "do the job for a fraction of SMA prices."

Here, by popular demand, are 8 more.

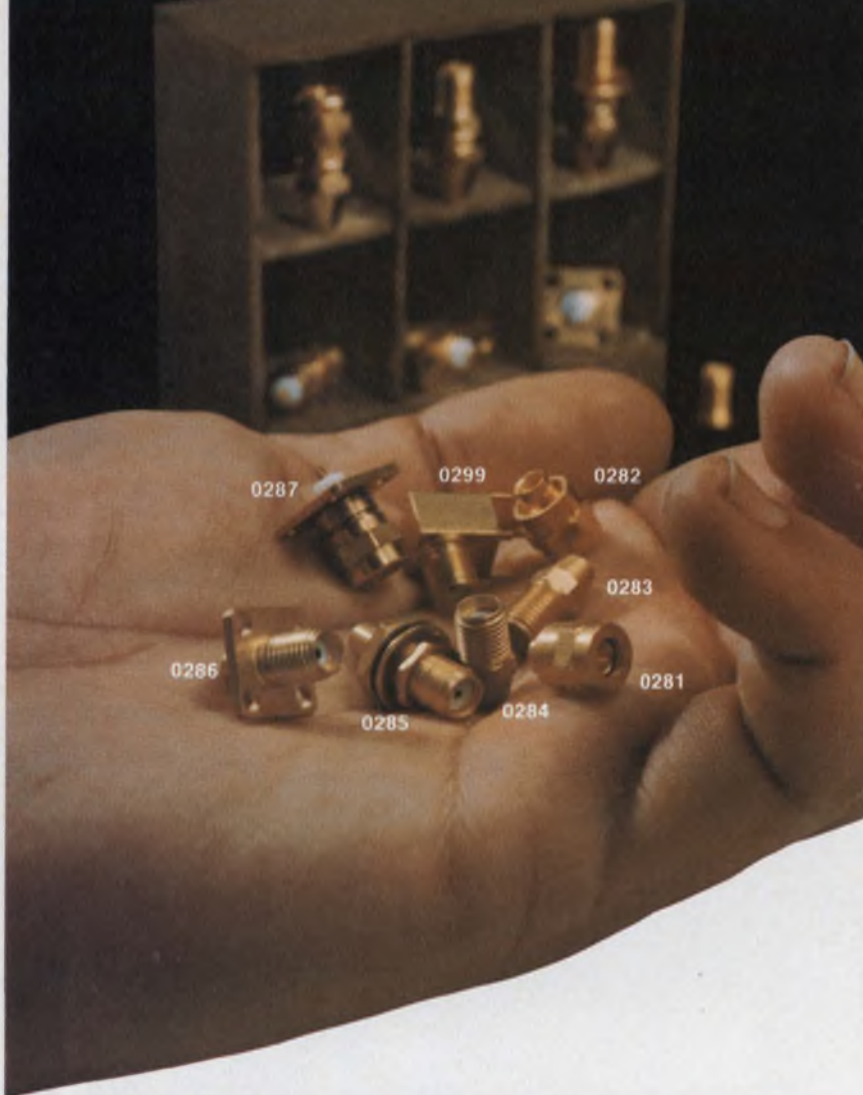

If you don't require all the electrical performance built into SMA type connectors, why pay for it? Up to 3 GHz for flexible cable assembly and even beyond 6 GHz for semi-rigid assembly, our new JCM series gives you the same electrical performance as the far more expensive SMA types. The series includes connectors for both panel and PC mounting. All are interchangeable and intermateable with the standard, expensive SMA connectors. So you can use them without making any changes . . . and without compromising required performance. There are JCM connectors to accept virtually any miniature size cable, so you don't have to stock a big variety. It's worth looking into, isn't it? All it costs is a stamp.

E. F. JOHNSON COMPANY / Waseca, Minnesota 56093

Dept. ED-1

Please check for technical information or test samples of our new low-cost series 142-0200-001 JCM connectors.

- Please send technical information.
- I desire test samples. Please call me at _____

NAME _____

FIRM _____ TITLE _____

ADDRESS _____

CITY _____ STATE _____ ZIP _____



E. F. JOHNSON COMPANY

INFORMATION RETRIEVAL NUMBER 10

ACROSS THE DESK

(continued from page 7)

Transparent Conductors Inc., makes DS displays up to 8 × 10 in. Actually the company can make custom displays up to at least 14 × 17 in., and the size of that Hitachi display pictured on the preceding page is clearly of the same order. Liquid Crystal Inc. also makes very large DS displays.

The facts are that apart from the obvious problem of maintaining plate separation, large DS displays are difficult to fill (dopant in the LC material tends to concentrate around the fill hole), and large TN displays are difficult to align (the most stable technique requires vacuum deposition at a controlled glancing-angle, which is difficult to do on a large substrate).

Your list at the end of the Focus contains between 12 and 15 companies that manufacture LCDs, but three of those are researching and may or may not yet have products to sell. The worldwide total is over 45 companies, and your U.S. selection omitted such important names as Liquid Crystal Inc., Liquid Xtal Displays (formerly Ilixco), Optel and Rockwell International. The LCD industry and the prospects for these devices are much greater than your text suggests.

I can't let the article following ("Consider LCDs for Your Next Design") pass wholly unscathed either. Although it is generally accurate, the curve in Fig. 3a, showing variation of threshold voltage with temperature, should not be considered general. Threshold voltage is a function of the dielectric and the elastic constants of the LC material. How these vary with temperature, and the result, are different from one LC material to another. Some manufacturers report that their threshold voltages are more or less unaffected by temperature.

I'm sorry to be so critical. Till now, it's been difficult to get accurate and nonpartisan information on LCDs. If your readers want to find out the details, try the "International Handbook of Liquid Crystal Displays" (Ovum Ltd., 14

(continued on page 16)

With MINI BUS®

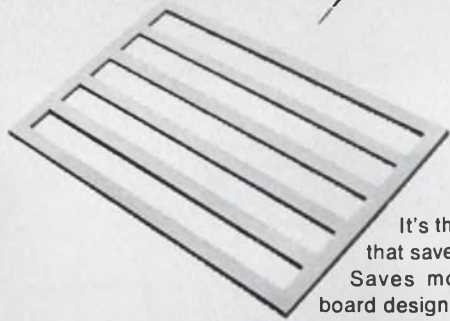

It's the PC card bus bar that saves space on a PCB. Saves money too. Makes board design and layout easier.

all these DIPs



How can you put 30 DIPs on a 30 sq. inch board without using costly multi-layer PCBs?

go on a 5" x 6" 2-sided PCB

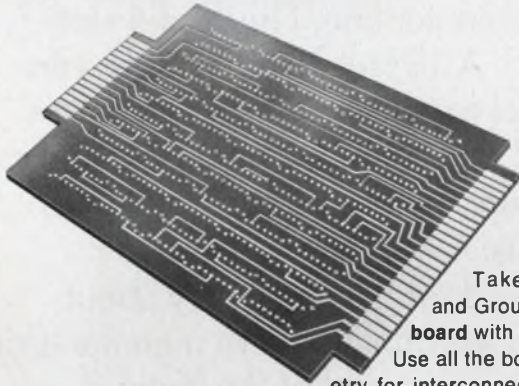

Take Voltages and Grounds off the board with MINI/BUS. Use all the board geometry for interconnecting DIPs.

like this

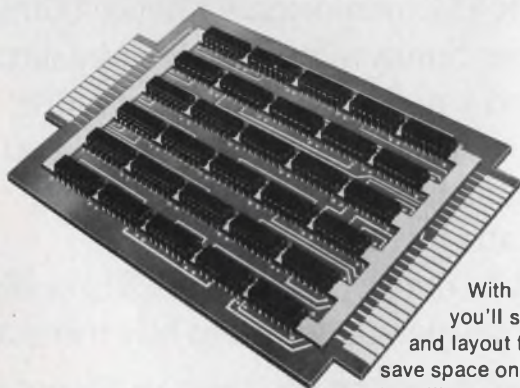

With MINI/BUS, you'll save design and layout time. You'll save space on the board. And you'll save money — up to half the cost of a typical 4-layer PCB.



Rogers Corporation Chandler, Arizona 85224
Phone: (602) 963-4584

INFORMATION RETRIEVAL NUMBER 11

ELECTRONIC DESIGN 2, January 19, 1976

Dialight sees a need:

(Need: The widest choice for your every application.)

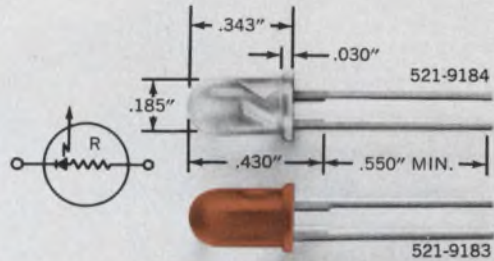

Available in red or clear LED packages with or without a built-in current limiting resistor. Red LED is also made without resistor. Suitable for circuit status indication, alpha-numeric displays and visual indicators. Features long wire-wrappable leads. IC compatible with solid state reliability. High luminous intensity, low power consumption, low cost.

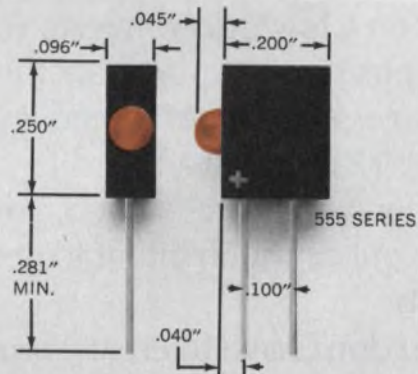

LED logic state fault indicators available in 14 models with voltage ratings from 1.7 to 14. Suitable for dense packaging on printed circuit boards—up to 10 units to the inch—IC compatible. With built-in series resistor. Polarity identified. Low power consumption.



Dialight, the company with the widest choice in switches, LEDs, indicator lights and readouts, looks for needs . . . your needs . . . and then they develop solutions for your every application. No other company offers you one-stop shopping in all these product areas. And no other company has more experience in the visual display field. Dialight helps you do more with these products than any other company in the business, because we are specialists that have done more with them. Talk to the specialists at Dialight first. You won't have to talk to anyone else. Send for your free new copy of Dialight's current catalog.

DIALIGHT

Dialight, A North American Philips Company
203 Harrison Place, Brooklyn, N. Y. 11237
(212) 497-7600

See Dialight.

INFORMATION RETRIEVAL NUMBER 12

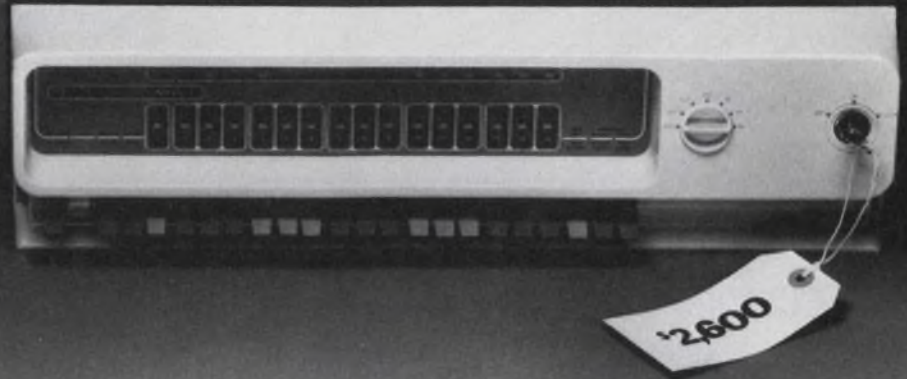

Has your \$500 micro ended up costing more than our \$2,600 mini?

If you've had to spend a lot of money on a low priced micro, you may be in a position to appreciate the cost advantages of a higher priced computer.

Our \$2600 Nova 3*.

When you buy a Nova 3, you don't have to put as much into it to get it to do your job.

You don't have to create your own operating systems. Nova 3 is software compatible with our other Novas. So you get to use all the existing Nova operating systems, language processors and utilities.

And you don't have to worry about performance. Nova 3 executes instructions in 700 nanoseconds using MOS memory. And its sophisticated architecture lets you use up to 128K Words with the optional Memory Management Unit.

You don't have to buy more

computer than you need. Nova 3 has the broadest range of compatible configurations you can get in an OEM minicomputer line. There's a 4 slot Nova 3. A 12 slot Nova 3. (It has an optional expansion chassis that gives you 12 more slots of I/O.) And you can configure multiple processor Nova 3 systems.

You don't have to worry about Nova 3 availability. We're manufacturing virtually every part of the Nova 3. Including the silicon gate N-channel MOS RAM memories. (They're coming from our Sunnyvale, California facility.)

And you don't have to go it alone. Because when you buy a Nova 3, you can get all the support Data General offers an OEM.

Write or call for the Nova 3 brochure. It may persuade you to buy more and spend less. *\$2600 is the single unit price for a 4K MOS memory Nova 3. Before the OEM and quantity discounts get figured in.

DataGeneral

Nova 3: The biggest thing to ever hit the OEM market.

• Data General, Dept. I.4, Route 9, Southboro, Mass. 01772 (617) 485-9100. Data General (Canada) Ltd., Ontario. Data General Europe, 15 Rue Le Sueur, Paris 75116, France. Data General Australia, Melbourne (03) 82-1361/Sydney (02) 908-1366.

Why SkyCaps are blue on the outside.

So you'll know it's AVX on the inside. A quality monolithic capacitor that delivers the exact capacitance and temperature characteristics specified. Consistently over large quantity orders.

AVX is the quality leader in multi-layer capacitors. Leadership based on innovative design, careful manufacturing, exhaustive testing. And AVX is the technology leader. With more experience in ceramic formulation and precision metallization

than any other capacitor manufacturer.

Sky Caps are immediately available, in volume, from your service-oriented AVX distributor. They're an easy and economical way to build AVX quality inside your products.

AVX: The Insiders

AVX Ceramics, P.O. Box 867, Myrtle Beach, SC 29577 (803) 448-3191 TWX: 810-661-2252
Olean, NY (716) 372-6611 TWX: 510-245-2815



Sky Cap dipped monolithics are available in the broadest range of sizes and ratings.

Dimensions

Body: 0.1 square to 0.5 square

Leads: Length 1.25 standard (others available)

Space 0.1 to 0.4 standard (others available)

Capacitance: 1.8pf to 4.7mfd

Voltages: 25, 50, 100, 200 VDC

Four temperature characteristics

AVX Distributors:
Cramer Electronics, Inc.
Elmar-Liberty Electronics
Jaco Electronics, Inc.
Newark Electronics
Texas Instrument Supply

INFORMATION RETRIEVAL NUMBER 14

BETTER COMMUTATING CAPACITORS FOR SCRs

(and other non-sine wave voltage applications)



THE CAPACITORS:

Type 355P and 356P, newest members of the proven Sprague Clorinol® Capacitor family . . . paper and paper/polypropylene film dielectrics with non-flammable synthetic askarel impregnant.

THE APPLICATIONS:

Chopper circuits such as those in d-c motor control, inverter circuits for induction heating, high frequency lighting, high frequency power supplies, ultrasonic cleaners.

THE ADVANTAGES:

Volt-ampere ratings as much as 250% higher than those of older designs. Deliver large peak currents with lowest possible inductance and dissipation factor.

For complete technical data, write for Engineering Bulletin 4701 to Technical Literature Service, Sprague Electric Co., 347 Marshall St., North Adams, Mass. 01247.



THE BROAD-LINE PRODUCER OF ELECTRONIC PARTS

ACROSS THE DESK

(continued from page 12)

Penn Rd., London N7 9RD, Britain). This is the first-ever handbook on these devices. It covers them from every possible angle, and it contains a worldwide manufacturer and product directory both for LCDs and for dedicated connectors and integrated circuits.

Martin Tobias

OmniScience
43 Shakespeare Rd., St. Ives,
Huntingdon, PE17 4TT,
Cambridgeshire, England

Misplaced Caption Dept.



"That's the last time I eat in the company cafeteria."

Sorry. That's Pierre-Auguste Renoir's "Paul Durand-Ruel," which hangs in the Durand-Ruel collection in Paris.

Terminal omission

In the list of manufacturers included in "Focus on CRT Terminals," (ED No. 22, Oct. 25, 1975, pp. 86-93), we inadvertently omitted Teletype Corp., 5555 Touhy Ave., Skokie, IL 60076 (312) 982-2000. Teletype Corp. is a prominent manufacturer of CRT terminals, as well as the teletypewriters and teleprinters that everybody knows about. Like some information?

CIRCLE NO. 319

MOTOROLA CMOS INTEGRATED CIRCUITS

MC14000, MC14500, AND MC14400 SERIES COMPLEMENTARY MOS

Add suffix to part number on all orders.
 AL: 3 — 18 V, —55 to +125°C, ceramic package
 CL: 3 — 18 V, —40 to +85°C, ceramic package
 CP: 3 — 18 V, —40 to +85°C, plastic package
 L: Limited voltage range, limited temp. range, ceramic package
 P: Limited voltage range, limited temp. range, plastic package
 EFL: 3 — 18 V, —55 to +125°C, ceramic package
 FL: 3 — 18 V, —40 to +85°C, ceramic package
 FP: 3 — 18 V, —40 to +85°C, plastic package
 EVL: 3 — 6 V, —55 to +125°C, ceramic package
 VL: 3 — 6 V, —40 to +85°C, ceramic package
 VP: 3 — 6 V, —40 to +85°C, plastic package

Chips are available for all McMOS types. Consult your Motorola Sales Office or Authorized Motorola Distributor.

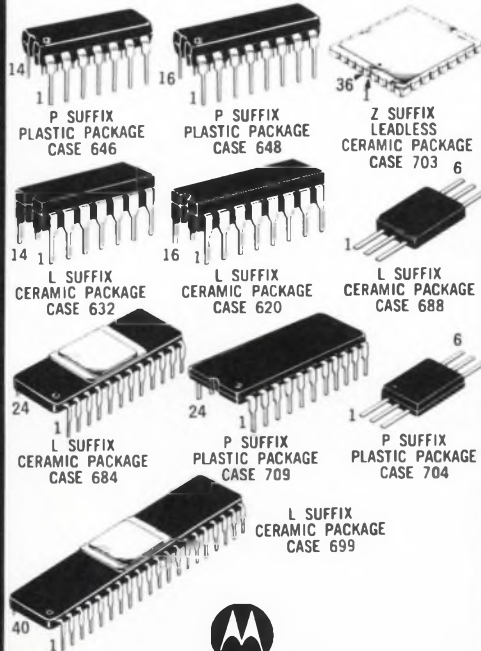

MOTOROLA McMOS
 CMOS reliability at its BEST

PART NUMBER	FUNCTION	SUFFIX	PINS	SECOND SOURCED
MC14000	Dual 3-Input NOR Gate/Inverter	AL,CL,CP	14	✓
MC14001	Quad 2-Input NOR Gate	AL,CL,CP	14	✓
MC14001B	Quad 2-Input NOR Gate	AL,CL,CP	14	✓
MC14002	Dual 4-Input NOR Gate	AL,CL,CP	14	✓
MC14002B	Dual 4-Input NOR Gate	AL,CL,CP	14	✓
MC14006B	18-Bit Static Shift Register	AL,CL,CP	14	✓
MC14007	Dual Pair and Inverter	AL,CL,CP	14	✓
MC14008B	4-Bit Full Adder	AL,CL,CP	16	✓
MC14011	Quad 2-Input NAND Gate	AL,CL,CP	14	✓
MC14011B	Quad 2-Input NAND Gate	AL,CL,CP	14	✓
MC14012	Dual 4-Input NAND Gate	AL,CL,CP	14	✓
MC14012B	Dual 4-Input NAND Gate	AL,CL,CP	14	✓
MC14013B	Dual D Flip-Flop	AL,CL,CP	14	✓
MC14014B	8-Bit Static Shift Register	AL,CL,CP	16	✓
MC14015B	Dual 4-Bit Static Shift Register	AL,CL,CP	16	✓
MC14016	Quad Analog Switch/Quad Multiplexer	AL,CL,CP	14	✓
MC14017B	Decade Counter/Divider	AL,CL,CP	16	✓
MC14018B*	Presetable Divide-by-N Counter	AL,CL,CP	16	✓
MC14020B	14-Bit Binary Counter	AL,CL,CP	16	✓
MC14021B	8-Bit Static Shift Register	AL,CL,CP	16	✓
MC14022B	Octal Counter/Divider	AL,CL,CP	16	✓
MC14023	Triple 3-Input NAND Gate	AL,CL,CP	14	✓
MC14023B	Triple 3-Input NAND Gate	AL,CL,CP	14	✓
MC14024B	Seven Stage Ripple Counter	AL,CL,CP	14	✓
MC14025	Triple 3-Input NOR Gate	AL,CL,CP	14	✓
MC14025B	Triple 3-Input NOR Gate	AL,CL,CP	14	✓
MC14027B	Dual J-K Flip-Flop	AL,CL,CP	16	✓
MC14028B	BCD-to-Decimal Decoder	AL,CL,CP	16	✓
MC14032B	Triple Serial Adder (Positive)	AL,CL,CP	16	✓
MC14034B	8-Bit Universal Bus Register	AL,CL,CP	24	✓
MC14035B	4-Stage Shift Register	AL,CL,CP	16	✓
MC14038B	Triple Serial Adder (Negative)	AL,CL,CP	16	✓
MC14040B	12-Bit Binary Counter	AL,CL,CP	16	✓
MC14042B	Quad Latch	AL,CL,CP	16	✓
MC14043B	Quad NOR R-S Latch	AL,CL,CP	16	✓
MC14044B	Quad NAND R-S Latch	AL,CL,CP	16	✓
MC14046B	Phase-Locked Loop	AL,CL,CP	16	✓
MC14049B	Hex Inverter/Buffer	AL,CL,CP	16	✓
MC14050B	Hex Buffer	AL,CL,CP	16	✓
MC14051	8-Channel Analog Multiplexer	AL,CL,CP	16	✓
MC14052	Dual 4-Channel Analog Multiplexer	AL,CL,CP	16	✓
MC14053	Triple 2-Channel Analog Multiplexer	AL,CL,CP	16	✓
MC14066	Quad Bilateral Switch	AL,CL,CP	14	✓
MC14068B	8-Input NAND Gate	AL,CL,CP	14	✓
MC14069B	Hex Inverter	AL,CL,CP	14	✓
MC14070B	Quad Exclusive-OR Gate	AL,CL,CP	14	✓
MC14071	Quad 2-Input OR Gate	AL,CL,CP	14	✓
MC14071B	Quad 2-Input OR Gate	AL,CL,CP	14	✓
MC14072B	Dual 4-Input OR Gate	AL,CL,CP	14	✓
MC14073B	Triple 3-Input AND Gate	AL,CL,CP	14	✓
MC14075B	Triple 3-Input OR Gate	AL,CL,CP	14	✓
MC14076B	Quad D-Type Register	AL,CL,CP	16	✓
MC14077B	Quad Exclusive-NOR Gate	AL,CL,CP	14	✓
MC14078B	8-Input NOR Gate	AL,CL,CP	14	✓
MC14081	Quad 2-Input AND Gate	AL,CL,CP	14	✓
MC14081B	Quad 2-Input AND Gate	AL,CL,CP	14	✓
MC14082B	Dual 4-Input AND Gate	AL,CL,CP	14	✓
MC14160B	Decade Counter (Asynchronous Clear)	AL,CL,CP	16	✓
MC14161B	Binary Counter (Asynchronous Clear)	AL,CL,CP	16	✓
MC14162B	Decade Counter (Synchronous Clear)	AL,CL,CP	16	✓
MC14163B	Binary Counter (Synchronous Clear)	AL,CL,CP	16	✓
MC14174B	Hex D Flip-Flop	AL,CL,CP	16	✓
MC14175B	Quad D Flip-Flop	AL,CL,CP	16	✓
MC14194B	4-Bit Universal Shift Register	AL,CL,CP	16	✓
MC14408	Binary-to-Phone Pulse Converter	L,P	16	✓
MC14409	Binary-to-Phone Pulse Converter	L,P	16	✓
MC14410	2-of-8 Tone Encoder	L,P	16	✓
MC14411	Bit-Rate Frequency Generator	L,P	24	✓
MC14412	Universal Low-Speed Modem	FL,VL	16	✓

PART NUMBER	FUNCTION	SUFFIX	PINS	SECOND SOURCED
MC14415	Quad Precision Timer/Driver	EFL,FL,FP,EVL,VL,VP	16	✓
MC14419	2-of-8 Keypad-to-Binary Encoder	L,P	16	✓
MC14431*	12-Bit A/D Converter	L,P	24	✓
MC14433*	3½ Digit A/D Converter	L,P	24	✓
MC14435	3½ Digit A/D Logic Subsystem	EFL,FL,FP,EVL,VL,VP	16	✓
MC14440	LCD Watch/Clock Circuit	L,Z	40,36	✓
MC14450	Oscillator 2÷ Divider	L,P	6	✓
MC14451	Oscillator/Divider/Buffer	L,P	16	✓
MC14490	Hex Contact Bounce Eliminator	EFL,FL,FP,EVL,VL,VP	16	✓
MC14501	Triple Gate	AL,CL,CP	16	✓
MC14502B	Strobed Hex Inverter/Buffer	AL,CL,CP	16	✓
MC14503B	Hex Bus Driver	AL,CL,CP	16	✓
MCM14505	64 x 1 Static RAM	AL,CL,CP	14	✓
MC14506B	Dual Expandable A.O.I. Gate	AL,CL,CP	16	✓
MC14507	Quad Exclusive-OR Gate	AL,CL,CP	14	✓
MC14508B	Dual 4-Bit Latch	AL,CL,CP	24	✓
MC14510B	BCD Up/Down Counter	AL,CL,CP	16	✓
MC14511B	BCD-to-7 Segment Latch/Decoder/Driver	AL,CL,CP	16	✓
MC14512	8-Channel Data Selector	AL,CL,CP	16	✓
MC14514B	4/16 Line Decoder (High)	AL,CL,CP	24	✓
MC14515B	4/16 Line Decoder (Low)	AL,CL,CP	24	✓
MC14516B	Binary Up/Down Counter	AL,CL,CP	16	✓
MC14517B	Dual 64-Bit Static Shift Register	AL,CL,CP	16	✓
MC14518B	Dual BCD Up Counter	AL,CL,CP	16	✓
MC14519B	4-Bit AND/OR Selector	AL,CL,CP	16	✓
MC14520B	Dual Binary Up Counter	AL,CL,CP	16	✓
MC14521B	24-Stage Frequency Divider	AL,CL,CP	16	✓
MC14522B	BCD Divide-by-N Counter	AL,CL,CP	16	✓
MCM14524	256 x 4 Read Only Memory	AL,CL,CP	16	✓
MC14526B	Binary Divide-by-N Counter	AL,CL,CP	16	✓
MC14527B	BCD Rate Multiplier	AL,CL,CP	16	✓
MC14528B	Dual Monostable Multivibrator	AL,CL,CP	16	✓
MC14529	Dual 4-Channel Multiplexer	AL,CL,CP	16	✓
MC14530B	Dual 5-Input Majority Logic Gate	AL,CL,CP	16	✓
MC14531B	12-Bit Parity Tree	AL,CL,CP	16	✓
MC14532B	8-Bit Priority Encoder	AL,CL,CP	16	✓
MC14534B	Real Time 5-Decade Counter	AL,CL,CP	24	✓
MC14536B	Programmable Timer	AL,CL,CP	16	✓
MCM14537	256 x 1 Static RAM	AL,CL,CP	16	✓
MC14538B*	Dual Precision Monostable Multivibrator	AL,CL,CP	16	✓
MC14539B	Dual 4-Channel Digital Mixer	AL,CL,CP	16	✓
MC14541B	Oscillator-Timer	AL,CL,CP	14	✓
MC14543B	BCD-to-7 Segment Latch/Decoder/Driver	AL,CL,CP	16	✓
MC14549B	Successive Approximation Register	AL,CL,CP	16	✓
MCM14552	64 x 4 Static RAM	AL,CL,CP	24	✓
MC14553B	3-Digit BCD Counter	AL,CL,CP	16	✓
MC14554B	2 x 2-Bit Parallel Binary Multiplier	AL,CL,CP	16	✓
MC14555B	Dual Binary 1-of-4 Decoder	AL,CL,CP	16	✓
MC14556B	Dual Binary 1-of-4 Decoder (Inv)	AL,CL,CP	16	✓
MC14557B	1-to-64-Bit Shift Register	AL,CL,CP	16	✓
MC14558B	BCD-to-7 Segment Decoder	AL,CL,CP	16	✓
MC14559B	Successive Approximation Register	AL,CL,CP	16	✓
MC14560B	NBCD Adder	AL,CL,CP	16	✓
MC14561B	9's Complementer	AL,CL,CP	14	✓
MC14562B	128-Bit Static Shift Register	AL,CL,CP	14	✓
MC14566B	Industrial Time Base Generator	AL,CL,CP	16	✓
MC14568B*	Phase Comparator/Programmable Counter	AL,CL,CP	16	✓
MC14569B*	Dual Programmable BCD/Binary Counter	AL,CL,CP	16	✓
MC14572	Hex Gate	AL,CL,CP	16	✓
MC14580B	4 x 4 Multiport Register	AL,CL,CP	24	✓
MC14581B	4-Bit Arithmetic Logic Unit	AL,CL,CP	24	✓
MC14582B	Look-Ahead Carry Block	AL,CL,CP	16	✓
MC14583B	Dual Schmitt Trigger	AL,CL,CP	16	✓
MC14585B	4-Bit Magnitude Comparator	AL,CL,CP	16	✓

* Available during 1976

McMOS IS THE ONE...

**BUFFERED
OUTPUTS**

**RELIABLE
3 TO 18 VOLT
OPERATION**

**DRIVES
LOW-POWER
SCHOTTKY
TTL LOADS**

SERIES

FOR

- **FULL-LINE — NEARLY 100 TYPES**
- **OUTPUT INDEPENDENT OF INPUT**
- **INCREASED NOISE IMMUNITY**
- **PLASTIC PACKAGE RELIABILITY**
- **RATINGS AND SPECS FOR 5, 10, AND 15 V OPERATION**

McMOS B Series is the broad line of buffered output CMOS, with a big complement of MSI. The line is broad enough for complete CMOS systems, and because it's compatible with our non-buffered CMOS and has the capability to drive low power Schottky TTL, our B Series also has mix and match versatility.

Operate it at higher voltages with complete confidence. At 18 V, you get the same reliability you count on with all MCMOS.

ORDER from your Motorola Sales Office or Authorized Motorola Distributor.

McMOS... THE BROAD LINE CMOS FAMILY

The McMOS* family of standard monolithic integrated circuits provides the design engineer with several medium speed series which approach the ideal in performance. The low power dissipation and flexible power supply requirements simplify supply design, and the high noise immunity and fanout capability reduce parts counts and streamline printed circuit board layout.

*TRADEMARK OF MOTOROLA INC.

MC14000 AND MC14500 SERIES

- Large compatible B Series
- Reliable 3-18 V operation
- Largest MSI complement
- Fanout > 50
- Low quiescent power dissipation
- Diode protection - all inputs
- High noise immunity — 45% of supply voltage

MC14400 STANDARD LSI SERIES

Here's a group of LSI devices whose designs and specifications are tailored for specific subsystem applications. The MC14400 devices are manufactured with the same high yield complementary MOS processing techniques as the familiar MC14000 and MC14500 Series, and they exhibit the same inherent low power dissipation, high tolerance to power supply variance, and high noise immunity for industrial/commercial environments. These subsystem LSI devices are designed for maximum efficiency in their intended applications.

Design techniques developed by Motorola permit some of these LSI subsystems to combine both digital and linear functions on the same chip, a powerful systems design tool.

CUSTOM CMOS FROM MOTOROLA

The industry's most modern CMOS design and manufacturing facility is at your service in Austin, Texas, to handle your custom CMOS requirements.

Contact your Motorola Sales Office for details.



CMOS SELECTOR GUIDE

**MOTOROLA SEMICONDUCTOR PRODUCTS, INC.
TECHNICAL INFORMATION CENTER**
P.O. Box 20912, Phoenix, AZ 85036

CMOS FACILITY
3501 Ed Bluestein Blvd., Austin, TX 78721



MOTOROLA McMOS
CMOS reliability at its BEST

IBM. You rascals. You've done it again.

We're referring to your new IBM 5100 "Portable Computer".

That's a very neat system.

Compact.

Portable.

Applicable.

Usable.

And at a great price to a great many potential users.

Our personal interest is, of course, prompted by your use of the 1/4" cartridge. We're sure you know that 3M makes one. And, that we make a great one.

Ours is certified 100%.

And comes in a protective, reusable box.

It could make quite a difference to someone.

Our whole line of magnetic media is like that.

Like IBM's new 5100. Neat. Applicable.

Usable.

So as we said before:

"IBM.

You rascals.

You've done it again."

Peace!

 **Information
Terminals**

323 Soquel Way
Sunnyvale, Ca. 94086
(408) 245-4400
TWX (910) 339-9381

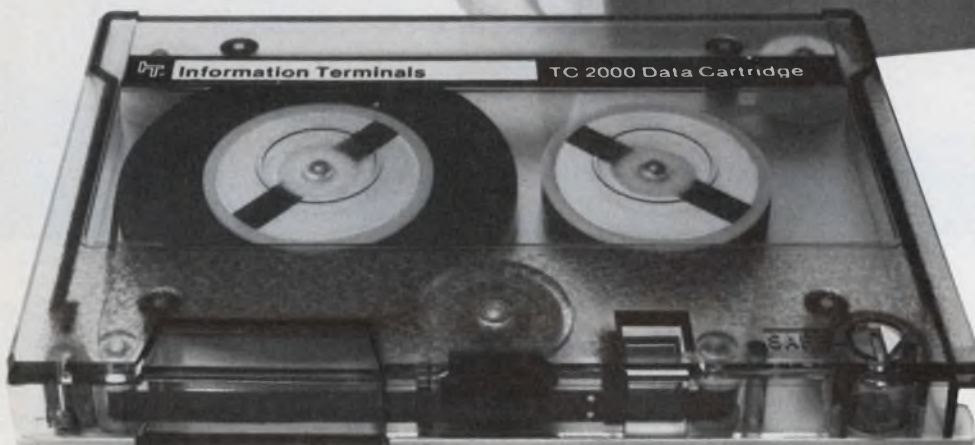

“Make a million of these. Cheap!”

That's quite a challenge – especially if it can't be done. But at Coors Porcelain Company, there's always somebody around who says, “Let's do it, anyhow.”

The customer wanted a special, metallized ceramic part – more than a million a year – to be used in an electronic assembly. He wanted the first shipment in 10 to 12 weeks. Furthermore – and here was the real pinch – the customer was dictating a very low cost.

The Bachman brothers solved the problem together. Al, a ceramics specialist, developed a high-speed cutting machine similar to a Gatling gun. And Jim came up with a low-cost

metallizing process that increased the production rate without sacrificing quality.



This is the kind of challenge we like to sink our teeth into at Coors Porcelain Company. Problems that force

us to create new technology, new processes for new or

improved ceramic products – at competitive prices.

Go ahead. Give us a challenge. Chances are we'll accept it – even if it's something that “can't be done.”

Coors Porcelain Company

600 Ninth Street / Golden, Colorado 80401 / (303) 279-6565 / Telex 45-593

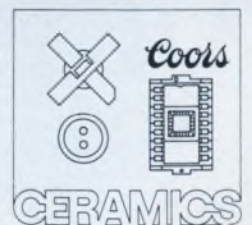

JANUARY 19, 1976

Programmable calculator announced for consumers

The first programmable consumer calculator—it lists for \$29.95—can store and execute a sequence of 10 program steps. The 2290, developed by Litronix, Cupertino, CA, simplifies calculations wherever a repetitive sequence of steps is involved, such as in figuring markups or discounts on store inventory, or in calculating the prices and total of a string of purchases with the sales tax included. It is also suitable for solving math problems such as the sum of squares and the value of a string of parallel resistances.

"The calculator remembers a sequence of function-key operations up to a total of 10," says George E. Smith, Litronix vice president of R & D. "This includes any sequence of plus-equals (+ =); minus-equals (- =); multiply (×); divide (÷); percent (%); add to memory (M+); subtract from memory (M-); and recall memory (RM). Clear memory (CM) cannot be used in a program, but this function is programmed by depressing recall-memory twice."

Smith points out that the \$29.95 calculator (\$39.95 in the rechargeable version) does not have exotic programming and branching as the high-priced programmable scientific machines do. But he notes that the user can store a program and repeat it without having to remember the particular key operations initially required.

To insert a program in the 2290, the display and memory are first cleared. To instruct the machine to store the program, a "learn" (L) key is pressed. The sequence of data and function keys is then pressed in the proper order until the program sequence is finished, at which point a "stop" or S key is pushed. To execute a program, the numerical data are entered and an "execute" key (E)



Consumer calculator can store and execute 10 program steps.

is operated in the proper sequence.

For example, the program to calculate the prices of a number of items, including a 6% sales tax on each, involves the following:

	Key pressed	Display
Clear display	C/ON	0.
Clear memory	CM	0.
Enter tax (%)	6	6
Add to memory	M+	6.
Learn program	L	6.
Enter item price (\$)	10	10
Multiply	×	10.
Recall tax from memory	RM	6.
Times percent	%	.6
Answer (\$)	+ =	10.6
Stop program	S	10.6

From this point on sales tax computations are made simply by entering any article price and pressing the execute (E) key, which then displays the price-plus-sales-tax total.

"The 2290 is part of a new Litronix calculator family with two full memories," says Smith. "In the 2290 we use one of those memories to store the 10 program steps."

While no square-root key appears, Smith says the chip has been designed to give that function in a nonorthodox manner. For example, to obtain a square root, the number is entered followed by depressing the divide-by and plus-equal keys.

The LED display on the 2290 is

unusually bright because each digit draws 150 mA instead of the usual 100, Smith says. Battery life with alkaline dry cells is 18 hours.

The 2290 also has standard four-function Litronix consumer-calculator features with a four-key accumulating memory, and the usual constant K. A significant battery-saving feature of the line is that the calculator automatically turns itself off after 12 minutes without an entry.

CIRCLE NO. 318

Cheap sun power by '85 is Government's aim

By 1985 the Government hopes to get electrical energy from the sun nearly as cheaply as the projected cost for electricity from conventional plants at the same time.

Specifically, the Energy Research and Development Administration, which is responsible for achieving this goal, hopes to establish an industrial capacity that can produce solar photovoltaic arrays with an annual total output of 500 MW of electricity at a sales price for solar panels of less than \$500 per peak kW.

Present photovoltaic systems using single-crystal silicon cells produce electricity at a solar cell array cost of about \$20,000 to \$25,000 per peak kW. It takes about 10 m² of cell area to produce a single kW at peak output.

In addition to bringing cost down by finding new materials and production techniques, further cuts should come from mass production. Today's market for solar cells is estimated to be about 100 kW annually. The projected market for 1985, according to an ERDA spokesman, is 500,000 kW a year.

Sandia Laboratories, Albuquerque, NM, is responsible for systems engineering and analysis and for developing tracking and concentrator systems for ERDA's National Photovoltaic Conversion Program.

Jet Propulsion Laboratories, Pasadena, CA, is overseeing a concerted effort to develop a low-cost silicon solar array, and the NASA-Lewis Research Center, Cleveland, OH, will carry out tests and provide standards.

Working competitively on conceptual designs of photovoltaic sys-

tems are General Electric, Westinghouse and Spectra-Labs. Progress is purposely not publicized in an attempt to prevent premature sharing of information.

JPL's pursuit of low-cost solar cells is being carried out by 16 companies and is divided into four categories:

- Production of low-cost solar-grade silicon.
- Economical production of silicon in large sheets suitable for use in solar cells.
- Development of economic encapsulation materials and techniques for array lifetimes greater than 20 years.
- Development of automated processes and facilities for the low-cost production arrays.

"Soon," an ERDA spokesman says, "we expect to sign contracts for procurement of array modules, which means putting together the results of the four efforts of JPL's supervisory work."

The photovoltaic program will also offer work in other areas: systems engineering and analysis, test and applications, R&D on materials and devices other than single crystal silicon, concentrator systems, and storage and power conditioning.

Particular emphasis will be placed on further development of techniques for the continuous drawing of silicon ribbon.

One of Sandia's tasks is to develop alternatives to fixed, flat-plate photovoltaic arrays that simply face the sun but neither track it nor focus the sun's rays through the use of curved reflectors or other devices—a technique that increases electrical output.

In this task, a number of optical systems for concentrating sunlight into solar cells will be explored, as well as methods of designing solar cells to operate efficiently under high illumination at high temperatures. The heat generated by concentrated sunlight is a particularly serious problem, since the solar cells work most efficiently at low temperatures.

"Whether our final results will indicate that photovoltaic systems can be used efficiently to generate electricity for an entire city remains to be seen," says Dr. Morton B. Prince, Chief of ERDA's Photovoltaic Branch. "We should know more in three to five

months."

Desert laser system detects earth tremors

Detecting and identifying earth tremors caused by nuclear explosions or by earthquakes is possible using a special mile-long Sandia Laboratories' laser-interferometer system, set up in the desert near Albuquerque, NM.

The system detects seismic strains in the earth by measuring the changes in the distance between two granite piers located at the opposite ends of an evacuated pipe through which a helium-neon laser beam makes a round trip. This laser-strain seismometer can measure movements of a few micro-inches between the granite piers.

The unusually broad bandwidth of the laser seismometer—up to 10 Hz—is useful in "fingerprinting" the differences between the sources of the seismic tremors. The earth movement in New Mexico due to variations in tidal pressures around the world is easily seen and displayed.

The system can detect movements as small as one-eighth the wavelength of the 632.8-nm helium-neon laser radiation. The laser uses a temperature-controlled Fabry-Perot interferometer cavity to stabilize its radiation. The laser system is located in a temperature-controlled room at one end of the pipe.

The laser beam is sent through the pipe to the far end, where a mirror bounces the beam back through the pipe to beat against itself in a separate interferometer setup.

Vacuum-pumping stations are located at three points along the pipe to maintain an internal pressure of about 10^{-3} Torr. Windows in the ends of the pipe are 1-1/2-inches thick to minimize optical distortion caused by the difference in pressure between the vacuum and the atmosphere.

DEC introduces new mainframe computer

A large-scale general-purpose mainframe computer known as the

Decsystem-20 was unveiled this week by Digital Equipment Corp., Marlboro, MA.

By integrating the central-processing-unit, the core memory, and the controllers into a single functioning unit, Digital's engineers have managed to compress the new computer's entire hardware into a maximum of only three bays, according to a company spokesman. This number is compared with approximately 10 to 20 bays required by the system's predecessor, Decsystem-10.

Described as a machine that bridges the gap between the world of the large-scale computer and that of the minicomputer, the new system can be operated from a single console or from one of up to 64 time-shared terminals.

Despite its relatively small size and low cost (selling price is reported to be in the \$300,000 to \$350,000 range) the system will provide many of the functions of a large-scale computer, the DEC spokesman said. These features include multistream batch processing, virtual memory, demand paging, data-base management, and a business instruction set.

Navy builds compact MJ energy storage system

Scientists at the Naval Research Laboratory, Washington, DC, have developed a high-speed flywheel energy-storage system in which enough electrical energy can be stored to power lasers, electron-beam generators and high-energy-density plasma generators used in thermonuclear reactor research.

The system occupies a hundredth the space of a conventional capacitor bank, which normally powers such equipment.

Electrical energy is extracted from the flywheel by applying a magnetic field parallel to the axis of the wheels. A radial current is generated which charges a storage inductor. The electrical energy is rapidly transferred to a load by opening the inductive circuit.

Currently operating at a level of about 1 MJ, the system will eventually be capable of transferring about 5 MJ's to a load in 500 μ s, which represents a pulsed-power output of 10 GW.

Five hundred million thumbwheel

switches
can't be wrong.
Theoretically
we could ship you
500,000,000
thumbwheel switches
without duplicating
any one.
If you need
any thumbwheel switch
you can probably find it
among that 500,000,000.
Our four big sellers are:

Stripswitch.

PC board mounted
with coded outputs,
less than \$2.

Series 1776.

Standard miniature,
general purpose,
low price.

Series 1976.

Miniature slimline,
same features as 1776,
also low price.

Series 2000.

Full size,
general purpose,
low price.



Stripswitch

1776

1976

2000

Believe it or not,
those four switches
give us the broadest line
of industrial thumbwheel switches
of any company
in the world.

Send for
our free Switch Products Guide.
We've got your switch.

EISCO

SWITCHES/READERS/PACKAGING

1441 East Chestnut Avenue, Santa Ana, California 92701
Phone 714/835-6000

Also stocked and serviced in North America by G. S. Marshall, Hall-Mark, Schweber, R-A-E, Zentronics.

This display makes oscilloscope timing measurements easier, faster and more accurate.

Main sweep has two intensified zones.

Two intensified zones on the main sweep correspond to the two expanded, delayed sweeps shown below. They are quickly and independently positioned to provide a visual approximation of the Δ time measurement.

Two expanded sweeps.

Both intensified zones are expanded at a faster rate for better resolution and are swept alternately with the main sweep trace for a complete, powerful measurement display. Δ time accuracy is enhanced by superimposing one trace over the other, yet they can be vertically separated for independent analysis.

Sweep rates displayed digitally.

Digital crt readout displays both sweep rates for measurement ease and convenient photographic documentation. To the left is the main sweep rate and to the right is the sweep rate for the two alternate (or delayed) sweeps.

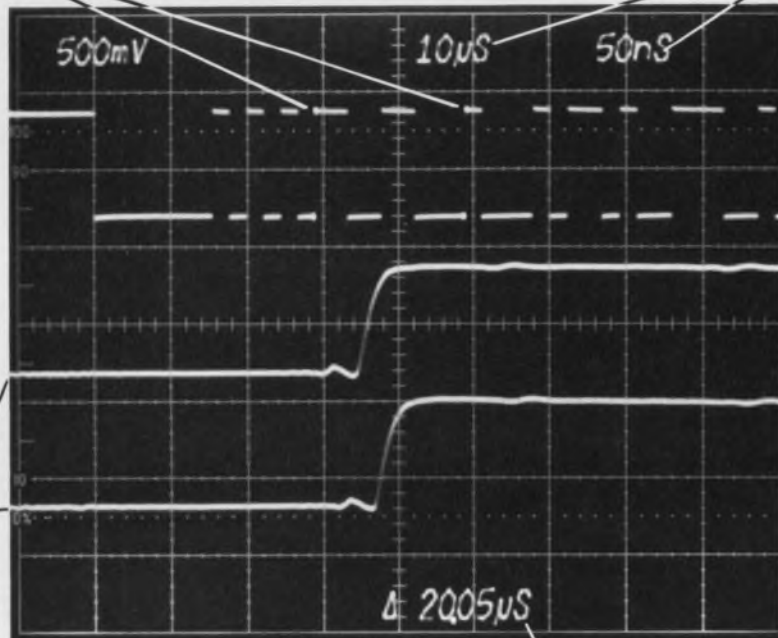

Time difference is computed and displayed digitally.

The time difference (Δ time) between each of delayed sweeps (or intensified zones) is digitally computed and displayed directly on the crt for swift and convenient measurement. When similar points on each of the alternate delayed traces are aligned, the Δ time readout gives you a highly accurate measurement of the time between the points.

CRT display, photographed on a 7904 oscilloscope, shown full size.

Fill out and mail to: Tektronix, Inc., P.O. Box 500, Beaverton, OR 97077

Please send me

- The new 7B80-Series brochure
- Δ time measurement application notes.
- A catalog of 7000-Series oscilloscope mainframes and plug-ins.
- Please have a Tektronix Field Engineer contact me about a demonstration.

Name _____ Position _____
 Company _____ Mail Sta _____
 Address _____
 City _____ State _____ Zip _____
 Phone (_____) _____

Only these new plug-in time bases make it possible.

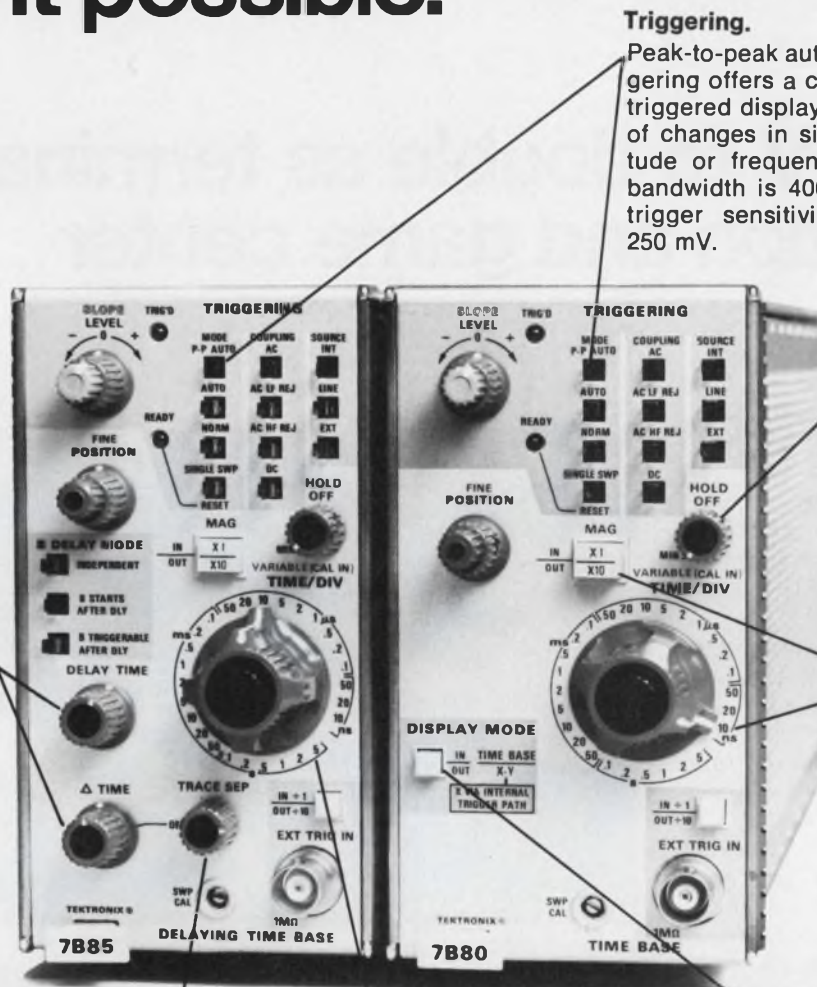

Triggering.
Peak-to-peak automatic triggering offers a continuously triggered display regardless of changes in signal amplitude or frequency. Trigger bandwidth is 400 MHz with trigger sensitivity at least 250 mV.

Trigger holdoff adjustable.
Variable trigger hold-off allows you to obtain stable displays on complex signals like digital data trains.

Controls position both intensified zones.

DELAY TIME positions the first intensified zone. Δ TIME positions the second intensified zone relative to the first. The Δ delay time value — the time between the two intensified zones — is presented digitally on the crt.

7B80 sweep rates.
The alternate (delayed) sweeps can be set to any rate up to 1 ns/division on the 7B80. Naturally, other 7000 Series time bases with different performance features can be used with the 7B85 to make Δ time delay measurements.

Alternate traces can be separated.
TRACE SEPARATION activates the Δ delay time mode and permits the two delayed traces to be vertically positioned with respect to each other for your most convenient display.

7B85 sweep rates.
Sweep rate for the main sweep can be set from 1 ns/division to 5 s/division.

Optional X-Y mode.
For phase relationship measurements, an optional X-Y mode routes the X (horizontal) signal from an oscilloscope vertical amplifier to the horizontal sweep unit without changing input probes.

Here's how to get more information

Your nearby Tektronix Field Engineer will be happy to show you how these new time bases combine with a 7000-Series oscilloscope mainframe and other 7000-Series plug-in instrumentation to fit your measurement needs. Just call your local Tektronix Field Office or send the coupon to Tektronix, Inc., P.O. Box 500, Beaverton, OR 97077. In Europe, Tektronix Limited, P.O. Box 36, St. Peter Port, Guernsey, Channel Islands.



The 7000 Series...more than an oscilloscope

FOR TECHNICAL DATA CIRCLE # 241
FOR DEMONSTRATION CIRCLE # 242

Home TV to double as terminal, information and game center

The home television receiver is taking on a more important role. Although intended originally only to receive broadcasted TV programs, the set is being eyed for such applications as these:

- An information service, whereby up to 100 pages of information are available at the touch of a button.

- Recreation, with improved and cheaper electronic games using the picture tube for a display.

- A home computer terminal, with the user simply plugging in a typewriter keyboard that has some extra electronic circuitry.

The most dramatic new development is a system that can give headlines, local and national news, stock market reports, sports scores, weather and a variety of other information in both alphanumeric and graphic form.

The new system is known both as CEEFAX (for seeing facts) and ORACLE (for optional reception of announcement by coded line electronics). It was developed in a joint effort in Britain by the BBC and the Independent Broadcasting Authority. Conceived in 1972, the information service is now part of BBC's regular TV programming.

Between the lines

Operation of the CEEFAX/ORACLE system is based on the fact that several lines in the TV signal carry no video information. These are lines that occur during the field blanking interval.

According to James Redmond, BBC's director of engineering, in-



Updated information is being entered into the CEEFAX system via computer terminal (upper left), while a TV monitor shows a weather map that is being transmitted (lower right).

formation transmitted as a series of coded pulses is carried by two of these normally invisible lines in each TV field. Two fields are interlaced to form one picture.

Television engineers have for years used these TV lines to transmit information on picture quality and to identify the source of a transmitted program in central control rooms.

In the CEEFAX system, which is based on a television picture composed of 625 lines (in contrast with the 525-line system in the United States), the extra information is added to the 17th and 18th lines of the first TV field and the 330th and 331st lines of the second TV field.

The time it takes to scan one line in a 625-line system is 64 μ s. Of that, 12 μ s are used for synchronization and line blanking.

The remaining 52 μ s are normally used to transmit the picture signal. But instead of sending a picture signal, engineers at the BBC decided to break this 52- μ s period up into 45 equal segments, each of which would contain one 8-bit word of data. Only 40 data words are needed to transmit the information to be displayed. The remaining five words are for synchronization and row identification.

The system uses an NRZ (non-return to zero) format to transmit data. The advantage is that this minimizes the bandwidth required, because it also minimizes the number of pulse transitions encountered. For example, if several bits that have the logic value ONE are transmitted one after the other, the voltage simply stays at the high level for the required number of bit periods instead of producing



MOS memories

TI's New TMS 4051

The fully TTL compatible 4K RAM in the 18-pin space saver package

Available now in the 18-pin space-saver package: A fully TTL compatible 4K RAM. In addition to the high board density achievable with the compact 18-pin package, board space is also minimized because the TMS 4051 is fully TTL compatible and fewer parts are necessary. Fewer parts, less wiring, and a smaller PC board mean the TMS 4051 will save you money.

Easiest 4K dynamic RAM to use.

The TMS 4051 is fully compatible and will plug directly into your Series 74 TTL system. No longer is a high voltage clock driver needed to interface from TTL to MOS. All TMS 4051 inputs (including the single clock) and output interface directly with TTL.

Reduce parts. Save PC board space.

In addition to eliminating the need

TI's 18-PIN 4K RAM FAMILY			
		ACCESS TIME (MAX)	READ OR WRITE CYCLE (MIN)
TMS 4051	TTL CLOCK	300 ns	470 ns
TMS 4051-1	TTL CLOCK	250 ns	430 ns
TMS 4050	HI-LEVEL CLOCK	300 ns	470 ns
TMS 4050-1	HI-LEVEL CLOCK	250 ns	430 ns
TMS 4050-2	HI-LEVEL CLOCK	200 ns	400 ns

for clock driver ICs, the TMS 4051 requires no external address multiplexers or address registers. The on-chip address registers provide full direct addressing eliminating system timing headaches. The TMS 4051's common data I/O eliminates the need for an external I/O multiplexer making it ideal for bus-oriented and microprocessor based systems. And the space saver package alone yields as much as 30% board savings over 22-pin 4K RAMs.

Availability is now.

TMS 4051 adds to TI's pioneering experience and volume production of 4K RAMs. TMS 4051 uses the same proven single transistor cell design as TI's popular TMS 4030 and 4060. Result: High density. High yield. Lower cost to you. The TMS 4051 is available in 300 mil wide 18-pin plastic and ceramic packages.

Proven reliability.

The TMS 4051 uses TI's reliable N-channel silicon gate process, the same as TI's other RAMs. And TI has proven field reliability.

For a 24-page reliability report of TI's 4K RAM family or a data sheet, write on your letterhead to: Texas Instruments Incorporated P.O. Box 5012, M/S 308, Dallas, Texas 75222.



TEXAS INSTRUMENTS
INCORPORATED

a pulse for each bit.

The reduction in bandwidth, however, comes at a price. The receiving system must provide its own clock, because with the NRZ coding, there is no built-in clock in the signal when several bits with the same state follow one another. The frequency of the receiving system clock is 444 times the line scan frequency, or 6.9375 MHz. This is also the bit rate of the data received.

In operation, a subscriber to the CEEFAX/ORACLE system pushes one of two buttons on a hand-held, calculator-like keyboard to select either normal viewing or CEEFAX. If the CEEFAX viewing is chosen, the picture that would normally be seen on the channel the set is tuned to is blanked out and the CEEFAX data are displayed instead.

To choose a particular page, a user merely punches in the number of the page he is interested in. Different pages are used for different subjects.

A page of information on the CEEFAX/ORACLE system consists of 24 lines of information, each containing 40 characters. Since there are only two lines available per field, and there are 50 fields per second (with a 625-line system), it takes 0.24 s to transmit a full page of 24 lines.

Once a page has been selected, the 960 words of digital data that make up the 40-by-24 character array are entered into a random access memory. The RAM allows the page of data selected to stay on the TV screen until a new page is selected, or the Normal Viewing button is pushed.

BBC's Redmond notes that a 100-page magazine, containing between 150 and 200 words on each page, can be serially transmitted in about 25 s. Thus the average access time to any particular page is 12.5 s. Each television channel is capable of carrying up to eight magazines.

Special decoder needed

The major obstacle preventing widespread adoption and use of the CEEFAX/ORACLE system at present is a lack of decoders to process the received signal. There are only about 200 TV receivers in Britain equipped to receive the

special signal. But British TV manufacturers are busy developing decoders for their top-of-the-line sets, while other manufacturers are looking at the add-on market for already existing sets.

Texas Instruments Ltd. of Bedford, England, has developed a decoding module that it calls Tifax. The decoder, which should be going into production by the first quarter of 1976, will initially cost TV makers about \$100 each. A TI spokesman notes, however, that as production increases, the price of the decoder could drop to about \$20. The company sees this coming sometime in 1978.

The Tifax decoder is on a 4-by-6-in. PC board and is designed for use in new TV sets. It requires only a composite video signal, a line pulse feed for synchronization and a 5-V power supply. The signal and blanking outputs it provides can be easily connected to a cascade video output stage.

An external adapter that could be connected to already existing sets would cost considerably more, because it would need a separate tuner, i-f strip modulator.

New interest in TV games

Ever since Magnavox introduced its Odyssey TV game in 1972, consumers have been interested in add-on devices for their TVs. But at a cost of around \$100 for these games, there has been no widespread acceptance.

However with the potential low price of large-volume LSI circuits, game prices are now dropping and with manufacturers looking for new consumer markets as large as the calculator one, much design effort is underway on TV games. One result is a new game under the trade name "Novus," from National Semiconductor's Consumer Products Division, Santa Clara, CA. This unit provides three games not only with sound, but in color, and is reported to use an LSI chip with metal-gate p-channel MOS. The game, which can also be used on black and white sets, attaches to the antenna terminals of the television receiver.

National's unit is expected to sell at from \$75 to \$100. It will be introduced at this year's summer Consumer Electronics Show.

Atari Inc. of Los Gatos, CA, one

of the earliest entrants into the electronic-game competition, is currently marketing "Pong," a home-TV table-tennis game. "Pong" uses a MOS chip in place of hard-wired circuitry.

Other developments for the TV sportsman come from Magnavox. The original Odyssey 100 featured two games, hockey and tennis. Current versions allow the players to vary the speed of the ball and to apply "English" to it. In addition, the sound of the ball or puck's rebound is heard.

The newer Odyssey 200 adds handball to the original two games and includes a switch so that either two or four individuals can play. Electronic scoring, displayed on the screen, is also provided in the newer model.

TV becomes terminal

By hooking up a TV typewriter to a television set, the user can convert it to a computer terminal. TV typewriters come as assembled units, but they are also available in kit form. An example is the CT-1024 from Southwest Technical Products Corp., San Antonio, TX.

The CT-1024 has a ROM that generates ASCII characters and 1 k of memory to store information for display on the TV screen. The input is an ASCII keyboard, and the output is connected to the TV's amplifier by a 75- Ω coaxial cable. Some TV typewriters are connected to the television receiver through the antenna terminal.

According to Dan Meyer, president of Southwest, the CT-1024 can display a page of information, consisting of 16 lines of 32 characters each. The unit's memory can store up to two pages of information, or 1024 characters.

The CT-1024 also comes with an optional cassette recorder adaptor, so that information can be entered on or retrieved from standard cassette tapes, thereby providing virtually unlimited storage.

Like the electronic games, the CT-1024 is designed to be used on an unoccupied TV channel. However, it is possible to hook it up for titling on standard TV pictures.

The complete computer unit ranges in price from \$200 to \$300, depending on options. ■■

Amphenol wants to break up your marriage.



You and your
SMA supplier —
maybe you've
been a twosome
long enough.

Now there's an alternative — Amphenol. You can't get better SMA connectors than Amphenol's. Ours operate at all microwave frequencies up to 25 GHz. RF performance and mechanical integrity comply with MIL-C-39012. They're easy to assemble with either crimp or solder connections. And our quality will give you a change of heart: all shell and body parts are gold-plated stainless steel. The center contact is gold-plated beryllium-copper. The dielectric is solid TFE, making Amphenol SMA's completely interchangeable with your present source.

Our price will make you want to change partners. When you hear our price, you'll know our SMA's are the best value around. So ask for a quote.

There's a big selection of popular types. Including styles for cable mounting, flange and bulkhead mounting, and stripline mounting. We also offer between-series adapters.

And our SMA's are available. Wherever you are. Your Amphenol Industrial Distributor can fix you up with the SMA connectors you need, by giving you fast off-the-shelf service. He's close to you (there are over sixty Amphenol Industrial Distributors — nationwide). Give him a ring (on the phone, not the finger). Or for more information, write or call us: Amphenol RF Division, 33 East Franklin Street, Danbury, Connecticut 06810. (203) 743-9272.



**BUNKER
RAMO**

*When you can connect it
and forget it...that's quality.*

AMPHENOL

Cathodochromic CRT stores image indefinitely, erases easily

A major advance in both direct view and projection cathodochromic CRT technology has been announced by MIT. It holds two patents—and has filed for three more—on cathodochromic cathode ray tubes (CCRTs), whose advantages are said to surpass all other CCRT devices.

The tubes were invented at the Massachusetts Institute of Technology by Dr. Lee T. Todd, Jr. with the assistance of Eugene F. Farrell and Dr. Arthur Linz. Todd says that once a message is written on a CCRT, it is almost permanent. Erasure is accomplished by heating the material to approximately 300 C.

Since World War II, engineers have sought to develop a CRT that would store or retain its display indefinitely, have sufficiently high resolution to allow printed matter to be shown, have enough brightness and contrast to operate in high ambient light (such as sunlight)—and yet not require continuous power.

According to Todd, now on the faculty of the University of Kentucky, the new CCRT achieves these goals by use of a material that can be easily erased—an oxidized variation of bromine-sodalite and an overlapping electron-beam erase technique.

The MIT direct-view tube is built with only one electron gun and with screen material settled directly on the inside faceplate of the CRT envelope. Information is written by exposing the image screen with a 500 μ A, 20-kV electron beam that provides an energy density of about 0.3 joule/sq. cm.

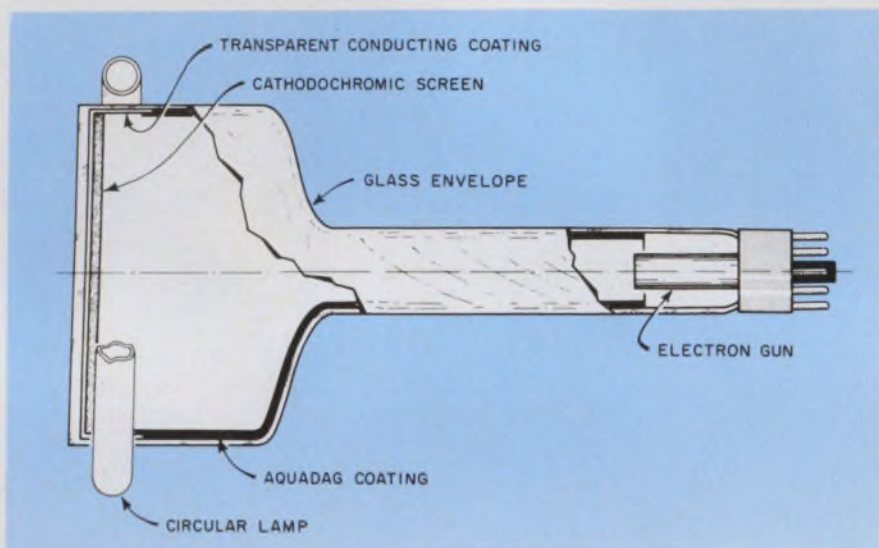

MIT's transmission cathodochromic CRT stores indefinitely an image inscribed by electron beam. Heating the material on the screen erases it in one second.

The excitation changes the color of the material from white to purple.

Coloration results from the formation of F centers, which cause an absorption band at approximately 5550 Å. While a portion of the induced coloration may be erased by irradiation with visible light, the remaining coloration can be erased only by heating the material to approximately 300 C. In this tube, erasure is obtained by increasing the electron beam exposure to about 1 joule/sq. cm. To give complete erasure, overlapping horizontal lines are raster scanned.

Airport displays waste power

Phosphor television screens used in home TV units, and at airports to display departures and arrivals, require continuous power; the electron beam must scan the image 30 times a second, which represents a tremendous power waste for displays such as those at airports that may not change for 10 minutes or

more at a stretch.

Cathodochromic CRTs employing electron-beam erase and operating in the thermal-erase mode offer a number of advantages over the usual phosphor displays, according to Todd:

- They provide flicker-free display, with inherent memory that doesn't need refreshing.
- Selective erase—a small portion of a display can be erased.
- The screen accepts rewriting immediately after erasures.
- The high resolution capability (100 to 200 lines/inch) allows the viewing of typed documents with fine print, on a screen, 9 inches by 12 inches or smaller.
- Hard copies of the displayed information can be obtained easily using normal photocopying techniques because the image doesn't fade in bright light.
- The gray-scale capability permits viewing of many types of information not possible on bistable displays.

INTRODUCING THE FLUKE SUMMA II SERIES DATA LOGGERS

The first data logger with full "microprocessor power"... As the leading manufacturer of digital voltmeters, Fluke is the industry's greatest expert on low level analog measurements.

Because Fluke is an innovator in the use of microprocessors in instrumentation, our new Summa II Series data loggers offer maximum "microprocessor power."

Top of the line is the Summa II Model 2240A. Scan 1 to 1,000 inputs, up to 60 in the mainframe with resolution to 1 microvolt and 0.1°.

Wide dynamic range (40,000 counts) and high resolution allow the user to scan faster and more economically over a greater variety of inputs.

Keyboard entry allows the user to program range, function, skip, alarm limits, time interval and fixed data from the front panel. Skip an open channel or an unused channel without disabling the entire block of channels. The data logger has several alarm scan modes which make it ideally suited to process monitoring.

Scan intervals are keyboard selectable from 1 second to 24 hours—that's 86,400 possible intervals in all. And the first interval can be different from the remaining

intervals. Program the Summa II 2240A to begin automatically scanning any time you like. The keyboard programmable 9-digit calendar clock has resolution to 1 second.

Better Specs Across-the-Board

Because we didn't simply update an old product, but made the microprocessor the basis for an integral design, Summa II data loggers are many ways better. The Summa II Series reads all common thermocouple types better and more accurately. The LSI microprocessor lets us drastically reduce the number of IC's, lowering power consumption, thus eliminating the need for fans and vastly improving reliability.

Wide Choice of Options

Options include alarms, program memory expansion, mag and paper tape, teletype and RS232C interfaces, digital input and thermocouple conditioning.

Standard features on the Summa II 2240A include 6 digits of fixed data, complete program printout, and program storage good for *more than five years*.

An Outstanding Value

At \$4295* the Summa II 2240A is the most complete data logger in a single box on the market. And it's backed by the Fluke reputation for quality and dependability that is recognized throughout the world. Other models in Fluke's Summa II Series start at \$2865*

For data out today, dial our toll-free number, 800-426-0361.



*USA only

John Fluke Mfg. Co., Inc.
P.O. Box 43210
Mountlake Terrace, WA 98043

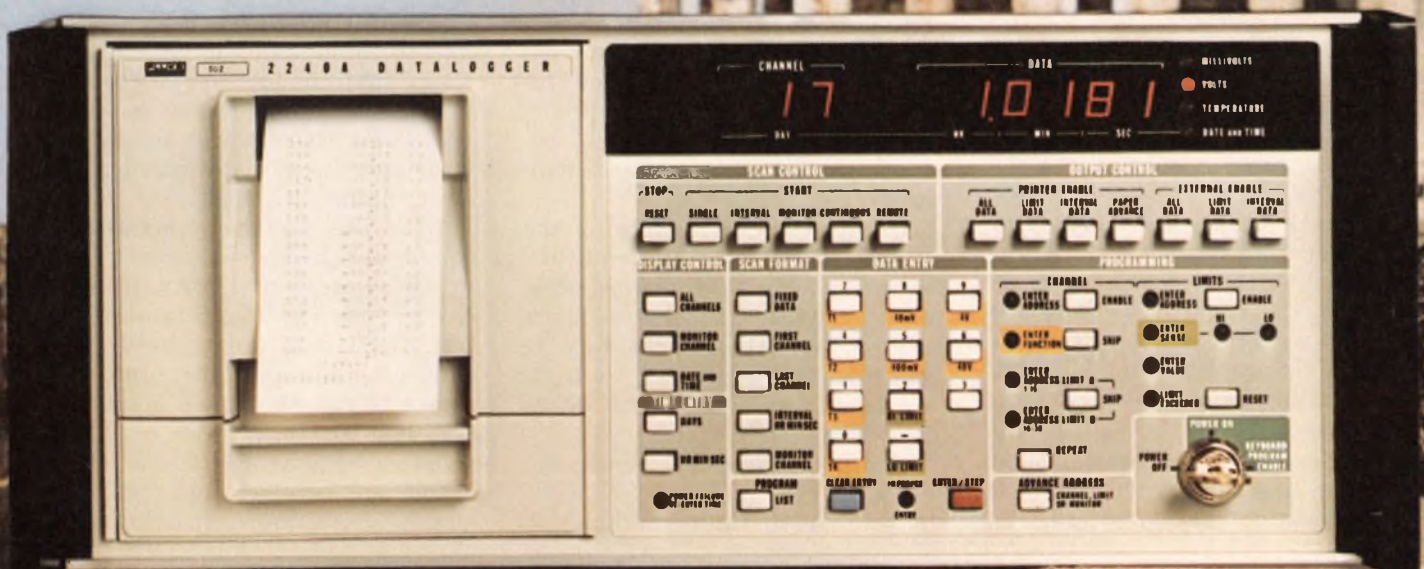

For demo circle No. 261

For literature only circle No. 262

■ The display is generally a dark image on a white background rather than the light-on-dark of most phosphor-storage scopes.

Both writing and erasing rates are slower than those of standard phosphor displays, but there are a number of applications that can tolerate these slower speeds—document retrieval, airport flight schedule displays, signature verification, electronic mail, and numerous medical applications, Todd says. Slower data rates are also compatible with transmission over telephone and radio communications channels, and make possible remote terminals in homes, offices, and motor vehicles without extensive transmission and receiving systems.

A cathodochromic CRT developed and abandoned by RCA, Princeton, NJ, used resistive heating to erase. With this technique, sodalite powder is settled on a thin mica substrate coated with a transparent conductive layer and supported slightly behind the faceplate. Information is written on the screen with the electron beam and erased by passing a current through the transparent heater. Erasure takes about two seconds for a 3-inch by 3-inch substrate.

A storage tube being produced by Thomas Electronics, Wayne, NJ, uses potassium chloride for an image screen deposited on a thin mica sheet or other substrate suspended slightly behind the faceplate.

Writing is achieved by directly exposing the image-screen material with a low-current electron beam. Erasure is accomplished by heating the screen structure with a heating element located near the screen, within the CCRT envelope.

Todd studied two types of direct-view CCRTs, reflective and transmission tubes, before deciding which design to develop further.

Reflective tubes use a thin layer of aluminum on the back of the image screen that serves as a portion of the anode. The image is read using light reflected from the screen. Transmission CCRTs employ a transparent conductive layer on the faceplate that allows the image to be read by passing light through the screen. The light is modulated by the information on the screen.



Dr. Lee T. Todd, Jr., inventor of MIT's CCRT tube, shows the selective erase capability of a projection tube display.

Todd found the electron beam erase technique was severely limited in reflective CCRTs due to the evaporation of the aluminum anode caused by the heat of the electron beam during erase. However, with a transmission CCRT, over 5000 write-erase cycles were performed with no deterioration.

There are pros and cons for all CCRT tubes considered, Todd says. The RCA CCRT offered two advantages over the direct-view MIT transmission CCRT. First, the erase time per frame was approximately three times faster than for the MIT tube with the same viewing area. This advantage was diminished, however, because the substrate had to cool slightly before rewriting. Second, a display system using the RCA tube could provide high resolution images without off-axis focus-correction circuitry. (Off-axis focus is necessary in the MIT tube for the erase technique to work properly.)

On the other hand, the RCA tube was more fragile, more difficult to produce and thus more expensive, Todd says. It did not provide selective erase, and its screen size was difficult to increase because of the thinness of the substrate.

He says the MIT tube is the most inexpensive direct view CCRT operating in the thermal-erase mode: the cost of parts to fabricate a five-inch-diameter tube is less than \$50, even when the parts are bought as single items rather than in quantity.

Additional applications are envisioned due to a new class of luminescent display materials that are cathodochromic and can be

viewed in both bright ambient light and in low ambient light when exposed to ultraviolet excitation. These materials are germanium-doped bromine-sodalite powders.

Writing on the luminescent CCRTs is done with an electron beam. In high ambient light the image appears in purple on white, as with usual CCRT displays. In low ambient light the entire screen is exposed to ultraviolet light, which causes the uncolored portion to luminesce while the colored areas do not; the image appears as black on green.

Luminescent CCRTs are ideal for applications in which high resolution and high contrast are desirable, or when storage displays are needed for both high and low ambient light, such as in aircraft, in motor vehicles and on board ships, Todd says.

The erase time for Todd's direct view CCRT is approximately six seconds for a 3-inch by 3-inch image screen. For larger screens the erase time takes somewhat longer.

Projection model on the way

Todd is now developing a projection CCRT that will permit the use of a 1-inch by 1-1/2-inch image screen that can be enlarged to an 8-1/2-inch by 11-inch display while providing high resolution and high contrast at a distance of about one foot.

Since the size of the image screen is reduced, a much shorter erase time is possible.

The projection system, which is based on a variation of a projection tube made by the Advent Corp. of Cambridge, MA, uses a mirror to reflect and project the image from the interior face of the CCRT screen. The image is written in a low-current, high-resolution mode and erased in a high-current, large, beamwidth mode.

With the system an 8-1/2-inch by 11-inch printed document, for example, can be presented in about five seconds and erased in one second. Hard copy can be easily obtained by allowing the projected image to fall on a piece of photosensitive copying paper.

Large displays for use in command and control and business presentations can be made by using larger projection CCRTs. ■■

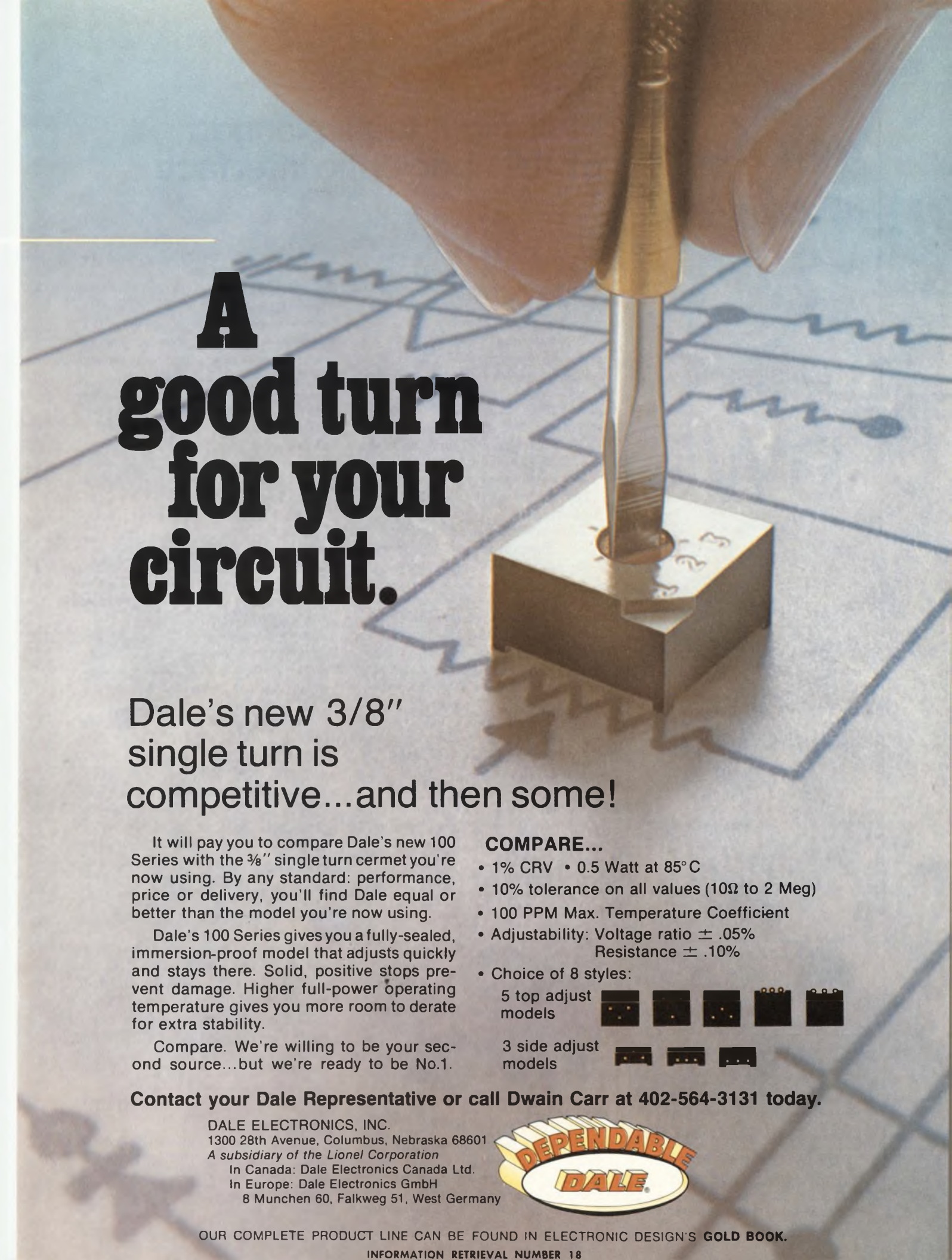

A good turn for your circuit.

Dale's new 3/8" single turn is competitive...and then some!

It will pay you to compare Dale's new 100 Series with the 3/8" single turn cermet you're now using. By any standard: performance, price or delivery, you'll find Dale equal or better than the model you're now using.

Dale's 100 Series gives you a fully-sealed, immersion-proof model that adjusts quickly and stays there. Solid, positive stops prevent damage. Higher full-power operating temperature gives you more room to derate for extra stability.

Compare. We're willing to be your second source...but we're ready to be No.1.

COMPARE...

- 1% CRV • 0.5 Watt at 85°C
- 10% tolerance on all values (10Ω to 2 Meg)
- 100 PPM Max. Temperature Coefficient
- Adjustability: Voltage ratio $\pm .05\%$
Resistance $\pm .10\%$
- Choice of 8 styles:

5 top adjust models



3 side adjust models



Contact your Dale Representative or call Dwain Carr at 402-564-3131 today.

DALE ELECTRONICS, INC.
1300 28th Avenue, Columbus, Nebraska 68601
A subsidiary of the Lionel Corporation
In Canada: Dale Electronics Canada Ltd.
In Europe: Dale Electronics GmbH
8 Munchen 60, Falkweg 51, West Germany



OUR COMPLETE PRODUCT LINE CAN BE FOUND IN ELECTRONIC DESIGN'S GOLD BOOK.

INFORMATION RETRIEVAL NUMBER 18

*Now
you have
a choice!*

RCL

...A SECOND
SOURCE FOR

BW's

Molded
Wire-Wound Resistors



...AS LOW AS 5¢ EACH!

"SPECIALS" AVAILABLE

△ VALUES AS LOW
AS .01 OHMS!

△ TCs AS LOW AS
10 PPM!

△ TOLERANCES AS
LOW AS 1%!

Send For New '76 Catalog Or
Call our Hotline For Name
Of Your Local Representative
Or Stocking Distributor.
(603) 627-3831

AMF

RCL Electronics

195 McGregor Street
Manchester, N.H. 03102

INFORMATION RETRIEVAL NUMBER 23

NEWS

First flight tests planned of full fiber-optic interface

Sometime this month the Navy will begin flight testing the first complete fiber-optic system—an interface for data communications. Previous airborne tests of fiber optics were restricted to small subsystems.

Developed by IBM Federal Systems in Owego, NY, the optical cabling system will be installed at the Naval Weapons Center, China Lake, CA, in a tactical computer aboard an A-7 attack aircraft. The IBM interface will allow data signals to be transmitted to the computer peripherals through fiber-optic cables rather than copper conductors.

The advantages of converting were described by Commander John Ellis, project manager of the ALOFT (airborne light optical fiber technology) program at the Naval Electronics Laboratory Center, San Diego. These include a reduction of 21 to 1 in the weight of point-to-point cabling, as well as increased immunity to electromagnetic pulse interference.

The weight reduction was actually developed in two steps. Initially in the design program, 115 selected computer signals were time-division-multiplexed into 13 serial-data channels. At this stage coaxial cables could have been used to transmit the high-data-rate signals (10 Mbits/sec). This would have achieved an immediate weight reduction of 8 to 1 over point-to-point connections.



Fiber-optic coupling interface for Naval aircraft offers significant size and weight reduction over point-to-point wire cabling.

The Navy, however, went directly to the IBM fiber-optic configuration to improve the weight reduction ratio 21 to 1.

Few difficulties arose in the fiber-optic design, Ellis reports. The design of the high-speed multiplexer, however, required special care to minimize cross-talk caused by stray electrical couplings.

More than just feasibility information is expected from the combined 50 to 100 hours of scheduled flight tests plus ground-based environmental tests now under way. Also anticipated are sufficient data from which to write future MIL specifications on airborne fiber-optic systems.

Although the program was not intended to develop new components, Ellis points out that significant new devices did emerge from the design effort. One was a fiber-optic rack and panel multichannel connector developed by ITT Cannon. Another was a pressure bulkhead optical penetration device. This provides an optical path into a pressurized enclosure from the outside.

The next goal of the ALOFT program, Ellis believes, will be the development of a fiber-optic data bus—a single optical connector that can carry all the information between the computer and the peripherals. This must await completion of current work on fiber-optic access couplers—devices that transfer the signals on and off the data bus.

Another aspect of the test program, according to Ellis, is the availability of a fiber-optic field repair kit. This will permit Navy technicians to make ground repairs, should a break occur in the fiber cables. Each splice would introduce a signal loss of 2.8 to 3 dB, but Ellis says, this is well within the allowed margin in the ALOFT configuration.

The Navy commander predicts that by the early 1980s fiber-optic and coaxial-cable data links will be cost-competitive. ■■

Stripline Wideband Microwave Signal-Processing Components and Subassemblies .030 to 18 GHz

Couplers

90° and 180° 3dB hybrid, octave and wider bandwidths from 0.030 to 18.0 GHz. Standard and miniature cases with SMA connectors. Low cost ultra-miniature models with tab connectors.

Typical specifications are:

Model	Type	Freq. (GHz)	Isolation (dB)	Amplitude Balance (dB)	Phase Balance
10016-3	90°	2.0- 4.0	28	±0.5	±1.5°
1J0568-3	90°, miniature	7.0-11.0	22	±0.5	±3.0°
10260-3	90°, ultra-miniature	0.225-0.400	25	±0.5	±1.5°
30057-3	180°	4.0-8.0	20	±0.5	±8.0°

We make H-style and in-line directional couplers, in 6, 10, 20 & 30 coupling values, from .06 to 18 GHz.

Model	Type	Freq. (GHz)	Coupling Variation (dB)	Coupling Frequency Sensitivity (dB)	Minimum Directivity (dB)
10616-10	10 dB	2.0- 4.0	±0.5	±0.75	20
1F062810	10 dB, miniature	8.0-12.4	±0.5	±0.6	18

Power Dividers/Combiner-Dividers

In-phase, octave and wider bandwidths from 0.06 to 18.0 GHz. 2ⁿ outputs, or n, if you don't need equal phase division. Standard cases with SMA connectors. Low cost ultra-miniature combiner/dividers with tab connectors from 0.115 to 3.365 GHz.

Two typical models:

Model	Type	Freq. (GHz)	Isolation (dB)	Insertion Loss (dB)	Amplitude Balance (dB)
40266	In-phase, 2-way	2.0-4.0	25	0.3	±0.2
40110	Combiner-divider, ultra-miniature, 4-way, tab connectors	0.225-0.400	20	0.5	±0.9

Balanced Mixers/DSB Modulators

Double-balanced mixers, 7 models from 1 to 12.4 GHz 90° biased and unbiased balanced mixers, octave and wider bandwidths from 0.5 to 18.0 GHz, with broadband IF outputs. Also, models using 180° hybrids (for good LO/RF isolation and 10 dB typical carrier suppression as DSB modulators). Plus, Ortho-Quad® models using a unique patented design (for guaranteed VSWR, NF, and LO/RF isolation).

Typical specifications are:

Model	Type	Freq. (GHz)	Conversion Loss (dB)	LO/RF Isolation (dB)	VSWR	LO Power (dBm)
72340	Dbl. Bal.	2.6-5.2	7.0	25	1.8	—
70117	90° Unbiased	4.0-8.0	6.5	10	1.4	—
70060	90° Biased	1.3-2.6	6.5	18	1.5	-3
70057	180°	4.0-8.0	7.0	18	1.8	—
7A0127	Ortho-Quad®	4.0-8.0	7.0	25	1.25	—

Pin Diode Switches, Attenuators, and Modulators

Attenuator/SPST switch (reflective), 6 models from 0.5 to 18.0 GHz, 7 digital attenuator models (absorptive), from 1.0 to 18.0 GHz, with 63 dB attenuation in 1 dB steps. Plus analog attenuators (absorptive), current controlled or voltage controlled, the latter with or without separate linearizing unit for response of 5.5 dB/V ± 3.0 dB (± 1 dB with custom alignment).

Typical specifications are:

Model	Type	Freq. (GHz)	Isolation (dB)	Switching Speed, Max (ns)	Insertion Loss (dB)	VSWR
80627	SPST	4.0-8.0	60	5	1.5	1.8

Model	Type	Freq. (GHz)	Attenuation Range (dB)	Attenuation Flatness (dB)	Insertion Loss (dB)	VSWR
60657	analog	4.0-8.0	0-55	±1.0	2.0	1.6
61017	digital	4.0-8.0	0.63	±0.5	4.5	2.0

Phase and Frequency Discriminators

10 phase discriminator (correlator) models in octave bandwidths from 1 to 18 GHz, Series 20750, 2A0750, the latter with an AC coupled, low noise, video amplifier. 10 frequency discriminator models from 1 to 18 GHz, Series 120755, 12A0755, the latter with video amplifier. 2, 3, and 4 channel instantaneous frequency discriminator subassemblies (IFDs) also available.

...And Much More,

including SSB modulators, image rejection mixers, mixer-preamplifiers, quadrature IF mixers, and four-phase modulators. Plus selected couplers, power dividers, and balanced mixers for telecommunication applications. Plus wideband front-end receiver subassemblies, and new digital frequency discriminator (DFD) line combining a 4 channel IFD with analog comparator and digital coding network.

Anaren

We Stock What You Need.

What are your component or subassembly needs? Ask your Anaren sales representative, or write/call us for the 1976 full-line catalog. Anaren Microwave, Inc., 185 Ainsley Drive, Syracuse, N.Y. 13205, U.S.A. Phone (Area Code 315) 476-7901, TWX: 710-541-1507, Telex: 937351

INFORMATION RETRIEVAL NUMBER 24



The complete solution to the micro madness: PDP-11 software for the LSI-11.

The most expensive part of using micros isn't paying for the hardware. It's developing the software. With every kind of micro device except one:

The LSI-11. Digital's powerful 16-bit microcomputer on an 8½" x 10" board.

Because thanks to our RXV11 Dual Floppy Disc Drive, you can use the proven software from our famous PDP-11 minicomputers. To get your applications going. Fast.

You can program in easy-to-use BASIC, FORTRAN, or FOCAL, in addition to the assembly-level language other micros force you to use from the start.

You get utilities for editing,

compiling, assembling, loading, linking, and de-bugging your programs. Our RT11 operating system for real time task-oriented control. Even applications programs, through our DECUS customer network.

The RXV11 also helps you develop programs right on the LSI-11, without using time-sharing facilities or development machines, although if you want, we have those too.

And we haven't forgotten the hardware either. In addition to the basic CPU and 4K of RAM, we also offer CORE, ROM, and PROM memories; additional modules for system expansion; plus the PDP-11/03 — the LSI-11 in a nice neat box,

ready to be plugged in.

And it's priced at just \$634 in 100's for the CPU and 4K of RAM.

LSI-11. Powerful software for the micro market.

For details, call 800-225-9480 (MA 617-481-7400, ext. 6410).

Components Group, Digital Equipment Corp., One Iron Way, Marlborough, Mass. 01752. Canada: Digital Equipment of Canada, Ltd. Europe: 81 Route de l' Aire, 1211 Geneva 26, Tel. 42 79 50.

Prices apply to USA only.

digital
COMPONENTS
GROUP

Washington Report

A year of labor contracts coming up

Although the big electrical firms don't expect unusual turmoil, the possibility of strikes is intensified this year according to informed observers in Washington. More than two thirds of the International Union of Electrical, Radio and Machine Workers' (AFL-CIO) 250,000 members will be involved in contract negotiations this year.

The union leadership argues that workers will need wage increases of around 20% "just to be made whole" and management is indicating that half of that might be reasonable.

IUE's national contract with General Electric expires in June, the Westinghouse contract in July. The Union will also be negotiating this year with TRW, Wagner Electric, Rockwell International, Sprague Electric, ESB, Honeywell, Ingersoll-Rand, Louis Allis, White Consolidated, Monsanto, Warwick, General Motors, Sperry-Rand, ITT, General Signal, American Safety Razor, Chrysler Airtemp, Sylvania, RCA, and National Electric Coil.

Congress cuts President's defense budget \$8.6 billion

Congress finally settled on the FY 1976 Defense Dept. appropriations bill late last month after hectic bargaining between House and Senate conferees. They agreed to a \$90.467-billion funding level for the year ending June 30, plus \$21.86 billion to cover the period to Sept. 30, when future fiscal years start under the new budget system. This was \$8.647 billion below the Administration's amended request for money to cover Pentagon operations, salaries, weapons procurement and research and development for 15 months.

As a result of the compromise, the AWACs program was cut from six to four aircraft and the Condor missile program kept alive but in doubt, pending test evaluation. The B-1 bomber program received funds for advance procurement of parts, but not for a firm go-ahead. Funds were also voted for 108 T/TF-15 fighters instead of 96.

Meanwhile, the furor was building on the next fiscal year budget even before its details were announced. Indications at year's end were that the President's \$7-billion reduction in the DOD budget request for FY 1977 was firming up. Probable casualties are manpower, a few facilities, a new nuclear-powered aircraft carrier, Minuteman III production and the Lance and Condor missiles.

Aerospace prospects look bleak for '76

The aerospace industry has fallen victim to Congressional power, says Karl G. Harr, Jr., president of the Aerospace Industries Association, who reports that total dollar sales for 1975 will be around \$29 billion, with

only a slight rise expected in 1976.

Sales in 1968 were also \$29 billion but, he points out, \$29 billion then represented \$10 billion more than the same amount today.

For 1976, Harr sees sales rising to \$29.2 billion, up \$800 million over 1975. The industry expects rises in all categories except civil aircraft, which may decline as much as \$2 billion. Exports are expected to be \$7.6 billion, down \$200 million. Last year's employment was an estimated 921,000, but Harr expects a decline to 900,000 by year's end.

Although DOD sales increased by \$700 million in 1975, the aerospace share continued to decline.

Another cause for industry concern, Harr says, is the sharp drop in the number of commercial transport aircraft being sold. In 1975 there were 282 shipped, and for 1976 215 are on order, compared with 702 in 1968, and 514 in 1969.

NASA distributes new standard-parts list

The first standard-parts list compiled by the National Aeronautics and Space Administration is being distributed this month to NASA centers and contractors to limit the use of electronic parts to those parts with adequate reliability and lowest over-all cost.

Included on the list are capacitors, resistors, transistors, diodes and microcircuits, all with a prerequisite of having seen actual use, according to NASA officials.

In the past, correcting a problem caused by parts failure has sometimes cost a hundred times more than the part itself. An Army study carried out by Boeing underlines the importance of quality control. The study found that after eight years of storage, three out of 10,000 missile components had failed; 24 others showed sufficient aging to be considered near failures. All 27 had below-average performance records when they were first tested in 1967.

Capital Capsules: The National Aeronautics and Space Administration has issued a **request for proposals for a Space Station Systems Analysis Study**. The two winning contractors will study low and synchronous-orbit space-station facilities; modular construction could begin in the mid-1980s. . . . **Congress has stalled temporarily on revising the Renegotiation Act**, but the revision expected by Spring will likely require negotiation by product line rather than on the present aggregate basis, raise the commercial exemption base from 55 to 75 percent, and put the burden on the contractor rather than the Government to prove or disprove excess profits. . . . **The President is expected to sign the new metric conversion bill early this year**. House and Senate conferees agreed the program will be voluntary and have no time limit. It will be up to individual industries to set their own schedules. . . . The Navy's continued efforts to obtain a **communications network for talking with its submerged submarines around the globe continue to run into trouble**. Sanguine, the ELF network that was to be built underground in Michigan, then in Wisconsin and finally in Texas, was scrubbed because of its dangers to the environment. And now Seafarer, a proposed above-ground network, is being examined by Congress because it is rumored to elevate the level in human beings of triglyceride, a lipid substance found in human blood and related to heart disease.

New Tektronix Logic Analyzer Acquires 16 channels

Here's how the new TEKTRONIX LA 501 Logic Analyzer acquires more data than other analyzers in its price range; does it with a higher sampling rate; and provides improved ways of displaying that information.

Acquires up to 16 data channels simultaneously. In fact, you can select storage formats of 16 channels x 256 bits, 8 channels x 512 bits, or 4 channels x 1024 bits to best suit your application.

Stores 4096 data bits on a single pass for display and study of large blocks of nonrepetitive information.

Displays data before a trigger in the pre-trigger mode. Two other modes provide for display of data centered around the trigger or after the trigger.

Provides timing analysis with 15 ns resolution in the asynchronous (internal clock) mode. For logic state analysis, the LA 501 accepts external synchronous clocks with rates up to 50 MHz.

Compares timing between channels easily using the unique capability of selecting any one of the displayed channels and positioning it vertically.

Assures detailed views of logic timing with the unmatched capability of zooming in on any segment of the 4096 bits of data for full screen display. For maximum visual resolution display units with up to 6½" screens are available.

Offers selection of the data window to be stored and displayed. This is accomplished by delaying the store trigger with a DD 501 Digital Delay.

With all of this outstanding capability, the LA 501 is priced at only \$3,250 and plugs

into any of four TEKTRONIX TM 500 mainframes priced from \$150. It works with virtually any x-y display.

For a demonstration of how the LA 501 provides solutions to your logic analysis problems, contact your Tektronix Field Engineer. Or for a descriptive brochure, including specifications, write: Tektronix, Inc., P.O. Box 500, Beaverton, Oregon 97077. In Europe, write: Tektronix Limited, P.O. Box 36, St. Peter Port, Guernsey, Channel Islands.

U.S. Sales Prices FOB Beaverton, Oregon



TEKTRONIX®

committed to
technical excellence

FOR TECHNICAL DATA CIRCLE #271

FOR DEMONSTRATION CIRCLE #272

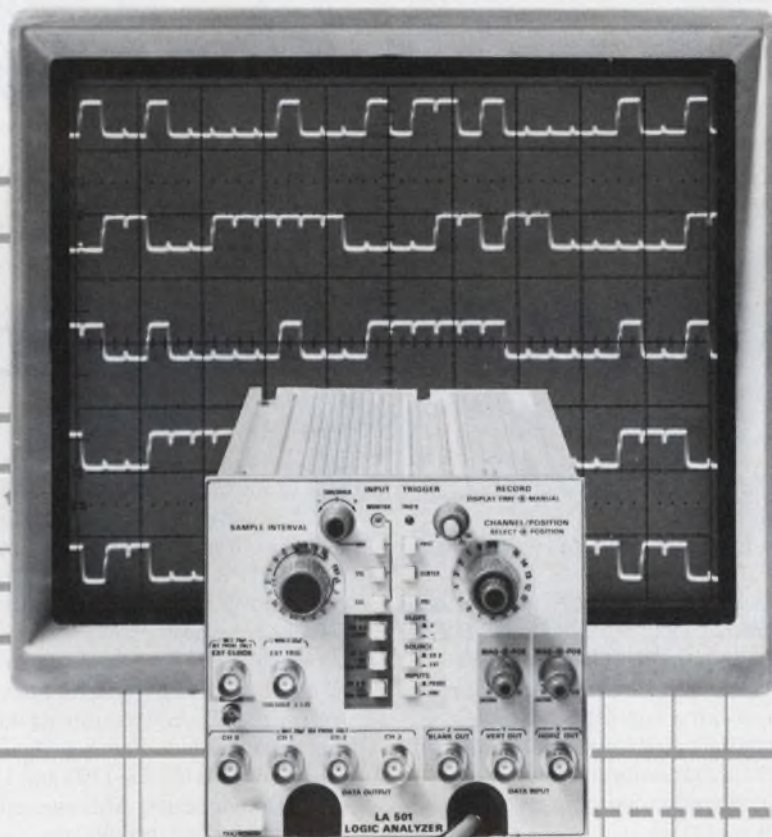

10X Magnified View
of 16 Channel Display

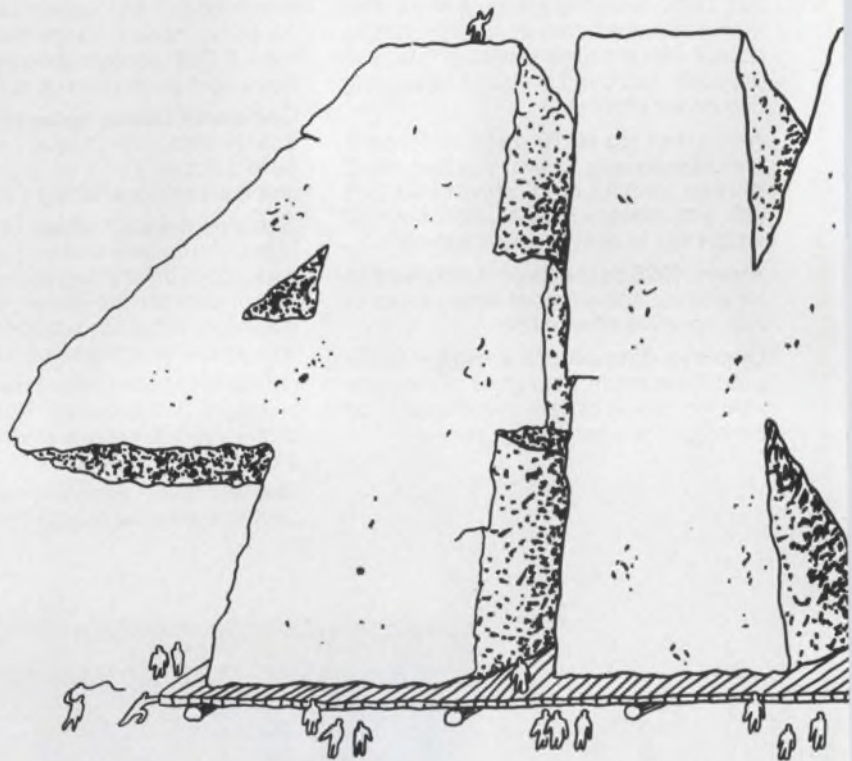

12,000,000 dynamic RAMs

The AMI 16 and 22 pin 4K RAMs were worth waiting for. But you don't have to wait any longer.

We have 22 pin parts on hand right now. And we're geared up for large-scale orders.

Both RAMs are compatible with existing 4096-bit memories. Our S4021 with Texas Instrument's TMS 4060 and Intel's 2107B. And our S4096 with Mostek's 16 pin MK4096.

Being a bit later also let us be a bit better. For instance, our S4021 has a unique sense amplifier that cuts down on power while providing high noise immunity. And we offer three different speeds: 200 ns, 250 ns and 300 ns maximum access times. All three versions have low power dissipation due to typical current of 30 mA (40 mA maximum).

Using an N-Channel silicon gate process and single transistor cell design, we've managed to produce the smallest 22 pin 4K RAM yet.

And its 17,931 square mils give you the best speed-to-power

ratio of any single transistor cell 4096-bit dynamic RAM.

Coming right along is the 16 pin S4096, with the same memory cell structure and process as our S4021. It has an access time of 250 ns maximum, a read or write cycle time of 375 ns minimum. Other versions offer access times of 300 ns and 350 ns. Samples are available now.

So here you have them: the most cost-effective 4K RAMs for all major applications — mainframes, minicomputers, terminals and peripherals. And you can get them now from the company that in the past four years has shipped more than twelve million dynamic RAMs like the 1103 and 1103A.

Call your nearest AMI sales office or distributor for price and delivery information. Or contact us at AMI, 3800 Homestead Road, Santa Clara, CA 95051. Phone: (408) 246-0330.

**it's
standard
at AMI.**
AMERICAN MICROSYSTEMS, INC.

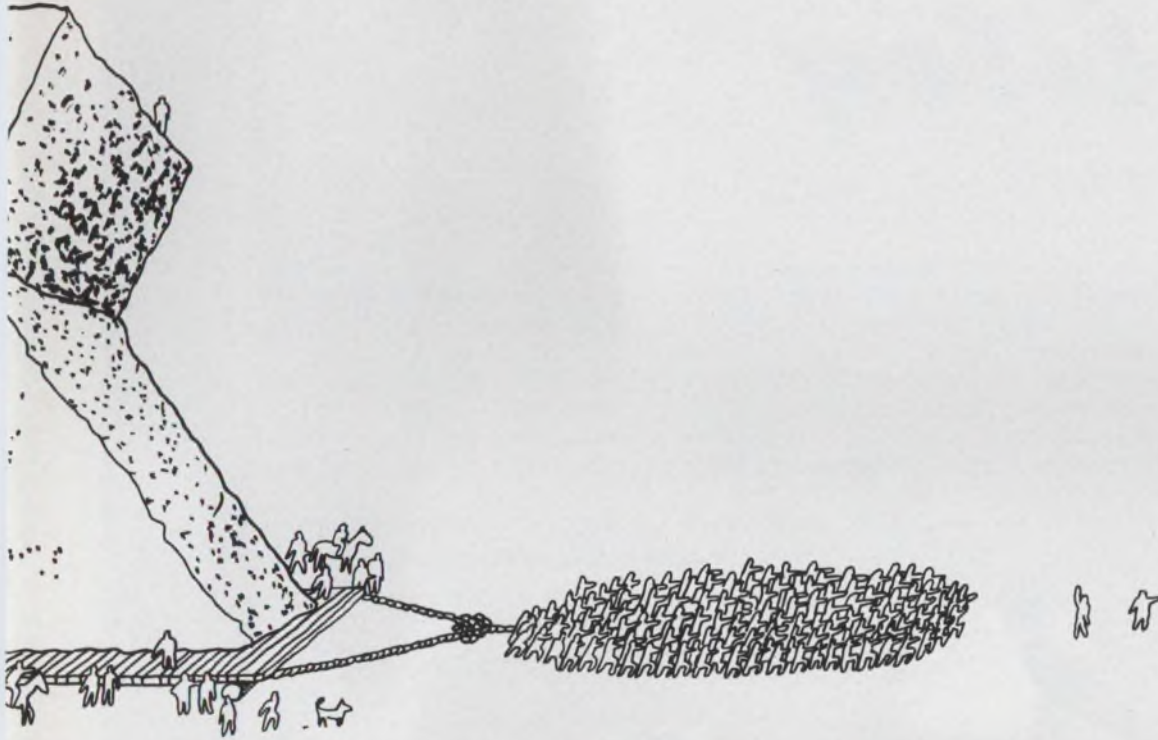

later: THE ULTIMATE 4K.

Specifications	S4021			S4096		
Part Number	-4	-3	-2	-3	-2	-1
Access time (maximum)	200 ns	250 ns	300 ns	250 ns	300 ns	350 ns
Read or write cycle time	400 ns minimum			375 ns minimum		
Read modify write cycle time	510 ns minimum			520 ns minimum		
Power dissipation	30 mA (typical) 40 mA maximum			30 mA typical 40 mA maximum		
Output	Three-state; TTL compatible			Three-state; TTL compatible		
Refresh period	2 ms			2 ms		
Package	22-pin, plastic or Cer-DIP			16-pin, plastic or Cer-DIP		
Pin compatibility	TMS 4060, 2107B			MK 4096		
Technology	N-Channel silicon gate			N-Channel silicon gate		
Cell design	Single transistor			Single transistor		
Size	129 X 139 mils			125 X 148 mils		

Our 4K RAMs are here!

SALES OFFICES

Manhattan Beach CA • (213) 379-2452
 San Jose CA • (408) 249-4550
 Altamonte Springs FL • (305) 830-8888
 Elk Grove Village IL • (312) 437-6496
 Norwood MA • (617) 782-0726
 Livonia MI • (313) 478-9339
 Minneapolis MN • (612) 559-9004
 Monsey NY • (914) 352-5333
 Cleveland OH • (216) 292-6850
 Ambler PA • (215) 643-0217
 Richardson TX • (214) 231-5721

DISTRIBUTORS

ALTA ELECTRONICS
 Utah—Salt Lake City (801) 488-7227
 ARROW ELECTRONICS:
 Minnesota—Bloomington (612) 888-5522
 CENTURY ELECTRONICS:
 New Mexico—Albuquerque (505) 292-2700
 Utah—Salt Lake City (801) 487-8551
 INTERMARK ELECTRONICS:
 Washington—Seattle (206) 767-3160
 SCHWEBER ELECTRONICS:
 California—Costa Mesa (213) 924-5594 and (714) 556-3880

Connecticut—Danbury (203) 792-3500
 Florida—Hollywood (305) 927-0511
 Georgia—Atlanta (404) 448-9170
 Illinois—Elk Grove Village (312) 593-2740
 Iowa—Cedar Rapids "Lorenz Sales" (319) 393-0100
 Maryland—Rockville (301) 881-3300
 Massachusetts—Waltham (617) 890-8484
 Michigan—Troy (313) 583-9242
 Minnesota—Edina (612) 941-5280
 New Jersey—Somerset (201) 469-6008
 New York—Rochester (716) 461-4000
 Westbury (516) 334-7474
 Ohio—Beachwood (216) 464-2970
 Texas—Austin (512) 837-2890
 Dallas (214) 661-5010
 Houston (713) 784-3600
 Canada—Mississauga, Ont. (416) 678-9050
 SEMICOMP CORP.:
 California—Newport Beach (213) 971-5253 and (714) 833-3070

STERLING ELECTRONICS:
 Arizona—Phoenix (602) 258-4531
 Louisiana—Metairie (504) 887-7610
 Massachusetts—Watertown (617) 928-9720
 New Jersey—Parth Amboy (201) 442-8000
 New Mexico—Albuquerque (505) 345-6601
 Texas—Dallas (214) 357-9131
 Houston (713) 627-9800
 Virginia—Richmond "Meridian" (804) 335-6521
 R. V. WEATHERFORD CO.:
 Arizona—Phoenix (602) 272-7144
 California—Anaheim (714) 547-0891
 Glendale (213) 849-3451
 Palo Alto (415) 493-5373
 Pomona (714) 823-1261
 San Diego (714) 278-7400
 Colorado—Englewood (303) 761-5432
 New Mexico—Albuquerque (505) 842-0868
 Texas—Dallas (214) 243-1571
 Houston (713) 688-7406
 Washington—Seattle (206) 243-6340

Bliley

First name in frequency control.

We didn't invent this motto—the electronics industry gave it to us.

Only Bliley manufactures its own crystals, grows and sweeps (for radiation hardening) its own quartz. That means only Bliley can totally control its product quality from raw material to finished unit.

We have never been too interested in making Citizen Band or watch crystals.

What *does* interest us is the design and production of units whose specifications mandate a level of precision that's difficult—if not impossible—to find elsewhere. It's this emphatic commitment to quality that makes Bliley the preferred supplier at the more sophisticated levels of electronics.

Bliley components were selected for these critical aerospace and defense programs:

- Surveyor and Apollo space flights.
- Poseidon/Trident, Phoenix, Maverick and Minuteman missiles.
- F-14 and F-15 Guidance Systems.



Request our new Catalog C/A for complete product information.
BLILEY ELECTRIC COMPANY 2545 West Grandview Boulevard,
P.O. Box 3428, Erie, PA 16508
Tel. (814) 838-3571 TWX 510-696-6886

Microprocessor Design

16-bit, single-chip microcomputer will duplicate many multi-chip tasks

"By 1980, we will see a 16-bit, single-chip microcomputer having sufficient memory on the chip to perform most of the tasks now performed by the multi-chip systems of today."

The prediction was made by Dr. C. Morris Chang, group vice president, Texas Instruments, Dallas, at the recent Morgan Stanley Semiconductor Forum in New York.

The trend to integrate more and more functions, such as RAMs, ROMs, PROMs, processor logic and peripherals, will result in continued learning-curve cost reductions and improved reliability, Chang says. These gains, he points out, will in turn expand the usefulness of μ Ps and open new markets.

(continued on page 44)



Dr. C. Morris Chang, Group Vice President, Texas Instruments, Dallas.

Hardware multiply/divide module made for 8080-based system

The GNAT 8005 hardware multiply/divide module operates at either 2.3 or 5 μ s, compared with the usual 250 to 400 μ s with software multiply/divide. The module, made by GNAT Computers (8869 Balboa Ave., Suite C, San Diego, CA 92123. 714-560-0433), is designed for the 8080 μ C system. Other versions are available for the Altair and Intel MDS systems. Price for the 8005 Module is \$225 for 5- μ s operation and \$275 for the 2.3- μ s option. Delivery is 45 days.

CIRCLE NO. 570

μ C board simplifies hardware development

An 8 \times 8-1/2-in. wire-wrapped board contains the Micromite, a microcomputer from Data Numerics (141-A Central Ave., Farmingdale, NY 11735. 516-293-6600). The compact system allows designers to shorten hardware development time. Any 14-to-40-pin configuration can be accommodated, and the system can be upgraded for newer, higher-density elements.

Costs depend on the configuration selected. For example, a unit price of \$925 covers the following: an 8080 microprocessor, 2-k words of RAM, 1-k words of PROM, 8-bit input and output ports, UART channel and a TTL or RS-232 interface. Delivery time is 30 days.



CIRCLE NO. 571

MICROPROCESSOR DESIGN

(continued from page 43)

TI's current integration effort is its TMS1000 single-chip microcomputer, which offers a 4-bit processor, 1024 8-bit words of instruction storage and 64 4-bit words of data storage—all on one chip.

The trend in digital circuitry is clearly toward low power and high density rather than higher speed, Chang says. Demand for the standard TTL family is consequently expected to drop from 50% of the total market to 25% by the end of this decade, while the low-power Schottky of SSI and MSI complexity grows to almost 25%.

TTL-compatible circuitry, such as μ Ps and high-speed Schottky TTL, will account for almost 80% of the market, Chang predicts.

For these reasons, he continues, the time for low-power Schottky TTL has arrived. As larger portions of digital signal processing are accomplished by low-power LSI units, designers are using low-power Schottky TTL for the peripheral SSI and MSI circuits. In other cases, the cost of power supplies, which have become an increasingly more significant portion of equipment cost, have been offset by low-power Schottky TTL.

Schottky TTL is attractive for military applications that require low power, as well as for serially organized logic that demands faster speed than that afforded by μ Ps or whose organization just doesn't lend itself to the highly structured logic of μ Ps, Chang says.

Based on the very heavy new design effort for Schottky TTL over the past year, Chang says, it should enjoy strong growth for the remainder of the decade.

WORLDWIDE MARKET MICROCOMPUTER COMPONENTS

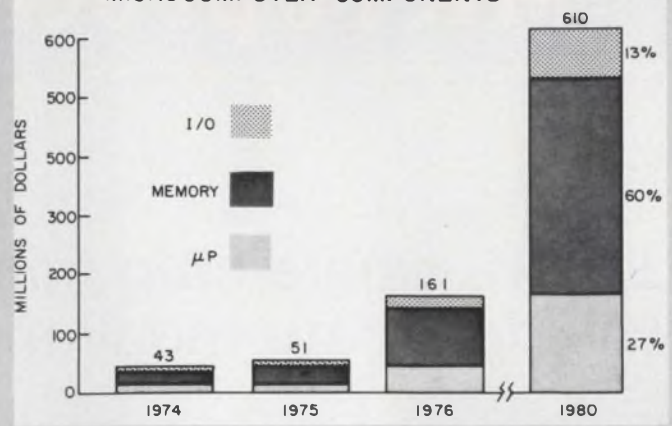

Trend to low-power bipolar logic

	Standard TTL	Low-power Schottky	I ² L
Gate delay (ns)	10	10	30 @ 150 μ A
Power drain (mW)	10	2	0.07
Current range	2 mA	0.4 mA	10 nA to 150 μ A
Speed-power (pJ)	100	20	2
Supply voltage (V)	5	5	5 to 1
Gate area (sq. mil)	53	20	5

In the μ P area, there are two emergent families—Schottky TTL processors (which use a variation of low-power Schottky for their internal gates) and IIL processors. The latter are designed with TTL inputs and outputs, so that they behave essentially as TTL parts but with a considerably higher density and lower-power drain. Thus the applications for

(continued on page 46)

Now...Mike 3!



\$149
CPU Board

The **MIKE 3** is a good example of the flexibility of the modular micro approach. An optimal small system — yet fully expandable. A three-board version, the AT813, includes the Model 471 CPU board (with 8080A); memory board with 8080 Monitor PROM, 512 bytes RAM (expandable to 2K PROM, 1K RAM); console board with keyboard, six LED digits; connectors; and Manual . . . only \$395. (Manual alone, \$35.) Priced at \$149. in quantities of one, with 8080A, the 471 CPU features:

- 3 interrupt levels (8-level priority interrupt board optional)
- Automatic hardware exit from masked interrupt after set interval
- Controls for one DMA channel (8-level prioritized DMA control optional)
- Power bus drivers for system expansion
- 8080, 6800, 8008 I/O address modes



martin research
3336 Commercial Ave.
Northbrook, IL 60062 (312) 498-5060



From General Electric New Transient Protection Manual

New 112 page manual combines in one publication theory, knowledge and experience relating to transient cause, detection and protection accumulated by General Electric scientists and engineers...includes a comprehensive selection guide and product specification sheets for determining the optimum GE-MOV® Varistor.

Copies are available from any authorized GE distributor, GE OEM Electronic Components Sales Office, or by sending \$2.50 plus applicable tax to General Electric, Semiconductor Products Department, Electronics Park, Bldg. 7-49, Syracuse, New York 13201.

GENERAL  ELECTRIC

MICROPROCESSOR DESIGN

(continued from page 44)

the IIL μ P promise to be just as widespread and varied—from military to consumer—as in the basic TTL family, Chang predicts.

A unique advantage of IIL is that its speed and current drain are not fixed to operate only at one point, as with TTL gates, Chang points out. The IIL gate will operate over a current range of four orders of magnitude, with the speed varying accordingly.

One of the more exciting aspects of the IIL structure, Chang suggests, is that it's still in an early stage of development. "We believe that order-of-magnitude improvements in its speed-power product are potentially possible over the remainder of the decade," Chang says.

As this occurs, he predicts, a new measure of performance for high-density logic parts will be provided.

The IIL gate is considerably smaller than any bipolar gate, and it compares favorably with p and n-channel MOS. However, silicon gate n-channel MOS has a distinct density advantage when interconnected; its polysilicon layers provide dense interconnections, whereas bipolar devices must provide area for multiple levels of metal interconnections.

One significant feature of IIL is relative simplicity of structure and fewer processing steps, compared with other logic structures.

IIL has two fewer masks and diffusion steps than TTL and one less mask step than NMOS. Currently, though, the control of the IIL

process is more demanding than TTL. However, these fewer steps do suggest a potential for an economical logic form, and IIL should become a strong competitor for complex logic requirements, Chang says.

TI's IIL μ P, the SP 0400, is approximately 180 mils square and contains about 800 logic gates. The initial engineering parts introduced last fall are currently being upgraded with parts having instruction times of 750 ns, Chang reports.

For the remainder of the decade, for the design needing the speed of bipolar logic, there are these options in an essentially TTL performance:

- IIL μ P with TTL I/O for high-density, moderate performance logic that meets the rigors of full military temperature environment.

- Schottky μ Ps for faster, less dense processors.

- Low-power Schottky TTL of SSI, MSI and LSI complexity for peripheral units to the above processors, or for those applications where either the architecture or speed range of the processors is just not appropriate.

The main trend in semiconductor memories for the remainder of the decade will be a steady progression of increased density for both bipolar and MOS structures, Chang says.

Not too far down the pike are 16-kbit MOS and 4-kbit bipolar random-access memories. And by the end of the decade these products should advance to the next level—64-kbit MOS devices and a 16-k bipolar RAM. Concurrent with these advances in density, there will also be advances in performance.

Power supplies for micros end noise and drift problems

Supply problems for μ Ps can be overcome with the Series 4500/4600 from Dynamic Measurements Corp. (6 Lowell Ave., Winchester, MA 01890. 617-729-7870). The new supplies deliver virtually noise-free power—total noise plus ripple are 100 μ V maximum—and they have output-voltage temperature drift of less than 100 ppm/ $^{\circ}$ C, with waveforms specifically shaped for existing μ Ps. The 4500/4600 has a 30-W rating, and it includes triple, dual and single-output models.

Available in ac input-voltage ranges of 105 to 125 V at 50 to 420 Hz, the family features input isolation of 50 M Ω at 60 Hz, up to 500 V, across the entire operating temperature range of -25 to 85 C. The supplies cost \$120 to \$145.

CIRCLE NO. 572

Pin-for-pin replacement for 8080 offers some extras

The 9080A—a pin-for-pin replacement for the Intel 8080A μ P—has been officially announced by Advanced Micro Devices (901 Thompson Pl., Sunnyvale, CA 94086. 408-732-2400). There are three speed versions of the 9080A available—a 2- μ s, 1.5- μ s

(continued on page 48)

116 reasons why *only* Buchanan® PC Board Connectors provide **Lowest Total Applied Cost!**

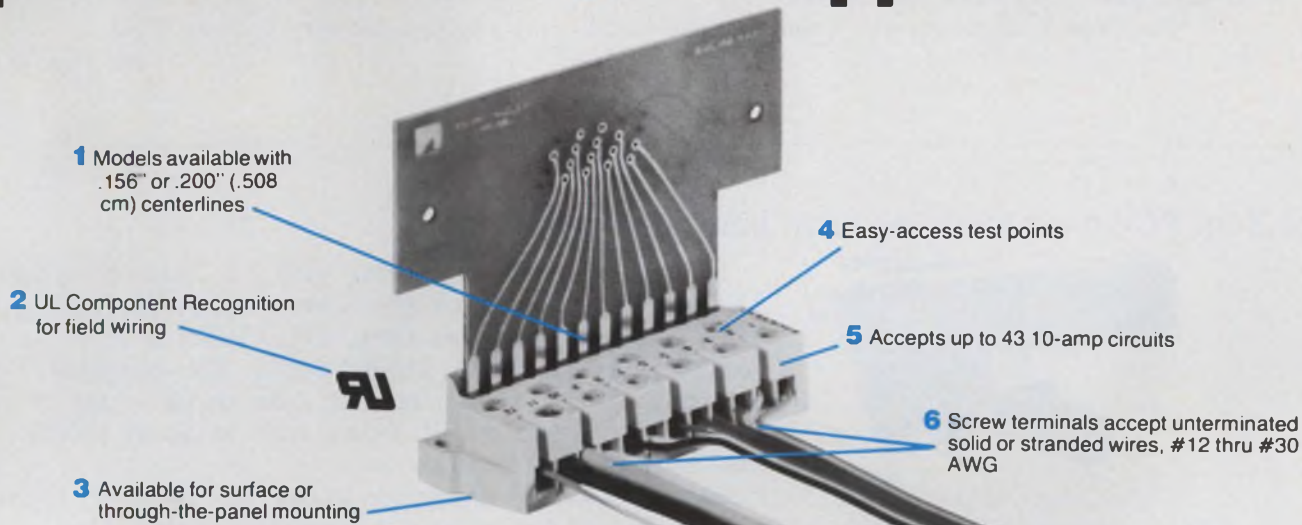

And here are 110 more—the 110 connections you eliminate!

Here's how to achieve significant Lower Total Applied Cost when building control panels or other equipment using printed circuit boards.

Simply specify the new Buchanan Connector that eliminates hybrid interfaces between electronic circuitry and electrical connections. It replaces multiple terminal strips and costly interwiring; actually saves up to 5 separate connection points—potential trouble spots—per circuit!

Models are available for just about every standard requirement. For complete engineering and ordering information, use the Reader Service Card. Or, call one of our Factory Regional Offices shown below. They'll also be happy to talk to you about special configurations.

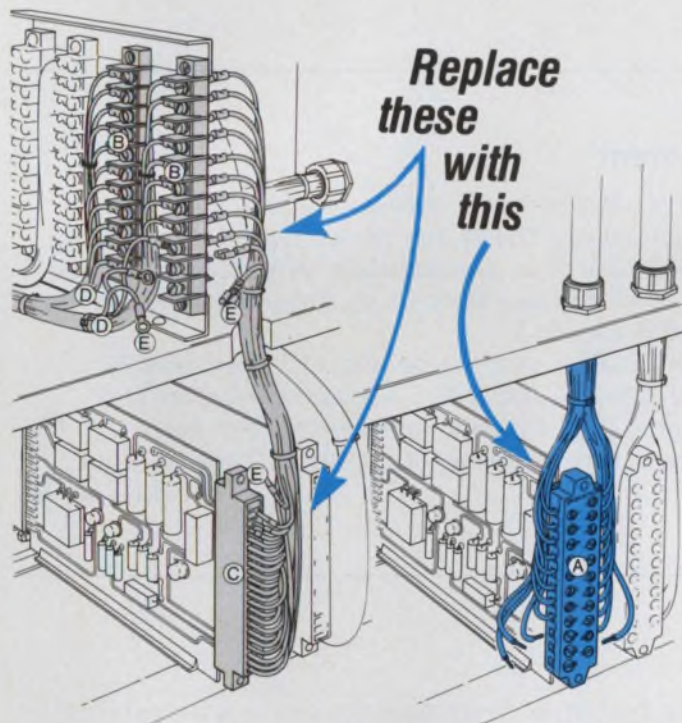

Just one Buchanan Printed Circuit Board Connector (A) replaces the two terminal strips (B), the edge card connector (C), the double wiring (D), and the 110 costly terminations (E) shown at left. Result: LTAC (Lower Total Applied Cost)!



Models available for surface or through-the-panel mounting, with or without card guides and keys.



**CONTROL PRODUCTS
DIVISION**

Amerace Corporation
Control Products Division
Union, New Jersey

21

Atlanta—(404) 261-1224 • Cleveland—(216) 333-8540 • Chicago—(312) 437-8354 • New York Metro.—(201) 355-7770 • Los Angeles—(213) 863-5753

INFORMATION RETRIEVAL NUMBER 31

(continued from page 46)

(MIL version) and 1.3- μ s unit. (Speeds refer to instruction cycle time.)

The Am9080A, although plug-compatible with the 8080, offers the following advantages: Three-byte interrupt capability compared with one for the 8080, on-chip hold control synchronization, which previously was unavailable, and a 9-V input high-clock level compared with 11 V for the 8080.

The 9080A (2- μ s version) costs \$29.95 in 100-unit lots and delivery is from stock.

CIRCLE NO. 573

2 × 3-in. PC-board modules form basis of 8-bit μ C



PC-board modules measuring just 2 × 3-in. constitute the building blocks of an 8080A-based microcomputer from Information Control Corp. (9610 Bellanca Ave., Los Angeles, CA 90045. 213-641-9520). The complete system comes in preassembled kit form or as a fully assembled and tested unit. Prices start at about \$1000, and delivery is 30 to 45 days.

The μ C development system includes the following: assembler, editor and monitor; high-speed magnetic-tape cassette I/O; alphanumeric display; and optional line printer. Also, a special debug package allows a complete test of the microcomputer prior to program storing in PROMs.

CIRCLE NO. 574

μ C family seeks work in industrial equipment

A family of desk-top, rack-mounted and NEMA-enclosed microcomputers aims for industrial-control and instrumentation applications. The M-800 Series from Control Logic (9 Tech Circle, Natick, MA 01760. 617-655-1170) can accommodate up to 256 inputs and 256 outputs, and it can complete a control cycle in less than 10 μ s. Typical M-800 systems have 4-k to 8-k words of memory, expandable to 64-k.

Inputs and outputs can accommodate both digital and analog signals. They handle common relay voltages—like 24, 120 and 220 V—and 5 V for instrumentation and various digital devices. Options include opto-isolated signal conditioning for noisy environments, brownout protection and power-line filtering. Unit prices start at \$995.

CIRCLE NO. 575

8-bit μ C on three cards features DMA

Three cards hold an 8-bit microcomputer featuring direct memory access with priority. Priced at \$1500 in quantities of 100, the module set (SIA-3000) offered by System Integration Associates (RD 1, Box 126, Glenmoore, PA 19343. 215-286-5136) includes an 8080- μ P board, RAM board, utility board, and a card cage that can hold up to five boards. Power supplies are also available.

The special DMA/priority feature eliminates memory-access delays often found in other microprocessor systems. Other features include 16-k bytes of PROM, 16-k bytes of RAM, direct test monitoring and debugging facilities, and microcode-development software. The processor board's clock cycle is 540 ns, and the utility board allows for wire-wrapping a mix of 40, 24, 16 and 14-pin packages. Delivery is 60 days.

CIRCLE NO. 576

(continued on page 50)

FACTORY SALE: 1 MILLION 18-PIN 4K RAM's.

One million of the best 4K RAM's money can buy. Now. First come, first served.

They're terrific.

If you'd rather not start with the whole million, we'd be happy to break the set. \$8,000 for a thousand (AM9050CPC). The best offer over \$60,000 for ten thousand.

Like the story? Wait till you read the book. Write for it and it's yours.

The Am9050's.

A 150ns to 200ns improvement in your system cycle time compared with equivalent-speed 16-pin parts. If you don't need the speed, enjoy the safety margin.

One less clock than the 16-pin. Less noise and error in your system.

100% hot testing – functional, parametric and refresh – at worst case temperatures.

They're plug-in replacements for the TMS4050's. And then some!

Processed to MIL-STD-883. For free.

Purely capacitive inputs that are easier to drive, eliminating extraneous current surges.

Static input circuitry for simpler timing, easier operation and better margins.

Note: For you 22-pin users, the Am9060 is a plug-in replacement for the TMS4060.

Advanced MOS/LSI



Advanced Micro Devices • 901 Thompson Place, Sunnyvale, California 94086 • Telephone (408) 732-2400 •
Distributed nationally by Hamilton/Avnet, Cramer and Schweber Electronics.

INFORMATION RETRIEVAL NUMBER 32

Disc-based μ C extends PDP-11 line



The PDP-11 family now includes a disc-based, packaged microcomputer with operating system and high-level-language capability. And the complete PDP-11V03 from Digital Equipment Corp. (Marlborough, MA 01752. 617-481-7400) costs \$9950.

For this price, the standard model includes the following: a dual floppy-disc drive, choice of either LA36 keyboard-terminal printer or a VT52 DECscope video terminal and the RT11 real-time operating system.

The RT-11 operating system can be used to develop and operate application programs written in either a high-level or machine language. RT-11 includes program modules for software debugging, editing, file maintenance and utility-program operations.

The system's floppy disc, the RXV11, has total storage capacity exceeding one-half megabyte. It has an average access time of 483 μ s and can transfer data between disc and μ C at the rate of 10,000 bits per second.

A 14 \times 19 \times 17-in. unit houses both the microcomputer, with its 8-k words of RAM, and the floppy disc. In units of 100, the complete PDP-11V03 costs \$3500. Delivery begins in January.

CIRCLE NO. 577

High level programming language written for Motorola μ P

The PL/M6800 compiler from Intermetrics, Inc. (701 Concord Ave., Cambridge, MA 02138. 617-661-1840) is available on the General Electric Information Services computer network. It can also be purchased directly from Intermetrics for in-house installation on IBM 360 or 370 computers.

According to Intermetrics, PL/M6800 is an effective microprocessor software development aid. It brings the benefits of high-level language programming to the field of microprocessor programming. PL/M6800 can cut programming time and effort to a fraction of that required for assembly language.

PL/M6800 has a one-pass compiler which produces optimized object code in a format directly usable by the Motorola MINIBUG/MIKBUG and EXbug Loader Function. The compiler includes a number of user-controlled features such as: source program listing, object code listing, assembler code listing and symbol table dumps.

The cost for PL/M6800 is \$1000 when purchased for in-house installation.

CIRCLE NO. 578

Microprogram sequencer handles up to four subroutine levels

The Am2909, an expandable 4-bit microprogram sequencer, can perform up to four levels of subroutine. This low-power Schottky LSI element made by Advanced Micro Devices (901 Thompson Pl., Sunnyvale, CA 94086. 408-732-2400) can generate, increment and store addresses. It is applicable in any microprogrammed situation, but was specifically designed for operation with the Am2901 microprocessor element. The Am2909 is a 45-ns circuit designed for high-speed and pipelined microprogrammed systems. The commercial version of the sequencer costs \$21.06 in 100-up quantities and is available from stock. A MIL version is also available and costs \$84.64.

CIRCLE NO. 579

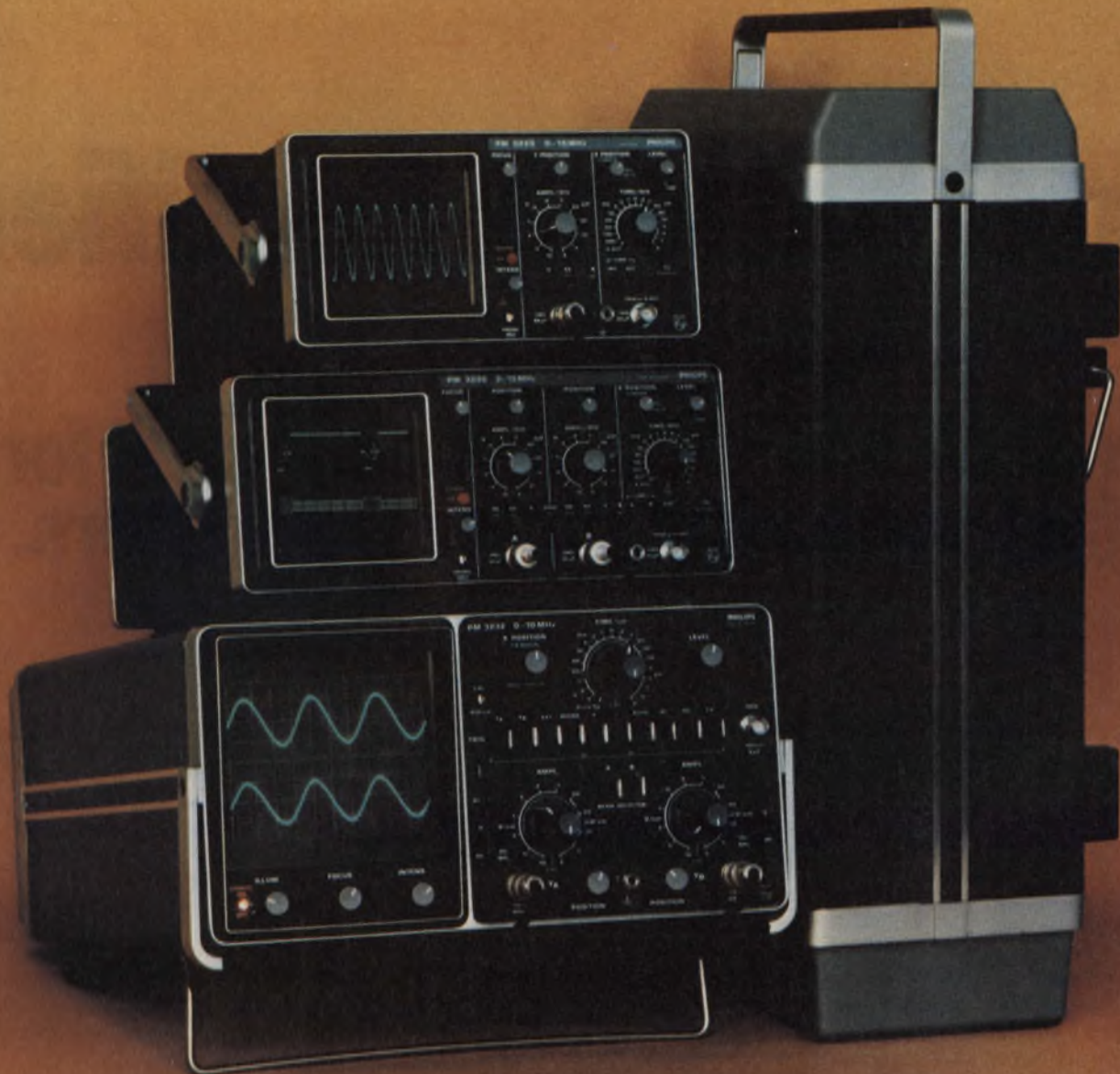

It wasn't easy to design TWO NEW SCOPES, EACH HAVING SUCH A UNIQUE COMBINATION OF FEATURES as our dual beam haswe almost succeeded!

TWO NEW COMPACTS !

THE NEW PHILIPS PM3225 SINGLE TRACE OSCILLOSCOPE

Only 8 pounds, 2 ounces
 5.4" H x 10.1" W x 12.4" D
 Sensitivity 2mV/div at 15 MHz bandwidth
 8 x 10 division screen
 Complete triggering facilities: Auto, Line, Ext., TV line or frame
 Automatic DC balancing and drift control
 Logical layout of operating controls for quick error-free setup

THE NEW PHILIPS PM3226 DUAL TRACE OSCILLOSCOPE

Only 9 pounds, 10 ounces
 5.4" H x 11.9" W x 12.4" D

THE POPULAR AND PROVEN -

PHILIPS PM3232 and PM3233 DUAL BEAM OSCILLOSCOPES

True dual beam display
 2mV/cm at 10 MHz
 10KV brilliant display
 Comprehensive triggering facilities: Auto, AC, DC and TV
 Logical layout of operating controls for quick error-free setup

Act now and find out how you get more from Philips. For complete price and technical data, call our toll free HOT LINE number 800 645-3043. New York State residents, call (516) 921-8880 collect. Philips Test & Measuring Instruments, Inc.



In the United States:
 400 Crossways Park Drive
 Woodbury, New York 11797
 (516) 921-8880

In Canada:
 6 Leswyn Road
 Toronto, Ontario M6A 1K2
 (416) 789-7188

PHILIPS

International Rectifier.

New 10 Amp device makes one-stop shopping easy for fast-switching power transistors.

Now, IR is your source for a wide variety of 3, 5 and 10 Amp JEDEC fast-switching power transistors, to simplify your buying. These hard-glass passivated devices are the ones to use for better reliability and lower costs in line operated power supplies, whether you're chopping line voltages at 20 KHz or inverting and stepping down at high frequency.

Fast Switching Speed—Cooler Operation . . . the oscillographs show typical fall times in the one-micro-second and lower range. Gives extremely low switching losses for cooler operation and higher reliability.

Lower Leakage — High Temperature Stability . . . with ICEO in the micro-amp range, IR devices are about one-tenth the accepted leakage rates of others. Provides the higher stability important for high performance at elevated temperatures.

High Second Breakdown — High Reliability . . . high second breakdown helps provide a broad safe-operating area for an extra margin of safety.

Glass Passivation — Long Term Reliability . . . high reliability and long term stability is achieved by hard glass passivation. Also, if you're using chips to make your own circuits,

IR's glass passivation gives you the most stable, easy to assemble chips you can start with, making your yields higher.

If you are paralleling devices, the tight gain, switching time and saturation voltage control of these transistors make the job easier. And through 100% testing of key parameters we can provide even closer matching if necessary.

JEDEC types listed are immediately available, so contact your local IR salesman, rep or distributor today.

International Rectifier, 233 Kansas Street, El Segundo, California 90245. (213) 678-8261.

New International Rectifier Fast Switching Power Transistors									
IR Part No.	V _{CEO} (sus) (Max V)	I _C Peak (A)	h _{FE} (min, max)	β (A)	V _{CE} (sat) (Max V)	I _C (A)	P _d (W)	I _r /I _f (μs)	
2N6306	250	16	15/75	3.0	0.8	3.0	125	6/4	
2N6307	300	16	15/75	3.0	1.0	3.0	125	6/4	
2N6308	350	16	12/60	3.0	1.5	3.0	125	6/4	
2N6542	300	10	7/35	3.0	1.0	3.0	100	.7/8	
2N6543	400	10	7/35	3.0	1.0	3.0	100	.7/8	
2N6544	300	16	7/35	5.0	1.5	5.0	125	1/1	
2N6545	400	16	7/35	5.0	1.5	5.0	125	1/1	
2N6249	200	30	10/50	10.0	1.5	10.0	175	2/1	
2N6250	275	30	8/50	10.0	1.5	10.0	175	2/1	
2N6251	350	30	6/50	10.0	1.5	10.0	175	2/1	

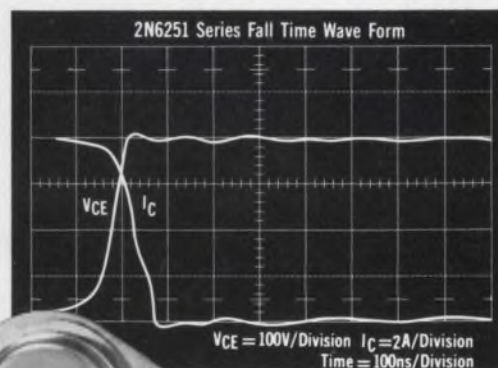
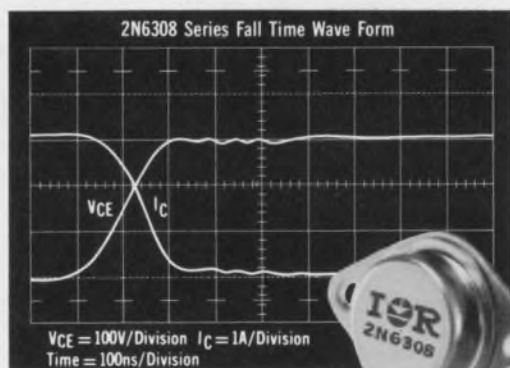

INTERNATIONAL RECTIFIER
the innovative power people



SEMICONDUCTOR DIVISION, 233 KANSAS STREET, EL SEGUNDO, CALIFORNIA 90245, PHONE (213) 678-6281

INFORMATION RETRIEVAL NUMBER 35

RACK MOUNT POWER SUPPLIES ...TO 60 AMPS

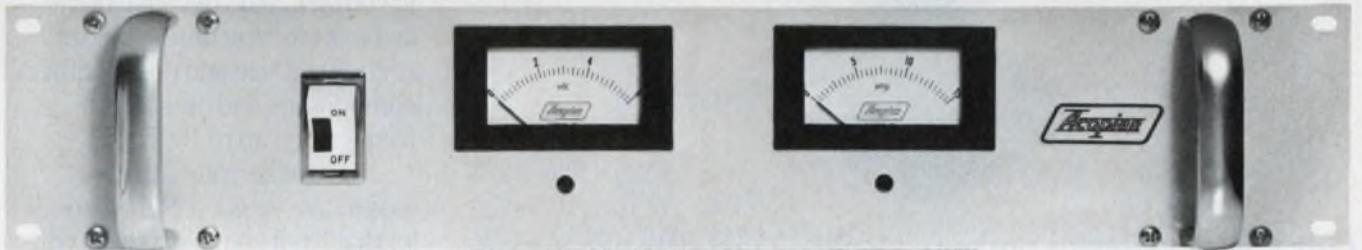

ALL MODELS U.L. RECOGNIZED

NOMINAL OUTPUT VOLTAGE	OUTPUT CURRENT AMPS	PRICE	MODEL	DIMENSIONS (INCHES)	
				HEIGHT	DEPTH
5	20	\$280	5PT20	3½	11
5	32	330	5PT32	5¼	12
5	60	525	5PT60	5¼	17
12	20	330	12PT20	5¼	12
12	45	550	12PT45	5¼	17
15	10	280	15PT10	3½	11
15	19	330	15PT19	5¼	12
15	40	590	15PT40	5¼	17

OPTIONS

Overvoltage protection—Add prefix "V" to model number and \$25.00 to price of models with output current rating of 20 amps or less, \$75.00 to price of other models.

Ammeter—Add suffix "A" to model number, \$15.00 to price.

Voltmeter—Add suffix "F" to model number, \$15.00 to price.

Handles—Add suffix "H" to

model number, \$10.00 to price.

Regulation, $\pm 0.05\%$ or better.
Ripple, 1 mv rms or better.
Many other models from 1 to 50 volts. Write for complete catalog.



Corp., Easton, Pa. 18042. Telephone: (215) 258-5441.

INFORMATION RETRIEVAL NUMBER 36

Now you can build a higher current switching regulator in half the time.



Our PIC-600 Series power switching circuits are now available in a TO-3 with positive and negative outputs, in current ranges up to 20 amps peak and voltage capabilities up to 100 volts.

You know that a switching regulator can quadruple the efficiency of your power supply. It'll save power, cut heat loss, simplify your design, save board space, weigh less, and maybe cost less than a linear regulator.

But until now, if you wanted a switching regulator, you had to start from scratch. It took a lot of time and a lot of effort.

Our power switching circuit is the breakthrough you've been waiting for.

The power circuit is the trickiest part of the switching regulator to design, since it involves choosing the commutating diode and switching transistors, then fiddling with the circuit to get the best drive and bias conditions.

We've taken care of all that. And the power circuit is the one that can contribute most in terms of improving the regulator's performance. We've taken care of that, too. Thanks to our special design and packaging, you can

expect faster response time and lower noise than you could design in yourself. And because of the faster switching time, you can reduce the size and cost of other components and operate at frequencies up to 100KHz.

To make your life even easier, we've got a 24-page booklet that'll tell you everything you need to know about designing a switching regulator. It's the only booklet of its kind available, and it's free. To get yours, along with detailed specs for our power switching circuits, circle our number on the reader service card.

Unitrode Corporation,
580 Pleasant St., Watertown,
Mass. 02172.



UNITRODE

Naughty words

I did it. I really did it. Chatting with a genuine native of San Francisco, I referred to his city as Frisco. When I heard myself blurt it out, I bit my tongue and waited, fully expecting the world to fall down or, at the very least, that I should be struck by a bolt from the blue. And what happened? Nothing.

That puzzled me because, for as long as I could remember, people from the best circles had warned me that one must never call that city anything but San Francisco, and never, never refer to it as Frisco. The word is used only by boors—the type of men who would use dirty words in mixed company in the days when women were different from men.

San Franciscans, I was told by San Franciscans, feel shamefully insulted, if not mortally wounded, when they hear that word. Now I never met a San Franciscan who was bothered by it, but everybody in San Francisco knows others who can't stand the word. So my behavior was always guided by those who were guided by what they felt guided others.

I wonder if I'm alone. I wonder how many of us make engineering and business decisions on the basis of opinions that other people may hold regarding the opinions of others. How many of us fail to make a judgment on the merits of an issue and, instead, judge on the basis of what somebody else might think?

Worrying about what others might think may not be so terrible in itself. But it often leads us into mental straightjackets, and that's not suitable attire for engineers. We start by worrying about what others will think. Then we worry that we, ourselves, might be departing from conventional thinking. Then we slip into the easiest mental adjustment; we stop thinking.

I wonder if that doesn't show in many of our designs. Sure we see scores of brilliant new designs every year. But we see hundreds of new products that are drab, warmed-over versions of last year's model. We see new designs that are born tired. Can this be the result of tired thinking? Of worried thinking? Of thinking too much about what others might think?



A handwritten signature in dark ink that reads "George Rostky". The signature is fluid and cursive, written in a professional style.

GEORGE ROSTKY
Editor-in-Chief



AN HISTORIC PUBLISHING EVENT.

ELECTRONIC DESIGN'S BICENTENNIAL ISSUE -- FEBRUARY 16th --

Unquestionably this issue is the most significant publishing effort ever undertaken by any electronics magazine anywhere in the world.

In a message from the White House to be published in the Bicentennial issue, President Ford commends this issue as a very special part of America's 200th Anniversary.

The Bicentennial issue traces the electronics industry from experiments in the Colonial period to today's large-scale integrated circuits. It shows how the industry has been shaped and re-shaped, not only by technological breakthroughs, but by the socio-economic, political and even the artistic climate of the times. It is informed, thought-provoking and authoritative.

This is an issue that everyone will want to read.

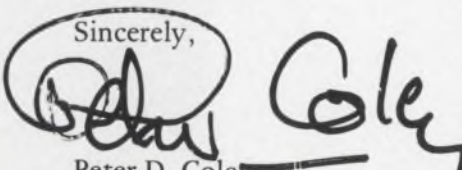
Sincerely,

Peter D. Coley
Publisher & Senior Vice President

Electronic Design

Hayden Publishing Company, Inc. • 50 Essex Street • Rochelle Park, N.J. 07662 • (201) 843-0550

THE ONLY 16K ROM YOU CAN USE

**If you want to operate your 8080 or M6800 at peak speed.
If you want 6 weeks or less turnaround time.
If you want the fastest single +5V supply 16K ROM -
450ns access time.**

You're not getting the most out of your microprocessor. Not without General Instrument's RO-3-8316B static 16K ROM. With 450ns access time, it's the fastest single +5V supply 16K ROM around. It's almost twice as fast as Intel's 8316A which it replaces, pin-for-pin.

And you get a sizzling 6 week or less prototype turnaround that puts your programs on-line in record-breaking time. That's why we say, if you want these unique advantages, General Instrument's RO-3-8316B is the only 16K ROM you can use.

For complete information call toll free 800-645-9247 (in N.Y. State: 516-733-3107) or write, General Instrument Corporation, Microelectronics, Dept. R 23, 600 W. John St., Hicksville, N.Y. 11802.

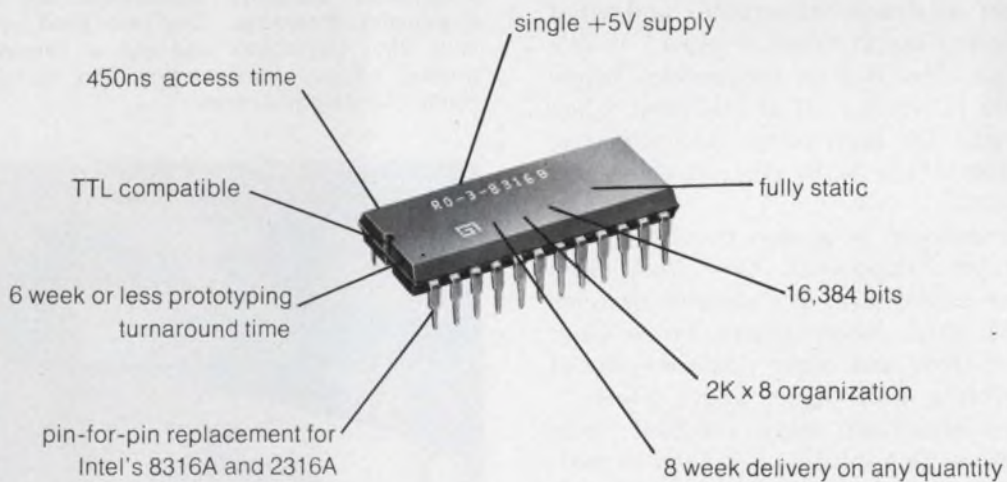

**GENERAL INSTRUMENT CORPORATION
MICROELECTRONICS**



INFORMATION RETRIEVAL NUMBER 39

FOCUS

on Passive microwave components

The world above 1 GHz is a strange one. Unseen (distributed) circuit elements make it difficult to specify even the simplest of passive microwave components. The components are packaged for various signal-transmission media, and the spec sheets don't begin to describe the problems you will run into if you make the wrong choices.

Of the plethora of competing transmission media, the most common are waveguide, coaxial, stripline and microstrip. Of the various passive microwave components around, the most difficult to specify are filters, ferrite devices, couplers, attenuators and switches.

What is the transmission line?

Microwave engineers have long lived with the nickname "plumbers." For years, the main transmission medium used was waveguide; and what are waveguides but metal tubes or pipes? Waveguide is still popular. But at frequencies below 18 GHz, its use is waning. It is still best when the situation calls for high power and low loss. But it leaves something to be desired when you need small size.

Coaxial transmission is a step towards small size. But coaxial components have long been limited by poor connectors, and coaxial systems tend to handle much lower power levels than waveguide. For these and other reasons, coaxial component design is not too good above 4 GHz.

Further size reductions have resulted from system integration. One solution has been to modify the coaxial transmission media into a center conductor between a pair of flat ground planes—rather than surrounded by a cylindrical ground



Rock-stable miniature attenuators are produced by Engelmann Microwave. They are good up to 18 GHz, have SMA connectors and use a pyrolytic deposition process to put down carbon film resistors on heat-conductive ceramic cores.

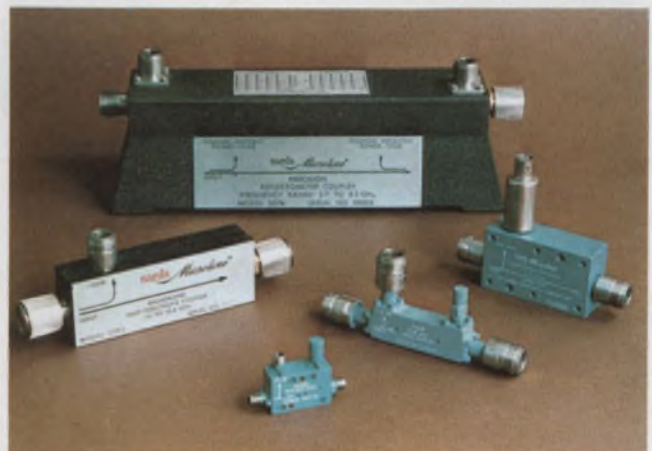

Both measurement and system directional couplers are produced by Narda Microwave in coaxial configurations up to 26.5 GHz.

David N. Kaye
Senior Western Editor

plane. And by use of high dielectric constant materials around the center conductor, the size of the resulting stripline components has been considerably decreased.

To achieve true miniaturization, engineers have recently taken the next logical step and have reduced stripline to microstrip. This is an asymmetrical transmission medium in which the conductor pattern is etched on a good dielectric material, such as alumina or sapphire. A single metal ground plane covers the other side of the dielectric. Microstrip circuits, therefore, are hybrid circuits—commonly called microwave integrated circuits (MICs). Many passive components are now designed with microstrip techniques. Many others are designed to be incorporated as parts of a large microstrip system.

Most types of microwave passive components can be obtained in various forms, designed to work with each of the different transmission media.

Filtering out the noise

Filters are probably the most difficult type of passive microwave component to specify satisfactorily. Perhaps it is time to filter some of the noise out of filter data sheets. The first problem with filters is that there are so many different kinds. They are referred to by such terms as bandpass, bandstop, notch, elliptic function, Chebyshev, Butterworth, maximally flat and many others. Each name either refers to what the filter does (bandpass, etc.) or the shape of the response (maximally flat, equal ripple, etc.).

In specifying filters, the type of filter is only the beginning. Other important electrical specs are the band-edge frequencies, insertion loss, ripple, VSWR, impedance, phase, average and peak powers. In the microwave frequency range, mechanical specs are also important. What does the filter assembly look like? And what kinds of connectors and flanges does it have? Finally, microwave components tend to be very sensitive to the environment. So be careful if you need a wide temperature range or have unusual specs on humidity, shock, vibration, altitude or salt spray.

Everyone writes electrical specs differently. Even a spec as important as the passband of a bandpass filter can be misconstrued. Generally it's called "bandwidth." But is it the 3-dB, 1-dB or ripple bandwidth? Make sure that the manufacturer clearly defines the points on the filter response. As a general rule, the bandwidth of a Butterworth or maximally flat filter is defined as the bandwidth measured at the points on the

filter skirts that are 3 dB down from the peak of the response in the center of the band. For a Chebyshev or equal-ripple filter, the magnitude of the ripple must first be defined. The bandwidth is then defined as the ripple bandwidth—that is, the points on the skirts where the attenuation is the same as the maximum ripple attenuation. For the other types of filters, make sure that the definition of the bandwidth is given.

Check the characteristic impedance

Although most microwave systems are designed with transmission media that have a characteristic impedance of 50 Ω , some systems use 75 Ω or other values. Make sure that the

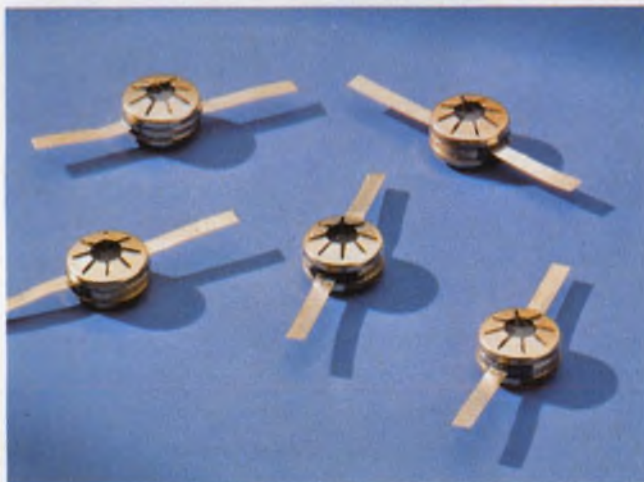

Resilient microwave terminations from KDI Pyrofilm fit stripline circuits at frequencies through X band. They typically handle 1 or 3 W with a max VSWR of 1.35.

filter impedance in the passband matches the system impedance. Often 50 Ω is assumed and not stated on the data sheet. Ideally a bandpass filter should look invisible in the passband. Unfortunately, real filters do not maintain a constant impedance across the band, and they have a finite amount of dissipation and reflective losses called "insertion loss" when lumped together. They also introduce a varying phase shift across the band.

Furthermore these characteristics all vary with temperature. And rarely does the manufacturer tell how parameters vary with temperature. In fact, specs are often given only at a few frequencies or as maximums for the entire band. Almost never is a curve given that shows how they vary—even at a single temperature.

Power-handling capability in the passband is

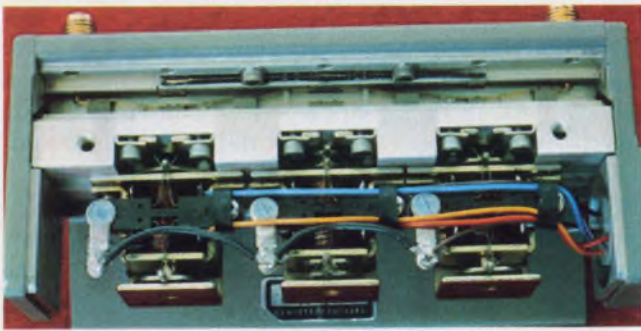

Edge-line transmission line flippers are used in Hewlett-Packard's 8495H Programmable Step Attenuator to switch in 10-20-40 dB pads. The attenuator response is very flat from dc to 18 GHz.

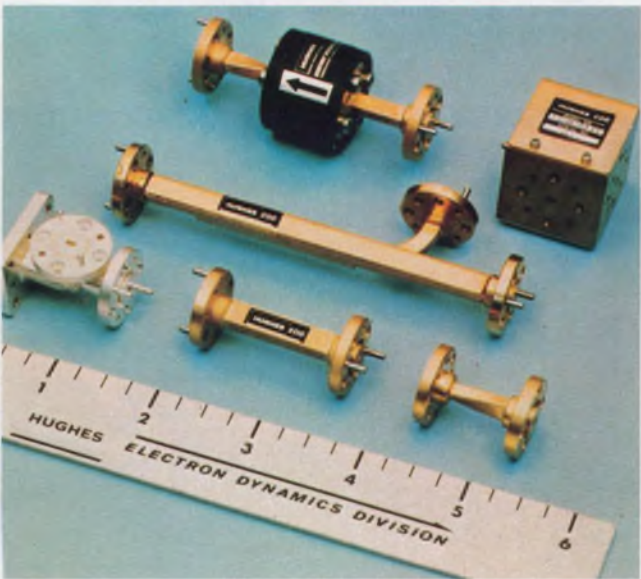

Passive microwave components are produced in six waveguide bands from 26.5 to 110 GHz by Hughes' Electron Dynamics Division. Shown here are some of the company's ferrite devices, couplers, twists, a waveguide run and a magic tee.

often called just "power." Rarely is it defined as peak power or average power, nor is the capability described as temperature-dependent.

Even when the passband of the filter is well-defined, you are rarely told what happens if you operate near the band edges. In fact, the phase response of the filter, along with its VSWR, usually varies all over the place near the band edges. Better ask how fast and how far the skirts of the filter decline.

Finally, it is often important to know the characteristics of the filter in the stopband. If the filter is of the elliptic-function type, there will be large glitches in the out-of-band rejection region. Microstrip low-pass filters tend to have large resonances in the stopband. Other filters



A connector with a built-in line stretcher is the Phase Adjustable SMA from Amphenol. The connector comes either as an individual component or as a cable terminator. VSWR is better than 1.28:1 up through 18 GHz, and the phase can be adjusted by 10° times the frequency in GHz. Thus, at 10 GHz, the phase can be adjusted up to 100° .

have equally disturbing responses—usually in the most embarrassing places. Manufacturers virtually never specify out-of-band characteristics. Sometimes they don't want to tell you even when you ask.

Tunable filters are in a class by themselves. The most common type has a dial and a calibration curve. The curve tells the center frequency corresponding to the dial setting. What you are not told is that the calibration curve is accurate only when you turn it in one direction—backlash is rampant in these dials—and that the dial is only meant to be an approximate indicator. These filters should always be tuned with a frequency meter and a scope.

Finally, the bandwidth of these filters is usually given as a fixed number with a large tolerance on it. In fact, no filter can be tuned to keep a constant bandwidth. What can be kept fairly constant is the percentage bandwidth. But, for some reason, percentage bandwidth is rarely specified.

Circulate and isolate

After filters, ferrite devices are usually considered the hardest passive microwave components to specify. The most common ferrite devices are junction circulators and isolators. They are nonreciprocal devices that will pass a signal in one direction only, presenting a very large insertion loss in the opposite direction. As two-port devices, they are known as isolators; as three-port devices, they are called circulators. A signal in a circulator can go from port 1 to port

2; also from 2 to 3, and from 3 back to 1. But signals cannot pass in any other way.

The major problems in specifying ferrite devices are temperature, phase shift and glitches in the band. Most ferrite materials change properties radically as the temperature varies widely. Some even change for narrow variations. The characteristics that suffer most with temperature are VSWR, isolation and phase shift. Care is needed in soldering to stripline tabs on a ferrite device, since the heat can cause damage.

The properties of ferrite devices can also change if they're operated at too high a power level. The internal dissipation will cause a temperature rise.

It is hard to design a predictable phase shift into a ferrite device; therefore phase is difficult to specify. If the unit is a broadband device, it has probably been individually tuned over the band. Since the units are all hand trimmed, they are all a little bit different—with different phase characteristics. Therefore, most manufacturers say nothing about phase on their data sheets.

Virtually every characteristic of a ferrite device changes radically as the band edges are neared. So it's important to work well within the design bandwidth.

Ferrite devices are notorious for narrow glitches in the band. These glitches often don't show up when the device is tested at just a few frequencies. So swept measurements must be made on these devices. It would be nice if manufacturers supplied Smith Chart plots automatically with ferrite devices to show the swept impedance-vs-frequency characteristics, but few manufacturers do. Curves of insertion loss and isolation vs frequency would also be welcome.

Finally, S-parameters are never given for ferrite devices.

Coupling has direction

Couplers and dividers suffer some of the same problems as ferrite devices, though less severely. Couplers come in two classes and two types. The classes are measurement devices and system components. The types are directional and otherwise.

Directional couplers for systems are specified very loosely and usually are just sampling devices. But power dividers for systems are often very tightly specified. Precision couplers and dividers intended for lab measurements are, of course, always tightly specified.

Among the many specs for couplers, the most important are usually coupling, isolation and directivity.

Depending upon the construction technique

used, coupling can be very temperature-sensitive. The worst offenders are stripline and microstrip couplers. This sensitivity is rarely alluded to in data sheets. In directional couplers the problems are even worse. The most important characteristic, directivity, varies all over the lot and is extremely unpredictable. A directional coupler has a straight-through arm and a coupled arm. Directivity is defined as the ratio of the output signals in the coupled arm for reverse and forward propagation in the main arm. Most manufacturers specify a minimum directivity without giving information about how it varies—which is sufficient for most applications. Good directivity would be -40 dB or better.

In the case of directivity and coupling, it is even hard to check the performance. The meas-

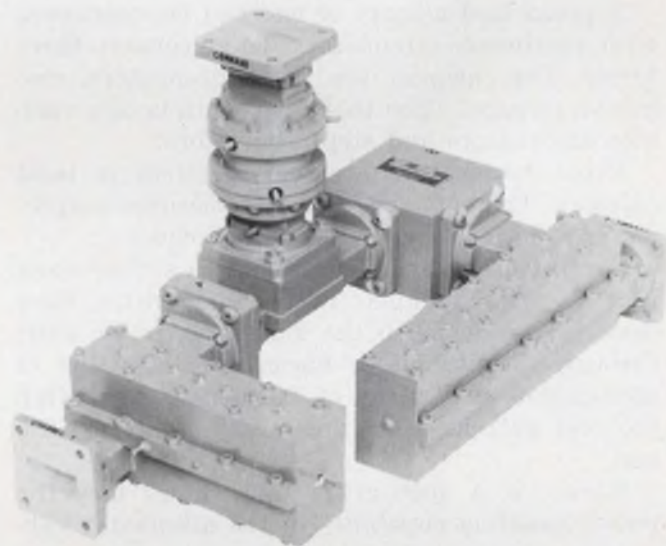

This X-band triplexer is a combination of filters with an 8-section elliptic-function filter in channel 1, a 12-section arbitrary time delay network in channel 2, and a 4-section dual-mode elliptic function filter in channel 3.

urements must be made with all unused ports terminated in a perfect match. Also, the source match must be excellent. Since no match is perfect, your measurements will vary from what the manufacturer says. Hopefully, you will at least be close.

Find out what happens to coupling and directivity when the match varies on some of the ports. The manufacturer usually won't be able to tell you. But if it's important, write it into the specifications.

If the coupler is a four-port tracking coupler for use in a reflectometer, does the manufacturer tell you how the coupling tracks on the two output ports?

If the coupler is a multiport combiner or divider, have you been told about the phase and isolation variation from port to port? How about

power balance vs temperature?

With all couplers you are never told the effects on coupling and isolation caused by spurious out-of-band signals fed simultaneously into the coupler along with the desired signal.

And though they are never provided, two specs that would help system designers in many applications are phase variation with temperature and power-handling capability vs frequency.

Too often the system designer picks an off-the-shelf coupler for a system prototype. Generally he has an ultimate environmental requirement in mind. Remember that the characteristics of the off-the-shelf unit still might not be valid for a unit that meets your environmental spec.

Fix the loss

A prescribed amount of loss can be introduced with microwave attenuators. These come in three forms. The cheapest are fixed attenuators, also known as pads. Then there are continuously variable attenuators and step attenuators.

Fixed attenuators are well-specified in most catalogs. The only spec that is sometimes suspect is variation of attenuation with frequency.

Continuously variable attenuators suffer many ills. As with tunable filters, these often have backlash problems in the dial. Also, phase shift through the attenuator varies as a function of attenuation as well as of frequency. And often the dial gets loose or sloppy after only a little use.

Rarely is a spec given that shows how the power-handling capability of the attenuator var-

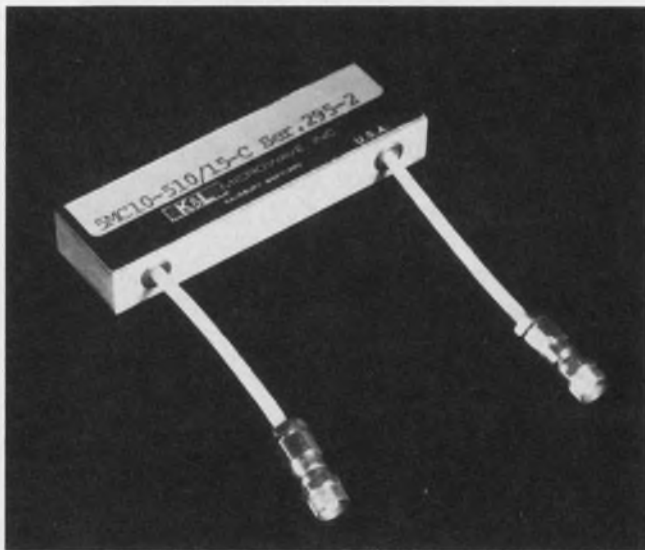

Miniature cavity filters from K&L offer low insertion loss and extremely small size. The filters use small helical resonators and comb line coupling.

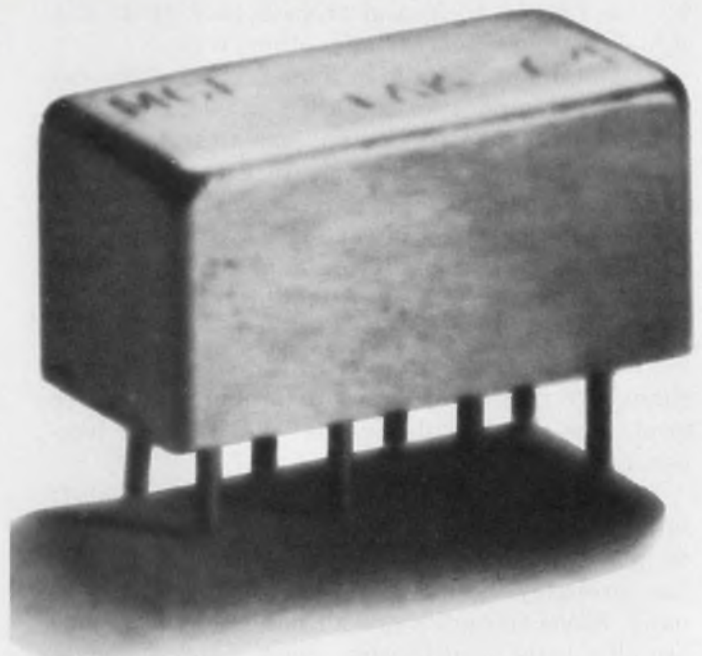

PSC-2 splitter/combiner by Mini-Circuits is made to plug into a printed-circuit board. Because of a unique design, there is no phase shift between the outputs, and isolation is at least 25 dB. These hermetically sealed units come in frequency bands up to 1 GHz.

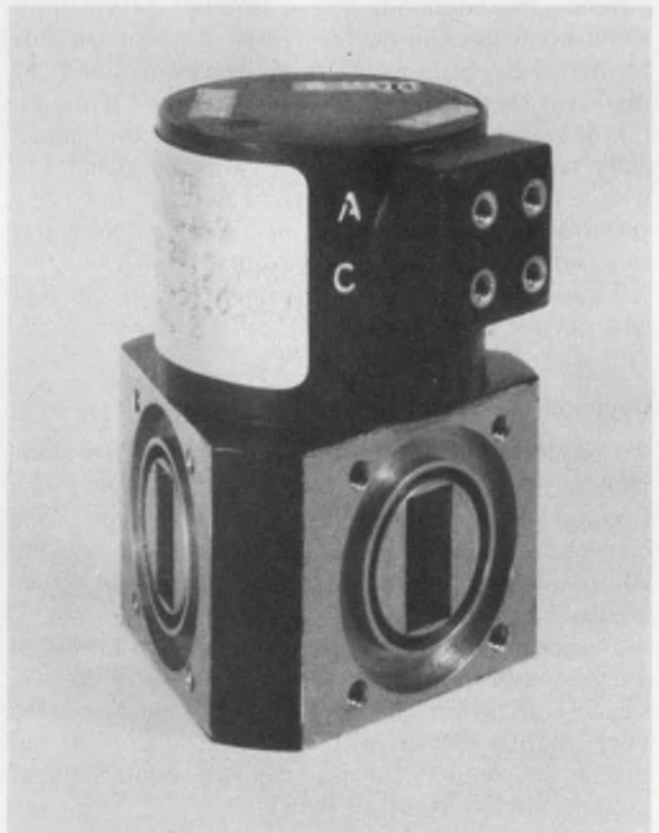

Delta-configuration X-band mechanical waveguide switch from Microlab/FXR is one of a series produced by the company to cover full waveguide bands up through 18 GHz.

ies as a function of attenuation.

Step attenuators suffer most of the same ills as variable attenuators, with a few notable additions. A step attenuator is often used as a relative indicator. Thus the difference in attenuation from one step to the next is often more important than the absolute attenuation of any given step. Unfortunately, you are almost never given a curve of attenuation vs frequency for each step. Sometimes a spec is given for the incremental attenuation accuracy of the device. But this spec does not take into account the cumulative errors that build up if you move more than one step.

Furthermore, when accuracy is quoted on the spec sheet, it is often difficult to decide whether the manufacturer is talking about variation with frequency, dc accuracy or incremental attenuation accuracy.

There are two basic types of passive microwave switches—coaxial and waveguide. Both are very easy to specify. However, switches suffer from reliability problems. The specs that held yesterday might not hold today. Coaxial switches develop partial loss of contact, and waveguide switches start to go out of mechanical alignment. The results of both these problems are discontinuities leading to reflective losses in the switch. Sometimes the mechanical problems get so bad that the switch won't switch.

A major improvement in coaxial switches has just been announced by Hewlett-Packard. This switch uses an edge line structure. Only the center conductor switches, leaving the outer conductor always in the same place. HP reports that this structure increases at least a tenfold the reliability of passive coaxial switches.

Into the millimeter waves

Up above 30 GHz, in the millimeter-wave region, all passive microwave components use waveguide structures. The most serious problem in this frequency range is flange misalignment. Mismatches due to flange misalignment can negate the performance of almost any device. Once extreme care is taken to avoid this problem, specifying mm-wave components reverts to the same problems encountered at lower frequencies.

And here's a final suggestion. Much grief can be avoided if manufacturers define the test procedures used in measuring the various characteristics of passive microwave devices. Too often, the manufacturer measures the device one way and the customer another way, yielding different results. Some measurement techniques tend to ignore factors that other measurement techniques consider important. ■■

Need more information?

Passive microwave components have been discussed in this report only in general terms. We haven't attempted to describe specific units. For additional information on specific product lines, circle the appropriate information retrieval numbers. For data sheets on many passive microwave components, consult ELECTRONIC DESIGN's GOLD BOOK.

- A&A Ramco Engineering, Inc., 9811 Independence Ave., Chatsworth, CA 91311. (213) 882-4700. **Circle No. 401**
- Acrodyne Inc., 21 Commerce Dr., Montgomeryville, PA 18936. (215) 368-2600. (J. R. Nagy). **Circle No. 402**
- Adams Russell Co., Inc., Antenna & Microwave Div., Haverhill Rd., Amesbury, MA 01913. (617) 388-5210. (C. M. Jones). **Circle No. 403**
- AD Data Sys., Inc., 830 Linden Ave., Rochester, NY 14625. (716) 381-7362. (H. Turner). **Circle No. 404**
- Addington Labs, Inc., Microwave Components Div., 1043 Di Giulio Ave., Santa Clara, CA 95050. (408) 248-5511. (J. Vance). **Circle No. 405**
- AEL, P.O. Box 552, Lansdale, PA 19446. (215) 822-2929. (B. Bernard). **Circle No. 406**
- Aerolite Elecs. Corp., 2207 Summit Ave., Union City, NJ 07087. (201) 863-2955. **Circle No. 407**
- ALL, Walt Whitman Rd., Melville, NY 11746. (516) 595-5000. (R. Domchick). **Circle No. 408**
- Airborne Instrument Labs, Comac Rd., Deer Park, NY 11729. (516) 595-3094. (J. W. Kearney). **Circle No. 409**
- Aircorn Inc., Route 16 B, Union, NH 03887. (603) 473-2323. **Circle No. 410**
- Alan Ind., Inc., P.O. Box 1203 A, Columbus, IN 47201. (812) 372-8869. **Circle No. 411**
- Alford Manufacturing Co., 120 Cross St., Winchester, MA 01890. (617) 729-8050. **Circle No. 412**
- Alpha Ind., Sylvan Rd., Woburn, MA 01801. (617) 935-5150. **Circle No. 413**
- Aluminum Design Corp., 9301 W. 47 St., Brookfield, IL 60513. (312) 485-6290. (O. J. Zamazal). **Circle No. 414**
- American Microwave Inc., 140 Fourth Ave., Waltham, MA 02154. (617) 891-5230. **Circle No. 415**
- Amperex Elec. Corp., 230 Duffy Ave., Hicksville, NY 11802. (516) 931-6200. (M. Smoller). **Circle No. 416**
- Amphenol RF Div., Bunker-Ramo Corp., 33 E. Franklin St., Danbury, CT 06810. (203) 743-9272. (L. E. Eichenseer). **Circle No. 417**
- Anaren Microwave Inc., 185 Ainsley Dr., Syracuse, NY 13205. (315) 476-7909. (R. A. Worden). **Circle No. 418**
- Anzac Electronics Div., Adams-Russell, 39 Green St., Waltham, MA 02154. (617) 899-1900. (A. Le May). **Circle No. 419**
- Applied Microwave Div., Epsco Inc., 411 Providence Hwy., Westwood, MA 02090. (617) 329-1500. (E. R. Barton). **Circle No. 420**
- Applied Research Inc., 76 S. Bayles Ave., Port Washington, NY 11050. (516) 883-5700. **Circle No. 421**
- Arra Inc., 15 Harold Ct., Bay Shore, NY 11706. (516) 231-8400. (P. L. Bleifer). **Circle No. 422**
- Artech Corp., 2816 Fairfax Dr., Falls Church, VA 22042. (703) 560-3292. **Circle No. 423**
- Arwood Corp., Rockleigh Industrial Park, Rockleigh, NJ 07647. (201) 767-0600. (N. Silverberg). **Circle No. 424**
- Astrolab Inc., 1600 Essex St., Rahway, NJ 07065. (201) 382-8204. (J. R. Toma). **Circle No. 425**
- Atlantic Microwave Corp., Route 117, Boston, MA 01740. (617) 779-5525. (R. Dalton). **Circle No. 426**
- AVA Electronic Corp., 242 Pembroke Ave., P. O. Box 338, Lansdowne, PA 19050. (215) 284-2500. (A. Jackson). **Circle No. 427**
- Bendix Corp., Electrical Components Div., Sherman Ave., Sidney, NY 13838. (607) 563-9511. (J. C. Youmans). **Circle No. 428**
- Bird Elec. Corp., 30303 Aurora Rd., Cleveland, OH 44139. (216) 248-1200. (H. H. Heller). **Circle No. 429**
- Bunker Ramo Corp., Micromega Div., 31717 La Tienda Dr., Westlake Village, CA 90066. (213) 889-2211. (D. C. Wright). **Circle No. 430**
- B&W Assoc., 21 B St., Burlington, MA 01803. (617) 272-4420. (R. A. Bellefeuille). **Circle No. 431**
- California Microwave, 445 W. Maude Ave., Sunnyvale, CA 94086. (408) 732-4000. (A. F. Kenrick). **Circle No. 432**
- Cardwell Condenser Corp., Belz Ind. Div., 80 E. Montauk Highway, Lindenhurst, NY 11757. (516) 884-4300. **Circle No. 433**
- Cerro Com. Prods., Halls Mill Rd., Freehold, NJ 07728. (201) 462-8700. (H. MacIntosh). **Circle No. 434**
- Chomerics Inc., 77 Dragon Ct., Woburn, MA 01801. (617) 935-4850. (J. N. White). **Circle No. 435**

(continued on page 64)

- CirTel Inc., 10504 Wheatley St., Kensington, MD 20795. (301) 946-1800. (D. E. Claycomb). **Circle No. 436**
- Co-Ax Devices Inc., P. O. Box 234, Chelsea, MA 02150. (617) 884-6983. **Circle No. 437**
- Coaxial Dynamics Inc., 13110 Enterprise Ave., Cleveland, OH 44135. (216) 267-2233. (R. J. Scott). **Circle No. 438**
- Coil-Craft Inc., 340 Bronxville Rd., Bronxville, NY 10708. (914) 337-4775. **Circle No. 439**
- Comtech Labs, Inc., 135 Engineers Rd., Smithtown, NY 11787. (516) 231-5454. (J. Rosenbloom). **Circle No. 440**
- Connecticut Microwave Corp., Route 44, New Hartford, CT 06057. (203) 693-4247. (S. T. Unbank). **Circle No. 441**
- Continental Leasing Co., Inc., 175 Middlesex Turnpike, Bedford, MA 01730. (617) 275-0850. **Circle No. 442**
- Corry Micronics Inc., P. O. Box 31, Corry, PA 16407. (814) 664-7728. **Circle No. 443**
- Crown Microwave, Inc., 6 Executive Park Dr., North Billerica, MA 01862. (617) 667-4165. (J. J. Powell). **Circle No. 444**
- Custom Components Div., Lauriat Corp., 21 Passaic Ave., Fairfield, NJ 07006. (201) 227-5340. **Circle No. 445**
- Decibel Products Inc., 3184 Quebec St., Dallas, TX 75247. (214) 631-0310. (E. O. Rinehart). **Circle No. 446**
- Delta Microwave, 790 Hampshire Rd., Suite D, Westlake Village, CA 91361. (213) 889-6582. **Circle No. 447**
- Detoronics Corp., 10660 E. Rush St., South El Monte, CA 91733. (213) 579-7130. (D. Baroda). **Circle No. 448**
- Diamond Antenna & Microwave Corp., 35 River St., Winchester, MA 01890. (617) 729-5500. (C. Theophile). **Circle No. 449**
- Dielectric Coms., Meadow Rd., Raymond, ME 04071. (207) 655-4555. (S. O. Thomas). **Circle No. 450**
- Domain Systems, 215M Central Ave., East Farmingdale, NY 11735. (516) 293-6505. (L. C. Weiner). **Circle No. 451**
- Eastern Microwave Corp., 4 Gill St., Woburn, MA 01801. (617) 935-8600. (M. E. Devane). **Circle No. 452**
- Elcom Systems, Inc., 127 Brook Ave., Deer Park, NY 11729. (516) 667-5800. **Circle No. 453**
- Electromagnetic Sciences, Inc., 125 Technology Park, Atlanta Norcross, GA 30071. (404) 448-5770. (W. K. Alverson). **Circle No. 454**
- Electronic Research Labs, Inc., 1423 Ferry Ave., Camden, NJ 08104. (609) 541-4200. **Circle No. 455**
- EMC Tech., Inc., 1971 Old Cuthbert, Cherry Hill, NJ 08034. (609) 429-7800. (M. Steidlitz). **Circle No. 456**
- Emerson & Cuming, Inc., 60 Walpole St., Canton, MA 02021. (617) 828-3300. (W. R. Cuming). **Circle No. 457**
- Emerson Electric Co., Rantec Div., 24003 Ventura Blvd., Calabasas, CA 91302. (213) 347-5446. (L. E. Roby). **Circle No. 458**
- E & M Labs., Inc., 5388 Sterling Center Dr., Westlake Village, CA 91361. (910) 494-1953. (W. R. Reed). **Circle No. 459**
- Engelmann Microwave Co., Skyline Dr., Montville, NJ 07045. (201) 334-5700. **Circle No. 460**
- Ercona Corp., 2492 Merrick Rd., Bellmore, NY 11710. (516) 781-2770. **Circle No. 461**
- Erie Tech. Prods., 644 W. 12th St., Erie, PA 16512. (814) 453-5611. (P. E. Snyder). **Circle No. 462**
- Frequency Elecs., Inc., 3 Delaware Dr., New Hyde Park, NY 11040. (516) 828-0100. (A. Lazar). **Circle No. 463**
- Frequency Engineering Labs, P. O. Box 527, Farmingdale, NJ 07727. (201) 938-9221. (R. V. Snyder). **Circle No. 464**
- Frequency West Inc., 3140 Alfred St., Santa Clara, CA 95050. (408) 249-2850. (S. B. Rupp). **Circle No. 465**
- Gamma-F Corp., 145 Sheldon St., El Segundo, CA 90245. (213) 322-8250. (C. B. Goss). **Circle No. 466**
- General Electric, Elec. Components, Electronics Park Blvd., Liverpool, NY 13088. **Circle No. 467**
- General Microwave Corp., 155 Marine, Farmingdale, NY 11735. (516) 694-3600. (M. Wind). **Circle No. 468**
- GHZ Devices, 16 Maple Rd., South Chelmsford, MA 01824. (617) 256-8101. (R. Tremblay). **Circle No. 469**
- Herley Ind., Inc., 160 Eileen Way, Syosset, NY 11791. (516) 364-0100 (G. Sacks). **Circle No. 470**
- Hewlett-Packard, 1501 Page Mill Rd., Palo Alto, CA 94304. (415) 493-1501. (R. Snyder). **Circle No. 471**
- Hope Elecs., Box 773, Clifton, NJ 07013. (201) 777-3522. **Circle No. 472**
- HRB Singer Inc., P. O. Box 60, Science Pk., State College, PA 16801. (814) 238-4311. (R. R. Goldsborough). **Circle No. 473**
- Hughes Aircraft Co., Electron Dynamics Div., 3100 W. Lomita Blvd., Torrance, CA 90509. (213) 534-2121. (L. Hill). **Circle No. 474**
- ITT Jennings, 970 McLaughlin Ave., San Jose, CA 95116. (408) 292-4025. (E. Valehrach). **Circle No. 475**
- Junction Devices, 790 Hampshire Rd., Westlake, CA 91361. (213) 889-6528. **Circle No. 476**
- K & L Microwave, Inc., 408 Coles Circle, Salisbury, MD 21801. (301) 749-2424. (C. Schaub). **Circle No. 477**
- Lark Engineering Co., Inc., 866 W. 16th St., Newport Beach, CA 92660. (714) 642-9200. (F. J. Baier). **Circle No. 478**
- Laseration Inc., 2629 N. 15th St., Philadelphia, PA 19132. (215) 842-3030. **Circle No. 479**
- Litton Industries, Airtron Div., 200 E. Hanover Ave., Morris Plains, NJ 07950. (201) 539-5500. (D. Ryan). **Circle No. 480**
- Locus Inc., 1517 Science St., State College, PA 16801. (814) 237-0301. (J. E. Hess). **Circle No. 481**
- Logus Manufacturing Corp., 57 Verdi St., Farmingdale, NY 11762. (516) 242-5970. **Circle No. 482**
- LRC Inc., 101 Digital Dr., Hudson, NH 03051. (710) 228-1377. (F. Solla). **Circle No. 483**
- Lundy Electronics & Systems, Inc., Robert Lane, Glen Head, NY 11545. (516) 671-9000. (D. Casadonte). **Circle No. 484**
- Maury Microwave Corp., 8610 Helms Ave., Cucamonga, CA 91730. (714) 987-4715. **Circle No. 485**
- MCL Inc., 12 N. Beach, La Grange, IL 60525. (312) 354-4350. **Circle No. 486**
- MCS Corp., 1307 S. Myrtle Ave., Monrovia, CA 91016. (213) 357-3285. (G. Churchouse). **Circle No. 487**
- Mecco/Electra Substrate Div., 10439 Roselle, San Diego, CA 92121. (714) 453-4733. (R. J. Gebhard). **Circle No. 488**
- Merrimac Ind., Inc., 41 Fairfield Pl., West Caldwell, NJ 07006. (201) 228-3890. (F. J. Weber). **Circle No. 489**
- Metavac Inc., 45-68 162 St., Flushing, NY 11358. (212) 445-0400. **Circle No. 490**
- Microwave Research Corp., 1429 Osgood St., North Andover, MA 01845. (617) 687-3141. (J. M. Herrmann). **Circle No. 491**
- MicroComs Inc., Grenier Field, RFD 3, Manchester, NH 03103. (603) 624-4351. **Circle No. 492**
- Micro-Dynamics, Inc., 10A Sonar Dr., Woburn, MA 01801. (617) 729-9450. (R. D. Ranta). **Circle No. 493**
- Microlab/FRX, 10 Microlab Rd., Livingston, NJ 07039. (201) 992-7700. (R. Vincent). **Circle No. 494**
- Micro Mode Prods Inc., 8400 N. Magnolia Ave., Santee, CA 92071. (714) 449-3844. **Circle No. 495**
- Microphase Corp., 35B River Rd., Cos Cob, CT 06807. (203) 661-6200. (G. P. Vratatos). **Circle No. 496**
- Microwave Assoc., Inc., South Avenue, NW Industrial Pk., Burlington, MA 01803. (617) 272-3000. (J. F. Bunker). **Circle No. 497**
- Microwave Control Co., 1105 Industrial Parkway, Bricktown, NJ 08723. (201) 458-3000. **Circle No. 498**
- Microwave Development Labs, Inc., 87 Crescent Rd., Needham Heights, MA 02194. (617) 449-0700. **Circle No. 499**
- Microwave/Sys. Inc., 1 Adler Dr., East Syracuse, NY 13057. (315) 437-9951. **Circle No. 500**
- Midwest Microwave In, 3801 Packard Rd., Ann Arbor, MI 48104. (313) 971-1992. (J. D. Kistner). **Circle No. 501**
- Mini-Circuits Laboratory, 837-843 Utica Ave., Brooklyn, NY 11203. (212) 342-2500. **Circle No. 502**
- Narda Microwave Corp., 75 Commercial, Plainview, NY 11803. (516) 433-9000. (J. F. Schindler). **Circle No. 503**
- Neico Microwave Co., 211 Second Ave., Waltham MA 02154. (617) 890-3535. **Circle No. 504**
- Norsal Ind Inc., 34 Grand Blvd., Brentwood, NY 11717. (516) 231-4040. **Circle No. 505**
- North Hills Elecs. Inc., Alexander Pl., Glen Cove, NY 11542. (516) 671-5700. **Circle No. 506**
- Nytek Elecs., 800 San Antonio Rd., Palo Alto, CA 94303. (415) 321-4191. **Circle No. 507**
- Omega Labs, Inc., 408 Haverhill St., Rowley, MA 01969. (617) 948-7757. **Circle No. 508**
- Omni Spectra Inc., 24600 Hallwood Ct., Farmington, MI 48024. (313) 477-1234. **Circle No. 509**
- Phelps Dodge Coms. Co., 441 Saw Mill River Rd., Yonkers, NY 10701. (914) 963-8200. (J. F. Jennings). **Circle No. 510**
- P&H Labs, 20940 Knapp St., Chatsworth, CA 91311. (213) 882-5616. **Circle No. 511**
- Power Hybrids Inc., 1742 Crenshaw Blvd., Torrance, CA 90501. (213) 320-6160. (W. E. Schaub). **Circle No. 512**
- Power Waves, Inc., 810 4th Ave., Asbury Park, NJ 07712. (201) 774-8322. (I. Uiman). **Circle No. 513**
- PRD Electronics Inc., Subsidiary of Harris Corp., 1200 Prospect Ave., Westbury, NY 11590. (516) 334-7810. (R. R. Uhrich). **Circle No. 514**
- Premier Microwave Corp., 33 New Broad St., Port Chester, NY 10573. (710) 569-1609. **Circle No. 515**
- QCI Corp., P. O. Box 606, Farmingdale, NJ 07727. (201) 681-5100. (J. R. Karr). **Circle No. 516**
- Radiation Devices Co., P. O. Box 8450, Baltimore, MD 21234. (301) 665-2764. **Circle No. 517**
- Raytheon Corp., 141 Spring St., Lexington, MA 02173. (617) 862-6600. **Circle No. 518**
- RCA Elec. Ind., Engineering Div., 7355 Fulton Ave., North Hollywood, CA 91605. (213) 674-2411. (W. Hansen). **Circle No. 519**

Reaction Instruments, Inc., 1757 Old Meadow Rd., McLean, VA 22101. (703) 471-6060. (T. Light). **Circle No. 520**

Reeve Electronics, Inc., 609 W. Lake St., Chicago, IL 60606. (312) 726-9755. (M. A. Boaz). **Circle No. 521**

RFD Inc., 5024 Nassau St., Tampa, FL 33607. (813) 872-1502. **Circle No. 522**

RF Systems, Inc., 155 King St., Cohasset, MA 02025. (617) 383-1200. (J. E. Hayes). **Circle No. 523**

RGA Research & Development Co., Inc., P. O. Box 53, Syracuse, NY 13215. (315) 469-8593. **Circle No. 524**

RHG Electronics Lab, Inc., 161 E. Industry Court, Deer Park, NY 11729. (516) 242-1100. (S. Wolin). **Circle No. 525**

RMS Electronics, Inc., 50 Antin Pl., Bronx, NY 10462. (212) 892-6700. (A. Goldstein). **Circle No. 526**

Ross Engineering Corp., 559 Westchester Dr., Campbell, CA 95008. (408) 377-4621. T. Hostek). **Circle No. 527**

Sage Labs Inc., 3 Huron Dr., Natick, MA 01760. (617) 653-0844. (W. J. Kennedy). **Circle No. 528**

Sanders Assoc., Daniel Webster Highway S., Nashua, NH 03060. (603) 885-2817. (R. Hall). **Circle No. 529**

Scientific Research Corp., Subsidiary of TRAK Microwave Corp., 4724 Eisenhower Blvd., Tampa, FL 33614. (813) 884-1411. (T. L. Roberts). **Circle No. 530**

Sealectro Corp., 225 Hoyt St., Mamaroneck, NY 10543. (914) 698-5600. (S. A. Lescarboursa). **Circle No. 531**

Siemens Corp., 186 Wood Ave. S., Iselin, NJ 08830. (201) 494-1000. (B. Mayer). **Circle No. 532**

Sierra Elec. Op., Philco-Ford Corp., 3885 Bohannon Dr., Menlo Park, CA 94025. (415) 322-7222. (H. E. Corey). **Circle No. 533**

Silverslab USA, P. O. Box 747, Corona Del Mar, CA 92625. (714) 673-3787. (P. Fredholm). **Circle No. 535**

Singer Co., 3176 Porter Dr., Palo Alto, CA 94304. (415) 493-3231. (P. N. Fulton). **Circle No. 534**

Solid State Tech., 3650 Charles, Santa Clara, CA 95050. (408) 247-8620. (C. M. Cheffer). **Circle No. 536**

Solitron Microwave, P. O. Box 278, Port Salerno, FL 33492. (305) 287-5000. **Circle No. 537**

Sperry Microwave Components, Waldo Rd., Gainesville, FL 32601. (904) 372-0411. (M. J. Drach). **Circle No. 538**

Struthers Electronics Corp., 4 Dubon Court, Farmingdale, NY 11735. (516) 420-9000. **Circle No. 539**

Systron-Donner Corp., Microwave Div., 14844 Oxnard St., Van Nuys, CA 91409. (213) 786-1760. (T. Anderson). **Circle No. 540**

Tek-Wave, Inc., 71 Old Camplain Rd., Somerville, NJ 08876. (201) 526-1150. (M. Lehrfeld). **Circle No. 541**

Teledyne Microwave, 1290 Terra Bella, Mountain View, CA 94043. (415) 968-2211. (K. W. Mills). **Circle No. 542**

TRAK Microwave Corp., 4726 Eisenhower Blvd., Tampa, FL 33614. (813) 884-1411. **Circle No. 543**

Transco Products, Inc., 4241 Glencoe Ave., Venice, CA 90291. (213) 821-7911. (W. Hoover). **Circle No. 544**

Transmission Lines, Inc., P. O. Box 292, Ipswich, MA 01939. (617) 356-4378. **Circle No. 545**

TRG Div. Alpha Ind., 20 Sylvan Rd., Woburn, MA 01801. (617) 935-5150. **Circle No. 546**

Trompeter Electronics, 8936 Comanche, Chatsworth, CA 91311. (213) 882-1020. (E. Trompeter). **Circle No. 547**

United Technology Labs, Inc., 1755 Jefferson Davis Highway, Suite 505, Arlington, VA 22202. (703) 920-1444. (H. Alsop). **Circle No. 548**

UTE Microwave, Inc., 3500 Sunset Ave., Asbury Park, NJ 07712. (201) 922-1009. (L. Nilson). **Circle No. 549**

Varian Assoc., 611 Hansen Way, Palo Alto, CA 94303. (415) 493-4000. (J. Heldack). **Circle No. 550**

Vectronics Microwave Corp., 276 Lincoln Blvd., Middlesex, NJ 08846. (201) 356-2377. **Circle No. 551**

Victor Microwave Inc., 38 W. Water St., Wakefield, MA 01880. (617) 245-4472. **Circle No. 552**

Watkins-Johnson Co., 3333 Hillview Ave., Palo Alto, CA 94304. (415) 493-4141. **Circle No. 553**

Wavecom Inc., 9036 Winnetka Ave., Northridge, CA 91324. (213) 882-3010. (E. S. Hensperger). **Circle No. 554**

Waveline Inc., P. O. Box 718, Caldwell, NJ 07006. (201) 226-9100. (J. A. McGregor). **Circle No. 555**

Wavetek, 9045 Balboa Ave., San Diego, CA 92123. (714) 279-2200. **Circle No. 556**

Weinschel Engineering, 1 Weinschel Lane, Gaithersburg, MD 20760. (301) 948-3434. (W. Ronis). **Circle No. 557**

Werlatone Inc., P. O. Box 258, Brewster, NY 10509. (914) 279-6187. **Circle No. 558**

Western Microwave Labs, 1260 Birchwood, Sunnyvale, CA 94086. (408) 734-1631. (R. G. Sanders). **Circle No. 559**

Wide Bank Engineering Co., Inc., P. O. Box 21652, Phoenix, AZ 85036. (602) 254-1570. **Circle No. 560**

Yig-Tec Corp., 1725 De La Cruz Blvd., Santa Clara, CA 95050. (408) 244-3240. (R. J. Bell). **Circle No. 561**

If you need a few custom ICs and can't afford them, call us.

When others quote you high prices for a few custom ICs, it's because they treat them as a sideline. At Silicon Systems, custom ICs are our bread and butter. Especially low quantity orders—even under 5000. Priced to compete with catalogue ICs.

One reason for our low prices is our proprietary design system. Developed in our own computer lab, this system helps us solve design problems in any technology—TTL, Schottky, ECL, Linear, PMOS, NMOS, CMOS, I²L—whatever is best for you. Designs that are fully protected because they can't be copied.

Over the years, we've become expert at satisfying all kinds of special design requirements. With ICs that replace entire groups of catalogue ICs, saving you board area, power, cooling, testing, spares—money and grief.

So when you think you can't afford custom ICs, write us. Silicon Systems, Inc., 2913 Daimler Street, Santa Ana, CA 92705. Better yet, call:

(714) 979-0941

Silicon Systems
The One-of-a-Kind IC Company

High Power Microwave Devices From Transco

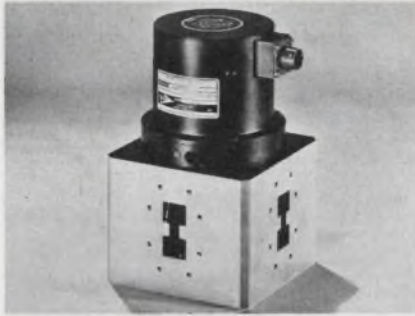

WAVEGUIDE SWITCH . . . double ridge, 5 kW average power features the unique Transco Transactor actuator which combines the actuator rotor and switch R.F. rotor in a single integrated assembly. Inquire about other WG types.

ANTENNAS (blade, horn, spiral, slot) ■ **HYBRIDS**
WAVEGUIDE SWITCHES ■ **COAXIAL SWITCHES**
FILTERS ■ **COUPLERS** ■ **POWER DIVIDERS**



FILTERS . . . coaxial, low pass, cut off 350 to 1000 MHz are computer designed with a power handling capability of 400 W CW for the filters with LT connectors. Other high power filters, hybrids and power dividers are available.

SPIRAL ANTENNA . . . high power, high performance spiral antenna specially designed for EW applications. Operates continuously at 100 W average, 4 kW peak power in environments which meet or exceed MIL-E-5400.

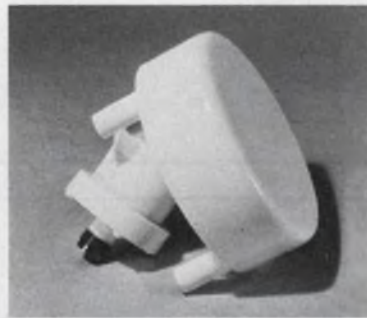

HORN ANTENNA . . . I/J Band, circularly polarized, octave bandwidth, fan beam, 500 W CW, WRD750 WG input and a sampling probe. ECM application. Part shown with a pressure window and flexible WG.



COAXIAL SWITCHES, Type DX, MX and HX are designed for high average power up to 6.5 GHz; example: 1500 watts at 1 GHz. All actuators are 28 Vdc, fail-safe for SPDT and Transfer, selective for multi-throw. All have type SC connectors.

HCI . . . Heat Conducting Dielectric, a Transco proprietary material, increases the average power handling capability. Test results on a large number of components employing HCI have consistently indicated a CW power rating 2½ times greater than conventional low-loss dielectric materials.

PRODUCTS TO DIRECT RF ENERGY

Shown: small representative sample of the many Transco high power microwave components for ECM, radar, communication systems, high power test sets. Circle our number on the publication postcard to receive our Short-Form Catalog. Call or write for a prompt reply.



NEW! TRANSPAC PORTABLE ANECHOIC CHAMBER . . . Request Data Sheet No. 422.

TRANSCO PRODUCTS, INC., 4241 GLENCOE AVENUE, VENICE, CALIFORNIA 90291
TELEPHONE: Area Code 213 / 821-7911 • **TELEX** 65 - 2448 • **TWX** 910 - 343 - 6569
PRODUCTS TO DIRECT RF ENERGY... Switches Coaxial/Waveguide • Front Ends • Filters
• **Antennas**—Communications, Guidance, ECM • Couplers • Multiplexers • Power Dividers • Hybrids • RF and Antenna Subsystems. **Quality Products Since 1942. Equal Opportunity Employer.**



Precision can't depend on typical specs.

PMI's got your number!

PMI decided long ago to provide circuit designers with the precision they need. And to quote key specs in meaningful MAX. (or MIN.) numbers.

For example: Our OP-05, a direct replacement for 725's, 108A's, and un-nulled 741's, has a MAX. noise spec of $0.6\mu\text{V}$ p-p, 0.1 to 10Hz. And the data sheet shows that you can depend on the device not to drift more than $0.5\mu\text{V}/^\circ\text{C}$ (the MAX. spec).

— Long term drift is guaranteed at $8\mu\text{V}/\text{month}$. MAX.

— V_{os} is 0.15mV. MAX.

— Bias current is 2.0 nA. MAX.

— And CMRR, PSRR, GAIN and R_{in} DIFF are all quoted MIN.

The point is, we know the designer's op amp problems: accuracy and repeatability. That's why we specify exactly what they'll do, MAX.

To check out our precision op amp numbers and ponder the intrinsic simplicity of our monolithics, circle the bingo card or contact us.

Precision Monolithics, Incorporated
1500 Space Park Drive, Santa Clara, CA 95050
(408) 246-9222. TWX 910-338-0528.
Cable MONO.



INFORMATION RETRIEVAL NUMBER 42



Consider low-cost lasers for your light-source application. The coherent sources offer minimal spot size and high spectral purity. Here are tips in selecting them.

Though not as inexpensive or reliable as tungsten lamps or light-emitting diodes, small low-cost lasers offer several advantages over incoherent light sources.

The major laser benefits result from outstanding collimation and focusing characteristics. A laser's beam divergence and focused spot size are determined by light diffraction. Hence they are the smallest that can be achieved. Small spot size or small beam divergence can be obtained with incoherent light sources, but with a sacrifice in light intensity.

Another important advantage is a laser's spectral purity, or narrow wavelength spread. This spread ranges from one part in 10^4 for some semiconductor units to one part in 10^9 for some gas lasers. The very narrow spread means that narrowband interference filters can be used to suppress unwanted background light.

For these reasons and more, low-cost lasers are turning up in a wide range of applications. These lasers can be found in facsimile equipment, video discs and high-speed printers. Also, they are being used for precision-distance measuring, fiber-optics communication, and alignment and leveling in the construction industry.

However, the selection of the right laser requires a knowledge of both the tradeoffs in performance and specification limitations. Low-cost lasers encompass various semiconductor and gas types, and they have a wide price range—from less than \$100 to a few thousand dollars. The important laser characteristics to check are these:

- Noise.
- Longitudinal modes.
- Polarization effects.
- Transverse-mode structures.
- Operating wavelengths.
- Lifetimes.
- Power requirements.

Numerous sources of noise can contribute to fluctuations in the output of a laser. These sources

include microphonic types of noise caused by vibrations due to coolant flow or acoustic pickup, as well as noise due to discharge fluctuations, competition between modes of oscillation or air currents within the laser cavity. Before selecting a laser, carefully check the laser noise against that required by your system in an environment as close to the operating one as possible.

Most manufacturers specify a laser's amplitude fluctuation for frequencies in the kilohertz to low megahertz range. But for very broadband systems, you must deal with the very strong discrete spectrum of noise lines that occur at integral multiples of the cavity-mode spacing frequency, $f = c/2L$. In this expression c is the velocity of light, and L is the cavity length (Fig. 1). For example, a small laser of 30-cm length usually possesses strong internal intensity modulations at 500 MHz. This fluctuation could cause severe problems in a broadband system, although it would pass completely unnoticed in systems with bandwidths up to a few tens of megahertz.

Lasers with a low-frequency noise problem can be stabilized by a feedback loop (Fig. 2). This circuit has additional benefits; it linearizes the modulator and eliminates drift in the power output.

Many longitudinal modes are possible

In essence, a laser consists of a gain medium contained between two mirrors, which provide the feedback for oscillation. The mirrors form a cavity with many resonant modes. The laser may oscillate in any of these modes when the cavity Q is high enough and the frequency matches that at which the medium has gain.

As previously mentioned, the longitudinal modes are located at frequencies that are integral multiples of the velocity of light, c , divided by twice the cavity length, L . For example, a helium-neon laser with a 2-m cavity length has a spacing between modes of $c/2L = 75$ MHz. The He-Ne medium has appreciable gain over a band of approximately 1000 MHz centered on 4.74×10^{14} Hz (corresponding to a wavelength of 0.632μ). Therefore this laser can oscillate

Robert Montgomery, Ph.D., Director of Custom Products and Devices, Harris Corp., Electronic Systems Div., P.O. Box 37, Melbourne, FL 32901.

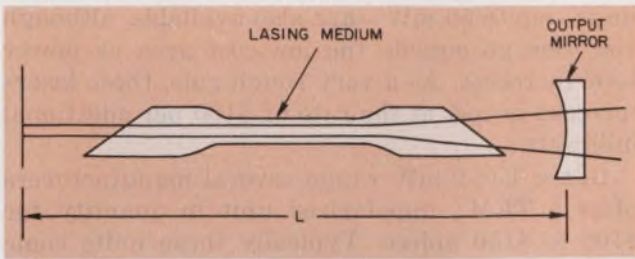

1. A laser is actually a resonant cavity that can support oscillations at light frequencies. The cavity's lasing medium provides gain, while the mirrors at each end provide feedback. A slightly transparent mirror serves as the cavity's output.

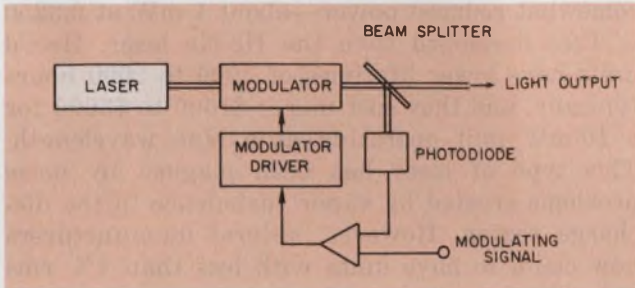

2. A feedback modulation scheme cancels low-frequency noise, eliminates drift and linearizes the modulator.

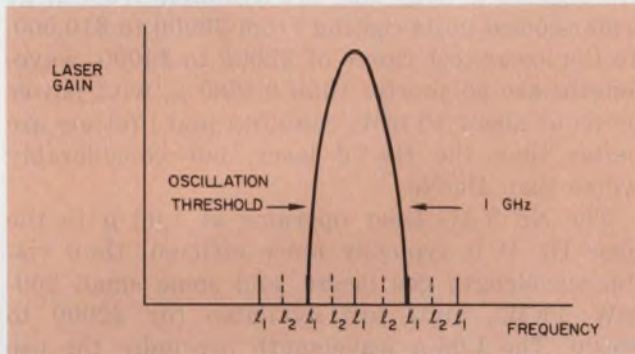

3. Slight variations in the length of short laser cavities can cause more than one longitudinal mode to propagate, thereby affecting power and polarization.

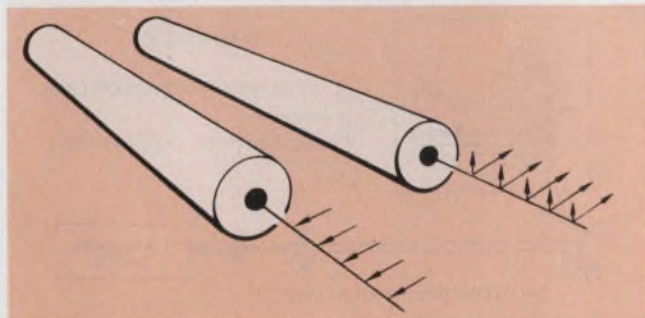

4. Output-power concentration differs markedly for polarized and unpolarized lasers. In a linearly polarized laser (left), power concentrates in a single plane. An unpolarized unit distributes most of the power between two orthogonal planes.

simultaneously in about $1000/75 = 15$ longitudinal modes. The distribution of energy in these modes fluctuates randomly, leading to a low-frequency noise (less than 50 kHz), referred to as mode-competition noise.

For a smaller laser, such as the 30-cm unit, the mode spacing is about 500 MHz, and only one or two modes oscillate simultaneously. Whether the laser oscillates in a single mode or two modes depends on the exact cavity frequency (Fig. 3). With cavity length l_1 , only a single mode of oscillation is possible. However, with a cavity length of l_2 , the laser oscillates in two modes. The difference between the lengths l_1 and l_2 for the 30-cm laser is only 1 ppm of the cavity length.

This minute difference leads to a situation in which the oscillation changes from single to double mode and back again as the cavity length changes with temperature. The phenomenon is especially evident when the laser is turned on from a cold start. Power-output fluctuations of 3 to 10% can be expected each time the laser hops from single to double-mode oscillation.

Perhaps more significant than the level change with mode hopping are the associated polarization effects. In a nominally "unpolarized" laser, the light from single-mode operation will usually be strongly polarized (Fig. 4). When the laser oscillates in two modes, the light from one mode is polarized orthogonally to that from the other. Thus as the oscillating modes "walk through" the laser warmup period, the laser's polarization changes drastically every few seconds. These polarization shifts can be converted to undesired amplitude fluctuations by modulators or mirrors in the optical system.

The problem can be avoided by the use of a polarized laser, but at a slight increase in cost. Or the polarization shifts can be tolerated if the system is not sensitive to polarization. Of course, this means that all mirrors, windows, etc., must be designed to be insensitive to polarization.

Specify transverse modes

Like a microwave cavity, the laser cavity can sustain several modes that have transverse structures. Usually, though, only the lowest order, or TEM_{00} transverse mode, is allowed to oscillate. Oscillations in higher-order modes correspond roughly to the generation of several beams simultaneously, or some loss of spatial coherence. Most gas lasers are designed for TEM_{00} oscillation, although slightly higher efficiency and power output can be obtained with multimode oscillation.

In solid-state lasers, such as Nd:YAG (neodymium-doped yttrium-aluminum garnet) and Nd:glass, it is difficult to maintain TEM_{00} -mode oscillation because of irregularities in the lasing

material in the cavity. Especially when considering these lasers, be aware of the possible transverse modes that can oscillate and be sure to specify the type of operation desired.

The operating wavelength is usually dictated by the wavelength sensitivity of detectors, the sensitivity of the material on which information is to be written, visibility and scattering effects of the transmission medium. Most recording materials that don't require wet, chemical techniques operate in the UV-to-blue region of the spectrum. Detectors are adequate in the UV-to-near-IR (0.3 to 1 μ) region, but they don't work well in the long-wave IR region.

Laser reliability has improved markedly in the last five years, and lifetimes for almost all commercial units now range from about 2000 to 30,000 hours. The most highly developed and documented units—in terms of lifetime data—are the He-Ne (helium-neon), Argon, Nd:YAG and He-Cd (helium-cadmium) lasers. Continuous-wave GaAs (gallium arsenide) lasers are still being developed, and promising results have been obtained from laboratory units.

Most small low-cost lasers have efficiencies of 0.01 to 0.2%. With power output levels in the milliwatt range, power requirements are modest—in the range of tens of watts. Usually some moderately high voltages, in the 500-to-3000-V range, are required. The notable exception to the general rule is the GaAs injection laser. This device has efficiencies of 1 to 50% and therefore typically requires only a fraction of a watt of input power. The pulsed GaAs laser usually requires current pulses of 10 to 100 A with a duty factor of less than 1%.

The most frequently used lasers

The He-Ne laser tops the list of most frequently used lasers. It is available in low-cost OEM versions at the 1-to-2-mW level. Larger

units—up to 50 mW—are also available, although you soon go outside the low-cost area as power level increases. As a very rough rule, these lasers increase in cost at the rate of \$100 per additional milliwatt.

In the 1-to-2-mW range several manufacturers offer a TEM₀₀ unpolarized unit in quantity for \$100 to \$150 apiece. Typically these units come with a one-year warranty, and they provide a very stable, reliable source of red light (wavelength of 0.6328 μ). Noise levels are typically below 1%, but you must guard against mode hopping and polarization effects.

The He-Cd laser provides a coherent source of light in deep blue (0.4416 μ) and in UV, but with somewhat reduced power—about 1 mW at 0.3250 μ . Less developed than the He-Ne laser, He-Cd units have lower lifetimes of 1000 to 2000 hours typically, and they cost more: \$1500 to \$3000 for a 10-mW unit operating at a blue wavelength. This type of laser has been plagued by noise problems created by vapor turbulence in the discharge region. However, several manufacturers now claim to have units with less than 1% rms noise.

Among larger and more expensive units, the Argon laser constitutes one of the most versatile, reliable and stable. Several wavelengths ranging from green to deep blue are available from large water-cooled units costing from \$6000 to \$10,000. In the lower-cost range of \$2000 to \$4000, wavelengths are no shorter than 0.4880 μ , with power levels at about 10 mW. Stability and lifetime are better than the He-Cd laser, but considerably worse than He-Ne.

The Nd:YAG laser operates at 1.06 μ in the near IR. It is typically more efficient than visible-wavelength gas lasers, and some small 200-mW TEM₀₀ units are available for \$2000 to \$5000. The 1.06- μ wavelength precludes the use of this laser for writing on photosensitive films or plates. However, it may find wide use in fiber-

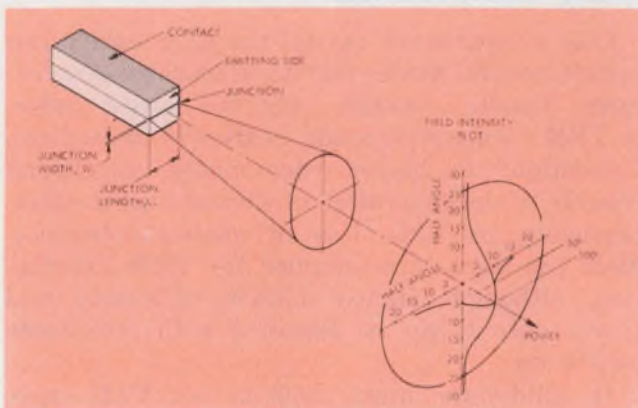

5. A gallium-arsenide laser emits light from a narrow junction, or line. This type of laser can output peak powers of 10 W; duty factors are about 0.1%.

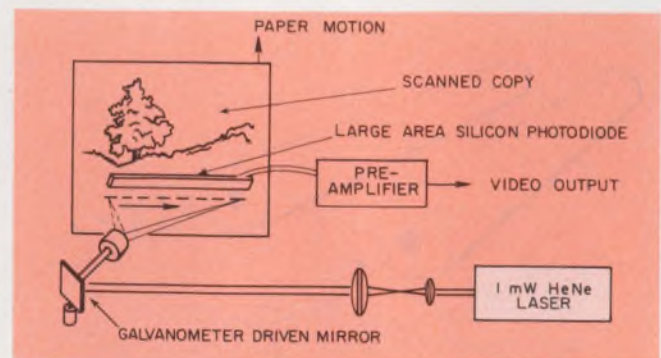

6. Facsimile equipment employs a laser-based flying-spot scanner. High-resolution laser light scans an image a line at a time, while a photodiode detector picks up the intensity-modulated signal. The image, or scanned copy, moves vertically.

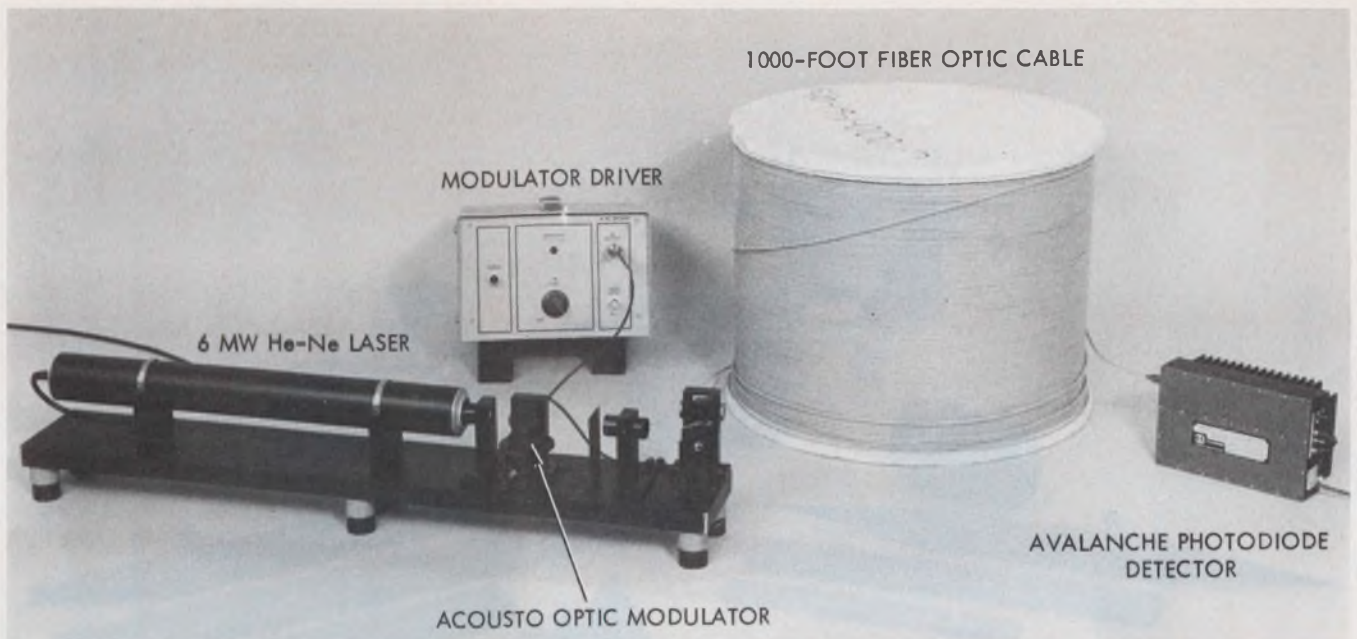

optic communication systems, since fiber attenuation is very low at this wavelength. Lifetimes are very high for the Nd:YAG laser, although pump lamps must be replaced every few hundred hours.

Presently available GaAs lasers operate only in a pulsed mode and at room temperature. Peak powers up to 10 W can be obtained, and maximum duty factors reach about 0.1%. GaAs lasers emit light from a thin line along the side of the GaAs chip (Fig. 5). The line or junction typically measures $1 \mu \times 50 \mu$. Beam divergence is typically 30° in the plane normal to the line and 10° in the plane of the line. The 10° divergence is several times larger than that of a TEM₀₀ beam of the same size.

Pulsed GaAs laser units can be purchased for less than \$50, making them the least expensive of the available lasers. A relatively simple SCR pulser can be used to produce the 20-to-100-A drive pulses needed. The high efficiency and small size of the GaAs laser make it attractive for use in hand-held communication and ranging instruments. When room-temperature cw units become available—probably later this year—these lasers will probably find wide application throughout the industry.

Some uses for low-cost lasers

One application for low-cost lasers is in a flying-spot scanner (Fig. 6), presently in use in a number of facsimile and newspaper plate-making systems. The term "flying spot" refers to the fact that illumination is confined to a single resolution element, while the detector field of view encompasses the entire object being scanned. In a typical example, the distance from

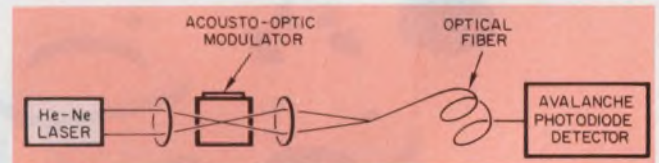

7. A laser-based fiber-optic communication link exhibits 40-dB signal-to-noise ratio, even though the He-Ne laser's wavelength isn't the one recommended for minimum fiber-attenuation loss.

lens to paper might be about 30 in., so that an 8-in. scan would subtend an angle of slightly over 15 degrees. This degree of scan is obtained with a total scan angle of 7.5 degrees at the mirror.

For a laser spot diameter of 0.005 in. (125μ) at the $1/e^2$ intensity points, the laser beam diameter at the lens is 4.9 mm to the $1/e^2$ points. (The $1/e^2$ point refers to the point in the beam where the optical intensity falls to about 13.5% of the maximum.) This size beam can be accommodated by a mirror of approximately 1 cm diameter.

If the photodetector is $1/2$ cm wide by 20 cm long and located 1 cm from the paper, a photocurrent of about $10 \mu\text{A}$ results for a 1-mW laser beam incident on a white page. These values provide a 40-dB S/N (peak signal to rms noise) for a 50-kHz bandwidth.

A fiber-optic communication link appears in Fig. 7. The photograph shows a system that was built to transmit three real-time TV channels, three digital data channels and three voice channels. All channels are frequency-multiplexed, and they modulate the intensity of a single 6-mW He-Ne laser beam. Though the laser's wavelength isn't the best one for fiber transmission, the system has a 40-dB S/N ratio at the receiver, despite a 1000-ft. length of fiber. ■■

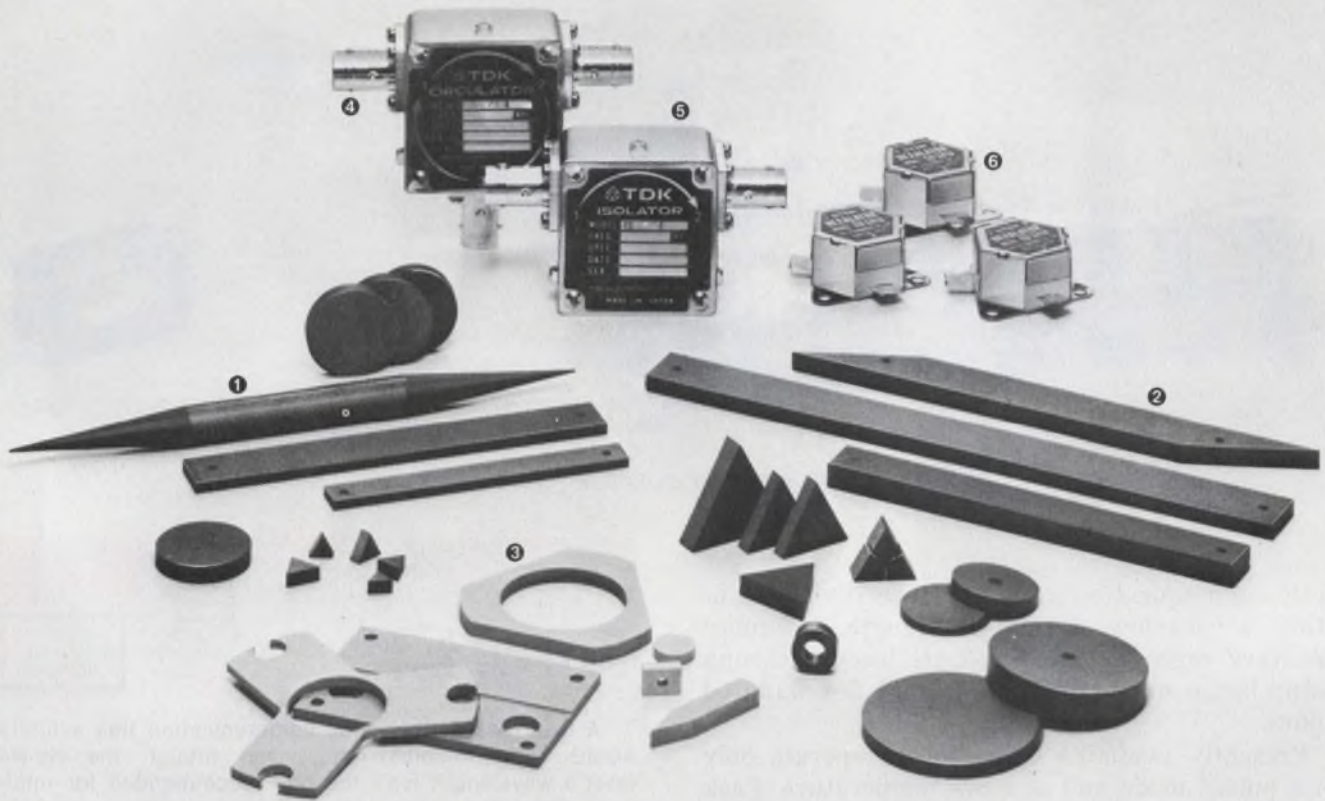

TDK introduces another series of "firsts" in microwave technology

Building on several decades of experience in ferrite manufacturing, TDK has continued to develop high performance microwave materials and products. Two outstanding materials which have been making headlines recently are a polycrystalline ferrite which utilizes electron gyration, and a dielectric material which is used in the matching of microwave impedance.

TDK has put these basic materials to work in several innovative devices developed by the company—circulators, isolators, and hexalators—all of which are indispensable to top performance of microwave equipment.

① Spinel Ferrite

This polycrystalline ferrite has a $4\pi M_s$ of 840 to 5100 (gauss) and minimal loss. It can be made into any shape desired.

② Garnet Ferrite

Two types are available.

Yttrium (Y-Al): $4\pi M_s=250$ to 1800 (gauss)

Yttrium-gadolinium (Y-Gd-Al):

$4\pi M_s=800$ to 1000 (gauss)

Like the spinel, loss is extremely small, and it can be made into any shape.

③ Dielectric Material (KU Material)

KU material is a dielectric material used for microwave circuit elements and developed exclusively by TDK. It has minimal loss over a wide frequency range and the advantage of being exceptionally easy to work with. The range of its dielectric constant is 4 to 25.

④ Circulator

TDK offers an entire line of compact, high performance circulators which can be adapted to frequencies ranging from several dozen MHz to 10 GHz. The circulators come in two basic types: a distributed parameter and

lumped parameter. Both types come in an external case which is itself a closed magnetic loop, and are therefore totally unaffected by stray magnetism.

⑤ Isolator

Depending on its use, a circulator requires a dummy load. In such cases, TDK makes an isolator—terminated circulator with a built-in dummy load. Most circulators are so equipped (with consideration given to heat radiation) when power input is less than 100W.

⑥ Hexalator

This TDK exclusive can be used both as a circulator and isolator by connecting matching external circuits for adjusting its tuning frequency. It is a stable, compact apparatus which is virtually unaffected by the external load. Frequency range is from 100 to 1000 MHz.

Representative in U.S.A. & Canada for telecommunication and industrial use ferrites

MH&W INTERNATIONAL CORP.

280, Midland Avenue, Saddle Brook, N.J. 07662 USA

Phone: N.J. (201) 791-6277, N.Y. (212) 244-0695 Telex: 134484, 134545

MH&W INTERNATIONAL (CANADA) LTD.

81 Kelfield Str., Rexdale, Ont. M9W 5A3 CANADA

Phone: 416-245-3606 Telex: 06-965656 TWX: 610-492-2352

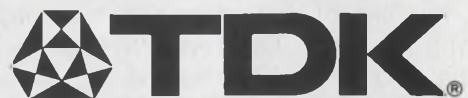

TDK ELECTRONICS CO., LTD.

14-6, 2-chome, Uchikanda, Chiyoda-ku, Tokyo 101, Japan

The way our distributors stock Wood Mini-Mag Circuit Breakers, they're practically on their way to you right now.

Say you need a supply of circuit breakers, the kind that trips instantaneously on short circuit. And you need them installed now.

Call your authorized Wood Electric Circuit Breaker distributor. He's nearby to give you quick delivery. And chances are he has what you need, right in stock: Mini-Mag compact magnetic-hydraulic circuit breakers. Ratings from 0.5 to 30 amperes.

Voltages from DC to 400 Hz. Trip times from .009 to 10 seconds at 200% of rated load.

In single, double and 3-pole units.

He also has a complete line of other magnetic-hydraulic models, plus thermal types.

For technical literature, call the Wood Electric Circuit Breaker distributor or our sales representative nearest you, or write Potter & Brumfield Division AMF Incorporated, Princeton, Indiana 47671. Telephone 812-385-5251.

Potter & Brumfield

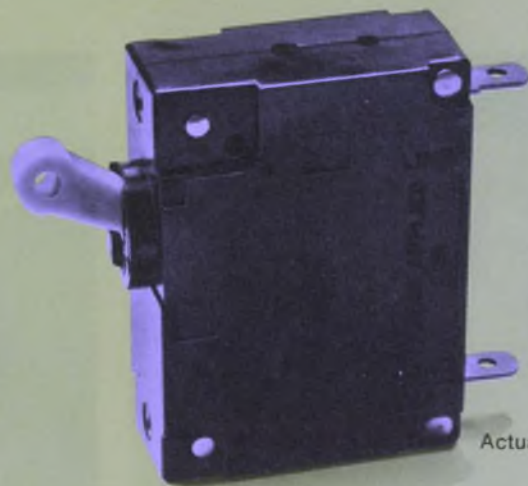

Actual Size

Quartz-crystal timing accuracy

is hard to beat. Crystals don't wear out; they improve with age. But Qs must be high for good stability and settability.

Quartz crystals have been used for many years for precise frequency control. However, the design and production of subminiature, low-frequency crystal units as used in wristwatches is a particularly difficult challenge. Tiny crystal blanks must be precisely cut, crystal Qs must be made high and the unit's mounting and housing must be carefully designed and processed under white-room conditions.

Despite initial start-up problems, crystal engineers have been able to design units for mass production with accuracies of ± 5 seconds per month. This is 12 times better than metal tuning-fork timing devices.

Further, quartz-controlled oscillators are unaffected by altitude or position; timekeeping accuracy improves with the passage of time; and significantly less deviation occurs because of temperature change.

A quartz-controlled wristwatch's "heart" beats at a frequency of 32,768 Hz. To achieve this

exact vibration rate, quartz blank crystals must be aligned along three specifically selected atomic planes with the help of X-rays.

Then each plane is precision-cut, ground and fine-lapped to an exact dimension. Vacuum-deposited electrodes convert the quartz blank into a rugged two-terminal electromechanically resonant assembly. An almost zero-temperature coefficient—measured in a few parts per million—can be attained for the assembly's resonant frequency if the crystal-plane orientation is properly chosen.

There are 12 identifiable crystal cuts. They divide into four general modes: flexure, extension, face shear and thickness shear. Each mode works best within a particular frequency range (Table 1). For wristwatches at 32.768 kHz, the XY' cut is usually used.

Electrical equivalent of a mechanical assembly

A quartz assembly is an electromechanical structure, but it can be represented by an equivalent electrical circuit (Fig. 1). Inductance L_1 represents the quartz' mass; C_1 , its mechanical

Anthony S. Matistic, Chief Crystal Engineer, Quartz Time Products, Communications Div., Motorola, Inc., 2553 N. Edgington Ave., Franklin Park, IL 60131.



Before World War II, Brazilian natural quartz was employed for most oscillator crystals. Now artificially cul-

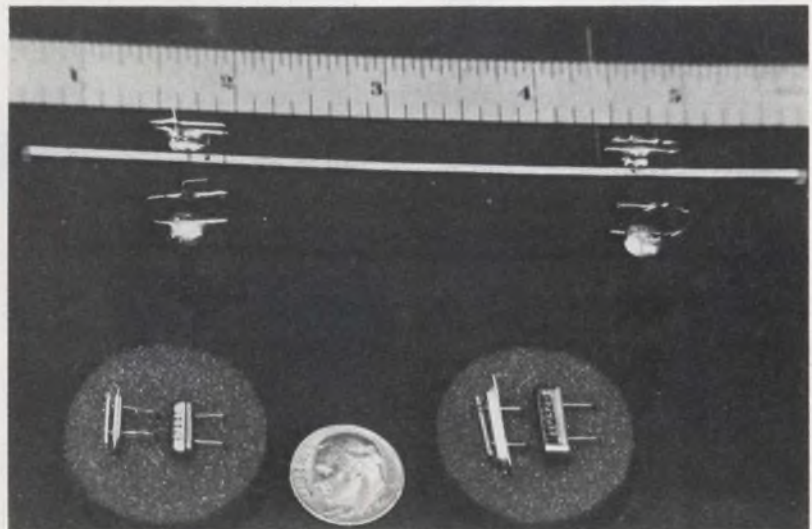

tured crystals are usually used to make crystals for watches, such as these 32.768-kHz units.

compliance, or elasticity; R_1 , friction, which produces heating; and C_o , the shunt capacitance of the crystal unit, which is composed of two parallel parts— C_1 , the capacitance between the crystal's metal electrodes with the quartz as the dielectric, plus C_h , the crystal-holder capacitance.

In a series-resonant mode, L_1 and C_1 cancel each other at the crystal's resonant frequency, and the crystal impedance is then mostly a low resistance, R_1 . In a second mode, the resonant circuit behaves as a parallel-resonant circuit, with the crystal acting as an inductance in parallel with C_o . The parallel-resonant frequency is slightly higher than that of the series resonant.

The way the crystal is cut relative to its atomic planes, shape and size, and the way it is mounted and electrically coupled in a circuit, all determine the values of these electric-equivalence parameters.

Inductance L_1 can vary from 300,000 H for a low-frequency crystal to about 5 mH for a 200-MHz unit operating on the ninth overtone. And C_1 can range from 0.00005 to 0.2 pF; C_o , from 1 to 50 pF; and R_1 from a few ohms to 1 M Ω .

Q is a measure of quality

All timing systems employ an oscillating or vibrating device. For example, in mechanical watches, a balance wheel oscillates at 2.5 to 10 Hz. In a tuning-fork watch, the frequency of the fork is 360 Hz. And an atomic frequency standard operates at 9000 MHz. The parameter that

most determines the stability and settability of an oscillating device is its Q. Table 2 lists correlations between Q and timing accuracy for the four different timing devices.

In mechanical terms, a crystal's Q is the ratio of energy stored to energy dissipated when the unit is oscillating; electrically it is the ratio of the equivalent inductive reactance to resistance. The formula is $Q = 2\pi f_s L_1/R_1$, where f_s is the crystal's series resonant frequency.

In a sample crystal unit for wristwatches, f_s was 32,768 Hz, L_1 was 4451 H and R_1 was 11,200 Ω .

Then

$$Q = \frac{6.28 \times 32,768 \times 4451}{11,200} = 81,780.$$

In a group of over 300 such identically designed crystals, Q values varied from 40,000 to 160,000. This 4:1 distribution of Q is typical for wristwatch quartz crystals. Of the equivalent circuit parameters, L_1 , C_1 , R_1 and C_o , resistance, R_1 , varies the most, and thus accounts for most of the spread in Q. The other parameters deviate no more than 10% from the average.

Q controls circuit performance

An oscillating crystal dominates its circuit; all other components play a subservient role. Dominance results from high crystal Q.

A crystal oscillator circuit can be considered to consist of a feedback network containing a quartz resonator and an amplifier (Fig. 2). Ideally the amplifier provides a 180-degree phase shift between its input and output, and the feedback network provides an additional 180-degree phase shift. The net gain around the loop must be equal to or greater than unity to sustain oscillation.

But in most cases the amplifier's phase shift is not precisely 180 degrees, and the shift varies because of variations in supply voltages, component values, semiconductor performance and temperature. To maintain the required over-all 360-degree loop phase shift, the feedback network provides a compensating phase change for changes in amplifier phase shifts. The compensating phase change is brought about by a shift in oscillator frequency. But the higher the Q of the crystal in the feedback network, the less the required frequency shift. Large Qs also allow more accurate initial setting of the frequency.

Fig. 3a shows the pass response of a crystal. Frequency f_s is the series-resonant frequency

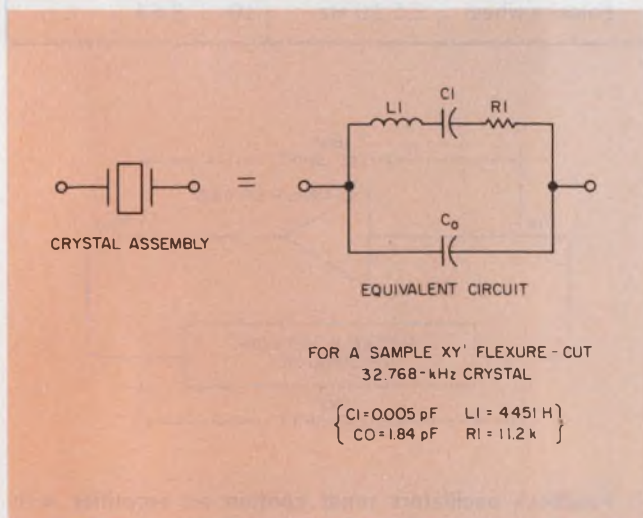

1. A quartz crystal is an electromechanical piezo-effect assembly, but its characteristics can be represented by an equivalent two-terminal electrical circuit.

Table 1. Crystal-vibration modes and frequency ranges

Mode of vibration	Crystal cut	Crystal frequency	Approximate G force	Drive level	Mechanical displacement
W/L flexure	XY'	1 kHz	5,000	0.1 mW	1×10^{-1} in.
W/L flexure	XY'	10 kHz	5,000	0.1 mW	1×10^{-3} in.
Face shear	DT	100 kHz	100,000	2.0 mW	2×10^{-4} in.
Face shear	DT	1,000 kHz	100,000	2.0 mW	2×10^{-6} in.
Thickness shear	AT	1,000 kHz	1,000,000	20.0 mW	2×10^{-5} in.
Thickness shear	AT	10,000 kHz	1,000,000	20.0 mW	2×10^{-7} in.

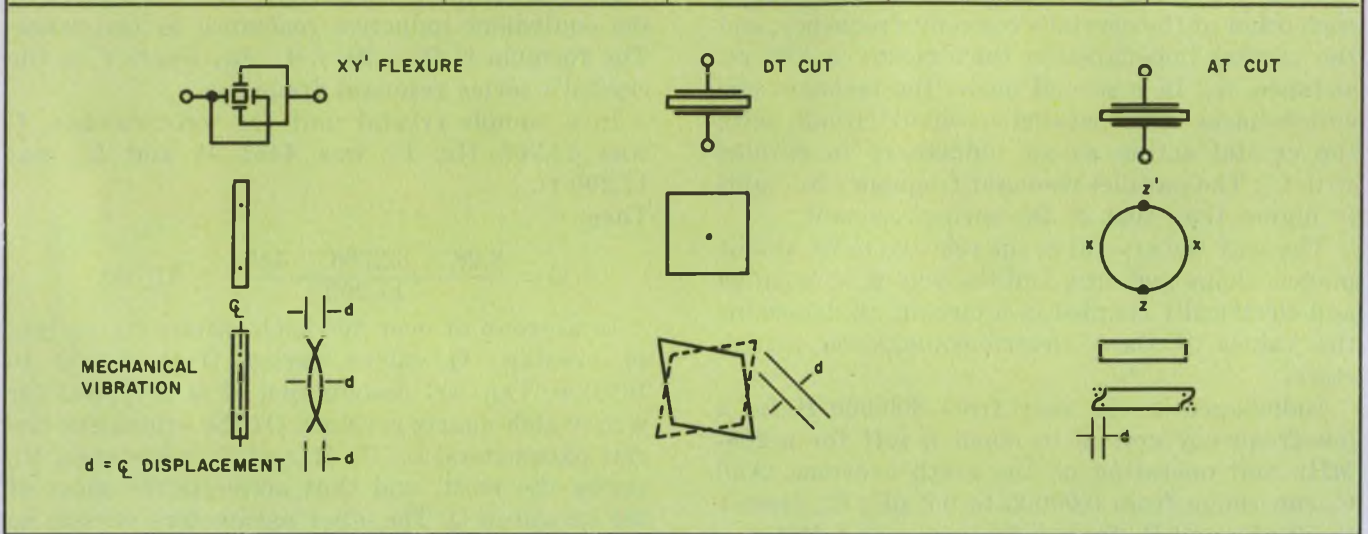

and f_a the anti-resonant, or parallel-resonant, frequency. The 3-dB bandwidth points are related to Q by

$$BW = f_s / Q,$$

where BW and f_s are in Hz.

Relatively inexperienced personnel can set a watch with a trim capacitor to stay within approximately 1% of this 3-dB bandwidth. Time-keeping accuracy depends upon this initial setting, of course. Table 3 shows the relationship between Q , the 3-dB BW and timing error per day, based upon setting ability of 1% of BW.

To prove that high Q s produce high-stability oscillators, consider again the crystal's equivalent circuit (Fig. 1). From the circuit parameters, reactance vs frequency characteristics can be determined (Fig. 3b). Note that the crystal unit behaves as a capacitive reactance at frequencies both above f_a and below f_s , and as an inductive reactance at frequencies between f_s and f_a . At f_a and f_s , the reactances of the crystal cancel each other. Thus the crystal acts as a resistance at these frequencies.

Note also that the slope of the reactance-vs-frequency curve is approximately linear near f_s . Thus, as the crystal reactance passes through zero at f_s , a small change of reactance in the positive, or inductive, region has about the same magnitude as a small change in the negative, or

Table 2. Stability increases with Q

Timing device	Frequency	Q	Drift seconds per day
Atomic clock	9000 MHz	10^8	0.00000864
Quartz crystal	32.768 kHz	10^4	0.01034
Tuning fork	360 Hz	10^3	0.864
Balance wheel	2.5-10 Hz	10^2	8.64

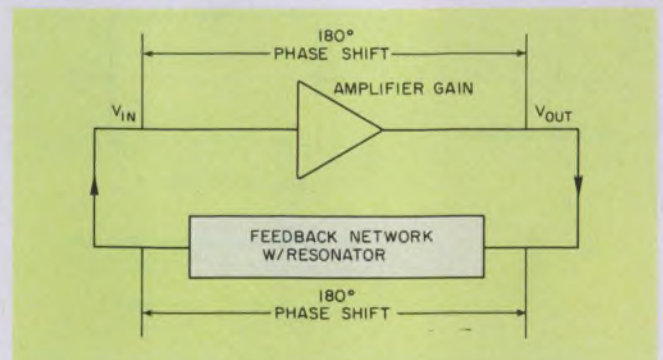

2. Feedback oscillators must contain an amplifier with sufficient gain to overcome all signal losses around the circuit's loop. The feedback-network and amplifier phase shifts must total 360 degrees, with each shift preferably an exact 180 degrees.

capacitive, region. As a result, the total change of reactance for a small frequency shift that symmetrically straddles f_s can be said to be

$$\Delta X_e \cong \Delta X_L + \Delta X_C \cong 2 \Delta X_L,$$

since

$$\Delta X_L \cong \Delta X_C.$$

Therefore

$$2 \Delta X_L \cong 2 \Delta \omega L.$$

The phase-shift change near f_s is then

$$\tan \Delta \phi \cong \frac{\Delta X_e}{R_1} \cong \frac{2 \Delta \omega L}{R_1},$$

and since the tangent of small angles equals the angle value in radians,

$$\frac{\Delta \phi}{\Delta \omega} \cong \frac{2L}{R_1}.$$

For crystal oscillators, it's reasonable to define frequency stability by an index, $S_i = \Delta \phi / \Delta \omega$. Thus

$$S_i = \frac{\Delta \phi}{\Delta \omega} \cong \frac{2Q}{\omega}.$$

Conclusion: Large crystal Qs require only small frequency shifts to produce a given phase change that compensates for phase shifts in a crystal-oscillator's amplifier and other sections of the circuit.

Phase-angle changes, $\Delta \phi$, and corresponding frequency shifts, Δf , for a sample crystal unit, where L is 4451 H and R_1 is 11,200 Ω , are plotted in Fig. 4. Phase shifts are tabulated for oscillator-frequency shifts of 1 to 5 ppm for frequencies near f_s and f_a . Because of scale limitations, these tabulated small changes can't be readily determined from the curve.

Factors affecting Q

Any impediment to the free mechanical vibration of a crystal increases its equivalent series-resonant resistance, with a resulting decrease in Q. At frequencies below 1 MHz, the greatest single factor that increases a crystal's resistance is an air or gas-loaded crystal enclosure. An enclosure with 90% nitrogen and 10% helium at 1-atmosphere pressure produces three to five times the resistance of an evacuated holder.

In addition gas-filled holders exhibit a detrimental phenomenon called acoustic reflection—well known to low-frequency crystal designers. The vibrating quartz transmits a supersonic wave motion to the confined gas. When these waves strike the inner surfaces of the crystal enclosure, they are reflected back to the vibrating crystal. In-phase crystal impacts enhance or reinforce crystal vibration, and out-of-phase impacts impede them. Disturbing perturbations result that produce vacillating series resonant frequency and resistance values.

A solution to this problem is to evacuate the crystal holder. Motorola quartz watch crystal units are cold-weld sealed in a vacuum. However,

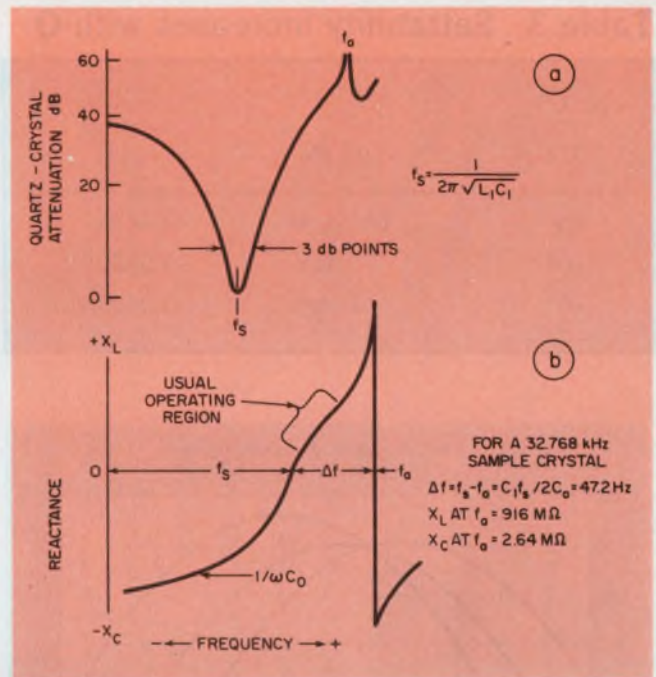

3. A crystal's signal-pass response (a) and reactance (b) can be calculated with help of the equivalent electrical circuit.

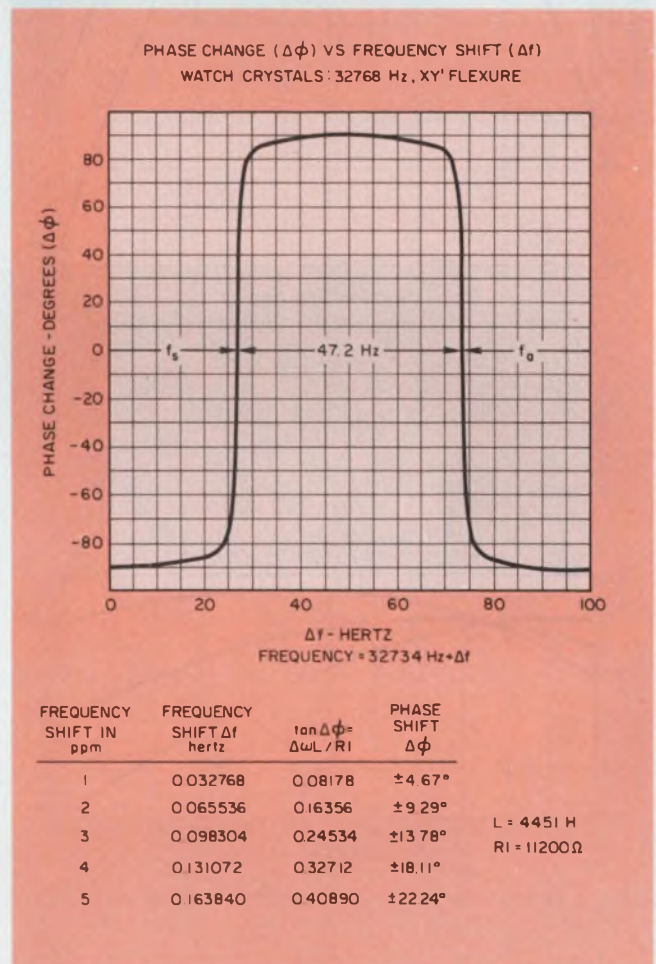

4. The phase of a signal passing through a crystal changes sharply from -90 to $+90$ degrees as it passes through its series-resonant frequency, f_s . It changes from $+90$ to -90 at its anti-resonant frequency, f_a . The higher the Q, the sharper the change.

Table 3. Settability increases with Q

Q	3 dB BW	Timing error seconds per day
10 ⁴	100 ppm	0.0864
10 ⁵	10 ppm	0.00864
10 ⁶	1 ppm	0.000864

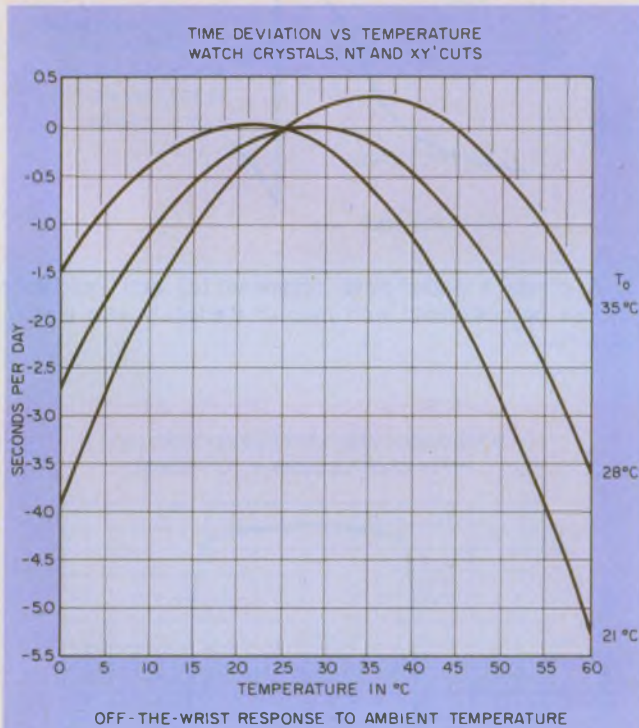

(a)

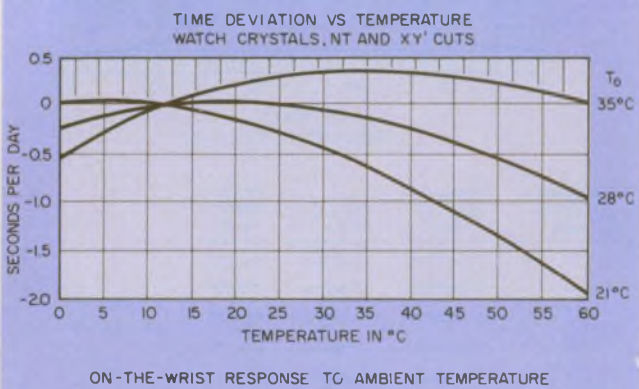

(b)

5. Temperature has a small effect upon properly cut and processed crystals. The effects of ambient temperature off the wrist (a) are clearly greater than on the wrist (b). The wrist acts as a partial heat regulator.

evacuation does not solve all crystal resistance problems.

In low-frequency XY' flexure crystal units, the crystal mounting structure is part of the resonating system. Thus the lead wire length must be in odd quarter-wavelength increments. Otherwise out-of-phase resonance is generated in the wires, resulting in interference with the crystal's oscillation and increasing the crystal's resistance.

Crystal lead wires should be attached to the nodal-point locations on the quartz blank; deviations from these points produce another out-of-phase impediment to crystal oscillation. In addition crystal leads that are attached in a stressed condition interfere with crystal motion.

Another factor affecting resistance is the surface finish on the quartz blank. Lapping can produce microscopic cracks and chips that add weight. Although etching after lapping can remove most of such a disturbed surface layer, some flaws may remain to impede crystal oscillation.

And there are other potential problems. Excessive solder on the lead attachment to the crystal increases the crystal resistance. Poor plating adhesion produces a loosely attached plated film that interferes with crystal oscillation. If the plated film is not firmly attached to the crystal, there is parasitic drag as the crystal moves and an accompanying impediment to crystal oscillation. And, of course, any dirt is detrimental.

Although each of these effects can be readily demonstrated, even microscopic examination cannot pinpoint why they occur. The variations persist in spite of many processing refinements and in spite of 1-mil tolerances in the placement of plating patterns and the control of crystal-lead wire lengths and bends.

Temperature effects are minimal

If the designer chooses the proper crystal planes when he cuts a quartz blank, a finished unit will have a zero temperature coefficient at the midpoint of the unit's ambient-temperature range. For XY' and NT cuts, frequency deviation plotted against ambient temperature is a parabolic curve; the frequency reaches a maximum at the zero temperature-coefficient point, T₀ (Fig. 5).

Frequency deviation at any temperature, T_x, above or below T₀ can be calculated from the formula

$$-\Delta f = K \Delta t^2,$$

where -Δf is frequency change in ppm, the parabolic curvature constant, K, is 0.04 for an XY' or NT cut, and Δt = T₀ - T_x in degrees C.

The nominal value of T₀ for quartz watch applications is usually

$$T_0 = 28 \pm 7 \text{ C.}$$

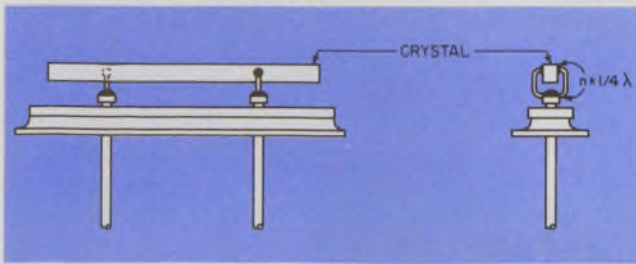

6. A crystal's mounting leads are part of the vibrating structure and must be carefully placed and dimensioned.

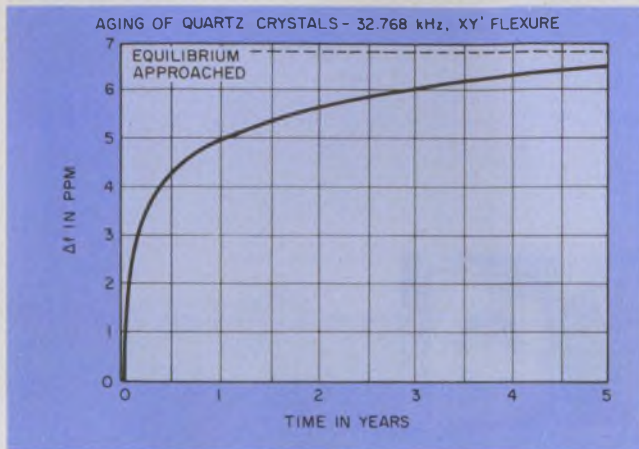

7. Quartz-crystal watch oscillators gradually approach an equilibrium state as they age. Thus accuracy improves as the watch grows older.

And the usual ambient temperature range is from 0 to 60 C. For timekeeping applications, the frequency-change formula becomes

$$\Delta S = 0.003456 \Delta t^2,$$

where ΔS is time deviation in seconds per day and 0.003456 is a new constant— 0.04×0.0864 . The quantity 0.04 is the prior K factor, and 0.0864 derives from the 86,400 seconds in one day divided by 10^6 , since Δf is in ppm. Three curves based on $T_x = 21, 28$ and 35 C have been normalized at an ambient temperature of 25 C when the watch is off the wrist (Fig. 5a).

Tests of watches worn on the wrist result in much lower time variations, as would be expected (Fig. 5b). The wrist acts as a thermal regulator.

Vibration of no major concern

Although vibration is generally not of major concern to watch manufacturers, it's reassuring that quartz watch crystals have excellent immunity. When vibration tests are performed over a frequency range of 5 to 55 Hz at a 0.06-in., double-amplitude, the crystal's frequency changes less than 2 ppm. For vibration frequency range 50 to 500 Hz at a level of 10 G, the frequency change is less than 5 ppm. The resistance change

is less than 10% for both tests.

After shock tests, frequency and resistance are only temporarily altered to, at most, 5 ppm at 1000 G to 20 ppm at 3000 G and $\pm 10\%$, respectively, for 40 to 60 minutes after the tests. With the passage of time, the crystal units tend to recover or return to their pretest values. For a 1000-G shock, recovery is complete for most of the crystal units in 18 to 30 hours. Longer periods of 4 to 12 days are required for 3000-G levels.

Recovery time results from a wire "memory" effect. Severely stressed and slightly deformed wire returns to its original equilibrium condition after a time lapse.

A sketch of a crystal support structure (Fig. 6) shows the lead length dimensioned in increments of $1/4 \lambda$. For 0.0035-in.-diameter lead wire, the calculated length is 0.056 in. at 32.768 kHz. The two bends in the wire reduce the effective displacement range at the crystal mount's resonant frequencies and provide balanced crystal support in three orthogonal vibration planes.

Quartz crystals get better with 'age'

A quartz crystal asymptotically approaches an equilibrium frequency as it "ages" (Fig. 7). The type of crystal cut, frequency, mounting, plating and sealing methods used all affect so-called aging.

The main factors that change with time are the transfer of mass to or from the crystal surface, the migration of mass on the crystal surface and stress changes in either of the plating film or in the crystal mounting structure. These factors must be stabilized by good process techniques.

Stabilization can be accelerated by heat. Though most crystal manufacturers employ a heat treatment, they don't use identical temperatures, exposure periods and other conditions; they consider their processes proprietary. However, a general description is possible.

Organic and inorganic solvent baths and rinses are used to remove contaminants from plated crystal surfaces. Dried and mounted, the watch crystals are then subjected to heat. This eliminates future chemical reactions by fixing them and making them irreversible. It also prevents galvanic cell erosion by outgassing all volatile compounds, and it promotes the buildup of a protective oxide coating.

After cooling, the crystal units are adjusted to final frequency in a clean-and-dry process and cold-weld sealed in a vacuum. A second heat treatment, annealing, then removes stresses from the plating film and mounting structure. Thus, with the unit's mass content fixed and stresses removed, stable operation and a low aging period are assured. ■■

We stake our claim!

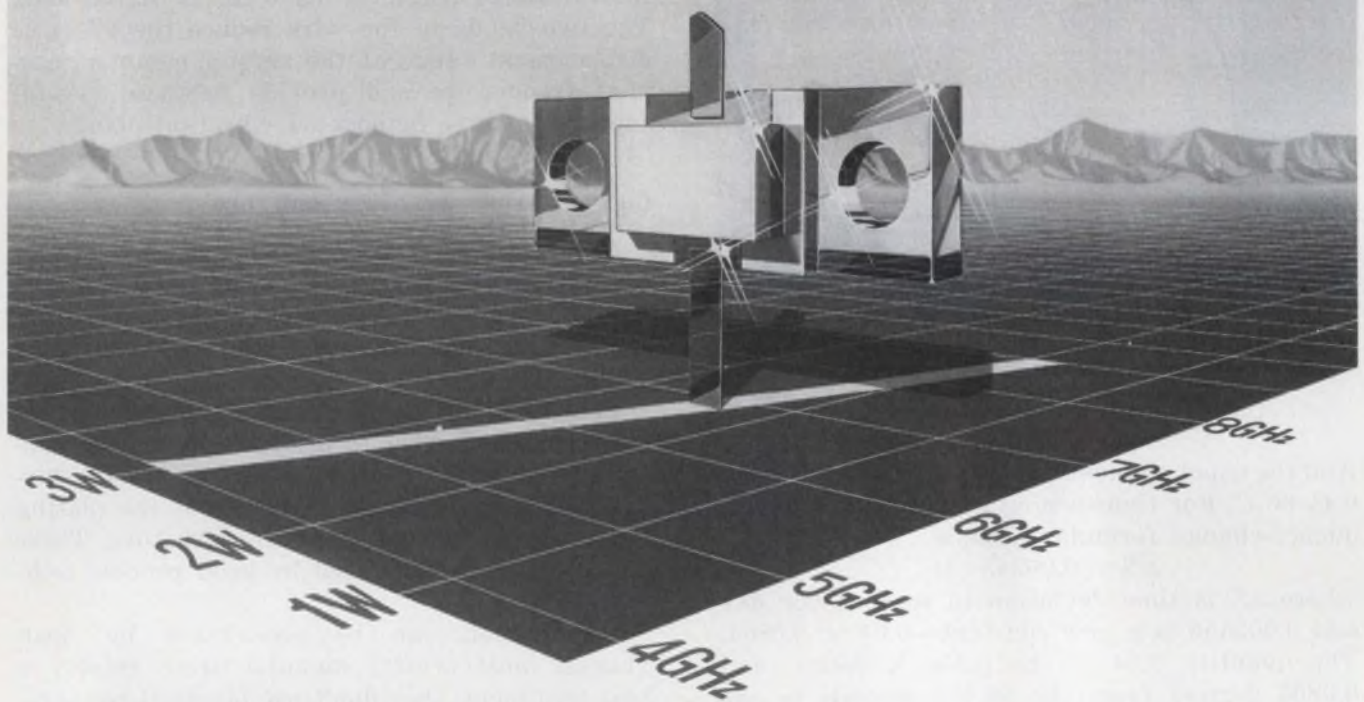

with the first C-band microwave power transistors

FUJITSU Microwave semiconductor technology takes a giant step forward with the introduction of the first commercially-available, high performance transistors for C-band power applications — the FLC series from Fujitsu. These three specially-designed, N-channel GaAs Schottky-Barrier FETs feature an overlaid gate electrode construction, and are fully suitable for use in common source Class A microwave linear power amplifier and oscillator applications at frequencies up to 8GHz.

What kind of power can you expect? Well, the high power

FLC30 provides a substantial 2.4 watts at 6GHz (1.9W at 8GHz), the mid-range FLC15 offers 1.2 watts at 6GHz (1.0W at 8GHz), and the FLC08 gives 0.7 watts at 6GHz (with 0.6W at 8GHz); and all models with third-order intermodulation products typically below -25dB. Remember, these outstanding microwave transistors are available NOW for your state-of-the-art equipment needs.

FUJITSU LIMITED
Communications and Electronics
Marunouchi, Tokyo, Japan

For further information please contact:

■ **Components Division (Head Office):** Syuwa Onarimon Bldg., 1-1, Shinbashi 6-chome, Minato-ku, Tokyo 105, Japan Phone Tokyo (03) 437-2111 Cable: FUJITSULIMITED TOKYO Telex: 2422808 FT SIN J ■ **New York Office:** 680 Fifth Avenue, New York, N.Y. 10019, U.S.A. Phone (212) 265-5360 Telex: 23-234969 ■ **London Office:** Norman House, 105/109 Strand, London, W.C.2, England Phone 240-0461/0462 Telex: 51-22305

MAIN PRODUCTS □ Telephone Exchange Equipment □ Carrier Transmission Equipment □ Radio Communication Equipment □ Space Electronics Systems □ Electronic Computers & Peripheral Equipment (FACOM) □ Telegraph & Data Communication Equipment □ Remote Control & Telemetering Equipment □ Electronic Components

INFORMATION RETRIEVAL NUMBER 45

Rockwell is there with a complete microcomputer on two chips.

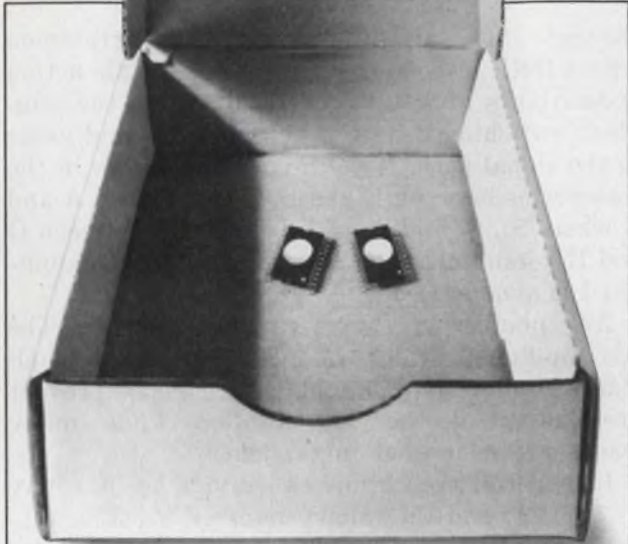

WE'VE CUT THE NUMBER OF COMPONENTS

One chip of our new PPS 4/2 contains a clock, CPU, and 12 I/O lines.

The other holds 2K x 8 ROM, 128 x 4 RAM and 16 bidirectional I/O lines.

There you have it: a complete microcomputer on two chips. For many applications, that's all you'll ever need.

SO YOU CAN CUT COSTS

For example, the complete PPS 4/2 system is priced at less than \$35 in quantities of 1000.

As your needs grow, you can add any of seventeen I/O, memory, or peripheral controller chips to your system at similar cost savings.

EIGHT-BIT PERFORMANCE FROM A FOUR-BIT MICROPROCESSOR

Rockwell's parallel processing and independently intelligent I/Os throughout the microprocessor system permit simultaneous performance of various functions, freeing the

CPU for system thinking. In fact, with Rockwell's unique parallel processing system (PPS), your 4-bit system will actually outperform many 8-bit systems.



APPLICATIONS GALORE

The PPS 4/2 will control any number of mechanical or electromechanical devices — office machines, vending machines, electronic

games and low-end cash registers to name a few.

It will also serve well as peripheral controller on larger microprocessing systems, including non-Rockwell CPUs you've already programmed.

For samples, specs or sage advice, call

**714•
632•3729**

Because Rockwell's applications people and engineers all have backgrounds in systems and product design, they'll be able to give you specific answers as to how the PPS 4/2 relates to your product. Just call (714) 632-3729 and ask for Scotty Maxwell.

For technical literature or samples — without the advice — just drop us a line:

Department 3 C 117
Microelectronic Device
Division
Rockwell International
P.O. Box 3669
Anaheim, CA 92803

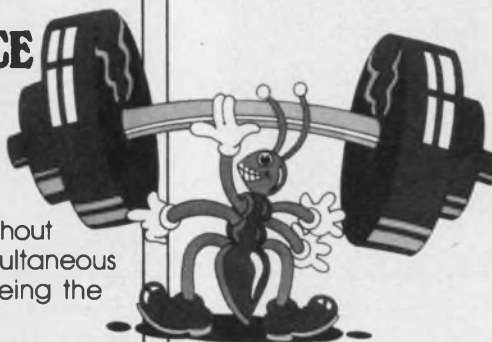

Rockwell International

...where science gets down to business

Programmable divide-by-n counter provides symmetrical outputs for all divisors

Most counter frequency dividers don't give symmetrical outputs for odd divisors unless an analog type of delay device is used in the otherwise digital circuit. Here's a programmable four-stage counter divider with symmetrical output for both odd and even divisors that is built with only conventional digital ICs (Fig. 1). Each stage of the counter consists of only a J-K flip-flop, an Exclusive-OR gate and an AND gate.

The circuit can be programmed to divide by any number, n , from 1 to 16 by application of a binary number equal to $16-n$ to the four inputs S_1, S_3, S_2 and S_4 . For example, if $n = 9$, then binary number $0111 = 7$ is applied, respectively, to the four S inputs.

The input to each flip-flop is controlled by the externally programmed inputs to S_1, S_2, S_3 and S_4 and a feedback signal, I , from the output of FF₁. When either a programmed input is a logic ZERO or the feedback is ZERO, a flip-flop input is of the same phase as the output of the previous flip-flop stage. But when both the program input and the feedback signal are logic ONE, the signal from one flip-flop to the next is inverted by the Exclusive-ORs.

In the timing waveforms (Fig. 2), $n = 9$. Note that for every $n/2$ input time periods, the output and feedback, I , change state. Whenever I

changes state, all flip-flop inputs programmed with a ONE also change their phases. This action is delayed by time t , which results from the combined switching delays of the flip-flops and gates in the signal path. Note the phase changes in the waveforms between E and F, C and D, and A and B where S_1, S_2 and $S_3 = 1$. The phase between G and H doesn't change; $S_4 = 0$. The resulting output I is symmetrical.

Any number of stages can be cascaded. The last flip-flop provides the feedback signal to all stages. But a buffer might be needed to prevent overloading of the last flip-flop when many stages are connected in tandem.

In general, the circuit can divide by n where $1 \leq n < 2^N$ and the binary number $S_N, S_{N-1}, S_{N-2} \dots S_1$ is set equal to $2^N - n$ at the program inputs.

Reference

1. Huertas, J. L. and Civit, A., "Square-Wave Frequency Divider Provides Symmetrical Output for Odd Divisors," *Electronic Design* No. 13, June 21, 1975, p. 100.

M. V. Subba Rao, Scientist, Central Electronics Engineering Research Institute, P. O. Pilani-Rajasthan 333031, India.

CIRCLE No. 311

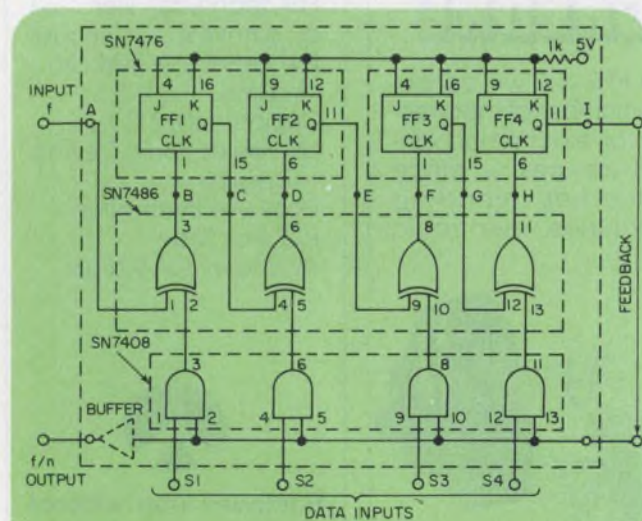

1. This programmable divide-by-n-counter can provide symmetrical outputs with the use of only conventional digital ICs.

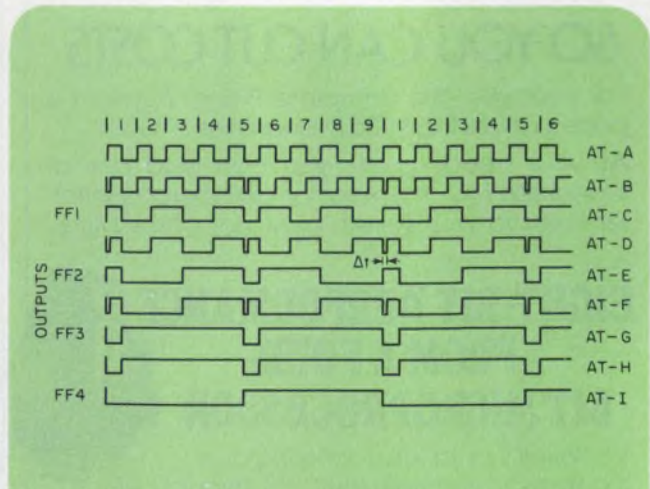

2. When $n = 9$, the output and feedback line, I , can cause a phase reversal in inputs to only FF₁, FF₂ and FF₃, because program inputs S_1, S_3, S_2 and S_4 are 0111, respectively.



BE A WINNER!

ENTER TELEDYNE/CRYSTALONICS' HYBRIDIZATION CONTEST.

\$3,000 IN CASH PRIZES!

One Grand Prize of

\$500

Ten First Prizes of

\$200 each

Ten Second Prizes of

\$50 each

**21 WINNERS IN ALL!
YOUR CHANCES ARE GREAT!**

It's easy to enter. Design or select a hybrid or discrete circuit that can be hybridized by Crystalonics. Send your circuit design, along with a description of the circuit, the function it performs and how it operates, to Crystalonics. (All entries must be accompanied by an entry form.)

Winners will be selected by a panel of 3 independent judges, active in hybrid design, on the basis of:

1. General usefulness.
2. Ratio of complexity of circuit to ease of hybridization.

Winners will be notified by May 1st and announced in the May 10th issue of Electronic Engineering Times Magazine.

CONTEST CLOSES APRIL 1st, 1976.

Don't delay . . . circle the reader service number for your entry form today!

 **TELEDYNE
CRYSTALONICS**

147 Sherman Street, Cambridge, Mass. 02140
Tel: (617) 491-1670 • TWX: 710-320-1196

INFORMATION RETRIEVAL NUMBER 47

Digital probe shows voltage, duty cycle and signal quality

An IC digital logic probe not only quantifies TTL signals into 16 levels but also shows the signal's quality and duty cycle.

The probe has 16 LEDs, arranged in a column, with each LED representing a potential difference of 400 mV. With the probe's two input terminals open or shorted, the bottom red LED lights to indicate that no potential difference is present. The probe circuit is scaled so the top diode lights when a potential difference of 6 V is applied across the input (Fig. 1).

Three red LEDs are used at the top of the array to indicate voltages that are higher than those normally used for TTL. The red LED at the bottom of the array turns off when the adjacent green LED turns on as the input voltage rises above 200 mV. Thus the lowest, or first green, LED is on when the probe is connected to a logic ZERO.

In this way the probe indicates the quality of the logic signal as well as its value. If the ap-

plied signal is a rectangular wave, two LEDs light. The duty cycle of the waveform can then be estimated, since the brightness of each LED is proportional to the time it is on.

A 12-V nickel-cadmium battery is used as a power supply. The UAA170 IC will not operate properly with less than 9.5 V. An internal zener regulator establishes the voltage range, determines the biasing of the chip and makes the probe insensitive to normal changes of battery voltage.

The probe's design allows the probe's input to be plugged into a source of voltage somewhat greater than 12 V to charge the battery. Zener D_1 protects the input during the charge process. A combination battery charger and calibration zener are shown in Fig. 2.

Dennis Bahr, P.E., Director of Research & Development, and Tom Suter, Technician, Advanced Instrumentation Corp., 7433 Hubbard, Middleton, WI 53562.

CIRCLE No. 312

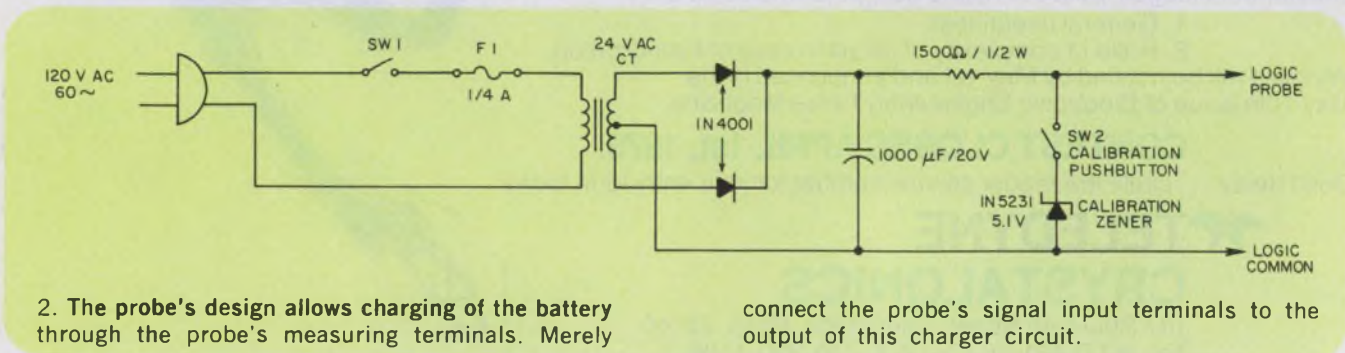
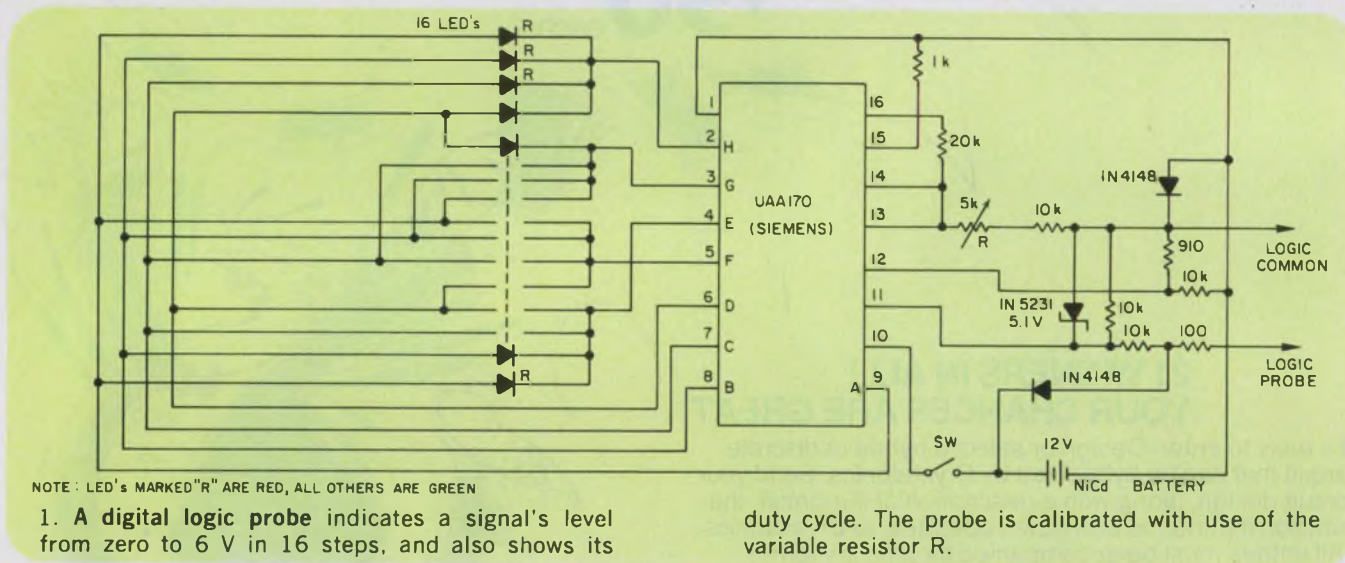

A QUICK PEEK AT A MICROPROCESSOR'S PRIVATE PARTS.

PACE, THE EASY TO USE, STATE OF THE ART MICROPROCESSOR

DATA MANIPULATION

Four accumulators provide temporary on-chip storage for intermediate and arithmetic results, thus reducing program length, instructions during program operation and the number of memory operations. Ten addressing modes provide easy access to system memory. That means short, simple and efficient programs for you.

PARALLEL COMMUNICATIONS (16-BIT ADDRESS AND DATA BUS.)

All address, input and output data are transferred on a common 16-bit bus, making interfacing easy and reducing the number of system bus buffers required, thereby simplifying interface logic and cutting system cost.

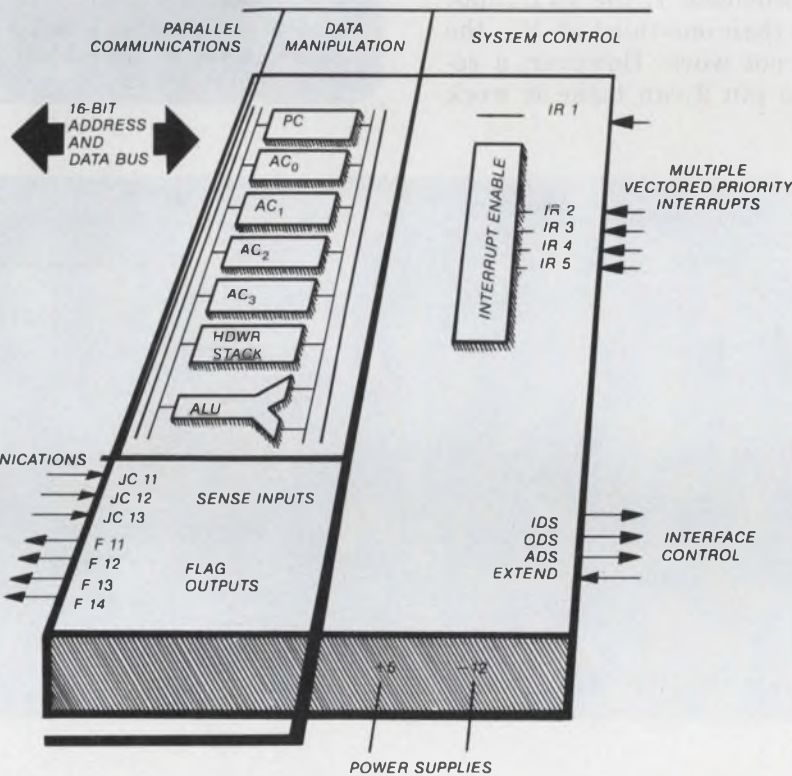

MULTIPLE VECTORED PRIORITY INTERRUPTS

Multiple peripheral control is made easier by six hardware-vectored, priority interrupt control lines. These lines allow PACE to rapidly identify and service interrupting devices. The benefits are faster interrupt response and lower memory cost.

INTERFACE CONTROL.

All address decoding and system control is done on chip.

IDS (Input Data Strobe)— An output signal that enables external devices that are sending data to CPU.

ODS (Output Data Strobe)— An output signal that enables external devices that will receive data from CPU.

ADS (Address Data Strobe)— An output signal used to clock address information to the systems' memory or peripherals.

EXTEND (Extended Data Transfer)— An input signal that allows the processor to accommodate a slow memory or peripheral.

SERIAL COMMUNICATIONS.

These serial input/output lines are fully decoded on the CPU chip and provide a means of direct interface to a teletype, tape cassette or any other serial device. They also provide for direct control of user system functions or peripherals.

PACE CHIP

Please send PACE Technical Description to:

NAME _____

COMPANY _____ TITLE _____

ADDRESS _____

CITY _____ STATE _____ ZIP _____

Mail to: National Semiconductor Corporation
2900 Semiconductor Drive, Santa Clara, Calif. 95051

NATIONAL SEMICONDUCTOR

Line drivers made from 555 timers provide inverted or noninverted outputs

A 555 timer can be used as a medium-current line driver with either an inverting or noninverting output (Fig. 1). Its output voltage swing almost reaches each rail, and the device can source and sink 150 mA. This drive capability is adequate for either single-ended or balanced lines that terminate in optical isolators (Fig. 2).

Since the 555 input operates as a comparator, it can simultaneously serve as a level shifter. For example, with only a 5-V input signal, a 12-V swing can be applied to the line.

But there are some problems. If the TTL input level to the 555 is less than one-third of V_{CC} , the circuit of Fig. 1a will not work. However, a resistor pull-up circuit to pin 2 can make it work

for a limited range of such low inputs. Also, the speed of the device is limited to about 100 kHz.

Mark R. Gardner, *Electrical Engineer, Illinois State Water Survey, Box 232, Urbana, IL 61801.*

CIRCLE NO. 313

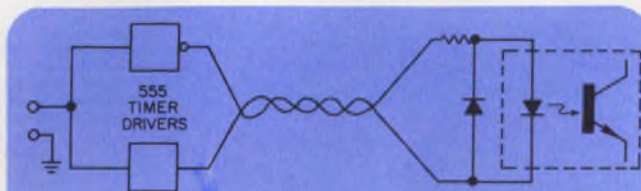

2. A pair of 555s, or a single 556, can be used to drive a balanced twisted-pair line that terminates in an optical isolator.

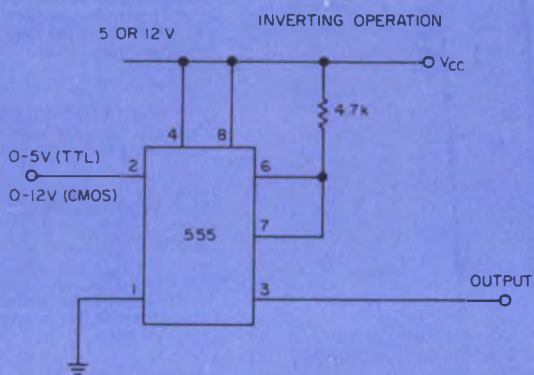

(a)

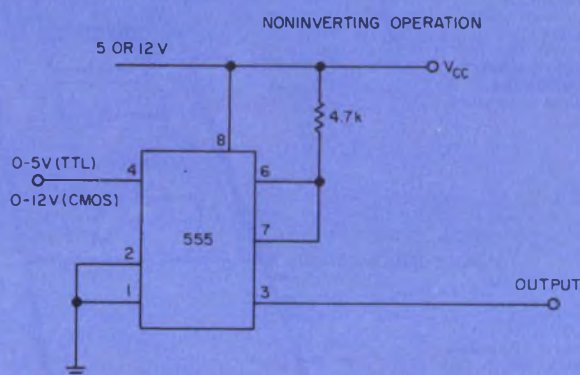

(b)

1. A 555 timer can drive a line either in an inverting (a) or noninverting mode (b).

IFD Winner of September 13, 1975

Ulrich L. Rohde, President, Rohde & Schwarz Sales Co., Inc., 14 Gloria Lane, Fairfield, NJ 07006. His idea "Match Antenna Over 1.5-to-30-MHz Range with Only Two Adjustable Elements" has been voted the Most Valuable of Issue Award.

Vote for the Best Idea in this issue by circling the number for your selection on the Information Retrieval Card at the back of this issue.

SEND US YOUR IDEAS FOR DESIGN. You may win a grand total of \$1050 (cash)! Here's how. Submit your IFD describing a new or important circuit or design technique, the clever use of a new component or test equipment, packaging tips, cost-saving ideas to our Ideas for Design editor. Ideas can only be considered for publication if they are submitted exclusively to ELECTRONIC DESIGN. You will receive \$20 for each published idea, \$30 more if it is voted best of issue by our readers. The best-of-issue winners become eligible for the Idea of the Year award of \$1000.

ELECTRONIC DESIGN cannot assume responsibility for circuits shown nor represent freedom from patent infringement.

1+1=10

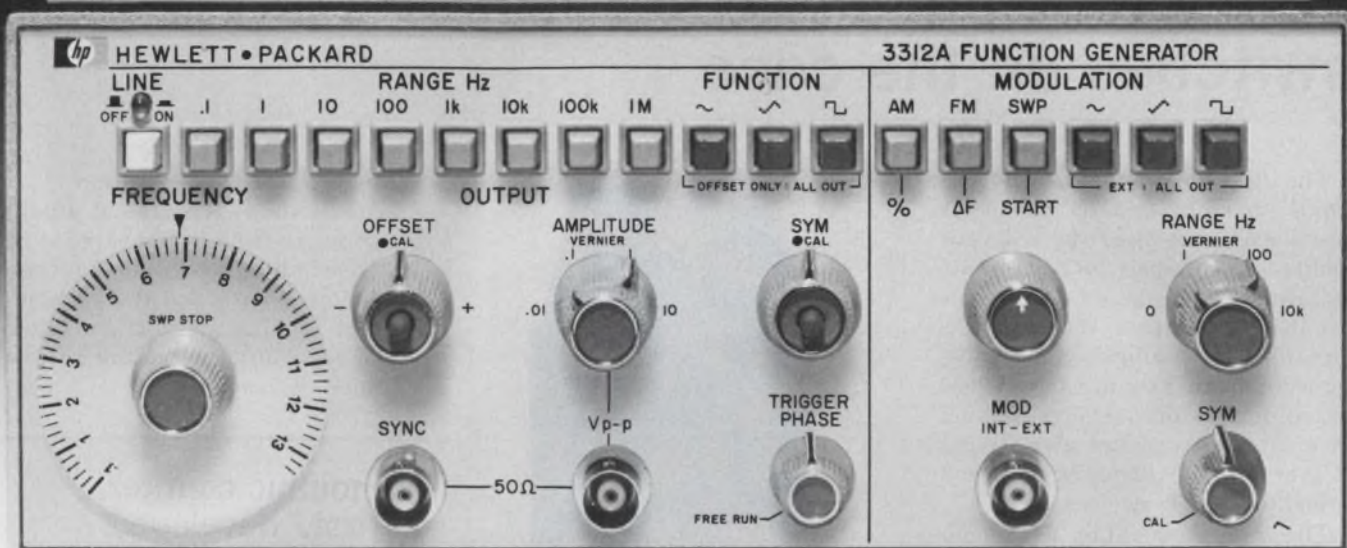

Two function generators in one box equals ten good reasons to buy one.

HP's 3312A function generator gives you FM signals, AM signals, dc levels, sweeps, sine waves, square waves, triangle waves, ramps, tone bursts and single or multiple pulses. You get all these functions for only \$900* plus many other

output waveforms. And you get top performance too... like square waves that don't become sine waves above 10MHz. For all the details on this dual function generator—HP's 3312A—give your local HP field engineer a call today.

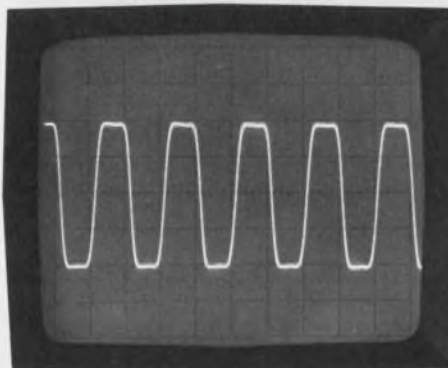

Unretouched scope display of the 3312A's 10 MHz square-wave output, showing 18 nsec rise time.

HEWLETT  PACKARD

Sales and service from 172 offices in 65 countries
1501 Page Mill Road, Palo Alto, California 94304

INFORMATION RETRIEVAL NUMBER 49

I²L watch eliminates switches on the case

The first production-model electronic watch to use I²L technology has been announced by Sinclair Radionics, Europe's largest manufacturer of calculators. Electronic circuitry to control the watch is contained on a single, Sinclair-designed chip that contains over 2000 active devices on a 117 × 123-mil base. This size has an area saving of over 1.5 to 1 compared with ion-implanted CMOS devices.

The chip, produced by ITT Semiconductors in England, provides a three-function watch that displays hours, minutes or seconds, depending upon which switch is operated.

The watch uses a 32.768-kHz flexural bar crystal for the oscillator. In production, the crystal is trimmed to frequency to give typical accuracy of 5 seconds a month.

The most innovative feature of the watch is the absence of switches on the case. The four-digit LED display is illuminated when the front of the case is touched. The lefthand side indicates hours and minutes and the righthand side minutes and seconds.

The switches were eliminated in the Sinclair watch by use of flexible diaphragms of spring plastic.



These diaphragms form an integral part of the case and are totally sealed.

Contact is made inside the watch by the shorting of two conductor paths with a conductor mounted on the plastic diaphragm.

more resistant to passivation.

Niposit 468 is operated at a bath temperature of 65 C, compared with 90 C for Shipley's Niposit 65 nickel-phosphorous bath, and at the recommended loading of 1.2 dm² liter (0.5 ft²/gallon) the plating rate is 7.5 microns/hour.

Monolithic counter, a 'first,' developed

The first truly monolithic counter, a dual-mode, 8-bit a/d and d/a converter, has been developed by Ferranti in England. Designated ZN425E, the device incorporates on a single chip an R-2R ladder, an array of precision bipolar switches, an 8-bit binary counter and precision voltage reference.

A feature of the device is the low cost of \$5 for quantities of 100 up. The ladder network was designed to eliminate the need for expensive deposited film resistors. Ferranti says it will not disclose details until its patent applications are processed.

The other major feature is the use of a high-density collector diffusion isolation process, which allows the counter to be included on the chip without need for excessive chip size. A complete a/d converter requires the addition of only one 7400 quad gate and one op amp.

In the DAC mode, the accuracy and differential nonlinearity are one-half the least significant bit, and settling time is typically 1.6 μs. When used as an ADC, the minimum conversion time is typically 250 μs. An optional internal reference is nominally 2.55 V, and it has a slope resistance of 2 and a temperature coefficient of 40 ppm/°C.

Nickel process viewed as replacement for gold

A new low-boron, phosphorous-free, electroless nickel process developed by Shipley Chemicals Ltd. of Coventry, England, is seen as a possible replacement for gold in many electronic applications. The process, designated Niposit 468, produces deposits that are at least 99.5% pure nickel, with the remainder boron.

The process was developed for

plating semiconductor devices, PCBs and connector contacts.

The primary advantages of Niposit 468, compared with the more usual nickel phosphorous deposits, are a high melting temperature of 1400-1450 C (against 890 C for nickel phosphorous), improved ductility and better appearance. The deposits also etch more easily, because of the high purity, and are

When RFI problems get sticky, try *stickn* fingers®

Attaches faster, shields better than anything else!

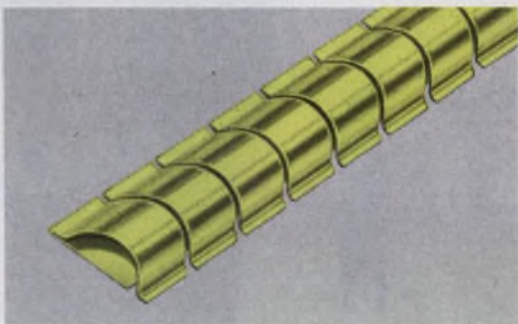

SERIES 97-500 The original Sticky Fingers with superior shielding effectiveness.

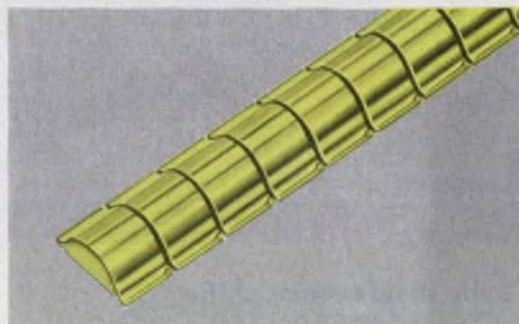

SERIES 97-520 A smaller size Sticky Fingers for high shielding effectiveness in less space.

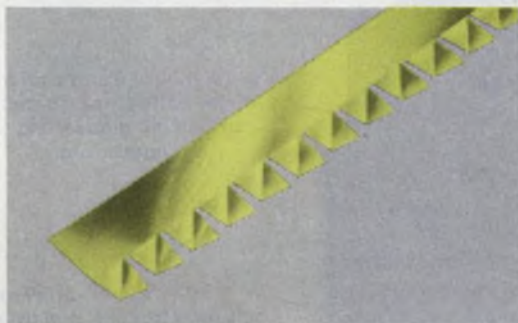

SERIES 97-555 New Single-Twist Series for use when space is at a premium. Measures a scant $\frac{3}{8}$ " wide.

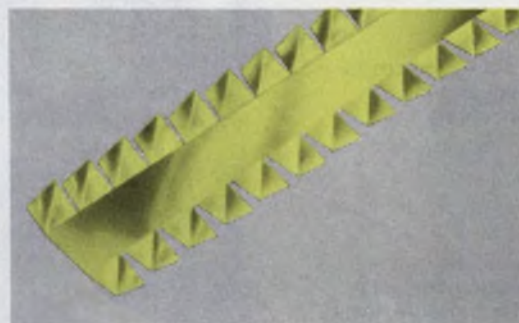

SERIES 97-560 New $\frac{1}{2}$ " wide Double-Twist Series, ideal for panel divider bar cabinets.

Now you can specify the exact type beryllium copper gasket that solves just about every RFI/EMI problem. Perfect for quick, simple installation; ideal for retro-fitting. Self-adhesive eliminates need for special tools or fasteners. Write for free samples and catalog.

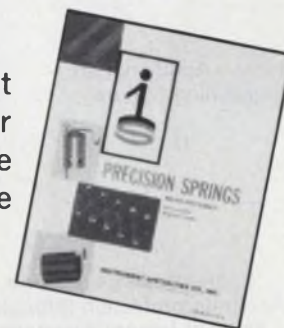

INSTRUMENT SPECIALTIES COMPANY, Dept. ED-65

Little Falls, N.J. 07424

Phone—201-256-3500 • TWX—710-988-5732

AIRPAX

TYPE 209 E-Frame Circuit Breakers

Airpax Type 209 molded-case circuit breakers are designed for use by the original equipment manufacturer. The hydraulic/magnetic principle provides stable trip points over a wide ambient temperature range. Typical applications include: refrigeration, air conditioning, power supplies, computers, and others.

Features:

U.L. listed for branch circuit protection.

Current ratings to 100 amperes.

Voltage: 125V dc 120/240V ac
240V ac 277/480V ac

Construction: Series, relay, shunt, auxiliary switch.

Terminations: Solderless connector, screw or stud terminals.

Time Delays: Instant, short, medium, or long.



Here's the inside story of the Airpax Type 209 Circuit Breaker:

Solderless Connector -

Accepts 14-0 copper and 12-0 aluminum wire. (Also available with back connected stud terminals)

Mounting Foot - Provides for versatility and ease in mounting.

Contact Terminal -

Self-cleaning contacts, sliding under pressure, insure low resistance and long contact life.

Arc Plate - Additional arc extinguishing feature.

Hydraulic-Magnetic Unit -

Accurate protection throughout ambient temperature range.

Barrier - Integral part of molded case.

Arc Chamber - Ten positioned metal baffles and screen to quickly diffuse and extinguish arc.

Inertia Wheel - Prevents nuisance tripping due to inrush currents of 20 times breaker rating without affecting delay curve.

Handle - Definite ON-OFF positions. Automatic reset.

Mechanism - Positive latching with trip-free construction. Balanced armature. Moisture-resistant finishes.

AIRPAX

Cambridge Division

Airpax Electronics
Cambridge, Maryland 21613
Phone (301) 228-4600

Want to know more about these compact, competitive Type 209 breakers? Write for Airpax Bulletin 2012.

Hybrid isolation amplifier avoids transformers but maintains isolation

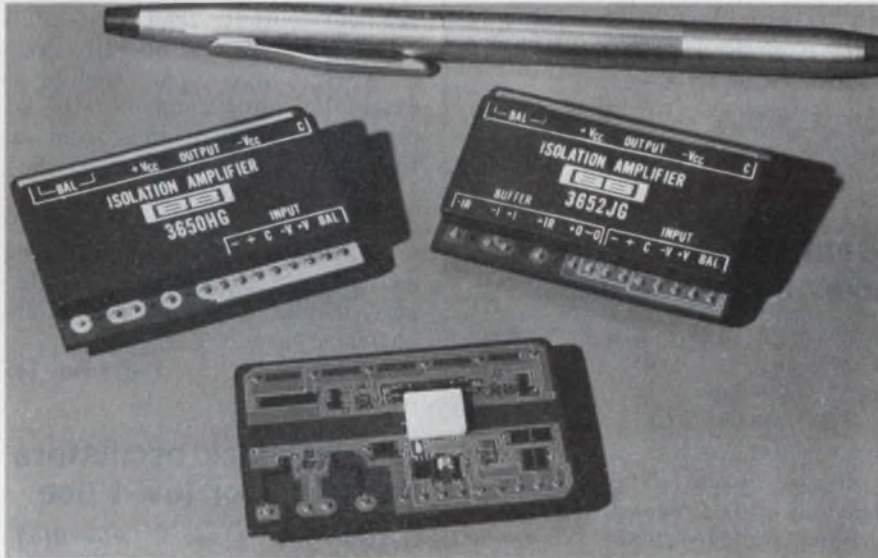

Burr-Brown, International Airport Industrial Park, Tucson, AZ 85734. (602) 294-1431. See text.

Need total isolation, yet you don't have the space for a transformer-coupled isolation amplifier? Burr-Brown has managed to shrink the size of the amplifier by using matched opto-couplers in a hybrid microelectronic circuit instead of transformers to provide 2000 V of isolation without sacrificing performance.

The two basic versions of the isolation amplifier, types 3650 and 3652, are housed in DIP-like packages that measure $0.22 \times 1.75 \times 1.15$ in. Because of the small size, an external, isolated power supply is required to maintain rated operation. However, even with the additional cost of the supply, prices for the isolation amplifier are about the same as for equivalent transformer-coupled amplifiers.

Isolation mode rejection at dc is 140 dB, and this drops to 120 dB at 60 Hz. Common-mode rejection at 60 Hz is a high 90 dB even with a source imbalance of 5 k Ω . Leakage

currents are less than 0.5 μA (for 240-V, 60-Hz input), while the isolation impedance is a high $50 \times 10^9 \Omega$. Slew rate for both amplifiers is 0.8 V/ μs , and small-signal bandwidth is specified as 10 kHz (for ± 3 -dB response). Output distortion at the 10-kHz frequency, though, is 5%. The amplifiers require 400 μs to settle to within 0.01% of the output and 200 μs to get within 0.1%.

Four versions of the 3650 series are available: the 3650HG, 3650JG, 3652HG and 3652JG. Both HG models have an initial input offset of ± 5 mV, while the JG models have ± 1 mV. Offsets for all four, though, are trimmable to zero. Offset drift vs temperature is different for each model: for the 3650HG it's $\pm 25 \mu\text{V}/^\circ\text{C}$, for the 50JG, $\pm 10 \mu\text{V}/^\circ\text{C}$; for the 3652HG, $\pm 50 \mu\text{V}/^\circ\text{C}$; and for the 52JG, $\pm 30 \mu\text{V}/^\circ\text{C}$. Gain nonlinearity is $\pm 0.7\%$, max, for the HG models and $\pm 0.25\%$ for the JG units.

The only head-to-head competition for this type of amplifier is

from Analog Devices (Norwood, MA) with its 270 and 280 isolation amplifiers. The lowest-cost Analog Devices units, the 285 series, start at \$89 for single quantity. They have 2500-V isolation capability (60-s duration) and a minimum of 115 dB CMRR with a 1-k Ω source imbalance at 60 Hz. Available input offset drifts are ± 15 , 10 or 5 $\mu\text{V}/^\circ\text{C}$, and nonlinearities of ± 0.05 , 0.04 or 0.03%, maximum, are available.

Single unit prices for the Burr-Brown isolation amplifiers start at \$41 for the 3650HG and increase to \$49, \$55 and \$62 for the 3650JG, 3652HG and 3652JG, respectively. Prices for 100-up quantities are approximately 40% lower. Delivery is from 10 to 12 weeks.

Burr-Brown CIRCLE NO. 301
Analog Devices CIRCLE NO. 302

Multiplying 8-bit DACs operate in 4 quadrants

Dynamic Measurements, 6 Lowell Ave., Winchester, MA 01890. (617) 729-7870. \$66 (unit qty.); stock.

A four-quadrant, 8-bit multiplying d/a converter, the Model 2013, has an over-all gain temperature coefficient of 40 ppm/ $^\circ\text{C}$ and a bandwidth of 100 kHz. The converter has a maximum differential nonlinearity of $\pm 1/2$ LSB. The 2013 is completely self-contained and includes an output amplifier. The converter's input circuits are compatible with DTL and TTL. These circuits are designed to protect the unit from failure if active inputs are applied before power is turned on.

CIRCLE NO. 303

Complete hybrid a/d comes in 32-pin case

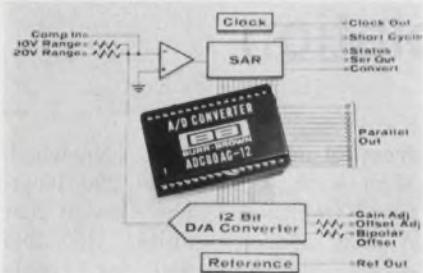

Burr-Brown, International Airport Industrial Park, Tucson, AZ 85734. (602) 294-1431. See text.

The ADC80 successive approximation a/d converter includes clock, comparator and reference, all within its 32-pin ceramic package. It is available in 12-bit and 10-bit versions that cost \$47.50 and \$45, respectively, in 100-up lots. Performance characteristics for the 12-bit unit include 0.01% maximum nonlinearity, 25- μ s conversion speed and a gain-drift error of only ± 30 ppm/ $^{\circ}$ C. Gain-drift error is identical for the 10-bit unit, while maximum nonlinearity is 0.048% and conversion speed is 21 μ s. Both operate over -25 to +85 C and include a "short cycling" mode which offers conversion speeds of 5 μ s for 8 bits and 12 μ s for 10 bits using an external clock. Internal scaling resistors permit selection of input signal range of ± 2.5 , ± 5 , ± 10 , 0 to +5, or 0 to +10 V.

CIRCLE NO. 304

Telephone tone receiver just requires power

Mitel Corp., P.O. Box 704, Ogdensburg, NY 13669. (613) 592-2122. Under \$150 (prod. qty.).

A complete telephone-tone receiver in a dual-in-line module, the CM8822, costs less than \$150 when purchased in production quantities. Just add power to the CM-8822, and it is in service for control systems, data transmission or mobile radio applications. The module measures only 5.3 x 3.5 x 0.47 in. and is designed to mount on PC cards. Power consumption is 20 mA at 12 V dc and the input impedance is 30 k Ω .

CIRCLE NO. 305

Data transceivers work over telephone lines

Richard Lee Co., Box 724, New Providence, NJ 07974. (201) 665-1333. \$460/pair.

The Models TX-1 and RX-1 transmitter-receiver systems can transmit analog data on a telephone line. The transmitter section accepts standard input ranges of 0 to 100 mV, 0 to 1 V or 0 to 10 V. Other ranges are available on a special order. The receiver will reproduce and/or factor the analog signal with a worst-case error of $\pm 0.1\%$ of full scale. The maximum output signal is 1 mA or 1 V across 1000 Ω . Telephone couplers, required to interface between the telephone line and the TX-1 and RX-1, are supplied as part of a normal telephone company installation.

CIRCLE NO. 306

Micro data system uses calculator circuit

Elcom Industries, Civilian Terminal, Hanscom Field, Bedford, MA 01730. (617) 274-6656. \$289; stock to 60 day.

The Procal-4, a programmable, micro data system, accepts BCD inputs from any source. It performs arithmetic calculations (+, -, x, \div) and provides outputs for printers, machine control functions, LED displays, d/a converters, etc. It supplies eight latched BCD decades and a multiplexed seven-segment output. The system is TTL-compatible and operates from a +5-V supply. The module is externally programmable—it accepts function commands from external keyboards, ROMs, switches, or any other BCD device. A second model, the Procal-4U, comes with thumbwheel programming switches, an eight-digit LED display, and is housed in a small instrument case.

CIRCLE NO. 307

Crystal clock oscillators designed for low f use

Q-Tech Corp., 11529 W. Pico Blvd., Los Angeles, CA 90064. (213) 479-4231. From under \$30 (100-up); 6 wk.

The QT-4 series of crystal clock oscillators is available with TTL or CMOS-compatible outputs. They are intended for low-frequency applications, down to a fraction of a hertz. Tolerances of 0.005% are available over the full military temperature range of -55 to +125 C. Multiple outputs and custom logic are also available.

CIRCLE NO. 308

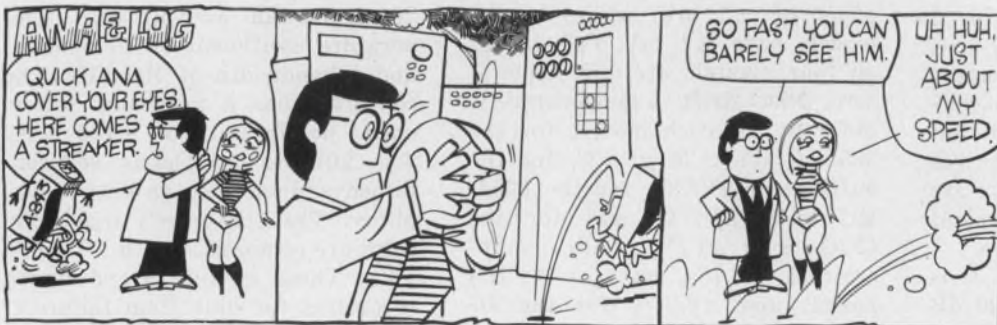

ANALOGY
GET THE BARE FACTS ON THE A-843 VOLTAGE TO FREQUENCY CONVERTER. STREAKS YOUR SYSTEM AT 0.1MHz IN A STRAIGHT LINE $\pm 0.01\%$. NEAT LITTLE 1 $\frac{1}{2}$ " x 3" PACKAGE. RUN OUT AND GET ONE.

intech INCORPORATED
(408) 244-0500
1220 COLEMAN, SANTA CLARA CA 95050

COMPONENTS

Silicon camera tube gives 50% less bloom

RCA Solid State Div., Route 202, Somerville, NJ 08876. (201) 733-3200. \$1750; production available first quarter 1976.

A new development in silicon target manufacturing has made possible a silicon intensifier target (SIT), Type C21200, camera tube that reduces bloom. The bloom effect is reduced about 50% at more than 100 times light overload, according to RCA. The tube is a variant of the RCA 4804 family of camera tubes, but with a 16-mm fiber-optic faceplate. All of the features of the 4804 are incorporated in the C21200. Three product grades are available, which differ in responsivity and picture blemishes. The tubes operate at light levels near the photoelectron noise limit.

CIRCLE NO. 309

Tiny lamp illuminates LCD wristwatches



Chicago Miniature Lamp, 4433 N. Ravenswood Ave., Chicago, IL 60640. (312) 784-1020. \$0.45 to \$1.00; stock.

Three new microminiature incandescent lamps, designed primarily for liquid-crystal wristwatches, are rated at 1000 h, though the new lamps have exceeded 3000 h in actual life testing and provide a 95% reliability at the 1000-h level. Other similar lamps offer only 50% reliability at 100 to 800-h design-life. Two styles come in T-3/8 size with vertical-filaments. Both an axial-lead, type CM8-3986, and a radial-lead, 3982, provide lateral illumination for edge-lighting. In a T-1/2 size, a C2R-type arched filament, CM8-3970, provides a more directional illumination for backlighting applications. Input is rated at 1.5 V with a current of 15 ± 2 mA and output is 0.06 lumens.

CIRCLE NO. 310

DIP switch allows easy flux flush-out

Control Switch, 1420 Delmar Dr., Folcroft, PA 19032. (215) 586-7500. \$1.10; 8 pole (10,000 up).

Series SL DIP switches feature a depression in the slide button to prevent tool slippage during actuation. Flow soldering and flux wash-out are made possible by a combination of a UL-rated polyester case,

stand-offs and integral drain holes. An overcenter switch action gives both a decisive contact make or break and a positive tactile feel. Other features include 30-micron gold-plated and heat-treated beryllium-copper terminals and contacts, low-contact resistance and a current-carrying capacity of 100 mA max at 50 V dc. Standard units are available for 4, 7 and 8 bits.

CIRCLE NO. 320

THE NEW 4151. WORLD'S FIRST MONOLITHIC IC VFC.

Raytheon Semiconductor introduces the 4151 Voltage-to-Frequency Converter. \$5 in lots of 100, versus \$30 to \$60 for other VFC's—there is no comparison. And that's not all. The 4151 comes in a standard 8-pin dual in-line package or a TO-5 metal can. The pulse output is compatible with all logic forms. It has high noise rejection, single-ended input referenced to ground. And it

provides frequency-to-voltage conversion, too. It's the simplest and most cost-effective method for analog-to-digital conversion. And Raytheon Semiconductor is the only company with a device like it.

Contact Raytheon Semiconductor or your local distributor for complete details. For your *free sample*, write Raytheon Semiconductor on your company letterhead.



RAYTHEON SEMICONDUCTOR

Dept. 4151, 350 Ellis Street, Mountain View, CA 94042

INFORMATION RETRIEVAL NUMBER 53

Electronic Design's

BICENTENNIAL

Published February 16, 1976 — Closing January 9, 1976



AN HISTORIC PUBLISHING EVENT

YOU'LL NEVER SEE ANOTHER ISSUE LIKE THIS ONE FOR 200 YEARS!

SSUE

200
YEARS
OF
PROGRESS

NO PUBLICATION HAS EVER ATTEMPTED THIS BEFORE IN OUR INDUSTRY!

A UNIQUE PUBLISHING "FIRST"

On February 16, 1976, *Electronic Design's* editors are presenting a special BICENTENNIAL ISSUE — a salute to the 200 years of technological progress that has led to the electronics industry as we know it today. This material will be *in addition* to all of the regularly-scheduled technical articles and features.

Is history or nostalgia a worthwhile topic for a technical magazine? Our 20th Anniversary issue proved that it is. Electronics engineers are proud of their profession and proud of their industry. They're deeply involved. They care about its past, present and future. Our anniversary issue brought tremendous reader response. Readers dug into their own pockets to buy extra copies. Letters and phone calls to the editors broke all records. And almost 70,000 inquiries from this single issue clearly showed that information about the past can produce business in the *present*.

Now our editors are going to do it again — only more so — with the issue for this century... for a lifetime.

The February 16 BICENTENNIAL ISSUE traces the electronics industry from experiments in the Colonial period to today's large-scale integrated circuits; shows how it's been shaped and re-shaped, not only by technological breakthroughs, but by the socio-economic, political and even artistic climate of the times. It's a technical review that engineers will read, reread and treasure as the industry continues its march upward to new heights; new achievements.

ALMOST EVERY TYPE OF PRODUCT IS INVOLVED

There isn't a component or system manufacturer that hasn't been affected by this technological revolution — from capacitor and resistor suppliers to communications and computer system companies.

America, the melting pot of peoples, is also the melting pot of technology. And this is especially evident in electronics. America has become the focus for electronics engineers from all nations. Each has contributed to the growth and progress of our \$40 billion industry.

When Benjamin Franklin demonstrated the electrical nature of lightning a little more than two centuries ago, he not only advanced man's knowledge, he created an industry as well. Lightning rods spread quickly throughout the U.S., to England, and the Continent.

The story is the same today. Each major development is almost always dependent on work that had preceded it. The tube from Lee DeForest, from J. A. Fleming, from J. J. Thompson, from Thomas Edison. The transistor, in part, from Julius Lilienfeld. And so on.

But the timing, the rate of development, is bound to the human condition: to population, to climate, to wars, to the industrial revolution, to automation, to education, to art, to *people*.

AN ISSUE THAT WILL BE READ, REREAD, KEPT AND TREASURED

Electronic Design's BICENTENNIAL ISSUE is possibly the most valuable issue for readers and advertisers that we've ever published.

It presents a perspective, a design overview of an industry that is probably poised for its greatest growth period of all time.

The way this growth will take place, and the speed with which it evolves is bound to the imaginations of all of us, scientist and citizen alike. As the U.S. approaches its BICENTENNIAL year, we hope to draw lessons from the past that can and will help to shape a more positive electronic future for all nations.

Electronic Design

A HAYDEN PUBLICATION

50 ESSEX STREET, ROCHELLE PARK, NEW JERSEY 07662

COMPONENTS

Liquid-crystal displays come in 14 versions

Liquid Xtal Displays Inc., 24500 Highpoint Rd., Cleveland OH 44122. (216) 831-8100.

Dual in-line liquid-crystal digital readouts, designated the DIL Felix series, come in 14 versions that include 3-1/2, 4 and 4-1/2-digit instrument and clock displays

on 0.5, 0.7 and 1-in. heights—and six-digit instrument and timer displays in 0.5 and 0.7-in. heights. The displays require no edge card connector or other type of mounting. Evenly spaced, 0.10-in. substrate clips simply plug in and are soldered. The displays are CMOS-compatible, offer 50,000 h of always-on life, and they are available in voltage ranges of 3 to 6 V or 9 to 18 V. Use in battery-powered equipment is especially appropriate, because of their extremely low power drain.

CIRCLE NO. 321

Readout for PC boards provides 1-in. number



Dialight, 203 Harrison Pl., Brooklyn, NY 11237. (212) 371-8800. \$2.99 (1000 up); 4 to 6 wks.

For readouts on PC boards, the Model 710-0307 is recommended for use with incandescent illumination or unbased neon lamps (NE2H-1), which ensure a bright reading display in 1-in. characters.

CIRCLE NO. 322

EFFICIENCY EXPERT.

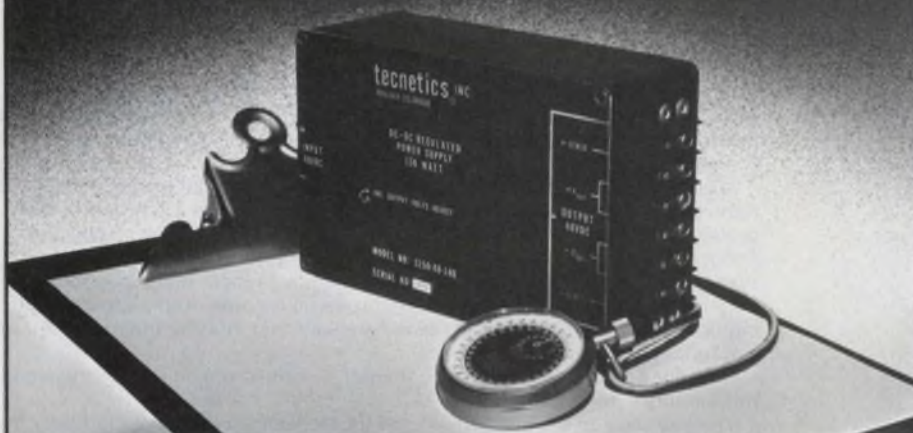

Up to 86% efficiency in Tecnetics DC to DC regulated converters.

When your design calls for a highly efficient regulated converter in a compact package, Tecnetics' 3000 series fits the bill. Efficiencies range from 66% to 86% with packing densities up to 2.78 watts per cubic inch. Our broad product line gives you a choice of models with 25, 50, 100 and 150 watts of power and outputs from 5 to 48 volts.

Standard features of the 3000 series include input-output isolation, overload and short circuit protection, input filters to reduce conducted EMI, and remote error

sensing to insure that the proper voltage is maintained at the point of load. All units are fully encapsulated and designed to meet the vibration, shock, humidity and altitude specs of MIL-E-5400.

So, when you are looking for state-of-the-art power converters, look to Tecnetics, the company with proven expertise. For more information and prices on the 3000 series, or three-hundred other power supplies, write for our 26 page catalog.

3000 SERIES HIGH EFFICIENCY REGULATED CONVERTERS

Output Power	150, 100, 50, & 25 watt models	
Output Voltages	13 standard outputs from 5 to 48 V	
Input Voltages	28VDC or 48VDC (48 VDC only on 150 w units)	
Dimensions (excluding terminals):		
25 & 50 watt:	4x4x2 inches 36 oz. Fully encapsulated	Regulation:
100 & 150 watt:	6x4x2 1/4 inches 60 oz. Fully encapsulated	Line (LL to HL) 0.3% Load (1/2 to FL) 0.1% Load (NL to FL) 0.4% Temp 0.01% / °C

tecnetics® The Power Conversion Specialists P.O. Box 910,
1625 Range Street, Boulder, Colorado 80302 (303) 442-3837 TWX 910-940-3246

INFORMATION RETRIEVAL NUMBER 54

Thermal breaker meets UL requirements



E-T-A Products Co. of America, 7400 N. Croname Rd., Chicago, IL 60648. (312) 647-8303.

The compact Series 45-700-P-CL2 thermal circuit breaker satisfies UL requirements for Class 2 transformer protection (UL506). Said to be trip free and foolproof, the single-pole breakers are especially suited for transformers with secondary outputs of 3.2 A at 16 to 30 V or 5 A at 15 V or less. Maximum voltage ratings are 250 V ac or 24 V dc and maximum interrupting capacity is 100 A. Life is 5000 cycles at rated current, and dielectric strength is 1500 V ac.

CIRCLE NO. 323

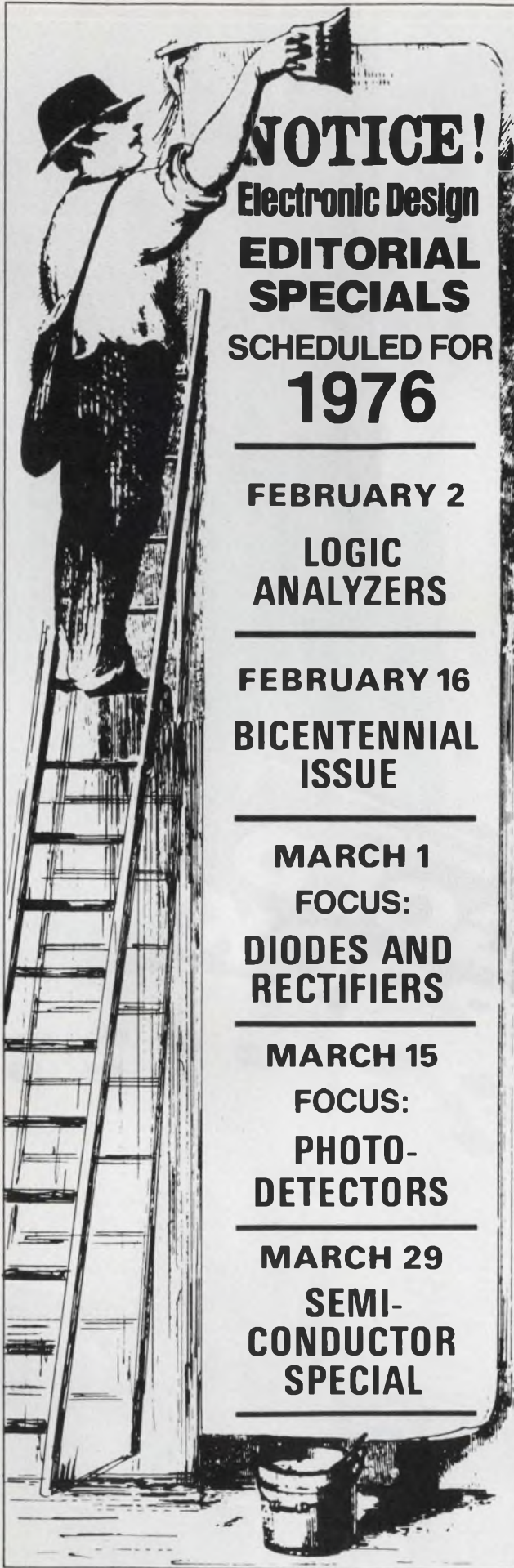

NOTICE!
Electronic Design
EDITORIAL
SPECIALS
SCHEDULED FOR
1976

FEBRUARY 2
LOGIC
ANALYZERS

FEBRUARY 16
BICENTENNIAL
ISSUE

MARCH 1
FOCUS:
DIODES AND
RECTIFIERS

MARCH 15
FOCUS:
PHOTO-
DETECTORS

MARCH 29
SEMI-
CONDUCTOR
SPECIAL

Multiple choice

1,700 answers
to electrical enclosure needs
by Hoffman.

Quick answers too. Hoffman offers you "off-the-shelf" shipment on most of over 1,700 standard electrical/electronic enclosures.

Each of them is built to meet the quality standards that made Hoffman's reputation. They include:

1. NEMA 1, 3, 4, 9 and 12 enclosures
2. JIC-type boxes
3. Pushbutton enclosures
4. Wireways
5. Consoles and consolets
6. Fiberglass enclosures
7. Cutout and pull boxes
8. Transformer cabinets

If you have a need that isn't met by one of our over 1,700 standard enclosures, we can modify them or custom engineer and fabricate per your specifications. Our free catalog gives details on quality Hoffman enclosures and is available on request. Put Hoffman to the test.

Hoffman **ELECTRICAL ENCLOSURES**

HOFFMAN ENGINEERING COMPANY
Division of Federal Cartridge Corporation
ANOKA, MN 55303 DEPT. ED 523

INFORMATION RETRIEVAL NUMBER 56

IT'S FA

We're still
J

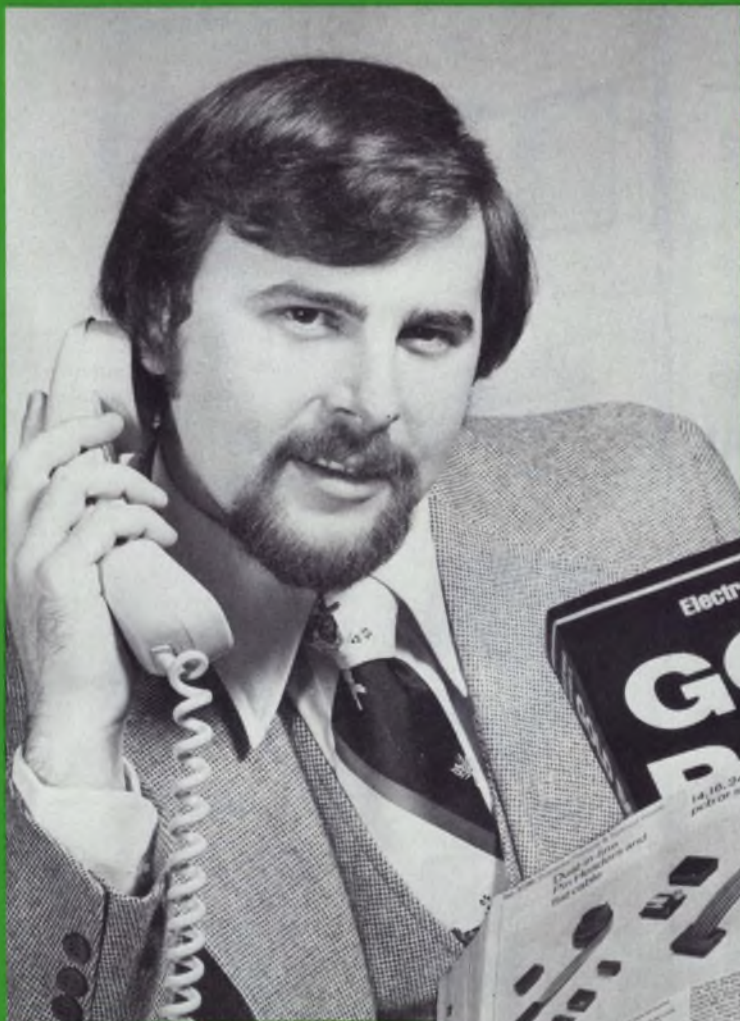

Stephen J. Scorza
General Manager
NOBEL ELECTRONICS, INC.



Tell us what you think about the GOLD BOOK. (If it's good, we'd like to hear it. If it's bad, we want to improve it.)

NTASTIC!

Getting business from Jermyn's catalog pages in the **GOLD BOOK**

"We receive numerous calls and letters, both from the U.S.A. and all over the world, which we can readily ascribe to the **GOLD BOOK**," writes Stephen J. Scorza, General Manager, Nobel Electronics, Inc., New City, New York.

In July 1975, Nobel assumed U.S. stocking, marketing, and sales operations for Jermyn, an English company. (Jermyn manufactures semiconductor hardware: IC and transistor sockets, mounting pads, transi-pads, insulators, and heat sinks.)

"Many of the engineers who contact us refer to specific Jermyn products illustrated in the **GOLD BOOK**, requiring either the standard item or a slightly modified version. A brief phone conversation, followed-up with evaluation samples, is frequently all that is needed to produce the initial order. Now, that's cost-effective selling—and all because the catalog pages serve to qualify readers, making them much stronger prospects.

"The **GOLD BOOK** is a good *selling* tool because it is an extremely good *buying* tool. We use it ourselves to locate new sources of old items and to discover new items that may be useful in design and test."

Because the **GOLD BOOK** goes primarily to *Electronic Design's* audience of specifiers, Jermyn (and now Nobel Electronics) gets the benefit of 78,000 engineers, engineering managers, purchasing agents and distributors throughout the U.S.A., not to mention 13,000 overseas. These are the men who are ready to talk business—the men who have the authority to *buy*.

**ELECTRONIC DESIGN'S GOLD BOOK IS WORKING
...IT'S WORKING FOR READERS...AND IT'S
WORKING FOR ADVERTISERS, TOO.**

Aerospace Optics make this the only miniature pushbutton switch that is Sunlight Readable



Tested and Proven

Only Vivisun 20/20 legends are readable in a light ambient of 10,000 foot-candles (sunlight). When the lamps are not energized the hidden legend characters are not discernable in a 10,000 foot-candle ambient (sunlight).

- Switches are designed in accordance with MIL-S-22885
- Single or multi-color legend option
- Individual unit or matrix mounting options
- Momentary or alternate pushbutton action available with SPDT, DPDT, or 3PDT switches
- Companion sunlight readable annunciator available (without switching)
- 1, 2, 3, or 4 separate messages
- Messages available in green, yellow, red, or white
- Designed for low power consumption (5, 12, 14, 18 or 28 volts available)
- Lamps replace from front without tools



AEROSPACE OPTICS INC.

7112 Burns Street, Dept. 33,
Fort Worth, Texas 76118

(817) 284-2293 (Ext 33) Telex 75-8461

Researchers, Designers and Manufacturers
of Sunlight Readable Lighted Displays

INTEGRATED CIRCUITS

2-k bit NMOS RAM has 500-ns access

Fairchild, 464 Ellis St., Mountain View, CA 94042. (415) 962-3816. \$8.50 to \$9 (100).

A 2048-bit static n-channel RAM—the 3539—has a 256×8 -bit organization and comes with maximum access times of 650 or 500 ns (dash-2 version). The 3539 has two separate chip-select inputs, which allow direct expansion to 512 bytes of memory. Power dissipation is less than 500 mW, and the device requires only a single 5-V power supply. Inputs and outputs are compatible with standard-TTL circuitry. The 3539 comes in a standard 22-pin DIP, and it uses the company's Isoplanar process.

CIRCLE NO. 324

See the Microprocessor Design section for microprocessors and related products.

A/d converter has MIL-temperature range

Precision Monolithics, 1500 Space Park Dr., Santa Clara, CA 95050. (408) 246-9222. \$150 to \$227 (100-999).

A complete successive-approximation a/d converter that offers 12-bit resolution comes in a single 40-pin DIP and guarantees specs over the full MIL-temperature range. The converter has maximum nonlinearity of $\pm 0.2\%$ over the full temperature range and maximum full-scale tempco of 60 to 120 ppm/ $^{\circ}\text{C}$. The package includes a high-speed d/a converter, a high-speed comparator, and a 12-bit successive-approximation register. Eight bits can be encoded in 8 μs and 6 bits in 6 μs . Input voltage ranges of 0 to +5 V, 0 to +10 V, ± 2.5 V, ± 5 V, and ± 10 V are pin-selectable and may be precisely adjusted for binary, offset binary, and two's-complement output modes in both parallel and serial form. Outputs are TTL-compatible and the converter uses just 500 mW with ± 15 and +5-V supplies.

CIRCLE NO. 325

IC holds random logic for a/d converter

National Semiconductor, 2900 Semiconductor Dr., Santa Clara, CA 95051. (408) 732-5000. \$4.95 to \$8.45 (100); stock.

All the random logic needed for a TTL a/d converter is available in the form of a single-package successive-approximation register. Three versions are offered. The DM2502 has an 8-bit capacity and serial capability but is not expandable. The capacity of the DM2503 is 8 bits, and it is expandable, but it doesn't have serial capability. A 12-bit version, the DM2504, is expandable, and it has serial capability. The 8-bit devices come in 16-pin packages while the 12-bit register comes in a 24-pin DIP. Registers allow short-cycles as well as continuous or start-stop operation. Also, they are compatible with d/a converters using any logic code.

CIRCLE NO. 326

8-bit d/a converter costs \$8.95

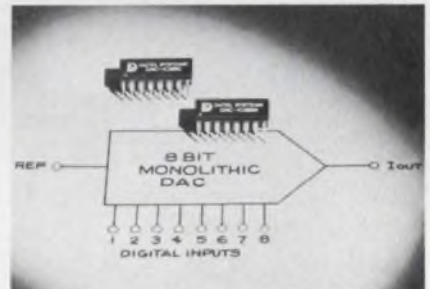

Datel Systems, 1020 Turnpike St., Canton, MA 02021. (617) 828-8000.

Monolithic 8-bit d/a converter—the DAC-IC8B—costs just \$8.95 in quantities of 1 to 9. The device can deliver either 2-mA full-scale unipolar output in response to a straight binary-coded digital input or a ± 1 -mA bipolar output in response to an offset binary code. Compliance voltage is +0.5 and -0.6 V. Also, the DAC-IC8B can perform one, two and four-quadrant multiplication between moderately fast analog and digital signals. The digital response accommodates a 3.3-MHz update rate, with the output settling in 300 ns to within 0.5 LSB. Analog, or reference, response is 4 mA/ μs .

CIRCLE NO. 327

LAST YEAR'S J.C.E. WILD CARD

Distributed
in U.S.A. by
SPEEDIMPEX
23-16 40th Ave.
L.I. City, N.Y.



SERAFINI'S HISTORICAL TV ISSUE

- ⌘ 100 years of research
- ⌘ 50 years of development
- ⌘ 25 years of mass media
- ⌘ The future of television
- ⌘ Interview with
Dr. V.K. Zworykin
- ⌘ Exclusive photographs
- ⌘ General Sarnoff's role
- ⌘ Much, much more

Jacopo Castelfranchi Editore; also publishes

THE WINNING CARDS FOR THE ELECTRONIC GAME OF KNOWLEDGE

ELETTRONICA OGGI.... For the design engineer, manager
MILLECANALI For the broadcaster, CATV operator
SPERIMENTARE For the hobbyist, student

THE LEADING ELECTRONIC PUBLICATIONS ON THE ITALIAN SPEAKING MARKET

For more information and rate card write:

in Italy

J.C.E. Publications
via Pelizza da Volpedo 1
Cinisello B., Milan

in U.S.A.

Domenico Serafini
J.C.E. Publications
L.I., N.Y. 11951

INFORMATION RETRIEVAL NUMBER 58

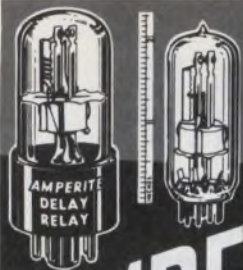

AMPERITE

THERMOSTATIC
DELAY RELAYS

For **LOW COST,**
LONG LIFE,
Maximum Stability

Delays: 2 to 180 Sec.*

Hermetically sealed — not affected by altitude, moisture, or climate changes... **SPST only** — normally open or normally closed... Compensated for ambient temperature changes from -55° to $+80^{\circ}\text{C}$... **Rugged, explosion-proof, long-lived**... Standard radio octal and 9-pin miniatures.

Price, standard or min., under \$4.00 ea.

*Miniatures delays: 2 to 120 seconds.

PROBLEM? Send for Bulletin No. TR-81.

New! LONG DELAYS

240 & 300 Sec.

Same rugged construction, hermetic sealing and stability as the shorter Delay Relays described above... For delays beyond 300 seconds, these Relays may be used in series.

Price, under \$6.00 ea.

Write for Bulletin No. LD-73.



DIFFERENTIAL RELAYS

For automatic overload, over-voltage or under-voltage protection... Made only to specifications for 70V, 80V, 90V and 100V.

Price, under \$6.00 ea.

AMPERITE BALLAST REGULATORS

Automatically keeps current and voltage at a definite value. For AC or DC... **Hermetically sealed, rugged, vibration-resistant, compact, most inexpensive.**

Price, under \$3.00 ea.

Write for 4-p. Bulletin No. AB-51.



AMPERITE

600 PALISADE AVE., UNION CITY, N.J. 07087

Telephone: 201 UNION 4-9503

In Canada: Atlas Electronics, Ltd.,
50 Wingold Ave., Toronto 19

OUR COMPLETE PRODUCT LINE CAN BE FOUND
IN ELECTRONIC DESIGN'S GOLD BOOK.

INFORMATION RETRIEVAL NUMBER 62

INSTRUMENTATION

Board tester handles both analog & digital

Hughes Aircraft, 2020 Oceanside Blvd., Oceanside, CA 92054. (714) 757-1200. \$150,000 to \$225,000; 90 days.

This circuit-board test system, the 1024H, features analog and digital capability plus an in-circuit component test capability. The system is one of a series designed for high-speed functional testing and troubleshooting of printed-circuit assemblies during prototype design, production testing and depot repair. Common failures such as open etch runs, etch-to-etch shorts, faulty IC components, shorted inputs and multiple failures are rapidly identified by the probe control software.

CIRCLE NO. 328

Automatic tester works at 50 MHz



TRW Colorado Electronics, 3450 N. Nevada Ave., Colorado Springs, CO 80907. (303) 475-0660. Station price: \$65 k to \$200 k; 3-6 mos.

SYSTEM IV is a production-oriented automatic test system that operates to 50 MHz—said to be faster than almost any other similar ATE. The tester consists of a computer-controlled central station and one or more test stations. The flexible building-block approach permits either identical or mixed test stations for digital, rf and analog testing. Up to 264 programmable drivers and comparators, programmable power supplies and multimeters are standard digital test station features. Standard peripherals include disc files, magnetic tape and cartridge storage, paper tape punch and readers, line printers, keyboard/printer, and keyboard/CRT terminals. Test language consists of an expanded Basic.

CIRCLE NO. 329

"off the shelf"
a rugged, well
constructed,
high quality switch
from **Capitol** it has the
same solid reputation
as our custom
ordered switches

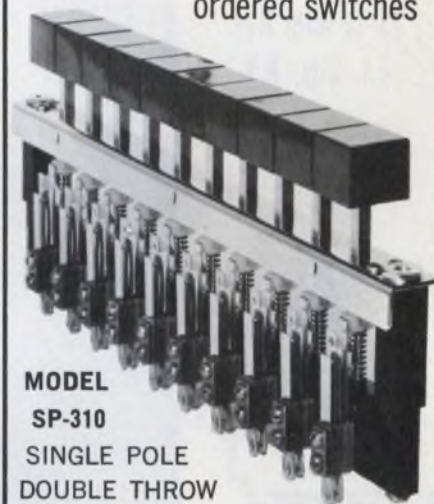

MODEL

SP-310

SINGLE POLE
DOUBLE THROW
CONTACT

SQUARE BUTTON,
NON-ILLUMINATED

Contacts: Palladium
rated at 3 amp, 110VAC, non-inductive

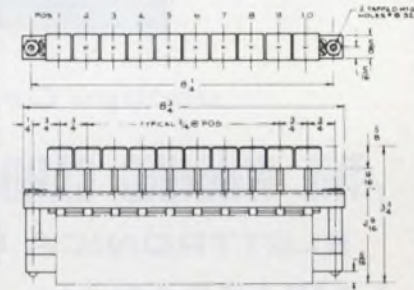

NOTES: 1. CONTACTS: 1 FORM C EACH POS. SEC. 1.
2. MECHANICAL ACTION: INTERLOCKING WITH POSITIVE LOCKOUT BETWEEN POS.
3. BUTTONS: 23-32 SA.

We manufacture
top quality push button
and lever circuit
selector switches
single switches or
banked assemblies.
Write for our catalog.

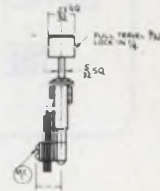

Representatives in principal cities.

CAPITOL SWITCHES

THE CAPITOL MACHINE & SWITCH CO.
87 NEWTOWN RD. DANBURY, CONN. 06810
(203) 744-3300

INFORMATION RETRIEVAL NUMBER 63
ELECTRONIC DESIGN 2, January 19, 1976

3-1/2-digit DPM sells for \$49

International Microtronics, 4016 E. Tennessee St., Tucson, AZ 85714. (602) 748-7900. \$49; stock-4 wks.

The Series 500 sells for \$49 in singles. The unit offers: 3-1/2-digits, 0.4-in. LED readout, unipolar operation, with linearity and accuracy rated at $\pm 0.05\% \pm 1$ digit. Other features include zero and full-scale front-panel adjustments, lamp test, reading hold and display blank. The standard unit operates at 5 V dc $\pm 10\%$ with 115/230, 50/60 Hz or 12 V dc $\pm 10\%$ available as options.

CIRCLE NO. 330

Scope? DMM? Counter? It's all three!



Vu-Data, 7170 Convoy Ct., San Diego, CA 92111. (714) 279-6572. \$1250; 30 days.

Model PS915/975 is the world's first and only test instrument that includes a digital multimeter (DMM), a frequency counter and an oscilloscope packaged together in a single unit with all three measuring devices possessing their own dedicated displays. All three "subinstruments" can be used simultaneously or independently.

The Model PS915 miniscope offers 20-MHz bw, triggered sweep and single-trace operation. Vertical sensitivity is 10 mV/div, and fastest sweep rate is 10 ns/div, which can be increased to 20 ns/div by a X 5 magnifier. Model 975 DMM-counter includes a 3-1/2 digit, autoranging digital multimeter (ac V, dc V, and k Ω), as well as a 4-digit, 20-MHz frequency counter.

The unit can be operated from the ac power line, from an external 12-V-dc source, or from an optional battery pack. Basic dimensions for the Model PS915 are 2-1/2 x 8-1/2 x 12-1/2-in. With the 975 added, total package height is increased to 3-1/2 in. Combined weight is 10 lb.

CIRCLE NO. 331

Problem solving... with Victoreen High Voltage Technology

1 UNORTHODOX CRT DRIVE

How did we meet ever-expanding requirements for increased bandwidth and lower power consumption, coupled with the availability of high-voltage zener-type diodes (Victoreen Corotrons)? With an unorthodox drive scheme for CRT's.

Instead of supplying the CRT anode with very high voltage, we ground the anode and supply a drive signal, riding at approximately -1800 volts, to the grid. The advantages? Being direct-coupled there are no reactive components to limit high-end frequency response or cause roll-off at the low end.

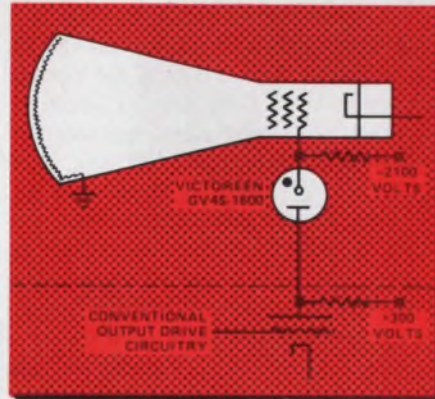

Even though the Corotron operates in the corona mode of discharge, it has no voltage jumps or jitters. Corotrons are not tied to "natural" operating voltages and are adjustable in manufacture from 350 to 30,000 volts.

2 FROG MUSCLES TO BRAIN WAVES

Colleges and universities, medical research laboratories and R&D firms need amplification of low level signals. Such signals are derived from frog-muscle experiments, brain-wave measurements, cardiac research, avalanche-breakdown, currents in ionization chambers as well as from a range of constant-current sources.

Victoreen MINI-MOX resistors are used widely to modify op-amp characteristics to:

1. Stabilize output and eliminate oscillation.
2. Define gain so measurements can be quantified.
3. Restrict bandwidth to the region of specific interest.

They typically have a voltage coefficient of -5 ppm/volt, full-load drift of less than 2% in 1000 hours, temperature coefficient of 100

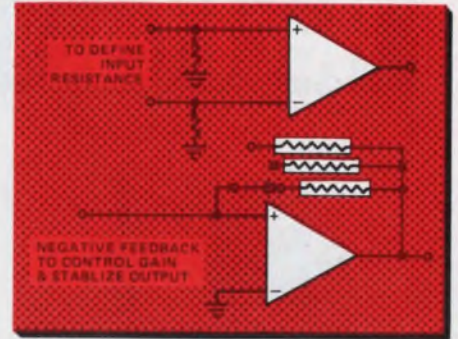

ppm, and a Quantech noise of less than 1.5 V/volt at 20M ohms. They are available in values from 100K to 10,000M ohms in 1, 2, 5 and 10% tolerances.

3 A PROBE FOR HIGH POTENTIAL

Two Victoreen MAXI-MOX resistors used in series can serve as a probe in radar circuitry capable of measuring voltages up to 60,000 volts. The probe, compatible with a number of voltmeters of different manufacture, has both short- and long-term stability. Short-term stability assures negligible drift and fluctuation during measurement, while long-term stability maintains the original calibration accuracy of the probe.

Each MOX-5 resistor used in the probe has a maximum operating voltage of 37,500 volts with a power rating of 12 1/2 watts. The voltage coefficient is 1 ppm/volt over the complete voltage range of the MOX-5, while the temperature coefficient is better than 300 ppm for -55° to 125°C.

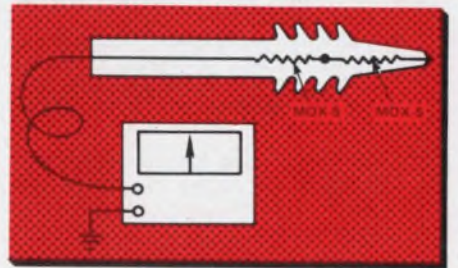

MAXI-MOX resistors have full-load drift less than 1% in 2000 hours of operation, and are available in tolerances of 1, 2, and 5% in values from 10K to 2,500M ohms. A silicone varnish conformal coating provides environmental protection while allowing a maximum hot-spot temperature of 220°C.

Victoreen Instrument Division
of VLN Corp.
10101 Woodland Avenue
Cleveland, Ohio 44104



INFORMATION RETRIEVAL NUMBER 64

NEW SERIES

Schottky Barrier Rectifiers

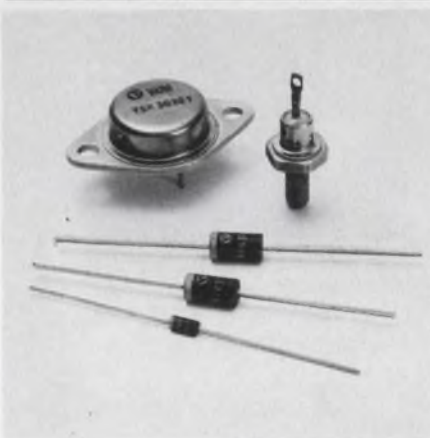

- Five series: 1A, 3A, 5A, 15A & 30A (I_o) with 20V, 30V and 40V (V_{RRM}).
- Extremely fast recovery (t_{rr}), very low forward voltages (V_F), high reliability and low cost.
- VSK 120, 130 & 140-1A series in DO-41 packages. 550 mV (V_F). 40A peak $\frac{1}{2}$ cycle surge (I_{FSM}). 10 mA (I_R) at $T_L = 100^\circ\text{C}$.
- VSK 320, 330 & 340-3A series. Epoxy package, axial leads. 475 mV (V_F). 150A surge. 30 mA (I_R) at $T_L = 100^\circ\text{C}$.
- VSK 520, 530 & 540-5A series. Epoxy package, axial leads. 450 mV (V_F). 250A surge. 75 mA (I_R) at $T_L = 100^\circ\text{C}$.
- VSK 1520, 1530 & 1540-15A series in DO-4 metal stud cases. 600 mV (V_F). 300A surge. 75 mA (I_R) at $T_c = 100^\circ\text{C}$.
- VSK3020T, 3030T & 3040T-30A series. Center-tapped, common cathode, 15A per leg in TO-3 package. 630 mV (V_F). 300A surge. 75 mA (I_R) at $T_c = 100^\circ\text{C}$.

All series have junction operating temperature range of -65°C to $+150^\circ\text{C}$.

Call Mike Hawkins
214/272-4551 for more information



Design us in —
We'll stay there

VARO SEMICONDUCTOR, INC.

P.O. BOX 676, 1000 NORTH SHILOH,
GARLAND, TEXAS 75040
(214) 272-4551 TWX 910-860-5178

INFORMATION RETRIEVAL NUMBER 66

DATA PROCESSING

Matrix printer operates at 180 char/s



Digital Equipment Corp., One Iron Way, Marlborough, MA 01752. (617) 481-7400. \$1975 (100 up); available early 1976.

A 180-char/s printer, the LA 180, provides a 96-character ASCII-set output with a 7×7 dot-matrix impact head. The printer features upper and lower-case symbols, up to 132-column capability and handles forms from 3 to 14-7/8 in. wide. Seven constant-current solenoid-driven wires are used to form the output characters, and the unit is operator adjustable to accommodate multicopy forms.

CIRCLE NO. 332

Graphic terminal uses conic contour sections

Hughes Industrial Products Div., 6855 El Camino Real, Carlsbad, CA 92008. (714) 438-9191. \$9750: Basic price; 120 days.

The new fully interactive Conographic-9 terminal does with hardware what most terminals do with software. Standard features include a 17-in., 1029-line-can video monitor with high screen-light output, a built-in zoom/pan; a joystick for graphics interaction and a hardware graphics processor for scaling graphics and alphanumerics. Architecture of the terminal embodies a microprocessor driven by microprograms contained in read-only memories. Curvilinear information is displayed by use of conic curves. This produces smoother curves than conventional X-Y plotting and needs considerably less data.

CIRCLE NO. 333



A Public Service of
This Magazine &
The Advertising Council



ENERGY MANAGEMENT:

Can your company afford to be without this vital management function?

Frederick B. Dent
Secretary of Commerce

We would like to tell you how Energy Management can help maintain your company's profitability. So we have prepared a free booklet called "How to start an energy management program." It is based on actual company case histories, and it is filled with all the basic information you will need to get your energy savings plan underway. We will also send you another booklet called "33 Money-Saving Ways to Conserve Energy in Your Business," all practical, proven methods based on the real-life experiences of businessmen like yourself.

For both of these useful booklets,
just fill in the coupon.

To: U.S. Department
of Commerce
Office of Energy Programs
Washington, D.C. 20230

Please send me your two free booklets on "33 Ways to Conserve Energy" and "How to Start An Energy Management Program."

Name _____

Title _____

Company _____

Address _____

City _____ State _____ ZIP _____

Type of Business _____

Interface matches computer to instrument

California Avionics Laboratories, P.O. Box 701, Palo Alto, CA 94302. (415) 328-7999. \$445; stock to 6 wks.

Compatible with either bus or instrument-oriented computers, the Model 600A interface provides control of up to eight BCD programmable digits for counters, timers, delay generators, etc. The interface operates with 12 or 16-bit computers and it provides the necessary "handshaking" routine for multiple-word data transfers. Input and output logic polarity are independently switch selectable, and the interface includes a switch-selectable address code of up to eight bits. The unit is available as an 8 × 7.2-in. card, and also in cabinet, rack and NIM versions.

CIRCLE NO. 334

Data terminals share dot-matrix printer



Research Inc., P.O. Box 24064, Minneapolis, MN 55424. (612) 941-3300.

Teleray CRT terminals are now offered in clusters of two to six terminals with a common printer. Individual terminal operators can select hard copy by pressing a button on their keyboard. An indicator light shows that the printer is being operated by a particular CRT. Other terminals in the cluster are not disturbed. The new printer forms characters with a 5 × 7 dot matrix. Printer speeds of 110 or 300 baud automatically match the terminal in the cluster that is asking for hard copy.

CIRCLE NO. 335

TMI CLADS CLICK WITH POLAROID

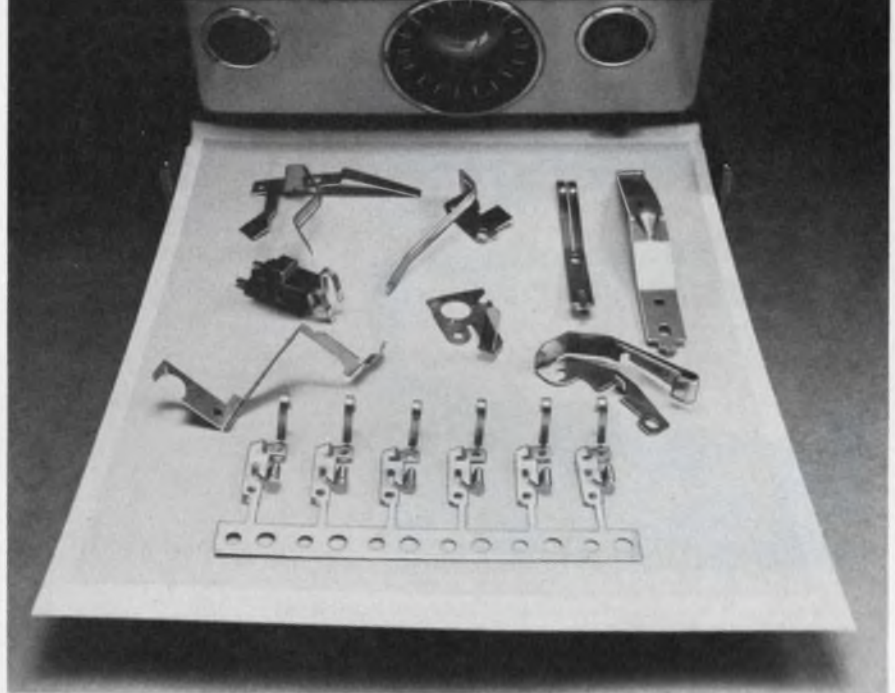

Polaroid uses TMI clad contact springs in both their Square Shooter and their SX 70 cameras for the best of reasons. Economy. Ease of Manufacturing. Reliability.

ECONOMY. Where sliding friction makes the use of silver alloy possible (such as the battery clip), TMI provides Polaroid with a coin silver contact. And where gold contacts are required (low voltage passing through the electronic shutter), Polaroid has found that TMI's 14 karat gold alloy inlay meets their performance requirements at a 50% gold savings over 24 karat gold.

EASE OF MANUFACTURING. When Polaroid selected clad contacts, a prime consideration was that cladding would allow the stamper to provide a one-step, completed assembly rather than having to rely on multiple sources inherent with either plating or welded contacts. A second consideration was the different stresses each of the springs would be subjected to. Here, Polaroid engineers were able to utilize base spring metals that included stainless steel, nickel silver, phosphor bronze, and beryllium copper.

RELIABILITY. Polaroid cameras are in use from the tropics to the Antarctic and continue to function time after time with exceptional reliability. If you're beginning to get the picture, why not write to TMI and see what we can develop for you.



TECHNICAL MATERIALS, INC.

5 Wellington Road, Lincoln, Rhode Island 02865
Telephone 401-728-7200

INFORMATION RETRIEVAL NUMBER 67

19483

TTL Programmable microvolts

\$1595.

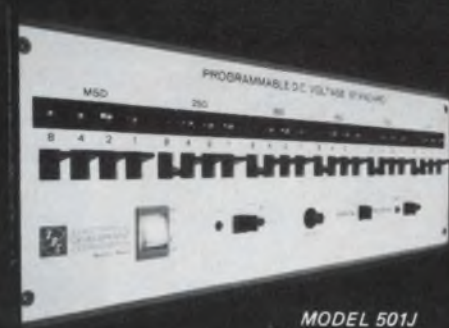

MODEL 501J

The 501J lets you marry your test system to NBS traceable DC voltages for high speed device calibration or signal simulation.

SPEED: 50µs switching and settling.

RANGES: (f.s.) 100mV, 10V, 100V, 200VDC.

RESOLUTION: from steps of 100 nanovolts.

ACCURACY: ±0.005% of selected value.

PROGRAMMING: TTL logic, BCD; Optional ASCII, Binary and IEEE 488 interface.

ACCESSORIES (Field Plug-in): I/O option; π converter; Memory; Optoisolators; Ranging amplifier.

For engineering or application assistance phone Bob Ross (617) 258-9595.

UNIT BLOCK DIAGRAM

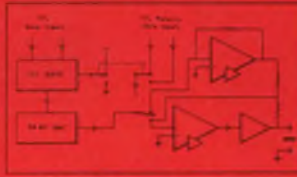

ELECTRONIC DEVELOPMENT CORPORATION

11 Hamlin Street, Boston, Ma. 02127

INFORMATION RETRIEVAL NUMBER 68

SAM[®] IS THE LOWEST PRICED READER YOU CAN BUY. BUT YOU DON'T GET SHORT CHANGED.



You could spend a lot more for a tape reader and still not get all of SAM'S quality features. SAM clips along at 300 cps, has our sure-footed dual sprocket drive and our state-of-the-art fiber optic light source and photo transistor read head. We can make SAM do all this *and* save you money because we do things differently.



This is the plain, brown wrapper SAM comes in.

The more you know about punched tape equipment, the better you read us.

DECITEK

250 CHANDLER STREET, WORCESTER, MASSACHUSETTS 01602, U.S.A. (617) 798-8731

INFORMATION RETRIEVAL NUMBER 69

PACKAGING & MATERIALS

Socket assemblies hold 11-pin relays or timers

Reed Devices Inc., 21 W. 183 Hill Ave., Glen Ellyn, IL 60137. (312) 858-2050. \$2.11 (100-up); stock.

The SM11 series of 11-pin socket assemblies is designed for plug-in relays and timers. They are molded of U.L. grade polycarbonate plastic and use socket pins of phosphor-bronze material. Captive wide-clamp plates on screws provide fast wiring. The sockets are rated for 10 A, 300 V.

CIRCLE NO. 336

Breadboards can hold from 1 to 50 ICs

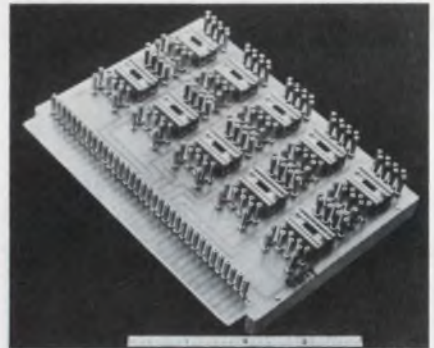

Garry Manufacturing Co., 1010 Jersey Ave., New Brunswick, NJ 08902. (201) 545-2424. From \$4.80 per IC position; stock to 4 wk.

A series of plug-in breadboards created to facilitate prototype design can hold 14 or 16-pin DIPs and other packages. They are available in various sizes to accept from one to as many as 50 integrated circuits. A full range of accessories for these boards is also available.

CIRCLE NO. 337

Miniature bi-pin socket holds T-1-3/4 lamps

Chicago Miniature/Drake, 4626 N. Olcott Ave., Harwood Heights, IL 60656. (312) 784-1020. 18.7¢ (250-piece lots); stock.

The 4999-004 bi-pin lampholder permits the installation of replaceable T-1-3/4 bi-pin lamps on PC boards. The lampholder has an above-board height of 0.115 in. and an outside diameter of 0.215 in. It has a cylindrical nylon insulating body, with beryllium-copper gold-plated pin sockets.

CIRCLE NO. 338

Power to the μ P



Sola offers DUAL and TRIPLE OUTPUT POWER SUPPLIES for MICROPROCESSORS and accessories: RAM's, PROM's, ROM's, FEPROM's, CLOCKS and IO devices.

All available from your local electronic distributor. At competitive pricing. From a name you can count on—Sola.

Our versatile power supplies offer fully isolated independent outputs for either positive or negative operation. Series or parallel operation. Plus, remote sensing/programming, and complete serviceability. Just call or write for Catalog 647.

For added protection, consider our minicomputer regulators, UPS, and Standby units. Everything you need for MPU power and protection.

Sola Electric, 1717 Busse Road, Elk Grove Village, Ill. 60007 (312) 439-2800.

SOLA ELECTRIC



Think of us as your supply line.

INFORMATION RETRIEVAL NUMBER 70

CUSTOM-CRAFTED Constant Voltage Transformers

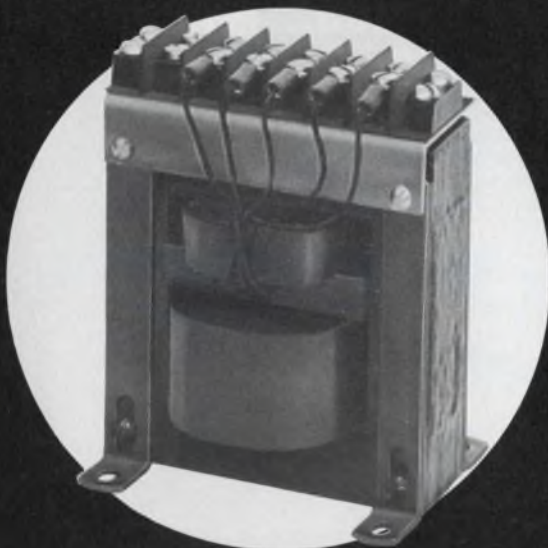

Datatex manufactures a wide range of transformers, inductors, toroids, chokes, matched audio and sub-audio units in many sizes and voltages. For automatic controls, aerospace, computers, biomedicine, and other industrial uses.

DATATEX CORPORATION

TRANSFORMER DIVISION

10935 South Wilcrest Drive □ Houston, Texas 77072 □ (713) 495-1171

INFORMATION RETRIEVAL NUMBER 71

ELECTRONIC DESIGN 2, January 19, 1976

Rose enclosures. New. Beautiful. Quality. Standards.



Rose Enclosures, made specifically for electronic use, culminate years of design, engineering and production experience. Extra high quality, precision-finished units provide functional protection, easy access, excellent esthetics. Available materials: Lexan, Aluminum, Polyester and ABS. Clear plastic covers with Lexan and ABS. A competitively-priced stock of Rose Enclosures is maintained in Belding, Mich. for immediate shipment. Contact us at (616) 794-0700.

STAHLIN
BROTHERS, INC.
Belding, Michigan 48809

INFORMATION RETRIEVAL NUMBER 72

107

Conductive spheres make resilient contacts

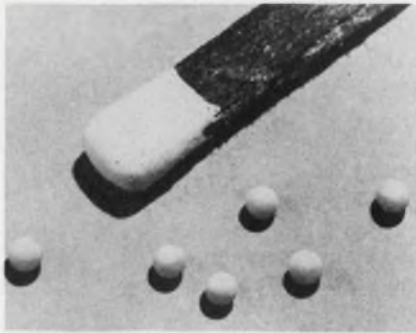

Technit, 129 Dermody St., Cranford, NJ 07016. (201) 272-5500. From \$0.14 (2500 up).

Conductive elastomeric spheres make resilient contacts without expensive tooling charges. The spheres use a silver or carbon filled elastomer, and are molded with a 0.05 in. \pm 0.003 in. diameter. They have an operating range from -70 to +350 F. Other sized spheres can be produced for specific elements and applications.

CIRCLE NO. 370

Test sockets handle units with up to 12 pins

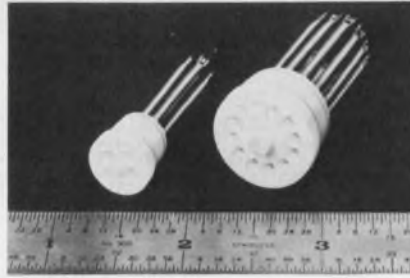

Garry Manufacturing, 1010 Jersey Ave., New Brunswick, NJ 08902. (201) 545-2424. \$0.25 to \$3; stock to 6 wk.

A line of test sockets that accepts uncut transistor leads has smoothly chamfered entry holes for fast insertion. The sockets are available for three to 12-lead components, with pin circle diameters ranging from 0.2 to 0.51 in. They are made in two basic versions: one to accept leads with minimum lengths of 0.187 in. and the other for leads with min. lengths of 0.5 in. Both accept leads with diameters ranging from 0.015 to 0.032 in. Contact resistance is 0.015 Ω maximum.

CIRCLE NO. 371

Solderless breadboard holds up to 6 DIPs



Continental Specialties, 44 Kendall St., P.O. Box 1942, New Haven, CT 06509. (203) 624-3103. \$15.95; stock.

The Proto-Board 6 solderless breadboard kit can handle six 14-pin DIPs. The PB-6 includes one of the company's QT-47S solderless breadboarding sockets, two QT-47B bus strips, four 5-way binding posts, a metal ground and base plate, rubber feet to prevent scratching work surfaces, all nuts, bolts and screws and complete easy-assembly instructions. The breadboard measures 6 x 4 in.

CIRCLE NO. 372

DIP REED RELAYS 35 MODELS

Your choice of:

- SPST, DPST & SPDT dry reed contacts, 3 to 10 watts.
- SPST mercury wetted reed contacts, 28 watts.
- 5 to 24 VDC coils. 4, 8, or 14 terminals. TTL compatible.
- Optional clamping diodes and electrostatic shielding.

Available from distributors. Or contact us today.

26477 N. Golden Valley Road • Saugus, Calif. 91350
(805) 252-8330 • (213) 788-7292 • TWX 910-336-1556

ELEC-TROL, INC.

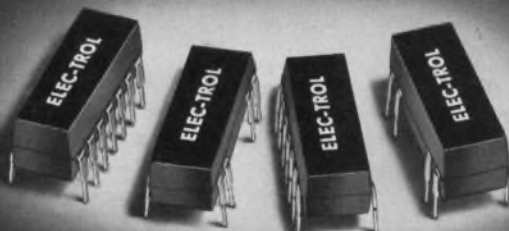

eem

REED RELAYS TO FIT YOUR SPECS... AND BUDGET

Our **Open-Line** reed relays will give you high performance at remarkably low cost if you have no critical environmental factors to worry about.

Our **Encased-Line** is epoxy sealed to meet extreme environmental and handling conditions.

Both offer top performance; choice of Form A, B, or C dry reed contacts; Form A mercury wetted reed contacts; up to 6 poles; coil voltages 5 to 48 Vdc; either .1" or .15" terminal spacing; optional electrostatic or magnetic shielding.

Available from distributors. Or contact us today.

26477 North Golden Valley Road • Saugus, Calif. 91350
(805) 252-8330 • (213) 788-7292 • TWX 910-336-1556

ELEC-TROL, INC.



eem



Small Wonder
 * It's PICOTEMP thermal cutoff
 New from Micro Devices
 (Actual Size)

PICOTEMP thermal cutoffs. Fit tight spaces — and limited budgets. Same accuracy and similar capabilities as the widely used MICROTEMP® safety thermal cutoffs... but smaller in size. Weighs just 1/48th of an ounce. Installed costs are less, too.

Use PICOTEMP thermal cutoffs when installation or space restrictions rule out MICROTEMP. At present, motors and transformers are two leading applications. But, wherever you use PICOTEMP thermal cutoffs, you're assured of positive, low cost protection against overheating caused by malfunctions in electrical circuits and components. The PICOTEMP thermal cutoff is completely sealed against atmosphere. Because of its unique design and construction, it won't degrade. And it is unaffected by age or extended use.

Here are some other things you'll want to know:
 ● current capacity—to 5 amps, at 120 VAC. Will hold this rating up to and including 240 VAC.
 ● temperature tolerance +0° C.—3.3° C.
 ● temperature ratings—63 °C.—150° C. (143° to 300° F.)
 ● leads are 26 gauge silver plated wire.

For more information, check the reader service card, or call or write.



MICRO DEVICES CORP.
 1881 Southtown Blvd., Dayton, Ohio 45439
 Ph: (513) 294-0581 Telex: 28-8087

MICROPROCESSOR FAMILIARIZOR — \$229.00

COMPLETE SYSTEM FOR THE BEGINNER DOESN'T REQUIRE A TERMINAL



The 6502 FAMILIARIZOR is a microcomputer with a keyboard and display, all on a single printed circuit board, eliminating the need for a teletype or any other expensive terminal. It is designed to give the beginner "hands on" experience with a microprocessor. The two manuals that are included can be easily understood without any prior knowledge of microprocessors.

A monitor program included in PROM memory enables you to load, run, debug and modify programs easily using the on-board keyboard and hexadecimal display. Breakpoints can be entered anywhere in your program and can be used to display the internal registers or branch to a separate routine that you've loaded.

The system is designed around the MOS TECHNOLOGY 6502 microprocessor and includes 1K bytes of RAM, 256 bytes of PROM (contains monitor program), one 8 bit input port and one 8 bit output port. For those who wish to store programs in PROM, provision is made for 3 additional 1702A PROMS (768 bytes). The system bus is available for easy expansion. Add on memory and interface cards will be available soon.

The 6502 FAMILIARIZOR kit comes complete with all parts, circuit board, manuals and complete documentation. The only thing you need to add is a power supply (+5 volts at 1.2 amp and -9 volts at 50 ma).

- 6502 FAMILIARIZOR**
- COMPLETE KIT.....\$229.00
 - KIT LESS MICROPROCESSOR AND MANUALS.....194.00
 - ASSEMBLED.....285.00
 - ACCESSORIES**
 - IC SOCKET KIT.....14.50
 - POWER SUPPLY.....58.00

All orders postpaid
 Order direct (prepaid only) from:

EBKA
INDUSTRIES INC.
 6920 MELROSE LANE 405/ 787-3671
 OKLAHOMA CITY, OKLAHOMA 73127

A WIDEBAND AMPLIFIER WITH WIDEBAND FEATURES

It's IFI's Model 5100. Exclusive features include automatic remote leveling and remote level control. Also prominent in its broad performance spectrum: auto pulse and auto limit to confine amplifier current to safe levels in pulsed operation... Operates into any load from open to short... Frequency range, 10 KHz to 250 MHz... Peak RF input, 1 V; 40 dB gain; output, 10 W... Model 5100 was designed primarily as a preamplifier for IFI and other high power wideband amplifiers. As such, it's a direct replacement for IFI's Model 5000—with all of that unit's proven performance AND the advanced features you will find only in Model 5100. Write for technical data.



instruments for industry, inc.

151 TOLEDO STREET • FARMINGDALE, N.Y. 11735
516-694-1414 Cable: Electronic Hallendale, Fla. Telex: 51-43-32

INFORMATION RETRIEVAL NUMBER 76

We're on the move ... with a 15-ns track/hold!

The new Computer Labs modular THS Series track-and-hold amplifiers have acquisition times from 15 ns; ultra-fast apertures of 20 ps; linearity of 0.01%; dc-coupling; and input buffering. The THS Series and slower-speed THC Series modules offer the user the industry's broadest line of track-and-hold modules. (Note in the scope trace the THS output reacquires the input just 12 ns after the end of the hold time.)

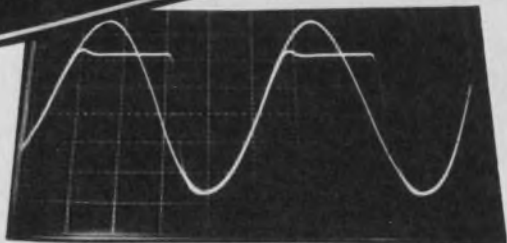

Vertical
0.2 V/div.

Horizontal
20 nsec/div.

(10 MHz sine wave)

COMPUTER LABS

COMPUTER LABS, INCORPORATED
505 EDWARDIA DR. • GREENSBORO, N. C. 27409 • 919/292-6427

INFORMATION RETRIEVAL NUMBER 77

DISCRETE SEMICONDUCTORS

Power transistors have 20-A collector rating

RCA, Route 202, Somerville, NJ 08876. (201) 722-3200. \$2.54 (100-up); stock.

The RCS258 power transistor provides the voltage and current capabilities of the widely accepted 2N3772 but with a higher power dissipation rating. The transistors are housed in JEDEC TO-3 packages and have a power-dissipation rating of 250 W. Its ratings include a continuous collector current of 20 A, a peak collector current of 30 A and a collector-to-emitter voltage of 80 V.

CIRCLE NO. 344

Double-drift Impatts deliver up to 3 W

Hewlett-Packard, 1501 Page Mill Rd., Palo Alto, CA 94304. (415) 493-1501. From \$150 (1 to 9); stock.

High-efficiency silicon, double-drift Impatt diodes have an output up to 3 W from 5.9 to 8.4 GHz. The Model 5082-0608, 3-W unit can be used as the output stage for a transmitter. The 5082-0607 is rated for 1.5 W over the same frequency range. Efficiency of the 5082-0607 is typically 11% and 10.5% for the 5082-0608. Both devices are designed to exceed the reliability requirements of MIL S-19500.

CIRCLE NO. 345

Power transistors have 15-A, 150-W ratings

Westinghouse Electric Semiconductor Div., Youngwood, PA 15697. (412) 925-7222. 100-up prices: \$1.40 (2N6254), \$3.45 (6262); stock.

The JEDEC 2N6254 and 2N6262 transistors are rated at 15 A and 150 W. The 2N6254 transistor is rated at 80 V and the 2N6262 device at 150 V. A 200-C temperature range permits reliable operation in high ambients, and a hermetically sealed TO-3 case ensures high reliability and long life. Both devices are 100% power tested at full rated load.

CIRCLE NO. 346

Everything in precision voltage sources from A to B.



6-digit Model M106 A. Accuracy $\pm 0.002\%$. Range ± 1 microvolt to $\pm 1,000$ VDC in 4 ranges. Solid-state voltage selections and digital display. **Isolated remote BCD programming optional.** A proven, versatile performer for bench, production or computer-controlled test systems... with a low basic price of \$2,615.



5-digit Model M106 B. Same as A version except: Accuracy $\pm 0.008\%$, range ± 10 μ V to ± 100 VDC in 3 ranges. (± 1000 VDC ranges optional). No need to pay for super-precision if you don't need it: basic price is only \$1,975.

For further details on both A and B. Contact your Scientific Devices office or Systron-Donner at 10 Systron Drive, Concord, CA 94518. For immediate details, call our Quick Reaction line (415) 682-6471 collect.



SYSTRON-DONNER

POWER SOURCES

H-V lab supplies show high stability

Brandenberg Ltd., 939 London Rd., Thornton Heath, Surrey CR4 6JE, England.

Alpha Mark II are stabilized dc high-voltage power supplies. Five models are available, with output voltage ranges from 500 V to 5 kV at 5 mA up to 6 kV to 60 kV at 400 μ A from a 220/240-V, 50/60-Hz input at approximately 100 VA. Output stability against load changes (250 μ A to full load) is 20 parts in 10^6 , and against mains-voltage variation ($\pm 10\%$) is 10 parts in 10^6 per deg C, and drift is within 30 parts in 10^6 over a 15-min period 2 h after switching on. Ripple (33-kHz conversion frequency) is 100 parts in 10^6 .

CIRCLE NO. 373

375-W switcher weighs just 7-1/2 lb



LH Research, 1821 Langley Ave., Irvine, CA 92714. (714) 546-5279. \$445; 8 wks.

MM Series 100 single-output power supply switcher (the "Mighty Mite") offers high power in a small package. The MM 100 measures only 4 x 5 x 12 in. and weighs 7-1/2 lb. Standard output voltages are 5 V at 75 A, 12 V at 31 A, 15 V at 75 A, 18 V at 21 A and 24 V at 15 A. Like all Series MM units, the 100 is up to 80% efficient, features 1% pk-pk or 50 mV pk-pk ripple and noise on output, line regulation of 0.4% over the entire input range, load regulation of 0.4% from no-load to full-load. Response time is 200 μ s to 1% after 25% load change.

CIRCLE NO. 374



... so I said ... OK, show me a switching power supply with the brains to perform reliably in my environment, where others have failed

... and **TODD** did.

Todd's units feature:

- A dynamic circuit controller **BRAIN** that optimizes the reliability, efficiency, and performance in any surroundings ... all the time.
- Complete range of single and multiple outputs thru 48 volts, currents to 120 amps.
- Full 5-year warranty.
- Competitively priced.

Start getting your moneys worth. Write or call for complete information today.

TODD PRODUCTS CORP.

123 Milbar Blvd., Farmingdale, N.Y. 11735. (516) 293-3440.



10MHz 3" Triggered Sweep Scope
 ... 1/3 the size of comparably
 performing scopes



Model
1431
\$399.00
 only 4 3/4"
 high

It's a lightweight 13 pounds in your hand with heavy-weight wideband scope performance on your bench or jobsite. Only 35 nanosecond rise time, 10 millivolts/division sensitivity and 19 calibrated auto or triggered sweep speeds from 0.5 usec/cm to 0.5 sec/cm with 5X magnification. Pushbutton selected sync modes include internal, external, pos and neg slope, and TV horizontal and TV vertical with exclusive TV sync separator. If you've been waiting to buy a portable scope until you could get all the features you'll ever need at a price you want to pay, you've been waiting for the B&K Precision Model 1431. See your distributor or write Dynascan Corporation.

B&K PRODUCTS OF
DYNASCAN
 1801 W. Belle Plaine Ave.
 Chicago, IL 60613 • (312) 327-7270

INFORMATION RETRIEVAL NUMBER 79

Facts.
The GOULD 2400
 delivers more of them with
 less fuss, bother and cost
 than any other oscillograph
 you can buy.

And it does it on a wide 100mm channel and at a remarkable 30Hz. Available in 2, 3 and 4 channel models with all the Gould exclusives, of course.

For the full Gould 2400 story, write Gould Inc., Instrument Systems Division, 3631 Perkins Avenue, Cleveland, Ohio 44114. Or Gould Allco S.A., 57 rue St. Sauveur, 91160 Ballainvilliers, France.

PHONE FREE (800) 648-4990 FOR BROCHURE.



INFORMATION RETRIEVAL NUMBER 82

**RIGHT-ANGLE
 PC TOGGLE**



TT-RA
 SERIES

The ultimate in submini-toggle switches which are designed expressly for PC applications. Terminals and mounts fit 0.1" hole centers on X and Y axis. Gold or silver contacts are optional. Plain or threaded bushing. Custom PC terminals, too!

Write or call (617) 685-4371 for further information on this and other TT Series models.

INFORMATION RETRIEVAL NUMBER 80

**QUALITY
 SLIDE SWITCH**



MSS-22
 SERIES

Alco's finest subminiature slide switches for PC use and instrumentation applications. Gold contacts permit its use in dry or low current circuits. N.O.-N.C. or DPDT available. Rated 500 ma @ 125 VAC with a life expectancy of 50,000 operations.

Call (617) 685-4371 or write for additional information, samples and pricing.

INFORMATION RETRIEVAL NUMBER 81

ALCO ELECTRONIC PRODUCTS, INC.
 1551 OSGOOD STREET NORTH ANDOVER, MA 01854 U.S.A.
 Tel: (617) 685-2371 Telex: 710 342 0512 A SUBSIDIARY OF **AUGAT** INC.

RADIOTELEPHONE TEST SET



65Hz-510MHz • AM-FM-OM • Semi-Automatic • Low cost
 RX Sensitivity • Selectivity • Frequency • Response • IF • AF
 TX Power • Modulation • Frequency • Response
 Duplex & Talk Thru Tests • CDI Frequency Counter • 230/115Vac¹²Vdc

SYNTHESIZED SIGNAL GENERATOR



100Hz-100MHz • 1uV-1V • AM & FM • 100Hz-10KHz Mod
 Fully Programmable • Accuracy 1:10⁷ • Stability 3:10⁹
 Resolution 1:10⁹ • Competitive Price

MANUFACTURER seeks JOINT VENTURE for US SALES
 OF THESE & OTHER PRODUCTS. ORDER PARTICIPATION \$600,000 PA

GREEN ELECTRONIC & COMMUNICATIONS EQUIPMENT LTD
 5-15 THOROLD ROAD, LONDON N22 4YE, ENGLAND. Tel 01-889 2700

DIRECT CUSTOMER ENQUIRIES WELCOME

INFORMATION RETRIEVAL NUMBER 83

POWER SOURCES

Switcher protects against line problems

Pioneer Magnetics, 1745 Berkeley St., Santa Monica, CA 90404. (213) 829-3305. \$665; stock-30 days.

Model PM 2497, type 5D150, a 5-V-dc, 150-A unit, joins the company's DEPENDABLES line of brownout proof switching power supplies. This line is designed for add-on memories and other computer peripherals. The unit provides full power to 50 C without derating and can deliver 150 A at 60 C on special order. The unit operates from 92-to-138, or 184-to-250-V rms input and maintains regulation through line dips to 80 or 160 V rms. If utility power is lost, the 5D150 maintains output regulation for up to 30 ms. Typical transient response is less than 50 mV excursion for 25% load steps.

CIRCLE NO. 347

Mag-amp regulators work at high efficiency



Arnold Magnetics, Union Bank Plaza, 201 S. Lake Ave., Pasadena, CA 91101. (213) 795-5985. \$152; stock-6 wks.

Thermal efficiency as high as 90%, subminiature packaging and many performance options characterize the ARF-Series of submodular power supplies. The mini magnetic-amplifier-regulator line provides up to 90 W from a package only $0.9 \times 1.4 \times 3.2$ in.—20 W per cubic inch. Dc-voltage outputs range from 4.2 to 30 V, ac inputs from 100 to 440 V, at line frequencies from 47 to 500 Hz. Specs include line and load regulation of 0.2%, with output ripple 0.5% max. Tempco is $0.02\%/^{\circ}\text{C}$ from -10 to $+71$ C.

CIRCLE NO. 348

Switching units give four outputs



Boschert Associates, 3010 Lawrence Expwy., Santa Clara, CA 95051. (408) 732-2441. \$55.90 to \$349 (100).

This series features open-frame, general-purpose, quad-output supplies for the computer peripheral OEM market. Power outputs of 10, 60, 150 and 300 W are available and all are short-circuit proof, reverse polarity protected and have overvoltage protection. Output voltages are customized for each application and a single unit replaces four linear supplies. Output voltage up to 300 V and currents up to 25 A are available. Efficiency is typically 75 to 80% depending on output voltage. Ripple and spikes are held to 40 mV rms and 100 mV pk-pk. Weight for the 300-W unit is 4.5 lb., the 150 W is 3.5 lb., the 60 W is 15 ounces and the 10 W is 6 ounces.

CIRCLE NO. 349

Isolated, floating unit aims at strain gauges

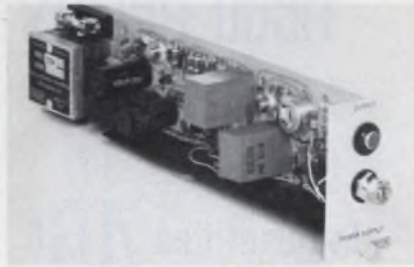

Incor Instrumentation, 144 Lamar St., West Babylon, NY 11704. (516) 643-7070. \$130; stock.

Model 215A isolated floating power supply provides adjustable 0 to 30 V dc at 200 mA for transducer excitation. 10 kM Ω and 0.1-pF isolation from ac line power is provided. A unique sensing circuit, requiring only 1 μA , virtually eliminates errors resulting from sensing lead line changes. Up to 10 channels may be mounted in Series 103 19 \times 3-1/2-in. high rack adapters.

CIRCLE NO. 350

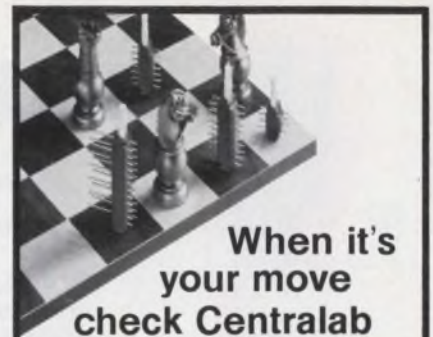

When it's
your move
check Centralab

Visual display

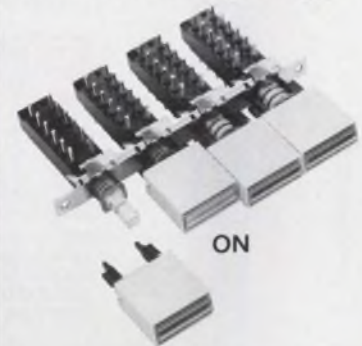

in a non-lighted pushbutton switch

Now you can add visual display to Centralab non-lighted pushbutton switches. Our new status indicator button with a unique fluorescent reflective surface operates with ambient light to indicate switch status when activated. No power is required. There are no lamps to burn out.

Other features include:

- Choice of 6 display colors. 3 lens options and 5 button colors.
- Available with push-push or interlocking action.
- 140° peripheral viewing angle.
- Vertical or horizontal button mounting.

See your Centralab Pushbutton Distributor or send inquiry card for complete specifications.

Isostat Licensed



CENTRALAB

Electronics Division

GLOBE UNION INC.

P.O. BOX 858

FORT DODGE, IOWA 50501

INFORMATION RETRIEVAL NUMBER 84

Klip-N-Wrap

Fast Connections with the Trifurcated KLIP-WRAP Post

Clip-action clutches .010" to .040" leads for substitution/testing, or as a handy holder prior to soldering. The T49's .025 inch² shank takes high wrapping torque and may be spaced as closely as alternate .10" centers. We also sell a low-cost hand insertion tool, P-156. We'll send you FREE SAMPLES of all 5 wrap post designs shown, and data on solder types, at your request.

T49 in
.042"
hole,
1/16" card



R32. IC socket pin wrap post with knurl for .042" VECTOR-BORD[®] holes.

T44 square wrap post tail with slotted end to accept leads

K32 lowest cost .025 inch² "J" Klip wrap post.

T46-2 unique star-shaped swage stabilizes above and below board



Vector

ELECTRONIC COMPANY, INC. Dept. TW
12460 Gladstone Ave. • Sylmar, CA 91342
(213) 365-9661 TWX 910 496-1539

INFORMATION RETRIEVAL NUMBER 85

USC'S UMI most compact ULTRA MINIATURE CONNECTORS

7 UMI Series -- Standard & Closed-Entry
MIL-C-28748/7, 8 and others.

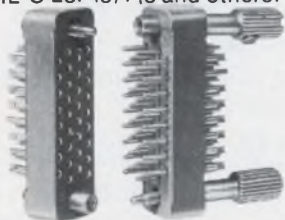

Highest reliability -- proved in Gemini/Apollo flights! 1 of over 20,000 types of connectors. Write or phone for UMI Series catalog -- today!

U.S. COMPONENTS, INC.



Leader in advanced engineering & design
1320 Zerega Avenue, Bronx, N.Y. 10462
(212) 824-1600 TWX: 710-593-2141
Cable: COMPONENTS, NYK

INFORMATION RETRIEVAL NUMBER 86

Little Red Reed Relays



Pat. Pend.
In Quantities as low as **49¢**

- ★ Red Flame Retardant Shell
- ★ Instrument Grade Contacts
- ★ Coto's High Reliability Testing
- ★ Premium Grade Catalogued Switches
- ★ Epoxy Encapsulated
- ★ Low Water Absorption
- ★ ... and Much More!

Write or Call for Bulletin MR 12.1



**COTO-COIL
COMPANY, INC.**
59 Pavillon Ave.
Providence, R. I. 02805
Tel: (401) 467-4777

INFORMATION RETRIEVAL NUMBER 87

New Literature

μC development system

The capabilities of the Intellex MDS microcomputer development system are described in a six-page brochure. Intel, Santa Clara, CA

CIRCLE NO. 351

DIP switches

Features of slide-action DIP switches are covered in a four-page brochure. A cutaway view of the SL series switch depicts how the switch is constructed. Dimensional diagrams are included. Control Switch, Folcroft, PA

CIRCLE NO. 352

Digital multimeters

Specifications, features and options of seven digital multimeters are detailed in an eight-page brochure. Data Technology, Santa Ana, CA

CIRCLE NO. 353

Thick-film materials

An eight-page thick-film materials catalog covers applications for microcircuits, optoelectronics, trimmers and potentiometers. Du Pont, Wilmington, DE

CIRCLE NO. 354

The impossible hookers . . .

Fifty-two illustrated pages provide complete specifications on test connectors, leads, coaxial cables and adapters. Color-coded sections make it easy to find the tester needed. E-Z-Hook, Arcadia, CA

CIRCLE NO. 355

Magnetic reed switches

A 12-page magnetic reed switch catalog includes a guide to aid in selection of the right switch for the right application. All models are cataloged with their capacities, specifications and physical dimensions. Hamlin, Lake Mills, WI

CIRCLE NO. 356

Power Power Power

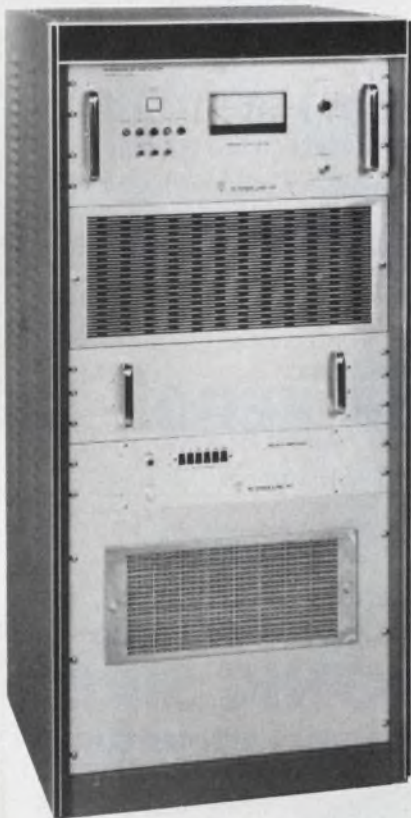

MODEL 220-2K30

- * 2000 WATTS
- * BROADBAND
- * 2 - 35 MHz
- * LINEAR, CW
- * -34 dB I.M.D.
- * RELIABLE, SAFE



R.F. POWER LABS, INC.
11013-118th Place N.E.
Kirkland, Washington 98033
Phone (206) 822-1251
Telex No. 32-1042

INFORMATION RETRIEVAL NUMBER 88
ELECTRONIC DESIGN 2, January 19, 1976

Power supplies

Dc, HV, high-speed (wideband) programmable, digital, bipolar and laboratory power supplies are featured in a 32-page catalog. Kepco, Flushing, NY

CIRCLE NO. 357

Microcircuits

A catalog of high reliability microcircuits includes circuits for commutation, analog and dc switching, gating, multiplexing, chopping, d/a conversion, s/h, modulation, demodulation, solid-state relays, lamp/relay driving and TTL-to-MOS level shifting. Teledyne Crystals, Cambridge, MA

CIRCLE NO. 358

Technical journal

Monochip Technical Journal No. 10 contains the design of an integrated EIA receiver. The 12-page journal also describes a novel design in which one circuit uses a loudspeaker both as a beeper and a microphone. A third article discusses unexpected effects of metal resistance in ICs. Interdesign, Sunnyvale, CA

CIRCLE NO. 359

Data logger

Specifications, options and expansion features of a data logging and/or acquisition system are covered in a 14-page brochure. E-H Research Laboratories, Oakland, CA

CIRCLE NO. 360

Electronic enclosures

Cabinets, small cases, racks, consoles and electronic desks are described in an eight-page booklet. Optima Enclosures, Scientific-Atlanta, Tucker, GA

CIRCLE NO. 361

Dc and ac motors

"Design Engineer's Guide to DC Stepping and AC Synchronous Motors," a 52-pager, covers terminology, construction and operation, ratings and specifications, selection and applications. The Superior Electric Co., Bristol, CT

CIRCLE NO. 362



When it's
your move
check Centralab

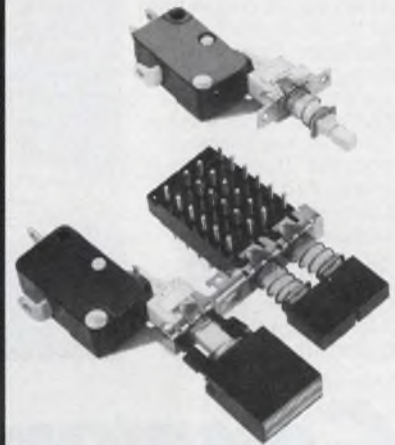

5 amp pushbutton switch

You'll meet even the most stringent requirements with this new line switch. It's UL listed for TV-5 rating (120V, 5A, 78A peak in-rush current).

Other features include:

- Furnished as a single station or for left or right mounting on any Centralab pushbutton switch assembly.
- Three circuit options — SPDT, SPST, normally open and SPST, normally closed.
- Button options include lighted, non-lighted or status indicator button (shown above).

See your Centralab Pushbutton Distributor or send inquiry card for complete specifications.

Isostat Licensed



CENTRALAB

Electronics Division
GLOBE-UNION INC.
P.O. BOX 858
FORT DODGE, IOWA 50501

INFORMATION RETRIEVAL NUMBER 89

What every IC system designer needs is easy to get.

Cambion's Integrated Packaging catalog 119A has 70 pages full of products for the designer. Breadboards, Wire-Wrap* cards, card files and hardware, logic assemblies, power supplies, sockets. These are only a few of the quality Cambion products featured. Write today for your FREE copy. Cambridge Thermionic Corporation, ED-1, 445 Concord Avenue, Cambridge, MA 02138.



Standardize on

CAMBION®

The Guaranteed Electronic Components

*Reg. TM
Gardner Denver Co.

INFORMATION RETRIEVAL NUMBER 90



Model MB-3
"A" 0° to -100°F.
"B" 0° to +100°F.
"C" +100° to +400°F.

Multi-Bath Test Stand for efficient production line testing

For chilling charpy specimens, calibration, shock testing and other special test requirements, rely on CSZ Multi-Bath test stands. Stainless steel chambers, liquid agitators, immersion heaters for high temperature operation, mechanical refrigeration systems for low temperature operation. Eye level indicating controllers and switches for each chamber. Caster mounted units for portability.

Write for literature kit

CINCINNATI SUBZERO PRODUCTS INC.

2612 Gilbert Ave., Cincinnati, Ohio 45206
Phone: (513) 751-8810

INFORMATION RETRIEVAL NUMBER 92

SMART new data system learns from your finger to do YOUR job



1. Measure up to 248 low level signals accurately, immune from noise—*analog, digital, non linear*. Print them out, tape them, feed your computer (alarms too!).
2. Key program—with one finger—all clock timing, scan intervals, channel gains, I/O, engineering units, powerful subroutines like automatic programming and optional integration. Everything to do your job.

In the new PD-2064, a proven microprocessor, RAMs, and ROMs replace a bushel of expensive circuitry to make a versatile, standardized data acquisition system you can use for general or specific jobs. The big benefit to you is more data *reduced* per dollar. Request Bulletin B110 from Esterline Angus Instrument Corporation, P.O. Box 24000, Indianapolis, IN 46224. 317/244-7611.

 **ESTERLINE ANGUS**
AN ESTERLINE COMPANY

INFORMATION RETRIEVAL NUMBER 91

Small—but Powerful ELECTRONIC SIREN Now, for Panel Mounting!

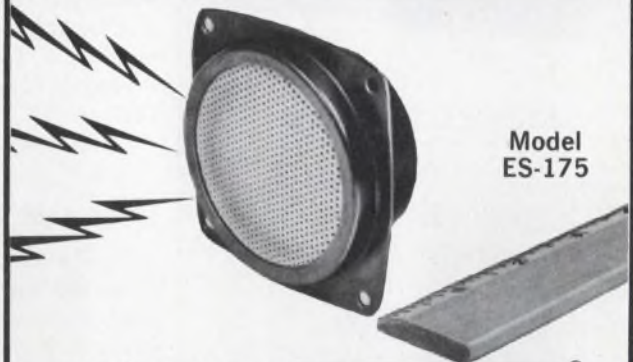

Model
ES-175

Micro EARSPLITTER®

Loud yelping signal in small space—ideal for alarms, machines & equipment: 3" x 3"—depth, 1 1/8". Self-contained; completely electronic. 6 to 12 VDC—uses only 175 milliamps at 12 V. Low cost, \$4.37 ea., in quantities of 100.

Write or phone for illustrated bulletin—today!

KOLIN INDUSTRIES, INC.

Manufacturers of Electronic Warning Signals and Alarm Devices
59-B West Pondfield Road, Bronxville, N.Y. 10708
(914) 961-5065. Telex: 137453

INFORMATION RETRIEVAL NUMBER 93

recruitment
and
classified ads

RADAR SYSTEMS

Nike Hercules, Nike Ajax, M-33, MPS-9, SCR-584, TPS-1E, TPS-2B, FPS-6, FPS-14, FPS-1B, FPS-7S, UPX-6, MPO-10A, IBM 705 Computers, HUNDREDS MORE.

RADAR SYSTEMS

K BAND MONOPULSE 40KW E-34
KU BAND SEARCH 135KW B-58
X BAND WEATHER/SEARCH 250KW AN/CPS-9
X BAND AIRBORNE TRACKER 50KW B-47
X BAND MOBILE TRACKER 40KW AN/MPQ-29
X BAND WEATHER/SEARCH 40KW AN/SPN-5
X BAND TRANSPONDER 100W AN/DPN-62
C BAND HGT FDR 5MW FPS-26 1MW TPS-37
C BAND SEARCH 285KW AN/SPS-5B/D
S BAND ACQUISITION 1MW NIKE AJAX/HERC
S BAND TRACKER 10' DISH 500KW AN/MPQ-18
L BAND SEARCH 500KW AN/TPS-1D/GSS-1
L BAND IFF SYS. 1.5KW AN/TPX-27

DRONE CONTROL SYSTEMS
UMF COMMAND SYSTEM AN/URW-14
X BAND DATA LINK AN/UPW-1
X BAND TRACKER AN/MPQ-29
X BAND TRACKER AN/MSQ-51

SEND FOR FREE 24 PAGE

CATALOG ON YOUR LETTERHEAD

RADIO RESEARCH INSTRUMENT CO.

3 Quincy Street, Norwalk, Ct. 06850 (203) 853-2600

KEEP

Electronic Design's

GOLD BOOK HANDY



When You Call

Save time when you contact suppliers. Check their catalog pages first in *Electronic Design's* GOLD BOOK. Maybe the information you need is right at your fingertips.

Electronic Design

Advertising Sales Staff

Tom W. Carr, Sales Director
 Rochelle Park, NJ 07662
 Robert W. Gascoigne
 Daniel J. Rowland
 50 Essex Street
 (201) 843-0550
 TWX: 710-9990-5071

Philadelphia

Thomas P. Barth
 50 Essex Street
 Rochelle Park, NJ 07662
 (201) 843-0550

Boston 02178

Gene Pritchard
 P.O. Box 379
 Belmont, MA 02178

Chicago 60611

Thomas P. Kavooras
 Berry Conner, Jr.
 200 East Ontario
 (312) 337-5088

Cleveland

Thomas P. Kavooras
 (Chicago)
 (312) 337-0588

Los Angeles 90045

Stanley I. Ehrenclou
 Burt Underwood
 8939 Sepulveda Boulevard
 Los Angeles, CA
 (213) 641-6544

Texas/Oklahoma

Burt Underwood
 (Los Angeles)
 (213) 641-6544

San Francisco 94040

Robert A. Lukas
 3579 Cambridge Lane
 Mountain View, CA 94040
 (415) 965-2636

London, Amsterdam, Tokyo, Seoul

Malcolm M. Thiele
 Wood Cottage, Shurlock Row
 Reading RG 10-QE, England
 Phone: Shurlock Row 302 & 619

S.T.D. 073 581

W. J. M. Sanders

Oosterpark 6, De Rijk,
 Holland

Phone: 02997-3020

Haruki Hirayama

Electronic Media Service

5th Floor, Lila Bldg.,

4-9-8 Roppongi

Minato-ku, Tokyo, Japan

Phone: 402-4556

Cable: Electronicmedia, Tokyo

Mr. O-kyu Park, President

Dongbo Int'l Corp.—

World Marketing

C.P.O. Box 4010

Seoul, Korea

Tel. 76-3910/3911

Cable: DONGBO SEOUL

Telex: EBKOREA K27286

ABP

BPA



When it's
your move
check Centralab

NEW!

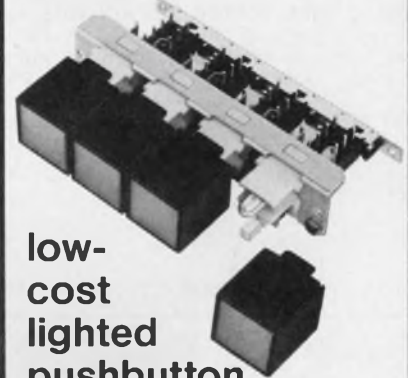

low-
cost
lighted
pushbutton
switch

Centralab reliability, low cost and new design freedom can be yours in this new lighted switch. Its T1-3/4 wedge base lamp brings the price way down*. Its many options make it easier than ever to achieve an aesthetically harmonized panel. You get features like these:

- Flat, concave or recessed lenses with uniform light diffusion.
- Eight lens colors.
- PC terminated independent lamp circuit.
- 15mm, 17.5mm or 20mm. spacing options.
- Ganged assemblies through 16 stations.

See your Centralab Pushbutton Distributor or send inquiry card for complete specifications.

* Per station cost at 1000 pieces, \$1.36
 2 PDT switch includes bulb.

Isostat Licensed



CENTRALAB

Electronics Division

GLOBE-UNION INC.

P.O. BOX 858

FORT DODGE, IOWA 50501

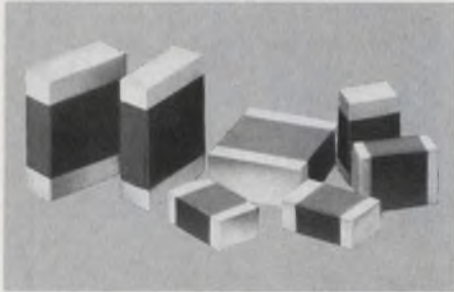

HIGH Q MULTILAYER CAPACITORS feature very high quality factors at microwave frequencies. Offered in three standard sizes: .050 x .040, .080 x .050, .125 x .095. Capacitance values from 0.1 pf to 1000 pf with close tolerance and voltages to 1000 VDCW. Johanson/Monolithic Dielectrics Div., Box 6456, Burbank, Ca. 91510, (213) 848-4465.

MULTILAYER CHIP CAPACITORS 601

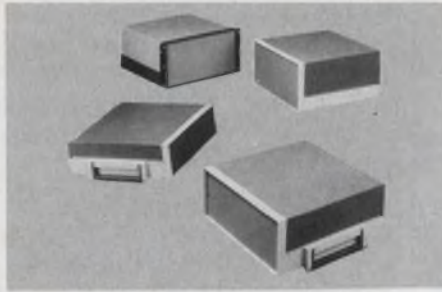

Optima 17- a combination chassis and case. 4 models are offered with handles, tilt-feeet and rack adapters. Panel heights are 3.47", 5.22", 6.97" and 8.72". Panel width is 16.44" and panel-to-panel depth is 16.22".
Optima Division, Scientific-Atlanta, Inc. 2166 Mountain Industrial Blvd., Tucker, Ga. 30084 (404) 939-6340

ELECTRONIC ENCLOSURES 604

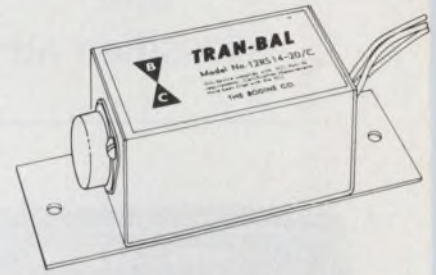

TRAN-BAL, INVERTER BALLAST; allow designer to utilize fluorescent lamp for long photo electric light source by eliminating flicker associated with 60 Hz operation. Models available for all lamp through 40 watts. Input voltage 12 to 4 v.d.c. The Bodine Co., 236 Mt. Pleasant Rd., Collierville, TN (901) 853-7211

INVERTER BALLAST 600

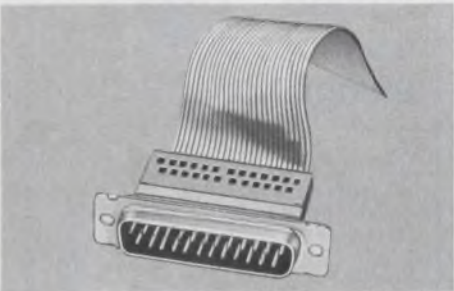

AMPLIMITE HDF CONNECTOR mass-terminates quickly, at low cost. Accommodates solid or stranded round-conductor flexible cable on .050" centers. Forks penetrate cable from opposite sides, trap each conductor, then interlock with housing. Pin and socket contacts intermateable with industry standards. From the people who offer you technical assistance: AMP Incorporated, Harrisburg, Pa. (717) 564-0100.

HDF CONNECTOR 602



DIGITAL SIGNAL ANALYSIS, S. Stearns. Contains the most recent advances, brand-new design material, and a comparison between continuous and digital systems, making it an ideal master reference to today's signal processing techniques and systems. #5828-4, 288 pages, \$18.95. Circle the Info Retrieval Number to order 15-day exam copy. When billed, remit or return book with no obligation. Hayden Book Co., 50 Essex Street, Rochelle Park, N.J. 07662.

DIGITAL SIGNAL ANALYSIS 605



Free Catalog. 112 pages of hard-to-find precision tools—pliers, tweezers, tool kits etc. Contains more than 2,500 items. Also includes ten pages of useful "Top Tips" to aid in tool selection. Jensen Tools and Alloys, 4117 No. 44th St. Phoenix, AZ 85018 (602) 959-2210.

PRECISION TOOL CATALOG 608

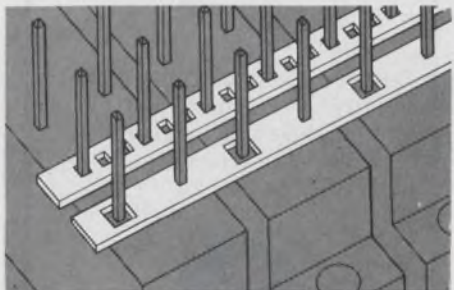

STRIP/BUS BY ROGERS. Low Cost Bussing Systems; easy installation, reliable solder joints; greater pin exposure. Write or call for details. Rogers Corporation, Rogers, CT 06263. Phone (203) 774-9605.

STRIP/BUS 603

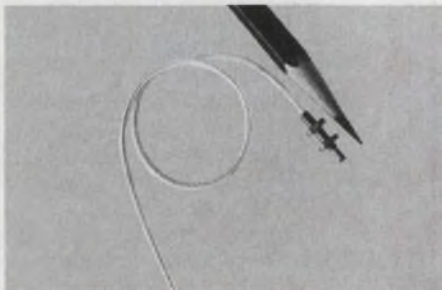

World's Smallest Displacement Transducer. Make precision, noncontacting displacement measurements at points never before possible. This new transducer, 0.080" OD, gives accuracy of <math>< 100 \mu\text{in.}</math> in a range up to 0.020". Temperature stable. Repeatability and resolution is better than 10 $\mu\text{in.}</math> Price $485, including associated electronics. Kaman Colorado Corporation, P. O. Box 7463, Colorado Springs, CO 80933. (303) 599-1892.$

TRANSDUCER 606



Basic Electricity & Basic Electronics by Van Valkenburgh, Nooger & Neville, Inc. Derived from the COMMON-CORE Training Program initially developed for the U.S. Navy. Thorough, comprehensive coverage. Available in separate paperbacks or cloth volume. Write for FREE brochure. Hayden Book Co., Inc., 50 Essex St., Rochelle Pk, N.J. 07662 (201) 843-0550.

TRAINING TEXT 609

Electronic Design

ELECTRONIC DESIGN's function is:

- To aid progress in the electronics manufacturing industry by promoting good design.
- To give the electronic design engineer concepts and ideas that make his job easier and more productive.
- To provide a central source of timely electronics information.
- To promote communication among members of the electronics engineering community.

Want a subscription? ELECTRONIC DESIGN is sent free to qualified engineers and engineering managers doing design work, supervising design or setting standards in the United States and Western Europe. For a free subscription, use the application form bound in the magazine. If none is included, write to us direct for an application form.

If you do not qualify, you may take out a paid subscription for \$30 a year in the U.S.A., \$40 a year elsewhere. Single copies are \$1.50 each.

If you change your address, send us an old mailing label and your new address; there is generally a postcard for this bound in the magazine. You will have to requalify to continue receiving ELECTRONIC DESIGN free.

The accuracy policy of ELECTRONIC DESIGN is:

- To make diligent efforts to ensure the accuracy of editorial matter.
- To publish prompt corrections whenever inaccuracies are brought to our attention. Corrections appear in "Across the Desk."
- To encourage our readers as responsible members of our business community to report to us misleading or fraudulent advertising.
- To refuse any advertisement deemed to be misleading or fraudulent.

Microfilm copies are available of complete volumes of ELECTRONIC DESIGN at \$19 per volume, beginning with Volume 1, 1952 through Volume 20. Reprints of individual articles may be obtained for \$3.00 each, prepaid (\$5.00 for each additional copy of the same article) no matter how long the article. For further details and to place orders, contact the Customer Services Department, University Microfilms, 300 North Zeeb Road, Ann Arbor, Michigan 48106 telephone (313) 761-4700.

Want to contact us? If you have any comments or wish to submit a manuscript or article outline, address your correspondence to:

Editor
ELECTRONIC DESIGN
50 Essex Street
Rochelle Park, N.J. 07662

INFORMATION RETRIEVAL NUMBER 101 ▶

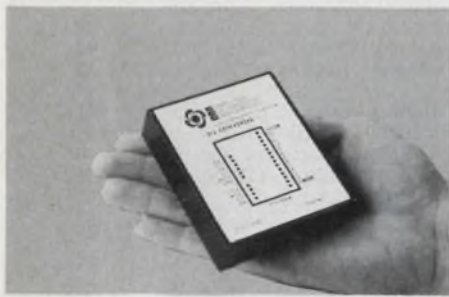

DIGITAL TO SYNCHRO CONVERTERS— 14, 12 or 10 bit input, 11.8/90V, 400 or 60Hz transformer isolated output, accuracy ± 4 , ± 15 or ± 30 min. Driving 1VA, 2VA (2.6" x 3.1" x 82"H module) or 5 VA loads (4 1/2" x 9 1/4" PC card). Price from \$350 in qty. Other CCC products are Synchro to Digital or DC, and DC to Synchro Converters, Solid State C.T.'s or CDX's, and Absolute Encoders. Send for Free Catalog & Application Notes. Computer Conversions Corp., East Northport, N.Y. 11731 (516) 261-3300.

DIGITAL TO SYNCHRO

610



6800 μ P HARDWARE AND SOFTWARE. Hardware modules include MPU, RAM, ROM, I/O, cabinet, power supply, etc. Software includes cross assembler, simulator, WINTEK PL/M, linking loader. Custom hardware, software, consulting. Software also available on TYM-SHARE. WINTEK CORP., 902 N. 9th St., Lafayette, IN 47904. (317) 742-6802

6800 MICROPROCESSORS

611



LOW COST MAGNETIC FLUX DETECTOR Model FD01 series provides continuous north reference when used with directional gyro or servo compass. TSO'd for autopilots and ideal for guidance and control systems for RPV's, drones, marine vehicles, buoys. Sensing element uses flux gate windings suspended in pendulous position. Freedom to $\pm 45^\circ$ pitch and roll. Operates on 14 mA, frequency 400-Hz. 2.28" dia. x 1.91" high. Humphrey, Inc., 9212 Balboa Ave., San Diego, CA 92123. (714) 565-6631.

FLUX DETECTOR

612

Only with an EMR Real-Time Spectrum Analyzer...

Change a switch setting...

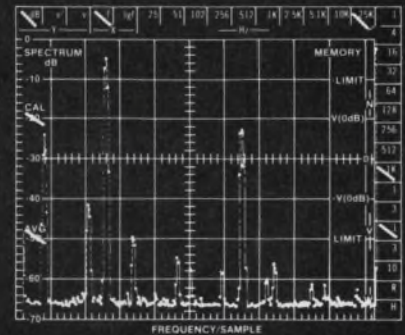

update a unique CRT status display

Couple these facts together... most Real-Time Analyzers do not have an integral CRT display, and those that do, have no provision for an instantaneous visual readout of switch settings. It all adds up to confusion when you have to obtain a photographic record of an important test result. The EMR 1510 eliminates transcription errors when recording critical parameters.

We did it because we're all digital. But, we did not stop there... 60dB Dynamic Range. Selectable Window Functions, Digital Readout of Frequency/Amplitude/Averaging Time, Total Computer Interface, and much more!

Only From EMR!



EMR Schlumberger

EMR Telemetry
Weston Instruments, Inc.
Box 3041, Sarasota, Florida 33578
813-371-0811

Advertiser's Index

Advertiser	Page
ACDC Electronics, Inc.	10
AMP, Incorporated	118
AVX Ceramics	15
Acopian Corp.	53
Advanced Micro Devices	49
Aerospace Optics Inc.	100
Airpax Electronics, Cambridge Division	90
Alco Electronic Products, Inc.	112
American Microsystems, Inc.	40, 41
Amperite Co., Inc.	102
Amphenol RF Division, The Bunker-Ramo Corporation	29
Anaren Microwave, Inc.	35
B & K Products of Dynascan Corporation	112, 121
Belden Corporation	8, 9
Bliley Electric Co.	42
Bodine Co., The	118
Bourns, Inc., Trimpot Products Division	Cover II
Cambridge Thermionic Corporation	116
Capitol Machine & Switch Co., Inc., The	102
Centralab, The Electronics Division of Globe-Union, Inc.	113, 115, 117
Cincinnati Sub-Zero Products, Inc.	116
Computer Automation, Inc.	4, 5
Computer Conversions Corp.	119
Computer Labs, Inc.	110
Control Products Division, Amerace Corporation	47
Coors Porcelain Company	20
Coto Coil Company, Inc.	114
Dale Electronics, Inc.	33
Data General Corporation	14

Advertiser	Page
Datatex Corporation	107
Decitek, A Division of Jamesbury Corp.	106
Dialight, A North American Philips Company	13
Digital Equipment Corporation, Components Group	36
EECO	23
EMR Telemetry, Weston Instruments, Inc.	119
Ebka Industries, Inc.	109
Elec-Trol, Inc.	108
Electronic Design	56, 94, 95, 97
Electronic Development Corp.	106
Esterline Angus Instrument Corporation	116
Fairchild Systems Technology, A Division of Fairchild Camera and Instrument Corporation	34A-B
Falstrom Company	120
Fluke Mfg. Co., Inc., John	31
Fujitsu Limited	80
General Electric Company, Semiconductor Products Department	45
General Instrument Corporation	57
Gold Book, The	98, 98A-B, 99, 117
Gould, Inc.	112
Green Electronic & Communications Equipment Ltd.	112
Hayden Book Company, Inc.	118
Hewlett-Packard	87
Hoffman Engineering Company	97
Humphry, Inc.	119

Advertiser	Page
Illuminated Products Co.	7
Information Terminals	19
Instruments for Industry, Inc.	110
Instrument Specialties Company, Inc.	89
Intech Incorporated	92
International Rectifier	52
JCE Publications	101
Jensen Tools & Alloys	118
Johanson Manufacturing Corp.	6
Johanson/Monolithic Dielectrics Division	118
Johnson Company, E. F.	12
Kaman Sciences Corp.	118
Kolin Industries, Inc.	116
LogiMetrics	11
Magnecraft Electric Company Cover III	
Martin Research	44
*Membrain Ltd.	53
Micro Devices Corp.	109
Minelco Division/General Time Corp.	122
Mini-Circuits Laboratory, A Division of Scientific Components Corp.	2
Motorola Semiconductor Products, Inc.	17, 18
NEC Microsystems Division of Norch Electric	121
National Semiconductor Corporation	85
Optima Division, Scientific-Atlanta, Inc.	118
*Philips Industries, Electronic Components and Materials Division	56
Philips Test & Measuring Instruments, Inc.	51
Potter & Brumfield, Division of AMF Incorporated	73
Precision Monolithics, Incorporated	67
RCA Solid State	Cover IV
RCL Electronics, Inc.	34
R. F. Power Labs, Inc.	115
Raytheon Semiconductor	93
Rockwell International	81
Rogers Corporation	13, 118
Shigoto Industries, Ltd.	121
Silicon Systems, Inc.	65
Sola Electric, Division of Sola Basic Industries	107
Sprague Electric Company	16
Stahlin Bros., Inc.	107
Systron-Donner	111
TDK Electronics	72
Technical Materials, Inc.	105
Tecnetics, Inc.	96
Tektronix, Inc.	24, 25, 39
Teledyne Crystalonics	83
Texas Instruments, Incorporated	27
Todd Products Co.	111
Transco Products, Inc.	66
U. S. Components, Inc.	114
Underwriters' Safety Device Company	121
Unitrode Corporation	54
Varo Semiconductor, Inc.	104
Vector Electronic Co., Inc.	114
Victoreen Instrument Division, Shellar-Globe Corporation	103
Wavetek San Diego, Inc.	1
Wintek Corp.	119

Design Data from Manufacturers

Advertisements of booklets, brochures, catalogs and data sheets. To order use Reader-Service Card (Advertisement)

FREE CATALOG AVAILABLE

Falstrom designs for special purpose cabinets



Where "stock" does not give you what you want, and "custom" sounds expensive, the Falstrom "standard" approach to special purpose cabinets, racks, and consoles satisfies the requirements of the responsible buyer! Enclosures in steel or aluminum are illustrated, including cross-sectional views and details of tops, sides, doors, and inner brackets for chassis, panels and drawer installation. Economical sizes, configurations, paint finishes, and other design data are included.

CIRCLE NO. 171

Falstrom Company
22 Falstrom Court
Passaic, N. J. 07055

*Advertisers in non-U.S. edition

HERE TODAY...



HERE TOMORROW

For years, NEC Microsystems has quietly demonstrated extraordinary competence and dependability as a supplier of economical, high quality hybrid microcircuits. Let us evaluate your requirements for custom hybrids. We'll do the job right today and we'll still be around when you need us, tomorrow.



NEC MICROSYSTEMS
DIVISION OF NORTH ELECTRIC
A UNITED TELECOM COMPANY

1150 N. W. 70 ST. FORT LAUDERDALE, FLA. 33309
PHONE (305) 974-5400 — TWX 510- 956-9897

INFORMATION RETRIEVAL NUMBER 102

Affordable frequency counter for jobs that have always needed one

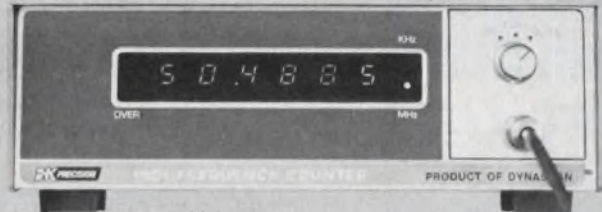

MODEL 1801 \$230

With a good autoranging frequency counter you can watch oscillator adjustments, monitor RF and audio frequencies *precisely*, do *fast* production testing, *check* critical countdown chains, *calibrate* signal generators, *check* pull-in range of AFT circuits and CB frequencies accurately. The 1801 is good because its accuracy is typically better than 10PPM; it typically reads 10Hz-60MHz and is *guaranteed* to read 20Hz-40MHz. It's automatic—there's just one control and gate times, decimal points and scalings are automatically selected for best speed and accuracy. And it's fast—the display is refreshed up to 5 times per second.

In stock at your distributor.

B+K PRECISION

PRODUCTS OF DYNASCAN

1801 W. Belle Plaine Avenue Chicago, IL 60613

INFORMATION RETRIEVAL NUMBER 79

the light heavyweights

When you insist on excellence, go with the winner, Shigoto. Makers of the most complete line of miniature, sub-miniature, micro-miniature, neon, and axial lead lamps. Every Shigoto lamp is designed to optimize efficiency at lower costs. Engineered to perform exactly or higher than rated. To do what it promises to do dependably. With delivery that makes sure your ideas can see the light fast. Get our Catalog. You'll find just what you're looking for. Or we'll make it up for you... no matter how exacting your specifications. Our other outstanding O. E. M. components, will help you see a bright light too.

shigoto

WE CAN MEET YOUR CHALLENGE

Write or phone for our catalog and more information.

Shigoto Industries Ltd.

350 Fifth Ave., N.Y. 10001 • (212) 695-0200 / Telex 224219
One of the World's Largest Manufacturing Importers

INFORMATION RETRIEVAL NUMBER 103

ELECTRONIC DESIGN 2, January 19, 1976

Choose Quick - Connect

Terminal Blocks

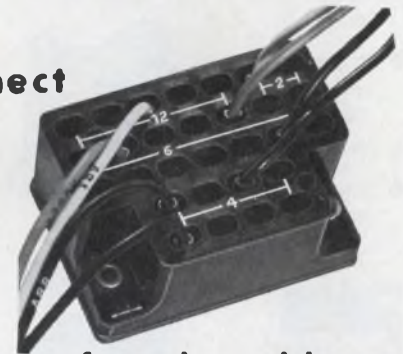

from our wide range of stock molds
.250, .187, .110 terminal sizes

- Centralized wiring assembly
- Temperature resistant
- Completely insulated
- Specific identification
- Kit-form blocks available
- Easy laboratory or experimental assembly

Underwriters Safety Device Co. delivers all of these features and more in the versatile terminal blocks offered out-of-stock. If we do not have the stock mold to suit your purpose, our staff will design one to fit your specific need. Send for brochure describing many models.

Underwriters Safety Device Company

7300 W. Wilson Ave., Chicago, Ill. 60656 • 312-867-4600

INFORMATION RETRIEVAL NUMBER 105

Fail-Proof Miniature BITE Indicators

**BUILT-IN TEST
EQUIPMENT**

- Complete selection from one source!
- Mil-spec or commercial quality
- Ball or Flag Indicators and Annunciators
- Magnetic Latching, Self-Restoring and Manual-Reset models
- Micro-miniature sizes
- Positive indication
- Excellent visibility
- Fast reliable response
- Negligible power drain
- Standard voltages 1.5, 3, 6, 12, 24, 28 VDC
- Off-shelf delivery
- Write or phone for catalog



Sudden Service on Small Quantities!

PROTOTYPES

available on phone or letterhead request

MINELCO Div. General Time

135 South Main St., Thomaston, Conn. 06787
Phone 203-283-8261

A TALLEY INDUSTRIES COMPANY

...from **Minelco**

INFORMATION RETRIEVAL NUMBER 106

Product Index

Information Retrieval Service. New Products, Evaluation Samples (ES), Design Aids (DA), Application Notes (AN), and New Literature (NL) in this issue are listed here with page and Information Retrieval numbers. Reader requests will be promptly processed by computer and mailed to the manufacturer within three days.

Category	Page	IRN	Category	Page	IRN
Components			Integrated Circuits		
capacitors	16	15	converter, a/d	100	325
capacitors, monolithic	15	14	converter, v/f	93	53
circuit breaker, thermal	96	323	custom ICs	97	55
circuit breakers	73	44	op amps	67	42
circuit breakers	90	51	RAMs, 4-k	41	27
crystals	42	28	RAMs, 4-k	49	32
diodes and resistors	103	64	ROM, 16-k	57	39
display, numeric	96	322	Microprocessor Design		
displays, liquid-crystal	96	321	computer on a board	43	571
electronic siren	116	93	disc-based micro	50	577
iconoscope	93	309	language, high-level	50	578
indicators	13	12	microcomputer	48	574
indicators	122	106	microcomputer	109	75
lamps	121	103	micro family	48	575
lamps, miniature	93	310	μC chips	81	46
potentiometer	11	282	μP	46	573
relays	97	56	μP	1V	284
relays, delay	102	62	multiply/divide hardware	43	570
single-turn cermet	33	22	sequencer, program	50	579
switch, DIP	93	320	supplies	46	572
switch, PB	113	84	three-card system	48	576
switch, PB 5-A	115	89	Microwaves & Lasers		
switch, lighted-PB	117	94	microwave devices	66	41
switch, pushbutton	100	57	microwave materials	72	43
switch, slide	112	81	microwave transistors	80	45
switch, toggle	112	80	power splitter	2	3
switches	102	63	rf generators, TWT amps	11	9
transformers	107	71	Modules & Subassemblies		
transient protection	45	30	amplifiers, isolation	91	301
Data Processing			amplifiers, s/h	110	77
data cartridge	19	16	converter, a/d	92	304
data system	121	104	converter, multiplying	91	303
data terminal, graphic	104	333	hybrid circuits contest	83	47
interface circuit	105	334	hybrid microcircuits	121	102
minicomputer	5	4	ignition	104	65
printer, dot-matrix	105	335	v/f converter	92	52
printer, matrix	104	332	Packaging & Materials		
tape reader	105	69	bus, mini	13	11
Discrete Semiconductors			ceramic parts	20	17
Impatts, double-drift	110	345	connectors	29	20
rectifiers	104	66	connectors, coaxial	12	10
transistors, power	110	344	connectors, miniature	114	86
transistors, power	110	346	contact springs	105	67
Instrumentation			copper gasket	89	50
amplifier, wideband	110	76	enclosures	65	40
automatic tester	102	329	enclosures	107	72
communications equipment	112	83	integrated packaging	116	90
DPM	103	330	PC-board connectors	47	31
frequency counter	116	91	posts	114	85
function generators	87	49	terminal blocks	121	105
logic analyzer	39	271	test stand	116	92
oscilloscope	112	82	wire, cable and cord	9	7
oscilloscope	25	241	Power Sources		
PC-board tester	102	328	converters, dc-dc	96	54
scope	112	79	dc voltage source	108	73
scope/DMM/counter	103	331	power supplies	10	8
scopes	51	33	power supplies	53	36
signal generator	1	2	voltage sources	108	73
spectrum analyzer	119	101			

Introducing, a New Design Spectrum* of Low Profile Relays.

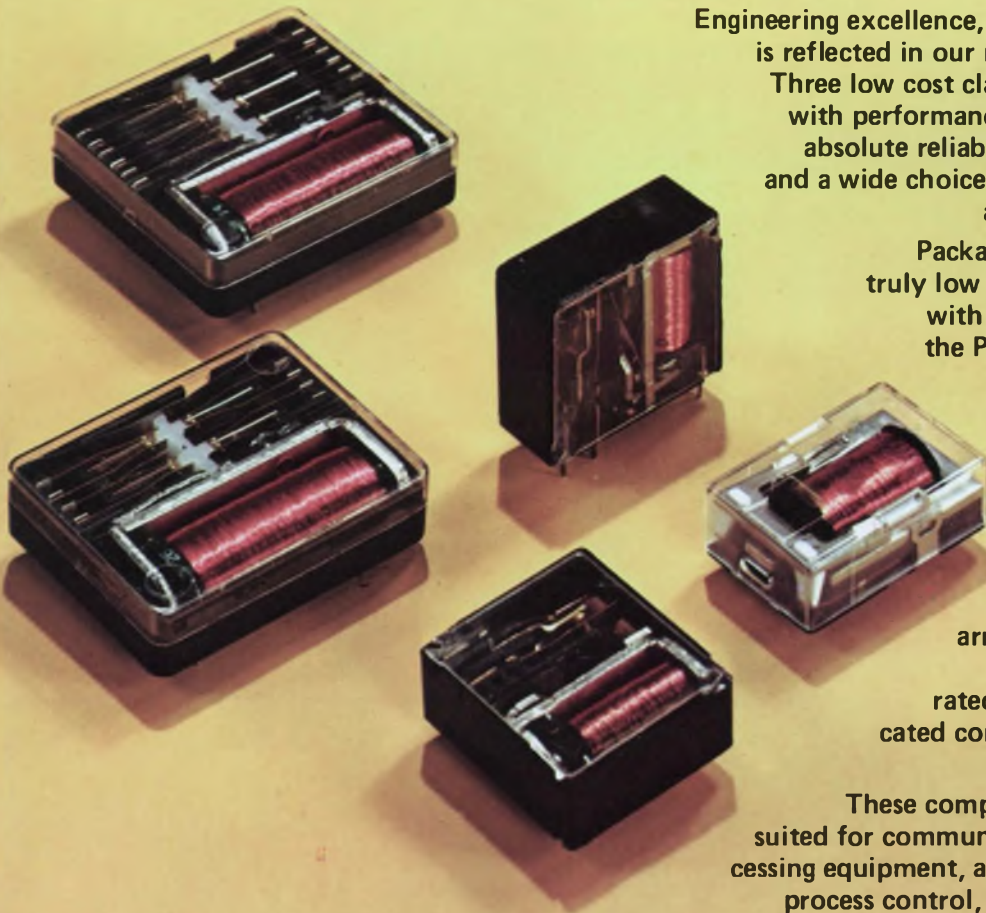

Engineering excellence, a tradition at Magnecraft, is reflected in our new printed circuit relays.

Three low cost classes are available in stock with performance specifications including absolute reliability, long mechanical life, and a wide choice of contact configurations and switching capabilities.

Packaging flexibility includes, a truly low profile dust proof design, with a minimum height above the P.C. board, and a vertically mounted space saving version. The relays feature industry standard .1 inch grid spacing for terminals, and high density center to center board spacing. Contact arrangements include SPDT, DPDT, 4PDT, and 6PDT rated from 1 to 8 amps. Bifurcated contacts are optional on certain configurations.

These compact relays are particularly suited for communication systems, data processing equipment, automatic control systems, process control, automotive and consumer electronics.

*Family of Relays



Free!

LOW PROFILE
RELAY BROCHURE

Specifications, photos, and line drawings are included in Magnecraft's latest 4 page bulletin, number 750. A 36 page stock relay catalog will accompany the bulletin for all your relay applications.

Find Magnecraft Relays in EEM and the Gold Book

Magnecraft ELECTRIC COMPANY

5575 NORTH LYNCH AVENUE • CHICAGO, ILLINOIS 60630 • 312 • 282-5500 • TWX 910 221 5221

What's new in solid state...

RCA announces a no-nonsense price for the no-nonsense μ P.

Has high cost kept you away from microprocessors? RCA just demolished that reason. Even in small quantities you can buy our versatile CDP1801 8-bit CPUs at only \$40 for the 4-6-volt version, \$56 for the 3-12-volt version.

This, of course, is the RCA 1800 no-nonsense microprocessor family. Simple, easy to program, flexible. COSMAC architecture was designed with one no-nonsense objective: maximum flexibility with minimum cost. COSMAC cost-effective features include: single power supply; single phase clock; compact programs and strong I/O to reduce memory and I/O circuit requirements. Plus the CMOS benefits of low power and high tolerance of temperature extremes, supply variations and noise.

Compare support systems, too. The RCA Software Development Package is available two ways:

in Fortran IV and on GE Timeshare. Our Microkit gives you low-cost systems breadboarding. And for low-budget programming we offer a Resident Software Package. A listing of memory and logic (I/O) parts, Microkit cards and other literature available to you is in the RCA 1800 brochure 2M1135.

Microprocessors (CPU), 1-99 quantities

CDP1801D (3-12 volts).....	\$56.00
CDP1801CD (4-6 volts).....	\$40.00

Hardware support

CDP18S001 Microkit (basic).....	\$2250.00
CDP18S002 Microkit (Stand-alone).....	\$3000.00
(Includes resident Assembler & Editor)	

Software support

CDP18S900 Software Development Pkg.....	\$2000.00
CDP18S902 Batch Assembler.....	\$700.00
MPM-101 RCA 1800 User Manual.....	\$5.00
MPM-102 Program Development Guide.....	\$10.00

For more information, contact your local RCA Solid State distributor. Or RCA.

Write: RCA Solid State, Box 3200, Somerville, New Jersey 08876; Ste. Anne de Bellevue 810, Canada; Sunbury-on-Thames, U.K.; Fuji Bldg., Tokyo, Japan.

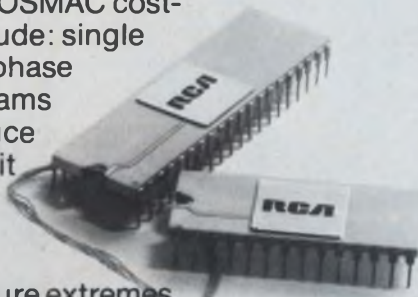

RCA

INFORMATION RETRIEVAL NUMBER 284

RCA 1800. Low-cost approach to microprocessing.