

# Electronic Design.26

VOL. 23 NO.

FOR ENGINEERS AND ENGINEERING MANAGERS

DEC. 20, 1975

**Microcomputer software** costs can vary widely. Much depends on the design approach used. The hardware designer, drafted as a software expert, faces unfamiliar

choices like type of language and whether to use in-house or outside development aids and services. For a detailed look at  $\mu$ P software, turn to page 20.





# New Hybrid Potentiometer Combines the Best of Wirewound and Conductive Plastic— \$5<sup>33</sup>\*

New HYBRITRON™  
resistance element . . .  
conductive plastic  
material on wirewound  
mandrel.

The new BOURNS®  
HYBRITRON™ resist-  
ance element brings  
you the best of both  
worlds . . . the long life and  
infinite resolution of con-  
ductive plastic . . . plus the  
tight linearity and low tem-  
perature coefficient of a wire-  
wound . . . at a new, low price.

You'll find this new element in  
BOURNS® Model 3541 ten-turn  
precision potentiometer . . . a new  
member of BOURNS popular 3540  
family of compact ( $\frac{7}{8}$ " dia.,  $\frac{3}{4}$ " deep),  
low-cost multi-turn potentiometers.

Significant specifications of the Model  
3541: service life of 5,000,000 shaft revo-  
lutions; linearity 0.25%; temperature coef-  
ficient of  $\pm 100$  ppm/°C maximum; reliable  
SILVERWELD® direct terminal-to-element  
bond; output smoothness of 0.015%; essentially  
infinite resolution; rugged, mechanically locked  
construction (no rear lid "pop-off"); special heat  
resistant insert around rear terminals to prevent damage  
during soldering.

If a low-cost wirewound satisfies your control requirement  
. . . you can't do better than our Model 3540 ten-turn at \$3.97\*.  
Same quality construction features, same 0.25% linearity . . . with  
rotational life of 1,000,000 revolutions. A wide range of standard and  
custom options are available, including three- and five-turn versions.

#### FREE SAMPLE:

Write or phone the BOURNS PANEL POWER PEOPLE and tell us about your  
application. We'll send you the Model 3540/41 that best suits your needs.

Available off-the-shelf from extensive factory stock and nearly 100 local distributor  
inventories. TRIMPOT PRODUCTS DIVISION, BOURNS, INC., 1200 Columbia Avenue,  
Riverside, California 92507. Telephone 714 684-1700. TWX 910 332-1252.

INFORMATION RETRIEVAL NUMBER 256

\*1,000 pieces, same R.C., U.S. Dollars, F.O.B. Riverside, California





# The Model 186 art gallery.

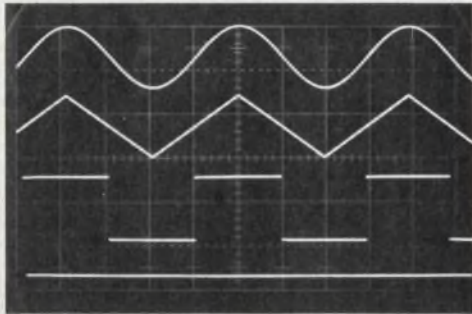

Sine, square, triangle and dc

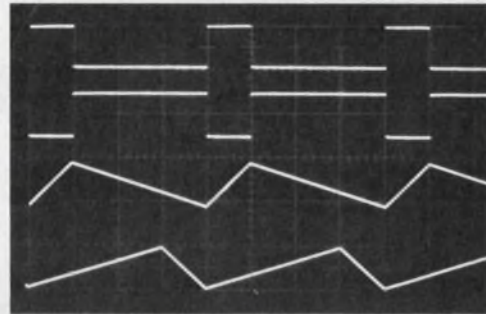

Pulse and ramp

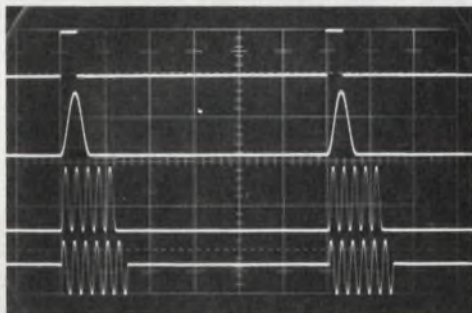

Trigger and gate

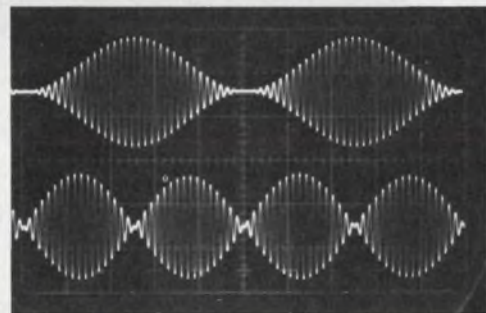

Amplitude Modulation

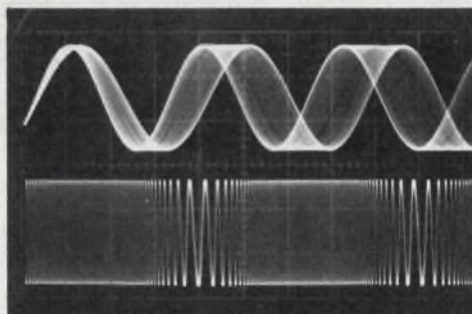

Frequency Modulation

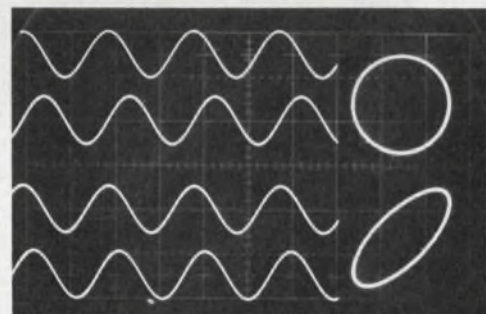

Phase lock

There's a whole lot more to the Model 186 than just pretty pictures. Like its calibrated phase lock and built-in oscillator for 1 kHz AM/FM capabilities. It also has 30 v p-p output plus continuous, triggered and gated modes. And it's the only generator that gives you the combination of AM and phase lock.

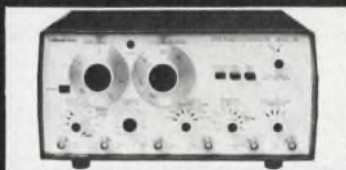

The Model 186 has a frequency range of 0.0001 Hz to 5 MHz and sells for just \$795. Just circle our bingo number and we'll send you the complete picture.

## WAVETEK®

P.O. BOX 651, SAN DIEGO, CALIFORNIA 92112  
TELEPHONE (714) 279-2200, TWX 910-335-2007



**.05 MHz**  
to  
**3 GHz**  
(+17dBm LO)

# HIGH-LEVEL

## Double Balanced Mixers

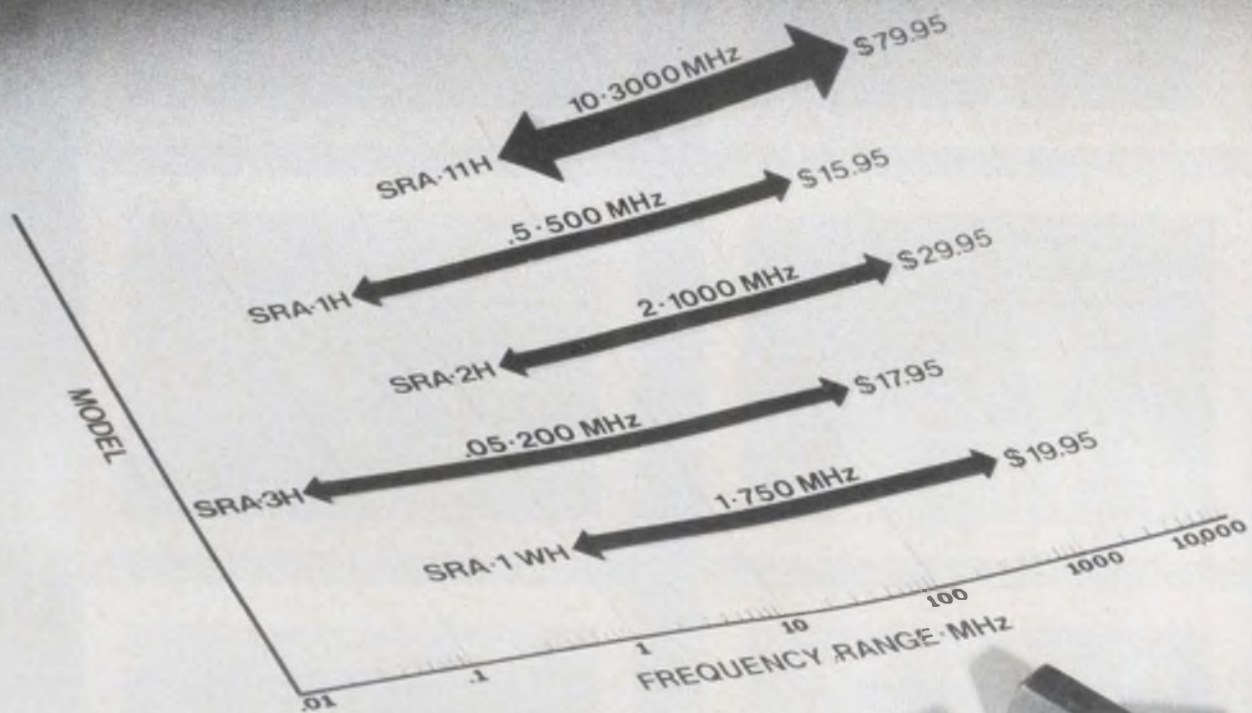

Model	Frequency Range (MHz)	Conversion loss (dB) Total Range	Isolation, dB						Price Quant.
			Lower band edge to one decade higher		Mid range		Upper band edge to one octave lower		
			LO-RF	LO-IF	LO-RF	LO-IF	LO-RF	LO-IF	
SRA-11H	RF, LO-10-3000 IF - DC-1000	9.5 typ. 12 max.	27 typ. 20 min.	27 typ. 20 min.	25 typ. 18 min.	25 typ. 18 min.	23 typ. 16 min.	23 typ. 16 min.	\$79.95 (1-24)
SRA-1H	RF, LO-5-500 IF - DC-500	6.5 typ. 8.5 max.	55 typ. 45 min.	45 typ. 35 min.	45 typ. 30 min.	45 typ. 30 min.	35 typ. 25 min.	30 typ. 20 min.	\$15.95 (5-24)
SRA-2H	RF, LO-2-1000 IF - DC-1000	7.5 typ. 9.5 max.	50 typ. 40 min.	45 typ. 35 min.	45 typ. 25 min.	40 typ. 25 min.	35 typ. 25 min.	25 typ. 20 min.	\$29.95 (4-24)
SRA-3H	RF, LO-05-200 IF - DC-200	5.5 typ. 7.5 max.	55 typ. 45 min.	45 typ. 35 min.	45 typ. 30 min.	40 typ. 30 min.	35 typ. 25 min.	30 typ. 20 min.	\$17.95 (5-24)
SRA-1WH	RF, LO-1-750 IF - DC-750	5.5 typ. 7.5 max.	50 typ. 40 min.	45 typ. 35 min.	45 typ. 25 min.	40 typ. 25 min.	35 typ. 25 min.	30 typ. 20 min.	\$19.95 (5-24)

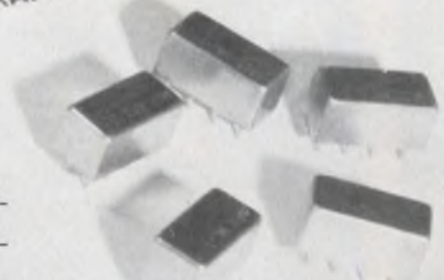

Conversion compression: 1 dB at +10 dBm rf input

World's largest supplier of double balanced mixers

**Mini-Circuits Laboratory**  
A Division Scientific Components Corp

837-843 Utica Avenue, Brooklyn, NY 11203

(212) 342-2500 Int'l Telex 620156 Domestic Telex 125460

International Representatives:  AUSTRALIA General Electronic Services, 99 Alexander Street, New South Wales, Australia 2065;  ENGLAND Dale Electronics, Dale House, Wharf Road, Frimley Green, Camberley Surrey;  FRANCE S.C.I.E. - D.I.M.E.S., 31 Rue George - Sand, 91120 Palaiseau, France;  GERMANY, AUSTRIA, SWITZERLAND Industrial Electronics GMBH, Klüberstrasse 14, 6000 Frankfurt/Main, Germany;  ISRAEL Vectronics, Ltd., 69 Gordon Street, Tel-Aviv, Israel;  JAPAN Densho Kaisha, Ltd., Eguchi Building, 8-1-1 Chome Hamamatsucho Minato-ku, Tokyo;  EASTERN CANADA B. D. Hummel, 2224 Maynard Avenue, Utica, NY 13502 (315) 736-7821;  NETHERLANDS, BELGIUM, LUXEMBOURG: Coimex, Veldweg 11, Hattem, Holland.

US Distributors:  NORTHERN CALIFORNIA Cain-White & Co., Foothill Office Center, 105 Fremont Avenue, Los Altos, CA 94022 (415) 948-6533;  SOUTHERN CALIFORNIA, ARIZONA Crown Electronics, 11440 Collins Street, No. Hollywood, CA 91601 (213) 877-3550

INFORMATION RETRIEVAL NUMBER 3



---

## NEWS

- 15 **News Scope**
- 20 **Experts tell how to hold down the high cost of microprocessor programs**—An Electronic Design special report.
- 28 **A sensor-minicomputer network** at Sandia Laboratories predicts when static discharges and lightning strikes might occur.
- 43 **Washington Report**

---

## TECHNOLOGY

- 33 **MICROPROCESSOR DESIGN**
- 50 **Employ  $\mu$ P software tools properly**, and you'll shorten development time and reduce errors. Get to know the three types of design aids offered by vendors.
- 58 **Assembly language for  $\mu$ Ps**: Mnemonic programming isn't hard once you learn the coding. Here's how to organize and write a program.
- 66 **Let a  $\mu$ P keep track of your process**. Built around a central processor, this analog monitor samples and displays transducer outputs.
- 70 **Ideas for Design:**  
Keyboard circuit saves time, needs no microprocessor scanning software.  
Single-chip pulse generator provides 50 MHz with adjustable duty cycle.  
Current sinks increase the range of IC function generators.

---

## PRODUCTS

- 77 **Integrated Circuits:** Hybrid FET-input op amps match modules for performance at low cost.
- 80 **Instrumentation:** It looks like a logic analyzer; it's also a word generator.
- 82 **Modules & Subassemblies:** A/d converters with accuracies to 0.0015% drop prices sharply.
- 79 Components
- 84 Packaging & Materials
- 85 Power Sources
- 86 Discrete Semiconductors
- 87 Data Processing

---

## DEPARTMENTS

- 47 **Editorial:** Delegating authority
- 7 Across the Desk
- 88 Design Aids
- 88 Application Notes
- 89 New Literature
- 93 Bulletin Board
- 93 Vendors Report
- 98 Advertisers' Index
- 100 Product Index
- 100 Information Retrieval Card

**Cover:** Photo by Patrick S. Tchakian, courtesy of Intel Corp.



# Meet the new 990 Computer Family from Texas Instruments



**Introducing the 9900 Microprocessor  
and 990 Series Micro/Minicomputers**



# Upward Compatible Software and Downward Competitive Prices

At TI, we've started a new family tradition in micro/minicomputers with the 990 computer family . . . a new tradition based upon a heritage of semiconductor leadership.

The 990 computer family sets new price/performance standards because of an important milestone in MOS technology . . .

## **The TMS 9900 single-chip, 16-bit microprocessor.**

Powerful enough to be the heart of a full minicomputer, the TMS 9900 is also the best microprocessor going for terminals, machine monitoring and control, and a host of OEM applications.

## **All in the Family**

The same company . . . Texas Instruments . . . makes every member of the family, and makes every member software compatible, from the bottom up. The new Model 990/4 microcomputer and Model 990/10 minicomputer use the instruction set of the TMS 9900 microprocessor. This means that software developed for the low-end computers will be compatible with the higher performance models. And, users can expand their systems with a minimum of interface and software adaptation.

## **The TMS 9900 Microprocessor**

The TMS 9900 is a 16-bit, single-chip microprocessor using MOS N-channel silicon-gate technology. Its unique architecture permits data manipulation not easily achievable in earlier devices. With its repertoire of versatile instructions and high-speed interrupt capability, the TMS 9900 microprocessor provides computing power expected from a 16-bit TTL computer.

## **The Model 990/4 Microcomputer**

It's a complete computer on a single printed circuit board using the TMS 9900 as its central

processor. The 990/4 is ideally suited for terminal control, peripheral device interface control, and as a CPU for OEM customers.

In addition to the TMS 9900 microprocessor, the 990/4 microcomputer contains up to 8K bytes of dynamic RAM, up to 2K bytes of static RAM and/or PROM, eight vectored interrupts, front panel interface, real-time clock input, two I/O buses for low- and high-speed devices, and optional ROM utilities.

With the 990/4, you can select a low-cost OEM package, a 7-inch or 12¼-inch rack-mountable chassis, or a table-top enclosure . . . and memory expansion to 58K bytes.

**Price: The Model 990/4 microcomputer with 512 bytes of memory is only \$368\* without chassis and power supply. This same model with 8K bytes of memory is only \$512\*.**

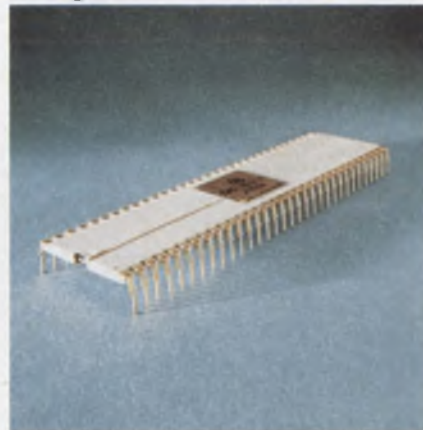

State-of-the-art TMS 9900 microprocessor . . . 16-bit, single-chip CPU with minicomputer instruction power.

## **The Model 990/10 Minicomputer**

The most powerful member of the family is the Model 990/10 general-purpose minicomputer. The 990/10, a TTL implementation of the 990 architecture, provides the high-performance speeds demanded in many applications.

A memory mapping feature providing memory protection and privileged instructions supports memory expansion to two million bytes. And TILINE\*\*, an asynchronous high-speed I/O bus, supports both high-speed and low-speed devices. Chassis options are the same as those for the 990/4.

**Price: With 16K bytes of memory, chassis, power supply and programmer's panel, the Model 990/10 minicomputer is only \$1968\*.**

## **Built Better Backed Better**

In addition to the family of compatible hardware, Texas Instruments backs you with complete software and support. **Standard software packages include memory-resident and disc-based operating systems; FORTRAN, COBOL, and BASIC compilers; and program development packages with utilities.** And, for you to develop application programs for the 990/9900 family, we offer **cross support on timesharing networks and standalone software development systems.** One is a low cost system using the 990/4 . . . the other is a disc-based system using the 990/10. And, a **prototyping system** is offered for TMS 9900 users to develop custom software and firmware modules.

TI supports you with training and applications assistance, plus an installed nationwide service network backed by TI-CARE†, our automated remote diagnostic, service dispatching, and real-time field service management information system.

Get to know our new family. Call your nearest TI office, or write Texas Instruments Incorporated, P. O. Box 1444, M/S 784, Houston, Texas 77001. Or, phone Computer Equipment Marketing at (512) 258-5121.

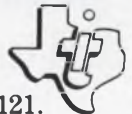

Arlington, Va (703) 527-2800 • Atlanta, Ga (404) 458-7791 • Boston, Ma (617) 890-7400 • Chicago, Il (312) 671-0300 • Clark, N.J. (201) 574-9800 • Cleveland, Oh (216) 463-2990 • Costa Mesa, Ca (714) 540-7311 • Dallas, Tx (214) 238-5318 • Dayton, Oh (513) 253-6128 • Denver, Co (303) 751-1780 • Detroit, Mi (313) 353-0830 • El Segundo, Ca (213) 973-2571 • Hamden, Ct (203) 281-0074 • Houston, Tx (713) 494-5115 • Indianapolis, In (317) 248-8555 • Milwaukee, Wi (414) 475-1690 • Minneapolis, Mn (612) 835-5711 • Philadelphia, Pa (215) 643-6450 • Rochester, N.Y. (716) 461-1800 • San Francisco, Ca (415) 392-0229 • Seattle, Wa (206) 455-1711 • St. Louis, Mo (314) 993-4546 • Sunnyvale, Ca (408) 732-1840 • Winter Park, Fl (305) 644-3535 • Amstelveen, Holland 020-456256 • Bedford, England 58701 • Beirut, Lebanon 452010 • Cheshire, England 061-442-8448 • Copenhagen, Denmark (01) 917400 • Croydon, England 01-686-0061 • Essen, Germany 01241/20916 • Frankfurt, Germany 0611/39 90 61 • Freising, Germany 08161/801 • Milan, Italy 02-688-8051 • Montreal, Canada (514) 341-5224 • Nice, France (93) 20-0101 • Paris, France (1) 630-2343 • Slough, England 33411 • Stockholm, Sweden 62 71 59/62 71 65 • Sydney, Australia 831-2555 • Tokyo, Japan (3) 402-6181 • Toronto, Canada (416) 889-7373

**TEXAS INSTRUMENTS**  
INCORPORATED

\*OEM quantity 50, U.S. domestic prices.

\*\* Trademark of Texas Instruments.  
† Service Mark of Texas Instruments.



Cut package count . . . Simplify board layout . . .  
Reduce equipment size . . . with

# DIP MULTI-COMP<sup>®</sup> RESISTOR-CAPACITOR NETWORKS



(Metanel<sup>®</sup> Film Resistors, Monolythic<sup>®</sup> Ceramic Capacitors)

## STANDARDIZED DESIGNS\* FOR BETTER AVAILABILITY, BETTER PRICES

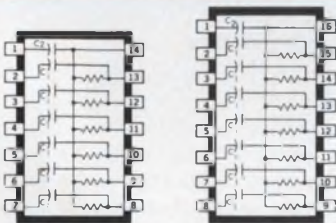

R (Ω)			C <sub>1</sub>
100	470	2000	100pF
150	500	2200	330pF
200	680	3300	0.01μF
220	1000	4700	C <sub>2</sub>
330	1500	6800	

### BYPASSED PULL-UP AND R-C COUPLING NETWORKS

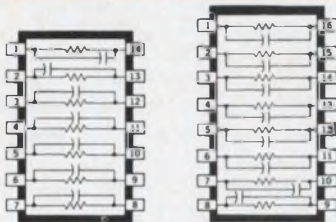

R (Ω)			C
100	470	2000	1000pF
150	500	2200	
200	680	3300	
220	1000	4700	
330	1500	6800	

### SPEED-UP NETWORKS

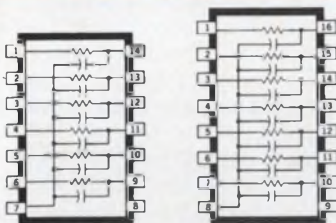

R (Ω)			C (pF)
100	470	2000	100
150	500	2200	
200	680	3300	
220	1000	4700	
330	1500	6800	

### ACTIVE TERMINATOR NETWORKS

\* OTHER PACKAGES, CIRCUIT CONFIGURATIONS, AND RATINGS AVAILABLE ON SPECIAL ORDER

**Sprague puts more passive component families into dual in-line packages than any other manufacturer:**

- TANTALUM CAPACITORS
- CERAMIC CAPACITORS
- TANTALUM-CERAMIC NETWORKS
- RESISTOR-CAPACITOR NETWORKS
- PULSE TRANSFORMERS
- TOROIDAL INDUCTORS
- HYBRID CIRCUITS
- TAPPED DELAY LINES
- SPECIAL COMPONENT COMBINATIONS
- THICK-FILM RESISTOR NETWORKS
- THIN-FILM RESISTOR NETWORKS
- ION-IMPLANTED RESISTOR NETWORKS

For more information on Sprague DIP components, write or call Ed Geissler, Manager, Specialty Components Marketing, Sprague Electric Co., 347 Marshall St., North Adams, Mass. 01247. Tel. 413/664-4411.

THE BROAD-LINE PRODUCER OF ELECTRONIC PARTS



INFORMATION RETRIEVAL NUMBER 5

Sr. Vice President, Publisher  
Peter Coley

### Editors

Editorial Offices  
50 Essex St.  
Rochelle Park, NJ 07662  
(201) 843-0550  
TWX: 710-990 5071  
Cable: Haydenpubs Rochellepark

Editor-in-Chief George Rostky

### Managing Editors:

Ralph Dobriner  
Michael Elphick

### Associate Editors:

Dave Bursky  
Morris Grossman  
John F. Mason  
Stanley Runyon  
Edward A. Torrero

### Contributing Editors:

Peter N. Budzilovich  
Alberto Socolovsky  
Nathan Sussman

### Editorial Field Offices

#### East

Jim McDermott, Eastern Editor  
P.O. Box 272  
Easthampton, MA 01027  
(413) 527-3632

#### West

David N. Kaye, Senior Western Editor  
8939 S. Sepulveda Blvd.,  
Suite 510  
Los Angeles, CA 90045  
(213) 641-6544  
TWX: 1-910-328-7240

### Editorial Production

Marjorie A. Duffy

### Art

Art Director, William Kelly  
Richard Luce  
Anthony J. Fischetto

### Production

Manager, Dollie S. Viebig  
Helen De Polo  
Anne Molfetas

### Circulation

Manager, Evan Phoutrides

### Information Retrieval

Peggy Long

### Promotion, Creative Layouts

Manager, Albert B. Stempel  
Maxine Correal  
Nancy Gordon (Reprints)



## Across the Desk

### How to turn an HP-45 into a stop watch

Readers of ELECTRONIC DESIGN who are also the owners of Hewlett-Packard HP-45 calculators may be interested to know they can use their machines as a digital stop watch and elapsed-time indicator, similar to the functions found on the HP-55 programmable version.

To gain access to the clock function, first clear the machine, using the gold alternate-function key. Then press the RCL key, and then simultaneously press the CHS key and the digits 7 & 8, or 4 & 5, or 1 & 2. The machine now displays the format:

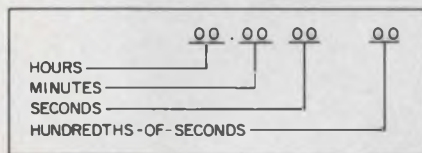

To start the clock function, press the CHS key. Pressing the CHS key again will stop the clock without resetting the display to zero. (To reset the display to zero, press the CLx key.)

To save power during battery operation, you can turn off the last two digits (hundredths of seconds) by pressing the EEX key; depressing the EEX key will again turn on the last two digits.

The clock function can also be used as an elapsed-time indicator for timing and storing the elapsed-time measurements of up to nine separate events (assuming all events started from the same point in time). This function can be quite handy for measurement of physical phenomena, chemical reactions or even at a race track. While the clock is running, de-

pressing any digit key (1 to 9) stores the displayed time up to that point in the respective register, the clock keeps running and is not otherwise affected.

After the clock is stopped by pressure on the CHS key, pressing any of the digit keys recalls to the display the time displayed in the respective register. Note that the STO key (while the clock is running) and the RCL key (after the clock is stopped) need not be pressed; the "store" and "recall" functions are automatically executed, depending on whether the clock is running or stopped. (The CLx key should again be pressed after the last measurement is recalled, as the clock, when started again, will resume counting from the number on the display.)

After the clock function is no longer needed, you can return the machine to normal operation by pressing the ENTER key (which returns the machine to fixed-point, 2-decimal operation) or by turning the machine OFF and then ON again. (The latter method is preferred, as the registers are cleared before the machine is used; however, the registers do not need to be cleared if the user wishes to store new elapsed-time data, as the registers are overwritten with new data any time the clock is running and one of the digit keys is depressed.)

While the clock function is operating, the only keys having any effect are the CHS, EEX, CLx, ".", and the digit keys. All other keys, including the -, +, ×, and ÷, are nonoperating.

Accuracy? It seems the HP-45 was designed with the HP-55 in

(continued on page 13)

## Thin-Trim<sup>®</sup> capacitors



Tucked in the corner of this Pulsar Watch is a miniature capacitor which is used to trim the crystal. This Thin-Trim capacitor is one of our 9410 series, has an adjustment range of 7 to 45 pf., and is .200" x .200" x .050" thick. The Thin-Trim concept provides a variable device to replace fixed tuning techniques and cut-and-try methods of adjustment. Thin-Trim capacitors are available in a variety of lead configurations making them very easy to mount.

A smaller version of the 9410 is the 9402 series with a maximum capacitance value of 25 pf. These are perfect for applications in sub-miniature circuits such as ladies electronic wrist watches and phased array MIC's.

Johanson Manufacturing Corporation, Rockaway Valley Road., Boonton, N.J. 07005. Phone (201) 334-2676, TWX 710-987-8367.

*Johanson*

Electronic Design welcomes the opinions of its readers on the issues raised in the magazine's editorial columns. Address letters to Managing Editor, Electronic Design, 50 Essex St. Rochelle Park, N.J. 07662. Try to keep letters under 200 words. Letters must be signed. Names will be withheld on request.



# AMI 6800: The whole Kit.

## Smart Terminal.

Complete program editing through CRT and keyboard. Also includes Modem communication to remote computers. (Avail. Feb.)

## Magnetic Tape.

Cross product software— assembler, loader, simulator. (Avail. Now)

## AMI 6800 Family.

It's all here: MPU, RAM, ROM, PIA, ACIA, PROM, USRT and Modem. By test, the best. (Avail. Now)

## Evaluation Board.

Includes everything you need to evaluate parts, program PROMs and, connected with a peripheral, run programs. (Avail. Jan.)

## Dual Floppy Disk.

Storage for resident software— assembler, editor, etc. (Avail. Feb.)

## Disk Program Storage.

500K bytes for program development and on-line data storage. Cuts out the paper tape! (Avail. Feb.)

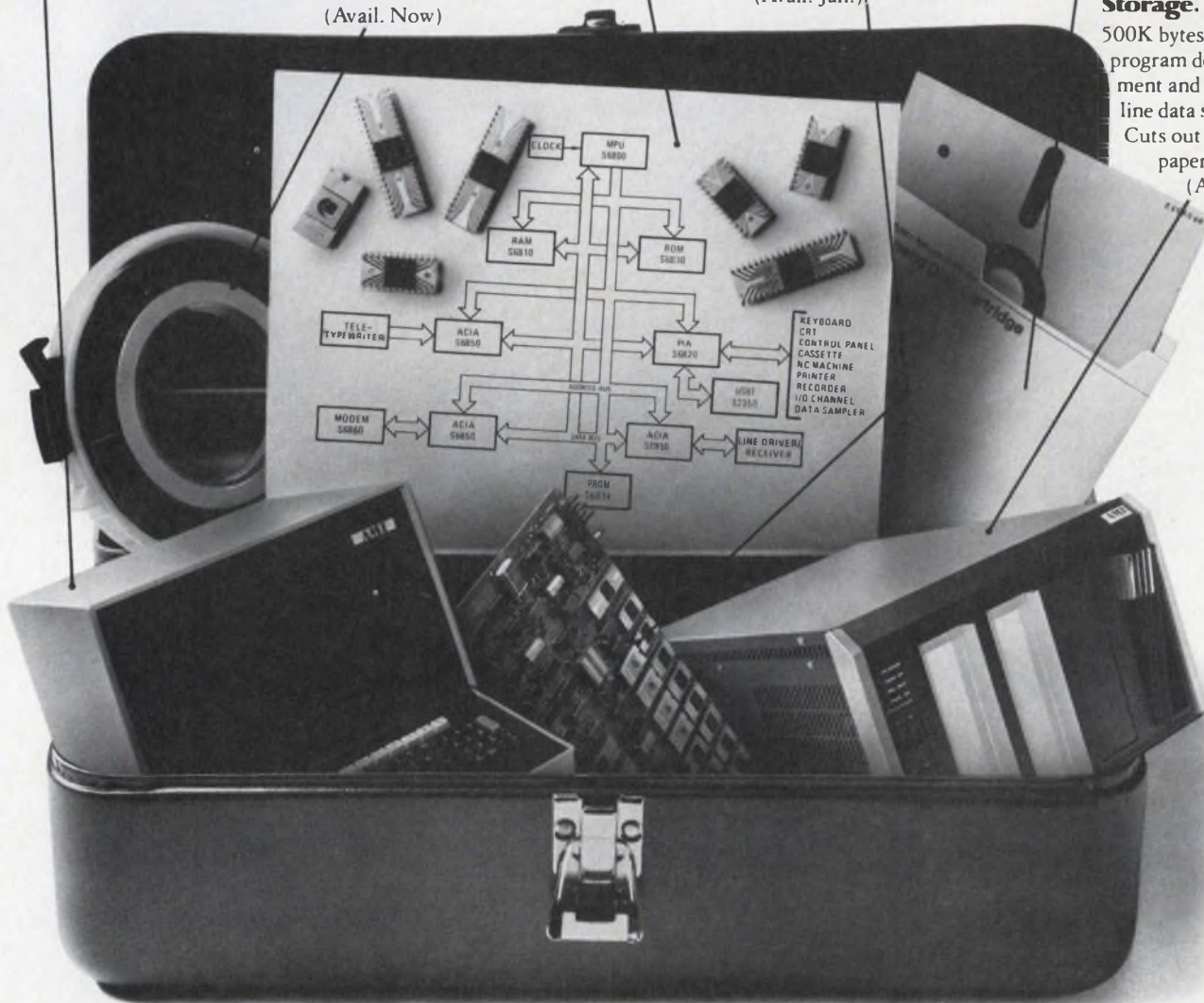

Our AMI 6800 Kit is a big step forward in simplifying your design, evaluation and test programs. For example, our intelligent CRT is simple to operate with either resident or remote software. It really is smart, because it contains an S6800! And it's planned to have an in-circuit emulator added later.

Our dual disk is extremely useful for developing programs, and saves you hours of paper tape shuffling. And our Evaluation Board is loaded with

all the parts you need to get your product on the market on time.

Now for the Caboodle. The dictionary calls it a "package." You'll call it the neatest set of instructions for any kit you've ever bought.

Now why don't you call your nearest AMI sales office or distributor, and ask them for the whole Kit and Caboodle. Or write AMI, 3800 Homestead Road, Santa Clara, CA 95051. What could be easier?

## Here's where you pick up your Kit.

### SALES OFFICES

Manhattan Beach CA • (213) 379-2452  
San Jose CA • (408) 249-4550  
Altamonte Springs FL • (305) 830-8889  
Elk Grove Village IL • (312) 437-6496  
Norwood MA • (617) 782-0728  
Livonia MI • (313) 478-9339  
Minneapolis MN • (612) 559-9004  
Monsey NY • (914) 352-5333  
Cleveland OH • (216) 292-8850  
Ambler PA • (215) 643-0217  
Richardson TX • (214) 231-5721



# And Caboodle.

## Software Brochure.

A rundown on AMI software products including assembler, loader and simulator.  
(Avail. Now)

## Evaluation Board Application Notes.

The why and wherefore of our Prototyping System, and how to make the most of it!  
(Avail. Jan.)

## Assembly Language Programming Manual.

Describes the instruction set and how to use the AMI Assembler and Simulator.  
(Avail. Now)

## NCSS Users Manual.

All the magic necessary to work with National CSS time-sharing network.  
(Avail. Now)

## AMI Guide to Standard Products.

All the MOS you might need in addition to microprocessors.  
(Avail. Now)

## Hardware Reference Manual.

A detailed description of each component in the system, and how to make them work!  
(Avail. Jan.)



## DISTRIBUTORS

ALTA ELECTRONICS  
Utah—Salt Lake City (801) 486-7227  
ARROW ELECTRONICS  
Minnesota—Bloomington  
(612) 888-5522  
CENTURY ELECTRONICS  
New Mexico—Albuquerque  
(505) 292-2700  
Utah—Salt Lake City (801) 487-8551  
INTERMARK ELECTRONICS  
Washington—Seattle (206) 767-3160  
SCHWEBER ELECTRONICS  
California—Costa Mesa (714) 924-5594  
and (714) 556-3880  
Connecticut—Danbury (203) 792-3500

Florida—Hollywood (305) 927-0511  
Georgia—Atlanta (404) 449-9170  
Illinois—Elk Grove Village  
(312) 593-2740  
Iowa—Cedar Rapids—Lorenz Sales  
(319) 393-0100  
Maryland—Rockville (301) 881-3300  
Massachusetts—Waltham  
(617) 890-8484  
Michigan—Troy (313) 583-9242  
Minnesota—Edina (612) 941-5280  
New Jersey—Somerset  
(201) 469-6008  
New York—Rochester (716) 461-4000  
Westbury (516) 334-7474  
Ohio—Beachwood (216) 464-2970  
Texas—Austin (512) 837-2890  
Dallas (214) 661-5010  
Houston (713) 784-3600

Canada—Mississauga, Ont.  
(416) 678-9050  
SEMCOMP CORP.  
California—Newport Beach  
(213) 971-5253 and  
(714) 833-3070  
STERLING ELECTRONICS  
Arizona—Phoenix (602) 258-4531  
Louisiana—Metairie  
(504) 887-7610  
Massachusetts—Watertown  
(617) 926-9720  
New Jersey—Perth Amboy  
(201) 442-8000  
New Mexico—Albuquerque  
(505) 345-6601  
Texas—Dallas (214) 357-9131  
Houston (713) 627-9800

Virginia—Richmond—Meridian  
(804) 335-6521  
R V WEATHERFORD CO.  
Arizona—Phoenix (602) 272-7144  
California—Anaheim (714) 547-0891  
Glendale (213) 849-3451  
Palo Alto (415) 493-5373  
Pomona (714) 623-1261  
San Diego  
(714) 278-7400  
Colorado—Englewood  
(303) 761-5432  
New Mexico—Albuquerque  
(505) 842-0868  
Texas—Dallas (214) 243-1571  
Houston (713) 888-7406  
Washington—Seattle  
(206) 243-6340

it's  
standard  
at AMI.  
AMERICAN MICROSYSTEMS, INC.

INFORMATION RETRIEVAL NUMBER 7





## Meet the Best AC Calibration Team Going

**When you put the Fluke 5200A Precision ac Calibrator and 5205A Precision Power Amplifier together, you'll be working with a fully programmable ac cal set-up offering outstanding range, superb stability and excellent accuracy.**

Now you can calibrate ac devices up to 1200 volts rms over a frequency range of dc to 1.2 MHz. DC output of 1600 volts is available. Current levels range up to 200 milliamperes with a total output power of 220 watts.

Response is a fast 0.5 second. Both instruments are short-circuit proof. These Fluke instruments are the only ones on the market to meet the safety requirements of IEC 348. The field installable programming capability is offered in 8, 12, 16 or 52 bit formats so the system interfaces easily with almost any computer.

Midband accuracy is 0.02% overall and long term stability 200 ppm for six months. Instruments are fully guarded and interlocked. Phase lock and quadrature outputs are featured.

#### **How much?**

Cost of the 5200A and 5205A calibrator set-up in the U.S. is \$8990. That's more than some other calibrators. But with Fluke, the short circuit feature alone will give you lower cost of ownership. Your Fluke sales engineer can point out other features that make our system your better buy.

#### **Or use either unit alone**

The Fluke 5205A Power Amplifier is a true dual mode instrument usable as a stand-alone, dc coupled HV precision amplifier and 1200 range calibrator amplifier. The 5205A is the only unit on the market that can deliver 200 mA rms at 100 volts as well as at 1000 volts. And it's the unit with the usable accuracy statement, 0.04% for 90 days at 23°C ±5°C. Fluke specs accuracy,

time and temperature span!

Gain is 100 with a midband accuracy of 0.04%. Get dc to 120 KHz and get up to 1200 volts rms or 1600 volts dc at current levels up to 200 mA and 220 watts output power. Price of the 5205A alone is \$3995 (U.S. price).

If you don't need the high voltage capability set-up, use the 5200A alone. Get outputs up to 50 mA from 100 microvolts to 120 volts with midband accuracies of 0.02%. The instrument offers isolated remote programming for all functions including frequency and amplitude. Price in the U.S. is \$4995.

#### **Learn more about using full ac measure power.**

Call your nearby Fluke sales engineer listed in EEM and the Gold Book for a demonstration or complete literature. Or if more convenient, dial our toll-free hotline, **800-426-0361**, for data out today.

**John Fluke Mfg. Co., Inc.**  
P.O. Box 43210  
Mountlake Terrace, WA 98043

For a demo, circle 291  
For literature only, circle 292





# O.K., you guys, back to the old drawing board.

It's a whole new ball game. And just when you'd made all your panel lamp decisions, right? But Monsanto's patented nitrogen doping process for GaAsP on GaP substrates has improved the light-emitting efficiencies of our LED lamps so dramatically that every good designer will want to take another look.

Monsanto has T-1 and T-1 $\frac{3}{4}$  replacement lamps in standard red color (improved significantly over last year's red LEDs) and new bright red which is *unbelievably* bright. Red. Plus green, yellow, and a dazzling new orange. In two lens choices and two lead lengths. And all improved, as you can see on the chart.



Model Number	Color	Size	Luminous Intensity	Viewing Angle
5174B*	Orange	T-1	5.0 mcd	90°
5274B*	Green	T-1	1.0 mcd	90°
5374B*	Yellow	T-1	4.0 mcd	90°
5774B*	Red	T-1	5.0 mcd	90°
5152**	Orange	T-1 $\frac{3}{4}$	40.0 mcd	28°
5252**	Green	T-1 $\frac{3}{4}$	15.0 mcd	28°
5352**	Yellow	T-1 $\frac{3}{4}$	45.0 mcd	28°
5752**	Red	T-1 $\frac{3}{4}$	40.0 mcd	28°

\*Also available with 1" lead lengths, low profile (.138" high) lens, and 180° viewing angle.

\*\*Also available with 24° and 65° viewing angles.

Last year there were some sockets that demanded filament lamps, despite their inherent failure-and-replacement problems. *Bright* was needed, and damn the torpedos.

This year you just might find the bright you need in a shake-rattle-and-roll-proof LED lamp. Come and see.

If you can take the time, you just might be able to add a lot of T to your MTBF.

So it's reset to zero, folks, if you want the best indicator lamps (and widest choice of functional differentiation colors) in your gear.

For product information, circle the service number or call your local Monsanto man. Or write Monsanto Electronics Division, 3400 Hillview Avenue, Palo Alto, CA 94304.

Putting innovation to work.

**Monsanto:**  
the science  
company.



# They're good...no matter how bad

**TW MEETS MIL-S-83731.** OFFERS SWITCHING VERSATILITY OF LARGER TOGGLES WITH ADVANTAGE OF SMALL SIZE, PANEL SEALING. IDEAL FOR APPLICATIONS LIKE ON/OFF SWITCH IN THIS MANPACK EQUIPMENT.

**SERIES 1 ROUND LIGHTED PUSHBUTTONS** OFFER FLUSH MOUNTING, PANEL SEALING AND VERSATILE SWITCH CIRCUITRY; INCLUDING SOLID STATE. MIL SPEC QUALITY (MIL-S-22885) AT COMMERCIAL PRICES FOR CONTROL CONSOLES.

**DS SERIES PUSHBUTTONS.** COMPACT .75 INCH SQUARE DESIGN OFFERS PLUG-IN-DESIGN AND 4 LAMP DISPLAY. RFI ATTENUATION. MIL-S-22885.

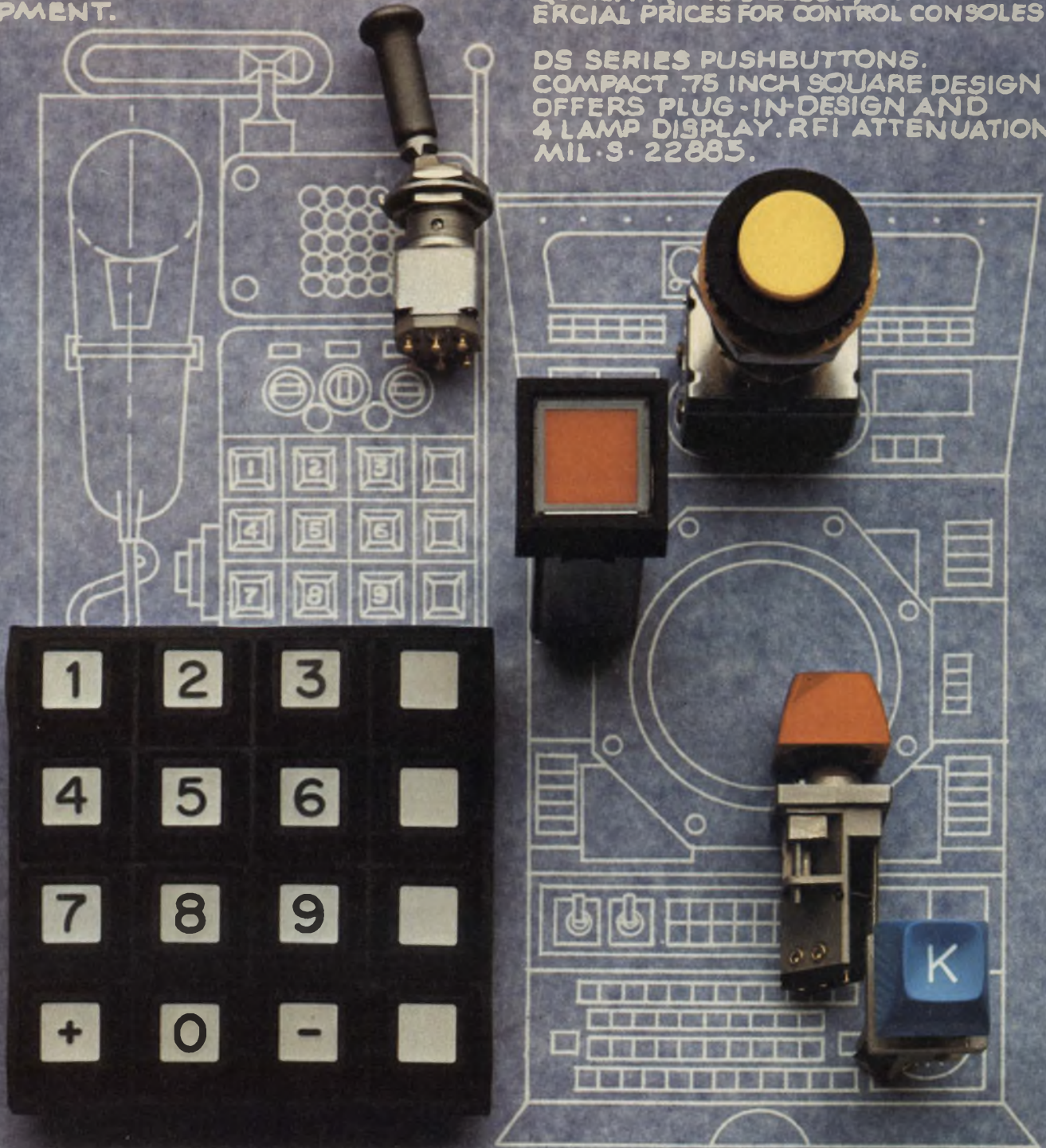

**PX KEYBOARDS.** TOTALLY SEALED WHEN MOUNTED, WITH ZERO DEPTH BEHIND PANEL, PX IS A NATURAL CHOICE FOR MANPACK EQUIPMENT SWITCH MATRICES.

**PANEL SEALED KS KEY SWITCHES.** USE OF SPDT SNAP-ACTION SWITCHES (MIL-S-8805) AND FRONT-OF-PANEL REPLACEMENT, MAKE KS IDEAL FOR RUGGEDIZED CONTROL PANEL KEYBOARD APPLICATIONS.



# things get.

The five switches you see here have all been designed to operate reliably under extremely rugged environmental conditions. Exactly the kinds of environments where Command, Communications & Control Systems are required to work.

But if these switches aren't exactly what you need, you're not out of luck.

Because they're only a sampling of literally thousands of MICRO SWITCH listings available to fill your needs. Including toggle switches. Lighted pushbuttons. Unlighted pushbuttons. Key switches. Sealed keyboards. Plus hermetically and environmentally sealed limit, proximity and basic switches.

All of them available almost anywhere in the world, through over 500 MICRO SWITCH Authorized Distributors and Branch Offices.

And if that still isn't enough, our Application Engineers will work with you to modify an existing MICRO SWITCH product to your needs. Or come up with a new one, through our field and factory engineering staff.

If you'd like more information on the devices you see here, or more information on how we can help, write or call your nearest MICRO SWITCH Branch Office or Authorized Distributor.

## MICRO SWITCH

FREEPORT, ILLINOIS 61032

A DIVISION OF HONEYWELL

MICRO SWITCH products are available worldwide through Honeywell International.

## ACROSS THE DESK

(continued from page 7)

mind, and consequently it uses some of the circuitry of the HP-55. However, the HP-55's internal oscillator is apparently "trimmed" for the required frequency, while that of the HP-45 is not. At any rate, the HP-45 should exhibit reasonable accuracy as is. (My own HP-45 measures about 5.3% slow when compared with a known time standard; I have used my machine on internal battery pack and on external power pack, and obtained similar accuracy results both ways.)

Owners of the HP-45 can compare their machines against a known time standard and use the resulting correction factor as required in future measurements. And although the absolute accuracy of the HP-45 may not equal that of the HP-55, the time function used during relative measurements—and particularly the storing of up to nine elapsed-time measurements—can be very, very useful indeed.

Paul E. Miller

Engineering Technician

AMF Electrical Products

Development Div.

1025 N. Royal St.

Alexandria, VA 22314

## Jobs, anyone?

In the April 1, 1975 issue we published an editorial in which we offered to try to match out-of-work engineers with potential employers. As one might expect, we received far more applications for jobs than announcements for job openings. We were successful in effecting a few matches but we're still overstocked on resumes of engineers sprinkled around the country (and one in Germany who would like to come back to the U.S.). Some of the credentials look awfully impressive.

If you have some jobs available, get in touch with our Evelyn Morris (ELECTRONIC DESIGN, 50 Essex St., Rochelle Park, NJ 07662). Good engineers are going to be a lot tougher to find a few months from now.

◀ CIRCLE 261 FOR DATA

◀ CIRCLE 262 FOR SALESMAN CALL

## Misplaced Caption Dept.



"We've got to clear out of the cafeteria for the next shift."

Sorry. That's Pierre-Auguste Renoir's "The Luncheon of the Boating Party at Bougival," which hangs in the Philips Memorial Gallery in Washington.

## Calculator errors and how some arise

In the Sept. 27 issue, a letter from Peter A. Stark discussed two types of alleged mistakes made by some calculators that employ algebraic notation with parentheses. I would like to point out that his second example actually gives the correct answer. It is his lack of understanding of the sequential operations of such calculators that causes the apparent error.

Algebraic calculators perform complex chain calculations in the order in which they are entered, rather than according to the standard mathematical hierarchy (in which exponentiation is done first, then multiplication and division, then addition and subtraction). For example, most users are aware that  $AB \& CD$  must be entered as

$$A \times B + (C \times D) =$$

Entering it as

$$A \times B + C \times D =$$

gives the erroneous answer  $(AB + C)D$ .

The calculation that tripped up Mr. Stark was of the general form  $A^3B^3$ , for which he should have entered

$$A \times^3 3 \times (B \times^3 3) =$$

The incorrect answer was obtained by entering it as

$$A \times^3 3 \times B \times^3 3 =$$

which gives  $(A^3B)^3$ .

George Fergus

3341 W. Cullom Ave.  
Chicago, IL 60618



# The tight-fisted IC testers.

**FOR INCOMING IC INSPECTION \$1K STILL GOES A LONG WAY.**

The three IC testers below are unique, thoroughly proven, and they are the tight-fisted, inflation-beating answer to the requirements of incoming inspection. All identify the bad devices as rapidly and unfailingly as machines costing five to six times as much.

In addition to being economical ESI testers are reliable, simple to operate and will test devices as they are developed. For a demonstration or technical information on any of these instruments, circle the appropriate numbers below. If you need immediate response, please call Jim Currier (503) 646-4141, Portland, OR.



## LINEAR IC TESTER \$990.

Devices tested: Monolithic or Hybrid Operational amplifiers.

Tests performed:  $E_{OS}$ ,  $I_{B-}$ ,  $I_{B+}$ , DC open loop gain, DC CMRR, oscillation detection.

Remarks, 3-digit direct reading digital display which enables go-no-go testing.

### MODEL 1234

For demo circle Reader Service # 271  
For literature only circle # 272

## DIGITAL IC TESTER \$580.

Devices tested: 14 and 16 pins. TTL, DTL and CMOS @ 5V.

Tests performed: Fixed pattern functional test.

Remarks: Performs 2<sup>20</sup> inspections per test in from 1 to 5 seconds. No comparison with a "good" IC is necessary. 4-digit display gives absolute test results. Can also be used to check continuity of resistor network.

### MODEL 1248

For demo circle Reader Service # 273  
For literature only circle # 274

## DIGITAL IC TESTER \$1195.

Devices tested: TTL, DTL @ 5V, HTL @ 15V, CMOS @ 5V, 10V, 15V.

Tests performed: Same as 1248.

Remarks: Interfaces with manual and automatic handlers. Multiple voltages for CMOS.

### MODEL 1249

For demo circle Reader Service # 275  
For literature only circle # 276





DECEMBER 20, 1975

## East German computer proves better than expected

Tests and studies by Control Data Corp. show that East European data-processing machines are much more advanced than most U.S. experts have believed, while the peripheral equipment lags behind that produced in this country.

For example, the Robotron ES-1040 medium-to-large-scale computer, made in East Germany, is three to four times faster than the IBM 370/145 in processing scientific calculations, but in commercial applications the speed of the two machines are comparable, according to the CDC report.

However, when the memory speed of the German ES-1040 was tested along with that of the IBM 370/145 and the CDC Cyber 73, the ES-1040 took twice as long as the IBM machine and about six times longer than the Cyber 73.

Together, the two tests—that of arithmetic speed and memory speed—reveal that the ES-1040 is approximately twice as powerful as the IBM 370/145 in internal computing power.

Other findings by CDC:

The core memory of the ES-1040 is somewhat slow compared with the processor's speed—performance could be enhanced considerably with a faster memory.

- The ES-1040 executes the IBM 360 instruction set.

- The system could be improved through the use of more modern peripherals, chiefly in the mass storage area.

- In general, the East German machine is "very reliable."

The ES-1040 is constructed from ICs made in East Germany that are identical in logic to those produced in the U.S. by Texas Instruments, Motorola and Fairchild. The appearance of the ES-1040 prototype in late 1972 indicates a technology lag of three to four years in the IC area.

The logic design of the CPU is also very advanced, CDC says.

The processor employs microprogram control, a technique not too different from that used in the IBM 370 series. The processor includes a "lookahead" instruction feature, which allows various processor functions to be overlapped.

The memory is composed of 21-mil cores, has an access time of 450 ns and a system level cycle time of 1350 ns. The memory is composed of two to four independent modules, allowing memory interleaving. The path to memory is eight bytes wide. The theoretical memory transfer rate is about 142 million bps. CDC testing on a two-module memory showed that the memory speed was not well matched to the speed of the CPU.

The input/output channels operate under microprogram control and are compatible with the IBM multiplexer and selector channels. These channels are fast enough to allow connection of most modern U.S. peripherals, CDC says.

The two disc drives that came with the ES-1040 can store about seven million characters. The Control Data disc drives now connected to the ES-1040 have four times that capacity, and can also transfer data at twice the speed.

The tape drives that came with the East German machine were found to be equivalent in performance to U.S. units, but bulkier.

The East German printer offers a feature not provided by any U.S. manufacturer, CDC says. It allows different forms to be printed simultaneously. However, CDC points out that its printer outperforms the East German product in other ways: better print quality, slightly higher speed and an interchangeable character set.

Both the card reader and the

punch were built in the Soviet Union and use standard 80-column cards.

## Soft-recovery test cuts cost of diodes 30%

A new procedure for characterizing power diodes that removes ambiguities and cuts costs by 30% is reported by General Electric, Schenectady, NY.

GE says it has achieved this by finding an easy way to test the soft-recovery characteristics of these devices. Until now, this characteristic has been hard to test, and even the results of the tests were open to many different interpretations, notes Ralph Locher, a product engineer for GE.

High-current diodes (over 100 A), when used in an antiparallel connection with SCRs in large switching supplies, prevent spikes caused by collapsing magnetic fields from destroying the SCRs. However, these diodes must have peak inverse voltages that are high enough to withstand the spikes.

By being able to measure the soft recovery time of the diodes accurately, Locher says, the more efficient units can be picked and thus diodes with lower PIVs can be used. And the lower the PIV, the lower the cost of the diode.

For example, GE says, where a 250-A, 1000-V device had to be used at a cost of \$26 in 10-to-99-piece lots, a 250-A, 600-V diode can now be used at a cost of about \$20 for similar quantities. Diodes are available with current ratings of 100 to 1000 A rms and with PIVs from 50 to 1500 V.

## 3-D radar improves target resolution

A monopulse tracking radar capable of providing three-dimensional target information and range resolution down to 1.5 ft is under development at the Naval Research Laboratory, Washington, DC.

Other features include the following:

- Ability to counteract enemy repeater-type countermeasures.

- Improved low-angle multipath tracking.



- Increased resolution of multiple targets.

- Improved target tracking in chaff and clutter.

The experimental radar uses a very narrow pulse width of 3 ns in conjunction with wideband monopulse processing to obtain azimuth and elevation information of each resolved part of the target.

Present high-range-resolution radars provide only one dimensional range-amplitude profiles. The 3-D radar, according to two of its developers, Dean Howard and David Cross, extends this capability, in that a target aircraft can be resolved into its major structural parts. Prominent features such as engines, tail surfaces, and wings can be located precisely in both range and angle. This is accomplished by processing the high-speed return pulses through special sampling and holding circuits, which convert the pulses to digital form for display, storage and analysis by computer pattern-recognition methods.

According to Cross, the next step in the program is to improve the radar performance and extend its range. This will be done by pulse-compression techniques to increase average transmitted power.

A similar radar, developed at Lincoln Laboratory, Lexington, MA, has been in use since 1968, primarily for long-range tracking. The Naval Research Laboratory radar differs in its method of processing and using target angular information.

## Speed of CCD memory is boosted tenfold

A tenfold increase in speed—from about 20 MHz to over 230 MHz—has been achieved for a CCD dual-speed, shift-register device. The development by Rockwell International's Autonetics Group in Anaheim, CA, is aimed at a transient recorder application.

According to Dr. Barry French, CCD research group leader: "The device can operate in two modes. In the first mode it accepts data at up to 234 Mb/s and transfers it out at up to 86 Mb/s. We call this the fast-slow mode. In the second mode it operates in a continuous way with up to 86 Mb/s data in

and up to 86 Mb/s data out."

This device has 130 cells and uses a two-phase overlapping gate approach—that is, there is a separate gate for transfer and a separate gate for storage associated with each cell. Charge transfer efficiency per cell is 0.999 at a 230 Mb/s transfer rate.

French notes that the device has a ion-implanted epitaxial n-channel that is deeply buried. It also has a gate length of 0.2 mil in the direction of charge propagation. Each cell has a 10-mil-wide channel that allows the full cell to contain about 0.76 picocoulombs of charge.

## Laser 'thermometer' to detect 80 million C

A laser "thermometer" to measure temperatures as high as 80 million degrees centigrade is being developed at the Massachusetts Institute of Technology, Cambridge, for thermonuclear fusion research.

The temperature-measuring system, being designed at MIT's Francis Bitter National Magnet Laboratory, consists of a new high-power, methyl fluoride gas laser and an infrared detection system. The laser wavelength is 500  $\mu\text{m}$ —in the far infrared.

The system, being developed under a \$350,000 contract with the Federal Energy Research and Development Administration, will measure the temperature of deuterium ions in a plasma confined by strong magnetic fields inside a tokamak—a structure shaped like a hollow doughnut.

The thermal measurements will monitor the ion temperatures, according to Dr. Daniel R. Cohn, who is in charge of plasma physics research at the Magnet Laboratory.

"Measurements of ion temperatures are a crucial indicator of progress towards self-sustained thermonuclear fusion," says Cohn. "The hotter the ions, the more often they will fuse into helium ions, giving off energy in the process."

Fusion occurs at 80 million C, he notes.

Ion temperature is measured by use of a phenomenon called Thomson Scattering, Cohn explains. The laser beam is directed at the plasma, and as the beam hits and

bounces off the ions, the laser frequency is shifted. By measurement of this shift, both ion temperature and concentration of impurities in the plasma can be determined.

## ROM capacity cut in voice synthesizer

A digital coding system used in a new electronic voice synthesizer reduces the required ROM capacity to only 2% of that needed in competitive voice systems, according to John E. Stork, president of Speech Technology, Inc., system developer.

"Conventional voice digitizing requires at least 50,000 bits/s to reproduce telephone-grade speech," Stork points out. "With our coding method, we compress that down to 1000 bits/s."

The Speech Technology synthesizer—the Model 200—uses a standard approach, Stork explains, in that it produces an electrical analog of the voice tract. It duplicates the resonances and other characteristics of speech.

"We take voice recordings—words or statements—and digitize them at a 100,000 bits/s rate. But our trick is to extract from the recording features that can be stored in the digitizer and recalled upon command.

"We do that by running the voice data through a computer analysis that compresses and transforms the data into unique code sequences that control the sound-generation portion of the synthesizer.

"To produce a particular sound, you send a 24-bit code to a control register in the synthesizer. The code—it is transferred in and out of the register in microseconds—programs the resonances, pitch frequencies and other sounds needed.

"For example, a sound like the vowel 'aah' in the word fox lasts for some 100 or 200 ms in normal speech. So the code directs the synthesizer to make that sound for 100 to 200 ms.

"Upon termination of that period, the code is replaced in the register by another code group, which is sent in for, say, 10 to 50 ms, until it is replaced by still another code, and so on."



# JOIN OUR BME-KAP<sup>TM</sup> SAVINGS PLAN

## SAVE 30% TO 50% ON THE COST OF MONOLITHIC CERAMIC CAPACITORS

This major cost saving is the result of our new BME<sup>TM</sup> capacitor technology. We've eliminated precious metals entirely from the electrodes and terminations of our BME<sup>TM</sup> capacitors. No precious metals means lower cost. So now we offer you our complete line of monolithic ceramic capacitors — BME Chips<sup>TM</sup>, BME Radials<sup>TM</sup> and BME Axials<sup>TM</sup> — at a genuine savings of 30% to 50%.

This significant reduction is not based on a momentary drop in precious metal prices. This is a long-term solution due to the replacement of precious metals by non-noble metals which are not subject to the same dramatic cost spirals.

## SAVE WITH RELIABILITY

Our BME<sup>TM</sup> capacitors have not sacrificed the inherent electrical and mechanical Ceramolitic<sup>®</sup> quality. Their reliability can be demonstrated by the extensive test procedures to which they have been subjected. Write to our Applications Engineering Department for complete test reports.

## SAVE WITH DESIGN FLEXIBILITY

Now you can seriously consider monolithics to replace micas and tantalums. Our BME<sup>TM</sup> capacitors feature non-polarity, a wide range of capacitance value, low leakage, high volumetric efficiency, availability in chip, radial and axial packages at prices competitive with mica below 1000pF and tantalum up to 2.2 $\mu$ F.



### TYPICAL SELLING PRICES PER UNIT QUANTITIES OF 5000 OR MORE

BME <sup>TM</sup> "J" DIELECTRIC (COG)	BME-Chip <sup>TM</sup>	BME-Axial <sup>TM</sup>	BME-Radial <sup>TM</sup>
1 thru 100 pF, 5%, 50WVDC	5.1¢	6.8¢	7.5¢
1000 pF, 5%, 50WVDC	12¢	16¢	16¢
BME <sup>TM</sup> "S" DIELECTRIC (X7R)	BME-Chip <sup>TM</sup>	BME-Axial <sup>TM</sup>	BME-Radial <sup>TM</sup>
.01 $\mu$ F, 20%, 50WVDC	3.5¢	5.8¢	5.8¢
.1 $\mu$ F, 20%, 25WVDC	9¢	16¢	14¢
1.0 $\mu$ F, 20%, 25WVDC	52¢	—	73¢
BME <sup>TM</sup> "R" DIELECTRIC (Z5U)	BME-Chip <sup>TM</sup>	BME-Axial <sup>TM</sup>	BME-Radial <sup>TM</sup>
.1 $\mu$ F, +80 -20%, 25WVDC	5.7¢	8.8¢	8.8¢
.47 $\mu$ F, +80 -20%, 25WVDC	13¢	16.5¢	16.5¢
1.0 $\mu$ F, +80 -20%, 25WVDC	19¢	27¢	25¢
2.2 $\mu$ F, +80 -20%, 25WVDC	35¢	—	49¢

## JOIN THE USCC/CENTRALAB BME<sup>TM</sup> CAPACITOR SAVINGS PLAN

Get all the details today. Write on your company letterhead for your concise Savings Plan Price list — your pass book to the lowest monolithic ceramic capacitor prices available. Compare it with anyone else's price list and see.

Remember, USCC/Centralab— Quality, Volume, Savings.



**USCC/Centralab**

Electronics Division ■ Globe-Union Inc.

4561 Colorado Boulevard ■ Los Angeles, Ca. 90039

(213) 240-4880



INFORMATION RETRIEVAL NUMBER 13



# 'Electronic Design's brought in for

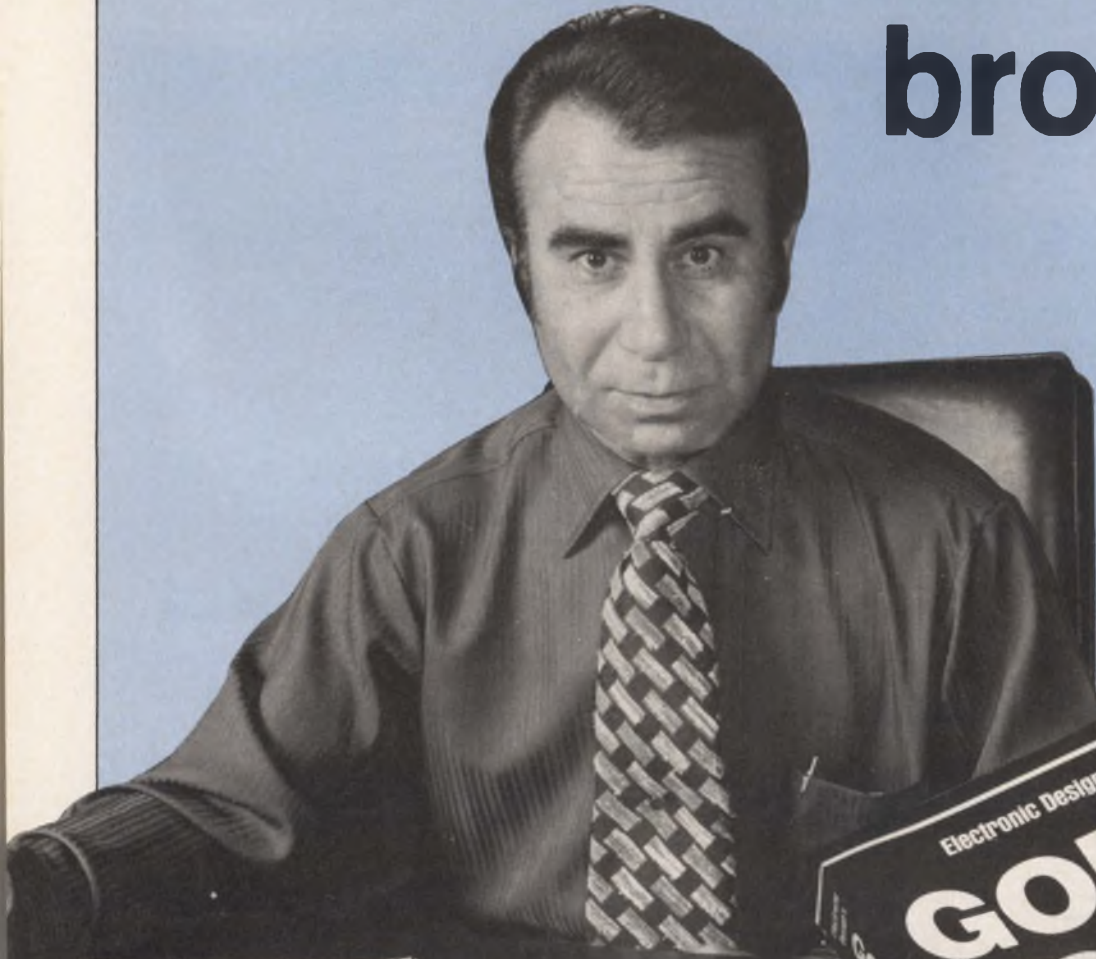

**James Zaros**  
Vice President of Sales  
Datel Systems, Inc.

Tell us what you think about the GOLD BOOK. (If it's good, we'd like to hear it. If it's bad, we want to improve it.)





# **GOLD BOOK just two pending orders \$75,000!**

"We're getting a good flow of orders from engineers who tell our salesmen that they have the GOLD BOOK in front of them while they're talking on the phone." writes Mr. James Zaros, Vice President of Sales, Datel Systems, Inc., Canton, Mass.

"I have just confirmed that we have two specific orders pending in our plant, one for \$25,000 and one for \$50,000, that we know are directly traceable to the GOLD BOOK.

"In addition to these phone and mail contacts, we also are receiving a fair number of direct response cards — the ones that are bound in the GOLD BOOK — many of which represent actual or potential business.

"Yes, the GOLD BOOK is definitely working for us."

Datel carries 10 short-form catalog pages in the 1975-76 GOLD BOOK. They feature, among other products, Dattel's line of A/D and D/A converters, wideband operational amplifiers and analog multiplexers. The pages are packed with detailed specs, data and price information. Dattel makes it easy for engineers to talk business over the phone.

Because the GOLD BOOK is primarily distributed to *Electronic Design's* audience, Dattel gets the best of both worlds — 78,000 engineers and engineering managers, purchasing agents and distributors throughout the U.S. plus 13,000 in key markets abroad. These are the men who have the authority to specify and buy.

**ELECTRONIC DESIGN'S GOLD BOOK IS WORKING  
...IT'S WORKING FOR READERS...AND IT'S  
WORKING FOR ADVERTISERS, TOO.**



## REPORT ON MICROCOMPUTER SOFTWARE

# Experts tell how to hold down high cost of processor programs

The hardware designer, enticed by ads for low-cost microprocessor boards, has several surprises in store when he embarks on his first micro-systems design.

First, he'll learn that for a simple microprocessor control system, he'll wind up with at least 25 additional chips surrounding the basic processor. For fairly complex systems, the number can rise substantially above 100.

But the big shock comes when the designer gets into microcomputer software. It can cost from hundreds of dollars to thousands for the finished system. For a \$30 microprocessor, software has been known to cost \$65,000 to \$70,000.

Like it or not, the designer will have to become involved in programming to produce effective designs at minimum cost. And he'll find himself in a design team that includes a specialized programmer.

## A two-man team

"You need at least two people on the microprocessor team," says Gordon Gould, hardware designer for Advanced Electronics Development, Chester, CT, who has several successful micro-systems designs to his credit.

"You need the hardware man and the programmer. But the hardware man, to be effective, must have a good knowledge of programming language.

Software is more an integral part of microcomputer design than it is for a large computer, Gould notes, because much of the processing is related to the outside world rather than number crunching.

---

**Jim McDermott**  
Eastern Editor



**Microprocessor software programs can cost orders of magnitude more than the hardware.** Programs can be generated using only a teletypewriter and a time-sharing service (top). But the slow speed of this system limits the lines of instruction code produced per hour. Fast, cost-effective software generation requires an investment like that of the National Development System (bottom) that incorporates an IMP-16P, an interactive CRT, a high-speed printer, a floppy-disc system and a teletypewriter.



Costs of software development can vary widely, Gould points out, depending upon which of several approaches is taken and the skill of the programmer. A skillful programmer can reduce hardware costs by assigning hardware functions to software.

"Our initial discussions on a design," says Tony Matthews, the programmer teamed with Gould, "are based on the assumption that software does everything. Then we back off from it when we find we can't.

"We use this attack because once the software is completed, there is no more design work to do."

Gould notes: "The more functions you can delegate to software, the better off you are, because you have more flexibility. For example, as changes come along, you can revise the software—on paper—and leave the hardware alone. Also, the less hardware, the lower the cost and the more reliable the system is."

Decision-making in microprocessor hardware and software design can be a confusing experience. Some 60 or 70 vendors—semiconductor manufacturers, independent microprocessor hardware and software design houses and microprocessor hardware distributors—are marketing microprocessor design courses as well as software and development aids. The aids range from 4-bit microprocessor kits that are programmed by manual operation to extensive emulation systems, like Intel's MDS or National's IMP-16.

In addition time-sharing houses are available for running cross-assembler programs provided by the microchip manufacturer. And many of these programs can also be run on in-house computers.

### Kits and courses help

For the hardware designer digging into microprocessor system design for the first time, the purchase of a kit or attendance at one of the many courses now given throughout the country can be of substantial advantage.

"Kits are extremely useful as a primary learning tool," says Robert K. Lowry, executive vice president of Technology Marketing, Inc., a design house for computer based systems.

Just what microprocessor course to take depends upon how well the course presentation fits the designer's approach to study. For example, Jerry Ogden, president of Microcomputer Technology, Inc., Reston, VA, who conducts seminars and is also responsible for the training at the 13 Cramer Microprocessor Design Centers, points out that "our courses are an intellectual exercise.

"We're different from others," he says, "in that we don't teach

Once a microcomputer is in hand, the tendency is great for a user to develop his own instruction set. But this, according to Robert Richards, president of Megadata, Bohemia, NY, a microcomputer design house, "is the biggest mistake the designer can make.

"While instruction sets and documentation are getting better," he says, "they're still not as good as anything from a company like DEC or Data General."

For minimum software costs,

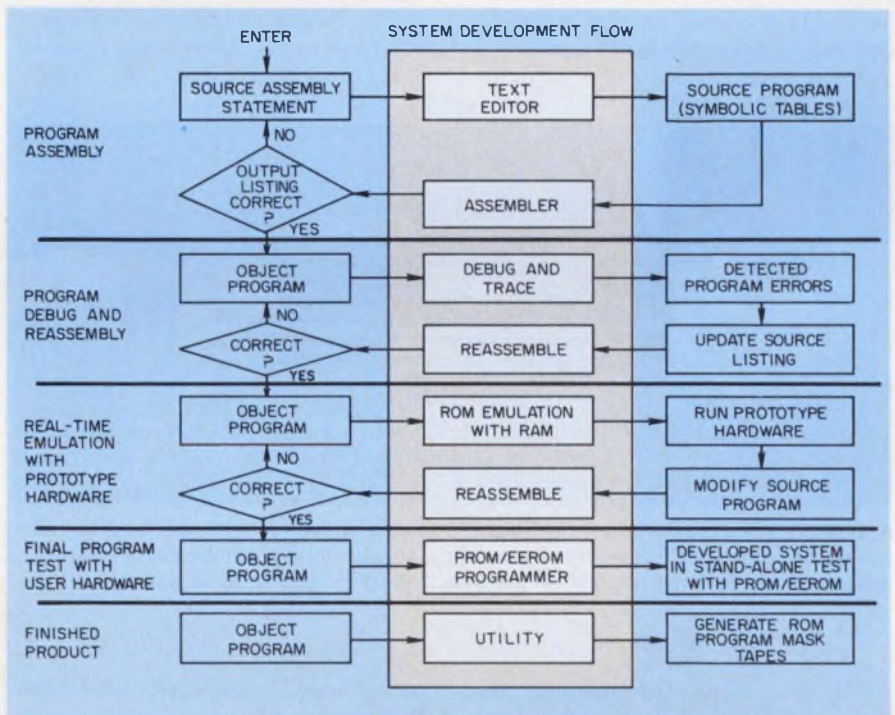

**Microprocessor system software development**—assembly, test, debug, reassembly and verification—requires a series of organized steps. The final step puts the program in a ROM.

in terms of hands-on experience. We don't believe that you need hands-on work in the initial stages."

On the other hand, Edwin Lee, president of Pro-Log, Monterey, CA, insists on a hands-on approach in his courses. And he's dead set against the usual course approach that considers the microprocessor a "baby computer." He uses "a very simple documentation approach" to software.

One reason for the high cost of microprocessor software is that the languages are still fairly new. This software has not yet reached the high degree of refinement and power that software for minicomputers and large machines has achieved.

Richards advises the designer to follow Megadata's procedure.

"We evolve our microprocessor technology about well-known mini-computer systems," he notes. "For example, we're using Intersil's IM 6100 because it uses the DEC PDP-8/E instruction set.

"Software cost problems arise when you throw capable programmers into a new and totally unfamiliar instruction set. Finding programmers who can program by the pound—and that's the way to look at it—is a lot easier for us, because there are so many available with experience on the DEC machine."

A. Thampy Thomas, manager of microprocessor development at In-



tersil, Cupertino, CA, agrees with that philosophy.

"About two years ago we decided to build a microprocessor that emulated an existing instruction set, so we could use the software already developed for it," Thomas says.

The reason for that decision, he notes, is that "microprocessors usually take about two years to develop a resident assembler.

"For example," Thomas continues, "both Intel and National supported their microprocessors for two years on a Fortran processor before they wrote an assembler in the microprocessor language.

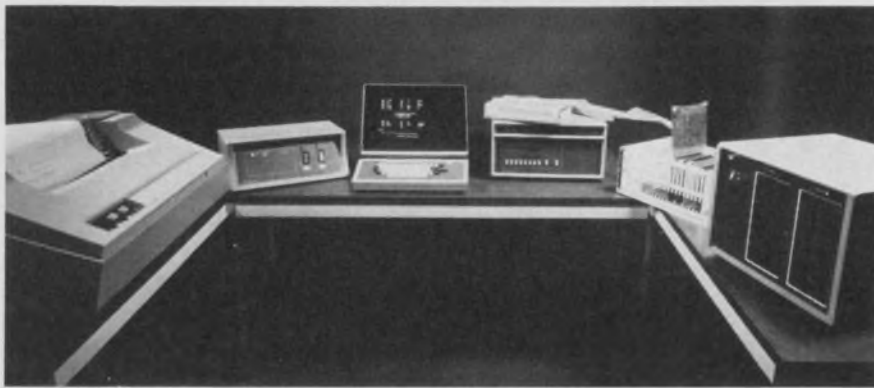

A complete microcomputer software-hardware development package is contained in Intel's MDS system. Its multiprocessor configuration permits design, development and debugging of systems based on the Intel 8080.

"In our case, the moment we came out, we had four or five self-assemblers available from DEC. We have compilers that recognize Fortran, Basic, Cobol and other high-level languages. And all this software was available without any development effort."

Minicomputer manufacturers are beginning to reduce microcomputer software costs by marketing new microprocessor boards and chip sets that are compatible with their own software.

One such manufacturer is General Automation. It is providing a one-board GA-16/110 and a two-board GA-16/220 microprocessor set. Both use the software developed over the last six years for the General Automation SPEC-16 minicomputer. In addition the micros are also compatible with the latest GA-16/330 and GA-16/440 minicomputer software.

Designers disagree on how much equipment is needed to program

a microprocessor satisfactorily.

Chuck Pedal, marketing director for microcomputers at MOS Technology, Norristown, PA, suggests that for a small program, such as debugging a printer or a piece of hardware, the use of a Teletype can be satisfactory.

For a larger program, on the order of 1 to 2 k, he recommends a resident assembler that has some kind of file structure.

"You can probably use a cassette and perhaps use a paper tape," Pedal says. But, in any event, a printout is mandatory, he notes.

For larger programs, Pedal says it's best to use the cross-assembler

kits—the stand-alone processor, like the Intellec 8—is not a very productive machine because its editing capability is minimal.

"In particular, the data input-output program gets to be enormous. You read paper tape forever for one cycle of a program development. And when you find you made a mistake, you do it again and again.

"When you think of the time you're spending and of the value of the time, you have to realize that software is a substantial investment in any microprocessor-based system. I think Intel is on the right track with its MDS system, where you can use a floppy disc and put through program changes in a realistically small amount of time.

"We have a PDP-8/E system, which has a dual mag tape drive and a line printer. I've been looking at 8-bit processors, and so far I haven't found any instruction set that I can't trick the DEC PAL8 assembler into assembling for me.

"Another thing you need is a reasonable rate of creating hard copy. You can run with a Teletype, but to do a 4-k listing means that you walk away from it and let it run for the morning.

"So you have to size the development equipment to suit the job you're running. My own impression is that people sadly underestimate the amount of software they're going to wind up wanting to have. You usually wind up with three times the program you expected in terms of added functions. And that's liable to be five or six times as big in memory locations."

### In-house development backed

George F. Martin, vice president of Advanced Electronics Development, favors an in-house development system for producing new designs.

"A company that's just designing one or two systems can't usually justify the cost of a full development system," he says.

"We started with just a microprocessor and a Teletype for editing, but it took a 12-hour day to edit and assemble one large program.

"If you're a small manufacturing

on a large computer, preferably in-house.

Richard Lee, manager of engineering development at Boonton Electronics, Boonton, NJ, has a different view. He says:

"There are only two reasonable approaches to software development. One is to go with a time-sharing house to do your program development, and the other is to buy either a resident operating system device or a cross-assembler operating system with a minicomputer."

### Needed: two capabilities

"You must have, in a productive system, file-handling and file-editing capability in order to get the job done in any reasonable length of time. It is possible to write programs in machine language, but your productivity is small. And even the little resident assemblers found in some of the development



# New Honeywell portable packs 28 channels, meter monitoring and solid ferrite heads all into one small, superb unit.

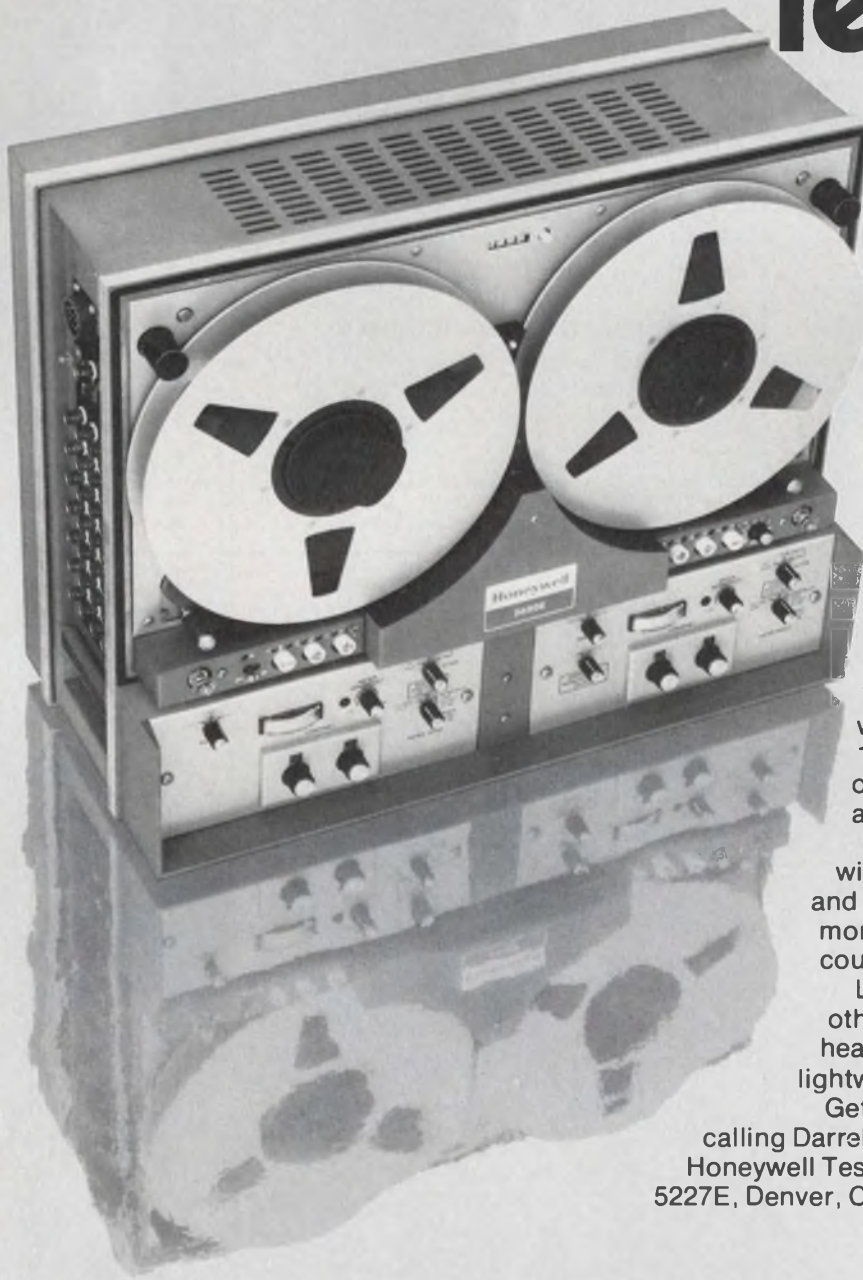

If you've been waiting for better features and more capability in a portable tape recorder — you've got it. The Model 5600E from Honeywell!

Our new portable gives you up to 28 tracks, 7 speeds, field-convertible intermediate or wideband, solid ferrite wideband heads and 10 1/2-inch reel capacity. There's also a variety of rack and shock mount configurations and an integral dc power supply option.

Our meter monitoring isn't typical either. Not with simultaneous monitoring of record input and reproduce output on any channel, plus track monitoring with rms or peak ac or dc meter coupling, and there's more . . .

Like electronics and parts commonality with other Honeywell portables; a 3,000-hour ferrite head warranty and a proven transport all in a lightweight compact package.

Get complete technical specifications by calling Darrell Petersen, (303) 771-4700, or write Honeywell Test Instruments Division, P. O. Box 5227E, Denver, Colorado 80217.

# Honeywell



# Microprocessor manufacturers and software support

Manufacturer	Microprocessor and architecture	Microprocessor system on a card	Hardware/software development systems	Emulator to test system in place	Manufacturer's software support					
					Cross assembler	Resident assembler	Simulator	Debug program	Diagnostic program	Editor
Advanced Micro Devices	2901 4-bit slice	—	—	—	—	—	—	—	—	—
	9080 8-bit CPU	—	—	—	✓	✓	✓	✓	✓	✓
American MicroSystems	S6800 8-bit CPU	✓	—	—	Fortran IV	—	Fortran IV	—	—	—
Electronic Arrays	EA9002 8-bit CPU	✓	—	—	Fortran IV Time-share	✓	✓	—	—	—
Fairchild	F8 8-bit CPU	✓	✓	—	Fortran IV	✓	Fortran IV	✓	✓	✓
General Instrument	CP-1600 16-bit CPU	✓	✓	—	Fortran IV	✓	Fortran IV	✓	✓	✓
Intel	4004 4-bit CPU	✓	✓	—	Fortran IV	✓	Fortran IV	✓	✓	✓
	4040 4-bit CPU	✓	✓	—	Fortran IV	✓	Fortran IV	✓	✓	✓
	8008 8-bit CPU	✓	✓	✓	Fortran IV	✓	Fortran IV	✓	✓	✓
	8080/A 8-bit CPU	✓	✓	✓	Fortran IV	✓	Fortran IV	✓	✓	✓
Intersil	IM6100 12-bit CPU	✓	✓	PDP8/E	Fortran IV	✓	✓	✓	✓	✓
Monolithic Memories	6701 4-bit slice	✓	✓	—	—	✓	—	✓	✓	✓
MOS Technology	6501/2/3 8-bit CPU	✓	✓	✓	Fortran IV	✓	Fortran IV	✓	✓	—
Mostek	F8 8-bit CPU	✓	✓	✓	Fortran IV	✓	Time-sharing	✓	✓	✓
Motorola	M6800 8-bit CPU	✓	✓	✓	Fortran IV	✓	Fortran IV	✓	✓	✓
National Semiconductor	IMP-4/8/16 4-bit slices	✓	✓	—	Fortran IV	✓	—	✓	✓	✓
	INS4004 4-bit CPU	—	—	—	—	—	—	—	—	—
	SCAMP-ISP500A 8-bit CPU	✓	✓	—	Fortran IV Time-sharing	✓	✓	✓	✓	✓
	PACE-IPC-16 16-bit CPU	✓	✓	✓	Fortran IV	✓	—	✓	✓	✓
NEC Microcomputers	$\mu$ PD8080A 8-bit CPU	✓	✓	✓	Fortran IV	✓	Fortran IV	✓	✓	✓
Plessey	MIPROC 16-bit CPU	✓	✓	—	Time-share DEC10	—	Time-share DEC 10	—	—	—
RCA	CPD 1800 8-bit CPU	✓	✓	✓	Fortran IV	✓	✓	✓	✓	✓
Rockwell	PPS-4/2 4-bit CPU	✓	✓	✓	Fortran IV Time-share	✓	✓	✓	✓	✓
	PPS-8 8-bit CPU	✓	✓	✓	Fortran IV Time-share	✓	✓	✓	✓	✓
Signetics	2650 8-bit CPU	✓	✓	✓	Fortran IV	—	Fortran IV	✓	✓	✓
Texas Instruments	TMS 1000/1200 4-bit $\mu$ Comp.	—	✓	—	Time-share	✓	Time-share	✓	✓	✓
	TMS8080 8-bit CPU	—	—	—	Time-share	—	Time-share	✓	✓	✓
	TMS 9900 16-bit CPU	✓	✓	✓	Time-share	—	Time-share	✓	✓	✓
Western Digital	MCP1600 9-bit CPU	✓	—	✓	Time-share	—	Time-share	✓	✓	—



It's good to know that in low power dividers you don't have to be constantly comparing which is best, which is new, on and on.

Just look to Plessey Semiconductors if you're working on hand-held or mobile synthesizers, or high-speed instrumentation.

It makes sense. Plessey offers the most comprehensive line of dividers with frequencies of up to 1.2 GHz, and division ratios of 2, 4, 5, 10, 10/11, 16, 20 or 32. Three guaranteed temperature ranges are available:  $-40^{\circ}\text{C}$  to  $+85^{\circ}\text{C}$ ,  $0^{\circ}\text{C}$  to  $+70^{\circ}\text{C}$ , or  $-55^{\circ}\text{C}$  to  $+125^{\circ}\text{C}$  on MIL grades.

Most important, you get an incredibly low power drain. For example:

Type	Description	Power Consumption
Motorola MC12012	$\div 10/11$ at 200 MHz	95 mA typical
Plessey SP8695	$\div 10/11$ at 200 MHz	20 mA typical
Fairchild 95H90	$\div 10/11$ at 200 MHz	70 mA typical
Plessey SP8690	$\div 10/11$ at 200 MHz	14 mA typical

Other examples of Plessey's extremely low power devices with no competition:

Type	Description	Power Consumption
SP8667	$\div 10$ at 1.2 GHz	80 mA typical
SP8602	$\div 2$ at 500 MHz	12 mA typical
SP8685	$\div 10/11$ at 500 MHz	45 mA typical
SP8655	$\div 32$ at 200 MHz	10 mA typical
SP8660	$\div 10$ at 200 MHz	10 mA typical
SP8790	$\div 4$ at 200 MHz	10 mA typical

Still scratching your head, and saying, "Well, maybe...?" Then we've got something for you. Request copies of our data sheets with all the facts. The truth is there for all to see.



## PLESSEY SEMICONDUCTORS

1674 McGaw Avenue, Santa Ana, California 92705,  
Tel: (714) 540-9979, TWX: 910-595-1930; Cheney Manor,  
Swindon Wiltshire, England, Tel: (0793) 6251, Telex: 449637;  
West Germany, Tel: 811 3516021, Telex: 5215322; France,  
Tel: 727-4349, Telex: 62789; Italy, Tel: 3491741, Telex: 33245;  
Sweden, Tel: (08) 23 55 40, Telex: 10558.

INFORMATION RETRIEVAL NUMBER 17

# Compare Plessey's low power, high-speed dividers with the competition? Rubbish!





company and you want to automate your product, you can live with that, because in three months you'll have a system that you'll be selling for the next five years. So you don't want a lot of expensive prototyping equipment around.

"But in our business—designing microprocessor systems under contract—the initial \$3000 for the prototype was a good investment."

In fact, each additional dollar invested, until we got up around \$12,000, bought us more speed. For example, part of our system is an expensive high-speed card reader.

"But above \$12,000 it takes considerably more dollars to get more programming output per hour. We believe that Intel has taken the right approach for our kind of need with its MDS system."

But Martin's advice is to go slowly and carefully before you make a large investment, "because once you start with a microcomputer that has its own unique software and development hardware, the investment in the software grows so rapidly that to convert to another system is usually a prohibitive expense."

The extent of development and software support provided by semiconductor manufacturers is very important in holding down software cost. A look at the table shows that for some microprocessors, across-the-board software support is provided.

### The case for 16 bits

Another point that has been made is that in some cases software costs can be lower with use of a 16-bit processor, instead of an 8-bit device. The hardware price is usually about the same.

One reason for lower 16-bit software costs is that in some applications it may take more than 8 bits to define one instruction. In the 8-bit machine the machine must read in and fetch from two memory locations to get the instruction.

In one example, a system using a 16-bit processor took 1800 lines of coding in 1800 memory locations. Use of the 8-bit machine for the same job would have taken 5000 to 6000 memory locations. For, although the microprocessor is only 8 bits wide, the number of locations could have been divided

by 2, but the software would still have come out with 2500 to 3000 lines of coding. And this would have required the debugging of 700 to 1200 lines more than necessary with the 16-bit machine.

### High-level languages useful?

There has been much argument about the usefulness of high-level languages for microprocessor system development. So far four high-level languages for microprocessors have been offered.

The first entry, introduced two years ago, was Intel's PL/M. Motorola has just announced a



**Microcomputer emulators**, like this Rockwell PPS-8MP, shorten the time and reduce costs required for software design and system debugging.

new language: MPL. Plessey has a high-level language called PL-MIPROC, which is a super-set of Algol. And a "super-enhanced industrial Basic" has been generated by MITS, Inc., Albuquerque, NM, for the company's Altair 8800 microcomputer.

Phil Roybal, microprocessor marketing manager of National Semiconductor, Santa Clara, CA, feels that most high-level languages are not good for bit manipulation or I/O instructions.

"That is why," he says, "almost no minicomputers or large-scale machines use these languages for writing the operating systems and the drivers or anything normally done with microprocessors.

"If you can intermix high-level and assembly languages, it helps. Unfortunately, some are attracted to the high-level languages because it looks so easy to program. But they're wrong."

James Lally, manager of systems products for Intel, Santa Clara, CA, notes that "you use languages like Basic or Fortran or Cobol or Algol to do programming in which there is a lot of numerical analysis."

But Lally points out that the operating system itself is generally written in assembly language. Intel's PL/M language, he insists, is different from Fortran and the others, in that it is a systems oriented, rather than an applications oriented, language. The best indication of the effectiveness of a systems language is its use by the manufacturer, Lally says.

"We've used PL/M exclusively in the development of all of our software," he notes. "We've written our disc operating system, the ICE 80 executive, all of our assemblers and our text editors—everything—in PL/M."

### Language merger

Robert Albrecht, a Basic language expert and an executive of the People's Computing Co., a non-profit organization in Menlo Park, CA, likes MITS' unique merger of Basic and machine language.

"The enhanced Altair Basic can load in octal machine-language instructions as part of data statements in Basic, and then position them in memory," he notes.

And Altair Basic has a potential for teaching machine-language programming, Albrecht points out.

The language can also be used to control output devices and perform bit manipulation, according to Paul Wasmund, programming specialist at MITS.

"You can directly address any I/O port with the IN and OUT instructions that correspond to the IN and OUT instructions of the machine itself," Wasmund says.

"It also has 'peek and poke' functions for recalling any memory location desired. In addition there's a WAIT function that gives you a bit mask. For example, if you use a bit mask for ONE, the computer waits for that ONE to go either high or low, depending upon what else you tell it in the WAIT statement.

"With this function you can wait on a port until it inputs, and as a result the computer can handle devices like a/d's." ■■





**Where other data terminal systems grow old,  
this one is designed to simply grow.**

The Teletype® model 40 is the data terminal system to start with because it's completely modular, and is designed to grow as your needs grow.

The display, operator console, printer and controller modules form the heart of the model 40 system and permit a variety of configurations to suit your application.

There's a wide range of options, too, such as expandable memory with scrolling; half/full duplex modes; fixed and variable field transmission; protected formats; a variety of on-line controls; current loop and EIA (RS232) interfaces; and speeds from 110 to 4800 bps. Printer options include 80 column friction and adjustable tractor feed units.

And don't worry about obsolescence. Since the model 40 design consists of separate modules, you can select only those capabilities you need now—and add others later.

Add it all up. The model 40 system offers outstanding reliability, versatility and economy. And delivery is sooner than you may expect. No wonder you can't beat the model 40 on a price/performance basis. To start with. Or to grow with.

For complete information, please contact our Sales Headquarters at: 5555 Touhy Ave., Skokie, Ill. 60076. Or call Terminal Central at: 312/982-2000.

Teletype is a trademark and service mark registered in the United States Patent and Trademark Office.



**The Teletype model 40 system.  
Nothing even comes close.**



# Sensor-minicomputer network tells when lightning will strike

Because Sandia Laboratories conducts many tests of military ordnance in the sands at Albuquerque, NM, atmospheric static discharges and lightning are a constant hazard. They might trigger explosions, with resulting damage to telemetering cables and instrumentation at the test sites. Sandia asked: Why not predict when static discharges and lightning strikes might occur?

The result has been a minicomputer-controlled network called the Lightning Early Warning System. It collects and processes atmospheric and potential-gradient data from 14 sensors placed from two to 30 miles from a main station, reports William W. Shurtleff, project leader. The data are interpreted at the main station and then retransmitted to test sites that store explosives.

The computer controlling the system—a Hewlett-Packard 2114B with a 20-k memory—also obtains weather data from four remote stations located in known paths of lightning and dust storms.

Although the Sandia application for the early-warning system is unique, Shurtleff sees the basic long-line acquisition and monitoring functions applied to other uses, such as in solar energy experiments and intruder detection.

He points out that the weather station acquisition system, in particular, is a general-purpose, long-distance system that can be adapted to other applications.

The potential-gradient sensors are laid out in a grid system. Data are fed to the main station, analyzed and retransmitted to users at the various test sites. If the potential gradient at any sensor

reaches 2000 V/m, visual and audible alarms are sounded. The explosives are then stored until the danger is past.

The user, or test site operator, can adjust the potential level at which an alarm sounds. He may, says Shurtleff, reduce the level to as low as 500 V/m when he is monitoring tests that employ particularly sensitive explosives.

The test-site equipment has, as part of its display, a potential-gradient map with 2000 V/m warning lights. The observer can follow the path of a storm by watching the sequence in which the lights go on and off (see photo).

## Sensors are radioactive

The key element of the system, Shurtleff explains, is the potential-

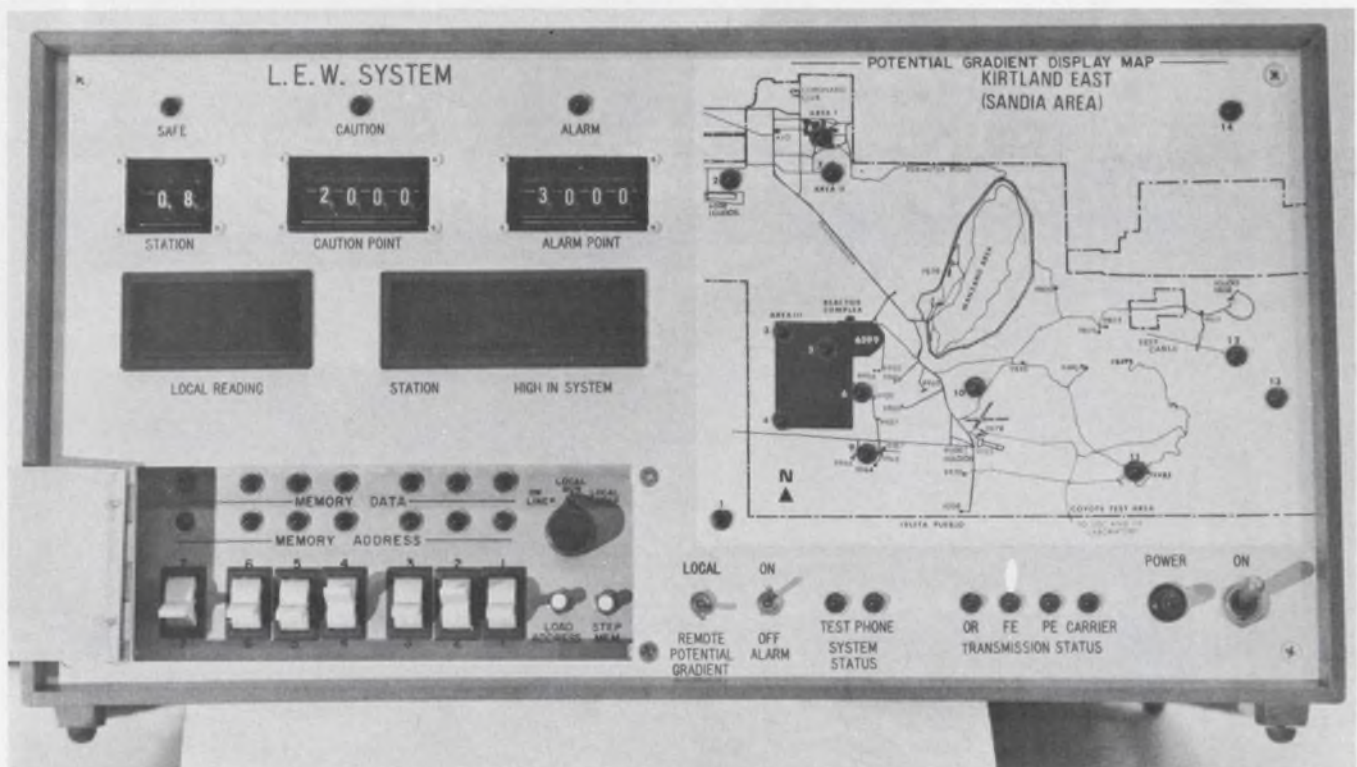

Display panel of on-site early-warning system equipment has a map with sensors pinpointed by warning lights.

Storms can be traced by watching the lights go on. The system is installed at Sandia Laboratories test sites.



Amphenol Scot Pot.<sup>TM</sup>  
 Amphenol trimmers.  
 Two bargains  
 your competitors  
 may not know about . .  
**YET.**



The word is out — Amphenol offers a big selection of quality precision pots and trimmers. They can replace what you're using now — in form, fit, and function — and save you money in the bargain.

**Our Scot Pot** is as good as (or better than) any other 10-turn wirewound miniature precision pot on the market. It has improved electrical, mechanical, and environmental characteristics. Yet Scot Pots cost as much as 25% less than other equivalent pots.

And that's news that won't stay secret for very long.

**Our 3/4" rectangular trimmers** come in a full range of resistances and in all popular pin spacings. They're sealed to withstand automatic board cleaning. And they're highly stable — no drift. Two series to choose from: 3810 wirewound (available with Vista-Trim for fast, approximate visual settings). And 6034 cermet trimmers. Both series save you plenty. Ask for a quote and see how much you can beat the competition by.

**For off-the-shelf delivery**, call your local Amphenol Industrial Distributor. Your competitors may have already discovered his great service — so should you. Give him a call. Or for more information (and spec sheets on our pots and trimmers) contact: George Boyd, Amphenol Connector Division, Controls Operation, 2801 South 25th Avenue, Broadview, Illinois 60153. Phone: (312) 261-2000.

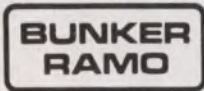
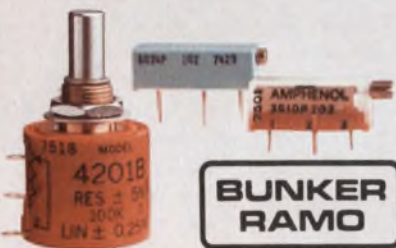

*When you can connect it  
 and forget it...that's quality.*  
**AMPHENOL**



# The Switch Is To RCL SWITCHES

From A Sophisticated

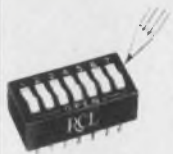

"PIP"<sup>®</sup>  
("Programmable  
In-Line Package")  
To

13 Series of Low Cost  
**COMMERCIAL  
SWITCHES**

From



**KEYLOCK  
SWITCHES**

To

**HOMING  
SWITCHES**

From

**4 POSITIONS**

To

**24 POSITIONS**



From  
**1 DECK**  
To  
**20 DECKS**

**RCL DELIVERS  
FROM STOCK**

Call our hotline for prompt  
service and delivery.  
(201) 374-3311

**AMF**

**RCL Electronics**

General Sales Office:

**700 So. 21st Street  
Irvington, N. J. 07111**

## NEWS

(continued from page 28)

gradient sensor. Eleven of these probes are linked to the central station by telephone wires and three by an rf telemetering system. Designed by Sweeney Manufacturing, Denver, each sensor contains a small amount of radioactive tritium, which ionizes the air surrounding the probe. The output ionization signal, which is detected by an electrometer FET amplifier, increases with an ambient, positive potential and decreases with a negative.

The FET output is detected, amplified and converted to a frequency by a Sandia-designed voltage-controlled oscillator. With a zero ambient atmospheric potential at the probe, the VCO output is 1000 cycles. For a positive 2000 V/m gradient, the frequency increases to 1500 Hz; for a negative 2000 V/m voltage, the frequency decreases to 500 Hz.

The probe signal is sent over phone lines or an rf transmitter. The transceiver is powered by a solar-energy panel.

As Shurtleff explains the rf-probe operation, the main station, under computer control, sends out a tone that is unique to a field station. Upon receiving the tone, the field unit switches from standby to full power, takes a reading and sends back a tone frequency that is proportional to the gradient measured. The field transceiver unit then returns to standby power status to wait for the next interrogation signal.

At the main station, the rf signal is received, detected, amplified and filtered to produce a pure af tone. The tone is multiplexed into a frequency-to-voltage converter, which translates it to a dc voltage that is proportional to the measured potential gradient.

The dc voltage is fed to an a/d converter having 11 bits plus a sign bit. The a/d output is computer-compatible.

### System needs maintenance

Experience with the rf system has shown that the batteries must be recharged once every six months, despite the constant charge from the solar panel.

Shurtleff points out that recalibration and maintenance are performed at the same time and that the system has worked well through snow, rain and dust storms.

Signals received at the main station via remote-probe telephone lines are converted, in the same way as the rf signals, to digital data that can be fed into the computer.

In addition to the probes, the four remote weather stations transmit, over phone lines and upon computer command, wind speed, wind direction and temperature. The weather system has 16 channels at each station, thus providing 13 spares that can be used for additional meteorological data or weather-related experiments.

The computer requests a weather station to transmit data by sending a 360-Hz tone over its telephone line. The tone resets an a/d converter at that station to the first channel, and a reading is taken locally. The reading is converted to a series of digitally encoded FSK tones that contain the station and channel numbers, and 10 bits of data that are sent back down the line to the computer.

In like fashion, the readings of the other weather channels are converted, encoded and transmitted to the computer, until all active channels are interrogated and have replied. The system is then automatically reset and ready to start over again.

At the main station, the data tones are converted to digital levels, checked for errors and presented to the computer. Once the computer request has been satisfied, the 360-Hz tone is turned off and the process stops.

The remote stations have their own self-test features, Shurtleff points out, including test points, LED displays of critical levels and manual cycling capability.

After a weather station was struck by lightning, destroying a wind-direction sensor and translator circuitry, lightning surge arrestors were placed at all stations.

At the main station, the programming support consists of a high speed paper-tape reader and punch and a Texas Instruments operator terminal. Twin cassette tapes are available for recording data and programs. ■■



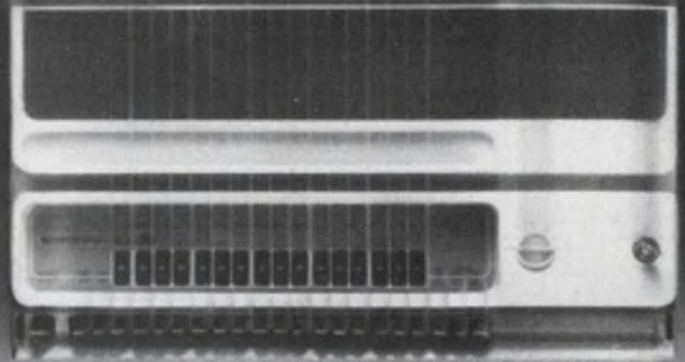
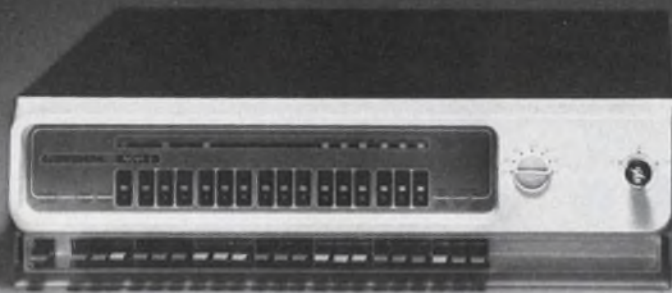

## The biggest thing to ever hit the OEM market, gets even bigger.

The four slot version of the Nova 3 gets pretty big. Up to 32K words of memory. But Nova 3 doesn't stop there. If you want to go further, consider the 12 slot Nova 3.

It can take on up to 128K words of memory. And our optional Memory Management Unit makes efficient use of all that memory, without a lot of systems overhead.

If you're going to need more I/O than the 12 slot Nova 3 can give you, there's an optional 12 slot expansion chassis.

And if one fully expanded Nova 3 still isn't big enough to handle the problem, you can add more Nova 3's and make multiprocessor systems. And they come with standard off-the-shelf software.

Why do we go to the trouble of offering such a wide range of configurations?

So you can meet any number of different systems requirements with the same processor. Without buying a lot of

different spares. Without training your people in a lot of different test and maintenance procedures.

And so you can take your smallest product and make it a lot bigger. Without systems redesign. Without rebuilding your interfaces. Without rewriting your software.

And, no matter how small a Nova 3 you start out with, you get big performance. Nova 3 executes instructions in only 700 nanoseconds. Or more than twice as fast as the computers you're apt to compare it with.

Yet for all its bigness, there is one small feature in the Nova 3. Price. You can get a 64K word MOS memory Nova 3 with Memory Management Unit, Automatic Program Load and Power Fail Protection for just \$16,800\* (Or a smaller Nova 3 for an even smaller price. A 4K MOS system for \$2,600\*.)

Write for the brochure.

You may discover that bigger is better.

\*Single unit price before OEM and quantity discounts get figured in.

# DataGeneral

## Nova 3: The biggest thing to ever hit the OEM market.

\*Data General, Dept. N2, Route 9, Southboro, Mass. 01772 (617) 485-9100. Data General (Canada) Ltd., Ontario. Data General Europe, 15 Rue Le Sueur, Paris 75116, France. Data General Australia, Melbourne (03) 82-1361. Sydney (02) 908-1366.

INFORMATION RETRIEVAL NUMBER 21



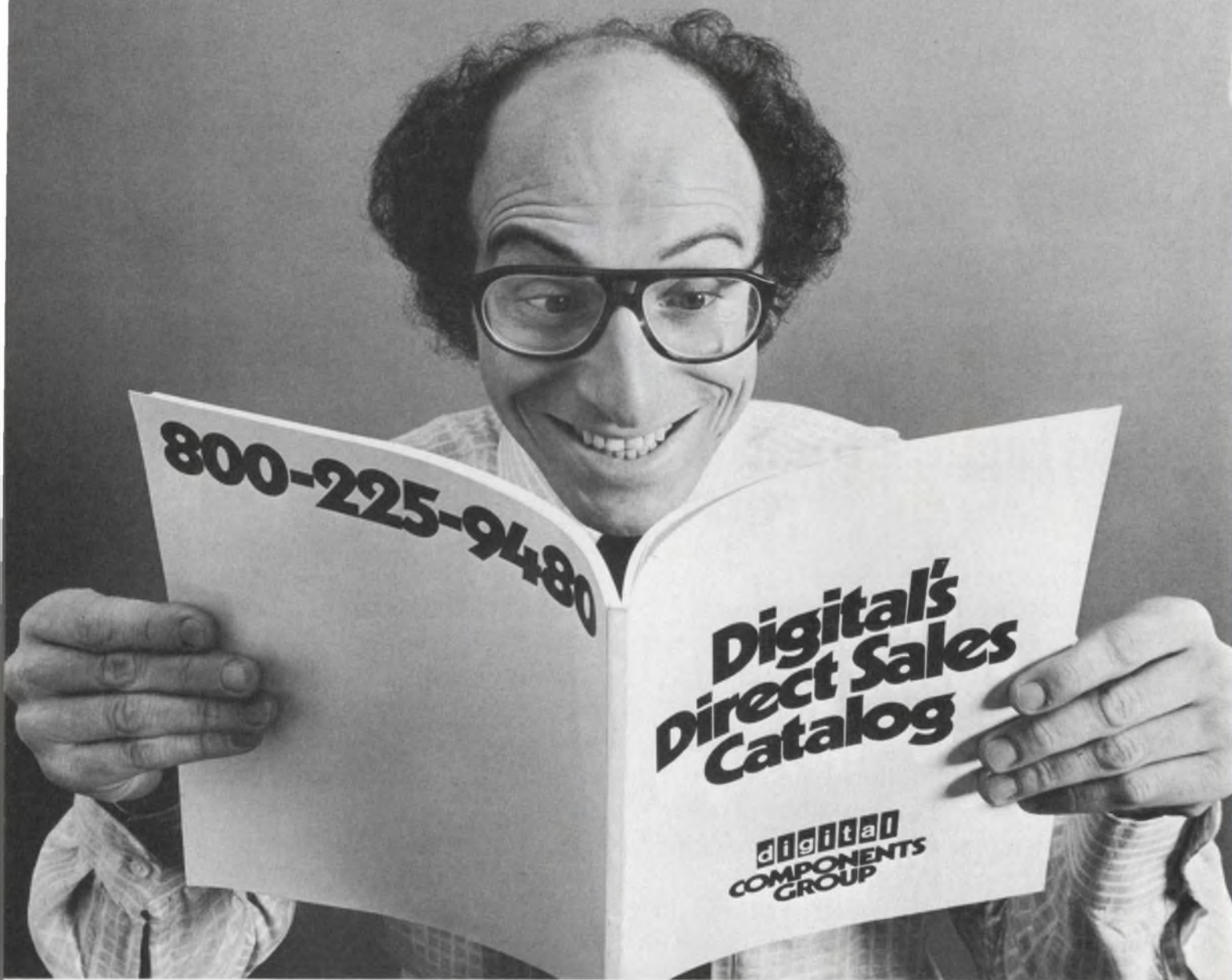

## Sears Roebuck, look out.

Introducing Digital's Direct Sales Catalog. The world's first catalog to offer computers and computer-related products by mail, with off-the-shelf delivery.

In addition to the convenience of catalog buying, you also get a nifty 5% discount on quantities to 49, plus another 4% if you send cash with your order.

Products offered include micro-computers, logic modules, terminals, even things like cabinets, connectors, supplies, and accessories.

You get a 10-day free trial period, plus our standard 90-day warranty. (Though since we're selling by mail, you do have to install the equipment yourself.)

The Digital Direct Sales Catalog. A 9% discount. A 100% convenience.

For your free copy, call 800-225-9480 (Mass. 617-481-7400 ext. 6608). Or write: Components Group, Digital Equipment Corp., One Iron Way, Marlborough, Mass. 01752. (Catalog sales to U.S. only.)

**digital**  
**COMPONENTS**  
**GROUP**

INFORMATION RETRIEVAL NUMBER 22



# Microprocessor Design

## Compiler for 6800 offers a high-level language to speed $\mu$ C programming

No longer does Intel have the only high-level language, and associated compiler, for microprocessors. Motorola now offers a compiler for its language, called MPL, that works with systems based on the company's 6800  $\mu$ P. Thus 6800 users have many of the benefits hitherto available only to users of the 8080 and 8088. But in addition the MPL (short for Microprocessor Programming Language) compiler contains such features as the ability to accept assembly-language statements, to manipulate bits, and to handle and reference data structures—collections of different kinds of data.

Both Intel's PL/M and Motorola's MPL languages are based on IBM's PL/1. The Intel compiler has been the sole microprocessor-compatible entry for the past two years or so.

Similar compilers are expected next year from Fairchild and National Semiconductor among others, though at least one manufacturer—Texas Instruments—plans to introduce Cobol, Fortran and Basic for its new  $\mu$ P (see "Processor Family Debuts," *Electronic Design* 22, Oct. 25, 1975, p. 137).

Like Intel's PL/M, the MPL compiler from Motorola (Phoenix, AZ 85036. 602-244-3466) can be used to reduce programming costs, increase software reliability and simplify program maintenance and documentation when compared with an assembly-language approach. But a program written in assembly language typically requires less memory space than one written in a high-level language.

(continued on page 34)

## Floppy-disc systems speed program development

The most time-consuming part of a microcomputer design—program development—can be slashed by a factor of 10 or more by the use of the floppy-disc operating system, or FDOS, from Icom (6741 Variel St., Canoga Park, CA 91303. 213-348-1391). With FDOS, a typical edit and assembly sequence takes 5 to 10 minutes, compared with 3 hours for a teletypewriter and 45 minutes with a high-speed paper-tape reader.

FDOS works in conjunction with the company's FD360 floppy-disc. Versions of the combined hardware/software system are offered for use with Intel's MDS-800 development tool and the Micropac 80A design aid from Process Computer Systems (Flint, MI). However, the basic FDOS/FD360 system can be applied to most microprocessors with the aid of standard interface circuitry.

Contained in FDOS are such single-command operations as disc-to-disc program editing and assembling, disc-to-memory program loading, and file transferring between paper tape and disc or between discs. Also, the operating system allows variable-length named files. The storage area on each diskette is available for any number of files of any length from a single sector of 128 bytes up to an entire diskette, or 256-k bytes. The files may contain program source data, program object data or user-generated data.

Prices for the MDS-compatible version start at \$2650 for a single-drive system, including all software and an MDS-interface card. The corresponding price for the Micropac-compatible unit is \$2400. Delivery is 2 to 4 weeks.



CIRCLE NO. 501



## MICROPROCESSOR DESIGN

(continued from page 33)

An important difference, however, between PL/M and MPL is that the Motorola compiler produces assembly language as an output, rather than going directly to machine code as PL/M does. MPL works in conjunction with the 6800's assembler. Thus MPL takes slightly longer for compilations because of the additional step.

But this provides several direct benefits. First, assembly-language statements can be embedded in a compiler-language program. Thus, you can optimize portions of a program by writing them in assembly language, without the entire program written that way. Another benefit is that assembly-language subroutines from, say, a user's library can be applied directly within a program otherwise written in the compiler language.

In addition, program debugging can be greatly simplified. You can more easily see what the computer is doing. If necessary you can use Motorola's Exorciser development system to insert breakpoints in the program, follow the processor's execution step-by-step and actually see the instructions in the assembly-language output as they are to be executed.

Further, portions of the program already written in the compiler language can be shortened somewhat if, say, available memory space is slightly less than that called for by the program. Motorola's MPL allows programs that occupy memory space as large as 65-k bytes, as does the latest PL/M versions.

In another difference, MPL permits data structures, like those found in Cobol. A particular data structure can include 8-bit and 16-bit

integers, as well as, alphanumeric characters such as might exist in an inventory system or anywhere that data isn't homogeneous. Data structures contrast with the more common data arrays—like those of Fortran—in which data must be of the same type.

The types of data that can be handled by MPL include bit, binary (1 or 2 bytes long), decimal, and label. The compiler's ability to manipulate individual bits overcomes one of the major drawbacks of existing high-level languages. Micros spend much of their time talking to the "outside world" in terms of bits, but earlier languages don't permit bit manipulation.

Another feature of MPL is that it can perform an automatic conversion of two binary numbers of different length or a binary and decimal number for arithmetic operations. And it allows three-dimensional arrays of data. Thus three levels of data can be stored and indexed.

Other improvements include signed integer arithmetic—the language allows the representation of negative numbers. Also subroutine arguments may be passed in internal registers, thereby saving program steps and memory space for subroutine calls.

Presently the MPL compiler is available on GE time-share services. Beginning during the first quarter of next year, versions priced at \$1250 will be available in Fortran on standard cards or magnetic tapes. Portable versions will run on any computer that has a word length of 16 bits or more. Thus many popular minis as well as large computers will be able to run the compiler. For more information

CIRCLE NO. 502 MOTOROLA, 503 INTEL.  
(continued on page 36)

**QUICK...**  
**What number**  
**is this?**



If you have to read your microcomputer the old-fashioned way — bit by bit, from rows of lights — the computer's making you do its work!

- Don't **toggle** in a program on a bank of switches — **key** it in.
- Don't read date and addresses **bit by bit** — read a series of **fully decoded digits** (octal or hex).
- Don't debug by **single-stepping** through a program — set **breakpoints**.



The **modular micros** from Martin Research. A 20-pad keyboard; six bright digits; and a Monitor program in a PROM make program entry easy. And, even the smallest system comes with enough RAM to get started! The **MIKE 2** system, with the 8008 and the 8080-based **MIKE 3** use the **same** bus structure. Accessories — like our 4K RAM — work with these and other 8-bit CPU's. And, systems start at under \$400!

Still available from Martin Research — our innovative book, **Microcomputer Design**. An industry standard for the engineer designing with microprocessors.



With 8080, \$150.  
With 8008-1, \$110.  
With 8008, \$100.  
Alone, \$75.

School and quantity discounts. Over 300 pages, dozens of schematics. Worth its weight in microprocessors!



**martin research**

3336 Commercial Ave.  
Northbrook, IL 60062 (312) 498-5060



# Hot-molded resistors provide low temperature coefficient and unmatched reliability.

The Resistance Temperature Coefficient of Allen-Bradley hot-molded fixed resistors is typically less than 200 PPM over the entire resistor range shown in the normal equipment operating temperature of +15°C to +75°C. Excellent RTC ratings have always been an Allen-Bradley benefit. And consistency of Allen-Bradley resistors means repeatable results and tight performance patterns. Allen-Bradley resistors offer the **lowest cost—on the board—**where it counts!

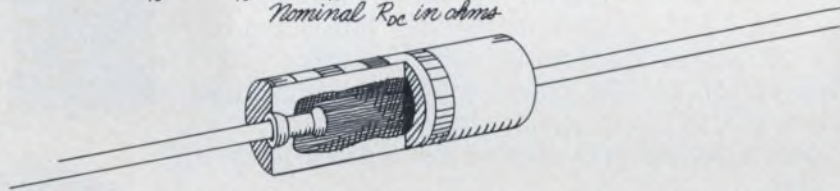
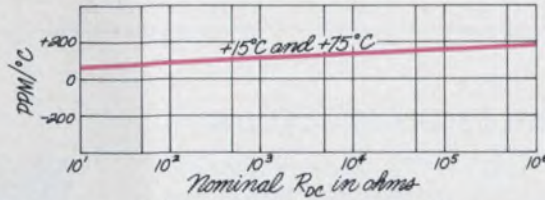

## *Reliability*

is unsurpassed. Over 700 million unit test hours without a single failure.

## *No coatings*

Insulation and resistance element integrally molded into one solid structure.

## *Pulse handling*

characteristics offer outstanding protection against surges and transients.

## Quality in the best tradition.



**ALLEN-BRADLEY**

Electronics Division  
Milwaukee, Wisconsin 53204

INFORMATION RETRIEVAL NUMBER 24

EC113



## Next in kits: do-it-yourself gas-discharge displays

Look for Burroughs to enter the rapidly growing microcomputer design-aid field with a display kit that will make it easier to monitor and check a developing micro system. The Plainfield, NJ, manufacturer is rumored to be working on a kit to be used with do-it-yourself processor systems to be offered by Intel, Motorola and others. The Burroughs' entry will have a single-line Self-Scan display with 16 or 32 characters, and it will contain a dc-to-dc converter to translate the low  $\mu\text{P}$  voltage levels to the 180 V or so needed for the gas-discharge displays.

## 16-bit microcomputer system cycles in 350 $\mu\text{s}$

Plessey Microsystems, Inc. (1674 McGaw Ave., Santa Ana, CA 92705. 714-540-9945) has introduced the Miproc 16, a high-speed 16-bit microcomputer with a cycle time of 350 ns. The computer has 82 instructions, which include multiply and divide. It is a complete processor on a card and is configured for parallel fetch and execution.

Included in the Miproc 16 are two separate program memory and data memory architectures, so most instructions take a single cycle. Conditional branches take 700 ns, and multiply or divide times are 5.6 and 11.2  $\mu\text{s}$ , respectively. The system is supported by a versatile prototype development system and a Fortran IV cross-assembler simulator for use on the Tymshare and GE Mark III networks.

The price of the CPU board is between \$700 to \$800 for large quantities, and delivery is 30 days.



CIRCLE NO. 504

## Security field turns to micros for monitoring and control

The security electronics field, long dominated by the relay and battery, is taking on new sophistication with the introduction of microprocessor-controlled monitoring and scanning equipment. The microprocessor is starting to do a good portion of the job once done exclusively by either hard-wired logic or manual control.

For years, large apartment complexes and office buildings have used guards, sitting at panels of video monitors, to detect trouble. Today these monitors are still used, but added to their effectiveness are  $\mu\text{P}$ -controlled scanners that can monitor alarms in up to 1000 locations. In addition card readers controlled by microprocessors are permitting selective access to restricted areas.

Whether the system application is scanning or selective access, microprocessors are ideal as control elements because of their inherent flexibility, says Victor White, vice president of Receptors, Inc., Torrance, CA. "We presently use the Digital Equipment Corp. LSI-11 microcomputer to handle the data from our Model 300 multiplex monitoring and control system," he notes. The LSI-11 is built around a custom microprocessor.

Microprocessor systems developed by Keltron, Waltham, MA, are based on the Intel 8080. These systems can monitor up to 1000 points and provide visual and audible alarms. Two basic systems are being offered by Keltron: the DM-600, a 100-zone system, and the DM-700, a 1000-zone system. The smaller system, complete with all zone circuits, costs about \$3500 and can connect to an optional printer, if hard-copy printout of conditions is needed. The larger system costs about \$6000 when equipped with 100 zone circuits and a printer, but it is expandable to 1000 zones.

(continued on page 38)



The real test for a display's readability is direct sunlight. Most of them are washouts.

By comparison, Beckman displays stand out. With wider viewing angles and more brightness by the foot. Important factors when you're looking at critical readouts in the air or on the ground.

The reason for most of our product advantages can be summed up in two words: Neoptic™ displays. Combining neon and advanced electronics for a feat in human engineering.

Besides outstanding visibility, Beckman Neoptic displays give you letter-perfect numbers. No breaks or gaps. Natural, flowing lines to the eye. In any number. And in pleasing oranges you can filter to bright reds. Perfect for the designer who wants his numbers to look like numbers. Not like jigsaw puzzles.

Beckman Neoptic displays are the designer's designs. Modular. In character heights from 1/3" to 1". Arranged on

one- to four-digit, plug-in building blocks that save space and assembly time.

Reliability is part of the Beckman Neoptic display picture. Assured by extensive in-process testing and 100% burn-in. As a result, we can give you a warranty that's good for 1 year. (Or you may qualify for our Warranty Plus Option.)

To top it all, Beckman Neoptic displays can give you a visible edge in your market — a simple case of product differentiation.

This is how Beckman displays beat the daylights out of all others. Point for point, digit by digit. Clearly and decisively. And if you're not convinced, just plug in one of ours. Then compare it to theirs. The difference will show up day or night.

For complete details, write: Beckman Instruments, Inc., Information Displays Operations, P.O. Box 3579, Scottsdale, Arizona 85257, or call: (602) 947-8371.

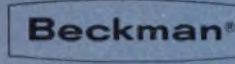

INFORMATION DISPLAYS OPERATIONS

INFORMATION RETRIEVAL NUMBER 25

## Beckman beats the daylights out of all other displays.

A close-up photograph of a man with grey hair, wearing dark sunglasses and a suit. He is holding a small, rectangular Beckman display in his right hand. The display shows a bright orange digit '2' on a dark background. The background is a bright, clear blue sky, suggesting a sunny day.

**Beckman displays.  
The visible edge.**

This photo of our model SP-101 was taken in actual daylight.



*(continued from page 36)*

Selective entrance or exit in large company stock rooms, data-processing centers and vaults can be critical. To keep track of who enters and leaves, microprocessors and other dedicated processors are being used to control the opening and closing of doors and gates.

Encoded pass cards, about the size of plastic credit cards, contain data that are keyed back to a central controller or used by a "smart lock" to open doors. The controllers can usually check the code against a list of stolen and defunct cards and either generate an alarm if an illegal card turns up or open the door if the card holder is authorized.

On large processor-controlled systems entry codes can be changed at the flick of a switch. Smart locks, on the other hand, must either be rewired or all the pass cards must be changed. Processor-controlled system prices start at \$10,000 for a system that can handle 1000 remote readers and 20,000 individuals. Smart readers cost about \$650 each.

## PC-board PROM permits easy word changes

The Plug-Prom ROM uses small, 0.5 × 1-in. plug-in printed-circuit boards to program half an 8-bit word. Two plugs are needed for each memory word. Each plug is labeled with a hexadecimal value (0 to 9, A to F) that programs a diode matrix.

The Plug-Prom connects easily to any system using a short cable with a 24-pin plug on the end and is electrically equivalent to a type 1702 PROM. A LED option, a helpful tool, lights a LED in every word position when that word is selected. If the execution time is slowed or single-cycled, the LED indicators will visually show every fetch, jump, jump-to-subroutine and return-to-subroutine in the program.

Brent Olson (1950 Colony St., Mountain View, CA 94043. 415-326-2000) offers eight models, with dimensions ranging from 15 × 8 to 15 × 30 in. Organizations of 8 × 32 to 8 × 256 are available, and prices range from \$250 to \$1995. The plugs cost extra. Delivery of standard units is from stock to 60 days.

CIRCLE NO. 505

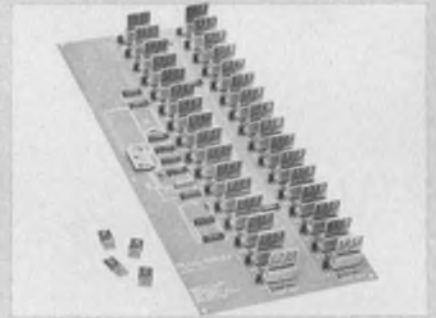

## 16-bit processor system has multiple-sourced software

Execution times of less than 1 μs and multiple-sourced software are offered by the Micromini System 300, a 16-bit microprocessor from Monolithic Memories (1165 E. Arques Ave., Sunnyvale, CA 94086. 408-739-3535). The μP system is based on the company's Model 6701 bipolar bit-slice processor.

The system comes in a variety of forms. It is available as a fully tested kit of components, as a set of PC cards, as a stand-alone six or 12-slot card file, or as a chassis-mounted computer with power supply and programmer's front panel.

The System 300 is software compatible with Data General's NOVA series. Compatible mass-storage operating systems with full software-development support are available from both Xebec Systems (Sunnyvale, CA) and Educational Data Systems (Newport Beach, CA).

Versions of the System 300 come in two performance ranges, as well as, in a militarized

*(continued on page 40)*





# I/O To Go.

**The Am2905/6/7 Bus Transceivers:**  
High-speed I/O for your microprocessor any way you want it. Three versions of the same superb low-power Schottky LSI slice. Yours. Off the shelf. Now.

Single or dual driver input ports. With or without parity checking and generation. With or without three-state receiver outputs.

The Am2905/6/7 have open collector outputs that drive 50-ohm loads on terminated long lines. They store driver and receiver data for pipeline operation. And, with a bus-to-receiver delay of just 17 nanoseconds, they're ideal for any microprocessor, bipolar or MOS.

The Am2905/6/7 are the best microprocessor I/O's you can get. Any way you slice it.

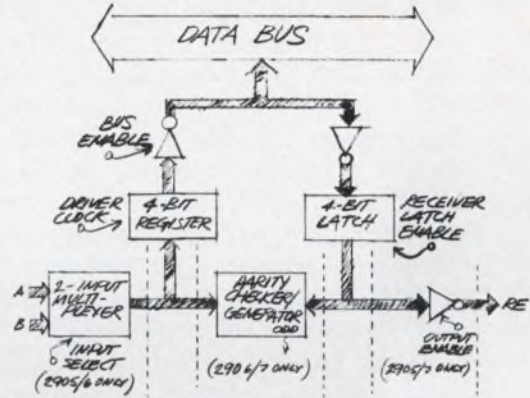

## Bye bye, MSI.

Say bye bye to your complicated, costly MSI systems. The Am2900 family is here!

We started with the world's fastest, most powerful LSI microprocessor, the Am2901. And went on from there until now we have eleven large scale, low-power Schottky circuits that combine the architectural simplicity and functional flexibility of MSI with the performance and cost advantages of LSI. Check the block diagram of a typical high-speed microcomputer, and you'll find everything you'll ever need for computation, control, communications and storage in any high-speed microprogrammed application.

If you like the picture, you'll love the book. Send for the Am2900 story, and wave bye bye. Bye bye, MSI!

# Advanced Microprocessors



Advanced Micro Devices • 901 Thompson Place, Sunnyvale, California 94086 • Telephone (408) 732-2400 • Distributed nationally by Hamilton/Avnet, Cramer and Schweber Electronics.

INFORMATION RETRIEVAL NUMBER 26



(continued from page 38)

form. The 301 CPU (\$1250 in unit quantities) allows instruction execution time of 900 ns, and the 304 CPU (\$625 in unit quantities) permits 1800 ns. The 302 CPU operates over the -55-to-100-C temperature range.

CIRCLE NO. 506

## Portable analyzers design and test $\mu$ P systems

Both the program and hardware for systems using popular 4-bit and 8-bit  $\mu$ Ps can be designed and tested with a new series of portable analyzers from Pro-Log (852 Airport Rd., Monterey, CA 93940. 408-372-4593). The new instruments eliminate the need for control panels, diagnostic routines or other data-processing tools for testing microprocessor-based systems.

The series consists of units that test systems based on 4004, 4040, 8008, 8080 and 6800  $\mu$ Ps. Used in conjunction with standard oscilloscopes, they can test program and hardware either together or individually. The analyzers display all data related to a selected instruction cycle and generate a scope sync pulse. They interface to the system under test through use of a DIP connector that clips onto the microprocessor.

Prices range from \$550 to \$750, and all analyzers are available from stock.

CIRCLE NO. 507



## 16-bit $\mu$ P chip set includes DMA chip

The latest microprocessor entry is a 16-bit, three-chip set from Panafacom (P.O. Box 4637, Mountain View, CA 94040). It features a CPU IC that can perform 16-bit parallel operations in 3  $\mu$ s or less. The two other chips—the Subchannel Adapter (SCA) and Direct Memory Access Controller (DMAC)—provide the I/O functions for the new PFL-16A chip set and permit data-transfer rates up to 1 Mbit per second.

The CPU chip responds to 33 basic instructions, allows six addressing modes and has five 16-bit registers. Like other processor chips, it contains control logic, arithmetic and index registers and stack pointer. But in addition the new CPU has three levels of program-maskable interrupt control and a type of software interrupt called program-status-word switching. And its auto-start feature ensures startup from a specified address whenever power is turned on.

The SCA chip operates in a program-control mode if used alone and in a DMA mode when used with the DMAC. Up to eight DMA channels, each with four subchannels, can be accommodated by the PFL-16A. The total subchannel capacity is 32, and up to 256 input and 256 output device addresses can be connected. Further, the chip set operates with either 8 or 16-bit data; external systems using either can be interfaced directly.

Each of the three chips in the set is a silicon-gate NMOS circuit requiring 12, 5 and -3-V supplies. Each chip features TTL compatibility and comes in a 40-pin DIP.

The PFL-16A system is available on preassembled, standard-sized cards. Thirteen cards are offered, and their use simplifies hardware development. For software development, Panafacom provides three complete debugging and program-maintenance systems. Other software support includes resident and cross-assemblers, editors and loaders.

CIRCLE NO. 508

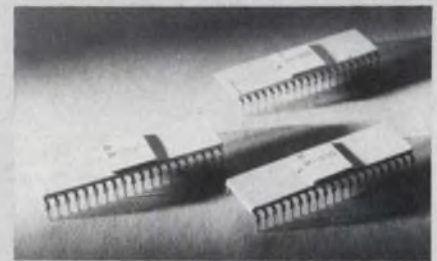



What's new in solid state...

# RCA announces a no-nonsense price for the no-nonsense $\mu$ P

Has high cost kept you away from microprocessors? RCA just demolished that reason. Even in small quantities you can buy our versatile CDP1801 8-bit CPUs at only \$40 for the 4-6-volt version, \$56 for the 3-12-volt version.

This, of course, is the RCA 1800 no-nonsense microprocessor family. Simple, easy to program, flexible. COSMAC architecture was designed with one no-nonsense objective: maximum flexibility with minimum cost. COSMAC cost-effective features include: single power supply; single phase clock; compact programs and strong I/O to reduce memory and I/O circuit requirements. Plus the CMOS benefits of low power and high tolerance of temperature extremes, supply variations and noise.

Compare support systems, too. The RCA Software Development Package is available two ways:

in Fortran IV and on GE Timeshare. Our Microkit gives you low-cost systems breadboarding. And for low-budget programming we offer a Resident Software Package. A listing of memory and logic (I/O) parts, Microkit cards and other literature available to you is in the RCA 1800 brochure 2M1135.

#### Microprocessors (CPU), 1-99 quantities

CDP1801D (3-12 volts).....	\$56.00
CDP1801CD (4-6 volts).....	\$40.00

#### Hardware support

CDP18S001 Microkit (basic).....	\$2250.00
CDP18S002 Microkit (Stand-alone).....	\$3000.00
(Includes resident Assembler & Editor)	

#### Software support

CDP18S900 Software Development Pkg.....	\$2000.00
CDP18S902 Batch Assembler.....	\$750.00
MPM-101 RCA 1800 User Manual.....	\$5.00
MPM-102 Program Development Guide.....	\$10.00

For more information, contact your local RCA Solid State distributor. Or RCA.

Write: RCA Solid State, Box 3200, Somerville, New Jersey 08876; Ste. Anne de Bellevue 810, Canada; Sunbury-on-Thames, U.K.; Fuji Bldg., Tokyo, Japan.

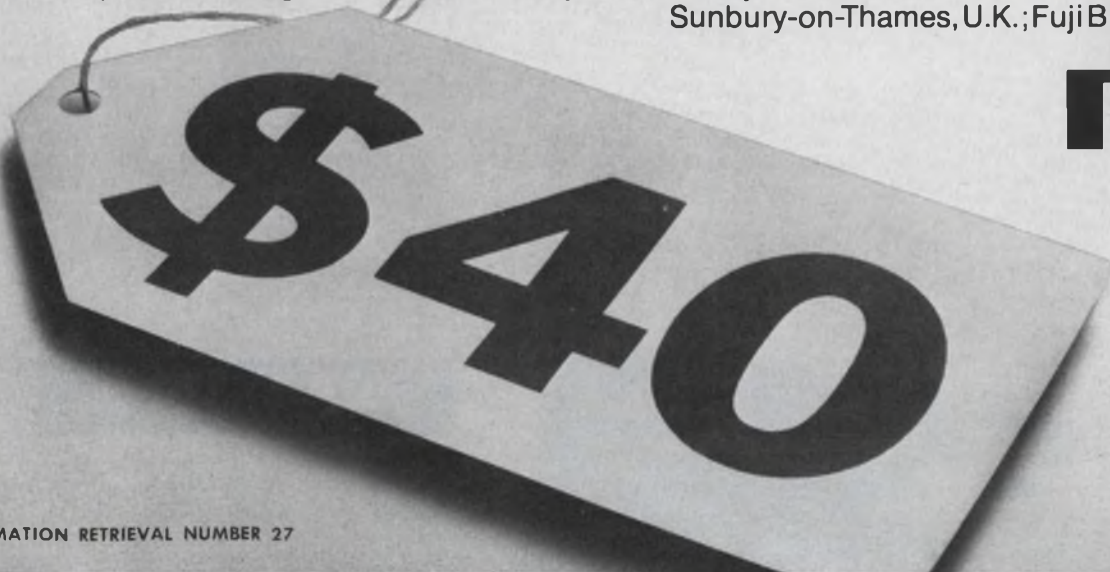
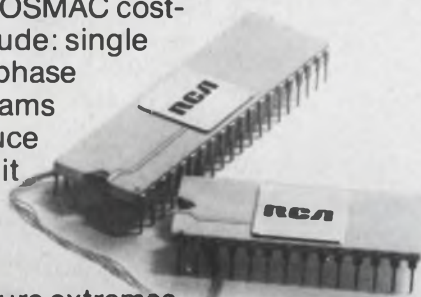

# RCA

INFORMATION RETRIEVAL NUMBER 27

RCA 1800. Low-cost approach to microprocessing.



**EXTRA!  
EXTRA!**

**Free Demos  
Arranged!**

★★★★★

## Compatible Memory News

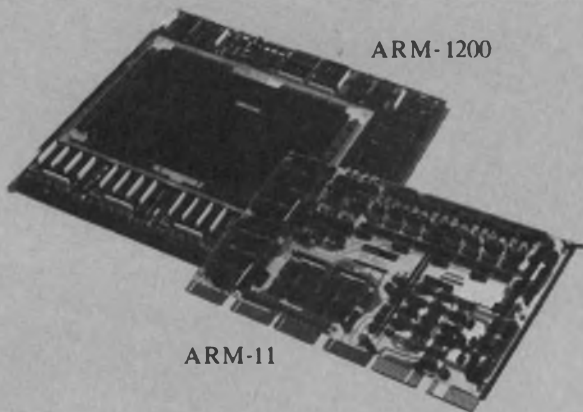

ARM-1200

ARM-11

### DEC AND NOVA\* USERS SAVE \$\$\$

Now Ampex representatives have immediate stock of add-in memories for PDP-11 and Nova 1200 series computers.

Call your closest Ampex Memory Man today and tell him to bring out an Ampex add-in so you can see how well it works, how easy it is to expand your capacity, and how much money you can save.

#### EXTRA SAVINGS

Ampex add-in memory modules save hundreds of dollars (20% or more) over the original mainframe manufacturer's list price.

#### EXTRA CAPACITY

Ampex add-in modules give you 16K capacity per unit, and use only two slots in PDP-11, and use only one slot in Nova 1200 computers.

#### EXTRA RELIABILITY

Ampex add-in memories offer better margins, lower noise, and more conservative design overall than any competitive product you can buy.

#### EXTRA AVAILABILITY

Ampex ARM-11 and ARM-1200 memory add-in modules are available immediately from stock.

#### TEST ONE TODAY. CALL AMPEX

(201) 489-7400	(312) 593-6000
(206) 454-9332	(412) 371-6050
(212) 736-6116	(415) 367-3861
(213) 821-8933	(505) 294-1491
(214) 637-5100	(516) 822-9110
(215) 887-7650	(602) 242-5551
(301) 530-8800	(617) 890-2040
(303) 674-5255	(713) 774-8714
(305) 783-1811	(801) 278-6920

\*TM. Data General Corporation

# AMPEX

Ampex Memory Products Division  
13031 West Jefferson Blvd.  
Marina Del Rey, CA 90291



# Washington Report

## Competition sought in common-carrier communications

An inquiry by the House Subcommittee on Communications into regulations affecting domestic common-carrier communications is setting the stage for regulatory reforms that could shake up the communications industry.

The White House policy on the communications industry emerged loud and clear in testimony: Market competition should be the rule and regulated monopolies the exception.

One beneficiary of competition would be the Federal Government, the nation's largest customer of telecommunications, with a current investment of \$50 billion and an annual expenditure of \$10 billion. Government procurement has largely been sole-source from monopoly common carriers, and a competitive market would ostensibly result in savings.

"We still have today a kind of presumption in favor of regulated monopoly," says John Eger, acting director of the Office of Telecommunications Policy in the White House. "This means, in practice, that any would-be provider of a new or improved service must bear the onus of justifying his entry into the market and must undergo the accompanying burden of regulatory delays—and must usually accept the added cost of some kind of regulations."

The Ford Administration contends that the burden of proof should be shifted in favor of competition and that those opposing it should be obliged to show concretely that the detriments outweigh the benefits.

## Rise in defense budget spending planned in '77 budget

The Ford Administration's tentative budget estimate for fiscal 1977 calls for \$11.5 billion more for defense than was authorized for 1976. Defense budget authority would increase from the current \$103 billion to \$114.2 billion, and outlays from \$91.5 billion this fiscal year to \$103 billion in fiscal 1977.

Procurement of defense items again takes a back seat to personnel costs, which would account for over \$6 billion of the increase. Budget authority for procurement would rise from the current \$22.2 billion to \$24.4-billion. Actual outlays would increase from this year's \$16.2 billion to \$18.3 billion.

The Defense Dept.'s research and development budget authority would increase to \$10.6 billion from \$9.7 billion, and outlays are expected to be \$10 billion, compared with \$9.3 billion this year.

Almost no change is projected for general science and technology, which includes the National Aeronautics and Space Administration budget. That



category will climb \$300 million to a total of \$4.6 billion, and all of the hike is for manned space flight in connection with the space-shuttle program.

The President will officially transmit the 1977 budget to Congress early next month.

## **FAA landing and beacon programs pushed**

The Federal Aviation Administration has a green light from Congress to move ahead with three systems: microwave landing, discrete-address beacon and aeronautical satellite. This approval came with passage of the Dept. of Transportation money bill for fiscal 1976, in which \$67.5 million was earmarked for FAA's research, engineering and development.

Congress didn't specifically break out the allocations for the programs, leaving that to the agency, but it did say that the funds were intended to provide sufficient capital to ensure essential progress in the microwave landing and beacon systems. In restoring funds for Aerosat, Congress said it expected the FAA to test both L-band and vhf capabilities and to present findings to the Congress to acceptance of either frequency.

## **Minimum altitude control sought by military**

In the near future air controllers and military control centers are going to be alerted instantly when aircraft are below minimum safe flying altitude. This capability will come from a programmable indicator data processor system now under development by the Air Force, which plans to buy 91 units under a contract to be awarded in the spring of 1976. Navy flying fields will also get the units.

The heart of the new system is a programmable digital minicomputer which will generate alphanumerics to indicate flight density, ground speed and message data. Radar scopes will either have to be modified or replaced to accommodate this more detailed presentation of flight information.

**Capital Capsules:** The Dept. of Transportation has authority in its budget to begin deployment of a Loran C navigation network in the Gulf of Mexico and along the Atlantic Coast. . . . The Air Force is testing a new electronic security system in a variety of terrains. Tests have been made at sandy Eglin AFB in Florida, and Fort Drum in northern New York State is to be the next site. The transducers under development are said to be so sensitive that they can detect ground vibration caused by air waves from a helicopter flying overhead. The object of the tests is to program the system's logic so it can tell the difference between a man crossing a field of sensors and, for example, a rabbit. . . . The Air Force Systems Command wants a source to develop a low-cost high-performance integrated circuit capable of amplifying photodiode signals at data rates to 10 Mbits/s. The Directorate of R&D Procurement (ASD/PPM-1) at Wright-Patterson Air Force Base also is looking for low-cost fiber-optic transmitter and receiver modules for those data rates. . . . Congressional pressure is reportedly one reason why the Energy Research and Development Administration has deferred to next month or later that issuance of guidelines for submission of proposals for the Solar Energy Research Institute. Southwestern states are on record as saying their area would be ideal for such a facility.



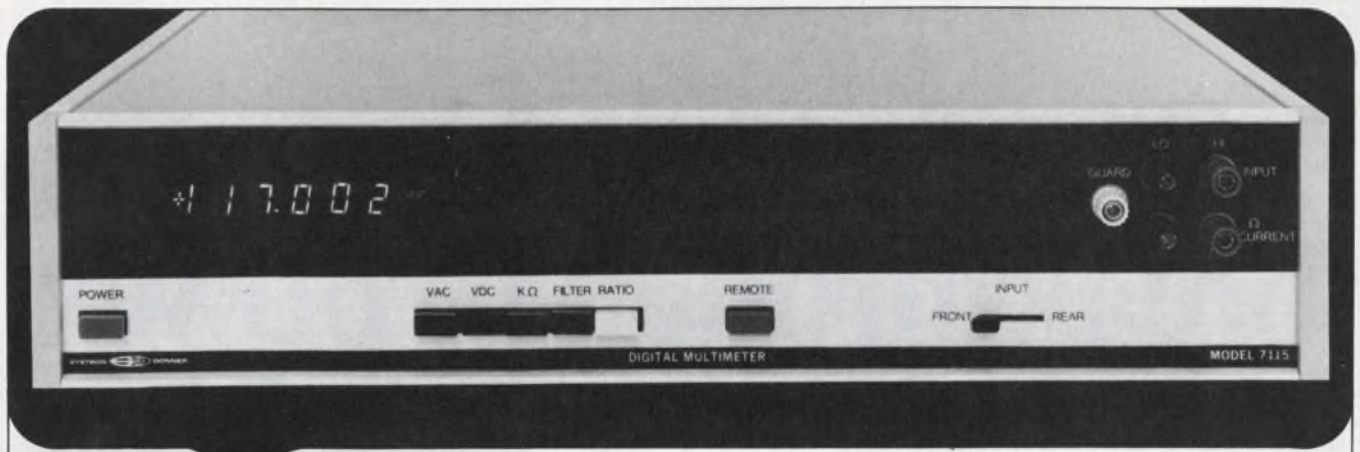

# Go SDVM\*

## \*Systron-Donner "smart" DVM

Meet Model 7115, the industry's first **microprocessor**-based digital multimeter. It does what no conventional DVM could hope to do:

**Automatic zero/self calibration.** Using its computing power and built-in memory, Model 7115 continually calibrates itself against drift and component aging. Similarly, it detects and corrects for zero drift and offset error. Result: accurate readings all the time!

**Self-diagnosis.** Microprocessor power again. Out-of-limit conditions or failures are signalled

on the front panel; internal LED's direct the operator to their location inside.

**High-speed autoranging.** A rapid new S-D autoranging technique finds the correct range, goes there immediately and reads. It's not only a big improvement for bench use, but systems users can now use autoranging.

**Command performances.** An optional keyboard for programming the Model 7115 allows it to linearize and normalize, run comparison programs for checking out-of-tolerance conditions, multiply by a constant, average readings... and much more.

**These features, too.** Up to 100 readings/sec. • DC accuracy of  $\pm 0.002\%$  rdg. • Parallel programming or ASCII option • True RMS AC volts option • High accuracy resistance measuring option.

Get the full story on the first SDVM from Scientific Devices, or contact us at 10 Systron Drive, Concord, California 94518. Phone (415) 676-5000. Overseas, contact Systron-Donner in Munich; Leamington Spa, U.K.; Paris (Le Port Marly); Melbourne.

SYSTRON  DONNER



# The first packaging breakthrough in power transistors for switching power supplies:

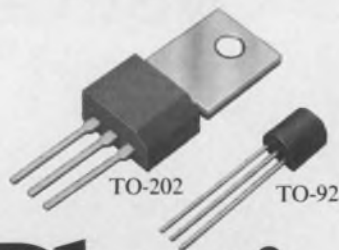

## Plastic.

Introducing the Unitrode Plastic Power Switching Transistors.

The first series of power transistors in plastic designed and characterized for maximum efficiency at 20KHz and above in switching power supplies up to 300W.

This means that now, for the first time, you can get high-

priced power switching performance in a low-cost package.

For complete specs on the

whole line, simply circle the reader service number, drop us a line, or call Ed Rodriguez at 617-926-0404.

And find out how to get everything you want in a power switching transistor.

For less than you're willing to pay.

Unitrode Corporation, 580 Pleasant Street, Watertown, Mass. 02172.

### PERFORMANCE

SERIES	UPTD	UPTC	UPTF	UPTA	UPTB
PACKAGE	*	*	*	**	**
$BV_{CEO}$	60-100V	60-100V	100-300V	100-300V	200-500V
$I_c$	5A	2A	2A	.5A	.1A
$t_r(\mu s)$ typical	.2	.2	.5	.2	1.0
$t_s(\mu s)$ typical	.3	.2	.5	.2	.25

\*TO-202

\*\* TO-202 OR TO-92



**UNITRODE**

INFORMATION RETRIEVAL NUMBER 30



## Delegating authority

Joe's a great manager. If you don't believe it, ask him. He's read just about every book anybody has ever written on management and he subscribes to all the management publications. He has probably read everything Peter Drucker has written 16 times.

One of the cornerstones of his success, he confides, is that he knows how to delegate authority. Just about everybody working for him is authorized to do something. But if you ask his people, they offer a different view.

"Sure he delegates authority," Stan will tell you, "but he gives it to you with one hand and takes it away with the other." If one of Stan's engineers screws up, Joe will be in there chewing him out. And if one of Stan's engineers does a sensational job, Joe will promise him a raise—often forgetting to mention this to Stan.

So Stan has all the authority he wants and needs to do his job properly, but Joe frequently takes it away without telling him. Under pressure of a deadline, Stan gives one of his engineers a time-sensitive assignment, only to discover later that Joe has stopped by to chat and asked the engineer to run through some tests on a different project. The engineer, unfortunately, hadn't read all the management books so when his boss' boss asks him to do something, he does it.

I'm particularly sensitive to this problem because, eleven years ago, I lost a fine editor, who resigned one day because he never got the fantastic raise promised him by my boss, who never bothered to tell me about it.

It's unfortunate that our industry has bred so many hundreds of well-intentioned Joes for whom thousands of Stans must bear a double burden. It might make a major contribution to improving the way we operate if they could teach themselves, when speaking to their subordinates' subordinates, to restrict their conversations to: "Good morning," "How are things going?," "Did you hear about these two guys in a saloon who. . .?"



A handwritten signature in dark ink, appearing to read "George Rostky". The signature is written in a cursive, flowing style.

GEORGE ROSTKY  
Editor-in-Chief



# THIS YEAR...





# LET ELECTRONIC DESIGN PAY FOR YOUR VACATION

ENTER OUR JAN. 5, 1976

# TOP TEN CONTEST



## WIN THE POPULAR CARIBBEAN WINDJAMMER CRUISE FOR TWO

Once again, by reader demand, a week's Windjammer Cruise for two in the fabulous blue Caribbean is waiting for the lucky winner of *Electronic Design's* annual TOP TEN CONTEST. Think of it . . . a complete vacation absolutely FREE! Spend easy carefree days sailing among the Bahama Out Islands, the U.S. and British Virgin Islands, or the exotic Windwards and Leewards. Shop in the free ports, sun, swim, snorkel, help sail the ship or just relax by the rail. It's truly the cruise of a lifetime.



## PLUS A COOL \$1,000 CASH AND PRE-PAID AIR TRANSPORTATION FOR TWO

In addition to the cruise, the first prize winner gets \$1,000 cash, plus air transportation for two to and from the cruise ship's point of departure.

## PLUS FREE AD RERUNS FOR YOUR COMPANY

If your company has an ad in *Electronic Design's* Jan. 5, 1976 issue, and you are one of the top three reader or advertiser winners, you earn a free ad rerun\* that can be worth up to several thousand dollars for your firm.

## 100 PRIZES IN ALL

### READER PRIZES

**1st Prize:** Caribbean Windjammer Cruise for two, \$1,000 cash, air transportation for two, free ad rerun\*.

**2nd Prize:** Portable color TV set, free ad rerun\*.

**3rd, 4th, & 5th Prizes:** Digital wristwatch, free ad rerun\* (3rd prize only).

**6th through 100th Prizes:** Technical books.

### SEPARATE CONTEST FOR ADVERTISERS AND THEIR AGENCIES

Advertisers, marketing men, and advertising agencies can enter too. Duplicate awards are given to the top three winners (cruise, cash, air transportation, free ad rerun\*, color TV and digital watch). Remind your advertising people it's the issue of the year to build business for your company and win valuable prizes at the same time.

### HERE'S ALL YOU HAVE TO DO TO ENTER

Examine the January 5, 1976 issue of *Electronic Design* with extra care. Read the Rules. Then:

- (1) Select the ten ads you think will be best seen and read.
- (2) List the ten ads by company name and inquiry number on the contest entry card.
- (3) Fill in your name and address and mail before midnight Feb. 15, 1976.

\*The top ten ads will also receive free reruns. Only one free rerun per company. The first three prize winners in the reader contest and the first three prize winners in the advertiser contest awarded reruns only if their companies have an ad in the Jan. 5, 1976 issue.

## COMPLETE RULES AND ENTRY BLANKS IN JAN. 5 ISSUE



## Employ $\mu$ P software tools properly,

and you'll shorten development time and reduce errors. Get to know the three types of design aids offered by vendors.

Software provided by microprocessor vendors is an invaluable tool for the digital system designer. Properly used, it can greatly speed the development and reduce the errors in a program design. For these reasons, logic designers ought to be aware of what software packages are available and how they can be used effectively.

There are three types of computer software: operating, program-development and diagnostic (Fig. 1). This is true for microprocessors as well as for minicomputers and large mainframe computers.

Operating software is the group of programs that runs on the computer under normal use. In a dedicated computer system, the programs are in the read-only memories (ROMs) that come with the machine. For example, in a microprocessor-controlled automatic weighing system, the operating software is the program that calculates and displays the weight. Usually operating software combines user-written and vendor-supplied programs.

Program-development software refers to design tools that help in the creation of operating software. It is a computer-aided-design package, and the tools range from simple assemblers to complex high-level-language compilers.

Diagnostic programs test the computer hardware and verify that the system is operating properly. Typical programs test the central processing unit, memory and selected I/O devices. There are also software diagnostic programs, such as simulators and debuggers. These test for proper program sequencing and functioning.

### Who does what in software?

The user must write his own operating software, since this represents the logic design of the system or product being built. The computer vendor can supply some prepackaged items, such as binary loaders and mathematical subroutine packages, but the rest is created by the user for

his application. On the other hand, diagnostic software is a fixed package of programs supplied by the  $\mu$ P vendor.

Program-development software represents the largest investment on the part of the computer supplier. It is this type of software that is usually referred to when one speaks of a vendor's software support, and the degree of support can vary markedly from one vendor to another.

If you are a logic designer using microprocessors for the first time, you may ask: "What does all this software do for me?" You have to answer this question to know what you need for your design and how to evaluate what the microprocessor vendor is supplying. The three types of software may be needed even for very simple systems.

A computer system design for, say, an automatic meat scale typically goes through the following steps:

1. State the problem. (Create an automatic meat-weighing scale with digital readout.)
2. Analyze the problem into a sequence of operations that will perform the function.
3. Arrange the sequences in a list or flow chart that will show how they are to be performed.
4. Write the program from the flow chart of operations. If the definition of the operations is detailed enough, this should be a simple conversion. Each operation will be performed typically by a few instructions.
5. Enter the instructions into the computer-system memory. Let us assume that we enter it manually through the computer front panel.
6. Test the program. This will probably be done first by stepping the computer through the program, instruction by instruction, and then at full speed. This corresponds exactly to testing a hard-wired logic system, clock-step by clock-step, and then at full speed. When the program and system have passed these tests, the program design is complete.

### Small systems can be designed easily

For a simple program of, say, 20 words, the design is straightforward. Instructions, address-

---

David C. Wyland, Microprocessor Design Manager, Monolithic Memories, 1165 E. Arques Ave., Sunnyvale, CA 94086



es and data can be generated as binary bit patterns. These bit patterns are entered through the front panel, and the program is then tested. Programs of 100 words or larger, however, create the following problems:

1. Instructions are hard to remember as binary numbers.
2. Addresses are difficult to remember as binary numbers. Also, addresses change when the program changes. It is often hard to remember what the address locations are being used for.
3. It is difficult to follow the program flow with binary addresses and data during debugging.
4. The program must be entered into the computer memory. Programs of over 100 words are impractical to enter manually through the front panel.
5. If you have a system failure during debug-

#### Operating software:

- Customer application programs
- Binary loaders
- Relocatable binary loaders
- Operating systems
- Miscellaneous utility programs:
  - Math subroutines
  - I/O control subroutines
  - Paper tape copy and list programs
  - Etc.

#### Program development software:

- Assemblers
- Relocatable assemblers
- Paper tape editors
- Macroassemblers
- Compilers
- General-purpose microassemblers

#### Diagnostic software:

- CPU diagnostics
- Memory diagnostics
- I/O device diagnostics
- Software diagnostics:
  - Debuggers
  - Simulators

1. **Three types of software**—operating, program-development and diagnostic—exist for all computers, from micros to large mainframes.

#### Source Tape Listing:

```

                                Sample Program
Start: . LOC 2      ; First Word to Location 2
      DIA 0, 15   ; Load Reg 0 From Device
                        15, Reg A
      LDA 1, X    ; Load Reg 1 From Location
                        X
      ADD 1, 0    ; Add Reg 1 to Reg 0
      STA 0, Y    ; Save Result In Location Y
      DOB 0, 15  ; Output Result To Device
                        15, Reg B
      JMP Start  ; Loop Back To Start
X:    30         ; Octal Data
Y:    0         ; Result: Initial Value = 0
      . End

```

#### Assembler Program Printout:

```

                                Sample Program
000002      . LOC 2      ; First Word To Lo-
                                cation 2
060415 Start: DIA 0, 15 ; Load Reg 0 From
                                Device 15, Reg A
024010      LDA 1, X    ; Load Reg 1 From
                                Location X
123000      ADD 1, 0    ; Add Reg 1 To Reg
                                0
040011      STA 0, Y    ; Save Result In Lo-
                                cation Y
062015      DOB 0, 15  ; Output Result To
                                Device 15, Reg B
000002      JMP Start  ; Loop Back To Start
000030 X:    30         ; Octal Data
000000 Y:    0         ; Result: Initial Val-
                                ue = 0
                                . END

```

#### Binary Tape Contents:

```

000002
060415
024010
123000
040011
062015
000002
000030
000000

```

2. **An assembler generates this sample program.** Each line of the source-tape listing contains one or more symbols that define a binary word.



Command	Description
Y	Read in a tape. Tape is terminated by a special end-of-page character.
P	Punch the contents of the buffer with an end-of-page character.
Pn	Punch (n) lines of the buffer with an end-of-page character. Begin at line pointer.
W	Punch the buffer without an end-of-page.
Wn	Punch (n) lines without an end-of-page.
T	Type the contents of the buffer.
Tn	Type (n) lines of the buffer.
I	Insert text following (I) at the line pointer location. Terminate with Escape character.
C	Change line: Find (within the current line) the text string between (C) and the first Escape character. Replace with the text string between the first and second Escape character following (C).
Kn	Erase (n) lines following line pointer.
B	Set line pointer to beginning of buffer.
Ln	Move line pointer down (n) lines. (n) can be negative.

Command Formats: A, An  
A = alphabetic command character  
n = modifier number, as required

A paper-tape editor employs various commands to read alphanumeric characters into a buffer area in memory, modify the buffer's contents and punch a new tape from the modified buffer. Modifications are performed on lines of text, and each line consists of a string of characters terminated by a carriage return.

ging, you need to know what is failing, the program or the hardware.

Program-development software packages attack the first three problems. They make instructions, addresses, and data easier to remember and manipulate by the program designer. Operating software, such as loaders and operating systems, attacks the fourth problem of entering and running the program. Diagnostic software for both hardware and software functions attacks the fifth problem by providing tools that help the designer locate the problem.

### Assemblers: Simple, but powerful

Assembler programs represent the lowest level of program-development software. But though an assembler provides but a few basic bookkeeping functions, it allows a programmer to design programs of up to several thousand words.

An assembler provides three functions to the programmer: It allows him to specify instructions by name, to specify addresses by name, and to specify data in several forms other than binary. Instead of writing down a list of binary numbers for instructions, addresses, and data words, the

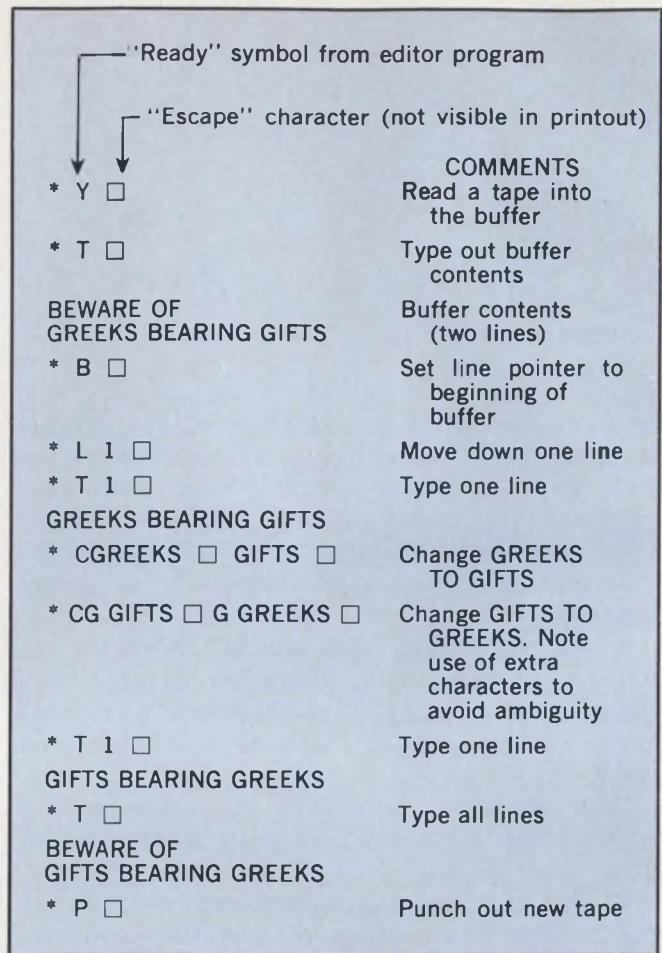

An example of a paper-tape editor's operation employs a Ready symbol and an Escape character.

programmer lists shorthand symbols for the instruction words and names for the address words, and he specifies data constants in more convenient decimal, octal, or hexadecimal data formats. The assembler program then processes this list to create a corresponding list of binary numbers.

The list of symbols that an assembler processes to create the binary program is called the source program. Each line of the list contains one or several symbols to define one binary word. A line in the source program may also provide information to the assembler program, such as indicating the start and the end of the source program, as well as where the binary program is to be placed in memory. A small assembly-language program illustrates these features (Fig. 2).

Each assembler has its own list of shorthand symbols or mnemonics for instructions. This list may be either fixed or expandable, depending on the design of the assembler. It is possible to write a general-purpose assembler in which all of the instruction mnemonics are defined by the user. These mnemonics are usually three to five characters long.



Memory locations are named by writing the name, followed by a colon, before a line that specifies an instruction, a data constant or another address. The assembler associates the address value for that location with that name. Names are usually restricted to five or fewer characters. There may be other restrictions about numbers and nonalphabetic characters in the names.

Once a location has been named, it can be referred to by that name throughout the rest of the program. This is very convenient, because if the program is changed and the named location becomes a different address, the assembler will automatically use the new number. The programmer does not have to perform any calculations to determine the new address. Likewise he does not have to scan the program to find all of the places where that address may be used and then update them.

The ability to specify data in other than binary form is also a useful feature. It is very time-consuming for a programmer to convert decimal data to binary if he needs to specify a decimal constant. And manual conversion is prone to error.

Microprocessors and small minicomputer systems use paper-tape assemblers. These programs accept the source data on paper tape and also produce the binary program output on paper tape. In the source paper tape, one line of teletypewriter data is interpreted as one line of source code. A paper-tape assembler assumes the existence of a small operating program called a binary loader. The binary loader reads the binary paper-tape output from the assembler and generates the corresponding binary words in the memory of the computer.

The binary loader program, although small, may itself be too long to be loaded into the computer by hand. A second, smaller paper-tape loader program, called a bootstrap loader, is used to load the binary loader into memory. This bootstrap loader is designed for minimum size and easy entry from the front panel.

A paper-tape assembler package usually includes a program called a paper-tape editor whose primary purpose is to overcome a problem that occurs when source tapes are generated. It is difficult to add or delete characters or a line of characters in the middle of a paper tape. The editor overcomes this problem by reading the source tape into a buffer area in memory. It allows the user to add and delete lines and characters to and from this buffer. It punches out the new source tape when additions, deletions and modifications are complete.

Diagnostic programs determine whether a system failure is caused by hardware or software. Hardware diagnostic programs are usually sup-

plied with each machine. Typically one diagnostic program is supplied for the CPU, memory and each I/O device. When a user designs a custom I/O interface, he must also write the corresponding diagnostics. Software diagnostics are called debugger programs. These tend to be loosely classified under the heading of program development software, although, in fact, they are a type of operating software. Obviously, debugger software is considered a marketing tool by the computer vendor in the same category as program development software.

The software debugger program is a collection of useful functions. A simple, teletypewriter-based debugger program will include the ability to load memory from paper tape, dump a section of memory to paper tape, and dump a section of memory to the teletypewriter printer in readable format. It will also include the ability to examine and modify memory locations and to execute a program starting at a specified address.

### **Debugger permits breakpoints**

A debugger has another important feature, called breakpoint. This allows the programmer to stop the program when it reaches a specified point. To use the feature, the programmer inserts a breakpoint at an address in the program. The debugger program then goes to that address, removes and saves the instruction and inserts an instruction that causes the computer to jump back to the debugger program. After returning to the debugger, the original instruction is replaced. Thus the program can be executed up to a point and then stopped. The programmer can then examine the memory to see if failures have occurred.

The debugger program duplicates many of the functions of the computer front panel. But while the computer front panel directly controls computer hardware and is useful for debugging hardware problems, the debugger program focuses on software problems. Its use assumes that the hardware is working well enough for the debugger program itself to run.

### **More powerful tools**

The amount of support software required by the logic system designer depends on the size of the program he intends to write. If the program is less than 200 words, support software may not be required. It may be practical to create the program directly in binary or hexadecimal form, enter it through the front panel and debug it manually through the front panel.

For common programs of approximately 200 to 4000 words, a paper-tape assembler and debug package are sufficient. But for larger programs,



systems of programs and programs of a high degree of complexity, more extensive software support packages have been developed. These include (in order of increasing sophistication) relocatable assemblers and loaders, macroassemblers and high-level-language compilers.

A relocatable assembler is the same as a simple assembler, except that it produces its binary tape in a format that is compatible with a relocatable loader. This loader allows the programmer to load several programs at the same time and to stack them automatically in memory. It also provides any necessary communication between programs, such as in a program that calls several common mathematical subroutines. The relocatable loader must modify all addresses used by a given program, since these addresses depend on where the program finally ends up in memory. Thus a relocatable loader is considerably larger and more complex than a simple binary loader.

A macroassembler allows the programmer to create and specify blocks of instructions. Suppose a programmer uses a three-instruction sequence for any call to an I/O device. A macroassembler allows the programmer to define this three-instruction sequence and to assign a special mnemonic to it. When this mnemonic is encountered by the macroassembler during processing of a source program, it will create the corresponding three binary words. These user-defined multiple-word instructions are called macroinstructions.

High-level-language compilers, such as those for Fortran and PL/1, are somewhat like macroassemblers. A high-level language provides these four features:

1. The ability to specify mathematical operations in algebraic form and have them converted to a series of instructions.
2. A convenient method of handling real numbers in floating-point notation. This is the same as adding a floating-point feature to a fixed-point calculator, since most computers are binary fixed-point machines in operation.
3. The ability to specify data in a matrix or subscript form. Data can be identified by row and column location within a matrix. This is convenient for handling large amounts of data and data arranged in matrix or table form.
4. Indexing macros for a loop sequence. Program loops are very common and typically require several instructions in the beginning and end of each loop.

### Programming vs debugging time

These sophisticated software packages have a disadvantage, though. Because of their size and sophistication, they create a distance between the

source code and the binary object code. This is inherent in any program-development tool, from a simple assembler up to the most complex compiler, and it's easy to understand why this is so. The more a program does for you automatically, the less aware you are of what it is doing in the resulting binary code. A programmer using the simple paper-tape assembler creates a source program that is very close to the resulting binary code. The symbols used are one-for-one representations of the binary code.

A programmer writing in a high-level language like Fortran may never see the binary code except when he is debugging the program. This distance from the machine code is significant only during program debugging, which requires dealing with the binary instructions being exe-

Command	Description
An	Examine/modify accumulator register (n)
En	Examine/modify memory location (n)
Gn	Go to location (n) and execute program
Il,m,n	Initialize: load (n) into all memory locations between (l) and (m)
Dm,n	Dump memory to teletypewriter printer, locations (m) through (n)
R	Read in program from teletypewriter paper tape reader (binary loader function)
Om,n	Punch out memory contents from locations (m) through (n) in binary loader format on teletypewriter paper tape punch
B	Breakpoint examine/set
C	Continue from last breakpoint

Command Formats: A, An; Am,n; Al,m,n  
 A = Alphabetic command character  
 l,m,n = modifier number as required by command

**Commands for a debugger program** allow the isolation of software errors. The debugger has a breakpoint capability that permits the program to be stopped when it reaches a specified point.

executed by the machine. Debugging a simple assembly-language program is fairly straightforward. Usually the assembler will print a listing of the source-language statement, the resulting binary data and the address where that data will be loaded by the binary loader.

A program written with a relocatable assembler forces you to find out where the relocatable loader put the program in the memory and mentally change all of the addresses on the listing. A program written in Fortran will give you no listing of the binary data that is loaded in the memory, but it will give you the addresses for the data and subroutine packages used. You must



then know or learn how the Fortran compiler generates the resulting binary code from its source-statement input.

The use of program-development software tends to result in fewer program errors, because these tools do many things automatically and provide many design-checking features. But if the program doesn't work, sophisticated debugging techniques may be needed.

### Special techniques for special problems

Several other program packages commonly available represent solutions to special problems. One of these is the "microassembler," which is actually a misnomer. A microassembler is really a general-purpose assembler that allows the programmer to define the word size of the machine, the instruction mnemonics, and their corresponding binary bit patterns. A microassembler can therefore be used to generate an assembler for a specific machine.

Operating systems are similar to debuggers. They can load and run programs and dump the contents of the memory to a printer or other output device. Often they provide software-diagnostic features. Unlike a debugger, the operating system contains a relocatable loader and can load programs from different sources, such as paper tape, magnetic tape and disc.

An operating system is typically used in conjunction with a disc file or other storage medium and provides a library function as well. This means that the user can specify a program by name, load it, and execute it. The operating system includes facilities for program filing on the storage units. These facilities include program loading, dumping, copying, renaming and deleting.

The operating system also provides a standard set of I/O control subroutines. These allow all programs to use the same method of calling I/O devices. The system can then provide various I/O utility features, such as stopping the program to add paper to the printer.

Simulators are diagnostic tools for the debugging of software. A simulator creates a software model of a hardware computer. Each step of the internal operation of the simulated CPU is visible to the programmer. Complex problems of hardware and software interaction can often be solved with this tool, but it runs 10 to 1000 times slower than the hardware it simulates. This means you cannot use it to solve timing-related problems. ■■

#### Bibliography:

Wyland, David C., "Design Your Own Microcomputer," *Electronic Design* No. 20, Sept. 27, 1975, pp. 72-78.

Wyland, David C., "Increase Microcomputer Efficiency," *Electronic Design* No. 23, Nov. 8, 1975, pp. 70-75.



## Plug in to our program loader— STR-LINK™ ... ...for reliable, low-cost program loading.

STR-LINK is the first portable program loader to give you so many advantages in one package.

It's so compact that you can carry it wherever you go. And it's versatile too. A built-in interface makes it compatible with line printers, MODEM's, mini-computers, CRT's, programmable controllers, and send/receive printing terminals.

The key to STR-LINK's performance is our patented Speed-Tolerant Recording, a single-track, self-clocked technique that eliminates the need for an ultra precise drive mechanism.

Other features include:

- 20 MA current loop or RS232C.
- Read/Write capability at 110, 150, 300, 600 and 1200 baud.
- Ability to write at one speed, play back at that speed or any higher.
- 19" Relay Rack-Mount Kit available.

STR-LINK is available through sales offices in over 25 major cities in the U.S. and Canada.

And best of all, it costs as little as \$995 in OEM quantities!

For complete information on the most revolutionary program loader ever, write or call today.

**ELECTRONIC PROCESSORS  
INCORPORATED**

1265 W. Dartmouth Avenue, Englewood, Colorado 80110  
Phone: 303/761-8540 TWX 910-933-0171

INFORMATION RETRIEVAL NUMBER 31



# 'Electronic Design has in getting the



**Richard D. Vance**  
President  
AD-VANCE MAGNETICS, INC.



**MAGNETIC SHIELD COSTS REDUCED**

**AD-MU FULL PERMEABILITY SHIELDS**

**AD-MU CUSTOM FABRICATED SHIELDS FOR COMPONENTS AND SYSTEMS**

**COMPLETE FACILITIES IN 3 LARGE MODERN PLANTS**

**PHYSICAL CHARACTERISTICS OF AD-MU ALLOYS**

**AD-MU ALLOYS PROTECT PERMANENTLY**

**AD-MU CORE SHIELDS**

**AD-MU TAPE DATA PROTECTORS**

**AD-MU CORE SHIELDS**

**AD-MU CORE SHIELDS**

**MAGNETIC SHIELDS—ANY SIZE OR SHAPE**

From Ad-Vance Magnetics, Inc., The Precision Sliding Magnetic Shielding Specialists

**Typical DC Magnetic Properties for AD-MU Shielding Alloys**

PROPERTY	AD-MU-100	AD-MU-100	AD-MU-100	AD-MU-100	AD-MU-100
High Permeability	AD-MU-100	AD-MU-100	AD-MU-100	AD-MU-100	AD-MU-100
Med. Permeability	AD-MU-100	AD-MU-100	AD-MU-100	AD-MU-100	AD-MU-100
Low Permeability	AD-MU-100	AD-MU-100	AD-MU-100	AD-MU-100	AD-MU-100

AD-VANCE MAGNETICS, INC., 226 SEVENTH ST. / ROCHESTER, NH 05601 / 216 223-5158 / TWX 818-196-0000

Tell us what you think about the GOLD BOOK. (If it's good, we'd like to hear it. If it's bad, we want to improve it.)



# done one Hell of a job the **GOLD BOOK** to places it should be'

"The majority of our new business or new bids can be attributed to the **GOLD BOOK**," says Richard D. Vance, President, Ad-Vance Magnetics, Inc., Rochester, Indiana. Ad-Vance describes itself as the industry's largest, oldest, most experienced independent firm exclusively manufacturing magnetic shielding. Mr. Vance continues:

**"We're an old company with a new name, so not too well known in the field. Our two-page spread in the **GOLD BOOK** has made us much better known.**

**"The **GOLD BOOK** gave us opportunities to bid from firms who had never heard of us before they saw our **GOLD BOOK** ad. For example, just today we got to bid on 1,000 CRT magnetic shields for a midwest firm who found us in the **GOLD BOOK**.**

**"Engineers don't hesitate to tell us they saw our ad in the **GOLD BOOK** when they call. I do a lot of sales work in the field, and I run into the **GOLD BOOK** almost everywhere our magnetic shielding has an application, both in purchasing and engineering. You've done one hell of a job in getting the **GOLD BOOK** to the places it should be."**

Ad-Vance states that over 90% of past and present magnetic shield designs have been fabricated in the Ad-Vance plant during the past 20 years. Its magnetic shielding is used off-planet in spacecraft and satellites, and worldwide in precision industrial, laboratory, military and consumer applications.

Because the **GOLD BOOK** goes primarily to *Electronic Design's* audience of specifiers, Ad-Vance gets the benefit of 78,000 engineers, engineering managers, purchasing agents and distributors throughout the U.S.A., not to mention 13,000 overseas. These are the men who are ready to talk shielding—the men who have the authority to *buy*.

**ELECTRONIC DESIGN'S GOLD BOOK IS WORKING  
...IT'S WORKING FOR READERS...AND IT'S  
WORKING FOR ADVERTISERS, TOO.**



# Assembly language for $\mu$ Ps: Mnemonic programming isn't hard once you learn the coding. Here's how to organize and write a program.

Learning assembly language programming isn't hard. All an assembly language program consists of is a list of mnemonic commands that tell the microprocessor what to shift, pull from memory, which registers to clear, where to store data, etc. To do any work with microprocessor systems, programming is a necessity.

All  $\mu$ P manufacturers use a form of mnemonics, but unfortunately they are different from one vendor to the next. Therefore, to learn the basics of assembly-language programming, we will use the Motorola M6800  $\mu$ P and its software as an example, since its structure is fairly generic and since it is now available from more than one source.

A  $\mu$ P can be viewed as a group of registers that, upon command, extract data from a memory bank, perform the programmed operations and then return the data to the memory or to an output device. To do all these operations, the  $\mu$ P-based system must contain these main sections (Fig. 1):

- MPU—the main processing unit. This houses the registers, control gating and counters needed to manipulate and keep track of the data.
- ROM—the read-only memory. It usually contains the binary equivalent of the assembly-language program that gives the MPU all of its instructions.
- RAM—the random-access memory. This can be used to hold the active part of the program and any other data that are being inputted or generated. It usually is very volatile and is only for temporary storage.
- PIA—the peripheral interface adapter. This lets the MPU and memories talk to external devices, such as terminals, printers and tape drives in parallel data words.

Communication between the various sections of the  $\mu$ P system is done over a multi-line communications bus. One part of this bus is unidirectional—from the ROM to the MPU and contains mainly instructions and perhaps key

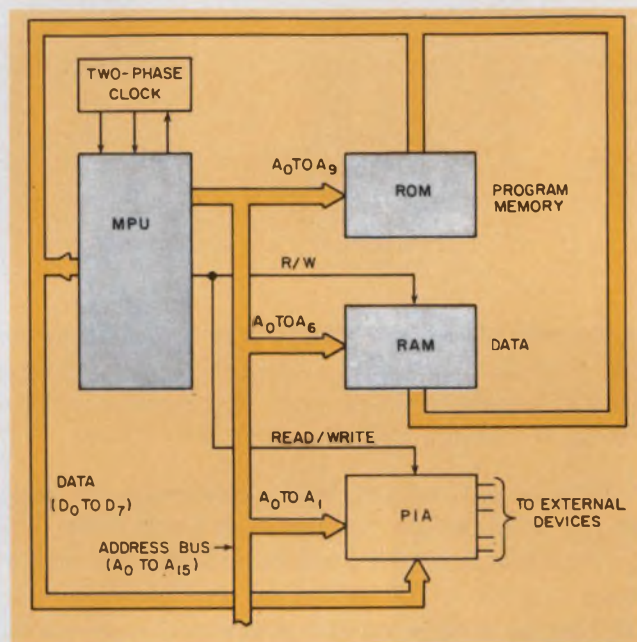

1. All major functional blocks are connected by a 16-bit address bus and an 8-bit data bus in the M6800  $\mu$ P-based system.

constants. The rest of the bus is bidirectional—the MPU can communicate with the RAM and PIA, and the PIA can talk to the RAM directly as if all of these were simply read/write memory.

In large systems the computer words are usually long enough to obtain the entire data word or instruction at once. In the smaller  $\mu$ P systems the words are only about half the size, and in some cases two or more words (of 8 bits each) must be used to supply data or give instructions. One prime example of this is when the data needed for the MPU to complete an instruction is external to the MPU.

When this happens, the MPU must reach out to successive locations where the data are stored and bring them to the registers within the MPU. To do this, address words must be issued to direct the data into the register.

Since all the MPU consists of is a bunch of registers connected by a complex gating arrangement and a controlling set of counters, let's examine these sections a little closer. The MPU



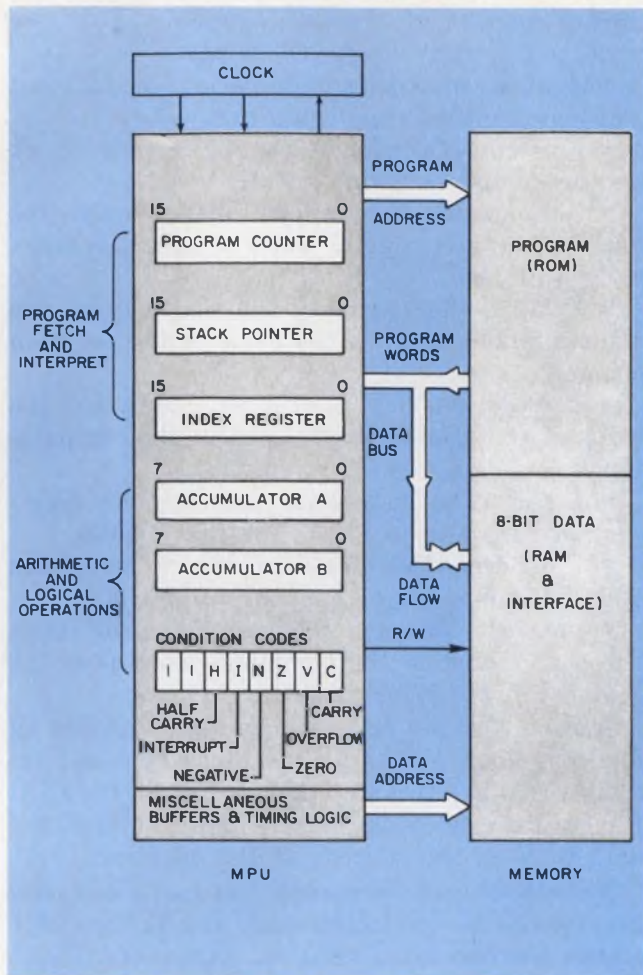

2. Inside the MPU are the different counters and registers that let you separately keep track of both the program and data. And, correspondingly, the programmer treats memory as if it were composed of two parts—a data or variable section and a command or instruction section. Also included are the logic circuits and control gates needed to do all the arithmetic operations.

can be divided into two main blocks (Fig. 2): (1) Program fetch and decode, and (2) The arithmetic/logical processor.

### Separate the commands and data

The first steps of the processing cycle depend on the data within the program counter of the MPU. These data determine which operation the computer is to perform. Subsequent cycles may generate read or write commands to the data or variable section of the memory in order for the processor to manipulate the data.

As a rule, the clocked program counter (PC) generates sequentially increasing addresses to pull control words from the ROM or other control block. The PC controls the entire operation of the processor, unless commands are encountered in the program flow that cause the counter to depart from sequential operation. The next value of the PC may then depend upon commands for conditional branching (similar to Fortran IF

statements) or direct branching (like GO TO in Fortran). The PC value may also be forced to a specific location by the presence of an external interrupt.

Data addresses depend on the type of command and can be modified by the value stored in the index register. The read/write control line of the MPU tells it whether it should fetch or store data.

Although the MPU operates under binary control, the chance for an error, should the program or data be entered manually, is enormous.

Assembly language is a shorthand way of writing the binary instructions that can be converted into binary form by an assembler. And, as a rule, a single statement generates a single storable command. These shorthand statements are grouped into fields and are designated by the following four names: Label, Operator, Operand, Comments.

The four elements when combined on a single line are separated from one another by some form of delimiter, such as one or more blank spaces, a slash or a comma. The Comments field is used only to help others understand what the programmer intends; it will not generate any instructions for the computer.

A sample working instruction for the M6800 might appear as follows:

```
UPDAT: LDA A, NB, BEGIN THE LOOP
Label Mnemonic Operand Comment
```

Labels help the programmer use branching commands, since he can then write the equivalent of a GO TO statement just by associating it with the label. The mnemonic command LDA A instructs the  $\mu$ P to load the accumulator known as A with the data that will come from the location described by the operand. The operand, NB, instructs the  $\mu$ P to fetch data from the location called NB. This pseudo English tells the MPU that the binary data in the byte following the LDA instruction names or points to the address from which the MPU is to fetch the desired data (Fig. 3).

### Assign values to the symbols

Once an assembly language program is written, you must systematically determine the locations in which the program is stored in ROM or RAM. First, concentrate on the commands and store each command in sequentially ascending order of memory locations.

Whenever a label is noted, write the address of the memory location presently associated with that label. Since the mnemonic operation codes have unique binary descriptions assigned by the manufacturer, there is no difficulty in storing them. This process is usually done in most larger systems by the assembler, which converts the



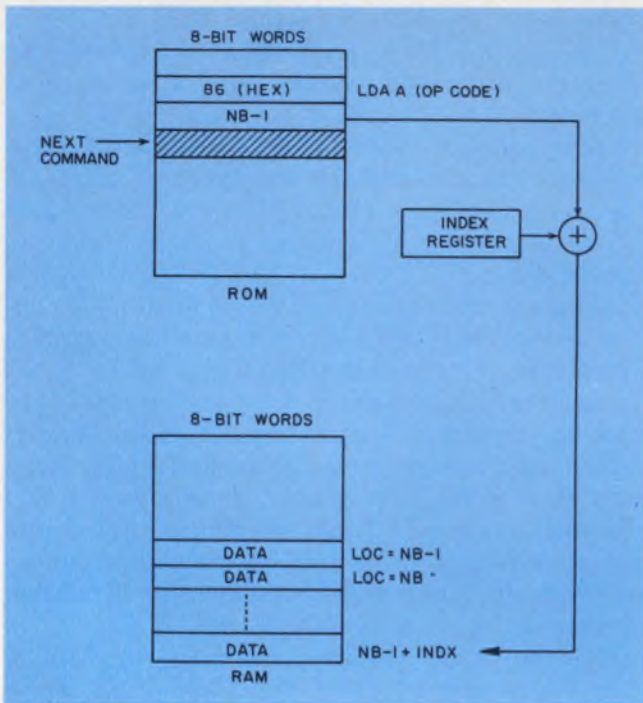

3. When the op code LDA A is given, the byte of binary data following the instruction is added to the index register information to supply the address of the data needed by the op-code instruction.

mnemonic into binary and assigns numbers to all labels.

After the commands are all located, you must provide unique locations for storing the operands or data. These locations don't have to be in any particular sequence, except that arrays usually receive consecutive assignments. Once fixed, these addresses provide the data to fill in some of the missing command words when the assembler assigns location and sequence numbers.

Returning to the sample instruction given earlier, we could have chosen the location FFF (hexadecimal notation) for NB. Assemblers let the user specify the origin or starting address for his commands and the locations for his data.

These addresses are referred to as directives (to the assembler), and while they influence the final values selected for the numerical data other than operation codes, they do not result in any extra instructions. But they can be confusing, since the format of the directives often resembles the actual assembly code. Similarly directives to insert constant values at certain locations in ROM resemble MPU commands. Fortunately most assemblers sort them out and arrange them in columns.

### Address the data properly

When you specify the address of data, use the most direct way—too long an address and the computer slows down, too short and you have a

limited amount of memory available. This can break a system if you're not careful.

The M6800 provides a wide variety of different addressing modes (see Table 1):

- Inherent—Operations are performed on or between registers within the MPU chip.
- Accumulator—Operations affect only the data in the accumulator such as clear, complement, shift, etc.
- Relative—The memory address to which the MPU refers depends on the value of the program counter.
- Immediate—The instruction contains the value of the operand to be used in the computation.
- Direct—The instruction provides the necessary address (up to 8 bits for the M6800).
- Extended—This form of direct mode can address 64 k words of memory (16-bit address).
- Indexed—Memory reference depends upon the data stored in the command word plus the contents of the index register.

Another form of addressing used on almost all minicomputers and large machines is called indirect. This is a two-step process: First, the CPU fetches data from an address. Then it uses the data word as the address of the operand.

The M6800 uses commands that range from one to three bytes long: Inherent and accumulator modes use one byte; relative, immediate, direct and indexed modes use two; and extended uses three.

Motorola has developed a program that accepts symbols and mnemonics to assemble a program. The symbols that indicate the address mode include the asterisk, period, pound and single alphabetic characters. These are used in the operand field.

The asterisk indicates that the relative address mode is to be used, and it has been accepted as the de facto standard for this mode by many companies. Another way of looking at this symbol is to think of it as the present value of the program counter.

The pound character, #, designates the use of the immediate addressing mode. An alphabetic character (X for Motorola) indicates that indexed addressing is to be used. Each of the symbols is, of course, mutually exclusive—only one addressing mode can be used at a time. The Motorola assembler will select either extended or direct addressing by default if the other modes are not specified. If the numerical address lies within the range 0 to 255, default is to direct addressing, while if the address specifies a location out of that range, extended addressing is used.

The relative addressing mode, though, is restricted to branching instructions, such as BSR (branch to subroutine).



**Table 1. Explanation of various addressing modes**

Addressing mode	Processing required to load address into internal address register	Byte appearance of instruction	Comments								
Immediate	Current value of PC indicates the op code and the digital information represented by PC + 1 is the data the op code is to perform its operation on.	<table border="1"> <tr><td>op code</td><td>K</td></tr> <tr><td>data</td><td>K + 1</td></tr> <tr><td>see comments</td><td>K + 2</td></tr> <tr><td>bit</td><td>0 . . . . . 7</td></tr> </table>	op code	K	data	K + 1	see comments	K + 2	bit	0 . . . . . 7	Only one data byte is used except for mnemonic instructions CPX, LDS and LDX which use a second byte.
op code	K										
data	K + 1										
see comments	K + 2										
bit	0 . . . . . 7										
Direct	The current value of the PC indicates the op code. Increment the PC and then move the data from the location specified by PC + 1 to the address register.	<table border="1"> <tr><td>op code</td><td>K</td></tr> <tr><td>address</td><td>K + 1</td></tr> <tr><td>bit</td><td>0 . . . . . 7</td></tr> </table>	op code	K	address	K + 1	bit	0 . . . . . 7	Two data bytes are used.		
op code	K										
address	K + 1										
bit	0 . . . . . 7										
Extended	The current value of the PC indicates the op code. Increment the PC by 1 and transfer the data from the location specified by PC + 1 to the address register. Increment the PC again to PC + 2 and transfer the data from the location specified by PC + 2 to the address register.	<table border="1"> <tr><td>op code</td><td>K</td></tr> <tr><td>address</td><td>K + 1</td></tr> <tr><td>address</td><td>K + 2</td></tr> <tr><td>bit</td><td>0 . . . . . 7</td></tr> </table> } 16 bits	op code	K	address	K + 1	address	K + 2	bit	0 . . . . . 7	Two data bytes are used.
op code	K										
address	K + 1										
address	K + 2										
bit	0 . . . . . 7										
Relative	The current value of the PC indicates the op code. Increment the PC by 1 and add the contents of the location specified by PC + 1 to the value of the PC after it is incremented again (PC + 2)	<table border="1"> <tr><td>op code</td><td>K</td></tr> <tr><td>displacement</td><td>K + 1</td></tr> <tr><td>bit</td><td>0 . . . . . 7</td></tr> </table>	op code	K	displacement	K + 1	bit	0 . . . . . 7	One data byte used. This applies only for branch instructions.		
op code	K										
displacement	K + 1										
bit	0 . . . . . 7										
Indexed	The current value of the PC indicates the op code. Increment the PC by 1 and add the contents of the location specified by PC + 1 to the index register.	<table border="1"> <tr><td>op code</td><td>K</td></tr> <tr><td>data from</td><td>K + 1</td></tr> <tr><td>memory location</td><td>K + 1</td></tr> <tr><td>bit</td><td>0 . . . . . 7</td></tr> </table>	op code	K	data from	K + 1	memory location	K + 1	bit	0 . . . . . 7	One data byte used.
op code	K										
data from	K + 1										
memory location	K + 1										
bit	0 . . . . . 7										

When you write programs for the M6800, they can be done in modular form and then strung together. To do this, though, you must make use of the stack pointer (SP) within the  $\mu$ P chip. The SP register provides an address that is used for subroutine jumps, or if the program is interrupted, it holds data from some of the other registers.

The stack is a set of memory locations that are addressed and sometimes modified when interrupts or subroutine jumps are invoked. A jump-to-subroutine (JSR) command orders the  $\mu$ P to increment and store the program counter value in the next empty stack location and then jump to the new (subroutine) location. The stack pointer is also set to the next empty location, just in case another subroutine or interrupt command is given.

The return-from-subroutine (RTS) instruction decrements the stack pointer and places the contents of the register specified by the pointer back into the program counter. Two additional instructions—mnemonics PSH (push data) and PUL (pull data) allow transfer of accumulator data to and from the stack.

An interrupt command causes the  $\mu$ P to react as if indirect addressing is in effect. After the MPU completes its current instruction, it initiates the following sequence of operations:

- Stores the contents of the program counter, accumulators and condition code registers into

the interrupt stack registers.

- Generates a 16-bit address that points to locations n-2 and n-3.
- Follows instructions starting at a location prestored by the user in locations n-2 and n-3.

The last eight memory locations of the stack should be reserved for interrupt vectoring (another name for such indirect addressing). This allows for four 16-bit words to redirect the MPU. For instance, beginning with location FFF8 (hex), you could have:

FFF8	MS	Hardware interrupt
FFF9	LS	
FFFA	MS	Software interrupt
FFFB	LS	
FFFC	MS	Nonmaskable interrupt
FFFD	LS	
FFFE	MS	Restart
FFFF	LS	

The software interrupt lets you develop an over-all systems executive or monitor. Thus if a program module has some data to send through the asynchronous communications interface adapter (serial data port)—ACIA—it could execute a software interrupt and vector the MPU to the appropriate input/output routine.

**Let's look at a sample program**

To write a program without the aid of an assembler, start with a list of the commands you



**Table 2. Program to clear 10 registers**

ROM Location (decimal)	ROM Content	
	(hex)	comment
000	7F	op code address of buffer (1) in binary
001	8 bits	
002	8 bits	
003	7F	address of buffer (2)
004	8 bits	
005	8 bits	
.	.	
.	.	
027	7F	address of buffer (10)
028	.	
029	.	

**Table 3. Rewritten clearing program**

Label	Op code	Operand or location
BEGIN	LDX	#BUFFR*
	LDA A	# 1
	CMP	A # 11
	BEQ	PROC
	CLR	O, X
	INC	A
	INX	
PROC	BRA	BEGIN
	.	New program section

\*The pound sign shows that immediate addressing is to be used for the first three commands.

**Table 4. Assembled clearing program**

Label	ROM location (decimal)	Op-code (hexadecimal)	Description or name of op code
BEGIN	000	FE	LDX
	001	{ two binary } { bytes }	extended address to first location of data-symbol BUFFR
	002		
	003	86	LDA A
	004	01	with literal 1
	005	81	CMP A
	006	0B	with literal 11
	007	27	BEQ
008	06	relative address to location 015	
PROC	009	6F	CLR (see note 2)
	010	00	indexed by 0
	011	4C	INC A
	012	08	INX
	013	20	BRA
	014	see note 1	Any op code
	015	XX	Subsequent instructions and literals
	.	.	.

Notes:  
 1. Use hex equivalent of -10 in location 14 to get a relative branch back to location 005 which continues the loop.  
 2. This is an indexed address command with 0 shift that refers to one of the locations in the array BUFFR.

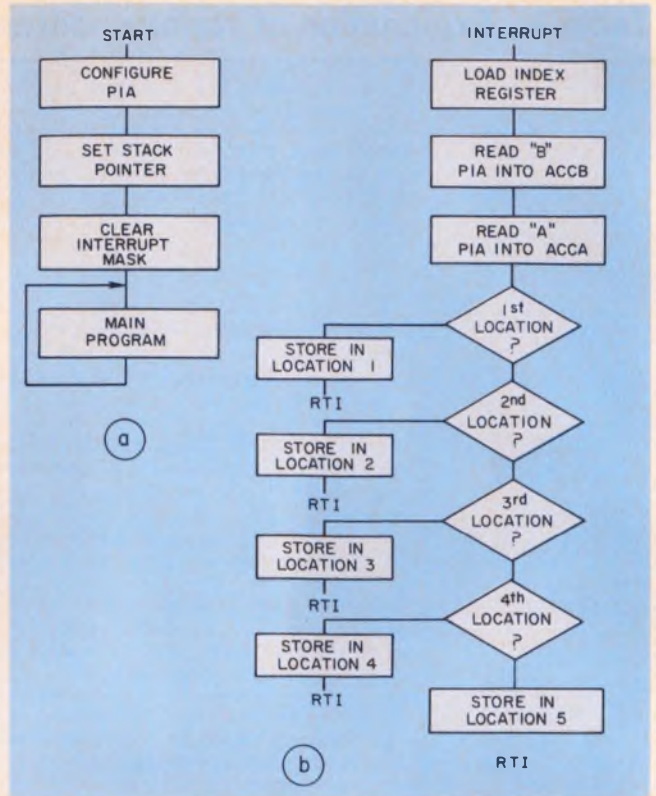

4. The interface program has an executive portion (a) with only a few steps and an interrupt subroutine (b) with many steps.

will use to process the data. Remember, the program will reside in the ROM until needed, and the RAM will be used to hold the active part of the program.

Let's start with a simple program that will clear a set of data locations named BUFFR. We will assume that BUFFR consists of 10 consecutive locations and exists in the RAM data space. The program could then consist of the clear command (CLR) given 10 times, with the location in the operand field:

```
CLR  BUFFR(1)
CLR  BUFFR(2)
.
.
.
CLR  BUFFR(10)
```

The location of BUFFR was chosen so that extended addressing is used. The resulting hex characters appear in ROM as shown in Table 2. The contents of the op-code byte—in this case, 7F—informs the MPU that extended addressing is to be used. Use of an index register, though, can replace the repetition of the same command with a short program loop. The same program to clear 10 locations can be rewritten as shown in Table 3.

The program operates as follows: Before the main program loop begins, the program loads the



**Table 5. Complete interface program**

00100			ORG	10	
00120	0000		ORG	5	
00130	0000 0005	DATLOC	RMB	5	
00140	0100		ORG	\$100	
00150	0100 0001	PIA1A	RMB	1	
00160	0101 0001	PIA1A	RMB	1	
00170	0102 0001	PIA1B	RMB	1	
00180	0103 0001	PIA1B	RMB	1	
00190	FF00		ORG	1FFF00	
00200	FF06 36 07	START	LDA	A	#7
00210	FF02 37 0101		STA	A	PIA1A
00220	FF05 36 04		LDA	A	#104
00230	FF07 37 0103		STA	A	PIA1B
00240	FF0A 3E 007F		LDS		#87F
00250	FF0D 0E		CLI		
00260	FF0E 01	MAIN	NOP		
00270	FF0F 20 FD	MAIN	LDA	A	MAIN
00280	FFF8		ORG	1FFF8	
00290	FFF3 0500		FDB		INITR
00300	FFFE		ORG	1FFFE	
00310	FFFE FF00		FDB		START
00315	0500		ORG	\$500	
00320	0500 CE 0000	INTER	LDX		DATLOC
00330	0503 F6 0102		LDA	B	PIA1D
00340	0506 E6 0100		LDA	B	PIA1A
00350	0509 49		PDL	A	
00360	050A 25 0C		BCS	A	ST01
00370	050C 49		PDL	A	ST02
00380	050D 25 0C		BCS	A	ST03
00390	050F 49		PDL	A	ST04
00400	0510 25 0C		BCS	A	ST04
00420	0513 25 0C		BCS	A	ST04
00430	0515 A7 04		STA	B	4+X
00440	0517 3B		RTI		
00450	0518 A7 00	ST01	STA	B	0+X
00460	051A 3B		RTI		
00470	051B A7 01	ST02	STA	B	1+X
00480	051D 3B		RTI		
00490	051E A7 02	ST03	STA	B	2+X
00500	0520 3B		RTI		
00510	0521 A7 03	ST04	STA	B	3+X
00520	0523 3B		RTI		
00530			END		

address of BUFFR(1) into the index register and sets location A to 1. At the command labeled BEGIN, the program compares A to 11 (decimal notation) and if  $A \neq 11$ , the program performs the next instruction, CLR. As the program continues in the loop, A will increase to 11, and when the program reaches the BEQ command it breaks out of the loop into the next program.

The entire program that must either be put on paper tape or into ROM is shown in Table 4. This type of programming is fine for small programs where you can keep track of variable locations, but for larger programs some sort of assembler is needed. Assemblers can refer to unnamed locations as a numeric expression that involves a label name. Thus  $BRA = BEGIN + 1$  would refer to location 5—that of the next instruction.

Commercial assemblers let you locate the origin of programs anywhere in ROM through the ORG directive. For example, ORG 100 states that the given program segment is to start at ROM location 100. The EQU directive equates a symbol with a numerical value, another symbol or an expression. The RMB command reserves memory bytes. These and other directives assign values and addresses in data memory.

### Interface instruments with software

To interface anything to the  $\mu P$ , you must make connections through a form of PIA or ACIA. The PIA handles parallel data, while the ACIA handles serial. Let's look at the complex problem of interfacing an instrument to the  $\mu P$ .

As a starting point, assume the instrument delivers a parallel digital data word. The PIA

would then be used to interface the instrument. Inside the PIA are enough interface circuits to handle two peripherals. The PIA is internally divided into two symmetrical (noted as A and B), but independent, circuits that consist of three registers each. Each half contains a data direction register, a control register and an output register.

The registers are eight bits wide and are externally controllable. To define the operation of the PIA A or B side, an 8-bit word is loaded into the control register, and to define the data lines as inputs or outputs, an 8-bit word is loaded into the data direction register. Finally the actual data to be transferred goes into the output register.

The instrument we want to interface has data and a data ready line that can be used to signal an interrupt of the processor. Both halves of the PIA must be used to move the data from the instrument to the memory. The B side of the PIA holds the data word, and the A side identifies that word.

Basically the PIA and  $\mu P$  operate together as follows: When the interrupt occurs, the B side of the PIA is read into the B accumulator of the  $\mu P$ . Then the A side of the PIA is read to define the memory location of where the data stored in accumulator B should be placed. Next the data are transferred from the accumulator to the memory location, and then the  $\mu P$  goes back to waiting for another interrupt.

The MSB of the A side data word specifies the first location, the next bit the next location, and so on. If a ONE is not present in any of the four MSBs, the data are to be stored in the fifth location. These data locations are contiguous, with the first at an address we'll call DATLOC and all others in increasing sequence. When any of these locations receives a data word, the new data wipe out the old.

The CA1 terminal of the PIA can accept the interrupt signal generated by the rising edge of a waveform. This configures all the data ports as inputs, while the other interrupt lines CA2, CB1 and CB2 are not used. The flow charts for the system program to pull in data are shown in Fig. 4.

When started, the program configures the PIA, sets the stack pointer and clears the interrupt line and can proceed to do any program it has in memory. When an interrupt comes, present values of the last instruction and program counter and registers are stored in the stack, and the interrupt program is set in the program counter. When the interrupt routine is finished, the  $\mu P$  registers are reset to their values just before the interrupt and the main program continues along.

Table 5 shows the complete instrument interface program developed by Motorola Semiconductor Products to do the job. ■■



# Two years of a wealth of incredible information on MICROPROCESSORS brought right up to date by Electronic Design

We sifted through the last two years of ED and found an incredible amount of practical information and advice on selecting micros . . . using them to your best advantage . . . improving them for better speed and broader application. We compiled it all into one

convenient handbook — **MICROPROCESSORS: New Directions for Designers**. If you'd like to see a copy, circle the information retrieval number below and we'll send you one to read and use FREE for 15 days. At the end of time, just send in a check for \$8.95, or return the book.

**Hayden Book Company, Inc.**

50 Essex Street  
Rochelle Park, N.J. 07662  
(201) 843-0550

INFORMATION RETRIEVAL NUMBER 95





# Ise introduces five new ways to make the competition turn green.

Your competition probably already thinks they're using the perfect display in whatever it is they make. Let them keep thinking it. While you prove them wrong with a new Itron display. They're designed to make the competition turn green. Which also happens to be the color of the segments.

All 17 of them on the 17-digit Itron. All 5 on the FG-512A1. Next comes an Alfa-Numerical Itron. A Linear-Analog Itron. And a Digital Clock Itron. Five ways to be heartless if you put a little heart into it.

## *itron*<sup>®</sup>

*Alfa-Numerical Display*

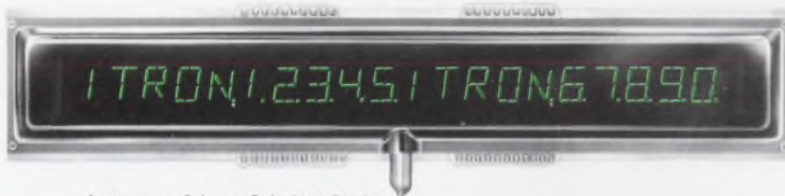

**FG209M2**

ef=10V  
ec=eb=40Vp-p  
ic=10mA-p-p  
ib=8mA-p-p  
Wd. 205mm  
Lg. 40mm  
Segment 9mm

*Instruments & Large Calculator Display*



**FG179F2**

ef=7V  
ec=eb=35Vp-p  
ic=7mA-p-p  
ib=5.5mA-p-p  
Wd. 170mm  
Lg. 40mm  
Segment 9.5mm

*Instruments & Terminal Units Display*



**FG512A1**

ef=3.5V  
ec=eb=24Vp-p  
ic=4mA-p-p  
ib=3mA-p-p  
Wd. 100mm  
Lg. 40mm  
Segment 12mm

*Digital Clock Display*



**FG425A1**

ef=5.5V  
ec=eb=35Vp-p  
ic=8mA-p-p  
ib=6.5mA-p-p  
Wd. 140mm  
Lg. 59mm  
Segment 25mm

*Linear Analog Display*



**FG120S1**

ef=5.5V  
ec=eb=35Vp-p  
ic=4mA-p-p  
ib=0.2mA-p-p  
Wd. 140mm  
Lg. 40mm  
Segment 8mm

### **NORITAKE CO., LTD.**

#### **Electronics Office (U.S.A.)**

22410 Hawthorne Blvd. Torrance California 90505,  
U.S.A.  
Phone: (213) 373 6704.  
Telex "230674910"

#### **Electronics Division**

1-1, Noritake-Shinmachi, Nishi-ku, Nagoya-City,  
Japan  
Phone NAGOYA (052) 561-7111  
Telex J59738 NORITAKE

### **ISE ELECTRONICS CORP.**

#### **London Office**

c/o NORITAKE (UK) LTD  
Noritake House 2, York Street W1H 1 Be. England  
Phone (01) 935 7543 Cable: LUCTUAL LONDON

#### **Munachen Office**

c/o NEUMULLER GmbH - 8 Muenchen 2, Karlstrasse 55  
West Germany Phone 592 421 Telex 522106

#### **Hong Kong Office**

Room 1403 Shing Lon Building  
24-26 Stanley Street, Hong Kong  
Phone 5 232420 Telex HKB3151

#### **Taipei Office**

72 9 SEC. 2, JEN AI RD. Taipei  
Phone 351 0293 Telex 11176

INFORMATION RETRIEVAL NUMBER 35



# Let a $\mu$ P keep track of your process.

Built around a central processor, this analog monitor samples and displays transducer outputs.

You can keep an eye on various physical parameters or monitor a number of other analog voltages with a microprocessor-based system. Built around the 6800  $\mu$ P and an a/d converter subsystem, the system can monitor and display any of four switch-selected voltages or various software-controlled functions (see table).

The monitor can interface to a main control system or operate as a stand-alone system. And, if necessary, a large number of parameters—with certain restrictions—can be monitored. These restrictions stem from the finite scan frequency, which is inversely proportional to the number of parameters.

Also, the scan frequency affects the type of parameter to be monitored since, for reliable conversion, the sensed quantity should not vary appreciably between conversion periods. Usually, though, physical quantities like temperature and pressure vary so slowly that a single a/d converter can monitor a large number of sensors.

In addition to the basic CPU, the system uses a peripheral interface adapter (PIA), such as the MC6820, and memory for the control program. Fig. 1 shows the allocation of the PIA register and control lines. To interface all the required operations of the display board through one PIA, the BCD inputs to the display decoder/drivers are multiplexed.

Also, all the ramp control lines for the a/d subsystems are tied to a single line in the register that interfaces the comparator outputs of the a/d to the CPU. This configuration allows up to seven a/d subsystems per PIA register to be interfaced to the CPU.

## Higher voltage improves S/N

Hardware external to the CPU mounts on the display board. Included are the display select switch, the a/d subsystem chips (MC1405), dis-

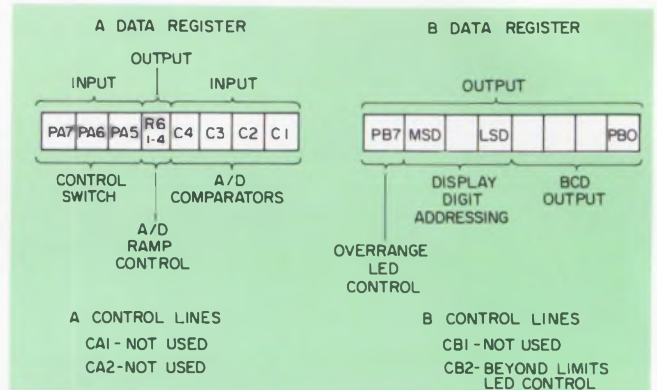

1. With multiplexing, just one PIA is needed to couple the display board to the  $\mu$ P. PIA allocations are shown.

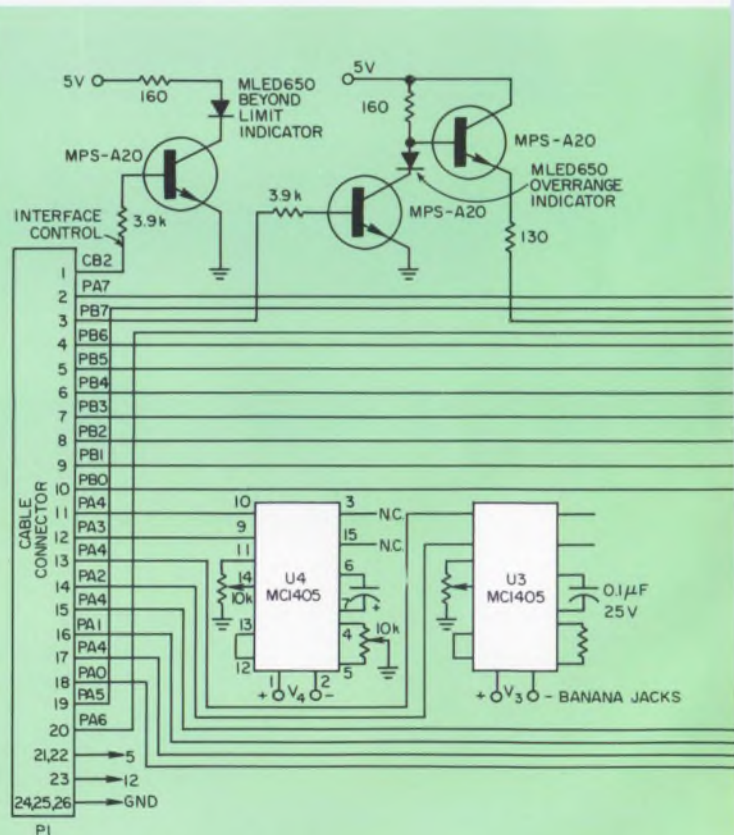

NOTE: PA0 TO PA7 FORM I/O PORT 1.  
PBO TO PB7 FORM I/O PORT 2

John Kaufmann, Software Engineer, Motorola Semiconductor Products, 5005 E. McDowell Rd., Phoenix, AZ 85008.



**Table. Display-select switch settings**

Position	Display
1	$V_1$
2	$V_2$
3	$V_3$
4	$V_4$
5	$V_1^2$
6	$V_1 + V_2$
7	$ V_1 - V_2 $
8	$V_1 \cdot V_2$

play latch/decoder/drivers (MC14511), and seven-segment LED displays (Fig. 2). The a/d chips are powered by a 12-V supply, permitting a higher integrator-capacitor peak voltage than would a 5-V excitation. This improves the signal-to-noise ratio. The other parts on the display board are powered by a 5-V source.

After it initializes the system, the control program reads the control switch, performs the necessary a/d conversions, does any required calculations and displays the result. Since the object is to represent an analog voltage digitally, the main segment of the program is the routine that controls the MC1405s and performs the analog-to-digital conversion (Fig. 3). The assembly-language coding for the conversion is listed in Fig. 4.

The a/d routine is entered with (1) the addresses of the appropriate limits in the X register; and (2) a bit set in the B accumulator corresponding to the PIA register line that carries the comparator input signal.

The routine first stores the limit addresses and loads the X register with the address of that PIA register interfacing with the MC1405. After the routine loads the A accumulator with 99—one less than the value of 100 required as a base count for a 2-1/2-digit conversion—it checks to

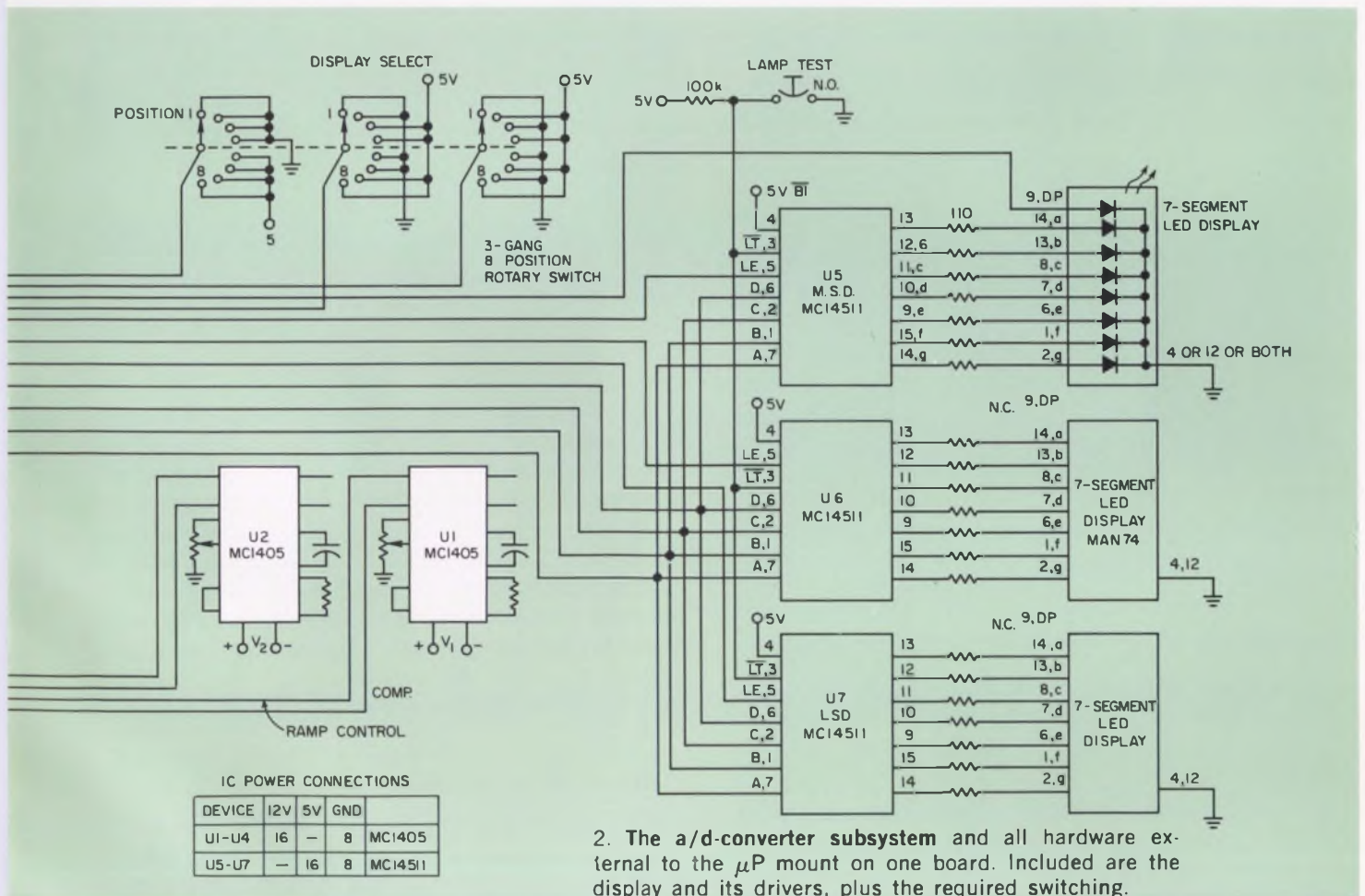



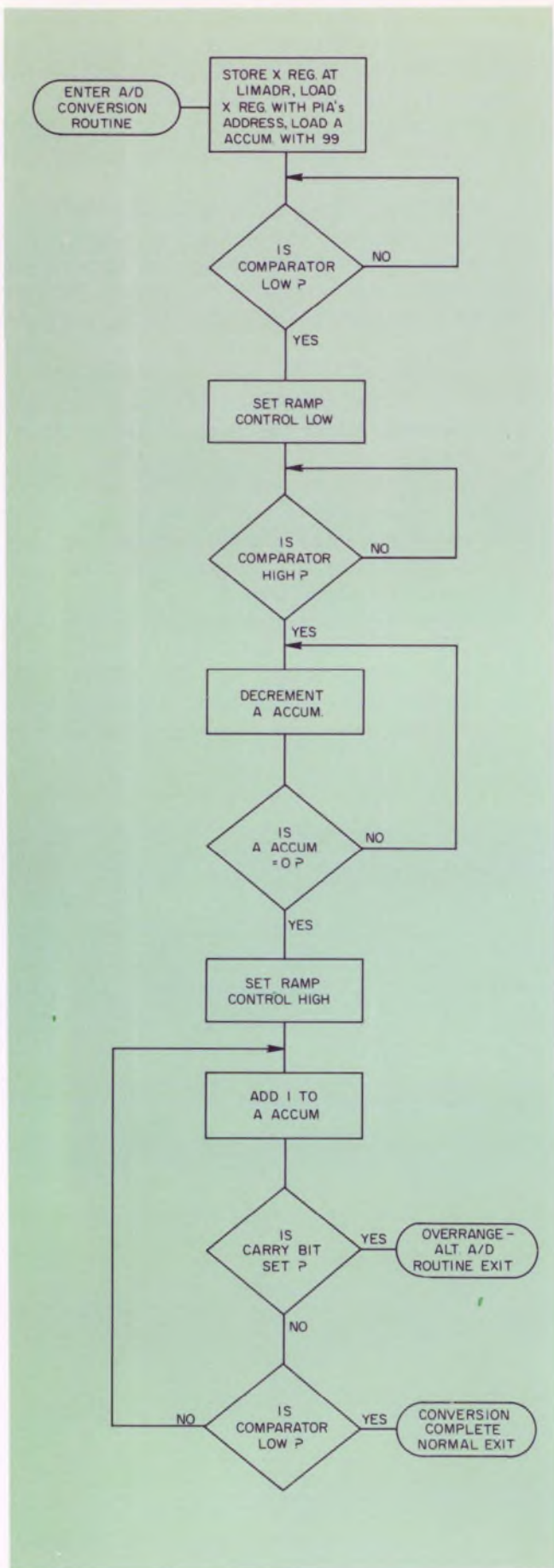

3. Flow chart shows the section of the program that controls the converter chips and performs the analog-to-digital conversion routine.

A2DRTN	STX	LIMADR	Save address of limits
	LDX	#PIAADR	Get PIA address
	LDA	A #99	
LOWC	BIT	B O,X	Is the comparator low?
	BNE	LOWC	No—Check it again
	CLR	O,X	Yes—Set ramp control low
HIGHC	BIT	B O,X	Is the comparator high?
	BEQ	HIGHC	No—Check it again
CNTDWN	BIT	B O,X	Yes—Count-down 100
	NOP		
	NOP		
	DEC	A	A = 0?
	BNE	CNTDWN	No—Decrement A again
RCHIGH	NOP		Yes—Set ramp control high
	NOP		
	NOP		
	CLR	A	
	COM	O,X	
CNTLP	ADD	A #1	Then do conversion count
	BCS	OVRNG	Exit if count = 256
	BIT	B O,X	Is the comparator low?
	BNE	CNTLP	No—Continue counting
	SUB	A #10	Yes—Adjust count

4. Assembly-language coding for the analog-to-digital conversion. The routine takes about 4.6 ms.

see if the comparator output is low. If it isn't low the routine waits until it is. Otherwise, a false conversion value would be obtained. When a low occurs, the routine sets the ramp control high and waits until the comparator output goes high.

When the high appears, the routine begins its base count: It decrements the A accumulator in a loop from 99 to 0 to produce the basic a/d-conversion time interval. The BIT B O,X and NOP instructions act as "filler" in the base-count loop so the time per decrement equals the time per increment in the conversion-count loop.

#### Carry bit serves as overrange

The hundredth count time required for the 2-1 2-digit conversion is provided by the COM O,X instruction, which sets the ramp control high



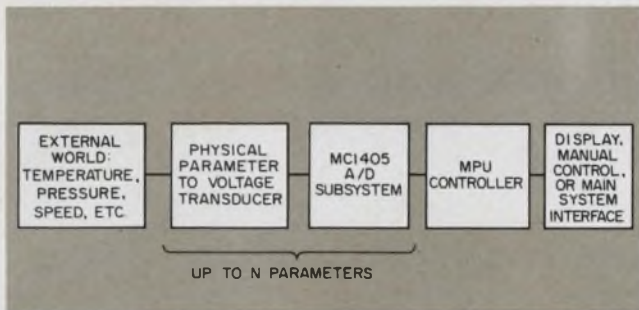

5. In a typical application, the  $\mu\text{P}$  controlled system monitors physical parameters, such as pressure, and provides a digital readout of a desired value.

and the CLR A and NOP instructions immediately preceding. In this way, the ramp control goes high at the end of the base count and the conversion count immediately begins.

To perform the conversion count, 1 is added to the A accumulator. The carry bit acts as an over-range detector for the BCS OVRNG instruction since the bit is set if the count reaches 256. When this happens, the program exits from the conversion-count loop and goes to the voltage-overrange display routine.

Continuing in the conversion count loop, the program next checks the comparator output. To do this, the routine loops back up and adds 1 to the A accumulator if the comparator output is still high. When the output goes low, the program exits from the conversion-count loop and corrects the conversion value by subtraction of 10 as the MC1405 requires.

The value now in the A accumulator is the digital representation of the analog input voltage. Since the conversion-count loop requires 15 CPU clock cycles per count, at a CPU clock frequency of 1 MHz for a full scale conversion, the a/d routine requires  $15 \mu\text{s} \text{ count} \times (100 + 199 + 10) \text{ counts} = 4.64 \text{ ms}$  plus the comparator check time.

For use in a parameter sensing system, the outlined routine can be easily converted to a subroutine independent of the PIA address. Just put the first two instructions before the subroutine call and begin the subroutine with the LDA A #99 instruction. No other modifications are required since the routine is already independent of the PIA data register line on which the comparator signal appears.

If you do convert to a subroutine you can retain the overrange-detect feature by setting a flag before returning from the subroutine and after the conversion has gone to overrange. A check of the conversion value against preprogrammed limits can also be included in the subroutine. In this way, you can apply the subroutine to a  $\mu\text{P}$  controlled, parameter-sensing system (Fig. 5). ■■

# NEW

## '76 POWER SUPPLY CATALOG

More new products...

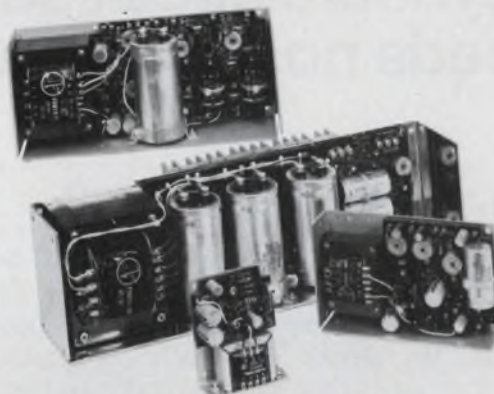

...same low prices!

Send for your copy today. For immediate product information, contact Power-One or your local factory representative.

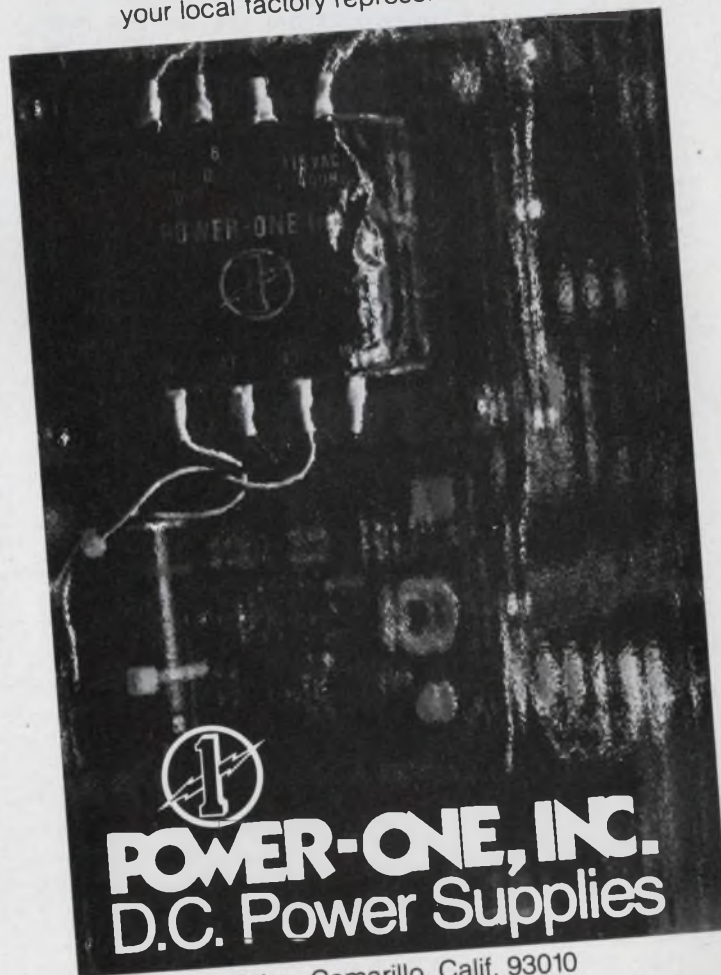

**POWER-ONE, INC.**  
D.C. Power Supplies

531 Dawson Drive, Camarillo, Calif. 93010  
(805) 484-2806 TWX: 910-336-1297



## Keyboard circuit saves time, needs no microprocessor scanning software

As much as 20 to 30 ms of valuable microprocessor time wasted in scanning keyboard inputs can be saved with a circuit that does not need any software and uses only a few TTL ICs.

Though the example in the figure is an  $8 \times 4$  matrix, the circuit can easily be expanded to  $8 \times 8$  or any other suitable configuration. Decimal-decoded outputs of a 74142 BCD counter drive the columns of the matrix. The counter's input signal is derived from the microprocessor's SYNC clock and the circuit's KEYN signal. The KEYN signal is derived from the matrix rows, via a NOR gate, whenever any key is closed. The KEYN signal also clocks a D flip-flop to provide an interrupt signal for the microprocessor.

Three-state output 74173 TTL latch ICs serve as the input port of the system. The interrupt

signal, when it goes HIGH, clocks the data into the 74173s. An RC time constant of 2 to 3 ms on the KEYN signal, before it's used to clock the D flip-flop, takes care of switch bounce. An interrupt-acknowledge signal from the microprocessor then resets the 74173s and the D flip-flop, after the input ports are read.

A second interrupt signal will not be generated unless the first key is released. Thus the circuit automatically provides a two-key lockout. Further, the microprocessor should be programmed to provide an error signal if it detects more than one HIGH bit at any one time in the input port latches.

*Ram N. Sahni, Project Engineer, NCR Corp., Ithaca, NY 14850.* CIRCLE NO. 311

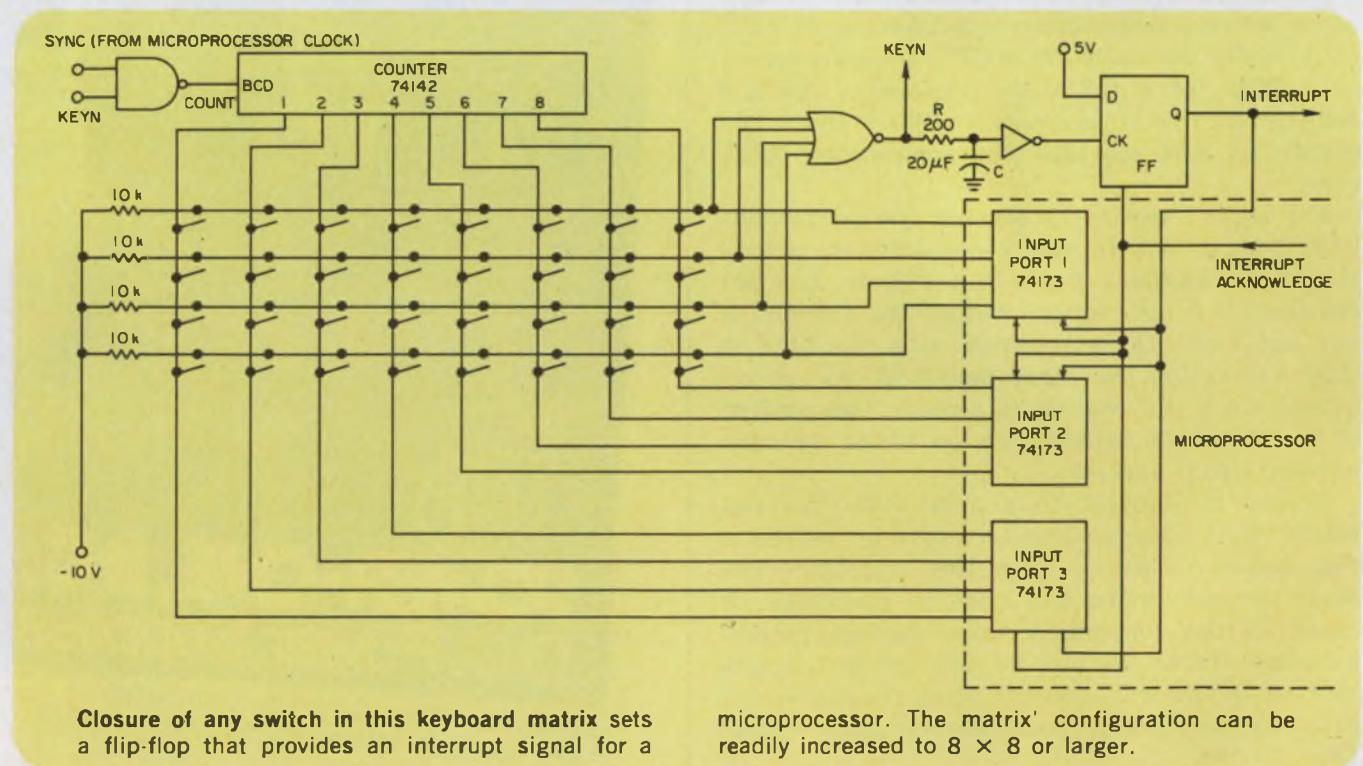





## Surely, that can't be the whole answer? Something's missing!

When you calculate the important personal investment you've made in your education, is this all the answer you want? You're you. And there's more to life than just "a job"—or should be.

**What could you expect if you joined us? A quality of life that means the difference between "a job" and a way of living.**

We design and manufacture complete electronic systems of various kinds for business, industry and government. It is our practice to hire very able people and then put them to work doing what they most like to do.

Because we are a large company, we offer a total career growth-potential that is as big as we are. And because we work in relatively small product-oriented divisions, your abilities and contributions are highly visible from the time you join us, with prompt recognition of superior performance.

Whether you work for us in California, New York, Ohio, South Carolina, Florida, Kansas or Delaware, you'll find yourself look-

ing forward to coming to work in the morning. And your technology won't become obsolescent in 5 or 10 years, because, to remain a leader, we must continue to work on the leading edge of the current state of the art.

**Professional involvement . . . continuing development as an engineer . . . an environment of individual responsibility that encourages new ideas and rewards initiative. These are good dividends on the personal investment you've already made on your education!**

If you're not realizing them now, write:

Mr. Vernon L. Mirre, Dept. ED-12-20  
Corporate Executive &  
Professional Recruitment  
NCR Corporation  
Dayton, Ohio 45479

An Equal Opportunity Employer



INFORMATION RETRIEVAL NUMBER 900



# Single-chip pulse generator provides 50 MHz with adjustable duty cycle

One chip, the MC10116, can be used to construct a pulse generator with a variable duty cycle. And even with the generator operating at repetition rates above 50 MHz, the duty-cycle adjustment still remains fully effective. Interactions between the duty-cycle adjustment and oscillator frequency are nearly imperceptible.

The circuit is divided into three main blocks—an oscillator, reference-voltage supply and comparator (Fig. 1). Only a change in the reference voltage, B, changes the comparison point and thus the duty cycle (Fig. 2). The duty cycle is independent of the frequency as long as the voltage output of the oscillator remains constant.

Pull-down resistors to pins 3 and 6 help keep the power-supply currents balanced to minimize interaction between the function blocks. Positive feedback in the comparator between pins 7 and 10 reduces the rise and fall times of the output

pulses and also minimizes narrow-pulse jitter. The 47- $\Omega$  resistor, in series with the output terminal, ensures a 50- $\Omega$  output-impedance match to a coaxial cable.

William A. Palm, Principal Engineer, Control Data Corp., 7801 Computer Ave., Minneapolis, MN 55435. CIRCLE No. 312

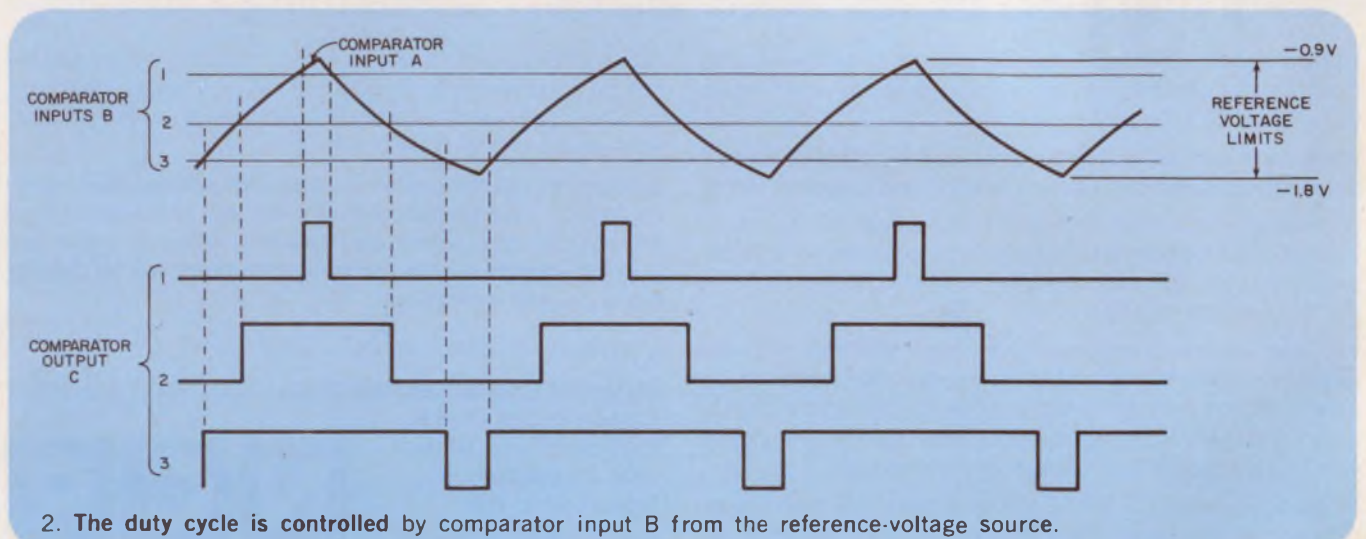
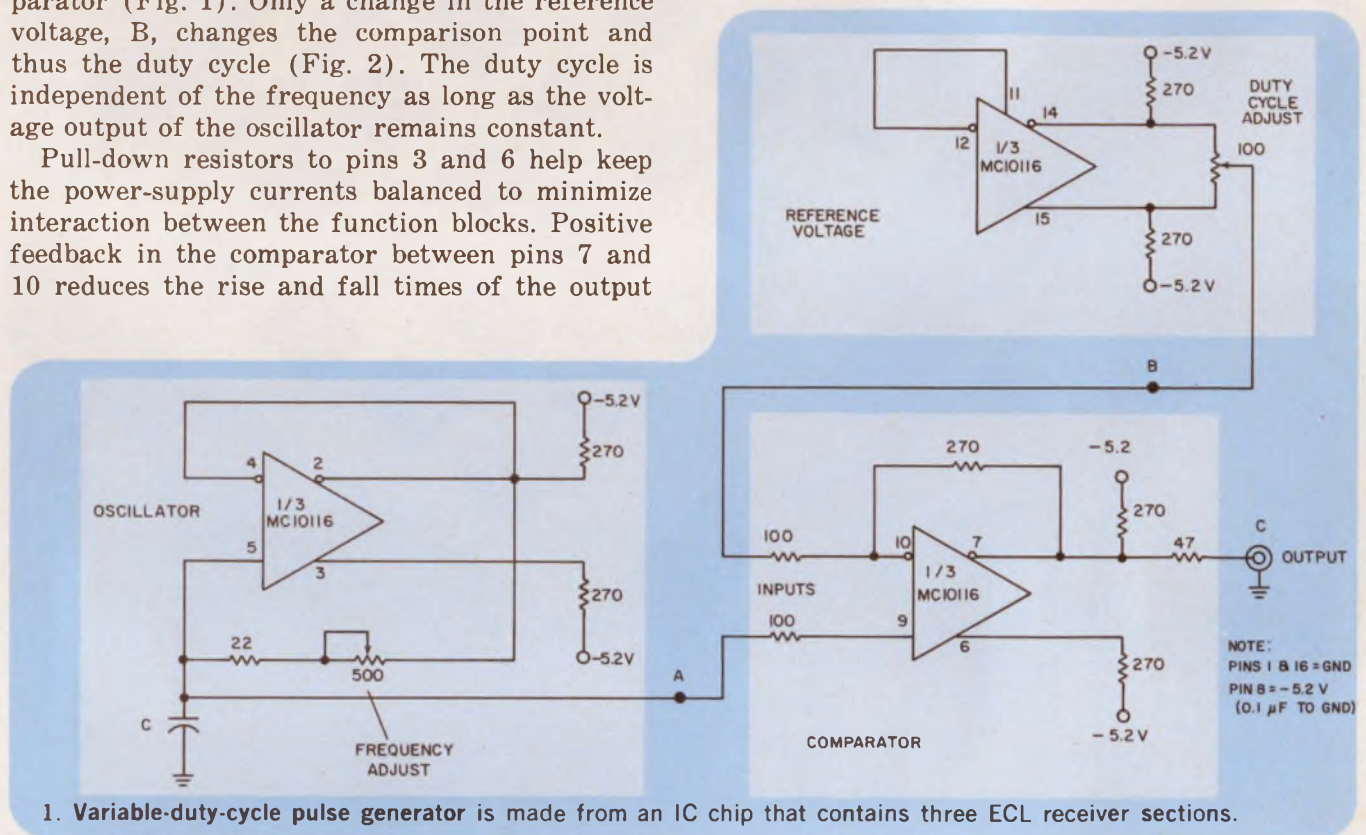



# PERSONALIZED TRANSFORMERS

## No matter what function.

Pulse, isolation, matching, converter, etc.

## No matter what specs.

Tough electrical, environmental, or both.

## No matter what package.

DIP, substrate, header, conventional, or . . . ?

Technitrol has engineered transformers and transformer packages to meet the most stringent electrical and environmental requirements. Transformers have been produced mounted singly or in multiples in a broad spectrum of configurations.

Call Bill Chamberlin at 215-426-9105 or write. State your application; we'll put over 25 years of transformer know-how to work for you.



**Technitrol, Inc.**

1952 E. Allegheny Avenue  
Philadelphia, Pa. 19134

*Specialists in pulse transformers and completely transfer molded, welded DIP delay lines under 1/8" high — to 250 ns.*

INFORMATION RETRIEVAL NUMBER 39



## SINGLE & DUAL

# MCLEAN CENTRIFUGALS

Std. or Mil. Spec. Over 25 models with airflows from 50 to 2000 CFM. Static pressures from 0." to 3.0". Motors and wheels precision balanced — quiet, vibration free. UL approved motors for any AC frequency or power, single or three phase. Custom-built units available.

SEND FOR CATALOG

**MCLEAN** ENGINEERING LABORATORIES

P.O. Box 127D PRINCETON JUNCTION, NEW JERSEY 08560  
PHONE 609-799-0100 • TELEX 84-3422

INFORMATION RETRIEVAL NUMBER 41

# Isolate noise.



Clairex® gives you the broadest choice of LED-photoconductor opto-isolators.

- Eleven standard axial lead types.
- Two units with dual photocell output.
- Wide choice of resistance ranges.
- Standard isolation voltages 1500 to 4000 VPAC.
- Photocells hermetically sealed or plastic.
- 100% pretested for performance.

Come to the leader in opto-electronics.  
Tell us the problem. We'll develop the solution.

**CLAIREX ELECTRONICS**

560 South Third Ave., Mount Vernon, N.Y. 10550 (914) 664-6602

INFORMATION RETRIEVAL NUMBER 40

ELECTRONIC DESIGN 26, December 20, 1975

# NEW! OAK SNAP-IN TWO-LAMP PUSHBUTTON SWITCH

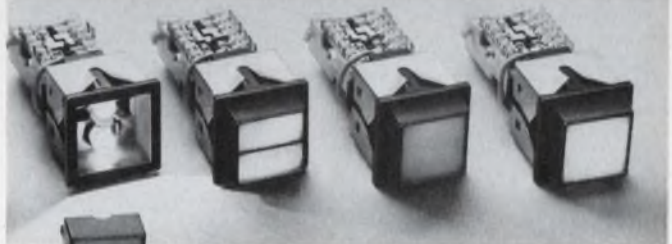

More circuitry for your money

- Up to 4 pole, 2 throw capacity
  - Single or split display
  - 100,000 cycle minimum life
  - Front relampable; T-1 3/4 lamp
- Contact your Oak Distributor for additional information on the Series 300 SL or write for Engineering Bulletin SP-730. For price and delivery quotations, call toll-free 800-435-6106

**OAK Industries Inc.**  
SWITCH DIVISION / CRYSTAL LAKE, ILLINOIS 60014

INFORMATION RETRIEVAL NUMBER 42



# Current sinks increase the range of IC function generators

When a current sink is substituted for the external control resistors<sup>1</sup> in IC function generators, the range of adjustment is greatly expanded. For example, the XR-2206, with the factory recommended resistor hookup shown in dashed lines, has a frequency range of 2000:1, but with a current sink, a tuning range of 8000:1 is attainable (Fig. 1).

The XR-2206 can also be used as a variable duty cycle pulse generator if a second current sink is arranged to track the first (Fig. 2). However performance of the factory-recommended hookup with two fixed resistors is limited to a single frequency and duty cycle. The current-sink circuit gives just over a 100:1 duty-cycle range controlled by variable-resistor R. The output frequency can still be controlled over about the same range as with the circuit of Fig. 1, but the duty cycle varies at the extremes of the frequency range.

The major parameter that affects performance of the circuit is the threshold current of the tuning inputs. In particular, differences between the thresholds of terminals 7 and 8 limit the performance of the circuit in Fig. 2. Tuning becomes somewhat nonlinear as control currents

approach the threshold levels.

The frequency can be controlled if the input amplifier is driven by a current-output DAC (Fig. 3). The value of  $R_1$  must match the DAC output capability, and the  $R_1/R_2$  ratio must then be chosen to give the required current range. Threshold current limits allow the use of a 10-bit DAC in a Fig. 1 configuration, but only a 7-bit DAC for the Fig. 2 configuration with constant duty-cycle operation.<sup>2</sup>

## Reference

1. Grebne, A. B., "Generate Waveforms with a Single IC," *Electronic Design*, Sept. 13, 1974, p. 132.
2. Kaye, D. N., "Focus on A/D and D/A Converters," *Electronic Design*, Jan. 4, 1973, pp. 58-65.

Ralph Tenny, Senior Research Assistant, Texas Instruments, Inc., P.O. Box 5936, Dallas, TX 75222. CIRCLE NO. 313

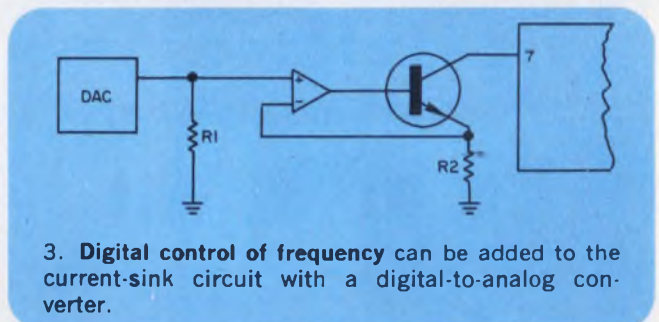
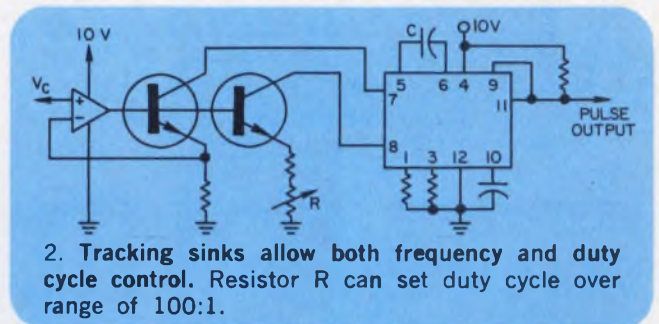
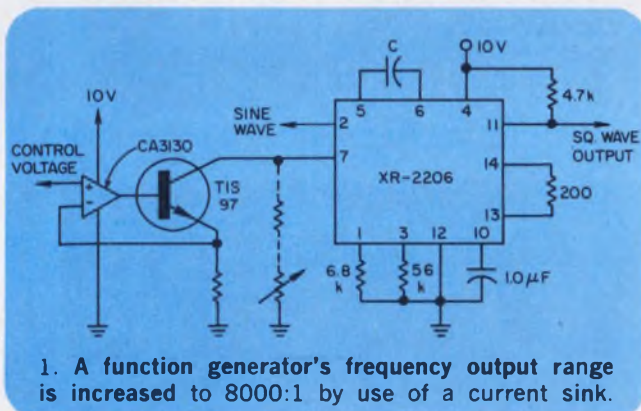

## IFD Winner for August 16, 1975

G. R. Lewis, Engineer, Cerwin-Vega, Inc., 6945 Tujunga Ave., North Hollywood, CA 91605. His idea "Low-Cost Temperature Controller Built with Timer Circuit" has been voted the most valuable of Issue Award.

Vote for the Best Idea in this issue by circling the number of your selection on the Information Retrieval Card at the back of this issue.

**SEND US YOUR IDEAS FOR DESIGN.** You may win a grand total of \$1050 (cash)! Here's how. Submit your IFD describing a new or important circuit or design technique, the clever use of a new component or test equipment, packaging tips, cost-saving ideas to our Ideas for Design editor. Ideas can only be considered for publication if they are submitted exclusively to ELECTRONIC DESIGN. You will receive \$20 for each published idea, \$30 more if it is voted best of issue by our readers. The best-of-issue winners become eligible for the Idea of the Year award of \$1000.



**Fast start/stop...  
positive  
directional  
stability**



**It's great on torque and price, too!  
The compact 81700 synchronous motor.**

High torque-to-frame size ratio, superior performance characteristics and attractive low price make the 81700 synchronous motor ideal for computer peripherals, business machines and home entertainment equipment. Included are turntables, remote tuners, credit card readers and facsimile transmission equipment.

The motor's inherent reliability and 6 oz. in. @ 300 rpm are key factors. Instantaneous start/stop eliminates clutching and prestarting. Directional stability and low cost are other important advantages. A permanently lubricated bearing prolongs motor life and minimizes maintenance.

Write for information today!

**NORTH AMERICAN PHILIPS CONTROLS CORP.**

Cheshire, Conn. 06410 • (203) 272-0301

INFORMATION RETRIEVAL NUMBER 43

## Introducing the Gould 110 strip chart recorder—with a thermal writing pen guaranteed for life.

There isn't another strip chart recorder on the market today that can match the Gould 110's performance, ruggedness, versatility and writing dependability.

The new hot-tip thermal writing system produces clear, sharp, highly reproducible blue traces **with no smudges, no smears, no skips and no puddles.**

For complete information, write Gould Inc., Instrument Systems Division, 3631 Perkins Ave., Cleveland, Ohio 44114. Or Gould Allco S.A., 57 rue St. Sauveur, 91160 Ballainvilliers, France.

**PHONE FREE (800) 648-4990 FOR BROCHURE.**



INFORMATION RETRIEVAL NUMBER 44

ELECTRONIC DESIGN 26, December 20, 1975

## PANCAKE SYNCHROS AND RESOLVERS PROVIDE...

... Lower cost and higher accuracy in position sensing systems. Gimbal mounted synchros, resolvers and linear transformers are available in various configurations ... single speed accuracies to 10 seconds ... dual and multi-speed units with accuracies to 3 seconds. Other provisions include wide ranges of frequency, voltage, and temperature. Vernitron Control Components, A Division of Vernitron Corp., 2440 W. Carson St., Torrance, Ca. 90501, (213) 328-2504. Write or phone for new 20 page catalog.

**VERNITRON CONTROL COMPONENTS**



INFORMATION RETRIEVAL NUMBER 45

New miniature open-frame models designed specifically for low power applications where absolute minimum size is essential.

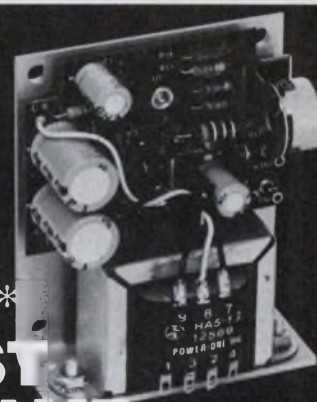

## WORLD'S\* SMALLEST OPEN-FRAME POWER SUPPLY

\$1995  
Single  
Quantities

\*only 3.75" H x 3.00" W x 1.60" D.

MODELS: HA5-1 2 OVP, 5V @ 12A w/OVP  
HA15-0.5 9V to 15V @ 0.5A

FEATURES: 115/230 VAC input • OVP on 5V models • I.C. Regulated • ± 0.5% Regulation • 1.5 MV Ripple • Foldback Current Limiting • Full Rated to +50°C • 2 Hour Burn-in • 2 Year Warranty.

For a copy of our New 1976 D.C. Power Supplies Catalog, contact Power-One or your local factory representative.



531 Dawson Dr. Camarillo, Ca 93010  
Phone 805/484-2806 TWX 910-336-1297

# POWER-ONE, INC.

INFORMATION RETRIEVAL NUMBER 46



# The best talents in your business can be bought...

## PRACTICAL DESIGN FOR ELECTROMAGNETIC COMPATABILITY

edited by ROCCO FICCHI

A complete guide to electromagnetic compatibility for electronic systems and equipment. Includes the current techniques for analyzing, predicting, controlling and reducing unwanted signals, along with numerous charts, graphs and nomographs. Recent advances in filtering and shielding, and exhaustive treatment of the special problems encountered in computers, semiconductors and solid-state devices. #5685-0, \$17.20

## PRACTICAL VALUE ANALYSIS METHODS

by JOHN H. FASAL

This step-by-step guide transforms sophisticated VA-VE theory into concrete techniques and methods enabling you to literally take apart and scrutinize every facet of your operation—streamline everything from product costs to worker efficiency. An unlimited planning tool in the hands of today's ambitious executive or manager. #5845-4, \$13.75

## MODERN DATA COMMUNICATION

by WILLIAM P. DAVENPORT

An on-the-job handbook mapping out the latest techniques, systems and services for the most efficient data transmission. Includes simplified coding techniques; ways of dealing with distortion, distraction, interference; efficiency and control techniques; modulating and multiplexing methods; and advice on using today's commercially available services. #5810-1, \$10.30

## BASIC TELEPHONE SWITCHING SYSTEMS

by DAVID TALLEY

Offers the full array of switching techniques—from the early step-by-step type, through the common electro-mechanical group, to today's sophisticated electronic system. Special attention given to the No. 1 ESS type being installed by many companies. Here's a versatile, clearly-written handbook for the engineer, executive, and trainee alike. #5750-4, \$6.60

## RELIABILITY, MAINTAINABILITY AND AVAILABILITY ASSESSMENT

by MITCHELL O. LOCKS

All the techniques and formulas you need for calculating the reliability, maintainability and availability of your repairable and non-repairable systems and components. You'll find sample models using point and interval values, and time-to-failure and time-to-repair data; binomial and other bernoulli-type distributions; simplified goodness-to-fit techniques, and much more. #9204, \$15.95

## VIBRATION AND ACOUSTIC MEASUREMENT HANDBOOK

edited by MICHAEL BLAKE & WILLIAM S. MITCHELL

This giant, field-tested, 680-page manual enables you to master today's vibration equipment and techniques—shows you how to spot up to 90% of equipment problems months in advance and take corrective action before trouble starts. Uses scores of actual industrial problems and solutions in outlining specific procedures and techniques. #9195, \$34.50

# on a 15-day money-back guarantee.

**I'm buying!** Please send me the books listed below to read and use FREE for 15 days. At the end of that time I will send payment, plus postage, or return the book(s) and owe nothing.

Number	Title	Price
_____	_____	_____
_____	_____	_____
_____	_____	_____
_____	_____	_____
TOTAL		_____

Name \_\_\_\_\_

Firm \_\_\_\_\_

Street \_\_\_\_\_

City/State/Zip \_\_\_\_\_

I want to save money! Payment enclosed. Publisher pays postage. Same 15-day guarantee.

75-50



**Hayden Book Company, Inc., 50 Essex St., Rochelle Park, N. J. 07662**



# FET-input hybrid op amps match modules for performance at low cost

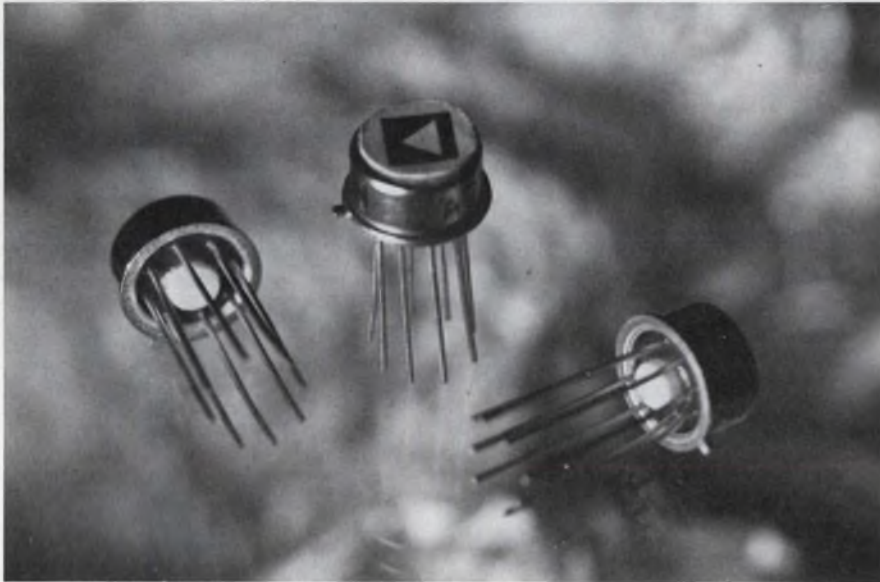

Analog Devices, Route 1 Industrial Park, P.O. Box 280, Norwood, MA 02062. (617) 329-4700. P & A: See text.

By combining a matched FET pair with a wideband amplifier, Analog Devices has come up with a hybrid op amp that rivals the high performance of modules and the low cost of ICs. The 515 series of electrometer op amps has input bias currents as low as 75 fA, maximum, and small-signal bandwidths of over 350 kHz. And they cost about half as much as competing modules and about 20% less than competing monolithic ICs.

The Model 515 amplifiers use a separate matched FET chip and laser trimming to minimize input offset to 1 mV, maximum, and drift to only 15  $\mu\text{V}/^\circ\text{C}$ . Noise has also been kept low—only 4  $\mu\text{V}$ , pk-pk, over a 0.1-to-10-Hz bandwidth. The op amp has internal compensation, is free of latch-up and is short-circuit-protected on the output. A case guard connection in the hermetic TO-99 metal package minimizes stray leakage

to the case and shields the input circuitry from external noise and transients.

Quiescent current drawn by the op amp is claimed to be around the lowest available—only 1.5 mA, max, for  $\pm 15\text{-V}$  supplies. With  $\pm 5\text{-V}$  supplies, the quiescent drain drops to 0.5 mA. The op amp has a 0-to-70-C operating temperature range and comes in three performance versions.

The 515J, K and L have maximum input-bias currents of 300, 150 and 75 fA, respectively, when measured after warmup on  $\pm 15\text{-V}$  supplies. Maximum input offset voltages are 3, 1 and 1 mV, respectively, and offset voltage drifts are 50, 15 and 25  $\mu\text{V}/^\circ\text{C}$ , respectively. All amplifiers have a differential input of  $10^{13} \Omega$  and a common-mode input impedance of  $10^{15} \Omega$ .

Prices for the Analog Devices 515 series amplifiers are \$16, \$21 and \$27 for the J, K and L models, respectively, in 1 to 24 pieces. In 100 unit lots the prices drop to \$9.90, \$14 and \$18, respectively.

Delivery of all three versions is from stock.

Competitive modules, such as the 102901 from Teledyne-Philbrick (Dedham, MA) or the A-127 from Intech (Santa Clara, CA), are about double the cost of the 515. They are also many times the size, with both the 102901 and the A-127 modules at least  $1.5 \times 1.5$  in.

There are, though, some IC op amps that can meet some of the 515's specs—such as the 3523 series from Burr-Brown (Tucson, AZ) or the 142902 from Teledyne-Philbrick—but they tend to cost more.

Analog Devices	CIRCLE NO. 302
Burr-Brown	CIRCLE NO. 303
Intech	CIRCLE NO. 304
Teledyne-Philbrick	CIRCLE NO. 305

## 130-bit CCD register delays up to 25 ns

Fairchild, 464 Ellis St., Mountain View, CA 94042. (415) 962-3816. \$49 (100-999); factory stock.

A charge-coupled analog shift register, the CCD311, functions as a wide-range analog delay line. The device can be operated either as a single 130-bit device, or a 260-bit device using multiplexing techniques. It can operate over frequencies extending from 10 kHz to video rates up to 15 MHz. A range of delay times from 20  $\mu\text{s}$  to 25 ms can be obtained simply by varying the rate of an external clock signal. The device comes in an 18-pin DIP, and features a signal-to-noise ratio of more than 50 dB and an input bandwidth of greater than 4 MHz.

CIRCLE NO. 308



**RF power**  
 We've made the  
 most of it...  
 You can, too!!

All wrapped up in a neat little package, our Model 510L is an ultra-wideband RF power amplifier whose wide range of frequency coverage and power output provide the user with the ultimate in flexibility and versatility in a laboratory, instrument. Easily mated with any signal generator, this completely solid state unit amplifies AM, FM, SSB, TV, pulse and other complex modulations with a minimum of distortion.

Constant forward power is continuously available regardless of the output load impedance match making the 510L ideal for driving highly reactive loads.

Unconditional stability and instantaneous fail-safe provisions in the unit provide absolute protection from damage due to transients and overloads.

This outstanding unit covers the frequency range of 1.7 to 500 MHz with a linear power output of more than 9.5 watts and there is no tuning.

For further information or a demonstration, contact ENI, 3000 Winton Road South, Rochester, New York 14623. Call 716-473-6900 or TELEX 97-8283 E N I ROC



**ENI**

SEE  
 Electronic Design's  
**GOLD BOOK**  
 FOR COMPLETE  
 PERFORMANCE  
 INFORMATION

The world's leader  
 in solid state power amplifiers

INFORMATION RETRIEVAL NUMBER 48

## INTEGRATED CIRCUITS

### Quad amp boosts specs for 741-type units

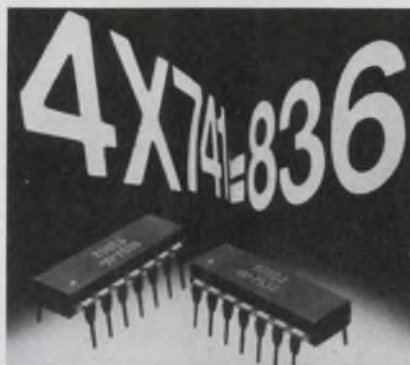

Teledyne Semiconductor, 1300 Terra Bella Ave., Mountain View, CA 94041. (415) 968-9241. \$3.40 to \$11.50 (100-999).

The 836 quad op amp—an improved 741-type amplifier—has a typical slew rate of 1.2 V/ $\mu$ s, small signal bandwidth (unit-gain frequency) of 1.5 MHz and power bandwidth to 20 kHz. The internally compensated amplifier permits class AB output operation. At maximum output voltage, an 836 output remains symmetrical about ground and typically swings within 1 V of either supply. Input common-mode voltage range is  $-15$  to 13.5 V. Typical supply current at  $\pm 15$  V is only 700  $\mu$ A per amplifier resulting in a total dissipation per package of 84 mW, or only 21 mW per amplifier.

CIRCLE NO. 320

### 1-k bipolar PROMs start at \$5.95

Monolithic Memories, 1165 E. Arques, Ave., Sunnyvale, CA 94086. (408) 739-3535.

A series of low-cost 1024-bit bipolar PROMs, with 256  $\times$  4-bit organizations, are offered in both commercial and MIL temperature versions. The 6300-1 (open collector) and 6301- (three-state) commercial parts are priced at \$5.95 in quantities of a hundred. The 5300-1 (open collector) and 5301-1 (three-state) military parts are priced at \$11.95 (100-999). All units are said to have the lowest power dissipation available. At least 95% of all units will program to completion in two seconds or less.

CIRCLE NO. 321

### CMOS family simplifies counting and timing

Intersil, 10900 N. Tantau Ave., Cupertino, CA 95014. (408) 257-5450. \$1.50 to \$17.00 (1000).

Seven CMOS devices complete the company's line of timing microcircuits for industrial control and instrumentation applications. The new devices consist of the 7045 and 7205 low-power counter-timers; the 7208 counter; and the 7038A, 7207, 7209 and 7213 crystal frequency generators. The 7045, which times intervals from 0.01 s to 24 h, typically dissipates 0.9 mW. The 7205 times from 0.01 s to 1 h and dissipates 2.5 mW typical. The 7208 is a 7-digit unit counter, requiring a LED display, two resistors, a capacitor and control switches for operation.

The 7038A is a CMOS oscillator, frequency divider and driver. It accepts crystals with frequencies from 200 kHz to 15 MHz, and provides outputs at the crystal frequency and at  $\div 2^{13}$  and  $\div 2^{16}$  frequency-divider stages. The 7207 is a complete frequency counter time base that dissipates less than 5 mW at 5 V. The 7207 accepts crystals from 1 to 10 MHz, and it provides outputs at the crystal frequency, and at  $\div 2^{13}$ ,  $\div 2^{17}$  and  $\div 10(2^{17})$  divider stages. The 7209, a high-frequency clock generator for 5-V systems, accommodates crystals from 10 kHz to 10 MHz and provides outputs at crystal frequency and  $\div 2^3$  divider stage. The 7213 is an oscillator, divider and waveshaping circuit using crystals from 1 to 6 MHz. Outputs are at crystal frequency,  $\div 2^{22}$  frequency, and one-second and one-minute pulses.

CIRCLE NO. 322

### \$10 circuit provides 10-V reference

Analog Devices, Route 1 Industrial Park, P.O. Box 280, Norwood, MA 02062. (617) 329-4700.

The AD2700/L, a 10.000  $\pm$  0.001-V reference, costs just \$10 in hundred quantities. The thin-film circuit has  $\pm 0.03\%$  maximum output error at 70 C and 50-ppm/year long-term stability. The unit comes in a 14-pin DIP, and it is available from stock.

CIRCLE NO. 323



## COMPONENTS

### Pushbutton switches withstand PC processes

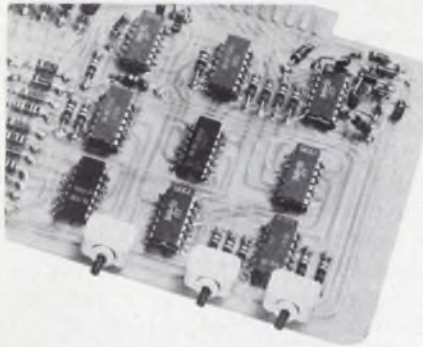

Grayhill Inc., 561 Hillgrove Ave., La Grange, IL 60525. (312) 354-1040. \$0.98 (100 up); stock to 7 wks.

New PC-board mounted pushbutton switches, Series 39-251, withstand wave soldering and related cleaning processes. The switches have the terminals ultrasonically welded to the switch body, and the top and bottom halves of the cases are molded from high-temperature polyester, also ultrasonically welded. An optional semirigid boot is available to fit over the plunger. The switch can provide SPDT, SPST-NO or SPST-NC contact action. Gold-plated contacts can handle logic-level loads to 1/4 A for a minimum of 250,000 operations.

CIRCLE NO. 324

### Toggle switches added to line



Oak Industries Inc., Crystal Lake, IL 60014. (800) 435-6106. Stock.

Oak's lines of switches now include miniature toggles with either SPDT, DPDT, 3PDT or 4PDT switching action. The new lines are Series 31, with standard toggles, Series 32, with long toggles and Series 33, with decorative flat plastic caps. Each consists of 20 basic switch models, with either solder or PC terminals. Several momentary-action types are also available. Contacts are rated at 6 A, 125 V ac. Mechanical life is 100,000 cycles and electrical life is 25,000 to 50,000 cycles.

CIRCLE NO. 325

### Electronic buzzer generates no rf

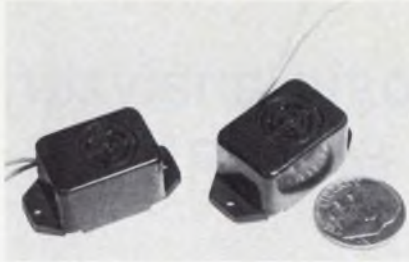

Kolin Industries Inc., 59 W. Pondfield Rd., Bronxville, NY 10708. (914) 961-5065. \$1.99 list.

New Li'l Earsplitter miniature solid-state electronic buzzers, less than 1-in. long, 5/8-in. wide and 5/16-in. high, give off a big, rich sound. There are no mechanical points to arc and require maintenance, and no rf noise is generated. They are available with 3, 6, 9, 12 and 24-V ratings.

CIRCLE NO. 326

# THE NEW 3403A. OUTPERFORMS ALL QUAD OP AMPS. FASTER SLEW RATE. DISTORTION FREE.

Raytheon Semiconductor's new 3403A Quad Op Amp gives you a faster slew rate and absolutely no output distortion, plus other improved AC and DC characteristics. The 3403A is significantly better than either the standard MC3403 or LM324. And it's pin compatible too. Our 3403A is simply the best quad op amp

from the leader in linear quads.

For complete details and your own Quad/Dual brochure, contact Raytheon Semiconductor or your local distributor. For your *free sample*, write Raytheon Semiconductor on your company letterhead.



## RAYTHEON SEMICONDUCTOR

Dept. 3403A, 350 Ellis Street, Mountain View, CA 94042



## It looks like a logic analyzer; it's also a word generator

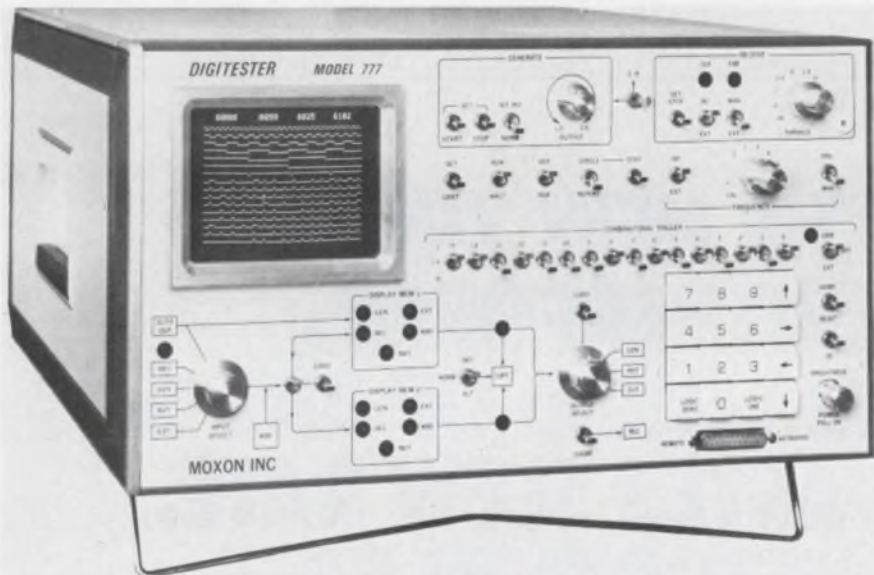

Moxon Inc., SRC Div., 2222 Michelson Dr., Irvine, CA 92664. (714) 833-2000. See text.

One quick glance at the timing-diagram display on Moxon's Model 777 Digitester, and you get the feeling that you're looking at yet another logic analyzer. But peer closer. Panel legends such as "generate" and "receive," along with a calculator-like numerical keyboard, tell you that there's more here than meets the eye. The 777 not only receives data; it generates words. And that, no other logic analyzer can do.

Thus with the 777 you can "tickle," say, a microprocessor with any desired bit pattern, and use the same piece of equipment to watch the  $\mu$ P respond. The pattern can consist of up to 1024 bits of serial data at rates up to 20 MHz. Or if parallel bits are what you need, you've got them: up to 64 sixteen-bit words. What the 777 dishes out, it can take right back—in either serial or parallel modes.

It costs \$11,950, to be sure. But you can spend more than that for a logic analyzer alone.

Five internal memories in the Moxon unit let you do all kinds of good things. You can generate

only, receive only or do both simultaneously. With one memory used as a scratch pad, you can direct the integral CRT to display the program as you formulate it. When you're satisfied with the pattern, you can then load it into a transmit memory for delivery to the circuit under test.

How fast do the data come out? As fast as you'd like, up to the maximum 20 MHz. Just dial in the crystal-controlled bit rate or let your system clock replace the internal oscillator for synchronous operation. And data can be delivered continuously or in bursts. Another parameter you can dial in is the logic ONE output level—it can be set to anywhere from 1.5 to 3.5 V.

With the 12-key numeric pad, entry of individual bits or strings of ONES and ZEROS couldn't be simpler. Hit a number and then the LOGIC ONE or LOGIC ZERO button. For instance, the sequence, 1, 5, 6, LOGIC ONE, programs 156 consecutive ONES.

In the serial mode, the bits appear horizontally along each line, from left to right, on the CRT. In parallel, the bits appear vertically for each word, from top to bottom,

on the CRT. With the aid of a displayed cursor and a toggle switch, you can invert any bit without reprogramming or reloading memory. Thus you can examine the response to parity errors or the effects of single-bit changes. Other alphanumeric displays help even more.

As a receiver, the 777 gives you all the features you'd expect in a logic analyzer and more: You can store results, adjust the input threshold ( $-10$  to  $10$  V), set a 16-bit combinatorial trigger and look forward or backward in time.

You can juggle and transfer data between memories, take a snapshot and display just a portion of a data stream, or compare the contents of various memories. One memory can be the response, the other the preloaded, expected response or the transmitted data. If the contents of the two memories disagree, you'll know it right off by the flashing bits on the CRT.

These aren't all the tricks in the Moxon 777 repertoire. There are lots more. If you can wait 90 days to get one, you can check the unit out in your own lab.

CIRCLE NO. 301

## Function generator sells for just \$245



Exact Electronics, 455 S.E. 2nd Ave., Hillsboro, OR 97123. (503) 648-6661. \$245.

Model 119 vcf function generator offers a dynamic frequency range from 0.02 Hz to 2.2 MHz with sine, square, triangle and variable time symmetry of all waveforms for ramp and pulse operation. A vcf input allows the generator frequency to be varied either up or down over a range of 1000:1. The HI output delivers 20 V pk-pk open circuit, 10 V pk-pk into 50  $\Omega$ . The LO output delivers 632 mV pk-pk open circuit, 316 mV pk-pk into 50  $\Omega$ .

CIRCLE NO. 327



## Test system handles $\mu$ Ps and other LSI



Fairchild Systems Technology, 1725 Technology Dr., San Jose, CA 95110. (415) 962-3047. \$250,000 to \$350,000; 90 days.

Sentry II is a computer-controlled semiconductor test system that uses multiprocessor techniques. The system is said to accommodate the most intricate semiconductor circuitry used or produced today, including microprocessors and equivalent memory components in which cells must be individually verified. It can test each device at its individual operational speed. Key feature of the Sentry II is its use of two special purpose processors, a Sequence Processor and a Pattern Processor.

CIRCLE NO. 328

## Probe converts rms to dc output signal



Non Linear Systems, P.O. Box N, Del Mar, CA 92014. (714) 755-1134. \$149; stock.

Model RMS-10 is a portable, battery powered probe for measurement of true rms. The unit has three ranges—2, 20 or 200 V fs. A dc output signal of 0 to 2 V represents the rms value of the input, whether dc, ac or a combination of both. Accuracy of the conversion is  $\pm 1\%$ . Input impedance is 1 M $\Omega$  and response is  $-3$  dB at 10 kHz. NiCd batteries and a charger unit are included. Size is only 1.4-in. dia. and 7-in. long.

CIRCLE NO. 329

# 1024 Element Analog Delay 75 DB S/N

RETICON's SAD-1024 Serial Analog Delay is the most recent in our line of analog signal processing devices. It is designed for variable or fixed delay of analog signals including various audio applications (e.g., reverberation, echo and chorus effects in electronic organs and musical instruments, speech compression, voice scrambling, etc.) It is packaged in a 16 lead DIP and is priced at less than 1¢/bit in OEM quantities.

Other units offer up to 12 MHz sampling frequency, independent read-in/read-out, and can be used to perform analog storage, digital filtering, convolution, correlation, real time Fourier transforms and many other functions.

There are over 70 salesmen and 16 distributors to serve you worldwide.



**RETICON**<sup>®</sup>  
910 Benicia Avenue  
Sunnyvale, Ca. 94086  
(408) 738-4266  
TWX: 910-339-9343



# A/d converters with accuracies to 0.0015% drop prices sharply

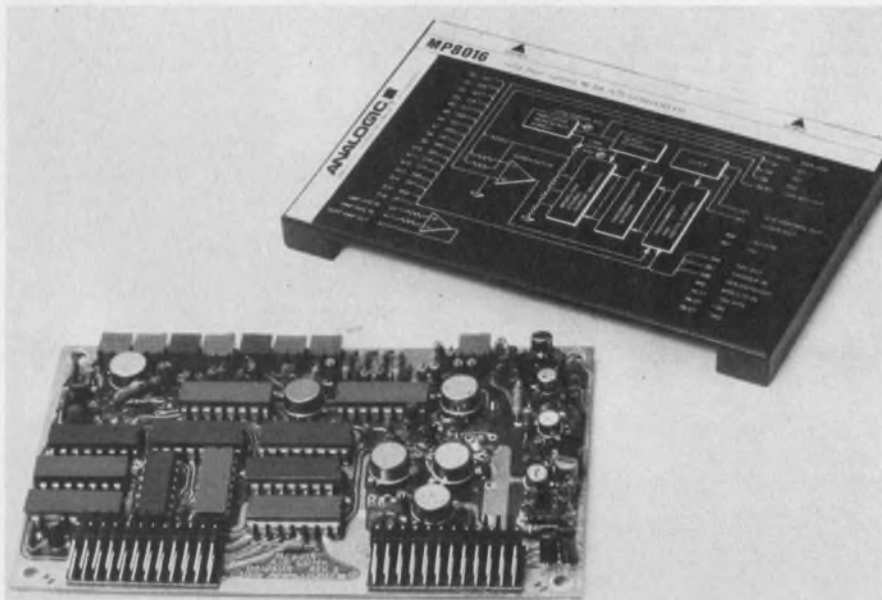

Analogic, Audubon Rd., Wakefield, MA 01880. (617) 246-0300. See text.

High-precision analog-to-digital converters have been available, but at prices not all users could afford. Analogic, with its 8000 series of 14-bit through 16-bit converters, does the job without putting the customer into hock—prices start at \$480. Heretofore the going price for this precision was about \$1000.

There are three units in the series: the 8014, a 14-bit; the 8015, a 15-bit; and the 8016, a 16-bit a/d converter. All converters

can be short-cycled if shorter word lengths are needed. Accuracies, based on measurements traceable to NBS standards, are 0.006%, 0.003% and 0.0015%, FSR, for the 14, 15 and 16-bit converters, respectively.

Absolute accuracy is  $\pm 0.006\%$  for the 14 and 15-bit models and 0.003% for the 16-bit model. Noise produced by the converters is less than 1 LSB—at 300  $\mu\text{V}$ , pk-pk, for a 3  $\sigma$  measurement. Power-supply sensitivity for all three models per 1% change in supply voltage is 0.0005%. Warmup time to full-

rated accuracy is only 10 minutes, and the recommended recalibration interval is six months.

The converters won't drift out of spec either—the differential linearity tempco is a low 1 ppm/ $^{\circ}\text{C}$  max, the gain tempco less than 2 ppm/ $^{\circ}\text{C}$  and the offset tempco less than 1.5 ppm/ $^{\circ}\text{C}$ .

All converters have a built-in buffer amplifier that provides an input impedance of 1000 M $\Omega$ . The converters can handle input voltages of 0 to 10 V or -10 to 10 V, and they deliver either offset binary, ONEs complement or TWOs complement binary outputs.

All units have a conversion speed that is externally adjustable from fixed times of 1.5, 2 and 2.5  $\mu\text{s}$  per bit to a minimum of 0.6  $\mu\text{s}$  per bit. And the internal clock has a stability of 0.1%/ $^{\circ}\text{C}$ .

Competitive converters are few. Analog Devices (Norwood, MA) has several models that provide 14 or 16-bit outputs, but they tend to be slower or much more expensive. For instance, that company's ADC-141 and 171, which are 14 and 16-bit converters, have conversion times of 10 ms and cost \$272—almost 100 times slower than the Analogic converter, but at half the cost. The ADC-16Q, on the other hand, converts in 400  $\mu\text{s}$  but costs \$1418—still slower but almost



## ANALOGY

A-TO-D OR D-TO-A. THERE'S AN INTECH CONVERTER MODULE WITH HIGH ACCURACY AT BIG COST SAVINGS. WE STOCK 20 DIFFERENT TYPES WITH BINARY RESOLUTIONS FROM 8 TO 16 BITS FROM 4 TO 5 1/2 BCD DIGITS. LINEARITIES TO BETTER THAN  $\pm 0.0025\%$ . EVEN OUR LOWEST COST DACS REMAIN MONOTONIC THROUGHOUT TEMP RANGE WITH CONVERSION TIMES TO 800 NS.

**intech/FMI**  
282 BROKAW RD. SANTA CLARA,  
CA 95050 (408) 244-0500



double the cost of an equivalent unit from Analogic.

Prices for the Analogic converters start at \$480 for the 14-bit unit, \$560 for the 15-bit unit and \$640 for the 16-bit. All units are available from stock.

Analogic **CIRCLE NO. 306**  
Analog Devices **CIRCLE NO. 307**

## High accuracy modulator is linear to $\pm 0.1\%$

*Computer Conversions, 6 Dunton Ct., East Northport, NY 11731. (516) 261-3300. Under \$100 (large qty.); stock to 4 wk.*

The MOD 503 series of high-accuracy modulators with up to  $\pm 0.1\%$  full-scale linearity converts dc-input signals to linearly proportional ac-output signals. The modulators accept  $\pm 10$ -V-dc or  $\pm 100$ -V-dc inputs and provide an ac output of 0 to 7 V rms. These modulators have an output impedance of only 1  $\Omega$ , maximum, and are insensitive to  $\pm 10\%$  reference line changes. Any ac output voltage can be provided via internal or external transformers, and the output is short-circuit protected. Gain and zero adjustments are also standard. The units have a reference input of 26 V, 400 Hz  $\pm 5\%$  (60-Hz units available); input impedances of 100 k $\Omega$ , minimum; operating temperature ranges of 0 to 70 C (MOD 503-1) or  $-55$  to 70 C (MOD 503-2); and measure  $2.6 \times 3.1 \times 0.625$  in. The modulators require  $\pm 15$  V at 50-mA supplies.

**CIRCLE NO. 330**

## Solid-state flasher handles 10-A surges

*SSAC Precision Products, P.O. Box 395, Liverpool, NY 13088. (315) 457-9610. From \$1.95.*

The Mini-Flasher, a solid-state on/off blinker, can handle 10-A surges. It will operate 120-W resistive, incandescent or inductive loads. The flasher has a 1-A, 115-V-ac steady-state rating; with a 50% duty cycle. The flash rate is 75 fpm and the unit operates over a 0-to-135-F range. A cylindrical case that measures 1.5 in. long and has a diameter of 15/16 in. houses the flasher.

**CIRCLE NO. 331**

**AIRPAX™**  
**Miniature**  
TOGGLE, ROCKER, AND LEVER HANDLE  
**Switches**

**AIRPAX**  
QUALITY

**AIRPAX**  
PERFORMANCE

**AIRPAX**  
SERVICE

American made. Competitively priced. Airpax miniature switches are the product of years of experience in the design and manufacture of electromechanical devices.

Single and two pole models. Maintaining or momentary switching actions. A wide range of options for appliances, industrial, military, and consumer applications.

You can choose the exact combination required from the selection of basic switching functions, contact ratings, terminations, handle types, and hardware.

Airpax miniature switches assure you of the superior quality, performance, and service that has been synonymous with Airpax products throughout the years.

Send for catalog.

**AIRPAX™**

**AIRPAX ELECTRONICS**  
**CAMBRIDGE DIVISION**  
Cambridge, Maryland 21613  
Switches, Circuit Breakers,  
Glass-to-Metal Seals

Other Airpax Divisions:  
CONTROLS DIVISION, Ft. Lauderdale, Florida - Instruments for Industry  
AMERICAN DATA, Huntsville, Alabama - TV Products

INFORMATION RETRIEVAL NUMBER 53



## ALLISON

'OPTO-ELECTRIC'  
The BEST...the ULTIMATE  
of ALL Ignition Systems!



Never wears out or needs any Maintenance!



● gives you Maximum Power  
with continuous PEAK PERFORMANCE

...while reducing Maintenance  
and Operating Costs!

★ The Allison OPTO-ELECTRIC System eliminates the Points and Condenser, replacing them with an OPTO-ELECTRONIC TRIGGER, using a Light-Emitting Diode and Photo transistor. The System operates on a beam of Light. As there are NO moving parts in rubbing contact "Friction-wear" is completely eliminated. Timing adjustments are PERMANENT.

● Gives 40-Times more Timing accuracy than ANY system using "Mechanical" Breaker-Points! UNLIMITED RPM! "Electronically-Controlled" DWELL automatically supplies HIGHEST Performance at both Low and High speeds. Spark strength does not fall off at high RPM. POSITIVE SPARK helps eliminate "Misfire" for faster acceleration and improved Engine Performance. Sparkplugs LAST 3 to 10-Times LONGER.

● Easier Starting under any condition! Smoother running... (NO TIMING FLUCTUATION as with Magnetic Impulse Units) All SOLID-STATE Components. UNAFFECTED By Temperature, Moisture, or Vibration! Only Highest grade materials used. Guarantees you Solid, Dependable Performance!

● PERFECT TIMING INCREASES Engine Efficiency and Gas Mileage. SAVES Precious Fuel! Allison gives you MAXIMUM Engine Efficiency 100% of the Time and that's the name of the game for the BEST in GAS MILEAGE AND ECONOMY.

★ Perfect Timing and Dwell never change.

● Pays for itself! Eliminates ignition Tune-Ups forever! "INFINITE LIFE"...Once installed. Never needs replacing!



★ PROVEN RELIABILITY!  
Each Unit Tested to 15,000 RPM.

● Road and Race Proven.  
(Opto-Electric Systems won at  
INDY Two years in a row!)

You CAN install the ALLISON System in ALL  
the U.S. made & Foreign Cars! (4, 6, or 8-Cylinder)

"EASIEST-TO-INSTALL" UNIT ON THE MARKET.  
(Not necessary to dismantle Distributor as with other systems)

★ If you want the BEST, and SAVE! This is IT!

ORDER with CONFIDENCE...  
SATISFACTION GUARANTEED

10-YEAR FACTORY WARRANTY!  
(Free Repair or Replacement)

● Send Check or M.O.  
State Make, Year, Engine Size. (Calif. Res. add Tax).

★ (So New...it's Sold ONLY FROM FACTORY DIRECT).

● You may use your MASTER CHARGE or BANKAMERICARD  
Send us (1) Your Number, (2) Interbank No., (3) Exp. Date

★ Before buying any other Type ignition system

Send Postcard for our FREE BROCHURE.

★ If you have already installed a C-D ignition system,  
Modernize and Increase its Efficiency...  
CONVERT YOUR "C-D" UNIT TO BREAKERLESS!  
Opto-Electric "TRIGGER UNIT"...Only \$34.95

● Our BEST Salesmen are the users of our ALLISON System!



America's Oldest and Largest Mfg. of  
Opto-Electronic Ignition Systems.

ALLISON

AUTOMOTIVE COMPANY

1267-F, East EDNA PL., COVINA, CAL. 91722

## PACKAGING & MATERIALS

### Ultraviolet lamp has intensity of 72 mW/cm<sup>2</sup>

American Ultraviolet, Commerce  
St., Chatham, NJ 07928. (201) 635-  
8355. \$160, \$20 (tripod); stock.

The Porta-Cure 1/100 ultraviolet  
irradiator has a typical intensity  
at 12 in. from light source of 72  
mW/cm<sup>2</sup>. This power is in the  
spectral range of 325 to 382 nm.  
The lamp requires 120 V ac at 2.1  
A, measures 8 × 6.125 × 8.5 in.  
and has an optional tripod stand.

CIRCLE NO. 332

### Reinforced nylon has high tensile strength

Fiberfil Div., Dart Industries, 1701  
N. Heidelberg Ave., Evansville, IN  
47711. (812) 424-3831. \$1.28/lb  
(32,000 lb and up); stock.

Type 66 fiberglass reinforced nylon  
with silicone additive, Hilube  
Nylafil J-1/30/SI/3, has an in-  
creased service life under load  
bearing conditions. This is due to  
the silicone additive that reduces  
the coefficient of friction. Proper-  
ty test values include tensile  
strength of 22,000 psi, flexural  
strength of 30,000 psi, elongation  
of 2%, coefficient of linear thermal  
expansion of 2.1 × 10<sup>-5</sup> and a  
deflection temperature under load  
at 264 psi of 485 F.

CIRCLE NO. 333

### Conductive adhesive has R of only 0.0005 Ω-cm

Aremco Products, P.O. Box 429,  
Ossining, NY 10562. (914) 762-  
0685. From \$21.50 (50 grams).

Aremco-Bond 556, a two-com-  
ponent silver filled epoxy, has a  
volume resistivity as low as 0.0005  
Ω-cm. Its shear strength after  
bonding to metals, ceramics, glass  
or epoxy ranges from 3000 to 4000  
psi. The material has a pot life  
of 30 m and a shelf life (unmixed)  
of 6 mo. It can be cured at room  
temperature in 12 h, or there are  
several optional heat cure cycles  
such as 105 C for 3/4 h, or 65 C  
for 3 h. After curing the material  
has an operating temperature  
range of -60 to +200 C.

CIRCLE NO. 334

## NEW SERIES

# Schottky Barrier Rectifiers



- Five series: 1A, 3A, 5A, 15A & 30A (I<sub>0</sub>) with 20V, 30V and 40V (V<sub>RRM</sub>).
- Extremely fast recovery (t<sub>r</sub>), very low forward voltages (V<sub>F</sub>), high reliability and low cost.
- VSK 120, 130 & 140-1A series in DO-41 packages. 550 mV (V<sub>F</sub>), 40A peak 1/2 cycle surge (I<sub>FSM</sub>), 10 mA (I<sub>R</sub>) at T<sub>L</sub> = 100°C.
- VSK 320, 330 & 340-3A series. Epoxy package, axial leads. 475 mV (V<sub>F</sub>), 150A surge, 30 mA (I<sub>R</sub>) at T<sub>L</sub> = 100°C.
- VSK 520, 530 & 540-5A series. Epoxy package, axial leads. 450 mV (V<sub>F</sub>), 250A surge, 75 mA (I<sub>R</sub>) at T<sub>L</sub> = 100°C.
- VSK 1520, 1530 & 1540-15A series in DO-4 metal stud cases. 600 mV (V<sub>F</sub>), 300A surge, 75 mA (I<sub>R</sub>) at T<sub>c</sub> = 100°C.
- VSK3020T, 3030T & 3040T-30A series. Center-tapped, common cathode, 15A per leg in TO-3 package. 630 mV (V<sub>F</sub>), 300A surge, 75 mA (I<sub>R</sub>) at T<sub>c</sub> = 100°C.

All series have junction operating  
temperature range of -65°C to  
+150°C.

Call Mike Hawkins

214/272-4551 for more information



VARO

Design us in —  
We'll stay there  
VARO SEMICONDUCTOR, INC.

P.O. BOX 676, 1000 NORTH SHILOH,  
GARLAND, TEXAS 75040  
(214) 272-4551 TWX 910-860-5178

INFORMATION RETRIEVAL NUMBER 64

ELECTRONIC DESIGN 26, December 20, 1975

INFORMATION RETRIEVAL NUMBER 54



## POWER SOURCES

### Switcher weighs 4 lb, yet delivers 50 W

*Nippon Electronics Memory Industry Co., Ltd., Park Avenue Bldg., 1-20-1 Sendagaya Shibuya-ku, Tokyo, 151, Japan. Start at \$87 (50-W unit).*

HR series of switching power supplies delivers various voltages from 5 to 48 V at 50, 100 and 150 W. Size of the 50-W unit is 2.68 × 7.65 × 7.09 in., and weight is 4.19 lb. Efficiencies range from 70 to 80%. The MTBF is listed as 120,000 h. Features include remote control and sensing, overvoltage and overload protection.

CIRCLE NO. 338

### Solid-state supply provides 60 kV

*Spellman High-Voltage Electronics, 1930 Adeo Ave., Bronx, NY 10463. (212) 671-0300. \$550; 4-6 wks.*

Model UHP60P5, zero-to-60-kV dc power supply operates from an input voltage of 115 V rms, 60 Hz. Output current is 75  $\mu$ A at 60 kV and increases to 250  $\mu$ A below 20 kV. The output is positive with respect to ground and the unit features ripple of less than 0.5% rms. A  $\pm 2\%$  meter reads the output voltage directly through a high-voltage multiplier resistor.

CIRCLE NO. 339

### Supply maintains power on RAMs when line fails

*Scarpa Laboratories, Inc., 46 Liberty St., Braintree Station, Metuchen, NJ 08840. (201) 549-4260. \$150; 2-4 wks.*

This 5-V, 6-A open-frame supply features an auxiliary battery backup which can automatically keep permanent power on a 4-k by 8-bit RAM memory bank of 2102s. The stand-by battery pack is continuously trickle charged as long as line voltage is present. Power outages can range from between one week and one month without loss of data. The modules feature short-circuit-proof operation and overvoltage-crowbar protection.

CIRCLE NO. 340

# We'll go to any lengths

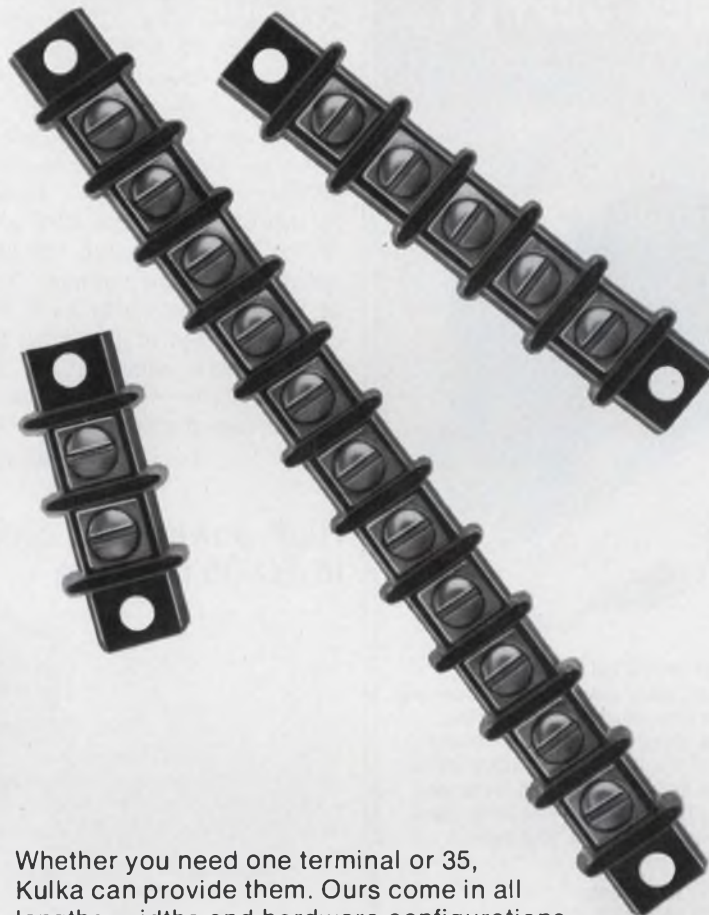

Whether you need one terminal or 35, Kulka can provide them. Ours come in all lengths, widths and hardware configurations. Along with one of the most comprehensive sales and distribution networks in the industry. Rest assured, whatever type of terminal board, block or strip you order, they will have the durability and workmanship that has made Kulka a benchmark for quality for over thirty years. Which is why we feel no competitor can ever measure up.

# Kulka

A NORTH AMERICAN PHILIPS COMPANY

Kulka Electric Corp., 520 South Fulton Avenue, Mount Vernon, New York 10551



# JOIN THE REVOLUTION AGAINST CUSTOM POWER SUPPLIES



Now is the time to put an end to high cost custom power supplies . . . and the long lead times they require. Join the Arnold Magnetics "Design-As-You-Order" revolution. Choose from over 1200 miniaturized off-the-shelf input and output submodules to meet your specific needs. Save time, save space, save money . . . and get outstanding performance.

- Single or dual inputs:  
115-220 VAC, 47-500 Hz,  
12, 18, 48, 115, 150 VDC.
- Multiple isolated and regulated DC outputs  
from 4.2 to 300 VDC.
- Line & load regulation to 0.1%.
- Up to 800 watts per output.
- Efficiencies to 85%.
- Completed units provided in tested and  
encapsulated, conduction cooled packages.

Phone or write for your "Declaration Of Non-Dependence" (our new Catalog and Specification Form) on custom power supplies . . . join the revolution today!



## ARNOLD MAGNETICS CORPORATION

11520 W. Jefferson Blvd.  
Culver City, Ca. 90230 ● (213) 870-7014

## DISCRETE SEMICONDUCTORS

### 12 and 24-A rectifiers housed in TO-3 cases

*Solitron Devices, Inc., 1177 Blue Heron Blvd., Riviera Beach, FL 33404. (305) 848-4311. From \$2.10 (100-up); stock.*

Two series of fast switching silicon planar integrated power rectifiers are available in hermetic TO-3 cases. The SPDA 6205, 10, 20, 30 are 12-A devices (6 A per chip) and the SPDA 12205, 10, 20, 30 are 24-A units (12 A per chip). Each series is available with common-cathode, common-anode or doubler construction. Both the SPDA 6205 through 6230 and the SPDA 12205 through 12230 offer rated breakdown voltages from 50 to 300 V. The units have reverse recovery times of less than 200 ns and storage temperature ranges from -65 to +200 C. The TO-3 copper case dissipates 1.25 C/W.

CIRCLE NO. 341

### High power triac comes in TO-65 package

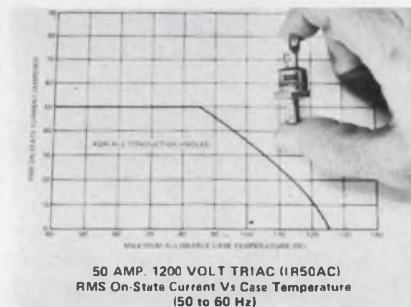

*International Rectifier, Semiconductor Div., 233 Kansas St., El Segundo, CA 90245. (213) 678-6281. From \$15.40 (25-up); stock.*

The 50 AC series of triacs is rated for operation at 50 A, with voltage ratings up to 1200 V. The company believes these units to be the first rated for such high power operation that are available in standard TO-65 packages. The line offers a choice of gate drive currents—a standard 500-mA gate and a sensitive 200-mA gate. Triacs in the series are available with blocking voltage ratings of 400, 600, 800, 1000 and 1200 V and a surge current of 1200 A, maximum. Commutation  $dV/dt$  is 10 V/ $\mu$ s at rated voltage and 125-C junction temperature.

CIRCLE NO. 342

## Impedance converter also houses IR detector

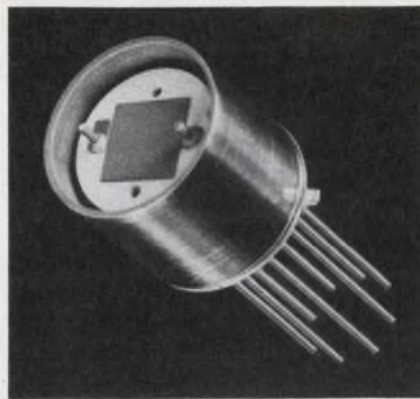

*Eltec Instruments Inc., Central Industrial Park, Daytona Beach, FL 32014. (904) 252-0411. \$45 (10 up); 2 wks.*

Model 320 impedance converter is designed for IR radiation detectors that need high-impedance, low-capacitance and low-noise coupling. This package allows selection of detector and window material, load resistor and mounting for the detector without interfering with the impedance converter performance. The converter circuit is hermetically sealed in a TO-99 housing and detectors up to 3-mm dia can be used. The circuit uses an n-channel JFET, a selection of three load resistors and one output resistor. The entire circuit floats. Voltage noise with  $R_{in} = 5 \times 10^{11} \Omega$  is  $90 \mu V/\sqrt{Hz}$ . Input capacitance is 3 pF and gain is 0.6. The supply voltage can be between 5 and 15 V dc. Power consumption is 2.5 mW max.

CIRCLE NO. 343

## LED displays use light pipes for 1-in. height

*IEE, 7740 Lemona Ave., Van Nuys, CA 91405. (213) 787-0311. \$4.35 (100-up); 60 day.*

The single-digit "light-pipe" series 1720R/1723R are 1-in.-high LED numeric displays. They are available with either a common-anode (1720R) or common-cathode (1723R) and are housed in an electrically nonconductive, plastic-compound base that measures  $1.3 \times 0.886 \times 0.334$  in. Typical luminous intensity is 250  $\mu$ cd at 20 mA and 3.3 V per segment. The maximum dissipation is 760 mW per digit.

CIRCLE NO. 344



## DATA PROCESSING

### Cursor enters data from maps and graphs



Instronics Inc., One Regency Dr., Bloomfield, CT 06002. (203) 242-2219.

A keyboard cursor facilitates the entering of numerical data while digitizing maps and charts. A keyboard is built right into the new cursor. A Gradicon digitizer then senses the cursor position and converts the coordinate data into digital form for computer processing.

CIRCLE NO. 347

### Sound-sensor system digitizes 3 dimensions



Science Accessories Corp., Kings Highway West, Southport, CT 06490. (203) 255-1526.

A new three-dimensional Graf/Pen sonic digitizer, Model GP-3/3-D, is used to convert descriptions of three-dimensional objects into digital form suitable as inputs to data-processing systems. Slant-range distances are converted to orthogonal coordinate sets by the software of the data system. The operator traces an object with a stylus that generates supersonic pulses. The time for the sound wave to reach three linear microphones is a measure of the distance. Outputs are in English or metric units. Resolution of English units is 0.01 in. and sensor lengths are up to 24 in. Standard size is the cube enclosed by 14-in. sensors.

CIRCLE NO. 348

### Disc memory system handles to 4500 Mbytes

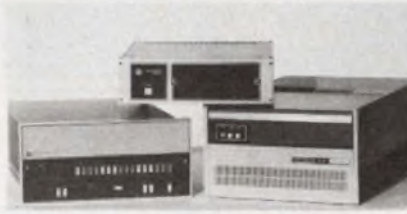

Microcomputer Systems Corp., 3068 Kenneth St., Santa Clara, CA

95051. (408) 985-1414. \$17,500: 40 Mbyte: 30 days.

The MSM-10 disc systems for HP-2100 and 21MX computers consist of an Ampex, CDC or Century Data disc drive, Microcomputer System microprogrammed controller and host adapter. Expandable up to 15 drives and multiported up to eight computers, the system can provide 4500 Megabytes of disc storage with a single controller.

CIRCLE NO. 349



**Announcing new frontiers in transistor chips.**

We're into new technology areas where other companies have never been: a UHF amplifier with 8dB gain at 1.6GHz; a 30W, TO-5 Darlington with BVceo 120V at 5A, gain 10,000 at 5A, and ft 100MHz; an RF amplifier at 1.0GHz, <\$1.00 in quantity; or a 200W, 100A, 120V, 40MHz switching transistor. If this kind of technology interests you, call us and find out what's new today.

**SEMICOA**

**We'll take you places you've never been before.**

333 McCormick Avenue, Costa Mesa, California 92626, 714/979-1900

FOR IMMEDIATE NEED CIRCLE #201

FOR INFORMATION ONLY CIRCLE #202



# NEW APPROACH TO LOW LEVEL DATA ACQUISITION



Phoenix Data's new 8000 Series

Phoenix Data's floating point 8000 Series data acquisition system features adaptability to virtually any analog input signal currently in use—offering automatic or programmed gain selection with 11 binary ranges from  $\pm 10$  millivolts to  $\pm 10.24$  volts full scale. The data word (12 binary bits) is combined with the range data (4 binary bits) for a 16 bit output word in the automatic ranging mode. The system will resolve input changes of 5 microvolts on the  $\pm 10$  millivolt range for an overall analog dynamic range of 132 db.

#### FEATURES:

- ADC resolution of 12 binary bits.
- 11 binary gain ranges.
- $\pm 10$  mv to  $\pm 10.24$ V input ranges.
- Solid state MOSFET multiplexing.
- Thruput rates from 1 to 20 KHz.
- Auto or programmable gains.
- Up to 128 channels per chassis.
- System accuracy of .05% of reading.
- System T.C.:  $0.001\% \text{FSR} \pm 1\mu \text{ volt RTI}/^\circ\text{C}$ .

If it's stability, accuracy, speed, or all-around quality you need in Data Conversion, contact Phoenix Data now!



## PHOENIX DATA, INC.

3384 W. OSBORN RD. PHOENIX, AZ 85017  
Ph. (602) 278-8528, TWX 910-951-1364

INFORMATION RETRIEVAL NUMBER 58

## Application Notes

### Curve tracer

A "Testing Opto-isolators" bulletin deals with using a standard curve tracer to check the most important opto-isolator device specifications. Tektronix, Beaverton, OR

CIRCLE NO. 350

### Dc clocks

Simplified dc circuitry for driving the company's SP-151, SP-152 and SP-352 planar gas discharge displays is presented in a four-page bulletin. Beckman Instruments, Helipot Div., Fullerton, CA

CIRCLE NO. 351

### Impatt diodes

Advantages of double-drift Impatt diodes for high-power cw microwave applications are given in a 12-page brochure. Information about circuits and operating characteristics are included. Hewlett-Packard, Palo Alto, CA

CIRCLE NO. 352

### Impedance measurement

An application note is intended as an introduction to mechanical-impedance testing. Described are some of the terms used, problems encountered and techniques employed in mechanical-impedance testing. EMR Telemetry, Sarasota, FL

CIRCLE NO. 353

### RFI suppression

Among the topics discussed in the illustrated eight-page "Radio Frequency Interference Suppression in Switched-Mode Power Supplies" applications note are interference specifications; effects of circuit design and construction on RFI; RFI produced by heat-sink current, interwinding capacitance and currents in the transformer core; wiring layout; RFI generated by diodes; and RFI at the output. Ferroxcube, Saugerties, CA

CIRCLE NO. 354

## Design Aids

### Microwave materials

Typical properties of 3M microwave materials are highlighted in a six-page foldout. 3M

CIRCLE NO. 355

### Copper-clad laminates

An easy-to-read six-page foldout chart lists applications and specifications for copper-clad laminates for PC boards. Westinghouse Electric, Micarta Div.

CIRCLE NO. 356

### Metric conversion

"Conversion Factors," a 24-page booklet, provides multiplication factors for literally hundreds of industrial and scientific measurement units. They run the gamut from A to Y (abamperes to years) and from common to esoteric terms (bushels to parsecs). Engelhard Minerals & Chemicals.

CIRCLE NO. 357

### Data code conversion chart

A Universal Code Chart provides a cross-index of ALPHA-NUMERIC, HEX and OCTAL for fast, easy reference. Codes listed are ASCII-8, ASCII-7, EBCDIC, EBCD, FIELD DATA, 6-BIT TRANSCODE, SELECTRIC and BAUDOT. The Hex-to-Character Code Chart provides reference from Hex to character in the same codes as the aforementioned. Atlantic Research.

CIRCLE NO. 358

### LED cross-reference

A four-page folder matches all widely used LEDs primarily on the basis of size, shape, input and output characteristics. Actual part numbers are listed on side-by-side charts to show which LEDs are interchangeable with the company's products, and an alphabetical code is used to indicate specific differences in cross-referenced pairs. Chicago Miniature Lamp.

CIRCLE NO. 359



## New Literature

### Freq control components

Forty types and series of quartz crystals, crystal oscillators, crystal filters and solid ultrasonic delay lines are covered in a 12-page catalog. Frequency ranges and tolerances, temperature ranges, drive levels and other application data are included. Bliley Electric, Erie, PA

CIRCLE NO. 360

### Switches

Toggle, rocker and lever-handle miniature switches are illustrated in an eight-page catalog. Data include basic switching functions, contact ratings, terminations, handle types and hardware options. Airpax Electronics, Cambridge Div., Cambridge, MD

CIRCLE NO. 361

### Power transistors

An updated and expanded 44-page edition of the power transistor directory lists power transistors and power hybrid circuits. Applications information, a list of transistors which may be used as complementary pairs and charts are included. RCA Solid State Div., Somerville, NJ

CIRCLE NO. 362

### Bridges

Impedance, capacitance, resistance, and inductance bridges are covered in four sections of a 40-page catalog. Specifications are included for 25 instruments, and each major section is introduced by a brief description of measurement techniques and theory related to that section. General Radio, Concord, MA

CIRCLE NO. 363

### Thermistor thermometers

A four-page brochure features the DigiTec HT Series (High Technology) portable thermistor thermometers. United Systems, Dayton, OH

CIRCLE NO. 364

# SEALED CONTACT KEY SWITCH APPLICATIONS

## WE'VE COVERED THE BOARD\*



## NOW IT'S YOUR MOVE

Our flexible tube, mercury contact has proven long life, reliable performance, and it provides you sealed switching at a price competitive with mechanical contacts.

We offer a large variety of keytop styles and contact configurations including front panel relampable lighted models, single and double pole versions, and alternate action type. All of our keytop switches are designed for easy and secure P.C. board mounting without requiring any sheet metal structures.

Other features of our sealed contact switches are: • Doubleshot molded keytops for 3/4" or 5/8" mounting • Easy change legend system • 0.170 plunger travel for good tactile response

Also consider our complete line of standard small encoded and non-encoded keyboards — they may be just what will put you a move ahead.

YOUR LETTERHEAD REQUEST OR PHONE CALL WILL BRING A FREE SAMPLE SWITCH WITH KEYTOP.

\*Particularly P.C. boards.

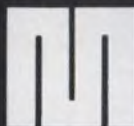

MECHANICAL ENTERPRISES, INC.  
8000 Forbes Place Springfield, Virginia 22151  
(703) 321-8282 TWX 710-832-0942

In Germany — NEUMÜLLER GMBH, MUNICH  
In U.K. — TEKDATA Ltd., STOKE-ON-TRENT

INFORMATION RETRIEVAL NUMBER 59



## NEW LITERATURE



### Amplifiers

The application, theory and selection of single and multichannel isolation amplifiers and instrumentation amplifiers are covered in a 16-page brochure. Specifications and definitions are included. Analog Devices, Norwood, MA

CIRCLE NO. 371

### Switches

Photos, line drawings and specifications of switches are contained in a 16-page catalog. Molex, Lisle, IL

CIRCLE NO. 372

### Terminal blocks

More than a dozen different types of modular rail mounted blocks are featured in a 36-page catalog. All are described with ratings, dimensions, AWG wire sizes, material specifications and tables of accessories. Technical and application data are included. Electrovert, Mount Vernon, NY

CIRCLE NO. 373

### Microelectronic technologies

"Microelectronics Interconnections and Packaging," a 16-page booklet, is devoted to ceramic packaging and to microinterconnect systems and their primary application: beam tape technology. 3M, St. Paul, MN

CIRCLE NO. 374

### Circuits, interconnections

Custom, high-reliability flexible circuits and interconnections are illustrated in a 16-page brochure. It includes several charts outlining properties of conductors and insulators, as well as round-to-flat conductor conversions and a cable-material selection guide. Hughes Connecting Devices Div., Irvine, CA

CIRCLE NO. 375

### Conductive silvers

Applications of conductive silvers in semiconductor work, thick-film hybrid and thin-film microelectronic circuits, as well as capacitor terminations, are covered in a 10-page catalog. Transene, Rowley, MA

CIRCLE NO. 376

### Crystal impedance meter

Features and specifications of a crystal impedance meter are covered in a four-page brochure. RFL Industries, Boonton, NJ

CIRCLE NO. 377

# SSR





## Power supplies

Power supplies for integrated-circuit logic and op amps are described in a four-page brochure. Accopian, Easton, PA

CIRCLE NO. 378

## Relays

Dimensional drawings, specifications, ordering data and prices on hundreds of relays, stepping relays (steppers), solenoids and solid-state controls are included in a 16-page catalog. Guardian Electric, Chicago, IL

CIRCLE NO. 379

## Process controller

A 60-page bulletin describes the operation and applications of the Bristol UCS 3000 process controller. Included are a sample flow diagram, a wiring drawing of the control and reporting system, module coding sheets used to enter the system configuration and system documentation automatically prepared by the Accol compiler. Acco, Bridgeport, CT

CIRCLE NO. 380

## Pluggable gp relay

A general-purpose pluggable relay available in 6 to 230 V ac or 6 to 110 V dc operation is described in a four-page bulletin. Included are specifications, selection procedures, mounting dimensions and life charts. North American Philips Controls, Cheshire, CT

CIRCLE NO. 381

## Microwave, rf components

A 96-page loose-leaf data booklet covers microwave and rf components. Complete specifications are given on all products, and curves, block diagrams and outline drawings are included. Trak Microwave, Tampa, FL

CIRCLE NO. 382

## Accelerometers

Features and characteristics of semiconductor strain gauge accelerometers are described in a 28-page manual. Entran Devices, Little Falls, NJ

CIRCLE NO. 383

## Wirewound trimmers

Three-quarter-inch rectangular wirewound trimming potentiometers are featured in a data sheet. Data on special options, a chart of standard resistance specifications and ordering information are included. Amphenol Connector Div., Broadview, IL

CIRCLE NO. 384

## Modular microcomputers

A 16-page catalog describes modular microcomputers. The company's book on designing with microprocessors, "Microcomputer Design," is included in the catalog. Martin Research, Northbrook, IL

CIRCLE NO. 385

## Audio ICs

The "Audio IC Selection Guide" indicates the operating supply voltage range and the package used for each audio IC manufactured by the company. SGS-ATES Semiconductor, Newtonville, MA

CIRCLE NO. 386

# Breakthrough.

## Switch 7 amps for under \$3.85.\*

Sigma's new Series 226 miniature Solid State Relay gives you better price/performance than any other SSR on the market.

It will switch up to 7 amps, yet has a quantity price far under the \$7 to \$10 you would pay for competitive devices.

The 226 is a designer's delight. It measures only 1.5" x .73" x .66" overall, including heat-sink flange and termination pins. When inserted in a PC board, it stands less than 0.5 inches high. Or unit can be chassis-mounted via standard slip-on connectors.

The 226 is completely solid state and opto-isolated with TTL compatible LED input. Output is a triac, with versions rated at both 120 VAC and 240 VAC. Units are ultrasonically sealed and potted internally to resist moisture and vibration.

All standard input voltages are available.

The low price, current handling capability and convenient packaging of this unit make it ideal for switching AC loads with low level logic signals. Contact your distributor or Sigma to learn how the Series 226 can help cut your costs.

\*1,000 quantity price.

SIGMA INSTRUMENTS, INC., 170 Pearl Street, Braintree, MA. 02184, (617) 843-5000

CANADA: Sigma Instruments (Canada) Ltd., 55 Six Point Road, Toronto, Ont. M8Z 2X3, (416) 239-8161

EUROPE: Sigma Instruments GmbH, Burgsteinstrasse 14 D-817 Bad Toelz, West Germany, (08041) 9127

# SIGMA



# EXCEL has a competitive ADVANTAGE over AUGAT.

## VERTICAL INTEGRATION



- We make our own pins & sockets here, and have for 20 years, selling to connector companies like AMP, Burndy, Amphenol, Thomas & Betts, Elco, Bendix and many others.
- We make our own printed circuit boards here, with complete facilities from artwork to finished boards.
- We do our own wire-wrap here, wrapping over 1 million wires per week for Burroughs, Xerox, Univac, Westinghouse, Storage Technology.
- We have progressive, stocking distributors - and representatives in all areas.
- Excel can offer an interesting and economical alternative. We sell packaging panels that are absolutely interchangeable with all Augat standard and custom I.C. boards, plus our engineers can and do make innovative suggestions, to meet your unique requirements at a lower cost.

All types of Wire  
Wrap\* and Connector  
Pins & Sockets

All Standard  
and Custom  
I.C. Packaging  
Panels

Largest  
Independent Wire  
Wrap\* Facility  
in U.S.A.

10 Complete lines  
of DIP Sockets  
from 8 to 40  
Pins

P.C. Boards  
Enclosures  
Back Panels

\* trademark  
Gardner-Denver Corp.

# EXCEL

401 Joyce Kilmer Ave  
P.O. Box 168,  
New Brunswick, N.J.  
(201) 249-6600

### Distributed by:

California, Costa Mesa 92626  
COMPONENTS CENTER  
714 979 0433 / 213 620 0311

Illinois, Chicago 60607  
SCHWEBER ELECTRONICS  
312 593 2740

New Jersey, Somerset 08873  
SCHWEBER ELECTRONICS  
201 469 6008

Texas, Houston 77036  
SCHWEBER ELECTRONICS  
713 784 3600

California, Costa Mesa 92626  
SCHWEBER ELECTRONICS  
714 556 3880 / 213 924 5594 L.A.

Maryland, Rockville 20852  
SCHWEBER ELECTRONICS  
301 881 3300

New York, Rochester 14622  
SCHWEBER ELECTRONICS  
716 461 4000

Texas, Richardson 75080  
SOUTHWEST ELECTRONICS  
(Dallas area)  
214 234 3050

Connecticut, Danbury 06810  
SCHWEBER ELECTRONICS  
203 792 3500

Mass, Waltham 02154  
SCHWEBER ELECTRONICS  
617 890 8484

New York, Westbury 11590  
SCHWEBER ELECTRONICS  
(main loc.) 516 334 7474

Texas, Stafford 77477  
SOUTHWEST ELECTRONICS  
(Houston area)  
713 494 6021

Florida, Clearwater 33515  
DIPLOMAT / SOUTHWEST  
813 443 4514

Mass, West Newton 02165  
A.W. MAYER  
617 965 1111

Ohio, Beechwood 44122  
SCHWEBER ELECTRONICS  
216 464 2970

CANADA  
Canada, Mississauga, Ontario L4B1J9  
SCHWEBER ELECTRONICS  
416 678 9050

Florida, Hollywood 33020  
SCHWEBER ELECTRONICS  
305 927 0511

Michigan, Troy 48064  
SCHWEBER ELECTRONICS  
313 583 9242

Texas, Austin 78758  
SCHWEBER ELECTRONICS  
512 837 2890

ISRAEL  
Israel, Tel Aviv  
SCHWEBER ELECTRONICS  
44 2219

Georgia, Atlanta 30340  
SCHWEBER ELECTRONICS  
404 449 9170

Minn., Minneapolis 55400  
SCHWEBER ELECTRONICS  
Minnesota, Eden Prairie 55343  
612 941 5280

Texas, Dallas 75240  
SCHWEBER ELECTRONICS  
214 661 5010

because you deserve the very best



INFORMATION RETRIEVAL NUMBER 67

## NEW LITERATURE

### Electronic components

Electronic components, test equipment and production tools are covered in a 48-page catalog. Prices are included. Mouser Electronics, Lakeside, CA

CIRCLE NO. 366

### Thermal printers

Specifications and application data on the Model DPP-7 miniature seven-column panel-mounting printer are covered in a 12-page catalog. Block and wiring diagrams are included. Datel Systems, Canton, MA

CIRCLE NO. 365

### Rf inductors

A 16-page catalog highlights rf inductors. Special and nonstandard coil capabilities are shown in diagrams and photos. Airco Electronics, Nogales, AZ

CIRCLE NO. 367

### Transducers

Subminiature pressure transducers for industrial and aerospace testing are featured in a six-page catalog. Sensotec, Columbus, OH

CIRCLE NO. 368

### Gas discharge displays

Technical and application data for Plasma-Lux gas discharge display panels are contained in a literature kit. Included are individual sheets containing dimensional drawings and electrical specifications. Cherry Electrical Products, Waukegan, IL

CIRCLE NO. 369

### Instrumentation

"News from Rohde & Schwarz" presents equipment shown by R&S at the 1975 Hanover Fair. Detailed articles cover the uhf-vhf receiving system ET 001, the motor-vehicle sound-level meter ELMOT and the tone-sequence generator SSN/SSN-Z. An article shows how to combine the automatic radio-telephone test assembly SMPU with Tektronix' desktop calculator TEK 31. Rohde & Schwarz, 8000 Munchen 80, Muhldorfstrasse 15, West Germany

CIRCLE NO. 370



## Bulletin Board

**Monolithic Memories** is second-sourcing National Semiconductor's 18-pin Model MM5270 and 22-pin Model MM5280 4096-bit RAMs.

CIRCLE NO. 387

**Signetics** has introduced 19 more 74LS-TTL elements. Twelve devices are MSI functions and seven are SSI.

CIRCLE NO. 388

**Systems Engineering Laboratories** has announced a program translator that converts SEL 800 series computer programs to SEL 32 series computer programs.

CIRCLE NO. 389

**General Semiconductor Industries** has completed qualification of its 2N3418/19/20/21 npn transistors to MIL-S-19500/393 (USAF).

CIRCLE NO. 390

**Facsimile, word-processing and time-sharing terminals** can now file Western Union's Mailgrams.

CIRCLE NO. 391

**Fairchild and Mostek** have jointly announced that Mostek will second source Fairchild's F8 microprocessor.

CIRCLE NO. 392

**Digital Equipment** has introduced Fortran/RT-11 extensions that add extensive software support for PDP-11 laboratory peripherals to the RT-11 disc operating system.

CIRCLE NO. 393

**Exar Integrated Systems** is offering custom integrated injection logic (I<sup>2</sup>L) in volume quantities.

CIRCLE NO. 394

Significant steps in a program to standardize and improve specifications and performance for COS/MOS ICs have been announced by RCA Solid State Div.

CIRCLE NO. 395

## Vendors Report

Annual and interim reports can provide much more than financial-position information. They often include the first public disclosure of new products, new techniques and new directions of our vendors and customers. Further, they often contain superb analyses of segments of industry that a company serves.

Selected companies with recent reports are listed here with their main electronic products or services. For a copy, circle the indicated number.

**Weil-McLain.** Heating and air conditioning, fluid systems and air handling systems.

CIRCLE NO. 396

**Tracor.** Components, instruments, and research and development.

CIRCLE NO. 397

**AMP.** Electrical connection, switching and programming devices and application machines and tools, and power units.

CIRCLE NO. 398

**Superior Electric.** Industrial products for voltage and motion control.

CIRCLE NO. 399

**Philip Morris Industrial.** Electro-sensitive paper, packaging adhesives and materials, and coatings.

CIRCLE NO. 400

**Reynolds Metals.** Aluminum.

CIRCLE NO. 401

**The International Nickel Co. of Canada.** Metals and batteries.

CIRCLE NO. 402

**Pfizer.** Chemicals, materials-science products and pharmaceuticals.

CIRCLE NO. 403

**Conrac.** Communications, control products, information displays and automated assembly.

CIRCLE NO. 404

## THE INSIDE STORY OF CHIP CAPACITORS

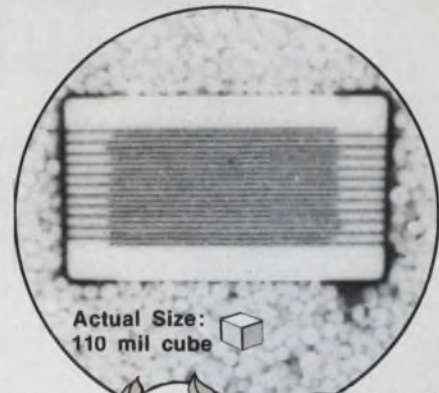

### NOW HEAR THIS ...

If you're interested in the basics of monolithic chip capacitor construction, circle the reader service number below for your copy of "The Inside Story" and a sectioned ATC 100 chip capacitor.

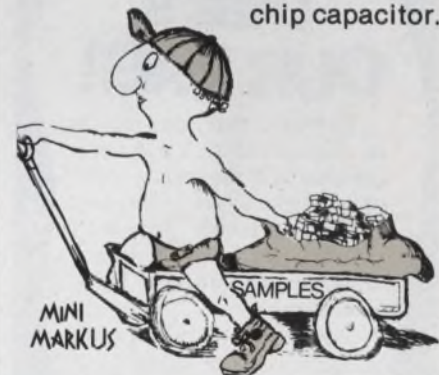

If you'd like samples of any other ATC UHF / Microwave Capacitors, call Ralph Wood at (516) 271-9600.

**american technical ceramics**

ONE NORDEN LANE,  
HUNTINGTON STATION, N.Y. 11746  
(516) 271-9600 • TWX 510-226-6993

INFORMATION RETRIEVAL NUMBER 68



# Transient Digitizer



Put images into your computer conveniently and economically with CVI's low cost video disc and data sampler.



Video instruments for data acquisition, processing, transmission and display.

**CVI** Colorado Video Incorporated  
 P. O. Box 928  
 Boulder, Colorado 80302  
 (303) 444-3972  
 TWX 910-940-3248 COLO VIDEO BDR

INFORMATION RETRIEVAL NUMBER 62

# Electronic Design

ELECTRONIC DESIGN's function is:

- To aid progress in the electronics manufacturing industry by promoting good design.
- To give the electronic design engineer concepts and ideas that make his job easier and more productive.
- To provide a central source of timely electronics information.
- To promote communication among members of the electronics engineering community.

**Want a subscription?** ELECTRONIC DESIGN is sent free to qualified engineers and engineering managers doing design work, supervising design or setting standards in the United States and Western Europe. For a free subscription, use the application form bound in the magazine. If none is included, write to our direct for an application form.

If you do not qualify, you may take out a paid subscription for \$30 a year in the U.S.A., \$40 a year elsewhere. Single copies are \$1.50 each.

**If you change your address,** send us an old mailing label and your new address; there is generally a postcard for this bound in the magazine. You will have to requalify to continue receiving ELECTRONIC DESIGN free.

**The accuracy policy of ELECTRONIC DESIGN is:**

- To make diligent efforts to ensure the accuracy of editorial matter.
- To publish prompt corrections whenever inaccuracies are brought to our attention. Corrections appear in "Across the Desk."
- To encourage our readers as responsible members of our business community to report to us misleading or fraudulent advertising.
- To refuse any advertisement deemed to be misleading or fraudulent.

Microfilm copies are available of complete volumes of ELECTRONIC DESIGN at \$19 per volume, beginning with Volume 1, 1952 through Volume 20. Reprints of individual articles may be obtained for \$3.00 each, prepaid (\$5.00 for each additional copy of the same article) no matter how long the article. For further details and to place orders, contact the Customer Services Department, University Microfilms, 300 North Zeeb Road, Ann Arbor, Michigan 48106 telephone (313) 761-4700.

**Want to contact us?** If you have any comments or wish to submit a manuscript or article outline, address your correspondence to:

Editor  
 ELECTRONIC DESIGN  
 50 Essex Street  
 Rochelle Park, N.J. 07662

## That's OUR BAG!

Software that adds muscle to microprocessors and mini-computers is the special forte' of Scientific Systems Services. We're a 'software' firm with a strong and diversified systems engineering and hardware capability.

For consultation without obligation, write or call collect today.

**Scientific Systems Services**

476 N. Highway A1A P. O. Box 2519  
 Satellite Beach, Florida 32937  
 (305) 777-1300

*Need an LSI-11? Ask about quick delivery and low-quantity discounts; pre-packaged chassis, power supply and clock.*

## Please Help Children Live

Research is our only weapon against childhood cancer.

St. Jude Children's Research Hospital, which is non-sectarian, is the largest childhood cancer research center in the world.

Please join in the fight against childhood cancer.

Send your special gift now.



**ST. JUDE CHILDREN'S RESEARCH HOSPITAL**

Danny Thomas, Founder

**Send contributions to:**  
 MEMPHIS, TENN. 38101  
 This space donated by publication

INFORMATION RETRIEVAL NUMBER 63



# Electronic Design

## Advertising Sales Staff

Tom W. Carr, Sales Director

Rochelle Park, NJ 07662

Robert W. Gascoigne

Daniel J. Rowland

50 Essex Street

(201) 843-0550

TWX: 710-9990-5071

## Philadelphia

Thomas P. Barth

50 Essex Street

Rochelle Park, NJ 07662

(201) 843-0550

## Boston 02178

Gene Pritchard

P.O. Box 379

Belmont, MA 02178

## Chicago 60611

Thomas P. Kavooras

Berry Conner, Jr.

200 East Ontario

(312) 337-5088

## Cleveland

Thomas P. Kavooras

(Chicago)

(312) 337-0588

## Los Angeles 90045

Stanley I. Ehrenclou

Burt Underwood

8939 Sepulveda Boulevard

Los Angeles, CA

(213) 641-6544

## Texas/Oklahoma

Burt Underwood

(Los Angeles)

(213) 641-6544

## San Francisco 94040

Robert A. Lukas

3579 Cambridge Lane

Mountain View, CA 94040

(415) 965-2636

## London, Amsterdam, Tokyo, Seoul

Malcolm M. Thiele

Wood Cottage, Shurlock Row

Reading RG 10-QE, England

Phone: Shurlock Row 302 & 619

S.T.D. 073 581

W. J. M. Sanders

Oosterpark 6, De Rijp,

Holland

Phone: 02997-3020

Haruki Hirayama

Electronic Media Service

5th Floor, Lila Bldg.,

4-9-8 Roppongi

Minato-ku, Tokyo, Japan

Phone: 402-4556

Cable: Electronicmedia, Tokyo

Mr. O-kyu Park, President

Dongbo Int'l Corp.—

World Marketing

C.P.O. Box 4010

Seoul, Korea

Tel. 76-3910/3911

Cable: DONGBO SEOUL

Telex: EBKOREA K27286

# We're on the move ... with a 15-ns deglitcher.



Computer Labs introduces a new line of modular deglitchers with the DGM-1040 & DGM-1080. Used to eliminate the non-linear effects of glitches in the output of D/A Converters, these miniature modules generate an output signal with extremely high spectral purity, required for TV signal reproduction, CRT displays, and waveform generation. Acquisition times as low as 15 ns and linearity of 0.01% make these the highest speed and most versatile deglitchers available commercially.

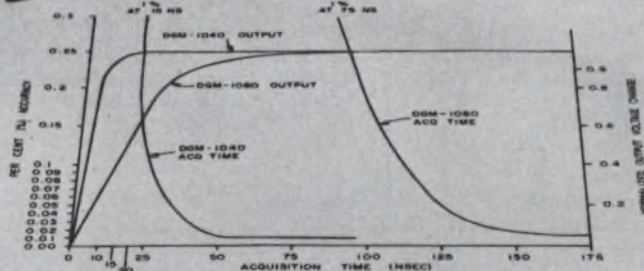

FIG. 3  
ACQUISITION TIME VS.  
SETTLING ACCURACY

**COMPUTER LABS**

COMPUTER LABS, INCORPORATED

505 EDWARDIA DR. • GREENSBORO, N. C. 27409 • 919/292-6427

INFORMATION RETRIEVAL NUMBER 60

# OUR PROTO-CLIP™ CAN PAY FOR ITSELF THE 1ST TIME YOU USE IT.

The reason's as simple as the time you'll save testing, signal tracing or wiring in DIP's. Not to mention the cost of IC's ruined by accidental shorts. A Proto-Clip is the foolproof, short proof way to bring up leads from crowded circuit boards. Its patented, molded design and unique gripping teeth free hands for other work. Built to withstand tough day-to-day use, CSC clips are available with or without cable for 14-, 16-, and 24-pin DIP's, starting at \$4.50.\* For more information, see your dealer or write for our full-line catalog and distributor list.

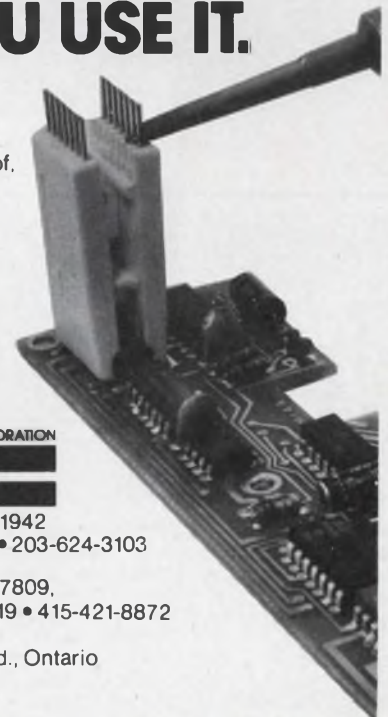

CONTINENTAL SPECIALTIES CORPORATION



44 Kendall Street, Box 1942

New Haven, CT 06509 • 203-624-3103

TWX: 710-465-1227

West Coast office: Box 7809,

San Francisco, CA 94119 • 415-421-8872

TWX: 910-372-7992

Canada: Len Finkler Ltd., Ontario

U.S. Pat No. 3,914,007

\*Mfr's. sugg. retail

© 1975, Continental Specialties Corp.

ABP

BPA



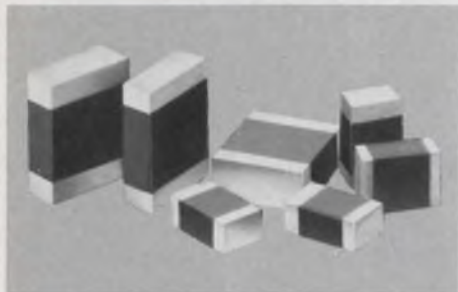

**HIGH Q MULTILAYER CAPACITORS** feature very high quality factors at microwave frequencies. Offered in three standard sizes: .050 x .040, .080 x .050, .125 x .095. Capacitance values from 0.1 pf to 1000 pf with close tolerance and voltages to 1000 VDCW. Johanson/Monolithic Dielectrics Div., Box 6456, Burbank, Ca. 91510, (213) 848-4465.

MULTILAYER CHIP CAPACITORS 601

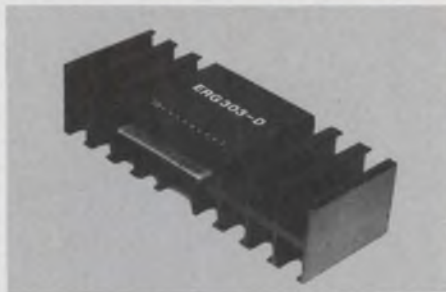

**Transconductance Power Driver for \$33.50.** The ERG 303D drives high-power audio amplifiers; accurately controls servo motors. With  $\pm 50V$ . supply and output transistor pair, the ERG 303D produces 100-300+ Watts R.M.S., 0.02% T.H.D. Bandwidth 80kHz-200kHz. \$29.95 in quantity. Electronics Research Group, Inc., 134 Mt. Auburn St., Cambridge, MA 02138 (617) 661-9383

ERG 303D 604



**ASCII DISC DATA SYSTEM: BRD D-474** Floppy Disc System, RS-232 plug compatible for any serial ASCII central processor or other ASCII I/O device. Features: 277,504 alphanumeric character storage; only 8 basic ASCII instruction characters; Fully buffered I/O memories; Selectable 110-9600 baud rates; Average 200 millisecond access time per sector. BRD inc, Box 10237, Bainbridge Island, Wash. 98110 (206) 842-4777

DISC SYSTEM 607

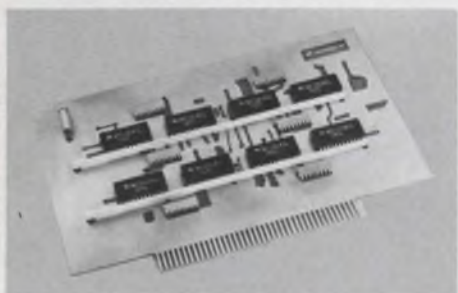

**EASIER ECL VOLTAGE AND GROUND DISTRIBUTION SYSTEMS**—Reduced system noise, high packaging density and less design time for PC boards with ECL circuits are yours with Mini/Bus®, the Rogers way to eliminate the cost of multilayer boards by off-board voltage and ground distribution. Rogers Corp., Chandler, AZ 85224 (602) 963-4584.

MINI/BUS 602



**DIGITAL SIGNAL ANALYSIS, S. Stearns.** Contains the most recent advances, brand-new design material, and a comparison between continuous and digital systems, making it an ideal master reference to today's signal processing techniques and systems. #5828-4, 288 pages, \$18.95. Circle the Info Retrieval Number to order 15-day exam copy. When billed, remit or return book with no obligation. Hayden Book Co., 50 Essex Street, Rochelle Park, N.J. 07662.

DIGITAL SIGNAL ANALYSIS 605



**48 HOUR TRANSFORMER SERVICE FOR \$49.00.** 115 volts Input with any one voltage you specify as the output voltage. Up to 100 watts 60HZ, 500 watts 400HZ. Don't settle for a stock item, get what you need. Call 516-654-1166 or Write MAGNETICO, INC., Holtsville, N.Y. 11742.

TRANSFORMER SERVICE 608



**New combination spacer/bushing.** Cut assembly time and costs substantially with these new, low Polyamide Spacer/Bushings from Johnson. Allows quick mount of PC boards to chassis. "Mechanically secure, yet P.C. boards easily removed." Made of non-conductive polyamide in various sizes. E. F. Johnson, Waseca, MN 56093 (507) 835-2050.

POLYAMIDE SPACER-BUSHING 603



**Low Cost Image Sensing Module** contains a 1024 element (32-by-32) image sensor and all support circuitry on a single pc board. Digital video output may be displayed directly on an oscilloscope. Complete module (SE1024W) is \$150. Kit (SE1024K) is \$90. Cromemco, 26655 Laurel, Los Altos, CA 94022.

MODULE 606



**Basic Electricity & Basic Electronics** by Van Valkenburgh, Nooger & Neville, Inc. Derived from the COMMON-CORE Training Program initially developed for the U.S. Navy. Thorough, comprehensive coverage. Available in separate paperbacks or cloth volume. Write for FREE brochure. Hayden Book Co., Inc., 50 Essex St., Rochelle Pk, N.J. 07662 (201) 843-0550.

TRAINING TEXT 609





**MODULAR DC/DC CONVERTERS** offer 5 and 10 W dual output and 15 W single output with eff. from 55 to 68%. Regulation is 5 mv. Dual units allow rated power from one output. L/C filtering on both input and output for low noise. (1-9) from \$78.60. B. H. INDUSTRIES, 5784 Venice Bl., Los Angeles, CA 90019 (213) 337-4763.

MODULAR DC/DC CONVERTERS 610



**Model A-101 Ultrasonic Pulser/Receiver** drives piezoelectric transducers. High energy negative spike output variable from -50 to -350 volts into 50 ohms. Pulse repetition rate adjustable from 100 Hz to over 10 kHz. Pulse risetime better than 15 nsec., output pulse monitor, adjustable damping. TTL-compatible external trigger, sync. Low noise receiver amplifier has selectable gain, 15 MHz bandwidth, switchable high-pass filter. MetroTek, Inc., P. O. Box 101, Richland, WA 99352, (509) 946-4778.

ULTRASONIC PULSER 613



Free New '75 catalog contains over 34,500 quality power supplies from the world's largest manufacturer, Power/Mate Corp. Power Supplies for every application including submodulars, open frame, variorated, encapsulated, laboratory & system. All units UL approved and meet most military and commercial specs for industrial and computer uses. Power/Mate Corp., 514 S. River St., Hackensack, NJ 07601 (201) 343-6294

POWER SUPPLIES 616

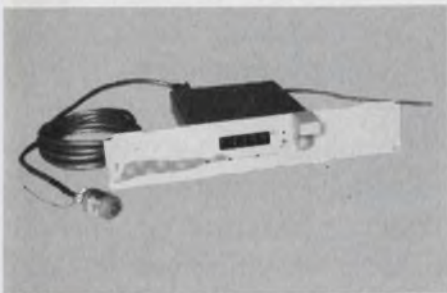

**ABSOLUTE ENCODER**— $\pm 1$  Part in 3600 System Accuracy, Electro-Magnetic Transducer + LED Display + BCD, Binary, and DC Output—Infinitely Adjustable Scale Factor (0 to 9999)—Hi Noise Immunity—Zero Offset—Single and Multi-Channel Units From \$375/Axis (1 pc.) Computer Conversion Corporation, East Northport, NY 11731 516-261-3300

ENCODER 611



**Solid State Digital Power Line Monitor** is ideally suited for use with power generation equipment, computer systems, control panel installation labs where power sources must be monitored for assuring test equipment accuracies. Four models available. From \$129 ea. Electro Industries, P.O. Box 3542, No. New Hyde Park, N.Y. 11040. (516) 621-6652

POWER LINE MONITOR 614

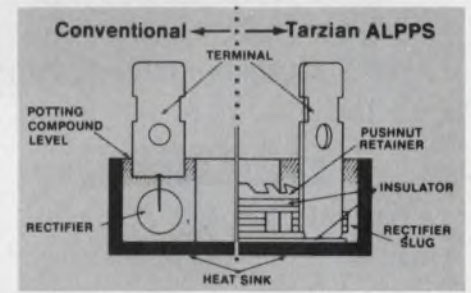

**TARZIAN BRIDGE RECTIFIER ASSEMBLIES.** Patented ALPPS design has faster, more consistent heat dissipation for high stability and conservative rating. 0.6" sq. 10A unit has 200A surge. 30A 1-1/4" round has 400A surge. ALPPS design available in custom units too. Sarkes Tarzian Inc., 415 N. College, Bloomington, IN 47401 (812) 332-1435.

BRIDGE RECTIFIERS 617



**Low-cost tape reader is fast**—up to 300 cps—and quality-built. Dual sprocket drive, a state-of-the-art fiber optic light source and photo transistor read head. Simplicity of design makes it easy to adapt to specific OEM requirements. Decitek, 250 Chandler Street, Worcester, MA 01602 (617) 798-8731

SAM<sup>®</sup> TAPE READER 612

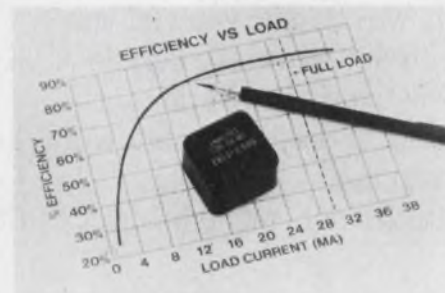

**Activate gas discharge readouts!** DC-to-DC power supplies convert low DC line voltages of 5, 9, 12 or 15 volts to nominal 200 and 250 volt DC levels required to run gas discharge information displays. Ideal for battery powered applications! Free literature. Endicott Coil Co., Inc., 31 Charlotte Street, Binghamton, N.Y. 13905

POWER SUPPLY 615



**Overcurrent Protector, manual reset** eliminates fuse replacement. Convenient panel mounting. 19 fractional ratings from 0.1 to 5 amp. Other models up to 400 amp. Trip-free and fool-proof, UL and CSA approved. High quality, low cost \$1.29 ea. in 1000 lots. E-T-A Products Co. of America, 7400 N. Croname Rd., Chicago, Ill. 60648. Tel: (312) 647-8303. Telex: 253780.

CIRCUIT BREAKER 618



# ALL 8080As DON'T COME FROM THE SAME PLACE.



Meet the  $\mu$ PD8080A. From NEC Microcomputers, Inc. The microprocessor that's both fully software and pin compatible with Intel's new 8080A. And it's backed by all the chips, support systems, software, and service you need to make it into a complete microcomputer system — the  $\mu$ COM-8.

## THE CHIPS.

We start with not one, but four 8080-type microprocessors.

At the top of the line is the  $\mu$ PD8080A. It gives you everything their 8080A does, plus extras like full BCD capability for both addition and subtraction. For low-cost applications, we also have a 1.25 MHz option — the 8080A-E. Plus there are two other models, featuring improved I/O.

In addition, we can give you the best in RAMs, ROMs, and PROMs, includ-

ing the only Electrically Alterable PROM with the speed to match the processor.

## THE SUPPORT SYSTEMS.

We offer both a full-scale microcomputer — the PDA-80 — for software development and hardware emulation; *and* a microcomputer-on-a-board — the EVAKIT — for evaluation purposes.

## THE SOFTWARE.

For the PDA-80 we have a full line of resident software. Or, we can give you a full line of cross software, available on national timesharing services or installed on your own computer system. This includes our unique Macro

Maintenance Program (MMP) for storing common macros and sub-routines for use with our Macro Assembler.

## AND THE SERVICE.

The  $\mu$ COM-8 package also includes complete documentation, an ever-expanding library of Applications Notes, and a responsive, in-depth applications engineering service, available nationwide.

## SO...

Whatever your application or your needs — first source or second source, large volume or small, chips or complete systems — take a look at everything *our* 8080A gives you.

You really can't afford not to.

NEC Microcomputers, Inc., Five Militia Drive, Lexington, Mass. 02173, 617-862-6410.

# NEC microcomputers, inc.



# WHERE TO BUY IT.

## New England:

Circuit Sales Company  
Lexington, MA  
617/861-0567

## Mid-Atlantic:

Trionic Associates, Inc.  
Great Neck, NY  
516/466-2300  
C. H. Newson & Associates  
Philadelphia, PA  
215/248-3377

C. H. Newson & Associates  
Hershey, PA  
717/233-8576 (Harrisburg)  
301/825-0001 (Baltimore)

## Southeast:

Perrott Associates, Inc.  
Orlando, FL  
305/275-1132  
Perrott Associates, Inc.  
Clearwater, FL  
813/726-1549

## Midwest:

McFadden Sales, Inc.  
Columbus, OH  
614/221-3363  
Bitronics Sales Company  
Minneapolis, MN  
612/835-7744  
RF Specialists  
Park Ridge, IL  
312/698-2044

## Southwest:

Merino Sales Company  
Dallas, TX  
214/233-6002  
Tri-Tronix  
Albuquerque, NM 87110  
505/265-8400  
Summit Sales  
Scottsdale, AZ 85251  
602/994-4587

## Northwest:

Tri-Tronix  
Bellevue, WA  
206/454-0940

## So. California:

Electronic Component Marketing  
Woodland Hills, CA  
213/340-1745

Electronic Component Marketing  
El Toro, CA  
714/830-3939

Electronic Component Marketing  
San Diego, CA  
714/295-6122

## No. California:

Trident Associates  
Mountain View, CA  
415/967-7031

## Canada:

R. F. Q., Ltd.  
Toronto, ONT.  
416/625-8874  
R. F. Q., Ltd.  
Montreal, QUE.  
514/626-8324

**NEC microcomputers, inc.**

# Advertiser's Index

Advertiser	Page	Advertiser	Page
Advanced Micro Devices .....	39	Magnecraft Electric Corporation .....	Cover III
Airpax Electronics, Cambridge Division .....	83	Magnetico, Inc. ....	96
Allen Bradley Co. ....	35	Martin Research .....	34
Allison Automotive Company .....	84	McLean Engineering Laboratories ....	73
American Microsystems, Inc. ....	8, 9	Mechanical Enterprises, Inc. ....	89
American Technical Ceramics .....	93	MetroTek, Inc. ....	97
Ampex Memory Products Division ..	42	Microswitch, A Division of Honeywell .....	12, 13
Amphenol Connector Division, Bunker-Ramo Corp. ....	29	Mini-Circuits Laboratory, A Division of Scientific Components Corp. ....	2
Arnold Magnetics Corp. ....	86	Monsanto Company .....	11
B & H Industries .....	97	NCR Corporation .....	71
BRD, Inc. ....	96	NEC Microcomputer, Inc. ....	98, 99
Beckman Instruments, Inc., Information Displays Operations ..	37	North American Philips Controls Corp. ....	75
Bourns Inc., Trimpot Products Division ...	Cover II	 	
 		Oak Industries, Inc. ....	73
Clairex Electronics .....	73	Optical Electronics, Inc. ....	100
Colorado Video Incorporated .....	94	 	
Computer Conversion Corp. ....	97	*Philips Electronic Components and Materials .....	35
Computer Labs .....	95	Phoenix Data, Inc. ....	88
Continental Specialties Corporation ..	95	Plessey Semiconductors .....	25
Cromemco .....	96	Power/Mate Corp. ....	97
 		Power One, Inc. ....	69, 75
Data General Corporation .....	31	 	
Decitek, A Division of Jamesbury Corp. ....	97	RCA Solid State .....	41, Cover IV
Digital Equipment Corporation Components Group .....	32	RCL Electronics, Inc. ....	30
 		*Rafi-Raimund Finsterholz .....	64
E-T-A Products Co. of America .....	97	Raytheon Semiconductor .....	79
Electro Industries .....	97	Reader Service Card .....	100A-B
Electro Scientific Industries .....	14	Reticon .....	81
Electronic Design .....	48, 49	Rogers Corporation .....	96
Electronic Navigation Industries ....	78	 	
Electronic Processors Incorporated ..	55	Sarkes-Tarzian, Inc. ....	97
Electronics Research Group, Inc. ....	96	Scientific Systems Services .....	94
Endicott Coil Co., Inc. ....	97	Semicoa .....	87
Excel Products Company, Inc. ....	92	Sigma Instruments .....	90, 91
 		Sprague Electric Company .....	6
Fluke Mfg. Co., Inc., John .....	10	Systron-Donner .....	45
 		Systems Engineering .....	64A-H
Gold Book, The .....	18, 19, 56, 57	 	
Gould Inc., Instrument Systems Division .....	75	Technitrol, Inc. ....	73
 		Teletype Corporation .....	27
Hayden Book Company, Inc. ....	64, 76, 96	Texas Instruments, Incorporated ....	4, 5
Honeywell Test Instruments Division	23	 	
 		USCC/Centralab Electronics Division, Globe-Union, Inc. ....	17
ISE Electronics Corporation .....	65	*United State Department of Commerce .....	64
Intech, Incorporated .....	82	Unitrode Corporation .....	46
Johanson Manufacturing Corp. ....	7	Varo Semiconductor, Inc. ....	84
Johanson/Monolithic Dielectrics Division .....	96	Vernitron Control Components .....	75
Johnson Company, E. F. ....	96	 	
 		Wavetek San Diego, Inc. ....	1
Kulka Electric Corp. ....	85	 	

\*Advertisers in non-U.S. edition



MODELS  
9906 & 9910  
**MINIDIPS**

FROM



**WIDEBAND BIPOLAR  
DIFFERENTIAL OP AMP  
& CURRENT BOOSTER  
AMPLIFIER**

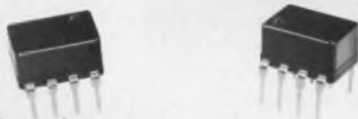

**MODEL 9906 WIDEBAND OP AMP  
FEATURES:**

- 100 MHz min. unity gain frequency.
- 300 MHz min. gain bandwidth product at X100.
- $\pm 250$  V/ $\mu$ S min. slewing rate.
- $\pm 10$  volts swing.
- $\pm 4.5$  mA output current.
- 150 nS 0.1% settling time.
- Temperature operating range:  
-65°C to +125°C.

**MODEL 9910 CURRENT BOOSTER  
FEATURES:**

- 0.97 typ. voltage gain.
- $\pm 12$  V input voltage.
- $\pm 10$  output voltage swing.
- $\pm 100$  mA output current.
- $\pm 2000$  V/ $\mu$ S slew rate.
- DC to 60 MHz small signal bandwidth.
- Temperature operating range:  
-65°C to +125°C.

**COMPLETE SPECIFICATIONS  
ON REQUEST**

Note these low prices:

9906	9910
\$18.00 1-2	\$26.00 1-2
16.25 3-9	23.50 3-9
14.75 10-29	21.00 10-29

Optical Electronics, Inc., manufactures a complete line of OP AMPS, analog function modules, 3-D displays, and ultrasonic imaging systems.



**OPTICAL ELECTRONICS INC.**

P. O. BOX 11140 • Tucson, Arizona 85734  
PH. (602) 624-8358 • TWX (910) 952-1283

# Product Index

**Information Retrieval Service.** New Products, Evaluation Samples (ES), Design Aids (DA), Application Notes (AN), and New Literature (NL) in this issue are listed here with page and Information Retrieval numbers. Reader requests will be promptly processed by computer and mailed to the manufacturer within three days.

Category	Page	IRN	Category	Page	IRN
<b>Components</b>			<b>Integrated Circuits</b>		
buzzer, electronic	79	326	amplifiers, FET-input	77	302
capacitors	6	5	analog delay	81	51
capacitors, ceramic	17	13	chip set, 16-bit $\mu$ P	40	508
displays	37	25	counter/timers	78	322
mixers, double-balanced	2	3	low-power dividers	25	17
motors, centrifugal	73	41	PROMs	78	321
opto-isolators	73	40	quad amp	78	320
relays	III	257	quad op amp	79	49
resistors	35	24	reference	78	323
switch, pushbutton, PC	79	324	register, CCD	77	308
switches	13	11	SOS RAM	IV	258
switches	30	20			
switches	73	42			
switches	83	53			
switches, toggle	79	325			
synchronous motors	75	43			
synchros and resolvers	75	45			
transformers	73	39			
trimmers	29	19			
<b>Data Processing</b>			<b>Microprocessor Design</b>		
compiler	33	502	chip set, 16-bit $\mu$ P	40	508
computer family	5	4	compiler	33	502
cursor, keyboard	87	347	floppy disc	33	501
DEC's Direct Sales			microprocessors	39	26
Catalog	32	22	PROM, PC-board	38	505
data terminal systems	27	18	portable analyzer	40	507
digitizer, 3-D	87	348	processor system	38	506
disc memory	87	349	semiconductor tester	81	328
logic analyzer	80	301	system, microcomputer	36	504
memory add-in modules	42	28			
<b>Discrete Semiconductors</b>			<b>Modules &amp; Subassemblies</b>		
display, LED numeric	86	344	a/d, d/a converters	82	52
impedance converter	86	343	converters, a/d	82	306
LEDs	86	346	flasher, solid-state	83	331
rectifiers	94	64	ignition systems	84	54
rectifiers, TO-3 cased	86	341	modulator, high-accuracy	83	330
SCRs, medium current	86	345	op amps	96	66
transistor chips	87	202			
triac, high power	86	342			
<b>Instrumentation</b>			<b>Packaging &amp; Materials</b>		
data-acquisition system	88	58	adhesive, conductive	84	334
function generator	80	327	assembly, socket	84	335
IC testers	14	272	breadboards, IC	84	336
logic analyzer	80	301	lamp, ultraviolet	84	332
power amplifier, rf	78	48	nylon, reinforced	84	333
probe	81	329	socket, lamp	84	337
semiconductor tester	81	328	terminal boards	85	55
strip-chart recorder	75	44			
tape recorder, portable	23	241			
			<b>Power Sources</b>		
			high-voltage supply	85	339
			memory supply	85	340
			power supply, open-frame	75	46
			switchers	85	338



# Just How Broad is the **MAGNECRAFT** Stock Relay Line?



**free  
wall  
chart!**

Magnecraft's stock relay line consists of 1200 versions derived from 17 categories - - - - that is the largest and broadest line in the industry.

Oh? Did I read that correctly?

Yes, Magnecraft Electric provides 1200 relay versions in stock through our nationwide distributor network. Those 17 categories include; low profile, general purpose, power, mercury displacement, sensitive, coaxial, telephone type, air dashpot time delay, solid state, latching types, high voltage, mercury wetted reeds, dry reeds, and dip reed relays.

Magnecraft can offer you the design engineer, a quality product, local distributors, and the broadest relay line in the industry to choose from. If we don't have the relay in stock we will custom design a relay to meet your requirements.

Full color 22"x 34" relay specification chart.



**Magnecraft** ELECTRIC COMPANY

5575 NORTH LYNCH AVENUE • CHICAGO, ILLINOIS 60630 • 312 • 282 5500 • TWX 910 221 5221



What's new in solid state...

# Join the SOS Revolution. Just \$17.76.

## RCA fires it up with a 150 ns, 4 mW static RAM.

We're ready if you are! RCA is making good on the speed/power promise of silicon-on-sapphire: we've got the production, the product, the price. In fact, for a limited time, RCA offers its 1024 x 1-bit SOS RAM for a revolutionary price of \$17.76. The MWS5001 gives you 150 ns with only 4 mW of operating power.

Key to 5001 performance is our SOS structure with a self-aligned silicon gate. It virtually eliminates overlap of the gate onto source and drain areas. Which greatly reduces interelectrode capacitances compared to aluminum gate SOS.

### Cost effectiveness

Our revolutionary low introductory price of \$17.76 is only part of the cost story. When all factors are considered —

Type	Technology	Voltage	Access from address	Power @ 1 MHz
RCA MWS5001	SOS/CMOS	5 V	150 ns	4 mW
Compet. 6508	Bulk CMOS	5 V	400 ns	8 mW

including capability, power and parts-count savings — overall system savings can turn out to be even more dramatic. Since it's static, the 5001 saves on parts by requiring no memory refreshing, no clock, no pulsing. And it has a 3-state output, which allows power savings from common busing.

### Design flexibility

CMOS on sapphire gives the 5001 wide usefulness, with its  $-20^{\circ}\text{C}$  to  $+85^{\circ}\text{C}$  temperature range and  $+4.5\text{ V}$  to  $+6\text{ V}$  voltage range. Bear in mind, too, this is only an early shot in the SOS revolution.

Following the 1024 x 1-bit RAM, RCA will announce one with 256 x 4-bit organization. Then, higher performance versions of both, providing even faster access

time. To less than 100 ns. With very little increase in power. You'll also have a choice of open drain or 3-state output.

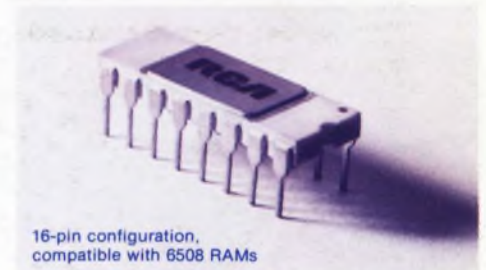

16-pin configuration,  
compatible with 6508 RAMs

For more information and your \$17.76 samples, use the coupon below.

# RCA

## JOIN THE REVOLUTION NOW!

To purchase sample(s) of the MWS5001 for \$17.76 each, send this coupon to RCA, Box 3200, Somerville, N.J. 08876; or check your local distributor. In Europe, mail the equivalent of \$17.76 each to: RCA Solid State, Sunbury-on-Thames, England TW16 7HW.

This coupon good for up to 10 RCA MWS5001 Random Access Memories. Offer good until January 31, 1976.

Please send me \_\_\_\_\_ of your MWS5001 for \$17.76 each. Enclosed is my  check  money order for \$\_\_\_\_\_  Please send me more information only.

Name \_\_\_\_\_ Title \_\_\_\_\_

Firm \_\_\_\_\_

Address \_\_\_\_\_

City, State, ZIP \_\_\_\_\_

Distributor \_\_\_\_\_

ED1220

RCA. First house in CMOS adds SOS.