

Electronic Design.25

VOL. 23 NO.

FOR ENGINEERS AND ENGINEERING MANAGERS

DEC. 6, 1975

Monolithic power Darlington fill the gap between the high-voltage, low-current switching transistors and the higher-power, but slower, thyristors. They can now deliver

currents of over 20 A, peak, and sustain voltages that exceed 900 V. And storage times have been kept under 8 μ s. For more Darlington details, see p. 101.



DALE FILM RESISTORS for single source versatility to help you get growing again.

Versatility makes the difference in Dale film resistors. Dale versatility lets you pinpoint exactly what you need in any standard size. Dale volume production and in-depth stocking lets you get what you need faster, while keeping inventories low. It's the right combination for getting recession-stalled projects moving again. Take a look at this chart... then call Dale at 402-371-0080.



WATTAGE	COMMERCIAL	PRECISION	E-REL	HI-VALUE	LOW VALUE
1/20	MF50 24.9-100K .1-1% RN-50	MF50 24.9-100K .1-1% RN-50	EMF50 49.9-100K .1-1%	HMF50 101K-700K 1%	
1/10	CMF-1/10 10Ω-499K .1-5%	CMF55, MF-1/10 30.1-499K .1-1% RN-55	EMF55 30.1-301K .1-1% RNR-55, RNC-55	HMF-1/10 500K-5M 1%	LMF-1/10 LFF-1/10 1Ω-30Ω 1%
1/8	CMF-1/8, MFF-1/8 10Ω-1M .1-5%	CMF60, MF-1/8 30.1-499K .1-1% RN-60	EMF60, EMF-50-10 10-499K .1-1% RNR-60, RNC-60, RLR-05	HMF-1/8 1.01M-10M	LMF-1/8 LFF-1/8 1Ω-30Ω 1%
1/4	CMF-1/4, MFF-1/4 10Ω-2M .1-5%	CMF65 24.9-2M .1-1% RN-65	EMF65 24.9-2M .1-1% RNR-65, RNC-65	HMF-1/4 2.01M-20M 1%	LMF-1/4 LFF-1/4 1Ω-30Ω 1%

FREE! Send for Dale's latest Resistor Wall Chart. A handy, comprehensive reference to more than 100 film resistor styles.

DALE ELECTRONICS, INC.
P.O. Box 74, Norfolk, Nebraska 68701
A subsidiary of The Lionel Corporation
In Canada: Dale Electronics Canada Ltd.
In Europe: Dale Electronics GmbH,
8 Munchen 60,
Falkweg 51, West Germany



INFORMATION RETRIEVAL NUMBER 246

Finding lower cost GHz parts that last is like finding gold.

Lots of you prospect around for low noise, high gain RF devices and end up paying 20 or 30 bucks a throw. And maybe pick up units that soon turn insensitive in your amplifier. Your design's neither economized nor optimized and that's a lot of bullion.

We're introducing a bank of gold-metallized RF pieces that eliminate those problems, have equal or better specs and are priced so low your front end won't believe what it hears. Priced lower than anyone's, onshore

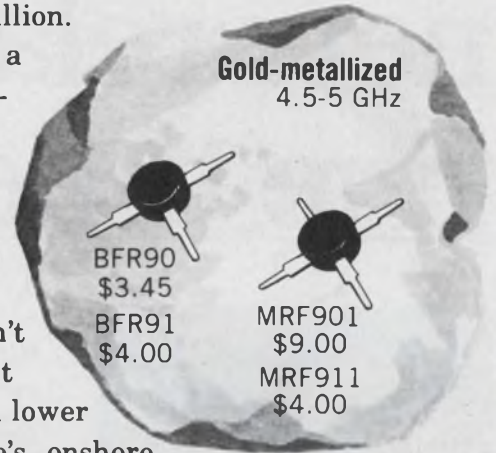

or off. ■ Size up the popular plastic BFR90 with 3 dB noise figure and 10 dB gain at 1 GHz. It's just \$3.45 . . . more than 27% less than a comparable. Cross-check the new \$13.80 ceramic MRF902 furnishing better noise figure — 2 dB at 1 GHz — with another assaying more than double. ■ Explore the metal can MRF904. This gem produces just 1.5

dB noise figure at 0.5 GHz with a price tag of only \$3.20. Otherwise, your cost can be an unbelievable \$16.50! ■ With our little nuggets and chips it's like being Midas. ■ If you're not turned on by the crass approach, consider the process. Gold-metallization is unquestionably the key to rugged, reliable operation in all military/commercial RF designs. No exception here.

Metal and ceramic are qualifiable to MIL Std 19500E and have a theoretical metallization system MTBF of 2.5×10^7 hours at max conditions. (Aluminum's about 3×10^3 hours.) ■ That's reliability. ■ That's mass production technology.

■ That's Motorola. □ Write us at Box 20912, Phoenix 85036 for data; or, see your

authorized Motorola distributor. ■ Get our gold. Don't be touched for yours.

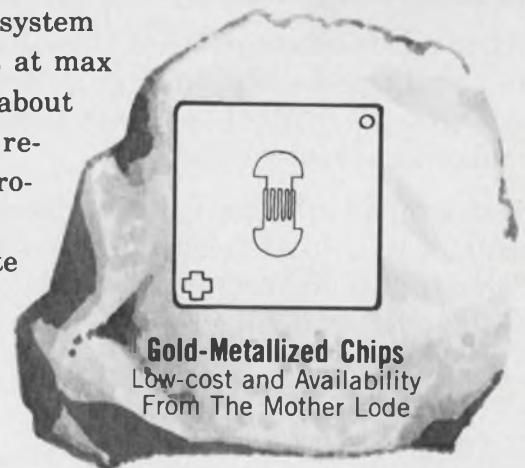
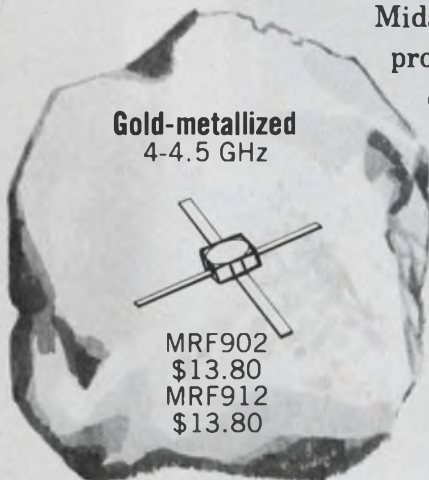

*All prices 1-up.



MOTOROLA RF Practically Priceless.

DC solid state update: new relays now handle five times the voltage.



Not long ago we introduced a line of 50VDC solid state relays. But a lot of circuit designers told us they needed higher voltage switching capability. To deliver meant coming up with an industry *first*. We did. Now Teledyne's new DC solid state relays provide a maximum load rating of *5 amps at 250VDC*, with two control voltage ranges.

Our new 603-3 relay offers a TTL compatible 3-10VDC input, and the 603-4

PART NUMBER	OUTPUT CURRENT RATING (AMPS)	OUTPUT VOLTAGE RATING (VDC)	
603-1	2	50	
603-2	5	50	
603-3, -4	5	250	
603-21	2	50	Controlled Rise and Fall Time
603-22	5	50	

a high level logic compatible 10-32VDC input. What's more, they feature transformer coupling to provide 1500V input/output isolation, and direct drive from the control source for low off-state leakage.

Package configurations provide three mounting options. You can select screw terminals, quick-disconnect terminals, or solder pins for direct pc board mounting.

All in all, Teledyne now has DC solid state relays to handle special high voltage switching problems — particularly for those heavy industrial machine and process control jobs.

For detailed information or applications help, contact your local Teledyne Relays people. They're sure to bring you up-to-date on high voltage DC switching.



 **TELEDYNE RELAYS**

3155 West El Segundo Boulevard, Hawthorne, California 90250
Telephone (213) 973-4545

INFORMATION RETRIEVAL NUMBER 3

NEWS

- 25 **News Scope**
- 28 **Power levels are reported rising** for low-frequency to microwave solid-state devices.
- 29 **The performance of optical integrated circuits** is being improved with the use of silicon substrate.
- 32 **Wireless power-transmission tests** are aimed at harnessing the sun's energy one day.
- 41 **Washington Report**

TECHNOLOGY

- 47 **Microprocessor Design**
- 62 **FOCUS on printed circuits:** Specifying PC boards and finding the right vendors is a tough job. You must anticipate possible problems in artwork, etching, plating, soldering and material selection—technologies far removed from circuit design.
- 72 **Improve your PC artwork techniques.** Even if you only supervise and check the work of others, you'll do a better job if you know the tricks of the trade.
- 80 **Avoid CMOS noise-sensitivity problems** by filtering power supplies, isolating high-frequency noise sources and controlling edge speeds.
- 86 **Test a/d converters digitally** by use of a microprocessor or minicomputer and a simple Basic program. Accuracy and resolution are easily determined.
- 90 **Ideas for Design:**
Microvolt probe traces PC current paths to help locate those defective ICs.
CMOS switch inverts analog signal under control of digital logic.
Dual-voltage regulated power supply has adjustable outputs that keep track.
- 96 **International Technology**

PRODUCTS

- 101 **Discrete Semiconductors:** Power Darlington transistors challenge thyristors for high-power control.
- 111 **Modules & Subassemblies:** Data acquisition module designed for wrapped-wire installation.
- 104 Instrumentation
- 107 Integrated Circuits
- 115 Data Processing
- 118 Microwaves & Lasers
- 122 Components
- 125 Packaging & Materials
- 129 Power Sources

Departments

- 59 **Editorial:** Wanted: S.O.B.s
- 7 Across the Desk
- 132 Application Notes
- 133 Bulletin Board
- 134 New Literature
- 137 Vendors Report
- 142 Advertisers' Index
- 145 Product Index
- 146 Information Retrieval Card

Cover: Photo by Jerry Nichols, courtesy of International Rectifier.

Intel is the way memory drivers and

Intel industry standard 2104, 16 pin and 2107B, 22 pin, 4K dynamic MOS RAMs help you keep system costs low. Now you can save even more with our new family of quad memory drivers and refresh controllers.

The new bipolar 3245 TTL to MOS driver is the first quad driver that does not require an extra 15 volt supply or an external transistor to generate and maintain the MOS clock level. The 3245 is a plug-in replacement for our 3235 and other MOS clock drivers. For ECL logic systems, choose the bipolar 3246 driver.

For CMOS and TTL logic systems where low power, battery back-up operation is required, use our new CMOS low power 5234 and 5235 drivers.

To make our 22 pin RAMs even easier to use and further reduce cost, all our new drivers feature individual address, as well as common refresh, clock and enable inputs. And all four drivers operate without the extra 15 volt supply or external transistor which was required with previous designs.

This simplifies system design and reduces cost even more.

We're also announcing two new refresh support circuits. The 3222 is used with Intel's 2107B and other 22 pin 4K dynamic

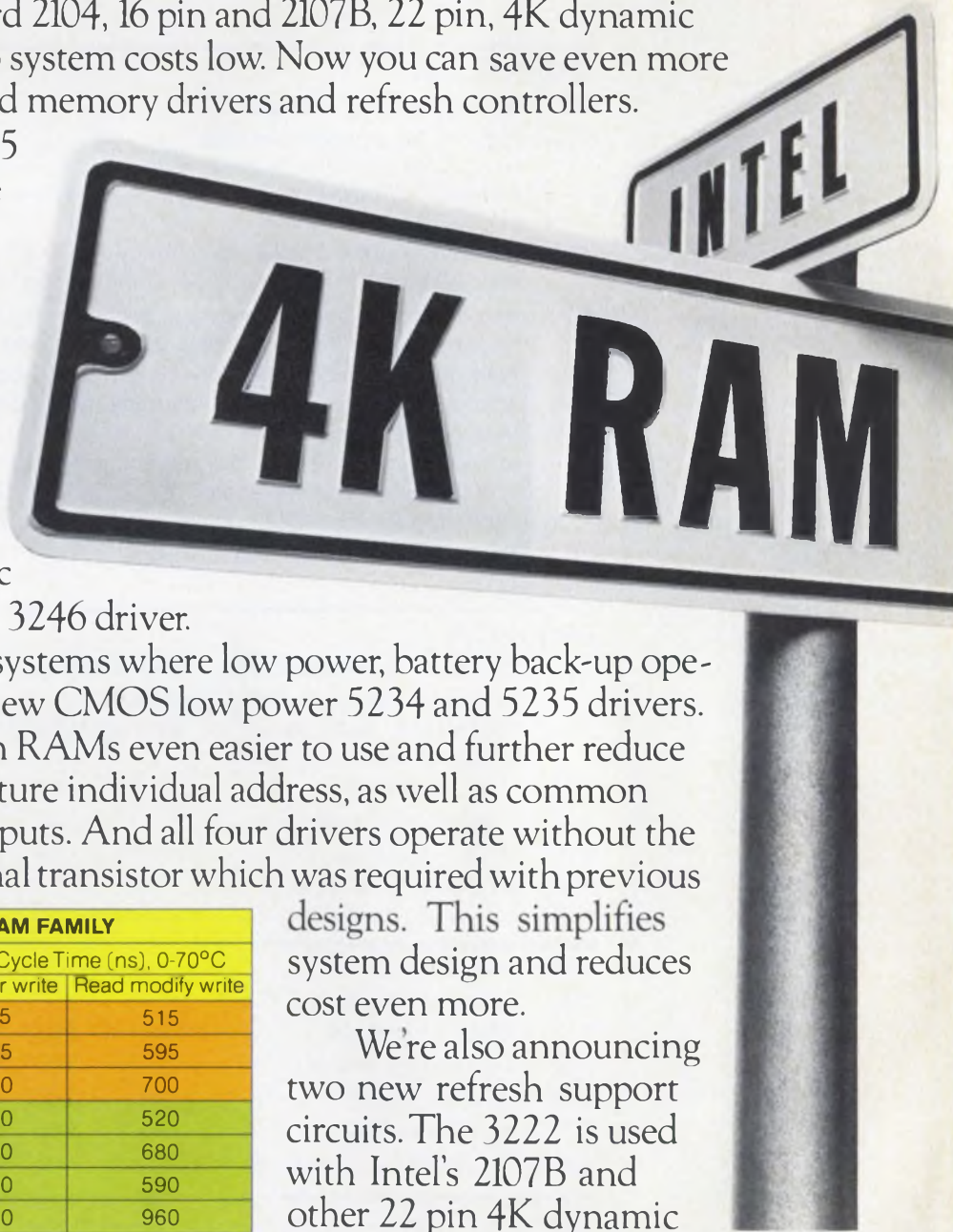

INTEL'S STANDARD 4K RAM FAMILY

Part Number	Pins	Max. Access Time (ns), 0-70°C	Min. Cycle Time (ns), 0-70°C	
			Read or write	Read modify write
D2104-2	16	250	375	515
D2104-4	16	300	425	595
D2104	16	350	500	700
2107B	22	200	400	520
2107B-2	22	220	470	680
2107B-4	22	270	470	590
2107B-6	22	350	800	960

to go for 4K RAMs, refresh controllers.

RAMs, while the 3232 is designed for Intel's 2104 and other industry standard 16 pin 4K dynamic RAMs. Both of these new circuits operate from a single +5 volt supply, help you simplify system design, reduce power and reduce the number of discrete packages required.

Intel 16 pin and 22 pin 4K MOS RAMs are helping engineers

cut system design costs. Now our new quad drivers and refresh controllers make Intel 4K RAMs even easier to use. Save dollars, save space, and eliminate extra power supplies and discrete components. Start saving now. To order contact our franchised distributors: Almac/Stroum, Component Specialties, Cramer, Elmar, Hamilton/Avnet, Industrial Components, Liberty, Pioneer, Sheridan or L.A. Varah.

For data sheets on the new drivers and refresh controllers write: Intel Corporation, 3065 Bowers Avenue, Santa Clara, California 95051. For \$5.00 we'll send you our new 288 page "Memory Design Handbook." This handbook contains applications notes and useful design information on our line of RAMs, ROMs, PROMs and support circuits.

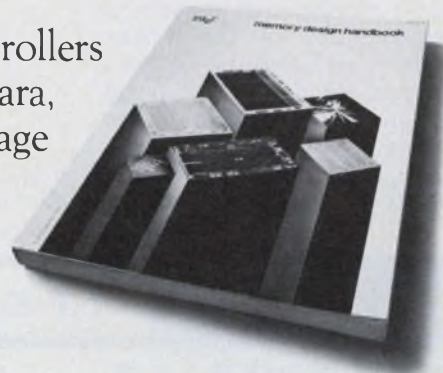

16 PIN QUAD MOS DRIVERS FOR INTEL 2107B 22 PIN 4K RAMs

Note: Intel 16 pin 2104 4K RAMs are TTL compatible

Part Number	Technology	Input Levels	Worse Case Delay & Rise Time 0-75°C	Power Supplies	Power Dissipation Channel
D3245	Schottky Bipolar	TTL	32ns	+5, +12V	75mW
D3246	Schottky Bipolar	ECL	30ns	-5.2, +5, +12V	110mW
D5234	CMOS	CMOS	100ns	+12V	3mW @
D5235	CMOS	TTL	125ns	+12V	0Hz, 39mW
D5235-1	CMOS	TTL	95ns	+12V	@ 1MHz

REFRESH CONTROLLERS FOR INTEL 16 & 22 PIN 4K RAMs

Part Number	Pins	Maximum Address Input to Output Delay 0-75°C	Power Supply	Used With
D3222	22	12ns	+5V	2107B
D3232*	24	8ns	+5V	2104

* Available 1st quarter 1976

intel® delivers.

When You Buy a Power Supply, Why Not Get the Best?



28 VDC to DC
(55,463 Hrs.)
Model C95D

28 VDC to 400 A
(61,387 Hrs.)
Model S3D

400 A to DC
(56,148 Hrs.)
Model W5D

Abbott's New Hi-Performance Modules

are designed to operate in the stringent environment required by aerospace systems — MIL-STD-810B and MIL-STD-461A for electromagnetic interference.

RELIABILITY — MTBF (mean time between failures) as calculated in the MIL-HDBK-217 handbook can be expected in excess of 50,000 hours at 100°C for all of these power modules. The hours listed under the photos above are the MTBF figures for each of the models shown. Additional information on typical MTBF's for our other models can be obtained by phoning or writing to us at the address below.

QUALITY CONTROL — High reliability can only be obtained through high quality control. Only the highest quality components are used in the construction of the Abbott power module. Each unit is tested no less than **41 times** as it passes through our factory during fabrication — tests which include the scru-

tinizing of the power module and all of its component parts by our experienced inspectors.

NEW CATALOG—Useful data is contained in the new Abbott Catalog. It includes a discussion of thermal considerations using heat sinks and air convection, a description of optional features, a discussion of environmental testing, electromagnetic interference and operating hints.

WIDE RANGE OF OUTPUTS — The Abbott line of power modules includes output voltages from 5.0 volts DC to 740 volts DC with output currents from 2 milliamperes to 20 amperes. Over 3000 models are listed *with prices* in the new Abbott Catalog with various inputs:

- 60A to DC
- 400A to DC
- 28 VDC to DC
- 28 VDC to 400A
- 12-28 VDC to 60 A

Please see pages 1037-1056 Volume 1 of your 1975-76 EEM (ELECTRONIC ENGINEERS MASTER Catalog) or pages 612-620 Volume 2 of your 1975-76 GOLD BOOK for complete information on Abbott Modules.

Send for our new 60 page FREE catalog.



LABORATORIES, INCORPORATED
general offices eastern office

5200 W. Jefferson Blvd./Los Angeles 90016
(213) 936-8185 Telex: 69-1398

1224 Anderson Ave./Fort Lee, N.J. 07024
(201) 224-6900 Telex: 13-5332

INFORMATION RETRIEVAL NUMBER 5

Sr. Vice President, Publisher
Peter Coley

Editors

Editorial Offices
50 Essex St.
Rochelle Park, NJ 07662
(201) 843-0550
TWX: 710-990 5071
Cable: Haydenpubs Rochellepark

Editor-in-Chief George Rostky

Managing Editors:

Ralph Dobriner
Michael Elphick

Associate Editors:

Dave Bursky
Morris Grossman
John F. Mason
Stanley Runyon
Edward A. Torrero

Contributing Editors:

Peter N. Budzilovich
Alberto Socolovsky
Nathan Sussman

Editorial Field Offices

East

Jim McDermott, Eastern Editor
P.O. Box 272
Easthampton, MA 01027
(413) 527-3632

West

David N. Kaye, Senior Western Editor
8939 S. Sepulveda Blvd.,
Suite 510
Los Angeles, CA 90045
(213) 641-6544
TWX: 1-910-328-7240

Editorial Production

Marjorie A. Duffy

Art

Art Director, William Kelly
Richard Luce
Anthony J. Fischetto

Production

Manager, Dollie S. Viebig
Helen De Polo
Anne Molfetas

Circulation

Manager, Evan Phoutrides

Information Retrieval

Peggy Long

Promotion, Creative Layouts

Manager, Albert B. Stempel
Maxine Correal
Nancy Gordon (Reprints)

Across the Desk

The cons and pros of ADC testing

Robert Havener's point in "Catch Missing Codes" (ED No. 16, Aug. 2, 1975, p. 58) that many manufacturers fail to do enough testing to ensure conformance to catalog specifications is well taken. However, the testing technique he suggests—and which, according to him, is in use at Analogic—also has some shortcomings.

First, an ADC tester of the type described by Havener cannot easily be used to check directly for integral linearity (or absolute linearity), a very important a/d converter specification.

Absolute, or integral, linearity error is a measure of how close each ADC code center is to the straight line through which all code centers would pass in a perfect converter. And, in any case, the indirect method (which is too time consuming for regular production use) it uses for checking integral linearity is not optimally precise.

Furthermore, Analog Devices uses a precision dc reference for the input to the unit under test, rather than feedback from the unit itself. This ensures that slowly changing errors are displayed and not compensated.

Second, we've found Mr. Havener's technique of displaying 16 code steps on a standard scope screen to be inadequate, if characterization of code widths and noise to better than 1/4-bit accuracy is desirable. The resolution of the display simply won't permit it.

Third, Mr. Havener's missing code detector can't check for codes that are two bits wide. This is as gross an error as missing codes

and as likely to occur in successive-approximation converters. Analog Devices checks its a/d converters with what we call a dynamic cross-plot tester, which displays wide, narrow or missing codes with equal clarity.

One final note: Although Mr. Havener didn't caution his readers, he surely is aware that building test equipment capable of accurately testing ADCs of 12-bit or greater resolution is in itself no trivial task. It requires that great care be given to grounding, shielding, separating analog and digital leads, etc. Our dynamic cross-plot technique, plus other aspects of testing a/d's and d/a's are discussed in more detail in *Analog-Digital Conversion Handbook*, published in 1972, and available from Analog Devices.

Jeff Riskin

Manager of Converter Engineering
Analog Devices Inc.

Modular Instrumentation Div.
Route 1 Industrial Park
P.O. Box 280
Norwood, MA 02062

The author replies

It is important for users of a/d converters to understand how to test converters themselves. While the techniques described in my article are used in various stages of testing at Analogic, we also use high-speed, computer-controlled testers that make literally millions of measurements on every a/d converter, with standards traceable to a few parts per million relative to the Bureau of Standards definition of absolute accuracy. In addition our computerized test equipment is programmed to

(continued on page 8)

Electronic Design welcomes the opinions of its readers on the issues raised in the magazine's editorial columns. Address letters to Managing Editor, Electronic Design, 50 Essex St. Rochelle Park, N.J. 07662. Try to keep letters under 200 words. Letters must be signed. Names will be withheld on request.



5 kV ISOLATION
"DIP"
Isolators

OPTRON OPTICALLY COUPLED ISOLATORS

NEW HIGH ISOLATION VOLTAGE
"DIP" SERIES OFFERS
HIGH TRANSFER RATIO

Now, OPTRON provides a 5 kV isolation voltage capability for its standard six pin plastic dual-in-line isolators. A new, unique internal design allows high voltage isolation while still maintaining a high current transfer ratio. The 5 kV DC or 3750 rms AC feature is available for all devices in OPTRON's popular OPI 2100 and OPI 3100 series.

OPTRON's extended "DIP" series includes JEDEC types 4N25 through 4N38A, features complete interchangeability with popular industry types and provides an inexpensive coupler for every application. Devices are available with isolation voltages of 1500, 2500 or 5000 volts with minimum current transfer ratios ranging from 2.0 to 500%.

OPTRON's "DIP" and a full line of other isolator packages with isolation voltages to 50 kV provide the versatility required for maximum electrical and mechanical design flexibility.

1.5 kV isolation with 60% current transfer ratio. Phototransistor base lead available. Hermetic TO-5 package.



OPI 102

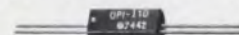

OPI 110

10 kV isolation and 40% current transfer ratio. 4 μ sec switching time in low cost miniature plastic package.

Detailed technical information on "DIP" and other isolators as well as all OPTRON optoelectronic products... chips, discrete components, assemblies, and PC board arrays... is available from your nearest OPTRON sales representative or the factory direct.



OPTRON, INC.

1201 Tappan Circle
Carrollton, Texas 75006, U.S.A.
214/242-6571 • TELEX-73-0701
© TWX-910-860-5958

ACROSS THE DESK

(continued from page 7)

perform a multiplicity of tests encompassing hysteresis, differential linearity, etc., and can plot out complete histograms of transfer functions.

The dynamic Cross-Plot Tester is the common test method described in my article, and I go on to indicate how to overcome the deficiencies of this basic technique.

With respect to absolute linearity, it is well known that properly designed DVMS have integral linearity well beyond that which can be achieved by other methods.

Mr. Riskin's comments about scope resolution make me wonder if he read my article thoroughly. The number of code steps to be displayed on the scope is controlled by switch S₁ in the diagrams. By expansion of the number of poles on the switch, any number (2, 4, 8, 16 . . . etc.) of steps can be displayed.

As for missing codes, quite clearly a code that is 2 bits wide is not missing. A unit with such codes may be out of spec, but that condition will be found either on checks for differential linearity or on histographic printouts. The method described in my article will check for the presence of all codes.

Robert W. Havener

Analogic Corp.
Audubon Rd.
Wakefield, MA 01880

A small gap noticed in Wescon coverage

I was very pleased to see an article covering our Wescon session on "Microprocessors in Medical Instrumentation" in your Sept. 13 issue. However, as chairman of that session (Session 24), I found it rather strange that you should so nicely cover three of the four papers in the session without even mentioning the fourth.

In addition to the three papers cited, there was an excellent paper on "The Microcomputer in Diagnostic Health Care and Patient Monitoring," by Radha Ramaswami of Xerox Corp. In this paper, she not only covered a very

important area of application for microprocessors in the medical field, but also discussed the approach of using the microprocessor in a general-purpose microcomputer that can then be incorporated into an instrumentation system.

We find it difficult to understand why coverage of this paper was omitted.

Fred J. Weibell
Chief, BECC

Veterans Administration Hospital
Sepulveda, CA 91343

Editor's Note: The article was written before Wescon opened, and our reporter made three or four telephone calls to the author to elicit information. She was unavailable each time and did not return the calls. It's difficult to publish information when it isn't made available.

Misplaced Caption Dept.



Sorry. That's Rembrandt's "The Night Watch," which hangs in The Rijksmuseum, Amsterdam.

A plug for digital control of microprocessors

I wish to comment on the article "Mating Microprocessors with Converters" (ED No. 18, Sept. 1, 1975, p. 76).

The full potential of microprocessors will be realized in digital control systems that use digital sensors and digital actuators, not in control systems employing analog inputs and outputs and conversion modules. To take advantage of the cost, power, weight and size benefits of microprocessor technology will require the use of

digital sensors and digital actuators, such as stepping motors. Control-loop problems resulting from conversion errors are eliminated and noise and interface problems are greatly reduced.

Siltran presently offers position sensors with word lengths up to 12 bits and pressure sensors with word lengths up to 7 bits. All sensors are fully compatible with TTL or CMOS logic levels.

M. F. Hordeski
President

Siltran Digital
P.O. Box 437
Silverado, CA 92676

A double-cross

Two captions that appeared in the special computer issue, ED No. 22, Oct. 25, 1975, were placed under the wrong photos. The caption on Hewlett-Packard's 2644A Data Terminal, which appeared under the photo on p. 55, belongs with the photo on top of p. 91. The Omron 8025 caption on p. 91 belongs under the photo on p. 55.

Comments on 'Females' and 'The Shortcut'

I would like to comment on two of George Rostky's recent editorials. First, I doubt that anyone, not even Charlie, could confuse chipped beef on toast with French delicacies ("Look Men, Females," ED No. 20, Sept. 27, 1975, p. 49). Charlie would much more likely to be thinking of ways to make the same ingredients more appetizing. Innovation most often begins not with some pointless desire merely to be different, but with a value judgment: "This is ridiculous. There must be a better way." (Incidentally, such value judgments are often confused with arrogance, particularly when a well-established orthodoxy is called into question.)

"Necessity is the mother of invention" is another way of saying it, except that nowadays it's important to add: ". . . if there's time to think and freedom to act." One of the great benefits of a free market is precisely the freedom of action it affords.

(continued on page 19)



MEASUREMENT COMPUTATION

innovations from Hewlett-Packard

NEWS

DECEMBER 1975

in this issue

Third channel
trigger view with
new data domain scope

Microprocessor controlled
SLMS for FDM systems

New low-profile LED



New On-line/Off-line Mini DataStation saves computer time and data transmission costs

Program preparation, editing, tape copying, and tape-to-printer operations are now the domain of an off-line CRT terminal. HP's newest microprocessor-controlled 2644A Mini DataStation allows you to perform these and myriads of other operations normally requiring costly and often inconvenient connection to a computer.

220,000 bytes of local mass data storage has transformed the powerful HP 2640A CRT terminal into a new kind of terminal. The key to data storage is in the two fully-integrated cartridge tape transports using the newly developed shirt-pocket size version of the 3M data cartridge. The advantages over cassettes include reliability, assured inter-

(continued on third page)

HP-9815A: Big calculator features in a new small package

The new 9815 calculator combines keystroke calculating convenience, dedicated problem solving and an optional two-channel I/O to give you versatility and power in solving problems from the simple to the sophisticated.



A new AUTO-START capability and high-speed dual-track data cartridge capable of storing 96,384 bytes of data and programs are features that make the 9815A calculator a viable and easily customized choice for virtually any lab. Add the optional interface capabilities and you can easily extend powerful 9815 desk-top computing capabilities.

The 13-pound (5.9 kg) calculator features the Hewlett-Packard stack-oriented logic system simplifying keystroke calculations and giving you answers you can trust. The buffered keyboard contains 24 preprogrammed functions, 4 arithmetic keys plus keys for memory-stack manipulation.

The thermal printer prints up to 16 characters per line at 2.8 lines per second. In addition, there is an easy-to-read numeric display.

With the addition of the optional two-channel I/O structure, you can add 9800 Series peripheral devices, including the new 9871 printer/plotter, (see

right column), 9862 plotter, tape readers or tape punches, or a digitizer.

The 9815 also mates with BCD instruments and devices with 8-bit parallel interfaces. The 9815 accommodates the Hewlett-Packard Interface Bus, (HP-IB) allowing you to control, gather, and process data from as many as 14 different HP-IB compatible test and measurement instruments.

The 9815 contains computer language functions for programming power and performance. The standard 9815 has 472 steps of program memory and 10 data storage registers. An option is available to expand the calculator's internal memory to 2,008 program steps.

Many standard problem solutions are available from the extensive library of pre-recorded programs in statistics, engineering, science and surveying.

For more information, check P on the HP Reply Card.

Prepare charts, graphs and text easily under program control with new printer

The new HP 9871A printer extends the output characteristics of the 9800 series desk-top programmable calculators including the new HP 9815A (see story on this page).

This new impact printer is a full-character, fixed carriage peripheral that can be used to fill out forms, create reports, draw charts and plot graphs using the bi-directional platen and carrier. It also features programmable horizontal and vertical tabulation.

In addition to the standard 96-character, upper/lower case print wheel, optional interchangeable wheels are available for ASCII character sets and European character sets.

The 9871 is a versatile printer, accommodating paper up to 15 inches (38 cm) wide and prints up to 132 columns at 10 characters per inch. Average printing speed is 30 cps. Six-part paper in single-sheet or continuous-feed form may also be used.

For more information on interfacing this new printer/plotter to your 9800 series calculator, check Q on the HP Reply Card.

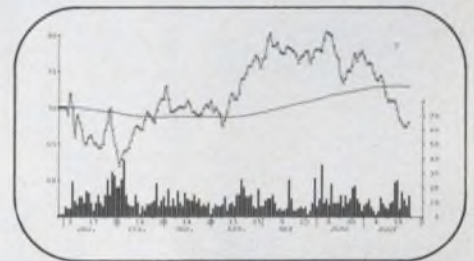

Interchangeable printwheels are shown with new rugged 9871 output printer.

New On-line/Off-line Mini DataStation saves computer time and data transmission costs

(continued from first page)

changeability, and lower error rates. One cartridge contains the equivalent of 1000 feet of paper tape—enough for many hours of off-line work.

Here are some of the operations you can perform on the 2644:

- Enter data from the keyboard and view the data instantly on a high-resolution 7×9 dot enhanced display. Up to 4 different 128-character sets may be in the 2644.
- Store data on tape. Many hours of work at the keyboard can be stored on a single cartridge by pushing a single button—and selectively retrieved in seconds.
- If data entry requires a form, call any of up to 255 variable-length files stored on tape and retrieve the form you want at 60 ips search speed, usually within 10 seconds—with pushbutton ease.
- Edit the data, using the 2644's full editing capabilities, including character and line insert and delete, cursor sensing and positioning, and programmable protected fields.
- Batch-transmit stored data to the computer directly from the cartridge, at transfer rates up to 2400 baud.
- Move data among the 2644's functional units by pushbutton—between tapes, semiconductor memory, optional printer, and data communications interface.
- Expand terminal applications by using the 2644's dual tape unit so that one cartridge provides a write-protected input while the other provides a separate output.

The 2644 not only conserves computer resources and reduces communications line charges, it also improves the efficiency of data entry and provides a valuable backup during computer down-time.

To receive your copy of detailed specifications and performance information, check C on the HP Reply Card.

More markers, more sweeps, with new sweeper mainframe

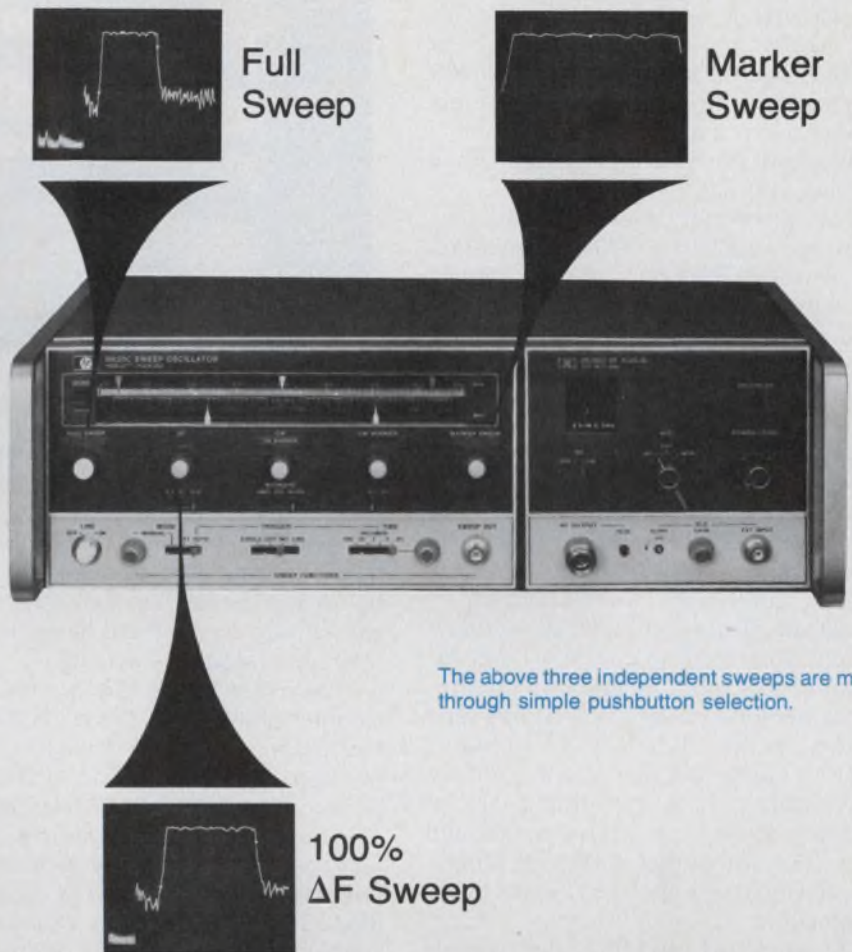

The above three independent sweeps are made through simple pushbutton selection.

The new HP 8620C mainframe for HP's solid-state sweep oscillators offers highly useful new sweep modes plus up to three frequency markers for additional operating flexibility. Start with the FULL SWEEP mode: Just press the button and the RF plug-in's full band is swept. You have three frequency markers (select either "amplitude" or "intensity" markers) available to bracket and pinpoint portions of the full-band sweep. Then press the MARKER SWEEP button and the sweep now covers from the START marker to the STOP marker. In this mode, the CW marker is still available. Press the CW and ΔF buttons and you now have another independent sweep (in which the START and STOP markers can be used). The ΔF sweep, symmetrical around the CW frequency, can be as wide as 100% of the full band. This is 10 times greater than could be swept with

the 8620C's predecessor (HP 8620A). Yet the 8620C still retains the narrow band ΔF and "CW Vernier" capabilities that permit very high frequency resolution and settability.

The 8620C mainframe offers two forms of frequency programming as options: BCD programming (Option 001) or through the HP Interface Bus (Option 011). Either form permits selection of 10,000 frequency points per band. RF plug-ins covering from 3 MHz to 18 GHz are available for the 8620C, including ultra wideband units spanning 10 to 2400 MHz and 2 to 18 GHz.

For more data, check N on the HP Reply Card.

New portable DMM has five full functions and 1 μV dc/10 μV ac sensitivity

HP's new 3465A digital multimeter lets you measure low-level voltage with 1 microvolt dc resolution and sensitivity. AC voltage resolution and sensitivity of 10 microvolts is provided on the 100 MV range. Your choice of ac lines or battery power make it attractive for use as a lightweight portable service tool, while serving your lab needs.

Full functional capability with high sensitivity make it a preferred measurement tool for troubleshooting in the lab or in the field. Its ease of use, low cost and unambiguous display, plus input protection, makes the HP 3465A especially attractive.

This new DMM gives you dc voltage accuracy of $\pm 0.02\%$ of reading $\pm 0.01\%$ of range on most often used ranges. The ac voltage accuracy is $\pm 0.15\%$ of reading $\pm 0.05\%$ of range for midband frequencies over the audio range. Ohms are measured from 10 milliohm sensitivity to 20 megohms with an accuracy of $\pm 0.02\%$ of reading $\pm 0.01\%$ of range for most ranges. Both ac and dc current measurements range from 10 mA sensitivity on the 100 μA to 2 A on the highest range. The dc current accuracy is typically $\pm 0.11\%$ of reading $\pm 0.01\%$ of range, and the ac accuracy at midband is $\pm 0.25\%$ of reading $\pm 0.05\%$ of range. There is a front panel 2A fuse for input protection.

The standard 3465A has rechargeable batteries. Option 001 is for AC operation only, Option 002 uses 4 Type D batteries.

For additional details, check D on the HP Reply Card.

Look at the front panel and you see what the 3465A can do for you. Look inside and you will see the latest technology with only seven adjustments for routine maintenance. Low cost to buy, and low cost to own were design considerations.

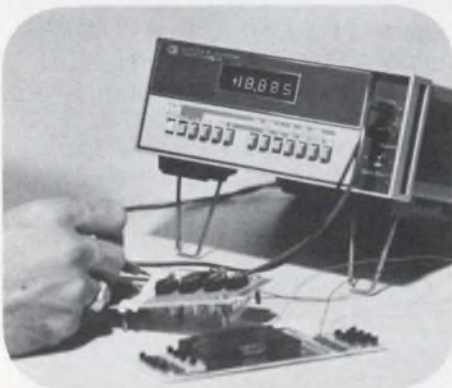

New synchronizer/counter improves usefulness of low cost signal generator



Now you can phase-lock the 8654A/B signal generator with the new HP 8655A synchronizer/counter for very low drift and 500 Hz resolution.

Tuned-circuit-type signal generators such as the HP 8654B are hard to beat for good spectral purity and non-harmonic signals more than 100 dB below the carrier. But they tend to exhibit turn-on drift and have only moderate frequency accuracy.

Now a new HP 8655A Synchronizer/Counter phase-locks the HP 8654A/B Generator to bring drift down to 0.1 ppm per hour. It can be locked to 500 Hz points across its 10-520 MHz range.

In the phase-locked mode, the excellent spectral purity of the generator is preserved as well as the FM capability (up to 100 kHz deviation). Operation is simple; after tuning to the desired frequency as indicated on the 6-digit LED display, a push of the LOCK button establishes phase lock to the displayed frequency.

The 8655A also serves as a versatile counter with excellent RFI performance, a very important consideration when used next to microvolt test signals. Less than 1.5 μV leakage is induced in a 2 turn-1 inch diameter loop at a 1 inch distance.

In the external count mode, frequencies from 1 kHz to 520 MHz may be measured to a sensitivity of 100 mV into 50 ohms. An internal crystal oscillator provides better than ± 2 ppm accuracy within 3 months and over 15° to 35°C.

Provision is made to mechanically couple the synchronizer to the 8654A/B generator for excellent portability. The combination weighs 14 kg (31 lbs.) and is small in size.

To learn more, check O on the HP Reply Card.

Automate your process with a calculator-based multi-programmer

Process engineers can now plug together and program their own automatic test and process control system quickly and economically. It's all made possible with a calculator-based HP Interface Bus (HP-IB) Multiprogrammer System designed for ease in communicating bi-directionally with your process instrumentation.

A basic system includes the controller, a desk-top programmable calculator (HP Models 9830, 9821, or 9820), connected via the HP-IB to a multiprogrammer interface unit, a 6940B multiprogrammer, and from 1 to 15 randomly-addressable I/O cards that plug into the 6940B mainframe.

Up to 15 extender mainframes, each holding 15 plug-in cards, can be combined permitting system expansion up to 240 I/O channels controlled by a single calculator.

Several different types of multiprogrammer input and output cards are available to interface with your process instruments. Input card functions include current monitoring, voltage monitoring, digital input, counting, and event sensing. Output functions cover stimulus and control including voltage, current, resistance, relay contacts, digital bit patterns, stepping motor control, time and frequency references. Cards may be added or changed as the functions of a real-time test and control system change.

To learn more, check J on the HP Reply Card.



HP-IB Multiprogrammer building-block components (center modules above), bring the power, economy, and ease of programming of HP desk-top programmable calculators to your automation job.

Programmable HP-25 has built-in power to solve technical problems



Preprogrammed to solve 72 scientific, engineering and mathematical functions, the HP-25 saves you time solving your difficult technical problems. In addition, it has 8 addressable memories, each capable of register arithmetic.

The HP-25's programming power includes a 49-step memory. Each step in this memory can accommodate multi-keystroke functions, because the keycodes of *all* prefixed functions—including the register arithmetic functions—merge. Thus, you gain extra capacity.

With the HP-25, you enter the keystrokes necessary to solve your repetitive problems only *once*. Thereafter, you just enter the variables and press

the Run/Stop key for an almost instant answer you know is accurate.

You can add, change or skip steps. You can program the HP-25 to perform direct branches or conditional tests.

And it's the first hand-held to offer not only *fixed* and *scientific* but also *engineering* notation (i.e., exponent displayed as a multiple of $10^{\pm 3}$ as in giga and nano).

The RPN logic system with 4-register stack allows you to evaluate any expression without copying parenthesis or worrying about hierarchies or restructuring before entering.

For your copy of a descriptive brochure, check the HP Reply Card.

Short form catalog of power supplies for the lab or system

Hewlett-Packard power supplies are available in many types, sizes and ranges. Most DC supplies available from HP are described in a new 8-page illustrated catalog. Voltage and current ratings, performance specs, size and operating features are included.

Covered in this catalog are bench-type units for circuit testing and development, modular supplies to power

systems, high-power supplies for industrial processes and many special purpose units ranging from bi-polar supply/amplifiers to digital power sources.

Available power options and ordering information are included.

This catalog is free of charge and may be obtained by checking 5 on the HP Reply Card.



To help you select the power supply most suitable for your application, this new catalog will be of valuable assistance.

Coaxial and Waveguide catalog and Microwave Measurement handbook



RF and microwave engineers will find plenty of use for HP's brand new 1975-76 edition of the *Coaxial & Waveguide Catalog*, 80 pages of product descriptions and specifications on over 300 microwave components. Product sections include Attenuators, Detectors, Couplers, Filters, Power sensors, Slotted lines, and many more.

The book is also intended as a *Microwave Measurement Handbook*. Over 20 pages are devoted to a technical summary of common measurements of impedance, attenuation, power, frequency, noise figure in both waveguide

and coaxial systems.

Typical section titles listed below will interest design engineers, production test personnel, metrology labs, and others working on microwave measurements.

*Microwave Measurement Matrix
Equipment Selection Matrix
Associated Instrumentation
Reference Literature for Microwave Engineers
Important Specifications for Attenuators
Waveguide Standard Data Chart*

For your free copy, check R on the HP Reply Card.

Application Note describes dynamic measurement of microwave VCO's

The new Application Note 173-1, "Dynamic Measurement of Microwave VCO's with the 5345A Electronic Counter," describes a simple technique for determining the frequency-vs-time characteristics of fast-tuning VCO's to 18 GHz. This technique, centered about the 5345A Electronic Counter and its microwave plug-ins, is ideal for measuring VCO ringing and overshoot characteristics, risetime, settling time, and post-tuning drift.

Using the set-up described in AN 173-1, measurement resolution of microwave frequencies is better than 1 MHz, while resolution on the time axis is as fine as 5 nanoseconds. These values far exceed the capabilities of discriminators now used to make these measurements.

Of course, the technique is also applicable to sub-microwave VCO's. An accompanying application note AN 173, "Recent Advances in Pulsed RF and Microwave Frequency Measurements," discusses in detail the theory, techniques, and set-up considerations for this class of measurements.

For your copy of both of these Application Notes, check T on the HP Reply Card.



Several unique features of the 5345A Electronic Counter—external gating, frequency averaging, and the ability to accept plug-in microwave down-converters—are exploited to achieve an exciting new class of high-speed frequency measurements.

Display the external trigger as a *third* trace on new data domain oscilloscope



A new scope ideally suited for data-domain analysis and general purpose measurements including low-level signals of read/write heads, power supplies, electro-mechanical transducer outputs.

Special characteristics of the new Hewlett-Packard 1740A 100-MHz oscilloscope make it a logical first choice as companion instrumentation for today's data-domain analysis.

With the new third channel trigger, you can have a simultaneous display of the trigger waveform *plus* channel A and B traces. You can make accurate time measurements from the trigger signal to events on either or both channels.

In the data domain, you can combine the 1740A with HP's 1607A logic state analyzer offering a solution to digital troubleshooting with the combination of logic state and electrical analysis. Option 101 to the 1740A adds rear-panel inputs with internal switching circuits for convenient single push-button switching between the standard front panel inputs and the rear panel state display inputs without changing any cables. This single pushbutton switching capability is very useful when digital word-flow errors require analysis of electrical parameters to determine correcting measures.

5 mV/division at 100 MHz provides the detail needed to study ECL and other fast, low-level signals. A vertical magnifier provides 1 mV sensitivity on both channels to 40 MHz for measuring low-level signals without cascading problems. And, for maximum measuring flexibility, the 1740A has switch selectable 1 megohm or 50 Ω inputs.

This scope with its new ideas simplifies both real-time and data-domain measurements.

For your copy of a technical data sheet, check B on the HP Reply Card.

8580B Component Test System and new application program for more effective stimulus-response testing

The HP 8580B Automatic Spectrum Analyzer is now available with a new component test option (Option 300) that makes major contributions to stimulus-response testing. These contributions include the capability for swept IM measurements for amplifiers and mixers, conversion loss for mixers, and for high dynamic range (120 dB) measurements. These measurements are difficult, if not impossible, to make manually.

The 8580B Option 300 adds to the base system an additional source control unit which can multiplex up to three sources plus CTEST, a microwave application program that provides powerful and flexible measurement capabilities.

Difficult test measurements can be made quickly and easily using CTEST, or programs can be easily generated by the customer in high level BASIC or FORTRAN with the TODS-II Disc Operating System.

The HP 8580B with Option 300 is capable of making the following measurements:

- VSWR
- Return Loss
- Frequency
- Power
- Isolation
- Conversion Loss/Gain
- Gain/Loss at equal frequencies
- IM and Harmonic Distortion
- Unwanted Mixing Products

The system is flexible enough to test a variety of devices such as active and passive components, subsystem modules and systems.

The Component Test System provides a practical solution to production testing needs. Its accuracy, speed, ease of operation and measurement versatility will provide an attractive return on investment through lower test costs, higher yield, and improved productivity.

For more information on the HP 8580B with Option 300, check M on the HP Reply Card.

Add a new dimension to your plotted graphics with a time-share plotter

Using a highly efficient data transfer format, the HP 7203A high speed X-Y plotter can plot up to seven vectors per second in any direction.

Each data coordinate is expressed with a binary number and represented by the bit pattern of two successive ASCII characters. Thus, only 4 characters are required to define any move. ASCII characters are accepted at 10 or 30 cps through a standard RS232C compatible interface.

Operating in parallel with data communications terminals, graphs can be

plotted on any size paper up to 27.9 × 43.2 cm (11 × 17 in).

Paper is held by an electrostatic paper holdown. Front panel controls allow adjustment of graph limits to fit a plot to any preprinted grid. Four colors of ink are available in disposable pens. Pens are changed quickly and easily so that plots may be superimposed in color for comparison.

For more information, check K on the HP Reply Card.

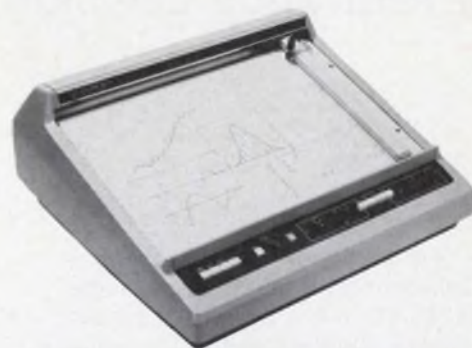

Add a fast digital X-Y plotter to your communications terminal and display your data in easy-to-understand charts and graphs.

HEWLETT-PACKARD COMPONENT NEWS

New low-profile lamps in three colors

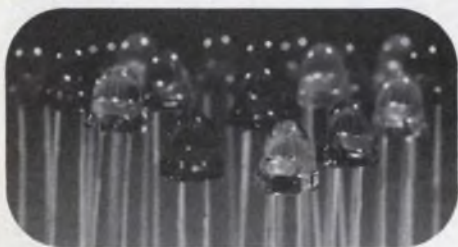

New low profile LEDs in three colors, narrow or wide beam, ideal for compact applications.

HP introduces a new low-profile configuration of solid state lamps: 5.8 mm (0.23 in) nominal. These high-efficiency red, yellow and green LED lamps are packaged in a T-1 3/4 outline and are available in diffused and non-diffused types providing you with the choice of wide or narrow viewing angles.

These lamps are high intensity, IC compatible, have general purpose leads and operate at low current levels.

Models available are as follows:

Color	Viewing Angle	
	Wide	Narrow
Yellow	5082-4590/92	5082-4595/97
Hi-Efficiency Red	5082-4690/93	5082-4694/95
Red	5082-4790/91	—
Green	5082-4990/92	5082-4995/97

For more information, check R on the HP Reply Card.

New microwave high Q varactor offers maximum stability even in harsh environments

Hewlett-Packard 5082-1300 series tuning varactors are manufactured using a diffused junction mesa structure. Low surface leakage is insured in that the diode is passivated with silicon nitride and silicon dioxide.

These varactors are optimized for high Q with high tuning ratio. Various package styles, as well as chips are available.

Designed for applications requiring a high Q with high tuning ratio, the devices are also suitable for use with transistor, Gunn or IMPATT oscillators.

For a technical data sheet with specifications, check H on the HP Reply Card.



Applications for these new varactors include tunable filters, voltage tuned oscillators and AFC loops.

New high power, high efficiency silicon double drift IMPATT diodes for CW power sources

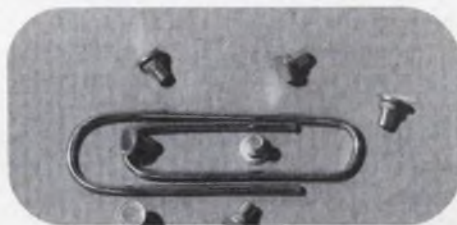

New IMPATT diodes have the reliability to exceed the requirements of MIL-S-19500.

Two new double drift silicon IMPATT (Impact Ionization Avalanche Transit Time) diodes are now available with output of 3W from 5.9 to 8.4 GHz.

Double drift IMPATT diodes offer advantages of higher power and efficiency, lower junction capacitance per unit area, and lower fm noise, as compared to single drift IMPATT diodes.

Because of their high output power, efficiency, and reliability, these devices are ideally suited for use as the active element in C-band oscillators and amplifiers in point-to-point telecommunications links.

For details, check G on the HP Reply Card.

New selective level measuring set for faster, more accurate management of Frequency Division Multiplex system

HP introduces a new concept in selective level measuring sets, the 3745A/B. It is a powerful new tool specifically designed for surveillance, maintenance and commissioning of Frequency Division Multiplex (FDM) Carrier Systems. Ability to tune in terms of an FDM Plan numbering scheme and make highly-accurate measurements using dedicated filters, distinguishes the 3745A/B from a traditional SLMS.

Measurement capability includes a frequency range from 1 kHz to 25 MHz and true rms measurements from +15 dBm to -125 dBm, depending upon the filter selected. A resolution of 0.01 dB and purpose-designed, flat-topped filters give accurate measurements of channel powers, group powers and pilot levels. The narrow-band pilot filter can be used for other single-tone measurements.

A micro-processor controls all instrument functions, including receiver tuning via a synthesized local oscillator. The SLMS can be operated from the keyboard or remotely, using a suitable calculator or computer, via the Hewlett-Packard Interface Bus (HP-IB).

New selective level measuring set for attended or unattended FDM system surveillance.



There are two versions of SLMS, the 3745A and 3745B. The 3745A contains information on CCITT Recommended FDM Plans, and the 3745B contains information on BELL FDM Plans.

For a data sheet on the 3745A (CCITT), check E on the HP Reply Card. For information on the 3745B (BELL), check F on the HP Reply Card.

HEWLETT  **PACKARD**

East-4 Choke Cherry Road, Rockville, MD 20850

Ph. (301) 948-6370.

South-P.O. Box 28234, Atlanta, GA 30328,

Ph. (404) 434-4000.

Midwest-5500 Howard Street, Skokie, IL 60076,

Ph. (312) 677-0400.

West-3939 Lankershim Blvd, North Hollywood, CA

91604, Ph. (213) 877-1282.

Europe-P.O. Box 349, CH-1217 Meyrin 1, Geneva,

Switzerland, Ph. (022) 41 54 00.

Canada-6877 Goreway Drive, Mississauga, Ontario,

L4V 1L9, Ph. (416) 678-9430.

Japan-Yokogawa-Hewlett-Packard Ltd., Ohashi

Bldg., 59-1 Yoyogi, 1-chome, Shibuya-ku,

Tokyo 151, Ph. 03-370-2281/92.

when it comes to Scan Converters, PEP is ...

THE FIRST

TO DEVELOP
A PRACTICAL
SCAN CONVERTER

Princeton Electronic Products was the first to develop a high performance, commercial quality, low cost scan converter. Made possible in 1969 by our unique Lithocon Silicon Target Image Storage Tube, we were the first to make ultra sound medicine feasible by providing diagnostic quality images. We radically altered air travel by enabling the first practical baggage X-Ray system. Because PEP pioneered the practical scan converter, we have virtually every "first" there is.

THE BIGGEST

WORLD'S LARGEST
EXCLUSIVE
MANUFACTURER

Thousands of PEP Scan Converters are at work on hundreds of different OEM and single system applications. PEP "image computers" are being used in industrial process controls. At research laboratories. For medical electronics. In the fields of X-Ray and Ultra Sound. PEP has solved the largest range of image storage problems. And PEP has the largest staff of specialists exclusively dedicated to the design, manufacture, sales and service of scan converters.

THE BEST

IN PERFORMANCE
AND
TECHNOLOGY

PEP's Lithocon II has made possible the practical world of electronic imaging. It accepts millions of bits of information, manipulates it, and then puts the information out again in a form specially processed for television and visual display. During the past seven years our constant refinement and practical experience in image processing has resulted in the best performing, most technically advanced equipment available anywhere.

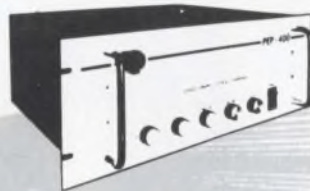

THE ONLY Exclusive Maker of Scan Converters

With PEP, it's a total commitment to developing better equipment to process images.

When you hear about a better scan converter, you can bet it's from PEP.

Tell us about your application. We'll tell you more.

Call or write: Princeton Electronic Products Inc.,

Box 101, North Brunswick, N.J. 08902. Telephone 201-297-4448.



PRINCETON ELECTRONIC PRODUCTS, INC.

INFORMATION RETRIEVAL NUMBER 161

These semiconductor cooling ideas improve circuit performance and reliability, cut costs.

No. 7 of a Series

Engineers use Staggered Finger heat dissipators, Thermal Links, Fan Tops, and other IERC thermal management devices to solve a wide range of circuit design and packaging problems dealing with power, reliability, switching speeds, circuit density, stability, reproducibility, and cost. Here are four ideas that may suggest new ways you can put IERC dissipators to work for you.

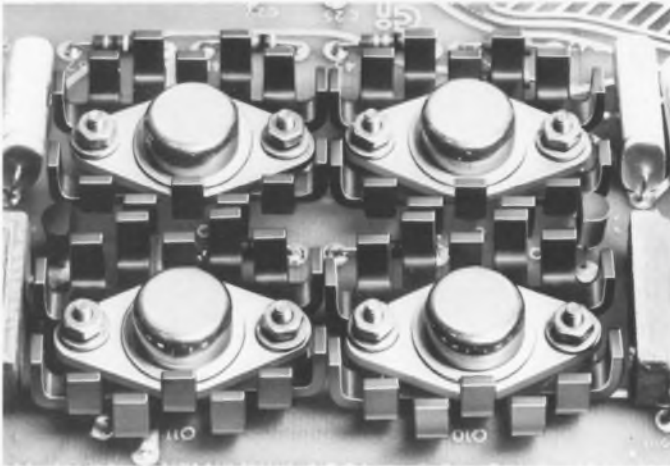

More power, higher reliability from the same TO-66s is a paradoxical requirement, but designer met it in this amplifier circuit with LB Series Staggered Finger dissipators. Nominal case rise above ambient of 90°C for bare case TO-66s permits 3 watts dissipation per device. Adding LB's doubled transistor life by giving 10°C temperature drop while increasing power to 5.5 watts per device.

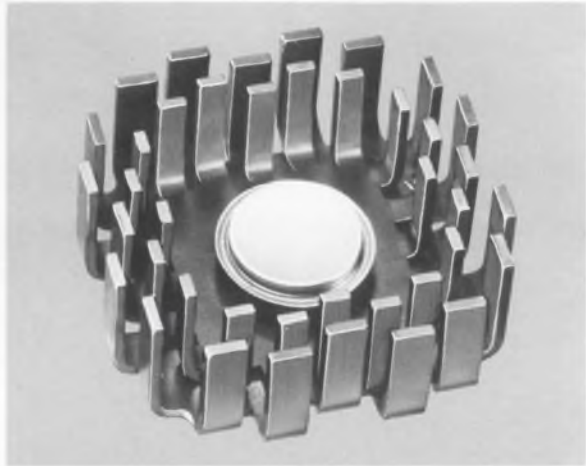

Design-to-cost criteria were missed in a touchy servo amplifier because 4 parallel devices required too much testing and matching. Designers went to single TO-6 cooled by nested HP1 and HP3 Staggered Finger dissipators. At 100°C case rise above ambient, the single TO-6 dissipates 36 watts, plenty for the application.

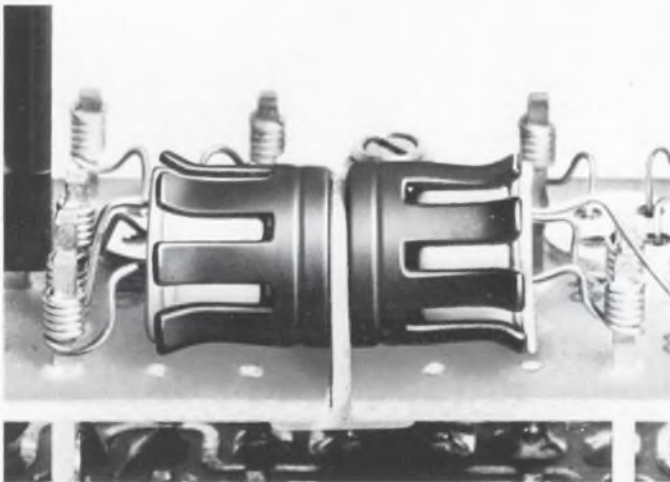

Erratic flip-flop in high-G environment posed problem until IERC Thermal Links came to the rescue. Thermal Links held the TO-5s firm, increased their thermal mass, and linked the two cases to a common heat sink. Resulting lowered junction temperature permitted more stable operation and higher reliability while thermal matching assured a balanced circuit.

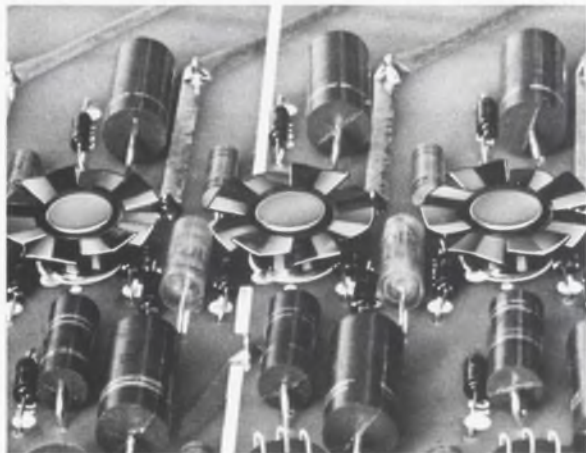

Faster switching speeds and lower junction temperatures at the same power levels without spending a bundle was called for after bread board testing of this circuit. Adding IERC Fan Top dissipators to the TO-5s held junction temperatures well below maximums and substantially improved rise and fall times. And the press-on Fan Tops cost just pennies.



For more information on heat sinks and dissipators for milliwatts to kilowatts, send for the IERC Short Form Catalog today. It covers the most complete line of thermal problem solving devices available anywhere.



Heat Sinks/Dissipators

INTERNATIONAL ELECTRONIC RESEARCH CORPORATION / A SUBSIDIARY OF DYNAMICS CORPORATION OF AMERICA / 135 WEST MAGNOLIA AVENUE, BURBANK, CALIFORNIA 91502

INFORMATION RETRIEVAL NUMBER 162

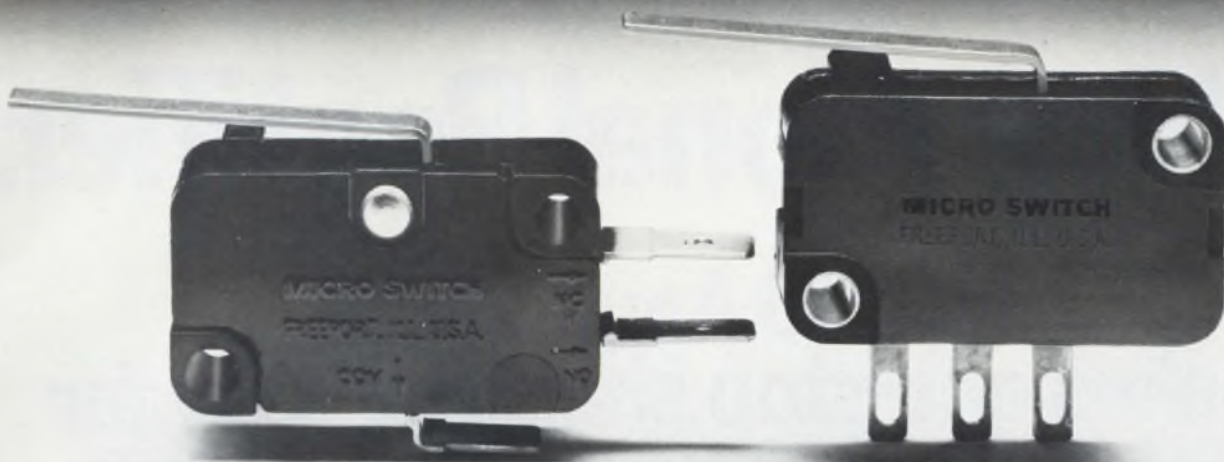

One of these is a new solid state switch. It's important that you can't tell which one.

The switch on the left is the V3. A mechanically-actuated snap-action switch the size of a postage stamp. It was an industry first when MICRO SWITCH introduced it in 1943. And it's gone on to become the industry standard, with hundreds of millions in use worldwide.

The switch on the right looks like the V3. Mounts like the V3. It's even actuated like the V3. And that's exactly where the similarities end. Because it's all solid state inside.

Designed around a Hall-effect integrated circuit perfected by MICRO SWITCH, the XL has been made to provide every benefit of true solid state design without the necessity of getting out of mechanical control.

Because the XL is all solid state, there are no contacts to bounce or become contaminated. And the Hall-effect integrated circuit has been performance tested through over 12 billion operations without a single failure. Unlike

standard mechanical switch designs, the XL can also interface directly with other solid state components. Its 20MA output eliminates the need for amplifiers, in most applications. And you can order it with either current sinking or current sourcing outputs.

It needs very little force for actuation—down to 10 grams. Even less with a lever. And the choice of actuator styles is the same as for the V3: over 500 different actuators in all. Including simple pin plunger, straight lever, simulated roller or roller lever.

Power supply requirements are also flexible. 5 VDC or 6 to 16 VDC with built-in regulator, over a temperature range of -40°C to $+100^{\circ}\text{C}$.

So the XL obviously offers some unique advantages. It's just one of a wide range of MICRO SWITCH solid state designs that do. Including a complete range of magnetically operated solid state position sensors, like the ones pictured here.

If you'd like more information on the XL, or any of the other MICRO SWITCH solid state switches, call your nearest MICRO SWITCH Branch Office or Authorized Distributor. Or write for literature.

We'll tell you the advantages of solid state design in your particular application.

And about a switch that looks very familiar. But works like nothing you've ever seen.



Products shown are actual size.

MICRO SWITCH
FREEPORT, ILLINOIS 61032
A DIVISION OF HONEYWELL

MICRO SWITCH products are available worldwide through Honeywell International.

CIRCLE 231 FOR DATA
CIRCLE 232 FOR SALESMAN CALL

International Rectifier

New 10 Amp device makes one-stop shopping easy for fast-switching power transistors.

Now, IR is your source for a wide variety of 3, 5 and 10 Amp JEDEC fast-switching power transistors, to simplify your buying. These hard-glass passivated devices are the ones to use for better reliability and lower costs in line operated power supplies, whether you're chopping line voltages at 20 KHz or inverting and stepping down at high frequency.

Fast Switching Speed—Cooler Operation . . . the oscillographs show typical fall times in the one-micro-second and lower range. Gives extremely low switching losses for cooler operation and higher reliability.

Lower Leakage — High Temperature Stability . . . with ICEO in the micro-amp range, IR devices are about one-tenth the accepted leakage rates of others. Provides the higher stability important for high performance at elevated temperatures.

High Second Breakdown — High Reliability . . . high second breakdown helps provide a broad safe-operating area for an extra margin of safety.

Glass Passivation — Long Term Reliability . . . high reliability and long term stability is achieved by hard glass passivation. Also, if you're using chips to make your own circuits,

IR's glass passivation gives you the most stable, easy to assemble chips you can start with, making your yields higher.

If you are paralleling devices, the tight gain, switching time and saturation voltage control of these transistors make the job easier. And through 100% testing of key parameters we can provide even closer matching if necessary.

JEDEC types listed are immediately available, so contact your local IR salesman, rep or distributor today.

International Rectifier, 233 Kansas Street, El Segundo, California 90245. (213) 678-8261.

New International Rectifier Fast Switching Power Transistors

IR Part No	V _{CEO} (sus) (Max V)	I _C Peak (A)	h _{FE} (min/max)	β @ I _C (A)	V _{CE} (sat) (Max V)	β @ I _C (A)	P _d (W)	t _r /t _f (μs)
2N6306	250	16	15/75	3.0	0.8	3.0	125	6/4
2N6307	300	16	15/75	3.0	1.0	3.0	125	6/4
2N6308	350	16	12/60	3.0	1.5	3.0	125	6/4
2N6542	300	10	7/35	3.0	1.0	3.0	100	.7/8
2N6543	400	10	7/35	3.0	1.0	3.0	100	.7/8
2N6544	300	16	7/35	5.0	1.5	5.0	125	1/1
2N6545	400	16	7/35	5.0	1.5	5.0	125	1/1
2N6249	200	30	10/50	10.0	1.5	10.0	175	2/1
2N6250	275	30	8/50	10.0	1.5	10.0	175	2/1
2N6251	350	30	6/50	10.0	1.5	10.0	175	2/1

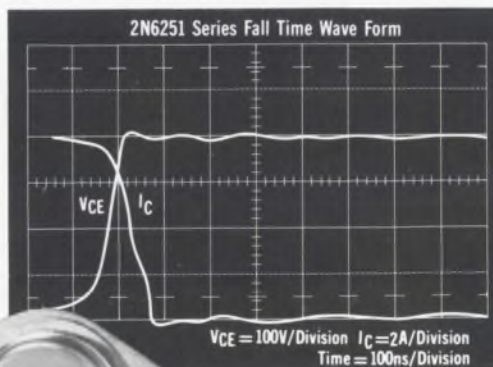
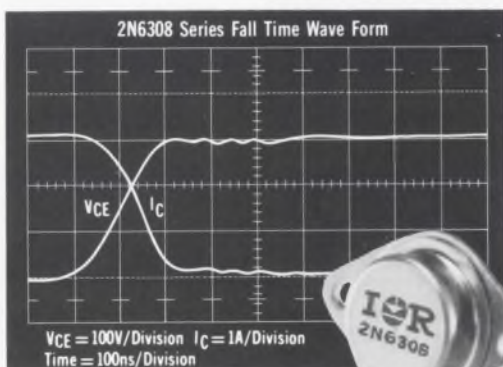

INTERNATIONAL RECTIFIER
the innovative power people



SEMICONDUCTOR DIVISION, 233 KANSAS STREET, EL SEGUNDO, CALIFORNIA 90245, PHONE (213) 678-6281

INFORMATION RETRIEVAL NUMBER 163

DANA INTRODUCES THE SMART COUNTER.

Series 9000: World's First Microprocessing Timer/Counter.

The Dana Series 9000 is smart enough to make your work a lot easier.

Microprocessing controls provide all the features of a premium timer/counter, a reciprocating counter and a calculator. Plus interfacing options and operating capabilities never before available in one instrument. Like automatic measurement of rise/fall time and pulse width.

The Dana Series 9000 Microprocessing Timer/Counter goes so far beyond all other counters it takes a whole brochure just to explain its capabilities. Ask for it. It's the smart thing to do.

Dana Laboratories, Inc., 2401 Campus Drive, Irvine, California 92664.



OR PRODUCT DEMONSTRATION CIRCLE # 251
OR LITERATURE CIRCLE # 222

DANA[®]
Others measure by us.

MEET OUR family

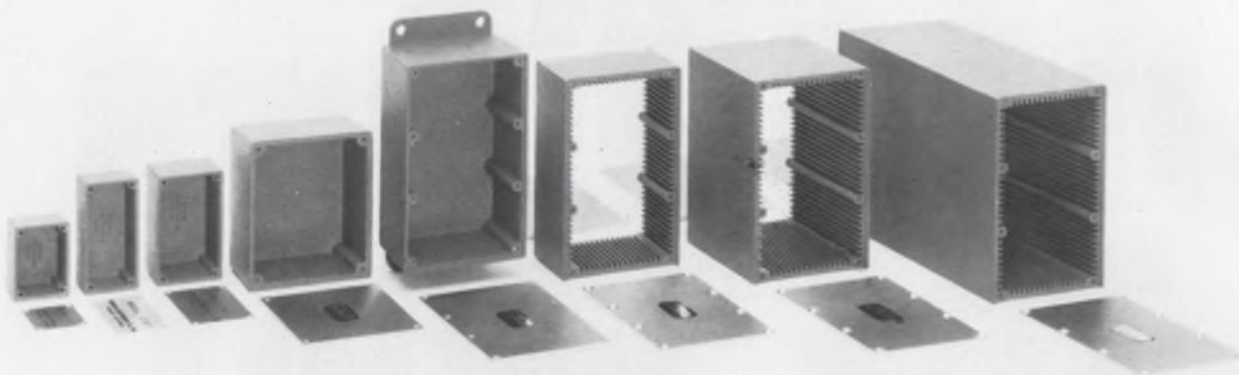

of shielded "black boxes"

Almost 10 years ago (1966 to be exact) we introduced our first two series of shielded electronic enclosures. They became an overnight success. Since then the demand for different sizes, shapes and applications has increased our family to eight series of models, each with a noise rejection greater than 70db.

Sizes range from 1.50" x 1.13" x 0.88" to 4.13" x 2.68" x 6.0"; in blank versions or with a complete choice of coaxial connectors; painted or unpainted; with or without printed circuit card guides; with mounting flanges or bottom mounting plates. All models supplied with aluminum covers and screws.



POMONA ELECTRONICS ITT

1500 East Ninth St., Pomona, California 91766 Tel: (714) 623-3463

INFORMATION RETRIEVAL NUMBER 164

Portable Digital Multimeter at an Analog Price

MODEL 280
\$99⁹⁵



Enjoy the benefits of auto-polarity digital read-out plus full overload protection and high-low power ohms for accurate tests in solid-state circuits.

Accuracy better than analog VOM's!

22 RANGES

Reads in decades: AC and DC volts and mA, 1-1000; ohms, 100-10 meg. Resolution: 1mV, 1mA, 0.1ohm.

Accuracy: DC typically $\pm 1\%$ F.S.; AC and ohms typically $\pm 2\%$ F.S. except $\pm 2.5\%$ on highest range. Uses "C" cells. Optional AC adapter/charger.

In stock at your local distributor

BK PRECISION

PRODUCTS OF DYNASCAN

1801 W. Belle Plaine Avenue Chicago, IL 60613

INFORMATION RETRIEVAL NUMBER 165

Automatic transistor tester works in-circuit when others can't



BK PRECISION

520 Dynapeak™
\$150.00

TESTS IN ONLY 9 SECONDS Tests diodes, SCR's and unijunctions, too. Avoids time wasting unsoldering of good transistors that tested bad in circuit and then good out-of-circuit because of erroneous testing. B&K-Precision 520 Dynapeak™ even tests automatically in-circuit with shunts of 10 ohms or 50 mfd. Random lead connection; turn the switch—the rest is automatic: Pulsating audio tone and LED indicates good device; PNP/NPN, Ge/Si shown by LED. No-charts leakage tests. Tests transistor action, not just junction or diode characteristics. Write today!

BK PRECISION

PRODUCTS OF DYNASCAN

1801 W. Belle Plaine Avenue • Chicago, IL 60613

INFORMATION RETRIEVAL NUMBER 166

General Electric's New "44 Series" CCTV Cameras Provide...



**1" VIDICON PERFORMANCE
AT 2/3" PRICES!**

And that's only the beginning! General Electric's 4TE-44 camera systems feature:

- Twilight to Sunlight Performance—Featuring "hands-off" operation!
- Automatic Light Level: 50,000:1 (with vidicon) and 100,000:1 (with silicon target vidicon)!
- Automatic Operation—NO External Controls!
- Automatic patented beam current regulation—NO image tube adjustment!
- Sensitivity of 0.05 FC faceplate is unmatched!
- Resolution of 600 TV Lines!
- Indoor, Outdoor models!

Put this CCTV innovation by General Electric to work. Use the Reader Service Card number below or contact General Electric Company, Imaging Systems Operation, Rm. 104-Bldg. 7, Electronics Park, Syracuse, N.Y. (315-456-3293).

GENERAL  ELECTRIC

Two years of a wealth of incredible information on MICROPROCESSORS brought right up to date by Electronic Design

We sifted through the last two years of ED and found an incredible amount of practical information and advice on selecting micros . . . using them to your best advantage . . . improving them for better speed and broader application. We compiled it all into one

convenient handbook — **MICROPROCESSORS: New Directions for Designers**. If you'd like to see a copy, circle the information retrieval number below and we'll send you one to read and use FREE for 15 days. At the end of time, just send in a check for \$8.95, or return the book.

Hayden Book Company, Inc.

50 Essex Street
Rochelle Park, N.J. 07662
(201) 843-0550

INFORMATION RETRIEVAL NUMBER 95



ACROSS THE DESK

(continued from page 8)

"The Shortcut" (ED No. 21, Oct. 11, 1975, p. 55) may have been an attempt to illustrate the difference between finding "a better way" and sacrificing product integrity for the sake of expediency. But the term "shortcut" actually obliterates the distinction by emphasizing deviation from orthodoxy, as if the orthodoxy and the act of deviating from it were more significant than the nature of the new idea itself.

When new ideas fail, what is important is not that they were new but that their underlying reasons were inadequately recognized.

The same is true of old ideas that fail when used indiscriminately. (I say indiscriminately because the problem is quite different when an idea is used with the expectation that it will fail, as so often happens when loyalty to orthodoxy is given precedence over the integrity of the work.) Good maps and careful planning are indeed invaluable, even when you're traveling on a well-beaten path.

David W. Johnson

17062 Green St.
Huntington Beach, CA 92649

The prime test

Dr. Jack Hubbs, president of E-H Research Labs, divulges an engineer's test of the hypothesis that all odd numbers are prime:

One? Yes. . . . Three? Yes. . . . Five? Yes. . . . Seven? Yes. . . . Nine? Well, experimental error. . . . Eleven? . . .

Vendor missing

Milton Ausman, 787 Mesa Way, Richmond, CA 94805, is looking for a vendor who has apparently disappeared. The company, John Griffin Co., used to be in St. Paul and made circuit-symbol stamps that were handy for making reproducible schematics on hatched paper. Can anybody help?



Now! Type 135D Tantalum-Cased Wet-Anode Tantalum Capacitors for Space Age Reliability

Sintered-anode capacitors with tantalum instead of conventional silver cases! The new Sprague Type 135D Tantalex® Capacitor is a breakthrough in the art of manufacturing gelled-electrolyte, sintered-anode, hermetically-sealed tantalum capacitors.

This unique construction feature eliminates the problem of possible silver migration caused by reverse voltages or excessive ripple currents that result in ultimate short-circuits from silver case to anode.

With a 3-volt reversal capability, Type 135D Tantalex® Capacitors also withstand high ripple

currents and high vacuum conditions without any degradation in function or appearance.

The Sprague-perfected true glass-to-tantalum hermetic seal is welded to the case rather than being soldered in the conventional manner, another feature which contributes to a shelf life in excess of ten years.

This all-tantalum capacitor was developed by Sprague under partial sponsorship of NASA, providing space age reliability that cannot be matched. . . . Sprague's military equivalent, Style CLR79, is approved to MIL-C-39006/22A.

For complete technical data, write for Engineering Bulletin 3760 to: Technical Literature Service, Sprague Electric Co., 347 Marshall St., North Adams, Mass. 01247.

THE BROAD-LINE PRODUCER OF ELECTRONIC PARTS





Yet our new Econo-Line Stepper Motor is big enough for tough EDP jobs, and versatile enough to use wherever you might need it.

This is one time when 13 has to be considered a *lucky* number. Our new stepper motor costs only \$13 each in 10,000 quantities. (We've equally remarkable prices for lesser quantities.)

And not only is the price tag on Kearfott's Econo-Line outstanding, but so is what's inside the motor.

This stepper motor takes the tough jobs in stride—for example, in printers, card punches, tape readers, paper drives. Plus any other application calling for a size 19 motor producing stepping torque up to 6 inch ounces at stepping rates of 200 pulses per second.

Its many attractive features include:

- Number of phases _____ 4
- Stepping angle _____ 15°
- Nominal voltage _____ 12Vdc
- Winding resistance _____ 5.8 ohms/phase

The Econo-Line also fits in a smaller space than that variable motor drive you may be paying more for right now. And, in keeping with its thrifty price, it is easily mounted in your product with a standard 27¢ capacitor clamp.

In these inflationary times, it takes more than good luck to get a good product from a good source at a good price. So, why not get all the details?

Write The Singer Company, Kearfott Division, 1150 McBride Avenue, Little Falls, New Jersey 07424.



SINGER

AEROSPACE & MARINE SYSTEMS

INFORMATION RETRIEVAL NUMBER 8

we got the bugs out of D.I.P. switches



The most common bug in dual in-line program (D.I.P.) switches has been the problem of open circuits.

Contamination resulted from solder, flux, solvents, etc. penetrating the switch during installation. Licon solved the problem with proper sealing. Nine Licon® Standard D.I.P. Switch Models feature ultrasonically welded base and cover junctions, and molded-in terminals. Only .280 inches high, these 2 through 10 pole, low profile Standard Switches are also available with a "pop-top" cover providing complete protection top and bottom during installation. After cleaning, the "pop-top" cover removes easily to program switch functions. Snap-on dust covers are available for after-installation use.

The slide detent mechanism provides positive feel

actuation into both open and closed positions, and locks into the desired position preventing accidental actuation. The slide actuators also provide quick visual indication of open and closed positions.

Designed with .100 x .300 inch terminal spacings, the switches insert easily and save space on PC boards.

Licon has expanded the typical D.I.P. switch line to include four unique L.E.D. lighted pushbutton models for press-to-test applications.

Call your local Licon rep or distributor for full details or call or write us for a catalog. Licon, A Division of Illinois Tool Works Inc., 6615 W. Irving Park Road, Chicago, Illinois 60634. Phone: (312) 282-4040. TWX 910-221-0275.



LICON

A DIVISION OF ILLINOIS TOOL WORKS INC.

The Innovative Electronic Products Group of ITW

© Illinois Tool Works Inc. 1975

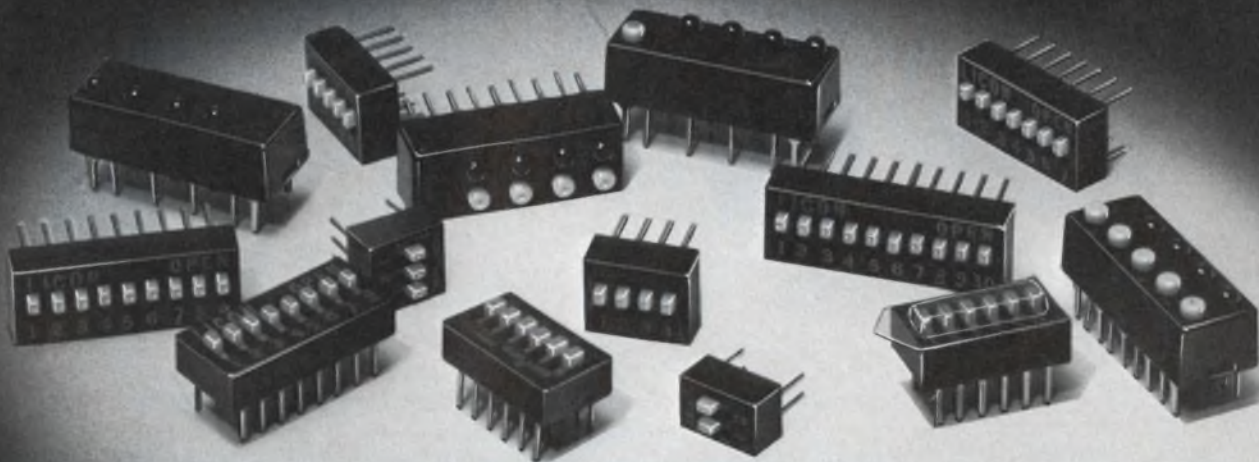

Now! A better answer of connecting PCB's

replace this...

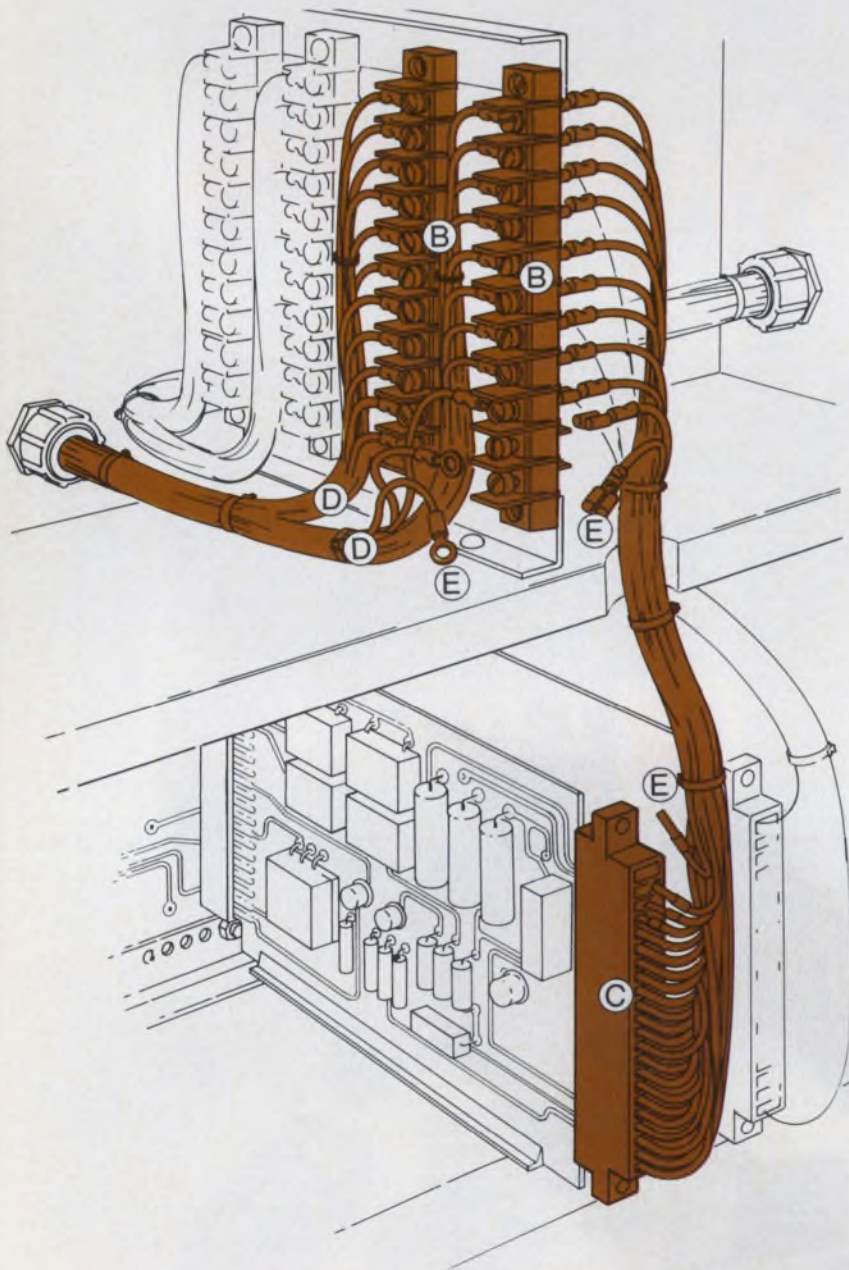

with this...

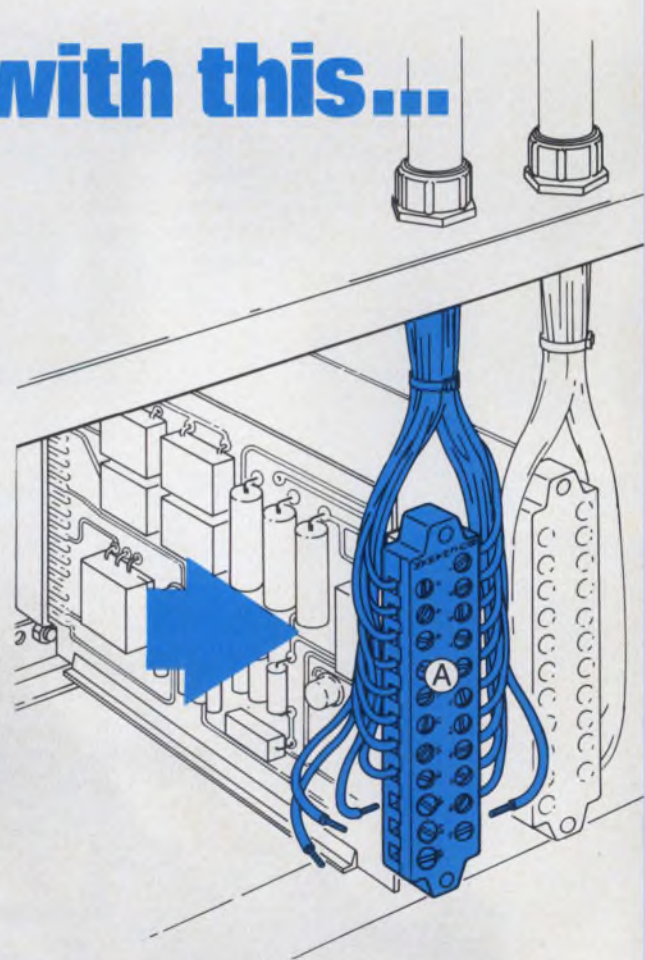

Just one Buchanan Printed Circuit Board Connector (A) replaces the two barrier strips (B), the edge card connector (C), the double wiring (D), and the 110 costly terminations (E) shown at left. Result: LTIC (Lower Total Installed Cost)!

to the problem to the outside world!

with **Buchanan®** PCB Connectors

- Accept unterminated wires from 12 through 30 AWG
- Save up to 5 connection points per circuit
- Eliminate barrier strips & terminal blocks
- Available for inside or through-the-panel wiring
- Save time, money and cabinet space

If you're building control panels or other electrical/electronic equipment that uses printed circuit boards, here's a new PCB connector that's sure to give you LTIC (Lower Total Installed Cost)!

The new Buchanan connector eliminates hybrid interfaces between electronic circuitry and electrical connections. It replaces terminal blocks and barrier strips and the costly wiring between them and internal electronics. Actually saves you up to 5 separate connection points per circuit!

The unique screw terminals accommodate unterminated solid or stranded wires, #30 through #12 AWG. Models are available with .156" or .200" (.508 cm) centerlines; for up to 43 10-Amp circuits; and for inside panel or through-the-panel mounting. Many carry UL component recognition for field wiring.

For complete engineering and ordering information, use the Reader Service Card. Or, call one of our Factory Regional Offices shown below. They'll also be happy to talk to you about special configurations.

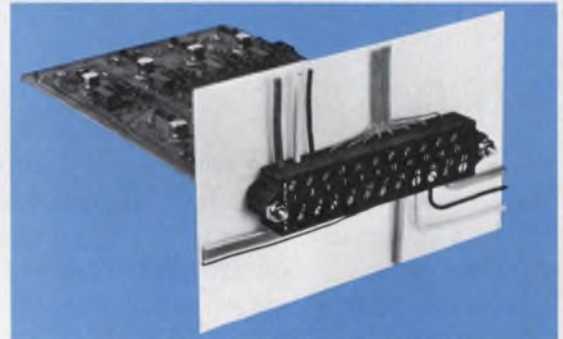

Models available for surface or through-the-panel mounting, with or without card guides and keys.



**CONTROL PRODUCTS
DIVISION**

Amerace Corporation
Control Products Division
Union, New Jersey

We'll lease you this scope for \$42 per month.

You can't buy a better deal.

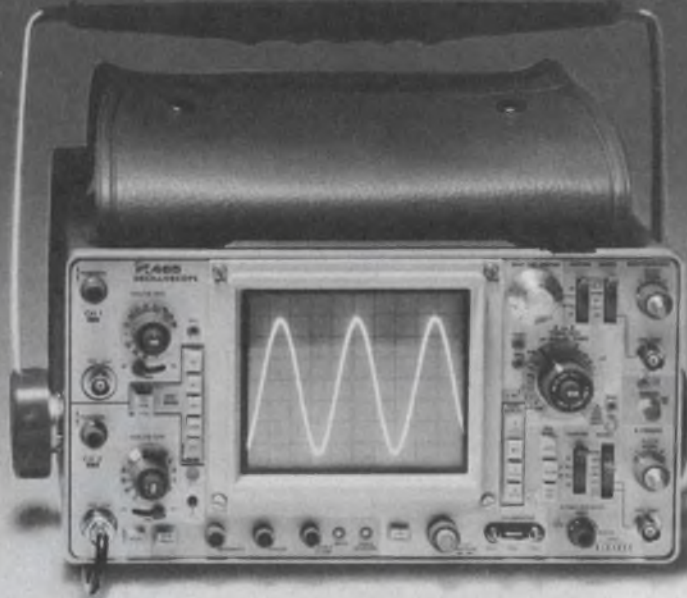

If you bought a Tektronix 465 outright, it would cost you about \$2,100.* If you lease it from REI for 36 months, it'll cost you \$42 a month. And, we can give you immediate delivery of these brand-new instruments, even in multiple quantities.

No matter what kind of test instrumentation you need . . . scopes, analyzers, counters, recorders, generators, power supplies, you name it . . . we can lease it to you at a rate that lets you get more equipment out of your equipment budget.

For the full story of how REI can solve your electronic test equipment acquisition problems . . . through rental, leasing, or outright purchase . . . call your nearest Instant Inventory Center, or send the coupon.

*Based upon Tektronix current list price.

Rental Electronics, Inc.,
99 Hartwell Avenue, Lexington, Mass. 02173.

Please send me: information on your TEK 465 offer.
 information on the following test equipment _____

Name _____ Title _____

Company _____

Address _____

City _____ State _____ Zip _____

Tel. Number _____

Rental Electronics, Inc.

A PEPSICO LEASING COMPANY

Burlington, MA (617) 273-2770 • Gaithersburg, MD (301) 948-0620 • Oakland, NJ (201) 337-3757 • Ft. Lauderdale, FL (305) 771-3500
Des Plaines, IL (312) 827-6670 • Dallas, TX (214) 661-8082 • Mountain View, CA (415) 968-8845 • Anaheim, CA (714) 879-0561
Rexdale, Ontario (PLC Leasing Ltd.) (416) 677-7513

INFORMATION RETRIEVAL NUMBER 12

DECEMBER 6, 1975

FAA close to breakthrough in mid-air collision detector

The Federal Aviation Administration has awarded a contract for two experimental models of a mid-air collision system that—unlike all other systems under consideration—uses signals from transponders already on board the vast majority of aircraft in this country.

The new system could be the breakthrough that the Federal agency has been seeking in anti-collision equipment.

Invented by George B. Litchford of Litchford Electronics, Inc., Northport, NY, the system has already passed feasibility tests for the Air Force. The principal feature of the system, Litchford says, is that it operates by simply listening to aircraft transponder returns from ground radar-beacon interrogation.

"Anyone equipped with the system, which is comprised of a 1090-MHz receiver, a microcomputer and a display, can immediately 'see' any threats of mid-air collision from other planes," the inventor says.

"Before this system, we've never had any way to detect another airplane from your own, except for those systems which have been proposed and tested but which are of the cooperative type—they require costly special equipment in all planes in the system."

Such cooperative systems now under consideration by the FAA include those from McDonnell Douglas, RCA, Minneapolis-Honeywell and an in-house FAA development, the Direct Address Beacon System. For full protection, all planes must be equipped with special avionics.

The Litchford system makes use of the fact that almost all aircraft that are collision threats are already carrying transponders. Trans-

ponders are mandatory in all high-density air traffic areas.

"Since these planes are transmitting sharp pulses in reply to ground radar interrogations," Litchford points out, "it is only necessary to put in an intercept receiver and pick up those pulses, which give us information that can be processed in an on-board microcomputer, to provide the direction and velocity of the other aircraft."

An indication of aircraft altitude is transmitted by transponders in all planes with altitude encoders. These are carried by all airlines and are mandatory in the highest traffic density areas.

"If we intercept this information," Litchford says, "we can determine where other planes are, relative to our own plane, without imposing on the aviation community some odd-ball transponder that differs from the U.S. transponder, which also is an international standard.

"With my system, the first day it is installed, you'll be able to see everybody else carrying a transponder, whereas with a cooperative system, you can install it and not detect anybody for years, because no one else has it."

The FAA contract to Litchford Electronics calls for delivery of the two experimental models by January and complete evaluation by next June.

"This country has been looking for a collision-avoidance system for over 20 years," Litchford notes, "and we've had at least 10 different systems proposed, tested and not accepted."

The Litchford system makes use of the 700 ground radars in the FAA air traffic control network and—an important point—doesn't require vast FAA ground-station expenditures. The only modification

to the ground radar is a simple kit to permit the radar to transmit a pulse when it passes through a North bearing.

When a pilot is flying with the Litchford system in a busy radar environment—for example, over New York City at 7000 feet—he can receive 30 ground radars because the system is purely passive.

But in areas where there are less than three radars interrogating the transponder, Litchford's system incorporated an on-board interrogator at 1030 MHz, which takes over and queries other aircraft when there are too few returns—that is, when insufficient interrogations from the ground are not providing enough information.

The system range, Litchford says, is about 20 miles, but a real collision threat does not occur until aircraft close to within 10 to five miles, he points out.

The type of display and amount of information in it would depend to a large extent upon the system cost, which Litchford estimates will range from about \$1000 for a general-aviation model to \$15,000 or \$20,000 for an airline system.

CCD memories step up from 16 k to 64 k

Although 16-k CCD memories have just recently been introduced, 64-k CCD memories are already on their way.

"Our chip is five times denser than the existing chips from Intel and Fairchild," says Robert Bower, executive vice president of Mnemonics, Cupertino, CA.

Bower notes that while Intel and Fairchild use an overlapping gate two-phase approach, Mnemonics uses an offset design. The key advantage of the Mnemonics approach, he says, is that a single-gate electrode controls both the transfer and storage regions of each bit location. The other approach requires two separate gate electrodes.

Initially Mnemonics will only be making the chips for internal use.

"We are building a 1/4-to-2-Mbyte modular memory system," Bower says. "The system will be random access by block, with each block 4000 bits long. Average access time for the chip will be under

a millisecond, and for the system, just a few milliseconds."

Mnemonics plans to sell the systems as disc augmentation devices. They will be buffers or cache memories that interface to small moving-head disc memories in minicomputer systems.

Bower says the memory systems will be on the market in the first half of 1976, and the chips will be offered about six months later.

Green-light laser maps stretch of ocean floor

A patch of ocean floor near Key West, FL, has been successfully mapped through 10 meters of water by a green-light laser (5300 Å) carried in an aircraft. The plane was flying at 160 knots at altitudes of from 150 to 600 meters. The irregularities of the ocean bottom were recorded with a resolution of less than 20 cm (8 in.).

The new technique promises great savings in time and expense over the usual acoustic sounding techniques used in mapping the navigational channels and sand shoal movements in coastal waters, according to its developers at the National Aeronautics and Space Administration research center at Wallops Island, VA.

"The work is needed," says NASA experimenter Hongsuk H. Kim, "because some of our maps date back to the 18th century."

Theoretically the system can operate in 50 meters of water at night and from 10 to 20 meters during the day. The limitations are due to atmospheric light during the day and to sea state and water turbidity day and night—conditions that reflect and attenuate the laser beam.

The tests were made as part of a five-year research program on laser applications in hydrographic studies being carried out by NASA's Wallops Island facilities and the Naval Oceanographic Office. The Key West flights were carried out by NASA, the Navy and Computer Sciences Corp., El Segundo, CA, which provides technical support to the Wallops Island facility.

The laser used in the experiment was a neodymium-YAG Pockels cell, Q-switched, frequency-doubled

instrument capable of providing a power output of 10 mJ in 8 ns at a maximum repetition rate of 50 times a second.

Attached to the laser was a waveform digitizer to record the returned signals. Ocean depth was calculated from the time differences of each pulse reflected first off the water's surface and then off the ocean floor. Depths can be displayed on a videoscope or recorded on film and magnetic tape.

While the present test version provides a straight-line profile, an advanced unit will soon be built by Avco Everett Research Laboratory, Everett, MA, that will have scanning capability. The Avco system will carry a minicomputer on the aircraft. The present system's data processing is handled on the ground after the flight.

16-k RAMs make debut in computer

The industry's first computer using 16-k RAMs has been introduced by Four-Phase Systems, Cupertino, CA.

The new processor, called the NP/80, can support a local data base of up to 270 megabytes. The data base can be accessed by up to 64 local displays through direct connection of Four-Phase System IV/70's. While communicating with the central mainframe at speeds up to 50-k baud, the NP/80 can also control a network of remote Four-Phase systems over multiple 9600-baud lines.

The NP/80 includes multiple DMA channels, software and hardware error recovery, firmware diagnostics, a memory relocation and protection system and communications control for up to six high-speed lines.

Dual register banks and separate program counters are provided for rapid context switching without save-and-restore overhead.

According to a company spokesman "The processor enables network users to geographically distribute their data base in a hierarchical form that closely parallels the organizational structure of most major corporations."

The NP/80 contains a 16-bit computer with 500 ns cycle time and up to 256-k bytes of MOS/

LSI memory. The 16-k-bit n-channel silicon-gate RAM chips are designed and produced by Four-Phase to occupy a single printed-circuit board.

Monthly rental for the NP/80, with 16-k bytes of memory and communications support for three 9600-baud lines, is \$312 on a 42-month lease.

First deliveries of the new system are scheduled for next spring.

CIRCLE NO. 319

A talking calculator is new aid for blind

An electronic calculator that displays braille and a calculator that talks have been announced by the American Foundation for the Blind in New York City.

The braille calculator, developed by the foundation's Engineering Dept., provides results in two modes, one a visible gas discharge display and the other a braille display. After a readout button is depressed, the digits and decimal points, as displayed on the visual readout, are sequentially translated to a braille cell. The signals are demultiplexed and decoded by a ROM and then multiplexed at a very slow rate and converted to four-dot braille information.

The calculator forms a braille digit by energizing electrical solenoids, forcing small dots or pins to protrude beyond the face of the braille cell. These are coded to represent the braille notation for each digit displayed. All the braille pins are de-energized momentarily when the calculator sequences to the next digit.

The talking calculator, developed by Telesensory Systems, Inc., Palo Alto, CA, receives inputs from a keyboard and provides answers from a 24-word tape over a self-contained speaker on an earphone.

As the user pushes a key, the loudspeaker repeats the number. When he pushes the readout button, the calculator reads out the display. The unit is built with a pre-programmed ROM whose digital format is converted to analog speech through a d/a converter.

The units will be available in February at the American Foundation for the Blind, 15 West 16th St., New York City 10011.

The largest selection of "OFF-THE-SHELF" POWER SPLITTERS/COMBINERS Available!

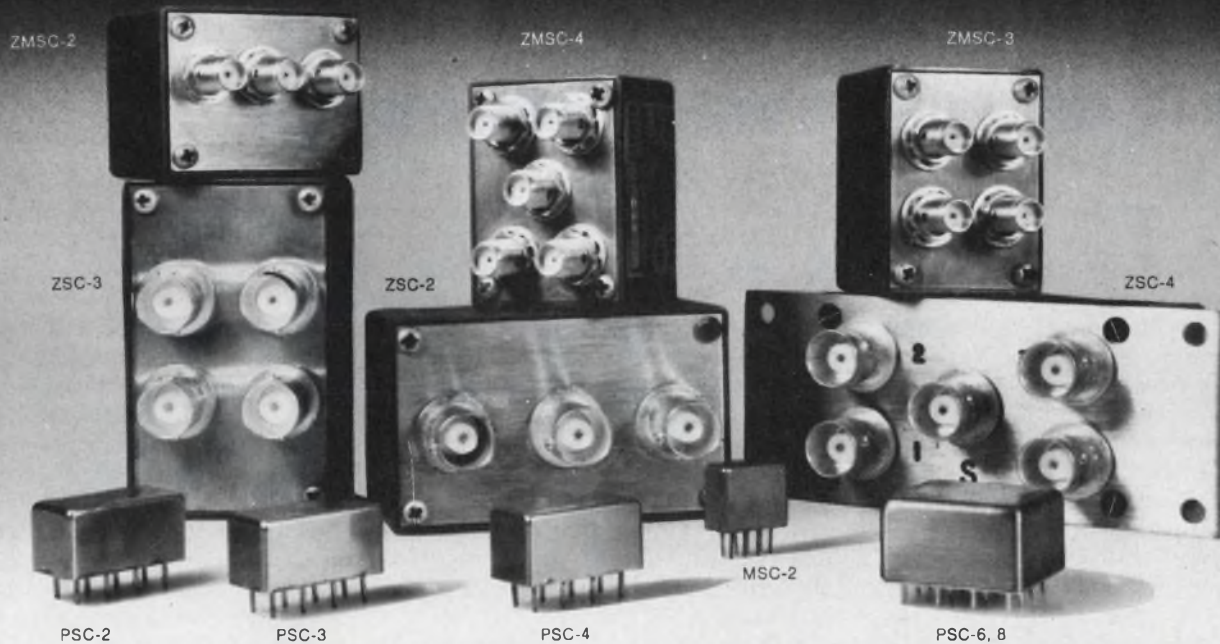

TWO-WAY, THREE-WAY, FOUR-WAY, SIX-WAY AND EIGHT-WAY POWER SPLITTER/COMBINERS

Model No.	Freq. range (MHz)	Isolation between outputs (dB) typical	Insertion loss (dB) (typical)	Unbalance		Price (Quantity)	Model No.	Freq. range (MHz)	Isolation between outputs (dB) typical	Insertion loss (dB) (typical)	Unbalance		Price (Quantity)					
				ϕ (deg)	Amp (dB)						ϕ (deg)	Amp (dB)						
Two-way 0°																		
PSC 2-1	0.1-400	25	0.4 above 3dB split	1	0.1	\$ 9.95 (6-49)	Three-way 0°						\$19.95 (6-49)					
ZSC 2-1						\$24.95 (4-24)	PSC 3-1	1-200	30	0.4 above 4.8 split	2	0.1	\$34.95 (4-24)					
ZMSC 2-1						\$34.95 (4-24)	ZSC 3-1						\$44.95 (4-24)					
Two-way 180°																		
PSC 2-2	0.002-60	40	0.3 above 3dB split	1	0.1	\$19.95 (6-49)	Four-way 0°						\$26.95 (6-49)					
ZSC 2-2						\$34.95 (4-24)	PSC 4-1	0.1-200	30	0.5 above 6dB split	2	0.1	\$41.95 (4-24)					
ZMSC 2-2						\$44.95 (4-24)	ZSC 4-1						\$51.95 (4-24)					
Two-way 90°																		
PSC 2-1W	1-650	25	0.5 above 3dB split	3	0.20	\$14.95 (6-49)	Six-way 0°						\$59.95 (1-5)					
ZSC 2-1W						\$29.95 (6-49)	ZSC 4-2	0.002-20	33	0.45 above 6dB split	2	0.1	\$64.95 (4-24)					
ZMSC 2-1W						\$39.95 (6-49)	ZMSC 4-2						\$74.95 (4-24)					
Two-way 180°																		
PSC 2-1.75*	0.25-300	25	0.4 above 3dB split	1	0.05	\$11.95 (6-49)	Eight-way 0°						\$59.95 (1-5)					
MSC 2-1						0.1-450	30	0.4 above 3dB split	1	0.1	\$16.95 (6-24)	Two-way 90°						\$19.95 (5-49)
Two-way 180°																		
PSCJ 2-1**	1-200	33	0.6 above 3dB split	2.5	15						\$19.95 (5-49)	Two-way 90°						\$19.95 (5-49)
ZSCJ 2-1						\$34.95 (4-24)	Two-way 180°						\$19.95 (5-49)					
Two-way 90°																		
PSCQ 2-90	55-90	30	average of coupled outputs less 3dB 0.3	3	1.0	\$19.95 (5-49)	Two-way 180°						\$19.95 (5-49)					

COMMON SPECIFICATIONS FOR ALL MODELS: Impedance all ports, 50 ohms *Except 75 suffix denotes 75 ohms VSWR:1.1-1.2 typical Nominal phase difference between output ports, 0° **Except J suffix denotes 180° Q denotes 90° Delivery from stock; One week max.

For complete product specifications and U.S. Rep. listing see MicroWaves' "Product Data Directory,"
Electronic Designs' "Gold Book" or Electronic Engineers Master "EEM"

World's largest supplier of double balanced mixers

Mini-Circuits Laboratory
A Division Scientific Components Corp

837-843 Utica Avenue, Brooklyn, NY 11203

(212) 342-2500 Int'l Telex 620156 Domestic Telex 125460

International Representatives: AUSTRALIA General Electronic Services, 99 Alexander Street, New South Wales, Australia 2065; ENGLAND Dale Electronics, Dale House, Wharf Road, Frimley Green, Camberley Surrey; FRANCE S C I E - D. I. M. E. S., 31 Rue George - Sand, 91120 Palaiseau, France; GERMANY, AUSTRIA, SWITZERLAND Industrial Electronics GMBH, Klüberstrasse 14, 6000 Frankfurt/Main, Germany; ISRAEL Vectronics, Ltd., 69 Gordon Street, Tel-Aviv, Israel; JAPAN Densho Kaisha, Ltd., Eguchi Building, 8-1-1 Chome Hamamatsucho Minato-ku, Tokyo; EASTERN CANADA B. D. Hummel, 2224 Maynard Avenue, Utica, NY 13502 (315) 736-7821; NETHERLANDS, BELGIUM, LUXEMBOURG: Coimex, Velweg 11, Hattem, Holland.

US Distributors: NORTHERN CALIFORNIA Cain-White & Co., Foothill Office Center, 105 Fremont Avenue, Los Altos, CA 94022 (415) 948-6533; SOUTHERN CALIFORNIA, ARIZONA Crown Electronics, 11440 Collins Street, No. Hollywood, CA 91601 (213) 877-3550

INFORMATION RETRIEVAL NUMBER 13

INTERNATIONAL ELECTRON DEVICES MEETING

Power levels reported rising for If to microwave elements

Under pressing demand from users for ever higher semiconductor power, solid-state device designers are coming up with new devices that show substantial power gains.

The devices, ranging from low-frequency industrial units to high-power microwave elements, were disclosed last week at the International Electron Devices Meeting in Washington, DC.

A new industrial power semiconductor with advantages over both SCRs and transistors was described by General Electric in a Session 16 paper entitled "The Field-Controlled Thyristor (FCT)

Jim McDermott
Eastern Editor

—a New Electronic Component."

According to D. E. Houston, staff research physicist at the GE Research Center in Schenectady, the field-controlled unit—it can handle 20 A at 650 V—has a lower voltage drop than a power transistor, and it also has reverse blocking, which the transistor does not have.

"It's like a thyristor, in that it can be turned off and maintained in a forward blocking state," Houston said in an interview prior to the Washington meeting. "But unlike the thyristor, it's not regenerative; so it can't be inadvertently turned on by a voltage spike. This results in higher dv/dt and di/dt ratings than those of a conventional thyristor."

Houston points out that the new field-controlled thyristor can be thought of as a power rectifier, like a PIN diode, except that the GE device has a special type of grid structure.

"We've fabricated the device

with a planar p-type grid, which can be reverse-biased to deplete the channels between the grids," he explained.

"And that makes a potential barrier which prevents any injection into the base region and gives us a forward blocking state."

The FCT planar grid is metalized. It can be reverse-biased, in which case it becomes a collector of holes and turns off the device. This, Houston insists, gives the special current-interrupt capabilities and the ability to provide both forward and reverse blocking.

The FCT has two injection junctions and does not require any driving current to maintain it in an ON state, the way a transistor does. For a given voltage rating, the thyristor can handle higher working currents with lower forward voltage drops than a transistor with the same area.

The surge-handling capacity of the FCT is better than a transistor's, Houston says, having a

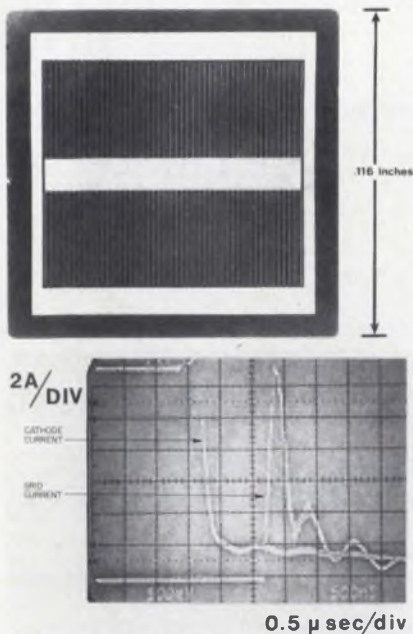

The cathode and grid structures of the General Electric FCT are highly interdigitated (top). Cathode current is interrupted by the grid control in 0.3 μs, as shown at bottom.

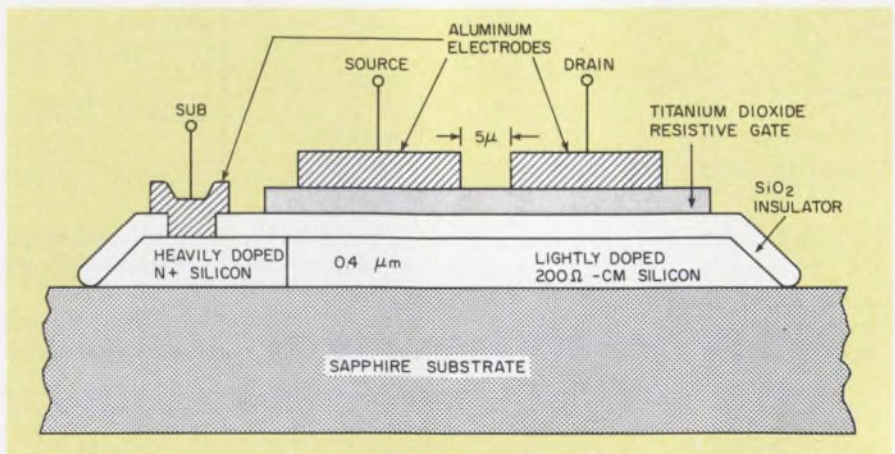

1. A titanium dioxide resistive gate is the key element in this Hughes MOS microwave switch. The rf is switched between the source and drain electrodes via a 1 to 2 accumulation layer beneath the silicon dioxide film.

capacity that is comparable to that of a PIN rectifier.

The FCT compares favorably with the conventional SCR and gate turn-off device, Houston points out. It is turned on simply by removal of the grid bias, and consequently it has a higher rate of rise of the load current than the usual thyristor.

New microwave switch

A new type of high-power silicon-on-sapphire device that can switch 100 W of rf at 3.5 GHz, using less than 1 μ W of control power, was disclosed at the conference by the Hughes Research Center, Newport Beach, CA. The device, developed for radar phased arrays, requires but 1/50,000th of 50 mW of control power now dissipated by each of the thousands of PIN diodes in present phased arrays.

The Hughes device, described in a Session 27 paper, "The RIS Device—a Resistor-Insulator-Semiconductor Microwave Switch," is a three-terminal MOS structure that has a diode off/on ratio of greater than 1500 and an insertion loss of only 1.2 dB, according to Denis J. McGreivy, senior member of the Hughes technical staff and a co-

author of the paper.

The RIS consumes drive power only during the switching transient, he points out. The key to its development was the creation of a new gate material—resistive titanium dioxide, which is rf sputter-deposited. The resistivity of the titanium dioxide, which is deposited in a layer about 500 Å thick, can be controlled from about 10 to 10^{12} Ω cm, McGreivy says.

"To get a device that would give zero or very low dc current in both ON and OFF states, we went to a MOS type of device," he explained in an interview, "using the titanium dioxide as a resistive gate material."

The MOS device developed (Fig. 1) has two aluminum electrodes—the source and drain—deposited on top of the titanium gate, which in turn is deposited over the silicon dioxide insulating film. The latter is lying over a 0.4 μ m silicon film on the sapphire substrate.

Ohmic contact is made to the silicon film in the heavily doped n+ region. The source and drain electrodes are the microwave input and output terminals.

"In the 5- μ m distance between the source and drain electrodes, we get an effective dc resistance on the order of 3000 Ω ," McGreivy

noted. "But the silicon oxide resistance is in the region of 10^{12} Ω ."

"The rf is put into the source and taken from the drain. When there is a zero dc bias between the metal electrode and the substrate, the rf signal sees only the dc resistance between the electrodes plus a fringing capacitance of 1 pF."

If a positive dc bias is applied between the substrate (SUB) contact and either the source or drain, an accumulation layer is formed on one of the contacts. This layer spreads through the titanium and accumulates underneath the entire resistive gate.

The microwave signal sees the 3000- Ω dc resistance between source and drain and detours through the thin oxide of the silicon film to the accumulation layer, which has a resistance of 1 or 2 Ω . Thus the rf signal travels along the low conductivity path and then up and out again through the other electrode.

"So now," McGreivy pointed out, "we've made a switch which, in either the ON or OFF state, conducts essentially zero dc current because of the silicon oxide insulation. This insulation resistance also prevents any dc current from flowing between the substrate and metal rf input electrode." ■■

OIC performance is improved with use of silicon substrate

In optical IC technology, the Washington meeting was told, new developments are improving the efficiency, sensitivity and bandwidths of optical integrated systems. Silicon is being used instead of more exotic materials.

The integration of a silicon detector array into a silicon optical waveguide structure was reported in a Session 26 paper by Prof. J. T. Boyd and Prof. C. L. Chen of the University of Cincinnati Electrical Engineering Dept. The array gave a high measured value of quantum efficiency of 0.8 compared with a theoretical efficiency of 0.93, the authors said.

A silicon substrate was chosen for the array waveguide system, Boyd said in an interview, because it permits the fabrication of CCD array-addressing circuitry, signal-enhancement circuitry and signal-processing circuitry on the same substrate as the optical waveguide.

A further advantage of the silicon substrate, according to Boyd, is that silicon is well-suited for the formation of three-dimensional channel waveguides by preferential etching. Another advantage is that a thermally grown silicon dioxide layer, which supports a thin-film optical waveguide, has a low refractive index and a very

smooth surface for waveguide deposition.

In the Cincinnati integrated waveguide photodiode structure, a row of masked p-type shallow diffusions were made in a silicon wafer having a high-resistivity epitaxial layer. The layer was grown on an n-type substrate to form the p-i-n photodiode array.

Each photodiode, Boyd reports, had a separately diffused guard ring that gives the junction a high breakdown voltage while maintaining a very thin p+ region for highest sensitivity. The substrate for a low-loss KRP photoresist waveguide was the thermally grown

Thin-Trim[®] capacitors



Tucked in the corner of this Pulsar Watch is a miniature capacitor which is used to trim the crystal. This Thin-Trim capacitor is one of our 9410 series, has an adjustment range of 7 to 45 pf., and is .200" x .200" x .050" thick. The Thin-Trim concept provides a variable device to replace fixed tuning techniques and cut-and-try methods of adjustment. Thin-Trim capacitors are available in a variety of lead configurations making them very easy to mount.

A smaller version of the 9410 is the 9402 series with a maximum capacitance value of 25 pf. These are perfect for applications in sub-miniature circuits such as ladies electronic wrist watches and phased array MIC's.

Johanson Manufacturing Corporation, Rockaway Valley Road., Boonton, N.J. 07005. Phone (201) 334-2676, TWX 710-987-8367.

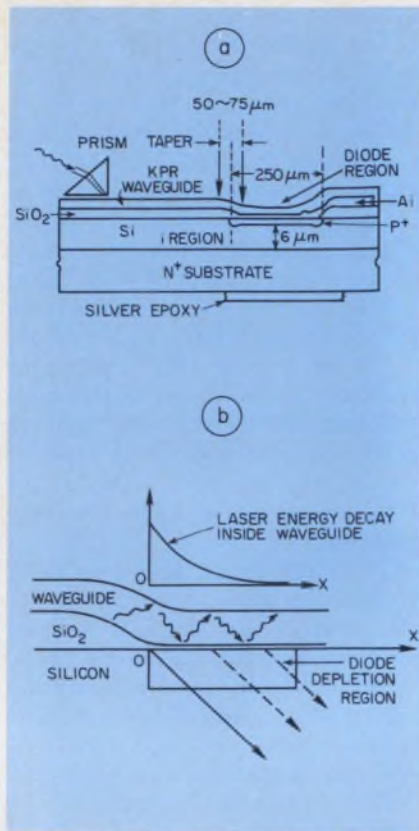

2. A 128-element photodiode array has been integrated, at the University of Cincinnati, into a silicon waveguide structure (a). Laser energy from the prism is transferred from waveguide to diode by the tapered SiO₂ film (b).

SiO₂ layer (Fig. 2).

To minimize optical scattering of light and to obtain maximum transfer of energy into the detectors, the thickness of the SiO₂ layers was tapered, Boyd notes. Because the photodetector region is parallel to the waveguide surface, tapering of the SiO₂ layer to zero in the detector region produced maximum energy transfer through multiple refraction and through the evanescent field.

The taper of the SiO₂ region was achieved by undercutting during etching and prior to the p⁺ diffusion, according to Boyd. The KPR waveguide was solution-deposited.

Optical waveguide arrays

Density of more than 1000 low-loss optical waveguides per inch was reported by the IBM Research Center, Yorktown Heights, NY. The researchers used preferential etching of grooves in silicon substrates.

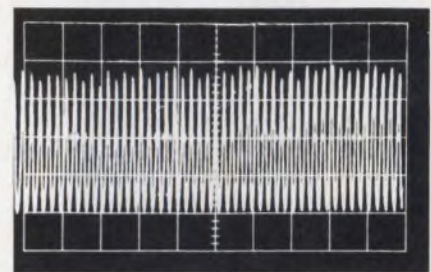
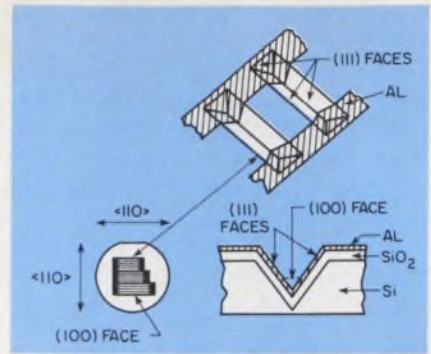

3. Multichannel arrays of optical waveguides, by IBM, have integrated couplers (top). Outputs of the arrays are uniform within 5% (bottom) and the cross-talk is below -30 dB.

In a paper on "High Density Multichannel Optical Waveguides with Integrated Couplers," P. F. Heidrich, J. S. Harper, E. G. Lean and H. N. Yu, members of the IBM technical staff, noted in Session 26 that optical attenuation had been minimized by the thermal growing of an oxide layer over the wafer. The layer, about 1 μm thick, provides a low-index-of-refraction buffer layer.

For higher optical throughput, the reflectivity of the input and output surfaces were coated with a mirror-like layer of aluminum. In addition the grooves were filled with optical epoxy.

Preferential etching techniques have been used for fabricating other integrated optical structures in crystalline silicon and gallium arsenide. These devices include diffraction gratings, single-element channel waveguides and tapered couplers between thin-film waveguides and optical fibers.

The waveguides in the silicon grooves have a surface smoothness associated with crystalline planes, which minimizes surface scattering loss. IBM's efforts have extended the etching technique to the production of waveguide arrays having 50, 25 and 12.5-μm channel widths. ■■

INTRODUCING TWO IC PRECISION OP AMPS TO IMPROVE YOUR SYSTEM. AND YOUR BOTTOM LINE.

The AD510. At \$5.95 in 100's, the lowest cost, laser trimmed precision IC op amp you can buy.

There are other super op amps that approach the AD510's high performance. Not one that can deliver it at the AD510's low price.

It has $25\mu\text{V}$ max. offset voltage. It's laser trimmed so you never have to adjust it. Drift of $0.5\mu\text{V}/^\circ\text{C}$, max. And bias currents of 10nA , max.

And it's 741/725-pin compatible, so even if you haven't been using precision op

amps before, you can upgrade economically and easily, right now.

If ultra low bias current is what you're after, we've also got the AD515.

AD515. At \$9.90 in 100's, the lowest cost ultra low bias current IC op amp ever offered.

The AD515's I_{b} is as low as 75fA , max., warmed up. The AD515 also gives you a combination of features never before available in an ultra low bias current circuit.

Like a low 1.5mA power requirement for portable instrumentation.

Offset voltage laser trimmed to 1.0mV . Drift of $15\mu\text{V}/^\circ\text{C}$. And low noise of $4\mu\text{Vp-p}$. All max.

So take your pick. The AD510. Unbelievable performance at the price. Or AD515. Unbelievable performance at any price.

Analog Devices Semiconductor. Components for test and measurement instrumentation and control systems. Norwood, Mass. 02062.

East Coast: 617-329-4700.

Midwest: 312-894-3300.

West Coast: 213-595-1783.

Texas: 214-231-5094.

 **ANALOG
DEVICES**

INFORMATION RETRIEVAL NUMBER 15



Wireless power-transmission test aims at harnessing sun one day

For 75 years, engineers have tried to transmit power through the air without benefit of wires or other man-made conduits. Now a group of engineers in the Mojave Desert are doing it every few weeks via microwave signals.

They are from the California Institute of Technology's Jet Propulsion Laboratory, in Pasadena, and Raytheon's Microwave and Power Tube Div., Waltham, MA. Their work is being sponsored by the National Aeronautics and Space Administration's Office of Applications and Office of Energy Programs.

The distance covered and the power transmitted in the Mojave experiments are both small (a little over 30 kW of dc output over 1.54 km), but the techniques for improving both are being defined.

John F. Mason
Associate Editor

The ultimate goal is to develop equipment capable of efficiently transmitting power captured by a solar-energy collector in space to a receiving station on earth. Such a proposal was first made in 1968 by a team consisting of Arthur D. Little, Raytheon, Grumman and Textron.

A more earthly application might be to beam power to a high-altitude, stationary, electrically powered, unmanned helicopter—say, at

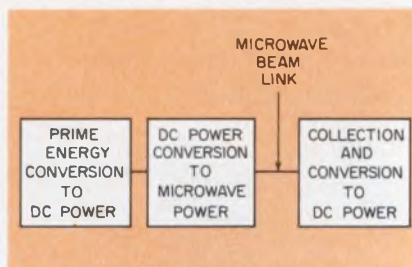

To transfer the electrical energy captured in space to earth, an electromagnetic beam link is created.

50,000 feet—that would relay television signals for weeks or months at a time without having to land.

Point-to-point transmissions on earth are, of course, possible applications, but highly improbable, according to Raytheon's consulting scientist William C. Brown, who developed the rectifying antennas used in the current experiments.

"The attenuation and scattering through many miles of rain would be a problem," he says. "To replace high-power transmission lines, the power density in the beam would be far above safe exposure limits. The economics might also be questioned."

There could be isolated applications, Brown continues, that might be practical—for example, where power could be profitably transmitted over deep canyons or bodies of water.

But the main goal is to capture clean, nonpolluting energy from the sun. Earth-orbiting stations would collect solar energy, convert it to microwave radiation and beam it to receiving stations on earth.

"A typical satellite using a microwave beam at a 10-cm wavelength could provide 10,000 MW," says Peter E. Glaser, vice president of Arthur D. Little, Inc., Cambridge, MA. "A network of such satellites could generate enough power to meet a significant portion of the foreseeable U.S. energy demands."

The space station would require an energy-collecting area of at least 70 sq. km of solar photovoltaic cells, according to Raytheon's Brown. "The area needed for ground-based 'rectenna' arrays, as the antenna elements are called, measures some 40 to 59 km," he says.

The immediate goal of the current experiments is to test the

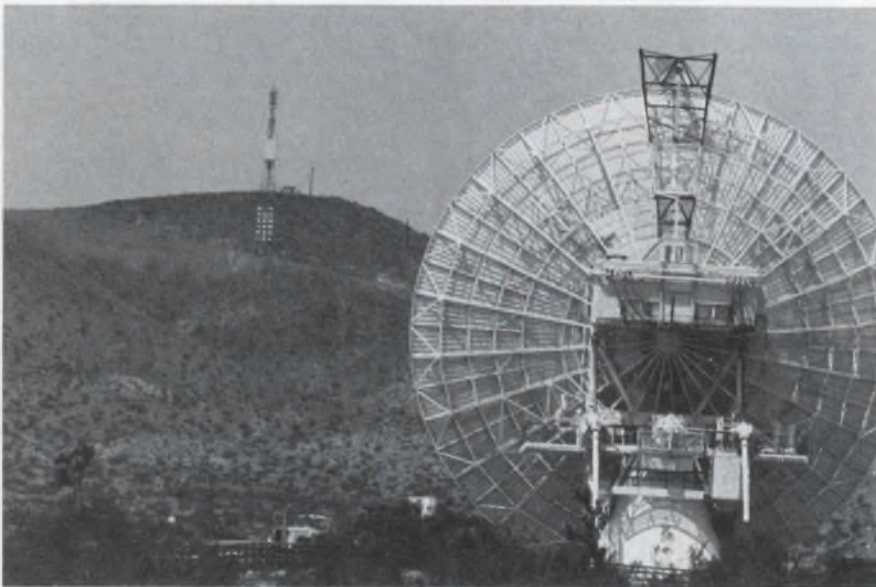

An 85-foot parabolic antenna and a 100-foot-tall collimation tower, located a mile apart, are used to transmit and receive electrical energy.



We specialize in flat cable and flexible circuit problems nobody else can crack.

A lot of people make flat cable. A lot of people make flexible circuits. We're one of the few who make both.

But the big difference isn't only what we can manufacture, it's what we can design.

Hughes CONTOUR™ Cable solved problems for the Viking Mars probe. We worked out solutions for the Minuteman missiles. We cracked tough packaging problems for shipboard and airborne systems, radar, sonar, high-speed computers.

And we can crack your tough ones, too.

Not wild-eyed, super-expensive,

forever-and-a-day solutions. Practical solutions. Maybe even less-expensive-in-the-long-run solutions.

And once we design it, we'll make it. In one of the industry's newest, most complete facilities.

Think of it this way. If it's simple and easy, anybody can do it, including us. But the tough nut is our specialty.

A tour? Or a consultation to discuss your design requirements? Just call (714) 549-5701 and ask for Dave Cianciulli.

Or write: 17150

Von Karman Avenue, Irvine, California 92705.



HUGHES MICROELECTRONICS LTD.: BELGIAN BRANCH - Passage International 29, 1000 Bruxelles 1 Belgium. Telephone 2179172.
UNITED KINGDOM - Clive House, 12-18 Queens Road, Weybridge, Surrey, England. Telephone Weybridge 47262.

INFORMATION RETRIEVAL NUMBER 16

high-power performance of a reception-conversion array rather than an over-all system. Existing transmitting equipment is being used, consisting of a klystron with a maximum output of 450 kW at 2.388 GHz, a 26-m-diameter (85-ft) parabolic reflector antenna, and a 30.5-m-tall (100-ft) collimation tower located approximately 1.54 km (1 mile) from the antenna.

The equipment is part of the Venus station, a research and development facility of NASA's Deep Space Network at Goldstone near Barstow, CA.

Thus far the Mojave Desert tests have shown, JPL says, that the present rectenna array concept should be adequate for a somewhat weather-dependent, yet highly efficient, receiving mechanization for a high-power microwave power transmission link.

To improve the system, a number of innovations are needed, JPL says: diodes with higher conversion-efficiency, a better array impedance match and simplified techniques for mass manufacturing and assembly.

Collecting the power

The transmission of power via microwave differs from transmission of communication signals, in that a greater percentage of the power must be received. You can amplify weak communication signals but not power.

In the space station, a series of microwave generators would be combined in a subarray about 15 meters square, and the latter would form part of the transmitting antenna, according to Peter E. Glaser, vice president of Arthur D. Little, Inc., Cambridge, MA.

The generator design, Glaser says, is based on use of a crossed-field device such as an Amplitron, which has the potential of high efficiency, high reliability and very long life.

Each generator subarray must be provided with an automatic phasing system, so that the individual radiating elements of the antenna are in phase. These subarrays would be assembled into a slotted-waveguide phased-array transmitting antenna, about 1 km in diameter, to obtain a microwave beam. The distribution within the beam could be designed to

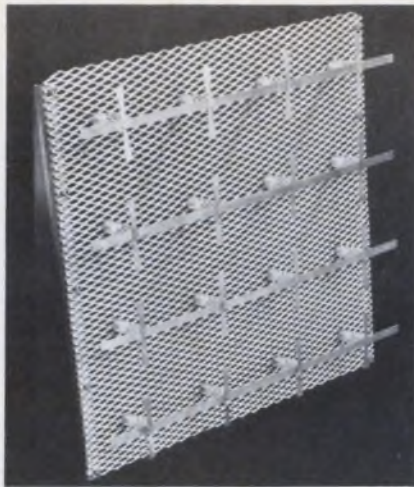

Receiving antenna of a microwave power link consists of dipole rectifiers separated one-half wavelength from each other.

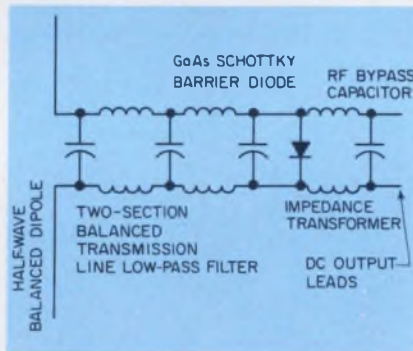

Rectenna element equivalent circuit is used to calculate the antenna's electrical characteristics.

range from uniform to Gaussian.

In the ground experiment microwave power is being received and rectified with a Schottky barrier diode detector. However, the diode operates at a power level of +39 dBm, and the output is dc. Although other power output forms, such as pulsating dc or even low-frequency ac (60 Hz), can be obtained, dc was selected for system simplicity at this time.

The function of the receiving system is to collect the incident rf and convert it to dc. This is done by building the receiving antenna in the form of a planar array of half-wave dipole rectenna elements over a ground plane facing the transmitter incident beam (see illustration). Each dipole has an integral low-pass filter, diode rectifier and rf-bypass capacitor.

The dipoles are dc-insulated from the ground plane and appear as rf absorbers in parallel to the

incoming rf wave. Their dc outputs are in a parallel and series combination to produce the desired output voltage and current levels.

The size of the dipoles and their configurations are adjusted so that when they are in combination with the transformed dc load impedance the array provides a match for the incoming rf wave. The dipoles are 0.74λ long; they are spaced 0.6λ apart in a triangular lattice and are 0.2λ from a ground plane.

The low-pass filter design represents a compromise between insertion loss at the fundamental and proper rejection at the harmonics. The harmonics must be trapped and phased properly to result in maximum rf-to-dc conversion (inverse Fourier Transform).

The rf-bypass capacitor in the rectenna performs the dual function of a smoothing filter for removing rf and harmonic ripple from the dc output and resonating the diode capacitance so that the proper impedance match between the diode and the low-pass filter is obtained.

Collection efficiency approaching 90 per cent in the 3-GHz region is expected ultimately for the rectenna, Brown says. The present efficiency of the rectennas at Goldstone is 82%. A principal reason for this optimism is the very high potential rectification efficiency of the GaAs Schottky barrier diode when its depletion layer is optimally designed for this application and when rectifier circuits using such improved diodes are also optimally designed.

The physical capture area of the array, including the interstices between subarrays, is 24.5 m^2 (263.5 ft^2). Each of the 17 subarrays is positioned normal to the beam from the Venus station antenna. All subarrays lie in the same plane.

The 17 separate dc load and instrumentation wires from each subarray are routed to a central load and instrumentation complex, located in and near the collimation tower support building.

Additional tests of the ground system are planned to determine performance vs frequency, incident polarization, treatment of the interstices and the effects of various environmental conditions, including rain, snow and angle-of-incidence variations. ■■

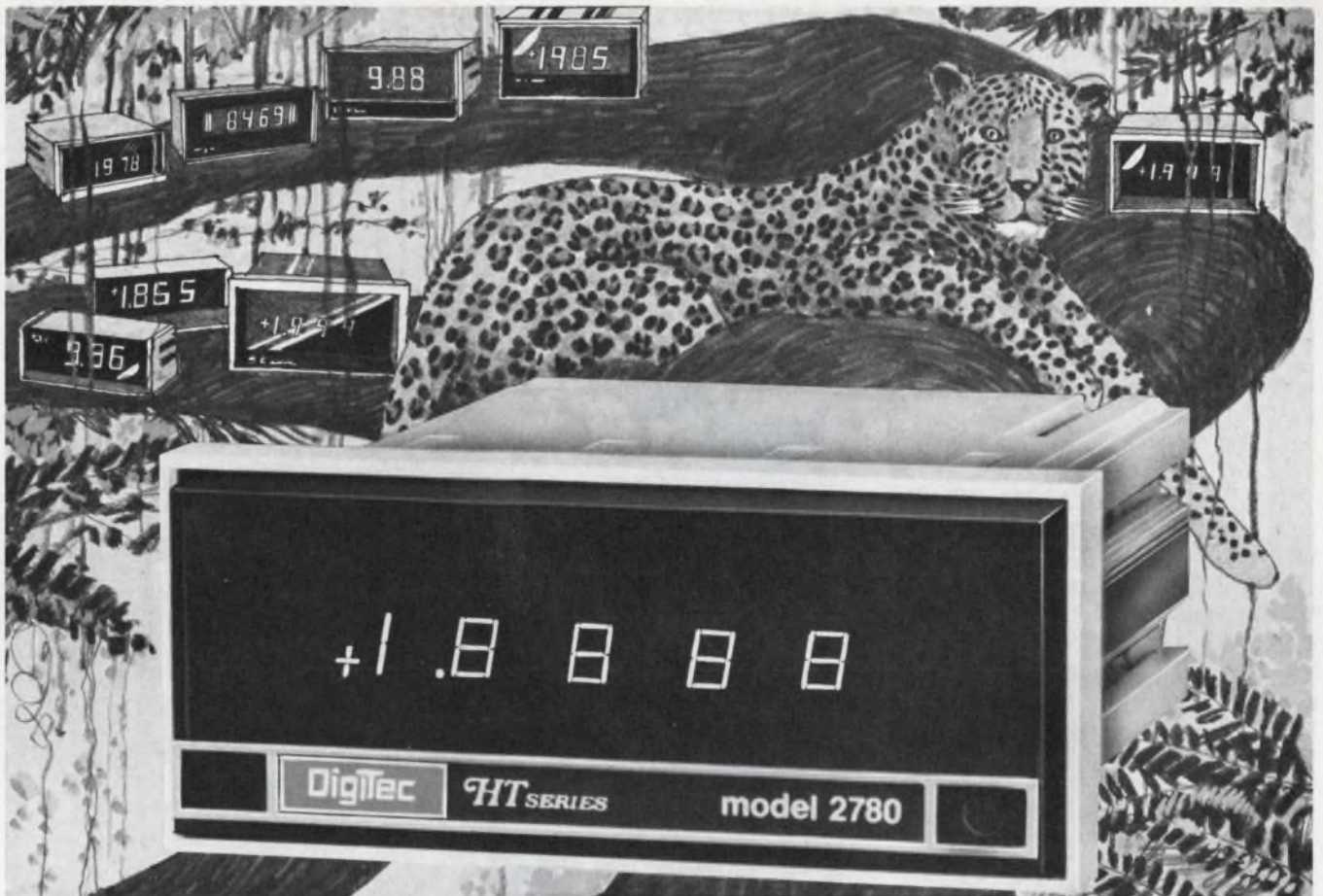

The 'toughest' Panel Meter in the jungle!

Fierce Reliability and Performance

There's a teeming jungle of panel meters available today. You need to slash thru the tangle of prices and specifications to the very roots. You must find a panel meter that can take anything while it gives continuous reliability and accuracy.

Lean, muscular stamina

Every DigiTec panel meter is bred to survive and deliver under any conditions. Proprietary CMOS LSI circuitry gives a lean component count with 5 times the reliability of competitive TTL models. All components are selected for savage stamina, with critical components 100% inspected and socket mounted to avoid assembly heat damage. Every LED display is pre-tested and rated at 1 million hours. Circuit boards are immune to humidity or floods because

they're conformally coated on both sides. Shock, vibration and corrosion damage have been eliminated by extra mechanical reinforcement and gold plated connectors.

Endurance tested and certified

All DigiTec panel meters are subjected to a minimum 168 consecutive hours of failure free burn-in at temperatures that vary from +25°C to +55°C. Before and after burn-in, each meter is visually inspected and electrically tested. When a DigiTec panel meter goes into that jungle... it's ready for anything and tough enough to last 9 lifetimes!

Model 2780 — 4½ digits, 0.01% accuracy (shown)

*** Model 276** — 3½ digits, unipolar, 0.1% accuracy

Model 277 — 3½ digits, bipolar, 0.05% accuracy

Optional buffered. BCD output available - field installable.

Priced under **\$100*** in OEM quantities

Call your nearest United Systems representative for complete specifications.
All models available from stock.

DigiTec

UNITED SYSTEMS CORPORATION

918 Woodley Road • Dayton, Ohio 45403 • Ph: (513) 254-6251 • TWX: (810) 459-1728

These instruments available under GSA Contract GS-OOS-27741

FOR INFORMATION ONLY CIRCLE #281

FOR DEMONSTRATION ONLY CIRCLE #282

Infrared device detects ice before it forms

A device with an infrared sensor detects icing conditions before ice has actually formed and turns on a heater to prevent its formation.

The unit was built by Environmental and Process Controls, Sterling Heights, MI, for use on the air intake of gas turbines in stationary outdoor installations, including those that drive gas or oil-line pumps, offshore oil-drilling pumps and electric power generators. When ice forms on the inlet vanes of these turbines, the efficiency of the turbine is reduced and the blades may be damaged. The new unit enables turbines to operate continuously with maximum power output at temperatures down to -120 F.

The ice detection system consists of an infrared dew-point-measuring sensor mounted on the turbine air intake and a remotely mounted electronic monitor connected to the sensor by cable.

The sensor uses infrared LEDs and phototransistors to identify the formation of moisture. First, one infrared diode and one phototransistor are focused on a thermocooler module reflective surface. At the same time another diode and transistor pair are focused on an identical uncooled reflective surface to provide compensating and reference photo-optics. The compensating photo-optics serve as a floating reference for an operational amplifier and also as a means of providing both temperature compensation and surface-contamination detection.

The electronic monitoring setup includes 10 operational amplifiers that control the power supply to the thermocooler, adjust the ambient temperature zero point, adjust dew point offset, and compare dew point and ambient temperature measurements.

The temperature-comparator operational amplifier also includes

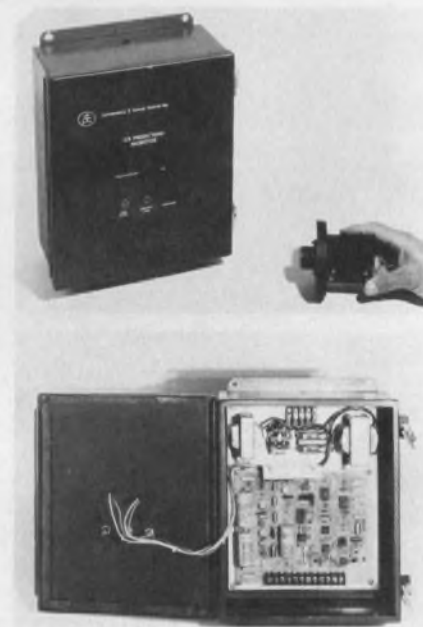

Infrared sensor (top) predicts ice formation on outdoor gas turbine installations and turns on a heater. The electronic control monitor (bottom) contains 10 op amps.

offset adjustments. In a typical operation, the relay that switches on the heater system is actuated when the dew point measures 4 degrees less than a freezing point setting of 41 F.

Independent monitor points on the comparator amplifier provide access for continuous dew point, ambient or surface temperature readings. LEDs continuously indicate amplifier state, a red diode showing ice warning and a green diode showing sensor assembly operation.

A switch provides self-testing and indicates anti-icing control performance.

The system consumes 6 W of power continuously and 15 W intermittent. Dew point and ambient temperature ranges are from -120 F to $+150$ F. ■■

New MMI 1K x 4 PROM

Sales Offices:

EASTERN AREA SALES OFFICE: (617) 655-7070 • NEW ENGLAND REGION: (617) 475-8883 • MID-ATLANTIC REGION: (215) 643-0883 • CENTRAL AREA SALES OFFICE: (815) 385-8767 • MINNEAPOLIS REGION: (612) 884-2686 • SOUTH CENTRAL AREA SALES OFFICE: (214) 369-7952 • SOUTHERN CALIFORNIA AREA SALES OFFICE: (714) 557-1216 • WESTERN AREA SALES OFFICE: (415) 969-4061 • BAY AREA REGION: (408) 227-1472

Representatives:

ARIZONA: Phoenix (602) 264-7971 • CALIFORNIA: Mountain View (415) 965-9180; San Diego (714) 277-8044 • COLORADO: Wheatridge (303) 423-1020 • CONNECTICUT: North Haven (203) 239-9762 • FLORIDA: Clearwater (813) 441-4702; Ft. Lauderdale (305) 944-5031; Orlando (305) 299-5303 • ILLINOIS: Chicago (312) 774-9022; Rolling Meadows (312) 394-4900 • MARYLAND: Baltimore (301) 825-3330 • MASSACHUSETTS: Needham (617) 444-2484 • MICHIGAN: Gross Point (313) 499-0188 • MINNESOTA: Minneapolis (612) 884-7471 • NEW JERSEY: Teaneck (201) 692-0200 • OREGON: Beaverton (503) 643-5754 • PENNSYLVANIA: Horsham (215) 672-8300 • WASHINGTON: Seattle (206) 762-7664 • CANADA: Scarborough, Ontario (416) 751-5980; Ottawa, Ontario (613) 729-6090; Richmond, B.C. (604) 277-0414; Winnipeg, Manitoba (204) 889-7966.

Distributors:

ALABAMA: Huntsville, Hall-Mark (205) 837-8700 • ARIZONA: Phoenix, Kierulff (602) 273-7331; Phoenix, Sterling (602) 258-4531 • CALIFORNIA: Los Angeles, Kierulff (213) 685-5511; Los Angeles, Sterling (213) 767-5030; Palo Alto, Kierulff (415) 968-6292; San Carlos, Sterling (415) 592-2353; San Diego, Intermark (714) 279-5200; San Diego, Kierulff (714) 278-2112; Santa Ana, Intermark (213) 436-5275; Sunnyvale, Intermark (408) 738-1111 • COLORADO: Denver, Kierulff (303) 343-7090; Wheatridge, Century (303) 424-1985 • CONNECTICUT: Hamden, Arrow (203) 248-3801 • FLORIDA: Orlando, Hall-Mark (305) 855-4020 • ILLINOIS: Chicago, Hall-Mark (312) 437-8800 • INDIANA: Indianapolis, Pioneer/Indiana (317) 849-7300 • KANSAS: Lenexa, Hall-Mark (913) 888-4747 • MARYLAND: Baltimore, Arrow (202) 737-1700; Technico, Inc. (301) 828-6416; Gaithersburg, Kierulff (301) 948-0250 • MASSACHUSETTS: Billerica, Kierulff (617) 935-5314; Burlington, Arrow (617) 273-0100 • MINNESOTA: Bloomington, Arrow (612) 888-5522; Bloomington, Hall-Mark (612) 884-9056 • MICHIGAN: Livonia, Pioneer/Michigan (313) 525-1800 • MISSOURI: Earth City, Hall-Mark (314) 291-5350 • NEW JERSEY: Moorestown, Arrow (609) 235-1900; Saddlebrook, Arrow (201) 797-5800; Rutherford, Kierulff (201) 935-2120 • NEW MEXICO: Albuquerque, Century (505) 292-2700 • NEW YORK: Buffalo, Summit Distributors (716) 884-3450; Farmingdale, Arrow (516) 694-6800; Rochester, Summit Distributors (716) 334-8110 • NORTH CAROLINA: Raleigh, Hall-Mark (919) 832-4465 • OHIO: Cleveland, Arrow (216) 464-2000; Cleveland, Pioneer/Cleveland (216) 587-3600; Dayton, Arrow (513) 253-9176; Dayton, Pioneer/Dayton (513) 236-9900 • OKLAHOMA: Tulsa, Hall-Mark (918) 835-8458 • OREGON: Portland, Almac/Stroum (503) 292-3534 • PENNSYLVANIA: Horsham, Pioneer/Delaware Valley (215) 674-5710; Pittsburgh, Pioneer/Pittsburgh (412) 782-2300 • TEXAS: Houston, Hall-Mark (713) 781-6100; Houston, Component Specialties (713) 771-7237; Dallas, Component Specialties (214) 357-4576; Dallas, Hall-Mark (214) 231-6111 • UTAH: Salt Lake City, Century (801) 487-8551 • WASHINGTON: Seattle, Almac/Stroum (206) 763-2300; Seattle, Intermark (206) 767-3160 • WISCONSIN: West Allis, Hall-Mark (414) 476-1270 • CANADA: Montreal, Quebec (514) 735-5775; Toronto, Rexdale (416) 677-7820; Vancouver, B.C. (604) 261-1335.

“This is the year for the 60ns 1K x 4 PROM.”

MMI has always set the trends in bipolar memories. The first 1K, 2K and 512 x 8 4K PROMs had MMI stamped on them. Now we offer the designer another first: a 4K PROM configured 1K x 4, the way you've told us you want it.

We've drawn on our vast experience in making PROMs coupled with our proven Schottky process, and here it is: Speed is 60ns max. over temp and voltage ranges. Power dissipation is only 150 microwatts/bit. Reliability is improved, growback is nonexistent, and wait until you see the programmability — better than 90%. It's packaged in an 18-pin DIP for best board density, and priced at only \$30 in 100 quantities. Totally compatible ROMs are ready for your truth table now.

Our newest 4K PROM is only the latest in a series of leadership moves. MMI grew to be the largest

manufacturer of bipolar memories in the world by finding what the industry wanted and delivering better devices. Our new 1K x 4 PROM is better because its 18-pin package allows you four times the packing density of 1K PROMs. It's available in both commercial and mil spec versions. And it clearly offers you the opportunity of upgrading from 1K, 2K or even 512 x 8 PROMs.

One
6350/51 is
worth a
thousand
words.

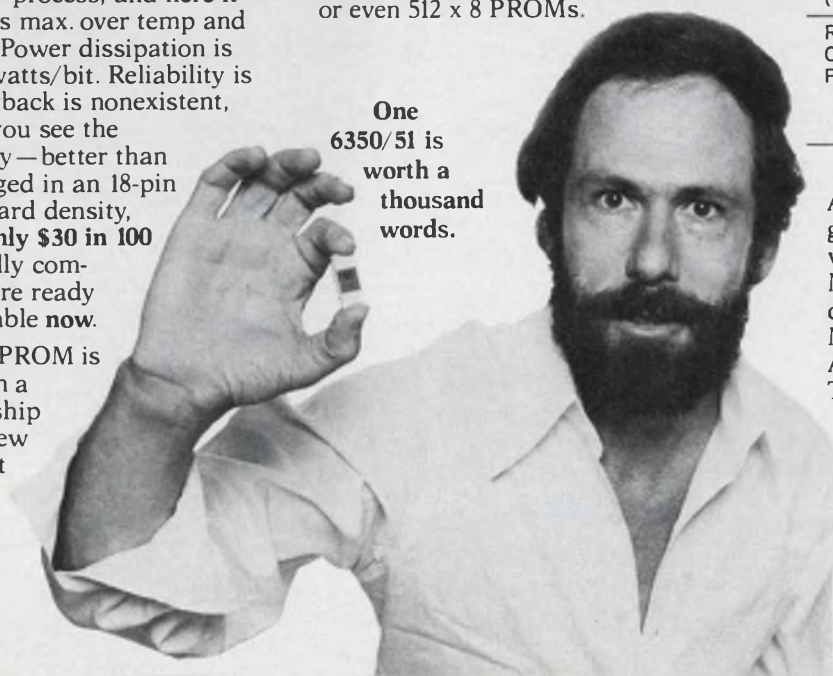

MMI 1K x 4 MMI PROMs

OC TS	COMMERCIAL	MIL SPEC
	6350J 6351J	5350D 5351D
TEMP. RANGE	0°C to 75°C	-55°C to +125°C
MAX. ACCESS TIME OVER TEMP. RANGE	60 nsec	75 nsec
PRICE (@ 100 QUAN.)	\$30	\$55
ROM COMPATIBLE PART NO.	6250J 6251J	5250D 5251D

Availability is off the shelf. We'll be glad to ship you some. Call, TWX or write Ed Bohn (408) 739-3535 or any of MMI's sales offices, representatives or distributors. We are at your service. Monolithic Memories, Inc., 1165 East Arques Avenue, Sunnyvale, CA 94086. TWX 910 339 9229.

mmi
This is our year.

If you need HYBRIDS...

TELEPHONE HIGH BAND ACTIVE FILTER

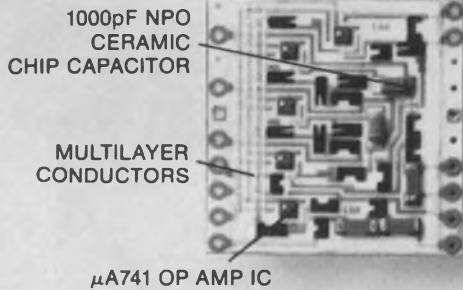

AUDIO FREQUENCY MODULATOR

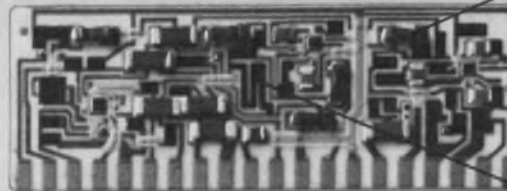

13-BIT MULTIPLYING DAC

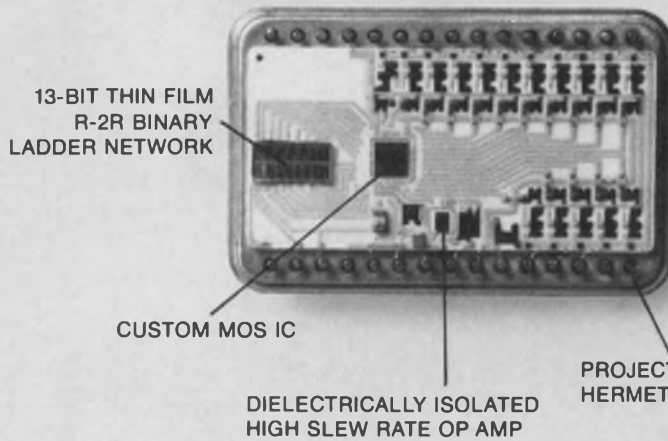

MULTICHANNEL TIME DELAY

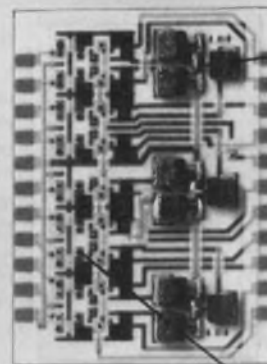

you should know about BECKMAN!

We offer *expert* application assistance and *quality products* at *competitive prices*.

Beckman Hybrids can solve your system packaging problems in:

- Active Filters and Telephone Tone Filter/Modem products
- DACs and ADCs from Industrial to Military standards
- Power Linears from Amplifiers to Voltage Regulators
- Complex Customs from Passive Substrates to Multilayer Digital hybrids

For fast response, call (714) 871-4848, Ext. 1776

Beckman[®]

HELIPOT DIVISION

INFORMATION RETRIEVAL NUMBER 20

64 crosspoint Self-latching reed matrix

CLARE'S NEW MINI MEMORY MATRIX OFFERS A PACKAGING SELECTION THAT STRETCHES THE IMAGINATION.

Four compact packaging formats offer engineers real flexibility in creating multi-pole switching arrays for telecommunications, process controls and automatic test equipment systems. The basic 64-crosspoint switching module is built around Clare's durable magnetic self-latching dry reed switch capsule. With Rhodium-plated contacts insuring several million operations.

IT REMEMBERS. IT ERASES.

The multiple crosspoint coils are uniquely interconnected to provide coincident selection paths. Simultaneous current pulses on the X and Y axes address the crosspoints. A new selection automatically erases the previous selection. Dielectric spacing inhibits crosstalk while providing a stand-off rating at 600 Vdc on standard models, 800 Vdc as an option.

CHOOSE FROM WIREWRAP, CABLE PLUG-IN, OR PCB TERMINALS.

Both the wirewrap and cable plug-in units are available in 2 or 4-pole 8X8 arrays. The PCB unit comes in 2-pole 8X8 and 8X16 arrays.

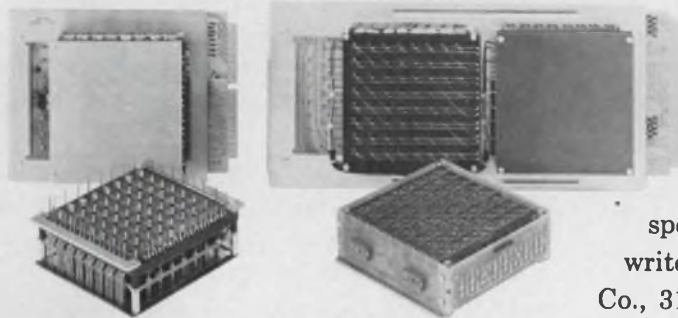

The PCB unit is compatible with conventional pre-wired card cage assembly techniques. The cable plug-in units mate with standard 9-pin in-line socket and 16-pin DIP jack terminations.



It's New! It's Revolutionary!
We call it the Mini Memory Matrix

FOR MORE INFORMATION ...

The new 969 Series is certainly worth finding out about. A New Mini Memory Matrix catalog is now available. Also available are two "TAR" (Technical Application Reference) publications: TAR-Clare Mini Memory Matrix and TAR-Clare Self-Latching Dry Reed Relays. For more specific design information, write G. Neeno, C. P. Clare & Co., 3101 W. Pratt Ave., Chicago, Ill. 60645. Phone: (312) 262-7700.

**QUALITY, SERVICE,
RELIABILITY**

C. P. CLARE & COMPANY a subsidiary of
GENERAL INSTRUMENT CORPORATION



new from CLARE

INFORMATION RETRIEVAL NUMBER 21

the KEPCO **PTR**

is an **OEM** modular power supply *with a difference!*

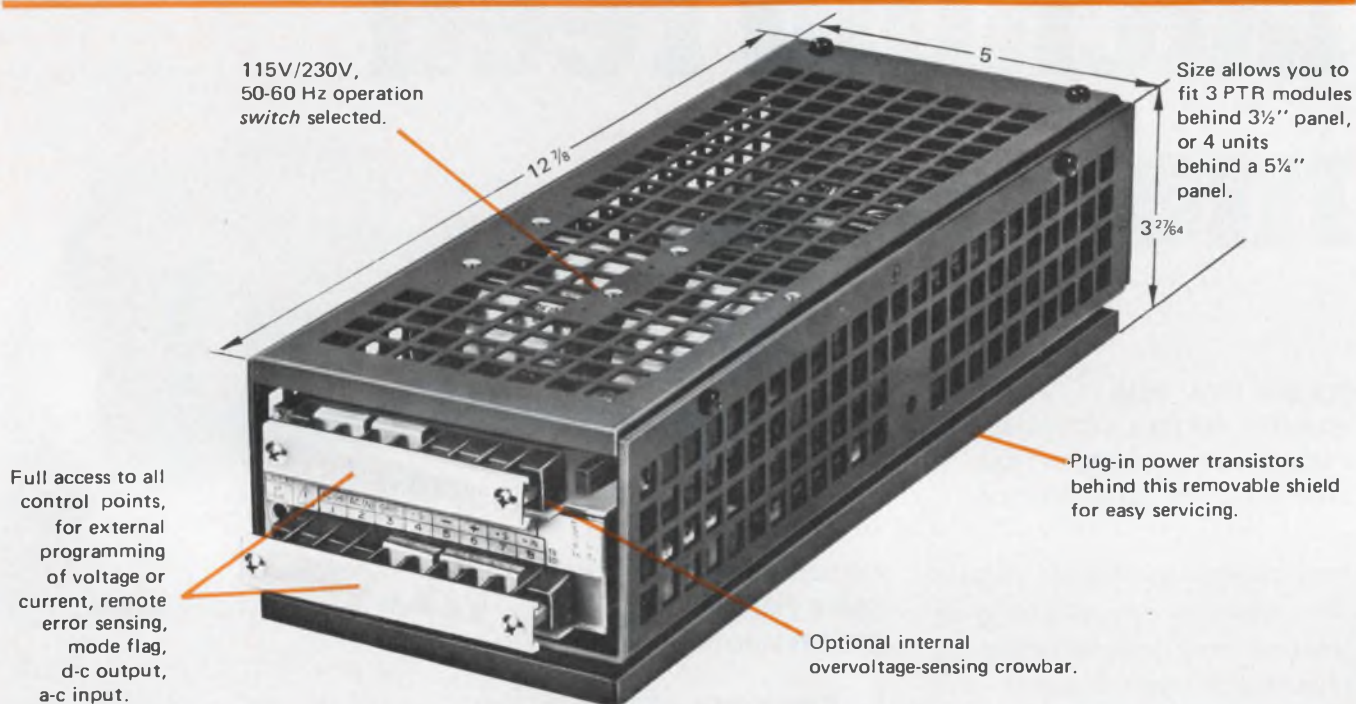

The Kepco PTR is an OEM modular power supply . . . with a difference.

The difference is that for \$273.00 you don't get a stripped-down, open-frame module with external heat sink fins, skimpy capacitors and a tricky derating chart versus ambient temperature—nor do you get a limited-range voltage stabilizer with fold back over-current protection.

For \$273.00, you get a Kepco PTR . . . a fully programmable, automatic crossover voltage and current stabilizer that functions with its self-contained, convection-cooled heat sink to produce *full output to +71°C with no derating.*

PTR's produce from 0–7 volts at 5.5 amperes to 0–100 volts at 0.6 amperes in six different models. All units have two control channels with plug-in I-C control amplifiers for excellent stabilization (0.005%) and temperature immunity (0.01%/°C).

For an extra \$25.00, you can get a built-in overvoltage-sensing crowbar.

The PTR is a truly remarkable value—the features and performance of lab and systems-type power supplies in an inexpensive, value packed OEM module. Write for Catalog 146-1278 for the full details.



KEPCO®

For complete specifications,
write Dept. EL-05

*with KEPCO
you're in control!*

KEPCO, INC. • 131-38 SANFORD AVENUE • FLUSHING, N.Y. 11352 • (212) 461-7000 • TWX = 710-582-2631 • Cable: KEPCOPOWER NEWYORK

INFORMATION RETRIEVAL NUMBER 22

Washington Report

Changes expected in weapons acquisition

According to a new report, the Defense Dept.'s procedures for acquiring major weapon systems could be improved. Prepared by an Acquisition Advisory Group established to review recommendations from the armed services, the report proposed 18 principal and 43 minor revisions to the process.

Just how many of these will be adopted by the Secretary of Defense won't be known until after an ongoing evaluation. Industry experts believe that certainly more decentralization of the acquisition process can be anticipated, which should benefit contractors by shortening the response time to their proposals.

Other proposed changes: Many programs that now must be reviewed by a top level defense council can be approved by the military service itself. Each service would also have the authority to initiate its own analyses of specific mission areas, such as antisubmarine warfare. It would then conduct studies and recommend solutions for any problems that may have emerged.

Competing proposals by the services would be reviewed by the Defense Dept.'s Weapons Systems Evaluation Group rather than the top level Defense Systems Acquisition Review Council.

Finally, a cost range would be used rather than a finite limit for a project—"between \$90-million and \$100-million," rather than a binding "93.5-million."

GAO notes rise in Citizen Band problems

A recent General Accounting Office report has told the Federal Communications Commission something it already knows—that Citizen Band radio problems are mounting and the entire situation may, in fact, be uncontrollable without some legislative help.

The GAO concurs with the FCC that legislation is needed to allow the FCC to assess fines against unlicensed operators and make it a crime to kill, assault or intimidate FCC personnel making station checks. As it now stands, the FCC can't levy a fine against an unlicensed user. The recourse is to turn the case over to the Justice Dept., which is reluctant to process small violations of Federal law and further clutter the court dockets. During fiscal year 1974 the FCC found that 2200 truckers out of 3400 violators it caught were unlicensed. In checks, the agency learned that 57% of the truckers were unlicensed.

The FCC reports that its agents are increasingly being subjected to

vocal and physical abuse. When violence occurs, the only recourse now is to go through local and state courts. A bill is in the Congressional hopper to remedy this situation, but there's been no action thus far.

Presidential science adviser planned

After a three-year absence, it's just a matter of time before there will again be a full-time science adviser to the President. Since being abolished by the Nixon Administration in 1973, that function has been an additional duty for the director of the National Science Foundation.

By a vote of 362 to 28, the House passed a bill that specifically authorizes a science adviser in the White House, and Senate passage is virtually assured. President Ford also supports the bill.

As passed by the House, the bill reaffirms the need and value of science and technology through a general policy statement; establishes an Office of Science and Technology, the director of which will be the principal adviser to the President; and sets up a special science and technology survey committee to analyze Federal science operations and to report back to the President and Congress within two years.

The office is to have a \$2.1-million annual budget for operating expenses. The survey will cost an estimated \$1-million.

Antisecrecy measure passed in Senate

The Senate is trying to let the sunshine in to illuminate its own activities and those of more than 40 Government agencies, including regulatory bodies, such as the Federal Communications Commission.

By a 94-to-0 vote the upper chamber passed a bill providing for a "Government in the Sunshine Act." It would require legislative committees and regulatory agencies to stop holding most meetings in secret. It would prohibit secret contacts with commissioners and board meetings when a case is pending before a particular agency. Closed meetings by agencies could be held only to consider matters such as national security, personal privacy, trade secrets, committee personnel or an ongoing criminal investigation.

The new rules would force Congressional committees to meet in public, too, unless the committee members, meeting in public, voted otherwise. The real blockbuster and a point that could kill the legislation when it goes to the House is a provision that conference committees—those that hammer out the compromises between bills—would have to open their doors to the public unless the members voted otherwise.

Capital Capsules: NASA has selected 16 organizations to develop low-cost solar cells for residential and commercial use. The project aims at production of cells for less than \$500 a kilowatt hour. The present cost is between \$20,000 and \$25,000. . . . The Pentagon warns that the Soviet ground forces are getting four new weapons; a tank, an armored fighting vehicle, a missile system mounted on an armored vehicle and an assault helicopter. The Soviet navy is getting two new aircraft carriers. And the Air Force is modernizing its tactical air force. . . . The Navy has given RCA an \$8.4-million contract to design and build an integrated radio room for the Trident ballistic missile sub. . . . The Electronic Industries Associations of the U.S. and Germany are going to work towards developing a truly international system of nomenclature for solid-state devices, electron tubes and passive parts.

ANNOUNCING the TEKTRONIX T900 Oscilloscopes

from \$695
probes included and more...

Here's important news for engineers, technicians and educators who want the quality, reliability and support associated with TEKTRONIX Oscilloscopes - all at a moderate price. T900* Oscilloscopes are an entirely new line designed for cost savings without sacrifice of basic performance.

This New Line Includes:

T921—Dc to 15 MHz; single-trace, mono time-base	\$ 695**
T922—Dc to 15 MHz; dual-trace, mono time-base	\$ 850**
T932—Dc to 35 MHz; dual-trace, mono time-base	\$1050**
T935—Dc to 35 MHz; dual-trace, dual time-base with delayed sweep	\$1250**
T912—(Storage model) Dc to 10 MHz, dual-trace mono time-base ..	\$1195**

Easy to Use

T900 Oscilloscopes are simple to use. All have a large, bright (8 x 10 cm) crt, beam finder, single knob trigger control, delay line to enable viewing of waveform leading edge, automatic selection of tv line or frame display and functionally color-coded control panels. Convenience is also enhanced by a full complement of accessories including 10X probes (included in price), optional scope stand, camera, rain jacket and more... T900 Oscilloscopes are easy to handle and fit into small spaces. They weigh only 15-18 lbs. and measure only 7" x 10" x 19".

Tektronix Support

T900 Oscilloscopes are warranted against defective materials and workmanship for one year. There are over 37 service centers and 50

field offices across the U.S. Whenever you need help in the selection, operation, application or servicing of T900 Oscilloscopes your local field engineer is available to help you... no extra charge... just extra value.

For a copy of the new T900 Brochure (includes complete specifications), or ordering information write to Tektronix, Inc., P.O. Box 500, Beaverton, Oregon 97077. For immediate information call your local Tektronix field engineer or Tektronix, Inc. (503) 644-0161 extension T900.



TEKTRONIX®

committed to
technical excellence

* Available presently in U.S.A. only.
** U.S.A. price FOB Beaverton, Oregon.

FOR TECHNICAL DATA CIRCLE #201
FOR DEMONSTRATION CIRCLE #202

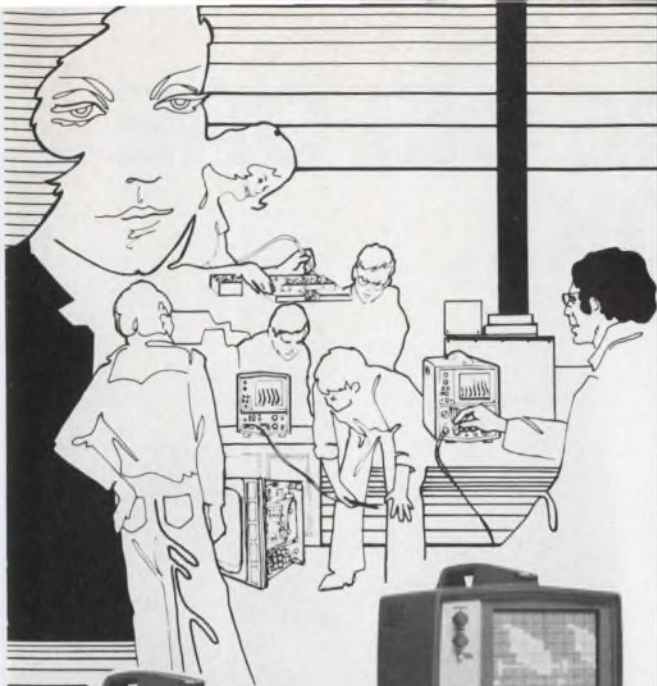

T912



T921



T922



T935



T932

IF YOU COMPARE BEFORE YOU LOOK...

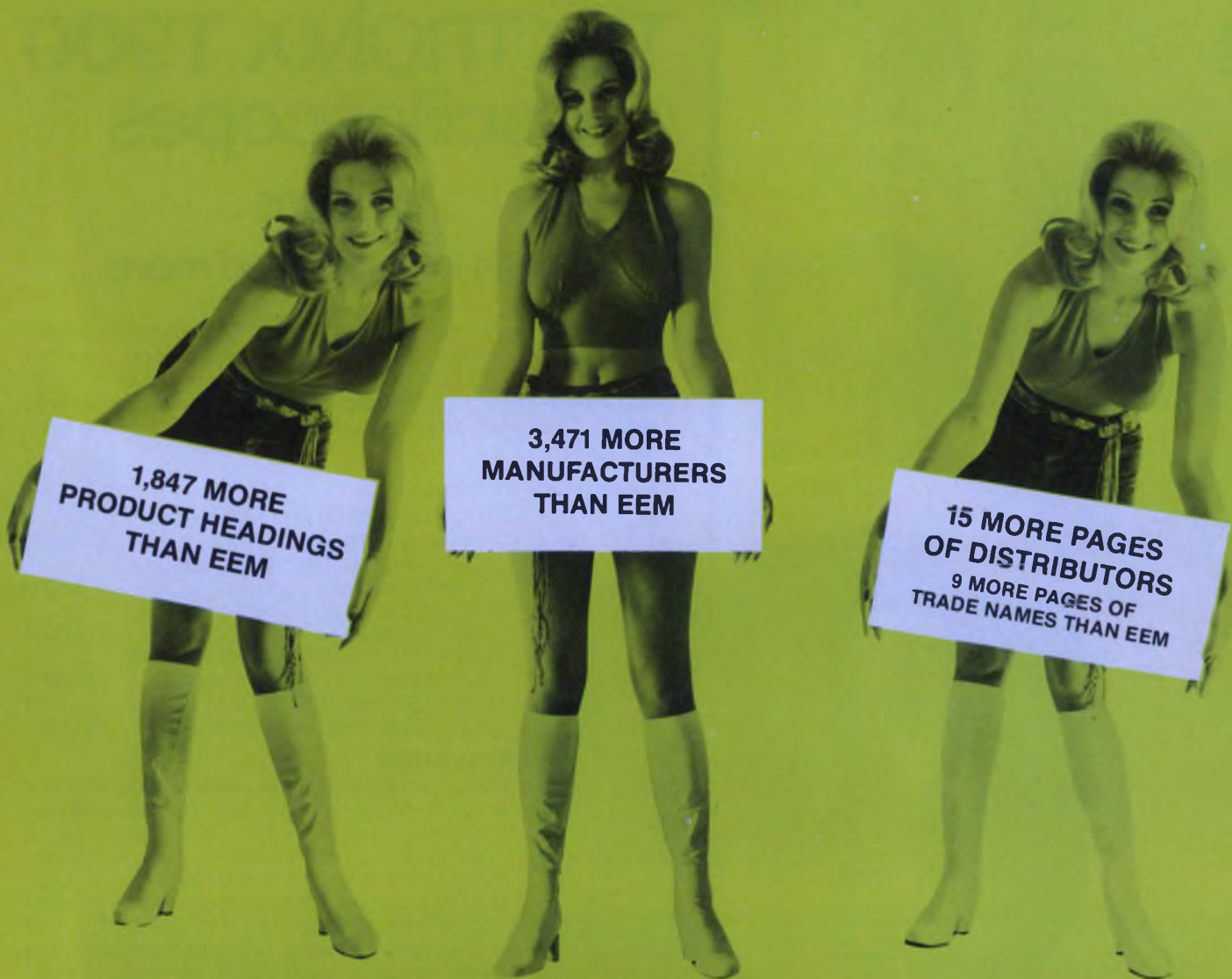

**1,847 MORE
PRODUCT HEADINGS
THAN EEM**

**3,471 MORE
MANUFACTURERS
THAN EEM**

**15 MORE PAGES
OF DISTRIBUTORS
9 MORE PAGES OF
TRADE NAMES THAN EEM**

YOU'LL LOOK *FIRST* IN THE **GOLD BOOK**



Gold Book vs. EEM 1975/76 Comparison of Editorial Pages	EEM*	GOLD BOOK
Number of product headings in Product Directory	3335*	5182
Pages in Product Directory	255†	542
Pages in Trade Name Directory	24	33
Number of Manufacturers	3300*	6771
Pages in Manufacturers Directory	338	397
Pages in Distributors Directory- Geographic	19	17
Alphabetic	0	17

*Maximum estimates.
†Includes approximately 25 pages of cross reference from one volume to the other.

SOURCE: ELECTRONIC DESIGN'S RESEARCH DEPT.



Granted, our new ADM-3 is basic. Especially if you compare it with all the smart video terminals around (our ADM-1 or -2, for example). But the \$995 unit price puts it into a different perspective.

As simple as it is, the ADM-3's one-card brain can help you move a lot of data. And it's compatible with most popular computers. That means, it fits all kinds of applications. Including yours.

Here's what you get for \$995. 12" diagonal screen. Full or half duplex operation at 11 selectable data rates. Bright, easy-to-read characters — 960 or 1920,* displayed in 12 or 24 rows of 80 letters. 59 data entry keys arranged like on a typewriter which keeps operator training short and basic, too. What's more, our ADM-3 is alert. It says "beep" when you come to the end of a line. The rest of the time, it just keeps cool and quiet.

Our DUMB TERMINAL also offers you room for

*1920 Characters is an option available at additional cost.

improvements. Its RS 232C interface extension port lets you hook up hard copy printer, magnetic tape recorder or additional (smarter) data terminals. And with a few options, you can make our ADM-3 answer back. Increase its vocabulary by adding upper and lower case. Transmit and receive independently selectable rates. Even enter just numbers on a numeric key pad.

After counting all its limited blessings, you have to admit one thing: you simply couldn't ask for more for \$995. At this low level, you can afford to order a dozen or more DUMB TERMINALS (and buy them at our even lower quantity discount price).



DUMB TERMINAL. SMART BUY.

LEAR SIEGLER, INC.
ELECTRONIC INSTRUMENTATION
DIVISION DATA PRODUCTS



714 N Brookhurst St.
Anaheim, CA 92803
Telephone:
(714) 774-1010

INTRODUCING THE \$995 DUMB TERMINAL.

INFORMATION RETRIEVAL NUMBER 25

So good ... you can actually feel the difference!



BOURNS announces an **ADVANCED** building-block potentiometer...

... with a velvety smooth control feel that will enhance the quality image of your equipment. It's BOURNS® new Model 80 Building-Block potentiometer.

The Model 80 incorporates a unique new shaft torque control device which enables us to produce an advanced modular potentiometer with a smooth, consistent high quality "feel" ... regardless of the number of modules ganged on a single shaft (shaft torque only .3 to 2.0 oz.-in.).

MODULAR VERSATILITY, FACTORY ASSEMBLY

Bourns modular concept combines the versatility of advanced building-

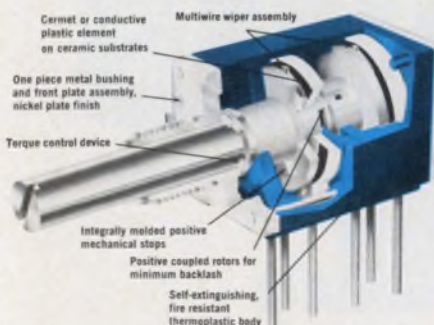

block construction ... with factory assembled reliability and quality control. All Model 80 potentiometers are built to your "prescription" by full-time production personnel, under the supervision and control of the industry's most respected quality assurance organization. High-volume assembly techniques, plus mass-produced modular components stock means fast delivery ... at competitive prices.

CERMET OR CONDUCTIVE PLASTIC

Bourns Model 80 is available with either cermet or conductive plastic elements in virtually all linear and non-linear tapers. Element types may be mixed in multiple section units. **INDEPENDENT LINEARITY IS $\pm 5\%$** ... offering more precise phasing of potentiometer output to panel calibration.

SUPER SETABILITY

A multifinger wiper and precise resistive ink formulations provide tight 1% CRV in both cermet and conductive plastic elements. This — combined with a smooth, no backlash feel — makes for easy, accurate operator settings.

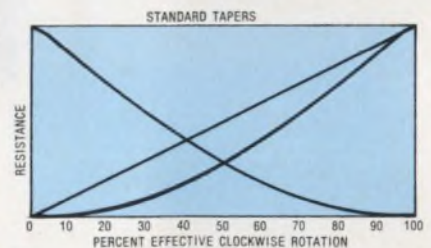

NO SHARP KNEE ON TAPERS

Model 80 audio tapers provide a smooth "knee", which allows improved setability within the crossover area on both cermet and conductive plastic.



FREE SAMPLES

Write on your company letterhead and tell us about your application. We'll send you the Model 80 that best suits your needs.



TRIMPOT PRODUCTS DIVISION

1200 COLUMBIA AVENUE, RIVERSIDE, CALIFORNIA 92507
 PHONE 714 684-1700 TWX 910 332-1252 CABLE BOURNSINC

Microprocessor Design

Where are high-level languages headed? 3 specialists in industry give views

The microprocessor industry has settled on a high-level language standard, even if by default. Intel's PL/M language—the sole entry for over two years—is setting the pattern for several compiler languages being developed by competing vendors.

However, most μ P makers say they would prefer a somewhat different subset of IBM's PL/1, because of shortcomings in some versions of PL/M. Moreover other high-level languages, especially Fortran, could come from several sources within a year. Already Texas Instruments has announced just such

an alternative with its 16-bit μ P chip (see "Processor Family Debuts," ED No. 22, Oct. 25, 1975, p. 137).

ELECTRONIC DESIGN interviewed three experts on the current benefits of high-level languages and what the near future holds. Sharing their views are Phil Roybal, microprocessor marketing manager at National Semiconductor (Santa Clara, CA); Scott McPhillips, vice president at Microcomputer Technique (Reston, VA), and Paul Rosenfeld, software product manager at Intel (Santa Clara, CA).

By **PHIL ROYBAL**
Microprocessor Marketing Manager
National Semiconductor

The biggest plus of a high-level language is that it makes programming understandable to the engineer who isn't an expert in assembly language. It lets him write in a language that looks like English. However, most high-level languages, which have been around for about 15 years, were really designed for mathematics. In fact, Fortran stands for formula translation—it was an algebra language.

So they're super if what you want is an accounts-payable program or to do your homework. But they're not very good for what microprocessors spend most of their time doing—talking to the outside world in terms of bits and bytes.

In addition early PL/M versions have several shortcomings, such as the fact that arithmetic isn't signed. For example, in the comparison "if $A > B$, do this," the signs of A and B are not checked. If A is 5 and B is 3, it's obvious that A is greater than B. However, suppose A is -5, then A is less than B, but the language doesn't check for that. It's not overwhelming, but it's an annoyance.



A more serious shortcoming is the inability to manipulate individual bits and bit fields. Most present high-level languages suffer from this. But it's the single most important area for microprocessors.

There's another class of languages that really hasn't been touched on at all for micros, but

(continued on page 48)

MICROPROCESSOR DESIGN

(continued from page 47)

I think will be. It's called POL, short for problem-oriented language. POLs are special-purpose languages that have commands for certain applications. For instance, a POL for civil engineers building dams, power stations and pipeline controllers might have commands like Open Valve or Measure Flow. These are part of the working vocabulary of the engineer.

By **SCOTT McPHILLIPS**
Vice President
Microcomputer Technique

We applied data and test programs to PL/M and concluded that you need about twice as much memory as you do with assembly language. On the other hand, in the actual coding phase of design—ignoring the software design—it'll save you about half the time.

But the PL/M version we used does suffer from several drawbacks. For example, it has several constructs—or instructions if you will—that are unique to the 8080; so it's not a general-purpose language because of that. Probably the largest disadvantage of PL/M as a program tool is the fact that it doesn't protect you from the vagaries of the machine. You're working with 8-bit quantities that only have a certain range; it has no ability to work with larger numbers. If you want to add up some 32-bit numbers, you have to do it 8 bits at a time, just as you would in assembly language.

Another disadvantage—one that really applies to any compiler language—is that the code generated is very difficult to understand. You

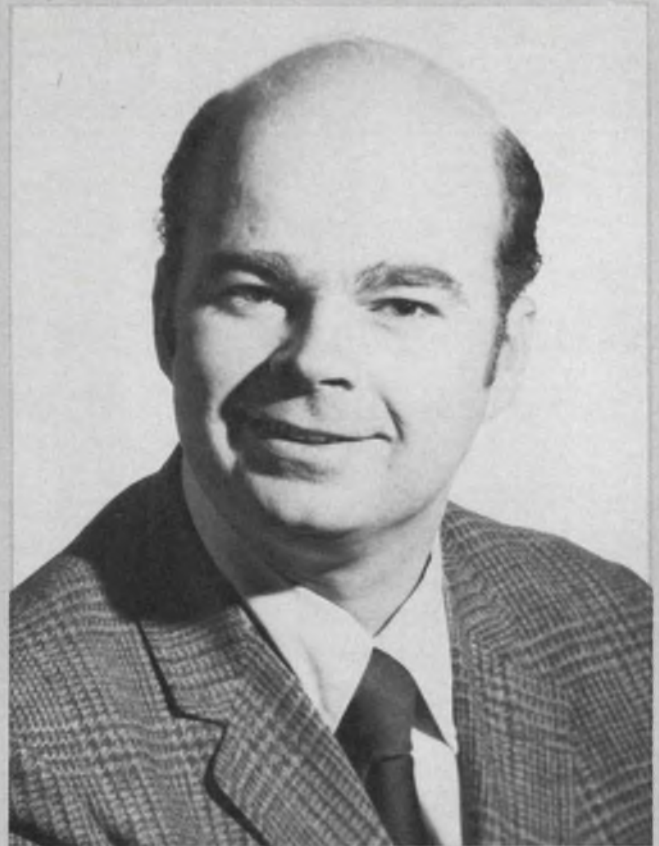

can't always follow the assembly-language code generated by PL/M very well and could, therefore, have great trouble correcting the program. You might wind up with something in your computer that you don't understand.

Nevertheless the general language structures of PL/M are very good. They are much better than those in languages such as Fortran. The structures used to make decisions, loops and so on very closely parallel basic concepts

(continued on page 50)

QUICK... What number is this?



If you have to read your microcomputer the old-fashioned way — bit by bit, from rows of lights — the computer's making you do its work!

- Don't **toggle in** a program on a bank of switches — **key** it in.
- Don't read date and addresses **bit by bit** — read a series of **fully decoded digits** (octal or hex).
- Don't debug by **single-stepping** through a program — set **breakpoints**.



The **modular micros** from Martin Research. A 20-pad keyboard; six bright digits; and a Monitor program in a PROM make program entry easy. And, even the smallest system comes with enough RAM to get started! The **MIKE 2** system, with the 8008 and the 8080-based **MIKE 3** use the **same** bus structure. Accessories — like our 4K RAM — work with these and other 8-bit CPU's. And, systems start at under \$400!

Still available from Martin Research — our innovative book, **Microcomputer Design**. An industry standard for the engineer designing with microprocessors.



With 8080, \$150.
With 8008-1, \$110.
With 8008, \$100.
Alone, \$75.

School and quantity discounts. Over 300 pages, dozens of schematics. Worth its weight in microprocessors!



martin research

3336 Commercial Ave.
Northbrook, IL 60062 (312) 498-5060

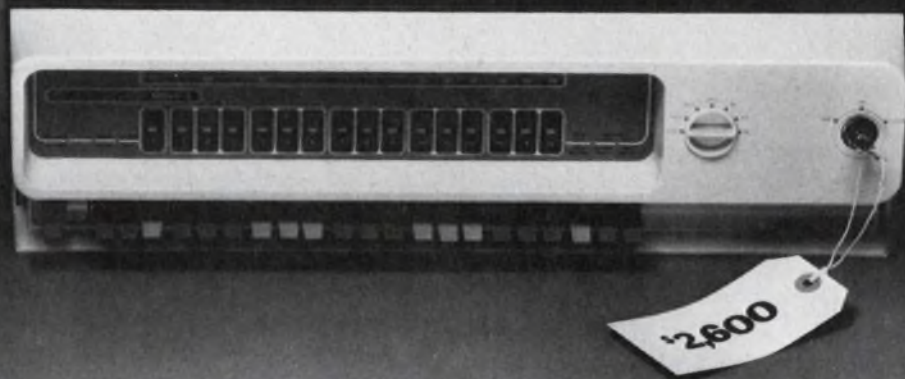

Has your \$500 micro ended up costing more than our \$2,600 mini?

If you've had to spend a lot of money on a low priced micro, you may be in a position to appreciate the cost advantages of a higher priced computer.

Our \$2600 Nova 3.*

When you buy a Nova 3, you don't have to put as much into it to get it to do your job.

You don't have to create your own operating systems. Nova 3 is software compatible with our other Novas. So you get to use all the existing Nova operating systems, language processors and utilities.

And you don't have to worry about performance. Nova 3 executes instructions in 700 nanoseconds using MOS memory. And its sophisticated architecture lets you use up to 128K Words with the optional Memory Management Unit.

You don't have to buy more

computer than you need. Nova 3 has the broadest range of compatible configurations you can get in an OEM minicomputer line. There's a 4 slot Nova 3. A 12 slot Nova 3. (It has an optional expansion chassis that gives you 12 more slots of I/O.) And you can configure multiple processor Nova 3 systems.

You don't have to worry about Nova 3 availability. We're manufacturing virtually every part of the Nova 3. Including the silicon gate N-channel MOS RAM memories. (They're coming from our Sunnyvale, California facility.)

And you don't have to go it alone. Because when you buy a Nova 3, you can get all the support Data General offers an OEM.

Write or call for the Nova 3 brochure. It may persuade you to buy more and spend less. *\$2600 is the single unit price for a 4K MOS memory Nova 3. Before the OEM and quantity discounts get figured in.

DataGeneral

Nova 3: The biggest thing to ever hit the OEM market.

MICROPROCESSOR DESIGN

(continued from page 48)

advocated in a field called structured programming, or software engineering. A language like Fortran is so full of detail, you can't separate the big decisions from the semicolons and the dashes.

By **PAUL ROSENFELD**
Software Product Manager
Intel

High-level languages will dominate over assembly languages because they reduce programming costs, make software more reliable and simplify program documentation and maintenance. An assembly language requires a programmer to make numerous decisions on detail, such as the use of registers and memory, and when to save data in registers. It also requires him to write the basic program steps.

A high-level language like PL/M solves these problems but at the cost of a somewhat higher memory cost. However, memory costs are dropping while programming costs are rising. The tradeoff already favors high-level language in many cases, and in the future the extra memory will be an insignificant part of total programming costs in most cases.

PL/M has been used effectively for 2-1/2 years. It has resulted in an average reduction of 5:1 in programming costs. Also, the language has been continuously improved. A typical program using the current PL/M version requires 30 to 50% less code than one using the very first PL/M. And the amount of program-storage space available for large applications programs has been increased from 16-k to 65-k words. Intel has committed itself to further development of PL/M for future microprocessors.

It's simply not true, as some believe, that PL/M is too oriented to the 8080. PL/M consists of two parts: a so-called kernel of basic control structures that is machine-independent and another part that does depend on the



machine. The latter is added to the kernel to specialize it to different μ Ps. To date, the second part has been developed for the 8008 and 8080. Specializing functions for μ Ps with entirely different architectures will be added, as needed, to the PL/M kernel.

Also, 8 and 16-bit processing are integral parts of the PL/M language. This capability includes both arithmetic functions and logic operations. Floating point could be added, but there is no need to. Instead a simple Call can be used to link the high-level program to any of several floating-point routines available in the Intel users' library. Double-precision operations are implemented with the 16-bit capability. Multiple-precision operations can be handled with Calls to subroutines available in the users' library or specially written subroutines in assembly language.

As programmers become familiar with PL/M, they can develop shortcuts that can often reduce subroutine length by as much as 2/3 or more. If they're careful and use the most efficient means, they can come up with a PL/M program that is almost as compact as one in assembly language.

Study predicts sixfold surge in μ P use by 1980

The U.S. microprocessor market is expected to increase sixfold between 1974 and 1980, according to a study by Gnostic Concepts, a market-research organization (2710 Sand Hill Rd., Menlo Park, CA 94025. 415-854-4672). The annual dollar value of μ P chips used in U.S. produced equipment will move from \$13.5-million, or 400,000 circuits, this year to \$83.5-million, or 5.2 million circuits by 1980, Gnostic Concepts says.

These figures don't include the additional support circuitry, memory and peripheral

(continued on page 52)

New socket cards for microprocessors.

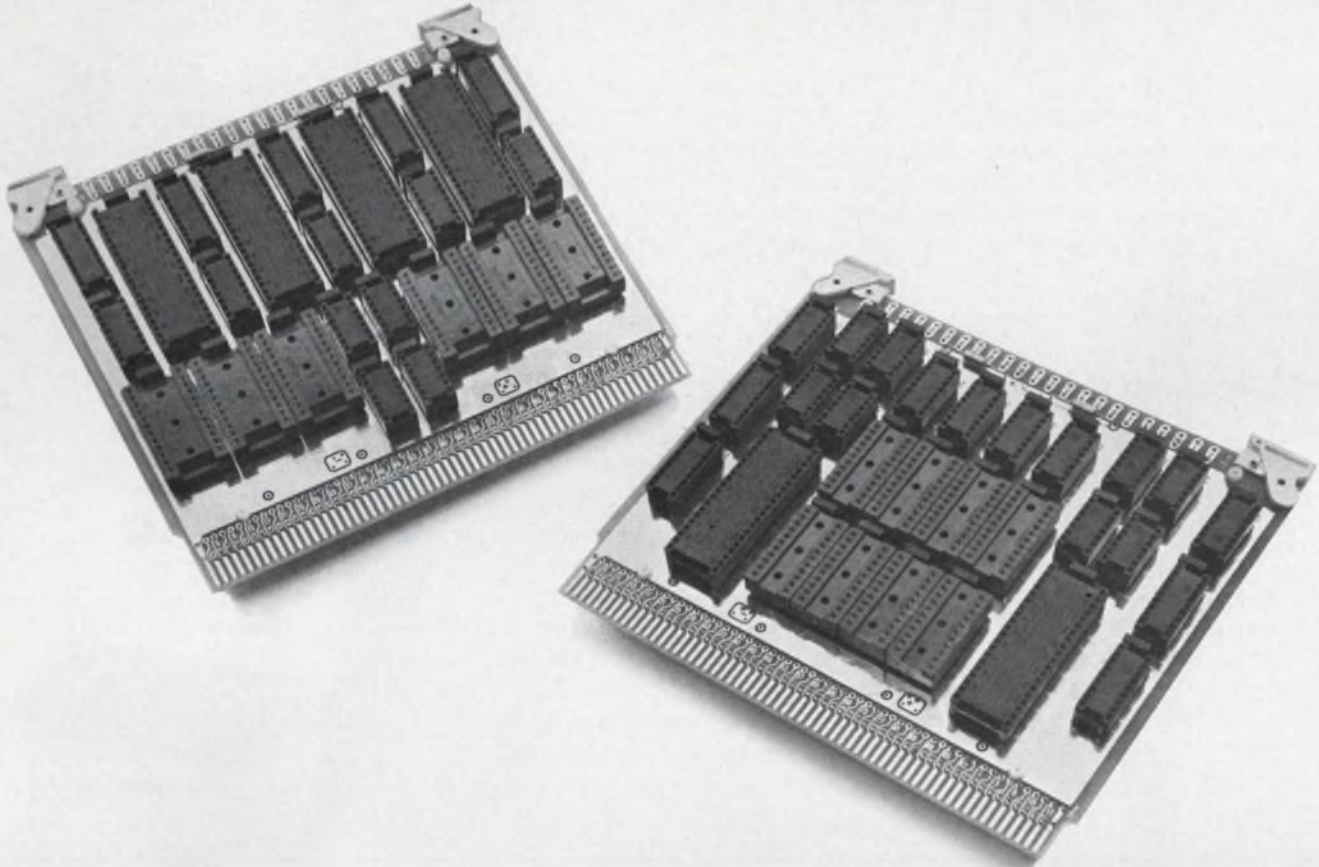

Instantly available, these two new cards are your answer to second-source problems. They enable you to change ICs and wiring for new pin patterns with great ease.

They are designed specifically for microprocessor applications, including controllers, random access memories, and erasable programmable memories. As such they are the newest in our line of 3D socket cards:

3D2017 Four 40-pin sockets, six 24-pin sockets, five 18-pin sockets, five 16-pin sockets, and four 14-pin sockets. \$124.70.

3D2018 Two 40-pin sockets, eight 22-pin sockets, four 18-pin sockets, six 16-pin sockets, and eight 14-pin sockets. \$140.70.

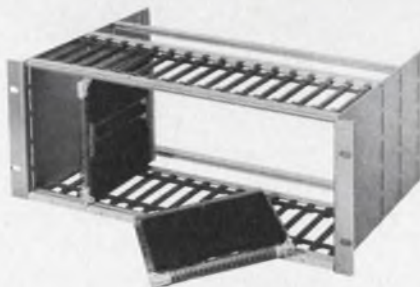

In addition, both cards provide a good ground plane for high-speed operation. They include a ceramic monolithic bypass capacitor at every socket, and provision for bypassing other voltages that may be required for chips. Power can be connected to various pins on LSI chips by means of solder tabs. And each card includes 22 built-in test points.

These cards are complemented by our line of Card-Pak card files, and our automated wiring service.

We're ready for you right now. And so is our nationwide distributor, G. S. Marshall. So call either of us today. Or, tear out this page and keep it handy until you are ready for us.

EECO
FOR PACKAGING

1441 East Chestnut Avenue, Santa Ana, California 92701
Phone 714/835-6000

INFORMATION RETRIEVAL NUMBER 29

(continued from page 50)

gear needed to form complete, stand-alone microcomputers. When these extras are included, dollar values increase eightfold, the researchers say, bringing the 1980 microcomputer market to well over \$650-million.

Other findings of the study show an average μ P-chip price drop from the present \$31.19 to \$15.99 in five years. The study also says most microprocessors will have cycle times of 1-to-3 μ s by 1980.

Furthermore, it adds, 4-bit μ Ps will dominate in business and consumer applications, whereas 8-bit units will prevail in communications, computer, industrial and instrumentation applications. On the other hand, Gnostic Concepts predicts, 12-bit μ Ps will amount to only a small percentage in all equipment sectors. But 16-bit microprocessors will pervade computer and government applications.

These and other findings are contained in the report "Digital Integrated Circuits."

Bench-top microprocessor tester does μ P comparisons

A compact, bench-top microprocessor and software development system is offered by Micro Control Co. (1601 37th Ave. N.E., Minneapolis, MN 55421. 612-781-2612). The unit, designated the MPU-1, can compare the chip under test with a standard microprocessor chip. The test uses worst-case voltages and timing, including both fast and slow rep rates.

The system adapts to most μ P chips and has complete panel controls for entering and displaying data, plus STEP mode for manually stepping through programs. The bench-top tester, complete with test programs and TTY software loader, costs \$8500.

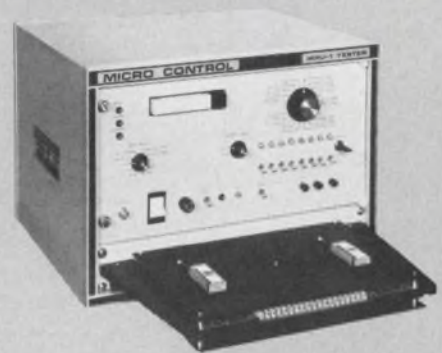

CIRCLE NO. 540

Bipolar processors advance to complete CPUs

No longer are bipolar μ Ps just processor slices. The SMS 300 from Scientific Micro Systems (520 Clyde Ave., Mountain View, CA 94043. 415-964-5700) has emerged as the first available bipolar CPU chip, complete with fixed instruction set. Thus application programs for the SMS 300—unlike those for bipolar bit-slice units—can be developed without recourse to microprogramming techniques.

The 8-bit Schottky-TTL microprocessor executes complete instructions (including fetch, decode and execute operations) within 300 ns. Packaged in a 48-pin DIP, the chip contains eight scratch-pad registers, in addition to an arithmetic-logic unit. All inputs and outputs interface directly with other TTL circuits.

Actually Scientific Micro Systems has offered the SMS 300 (also called the Interpreter) since last January. But, the chip was part of the company's Microcontroller system. Now the Corning subsidiary has unbundled the Microcontroller, making the system available as components and modules, and in kit form.

A starter kit priced at \$495 includes one SMS 300 Interpreter, six SMS 82S115 512 \times 8-bit PROMs, and four SMS 360 input/output components called Interface Vector bytes. The latter are 8-bit I/O registers, one with three-state outputs and the other with open-collector input. Each interface circuit is housed in a 24-pin package.



CIRCLE NO. 541

World Leader in Ceramic Capacitors

NAME **3** PRODUCERS OF HIGH VOLTAGE CERAMIC CAPACITORS

If you name ERIE first, you're right on target. For we produce a full line of quality High Voltage Ceramic Capacitors . . . 3kV to more than 30kV . . . in the capacitance value and temperature characteristic to suit your circuit needs. We have all sizes and shapes with the terminal arrangement you want. In fact, you name the application . . . chances are ERIE has a standard unit available. If not, let's talk about it.

You'll find ERIE HV Capacitors in electric utility transformers. Miniature power supplies. CRT displays. Lasers. Lightning arrestors. TV power supplies. Image intensifiers for night vision apparatus. Just about any application where high voltage is involved.

So look to ERIE first. When it comes to High Voltage Ceramic Capacitors, ERIE continues to lead the way. Your letterhead request will get you our new catalog HV/SC-200 . . . or call Customer Engineering at our State College, Pa. plant — 814/237-1431.

ERIE TECHNOLOGICAL PRODUCTS, INC.
Erie, Pennsylvania 16512



INFORMATION RETRIEVAL NUMBER 30

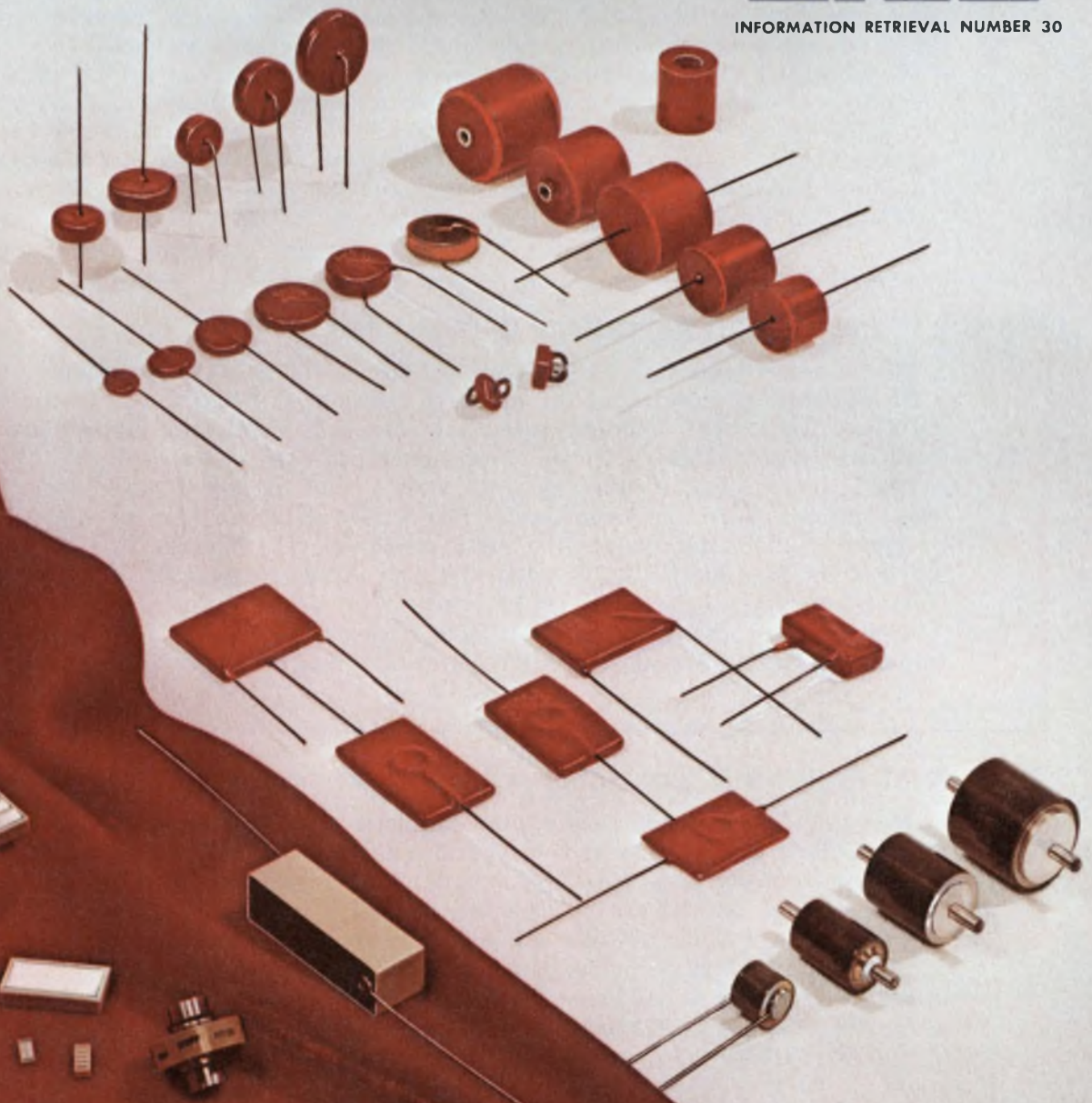

μ C system extends capabilities of industrial controllers

Features often associated with minicomputers combine with the ease-of-use of other programmable controllers in the Eptak industrial control system from Eagle Signal (736 Federal St., Davenport, IA 52803. 319-326-8113). Based on the 8080 μ P, Eptak offers a lower-priced alternative to most minis for applications ranging from the control of a single machine to the supervision of a complex process.

The Eptak family consists of a programmable logic controller, process controller and a dedicated machine controller. The first is available now, while the latter two models will be next year. Basic system components for each member of the modular family include a central processor, I/O unit and programming equipment.

The new family performs arithmetic computations, provides analog interfaces (a/d input, d/a output and thermocouple) and allows the use of three types of memory: semiconductor RAM, UV-erasable PROM and core. Furthermore units can interface with a complete line of peripherals, including computers, video terminals and printers.

And they permit the use of four different languages for the development of application programs. The four consist of high-level and assembly languages, a control language based on solid-state logic expressions and a relay-diagram language.

Costs depend on the configuration selected. For example, a unit price of \$6500 (in quantities of 10 or fewer) covers the following: central processor and power supply with 80 120-V inputs, 40 120-V outputs and standard 500-ft remote I/O; eight 4-to-20-mA analog inputs; 64 internal timer or counter functions in any mix; 12 256-step shift registers; add, subtract and compare functions; and 2048 words of RAM or UV-PROM memory. The price includes a 20-h internal battery backup supply.



CIRCLE NO. 542

CMOS μ P and support get official part numbers

RCA Corp. (Route 202, Somerville, NJ 08876. 201-722-3200) has officially announced its CDP1800 microprocessor family (formerly known as COSMAC). The family includes the CDP1801 CMOS 8-bit microprocessor, the "Microkit" hardware support kit, microprocessor manuals and software development packages.

The CDP1801 architecture permits simple, fast, mostly 1-byte instructions, all executed in a single instruction cycle. The sixteen 16-bit registers on-chip can be used as program counters, data pointers or for data storage. The Microkit is a hardware support kit that contains the CPU, 1-k word of RAM, 512 words of ROM, space for additional memory and user-designed interface cards.

The CDP1800 family is now available from stock, with the CDP1801 full-voltage (15 V) chips available at \$56 and the CDP1801C 5-V chips at \$40, both in quantities of 1 to 99.

CIRCLE NO. 543

Cut cost of floppy-disc controller with μ P I/O circuit

Rockwell International Corp. (3310 Miraloma Ave., P.O. Box 3669, Anaheim, CA 92803. 714-632-1650) has introduced a floppy-disc controller I/O circuit as part of its PPS-8 microprocessor system. With the circuit, the firm estimates costs of IBM-compatible disc controllers can be cut by as much as 80%.

Rockwell says that IBM-compatible floppy-disc control systems made with Rockwell components now can be manufactured for about \$200 each in lots of 1000, compared with \$1000 or more for other controllers in similar quantities. The floppy-disc controller chip, No. 10936, costs \$125 each in 1 to 24 quantities and drops to \$80 in 100 to 199. The circuit is available from stock.

CIRCLE NO. 544



**When Price Is Part Of
Your Wire Terminal
Problem, Malco's
Terminal Specialists
Have Everything In
Terminals And Splices
To Make Ends Meet.**

We have tabs, blades, bullets, bayonets, rings, spades, hooks, bullet receptacles and every other kind of standard configuration. You can order them in strip for use with Malco automatic machines. They're also available loose and pre-insulated. At Malco we really are terminal specialists. Our total Franklin Park facility is devoted to the production of terminals, splices and printed circuit terminals and our engineering know-how gives us the capability to furnish you with a completely automatic, rapid-fire system that turns out crimped and printed circuit terminals at a rate that's bound to cut your in-house production costs. All at a price to help make ends meet. Let's get together. Write Malco, 12 Progress Drive, Montgomeryville, Pennsylvania 18936 or call . . . (215) 628-9800.



MALCO
A Microdot Company
Helping industry put things together.™



IBM's new 5100 Portable Computer

A compact problem-solving aid for engineers,
statisticians, scientists and financial and business analysts.

Now you can have a computer right on your desk. Exactly where you need it. When you need it.

The new IBM 5100 Portable Computer incorporates the latest in semi-conductor technology. It features a typewriter-like keyboard and numeric key-pad for simplified data entry, a 1024 character display screen, an integrated magnetic tape drive, and 16K characters of memory.

Options available with the 5100 include a bi-directional 80-characters per second printer, a second magnetic tape drive, and additional memory up to a maximum of 64K characters. Also available is a communications feature which allows the 5100 to be used as a terminal.

The IBM 5100 comes with either APL or BASIC language or both.

Over 100 often-used analytical routines in mathematical, statistical and financial calculations are available for such functions as forecasting, modeling, matrix arithmetic, engineering and design calculations, regression and correlation analysis, return on investment and cash flow analysis.

In addition, the 5100 features a self-study training package that makes it easy to learn and easy to use without taking any classes or relying on specially trained experts.

If you'd like to find out more about IBM's new 5100 Portable Computer and arrange for a demonstration right at your desk, call your IBM General Systems Division office or fill out this coupon.

IBM	IBM General Systems Division P.O. Box 2068, Atlanta, Georgia 30301	ED
<input type="checkbox"/> I would like more information about IBM's new 5100.		
<input type="checkbox"/> I would like a demonstration of IBM's new 5100.		
My major area of interest is:		
<input type="checkbox"/> Engineering/Scientific <input type="checkbox"/> Statistical Analysis		
<input type="checkbox"/> Business/Financial Analysis		
Name _____		
Title _____		
Company _____		
Address _____		
City _____ State _____ Zip _____		
Phone _____		

HiNIL Interface

Prevent CMOS latch-ups and failures with a high noise immunity logic I/O.

CMOS systems are subject to latch-ups and failures in the field because of high voltage transients, static charge and improper field maintenance procedures. Moreover, due to their increased output impedance, CMOS is more susceptible to transient errors than corresponding bipolar logic.

A simple solution to these problems is to use Teledyne's bipolar High Noise Immunity Logic (HiNIL) as the system I/O interface. The I/O design approach shown in Figure 1 has solved these problems in applications such as business equipment, industrial controls and electronic games. The HiNIL interfaces protect the delicate CMOS inputs with a rugged bipolar "front end" not susceptible to CMOS failure modes. Also system noise immunity is maximized, and the HiNIL output devices provide direct, high current logic drive of relays, displays and long lines.

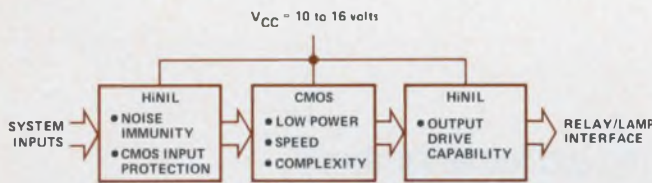

Figure 1. HiNIL input interface protects CMOS inputs while HiNIL outputs directly drive long lines and peripheral devices

The two families are directly compatible at the 10 to 16 volts V_{CC} range. The designer can take full advantage both of HiNIL's capabilities and of CMOS' low power dissipation, supply voltage flexibility and improved noise margin at higher supply voltages.

Parasitic SCR latch-up is an all too common CMOS malfunction. Large noise transients and DC input levels below ground or above V_{CC} could force CMOS input diodes into forward conduction, causing SCR action in the four-layer diodes formed by the diode and parasitic p-n substrate junctions. This condition leads to device latch-up, increased I_{CC} current and, when current is not limited, to gate destruction. Maximum protection can be obtained by using

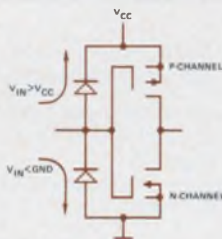

Figure 2A. CMOS latch-up causes

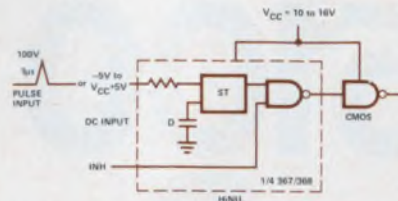

Figure 2B. HiNIL input protection

HiNIL Schmitt triggers. They prevent latch-up at DC input levels from -5 volts to $V_{CC} + 5$ volts and suppress 100 volts transients as wide as $1\mu\text{sec}$ (Figure 2).

HiNIL inputs on plug-in cards will protect a CMOS system from problems associated with "on power" fault isolation, a widely used TTL system maintenance method. Plugging CMOS into powered connectors has led to latch-up failures because it allows inputs to see logic "1" signals before V_{CC} rises on the card. The failure is frequently catastrophic if input current is not limited.

HiNIL's lower output impedance and DC noise margin of 3.5 volts ignore large voltage noise transients that can cause CMOS logic errors. Also, static charges large enough to rupture CMOS oxide regions are often generated in dry environments by movement of materials and users. A HiNIL input gives more immunity to static and maximizes noise protection.

Examples of HiNIL Interface Devices

301 Dual 5-Input Power Gate	65mA relay or lamp driver
302 Quad Power NAND Gate (OC)	
323 Quad NAND Gate (OC)	Input noise protection plus open-collector pullup to other logic levels
332 Hex Inverter (OC)	
334 Strobed Hex Inverter (OC)	
350 8-Bit Multiplexer	Drive longer lines than TTL with 10X noise immunity ($I_{OH} = 12\text{mA}$)
351 Dual 4-Bit Multiplexer	
361 Dual Input Interface	361 directly connects HiNIL to DTL/RTL/TTL
362 Dual Output Interface	362 and 363 connect DTL/RTL/TTL to HiNIL
363 Quad Output Interface	
367 Quad Schmitt Trigger	Suppress 100V/1 μs spikes, protect CMOS
368 Quad Schmitt Trigger (OC)	decode switches, etc
380 BCD to Decade Decoder	
381 BCD to Decade Decoder (OC)	Provide decode/drive for lamps LEDs, gas discharge displays, etc
382 BCD to Decade Decoder	
383 BCD to 7-Segment Decoder	
390 Interface Buffer Series	250mA HiNIL driver series will be available soon

HiNIL reliability insurance costs little since the I/O circuits—unlike filters and shielding—generally replace other logic and drive circuits. So, don't wait until your new CMOS system runs into costly problems in the field. We'll show you how to build foolproof low-power systems. Call or write today for HiNIL application notes and specifications.

TELEDYNE SEMICONDUCTOR

1300 Terra Bella Avenue, Mountain View, California 94043 Tel: (415) 968-9241 TWX: 910-379-6494 Telex: 34-8416

ENGLAND: Heathrow House, Cranford, Hounslow, Middlesex, Tel: (44) 01-897-2503 Telex: 851-935008

WEST GERMANY: Albert Gebhardtstrasse 32, 7897 Tiengen, Tel: 7741-5066 Telex: 841-792-1462

JAPAN: Nihon Seimei-Akasaka Bldg (3F), 1-19, Akasaka 8-chome, Minato-ku, Tokyo 107, Tel: 03-405-5738 TWX: 781-2424241

Additional offices in West Germany, Hong Kong and the United States. Representatives and distributors worldwide.

Wanted: S.O.B.s

I was having a beer the other day with Jack, the press liaison man for a leading semiconductor house. "Your guy, Ted," he said (but I just changed the name because it could have been any of our editors), "visited us the other day and really roughed up some of our executives.

"Sure he asked all the questions they expected but then he started sneaking in those tough questions they didn't want to answer. He asked about characteristics we didn't measure. He asked us to define 'typical.' He asked us exactly how we measured some parameters that no two manufacturers seem to measure the same way. He was loaded with unkind questions.

"When we described some of our products with some of the exaggeration that's common in our business, he sort of smiled a bit as if he appreciated the humor. He had us all laughing at his jokes—even the bad ones—but he made us squirm a bit when he was digging for technical information. When we later saw his article, we could tell that we weren't the only ones he had grilled. Later, our chief engineer said to me: 'That fellow's a nice guy but he's a tough S.O.B.'"

When I heard Jack's story, I must confess, I glowed. Editors are supposed to know the industry they serve and they're supposed to be able to separate truth from hyperbole. But they can't know every technology as well as can the experts in that technology. So they've got to learn to ask lots of very sharp questions. They've got to develop finely honed ears so they can distinguish fact from the stuff that comes from the end of a horse that doesn't eat. When an editor develops that facility, some people, with admiration and respect, will call him an S.O.B.

Electronic Design can use some more S.O.B.s like Ted. We need one in San Francisco's Bay Area (in the heart of Silicon Valley) and another in our home office in New Jersey. If you're interested, or know somebody who might be, let us know. And if you're a nice guy (or gal) don't worry, we can train you.



A handwritten signature in dark ink that reads "George Rostky". The signature is fluid and cursive, written in a professional style.

GEORGE ROSTKY
Editor-in-Chief

**INTRODUCING
THE EC SERIES
-A NEW LINE OF**

**STOCK DELIVERY
2 YEAR GUARANTEE
18 WORLD-WIDE SERVICE CENTERS**

The EC series is ACDC's new line of power supplies designed for OEM applications. No bells and whistles, no fancy frills or extras. Just solid, reliable power supplies designed and built by ACDC Electronics . . . a name synonymous with quality.

The EC series is mechanically and electrically interchangeable in form, fit and function with other open frame power supplies that meet accepted industry standard. There are over 50 models to choose from in a wide range of voltages and currents so you can order the exact power supply for your application. Power supplies with a maximum of reliability at minimum cost.

LOW COST POWER SUPPLIES

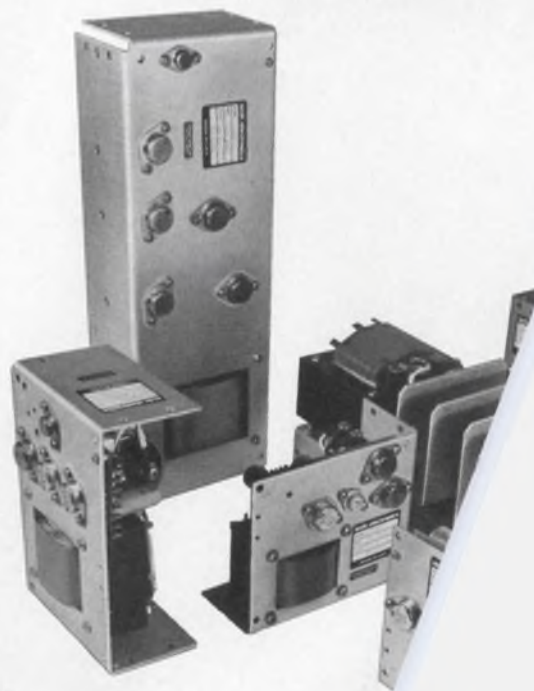

ACDC POWER SUPPLIES

SINGLE OUTPUT POWER SUPPLIES

Nominal Output Voltage	Max. Current (amps)	Model Number	Price		
			1	100	250
2 V.	3.0	EC2N3	\$ 31.00	\$ 24.95	\$ 22.95
	6.0	EC2N6	51.00	41.50	39.00
	9.5	EC2N9.5	63.00	51.00	48.50
	12.0	EC2N12	80.00	65.50	62.00
	17.0	EC2N17	101.00	82.00	78.00
	25.0	EC2N25	137.00	112.00	106.00
5 V.	3.0	EC5N3	31.00	24.95	22.95
	6.0	EC5N6	51.00	41.50	39.00
	9.5	EC5N9.5	63.00	51.00	48.50
	12.0	EC5N12	80.00	65.50	62.00
	17.0	EC5N17	101.00	82.00	78.00
	25.0	EC5N25	137.00	112.00	106.00
6 V.	2.6	EC6N2.6	31.00	24.95	22.95
	5.4	EC6N5.4	51.00	41.50	39.00
	8.5	EC6N8.5	63.00	51.00	48.50
	11.0	EC6N11	80.00	65.50	62.00
	15.0	EC6N15	101.00	82.00	78.00
	23.0	EC6N23	137.00	112.00	106.00
12 V.	2.2	EC12N2.2	31.00	24.95	22.95
	3.5	EC12N3.5	51.00	41.50	39.00
	6.0	EC12N6	63.00	51.00	48.50
	7.5	EC12N7.5	80.00	65.50	62.00
	11.0	EC12N10	101.00	82.00	78.00
	16.0	EC12N16	137.00	112.00	106.00
15 V.	1.8	EC15N1.8	31.00	24.95	22.95
	3.0	EC15N3	51.00	41.50	39.00
	5.0	EC15N5	63.00	51.00	48.50
	6.5	EC15N6.5	80.00	65.50	62.00
	9.5	EC15N9.5	101.00	82.00	78.00
	14.0	EC15N14	137.00	112.00	106.00
20 V.	1.5	EC20N1.5	31.00	24.95	22.95
	2.5	EC20N2.5	51.00	41.50	39.00
	4.2	EC20N4.2	63.00	51.00	48.50
	5.3	EC20N5.3	80.00	65.50	62.00
	8.0	EC20N8	101.00	82.00	78.00
	11.0	EC20N11	137.00	112.00	106.00

Nominal Output Voltage	Max. Current (amps)	Model Number	Price		
			1	100	250
24 V.	1.3	EC24N1.3	31.00	24.95	22.95
	2.4	EC24N2.4	51.00	41.50	39.00
	4.0	EC24N4	63.00	51.00	48.50
	5.0	EC24N5	80.00	65.50	62.00
	7.5	EC24N7.5	101.00	82.00	78.00
	10.0	EC24N10	137.00	112.00	106.00

DUAL OUTPUT POWER SUPPLIES

Nominal Output Voltage	Max. Current (amps)	Model Number	Price		
			1	100	250
±12/15	0.5	EC12D0.5	\$ 45.00	\$ 38.00	\$ 35.00
±12/15	1.5	EC12D1.5	69.00	57.00	53.00
±12	3.0	EC12D3	89.00	72.00	67.00
±15	3.0	EC15D3	89.00	72.00	67.00
±12	5.0	EC12D5	122.00	99.00	92.00
±15	5.0	EC15D5	122.00	99.00	92.00

TRIPLE OUTPUT POWER SUPPLIES

Nominal Output Voltage	Max. Current (amps)	Model Number	Price		
			1	100	250
5V	6.0	ET401	\$113.00	\$ 92.00	\$ 85.00
±12/15	1.0				
5V	12	ET601	165.00	135.00	125.00
±12	3				
5V	12	ET602	165.00	135.00	125.00
±15	3				

OVERVOLTAGE PROTECTION OPTION

Rated output current of power supply	Price		
	1	100	250
0 to 12 Amps	\$ 8.00	\$ 7.50	\$ 6.50
12 to 25 Amps	12.00	10.50	10.00

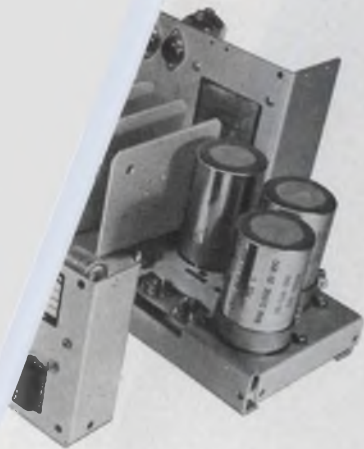

acdc electronics

ACDC Electronics, 401 Jones Road, Oceanside, CA 92054 • West Coast (714) 757-1880; East Coast (201) 687-6633

ELECTRONIC DESIGN 25, December 6, 1975

INFORMATION RETRIEVAL NUMBER 35

FOCUS

on
Printed
circuits

Don't be too discouraged if a printed-circuit manufacturer says your job can't be done. What one PC vendor feels is impossible or impractical to achieve, another vendor may consider routine.

Your design may not be all that unusual. Circuit designers continually press the state of the art and many, but not all, board manufacturers find ways of meeting these demands.

Morris Grossman
Associate Editor

It's wise to remember that though PC technology is based upon a large body of common knowledge, every vendor has his own proprietary touches. Thus you should check several PC sources before you conclude that your design requirements can't be met or that there is only one, expensive, way to do the job.

However, be sure that the vendors know exactly what you want. To avoid misunderstandings,



Additive processing for PC boards has the potential of becoming the most economical method, according to

Photocircuits Div. of Kollmorgan Corp. High definition patterns are made without the use of resists.

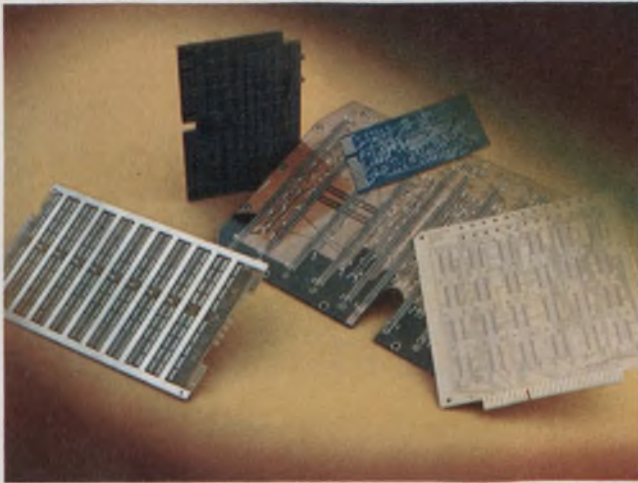

Multilayer boards and plated-through holes are now routinely made, as illustrated by these TRW/Cinch Graphic boards.

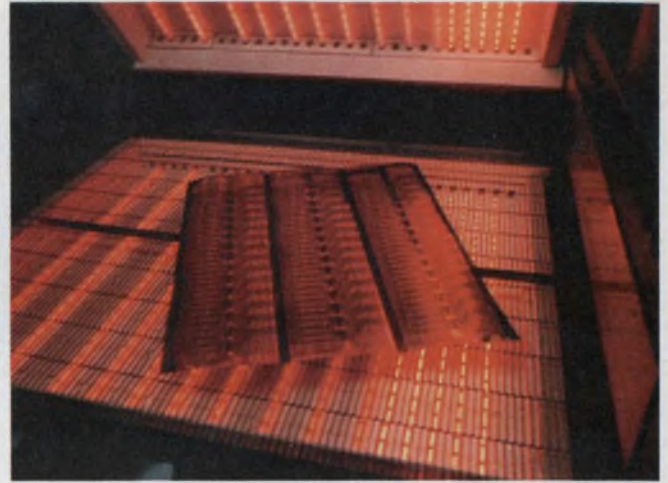

A reflow solder machine at Buckbee-Mears Co. ensures dependable reflow and wicking when component pins are connected to solder pads.

you must give the vendor drawings and specs that are free of contradictions or errors and that contain all the essential information. Some of the common problem areas are these:

- Outdated and superfluous specs.
- Defective artwork—poor registration, pad tolerances not maintained.
- Contradictory hole-location data.
- Excessive number of different hole sizes.
- Mixing plated-through with nonplated-through holes.
- Inadequate base-material description and unclear copper-weight specs.

PC technology has been around a long time. It's a mature industry. But that's no reason why the PC specs must be ossified. Specifications need to be continually examined and rewritten. Far too many that originated many years ago still contain requirements intended for vacuum tubes and high voltages. When the specs are outdated, costs may climb.

Artwork often at fault

How about poorly executed artwork? A common problem is that pads, which locate clusters of fixed mounting pins—such as for IC packages, transformers or relays—have been sloppily positioned. If a PC vendor drills through the pad center holes and ignores a dimensioned drawing of the part, the part may not fit. But drilling in accordance with the dimensioned drawing may result in broken-out lands on the pads. Solution: Be precise.

A companion problem occurs when the PC holes must be located by X-Y coordinates to allow for drilling with numerically controlled (NC) machines.

Most PC vendors are set up to locate holes from the artwork, since this approach ensures

placement of the hole in the center of the pads and also because most commercial PC drawing sets require this approach. Thus if your needs call for the X-Y coordinate approach, check first to see if the vendor is equipped to handle NC work economically, and then make doubly sure your artwork conforms to the hole-location dimensions.

Another complaint frequently reported by PC vendors is that the artwork registration between the component and soldering sides of double-



The advantages of additive PC processing include no copper undercutting and more efficient copper use.



Numerically controlled drills at the Bureau of Engraving, Inc., handle panel sizes to 25 × 25 in. Taped data

automatically direct multipindle machines to accurately drill PC-board hole patterns.

sided boards is not adequately maintained. Misaligned pads break out when drilled through.

Don't specify many different hole sizes for your board. Each size needs a drill change; that takes time, costs money and may produce errors. Usually the number of hole sizes is more important from the standpoint of cost than the total number of holes drilled in the average board.

And don't specify both plated-through and nonplated-through holes on the same board. The double handling is costly. If some of the holes must be plated through, plate all of them. Understandably there are exceptions to this rule, such as when several large holes are needed for routing purposes or where components shouldn't be soldered into a hole.

Of course, the board base material should be thoroughly and unambiguously described. Identify the material by industrywide designations. If a specific laminator's part number is given, provide equivalent designations as well. Provide material thickness, any applicable military specs and the final board copper thickness or weight.

Copper weight specs are a common source of ambiguity when plated-through holes are used. The plating operation adds thickness to the copper on all parts of the board, and it's not always clear whether the spec refers to the final or initial copper thickness. Suppose you want a final weight of 2 oz/ft². From the PC vendor's point of view, it's better to start with a thinner copper layer—say, 1-oz of copper—and let the plating operation put on the additional ounce. But in any event, specify the final weight.

Which laminate?

The first decision the design engineer faces when specifying a PC board is: "What shall I use for laminate base material?" The more de-

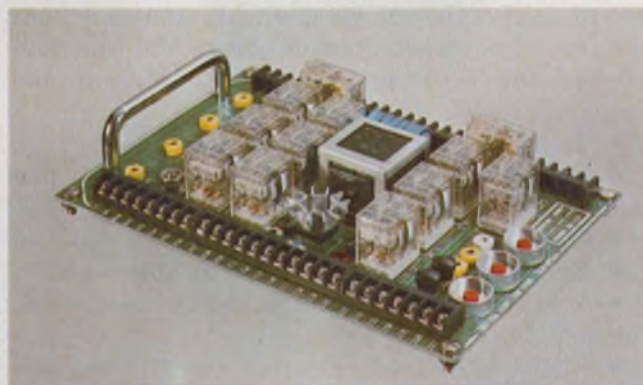

Many PC vendors provide a complete service. Like Dattilo Enterprises, they do everything from artwork to board assembly, and test to customer specs.

manding the environment for the PC board, the more restricted the choice. Note the classification of NEMA-grade laminates against temperature in the table of substrate materials. Above 310 F, only G-7 and G-11 are permissible. The choice of permitted materials rapidly increases at lower temperatures.

Paper phenolic base material is the lowest cost and most widely used, but glass epoxy, though considerably more expensive, is the type most often specified by the military and for demanding environments. Glass epoxies can cost three to five times as much as paper-phenolic grades.

In addition glass epoxy has a disadvantage: Carbide-steel tools must be used to cut or drill the material in production work. Holes punched in glass epoxy leave crazed edges, so glass boards are generally drilled, especially when the holes are to be plated-through. And drilling is a more expensive operation than punching.

Nevertheless, for dimensional stability and strength, glass epoxy is the usual choice. For many years, continuous-filament G-10 was the

Substrate temperature characteristics

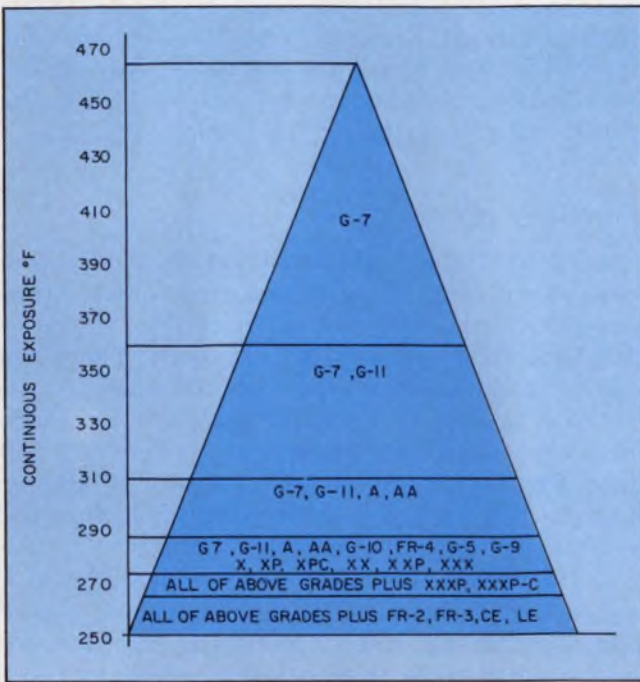

From Institute of Printed Circuits—Printed Wiring Design Guide.

most widely used glass epoxy, but it is being replaced by flame-retardant FR-4.

Between the cheapest and most expensive materials there are gradual variations of electrical, mechanical and chemical properties to fit almost any need. For example paper-phenolic grades XXXP and XXXPC differ mainly in insulation resistance and cold-punching characteristics. Another paper phenolic, FR-2, is similar in properties to XXXPC and also flame-retardant. The paper-epoxy FR-3 is flame-retardant and has higher flexural strength than XXPC, but it is nearly double the cost.

Putting more in less space

Circuit design engineers are forever pressuring PC manufacturers to squeeze more components onto the boards. But modern parts are no longer restricted to simple two-terminal resistors, capacitors and inductors. Most are multiterminal packages with many closely spaced connections (see layouts for DIP and T-100 can), and this makes it tough to squeeze the required interconnections onto the board.

Part of the solution is closer spacing and narrower conductor paths. But closely spaced conduction paths present reliability hazards and reduce production yields. Specks of dust in a resist coating can cause fine lines to be etched with interrupts or short-circuits. Correcting or avoiding such defects can be expensive especially on large, complex boards. Further, the defective

PC substrate materials

NEMA grade	Base material	Resin	Military	
			Specification	Type
X XP XPC	Paper Paper Paper	Phenolic Phenolic Phenolic	MIL-P-79 MIL-P-78 —	PBM HSP —
XX XXP XXX	Paper Paper Paper	Phenolic Phenolic Phenolic	MIL-P-3115 MIL-P-3115 MIL-P-3115	PBG PBE-P PBE
XXXP XXXPC	Paper Paper	Phenolic Phenolic	MIL-P-3115 MIL-P-3115	PBE-P PBE-P
CE LE	Cotton Cotton	Phenolic Phenolic	MIL-P-15035 MIL-P-15035	FBG FBE
A AA	Asb. paper Asb. fabric	Phenolic Phenolic	MIL-P-8059 MIL-P-8059	PBA FBA
G-2 G-5	Staple glass Cont. glass	Phenolic Melamine	— MIL-P-15037	— GMG
G-7 G-9 G-10	Cont. glass Cont. glass Cont. glass	Silicone Melamine Epoxy	MIL-P-997 MIL-P-15037 MIL-P-18177	GSG GME GEE
G-11 N-1	Cont. glass Nylon	Epoxy Phenolic	MIL-P-18177 MIL-P-15047	GEB NPG
FR-2 FR-3 FR-4 FR-5 GPO-1	Paper Paper Cont. glass Cont. glass Glass mat	Phenolic Epoxy Epoxy Epoxy Polyester	MIL-P-3115 MIL-P-3115 MIL-P-18177 — —	PBE-P PEE GEE — —

From Institute of Printed Circuits—Printed Wiring Design Guide.

board might pass unnoticed to the final assembly stage and lead to difficult-to-detect problems.

Of course, double-sided and multilayer boards allow higher component densities than do single-sided boards, but the board price increases faster than the density. Not only does the layout and fabrication of double-sided and multilayer boards cost more, but more costly laminate material must be used to provide the required dimensional stability.

And a choice must be made between using plated-through and eyelet connections through the boards with double-sided and multilayer boards. Many manufacturers claim plated-through holes to be more reliable, less expensive and to facilitate wave solderings.

Another choice the engineer must make is between a few large boards or many small ones. In spite of compelling arguments for small boards—low-cost, throw-away packaging, modularity, easy fault isolation—PC experts, such as those at Lockheed Electronics Co., Los Angeles, report that the trend is to large boards.

Smaller boards need more connectors, wiring and cables. And systems built with small boards generally occupy more space, weigh more and leave less room on the board for such conveniences as built-in card extractors.

Fortunately the choices need no longer be influenced by the manufacturing problems of the recent past. PC manufacturers say there no long-

Typical line spacing on PC boards

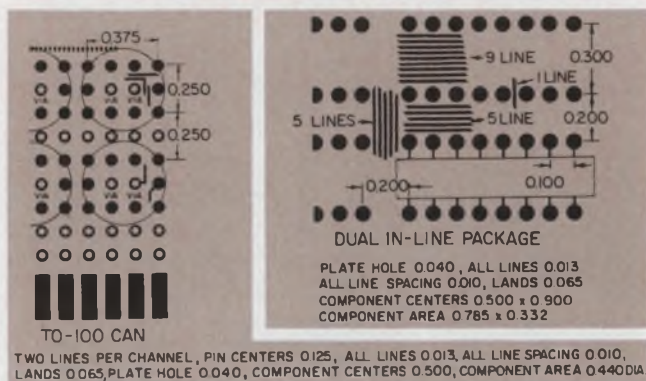

From Institute of Printed Circuits—Printed Wiring Design Guide.

er is any reason to hesitate to use either multi-layer boards or plated-through holes, which were formerly considered difficult to produce. Most manufacturing problems have been solved, and engineers can now concentrate on the cost trade-offs.

Rules of thumb when buying

Cost comparisons aren't easy. Costs can depend upon such intangibles as vendor competition, economic conditions and even geographic location. But there are some rules of thumb to follow.

Where small boards in moderate quantities (100 to 500) may cost \$2 to \$6, larger designs run from \$20 to \$50 for single or double-sided units and \$50 to \$70 for multilayer.

Of course, it pays to order in quantity. A typical 4 × 6-in. board might cost \$19 each in quantities of 10, or \$5 in quantities of 100, and only \$3.50 when 500 are ordered.

For a board with half the area, say 3 × 4 in., prices might drop only 10 to 20%—\$17, \$4.25 and \$2.80. Not much of a saving. But double the 4 × 6 board to 6 × 8 in., and the price doesn't quite double. It may go up only 80%—\$35, \$8 and \$5.50. Thus a large board gives you more real estate per dollar.

Reduce the number of different hole sizes—say, from eight to four—and you can save up to 5%. Knock off the request for rounded edges, and you save another 10¢ per board in the 500 quantities.

Don't ask for solder plating. Instead, accept simple etched copper with only a protective water-dip lacquer, and you can save as much as 20% more.

A double-sided board costs 2 to 2.5 times more than a single-sided, when both sides have about the same density. And for multilayer boards, one rule of thumb takes the cost of a two-sided board of the same area and density and multiplies it by the number of layers, plus 20% for bonding and

checkout. Thus a 4 × 6, two-sided board that sells for \$3.50 might cost about \$16.80 in a four-layered version. But other opinions hold that for more than four layers, cost increments go down; so a 10-layer board might add only \$10.50, to the four-layer cost, bringing the total to \$27.30.

Choosing a vendor

Some PC vendors are small and serve only local companies. This is excellent for quick turn-around. Others serve the entire nation. If you've got time to shop for price, try both. There are plenty to choose from—perhaps too many.

Some vendors will provide samples of the circuit you design, if a large order is likely to follow. Or they might supply samples of similar boards they made for other companies. But you can't really judge a vendor by samples.

No vendor in his right mind will send you a board that reveals shoddy workmanship. You're not likely to get pitted, blistered, crazed (connected white spots on or below laminate surface) or measled (discrete white spots below laminate surface) boards, or boards that have peeling copper or bridging solder.

On the other hand, don't be overly critical and reject boards merely because the cosmetics don't please you. Slightly rough-edged lines, small copper blemishes or even somewhat over-tolerance holes are not good reasons for automatic rejection, if the board will reliably perform its intended function. A gold-plated board may look good, but obviously it will be expensive.

And even if samples are perfect, there is no assurance that ones you buy will be like the samples you evaluated.

This makes vendor selection a tough job. PC vendors sell a capability and service. It's therefore essential to check for process control, quality control, cleanliness and past performance. Does the vendor have a good reputation for keeping delivery promises? And does he deliver for the agreed-upon price?

Services vary widely. Some vendors can handle only conventional single or double-sided boards; others are more versatile and can do multilayer work and special work, not widely available. A few can work from schematic drawings and provide completely assembled boards; most, however, must have the finished scaled-up artwork and prefer to deliver only blank PC boards. A minority of vendors prefers to work from dimensioned mechanical drawings to extract X-Y coordinates for NC drilling. Also, by preparing their own artwork, some can adapt line widths and layout to take advantage of special processes.

In many large companies the design engineer must use in-house PC facilities. Some experts report that as many as two-thirds of the boards

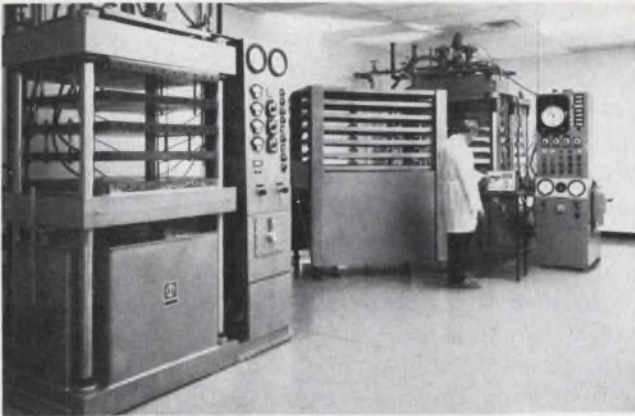

Presses for bonding multilayer boards at Bureau of Engraving, Inc., are controlled by thermocouples that check the internal temperature of the laminates.

made in this country are built in-house. But there is still plenty of business for independent PC vendors. The two-thirds proportion appears high only because the large electronics companies make a tremendous number of boards; it doesn't mean that two-thirds of the companies make their own boards.

Any company can do as much or as little as it wants of its PC board production. A vendor can always be found to start at any point in the design/production cycle and to deliver at any stage. You can work with several vendors—one to do the artwork, another to provide blank PC boards, a third to assemble and perhaps a fourth to test.

A large company like IBM can start from scratch and even make its own laminate from raw bulk materials. And yet even IBM still buys many boards from outside vendors.

Most manufacturers, both in-house and independent, buy their laminates from companies like the 3M Co., Mica Corp., GE, Keystone Electronics, Shigoto Industries, Schjeldahl, Synthane, TME Corp., Woodrow Corp. and others.

Many circuit and system design companies have at least a prototype PC facility. And many can prepare their own artwork with supplies of masking film from a company like Ulano and tapes, stick-on component clusters and pads from Brady, Bishop Graphics, Circuit-Stik, Keuffel & Esser, Datak and Russel Industries.

PC technology advances, but gradually

What does the future hold?

Marvin A. Larson, a vice president with Bureau of Engraving, Inc., says: "The future of printed circuits will continue to be evolutionary. There is nothing on the present horizon that will revolutionize our industry. But there will be change, though it will be gradual."

Larson predicts that microthin foils will have

a significant impact upon PC technology—but slowly. And additive-copper board production will have only a limited use—much as we see it today—especially as more of its negative aspects are realized, he says.

PC experts at Lockheed Electronics also foresee gradual changes. Their forecast for the next two to five years includes the following:

- Line widths as small as 0.003 to 0.005 in. will be developed and used commonly.
- Small holes from 0.013 to 0.015 in. will be frequently used for some IC devices.
- Very thin foils will increase in use and aid in the production of very narrow lines. Copper-plating thickness, now specified mostly at 0.001 in. maximum, may be reduced to as low as 0.0001 in.
- Gold-on-edge connectors will be eliminated. A plating material that is less costly and can be applied over the entire board will become common.
- Tin/lead etch resists will probably be replaced by nonmetallic resists, when the price of the nonmetallic drops.
- Dry-film photosensitive coatings can provide high resolution and will increase in use. Screen printing will be used only for boards with wide lines and spaces.
- Additive-copper processes will be used more as cost savings are proved and specs—in particular military specs—are changed to allow their use.

Lockheed seems more optimistic about the future of additive processes than Larson of Bureau Engraving, Inc., and most PC vendors seem to agree with Lockheed. Mike D'Ambrosio, general manager of the Photronics Div. of Control Systems Research, mentions two additional innovations he sees in PC technology:

1. Ultraviolet curing of screen inks and solder masking will be used increasingly instead of heat. The advantages include lower power costs, elimination of toxic fumes, less labor and better final quality.

2. Light-sensitive water-soluble emulsions, now being introduced, will produce finer lines at lower costs than the current dry film and wet resists.

D'Ambrosio expects screen-printing methods to remain constant, with only minor changes for the foreseeable future, and limited to line widths larger than 0.015 in. And he looks for photo-printing to be used for higher resolutions.

Photocircuits, Div. of Kollmorgen Corp., is particularly bullish on additive PC methods. Recently the company announced its Photoform process, which it claims can produce high definition without the use of a resist. The company also believes that coated metal-core substrates, with conductive paths formed by additive methods, should prove a winning combination. Advantages

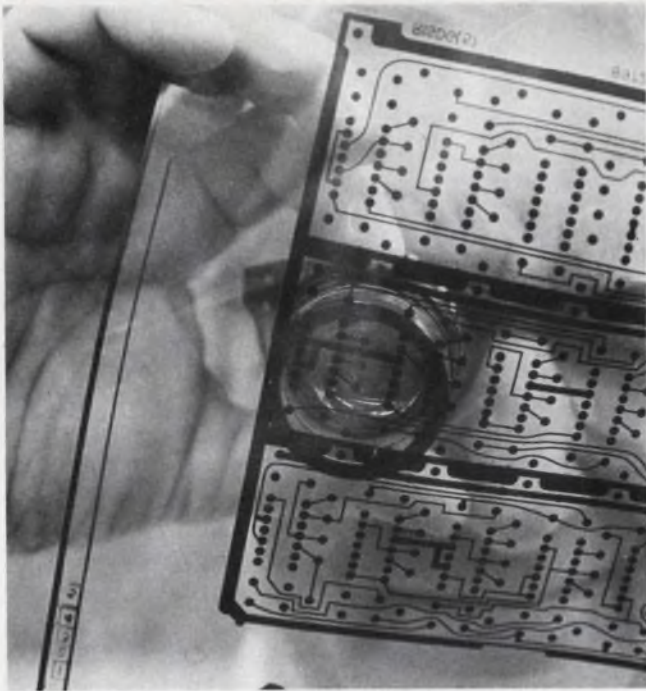

Phototechniques enable fine line resolution in PC-board manufacturing. Scott Graphics Positive II dry-process film can resolve over 500 line pairs/mm.

claimed include unbreakable, nonflammable boards with built-in heat sinks and low costs.

Additive processes for manufacturing PC boards are one of the few recent innovations in the industry. They now account for about 5% of the double-sided PC boards made in this country, and a rise to 20% by 1980 is predicted in a recent study, "Printed Circuit Technology and Market Assessment," by Darling & Alsobrook, Los Angeles. Though costs are still high, the study predicts that by 1978, savings in etchant, copper and manpower should overcome the high initial investment in equipment and the greater automation that the additive processes require.

Though 5-to-10-mil spacing and lines are realistically routine with additive methods, 3-mil lines are not far off. Additive is not subject to the dangers of overetching or underetching and is thus said to produce cleaner lines than subtractive methods. Additives can also automatically provide plated-through holes, while subtractive methods can damage the holes if the resist comes off.

While a fully additive method requires new capital equipment outlays, a semiadditive method may be used with equipment now common to conventional subtractive circuit manufacturing, and requires only a few extra steps. The method uses a plain insulating substrate. After holes for plating-through are drilled, the substrate is coated with a thin adhesive layer and then treated to render it catalytic to electroless metal deposition. A thin layer—typically 0.001-in. thick—of cop-

per is then electrolessly deposited on the board surfaces and in the holes. A screen or photoresist pattern on this layer enables subsequent electroplate buildup of the conductor paths. The conductors are thereafter coated with etch-resistant metal. And after the screen or photoresist material is stripped away, the thin-layer copper background can be quickly etched away.

Because the etched material is very thin, not much copper is lost and very little undercutting can occur. Plated-through holes are produced with plating thickness equal to the surface conductors, and no discontinuities develop between the metal in the holes and the conductors.

While in semiadditive, most of the copper is applied by electroplating, in a purely additive process, electroplating is not practical, because the separate parts of a pattern are not electrically connected. Thus the full thickness of the conductors must be deposited by electroless methods, which may be slower and more expensive.

A major advantage that was initially attributed to additive processes was the promise of alleviating waste-disposal problems. But though additive techniques don't generate the etchant-disposal and copper-recovery problems of subtractive methods, depleted additive electroless baths must still be disposed of. An ideal solution would be a combination of additive and subtractive methods, where copper compounds that build up as a waste product in a subtractive process would be used to replenish the copper content of an additive electroless solution.

Many of the advantages claimed for additive processing are being challenged by subtractive methods that use clad foil of less than 1-oz/ft² weight. The principle advantage of thin-foil laminates is that they use the capital equipment and process technology already familiar to the majority of PC fabricators. However, for the long term, according to James A. Brewer, section head of research and development, Litton Industries, Beverly Hills, CA, both additive and subtractive methods will find an overlapping market.

William H. Taylor 3d, vice president of engineering at Excel Products explains: "With 1/4-oz/ft² foil, a subtractive-oriented shop can print line densities below the presently accepted threshold of 10-mil lines and spaces with no new capital investment. And even more important, learning-curve expenses and problems are minimal. Yet thin-foil techniques gain most of the pollution-reduction advantages of additive processing. This is an important consideration, because pollution abatement will be a major PC industry headache shortly.

R. E. Pritchard, executive director of the Institute of Printed Circuits, Evanston, IL, re-

ports: "Possibly the biggest impact on our industry in the next few years will be the EPA [Environmental Protection Administration]. The National Commission on Water Quality has recently estimated that the capital requirements for pollution-control equipment will be several

times higher than the original investment in production equipment. Most companies are not prepared for such expenditures."

Battle lines are now forming. The institute is leading a contingent of companies in the demand for more "realistic" regulations. ■■

Available literature

Specifying and inspecting PC boards is more complicated than it seems. Following are some of the published standards and methods available to help designers.

From the Institute of Printed Circuits, 1717 Howard St., Evanston, IL 60202:

IPC Printed Wiring Design Guide, IPC Test Methods Manual and IPC Assembly-Joining Handbook, three looseleaf manuals that can be expanded and updated periodically. In addition the institute provides an extensive listing of individual specification and standards, such as *Acceptability of Printed Wiring Boards (IPC-A-600B)* and *Suggested Guidelines for Printed Wiring Board Repair and Modification (IPC-R-700A)*.

From Martin Marietta Aerospace, MP-29, P.O. Box 5837, Orlando, FL 32805:

Workmanship Standards, containing colored photos of preferred acceptable and reject criteria for PC boards.

From N. V. Philips' Gloeilampenfabrieken, Publications Dept. Electronic Components and Materials Div., Eindhoven, the Netherlands:

Printed Circuit Boards, a guide to specifying and designing. It provides extensive coverage, from preparation of artwork to soldering, with many useful tables and color photos.

From Electrochemical Publications Ltd., 29 Barns St., Ayr, KA7 1XB, Scotland:

Printed Circuit Troubleshooting, H. R. Shemilt. A reference for pinpointing the cause of problems with suggested remedies, mostly in tabular form.

Need more information?

PC technology encompasses many diverse disciplines and services—artwork, photography, silk-screening, etching, plating—and also many sources of materials. Following is a partial list of companies in the field. Companies marked (v) are vendors of single, double-sided or multilayer boards, (p) provide PC production services, (m) provide production machinery, (c) provide chemicals, (b) provide PC-board materials and (s) provide silk-screen equipment. For a more extensive listing, consult ELECTRONIC DESIGN'S GOLD BOOK.

AAI Corp., P.O. Box 6767, Baltimore, MD 21204. (301) 666-1400. (v) **Circle No. 401**
 AD Ckts, Panorama Creek Dr., Rochester, NY 14625. (716) 381-2370. (p) **Circle No. 402**
 Adv Circuitry, P.O. Box 2847, Commercial Station, Springfield, MO 65803. (417) 862-0751. (v) **Circle No. 403**
 AEL, P.O. Box 552, Lansdale, PA 19446. (215) 822-2929. (p, v) **Circle No. 404**
 Air Prods & Chem Inc., Specialty Gas Dept., P.O. Box 538, Allentown, PA 18105. (215) 395-8257. (c) **Circle No. 405**
 Algorex Data Corp., 6901 Jericho Turnpike, Syosset, NY 11791. (516) 921-7600. (p) **Circle No. 406**
 Allied Chemical Corp., Specialty Chem Div., P.O. Box 1087, Morristown, NJ 07950. (201) 455-5083. (c) **Circle No. 407**
 American Screen Printing Equipment Co., 404 N. Noble St., Chicago, IL 60622. (312) 829-4004. (s) **Circle No. 408**
 Amon Ra Inc., 149 E. Third St., Beaumont, CA 92223. (714) 845-4715. (v) **Circle No. 409**
 Amphenol Cadre Div., Bunker Ramo Corp., P.O. Box 150, Endicott, NY 13760. (607) 754-4444. (p) **Circle No. 410**
 Ansley Elecs Corp., 3208 Humboldt St., Los Angeles, CA 90031. (213) 223-2331. (v) **Circle No. 411**
 ARF Prods Inc., 25596 75th St., Boulder, CO 80301. (301) 443-4844. (p) **Circle No. 412**
 Artech Corp., 2816 Fallfax Dr., Falls Church, VA 22042. (703) 560-3292. (p, v) **Circle No. 413**
 Astrocom Corp., 15012 Minnetonka Ind., Minnetonka, MN 55343. (612) 933-2208. (v) **Circle No. 414**

Attronics Corp., 530 Turnpike St., Rte. 114, North Andover, MA 01845. (617) 685-4336. (v) **Circle No. 415**
 Autosplince Div., 222 E. 23 St., New York, NY 10010. (212) 674-4369. (v) **Circle No. 416**
 Beco Inc., 740 Kesler Mill Rd., Salem, VA 24153. (703) 389-3053. (v) **Circle No. 417**
 Bishop Graphics Inc., 20450 Plummer St., Chatsworth, CA 91311. (213) 993-1000. (b) **Circle No. 418**
 Boston Digital Corp., 86 South St., Hopkinton, MA 01748. (617) 435-6871. (m) **Circle No. 419**
 Buckbee-Mears Co., 245 E. 6th St., St. Paul, MN 55101. (612) 228-6371. (p, v) **Circle No. 420**
 Bureau of Engraving Inc., 219 N. 2nd St., Minneapolis, MN 55401. (612) 339-8001. (v, p) **Circle No. 421**
 Cambridge Thermionic, 445 Concord Ave., Cambridge, MA 02138. (617) 491-5400. (v, m) **Circle No. 422**
 Casso-Solar Corp., 125-10 Queens Blvd., Kew Gardens, NY 11424. (212) 544-2424. (s, m) **Circle No. 423**
 Cavatron Corp., 1290 Ave. of the Americas, New York, NY 10019. (212) 944-8430. (m) **Circle No. 424**
 Center Line Specialties, Box 656, Boulder, CO 80302. (303) 443-9040. (p) **Circle No. 425**
 Chemplast Inc., 115-150 Dey Rd., Wayne, NJ 07470. (201) 696-4700. (c) **Circle No. 426**
 Christiansen Radio Inc., 1950 San Remod, Laguna Beach, CA 92651. (714) 497-1506. (v) **Circle No. 427**
 Cincinnati Elecs Corp., 2630 Glendi-Milford, Cincinnati, OH 45241. (513) 563-6000. (p, v) **Circle No. 428**
 Circuit Science Inc., 615 N. Country Rd. 18, Minneapolis, MN 55427. (612) 544-8635. (p, v) **Circle No. 429**
 Circuit-Stik Inc., Centron Engrg Inc., 24015 Garnier St., Torrance, CA 90510. (213) 530-5530. (b) **Circle No. 430**
 Colight Inc., 123 N. 3rd St., Minneapolis, MN 55401. (612) 333-8201. (m, s) **Circle No. 431**
 Control Sys Research Inc., 1811 Main St., Pittsburgh, PA 15215. (412) 782-5300. (p, v) **Circle No. 432**
 Custom Sys Assoc., 1427 N. W. Davis, Portland, OR 97209. (503) 224-7527. (p, v) **Circle No. 433**
 Cyclo-Tronics, 3858 N. Cicero, Chicago, IL 60641. (312) 282-6141. (m) **Circle No. 434**
 DAC, 725 Reddick Ave., Santa Barbara, CA 93103. (805) 963-3708. (m) **Circle No. 435**
 Datak Corp., 65 71 St., Guttenberg, NJ 07093. (201) 869-2200. (b, c) **Circle No. 436**
 Dattilo Enterprises, Inc., 9405 Doral Ct., Louisville, KY 40220. (502) 491-6262. (p, v) **Circle No. 437**
 De Coursey Engrg., 11828 W. Jefferson, Culver City, CA 90230. (213) 397-9668. (v, p) **Circle No. 438**

(continued on page 70)

- Defiance Circuit Corp., 12 Shepard St., Lawrence, MA 01843. (617) 688-1856. (p, v) **Circle No. 439**
- Diablo Ind., 1713-B Junction, San Jose, CA 95112. (408) 288-6728. (p) **Circle No. 440**
- Diceon Elecs Inc., 18522 Von Karman, Irvine, CA 92664. (714) 833-0870. (p, v) **Circle No. 441**
- Digital Sys Inc., 232 E. Live Oak, Arcadia, CA 91006. (213) 445-6100. (m) **Circle No. 442**
- Douglas Elecs, 718 Marina Blvd., San Leandro, CA 94577. (415) 483-8770. (p) **Circle No. 443**
- Dow Chemical Co., 2020 Dow Center, Midland, MI 48640. (517) 636-1000. (c) **Circle No. 444**
- DuPont De Nemours E. I., 1007 Market St., Wilmington, DE 19898. (302) 774-2421. (c, b) **Circle No. 445**
- Dynell Elecs Corp., 75 Maxess Rd., Melville, NY 11746. (516) 694-0900. (v, p) **Circle No. 446**
- Eastern Marking Machine, 30 Alabama Ave., Island Park, NY 11558. (516) 889-9090. (s) **Circle No. 447**
- Eder Ind., 4865 S. 10 St., Milwaukee, WI 53221. (414) 482-2700. (p) **Circle No. 448**
- EDI Inc., P.O. Box 66, Cairo, IL 62914. (618) 734-1694. (p, v) **Circle No. 449**
- Electro-Science Labs Inc., 1601 Sherman Ave., Pennsauken, NJ 08110. (609) 663-7777. (c) **Circle No. 450**
- Elecs Plastics, 21601 Parthenia, Canoga Park, CA 91304. (213) 882-1700. (v) **Circle No. 451**
- Elgin Elecs, Walnut St., Waterford, PA 16441. (814) 796-2601. (p, v) **Circle No. 452**
- Engineered Tech Prods Inc., 3421 U.S. Hwy 22, Somerville, NJ 08876. (201) 725-0330. (s) **Circle No. 453**
- Enthone Inc., P.O. Box 1900, New Haven, CT 06508. (203) 934-8611. (c) **Circle No. 454**
- Etchomatic Inc., 151 Newton St., Boston, MA 02154. (617) 893-2020. (b, s) **Circle No. 455**
- Excel Prods Co., Inc., 700 Joyce Kilmer Ave., New Brunswick, NJ 08903. (201) 249-6600. (v) **Circle No. 456**
- Fabri-Tek Inc., 5091 S. County Rd. 18, Minneapolis, MN 55436. (612) 935-8811. (p) **Circle No. 457**
- Faul-Coradi Inc., 643 W. Onondaga St., Syracuse, NY 13204. (315) 475-2155. (p) **Circle No. 458**
- Flexible Ckts, Paul Val Indl. Pk., Warrington, PA 18976. (215) 343-2300. (v) **Circle No. 459**
- Flex-Link Prods Inc., 1923 First St., San Fernando, CA 91340. (213) 365-9355. (p) **Circle No. 460**
- Garry Mfg. Co., 1010 Jersey Ave., New Brunswick, NJ 08901. (201) 545-2424. (b) **Circle No. 461**
- GC Elecs, 400 S. Wyman St., Rockford, L 61101. (815) 968-9661. (v, c) **Circle No. 462**
- General Automation, 11842 Vose St., North Hollywood, CA 91605. (213) 875-0618. (m) **Circle No. 465**
- General Electric Co., Laminated & Insulating Matls Business, Coshocton, OH 43812. (614) 622-5310. (b) **Circle No. 464**
- General Printed Ckts, Box 4013, Downey, CA 90241. (714) 997-3771. (v) **Circle No. 463**
- General Research Inc., 309 S. Union St., Sparta, MI 49345. (616) 887-8221. (s) **Circle No. 466**
- GT Schjeldahl Co., Electrical Prods Div., P.O. Box 170, Northfield, MN 55057. (507) 645-5633. (v) **Circle No. 467**
- GTE Sylvania-Elec Components Grp., 100 First Ave., Waltham, MA 02154. (617) 890-9200. (p, v) **Circle No. 468**
- Harshaw Chemical Co., Div. Kewanee Oil Co., 1945 E. 97 St., Cleveland, OH 44106. (216) 721-8300. (c) **Circle No. 469**
- Hi-G Inc., 580 Spring St., Windsor Locks, CT 06096. (203) 623-2481. (v) **Circle No. 470**
- Hughes Aircraft Co., Centinela & Teale St., Culver City, CA 90230. (213) 391-0711. (b) **Circle No. 471**
- Hyde Park Elecs, 4547 Gateway Cir., Dayton, OH 45440. (513) 435-2121. (p, v) **Circle No. 472**
- Hysol Div., Dexter Corp., 15051 E. Don Julian, City of Industry, CA 91744. (213) 968-6511. (c, v, s) **Circle No. 473**
- IEC Elecs Corp., 319 Chestnut E., Rochester, NY 14445. (716) 586-7850. (p) **Circle No. 474**
- Injectorall Elecs Corp., 98-100 Glen St., Glen Cove, NY 14445. (516) 671-6010. (m, c) **Circle No. 475**
- Intl Elec Research, Sub Dynamics Corp. of America, 135 W. Magnolia, Burbank, CA 91502. (213) 849-2481. (v, p) **Circle No. 476**
- Jaesic Ind. Co. Inc., 29830 Beck, Wixom, MI 48096. (313) 624-6411. (v) **Circle No. 477**
- Kaimus & Associates, 2424 S. 25 Ave., Broadview, IL 60153. (312) 343-7004. (p) **Circle No. 478**
- Kepron Ckts. System, 3630 Scarlet Oak St., St. Louis, MO 63122. (314) 225-5166. (c, b, m) **Circle No. 479**
- Keystone Elecs. Corp., 43-49 Bleecker St., New York, NY 10012. (212) 475-4600. (b) **Circle No. 480**
- Kinetic Sys. Corp., Maryknoll, Dr., Lockport, IL 60441. (815) 838-0005. (p) **Circle No. 481**
- Lamart Corp., 16 Richmond St., Clifton, NJ 07015. (201) 772-6262. (b) **Circle No. 482**
- Lehighon Elecs. Inc., RD 1, Lehighon, PA 18235. (717) 386-4156. (p, v) **Circle No. 483**
- Lockheed Elec. Co., Data Prods Div., 6201 E. Randolph St., Los Angeles, CA 90040. (213) 722-6810. (p, v) **Circle No. 484**
- Maine Elec., Rockwell Intl, Rlver St., Lisbon, ME 04250. (207) 353-8611. (v) **Circle No. 485**
- Matheson Gas Prods., P.O. Box 85, East Rutherford, NJ 07023. (201) 933-2400. (c) **Circle No. 486**
- Mervap Coldlight Prods., 2654 S. La Cienega Ave., Los Angeles, CA 90034. (213) 870-2363. (m) **Circle No. 487**
- Mica Corp., Box 2578, Culver City, CA 90230. (213) 559-4223. (b) **Circle No. 488**
- 3M Co., Indl. Elec. Div., 3M Center, St. Paul, MN 55101. (612) 733-1110. (b) **Circle No. 489**
- New Hermes Engraving Machine Corp., 20 Cooper Square, New York, NY 10003. (212) 777-3080. (m) **Circle No. 490**
- Norplex Div., UOP, Norplex Dr., La Crosse, WI 54601. (608) 784-6070. (b) **Circle No. 491**
- Orbital Prod., Inc., 191 Factory Rd., Addison, IL 60101. (312) 543-7050. (v, p) **Circle No. 492**
- Panob Corp., 18 Merritt, Port Chester, NY 10573. (914) 939-3066. (v) **Circle No. 493**
- Paraplegics Mfg. Co., Inc., 303 N. York Rd., Bensenville, IL 60106. (312) 625-7741. (p) **Circle No. 494**
- Parlex Corp., Box 488, Methuen, MA 01844. (617) 685-4341. (p, v) **Circle No. 495**
- Pemco Inc., 820 Decatur N., Minneapolis, MN 55427. (612) 546-2431. (c) **Circle No. 496**
- Perforated Prod., 68 Harvard, Brookline, MA 02146. (617) 232-6044. (v) **Circle No. 497**
- Photocircuits Div., Kollmorgen Corp., 31 Sea Cliff Ave., Glen Cove, NY 11542. (516) 676-8000. (c, v) **Circle No. 498**
- Polyscienca Inc., Paul Valley Indl. Park, Warrington, PA 18976. (215) 343-6484. (c) **Circle No. 499**
- Precision Electrical Mfg Co., 9628 6 Ave. N., Minneapolis, MN 55441. (612) 544-8655. (p) **Circle No. 500**
- Precision Gas Prods., 681 Mill St., Rahway, NJ 07065. (201) 381-7600. (c) **Circle No. 501**
- Printed Circuit Corp., 180 Elm St., Waltham, MA 02154. (617) 899-0380. (v) **Circle No. 502**
- Rectico Inc., 20 Village Park Rd., Cedar Grove, NJ 07009. (201) 239-6464. (p) **Circle No. 503**
- Relwood Ckts. Inc., 1117 Isabel St., Burbank, CA 91506. (213) 842-4859. (v) **Circle No. 504**
- R K Electric Co. Inc., 11315 Williamson, Cincinnati, OH 45241. (513) 793-4060. (s) **Circle No. 505**
- Rogers Corp., 77 Main St., Rogers, CT 06263. (203) 774-9605. (b) **Circle No. 506**
- Rosemount Nashville, Inc., P.O. Box 107, Nashville, TN 37202. (615) 793-7561. (v) **Circle No. 507**
- Rowe Engravers, 68-1 Union Ave., Clifton, NJ 07011. (201) 546-2776. (p, v) **Circle No. 508**
- Sanders Assoc., Daniel Webster Highway S., Nashua, NH 03060. (603) 895-2817. (s) **Circle No. 509**
- Scott Graphics, Inc., Holyoke, MA 01940. (413) 536-7800. (c, b) **Circle No. 510**
- Sel-Rex Co., 75 River Rd., Nutley, NJ 07110. (201) 667-5200. (s) **Circle No. 511**
- Sermetel Div., Teleflex Inc., Dickerson Rd. & Wissahickon Ave., North Wales, PA 19454. (215) 699-4861. (p) **Circle No. 512**
- Shigoto Ind. Ltd., 350 Fifth Ave., New York, NY 10001. (212) 695-0200. (v, b) **Circle No. 513**
- Sibley Co., 23 Bridge St., Haddam, CT 06438. (203) 345-4523. (v) **Circle No. 514**
- Spartanics Ltd., 3605 Edison Pl., Rolling Meadows, IL 60008. (312) 394-5700. (m) **Circle No. 515**
- Stanford Applied Engrg., 340 Martin, Santa Clara, CA 95050. (498) 243-9200. (v) **Circle No. 516**
- Sumitomo Bakelite Chemical Div., 345 Park Ave., New York, NY 10022. (212) 935-8888. (b) **Circle No. 517**
- Superior Electric Co., 3000 Middle St., Bristol, CT 06010. (203) 582-9561. (m) **Circle No. 518**
- Techniques, 236 Jackson St., Englewood, NJ 07631. (201) 569-5900. (v, p) **Circle No. 519**
- Texas Instruments Inc., P.O. Box 5012, Mail Station 84, Dallas, TX 75222. (214) 238-2011. (v) **Circle No. 520**
- TFE Inc., 100 Gilbane St., Warwick, RI 02886. (401) 738-7550. (c) **Circle No. 521**
- Thermo-O-Lab Corp., Farmdale Hart Ave., North Hollywood, CA 91605. (213) 875-0105. (v) **Circle No. 522**
- TME Corp., Salem Indl. Pk., Salem, NH 03079. (603) 893-1661. (b) **Circle No. 523**
- Total System Concept., 3630 Scarlet Oak, St. Louis, MO 63122. (314) 225-5166. (m) **Circle No. 524**
- Transene Co., Inc., Route 1, Rowley, MA 01969. (617) 948-2501. (c) **Circle No. 525**
- Tran-Sil Prods., 2974 SW Temple, Salt Lake City, UT 84115. (801) 466-3636. (c) **Circle No. 526**
- Tronic Corp., Div. Vacu-Blast Corp., Box 247, Belmont, CA 94002. (415) 593-1487. (m) **Circle No. 527**
- TRW Cinch Div., 1500 Morse Ave., Elk Grove Village, IL 60007. (312) 439-8800. (v) **Circle No. 528**
- Union Carbide, Chem-Plastics, 270 Park Ave., New York, NY 10017. (212) 551-2345. (c) **Circle No. 529**
- Universal Scientific, 1312 S. 13 St., Vincennes, IN 47591. (812) 882-2970. (v) **Circle No. 530**
- US Poymeric Armco Co., P.O. Box 671, Stamford, CT 06904. (203) 324-7545. (b) **Circle No. 531**
- Vector Elec. Co., 12460 Gladstone Ave., Sylmar, CA 91342. (213) 365-9661. (v, b) **Circle No. 532**
- Ventronics Inc., 346 Monroe Ave., Kenilworth, NJ 07033. (201) 272-9262. (v) **Circle No. 533**
- Zagar Inc., 23922 Lakeland Blvd., Cleveland, OH 44132. (216) 731-0500. (m) **Circle No. 534**

IC PLUGGABLE PACKAGING ASSEMBLIES NOW AVAILABLE IN METRIC SIZES

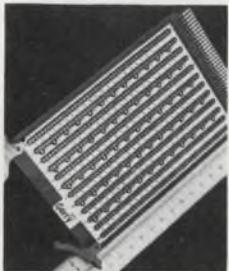

Metric-sized IC pluggable packaging assemblies are now available from Garry Manufacturing Co., of New Brunswick, N.J. These meet the needs of European electronic manufacturers and of the machine tool industry.

The new packaging assemblies can be obtained in many metric sizes, including: 100 mm x 160 mm.

The new metric boards offer large solder-plated ground and voltage plane area, and are offered with or without decoupling capacitors. Board is fabricated from glass epoxy 94V2.

Options include committed or non-committed power and ground planes. Contact pins in a variety of lengths permit one-, two-, or three-level wire wrapping. Pins are available in various thicknesses of gold over ductile nickel.

For complete information, use the Reader Service Card or contact Garry Manufacturing Co., 1010 Jersey Avenue, New Brunswick, N.J. Telephone 201-545-2424.

NEW SOLDERLESS BREADBOARDS FOR EXPERIMENT AND TEST

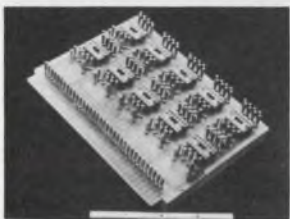

NEW BRUNSWICK, N.J. — A new series of plug-in breadboards is now available from Garry Manufacturing Company, of New Brunswick, N.J. Created to facilitate prototype design, experimentation, and testing of circuitry without the need for

hardwiring, the new boards accommodate 14- or 16-pin DIPs and other packages, and are made in various sizes to accept from one up to as many as 50 integrated circuits.

Principal feature of the new boards is that they employ plug-in socket pins instead of the usual wire-wrappable or solderable connections. Thus, reliable yet temporary circuit interconnections can be quickly made and quickly changed during the course of design or test.

For complete information, use the Reader Service Card or contact Garry Manufacturing Co., 1010 Jersey Avenue, New Brunswick, N.J. Telephone 201-545-2424.

NEW TEST SOCKETS FOR TRANSISTORS



NEW BRUNSWICK, N.J. — A new line of test sockets, which accept the uncut leads of transistors, is now available from Garry Manufacturing Co., of New Brunswick, N.J. The new sockets have smoothly chamfered entry holes for fast insertion,

and long, gold-over-nickel-plated beryllium copper elements that make reliable contact with the leads of the inserted components.

The sockets are available for three- to twelve-lead components, with pin circle diameters ranging from 0.200 inch to 0.510 inch. They are made in two basic versions: one to accept leads of 0.187 inch minimum length, the other for leads of 0.500 inch minimum length. Both accept leads ranging from 0.015 to 0.032 inch diameter. Contact resistance is 0.015 Ohm, maximum.

For complete information, use the Reader Service Card or contact Garry Manufacturing Co., 1010 Jersey Avenue, New Brunswick, N.J. Telephone 201-545-2424.

Joan Borst is doing 5 to 10 on a bum wrap.

Joan should've talked to Garry. Instead of condemning her to a faulty Wire Wrap*, we would've given her a wrap that worked. With pin squareness that's exactly .025 inch. A precision beryllium spring clip that has the most consistent IC insertion/withdrawal rate in the industry. And the widest line in the industry.

In short, we would've given her a good wrap. Backed up by a complete IC packaging facility (boards, headers, wrapping, racks), as well as dependable service, good prices and fast delivery.

Ask us about it. We won't pin a bum wrap on you. Garry Manufacturing, 1010 Jersey Avenue, New Brunswick, New Jersey 08902. (201) 545-2424.

*Registered trademark of Gardner-Denver Co.

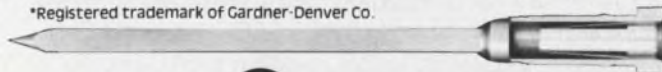

Garry

Manufacturing Co.

We won't pin a bum wrap on you.



Improve your PC artwork techniques.

Even if you only supervise and check the work of others, you'll do a better job if you know the tricks of the trade.

You've completed your circuit design, you've got a schematic and detailed parts list. Now you're ready to implement the design on a printed-circuit (PC) board. The next stage—the circuit-board artwork—may present problems.

In some companies the work is farmed out to either a drafting department or some outside service, and the circuit designer only checks the final photomaster. In other companies, he may be required to supervise the artwork.

And in some companies, for some classes of design work—prototypes, one-of-a-kind designs, short runs, experimental work, etc.—the circuit engineer may be required to do his own artwork.

Because the artwork can be as important as the circuit design in the building of a successful system, here is a review of some "tricks of the trade."

Scale the artwork

Professional artwork is usually prepared on an enlarged scale for ease of viewing and sharpness of detail. When reduced to actual size, imperfections also are reduced. But don't become confused by scale terminology.

Artwork done to a 2:1 scale occupies four times the actual area. Thus, when you are told that the artwork is four-times actual size, 1 in. of artwork will be 0.5 in. on the finished board—a 2:1 scale reduction, not 4:1. Though 90% of all boards produced are made from 2:1 artwork, applications that require extra-fine detail often use 4:1 and some subminiature boards as high as 28:1.

The first step in laying out a PC board is to prepare the drawing table. Tape a sheet of grid paper to the table. In most cases, 10-squares/in. paper is best. Many components standardized for PC mounting have lead spacing on 0.1-in. centers. Make sure the paper lies flat, with no wrinkles.

Now place a sheet of clear Mylar over the grid paper. Do not tape it directly to the grid paper,

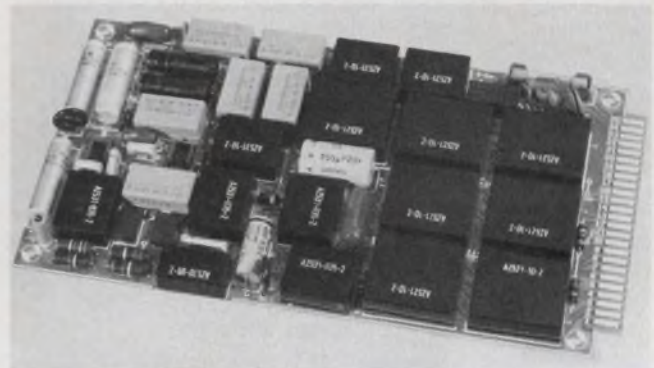

PC boards need skillful artwork to achieve high packaging density and a properly functioning circuit.

because this will cause the paper to wrinkle. Always use a sheet that is large enough to cover the grid paper completely, and then tape the Mylar to the table. Of course, choose a size that is compatible with the size of the circuit board. The generally recommended Mylar thickness ranges from 0.005 to 0.0075-in.

The PC board size may be a standard one. You may have already built a breadboard or prototype and know fairly well how much space is needed. Or perhaps you have "played checkers" with paper or plastic cutouts of the components and have thus gained a pretty good idea of the parts layout.

Having decided on the board size, identify the corners of your circuit board by placing "corner marks" with strips of black drafting tape (Fig. 1). The inside edges of the corner marks correspond to the outside edges of the finished circuit board. Drafting tapes of various widths and a large variety of component pads are available from several companies. Strips of tape are used to form the circuit's conducting paths. The strips generally terminate on component pads, which define component-lead locations by the center of the hole in each pad. Of course, tape and pad dimensions must conform to the scale used.

Suppliers of tapes and pads include Bishop Graphics, Inc., W.H. Brady Co., Centron Engineering Co., Keuffel & Esser Co., Datak Corp. Most companies supply a catalog upon request.

Donald P. Dattilo, President, Dattilo Enterprises, Inc., 9405 Doral Court, Louisville, KY 40220.

Before you can proceed, you must determine the dimensions of each component. Check the manufacturer's specifications carefully. If you aren't sure about any one dimension, find a second source to verify its accuracy. Check and double check. An error here can be disastrous. Measure a sample of the component with a quality dial micrometer.

Now make templates of the components to the scale you are using. These don't have to be fancy, but they should be accurate in all dimensions,

certain that you don't box in leads or pins that you will need to get to later. This sounds obvious, but it happens even to the most experienced.

Let the jumpers fall where they may

Some people judge the quality of a circuit layout by the number of jumpers on it—the fewer the better. This is not necessarily true. If it takes jumpers to place a part, where important considerations dictate, use them. However, dur-

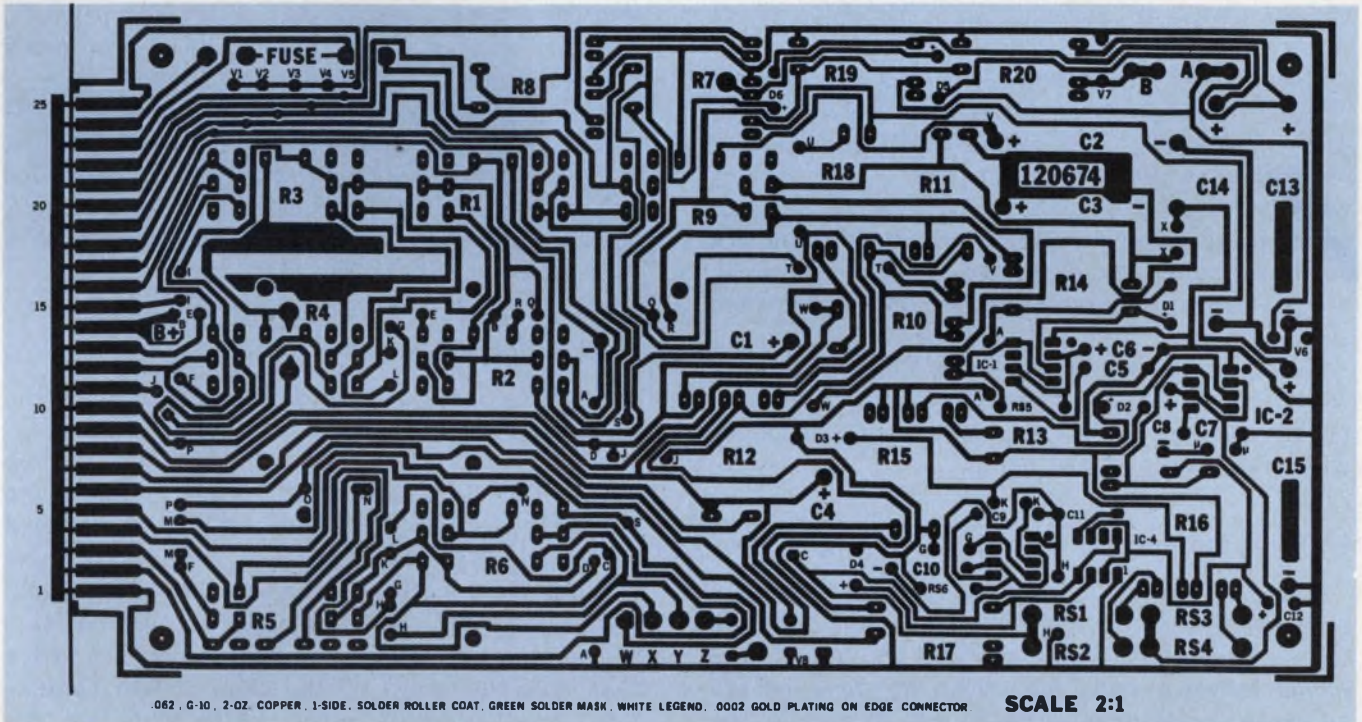

1. Printed-circuit artwork is usually done on an enlarged scale and then photographically reduced to the correct

size. Thoroughly marking the artwork with component designations helps in assembly and testing.

especially the pin or lead locations. Use scrap pieces of Mylar and drafting tape to make the templates. And use pads with small holes; this will help maintain pin-location accuracy.

But, remember, the templates should represent a bottom view. When you lay out a part on a circuit board, the bottom view is the reverse of the top view; thus right becomes left. It's very easy to make a mistake if you haven't provided some quick reference aids. It's wise to label the leads with their correct designation—on transistors, E, B, C; on ICs, pin 1, 2, 3, etc. Don't assume that you will remember later which lead is which.

Don't try to locate all the components on the Mylar in one step, with the intent of working out the connecting pattern later. Instead locate a few components at a time and complete the connection paths between them. Think ahead. It's easy to "paint" yourself into a corner. Make

ing assembly, jumpers are treated as components and they add to the labor cost. Don't overdo them.

Pay attention to special component requirements. Make notes on the schematic, especially if you are farming out the work. For example: Mount tuning coils away from transformers; allow space for switch movement; keep output leads away from inputs.

Since the component templates are movable and sized to scale, you can see how any one component will locate in relation to any other component. When you decide upon a component site, hold the template firmly on the spot. And with a pointed tool, punch completely through both the template and the Mylar to mark the pin or lead.

Apply suitably sized pads to the Mylar, and align the punched hole in the Mylar with the hole in the pad. A trade trick is to use an Exacto knife, with the tip broken off about 1/16-in. from the point, to pick up and apply the stick-on

Table 1. Recommended conductor width

2-oz. Copper	0.010	0.015	0.019	0.031	0.046	0.062	0.078	0.100	0.125	0.187	0.218
1-oz. Copper	0.015	0.026	0.032	0.062	0.078	0.100	0.112	0.125	0.156	0.203	0.312
Current	1-A	1.5-A	2-A	2.5-A	3-A	3.5-A	4-A	4.5-A	5-A	8-A	10-A

Maximum continuous current at 100 F.

pads. Trying to do it with your fingers is next to impossible.

Don't worry about punching holes in the Mylar. If you decide to move a part, the holes won't show up on the finished circuit board.

Recommended copper-path widths and spacing between conductors are shown in Tables 1 and 2. You may use wider copper paths and spacing for increased safety. A path that is too narrow will overheat. This can cause damage ranging from a raised etch pattern to an explosion. To meet minimum requirements for UL approval, the pattern must have at least 0.062 in. between all conductors.

But, remember, the widths of the tape strips, which represent the copper paths and the component pads on the Mylar, must be in accordance with the scale you are using.

Speeding the work

The application of drafting tape may seem to be a simple and obvious procedure, but here are some reminders: Don't merely lay down long strips between pads and then try to slice off unwanted portions with your knife. If you do, the connected pads will have slice marks that show up on the finished board. Instead, apply the tape and completely overlap the pads to be connected.

To remove excess tape at both ends of the run, don't cut down against the pad; instead pull the unwanted portion of the tape against the cutting edge at approximately a 70-degree angle. The result will be a clean cut, with no frayed edges. Of course, leave enough length to partially overlap the pads but don't cover the holes. Then apply pressure with the back, rounded end of the Exacto knife to make the tape stick firmly to the Mylar.

Advice on how to dispose of unwanted cut tape pieces may seem trivial, but professionals save 15 minutes of every hour with this simple procedure. If you pick up a piece of tape with one hand, don't try to pull it from your fingers with the other hand. The stuff is like fly paper. Use your mouth.

Here are a few more tricks:

- Don't stretch the tape when applying it. It will creep back to a shorter length and produce

hair-line gaps between tape and the pads.

- Don't force an excessively sharp bend, when you apply tape in a curve. A little experience will show what's permissible. With sharp bends, the tape won't stay put regardless of how much you press on it.

- Don't route a section of tape along the outside edge of the board. Allow at least 1/32 in. between any conductor path and the outside edge. When the finished board is sheared to size, the shearing action may cause the copper path to separate from the board.

Choose compatible pads

Select a pad size that is compatible with the component's size and weight. But, remember, you are working to scale. The hole size in the stick-on pad is unimportant; it serves merely to locate the center of the hole that will be punched or drilled in the finished board. The final hole is usually larger than the hole in the stick-on pad.

The minimum length of material that remains around the hole after drilling should be greater than half the width of the copper path connecting it to other points in the circuit. This is measured from the outside edge of the hole to the outside edge of the pad. For mounting heavy components, such as transformers, provide extra pad area. For example, a transformer weighing 9 oz, with six 0.055-in.-diameter mounting pins, may be safely held in place with 0.2-in.-diameter pads. Unfortunately there are no fixed rules to help you select the proper sized pad. Reasonable mechanical considerations and experience are your best guides.

Normally, for manual parts assembly, the holes are 0.005-in. larger than the diameter of the lead or pin to be inserted; for automatic parts stuffing, the hole should be 0.010 to 0.025-in. larger. Automatic insertion equipment needs large target holes. For rectangular pins, observe the manufacturer's recommendations. But these specs usually don't consider the use of automatic inserters, so you may need to modify the given tolerance values.

Allow sufficient space between component pads to provide for bends in the leads. And when spacing the pads for components that attach with

fixed pins, make sure that the hole center-to-center spacing is accurate. Stick-on component pads are available for many standard components. Professional designers use TO-can and IC-package patterns regularly; however, patterns for some small transistors are often made up to allow flexibility in special placement problems.

Some experts say never trim a pad to provide greater conductor spacing. If you must, go ahead and do it, but don't go to extremes. Just make sure the pad still meets mechanical and electrical specifications.

Use of transfer letters requires skill

Transfer letters should be used to mark part numbers, jumper pads, dates and other identification on the etch side of the board. It's desirable to identify as many components as the density of the circuit allows. This will greatly simplify testing and the servicing of finished assemblies. Transfer letter sets and symbols are available in a large variety of sizes and styles.

The use of transfer letters requires some skill. But a few minutes of practice on a scrap of paper with a ballpoint pen that no longer writes should be enough. The trick lies in rubbing very lightly during the first pass over the letter to be transferred. Gradually increase the pressure for each successive pass until the letter is completely transferred. With practice, you'll be able to do this quickly without lifting the pen from the transfer sheet.

Transfer letters can be easily removed from Mylar. Hold an Exacto knife at a 45-degree angle and scrape in the direction of the slant of the knife. If there is a large area of lettering to be removed, use any clear industrial-grade lacquer thinner on a smooth rag. The thinner won't affect the Mylar sheet, but don't allow it to touch any of the pads or sections of drafting tape. It removes the black pigmentation.

There's another side to the board

If the circuit won't fit on one side of the circuit board, a two-sided circuit-board configuration can be used. Two methods are used.

One is a two-color method, such as offered by W.H. Brady Co. and Bishop Graphics, Inc. Bishop uses red and blue tapes and pads, and Brady amber and magenta. With these processes, both sides of a circuit board can be laid out on only one piece of Mylar. The second method requires two separate pieces of artwork, one for each side of the circuit board.

With the Bishop method, for example, the circuit paths for one side of the board are laid out with red tape and pads, and the other side with blue. But both patterns are done on the same

Table 2. Recommended spacing between conductors

Volts	Exposed copper	Copper covered with insulating coating
5	0.010	0.008
10	0.011	0.009
24	0.013	0.011
48	0.015	0.012
120	0.062	0.030
220	0.125	0.062
440	0.156	0.078
550	0.171	0.093

All voltages are dc at 100 F.

Mylar sheet.

Points common to both sides are laid out in black. The colored tape materials are transparent and act as photographic filters to allow the process to "see" one side of the board at a time.

The most obvious advantage of the two-color method is that it takes less time to lay out one, rather than two, pieces of artwork. Another is the method's inherent ability to maintain perfect registration between the two sides.

But the colored tapes can't bend as much as conventional black drafting tape. Thus the layouts must almost be straight-line configurations. Also, the colored tapes are thinner and slicker, which makes them harder to work with. And colored lettering is available only in limited sizes and styles.

The critical factor when you work with two pieces of artwork is to maintain the registration between them. With the so-called flip method, this can be held to ± 0.003 in. when a 2:1 scale is used.

To use the flip method, tape the first sheet of Mylar to the drafting table, as you did for a single-sided board. Place a second sheet of Mylar—slightly larger than the first—over the first sheet, and tape it securely to the table at the top only. This second sheet is now hinged at the top and able to be flipped like the page on a note pad. The top sheet is called the component side of the board.

Apply corner marks and start to lay out the bottom, or stationary, sheet first. When the upper sheet is needed, apply corner marks to it also, so they align with the marks on the stationary sheet.

Try to route all conductor paths so they terminate at component pads. Also, run the paths horizontally on one side of the board and vertically on the other side.

Don't place jumpers under component parts. Also, try to keep the jumpers straight; they may

travel in any direction, but they should not bend around components. Special bending requires additional labor, which increases cost.

As you complete a connection, mark the line on the schematic. This allows you to leave your drawing table without forgetting where you were; and it also makes it easier to decide which conductor paths should be run next. You need not lay out the etch pattern in the same sequence as the schematic is drawn. Quite often, it is better to jump around and take care of special situations and components.

If needed, you may use a felt-tip pen to mark the Mylar with temporary notes or identification. When no longer needed, the marks can easily be wiped off.

The component side of the board may be connected to the etch side with small eyelets, pin terminals staked in place, pieces of wire or component leads soldered to pads on both sides of the board. The easiest way is to specify plated-through holes. This process deposits a conductive metal plating on the inside walls of the hole. Be sure to specify all the hole sizes as "finished-hole sizes." This tells the board manufacturer that the drilled hole must be larger.

After you complete your layout, check it against an unmarked schematic drawing. Cross out each line in the schematic as you trace the pattern on the layout. Once you have confirmed

that the layout is correct, go back and check each pad and drafting-tape path to make sure that they are firmly stuck to the Mylar.

Use a protective coating

Apply a clear acrylic spray, such as Krylon 1304, as a protective coating for the completed artwork. Spray it on with a side-to-side motion and with the can held 10 in. from the Mylar. Two thin but wet coats, applied 20 minutes apart, are much better than one thick coat. In addition to providing protection, the acrylic makes all cut marks and unused holes seem to disappear. But do not use this process on red and blue artwork; it will cause their colors to run together.

When the final coating has dried, the Mylar should be treated to prevent it from sticking to other surfaces. You can use a very thin coat of talcum powder, but this often results in a build-up of powder along the tape paths and pads. A better way is to use the acrylic spray again. But now spray from four feet away, and aim the spray about 14 in. above the Mylar. When done in this way, the spray dries to extremely fine powdery dust before it hits the artwork. Spread the spray over the entire surface with a circular motion. Don't apply too much spray dust; only a small amount is needed to remove any sticky feeling. ■■

Touché!

Target: to eliminate the warp problem in space-saving $\frac{1}{16}$ " plug-in panels.

The winning combination: EMC's Wire-Wrap® Panels with Nurl-Loc® Terminals. EMC panels stay flat, without stiffeners, because Nurl-Loc's splined cylinder distributes stress evenly throughout board thickness, even on boards as large as 15" x 18" (shown). A flat panel means more accurate true positioning between pins for better wrapping. Nurl-Loc also permits easy pin removal without damage. And the four-finger contact holds any I.C. lead firmly, even as small as .011 dia. Call Allan Klepper (401) 769-3800 for your copy of the interesting and informative "Inside Story", or write Electronic Molding Corp., 96 Mill St., Woonsocket, Rhode Island 02895.

Wire-Wrap® Gardner-Desver Co.

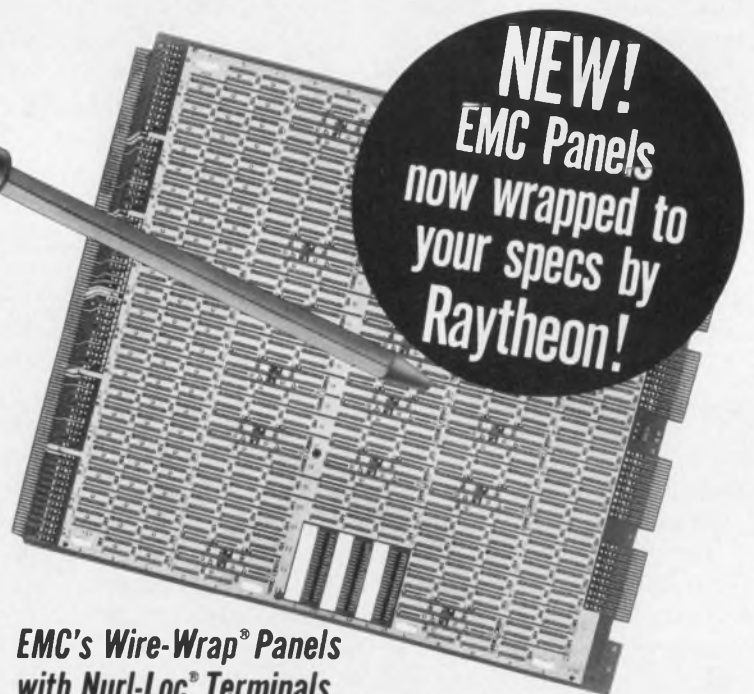

**EMC's Wire-Wrap® Panels
with Nurl-Loc® Terminals
... better performance by design!**





General Electric's Z-7906 provides 200 TVL at 10^{-5} Foot-candles!

General Electric's new Z-7906 Miniature Intensified EPICON[®] facilitates design of compact, low-light-level CCTV cameras. The Z-7906 provides 200-TV lines at 10^{-5} foot-candles. This new EPICON[®] is ideal for low-light-level surveillance, pipe inspection, aerospace, military, underwater and other applications where space is at a premium.

Call GE's Microwave and Imaging Devices Products Section at (315) 456-3210 for more information and pricing, or write MIDPS Room 301, Building 7 Electronics Park, Syracuse, N.Y. 13201.

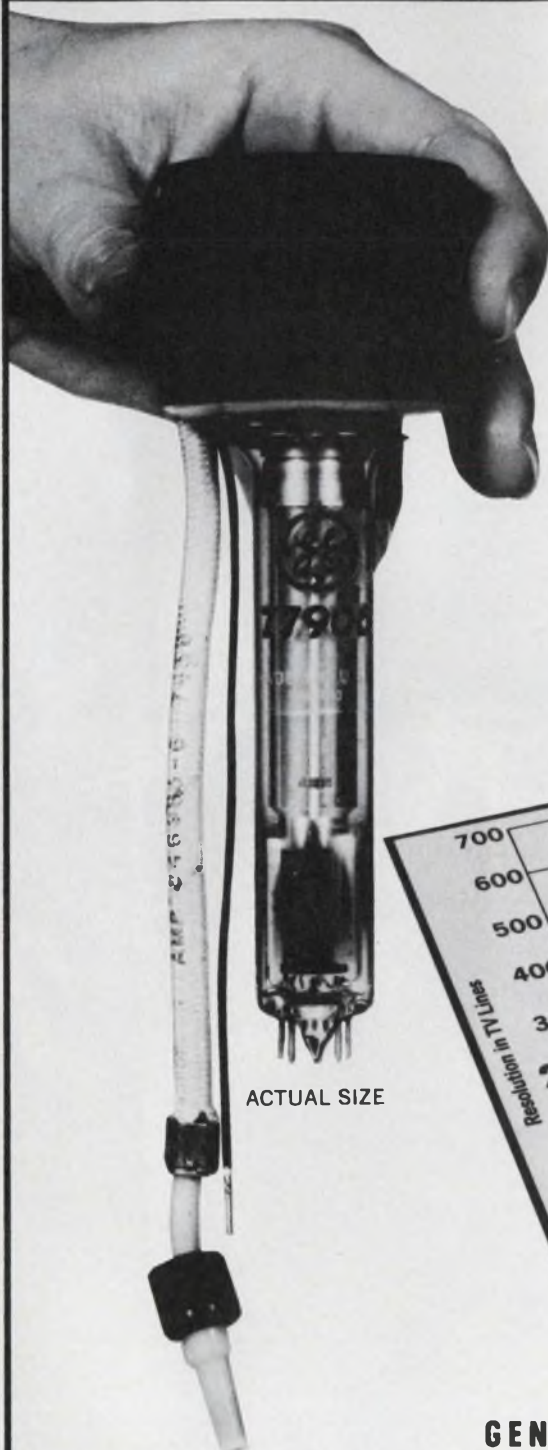

ACTUAL SIZE

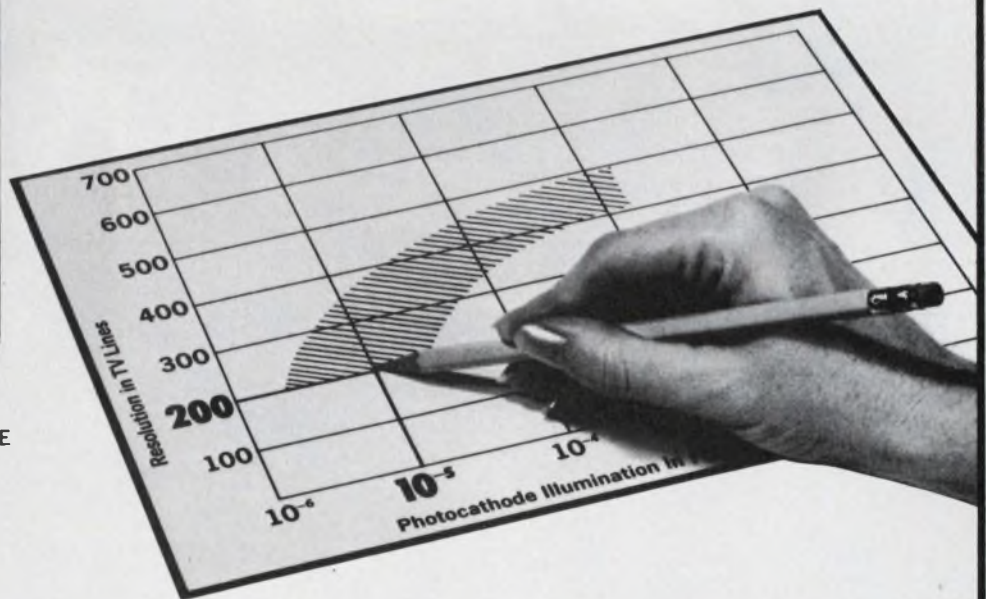

GENERAL  ELECTRIC

INFORMATION RETRIEVAL NUMBER 38

Pick a Plug-in Scope For

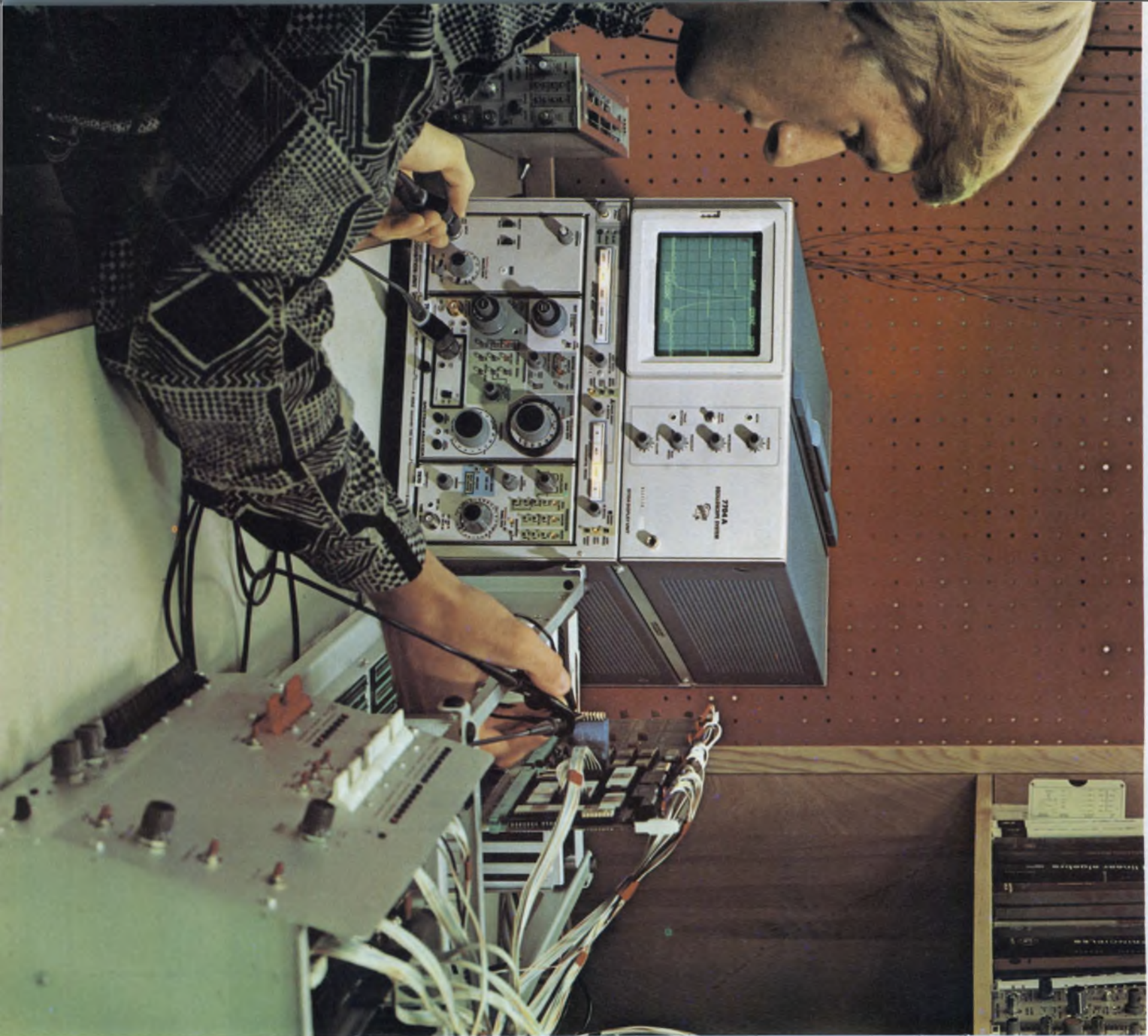

Measurement Flexibility

In today's research and development laboratory your work calls for measurements of many different types. For example, in integrated circuit development you most likely need a real time oscilloscope, a sampling oscilloscope, a digital multimeter and digital counters/timers. Or in communications R & D you probably use a spectrum analyzer in addition to all of or most of the instruments mentioned for the IC lab.

However, your space limitations, budget considerations and operator's convenience all demand that you get the maximum measurement flexibility from each instrument package.

The TEKTRONIX 7000 Series offers just such flexibility in a system of laboratory instruments. Its flexibility allows you to tailor the oscilloscope-based measurement system that most closely fits your needs. You select the measurement parameters—and the measurement techniques—you need, and combine them into interchangeable mainframe and plug-in packages.

Here are a few examples of 7000-Series flexibility:

BANDWIDTH RANGE—Whether your maximum bandwidth requirement is less than 100 MHz or up to 500 MHz (or even up to 1 GHz in some circumstances), there is a mainframe to match your needs. Eleven amplifier plug-ins and five time-base plug-ins (with sweep speeds to 0.5 ns per division) further help you tailor your system.

INPUT CHANNELS—Whether you need only one trace or up to four inputs, you can select just as many amplifier channels as you need.



Microprocessor designer uses time domain plug-ins (7A16A/7B70) and spectrum analyzer plug-in (7L5) to give a combined display on 7704A mainframe. While the oscilloscope displays pulse characteristics, the spectrum analyzer identifies clock jitter down to 10 Hz and measures system noise directly in dB.

SIGNAL ACCESS—For special signal access or processing such as Z-axis input, sweep gate and sawtooth, remote reset input, or vertical amplifier output, the interconnection scheme of the plug-in scope gives you convenient access points.



DELAYED SWEEPS—For complex measurements requiring delayed sweep, the 7000 Series offers both analog and digital techniques for delaying and expanding sweeps.

DIGITAL ACCURACY—For digital accuracy to measure selected portions of complex signals, Tektronix's unique capability to interconnect an oscilloscope with digital voltmeters, counters, and timers provides convenient measurement solutions.



DIFFERENTIAL INPUTS—When common mode noise inhibits your measurement of low level signals, differential amplifiers (with up to 100,000:1 cmrr) can be included in your system.

SAMPLING DISPLAYS—When you need to display high-frequency repetitive signals, sampling plug-ins give your system up to 14 GHz of equivalent bandwidth.

What about your measurement needs that are outside the realm of a conventional oscilloscope, such as spectrum analysis, curve tracing and rapid scan spectrometry? Three spectrum analyzer plug-ins handle up to 1.8 GHz with 30 Hz resolution. A curve tracer plug-in displays

dynamic parameters of devices up to one-half watt. And the RSS plug-in scans 400 nm in just 4 ms. (RSS available in U. S. only.)

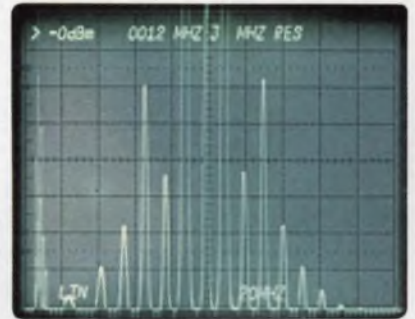

One more thing about 7000-Series flexibility: with a choice of more than 30 plug-ins and 17 mainframes in a continually evolving family, you can be assured of a long-lived oscilloscope system that will continue to accommodate your needs.

For a catalog describing all the 7000-Series instrument mainframes and their plug-ins, call your local Tektronix Field Engineer, or write Tektronix, Inc., P.O. Box 500, Beaverton, OR, 97077. In Europe, write Tektronix Limited, P.O. Box 36, St. Peter Port, Guernsey, Channel Islands.

The 7000 Series . . . more than an oscilloscope



TEKTRONIX®
committed to
technical excellence

Avoid CMOS noise-sensitivity problems

by filtering power supplies, isolating high-frequency noise sources and controlling edge speeds.

Though the noise margin of complementary MOS is far greater than that of other popular logic families, designs employing CMOS sometimes require special care. There are noise-sensitivity problems peculiar to MOS technologies that must be avoided.

For example, CMOS-gate threshold tracks supply voltage. So multiple toggling of edge-sensitive flip-flops may occur if both power and clock signals are not relatively noise-free. Also, parasitic bipolar transistors—especially on transmission-gate inputs—may cause flip-flop data loss if these inputs become forward-biased because of signal overshoot or voltage-supply noise. Noise-related problems such as these can neutralize CMOS benefits, like low power consumption, loose power-supply regulation and high dc fanout.

Fortunately the problems can be overcome by these fairly simple solutions: adequate filtering of power supplies, isolation of high-frequency noise sources and control of signal rise and fall times at edge-sensitive inputs. In most cases, adherence to these basic guidelines ensures trouble-free operation.

Ideal transfer characteristics

The CMOS transfer characteristic (Fig. 1), with its output transition centered between its V_{DD} -to- V_{SS} signal swings, yields potentially the most ideal set of noise-rejection characteristics available in a logic family. Other popular technologies, such as TTL, rely on forward-biased silicon diodes to set gate-threshold levels. For TTL, two forward drops usually define the threshold at a level between 0.8 and 2.0 V, and the actual level depends heavily on temperature. In addition TTL thresholds are far from the center of their 0.2-to-3.0-V typical signal swing, yielding unbalanced voltage noise immunity at ONE and ZERO logic levels.

A simple CMOS inverter consists of a single complementary transistor pair. When transistor

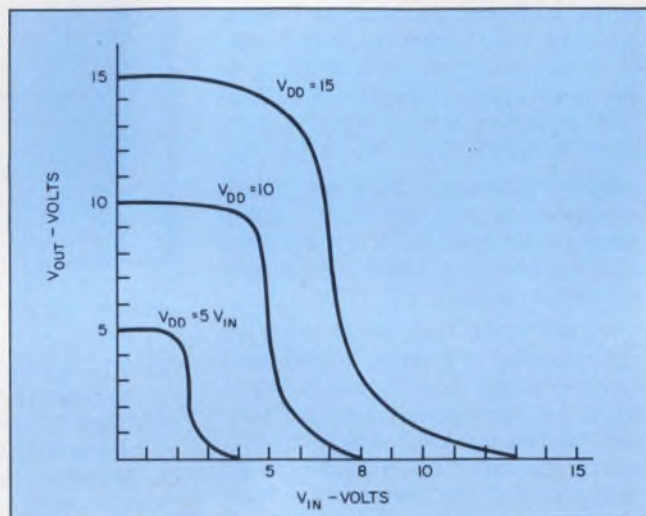

1. The threshold of a CMOS inverter remains nearly centered between supply-voltage limits, regardless of the actual supply voltage.

parameters and geometries are properly balanced, these devices represent nearly equal impedances when equivalent gate-to-source bias is applied. Ideally if the gate input is held midway between V_{DD} and V_{SS} , then the output would also be at the supply midpoint. Thus, operation anywhere within the permitted voltage-supply range results in nearly centered inverter or gate threshold, and therefore nearly equal ONE and ZERO-level noise margins.

In addition temperature variations don't have substantial effect on the CMOS inverter or logic gate threshold; temperature affects both the p and n-channel transistors in the same way. The voltage-divider effect of a complementary pair is relatively unchanged with temperature variations, even though absolute impedances vary substantially.

The V_{DD} -to- V_{SS} signal swings and centered gate thresholds of CMOS are indeed strong medicine when noise is the ailment. Typically, they provide the maximum dc noise margin possible for conventional logic circuits.

But like any medicine, you must heed directions on the label. In spite of the many strong

Ken Stephenson, Applications Engineer, Harris Semiconductor, P. O. Box 883, Melbourne, FL 32901.

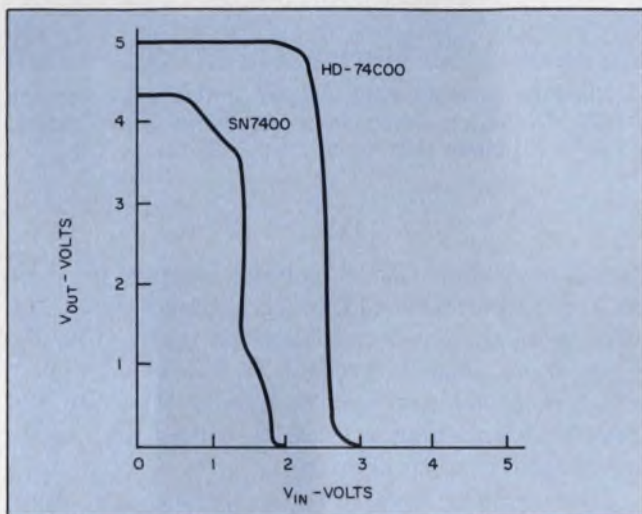

2. The improved transfer characteristics of CMOS over TTL can be seen from a comparison of the TTL SN7400 and CMOS HD74C00, shown for $V_{DD} = V_{CC} = 5$ V.

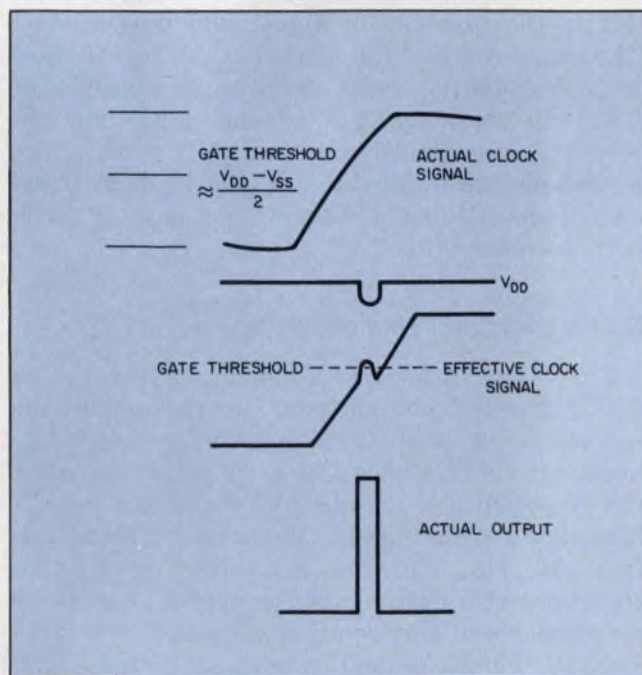

3. Noise on V_{DD} can cause multiple toggling of an edge-sensitive flip-flop. CMOS gate thresholds track supply variations, and therefore add or subtract noise at signal transitions.

points of CMOS, there are some cases where these circuits are actually more sensitive to noise-related failures. Awareness of these areas and careful design will, however, preclude difficulties.

Let's take a look at some noise-margin definitions and see how they relate to CMOS specifications and performance. Logic ONE and ZERO-level worst-case noise margins are defined as the difference between respective worst-case input threshold levels and output ONE and ZERO levels (Fig. 2).

Even with worst-case specifications, CMOS noise immunity is still higher than that of TTL. However, noise immunity is specified differently by the two major CMOS lines, the 4000 series and 54C/74C. Manufacturers supplying the 4000 series specify the parameters V_{NL} and V_{NH} . The V_{NL} defines the noise immunity of a CMOS input in the low state. The value normally specified for noise positive-going from V_{SS} is 30% of the total supply voltage ($V_{DD} - V_{SS}$). For 5 and 10-V operation, 1.5 and 3.0-V noise levels are specified, respectively. V_{NH} defines the noise immunity for an input in the high state. Negative-going noise (negative from V_{DD}) equal to 30% of the supply voltage is specified in the same manner as for V_{NL} .

Specification pitfalls

The V_{NL} and V_{NH} specifications for the 4000 series have one feature that can present difficulties when worst-case design is a requirement. Worst-case output-voltage degradations are nearly equal to the 30% input offset. Any injection of additional noise into subsequent stages could yield undefined gate outputs.

Statistically a worst-case gate is rare, and there is little likelihood of plugging that gate into a socket with worst-case noise. Therefore the implication here is not that actual noise characteristics of the 4000 series are poor or that a system failure is likely, but simply that specifications do not guarantee substantial noise margins.

The low guaranteed noise margins described don't prevail across the board for 4000 series. They are primarily specified for the early vintage

single-stage gate and inverter/buffer functions. Those gate or logic functions that have two or more stages from input to output are generally specified to have higher dc noise margin.

The 54C/74C series specifies noise immunity across the board in a way that allows designs with higher guaranteed noise margins. For 5-V operation, inputs can deviate 1.5 V from supply, with outputs pulling to within 0.5 V of supply. At 10-V supply levels, inputs and outputs are specified within 2.0 and 1.0 V of supply, respectively. This specification guarantees a minimum ONE and ZERO-level noise margin of 1 V for both 5 and 10-V operation.

When driving low-power TTL, 74C outputs are guaranteed to be above 2.4 V or below 0.4 V with 360 μ A source and sink currents, respectively. 74C inputs must be above 4 V or below 1 V to maintain these specified output drive levels.

Manufacturers indicate that the 54C/74C-type specification might become standard for other CMOS logic families. Most products in the 4000-series and 14500-series CMOS can meet the 54C/74C limits.

While considering noise immunity and assessing system noise rejection, you must look at more than the dc input/output drive levels. A properly designed system employing CMOS exclusively can exhibit excellent noise characteristics. But problems can arise when you mix other high-energy or high-frequency technologies without proper precaution or you don't give proper attention to the filtering of power distribution.

Hold that line

The output impedance of CMOS logic circuits is generally an order of magnitude greater than that of TTL, and it is this termination impedance that drives and must maintain signal levels against the barrage of noise. Signal lines driven by CMOS are therefore more vulnerable to coupled noise from high-energy sources.

The CMOS functions most affected by such noises are those clocked devices with memory capability, such as D-type flip-flops and shift registers. Noise glitches injected into combinational logic are, in many cases, filtered by the inherent gate delays and without harmful side effects. But such a glitch on a flip-flop clock input may cause a state change.

When using edge-sensitive devices in a system, particular attention must be paid to minimizing clock rise and fall times and providing adequate power-supply filtering. Noise on the clock line or on either V_{DD} or V_{SS} can cause multiple clocking. A clock with long rise and fall time is particularly vulnerable to such a failure.

Another key point to remember is that CMOS logic-gate thresholds track supply variations.

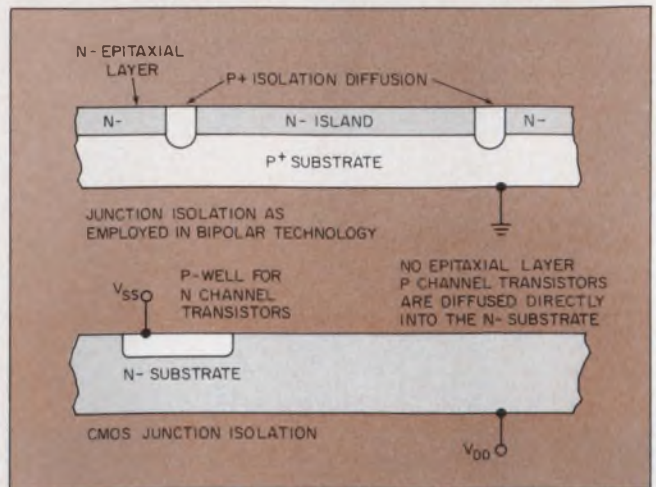

4. Junction isolation differs significantly for bipolar and CMOS. The latter, which uses less complex processing, employs a simpler technique.

Noise on either CMOS voltage supply (V_{DD} or V_{SS}) can therefore add to or subtract from the voltage of an edge-sensitive clock input (Fig. 3). Even if no noise is present on the clock line, a glitch in power that occurs when a slow rise and fall-time clock-input crosses threshold may cause an undesired state change.

Many CMOS data sheets specify maximum clock rise and fall times of 15 and 5 μ s at 5 and 10-V operation, respectively. This is generally considered to be the maximum figure for reliable operation assuming noise-free power and signal lines. Most real system applications, however, won't tolerate such extended transition times, due to the presence of signal and power noise. The actual rise and fall time that can be tolerated when substantial noise is present depends on both the characteristics of the noise and the specified edge-sensitive device. It is, with a few exceptions, desirable to keep clock transitions very short. Multiple clocking because of noise then becomes unlikely.

Bipolar parasitics: They're everywhere

The isolation scheme commonly employed in CMOS does not provide true isolation of individual transistor or diffused interconnect elements under all circumstances. A satisfactory isolation can be obtained if the absolute maximum voltage limitations are observed. Violation of these ratings—by, say, allowing excessive forward-bias conditions at a CMOS input or output—results in a breakdown of the isolation scheme, due to activation of bipolar parasitics inherent to the CMOS structure. These parasitics can, in some cases, adversely influence circuit operation.

Junction isolation is most commonly used for CMOS. This method, however, differs greatly

from the scheme used in TTL. In CMOS, many transistor sources and drains and interconnects are diffused side-by-side at the substrate (Fig. 4). All junctions within this structure are intended to operate reverse-biased.

Parasitic bipolar transistors are always present in this CMOS structure, although they do not normally come into play unless maximum ratings are exceeded. Several chip-design techniques are used to minimize parasitic effects. The techniques include adequate spacing of critical diffusions and the use of guard bands to minimize gain and break up parasitic action.

The most common way to bring such parasitics into play is to cause an input or output junction to become forward-biased. Noise on power or signal lines is the most probable cause of a forward bias. Diffusions at CMOS inputs and outputs form junctions with both the n^- substrate material and the p^- wells that contain the n-channel transistors. The n^- substrate biases to V_{DD} , and the p^- wells bias to V_{SS} . Noise that is more positive than V_{DD} therefore causes the p^+n^- junction to forward bias. Noise more negative than V_{SS} forward-biases the n^+p^- junction.

Note that voltage between pins is relative; noise on inputs or outputs should be considered with regard to supply noise. Supply noise adds directly to signal noise when the two occur simultaneously.

In general, the voltage required to activate bipolar parasitics decreases with increased operating temperatures. At 125 C, the actual forward bias required to bias a parasitic ON is between 0.4 and 0.5 V. Absolute ratings specified by various manufacturers set the maximum permissible forward bias at some level between 0 and 0.5 V.

The gain of a lateral bipolar parasitic varies inversely with junction spacings. Adjacent source-to-drain diffusions therefore produce the strongest parasitics, since the spacing is minimized. The CMOS configuration most sensitive to parasitic interference is probably the transmission gate, or bilateral switch. This sensitivity results from the use of the transmission gate in certain applications where the parasitic may have access to both device pin and internally stored data (Fig. 5).

Some counters, shift registers and simple flip-flop functions employ the transmission gate as part of the mechanism to load data. Noise at the transmission-gate input that is positive with respect to V_{DD} or negative with respect to V_{SS} may activate the high-gain drain-to-source parasitic. Direct access of this parasitic to the storage node may cause loss of data.

Activation of bipolar parasitics in CMOS circuits constitutes their most serious noise-sensitivity drawback. This is unfortunately true because signal and power-noise polarities and

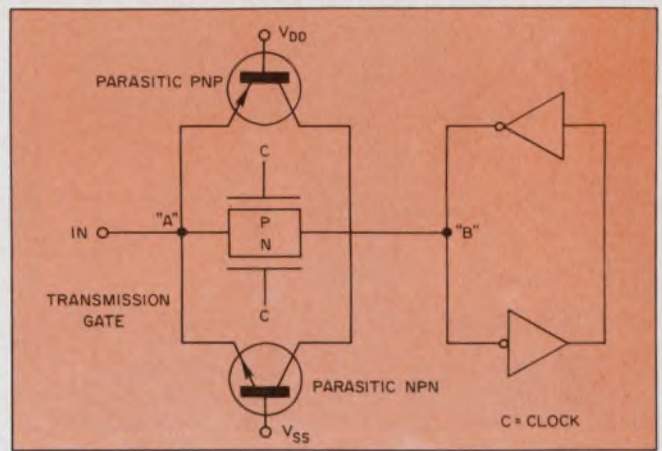

5. Normal loading for a transmission gate occurs when the clock signal equals V_{DD} . But if either bipolar parasitic base emitter becomes forward-biased, a lateral transistor will turn on. And latch "B" may be forced to an alternative state, thus losing data.

amplitudes frequently generate undesired forward-bias conditions.

When noise on the power line is the culprit, the solutions are easy. Simply filter and control ground differences in power distribution. Anticipation of power distribution noise levels, though, isn't always possible. It's wise to provide an ample number of decoupling capacitors distributed throughout the PC board, rather than one filter only at the board's power input.

Large-signal overshoots generally don't present a problem in an all-CMOS system. Existing general-purpose CMOS is too slow to suffer transmission-line difficulties, because signal transition times aren't comparable in magnitude with line delays. Most signal noise in a CMOS system is coupled or related to poorly filtered power lines. Attention to the length of parallel signal lines, control of noise sources and adequate power-distribution filtering should curb excessive signal-line noise.

A comparison of CMOS vs TTL is difficult when it comes to ac noise immunity based on circuit speed. Significant differences in logic-gate threshold levels and the proliferation of TTL and CMOS manufacturers account for the problem. In general, though, CMOS ac noise immunity will be higher, if only because of the comparatively lower speed of present CMOS. The centered-gate threshold also enhances the CMOS ac noise margin. Actual ac noise immunity for the CMOS HD740C02 and its TTL counterpart, the SN7402, appears in Fig. 6.

A common method to define ac noise characteristics employs a plot of noise pulse widths vs noise amplitude. In most cases, the noise sensitivity of a device that is sensitive to pulse width, such as a flip-flop, plays a key part in the definition of system-noise tolerance. The

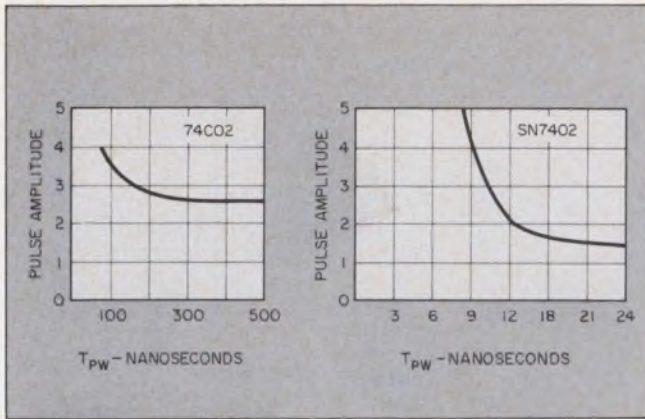

6. CMOS ac-noise immunity is generally higher than that of TTL, as indicated by a comparison of the CMOS 74C02 with the TTL SN7402.

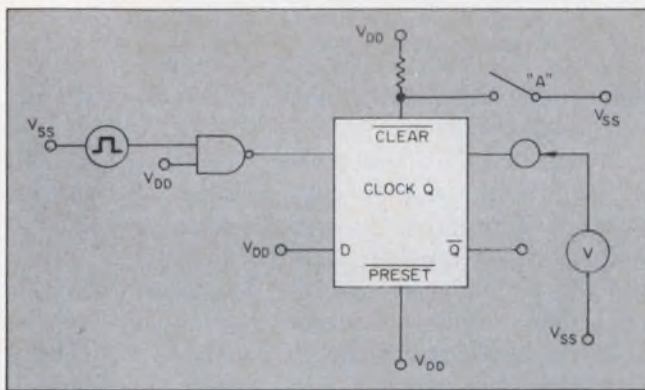

7. A test setup measures ac noise immunity. Before each reading, the flip-flop is initialized when switch A is closed. Then, for a given pulse width, pulse amplitude is increased to the minimum that will toggle Q to V_{DD} .

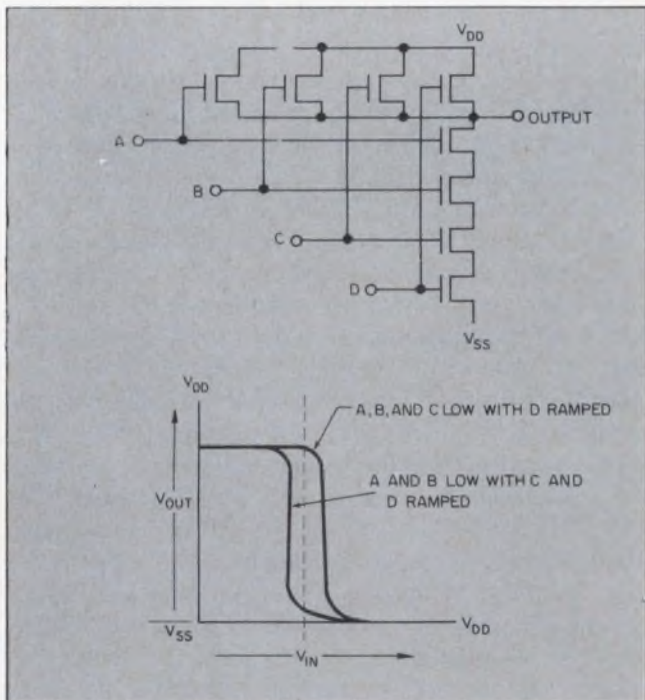

8. A dual four-input CMOS NAND gate illustrates how logic pattern sensitivity affects gate-threshold voltage.

minimum noise pulse amplitude vs width required to clock the worst-case noise-sensitive flip-flop is therefore a viable tool in assessment of system-noise tolerance. A test jig for noise measurement appears in Fig. 7.

Logic-pattern sensitivity

Gate threshold, and hence noise margin, for single-stage CMOS gate functions has a sensitivity to the input logic pattern. The position and shape of the vertical portion of the transfer characteristic depends on the voltage division between complementary-MOS transistors as the switching input or outputs traverse the linear region.

For example, consider the four-input NOR gate (Fig. 8). It consists of four n-channel transistors connected in parallel between the output and V_{SS} , and four p-channel transistors in series between V_{DD} and the output. If inputs A, B and C are held low and D is ramped through the active region, three dc-biased p-channel transistors and one ramped p-channel transistor will divide the supply voltage with one ramped n-channel unit. If A and B are held low, with C and D ramped, the voltage divider characteristic will be modified and the transfer characteristic shifted, as shown.

Usually the input pattern sensitivity appears only in devices that have single-level gate functions. Multilevel-function devices—such as decoders, some flip-flops and adders—have two or more gate or inverter functions that isolate inputs from outputs. These additional stages, in effect, perform a buffering function, even when buffering isn't their primary reason for inclusion.

The addition of buffer stages to functions that can be performed with a single logic level can eliminate pattern sensitivity. Additional gain provided by buffers also has the effect of sharpening the vertical portion of the transfer curve.

However, some penalty must be paid when buffer stages are added. Gate delay for a single-stage gate is primarily a function of input and output rise and fall times. There is very little inherent delay through the gate. The equivalent logic function performed with buffering will have added internal delays.

For heavy external capacitive loading, these internal delays may become insignificant compared with the total gate delay, resulting in speeds comparable to or possibly faster than an unbuffered gate. For light-to-moderate capacitive loading, these internal delays will exact a speed penalty because of small internal stage loading. ■■

New from Potter & Brumfield



8 major P&B relays to solve today's design challenges.

1. R10S. Sensitivity to 5mW per pole. Available in 1, 2, and 4 Form C contacts. Ratings from dry circuit to 3 amps. Less than \$3.00 in lots of 500.

2. R50 relays. Help you solve cost and space problems. Less than \$2.00 in quantity, the R50 allows 0.6" center-to-center pc board spacing.

Coil ratings of 5, 6, 12, 24, and 48 VDC. Available in 1 and 2 Form C contacts.

3. CG relay. Extended-range CMOS IC time delay or interval timer. Repeatability including first cycle is typically .01% for DC units and 0.1% for AC units. Time delays up to 100 minutes standard.

4. R16 time delay module. Offers big savings at under \$7.00 in quantities. Timing ranges, potentiometer adjustable, are 0.2 to 2, 2 to 30 and 10 to 100 seconds for delay on operate.

5. T10 series relays. Only 0.375" high. Ideal for high density applications—permit pc boards to be mounted on 0.5" centers. Two and 4 Form C contacts provide 0.1 to 3 amp switching @ 30 VDC. Coil ratings: 6, 12, 24 and 48 VDC.

6. JDO relays. Solid state switching with total opto-coupler isolation. Zero voltage turn on and zero current turn off minimizes EMI and RFI. Low profile

permits pc board mounting on 0.5" centers. Coil ratings: 5, 6, 12 and 24 VDC. Shockproof.

7. EOT series relays. Opto-coupled, all solid state. Solve high cyclic switching problems. Synchronous zero crossover switching virtually eliminates EMI and RFI. Output: 2, 4, 5 or 7 amps @ 120 VAC standard.

8. PRD series power relays. New improved design. Interchangeable with famous PR series. Save 50¢ at list price! UL and CSA listed. Rugged terminals designed for power screwdrivers.

For detailed product specifications, contact the Potter & Brumfield sales representative or authorized distributor nearest you, or write Potter & Brumfield Division AMF Incorporated, Princeton, Indiana 47671. Telephone 812-385-5251.

EUROPE: Electrical Products Group,
AMF International Limited, AMF
House, Whitby Road,
BRISTOL BS4 4AZ.

England.
Telephone:
(0272) 778383
Telex: 449481
AMMAFOCO
BRSTL

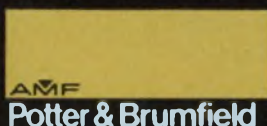

Solving switching problems is what we're all about.

Test a/d converters digitally

by use of a microprocessor or minicomputer and a simple Basic program. Accuracy and resolution are easily determined.

Direct measurement of analog-to-digital converter resolution and accuracy, both high and low-frequency, can be done at sample frequencies as high as 15 MHz. All that's needed is a simple program written in Basic and a digital processing system—either a minicomputer or specialized high-speed microprocessor will do.

The direct measurements permit high-speed determination of a/d converter accuracy and resolution to 10 bits, although tests for resolution can be extended to 13 or more bits without loss of accuracy. Only some small hardware changes in the test set are needed.

Both accuracy and resolution affect the signal fidelity as a signal is translated from the analog to the digital domain. Lack of accuracy causes distortion of the digitized signal, while lack of resolution results in a small dynamic range or poor signal-to-noise ratios.

Traditionally parameters like dc accuracy and aperture error have been used to indicate the accuracy and resolution of the converter. However, these results are taken from special cases of input signal frequency. Tests such as dc, sample-rate, sample-rate/2, double-pulse and synchronous "ramp-walking" all depend on the input signal frequency. Efforts to make direct measurements of accuracy and signal-to-noise ratio at high speeds and high resolution, by use of non-synchronous signals, are thwarted by lack of adequate instrumentation at reasonable prices.

Until recently, the inaccuracies of digital-to-analog conversion and measuring instruments have been limiting factors in the direct testing of high-speed a/d converters. But by using a digital processing system operating in the digital domain, you can eliminate the errors caused by d/a converters and their associated analog instrumentation. The only analog instruments needed are the signal source and the filter (Fig. 1).

The input signal should be as pure a sine wave as possible; for that reason, it is fed through a bandpass filter, which removes any harmonics and spurious signals. The test signal frequency

is not locked to the encode frequency or any of its harmonics; as a result, the sample-to-sample variations in the sampled input signal or encoded output voltage of the a/d converter are unpredictable and nonrepeatable. Thus the measured results indicate the true linearity and resolution under normal a/d converter operating conditions.

Basically the test set feeds a filtered sine-wave signal to a converter under test, lets the converter encode up to 1024 samples of the waveform and stores the samples in a buffer memory. Next, the contents of the buffer are transferred into the main processor memory for analysis.

The best way to do the analysis is to use a discrete Fourier transform (DFT). Thus the first step in the analysis is to apply time-weighting to the data to reduce frequency side lobes. And unless the proper weighting function is provided, the main lobe energy spills over into many other frequency bins and makes noise measurements impossible.

To use the DFT, first determine the weighting function. For the method used in this article, this is the \cos^2 function without a pedestal. Thus the expression for the input data multiplied by the weighting function becomes

$$WD_n = D_n [0.5 - 0.5 \cos (2\pi n/N)], \quad (1)$$

where WD_n is the n th weighted data sample, D_n is the n th input data sample, and N is the total number of samples.

By weighting the inputs, you can compress the spillover energy (leakage) into a small band of frequencies centered on the carrier frequency. This eliminates contamination of a large portion of the over-all spectrum.

Next, the program must find the DFT of the sequence of weighted data samples for $N/2$ frequencies. To do that, the program must solve these two equations for the K th frequency:

$$A_k = 1/N \sum_{n=1}^N WD_n \cos [2\pi k(n-1)/N] \quad (2)$$

$$B_k = 1/N \sum_{n=1}^N WD_n \sin [2\pi k(n-1)/N], \quad (3)$$

Bill Pratt, Senior Engineer, Computer Labs, 505 Edwardia Dr., Greensboro, NC 27409.

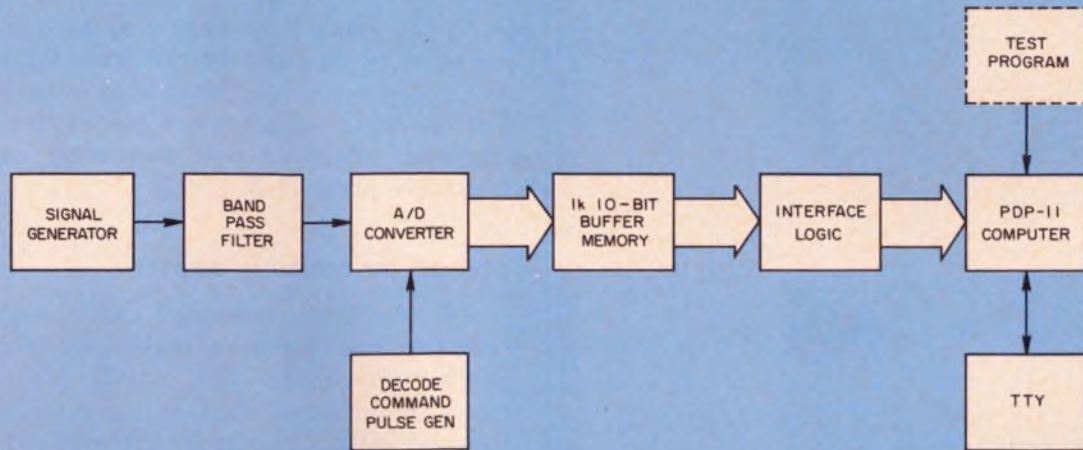

1. **Block diagram for the entire test bed** shows that only a single analog instrument—a signal source—is needed

to test a/d converters. This system can operate at speeds up to 15 MHz.

where A_k and B_k represent the magnitudes of the cosine and sine parts of the K th spectral line.

The total magnitude of the K th spectral line is then expressed by the equation

$$\text{Mag}_k = \sqrt{A_k^2 + B_k^2}, \quad (4)$$

which is used by the processor to determine linearity (accuracy) and signal-to-noise ratio (true resolution).

Program finds the linearity

You can measure the linearity of the a/d converter by observing the relative amplitude of the m th harmonic relative to the fundamental frequency (measured in dB). This can be expressed by

$$\text{Amplitude} = 20 \log (\text{Mag}_r / \text{Mag}_{nr}). \quad (5)$$

In Eq. 5, Mag_r is the magnitude of the fundamental and Mag_{nr} the magnitude of the m th harmonic. Thus this equation provides a direct indication of linearity of the transfer function. If you want to find the maximum deviation from linear, combine the A and B components of Eq. 4 by adding them algebraically. This gives the peak amplitude of the summed signal. The program in Fig. 2 does not do this, however, since harmonic distortion alone is a good criterion.

True resolution of the a/d converter can be found by first establishing the residual noise floor in all frequency bins except those occupied by the input signal. The processor program can do this by squaring a magnitude of each frequency bin that doesn't contain the input signal, adding all $N/2$ squared magnitudes and then solving for the square root:

Basic program for high-speed A/D S/N test

```

10 P2=6.28319
20 DIM D(1024), S(1024), C(1024)
30 REM - COMPUTER COEFFICIENTS
40 FOR N=0 TO 1023
50 S(N)=SIN (P2*N/1024)
60 C(N)=COS(P2*N/1024)
70 NEXT N
80 REM - INPUT DATA
90 FOR N=0 TO 1023
100 INPUT # 1 : D(N)
110 NEXT N
120 REM - WEIGHT DATA
130 FOR N=0 TO 1023
140 W=0.5 - 0.5*COS(P2*(N+0.5)/1024)
150 D(N)=D(N)*W
160 NEXT N
170 REM - COMPUTE SPECTRUM
180 FOR K=0 TO 511
190 X=0
200 Y=0
210 FOR N=0 TO 1023
220 L=K*N
230 IF L > 1024 THEN 250
240 L=L-1024\GO TO 230
250 X=X+D(N)*S(L)
260 Y=Y+D(N)*C(L)
270 NEXT N
280 X=X/1024\Y=Y/1024
290 X=2.83 * SQR (X^2+Y^2)
300 X=8.67*LOG(X)
310 PRINT K, X
320 NEXT K
330 END
  
```

2. This short **Basic program** is all that's needed to compute the different errors of the high-speed a/d converter under test.



Small Wonder
 *It's PICOTEMP thermal cutoff
 New from Micro Devices
 (Actual Size)

PICOTEMP thermal cutoffs. Fit tight spaces — and limited budgets. Same accuracy and similar capabilities as the widely used MICROTEMP® safety thermal cutoffs...but smaller in size. Weighs just 1/48th of an ounce. Installed costs are less, too.

Use PICOTEMP thermal cutoffs when installation or space restrictions rule out MICROTEMP. At present, motors and transformers are two leading applications.

But, wherever you use PICOTEMP thermal cutoffs, you're assured of positive, low cost protection against overheating caused by malfunctions in electrical circuits and components.

The PICOTEMP thermal cutoff is completely sealed

against atmosphere. Because of its unique design and construction, it won't derate. And it is unaffected by age or extended use.

Here are some other things you'll want to know:

- current capacity—to 5 amps. at 120 VAC. Will hold this rating up to and including 240 VAC.
- temperature tolerance $\pm 3^\circ\text{F}$. (1.7°C).
- temperature ratings—136° to 300° F. (58°-150° C).
- leads are 26 gauge silver plated wire.
- facilitates approval to UL 506, UL 544, UL 547, UL 697, UL 492 and UL 859. signed to comply to UL 1020. Currently being tested by UL for yellow card recognition.

For more information, check the reader service card, or call or write.



MICRO DEVICES CORP.

1881 Southtown Blvd., Dayton, Ohio 45439
 Ph: (513) 294-0581 Telex: 28-8087

$$\text{Noise} = \sqrt{\sum_{K=1}^{N/2} \text{Mag}^2 K} \quad (6)$$

At the same time Mag_{r-7} to Mag_{r+7} should be set equal to zero and deleted from Eq. 6. In practice, these seven frequency bins on either side of the sine-wave bin must be ignored; the main lobe widening effect of \cos^2 weighting causes only negligible error if $N \geq 256$.

Evaluate the computer outputs

An "ideal" a/d converter can be used to compare the true resolution and signal-to-noise ratio of the units under test. Ideally an a/d has a quantization error that is an equal-probability function, with a maximum error of $\pm q/2$ ($q = 1$ quanta or 1 LSB). The rms voltage associated with an equal-probability error signal is $q/\sqrt{12}$. Therefore this is the expected noise floor for an ideal a/d. Expressed in dB, relative to full scale, the equation becomes

$$S/N = 6n + 10.8 \text{ dB} \quad (n = \text{number of bits}), \quad (7)$$

$$\text{sine wave } S/N \text{ (ideal)} = 6n + 1.8 \text{ dB}. \quad (8)$$

However, the weighting function used to implement the test causes a loss of 1.8 dB. Thus the ideal case can be modified by subtraction of the 1.8 dB, which leaves, for the rms case,

$$S/N = 6n \text{ dB}.$$

For an ideal 10-bit converter, the measured result would be 60 dB. In practice, an a/d converter will measure less than this figure because of analog errors associated with the converter itself.

For example, a typical a/d converter with 10-bit accuracy has an over-all specification of 0.05% ± 0.5 LSB. The first part of that spec (0.05%) is called the analog error and is caused by aberrations in the transfer function. The other half of the spec is the quantization error associated with any a/d converter, including the so-called ideal.

Since the rms contribution of the quantization noise is $q/\sqrt{12} = 0.29 q$, and the rms contribution of the worst-case analog error is $0.5 q$ (assuming a square-wave error function), the worst case noise for an a/d converter that meets its accuracy (linearity) specification is

$$(0.29 q)^2 + (0.5 q)^2 = 0.58 q,$$

which is approximately 6 dB worse than an ideal a/d converter.

Thus, an acceptable criterion for an n-bit a/d could be: $\text{Min } S/N = 6n - 6 \text{ dB}$.

This is the minimum acceptable sine-wave signal-to-noise ratio for an n-bit a/d converter. However, note that $6n - 6$ can be written as $6(n - 1)$. Expressed another way, a converter with n-bit resolution and operated with worst-case tolerances would perform equally well or better than an ideal converter with $n - 1$ bits of resolution. ■■

Save Money

NOW
JUST
\$2400*

on 32K NMOS memory for NOVA 1200

Sure you can buy your mini-computer memory from the minicomputer company. Lots of people do. And they pay a premium for the privilege.

But if you want to save money on memory, buy it from the memory company . . . EMM. You'll not only save money — you'll get the latest developments in memory technology — even before the minicomputer companies get them.

Take this 32K NMOS memory for example. You can plug it right in to your NOVA 1200 mini-computer; no modifications

of any kind needed. And you can have *error checking and correction* as an option — something not even the minicomputer company can offer you.

Get all the details on our money saving minicomputer add-in memories from your local EMM office today. Or write us at the address below.

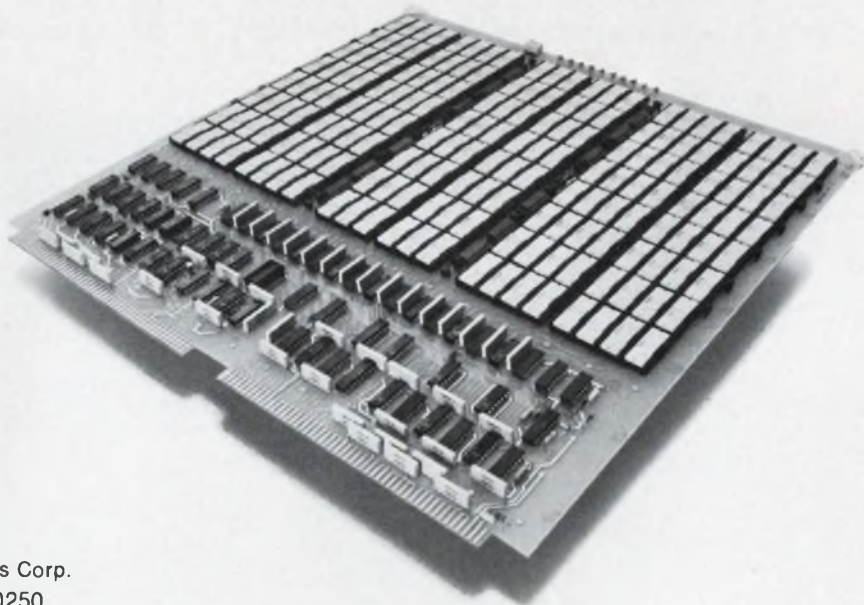

EMM ELECTRONIC
MEMORIES
COMMERCIAL MEMORY PRODUCTS

A Division of Electronic Memories & Magnetics Corp.
12621 Chadron Ave., Hawthorne, Calif. 90250

***32K capacity, quantity 1. 16K: \$1230. 8K: \$860. Quotes on OEM quantities.**

EMM OFFICES: WESTERN REGION, Regional Office, San Francisco (408) 247-9711, Los Angeles Area (213) 644-9881, Orange County Area (714) 639-5811, Phoenix Area (602) 968-2492, EASTERN REGION, Regional Office, Boston (617) 861-9650, Chicago Area (312) 297-7090, New York Area (516) 423-5800, Akron Area (216) 867-5435, INTERNATIONAL OFFICES, European Headquarters, United Kingdom (01) 751-1213, Belgium (031) 76.69.75, West Germany (089) 714.30.40. REPRESENTATIVES: Gentry Associates: Orlando (305) 894-4401, Huntsville (205) 534-9771, Burlington, N.C. (919) 227-3639. In Japan, Nissho Electronics (03) 544-8396.

INFORMATION RETRIEVAL NUMBER 42

Microvolt probe traces PC current paths to help locate those defective ICs

It's tough to find a defective IC chip on a PC board when the power-supply lead is routed to several chips in parallel. The usual procedure of cutting PC traces or unsoldering chips often causes additional damage. But a simple current tracer can eliminate the frustration and lead directly to the faulty IC that is loading down the power supply.

The tracer amplifies the small voltage drop caused by current flow along a fraction of an inch of PC wiring and drives an ordinary microammeter. Needle-point test probes are used to contact the edge of a PC trace and to follow the current to determine which branch the current takes.

One-half of a dual 741 op amp forms a dc amplifier with ac feedback to prevent oscillations and

hum-pickup problems. It drives a 50-to-100- μ A meter, such as is found in many VOMs. The other op amp provides a center tap for the 9-V battery supply and zero adjustment with R_4 . Two diodes protect the meter. Resistor R_1 eliminates the necessity for shorting the probes when the meter is zeroed. The value of 1Ω is large when compared with the resistance of the meter leads plus the bridged portion of PC wiring.

The effects of drift and thermal emf—though readily apparent, since microvolts are being measured—do not hinder the circuit's current-tracing ability. The absolute value of the readings is unimportant.

Roy A. McCarthy, Production Engineer, GYYR Div., Odetics, Inc., 1845 S. Manchester Ave., Anaheim, CA 92802. CIRCLE NO. 311

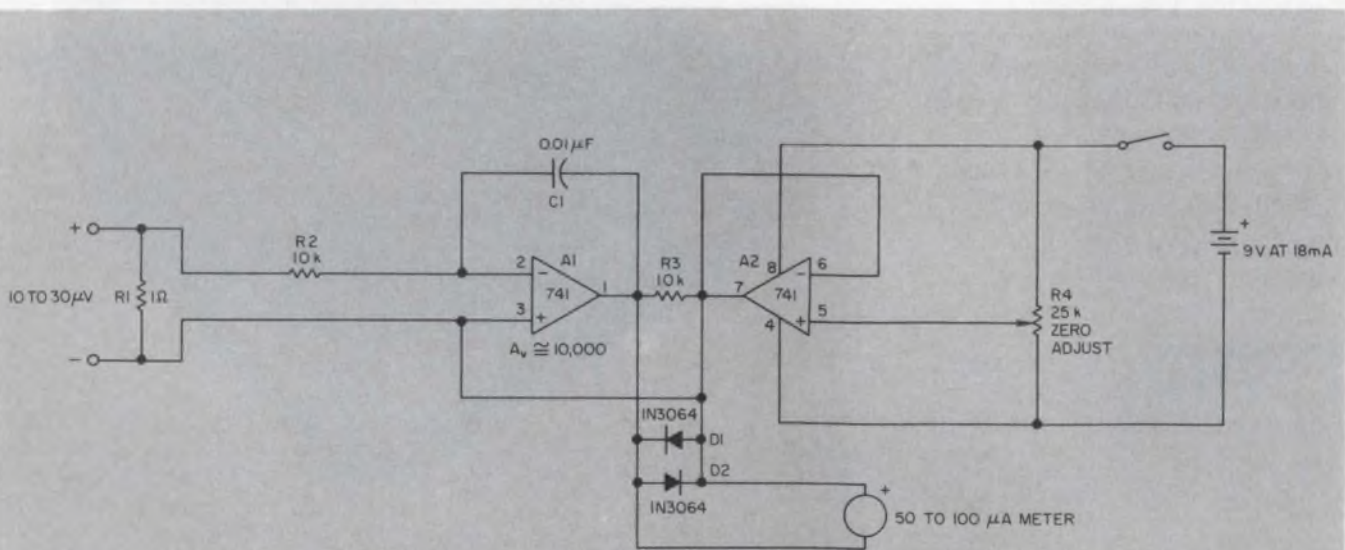

The sensitive microvolt probe circuit is nulled with potentiometer R_4 . Op-amp A_1 provides a gain of

about 10,000 for dc levels, and A_2 acts as a center-tap for the 9-V battery.

Triplett 310 mini-VOM's fit your hand and your wallet...



only \$49

The high quality Triplett 310 is a little all-in-one VOM. This made in the U.S.A. VOM gets around a lot for half fare. It packs most of the features you'd expect to find only on a meter twice the size and price. It fits in your shirtpocket easily. The small size and its versatility is a boon to field servicemen as well as circuit designers, technicians, electrical maintenance engineers, and the price is right for vocational and hobbyist use.

A newly designed high impact, drop resistant case makes it practically indestructible . . . 20K ohms/volt DC and 5K ohms/volt AC ranges provide plenty of sensitivity for most applications . . . and, there's diode overload protection with a fused R X 1 ohm range. The single range selector switch is a real time saver for reading 0 - 1200 DC or AC volts, 0 - 20 megohms, and 0 - 600 micro-amps or 0 - 600 milliamps at 250 millivolts.

Comes complete with 42" leads, alligator clips, batteries and instruction manual. Accessories triple the versatility of a 310. Adding the Model 10 clamp-on ammeter allows you to measure AC currents easily with one hand.

Visit your local distributor or Mod Center and shake hands with a real bargain.



TRIPLETT
BLUFFTON, OHIO 45817

Triplett. The easy readers

CMOS switch inverts analog signal under control of digital logic

Circuit designers often need to invert an analog signal under direction of a logic signal. But logic-controlled converters generally suffer from voltage offset errors. A control circuit that uses a single CMOS IC to switch the inputs of an op amp can overcome this problem.

In the simplified schematic (Fig. 1) the inverter between the logic input and SW₂ symbolically indicates that SW₂ is open when SW₁ is closed, and vice versa. For a typical CMOS switch, the on-resistance, R_c, is about 300 Ω and the off-resistance, R_o, about 1000 MΩ with a ±7.5-V supply.

Assume the op amp is ideal. With SW₁ open and SW₂ closed, the circuit inverts. By superposition, the output voltage is

$$V_o = \frac{-V_{in}R_2}{R_1} + \frac{V_{in}R_c}{R_o + R_c} \left(\frac{R_2}{R_1} + 1 \right) \quad (1)$$

Since

$$\frac{R_c}{R_o + R_c} < 3 \times 10^{-7}, \quad (2)$$

the second term in Eq. 1 can be neglected, and if R₁ = R₂, then V_o = -V_{in}.

When SW₁ is closed and SW₂ open, the circuit is noninverting, and now the output is

$$V_o = \frac{-V_{in}R_2}{R_1} + \frac{V_{in}R_o}{R_c + R_o} \left(\frac{R_2}{R_1} + 1 \right) \quad (3)$$

Since

$$\frac{R_o}{R_c + R_o} = 1$$

to within 0.001%, the second term can be simplified to V_{in} $\left(\frac{R_2}{R_1} + 1 \right)$ and, now, V_o = V_{in}.

The required logic inverter is formed from the SWD section of the CD4016 IC and a 10-kΩ resistor (Fig. 2). The input signal can come from prior CMOS circuitry, also operating from ±7.5-V supplies, or from TTL logic if a logic-level translator is used (Fig. 3).

The input-voltage swing is limited by the CMOS logic. With the CD4000-series, this is about ±6 V when operated with ±7.5-V supplies. If higher voltage swing is required, a hybrid FET switch, such as the Siliconix DG182, can provide ±10 V.

Mark Stitt, Engineer, Burr-Brown Research Corp., International Airport Industrial Park, Tucson, AZ 85734.

CIRCLE NO. 312

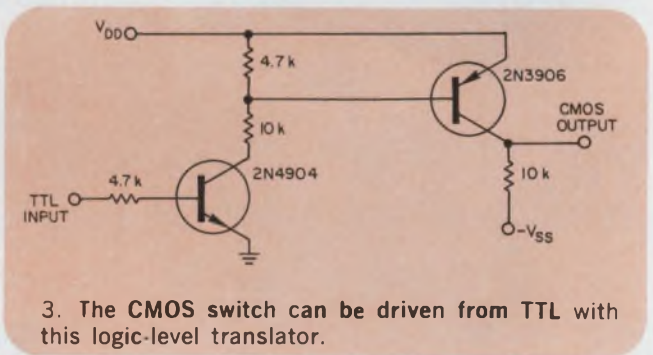
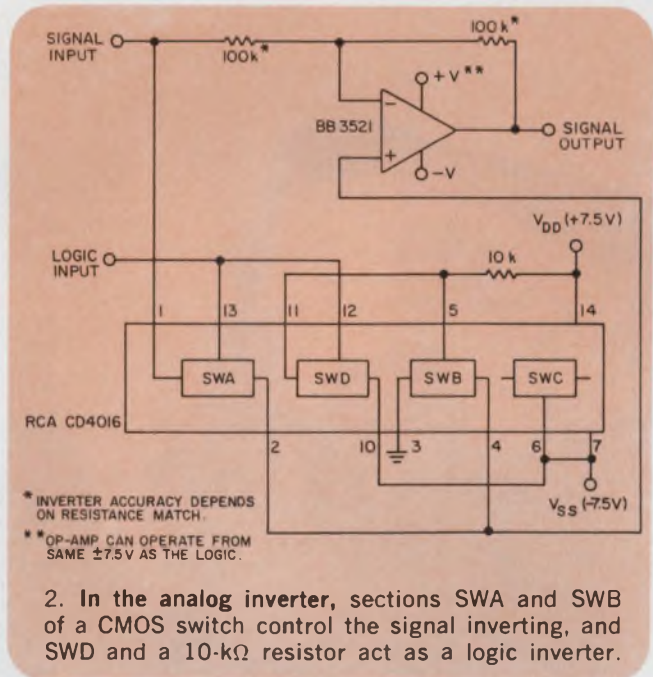
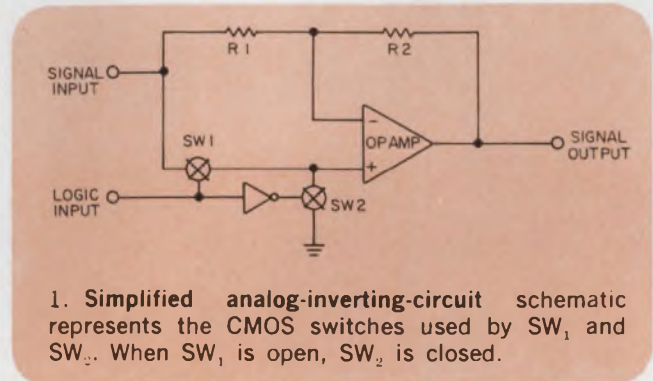

There's a reason why we're so open about our **Q Series** Open Frame Power Supplies. We want you to know everything about them. Like our one year warranty. And stock delivery. And our socketed semiconductors which makes field spares support a snap.

About our thermal design, the best around, making our heat sensitive parts run cooler and operate longer. And we're the *only* maker of Open Frame Power Supplies where *all* components operate well within mfrs. specs.

That's why Deltron "Open Frames" save you money three ways: When you buy them. By avoiding costly downtime. And by lasting longer.

We want you to compare Deltron "Opens" with others. In fact, we'll send you our Comparative Engineering Reports matching Deltron against other major mfrs. You'll find as others have that Deltron is unsurpassed for quality and performance.

For some more open talk about Deltron Q Series and a copy of our Comparative Engineering Reports, write or call collect to Deltron, Inc. Wissahickon Avenue, North Wales, Pa. 19454. Telephone: 215-699-9261, TWX 510-661-8061.



Size A Model No.	Size B Model No.	Size C Model No.	Size D Model No.	Size F Model No.
volts — amps	volts — amps	volts — amps	volts — amps	volts — amps
Q 5 — 3.0	Q 5 — 6.0	Q 5 — 9.0	Q 5 — 12.0	Q 5 — 18.0
Q 6 — 3.0	Q 6 — 6.0	Q 6 — 9.0	Q 6 — 12.0	Q 6 — 18.0
Q 12 — 1.7	Q 12 — 3.4	Q 12 — 5.7	Q 12 — 7.0	Q 12 — 10.8
Q 15 — 1.5	Q 15 — 3.0	Q 15 — 4.8	Q 15 — 6.3	Q 15 — 9.5
Q 18 — 1.3	Q 18 — 2.6	Q 18 — 4.0	Q 18 — 5.2	Q 18 — 7.8
Q 20 — 1.3	Q 20 — 2.6	Q 20 — 4.0	Q 20 — 5.2	Q 20 — 7.8
Q 24 — 1.2	Q 24 — 2.4	Q 24 — 3.3	Q 24 — 4.8	Q 24 — 7.2
Q 28 — 1.0	Q 28 — 2.0	Q 28 — 3.1	Q 28 — 4.2	Q 28 — 6.0
Dimensions: 4 7/8 x 4 x 1 1/8	Dimensions: 5 3/8 x 4 7/8 x 2 1/2	Dimensions: 7 x 4 7/8 x 2 3/4	Dimensions: 9 x 4 7/8 x 2 3/4	Dimensions: 14 x 4 7/8 x 2 3/4
Price: 1 — \$32.00 100 — \$26.00 250 — \$24.00	Price: 1 — \$54.00 100 — \$44.00 250 — \$41.00	Price: 1 — \$67.00 100 — \$54.00 250 — \$51.00	Price: 1 — \$87.00 100 — \$70.00 250 — \$66.00	Price: 1 — \$113.00 100 — \$ 91.00 250 — \$ 85.00

Some open talk about open frame power supplies

Socketed power semiconductors.
Iridited aluminum chassis.
Computer grade electrolytics.
Special circuits to protect IC.

Forward and reverse voltage protection.
Barrier block interface.
Infinite resolution adjustments.
Full interchangeability.
115/230 vac, 47-440 hz.

Socketed IC regulation system.
Filters meet mfrs. ripple ratings.
Glass epoxy PC boards.
Loss of sense protection.
Designed for U.L. Recognized
Component Index.

For some more open talk about Deltron Q Series and a copy of our Comparative Engineering Reports, write or call collect.

Deltron inc.

INFORMATION RETRIEVAL NUMBER 44

Dual-voltage regulated power supply has adjustable outputs that track

A comparator and a few external parts can transform two IC regulators into a dual-voltage regulator that tracks, has safe-area limiting, and protection against short-circuits and thermal overload. The combination can deliver currents to 500 mA, and the positive and negative outputs of the two integrated regulators can be adjusted independently with variable resistors, R_1 and R_2 .

The component values in the figure provide output voltages from the positive regulator—the $\mu A78MG$ —over a range of 5 to 30 V and from the negative—the $\mu A79MG$ —from -2.2 to 27.2 V. But care must be taken not to exceed the maximum voltage ratings of the $\mu A741$.

To achieve tracking, the common terminals of the two regulators are both tied to the output of the $\mu A741$. Thus a decrease in, say, the positive output because of temperature or a line or load variation would cause a reduction in the $\mu A741$ inverting input voltage. This, in turn, would raise the potential of the common terminals of the two IC regulators to reduce the output of the negative regulator.

In this way changes in one of the outputs tend to produce a corresponding change in the common regulator terminals, to force the other output to track. Since each regulator has its own reference, there is no slaving. The outputs and degree of tracking are proportional to the ratio $(R_1 + R_3)/(R_2 + R_4)$.

Andy Adamian, Supervising Engineer, Fairchild Semiconductor, 464 Ellis St., Mountain View, CA 94040
 CIRCLE NO. 313

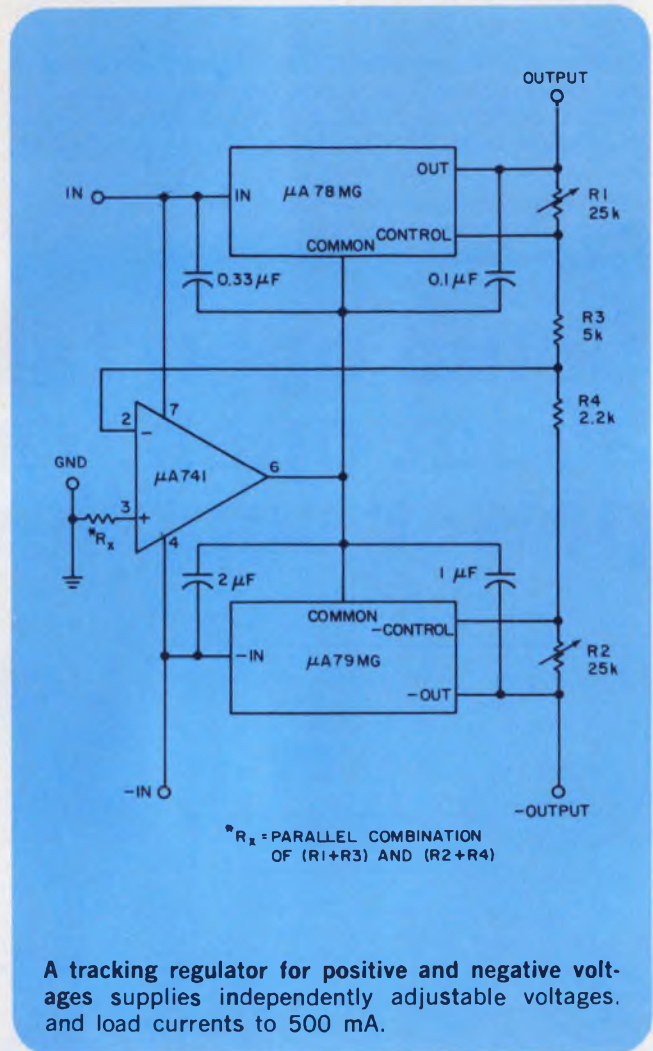

A tracking regulator for positive and negative voltages supplies independently adjustable voltages and load currents to 500 mA.

IFD Winner of August 2, 1975

J. Brian Dance, Physics Dept., The University of Birmingham, P.O. Box 363, Birmingham B15 2TT, England. His idea "Ultrasonic Transmitter/Receiver Generates a 20-ft Beam That Detects Objects" has been voted the Most Valuable of Issue Award.

Vote for the Best Idea in this issue by circling the number of your selection on the Information Retrieval Card at the back of this issue.

SEND US YOUR IDEAS FOR DESIGN. You may win a grand total of \$1050 (cash)! Here's how. Submit your IFD describing a new or important circuit or design technique, the clever use of a new component or test equipment, packaging tips, cost-saving ideas to our Ideas for Design editor. Ideas can only be considered for publication if they are submitted exclusively to ELECTRONIC DESIGN. You will receive \$20 for each published idea, \$30 more if it is voted best of issue by our readers. The best-of-issue winners become eligible for the Idea of the Year award of \$1000.

ELECTRONIC DESIGN cannot assume responsibility for circuits shown nor represent freedom from patent infringement.

A better answer

The new Slim-Line II audio connector line from Switchcraft, the leading supplier of audio and microphone connectors. A new money-saving interchangeable connector system provides the design flexibility equipment and instrument manufacturers need for quick and inexpensive model changes.

Before Switchcraft's interchangeable connector system, you could get connectors two ways. First you could buy male or female line cord plugs and receptacles completely assembled, and at times, packaged individually. (This required disassembly before installation and adds at least 10% to the price of the connector alone.) Secondly, you could specify a disassembled connector which required long delays in obtaining special part numbers and prices.

Now the people who brought you the Q-G (Quick Ground) Audio Connector bring you the best of two worlds. The first complete audio/microphone connector line that gives you economy and flexibility using a unique interchangeable connector system.

The Slim-Line II line cord plugs consist of only four parts for simple trouble-free installation, assembly and low cost. The receptacles consist of

only two parts, plus mounting hardware.

The inserts available from 2 to 5 pins and/or contacts, plus a shunt circuit, can be assembled into any line cord plug or receptacle housing. Using Switchcraft's established listings of Slim-Line II connector components, manufacturers can choose any combination of components and assemble any type of male and/or female connector...without costly labor or component revision.

This is the new Slim-Line II audio connector line from Switchcraft, a dependable low cost connector line for instrumentation, recorders, microphones, computers, industrial controls, broadcast and telecommunication apparatus, and other equipment where a connector is required. For more information write for Engineering Specification Catalog C-520a to Switchcraft, Inc., 5555 N. Elston Avenue, Chicago, Illinois 60630.

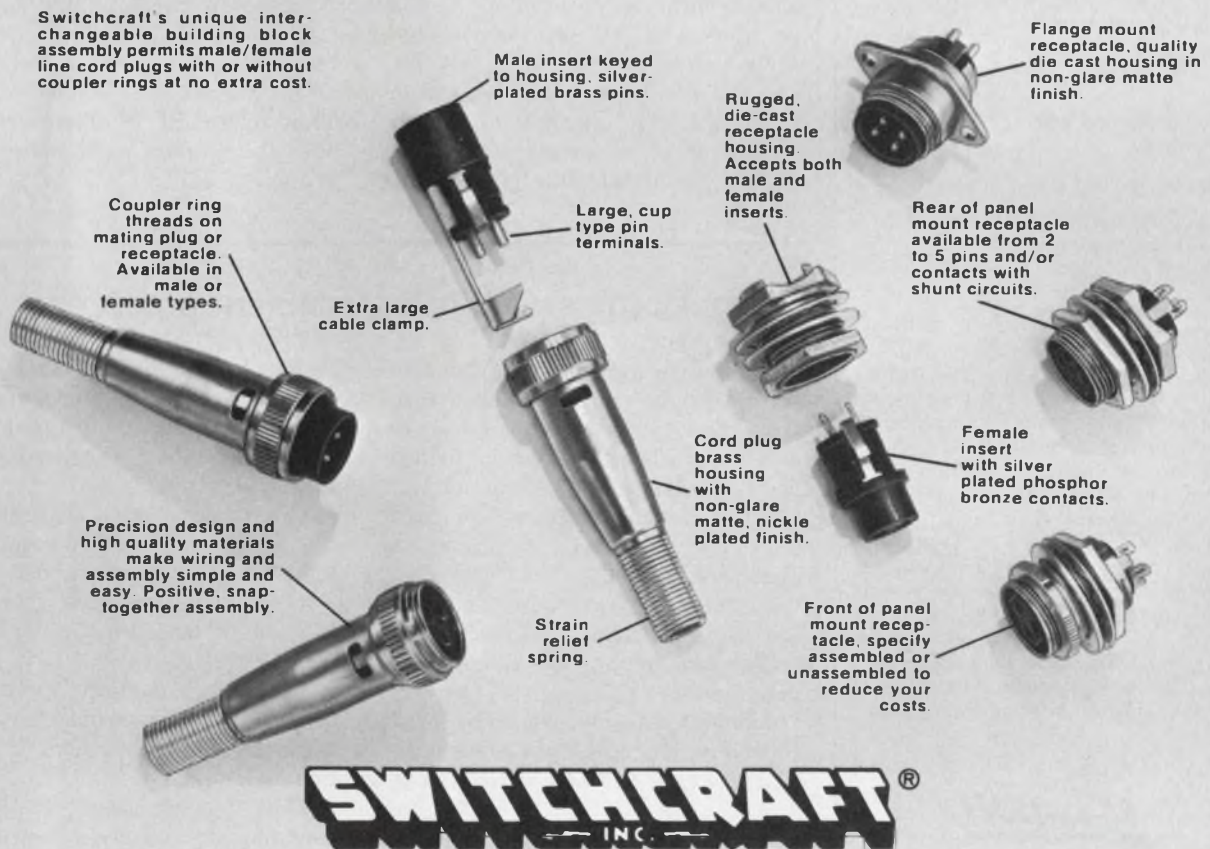

Grayhill coded output switch modules stack up!



**new performance
standards...
1,500,000 cycles
with less than
10 milliseconds bounce**

- Self-generated logic...7 wire coding capability
- Can be stacked in any array
- Telephone array will provide standard frequency selection

This "second generation" of low-profile Grayhill pc mountable push-button switch modules passes exacting test for life and for bounce. Choose 6-, 3-, 2- and 1-button horizontal or vertical modules, to array in any format, including telephone key set, while maintaining constant center-to-center spacing! Circuitry available as SPST through 4 PST, normally open, or the poles can be internally shorted so several terminals connect when button is actuated. Choice of colors, with hot stamped or molded-in legends. For more information on these Series 82 modules, consult EEM or ask Grayhill for engineering data.



561 Hillgrove Avenue • LaGrange, Illinois 60525
(312) 354-1040

INFORMATION RETRIEVAL NUMBER 46

International Technology

Interference prevented in loudspeaker setup

Undesirable group radiation or interference effects that occur when identical loudspeakers are used in a single small cabinet are prevented by use of a method developed by Saba Schwarzwalder Apparate-Bau-Anstalt August Schwer Sohne GmbH of West Germany.

Where one high-frequency tweeter or midrange unit is used with more than one identical bass speaker, the bass speakers cannot, without interference, share the same load at the region of cross-over with the middle or high range units. Although the bass units may share the same load over a part of their operating frequency range, all but one must be rolled off to zero well before the crossover range. According to the German designers, this roll-off should be about 12 dB per octave and should start at least an octave below the crossover point, as shown in Fig. a. The speaker circuit is in Fig. b.

Two identical low-frequency

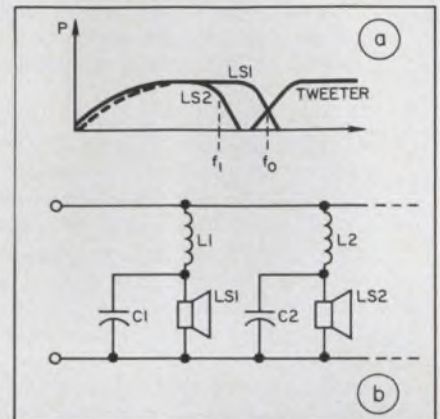

speakers are independently filtered.

The filter for LS1 (Fig. a) is a low-pass unit with a top cut-off of substantially f_0 . The filter has a slope of 12 dB per octave and overlaps the curve of the high-pass filter for a tweeter. The filter for LS2 also acts as a low-pass filter but with a cut-off at f_1 , which lies more than an octave lower than f_0 . Thus only LS1 is effective at the overlap region, and there is no group effect.

Piezoelectric switch is environment proof

Many elevators and television sets are equipped with touch controls and proximity switches in which the user's finger brings about a change in the conductivity or capacitance of the sensor area and, by doing so, generates a switching signal.

Problems with these switches are that they can be inadvertently triggered and they are sensitive to moisture.

Siemens AG of Erlangen, West Germany, has developed a pushbutton in which the actuating area is designed as part of a rigid and hermetically sealed surface. Moisture and soiling are said to have no effect on the switching charac-

teristics and inadvertent contact does not result in false operation because a definite minimum pressure is required for actuation of the pushbutton.

The piezoceramic transducer in the pushbutton switch responds to light finger pressure (about 150 g). The deformation that occurs is less than $0.5 \mu\text{m}$ and produces about 0.8 V.

The switch contains an RC low-pass filter to prevent false trigger action by vibrations of a particular amplitude and frequency.

The piezoceramic pushbutton does not pick up stray current and is particularly suitable for battery operated radios and TV sets.

ROLL'EM SMOOTH

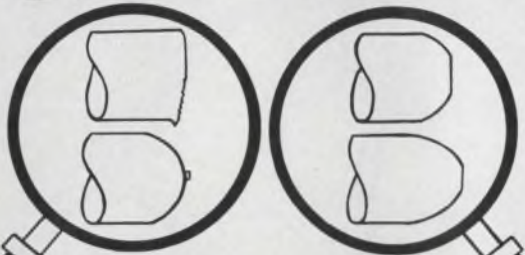

**DON'T BUY
BURRS**

**BUY SMOOTH
RADII**

Mating, feeding, assembly, and electrical contacts are easier, more reliable and faster with radiused or bullet nosed smooth blended cut-offs. Available by special techniques from Auto-Swage for probably less money than those with burrs, sharp corners, cutoff tits or insufficient tumbled corner breaks. Ask about our capabilities. They can smooth out your problems.



auto-swage
PRODUCTS, INC.

726 River Road, Shelton, Conn. 06484. Tel. (203) 929-1401

INFORMATION RETRIEVAL NUMBER 131



Standard Grigsby has P.C. Board "Switchability"

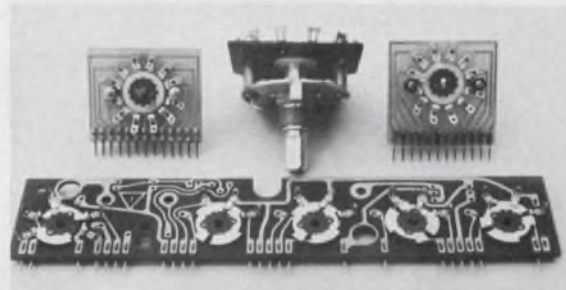

Our P.C. Board switches provide you with a cost savings by eliminating hand wiring and soldering operations.

In either an individual switch or "systems" approach, we can provide you with an endless array of detents, contact configurations, plating and size.

We call this "Switchability."

Send for Free "Yes" button and literature.



standard grigsby, inc.

920 Rathbone Avenue • Aurora, Illinois 60507
(312) 897-8417

INFORMATION RETRIEVAL NUMBER 133

New miniature open-frame models designed specifically for low power applications where absolute minimum size is essential.



WORLD'S* SMALLEST OPEN-FRAME POWER SUPPLY

\$1995
Single
Quantities

* only 3.75" H x 3.00" W x 1.60" D.

MODELS: HA5-1.2/OVP: 5V @ 1.2A w/OVP
HA15-0.5: 9V to 15V @ 0.5A

FEATURES: 115/230 VAC input • OVP on 5V models • I.C. Regulated • $\pm .05\%$ Regulation • 1.5 MV Ripple • Foldback Current Limiting • Full Rated to +50°C • 2 Hour Burn-in • 2 Year Warranty

For a copy of our New 1976 D.C. Power Supplies Catalog, contact Power-One or your local factory representative



531 Dawson Dr. Camarillo, Ca. 93010
Phone 805/484-2806 TWX. 910-336-1297

POWER-ONE, INC.

INFORMATION RETRIEVAL NUMBER 132

ELECTRONIC DESIGN 25, December 6, 1975

edi cuts corners to cut costs and improve performance



LOW COST SILICON RECTIFIER BRIDGES

Only \$1.10 for this new, low cost, small size bridge rectifier. Rated at 10 Amp continuous duty, 20 A. Peak, 150 A. surge. 50 to 800. Peak Reverse Voltage. Unique round shape provides small size: .89" dia x .30" high.

FREE SAMPLES. Write on letterhead or call outlining your application for evaluation samples and catalog information. Use Reader Service Card for just catalogs. *buy from the specialist.*

edi® electronic devices inc.
21 GRAY OAKS AVE., YONKERS, N.Y. 10710
(914) 965-4400, TWX (710) 560-0021

Manufacturer of high voltage and high current assemblies.

INFORMATION RETRIEVAL NUMBER 134

THIS YEAR...



LET ELECTRONIC DESIGN PAY FOR YOUR VACATION

ENTER OUR JAN. 5, 1976

TOP TEN CONTEST



WIN THE POPULAR CARIBBEAN WINDJAMMER CRUISE FOR TWO

Once again, by reader demand, a week's Windjammer Cruise for two in the fabulous blue Caribbean is waiting for the lucky winner of *Electronic Design's* annual TOP TEN CONTEST. Think of it . . . a complete vacation absolutely FREE! Spend easy carefree days sailing among the Bahama Out Islands, the U.S. and British Virgin Islands, or the exotic Windwards and Leewards. Shop in the free ports, sun, swim, snorkel, help sail the ship or just relax by the rail. It's truly the cruise of a lifetime.



PLUS A COOL \$1,000 CASH AND PRE-PAID AIR TRANSPORTATION FOR TWO

In addition to the cruise, the first prize winner gets \$1,000 cash, plus air transportation for two to and from the cruise ship's point of departure.

PLUS FREE AD RERUNS FOR YOUR COMPANY

If your company has an ad in *Electronic Design's* Jan. 5, 1976 issue, and you are one of the top three reader or advertiser winners, you earn a free ad rerun* that can be worth up to several thousand dollars for your firm.

100 PRIZES IN ALL

READER PRIZES

1st Prize: Caribbean Windjammer Cruise for two, \$1,000 cash, air transportation for two, free ad rerun*.

2nd Prize: Portable color TV set, free ad rerun*.

3rd, 4th, & 5th Prizes: Digital wristwatch, free ad rerun* (3rd prize only).

6th through 100th Prizes: Technical books.

SEPARATE CONTEST FOR ADVERTISERS AND THEIR AGENCIES

Advertisers, marketing men, and advertising agencies can enter too. Duplicate awards are given to the top three winners (cruise, cash, air transportation, free ad rerun*, color TV and digital watch). Remind your advertising people it's the issue of the year to build business for your company and win valuable prizes at the same time.

HERE'S ALL YOU HAVE TO DO TO ENTER

Examine the January 5, 1976 issue of *Electronic Design* with extra care. Read the Rules. Then:

- (1) Select the ten ads you think will be best seen and read.
- (2) List the ten ads by company name and inquiry number on the contest entry card.
- (3) Fill in your name and address and mail before midnight Feb. 15, 1976.

*The top ten ads will also receive free reruns. Only one free rerun per company. The first three prize winners in the reader contest and the first three prize winners in the advertiser contest awarded reruns only if their companies have an ad in the Jan. 5, 1976 issue.

COMPLETE RULES AND ENTRY BLANKS IN JAN. 5 ISSUE

Ise introduces five new ways to make the competition turn green.

Your competition probably already thinks they're using the perfect display in whatever it is they make. Let them keep thinking it. While you prove them wrong with a new Itron display. They're designed to make the competition turn green. Which also happens to be the color of the segments.

All 17 of them on the 17-digit Itron. All 5 on the FG-512A1. Next comes an Alfa-Numerical Itron. A Linear-Analog Itron. And a Digital Clock Itron. Five ways to be heartless if you put a little heart into it.

itron[®]

Alfa-Numerical Display



FG209M2

ef = 10V
ec = eb = 40Vp-p
ic = 10mA-p-p
ib = 8mA-p-p
Wd. 205mm
Lg. 40mm
Segment 9mm

Instruments & Large Calculator Display



FG179F2

ef = 7V
ec = eb = 35Vp-p
ic = 7mA-p-p
ib = 5.5mA-p-p
Wd. 170mm
Lg. 40mm
Segment 9.5mm

Instruments & Terminal Units Display



FG512A1

ef = 3.5V
ec = eb = 24Vp-p
ic = 4mA-p-p
ib = 3mA-p-p
Wd. 100mm
Lg. 40mm
Segment 12mm

Digital Clock Display



FG425A1

ef = 5.5V
ec = eb = 35Vp-p
ic = 8mA-p-p
ib = 6.5mA-p-p
Wd. 140mm
Lg. 59mm
Segment 25mm

Linear Analog Display

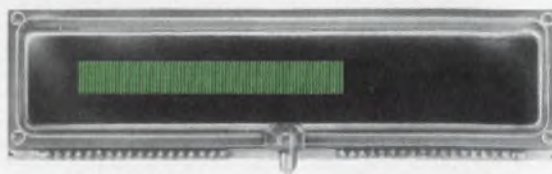

FG120S1

ef = 5.5V
ec = eb = 35Vp-p
ic = 4mA-p-p
ib = 0.2mA-p-p
Wd. 140mm
Lg. 40mm
Segment 8mm

NORITAKE CO., LTD.

Electronics Office (U.S.A.)
22410 Hawthorne Blvd. Torrance California 90505
U.S.A.
Phone: (213) 373-6704
Telex: "230674910"

Electronics Division
1-1, Noritake-Shinmachi, Nishi-ku, Nagoya-City,
Japan
Phone: NAGOYA (052) 561-7111
Telex: J59738 NORITAKE

ISE ELECTRONICS CORP.

London Office
c/o NORITAKE (U.K.) LTD
Nortake House 2, York Street W1H 1 Be., England
Phone: (01) 935-7543 Cable: "LUCTUAL" LONDON
Munachen Office
c/o NEUMÜLLER GmbH 8 Muenchen 2, Karlsruherstr. 55
West Germany. Phone: 592-421 Telex: 522106

Hong Kong Office
Room 1403 Shing Loon Bldg
24-26 Stanley Street Hong Kong
Phone: 5-232420 Telex: HX83151
Taipei Office
72-9 SEC. 2, JEN AI RD., Taipei
Phone: 351-0293 Telex: 11176

Power Darlington transistors challenge thyristors for high-power control

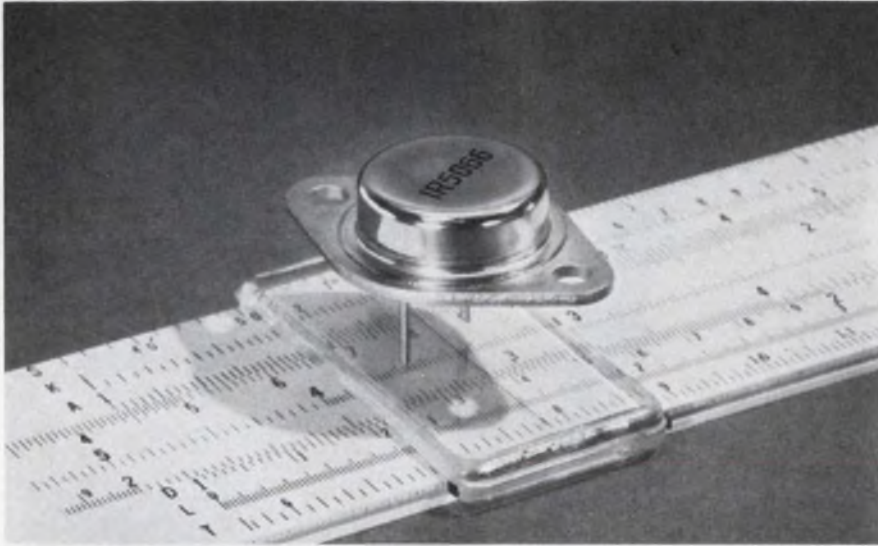

International Rectifier, 233 Kansas St., El Segundo, CA 90245. (213) 678-6281. P&A: See text.

Manufacturers of power semiconductors have long been trying to develop fast-switching monolithic control elements that don't require complex drive circuits. Now International Rectifier has taken a big leap forward with its IR5065 and 5066 monolithic power Darlington switching transistors, housed in TO-3 metal cases.

These transistors have collector-emitter sustaining voltages of over 900 V and can control peak currents of more than 20 A. Collector currents of up to 15 A, continuous, can also be handled. Storage times have also been kept low—only 20 μs max and less than 8 μs typical for the regular series and less than 5 μs max, for a premium series available soon.

There are two basic series of power Darlington: the 5065 units have 20-A I_C , 750-V $V_{CE0(SUS)}$ ratings, and the 5066 series has a 20-A, 900-V rating. According to Dave Cooper, vice president of engineering product development

for International Rectifier, no other commercially available power transistor can handle such a tough combination of parameters.

The only other devices that can do the job, he continues, are thyristors (SCRs, triacs, etc.). They can handle the voltages and currents, but tend to cost about double that of the Darlington since they require much more complex control circuitry for turn off. All the transistors need are simple base-drive circuits that can handle the collector current divided by the gain (I_C/β).

Both series of power Darlington are rated for operation over a -65 to $+165$ -C range and have a thermal resistance of 1 C/W, maximum. The sustaining voltages—the voltages fed back from the load during turn-off—are specified for a 1-mH load and a collector current of 4 A.

The transistors have maximum base currents of 2.2 A, continuous, and collector-emitter saturation voltages of only 1.6 V, maximum, when a collector current of 10 A flows. Dc current gain for both

series at a collector current of 10 A and a V_{CE} of 5 V is guaranteed to be a minimum of 20. The gain drops to 12 if the collector current increases to 15 A for the 750-V series, and it falls to 10 for the 900-V units.

Rise, fall and storage times for the transistors are specified at a collector current of 10 A and a forward base current, I_{B1} , of 600 mA, or reverse base current, I_{B2} , of 1.2 A. For the 5065 series, the rise time is 3.6 μs , and for the 5066 series, 5 μs , maximum. Fall times are the same as the rise times.

Storage times, though, are short, says Cooper, and that, combined with a low saturation voltage, determines the power dissipation of the transistor. Maximum storage times are only 15 μs for the 750-V units and 20 μs for the 900-V devices. Power dissipation for the Darlington is specified at a low 125 W.

The transistors are made with the triple-diffused process to give high second breakdown voltages of 850 and 1000 V, respectively, for the 5065 series and the IR5066 series. Integrated on a single chip are the two transistors, two resistors and a diode. Hard glass passivation is used on the chip to ensure stability and improve reliability.

Applications for the power Darlington include auto ignition systems, ac/dc motor drives and off-line switching power supplies.

Prices for the transistors start at \$18 each for 1 to 49 units and drop to \$12 each in lots of 5000 for the IR5065 series. Similarly, prices for the IR5066 series are \$22 and \$14, respectively.

Delivery for the Darlington is from stock to eight weeks.

CIRCLE NO. 301

**New, easy-action
swivel
cord.**

**Smooth,
reliable
360° rotation.**



Victor offers you a high quality swivel cord with outstanding flexibility and ease of handling. Its advanced-design 360° rotation effectively eliminates kinking and snarling. Ideal for personal care equipment and similar small appliances. Standard cords available, but our engineers can provide you custom designs for your special application. Units are easy to assemble and

provide remarkably trouble-free performance.

Write or phone for details, and find out why Victor has become the standard of quality in cord sets and other wire specialty items.

Victor Electric Wire & Cable Corp.
618 Main St., West Warwick, R.I. 02893
Telephone: 401 821-1700

Victor

INFORMATION RETRIEVAL NUMBER 50

DISCRETE SEMICONDUCTORS

Pnp power transistors handle 100 V at 5 A

*Semicoa, 333 McCormick Ave.,
Costa Mesa, CA 92626. (714) 979-
1900. From \$4 (1000-up); stock.*

A series of 100-V, 5-A pnp transistors is intended for switching and wideband amplifier applications. The four units, the 2N6190 through 2N6193, are complements of the company's npn transistors, the 2N5336 through 2N5339. The pnp units have an emitter saturation voltage of only 1.2 V at 5 A and are rated for applications with frequencies up to 60 MHz. The transistors are housed in TO-39 packages that permit up to 10 W of heat dissipation.

CIRCLE NO. 303

Fast switching diodes available in kit form



*Solid State Devices, 14830 Valley
View Ave., La Mirada, CA 90638.
(213) 421-9660. \$98.75; stock.*

A designer's kit of ion-implanted ultra-fast recovery rectifiers permits evaluation and prototype of fast-switching supply designs. The kit consists of twelve 50 V Epion devices, four each of the 20, 50 and 100-A units. The 20-A units are supplied in DO-4 cases, and the 50 and 100-A devices in DO-5. Performance characteristics include a forward voltage drop of less than 450 mV, rated at a maximum full-cycle average forward voltage drop halfwave at a temperature of 55 C and maximum reverse recovery time of 75 ns or less.

CIRCLE NO. 304

UV photodetectors claim to have top performance

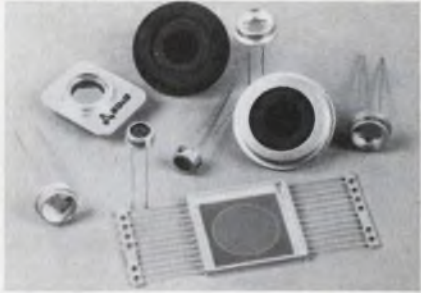

EG&G, 35 Congress St., Salem, MA 01970. (617) 745-3200. From \$29; stock.

The UV series of silicon photodetectors incorporates processing changes which are claimed to completely eliminate UV spectral instability. As a bonus, the series also boasts an anti-reflection coating that enhances the UV response by as much as 60%. The spectral range is from 200 to 1150 nm with an absolute responsivity of 180 mA/W at 250 nm. Noise equivalent power is as low as 7×10^{-14} W/Hz^{1/2} at 250 nm for an active area size of 5.1 mm². The new series is claimed by the company to have the highest shunt resistance and lowest noise current per unit area of any commercially available detector. The responsivity is linear within 1% over a 7 to 12 decade range of light intensities. The UV series is available in four different package styles with active areas ranging from 5.1 to 314 mm². They are also available with compatible FET-input op amps (the HUV series) for use as photodetector/amplifiers.

CIRCLE NO. 305

Npn and pnp transistors have 800 MHz BW

AEG-Telefunken, 570 Sylvan Ave., Englewood Cliffs, NJ 07632. (201) 568-8570. From \$1.05 (100-up); 6 to 8 wk.

A series of npn, rf transistors, types BF 362 and BF 363 and pnp types BF 679 and BF 680, have a gain-bandwidth product of 800 MHz, typical. The power gain is typically 12 dB; noise figure, 4 dB; and the reverse attenuation, 20 dB. The devices are housed in a flat plastic pack similar to the JEDEC TO-50 package.

CIRCLE NO. 306

Schottky mixer diodes have low V_f 's

Hewlett-Packard, 1501 Page Mill Rd., Palo Alto, CA 94304. (415) 493-1501. From \$5.95 to \$62.40; stock.

Low forward-voltage equivalents of HP's Schottky mixer diode line have V_f 's of 200 to 300 mV. A total of 23 devices are available, which include chips, beam lead and quad configurations. The diodes are closer to a 50- Ω impedance than standard Schottky mixer diodes, which results in a lower VSWR over the band. Noise figure of the diodes is typically less than 6 dB at 9 GHz for power levels ranging from -5 dBm to +5 dBm. Beam lead versions are the 5082-2229 series; microstrip quads are available as the 5082-2231 series (hermetic) and the 5082-2271 series (broadband); single chip microstrip packages are the 5082-2765 (hermetic) and the 5082-2774 (broadband), respectively.

CIRCLE NO. 307

Rf power transistors have internal matching

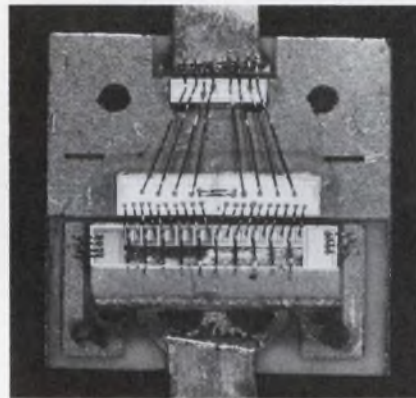

TRW RF Semiconductors, 14520 Aviation Blvd., Laundale, CA 90260. (213) 679-4561. For the MRA 2023, 12 W unit: \$200 (25-up); stock.

The MRA 2023 series of broadband, high gain transistors has internal impedance-matching circuitry. They are designed for 28-V operation and MRAL 2023 series is intended for 22-V operation. Both series are rated for broadband operation from 2 to 2.3 GHz. Units in the line offer power ratings of 1.5, 3, 6 and 12 W, with saturated output power typically 1 dB higher than the device rating for all units in broadband circuits.

CIRCLE NO. 308

Advertisement

ELECTRONIC PACKAGING Rack panels removed; inside not disturbed



Bud Radio, Inc., 4605 E. 355 St., Willoughby, O. 44094, (216) 946-3200. Panels, door 18 ga. steel.

Classic II cabinet racks from Bud. Brushed aluminum extrusion frames front panel. Sides removed from outside. Mounting rails adjustable front to rear. Rear door can be mounted to open right or left. Supports more than average load. All-steel, extra-rigid frame. Comes assembled. Compatible with Classic II cabinets. For further information phone —

1-800-321-1764, TOLL FREE

IN OHIO, 1-800-362-2265, TOLL FREE

Custom-made look, yet standard enclosures.

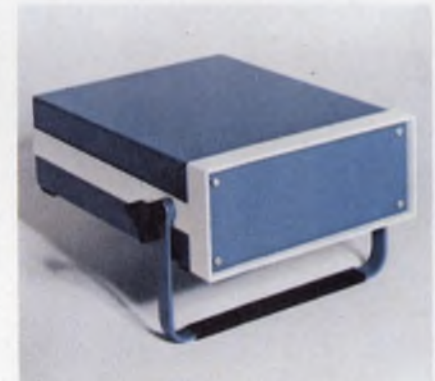

Bud Radio, Inc., 4605 E. 355 St., Willoughby, O. 44094, (216) 946-3200. The sleek TR Series.

Available at your Bud Distributor. Four sizes, plus accessory chassis. Also accepts P.C. boards. Body, .050 aluminum; front panel, .090 aluminum. Top and bottom removed easily for access to dust-free interior. Carrying handle used as tilting bail. Handle/bail, front panel and self-adhesive rubber feet included. Finished in mar-resistant, durable Nextel. Compare delivery, value, shipping economies. For further information, phone —

1-800-321-1764, TOLL FREE

IN OHIO, 1-800-362-2265, TOLL FREE

ELECTRONIC PACKAGING

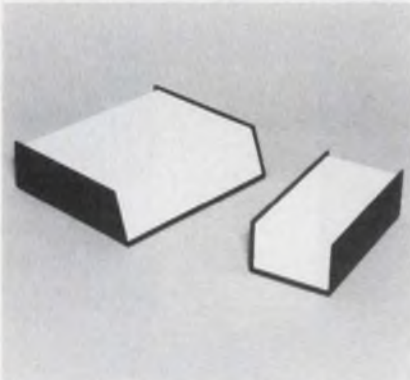
Versatile enclosures,
economical too

Bud Radio, Inc., 4605 E. 355 St., Willoughby, O. 44094, (216) 946-3200. All aluminum.

Each is immediately available in two configurations at your Bud Distributor: the Slope (left), the Linear (right). Both offer an economical means for enclosing sub-systems and instrumentation. One-piece covers are easily removed. No visible fasteners on panel areas. All aluminum: covers, .057; base, $\frac{3}{8}$ ". Rubber feet furnished. Black texture with smooth white enamel finish. For further information, phone —

**1-800-321-1764, TOLL FREE
IN OHIO, 1-800-362-2265, TOLL FREE**

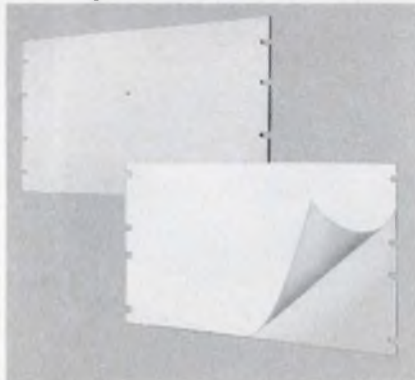
Widest selection of relay
rack panels — 84

Bud Radio, Inc., 4605 E. 355 St., Willoughby, O. 44094, (216) 946-3200. A choice of seven finishes.

At your Bud Distributor! Steel: $\frac{3}{8}$ ", 19" wide, 12 heights. Standard aluminum: $\frac{3}{8}$ ", 19" wide, 12 heights; $\frac{3}{4}$ ", 19" wide, 12 heights. 2024 T-3 aluminum: $\frac{3}{8}$ ", 19" wide, 12 heights; 24" wide, 12 heights. "Surface Shield" panels: $\frac{1}{8}$ " and $\frac{3}{16}$ ", each in 12 heights, 19" wide; mill-finish aluminum alloy; white pressure sensitive paper protects panel, provides surface for indicating drilling or punching position. For further information, phone —

**1-800-321-1764, TOLL FREE
IN OHIO, 1-800-362-2265, TOLL FREE**

INSTRUMENTATION

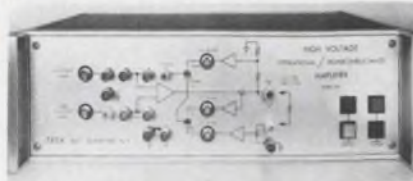
An op amp with an
output of ± 10 kV? Yup!

Trek, Inc., 8460 Ridge Rd., Gasport, NY 14067. (716) 772-2427. \$2285.

Model 606 high-voltage operational/transconductance amplifier has all the typical specs found in its little brother, the monolithic IC op amp, but features an output voltage range of $\pm 10,000$ V at a current of ± 1.6 mA. In addition, with a flip of a switch, the unit becomes a precision transconductance amplifier capable of precise control of the output current. Like any other op amp, the 606 can be gain programmed with various input and feedback elements.

CIRCLE NO. 320

Dataloggers handle
picoamp currents

Keithley Instruments, 28775 Aurora Rd., Cleveland, OH 44139. (216) 248-0400. 90 days.

System 70 embodies six basic Datalogger configurations, each centered around a particular DMM, electrometer, or nanovoltmeter. A 10-channel scanner precedes the measuring instrument in the circuit and an 18-column printer provides a record of time-of-day, channel, data, exponent if applicable, and, in most cases, engineering units. The number of input channels can be expanded, if necessary, in multiples of 10 channels. System 70/616/18, an electrometer-based datalogger, is said to be the first of its kind. It features current sensitivity from 10^{-13} A to 100 mA.

CIRCLE NO. 321

4-1/2-digit DMM uses
line or battery pack

Data Precision, Audubon Rd., Wakefield, MA 01880. (617) 246-1600. \$355.

Model 1455 is both a line-powered bench and battery-powered portable DMM. Featured are a 1/2-in-high seven-segment planar display, 100% overranging and 21 function/range operation. DC volts are measured from 100 μ V to 1000 V; ac volts from 100 μ V to 500 V rms; resistance from 100 m Ω to 20 M Ω ; current, both ac and dc, from 1 μ A to 2 A. Frequency response for ac current and voltage is from 30 Hz to 50 kHz. Basic accuracy on dc V is $\pm 0.02\%$ rdg $\pm 0.01\%$ fs, ± 1 digit for six months.

CIRCLE NO. 322

Unit converts CRT
to logic analyzer

Tektronix, P.O. Box 500, Beaverton, OR 97077. (503) 644-0161. \$3250 including probes; 10 wks.

Model LA 501 digital storage unit converts any CRT display into a logic analyzer. The unit displays up to 16 channels of data in timing diagram format, stores 4096 bits, provides variable storage and display format (4 channels \times 1024 words through 16 channels \times 256 words) and samples to 100 MHz. Other features include pre-trigger, center-trigger, and post-trigger modes, accommodates any logic family, choice of synchronous or asynchronous sampling of machine data.

CIRCLE NO. 323

Unit captures and displays four signals



Devices Limited, Hyde Way, Welwyn Garden City, Hertfordshire AL7 3AP, England.

This instrument offers four-channel digital display and tape-memory system with modular pre-amplifiers and signal processing facilities. Signals are displayed on a nonfade CRT with a graticule size of 20×15 cm. Slowly varying signals, difficult to interpret on an oscilloscope, can be presented as stationary images which can be frozen for an indefinite period and expanded five times for inspection of any portion of the waveform. Alternatively, a "wipe" facility is provided to momentarily hold a free-running signal. Input signals up to 1 kHz from levels as low as a few microvolts are digitally sampled and stored at up to 5000 samples per second at a sampling resolution better than 1 in 200 for each of the four channels.

CIRCLE NO. 324

Analyzer shows average & instantaneous waves

Spectral Dynamics, P.O. Box 671, San Diego, CA 92112. (714) 565-8211. \$9950.

This 500-line real-time spectrum analyzer operates over a frequency range of 0.06 Hz to 50 kHz and contains a dual memory and built-in scope. Thus you can view on-line and averaged spectra on the same screen for direct, visual comparison. Two different averages may also be displayed and directly compared. Dynamic range of greater than 60 dB and the ability to average up to 1024 ensembles of data allows the unit to retrieve signals hidden by background noise.

CIRCLE NO. 325

SCR POWER SUPPLIES YOU CAN RELATE TO

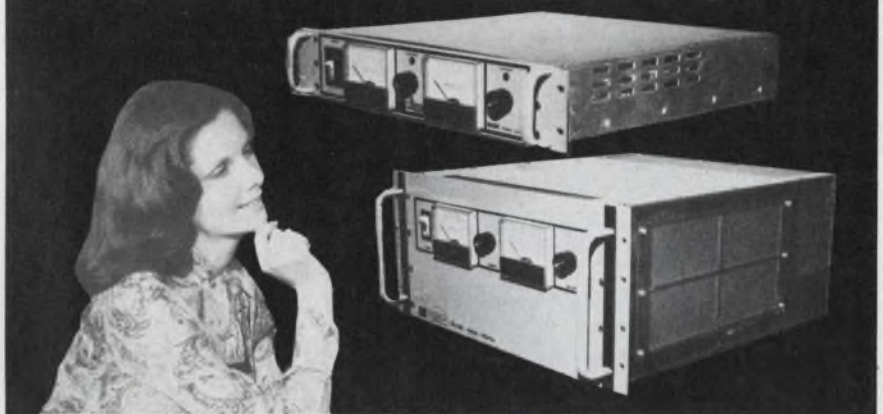

Enter into a permanent relationship with either of these Phase Controlled E/M Power Supplies. The SCR model on top is a single phase input unit offering from 500 to 2,400 watts of power and precise 0.1% regulation in both voltage and current modes.

The bottom unit is our three phase input SCR model boasting power ratings in the 2,500 through 10,000 watt range. It too features 0.1% regulation. Both types offer the highest power output per mechanical volume in the industry.

Check these superior benefits:

- * High Efficiency
- * Remote Sensing
- * Remote Programming
- * Series or Parallel Operation
- * 5 Year Warranty
- * Rack or Bench Mount
- * Overvoltage Protected
- * Constant voltage or current with automatic crossover
- * Optional Input Voltages

For technical information, Phone TOLL FREE (800) 631-4298

SCR MODELS														
VOLTS	1 ϕ INPUT								3 ϕ INPUT					
	500 Watts		800 Watts		1600 Watts		2400 Watts		2500 Watts		5000 Watts		10,000 Watts	
	A	S	A	S	A	S	A	S	A	S	A	S	A	S
0 - 6											600	2300		
0 - 7.5			100	650	180	850	250	1100	300	1600				
0 - 10	40	450	80	600	150	850	210	1100	250	1500	500	2300		
0 - 20	25	450	40	600	80	800	120	1000	125	1400	250	1900	500	2900
0 - 30									100	1400	200	1900		
0 - 40	13	425	20	500	40	750	60	900	60	1400	125	1800	250	2700
0 - 50													200	2900
0 - 60	9	450	13	500	26	850	40	1000						
0 - 80	6	450	10	500	20	850	30	1000	30	1400	60	1800		
0 - 100													100	2900
0 - 120									20	1400	40	1800		
0 - 150	3	425	5	500	10	850	15	1000						
0 - 160									15	1400	30	1800	60	2700
0 - 250									10	1400	20	1900	40	2900
0 - 300	1.5	475	3	550	5	850	8	1000						
25 - 500									5	1600	10	2300	20	2900
0 - 600	75	500	1.5	650	3	850	4	1100						



ELECTRONIC MEASUREMENTS INC.

405 Essex Road, Neptune, N. J. 07753

Phone: (New Jersey) 201 - 922-9300 • (Toll-Free) 800 - 631-4298

Specialists in Power Conversion Equipment

INFORMATION RETRIEVAL NUMBER 54

1 / %
 AMERICAN MADE

Tolerance
SCHAUER
 1-Watt
ZENERS

**Immediate Shipment
 Low Prices**

ANY voltage from 2.0 to 16.0

Quantity	Price each
1-99	\$1.07
100-499	.97
500-999	.91
1000-4999	.86
5000 up	.82



All welded and
 brazed assembly

No fragile
 nail heads

Gold
 plated
 leads

Write for complete
 rating data and other
 tolerance prices.

**Buy the kit-
 Save
 a lot**



Kit contains a 51-piece assortment of SCHAUER 1% tolerance 1-watt zeners covering the voltage range of 2.7 to 16.0. Three diodes of each voltage packaged in reusable poly bags. Stored in a handy file box. Contact your distributor or order direct.

A \$54.57 value for
ONLY \$24⁵⁰

Semiconductor Division
SCHAUER
 Manufacturing Corp.

4511 Alpine Ave. Cincinnati, Ohio 45242
 Telephone: 513/791-3030

INSTRUMENTATION

**Function generators
 cover low frequencies**



Philips Test & Measuring Instruments, 400 Crossways Park Dr., Woodbury, NY 11797. (516) 921-8880. PM5108, \$600; PM5127, \$795.

Two new low-frequency function generators offer a variety of outputs and features. The three-function PM5108 has a 1-Hz-to-1-MHz range with a 20-V output, while the four-function PM5127 covers the 0.1-Hz-to-1-MHz range, and has a 30-V output. PM5108 gives sine, triangular, and square waves and has six overlapping ranges. Accuracy is $\pm 2\%$ up to 100 kHz. Output impedance is 600 Ω . PM5127 offers sine, triangular and square waves with variable duty cycle in seven overlapping ranges. Accuracy is $\pm 3\%$.

CIRCLE NO. 326

**Spectrum analyzer
 fits in suitcase**

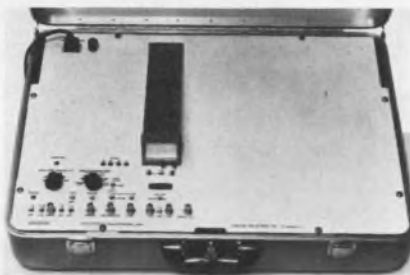

Unigon Industries, 1 Park Ave., Mount Vernon, NY 10550. (914) 699-7545. \$7500; 60 days.

Said to be the first FFT spectrum analyzer fully contained in an aluminum suitcase 17 x 21 x 7-1/2 in., the FFT MINI U512 weighs 30 pounds and fits under an airplane seat. The unit features a built-in CRT display, LED cursor, analysis range to 40 kHz, dynamic range of 60 dB, fully real time to 32 kHz, spectral averaging, transient capture, and hanning or flat weighting. FFT MINI U512 provides all digital real time FFT spectrum analysis in 12 ranges from dc to 10 Hz to dc to 40 kHz (resolution from 0.02 to 80 Hz).

CIRCLE NO. 327

**3-1/2-digit DMM
 costs just \$149.95**



Sinclair Radionics, 375 Park Ave., New York, NY 10022. (212) 688-6623. \$149.95, including ac adapter.

The DM2 multimeter measures ac and dc volts, ac and dc current and resistance in a total of 20 combinations—five functions each with four ranges—with a basic accuracy of 0.4%. Operation is by press-button selection, and contact is made by two clip probes on long leads. The unit features a 0.3-in. LED display and a violet screen to boost contrast in high ambient light conditions. Maximum reading is 1.999. The DM2 uses a MOS IC and dual-slope integration. Separate fuses for current and resistance ranges protect the unit against overload.

CIRCLE NO. 328

**DPM monitors line
 voltage and frequency**



Electro Industries, P.O. Box 3542, North New Hyde Park, NY 11040. (516) 621-6652. \$195; stock-4 wks.

Power-line monitor Model LM 1600 is a solid-state digital panel meter that combines the functions normally provided by two distinct conventional line monitoring panel meters: monitoring ac line voltage and line frequency. The unit measures voltage up to 300 V and frequency up to 100 Hz with a resolution of 0.1 Hz. An optional terminal can be provided to change the time base from 10 to 1 s. This feature extends the range of frequency measurement to 999 Hz with a resolution of 1 Hz.

CIRCLE NO. 329

INTEGRATED CIRCUITS

CMOS watch chips feature SPST action



Intersil Inc., 10900 N. Tantau Ave., Cupertino, CA 95014. (408) 257-5450. \$7.55 to \$11.70 (100-999).

A family of fully integrated digital-wristwatch CMOS circuits offers single-pole-single-throw switching action. The ICM7200A is a single-chip LED 12-hour circuit with alphanumeric capability, providing hours, minutes, day, date and seconds readout. The ICM-7203A is a 24-hour version. The ICM7202A is a numeric 12-hour circuit that interfaces with existing seven-segment LED displays. The ICM7204A is a 24-hour version of the 7202A. All circuits operate with two SPST switches that can be connected either to V_{DD} or to the midpoint of the watch case's battery stack. Antibounce circuitry on the switch inputs can handle up to 31 ms of switch bounce.

CIRCLE NO. 330

Self-protected ICs drive 48-V relays

National Semiconductor, 2900 Semiconductor Dr., Santa Clara, CA 95051. (408) 732-5000. \$3 (100); stock.

Two interface ICs can drive 48-V telephone relays without the need for external protection circuitry. The circuits are the DS-3686, a positive-voltage driver, and the DS3687, a driver for negative-voltage relays. Both convert standard bipolar and CMOS logic signals to the signals needed by telephone relays. Darlington-transistor outputs are rated at 65 V, and the devices can sink 300 mA from each of two channels. With both outputs ON, V_{OC} must provide 90 mW, typical.

CIRCLE NO. 331

1024 Element Analog Delay 75 DB S/N

RETICON's SAD-1024 Serial Analog Delay is the most recent in our line of analog signal processing devices. It is designed for variable or fixed delay of analog signals including various audio applications (e.g., reverberation, echo and chorus effects in electronic organs and musical instruments, speech compression, voice scrambling, etc.) It is packaged in a 16 lead DIP and is priced at less than 1¢/bit in OEM quantities.

Other units offer up to 12 MHz sampling frequency, independent read-in/read-out, and can be used to perform analog storage, digital filtering, convolution, correlation, real time Fourier transforms and many other functions.

There are over 70 salesmen and 16 distributors to serve you worldwide.



RETICON®

910 Benicia Avenue
Sunnyvale, Ca. 94086
(408) 738-4266
TWX: 910-339-9343

INTEGRATED CIRCUITS

4-decade counters employ CMOS/LSI

Hughes Microelectronic Products, 500 Superior Ave., Newport Beach, CA 92663. (714) 548-0671. \$6 to \$8.50 (1000); stock.

Two CMOS/LSI counters contain four synchronous decade counters and their associated storage latches. The TTL-compatible circuits consist of the HCTR6010, a 16-pin up-only counter, and the HCTR4010, a 24-pin up/down counter. Both counters feature multiplexed BCD outputs.

CIRCLE NO. 332

6-function watch chip tracks two time zones

National Semiconductor, 2900 Semiconductor Dr., Santa Clara, CA 95051. (408) 732-5000. \$9.50 (100); factory stock.

The exact time in any two zones can be kept simultaneously by a new six-function CMOS watch circuit. The Model MM5880 provides all the control signals needed by a four-digit LED watch. The circuit provides hours, minutes, seconds, and month-with-date under control of a single pushbutton. A second pushbutton controls the display of seconds, minutes and hours in a different time zone. The circuits operate from any dc source supplying a voltage between 2.4 and 4 V.

CIRCLE NO. 333

12-bit DAC has \$27 price tag

Analog Devices, Rte. 1, Industrial Park, P.O. Box 280, Norwood, MA 02062. (617) 329-4700.

A 12-bit digital-to-analog converter guarantees monotonicity over its entire operating temperature range and costs as low as \$27 in quantities of a hundred. The AD563 comes in a 24-pin package that contains three chips; switch and control amplifier, thin-film resistor and reference. Maximum error at 25 C is 1/4 to 1/2 LSB. The gain tempco is as low as 10 ppm/°C max. Also the unit has a differential nonlinearity tempco of 1 ppm of FSR/°C.

CIRCLE NO. 334

MOS/LSI test circuits span technologies

Mosfet Micro Labs, Inc., Penn Centre Plaza, Quakertown, PA 18951. (215) 536-2104.

A set of four MOS/LSI test circuits encompasses CMOS (metal gate), p-channel and silicon-gate technologies, as well as charge-coupled devices (three-phase polysilicon or tungsten). The test chips can be used by designers to learn about IC design, or as an alternative to high-priced custom MOS. Each of the test-circuit patterns are layered, and each layer is individually colored, ready for the mask maker to cut rubys. Also included with each set is a full explanation of each individual test pattern for manual probing. Test patterns allow evaluation of p and/or n transistors for gate and field threshold voltages, source/drain breakdown voltage, and transistor-gain characteristics. Individual test-circuit patterns cost \$100 per process.

CIRCLE NO. 335

Convert binary data to dial pulses

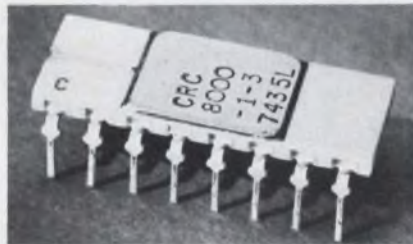

Collins Radio Group, Rockwell, Newport Beach, CA 92663. (714) 833-4600. \$9.95 (100).

The CRC-8000 ion-implanted, p-channel, MOS circuit converts binary-coded data into standard dial-pulse signals. Operation can be varied by changing an external clock frequency. With a 2-kHz clock input, the CRC-8000 accepts asynchronous binary data, stores it in a first-in-first-out memory, and generates a 10-pulse pair per second (60% break/40% make) dial pulse having a 650-ms minimum interdigit time. If a 4-kHz clock is used, the dial pulse frequency is 20 pps and the interdigit time is reduced to 325 ms minimum. A memory inhibit input signal can be used to delay the dial pulse output.

CIRCLE NO. 336

For off-the-shelf delivery, contact your closest Dialight Distributor:

Arizona
Moltronics (602) 272-7951

California
Richey Elect. (213) 875-2862;
Westates Elect. (213) 341-4411;
Western Electromotive/Shepard
(213) 820-3777;
Bell Indust. (408) 734-8570;
Fisher/Brownell (408) 244-6182

Colorado
Meter Master Inst. (303) 722-5766

Connecticut
Suburban Supply (203) 757-1251

Florida
Peerless Radio (305) 566-5966

Georgia
Lykes Electronics Corp. (404) 355-2223

Illinois
Newark Elect. (312) 638-4411

Indiana
Radio Dist. (219) 287-2911;
Graham Dist. (317) 634-8486

Kentucky
P. I. Burks (502) 589-3960

Louisiana
Ralph's of Lafayette (318) 234-4507

Maryland
Cramer/EW Wash (301) 948-0110

Massachusetts
Cramer Elect. (617) 969-7700;
Gerber Elect. (617) 329-2400;
Sager Elect. (617) 542-2281

Michigan
RS Elect. (313) 491-1000

Minnesota
Gopher Elect. (612) 645-0241

Missouri
Walters Radio (816) 531-7015;
LCOMP-St. Louis (314) 647-5505

Nebraska
Scott Elect. (402) 464-8308

New Jersey
Federated Elect. (201) 376-8900;
Gordon/Horne Inc. (201) 835-7400
State Elect. (201) 887-2550

New York
Rome Elect. (315) 337-5400;
Summit Dist. (716) 884-3450

Metro NY
Arrow Elect. (516) 694-6800;
Harrison Elect. (516) 293-7990;
Harvey Elect. (516) 921-8700;
Peerless Radio (516) 593-2121;
Ancar Elect. (914) 592-7100

North Carolina
Hammond Elect. (919) 275-6391

Ohio
Pioneer/Cleveland (216) 587-3600;
Hughes-Peters (513) 351-2000;
Stotts-Friedman (513) 224-1111;
Hughes-Peters (614) 294-5351

Oklahoma
Radio, Inc. (918) 587-9123

Oregon
Almac/Stroum (503) 292-3534

Pennsylvania
Almo Elect. (215) 698-4000;
Barbey Elect. (215) 376-7451;
Phila. Elect. (215) 568-7400;
Pyttronic Indust. (215) 643-2850

Rhode Island
Wm. Dandreta & Co. (401) 861-2800

Tennessee
Radio Elect. Supply (615) 247-8111

Texas
Texas Instruments Supply (214) 238-6821;
Harrison Equip. (713) 652-4700

Virginia
Meridian Elect. (804) 355-6521

Washington
Almac/Stroum (206) 763-2300

Wisconsin
Parts Mart (414) 276-4160

Canada
Saynor Elect. (416) 445-2340;
Zentronics (416) 789-5111;
L. A. Varah (604) 873-3211;
Wackid Radio (613) 728-1821

DIALIGHT

Dialight, A North American Philips Company
203 Harrison Place, Brooklyn, N. Y. 11237
(212) 497-7600

Dialight sees a need:

Need: A new computer-grade switch at a price you can afford.

LOW COST • COMPUTER GRADE QUALITY • DESIGN FLEXIBILITY • GOLD OR SILVER CONTACTS • CHOICE OF TERMINALS • MOMENTARY OR ALTERNATE SWITCHING ACTIONS • SPDT, DPDT • DESIGNED TO MEET UL SPECIFICATIONS • UNIFORM FRONT PANEL APPEARANCE AND REAR PROJECTION • MATCHING INDICATOR LIGHT • FRONT MOUNTING SNAP-IN BEZELS—4 SIZES/SHAPES TO CHOOSE FROM • REAR MOUNTING SWITCH WITH ANTI-ROTATION FEATURE • CHOICE OF OVER 200 CAP SHAPES, SIZES AND COLORS • CHOICE OF ENGRAVED, HOT STAMPED OR REPLACEABLE LEGENDS.

Dialight's low cost 554 series switches are available in a wide selection of rear panel and front bezel mounting types. Switches are available with silver or gold contacts for wide range of applications; operating life is 250,000 operations.

Fingertip grips permit easy cap removal . . . lamp replacement is from front of panel . . . no special tools needed.

Caps are available with or without underlying color filter in

$\frac{5}{8}$ " and $\frac{3}{4}$ " square, $\frac{5}{8}$ " x $\frac{3}{4}$ " and $\frac{3}{4}$ " x 1" rectangles. At Dialight it's your choice because we see your need.

DIALIGHT

Dialight, A North American Philips Company
203 Harrison Place, Brooklyn, N. Y. 11237
(212) 497-7600

INFORMATION RETRIEVAL NUMBER 57

\$165 EA

P/N 554-1121
(1K PRICING)

See
Dialight.



If it's a thick film resistor network...

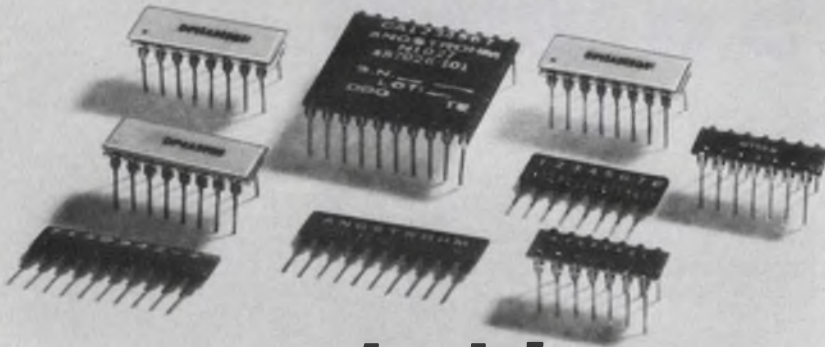

we make it!

SIPs, DIPs, Binary Ladders, all manufactured to meet the most critical specifications. SIPs and DIPs are offered in tolerances up to $\pm 1\%$, Binary Ladders to $\pm \frac{1}{2}$ LSB. What's more, we can provide custom resistor networks in almost any configuration to the very tightest tolerances possible. Write for complete technical details today.



angstrom precision, inc.

one precision place / hagerstown, maryland 21740
 telephone: 301-739-8722 twx: 710-853-6834

INFORMATION RETRIEVAL NUMBER 59

Built to amplify, no matter what the impedance.



The DC-300A power amplifier drives low impedance loads at full rated power as long as needed. Dependable AC or DC power for servo motors or force transducers.

Rated power 150 watts per channel (600 watts balanced single channel) into 8 ohms. Maximum power

depends on exact load impedance and operation of thermal overload protection. Essentially flat frequency and phase response from DC to 20KHz. Not affected by shorted, mismatched or open loads. Will not self-destruct under any conditions of use.

Sounds expensive? For three years your total cost is the original list price of \$799.00. Crown guarantees that the DC-300A will work as specified during that time or we'll fix it free—and pay shipping costs.

Interested? Send for spec sheet.



crown INTERNATIONAL

Industrial Products Division
 1718 W. Mishawaka Road, Elkhart, IN 46514

INFORMATION RETRIEVAL NUMBER 60

INTEGRATED CIRCUITS

1-k S-TTL RAM accesses in 45 ns

Intersil, 10900 N. Tantau Ave., Cupertino, CA 95014. (408) 257-5450. \$22.00 to \$61.60 (100-999).

Static Schottky-TTL 1024 \times 1-bit RAMs—the IM55S08 and IM55S18—offer a typical access time of 45 ns. The IM55S08 provides open-collector output, and the IM55S18 has three-state. Input current is 250 μ A maximum for both memories. Maximum read and write cycle times are 70 ns for commercial temperature-range versions and 75 ns for military parts.

CIRCLE NO. 337

Transceiver offers full-duplex at 40-k baud

Plessey Semiconductors, 1674 McGaw Ave., Santa Ana, CA 92705. (714) 540-9979. \$9.50 (100); stock.

A universal transceiver LSI circuit handles asynchronous, full-duplex communications at speeds up to 40-k baud. Called the MP1013, the unit is a second source to General Instruments' AY-5-1013. Completely DTL/TTL-compatible, and requiring no interfacing circuits, the device accepts serial-bit characters from a terminal or computer, and receives and transmits the characters. Baud rate, number of data bits, parity mode, and the number of stop bits are programmed externally.

CIRCLE NO. 338

Dual-port register uses positive clock

Advanced Micro Devices, 901 Thompson Pl., Sunnyvale, CA 94086. (408) 732-2400. \$2.16 to \$12.96 (100).

A 4-bit register with quad two-input multiplexed parallel inputs and positive-going clock—the Am25LS09—has a minimum clock frequency of 40 MHz, with a typical value of 65 MHz. The circuit is logically similar to the 74LS298 with the exception of the positive-going clock input. This eliminates the need for an additional external inverter package. The Am25LS09 is being second-sourced by Texas Instruments.

CIRCLE NO. 339

Data-acquisition module designed for wrapped-wire installation

Data Translation Inc., 109 Concord St., Framingham, MA 01701. (617) 879-3955. See text.

If you need 8 or 10-bit a/d converter precision in a low cost data-acquisition subsystem, Data Translation offers an answer with its Dax II series of modular data-acquisition systems. There are four models in the series—the DT820, 825, 830 and 835. Two models, the 820 and 825, offer 8-bit resolution and accuracy, while the 830 and 835 provide 10-bit. Prices start at \$130 for quantities of 100.

A unique feature of these modules is their packaging. The entire system—an input multiplexer, differential amplifier, sample-and-hold amplifier, a/d converter and all system logic—is housed in one 3



× 4 × 0.4-in. module. And the module itself is designed for wrapped-wire applications with the pins extending from the bottom 0.025 in. square instead of the typical 0.02-in.-diameter round pins usually found on circuit modules. The pins are on 0.1-in. centers, and there are two rows of 32 pins each.

The Dax modules are designed

for 16 or eight input channels and can be expanded to 64 channels. Temperature coefficients are guaranteed at ±30 ppm/°C max. Channel acquisition time for the sample-and-hold circuit is 8 μs for the 8-bit and 12 μs for the 10-bit units, both for accuracies to 0.05%. Input impedances are greater than 100 MΩ, and input ranges of ±5, ±10 and 0 to 10 V are available.

Prices for the DT-series data-acquisition systems start at \$130 for the DT820, 8-channel unit; \$140 for the DT825, 16-channel; \$140 for the 830 8-channel, and \$150 for the 835 16-channel model. Delivery for the units is from two to four weeks.

CIRCLE NO. 302

IC troubles?
try these high-performance
Super-Grip™
IC Test Clips

for fast, non-shorting access to all leads on dual-in-line IC packages

No more shorting across DIP leads... just quickly clip on an IC TEST CLIP to bring DIP leads out for safe attachment of scope probes and other leads. Ideal for signal input, tracing, troubleshooting, etc. Patented precision, "contact comb" design guarantees no shorting between DIP leads. Probes can hang "no-hands" free on Test Clip terminals in card racks (unique — see photo). Engineered Mechanical clamping plus gold-plated phosphor bronze terminals provide superior electrical contact. Also unequalled as a DIP removal tool.

11 models to fit all DIP's
TC-16 fits 16-pin DIP's, etc.

Model	Row-To-Row Dim.	Part Number	Price
TC-8	.3 IN.	923695	\$7.35
TC-14	.3 IN.	923698	4.50
TC-16	.3 IN.	923700	4.75
TC-16 LSI	.5 / .6 IN.	923702	8.95
TC-18	.3 IN.	923703	10.00
TC-20	.3 IN.	923704	11.55
TC-22	.4 IN.	923705	11.55
TC-24	.5 / .6 IN.	923714	13.85
TC-28	.5 / .6 IN.	923718	15.25
TC-36	.5 / .6 IN.	923720	19.95
TC-40	.5 / .6 IN.	923722	21.00

Quick phone service — call distributor number nearest you:
201/381-5700 215/698-4000 313/525-1800 415/969-9240 714/279-5281
206/682-5025 216/587-3600 314/863-7800 513/236-9900 714/549-8611
213/971-3721 303/761-7870 412/782-2300 617/879-0860 914/664-0088

If no distributor in your area — call the factory
All products guaranteed to meet or exceed published specifications

AP PRODUCTS INCORPORATED
Box 110-F • Painesville, OH 44077 • 216/354-2101

MEMORY SERIES NO. 11

WHAT ARE 16 INPUT VARIABLES WORTH IN OUR FPLA'S?

Four times the address-scan capability of competitive Field Programmable Logic Arrays. As a bonus you get chip enable. Simplifies expansion of our 48 product terms and 16 input variables. Permits tristate application in bus organization. Provides logic inhibit, preconditional decoding. Got it? Get it now.

For specs & data on our unique chip-enable FPLAs #82S100 (Tristate) & #82S101 (Open Collector), attach coupon to letterhead

Name _____
Tel _____ Ext _____
 Send pricing for sample parts

THINK
Signetics
811 E. ARQUES SUNNYVALE CALIF 94086

MODULES & SUBASSEMBLIES

Noncontact sensor has 6-ft range



Scientific Technology Inc., 1201 San Antonio Rd., Mountain View, CA 94043. (415) 965-0910. From \$153.50; 2 to 4 wk.

The Model 2070-series Optaxial controls detect any visible object or material in its field of view. It reads code marks as small as 0.06 in. or color changes and can see or see through, as required by the application, transparent and translucent materials, liquids or clouds. Its range is up to 1.5 in. (38.1 mm) proximity mode and 6 ft (1.8 meters) with a 3 in. (8 mm) diameter retarget. The sealed sensor head of the 2070-series is 2.75 in. (57.15 mm) long and is housed in a threaded tube that has an outside diameter of 0.375 in. (9.53 mm) and may be remotely mounted up to 100 ft (30 meters) from the control electronics. The 2070-series units operate from any 2.5-W input from 21 V dc to 240 V ac. Output switching may be selected to meet any requirement. Standard plug-in control option modules include time delays, one-shots, latches, predetermined counts, etc.

CIRCLE NO. 340

Mini 8-bit modular DAC fits 16-pin DIP

Cycon, Inc., 1240 Elko Dr., Sunnyvale, CA 94086. (408) 734-1575. \$11 (100-up); stock.

The cyDAC 371-8, a miniature modular digital-to-analog converter, measures only 1.3 × 0.6 × 0.5 in. and plugs into a 16-pin IC socket. The DAC has an 8-bit TTL/DTL-compatible input, an internal reference source and is monotonic.

CIRCLE NO. 341

Variable speed drive has speed range of 20:1

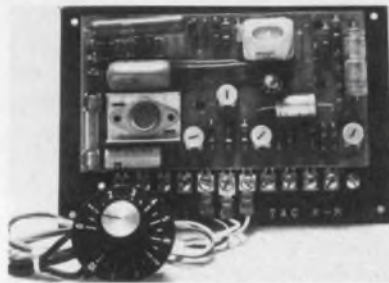

Mercer Controls Corp., 96 Mercer St., New York, NY 10012. (212) 966-5815. Under \$100; stock.

The AC-25C open chassis variable speed controller is specifically designed for use with sub-fractional and fractional (up to 1/4 horsepower) ac motors. The control operates geared or ungeared permanent split-capacitor single-phase ac motors. Typical speed range for the AC-25C is 20 to 1, with 1% load regulation throughout the speed range. The unit also includes an ac tachometer for precise velocity feedback control.

CIRCLE NO. 342

Multichannel amplifiers built for high isolation

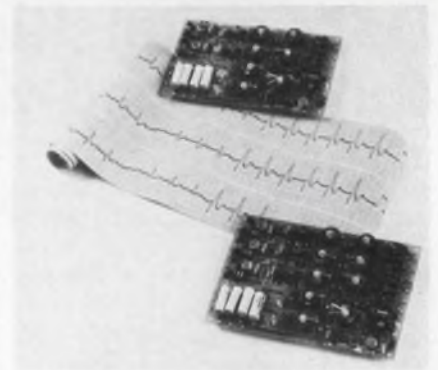

Analog Devices, Route 1 Industrial Park, P.O. Box 280, Norwood, MA 02062. (617) 329-4700. From \$149 (1 to 9); stock.

Multichannel isolation amplifiers, the two-channel 282J and three channel 283J, are built on 3 × 5.5 × 0.67 in. open circuit boards. Each isolator has dual, isolated regulated power outputs of ±6 V dc at ±10 mA and ±3 V dc at ±5 mA, designed for exciting external circuits and transducers. The isolators offer adjustable gain from 1 to 100 V/V, only 1.5 μV rms of input noise (1 kHz bandwidth), a low of 2.4 μA rms maximum ground leakage current (at 115 V ac, 60 Hz) and 160 dB of common-mode rejection (at dc). Both models use a floating guard to provide high common-mode rejection. The 160 dB CMR at dc degrades to only 135 dB at 60 Hz and a 5-kΩ source imbalance. Each channel will also withstand 220 V rms, continuously, applied directly across its differential input.

CIRCLE NO. 343



ANALOGY

FEED TRANSDUCER DATA FROM TOUGH ENVIRONMENTS TO REMOTE MINIS THROUGH THE FIRST CRYSTAL CONTROLLED VOLTAGE-TO-FREQUENCY CONVERTER MODULES WITH TOTAL ISOLATION AND 15-BIT ADC PERFORMANCE. INTECH'S NEW A-841 HAS BUILT-IN OPTICAL ISOLATOR. A-842 DRIVES 2000 FT. OF CABLE THROUGH ITS PULSE TRANSFORMER, BOTH AT TTL LEVELS. WE ALSO SUPPLY BETTER ADC, DAC, SEH, OP AMP AND MATH MODULES AT PRICES THAT SAVE.

intech/FMI
282 BROKAW RD. SANTA CLARA,
CA 95050 (408) 244 0500

Stepping motor control operates from TTL levels

NEC Microsystems, 1150 N.W. 70th St., Fort Lauderdale, FL 33309. (305) 974-5400. \$31.75 (1 to 24); stock to 8 wk.

The Type 2030 hybrid microcircuit controller for stepping motors includes TTL control logic, "pre-driver" circuitry. Because stepping motors vary in power driver requirements, the final driver transistors are not included in the 2030. Instead, the circuit was designed with sufficient capability to control many different types of driver transistors. Each of the four outputs will deliver a minimum of 40 mA and will operate with motor supply voltages of 40 V dc or less. The 2030 controller operates from standard TTL input logic levels. It controls bi-directional motors and operates 1 of 3 phase, 1 of 4 phase or 2 of 4 phase motors. The circuit is housed in a 1.9 × 0.775 × 0.23 in. 20-pin DIP like case.

CIRCLE NO. 344

High speed drivers deliver up to 100 mA

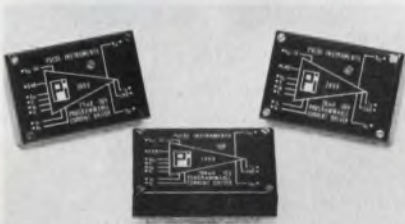

Pulse Instruments, P.O. Box 1655, San Pedro, CA 90733. (213) 541-3204. \$80 (1 to 4); stock to 4 wk.

The PI-1000, PI-2000 and PI-3000 are programmable high-speed, high-voltage interface drivers. They can deliver 100 mA at 15 V, 50 mA at 40 V and 25 mA at 80 V, respectively. The output currents of these drivers can be programmed by means of reference voltages, currents or resistances. When used with matched 50 Ω systems, their respective output characteristics are: Rise/fall times, 3, 5 and 15 ns; max rep. rate, 50, 35 and 10 MHz; propagation delay, 10, 15 and 50 ns; and max output offset, ±10, +35/-30, +75/-65 V. The PI-1000, PI-2000 and PI-3000 can be operated from single power supplies of 10 to 20, 15 to 45 and 20 to 85 V, respectively.

CIRCLE NO. 345

TRIDENT

CUSTOM HYBRID
MICROCIRCUITS

by

CTI

will be aboard!

Circuit Technology, Inc.

160 Smith Street, Farmingdale, N.Y. 11735

Phone (516) 293-8686 • (213) 374-7446

INFORMATION RETRIEVAL NUMBER 64

Exam for close-up of evaluation model U S Navy photo

cut square wire pin costs up to 40%

Standard or Custom



Cut costs on
Square Wire-Wrap®
Pins up to 40% with multi-
swaged parts. Bead square pins
are top quality too. Straight to .003"
and burr free to hold production problems
to a minimum. They may be inserted automatically
using hopper feed. Our conical ends are the finest
in the industry for insertion in preplated holes.
Engineering and design assistance is available.
Phone today or send your prints for a quotation.



bead electronics

A Division of Bead Chain Mfg. Co.
P.O. Box K, Bridgeport, CT 06805
Phone: (203) 334-4124

INFORMATION RETRIEVAL NUMBER 65

Be an isolationist with Intronics' Isolation Amplifiers



When you require extreme input/output isolation, Intronics' IA100 series isolation amplifiers can provide the best in safety and performance. These models offer up to 5000 volt isolation capacity with accuracies of $\pm 0.01\%$, operable over a wide temperature range. They're the sure way to transmit signals in the presence of very large common mode voltages for medical/biomedical, nuclear and industrial control applications where safety and reliability are paramount.

Intronics makes a broad line of signal processing modules to meet your specific requirements. For complete information send for our new catalog, or for immediate assistance call Rick Sakakeeny at (617) 332-7350.



57 Chapel Street, Newton, Massachusetts 02158 U.S.A.
(617) 332-7350. TWX 710-335-6835

Overseas call:
Brussels, Belgium (02) 513-73-84
Kent, England Maidstone 54224/6
Orsay, France 9077844
Munich, Germany 524181
Tel-Aviv, Israel (03) 415645
Cernusco, Italy 9041319
The Hague, Netherlands 678380
Walsjellen, Switzerland 01/8303161

INFORMATION RETRIEVAL NUMBER 66

MODULES & SUBASSEMBLIES

Multifunction converter squeezed into 14-pin DIP

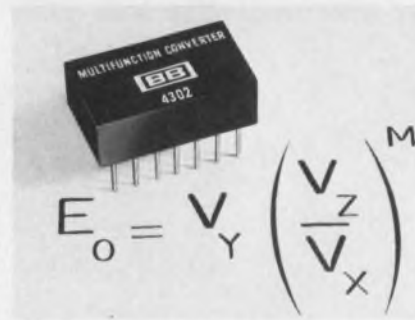

Burr-Brown, International Airport Industrial Park, Tucson, AZ 85734. (602) 294-1431. \$32 (1 to 24); stock.

The Model 4302 multifunction converters multiply and divide with a typical accuracy of 0.25%. The general transfer function is $E_o = V_y (V_z/V_x)^m$, where V_x , V_y , and V_z refer to input voltages which are applied to produce E_o . The exponent, m , is resistor programmable and can be varied from 0.2 to 5. The unit is housed in a 14-pin DIP and has an output capability of ± 10 V at 5 mA when driven from ± 15 V dc. The unit is pin compatible with the company's 4301 and Bell & Howell's Model 435. Typical accuracies expressed as a percentage of output full scale are as follows: multiply or divide, $\pm 0.25\%$; square, $\pm 0.03\%$, square root, $\pm 0.07\%$; sine, $\pm 0.5\%$; cosine, $\pm 0.8\%$; and arctangent, $\pm 0.6\%$.

CIRCLE NO. 346

Synchro modules deliver 8, 10 or 12-bit data

Astrosystems, 6 Nevada Dr., Lake Success, NY 11040. (516) 328-1600. From \$300 (1 to 9); stock.

The M series of modules handles the analog signals from synchros, resolvers and selsyns. It converts them to binary or BCD digital format. Accuracy and resolution of 8, 10 and 12 bits binary or 0.1° BCD are available. Units will accommodate all standard synchro frequencies and voltages. All converters contain an output register. Modules will track inputs at a maximum rate of $2000^\circ/s$ and will respond to a 180° step input in less than 4 ms. The modules may be combined for two speed conversion.

CIRCLE NO. 347

Deglitched d/a converter has 15-MHz update rate

Computer Labs, 1109 S. Chapman St., Greensboro, NC 27403. (919) 292-6427. From \$900; 8 to 10 wk.

The TVDA "deglitched" d/a converters are available in 8 and 10-bit models. The TVDA-0815 and TVDA-1015 units include a deglitching circuit for suppressing transients in the analog output. Input word rates as high as 15 MHz are specified, thus making it possible to operate at either three times or four times the NTSC color burst frequency for video applications. Accuracies, including linearity, are specified to within $\pm 0.05\%$. The converters are constructed on PC boards that measure $5.5 \times 6 \times 1$ in.

CIRCLE NO. 348

Serdex subsystems include all parts

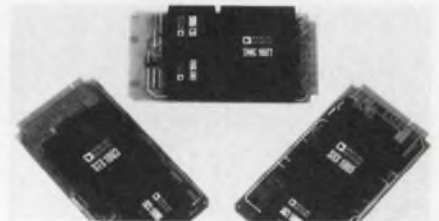

Analog Devices, Route 1 Industrial Park, P.O. Box 280, Norwood, MA 02062. (617) 329-4700. From \$395 (1 to 9); stock.

A series of Serdex subsystems-on-a-card simplifies interfacing between parallel digital data and asynchronous serial data networks. The Serdex units permit simple two-wire serial communications between equipment. The subsystems perform the complete transmit, receive and multiplex functions. Each subsystem is available on a 4.5×8 -in. PC board and requires only 5-V-dc power for operation. The STX2603 subsystem converts parallel data into asynchronous serial ASCII and consists of a transmit module (STX1003), clock module (SCL1006), two additional shift registers, and all necessary interconnections and pull-up resistors. The STX2605 receive subsystem converts asynchronous serial ASCII into parallel digital data. It includes an SRX1005 receive module, an SCL1006 clock and all interconnects and pull-up resistors.

CIRCLE NO. 349

RACK MOUNT POWER SUPPLIES ...TO 60 AMPS

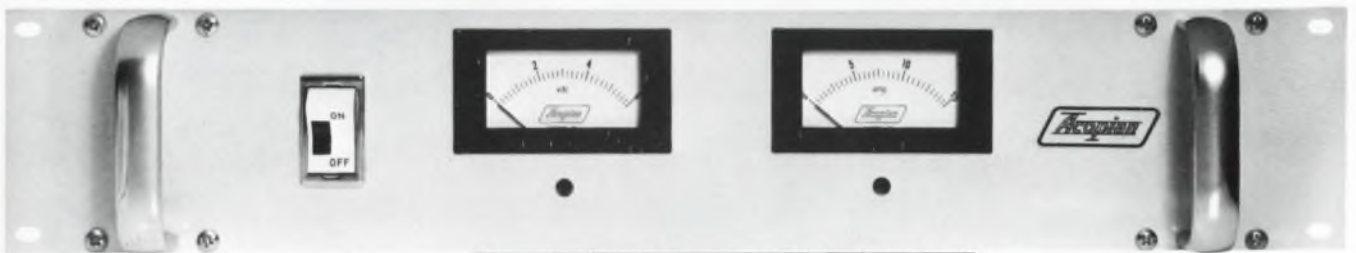

ALL MODELS U.L. RECOGNIZED

NOMINAL OUTPUT VOLTAGE	OUTPUT CURRENT AMPS	PRICE	MODEL	DIMENSIONS (INCHES)	
				HEIGHT	DEPTH
5	20	\$280	5PT20	3½	11
5	32	330	5PT32	5¼	12
5	60	525	5PT60	5¼	17
12	20	330	12PT20	5¼	12
12	45	550	12PT45	5¼	17
15	10	280	15PT10	3½	11
15	16	330	15PT16	5¼	12
15	31	590	15PT31	5¼	17

OPTIONS

Overvoltage protection—Add prefix "V" to model number and \$25.00 to price of models with output current rating of 20 amps or less, \$75.00 to price of other models.

Ammeter—Add suffix "A" to model number, \$15.00 to price.

Voltmeter—Add suffix "F" to model number, \$15.00 to price.

Handles—Add suffix "H" to

model number, \$10.00 to price.

Regulation, $\pm 0.05\%$ or better.

Ripple, 1 mv rms or better.

Many other models from 1 to 50 volts. Write for complete catalog.



Corp., Easton, Pa. 18042. Telephone: (215) 258-5441.

INFORMATION RETRIEVAL NUMBER 151



How far will the Guardian Angel go?



She just spent a bundle to save you a bundle by slashing solenoid prices.

The money-saving "bundle" went for research and tooling.

The result: our new Uni-Guard® II molded bobbin and coil cover that gives you solenoids that cost up to 25% **less** . . . with at least 25% **longer** life. Plus QC termination for easier, faster, less expensive installation.

Uni-Guard II is available in a whole array of Guardian's most popular box frame and U-frame solenoids—from the No. 2 right on up thru the No. 38. In AC and DC, push, pull and solenoid switch versions. All with the new, stronger, better looking molded assembly that saves you money. And meets tough new specs controlling flammability and out-gassing. (It's progress like this that **keeps** Guardian No. 1 in solenoids!)

WANT EVEN LONGER LIFE? GUARDIAN CAN DO! With the new line of long-life tubular solenoids that increase expected mechanical life for most tubulars from 1 million . . . to 100 million!



SEND FOR THE BOOK THAT TELLS IT ALL:

Guardian's 72 page solenoid catalog. Full of facts and specs to make selecting a solenoid a snap. Yours free for the asking.



GUARDIAN®

GUARDIAN ELECTRIC MANUFACTURING CO.
1572 West Carroll Ave., Chicago, Illinois 60607

INFORMATION RETRIEVAL NUMBER 152

RIGHT ON TARGET AGAIN



Gala performance



TDA 2020=20 watts from a chip: hi-fi!

Meaning only 1 per cent distortion over the audio band for a typical output of twenty watts. All for a few hundred millivolts in. The single or split supply arrangement lets you eliminate costly and troublesome electrolytics.

The standard package allows easy assembly. Thanks to thermal shutdown the heatsink

dimensions are not critical and the integral copper slug ensures efficient heat transfer.

No problems with loudspeaker connections either, because the output is short-circuit proof.

The TDA 2020 shares its versatile power op amp configuration with the lower-rated TDA 2010.

Two soloists, but a full symphony of applications.

Speech synthesizer talks in foreign languages

Federal Screw Works, 500 Stephenson Highway, Troy, MI 48084. (313) 588-2050. Under \$2000 (100 up); 60 to 90 days.

The Votrax ML-I multilingual voice system is a small solid-state system that produces electronically synthesized speech; not only English, but other languages as well. The first foreign language available is German. Plans call for the development of several additional languages, such as Spanish, French, Italian and Japanese. The ML-I converts the output of a computer or other digital device into speech from a 300-b/s data-rate input in the form of standard ASCII characters. Inflection, speech rate and volume are controlled by the software.

CIRCLE NO. 350

Tape system mates with PDP-11 mini family

Digital Equipment Corp., Maynard, MA 01754. (617) 897-5111. See text.

A new nine-track, 75-ips magnetic tape subsystem is available in different configurations for PDP-11/70 and other PDP-11 family computers. The units feature a data density of 800 bpi NRZI and 1600-bpi phase-encoded. Up to eight tape drives can be tied to each subsystem controller. Called the TWU45 for PDP-11/70 computers, and TJU45 for other PDP-11 computers, both subsystems are priced at \$26,500 for the first unit and \$14,000 each for additional tape drives. Quantity discounts of controller-tape drive combinations are available. First deliveries are scheduled for July, 1975. The tape units employ a vacuum column for tape buffering and tension control. A servo-controlled single capstan and vacuum-type tape cleaner are used. Additional features include dual-gap, read-after-write magnetic head, data checking, error correction for a single track dropout, a transfer rate of 120,000 characters per second and a rewind speed of 250 in/s.

CIRCLE NO. 351



Reliability and Price go together in our new Dip Switch

- Self-centering slide button prevents tool slippage
- Tactile feel
- Ready visual indicator of switch position
- Resists dust entry
- Drain holes enhance cleaning after soldering
- Low profile—only 0.3" high

• **Low unit price**—e.g., 8-station unit in 1000-piece quantities \$1.45 each. Larger quantities even lower!

4, 7 and 8 station units immediately available. For other configurations consult factory.

Send for application bulletin



CONTROL SWITCH

A CUTLER-HAMMER COMPANY

1420 DELMAR DRIVE, FOLCROFT, PA. 19032 215/586-7500

14

INFORMATION RETRIEVAL NUMBER 67



NEW from CSC

STILL MORE POWER for the PROFESSIONAL!

New ProtoBoard 203A offers expanded breadboarding! 3 output voltages from built-in regulated power supply!

Just plug in the short-proof PB203A and you've got three regulated power supplies . . . 5v, 1 amp and/or internally adjustable $\pm 15V$, 1/2 amp. Ready-to-use. Completely self-contained, with power switch, indicator lamp, power fuse and big 24 14-pin DIP capacity, 2-tone all metal quality construction. Compact. Practical. Versatile. Inexpensive. Order your PB203A today off-the-shelf direct from CSC, via BankAmericard, Master Charge, American Exp. or from your local distributor.

\$120. Add \$2.50 for shipping/handling

CONTINENTAL SPECIALTIES CORPORATION
 Box 1942, New Haven, CT 06509 • 203/624-3103
 W. Coast Office: Box 7809, S. Francisco, CA 94119
 phone: 415/383-4207

© COPYRIGHT CONTINENTAL SPECIALTIES CORP. 1975

INFORMATION RETRIEVAL NUMBER 68



use pressure sensitive
TEMP-R-TAPE of fibreglass
for quick relief.

Excellent electrical properties plus most anything else you want in fibreglass tapes like high tensile and tear strength, dimensional stability, good conformability, thermal endurance, abrasion resistance, non-corrosiveness, Temperature to 180°C. Available with several adhesive systems. Low unit cost.

Find your nearest Distributor in the Yellow Pages under "Tapes, Industrial" or in Industrial Directories or write for complete specification kit and sample offer. The Connecticut Hard Rubber Company, New Haven, Conn. 06509

CHR

an ARMCO company

INFORMATION RETRIEVAL NUMBER 69

DATA PROCESSING

**D/a converter system
settles in 5 μs**

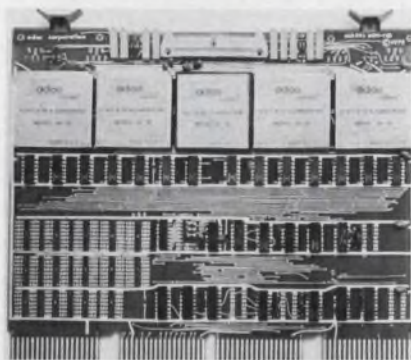

ADAC Corp., 29b Cummings Park, Woburn, MA 01801. (617) 935-6668. \$1350 fully loaded (unit qty); 4 wks.

Digital-to-analog converter systems, Models 600-11D and 600-8ED, which are compatible with the DEC PDP-11 and PDP-8E, F, M and A series of minicomputers, are high speed systems with fast settling time of 5 μs. The systems are contained on a 8-1/2 × 10-in. PC board, which can handle up to four, 12-bit d/a converters per card. The interfacing circuitry, power converter and cabling are included in the system.

CIRCLE NO. 352

**New PDP-8 uses second
processor for math**

Digital Equipment Corp., Maynard, MA 01754. (617) 897-5111. \$5995; available April, 1976.

A parallel-processor version of the PDP-8/A, called the Super-8, performs fixed and floating-point computations with up to 17-digit accuracy and uses hardware to do it. The Super-8 continues to use the conventional PDP-8/A processor for other functions, such as input-output operations and system management. The new mini was designed for OEMs and end users who need fast Fortran IV, floating-point and extended-precision arithmetic at reasonable cost. It performs calculations faster than previous PDP-8 models. Sample instruction times include 10.5-μs fixed-point add, 30-μs floating-point add, and 37.5-μs floating-point multiply. It is completely compatible with previous models of the PDP-8 family.

CIRCLE NO. 353

**DIRECT FROM
STOCK**

**SINGLES
72⁰⁰**

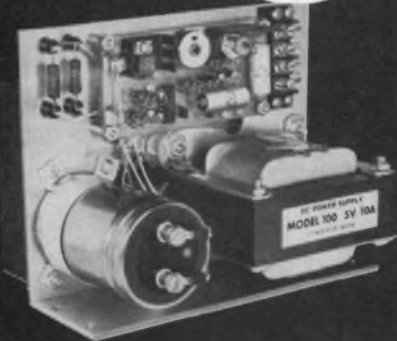

5V10A

**SINGLES AND DUALS
FULL RATING AT 71°C**

SPECIFICATIONS

Size: 7 x 5.5 x 5.5 overall
Input: 105-125V, 47-420 Hz
Output: Any DC voltage 3 to 30
Regulation: Line — 0.005%
Load — 0.05%
Ripple: Less than 500 Microvolts
Temp. Operative — 20 to +71°C
Storage — 65 to +85°C
Coefficient — 0.01%/°C Max.
Current Limiting: Fixed Foldback Type
Overvoltage: Optional

SINGLE OUTPUTS			DUAL OUTPUTS		
Model	Voltage	Amps	Model	Voltage	Amps
100-5	5.0	10.0	100-0505	5.0	5.0
				5.0	5.0
100-10	10.0	8.0	100-1212	12.0	3.5
				12.0	3.5
100-12	12.0	7.0	100-1515	15.0	3.0
				15.0	3.0
100-15	15.0	6.0	100-2424	24.0	2.0
				24.0	2.0
100-24	24.0	4.0	100-2828	28.0	2.0
				28.0	2.0
100-28	28.0	4.0			

ORDERING INFORMATION

Quantity	Singles	With O.V.*	Duals	With O.V.*
1-9	\$72 ea	\$78 ea	\$85 ea	\$97 ea
10-14	68	73	81	91
25-49	62	67	73	83
50-99	57	61	67	76
100-	53	57	63	72

*O.V. = Overvoltage protection

CALL (714) 279-1414

Electrostatics, inc.

7718 CLAIREMONT MESA BLVD. • SAN DIEGO, CA 92111

INFORMATION RETRIEVAL NUMBER 70

Mux data system handles 16-channels on wire pair

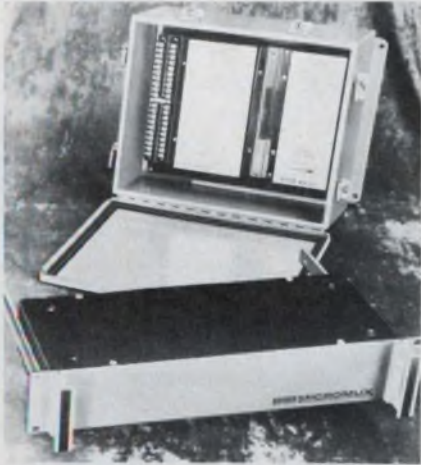

Burr-Brown, P.O. Box 11400, Tucson, AZ 85734. (602) 294-1431. \$2790 (one trans/rcvr pair).

Micromux consists of one or more remote transmitters located near sensors or contact closure points and a receiver. Each transmitter handles up to 16 data points, digitizes and multiplexes the information and transmits the data to a central receiver over a single wire pair. Power to the transmitter unit is also supplied over this same pair. One central receiver can handle up to four transmitters and thus monitor 64 points in a plant. And eight receivers can be connected to each communications interface of a computer for a total of 512 data points in a fully expanded system. The computer interface is a 2400-baud teleprinter port that uses a 20-mA current loop with ASCII coding. Signals can be transmitted up to 5000 ft.

CIRCLE NO. 354

Video terminal displays 16 lines, 1280 characters

Wintek Corp., 902 N. 9th St., Lafayette, IN 47904. (317) 742-6802. \$850 (unit qty).

The Wintek Model B-R-B video terminal displays 1280 ASCII dot-matrix characters in 16 lines. The unit features selectable baud rates from 110 to 9600, an RS-232 serial-data interface, backspace capability, detachable keyboard, half and full-duplex operation and composite video output. Also, a board-only model for OEM and custom designs and a suitcase model are available.

CIRCLE NO. 355



Johnson fills the price-performance gap with connectors in 3 sizes.

Between the high-cost MIL spec connectors and low-cost, low-performance types, you'll find Johnson miniature rectangular connectors. And now, you'll also find 3 models in 36, 23 and 14 contact sizes.

Johnson connectors are superbly and simply designed for high performance applications such as communications, instrumentation and industrial control. Contacts are nickel silver, available with either solder or crimp type terminals, recessed in the housing to provide proper mating and protection. Contacts may be removed with a simple tool. Available with or without jackscrews to provide maximum vibration resistance. A nylon hood gives positive cable strain relief. U. L. recognized.

We think our connector line nicely fills the price-quality gap. Like to see if it will fill the bill in your application? Just send in the coupon for more information.

E. F. Johnson Company
3005 Tenth Ave. S.W./Waseca, Minnesota 56093 ED 10

Please send me technical information on your rectangular connectors.

I want test samples. Please call me at _____

Name _____

Title _____

Firm _____

Address _____

City _____ State _____ Zip _____



E. F. JOHNSON COMPANY
® WASECA, MINNESOTA 56093

INFORMATION RETRIEVAL NUMBER 99

power
 8080
 4040
 6800
 PACE
 F8...
 for your

microprocessor... from SCI—the proven source.

There's an SCI AC/DC or DC/DC power source to match your microprocessor needs. Over 300 standard models, with outputs up to 35 watts. Extra-cool operation, overvoltage protection plus 150,000 hrs. MTBF... in compact, economical packages.

For the dependable, economical solution to your powering needs, contact Ron Garmon at 617-373-9104.



SEMICONDUCTOR CIRCUITS, INC.

306 River Street, Haverhill, Massachusetts 01830
 Telephone: 617-373-9104 • TWX: 710-347-0269

INFORMATION RETRIEVAL NUMBER 71



Actual Size

WE'RE WARNING YOU...

... nothing gets attention like these miniature solid state audio indicators. For pocket paging sets, terminals, battery alarm clocks, timers, test apparatus, telephones, electronic devices, security systems.

SERIES AI-100 ... penetrating 85 dB tone @ 400 Hz;
 models from 3 to 16 vdc. Compact, rugged, reliable. Distributed by:

CALIFORNIA, COSTA MESA
 MarVac Electronics

OHIO, COLUMBUS
 Hughes Peters, Inc.

WASHINGTON, SEATTLE
 Elwood Industries

MASSACHUSETTS, SHARON
 Adcour

TEXAS, DALLAS
 K. A. Electronics

WISCONSIN, MILWAUKEE
 Taylor Electric

NEW YORK, ROCHESTER
 Ossmann Components

UTAH, SALT LAKE
 Newark Electronics

ONTARIO, WILLOWDALE
 Electro Sonic, Inc.



projects[®]
 unlimited

3680 Wyse Road, Dayton, Ohio 45414
 Tel. 513-890-1918, TWX 810-450-2523

INFORMATION RETRIEVAL NUMBER 72

MICROWAVES & LASERS

Mixer-preamp spans multi-octave BW

Anaren Microwave, Inc., 185 Ainsley Dr., Syracuse, NY 13205. (315) 476-7901. \$437 (100).

The Model 220060 combines an integrated balanced mixer with a preamplifier. The unit has a 400-MHz preamplified i-f output and provides low-noise rf coverage from 1.01 to 10.75 GHz. Internal filtering suppresses unwanted 200-MHz mixing products. Over-all case size measures 7.75 × 2.50 × 0.76 in.

CIRCLE NO. 356

Wideband amp has auto, remote leveling



Instruments for Industry Inc., 151 Toledo St., Farmingdale, NY 11735. (516) 694-1414. \$3100.

The Model 5100 wideband amplifier, featuring automatic remote leveling, has a frequency range of 10 kHz to 250 MHz, rf output of 10 W and a gain of 40 dB. Designed to serve as a preamplifier, the 5100 can operate into any load from open circuit to virtually a dead short.

CIRCLE NO. 357

Amp modules seek CATV uses

Motorola Semiconductor, P.O. Box 20924, Phoenix, AZ 85036. (602) 244-3466.

Two amplifier modules can be used to form complete sections for 40-to-315-MHz CATV trunk and bridger stations. The MHW570 preamplifier offers 7.5-dB noise figure at 300 MHz. The MHW572 amplifier provides -57-dB 30-channel cross-modulation, -70-dB intermodulation and -80-dB triple-beat performance. Both units have 75-Ω input and output impedance and a minimum gain of 16-dB per block.

CIRCLE NO. 358

4-8 GHz circulators cut package size

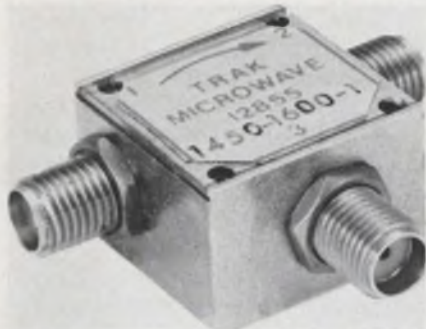

Trak Microwave Corp., 4726 Eisenhower Blvd., Tampa, FL 33614. (813) 884-1411. \$175 (Model 50A6001); stock.

Two 4-to-8-GHz circulators come in packages that measure only 0.75 × 0.75 × 0.5 in. and weigh 1.1 oz. The Model 50A6001 has 18-dB minimum isolation, 0.5-dB maximum insertion loss and 1.30 maximum VSWR. For Model 50B6001 minimum isolation is 17 dB, maximum insertion loss is 0.6 dB and maximum VSWR is 1.35. Both units operate from -45 to +95 C and no lumped circuit elements are employed.

CIRCLE NO. 359

Flange load works to 18 GHz

EMC Technology, Inc., 1971 Old Cuthbert Rd., Cherry Hill, NJ 08034. (609) 429-7800. \$3.15 (100); stock to 4 wks.

A 50-Ω flange load has a maximum VSWR of 1.30 over the frequency range of dc to 18 GHz. The unit can handle powers up to 20 W and voltages up to 100 V. Operating temperatures extend from -55 to 125 C.

CIRCLE NO. 360

Broadband amp has low NF

Anzac Electronics, 39 Green St., Waltham, MA 02154. (617) 899-1900. \$95; stock.

Model AM-102, 10-dB amplifier combines a noise figure of 5.5 dB with an output-power capability of +15 dBm. Operating over the 5-to-300-MHz frequency range, the unit has third-order intermodulation ratio of -60 dBm with 2-to-10-dBm signals at the output.

CIRCLE NO. 361

Module holds comb generator

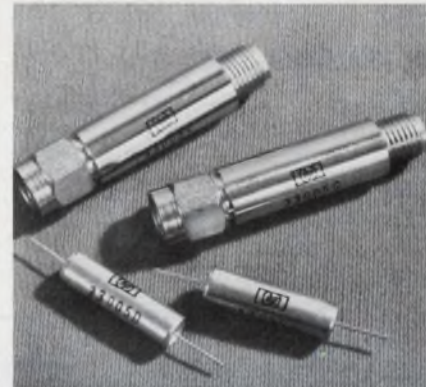

Hewlett-Packard, 1501 Page Mill Rd., Palo Alto, CA 94304. (415) 493-1501. \$205 to \$265 (1-9); stock.

Two step-recovery diode modules are offered for comb-generation application. Model 33005C is a complete impulse-train generator with dc return and 3-mm connectors; Model 33005D is a cylindrical module with axial leads. Input frequency for both is 1000 ± 50 MHz. Guaranteed output power at 18 GHz is -15 dBm with 0.5-W drive.

CIRCLE NO. 362

WHEN YOU COMPARE PRICE... COMPARE FEATURES TOO!

GREEN SERIES

These premium features are standard on all ALCO Green Series switches. We ask you to investigate first, we're sure ALCOSWITCH is your best buy!

- ✓ **LEVER-STOP DEVICE**
Prevents Push-In of Toggle
- ✓ **HI-TORQUE BUSHING**
Withstands Mechanical Abuse
- ✓ **NEW FRAME DESIGN**
Allows U.L. Listing 250V & 125V
- ✓ **CASE MATERIAL**
High Temp Diallyl Phthalate
- ✓ **ISOLATION BARRIERS**
Inside as well as Outside
- ✓ **FINE SILVER CONTACTS**
Provides High 6 Amp Rating
- ✓ **MOLDED-IN TERMINALS**
Eliminates Costly Epoxy Seals
- ✓ **GOLD FLASH**
Prevents Oxidation of Terminals
- ✓ **NO HIDDEN COSTS**
Investigate, You'll Buy Alcoswitch



For further information, contact Mr. Tom Clark — (617) 685-4371.

ALCO ELECTRONIC PRODUCTS, INC.
1561 OSGOOD STREET, NORTH ANDOVER, MA. 01842 U.S.A.

TEL: (617) 685-4371 TWX: 710 342-0562

A SUBSIDIARY OF **AUGAT INC.**

INFORMATION RETRIEVAL NUMBER 73

MEMORY SERIES NO. 13

PICK ANY 48 WORDS FROM A 65,538 POOL

IN THE FIELD, WITH JUST ONE FPLA. And edit your program at will. In our Field Programmable Logic Arrays with 16 inputs to the decoder, product terms can be added (up to 48) or removed—or delete input variables from your terms. And outputs programmed active-high are reprogrammable to active-low.

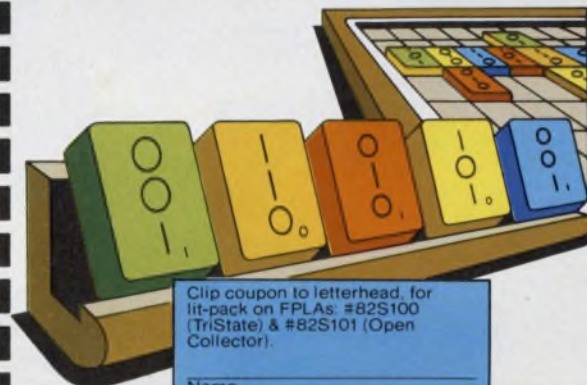

Clip coupon to letterhead, for lit-pack on FPLAs: #82S100 (TriState) & #82S101 (Open Collector).

Name _____

Tel _____

Ext _____

Call me with sample part quote

THINK

Signetics

811 E. ARQUES, SUNNYVALE, CALIF. 94086

INFORMATION RETRIEVAL NUMBER 74

MICROWAVES & LASERS

Low-noise amp aims for satcom use

LNR Communications, 180 Marcus Blvd., Hauppauge, NY 11787. (516) 273-7111. \$10,000 to \$15,005; 4-6 mos.

The NC4-91 low-noise amplifier,

designed for unattended ground-based terminals for satellite communications, features a noise temperature of 80°K typical, and a gain of 50 dB over the 3.7-to-4.2-GHz band. The noncryogenic unit measures 12 × 8 × 4 in., and it is weatherproof. The self-contained unit includes power supply and solid-state pump source.

CIRCLE NO. 363

Transistor oscillator covers 8-12-GHz band

Watkins-Johnson Co., 440 Mount Hermon Rd., Scotts Valley, CA 95066. (408) 438-2100. \$1825.

Model WJ-2835-25 varactor-tuned voltage-controlled oscillator produces a minimum power output of 5 mW across the 8-to-12-GHz frequency range. The unit operates over the full -54 to +71 C temperature range with a temperature coefficient of less than 30 ppm/°C. Voltage pushing is less than ±0.1%/V while pulling into a 2.0:1 VSWR. Harmonics are a minimum of 20 dB below the carrier.

CIRCLE NO. 364

10-mW laser costs \$995

Hughes Electron Dynamics, Laser Products Div., 3100 W. Lomita Blvd., Torrance, CA 90509. (213) 534-2121.

A 10-mW helium-neon laser system, priced at \$995 in single quantity, is said to be the lowest-priced 10-mW system available. With a 60-day delivery, the Model 3035H consists of separately packaged laser head and power supply. The 23-1/2-in. laser head has a cw output at 632.8 mm (TEM₀₀ mode) and features a near-hemispherical cavity to enhance beam stability and speed warm-up. The regulated power supply is available for ac operation at 100 V, 115 or 230 V.

CIRCLE NO. 365

Dual-polarized horns span 2 to 18 GHz

ESL Inc., 495 Java Dr., Sunnyvale, CA 94086. (408) 734-2244.

Horn antennas feature dual-linear, dual-circular and diversity-polarized operation over the 2-to-18-GHz frequency range. Phase imbalance between ports is less than 10 degrees to 12 GHz and 17 degrees to 18 GHz. Gain imbalance port-to-port (and gain spread, horn-to-horn) is less than 0.8 dB to 12 GHz and 1.3 dB to 18 GHz. Over the entire 2-to-18-GHz band, VSWR is less than 2.5:1, isolation between ports is 28 dB minimum, and gain varies linearly from 5 to 18 dBi.

CIRCLE NO. 366

The inside story of the amazing new \$31 Compact 1.

Take a close look.

Beneath the handsome exterior of Zero's new VIP Compact 1 you'll find a feature you've never found on a \$31* instrument enclosure before. Those rugged steel and aluminum panels are hiding a removable chassis. Which means you can now easily build up your equipment on the free chassis, and then simply re-assemble the enclosure around it.

A result of thorough design, Compact 1 delivers an amazing new level of quality, strength, efficiency and economy. If these are your requirements for a small instrument enclosure, you've found what you've been looking for. We're ready to ship any of the twelve standard sizes to you within two weeks.

Write for your free catalog today.



The Final Touch

*From \$30.80 to \$38.65 in quantities of 50.



ZERO MANUFACTURING CO.

Burbank, CA 213/846-4191 · Monson, MA 413/267-5561 · Clearwater, FL 813/531-8991

CIRCLE #261 FOR PRODUCT DEMONSTRATION

CIRCLE #262 FOR LITERATURE ONLY

Synthesizer outputs frequencies to 18 GHz



Syntest, 169 Millham St., Marlboro, MA 01752. (617) 481-7827. \$3450 (typical); 60 days.

The SI-203 microwave synthesizer covers any 10% band from 500 MHz to 18 GHz. Basic resolution is 100 Hz at 100 MHz. The resolution of the output signal is 100 Hz times the multiple used for phase lock. For example, a 2-GHz unit using a $\times 20$ multiple has a resolution of 2 kHz. Power output ranges from 5 mW at 18 GHz to 750 mW at 1 GHz depending on rf head. Inband spurious outputs are greater than 90 dbc. Second harmonic is typically 30 dbc. Frequency stability from -10 to $+50$ C is 1×10^{-8} .

CIRCLE NO. 367

Noise source checks μ wave relay systems



Scientific Atlanta, 3845 Pleasantdale Rd., Atlanta, GA 30340. (404) 449-2000. \$2070; 8 wks.

The Model 4643 baseband noise transmitter provides a simple noise-load source for quick performance checks of microwave relay systems. Frequency range is 12 kHz to 12.4 MHz, with output power 0 to -29 dBm. The baseband noise transmitter features automatic level control to maintain constant noise power output. The compact unit weighs 16 lb and operates from standard 110/220-V supplies.

CIRCLE NO. 368

Impatts operate at X-band and at mm waves



Plessey Semiconductors, 1674 McGaw Ave., Santa Ana, CA 92705. (714) 540-9979. \$675-\$7500, 12 to 16 wks.

A line of silicon Impatt oscillators covers the 40-to-90-GHz range, and GaAs versions operate in X-band. The series of silicon double-drift diodes, mounted in waveguide cavities, provides mechanical tuning over $\pm 0.5\%$ of the specified frequency. Output power ranges from 20 to 200 mW, depending on the type. Typical operating voltage is from 14 to 28 V, with maximum operating current from 200 to 250 mA. Frequency pushing is $+5$ MHz/mA, and maximum load VSWR is 1.3:1 for all phases. The GaAs Impatts are furnished with a fixed frequency from 8 to 11.5 GHz, mechanically tunable over a 1% range. Output power is as high as 1.5 W, with typical conversion efficiency of 12%. The units can operate into any load VSWR. The GaAs devices operate with voltage from 55 to 70 V, with maximum operating current of 250 mA. Frequency pushing is -2 MHz/mA.

CIRCLE NO. 369

VOR zero-phase meter has 0.01° resolution

Rohde & Schwarz, 14 Gloria Lane, Fairfield, NJ 07006. (201) 575-0750. \$3250; 30 days.

A vhf-omnidirectional-range zero-phase meter—Model POR—measures the phase difference between variable and reference-phase components of a VOR signal with a resolution of 0.01° . It can also check the standard deviation of the VOR subcarrier.

CIRCLE NO. 370

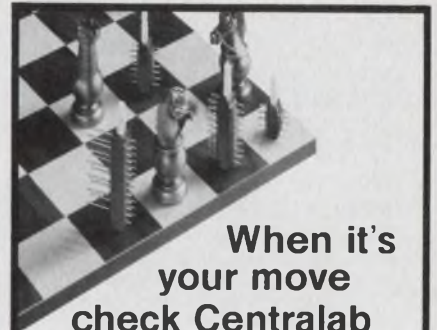

When it's your move check Centralab

Visual display

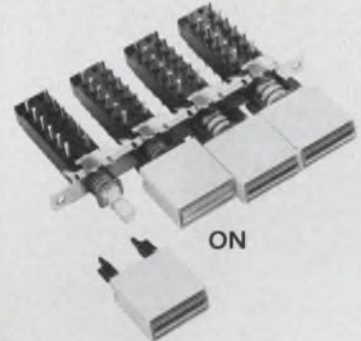

in a non-lighted pushbutton switch

Now you can add visual display to Centralab non-lighted pushbutton switches. Our new status indicator button with a unique fluorescent reflective surface operates with ambient light to indicate switch status when activated. No power is required. There are no lamps to burn out.

Other features include:

- Choice of 6 display colors, 3 lens options and 5 button colors.
- Available with push-push or interlocking action.
- 140° peripheral viewing angle.
- Vertical or horizontal button mounting.

See your Centralab Pushbutton Distributor or send inquiry card for complete specifications.

Isostat Licensed



CENTRALAB

Electronics Division

GLOBE-UNION INC.

P.O. BOX 858

FORT DODGE, IOWA 50501

INFORMATION RETRIEVAL NUMBER 76

THIS PROCESS MONITOR MEETS YOUR EXACT NEEDS FOR \$145⁰⁰

IT'S THE UNIVERSAL RECEIVER FOR PROCESS TRANSMITTERS

These easy-to-install digital process monitors will change the way you think digital systems should perform. They substantially cut costs and can build a whole new flexibility into your process control or test system. Here's how:

A full range of options include true RMS, suppression of polarity sign at zero, opto-isolation, extra zero, and others:

Years of trouble-free service are realized through the use of low voltage and low power devices that are designed into each monitor:

Your choice of two off-the-shelf models: Model 204 with 4000 count at \$145.00; and Model 203P with 2000 count at \$135.00.

At these prices you can't afford to miss getting all the facts. **For Immediate Response:** Call or write us and we'll provide a process monitor for your evaluation.

NEWPORT LABS —
630 East Young Street,
Santa Ana, California 92705
Phone: (714) 540-5486



DISPLAYS YOUR DATA IN ENGINEERING UNITS

LIQUID LEVEL, PRESSURE, FLOW, WEIGHT. . .

FEATURES INCLUDE: 13mm (½ in.) LED Display • Automatic Zero and Polarity • 10 μ V Resolution • Dual Slope, Average Value • 120dB CMR up to 500 V • V, I, and Ratio Measurements • Parallel BCD Output • Standard DIN Case

NEWPORT

INFORMATION RETRIEVAL NUMBER 77

COMPONENTS

Blue 'neon' lamp completes spectrum



Littelfuse Inc., 800 E. Northwest Highway, Des Plaines, IL 60016. (312) 824-1188. Under \$0.75.

Standard neon lamps emit light only in orange, red and yellow portions of the color spectrum. The blue "neon" lamps, which follow the recent addition of green "neons" to the line, now complete the color spectrum. Offered in 960, 970 and 980 Series, the lamps produce a highly visible blue light when used with a blue, white or colorless lens. The units have a built-in 30-k Ω resistor for operation at 125 V and a 100-k Ω resistor for 250-V applications. The lamp is rated at 1/3 W and has a life expectancy of 10,000 h.

CIRCLE NO. 371

Resolver provides 15° steps with 10 s accuracy

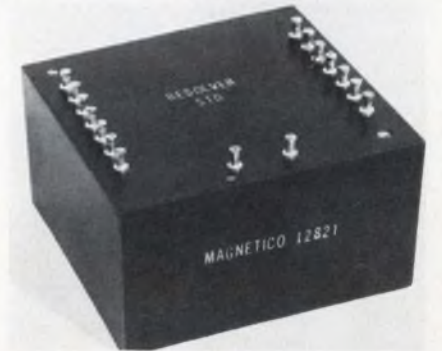

Magneto, Inc., 182 Morris Ave., Holtville, NY 11742. (516) 654-1166. \$125 (25 up).

A new 400-Hz resolver standard operates from 26 V, 400 Hz and provides isolated outputs of 11.8-V-rms sine and cosine voltages in 15-degree increments, accurate to 10 arc-seconds. It can be used to provide built-in equipment checks without costly external precision equipment. Its size is only 2-3/4 × 2-3/4 × 1-17/32 in.

CIRCLE NO. 372

our quiet one

Our low noise, punched tape I/O desktop unit, is designed to satisfy numerical control, graphic arts, data communications and computer peripheral applications.

It accommodates oiled paper, dry paper, metallized mylar, sandwich paper/mylar/paper and polyester. . . 5, 6, 7 or 8-level tapes. And, it's TTL/DTL compatible.

Asynchronous punching at up to 60 characters per second. Photoelectric reading at up to 150 characters per second, start/stop. Synchronous reading at up to 250 characters per second. Via a highly reliable stepping motor tape transport. At OEM prices.

For full details, write or call us.

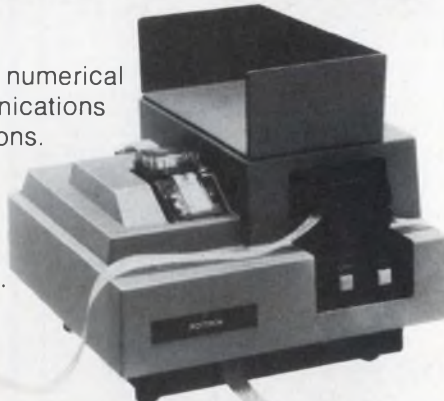

ROYTRON Model 1560 Reader/Punch

High speed, compact, with integral electronics and power supply self-contained in a quietized housing



OEM PRODUCTS
SWEDA INTERNATIONAL

Litton 34 Maple Avenue, Pine Brook, N.J. 07058/(201) 575-8100
IN U.K. — ADLER BUS. SYSTEMS/OEM PRODS., Airport House, Purley Way, Croydon, Surrey, England
IN FRANCE — SWEDA INTERNATIONAL/OEM, 103-107 Rue de Tocqueville, 75017 Paris, France

INFORMATION RETRIEVAL NUMBER 78

Liquid-crystal display is CMOS-compatible

Liquid Xtal Displays, Inc., 24500 Highpoint Rd., Cleveland, OH 44122. (216) 831-8100. \$8.00: 6-digit, 0.5-in. (2500 up).

The new Felix product line includes 14 different field-effect liquid crystal displays. The line includes 3-1/2, 4 and 4-1/2-digit arrays in three sizes—0.5, 0.7 and 1-in. heights. A 6-digit instrument and timer display comes in two sizes with 0.5 and 0.7-in. heights. The display's DIP substrate clips can be plugged in or directly soldered. The displays are CMOS-compatible and offer 50,000 h of life. Units with voltage ranges of either 3 to 6 or 9 to 18 V are available.

CIRCLE NO. 373

PC toggle switch mounts at right angles

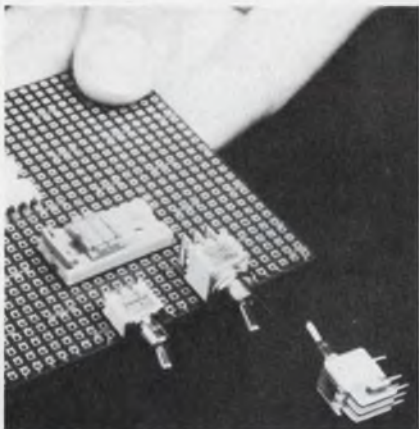

Alco Electronic Products Inc., 1551 Osgood St., North Andover, MA 01845. (617) 685-4371. \$0.92 (1000 up); stock to 90 days.

TT Series right-angle PC-mounted switches in double-pole versions occupy 60% less volume than comparable miniature right-angle switches, according to Alco. This is the first subminiature toggle switch that fits easily between PC boards placed on 1/2-in. centers. All terminals and mounting pins fall into 0.1-in. X and Y grids. The switch line is offered with options of plain or threaded bushing and a choice of five toggle levers, in either SPDT or DPDT case styles. They are normally stocked with gold terminals and contacts, primarily for dry or low current applications.

CIRCLE NO. 374

Brushless dc motor includes electronics

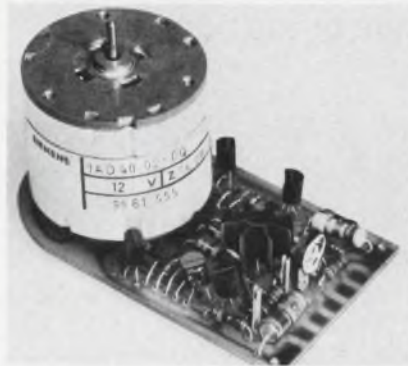

Siemens Corp., 186 Wood Ave. S., Iselin, NJ 08830. (201) 494-1000. \$30 (1000 up).

Brushless dc motor package, Model 1AD4002-0QQ99-AF, includes the motor integral with electronics. The motor can run without service for a minimum of 10,000 h with a continuous torque capability of 0.35 oz-in. and a speed-adjustment range of 2200 to 3300 rpm. Speed regulation over the entire torque range is 1%. The housing measures 1.57-in. dia \times 1.49-in. long. It operates from 12 \pm 5% V dc. A key feature of this motor is very low torque ripple, which makes it particularly suitable for cassette drives, tape recorders and turntables.

CIRCLE NO. 375

PROM programmer can copy another PROM



Technitrol, Inc., 1952 E. Allegheny Ave., Philadelphia, PA 19134. (215) 426-9105. \$850.

Technitrol Model 107, a new PROM programmer/copier/reader/verifier, can be used to program EARMOS, copy previously written PROMs, read data from addresses sequenced by a machine or randomly selected by an operator and verify data while writing or reading. The unit is 12 \times 14 \times 6 in., weighs less than 8 lb and operates with eight data bits and eight address bits.

CIRCLE NO. 376

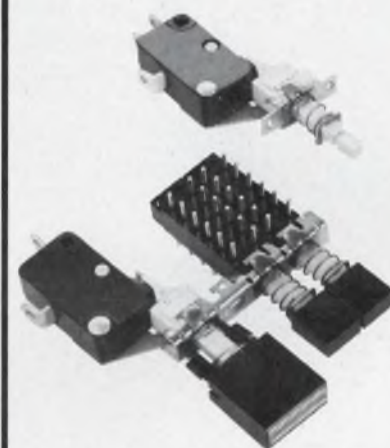

5 amp pushbutton switch

You'll meet even the most stringent requirements with this new line switch. It's UL listed for TV-5 rating (120V, 5A, 78A peak in-rush current).

Other features include:

- Furnished as a single station or for left or right mounting on any Centralab pushbutton switch assembly.
- Three circuit options — SPDT, SPST, normally open and SPST, normally closed.
- Button options include lighted, non-lighted or status indicator button (shown above).

See your Centralab Pushbutton Distributor or send inquiry card for complete specifications.

Isostat Licensed



CENTRALAB

Electronics Division
GLOBE-UNION INC.
P.O. BOX 858
FORT DODGE, IOWA 50501

INFORMATION RETRIEVAL NUMBER 79

NEW "FLAT PACK" DOUBLE BALANCED MIXERS

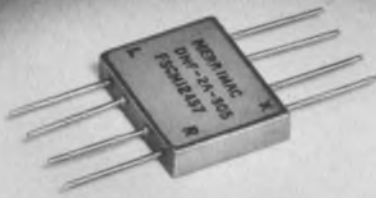

- Frequency range 10 MHz to 1000 MHz
- Low price
- Extremely compact, lightweight
- Custom models available

These new DMF-2A-505 double balanced mixers are ideal for high density packaging in stripline or printed circuit systems. Price is only \$26 in small quantities. Typical performance specs include: conversion loss less than 7 db, isolation 30 to 40 db, operating temperatures -54°C to $+85^{\circ}\text{C}$, and weight 1.4 grams.

Contact Merrimac today for more details on standard and custom-engineered DMF-2A-505 mixers.

**MERRIMAC
INDUSTRIES
INCORPORATED**

41 FAIRFIELD PLACE, WEST CALDWELL, N. J. 07006
(201) 228-3890 • TWX 710-734-4314

U.S. EXPORT REPRESENTATIVE:

Dage Corporation, 203 324 3123

INTERNATIONAL SALES REPRESENTATIVES:

Brussels, Belgium — Electron, S.p.r.l., tel: 513 7384, tlx: 0225437
Montreal, Canada — Mitec Electronics, Ltd., tel: 514 334 9140, twx: 610 421 3572
London, England — C. T. London Electronics Ltd., tel: 01 527 5641/3, tlx: 851 897488
Paris, France — Datron, tel: 808 02 60, tlx: 842 68135
Munich, Germany — Selectron, GmbH, tel: 089 591 053, tlx: 0524506
Tel-Aviv, Israel — Dage Israel Ltd., tel: 03 415645/410988, tlx: 92232377
Brada, Netherlands — Datron, B.V., tel: 1600/41152, tlx: 844 54512
Stockholm, Sweden — Aigjers Electronic AB, tel: 08 88 03 20, tlx: 854 10526
Zurich, Switzerland — Invertag, SA, tel: 01 65 56 30, tlx: 55670

COMPONENTS

Cermet trimmers offer side or top adjustment

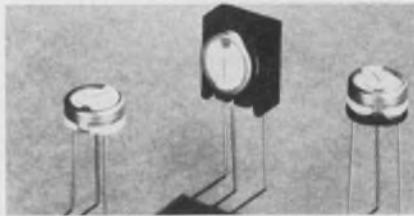

Allen-Bradley, 1201 S. Second St., Milwaukee, WI 53226. (414) 671-2000. \$1.12 to \$1.68 (1000 up).

A new 1/4-in. dia, single-turn, cermet trimmer, the Type A, is furnished with TO-5 or 0.1-in. grid-terminal spacings for top or side adjustment. The trimmer has a multifingered wiper for better adjustability and its temperature coefficient is 100 ppm/ $^{\circ}\text{C}$. Power rating is 0.5 W at 85 C. Standard values are in the range of 10 Ω to 2 M Ω with $\pm 10\%$ tolerance. End resistance is less than 2 Ω at both ends of rotation. Contact resistance variation is typically less than 1% or 1 Ω .

CIRCLE NO. 377

Electronic counter presettable to 999



Micro Switch, 11 W. Spring St., Freeport, IL 51032. (815) 232-1122. \$150 (OEM qty).

A predetermined electronic counter, the FE-STR1000, works at up to 300 counts/s. The count may be preset from one through 999. Once the preset count is reached, a follow-on operation such as routing or packaging is triggered before the unit resets itself for a new input series. The module will operate electromechanical or solid-state relays. Features include LED input and output indicators; top and front-count windows; instant-access count selector thumbwheels; sensitivity adjustment; and a light-operate/dark-operate selector switch for photoelectric actuation.

CIRCLE NO. 378



now you have
a choice!

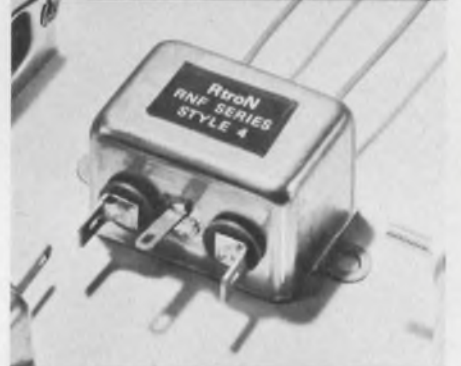

RFI/EMI FILTERS

For Data Processing,
Industrial Control and
Instrument Application

Rtron's RNF Type Filters represent three series of the most widely used, low cost filters available. Over 100 combinations of current and case style to choose from. "L" Series - low cost for general applications to combat line to ground noise. "P" Series - for suppression of line to line as well as line to ground interference. "T" Series - most effective for low impedance load applications. All types are U.L. Recognized and meet C.S.A. requirements. Rated at 115/250 VAC. Low leakage current insures safety.

For complete catalog and details, write:

Rtron corporation

P.O. Box 743, Skokie, Illinois 60076
(312) 679-7180

10 BITS AT 10 MHz

*
Ultra
High
Speed
*
Analog
to
Digital
Converters
*



12 BITS — 5 MHz
13 BITS — 1 MHz
15 BITS — 666 KHz

The above throughput rates include the signal acquisition time and the Analog-to-Digital Conversion time.

TUSTIN
ELECTRONICS COMPANY

1431 E. St. Andrews Place
Santa Ana, California 92705
(714) 549-0391

PACKAGING & MATERIALS

**SMA steel connectors
operate over 0 to 18 GHz**

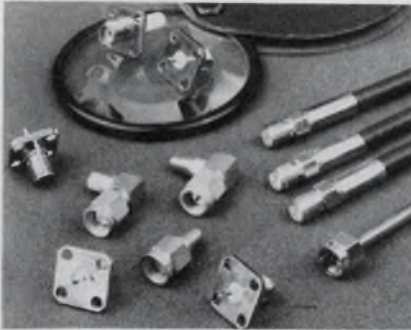

Amphenol, Bunker Ramo Corp., 33 E. Franklin St., Danbury, CT 06810. (203) 743-9272. Typical \$0.80 (1000-up); stock.

The 901 series of SMA stainless steel subminiature coaxial connectors duplicates in form, fit and function the most popular types in use today. The 50- Ω high frequency connectors are fully interchangeable and interchangeable with currently available SMA connectors. All shell and body parts of the connectors are type 303 stainless steel and are designed for operation in the 0-to-18-GHz range. The subminiature (3 mm) connectors meet all MIL-C-39012 requirements. The connectors include a solder-type straight plug for copper-jacketed 0.141-in. diameter semi-rigid coaxial cable, plus both solder and crimp plugs and jacks for the popular flexible cables; RG-174, 188A and 316/U cable and several flange-mounted receptacles.

CIRCLE NO. 381

**Conductive adhesive has
50 Ω /cm resistance**

Emerson & Cuming, Canton, MA 02021. (617) 828-3300. \$7/lb. (10 lb. lots); stock.

Eccobond 60 C is a one-part conductive adhesive which has a bulk resistivity of about 50 Ω /cm. The resistance through a thin film of the material is less than 1 Ω . It is supplied as a paste, with no mixing required. Coatings of Eccobond 60 C no greater than about 0.125 in. (0.3 cm) should be cured before any more is applied. Once cured the adhesive can be used at temperatures from -65 to +350 F (-50 to +177 C).

CIRCLE NO. 382

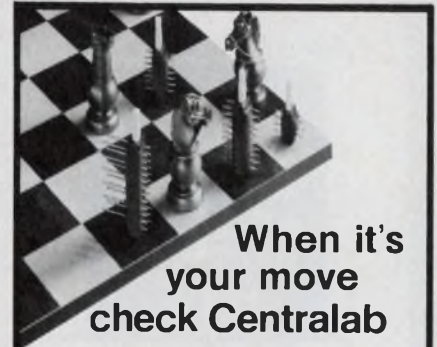

When it's
your move
check Centralab

NEW!

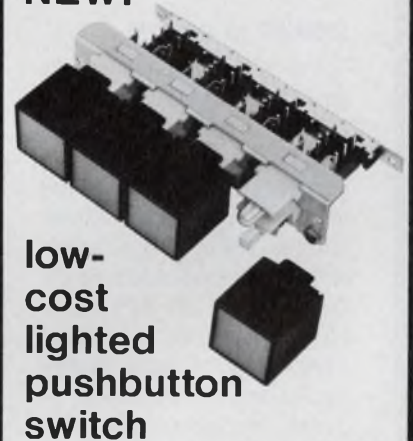

**low-
cost
lighted
pushbutton
switch**

Centralab reliability, low cost and new design freedom can be yours in this new lighted switch. Its T1-3/4 wedge base lamp brings the price way down*. Its many options make it easier than ever to achieve an aesthetically harmonized panel. You get features like these:

- Flat, concave or recessed lenses with uniform light diffusion.
- Eight lens colors.
- PC terminated independent lamp circuit.
- 15mm, 17.5mm or 20mm. spacing options.
- Ganged assemblies through 16 stations.

See your Centralab Pushbutton Distributor or send inquiry card for complete specifications.

* Per station cost at 1000 pieces. \$1.36
...2 PDT switch includes bulb.

Isostat Licensed



CENTRALAB

Electronics Division
GLOBE-UNION INC.
P.O. BOX 858
FORT DODGE, IOWA 50501

MONOLITHIC CRYSTAL FILTERS

the
State
of the
Art

SPEAKING TO THE DEAF

Our monolithics find their way into some fascinating and unusual applications. For instance — a narrow-band FM system which allows children with severely impaired hearing to participate in normal classroom activities. One of the requirements of the system was that both the students' receivers and the teacher's transmitter allow unhindered movement by the wearer. Another was freedom from interference, including interference from other systems in nearby classrooms. Cost was also an important factor. One of our standard 10.7 MHz tandem monolithic crystal filters in each receiver takes care of the interference. Its size is consistent with the needs of the wearer. Its cost is consistent with educational budgets.

HAVE IT YOUR WAY

As regular readers of this column know by now, we offer the broadest line going of standard monolithic crystal filters. It may be worth mentioning that we're just as interested in helping you with a custom monolithic as we are in showing you new ways to use our regular models. We've done hundreds of production "specials" from 5 to 180 MHz. May we do one for you?

What's your production application? Talk with us about it. We may be able to help. And if your interests include teaching the deaf, we'd be happy to put you in touch with the manufacturer of this equipment.

Pi

Piezo Technology Inc.

2400 Diversified Way Orlando, Florida 32804
305-425-1574

The Standard in monolithic crystal filters.

PACKAGING & MATERIALS

Kit of epoxy adhesives contains 17 types



Tra-Con, 55 North Street, Medford, MA 02155. (617) 391-5550. \$25; stock.

The Epoxylab kit is a 51-piece assortment of 17 different high-performance epoxy adhesive systems. Each epoxy adhesive system comes in its own individual ready-to-use package, which contains the exact amount of resin and hardener.

CIRCLE NO. 383

LSI IC sockets come in 24 and 40-pin sizes

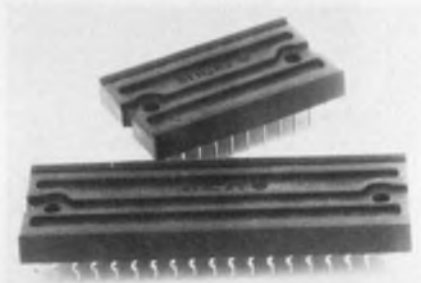

Augat, P.O. Box 779, 33 Perry Ave., Attleboro, MA 02703. (617) 222-2202. From \$0.25 to \$1.30; stock.

Two LSI contact sockets, the 324-AG (24 contact) and 340-AG (40 contact) series, use beryllium copper contacts. The sockets offer closed, tapered entry insulator design with large contact openings for quick LSI pin insertion and full seating. There is a 0.02-in. standoff between the insulator and the PC board for proper circuit clearance and flux cleaning. A 0.005-in.-thick polyester wafer is provided on the bottom of each socket to prevent IC leads from shorting to PC traces.

CIRCLE NO. 384

Copper-clad laminate permits clean punching

Norplex Div. of Universal Oil Products, 1300 Norplex Dr., La-Crosse, WI 54601. (608) 784-6070. Approx. \$1.30/sq. ft.; stock.

The NP-424, copper-clad laminate punches cleanly for through-hole plating. It satisfies the need for a glass epoxy such as G-10 or G-10FR at a lower cost. NP-424 meets the UL 94-V-0 flammability rating, will withstand over 20 seconds of 500-F solder float and will maintain peel strength of 9 lb./in. NP-424 is available in single and double-sided copper in a variety of thicknesses, copper weight and sheet sizes.

CIRCLE NO. 385

Flame-retardant resin machines easily

Emerson & Cuming, 60 Walpole St., Canton, MA 02021. (617) 828-3300. \$2/lb.; stock.

Stycast 2651-40 FR flame retardant casting resin provides the same versatility in application as the original Stycast 2651-40. For example, the viscosity of the resin is only 40,000 cps prior to addition of catalyst, a value which can be further reduced by raising the temperature to 100 F (38 C). Although the resin is normally black, it can be color coded per customer's specification. The cured resin is easily machined with carbide tools and meets the UL specification requirements of UL94, classification 94VE.

CIRCLE NO. 386

Knob display shows 10 different families

Alco Electronic Products, 1551 Os-good St., North Andover, MA 01845. (617) 685-4371. \$12.47; stock.

A product display board contains 10 knob families of machined aluminum knobs. All data, including part numbers, choice of anodized finishes, knob diameters and knob types stocked for 1/8 or 1/4-in. shafts, are given on the chart. The boards are available to design engineers at a cost of \$12.47, which is refundable on a first order for 500 knobs or more.

CIRCLE NO. 387

Low cost heat sink fits T-202 and 220 packages

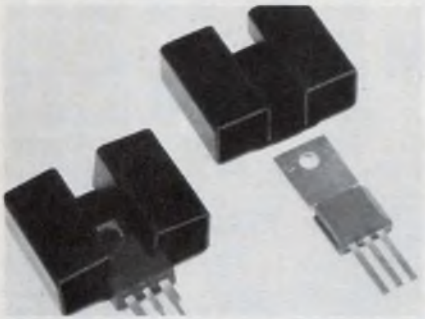

Fab-Tek, 17 Sugar Hollow Rd., Danbury, CT 06810. (203) 743-3312. See text; 2 wk.

The Models 106AB and 106BB heat sinks are designed for the JEDEC T-202 and TO-220AB plastic packages. Model 106AB fits the T-202 and can dissipate 3 W with a 67-C rise. Model 106BB fits both T-202 and TO-220AB and dissipates 4 W with a 58-C rise. Both sizes are available unfinished, gold chromate or black anodized. The unfinished 106A costs \$0.037; the unfinished 106B, \$0.056, both in 1000-piece lots.

CIRCLE NO. 388

Flat conductor cable made for flexing

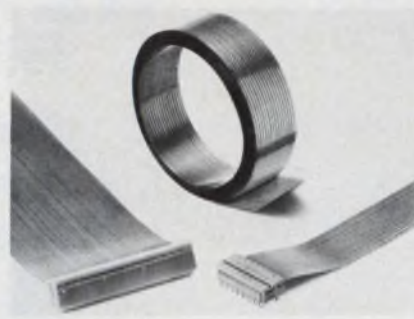

Ansley Electronics, 3208 Humboldt St., Los Angeles, CA 90031. (213) 223-2331. From \$0.016/conductor ft.; stock.

The 175 series of flat conductor cable is designed for maximum flex life. The cable combines a tough Mylar insulation with conductors on 0.05-in. centers. Cable thickness is 0.01 in. and has a flex life of over 10-million cycles. The cable is available in 10, 14, 16, 20, 24, 26, 34, 40 and 50-conductor widths. Cable specifications include a 90-V, 0.5-A rating and a maximum operating temperature of 80 C.

CIRCLE NO. 389

Low profile DIP sockets have no wicking problem

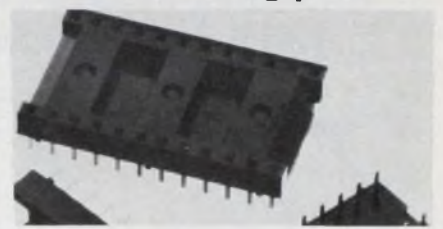

Scanbe Manufacturing, 3445 Fletcher Ave., El Monte, CA 91731. (213) 579-2300. From \$0.136 (large qty.); stock.

A low profile DIP socket series, the US-2, completely eliminates the problems of solder wicking, intermittent short-circuits and corrosion due to flux entrapment. Nominal insertion force of the US-2 was 195 g per contact while the withdrawal force was 28 g after conditioning. Contact resistance after conditioning was 15.2 mΩ. Contact material is copper alloy CA-770 with a 100-micron gold inlay on the contact surfaces. Sockets are available with from 8 to 40 pins.

CIRCLE NO. 390

GAUSSMETERS



ANALOG MODEL 750A

DIGITAL MODEL 750D

	ANALOG MODEL 750A	DIGITAL MODEL 750D
High Accuracy (up to)	±1.5% FS	± [0.2% of reading ±1 Digit]
Ranges (as high as)	50,000 Gauss	100,000 Gauss
Readouts	5½" Taut-band Meter	Four Digit (BCD output available)
Measurements	Permanent Magnet and DC Fields; AC Fields from 20 to 800Hz	
Internal Calibration	No Reference Magnet Needed	
Probes	Transverse, Axial and Tangential Available	
Power Req.	115/230V, 50/60Hz	
Price (less probe)	\$865.00	\$1,180.00

An optional (Model ID75) Differential and Incremental Adaptor is available.

RFL offers other models of magnetic measuring equipment, write for free technical booklet.

RFL Industries, Inc.
Boonton, N. J. 07005

Tel: 201-334-3100/TWX: 710-987-8352/CABLE: RADAIRCO, N. J.



EST. 1922

INFORMATION RETRIEVAL NUMBER 84

ELECTRONIC DESIGN 25, December 6, 1975

ANALOG SERIES No. 2

AT LAST: HIGH-CURRENT REGULATORS WITH SHORT CIRCUIT PROTECTION.

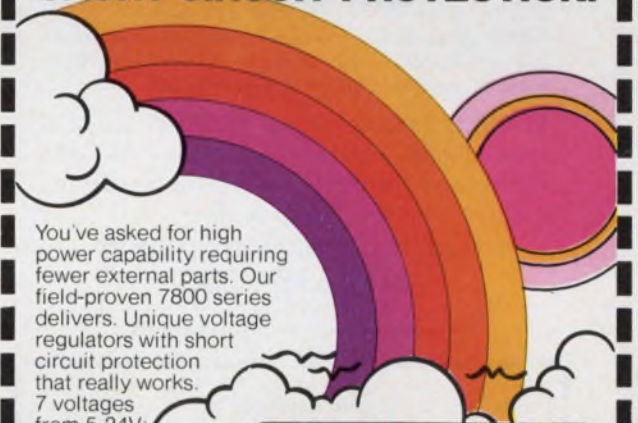

You've asked for high power capability requiring fewer external parts. Our field-proven 7800 series delivers. Unique voltage regulators with short circuit protection that really works. 7 voltages from 5-24V; TO-220 or TO-3.

Send me full specs on 7800 voltage regulators, coupon's attached to my letterhead.

Name _____

Tel. _____

Ext. _____

THINK

Signetics

811 E. ARQUES, SUNNYVALE, CALIF. 94086

INFORMATION RETRIEVAL NUMBER 85

**CONCORDE NEEDED THE FINEST
...THEY CHOSE JANCO!**

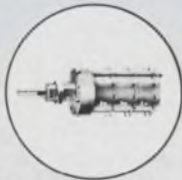
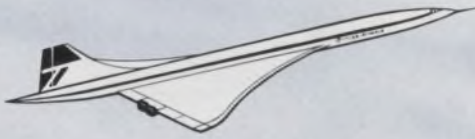

JANCO ROTARY SWITCHES

The reliability, performance, and long life of Janco Rotary Switches has been demonstrated over and over again since 1947. Today, as Janco continues to extend the frontiers of its technology around the world and beyond... we are prepared to offer a down-to-earth solution to your switching problem, too!

Janco
CORPORATION

3111 Winona Ave., Burbank, California 91504
Phone 213-845-7473 • TWX 910-498-2701

INFORMATION RETRIEVAL NUMBER 86

NEW POWER FROM POWER-ONE -ONE HIGH VOLTAGE

\$29.95
Single
Quantities



Powers the new "self-scanning" gas discharge displays as well as conventional display devices. IC regulated performance and reliability in a popular open-frame package.

FEATURES: 115/230 VAC Input • $\pm 0.05\%$ Regulation • 10 mv Ripple • Foldback Overload Protection • 50 μ sec Response • IC Regulated • UL Recognized • 2 Hour Burn-in • 2 Year Warranty

MODELS: HB200 - .12, 175 - 210 VDC @ .12A
HB250 - .10, 240 - 260 VDC @ .10A

For a catalog on our complete OEM power supply line, contact Power-One or your local factory representative.



531 Dawson Dr. Camarillo, Ca. 93010
Phone: 805/484-2806 TWX: 910-336-1297

POWER-ONE, INC.

INFORMATION RETRIEVAL NUMBER 88

FREE!

Chafitz Fall-Christmas Gift Catalog

SAVE up to 40% on selected name brand electronic specialty products and other prestigious items. Great for gifts, premiums, incentives, or yourself.

Products include: hand and desk calculators, digital watches and clocks, AM/FM radios and recorders, telephone answering devices, plus much, much more.

Call For Your Free Catalog
800-638-8280

Toll Free!

Maryland residents: 301-340-0200

Clip out coupon

Please send me free catalog.

Name _____

Company _____

Street _____

City _____

State _____ Zip _____

PO Box 2188 Dept. 280

Chafitz

Rockville, Maryland

20852

INFORMATION RETRIEVAL NUMBER 87

PHOTO ETCH PRINTED CIRCUIT KIT

Makes circuits **THREE WAYS**

- 1 FULL SCALE ARTWORK MASTER
- 2 MAGAZINE ART ILLUSTRATION → FILM POSITIVE → NEGATIVE → DEVELOPED PHOTO RESIST IMAGE ON COPPER CLAD CIRCUIT BOARD → ETCHED CIRCUIT BOARD
- 3 DIRECT ETCH DRY TRANSFERS APPLIED TO COPPER CLAD BOARD

NO CAMERA DARKROOM FILM CUTTING TRACING

USES DATAK'S POS-NEG PROCESS
The revolutionary photographic way that makes **PERFECT** printed circuits from original art or a printed page.

KIT CONTAINS: 5" x 6" steel printing frame, 4 sheets 5" x 6" photocopy film, yellow filter, chemicals for 1 pint film developer and 1 pint resist developer, 3" x 6" copper clad board, 3" x 4" copper clad board, spray can of photo etch resist, 1 pint resist developer, 2 sheets 8 1/2" x 11" layout film, 1 roll 1/8" printed circuit tape, 1 roll 1/32" printed circuit tape, 8 sheets dry transfer direct etch PC patterns including pads, transistors, round can and flat pack ICs, DIP ICs, edge card connectors, lines, circles, jogs, etc. 1/2 lb anhydrous ferric chloride to make 1 pint etchant, instructions.

ER-4 COMPLETE PHOTO ETCH SET	\$24.95
ER-2 PC patterns and tapes — refill	3.39
ER-3 1/4 pound dry etchant — refill	1.25
ER-5 6 sheets photocopy film — refill	3.39
ER-6 Film process chemicals — refill	1.79
ER-7 Photo resist spray, 2.5 oz. — refill	2.95
ER-8 Resist developer, 16 oz. can — refill	2.95

AT YOUR DISTRIBUTOR OR DIRECT

the **DATAK** corp.
65 71st St. • Guttenberg, N. J. 07093

INFORMATION RETRIEVAL NUMBER 89

ELECTRONIC DESIGN 25, December 6, 1975

POWER SOURCES

Open-frame unit sells for less than \$20



Xentek Inc., 1550 Linda Vista Dr., San Marcos, CA 92069. (714) 744-3346. \$18.95.

Seven models of regulated, single-output power supplies provide 5 to 24 V dc with 7-W output. Open frame and weighing only a fraction over a pound, the X17 series is only $4 \times 2.38 \times 1.69$ in. The units have thermal cutout protection, current limiting, short-circuit and reverse-voltage protection and may be ordered with optional voltage adjustment. Load and line regulation are better than 1% and ripple is less than 0.1%.

CIRCLE NO. 391

Modular switchers cost less than \$0.90/W

Control Data, 7801 Computer Ave. S., Minneapolis, MN 55435. (612) 830-5800. Less than \$0.90 per watt.

A standard line of switching power supplies is based on a modular design approach and is expressly built for applications where 300 or 600-W modules plug into a bulk module. Parallel operation, low noise and compact packaging are main features, combined with a less-than-90¢-per-watt selling price. Typical thermal related problems are overcome via derating of components and innovative packaging. Heat generating components are separated from temperature limited components, with the power devices capable of operating at a maximum of 100 C. Full output power is guaranteed up to 50 C.

CIRCLE NO. 392

Regulated dc/dc sources come in DIP-like package

Reliability, Inc., 5325 Glenmont, Houston, TX 77036. (713) 666-3261. \$38.20; stock-4 wks.

This series of regulated, dual-output dc/dc power sources are additions to the company's V-PAC Series. Depending upon the type, the new sources provide the designer with dual 15-V regulated outputs, positive and negative, from either 5-V (V5R 15-15) or 12-V (V12R 15-15) input. Maximum output current is 65 mA, with output ripple only 30 mV pk-pk over a bandwidth of 20 Hz to 20 MHz. Line and load regulation are 0.3%, and output voltage tolerance is $\pm 5\%$. Efficiency is at least 50% at full load. V-PAC sources are packaged in a 24-pin DIP-like package and occupy only 0.3 cubic inch.

CIRCLE NO. 393

High efficiency marks modular OEM supplies

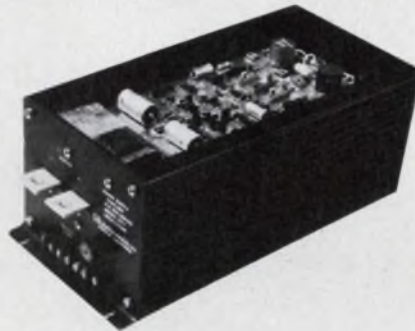

Electro-Module, Inc., 2855 Metropolitan Pl., Pomona, CA 91766. (714) 593-3565. Under \$600; stock-30 days.

DLR (direct line rectification) series of modular dc switching supplies features an efficiency of up to 85%. Models available include: 4.2 to 6 V dc (500, 600 and 750 W); 6 to 11 V dc (500, 600 and 750 W); 16 to 23 V dc (500, 600 and 750 W) and 22 to 30 V dc (500, 600 and 750 W). All models have 80% to 85% efficiency. Key specs include: Input voltage of 115/230 V ac, single phase, 47 to 1000 Hz; output ripple and noise (max) of 2% pk-pk, 0.5% rms; transient response time of 0.5 ms. Protection includes current limit and overvoltage. Full-rated temperature range is -20 to 40 C.

CIRCLE NO. 394

LASER MARKED UHF/MICROWAVE CHIP CAPACITOR KITS

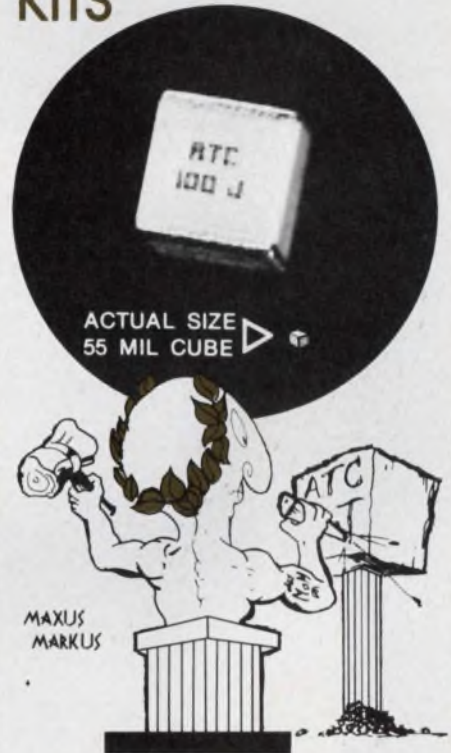

DESIGN VALUE KITS:

40 MARKED POPULAR VALUES
IMMEDIATELY AVAILABLE IN
KITS OR SEPARATELY.

BUY ANY DESIGN VALUE KIT
OF 100 ATC 100 LOW LOSS
PORCELAIN CHIP CAPACITORS
FOR \$77.00.



Just circle the number below
for more information on ATC's
new laser marked chip capacitor
kits.

**american
technical
ceramics**

ONE NORDEN LANE,
HUNTINGTON STATION, N.Y. 11746
(516) 271-9600 • TWX 510-226-6993

INFORMATION RETRIEVAL NUMBER 90

Electronic Design has in getting the



Richard D. Vane
President
AD-VANCE MAGNETICS, INC.



MAGNETIC SHIELD COSTS REDUCED

AD-MU FOLIO PROVIDES ECONOMICAL SHIELDING

AD-MU CUSTOM FABRICATED SHIELDS FOR COMPONENTS AND SYSTEMS

AD-MU SHEET STOCK - DELIVERY FROM STOCK

STURDY AD-MU TAPE DATA PROTECTORS

AD-MU CASE SHIELDS

MAGNETIC SHIELDS—ANY SIZE OR SHAPE

From Ad-Vance Magnetics, Inc. The Precision Spinning Magnetic Shielding Specialists

PHYSICAL CHARACTERISTICS OF AD-MU ALLOYS

ALLOY	TENSILE STRENGTH (PSI)	YIELD STRENGTH (PSI)	ELONGATION (%)	HARDNESS (HV)
AD-MU-10	100,000	50,000	10	100
AD-MU-15	150,000	75,000	10	150
AD-MU-20	200,000	100,000	10	200
AD-MU-25	250,000	125,000	10	250
AD-MU-30	300,000	150,000	10	300
AD-MU-35	350,000	175,000	10	350
AD-MU-40	400,000	200,000	10	400
AD-MU-45	450,000	225,000	10	450
AD-MU-50	500,000	250,000	10	500
AD-MU-55	550,000	275,000	10	550
AD-MU-60	600,000	300,000	10	600
AD-MU-65	650,000	325,000	10	650
AD-MU-70	700,000	350,000	10	700
AD-MU-75	750,000	375,000	10	750
AD-MU-80	800,000	400,000	10	800
AD-MU-85	850,000	425,000	10	850
AD-MU-90	900,000	450,000	10	900
AD-MU-95	950,000	475,000	10	950
AD-MU-100	1,000,000	500,000	10	1,000

Typical DC Magnetic Properties For AD-MU Shielding Alloys

ALLOY	PERMEABILITY	RESISTIVITY (OHM-IN)	THERMAL EXPANSION (PPM/°F)	CORROSION RESISTANCE
AD-MU-10	100,000	100,000	10	1.0
AD-MU-15	150,000	150,000	10	1.0
AD-MU-20	200,000	200,000	10	1.0
AD-MU-25	250,000	250,000	10	1.0
AD-MU-30	300,000	300,000	10	1.0
AD-MU-35	350,000	350,000	10	1.0
AD-MU-40	400,000	400,000	10	1.0
AD-MU-45	450,000	450,000	10	1.0
AD-MU-50	500,000	500,000	10	1.0
AD-MU-55	550,000	550,000	10	1.0
AD-MU-60	600,000	600,000	10	1.0
AD-MU-65	650,000	650,000	10	1.0
AD-MU-70	700,000	700,000	10	1.0
AD-MU-75	750,000	750,000	10	1.0
AD-MU-80	800,000	800,000	10	1.0
AD-MU-85	850,000	850,000	10	1.0
AD-MU-90	900,000	900,000	10	1.0
AD-MU-95	950,000	950,000	10	1.0
AD-MU-100	1,000,000	1,000,000	10	1.0

AD-VANCE MAGNETICS, INC., 726 S. SEVENTH ST., ROCHESTER, N.Y. 14625 / (716) 223-2158 / TWX 914-298-6294

See also Sec. 5495

GOLD BOOK 75/76

See also Sec. 5495

done one Hell of a job the **GOLD BOOK** to places it should be'

"The majority of our new business or new bids can be attributed to the **GOLD BOOK**," says Richard D. Vance, President, Ad-Vance Magnetics, Inc., Rochester, Indiana. Ad-Vance describes itself as the industry's largest, oldest, most experienced independent firm exclusively manufacturing magnetic shielding. Mr. Vance continues:

"We're an old company with a new name, so not too well known in the field. Our two-page spread in the **GOLD BOOK** has made us much better known.

"The **GOLD BOOK** gave us opportunities to bid from firms who had never heard of us before they saw our **GOLD BOOK** ad. For example, just today we got to bid on 1,000 CRT magnetic shields for a midwest firm who found us in the **GOLD BOOK**.

"Engineers don't hesitate to tell us they saw our ad in the **GOLD BOOK** when they call. I do a lot of sales work in the field, and I run into the **GOLD BOOK** almost everywhere our magnetic shielding has an application, both in purchasing and engineering. You've done one hell of a job in getting the **GOLD BOOK** to the places it should be."

Ad-Vance states that over 90% of past and present magnetic shield designs have been fabricated in the Ad-Vance plant during the past 20 years. Its magnetic shielding is used off-planet in spacecraft and satellites, and worldwide in precision industrial, laboratory, military and consumer applications.

Because the **GOLD BOOK** goes primarily to *Electronic Design's* audience of specifiers, Ad-Vance gets the benefit of 78,000 engineers, engineering managers, purchasing agents and distributors throughout the U.S.A., not to mention 13,000 overseas. These are the men who are ready to talk shielding—the men who have the authority to *buy*.

**ELECTRONIC DESIGN'S GOLD BOOK IS WORKING
...IT'S WORKING FOR READERS...AND IT'S
WORKING FOR ADVERTISERS, TOO.**

110C

20V, 5 ns variable rise

\$1250



Same old 110 model number and price, but a completely new design... with expanded capability. S-D's Model 110C pulse generator features 20 volts for driving logic families from TTL through MOS, which its famous predecessor, Model 110B, couldn't do. More good news! Thanks to its simple, clean design, Model 110C costs \$500 to \$600 less than its nearest competitors! Like the 110B, the 110C is a very sophisticated pulse generator featuring:

- Rise/fall time linear and variable from 5 ns to 1/2 sec.
- Upper level, lower level controls, rather than offset and amplitude (both variable from -20 to +20 volts)
- 50 ohm or 1K ohm source impedance
- Repetition rates to 50 MHz
- Single or double pulse output
- True or complement output
- Synchronous or asynchronous gating.

For complete details, call Scientific Devices or contact S-D at 10 Systron Drive, Concord, California 94518. Phone (415) 676-5000.



SYSTRON-DONNER

INFORMATION RETRIEVAL NUMBER 91

Application Notes

Gas-mixture technology

"Gas Mixtures—Facts and Fables" is a compact 23-page study of the technique and analysis of compressed-gas mixtures in cylinders, with chapters devoted to calibration, accuracy, impurities, sampling, storage and handling. Matheson Gas Products, East Rutherford, NJ

CIRCLE NO. 545

Cascadable amplifiers

Thin-film cascadable amplifiers are featured in a 28-page application note. The booklet is loaded with graphs, tables and photographs. Watkins-Johnson, Palo Alto, CA

CIRCLE NO. 546

Dual-delayed sweep

Especially for brief time intervals, such as cable length comparisons and computer-clock phasing adjustments, measurement is both easier and accurate by use of an oscilloscope with dual-delayed sweep. How and why this is so is spelled out in "Dual-Delayed Sweep for Precise Time Interval Measurements." Hewlett-Packard, Palo Alto, CA

CIRCLE NO. 547

Freq response analyzer

Ways to use a frequency response analyzer are shown in an eight-page application note. EMR Telemetry, Sarasota, FL

CIRCLE NO. 548

High-speed a/d converter

"Low Cost, High Speed Analog-to-Digital Conversion with the DAC-08" describes three practical a/d designs, with total conversion times of 1, 2 and 4 μ s. A discussion of basic successive approximation is given, followed by circuit designs and a PC-board layout for the 1- μ s version. Precision Monolithics, Santa Clara, CA

CIRCLE NO. 549

Low-noise ac amplifiers

"Your Easy Guide to Low-Noise ac Amplifiers" provides illustrated explanations of some of the terms used to describe and specify these amplifiers. The guide includes a two-page selection chart. Ortec, Oak Ridge, TN

CIRCLE NO. 550

Light pens

Principals of operation, system basics and performance of light pens are described in a literature package. Data on luminous intensity sensitivity, spectral response and phosphor emission characteristics are discussed. Information Control, Los Angeles, CA

CIRCLE NO. 551

Synchro conversion

Application and specification information for solid-state synchro converters are given in a 24-page brochure. Natel Engineering, Canoga Park, CA

CIRCLE NO. 552

Clad-gold inlays

Have you a question on gold-clad inlays, compared with gold plating, as a cost saver in producing electronic connectors? You'll probably find it answered in a 12-page brochure. Technical Materials, Lincoln, RI

CIRCLE NO. 553

Voiceband testing

"The Simplicity of Modern Voiceband Testing" describes transmission level, circuit noise, echo return loss and singing point, battery voltage, ac induction, loop and leakage resistance, cable capacitance and loop current. Wiltron, Palo Alto, CA

CIRCLE NO. 554

Cathode ray tubes

Covering only the most common applications, "CRTs... A Question of Choice" includes data on waveform monitors, photography, data display, radar, flying spot scanning and domestic TV. Clinton Electronics, Rockford, IL

CIRCLE NO. 555

Bulletin Board

A series of drivers that may be called by Fortran programs for the BP-721 graphics display interface has been introduced by Megatek.

CIRCLE NO. 556

A 15% improvement in total throughput speed for all Gould computer output microfilm systems has been announced.

CIRCLE NO. 557

Redactron's communicating typewriters can now be equipped with two options: unattended remote power turn-on and modem switch.

CIRCLE NO. 558

Solid Power Corp. has announced JAN/JANTX qualification approval of its 2N3715, 2N3716 and 2N5241 power transistors.

CIRCLE NO. 559

The Magnetic Media Group at the National Bureau of Standards has provided its first calibration service for medium-density magnetic disc surfaces.

CIRCLE NO. 560

Doric Scientific has announced an across-the-board price reduction of up to 20% on its DS-350 and DS-330 0.1° resolution digital thermocouple indicators.

CIRCLE NO. 561

The Digital Systems Div. of Texas Instruments has reduced memory prices for the Model 960B and 980B minicomputers by up to 38%.

CIRCLE NO. 562

Industrial Reproductions, a subsidiary of Buckbee-Mears, has dropped prices 20 to 25% for screens used in the production of thick-film hybrid circuits.

CIRCLE NO. 563

Rohde & Schwarz has cut the price 18% on its rubidium frequency standard XSRM.

CIRCLE NO. 591

Tektronix has announced a \$50 reduction in the monthly lease price on the 4023 alphanumeric terminal. Also, the Rulings Character Set option is now standard on all 4023s at no charge.

CIRCLE NO. 592

Agreement has been reached between National Semiconductor and Advanced Memory Systems, by which AMS will second-source two of National's 4096-bit RAMs.

CIRCLE NO. 593

Rogers Corp. is offering its Quik/Bus bars with a new insulation system that develops 350 pF per sq. in. capacitance.

CIRCLE NO. 594

American Videonetics dropped prices 23% on its Datacord DI 112 tape memories.

CIRCLE NO. 595

RCA Solid-State Div. has introduced 30 SK-series ICs and power devices as semiconductor replacement types.

CIRCLE NO. 596



The Digisec[®] Encoder keeps little bits from becoming big mistakes.

As some people have found out the hard way, all bits are not of equal length. And what may appear to be just a small error—say a fraction of an arc-second, can lead to a large accumulated error.

As the long recognized leader in encoders, Itek realizes the importance of maintaining accuracy commensurate with resolution. And Digisec Encoders have resolutions and accuracy up to 22 bits/revolution. But that's just part of the story.

Write for our free catalog. Read all about Digisec Encoders. They're more than a bit ahead of their time.

Itek Measurement Systems

A Division of Itek Corporation
27 Christina Street, Newton, Mass. 02161

INFORMATION RETRIEVAL NUMBER 92

ELECTRONIC DESIGN 25, December 6, 1975

MEMORY SERIES No. 7

DON'T SETTLE FOR OFF-THE-MARK SPEED/POWER TRADEOFFS.

1K MOS RAM in 12 combos. One dozen versions lets you target our #2102 static RAMs to application. Optimize speed, minimize power—pay only for what you can use. 10 fast standards + 2 in MIL. Quantity-stocked now.



Send complete specs on #2102 1K MOS RAM family. Clip coupon to letterhead.

Name _____

Tel. _____

Ext. _____

THINK

Signetics

811 E. ARQUES, SUNNYVALE, CALIF. 94086

INFORMATION RETRIEVAL NUMBER 93



If you're using screw machined parts as circuit board terminals, **we can save you money.**

ART WIRE KNOWS HOW!

We manufacture a variety of circuit board wire terminals and clips. We fabricate them accurately . . . at far less cost than parts made on screw machines. We supply these parts made from round wire, square wire, flat stock and ribbon . . . plated or unplated.

We'll supply a head or upset to solve your "locating" problems, a knurl or

flat to prevent "rocking" and a radius or chamfer to facilitate insertion and wire attaching. We do this as a single operation and pass the savings on to you.

If you're using these terminals . . . especially if you're using screw machine parts . . . send us a sample or print. We may be able to save you a lot more money than you realize.

ART WIRE & STAMPING COMPANY

116 Wing Drive, Cedar Knolls, New Jersey 07927

INFORMATION RETRIEVAL NUMBER 101

Circuit Savers



\$3.00
1000 pcs

DC
CROWBAR



Here's positive low cost protection for your IC's, transistors, power supplies and pc cards.

The LVC-1A crowbar switches to a short circuit whenever the voltage across it exceeds a specified level.

Any trip voltage level between 4.7V and 200V \pm 10% can be selected. The unit will handle a peak current of 50 Amps (8ms) and 3A continuously. MIL Temperature range. Call Mike Coyle for applications assistance.

Full line of protection modules for every hi-lo voltage/current requirement. Write or call for Catalog 749.

279 Skidmore Road
Deer Park, New York 11729
Telephone: 516 - 586-5125

MCG Electronics

INFORMATION RETRIEVAL NUMBER 103

Please Help Children Live

Research is our only weapon against childhood cancer.

St. Jude Children's Research Hospital, which is non-sectarian, is the largest childhood cancer research center in the world.

Please join in the fight against childhood cancer.

Send your special gift now.



ST. JUDE CHILDREN'S RESEARCH HOSPITAL

Danny Thomas, Founder

Send contributions to:
MEMPHIS, TENN. 38101

This space donated by publication

New Literature



Audio magnetic heads

A 96-page book features answers to frequently asked questions about magnetic head design, head applications and circuit considerations for typical audio applications. Nortronics, Minneapolis, MN

CIRCLE NO. 597

Switches

Standard toggle and pushbutton switch packages that meet custom specifications are covered in a 12-page catalog. Specifications, photos and diagrams are included. Machine Components, Plainview, NY

CIRCLE NO. 598

Vidicons

"Vidicon 7735" details parameters of GE's Vidicon camera tube for educational, industrial and other CCTV applications. The four-page publication presents specifications, maximum and typical ratings, a close-up photograph and drawings. General Electric, Tube Products Dept., Owensboro, KY

CIRCLE NO. 599

Gate-turn-off SCRs

Two bulletins describe 18 8.5-A gate-turn-off (GTO) SCRs, grouped in three series designated G5001, G5002 and G5003. RCA Solid State Div., Somerville, NJ

CIRCLE NO. 600

Rf semiconductors

Hf, uhf, vhf, single sideband and microwave discrete transistors and amplifier modules; amplifier and transistor products for mobile radio; and hybrid amplifiers and discrete transistors for CATV applications are covered in a 16-page catalog. Electrical and mechanical specifications, photographs and package dimensional drawings are included. TRW RF Semiconductors, Lawndale, CA

CIRCLE NO. 564

Alloy tubing

"Super Alloy Tubing," an 18-page catalog, describes small-diameter tubing cold drawn from alloys for service up to 1650 F. Superior Tube Co., Norristown, PA

CIRCLE NO. 565

Radio Shack catalog

A 164-page catalog has 100 full-color pages and describes electronics for home entertainment, hobbyists and experimenters. Radio Shack, Fort Worth, TX

CIRCLE NO. 566

Oscillators

High-performance miniature hybrid oscillators are described in a 38-page catalog. Technical data, performance curves and selection criteria are included. Greenray Industries, Mechanicsburg, PA

CIRCLE NO. 567

Lock-in amplifiers

A 44-page catalog describes the company's lock-in amplifiers, pre-amplifiers and accessory equipment. Princeton Applied Research, Princeton, NJ

CIRCLE NO. 568

Multiprogrammer

An eight-page brochure describes a do-it-yourself automatic test and process control system that manages up to 240 individually controlled I/O functions with a single programmable desktop calculator. "HP Interface Bus Kit for 6940B Multiprogrammer" is illustrated with photos and diagrams. Hewlett-Packard, Palo Alto, CA

CIRCLE NO. 569

Precision tools

A 40-page precision tool catalog is sectioned into 10 categories: adjusting tools, cleaning equipment, drivers, screw and nut, gauges, tool kits, production assembly and service tools, pliers, soldering equipment, telecommunication tools, and wrenches. Jonard Industries, Tuckahoe, NY

CIRCLE NO. 570

Overvoltage protection

Protection of electronic equipment against surge and interference voltages is the subject of a four-page bulletin. Cerberus, Ltd., Mannedorf, Switzerland

CIRCLE NO. 571

Quartz products

Thirty-six pages feature high-purity quartz products. Nearly 1000 standard diffusion tubes, boats, carriers, reactor tubes, bell jars, joints, raw materials, accessories and miscellaneous items are included. Quartz International, Santa Clara, CA

CIRCLE NO. 572

One of today's
lowest cost
SPDT GP
relays!



Actual Size

...and probably the most compact!

Think of it...these low cost Series 27 miniature GP relays provide low level to 3 amp switching in a 0.526" cube. And they're priced at only \$1.05 each in 1,000-piece lots for 3, 6 and 12 vdc units—slightly more for 24 vdc relays.

Designed for high density PC board mounting on .69" centers, our Series 27 relay weighs only 0.5 oz. and has a 450 mw pick-up sensitivity. (Also available at 180 mw.) Contact rating is 3 amp res @ 28 vdc, 120 vac and contact resistance is 0.10 ohm max.

Small size...small price...big performance. Consider it for appliance controls, industrial process and machine controls. It's ideal for large volume applications because each and every unit is subject to computerized inspection and individualized contact adjustment.

Write for information today!

NORTH AMERICAN PHILIPS CONTROLS CORP.

Frederick, Md. 21701 • (301) 663-5141

INFORMATION RETRIEVAL NUMBER 104

ELECTRONIC DESIGN 25, December 6, 1975

MEMORY SERIES No. 3

**SUPER GIVEAWAY:
6 YEARS
OF PROM RESEARCH**

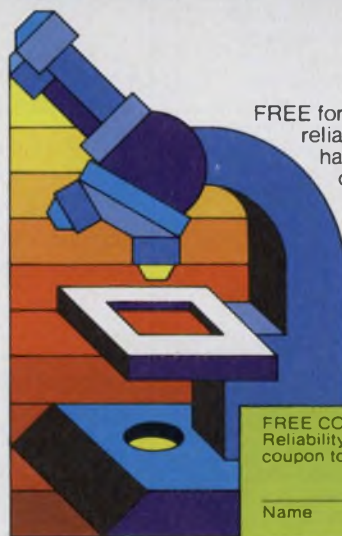

FREE for the asking: our PROM reliability report. The kind of hard-nosed data you need on nichrome fusing, and the critical conditions governing rel maximization. A strong evaluation of our PROM research, further supporting RADC findings.

FREE COPY of Signetics PROM Reliability summary: attach coupon to letterhead

Name _____

Tel _____

Ext _____

THINK

Signetics

311 E. ARQUES, SUNNYVALE, CALIF. 94086

INFORMATION RETRIEVAL NUMBER 105

135

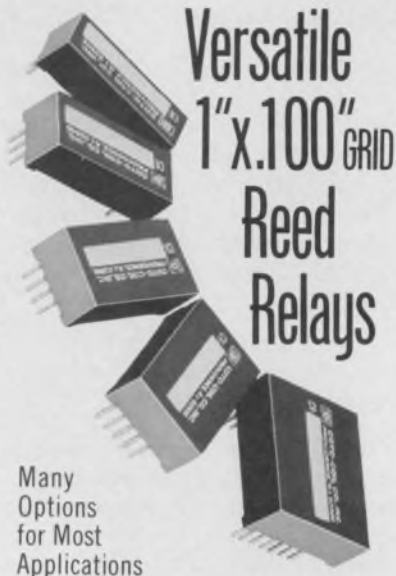

Many Options for Most Applications

New CR-2000 Series utilizes the popular 1" x .100" grid pattern, with 1 to 6 poles and a variety of options and contact forms for almost any application. Reliable low-level switches may be conditioned by special run-in and dynamic testing. Models can be epoxy-encapsulated or simply encased for added economy. Ask for Bulletin MR 11.1 for full details.



COTO-COIL COMPANY, INC.
59 Pavilion Ave.
Providence, R. I. 02905
Tel: (401) 467-4777

INFORMATION RETRIEVAL NUMBER 106

Eliminate Interference-Induced Errors in your Measurements . . .

by removing spurious components from the signal of interest *before* you measure it. The Model 189 Selective Amplifier provides a choice of narrow-band, lowpass, highpass and notch filtering to eliminate interfering signals and wideband noise. The corner/center frequency is continuously variable between 0.1 Hz and 110 kHz with equivalent circuit Q switch-selectable from 1 to 100.



To find out how the Model 189 can eliminate errors from your measurements, write Princeton Applied Research Corporation, P.O. Box 2565, Princeton, New Jersey 08540, or telephone (609) 452-2111. In Europe, contact Princeton Applied Research GmbH, D8034 Unterplaffenhofen, Waldstrasse 2, West Germany.



259

INFORMATION RETRIEVAL NUMBER 107

NEW LITERATURE

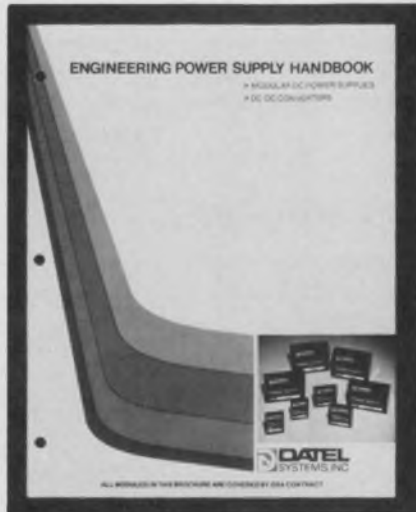

Power supplies

Twenty-one modular line operated power supplies and 37 dc-to-dc converter modules are covered in a 20-page catalog. A tabular selection guide categorizes units according to output voltage and current and lists regulation, tempco, size and price. Datel, Canton, MA

CIRCLE NO. 573

Limit switches

Operating principles, advantages and applications data on solid-state camless limit switches are given in a 12-page brochure. Astrosystems, Lake Success, NY

CIRCLE NO. 574

Ultra-miniature indicators

The characteristics and performance of incandescent, neon and light-emitting diode lights are covered in a 20-page catalog. Dialight, Brooklyn, NY

CIRCLE NO. 575

Industrial control timers

The design, operation and application of reset and repeat-cycle industrial control timers are described in a 56-page training manual. Design exercises with solutions are included so the reader can test his mastery of the material. Eagle Signal Industrial Controls Div., Davenport, IA

CIRCLE NO. 576

Function modules

Voltsensors, instrumentation amplifiers, function modules and power supplies are featured in a 56-page catalog. Two introductory discount coupons are included—one entitles the customer to a 30% discount on the first order and a free personalized clipboard folder. The other enables the customer to buy any two power supplies and get a third one free. Calnex, Pleasant Hill, CA

CIRCLE NO. 577

Ni-Resist cast irons

Engineering properties and applications of the Ni-Resist austenitic cast irons are described in a 52-page catalog. The International Nickel Co., New York, NY

CIRCLE NO. 578

Telecommunications

"Telecommunications from the Terminal Users Viewpoint" starts with the definition of the term "modem" and proceeds through large interactive time-shared computer networks using multiplexers, concentrators and front-end processors. Diagnostics, monitoring and test equipment are described. Moxon Electronics, Anaheim, CA

CIRCLE NO. 579

Wood miter grooving

A two-color illustrated data sheet features Myterwood, a wood-veneer miter grooving process used to make finished enclosures. Kell-Groove Corp., Somerville, NJ

CIRCLE NO. 580

Thyristors/rectifiers

More than 500 thyristors and rectifiers are described in a 40-page catalog. Data are given for both commercial and developmental types. Application information is also included. RCA Solid State Div., Somerville, NJ

CIRCLE NO. 581

Miniature lamps

Data on hundreds of lamps, including 61 new lamps, are included in a 40-page catalog. General Electric, Cleveland, OH

CIRCLE NO. 582

Vendors Report

Annual and interim reports can provide much more than financial-position information. They often include the first public disclosure of new products, new techniques and new directions of our vendors and customers. Further, they often contain superb analyses of segments of industry that a company serves.

Selected companies with recent reports are listed here with their main electronic products or services. For a copy, circle the indicated number.

Solid State Scientific. Microprocessors, memories, digital watch modules, telecommunications, automotive, mobile communications and avionics.

CIRCLE NO. 583

Raytheon. Energy services, major appliances, and military, commercial and marine electronics.

CIRCLE NO. 584

The Foxboro Co. Instruments and systems for process management and control.

CIRCLE NO. 585

Philip A. Hunt Chemical. Chemicals used in image-forming processes.

CIRCLE NO. 586

Thomas & Betts. Connectors, terminals, fittings, accessories and related tooling.

CIRCLE NO. 587

Comsat. Communications satellite services.

CIRCLE NO. 588

Augat. IC interconnection products, switches, precision materials and components.

CIRCLE NO. 589

General Instrument. Semiconductors, cable TV, consumer products, electro-optical/mechanical products, data systems and defense systems.

CIRCLE NO. 590

Imagine, a low cost, OEM - reliable Panel Mounting Thermal Printer... Better still, install it!

Mount this little 2.3LB, 7 column printer on your panel right alongside your digital panel meter or any digital instrument. The DPP-7 printer accepts BCD data directly from your TTL source (no extra electronics are needed). Only 2 moving parts are used, assuring OEM reliability. The thermal printhead does away with ink, ribbons, printwheels and hammers. Power the DPP-7 from AC or +5V.



DATTEL SYSTEMS, INC.

1020 TURNPIKE STREET, CANTON, MASSACHUSETTS 02021 TELEPHONE (617) 828-8000
 ● SANTA ANA, CALIF. (714) 835-2751 ● SANTA ANA, CALIF. (LA EXCHANGE) (213) 933-7256
 ● SUNNYVALE, CALIF. (408) 733-2424
 INFORMATION RETRIEVAL NUMBER 108

DPP-7 Features

- 6 Digits and sign up to 3 lines/second
- Accepts full parallel BCD TTL levels
- Positive or negative true selectable inputs
- Self-cleaning thermal printing uses no ink or hammers
- \$475 (singles)

COVERED BY
 GSA CONTRACT
 NO. GS-00S-27959

Send for your
 FREE Brochure

Our single-chip concept:

Copper grid distributes current most efficiently for lowest $V_{CE(sat)}$.

Integral solid copper leads and heat sink make pre-bond chip test and inventory possible.

Meet stringent MIL requirements best with the NPN silicon transistor that's single-minded about performance.

The concept: a unique single-chip design that packs the highest current rating in its class... keeps saturation voltage low and eliminates second breakdown problems. $V_{CE(sat)}$ is .60V max. @ 50 Amps, and guaranteed at 90 Amps. $E_{S/b}$ is 6 joules. And because its very simplicity allows pre-rating

One bigger, beefier chip.

Void-free bonding techniques eliminates hot spots.

and pre-testing, you can order our PT 7511 device off-the-shelf for switching regulators, motor controls and other hi-rel power circuits.

For tech. data and application assistance, write or call, PowerTech, Inc., 9 Baker Ct., Clifton, N.J. 07011; (201) 478-6205

PowerTech
 BIG IDEAS IN
 BIG POWER

**Top of its class.
 200v, 90A
 silicon transistor**

INFORMATION RETRIEVAL NUMBER 109

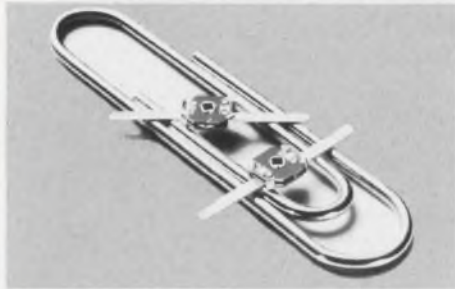

Thin-Trim variable capacitors provide a reliable means of adjusting capacitance without abrasive trimming or interchange of fixed capacitors. Series 9401 has high Q's and a range of capacitance values from 0.2-0.6 pf to 3.0-12.0 pf and 250 WVDC working voltage. Johanson Manufacturing Corporation, Boonton, New Jersey (201) 334-2676.

THIN-TRIM CAPACITORS

601

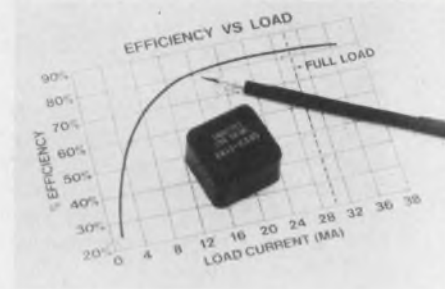

Activate gas discharge readouts! DC-to-DC power supplies convert low DC line voltages of 5, 9, 12 or 15 volts to nominal 200 and 250 volt DC levels required to run gas discharge information displays. Ideal for battery powered applications! Free literature. Endicott Coil Co., Inc., 31 Charlotte Street, Binghamton, N.Y. 13905

POWER SUPPLY

604



DIP Crystal Oscillator drives CMOS or TTL at any fixed frequency from 32kHz to 70 kHz, with frequency stability of $\pm 0.01\%$ from -25 C to $+70\text{ C}$, frequency accuracy of $\pm 0.003\%$ at $25\text{ C} \pm 3\text{ C}$, drives multiple CMOS loads or one TTL gate, package measures $0.78\text{ L} \times 0.49\text{ W} \times 0.3\text{ H}$, at lower frequencies, from 8Hz to 35 kHz, Model S14R4C drives multiple CMOS loads or Model S14R4T drives one TTL gate; availability 4 weeks ARO. Connor-Winfield Corp., West Chicago, IL 60185 (312) 231-5270

OSCILLATOR

607



48 HOUR TRANSFORMER SERVICE FOR \$49.00. 115 volts Input with any one voltage you specify as the output voltage. Up to 100 watts 60HZ, 500 watts 400HZ. Don't settle for a stock item, get what you need. Call 516-654-1166 or Write MAGNETICO, INC., Holtsville, N.Y. 11742.

TRANSFORMER SERVICE

602



48 pages of data on circuits for commutation, analog and D.C. switching, gating, multiplexing, chopping, D-to-A conversion, sample and hold, modulation, demodulation, solid state relays, lamp/relay driving, TTL to MOS level shifting. Teledyne Crystalonics, 147 Sherman Street, Cambridge, MA. 02140 (617) 491-1670

MICROCIRCUITS CATALOG

605



Basic Electricity & Basic Electronics by Van Valkenburgh, Nooger & Neville, Inc. Derived from the COMMON-CORE Training Program initially developed for the U.S. Navy. Thorough, comprehensive coverage. Available in separate paperbacks or cloth volume. Write for FREE brochure. Hayden Book Co., Inc., 50 Essex St., Rochelle Pk, N.J. 07662 (201) 843-0550.

TRAINING TEXT

608



FLEXIBLE CIRCUITS FOR HANDHELD CALCULATORS are one example of how your creativity can be given fresh stimulus and flexibility by using flexible circuits from Rogers. Mass-produced at amazingly low cost. Ask for details. Rogers Corporation, Chandler, AZ 85224. Phone (602) 963-4584.

FLEXIBLE CIRCUITS

603

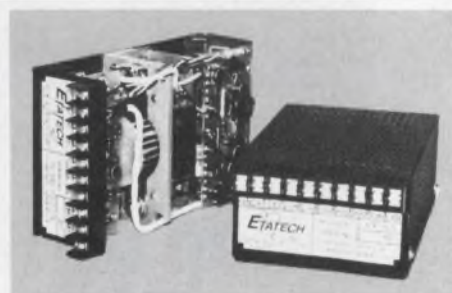

ETATECH'S 100 WATT SWITCHERS BREAK POWER DENSITY BARRIER: 2w/cu. in and 40w/lb. in an off-line fully regulated module. The highly efficient (75% min. @ 5v) units are easy to cool (33w max loss). Excellent reliability of 71K Hrs. MTBF. Outputs 5 to 60VDC. ETATECH, INC., 187M W. Orangethorpe, Placentia, CA 92670 (714) 996-0981.

100 WATT SWITCHERS

604

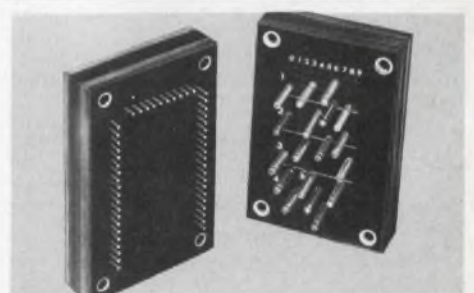

THREE DECK SUB-MINIATURE MATRIX PROGRAM BOARDS . . . designed to custom specification, provide a reliable and simple method for connecting complex networks while maintaining maximum switching flexibility units can be supplied on either .250, .125 or .100 centerlines, with up to 15,000 crosspoints; both Shorting and Diode Pins are available. Pricing for special prototype quantities starts at \$.15 per crosspoint, delivery 4-6 weeks ARO. LVC, Inc., 135-25-37th Avenue, Flushing, New York 11354. (212) 939-9777

PROGRAM BOARDS

606

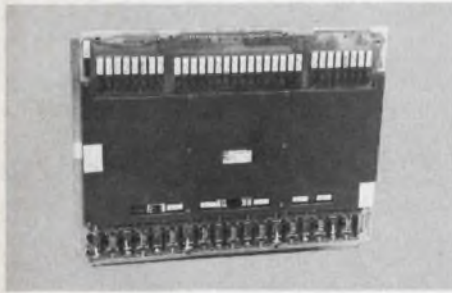

16K/32K Memory Systems. Model 696: 16K, 18-bits; to 256K X 9, 128K X 18, 64K X 36. Model 698: 32K, 18 bits; to 512K X 9, 256K X 18, 128K X 36. Cycle 650 nsec, access 250 nsec. Dir. rplcmnts for Micro 3000. Fabri-Tek, Inc., 5901 S. Cnty. Rd. 18, Mpls, MN 55436 (612) 935-8811

MEMORY SYSTEM

610



LED Digital Displays have attractive one piece metallic bezel. Uses H.P. hi intensity .43" high characters in Red, Yellow or Green. Termination is 30" cable or wire wrap pins.

100 piece pricing (4 digit unit)
 Display Unit \$25.20
 Display Unit with Decoder (TTL) 39.50
 as above plus Latch 40.50
 Counter (TTL) 63.00
 2-10 digits are stock. Rochester Digital Displays Inc., 120 N. Main St., Fairport, NY 14450 (716) 223-6855

LED DIGITAL DISPLAYS

613

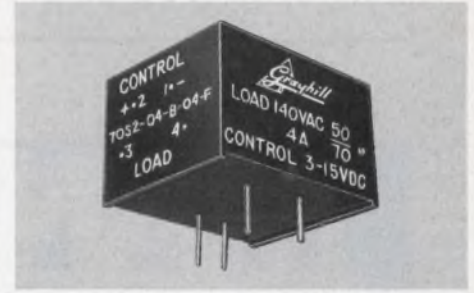

SPACE-SAVING 4 AMP SOLID STATE RELAY occupies only 1 cubic inch, is logic compatible, with switching capability from 0.1 to 4 amps, rated @25°C. Optically coupled; zero voltage turn-on. Offers inductive load switching, excellent transient protection. PC mountable. Prototype quantities from stock. Grayhill, Inc., (312) 354-1040.

SOLID STATE RELAY

616



New Model ERD & ERT (time delay) solid state dc relays for use with supervisory control equipment to initiate control. Nominal voltage: 6-250 vdc. Maximum reset time: 50 msec. Repeat accuracy: 0.1%. These units are offered in three enclosed-housing configurations, plus an open board version. Also ac models. LaMarche Mfg. Co., 106 Bradrock Drive, Des Plaines, IL 60018 (312/299-1188).

ERD/ERT DC RELAYS

611

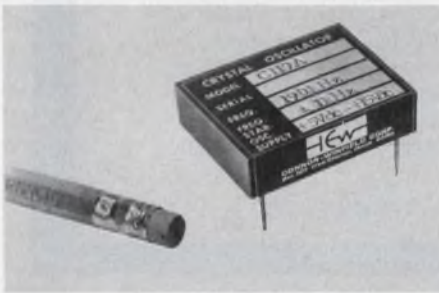

Oscillator Drives One TTL or Multiple CMOS Loads at any fixed frequency from 180kHz to 550 kHz, with frequency stability of $\pm 0.1\%$ from 0°C to +50°C, frequency accuracy of Model C119A is ± 1 kHz, of Model C119B is $\pm 0.1\%$; Model C119C has $\pm 2\%$ interval frequency adjust; flat package measures 1.6" x 1.2" x 0.4"; availability 5 weeks ARO. Connor-Winfield Corp., West Chicago, IL 60185 (312) 231-5270

OSCILLATOR

614



Free New '75 catalog contains over 34,500 quality power supplies from the world's largest manufacturer, Power/Mate Corp. Power Supplies for every application including submodulars, open frame, varietal, encapsulated, laboratory & system. All units UL approved and meet most military and commercial specs for industrial and computer uses. Power/Mate Corp., 514 S. River St., Hackensack, NJ 07601 (201) 343-6294

POWER SUPPLIES

617



LABTRONICS' Multiple Restrike (M-R) Ignition produces high energy repetitive spark on each power stroke for effective ignition of air/fuel mix. Increase mileage up to 40%, longer points/plug life. Model VI \$79.95, VI-B \$59.95 1 yr warranty, 30 day guaranteed refund. Check, M.O. (postpd US) Labtronics, Inc. 3635 Hillside, Ypsilanti MI 48197



DIGITAL SIGNAL ANALYSIS, S. Stearns. Contains the most recent advances, brand-new design material, and a comparison between continuous and digital systems, making it an ideal master reference to today's signal processing techniques and systems. #5828-4, 288 pages, \$18.95. Circle the Info Retrieval Number to order 15-day exam copy. When billed, remit or return book with no obligation. Hayden Book Co., 50 Essex Street, Rochelle Park, N.J. 07662.

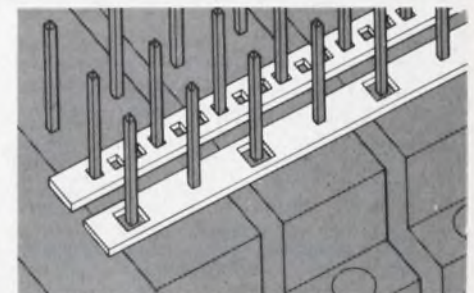

STRIP/BUS BY ROGERS. Low Cost Busing Systems; easy installation, reliable solder joints; greater pin exposure. Write or call for details. Rogers Corporation, Rogers, CT 06263. Phone (203) 774-9605.

recruitment and classified ads

MANAGER

Consumer Products R&D

Fortune 500 leader in consumer/industrial products marketing has career-building opportunity for an innovative R&D specialist skilled in electro-mechanical or optical-mechanical sciences. Managing a team of professionals and technicians, you will develop new and improved consumer-oriented products—from concept through prototype stage. A realistic approach to creation of marketable family-use products is essential. Position requires advanced degree in Physics, ME or EE plus meaningful R&D experience at group leader level in the business machine or photo industry. Northeastern location. Please send resume in confidence to: **BOX CM, HAYDEN PUBLISHING COMPANY., 50 Essex St., Rochelle Pk, NJ 07662**

An equal opportunity employer, m/f

ELECTRONIC DESIGN's function is:

- To aid progress in the electronics manufacturing industry by promoting good design.
- To give the electronic design engineer concepts and ideas that make his job easier and more productive.
- To provide a central source of timely electronics information.
- To promote communication among members of the electronics engineering community.

Want a subscription? ELECTRONIC DESIGN is sent free to qualified engineers and engineering managers doing design work, supervising design or setting standards in the United States and Western Europe. For a free subscription, use the application form bound in the magazine. If none is included, write to us direct for an application form.

If you do not qualify, you may take out a paid subscription for \$30 a year in the U.S.A., \$40 a year elsewhere. Single copies are \$1.50 each.

If you change your address, send us an old mailing label and your new address; there is generally a postcard for this bound in the magazine. You will have to requalify to continue receiving ELECTRONIC DESIGN free.

The accuracy policy of ELECTRONIC DESIGN is:

- To make diligent efforts to ensure the accuracy of editorial matter.
- To publish prompt corrections whenever inaccuracies are brought to our attention. Corrections appear in "Across the Desk."
- To encourage our readers as responsible members of our business community to report to us misleading or fraudulent advertising.
- To refuse any advertisement deemed to be misleading or fraudulent.

Microfilm copies are available of complete volumes of ELECTRONIC DESIGN at \$19 per volume, beginning with Volume 1, 1952 through Volume 20. Reprints of individual articles may be obtained for \$3.00 each, prepaid (\$5.00 for each additional copy of the same article) no matter how long the article. For further details and to place orders, contact the Customer Services Department, University Microfilms, 300 North Zeeb Road, Ann Arbor, Michigan 48106 telephone (313) 761-4700.

Want to contact us? If you have any comments or wish to submit a manuscript or article outline, address your correspondence to:

Editor
ELECTRONIC DESIGN
50 Essex Street
Rochelle Park, N.J. 07662



The President's Committee
on Employment of the Handicapped
Washington, D.C. 20210

FREE ALARM CATALOG

Huge selection of burglar & fire systems, supplies. Motion detectors, infrared beams; controls, door switches, bells sirens 500 items. 99 pp packed with technical details, notes.

(Outside U.S., send \$1.00)



mountain west alarm

4215 n. 16th st., phoenix, az. 85016

CIRCLE NO. 210

SUBSTANTIAL OWNERSHIP OPPORTUNITY AVAILABLE

Candidates must have a BS in EE plus extensive knowledge in latest circuitry design techniques. Candidates should have proven experience in the design and development of ionization type smoke detectors. Will consider however 5 years design experience in related field. Salary open. Submit full resumes in confidence to:

Box CG
Electronic Design
50 Essex Street
Rochelle Park, NJ 07662

Electronic Design

Manufacturers

Advertisements of booklets, brochures, catalogs and data sheets. To order use Reader-Service Card (Advertisement)

Advertising Sales Staff

Tom W. Carr, Sales Director

Rochelle Park, NJ 07662

Robert W. Gascoigne
Daniel J. Rowland
50 Essex Street
(201) 843-0550
TWX: 710-9990-5071

Philadelphia

Thomas P. Barth
50 Essex Street
Rochelle Park, NJ 07662
(201) 843-0550

Boston 02178

Gene Pritchard
P.O. Box 379
Belmont, MA 02178

Chicago 60611

Thomas P. Kavooras
Berry Conner, Jr.
200 East Ontario
(312) 337-5088

Cleveland

Thomas P. Kavooras
(Chicago)
(312) 337-0588

Los Angeles 90045

Stanley I. Ehrenclou
Burt Underwood
8939 Sepulveda Boulevard
Los Angeles, CA
(213) 641-6544

Texas/Oklahoma

Burt Underwood
(Los Angeles)
(213) 641-6544

San Francisco 94040

Robert A. Lukas
3579 Cambridge Lane
Mountain View, CA 94040
(415) 965-2636

London, Amsterdam, Tokyo, Seoul

John Ashcraft
12, Bear St.
Leicester Square
London WC2H 7AS England
Phone: 01-930-0525

W. J. M. Sanders
John Ashcraft & Co.
Herengracht 365
Amsterdam C., Holland
Phone: 020-24-09-08

Haruki Hirayama
Electronic Media Service
5th Floor, Lila Bldg.,
4-9-8 Roppongi
Minato-ku, Tokyo, Japan
Phone: 402-4556

Cable: Electronicmedia, Tokyo

Mr. O-kyu Park, President
Dongbo Int'l Corp.—
World Marketing
C.P.O. Box 4010
Seoul, Korea
Tel.: 76-3910/3911
Cable: DONGBO SEOUL
Telex: EBKOREA K27286



NEW PORTABLE MINI-FFT NEVER FORGETS!

For on-site instant diagnosis of noise/vibration, 440A real-time universal frequency analyzer/averager/waveform recorder always "remembers" to write test conditions and readings on its CRT—a Polaroid photo preserves them: perfect for inexperienced personnel.

Detects closely-spaced frequencies with 400-point resolution; senses small signals over a 60 dB (1000:1) dynamic range (greater with averaging). All-digital design means precision without recalibration. Includes digital reading of both frequency and amplitude at cursor. On-line real-time display of instantaneous frequency spectra and changing average; viewing and plotting of input time signal. Plug-in modules for special/future jobs. Annotated photos, X-Y plots, or digital recordings.

For machine analysis: reads frequency directly in RPM and Hz; harmonics are automatically identified. For noise reduction: subtracts factory background noise from a machine noise spectrum; log frequency scales available. For machine failure prediction: signature analysis of rotating machines in terms of orders; direct readout of differences between present and past spectra. For automatic systems: digital input or output, remote control/sensing. For transients: transient waveform can be held, viewed and plotted before analysis; spectrum of transient is undistorted because of true flat weighting.

FOR DEMO CIRCLE 170
FOR LIT CIRCLE 171

Nicolet Scientific Corporation (formerly Federal Scientific Corp.)

245 Livingston St., Northvale, N.J. 07647, 201-767-7100 TWX: 710 991 9619

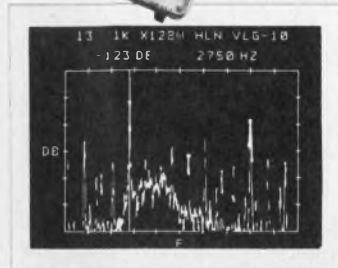

GIANT FREE CATALOG

New 164-page catalog! Packed with 1,000's of hard-to-find buys in Optics, Science, Electronics. Loaded with optical, scientific, electronic equipment available from stock. Rare surplus buys. Many "one-of-a-kinds". Ingenious scientific tools. Components galore: lenses, prisms, wedges, mirrors, mounts, accessories. 100's of instruments: pollution test equipment, lasers, comparators, magnifiers, microscopes, projectors, telescopes, binoculars, photo attachments, alternate energy sources. Shop, save by mail! Request free Catalog "DA".

CIRCLE NO. 172

Edmund Scientific Co.

America's Largest Science-Optics-Electronics Mart

300 Edscorp Bldg., Barrington, New Jersey 08007 (609) 547-3488

Share in the nation's top managerial policies, strategies, techniques . . .

MANUFACTURING MANAGEMENT SYSTEMS

New Challenges and Opportunities Edited by Fred Gruenberger



By crystallizing the results of the 1973 Informatics/UCLA Symposium, this book offers a powerful blend of technical and managerial expertise for enhancing the overall success and profitability of today's manufacturing management systems. Some of the nation's top industrial and technical leaders speak freely and in depth of their organization's objectives and specific operations, as well as their personal strategies and methods. You'll find the newest computerized tools available to manufacturers . . . crucial managerial skills for directing progressive systems . . . the tact and care needed for the sensitive human problems of system implementation, and more. #5940-x, 160 pages, \$10.50. Circle the Info Retrieval No. to order a 15-day exam copy. When billed, remit or return book. No obligation.

CIRCLE NO. 173

Hayden Book Company, 50 Essex St., Rochelle Pk, N.J. 07662

ABP

BPA

MADE IN KOREA • MADE IN KOREA

MADE IN KOREA • MADE IN KOREA

MADE IN KOREA • MADE IN KOREA

For QUALITY Call
"KOTRA!"
for finest Made-in-Korea
ELECTRONIC PRODUCTS
MOST ECONOMICAL AND EFFICIENT IN THE WORLD

Home Electric and Electronic Appliances
TVs • Radios • Tape Recorders • Cassettes
Speakers • Amplifiers • Turntables • Calculators
Electronic Watches • Electronic Components
Condensers • Resistors • Mag Heads • Semiconductors

KOREA TRADE CENTERS
Close to you. Close to your Phone.

NEW YORK (212) 594 9464	CANADA
CHICAGO (312) 644 4323	VANCOUVER (604) 683 1820
LOS ANGELES (213) 748 5331	MONTREAL (514) 878 3425
SAN FRANCISCO (415) 391 2637	TORONTO (416) 864 1076
DALLAS (214) 748 9341	SAN JUAN
SEATTLE (206) 623 3558	PUERTO RICO (809) 767 0540

KOREA TRADE PROMOTION CORPORATION, C.P.O. BOX 1621, SEOUL, KOREA

MADE IN KOREA • MADE IN KOREA

INFORMATION RETRIEVAL NUMBER 110



**FAST PORTABLE INSPECTION
INEXPENSIVE - READS TO .0005"**

Are you looking for a faster, more accurate way of measuring art work, camera negatives and positives, micro-electronic circuitry or aerial photographs? Accurate measurements can be made unbelievably fast by placing a SUPER GAGE containing a transparent glass scale grad-

uated in .001" directly over the work to be measured. Bausch & Lomb 40X microscopes display crisp images assuring accurate readings to .0005" (Available in metric read-out to .02mm).

We guarantee results. Send for Catalog No. 38-21.

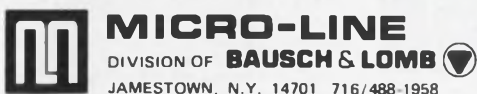

INFORMATION RETRIEVAL NUMBER 111

ELECTRONIC DESIGN 25, December 6, 1975

A COMPLETE
CLEANING KIT —



**COBRA™
Plus...**

- High Purity Solvent of Your Choice
- Extension Spray Nozzle
- Solvent Spray Brush
- 36" Flexible Nylon Hose

The New "Cobra" Extension Hose and Nozzle is ideal for remote applications and pin-point cleaning. The all nylon system includes an "on-off" valve which attaches to the aerosol, pressurizing the system, and allowing finger-tip control at the nozzle.

The Cleaning Kit includes two interchangeable cleaning tips: 6" extension spray nozzle plus the solvent spray brush. This new *solvent-with-in-a-brush* is recommended where scrubbing action is required for hard-to-remove residue.



SEND FOR
YOUR TRIAL
CLEANING
KIT...

TRIAL UNIT
\$5⁰⁰

The "Cobra" Cleaning Kit plus one of the following High Purity Cleaners listed below.

miller-stephenson chemical co., inc.

DANBURY, CT. 06810 / Phone: (203) 743-4447

I have enclosed \$5.00, please send my "Cobra" Cleaning Kit, plus one of the following aerosol cleaners...

Check one —

ED-12T

- MS-180 "FREON" Solvent
- MS-190 Flux Remover & Cleaner
- MS-190HD Flux Remover & Cleaner
- MS-200 Magnetic Tape Head Cleaner
- MS-230 Contact Re-Nu
- MS-160 "FREON" T-P 35 Solvent

Please send FREE literature and prices

Name.....Dept/Title.....

Company.....

Address.....

CHICAGO • LOS ANGELES • TORONTO • DANBURY, CT.
FREON is Du Pont's registered trademark for its fluorocarbon compounds

INFORMATION RETRIEVAL NUMBER 112

**SPEED PRODUCTION...
 SAVE SPACE AND WEIGHT...
 REDUCE ASSEMBLY COSTS...**

WITH BUCKBEE-MEARS FLEXIBLE CIRCUITRY

BMC flexible circuitry offers significant advantages over conventional hand wiring of discrete circuits. It can simplify assembly, reduce costs, and greatly improve wiring accuracy and reliability.

Buckbee-Mears' Circuits Division also can provide as much—or as little—engineering assistance as you require . . . from preliminary drawings through testing to finished products. This team of flexible circuit specialists can help define your requirements, then work with you in developing the circuitry to fit your exact application. For information, write or call Ed Dugan.



INFORMATION RETRIEVAL NUMBER 113

**NEW X-Y recorder
 2/3 fewer parts**



Spartan X-Y recorders deliver big new benefits. A revolutionary mechanical design eliminates more than 1/2 of the moving parts to boost reliability and performance. Parts reduction = cost reduction = more value per dollar. Spartan X-Y is stripped for OEM or dedicated use, or fitted with multi-range and time base for lab use. Features: 45"/sec or faster slewing speed, lifetime conductive plastic pot, disposable fiber-tip pen/ink unit, vacuum holddown, back-lighted grid alignment, op amp solid state electronics, 11" x 17" (or A3). 5 ranges: 1 MV to 10V/in*. 6 time bases: 0.01 to 2.0 in/sec*. (* or equivalent metric.) Request Bn. E 510 from Esterline Angus Instrument Corporation, Box 24000, Indianapolis, IN. 46224. 317/244-7611.



INFORMATION RETRIEVAL NUMBER 115

**NEW!
 MICROCOMPUTER
 DICTIONARY**

to be published December 15, 1975

TITLE: Microcomputer Dictionary & Guide

AUTHOR: Charles J. Sippl

DESCRIPTION: Over 3500 definitions and explanations of terms and concepts (approx. 350 pages) relating to microprocessors, microcomputers and microcontrollers. Special sections of programmable calculators; math and statistics; flow chart symbols and techniques; binary numbers systems and other related computer terms. In addition there is a comprehensive electronic/computer abbreviations and acronyms section.

\$14.95

MATRIX PUBLISHERS, INC.
 Dept. ED, 207 Kenyon Road, Champaign, IL 61820

Please send me new MICROCOMPUTER DICTIONARY under your 15 day no risk trial guarantee. Remittance enclosed. (Ill. customers add 5% sales tax)

Name _____
 Address _____
 City _____ State _____ Zip _____

INFORMATION RETRIEVAL NUMBER 114

**SWITCHES FOR
 KEYBOARDS**

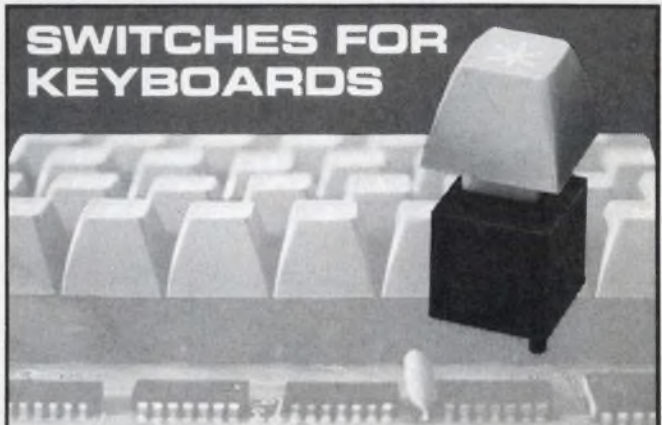

We offer the following for OEM's producing their own keyboards.

- Keyswitches in 3 sizes for 1/2", 5/8" or 3/4" centers
- Gold Bar mechanical contacts or sealed contacts
- Front panel relampable lighted models
- Single and double pole contacts including NC
- Alternate action models
- Doubleshot molded keytops for 3/4" or 5/8" mounting
- Easy change legend systems
- 100,000 pc. quantity prices as low as \$0.19 each

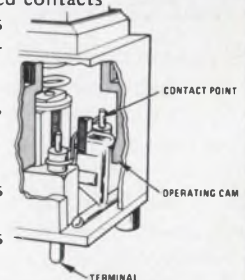

Letterhead request or phone call brings free sample switch w/keytop.



MECHANICAL ENTERPRISES, INC.
 8000 Forbes Place Springfield, Virginia 22151
 (703) 321-8282 TWX 710-832-0942

In Germany - NEUMÜLLER GMBH, MUNICH
 In U. K. - TEKDATA Ltd., STOKE-ON-TRENT

INFORMATION RETRIEVAL NUMBER 116

Product Index

Information Retrieval Service. New Products, Evaluation Samples (ES), Design Aids (DA), Application Notes (AN), and New Literature (NL) in this issue are listed here with page and Information Retrieval numbers. Reader requests will be promptly processed by computer and mailed to the manufacturer within three days.

Category	Page	IRN	Category	Page	IRN
Components					
capacitors, ceramic	53	18	counters	108	332
counter, electronic	124	378	DAC	108	334
crowbar, dc	134	103	driver, relay	107	331
cutoffs	146	118	RAM, 1-k	110	337
filters, crystal	126	83	register	110	339
potentiometers	46	26	transceiver	110	338
relays, reed	136	107	watch chip	108	333
relays, solid-state	2	3	watch chips	107	330
resistor, trimmer	124	377	Microprocessor Design		
resistor wall chart	II	246	bipolar processors	52	541
stepper motor	20	8	controller, floppy disc	54	544
switch, pushbutton, PC	124	379	controllers	54	542
switch, solid-state	35	17	tester, μ P	52	540
switch, toggle, PC	123	374	μ P, CMOS	54	543
switches	119	73	Microwaves & Lasers		
switches	144	116	amplifier	118	358
switches, DIP	21	9	comb generator	119	362
switches, rotary	128	86	mixers, double-balanced	124	80
switches, toggle	124	380	noise source	121	368
terminal boards	146	121	Modules & Subassemblies		
thermal cutoff	88	41	amplifiers, isolation	112	343
Data Processing					
data-acquisition	117	354	controller, motor	113	344
data terminal	117	355	converter, a/d	114	347
minicomputer	116	353	converter, d/a	114	348
NMOS memory	89	42	converter, multi-		
reader/punch	122	78	function	114	346
tape system	115	351	drivers, current	113	345
Discrete Semiconductors					
diodes, Scottky mixer	103	307	sensor, noncontact	112	340
optically coupled isolator	7	6	subsystems, Serdex	114	349
rf devices	1	2	system, data-acquisition	111	302
rectifiers, fast-recovery	102	109	Packaging & Materials		
transistor, silicon	137	109	adhesive, conductive	125	382
transistors, rf	103	306	adhesive, kit	126	383
transistors, rf	103	308	audio connector line	95	45
transistors, Darlington	101	301	breadboards	115	68
zeners	106	55	cable, flat	127	389
Instrumentation					
DMM	97	141	cleaning kit	143	112
DMM	104	322	connectors, PCB	23	11
DMM	106	328	connectors, SMA	125	381
data-acquisition	104	321	display, knobs	126	387
encoder	133	92	flexible circuitry	144	114
function generator	106	326	gauges, artwork	143	111
gaussmeters	127	84	heat sink, transistor	127	388
Korean electronic products	143	110	IC test clips	111	61
logic analyzer	104	323	laminare, copper-clad panels	126	385
oscilloscopes	43	201	panels	76	37
panel meter	51	281	resin, flame-retardant	126	386
power amplifier	110	60	sockets, LSI IC	126	384
power-line monitor	106	329	swivel cord	102	50
scope, plug-in	79	291	terminals	55	31
spectrum analyzer	105	325	terminals and clips	134	101
transistor tester	97	142	Power Source		
VOMs	91	43	dc/dc sources	129	393
X-Y recorder	144	115	open-frame supply	129	391
Integrated Circuits					
binary converter	108	336	power supplies	120	75
			power supplies	61	35
			power supply	6	5
			sockets, DIP	127	390
			switchers	129	392
			switchers	129	394

Only with an EMR Real-Time Spectrum Analyzer..

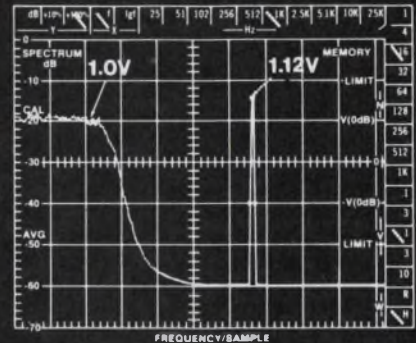

Accurate Power Spectral Averaging

If you had just completed averaging the power spectrum above, which value of V would you believe?

With an EMR Real-Time Spectrum Analyzer, they would both be correct. That's because the EMR Model 1510 uses an all digital technique for detecting, squaring, and averaging. Result: a true mean square value for all applied waveforms.

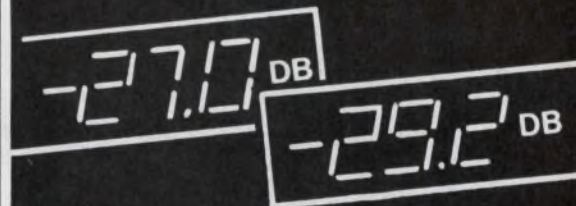

Don't settle for an analyzer that uses an approximating technique, and requires the application of messy correction factors. Get the facts on an EMR 1510 today with many proven user-oriented benefits... 60dB dynamic range, computer interface, LED display, CRT status display, and much more!

Only From EMR!



EMR EMR Schlumberger

EMR Telemetry
Weston Instruments, Inc.
Box 3041, Sarasota, Florida 33578
912 371 0811

Terminal Boards

READI-MADE



CUSTOM FABRICATED

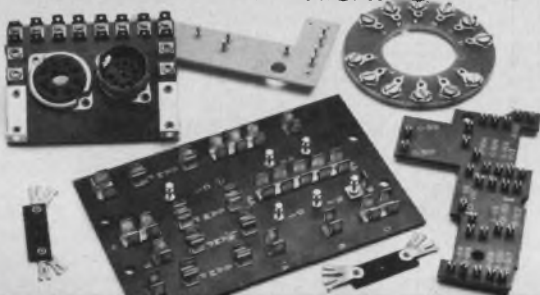

NEW FREE CATALOG ON REQUEST



KEYSTONE
ELECTRONICS CORP.

49 BLEECKER ST., NEW YORK, N.Y. 10012 • (212) 475-4600

INFORMATION RETRIEVAL NUMBER 118

MICROPROCESSOR POWER

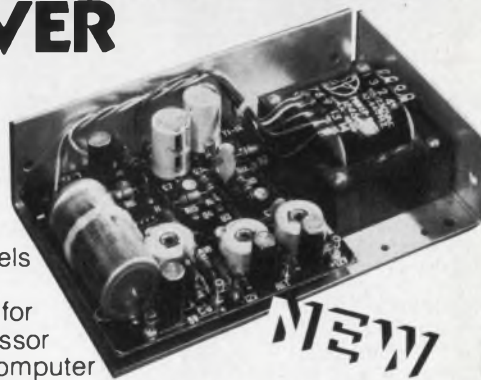

New dual and triple output models designed specifically for microprocessor and microcomputer applications.

MODELS

DUAL: HAA512, 5V @ 2A W/OVP	\$44.95
9 to 15V @ 0.5A	Single Quantities
TRIPLE: HTAA-16W, 5V @ 2A W/OVP	\$49.95
±9 to ±15V @ 0.2A	Single Quantities

FEATURES: 115/230 VAC Input • OVP on 5V Outputs • ±.05% Regulation • I.C. Regulated • 1.5 mv Ripple • Foldback Current Limit • Full Rated to 50°C • 2 Hour Burn-in • 2 Year Warranty

See our complete product listing in EEM & GOLDBOOK

For a copy of our NEW 1976 D.C. POWER SUPPLIES CATALOG, contact Power-One or your local factory representative



1531 Dawson Dr. Camarillo, Ca. 93010
Phone: 805/484-2806 TWX: 910-336-1297

POWER-ONE, INC.

INFORMATION RETRIEVAL NUMBER 120

Introducing the end of the educated guess in testing of AC/DC voltages, current, decibel and resistance.

For quicker, easier, more accurate electrical tests... select the

MERATESTER

Check these features:

- 100 MΩ input resistance • accurate to 1.5% AC/DC • 80 ranges • floating input for absolute user safety • full overload protection • 90 db common mode rejection factor • 1.5 mV to 50 kV FSD/AC/DC with probe
- battery or power line operation • 150 mm/6" Mirror backed scale • 0.15 uA to 150 A AC/DC FSD with shuntbox • resistance ranges to 1000 MΩ
- completely portable
- supplied in a lined leather carrying case

DEALER INQUIRIES
INVITED



SEND FOR CATALOG

INTERNATIONAL BUSINESS SYSTEMS, INC.

2522 18th Street, Racine, Wisconsin 53403

Name _____ Title _____

Company _____

Address _____

City _____ State _____ Zip _____

Phone _____ User Dealer

146

INFORMATION RETRIEVAL NUMBER 119

HERE TODAY...

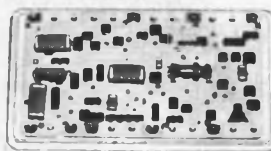

HERE TOMORROW

For years, NEC Microsystems has quietly demonstrated extraordinary competence and dependability as a supplier of economical, high quality hybrid microcircuits. Let us evaluate your requirements for custom hybrids. We'll do the job right today and we'll still be around when you need us, tomorrow.



NEC MICROSYSTEMS
DIVISION OF NORTH ELECTRIC
A UNITED TELECOM COMPANY

1150 N. W. 70 ST. FORT LAUDERDALE, FLA. 33309
PHONE (305) 974-5400 — TWX 510- 956-9897

INFORMATION RETRIEVAL NUMBER 121

ELECTRONIC DESIGN 25, December 6, 1975

Amphenol's **MERLIN™**
 is lighter, shorter, and
 more reliable than most
 other MIL-C-26482/0026482/83723
 connectors.

That takes guts:

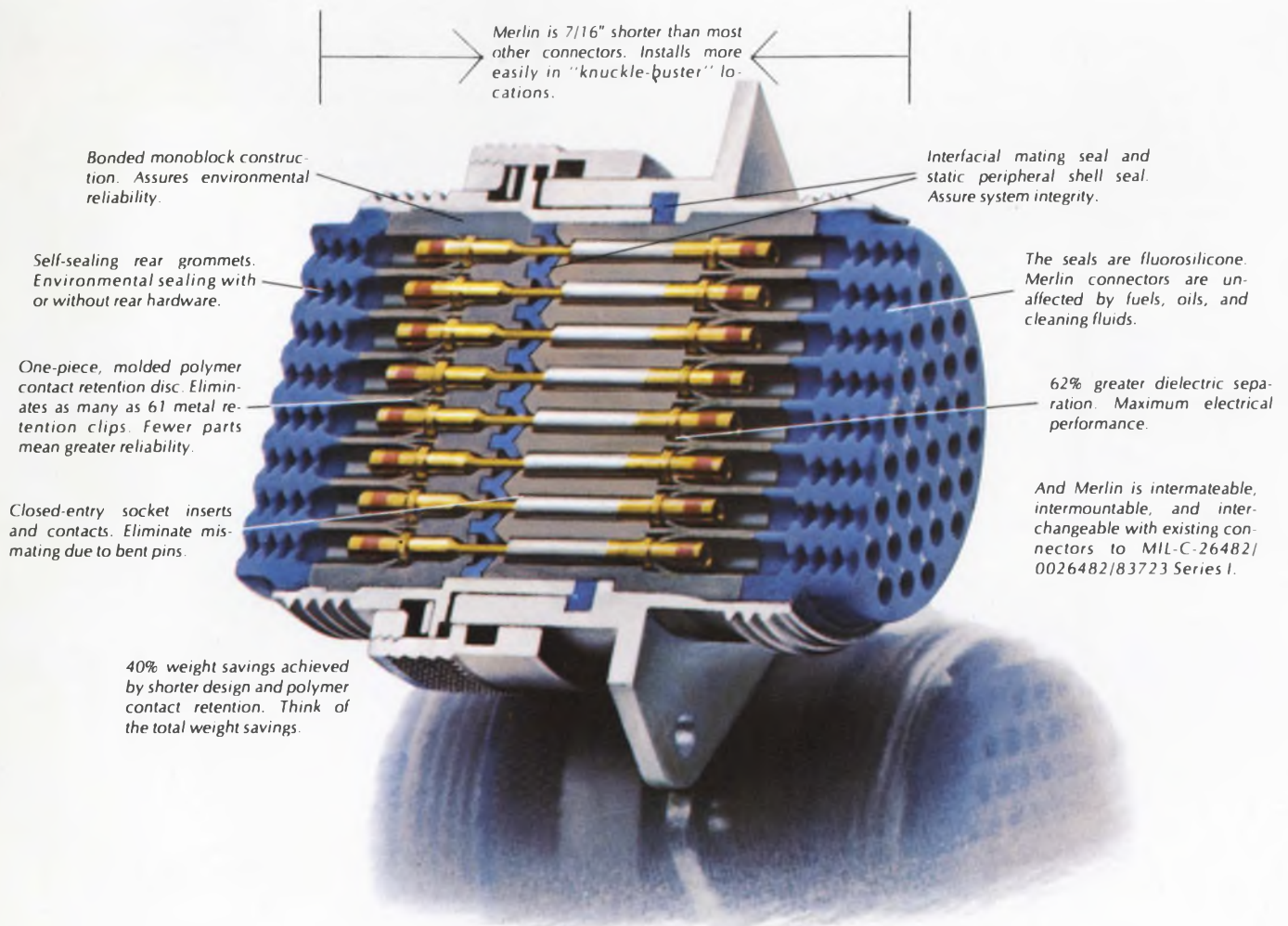

Merlin — a quality connector you can connect and forget. At a competitive price. Ask for a quotation. Most sizes and styles are available, off-the-shelf, from your Amphenol Industrial Distributor. Or call or write:
 Wayne Zimmerman, Amphenol Connector Division, 2801 South 25th Avenue, Broadview, Illinois 60153. Phone: (312) 345-9000.



*When you can connect it
 and forget it...that's quality.*

AMPHENOL

INFORMATION RETRIEVAL NUMBER 247

What's new in solid state...

The last word on reliability. From the first house in CMOS.

Reliability has many aspects. You have to look at it from more than one angle. As the creator of the CMOS technology, RCA has years of experience in measuring and improving the various aspects of CMOS reliability to prove it.

A new 24-page technical paper explores the total RCA reliability test program. It describes how RCA determines and controls the growing reliability of COS/MOS integrated circuits, both plastic and ceramic. It includes RCA developed real-time test procedures and controls. Plus a discussion of circuit and device mechanisms. This information can help designers improve equipment value by increasing reliability without component costs. Where essential, RCA has an Extra Value Program that offers enhanced product.

New reliability test specs

The paper details how RCA's comprehensive specifications help designers match device to application. Typical RCA specs and test circuits are shown. You'll see how a 4-step testing routine and real-time indication tests assure product quality and long-term reliability.

Designing for the environment

Curves and data in the paper reveal the effects of environmental extremes on various packaging systems such as plastic, frit seal and the new Gold CHIP. They show accelerated life and thermal cycling tests with high MTTF figures. An important section compares predictable life data of TTL vs. COS/MOS: under the same ambient temperature, COS/MOS would have a better failure rate by a factor exceeding 20.

There's much more in this important document, ST-6418. We want you to have it, free. Contact your local RCA Solid State distributor. Or RCA.

Write: RCA Solid State, Box 3200, Somerville, New Jersey 08876; Ste. Anne de Bellevue 810, Canada; Sunbury-on-Thames, U.K.; Fuji Bldg., Tokyo, Japan.

RCA

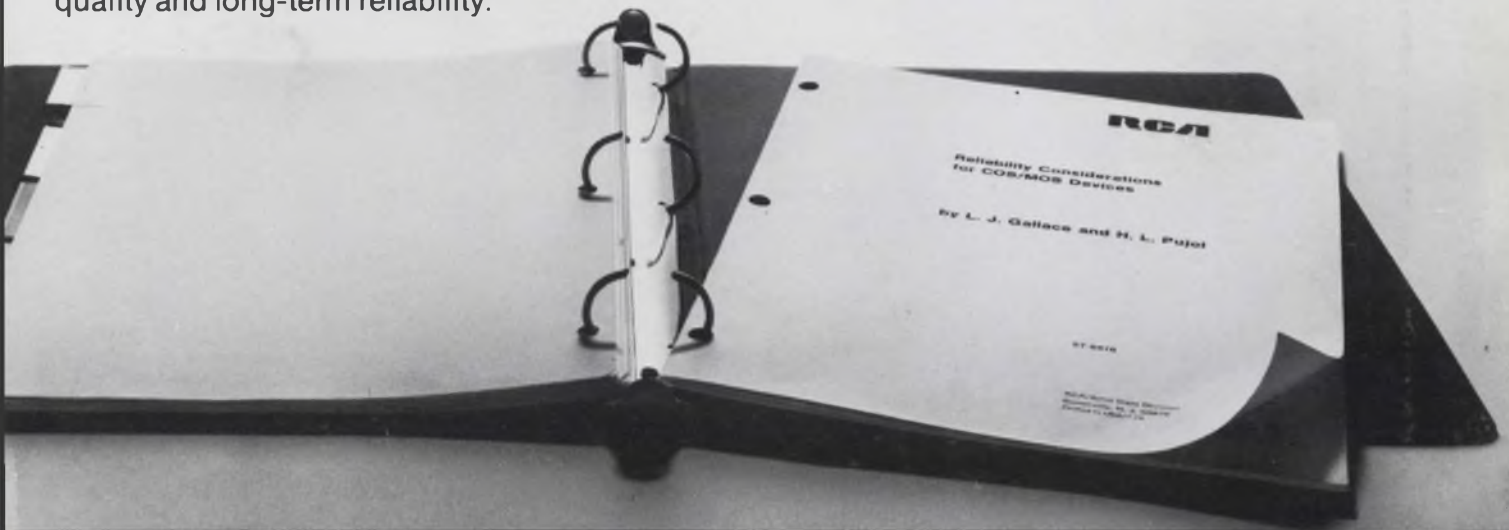

RCA. First house in CMOS.

INFORMATION RETRIEVAL NUMBER 248