

# Electronic Design<sup>®</sup> 24

VOL. 23 NO.

FOR ENGINEERS AND ENGINEERING MANAGERS

NOV. 22, 1975

**Instruments are getting smarter,** thanks to microprocessors. It's a marriage that's becoming an important factor in the industry. These tiny chips can now make

instruments easier to interface and a lot simpler to calibrate. Testers are being designed to handle complex ICs, such as  $\mu$ Ps. A report starts on P. 50.



A  
LOT  
MORE  
FOR A  
LITTLE  
LESS



**BOURNS®**  
**NEW**

**SINGLE-TURN CERMET TRIMMER**

- VASTLY IMPROVED ADJUSTABILITY
- TWELVE TERMINAL STYLES
- SEALED FOR WAVE SOLDERING

**45¢**

in quantities of 5000 per individual resistance

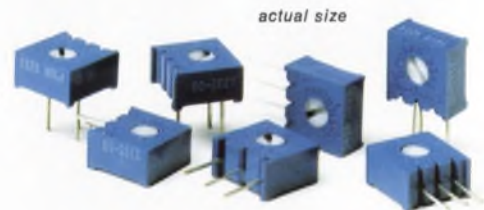

Meet Bourns new Model 3386, a product that both buyer and engineer can love . . . with super adjustability that makes for easy, accurate trimming, AND at a budget balancing price. Most importantly, it's a BOURNS product . . . and that means QUALITY and PERFORMANCE you can believe-in, and SERVICE you can depend-on.

**SIGNIFICANT SPECIFICATIONS**

- typical CRV less than 1% • infinite resolution • TC of  $\pm 100\text{PPM}/^\circ\text{C}$  to 200K ohms • power of .5 watt at 85°C • thin  $\frac{3}{8}$ " square size



*For complete details, contact your local Bourns representative or distributor, or the factory direct.*



TRIMPOT PRODUCTS DIVISION • 1200 COLUMBIA AVE., RIVERSIDE, CALIF. 92507

INFORMATION RETRIEVAL NUMBER 256



**H**oo boy, have we got a deal for you! Ordinarily you'd expect to pay at least \$965 for a good sweeper alone. But what good's a sweeper without a scope? So we're offering you both at this incredibly low price.

First there's our Model 1050A, a compact, laboratory-quality sweeper covering the frequency range of 1 to 400 MHz. It features excellent linearity, PIN diode leveling and has a built-in detector. Naturally, the 1050A is all solid state and

has provisions for up to 6 plug-in marker modules.

The other half of this combo is our Model 1901B X-Y Display Oscilloscope. It has a big 12-inch diagonal CRT and incorporates a very stable, low-noise vertical amplifier with sensitivities from 1mV per division. Just hook it up to your 1050A sweeper and you have the perfect test setup for measuring frequency response in the VHF region.

And that's not all. We're

also throwing in all the cables you'll need to connect these little winners. The complete set-up can be ordered as FRS-400.

If you can pass up a deal like this, you're crazier than we are. WAVETEK Indiana Incorporated, P.O. Box 190, 66 North First Avenue, Beech Grove, Indiana 46107, Phone (317) 783-3221, TWX 810-341-3226.

**WAVETEK**<sup>®</sup>  
INFORMATION RETRIEVAL NUMBER 2





# The largest selection of "OFF-THE-SHELF" POWER SPLITTERS/COMBINERS Available!

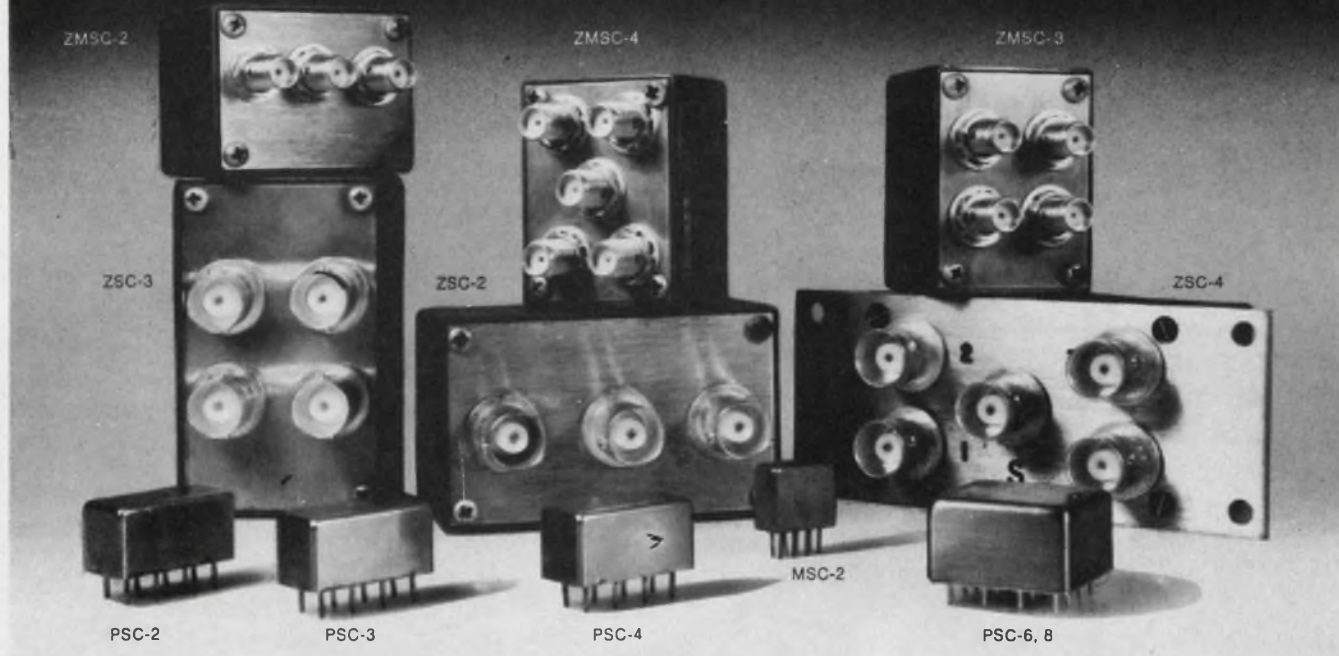

## TWO-WAY, THREE-WAY, FOUR-WAY, SIX-WAY AND EIGHT-WAY POWER SPLITTER/COMBINERS

| Model No.           | Freq. range (MHz) | Isolation between outputs (dB) typical | Insertion loss (dB) (typical)       | Unbalance    |           | Price (Quantity) | Model No.           | Freq. range (MHz) | Isolation between outputs (dB) typical | Insertion loss (dB) (typical) | Unbalance    |           | Price (Quantity) |
|---------------------|-------------------|--|-------------------------------------|--------------|-----------|------------------|---------------------|-------------------|--|-------------------------------|--------------|-----------|------------------|
|                     |                   |  |                                     | $\phi$ (deg) | Amp. (dB) |                  |                     |                   |  |                               | $\phi$ (deg) | Amp. (dB) |                  |
| <b>Two-way 0°</b>   |                   |  |                                     |              |           |                  | <b>Three-way 0°</b> |                   |  |                               |              |           |                  |
| PSC 2-1             | 0.1-400           | 25                                     | 0.4 above                           | 1            | 0.1       | \$ 9.95 (6-49)   | PSC 3-1             | 1-200             | 30                                     | 0.4 above                     | 2            | 0.1       | \$19.95 (6-49)   |
| ZSC 2-1             |                   |  | 3dB split                           |              |           | \$24.95 (4-24)   | ZSC 3-1             |                   |  | 4.8 split                     |              |           | \$34.95 (4-24)   |
| ZMSC 2-1            |                   |  |                                     |              |           | \$34.95 (4-24)   | ZMSC 3-1            |                   |  |                               |              |           | \$44.95 (4-24)   |
| PSC 2-2             | 0.002-60          | 40                                     | 0.3 above                           | 1            | 0.1       | \$19.95 (6-49)   | PSC 3-2             | 0.01-30           | 40                                     | 0.25 above                    | 2            | 0.1       | \$29.95 (6-49)   |
| ZSC 2-2             |                   |  | 3dB split                           |              |           | \$34.95 (4-24)   | ZSC 3-2             |                   |  | 4.8 split                     |              |           | \$44.95 (4-24)   |
| ZMSC 2-2            |                   |  |                                     |              |           | \$44.95 (4-24)   | ZMSC 3-2            |                   |  |                               |              |           | \$54.95 (4-24)   |
| <b>Two-way 180°</b> |                   |  |                                     |              |           |                  | <b>Four-way 0°</b>  |                   |  |                               |              |           |                  |
| PSC 2-1W            | 1-650             | 25                                     | 0.5 above                           | 3            | 0.20      | \$14.95 (6-49)   | PSC 4-1             | 0.1-200           | 30                                     | 0.5 above                     | 2            | 0.1       | \$26.95 (6-49)   |
| ZSC 2-1W            |                   |  | 3dB split                           |              |           | \$29.95 (6-49)   | ZSC 4-1             |                   |  | 6dB split                     |              |           | \$41.95 (4-24)   |
| ZMSC 2-1W           |                   |  |                                     |              |           | \$39.95 (6-49)   | ZMSC 4-1            |                   |  |                               |              |           | \$51.95 (4-24)   |
| PSC 2-1.75*         | 0.25-300          | 25                                     | 0.4 above                           | 1            | 0.05      | \$11.95 (6-49)   | ZSC 4-2             | 0.002-20          | 33                                     | 0.45 above                    | 2            | 0.1       | \$84.95 (4-24)   |
| MSC 2-1             | 0.1-450           | 30                                     | 0.4 above                           | 1            | 0.1       | \$16.95 (6-24)   | ZMSC 4-2            |                   |  | 6dB split                     |              |           | \$74.95 (4-24)   |
| <b>Two-way 90°</b>  |                   |  |                                     |              |           |                  | <b>Six-way 0°</b>   |                   |  |                               |              |           |                  |
| PSCJ 2-1**          | 1-200             | 33                                     | 0.6 above                           | 2.5          | .15       | \$19.95 (5-49)   | PSC 4-3             | 0.25-250          | 30                                     | 0.5 above                     | 2            | 0.1       | \$23.95 (6-49)   |
| ZSCJ 2-1            |                   |  | 3dB split                           |              |           | \$34.95 (4-24)   | ZSC 4-3             |                   |  | 6dB split                     |              |           | \$38.95 (4-24)   |
| ZMSC 4-3            |                   |  |                                     |              |           | \$48.95 (4-24)   | ZMSC 4-3            |                   |  |                               |              |           | \$48.95 (4-24)   |
| <b>Two-way 90°</b>  |                   |  |                                     |              |           |                  | <b>Eight-way 0°</b> |                   |  |                               |              |           |                  |
| PSCQ 2-90           | 55-90             | 30                                     | average of coupled outputs less 3dB | 3            | 1.0       | \$19.95 (5-49)   | PSC 6-1             | 1-175             | 30                                     | 0.75 above                    | 4            | 0.2       | \$59.95 (1-5)    |
|                     |                   |  | 0.3                                 |              |           |                  | ZSC 8-1             | 0.5-175           | 30                                     | 0.8 above                     | 3            | 0.2       | \$59.95 (1-5)    |
|                     |                   |  |                                     |              |           |                  |                     |                   |  | 9dB split                     |              |           |                  |

COMMON SPECIFICATIONS FOR ALL MODELS: Impedance all ports, 50 ohms. \*Except 75 suffix denotes 75 ohms VSWR:1.1-1.2 typical Nominal phase difference between output ports. 0° \*\*Except J suffix denotes 180° Q denotes 90° Delivery from stock; One week max.

For complete product specifications and U.S. Rep. listing see MicroWaves' "Product Data Directory," Electronic Designs' "Gold Book" or Electronic Engineers Master "EEM"

World's largest supplier of double balanced mixers

**Mini-Circuits Laboratory**  
A Division Scientific Components Corp

837-843 Utica Avenue, Brooklyn, NY 11203  
(212) 342-2500 Int'l Telex 620156 Domestic Telex 125460

International Representatives:  AUSTRALIA General Electronic Services, 99 Alexander Street, New South Wales, Australia 2065;  ENGLAND Dale Electronics, Dale House, Wharf Road, Frimley Green, Camberley Surrey;  FRANCE S.C.I.E.-D.I.M.E.S., 31 Rue George - Sand, 91120 Palaiseau, France;  GERMANY, AUSTRIA, SWITZERLAND Industrial Electronics GMBH, Klüberstrasse 14, 6000 Frankfurt/Main, Germany;  ISRAEL Vectronics, Ltd., 69 Gordon Street, Tel-Aviv, Israel;  JAPAN Densho Kaisha, Ltd., Equchi Building, 8-1-1 Chome Hamamatsucho Minato-ku, Tokyo;  EASTERN CANADA B. D. Hummel, 2224 Maynard Avenue, Utica, NY 13502 (315) 736-7821;  NETHERLANDS, BELGIUM, LUXEMBOURG: Coimex, Veldweg 11, Hattem, Holland

US Distributors:  NORTHERN CALIFORNIA Cain-White & Co., Foothill Office Center, 105 Fremont Avenue, Los Altos, CA 94022 (415) 948-6533;  SOUTHERN CALIFORNIA, ARIZONA Crown Electronics, 11440 Collins Street, No. Hollywood, CA 91601 (213) 877-3550



---

## NEWS

- 23 **News Scope**  
29 **Washington Report**  
50 **Instrument '75**—a special issue featuring current trends in instrumentation. Topics covered include: microprocessors in instruments; computer and calculator-based instrumentation; the latest in LSI testers; what's new in function generators?; instruments in the nonelectronics industry and new multifunction instruments. In addition, there are engineering management interviews with Bill Terry and Jack Lieberman of Hewlett-Packard and Henk Bodt of Philips Test & Measurement.

---

## TECHNOLOGY

- 37 **MICROPROCESSOR DESIGN**  
112 **Phase-meter specs can fool you**, unless you consider the input signal before buying. First, know your application, then see how the meter responds.  
120 **To test hybrid PC boards**, with mixed analog and digital circuits, requires a versatile test system. The practical choice narrows down to four types.  
128 **Test semiconductors automatically** with a computer. With a precision interface, you can accurately force voltage or current and measure response.  
134 **Avoid  $I_{CEO}$  measurements** and you will lighten your test load. But if you must measure this vague transistor parameter, here's how to do it faster.  
138 **Take oddball pulses in stride**. A new method, the pulse-width synthesizer, lets you accurately measure the widths of unpredictably shaped pulses.  
146 **Ideas for Design:**  
FET analog-switch circuit provides 63-dB on-off ratio.  
Capacitor drops voltage with little heat for low-cost, low-voltage power supply.  
Crystal control of a one-shot ensures accurate pulse-width output.

---

## PRODUCTS

- 153 **Instrumentation:** Systems DMM slashes price, yet holds performance.  
162 **Modules & Subassemblies:** Deglitching modules attenuate spikes on current-output d/a's by over 70 dB.  
171 **Data Processing:** Full APL computer delivers mainframe power in mini size.  
174 **Data Processing:** OEM mini line offers core or MOS memory.  
186 **Power Sources:** Modular sources carry high-MTBF label.  
178 Discrete Semiconductors                      202 Integrated Circuits  
190 Components                                      206 Microwaves & Lasers  
196 Packaging & Materials

---

## DEPARTMENTS

- 109 **Editorial:** The politicians  
7 Across the Desk                                      214 Vendors Report  
209 Evaluation Samples                              220 Advertisers' Index  
210 New Literature                                      222 Product Index  
214 Bulletin Board                                      224 Information Retrieval Card

**Cover:** Cover designed by Art Director, Bill Kelly. Instrument photos courtesy of Biomation, Hewlett-Packard, John Fluke Mfg. Co., Keithley Instruments, Norland Instruments, Philips Test & Measurement, Tektronix and Wavetek.



# Intel is the way to

You can go into production of higher density memory systems confidently now that Intel's new 2104 16-pin, 4096-bit dynamic RAM is in stock at Intel distributors, and readily available in OEM quantities.

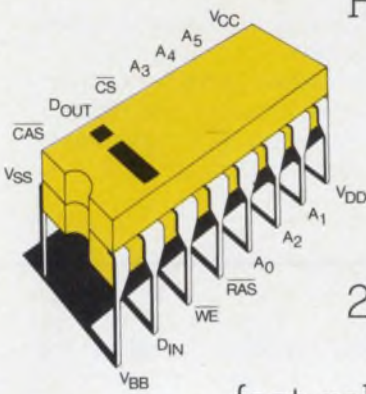

We are mass producing the 2104 on the same fabrication lines and with the same silicon gate n-channel MOS process as the industry standard 2107B 22-pin 4K RAM.

Intel's 16-pin RAM assures you fast, reliable parts as well as delivery in volume. The Intel 2104 is based on the proven single-transistor cell design of the Intel 2107B, the highest performance 22-pin 4K MOS RAM. Like the 2107B, the 2104 chip is much smaller than other 4K RAM chips produced today.

The fastest available 16-pin 4K RAMs are also in the 2104 series. Our 2104-2 guarantees an access time of only 250 nanoseconds and a cycle time of 375 nanoseconds over the full

| INTEL'S STANDARD 4K RAM FAMILY |      |                               |                              |                   |
|--------------------------------|------|-------------------------------|------------------------------|-------------------|
| Part Number                    | Pins | Max. Access Time (ns), 0-70°C | Min. Cycle Time (ns), 0-70°C |                   |
|                                |      |                               | Read or write                | Read modify write |
| D2104-2                        | 16   | 250                           | 375                          | 515               |
| D2104-4                        | 16   | 300                           | 425                          | 595               |
| D2104                          | 16   | 350                           | 500                          | 700               |
| 2107B                          | 22   | 200                           | 400                          | 520               |
| 2107B-2                        | 22   | 220                           | 470                          | 680               |
| 2107B-4                        | 22   | 270                           | 470                          | 590               |
| 2107B-6                        | 22   | 350                           | 800                          | 960               |

0 to 70°C operating temperature range.

To keep system costs low, the 2104 operates on standard -5, +5 and +12V power supplies, and TTL I/O levels. All inputs including clock

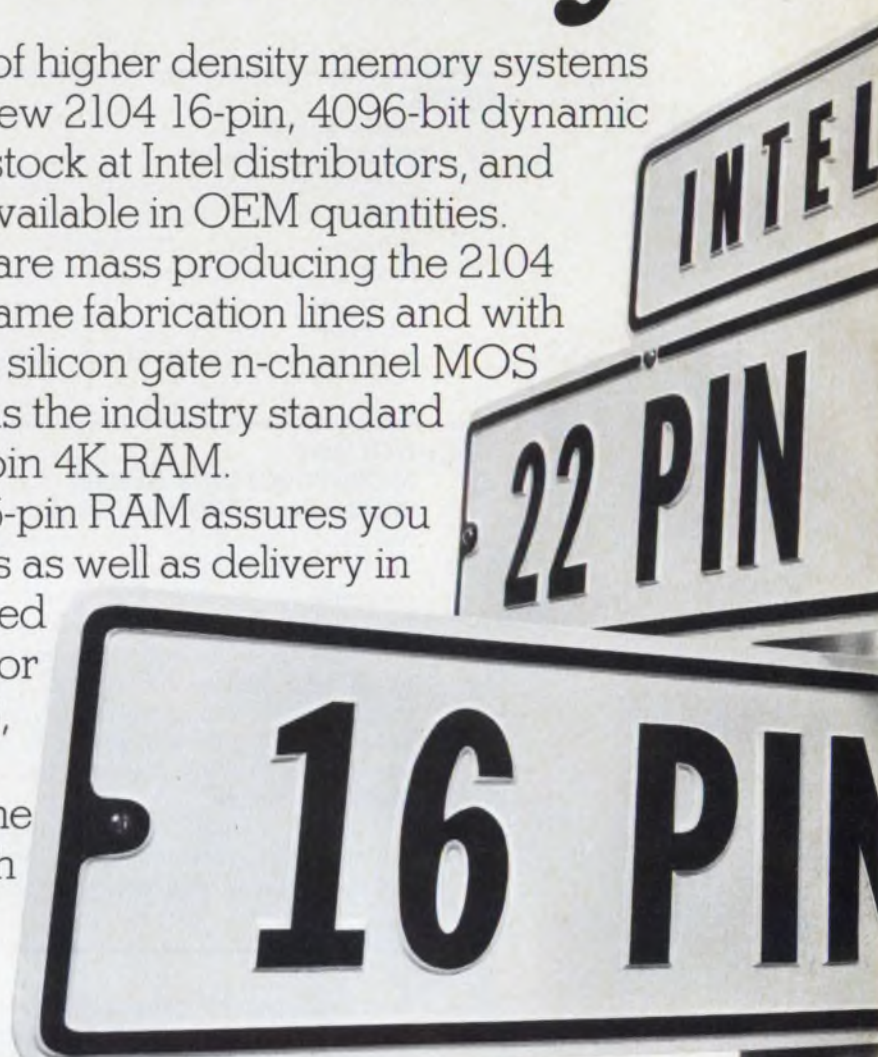



# go for 4K RAMs.

inputs are fully TTL compatible.

Overall system advantages of the 2104 are detailed in a new application brief, "Which Way for 4K... 16, 18, or 22 Pin?" It explains why the 16-pin 2104 is best for very compact systems such as minicomputers, microcomputers, terminals, business equipment, scientific calculators and anywhere high density is needed.

Moreover, we show how the 16-pin standard is compatible with the next generation of even higher density memories. The application brief also tells why the 2107B's simple, straightforward 22-pin design has become an industry standard for computer main memories and many other applications.

Now the industry has two standard configurations—16 pins with multiplexed addresses and 22 pins with parallel addresses. Which ever way you go, you'll find Intel ready to support both in volume production. For delivery of the 2104 or 2107B contact our franchised distributors: Almac/Stroum, Component Specialties, Cramer, Elmar, Hamilton/Avnet, Industrial Components, Liberty, Pioneer, Sheridan or L.A. Varah.

For your copy of "Which Way for 4K..." or data sheets on any of our 4K RAMs write: Intel Corporation, 3065 Bowers Avenue, Santa Clara, California 95051.

**intel<sup>®</sup> delivers.**





# Try this with a CRT or a digital display



or this



or this



or this



When it comes to displaying complete messages and graphics you just can't beat Shelly Multi-Message Modules.

Think of them as tiny, random access, electronically-controlled slide projectors, displaying characters 0.5" or 0.7" high.

Each module can instantly display any of 12, 24 or 64 digitally selectable messages. In black & white or any combination of colors.

Unlike CRT's and digital displays, you're not limited to alphanumeric characters either. With Shelly's versatile film chip you can display letters, numbers, words, complete messages (up to 5 lines), charts, graphs, photographs. You name it! And simultaneous illumination of up to 3 projectors

within a module makes it possible to overlay additional words, symbols, numerals or colors to vary the meaning of a message.

Applications are mind-boggling. Here's just a few. Teaching machines, aircraft cockpits, automobile dashboards, elevators, industrial control systems, electronic games, hospitals, security systems, point of sale terminals. The list is endless.

Without a doubt, when it comes to displaying a number of preselected messages, Shelly Multi-Message Modules provide the maximum in versatility at a minimum price.



Call Shelly today.

**shelly associates**

A Subsidiary of Datatron, Inc.

1562 REYNOLDS AVENUE, SANTA ANA, CALIFORNIA 92705  
PHONE (714) 549-3414 TWX 910-595-1859

INDICATORS • MULTI MESSAGE DISPLAYS • FIBER OPTICS • ANNUNCIATORS

**Sr. Vice President, Publisher**  
Peter Coley

## Editors

Editorial Offices  
50 Essex St.  
Rochelle Park, NJ 07662  
(201) 843-0550  
TWX: 710-990 5071  
Cable: Haydenpubs Rochellepark

**Editor-in-Chief** George Rostky

## Managing Editors:

Ralph Dobriner  
Michael Elphick

## Associate Editors:

Dave Bursky  
Jules H. Gilder  
Morris Grossman  
John F. Mason  
Stanley Runyon  
Edward A. Torrero

## Contributing Editors:

Peter N. Budzilovich  
Alberto Socolovsky  
Nathan Sussman

## Editorial Field Offices

### East

Jim McDermott, Eastern Editor  
P.O. Box 272  
Easthampton, MA 01027  
(413) 527-3632

### West

David N. Kaye, Senior Western Editor  
8939 S. Sepulveda Blvd.,  
Suite 510  
Los Angeles, CA 90045  
(213) 641-6544  
TWX: 1-910-328-7240

## Editorial Production

Marjorie A. Duffy

## Art

**Art Director**, William Kelly

Richard Luce  
Anthony J. Fischetto

## Production

**Manager**, Dollie S. Viebig

Helen De Polo  
Anne Molfetas

## Circulation

**Manager**, Evan Phoutrides

## Information Retrieval

Peggy Long

## Promotion, Creative Layouts

**Manager**, Albert B. Stempel

Maxine Correal  
Nancy Gordon (Reprints)



## Across the Desk

### Bioelectric measuring sparks a dissent

"The  $\alpha\beta$ s of Bioelectric Measurements" (ED No. 16, Aug. 2, 1975, p. 68) contains a number of errors. Most significant are the following:

1. The article implies that grounding of the right leg was necessary to avoid 60-Hz interference before the advent of differential amplifiers with "superior-mode rejection," and that the use of such amplifiers eliminated this necessity. It was really the driven right-leg technique, which is described later, that replaced the grounding.

2. The statement is made that "it's generally recognized that about 20 mA can be fatal." Except for microshock conditions, which I do not believe were intended here, the minimum threshold for ventricular fibrillation is in the neighborhood of 75 to 100 mA. While it is true that respiratory paralysis can occur just below 20 mA, electrocution due to respiratory paralysis is extremely unlikely.

3. Where did the data come from for Fig. 8? The general shape of the curve is very similar to "let-go-current" threshold data reported by C. F. Daziel a number of years ago. However, I know of no current vs frequency tests in dogs under microshock conditions. Further, to my knowledge no fibrillation has been reported in dogs at values below 20  $\mu$ A, making the 10- $\mu$ A level at 60 Hz very suspicious. There have been some reports of cardiac standstill in dogs at current levels below 20 microamperes as long as the current was applied,

but fibrillation did not occur.

4. Using this 10- $\mu$ A figure, the authors state that "extrapolation of such data for man gives an average minimum value of about 100  $\mu$ A." Although data are extremely sparse, they seem to indicate that the average microshock threshold in man is considerably higher than 100 microamperes. In some of Delmar Snider's work (yet unpublished) he was able to induce fibrillation at 108  $\mu$ A on only one occasion and twice at 150. However, in most cases it took considerably higher currents. There is one report from England of a human fibrillation at 80 microamperes, but the conditions were not very well described.

*Fred J. Weibell, Chief  
Biomedical Engineering and  
Computing Center  
Veterans Administration Hospital  
Sepulveda, CA 91343*

### The authors reply

We do not dispute the data quoted by Mr. Weibell; however, his commentary should be interpreted within the context of the article.

The primary reason for eliminating right-leg grounding was to reduce susceptibility of the patient to microshock hazard. The right-leg drive concept was one technique (there were several) that helped improve amplifier common-mode capability to the point where direct grounding could be avoided. In the article, we considered the right-leg drive circuitry an integral part of

*(continued on page 10)*

Electronic Design welcomes the opinions of its readers on the issues raised in the magazine's editorial columns. Address letters to Managing Editor, Electronic Design, 50 Essex St. Rochelle Park, N.J. 07662. Try to keep letters under 200 words. Letters must be signed. Names will be withheld on request.

## Thin-Trim<sup>®</sup> capacitors



Tucked in the corner of this Pulsar Watch is a miniature capacitor which is used to trim the crystal. This Thin-Trim capacitor is one of our 9410 series, has an adjustment range of 7 to 45 pf., and is .200" x .200" x .050" thick. The Thin-Trim concept provides a variable device to replace fixed tuning techniques and cut-and-try methods of adjustment. Thin-Trim capacitors are available in a variety of lead configurations making them very easy to mount.

A smaller version of the 9410 is the 9402 series with a maximum capacitance value of 25 pf. These are perfect for applications in sub-miniature circuits such as ladies electronic wrist watches and phased array MIC's.

Johanson Manufacturing Corporation,  
Rockaway Valley Road., Boonton, N.J.  
07005. Phone (201) 334-2676, TWX 710-  
987-8367.

*Johanson*



# Play the Model 1858 numbers game.

## 18 wins!

You get up to 18 channels in this completely self-contained data acquisition system.

## 8¾ wins!

The Model 1858 is an unbelievably short 8¾ inches high, including plug-in signal conditioning and internal paper take-up.

## 65 wins!

The 65-pound-light 1858 is easy to take anywhere, can be used in a rack, on a table, on the seat of a car or plane.

## 7 wins!

You get up to 7-inch trace amplitude for all channels that allow common baseline recording . . . the most useful and accurate record available.

## 5,000 wins!

Each channel has dc to 5,000 Hz response, (15 kHz squarewaves) and without amplitude restrictions for superior transient recording capability.

## 42 & 120 win!

You get 42 discrete paper speeds, from 0.1 to 120 inch/sec.

## ±0.1 wins!

Precision time lines, accurate to ±0.1% across record width each 0.001, 0.01, 0.1, 1.0 or 10 seconds, each tenth line accentuated and selected interval coded.

## 1870 wins!

New 14-channel 1870 housing permits up to 32-channel capacity, but adds only 5¼ inches to height. That's only ½-inch per channel!

## 1887 wins!

This new plug-in signal conditioning module (one of 7) provides simultaneous input signal conditioning for magnetic tape recording and the 1858 for parallel recording or serial record and playback from tape to the Model 1858.

And the 1858 wins in dozens of other ways you can't put a number on. Like constant trace width at all writing and chart speeds, yet without adjustment. And the elimination of overshoot and distortion of

wave pulses and other transient data.

For complete technical specifications, call or write Lloyd Moyer, Honeywell Test Instruments Division, P.O. Box 5227, Denver, CO 80217 (303) 771-4700.

## Honeywell Model 1858 Data Acquisition System

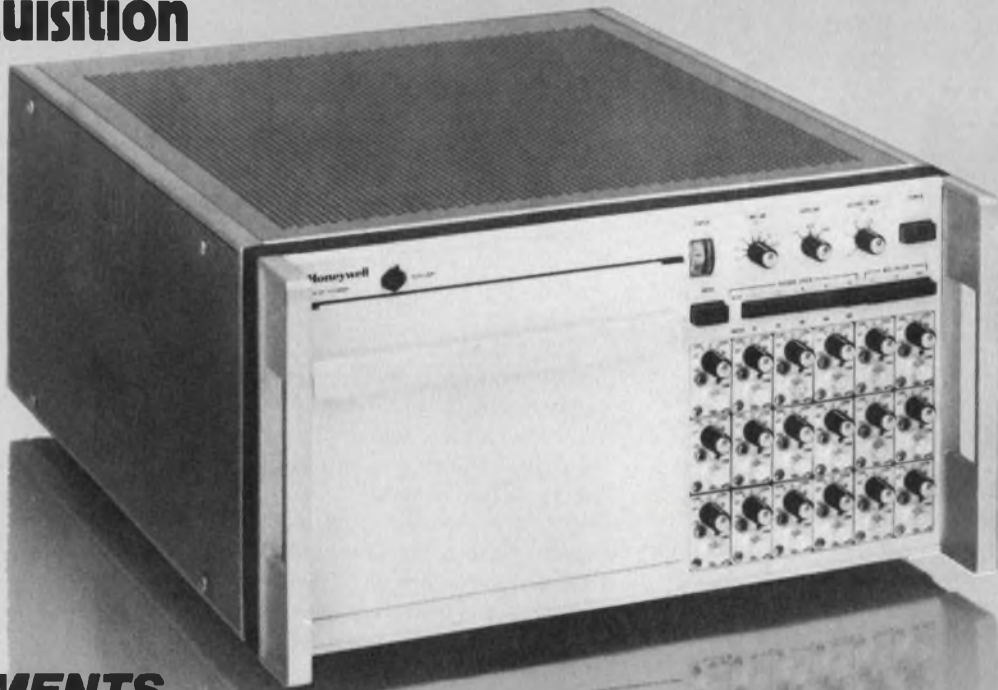

**TEST  
INSTRUMENTS  
DIVISION**

# Honeywell



**1881-HGD** — A high-gain, floating and guarded dc amplifier. Accepts low-level input signals of from  $\pm 1$  mV to  $\pm 1$  V/div at common mode voltages up to  $\pm 300$ V.

**1882-LGD** — A low-gain, floating and guarded dc amplifier. Accepts input signals of from  $+ 100$  mV to  $\pm 100$  V/div to a maximum of  $300$ V, and at common mode voltages to  $\pm 300$ V.

**1883-MPD** — A medium-gain, differential dc amplifier. Sensitivity is from  $\pm 50$  mV to  $\pm 1$  V/div.

**1884-IFM** — Adapts to inputs from existing or unique signal conditioning units to the 1858 system. Module is single-ended to ground and consists only of a voltage-to-time converter to convert the analog signal to the PDM format required by the Model 1858.



Model 1881-HGD  
High-Gain Differential  
Amplifier



Model 1882-LGD  
Low-Gain Differential  
Amplifier



Model 1883-MPD  
Medium-Gain  
Differential



Model 1884-IFM  
Interface

## These seven plug-in modules can solve hundreds of measurement problems.

Model 1885-SGC  
Strain Gage Control  
and Amplifier



Model 1886-TCU  
Thermocouple/Control and  
Microvolt Amplifier



Model 1887-TCD  
Tape-Compatible Differential  
Amplifier

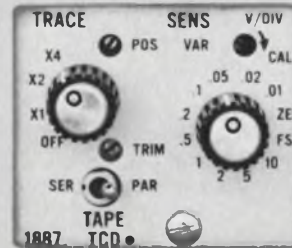

**1885-SGC** — For strain gage signal conditioning. In addition to signal amplification, provides for gage excitation and balance as well as "dial-in" voltage substitution calibration and suppression of the input signals. Sensitivity is from  $+ 1$  mV to  $\pm 100$  mV/div. Calibration and suppression range is  $+$  and  $- 1$  to  $100$  mV.

**1886-TCU** — For thermocouples or other low-level signals. High sensitivity range of from  $100 \mu$ V to  $50$  mV/div, dial-in voltage substitution calibration and suppression are provided. Thermocouple compensation units for standard thermocouple types are available as accessories.

**1887-TCD** — A high-sensitivity, wide-gain range differential amplifier designed to simultaneously provide input signal conditioning for the 1858 and instrumentation-type magnetic tape recorders. Convenient front-panel switch selection allows parallel recording on the 1858 and the tape recorder, or serial playback recording from the tape recorder to the 1858. Recordings to  $100$  kHz, beyond the  $5$  kHz frequency capability of the 1858, can be recorded at high tape speed and played back at a lower speed.



**FREE/NEW**

'76 Edition

**RCL's**

**Electromagnetic  
Delay Line  
Engineering  
Handbook**



- △ DIP Delay Lines
- △ Power Inductors
- △ Low Priced Commercial DIPs
- △ Delay Line Drivers
- △ Digital Delay Modules
- △ Option Blocks

Terms... Test Methods...  
Engineering Definitions...  
Characteristics... Specifications

Send For Your **FREE**  
Handbook Today!

**AMF**

**RCL Electronics**

195 McGregor Street  
Manchester, N.H. 03102  
(609) 627-3831

**ACROSS THE DESK**

(continued from page 7)  
the amplifier.

With reference to externally applied currents, Mr. Weibell takes exception to our statement, "it's generally recognized that about 20 mA can be fatal," and correctly points out that "the threshold for ventricular fibrillation is in the neighborhood of 75-100 mA." Paradoxically, in the next sentence, he also correctly states that "respiratory paralysis can occur just below 20 mA"—a condition equally fatal to an unconscious or immobile patient.

Also, it's important to remember that the fibrillation threshold is widely variable and is a function of current density at the surface of the heart. In addition this threshold is highly dependent on such variables as the mass of the patient, path of the current through the myocardium (heart muscle). Fig. 8 was intended to illustrate that the fibrillation threshold in dogs is also a function of frequency. The general shape of the curve was drawn from Geddes ("Medical and Biological Engineering," 1969, 7:293). The values, though, were chosen simply to illustrate our point.

Mr. Weibell's remaining comments take issue with our suggestion that 10  $\mu$ A be used as a design criterion for avoiding microshock hazards and indicate that the average microshock threshold in man is considerably higher than 100  $\mu$ A. Again, this is probably quite true. Unfortunately not enough experiments under controlled conditions have been performed on humans to verify this threshold because of the large number of variables and obvious risk to life. And Graystone and Ledsoe (*Digest of the 10th International Conference on Medical and Biological Engineering*, 1973, p. 159) have demonstrated that heart action can cease at current levels well below those necessary for fibrillation.

We are sure Mr. Weibell will agree that it's difficult to base a value on the average of presently available data. A level must be chosen (within the bound of present experimental minimums, technological capability and cost effectiveness) that protects as many

patients as possible from microshock hazards.

It is no accident that the standards adopted by both Underwriters Laboratories and the Association for the Advancement of Medical Instrumentation for electrically susceptible patients specify 10  $\mu$ A as the value for maximum source current. In addition NFPA, IEC and the Veterans Administration have included this same specification in their proposed guidelines.

Neil Duane  
Paul Svetz

Hewlett-Packard  
175 Wyman St.  
Waltham, MA 02154

**Misplaced Caption Dept.**



"He wanted me to type that engineering report for the sixth time."

Sorry. That's Sandro Botticelli's "Judith," which hangs in the Uffizi Gallery in Florence.

**What's in a name?  
Plenty of buyers**

I was particularly pleased to see the "Open Letter" by Signetics in your issue of Aug. 16 (see advertisement on pp. 68-69). Apparently the people who were responsible for the letter understand something many corporate heads do not.

When a company with a good  
(continued on page 14)



# Announcing the 1740A... a new 100MHz scope with fresh measurement ideas.

**In the time domain**—Push the third channel trigger display button, release, and you have a simultaneous display of the trigger waveform *plus* channel A and B traces. Now you can make accurate timing measurements from the trigger signal to events on either or both channels.

A X5 vertical magnifier provides 1 mV/div sensitivity on both channels to 40 MHz, without cascading, so you can monitor low-level signals directly. Signals such as the output of read/write heads of disc or mag tape units, low-level ripple on power supplies, or medical sensor and electro-mechanical transducer outputs.

**In the data domain**—You can combine the 1740A with HP's 1607A Logic State Analyzer and use the analyzer's pattern trigger or delayed trigger output for external scope triggering. Add the "Gold Button" (an optional logic-state push-button in lieu of A versus B) for just \$105\* and (with the 1607A) you have the convenience of logic-flow display or real-time display at the push of a button.

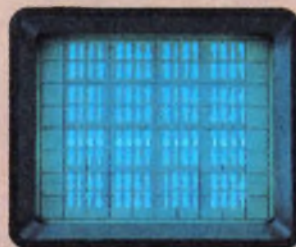

That means you can view the logic states of operational circuitry directly for pinpointing a program problem. Then—with a push of a button—take a look at the waveforms you've selected at that specific point in time.

Add to all this, features such as selectable input impedance (1 megohm or 50 ohms) and the time-tested 8 x 10 cm CRT used in our 180 System lab scopes for bright, easy-to-read displays. Priced at just \$1,995\*, the 1740A with its new ideas, simplifies both real-time and data-domain measurements.

When you get your hands on this scope—you'll know you're working with a quality instrument. Give your local HP field engineer a call today.

\*Domestic U.S.A. price only.

**Data/Time Domain  
Oscilloscopes**

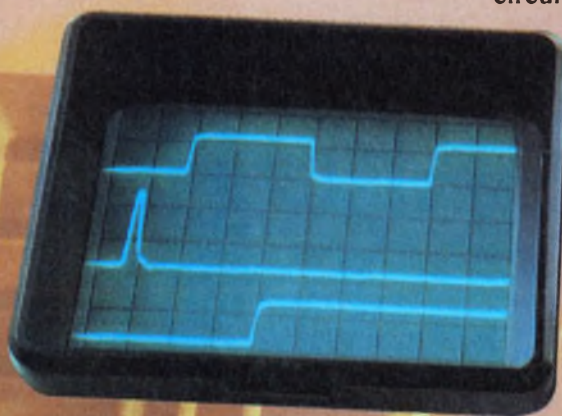

STATE  
DSPL

TRIG  
VIEW

FOR TECHNICAL INFORMATION CIRCLE #275  
FOR IMMEDIATE APPLICATIONS ASSISTANCE CIRCLE #276

HEWLETT **hp** PACKARD

Sales and service from 172 offices in 65 countries.  
1501 Page Mill Road, Palo Alto, California 94304

085711





**Introducing  
the lowest priced,  
16-bit, full-scale,  
fully compatible computer  
in the world.**

**The NAKED MILLI.™  
\$395**





## The ultimate solution to the micro/mini confusion

Just what you needed, right? Another computer to confuse things a bit more. And a millicomputer at that... whatever that is.

Well take heart, pilgrim. Because thanks to the whatever-it-is NAKED MILLI millicomputer, your hardware hardships are over.

### Solution No. 1

Start with your price problem: \$395 used to buy you a lot of grief in the form of

an 8- or 12-bit microprocessor. Which was still a bunch of bucks away from anything you could call a computer.

Now, \$395 buys you the NAKED MILLI LSI-3/05 with 256 16-bit words of RAM. A full-blown, full-scale computer with an amazingly powerful instruction set and two standard I/O systems including ComputerAutomation's new Distributed I/O System.™

### Solution No. 2

It also buys you membership in the NAKED MINI® LSI Family. Not just a casual relationship, but total hardware and software compatibility.

"Ah ha," you say, as you reach for a purchase order. "That means Maxi-Bus™ compatibility, too. Which means the NAKED MILLI is also compatible with ComputerAutomation's standard peripheral controllers and I/O interfaces. Which means..."  
Yeah.  
You're

going to save a fortune on interfaces. And software. And everything else. Because the NAKED MILLI really is a genuine, 100% full-fledged member of the LSI Family.

### Solution No. 3

Suppose, however, that you need more machine. Okay, how about a computer with 1K words of RAM for \$489? Or...

4K for \$616?

8K for \$914?

16K for \$1679?

And that's how it is. No matter where you buy in, the NAKED MILLI is positively the lowest-priced, low-end computer around.

### From the people who brought you the NAKED MINI

When ComputerAutomation offered the first NAKED MINI LSI for \$990, folks figured that was it... the all-time rock bottom price.

And now we're introducing the NAKED MILLI at \$395. True, it's the smallest computer in the LSI Family. But here's something to think about: The NAKED MILLI is more powerful than our original Model 816 minicomputer!

In short, ComputerAutomation has done it again.

But then, that's what leadership is all about.

 **ComputerAutomation**  
NAKED MINI® Division

18651 Von Karman, Irvine,  
Calif. 92664 (714) 833-8830

INFORMATION RETRIEVAL NUMBER 9





# HIGH-VOLTAGE CAPACITORS NEED NOT HAVE FRAGILE GLASS OR CERAMIC CASES... THE UNBREAKABLE FABMIKA® IS HERE!



## THE CAPACITORS:

Sprague Epoxy/Fiberglass-Encased Type 305M. Reconstituted mica dielectric, offering uniformity of performance and quality impractical with sheet mica. Impregnated with epoxy resin, forming solid capacitor section . . . no oil to leak. Ideal where impregnant seepage can't be tolerated.

## THE APPLICATIONS:

Airborne electronics, high-voltage power supplies, induction heating equipment, electrostatic precipitators, pressurized sonar equipment, etc.

## THE ADVANTAGES:

Meet or exceed major electrical specifications of high-voltage glass-encased or ceramic tubulars . . . but virtually unbreakable. High dielectric strength, high-temperature performance, low temp. coefficient of capacitance, corona resistance.

For complete technical data, write for Engineering Bulletin 1732 to: Technical Literature Service, Sprague Electric Co., 347 Marshall St., North Adams, Mass. 01247.



THE BROAD-LINE PRODUCER OF ELECTRONIC PARTS

INFORMATION RETRIEVAL NUMBER 10

## ACROSS THE DESK

(continued from page 10)

reputation—one that you have done business with for many years—merges with or is acquired by another company and its well-known name suddenly disappears, what do you do? How do you find a part for an Empire or Stoddart RFI receiver, replace a Gertsch Complex Ratio Bridge, a Measurements Corp. wattmeter, a Boonton Radio Q-meter, or find a part for a CEC leak detector?

Many organizations recognize that the trade name of the company they absorb is very important and choose to preserve it, indicating it as a branch or division of the acquiring company. Unfortunately many do not.

It is hoped that some of the names that have disappeared will re-emerge when their present owners realize how important these names are to the purchasing public.

C.R. Whitlow

Lockheed Missiles & Space Co.  
Box 504  
Sunnyvale, CA

## Three I<sup>2</sup>L circuits said to show promise

In updating your News Scope article "New Entries Heat Up Injection-Logic Race," ED No. 16, Aug. 2, 1975, p. 21, I wish to describe three I<sup>2</sup>L circuits we have had in the marketplace.

The DN816 is a T-type flip-flop with output drivers and regulators used as a frequency divider for electronic organs, measuring instruments and controllers.

The DN817 is a 1/60 frequency divider with appropriate input and output circuits primarily used for clocks and timing.

The DN818 is similar to the DN816, but it is in a plastic package.

These devices just show capability at this time. We are awaiting more extensive LSI circuits that will show this is the technology for future work.

Robert Zolkowski

Product Manager-Semiconductors  
Panasonic  
One Panasonic Way  
Secaucus, NJ 07094



# The fastest data acquisition system. Anywhere.

Our 4855 ultra-high speed sample-hold ahead of our 4133 ultra-high speed 12-bit ADC. System aperture time is an ultra-low 1 nsec. Guaranteed throughput rate is 350 kHz. And you get this system speed at 0.03% total accuracy.

The 4855/4133 combination gives you a functional capability you can't achieve elsewhere. For example, the exceptionally low feedthrough of the 4855 allows you to multiplex during conversion without affecting system speed and accuracy.

FFT, high speed data acquisition, video digitizing, radar pulse digitizing and multi-channel simultaneous sample and hold—applications where greater than nanosecond uncertainty slow you down.

The 4855's 250 nsec acquisition time to 0.01% accuracy assures exceptionally high throughput rates for precision systems. The 4133 gives you high linearity, excellent stability and 2.5  $\mu$ sec max. conversion time.

Together they're unbeatable for highly accurate, high speed data acquisition. And they're only available from Teledyne Philbrick at unbeatable prices (\$160 and \$485 in 100's).

For complete information, write for our Application Bulletin today. Or "DIAL" (our Direct Information Access Line) 617-329-1600. Teledyne Philbrick, Dedham, MA 02026. In Europe, Tel. 673.99.88, Telex: 25881. Or write, 181 Chaussee De La Hulpe, 1170 Brussels.

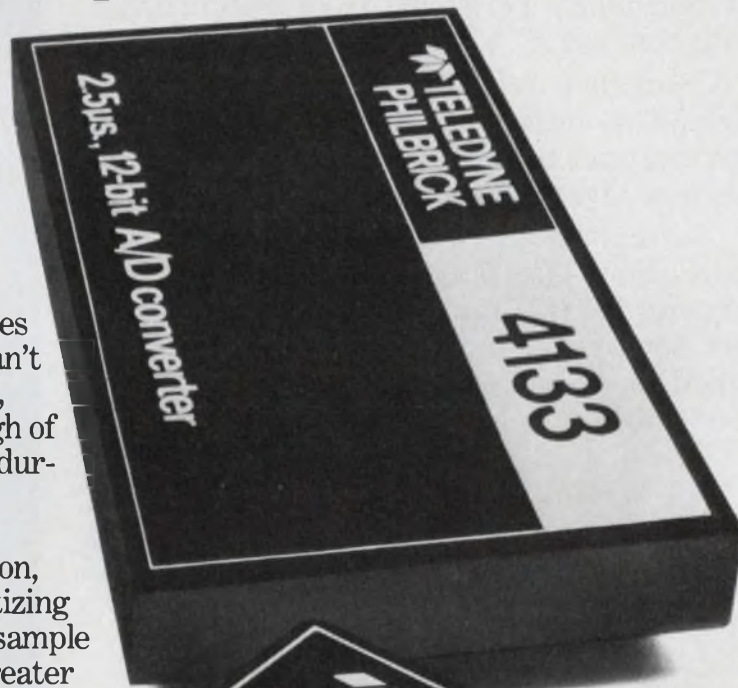



# Think of yourself as a heart specialist

The system is your patient and its power supply is your responsibility. For a long, happy system life, prescribe Sorensen STM modular switchers.

Compared to equivalent series-pass power supplies, STMs are twice as efficient, less than half the size, and price competitive. Yet they offer all of the inherent advantages of series-pass.

We've got a catalog that describes all 40 models, from 3.0 to 56 Vdc. It even has a prescription form ready to fill out. Simply circle the inquiry number. Sorensen Company, a unit of Raytheon, 676 Island Pond Road, Manchester, N.H. 03103. (603) 668-4500.

**Sorensen**  
**POWER SUPPLIES**

INFORMATION RETRIEVAL NUMBER 12





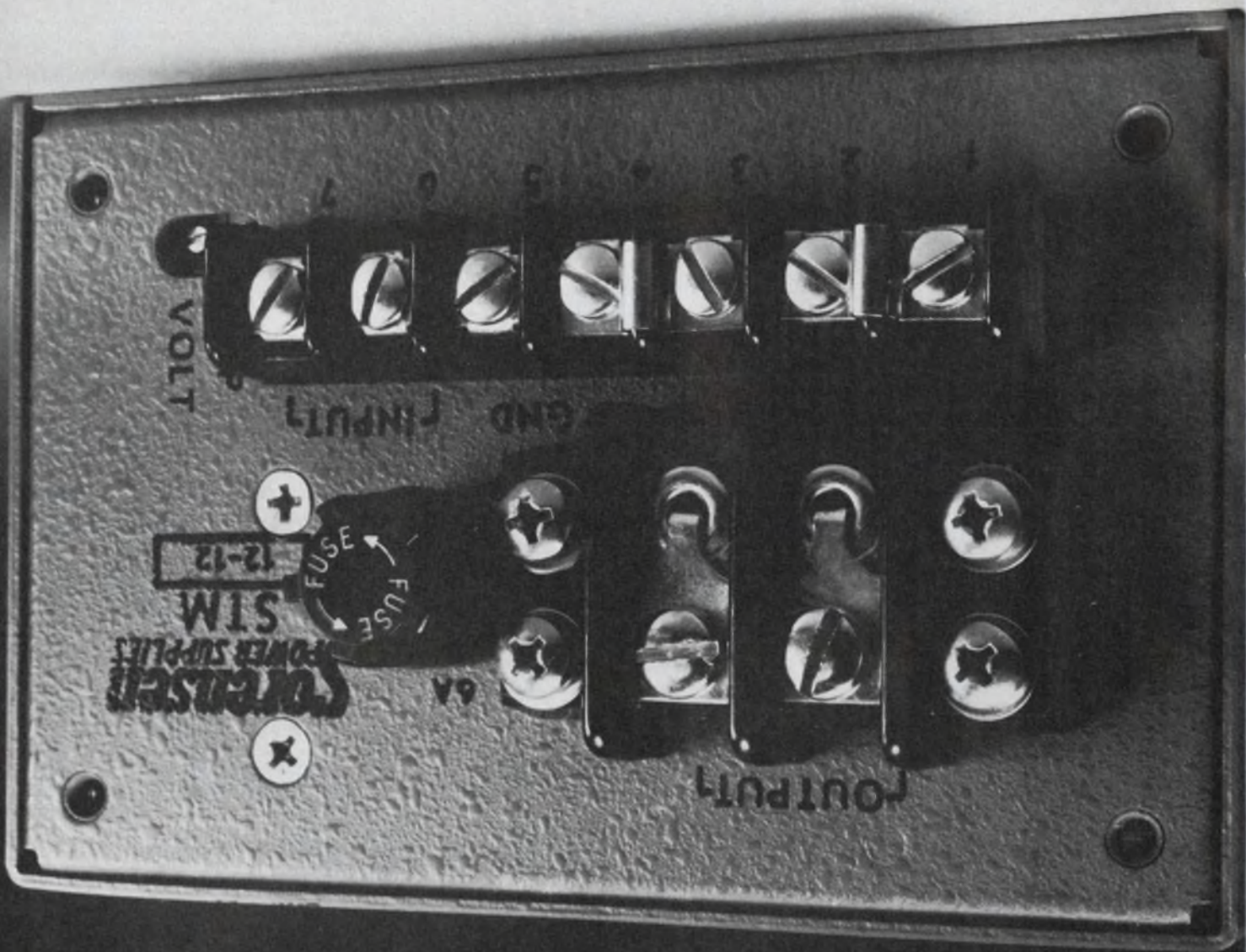

VOLT

INPUT

12-12  
STM  
CORNING  
POWER SUPPLIES

FUSE  
6A

OUTPUT



**Three colors.  
Three packages.**

**Only Litronix  
has them all.**

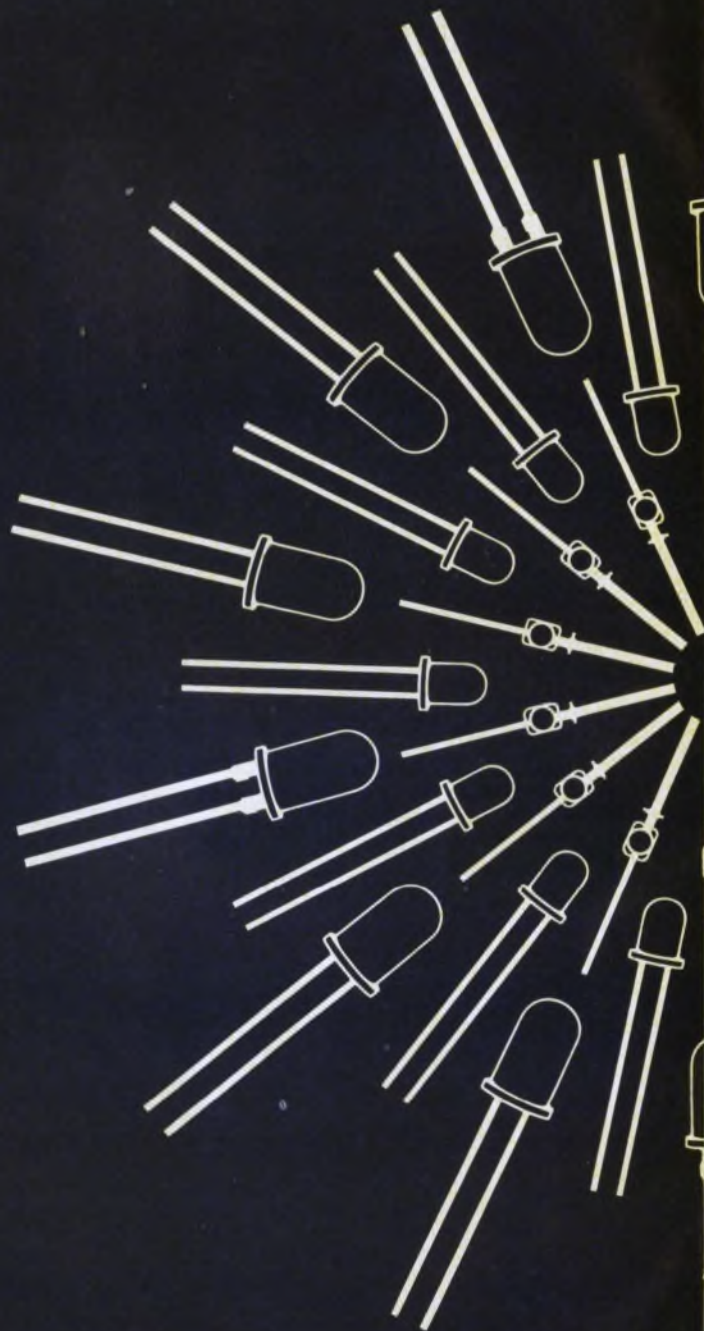



All three colors in all three packages. Yellow, green or red lamps in T-1, T-1<sup>3/4</sup> or axial packages. Only Litronix has them all.

T-1<sup>3/4</sup> packages. At 0.34" high and 0.20" in diameter, this lamp is ideal for panel mounting. We even make available a panel mounting clip. Cost for yellow and green is just 59¢ each in quantities of 1000.

T-1 package. Our red, yellow and green lamps are available in this smaller general-purpose package that's useful not only on front panels, but on PC boards, or any place where space is at a premium. Height is 0.20" and diameter is 0.125". 1000-unit price for yellow and green is also 59¢ each.

Axial lead package. Our axial lead package is intended for mounting on a PC board. It's only 90 mils wide, allowing it to be inserted in standard PC board spacing of 100 mils. Price for yellow and green is just 49¢ each in quantities of 1000.

So there you are—all three colors in all three package configurations.

Now add to that the lowest published prices in the industry. The convenience of dealing with just one supplier. And the fact that the No. 1 LED manufacturer is the No. 1 safe buy. It gives you the best package deal in town.

For details contact Litronix, Inc., 19000 Homestead Road, Cupertino, CA 95014. Phone (408) 257-7910.

**No wonder  
we're No.1  
in LEDs**

**litronix**

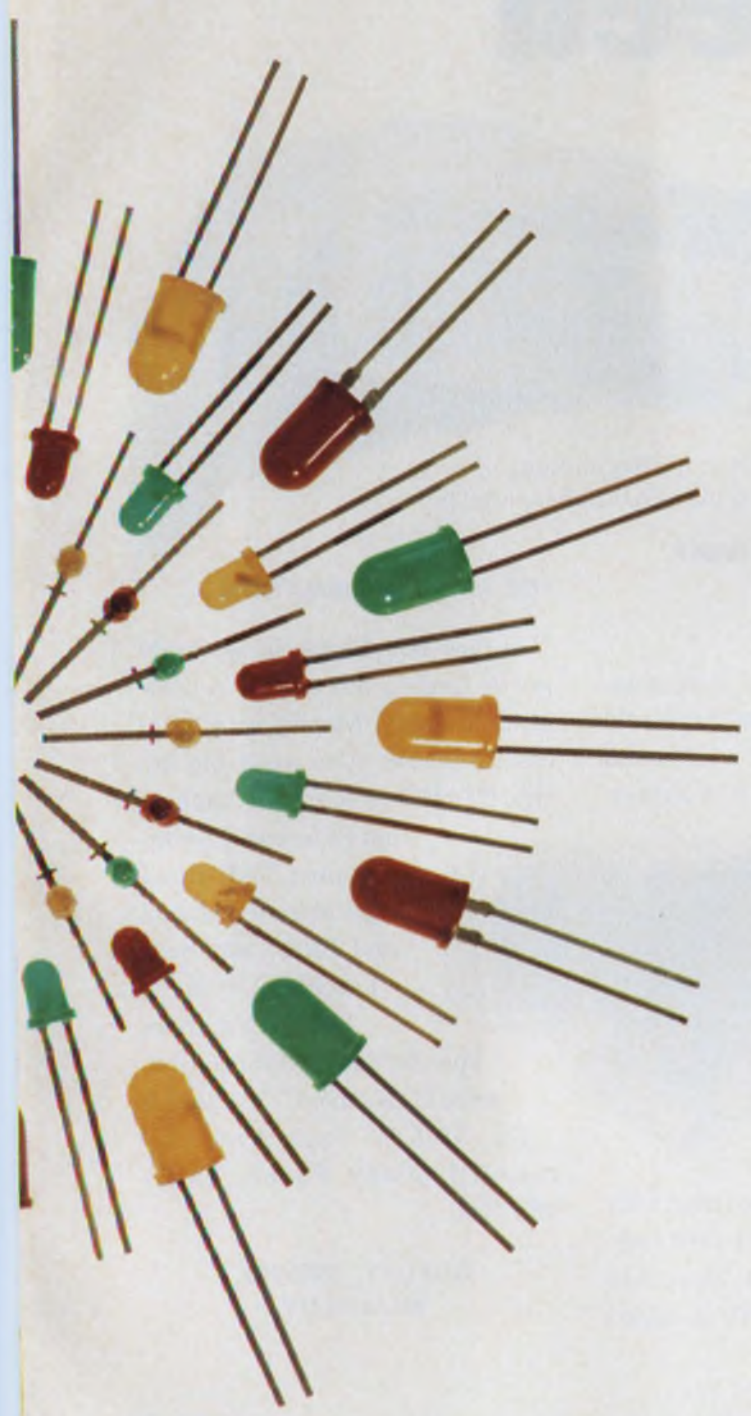



# 64 crosspoint Self-latching reed matrix



It's New! It's Revolutionary!  
We call it the Mini Memory Matrix

**CLARE'S NEW MINI MEMORY MATRIX OFFERS A PACKAGING SELECTION THAT STRETCHES THE IMAGINATION.**

Four compact packaging formats offer engineers real flexibility in creating multi-pole switching arrays for telecommunications, process controls and automatic test equipment systems. The basic 64-crosspoint switching module is built around Clare's durable magnetic self-latching dry reed switch capsule. With Rhodium-plated contacts insuring several million operations.

## IT REMEMBERS. IT ERASES.

The multiple crosspoint coils are uniquely interconnected to provide coincident selection paths. Simultaneous current pulses on the X and Y axes address the crosspoints. A new selection automatically erases the previous selection. Dielectric spacing inhibits crosstalk while providing a stand-off rating at 600 Vdc on standard models, 800 Vdc as an option.

## CHOOSE FROM WIREWRAP, CABLE PLUG-IN, OR PCB TERMINALS.

Both the wirewrap and cable plug-in units are available in 2 or 4-pole 8X8 arrays. The PCB unit comes in 2-pole 8X8 and 8X16 arrays.

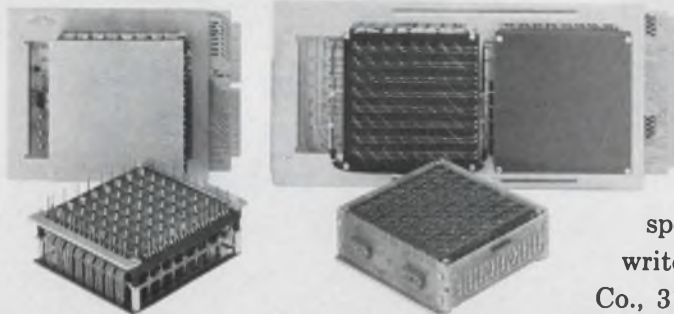

The PCB unit is compatible with conventional pre-wired card cage assembly techniques. The cable plug-in units mate with standard 9-pin in-line socket and 16-pin DIP jack terminations.

## FOR MORE INFORMATION ...

The new 969 Series is certainly worth finding out about. A New Mini Memory Matrix catalog is now available. Also available are two "TAR" (Technical Application Reference) publications: TAR-Clare Mini Memory Matrix and TAR-Clare Self-Latching Dry Reed Relays. For more specific design information, write G. Neeno, C. P. Clare & Co., 3101 W. Pratt Ave., Chicago, Ill. 60645. Phone: (312) 262-7700.

**QUALITY, SERVICE,  
RELIABILITY**

**C. P. CLARE & COMPANY** a subsidiary of  
**GENERAL INSTRUMENT CORPORATION**



# new from CLARE



# Test Equipment: Think of it as Money

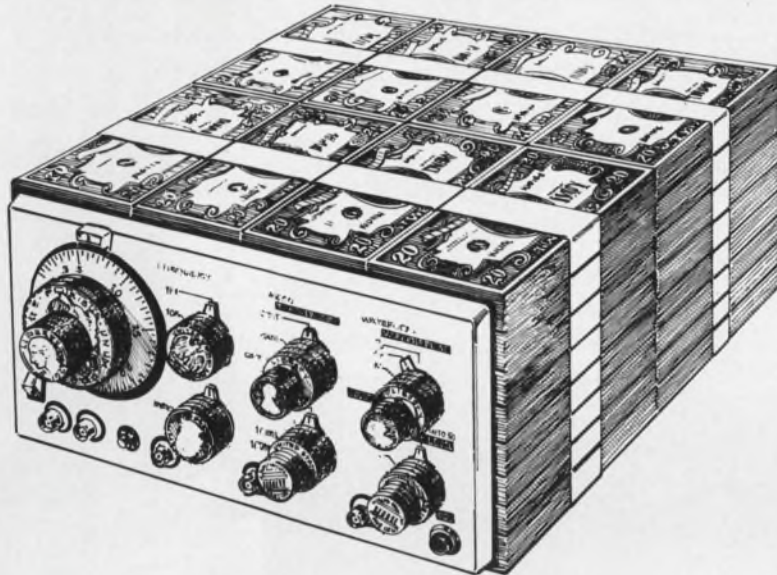

## US Instrument Rentals Helps you invest it wisely

You wouldn't let money gather dust on your shelves. Why allow unused equipment to languish there?

If some test equipment does sit idle on your shelves, maybe a better way exists to acquire that equipment. You carefully weighed alternative brands of function generators; did you weigh the alternatives of buying, renting or leasing?

To help you make a sound rent/

buy decision, U.S. Instrument Rentals wrote the only comprehensive guide on the topic. It provides an objective framework for decision making, as well as practical case studies. The financial and operational tradeoffs of renting are covered, including cash and credit conservation, obsolescence, tax considerations, maintenance and calibration, and budget stretching.

If, after reading our booklet, you decide to rent, think U.S. Instrument Rentals. The first and only rental company with a computerized inventory quotation system, repair replacements within 48 hours, automatic equipment return reminders, and much more.

Request your free copy now, before an unpredictable economy further shelves your profits.



### Regional Centers

(213) 849-5861      (301) 340-1353  
(415) 592-9230      (201) 381-3500  
(713) 462-6803      (617) 246-1515  
(312) 676-2032      (214) 234-3392  
(216) 475-6647

### Corporate Headquarters

951 Industrial Road  
San Carlos, California 94070



### Please:

Send me without cost or obligation USIR's new guide to cost effective instrumentation acquisition.

NAME \_\_\_\_\_

COMPANY \_\_\_\_\_

ADDRESS \_\_\_\_\_

CITY/STATE \_\_\_\_\_ ZIP \_\_\_\_\_

PHONE \_\_\_\_\_

951 Industrial Rd., San Carlos, CA 94070



# “Make a million of these. Cheap!”

That's quite a challenge – especially if it can't be done. But at Coors Porcelain Company, there's always somebody around who says, “Let's do it, anyhow.”

The customer wanted a special, metallized ceramic part – more than a million a year – to be used in an electronic assembly. He wanted the first shipment in 10 to 12 weeks.

Furthermore – and here was the real pinch – the customer was dictating a very low cost.

The Bachman brothers solved the problem together. Al, a ceramics specialist, developed a high-speed cutting machine similar to a Gatling gun.

And Jim came up with a low-cost

metallizing process that increased the production rate without sacrificing quality.



This is the kind of challenge we like to sink our teeth into at Coors Porcelain Company. Problems that force

us to create new technology, new processes for new or

improved ceramic products – at competitive prices.

Go ahead. Give us a challenge. Chances are we'll accept it – even if it's something that “can't be done.”

## Coors Porcelain Company

600 Ninth Street / Golden, Colorado 80401 / (303) 279-6565 / Telex 45-593

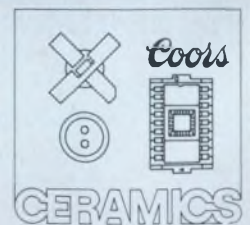



NOVEMBER 22, 1975

## Microprocessors shunned for TV tuning systems

Microprocessors, now being so widely adapted to complex control applications, will not, according to the experts, be used in TV tuning systems for several years—except in a few high-priced “super sets.”

“Microprocessors won’t be used for a long time yet,” says John Ma, responsible for TV tuner design at Zenith Corp., Chicago. “But there will be some exotic systems developed.”

Steven Hilliker, section manager of TV tuner applications at Motorola Semiconductor Products, Phoenix, AZ, notes:

“At present the use of microprocessors is not cost-effective for TV tuning systems. These systems require a low-cost device of fairly simple function. The excess capability of the microprocessor is too expensive.

“I think the use of microprocessors is about five years away, when you’ll have on-screen alphanumeric displays, two-way communications, a stop watch and a calculator, all integrated into the set.”

Hilliker points out that present systems that put channel numbers and clock time on the screen are limited in capability compared with what microprocessors can do.

Peter Alfke, manager of digital systems and applications at Fairchild Semiconductor, Mountain View, CA, agrees with Hilliker that the “standard microprocessors you can buy from Intel, Motorola, Fairchild and others are functionally an overkill when used in an electronic tuning system.”

“Also,” he points out, “they’re not capable of doing the job for TV tuners using the PLL-synthesizer systems, because the processor speed is too slow. They can only do an instruction rate of about 1 MHz, and that isn’t fast enough to control the high-speed phase-locked loops used in the TV

systems.”

“On the other hand, if you talk about a luxury TV set that incorporates functions like keying in a sequence of programs you want to see during the whole week, turning itself off and on and switching channels under stored program control—and in between washing the dishes and answering the telephone—then you can use a microprocessor.”

Stephen Field, marketing manager of consumer systems at National Semiconductor, Santa Clara, CA, sees microprocessors being withheld from TV tuning designs for another reason.

“The microprocessor,” he says, “is usable in relatively low volumes that don’t warrant a custom design. For the mass application of IC tuner systems, LSI parts will be customized.”

### Process improves plastic-bound magnets

A new process provides low-cost, plastic-bound magnets with a higher particle density and more uniform characteristics than previously obtainable with other plastic-bound or sintered ferrite devices.

The process encapsulates micron-sized particles of barium ferrite with a thin film of nylon.

The process developed by Rislan Corp. of Glen Rock, NJ, permits magnets to be produced by injection molding as well as by powder metallurgy impaction techniques, according to Robert Coch, technical manager. Other advantages of the nylon-coated magnets include:

- Surfaces of the molded magnet can also serve as bearings.
- Close tolerance magnetics can be cheaply produced.
- Complex shapes can be readily

molded.

- It is the only plastic-bound material that can be cold-compaction molded.

Of five grades of nylon-encapsulated ferrite injection-molding compositions, containing from 80 to 88% of the magnetic material, the residual flux density ranges from about 1000 to 1300 Gauss with a coercive force of about 900 to 1000 Oersteds.

Because of inherent high resistance to demagnetization, the nylon-bound magnets require a minimum of 10,000 Oersteds to magnetize them initially.

Coch sees the nylon-bound magnets used in low-cost devices requiring precise uniformity of magnetic characteristics, such as clock and timer motors, as well as motors for toys and games and for TV beam-bending and focusing.

### Connector resists corrosion in water

An electromagnetic connector for use in water—in offshore drilling and hospital operating rooms—is said to be shock, explosion and corrosion-proof.

The unit has a sensing circuit that turns the power on the moment the connector is plugged in. It also permits the operator to unplug the connector while the power is still on—an operation that would blow out the primary windings on other electromagnetically coupled connectors, according to John Weston, president of Pelcon Ltd., St. John’s, Newfoundland, Canada, where the device was developed.

The connector can be mated to make both electrical and electronic connections in depths up to 10,000 feet. Since the coupling is accomplished electromagnetically, there are no pins to lines up, and up to 100 uhf or vhf channels can be transmitted at a time.

This is done, Weston explains, by frequency multiplexing. Both FM and FSK modulation techniques are used, FM for analog signals and FSK for digital. “Normally a signal is multiplexed on one signal and power on another,” Weston says. The two can be integrated into the same package if independent cores are used.

Dc signals are coupled electro-



magnetically with circuitry that converts them to high-frequency signals, which pass through the coupler and are rectified and filtered.

Through the use of ferrite cores, the mid-band transmission efficiencies are typically 98 to 99%, Weston says.

Pelcon has developed an entire line of the connectors, with shells to accommodate the environment. "We might use stainless steel for offshore drilling, but we also have brass and plastic," Weston notes, adding that the electrical characteristics also differ—"someone might want a 10-W, 20-kHz configuration, while someone else needs 100 W at 40 kHz."

Other applications, according to Weston, include illumination of swimming pools, marinas and industrial basins and ponds.

## CCD television camera sensitive to low light

What is described as a "third-generation" charge-coupled TV camera, said to be as sensitive as  $125 \times 10^{-6}$  footcandles of illumination at the CCD elements, has been introduced by Fairchild Camera & Instrument Corp.'s Imaging Systems Div., Syosset, NY.

The camera will be available by the end of the year and is designed principally for military and industrial low-light applications. It weighs 12 oz and is just 2 in. high, 2.5 in. wide and 3.75 in. long. It has 244-line resolution and a bandwidth of 1.86 MHz.

The unit incorporates a 46,000-element CCD sensor developed by the Fairchild Memory and Logic Group and can be interfaced directly with conventional TV receivers. The power required is 4 W at 12 V, and battery operation is possible.

## Laser setup analyzes metals in components

Lasers are speeding analysis of the purity and thickness of gold and other precious metals needed in electronic components for telephone system equipment. The technique is now standard at Western Electric's plant in Allentown, PA.

Direct measurement of plated metals on small areas has always been tedious and time-consuming—some tests take as long as several hours. But with a laser, Western Electric engineers say, the tests are done in minutes and with greater reliability than ever.

"We can now see immediately on an oscilloscope if we're getting the gold where we want it and in the right thickness," says Tom Briggs, senior engineer responsible for the new system. The readout can also be programmed to detect impurities on plated surfaces that might cause future problems or to verify that printed wiring board insulation meets Bell System standards.

The system consists of a spectrograph, microscope, laser beam, digital processing oscilloscope and a minicomputer. The neodymium glass laser operates at  $1.064 \mu\text{m}$ . Its  $1\text{-}\mu\text{s}$  pulse envelope is mechanically Q-switched. It has a 1-joule output and a pulse repetition rate of up to 4 shots per minute.

"We can test 100 samples in a half hour for specific contents and have the results immediately," Briggs says. "Larger assemblies don't have to be taken apart for analysis. As long as we can get a 'bite' with the laser anywhere on the surface in question, we can get our reading. Anything from a 50-pound piece of equipment to a gold wire thinner than a human hair can be checked."

## Ion microprobe bares inner cell structure

A new ion microprobe, being developed by physicists at the Argonne National Laboratory, Argonne, IL, may aid both biologists and designers of microcircuits. Described as a high-resolution, liquid-metal electrohydrodynamic ion source, the device will give biologists a clearer glimpse into the chemical processes within living cells, while designers will be able to use it to make microcircuits.

The ion beam, which eats away a surface it strikes, "could help to increase the number of circuits in instruments, such as pocket calculators, by a factor of 10," according to Roy Ringo, who, along with Victor E. Krohn, developed the

unit. Both Ringo and Krohn are physicists in Argonne's Physics Div.

Used as a high-resolution milling device, Ringo says, the ion source could be used for ion implantation, for cutting a design for a mask, or for repairs—removing specific circuits from a microcircuit.

An ion microprobe is an instrument for analyzing many materials for their isotopic or atomic components. Instead of focusing light through a lens—which enlarges the image, as does a conventional light microscope—an ion microprobe scans a sharply focused ion beam over the sample. As the beam bombards a minute section of the sample, many secondary ions are emitted from the surface.

These secondary ions are then passed through a detector system, in which a mass spectrometer separates ions that have different atomic weights. In this way the detector system is made sensitive to an ion containing one or more of the isotopes to be traced. Then a picture of the distribution of a particular isotope is obtained by moving the focused ion beam over the sample and synchronizing it with the beam in a CRT. The brightness of the CRT is proportional to the number of traced ions emitted from the sample.

## Accurate inertial system developed by Rockwell

A low-cost inertial navigation system, said to be accurate to one-tenth of a nautical mile per hour, is under development at Rockwell International Corp.'s Autonetics Group, Anaheim, CA.

Key to the navigator, according to a Rockwell spokesman, is an instrument cluster which includes two electrostatically suspended gyros, a highly advanced inertial sensor and three electromagnetic accelerometers.

The cluster is constantly rotated 180 degrees clockwise and counterclockwise about the azimuth axis.

The rotation is said to average out certain case-related drift errors that are present in all gyroscopes and reportedly improves the accuracy of the gyroscope by an order of magnitude.



# DANA INTRODUCES THE SMART COUNTER.

## Series 9000: World's First Microprocessing Timer/Counter.

The Dana Series 9000 is smart enough to make your work a lot easier. Microprocessing controls provide all the features of a premium timer/counter, a reciprocating counter and a calculator. Plus interfacing options and operating capabilities never before available in one instrument. Like automatic measurement of rise/fall time and pulse width.

The Dana Series 9000 Microprocessing Timer/Counter goes so far beyond all other counters it takes a whole brochure just to explain its capabilities. Ask for it. It's the smart thing to do.

Dana Laboratories, Inc., 2401 Campus Drive, Irvine, California 92664.



FOR PRODUCT DEMONSTRATION CIRCLE # 291  
FOR LITERATURE CIRCLE # 292

**DANA**<sup>®</sup>  
Others measure by us.



# In the re

If your business involves measuring, and you're looking for precision instruments, you have to resolve some very real questions. What do I need? How much can I spend? Where can I get the most for my money?

Data Precision offers you a wide range of precision instruments that are the best values in the industry.

Instruments that are the result of innovative design and rigid testing.

When we developed and introduced Ratiohmic™ Resistance, Triphasic™ Conversion, and Isopolar™ Referencing we reduced the price of 5½ digit multimeters by 50% to 80%, breaking the \$2000 price barrier. We also developed the world's most accurate 4½ digit multimeter; the first,

## Model 134

3½ Digit DMM \$189.00

Competitively priced with the best analog meters, the Model 134 provides digital accuracy and an easy-to-read ½ inch digital display. The Model 134 is an ideal, low cost lab or production test instrument.

The Model 134 measures DC volts, AC volts, DC current, AC current and resistance with a basic accuracy of ±.2% through a total of 22 range scales.

It features auto-decimal positioning, auto-polarity, 100% overranging, high voltage protection circuit, probes and a one year warranty.

The Model 134 is the logical alternative to analog instrumentation at a competitive price.



## Model 245

Portable, 4½ Digit DMM \$295.00\*

Ideal for field use, the Model 245 is a rugged, truly miniature, lab-quality, 5-function instrument featuring a basic DC accuracy of ±0.05%, .005% resolution, 100% overranging, equipped with both rechargeable battery pack and battery recharger/line adapter.

Model 245 measures ACV (100µV to 500V RMS), DCV (100µV to 1000V), Resistance (100 milliohms to 20 Megohms), AC and DC current (1 microamp to 2 Amps). AC voltage/current response, 30 Hz to 50 kHz.

With over 25,000 in the field the Model 245 is still the only pocket-size portable 4½ digit DMM available.



## Model 1455

Bench/Portable 4½ Digit DMM \$355.00

Model 1455 — all the virtues of a laboratory bench instrument with the added benefits of complete portability.

A five function multimeter featuring ½" high display, 100% overranging, measures 100 µV to 1000 VDC, 100 µV to 500 VAC; resistance 100 milliohms to 20 Megohms; AC and DC current 1 microamp to 2 amps. AC response, 30 Hz to 50 kHz.

Basic accuracy on DCV is ±0.02% reading ±0.01% f.s., ±1 digit for 6 months. Internal NiCd battery module and recharger.

**Model 1450 4½ Digit DMM \$325.00**

The same specifications and features as the Model 1455, except batteries.





# al world.

and still only, 4½ digit "pocket size" multimeter and the first 4½ digit portable/bench multimeter; the first 7 digit, 100 MHz, Counter/Timer under \$300; and the first 5½ digit multimeter to break the \$1000 price barrier.

And Data Precision isn't stopping there. The first complete 4½ digit systems multimeter under \$1000; and the super-fast, super-programmable 5½ digit systems multimeter which will utilize our new circuit innovation, Quadrphasic Conversion, are on the way.

And when the competition keeps raising prices, Data Precision is keeping down your cost while giving you more.

Compare and save through innovative design.

## Model 2440

4½ Digit DMM \$675.00

The world's most accurate 4½ digit DMM, the Model 2440 features a basic accuracy of  $\pm 0.007\%$  of rdg.  $\pm 1$  L.S.D. for six months. 100  $\mu$ V to 1000 VDC, 100  $\mu$ Volts to 500 Volts AC, DC/DC ratio, AC/DC ratio, 2-wire and 4-wire resistance, 100 milliohms to 12 megohms. Standard features include autoranging, auto-zero, remote ranging and remote triggering.

Frequency response for AC current and voltage is 30 Hz to 100 kHz. Voltage ratio and isolated BCD output are included at no extra cost. Other Series 2400 models are available from \$580.00.

## Model 3500

5½ Digit DMM \$995.00

The Model 3500 delivers more features for less money than any other 5½ digit DMM available. It is a full function, autoranging DMM with 6 months basic accuracy of  $\pm 0.007\%$  of rdg.  $\pm 0.001\%$  f.s.  $\pm 1$  L.S.D. Remote ranging and trigger, 20% overrange and ½ inch planar displays.

• DCV 1 $\mu$ V to 1000 volts • ACV 1 $\mu$ V to 700 volts RMS. 30 Hz to 100 kHz • Resistance 1 milliohm to 12 Megohms • 1000 M $\Omega$  Input Impedance through 10 VDC • Ratiohm™ Resistance Method 2 and 4 wire. BCD output and voltage ratio are included at no extra cost.

## Model 5740

Multifunction Counter \$295.00

The first 100 MHz Counter Timer offered under \$300, Model 5740 measures Frequency, Period, Period Average, Total Events and Elapsed Time.

SPECIFICATIONS: Sinewaves, Square Waves, Pulses, Pulse Pairs, Complex Waves • Frequency: 5 Hz to 100 MHz; 10 ms/100 ms/1 sec./10 sec. gate times, resolution to 0.1 Hz • Period: ½ microsecond to 0.2 sec. • Period Average: 10, 100 and 1000 periods • Total Events: 0 to 9,999,999 (unlimited with "overflow" indicator) • Elapsed Time: 0 to 99,999.99 sec. (27.8 hrs.)



For complete information on these and other Data Precision instruments or a demonstration, contact your local Data Precision representative or Data Precision Corporation, Audubon Road, Wakefield, MA. 01880 (617) 246-1600. TELEX (0650) 949341.

 **DATA PRECISION** <sup>®</sup>  
...years ahead



# To measure lower distortion than ever before

## -- just push a button

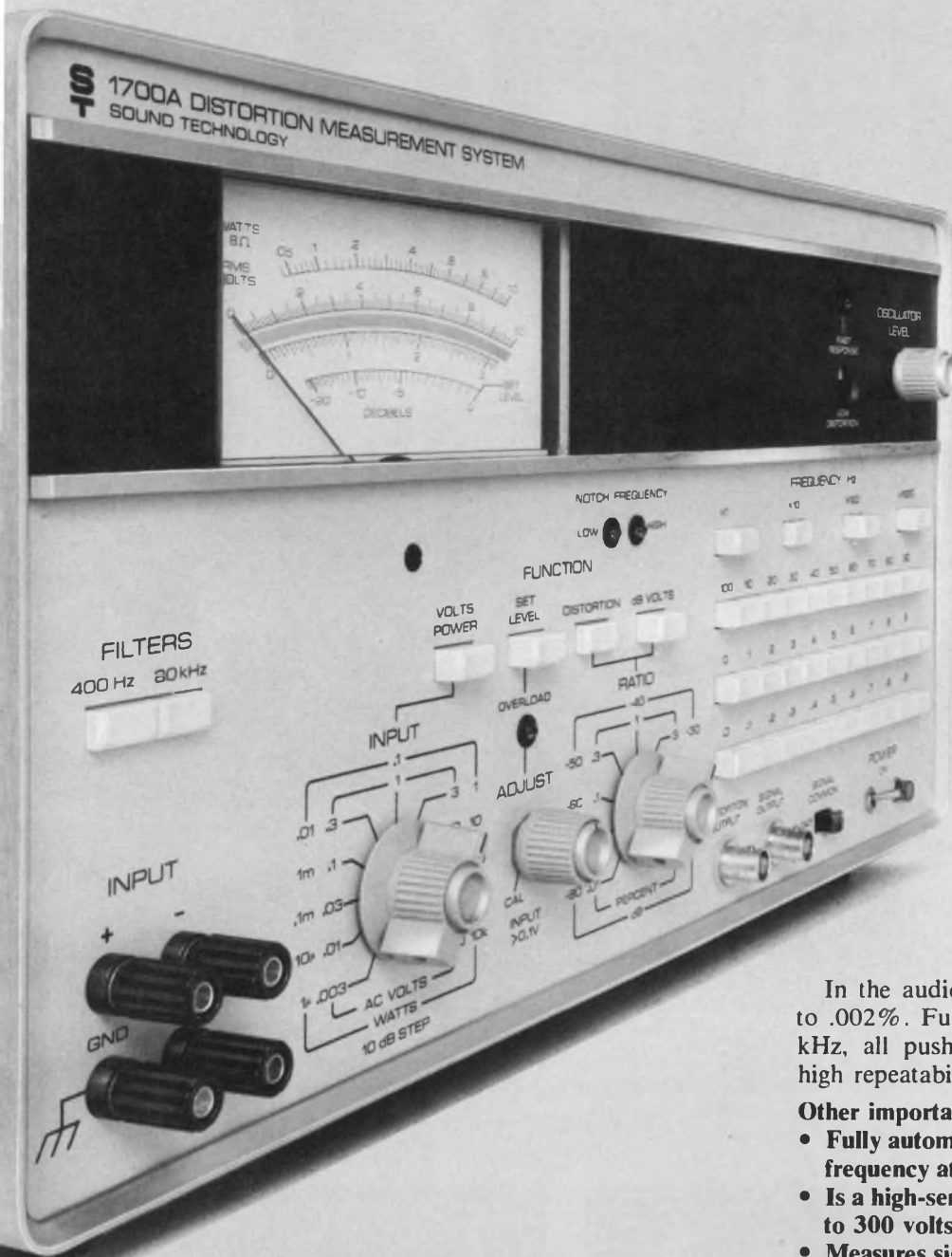

### MEASURE DOWN TO .002%

Here is an important new system for measuring distortion.

This new Sound Tech 1700A is both an ultra-low-distortion signal source and a total harmonic distortion analyzer.

It's an instrument that's fast and easy to use. You can make a measurement in 5 seconds — because both source and measuring circuits are tuned by the same pushbuttons. Even non-technical production personnel can measure with it. And that can save a lot of test dollars in the plant and lab.

### AUTOMATIC NULLING

In the audio range you can typically measure down to .002%. Full frequency range is from 10 Hz to 110 kHz, all pushbutton-controlled for fast selection and high repeatability.

### Other important features:

- Fully automatic nulling — just push a button for frequency at which you want the measurement.
- Is a high-sensitivity AC voltmeter — 30 microvolts to 300 volts.
- Measures signal ratios up to 100 dB.
- Has differential input.
- Reads power in 8-ohm loads.

### ECONOMICAL

The 1700A truly saves on initial outlay, too. It's only \$1625 (other models only \$1340). That's less than the cost of much lower performance oscillators and distortion analyzers.

### MAKE PROFIT HAPPEN — CALL NOW

So don't get caught short. Make profit happen. Call Larry Maguire or Bob Andersen and get full performance data on this important new development.



### SOUND TECHNOLOGY

1400 DELL AVENUE  
CAMPBELL, CALIFORNIA 95008  
(408) 378-6540

DEVELOPERS OF THE INDUSTRY-STANDARD 1000A STEREO ALIGNMENT GENERATOR AND 1400A ULTRA-LOW-DISTORTION OSCILLATOR

INFORMATION RETRIEVAL NUMBER 19



# Washington Report

## Rumsfeld to push for strong defense

In the aftermath of President Ford's Cabinet shakeup, a clear victor is Donald Henry Rumsfeld. In slightly more than a year the ambitious young former Illinois Congressman has come back from virtual exile as ambassador to NATO to head the Dept. of Defense.

While the initial furor and speculation centered on the firing of James R. Schlesinger, with conservatives and other advocates of a strong national defense certain that it heralded a sellout to those pushing for detente with the Soviet Union, calmer heads predict that basically nothing will change. President Ford's position on a strong national defense is unwavering. He will maintain that posture while continuing to reach a livable Salt agreement with the Soviet. That and the Sinai agreement would cement his reputation with the voters in the field of foreign policy and boost his chances for re-election in 1976.

Rumsfeld, a former Navy aviator, is a close friend of the President. He can be expected to fight for a strong national defense, as Schlesinger did, but with more finesse and political savvy. For example, he's expected to be more persuasive on Capitol Hill and not apt to tangle publically with such powerful Congressmen as George Mahon (D-TX), chairman of the House Appropriations Committee.

There is agreement in the Pentagon that this Cabinet shift does not signal a change in defense policy. Quite likely it will be a plus for the Dept. of Defense.

## Air Force looking to laser communications

If funding permits, Gen. William J. Evans, commander of the Air Force Systems Command, believes the military services will use lasers more extensively in the future to transmit information to and from airborne or space vehicles. Discussing Air Force systems of the future recently at an American Defense Preparedness Association meeting in Los Angeles, he pinpointed the Joint Tactical Communications program as one system offering great promise for the 1980s. TRITAC, as it is called, is being designed for compatibility with U.S. allies.

"Although it's a digital system—since that seems to be the wave of the future—it's also being designed to interface with the armed services' large current inventory of analog equipment," General Evans noted.

## More defense work for small contractors

Small businesses did a bit better in fiscal 1975 than in 1974 in getting a share of the defense dollar. Prime contracts to small companies totaled \$7.888-billion in 1975, or \$814-million more than in 1974, according to



the Defense Dept. The small businesses received 20.6% of the prime contracts, compared with 20.5% the previous year.

But in research and development work, the small firms didn't score as well. They won 5.6% of the contract dollars, down a bit from 5.8% in fiscal 1974. Even so, the total of \$316-million last year was \$16-million more than in the previous year.

With respect to subcontracts, the smaller companies did better. The big primes awarded 39.3% to small businesses in fiscal 1975, compared with 38.2% the previous year. The dollar total was \$5-billion in 1975 vs \$4.6-billion in 1974.

## Further drop in aerospace jobs looming

With a slackening in demand for commercial aircraft and fewer military aircraft in production a continuing decline in aerospace industry employment is indicated. The Aerospace Industries Association predicts employment will be down to 903,000 by mid-1976, a drop of 31,000 from the 934,000 who were working last June. A peak was reached in 1968, when 1.5 million people were employed in the industry.

According to the AIA, employment forecasts show a general decline of 3.3% for the entire nation, with increases expected only in the South Central region (up 5.1%) and in New England (up 1.1%).

The big employee reduction is coming in commercial aircraft production, the AIA says—14.2%. Missiles and space programs are expected to see a 4.5% decline in employment, and the layoff of some 5000 scientists and engineers is predicted.

## NASA to get bubble-memory data recorder

The National Aeronautics and Space Administration is moving closer to the day when it will have a solid-state, bubble-memory data recorder for space flights. Rockwell International's Electronic Research and Strategic Systems Div. has received a \$1.5-million contract that calls for a prototype by early 1977 and a flight-qualifiable model by 1978.

NASA officials say the recorder is expected to have a capacity of about 100 million bits and to use bubble-domain memory elements that will have a storage capacity of 102,400 bits each. Rockwell developed the elements under a NASA contract.

The new recorder will have serial or parallel data input-output operation, user-selected data rates and direct access to the memory element level. The recorder is to have a microprocessor controller.

**Capital Capsules:** There's a program afoot to pressure the FCC to allow CB licenses to be sold by merchants at point of purchase, just as hunting licenses are throughout the country. . . . Although the Army won't release specific performance data, Hughes Aircraft Co. officials say the new Mortar Locating Radar is exceeding all expectations. The reaction speed is reportedly so swift that on most tests the weapons were located before the first round had impacted. . . . A mini-chain Loran navigation system is now operating in a 10,000-square-mile area in Utah and Nevada to support the Air Force's remotely piloted vehicle program.



# TEKTRONIX ANNOUNCES

## A new concept in portable instrumentation

The TEKTRONIX TM 515 Traveler Mainframe looks like fashionable flight luggage, compact and easy to carry, or slide under an aircraft seat. In reality, it's a five-compartment power module/mainframe that provides power and interface connections for TM 500 plug-in modular instrumentation. Plug in the new (two-wide) SC 502 15-MHz dual-channel oscilloscope, and you have the beginnings of a powerful take-along instrumentation system.

You can optimize a TM 500 system to your needs by selecting from more than 30 plug-in modular instruments. With the TM 515 Traveler Mainframe and SC 502 Oscilloscope as a nucleus, select from DMM's, counters, generators, power supplies, signal processors, and even blank plug-ins for your "home-built" circuits. Intended applications include areas from digital field service to medical, from audio/communications to on-site industrial controls maintenance.

The SC 502 is Tektronix quality, featuring clean triggering characteristics, delay line input, trigger view, trigger holdoff, 1 mV sensitivity, and the capability of working through the rear interface circuit board with other TM 500 instruments. It features a specially brilliant crt designed and built by Tektronix for use in areas of high ambient light. Include a DD 501 Digital Delay alongside the SC 502 and gain the capability of delay-by-events—you can then obtain stable digital displays from electromechanical sources like disc drives that would otherwise be too jittery for accurate viewing on any conventional oscilloscope. Include the DC 505A Universal Counter and DM 502 Digital Multimeter to complete your TM 515 package, and discover the benefits of simultaneous counter and DMM capability with trigger level readout at the touch of a push button.

The TM 500 concept lets you take along on field servicing trips the same instruments you use in the lab or for production testing, thereby enabling you to maintain the same standards on the "outside". The SC 502 Oscilloscope, for example, may be used as a bench instrument in any multiple-compartment TM 500 mainframe, and it offers unique systems capabilities, as well, when operated in a rack in the RTM 506.

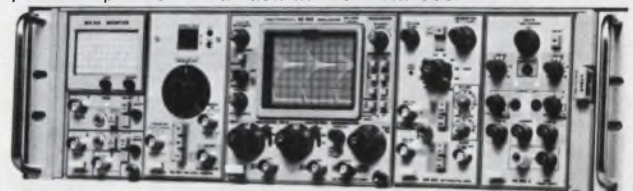

Contact your local Tektronix Field Engineer or circle the appropriate reader service number for a demonstration of TM 500 instrumentation or additional technical information on the TM 515 Traveler Mainframe and SC 502 Oscilloscope. For an up-to-date TM 500 Catalog write to Tektronix, Inc., P. O. Box 500, Beaverton, Oregon 97077. In Europe write Tektronix Limited, P. O. Box 36, St. Peter Port, Guernsey, Channel Islands.



**TEKTRONIX®**

committed to  
technical excellence





# International Rectifier

## New 10 Amp device makes one-stop shopping easy for fast-switching power transistors.

Now, IR is your source for a wide variety of 3, 5 and 10 Amp JEDEC fast-switching power transistors, to simplify your buying. These hard-glass passivated devices are the ones to use for better reliability and lower costs in line operated power supplies, whether you're chopping line voltages at 20 KHz or inverting and stepping down at high frequency.

**Fast Switching Speed—Cooler Operation** . . . the oscillographs show typical fall times in the one-micro-second and lower range. Gives extremely low switching losses for cooler operation and higher reliability.

**Lower Leakage — High Temperature Stability** . . . with ICEO in the micro-amp range, IR devices are about one-tenth the accepted leakage rates of others. Provides the higher stability important for high performance at elevated temperatures.

**High Second Breakdown — High Reliability** . . . high second breakdown helps provide a broad safe-operating area for an extra margin of safety.

**Glass Passivation — Long Term Reliability** . . . high reliability and long term stability is achieved by hard glass passivation. Also, if you're using chips to make your own circuits, IR's glass passivation gives you the most stable, easy to assemble chips you can start with, making your yields higher.

If you are paralleling devices, the tight gain, switching time and saturation voltage control of these transistors make the job easier. And through 100% testing of key parameters we can provide even closer matching if necessary.

JEDEC types listed are immediately available, so contact your local IR salesman, rep or distributor today. International Rectifier, 233 Kansas Street, El Segundo, California 90245. (213) 678-8261.

New International Rectifier Fast Switching Power Transistors

| IR Part No | V <sub>CEO</sub> (sus) (Max V) | I <sub>C</sub> Peak (A) | $\eta_{FE}$ (min/max) | $\beta$ (I <sub>C</sub> A) | V <sub>CE</sub> (sat) (Max V) | $\beta$ (I <sub>C</sub> A) | P <sub>d</sub> (W) | t <sub>r</sub> /t <sub>f</sub> ( $\mu$ s) |
|------------|--------------------------------|-------------------------|-----------------------|----------------------------|-------------------------------|----------------------------|--------------------|---|
| 2N6306     | 250                            | 16                      | 15/75                 | 3.0                        | 0.8                           | 3.0                        | 125                | .6/.4                                     |
| 2N6307     | 300                            | 16                      | 15/75                 | 3.0                        | 1.0                           | 3.0                        | 125                | .6/.4                                     |
| 2N6308     | 350                            | 16                      | 12/60                 | 3.0                        | 1.5                           | 3.0                        | 125                | .6/.4                                     |
| 2N6542     | 300                            | 10                      | 7/35                  | 3.0                        | 1.0                           | 3.0                        | 100                | .7/.8                                     |
| 2N6543     | 400                            | 10                      | 7/35                  | 3.0                        | 1.0                           | 3.0                        | 100                | .7/.8                                     |
| 2N6544     | 300                            | 16                      | 7/35                  | 5.0                        | 1.5                           | 5.0                        | 125                | 1/1                                       |
| 2N6545     | 400                            | 16                      | 7/35                  | 5.0                        | 1.5                           | 5.0                        | 125                | 1/1                                       |
| 2N6249     | 200                            | 30                      | 10/50                 | 10.0                       | 1.5                           | 10.0                       | 175                | 2/1                                       |
| 2N6250     | 275                            | 30                      | 8/50                  | 10.0                       | 1.5                           | 10.0                       | 175                | 2/1                                       |
| 2N6251     | 350                            | 30                      | 6/50                  | 10.0                       | 1.5                           | 10.0                       | 175                | 2/1                                       |

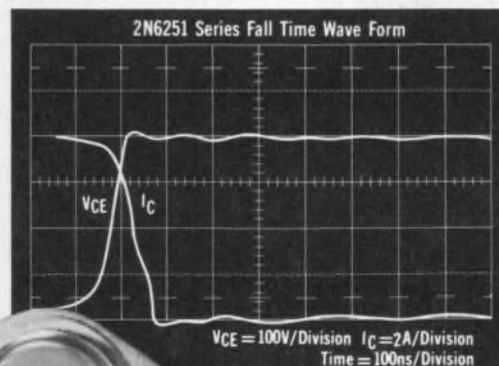
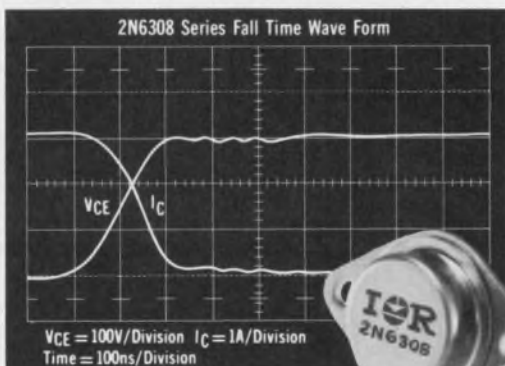

INTERNATIONAL RECTIFIER  
the innovative power people



SEMICONDUCTOR DIVISION, 233 KANSAS STREET, EL SEGUNDO, CALIFORNIA 90245. PHONE (213) 678-6281

INFORMATION RETRIEVAL NUMBER 20

ELECTRONIC DESIGN 24, November 22, 1975



# NEED 5V OR $\pm 15V$ FOR IC'S OR OP AMPS?

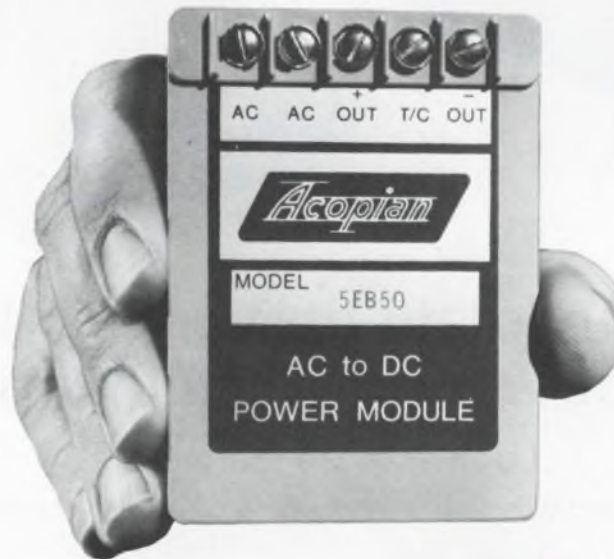

ALL MODELS U.L. RECOGNIZED

| OUTPUT VOLTAGE | OUTPUT CURRENT AMPS. | REGULATION LOAD $\pm\%$ | REGULATION LINE $\pm\%$ | RIPPLE MV RMS | SIZE INCHES LxWxH | PRICE    | MODEL   |
|----------------|----------------------|-------------------------|-------------------------|---------------|-------------------|----------|---------|
| 5              | .500                 | .15                     | .05                     | 1             | 3.5x2.5x1.38      | \$ 55.00 | 5EB50   |
| 5              | 1.0                  | .25                     | .05                     | 1             | 3.5x2.5x1.63      | 75.00    | 5EB100  |
| 5              | 1.5                  | .35                     | .1                      | 1             | 3.5x2.5x1.63      | 105.00   | 5EB150  |
| 5              | 2.0                  | .25                     | .05                     | 1             | 3.5x2.5x2.38      | 115.00   | 5EB200  |
| 5              | 2.5                  | .25                     | .05                     | 1             | 3.5x2.5x2.38      | 130.00   | 5EB250  |
| $\pm 15$       | .100                 | .05                     | .05                     | 1             | 3.5x2.5x1.38      | 55.00    | DB15-10 |
| $\pm 15$       | .150                 | .05                     | .05                     | 1             | 3.5x2.5x1.38      | 65.00    | DB15-15 |
| $\pm 15$       | .200                 | .05                     | .05                     | 1             | 3.5x2.5x1.38      | 75.00    | DB15-20 |
| $\pm 15$       | .300                 | .05                     | .05                     | 1             | 3.5x2.5x1.63      | 105.00   | DB15-30 |
| $\pm 15$       | .350                 | .05                     | .05                     | 1             | 3.5x2.5x1.63      | 110.00   | DB15-35 |
| $\pm 15$       | .500                 | .1                      | .05                     | 1             | 3.5x2.5x2.38      | 135.00   | DB15-50 |

Input, 105-125 VAC. Other mini power supplies from 1 to 75 volts. Three day shipment guaranteed. Complete details on these plus a comprehensive line of other power supplies and systems are included in the Acopian catalog. Request a copy.



Corp., Easton, Pa. 18042. Telephone: (215) 258-5441.

INFORMATION RETRIEVAL NUMBER 191



# The Low-Cost Beckman Model 89 Family Expands.

## Now with in-line pins.

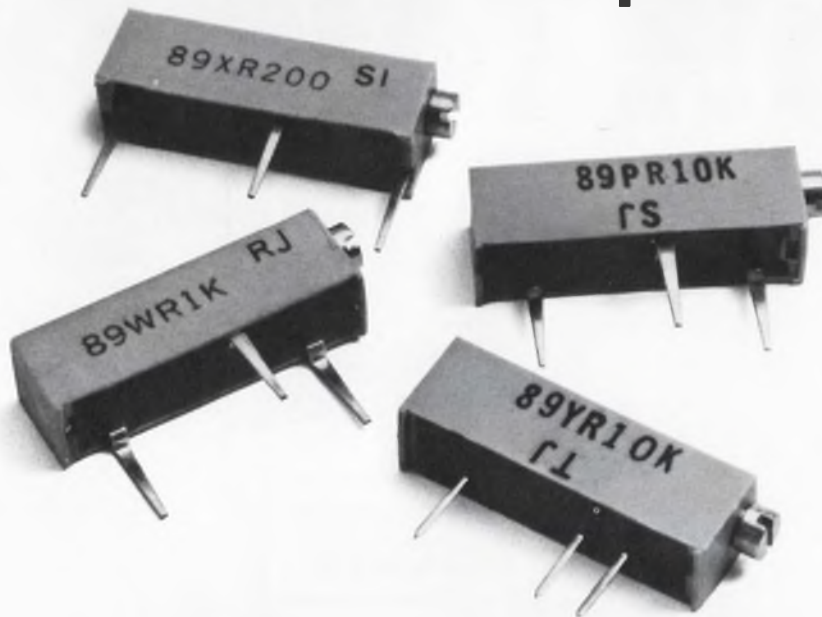

Get immediate delivery on these space-saving  $\frac{3}{4}$ " multiterms.

### Look at these features:

- Sealed for board washing
- Low profile—just 0.250" high
- Needs no O-ring because of our unique ultrasonic sealing technique
- Only 2 ohms of end resistance
- 15 turns for accurate, quick adjustment
- 4 pin styles for mounting versatility
- Panel mount adaptor available
- 100 ppm/°C tempco
- 19 resistance values: 10 ohms to 2 megohms
- 100% inspected

And the price: just \$1.05\*

\*1,000-piece price

Call your nearest Beckman Helipot distributor or (714) 871-4848, extension 1776, for evaluation samples.

**Beckman**  
HELIPOT DIVISION



One of Beckman's Cermet Seven That Handle 95% of Your Applications.





## Are you settling for dual trace when you can get true dual beam?

True dual beam operation is used in three of our 10 MHz: 2mV oscilloscopes to give bright, continuous displays and thereby eliminates the phase error problems of time-shared instruments.

All models feature comprehensive triggering facilities and a logical front panel layout, plus a rigid construction and line or 24 VDC operation. In addition, the storage version employs variable persistence to bring important additional display benefits.

**What is true dual beam operation ?**  
This is an improved display technique in which two beams are generated in one gun. The X-plates are shared but the Y-plates are entirely separate and driven independently thereby removing the need for chopped or alternate modes. The resulting continuous display eliminates ambiguity in the triggering conditions. This often occurs in time-shared instruments; for example, if the signal or part of the signal appears just as the beam is switched then it is lost completely !

As well as this important benefit, the technique also allows twice the normal light levels to be employed. Maximum advantage can therefore be taken of the 10 kV crt (8.5 kV for the storage instrument).

### Universal triggering

All controls are logically grouped and pushbutton selected. The oscilloscopes

have DC and AC coupling, plus a special TV position that gives fully automatic line or frame derived triggering (for models PM3232 and PM3233.)

All instruments also have an 'auto' position in which the trigger level is derived from the signal itself. In the absence of a signal the time base is free running, when the signal appears it triggers automatically. It is thus easy to find the trace at all times.

### Easy operation

The front panel layout speaks for itself. There is no clutter or confusion, making the instruments ideal for education and service applications. The screen is a large 8 x 10 cm with continuous, bright traces that do not need to be interpolated and that allow extremely low duty cycle signals to be displayed.

You can therefore see and measure more, and measure it more easily.

### New storage possibilities

The combination of true dual beam operation and 'half tone' storage is absolutely ideal for single shot and random signals. These phenomena are exactly the kind that can and do get lost in a time-shared instrument, that are difficult to interpolate and that may be impossible to repeat. The storage model PM3234, however, ensures that the whole signal is seen and captured, either for 15 minutes at minimum brightness or 3 minutes at maximum.

Another new display dimension comes from the use of variable persistence. This is adjustable from 0.3 seconds to 1.5 minutes and provides clear displays of difficult-to-see signals like low frequency signals suffering from flicker or high frequency, fast rise time pulses with low cycles.

All the previously described 'real time' features are also found in the PM3234, making it one of the most versatile and easy-to-operate storage instruments on the market.

### Satisfy your own doubts

Are you settling for dual trace with its inherent disadvantages when you can get dual beam ?

For further information or for a demonstration at your convenience, use our toll-free HOT LINE number (800) 645-3043. New York State residents call (516) 921-8880 collect.

Model PM3232 10 MHz/2mV dual beam oscilloscope priced at \$ 875.00

Model PM3233 dual beam oscilloscope with delay lines priced at \$ 925.00

Model PM3234 variable persistence and storage oscilloscope priced at \$ 2295.00.

Philips Test & Measuring Instruments, Inc.  
A NORTH AMERICAN PHILIPS COMPANY

400 Crossways Park Drive  
Woodbury, N.Y. 11797  
Tel: (516) 921-8880

# PHILIPS

FOR DEMONSTRATION CIRCLE #241

ELECTRONIC DESIGN 24, November 22, 1975



INFORMATION RETRIEVAL NUMBER 242

32C



# Electronic Design

## FREE SUBSCRIPTION APPLICATION

Do you wish to receive (continue to receive) ELECTRONIC DESIGN?

Yes \_\_\_\_\_ Date: \_\_\_\_\_  
 No \_\_\_\_\_ Signature: Does not obligate me or my company

FOR CHANGE OF ADDRESS . . .  
 Attach Old Address Label to Insure  
 Uninterrupted Service.

Area Code \_\_\_\_\_ Office Telephone \_\_\_\_\_

|                               |                |           |          |
|-------------------------------|----------------|-----------|----------|
| FIRST INITIAL                 | MIDDLE INITIAL | LAST NAME | TITLE    |
| COMPANY NAME IN FULL          |                |           |          |
| DIVISION/DEPARTMENT/MAIL STOP |                |           |          |
| STREET ADDRESS                |                |           |          |
| CITY                          |                | STATE     | ZIP CODE |

This questionnaire conforms to the guide lines of the Business Publications Audit of Circulation for eliciting comparable data. The publisher reserves the right to serve only those individuals who qualify for a free subscription. **ELECTRONIC DESIGN is sent free to qualified engineers and engineering managers doing design work, supervising design or setting the standards in the UNITED STATES and WESTERN EUROPE only.**

**1**  Title: (Insert letter)

|                                 |                    |
|---------------------------------|--------------------|
| A President                     | J Project Engineer |
| B Vice President                | K Senior Engineer  |
| C Vice President of Engineering | L Group Leader     |
| D Technical Director            | M Dept. Head       |
| E Chief Engineer                | N MTS              |
| F Principal Engineer            | O Engineer         |
| G Research Director             | P Consultant       |
| H Section Head                  | R Scientist        |
|                                 | S Physicist        |

**2**  Your principal job function: (Insert code)

- 1 General and Corporate Management
- 2 Design and Development Engineering (circuits, components, equipment systems)
- 3 Engineering Services (evaluation, quality control, reliability, standards, test)
- 4 Basic Research
- 5 Manufacturing and Production
- 6 Engineering Assistants (draftsman, lab assistant, technician)
- 7 Purchasing and Procurement
- 8 Marketing including Sales
- 9 Other Personnel (explain)

**3**  Plant  Your own work

The primary end product (or service performed) at your plant, and the product (or service) that is your own work. (Insert code in each box even if the same)

|   |   |
|---|---|
| A | A Large Computers   |
| B | B Mini-Computers  |
| C | C Computer Peripheral Equipment   |
| D | D Data Processing Systems (Systems Integration)   |
| T | T Office and Business Machines  |
| E | E Test, Measurement and Instrumentation Equipment   |
| F | F Communications Systems and Equipment  |
| H | H Navigation and Guidance Systems and Equipment   |
| J | J Consumer Entertainment Electronic Equipment   |
| G | G Consumer Electronic Appliances  |
| N | N Other Consumer Electronics  |
| K | K Industrial Controls, Systems and Equipment  |
| L | L Components and Sub Assemblies   |
| M | M Materials and Hardware  |
| O | O Aircraft, Missiles, Space and Ground Support Equipment  |
| P | P Oceanography and Support Equipment  |
| R | R Medical Electronics   |
| U | U Industrial Companies within the OEM incorporating Electronic Equipment in their end product, not elsewhere classified               |
| V | V Independent Research, Test and Design Laboratory and Consultant. (Only if you are not connected with a manufacturing company.)      |
| X | X Government Agency and Military  |
| 2 | 2 Industrial Companies using and/or incorporating any Electronic products in their manufacturing, research or development activities. |
| 1 | 1 Commercial Users of Electronic Equipment  |
| 3 | 3 Distributor   |
| 4 | 4 School, University or Library   |
| 5 | 5 Other (explain)   |

**4**    Your design function: (Insert each letter that applies)

- A I do electronic design or development engineering work
- B I supervise electronic design or development engineering work
- C I set standards for, or evaluate electronic design components, systems and materials

**5**  Your principal responsibility: (Insert code)

|                                     |               |
|-------------------------------------|---------------|
| 1 Management other than Engineering | 3 Engineering |
| 2 Engineering Management            |               |

**6**  Please estimate: (Insert letter)

The number of electronic engineers at this address:  
 (A) 1 (B) 2-5 (C) 6-19 (D) 20-49 (E) 50-99  
 (F) 100-249 (G) 250-499 (H) 500-999 (I) Over 1000

**7**  Please write in box total number (other than self) to be served by this subscription at this address and list individuals below:

| Name (Please Print) | Title |
|---------------------|-------|
|                     |       |
|                     |       |
|                     |       |
|                     |       |
|                     |       |
|                     |       |
|                     |       |
|                     |       |
|                     |       |
|                     |       |

**8** Products you specify or authorize purchase of: (Check all codes that apply.)

|                          |   |
|--------------------------|---|
| <input type="checkbox"/> | 1 Resistors and Capacitors                    |
| <input type="checkbox"/> | 2 Connectors                                  |
| <input type="checkbox"/> | 3 Switches and Relays                         |
| <input type="checkbox"/> | 4 Function Modules: Op Amps, Converters, etc. |
| <input type="checkbox"/> | 5 Potentiometers                              |
| <input type="checkbox"/> | 6 Test and Measurement Equipment              |
| <input type="checkbox"/> | 7 Computers, Medium and Large                 |
| <input type="checkbox"/> | 8 Electronic Power Supplies                   |
| <input type="checkbox"/> | 9 ICs and Semiconductors                      |
| <input type="checkbox"/> | 10 Microwave Devices                          |
| <input type="checkbox"/> | 11 Minicomputers                              |
| <input type="checkbox"/> | 12 Computer Peripherals                       |
| <input type="checkbox"/> | 13 Computer Components                        |
| <input type="checkbox"/> | 14 Cabinets and Enclosures                    |
| <input type="checkbox"/> | 15 Panel Meters, Analog or Digital            |
| <input type="checkbox"/> | 16 Readout and Display Devices                |
| <input type="checkbox"/> | 17 Rotating Components                        |
| <input type="checkbox"/> | 18 Cooling Products                           |
| <input type="checkbox"/> | 19 Printed Circuits                           |
| <input type="checkbox"/> | 20 Calculators                                |
| <input type="checkbox"/> | 21 Indicators including LEDs                  |
| <input type="checkbox"/> | 22 Materials, Potting and Stripping           |
| <input type="checkbox"/> | 23 Communications Equipment                   |

**9** Do you specify or buy through distributors?  
 YES  NO

**10** Minicomputers at this address:

|                            | Model | Qty. | Model | Qty. |
|----------------------------|-------|------|-------|------|
| 3 Cincinnati Milacron      |       |      |       |      |
| D Computer Automation      |       |      |       |      |
| C Control Data             |       |      |       |      |
| E Data General             |       |      |       |      |
| F Digital Equipment        |       |      |       |      |
| I General Automation       |       |      |       |      |
| K Hewlett Packard          |       |      |       |      |
| M Honeywell                |       |      |       |      |
| O IBM                      |       |      |       |      |
| N Interdata                |       |      |       |      |
| 7 Microdata                |       |      |       |      |
| Modular Computer           |       |      |       |      |
| ROLM                       |       |      |       |      |
| V Systems Engineering Labs |       |      |       |      |
| 9 Texas Instruments        |       |      |       |      |
| x Varian                   |       |      |       |      |
| Other                      |       |      |       |      |

Mail To: Electronic Design, Hayden Publishing Co., Inc., P.O. Box 13803, Philadelphia, Pa. 19101.



# TI's golden rule: no gold adder.

A lot of manufacturers give you a little something extra when they sell you gold sockets.

It's called a gold adder. And it can cost you a lot of extra money.

Not so with TI.

TI has a policy of no gold adder.

So when you order low profile solder tail sockets from us, the price we quote is the price you pay.

No matter what the cost of gold.

That's what you *don't* get from TI.

Here's what you *do* get.

- 100 microinch wrought gold contact surfaces for maximum reliability, serviceability, and longevity.

- Universal mounting and packaging.
- Stand-off tabs on the base for solder flush.
- Redundant contact points for low contact resistance, high reliability, and repetitive insertion.
- An anti-wicking wafer for better wave soldering.
- And a price that even competes with many tin-plated sockets.

We have a whole family of gold, low profile DIP sockets to choose from — all the way from 8 pins to 40 pins.

But if gold is a little rich for your needs, we offer an identical family of sockets with a tough 200-400 micro-inch plating of tin.

For literature, write Texas Instruments, Mail Station 10-5, Attleboro, Mass. 02703. For the name of your nearest distributor, or for information on our custom connectors, call Connector Systems Marketing, (617) 222-2800, Ext. 268 or 7216.



**TEXAS INSTRUMENTS**  
INCORPORATED  
INFORMATION RETRIEVAL NUMBER 21

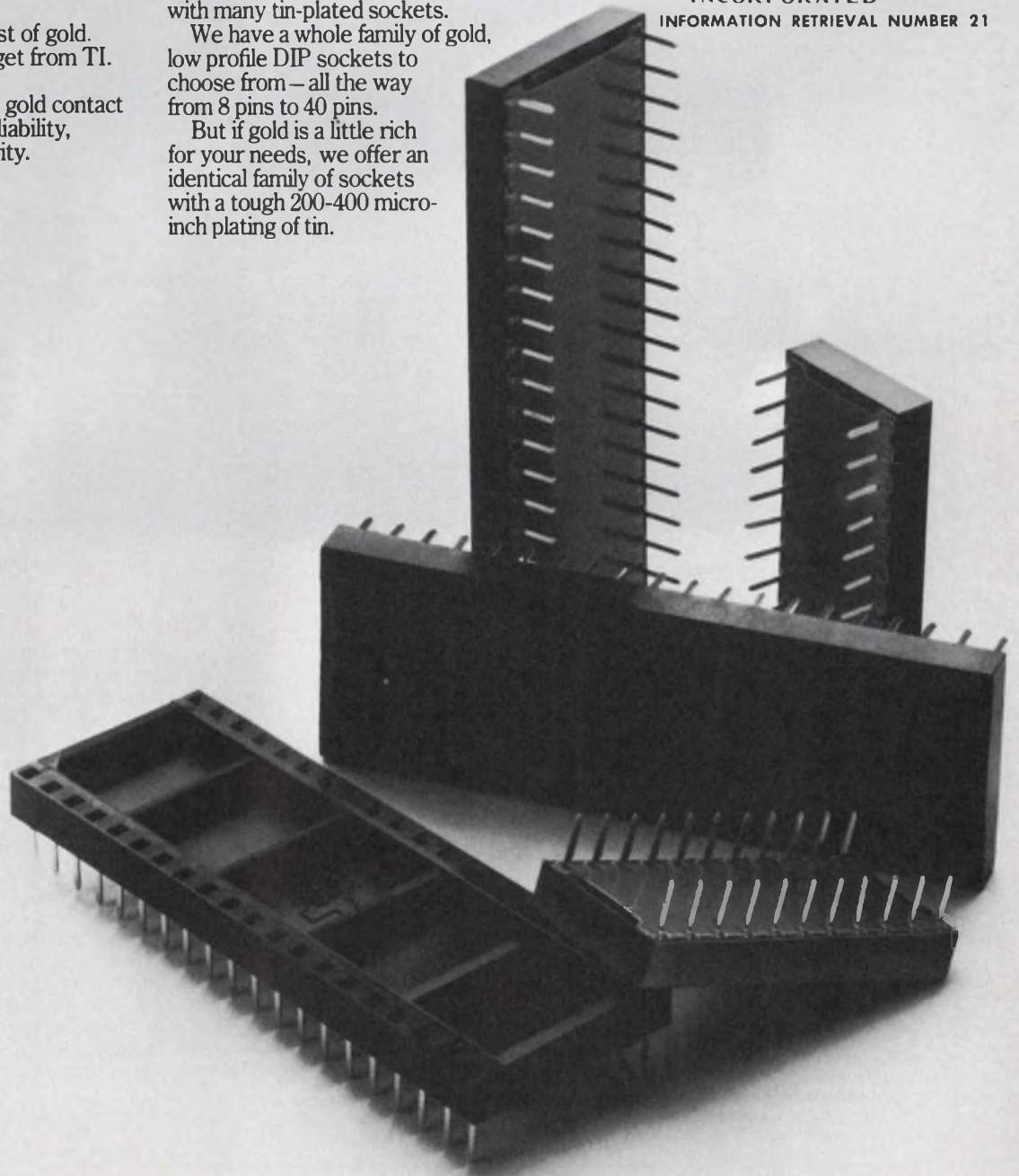



Another data domain

# Breakt

With two new ways to get inside your



HP invites you to step inside your 16-bit parallel circuits for an overall view – and a detailed view – of logic-circuit operation. How? Just connect our new 1600A Logic State Analyzer to an operating circuit, and view actual logic states on the CRT – at clock rates to 20 MHz. Select the data you want to observe with pinpoint accuracy. And choose from two display methods for viewing the data words.

What does this mean to you? It means a better way to see hardware and software in action... a faster way to spot problems and find solutions. For example:

**In the mapping mode**, the 1600A can display all possible combinations of its 16 data-channel inputs – over 65,000 in all. Each input combination or “word” appears as a discrete point whose location on screen identifies its address. Spot intensity shows relative frequency of occurrence, and the vectors show the sequential state locations.

This mode converts parallel data into a pattern that your eye can easily scan to quickly spot changing conditions or unusual events. You can even expand the view to zoom in on data of interest. And, with a

cursor, locate the address of any spot. You can then use the address as a trigger point for a detailed look with the tabular display, or to trigger your scope for electrical analysis.

**In store and compare mode**, the 1600A triggers on any preset word up to 16 bits wide. The analyzer then displays the trigger word and 15 sequential words before, after, or surrounding the trigger word, so you can easily analyze logic states in detail. You can store one table of data and compare it with an active data display... have the analyzer compare the two tables and give you a display of logic differences on a bit-by-bit basis for easy comparison... or you can set the instrument to automatically halt when all the data in one table isn't identical to data in the second – freeing you from the tedious task of waiting and watching for infrequent sequences.

**And that's just the beginning.** The 1600A gives you qualifier inputs to help locate the specific data you want on a busy bus. It gives you a sequential trigger by providing a trigger arm that inhibits the word trigger until an arming signal is received. You can



# through

logic designs: Mapping..... Store and compare.



delay the display up to 99,999 clock pulses from the trigger point, which lets you look virtually anywhere in your program flow.

The 1600A, priced at \$4,000\*, gives you new insight to operating logic circuits. With 16-bit word size, parallel operation, and 20 MHz speed, it's the ideal instrument for designers of minicomputers, peripherals, microcomputers, and microprocessor-based systems.

If 16-bit words aren't enough, our new 1600S, priced at \$6,800\*, displays words up to 32 bits wide. This powerful system includes both the 1600A and our new 1607A Logic State Analyzers. Hook it up to your 16-bit machine, and in single clock you can look at both the data and address simultaneously. In dual clock, you can view two independent active tables of 16 bits each—synchronized together through the bus triggering capabilities.

When you have all the details, you'll see how these new logic-state analyzers put you inside your logic programs for a better overall picture... and for a clear detailed look. And you'll see how they can save you



hours in design, debugging and troubleshooting. For the complete story, just contact your local HP field engineer. Or, write for our new 8-page data sheet on Logic State Analyzers.

For low-cost logic state analysis and electrical measurements too, add HP's new 1607A to your present scope and have a complete digital system... see the next page for details.

\*Domestic, USA price only.

085-7

HEWLETT  PACKARD

Sales and service from 172 offices in 65 countries  
1501 Page Mill Road, Palo Alto, California 94304



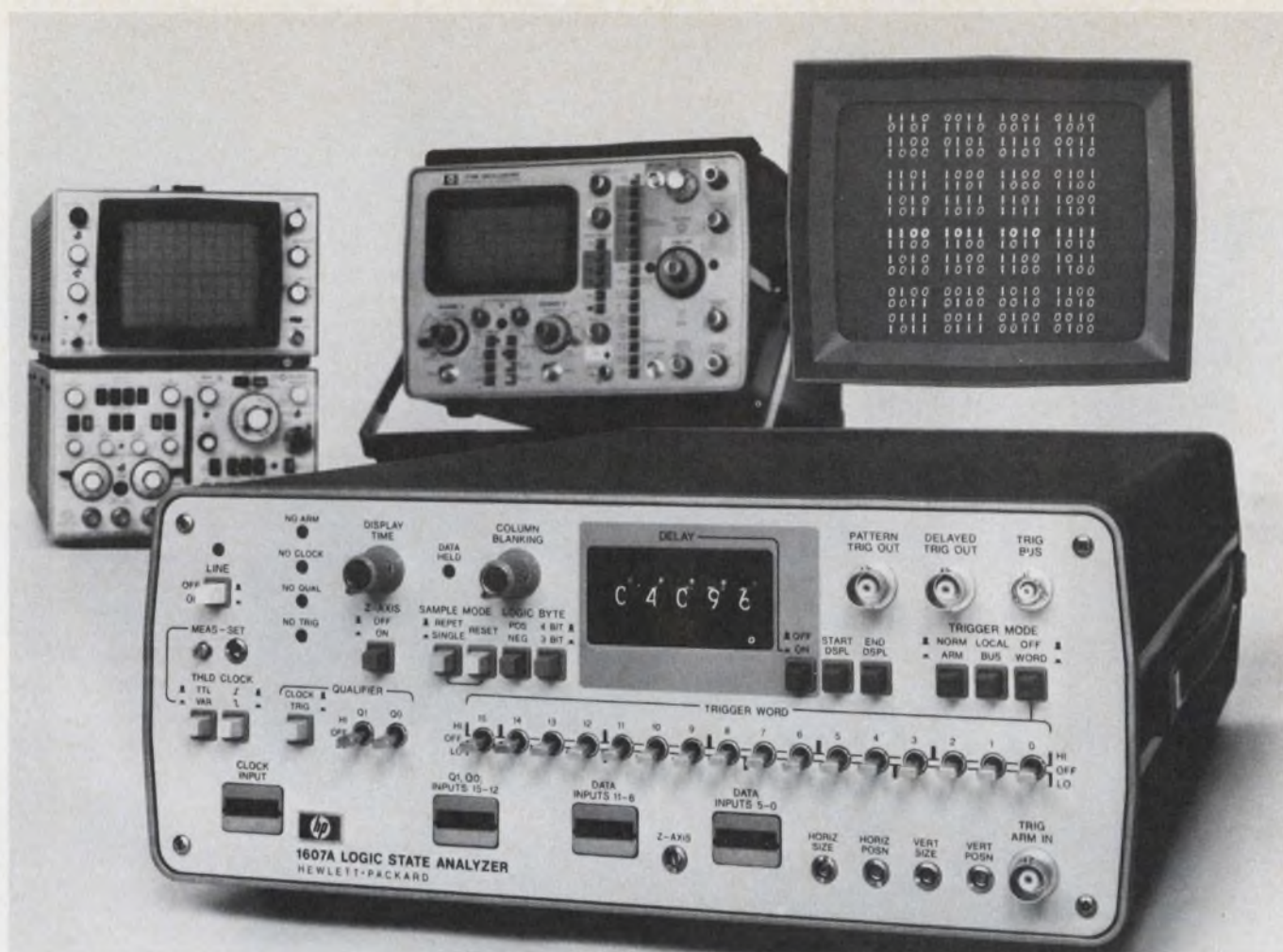

## Introducing a powerful new team to speed logic analysis - HP's 1607A and your present scope.

You already have half of a complete digital-analysis system... the scope you've been using for level and timing measurements. The other half is HP's new 1607A Logic State Analyzer. Simply make four BNC connections, and you have a combination logic analyzer and oscilloscope—a complete analysis system for the digital designer.

**Data domain or time domain.** In the data domain, the system shows you a display of logic states in operational circuits so you can pinpoint a program problem. Then, in the time domain, the 1607A triggers your scope at the point where the problem occurs so you can analyze the electrical characteristics of the waveform using the conventional scope input. Now you can really pin down those hardware/software compatibility problems.

**Parallel words to 16 bits.** The 1607A triggers on any preset word up to 16 bits wide... and at clock speeds to 20 MHz. In the data domain, it displays—on your scope's CRT—15 sequential words before, after, or surrounding the trigger word. You see the bits as 0's or 1's for easy analysis of your circuits or programs—while they're operating full speed.

**Qualifier inputs help locate data.** If you're looking for specific data on a busy bus, the 1607A's qualifier inputs let you selectively extract data of interest. In addition, a trigger arm gives you a sequential trigger by inhibiting the word trigger until an arming signal is received. You can delay the display up to 99.999 clock pulses from the trigger point, which lets you look virtually anywhere in your program flow.

With the 1607A, and your scope, you can select the data you want to observe with pinpoint accuracy... then observe either logic states or electrical parameters.

**Drives a scope or display.** The 1607A, priced at just \$2,750\*, drives nearly all modern scopes. You can even combine the logic state analyzer with a large-screen CRT display for easy viewing at a distance, such as a classroom situation.

Put this team to work in program analysis of micro-processor based systems... for microprogram analysis in minicomputers... or in situations where flow diagrams are the best way to describe your design. You'll find that its detailed view will result in faster design and debugging. And easier troubleshooting.

There's more to learn about this new logic-state analyzer... and how it gives you a better way to see hardware and software in action for faster solutions to your digital-design problems. Get all the details by contacting your local HP field sales engineer. Or by writing for the 8-page data sheet on HP's new Logic State Analyzers.

\*Domestic U.S.A. price only.

HEWLETT  PACKARD

Sales and service from 172 offices in 65 countries  
1501 Page Mill Road, Palo Alto, California 94304



# Microprocessor Design

## Microcomputer design kits can get you started painlessly and inexpensively

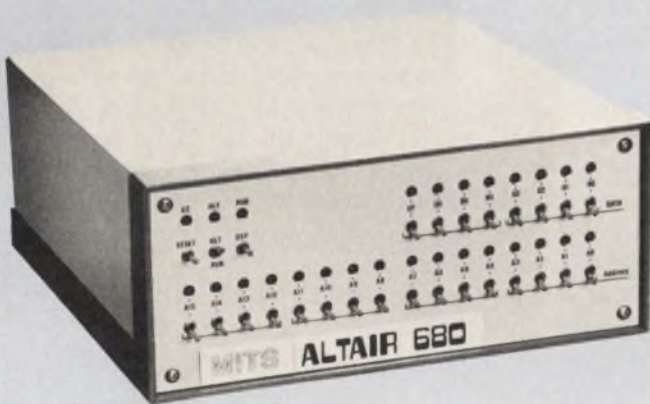

Capitalizing on the lack of knowledge on how to use microprocessors and the fact that they are difficult for the novice to use, many companies are beginning to offer microprocessor kits that make it easy to get a microcomputer system up and running.

The low cost of the kits and the technical support provided with them are among the

key reasons why kits are gaining in popularity over individual chips and sophisticated development systems.

The latest entry in the rash of microprocessor kits is MITS' Altair 680 (see photo), which is based on Motorola's 6800 processor. A barebones kit that consists just of the CPU board sells for \$180 while a full-blown computer kit with power supply, front panel, case, 1-k of RAM and a built-in RS-232 or 20 mA current loop interface goes for \$293.

The Altair 680 is the second entry in the computer market for MITS (6328 Linn Ave., Albuquerque, NM 87108. 505-265-7553). The first one, and the one that opened up the market in the first place, was the Altair 8800, a computer based on Intel's 8080 chip.

Another 6800 computer kit that has just been announced comes from Southwest Technical Products Corp. (219 W. Rhapsody, San Antonio, TX 78284. 512-344-3140). Like the MITS

*(continued on p. 38)*

## $\mu$ P-based computing system includes interactive graphics

Interactive graphics combined with the computing power of Basic language: That's the one-two punch behind the new 4051 computer/terminal/calculator from Tektronix (Beaverton, OR 97077. 503-638-3411). The microprocessor-based system is built around Motorola's 6800.

The unit's 11-in., direct-view storage CRT displays upper and lower-case alphanumeric, 72 characters per line, and 35 lines per page for a total of 2520 characters. The CRT screen has 1024  $\times$  780 addressable points and no core is needed for display up-keep on the flicker-free screen.

Standard features include a firmware implementation of Basic with 8-k bytes of workspace. Built into the 4051 is the new high-speed 3M tape drive, capable of up to 300-k bytes of storage. Options include 8-k, 16-k and 24-k add-on memory. Ten user definable keys, with shifted capability, allow 20 programmable functions. The IEEE general-purpose interface is standard. Price of the 4051 is \$6995.

CIRCLE NO. 501





## MICROPROCESSOR DESIGN

(continued from p. 37)

unit, this one comes complete with power supply and case. In addition, it contains 128 words of static scratch pad RAM, a main memory board with 2-k words and a special Mikbug ROM.

The ROM contains the program necessary to automatically place a loader and a mini operating system into operation. This is a big convenience because it means data can be entered from a keyboard the moment power is turned on, something not yet available in the MITS kit. The extra memory and special ROM make this kit more expensive. It goes for \$450.

The Jolt microcomputer kit is another new entry, and like most of the microcomputer kits available, it too comes from a small company, Microcomputer Associates Inc. (111 Main St., Los Altos, CA 94022. 408-247-8940).

The Jolt computer uses the MOS Technology 6502 8-bit micro. This is a chip that is very similar to Motorola's 6800, but with a few modifications and a much lower price tag. Also, unlike the 6800, the 6502 contains a built-in clock generator.

The computer kit contains what is said to be

an unusual self-adapting interface that can adjust to any terminal speed from 10 to 30 characters per second. A 20-mA current loop and EIA interface are also included in the kit which sells for \$249. Like the more expensive Southwest Technical kit, this one comes with a debug and monitor ROM to simplify operation. But the basic kit comes with only 512 bytes of memory.

Semiconductor manufacturers and distributors are also beginning to offer microcomputer kits, with the latest announcement coming from Cramer Electronics. Cramer is offering a TI and an Intel 8080 kit as well as a Motorola 6800 kit. The \$495 price tag of these kits includes 1-k bytes of RAM, a 1-k-bit erasable PROM that contains a system monitor and all the components needed to build support circuitry. But the kits do not include a power supply, printed circuit board or cabinet. Cramer feels each application will be slightly different so the user will probably use wrapped-wire panels to build his system.

For more information, CIRCLE No. 502, Cramer; 503, MITS; 504, Microcomputer Associates; 505, Southwest Technical Products.

## $\mu$ P for wide-range precise temperature measurements

A leading Japanese instrument manufacturer, Yokogawa Electric Works of Tokyo, is using a microprocessor to simplify measurements of temperature in the range of  $-200$  to  $+200$  C with an accuracy and resolution of 0.005 C. The instrument, still in development, is based on the fact that the resonant frequency of coil immersed in potassium chlorate will change very predictably with changes in temperature. But the changes are not linear. And that's where the microprocessor comes in. The instrument measures the coil's resonance point as it sweeps it with frequencies from 27 to 29 MHz. And the microprocessor, using conversion data stored in a ROM, converts resonance information to a digital readout of temperature.

**QUICK...**  
**What number**  
**is this?**



If you have to read your microcomputer the old-fashioned way — bit by bit, from rows of lights — the computer's making you do its work!

- Don't toggle in a program on a bank of switches — key it in.
- Don't read date and addresses bit by bit — read a series of fully decoded digits (octal or hex).
- Don't debug by single-stepping through a program — set breakpoints.



The modular micros from Martin Research. A 20-pad keyboard; six bright digits; and a Monitor program in a PROM make program entry easy. And, even the smallest system comes with enough RAM to get started! The MIKE 2 system, with the 8008 and the 8080-based MIKE 3 use the same bus structure. Accessories — like our 4K RAM — work with these and other 8-bit CPU's. And, systems start at under \$400!

Still available from Martin Research — our innovative book, **Microcomputer Design**. An industry standard for the engineer designing with microprocessors.



With 8080. \$150.  
With 8008-1. \$110.  
With 8008. \$100.  
Alone. \$75.

School and quantity discounts. Over 300 pages, dozens of schematics. Worth its weight in microprocessors!



**martin research**

3336 Commercial Ave.  
Northbrook, IL 60062 (312) 498-5060



# SIEMENS

## S.V.P.<sup>®</sup> SURGE VOLTAGE PROTECTORS



## Low-cost protection against damaging voltage transients.

Electronic equipment—especially solid state—needs protection from sudden surges in voltage that can lead to costly maintenance, long operational down-time or even loss of equipment.

Siemens Surge Voltage Protectors provide this protection. If you are now using or contemplating the need for gas tubes or spark gaps, check out Siemens SVP's on performance, price and delivery.

Highly reliable and of proven design, Siemens SVP's offer:

- High current capability.
- Accurate breakdown voltage.
- Low capacitance.

- High insulation resistance.
- Ability to withstand extreme environmental and operational extremes.
- A broad line: power, fail safe and 3-electrode types.

Beyond typical telephone and communications uses, Siemens SVP's have a variety of non-protective "switching" applications. Strobe/flash warning lights, photography, ignition or almost anywhere a voltage sensitive switch is required.

To learn more about Siemens SVP's, write for literature, free samples or applications engineering data. Immediate delivery is available from current stock.

**Siemens Corporation**  
**Special Components Division**

186 Wood Avenue South, Iselin, New Jersey 08830 (201) 494-1000



# Microprocessor Update

| Manufacturers            | Model                  | Technology                       | Bit slice | CPU (ALU controller and control memory) |          | Memory family |          | Data word size     | Memory capacity | Microprogrammable | Instructions | Stack levels | Interrupts | DIP pins         | Supply voltage | Alternate source  |
|--------------------------|------------------------|----------------------------------|-----------|---|----------|---------------|----------|--------------------|-----------------|-------------------|--------------|--------------|------------|------------------|----------------|---|
|                          |                        |                                  |           | One chip                                | Chip set | RAM           | ROM PROM |                    |                 |                   |              |              |            |                  |                |   |
| Advanced Micro Devices   | 2901                   | Schottky bipolar                 | yes       |   | ✓        | ✓             | ✓        | 4-bit slice*       |                 | yes               |              |              |            | 40               | +5             | Motorola  |
| American Microsystems    | 9209**                 | PMOS                             | no        |   | ✓        | on chip       | on chip  | 4                  | 64k             | yes               | 28           |              | no         | 40               | -15            |   |
| Burroughs                | Mini-D                 | PMOS                             | no        | ✓                                       |          | on chip       | on chip  | 8                  | 256             | no                |              |              | no         | 16               | -12, +5        |   |
| Fairchild                | F8                     | NMOS                             | no        |   | ✓        | ✓             | ✓        | 4/8                | 64k             | no                | 101          | 64           | Multilevel | 40               | -12, +5        | F8:<br>Mostek   |
|                          | PPS 25                 | PMOS                             | no        |   | ✓        | ✓             | ✓        | 4                  | 12k             | no                | 32           | 4            | no         | 16, 18, 24, 40   | -10, +5        |   |
|                          | 9400                   | Schottky bipolar                 | yes       |   | ✓        | ✓             | ✓        | 4-bit slice*       |                 | yes               |              |              |            | 24               | +5             |   |
| General Instrument       | CP 1600                | NMOS                             | no        |   | ✓        | ✓             | ✓        | 16                 | 64k             | no                | 68           | 8            | Multilevel | 40               | -12, +5        |   |
| Intel                    | 4004                   | PMOS                             | no        |   | ✓        | ✓             | ✓        | 4                  | 4k              | no                | 47           | 3            | no         | 16               | -10, +5        | 8080:<br>TI, AMD, NEC, NCR,<br>Mitsubishi<br>3000:<br>Signetics<br>4004: National |
|                          | 4040                   | PMOS                             | no        |   | ✓        | ✓             | ✓        | 4                  | 4k/8k           | no                | 60           | 7            | Multilevel | 24               | -10, +5        |   |
|                          | 8008                   | PMOS                             | no        |   | ✓        | ✓             | ✓        | 8                  | 16k             | no                | 48           | 7            | Multilevel | 18               | -10, +5        |   |
|                          | 8080                   | NMOS                             | no        |   | ✓        | ✓             | ✓        | 8                  | 64k             | no                | 78           | RAM          | Multilevel | 40               | ±5, -9         |   |
|                          | 3000                   | Schottky bipolar                 | yes       |   | ✓        |               | ✓        | 2-bit slice*       |                 | yes               |              |              |            | 28               | +5             |   |
| Intersil                 | 6100                   | CMOS                             | no        |   | ✓        | ✓             | ✓        | 12                 | 4k              | no                | 40           |              | 1          | 40               | +5             | Harris Semiconductor  |
| Monolithic Memories      | 5701/6701              | Schottky bipolar                 | yes       |   | ✓        | ✓             | ✓        | 4-bit slice*       |                 | yes               |              |              |            | 40               | +5             |   |
| MOS Technology           | 6501/6502<br>6503      | NMOS                             | no        |   | ✓        | ✓             | ✓        | 16                 | 65k<br>4k       | no                | 55           | RAM          | 1          | 40<br>28         | +5<br>+5       | Synertek  |
| Mostek                   | 5065                   | PMOS                             | no        |   | ✓        | ✓             | ✓        | 8                  | 32k             | no                | 51           | RAM          | 3          | 40               | ±5, -12        |   |
| Motorola                 | M6800<br>10800         | NMOS<br>ECL                      | no<br>yes |   | ✓<br>✓   | ✓<br>✓        | ✓<br>✓   | 16<br>4-bit slice* | 64k             | no<br>yes         | 72           | RAM          | 1          | 40<br>48         | +5<br>-5.2, -2 | 6800:<br>AMI  |
| National Semiconductor   | IMP4                   | PMOS                             | yes       |   | ✓        | ✓             | ✓        | 4                  | 64k             | yes               | 43           | 16           | 2          | 24               | -12, +5        | IMP 8, IMP 16,<br>PACE:<br>Rockwell   |
|                          | IMP8                   | PMOS                             | yes       |   | ✓        | ✓             | ✓        | 8                  | 64k             | yes               | 43           | 16           | 2          | 24               | -12, +5        |   |
|                          | IMP16                  | PMOS                             | yes       |   | ✓        | ✓             | ✓        | 16                 | 64k             | yes               | 43           | 16           | 2          | 24               | -12, +5        |   |
|                          | PACE                   | PMOS                             | no        |   | ✓        | ✓             | ✓        | 8/16               | 64k             | no                | 45           | 10           | Multilevel | 40               | -12, +5        |   |
|                          | SCAMP                  | PMOS                             | no        |   | ✓        | ✓             | ✓        | 8                  | 64k             | no                | 44           |              |            | 40               | -12, +5        |   |
| RCA                      | COSMAC                 | CMOS                             | no        |   | ✓        | ✓             | ✓        | 8                  | 64k             | no                | 37           | RAM          | Multilevel | 28, 40           | +12            |   |
| Rockwell                 | PPS 4                  | PMOS                             | no        |   | ✓        | ✓             | ✓        | 4                  | 12k             | no                | 50           | 3            | no         | 42               | -17            | National,<br>AEG-Telefunken   |
|                          | PPS 8                  | PMOS                             | no        |   | ✓        | ✓             | ✓        | 8                  | 12k             | no                | 90           | 2            | Multilevel | 42               | -17            |   |
| Signetics                | 2650                   | MNOS                             | no        |   | ✓        | ✓             | ✓        | 8                  | 32k             | no                | 72           | 8            | Multilevel | 40               | +5             |   |
| Solid State Scientific   | 7001                   | CMOS/SOS                         | no        |   | ✓        | ✓             | ✓        | 8                  | 64k             | no                | 249          | 2            | 1          | 40               | +5             |   |
| Texas Instruments        | TMS 1000**<br>SBP 0400 | PMOS<br>1 <sup>2</sup> L bipolar | no<br>yes | ✓                                       |          | on chip       | on chip  | 4<br>4-bit slice*  | 8k              | no<br>yes         | 43           | 1            | no         | 28, 40<br>40     | +15<br>+4      |   |
| Toshiba Transistor Works | TLCS 12                | NMOS                             | no        |   | ✓        | ✓             | ✓        | 12                 | 4k              | no                | 18           | RAM          | Multilevel | 16, 24<br>26, 42 | ±5             |   |

\* Expandable in increments of the bit-slice size.  
 \*\* Designed initially for calculators.

Courtesy of DCA Reliability Laboratory (Mountain View, CA)



## New from Potter & Brumfield

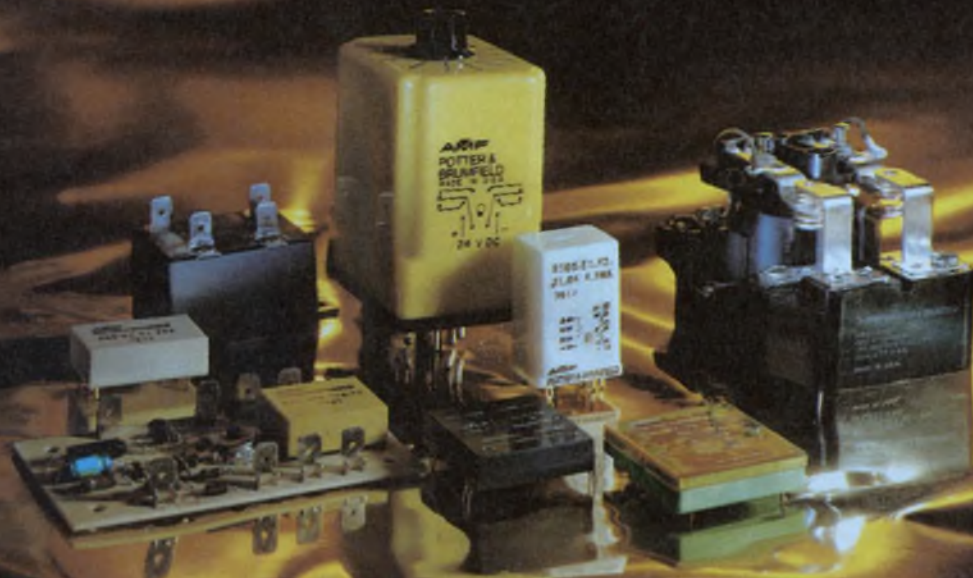

### 8 major P&B relays to solve today's design challenges.

1. R10S. Sensitivity to 5mW per pole. Available in 1, 2, and 4 Form C contacts. Ratings from dry circuit to 3 amps. Less than \$3.00 in lots of 500.

2. R50 relays. Help you solve cost and space problems. Less than \$2.00 in quantity, the R50 allows 0.6" center-to-center pc board spacing.

Coil ratings of 5, 6, 12, 24, and 48 VDC. Available in 1 and 2 Form C contacts.

3. CG relay. Extended-range CMOS IC time delay or interval timer. Repeatability including first cycle is typically .01% for DC units and 0.1% for AC units. Time delays up to 100 minutes standard.

4. R16 time delay module. Offers big savings at under \$7.00 in quantities. Timing ranges, potentiometer adjustable, are 0.2 to 2, 2 to 30 and 10 to 100 seconds for delay on operate.

5. T10 series relays. Only 0.375" high. Ideal for high density applications - permit pc boards to be mounted on 0.5" centers. Two and 4 Form C contacts provide 0.1 to 3 amp switching @ 30 VDC. Coil ratings: 6, 12, 24 and 48 VDC.

6. JDO relays. Solid state switching with total opto-coupler isolation. Zero voltage turn on and zero current turn off minimizes EMI and RFI. Low profile

permits pc board mounting on 0.5" centers. Coil ratings: 5, 6, 12 and 24 VDC. Shockproof.

7. EOT series relays. Opto-coupled, all solid state. Solve high cyclic switching problems. Synchronous zero crossover switching virtually eliminates EMI and RFI. Output: 2, 4, 5 or 7 amps @ 120 VAC standard.

8. PRD series power relays. New improved design. Interchangeable with famous PR series. Save 50% at list price! UL and CSA listed. Rugged terminals designed for power screwdrivers.

For detailed product specifications, contact the Potter & Brumfield sales representative or authorized distributor nearest you, or write Potter & Brumfield Division AMF Incorporated, Princeton, Indiana 47671. Telephone 812-385-5251.

**EUROPE:** Electrical Products Group,  
AMF International Limited, AMF  
House, Whitby Road,  
BRISTOL BS4 4AZ.

England  
Telephone:  
(0272) 778383  
Telex 449481  
AMMAFOCO  
BRSTL

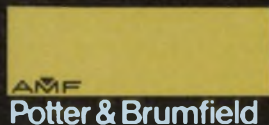

Solving switching problems is what we're all about.



## Microprocessor invasion of data communications viewed as near

*Dr. G. David Forney Jr. is vice president for research and development at Codex Corp., Newton, MA, a leading supplier of data-communications systems. He presents his views here for ELECTRONIC DESIGN readers.*

It's safe to predict that within a very short time you're going to see a flood of microprocessor-based products entering the data-communications market.

Data communications is a prime applications area for microprocessors because it requires the kind of small, highly repetitive nonarithmetic tasks that microprocessors excel at. You'll notice that every microprocessor vendor has data communications high on his list of potential applications.

The reason why  $\mu$ Ps haven't been used more widely is because the first processors didn't have the horsepower for the real-time processing you need in data communications. Although they were satisfactory for the human response time required in terminals, it was only when devices of the power of the Intel 8080 or the Motorola 6800 became available that you could even begin to think of putting them inside a data-communications network.

In general,  $\mu$ Ps are going to accelerate the trend of distributing intelligence throughout data networks and of removing more and more routine communications functions from general-purpose computers—both mainframes and minicomputers. Terminals are already benefiting from these developments.

The next major wave is going to be in building blocks for the data-transmission networks themselves; I'm talking about functions such as multiplexing, concentration, error protection, protocol conversion and so forth.

The last area where I expect to see  $\mu$ Ps used is modems, because of the high-speed digital signal processing needed there.

I see no special problems in providing communications interfaces, such as modems, for  $\mu$ Ps. The only problem really is one of selection, which depends very much on your application requirements. Some  $\mu$ P vendors, such as Motorola or Rockwell, offer a low-speed modem on a chip as part of their microprocessor families. And this may be adequate if, for example, you have to provide only a single port to the outside world from the terminal. For higher speed and more versatility, you might want to consider a programmable bus-oriented chip suitable for attachment to a modem or a digital transmission facility through a standard EIA interface. The Universal Asynchronous Receiver Transmitter is probably the most popular device of this type, although the new Astro from Western Digital is very attractive, and there are a variety of others.

What changes in data-communications equipment will result from using  $\mu$ Ps? As has always been true with the arrival of a new generation of integrated-circuit technology, equipment will be smaller, more reliable and use less power. Some aspects of  $\mu$ P-based products may be less obvious, however. For instance, you're going to see vastly expanded use of internal diagnostic programs, which will greatly simplify maintenance. The  $\mu$ P-based products are also going to be much easier for humans to interface with—for example, they can give you a lot more information and give it to you in English. Finally you're going to see completely new types of mass-produced data-communications equipment made possible by  $\mu$ Ps.

As an example, I refer to our new 6000 Series of Intelligent Network Processors ("Network Processor Has Unusual Structure," ED 21, Oct. 11, 1975, p. 23).

Our 6000 Series uses a multiple  $\mu$ P architecture, an approach that lends itself to higher reliability. But that wasn't the only reason we went to multiple processors. Usually system reliability is an AND function. All the components in the system have to work for the system to work. With multiple processors on a common bus you have the possibility of obtaining an OR function. You can take out one or more of the processor modules, and the system will still function.

*(continued on p. 44)*





# HERE'S HOW TO BUILD AN F8 MICROCOMPUTER IN 30 MINUTES.

What is the world of microprocessors coming to?

Every time you turn around there's another one. And here you go. More research. Another breadboard. More time. More expense.

Not any more. The easiest and least expensive way to evaluate the F8 is with this MOSTEK kit. All it takes is a soldering iron, 30 minutes of assembly, your teletype or CRT terminal and you can be writing and executing F8 programs.

The kit contains three F8 circuits (MK 3850 CPU, MK 3851 ROM - with DDT-1™, MK 3853 Static Memory Interface), 1K X 8 of static RAM, a crystal, 2 CMOS buffers and the 6.75" X 5.5" Board. Add a few discrete components and a TTL 7406 and you've got a complete F8 microcomputer with 24 lines of I/O.

Documentation support includes a detailed application note with step-by-step assembly instructions and sample programs.

And to aid in program development, the DDT-1™ ROM software will permit program leading, storing, modification, debugging (with "traps") and even hexadecimal arithmetic - all from the teletype.

Stop by one of our distributors and pick up an F8 Survival Kit. Only \$297.

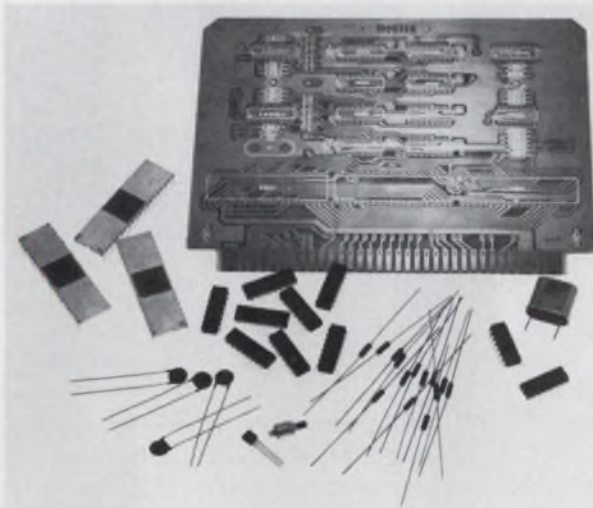

## DISTRIBUTORS

### ARIZONA

Phoenix:  
Cramer Electronics  
602/267-7312  
Kierulff Electronics  
602/273-7331

### CALIFORNIA

Irvine:  
Cramer Electronics  
213/771-8300  
Los Angeles:  
Kierulff Electronics  
714/636-1030  
Palo Alto:  
Kierulff Electronics  
415/968-6292  
San Diego:  
Cramer Electronics  
714/565-1881  
Kierulff Electronics  
714/278-2112  
Sunnyvale:  
Cramer Electronics  
408/739-3011

### COLORADO

Denver:  
Cramer Electronics  
303/758-2100  
Kierulff Electronics  
303/371-6500

### CONNECTICUT

Hamden:  
Arrow Electronics  
203/248-3807  
North Haven:  
Cramer Electronics  
203/239-5641

### FLORIDA

Clearwater:  
Diplomat/Southland, Inc.  
813/443-4514  
Hollywood:  
Cramer Electronics  
305/923-8181

Orlando:  
Cramer Electronics  
305/894-1511

### GEORGIA

Atlanta:  
Cramer Electronics  
404/448-9050

### ILLINOIS

Elmhurst:  
Semiconductor Specialists  
312/279-1000  
Mt. Prospect:  
Cramer Electronics  
312/593-8230  
Skokie:  
Bell Industries  
312/965-7500

### INDIANA

Anderson:  
Graham Electronics/  
Electronic Supply  
317/644-3381  
Fort Wayne:  
Graham Electronics/  
Ft. Wayne Electronics  
219/423-3422  
Indianapolis:  
Graham Electronics  
317/634-8202  
Semiconductor Specialists  
317/243-8271  
Lafayette:  
Graham Electronics/  
Lafayette Radio Electronics  
317/423-5564

Muncie:  
Graham Electronics/  
Muncie Electronics  
317/288-8837

### MARYLAND

Baltimore:  
Arrow Electronics  
202/737-1700  
Gaithersburg:  
Cramer Electronics  
301/948-0110  
Hanover:  
Cramer Electronics  
301/796-5790

### MASSACHUSETTS

Billerica:  
Kierulff Electronics  
617/667-8331  
Newton:  
Cramer Electronics  
617/969-7700

### MICHIGAN

Farmington:  
Semiconductor Specialists  
313/478-2700

### MINNESOTA

Edina:  
Cramer Electronics  
612/835-7811  
Minneapolis:  
Semiconductor Specialists  
612/854-8841  
Stark Electronics  
612/333-3361

### MISSOURI

Hazelwood:  
Semiconductor Specialists  
314/731-2400  
Kansas City:  
Semiconductor Specialists  
816/452-3900  
St. Louis:  
Olive Industrial Electronics  
314/863-7800

### NEW JERSEY

Cherry Hill:  
Cramer Electronics  
609/424-5993  
Moonachie:  
Cramer Electronics  
201/935-5600  
Moorestown:  
Arrow Electronics  
609/235-1900  
Saddlebrook:  
Arrow Electronics  
201/797-5800

### NEW MEXICO

Albuquerque:  
Cramer Electronics  
505/265-5767

### NEW YORK

East Syracuse:  
Cramer Electronics  
315/437-6671  
Farmingdale:  
Arrow Electronics  
516/694-6800  
Hauppauge, L.I.:  
Cramer Electronics  
516/231-5600  
Rochester:  
Cramer Electronics  
716/275-0300

### NORTH CAROLINA

Winston-Salem:  
Cramer Electronics  
919/275-8711

### OHIO

Cleveland:  
Arrow Electronics  
216/464-2000  
Cramer Electronics  
216/248-8400  
Dayton:  
Arrow Electronics  
Semiconductor Specialists  
513/278-9455

### PENNSYLVANIA

Pittsburgh:  
Semiconductor Specialists  
412/781-8120

### TEXAS

Dallas:  
Cramer Electronics  
214/661-9300

### UTAH

Salt Lake City:  
Diplomat/Alta Electronics  
801/486-7227  
Cramer Electronics  
801/487-4131

### WASHINGTON

Seattle:  
Cramer Electronics  
206/762-5755  
Kierulff Electronics  
206/763-1550

### WISCONSIN

Milwaukee:  
Semiconductor Specialists  
414/257-1300

### CANADA

Downsview, Ontario:  
Cramer Electronics  
416/661-9222  
Montreal:  
Preico Electronics  
514/389-8051

# MOSTEK

1215 W. Crosby Rd., Carrollton, Texas 75006

In Europe, Contact:  
MOSTEK GmbH, TALSTR. 172, 7024 Bernhausen, West Germany  
Telephone: (0711) 701096

INFORMATION RETRIEVAL NUMBER 28



(continued from p. 42)

I might mention a very interesting multiple-processor system called Pluribus (using minicomputers) that Bolt, Beranek & Newman has developed for the ARPA network. In this they have gone to the extreme of automatically diagnosing failed processors and automatically cutting them out of the system. It's not a simple thing to do, but it should give extraordinary reliability.

There are, however, problems in using multiple  $\mu$ Ps in a single system. People have been talking multiple processors for a long time, but a true parallel multiple-processor architecture has rarely been implemented. The general problems are to achieve communications between the processors and to assign tasks among them without excessive hardware and software overhead.

Some of the basic hardware issues involve bus organization. How you can handle interrupts, priorities, system timing, memory access and so forth. Each computer architect is going to weigh the tradeoffs differently, depending on the technology he's using and his functional requirements. There are also software problems in a multiple-processor operating system, such as interlocking of data structures, as well as the requirements that all code be re-entrant. These problems can be overcome, but it's a complicated, sophisticated design task that I wouldn't hand to a neophyte.

---

### Entire microcomputer costs \$430

Complete with power supply, keyboard input and LED output, the Micro-68 microcomputer system comes ready-to-use in a compact enclosure. Offered by Electronic Product Associates (1155 Vega St., San Diego, CA 92110. 714-276-8911), Micro-68 costs \$430. It contains the 6800 microprocessor, 128 words of RAM, 512 words of PROM and two peripheral-interface-adaptor ICs.

Internal memory can be expanded up to 1-k words of ROM and 640 words of RAM. Edge connectors provide for up to 64-k words of external memory and 16 bits of additional I/O.



CIRCLE NO. 506

---

### Alternate-sourced $\mu$ P club gains a CMOS member

Close on the heels of the recently announced alternate-source agreement between National Semiconductor and Rockwell comes a similar arrangement between Harris Semiconductor and Intersil. The latest move increases the number of multisourced  $\mu$ Ps to 13 (see chart entitled Microprocessor Update). And it reflects the current emphasis by vendors on improving availability rather than introducing new models.

In the new arrangement, Harris agrees to produce the IM6100, Intersil's 12-bit microprocessor. The micro has been designed to be a CMOS/LSI equivalent of Digital Equipment Corp.'s PDP-8 minicomputer, and therefore benefits from the sizable software support that exists for the popular mini.

In addition to the IM6100, the agreement covers all CMOS support circuits being developed. These circuits include the IM6312 1024  $\times$  12-bit ROM, the IM6101 parallel interface element and the IM6402 universal asynchronous receiver/transmitter. Harris has already developed the HM-6508 1024  $\times$  1-bit CMOS RAM, and it is developing the HM-6551 256  $\times$  4-bit CMOS RAM. These products are similar to like-numbered units in development at Intersil.

The earlier agreement between National Semiconductor and Rockwell entails a two-way exchange of technical information and expertise (see "Rockwell and National Sign Processor Pact," *Electronic Design* 20, Sept. 27, 1975, p. 24). This agreement doesn't bar either company from similar arrangements with other manufacturers, a fact made clear by Rockwell's subsequent cross-licensing with AEG-Telefunken of Germany.



# A giant step backward for microprogramming:

Any sequencer can get you there, but only one can get you back:

Advanced Micro Devices' Am2909.

The Am2909 LSI Microprogram Sequencer is an expandable 4-bit, 45 ns device that generates, increments and stores addresses.

But unlike other sequencers, the Am2909 is the only microprogram sequencer that can branch anywhere in memory, perform a sub-routine, then return, with up to four levels of sub-routine nesting.

It's the first completely flexible sequencer, made for high-speed and pipelined micro-programmed systems.

It's going to save you memory, money and bushels of MSI. So don't forget our number.

The Am2909.

Am 2909 BLOCK DIAGRAM

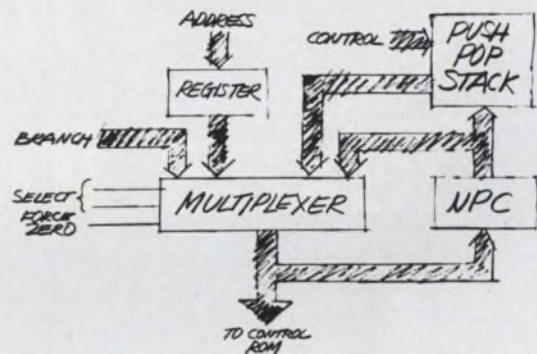

## Bye bye, MSI.

Say bye bye to your complicated, costly MSI systems. The Am2900 family is here! We started with the world's fastest, most powerful LSI microprocessor, the Am2901. And went on from there until now we have eight large scale, low-power Schottky circuits that combine the architectural simplicity and functional flexibility of MSI with the performance and cost advantages of LSI. Check the block diagram of a typical high-speed microcomputer, and you'll find everything you'll ever need for computation, control, communications and storage in any high-speed microprogrammed application. If you like the picture, you'll love the book. Send for the Am2900 story, and wave bye bye. Bye bye, MSI.

# Advanced Microprocessors



Advanced Micro Devices • 901 Thompson Place, Sunnyvale, California 94086 • Telephone (408) 732-2400 • Distributed nationally by Hamilton/Avnet, Cramer and Schweber Electronics.

INFORMATION RETRIEVAL NUMBER 29



# Meet the new 990 Computer Family from Texas Instruments



**Introducing the 9900 Microprocessor  
and 990 Series Micro/Minicomputers**



# Upward Compatible Software and Downward Competitive Prices

At TI, we've started a new family tradition in micro/minicomputers with the 990 computer family . . . a new tradition based upon a heritage of semiconductor leadership.

The 990 computer family sets new price/performance standards because of an important milestone in MOS technology . . .

## **The TMS 9900 single-chip, 16-bit microprocessor.**

Powerful enough to be the heart of a full minicomputer, the TMS 9900 is also the best microprocessor going for terminals, machine monitoring and control, and a host of OEM applications.

## **All in the Family**

The same company . . . Texas Instruments . . . makes every member of the family, and makes every member software compatible, from the bottom up. The new Model 990/4 microcomputer and Model 990/10 minicomputer use the instruction set of the TMS 9900 microprocessor. This means that software developed for the low-end computers will be compatible with the higher performance models. And, users can expand their systems with a minimum of interface and software adaptation.

## **The TMS 9900 Microprocessor**

The TMS 9900 is a 16-bit, single-chip microprocessor using MOS N-channel silicon-gate technology. Its unique architecture permits data manipulation not easily achievable in earlier devices. With its repertoire of versatile instructions and high-speed interrupt capability, the TMS 9900 microprocessor provides computing power expected from a 16-bit TTL computer.

## **The Model 990/4 Microcomputer**

It's a complete computer on a single printed circuit board using the TMS 9900 as its central

processor. The 990/4 is ideally suited for terminal control, peripheral device interface control, and as a CPU for OEM customers.

In addition to the TMS 9900 microprocessor, the 990/4 microcomputer contains up to 8K bytes of dynamic RAM, up to 2K bytes of static RAM and/or PROM, eight vectored interrupts, front panel interface, real-time clock input, two I/O buses for low- and high-speed devices, and optional ROM utilities.

With the 990/4, you can select a low-cost OEM package, a 7-inch or 12¼-inch rack-mountable chassis, or a table-top enclosure . . . and memory expansion to 58K bytes.

**Price: The Model 990/4 microcomputer with 512 bytes of memory is only \$368\* without chassis and power supply. This same model with 8K bytes of memory is only \$512\*.**

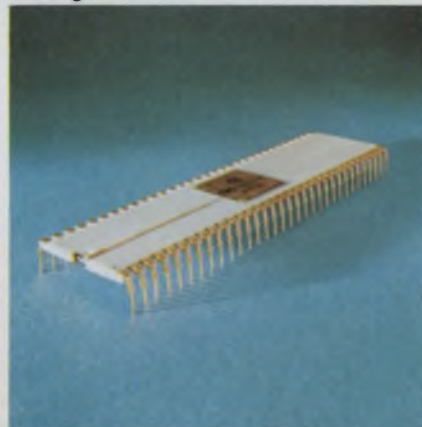

State-of-the-art TMS 9900 microprocessor . . . 16-bit, single-chip CPU with minicomputer instruction power.

## **The Model 990/10 Minicomputer**

The most powerful member of the family is the Model 990/10 general-purpose minicomputer. The 990/10, a TTL implementation of the 990 architecture, provides the high-performance speeds demanded in many applications.

A memory mapping feature providing memory protection and privileged instructions supports memory expansion to two million bytes. And TILINE\*\*, an asynchronous high-speed I/O bus, supports both high-speed and low-speed devices. Chassis options are the same as those for the 990/4.

**Price: With 16K bytes of memory, chassis, power supply and programmer's panel, the Model 990/10 minicomputer is only \$1968\*.**

## **Built Better Backed Better**

In addition to the family of compatible hardware, Texas Instruments backs you with complete software and support. **Standard software packages include memory-resident and disc-based operating systems; FORTRAN, COBOL, and BASIC compilers; and program development packages with utilities.** And, for you to develop application programs for the 990/9900 family, we offer **cross support on timesharing networks** and standalone software development systems. One is a low-cost system using the 990/4 . . . the other is a disc-based system using the 990/10. And, a **prototyping system** is offered for TMS 9900 users to develop custom software and firmware modules.

TI supports you with training and applications assistance, plus an installed nationwide service network backed by TI-CARE†, our automated remote diagnostic, service dispatching, and real-time field service management information system.

Get to know our new family. Call your nearest TI office, or write Texas Instruments Incorporated, P. O. Box 1444, M/S 784, Houston, Texas 77001. Or, phone Computer Equipment Marketing at (512) 258-5121.

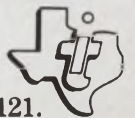

Arlington, Va. (703) 527-2800 • Atlanta, Ga. (404) 458-7791 • Boston, Ma. (617) 890-7400 • Chicago, Il. (312) 671-0300 • Clark, N.J. (201) 574-9800 • Cleveland, Oh. (216) 464-2990 • Costa Mesa, Ca. (714) 540-7311 • Dallas, Tx. (214) 238-5318 • Dayton, Oh. (513) 253-6128 • Denver, Co. (303) 751-1780 • Detroit, Mi. (313) 353-0830 • El Segundo, Ca. (213) 973-2571 • Hamden, Ct. (203) 281-0074 • Houston, Tx. (713) 494-5115 • Indianapolis, In. (317) 248-8555 • Milwaukee, Wi. (414) 475-1690 • Minneapolis, Mn. (612) 835-5711 • Philadelphia, Pa. (215) 643-6450 • Rochester, N.Y. (716) 461-1800 • San Francisco, Ca. (415) 392-0229 • Seattle, Wa. (206) 455-1711 • St. Louis, Mo. (314) 993-4546 • Sunnyvale, Ca. (408) 732-1840 • Winter Park, Fl. (305) 644-3535 • Amstelveen, Holland 020-456256 • Bedford, England 58701 • Beirut, Lebanon 452010 • Cheshire, England 061 442 8448 • Copenhagen, Denmark (01) 917400 • Croydon, England 01-686-0061 • Essen, Germany 01241/20916 • Frankfurt, Germany 0611/39 90 61 • Freising, Germany 08161/801 • Milan, Italy 6888051 • Montreal, Canada (514) 341-5224 • Nice, France (93) 20-0101 • Paris, France (1) 630-2343 • Slough, England 33411 • Stockholm, Sweden 62 71 59/62 71 65 • Sydney, Australia 831-2555 • Tokyo, Japan (3) 402-6181 • Toronto, Canada (416) 889-7373

## TEXAS INSTRUMENTS INCORPORATED

\* OEM quantity 50, U.S. domestic prices.

\*\* Trademark of Texas Instruments.  
† Service Mark of Texas Instruments.





◀ Also new from HP: The HP 9871 Page-width Printer/Plotter. Its unique bi-directional platen and 96-character printing disk let you run program-formulated charts and graphs; tables and text. Works with all HP 9800 series computing calculators.





# Announcing the HP9815. Look what your bucks will buy now.

**High-speed data cartridge** provides up to 96,384 bytes of program and data storage. Dual-track, 140 foot magnetic tape can be searched bi-directionally at 60 inches a second.

**Thermal printer** has full set of alphanumeric characters. Prints up to 16 characters per line at 2.8 lines a second.

**Easy-on-the-eyes display** can display up to 16 numeric characters or up to 10 digits in scientific notation.

**15 user definable keys** allow single keystroke execution of programmed routines.

**Auto-Start switch** initializes programs so an operator need only switch on the power and Auto-Start, and begin interacting with programs. It also provides power-fail restart.

**Simplified programming**, based on easy-to-understand logic and easy-to-remember mnemonics, lets you write powerful, complex programs easily.

**Powerful editing features** allow you to modify and update programs quickly and accurately.

**Built-in math and trig functions** provide simple, convenient keystroke calculations—just like you get from HP hand-held calculators.

**HP stack-oriented notation** is the efficient, powerful method for arithmetic operations. It reduces equations to a few easily-handled steps.

**Compact and portable**, the 13 pound HP 9815 is just 13½" x 13½" x 4".

**\$2900.\***

\*U.S. domestic price only. Does not include options, programs or peripherals.

## And that's just for starters.

At its base-price, the new HP 9815 computing calculator is a price/performance leader. And the powerful 9815 becomes a uniquely versatile performer as you add optional features.

**Interfacing capability** is provided through an optional \$200\* two-channel I/O module.

It allows a choice of seven different HP peripherals to work with the 9815, including the new 9871 page printer. You just plug them in, and they're ready to go.

HP interface cards and cables allow the 9815 to control, gather and process data from a variety of instruments. And by adding an HP-Interface Bus, up to 14 instruments can be monitored simultaneously.

**HP general-purpose programs** are now available for statistics, electrical engineering design, surveying and radioimmunoassay. With them, problem solving is reduced to data entry.

**Power, versatility, simplicity, low-cost**—these are the characteristics of the new 9815. We call it a four-dimensional machine. Call your local HP sales office, or write for a copy of the HP 9815 brochure, and you'll see why.

*HP computing calculators put the power where the problems are.*

HEWLETT  PACKARD

Sales and service from 172 offices in 65 countries.  
P.O. Box 301, Loveland, Colorado 80537

INFORMATION RETRIEVAL NUMBER 31



# A new sophistication is sweeping instruments, and the best is yet to come





The rush to incorporate microprocessors into all kinds of instruments is accelerating, and apparently it's just the beginning. Despite the fact that the cost of these new intelligent, programmable instruments may discourage some users, there is no longer any question that within three or four years customers will be able to select from a wide range of automatic and manual test equipment with built-in  $\mu$ Ps.

These computers-on-a-chip will not only improve the performance of instruments, but will also make it a lot easier to interface equipment. Much of the logic and overhead functions that until now have been done in the computer in software will be done instead by firmware in the processors.

Another significant instrument trend is the move toward replacing minicomputers in test and measurement systems with sophisticated electronic calculators. The reason? They're much simpler and less costly to program, and hardware cost is lower than that of comparable minicomputer.

A host of electronic calculators with interfaces designed to operate with various kinds of instru-

ments and peripherals are available from such manufacturers as Hewlett-Packard, Monroe, Tektronix and Wang.

A particularly red-hot subject in engineering circles today is the testing of commercial  $\mu$ Ps. The basic problem continues to be: How do you adequately test a monolithic chip with 5000 internal devices and only 18 to 40 external pins? How do you handle a chip when it is characterized by a dual or even multiple bus structure, does internal arithmetic and has response times that can vary all over the place? Large-scale IC testing today has become no less complex than the LSI circuits themselves. Test equipment is on the way, but, as usual, semiconductor complexity is outpacing the capability of the equipment.

A final trend in the instrument area continues to be the replacement of pneumatic, hydraulic and mechanical devices with electronic instrumentation in industrial nonelectronic applications.

For example: Electronic process controllers and transducer/transmitters are taking the place of pneumatic and hydraulic units; electronic digital panel meters are replacing electromechanical pointer types, and electronic gas chromatograph mass spectrometers are making tough chemical analyses routine.

For a look at the dramatic changes taking place in the world of instruments, turn the pages of this special section.

---

Automatic instrumentation from Siemens Corp. is used to test long-line telephone circuits.

## Contents

|   |     |
|---|-----|
| <b>Microprocessors are making the 'impossible' possible.</b><br>More are going into instruments .....             | 52  |
| <b>Sophisticated electronic calculators are taking over</b><br>the job once done by minicomputers .....           | 58  |
| <b>Bill Terry and Jack Lieberman of Hewlett-Packard speak</b><br>on challenges to the instrument designer .....   | 66  |
| <b>When testing those complex LSI circuits, it's important</b><br>to watch out for the 'ifs' and 'buts' .....     | 74  |
| <b>Today's versatile function generators are now offering</b><br>a lot more capability at less cost .....         | 82  |
| <b>Henk Bodt of Philips Test and Measuring speaks on challenges</b><br>to the European instrument designer .....  | 88  |
| <b>Electronic instrumentation is increasingly displacing</b><br>pneumatic, hydraulic and mechanical devices ..... | 96  |
| <b>Designers of logic analyzers are more and more</b><br>looking toward the digital domain .....                  | 104 |





Using hardware memory for the display and software memory for the printer, the 2240A Data Logger from Fluke illustrates hardware software tradeoffs.

## Microprocessors are making the 'impossible' possible

Compatibility with the IEEE interface bus, automatic calibration, error correction and simpler maintenance are only a few of the reasons why the magic word in instrumentation this year is microprocessor.

The computer-on-a-chip is popping up in a wide variety of instruments, including frequency synthesizers, data loggers, counters, digital voltmeters, specialized communications test equipment, wiring analyzers and oscilloscopes.

Functions that were previously impossible to achieve or were historically performed with analog devices are now being implemented with microprocessors.

Among the most recently announced microprocessor instruments are the 6011A signal generator and 2240A data logger, both from John Fluke Manufacturing Co., Mountlake Terrace, WA. These units have Intel 4040 processors.

According to Robert Lewandowski, signal generator product manager, the processor is used to perform all front-panel and interface control

functions. Commenting on the early design stages of the 6011A, Lewandowski notes that original plans called for building the unit with random logic. And, in fact, such a prototype was built. However, it was very difficult to get all the desired flexibility with random logic, so the unit was redesigned to use a microprocessor. Explaining further, he notes that if the full-scale range of the instrument is 10 MHz and 100 Hz was programmed in, it would be necessary to load in the preceding zeros to get the proper position. There is also a problem of representing the same number different ways.

For example, 100 Hz might be entered as 0.1 kHz. Pushbuttons proliferate in the majority of microprocessor-based instruments available today; the 11-MHz 6011A frequency synthesizer has a whole slew of them on its front panel. This proliferation of buttons seems to run counter to early trends, when manufacturers tried to hold down the controls a user had to deal with. But Lewandowski disagrees. The pushbuttons, he says, are replacing rotary switches that are a lot more difficult to manipulate. With the micro in the unit, you can set any frequency easily just by punching it in.



There are, however, two problems with using micros and pushbuttons to enter data, Lewandowski says. The first is that once a number is punched in, it can't be readily changed. This problem has been overcome in the 6011A, he notes, by use of the micro for editing so errors can be corrected.

The second problem is more difficult to solve. Typically, says Lewandowski, an engineer can walk up to most any piece of instrumentation, study the front panel, and with a little fumbling around, he can learn to operate it. But with a microprocessor-based instrument, the controls are not programmed to a unique position for each function. Instead the controls are generally used in a serial manner, and the order in which they are operated is critical. If the wrong order is used, the instrument may act strangely.

It's possible, notes Lewandowski, to make an instrument with a micro that does a very sophisticated job, but if it's not easy to operate, the user will go back to his old method.

In discussing Fluke's 2240A data logger, Mike Galavan, product manager, notes that hardware-software tradeoffs must be made but that before they can be, the user must study his application. This was done in the data logger, he says. The 2240A has two displays: a printer and a digital readout. The digital readout has to be refreshed at a high enough rate so the human eye won't see any flicker, while the printer requires only that the data be presented to it once every 15 ms.

To have the microprocessor continually update the display, Galavan goes on, would have required a lot of processor time. So a hardware memory, in the form of an extra RAM, was used to hold display information. But the printer required no constant refreshing, so a software memory was used.

### Micro adjusts counter trigger

Another recently introduced microprocessor instrument is the Series 9000 counter/timer from Dana Laboratories, Irvine, CA. This counter can measure 100 MHz, and it gets rid of most of the front-panel clutter associated with microprocessor instruments by having a disappearing calculator type of keyboard. The only control on the front panel is the power switch.

The microprocessor used is an Intel 4004, says Delbert Jackson, senior engineer. In addition to replacing a lot of TTL hardware, the microprocessor eliminates the need to adjust the trigger level manually. It does this by measuring the peaks of the applied signal, computing the mean value of the signal and placing the trigger level at that point.

The automatic trigger can also be used to calculate rise times, fall times and pulse widths

automatically. The rise and fall times are found when the micro determines the peak voltage and then measures the time it takes for the pulse to go from 10% to 90% of peak. The pulse width is determined by calculation of the midpoint of the pulse and measurement of the time between the rising and falling edges.

The microprocessor also permits greater breadth of operational capability, Jackson says. For example, it permits the selection of either direct frequency measurement, for maximum resolution and accuracy at frequencies above 10 MHz, or reciprocal measurement, for lower frequencies. As a reciprocal counter, the Dana 9000 allows the input signal to control the gate time, while the instrument measures the period of the signal with 10-ns resolution.

Another reason for including a microprocessor in the counter, Jackson notes, was to provide a flexible interface capability. Several configurations are possible, including parallel BCD, serial ASCII and a "do-it-yourself" option that provides extra high speed for custom requirements.

Commenting on the importance of the micro in the instrument, Jackson points out that it would be almost impossible to duplicate the 9000 with random logic components. The only way it



Twelve pieces of equipment can be replaced by this microprocessor-controlled radio-set test assembly from Rohde & Schwarz. It can automatically test for bandwidth, sensitivity, squelch response and signal-to-noise ratio.



could be done, he goes on, would be to use a minicomputer.

For years, engineers have dreamed about self-repairing machines, and while we're not there yet, microprocessors are bringing them a little closer to reality.

An instrument that uses a  $\mu$ P to do automatic troubleshooting is the 7115 digital voltmeter from Systron-Donner. If anything in this unit fails, says Systron's chief engineer, Walter Nickels, an indicator light on the front panel comes on. This prevents operation with a marginally accurate device or one that has failed completely.

Once the trouble light comes on, an engineer need only look inside the instrument, where other



An 8080 microprocessor is the heart of Norland's 2001 scope. The instrument can measure time intervals, frequency, dc voltage and percent difference between amplitudes.

indicating lamps will, with the help of a chart, pinpoint problems down to the subassembly level.

Another key use of the 4004 micro in the 7115 is automatic zeroing and calibration. Calibration is performed every 10, 100 or 1000 measurements at the user's option. Data for the calibration, says Nickels, are gathered during a special cycle in which the microprocessor looks at the instrument's internal references and measures them. The processor then looks at the readings produced by the instrument when the input is shorted to see what the instrument does in response to a known signal. A program then takes this information and corrects all readings.

The big advantage of auto-calibration, Nickels points out, is that it is not necessary to calibrate input-attenuator, gain-setting or ohms-converter resistors. Thus less-expensive, less-stable components can be used instead of precision potentiometers. The self-calibrating feature works so well, Nickels indicates, that 90% of all instruments are not calibrated before they leave the factory.

Describing the front panel of the 7115, he comments: "Ours has got to be the dullest front panel you've ever seen." He points out that, among other things, the range-selection switch has been eliminated through the use of auto-ranging. Auto-ranging is not new in DVMs, Nickels admits, but the way it is done in the 7115 is.

He notes that in all other DVMs, if the reading goes off scale during a measurement, the meter will go up one range and test to see if the reading is still off scale. If it is, it keeps on incrementing until the proper scale is found.

A more efficient technique is used in the 7115, Nickels asserts. If it goes off scale, it immediately jumps to the highest range and measures. At that range there is sufficient resolution to determine the correct range; the meter goes straight to it, without hunting around.

#### Fewer instruments to do the same job

As a programmable controller, the microprocessor reduces the pieces of equipment needed to perform tests. For example, a new automatic radio test set assembly introduced by Rohde & Schwarz uses a modified 4004 processor plus internal circuitry to replace at least a dozen pieces of equipment. And the price is halved, says Allen Freeland, the company's marketing director.

The test assembly, Freeland reports, contains an rf synthesizer up to 500 MHz, a 10-Hz-to-100-kHz af generator and AM, FM and PM modulators; an attenuator that goes up to 141 dB, an af level meter, a 50-W rf power meter, a distortion meter, a 520-MHz frequency counter and a 50-kHz audio frequency meter.

However, unlike the case with conventional measuring equipment, these instrumentation units are not directly and manually controllable. Instead a micro performs all the routine tasks. It automatically tunes the deviation meter, enables digital distortion factor measurement and converts signal-to-noise ratio measurements to dB.

The radio test assembly, Freeland says, can measure virtually all radiotelephone parameters automatically. That includes indirect measurements as well, such as sensitivity and bandwidth.

Operating procedures are reduced to a minimum, he goes on. Selection of a particular type of measurement requires no more than the press-



ing of a single button. All the settings associated with that measurement are then automatically made, even the correction of wrong settings. The only thing the user has to do, Freeland says, is enter the input data. He must determine, for example, whether a radio telephone set under test is amplitude or frequency-modulated.

The display, Freeland goes on, is designed so that the measured quantities are shown in digital form, while the quantities that require frequent adjustment appear in analog form.

The instrument, unlike most microprocessor systems, has a special combined mode that gives both the remote-data bus and the front-panel equal status. This means that data can be entered by a card reader and changed manually on the front panel.

The remote-data bus also makes it possible to combine the instrument with a desk-top programmable calculator for fully automatic operation, Freeland points out. Rohde & Schwarz, he notes, will provide customers with a prerecorded cassette containing all measurements already programmed and numbered. This, he contends, eliminates most of the software development problems users often face with microprocessor-based instruments.

The user simply looks up the desired measurements in a table, gets the code number and enters it into the calculator. The calculator then directs the instrument's internal microprocessor, and the test is performed.

### Scopes use micros, too

One of the earliest instruments to use a microprocessor was the Model 1722A oscilloscope from Hewlett-Packard, Palo Alto, CA. This 275-MHz, dual-channel scope was introduced a little more than a year ago, and it uses the microprocessor from the HP-35 calculator.

The unit provides a digital LED readout of time interval, frequency, dc voltage, peak or instantaneous voltage and percent difference between amplitudes. Measurements such as clock phase, rise time, pulse width, and period and propagation delay can be made with a resolution as great as 20 ps.

Following in HP's footsteps, Norland Instruments of Fort Atkinson, WI, combined an 8080 microprocessor with an oscilloscope to be the second company out with a smart scope. The unit requires no previous programming experience; everything is pre-programmed onto fixed function buttons on a keyboard. The unit, known as the 2001, is a lot more versatile than the HP 1722A. It can calculate rise times, integrals, differentials, peak areas, rms values, peak-to-peak measurements, n-point averaging, frequency and square root. ■■

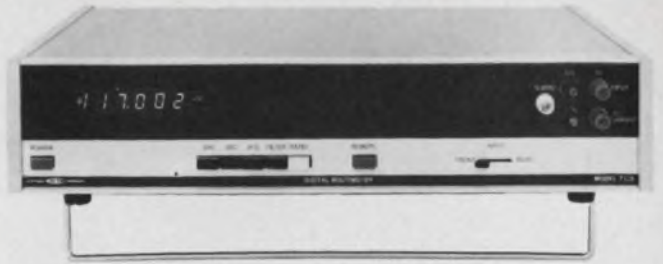

Automatic troubleshooting is one of the side benefits resulting from Systron-Donner incorporating a 4004  $\mu$ P in its 7115 DMM.

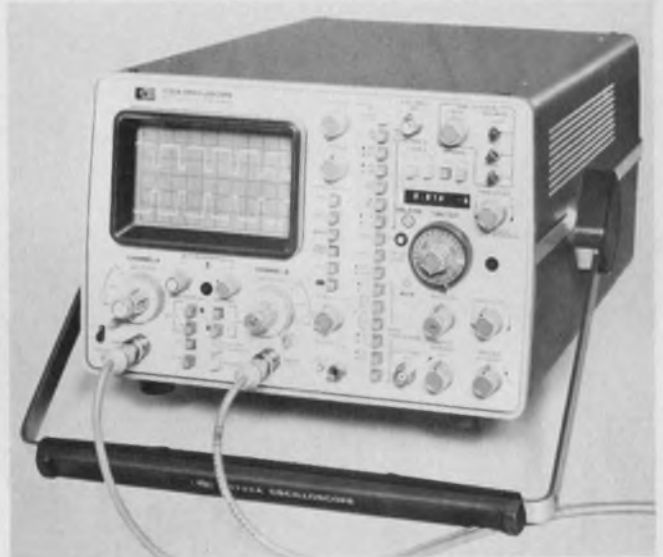

The first microprocessor-based scope was the HP 1722A. It uses the computer chip from the HP-35 calculator and can make measurements with a resolution of 20 ps.



The Series 9000 counter/timer from Dana uses a microprocessor to provide automatic triggering and calculate rise and fall times.







# IBM's new 5100 Portable Computer

A compact problem-solving aid for engineers,  
statisticians, scientists and financial and business analysts.

Now you can have a computer right on your desk. Exactly where you need it. When you need it.

The new IBM 5100 Portable Computer incorporates the latest in semi-conductor technology. It features a typewriter-like keyboard and numeric key-pad for simplified data entry, a 1024 character display screen, an integrated magnetic tape drive, and 16K characters of memory.

Options available with the 5100 include a bi-directional 80-characters per second printer, a second magnetic tape drive, and additional memory up to a maximum of 64K characters. Also available is a communications feature which allows the 5100 to be used as a terminal.

The IBM 5100 comes with either APL or BASIC language or both.

Over 100 often-used analytical routines in mathematical, statistical and financial calculations are available for such functions as forecasting, modeling, matrix arithmetic, engineering and design calculations, regression and correlation analysis, return on investment and cash flow analysis.

In addition, the 5100 features a self-study training package that makes it easy to learn and easy to use without taking any classes or relying on specially trained experts.

If you'd like to find out more about IBM's new 5100 Portable Computer and arrange for a demonstration right at your desk, call your IBM General Systems Division office or fill out this coupon.

|   |   |    |
|---|---|----|
| <b>IBM.</b>   | IBM General Systems Division<br>P.O. Box 2068, Atlanta, Georgia 30301 | ED |
| <input type="checkbox"/> I would like more information about IBM's new 5100.                  |   |    |
| <input type="checkbox"/> I would like a demonstration of IBM's new 5100.                      |   |    |
| My major area of interest is:   |   |    |
| <input type="checkbox"/> Engineering/Scientific <input type="checkbox"/> Statistical Analysis |   |    |
| <input type="checkbox"/> Business/Financial Analysis  |   |    |
| Name _____  |   |    |
| Title _____   |   |    |
| Company _____   |   |    |
| Address _____   |   |    |
| City _____ State _____ Zip _____  |   |    |
| Phone _____   |   |    |





Writing and debugging of programs can be accomplished while PC boards are simultaneously tested on this Systron-Donner 3600 Computer Automated Test System. It uses a Basic operator interactive test language.

# Calculators taking over jobs once done by minicomputers

**N**ot too long ago only computer-based systems had the power and capacity to manipulate the large amounts of data generated by automatic test and measurement systems. And application software costs were—and still are—high.

Today sophisticated electronic calculators, with interfaces tailored to various kinds of instruments and peripherals, are available from manufacturers like Hewlett-Packard, Monroe, Tektronix, and Wang.

These calculators are, in increasing numbers, taking over tasks formerly performed by minicomputers. Here's why:

- They are much simpler and less costly to program.
- They have added computing power, gained through the use of peripherals normally associated with computers, including disc files, printers and terminals.
- The hardware cost is lower than that of a comparable minicomputer.

## Automatic testing uses

The advantages of using calculators are demonstrated in a typical application, a system de-

signed to test telephone connector contacts automatically. The system, developed by Fluidyne Instrumentation, Oakland, CA, uses a Wang WCS/20 calculator, which includes a disc, to control three instruments: a 5-1/2-digit California Instrument digital voltmeter, a Keithley constant current source and a Keithley nanovoltmeter.

"In this system," says Roger Jennings, Fluidyne president, "up to 50 connector contacts are tested under specific conditions established by the calculator. From contact current and voltage, the calculator evaluates the resistance."

The Wang WCS/20 calculator in the Fluidyne system, like the HP 9830, uses a high-level programming language: Basic.

"The Wang calculator hardware is similar in cost to a minicomputer of equivalent capability," Jennings says. A complete Wang system costs about \$11,000, while a computer of equivalent capacity, sells for perhaps \$14,000 to \$15,000, he asserts.

"But those calculators which use Basic are much easier to program," Jennings points out, "because the Basic interpreter is resident in ROM; so you don't have the problem of loading interpreters."

"For instance, our total cost to write the entire program for testing up to 50 telephone connector contacts was only \$500. So although the hardware cost is close, the programming cost is generally an order of magnitude lower."



Jennings sees a trend toward use of Basic in calculators for on-line operations, "because we find that these applications are becoming so sophisticated that unless you have a very low-cost system for OEM applications, the use of Basic is a real requirement."

But even in the lower-cost calculators, the use of algebraic language—and reverse-Polish notation, as in HP's recently announced 9815—poses only minor programming problems for users compared with computer programming.

"Rather than spend 10 k to 12 k for a high-level language machine, we find that many instrumentation designers are willing to work with the calculator's own language, with the advantage of having a machine costing only 3 k to 4 k," reports John David, marketing specialist at Tektronix for information display systems.

"Many of these designers," he points out, "have been used to assembly language through previous minicomputer experience, and the programmable calculator offers an ease of programming that is an order of magnitude above that."

#### New sources of supply

Calculator-based data-acquisition, control and measurement systems are becoming available from new sources. Keithley, for example, has introduced a family of plug-in, compatible instruments and interfaces that it calls System 1.

The heart of System 1 is a programmable calculator—a modified Monroe 1880—that uses magnetic cards for program storage.

"The calculator is modified, in that we add keystroke subroutines that we use for communicating with the instruments," says David J. Bartos, Keithley's marketing manager. "You can communicate quickly. Two key strokes, for instance, copy the reading from an instrument into the entry register. Similarly a few more strokes will output a voltage or a signal to control a device or a power source that couples into the interface."

Bartos notes that System 1 has BCD parallel-line interfaces for five instruments: a digital electrometer, a digital nanovoltmeter, a digital picoammeter, and two digital multimeters.

"We have elected not to use the IEEE standard bus for our System 1 internal communications," Bartos says, "because we find it less costly to do it other ways. However, there are users who are willing to pay for the features of IEEE bus compatibility, so we will offer, as an option, an interface card that enables them to input Standard 488 bus instruments."

Tektronix and HP both provide calculator-driven instruments and systems that can use their own, as well as other manufacturers', instruments. HP offers the 9821 calculator, which is algebraically programmable; the 9830, which in-



A magnetic tape cartridge in the Tektronix 31/53 calculator provides automatic data acquisition, logging and statistical routines for interchangeable plug-in modules.

corporates Basic in its programs; and—the latest—the low-cost 9815, which uses reverse-Polish notation and is programmed like the HP programmable pocket calculators.

Both the HP 9821 and 9830 have cassettes for program storage, and the 9830 also has room for several ROMs besides those supplied with this machine.

A line of HP instruments, including frequency synthesizers, signal generators, counters, microwave oscillators, a digital multimeter, a word generator and a 40-channel scanner are all compatible with the HP-IB bus, which is Hewlett-Packard's implementation of the IEEE Standard 488-1975 digital interface for programmable instruments.

Preassembled HP-IB systems include those for data acquisition, spectrum analysis and network analysis.

The Tektronix 31/53 calculator can interface directly as plug-ins with that company's voltmeters, frequency counters, an A/D converter and a 16-channel scanner.

"Because almost every company at present makes instruments with a BCD parallel format," says David of Tektronix, "we have a general-purpose BCD interface—the 152—which provides a full input and output for most of the commonly available instruments in the electronic design field today. With the 152, we can take data



directly into the calculator memory by direct memory access—a feature you normally find only on a minicomputer—at upwards of 15 k readings per second.

“For those instruments that normally communicate with a Teletype using bit-serial data, we have a bit-serial interface, the 154.”

The bus structure in the Tek 31 calculator is unique to that machine, David notes, adding:

“While we do not make an interface to the IEEE standard bus, one has already been developed abroad. I think that the IEEE interface will predominate in two markets: the design test bench—where the designer wants to connect equipment together easily and rapidly for short-term projects and then disassemble the instrumentation and use the instruments separately—and in prototype testing.

“For dedicated data-acquisition systems, process control, quality control and environmental testing and monitoring, I think that those systems will use the simpler, less expensive digital formats.

“But I think it’s safe to say that Tektronix will, in the future, also be offering instruments using the IEEE interface.”

#### Broad acceptance of standard

The trend toward broad acceptance of the IEEE bus standard is now well established. In addition to HP, the following manufacturers, among others, are now producing programmable instruments that are compatible with the IEEE bus:

- Boonton—1-MHz capacitance bridge.
- Dana—digital voltmeter.
- Dana-Exact Electronics—function generators.
- Fluke—frequency synthesizer.
- Interface Technology—word generators.
- Ithaco—programmable filters.
- Rohde & Schwarz—vhf/uhf test set.
- Systron-Donner—pulse and waveform generators.
- Wavetek—function generators.

Donald C. Loughry, corporate interface engineer at Hewlett-Packard, Palo Alto, CA, and sometimes called the “father” of IEEE Bus Standard 488, sees major use of the bus in calculator-based instrumentation systems.

“That’s one of the applications that gave rise to the definition and that continues to be a strong area—where you have bench instruments that you wish to assemble easily into systems and easily reconfigure into different systems,” Loughry says. “In these systems, the number of instruments needed to communicate directly with one another is fairly small—15 or under—and



A test setup for measuring semiconductor parameters uses the Keithley System 1 instrumentation, controlled by a modified version of the Monroe 1880 calculator.

they are used together in close proximity.”

But Loughry also sees the bus ultimately being applied in a broader field—peripheral display, processing and storage devices.

Some instrument manufacturers say that it is more costly to develop interfaces for the IEEE bus system than for their own BCD systems.

Loughry agrees that it may be slightly more expensive, but he feels that the advantages of the IEEE interface far outweigh the added cost.

“If you have a common interface for several different products, it is an advantage for both the designer and the end user to have to learn the unique characteristics and features of the individual instruments at the interface level,” Loughry asserts.

The present rush to incorporate microprocessors in intelligent, programmable instruments will have an impact on both small and large systems. However, the cost of these instruments may discourage some users.

“We know that the microprocessors are very powerful and can add many functions to the instruments,” says Samuel Gagliano, manager of technical products for Wang Laboratories, Tewksbury, MA, “but I feel that they haven’t yet been evaluated carefully enough to obtain the maximum potential from them.

“Also, the inclusion of these microprocessors is, at present, driving the prices of intelligent instruments higher than the end user is willing to pay for the added automation.”

Microprocessors will benefit the large, hundred-thousand-dollar, computer-controlled automatic test systems, as well as small calculator-controlled instrumentation setups.

“Two trends will have a profound impact on the large automatic test systems,” says James McCabe, product line manager of general-purpose automatic test systems for Hewlett-Packard, Loveland, CO.

“The first trend is the incorporation of intelligence into instrumentation with microproces-





Automatic measurement and storage of resistance values for telephone-connector contacts is made with this Fluidyne system. A Wang WCS/20 calculator with a disc file is used.

sors. These are being designed in at a fast rate, and I think that in three or four years any user of automatic test equipment will have a wide range of instruments with microprocessors in them.

"The microprocessors will not only enhance the performance of the instrument itself, but will make interfacing the instrument with the system easier for both the customers and us. Some of the logic and overhead functions that heretofore have been done in the computer in software will now be done by firmware in the processors.

"The second factor will be the widespread use of the IEEE standard bus interface. In future general-purpose automatic test systems, like our 9500 and 9510, the IEEE interface will be used extensively, and it will be timed for use with new instruments coming from Hewlett-Packard and other manufacturers.

"For large, specialized high-precision automatic calibration systems, you probably won't see enough cost reduction through use of the bus to be able to justify its use in that type of system."

John Fluke Jr., technical director of the Automated Test Div. of the John Fluke Manufacturing Co., Seattle, agrees with McCabe. He points



Testing and calibration of PC circuit boards is provided by the Wavetek 159 programmable function generator shown here, under the control of an HP 9830 calculator. The Wavetek instrument is designed with an HP-IB compatible interface.



The frequencies to which the synthesizer of the HP 3045A Spectrum Analyzer are stepped is controlled by the calculator. The spectrum bandwidth is also under program control.

out that in his company's computer-based Terminal/10 Calibration System, a common interfacing element—the 1100 A Interface Processor—contains a collection of Fluke-designed interface cards. The interface can accommodate up to 15 instruments.

"One side of all the cards looks the same to the computer," Fluke says, "so that the interfacing element can communicate with theoretically minimum overhead. On the other side of each card the uniqueness of each instrument is accommodated.

"An alternative would have been to plug the instrument interface cards directly onto the computer's I/O bus—which in this case is the PDP-11 Unibus.

"We elected not to do it that way because we preferred a single physical port onto the computer's bus for each test station. This allows us to attach multiple test stations to a single com-





Digital waveform analysis of transients with up to 500-MHz bandwidth is recorded and displayed by this Tektronix Waveform Digitizing Instrument.

puter facility. The software takes care of multiplexing the computer's capability among the various test stations."

#### Standardized software pushed

Application software for large test systems is very costly. To reduce this expense, the software for the Fluke Terminal/10 has been developed with a standardized approach, Fluke reports. The language is an enriched Basic that can be expanded from one terminal to 15-terminal configurations.

Without an organized approach like this, Fluke points out, a customer can easily spend several times the original price of the system over a period of years to develop his own application software.

"The most dramatic happening in terms of software in the automatic test equipment industry in the last five years has been standardization on the Atlas program language," according to HP's McCabe. The standardization is being pushed by the Military Service Committee, which perceives a substantial reduction in support costs and in the transportability—the programs can be universally used—of the ATE programs.

The fundamental difference between Atlas and Basic, McCabe explains, is that the Atlas language is unit-under-test oriented rather than



Calibration of dc and ac calibrators, DMMs and analog and differential voltmeters is performed by the Fluke Terminal/10, a computer-automated precision tester.

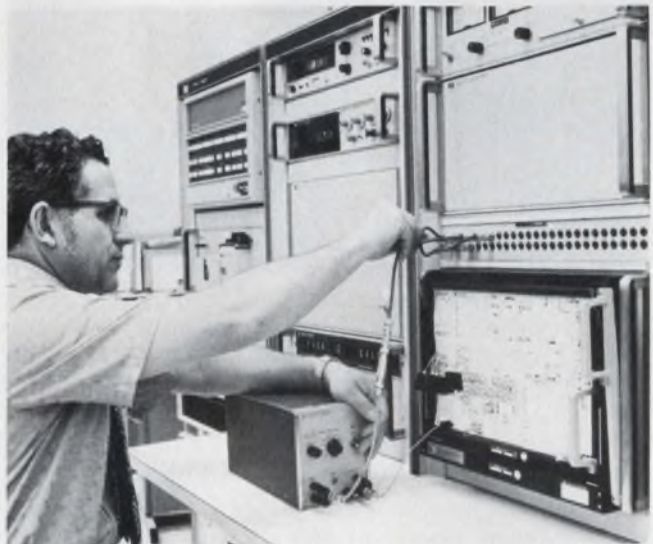

A total performance check on a line-replaceable avionics unit is being made here on the HP 9510D ATS. The system is driven by an HP 2100S computer.

automatic-test-system oriented—that is, all of the Atlas statements are referenced to the unit under test. The operator does not need the programming expertise required for Basic.

"For example," says McCabe, "using ATS Basic, you'd say, 'Call digital voltmeter,' and you'd give it some parameters that would define the voltage ranges to be used. With Atlas, the operator says, 'Measure voltage at pin 32 of the UUT.'"

"In this case the operator doesn't need to know the voltmeter is there, because the Atlas program takes care of the operation."

Because of their ease of use, the Atlas programs developed for one system can be passed on to a later refinement of that system. The programs can also be transferred from contractor to contractor with minimum cost, McCabe notes.

Although Atlas is a higher-level language than Basic, McCabe points out, it can work with Basic as the intermediate language. ■■



# Now, - an "Intelligent" Autoranging, 118 MHz Universal Counter at a Sensible Price ...



*Make us prove it...*

Send for all the  
"EVIDENCE" and  
request a demo.



## The Ballantine **AUTOMETRONIC\* 5500B**

This new universal counter/timer incorporates microprocessor control logic and ROM storage for ease of use and automatic ranging of ten measuring functions.

Simply set the unique "RESOLUTION" control knob to the number of places wanted — 5, 6, 7, or 8 (see picture). The counter displays this exact called-for resolution of the first measurement.

No cut and try. No underrange . . . No overrange . . . Just *all* the digits you asked for with the decimal point correctly positioned and the units properly indicated . . . no fuss, no wasted time, no error.

Same easy operation and autorange performance on single-shot, time interval measurements too!

With this built-in intelligence, even automatic test equipment applications (ATE) require less complex programming and fewer control lines.

Price? Only \$695 for the basic 6-digit model; a low \$760 for 8-digits.

### NOW CHECK THESE SPECS

- Autorange Frequency; dc to 118 MHz
  - Autorange Period
  - Period Average (to 1000 periods)
  - Automatic Positive or Negative Pulse Width
  - Time Interval
  - Elapsed Time
  - Total Count
  - Ratio
  - Oven-stabilized 10 MHz clock
  - DC coupled inputs
  - Options for printer outputs and remote programming
  - Bench or rack mounting
- Plus, highly visible jumbo sized, bright orange, 0.43-inch high LED's.**

\*Patent Pending

## Ballantine Laboratories, Inc.

P.O. Box 97, Boonton, New Jersey 07005,  
Phone (201) 335-0900, TWX (710) 987-8380

*Four Decades of Innovation in Electronic Instrumentation*





# OAK

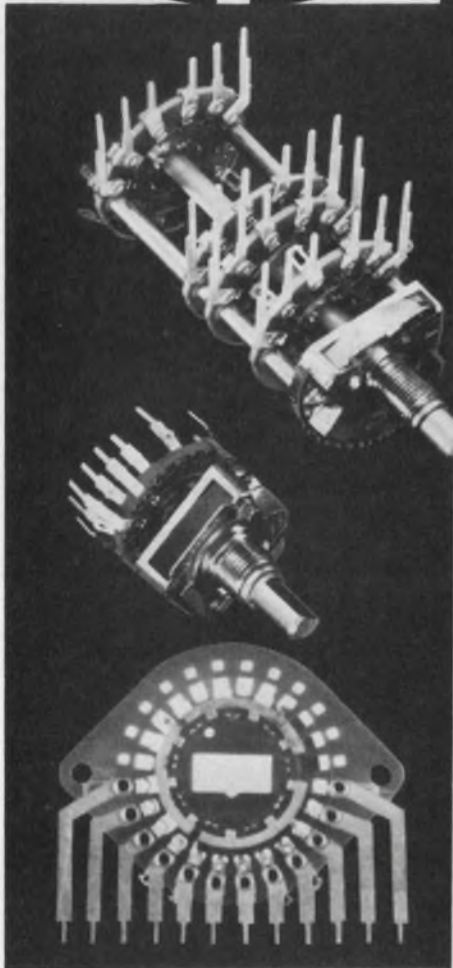

Headquarters  
for every kind of  
printed circuit  
rotary switch

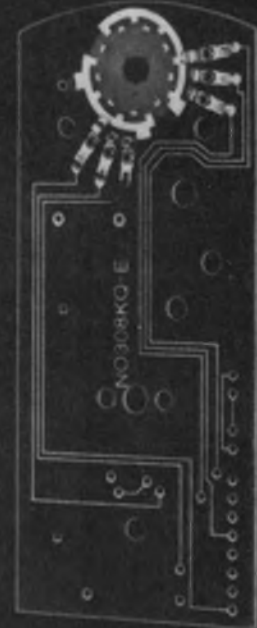
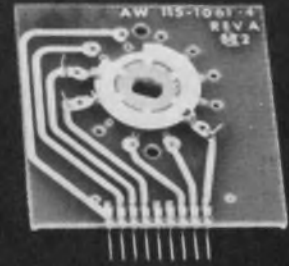
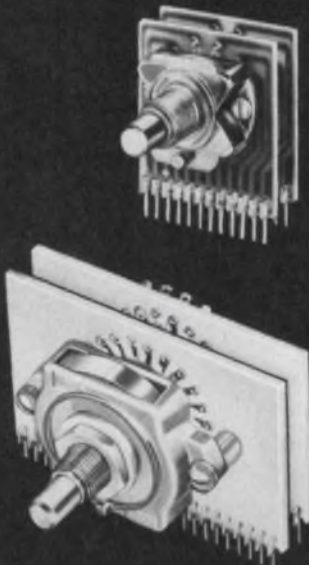

Simplify your equipment design and reduce assembly costs with this broad selection.

1. PCB Terminations can be provided on any conventional Oak rotary switch—the most extensive line in the industry—(1/2" to 2 5/16" diameter sections).

2. Standard PC Board section switches, 12 and 24 position, with PCB terminations are tooled for volume production.

3. Custom designs to meet special applications, including switching built directly into the PC board are readily supplied.

**A NEW CATALOG**

Detailing Oak PCB switch products and capabilities has just been published. Write for your free copy... or call our toll free number: 800-435-6106.

**OAK Industries Inc.**

**SWITCH DIVISION** / CRYSTAL LAKE, ILLINOIS 60014  
TELEPHONE: 815-459-5000 ■ TWX: 910-834-3353 ■ TELEX: 72-2447



**you've never seen a faster  
more accurate way of  
measuring frequency response  
from 30 Hz to 110 MHz**





# with pushbutton

100 dB displayed dynamic range on a 4 x 5 inch T.V. monitor tube (Eliminates costly storage tube replacement)

Digitally stored, scanned raster display provides

- High brightness; high definition
- Infinite persistence without blooming
- Dual image display for comparison analysis
- Electronically generated graticule, no parallax problems

Electronic Cursor

## Marconi Instruments Spectrum Analyzer Model 2370

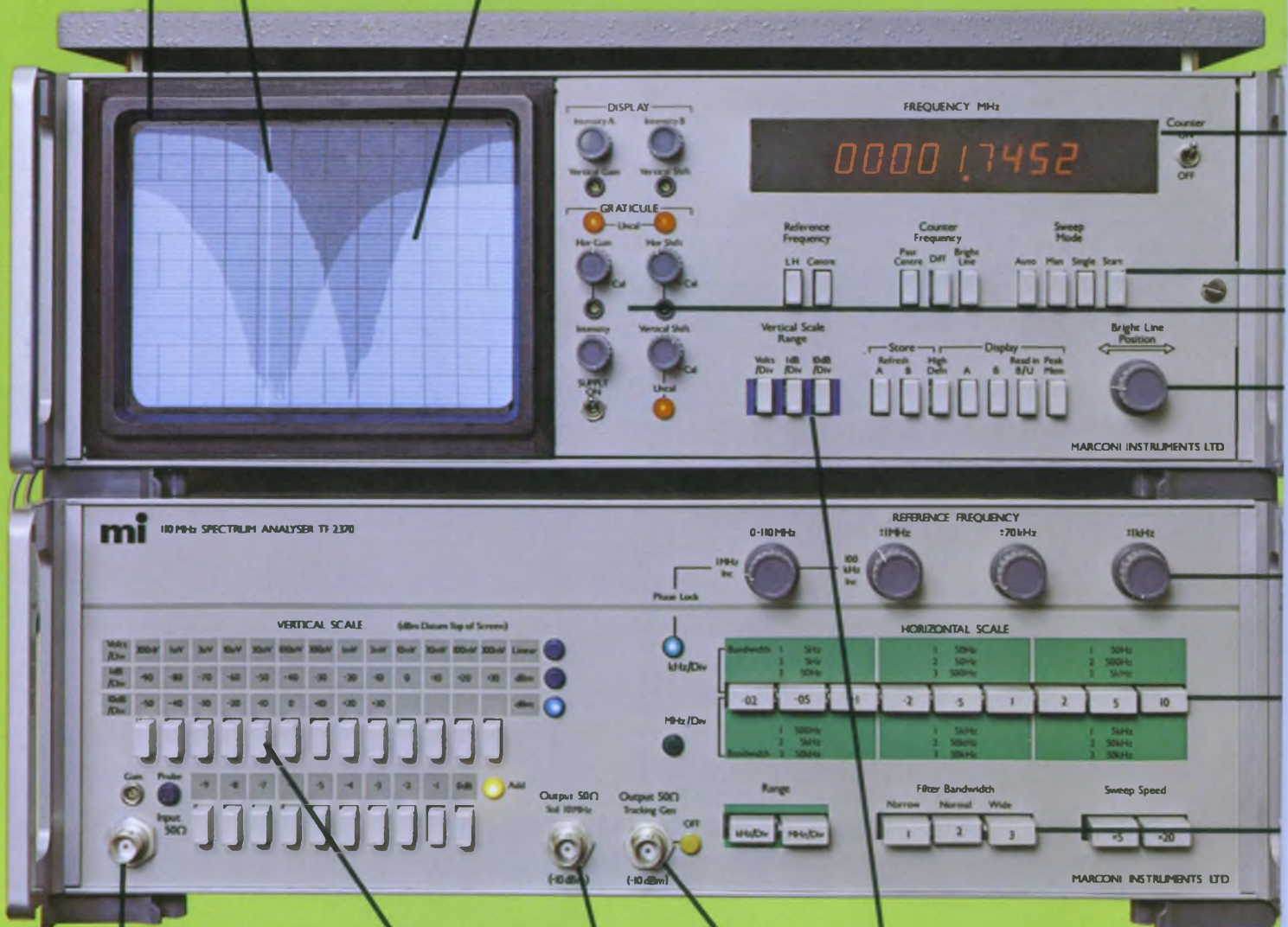

50 or 75Ω input, buffered for overload protection and 1:1.2 VSWR at all settings

Self-check and calibrator output

### RF/IF Gain Set Automatically

for optimum noise performance down to -159 dBm

Choice of linear or logarithmic vertical scale. 10 dB or 1 dB per div. for 0.1 dB resolution

Tracking generator for network analysis. Always within 2 Hz of input tuning point



# simplicity and **Automatic** features **Saving** you time and money

## **Counter Ranged Automatically to display**

Auto or manual  
sweep modes for maximum flexibility

- i) center frequency
- ii) electronic cursor position, or
- iii) difference between above

Sets electronic cursor for precise  
frequency measurement to 2 Hz

Graticule may be shifted or expanded  
for pin point alignment with display —  
enhances ease of analysis and measurement

Phase-locked tuning for precision,  
stability and ease of operation

Scan widths from 20 Hz/div. to a  
full 110 MHz display

Choice of IF Filter bandwidth from  
50 kHz to 5 Hz for maximum  
resolving power

## **Sweep Speed Optimized Automatically**

for chosen scan width and IF filter

# A Unique **mi** Tool for Lab and Production Line...



# And there's more... ...all fully described in this 12 page brochure!



- production testing of active and passive networks • des
- continuous F.M. on A.M. • filter tuning • PCM analysis • calibr
- intermodulation tests on SSB transmitters and receivers •
- networks • commissioning communication systems •
- depth • interference monitoring • spectral purity
- measure carrier intermodulation • crystal char
- measure hum sidebands • system compone
- ing • FDM baseband surveillance • television sign
- d return loss • selective level measurements on FDM base
- analysis • display mixer characteristics • Bessel null measure
- son
- n satte
- broadc
- QPSK ar
- drift a
- spectrum
- spurious
- in HF noise • filt
- on • IF design •
- ECM surveillance

**mi** **MARCONI INSTRUMENTS**  
DIVISION OF MARCONI ELECTRONICS INC.

100 STONEHURST COURT, NORTHVALE, NEW JERSEY 07647 • TELEPHONE: 201/767-7250 • TWX: 710-991-9752



# Low cost disc storage for DEC, NOVA and Interdata mini's.

Compare the Plessey disc system (PM/DS) with those furnished by the original mini supplier. With the Plessey PM/DS you achieve double the storage in half the space at a big reduction in cost.

The PM/DS is software, hardware, and media compatible with the DEC, Data General, and Interdata family of minicomputers. It consists of a disc controller (PM/DC) and a dual disc drive (PM/DD) either of which may be purchased separately. The PM/DC will accommodate disc drives made by numerous manufacturers including Diablo, Wangco, Pertec, Caelus, and Iomec. The PM/DD contains five megabytes of storage, 2.5 fixed, 2.5 removable, and may be daisy chained in your existing disc system.

The PM/DS is another step in the Plessey plan to expand—from a leading manufacturer of minicomputer add-on memory, to a complete supplier of a wide range of mini peripherals. If you use DEC, NOVA or Interdata minis you can satisfy all your requirements for disc, memory, and punched tape products with one supplier—Plessey.

Contact us today for details or a demonstration. Whatever you need, you are going to be impressed with what we can do for your minicomputer system and love what we can do for your budget.



**PLESSEY  
MICROSYSTEMS**

(714) 540-9945

INFORMATION RETRIEVAL NUMBER 35

## THE MINI EXPANDERS



# THE PLESSEY DS SERIES



# Bill Terry and Jack Lieberman of Hewlett-Packard Speak On Challenges to the Instrument Designer



**Bill Terry**

People never think of the instrument designer as someone who fights crime, pollution, inflation and even disease. But he does. In the process, he contributes to the advance of electronic technology across the board.

Consider crime. The battle against crime is helped very much by instant and reliable communications. Now the instrument designer doesn't design the communications equipment, but he creates the equipment used by the engineer who does design it. And he creates the instruments



**Jack Lieberman**

The instrument interface bus: what can we expect from it? First of all, the bus offers a general solution to a small system problem; it was not optimized for anything in particular, so it has tradeoffs.

One objective we kept in mind when we developed the bus was to solve the bench-top system problem—to provide an engineer with the test tools he needs on his bench today that he might not need tomorrow. We wanted to enable an engi-



needed to maintain and calibrate that equipment.

The users of instrumentation are growing, both in number and variety of skills. People responsible for maintaining communications equipment, for example, probably won't be engineers; they may be policemen or oil men on a platform at sea—people with little or no electronics background. The challenge? To design test gear so sophisticated that an extremely unsophisticated person can operate it.

The maintenance problem is becoming increasingly important in the developing countries, some of which find themselves in the twentieth century, suddenly faced with maintaining advanced systems such as microwave communications.

Such equipment must be maintained and calibrated by people without proper engineering experience or ready access to the factories that built the equipment. These people need easy-to-use, easy-to-understand, reliable test equipment.

We're also fighting pollution. But again, the electronic instruments we make are not very much involved in directly tackling the smog, the particles or the noise. We're standing behind those people who are making the sophisticated control systems that mix chemicals together, for example. We give them the more sophisticated and reliable equipment to test the control and sensing equipment they're designing.

**Testing, of course, is a crucial factor in improving productivity. It helps us get more stuff out the door at lower cost.**

We all have to test the product we're making to see that it meets our quality standards before we can ship it. If we can test better and faster, we've made progress.

The instrument manufacturer, incidentally, is not immune to productivity problems himself. He wants to make his own instruments more efficiently, too.

All this ties into inflation. Superior instrumentation enables us to make things better and cheaper because we can monitor and measure things on the production line more quickly, more accurately and more cheaply. We can produce things better and provide better value.

And this gets tougher and tougher because requirements are constantly changing. Every generation of products is more sophisticated than its predecessor. Just look at hearing aids, television receivers, stereo and quadraphonics, and other consumer products. They keep getting more complex.

But we can't let reliability slip. We've always

thought of cost being proportional to complexity and reliability being inversely proportional. That rule of thumb is no longer good enough. People have different expectations today. They expect things to cost more but they expect them to work much better and much more reliably.

Consumerism is on the rise. People want things to work when they get them, and for a long time. People want their microprocessor-based stove to be as reliable as their refrigerator or sewing machine.

**This business of reliability is not just a matter of people's feelings. Today it's a matter of people's lives.**

Now that instrumentation designers have moved into medical electronics, we have to worry about reliability as we've never worried before. Not only do we have the old problem of how much it costs to own the stuff and how much it costs to maintain it, but we now have a frightening obligation to make things even more reliable in the face of growing complexity.

The medical electronics business sort of snuck up on some of us. Several years ago, for many companies in this business, patient-monitoring and patient-care systems were an afterthought. They were an insignificant part of anybody's business.

But today that's an important business. There's a great deal of work being done by instrument designers to provide useful information to the physician or nurse and to provide patient care. And here, reliability and safety are critical.

We can't just extrapolate reliability the way we used to. We can't say that for every additional dollar you pay, the reliability is going to go down so much because the complexity and parts count have gone up. That's no longer acceptable because we're dealing with unforgiving problems—like people's lives.

With tough problems like these, it's no surprise that the instrument designer is constantly searching for new technologies that might help him.

**New technologies can be a trap if you don't use them wisely. You must not just jump on a bandwagon because it's new.**

You must decide how best to put new technologies to work for your customer. You must answer the question: "How can the new technology help us make a better measurement?" Charge-coupled devices, for example, can be used in a number of different ways—as memories or



as logic elements, for example. And, of course, the microprocessor is a revolutionary gadget in many ways, and there are wonderful things you can do with it. But you have to be careful that you don't just give the customer more and more data at a faster rate.

Most important is to use a new component like a microprocessor to give better or more useful measurement information. Perhaps we can give the customer information in a form he's more familiar with or we can simplify his instrument's operation for him. Perhaps we can simplify the complexity of the front panel or internally correct for errors. Perhaps we can do some computation on the measurement to give the customer a better answer or an answer that's more useful or easier to understand.

We learned this lesson when the minicomputer came out. We began using it to crank out more and more information. People were fascinated with the idea until they realized that there were more important things than an abundance of data.

We then began to use the computer to store error characteristics for various measurements in a microwave network-analyzer system. When a measurement was made, the computer was able to correct errors on a dynamic basis.

Look at another technology that's generating interest again—fiber optics. While newspapers are publicizing attempts to use these light-transmitting fibers for communications links across 3000 miles, we're looking at them to transmit signals across three inches.

Consider this. If you want to switch the beam on and off in a CRT you have to couple signals to the grid. If you're piping three-nanosecond signals to the CRT grid with copper wire, you often find these signals, too, in the horizontal amplifier—where you don't want them. If we could couple

## Who is Bill Terry?

Before becoming vice president of Hewlett-Packard and general manager of the Instrumentation Group in September, 1974, Bill Terry spent three years in HP's computer and calculator operations.

Terry joined HP as a sales engineer in 1957. Since then he has had assignments as a training supervisor and regional sales manager, and has served on the corporate marketing staff. In 1965 he moved to the Colorado Springs division as marketing manager and became general manager in 1967.

In February of 1971 he was named general manager of HP's Data Products Group, headquartered in Cupertino, CA. Included in this group are divisions producing minicomputers, hand-held and desktop calculators and other data-processing equipment and systems. Terry became a vice president of HP in December, 1971.

He graduated from the University of Santa Clara in 1955 with a BSEE.

those signals to the grid with fiber optics, we could eliminate that interference in the horizontal amplifier.

Look at another area where fiber optics may play a role. The IEEE interface bus calls for a lot of copper wire. And that means there's a problem of noise pickup, especially in an industrial environment. Will fiber optics, with its inherent noise immunity, bring us benefits here? Maybe.

In all cases, we'll have to evaluate new technology carefully. We can't just consider what's exciting intellectually. We must first consider the benefits to the customer. ■■

---

### Jack Lieberman, *continued*

need to pull two or three instruments out of a crib and make measurements with equipment from different manufacturers. We wanted these instruments to be able to talk with each other without an engineer having to invest a lot of time in a one-time, short-term measurement.

We wanted to do this without adding a great deal of system overhead. So it seemed to make sense to design an interface within the instrument itself. The engineer who wants to make such measurements doesn't want to spend his time doing a lot of systems engineering. He doesn't

want to worry about timing, for example. So we gave him something that was time independent. The bus would automatically slow itself down to the needs of the slowest unit on the line. That's one of the key features. It can do that because of its three-wire handshake—a feature that eliminates some of the magic, or guesswork, needed to put a system together.

The three-wire handshake is really simple. You have a talker and a listener. The listener says, "Hey, I'm ready for your data." The talker says, "OK, I'm ready to send." And the listener says, "All right, I've got it; now you can do something else."



So there's information on three different lines. One line is called "Ready for Data," the other, "Data Valid" and the third, "Data Received."

But we have more than just a pitcher-catcher arrangement. So if we have, say, one talker and six listeners on a line, the system will handle it. It will operate as slowly as the slowest listener.

**The interface system had to be useful at higher speeds as well as at low speeds. So the design of the electronics is such that the bus can go up to, say, a megahertz rate. But if you have an instrument that's popping along at two or three measurements a minute, the bus will wait.**

This one-megahertz rate is a tradeoff; it can, in fact, be a limitation, though, in most cases, it won't be. It's close to the direct-memory-access rate of most computers and is about as fast as you'd want information from almost any kind of instrumentation. But it does create a theoretical limitation—the one-megahertz rate precludes its use for a general-purpose data-communication bus. But the bus should be regarded as what it really is—an instrument interface bus, not a computer interface bus, or a universal interface bus.

Another limitation is that you can tie only 15 boxes on this system. Though it's hard to visualize a system with 15 prime instruments, there may be other functions within the system—timing or switching, for example—that eat up slots on the bus. Suppose, for example, you've got an ac scanner with 10 vhf contact closures. You've got some measurements on the other side of your contacts. As far as the bus is concerned, this is like having another 10 instruments.

Well, there are tricks you can pull. You can fool the system into thinking that several boxes are actually one. But this kind of expediency can cause problems. So if a guy has more than 15 boxes or if he wants to make measurements and transmit data at very high speeds, things are no longer quite so straightforward.

But let's look at the advantages. For the first time, we have something that can at least pave the way—if it is adopted as broadly as is likely—for instruments from different manufacturers to talk to each other readily.

Now there are some other important aspects here. The bus has a mechanical standard and an electrical standard. 1248 BCD was a standard at one time, too, but no-one made standard connectors. The connectors on this bus are all going to

## Who is Jack Lieberman?

When Hewlett-Packard started work on the interface bus five years ago, Jack Lieberman was manager of the Lab Section at the Loveland Instrument Division where the work was begun. The work soon became a joint effort of Loveland (with Jerry Nelson guiding most of the effort) and the Santa Clara Division (with most of the effort under Charles Trimble and Dave Ricci). In 1973 Lieberman was assigned to Santa Clara, where he now serves as manager of the division's digital test instrumentation product line and marketing manager.

He's been intimately involved with the bus since its inception and, in fact, was part of an HP task force charged with implementing the software and hardware throughout the company.

A 1957 graduate of the University of Pennsylvania with a BS in Physics, Lieberman took graduate work in electrical engineering at Stanford and in business administration at Colorado State University.

Before joining Hewlett-Packard in 1964, he served with the U.S. Army, then spent four years with RCA on the Ballistic Missile Early Warning System. Though he was headquartered in Riverton, NJ, he points out that he got to visit many of the world's pleasure spots—like Thule, Greenland.

look the same. Even when 1248 was a standard, we had things like  $-35\text{ V}$  and  $+4\text{-}1/2\text{ V}$  as the true and false levels. And we had positive true and negative true, and we had switch closures at almost any logic levels. That problem of inconsistencies in a so-called standard is gone now.

But there are things the bus won't do. As you know, each instrument does its job its own way. A voltmeter operates in its own fashion. And a counter, because it was designed by a different engineer, has a different sequence of internal operations. Even two voltmeters might work differently. With one voltmeter, for example, you might be able to issue a command that says, simply, "Make a measurement"—and the voltmeter will take care of everything. With another voltmeter you might have to tell it which range to use, then which polarity to switch to, and, finally, to make the measurement. And you have to wait between each set of instructions for things like settling time.

There's no effort made with the new bus to standardize a measurement routine. The com-



# asking about super bright LED DISCRETES?

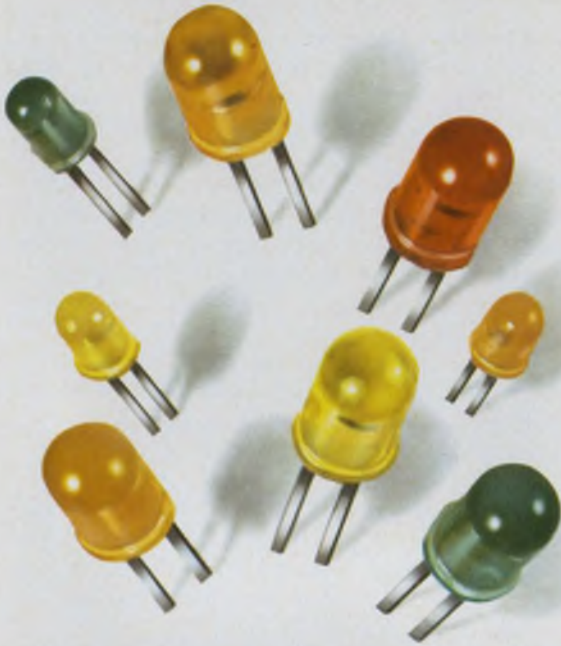

## CHICAGO MINIATURE HAS THE ANSWER!

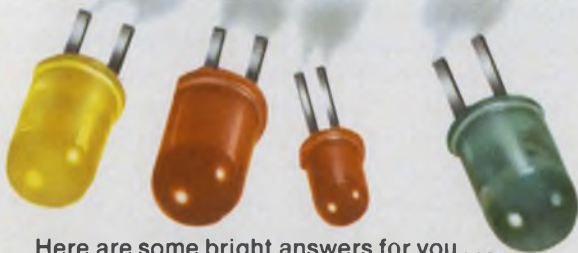

Here are some bright answers for you . . . passion red, clean green, screaming yellow, and flaming orange! In both T-1 and T-1 $\frac{3}{4}$  sizes. With *guaranteed* minimum luminous intensities, and up to 80 mcd typical intensity at rated current. Plus tin-plated leads for easier soldering. For more information, or expert design help with your applications, contact us at 4433 N. Ravenswood Avenue, Chicago, Illinois 60640.

### CHICAGO MINIATURE LAMP

SUBSIDIARY OF  
GENERAL INSTRUMENT CORPORATION   
INFORMATION RETRIEVAL NUMBER 36

mands you put on a bus, and the order in which you put them, may be different for a voltmeter and for a counter—even though you might want the same results. You may have to structure your commands differently, depending on the innards of the instruments you are directing. So one of the limitations of the bus is that you may have to provide some software. We have solved the backplane engineering problem and the electrical and mechanical standards problems, but we have not solved that software problem. Developing the software is going to be the engineer's biggest problem if he's going to use any level of control beyond basic measurements.

Now there's also a limit on cable length, which is 20 meters, about 65 feet. But you have to realize that all these numbers are arbitrary and related. Twenty meters is arbitrary and one megahertz is arbitrary and 15 boxes is arbitrary. If you know what you're doing, you can trade some of these things off. If you're not going to run 15 boxes, you could probably run longer cables or operate at higher speeds.

You can go further than 20 meters if you're willing to go a little slower, or if you don't have quite so many instruments on the line. What we're doing though is telling the user that he can get all these things at the same time, 15 instruments, 20 meters and one-megahertz data rates.

Where do we go from here? Well, it might be nice to have one large software package with, say, a whole bunch of look-up tables, one for each instrument you operate, so that your software would automatically take care of instructing each instrument. That's not likely to come about. One reason we didn't try to do that in the bus is that we felt that the technology was moving so fast, in things like read-only memories and microprocessors that might be used to instruct these instruments, that the job might be a lot simpler to solve in the future.

The bus interfaces with the control section of the instrument and it's in that section that huge strides have been made in five years and are likely in the near future. To nail the standard down on that is almost like saying, "We're satisfied with what we have and we're never going to do any better."

Where does the bus stand today? The instrument interface bus has already been adopted by the Institute of Electrical and Electronics Engineers (IEEE Std 488-1975) and by the American National Standards Institute. Balloting is currently under way for acceptance by the International Electrotechnical Commission, on whose initial work the standard is based. The returns probably won't all be counted before the end of this year. ■■



Amphenol's **MERLIN™**  
 is lighter, shorter, and  
 more reliable than most  
 other MIL-C-26482/0026482/83723  
 connectors.

That takes guts:

Merlin is 7/16" shorter than most other connectors. Installs more easily in "knuckle-buster" locations.

Bonded monoblock construction. Assures environmental reliability.

Interfacial mating seal and static peripheral shell seal. Assure system integrity.

Self-sealing rear grommets. Environmental sealing with or without rear hardware.

The seals are fluorosilicone. Merlin connectors are unaffected by fuels, oils, and cleaning fluids.

One-piece, molded polymer contact retention disc. Eliminates as many as 61 metal retention clips. Fewer parts mean greater reliability.

62% greater dielectric separation. Maximum electrical performance.

Closed-entry socket inserts and contacts. Eliminate mismatching due to bent pins.

And Merlin is intermateable, intermountable, and interchangeable with existing connectors to MIL-C-26482/0026482/83723 Series I.

40% weight savings achieved by shorter design and polymer contact retention. Think of the total weight savings.

**Merlin — a quality connector you can connect and forget.** At a competitive price. Ask for a quotation. Most sizes and styles are available, off-the-shelf, from your Amphenol Industrial Distributor. Or call or write: Wayne Zimmerman, Amphenol Connector Division, 2801 South 25th Avenue, Broadview, Illinois 60153. Phone: (312) 345-9000.



*When you can connect it  
 and forget it...that's quality.*

**AMPHENOL**

INFORMATION RETRIEVAL NUMBER 37



When it comes  
to wire processing  
we won't  
leave you stranded

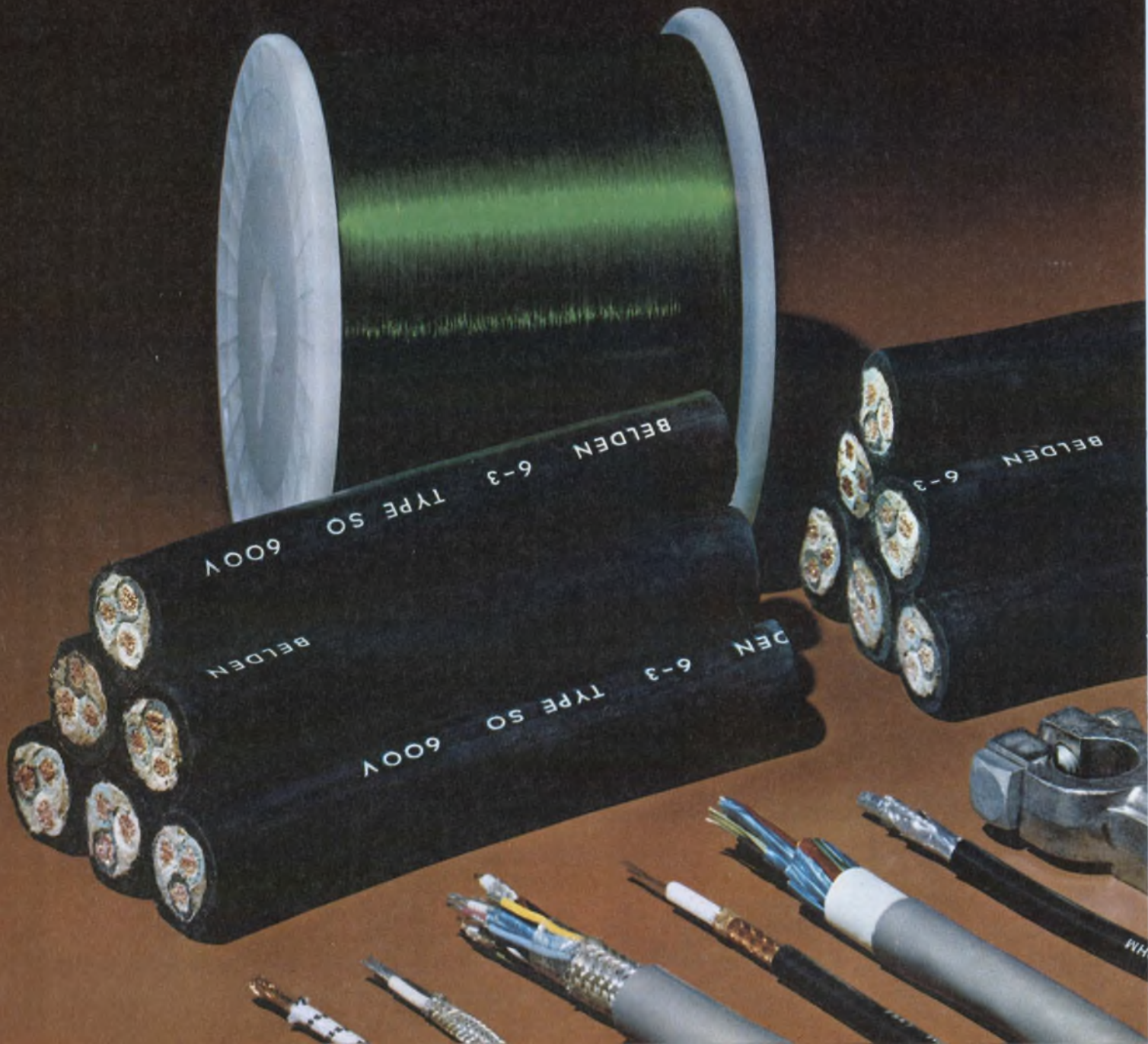



Your design is set. The components are on hand. The line is starting to roll. All of a sudden wham! That essential wire connection cannot be controlled. Your production schedule is "bottlenecked," and more importantly, your costs have skyrocketed.

While such situations are difficult to avoid completely, most wire processing problems can be foreseen if you take advantage of Belden's "total engineering view" to wire, cable, and cord applications.

Not only will it foresee a fabricating problem, for example, it can also uncover opportunities for cost reduction without hurting performance.

Consult Belden specialists when you get ready to look into the fine points of wire feeding, cutting, stripping, terminating, and

assembly. Our wire specialists and engineers will meet with your people, at your plant, to discuss a wire problem. Helping solve customer problems has always been our long suit. It still is.

We not only have the capability to provide standard techniques, we also have developed proprietary technology to anticipate your needs.

When we can't help you "get it all together" using standard procedures, we'll innovate a solution for your problem! For answers right now, phone:

(312) 887-1800, Transportation Division

(312) 986-1600, Electrical Division

(317) 966-6681, Electronic Division

Or write Belden Corporation, 2000 South Batavia Ave., Geneva, Illinois 60134.

**BELDEN** 

*...new ideas for moving electrical energy*

INFORMATION RETRIEVAL NUMBER 234

H-5-4A







**One burning test issue today:** How to test a microprocessor. Here the Tektronix 3260 generates and edits test patterns on the Intel 8080. Sector cards are the key to pin control.

## How to test those LSI chips: Watch out for 'ifs' and 'buts'

**L**arge-scale-IC testing today is no less complex than the LSI circuits themselves. Until recently, a test engineer had his hands full just with memories or custom LSI. Now, along come microprocessors ( $\mu P$ ), microcomputers ( $\mu C$ ), UARTs (universal, asynchronous receiver-transmitter), FPLAs (field-programmable logic array), I<sup>2</sup>L (integrated-injection logic), and you can't blame the engineer if he throws up his hands in dismay.

How to test effectively has always been a controversial area—one in which arguments become more heated as IC complexity grows. With the  $\mu P$  representing the highest level of commercial LSI available today, how to test it looms as a red-hot subject in engineering test circles.

While the solutions are cloudy, the basic problems are clear: How do you adequately test a monolithic chip with 5000 internal devices and only 18 to 40 external pins? How do you handle

a chip when it is characterized by a dual (or even multiple) bus structure, can do internal arithmetic and has response times that can vary all over the place? Initialization and synchronization alone, not to mention the time needed to run through thousands of test sequences, are enough to make you stay up late.

Compounding the problem is the lack of pin standardization, the many possible variations in  $\mu P$  internal structuring and the multiplicity of IC processes—PMOS, NMOS, I<sup>2</sup>L and others. And, of course, you may also have to test other LSI—with entirely different characteristics—as well as various logic families and arrangements: ECL, TTL, positive logic, negative logic and (horror of horrors) mixed families, polarities and processes. Even combined analog and digital ICs are not unheard of today—CCDs, for one—and you can expect more of them.

### The testing crossroad

To arrive at satisfactory solutions in the form of test hardware, the test engineer must ask him-



self: Should I look upon the LSI chip as a semiconductor component or should I treat it as a system? Which view will steer me to rigorous, economical testing?

Of course, the LSI manufacturer has little choice. He has to characterize his device and continually test to keep a weather eye on his process. This means he must work at the lowest level, while the chip is still one of hundreds on a wafer, and he must run a battery of functional and parametric tests. But the vendor doesn't stop there. He also tests his product in DIP form and as part of a system on a PC card with memory, I/O, peripherals and other equipment.

The LSI user, however, must decide whether to do the following: Run parametric tests? dynamic tests? go/no-go functional tests? worst-case or problem-solving instructions on a system basis? some of each? Or should he try to test all internal "components" individually? Another toughie: Should he buy a dedicated or general-purpose machine? The answers aren't pat, even for high-volume users.

Only after these and other questions are satisfied, however, should a user step into the LSI-tester market. The major question then is: Which commercial equipment—if any—can do the job?

The designation "LSI tester" is meaningless in itself. Many pieces of test gear—from small, benchtop units, to card testers, to large-scale, computerized machines—claim the designation. But can they run the tests you want on your set of circuits? Memories and calculator chips are LSI, and there are dedicated machines that do nothing but test such functions. These machines, though limited, can be called LSI testers, too.

But since the term "LSI" includes a broad variety of functions and processes, the implica-

tion exists that any gear called an LSI tester must be general-purpose—that is, able to test any LSI circuit. Otherwise the test gear should be labeled strictly for the function, or in some cases the functions it can handle.

Whether to go to a series of less expensive dedicated testers or a few semidedicated units or to opt for an expensive, computer-controlled, general-purpose test system has always been a problem. The ultimate goal, of course, is to boost throughput and minimize the cost of testing without degrading test quality. That is the key to profits.

### Which direction boosts profits?

Testers targeted especially for memories or such circuits as op amps, calculator chips, digital watches and the like, are readily available from vendors like Adar, Alma, Macrodata, Micro Control, Siemens/Computest, Tektronix and Tera-dyne. But LSI testers dedicated to  $\mu$ Ps, UARTs, PIAs, CCDs, FPLAs or other highly complex, job-oriented (rather than single-function) ICs are not yet widely available.

Whether such units will begin to appear soon remains to be seen. But random LSI needs new test approaches—at least in the opinion of some semiconductor vendors—and they have challenged the tester manufacturers to come up with an inexpensive unit to fulfill the need.

In a paper given at Wescon in September, Dan Izumi, director of  $\mu$ P engineering for National Semiconductor, threw down the gauntlet: "A small, dedicated or semidedicated tester is a must to support LSI products. The challenge is to produce such a test system—at a cost of approximately \$20,000 to \$40,000—and thereby open up



Using a microprogrammable multiprocessor approach, the Macrodata 501 performs functional and dc/ac para-

metric tests on all bipolar and MOS LSI devices. Test rates can go to 10 MHz. Pin electronics is universal.



widespread incoming inspection of LSI devices by end users."

Picking up the glove, Alyn Holt, director of marketing for Siemens/Computest, Cherry Hill, NJ, a noted supplier of memory testers, sees dedicated ATE as the solution to LSI test problems, as long as there is significant demand for each type of tester.

"The easiest LSI tester to define and design," Holt says, "is a million-dollar, do-everything machine that can literally test any LSI device imaginable. The toughest LSI tester to design is a \$15,000 or \$20,000 dedicated-application machine, such as a memory or a  $\mu$ P tester."

He sums up the case for dedication: Such machines are generally faster in throughput and more reliable because of their inherent simplicity. For a given cost, dedicated machines can be designed to do a much more rigorous job of testing than a general-purpose tester can do.

In a candid moment, Holt admitted that though Computest and others offer a memory tester as a  $\mu$ P tester, the unit really doesn't do an adequate job. One devoted to  $\mu$ Ps is needed, and Holt hints that such a unit is forthcoming.

Another proponent of dedication—and one of the largest vendors of ATE—is Teradyne Inc. in Boston. Teradyne's wide line of ATE includes many different systems that test everything from memories to d/a converters to linear circuits. Though the company recently demonstrated a unit that it called a  $\mu$ P tester, the equipment is not now available, having been called back apparently for reevaluation. It's interesting to observe that Teradyne at one time was noted for its large-scale, general-purpose test systems.

### Big machines, big price

Despite Teradyne's movement away from such systems, the manufacturers of general-purpose testers—among them Datatron, E-H Research, Fairchild, Macrodata and Tektronix—build a solid case for their equipment, and they continue to announce new products. And even those who mostly market dedicated units offer testers that stand somewhere in-between. Computest's 203, for instance, is a memory tester that sells for between \$100,000 and \$200,000 and has many features found in large-scale machines.

With general-purpose units, the uppermost question is: Can they really test anything, and how well? Dave McGreenery, manager of product marketing for Macrodata, points to the need for a generalized solution to all digital testing and sees this approach as a major trend today. He says: "Configure the tester for the job, rather than the device, and it won't become obsolete. Such a machine can share many jobs at once—wafer probing, final package testing, etc.—and



Teradyne's J325 digital IC tester accepts up to four test stations. Devices handled include ECL, TTL, DTL, CMOS and static MOS. Data logging, summary reports and Schmo plots are part of the unit's capabilities.

can also handle LSI ICs that are job oriented."

McGreenery offers Macrodata's MD501 as a tester that can handle all devices, including hard-to-test CCDs and  $\mu$ Ps. "It took just one week," he claims, "to write and develop the test program for the 8008  $\mu$ P with Macrodata's existing system concept."

But note that Macrodata also sells dedicated units. McGreenery confirms that the company's tester line is designed so that it can be configured to anything from a dedicated bench-topper to a large-scale, multi-user, multi-usage system, such as the 501.

Other manufacturers see flexibility as a necessary feature in LSI test equipment. Chuck Wiley, product manager for LSI testers at Tektronix, says that a potential LSI-tester purchaser should look into two areas of growth: ability to add instrumentation and the capabilities of the software. He says that "hardware is no longer the limitation in LSI testing—it's the software that must be adequate today."

### The software headache

Indeed the cost of writing and debugging test programs is probably the single largest expense in computerized automated LSI testing. Consequently all vendors of computer-based testers stress "easy-to-use" software. The Tektronix S-3260, for instance, offers Tektest III, an English-like programming language that is similar in syntax to Fortran or Basic.

Flexible software is partly responsible for the boast that the 3260 can test practically any tech-



nology or device: all the MOS variations, ECL, Schottky TTL,  $\mu$ Ps, UARTs, RAMs, and so on.

Another general-purpose test system that is said to test all current LSI devices, including  $\mu$ Ps, is the 4500 Series from E-H Research. Though the 4500 is several years old, E-H states that the system's expandable modularity—in software and hardware—enables it to run practically any kind of test.

Probably the machine that most exemplifies the large-scale approach is the Sentry 600 from Fairchild Systems Technology. A central processor oversees a series of specialized test stations plus a test-station controller. Tests include functional and dc parametric on both MOS and bipolar devices, discrete or in modular form. And the unit can perform data logging and analysis.

With all the flexibility and test power provided by equipment today, there still remains a body of opinion, though, that says that the advances in ATE aren't dramatic enough.

In a paper presented at IEEE Intercon last April, Roy H. Nesson, staff engineer at Hughes Aircraft, Culver City, argued that "the logarithmic increase in LSI complexity requires greater ingenuity in test system design than simple evolution can provide. In spite of the history of system development, the universal logic tester does not exist today, and the evolution of true LSI continues to require constant ATE redesign."

In speaking about  $\mu$ P testing, Nesson speculated about what might be needed: "Test systems for the future will have to operate interactively with the device under test and provide bursts of variable-length information with each time step of the device. The tester will have to store in-process data from the device to assist arithmetic functions, and provide extensive processing of output data to verify both sequence and response. Since the number of test sequence steps is very large, high test rates and some algorithmic capabilities are mandatory."

### The microprocessor: newest test problem

Nesson's call for new approaches has been heard. About two months ago, Fairchild Systems Technology took the wraps off the company's Sentry II—a tester aimed at hard-to-test random devices as well as organized arrays. As far as testing  $\mu$ Ps goes, Jim Campbell, staff engineer at Fairchild, says that though the 600 can test any  $\mu$ P around today, the II is even better.

Built around what Fairchild calls a sequence processor, the II can compress data, provide peculiar timing for free-running  $\mu$ Ps and resynchronize itself to the device under test. And microcode store allows conditional branching, subroutine calls, clock bursts and the like. One



For circuit boards containing  $\mu$ Ps, the System 390, from Instrumentation Engineering, offers a word generator/receiver that produces large pattern arrays.

of the II's strong suits: The user can write his test programs in the  $\mu$ P's own language and in the actual sequence that the  $\mu$ P will see in its working system.

Will the Sentry II handle all LSI? Campbell answers: "Flexible control of local memory gives the II the ability to handle devices not even thought of yet."

Campbell's optimistic claim is hard to dispute, for a simple reason. Nobody really knows how to fully test a  $\mu$ P or what its worst-case test pattern is. If you can't pin down a device's optimum test pattern or patterns, it follows that you can't totally evaluate the equipment needed to generate the patterns.

The  $\mu$ P test situation today is sketched by Earl Patterson, tester product manager for Datatron, a company known for its Hustler 45 general-purpose LSI tester and other units.

Patterson says: "The microprocessor thing is still very much up in the air. Everyone is fairly bogged down right now on what the ultimate pattern will be—like the RAM situation previously. What may eventually happen is that the semiconductor vendor will supply the test pattern to the user and say, 'This is the way to test our  $\mu$ P'—like Motorola does now with the 6800. The  $\mu$ P vendor will have to tie down the functional tests, just as he does the parametrics now, instead of leaving it up to each customer's judgement."

As for dedicated  $\mu$ P testers, Patterson offers this opinion: "Small LSI users will probably build their own test fixture or, more likely, go to a testing lab. If you're using limited numbers of  $\mu$ Ps, this makes more sense than looking for an inexpensive benchtop unit or a \$100,000 machine to do the job. I can't see a \$10,000 tester paying its own way—it's not going to do the job, at least not in the near future. Perhaps a \$20,000 or \$30,000 tester could do it."

Patterson's observations preceded by just a few weeks the 1975 Semiconductor Test Sym-



posium at which just such a tester was described, dedicated to incoming inspection of the Intel 8080. Held last month, the symposium was, predictably, heavily weighted toward  $\mu$ P and LSI testing.

Though no consensus was reached at the symposium (the dust won't settle for some time), it's clear that at least certain capabilities are needed to approach the LSI test problem with any hope of success. Which equipment offers these capabilities probably depends on when the tester was introduced. In any case, few testers combine all the qualifications discussed at the symposium. In general, these qualifications include:

- High test rates (0.5 to 10 or 20 MHz).
- Parallel bus operation.
- Bidirectional I/O pins.
- Flexible software and hardware, which provide for long test sequences with reasonable memory size.
- Ability to compare a known good device with the one under test.
- Diagnostic emulation or simulation.
- Special drivers, receivers, bias supplies and parametric capabilities (ac and dc) targeted for CMOS LSI testing.

These are just a sprinkling, of course, and many other performance features may be necessary, depending on your test viewpoint and a variety of testing subtleties. For example, can you adequately test a  $\mu$ P by consideration of the device as a collection of NAND-gate equivalents? Or must you directly check the  $\mu$ P's functions? The road to the necessary hardware and software is paved by the answers to these and many other questions.

To check a  $\mu$ P or any other LSI circuit functionally, you may decide that the best approach is to test systems or subsystems—that is, at the PC-board level. In this case, you may wonder: Is a PC-board or digital logic tester what I need?

Indeed many board testers claim to handle LSI. And this seems a reasonable claim. After all, if a board tester can handle a board with, say, 60 MSI ICs, shouldn't it be able to test a single LSI IC with equivalent functional complexity? A closer look reveals that most card testers aren't designed to do so.

As Hughes Aircraft's Nesson points out: "The problems inherent in device testing do not transfer directly into the higher levels of card assemblies and modules which incorporate these devices." The major reasons, Nesson says, are lack of accessibility to internal device points, the sheer volume of test steps needed and the large number of I/O pins found in the higher levels of packaging, which preclude the needed high test rates.

Some board tester vendors acknowledge that their products weren't intended to handle boards



Hot off the assembly line is the Siemens/Computest 203, a semiconductor memory test system that runs various tests at a blazing 20-MHz rate.

with, say, 50 MSI ICs plus an LSI device. Their advice is to unplug the device, then test the board. (Remember most board testers are oriented toward standard logic families and are primarily intended to weed out bad boards. To this end, some sophisticated equipment offers various computer-assisted fault-isolation and simulation schemes.)

But with random logic,  $\mu$ Ps and other LSI devices becoming increasingly important, you can bet that the board-tester vendors—which include Computer Automation, Data Test, Fluke/Trendar, General Radio, Instrumentation Engineering, Hughes and PRD—aren't sleeping.

Instrumentation Engineering, for one, has already announced a version of its System 390 aimed at  $\mu$ Ps and other LSI. The unit, called a digital word generator/receiver (DWG/R), allows a user to strobe in large arrays of bit patterns at high frequencies and to interrogate the resulting bit patterns at the same rates.

Whether the LSI test problem will ever be fully solved is debatable as long as the circuits keep getting more and more complex. One thing is certain: More and more, the LSI-device designer must assume the responsibility for built-in test circuitry and for generating the necessary test sequences. Otherwise adequate testing may well prove impossible in 1980. ■■





## **When it comes to flexibility, the model 40 gives you a lot of ways to go.**

When we designed the model 40 system, we included a long list of features and options to give it the flexibility for practically any data transmission requirement. Whatever your industry or application.

First, there's a variety of speeds ranging from 110 to 4800 bps, along with a choice of interfaces, half/full duplex operation and character and batch mode transmission. The model 40 system also has a number of on-line controls, even/odd parity generation and a destructive scrolling feature that permits continuous bottom line reception with no loss of data until memory overflow.

Flexibility features don't stop there, either. There's an expandable memory with line and page scrolling, protected format with variable field transmission, plus many other features and options to select from. And since the entire system is modular, it can be custom-tailored to fit your needs.

These are just some of the many reasons why the model 40 has the flexibility to fit just about any system. But the model 40's strongest suit is economy. Because on a cost/performance basis, nothing even comes close. And delivery is a lot sooner than expected.

For complete information, please contact our Sales Headquarters at: **TELETYPE**  
5555 Touhy Ave., Skokie, Ill. 60076. Or call Terminal Central at: (312) 982-2000. 

Teletype is a trademark and service mark registered in the United States Patent and Trademark Office.

**The Teletype model 40 system.  
Nothing even comes close.**



## Block 1.

Simultaneously-molded stationary contact and coil block assures excellent insulation and high stability, even after long use.

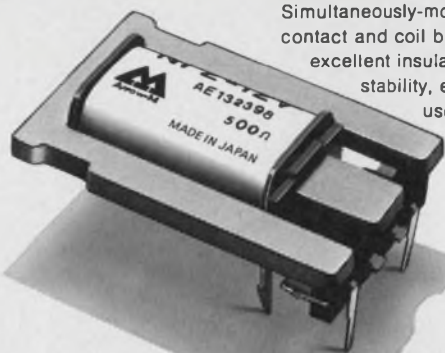

## Block 2.

Armature, adjusting plate and hinge spring are block-built and contribute to maintain long life.

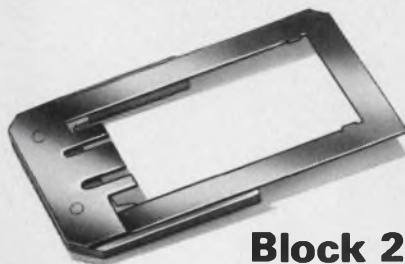

## Block 3.

From stamping of springs, through simultaneous-molding and welding process of contacts, this block is systematically manufactured. It prevents parts from loosening even under high-temperature conditions.

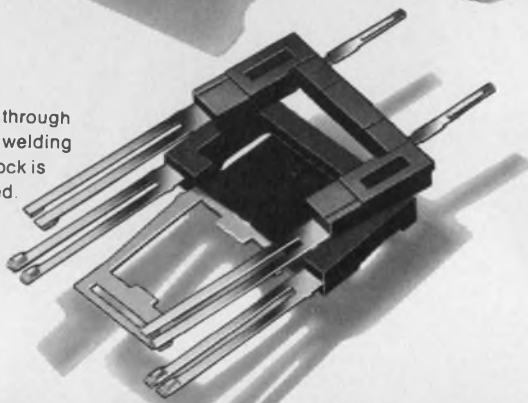

# Arrow-M's New Flatpack Relay. Block-Built For Total Reliability.

Arrow-M's block-building system eliminates the hand-assembly operations which cause relay failure. Arrow-M's NF relay has three blocks and a cover. Each block of parts forms a monolithic unit.

Each is automatically or semi-automatically assembled, without screws, to the exact specifications of hundreds of thousands of preceding blocks.

Furthermore, based upon over 50 years of experience in manufacturing techniques, our production system, which includes product design, production process design, as well

as fabrication of production equipment, is completely and systematically utilized in our factories to insure top-level reliability of Arrow-M relays.

But reliability is only part of NF's superiority.

These relays operate on half the power of similar flatpacks and at IC signal levels.

They're fast, with negligible bounce and chatter.

NF relays switch 2 amps, come in 2 and 4 Form C types, both in standard dust covers and plastic hermetically-sealed versions.

### NF relay production process

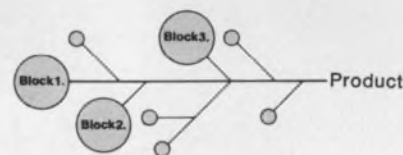

### Conventional production process

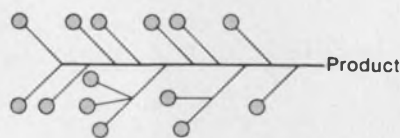

## Relays for advanced technology



# Arrow-M



Convince yourself. Send for comprehensive data. Or call your nearest Arrow-M representative.

Arrow-M Corporation, 250 Sheffield Street, Mountainside, N.J. 07092. Phone: 201-232-4260. A member of the Matsushita Group.



# The Value Added 8600A. Fluke has improved the specs and lowered the price.

Now \$549\* and with a dc accuracy spec of 0.02% for *six months*, the Fluke 8600A 4½ digit DMM gives you *high* value and *low* cost of ownership.

Here's a DMM with the widest dynamic range of measurements for its class. And you can go a long, long time without recalibration.

Add it up. Here's what the 8600A gives you. Guaranteed six month accuracy specs at 15°C to 35°C with an extremely low temperature coefficient. Five ranges

each of ac and dc volts to 1200 V with 0.02% dc and 0.2% ac accuracy. Five ranges each of ac and dc current to 2A with 0.1% dc and 0.3% ac accuracy. Six ranges of resistance to 20 megohms with 0.1% accuracy. AC bandwidth to 100 kHz.

Autoranging through all ranges plus individual range selection manually. Continuous overload specified for all ranges/functions with overload indication.

10,000 hour demonstrated MTBF. Environmental capability

specified and defined. Automatic zeroing. A full line of accessories including 40 kV high voltage probe, 500 MHz RF probe and 600A ac current probe.

A rechargeable battery option, completely built-in and self-contained. Low 7 watt power consumption for reliability.

All this, and more, for only \$549\*. Call your nearest Fluke sales engineer for details, or in the continental U.S., dial our toll-free hotline, **800-426-0361**.

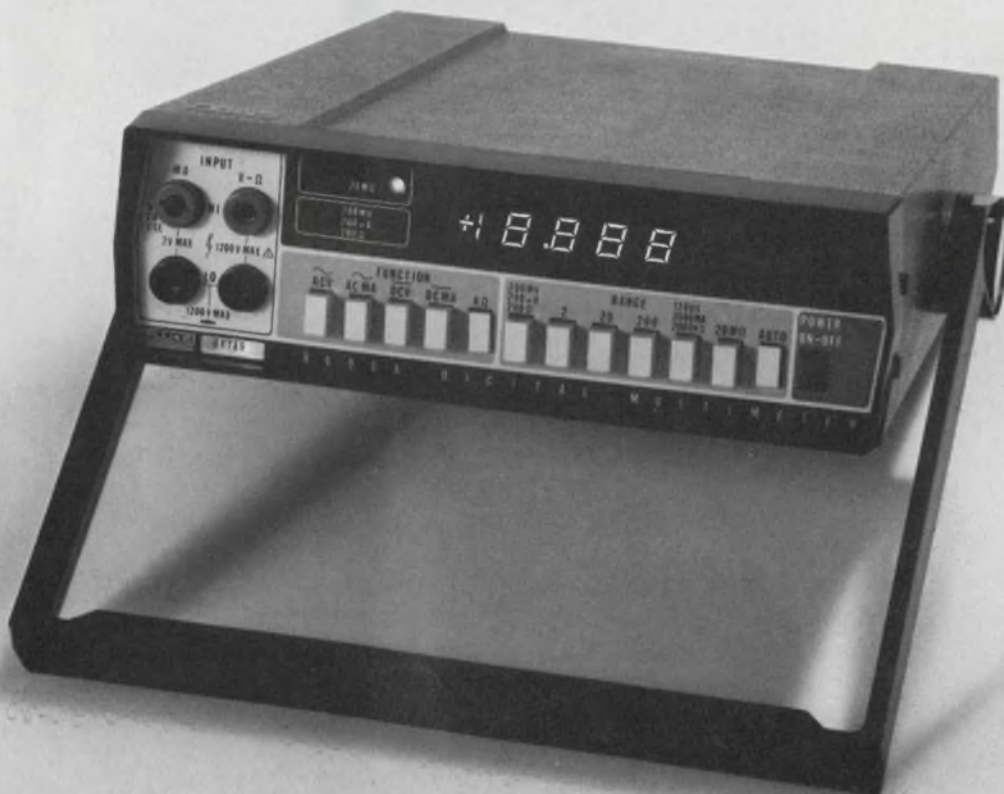

John Fluke Mfg. Co., Inc.  
P.O. Box 43210  
Mountlake Terrace, WA 98043

For demo, circle 271  
For literature only, circle 272



\*U.S. price only



# Q.

## Is there a recorder just for spectrum analyzers?

# A.

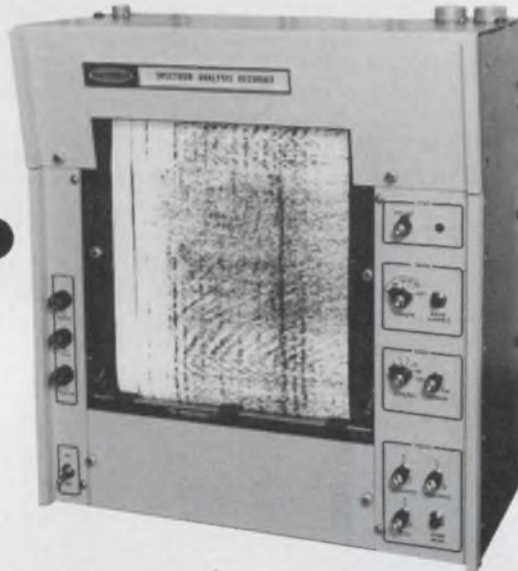

The new 19" rack-mounting SPECTRUM ANALYSIS RECORDER from Raytheon. It's the first dry paper line scanning recorder specifically developed for direct plug-in operation with commercially available spectrum analyzers.

Any new or existing spectrum analyzer equipped with the SAR-097 will have a lot more going for it. Like infinitely variable 100:1 speed range - 5 sec/scan to 50 millisc/scan . . . stylus position encoder . . . automatic recorder synchronization . . . computer/analyzer compatibility . . . high resolution and dynamic range . . . all-electronic drive. And more.

If you design and build - or buy and use - spectrum analyzers, you don't have to settle for multi-purpose recorders any more. The SAR-097 is here. For full details write the Marketing Manager, Raytheon Company, Ocean Systems Center, Portsmouth, R.I. 02871. (401) 847-8000.





The finest  
function generator  
money can buy.



The finest  
function generator  
\$595 can buy.



## The same quality at either price.

Interstate's SERIES 70 and SERIES 30 are both high-quality, highly capable function generators. Providing maximum versatility for general bench applications and more critical laboratory requirements, each instrument line presents the user a full spectrum of function generator features, with top-of-the-line models offering variable width pulse and linear/logarithmic sweep.

The difference in price reflects different levels of performance. The two lines are designed for you to select the instrument with the particular operating characteristics and specifications you want — and no more. You only pay for what you need.

**F77 at \$1095\*** is the ultimate blend of three instruments — function generator, sweep generator and true pulse generator. Top-performance characteristics include: 20 microhertz to 20 megahertz range; 15 volts p-p into high impedance loads; six output waveforms and seven operating modes; variable offset, variable start-stop and waveform inversion. Sweep characteristics: log linear output; 1000:1 sweep width; sweep up and sweep down, sweep burst, and sweep-and-hold modes. Pulse characteristics: 15 ns rise/fall times, pulse width setability from 30 ns, and both standard pulse and "constant duty cycle" pulse operation. PLUS these special features: Interstate's direct-reading sweep limit indicator and totally calibrated frequency tuning, "oscilloscope-style" triggering, frequency analog output, and operation as an auxiliary power amplifier.

\* U.S. prices; other SERIES 70 models available from \$695 to \$945.

**F34 at \$595\*** gives you 0.03 Hz to 3 MHz frequency range; 10 volt p-p into 50 ohms; clean sine, square, triangle, sweep, adjustable d-c, and variable width pulse waveforms, and trigger, gate, tone burst and sweep operating modes. PLUS all these human-engineering features: a well-organized front panel with functional, full-size controls; a ruggedized metal cabinet and the same Interstate sweep limit indicator and totally calibrated frequency tuning. (Other SERIES 30 generators include AM-FM features and higher amplitude levels.)

\* U.S. prices; other SERIES 30 models available from \$395 to \$745.

**INTERSTATE**  
**ELECTRONICS CORPORATION**  
Subsidiary of **A-T-O Inc.**



# At Telonic, we do 5 things well.

## **SWEEP. DISPLAY. FILTER. ATTENUATE.**

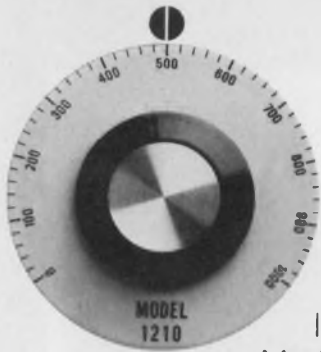

For example, Telonic *sweep generators* are used in well over 5,000 labs and production lines internationally. With a 20-year history of specialization in sweeper design, we invite any comparison with our newest solid-state 1200-Series. They offer you a broad choice of frequency ranges to 1.5 GHz, selectable band widths, precise frequency marking, and real-time dependability.

To make your test results even more visible, we also provide large-screen X-Y *display oscilloscopes* in single and dual trace versions, Models 121 and 122. Their sensitivity and stability make them well suited for the design bench or the production area. And for the OEM who wishes to incorporate a display in his own system, we even supply a naked display (Model 4060) – no case – just a basic chassis, interfaced to your specifications.

In the *filter* business, our customers in instrumentation, radar, E.W. and communications make up the top 100 of the electronics industry. The product line extends from low pass and band pass tubulars to cavities, interdigitals, combline, subminiature, and tunables, up to 12 GHz in some models. In addition to fine performance, these filters offer the user two other significant advantages – low price and fast delivery.

Our *attenuators* are another first choice by major instrument manufacturers. We use thick film substrates for precision and extra long life. We keep them small to minimize panel space. We design them for handling high power to simplify circuitry. We even modify them to meet your requirements.

And that 5th thing we do well is to *back up our products* – like our 5-year warranty on filters. With over 36 offices nationally, and 35 distributors overseas, Telonic has a man close at hand to assist you with application know-how, replacement parts, and service.

The information number below will provide a short form catalog, but if you need information on specific products right now, phone or write our Marketing Department directly.



**TelonicAltair** 

2825 Laguna Canyon Rd. • Box 277, Laguna Beach, California 92652 • Tel: 714 494-9401 • TWX: 910 596-1320 • Cable TELENG

**Telonic – the No. 1 name when you want to sweep, display, filter or attenuate.**

INFORMATION RETRIEVAL NUMBER 214



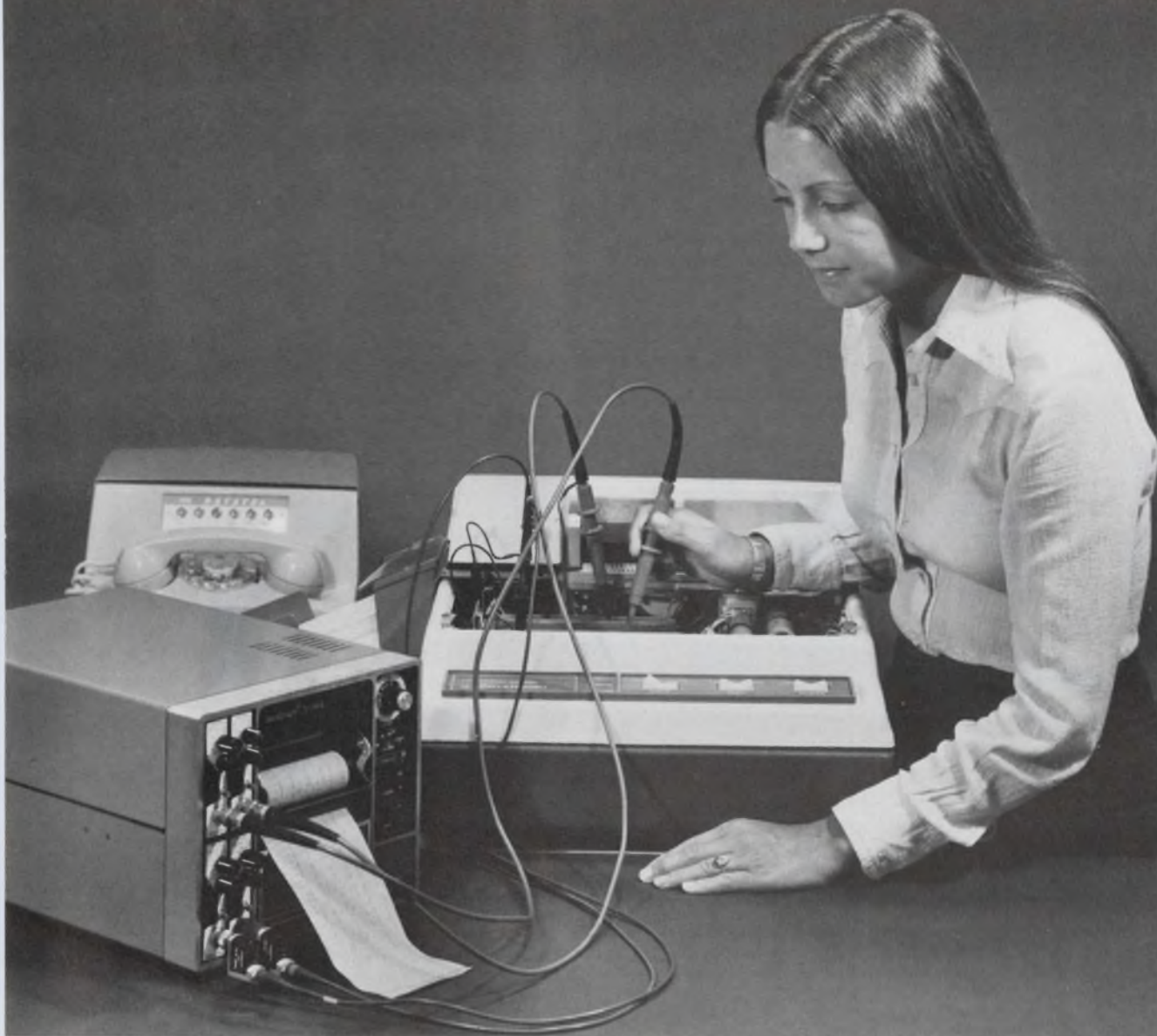

# Have a Closer Look

Bell & Howell's Datagraph® Model 5-144 recording oscillograph. Probably the most convenient test instrument you'll ever use.

In addition to the on-off switch, only five controls are needed to operate the Datagraph® 5-144.

Human engineered for efficiency, the 5-144 is as easy-to-use as an oscilloscope, and provides a permanent record up to 200 feet long for later study.

The Model 5-144 contains all of its own necessary electronics. Plug-in amplifiers eliminate the need for special cables or calculating complicated damping networks. Just plug in your scope probes and record your data.

Its four channels permit simultaneous examination of several data signals, and

with a frequency response greater than 10,000 Hz, the 5-144 is capable of recording both analog and digital data with equal ease. Complete systems from \$2570.00.

Bell & Howell's Datagraph® Model 5-144 recording oscillograph — backed by more than 35 years of experience in the development of quality, precision instrumentation.

## CEC DIVISION

360 Sierra Madre Villa, Pasadena, Calif. 91109 (213) 796-9381



# BELL & HOWELL

(In Canada: 125 Norfinch Drive, Downsview, Ontario M3M 9B5)

CEC is a registered trademark of Bell & Howell. © Bell & Howell 1975



# An incoming-inspection station for **PASSIVE COMPONENTS** need not occupy a lot of space.



## This is all you need.

It's the GR 1685 Digital Impedance Meter, which is loaded with convenient operating features. On each range it automatically measures series capacitance and inductance at either 120 Hz or 1 kHz and *measures resistance at dc*. A built-in digital limit comparator (optional) enables rapid GO/NO-GO sorting. The basic accuracy is 0.1% for dc and 1-kHz measurements and 0.5% for 120-Hz measurements. Measurement ranges are .01 pF to 20,000  $\mu$ F for capacitance, .01  $\mu$ H to 2000 H for inductance, and 0.1 m $\Omega$  to 20 M $\Omega$  for resistance.

Other benefits include:

- For ac measurements, D and Q limits automatically indicated (adjust dial to determine values).
- Measurement speed of four measurements per second.
- Lighted arrows indicate direction to turn range and D/Q limit dials.
- Parallel data output available for external equipment such as additional limit comparators, handlers, data printers, and card punches.
- Test fixture (optional) has PASS/FAIL lights.

The 1685 is equally convenient to use whether you screen many of the same type of components or measure the values of several different components.

If you're looking for even greater performance, look into the popular GR 1683 Automatic RLC Bridge. Here's what it does:

- Automatically measures R, L, C, and D.
- Programmable (option)
- Automatically changes range.
- Measures C and L at either 120 Hz or 1 kHz.
- Large digital readouts of all measurements.
- 0.1% basic accuracy.
- C range is 0.01 pF to 0.2 F; L range, 0.1 nH to 2000 H; R range; 1  $\mu$  $\Omega$  to 2 M $\Omega$ .
- Fast — up to 20 measurements per second.



For complete information on both instruments, write for our new Catalog of Impedance Measuring Instruments.



**General Radio**

300 BAKER AVENUE, CONCORD, MASSACHUSETTS 01742

NEW YORK (N.Y.) 212 964-2722, (N.J.) 201 791-8990 • BOSTON 617 646-0550 • DAYTON 513 294-1500  
 CHICAGO 312 992-0800 • WASHINGTON, D.C. 301 948-7071 • ATLANTA 404 394-5380  
 DALLAS 214 234-3357 • LOS ANGELES 714 540-9830 • SAN FRANCISCO 415 948-8233  
 TORONTO 416 252-3395 • ZURICH (01) 55 24 20

GR COMPANIES • Grason-Stadler • Time Data

INFORMATION RETRIEVAL NUMBER 216



# Precision can't depend on typical specs.

*PMI's got your number!*

PMI decided long ago to provide circuit designers with the precision they need. And to quote key specs in meaningful MAX. (or MIN.) numbers.

For example: Our OP-05, a direct replacement for 725's, 108A's, and un-nulled 741's, has a MAX. noise spec of  $0.6\mu\text{V}$  p-p, 0.1 to 10Hz. And the data sheet shows that you can depend on the device not to drift more than  $0.5\mu\text{V}/^\circ\text{C}$  (the MAX. spec).

- Long term drift is guaranteed at  $8\mu\text{V}/\text{month}$ . MAX.
- $V_{os}$  is  $0.15\text{mV}$ . MAX.
- Bias current is  $2.0\text{ nA}$ . MAX.
- And CMRR, PSRR, GAIN and  $R_{in}$ , DIFF are all quoted MIN.

The point is, we know the designer's op amp problems: accuracy and repeatability. That's why we specify exactly what they'll do, MAX.

To check out our precision op amp numbers and ponder the intrinsic simplicity of our monolithics, circle the bingo card or contact us.

Precision Monolithics, Incorporated  
1500 Space Park Drive, Santa Clara, CA 95050  
(408) 246-9222. TWX 910-338-0528.  
Cable MONO.



INFORMATION RETRIEVAL NUMBER 217





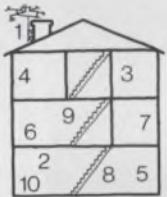
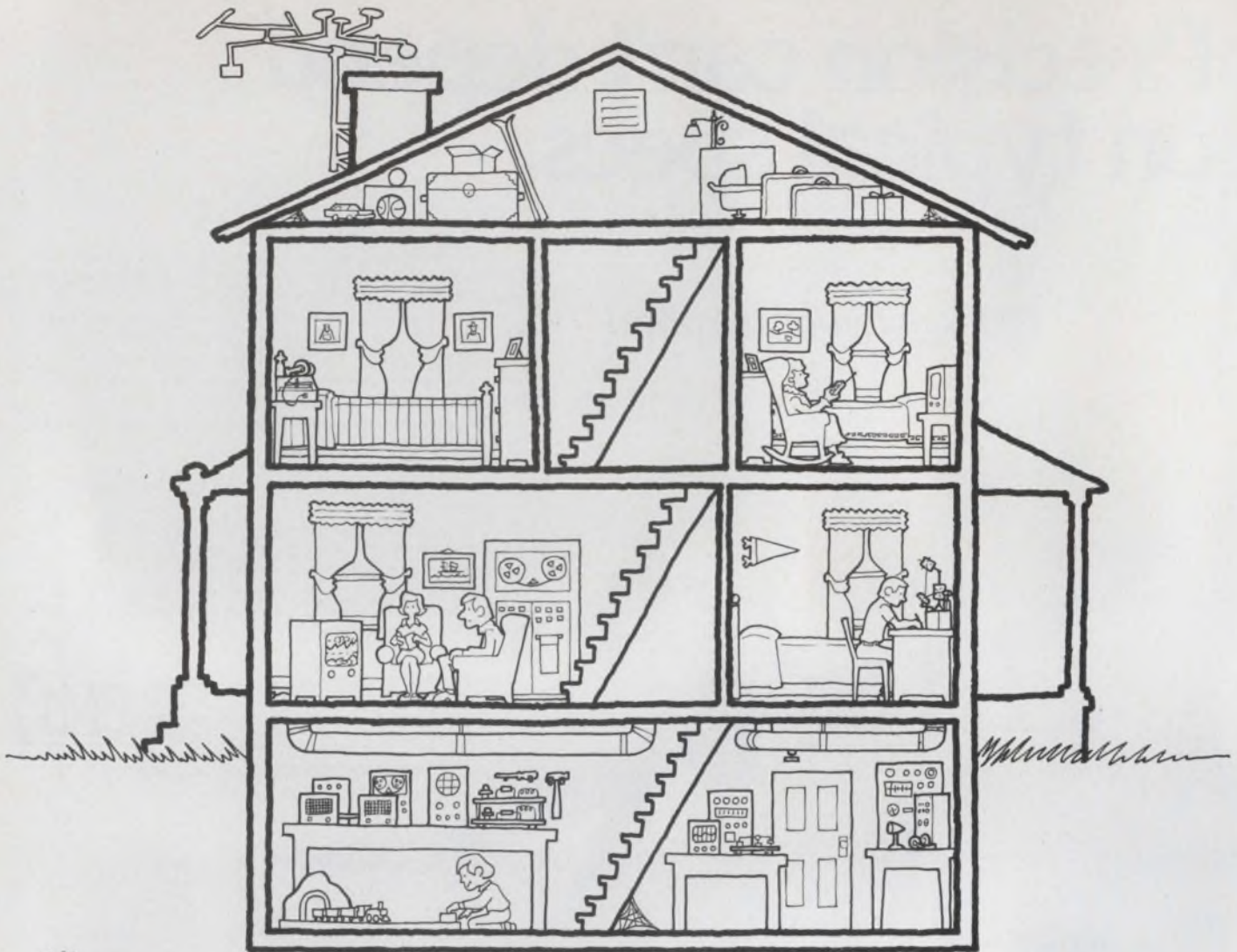

## Engineers gotta have fun, too!

Here are 10 hobby and project books that let the engineer use his special talents for improving his home or just having fun.

1. **HOW TO SELECT AND INSTALL ANTENNAS**, #0786-8, \$4.90. All aspects of antenna selection and installation. Instructions for putting up UHF, VHF, FM antennas or complete master TV systems.
2. **20 SOLID-STATE HOME AND HOBBY PROJECTS**, #0134-7, \$4.55. Two-station intercom, electronic siren, power regulator, metal detector, water-operated alarm, etc. Complete instructions, parts lists, diagrams.
3. **25 SOLID-STATE PROJECTS**, #5881-0, \$4.90. Auto burglar alarm, programmable auto-speed-minder, indoor-outdoor electrothermometer, telephone call timer, electronic dice, TV remote-sound system, etc., etc.
4. **50 IC PROJECTS YOU CAN BUILD**, #0723-x, \$4.55. Hi-fi headphone amp, auto tachometer, intercom, TV commercial killer, etc. Each project can be put together in one night with these simple instructions.
5. **BUILDING THE AMATEUR RADIO STATION**, #0709-4, \$4.30. Complete construction of amateur radio station. Schematic and wiring diagrams and chassis layouts for Novice and General Class stations.

6. **COLOR TELEVISION: Principles and Servicing**, #5929-9, \$5.70. Receiver troubleshooting and servicing techniques. Charts listing trouble symptoms, causes, and remedies. Instructions for using the latest test instruments.
7. **HOW TO BUILD A LOW-COST LASER**, #5934-5, \$4.55. How to build a laser at home, from readily available parts, for approximately \$100! Includes a collection of laser experiments.
8. **BENCH-TESTED COMMUNICATIONS PROJECTS**, #0788-4, \$3.75. Telephone broadcaster, party line listening, canned light music, rollaway ham

shack, VHF extender, 6-meter solid-state transmitter, etc.

9. **HOW TO BUILD A WORKING DIGITAL COMPUTER**, #0748-5, \$5.45. Step-by-step instructions for building an inexpensive digital computer simulator. Includes parts lists, theory of operation, and fundamental programming techniques for solving simple problems.

10. **110 THYRISTOR PROJECTS USING SCR'S AND TRIACS**, #5096-8, \$4.30. Burglar, fire and water level alarms, power control devices for electric tools, and other useful projects built and fully evaluated by the author.

**Hayden Book Company, Inc., 50 Essex St., Rochelle Park, N.J. 07662**

**I wanna have fun!** Please send me the books I've circled to read and use for 15 days FREE. At the end of that time, I'll send payment, plus postage, or return the book(s) with no further obligation. (To SAVE MONEY, enclose payment now. Publisher pays all shipping and handling charges. Same 15-day return guarantee.)

Name \_\_\_\_\_  
 Address \_\_\_\_\_  
 City \_\_\_\_\_ State \_\_\_\_\_ Zip \_\_\_\_\_

Prices subject to change without notice.

75-42



# UP-FRONT SIMPLICITY: LEVER-LITE III

Rugged modular construction gives you a reliable lighted lever switch that provides front-of-panel convenience on the assembly line or in the field.

Our new "Lever-Lite" III switches were designed to simplify installation and servicing of lighted lever switches on computers, telecommunications systems, industrial control equipment, intercoms, broadcast consoles and scientific or test instruments of all kinds.

**SIMPLE to mount and terminate.** "Lever-Lite" III switches are installed from the front. In a single hole. The lever assembly (lever-actuator, lamp and socket, and color filters) simply

slips into its housing. An escutcheon that "snaps-in" place secures the lever assembly and "trims" the mounted switch. Switching and lamp terminals are solder lug type but also accept standard quick connect-disconnect receptacles.

**SIMPLE to relamp.** Front-of-panel relamping or changing of color filters can be done easily by removing the escutcheon and lever assembly with your fingertips.

**SIMPLE to find what you need.** "Lever-Lite" III switches are available in 2- and 3-position types. With locking, non-locking and talk-listen functions. You can order multi-color (different colors in each position), mono-color (one color in all positions) or non-illuminated "Lever-Lite" III switches. And they can be specified with SPST to 8PDT switching.

**SIMPLE to get.** Contact your local Switchcraft distributor, sales representative, or write us direct. Switchcraft, Inc., 5541 N. Elston Avenue, Chicago, Illinois 60630.

**SWITCHCRAFT**  
INC.

INFORMATION RETRIEVAL NUMBER 40

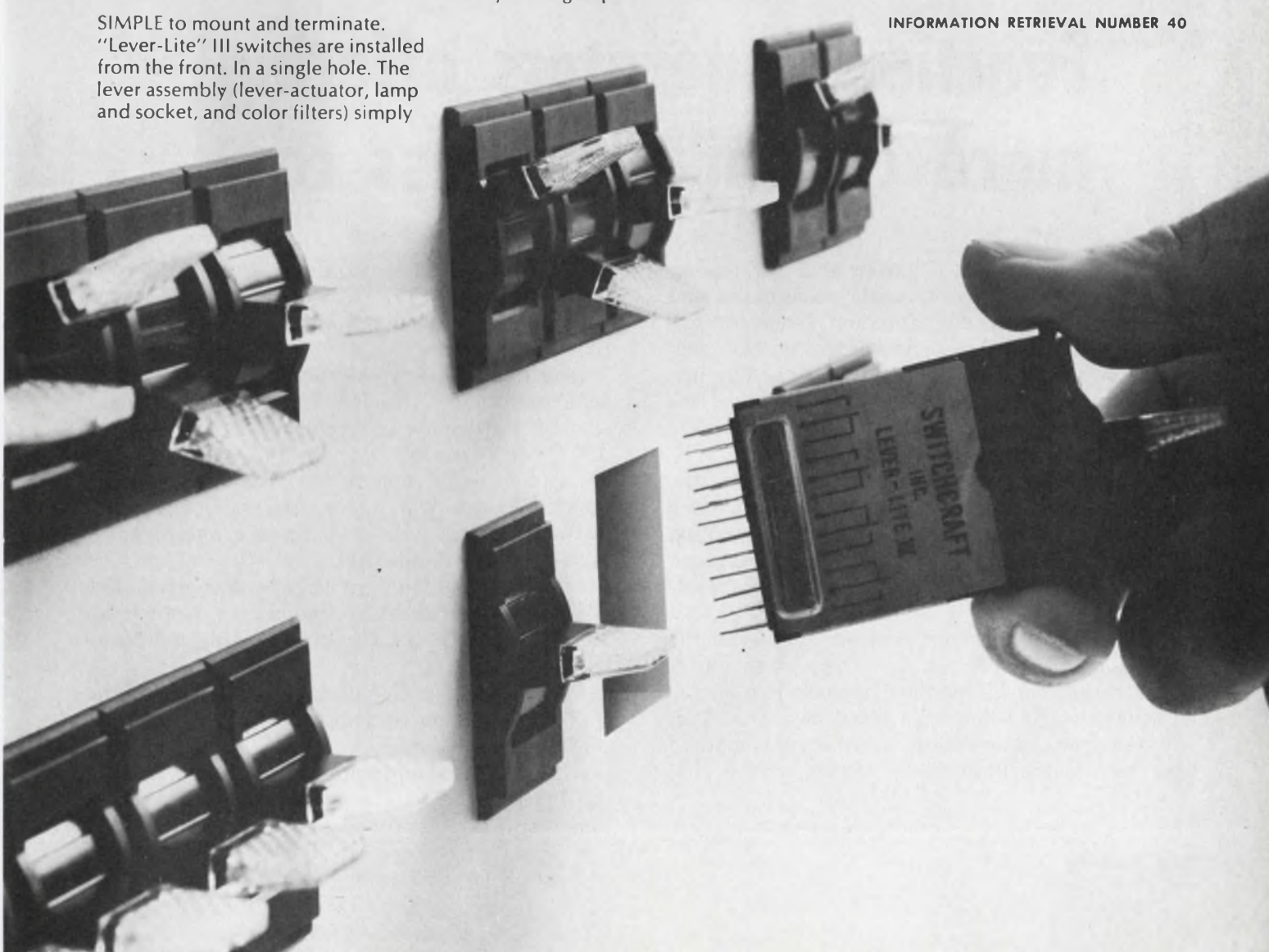





The Model 7059 from Dana/Exact offers pulse, sine, square, triangles and swept functions all in one compact instrument.

# Function generators offering more capability at less cost

**T**urn a knob, push a button and, presto—instant sine, square, triangle waveshapes and more. The versatile function generator has become an almost indispensable tool on the laboratory workbench and production line. The last few years have seen the frequency range of the generator increase, functional capability more than double and prices drop.

Not only can you get the simple outputs like sine, square or triangle waves but also complex functions—AM or FM, frequency sweeping, single cycle or burst outputs, gated or triggered modes, phase locking and digital programmability.

Today's function generators almost all use the same basic method to generate the waveforms. A linear ramp can be modified to look like a sine or square wave when it is integrated or differentiated over a time period. However, this method does have some limitations. Purity of the sine

waveforms is limited to about 0.1% total harmonic distortion (THD), while the square waves also suffer from leading and trailing-edge distortion and ringing.

Over the last few years there have been several advances in circuit design that have led to these changes in function generators:

- Complex analog ICs now form the heart of low-cost function generators that deliver sine, square and triangle waves and can modify the waves with external inputs. These generators are selling for less than \$200.

- Better circuit design is permitting function generators to operate at frequencies as high as 30 MHz or as low as 1  $\mu$ Hz while still maintaining the waveform.

- Phase-locking techniques are allowing high-stability operation equivalent to that of crystal-controlled oscillators.

- New generator designs are compatible with the IEEE standard bus or can be interfaced to computer controllers.

- Smart generators can display the amplitude and frequency of signals, and they can be pro-

---

**Dave Bursky**  
Associate Editor



grammed to switch between ranges, function and output levels.

### ICs cut function generator cost

Complex analog ICs like the waveform generators made by Exar (Sunnyvale, CA) and Intersil (Cupertino, CA) are being used in several low-cost function generators. One such unit is the Model 270 from Hickok (Cleveland), which costs \$166.

These generators offer sine, square and triangle waves of reasonable quality. Output signals are available over a 1-Hz-to-0.5-MHz range, with accuracies ranging to about 1 to 3% of reading. Sine-wave distortion, depending upon frequency, can be from less than 1% to almost 3%. The Hickok unit can also be modulated to produce pulses, sawtooths, sweeps or ramps through rear-panel connections.

Several other companies offer low-cost generators ranging in price from the \$89 Advanced Electronics Model 10 (Newton, MA) to the \$149.50 Dana-Exact Model 195 (Hillsboro, OR).

Wavetek (San Diego), on the other hand, has stayed with discrete components in its \$149 Model 30 function generator, according to Tom Kurtz, instrument sales manager for Wavetek. The Model 30 is completely portable and has a range of 2 Hz to 200 kHz, with a distortion of 2% THD over a 20-Hz-to-20-kHz bandwidth.

Moving up in price to the \$200 to \$300 range are generators made by companies like Hewlett-Packard (Palo Alto, CA), with its Model 3311A. This has a range of 0.01 Hz to 1 MHz and sine-wave THD of only 0.3%. It costs less than \$300.

Krohn-Hite (Cambridge, MA) has a similarly priced unit—the Model 5800. This generator offers the highest frequency range—0.2 Hz to 2 MHz—for the low-priced models. The THD of the Model 5800 is under 3% over its entire range.

Heath, a division of Schlumberger (Benton Harbor, MI), offers its Models EU-81A for \$265 and SG 1271 for \$150.

The HP, Dana-Exact and Wavetek function generators all have an extra—they allow external sweep control of the frequency for FM testing.

Many of these low-cost function generators do not have all the functions available simultaneously. After all, terminals and buffer amplifiers raise costs. Instead they provide switched outputs—just turn a knob, and from the same set of terminals, you get the sine, square or triangle waves.

If you don't have another voltage source and you need sweeping capability, you'll have to up the ante by about \$100. Function generators in the \$300-to-\$400 range start to include internal sweep as one of their features. Or they might have a trigger gate or a phase-angle trigger that lets you set the start and stop points on the out-

put waveform.

Along with the increase in price and capability, you also get some modest improvement in THD and bandwidth. For instance, Tektronix (Beaverton, OR) has several units in its TM-500 series of plug-in instruments. The Model FG-503, for example, has a 1-Hz-to-3-MHz bandwidth, a THD of under 2.5% over the entire bandwidth, and it costs \$375. It also has a built-in voltage-controlled sweep output. However, as with all units in the TM-500 series, you need one of the mainframes



The 20-MHz Model F-72 pulse/function generator made by Interstate Electronics offers the user variable pulse rise and fall times and sine, square and triangle output signals with variable offsets.

for the instrument to operate, and the mainframes start at \$100.

The Clarke-Hess (New York, NY) Model 743, which costs \$385, offers bandwidth of 1 Hz to 2 MHz and has a sine-wave THD of less than 2% over the entire frequency range. This model delivers sine, square, triangle and externally swept FM. Its dial accuracy is within 1% of full scale +1% of reading.

### \$400 to \$900 buys a mixed bag

As prices increase above \$400, function generators come crammed with different features. The \$400-to-\$900 range offers the best selection of units. Just about every company has a function generator in this bracket.

Two units in the Tektronix TM-500 series—the FG-501 and 502—provide sine, square, triangle, pulse and ramp outputs and have a burst/gate input. The latter will produce output signal bursts that are synchronous with the gate signal. Sine-wave distortion is less than 0.5% for the 501 over a 1-Hz-to-20-kHz bandwidth and less



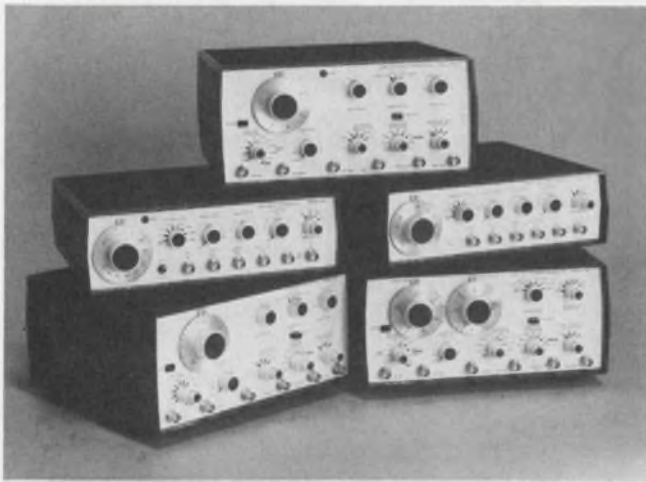

Function generators in the 180 series from Wavetek can lock onto a crystal reference source and thus provide stabilities to within 0.001%.

than 0.5% for the 502 over a 10-Hz-to-50-kHz bandwidth. The FG-501 costs \$450 and the FG-502, \$550.

If you need high-frequency waveshapes, Wavetek can probably fill the slot. Its Series 160 units have maximum output frequencies in excess of 30 MHz, and they are still the highest-frequency generators available.

Dana-Exact doesn't have units with quite so high an output frequency, but it does offer many choices of functions in its 500 series. You can choose from generators with outputs as high as 11 MHz and that offer such functions as internal sweep, logarithmic sweep, internal trigger and gating, as well as sine, square and triangle waves. Prices range from about \$450 to over \$700, with sine-wave THD specs running less than 0.5% over a 1-Hz-to-100-kHz bandwidth for the Models

513, 516 and 517.

Other companies that offer comparable models include Interstate Electronics Corp. (San Diego), Hewlett-Packard, Clarke-Hess, Systron-Donner/Datapulse (Culver City, CA), Philips, Test and Measuring Instruments (Woodbury, NY) and Krohn-Hite.

There are still more types of function generators to choose from. If you need rock-solid stability, try a generator that uses a phase-locking technique to get stabilities to within 0.005% and better. These generators make use of either an internal crystal oscillator or an input port for a frequency reference.

There is, though, a problem with the phase-locking technique. The generator has only a limited range over which it can lock, since it can only grab onto the harmonics and subharmonics of the reference. Some companies, however, are looking at an alternative that lets the function generator lock onto almost any frequency for synthesizer stability over the entire range.

Wavetek was probably the first to offer function generators with a built-in crystal for phase-locking. The units in the 180 series offer frequency stabilities to within 0.001% over limited frequency ranges. Clarke-Hess has also had phase-locking units available since 1969, but the user must supply his own reference source.

This method produces stabilities that are equal to those of frequency synthesizers. Costs for phase-locking units vary, depending upon whether the generator contains its own reference oscillator. The Model 181 from Wavetek costs \$495, including the reference, while the Model 744 from Clarke-Hess costs \$415.

Whatever the technique used to generate or

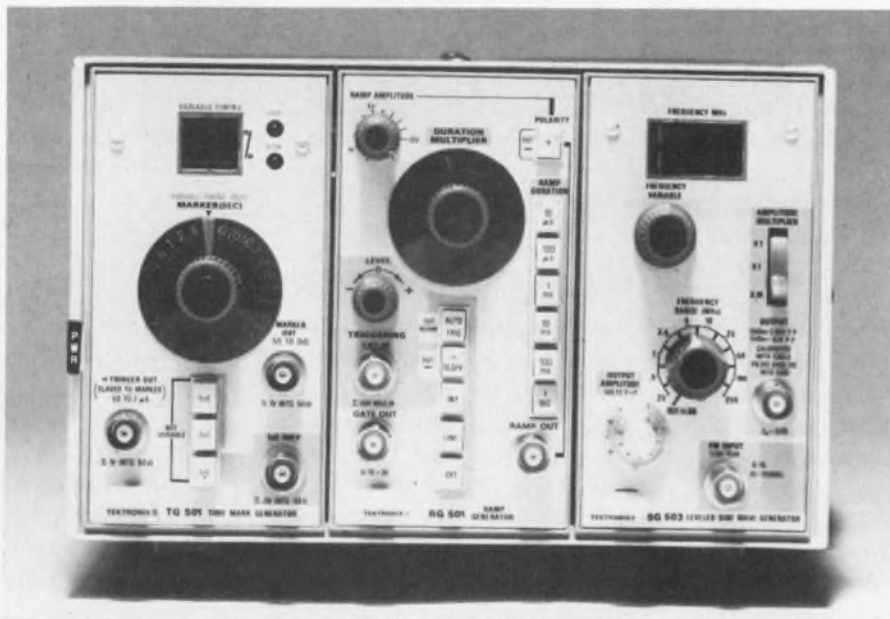

Plug-in analog function generators in the TM-500 series made by Tektronix offer a choice of ramps, time marks,

leveled sine waves (left) and a combination of sine, square and triangle waves (right).





A 2-MHz function generator, the Model 411, delivers sine, square and triangle waveforms. It is made by the Datapulse Div. of Systron-Donner.



The PM5167 function generator delivers signals over a 0.001-Hz-to-10-MHz range and has a linear dial indicator to make tuning easy. It is made by Philips.

stabilize the output signal from the function generator, digital control—and, in some cases, digital readout—of the frequency and amplitude are needed. To do the job, switching speeds of the generators must be increased so the computers can switch ranges and still allow the generator outputs enough time to settle.

#### Computers can control the functions

Only a handful of companies are offering computer-controlled function generators—Wavetek, Rohde & Schwarz (Fairfield, NJ), Krohn-Hite, Schneider Electronique (Rungis, France) and John Fluke (Mountlake Terrace, WA). Prices for these units range from \$1000 to over \$5000.

Wavetek claims a first with its Model 159 programmable function generator—the first to operate from the IEEE bus standard. The generator provides output signals in the 0.1-Hz-to-3-MHz

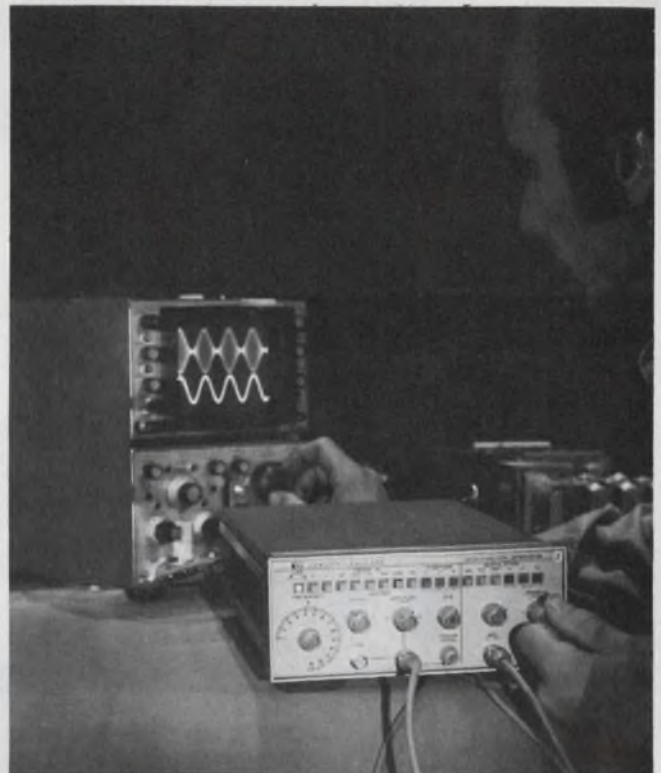

AM or FM control, along with sine, square and triangle waves, is available on the 3312A, a \$900 13-MHz function generator made by Hewlett-Packard.

range and costs \$1495.

Krohn-Hite has its Model 5500AR programmable generator, which offers a 0.0001-Hz-to-5-MHz frequency range and delivers sine, square, triangle, sawtooth and pulse waveforms. The generator also has an auxiliary square-wave output, and it allows independent control of positive and negative waveform duration. The THD of the output sine waves is 0.5% maximum for output frequencies under 100 kHz and this increases to over 2% as the frequencies reach 5 MHz. The 5500AR is controlled by a 1248 binary input code, and the unit costs \$1995.

Top-of-the-line units like the SSN from Rohde & Schwarz give the closest to synthesizer performance that you can get. The generator is programmable and has a 0.01-Hz-to-1.2-MHz output range, with sine, square and triangle waveforms simultaneously available.

The output purity for the sine wave is specified as less than 0.1% THD over a 10-Hz-to-50-kHz range and under 1% over the full range. However, for this performance you pay \$5500.

With the advent of low-cost microprocessors, many companies are looking toward the processor-controlled function generator/synthesizer. Most companies admit, though, that micros don't really add that much capability to the instrument, unless they are used to handle the bus interface and supervisory duties. These instruments will be appearing in the next few years. ■■



# Designers'

**Toggle Switches**  
Bat, lever lock, Designer  
Line, sealed. Big, broad  
choice.



**Rocker Switches**  
Singles and multiples.  
Wide, colorful selection  
range. Legends, too.



Cutler-Hammer, of course! The broadest  
line. Styled to meet today's and tomorrow's  
requirements. They're solid quality, look  
great, work long and hard. Carried in stock  
for local availability by Switch Distributors.  
Backed by Cutler-Hammer sales engineers  
who can deliver innovative design help for

**Pushbutton Switches**  
Choice of sizes, colors,  
circuits, ratings. Styled  
to "turn you on".



**Tool Handle &  
Slide Switches**  
Variable speed, reversing.  
Double insulated.



 **Switch to No.1**



# Choice.

the exact switch or relay you need—  
when you need it.

It's no wonder so many designers specify  
Cutler-Hammer. For quality, reliability,  
availability, and style. For commercial,  
industrial, and military applications.

We simply offer more—of everything!

## Snap Switches

Lever, roller, leaf, and  
pushbutton actuators.  
Four terminal styles.



## Rotary Switches

Precision and general  
purpose. Single and  
multiple wafer.



## Switch Accessories

Guards. Boots. Seals.  
Caps. Decorator  
facenuts. And much  
more to protect, code  
or customize.



## Illuminated Switches

Rockers, paddles,  
pushbuttons, indicators.  
Snap-in and bushing.



## Relays

Hermetics, non-sealed,  
potted. Power, latching,  
and timing functions.



**CUTLER-HAMMER**

SPECIALTY PRODUCTS DIVISION, Milwaukee, Wis. 53201





# Henk Bodt of Philips Speaks On Challenges to the European Instrument Designer



The principal difference between the European engineer and the American engineer is that they speak different languages. But that's important. When the American engineer thinks of Europe, he sees one homogeneous mass. But when he gets here, he may realize that Europe is a fiction; there's no such thing. There is France, there is Germany, there is Holland, there is England, and so on. The instrument designer who wants to design for the so-called European market must be conscious of the distinct needs of the engineers in these different countries.

You have, for example, different safety regulations and different regulations on ac-mains (or line-voltage, if you prefer) pollution. In Germany, for example, there are strict requirements on how much noise your instrument may pump back into the mains. In Italy, they hardly worry about mains pollution at all.

If you're designing for the consumer market, where volumes are high, you can design specifically for, say, France or Germany. But if you're building low-volume test equipment, you need a sharp pencil to work out a sound strategy. And



you have to worry about the American market as well, where standards and traditions are different.

In fact, at Philips, we have a separate group responsible for knowing the standards of different parts of the world. We can't expect an engineer to know his own job and to know worldwide standards as well.

### **The European and American engineers are pretty much the same. But not quite.**

Most applications of test equipment in Europe and in the United States are the same. So the users think pretty much the same way. But not always. For example, when military and aerospace spending was copious in the States, many American engineers spent money wildly. An American engineer might have purchased a five-digit voltmeter to check mains voltage. The European engineer who didn't have so much money would be more cautious. But if a European engineer is going to buy a five-digit voltmeter, he'll specify the same way. Both engineers will look for the same things.

I think lavishness is more a function of the company a man works for and his position in the company than of the country he lives in.

If the engineer works in a small company, where his influence on the company's return on investment is very visible, he'll be more careful with money. He'll be more inclined to buy an instrument that does the job and no more. If he works for a large laboratory or a university, where consequences of his purchases are less visible, he'll tend to overspecify.

There is a difference based on tradition. The European consumer tends to buy better quality, longer-lasting goods. In Europe we pay more for our TVs and radios, but we don't replace them so often.

This attitude spills over into our purchases of capital equipment. Some years ago, the cost of ownership—the required frequency of calibration, the average cost of repair, the frequency of breakdown—these things were certainly not factors in the buying decision in many companies.

But now, they play an enormous role. You see it popping up as a wave in many big international companies. Suddenly—this was not the case some years ago—engineers looked at the instrument in a different way.

They used to ask: Is it attractive? Is it easy to operate? Is it performing to specification? And that was, more or less, the total test they made. But now, in the big international companies in Europe, they go through extensive testing. They

really look for serviceability, cost of ownership, cost of recalibration, cost of repair, useful lifetime. These things are going to play a major role.

This carefulness, at least in Europe, is new. Years ago, in many companies, engineers bought instrumentation for a project, and when the project was over, they dumped the equipment; they wrote it off, or destroyed it, or left it on the shelf, unused and unnoticed, until it was worthless. But now, especially in the larger companies, they pool equipment in central instrumentation pools.

They give the equipment to a certain department that needs it. And when the job is over, the instruments come back to the pool. It's sort of an internal leasing system. And it's not just for specialized instruments. It's used for general-purpose equipment, too. For example, in the Philips Research Laboratories we have a huge instrument pool where 100-MHz, 50-MHz and even 15-MHz oscilloscopes are pooled and made available for various users.

Now, of course, there are some basic instruments that an engineer must have on his bench all the time. So you might suspect that these would never get to the pool. But look at this typical situation. Say you have a department with 10 engineers. When a project is concluded, the number of engineers may be reduced to, say, five. Formerly the head of the department would put the excess instruments in a cupboard because they were his special property, paid for by his department's budget. Those instruments would lay there, unused. The tendency now is to pool them and make them available for others.

So it's not a matter of a scope being shifted around every few days. It might be shifted every six months or so, as one project is replaced by another.

So the average use of the equipment is increasing. And because the equipment is seeing more hours of use, we have special demands on its reliability. Remember that there's a difference in an instrument being used and being merely switched on. In many labs, the mains switch is turned on at the start of the day and instruments at all benches are turned on by it—whether they'll be used or not. Being turned on doesn't cut instrument life as much as people turning switches, and pushing buttons and grabbing probes, and dropping probes.

**Engineers do look ahead. This is especially noticeable in bigger companies, where they want to write off instruments (and keep them useful) for seven, eight, or 10 years.**



Futher, engineers will try to standardize throughout a company. For a period of, say, four or five years, they want to have the same counter type for as many applications as possible. They want to use the counters in automated test systems, or semi-automated test systems, or bench systems. And they want to be able to interchange instruments. Again this uses the instrument pooling system.

Another factor enters the picture, here—and in the States. Some instruments become status symbols. An engineer may need to measure ripple from a dc power supply, but he wants a 500-MHz scope. In many companies, in the past, he got his 500-MHz scope, particularly when aerospace and government spending were carefree. It's less true today, but you still find it.

The reduction of government spending and the low profitability of many companies place enormous pressure on this practice. More and more, here and in the U.S., engineers must justify their purchase of expensive equipment. When they overspecify, they make fools of themselves. The willingness to overspecify is still there. But less of it takes place.

You can see this, for example, in the dramatic sales growth of portable (or compact) oscilloscopes. They are widely used instead of plug-in

scopes because, in many cases, engineers never took advantage of the plug-in's versatility. They used one horizontal plug and one vertical plug. And that was it.

What about some of the gimmicky instruments we see now and then? Do European engineers buy them? Yes. Once. They'll buy one to try it out. But not hundreds.

Sometimes a gimmick, if you can call it that, is a real success. For example, we have a digital multimeter, the 2513, that has an average European price of 650 guilders, about \$250. That unit has a temperature option that really is a practical, attractive feature.

What about other combination instruments? I think some will be bought because they are gimmicks. Those will be bought once. They won't have repeat sales. Some instruments will offer a unique combination of specifications. But the market for these is normally quite limited.

Look, for example, at a general-purpose combination, a DVM/counter. First, not everybody who needs a DVM needs a counter. While a man who needs a counter probably also needs a DVM, he may already have one. Further, the input-circuit requirements of a DVM and counter are different, so you boost complexity and cost. You don't need a DVM's sophisticated input attenua-

## Who is Henk Bodt?

He started as a jack-of-all-trades at the Philips Research Laboratories in Eindhoven, the Netherlands, in 1954, when he was 16 years old. Then he really got interested. So Henk Bodt took a company course in radio electronics and did a great deal of studying at home till he was able to pass the government's high-school equivalency examinations.

After a stint in the Signal Corps, he returned to Philips—no longer as a jack-of-all-trades—and he went to the Technical University of Eindhoven at night till, in 1966, he was awarded the Dutch equivalent of an American doctorate without thesis.

His final work at the university was in analog multipliers which, not surprisingly, are now found in the Philips 3265 multiplying scope. In time he became product specialist in oscilloscopes and eventually assumed his present position, manager of Philips Test and Measuring.

Henk and his wife Catrien enjoy sailing the River Maas, about 35 km from Eindhoven, on their 6-1/2-meter open dayboat. When he's not sailing or with his children—Hans, 16, Guido, 12, and Jacqueline, 9—Henk likes to design and build his own furniture.





tor in a counter, because nobody will stick a counter's probe into the ac mains.

If you make such combination instruments, you will always find a customer. But I don't think it's a substantial volume market. There can be a market, for example, where people don't want to carry two instruments. There can be a market where somebody's setting up a large facility from scratch and feels he can save lots of money if the cost of a DVM/counter is substantially less than the cost of separate instruments. But I still feel the market is limited. And because the market is limited and quantities are low, the price of the combination is going to be relatively high, so there may be little or no saving.

Like gimmick and combination instruments, plug-in instruments will have declining appeal in Europe—and in the U.S. As engineers grow more cost conscious, they realize that they seldom use the flexibility that plug-in modularity offers. So they're moving to a different form of modularity based on the substitution of circuit cards back at the factory.

### **What about options—like the IEC interface bus?**

There's an excellent example of the use of circuit-card modularity with the interface-bus standard that's already been adopted by the IEEE and is likely soon to be adopted by the International Electrotechnical Commission (which initiated the work leading to the standard). Even now, before official IEC adoption of the bus, engineers want to know if we will definitely offer an IEC interface card in a counter they might want to buy immediately.

In 80 percent of these cases, we can be pretty sure those engineers will never buy the interface card. But they want to be sure they can get it later if they need it. In a number of large companies, engineers insist that products we supply must in the future be interfaceable to the IEC bus. They won't buy any more equipment in a certain price class unless we assure them that we will supply an interface. So they'll pay a bit more now for the option of later getting a connector and interface card. But they don't want to buy the card now. Many will want to later.

Of course, this will depend on the cost of the card option. We're thinking of making the interface in the form of an integrated circuit, so the cost might be very low. But important decisions will have to be made here. Where do you put your cut? How much circuitry do you put on the interface card and how much in your instrument? Where does your instrument end and where does your interface begin?

### **The question of circuit partitioning raises an even more difficult one: How will European instrument designers fare when it's tough to get American components?**

We know that many of the recent advances in instrumentation have resulted from the use of microprocessors. And these, so far, are U.S. things. What will happen to European test-equipment manufacturers, who don't have ready access to these advanced products?

Important new components always start with a limited supply. When they're first introduced, it's hard to buy advanced microprocessors like the 8080 or the 6800. Because it's convenient for them, manufacturers of these products tend, at first, to sell them to major U.S. manufacturers. The European sales representatives of the U.S. semi manufacturers aren't ready to offer the most advanced components; they're still selling the 4004. So that places the European manufacturers at a disadvantage.

The microprocessor was developed in the States for the computer world, where it found its early applications. American instrument manufacturers were beneficiaries of that development. They were able to use microprocessors before Europeans could.

An instrument engineer in Palo Alto can sit on his backside and wait for the microprocessor sales engineer to call on him. We can't do that in Eindhoven.

Many U.S. semi manufacturers are tooled up to make custom LSI and this usually requires close contact between the customer engineer and the semiconductor engineer. But for an engineer sitting someplace in Europe to work on custom LSI with a U.S. semi manufacturer across an ocean and a continent—that's quite difficult and costly.

So we have an important handicap. To protect ourselves, we'll have to send our engineers to the States so they'll know quickly what the important component developments are.

And we'll depend more on American trade publications for information on U.S. component developments. At Philips we have an enormous advantage in the extensive technical facilities of North American Philips, whose liaison office can get technical information back to our people in Holland. We have a further advantage in our own, extensive semiconductor facility. But smaller companies in Europe don't.

Smaller companies, however, have less overhead. So they can put more material cost into an instrument by using standard ICs and associated hardware. Local manufacturers selling in a





local market can survive this way. They can sell directly from the factory to local users—as do many power-supply companies, for example. Their big danger is in growing too big, because then they have to go international and add overhead. There will always be a place for the specialized small company.

If you want to be competitive today you must go after the world market. You can no longer be content with the European market alone. A few years ago, because of our lower cost for a production hour or a development hour, we could make a profit even if we produced a third or a fourth the number of instruments an American manufacturer might make. But it's no longer true.

There are some problems that we face in common with American manufacturers. A major problem is how to sell low-cost instruments.

Years ago it would cost a sales representative \$25 to make a sales call and he could get a 20% commission on the sale of a \$2000 DVM. Today that sales call costs him \$70 and he may sell a \$300 DVM.

**What do you do about this “impossible” cost of getting an instrument to an engineer? You worry a lot. And you hope the problem will go away. That's what most manufacturers are doing because there is no easy answer.**

There are many techniques for economically getting instruments to users; there isn't one. Some techniques are suitable for some classes of users, not others. Some techniques work in some geographical areas, not others.

In France, for instance, there are wholesalers who sell components to the radio and TV dealer market. They are not in the instrumentation business. Some of them, nevertheless, will place an instrument on display. A serviceman coming in to buy components may buy the instrument on sight. He already has a credit account with that

wholesaler, so he can make an impulse buy; he doesn't have to pull 650 guilders out of his pocket.

Direct mail can work with some instruments. But in general an engineer won't buy your instrument by mail if he can get a similar one by picking up the phone—unless your instrument is unique. If you're selling routine instruments—gray mice—engineers would rather buy from somebody who will walk in and demonstrate them.

What about selling instruments through distributors? That's possible, but, to carry instruments, a distributor will have to see an advantage. He has to see money in it. Or he has to see himself providing an additional service that will induce customers to buy components from him. But engineers don't think in terms of buying instruments from distributors.

If you want to sell low-cost instruments through distributors or other such channels you must organize several things. First, of course, you must provide distributor inventory; then you have to advertise to let engineers know that their local distributors carry your instruments; then you have to provide credit facilities and repair and service centers. You don't do these things overnight.

Fortunately the major market for low-cost instruments is the large manufacturer who buys in quantity. So the sales rep doesn't sell a single \$300 instrument; he sells three or four—or ten.

Another approach may be more sales through catalogs available from the large instrument houses. Unfortunately the new customer, the man who buys one or two low-cost instruments every year or two, isn't called on by the sales rep and he doesn't have the catalogs. That man is an unattractive account, so instrument sales people don't call on him.

When he becomes a big customer, of course, we'll all pay him lots of attention. A few years ago, for example, there was much talk of expansion of electronics in hospitals. But hospitals, in fact, bought almost nothing.

**Do you think our sales engineers ever went into a hospital? Yes. For appendicitis. But never as sales engineers.**

Today the situation is different. There's a lot of electronic equipment in hospitals. And hospitals have doors with titles on them like “Electronic Instrumentation Department.” So our salesman now have a door to go into. And they do.

So we all face problems, Americans and Europeans alike. I'm sure we'll solve them. ■■



# The perfect atomic frequency standard

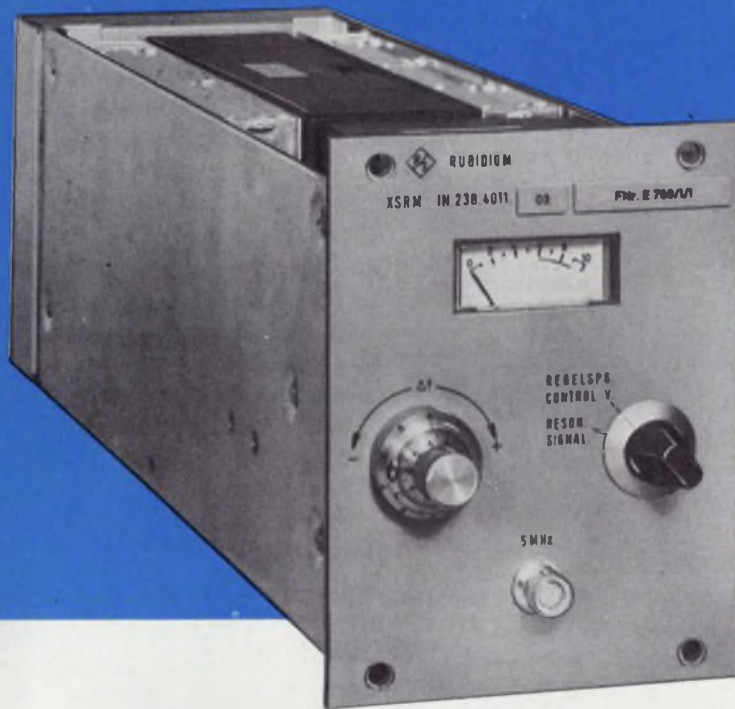

**For Economical Navigation, Standards Lab, Bench and Airborne Applications.**



Two accessories provide even greater usability: (1) Line/Battery Power Supply with automatic change-over; (2) Frequency Converter providing 10 MHz, 5 MHz, 1 MHz and 100 kHz locked-in phase. These modules and the XSRM are available in a single cabinet or in a 19" rack mount package.

The R&S Type XSRM Rubidium Frequency Standard has more features and benefits than any other standard.

- No daily adjustments necessary as there are for crystal-type units
- Package size is very compact — only 4 x 5 x 13.5 (inches)
- It's flyable — weighing only 11.5 lbs.
- Power consumption is exceptionally low — a mere 18.5 W min.
- Warm-up time is rapid — just 35 minutes.
- Spectral purity is very high — > 120 dB (spurious suppression and S/N)
- Frequency stability is superior — typically <  $2 \times 10^{-11}$  / month

Send for our complete descriptive brochure and/or to schedule a demonstration.

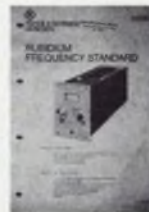

*World Leader in Test Inst. & Communications for Over 40 Years*

**ROHDE & SCHWARZ**

14 Gloria Lane, Fairfield, N.J. 07006 ■ (201) 575-0750 ■ Telex 133310



**Modular versatility.  
Zero entry force.  
And low cost.**

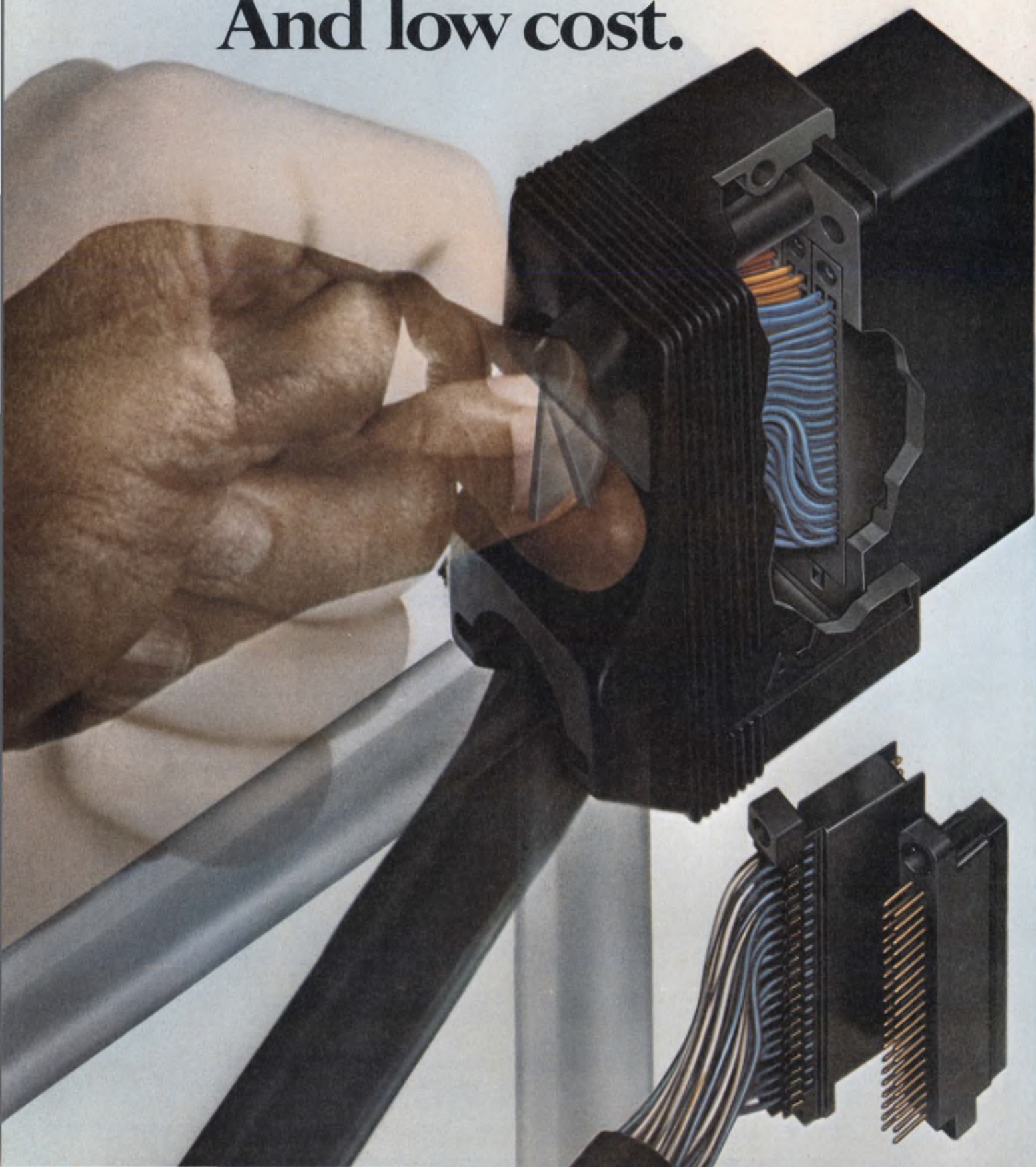



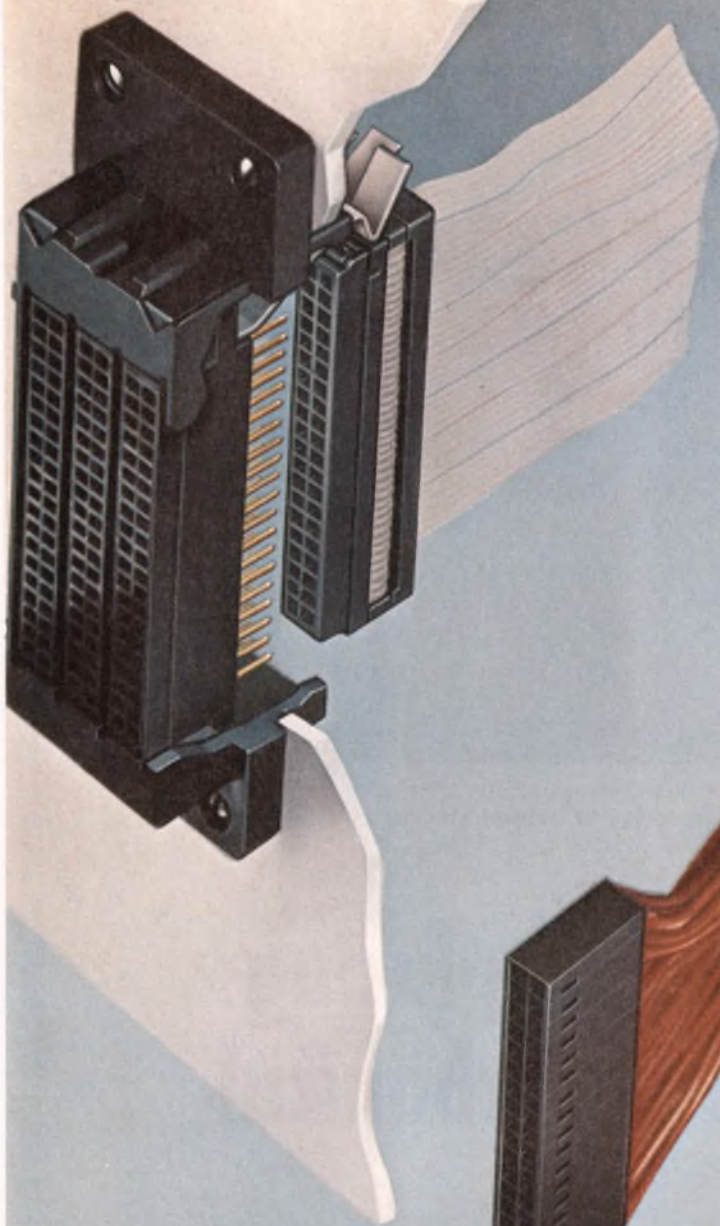

Versatile AMP CR uses connector modules for ribbon cable, discrete wires, flat flexible cable. Connections include wrap types, and the recently introduced mass termination technique—displation.

## New AMP CR Series I/O terminator

Just turn the cam 90° clockwise, and 120 or 156 contacts come together instantly. Connections are self-made with wipe and back-wipe actions.

With zero entry force. When the CR is closed there are over 150 grams of force on each contact. Yet there is virtually no contact wear for well over 5,000 cycles.

The new AMP CR Series connectors are designed for cable-to-cable, cable-to-board, and cable-to-panel applications. The Versatile CR is built of modules of your choice to accept connectors for ribbon cable, discrete wires and flat flexible cable. Additional economy is realized in the all-plastic construction which includes cable clamps and jack-screws, requiring no retaining hardware.

For easy, fast, zero-entry-force mating of large numbers of contacts, the new AMP CR Series is unequaled. For more information call (717) 564-0100, circle the Reader Service Number, or write AMP Incorporated, Harrisburg, PA 17105.

AMP is a trademark of AMP Incorporated.

# AMP

INCORPORATED

INFORMATION RETRIEVAL NUMBER 43



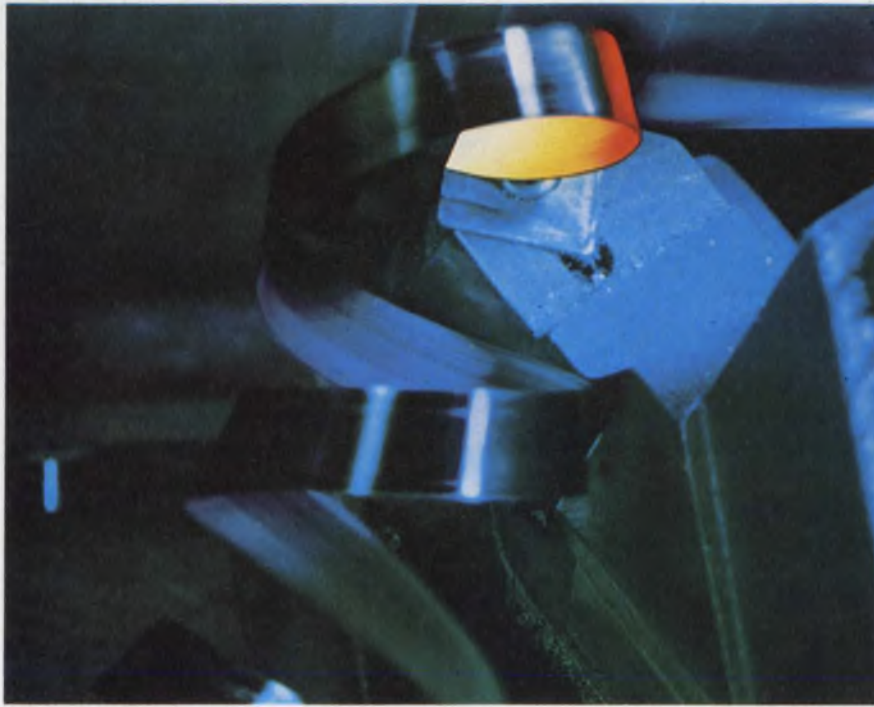

Measure machine-tool cutting forces with a quartz dynamometer. Kistler Instruments of Switzerland manufactures a wide range of transducers that can resolve forces into their components.

## Electronic devices displacing the hydraulic and mechanical

**E**lectronic instrumentation is replacing pneumatic, hydraulic and mechanical devices at an accelerating rate in industrial nonelectronic applications.

No longer, for example, is electronic gear automatically ruled out as a safety hazard. The low voltages and currents of solid-state circuits are allowing safe operation in places where pneumatic and hydraulic units were considered mandatory, because sparks could trigger explosions.

Areas being heavily invaded by electronic instrumentation include the following:

- Electronic process controllers and transducer/transmitters in place of pneumatic and hydraulic units.
- Electronic digital panel meters instead of electromechanical analog meters.
- Electronic instrumentation for recording formerly difficult-to-measure force components in

applications ranging from bionics to machine tools.

- Electronic gas chromatograph/mass spectrometers to make tough chemical analyses routine. Previously the analyses were only tediously done, if at all.

- Data-processing oscilloscope systems to enable the study of a wide range of transient phenomena. This was not even possible with nonelectronic methods.

The result is reversal of a trend in which heavy use of electronic instrumentation was confined almost solely to the electronics industry. Modern solid-state instruments are not only proving to be as reliable, rugged and long-lived as the nonelectronic; they are also offering more versatility, faster operation and the ability to perform more complex functions. And they do it all at competitive costs, or in some cases lower costs.

Indicative of the new trend is the entry of Beckman Instruments, Fullerton, CA, into the electronic controller field. Beckman is not new to industrial electronics, but as Roy F. Brown, vice

---

**Morris Grossman**  
Associate Editor



president of the company's process, instrument and control group, explains it: "Now process controllers and their accessories round out our line of instruments to allow us to bring electronic technology to almost all aspects of industrial instrumentation."

The controller line includes the 8600 series of transducers/transmitters, which directly convert pressure to electrical signals with  $\pm 0.25\%$  accuracy by use of a variable-reluctance technique. Beckman employs an energy-limiting barrier approach to ensure safety. Low-current 0.25-A fuses, current-limiting resistors and zener diodes protect the transmitter and maintain the currents below ignition limits for most classes of hazardous duty.

Beckman's Series 8800 electronic controllers combine analog and digital techniques to take optimum advantage of each. The controllers provide a 6-in. flat, linear indicator. The scale can be configured with adjustable bands of allowed deviation of a process variable. If no deviation band is required, the controller can be equipped with only a set pointer and a variable pointer. LED status lights and any needed control switches—like auto/manual, manual-loading, ratio—complete the controllers' panels.

To augment the control function, the controller line also provides electronic computer modules to do square-root, square, integrate, sum, multiply

and many other functions.

Whereas Beckman's pressure transducers can cover a range of 10 in. of water to 6000 lb/in.<sup>2</sup>, many processes require measurement and control at vacuum levels measured in fractions of a torr (1 torr = 1-mm Hg).

Robert J. Ferran, manager of engineering at MKS Instruments, Burlington, MA, asserts: "If you're still using liquid-manometer, thermocouple, McLeod or even the latest ionization or radiation vacuum gauges, you're behind the times. Solid-state circuitry enables us to use a variable-capacitor technique that is insensitive to gas contamination and does not need tedious compensation techniques and special handling."

Electronic instrumentation, like MKS' Tru-Torr vacuum gauge, permits direct digital reading with a four-place LED display over a range of 0.001 to 8,000 torr. Accuracy, including hysteresis and linearity, is 2%. Zero and span adjustments are set to numbers supplied for individual transducers to allow for changing of transducers. Other instruments and control systems in the MKS line can achieve  $10^{-7}$  torr sensitivity. Ranges go from  $10^{-6}$  to 15,000 torr ( $10^{-7}$  to 300 lb/in.<sup>2</sup>).

For many years, even before digital displays were generally available, human-engineering experts reported that digital readouts would produce fewer reading errors than analog pointer

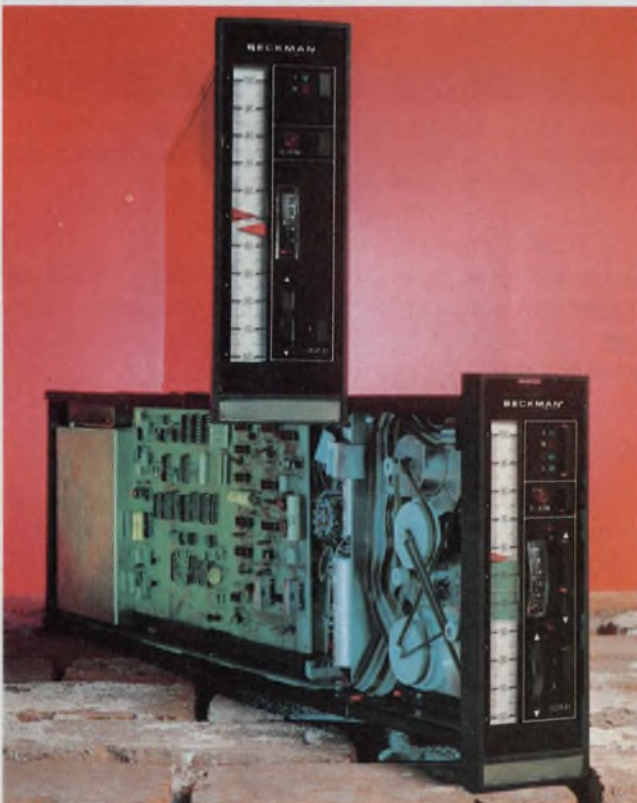

Electronic techniques replace pneumatics and hydraulics in Beckman's 8600 line of pressure transducers and transmitters for industrial process-control. And compati-

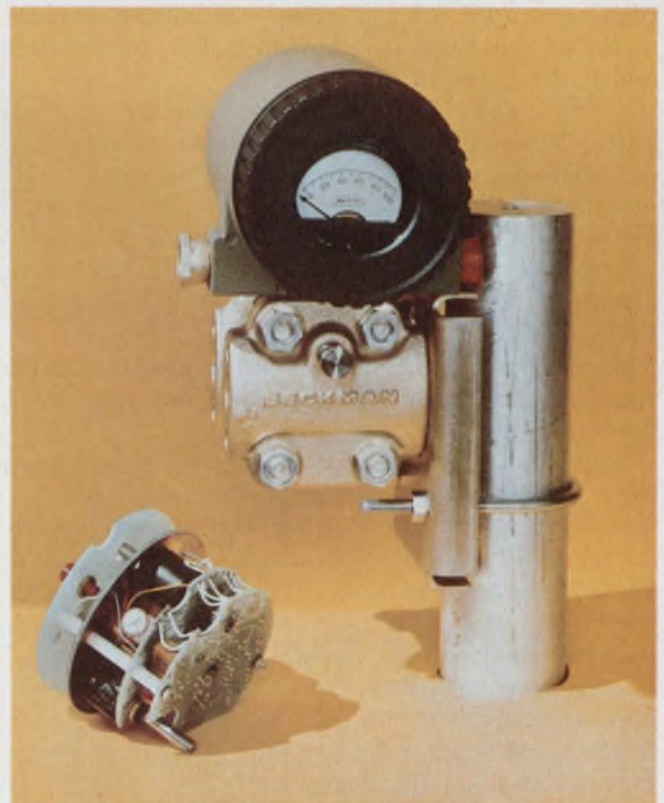

ble 8800 series electronic controller-indicator units provide easy adaptability with adjustable set points and an easily read flat scale.



meters. But high cost, unreliability and the relatively large amount of space the circuits needed, kept digital displays from widespread use.

### Digital meters replacing analog pointer units

Now, meters with electronic digital readouts are becoming more common than analog pointer meters. Many industrial instrument and control makers buy digital meters from companies like Newport Laboratories, Santa Ana, CA; Datel Systems, Canton, MA; Weston, Newark, NJ; Analog Devices, Norwood, MA, and Analogic, Wakefield, MA, and incorporate the meters into their own instruments. Though the digital units are basically dc voltmeters, the meters can be calibrated to provide readouts directly in measured engineering units—torr, inches of water, pounds, degrees C, rpm, etc. Applications are being made in pH meters, flow meters, calorimeters, gas analyzers, blood analyzers and humidity meters.

A particularly popular unit with industrial instrument OEMs is Newport's 200BS 3-1/2-digit (count to 1999) panel meter. It features Beckman's (formerly Sperry's) planar display, provides TTL-compatible parallel BCD outputs, external control of the decimal point and display blanking. The housing occupies only  $2.2 \times 4.35 \times 4.1$  in.—not much more than the average pointer panel meter—but the digital meter can do a lot more and is a lot more accurate (0.1% of reading  $\pm 0.1\%$  of full scale). A pointer analog meter of this accuracy is much larger, costs more and is a lot less rugged.

Many manufacturers make similar digital units. Analogic's 3-1/2-digit panel meter, the AN2536, is even smaller than Newport's. It measures only  $3.8 \times 1.4 \times 1.8$  in., includes true differential inputs, claims an accuracy to 0.05% of reading  $\pm 1$  count and also uses a Beckman digital display panel. Datel's DM 2000 series uses LED displays, and Analog Devices' AD 2011 can measure true rms. Price competition is keen, with some digital panel meters selling for less than \$100 in single units.

Ballantine Laboratories, Boonton, NJ, a pioneer in linear-log-scale and true-rms pointer meters, is now also making digital meters. Its 3620A true-rms unit was introduced at this year's Wescon show. It offers  $1\text{-}\mu\text{V}$  resolution and 4-1/2 digits (count to 19999). Because it computes the rms value of complex waveforms and doesn't rely on a thermal converter, the Ballantine meter has a high temperature stability of 50 ppm/ $^{\circ}\text{C}$ , and it can handle input signals with crest factors as high as 50:1 on the lower scales.

According to Milton J. Lichtenstein, a vice president at Ballantine: "The 3620A is particularly useful in industrial applications that abound



Digital displays, such as this second-generation Analog Devices' AD2021, are increasingly popular as built-in indicators for industrial instruments.



Ballantine's true-rms digital voltmeters are particularly suited for measuring the complex waveforms often found in industrial and automotive systems.

with complex waveforms—controlling welding equipment, measuring mechanical vibration, testing automobile engines, studying biological phenomena."

### Making biomechanical/chemical measurements

The measurement of biomechanical forces is being greatly aided by newly available electronic instrumentation. Measurement of human muscle forces and control, a branch of neurology, was previously done, if at all, with crude and awkward mechanical devices. Kristal Instrument Corp., Grand Island, NY, is offering the 9621A force platform made by Kistler Instruments AG of Winterthur, Switzerland. It can measure the three force components,  $F_x$ ,  $F_y$  and  $F_z$ , the coordinates  $a_x$  and  $a_y$  of the points of their application and the free moment,  $M_z$ , about a vertical axis. Thus a patient's posture control can be



studied, orthopedic and prosthetic devices can be checked, Romberg tests (balance control) and gait analysis can be done, and even an athlete's performance can be evaluated, whether in shot-putting, jumping or starting in a race.

The complete unit consists of a force platform, with quartz-crystal transducers, eight charge amplifiers, two summing amplifiers, an analog divider and a central control unit.

A similar unit, the 9257A Kiag-Swiss, also made by Kistler, measures the cutting forces in milling, grinding and lathe operations.

Another biomeasurement formerly difficult to make and now made easy with electronics is oximetry. Hewlett-Packard, Waltham, MA, solves this problem of measuring the percentage of arterial oxygen in a patient with its 47201A oximeter, and it does it without blood samples or any other body-invasive equipment. An "ear probe," which measures optical transmission at eight selected light wavelengths through a portion of the ear, is placed on the head like an earphone. Skin color and thickness, ear and head motion and many other potentially interfering influences don't affect the readings. Readings are taken 20 times per second, so rapid changes in blood oxygen are easily followed—formerly not possible. Thus new avenues of medical research, diagnosis and treatment are being opened.

#### Electronics aids chemical analysis

Where the oximeter is specialized equipment, the gas chromatograph/mass spectrometer (GC/MS) can analyze an almost unlimited number of complex substances—like cholesterol, DDT, the anticonvulsant methsuximide, the powerful toxin tetrachlorodibenzodioxin, urban air pollutants. Applications abound in biomedical and industrial research, forensic science, toxicology, environmental monitoring and medical diagnosis.

Chemists previously could analyze such substances only with tedious procedures. Electronic instrumentation, with computer assistance, now cuts days and hours of work to minutes.

In DuPont's new GC/MS, which it calls the Dimaspec, the operational parameters are set by pushbuttons. A preprogrammed mode, available as an accessory, permits the Dimaspec to remember procedures, and these can then be performed repetitively with the press of a button.

Hewlett-Packard, Palo Alto, CA, offers the Series 5980 GC/MS. The unit includes the HP 5933A data system, which employs an HP-2100S minicomputer and a 4012 graphic-display terminal. Together with an established and constantly updated library of software for the 5933A system, this dedicated mass spectrometer and gas chromatograph can collect, store and process a

*(continued on p. 100)*



**Blood oxygen can now be rapidly monitored** with this HP 47201A noninvasive oximeter. Readings are taken 20 times per second.



**Bioforce tables**, designed by Kistler, can evaluate the component forces in prosthesis loads, posture control, optokinetic effects and gait analysis.



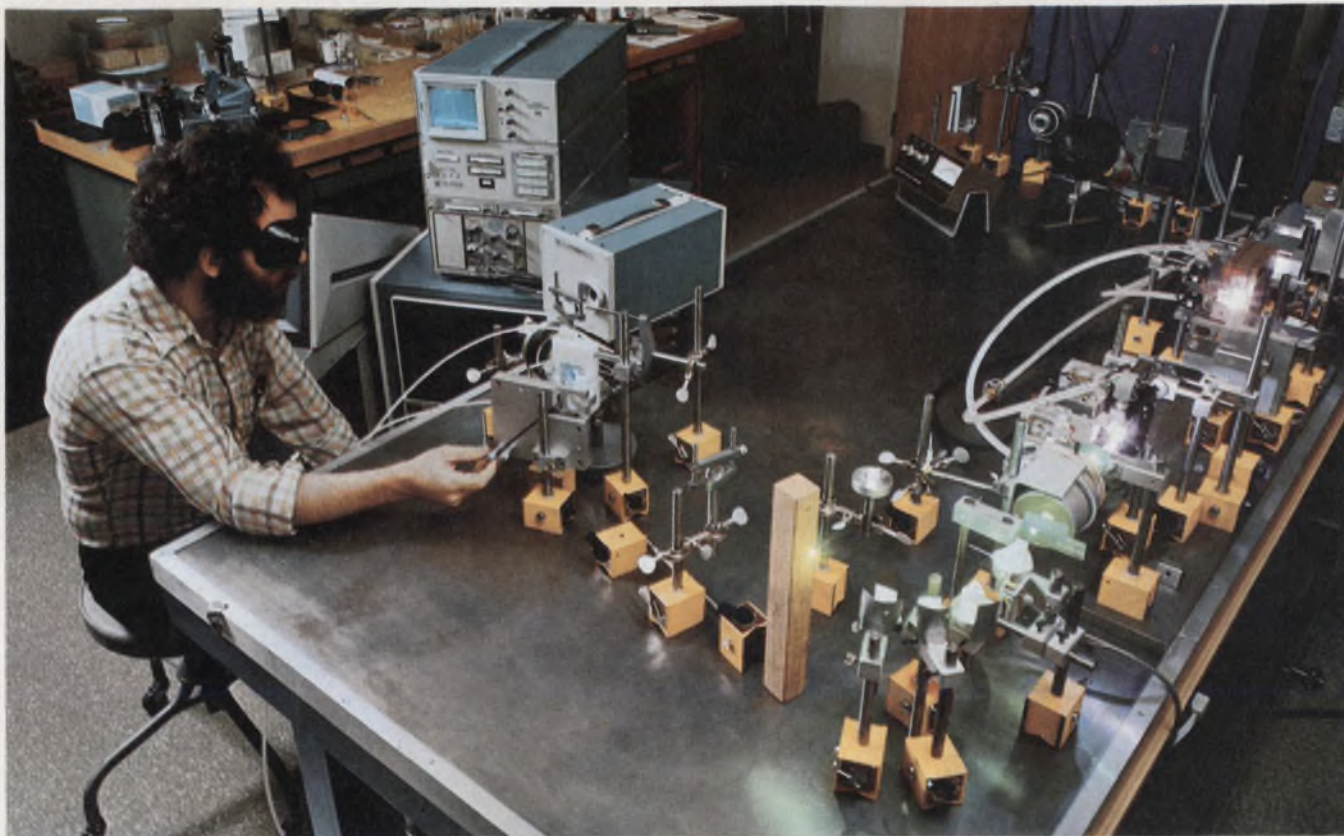

A versatile digital signal processing system, built around Tektronix 7000-series oscilloscope, is used in dye-laser development. Arithmetic functions, such as signal aver-

aging or the ratioing of two spectra, are done on data acquired in real time. Even fast Fourier transforms are performed with ease.

vast amount of data.

Thus electronic instrumentation has speeded and simplified complex chemical analysis and taken it from the fragrant environs of a chem lab to the chemist's office.

### Versatility exemplified

Digital-processing oscilloscope systems (DPOs) such as Tektronix WP1100 and WP1200 series, are prime examples of the versatility of electronic instruments. Automotive engineers are using DPOs to design efficient, pollution-free engines in this era of high fuel prices. Aerospace engineers are using DPOs for airframe and engine checkout and diagnosis. Structural engineers are studying shock and vibration problems with DPOs, and chemists and physicists are finding DPOs useful with a rapid-scan spectrometer to study chemical reactions and to develop test and sort new products. CRT phosphors, optical filters, LEDs, flash bulbs and die-laser emitters are being improved through use of DPOs.

The DPO acts as an intelligent interface between a transducer's analog output and a calculator or computer. It digitizes the raw analog data, processes it and then displays it in almost any form the user might want.

A large variety of transducers can be used to

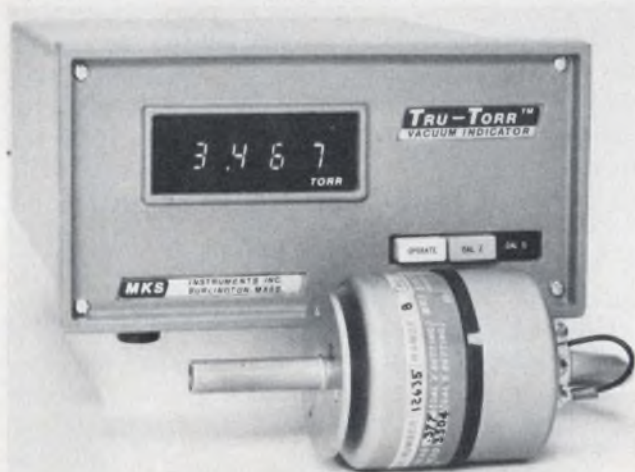

Many industrial instruments now have digital readouts like this vacuum indicator made by MKS Instruments. The readouts are directly readable in engineering units.

measure displacement, vibration, acceleration, temperature, force pressure or any other of a system's variables. And the system possesses a wide range of plug-ins to match them. Transient data, formerly studied only with great difficulty, can be readily recorded and analyzed with a DPO system. Even superfast transients, with time windows as short as 5 ns, can be handled with some DPO configurations. ■■





**Design versatility.**

**Rogan knobs and dials...  
in more colors, sizes, and styles  
than anyone else can offer.**

Samples of particular items will be sent upon request. Designate the color, size, style and shaft hole type. Inquiries directed to the factory sales office will receive our immediate attention.

 **ROGAN**  
CORPORATION

3455 WOODHEAD DR., NORTHBROOK, IL 60062  
TELEPHONE (312) 498-2300



# HIGH RELIABILITY



Get the **high reliability** that eliminates trouble. RNDIP sockets make contact with the wide, flat sides of your IC leads. This provides **100% greater surface contact** for positive electrical connection.

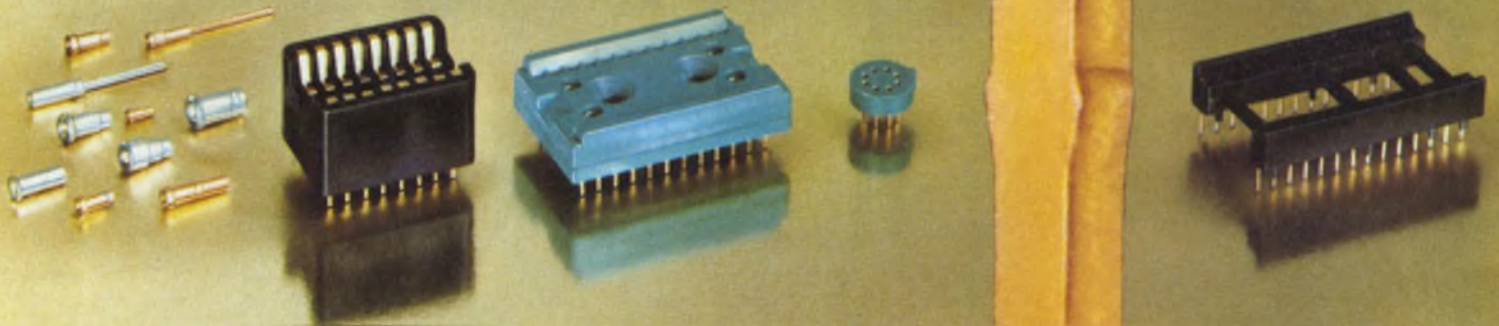



# DIP SOCKETS **for the price you're paying for junk!**

**Robinson Nugent "side-wipe" DIP sockets make 100% greater contact than any edge-bearing socket on the market.**

This 100% greater contact with the wide, flat surface of your IC leads is your guarantee of unmatched reliability. This RN "side-wipe" contact provides constant low contact resistance. No edge-bearing contact can possibly deliver this long term dependability. This designed-in reliability of RN DIP sockets is your assurance of trouble-free IC interconnects—yet they cost no more than ordinary sockets.

**Put an end to troublesome junk sockets!** Write today for catalog and informative book "What to Look for in IC Interconnects." It's free from RN—the people who make more kinds of high reliability IC sockets than anyone.

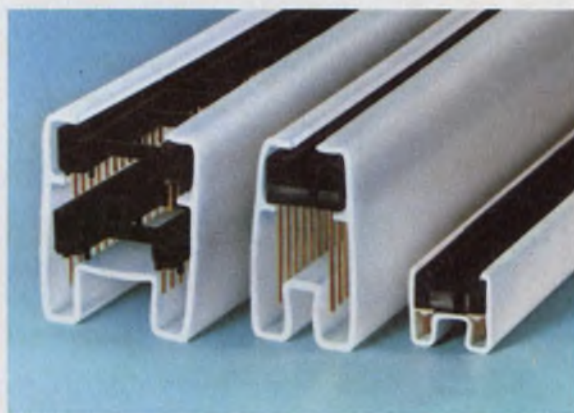

**They're even packaged for high reliability.**

"Protecto-pak"<sup>®</sup> packaging delivers consistently perfect RN sockets to your production line—for automated or manual assembly.

# **RN** **ROBINSON NUGENT, INC.**

800 East Eighth Street • New Albany, Indiana 47150 • Phone: (812) 945-0211

INFORMATION RETRIEVAL NUMBER 45

A photograph showing a variety of high reliability IC sockets. There are several black sockets of different sizes and pin configurations, as well as a few blue and green sockets. They are arranged on a reflective surface.

**High reliability IC sockets... we've got 'em all!**





A unique mapping mode is available with the Hewlett-Packard Model 1600A Logic State Analyzer. Digital words are presented as dots on the display, each word having a unique position. Vectors trace the digital sequence from word to word. It works with up to a 20-MHz clock.

## Logic analysis: The door opens to digital domain

Logic analyzers, multi-function instruments and microprocessor-based instruments are the new glamour products. While digital designers are eyeing logic analyzers, analog designers are focused on inexpensive, compact multi-function instruments—like oscilloscopes with built-in multimeters and counters, and spectrum analyzers with built-in generators and oscilloscopes. And both digital and analog designers are thinking about how to use  $\mu$ Ps in instruments.

Designers now have three ways of viewing data on logic analyzers. Most companies offer a simulated multi-channel timing diagram. Hewlett-Packard, Colorado Springs, CO, offers two alternatives. The first is a logic-state display of ONEs and ZEROs, where each word is displayed in its binary format. The second is something called a logic-domain map.

In the map, every possible word is shown as

a dot position on a CRT display. When a particular word is detected by the instrument, a dot is displayed in the appropriate location on the display. The pattern of dots becomes a sort of signature for a circuit.

According to Donald K. Corson, product line manager, HP's latest logic analyzers, the 1600A and 1607A are each 16-bit units. The 1600A offers display of ONEs and ZEROs and also mapping on a built-in CRT. The 1607A has no CRT; it shows the ONEs and ZEROs on most any auxiliary display.

When used together, 32-bit words can be displayed on the screen of the 1600A. By looking at the sequence of ONEs and ZEROs on the screen, the designer can do such things as examine a sequence of words stored in a ROM or check the sequence of words appearing at the output port of a microprocessor.

In the mapping mode, 65,536 dot positions are represented on the screen of the 1600A. Each dot position represents a 16-bit word. The dots are displayed with lines between them representing changing digital codes. An example of the use of the mapping mode would be debugging a  $\mu$ P.



Say the  $\mu$ P is caught in a loop somewhere in its program. Finding the particular loop in a long program is usually a formidable task. With the mapping mode, the addresses that the  $\mu$ P is looping through would show up as a few dots on the screen. With a cursor, the dots can be quickly identified and the loop determined. These instruments work with up to a 20-MHz clock and sell for \$4000 (1600A) and \$2800 (1607A).

### It's all a matter of time

Much more familiar to the logic designer is the timing-diagram approach to logic analysis. This complements the logic-state approach used by HP. Although the two techniques are often marketed as competitors, it is apparent that each has its own applications and that the complete laboratory will have both types of equipment.

In the timing-diagram approach the data word is looked at as a series of parallel ports. For 16-bit analysis, the first bit appears on the first line, the second bit on the second line and so on, for up to 16 bits in some analyzers. Then the series of bit transitions that appear in sequence on each line are displayed on a CRT face as a reconstructed or pseudo waveform. When all of the bit-line waveforms are viewed one above the other, the display is the common timing diagram so familiar to digital designers.

Two companies have pioneered this approach. They are E-H Research Laboratories, Oakland, CA, and Biomation, Cupertino, CA. E-H offers the 1320 Digiscope, which can accept up to four Model 1304 four-channel plug-ins. Thus the instrument can display 4, 8, 12 or 16 channels. The system samples at up to 50 MHz, and a built-in character generator displays the key test parameters on a CRT.

A trigger can be set to start recording only when a particular digital word comes by, and the system includes a glitch catcher that will detect and display transient pulses down to 5 ns wide. This system has a dual threshold to detect marginal ONEs and ZEROS. It sells for \$14,600 with 16 channels.

Biomation's latest entry is the 8100D, priced at \$8850. It samples at up to 100 MHz but has only eight channels. Its memory stores 2048 bits per channel, and it is fully programmable. This instrument does not come with a built-in CRT. However, it can be attached to most any scope or CRT monitor. Transient capture capability of the 8100D is a very good 3-ns pulse width.

Vector Associates of Bellport, NY, has its eye on the  $\mu$ P designer with its Vector 16. Priced at only \$4200, this is a 16-channel logic analyzer with a built-in 12-in. raster scan display. Settable address triggers and a 7-ns glitch catcher are featured, along with an adjustable cursor and

marker on the screen. A limitation of the instrument is a sampling rate of only 20 MHz.

The long-awaited entry of Tektronix, Beaverton, OR, into the logic-analyzer race is now reality. The approach is a timing diagram, and the instrument is called the LA501. It is a plug-in module that fits any of the TM-500 series mainframes. Priced at \$3250 without mainframe or CRT display, the instrument can be used for up to 16 channels of data.

Using a unique memory interleaving technique, the LA501 can sample four channels at up to 100 MHz, eight channels at 50 MHz or 16 channels at 20 MHz. It can also selectively place any trace anywhere on the screen for comparison purposes. But the instrument has two major drawbacks. It lacks a glitch catcher and a built-in word trigger.

¶ Newest of the companies in the logic-analyzer field is BP Instruments, Cupertino, CA. Jerome C. Blair, president, says: "We are going after the field-service portion of the market with a compact low-cost instrument called the BPI 20D Logiscope."

The name is somewhat of a misnomer, because



The LA 501 Logic Analyzer from Tektronix works with any CRT display. It displays up to 16 channels of data in a timing-diagram format and contains 4096 bits of storage. The unit is a plug-in module.



A calculating processor, the CP 70 from California Instruments, depends upon an internal LSI chip set. The unit performs calculations upon data received from a variety of instruments. The processed results are shown on an eight-digit LED display.





A complete stand-alone FFT processor with 15 built-in programmed calculations can analyze two signals simultaneously. The SD 360 from Spectral Dynamics shown here can perform cross-correlation and display probability-density histograms.



The 9650 Tracking Sweep Analyzer from Texscan works as a sweep generator-scope combination in one mode and as a spectrum analyzer in another. The instrument works up to 350 MHz.

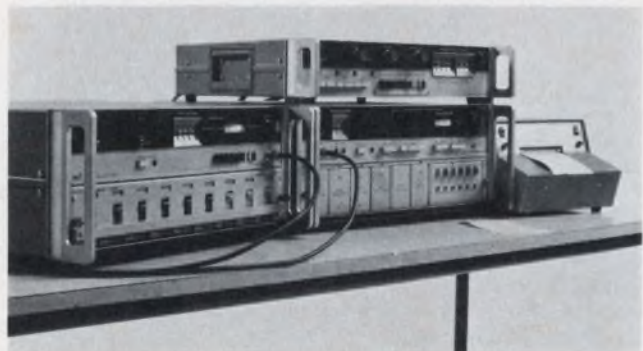

Marconi's white-noise test set, the 2090C, automatically measures noise under program control and displays results in decibels on a 2-1/2-digit readout.

the unit does not have a built-in CRT. It sells for \$2375, samples at up to 20 MHz and has eight channels of timing-diagram information. It can catch 10-ns glitches and has a combinatorial trigger. A unique feature is that four of the instrument's channels can be set at a different threshold than that of the other four channels.

A related instrument to logic analyzers, recently introduced by Biomation, is the serial data recorder. Roy Tottingham, product manager, says: "With the 110D, we can set a 16-bit or less code. The instrument accepts a serial data stream and searches until it recognizes the code. Then it triggers and can store up to 4096 bits in memory. It records a data stream sent either synchronously or asynchronously and can output the data to any scope or CRT display."

The 110D samples up to 10 Mb/s and can also provide a hexadecimal translation of each byte. It sells for \$2250.

### Call them multiscopes

There seems to be a rush among manufacturers to add additional instruments to oscilloscopes. Three notable examples have been introduced in the last year. Both Tektronix and Vu-data, San Diego, have added digital multimeters to mini-oscilloscopes. Vu-data has also added a digital counter. The Tektronix 213 displays the digital readout on the face of the CRT, while the Vu-data PS 915/975 has separate LED displays but makes measurements on the displayed waveform.

Texscan, Indianapolis, has a brand new spectrum analyzer, the 9650, that can also be used as an oscilloscope and a sweep generator simultaneously. Measurements can be made from 400 kHz to 350 MHz. Most spectrum analyzers have a built-in sweeper and oscilloscope, but Texscan has made them separately available to the user.

Although many instruments contain  $\mu$ Ps now, and large numbers are waiting in the wings, two new instruments are quite different.

California Instruments, San Diego, is producing a  $\mu$ P controller for instruments that is not built into the instruments. The first version, the CP 70, actually uses a calculator chip to perform various calculations upon data received from a variety of instruments that can be attached to it. The processed results are shown on an eight-digit LED display. The program can be changed only if the manufacturer plugs in a new ROM.

A two channel stand-alone FFT processor with 15 built-in programmed calculations, is the SD 360 from Spectral Dynamics. It can calculate and display on a large CRT the results of cross-correlation, convolution, probability density, probability distribution, auto-correlation and many more. The built-in processor is not reprogrammable. ■■



# We'll lease you this scope for \$42 per month.

## You can't buy a better deal.

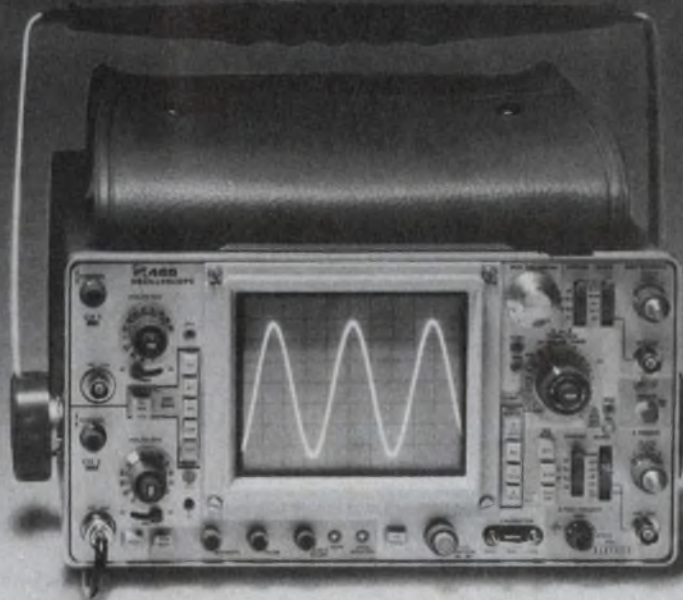

If you bought a Tektronix 465 outright, it would cost you about \$2,100.\* If you lease it from REI for 36 months, it'll cost you \$42 a month. And, we can give you immediate delivery of these brand-new instruments, even in multiple quantities.

No matter what kind of test instrumentation you need . . . scopes, analyzers, counters, recorders, generators, power supplies, you name it . . . we can lease it to you at a rate that lets you get more equipment out of your equipment budget.

For the full story of how REI can solve your electronic test equipment acquisition problems . . . through rental, leasing, or outright purchase . . . call your nearest Instant Inventory Center, or send the coupon.

\*Based upon Tektronix current list price.

Rental Electronics, Inc.,  
99 Hartwell Avenue, Lexington, Mass. 02173.

Please send me:  information on your TEK 465 offer.  
 information on the following test equipment \_\_\_\_\_

Name \_\_\_\_\_ Title \_\_\_\_\_

Company \_\_\_\_\_

Address \_\_\_\_\_

City \_\_\_\_\_ State \_\_\_\_\_ Zip \_\_\_\_\_

Tel. Number \_\_\_\_\_

## Rental Electronics, Inc.

A PEPSICO LEASING COMPANY

Burlington, MA (617) 273-2770 • Gaithersburg, MD (301) 948-0620 • Oakland, NJ (201) 337-3757 • Ft. Lauderdale, FL (305) 771-3500  
Des Plaines, IL (312) 827-6670 • Dallas, TX (214) 661-8082 • Mountain View, CA (415) 968-8845 • Anaheim, CA (714) 879-0561  
Rexdale, Ontario (PLC Leasing Ltd.) (416) 677-7513

INFORMATION RETRIEVAL NUMBER 46



# Build a switching regulator in half the time.

You know that a switching regulator can quadruple the efficiency of your power supply. It'll save power, cut heat loss, simplify your design, save board space, weigh less, and maybe cost less than a linear regulator.

But until now, if you wanted a switching regulator, you had to start from scratch. It took a lot of time and a lot of effort.

Our power switching circuit is the breakthrough you've been waiting for.

The power circuit is the trickiest part of the switching regulator to design, since it involves choosing the commutating diode and switching transistors, then fiddling with

the circuit to get the best drive and bias conditions.

We've taken care of all that. And the power circuit is the one that can contribute most in terms of improving the regulator's performance.

We've taken care of that, too. Thanks to our special design and packaging, you can expect faster response time and lower noise than you could design in yourself. And because of the faster switching time, you can reduce the size and cost of other components and operate at frequencies up to 100KHz.

Our PIC-600 Series power switching circuits are available with positive and negative outputs, in current ranges

from 5 to 15 amps and voltage capabilities up to 80 volts.

To make your life even easier, we've got a 24-page booklet that'll tell you everything you need to know about designing a switching regulator. It's the only booklet of its kind available, and it's free. To get yours, along with detailed specs for our power switching circuits, circle our number on the reader service card.

Unitrode Corporation,  
580 Pleasant St.,  
Watertown,  
Mass.  
02172.



UNITRODE



## The politicians

Maybe I'm too cynical but I often wish I had two votes—one to cast against the Democrats and the other against the Republicans. I sometimes feel that the principal qualification for success in American politics is an ability to lie with a straight face and show great sincerity. I find American politics nauseating at times, but many friends in Europe assure me that, in an hypocrisy contest, their politicians would beat the Americans with ease. So I often feel we might be better off if many politicians were to switch to nobler professions like bank-robbing or streetwalking.



I often thank my lucky stars that fate maneuvered me into the electronics industry rather than politics. And then comes my disappointment. I see organizations where politics takes up more time and effort than engineering, where jockeying for rungs on the political ladder is the main effort. I see too many cases—especially in the military and other government bodies—where the main occupation is protecting one's flanks while trying to crush political enemies.

I've been involved in too many interviews with government spokesmen who can speak uninterrupted for an hour—with power, sensitivity and sincerity—while saying nothing. I've seen too many company managers who are more concerned with preserving or advancing their own positions than with designing products to move their companies ahead. In too many companies the power rests, not with the man who knows how to get competitive products designed or how to guide the company through rough waters, but rather, with the man with the most political shrewdness.

Must this be? We've always enjoyed one of the cleanest industries, one that is free of the mud of political in-fighting. When industries get old and gray, they lose their youthful vitality; they lose their dependence on design innovation and they develop political sores. Our industry may still be vital enough, strong enough and young enough to cauterize itself and eliminate the political infections. Is it?

A handwritten signature in dark ink, which appears to read "George Rostky". The signature is written in a cursive, flowing style.

GEORGE ROSTKY  
Editor-in-Chief



Through Omron's 43-year history, each product has been designed and built as we have seen needs and filled them. One by one, year after year, as your needs grew, so did our family. And our family continues to grow—so that today Omron offers some of the broadest lines of control components available.

Omron enjoys a worldwide position of leadership—a position built on excellence in engineering, manufacturing, and marketing. And Omron's

commitment to quality products and service means you'll get *what you need, when you need it.*

So welcome Omron as your component supplier. Tell us your needs. Our applications engineering department will respond to your phone inquiries for key performance data within 48 hours.

**Omron will prove—you're not alone anymore!**



Omron Corporation of America  
Corporate Headquarters  
Sears Tower, Chicago, Illinois

Sales and Service  
1051 State Parkway  
Schaumburg, Illinois 60172  
Phone: (312) 885-9500



**Welcome  
to the family,  
little fella**



**Omron  
Representative  
Organization**

**EASTERN REGION**

**Andres Component  
Sales, Inc.**  
(716) 244-2445  
Upstate New York

**The Candor Co., Inc.**  
(803) 448-8361  
No. Carolina, So. Carolina,  
Tennessee, Mississippi,  
Georgia, Alabama, Florida

**Gerber Sales Co., Inc.**  
(617) 890-8040  
Maine, Vermont,  
New Hampshire,  
Massachusetts,  
Connecticut,  
Rhode Island

**S-J Associates, Inc.**  
(212) 291-3232  
Metro New York,  
Northern New Jersey

**Trinkle Sales, Inc.**  
(215) 922-2080  
Southern New Jersey,  
Delaware, Maryland,  
Virginia, West Virginia,  
Pennsylvania, D.C.

**CENTRAL REGION**

**Bear Marketing Inc.**  
(216) 659-3131  
Ohio

**Mark Kruvad Co., Inc.**  
(214) 691-4592  
Arkansas, Louisiana,  
Oklahoma, Texas

**R. C. Nordstrom & Co.**  
(313) 559-7373  
Michigan

**Quantum Sales, Inc.**  
(612) 831-8583  
North Dakota, South  
Dakota, Minnesota,  
Western Wisconsin

**The John G. Twist Co.**  
(312) 593-0200  
Eastern Wisconsin,  
Illinois, Iowa, Kansas,  
Missouri, Eastern  
Nebraska

**James Woolgar Co.**  
(317) 546-6888  
Indiana, Kentucky

**WESTERN REGION**

**N. R. Schultz Company**  
(206) 454-0300  
Washington, Oregon,  
Northern Idaho, Western  
Montana, Alaska

**Straube Associates, Inc.**  
(415) 321-9050  
Northern California,  
Nevada, Colorado, Utah,  
New Mexico, Wyoming,  
Eastern Montana,  
Southern Idaho, El Paso  
County, Texas,  
Western Nebraska

**Q. T. Wiles & Associates**  
(213) 478-0183  
Southern California,  
Arizona, Hawaii

For more information on  
branch offices, call  
representative's office  
or contact Omron Sales  
and Service office.

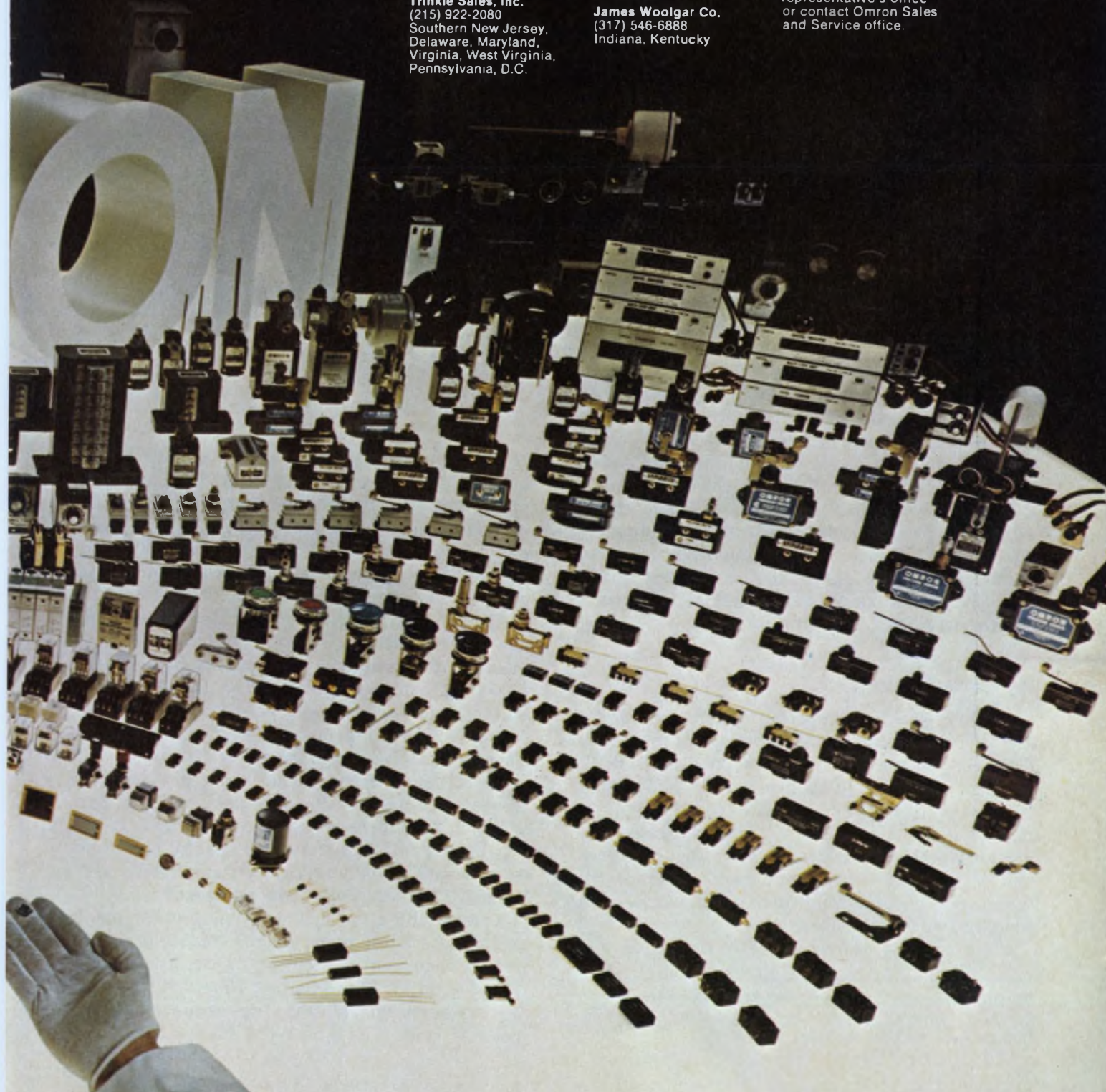



## Phase-meter specs can fool you, unless you consider the input signal before buying. First, know your application, then see how the meter responds.

Going by the specs isn't enough when it comes to buying a phase meter. Because the meter's performance depends more on the type of input signal than most other instruments do, you must know the intended use and what the signals will look like.

For instance, two competing meters may specify the same sine-wave accuracy. But one may actually be five times less accurate. Why? Because of harmonic distortion in the signal channel (Fig. 1). Waveform distortion can affect the meter's internal squaring circuits. And if the distortion isn't the same in both input signals, anomalous shifts occur in the apparent zero crossings, resulting in further errors.

At signal frequencies above 10 kHz—or with high-frequency harmonics present—parasitic cross-coupling between conditioning channels can create significant phase errors. This is especially true for large level differences between the input signals—say, 20 dB or more. How much error you'll get depends on the isolation between signal channels; so look for a figure on the data sheet.

Similarly you'd like to know how noise—either internally produced or riding on the inputs—affects performance. Large, random errors can result from noise unless the instrument somehow compensates with special inhibiting circuits or other means. Check into this.

### Dig beyond the specs

Another pair of competing meters may again list identical nominal accuracies. However, in practice, you may find that the two units don't perform equally. A little investigation shows that the two units respond unequally to variations in the two input levels (Fig. 2). Unfortunately, significant level differences between the reference and signal can introduce phase mismatch between the signal-conditioning channels—and thereby significant errors.

Close scrutiny should make it clear that you

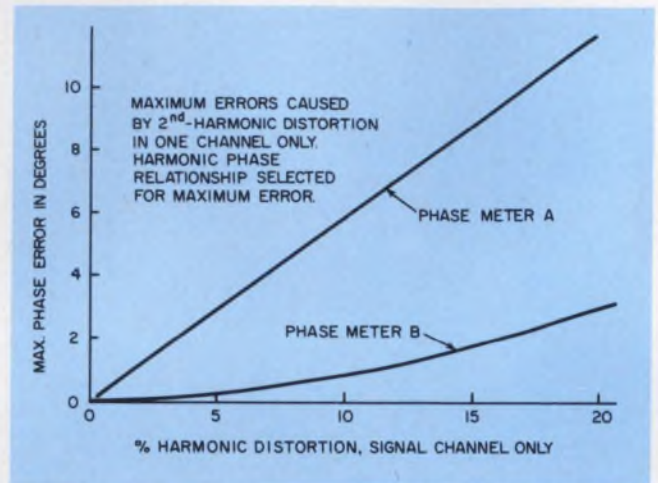

1. Effect of harmonic distortion on two competing phase meters. Note that meter A has the same nominal accuracy specification as meter B.

also can't select a phase meter merely by its nominal frequency range. Meters that are comparably rated may give widely divergent results beyond a certain frequency (Fig. 3). This happens because it's difficult—or impossible—to maintain the phase match in both channels over a wide frequency range.

Also, at high frequencies the internal squaring and differentiating circuits may be too slow to maintain the desired proportionality between the phase angle to be measured and the duty cycle of the circuits. One way out here is to opt for plug-in conditioning modules that are optimized for a desired frequency span.

Note that in some applications it's not just frequency response that's important, but how well the instrument tracks phase changes. If the instrument uses integration to smooth the input to the analog-to-digital (a/d) converter, ask: What's the integrator's time constant?

Another thing you'd like to find out for many applications is the meter's drift. Stability can be just as important as accuracy in phase measurements (Fig. 4). Temperature, time and line-voltage variations can all gang up to cause a phase meter to drift.

Abraham Dranetz, President, and Philip Cox, Sr., Project Engineer, Dranetz Engineering Laboratories, 2385 S. Clinton Ave., South Plainfield, NJ 07080.



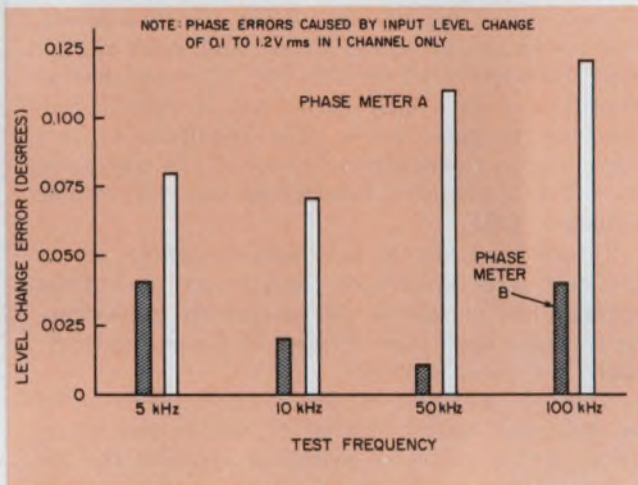

2. Two meters are rated with identical nominal accuracies. But the meters read differently because of unequal response to input-level variations.

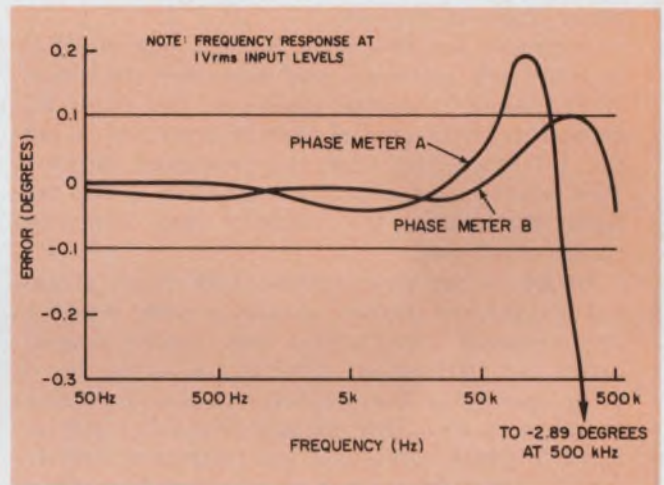

3. Both meters shown are specified at better than 0.1-degree accuracy. Note, however, the severe frequency error in meter A at some regions above 50 kHz.

Three circuits within most meters are particularly vulnerable to drift: the reference, or standard EMF, circuit; the integrator; and the dc amplifier. In digital instruments, add the a/d converter to the list. At present some phase meters hold short-term (one hour) drift, or repeatability, to 10 ppm, and keep tempco and line-voltage coefficient low enough to measure to accuracies of  $\pm 0.03$  degrees.

#### Watch for problems at band edges

If you expect to make many measurements near 0, 180, -180 or 360 degrees, see how the meter performs at these points. Since 0 and 360 are equivalent points in phase, as are 180 and -180, ambiguities can result when these points are near the edges of a range. Some meters randomly—and annoyingly—switch between one range extreme and another when angles are near band edges.

Other units automatically switch scales so that readings are made near band center and not at the edge of a band. Thus a reading that might cause trouble on a 0-to-360-degree scale falls nicely into the middle of a scale that runs from

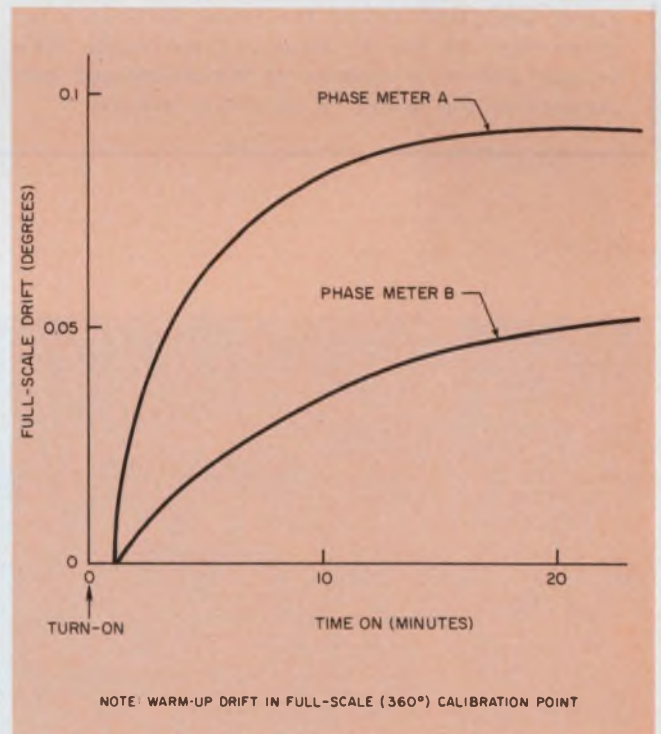

4. The warm-up stabilization characteristics of competing instruments can vary, even though both units are "comparably" rated in accuracy.



## How the new phase meters work

To understand why certain phase-meter performance specifications are crucial in certain applications, you must know how instruments measure phase.

In general, all meters measure the angle between two periodic signals of the same frequency by measuring the time interval between analogous zero crossings of the periodic waves and then computing the ratio of that time interval to one complete period. This ratio, multiplied by 360, is the phase angle in degrees.

Processed are two input signals, one of which is called the reference, and the other the signal. If the signal leads the reference, the phase difference is designated a positive angle; if it lags the reference, the angle is considered negative. This positive and negative convention is not uniform throughout the industry and sometimes causes confusion.

In all of the newer units, both input signals are conditioned before analogous zero crossings are measured. Conditioning may involve amplification or attenuation, filtering, squaring up or other operations. But whatever is done, care must be taken to treat both signals identically with respect to phase. Otherwise the instrument will introduce phase errors, and phase mismatch between the two signal-conditioning channels is a primary source of error in many designs.

However, it may be impossible to provide identical circuit paths for the two signals if they differ greatly in amplitude or in waveform. A very large signal may have to be attenuated and a very small signal amplified before the phase difference between the two can be measured accurately. This is only one of a number of signal-imposed constraints in the design of precision meters.

Before measurement of the time interval between zero crossings, the signals usually are transformed first into square waves (or at least rectangular waves, if the signals don't have equal positive and negative periods). In many phase meters this is done with several stages of amplification and limiting. This produces square waves whose transitions are amplifications of the zero crossings of the input signals. The next step is the differentiation of the leading edges of the square waves, and the use of, say, the two resulting positive-going spikes to set and reset a flip-flop. The output of the flip-flop is a rectangular waveform with a duty cycle that is exactly proportional to phase angle. The amplitude of this waveform is standardized by use of the waveform to switch a precisely determined and very stable standard EMF.

If care is taken to minimize switching errors and duty-cycle dependence, the average value of the standardized waveform will be directly proportional to phase angle, and it may be scaled appropriately for direct reading.

The analog output of this type of phase meter is developed by integration of the output waveform of the reference-switching circuit. The integral of this waveform is, of course, the average value, which is directly proportional to duty cycle. The integrating time constant introduces delay between the occurrence of a phase change and its output result.

A direct-reading display of the phase angle is obtained by digitization of the analog output in an a/d converter. Typical scale calibrations might be 000.0 to +360.0 or -180.0 to +180.0. Many phase meters offer both scales, though some use offset scales, such as -5 to +355.

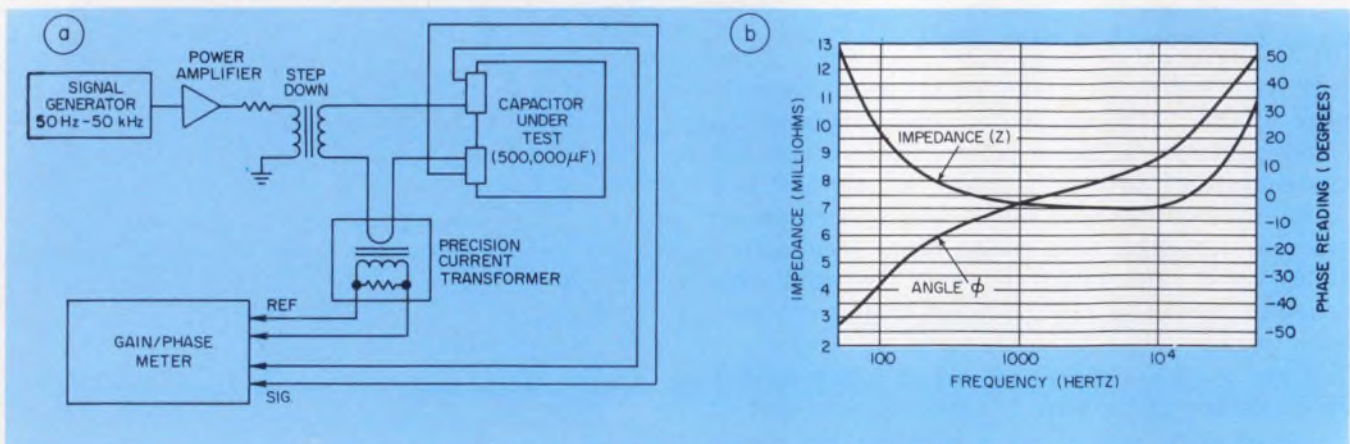

5. Gain/phase meters are ideal to measure very low impedances, such as that of a 0.5-F capacitor (a). The re-

sults of such a measurement are shown in "b." Note the ranges over which good accuracy are important.



## Phase-meter checklist

### Accuracy

- Over what frequency range?
- Over what signal-level range?
- How affected by level differences between signal and reference inputs?
- How affected by waveform (harmonics, noise, N/P asymmetry)?
- How affected by signal duty cycle?

### Input interface

- Sensitivity?
- Input impedance?
- Dynamic range?
- Autoranged or manual?
- Range indication provided?
- Are inputs isolated?
- Is range programmable?

### Angle ranges

- Single or dual?
- Manual or autoranged?
- Is range programmable?
- Is there a "dead band" (range-edge anomaly)?
- Is range-edge ambiguity possible?

### Output interface (analog)

### Scaling? (mV/degree)

- Response time constant—fixed or adjustable?
- Automatic selection of time constant?
- Temperature coefficient?
- Line-voltage coefficient?
- Short-term repeatability?
- Long-term stability?
- Linearity?

### Output interface (digital)

- Resolution?
- Repeatability?
- Computer compatible?
- Temperature coefficient?
- Short-term repeatability?
- Long-term stability?
- Linearity?

### Programmability

- Selectable time constants?
- Selectable filters?
- TTL interface?
- Selectable angle ranges?
- Autocalibration?
- Computer compatibility?

## Mating the phase meter to the application

| Application class                                 | Characteristics   |                                  |  |                            |             |  |                                    | Other Characteristics                               |
|---|-------------------|----------------------------------|--|----------------------------|-------------|--|------------------------------------|---|
|   | Absolute accuracy | Level independence (autoranging) | Fast response (time-constant tracking) | Time/temperature stability | Sensitivity | Waveform independence (complementary duty-cycle averaging) | Noise immunity (retrigger inhibit) |   |
| Measuring very low impedances                     | ✓                 |                                  |  | ✓                          | ✓           | ✓  | ✓                                  | Frequency range                                     |
| Controlling resistor trimming (laser or abrasive) | ✓                 |                                  | ✓                                      | ✓                          |             |  |                                    | Resolution  |
| Watt-meter and watt-hour-meter calibration        | ✓                 |                                  |  | ✓                          |             | ✓  |                                    | Input-circuit isolation                             |
| Measuring mechanical impedances                   |                   | ✓                                | ✓                                      |                            |             |  | ✓                                  | Frequency range                                     |
| Adjusting crystal frequency                       | ✓                 | ✓                                | ✓                                      |                            |             | ✓  |                                    | Autocalibration and Programmability                 |
| Testing and adjusting filter networks             | ✓                 | ✓                                | ✓                                      | ✓                          | ✓           | ✓  | ✓                                  | Frequency range and autocalibration programmability |
| Measuring distance and directivity                | ✓                 | ✓                                | ✓                                      | ✓                          |             |  |                                    | Programming   |
| Measuring group delay                             |                   | ✓                                |  | ✓                          | ✓           |  |                                    | Linearity, resolution                               |
| Measuring amplifier phase shift                   |                   | ✓                                |  |                            | ✓           |  | ✓                                  |   |
| Measuring transfer functions                      |                   | ✓                                |  |                            | ✓           | ✓  | ✓                                  |   |
| Calibrating attenuators                           | ✓                 | ✓                                |  | ✓                          | ✓           |  | ✓                                  | Autocalibration                                     |



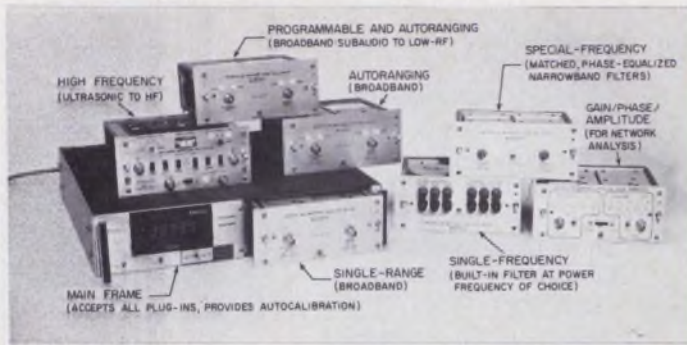

**Modular phase-meter family:** The mainframe provides power, a digital readout and autocalibration controls. Each plug-in is optimized for a dedicated application.

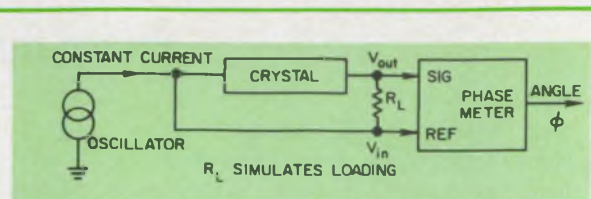

7. Crystal frequency is adjusted with a phase meter by use of resonance.

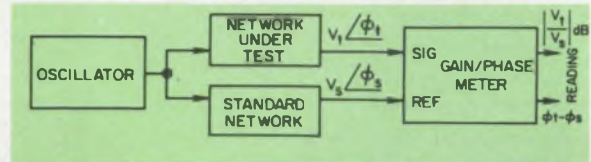

8. Use of a gain/phase meter to test filters. Meter should have no dead band near zero.

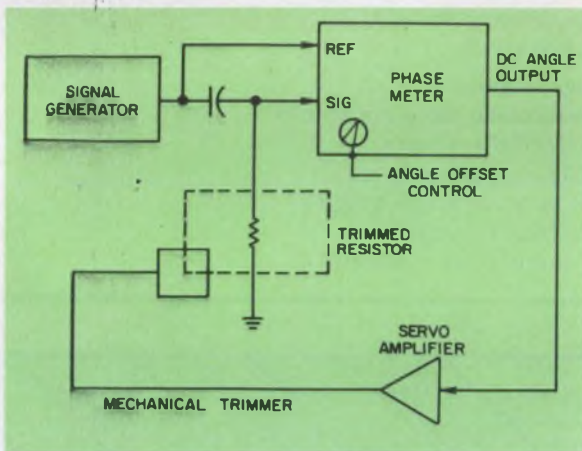

6. A phase meter controls the laser or abrasive trimming of resistors. The meter output drives the servo to null at a preselected angle.

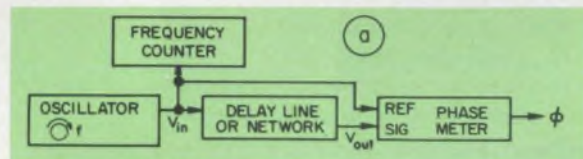

9. Determination of group delay of a network with a phase meter (a). The measurement is made by calculation of  $d\phi/d\omega$  in the desired frequency range (b).

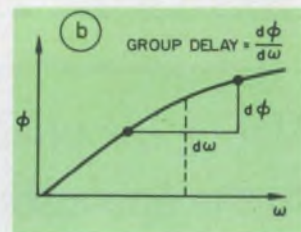

-180 to +180 degrees.

All of this is well and good. What, however, if your signals aren't sinusoidal? Can the meter handle, say, rectangular waveforms? Suppose the signals have different duty cycles (but the same periods for a meaningful phase relationship)? Is the meter equipped to avoid possible anomalies caused by the different duty cycles?

#### Look for error compensation

What other error-avoiding or convenience features does the instrument offer? Available are units that automatically range or automatically vary internal time constants to keep response speed high. You can also get units that compensate for phase differences at all gain or attenuation settings. These meters thus hold down errors caused by widely unequal signal amplitudes. If waveform distortion is a problem, look for units that are designed to handle such inputs—they're available.

A few instruments measure gain along with phase—that is, they give readings or deliver outputs that are proportional to the input levels or

to the ratio of the two input levels. The ratio is usually conveniently expressed in decibels of gain or loss. In Fig. 5 a gain/phase meter is shown measuring the impedance and phase angle of a very large (0.5 F) capacitor.

Low-impedance measurements, such as that of a 0.5-F capacitor, are crucial when the component is to be used for energy storage or in a switching regulator design. And the measurement is virtually impossible to make with a conventional bridge or voltmeter. Because the voltage across the capacitor can be as low as 10 mV at some frequencies, you'll need a phase meter with high sensitivity and good noise immunity, among other things.

Some other important measurements with phase meters are given in Figs. 6 through 9. The most important meter characteristics for each application shown, as well as some others, are summarized in the table.

Finally, because of the variety of possible specifications for each application, use a checklist. It can make the buying decision a lot easier. ■■





Meet the  
"Green  
Goddess"

**The ultimate capacitor — with automatic insertion equipment, the cost of the "Green Goddess" is lower than disc capacitors!**

Varadyne's "Green Goddess" Ceramic Capacitors are sealed in glass, the time proven package that offers superior: hermeticity, reliability, volumetric efficiency and lead "pull" strength.

"Green Goddess" capacitances range from 10 pF to 1.0 mFd and meet the requirements of MIL-C-11015 and MIL-C-39014.

Three formulations are offered: Type BN (Ultra Stable)

NPO, Type BR (Stable) X7R and Type GM (General Purpose) Z5U/Y5V.

Three standard case sizes are offered with maximum dimensions of .160 x .100, .260 x .100 and .400 x .155. Leads are tin plated, copper clad steel with a .020 diameter, 1¼" minimum length.

"Green Goddess" capacitors are available for immediate delivery!

---

**FREE:** Your own .01 mFd "Green Goddess" axial leaded ceramic capacitor. Call, write or circle our "Bingo" number and the "Green Goddess" is yours!

We're  
out to  
WIN



## VARADYNE

Varadyne Industries, Inc.  
1520 Cloverfield Blvd.  
Santa Monica, California 90404  
(213)829-2984 • TWX(910) 343-6856



# IT'S WORKING FOR US



James F. Freeman

**'I know the  
GOLD BOOK  
gets to engineers  
in Europe  
... I was there'**

James F. Freeman is Marketing Director for Sylvan Ginsbury, Ltd., exporters and importers of electronic components and instruments.

Back from a recent business trip to Scandinavia, Europe and the Middle East, Mr. Freeman reports:

**"Your GOLD BOOK is sure finding its way around the world. I saw it in Finland, Sweden, Denmark, France, Germany, Italy and Israel. I didn't expect to see it in technical and engineering offices. Technical people are referring to it. It gets around."**

Sylvan Ginsbury, based in Teaneck, N.J., handles overseas sales for a string of American electronics companies, including Arnold Engineering, Clairex Electronics, KMS Optical Systems, Quan Tech, Solar Systems, Electro Corp., Stackpole Carbon Co. and Thomas Electronics.

*Electronic Design's* GOLD BOOK offers the largest circulation among European engineer/specifiers of any U.S. electronics publication and it's the only U.S. directory to go overseas in quantity—more than 13,000 copies in 1975. Another 78,000 copies went to engineers, engineering managers, distributors and purchasing agents throughout the USA. This is *Electronic Design's* audience at work!

**THE GOLD BOOK IS WORKING FOR  
SYLVAN GINSBURY, LTD.  
... IT CAN WORK FOR YOU!**

***Electronic Design's* GOLD BOOK is working. It's working for users and  
it's working for advertisers, too.**



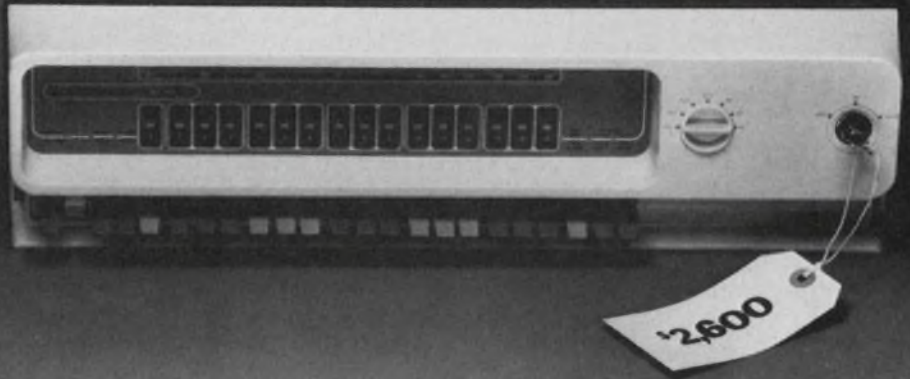

## Has your \$500 micro ended up costing more than our \$2,600 mini?

If you've had to spend a lot of money on a low priced micro, you may be in a position to appreciate the cost advantages of a higher priced computer.

Our \$2600 Nova 3.\*

When you buy a Nova 3, you don't have to put as much into it to get it to do your job.

You don't have to create your own operating systems. Nova 3 is software compatible with our other Novas. So you get to use all the existing Nova operating systems, language processors and utilities.

And you don't have to worry about performance. Nova 3 executes instructions in 700 nanoseconds using MOS memory. And its sophisticated architecture lets you use up to 128K Words with the optional Memory Management Unit.

You don't have to buy more

computer than you need. Nova 3 has the broadest range of compatible configurations you can get in an OEM minicomputer line. There's a 4 slot Nova 3. A 12 slot Nova 3. (It has an optional expansion chassis that gives you 12 more slots of I/O.) And you can configure multiple processor Nova 3 systems.

You don't have to worry about Nova 3 availability. We're manufacturing virtually every part of the Nova 3. Including the silicon gate N-channel MOS RAM memories. (They're coming from our Sunnyvale, California facility.)

And you don't have to go it alone. Because when you buy a Nova 3, you can get all the support Data General offers an OEM.

Write or call for the Nova 3 brochure. It may persuade you to buy more and spend less. \*\$2600 is the single unit price for a 4K MOS memory Nova 3. Before the OEM and quantity discounts get figured in.

# DataGeneral

Nova 3: The biggest thing to ever hit the OEM market.

INFORMATION RETRIEVAL NUMBER 50



## To test hybrid PC boards, with mixed analog and digital circuits, requires a versatile test system. The practical choice narrows down to four types.

Testing digital circuit boards is hard enough. Combine digital and analog circuitry on one "hybrid" board, and you've really got a tough problem. Which methods and what equipment to use boil down to four choices—each with its own flexibility.

The choice is complicated by such factors as anticipated board volumes, variety of board types, over-all corporate testing requirements, future plans and, of course, cost.

Individual circuits on hybrid boards can range from the most complex LSI to discrete packages. The boards may contain any combination of digital and analog packages, ranging from one of a type to well over 200. Some hybrid boards may have 250 pins, or more, each connected to a different circuit.

Whatever the mix on the board, the digital, analog and hybrid circuits are to some extent interdependent. The signals that occur across interface pins appear in random order from one board type to another. This complicates the problem of achieving maximum accuracy and reliability on any given pin.

Complicating matters further is the lack of standardization. A linear driver may be connected to pin 1 on one board, while the next board to be tested may have a digital flip-flop at that pin. An analog circuit may require, say, a phase-angle voltmeter or a timer-counter for measurement and a function generator or waveform synthesizer for stimulus. By contrast, the digital circuit might need a high-speed digital word generator or a programmable pulse generator for stimulus. For digital measurements, the assortment includes a high-speed digital word receiver or pulse analyzer.

In typical production-line testing, you may have to measure an analog output signal of 1 mV and then a rise time of 2 to 3 ns at the same pin on the next board. Can your test system cope with these widely varying situations?

Obviously large, single-batch production volumes ease this problem. To go from one batch to the next, you change the interface adaptor on a dedicated test system to one uniquely suited to the new batch. But this results in down time. Some test systems show more flexibility—they can handle a variety of hybrid boards without physical changes in adaptors or patch panels. Based on the degree of flexibility, hybrid testers can be categorized into four slots that stack up as follows: (1) Fully flexible; (2) Flexible non-switching; (3) Limited flexible and (4) Fully dedicated.

With the fully flexible test system, you can test the entire hybrid board simultaneously, without adaptors or patch panels and without regard to the circuit mix or the frequency of test changes on any board type. This is made possible by the hardware and software features of the system, which carries a higher initial cost. However, the relative long-term cost of operation may be less than that of other methods.

Where production operations are sufficiently large and diverse, dedicated subsystems can be tied into a flexible central test station to provide the benefits of both flexible and dedicated testing. You can realize considerable savings with this technique, because the subsystem uses the same test programs and a subset of the stimuli, measurement devices and switching from the central station.

For example, suppose a company has four different production lines, one of which has a high throughput of many different types of complex boards, while the other lines produce specific types of boards in varying volumes. The computerized central test station is located at the primary line to handle the heavy mix, and a subsystem—dedicated to each of the other lines—draws from the software and hardware of the central station. For example, each subsystem may handle as many as 30 distinct board types, but the central station may handle more than 100.

The second system type, flexible nonswitching, lacks automatic switching and is therefore most useful with large batches. But adaptors must be

---

**Philip Jackson**, Vice President of Engineering, Instrumentation Engineering, 769 Susquehanna Ave., Franklin Lakes, NJ 07417.



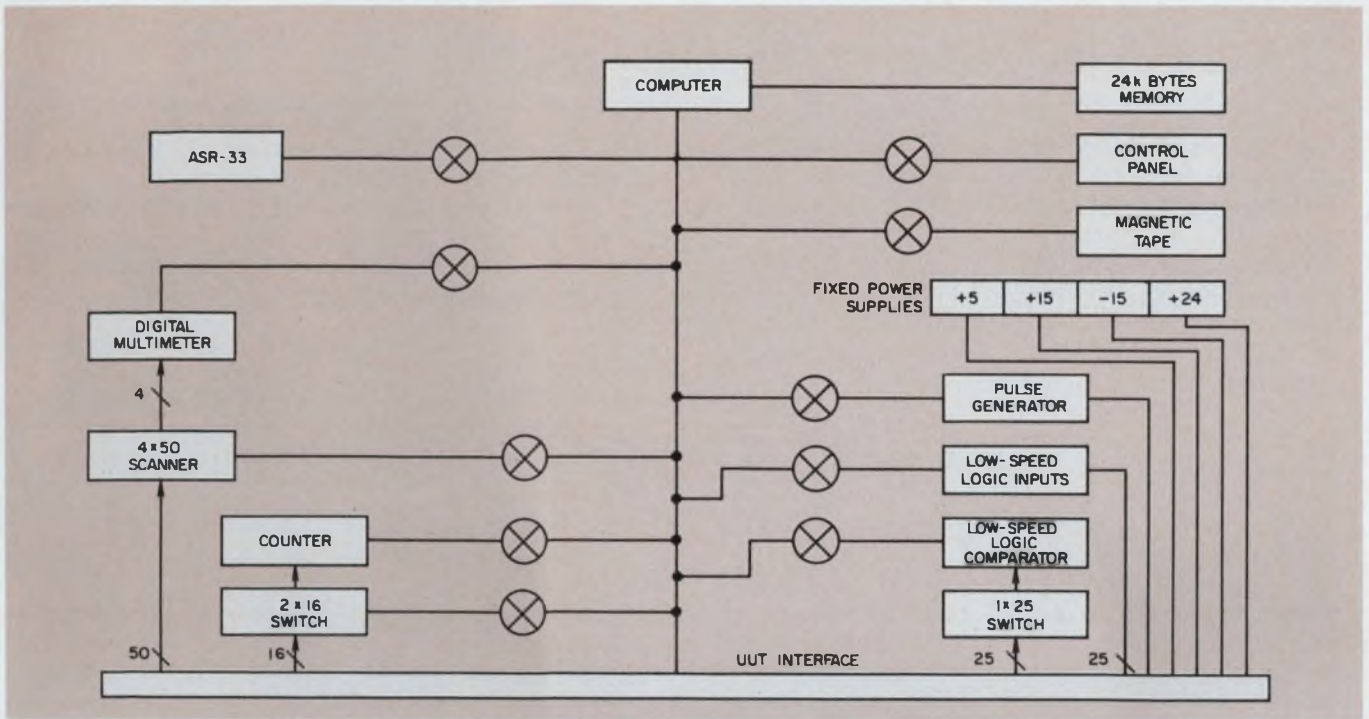

1. All components of a fully dedicated tester are targeted at just one device or family. Thus software, interfaces

and the measurement and stimulus instrumentation are designed with this in mind.

## Calculation of cost of ownership

|  | Present ATE | Type "A" ATE | Type "B" ATE |
|--|-------------|--------------|--------------|
| <b>Section I — System acquisition</b>          |             |              |              |
| (a) Hardware costs                             |             |              |              |
| (b) Software costs                             |             |              |              |
| (c) Support costs                              |             |              |              |
| <b>Total System Acquisition Costs</b>          |             |              |              |
| <b>Section II—Production testing</b>           |             |              |              |
| (a) Adaptors, patchboards, fixtures, etc.      |             |              |              |
| (b) Test program cost                          |             |              |              |
| (c) Set-up cost                                |             |              |              |
| (d) Test cost                                  |             |              |              |
| (e) Fault isolation cost (troubleshoot)        |             |              |              |
| (f) Set-up retest cost                         |             |              |              |
| (g) Retest cost                                |             |              |              |
| <b>Total production test cost</b>              |             |              |              |
| <b>Section III — Data analysis and reports</b> |             |              |              |
| (a) Quality control reports                    |             |              |              |
| (b) Logistics and field service reports        |             |              |              |
| (c) Configuration management reports           |             |              |              |
| <b>Total data analysis and report costs</b>    |             |              |              |
| <b>Section IV — Other corporate costs</b>      |             |              |              |
| (a) Refurbishment cost                         |             |              |              |
| (b) Multistation capability                    |             |              |              |
| (c) Remote station control                     |             |              |              |
| <b>Total other corporate costs</b>             |             |              |              |
| <b>TOTAL COST OF OWNERSHIP</b>                 |             |              |              |



## How much does a test system really cost?

If the initial price of a test system—including hardware, software, and any adaptors or patchboards—were the only consideration, the dedicated system would invariably prove most attractive. To take advantage of the test system for a number of years, however, you must consider the whole economic picture, based on such factors as programming time, future test requirements and possibly corporate-wide use of the test system.

With the form shown in the table, you can compare the total cost of three levels of circuit board testing: dedicated ATE, flexible ATE and all other methods (manual, automatic or combinations of both). Careful calculation yields the total cost of testing over the lifetime of the equipment.

If you must use ATE to test a variety of boards—each in varying quantities—and also want to use the test system for other corporate operations over a few years, a cost comparison may show that a flexible test system—though higher priced initially—is more economical in the long run. Under other conditions, a dedicated system may prove the best solution.

As an example, compare the costs of a dedicated system and the flexible ATE, based on the following assumptions:

1. To be tested: 200 board types—one-third digital, one-third analog and one-third hybrid.
2. Average number of boards per production lot: 10.
3. Programming and debugging costs: With a flexible ATE, 20 hours at \$25, or \$500 per program; for a dedicated ATE, 60 hours at \$25, or \$1500 per program.
4. Average test time per board for both flexible and dedicated systems: 1/2 minute.
5. Average setup time: For flexible ATE, 10 seconds per board, with no adaptors required; for dedicated ATE, 10 seconds per board plus 18 seconds (average) to cover changes in adaptors, figured at 3 minutes per adaptor and batches of 10. Total: 28 seconds per board.

6. Total test time: For flexible ATE, 40 seconds; for dedicated ATE, 58 seconds.

This means that throughput with the flexible system is 1.45 times faster than with a dedicated system. Based on this and other assumptions, the following cost comparisons can be made:

|                                  | Dedicated Tester           | Flexible Tester            |
|----------------------------------|----------------------------|----------------------------|
| Purchase price                   | \$140,000                  | \$250,000                  |
| Adaptors (200 at \$700)          | \$140,000                  | .....                      |
| Programs (200)                   | \$300,000                  | \$100,000                  |
| Total cost to become operational | \$580,000                  | \$350,000                  |
| Production throughput            | One board every 58 seconds | One board every 40 seconds |

It is difficult to attach cost figures to other corporate uses and benefits of automatic test systems. Note, nevertheless, that the flexible test system can perform functions that most dedicated systems cannot. Included are quality-control reports, data logging, remote facility control, universal testing and assembly rework.

Universal testing refers to a system that tests product A but can also handle products B, C, D, and so on, with the same hardware or with limited modifications. The value-added benefits of a flexible system that are not shared by dedicated systems include nonobsolescence, fault isolation and on-line program editing. Still another feature—self-testing—is shared in a limited way by dedicated systems. Finally, the flexible system can develop configuration management reports, while only certain dedicated systems can do this.

Nonobsolescence can prove extremely attractive to users who anticipate significant changes in circuit designs over the ensuing years. Savings can amount to thousands of dollars over new dedicated systems. Of course, when you focus on just an existing, well-defined test problem, obsolescence is of lesser importance.

inserted with each board type, and this can prove expensive in terms of downtime when batches run, say, 1 to 10 at a time.

The user must weigh the time required to make adaptor changes against the cost of the tester over the lifetime of the system. Another consideration: Is more than one switching system necessary? The added cost of a general switching system is relatively low, but a complete range of specialized switching systems may prove costly.

The third tester, limited flexible, can handle only analog or digital circuits, but it provides automatic internal switching. This permits a variety of tests. Stimulus and measurement de-

vices are limited to those required for the limited range.

For example, suppose you want to test for voltage gain on a low-frequency amplifier. The tester will be designed specifically for this analog circuit and will consist of just a general switching system with a function generator and digital voltmeter. This limited system is adequate and economical for its purpose. But if you suddenly must test hybrid boards, you can use this system only on the analog side of the board. You must ignore the digital side, check it manually or use a digital tester.

Because of the inherent interaction between



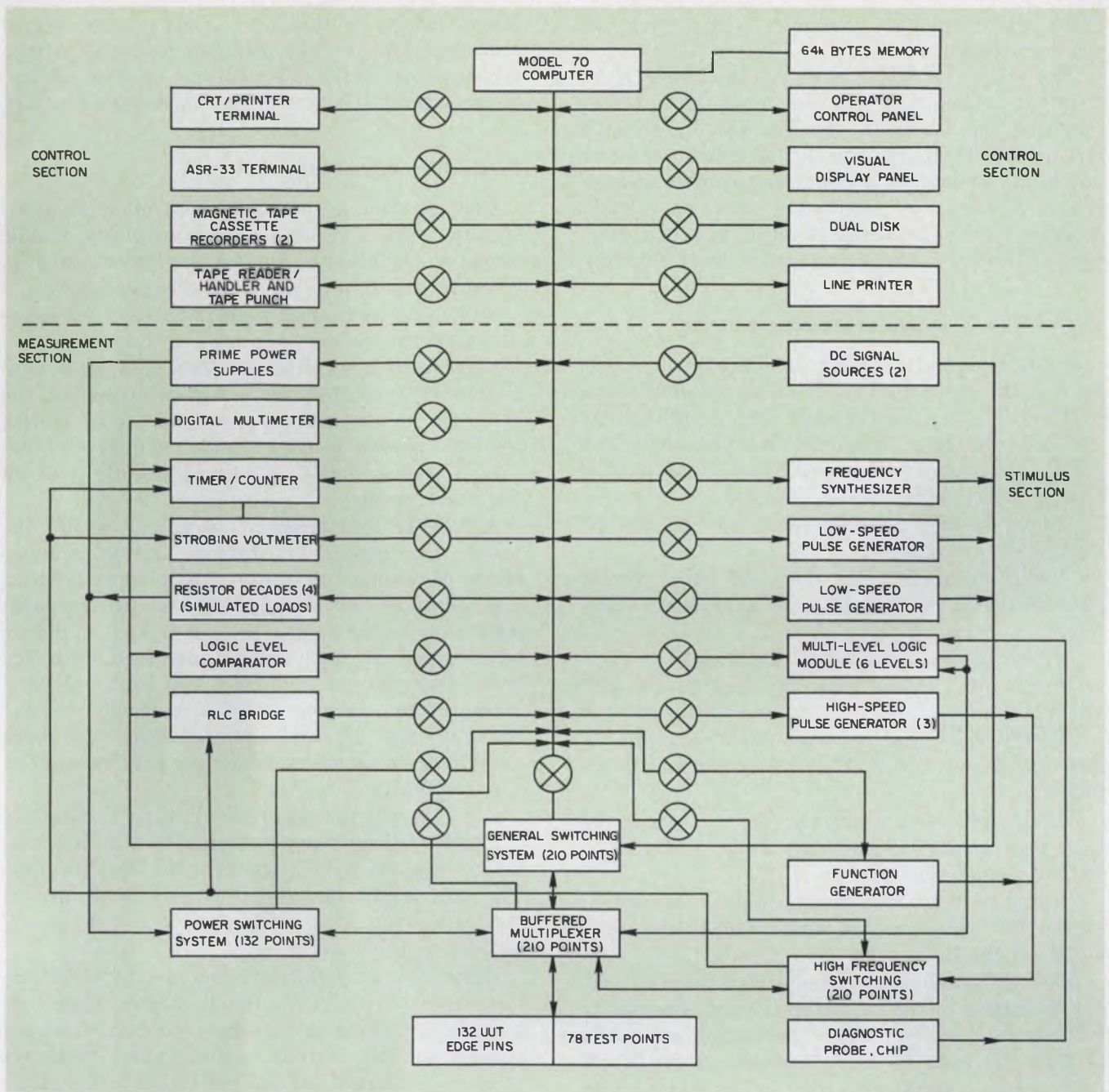

2. In a fully flexible test system, the various components are designed to handle any kind of circuit board, includ-

ing combined analog and digital. And static, dynamic and functional tests are possible.

the analog and digital circuits, the limited flexible method usually proves unsatisfactory. The probability of 100% valid testing is low, the operation is time-consuming and the use of two test systems—that is, two dedicated systems—may be too expensive.

By contrast, in the fully dedicated system—the fourth type—the stimulus and measurement devices, interfaces and software are all aimed at one test category, perhaps a series of digital CMOS logic, or a family of high-speed op amps. This system requires adaptors to interface with the units under test and cannot readily accommodate different boards, even if quite similar

to the one under test (Fig. 1).

Such a system can be built in-house or purchased commercially, and it offers an economical solution to high-volume and high-batch production situations. However, the dedicated unit can't test small batches or hybrid boards.

Where a minicomputer functions as the controller in dedicated or flexible systems, particular attention must be given to the input/output arrangement and the software.

For dedicated testers, programs are limited to the specific boards to be tested, and the computer controls only a few stimuli and measurement devices. The user writes test programs in a lower-



order programming language, with terms not readily recognizable.

The fully flexible system, on the other hand, requires no adaptors or other physical interface modifications. With it, you can test any type of circuit board: digital, analog, or hybrid. Internal automatic switching permits any combination of static, dynamic or functional tests on boards, modules and subassemblies. And you can diagnose faults down to the component level (Fig. 2).

### English-like language eases programming

A key aspect of the fully flexible system is programming and software. Here an adapted form of the ATLAS (Abbreviated Test Language for Avionics Systems) language lets you write and debug test programs in clear terms. Some typical analog instructions are as follows:

"Apply 20-mV, 200-kHz sine wave on pin 2." (Stimulus statement).

"Verify frequency less than 850 kHz, greater than 848 kHz, on pin D." (Measurement statement).

Typical digital test instructions are:

"Apply 5-V, 20-ns pulse on pins 9, 10, 47." (Stimulus statement).

"Verify rise time between 0.5 V and 4.5 V, less than 3 ns, on pin 220." (Measurement statement).

Finally, here is a typical hybrid test statement that uses a digital stimulus input and analog output measurement:

"Apply pattern 10011010 on pins 1 through 8; verify dc volts greater than 4.000, less than 4.020, on pin Z."

Such a high-order language also delivers useful messages to the operator. If you attempt to deliver, say, 200 mA when the station capability is only 100 mA, an error message is displayed. Any illegal procedures that cause inadvertent shorts across the unit under test will also be flagged immediately.

In this typical flexible system, the ATLAS programming terms are converted into bit patterns or object code by a resident generator, a software device residing permanently in core. Operating somewhat like a software interpreter, it permits on-line debugging of programs. All debugging is done without delay, in English terms, and the final statements are translated immediately to prove the corrected test procedures.

The keys to the high order of flexibility in this test system lie in two significant sections of the system: the peripherals and the switching.

Accommodated by the system are both standard and nonstandard stimuli and measurement devices—function and digital word generators, signal sources, d/a converters, frequency synthe-

sizers, clocks, multimeters, comparators, signal analyzers, and the like. But the very diversity of these devices poses the problem of how all can be made to interface with the computer's I/O bus.

### Practically no limit on peripherals

One approach is the device controller, designed so that only five types of controllers handle scores of peripherals. In fact, the system in Fig. 2 can incorporate as many as 200 peripherals.

Switching techniques used in this system make it possible to perform one type of test on an analog circuit at a specific pin, then conduct a completely different test on a digital circuit at the same pin on another card. And the same system conducts a wide range of tests on any combination of analog, digital or hybrid circuits built on the same board.

Among various types of switching within the tester, the general switching system handles either parametric digital or analog tests. With it, you can apply any stimulus devices (in the parametric digital or analog category) to any pin or combination of pins at the interface with the board being tested. Similarly you can apply any measurement devices in this category to the board in any allowable combination. And both stimuli and measurement devices may be applied simultaneously.

For example, the general switching system lets you test a hybrid board housing 70 or 80 ICs, discrete circuitry, hybrid components, and the like. The mix might include TTL and MOS digital logic, op amps, d/a converters, a/d converters, buffers or other circuits.

Other tests may call for even more diversification. In tests requiring currents higher than 1 A, a power-switching system may be needed to accommodate the various stimulus and measurement devices. And because of bandwidth limitations of the general and power-switching sections, a 50- $\Omega$  high-frequency switching system may be desirable. With it, you can get bandwidths up to 120 MHz, useful in high-speed dynamic pulse testing and in high-frequency analog testing.

With switching accomplished through a multiplexer located near the test fixture, the flexible test station can handle 256 pins at the interface. The user-configured test fixture forms the interface between the circuit board and the test station, and, depending on the physical arrangement of the board under test, the interface might be of the zero-insertion force type, pressure pins or ordinary edge connectors. For fault-diagnosis, you can use the so-called guided probe simulator or elaborate fault-isolation fixtures. Which fixture to use is based on careful analysis of the board types to be tested. ■■



# THE BUCK STOPS HERE!

## WHEN YOUR PROBLEMS MUST BE SOLVED



**AILTECH 360 DIRECT FREQUENCY SYNTHESIZER** delivers crystal controlled signals with:

- Clean signals — spurious 100 dB below the output
  - Quiet signals, phase noise floor typically 138 dB/Hz below the output
  - Resolution — 0.1 Hz available
  - Fast switching — 20  $\mu$ sec
  - Modular — for maximum versatility
  - Frequency — 10 KHz to 180 MHz (other ranges to become available)
- ALL AT NEW, LOW COSTS!**

**AILTECH Noise Figure measuring instruments, the standard of the industry.** Noise Figure Indicators, Hot/Cold Generators, Coaxial, Waveguide and Solid-State Noise Generators, Precision IF Attenuators and Test Receivers . . . A complete solution to your Noise Measurement needs. The 75 Precision Automatic Noise Figure Indicator measures Noise Figure with accuracy and resolution . . . Automatically. The 7009 Hot/Cold Standard Noise Generator — the instrument that put accuracy into Noise Figure measurements.



**AILTECH RF Power Signal Sources provide a broad range of High RF Power Generation.** A wide variety of standard product offerings are available, spanning 10 KHz to 8000 MHz in frequency and 50 microwatts to 100 watts CW up to 1000 watts peak, power output. AILTECH's line of RF Power Signal Sources includes octave, double-octave, and decade frequency bands, plus the extraordinary versatility of plug-in frequency bands.

**EAST COAST OPERATION** • 815 BROADHOLLOW ROAD • FARMINGDALE, NEW YORK 11753  
Telephone (516) 595-6471 • TELEX 510-224-6558

**WEST COAST OPERATION** • 19535 EAST WALNUT DRIVE • CITY OF INDUSTRY, CA 91748  
Telephone (213) 965-4911 • TELEX 910-584-1811

#### INTERNATIONAL OFFICES

FRANCE — La Garenne-Colombes, Telephone 7885100, Telex 62821

GERMANY — Munich, Telephone (089) 5233023, Telex 529420

UNITED KINGDOM — Crowthorne, Telephone 5777, Telex 847238

JAPAN — Tokyo, Telephone (404) 8701, Telex 781-02423320 (Nippon Automatic)

**AILTECH Spectrum Analyzers** provide 100 dB display range and 10 GHz scan widths . . . higher and wider than comparable analyzers available today.

**AILTECH Spectrum Analyzers feature:**

- Internal Preselection
- Spurious responses 80 dB down
- Ease of use
- Automatic phase lock
- Digital Frequency Readout
- Variable Persistence and Storage Displays available
- IF filter selectivity 5:1 (60 dB to 3 dB ratio)
- Frequency:
  - 727 — 1 MHz to 20 GHz
  - 707 — 1 MHz to 12.4 GHz



75



7009

**The AILTECH 7300 Series of System Noise Monitors** are designed to satisfy those field, production and on-line system monitoring applications that demand **Simplicity, Economy and Accuracy** in their instrumentation. The System Noise Monitor Series offer half rack and full rack models, analog and digital models and an assortment of options. The 7380 digital unit provides both Noise Figure and Gain monitoring simultaneously. This single instrument converts your complex test stations into one single operation.



**REMEMBER . . . THE BUCK STOPS HERE!**

. . . We can help you satisfy your most difficult applications . . . call **AILTECH** for free engineering consultation service.

**AILTECH**   
A CUTLER-HAMMER COMPANY **CONTROL**

INFORMATION RETRIEVAL NUMBER 51



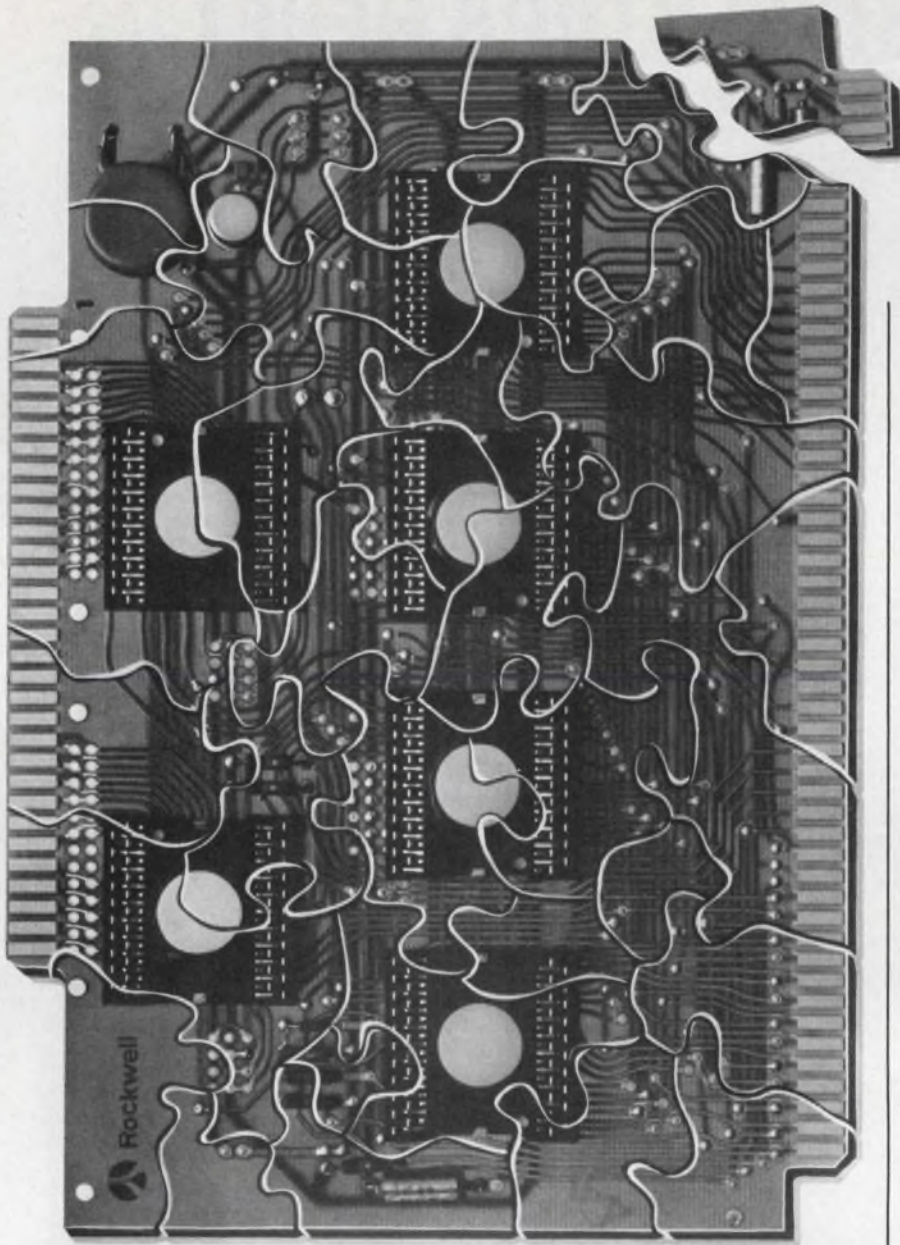

# Rockwell a system



**AFTER**



## DMAC:

**Another burden  
lifted from the CPU.**

Our 8 channel Direct Memory Access Control (DMAC) gives priority to data flow between the I/O's and the system's memory. Once again, the CPU is freed from a routine, time-consuming chore.

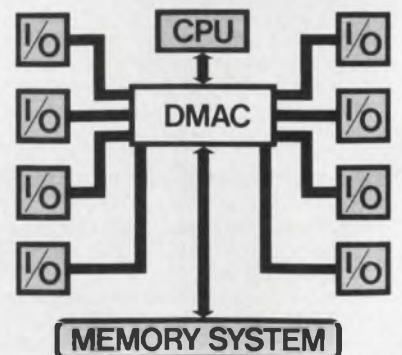

## Intelligent I/O's do the CPU's busywork.

We've identified many common tasks performed by micro-processing systems and designed intelligent LSI I/O's to control them — independent of the CPU. The CPU is thus able to delegate mundane chores such as running the peripherals, while concentrating on the serious thinking it does best.

The spreading of intelligence among the I/O's also reduces the amount and cost of program memory in your system. And because the CPU is no longer responsible for monitoring a multiplicity of functions all over the lot, programming becomes simpler, faster, and more flexible. You simply plug in or remove a chip with minor, not total, software changes to add or subtract functions.



# is there with approach to microprocessing.

## PARALLEL PROCESSING:

### HIGH SPEED RESULTS FROM LOW COST TECHNOLOGY

With so much independent intelligence spread through our system, many tasks can be executed at virtually the same time. With our parallel processing system (PPS) you can now perform tasks with MOS micro-processing that would otherwise require higher cost technologies.

## A THRILLING CASE HISTORY

A fellow designed a new cash register whose I/O's sprawled over three PC boards and cost about \$250. He felt there was a better way and went to a large microprocessing house, but one which sold chips, rather than systems. They reduced him to one large and two small PC boards, with a cost of about \$160. Finally, he came to Rockwell, where we applied

our LSI system approach to his problem. He walked out with his entire system in LSI on one PC board at a cost of about \$85.

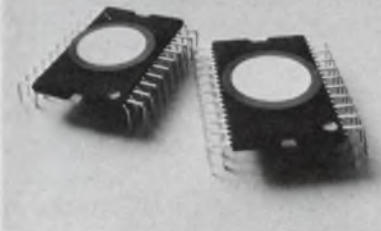

### MILLIONS OF DOLLARS SAY WE'RE SERIOUS ABOUT ALL THIS

We've spent millions of dollars to develop more than 40 LSI microprocessor circuits to offer you LSI options for most of

your electronic needs. As well as a worldwide sales and field service organization. Add to that a production capacity of tens of millions of circuits per year and you get the picture: giant Rockwell is very serious about tiny micro-processors. Don't let anyone tell you otherwise.

**Help is never more than  
ten digits away:**

**714•  
632•3729**

Just call us at any hour and tap into a wealth of Rockwell customer support: detailed literature, software libraries, assembler - simulators and other design aids. Programming and board development assistance. And training programs at our facilities or yours. Some of this help is free; some costs. Take as much or as little as you need. What's important is that it's there. Right now.

Stop trying to solve micro-processor problems by bits and pieces. Instead, see how Rockwell's LSI system approach can help you. Call Bill Roland at (714) 632-3729 or write to:

Department 2 C 1122  
Microelectronic Device Div.  
Rockwell International  
P.O. Box 3669  
Anaheim, California 92803



**Rockwell International**

...where science gets down to business



# Test semiconductors automatically with a computer. With a precision interface, you can accurately force voltage or current and measure response.

You can use your computer to precisely measure leakage currents, saturation voltages and other important semiconductor dc parameters. The key to the operation is a precision measurement unit (PMU), which functions as the interface between the computer and the device under test (Fig. 1).

With the PMU, you can excite the device under test (DUT) with an accurate voltage or current and simultaneously measure the resulting current or voltage—all under program control. Forcing voltage can vary from 1 V to 100 V, in four ranges, with up to 1-mV resolution; while current ranges from 1  $\mu$ A to 100 mA, with up to 1-nA resolution. The measured values cover the same ranges with the same resolution.

In Fig. 1, the positions of switches  $S_1$  and  $S_2$  determine the PMU's operating mode. For the voltage-force/current-measure mode, switches  $S_{1-B}$  and  $S_{2-A}$  are closed. The closure of  $S_{1-B}$  completes a voltage-feedback loop: The level sensed by the voltage follower feeds back to the open-loop summing amplifier  $A_1$ . The input of  $A_1$  is  $V_R$ , the output of DAC 1, a digital-to-analog converter whose inputs are determined by the test program.

## Program controls operating mode

By this means, a stable PMU output voltage,  $V_o$ , is produced, proportional to  $V_R$ . The ratio,  $V_o/V_R$ , is determined by the gain of amplifier  $A_5$ , which is also program controlled. Thus the value of gain establishes the output voltage range. In practice  $A_5$  can be an amplifier or a simple resistive voltage divider, depending on the voltage range selected.

The concurrent closure of  $S_{1-A}$  completes a current measuring circuit. The output voltage,  $V_i$ , of differential amplifier,  $A_1$ , is proportional to the current flow,  $I_o$ , into the DUT ( $V_i = I_o \times R_3$ ). Voltage  $V_i$  then becomes one input to comparator  $A_9$ . The other input is  $V_s$ , the output of DAC 2.

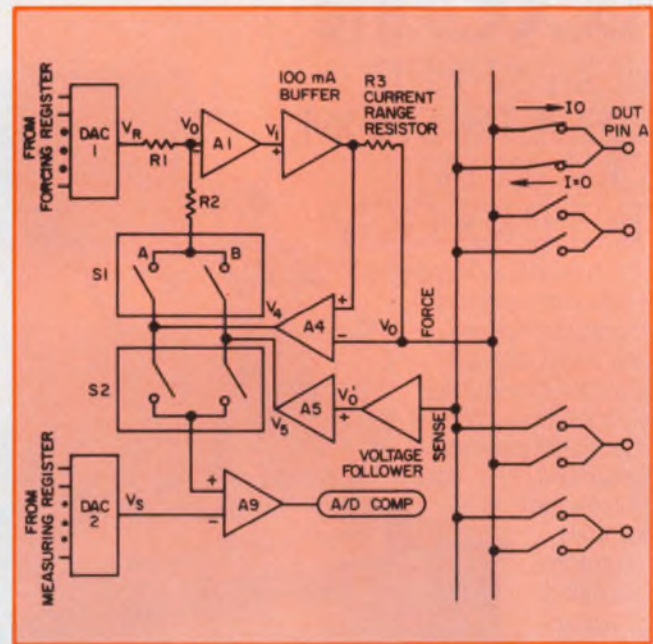

1. With a precision measurement unit (PMU), accurate voltages and currents can be forced and measured.

A software routine, which uses the output of  $A_9$  as a control signal, adjusts the inputs to DAC 2 until  $V_i$  and  $V_s$  are equal. This produces a quantity in digital form proportional to  $I_o$ , which can be read out of the measuring register as part of the data-logging process.

Closing of switches  $S_{1-A}$  and  $S_{2-B}$  puts the PMU in the current-force/voltage-measure mode. Closure of  $S_{1-A}$  completes a current-feedback loop, in which  $V_i$  must be equal to  $V_R$ . However, since  $V_i$  is proportional to  $I_o$ , a stable PMU output current results. The current is proportional to  $V_R$ , the level that drives or loads the DUT as determined by the program. The ratio,  $V_R/I_o$ , is set by the current range resistor,  $R_3$ , which is switched-in under program control to select the appropriate current range.

Concurrent closure of  $S_{2-B}$  connects the output of amplifier  $A_5$  to one input of comparator  $A_9$  and completes a voltage measuring circuit. The software routine adjusts the inputs of DAC 2 until  $V_5$  and  $V_s$  are equal. Thus a quantity proportional to  $V_o$  is retained in the measuring register.

George Niu, Senior System Design Engineer, Fairchild Systems Technology, 1725 Technology Dr., San Jose, CA 95110.



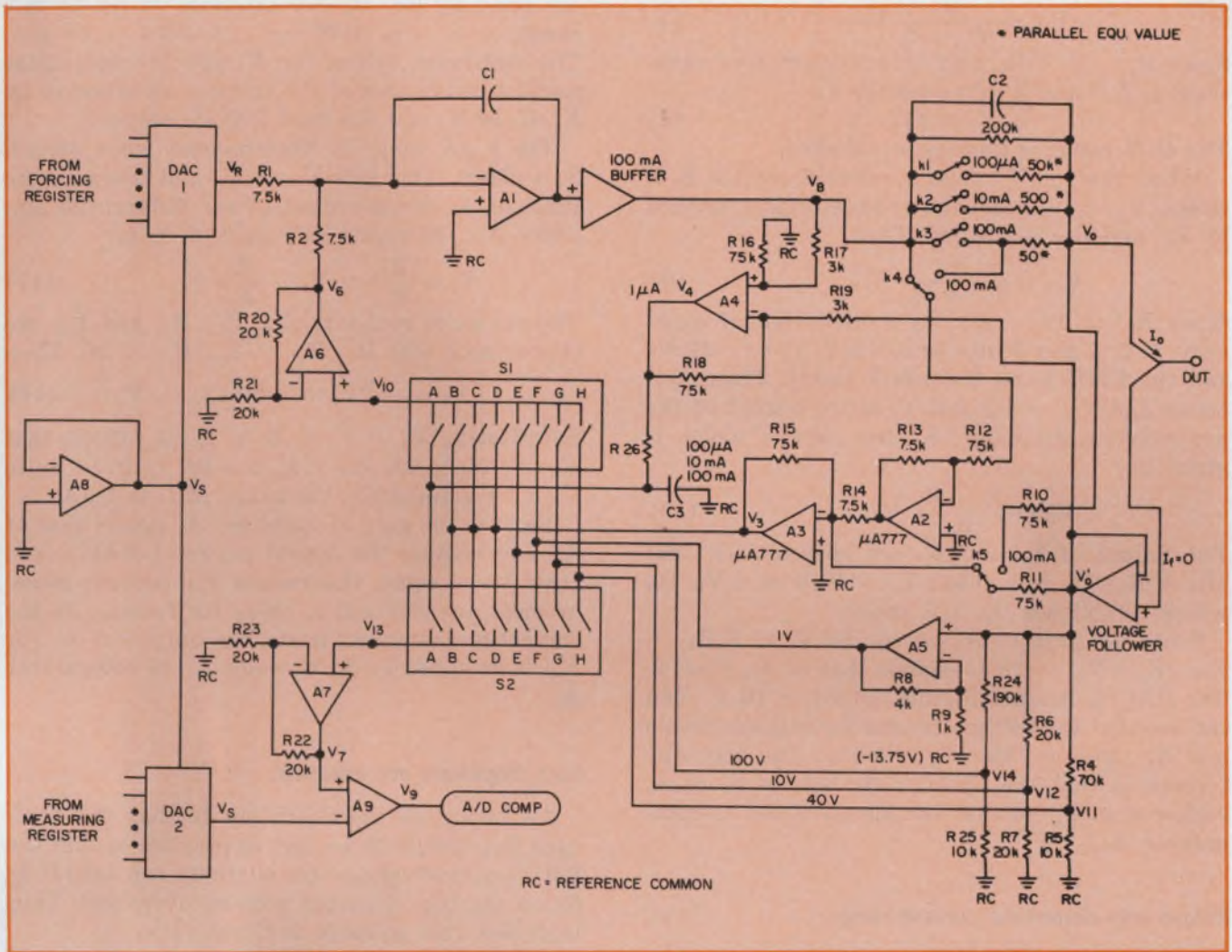

2. Circuit details of the measurement unit show how the computer controls the forcing and measuring func-

tions. Outputs are sampled and fed back to comparators to ensure accurate program emulation.

Fig. 2 is a detailed schematic of the forcing feedback loop and measuring circuit. The operating ranges cover most of the semiconductor devices available today (see table).

Both DAC 1 and DAC 2 have full-scale outputs of 10 V. Amplifier A<sub>1</sub> is an op amp with open-loop voltage gain on the order of 10<sup>5</sup> (100 dB). Because of the high gain, V<sub>o</sub> can be considered zero, and the input bias current of A<sub>1</sub> is negligible compared with the current flowing out of DAC 1. Thus

$$\frac{V_R}{R_1} + \frac{V_6}{R_2} = 0,$$

and since R<sub>1</sub> = R<sub>2</sub>,

$$V_6 = V_R. \quad (1)$$

#### Four ranges possible

To see how the voltage ranges are established, trace the voltage gain from the PMU output to amplifier A<sub>n</sub>'s output. Voltage V<sub>n</sub>' is the output of the voltage follower, a unity-gain, noninverting amplifier with high (10<sup>12</sup> Ω) input impedance. Thus:

$$V_o' = V_o. \quad (2)$$

When the 10-V range is selected, the voltage divider formed by R<sub>n</sub> and R<sub>7</sub> is used. Then

$$V_{12} = \frac{R_7}{R_n + R_7} V_o', \quad (3)$$

Since R<sub>n</sub> = R<sub>7</sub>, Eq. 3 becomes:

$$V_{12} = (1/2) V_o'. \quad (4)$$

When switch (S<sub>1</sub>-G) is closed, V<sub>10</sub> = V<sub>12</sub>. Finally, the gain of the noninverting amplifier, A<sub>n</sub>, is given by:

$$V_6 = \frac{R_{20} + R_{21}}{V_{21}} V_{10} = 2V_{10}. \quad (5)$$

Thus by substitution of equations 1, 2, 3 and 4 into equation 5,

$$V_o = V_R. \quad (6)$$

Therefore the PMU output has the same value as that of DAC 1 but is of opposite polarity. Since DAC 1 has an absolute full-scale output of 10 V, so does the PMU.

Similarly, when S<sub>1</sub>-H is closed, V<sub>10</sub> = V<sub>11</sub>, and the voltage divider formed by R<sub>4</sub> and R<sub>5</sub> comes into play. Then



$$V_{10} = \frac{R_5}{R_4 + R_5} V_o' \quad (7)$$

Since  $R_4 = 7 \times R_5$ , and by substitution of equations 1, 2, 3 and 5 into equation 7,

$$V_o = 4V_R \quad (8)$$

The 40-V range is thereby established.

When the 100-V range is selected, switch  $S_{1-E}$  closes,  $V_{10} = V_{14}$ , and the voltage divider formed by  $R_{24}$  and  $R_{25}$  is selected. Then,

$$V_{10} = \frac{R_{25}}{R_{24} + R_{25}} V_o' \quad (9)$$

Since  $R_{24} = 19 \times R_{25}$ , by substitution of equations 1, 2, 3 and 5 into equation 9,  $V_o = -10 V_R$  and the PMU is on the 100-V range. Then  $S_{1-F}$  closes and  $V_{10} = V_5$ . But  $V_5$  is the output of the noninverting amplifier,  $A_5$ , the gain of which is given by:

$$V_5 = \frac{R_8 + R_9}{R_9} V_o' \quad (10)$$

The values of  $R_8$  and  $R_9$  are chosen such that  $(R_8 + R_9)/R_9 = 5$ . Thus  $V_o = V_5/5 = -V_R/10$ , which establishes the 1-V range.

Since the gain of  $A_7$ —given by  $V_7 = [(R_{22} + R_{23})/R_{23}] V_{13} = 2V_{13}$ —equals that of  $A_6$ , DAC 2, like DAC 1, has a full-scale output of 10 V. You can see that the voltage ranges for measurements are the same as those for forcing. The only difference is that the appropriate legs of  $S_2$  close, rather than  $S_1$ , so that the signal is fed to comparator  $A_9$ .

### Relays also determine current range

Current forcing ranges are determined by the positions of switches  $K_{1-3}$  and  $S_{1-A, B, C, \text{ or } D}$ . When a current range of 100  $\mu\text{A}$ , 10 mA or 100 mA is chosen,  $S_{1-B, C, \text{ or } D}$ , respectively, is closed. In all three cases,  $V_{10} = V_3$ . Amplifiers  $A_2$  and  $A_3$  act together as a differential amplifier. Thus:

$$V_2 = -\frac{R_{13}}{R_{12}} V_B \quad (11)$$

$$V_3 = -\frac{R_{15}}{R_{14}} V_2 - \frac{R_{15}}{R_{11}} V_o' \quad (12)$$

If the values of  $R_{12}$ ,  $R_{13}$ ,  $R_{14}$  and  $R_{15}$  are chosen such that  $R_{15}/R_{14} = R_{13}/R_{12}$ , then  $R_{15} = R_{11}$  and, from equations 2, 11 and 12,  $V_3 = V_B - V_o$ . Hence,

$$V_R = -2(V_B - V_o) \quad (13)$$

Now  $(V_B - V_o)$  is related to the PMU output current,  $I_o$ , by  $V_B - V_o = I_o \times R_3$ , so that  $V_R = -2(I_o \times R_3)$ . By selection of the appropriate values of  $R_3$ —switched-in by  $K_1$ ,  $K_2$  or  $K_3$ —you establish the current ranges as follows:

$$\begin{aligned} V_R &= -2 I_o \times 50 \text{ k}\Omega = -100,000 I_o \text{ (100 } \mu\text{A range)} \\ &= -2 I_o \times 500 = -1000 I_o \text{ (10 mA range)} \\ &= -2 I_o \times 50 = -100 I_o \text{ (100 mA range)}. \end{aligned}$$

As before, DAC 1 output,  $V_R$ , has a full-scale range of 10 V, and the full-scale current ranges

are given by Eq. 14. For example, in the 10 mA range,  $I_o = -V_R/1000 = -10/1000 = 10 \text{ mA}$ . The resistance values for  $R_3$  are the equivalent parallel resistances of the resistor switched-in by  $K_1$ ,  $K_2$  or  $K_3$  and the fixed 200-k $\Omega$  resistor.

The 1  $\mu\text{A}$  range is implemented when switch  $S_{1-A}$  closes. This sets  $V_{10} = V_1$  and connects the input of  $A_6$  to the output of the differential amplifier  $A_4$ . The closed loop gain of  $A_4$  is:

$$V_4 = \frac{R_{16}}{R_{17}} \times V_B - \frac{R_{18}}{R_{19}} V_o \quad (15)$$

The values of resistors  $R_{16}$ ,  $R_{17}$ ,  $R_{18}$  and  $R_{19}$  are chosen such that  $R_{16}/R_{17} = R_{18}/R_{19} = 25$ . Then

$$V_R = -2V_4 = -50 (V_B - V_o) \quad (16)$$

Substituting  $V_B - V_o = I_o \times R_3$ , it follows that  $V_R = -50 \times 200 \text{ k}\Omega \times I_o = -10 \times 10^6 I_o$ . Since  $V_R$  is 10 V full scale, the range of  $I_o$  is 1  $\mu\text{A}$ .

Because the gain of amplifier  $A_7$  equals that of  $A_6$ , and because the output range of DAC 2 and DAC 1 are equal, the ranges for current measurement are identical to those for forcing. In the current-measurement mode, the output of  $A_3$  (or  $A_4$ ) is switched by  $S_2$ , through  $A_7$ , to comparator  $A_9$ .

### Fast amplifiers are essential

An important consideration is that the feedback loop should be as fast as possible so that the PMU's output voltage (or current) can faithfully follow the DAC 1 output without overshoot. Thus high slew rate op amps are necessary.

Amplifier  $A_6$  is particularly fast, has a high input impedance and a low input-bias current. The main function of  $A_6$  is to isolate the switching network,  $S_1$ , from the summing resistor,  $R_2$ , at the input of  $A_1$ . A high slew rate (20 V/ $\mu\text{s}$  or greater) op amp, the HA2705, does the job. The switches are solid-state MOS, with an ON resistance of about 1000  $\Omega$ . The low input-bias current of  $A_6$  ensures low current through  $S_1$  and, thus, a negligible voltage drop across  $S_1$ . This boosts the accuracy of the feedback portion of the basic forcing loop.

Amplifier  $A_7$  serves a function similar to  $A_6$ , but with respect to switches  $S_2$  and comparator  $A_9$ . Since the speed requirement is not critical, a general-purpose op amp ( $\mu\text{A}$  741) serves.

Also having a very high slew rate, plus a high common-mode rejection ratio, is  $A_4$ —a discrete op amp module connected as a differential amplifier. The gain of  $A_4$  is determined by the ratio of the feedback and input resistors and is relatively high (25). High gain is required because of the low current (1- $\mu\text{A}$  full scale) being measured. Since the gain results in significant amplification of noise on the 1- $\mu\text{A}$  range, a low-pass filter—composed of  $R_{20}$  and  $C_3$ —is inserted. A moderate value (200 k $\Omega$ ) for  $R_3$  keeps the RC



Table: Voltage and current ranges

| RANGE | VOLTAGE | RESOLUTION | CURRENT     | RESOLUTION  |
|-------|---------|------------|-------------|-------------|
| 1     | 1V      | 1mV        | 1 $\mu$ A   | 1nA         |
| 2     | 10V     | 10mV       | 100 $\mu$ A | 100nA       |
| 3     | 40V     | 40mV       | 10nA        | 10 $\mu$ A  |
| 4     | 100 V   | 100 mV     | 100 nA      | 100 $\mu$ A |

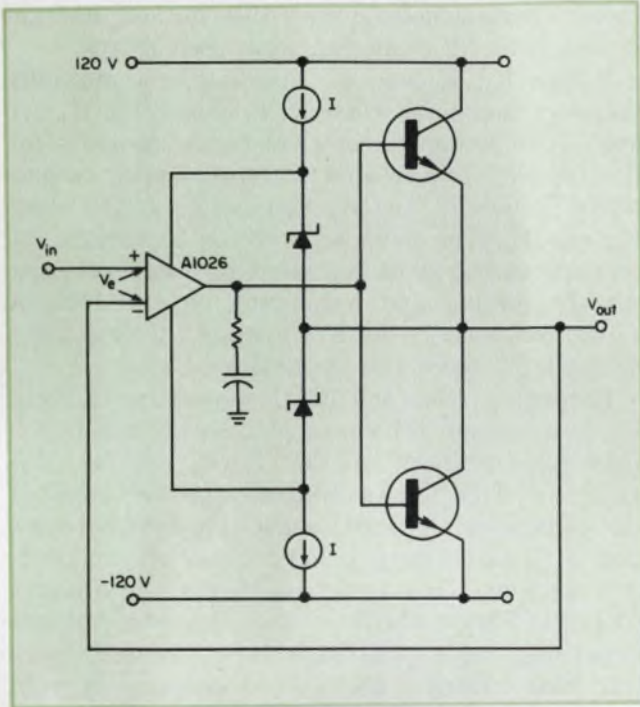

3. A voltage-follower circuit minimizes loading and thereby provides for accurate measurement of voltages on the PMU's sense line.

time constant short and boosts the response of the feedback loop.

Two low-voltage IC op amps,  $A_2$  and  $A_3$ , form a differential amplifier with high common-mode rejection ratio and a high common-mode range. The response of  $A_2$  and  $A_3$  need not be as fast as that of  $A_1$ , because the speed of the feedback loop depends on amplifier slew rate and the value of the current-sampling equivalent resistor  $R_3$ .

### Buffer offers protection

For the 1- $\mu$ A range, a larger value of  $R_3$  (200 k $\Omega$ ) is required, at the cost of response time. To compensate for this,  $A_1$  must be especially fast (slew rate  $> 100$  V/ $\mu$ s); hence  $A_1$  is built from discrete components. For the higher current ranges (100  $\mu$ A, 10 mA, 100 mA),  $R_3$  is lower and the  $A_2/A_3$  combination can be slower. Both  $A_2$  and  $A_3$  have low-bias current to avoid offset voltage errors at their outputs. Error is less than 5 mV—the LSB value at the points  $V_3$  and  $V_1$ .

The 100-mA buffer increases the current and

voltage capabilities of the forward loop. Open-loop gain of the buffer, is about 65 dB, but internal negative feedback brings the closed-loop gain down to about 11. Since  $A_1$  is capable of 10-V output, the 100-mA buffer can provide as much as 110 V out. The actual output, of course, depends on the power-supply voltages.

To protect the DUT, the PMU, and any peripheral test equipment (probe tips, handler contactors), the buffer must be current limited and short-circuit proof. Current limiting also protects the current sampling resistor,  $R_3$ , from excessive power dissipation during voltage forcing on the 10-mA range.

A 6 dB/octave frequency response ensures that the buffer is unconditionally stable. Slew rate of the buffer is high (100 V/ $\mu$ s) and is greater than that of  $A_1$ . This is necessary because the voltage swing at the buffer output is much higher than that at the input of  $A_1$ .

Solid-state MOS switches for  $S_1$  and  $S_2$  offer several advantages. Voltage and current ranges can be changed rapidly. And MOS offers better reliability. Each of the switches must handle the maximum analog signal voltage, which may be present at any time. To find the required switch rating, examine the signals at the switch input.

Each signal has a range of  $\pm 5$  V full scale in the forcing or measuring mode. However, voltages considerably in excess of 5 V can appear at some of the inputs at certain ranges. For this reason, zener-diode pairs are used to limit the voltages to about 5.8 V. The switches chosen are DB503s, with a  $\pm 10$ -V analog signal rating.

Digital-to-analog converters 1 and 2 are 12-bit DACs (CY2235s) that provide 10 significant bits plus sign. Specs of the DACs include a settling time of 20  $\mu$ s to one half LSB value and a gain accuracy within 0.1%.

### Ground serves as reference

It is important that the reference common between boards—and particularly between the system ground and the PMU board—carries no significant amount of current if it is to serve as a reliable 0-V standard. But DAC 1 and 2 deliver up to 70 mA each to their respective grounds. Thus a ground buffer circuit is included to provide a current return path, to isolate the ground current from common, and to maintain a high impedance to reference common.

This circuit consists of a general-purpose op amp, ( $A_4$ ), in a voltage-follower connection, with a discrete, high-current, buffer at the output. Voltage gain is unity, and the output current can reach 200 mA (maximum current must be greater than that flowing from the DACs to ground). The buffer must be fast enough to follow the rate of current switching in the DACs.

(continued on p. 132)





## Inside Story

Beat the "bends". EMC's Nurl-Loc® Terminals spread the stress evenly throughout the panel, eliminating warp (and the need for stiffeners) . . . even on  $\frac{1}{8}$ " boards. The straight male splined cylinder guides the terminal securely into a more accurate true position than a barbed ring. And the internal burr-free, four-finger contact grabs any IC lead firmly, even as small as .011 dia. Prototypes or production, call Allan Klepper (401) 769-3800 for a copy of our new, interesting "Inside Story" . . . or write Electronic Molding Corp., 96 Mill Street, Woonsocket, R. I. 02895.

**EMC's Wire-Wrap® Panels  
with Nurl-Loc® Terminals  
... better performance  
by design!**



Wire-Wrap® Gardner-Denver Co.

INFORMATION RETRIEVAL NUMBER 53

Because of the buffer, the DAC analog ground always maintains the same potential as the reference ground regardless of the bit configuration at the DAC inputs. This ensures the accuracy of the PMU forcing and measuring functions.

Since the PMU output can go as high as 100 V, mercury-film relays are used in the current-range relay circuits,  $K_1$  through  $K_5$ . These relays provide a mean-time-to-failure of about 250 million operations. Moreover, they have a clean closure characteristic, free from contact bounce and noise. Thermal noise across the contact junction is also reduced, compared with reed relays.

Relays  $K_1$ ,  $K_2$  and  $K_3$  operate in a mutually exclusive manner—when  $K_1$  is closed  $K_2$ ,  $K_3$  are open—and switch the current-range resistors for the 100- $\mu$ A, 10-mA, and 100-mA scales, respectively. Relays  $K_1$  and  $K_5$  also switch at the same time as  $K_3$ . The purpose of  $K_1$  is to bypass the contact resistance of  $K_3$ , allowing more accurate current forcing and measuring on the 100-mA range. Similarly, relay  $K_5$  bypasses the resistance of the DUT force and sense lines.

Extending from the PMU sense line to point  $V_o'$  is a voltage follower, which provides unity-gain amplification in the PMU sensing line (Fig. 3). This allows accurate measurement of the voltage on the PMU sense line by minimization of possible errors introduced by sense-circuit loading. This is of particular significance when the PMU is in the voltage forcing/current-measuring mode. The high input impedance in this case ensures that the measured current through  $R_3$  equals the current into the DUT.

The follower also provides a low-impedance source to drive the shield on the PMU force/sense lines. Consequently the PMU shield has the same potential as the PMU force/sense lines, reducing the effect of capacitive loading.

The FET input op amp, A1026, works with a floating power supply composed of two 15-V zener diodes. The output is taken from the zener center tap. Under these conditions, the input impedance is the product of the A1026's input impedance and the follower open-loop gain (approximately  $10^{15} \Omega$ ). In practice, however, the common-mode impedance of the A1026—about  $10^{12} \Omega$ —dominates so that this value is the effective loading on the PMU sense line. Note that this buffer should be faster than the PMU forward loop for high PMU speed.

Note that you can also use the PMU to make a variety of internal measurements within the test system itself, such as measuring test head analog reference voltages and functional test voltages, as well as voltages at certain test points located on the printed circuit cards within the system. This can be done automatically during self-check under the control of diagnostic programs. Thus the PMU is also a troubleshooting aid. ■■







# Avoid $I_{CEO}$ measurements and you will lighten your test load. But if you must measure this vague transistor parameter, here's how to do it faster.

Perhaps the best solution to the problems of  $I_{CEO}$  measurement is to avoid the job altogether. If this isn't possible, take heart. The test, at least, can be done quickly.

The design engineer usually doesn't care about  $I_{CEO}$ —a transistor parameter that causes more headaches than all others put together. He designs with  $I_{CES}$  or  $I_{CER}$ , two more-useful parameters. But those engineers who must test transistors at incoming or final inspection have two reasons to worry:  $I_{CEO}$  is vaguely defined, and it is tough to measure with accuracy.

Usually  $I_{CEO}$  is defined as the "leakage" current that flows between the collector and the emitter when the base is open. With the base open, however,  $I_{CEO}$  is the product of  $I_{CBO}$  and  $H_{FE}$ , and any resistance between base and emitter greatly influences  $I_{CEO}$ . The definition, therefore, raises two questions.

First, is it desirable for  $I_{CEO}$  to be very large or very small? One can argue that since  $I_{CBO}$  should be very small, the product of  $I_{CBO}$  and  $H_{FE}$  should be very small. This seems to be the logic of those who specify  $I_{CEO}$ , since they always specify a maximum limit. On the other hand, one can also argue that since  $H_{FE}$  should be very large, the product of  $I_{CBO}$  and  $H_{FE}$  should be very large. This would indicate that a minimum limit should be specified for  $I_{CEO}$ .

## How open is "open"?

In practice, there is no telling what value of  $I_{CEO}$  is optimum. Both  $I_{CBO}$  and  $H_{FE}$  have broad limits, so the product must also have extremely wide limits. It can be maximized or minimized only within those limits.

The second question is: What exactly is an "open circuit"? There is no such thing as a true open circuit—that is, infinite impedance. There is always some stray resistance and capacitance across the case of a transistor, across the test fixture, and so on.

Traditionally an open circuit has been con-

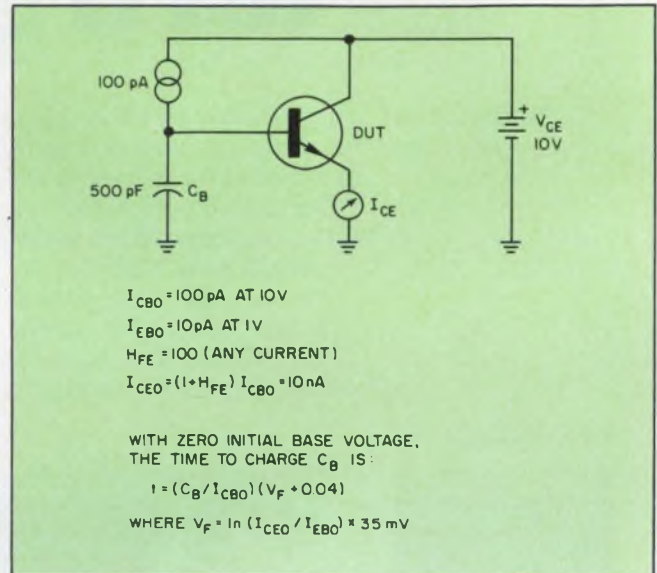

1. The effect of stray capacitance on  $I_{CEO}$  test time: With the values shown, it takes 1.4 s to charge the base capacitor—an unacceptably long time.

sidered a resistance that is one or two orders of magnitude greater than the device's input impedance. But a modern silicon transistor with an  $I_{CBO}$  of 100 pA has a small-signal input impedance ( $h_{ie}$ ) of 400 M $\Omega$  and a dc input impedance of as much as 2000 M $\Omega$ . An open circuit for such a device would have to be on the order of 100,000 M $\Omega$ —a hopelessly unrealistic value.

Decades ago vacuum-tube engineers faced the same problem and solved it very nicely with standard grid-leak resistors. The values of the resistors ranged from 100 k $\Omega$  to 22 M $\Omega$ , depending on the type of tube and the application. Now the problem is being repeated, but the lessons of history have not been learned.

It should be apparent that specification of an open, active terminal is quite unreasonable. If  $I_{CE}$  must be measured, it must be done with the base tied down somewhere. The base lead might be connected to the emitter by a resistor (an  $I_{CER}$  test), by a short (an  $I_{CES}$  test), or by a bias voltage that fixes the base potential (an  $I_{CEN}$  test). In any case, an  $I_{CER}$ ,  $I_{CES}$  or  $I_{CEN}$  test simulates the



true application of a transistor much more closely than an  $I_{CE0}$  test does.

The  $I_{CER}$  test is a particularly satisfactory solution: A resistor in the range of 10 to 10,000  $\Omega$  usually fills the requirements. The criterion is that the resistance should be one or two orders of magnitude smaller than the dc input impedance of the transistor. Stated another way, the leakage current,  $I_{CBO}$ , from the base, when flowing through the resistor, should not produce a voltage large enough to turn on the transistor.

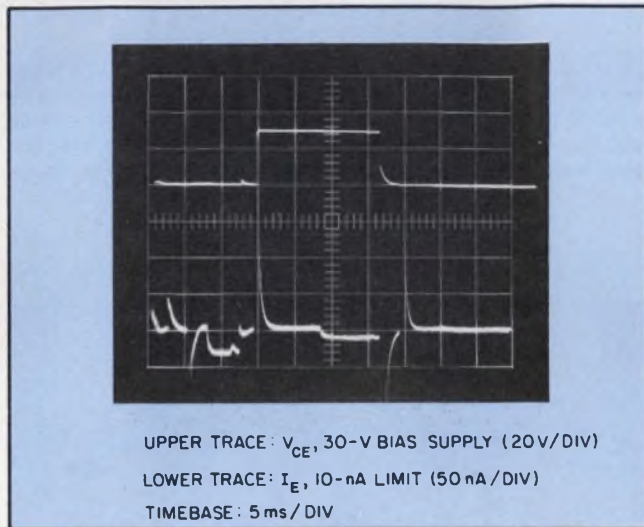

2. Scope waveforms show the rapid turn-on of the test transistor ( $V_{CE}$ , upper trace). Collector-emitter capacitance causes a brief  $I_E$  pulse (lower trace). Base-capacitance charge turns off the transistor and holds it off for the remaining test time.

Perhaps  $I_{CE0}$  tests will be dropped in the future. But being stuck with it, at least we can speed up the test time.

Consider the case in which a transistor under test is connected with coaxial cables to a test instrument. Even if we assume a high-quality test instrument and cables, we find some 500 pF of stray capacitance hanging on the base lead. We apply the test voltage to the transistor, and the base voltage rises—which means the stray capacitance on the base lead must be charged.

### Reducing test time

But the charge can come only from the device under test—specifically, from the base lead. Since the base current cannot be very large, it takes a long time to charge the capacitance. And since the value of  $I_{CE0}$  cannot stabilize until the base capacitance has charged, clearly it takes a long time to make the test. Typically it might take as long as 1.4 s, an interval that is quite unacceptable in industrial testing (Fig. 1).

Fig. 2 shows the transistor waveforms when a large base capacitance is present. Because the base capacitance keeps the transistor cut off, the emitter current exhibits one brief pulse that is traceable to collector-emitter capacitance. Then the current falls to zero for the remainder of the test time.

The only way to reduce the test time is to reduce the effect of the base capacitance. To do this, we use a reed relay to open the base-lead connection directly at the test socket. The relay

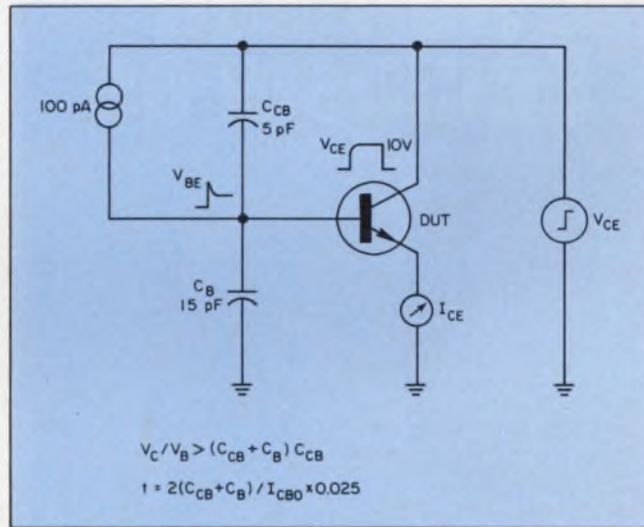

3. With reduced base capacitance, the Miller Effect causes the base voltage to rise rapidly until current limiting of the bias supply occurs. The stray base capacitance then discharges. Only 10 ms is needed to reach equilibrium.

opens before application of the test voltage to the collector, ensuring that the base-cable capacitance is minimized.

Consequently the collector-base and base-emitter capacitances form a divider that conveniently “primes” the base with a small injection of current, and the base voltage rises rapidly to its operating point. A test time of about 10 ms can be readily achieved this way, as long as the risetime of the collector voltage supply is quite rapid (Fig. 3).

Fig. 4 shows the transistor waveforms under these circumstances. The emitter current initially rises rapidly because of the Miller Effect. The collector supply limits the current, slowing the rate of rise of the collector voltage. Then, after a few milliseconds, the emitter current falls to a true  $I_{CE0}$  level, and the collector voltage attains its proper bias level.

This technique to reduce test time to a reasonable value can be used as long as the transistor and the stray impedances can be represented by lumped circuit elements. There are, however, cer-



# You can measure the quality of Hoffman Enclosures



Being close isn't good enough in lots of electrical enclosure applications. It either fits or it doesn't. Hoffman quality assures a proper fit. One of our customers put it this way: "What Hoffman says in its catalog is true. Hoffman Electrical Enclosures are consistently well built, and tolerances are what Hoffman says they'll be."

Hoffman is proud of its reputation. We guard it by making numerous checks for dimensional accuracy during our quality control inspections. As one of the country's major manufacturers of electrical enclosures we have a reputation to protect.

We can help you protect your reputation too, with over 1,700 high quality electrical enclosure products. For a copy of our free, problem-solving catalog, call or write:

**Hoffman** **ELECTRICAL ENCLOSURES**  
HOFFMAN ENGINEERING COMPANY  
 Division of Federal Cartridge Corporation  
 ANOKA, MN 55303 DEPT. ED542

INFORMATION RETRIEVAL NUMBER 55

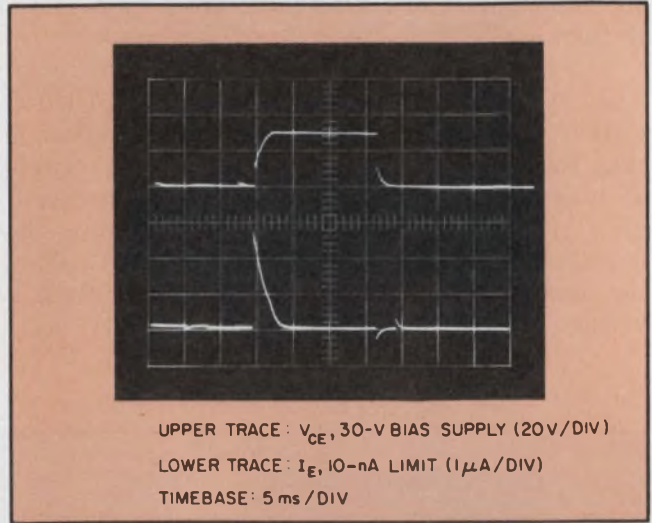

4. The effects of reduced base capacitance: As the base voltage stabilizes, the collector voltage rises to the full bias level, and the emitter current drops to the  $I_{CE0}$  level.

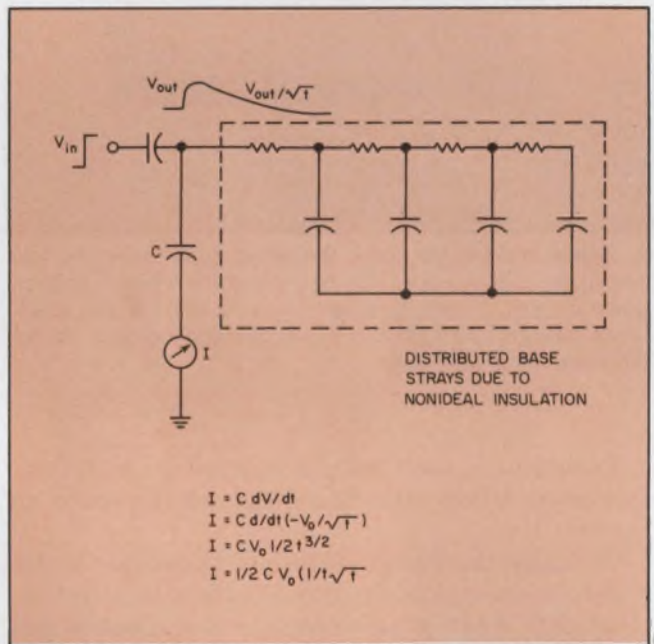

5. Test time stretches when stray base capacitance must be represented by a distributed line. The line exhibits a "long-tail" recovery that depends on  $1/(t\sqrt{t})$ . Thus to double the accuracy of a 100-ms test, the test time must be extended to 258 ms. Compare this with the lumped-capacitance case, where only 30 ms more is needed to double accuracy.

tain plastic insulation materials, used in transistor packages, that dictate the use of distributed circuit elements.

Such a distributed line (sometimes called a Thomson line) exhibits a long-tail recovery—a recovery time that is much longer than that of a normal capacitive discharge time (Fig. 5). This again results in long test time, inaccurate results or both. ■■



## 4K GENERIC PROM- new addition to the family.

With the introduction of the Harris family of GENERIC PROMs, stand alone PROM design is fast becoming obsolete. Diverse requirements for density, modularity, and performance within a system can be totally satisfied by this one generic family.

And now there's a brand new addition to the family. The 512x8 (4K) PROM device. Like the 256x4 (1K), the 512x4 (2K), and the 32x8 (256) devices, it is now in volume production. And can help upgrade your system's performance as well as lower your costs.

The advantages of the Harris GENERIC PROM family over ordinary PROMs are many. For instance, each device within a series features identical DC electrical specifications plus common programming requirements, permitting easy use of other family elements.

GENERIC PROMs have fast programming speeds. Equivalent I/O characteristics for easy upgrading. Faster access time. Guaranteed AC and DC performance over full temperature and voltage ranges. And improved testability.

For Harris, the addition of the 4K

PROM device marks another step in the continual development of the GENERIC PROM concept. A concept that only Harris offers.

So if you're considering PROM devices, consider the Harris GENERIC family. For details see your Harris distributor or representative.

| Device #                   | No. of Bits | Organi-<br>zation | No. of<br>Pins | Max.<br>Access<br>Time* |      | Price<br>100 up.         |         |
|----------------------------|-------------|-------------------|----------------|-------------------------|------|--------------------------|---------|
|                            |             |                   |                | Comm.                   | Mil. | Comm.                    | Mil.    |
| HM-7602<br>(open coll)     | 256         | 32 x 8            | 16             | 40ns                    | 50ns | \$2.95                   | \$5.95  |
| HM-7603<br>(three-state)   | 256         | 32 x 8            | 16             | 40ns                    | 50ns | \$2.95                   | \$5.95  |
| HM-7610<br>(open coll)     | 1024        | 256 x 4           | 16             | 60ns                    | 75ns | \$4.95                   | \$9.95  |
| HM-7611<br>(three-state)   | 1024        | 256 x 4           | 16             | 60ns                    | 75ns | \$4.95                   | \$9.95  |
| HM-7620<br>(open coll)     | 2048        | 512 x 4           | 16             | 70ns                    | 85ns | \$9.95                   | \$19.95 |
| HM-7621<br>(three-state)   | 2048        | 512 x 4           | 16             | 70ns                    | 85ns | \$9.95                   | \$19.95 |
| HM-7640<br>(open coll)     | 4096        | 512 x 8           | 24             | 70                      | 85ns | \$19.95                  | \$39.95 |
| HM-7641<br>(three-state)   | 4096        | 512 x 8           | 24             | 70                      | 85ns | \$19.95                  | \$39.95 |
| HM-7642<br>(open coll)     | 4096        | 1024 x 4          | 18             | 70                      | 85ns | Available<br>January '76 |         |
| HM-7643<br>(three-state)   | 4096        | 1024 x 4          | 18             | 70                      | 85ns |                          |         |
| HM-7644<br>(active pullup) | 4096        | 1024 x 4          | 16             | 70                      | 85ns |                          |         |

\*Access time guaranteed over full temperature and voltage range.  
Industrial ( $T_A = 0^\circ\text{C}$  to  $70^\circ\text{C}$ ,  $V_{CC} \pm 5\%$ )

Military ( $T_A = 55^\circ\text{C}$  to  $125^\circ\text{C}$ ,  $V_{CC} \pm 10\%$ )



**HARRIS**  
**SEMICONDUCTOR**  
A DIVISION OF HARRIS CORPORATION

P.O. Box 883, Melbourne, Florida 32901 (305) 724-7412

**WHERE TO BUY THEM: OEM SALES OFFICES: CALIFORNIA:** Long Beach (213) 426-7687. Palo Alto (415) 964-6443 **FLORIDA:** Melbourne, (305) 724-7430 **ILLINOIS:** Hinsdale, (312) 325-4242 **MASSACHUSETTS:** Wellesley Hills, (617) 237-5430 **MINNESOTA:** Minneapolis, (612) 835-2505 **NEW YORK:** Endwell, (607) 754-5464. Melville, L.I., (516) 249-4500 **OHIO:** Dayton (513) 226-0636 **PENNSYLVANIA:** Wayne, (215) 687-6680 **TEXAS:** Richardson (214) 9031

**SALES REPRESENTATIVES: ARIZONA:** Scottsdale, (602) 948-5590 **CALIFORNIA:** Los Angeles, (213) 870-9191. Mountain View, (415) 961-8121. San Diego, (714) 565-9444 **COLORADO:** Denver, (303) 773-0666 **FLORIDA:** Boca Raton, (305) 395-6108. Oviedo, (305) 365-3283. Tampa, (813) 933-3183 **ILLINOIS:** Elk Grove Village, (312) 640-1850 **KANSAS:** Wichita, (316) 943-6221 **MARYLAND:** Randallstown, (301) 922-1248 **MASSACHUSETTS:** Lawrence, (617) 685-7973 **MISSOURI:** Hazelwood, (314) 731-5799. Kansas City, (816) 761-6543 **NEW JERSEY:** Keasley, (516) 567-5900 **NEW YORK:** Albany, (518) 489-7408 or 4777. Huntington Station, (516) 567-5900 **NORTH CAROLINA:** Raleigh, (919) 828-0575 **OHIO:** Cleveland, (216) 831-8292. Dayton, (513) 890-2150 **OREGON:** Beaverton, (503) 643-1644 **PENNSYLVANIA:** Allison Park, (412) 487-4300. King of Prussia, (215) 265-0634 **TENNESSEE:** Shelbyville, (615) 684-4544 **TEXAS:** Dallas, (214) 691-4592. Houston, (713) 661-3007 **VIRGINIA:** Falls Church, (703) 534-1673. Lynchburg, (804) 237-4140. Troutville, (703) 345-3283 **VIRGINIA BEACH:** (804) 481-7200 **WASHINGTON:** Bellevue, (206) 454-0300 **CANADA:** Montreal, (514) 626-6723. Ottawa, (613) 749-0740. Toronto, (416) 676-1042

INFORMATION RETRIEVAL NUMBER 56



## Take oddball pulses in stride.

A new method, the pulse-width synthesizer, lets you accurately measure the widths of unpredictably shaped pulses.

How do you measure the width of a pulse when its shape is irregular or unpredictable? One approach—using the so-called pulse-width synthesizer (PWS)—arbitrarily establishes the width of any pulse as that period of time encompassing 80% of the total power of the pulse (Fig. 1). The PWS accepts a train of arbitrarily, but identically, shaped pulses and produces purely rectangular, TTL-compatible pulses that correspond to the 80% power width of the input pulses.

Like any "real-world" device, the pulse-width synthesizer has performance limits. The synthesizer shown handles pulse widths from 0.5 to 50 ms and amplitudes from 2 to 10 V. Any rep rate is fine—as long as the pulses do not overlap. And it is a fairly simple matter to modify the PWS to accept a broader range of inputs. To process a narrower pulse, increase the upper frequency limit of the PWS's voltage-controlled oscillator (VCO) from the present maximum of 2 MHz.

With a maximum VCO frequency of 20 MHz, the PWS can accept pulse widths down to 50  $\mu$ s. To increase the maximum width, just extend the lengths of the counter chains in the PWS. With an additional 54191 in each chain, the maximum width becomes 800 ms. To shift the input voltage range, use buffer amplifiers or attenuators. To broaden the voltage range, increase the VCO frequency. For instance, with a 20-MHz VCO, the PWS accepts input pulses from 600 mV to 10 V.

### Width is arbitrarily defined

As for the percentage of power used to establish the pulse width, the 80% figure is essentially arbitrary and can be changed to suit requirements. However, there are no hard and fast rules to establish an optimum percentage. The best guideline is to base the selection on the information to be derived from the synthesized pulse.

The major performance constraint of the PWS is its limited dynamic range. Factors affecting the range are: (1) Number of bits that the counters can store; (2) Frequency range of the

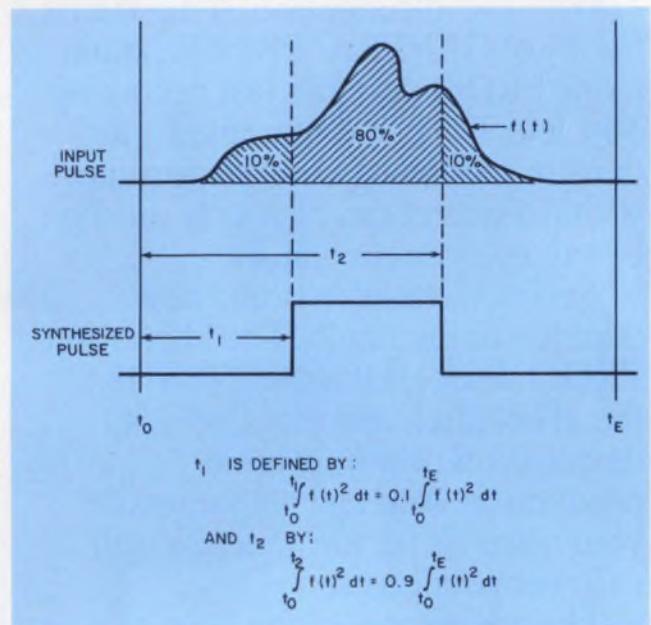

1. Defining the width, ( $t_2 - t_1$ ), of an arbitrarily shaped pulse: Points  $t_1$  and  $t_2$  are those that encompass 80% of the power contained in the pulse. Other values can be used, depending on the application.

VCO (the period of the VCO clock must be much less than the input width), and (3) The analog squarer, which ensures that whatever the dynamic range of the VCO digital processor combination, the range for the system will be only half that.

One other constraint is the need for two identical input pulses to produce one synthesized output pulse. This is unavoidable, since an acausal system would be needed to process a single pulse with the PWS technique. These limitations can be largely minimized by careful design and attention to the expected dynamic range of the signals to be processed.

In addition to the input pulse, the PWS requires a blanking pulse that functions as a marker between successive input pulses. In some cases the blanking pulse is available externally. For example, if the input pulse is the vertical deflection waveform of a spectrum analyzer, then the retrace blanking pulse of the analyzer can be used. The blanking pulse can be easily derived

David R. Howell, Design Engineer, Grumman Aerospace Corp., Bethpage, NY 11714.



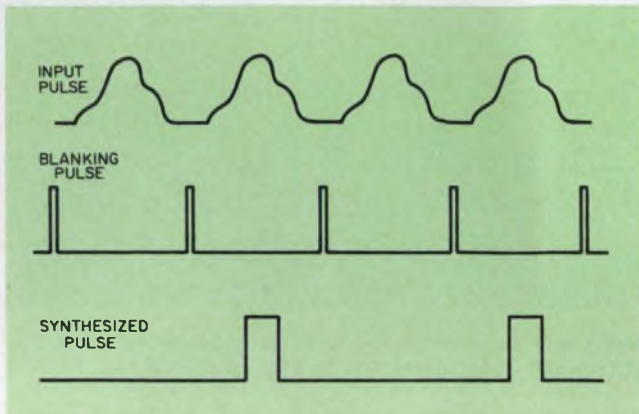

2. To form the synthesized pulse output, two inputs with a predetermined time relationship are needed. This delivers one output pulse for every two input pulses.

if an external pulse is not available.

The relationship between the input pulses, the blanking pulses and the synthesized pulses is shown in Fig. 2. The polarity of the blanking pulse is arbitrary, since the only point of concern is the negative-going edge. As long as this edge does not occur during the input pulse, any polarity or width for the blanking pulse is acceptable. An external blanking pulse must be TTL-compatible. The input pulse shown is positive; however, the PWS can be easily modified to accept negative pulses.

Three subassemblies make up the PWS: an input conditioner, the VCO and a digital processor (Fig. 3). The input conditioner's function is to modify the input signal to minimize the over-all system error. If the input is approximated as  $f(t) + N + V_{os}$ —where  $f(t)$  is the input pulse,  $N$  is the base-line noise and  $V_{os}$  is a dc offset voltage—the desired output is  $f(t)^2$  (Fig. 4).

### Signal processing cuts errors

To eliminate any offset voltage, a dc voltage—equal in magnitude and opposite in polarity to the offset—is added to the input signal. As shown in Fig. 4, an offset-adjust pot controls the amount of correction, and op amp 1 performs the addition (waveforms 1 and 2). The input signal is

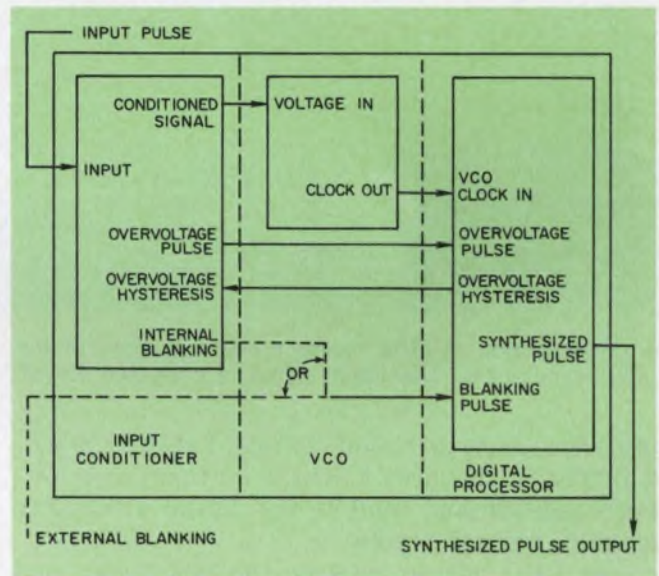

3. The pulse-width synthesizer (PWS) is composed of three major subsections: the conditioner, the VCO and a digital processor. Error correction, level shifting, squaring and amplification (or attenuation) are performed by the conditioner. The VCO provides a signal whose frequency is proportional to the square of the input signal, and the processor converts the signal to the final synthesized pulse. ICs are used extensively.

now approximated by  $f(t) + N$ .

The next step is to suppress baseline noise. To do this, a baseline clip-adjust control is set to a voltage that is slightly more negative than the baseline noise peaks. Whenever the input signal becomes less negative than this reference, the output of comparator 1 switches from a logic 1 to a logic 0. This causes the FET switch to close, which sets the gain of op amp 2 to zero and kills baseline noise (waveforms 2 and 3). The signal can now be approximated by  $f(t)$ . Note that the output of comparator 1 can be used as the blanking pulse.

Squaring the signal is the final step of input conditioning. This function is performed by a monolithic multiplier; an internally laser-trimmed type (Burr-Brown 4203S) minimizes the system alignment procedures. The signal is now approximated by  $f(t)^2$ —the desired output.

The input conditioner also contains the first



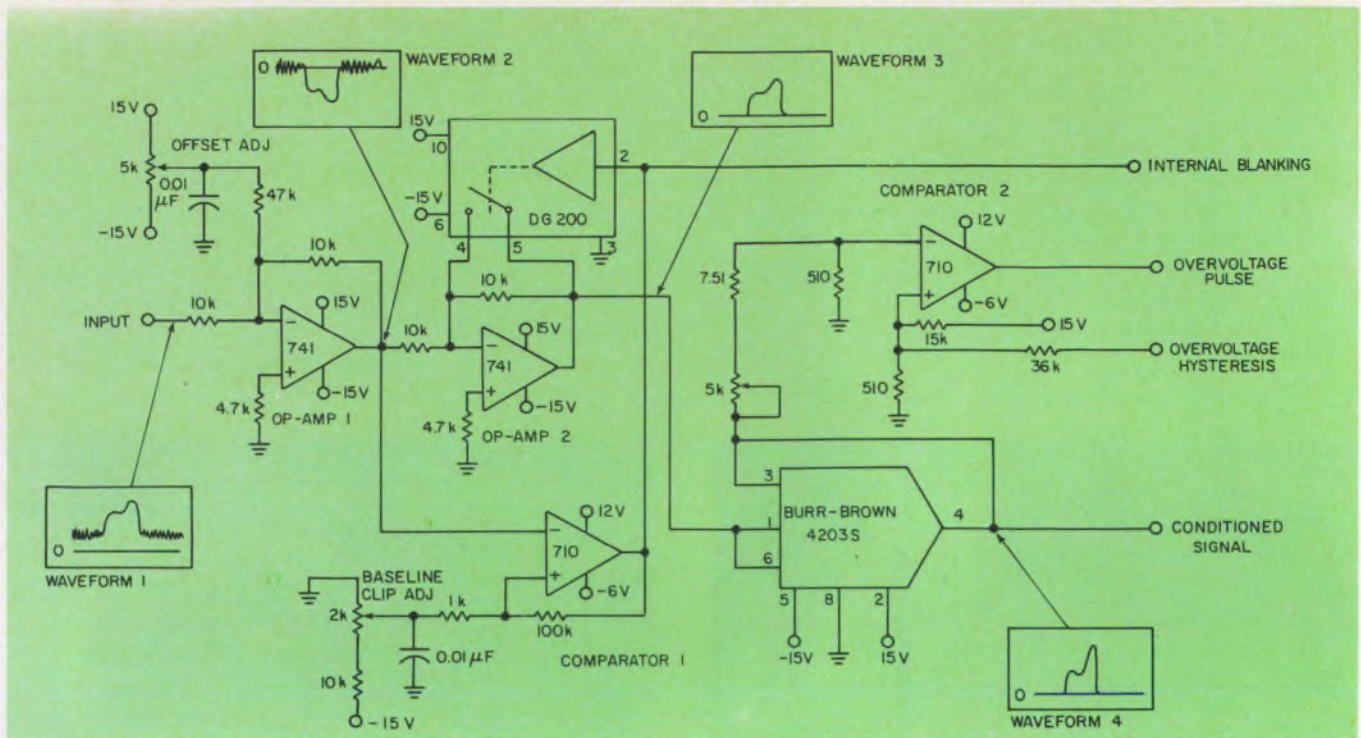

4. **Minimization of error** is the primary purpose of the input conditioner. The input signal is corrected for dc

of several fault-detection circuits. Labeled COMP-2 in Fig. 4, the circuit detects an input overvoltage condition and inhibits the digital processing stage to prevent errors.

The VCO, placed between the conditioner and the digital processor, acts as a linear interface between the analog and digital portions of the PWS (Fig. 5). Its operation is as follows:

The input voltage acts on the two buffers and resistors  $R_1$  through  $R_4$  to form two symmetrical current sources for the summing junction of the LM118 op amp. Transistors  $Q_1$  and  $Q_2$  act as switches that can disable the current sources. The output state of the 710 comparator determines which of the sources is disabled.

If, for example, the comparator's output is high, the positive current sources (+1 buffer,  $R_3$  and  $R_4$ ) is disabled. Accordingly the augmented integrator, composed of the LM118 and  $C_1$  and  $R_5$ , will slew in a positive direction until its output exceeds the voltage on the noninverting input. The comparator will then switch from a logic 1 output to a logic 0. This disables the negative current source and enables the positive source.

In addition the voltage on the noninverting input drops, and the augmented integrator slews negatively until it reaches the voltage on the noninverting input. The comparator switches back to a logic 1, and the cycle starts again.

#### Sources of VCO error

Linearity is the critical parameter of the VCO. As long as the voltage/frequency ratio remains

offset and baseline noise, then is squared to form the VCO input. Fault detection is also performed.

constant, the oscillator contributes very little error to the over-all system. The major source of nonlinearity is the delay from the time the comparator switches and the augmented integrator reverses its slew rate. This inherent error can, however, be nulled out; this is the function of  $R_5$ . The delay-caused voltage error is

$$V_e = 2 \frac{dV_I}{dt} (t_d),$$

where  $dV_I/dt$  equals the slew rate of the integrator and  $t_d$  equals the time delay. However,

$$\frac{dV_I}{dt} = \frac{i_s}{C_f},$$

where  $i_s$  = input current to the LM118 and  $C_f$  = the LM118's feedback capacitance. Therefore

$$V_e = -2 \left( \frac{t_d}{C_f} \right) i_s.$$

To correct for this error, it is necessary only to introduce into the 118's feedback loop an amount of resistance equal to  $2 t_d/C_f$ . The addition of this resistor decreases the worst-case nonlinearity to 0.5%.

The output of the comparator is a square wave, which drives two one-shots. Each one-shot is triggered by a different edge of the square wave. Thus, when the outputs of the one-shots are combined, the result is a clock pulse train of twice the frequency of the original square wave. This clock signal forms the output of the VCO; its frequency is proportional to the square of the input signal. Accordingly the clock signal constitutes a digital representation of the instantaneous power of the input signal.



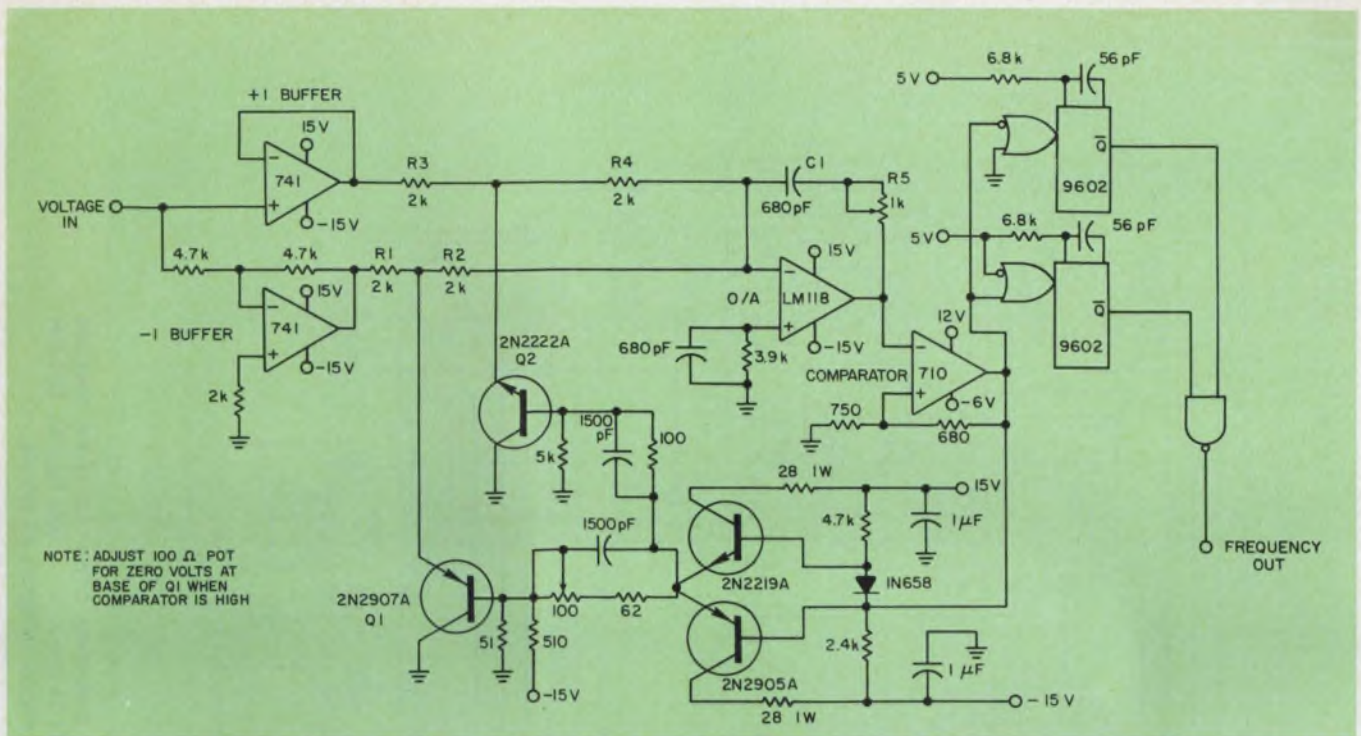

5. Conversion of the squared signal to a frequency is the VCO's job. Feedback and other circuitry is used to

Last in the chain is the digital processor, which acts upon the clock signal to produce the synthesized pulse (Fig. 6).

### The final step: digital processing

The processor has two operational modes: read and write. During the read mode no output occurs; rather, the processor derives from the input clock two numbers related to the total power of the input pulse being processed. During the write mode the processor compares the power of the incoming pulse against the totals derived from the preceding input pulse. It is by this comparison that the synthesized pulse is generated. Hence it takes two input signals to produce a single synthesized pulse.

Alternation between read and write modes occurs as a function of input blanking. The blanking pulse toggles the J-K flip-flop, and its outputs control the remaining processing modes. When the processor is in "read," the J-K is set. This programs the multiplier (labeled DECADE RATE MULTI I in Fig. 6) to multiply its input clock by 0.1. (Refer to Texas Instruments' data sheet for the SN54167.) Decade-rate multiplier II is programmed to multiply its input clock by 0.9. Both up/down counters I and II are placed in the count-up mode after being reset to zero. The synthesized pulse output (flip-flop 5-Q) is suppressed.

The stage is now set for the input signal, which arrives, is conditioned, and is applied to the

ensure high linearity and, consequently, a minimum of errors. Nonlinearity is limited to 0.5%.

VCO. The clock input to the digital processor now becomes active, and the counters start. The states at which the counters stop represent the digital integrals of the counter clock inputs. Since the clock frequency is directly proportional to the square of the input signal, the counter states are proportional to the definite integral of  $f(t)^2$ .

The number of clock pulses applied represents the total power of the input pulse. Because counter I is buffered by a 0.1-decade rate multiplier, its final count represents 10% of the total input power. Similarly counter II's final state represents 90% of the total input power. As you can see, these counter output states represent the right-hand sides of the equations that determine  $t_1$  and  $t_2$ , as defined in Fig. 1.

After the next blanking pulse, the J-K flip-flop changes state, thus placing the digital processor in the write mode. During this mode both counters are set to count down. Note that the decade-rate multipliers are disabled so that they no longer affect the counter clock rate.

Now the second input signal arrives and starts the VCO clock. Counter I counts down until it underflows. Since the counter's initial state represented 10% of the total input power, the point at which the counter underflows must correspond to that at which 10% of the input power has passed. This constitutes a solution of the equation that defines  $t_1$  in Fig. 1. Accordingly when counter I underflows, underflow detector I sets flip-flop 5 to a logic 1 and thus forms the leading edge of the synthesized pulse (Fig. 6).



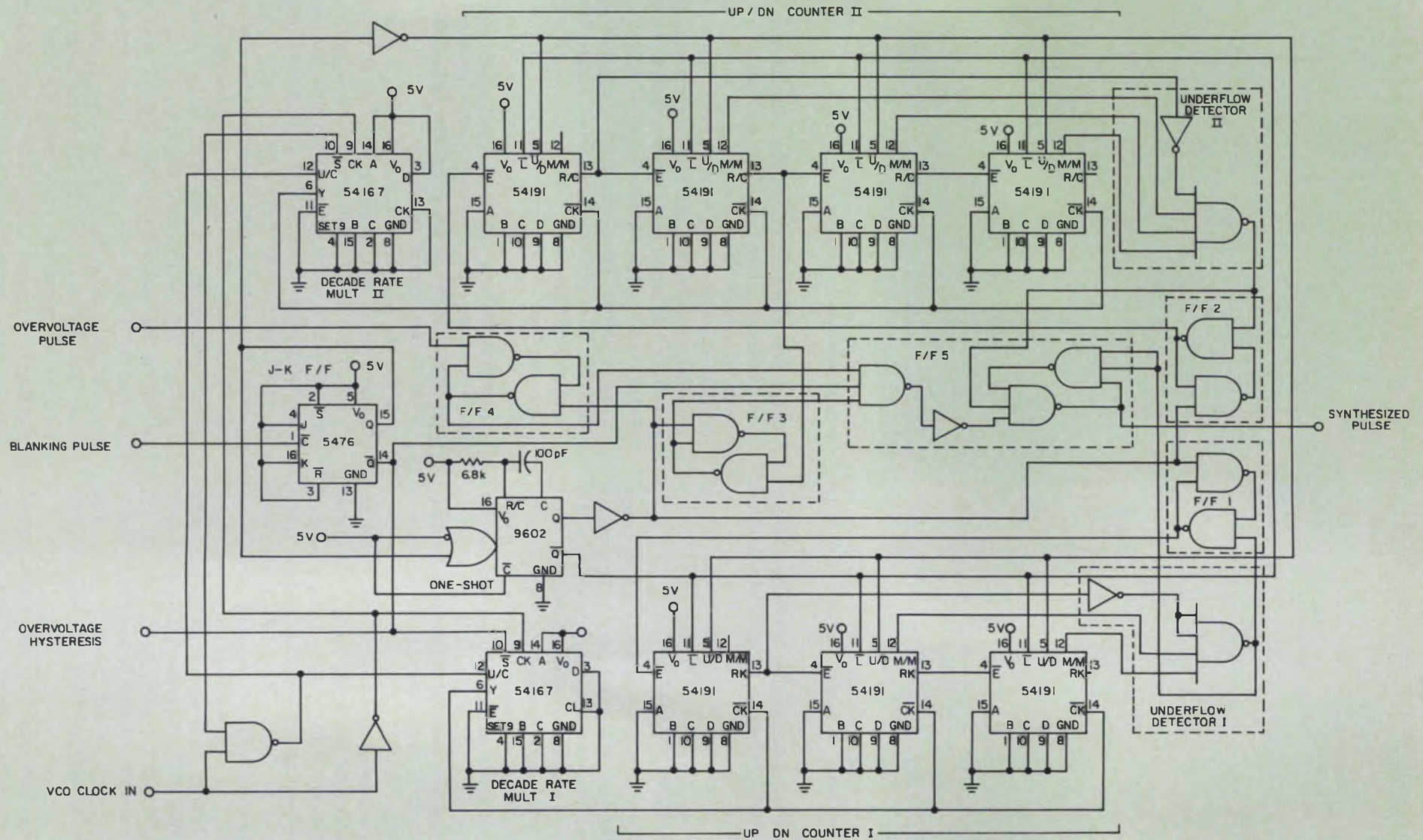

6. The digital section of the PWS converts the VCO signal to the final, synthesized pulse. To do this, the processor compares an incoming pulse's power with the

total power of the preceding pulse. Up/down counters sum the clock inputs to derive the power figures. Counter readings represent digital integrals of inputs.



Counter II also counts down during this interval and underflows sometime after counter I. The time of corresponding underflow constitutes a solution for  $t_c$ . At this point underflow detector II resets flip-flop 5 and forms the trailing edge of the synthesized pulse. Thus a complete synthesized pulse is generated and, clearly, the pulse is an accurate realization of the outlined definition.

When the next blanking pulse appears, the digital processor returns to the read mode. The one-shot triggers and resets the counters to zero to await the next processing cycle. Also reset by the one-shot are flip-flops 1 through 4. These suppress any incorrectly synthesized pulse outputs—that is, if the input signal power is too large, counters I and II will overflow while in the read mode and set flip-flops 1 and 2. Since this disables the counters, the write-mode output is suppressed. During normal operation counter I should overflow several times. But flip-flop 1 disables counter I after the first underflow and thereby prevents spurious outputs.

#### Low power signals ignored

If the input power is too low for an accurate measurement, no output is generated. Flip-flop 3 performs this function as follows: When the one-shot fires at the beginning of the read mode, flip-flop 3 is set and its Q output holds flip-flop 5 in the reset state. If the input signal has sufficient power, counter II will exceed some predetermined minimum output state,  $Q_{in}$ . When  $Q_D$  goes low, flip-flop 3 is reset, thus removing the reset from flip-flop 5. Counter II's minimum output state is a function of the required system resolution and must be determined for each application.

Input signal overvoltage is the third fault condition against which the system is protected. If the voltage is too high, it can drive one or more of the analog components to nonlinear operation. This would, of course, introduce unacceptable errors.

In the input-conditioner subassembly the conditioned signal voltage is monitored by comparator 2 (Fig. 4). An overvoltage condition causes the comparator's output to go low, and this signal enters the digital processor as the overvoltage pulse (Fig. 6). This pulse sets flip-flop 4, whose Q-output holds flip-flop 5 in the reset state. The overvoltage hysteresis feedback ensures that if the overvoltage comparator (comparator 2 of Fig. 4) does not trip during the read mode, it will not do so during the write mode.

Note: The capabilities of the PWS can be easily extended. For example, the rate multipliers that buffer the counters in the digital processor are fully programmable. Thus it would be simple to make the input output power ratios controllable by remotely located signals. ■■

# One good turn...

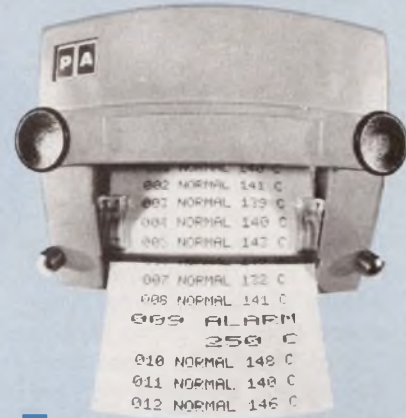

# deserves another.

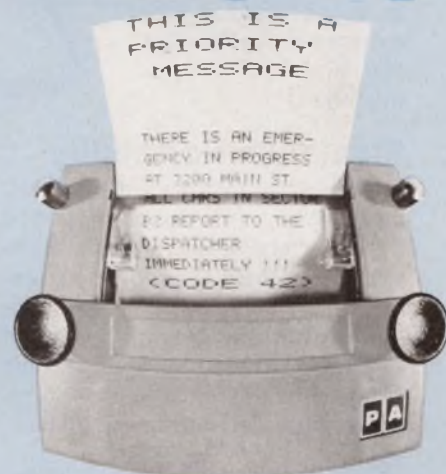

You flipped over our Matri-Dot alphanumeric mini for "first line down" data printing; now we've flipped our design to give you "first line up" text print format, too. So you're ahead, whatever your point of view. Because no one else makes printers as small as 3"H x 3 1/2"W x 7"D. No one else sells them as low as \$140 (in quantities of 100). And no one else offers our features. Instead of a drum, our unique print head purrs along at 138 lines per minute for 18 data columns, even faster for fewer columns. Instead of messy ribbons, our exclusive drop-in ink platen lasts for 75,000 lines and replaces from the front panel. And instead of engraved drum limitations, our 7 x 5 dot matrix characters provide full alphanumerics with a complete ASCII 63 character set. Enhanced characters are also available... 8, 10, 12, or 14 characters per inch. All this, plus multiple-copying capabilities and plug-in panel mounting. No matter how you look at Matri-Dot, it's a turn for the better.

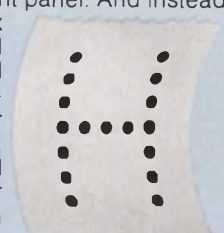

Trap Falls Road ■ Shelton, Connecticut 06484  
Tel: (203) 929-5381



# Performance For All Your Portable

Tektronix offers an unmatched selection of performance and value leading portable oscilloscopes. Wherever and whatever your portable oscilloscope application, you can choose the best cost/performance/weight combination for your needs from our comprehensive line of 16 models. These include the industry standard 465 (line 6 of the table) and such unique products as the 350 MHz 485, the 466 fast transfer storage oscilloscope with a 1350 cm/ $\mu$ s stored writing rate, the 3.5 pound 213 which combines a full function DMM with an oscilloscope, and 7 other extremely lightweight 200 and 300 series models.



## Maximum Portability

The wide bandwidth (up to 350 MHz), dual-trace, delayed sweep 400 Series offers seven high performance models for complex measurements on such systems as computers, communications gear, and radar. At 21 to 26 pounds, this series provides excellent performance and weight characteristics.

Tektronix offers the most compact, lightweight line of oscilloscopes anywhere with the 200 Series at 3.5 pounds and the 300 Series at 7 to 10.5 pounds.

All TEKTRONIX Portables offer battery power internally or as an option.

## Highest Bandwidth of Any Portable

Portable oscilloscope bandwidth is extended to 350 MHz at 5 mV/div by the 485. The highest gain-bandwidth of any portable is achieved by the 475 with 200 MHz at 2 mV/div. Both are excellent choices for measurements on fast logic signals.

## Storage Leadership

The world's fastest direct view storage is provided by the 466 which stores even single-shot events at its full 100 MHz bandwidth. Tektronix also offers the lightest weight storage by a wide margin with the 500 kHz 214 Portable Storage Oscilloscope at 3.5 pounds and the 10 MHz model 314 at 10.5 pounds.

## A Choice of Numerical Readout Models

Only Tektronix gives you a choice of four portable oscilloscopes with direct numerical readout of displayed time intervals (464 DM43, 465 DM43, 466 DM43, 475 DM43). In addition to providing faster, more repeatable, easier timing measurements, these models also measure dc volts, ohms, and temperature.

## Ruggedness for Field Use

To insure reliable operation under the rough handling and hostile environment encountered in the field or in production areas, TEKTRONIX Portable Oscilloscopes must pass stringent shock and vibration tests as well as subjection to extremes of temperature ( $-15^{\circ}$  to  $+55^{\circ}$  C) and humidity. They are also designed for minimum temperature rise to insure maximum component life.

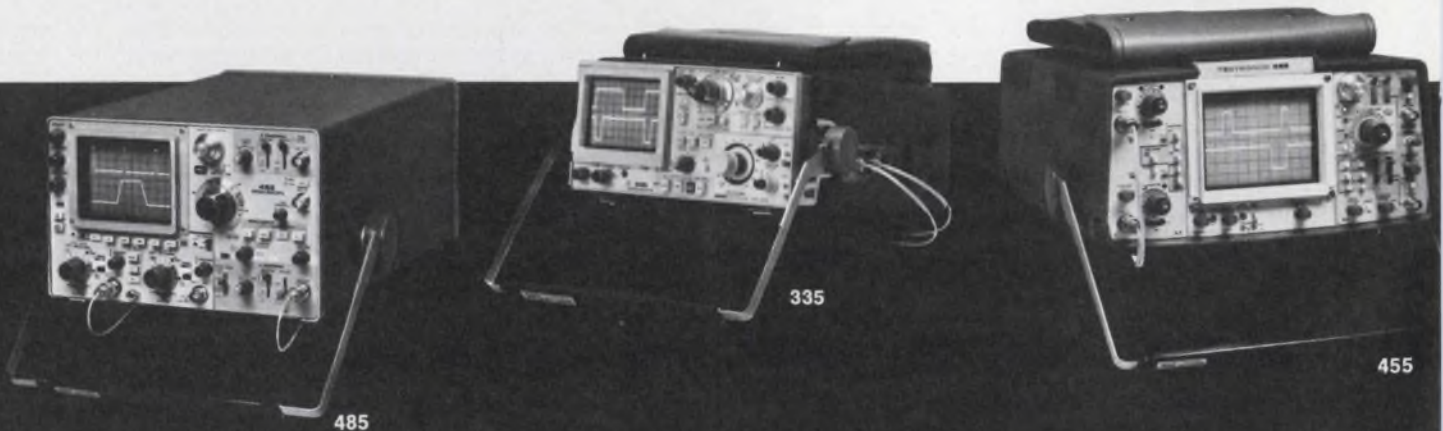

485

335

455



# Leadership Oscilloscope Needs

## Widest Selection of Portable Oscilloscopes

|                   | Product               | BW                  | Dual Trace   | Delayed Sweep | Fastest Sweep Rate | Other Special Features                   | Price             |
|-------------------|-----------------------|---------------------|--|---------------|--------------------|--|-------------------|
| Storage Models    | 466 & 464             | 100 MHz @ 5 mV/div  | yes  | yes           | 5 ns/div           | Stored writing speed to 1350 cm $\mu$ s  | \$4300/<br>\$3600 |
|                   | 434                   | 25 MHz @ 10 mV/div  | yes  |               | 20 ns/div          | Split screen storage                     | \$2900            |
|                   | 314 (NEW)             | 10 MHz @ 1 mV/div   | yes  |               | 10 ns/div          | Only 10.5 lbs.                           | \$1995            |
|                   | 214                   | 500 kHz @ 10 mV/div | yes  |               | 1 $\mu$ s/div      | Only 3.5 lbs.                            | \$1200            |
| Nonstorage Models | 485                   | 350 MHz @ 5 mV/div  | yes  | yes           | 1 ns/div           | Widest BW in a portable                  | \$4550            |
|                   | 475                   | 200 MHz @ 2 mV/div  | yes  | yes           | 1 ns/div           | Highest gain-BW in a portable            | \$2900            |
|                   | 465                   | 100 MHz @ 5 mV/div  | yes  | yes           | 5 ns/div           | Cost effective for 100 MHz BW            | \$2095            |
|                   | 455 (NEW)             | 50 MHz @ 5 mV/div   | yes  | yes           | 5 ns/div           | Cost effective for 50 MHz BW             | \$1695            |
|                   | 335 (NEW)             | 35 MHz @ 10 mV/div  | yes  | yes           | 20 ns/div          | Only 10.5 lbs.                           | \$1825            |
|                   | 326                   | 10 MHz @ 10 mV/div  | yes  |               | 100 ns/div         | Only 10 lbs.                             | \$1825            |
|                   | 323                   | 4 MHz @ 10 mV/div   |  |               | 500 ns/div         | Only 7 lbs.                              | \$1200            |
|                   | 221                   | 5 MHz @ 5 mV/div    |  |               | 100 ns/div         | Only 3.5 lbs.                            | \$825             |
|                   | 213 (NEW)             | 1 MHz @ 20 mV/div   |  |               | 400 ns/div         | DMM/Oscilloscope @ 3.7 lbs.              | \$1200            |
|                   | 212                   | 500 kHz @ 10 mV/div | yes  |               | 1 $\mu$ s/div      | Only 3.5 lbs.                            | \$875             |
|                   | D32 (NEW)             | 10 MHz @ 10 mV/div  | yes  |               | 100 ns/div         | Low cost for 10 MHz dual-trace & battery | \$1050            |
|                   | Time Interval Readout | DM43                | Optional direct numerical readout of time intervals and DMM functions for 464, 465, 466, and 475 models. |               |                    |  |                   |

## Let Us Show You

For a demonstration of how one of the above Portable Oscilloscopes can achieve results in your application, contact your Tektronix Field Engineer. Or for our latest Portable Oscilloscope brochure write: Tek-

tronix, Inc., P.O. Box 500, Beaverton, Oregon 97077. In Europe write: Tektronix Limited, P.O. Box 36, St. Peter Port, Guernsey, Channel Islands.

U.S. Sales Price FOB Beaverton, Oregon



**TEKTRONIX®**

committed to  
technical excellence

FOR TECHNICAL DATA CIRCLE # 58  
FOR DEMONSTRATION CIRCLE # 59





## FET analog-switch circuit provides 63-dB on-off ratio

Junction FETs in analog-switch circuits are almost always off and are turned on via a transistor-diode circuit (Fig. 1a). However, when off, the FET's gate is usually returned to the signal ground via a diode, a large-valued resistor and a bypass capacitor. The FET then acts as a high impedance between the analog-signal input and the output resistor.

But large signal voltages or high frequencies can leak through such an arrangement. Signal leakage at only a few hundred kHz, or with swings of more than  $\pm 3$  V, can be high enough to make the circuit unacceptable, particularly at high temperatures.

The circuit in Fig. 1b overcomes these limitations. When transistor  $Q_2$  turns on, FET  $Q_1$  turns off. Now, because  $Q_2$  is saturated, it provides a very low impedance return to the signal ground for  $Q_1$ 's gate via  $C_2$ . This low impedance produces a more effective off-state isolation in the FET than the Fig. 1a configuration. Less signal leaks through, and larger signals at higher frequencies can be handled. For the values shown, the on-to-off ratio is 63 dB at 750 kHz with a 15-V, peak-to-peak, signal.

When  $Q_2$  is off,  $Q_1$  is on and  $R_3$  provides the needed bias return for the  $Q_1$  gate. The gate's high impedance draws negligible current; thus the gate and signal source are at about the same voltage. This is the most desirable condition when  $Q_1$  is in the on state. Resistor  $R_3$  can range from 10 k $\Omega$  to 1 M $\Omega$ . High values are best for signal sources with high output resistance, because the high resistance minimizes any tendency to generate a dc step in the output. However, low values reduce the switching time. It's about 25 ns with the values shown.

The circuit in Fig. 1b can interface directly with a TTL input.

Michael F. Black, Engineer, Texas Instruments, Inc., MS 295, 13500 North Central Expressway, Dallas, TX 75222.

CIRCLE NO. 311

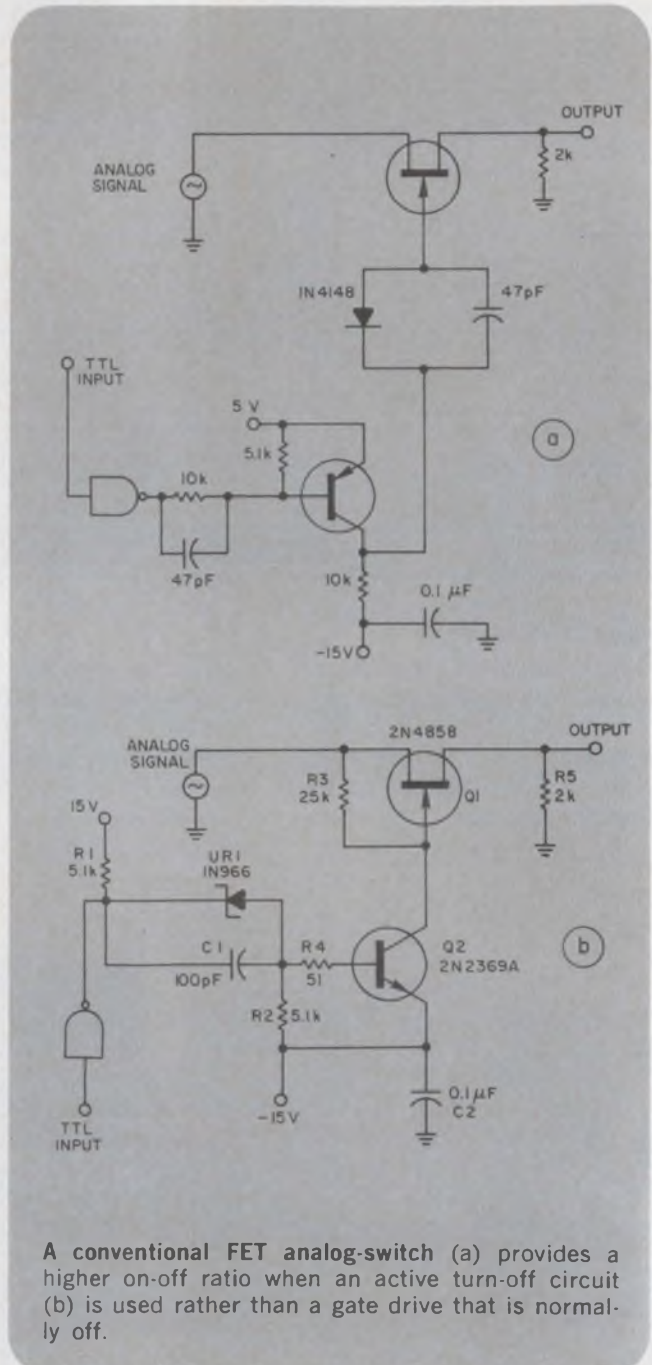

A conventional FET analog-switch (a) provides a higher on-off ratio when an active turn-off circuit (b) is used rather than a gate drive that is normally off.



# How to tell a Super-VOM from just the everyday garden-variety Brand X.

ONLY THE SUPER-VOM (Triplet's New 60) HAS ALL THESE FEATURES:

**DROP-PROOF CONSTRUCTION**  
(Virtually indestructible for an accidental drop up to a five-foot height)

**BUILT-IN "CONFIDENCE-TEST"**  
for periodic meter reassurance checks after overload/drops.

**BURNOUT-PROOF**  
(3-fuse arrangement, including diodes and 2 Amp/1000V protection fuse)

**SINGLE-RANGE SELECTOR SWITCH**  
(Most VOM's have 2 or more. Single switch minimizes range selection errors)

**SAFETY DESIGNED FOR YOU**  
(Completely insulated; new Safety Leads; prevents explosive arcs from high energy circuits up to 20 KW)

**48" SAFETY ENGINEERED TEST LEADS**  
(Especially designed recessed safety connectors and heavily insulated alligator clips)

**ONLY 2 RECESSED INPUT JACKS**  
(Makes lead changes unnecessary—Some VOM's have as many as seven)

**DETENTED HANDLE POSITION**



only \$90

Nobody else offers these features in a VOM at any price. So for only \$90, the Model 60 is the safest, most versatile, most honestly priced quality VOM you can buy. And, for just \$10 more, you can have the Model 60-A that has 1½% DC accuracy, plus a mirrored scale.

That's the kind of Triplet one-upmanship appreciated the world over by value-conscious users in industrial production and maintenance. TV - Radio - Hi-Fi shops, vocational training and hobbyists, airconditioning, appliance and automotive service, R & D, and application engineering . . . anyone who wants to be more productive with the latest in VOM technology.

Drop in on your nearest Triplet distributor or Mod Center and drop the new Model 60. Ask for a no-obligation demonstration of every feature. Compare it with any other VOM. You'll know why Triplet Models 60 and 60-A eliminate over 90% of the costly repairs from VOM misuses. Cultivate a profitable habit for selecting Triplet design-firsts.



**TRIPLETT**  
BLUFFTON, OHIO 45817

*Super-Safe*  
**Triplet. The easy readers**



# Capacitor drops voltage with little heat for low-cost, low-voltage power supply

In clocks, radios and other low-power electronic devices that use power supplies to convert 110 V ac to low dc, the typical approach is to use a step-down transformer. A transformer, however, is probably the most costly, bulky and heavy component in the power supply. It also generates heat because of core and copper losses. And if voltage-dropping resistors are used instead, they can become excessively hot. A capacitor, however, can drop the line voltage to the desired level with practically no heating. And a capacitor is light and generally lower in cost and smaller than a transformer.

This use of a capacitor might seem to be an obvious approach to many circuit designers, but despite the apparent advantages, especially for modern low-current transistorized or IC devices, few engineers have taken this approach. Perhaps designers have been waiting for application data.

The power supply can consist simply of a capacitor,  $C_1$ , in series with the bridge rectifier, filter capacitor  $C_2$  and load,  $R_L$  (Fig. 1a). The output voltage is approximately

$$V_{out} = \frac{V_{rms}(R_L)}{[R_L^2 + (1/\omega C_1)^2]^{1/2}}$$

Assume that the ac line voltage can vary from 105 to 130 V and the load from 100 to 200  $\Omega$ , and that the design center of the desired output is 15 V. To design such a circuit, first determine  $C_1$  by solving the  $V_{out}$  equation. For this example, use design-center values 117 V for  $V_{rms}$ , 150  $\Omega$  for  $R_L$  and 15 V for  $V_{out}$ . With these

values,  $C_1$  equals 2.6  $\mu F$ .

For the worst-case conditions of maximum line voltage at minimum load and for minimum line voltage at maximum load, the calculated output voltage varies from 21 to 9.4 V. A low-cost transformer supply does not provide much better regulation.

The measured values of a supply built as in Fig. 1a provide 19.5 and 8.6 V. The output characteristics of this unregulated supply are plotted in Fig. 1b.

The effect of clamping the output voltage with a 12-V zener also is shown in Fig. 1b. The slope of the regulated voltage curve is determined by the resistor in series with the zener,  $R_1$ , and the internal resistance of the zener. For output design limits of, say, 9.5 and 16 V at 130 V rms input, the current range is only about 100 to 105 mA without a zener. But with a 12-V zener, the current range widens to roughly 50 to 105 mA.

An unregulated supply appears to behave like a current source. Thus when the load doesn't absorb the current to obtain regulation, the regulating circuit must. Of course, the cost effectiveness of the supply might be offset by the cost of the zeners, if a highly regulated voltage supply is needed. Another disadvantage is that the circuit is not isolated from the power lines.

*Douglas Thom, Development Engineer, Novus Div., National Semiconductor Corp., 1177 Kern Ave., Sunnyvale, CA 94086. CIRCLE No. 312*

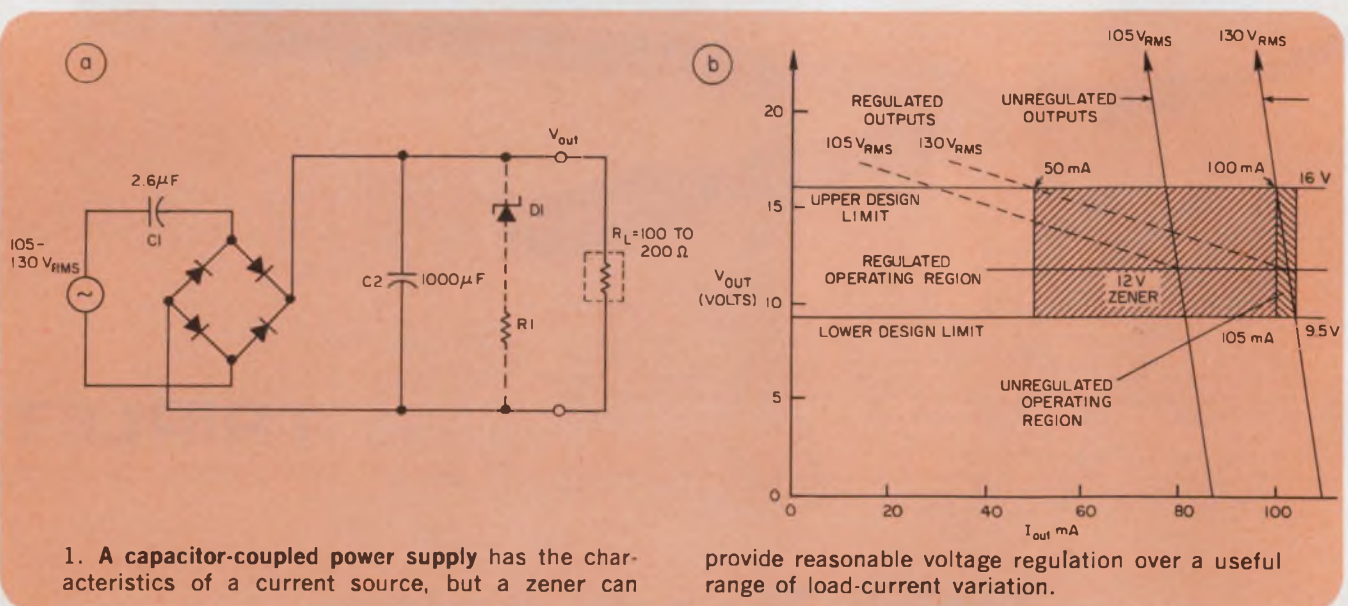

1. A capacitor-coupled power supply has the characteristics of a current source, but a zener can

provide reasonable voltage regulation over a useful range of load-current variation.



# LFE

## FIRST IS OUR MIDDLE NAME

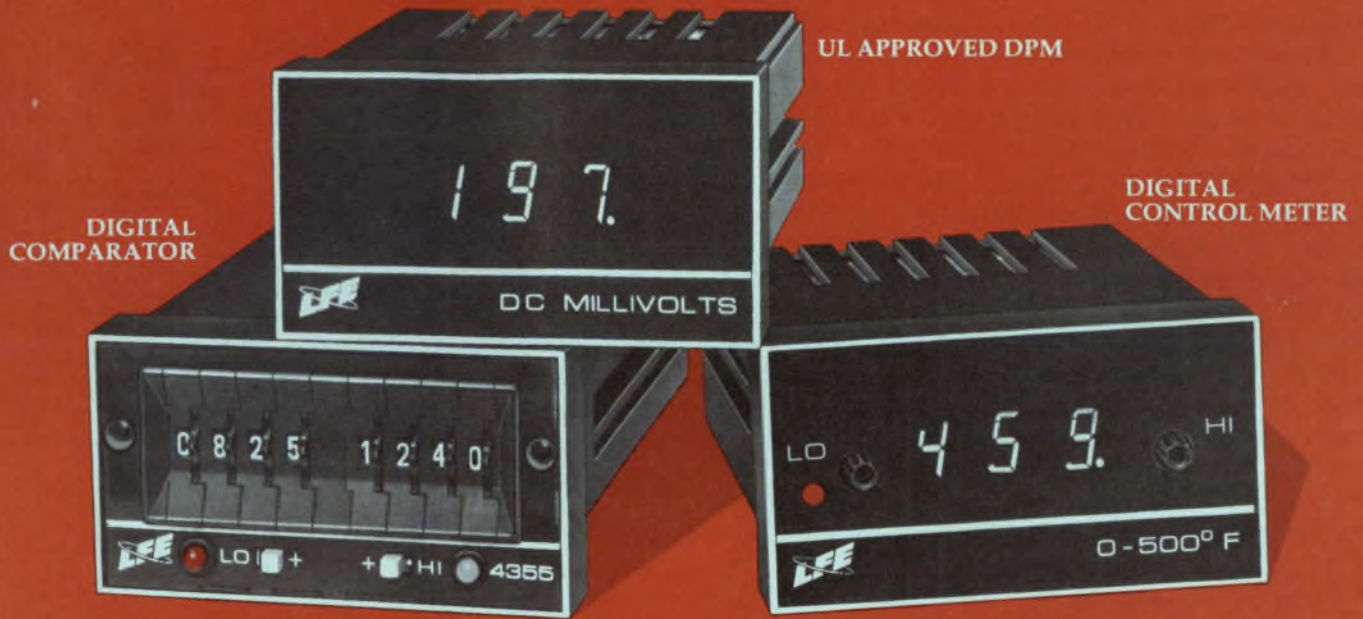

### FIRST UL RECOGNIZED DIGITAL PANEL METER FIRST SEVEN-SEGMENT DPM DISPLAY FIRST DIGITAL CONTROL METER

In 1968, LFE introduced the first DPM with a seven-segment planar display—our Model 4304. Ever since, we've been first with major benefits for DPM users. Not gimmicky, small details, or clever made-up words but substantial improvements to meet real needs, like these:

**UL-RECOGNIZED**—The LFE Model 4360, 2½ digits, is the first DPM to qualify as a component in the UL category Electrical and Electronic Metering and Testing Equipment. For certifiable safety in commercial, industrial, and medical applications.

**DIGITAL CONTROL METER**—The LFE Model 4354-K has 2 push-to-set continuously variable control points for 0.2% resolution in alarm or control of voltage, current, resistance, temperature and most other real world variables.

**DUAL CONTROL COMPARATOR**—The LFE Model 4355 provides full four digit HI/LO comparison with BCD input from any DPM,

counter, or other parallel-output device. Relay and logic output, front-panel LED indicators, AC or DC powered and latching options.

**FIRST IN RELIABILITY**—A lengthy elevated-temperature burn-in and exhaustive computer controlled checkout guarantee the most reliable DPM products available anywhere.

Our nationwide network of representatives, distributors, and modification centers stands ready to serve you. For leadership in value and quality in digital instruments, look to LFE . . . **FIRST**. For information contact LFE Corporation, 1601 Trapelo Road, Waltham, MA, 02154, (617) 890-2000

**LFE**  
CORPORATION

Process Control Division







# Greater RFI/EMI shielding in new, narrow-width contact strips from Instrument Specialties

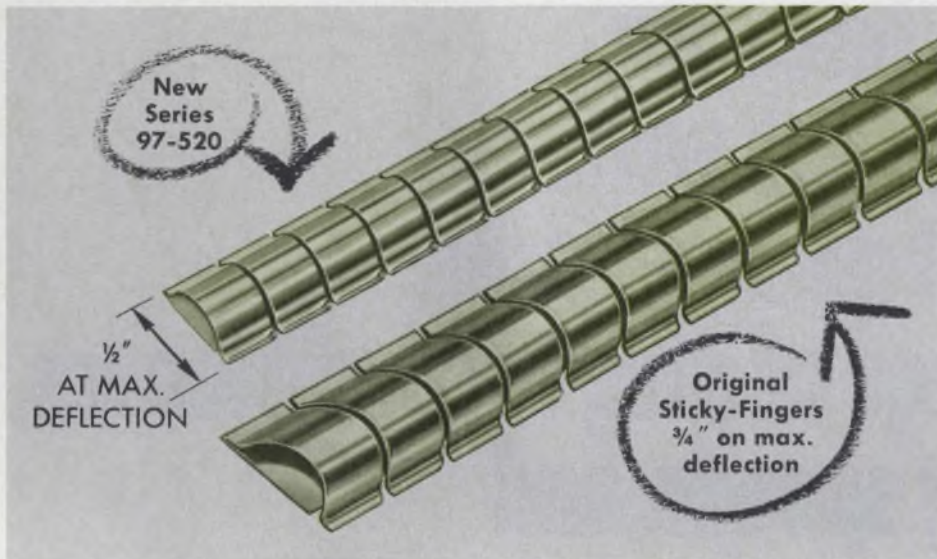

Latest addition to **stickyn fingers**® line!

Instrument Specialties now offers Sticky-Fingers self-adhesive, beryllium copper contact strips in three variations to solve your most critical RFI/EMI problems.

Comparable to the shielding effectiveness of the original Sticky-Fingers, our newest series 97-520\* offers shielding effectiveness of 92 dB at 10 GHz plane wave or greater than 92 dB at 1 MHz magnetic, and has a dynamic range of 0.10". Yet, it measures a scant 3/8" wide, and 1/2" at maximum deflection.

Supplied in standard 16" lengths, series 97-520 is ideal for metal cabinets and electronic enclosures where variations exist in the space to be shielded, and where high shielding effectiveness must be maintained in narrow spaces, even with frequent opening and closing of the cabinet.

Select the exact series that fits your application best. Write today for a complete catalog, list of finishes available, and our latest Independent Shielding Evaluation Report. Address: Dept. ED-68.

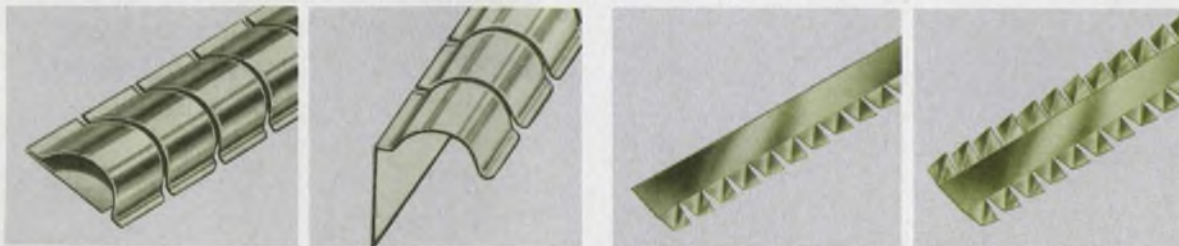

Series 97-500\*—the original 3/4" wide Sticky Fingers. For greatest possible shielding and where space permits. Also available: Series 97-505—90° configuration of Series 97-500; same shielding effectiveness.

For those all-purpose applications where economy and space are both factors, specify the 3/8" wide single-twist series 97-555, or 1/2" wide double-twist series 97-560 Sticky-Fingers.

*Specialists in beryllium copper springs since 1938*

\*Patented

INFORMATION RETRIEVAL NUMBER 62

ELECTRONIC DESIGN 24, November 22, 1975



INSTRUMENT SPECIALTIES CO., INC.  
Little Falls, New Jersey  
Phone 201-256-3500



**If it weren't for its frequency response  
of 30 Hz at 100 mm,  
its 99.65% linearity,  
its pressure-ink writing,  
its highest quality traces,  
its full range of plug-in conditioners,  
its 12 chart speeds, and  
its wide channels,  
the GOULD/Brush 2400 would be like  
most any other direct writing recorder.**

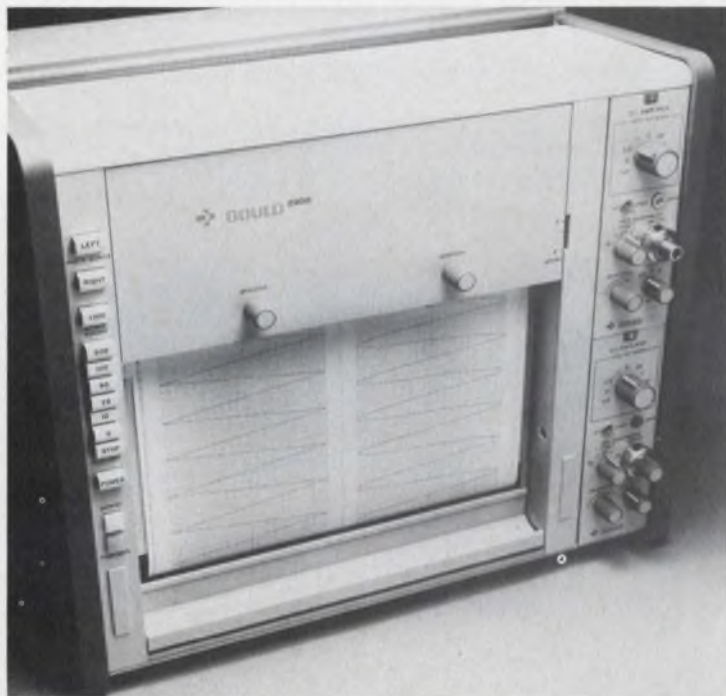

But because of all this, it's the best performing direct writing recorder on the market today. When you see it, you'll believe it. So call your nearest Gould Sales Engineer today for a demonstration. Or, for more details, write Gould Inc., Instrument Systems Division, 3631 Perkins Avenue, Cleveland, Ohio 44114. Or Gould Allco S.A., 57 rue St. Sauveur, 91160 Ballainvilliers, France.

 **GOULD**

**PHONE TOLL FREE TODAY FOR TECHNICAL BROCHURE (800) 648-4990.**

INFORMATION RETRIEVAL NUMBER 63



## New Products

# Systems DMM slashes price, yet holds performance



Data Precision, Audubon Rd., Wakefield, MA 01880. (617) 246-1600. 45 days.

What you get for \$795 in Data Precision's new 3400 DMM, you can't get for up to three times the price in any other 4-1/2-digit multimeter. Standard in the 3400 are:

- Rear-terminal programmability of ranges and functions.
- BCD parallel outputs, plus range and polarity indication.
- External triggering to 12 conversions/second.
- Four functions—dcV, acV, ohms and ratio (ac/dc and dc/dc).
- Resolution of 10  $\mu$ V (20,000 counts).
- Basic dcV accuracy of  $\pm 0.007\%$  of reading  $\pm 1$  LSD for six months—the best of any 4-1/2-digit meter.

With the line-up of features behind its attractive price, the Data Precision unit appears to fill the requirements of not only systems, but many bench applications, too. Totally pushbutton operated in the manual mode, the 3400 displays its

readings on 0.433-in. LEDs. And LED annunciators tell the user which function he's on.

When operated from the unit's internal trigger, the conversion rate of the 3400 is fixed at three per second. Top range of the meter is 1000 V on dc and 750 V rms on ac. Ac frequency response is 30 Hz to 100 kHz. Resistance measuring capability ranges from 10 m $\Omega$  to 20 M $\Omega$ , while ratios can be handled from 0.01000:1 to 100.00:1. Denominators range from 1 to 11 V dc and numerators from 10  $\mu$ V to 1000 V dc or peak ac.

Outputs of the Data Precision multimeter are TTL compatible, with provision for operation in the overlap mode for multiplexed systems. Inputs are floating and guarded, with electronic protection to 1000 V on dc and to 750 V rms on ac. Resistance ranges are protected to 270 V dc. Common-mode voltage is 500 V dc or peak ac.

Other key specs of the Data Precision 3400 include an input Z greater than 1000 M $\Omega$  on the 0.1 and 1-V-dc scales and 10 M $\Omega$  on

all others. Ac input Z is 1 M $\Omega$ . The 3400's NMR is 60 dB at 60 Hz and all multiples of 60 Hz, and its dc CMR is a high 160 dB at 1-k $\Omega$  imbalance. The unit's ac CMR drops to a still high 120 dB.

The accuracy spec of the 3400 holds at a temperature of  $23 \pm 5$  C. Below 18 C, and above 28 C, the unit's tempco on dc is given as ( $\pm 0.001\%$  of reading  $\pm 0.0005\%$  of fs)/ $^{\circ}$ C.

Closest competition to the 3400 appears to be two 4-1/2-digit units from California Instruments (Cimron) and Dana Laboratories. Both the Cimron DMM 42 and the Dana 4700A offer programming and outputs as standard. But while the \$1375 4700A includes acV and ohms in its price, the \$795 DMM 42 costs \$450 more with these optional functions.

Neither of the competing units offers ratio measurement, and neither is as accurate or as fast as the Data Precision meter. But the DMM 42 has better resolution—1  $\mu$ V dc and 0.1 m $\Omega$ —and wider dc voltage and resistance ranges.

Data Precision CIRCLE NO. 305  
California Instruments

Dana Laboratories CIRCLE NO. 306  
CIRCLE NO. 307

## 80-MHz counter/timer costs just \$750

John Fluke, P.O. Box 1094, Station D, Buffalo, NY 14210. (716) 842-0311. See text.

Model 1952B 80-MHz universal counter/timer is priced at just \$750. The 7-digit, six-function unit features direct-coupled inputs, dual-trigger status indicators, variable trigger level controls and an oscilloscope marker output. The 1952B also is optionally available as an 8-digit instrument with TCXO.

CIRCLE NO. 308



# New case styles!

Bezel, window and surface mounting styles are now included in the expanded line of Beede QA panel meters. There's a variety of meter styles, colors and options to give you complete design flexibility.

Now you can have the best of both... sophisticated appearance *and* high reliability when you specify Beede panel meters. Select from three styles in 1½", 2½", 3½" and 4½" cases. Meter movements available are shielded bar taut-band, Mag B taut-band or pivot-and-jewel, and AC iron vane. Wide choice of options including multi-colored scales, special resistances, different calibration points, tracking accuracies to ±½% and many more.

Each meter has the smart, clean design look. And behind the handsome face of the QA case is the reliable, ruggedized Beede meter you can depend on for long, trouble-free service. Think of Beede as your prime source of reliable, accurate, contemporary-styled panel meters at economical prices.

Write or call for complete information on Beede panel meters, meter relays and pyrometers in the QA case line.

**Beede QA panel meters.**  
**Where appearance is as important as reliability.**

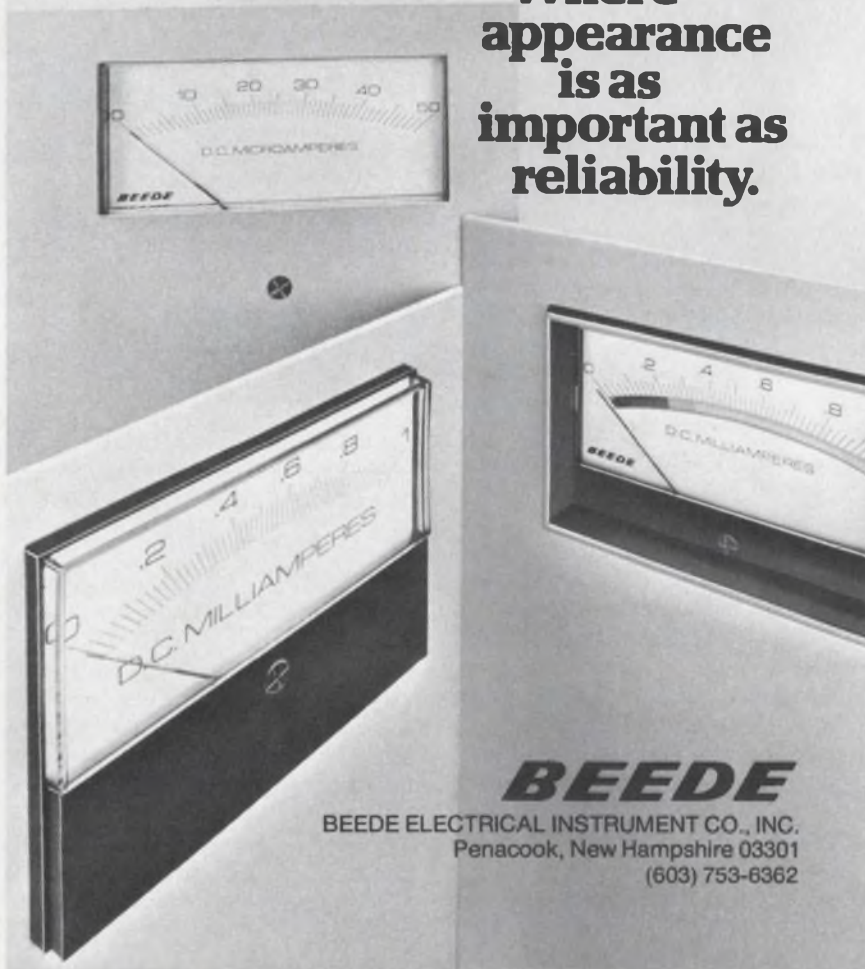

**BEEDE**  
BEEDE ELECTRICAL INSTRUMENT CO., INC.  
Penacook, New Hampshire 03301  
(603) 753-8362

## INSTRUMENTATION

### Counter series offers advanced features

*Racal Instruments, Duke St., Windsor, Berkshire, SL4 1SB.*

Features of the 99 Series of counter-timers and frequency meters stem from a unique custom-built LSI chip. Improved reliability has enabled the company to double the guarantee period to two years. The series consists initially of three universal counter-timers (9901, 9903 and 9905) and four frequency meters (9911, 9913, 9915 and 9917). Standard features include serial BCD data outputs, LED displays with segment check, precision frequency standards and lightweight shielding metal cases. The four meters cover direct frequency measurement from 10 Hz to over 3 GHz. Input dynamic range is well over 70 dB and sensitivity is better than 10 mV.

CIRCLE NO. 309

### 10-MHz, triggered scope displays TTL numerics



*B & K Precision, 1801 W. Belle Plaine Ave., Chicago, IL 60613. (312) 525-3992. \$495.*

Model 1471 dual-trace, triggered-sweep scope has 18 calibrated sweep ranges from 1 μs/cm to 0.5 s/cm and sweeps to 200 ns/cm. The 10-MHz unit displays alphanumeric characters directly from TTL drivers. Deflection factor is 0.01 V/cm to 20 V/cm ±5% in eleven ranges. Calibration accuracy is maintained from 105 to 130 V ac. Rise time is rated at 25 ns. Automatic triggering is obtained on waveforms with as little as 1 cm deflection at 10 MHz. Dual-trace mode shifts automatically between CHOP and ALTERNATE as sweep time is changed.

CIRCLE NO. 310



# If your bench scope says your ECL logic looks like this...

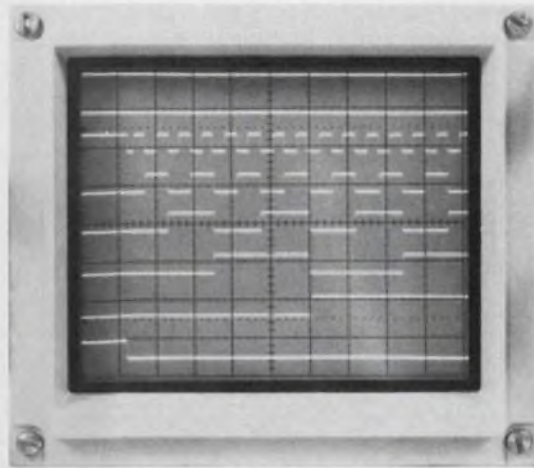

## ...you're using the new 100MHz 8100-D Digital Logic Recorder from Biomation.

**Introducing the new 100MHz Glitch Fixer: Biomation's 8100-D puts a faster fix on faster glitches.**

The original Glitch Fixer, Biomation's 810-D, has been helping a lot of engineers study timing relationships of 8-bit signals at speeds up to 10MHz.

But because the world's going faster—with MECL, ECL II, ECL III and Schottky-clamped I<sup>2</sup>L parts in your boards—we've built a new digital logic recorder, the 8100-D, with speeds up to 100MHz.

It's the new-and-faster way to turn your ordinary bench scope into a data stream display. It records 8 data channels at once and presents them in the same format you're used to seeing on data sheets.

The 8100-D features built-in combinatory logic setting to help you isolate your problem event fast. It has a big memory, too; can store up to 2,048 8-bit data words, including the often critical information that lies *just ahead* of the

triggering event. And it also provides digital output for computer analysis or mass storage.

The 8100-D is a piece of diagnostic instrumentation that circuit designers and troubleshooters have been asking us for. We will be glad to send you all the splendid details. Just use the reader service number or get in touch with us directly. Biomation, 10411 Bubb Road, Cupertino, CA 95014. (408) 255-9500. TWX 910 338 0226.

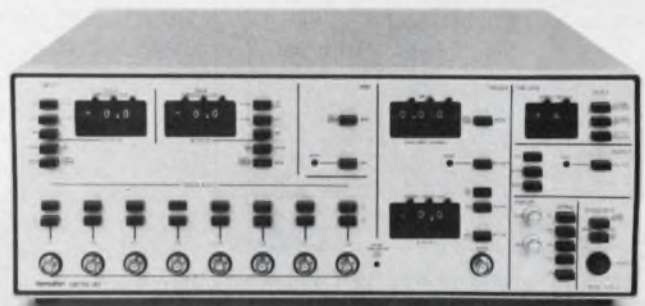

# biomation

INFORMATION RETRIEVAL NUMBER 65



# AMPERITE

## TOP QUALITY

Still at LOW PRICE!



### Thermostatic DELAY RELAYS

Hermetically Sealed for Maximum Stability

Delays: 2 to 180 Sec.\*

Hermetically sealed — not affected by altitude, moisture, or climate changes... SPST only — normally open or normally closed... Compensated for ambient temperature changes from  $-55^{\circ}$  to  $+80^{\circ}\text{C}$ ... Rugged, explosion-proof, long-lived... Standard radio octal and 9-pin miniatures.

Price, standard or min., under \$4.00 ea.

\*Miniatures delays: 2 to 120 seconds.

PROBLEM? Send for Bulletin No. TR-81.

## New! LONG DELAYS

240 & 300 Sec.

Same rugged construction, hermetic sealing and stability as the shorter Delay Relays described above... For delays beyond 300 seconds, these Relays may be used in series.

Price, under \$6.00 ea.

Write for Bulletin No. LD-73.



## DIFFERENTIAL RELAYS

For automatic overload, over-voltage or under-voltage protection... Made only to specifications for 70V, 80V, 90V and 100V.

Price, under \$6.00 ea.

## AMPERITE BALLAST REGULATORS

Automatically keeps current and voltage at a definite value. For AC or DC... Hermetically sealed, rugged, vibration-resistant, compact, most inexpensive.

Price, under \$3.00 ea.

Write for 4-p. Bulletin No. AB-51.



# AMPERITE

600 PALISADE AVE., UNION CITY, N.J. 07087

Telephone: 201 UNION 4-9503

In Canada: Atlas Electronics, Ltd.,  
50 Wingold Ave., Toronto 19

## INSTRUMENTATION

### True dual-beam unit joins scope family

Tektronix, P.O. Box 500, Beaverton, OR 97005. (503) 644-0161. \$4725.

Model 5444 true dual-beam scope is a new member of the company's 5000-Series line. The 60-MHz scope's two gun structures—two electron sources, two vertical deflection systems and two horizontal deflection systems—provide completely independent operation and full beam overlap: the ability to position each beam anywhere over the entire 8-division CRT area. Thus the 5444 will display one signal at two sweep speeds or two signals at the same or different sweep speeds. Or the unit can display up to four repetitive waveforms at 60 MHz in the alternate or chop mode (or up to 8 at reduced bandwidth), and four multiple-trace, single-shot events at sweep speeds up to  $100 \mu\text{s}/\text{div}$  in the chop mode.

CIRCLE NO. 320

### New DPM family debuts, offers improved features



Analog Devices, Route 1 Industrial Park, P.O. Box 280, Norwood, MA 02062. (617) 329-4700. See text.

A new family of "second generation" (left photo) DPMs features MOS-LSI circuitry, large (0.43-to-0.05-in.) LED displays and reduced prices. Power consumption has also been reduced. First products in the line are: a 5-V-dc (logic-powered), 3-1/2-digit unit, the AD2021 (\$128); an ac-line-powered, 4-1/2-digit unit, the AD2024 (\$207); and a 5-V-powered, 4-1/2-digit unit, the AD2027 (\$197). Key specs, such as accuracy, stability and operating temperature range are said to be comparable to the "first generation" counterparts (right photo). Bit parallel, character serial, BCD outputs are standard.

CIRCLE NO. 321

### DMM price tumbles to new low



B & K Precision, 1801 W. Belle Plaine Ave., Chicago, IL 60613. (312) 525-3992. \$99.95; stock.

At \$99.95, Model 280 3-digit DMM is sure to attract a lot of attention. The portable unit features LED readout, a self-contained 6-V power supply and HI/LO ohms, a feature that permits in-circuit resistance measurements at voltage levels below the conduction threshold of semiconductors. Model 280 settles in 0.5 s (typical) in 22 ranges, measures dc and ac voltage, current and resistance, with input impedance of  $10 \text{ M}\Omega$  at all voltages (to 1000 V). Also provided are automatic polarity indication (display flashes on-and-off), 1-mV resolution and built-in battery check. Measurement accuracy is typically  $\pm 1\%$  of full-range dc volts and  $\pm 2\%$  of full range ac volts and ohms, except for  $\pm 2.5\%$  on highest range.

CIRCLE NO. 322

### Spectrum analyzer offers wide freq range

Anritsu Electric Co., Ltd., 4-12-20, Minamiazabu, Minatoku, Tokyo 106, Japan.

MS62A/B spectrum analyzer accepts various waveforms in the frequency range from 100 kHz to 1700 MHz and, in conjunction with an antenna, measures field intensity. Dynamic range is over 70 dB and power consumption is less than 45 W (65 VA). Other features include sensitivity of  $-122 \text{ dBm}$ , and amplitude resolution in 0.1-dB steps.

CIRCLE NO. 323



# And now, for debugging serial data,

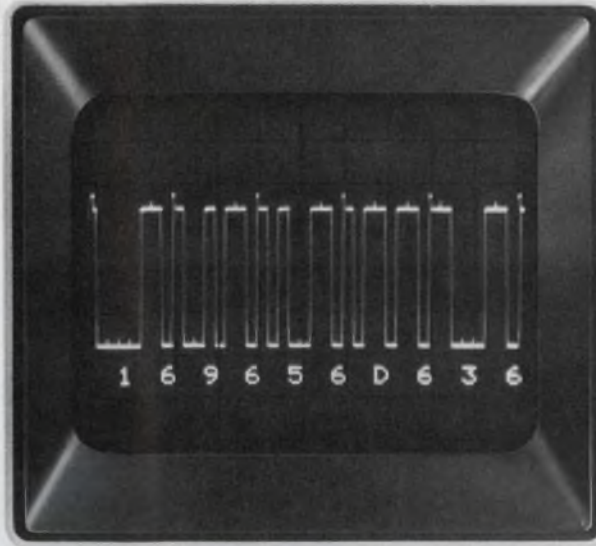

## Biomation brings you the 110-D.

Not just a new product. An entirely new kind of data recorder. From the folks who brought you the Glitch Fixer.

The best way to tell you about the Biomation 110-D's dramatic new way of debugging serial data is to show you the memo from our own engineering staff that sold us on the concept.

### Purpose

Designed to monitor, store, and display serial data, either synchronously or asynchronously. Major uses as follows:

#### 1. High speed synchronous data (up to 10MHz)

- Rotating memories (drums, disks, floppy disks).
- Digital tape decks—up to and including high performance 3200 bpi reel-to-reel decks.

*110-D will "snapshot" data and display it free of the jitter normally seen when using scope.*

- Shift register and delay line memories (MOS shift registers, magnetostrictive delay lines, glass delay lines, etc. such as found in CRT-type data communications terminals and other video-refresh applications).

*110-D will snapshot changing data patterns and allow stored analysis, otherwise impossible with scope.*

#### 2. Low speed synchronous data

110-D utilizes static RAMs to prevent data loss at low speeds.

- Synchronous modem channels—data between modem and terminal, between modem and computer front-end, etc. Includes Bell 201-type modems and other proprietary synchronous modems.

*Using a scope has same problems as above: changing data patterns and channel jitter makes analysis difficult or impossible.*

#### 3. Low speed asynchronous data

- Asynchronous modem channels—Bell 103- and 202-type modems and equivalent units from independent suppliers. **110-D has switchable internal clock for sampling data at normal data baud rates.** Also has start-bit validation logic, for "framing" the data in start-stop data.

- RS232 data channels—includes nearly all computer terminals, both video and hard-copy. Teletype KSR-33 and Dataspeed 40 terminal are typical examples.

*Asynchronous data is not only changing and jittering, but is coming in asynchronous bursts. The 110-D will time-compress the data to permit whole message groups to be easily observed.*

*Data from low speed computer peripherals—printers, card readers, card punches, paper-tape readers, etc. are often transmitted serially between them and the host main-frame. The 110-D is useful in developing and trouble-shooting these peripherals.*

There isn't enough room on this page to give you the whole story. Please call or write us for all the technical data and for a "hands-on" demonstration of a whole new solution to serial data problems. Biomation, 10411 Bubb Road, Cupertino, CA 95014. (408) 255-9500. TWX 910 338 0226.



# biomation

INFORMATION RETRIEVAL NUMBER 67



# Monsanto creates a 'counter' revolution...

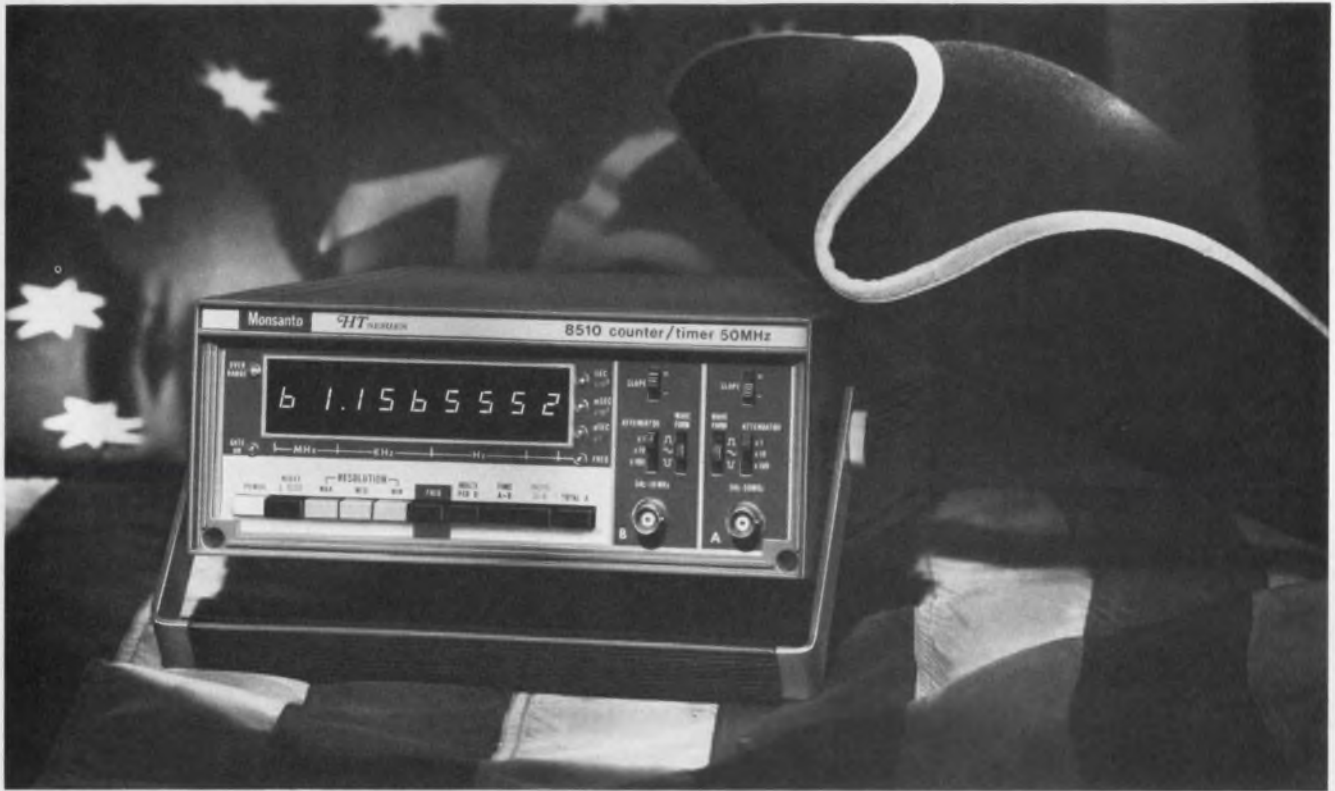

## Introducing two new revolutionary 'counter' features!

**1.** OPTI-RANGING; exclusive display technique. This unique process is a better kind of autoranging that organizes your data and displays it only in units most easily understood by you.

All our Opti-ranging counters are augmented by a standard LED display of 9 full digits that shows your complete measurement.

**2.** INPUT SHUTDOWN; our exclusive guarantee. Based on the standard input sensitivity of 10mV RMS, this technique shuts down the display if the input signal drops below a reliable measuring level, preventing erroneous readings. Additional measurement confidence is provided by AGC circuitry and an oven controlled crystal oscillator which is standard on these instruments.

### COMPARE BEFORE YOU BUY!

These counters are not partial-function. All our UNIVERSAL COUNTERS feature two separate channels for complete time interval measurements. Each channel has a separate set of input controls, including slope, waveform and attenuators for extra precision.

Every counter is housed in a rugged diecast and extruded aluminum case for lightweight convenience and total protection.

**8500 Series Universal Counter/Timers** consist of 4 models for measurements from 5Hz thru 1GHz

Start at **\$725.**

**8700 Series Frequency Counters** consist of 3 models for measurements from 5Hz thru 1GHz

Start at **\$625.**

We also offer 15 other counters from which to choose.

Call your nearest United Systems representative for complete specifications.

UNITED SYSTEMS CORPORATION

a subsidiary of **Monsanto**

918 Woodley Road • Dayton, Ohio 45403 • Ph: (513) 254-6251 • TWX: (810) 459-1728

These instruments available under GSA Contract GS-OOS-27741

FOR INFORMATION ONLY CIRCLE #226

FOR DEMONSTRATION ONLY CIRCLE #227



## INSTRUMENTATION

### 3-1/2-digit DMM costs just \$210

Simpson Electric Co., 853 Dundee Ave., Elgin, IL 60120. (312) 697-2260. \$210; stock.

Model 464 3-1/2-digit digital multimeter comes with extra-large 0.43-in. LED readouts. The unit is housed in an attractive, high-impact, shock-resistant molded case and features: full pushbutton operation for ranges and functions; low-profile design; tilt-and-view adjustable handle; 0.2% V dc reading accuracy; bi-polar operation and automatic zero; and built-in rechargeable battery circuit in one version.

CIRCLE NO. 324

### Two logic analyzers dig out functional ills

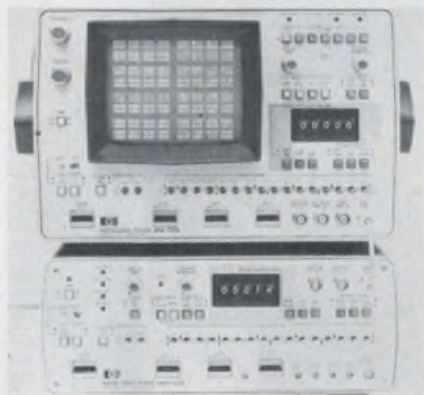

Hewlett-Packard, 1501 Page Mill Rd., Palo Alto, CA 94304. (415) 493-1501. 1607A, \$2750; 1600A, \$4000; 3-6 wks.

Two new logic-state analyzers, working together, can present in words formatted in 1's and 0's the sequential flow of data in 32 parallel channels. Model 1607A alone will produce a 16-channel word-format display on the screen of any modern lab scope. On its own CRT, Model 1600A can show a 16-channel sequence, or 32 channels when working with the 1607A. The 1600A introduces a new technique, "mapping" of logic operations, making characteristic performance instantly recognizable by taking advantage of the ease with which humans can detect patterns and pattern changes. Both analyzers work at clock speeds up to 20 MHz and trigger on preset data words.

CIRCLE NO. 325

### Digital current meter uses noncontact probe

FW Bell Inc., 4949 Freeway Dr. E., Columbus, OH 43229. \$850, 1 probe with instrument; late Nov.

Model 1776 digital current meter measures ac, dc (and ac on dc) currents with a noncontact clamp-on probe. The unit introduces virtually no load on dc readings and ex-

tremely low inductance on ac readings. Accurate readings can be made down to the 10-mA level while the upper limit is 1000 A dc or peak ac. Dynamic range is 100,000 to 1. Accuracy is  $\pm 0.5\%$ , fs for dc and  $\pm 2.0\%$ , fs for sinusoids. Peak detection accuracy (dc) is  $\pm 0.2\%$ , fs. Frequency response is dc to 10 kHz.

CIRCLE NO. 326

## Give 'em hell.

They can take it. And come back for more. Beautifully.

You've spent a great deal of time and money designing your equipment to work in the field. That means unpredictable conditions, rough handling and plenty of abuse. And when your product is 200 miles from the nearest service center, it had better work.

Give it the extra protection of Zero Centurion™ carrying cases, combining the best in classic styling with rugged durability. Durability that's been proven by people like yourself in environmental extremes around the world.

Choose from 59 standard sizes for two week delivery A.R.O., with unlimited modification capabilities. And the price is surprisingly low. Consider it low cost life insurance on your equipment.

Write for your free catalog today.



The Final Touch



ZERO MANUFACTURING CO.

Burbank, CA 213/846-4191 • Monson, MA 413/267-5561 • Clearwater, FL 813/531-8991

FOR IMMEDIATE REQUIREMENT CIRCLE 261  
FOR LITERATURE CIRCLE 262



# They're good... no matter how bad

**TW MEETS MIL-S-83731.** OFFERS SWITCHING VERSATILITY OF LARGER TOGGLES WITH ADVANTAGE OF SMALL SIZE, PANEL SEALING. IDEAL FOR APPLICATIONS LIKE ON/OFF SWITCH IN THIS MANPACK EQUIPMENT.

**SERIES 1 ROUND LIGHTED PUSHBUTTONS** OFFER FLUSH MOUNTING, PANEL SEALING AND VERSATILE SWITCH CIRCUITRY; INCLUDING SOLID STATE. MIL SPEC QUALITY (MIL-S-22885) AT COMMERCIAL PRICES FOR CONTROL CONSOLES.

**DS SERIES PUSHBUTTONS.** COMPACT .75 INCH SQUARE DESIGN OFFERS PLUG-IN DESIGN AND 4 LAMP DISPLAY. RFI ATTENUATION. MIL-S-22885.

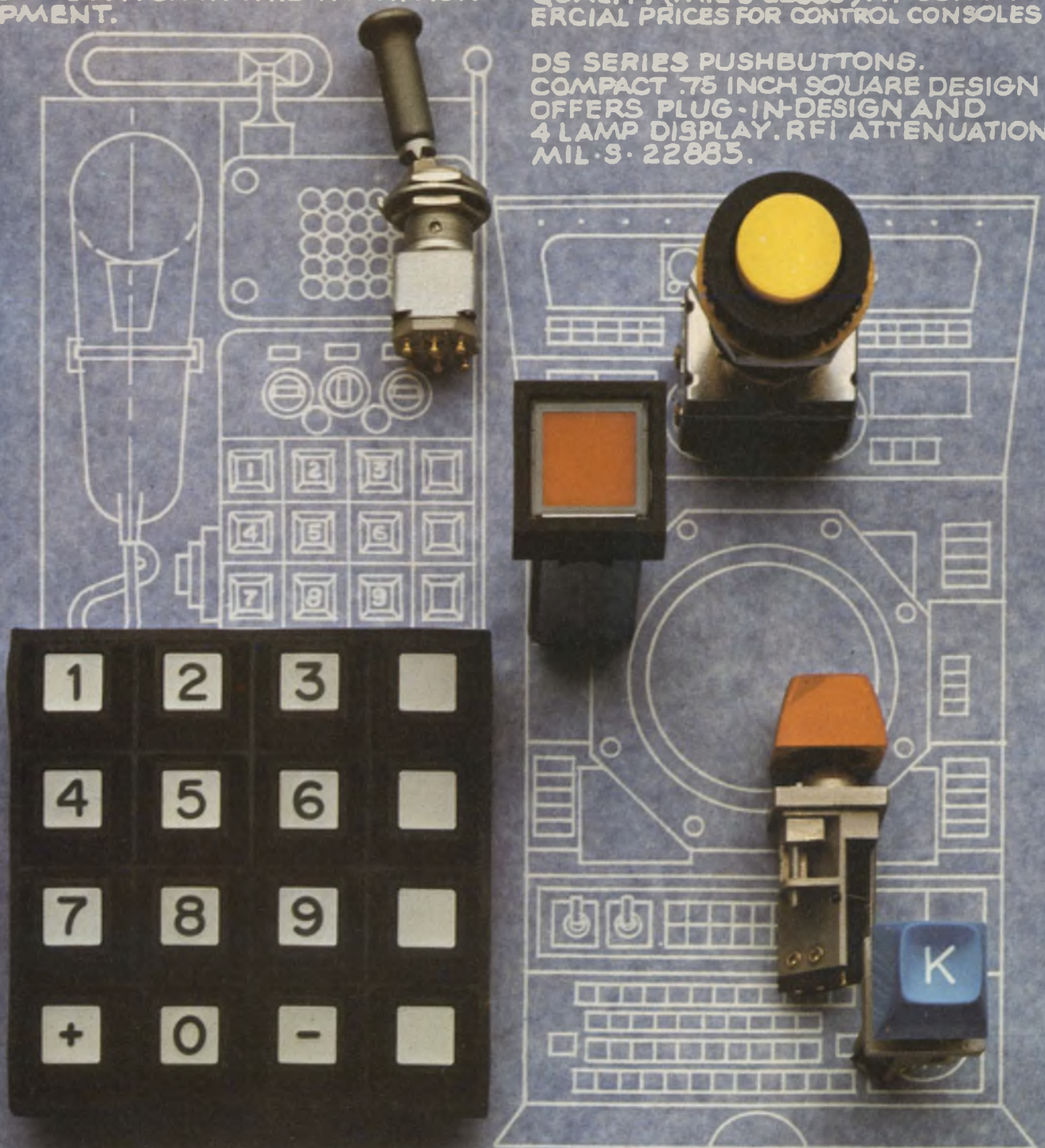

**PX KEYBOARDS.** TOTALLY SEALED WHEN MOUNTED, WITH ZERO DEPTH BEHIND PANEL. PX IS A NATURAL CHOICE FOR MANPACK EQUIPMENT SWITCH MATRICES.

**PANEL SEALED KS KEY SWITCHES.** USE OF SPDT SNAP-ACTION SWITCHES (MIL-S-8805) AND FRONT-OF-PANEL REPLACEMENT, MAKE KS IDEAL FOR RUGGEDIZED CONTROL PANEL KEYBOARD APPLICATIONS.



# things get.

The five switches you see here have all been designed to operate reliably under extremely rugged environmental conditions. Exactly the kinds of environments where Command, Communications & Control Systems are required to work.

But if these switches aren't exactly what you need, you're not out of luck.

Because they're only a sampling of literally thousands of MICRO SWITCH listings available to fill your needs. Including toggle switches. Lighted pushbuttons. Unlighted pushbuttons. Key switches. Sealed keyboards. Plus hermetically and environmentally sealed limit, proximity and basic switches.

All of them available almost anywhere in the world, through over 500 MICRO SWITCH Authorized Distributors and Branch Offices.

And if that still isn't enough, our Application Engineers will work with you to modify an existing MICRO SWITCH product to your needs. Or come up with a new one, through our field and factory engineering staff.

If you'd like more information on the devices you see here, or more information on how we can help, write or call your nearest MICRO SWITCH Branch Office or Authorized Distributor.

## MICRO SWITCH

FREEPORT, ILLINOIS 61032  
A DIVISION OF HONEYWELL

MICRO SWITCH products are available worldwide through Honeywell International

## INSTRUMENTATION

### Digital pyrometer linearizes inputs



Newport Laboratories, 630 E. Young St., Santa Ana, CA 92705. (714) 540-4914. \$180 (10-19); stock-30 days.

Model 267 digital pyrometer can be used with eight thermocouple types or a platinum RTD to provide accurate measurements over many temperature ranges with a resolution of 1.0 to 0.01 degree. The patent-applied-for POLYLOG linearizer can accommodate J, K, T, E, R, S, B and W type thermocouples to within a conformity error of 0.18%. For platinum RTD, the conformity error is less than 0.025%. In addition to a half-inch-high LED display, Model 267 offers standard BCD data outputs and cold-reference junction compensation.

CIRCLE NO. 327

### 4-1/2-digit DMM costs just \$425



Hewlett-Packard, 1501 Page Mill Rd., Palo Alto, CA 94304. (415) 493-1501. \$425; stock.

This new 4-1/2-digit, five function DMM combines low cost with high accuracy. Called the Model 3465A, the unit covers a dc measurement range from 1  $\mu$ V to 1 kV with a mid-range accuracy of  $\pm(0.02\%$  of rdg. + 0.01% of rnge.). Ac measurement range is 10  $\mu$ V to 500 V with a mid-range accuracy of  $\pm(0.15\%$  of rdg. + 0.05% of rnge.) over a 40-Hz-to-20-kHz bw. Ac and dc current measurement range is from 10 nA to 2 A. A choice of four power supplies is offered.

CIRCLE NO. 328

◀ CIRCLE 231 FOR DATA  
◀ CIRCLE 232 FOR SALESMAN CALL

## ALLISON 'OPTO-ELECTRIC' The BEST...the ULTIMATE of ALL Ignition Systems!



Never wears out or needs any Maintenance!



● gives you Maximum Power with continuous PEAK PERFORMANCE ...while reducing Maintenance and Operating Costs!

★ The Allison OPTO-ELECTRIC System eliminates the Points and Condenser, replacing them with an OPTO-ELECTRONIC TRIGGER, using a Light-Emitting Diode and Photo transistor. The System operates on a beam of Light! As there are NO moving parts in rubbing contact Friction-wear is completely eliminated. Timing adjustments are PERMANENT.

● Gives 40-Times more Timing accuracy than ANY system using Mechanical Breaker-Points! UNLIMITED RPM! "Electronically-Controlled" DWELL automatically supplies HIGHEST Performance at both Low and High speeds. Spark strength does not fall off at high RPM POSITIVE SPARK helps eliminate "Misfire" for faster acceleration and improved Engine Performance. Sparkplugs LAST 3 to 10-Times LONGER.

● Easier Starting under any condition! Smoother running... (NO TIMING FLUCTUATION as with Magnetic Impulse Units) All SOLID-STATE Components UNAFFECTED By Temperature, Moisture, or Vibration! Only Highest grade materials used... Guarantees you Solid, Dependable Performance!

● PERFECT TIMING INCREASES Engine Efficiency and Gas Mileage. SAVES Precious Fuel! Allison gives you MAXIMUM Engine Efficiency 100% of the Time... and that's the name of the game for the BEST in GAS MILEAGE AND ECONOMY.

★ Perfect Timing and Dwell never change.

● Pays for itself! Eliminates ignition Tune-Ups forever! "INFINITE LIFE"...Once installed... Never needs replacing!



### ★ PROVEN RELIABILITY!

Each Unit Tested to 15,000 RPM.

● Road and Race Proven.

(Opto-Electric Systems won at INDY Two years in a row!)

You CAN install the ALLISON System in ALL the U.S. made & Foreign Cars! (4, 6, or 8-Cylinder)

"EASIEST-TO-INSTALL" UNIT ON THE MARKET. (Not necessary to dismantle Distributor as with other systems)

★ If you want the BEST, and SAVE! This is IT!

ORDER with CONFIDENCE... SATISFACTION GUARANTEED

★ 10-YEAR FACTORY WARRANTY! (Free Repair or Replacement)

● Send Check or M.O. State Make, Year, Engine Size. (Calif. Res. add Tax). (So New...it's Sold ONLY FROM FACTORY DIRECT)

● You may use your MASTER CHARGE or BANKAMERICARD. Send us (1) Your Number, (2) Interbank No., (3) Exp. Date.

★ Before buying any other Type ignition system

Send Postcard for our FREE BROCHURE.

★ If you have already installed a C-D ignition system, Modernize and Increase its Efficiency... CONVERT YOUR "C-D" UNIT TO BREAKERLESS! Opto-Electric "TRIGGER UNIT"...Only \$34.95

● Our BEST Salesmen are the users of our ALLISON System!

America's Oldest and Largest Mfg. of Opto-Electronic Ignition Systems.

ALLISON  
AUTOMOTIVE COMPANY  
1267 - F. East EDNA PL., COVINA, CAL. 91722

INFORMATION RETRIEVAL NUMBER 70



# Deglitching modules attenuate glitches on current-output d/a's by over 70 dB

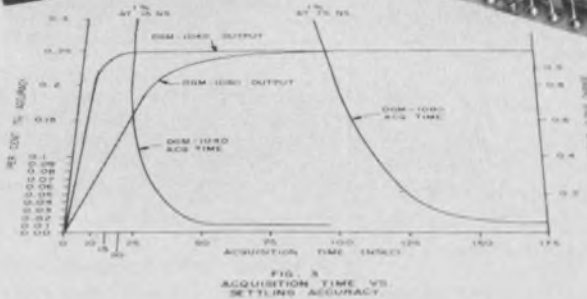
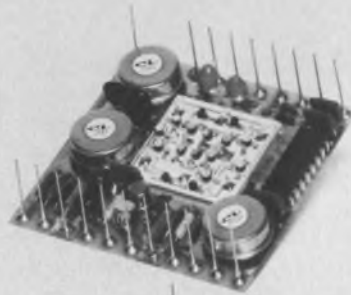

Computer Labs, 505 Edwardia Dr., Greensboro, NC 27409. (919) 292-6427. See text.

Finding suitable fast-settling digital-to-analog converters for video reconstruction and waveform generation is a tough enough task. But deglitching their outputs has been an even more formidable job. Now Computer Labs says it has solved most of the deglitching circuit design headaches with its

new DGM-1040 and 1080 modules.

The DGM modules handle inputs of  $\pm 2$  V, which, for high-speed current output converters, allow for a wide range. The circuits can attenuate input glitches by 70 dB without loading the d/a converter. Input impedance of the DGM-1040 and 80 is 1 M $\Omega$ , and the input bias current is a low 0.05 nA.

Without an input, the deglitchers have an output pedestal of 10

mV (1040) or 2 mV (1080) and a residual glitch of 30 mV or 20 mV, respectively. The 1040 has an acquisition time of 15 ns and a sampling rate of 30 MHz, while the 1080 an acquisition time of 75 ns and a sampling rate of 11 MHz.

And neither of the units will distort the converter output—linearity is 0.01%, and the droop rate is only 8 mV/ $\mu$ s for the 1040 and 1 mV/ $\mu$ s for the 1080. Output noise level has been kept low—only 0.2-mV rms for the 1040 and 0.1-mV rms for the 1080.

The deglitchers have a small offset that is trimmable to zero but drifts by up to 100 ppm/ $^{\circ}$ C. Analog output signals of  $\pm 2$  V at  $\pm 50$  mA can be delivered to a 50- $\Omega$  load. Either module can interface to ECL or TTL circuitry. Power requirements are  $\pm 15$  V at 100 mA when the internal current source is not connected, and +5 V at 20 mA and -5.2 V at 80 mA for the TTL option, or -5.2 V at 24 mA for the ECL.

Each circuit measures 2.3  $\times$  2.3  $\times$  0.43 in. and weighs 3 oz.

The DGM-1040 and the 1080 cost \$478 in single unit lots and drop to \$248 in 1000-pc. lots. Both are available from stock.

CIRCLE NO. 302

**ANALOG**

I'M DOING MY INCOME TAX WITH THIS NEW WIZARD CALCULATOR.

ARE YOU SURE YOU KNOW HOW TO USE IT?

SIMPLE. THERE YOU GO. I OWE UNCLE SAM  $\sqrt{\pi}^2$ ?

**ANALOGY**

SAVE ON ANALOG COMPUTATIONS WITH FMI MATH MODULES. OUR NEW RMS-TO-DC CONVERTER IS FASTER AND MORE ACCURATE THAN THERMAL RMS METERS. IT COMPUTES TRUE RMS LEVELS BY AVERAGING, SQUARING AND SQUARE-ROOTING. OUR DIVIDERS ACHIEVE 0.1% ACCURACY AND WIDE BANDWIDTH OVER A 100:1 DIVISOR RANGE. OUR 90 V<sub>OH</sub> 4-QUADRANT MULTIPLIERS ALSO DIVIDE, SQUARE, SQUARE-ROOT, ETC. AT ACCURACIES TO 0.1%. AND FOR SCALING OUR LOG AMPLIFIERS REMAIN PRECISE OVER AN 8-DECADE RANGE.

**intech/FMI**  
 282 BROOKAW RD. SANTA CLARA, CA 95050 (408) 244-0500



# 5 reasons why the Keithley model 168 should be your number 1 digital multimeter

**1.** Autoranging. All you do is connect the signal to the two-terminal input and push the function you want. The 168 takes it from there to save you time.

**2.** 5 Functions. Dc voltage from  $100\mu\text{V}$  to  $1000\text{V}$ , ac voltage from  $100\mu\text{V}$  to  $500\text{V}$ , ac and dc currents from  $0.1\mu\text{A}$  to  $1\text{A}$  and resistance from  $100\text{m}\Omega$  to  $20\text{M}\Omega$ .

**3.** Hi-Lo Ohms. Select ranges with 1-volt drop for turning on semiconductors or 100 millivolts for keeping them off.

**4.** Full 1-Year Guarantee. It's a Keithley, no less. And that means all specs including accuracy are guaranteed for a full year. Maintenance is easy too.

**5.** Low Price. Only \$315 puts the Model 168 in your hands. A complete line of accessories gives the 168 even more versatility.

The Model 168 Autoranging DMM will make your job easier . . . and that should make it your number 1 choice. Send for full details or phone (216) 248-0400 for a right-away demo.

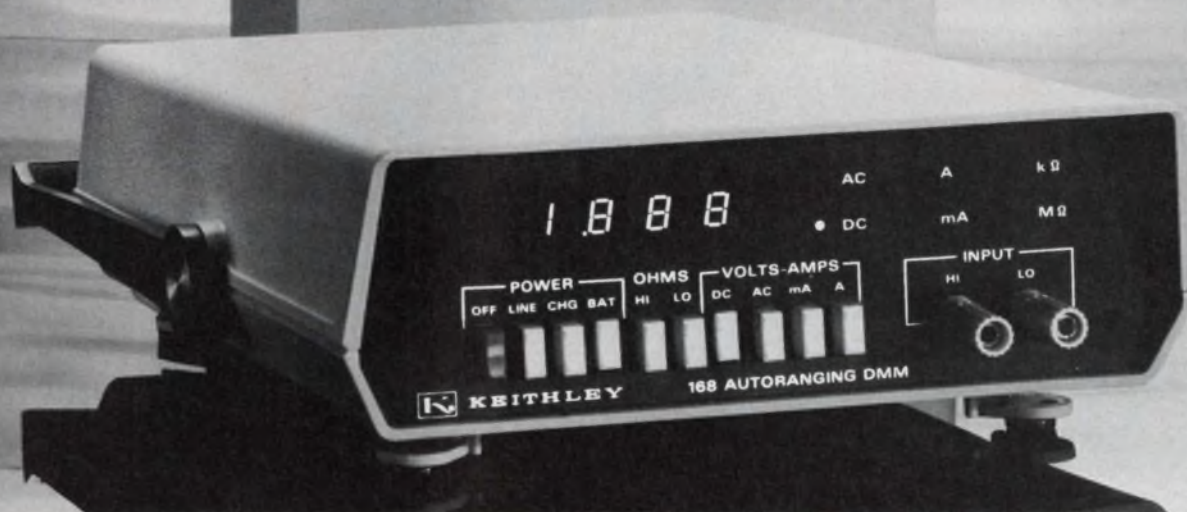

**KEITHLEY  
INSTRUMENTS**  
U.S.A. 28775 AURORA ROAD, CLEVELAND, OHIO 44139  
EUROPE 14, AVENUE VILLARDIN, 1009 PULLY, SUISSE

INFORMATION RETRIEVAL NUMBER 74





**THIS YEAR...**



# LET ELECTRONIC DESIGN PAY FOR YOUR VACATION

ENTER OUR JAN. 5, 1976

# TOP TEN CONTEST



## WIN THE POPULAR CARIBBEAN WINDJAMMER CRUISE FOR TWO

Once again, by reader demand, a week's Windjammer Cruise for two in the fabulous blue Caribbean is waiting for the lucky winner of *Electronic Design's* annual TOP TEN CONTEST. Think of it . . . a complete vacation absolutely FREE! Spend easy carefree days sailing among the Bahama Out Islands, the U.S. and British Virgin Islands, or the exotic Windwards and Leewards. Shop in the free ports, sun, swim, snorkel, help sail the ship or just relax by the rail. It's truly the cruise of a lifetime.

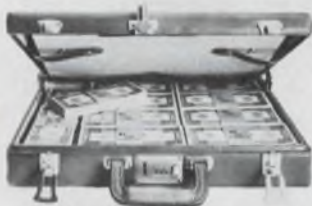

## PLUS A COOL \$1,000 CASH AND PRE-PAID AIR TRANSPORTATION FOR TWO

In addition to the cruise, the first prize winner gets \$1,000 cash, plus air transportation for two to and from the cruise ship's point of departure.

## PLUS FREE AD RERUNS FOR YOUR COMPANY

If your company has an ad in *Electronic Design's* Jan. 5, 1976 issue, and you are one of the top three reader or advertiser winners, you earn a free ad rerun\* that can be worth up to several thousand dollars for your firm.

## 100 PRIZES IN ALL

### READER PRIZES

**1st Prize:** Caribbean Windjammer Cruise for two, \$1,000 cash, air transportation for two, free ad rerun\*.

**2nd Prize:** Portable color TV set, free ad rerun\*.

**3rd, 4th, & 5th Prizes:** Digital wristwatch, free ad rerun\* (3rd prize only).

**6th through 100th Prizes:** Technical books.

### SEPARATE CONTEST FOR ADVERTISERS AND THEIR AGENCIES

Advertisers, marketing men, and advertising agencies can enter too. Duplicate awards are given to the top three winners (cruise, cash, air transportation, free ad rerun\*, color TV and digital watch). Remind your advertising people it's the issue of the year to build business for your company and win valuable prizes at the same time.

### HERE'S ALL YOU HAVE TO DO TO ENTER

Examine the January 5, 1976 issue of *Electronic Design* with extra care. Read the Rules. Then:

- (1) Select the ten ads you think will be best seen and read.
- (2) List the ten ads by company name and inquiry number on the contest entry card.
- (3) Fill in your name and address and mail before midnight Feb. 15, 1976.

\*The top ten ads will also receive free reruns. Only one free rerun per company. The first three prize winners in the reader contest and the first three prize winners in the advertiser contest awarded reruns only if their companies have an ad in the Jan. 5, 1976 issue.

**COMPLETE RULES AND ENTRY BLANKS IN JAN. 5 ISSUE**



# The PRD programmable vector voltmeter measures nearly everything...

It goes all the way up to 2.4 GHz. It measures ■ network parameters ■ harmonic generators ■ components ■ radars ■ crystals ■ antennas ■ parasitic effects ■ amplifiers ■ gain attenuation ■ circuits ■ group delay ■ receivers ■ phase shift ■ crystals ■ frequency response ■ filters ■ voltage/power ratio ■ transistors ■ voltage/power level ■ mixers ■ reflection ■ isolators ■ return loss ■ attenuators ■ complex impedance ■ delay lines ■ AM index ■ cables ■ s, h, y, z parameters ■ and much, much more.



Still the only programmable Vector Voltmeter available is the PRD 2020. It has 50-ohm coaxial inputs (no probes); and its control functions can be programmed through a single rear-panel connector by standard TTL logic levels. Planning to automate your RF and microwave testing? Learn more about the cost-effective P2020 Vector Voltmeter... send for latest application notes on our Vector Voltmeter series. Write: Harris Corporation, PRD Electronics Division, 1200 Prospect Avenue, Westbury, L.I., N.Y. 11590



INFORMATION RETRIEVAL NUMBER 75

## MODULES & SUBASSEMBLIES

### V/f converter output spans 1 Hz to 1 MHz



*Dynamic Measurements, 6 Lowell Ave., Winchester, MA 01890. (617) 729-7870. From \$95 (unit qty.); stock.*

The Model 841, 1-MHz v/f converter, uses a charge-switching scheme and performs 1000 conversions per second at 0.1% accuracy. It can also provide 0.01% accuracy if only 100 conversions per second are needed. The 841 has a linearity of 0.0025% typical over its six-decade (1 Hz to 1 MHz) dynamic range. It is available with three tempcos; the lowest is 25 ppm/°C. Inputs are programmable, and the 841's op-amp input stage provides input flexibility. Input impedance for voltage inputs is 10 kΩ for analog levels to +10 V. The 841 also allows you to sum input currents directly at the summing junction of the input amplifier.

CIRCLE NO. 331

### Modular pulse generator delivers 230-V spikes

*Metrotek, P.O. Box 101, Richland, WA 99352. (509) 946-4778. \$125; stock to 3 wk.*

Model P203 modular plug-in pulse generator is designed for broadband excitation of piezoelectric ultrasonic transducers. It generates a negative spike pulse that typically has a rise time of 7 ns and an amplitude of 230 V into a 50 Ω load. The pulse repetition rate is adjustable to over 10 kHz. A TTL-compatible sync output pulse and external trigger input are provided. The module measures 2 × 1.8 × 0.68 in. and weighs only 3 oz. It operates over a temperature range of -40 to +70 C.

CIRCLE NO. 332

### CMOS a/d converters consume only 600 μW

*Analog Devices, Rte. 1 Industrial Park, P.O. Box 280, Norwood, MA 02062. (617) 329-4700. \$299 (1 to 9); stock.*

A 10-bit low-power a/d converter consumes only 600 μW in the quiescent state and 76 mW at a 1-kHz conversion rate. The card-mounted ADC1123 may be powered from a single 12-to-15-V-dc supply. The successive approximation converter has a ±0.5-LSB relative accuracy and a 100-μs maximum conversion time. Its gain will vary by no more than ±0.5 LSB as the power-supply voltage varies. The ADC1123 has a ±5 ppm/°C maximum differential-nonlinearity temperature coefficient. The unit accepts analog inputs in ranges of 0 to 5, 0 to 10, ±5 or ±10 V. The converter is mounted on a 3.65 × 4.1 in. (92.7 × 104.1 mm) card and has a total height of 0.35 in. (8.89 mm).

CIRCLE NO. 333

### Hybrid d/a converter has all subsystems

*Burr-Brown, International Airport Industrial Park, Tucson, AZ 85734. (602) 294-1431. From \$37.50 (100-up); stock.*

The DAC80 hybrid 12-bit d/a converter includes its own reference source and optional output amplifier on the same substrate. All the DAC80 requires is three power-supply bypass capacitors, and if offset and gain trims are needed just five more passive components. The unit is hermetically sealed in a 24-pin ceramic DIP. Its thin-film resistors are laser trimmed to provide a maximum linearity error of ±0.012% (±1/2 LSB) over a 0-to-70-C operating temperature range. A maximum gain drift of ±30 ppm/°C and monotonicity are guaranteed over the full temperature range. Models are available with voltage or current outputs. The voltage output models provide user selectable ranges of ±2.5, ±5, ±10, 0 to +5, and 0 to +10 V, and the current output models provide ranges of ±1 or -2 mA. For a 10-V step change, voltage models settle to ±0.01% in 3 μs, while the current models take only 300 ns.

CIRCLE NO. 334



**newest member  
of the team...**

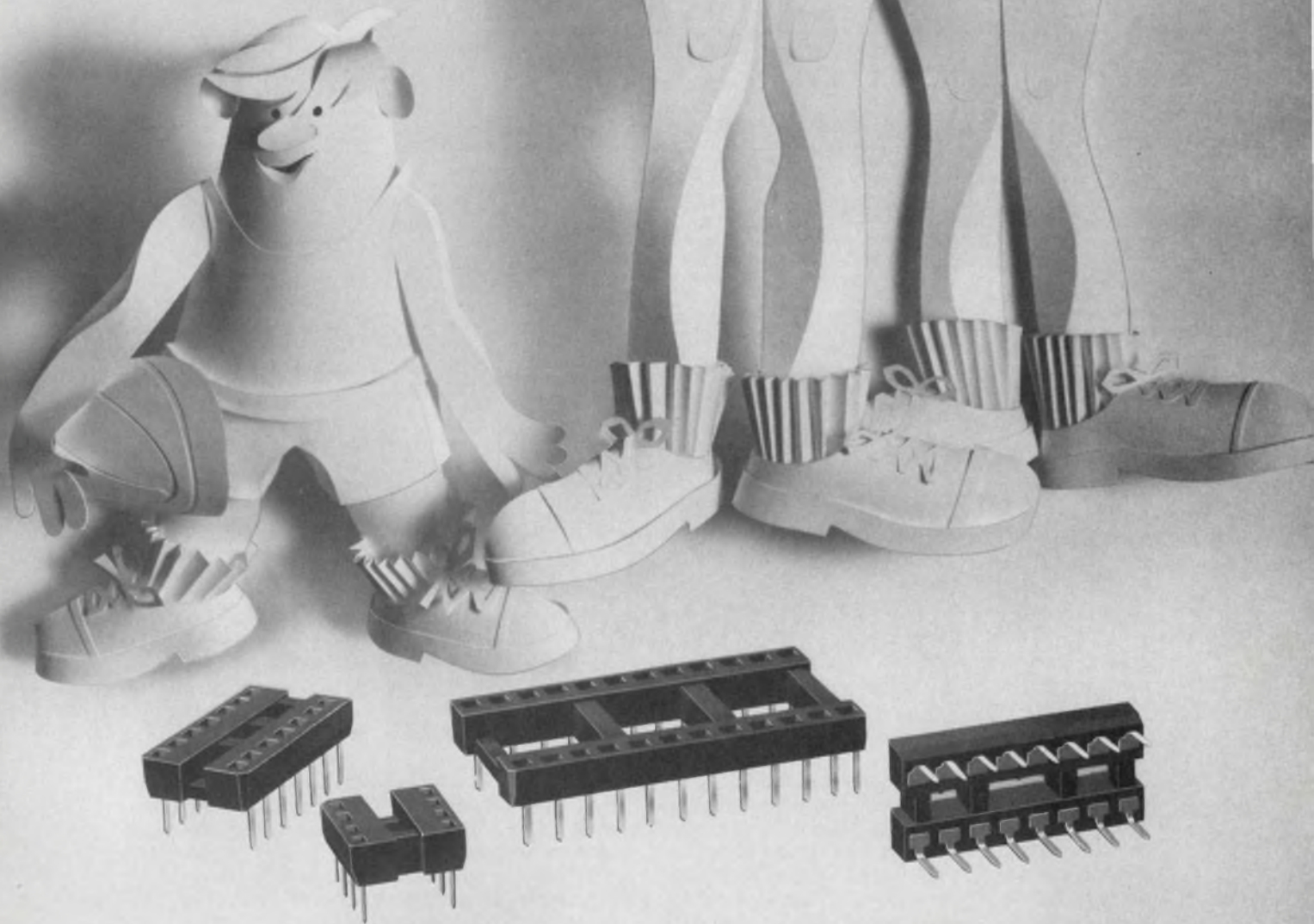

## **TRW/Cinch low profile D.I.P. sockets**

Don't let the small size and low cost fool you. These low profile DIP sockets are first string all the way. The unique TRW/Cinch design incorporates many features previously available only in larger more expensive sockets, resulting in improved performance and reduced assembly costs. With a height of only 0.150", these low-profile sockets are high scorers with a high tensile strength contact material that provides 4.0 ounce contact force, pointed terminal tips for easy PC insertion, generous lead-in dimensions and tapered socket entry to align bent DIP leads during automatic insertion.

Center slots with cross bars permit air flow under the DIP for more efficient cooling, and the glass-

fiber filled SE-0, U.L. rated insulator allows operating temperatures from  $-65^{\circ}\text{C}$  to  $+125^{\circ}\text{C}$ . The sockets also feature recessed ends for ample removal tool clearance and stand-off bosses for rapid flushing of flux residue.

TRW/Cinch low profile DIP sockets are available in 8, 14, 16 and 24 contact sizes. And a full bench of other sizes will be developed when the need arises. For fast team action, contact your local TRW/Cinch distributor, or TRW/Cinch Connectors, An Electronic Components Division of TRW Inc., 1501 Morse Avenue, Elk Grove Village, Illinois 60007; Phone: (312) 439-8800.

CC 7509

**TRW<sup>®</sup> CINCH CONNECTORS**



# Our reliable 15MHz scope syncs to 30MHz

RESPONSE CURVE

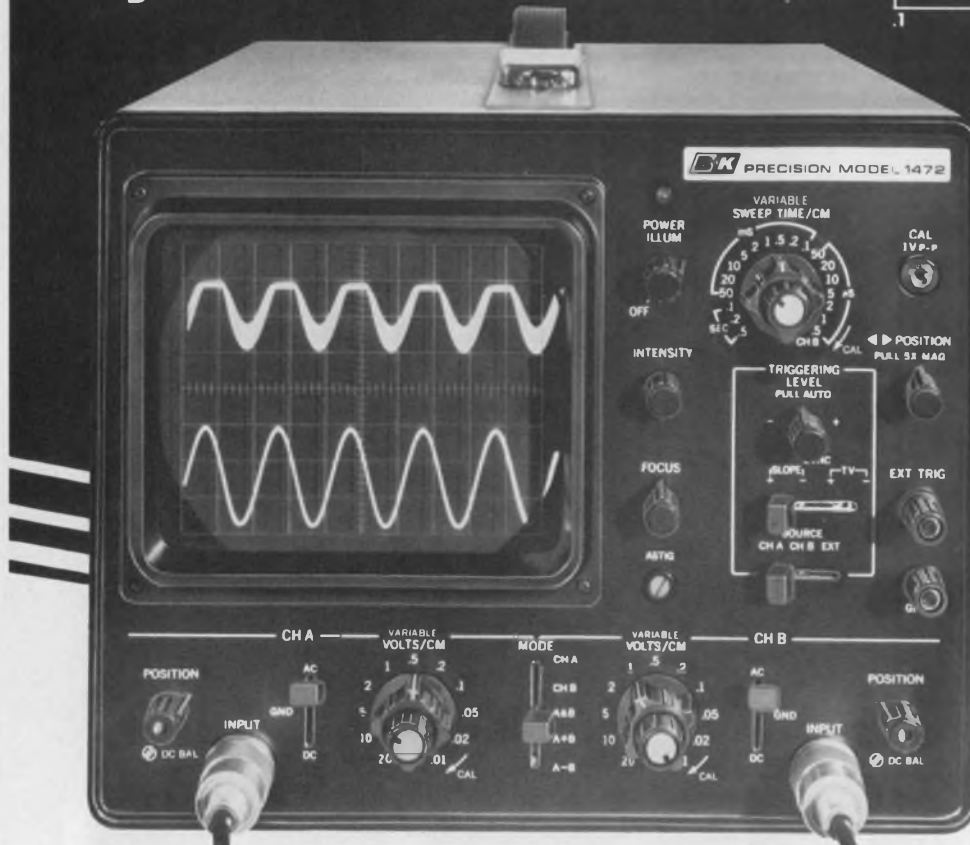
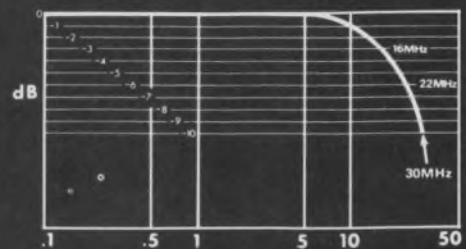

**BK PRECISION**

Model 1472 Dual Trace  
Oscilloscope: 27MHz modu-  
lated carrier and original  
audio displayed... \$599.00

Model 1472 Dual Trace Scope has reliable automatic sync and plenty of deflection for waveform analysis at frequencies far beyond its nominal range. Look at its actual, smooth roll-off curve and you can see how you can do an expensive scope's job with our far less costly but equally reliable, easy-to-use counterpart. Model 1472 lengthens the B&K-Precision complete line of 2 to 10MHz bandwidth scopes—a line of scopes that now outsells every other 10 to 15MHz scope because our users have discovered our reliability, performance and instant delivery from our distributors.

Model 1472 has 19 calibrated sweeps—.5 $\mu$ SEC/cm to .5SEC/cm and sweep to .1 $\mu$ SEC/cm with 5x and to 1.5SEC/cm with uncalibrated vernier. Deflection factor is 0.01V/cm to 20V/cm  $\pm$ 5% in 11 ranges plus fine adjustment. Regulation maintains calibration accuracies over 105-130VAC range. Rise time is 24nSEC, fast enough to check most digital logic circuitry, including CMOS. Automatic triggering is

obtained on waveforms with as little as 1cm deflection. Dual trace display has algebraic addition and subtraction and differential input capability. Mode automatically shifts between CHOP and ALTER-NATE as you change sweep time, speeding set-up. Extremely flat in-band response is particularly useful for demanding applications like adjusting color video to close tolerances in TV broadcast studios.

Front panel X-Y operation uses matched vertical amplifiers, preserving full calibration accuracy for both amplitude and phase. The intensity modulation input (Z axis) is available for time or frequency markers. Bright blue P31 phosphor and variable illuminated graticule make any waveform easy to see.

#### In Stock For Free Trial

Model 1472 or any B&K-Precision oscilloscope can be obtained from your local distributor for a free trial. You'll find the scope you need in stock today. Write for detailed specifications.

**B+K PRECISION**

PRODUCTS OF DYNASCAN

1801 W Belle Plaine Avenue Chicago IL 60613

INFORMATION RETRIEVAL NUMBER 77



## MODULES & SUBASSEMBLIES

### Active filters come in eight models

*Calex Manufacturing Co., Inc., 3305 Vincent Rd., Pleasant Hill, CA 94523. (415) 932-3911. \$69; stock.*

The AF-LP and AF-N series active filters are  $2 \times 2 \times 0.6$ -in. modules. Eight models—four low-pass filters (1, 10, 25 and 100 Hz) and four notch filters (50, 60, 120 and 400 Hz) are standard units. The low-pass filters have a four-pole Butterworth response at fixed frequencies. The notch filters have a two-pole response with a Q of 2.

CIRCLE NO. 335

### Instrumentation amps have low offset drift

*Datel Systems, Inc., 1020 Turnpike St., Canton, MA 02021. (617) 828-8000. From \$69 (1 to 9); stock to 4 wk.*

The AM-201A, 201B and 201C modular instrumentation amplifiers have guaranteed input offset voltage drifts of 1, 0.5, and 0.25  $\mu\text{V}/^\circ\text{C}$ , at a gain of 1000, respectively. Common-mode rejection is 100, 106 and 114 dB, minimum for the three models, respectively, also at a gain of 1000. Other specs include input bias currents of 50, 25, and 25 nA with a low input offset current drift of 20 pA/ $^\circ\text{C}$ . This low drift permits high balanced-source impedances to be used with these amplifiers—up to 50 k $\Omega$ . Input impedance is  $10^9 \Omega$  for either differential or common-mode inputs. Gain is set by a single external resistor and can be programmed from 1 to 1000. Gain nonlinearity for the AM-201 series is 0.01% maximum and gain temperature coefficient is 20 ppm/ $^\circ\text{C}$ . Bandwidth is 45 kHz at a gain of 1000 and 180 kHz at a gain of 100. Output settling time is 20  $\mu\text{s}$  to 0.01%. The output capability is  $\pm 10$  V at 5 mA with a slew rate of 1 V/ $\mu\text{s}$  and output has short-circuit protection. Power requirement is  $\pm 15$  V dc at 5 mA. The input noise is only 1  $\mu\text{V}$  pk-to-pk over 0.1 to 10 Hz and 1  $\mu\text{V}$  rms over 10 Hz to 10 kHz. The amplifiers are housed in  $1.5 \times 1.5 \times 0.375$  in. modules and are specified over 0 to 70  $^\circ\text{C}$ .

CIRCLE NO. 336

### High resolution DACs deliver up to $\pm 100$ V

*Preston Scientific, 805 E. Cerritos Ave., Anaheim, CA 92805. (714) 776-6400. \$845/channel; 60 days.*

The Model GMDAC-HV4Q-15B d/a converter accepts inputs of up to 15 bits long. It delivers outputs of up to  $\pm 100$  V at 30 mA and has an update rate of 500 kHz. The converter can also function as a four-quadrant multiplying converter.

The 15-bit resolution (14 binary bits plus sign) provides an accuracy to within  $\pm 0.005\%$  of full scale (100 V)  $\pm 0.005\%$  of reading. The maximum height of this converter module is only 5.25 in., and the complete assembly requires only 60 cubic inches of rack space. Converter settling time (to  $\pm 0.01\%$ ) is less than 25  $\mu\text{s}$  for a 200 V step and less than 5  $\mu\text{s}$  for a 10 V step change.

CIRCLE NO. 337

## Make your first impression last.

The built-in quality of Zero's VIP Series 19 electronic enclosure is obvious. From the first sales impression through detailed engineering inspection.

The Series 19 is a marriage of functional design and precision engineering. It has front-office good looks as well as rugged strength and practical economy. Accessibility is complete—from top, bottom, front and rear. All 10 sizes accept standard EIA panels in heights from 5 $\frac{1}{4}$ " to 28". The modular construction of Series 19 means greater versatility and lower shipping and inventory costs. Standardized components mean two-week delivery and off-the-shelf prices.

The first impression your product makes is important. So is the built-in quality that backs it up.

Write for your free catalog today.



The Final Touch

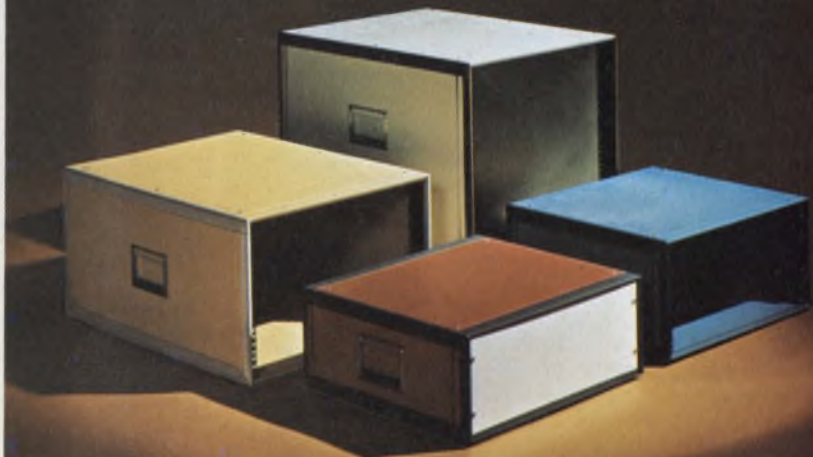

ZERO MANUFACTURING CO.  
Burbank, CA 213/846-4191 • Monson, MA 413/267-5561 • Clearwater, FL 813/531-8991

FOR IMMEDIATE REQUIREMENT CIRCLE 263  
FOR LITERATURE CIRCLE 264



## MODULES & SUBASSEMBLIES

### Frequency-to-dc module has 20-kHz input range

Computer Enterprises Inc., P.O. Box 503, Providence, RI 02901. (401) 738-0863. \$99; stock.

The Pulse-maker module provides analog output signal ranges of 4 to 20 or 10 to 50 mA for a frequency input. A magnetic pickup

delivers a frequency which is then converted to a proportional dc current. Adjustable frequency ranges between zero and 20 kHz are accommodated with an input sensitivity of 10 mV rms. The Pulse-maker is hermetically sealed in a  $2.5 \times 1.125 \times 1$  in. case and operates from a 17-to-95-V-dc supply.

CIRCLE NO. 446

### S/h amplifier series has many options

Phoenix Data, 3384 W. Osborne Rd., Phoenix, AZ 85017. (602) 278-8528. From \$90 (unit qty.); 30 to 45 day.

The sample/hold units in the 7000, 8000 and 9000 series are available with a single circuit or with identical dual circuits for special applications. In the dual configuration each circuit may be operated independently, or TTL-compatible input logic is provided for operation in alternate, ping-pong or simultaneous modes with the output multiplexed. The s/h units handle inputs from  $\pm 1$  to  $\pm 10$  V and have gain selectable outputs of up to  $\pm 10$  V. Accuracies of 0.007% of FS are available while speeds (acquisition times) of 1 to 17  $\mu$ s are available.

CIRCLE NO. 329

## OUR 54LS. SAME COST. BETTER PERFORMANCE.

With Raytheon Semiconductor's military 54LS, you'll get better performance. Like 5 ns speed and twice the fan-out. And they cost no more than ordinary TTLs. We have 39 different low-power Schottky types now available, plus 35 others in development. Superior performance at no extra cost from Raytheon Semiconductor

is why you should come to the second source in the first place.

For our new complete Low-power Schottky data book, circle the number below on the reader's service card or write us directly. For your *free sample*, write Raytheon Semiconductor on your company letterhead.



## RAYTHEON SEMICONDUCTOR

Dept. 54LS, 350 Ellis Street, Mountain View, CA 94042

INFORMATION RETRIEVAL NUMBER 78

### High-speed a/d does conversions in 4 $\mu$ s



Analogic, Audubon Rd., Wakefield, MA 01880. (617) 246-0300. \$229 (unit qty.); stock.

The MP2712 12-bit a/d converter provides digital outputs for up to 250,000 analog input samples per second. The gain tempco of only 12 ppm/ $^{\circ}$ C and the maximum differential linearity tempco of 3 ppm/ $^{\circ}$ C apply over the 0-to-70- $^{\circ}$ C operating range. The converter has four pin-selectable ranges of -0 to 5, -5 to +5, 0 to 10 and -10 to +10 V. The unit is housed in a  $2 \times 4 \times 0.44$  in. shielded case that isolates it from both electromagnetic and electrostatic fields. For additional versatility the MP2712 can be short cycled, permitting a tradeoff of resolution for speed if desired. The unit also has separate analog and digital power returns, which permit optimal configuration of power grounds. The  $3 \sigma$  noise referred to the input is guaranteed to be less than 0.01% of full scale range.

CIRCLE NO. 330



# Full APL computer delivers mainframe power in mini size



Micro Computer Machines, Inc., 85 Summit Dr., Smithtown, NY 11787. (516) 265-8487. See text.

Ever have to work late on a computer analysis? You don't have to stay at the office any more if you have one of MCM Corp.'s Series 700 portable computers. You can take the computer home with you.

These machines have a complete virtual operating system in APL and start with 2048 bytes of user workspace memory. Each is about the size of an electric typewriter, has a 32-character, single-line plasma display and full APL character set.

The MCM-700 series machines are stand-alone computers and can be interfaced to printers, displays, diskettes and standard EIA, ASCII, IBM and other equipment.

The internal solid-state memory of 2-k words can be expanded up to 8 k, and above that two built-in cassette tape drives can extend the memory by 204,800 bytes. A maximum of six external tape drives can also be addressed.

The programming language, APL, is compatible with APL/360, APLSV and includes all exten-

sions. The internal interpreter and operating system consists of 32-k bytes of ROM and is expandable. It has 87 primitive functions, 29 system functions, 16-digit precision and a range of  $-7 \times 10^{75}$  to  $+7 \times 10^{75}$ .

Power requirements for the computer are 85 to 140 V ac at 1 A, 50 to 400 Hz, or 14 V dc at 5 A. Built-in batteries and ROM software prevent data loss in the event of power failure; the operating system initiates an orderly shutdown, storing data on tape when possible and automatically reloading when power returns.

The computer, which measures  $6 \times 14.75 \times 15.75$  in., and weighs 21 lb, is designed to operate over a 10-to-45-C range.

The basic machine, Model 720 with 2 k of RAM, costs \$4970. A fully loaded machine with 8 k of RAM and two cassette drives costs \$9800. The RS-232 interface option costs \$1100, and prices range from \$350 to \$1600 for other interfaces.

All units are available from stock.

CIRCLE NO. 303

## Grayhill's value leader

switches  
from logic levels  
up to  
1/4 amp

1/2" diameter  
enclosed construction rotaries  
priced lower than many  
"open wafers"

- contamination-free construction, gold plated contact system, diallyl phthalate insulation, molded-in terminals.
- up to 12 positions, 30° or 36° angle of throw, up to 6 poles per deck, up to 12 decks
- fixed or adjustable stops, solder lug or PC terminals, 1/8", 1/4", or 4 mm shaft diameters, concentric shafts also available.

You have never seen so much switching versatility and quality in a compact switch at any price... yet Grayhill has engineered its Series 71 to reflect state-of-the-art capabilities and state-of-the-economy pricing. Review the many available features and options... and see why this switch family is revolutionizing switch specification standards throughout the industry. For complete information, consult EEM or ask Grayhill for Series 71 Rotary Switch data.

561 Hillgrove Avenue • La Grange, Illinois 60525  
Phone (312) 354-1040

INFORMATION RETRIEVAL NUMBER 79



# TWO YEARS OF A WEALTH

# MICROPROCESSORS

# TO DATE BY

*Electronic Design* can really help you out when it comes to microprocessors. We sifted through a whole pack of recent issues — going back two full years — and came up with an incredible amount of practical news, data and advice on how to select micros for specific purposes . . . how to use them to best advantage . . . and how to improve them for better speed and broader application.

We compiled it all neatly into one convenient handbook — *MICROPROCESSORS: New Directions for Designers*. Without a doubt, this is the “last word” in micros. Because it’s all ready-to-use, up-to-the-minute information. Because it covers everything from micro buying to special modifications. And because it’s written by your own colleagues in direct, on-the-job talk.

Over 20 pro’s speak frankly here, fresh from their own experience, on the various points and pitfalls in micro buying . . . the very latest applications in instrumentation and industrial electronics . . . different hardware features, capabilities, and operating techniques . . . how to make a micro run faster . . . how to eliminate micro limitations with specific techniques and circuitry . . . how to use a minicomputer to de-bug microprocessors systems, and much, much more. Everything’s been carefully edited by *Electronic Design*’s IC Editor, Edward Torrero.



# OF INFORMATION ON BROUGHT RIGHT UP ELECTRONIC DESIGN

If you'd like to see a copy of this new handbook, just cut out the coupon below and send it in. We'll send you *MICROPROCESSORS: New Directions for Designers* to read and use FREE for 15 days. When you're completely satisfied that it will help you time and time again, just send in a check for \$8.95 and it's yours to keep. Otherwise, just return it within 15 days and owe absolutely nothing. Fair enough?

 HAYDEN BOOK COMPANY, INC. 50 Essex Street, Rochelle Park, N.J. 07662

- Please send me *MICROPROCESSORS: New Directions for Designers* (#5777-6), edited by Edward Torrero, to read and use FREE for 15 days. At the end of that time, I will either send a check for \$8.95 or return the book.
- I want to save money! I have enclosed full payment with order. I understand that the publisher pays all postage and handling. I still get the 15-day money-back guarantee.

Name \_\_\_\_\_

Address \_\_\_\_\_

City/State/Zip \_\_\_\_\_





# You'll like what printer designers like about the 82900 logic stepper motor.

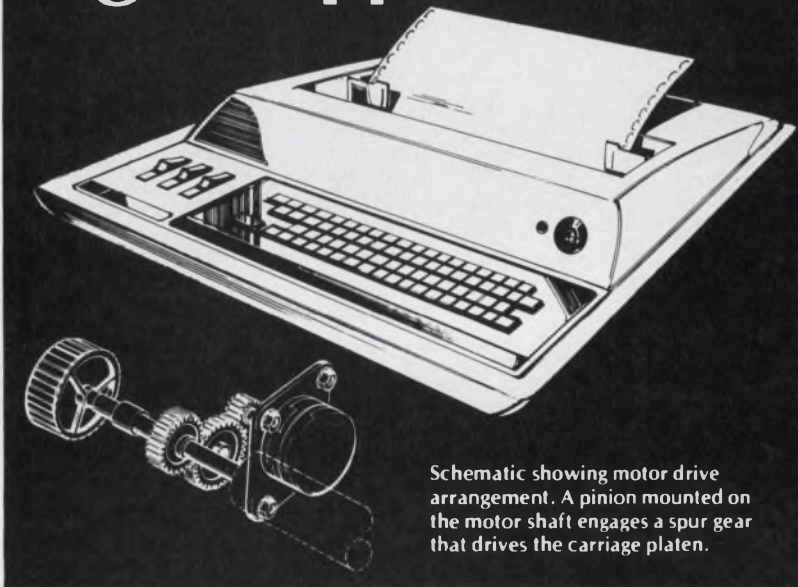

Schematic showing motor drive arrangement. A pinion mounted on the motor shaft engages a spur gear that drives the carriage platen.

## Take low price...top quality...compactness and 23 oz-in torque as starters.

The new 82900 stepper motor is built to do yeoman's service not only in impact and non-impact printers, but in small X-Y plotters, chart drives and computer peripherals. Yes, even medical instrumentation, where its reliability really pays off. Compact size, efficiency, low cost and 23 oz-in torque @ 200 PPS all combine to offer design advantages unobtainable in larger, bulkier and more expensive steppers.

A case in point. A high-speed impact terminal printer. Initially a mechanical linkage, actuated by a solenoid, was used to advance the carriage platen and paper automatically on command. This design proved to be somewhat cumbersome in making adjustments during assembly and required excessive downtime during servicing. After careful investigation, the 82900 stepper was adopted as a more vi-

able alternative. In addition to meeting the load requirements of the application, the 82900 proved capable of providing the necessary torque output, the required step angle and a minimum of 5000 hours operating time. Equally important, the motor met price parameters.

Consider the 82900 stepper in your own design. It's bidirectional. It has a nominal power rating of 12.38 w @ 5 vdc. And it is efficient, operating at lower than average temperatures. Standard construction provides 2-phase operation (requiring simplified drive circuitry) a 7.5° step angle and roller bearings. A 15° step angle, 4-phase operation or sleeve bearings in any combination desired can also be provided as options.

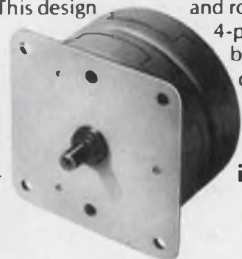

Send for  
information now!

A. W. HAYDON CO. PRODUCTS

**NORTH AMERICAN PHILIPS CONTROLS CORP.**

Cheshire, Conn. 06410 • (203) 272-0301

## DATA PROCESSING

### OEM mini line offers core or MOS memory

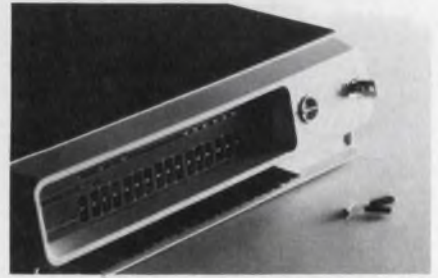

Data General, Route 9, Southboro, MA 01772. (617) 485-9100. See text.

The Nova 3 OEM minicomputer line is designed to compete with the Hewlett-Packard 21 MX, Digital's PDP-1103, 11/04, 11/35 and in some cases, LSI-11.

The four-slot Nova 3/4 and 12-slot Nova 3/12 are available with core memory in 8-k and 16-k-word increments, or MOS semiconductor memory in 4-k, 8-k and 16-k-word increments.

They are compatible with Novaline software and Data General peripherals and are supported by the company's real-time operating system (RTOS) and real-time disced operating system (RDOS).

The Nova 3 family features main memory expansion up to 128 k words, an extended data channel map capability, high-speed direct-memory access channel and 16-level priority interrupt structure.

Memory cycle speeds are 700 ns for MOS memory, 800 ns for 8-k-word core and 1000 ns for 16-k-word core. Core and semiconductor memories can be mixed in any combination in a single computer.

Semiconductor memory consists of dynamic n-channel 4-k MOS RAMs, currently being manufactured in Data General's Sunnyvale, CA, plant. An alternate memory board will be available using MOS parts from Texas Instruments.

Prices for the Nova 3 line are as follows: For the 3/4 with 4-k-word MOS memory and programmers console, \$2600. For the 3/12 with 32-k-word MOS memory, \$10,800. For the 3/12 with 48-k-word core memory, \$16,000. For the 3/12 with mixed 128-k-word memory (64-k MOS and 64-k core), \$34,200.

CIRCLE NO. 304



## Impact printer enclosed in acoustic cabinet



Centronics Data Computer Corp., 1 Wall St., Hudson, NH 03051. (603) 883-0111.

Model 104, 132-column, 200-line/min impact printer comes in an acoustically quiet, fully-enclosed cabinet with modular electronics. The printer has a self-test switch that allows testing of the printer off-line, and also checking of the line-up of preprinted multiple-part forms. The unit is plug-to-plug compatible with Centronics' entire line of printers and interfaces. Foreign-language and upper and lower-case character sets are available.

CIRCLE NO. 338

## Controller matches many disc drives



Western Peripherals, Inc., 2893 E. La Palma Ave., Anaheim, CA 92806. (714) 630-4310. \$2500.

A single-board controller, the DC-220, accommodates both plain and cartridge-type single or multi-platter drives for use with Data General computers. Plugged into a single slot inside the computer, the DC-220 controls drive units such as the 10-disc platter, Model 9746 CDC, or cartridge drives such as the Pertec or Diablo 100 and 200 TPI types.

CIRCLE NO. 339

## Tiny calculator fits palm of hand



Edmund Scientific Co., 380 Edscorp Bldg., Barrington, NJ 08007. (609) 547-3488. \$19.95; Stock No. 1945.

Though it's only  $2 \times 2.8 \times 0.4$  in. and weighs just 2 oz, this electronic calculator with an eight-digit readout does everything the big ones do. It features an automatic percentage key, floating decimal, constant key and lead-zero depression. The tiny unit operates on two 1.5-V Mallory PX 825 camera batteries, or equivalent. The calculator provides plenty of room for most fingers. Available only by mail.

CIRCLE NO. 340

*this costs you--*

*and your customer*

After Delivery Economies (ADE) are the reason Bodine fhp motors and drive systems have become the power behind the leading products.

Bodine motors perform. Reliably. Run stronger and last longer. You have fewer rejects. Less service problems. Far fewer downtime complaints from customers. You get consistent quality—motor to motor, lot to lot. It all helps protect your bottom line profitability, reputation and tomorrow's repeat sales.

If you're concerned about costs and profit take a close look at Bodine. (1/2000 thru 1/4 Hp).

ADE (After Delivery Economies) make Bodine a better fhp buy

**BODINE  
ELECTRIC  
COMPANY**

Bodine Electric Company, 2528 W. Bradley Place, Chicago IL 60618.

INFORMATION RETRIEVAL NUMBER 82

ELECTRONIC DESIGN 24, November 22, 1975

LOGIC SERIES No. 1

# WHAT'S A BI-DI I/O PORT?

Double value in a single package. This 8-bit latch with 2 sets of Bidirectional I/O's performs high-speed standard interface between processor, bus & peripherals. #8T31 saves 6 parts plus pre-test & manufacturing costs.

Rush data sheet on #8T31, your 8-bit Bi-Di I/O Port.

Name \_\_\_\_\_

Tel. \_\_\_\_\_ Ext. \_\_\_\_\_

Clip coupon to letterhead.

**THINK**

# SiMnetics

311 E. ARQUES, SUNNYVALE, CALIF 94086

INFORMATION RETRIEVAL NUMBER 83

175



# IT'S WORKING FOR ME



## "I'VE USED THE GOLD BOOK 150 TIMES, OR MORE"

N. Q. Brizzi is Chief Inspector at International Rectifier, Semiconductor Division, El Segundo, California. He is primarily involved with quality assurance—in line and final finished goods inspection. He rates the GOLD BOOK "extremely useful" and estimates that he has referred to the directory pages from 55 to 60 times; the catalog pages more than 100 times.

Mr. Brizzi writes:

"I have recommended many products for purchase through the use of the GOLD BOOK, as have others here at our facility.

"I use it because it has a great wealth of information, is compact and accurate, and is broken down by so many various categories.

"Also when I look up a prospective supplier I can get a feel for the company's size by its dollar volume, thus possibly eliminating delivery problems and determining product reliability. I can also find out who services the product in my area."

Mr. Brizzi adds: "I'm not familiar with either EEM or Electronics Buyers Guide, but due to my experience with the GOLD BOOK I don't see how they could be an improvement."

This is *Electronic Design's* audience at work. (The GOLD BOOK goes primarily to *Electronic Design's* qualified engineer and engineering management subscribers.)

**THE GOLD BOOK IS WORKING ALL DAY—EVERY DAY—THROUGHOUT THE U.S. AND OVERSEAS!**

*Electronic Design's* GOLD BOOK is working. It's working for users and it's working for advertisers, too.



## DATA PROCESSING

### Dumb data terminal replaces teletypewriter

Lear Siegler Inc., 714 N. Brookhurst St., Anaheim, CA 92803. (714) 774-1010. \$1095 (unit qty).

While the rest of the world concentrates on so-called intelligent terminals, Lear Siegler has taken a step in the other direction with its dumb terminal. The new 12-in. bare-bones video terminal, the ADM-3LC is only a simple input/output device that the user can tailor to his specific application. It has no fancy bells and whistles, but offers a standard 960-character display in 12 lines of 80 upper and lower-case characters. The unit can be used for direct replacement of a teletypewriter.

CIRCLE NO. 341

### Data-acquisition system provides 12-bit output

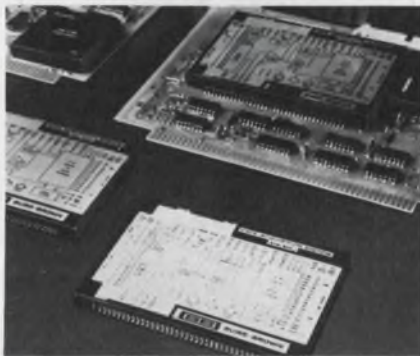

Burr-Brown, International Airport Industrial Park, Tucson, AZ 85734. (602) 294-1431. \$595 (unit qty).

Modular data-acquisition systems, Models SDM850 and SDM851, contain all of the components necessary to multiplex, sample and convert  $\pm 10$ -V analog data from 16 single-ended or eight differential sources. Digital data output is 12-bit parallel at throughput sampling rates in excess of 50,000 samples/s. Either unit can be operated in a continuous sequential sampling mode with no external components or can be controlled by a digital computer with random channel access. The SDM850 has a 16-channel single-ended multiplexer and the SDM851 has an eight-channel differential multiplexer. All units in the family are housed in  $3 \times 4.6 \times 0.375$  in. steel cases with a 72-pin mating connector.

CIRCLE NO. 342

|             |        |        |
|-------------|--------|--------|
| AGENA       | APOLLO | AWACS  |
| BLACK BRANT | B-1    | COMSAT |
| DOGWOOD     | ELMS   | ERTS   |
| F-15        | F-16   | F-5    |
| HLH         | MOHAWK | RPV    |
| SKYLAB      | TOW    | VIKING |

## Our power supplies work for a lot of well known names

Powercube's MIL power supply systems have provided high reliability power conversion for a high percentage of our major military and space programs. For nearly a decade military contractors have relied upon our proven ability to deliver custom power systems to meet the most stringent specs for sophistication, weight, size, environment, ruggedness, reliability, and performance — i.e., MIL-STD-704A, MIL-STD-461, and environmental conditions of MIL-E-5400.

If you're powering digital or analog circuitry for airborne computers, receivers, navigational systems, instrumentation, displays, cameras, data acquisition, test equipment, or any other application, it will pay you to look at Powercube's power supply systems.

Get the full story; call John Prestidge at 617-891-1830, or circle the reader response number for our complete catalog.

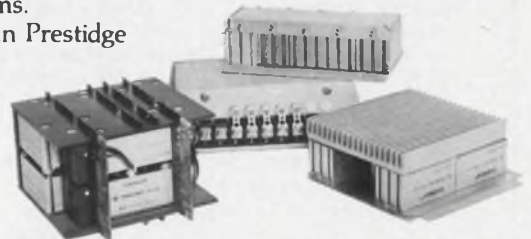

**POWERCUBE CORPORATION**  
214 CALVARY STREET, WALTHAM, MASS. 02154 (617) 891-1830  
SUBSIDIARY OF UNITRODE CORPORATION

INFORMATION RETRIEVAL NUMBER 85



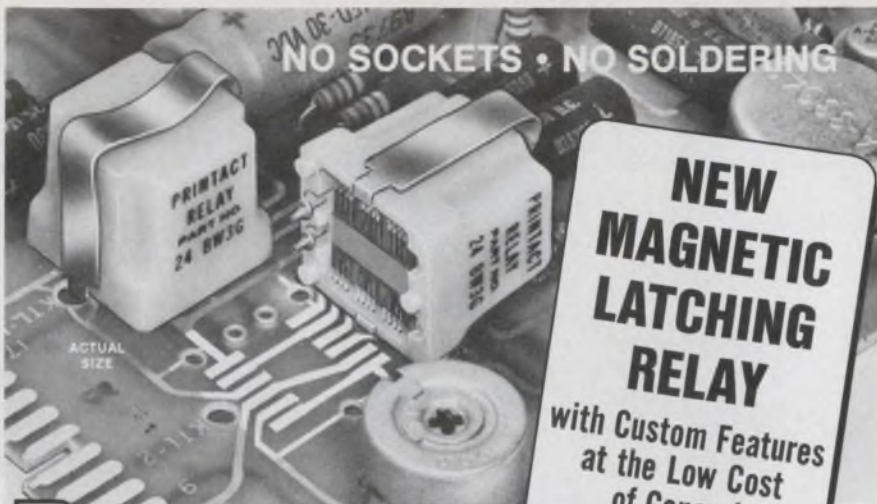

# Printact®

**Plugs into your PC board... mates with plated conductors**

This new single coil magnetic relay has memory without power and other custom features uniquely suited for specialized applications. It costs no more than most non-latching general purpose relays. Reversal of polarity resets the armature. Double coils available.

Low contact bounce, high cross-talk isolation, low thermal EMF, and other features permit use of Printact all purpose (latching and non-latching) relays for such functions as RF, audio and thermocouple switching. Printact Relays plug into a PC board without

solder or sockets, have encapsulated coils and series break swinger contacts. A permanent magnet holds the hinged armature. Elimination of pigtailed, return springs and mechanical linkage assures high reliability for millions of cycles.

Relays have 5 to 24 vdc, 500 mw coils with 2, 3 or 4 blades for up to 8 pole switching. Individual one to ten relay boards for point-to-point wiring or Bead Pin mounting, are available.

**Executone** For free catalog sample, and PC design aids, call (212) EX 2-4800, or write—  
**PRINTACT DIVISION, 29-10 Thomson Avenue, Long Island City, N.Y. 11101**  
 INFORMATION RETRIEVAL NUMBER 86

## DISCRETE SEMICONDUCTORS

### 20-A power Darlington handle up to 60 V

Silicon Transistor Corp., Katrina Rd., Chelmsford, MA 01824. (617) 256-3321. From \$2.03 (100-up); stock.

The 2N6355 through 2N6358 series of single diffused, Darlington npn silicon power transistors handles 20 A. The four types feature gains specified at three current levels including 20 A where the 40-V 2N6355 and 56 have a minimum gain of 100 and the 60-V 2N6357 and 58 have a minimum gain of 50. The units are supplied in hermetic, metal, TO-3 packages and can dissipate up to 150 W at 25 C.

CIRCLE NO. 343

### Temperature sensor delivers pulse output



Multi-State Devices, 1330 Trans-Canada Hwy., Dorval, Quebec H9P1H8, Canada. (514) 842-5281. \$0.50 (1000-up); stock.

The TS3-57S Moxie thermal avalanche switch can be interfaced directly with triacs and other common power control devices. It operates as a combination temperature sensor, discriminator and amplifier and generates pulses directly proportional to temperature. The TS3-57S requires only a series resistor to operate from 110/220 V ac mains. Its pulse output responds continuously to temperature with a nominal sensitivity of 2 V/°C. High switching speed (50 ns) and a stable energy threshold are two important features. The operating temperature range spans -4 to 46 C (25 to 115 F). Devices are housed in TO-18 metal cases.

CIRCLE NO. 344

## New...Words and Bits to 50 MHz



### MG-3 variable length, programmable data/word generator

If you need 8 bit parallel words up to 128 words (256 with the optional memory expansion) . . . or a serial word selectable in bit increments from 1 to 1,024 bits (2,048 option) — then our modular MG-3 will do your job.

An auxiliary ninth channel can be used as parity or variable position sync . . . it also has NRZ/RZ control, single cycle mode and remote control.

Load the generator's high speed memory using front panel controls or with the optical card reader shown. You program and change the cards with a pencil.

Apply the MG-3 to testing IC's, digital circuits, and communications components or systems.

Call or write for data sheets and demo.

**tau-tron**  
 inc

11 Esquire Road, North Billerica, Mass. 01862 Tel: (617) 667-3874

INFORMATION RETRIEVAL NUMBER 87



## Optical slotted switch delivers 1 mA when on

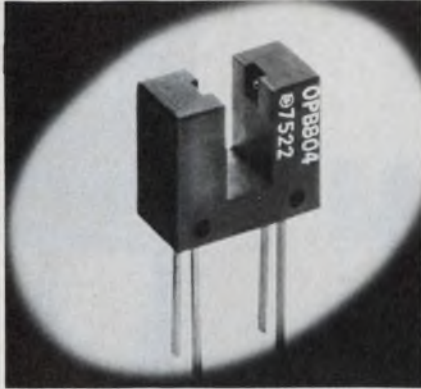

Optron, 120 Tappan Circle, Carrollton, TX 75006. (214) 242-6571. \$1.20 (100-up); stock.

The OPB 804 slotted optical switch consists of a gallium-arsenide infrared LED coupled with an npn phototransistor in a plastic housing. The phototransistor has a typical unblocked output current of 1 mA with a LED input of 20 mA. Standard gap width of the OPB 804 is 0.2 in. and the unit has pin spacing designed for use in standard DIP sockets or PC-board mounting.

CIRCLE NO. 345

## Complementary power semis switch fast

RCA Solid State Div., Box 3200, Somerville, NJ 08876. (201) 722-3200. From \$0.78 (100-up); stock.

Four series of epitaxial-based power transistors, the RCS29, RCS30, RCS31 and RCS32, are intended for medium-power switching and amplifiers. The RCS29 npn series is a complement of the RCS30 pnps and the RCS31 npn series is a complement of the RCS32 pnps. They are supplied in JEDEC TO-66 hermetic cases. Types in the RCS29 and RCS30 series have  $V_{CEO}$  ratings of 40, 60, 80, and 100 V. The turn-on and turn-off times for units in the RCS29 series are typically 0.4 and 1.2  $\mu$ s, respectively, and 0.2 and 1  $\mu$ s, respectively, for the RCS30 units. Minimum beta for the types in each series is 15, measured at 1 A. The types in the RCS31 and RCS32 series have similar  $V_{CEO}$  ratings and turn-on and turn-off times. Minimum beta for the types in the RCS30, and RCS32 series is 10, measured at 3 A.

CIRCLE NO. 346

## Bridge rectifier series handles currents to 10 A

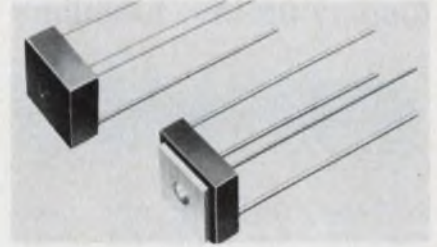

Sarkes Tarzian, 415 N. College Ave., Bloomington, IN 47401. (812) 332-1435. From \$1.58 (25-up); stock.

Two series of miniature full-wave bridge rectifiers rated at 6 and 10 A consist of seven units with PIV ratings from 100 to 1000 V at 60 Hz. Both series are encased in 0.6-in. square  $\times$  0.25-in. packages. Series S7006 is rated for 6 A and units can withstand single cycle surge currents of up to 150 A. The series S7007 is rated at 10 A with a surge capability of 200 A. Maximum heat dissipation for the two series is 12.5 and 24 W, respectively. Both series contain 0.156-in. holes for mounting to a heat sink with a No. 6 screw.

CIRCLE NO. 347

New miniature open-frame models designed specifically for low power applications where absolute minimum size is essential.



## WORLD'S\* SMALLEST OPEN-FRAME POWER SUPPLY

\$1995  
Single  
Quantities

\* only 3.75" H x 3.00" W x 1.60" D.

MODELS: HA5-1.2/OVP: 5V @ 1.2A w/OVP  
HA15-0.5: 9V to 15V @ 0.5A

FEATURES: 115/230 VAC input • OVP on 5V models • I.C. Regulated •  $\pm$  0.5% Regulation • 1.5 MV Ripple • Foldback Current Limiting • Full Rated to +50°C • 2 Hour Burn-in • 2 Year Warranty

For a copy of our New 1976 D.C. Power Supplies Catalog, contact Power-One or your local factory representative



531 Dawson Dr. Camarillo, Ca. 93010  
Phone: 805/484-2806 TWX: 910-336-1297

# POWER-ONE, INC.

INFORMATION RETRIEVAL NUMBER 88

ELECTRONIC DESIGN 24, November 22, 1975

ANALOG SERIES No. 3

## IF YOU'RE SICK & TIRED OF CALLING AROUND FOR ANALOG...

Read on. Here's one major analog supplier where one call can cover all needs: high technology, broad selection, low cost. One-stop shopping: over 150 basics, over 750 temp/pack combos (Hi Rel too). Dist. shelves now.

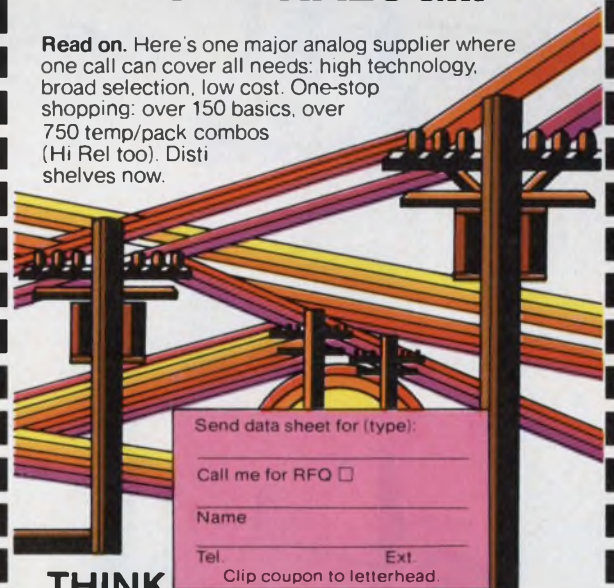

Send data sheet for (type):

Call me for RFO

Name \_\_\_\_\_

Tel. \_\_\_\_\_ Ext. \_\_\_\_\_

Clip coupon to letterhead.

THINK

# Signetics

311 E. ARQUES, SUNNYVALE, CALIF. 94086

INFORMATION RETRIEVAL NUMBER 89

179



## DISCRETE SEMICONDUCTORS

### LED indicator arrays display up to 8 functions

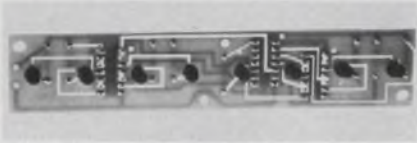

Electronic Solutions, 8070 Engineer Rd., San Diego, CA 92111. (714) 292-1325. \$23.99 (1 to 3); stock to 30 day.

A LED display module that can be used as an indicator for control panels contains eight red LEDs and TTL drivers. The  $5.9 \times 1.1 \times 0.75$ -in. board easily interfaces via ribbon cable and 14-pin DIP connectors. LEDs are spaced on 0.75-in. centers and the board requires +5 V at a standby current of 3.6 mA and 20 mA additional for each lighted LED. Each LED delivers 1.2 mcd and has a viewing angle of  $80^\circ$ .

CIRCLE NO. 348

### Optical switches use infrared sensors

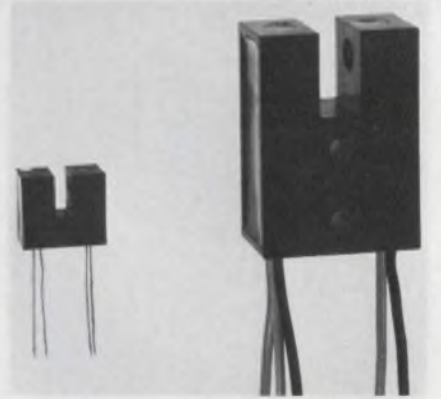

Clairex Electronics, 560 S. Third Ave., Mount Vernon, NY 10550. (914) 664-6602. From \$2.95 (1000-up); stock.

The CLI series of optical switches uses hermetically sealed infrared LEDs coupled with either an npn phototransistor or npn photo-Darlington sensor. Glass lenses are used to minimize dust pickup, prevent false triggering from ambient light and permit accurate positioning of the light beam. All devices are TTL-compatible and pretested to ensure operation. The switches are available in two standard sizes with gap widths of 0.1 or 0.25 in. They can also be custom tailored to any size or width specified. Typical devices in the family are Models CLI-55 and CLI-200. The CLI-55 develops an output current of 12 mA and is suited for bracket-mounting. The CLI-200 develops an output current of 1 mA, and is designed for PC-board mounting. Rise or fall times can be as low as  $5 \mu\text{s}$ . Both units have minimum reverse emitter voltages of 3 V; maximum forward voltages of 1.5 V and operating temperature ranges of  $-55$  to  $100^\circ\text{C}$ .

CIRCLE NO. 349

### Anywhere high efficiency power conversion is needed . . . look to Arnold Magnetics!

**Look at the performance:** AC (115-230 VAC, 47-500 Hz) and DC (12, 28, 48, 115, and 150 VDC) inputs . . . 1 to 6 isolated and regulated DC outputs from 4.2 to 300 VDC . . . line and load regulation to 0.1% . . . efficiencies to 85% . . . 3.9 watts delivered per cubic inch . . . short circuit and transient protected.

**Look at the design:** Over 1200 input/output configurations are available using off-the-shelf sub-modules. You specify to your needs using our exclusive "Design-As-You-Order" specification form that eliminates engineering cost, lost design time and long delivery schedules.

**Look at the package:** Compact, lightweight . . . your complete Power Conversion System is provided in a tested and encapsulated miniaturized, conduction cooled package.

Looking for high efficiency power conversion?

Look to Arnold Magnetics . . . today!



### ARNOLD MAGNETICS CORPORATION

11520 W. Jefferson Blvd.  
Culver City, CA 90230  
(213) 870-7014

### Germanium power semis handle up to 25 A

Germanium Power Devices, P.O. Box 65, Shawsheen Village Station, Andover, MA 01810. (617) 475-5982. From \$40 to \$50; 4 to 6 wk.

The 2N575 and 575A series of industrial pnp germanium power transistors handle peak currents of 25 A. These transistors have collector voltage ratings of up to 80 V. The series is available in standard MT-7 packages.

CIRCLE NO. 350



# for the **BEST** in... **ANALOG FILTERS**

## DUAL HI/LO

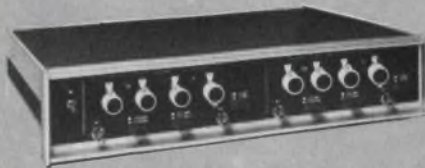

**Higher Performance  
Lower Cost**

*Model 452 rolloff: 24dB/octave/channel  
Model 852 rolloff: 48dB/octave/channel*

- **Higher Dynamic Range**
- **Lower Noise**
- **Frequency Range:**  
0.01 Hz to 111 KHz
- **Frequency Selection:**  
Digital, with 3 Digit Resolution
- **Cutoff Frequency Accuracy:**  $\pm 2\%$
- **Responses: Butterworth and Linear Phase**
- **Functions: Low Pass, High Pass, Band Pass, Band Reject**
- **Dynamic Range: 90 dB**
- **Passband Gains: 0, and 20 dB**

Model 452 from \$1175  
Model 852 from \$1725

## DATA CLEANER



**Anti-Aliasing  
Multi-Channel**

- **Local, Remote and On-Card Programming of Cutoff Frequency**
- **Up to 16 Independent Channels in 5 1/4" Panel**
- **Cutoff Frequency Range:** 0.01 Hz to 150 KHz
- **Rolloff: 48dB/octave/channel**
- **Responses: Butterworth and Bessel**
- **Functions: Low Pass, High Pass, Band Pass, Band Reject**
- **Dynamic Range: 80dB**
- **Passband Gain: 0dB**

FOR DATA ACQUISITION  
AND SIGNAL PROCESSING

System 816 Main Frame \$1500  
Filter Cards from \$675

## BUDGET

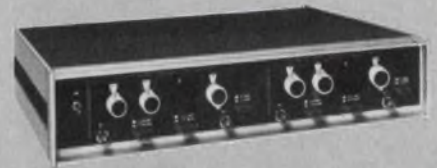

**Wide Range  
Low Cost**

*Model 432: 1 Hz to 110 KHz  
Model 442: 10 Hz to 1.1 MHz*

- **Low Cost**
- **Rolloff: 24dB/octave/channel**
- **Frequency Selection:** Digital, with 2 Digit Resolution
- **Cutoff Frequency Accuracy:**  $\pm 5\%$
- **Responses: Butterworth and Linear Phase**
- **Functions: Low Pass, High Pass, Band Pass, Band Reject**
- **Dynamic Range: 80 dB**
- **Passband Gains: 0, and 20 dB**
- **Low Noise**

Model 432 \$825  
Model 442 \$895

Prices U.S.A. Domestic

# ROCKLAND

Rockland Systems Corporation 230 W. Nyack Road, West Nyack, N. Y. 10994 • (914) 623-6666 • TWX 710-575-2631

INFORMATION RETRIEVAL NUMBER 91



## DISCRETE SEMICONDUCTORS

### High-voltage rectifiers handle currents of 25 mA

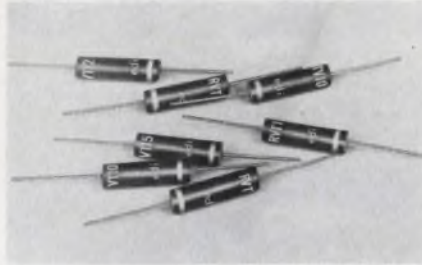

*Electronic Devices, 21 Gray Oaks Ave., Yonkers, NY 10710. (914) 965-4400. From \$0.72 (1000-up); stock.*

The VT and RVT series of high voltage silicon rectifiers have peak reverse voltage ratings of 10 to 15 kV. They have forward current ratings of 25 mA and are housed in a cylindrical case with a diameter of 0.16 in. and are 0.6 in. long. The rectifiers can withstand peak surge currents of 5 A. Series VT units are standard recovery diodes and Series RVT are 300-ns, fast-recovery diodes.

CIRCLE NO. 351

### High power LED delivers up to 20 mW, pulsed

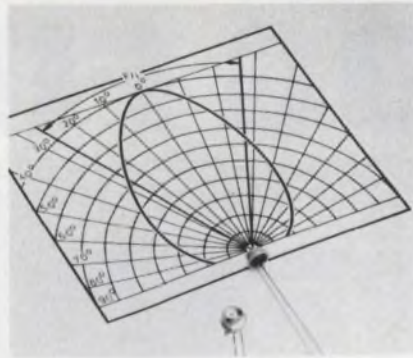

*Plessey Semiconductors, 1674 McGaw Ave., Santa Ana, CA 92705. (714) 540-9979. \$600 (1 to 9); 6-8 wks.*

The GAL-100 LED produces up to 20 mW in the pulsed mode, and over 500  $\mu$ W in continuous operation. This is claimed to be about 10 times the power output of competitive units. The LED can be used all the way down to dc but rise and fall times of 5 ns allow it to be modulated at rates up to 110 MHz. The 1.06 micron emission wavelength minimizes losses in optical fibers.

CIRCLE NO. 352

### Gunn diodes provide 60 GHz, 50 mW output

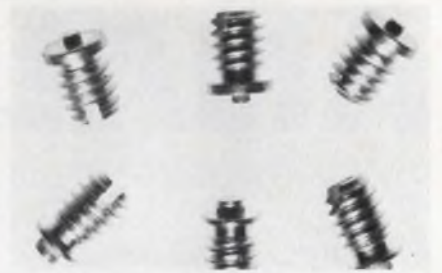

*Microwave Associates, South Ave., Burlington, MA 01803. (617) 272-3000. From \$96.25 (1 to 9); stock to 2 wk.*

Gunn diodes that can deliver up to 50 mW at 60 GHz are well-suited for use in paramp pumps and moderate power mm transmitters. These diodes, which operate from 18 to 60 GHz, are available with the following output power capabilities, all in a 5% band: MA 49178-118, 250 mW over 18 to 26.5 GHz; MA 49177-138, 150 mW over 26 to 35 GHz; MA 49173-138, 100 mW over 26 to 40 GHz; MA 49181-138, 50 mW over 40 to 50 GHz; and the MA 49182-138, 50 mW over 50 to 60 GHz.

CIRCLE NO. 353

So much more to choose from . . .

# Now, for the first time a line of 3 $\frac{3}{4}$ Digit, $\pm 4,000$ count Digital panel instruments

Analogic's reliable well-known line of  $\pm 2,000$  count DPis has led to the generation of our new  $\pm 4,000$  count series. All are Universal Line Powered, Bipolar and can be offset up to 4,000 counts — a really remarkable capability. Choice of 0.5" LED or 0.55" gas plasma display. Universal powering for anywhere in the world.

**AN2539** — Exceptional accuracy and stability. Measures voltages over full-scale ranges of  $\pm 3.999$  V DC or  $\pm 399.9$  mV. Resolution of  $\pm 0.025\%$ . True-differential, balanced symmetrical inputs. Optional BCD outputs.

**AN2560** — Combines the true balanced differential high impedance input with latched and buffered parallel BCD output, compatible with CMOS and TTL/DTL interfaces. Significant input/output versatility and flexibility.

### "Pick-A-Card" Engineering Design

**AN2559** — This host DPI is pre-engineered with a standardized connector to accept KLUGE cards (General Purpose Analog Function Cards). With the AN2559 and the suitable KLUGE card you have the ability to read directly in Engineering Units, i.e. RPM, angles, temperature, Ft/min., Gallons, Horsepower, Pounds, psi or any measurement from any of the standard industrial transducer outputs available on the market today. This remarkable versatility can be exploited for countless applications of digitizing instrumentation. Analogic has a library of cards assembled or can help you design to an unusual application.



Want complete data? Ready to evaluate? Call Analogic's Marketing Dept. at (617) 246-0300, for your local Analogic sales office or stocking distributor, or write today: Analogic Corp., Audubon Road, Wakefield, Mass. 01880.

**ANALOGIC** ■

...The Digitizers



## Vhf transistors deliver up to 4 W at 175 MHz

Solid State Scientific, Montgomeryville, PA 18936. (215) 855-8400. \$1.75 (100-up); stock.

The SD1127 and SD1131 vhf transistors are housed in TO-39 packages. This allows the emitter to be grounded to the package to reduce package parasitics. The transistors provide better than 13-dB gain. The SD1127 in the grounded emitter TO-39 can handle up to 4 W with 14-dB gain at 175 MHz. The SD1131 handles 3 W and delivers up to 15-dB gain at 225 MHz. Both operate at a 12.5-V bias.

CIRCLE NO. 447

## High-voltage transistors made for fast switching

Motorola Semiconductor Products Div., P.O. Box 20924, Phoenix, AZ 85036. (602) 244-3466. \$2.15 (100-up); stock.

The MRF531 high-speed, non-saturated transistor switch has a collector-emitter breakdown of 100 V minimum at an  $I_C$  of 10 mA. In resistive switching applications, the MRF531 switches collector currents of 200 mA at frequencies up to 800 MHz. As a nonlinear device, nonsaturated switching times are in the nanosecond range. The metal-cased transistor is characterized with safe operating area curves to 100 V at 25 C, has a minimum dc current gain of 25 at 5 mA, an output capacitance of 4 pF, maximum and an input capacitance of 9 pF, typical.

CIRCLE NO. 448

## Power Darlington series handles currents to 8 A

SGS-ATES Semiconductor, 435 Newtonville Ave., Newtonville, MA 02160. (617) 969-1610. From \$0.80 (100-up); stock.

The BDX 53 and 54 series of complementary power Darlington transistors are available in npn and pnp types with voltage ratings up to 100 V and currents to 8 A. Two popular plastic packages are used—TO-126 for the 4 A series and TO-220 for the 8 A series. The gain of all these Darlington transistors is specified at 750, minimum, for collector currents ranging from 1.5 to 3 A.

CIRCLE NO. 449

REAL TIME SPECTRUM ANALYSIS  
WITH 70 dB DYNAMIC RANGE  
AND DUAL DISPLAY... FOR UNDER \$10,000!

# SPECTRASCOPE II

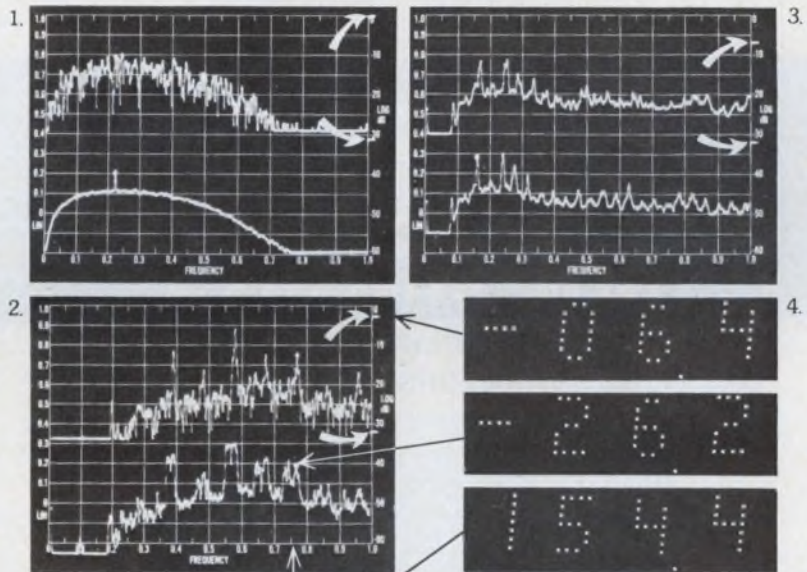

- 1. Direct Comparison of Real Time (upper) and Averaged (lower) spectra, showing dominant vibration peak.**
- 2. Direct Comparison of Real Time machinery-noise spectrum (upper) and Peak Hold spectrum (lower).**
- 3. Direct Comparison of aircraft engine noise spectra averaged at 2490 rpm (upper), 2340 rpm (lower).**
- 4. Instant Readout of... Overall (rms) level (top), Amplitude (center), Frequency (bottom).**

Arrows on photos point to overall (rms) level indications which appear automatically at right end of each Real Time, Averaged, or Peak Hold spectrum.

Above are just a few of the ways Spectrascope-II—our new SD335 Real Time Analyzer—displays instantaneous and/or averaged spectra at the same time... on the same screen. Built-in dual memories, averager and scope let you make such direct comparisons of data on-the-spot for monitoring test trends... checking the effects of a design change... or measuring a frequency shift as operating parameters change. Features? Consider these...

- Linear dynamic range to 70 dB ■ 500-line resolution
- 0.06 Hz to 50 kHz operation in 10 analysis ranges (with option all the way to 150 kHz) ■ Automatic, updated indication of the instantaneous overall (rms) level of each spectrum on scope, LED readout and X-Y plotter ■ 5-digit LED readout of frequency and amplitude (lin or log) under instant cursor control ■ "SIMULPLOT" for making X-Y plots under complete analyzer control while you're viewing the same data on the scope ■ Portability: carry the Spectrascope-II right to the job ■ Spectral's world-famous field serviceability and product support.

We've saved all the details—and the usual BIG PICTURE of the control panel—for the data sheet, which you should send for now.

(Also available: SD330A "Spectrascope," a 250-line RTA for under \$8,000.)



**Spectral Dynamics Corporation**

OF SAN DIEGO

P.O. Box 671, San Diego, Calif. 92112 (714) 565-8211, TWX 910-335-2022

INFORMATION RETRIEVAL NUMBER 102



## DISCRETE SEMICONDUCTORS

### Schottky rectifiers have 600-A surge capability

Solitron Devices, 1177 Blue Heron Blvd., Riviera Beach, FL 33404. (305) 848-4311. From \$2.50 (100-up); 4 wk.

A series of 20 A Schottky barrier diodes has rated breakdown

voltages of 10 to 50 V. These diodes are packaged in DO-4 (JEDEC) cases and are identified as the SSP 2010, 20, 30, 40 and 50 series. The rectifiers have a peak surge capability greater than 600 A for a 8.3-ms pulse and the  $V_F$  drop is less than 0.46 V at rated current. Other features include storage temperatures from -55 to +165 C; operating range from -55 to +135 C; and thermal impedances of 2 C/W.

CIRCLE NO. 354

### Transient suppressors handle up to 1500 W

Unitrode, 580 Pleasant St., Watertown, MA 02172. (617) 926-0404. From \$3.15 (100-up); stock.

The 1N5907 and 1N5629A through 1N5650A series of transient voltage suppressor diodes can dissipate 1500 W for 1 ms. The diodes have voltage ratings from 6 to 51 V and are housed in welded DO-13 packages. Package diameters are less than 0.235 in. These zeners respond to surges in under 1 ps and are available with 5 or 10% tolerances.

CIRCLE NO. 355

### Npn power transistors have f's of 25 MHz

Kertron, 7516 Central Industrial Dr., Riviera Beach, FL 33404. (305) 848-9606. From \$2.90 (100-up); stock.

A series of high-voltage npn silicon transistors is available screened to MIL-STD requirements or for industrial applications without screening. The series is designated the 2N6233, 34 and 35. The devices have turn-on times of less than 300 ns at a collector current of 1 A, storage times of less than 1  $\mu$ s and fall times of less than 400 ns. They have an  $f_t$  greater than 25 MHz and can handle voltages of 225, 275 and 325 V, respectively. The current gain is greater than 25 at an  $I_c$  of 1 A and the devices can handle up to 10-A peak currents. The transistors are housed in TO-66 packages.

CIRCLE NO. 356

### High-voltage transistor can dissipate 250 W

Sensitron Semiconductor, Div. RSM Electron Power Inc., 221 W. Industry Ct., Deer Park, NY 11729. (516) 586-7600. \$3.50 (100-up); stock to 1 wk.

The SEN-T-173 is a TO-3, npn, single diffused, high-voltage, high-current switching transistor that can dissipate 250 W. The transistor has a  $BV_{CEX}$  of 170 V minimum, a gain at 8 A of 15 minimum and a gain at 10 A of 10, minimum. The  $V_{CE(SAT)}$  at 10 A is 1 V max and the  $V_{RE}$  drop is 2 V, max at an  $I_C$  of 10 A.

CIRCLE NO. 357

## IMPULSE TEST SURGE PROTECTORS AND CIRCUITS

INCLUDING  
GAS TUBES - VARISTORS - ZENERS - NETWORKS



1500V  
8 x 20  
1.2 x 50

INCLUDING WAVESHAPES

500A  
10 x 1000  
10 x 50

and  
0.5 to 10kV/usec

The Keytek Model 424 Surge Generator/Monitor surges components and the circuits they're protecting; simultaneously measures resulting peak voltage and current for all generated waveshapes. Digital displays and GO/NO-GO indicators allow Engineering, QC and Production use.



Companion Component Test Fixture, KeyTek Model 450, is shown holding a gas tube surge protector. The Model 450 provides fast, safe, 4-wire connections for both axial and radial lead components.

**KeyTek**  
INSTRUMENT CORP.

40 GUINAN STREET, BOX 109, WALTHAM, MASS. 02154 - TEL. 617-899-6200

INFORMATION RETRIEVAL NUMBER 103



# Join the stampede. Corral big savings with Weston Mustang Meters.

Saddle up with a winner and join the stampede to Weston Mustang panel meters.

In creating Mustang, Weston has developed a series of panel meters that are superior in appearance, performance and value to any 2% meters you can find.

A completely new design and unique manufacturing methods result in prices that will surprise you.

And look what you get. A core magnet APM with the shallowest profile in the industry. Spot welding makes more reliable electrical connections. The Mustang unique Ring-Lock reduces installation time and cost by eliminating conventional mounting hardware.

If bulky meter barrels make your product larger than you want, you'll appreciate the Mustang Mini-Barrel. It is very small: only 1.5" diameter x .92" deep.

Corral some Mustang meters. They are in high volume production. Basic models are in stock. Let us price your requirements and surprise you even more. See your Weston distributor, or write for complete technical information. Weston Instruments, 614 Frelinghuysen Avenue, Newark, N.J. 07114.

In Canada: 1480 Dundas Highway, East Mississauga, Ontario.

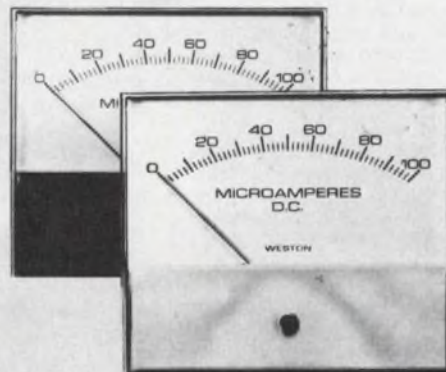

**We're either first or best. Or both.**  
**WESTON**®  
Schlumberger





NEW SERIES

# Schottky Barrier Rectifiers

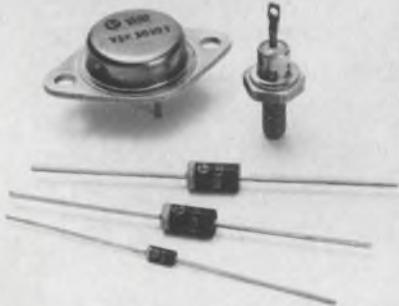

- Five series: 1A, 3A, 5A, 15A & 30A (I<sub>c</sub>) with 20V, 30V and 40V (V<sub>RRM</sub>).
- Extremely fast recovery (t<sub>r</sub>), very low forward voltages (V<sub>F</sub>), high reliability and low cost.
- VSK 120, 130 & 140-1A series in DO-41 packages. 550 mV (V<sub>F</sub>). 40A peak 1/2 cycle surge (I<sub>FSM</sub>). 10 mA (I<sub>R</sub>) at T<sub>L</sub> = 100°C.
- VSK 320, 330 & 340-3A series. Epoxy package, axial leads. 475 mV (V<sub>F</sub>). 150A surge. 30 mA (I<sub>R</sub>) at T<sub>L</sub> = 100°C.
- VSK 520, 530 & 540-5A series. Epoxy package, axial leads. 450 mV (V<sub>F</sub>). 250A surge. 75 mA (I<sub>R</sub>) at T<sub>L</sub> = 100°C.
- VSK 1520, 1530 & 1540-15A series in DO-4 metal stud cases. 600 mV (V<sub>F</sub>). 300A surge. 75 mA (I<sub>R</sub>) at T<sub>c</sub> = 100°C.
- VSK3020T, 3030T & 3040T-30A series. Center-tapped, common cathode, 15A per leg in TO-3 package. 630 mV (V<sub>F</sub>). 300A surge. 75 mA (I<sub>R</sub>) at T<sub>c</sub> = 100°C.

All series have junction operating temperature range of -65°C to +150°C.

Call Mike Hawkins  
214/272-4551 for more information



Design us in —  
We'll stay there

**VARO SEMICONDUCTOR, INC.**

P.O. BOX 676, 1000 NORTH SHILOH,  
GARLAND, TEXAS 75040  
(214) 272-4551 TWX 910-860-5178

INFORMATION RETRIEVAL NUMBER 105

## POWER SOURCES

Modular sources  
carry high-MTBF label

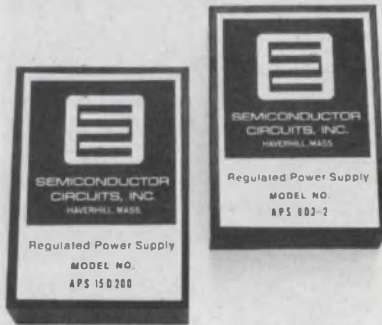

Semiconductor Circuits, 306 River St., Haverhill, MA 01830. (617) 373-9104. See text.

APS Series of line operated, encapsulated modular dc power supplies offers a mean-time-between-failure (MTBF) greater than 150,000 h under high line and full load at 25 C. Priced as much as \$35.00 below units with comparable output ratings, this family also features 0.5% regulation—said to be 10 times better than similarly priced units.

Four short-circuit-protected output ratings are available: ±12 V at ±100 mA, ±12 V at ±200 mA, ±15 V at ±100 mA and ±15 V at ±200 mA. The 100-mA models size-in at 2.5 × 3.5 × 0.875 in. and cost \$24.95 (1-9) and \$17.45 (1000 up).

The 200-mA units are packaged in 2.5 × 3.5 × 1.25-in. modules and sell for \$29.95 (1-9) and \$21.00 (1000 up). Each model is available with either 2.0 or 2.2-in. ac-input pin spacing—two widely used patterns.

For all models of the APS Series, operating efficiencies exceed 50%, thus promoting low case temperature rise: less than 10° for units to 3 W and less than about 18° to 6 W.

Over the full operating temperature range of 0 to 71 C, the output-voltage temperature coefficient is typically 0.02%/°C and no derating is required. All models operate from a standard input of 105 to 125 V ac at 50 to 440 Hz.

Deliveries of the APS Series are stock to two weeks.

CIRCLE NO. 301

# NEW and EXCLUSIVE A/D Converter

features

**HIGH SPEED:** 4 μsec.  
(220,000 conversions per sec.)

**HIGH RESOLUTION:** 15 bits

**HIGH ACCURACY:**  
0.0065% of FSR

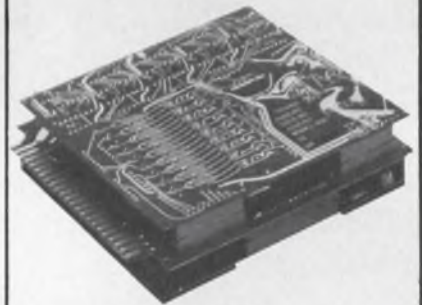

New Model ADC1215F converter from Phoenix Data is available in two basic models: Single-ended and differential.

Phoenix Data's new Model ADC1215F A/D converter has a resolution of 15 binary bits and a total conversion time of 4 microseconds (220,000 conversions per sec). Accuracy of 0.0065% of FSR is **guaranteed** in addition to complete monotonicity. Analog dynamic range is in excess of 86 db.

If it's stability, accuracy, speed, or all-around quality you need in Data Conversion, contact Phoenix Data now!



**PHOENIX DATA, INC.**

3384 W. Osborn Rd. Phoenix, AZ 85017  
Ph. (602) 278-8528, TWX 910-951-1364

INFORMATION RETRIEVAL NUMBER 106



## 500-VA ac source sells for \$1050



Pacific Electronics, 2643 N. San Gabriel Blvd., Rosemead, CA 91770. (213) 573-1686. \$1050; to 13 wks.

Model 105-H, 500-VA ac power source is said to introduce a unit cost approximately one-half that of competitive power sources. Performance specs include: output power 500 VA continuous, three-wire floating output; output voltage 0 to 125 V ac, continuously variable; output current 4 A rms; 16 A pk-pk is available at crest of sine wave; load regulation 0.75% max under worst case conditions (typical 0.4%); line regulation 0.25% max (typical 0.1%).

CIRCLE NO. 358

## Constant-current units aimed at I<sup>2</sup>L loads

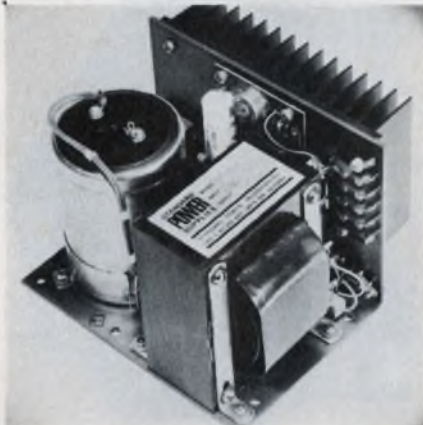

Standard Power Inc., 1400 S. Village Way, Santa Ana, CA 92705. (714) 558-8512. From \$55.

New constant-current supplies are designed specifically for digital applications such as I<sup>2</sup>L, LEDs and lamp circuits, as well as for inductive loads. The units control current to within 0.1% and are available in a variety of types, with compliance voltages from 8 to 30 V dc, in adjustable current ratings from 0.1 to 15 A, depending on the model. Computer-grade components are used throughout. All models operate on "universal" 115/230 V ac, 47 to 440-Hz inputs and provide line and load regulation to 0.1% (minimum load to short circuit).

CIRCLE NO. 359

## Power module converts 28 V to $\pm 15$ V dc

Abbott Transistor Labs, 5200 W. Jefferson Blvd., Los Angeles, CA 90016. (213) 936-8185. \$325 to \$450; 10 wks.

This series of dual-output power modules converts 28-V-dc input power to 25, 50, or 100 W of regulated dc power  $\pm 15$  V. BBN-15A Series is said to be one of the few

switching regulated power supplies capable of operating over the full military temperature range of  $-55$  to  $100$  C. The series regulates input voltages to 0.5% over its full input range of 20 to 32 V dc. Load regulation is 0.5% for no load to full load at constant input voltage. PARD (ripple and noise) has been reduced to 25 mV rms, 100 mV pk-pk from 25 to 100 C.

CIRCLE NO. 360

# This is a rack-full of counter capability.



HP's new 75 MHz Timer/Counter is easily held in your hands. Take a look at the front panel: Never before has there been so much counting capability in such a small package at such a small price. Seven other modules snap on to convert to other instruments — including a DMM — or to connect to the HP Interface Bus.

Features include: 1 nsec time interval averaging • autoranging of frequency, frequency ratio, period average, time interval average • full complement of triggering controls, monitor LEDs • preset ECL and TTL thresholds • an astonishingly low price of only \$910\* total for 5308A module with 5300B mainframe. \*Domestic USA price only.

**HEWLETT *hp* PACKARD**

Sales and service from 172 offices in 65 countries.  
1501 Page Mill Road, Palo Alto, California 94304

02503

INFORMATION RETRIEVAL NUMBER 107



# Speed Indicating Systems

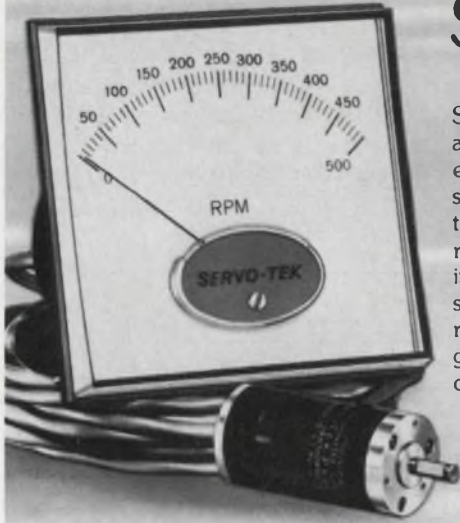

Servo-Tek's Speed Indicating Systems are self-powered—no batteries or external power needed. Standard scales covering ranges from 0-10 rpm to 0-12,000 rpm are available; special ranges are also offered. Bidirectional indicators with zero center and suppressed scale units for even greater readout accuracy are available. The dc generators are temperature compensated to provide consistent accuracy at temperatures ranging from  $-25^{\circ}\text{C}$  to  $+75^{\circ}\text{C}$ .

FREE CATALOG of rotating components available.

Be Selective. Turn To...

**SERVO-TEK**  
PRODUCTS COMPANY

1086 Goffle Road, Hawthorne, NJ 07506 · 201-427-3100

Servo-Tek of California, Inc.

8155 Van Nuys Blvd., Van Nuys, CA 91402 · 213-786-0690

INFORMATION RETRIEVAL NUMBER 108

# We're on the move ... with a 15-ns deglitcher.



Computer Labs introduces a new line of modular deglitchers with the DGM-1040 & DGM-1080. Used to eliminate the non-linear effects of glitches in the output of D/A Converters, these miniature modules generate an output signal with extremely high spectral purity, required for TV signal reproduction, CRT displays, and waveform generation. Acquisition times as low as 15 ns and linearity of 0.01% make these the highest speed and most versatile deglitchers available commercially.

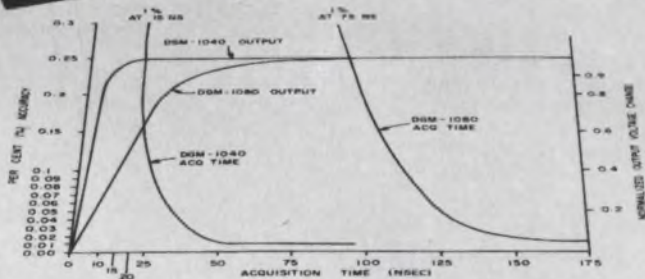

FIG. 3 ACQUISITION TIME VS. SETTLING ACCURACY

**COMPUTER LABS**

COMPUTER LABS, INCORPORATED  
505 EDWARDIA DR. ● GREENSBORO, N. C. 27409 ● 919/292-6427

INFORMATION RETRIEVAL NUMBER 109

## POWER SOURCES

### High-voltage unit delivers 1 kV at 3 W

Emco High Voltage, 2444 Old Middlefield Way, Mountain View, CA 94043. (415) 969-3056. \$49.50; 3 days.

Model 710 high voltage dc/dc converter module is designed to mount on a PC card. Input and output voltages are 15 and 1000 V, respectively. Output voltage tracks the input over a range from 650 to 1300 V. Rated power output is 3 W. No load to full-load regulation is 5% and ripple is 0.5%. The converter operates at a frequency greater than 20 kHz. Size is  $1.25 \times 1.85 \times 2.60$  in., and weight is approximately 4 oz.

CIRCLE NO. 361

### Switching units offer triple outputs



ACDC Electronics, 401 Jones Rd., Oceanside, CA 92054. (714) 757-1880. \$595.

A new line of switching power supplies with three outputs is designed for OEM computer peripherals. These supplies provide a single voltage output for driving IC logic and a dual voltage output for driving op amps and a/d converters. The 20-kHz units operate from a selectable input of 115/230 V ac, 47 to 63 Hz. Outputs are 5 V at 50 A/±12 V at 5 A/±15 V at 4 A. Overvoltage protection is built into the single output and is optional on the dual output. Overload protection is standard and EMI is minimized by shielding and filtering. Regulation is 0.1%.

CIRCLE NO. 362



## Power package assembly holds 16 modules



Powercube Corp., 214 Calvary St., Waltham, MA 02154. (617) 891-1830.

A new power-module assembly, called Block-Pac II, provides custom power supply packaging using standard Circuitblock modules. Block-Pac II will accommodate up to 16 1 x 1 x 2-in. power modules in various configurations and offers from four to 14 input/output terminals. Some RFI shielding is provided and conducted EMI is attenuated by use of bulkhead mounted feed-through filters. A barrier strip provides quick disconnect. Price depends on configuration.

CIRCLE NO. 363

## Supply automatically adjusts for ac changes

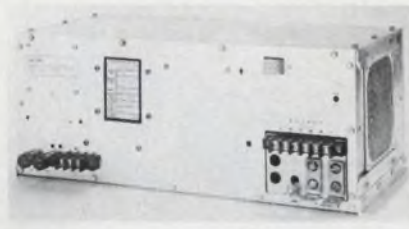

Modular Power, 4818 Ronson Ct., San Diego, CA 92111. (714) 279-1641. \$420 to \$630.

The "HPB" Series Limitran dc power supply automatically regulates ac line voltage changes. The supply uses a double regulator design to improve efficiency and reliability and provide brownout protection. As the ac line voltage changes, the ac regulator switches transformer taps to meet the new line conditions. Results of this and other circuit innovations include an 85-to-125-V input range, greater than 50% efficiency, 5-to-28-V-dc outputs at 50 to 18 A with 0.02% line and load regulation and 0.01% rms ripple. Response time is under 25  $\mu$ s for a 50 to 100% load current change.

CIRCLE NO. 364

## Dc/dc converters claim low output spike noise



Semiconductor Circuits, 306 River St., Haverhill, MA 01830. (617) 373-9104. \$85; 2-4 wks.

The 30C-LN Series is a family of low-noise, encapsulated dc/dc-converter modules. Output (spike) noise is guaranteed at 10 mV pk-pk max (typically 4 to 5 mV) with specific models that operate from 5, 12, 24, 28 or 48-V-dc inputs. Specific models provide  $\pm 12$  or  $\pm 15$  V out at  $\pm 100$  or  $\pm 125$  mA. Designed for PC-card or logic-panel mounting via 0.020 x 0.150-in. pins on 0.1-in. centers, all models are packaged in 2 x 2 x 0.4-in. modules with five sides electrostatically shielded internal.

CIRCLE NO. 365

## No down-time in rotary switches



Unique 5-second wafer replacement obsoletes other switches. Simply lift out old wafer, slip in new wafer. No unsoldering . . . no disassembling . . . no wire removing.

CDI patented switches with dust covers are available in sizes 2" x 2", 3" x 3", and 4" x 4" with lengths to accommodate up to 36 wafers. Switches can be customized to your specifications.

Operation may be manual, motor or solenoid for use in any rotary selector switch application. Now supplied for numerous military and commercial applications.

Mfd. under Tabet U. S. Patents 2,841,660, 2,971,066, 3,015,000, 2,956,131, 2,988,607.

**CHICAGO DYNAMIC INDUSTRIES, INC.**



PRECISION PRODUCTS DIVISION

1725 Diversey Blvd., Chicago, Ill. 60614 Phone 312, WE 5-4600

## MEMORY SERIES No. 3 SUPER GIVEAWAY: 6 YEARS OF PROM RESEARCH



FREE for the asking: our PROM reliability report. The kind of hard-nosed data you need on nichrome fusing, and the critical conditions governing reliability maximization. A strong evaluation of our PROM research, further supporting RADC findings.

FREE COPY of Signetics PROM Reliability summary attach coupon to letterhead

Name \_\_\_\_\_

Tel. \_\_\_\_\_

Ext. \_\_\_\_\_

THINK

**Signetics**

311 E. AROUES, SUNNYVALE, CALIF. 94086

INFORMATION RETRIEVAL NUMBER 110

ELECTRONIC DESIGN 24, November 22, 1975

INFORMATION RETRIEVAL NUMBER 111

189



## COMPONENTS

### Cartridge lamps mount on PC boards

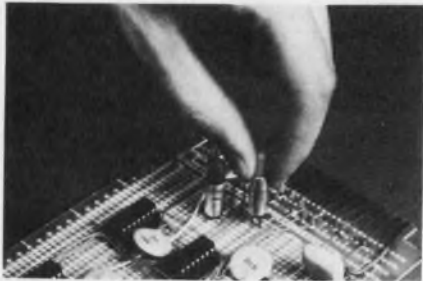

Littelfuse Inc., 800 E. Northwest Highway, Des Plaines, IL 60016. (312) 824-1188. Under \$0.50 (OEM qty).

Littelites cartridge lamps are now available with tin-plated, 0.040-in. diameter stainless-steel pins, solderable for PC-board mounting. The new terminations can be supplied as a standard on any of the 900-series solid-state neon or incandescent cartridge lamps and the 901-series neon cartridge lamps.

CIRCLE NO. 366

### PC-mounting chokes handle up to 15 A

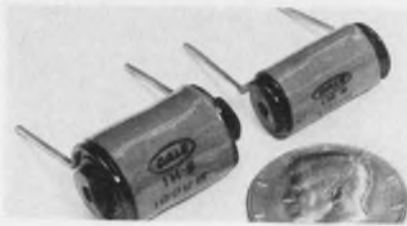

Dale Electronics, Inc., East Highway 50, Yankton, SD 57078. (605) 665-9301. Typical \$0.88: 10  $\mu$ H, 3 A (1000 up); 2-3 wks.

The Dale IH filter-choke line has been expanded to include 24 standard models with current ratings from 3 to 15 A and an inductance range from 5 to 250  $\mu$ H. All are designed for PC mounting with pretinned leads and a flame-retardant epoxy coating. Typical applications include noise filters, power amplifiers, power supplies and SCR or Triac control circuits. Above board size ranges from 0.625-to-1-in. diameter and from 0.875-to-1.625-in. board width.

CIRCLE NO. 367

### Cermet trimmer pot is only 1/4-in. diameter

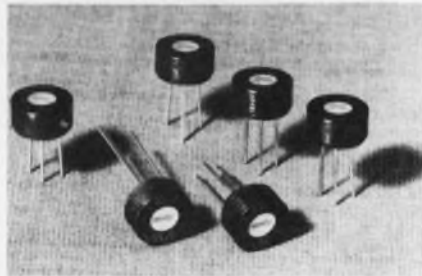

Mepco Electra Inc., 11468 Sorrento Valley Rd., San Diego, CA 92121. (714) 453-0353. \$0.49 (1000 up).

Series ET14W single-turn cermet trimmer is only 1/4-in. dia and has a maximum height of 0.150 in. Contact resistance variation is 1% maximum and less than 0.25% average regardless of direction of rotation. The trimmer is sealed against moisture, thermal shock during soldering, the corrosive action of solder-bath vapors and cleaning solvents. It even withstands potting in low viscosity compounds.

CIRCLE NO. 368

# MEET OUR family

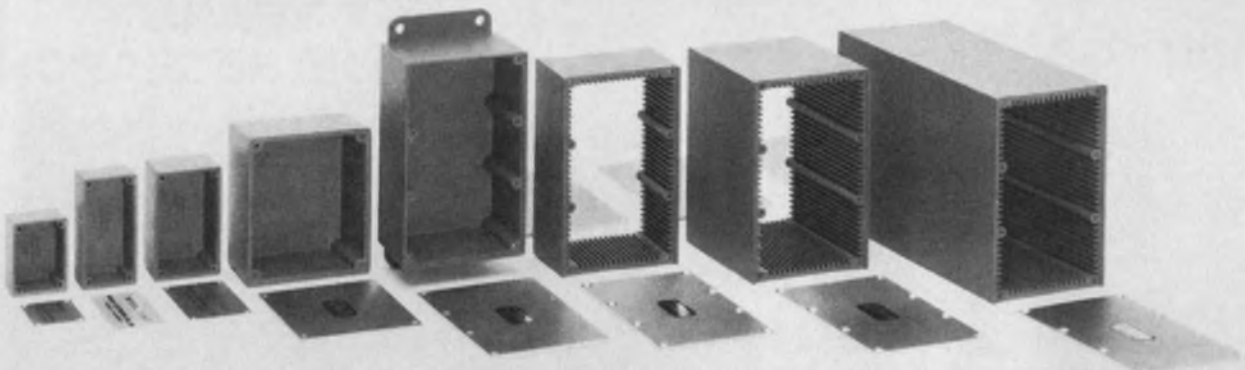

## of shielded "black boxes"

Almost 10 years ago (1966 to be exact) we introduced our first two series of shielded electronic enclosures. They became an overnight success. Since then the demand for different sizes, shapes and applications has increased our family to eight series of models, each with a noise rejection greater than 70db.

Sizes range from 1.50" x 1.13" x 0.88" to 4.13" x 2.68" x 6.0"; in blank versions or with a complete choice of coaxial connectors; painted or unpainted; with or without printed circuit card guides; with mounting flanges or bottom mounting plates. All models supplied with aluminum covers and screws.



**POMONA ELECTRONICS ITT**

1500 East Ninth St., Pomona, California 91766 Tel: (714) 623-3463

INFORMATION RETRIEVAL NUMBER 112



# Capable Recording



## OMNIGRAPHIC® 75

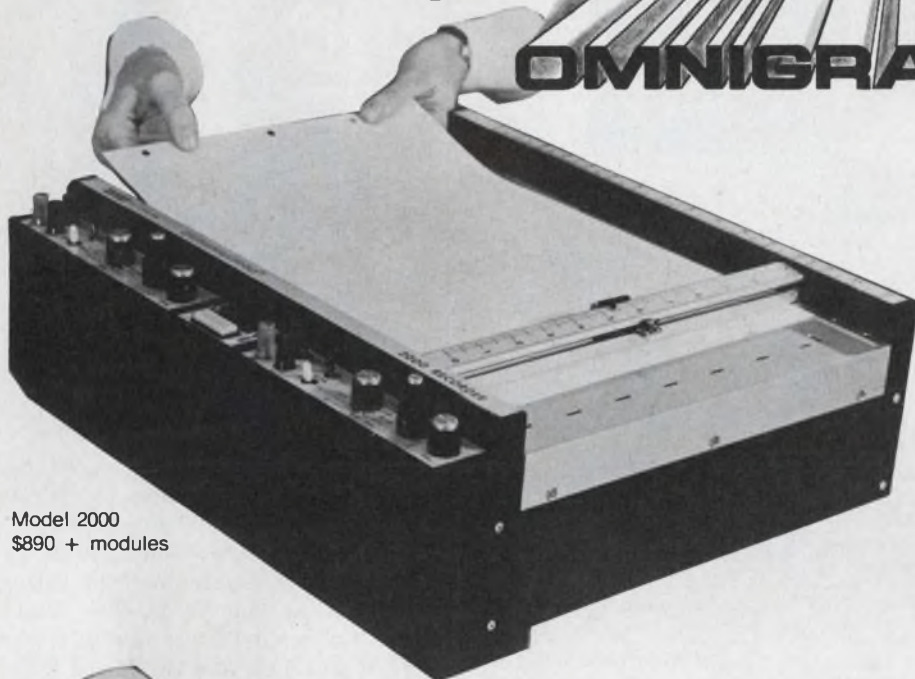

Model 2000  
\$890 + modules

## X-Y CAPABILITY

Some 21 interchangeable modules plug into the basic chassis to give you the most capable X-Y recorder in the world or any place else.

- 30 in/sec speed (40 in/sec available)
- $\pm 0.2\%$  accuracy
- local/remote pen control
- electric pen lift
- high input resistance
- interchangeable amplifiers

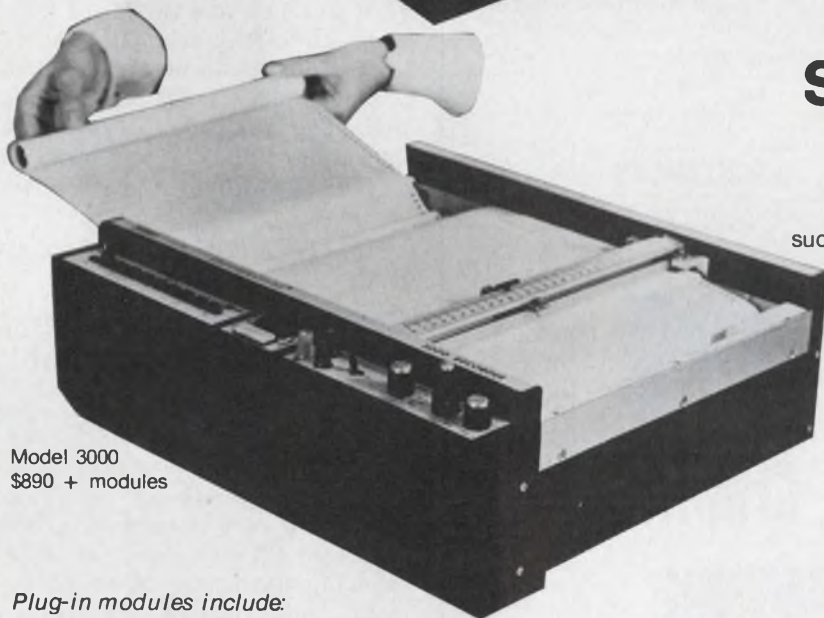

Model 3000  
\$890 + modules

## STRIP CHART CAPABILITY

A truly capable strip chart recorder for such diverse functions as GC or spectrometry.

- 9 pushbutton speeds from 20 to 0.05 in/min
- $\pm 0.2\%$  accuracy
- 30 in/sec slewing speed (with 40 in/sec available)
- English/Metric scaling at the flick of a switch
- Snap-in disposable pen
- Electric pen lift

### Plug-in modules include:

- Type 0 Customizing
- Type 1 DC Coupler
- Type 2 Ranging
- Type 3 Switching
- Type 4 Switching / Time Base

- Type 5 Precision Attenuator
- Type 6 Precision Attenuator / Time Base
- Type 7 Pre-Amp Attenuator
- Type 8 Pre-Amp Attenuator / Time Base

- Type 9 Precision Ranging
- Type 12 Precision Attenuator / Offset
- Type 14 Log Convertor
- Type 15 Two Channel
- Type 16/17 Point Plotter
- Type 26/17 Point Plotter

### Control modules:

- Type 50 Chart Drive
- Type 51 Chart Drive
- Type 52 Chart Drive
- Type 53 Chart Drive
- Type 100 Control
- Type 200 Control

**houston**  
**instrument**

**THE**  
**RECORDER**  
**COMPANY**

® A registered trademark of Houston Instrument

DIVISION OF BAUSCH & LOMB

ONE HOUSTON SQUARE (at 8500 Cameron Road) AUSTIN, TEXAS 78753  
(512) 837-2820 TWX 910 - 874-2022 cable HOINCO

EUROPEAN HEADQUARTERS Telecopier  
Rochesterlaan 6 8240 Gistel Belgium  
Phone 059 / 277445 Telex Bausch 81399

OEM DISCOUNT

*Be sure to ask about our unique module trade-in plan.*

INFORMATION RETRIEVAL NUMBER 113







## COMPONENTS

### Electrolytic's temp extended -70 to 150 C

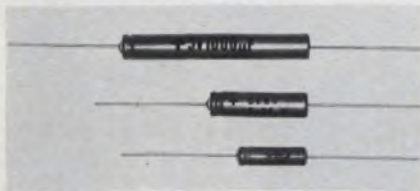

United Chemicon, Inc., 731 James St., Syracuse, NY 13203. (315) 474-2954.

The subminiature electrolytic capacitor, developed jointly by United Chemicon and its parent company, Nippon Chemical Condenser in Tokyo, Japan, extends the current maximum temperature range for aluminum electrolytics down to -70 C and up to +150 C. The developers thus state, "the potential life of this capacitor and its reliability at 85 C can be increased about 50 times compared with the current standard product." The new capacitor meets the requirements of MIL-C-39018. Rated voltages range from 6.3 through 50 WV and capacitance from 10 to 1000  $\mu$ F.

CIRCLE NO. 369

### Hollow-rotor motors give more torque



Micro Switch, 11 W. Spring St., Freeport, IL 61032. (815) 232-1122. \$12 (OEM qty).

A new line of miniature hollow-rotor motors, the 28EM series, with the addition of only 2 mm to the housing diameter of an earlier motor line, achieves 15% more torque. The motors also feature a higher torque-to-inertia ratio, high efficiency, low starting voltage and low ripple torque, according to the manufacturer. They come with a wide variety of voltage ratings, and all models feature silver and gold contacts and protective epoxy-coated housings.

CIRCLE NO. 370

# UNIVERSAL



FOR DIGITAL MEASUREMENT OF FREQUENCY, RATIO OR PERIOD

# PANEL COUNTER

VERSATILITY... is designed into this new Model 6130 digital panel counter. It's fully programmable into seven operating modes: Frequency (9999.9 Hz to 999.99 KHz), frequency ratio, period, period average, time interval, accumulate, and stop watch. Features of the 6130 include sixteen selectable time base periods from 1  $\mu$ s to 1 hour, five bright 13 mm LED digits, opto-isolated or TTL inputs and a DIN standard case.

When you add it all up it's your best buy in a panel counter at \$250.00. Ask for a demonstration.

#### FOR IMMEDIATE RESPONSE:

Call us collect at:  
(714) 540-5486  
Or, write us at:  
630 East Young Street  
Santa Ana, California 92705



INFORMATION RETRIEVAL NUMBER 115

# Dearest Darlington



For space, and weight saving designs the high gain 2N6282 thru 87 series of STC monolithic NPN and complimentary PNP Darlington Power Transistors feature a gain of 100 at 20 Amps, and VCEO sus. up to 100 Volts.

Whatever your power transistor needs you can get the *RIGHT* one.

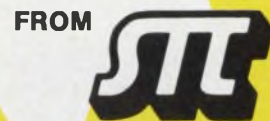

**SILICON TRANSISTOR CORP. ... THE POWER SOURCE**

KATRINA ROAD, CHELMSFORD, MA 01834 (617) 256-3321

Get complete data on these and other STC Power Transistors

INFORMATION RETRIEVAL NUMBER 116



# Hot Semis? Get relief fast!



**IERC**



**Heat Sinks**

INTERNATIONAL ELECTRONIC RESEARCH CORPORATION/A SUBSIDIARY OF DYNAMICS CORPORATION OF AMERICA/135 WEST MAGNOLIA AVENUE, BURBANK, CA 91502

INFORMATION RETRIEVAL NUMBER 117

## Electronic Cabinets & Cases by PREMIER METAL PRODUCTS CO.

337 Manida St., Bronx, N.Y. 10474/(212) 991-6600

OVER 1300 ITEMS IN OUR CATALOG



Complete catalog  
and prices on request.



INFORMATION RETRIEVAL NUMBER 118

## COMPONENTS

### Inductor, delay-line kit covers wide range

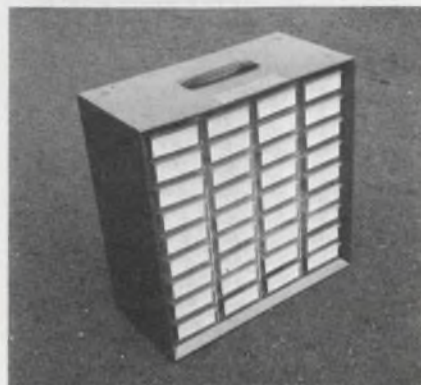

*Nytronics Components Group, Inc.,  
Orange St., Darlington, SC 29532.  
(803) 393-5421. \$529.50.*

Particularly useful to design and application engineers, this kit contains a comprehensive offering of variable inductors, shielded inductors, unshielded inductors, chip inductors and Nytronics' Wee-Bit delay lines. A total of 622 components cover a wide range—1 to 10,000  $\mu$ H and 10-to-200-ns delays. If priced individually, the total value of the components would exceed \$2200.00.

CIRCLE NO. 371

### Cam switches externally adjustable

*Precision Mechanisms Corp., 44  
Brooklyn Ave., Westbury, NY  
11590. (516) 333-5955. \$31 to \$85  
(unit qty); stock to 2 wks.*

For applications such as timing and control, conventional plate-cam switches require tedious internal cut-and-try adjustments and skilled personnel. The PMC cam switch combines the functions of an adjustable plate-cam, cam follower and snap-action switch in a single unit. It features external screwdriver adjustment for any on/off angles 3 to 357 degrees, even while the shaft is rotating. Preganged up to 12 independently adjustable switches—of SPDT, DPDT or two-circuit double-break types operate to 750 rpm over temperature ranges from -65 to 250 F. Standard ratings are 5 A at 250 V ac or 30 V dc and 25 A at 480 V ac; special ratings to 600 V ac. Large units have calibrated dials that are readable to better than 1 degree.

CIRCLE NO. 372



# What we standardized. And what we didn't.

Teradyne's Module Library is a complete, yet flexible, wire-wrappable interconnection system. Growing out of Teradyne's long experience in constructing electronic packaging systems to order, the Library's field-proven components form a system that enables you to move quickly into production without losing time in designing, ordering, and then waiting for packaging to be built.

Naturally, sizes have been standardized. 19" EIA interconnect files are available in single and double row configurations and in two heights. Families of pluggable modules designed to interface to .6" and 1.2" connector spacings add to the Library's flexibility.

The Module Library is no snap-it-together rig. Instead, it's a meticulously designed system built to combine all the elements often overlooked or compromised in standardized packaging.

Examine the file. You'll find a durable component engineered with unique concern for precise module guidance, vibration suppression, proper grounding, and power distribution.

Teradyne precision is evident in the families of digital, analog and interface pluggable modules. All incorporate unique provisions for heat sinking, noise suppression, and contact protection.

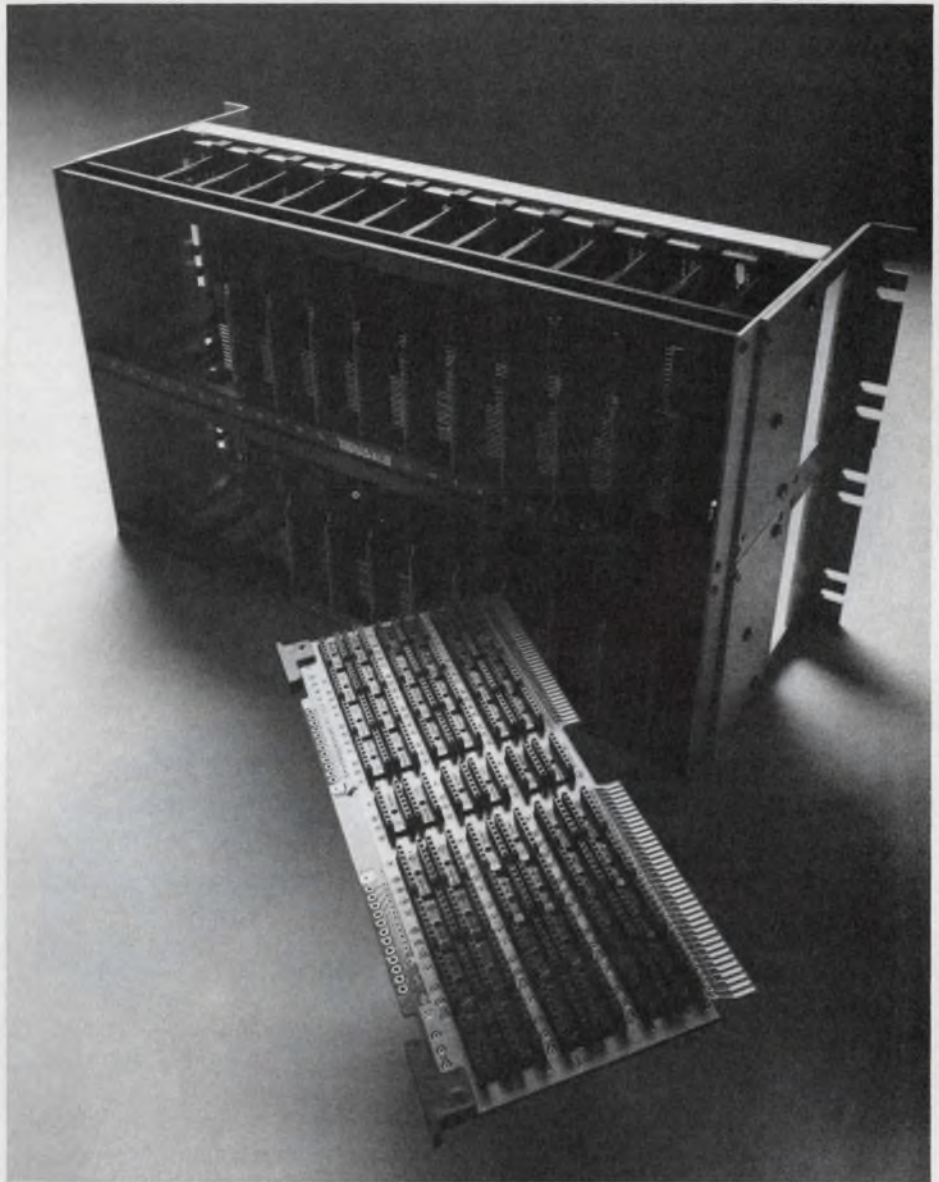

In short, standardized packaging of this quality is long overdue.

To serve you better, we've prepared a versatile 48-page catalog that tells you just about everything about our standardized packaging. Write for a free copy. Or dial (617) 454-9195.

## TERADYNE

ED

Maybe I should spend a night in the Library. Send me your catalog on standardized packaging.

Name \_\_\_\_\_  
Company \_\_\_\_\_  
Address \_\_\_\_\_  
City \_\_\_\_\_  
State \_\_\_\_\_ Zip \_\_\_\_\_  
Teradyne Components, 900 Lawrence St.,  
Lowell, MA 01852. ATTN: Tom Neavitt

INFORMATION RETRIEVAL NUMBER 119



**What you  
SEE IS  
ALL  
you carry.**



Model 1920A

**520 MHz ..... \$860\***



Model 1920A-13

**1000 MHz .... \$1055\***



Model 1920A-14

**1250 MHz ..... \$1155\***

**Fluke's newest  
portable counters.**

- Built-in batteries (optional)
- Sharp 9-digit LED display
- Burst or CW frequency measurements
- Sensitivity to 15 mV; AGC standard
- Optional resolution multiplier provides 0.001 Hz resolution in 1 sec.

For data out today, dial our toll-free number, 800-426-0361.

\*Domestic U.S.A. Price

**John Fluke Mfg. Co., Ltd.**

P.O. Box 1094, Station D  
Buffalo, N.Y. 14210  
Phone (716) 842-0311



INFORMATION RETRIEVAL NUMBER 120

**PACKAGING & MATERIALS**

**Heating elements have  
very low profiles**

*Photofabrication Technology, Grenier Industrial Village, Londonderry, NH 03053. (603) 668-4002. From \$10.25 (10 to 25).*

Thin and flexible heaters provide thermal control for electronic, fluidic and optical systems. They are constructed of polyimide or glass-reinforced silicone, are available in thicknesses from 0.001 to 0.04 in. and have power ratings from 50 mW/sq. in. to 50 W/sq. in. Alloys are available with positive tempco to provide temperature feedback for controllers and RTDs with resistance to 3 kΩ/sq. in.

CIRCLE NO. 373

**Card-edge connectors  
provide 24 contacts**



*Hugh H. Eby Co., 4701 Germantown Ave., Philadelphia, PA 19144. (215) 842-3000.*

The CE-CON Series 93 miniature card-edge connector has 24 contacts. It is specifically designed for flat cable or printed-circuit board solder terminations. The monoblock connector can accommodate a 0.062-in. thick printed-circuit board and the entry design prevents any overstressing or deforming of contacts. The bifurcated bellows type contacts, which will withstand a minimum of 500 insertions, are located on 0.1-in. centers and are made of gold-plated, spring-temper phosphor bronze. The housing is glass-filled diallyl phthalate. Also available is a free-standing nylon printed-circuit card guide, which can be used in conjunction with the connector.

CIRCLE NO. 374

**DIRECT FROM STOCK  
5V3A**

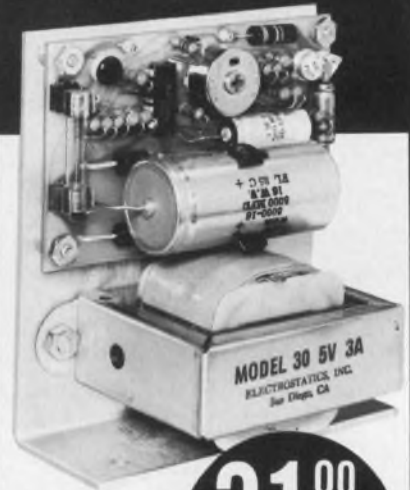

**31<sup>00</sup>**  
(1-9)  
\$23.70 - 100 pcs.

**Excellent regulation  
and ripple.**

**SPECIFICATIONS**

Size: 4 x 4.5 x 2.75 overall  
Input: 105-125V, 47-420 Hz  
Output: Any DC voltage 3 to 30  
Regulation: Line — 0.005%  
Load — 0.05%  
Ripple: Less than 250 Microvolts  
Temp: Operative —40 to +71°C  
Storage —65 to +85°C  
Coefficient —0.01%/°C Max.  
Current Limiting: Fixed Foldback Type  
Overvoltage: Optional

| MODEL | VOLTAGE | AMPS |
|-------|---------|------|
| 30-5  | 5.0     | 3.0  |
| 30-10 | 10.0    | 1.8  |
| 30-12 | 12.0    | 1.5  |
| 30-15 | 15.0    | 1.2  |
| 30-24 | 24.0    | 1.0  |
| 30-28 | 28.0    | 1.0  |

**ORDERING INFORMATION**

| QUANTITY | PRICE   | WITH O.V. |
|----------|---------|-----------|
| 1-9      | \$31.00 | \$36.00   |
| 10-24    | 29.20   | 33.70     |
| 25-49    | 26.60   | 29.90     |
| 50-99    | 25.10   | 28.20     |
| 100-     | 23.70   | 26.90     |

CALL (714) 279-1414 FOR DELIVERY

**Electrostatics, Inc.**  
7718 CLAIREMONT MESA BLVD • SAN DIEGO, CA 92111

INFORMATION RETRIEVAL NUMBER 121



## Heat dissipators boost power by over 2 W

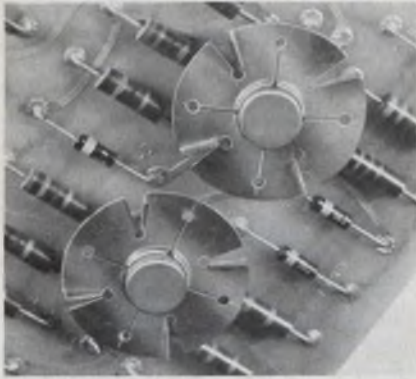

Unitrack Div., Calabro Plastics, Inc., 8738 W. Chester Pipe, Upper Darby, PA 19082. (215) 789-3820. Under 10¢ (moderate qty.); stock.

The Kooler-Kollar heat sink provides an increase in heat dissipation for TO-5 cases of almost 2 W at 90 C. When two Kooler-Kollars are mounted to one can, an increase of better than 2 W is produced. The Kooler-Kollar is simply slid down onto the can. By a unique slitting arrangement the collar grips circumferentially and prevents accidental removal.

CIRCLE NO. 375

## Parts marking machine handles almost any part

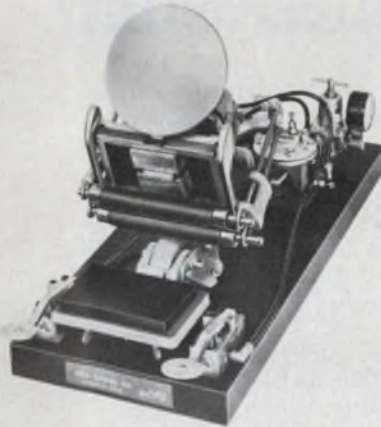

Allen Avionics, 224 E. 2nd St., Mineola, NY 11501. (516) 248-8080. \$498; 6 wk.

An air operated offset marking machine provides a convenient way to mark electronic parts. Almost any shaped object can be pressed or rolled across the offset pad to receive a sharply defined label. The Offset Marker is portable, weighs less than 30 lb., and is available with either foot controls or automatic cycling.

CIRCLE NO. 376

## Manual lead bender gives consistent bends



Azar Associates, 1405 Civic Center Dr., Santa Clara, CA 95050. (408) 249-0600. \$4.95; 30 day.

The 371A bending tool forms leads on 1/8, 1/4, 1/2, and 2-W resistors, and all other similarly sized components for prototype, production or repair work. Bend lead spacings are selectable from 0.3 to 1 in. on 0.05-in. increments. Components are automatically centered, and all bend radii meet NASA standards. Cutting flush across the bottom provides uniform 0.125-in. lead extensions. Over-all length of the tool is 8 in.

CIRCLE NO. 377

## Highest Performance with Lowest Cost per channel

Bell & Howell is introducing two new series of magnetic tape recorder/reproducers. Descendants of a line of high performance, rugged application recorders, these laboratory quality units deliver up to 14 channels with impressive savings. As low as \$1089 per channel.

Let us tell you how we do it.

DATATAPE DIVISION

300 Sierra Madre Villa, Pasadena, California 91109



**BELL & HOWELL**



INFORMATION RETRIEVAL NUMBER 122

ELECTRONIC DESIGN 24, November 22, 1975

MEMORY SERIES NO. 14

## 6 THINGS TO DO WITH OUR FPLA'S.

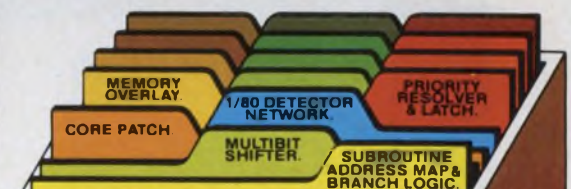

(BET YOU'LL THINK UP MORE.)

Just a few applications where the 16 inputs, 50ns speed, and optimized chip enable of our Field Programmable Logic Arrays provide major design/performance improvements.

Coupon clipped to letterhead gets you detailed applications data on FPLAs #82S100 (TriState) & #82S101 (Open Collector)

Name \_\_\_\_\_

Tel \_\_\_\_\_

Ext \_\_\_\_\_

Rush me sample parts quote

THINK

**Sinnetics**

311 E. ARQUES SUNNYVALE CALIF 94086

INFORMATION RETRIEVAL NUMBER 123

197



## IS YOUR AC METER TELLING YOU LIES?

If you're measuring anything other than undistorted sine waves, you need an instrument that reads out true RMS values.

Most people think that any AC DPM or DMM does this. But they don't. They read the rectified average value of the input, calibrated to the RMS value of a sine wave.

But now there's the AD2011. The first DPM to use implicit computing techniques to read true RMS values of AC signals. And it costs just \$295.

So why not write for the data sheet for the truth about true RMS. Analog Devices, Inc., Norwood, Mass.

02062. East Coast:

617-329-4700. Mid-

west: 312-894-3300.

West Coast:

213-595-1783.

Texas: 214-

231-5094.

 ANALOG  
DEVICES



INFORMATION RETRIEVAL NUMBER 125

## mammoth power miniature price



**1350w** RMS, 4 $\Omega$ . Forever. The M-600 won't blow up, quit or sulk no matter how you hook it up. Put two together for 2700w, 8 $\Omega$ . Also forever.

It's cheap. \$1,695 of the best quality amplifier you can buy. Others in the DC-20KHz range may cost you more, but they won't do more. Write for your free copy of M-600 performance specs.



**crown** INTERNATIONAL

1718 W. MISHAWAKA ROAD ELKHART, INDIANA 46514 219-294-5571

INFORMATION RETRIEVAL NUMBER 126

## PACKAGING & MATERIALS

### Plastic coating resists acids and alkalis

*Aremco Products, Inc., P.O. Box 429, Ossining, NY 10562. (914) 762-0685. \$42/gallon (50 gal. lots); stock.*

Aremco-Coat 545, a high temperature plastic coating, operates safely at 400 F. It can also withstand intermittent use at 600 F. The material can be applied by brushing or spraying and will stand up to alkali solutions such as 40% sodium hydroxide, magnesium hydroxide, 10% potassium hydroxide, calcium hydroxide, 50% sodium carbonate and tri-sodium phosphate. The coating will repel acid solutions such as 50% sulphuric, concentrated hydrochloric, 50% oxalic, 30% phosphoric and stand up to solvents such as alcohol-methyl, ethyl, isopropyl, butyl and gasolines.

CIRCLE NO. 378

### Flameless spot bonder wipes out heat problems

*Laurier Associates, Inc., 550 Newton Rd., Littleton, MA 01460. (617) 486-8100. \$1675; 4 wk.*

The HG730 hot gas bonder makes possible fast, safe, precision bonding and/or replacing of semiconductor components on circuit substrates. The unit uses a low-temperature heated air or nitrogen instead of 5000° hydrogen flames as with most other spot bonders. Water formation and leaching problems are also minimal. The bonder allows precision spot heating in areas as small as 0.02 in. Gold/silicon and gold/tin semiconductor die attachment to substrates without excessive heat is possible. Multilead components or semiconductor chips can be removed or attached without damaging adjacent components. Epoxy-mounted chips can also be removed quickly without damage to the substrate. A temperature-controlled preheater is supplied with the unit to prevent thermal shock to substrates. Other optional equipment available includes a 10 to 20 power microscope. The HG730 measures 15 × 15 × 12 in. and operates from 110 V ac.

CIRCLE NO. 379



# TKC® STACKING CONNECTORS FOR MICROPROCESSOR INSTALLATION



### Solderless Stacking Connectors

Connectors available with through holes and threaded inserts... various contact platings... and the number of contacts and spacing to match requirements. (Also: solder pins for thru-board mounting.)

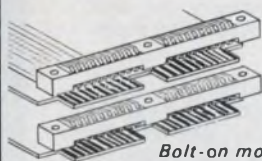

Bolt-on models can be stacked as deep as required to hold PC boards rigidly parallel.

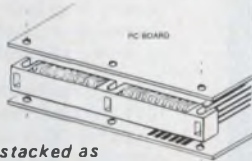

### FEATURES

- Easy mounting... low assembly costs • CONE-POINT® contacts for positive connection • Gold or tin-plated special alloy contacts • Two mounting methods: bolt-on or solder-post
- Rugged, glass-filled phenolic body • CUSTOM DESIGN AT OFF-SHELF PRICES

**TELEDYNE  
KINETICS**

410 S. Cedros Ave.  
Solana Beach, CA 92075 • (714) 755-1181  
TWX (910) 322-1135

INFORMATION RETRIEVAL NUMBER 127

# PHOTO ETCH PRINTED CIRCUIT KIT

Makes circuits **THREE WAYS**

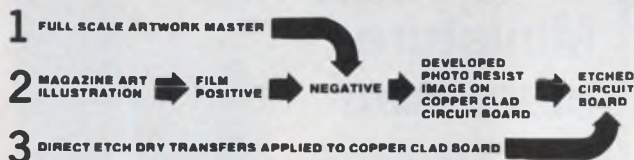

**NO** CAMERA  
DARKROOM  
FILM CUTTING  
TRACING

**USES DATAK'S POS-NEG PROCESS**  
The revolutionary photographic way  
that makes **PERFECT** printed circuits  
from original art or a printed page.

KIT CONTAINS: 5" x 8" steel printing frame; 4 sheets 5" x 8" photocopy film; yellow-liters; chemicals for 1 pint film developer and 1 pint film fixer; 3" x 8" copper clad board; 3" x 4 1/2" copper clad board; spray can of photo etch resist; 1 pint resist developer; 2 sheets 8 1/2" x 11" layout film; 1 roll 1/16" printed circuit tape; 1 roll 1/32" printed circuit tape; 8 sheets dry transfer direct etch PC patterns including pads, transistors, round can and flat pack ICs; DIP ICs; edge-card connectors; rings, circles, logs, etc.; 10 anhydrous ferric chloride to make 1 pint etchant; instructions.

|  |       |         |
|--|-------|---------|
| ER-4 COMPLETE PHOTO ETCH SET               | ..... | \$24.95 |
| ER-2 PC patterns and tapes — refill        | ..... | 3.39    |
| ER-3 1/4 pound dry etchant — refill        | ..... | 1.25    |
| ER-5 6 sheets photocopy film — refill      | ..... | 3.39    |
| ER-6 Film process chemicals — refill       | ..... | 1.79    |
| ER-7 Photo resist spray, 2.5 oz. — refill  | ..... | 2.95    |
| ER-8 Resist developer, 16 oz. can — refill | ..... | 2.95    |

AT YOUR DISTRIBUTOR OR DIRECT

the **DATAK** corp.  
65 71st St. • Guttenberg, N. J. 07093

INFORMATION RETRIEVAL NUMBER 128

ELECTRONIC DESIGN 24, November 22, 1975

# Complete 12 Bit D/A

Micro Networks MN3200 Series  
of thin film hybrid converters  
are the industry's first low cost  
family of "complete" 12 bit D/A's.

\*100 pc. quantity

These converters incorporate the internal reference and output amplifiers — and are totally adjustment free. The converters guarantee  $\pm 1/2$  LSB linearity from 0 to 70C as well as monotonic performance because of the laser trimmed ultra-stable nichrome resistor networks employed.

Other salient features of the MN3200 are:

- User Selectable Output Ranges.
- Hermetic Sealed Dip.
- Unipolar (MN3200), Bipolar (MN3201) and BCD (MN3202).

The MN3200 Series are available for immediate delivery.

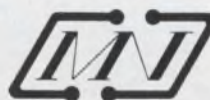

For complete data  
write or call —  
Jerry Flynn:  
Tel 617 852-5400.

**MICRO NETWORKS  
CORPORATION**

324 Clark Street • Worcester, Mass. 01606

INFORMATION RETRIEVAL NUMBER 129



# DRIREED RELAYS



GENERAL PURPOSE



LOW SILHOUETTE



DIP



RUGGED-MIDSIZE



RUGGED DUTY



CURRENT SENSORS

Immediate Availability from Stock or Custom Designed for Your Application

- 6 to 26 VDC coils
- Contact ratings to 200 VDC
- Gold alloy or rhodium contacts
- $5 \times 10^6$  operations at rated load
- Low in cost, High in value!

Write Today for Complete Catalog



controls, incorporated  
Mathews Ave., Canton, Miss. 39046  
(601) 859-5511/TWX (810) 990-0938

INFORMATION RETRIEVAL NUMBER 130

# PRECISION LOAD CELLS FOR TESTING, WEIGHING, FORCE MEASUREMENT



Specify Interface... offering industry the most innovative and comprehensive selection of superior load cells available.

Industry standards for accuracy, stability, versatility and cost have been established by Interface... providing a complete line of load cells for electronic weighing, testing or force measurement applications—in any industry! With standard ranges from 5 pounds to 100 tons, these load cells combine extremely high accuracy with low installed cost.

## Interface

7401 East Butherus Drive/Scottsdale, Arizona, USA 85260  
Telex: 668-394 Telephone: (602) 948-5555

INFORMATION RETRIEVAL NUMBER 132

Introducing the end of the educated guess in testing of AC/DC voltages, current, decibel and resistance.

For quicker, easier, more accurate electrical tests... select the

## MERATESTER

Check these features:

- 100 M $\Omega$  input resistance • accurate to 1.5% AC/DC • 80 ranges • floating input for absolute user safety • full overload protection • 90 db common mode rejection factor • 1.5 mV to 50 kV FSD/AC/DC with probe
- battery or power line operation • 150 mm/6" Mirror backed scale • 0.15  $\mu$ A to 150 A AC/DC FSD with shuntbox • resistance ranges to 1000 M $\Omega$
- completely portable
- supplied in a lined leather carrying case

DEALER INQUIRIES INVITED



SEND FOR CATALOG

INTERNATIONAL BUSINESS SYSTEMS, INC.

2522 18th Street, Racine, Wisconsin 53403

Name \_\_\_\_\_ Title \_\_\_\_\_

Company \_\_\_\_\_

Address \_\_\_\_\_

City \_\_\_\_\_ State \_\_\_\_\_ Zip \_\_\_\_\_

Phone \_\_\_\_\_  User  Dealer

INFORMATION RETRIEVAL NUMBER 131

# Free!

Axial-Radial

## Miniature aluminum electrolytic capacitor catalogs.

Capacitance values from .47 mfd through 10,000 mfd and voltages from 6.3V. to 100V. are readily available. Operating temperatures are from  $-40^{\circ}\text{C}$  to  $+85^{\circ}\text{C}$  at full rated voltage.

OTHER PRODUCTION ITEMS: Computer Grade Aluminum Electrolytics, Ceramic Capacitors, Film Capacitors, Oil Filled Capacitors—without P.C.B., Metallized Paper Capacitors, Wax Paper Capacitors, Mica Capacitors, Hybrid IC's and P.T.C. Thermistors.



nichicon We help keep your world turned on.

NICHICON AMERICA CORPORATION

Division of NICHICON CAPACITOR LTD., Kyoto, Japan  
6435 N. Proesel, Chicago, Ill. 60645 (312) 679-6530  
40 Orville Dr., Bohemia, N.Y. 11716 (516) 567-2994

INFORMATION RETRIEVAL NUMBER 133

ELECTRONIC DESIGN 24, November 22, 1975



## PACKAGING & MATERIALS

### Terminal blocks come in many styles and shapes



*Electrovert, 86 Hartford Ave., Mount Vernon, NY 10553. (914) 664-6090. From \$3.50; stock.*

A line of modular rail mounted terminal blocks includes a wide selection in a variety of sizes, ratings and types. These include fuse, disconnect, test, compensating, ground, miniature sizes as well as several unique designs such as a two-tier space-saver. The units are molded of Polyamid 6.6 and have all terminal screws deeply recessed. No metal parts are exposed to eliminate any danger of shorting and to offer complete safety in handling. As many as 64 blocks rated at 600 V are capable of being assembled per foot.

CIRCLE NO. 380

### BNC dust caps include 3-1/8-in. chain



*Pomona Electronics, A Div. of ITT, 1500 E. Ninth St., P.O. Box 2767, Pomona, CA 91766. (714) 623-3463. \$1.50; 1 wk.*

The Model 4157 female dust cap protects BNC plugs from dirt and accidental shorting. Key features include a nontarnish finish, a 3-1/8-in. bead chain, and a 0.28-in. diameter hole in the lug. Other accessories such as molded patch cords, cable assemblies, test socket adaptors and molded test leads are also available.

CIRCLE NO. 381

### Ultra-mini connectors have 4, 7 or 12 pins

*Microtech, Inc., The Park Square Bldg., 777 Henderson Blvd., Folcroft, PA 19032. (215) 532-3388. From \$0.95; stock.*

Four, seven and 12-pin ultra-miniature cable-connector combinations provide high density packaging, and extreme miniaturization required by many applications. The outer diameters are only 0.11, 0.12 and 0.14 in. for the 4, 7 and 12-conductor cables, respectively. The cables consist of Teflon insulated stranded AWG 30 wires, a silver-plated copper shield and an extruded-Teflon outer jacket. The connectors use 1/4-28, 5/16-24 and 3/8-24 threads for the four, seven and 12-contact connectors, respectively. All bodies, pins and sockets are gold-plated brass, the dielectric inserts, TFE Teflon and the washers, silicone rubber.

CIRCLE NO. 382

### PC-card cages handle 3.5-to-9.25-in. cards



*Unitrak Div. Calabro Plastics, 8738 West Chester Pike, Upper Darby, PA 17082. (215) 789-3820. From \$23; stock.*

Ten standard-sized PC-card cages in the Versacage series are available for use with standard 19-in. cabinets. PC cards from 3.5 to 9.25 in. wide and up to 9.75 in. deep, both single and double rows, can be housed in the cages. The cages use heavy-gauge end-plates with slots for adjustment. Also, cards can be spaced on 0.2, 0.5 and 0.75-in. centers. Another connector bar mounting bracket permits assembly of connectors as a unit for wrapped-wiring to be used, or as a frame assembly to hold a back plane. All parts (except the card guides) are iridited aluminum.

CIRCLE NO. 383

## LOW $X_L$ @ UHF



### NOW HEAR THIS ...

Connect to your microstrip circuitry with ATC low inductance MS (microstrip) silver leaded capacitors . . . .

Take advantage of the stable, low  $R_s$ , ATC line of capacitors in an "easy on production" configuration.



### ...AND GET THIS FREE

MINI MARKUS or your postman will deliver your free sample of an ATC 100-B-300-J-MS [that's 30 pf]. Just circle the number below.

For samples of other lead styles and capacity values, call Ralph Wood (516) 271-9600.

**american technical ceramics**

ONE NORDEN LANE,  
HUNTINGTON STATION, NEW YORK 11746  
516/271-9600 • TWX 510-226-6993

INFORMATION RETRIEVAL NUMBER 134



# PM MAGNETIC SHIELDS

**Immediate Delivery- For Over 90% Of Current Photomultiplier Tube Types**

These high permeability AD-MU magnetic shields are fully hydrogen annealed, ready for use. Already tooled—no tooling cost.

For your special application or specific environment, our Problem Solving Magnetic Shielding Specialists can either modify a stock shield, or custom design a shield to your exact requirement.

18 pages of advanced shielding techniques and components.

Also 4-Page Reprint from Electronic Design. Yours for the asking.



## AD-VANCE MAGNETICS, INC.

226 E SEVENTH ST. ROCHESTER, IND. 46975  
(219) 223-3158 TWX 810 290 0294

Our 3rd Decade of Magnetic Shielding Leadership

INFORMATION RETRIEVAL NUMBER 135

## INTEGRATED CIRCUITS

### Timers double as frequency generators

*Intersil, 10900 N. Tantau Ave., Cupertino, CA 95014. (408) 257-5450. \$3.25 to \$4.00 (100-999).*

A family of monolithic programmable counter-timers—the 8240, 8250 and 8260—can generate accurate, externally settable time delays from microseconds to five days. The circuits can also count external pulses, and be used as frequency generators, putting out 99 or 256 selectable frequencies. The 8260 performs its timing function in seconds, minutes and hours. The 8250 counts in decimal terms, while the 8240 uses straight binary counting.

CIRCLE NO. 384

### FIFO memories store 32 words

*Plessey Semiconductors, 1674 McGaw, Santa Ana, CA 92705. (714) 540-9979. \$19.40 (100); stock.*

A pair of first-in, first-out (FIFO) memory devices, the MP3812 and MP3813, stores 32 eight-bit and 32 nine-bit words, respectively. The new circuits second source Advanced Micro Devices' Am2812 and Am2813 units. The MP3812 features serial I/O buffers with serial-bit inputs and outputs shifted up to 3 MHz by an external clock. The devices come in 28-pin DIPs, and they operate from +5 and 12-V supplies.

CIRCLE NO. 385

### Voltage reference holds drift to 10 ppm/°C

*Analog Devices, Route 1 Industrial Park, P.O. Box 280, Norwood, MA 02062. (617) 329-4700. \$5.75 to \$25.00 (100); stock.*

A temperature-compensated voltage reference guarantees 10-ppm/°C temperature coefficient and 25- $\mu$ V/month stability. The AD580 three-terminal bandgap reference provides a fixed 2.5-V ( $\pm 1\%$ ) output for inputs between 4.5 and 30 V without any external components. Other features are a 1.0-mA maximum quiescent current and a 6- $\mu$ s turn-on time.

CIRCLE NO. 386

**TRY IT FOR 2 WEEKS... MONEY BACK GUARANTEE!**  
**SHORTS... OPENS... MISWIRES LOCATED INSTANTLY... ACCURATELY!**

New Cable-CHEK, a low cost cable and harness tester/assembly aid, will pay for itself in months and save plenty. Just plug cables under test into receptacles. Touch probes to other end. Pin number will appear on large, easy-to-read digital display. Digits will continue to cycle, showing where wire goes... if it's open... if it's short... and which wires it is shorted to. Faster, more accurate and less expensive than any comparable unit made today. Order your Cable-CHEK today.

**cable.//**

CT-100, 100 point capacity, \$290 complete.

**norfield electronics inc**  
3 Depot Place, E. Norwalk, CT 06855  
Telephone: 203/853-2777

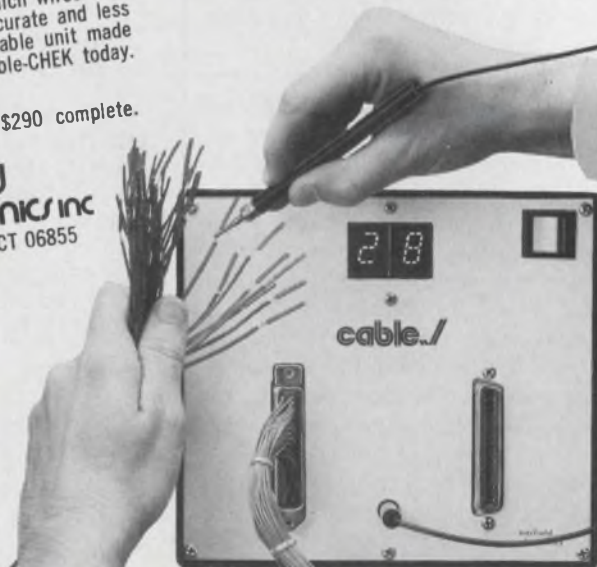

INFORMATION RETRIEVAL NUMBER 136



## Crosspoint switch has -94-dB crosstalk



Motorola, P.O. Box 20924, Phoenix, AZ 85036. (602) 244-3466. \$7.95 (100); stock.

A monolithic crosspoint switch, intended for use in telephony, employs dielectric-isolation techniques to obtain a typical crosstalk of -90 dB at 20 kHz. A four-pair by four-pair matrix, the circuit uses SCRs as switching elements. And these are selected by row and column control lines that are compatible with both CMOS and TTL logic levels. Other specs include OFF resistance of at least 100 MΩ, typical breakdown voltage of 30 V, and an SCR gate current of 1 mA typical. The unit comes in a 24-pin DIP.

CIRCLE NO. 387

## 16-pin DIP houses 4-k dynamic RAM

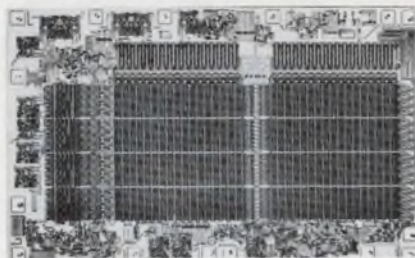

Intel Corp., 3065 Bowers Ave., Santa Clara, CA 95051. (408) 246-7501. \$15.00 to \$21.60 (100-999); stock.

Packaged in a 16-pin DIP, the Model 2104 4096-bit dynamic RAM has a worst-case access of 250 ns and a read or write cycle of 400 ns (suffix-2 version) over the 0-to-70-C temperature range. Other features include TTL-compatible levels for clocks, address, chip select, data and write-enable inputs, and a three-state, TTL output. The memory requires ±5 and +12-V supplies. Package pinouts are the same as Mostek's Model MK4096. Intel's chip measures only 108 × 176 mils.

CIRCLE NO. 388

## Quad 741-type amp reduces input noise

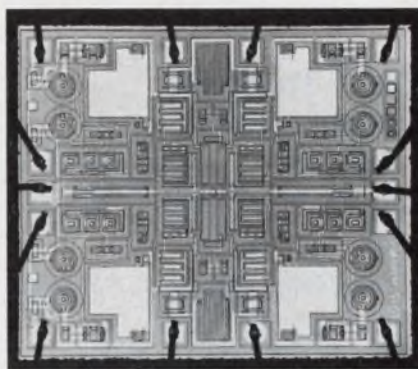

Harris Semiconductor, P.O. Box 883, Melbourne, FL 32901. (305) 727-5407. \$2.48 to \$4.60 (100).

A monolithic quad 741 op amp, the HA-4741, combines a 3.5-MHz bandwidth and 1.6-V/μs slew rate with a 9-nV/√Hz input voltage noise. Other features include supply current maximums of 5.0 mA for a MIL temperature-range version and 7.0 mA for the commercial part. The HA-4741 has true differential inputs, and crossover distortion isn't detectable even at 50 kHz, according to the company.

CIRCLE NO. 389

## New Low Cost TIME CODE GENERATOR/READER



Time Code Reader ..... \$890.  
Generator/Reader ..... \$1265.

The new LOW COST Series 9000 Time Code Units generate and read serial IRIG Time Codes used in analog magnetic tape instrumentation, hard wire transmission and telemetry systems. In addition, they provide buffered parallel BCD outputs, TTL compatible, for digital storage devices and computer inputs. Options include Multi-code units, Day-of-Year Calendars and Millisecond BCD outputs.

Write or call Chrono-log Corporation, 2 West Park Road, Havertown, Pa. 19083, (215) 853-1130



INFORMATION RETRIEVAL NUMBER 138

ELECTRONIC DESIGN 24, November 22, 1975

MEMORY SERIES No. 8

## INTERFACE SAVERS: 20 TTL COMPATIBLE MOS SHIFT REGISTERS



In stock now, and in love with TTL, our MOS registers save on go-betweens. Zero interface cuts parts and power costs. Max design flexibility, all from one source: 20 gives you plenty to pick from.

FREE Short Form Catalog lists all 20 MOS S-Rs. Clip coupon to letterhead for your copy.

Name \_\_\_\_\_  
Tel \_\_\_\_\_ Ext \_\_\_\_\_

**THINK**

# Signetics

811 E. ARQUES, SUNNYVALE, CALIF 94086

INFORMATION RETRIEVAL NUMBER 139

203







# What we would ask the ATE manu- facturers

Systron-Donner, of course, manufactures Automatic Test Equipment. Now, if we were buying instead of selling, here are several questions we would ask:

- How willing is the manufacturer to tailor a system to your unique requirements? Few firms are. However, Systron-Donner is!
- Is the software language easy to use and universally accepted? S-D uses industry-standard, English-like BASIC; a language with which most non-programmers are familiar.
- Who will process my order and provide engineering assistance well after the delivery date? At Systron-Donner, each order is processed by the same technical team with whom you discussed your needs prior to purchase. After delivery technical support? That's right, that same team of S-D hardware and software experts; your team!

Naturally, there are many questions to ask; such as multi-user operation, analog, RF and digital testing; fault tracing, and data logging capability—to mention a few. The point is, in addition to hardware and software questions . . . ask about the people who will give your A.T.E. the personal attention it desires during manufacture and after delivery.

To learn more about Systron-Donner's Model 3600 CATSystem, request our new brochure 3600 by contacting Scientific Devices or Systron-Donner at 935 Detroit Avenue, Concord, California 94518. Phone: (415) 798-9900.

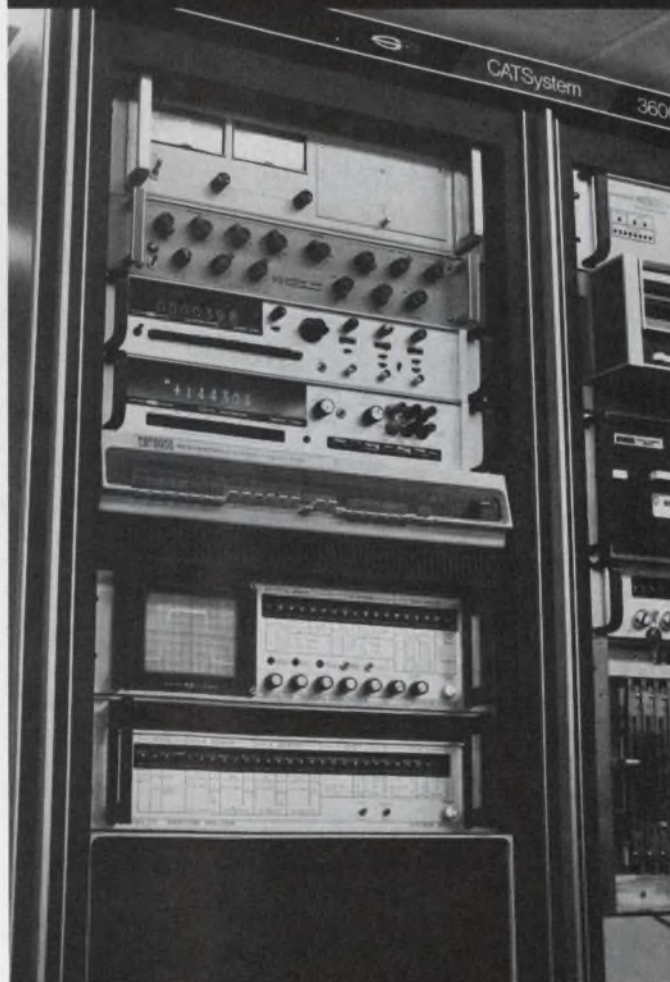

SYSTRON  DONNER

**Request new  
3600 brochure.**



**PROFESSIONAL  
DISCOUNT  
PRICES  
AVAILABLE ON**

**Texas  
Instruments  
Engineering  
Calculators**

**PHONE TOLL FREE  
800-638-8906**  
FOR THE CURRENT LOW DISCOUNT  
PRICE OF THE LATEST MODEL  
TEXAS INSTRUMENTS CALCULATOR  
OF YOUR CHOICE

**TEXAS INSTRUMENTS  
SR-50A**



Performs all classical slide rule functions — simple arithmetic, reciprocals, factorials, exponentiation, roots, trigonometric and logarithmic functions, all in free floating decimal point or in scientific notation. Rechargeable batteries, AC Adapter/Charger and case included.

**TEXAS INSTRUMENTS  
SR-51A**



Performs logarithms, trigonometrics, hyperbolics, powers, roots, reciprocals, factorials, linear regression, mean, variance and standard deviation. Three memories. Scientific notation. 20 preprogrammed engineering conversions. Rechargeable batteries, AC Adapter/Charger and case included.

**ALL THE FAMOUS  
TEXAS INSTRUMENTS  
ELECTRONIC CALCULATORS  
ARE AVAILABLE AT DISCOUNT PRICES**  
Mail and phone orders accepted. Master Charge and BankAmericard accepted. Add \$2.50 per unit for shipping and handling. Maryland residents add 4% sales tax.

Use our toll free phone: **800-638-8906** (Maryland residents phone: **(301) 340-7200**) to order or for current discount quotations on the leading brands of electronic calculators: Texas Instruments, Hewlett-Packard, Rockwell, Ricoh, Kingspoint, Corvus, Novus, and many more.

**THE GUARANTEE**

**10 day money back trial.** If you are not completely satisfied you may return the Texas Instruments calculator you order within 10 days for a cash refund or charge cancellation. In addition Texas Instruments Inc. and Capital Calculator Co. Inc. warrant each calculator for a period of one year against defective parts and workmanship.

**Capital Calculator Company**



Maryland residents phone:  
**(301) 340-7200**

**701 East Gude Drive  
Rockville, Maryland 20850**

**MICROWAVES & LASERS**

**Stripline unit gives  
900°/GHz phase shift**

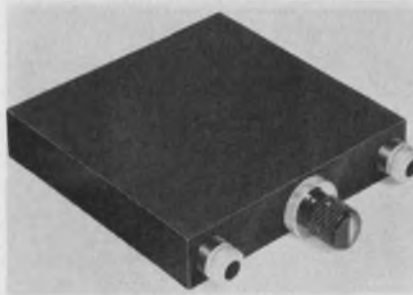

*Sage Laboratories Inc., 3 Huron Dr., Natick, MA 01760. (617) 653-0844. \$500; 60-90 days.*

The FS1784 stripline coaxial phase shifter provides 900 degrees per GHz of phase shift over the dc to 500 MHz frequency range. The unit's VSWR is 1.2 maximum and insertion loss is 1 dB maximum. Each revolution of the shaft provides a phase shift of 14 degrees/GHz. Stop-to-stop, there are 64 shaft turns. The shifter measures 7.95 × 5 × 1 in. and employs a multiple trombone construction.

**CIRCLE NO. 393**

**Comb gen comes  
in small housing**



*TRAK Microwave Corp., 4726 Eisenhower Blvd., Tampa, FL 33614. (813) 884-1411. \$590; 8 wks.*

Measuring only 1.17 × 0.67 × 0.49 in., a compact comb generator covers the 4-to-8-GHz frequency range. Comb spacing is 100 MHz and output power is -25 dBm ±10 dB with an rf input of 100 MHz at 0 dBm. Spurious emission is 40 dB below the lowest comb when measured within ±50 MHz of any comb line. The new unit has an operating temperature range of -55 to +71 C.

**CIRCLE NO. 394**

**1-2.5-GHz amps come  
in small packages**



*Avantek, Inc., 3175 Bowers Ave., Santa Clara, CA 95051. (408) 249-0700. 30 days.*

Two microwave-transistor amplifiers come in compact aluminum cases, measuring only 0.84 × 1.5 × 2.4 in., and weighing less than 4.2 oz. Both amplifiers meet MIL specs for aerospace, ground and vehicle environments. And they provide a minimum of 27 dB gain (±1-dB gain flatness), +10 dBm power output (at 1-dB gain compression) and intercept point of +20 dBm. The AMM-2000 operates from 1 to 2 GHz with a 3.5-dB noise figure and 2.0:1 maximum input and output VSWR, and the AMM-2500 performs to 2.5 GHz with 4.5-dB noise figure, 2.0:1 input and 2.5:1 output VSWR. Power requirements for both amplifiers are +15 V dc and 55 mA.

**CIRCLE NO. 395**

**Power modules  
operate at uhf, vhf**

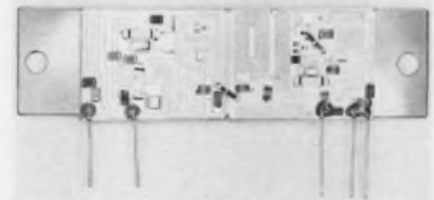

*Motorola Semiconductor Products Inc., P.O. Box 20924, Phoenix, AZ 85008. (602) 244-3466. \$35.65 to \$39.45 (25-100).*

A line of direct, plug-in power modules covers the uhf and vhf ranges. The vhf MHW601/602 modules offer 13 and 20-W output from 12.5-V supplies with 20.6 and 21.0-dB minimum power gain. The uhf MHW401 device has 1.5-W output from 7.5-V supply, while the MHW709/710 series furnishes 7.5 and 13.0-W output from 12.5-V supplies with 15.0 to 19.4-dB gain.

**CIRCLE NO. 396**



# RUBBER/URETHANES

## BONDING & MOLDING

968 W. FOOTHILL BLVD.

AZUSA, CALIF. 91702

213-334-0281

### CUSTOM FABRICATION TO YOUR SPECIFICATION

**RUBBER URETHANE** is a supplier of Precision Rotary Components with the capabilities of manufacturing to customer supplied drawing and specification or designing and recommending methods, materials and compounds in order to better supply superior components at competitive prices.

**RUBBER URETHANE** has the facilities to manufacture individual components, sub-assemblies and complete rotary component assembly packages, thus eliminating the need for separate source purchase increments.

**RUBBER URETHANE** is fully equipped with production machinery to do precision grinding of metal and rubber compounds to .0001 of an inch. **SPECIALISTS** in bonding urethanes to steel, aluminum, magnesium, plastic and other materials.

For a responsible and knowledgeable supplier "let" **RUBBER URETHANE** quote your next specific requirement.



INFORMATION RETRIEVAL NUMBER 143

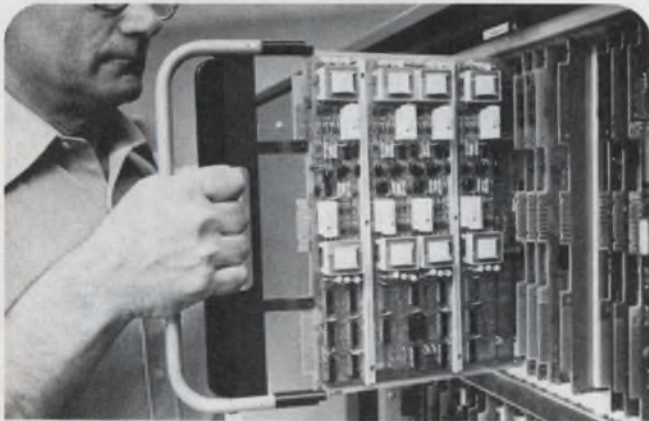

### END CIRCUIT BOARD DAMAGE

Protolab extractors protect expensive circuit boards by positive "balanced force" removal. They exert equal pressure against the card cage and board for smooth, even release. They are fast, certain, convenient . . . and boards stay on the extractor so they won't be dropped on the floor. Pin-mounted Protolab extractors are ideal for large PCB's, or boards with test points, connectors and components mounted near the front edge. Ask about a Protolab extractor for your equipment.

PHONE COLLECT TODAY FOR PRICES (415) 961-8033

### PROTO LAB

295 Polaris Avenue  
Mountain View, California 94043

INFORMATION RETRIEVAL NUMBER 144

ELECTRONIC DESIGN 24, November 22, 1975

we  
do it  
in sunny  
florida!



## Custom Devices

DIVISION OF CONTINENTAL TESTING LABORATORIES INC

### assembles\_\_

- HI REL HYBRIDS
- SEMICONDUCTOR SPECIALS
- ON-SHORE ASSEMBLY (Orlando)
- COMPLETE MIL-STD-883 and 750 TESTING

Ph. 305/834-3340  
763 U.S. Hwy. 17-92. Fern Park, Florida 32730



INFORMATION RETRIEVAL NUMBER 145

207



## MICROWAVES & LASERS

### 0.2-to-18-GHz switches turn off in 20 ns



General Microwave Corp., 155 Marine St., Farmingdale, NJ 11735. (516) 694-3600. \$410 to \$720; 30 days.

Models DM186BH, DM189H and DM190H absorptive SPST p-i-n diode switches come with integrated drivers. The switches operate over the 0.2-to-18-GHz range, and they have nominal isolations of 45, 65 and 35 dB, respectively. Turn-off time is 20 ns, while turn-on is 30 ns. All models can handle 2 W.

CIRCLE NO. 397

### 3.2-GHz rotary joint specs multimegawatts



Sage Laboratories Inc., 3 Huron Dr., Natick, MA 01760. (617) 653-0844. \$2000; 60 days.

The FRJ1840 high-power rotary joint offers 15% to 20% bandwidth at 3.2 GHz. And when pressurized, the joint can handle peak power at the multimegawatt level. However, the unit measures only 9-in. long, and it weighs less than 8 lbs. Seals are provided for operating pressures up to 30 psi with dry air nitrogen or SF<sub>6</sub> for multimegawatt operation.

CIRCLE NO. 398

### Small oscillator outputs 1 W



Trak Microwave Corp., 4726 Eisenhower Blvd., Tampa, FL 33614. (813) 884-1411. \$420; 90 days.

A 1-W crystal controlled oscillator, the 1046/1047 Series, covers the 60-to-1200-MHz frequency range. Designed for either printed-circuit board (1046 Series) or base-plate mounting (1047 Series), the oscillators employ thin-film techniques to achieve a package size of only 1.33 × 1.33 × 0.49 in. Frequency set accuracy at room temperature is ±0.0005% with stability rated at ±0.0025%. Operating temperature range is -54 to +85 C.

CIRCLE NO. 399

## PANCAKE SYNCHROS AND RESOLVERS PROVIDE ...

... Lower cost and higher accuracy in position sensing systems. Gimbal mounted synchros, resolvers and linear transformers are available in various configurations ... single speed accuracies to 10 seconds ... dual and multi-speed units with accuracies to 3 seconds. Other provisions include wide ranges of frequency, voltage, and temperature. Vernitron Control Components, A Division of Vernitron Corp., 2440 W. Carson St., Torrance, Ca. 90501, (213) 328-2504. Write or phone for new 20 page catalog.

### VERNITRON CONTROL COMPONENTS



INFORMATION RETRIEVAL NUMBER 146

# HERE TODAY...

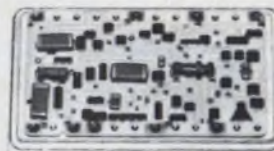

# HERE TOMORROW

For years, NEC Microsystems has quietly demonstrated extraordinary competence and dependability as a supplier of economical, high quality hybrid microcircuits. Let us evaluate your requirements for custom hybrids. We'll do the job right today and we'll still be around when you need us, tomorrow.



**NEC MICROSYSTEMS**  
DIVISION OF NORTH ELECTRIC  
A UNITED TELECOM COMPANY

1150 N. W. 70 ST. FORT LAUDERDALE, FLA. 33309  
PHONE (305) 974-5400 — TWX 510-956-9897

INFORMATION RETRIEVAL NUMBER 147



## Evaluation Samples

### Circuit-board support

The top of an edge retaining "long nose" circuit-board support features a 0.6-in. tapered tip on which the board is snapped. Series EHCBS comes in nylon or flame-retardant material in a choice of eight spacing heights from 3/16-in. to 1 in. Richeo Plastic.

CIRCLE NO. 400

### Terminals

Two types of 0.025-in. square post terminals, designated T51 and T46-4, have fluted shanks to ensure a secure press-fit in 0.042-in. circuit-board holes. The terminal heads protrude 0.030 in. or less above the board. The post on the T51 is 0.20 in. below the circuit board to accommodate one wrap, while the T46-4 has a 0.33-in. long post. The terminals are made of phosphor-bronze material, which is bright-tin plated. Vector Electronic.

CIRCLE NO. 401

### Solder glass

A low-temperature vitreous solder glass, used in digital displays, seals at 450 C. The sealing glass is delivered as a fine powder and is usually screened onto the face plates of LCDs. It is commonly available in one particle size—95% through a 325 mesh—although other sizes can be provided at special request. Its coefficient of thermal expansion is  $88 \times 10^{-7}/^{\circ}\text{C}$  and its softening point is 410 C. Corning Glass Works, Electronic Materials Dept.

CIRCLE NO. 402

### Latch/decoder/driver

With suitable buffers, a BCD/binary-to-seven-segment latch/decoder/driver can drive either common-cathode or common-anode read-outs. Send a letterhead request for a free sample and include complete product data to International Microcircuits, 3000 Lawrence Expressway, Santa Clara, CA 95051.

INQUIRE DIRECT

## With MINI BUS<sup>®</sup>

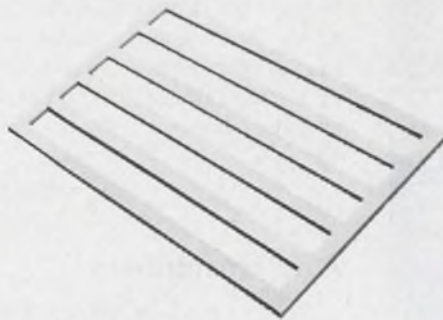

It's the PC card bus bar that saves space on a PCB. Saves money too. Makes board design and layout easier.

## all these DIPs



How can you put 36 DIPs on a 30 sq. inch board without using costly multi-layer PCBs?

## go on a 5" x 6" 2-sided PCB

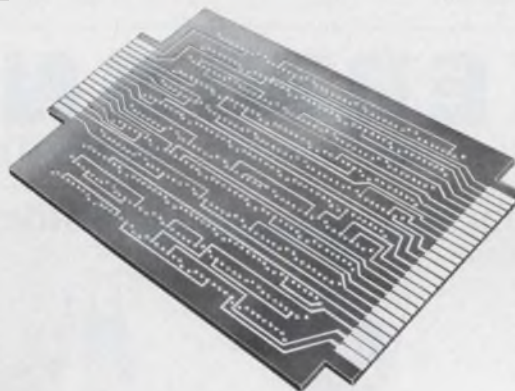

Take Voltages and Grounds off the board with MINI/BUS. Use all the board geometry for interconnecting DIPs.

## like this

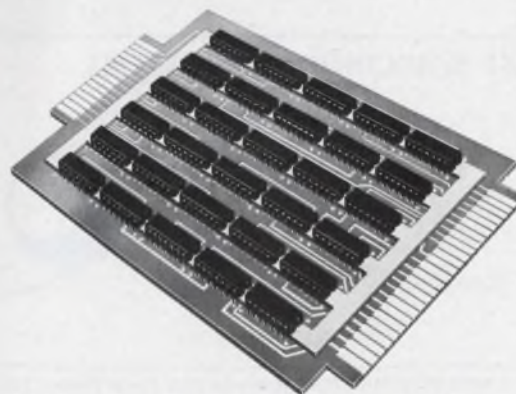

With MINI/BUS, you'll save design and layout time. You'll save space on the board. And you'll save money — up to half the cost of a typical 4-layer PCB.



Rogers Corporation Chandler, Arizona 85224 Phone: (602) 963-4584

Represented in Canada by LLOYD A. MEREDITH,  
1560 Watersedge Road, Clarkson, Ontario L5J 1A4 Phone: (416) 533-2367

INFORMATION RETRIEVAL NUMBER 148



# New Literature



## Ceramic capacitors

Ceramic disc and tubular feed-through capacitors are described in a 20-page catalog. The catalog includes specifications, dimensional drawings and ordering information. Centralab Electronics Div., Milwaukee, WI

CIRCLE NO. 403

## Power output switch

A two-page bulletin covers Model 50 Versa-Switch, a two-wire, noncontact metal sensing proximity device combined with an integral 5-A solid-state ac switch. Electro Corp., Sarasota, FL

CIRCLE NO. 404

## Autotransformers

Performance characteristics, load regulation, overload capacity and ambient temperature operation of Volt-Pac variable voltage autotransformers are given in a 16-page illustrated catalog. General Electric, Distribution Service, Scotia, NY

CIRCLE NO. 405

## PLL ICs

"SL650 Phase-Locked Loop Applications" introduces the reader to concepts of the PLL, describes a monolithic PLL device, and explains typical applications. Plessey Semiconductor, Santa Ana, CA

CIRCLE NO. 406

## Transducers

Different technologies applied to instrument transducers are described, along with their advantages and disadvantages, in a 16-page brochure. SE Labs (EMI) Ltd., Feltham, Middlesex, England.

CIRCLE NO. 407

## Semi protective fuses

Complete ratings, specifications and application data on 700-V-rms semiconductor protective fuses are given in a six-page bulletin. International Rectifier, Semiconductor Div., El Segundo, CA

CIRCLE NO. 408

## Crossed-field amplifiers

"Introduction to Pulsed Crossed-Field Amplifiers," 36 pages, is directed to the system designer considering the amplifier for use in a radar transmitter. The publication includes photos, schematics and performance data. Varian, Beverly Div., Beverly, MA

CIRCLE NO. 409



# KERTRON

## Setting the Pace with Power Transistors

### SILICON NPN HIGH VOLTAGE POWER TRANSISTORS

Discrete and Darlington

V<sub>CB</sub> 250V - 600V

V<sub>CE</sub> 200V - 400V

I<sub>C</sub> 1A - 10A

P<sub>D</sub> 40W - 100W



TO-3



TO-61



TO-66



TO-5

### NPN SILICON FAST SWITCHING TRANSISTORS

V<sub>CB</sub> 40V - 120V

V<sub>CE</sub> 40V - 100V

I<sub>C</sub> 0.5A - 25A

T<sub>on</sub> + T<sub>off</sub> 50NS - 200NS



TO-39



TO-60



TO-3



HYBRID



TO-37

CROSS REFERENCE FOR: Motorola, RCA, Power Physics, STC, Solitron, TRW, Transistron, Ampower, Westinghouse

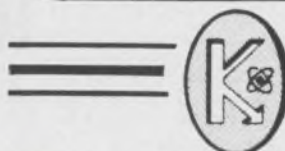

# KERTRON

INCORPORATED

Send for catalogue 7516 Central Dr., Riviera Beach, Fla. 33404 Tel. 305/848-9606 TWX 510/952-7611

INFORMATION RETRIEVAL NUMBER 149

ELECTRONIC DESIGN 24, November 22, 1975



# Electronic glass. All you need is vision.

Here is a designer's dream come true. Minimum form with maximum function.

It's PPG's electronic glass.

It lets you combine the sleek, simple elegance of glass and the dazzling magic of solid-state technology.

Which means you can literally change the faces of



Digital watches will never be the same. Electronic glass can make them more efficient and more affordable.

appliances, timepieces, visual displays, and instrumentation of every description.

The secret is the permanent conductive metallic-oxide coating on the glass.

It can be made to trigger functions at the mere touch of a finger. Like timing a roast, choosing a station, starting the wash, or even figuring the square root of 34.

In short, if it can be done electronically, it can probably be done a little better with electronic glass.

And, since the coating can be applied to form letters, numbers, or any visual display imaginable, there's almost no end to what you can do.

Digital clocks, wristwatches, speedometers, odometers, oscilloscopes, and radar screens are just a few of the obvious possibilities.

As for its reliability, there's really nothing to go wrong. No moving parts. No knobs, dials, switches, buttons—just glass.

It's here. It's now. It's ready. All it needs is you, and all you need is the vision to use it.

So test your vision. Send the coupon today.

Displays simulated.

This is a control panel for a microwave oven. Just one of the many possibilities for a countdown timer and digital display.

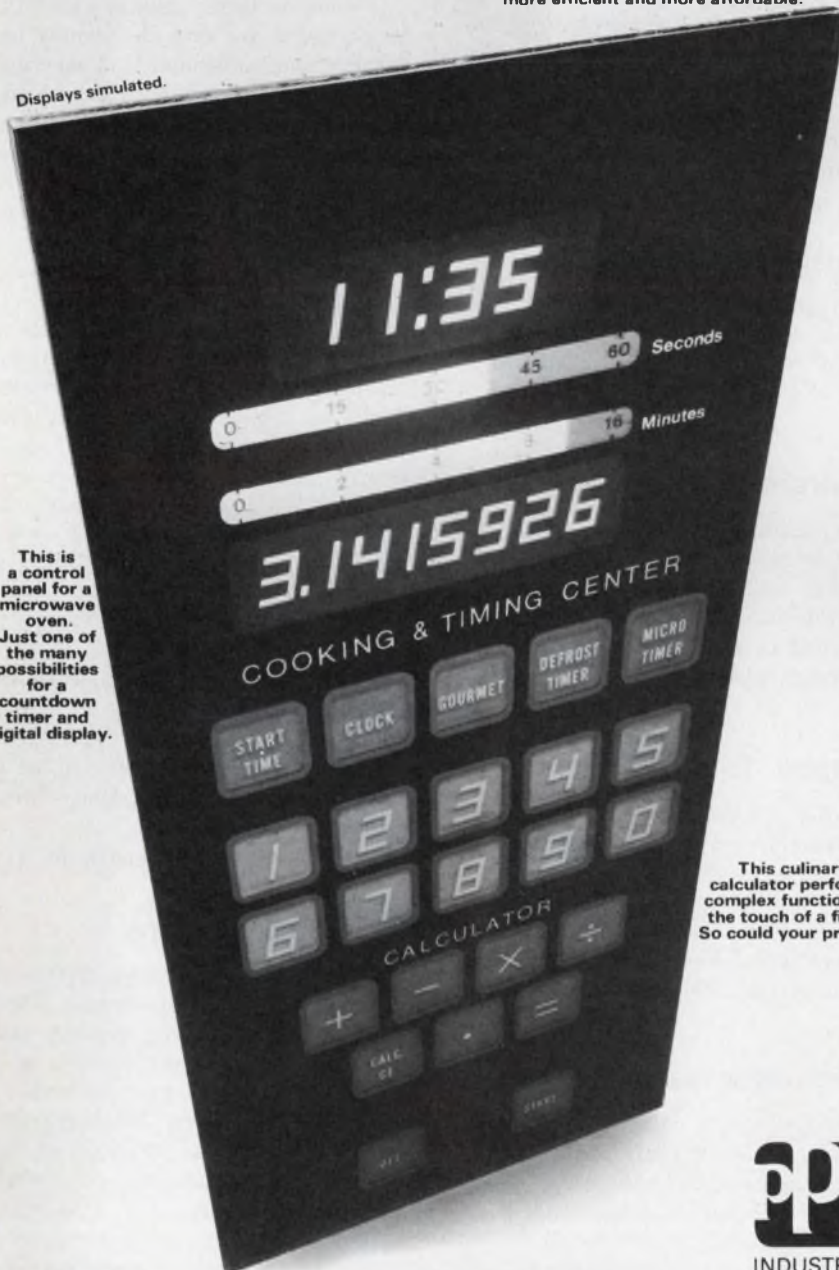

This culinary calculator performs complex functions at the touch of a finger. So could your product.

PPG: a Concern for the Future

PPG Industries, Inc.  
Industrial Glass Products  
One Gateway Center  
Pittsburgh, Pa. 15222

I want to test my vision.  
Send me more information about  
PPG's exciting electronic glass.

Name \_\_\_\_\_

Company \_\_\_\_\_

Address \_\_\_\_\_

City \_\_\_\_\_

State \_\_\_\_\_ Zip \_\_\_\_\_



FOR INFORMATION ON ELECTRONIC GLASS CIRCLE NUMBER 284



## VECTROL

### SCR Power Controllers

1Ø and 3Ø Models for loads from 30 to 400 amps at line voltages of 125 to 575 VAC.

#### AC Control

- Heating loads
- Power supplies
- Welding equipment

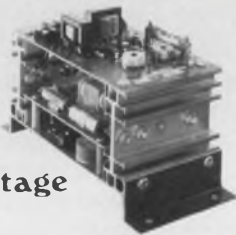

Phase and zero voltage

#### DC Control

- Field control
- Battery chargers
- Motor control
- Saturable reactor control

INFORMATION RETRIEVAL NUMBER 251

### Plug-In SCR Gate Drives and Regulator Boards



Vectrol, the world's leader in Thyristor Gate Drives introduces a new series of plug-in controls . . . SCR Gate Drives • Voltage Regulators • Current Limiters • Voltage and Current Regulators and • Pulse Amplifiers.

INFORMATION RETRIEVAL NUMBER 252



**VECTROL INC.**

1010 WESTMORE AVE., ROCKVILLE  
MD 20850, U.S.A. (301) 424 6900

## NEW LITERATURE



### Semiconductors

A 68-page two-color catalog provides a quick reference guide to the company's discrete power devices, hybrid power regulators and Schottky diodes. Package illustrations and dimensional drawings are included. Solitron Devices, Riviera Beach, FL

CIRCLE NO. 410

### Bipolar power supplies

High-voltage bipolar power supplies are illustrated in a four-page brochure. Kepco, Flushing, NY

CIRCLE NO. 411

### Instrumentation

Precision transducers and instrumentation for sensing, measuring, and analyzing all aspects of sound and vibration are described in a 40-page catalog. B&K Instruments, Cleveland, OH

CIRCLE NO. 412

### Display terminals

CRT displays and terminal equipment are detailed in an eight-page catalog. The catalog details RO and KSR models, outlining their characteristics in a chart form. Ann Arbor Terminals, Ann Arbor, MI

CIRCLE NO. 413

### Electrolytic capacitors

A four-page catalog covers the 400SL series subminiature aluminum electrolytic capacitors. General Instrument, Capacitor Div., Hicksville, NY

CIRCLE NO. 414

### Remote serial link

Technical information, including typical applications for the company's RTP7420/30 remote serial link, is provided in a six-page brochure. Computer Products, Fort Lauderdale, FL

CIRCLE NO. 415

### Stepping motors, encoders

Characteristics, tables and drawings illustrate the company's stepping motors and contact encoders. Moore Reed and Co., Ltd., Hampshire, SP105AB, England.

CIRCLE NO. 416

### Gases, gas mixtures

A 190-page catalog is divided into four sections: gases, gas mixtures, gases for the electronics industry and equipment. Two separate indices—alphabetical and numerical—make the catalog simple to use. Matheson Gas Products, Lyndhurst, NJ

CIRCLE NO. 417

### Temp instrumentation

Temperature indicating instruments are featured in a four-page brochure. Standard features, model numbers, dimensions and options for each instrument are listed. Power tables in wattage are included. Victory Engineering, Springfield, NJ

CIRCLE NO. 418

### Dc power supplies

Complete details on standard dc power supplies and custom capabilities, plus electrical specifications and prices are included in a 16-page catalog. Power-One, Camarillo, CA

CIRCLE NO. 419

### IC interconnections

How to choose between different IC interconnecting methods, what to look for concerning quality and reliability, design differences and the risks involved are covered in a 12-page brochure. Photographs, renderings and line drawings of the company's products are included. Augat Interconnection Products, Attleboro, MA

CIRCLE NO. 420



## LOW COST CIRCUIT BOARD HEAT SINKS



**AHAM** SERIES 400 HEAT SINK IS 1.78 INCHES SQUARE AND IS AVAILABLE IN FOUR HEIGHTS: 1/2", 3/4", 1" AND 1 1/2". IT CAN BE ORDERED WITH ONE OF FIVE HOLE PATTERNS: TO-3, TO-66, TO-8 AND ONE OR TWO TO-220. APPLICATION METHODS FOR THE VERSATILE SERIES 400 ARE ENDLESS AND IS PRICED BELOW COMPETITIVE MODELS.

**DISTRIBUTORS AND MANUFACTURING REPRESENTATIVES  
ARE INVITED**

CONTACT: HAROLD SULLIVAN

# AHAM

968 W. FOOTHILL BLVD., P.O. BOX 909,  
AZUSA, CALIF. 91702 (213) 334-5135

INFORMATION RETRIEVAL NUMBER 152

## WHEN IT'S TIME FOR A SWITCH...

It's time for Shigoto. Because every Shigoto switch is backed by solid engineering know-how. A reliable piece of equipment you can count on. To perform every time. We've got toggle and rocker, lever and leaf, push button, panel, rotary, radio, knife, slide and snap action switches. All sizes, all ratings. Leaf through our Catalog and pick the switch that's compatible with your requirements. If we haven't already made it, we can, specially for you. And while you're at it, check out our other outstanding O.E.M. components, too.



**SHIGOTO. A STANDARD FOR INDUSTRY**  
Write or phone for our catalog and more information

# Shigoto Industries Ltd.

350 Fifth Ave., N.Y., N.Y. 10001/(212) 695-0200/Telex 224219  
One of the World's Largest Manufacturing Importers

INFORMATION RETRIEVAL NUMBER 153

ELECTRONIC DESIGN 24, November 22, 1975

## Heath gives you more scope than you bargained for.

The single trace 4530...a professional  
service scope



It's hard to find a better 10 MHz scope value than the Heath 4530. It features DC-10 MHz bandwidth, 10 mV sensitivity...trigger bandwidth guaranteed to 15 MHz, AC & DC coupled...TV coupling for service work...time bases from 200 ms/cm to 200 ns/cm...and true X-Y capability. The 4530 is easy to operate and offers a lot of performance for the money. Only \$425.00\* for the factory assembled & calibrated SO-4530. Or order the easy-to-assemble Heathkit IO-4530, only \$299.95\*

The dual trace 4510...a precision  
lab-grade scope

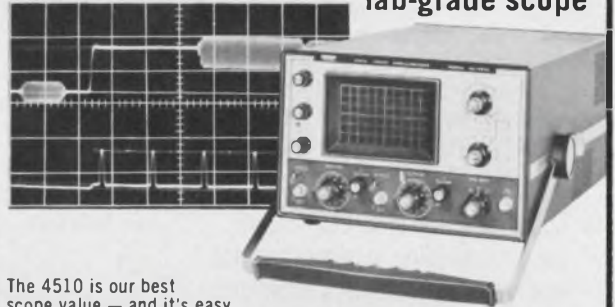

The 4510 is our best scope value — and it's easy to see why. With DC-15 MHz bandwidth...1 mV/cm input sensitivity...45 MHz typical triggering bandwidth, 30 MHz guaranteed...time base sweep 100 ns/cm...post-deflection accelerated CRT for high brightness...vertical delay lines for complete waveform display...X-Y capability...operates on any line voltage from 100 to 280 VAC. Assembled & calibrated SO-4510, only \$775.00\*. Kit-form IO-4510, only \$569.95\*.



**FREE** information on all Heath scopes

... send for your free copies of our latest catalogs. The Heath/Schlumberger Assembled Instruments Catalog features a complete line of high performance, low cost instruments for service and design applications. Our '75 Heathkit Catalog describes the world's largest selection of electronic kits — including a full line of lab & service instruments.

**HEATH COMPANY**  
Dept. 511-110  
Benton Harbor, Michigan 49022

**HEATH  
Schlumberger**

Please send my free copies of the Heath/Schlumberger and Heathkit Catalogs.

Name

Title

Company/Institution

Street

City  State  Zip

\*MAIL ORDER PRICES, F.O.B. FACTORY.  
PRICES & SPECIFICATIONS SUBJECT TO CHANGE WITHOUT NOTICE.

EK-451B

INFORMATION RETRIEVAL NUMBER 154



# MYCALEX

precision molded  
glass-bonded mica

... the only  
high-temperature  
electrical  
insulation  
MOLDABLE WITH  
METAL INSERTS ...

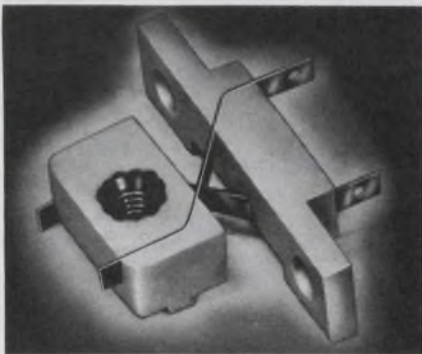

Design complex parts like this flex pivot with intricate geometry, metal inserts, and absolute dimensional stability ... excellent insulating properties at high temperatures; good strength and impact resistance; sharp detail and close tolerance control.

- Thermal expansion coefficient permits molding in of most metal inserts without voids, cracks or allowance for mold shrinkage
- Non-tracking, non-combustible, and resists arcing
- Withstands temperatures as high as 1200° F.
- Totally impervious to moisture

Precision molded MYCALEX glass-bonded mica and SUPRAMICA ceramoplastics are ideal electrical insulating materials for unusual environments and difficult design parameters.

Write or call for technical data and design recommendations — or send your prints for estimates.

# MYCALEX

Division of Spaulding Fibre Co. Inc.  
A Monogram Company

World's Largest Manufacturer of ceramoplastics,  
glass-bonded mica and synthetic mica products.

125 Clifton Boulevard, Clifton, N.J.

INFORMATION RETRIEVAL NUMBER 155

## Bulletin Board

Hysol has announced the qualification of three of its epoxy-based and two urethane-based coatings under MIL-I-46058 C.

CIRCLE NO. 421

Vishay lowers prices 10% for all Type 1240 trimmers.

CIRCLE NO. 422

Digital Equipment has introduced the Industrial 1117-M computer system, priced 15% less than equivalent systems.

CIRCLE NO. 423

Exar has agreed to second-source Fairchild's  $\mu$ A742 zero-crossing switch under the Exar part number XR-742.

CIRCLE NO. 424

Sensitron Semiconductor Div. has added JAN and JAN TX 1N5614 through and including JAN and JAN TX 1N5623 silicon rectifiers to its qualified products.

CIRCLE NO. 425

Monsanto expands JEDEC registered optoisolators to include the 4N35, 4N36 and 4N37 series.

CIRCLE NO. 426

A dynamic RAM memory system, which sells for \$0.33/bit in high volume prices, has been announced by National Semiconductor.

CIRCLE NO. 427

A dynamic RAM memory system, which sells for \$0.33/bit in high volume prices, has been announced by National Semiconductor 2900.

CIRCLE NO. 428

Varian Data Machines has dropped the price \$1000 on its Statos 3110 electrostatic printer/plotter.

CIRCLE NO. 429

HP's Data Systems Div. has reduced 21MX semiconductor memory module prices by 30%.

CIRCLE NO. 430

## Vendors Report

Annual and interim reports can provide much more than financial-position information. They often include the first public disclosure of new products, new techniques and new directions of our vendors and customers. Further, they often contain superb analyses of segments of industry that a company serves.

Selected companies with recent reports are listed here with their main electronic products or services. For a copy, circle the indicated number.

**Rapidata.** Time-sharing services.

CIRCLE NO. 431

**Modular Computer Systems.** Computer systems.

CIRCLE NO. 432

**Honeywell.** Control systems and information systems.

CIRCLE NO. 433

**ITT.** Telecommunications equipment and international communications, industrial products, natural resource materials, automotive components, consumer products and aerospace systems.

CIRCLE NO. 434

**T-Bar.** Line switching equipment for data-communications systems.

CIRCLE NO. 435

**Eastman Kodak.** Photographic products, microfiche products, X-ray products and chemicals.

CIRCLE NO. 436

**Memorex.** Information storage and retrieval products.

CIRCLE NO. 437

**Airpax Electronics.** Electronic industrial controls and electronic components.

CIRCLE NO. 438

**Erie Technological Products.** Passive electronic components.

CIRCLE NO. 439

**Mostek.** MOS ICs.

CIRCLE NO. 440



# VECTOR FITS IT ALL TOGETHER, BETTER

## MODULE CAGES



**CMA SERIES**

Strong, rugged all aluminum units supplied assembled for slide-in EFP modules in 3 1/2", 5 1/4", 7" and 8 3/4" heights and up to 15 3/4" deep.

## EFP MODULES



Sleek aluminum cases with slide-off side covers, extruded top and bottom rails hold cards 2.73", 4.5" and 7.98" wide and 4.5", 6.5", 9.6" and 11.31" long. 59 models available in widths from 1" to 4 1/2".

## CARD FILES AND CAGES



**CCK-13 SERIES**

Rugged all aluminum, card height adjustable card files supplied assembled ready for connectors which mount on 4-way adjustable struts. The cages are designed for cards with width ranges of 1.0" to 2.73"; 2.73" to 4 1/2"; 6.2" to 7.98"; and lengths up to 9.6". Plastic or metal guides available. *Continuous extruded aluminum plate style* has 106-0.075" wide continuous grooves on 0.150" centers for cards allowing maximum flexibility.

See **GOLD BOOK**  
Vol. 2, pp. 383, 412

## MULTI-USE CAGE KITS



**CA-HF SERIES**

Supplied unassembled in 11 different models for maximum flexibility to house cards and/or modules. Order card and module guides separately. Slotted side walls and bracket-mounted connector mounting struts provide wide adjustability. Available in 3 1/2", 5 1/4", 7" and 8 3/4" heights and 9", 12", and 15 3/4" depths. All parts and hardware of any Vector cage are available separately. For custom card or module cages, request our "design your own" form drawing.

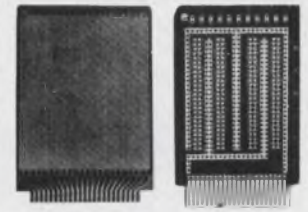

- PLUGBOARDS
- TERMINALS
- CONNECTORS



See **IBM** Vol. 1, pp. 100-103;  
Vol. 2, pp. 358-363, 1058-1061

34113

## PACKAGING HARDWARE FROM:

**Vector** ELECTRONIC CO., INC.  
12460 Gladstone Ave., Sylmar, California 91342



Phone (214) 365-7963  
1WX (910) 496-1539

INFORMATION RETRIEVAL NUMBER 156

# If you need a few custom ICs and can't afford them, call us.

When others quote you high prices for a few custom ICs, it's because they treat them as a sideline. At Silicon Systems, custom ICs are our bread and butter. Especially low quantity orders—even under 5000. Priced to compete with catalogue ICs.

One reason for our low prices is our proprietary design system. Developed in our own computer lab, this system helps us solve design problems in any technology—TTL, Schottky, ECL, Linear, PMOS, NMOS, CMOS, I<sup>2</sup>L—whatever is best for you. Designs that are fully protected because they can't be copied.

Over the years, we've become expert at satisfying all kinds of special design requirements. With ICs that replace entire groups of catalogue ICs, saving you board area, power, cooling, testing, spares—money and grief.

So when you think you can't afford custom ICs, write us. Silicon Systems, Inc., 2913 Daimler Street, Santa Ana, CA 92705. Better yet, call:

**(714) 979-0941**

**Silicon Systems**  
**The One-of-a-Kind IC Company**

INFORMATION RETRIEVAL NUMBER 157



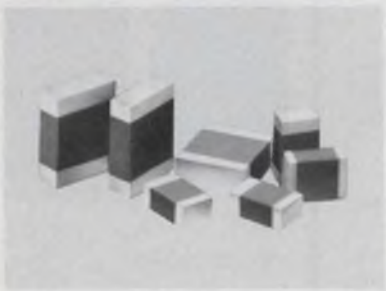

**HIGH Q MULTILAYER CAPACITORS** feature very high quality factors at microwave frequencies. Offered in three standard sizes: .050 x .040, .080 x .050, .125 x .095. Capacitance values from 0.1 pf to 1000 pf with close tolerance and voltages to 1000 VDCW. Johanson/Monolithic Dielectrics Div., Box 6456, Burbank, Ca. 91510, (213) 848-4465.

MULTILAYER CHIP CAPACITORS 601

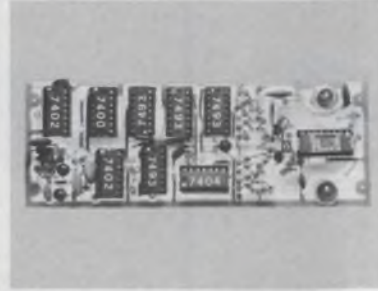

**Low Cost Image Sensing Module** contains a 1024 element (32-by-32) image sensor and all support circuitry on a single pc board. Digital video output may be displayed directly on an oscilloscope. Complete module (SE1024W) is \$150. Kit (SE1024K) is \$90. Cromemco, 26655 Laurel, Los Altos, CA 94022.

MODULE

604



**\$875. CRT terminal displays** 1280 ASCII characters in 16 lines, selectable baud rates from 110 to 9600, RS-232 serial data interface, backspace, detachable keyboard, half and full duplex, composite video output. Board only model also available. WINTEK CORPORATION, 902 N. Ninth St., Lafayette, IN 47904 (317) 742-6802.

TERMINAL DISPLAYS

607



**New low profile low cost TTL DIP Crystal Oscillator** measures only 0.3" high x 0.49" w x 0.78" L; plugs into single IC socket; available at any fixed frequency from 4 MHz to 20 MHz, with frequency tolerance  $\pm 0.01\%$  from  $-25^{\circ}\text{C}$  to  $+75^{\circ}\text{C}$ ; fan-out 10 TTL. Supply 5 Vdc  $\pm 5\%$ . Connor-Winfield Corp., West Chicago, Ill. 60185 (312) 231-5270.

OSCILLATOR

602



**Low Cost Model 5800A;** sine, square and triangle waveforms from 0.2Hz to 2 MHz. 15V p-p outputs, 50 Ohm output. Distortion typ. less than .3%. 1000:1 tuning dial covers audio range on one band. Aux. output sq. wave. Price \$245. Stock delivery. Krohn-Hite Corp. Avon Ind. Park, Avon MA. 02322 (617) 580-1660; TWX 710-345-0831.

FUNCTION GENERATOR

605

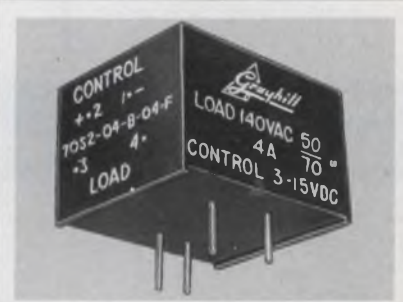

**SPACE-SAVING 4 AMP SOLID STATE RELAY** occupies only 1 cubic inch, is logic compatible, with switching capability from 0.1 to 4 amps, rated @25°C. Optically coupled; zero voltage turn-on. Offers inductive load switching, excellent transient protection. PC mountable. Prototype quantities from stock. Grayhill, Inc., (312) 354-1040.

SOLID STATE RELAY

608



**Activate gas discharge readouts!** DC-to-DC power supplies convert low DC line voltages of 5, 9, 12 or 15 volts to nominal 200 and 250 volt DC levels required to run gas discharge information displays. Ideal for battery powered applications! Free literature. Endicott Coil Co., Inc., 31 Charlotte Street, Binghamton, N.Y. 13905

POWER SUPPLY

603

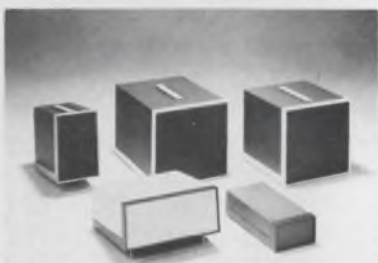

**Optima Small Cases**—portable, versatile and rugged with five panel heights and three widths, each available in a 10" or 14" depth. Features self-retracting handle, easy release cover, chassis, tiltstands, and rack adapters. In 11 colors. Optima Division, Scientific-Atlanta, Inc., 2166 Mtn. Ind. Blvd., Tucker, GA 30084 (404) 939-6340

SMALL CASES

606



**Rugged and low-cost 36-pin connector.** Suberly designed and produced with simplified construction. Cut your costs up to 50%. Moisture-resistant glass-filled nylon insulator Recessed contacts in both male and female housings. Hood provides positive cable strain relief. Interchangeable. E. F. Johnson Co., Waseca, MN. (507) 835-2050.

CONNECTOR

609



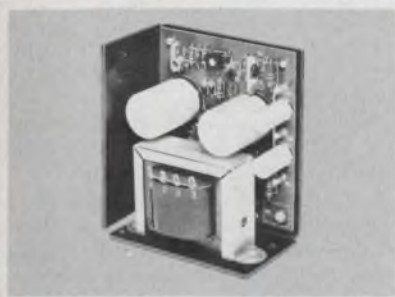

**Dual/Triple Output DC Supplies** reduce systems cost and size. 14 dual and 8 triple output DC power supply models available. Universal 115/230 Vdc 47-440 Hz input. Simultaneous, isolated multiple output voltages (adj. to  $\pm 10\%$ ). Temp. compensated, adjustable pullback current limiting. Standard Power, Inc., Santa Ana, CA 92705 (714) 558-8512.

DC POWER SUPPLIES 610

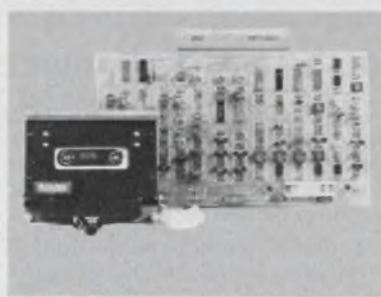

**Memodyne Model 763 High Speed Magnetic Tape Cassette Recorder.** For Computer or terminal peripheral storage. Records and playback at 20 IPS. Searches at 120 IPS. Uses patented servo system for constant speed. Has only two moving parts. For literature contact Memodyne Corporation, 385 Elliot Street, Newton, MA 02164.

CASSETTE RECORDER 613

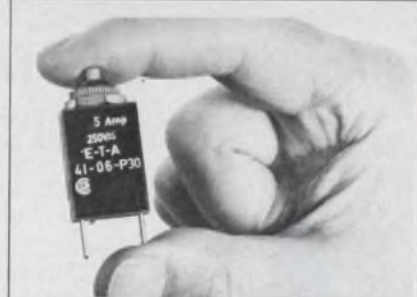

**Overcurrent Protector, manual reset** eliminates fuse replacement. Convenient panel mounting. 19 fractional ratings from 0.1 to 5 amp. Other models up to 400 amp. Trip-free and fool-proof, UL and CSA approved. High quality, low cost \$1.29 ea. in 1000 lots. E-T-A Products Co. of America, 7400 N. Croname Rd., Chicago, Ill. 60648. Tel: (312) 647-8303. Telex: 253780.

CIRCUIT BREAKER 616

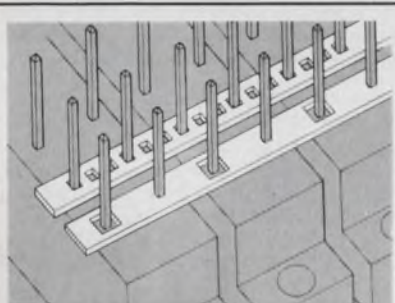

**STRIP/BUS BY ROGERS.** Low Cost Bussing Systems; easy installation, reliable solder joints; greater pin exposure. Write or call for details. Rogers Corporation, Rogers, Connecticut 06263. Phone (203) 774-9605.

STRIP/BUS 611

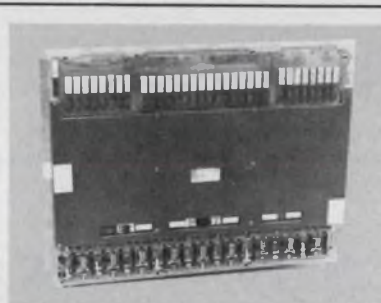

**16K/32K Memory Systems.** Model 696: 16K, 18-bits; to 256K X 9, 128K X 18, 64K X 36. Model 698: 32K, 18 bits; to 512K X 9, 256K X 18, 128K X 36. Cycle 650 nsec, access 250 nsec. Dir. rplcmnts for Micro 3000. Fabri-Tek, Inc., 5901 S. Cnty. Rd. 18, Mpls., MN 55436 (612) 935-8811

MEMORY SYSTEM 614



### HI-QUALITY SPRING PRESSED RESILIENT TERMINAL JACKS

#### FEATURES:

- Dust-Proof Mechanism Allows Perfect Contact with Each Insertion
- Quick Connect Solder Terminals
- Contact is Designed and Oriented in the Plastic Body to Generate Maximum Contact Pressure
- Reliable - 100,000 Heavy Duty Test Insertions Without Breakdown

**IMTRONICS INDUSTRIES, LTD.**  
813 2nd St., Ronkonkoma, N.Y. 11779  
(516) 981-3434

TERMINAL JACKS 617



**Free catalog of 34,500 power supplies** from the worlds largest manufacturer of quality Power Supplies. New '74 catalog covers over 34,500 D.C. Power Supplies for every application. All units are UL approved, and meet most military and commercial specs for industrial and computer uses. Power Mate Corp. (201) 343-6294.

POWER SUPPLY 612



**Precision rotary switches** for instrumentation and control applications. Many combinations of various electrical and mechanical features offer a wide range of switching functions in three basic sizes. Catalog 201. Shallco, Inc., P.O. Box 1089, Smithfield, NC 27577.

ROTARY SWITCHES 615

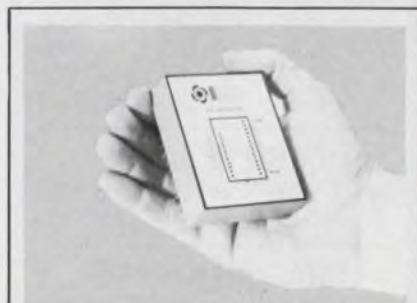

**"Synchro to digital converters - 10, 12, or 14 bit output, errorless tracking up to 4 r.p.s., accuracy  $\pm 4$  min. of arc  $\pm .9$ LSB, resolution - 1.3 minutes, 60 or 400 Hz input, Module 2.6 x 3.1 x .82" H, Price From \$350 in qty.** Computer Conversions Corp., East Northport, N.Y. 11731 (516) 261-3300."

SYNCHRO TO DIGITAL 618



# Design Data from Manufacturers

Advertisements of booklets, brochures, catalogs and data sheets. To order use Reader-Service Card  
(Advertisement)

# Electronic Design

## New Application Notes For Noise Test Instruments



Quan-Tech now has available a new series of **APPLICATION NOTES** complete with charts, graphs and abundant technical data utilizing the capabilities of the versatile Model 315B Resistor Noise Test Set and the newly developed Model 2494 Burst Noise Test set.

The text of these Application Notes cover such subjects as: The Determination of Noise Index for Thermistors — Measurement of Burst Noise in F715HC Integrated Circuits — Burst Noise Measurement in Integrated Circuits — The Effects of Base Bias Current on Burst Noise Rate of Junction Transistors — Zener Diode Noise Testing — Noise Testing of Three Terminal Voltage Regulators — Noise Testing of Light Emitting Diodes — Transistor Testing on a Resistor Noise Test Set and "Power" Noise Testing.

**Quan-Tech**<sup>®</sup>

Division of  
SCIENTIFIC-ATLANTA, INC.

Randolph Park West, Route 10, Randolph Township, N.J. 07801  
Phone: 201-361-3100

TWX: 710-987-7946

CIRCLE NO. 171

## recruitment and classified ads

### OVER 70 TOP BRANDS 1 DAY SHIPMENT

FROM OUR 42,000 SQ FT FACILITY

#### DEC MINIS

|           |        |
|-----------|--------|
| PDD 11/05 | \$3500 |
| 8         | 1000   |
| 8L        | 1500   |

#### DG NOVA 1210

#### PRINTERS

|           |          |        |
|-----------|----------|--------|
| ODEC 1321 | 110 LPM  | \$2000 |
| 1322      | 200 LPM  | 1500   |
| MDS 4330  | 300 LPM  | 2950   |
| DP 2440   | 700 LPM  | 7500   |
| 4300      | 1333 LPM | 7500   |

#### CARD READERS

|          |         |       |
|----------|---------|-------|
| GD1 100A | 200 CPM | \$350 |
| M110     | 300 CPM | 450   |

#### MAGNETIC TAPE

|             |         |        |
|-------------|---------|--------|
| Pertec 7830 | 7-Track | \$ 250 |
| 6840        | 9-Track | 1450   |
| Wangco 1137 | 9-Track | 1450   |

617-261-1100

### AMERICAN USED COMPUTER CORP.

Box 68, Kenmore Sta., Boston, MA 02215  
member COMPUTER DEALERS ASSOC.

CIRCLE NO. 210

### PATENTS FOR LICENSE

3,691,557 Microwave Object Identification Using Labels—AVI, MOI, Industrial and Materials ID, 3,790,939 Real Time High Resolution, Reconnaissance, Surveillance, Ground Mapping, 3,798,644 Beam Crossing Speed Measurement—Vector Velocity Measurement, 3,858,203 Real Time Synthetic Aperture—Optical Point-of-Sales, Postal Mail and Stock Certificate Bar Code Reader, 3,896,435 Collision Avoidance—Intruder Detection—Electronic Surveillance—Proximity Warning—Object Detection. Also signal processors, Signal Integrating System, Digital Matched Filter and Correlator. Principals only.

RCS ASSOCIATES

1603 Danbury Drive, Claremont, CA 91711

### AUDIO DESIGN ENGINEER

ELECTRO-HARMONIX needs a product designer to increase its line of electronic music accessories.

Applicant must have an E.E. degree and two years experience in all phases of product gestation, from initial concept to smooth production. A talent for analog circuit design is paramount, and a flair for technical writing would be an asset.

We work hard and pay well.

Write: David Cockerell

ELECTRO-HARMONIX

27 W. 23rd St., New York, N.Y. 10010

ELECTRONIC DESIGN's function is:

- To aid progress in the electronics manufacturing industry by promoting good design.
- To give the electronic design engineer concepts and ideas that make his job easier and more productive.
- To provide a central source of timely electronics information.
- To promote communication among members of the electronics engineering community.

**Want a subscription?** ELECTRONIC DESIGN is sent free to qualified engineers and engineering managers doing design work, supervising design or setting standards in the United States and Western Europe. For a free subscription, use the application form bound in the magazine. If none is included, write to us direct for an application form.

If you do not qualify, you may take out a paid subscription for \$30 a year in the U.S.A., \$40 a year elsewhere. Single copies are \$1.50 each.

If you change your address, send us an old mailing label and your new address; there is generally a postcard for this bound in the magazine. You will have to requalify to continue receiving ELECTRONIC DESIGN free.

The accuracy policy of ELECTRONIC DESIGN is:

- To make diligent efforts to ensure the accuracy of editorial matter.
- To publish prompt corrections whenever inaccuracies are brought to our attention. Corrections appear in "Across the Desk."
- To encourage our readers as responsible members of our business community to report to us misleading or fraudulent advertising.
- To refuse any advertisement deemed to be misleading or fraudulent.

Microfilm copies are available of complete volumes of ELECTRONIC DESIGN at \$19 per volume, beginning with Volume 1, 1952 through Volume 20. Reprints of individual articles may be obtained for \$3.00 each, prepaid (\$.50 for each additional copy of the same article) no matter how long the article. For further details and to place orders, contact the Customer Services Department, University Microfilms, 300 North Zeeb Road, Ann Arbor, Michigan 48106 telephone (313) 761-4700.

**Want to contact us?** If you have any comments or wish to submit a manuscript or article outline, address your correspondence to:

Editor

ELECTRONIC DESIGN

50 Essex Street

Rochelle Park, N.J. 07662



# Circuit Savers



Here's positive low cost protection for your IC's, transistors, power supplies and pc cards.

The LVC-1A crowbar switches to a short circuit whenever the voltage across it exceeds a specified level.

Any trip voltage level between 4.7V and 200V  $\pm$  10% can be selected. The unit will handle a peak current of 50 Amps (8ms) and 3A continuously. MIL Temperature range. Call Mike Coyle for applications assistance.

Full line of protection modules for every hi-lo voltage/current requirement. Write or call for Catalog 749.

279 Skidmore Road  
Deer Park, New York 11729  
Telephone: 516 - 586-5125

# MCG Electronics

INFORMATION RETRIEVAL NUMBER 168

## FREE CATALOG



**LOW-COST COMPONENTS, TEST EQUIPMENT, AND TOOLS**  
**AUDIO:** Speakers, earphones, microphones, headphones  
**CAPACITORS:** Ceramic, electrolytic, mylar, non-polar tantalum, high-voltage, mica, trimmer, variable  
**CONNECTORS:** Plugs, jacks, binding posts, hardware, alligator clips, battery snaps, terminals, lugs  
**LAMPS:** Incandescent, neon, neon, flash holders  
**MISCELLANEOUS:** Batteries, holders, chassis, fuses, line cords, knobs, antennas, chemicals, kits  
**PRINTED CIRCUIT AIDS:** Design templates, tapes and symbols, breadboarding kits, PC fabrication kits  
**RESISTORS:** Composition, film, power, slide, pots  
**SEMICONDUCTORS:** Transistor, diode, thyristor, IC  
**SOCKETS:** AC, IC, transistor, tube, lamp, fuseholder  
**SOLDERING EQUIPMENT:** Irons, holders, guns, solder, tips, flux, cordless irons, tip cleaning devices  
**SWITCHES:** Slide, rotary, toggle, knife, push button  
**TESTERS:** Precision multimeters, cordless VTVM's  
**TOOLS:** Screwdrivers, nutdrivers, wrenches, pliers, snips, drill bits, punches, micrometers, cutters  
**TRANSFORMERS:** Filament, LF, power, audio, isolation, trigger, variable, AC adaptors, line-matching

## MOUSER ELECTRONICS

11511 Woodside Ave., Lakeside CA 92040

Phone: 714-449-2220

TWX: 910-331-1176

INFORMATION RETRIEVAL NUMBER 169

ELECTRONIC DESIGN 24, November 22, 1975

# Electronic Design

Advertising Sales Staff  
Tom W. Carr, Sales Director

**Rochelle Park, NJ 07662**  
Robert W. Gascoigne  
Daniel J. Rowland  
50 Essex Street  
(201) 843-0550  
TWX: 710-9990-5071

**Philadelphia**  
Thomas P. Barth  
50 Essex Street  
Rochelle Park, NJ 07662  
(201) 843-0550

**Boston 02178**  
Gene Pritchard  
P.O. Box 379  
Belmont, MA 02178

**Chicago 60611**  
Thomas P. Kavooras  
Berry Conner, Jr.  
200 East Ontario  
(312) 337-5088

**Cleveland**  
Thomas P. Kavooras  
(Chicago)  
(312) 337-0588

**Los Angeles 90045**  
Stanley I. Ehrenclou  
Burt Underwood  
8939 Sepulveda Boulevard  
Los Angeles, CA  
(213) 641-6544

**Texas/Oklahoma**  
Burt Underwood  
(Los Angeles)  
(213) 641-6544

**San Francisco 94040**  
Robert A. Lukas  
3579 Cambridge Lane  
Mountain View, CA 94040  
(415) 965-2636

**London, Amsterdam, Tokyo, Seoul**  
John Ashcraft  
12, Bear St.  
Leicester Square  
London WC2H 7AS England  
Phone: 01-930-0525

W. J. M. Sanders  
John Ashcraft & Co.  
Herengracht 365  
Amsterdam C., Holland  
Phone: 020-24-09-08  
Haruki Hirayama  
Electronic Media Service  
5th Floor, Lila Bldg.,  
4-9-8 Roppongi  
Minato-ku, Tokyo, Japan  
Phone: 402-4556  
Cable: Electronicmedia, Tokyo

Mr. O-kyu Park, President  
Dongbo Int'l Corp.—  
World Marketing  
C.P.O. Box 4010  
Seoul, Korea  
Tel. 76-3910/3911  
Cable: DONGBO SEOUL  
Telex: EBKOREA K27286

ABP

BPA

# Regulated power where you NEED it

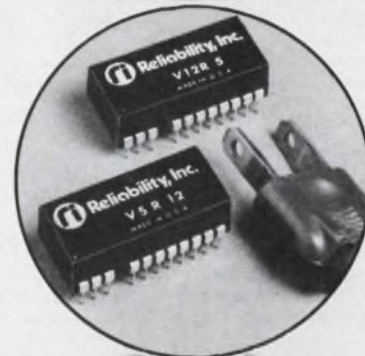

## ...On the PC card!

Have 5 or 12v DC, and need power for RAMs, ROMs, UARTs, OpAmps, line drivers? Use new regulated V-PAC\* DC-DC power sources. Isolated, protected against shorts and thermal overload, use them for either positive or negative voltage.

DC inputs: 5 or 12v

DC outputs: 3 to 15v (see table)

Output voltage tolerance:  $\pm$  5%

Output ripple: 100 mv, P-P, max.

Line regulation:  $\pm$  0.2%

Load regulation: 150 mv, no load to full load

Operating temperature range: 0 to 70°C

Temperature coefficient:  $\pm$  3mv/°C

Package: 24 pin DIP, .6 X 1.25 X .4 inches

Price: \$33.25 in 1 to 9 quantities.

| 12v input Part type | 5v input Part type | Output v DC | Output Ma |
|---------------------|--------------------|-------------|-----------|
| V12R 3              | V5R 3              | 3           | 90        |
| V12R 5              | V5R5               | 5           | 100       |
| V12R 9              | V5R 9              | 9           | 90        |
| V12R 12             | V5R 12             | 12          | 80        |
| V12R 15             | V5R 15             | 15          | 65        |



## Reliability, Inc.

5325 Glenmont/Houston, Texas 77036  
713-666-3261/TWX: 910-881-1739

Facilities in Nenagh, Ireland

\*Trademark, Reliability, Inc.

Price subject to change without notice

INFORMATION RETRIEVAL NUMBER 170









# electrocube capacitors

...are now offered in miniature AC rated models, of metallized polypropylene and with foil, in 135 VAC and 270 VAC versions with ratings to 10 mfd. Smaller than existing units, this may be the only 270 VAC dry capacitor available. And these can also be used for DC applications, to 200 VDC with 135 VAC units and to 400 VDC with 270 VAC capacitors. Get more data on these new components...write or call Electrocube, 1710 So. Del Mar Ave., San Gabriel, CA 91776; (213) 573-3300. **FREE...data file on request**

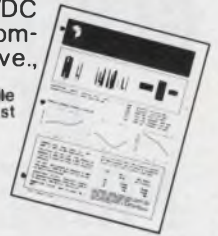

## DOUBLE EXPOSURE



## AC RATED...DC, TOO

INFORMATION RETRIEVAL NUMBER 160

| Advertiser  | Page     |
|---|----------|
| Rockland Systems Corporation                            | 181      |
| Rockwell International,<br>Microelectronic Devices Div. | 126, 127 |
| Rogan Corporation                                       | 101      |
| Rogers Corporation                                      | 209, 217 |
| Rohde & Schwarz   | 93       |
| Rubber/Urethanes Bonding &<br>Molding                   | 207      |

|   |                            |
|---|----------------------------|
| Scientific-Atlanta, Inc.                            | 216                        |
| Servo-Tek Products Company                          | 188                        |
| Shallco, Inc.                                       | 217                        |
| Shelly Associates                                   | 6                          |
| Shigoto Industries, Ltd.                            | 213                        |
| Siemens Corporation, Special<br>Components Division | 39                         |
| Signetics Corporation                               | 175, 179, 189,<br>197, 203 |
| Silicon Systems                                     | 215                        |
| Silicon Transistor Corporation                      | 193                        |
| *Sodeco   | 32D                        |
| Sorensen Company, A Unit of<br>Raytheon Company     | 16, 17                     |
| Sound Technology                                    | 28                         |
| Spectral Dynamics Corporation                       | 183                        |
| Sprague Electric Company                            | 14                         |
| Standard Power, Inc.                                | 217                        |
| Switchcraft, Inc.                                   | 81                         |
| Systron-Donner                                      | 80 A-B-C-D, 205            |

|  |              |
|--|--------------|
| TRW Cinch Connectors, an Electronic<br>Components Division of<br>TRW, Inc. | 167          |
| Tau Tron, Inc.   | 178          |
| Tektronix, Inc.  | 31, 144, 145 |
| Telecommunication Industries, Inc.   | 204          |
| Teledyne Kinetics  | 199          |
| Teledyne Philbrick   | 15           |
| Teletype Corporation   | 79           |
| Telonic Altair   | 80H          |
| Teradyne Components  | 195          |
| Texas Instruments,<br>Incorporated   | 33, 46, 47   |
| Triplett Corporation   | 147          |

|   |     |
|---|-----|
| U.S. Instrument Rentals, Inc.                           | 21  |
| *United States Department of<br>Commerce                | 32B |
| United Systems Corporation, a<br>Subsidiary of Monsanto | 158 |
| Unitrode Corporation                                    | 108 |

|                              |     |
|------------------------------|-----|
| Varo Semiconductor Inc.      | 186 |
| Varadyne Industries, Inc.    | 117 |
| Vector Electronic Co., Inc.  | 215 |
| Vectrol, Inc.                | 212 |
| Vernitron Control Components | 208 |

|                              |     |
|------------------------------|-----|
| Wavetek Indiana Incorporated | 1   |
| Weston Instruments, Inc.     | 185 |
| Wintek Corporation           | 216 |

|                        |          |
|------------------------|----------|
| Zero Manufacturing Co. | 159, 169 |
|------------------------|----------|

\*Advertisers in non-U.S. edition

## Measure and select components... better than 5% INSTANTLY!

### NEW! DESIGN MATE 3



Ever been bugged by color codes or unreadable component markings? Forget it! DM-3, the new, low cost R/C Bridge measures true component values — in seconds — to better than 5%! Only two operating controls and a unique solid-state null detector zero-in on exact component selection instantly. This quality, laboratory-grade instrument has 6 resistance ranges from 10Ω to 100 megΩ, and 5 capacitance ranges from 10pFd to 1mFd. 6.75" L x 7.5" W x 3.25" H. Completely assembled.

Order your DM-3 today off-the-shelf from your local distributor of direct from CSC on Master Charge, BankAmericard, Amer. Express. Prices subject to change. Patents pending.

Order your  
DM-3 today!

# 54<sup>95</sup>

Add \$2.50 shipping/handling



CONTINENTAL SPECIALTIES CORPORATION

Box 1942, New Haven, CT 06509. 203/624-3103  
W. Coast: Box 7809, S. Francisco, CA 94119 415/421-8872

Canada: Len Finkler Ltd., Ontario

© Copyright Continental Specialties Corp. 1975

INFORMATION RETRIEVAL NUMBER 161



# A PRECISION WAVEFORM GENERATOR AT A PRICE YOU CAN AFFORD.



The Hickok Model 270 Function Generator gives you a lot more waveform generating capability than you'd expect for its price.

- Puts stable, calibrated, high quality sine, square and triangle waveforms from 1 Hz to 500 kHz at your fingertips.
- With external connections you can produce logic pulses, sweeps and ramps, AM and FM outputs, phase and frequency shift keying signals, tone bursts and more.
- Its an audio generator and much more.

Before you buy another function generator, check out the Hickok Model 270. Ask your Hickok distributor for full details or write us for our 4-page technical brochure.

## \$166<sup>00</sup>

# HICKOK

**the value innovator**

INSTRUMENTATION & CONTROLS DIVISION  
THE HICKOK ELECTRICAL INSTRUMENT CO.  
10514 Dupont Avenue • Cleveland, Ohio 44108  
(216) 541-8060 • TWX: 810-421-8286

## Product Index

Information Retrieval Service. New Products, Evaluation Samples (ES), Design Aids (DA), Application Notes (AN), and New Literature (NL) in this issue are listed here with page and Information Retrieval numbers. Reader requests will be promptly processed by computer and mailed to the manufacturer within three days.

| Category                     | Page | IRN | Category                       | Page | IRN |
|------------------------------|------|-----|--------------------------------|------|-----|
| <b>Components</b>            |      |     | recorder                       | 10   | 7   |
| autotransformers (NL)        | 210  | 405 | remote serial link (NL)        | 212  | 415 |
| capacitors                   | 117  | 49  | teletypewriters                | 79   | 38  |
| capacitors                   | 201  | 134 | <b>Discrete Semiconductors</b> |      |     |
| capacitors, electrolytic     | 193  | 369 | arrays, LED display            | 180  | 348 |
| ceramic capacitors (NL)      | 210  | 403 | diodes, Gunn                   | 182  | 353 |
| chokes, PC mounting          | 190  | 367 | diodes, high-voltage           | 182  | 351 |
| component catalog            | 218  | 159 | diodes, Schottky               | 184  | 354 |
| crowbars                     | 218  | 158 | LED, high power                | 182  | 352 |
| delay line handbook          | 14   | 10  | LEDs                           | 19   | 13  |
| electrolytic capacitors (NL) | 212  | 414 | power transistor               | 193  | 116 |
| flatpack relay               | 80   | 39  | power transistors              | 32   | 20  |
| inductors                    | 194  | 371 | power transistors              | 210  | 149 |
| lamps                        | 190  | 366 | rectifiers                     | 196  | 120 |
| load cells                   | 200  | 132 | rectifiers, bridge             | 179  | 347 |
| motors                       | 175  | 82  | regulator, switching           | 108  | 47  |
| motors, hollow-rotor         | 193  | 370 | semiconductors (NL)            | 212  | 410 |
| power cutout switch (NL)     | 210  | 404 | sensor, temperature            | 178  | 344 |
| relay                        | 178  | 86  | suppressors, transient         | 184  | 355 |
| relays                       | 41   | 27  | switch, optical                | 179  | 345 |
| relays                       | 200  | 130 | switches, optical              | 180  | 349 |
| relays                       | III  | 257 | transistor, high V             | 184  | 357 |
| relays, delay                | 156  | 66  | transistors, Darlington        | 178  | 343 |
| self-latching reed matrix    | 20   | 14  | transistors, power             | 179  | 346 |
| semi protective fuses (NL)   | 210  | 408 | transistors, power             | 180  | 350 |
| stepper motor                | 174  | 81  | transistors, power             | 184  | 356 |
| stepping motors (NL)         | 212  | 416 | <b>Instrumentation</b>         |      |     |
| surge arresters              | 204  | 140 | control components             | 111  | 48  |
| surge protectors & circuits  | 184  | 103 | counter/timer                  | 153  | 308 |
| surge voltage protectors     | 39   | 26  | counters                       | 154  | 309 |
| switches                     | 81   | 40  | counters, portable             | 186  | 105 |
| switches                     | 161  | 231 | current meter                  | 159  | 326 |
| switches                     | 170  | 78  | curve tracer                   | 223  | 163 |
| switches                     | 213  | 153 | DMM                            | 153  | 305 |
| switches & relays            | 87   | 41  | DMM                            | 156  | 322 |
| switches, cam                | 194  | 372 | DMM                            | 159  | 324 |
| switches, rotary             | 189  | 110 | DMM                            | 161  | 328 |
| transducers (NL)             | 210  | 407 | DMM                            | 183  | 102 |
| trimmer                      | II   | 256 | DPM                            | 156  | 321 |
| trimmer, cermet              | 190  | 368 | DPMs                           | 149  | 61  |
| <b>Data Processing</b>       |      |     | data-acquisition systems       | 15   | 11  |
| calculator                   | 175  | 340 | data recorder                  | 157  | 67  |
| calculators                  | 206  | 142 | data system                    | 224  | 164 |
| computer family              | 47   | 30  | data/word generator            | 178  | 87  |
| computer, portable           | 57   | 32  | digital display                | 161  | 441 |
| computer, portable           | 170  | 303 | digital logic recorder         | 155  | 65  |
| computer, 16-bit             | 13   | 9   | digital pyrometer              | 161  | 327 |
| controller, disc             | 175  | 339 | frequency standard             | 93   | 42  |
| data-acquisition             | 177  | 342 | function generator             | 171  | 79  |
| data-acquisition system      | 9    | 281 | generator/reader               | 203  | 138 |
| data terminal                | 177  | 341 | instrumentation                | 125  | 51  |
| disc storage                 | 65   | 35  | instrumentation (NL)           | 212  | 412 |
| display terminals (NL)       | 212  | 413 | logic analyzers                | 159  | 325 |
| minicomputer                 | 174  | 304 | meters                         | 185  | 104 |
| printer                      | 175  | 338 | module library                 | 195  | 119 |
| printers                     | 143  | 57  | multimeter, digital            | 165  | 74  |
|                              |      |     | oscillograph, recording        | 163  | 72  |
|                              |      |     | oscilloscope                   | 154  | 310 |
|                              |      |     | oscilloscope                   | 168  | 77  |



| Category                           | Page | IRN |
|------------------------------------|------|-----|
| panel counter                      | 193  | 116 |
| panel meters                       | 154  | 64  |
| power amplifier                    | 198  | 126 |
| precision instruments              | 27   | 18  |
| R/C bridge                         | 221  | 161 |
| real-time analyzer                 | 164  | 73  |
| recorder, direct writing           | 152  | 63  |
| recorders/reproducers              | 197  | 123 |
| recorders, strip-chart             | 191  | 113 |
| rental equipment                   | 107  | 46  |
| scope                              | 156  | 320 |
| scopes                             | 213  | 154 |
| spectrum analyzer                  | 156  | 323 |
| spectrum analyzer                  | 161  | 442 |
| sweeper/scope                      | 1    | 2   |
| tester                             | 200  | 131 |
| timer/counter                      | 25   | 292 |
| timer/counters                     | 187  | 107 |
| voltmeter                          | 166  | 75  |
| VOMs                               | 147  | 60  |
| waveform generator                 | 222  | 162 |
| <b>Integrated Circuits</b>         |      |     |
| analog circuits                    | 179  | 89  |
| crosspoint switch                  | 203  | 387 |
| I/O port                           | 175  | 83  |
| memory, FIFO                       | 202  | 385 |
| MOS shift registers                | 203  | 139 |
| op amp                             | 203  | 389 |
| PLL ICs (NL)                       | 210  | 406 |
| PROM, 4-k                          | 137  | 56  |
| PROMs                              | 189  | 111 |
| pulse stretcher                    | 204  | 390 |
| RAM, 2-k                           | 204  | 392 |
| RAM, 4-k                           | 203  | 388 |
| switches                           | 204  | 391 |
| timer/counter                      | 202  | 384 |
| voltage reference                  | 202  | 386 |
| <b>Microprocessor Design</b>       |      |     |
| computer                           | 37   | 501 |
| microcomputer                      | 44   | 506 |
| $\mu$ C design kits                | 37   | 504 |
| $\mu$ C design kits                | 37   | 502 |
| $\mu$ C design kits                | 37   | 503 |
| $\mu$ C design kits                | 37   | 505 |
| <b>Microwaves &amp; Lasers</b>     |      |     |
| amplifiers                         | 206  | 395 |
| comb generator                     | 206  | 394 |
| oscillator                         | 208  | 399 |
| phase shifter                      | 206  | 393 |
| power modules                      | 206  | 396 |
| rotary joint                       | 208  | 398 |
| switches                           | 208  | 397 |
| <b>Modules &amp; Subassemblies</b> |      |     |
| amplifier, s/h                     | 164  | 329 |
| amplifier, instru-<br>mentation    | 169  | 336 |
| converter, a/d                     | 164  | 330 |
| converter, a/d                     | 166  | 333 |
| converter, a/d                     | 186  | 106 |
| converter, d/a                     | 166  | 334 |
| converter, rms-to-dc               | 162  | 71  |
| converter, v/f                     | 166  | 331 |
| converters, d/a                    | 169  | 337 |
| filter, active                     | 169  | 335 |
| generator, pulse                   | 166  | 332 |
| hybrid microcircuits               | 208  | 147 |
| hybrids, custom                    | 207  | 145 |
| module, deglitching                | 162  | 302 |
| SCR power controllers              | 212  | 251 |
| <b>Packaging &amp; Materials</b>   |      |     |
| bender, lead                       | 197  | 377 |
| blocks, terminal                   | 201  | 380 |
| bonder, spot                       | 198  | 379 |
| busses                             | 207  | 148 |

| Category                  | Page | IRN |
|---------------------------|------|-----|
| cage, PC card             | 201  | 383 |
| cap, BNC dust             | 201  | 381 |
| connector, multipin       | 201  | 382 |
| connectors                | 71   | 37  |
| connectors, card-edge     | 196  | 374 |
| cooler, TO-5              | 197  | 375 |
| electronic glass          | 211  | 150 |
| enclosures                | 136  | 55  |
| enclosures                | 159  | 262 |
| enclosures                | 194  | 118 |
| heat sinks                | 194  | 117 |
| heat sinks                | 213  | 152 |
| heaters, flexible         | 196  | 373 |
| knobs                     | 224  | 166 |
| knobs and dials           | 101  | 44  |
| marker, offset            | 197  | 376 |
| metallized ceramic parts  | 22   | 16  |
| mica                      | 214  | 155 |
| PC board extractors       | 207  | 144 |
| PM magnetic shields       | 202  | 135 |
| packaging hardware        | 215  | 156 |
| panels                    | 132  | 53  |
| plastic, high-temp        | 198  | 378 |
| RFI/EMI shielding         | 151  | 62  |
| rubber/urethanes          | 207  | 143 |
| enclosures, shielded      | 190  | 112 |
| sockets, DIP              | 103  | 45  |
| sockets, DIP              | 167  | 76  |
| solder tail sockets       | 33   | 21  |
| stacking connectors       | 199  | 127 |
| terminator, I/O           | 95   | 43  |
| wire, cable & cord        | 73   | 234 |
| <b>Power Sources</b>      |      |     |
| ac power source           | 187  | 358 |
| bipolar power             |      |     |
| supplies (NL)             | 212  | 411 |
| const. current units      | 187  | 359 |
| custom modules            | 189  | 363 |
| dc/dc converter           | 189  | 365 |
| dc/dc converters          | 187  | 360 |
| dc power supplies (NL)    | 212  | 419 |
| dc supply                 | 189  | 364 |
| H-V converter             | 188  | 361 |
| modular switchers         | 17   | 12  |
| PC-board supplies         | 186  | 301 |
| power supplies            | 119  | 50  |
| power supplies            | 196  | 121 |
| switchers                 | 188  | 362 |
| <b>new literature</b>     |      |     |
| autotransformers          | 210  | 405 |
| bipolar power supplies    | 212  | 411 |
| ceramic capacitors        | 210  | 403 |
| crossed-field amplifiers  | 210  | 409 |
| dc power supplies         | 212  | 419 |
| display terminals         | 212  | 413 |
| electrolytic capacitors   | 212  | 414 |
| gases, gas mixtures       | 212  | 417 |
| IC interconnections       | 212  | 420 |
| instrumentation           | 212  | 412 |
| PLL ICs                   | 210  | 406 |
| power output switch       | 210  | 404 |
| remote serial link        | 212  | 415 |
| semi protective fuses     | 210  | 408 |
| semiconductors            | 212  | 410 |
| stepping motors,          |      |     |
| encoders                  | 212  | 416 |
| temp instrumentation      | 212  | 418 |
| transducers               | 210  | 407 |
| <b>evaluation samples</b> |      |     |
| circuit-board support     | 209  | 400 |
| solder glass              | 209  | 402 |
| terminals                 | 209  | 401 |

# THE CURVE TRACER THAT WON'T COLLECT DUST.



The Hickok Model 440 semiconductor curve tracer is all purpose and convenient to use. It's the ideal instrument for testing, evaluating, classifying and matching all types of transistors, FET's and diodes. You'll get stable, full range dynamic displays that you can accurately scale right from the screen.

- Pull-out card for easy, fast set-up and operation.
- Set-up marks for rapid set-up of 80% of tests.
- Unique INSTA-BETA display takes the guesswork out of transistor and FET parameter measurement.
- In-or-out of circuit testing.
- A full range professional tracer at a price you can afford.

The Model 440 is the most modern, versatile tracer available. See it at your Hickok distributor or send for our technical bulletin.

**\$165<sup>00</sup>**

## HICKOK

**the value innovator**

INSTRUMENTATION & CONTROLS DIVISION  
THE HICKOK ELECTRICAL INSTRUMENT CO.  
10514 Dupont Avenue • Cleveland, Ohio 44108  
(216) 541-8060 • TWX: 810-421-8286

INFORMATION RETRIEVAL NUMBER 163



## SMART new data system learns from your finger to do YOUR job



1. Measure up to 248 low level signals accurately, immune from noise—*analog, digital, non linear*. Print them out, tape them, feed your computer (alarms too!).
2. Key program—with one finger—all clock timing, scan intervals, channel gains, I/O, engineering units, powerful subroutines like automatic programming and optional integration. Everything to do your job.

In the new PD-2064, a proven microprocessor, RAMs, and ROMs replace a bushel of expensive circuitry to make a versatile, standardized data acquisition system you can use for general or specific jobs. The big benefit to you is more data *reduced* per dollar. Request Bulletin B110 from Esterline Angus Instrument Corporation, P.O. Box 24000, Indianapolis, IN 46224. 317/244-7611.



INFORMATION RETRIEVAL NUMBER 164

## MICROPROCESSOR POWER

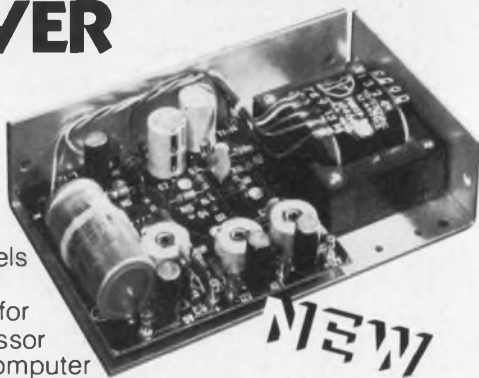

New dual and triple output models designed specifically for microprocessor and microcomputer applications.

### MODELS

|                                 |                   |
|---------------------------------|-------------------|
| DUAL: HAA512, 5V @ 2A W/OVP     | \$44.95           |
| 9 to 15V @ 0.5A                 | Single Quantities |
| TRIPLE: HTAA-16W, 5V @ 2A W/OVP | \$49.95           |
| ±9 to ±15V @ 0.2A               | Single Quantities |

**FEATURES:** 115/230 VAC Input • OVP on 5V Outputs • ±.05% Regulation • I.C. Regulated • 1.5 mv Ripple • Foldback Current Limit • Full Rated to 50°C • 2 Hour Burn-in • 2 Year Warranty

See our complete product listing in EEM & GOLDBOOK

For a copy of our NEW 1976 D.C. POWER SUPPLIES CATALOG, contact Power-One or your local factory representative.



531 Dawson Dr. Camarillo, Ca. 93010  
Phone: 805/484-2806 TWX: 910-336-1297

INFORMATION RETRIEVAL NUMBER 165

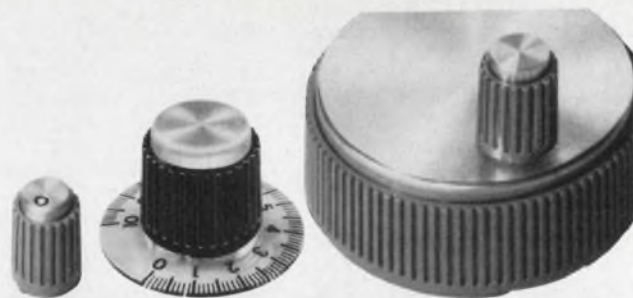

## BUCKEYE KNOBS

Supplementing Buckeye's full-line of matching instrument series knobs with unique facilities for fine markings of all types are complete instrument-packaging products crafted by experts and recognized for high quality. Labor-saving P.C.B. guide modules — Front-loading, rackable or portable cases — Full size-range of colorful cabinets — Four sizes of Bord-pak racks — and safe-locking, retractable tilt-stands.

Write today for free colorful literature!

the BUCKEYE stamping co.

555 Marion Rd., Columbus, Ohio 43207

"QUALITY PRODUCTS SINCE 1902"

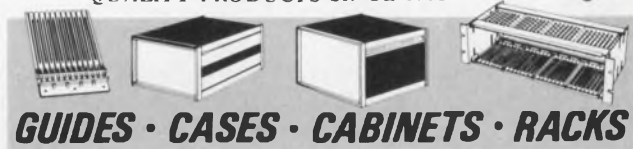

GUIDES • CASES • CABINETS • RACKS

INFORMATION RETRIEVAL NUMBER 166

*A Blow for  
Microprocessor  
Independence.*

for only \$14.95



Bugbooks are dedicated to the proposition that all men should be electronically independent and creative . . . that you should be able to conceive and execute your own circuit designs.

Bugbook III focuses on microprocessor system design, using an 8080 based system for microcomputer interfacing. Typical subjects: microcomputer programming and I/O; breadboarding the Micro-Designer™; clock cycles and timing loops; and more.

All practical. All clear. In 592 pages, with a glossary of 200 microcomputer terms. And, most important of all, 60 self-teaching experiments designed to make you independent and creative.

Strike a blow for independence — your independence. Bugbook III is available now for \$14.95 from the people who are revolutionizing the way digital electronics is learned. Send your check or money order today.



E&L INSTRUMENTS, INC.  
61 First Street, Derby, Conn. 06418  
Telephone (203) 735-8774

INFORMATION RETRIEVAL NUMBER 167



# Just How Broad is the **MAGNECRAFT** Stock Relay Line?



**free  
wall  
chart!**

Magnecraft's stock relay line consists of 1200 versions derived from 17 categories - - - - that is the largest and broadest line in the industry.

Oh? Did I read that correctly?

Yes, Magnecraft Electric provides 1200 relay versions in stock through our nationwide distributor network. Those 17 categories include; low profile, general purpose, power, mercury displacement, sensitive, coaxial, telephone type, air dashpot time delay, solid state, latching types, high voltage, mercury wetted reeds, dry reeds, and dip reed relays.

Magnecraft can offer you the design engineer, a quality product, local distributors, and the broadest relay line in the industry to choose from. If we don't have the relay in stock we will custom design a relay to meet your requirements.

Full color 22"x 34" relay specification chart.



**Magnecraft** ELECTRIC COMPANY

5575 NORTH LYNCH AVENUE • CHICAGO ILLINOIS 60630 • 312 • 282-5500 • TWX 910 221 5271



What's new in solid state...

# Join the SOS Revolution. Just \$17.76.

## RCA fires it up with a 150 ns, 4 mW static RAM.

We're ready if you are! RCA is making good on the speed/power promise of silicon-on-sapphire: we've got the production, the product, the price. In fact, for a limited time, RCA offers its 1024 x 1-bit SOS RAM for a revolutionary price of \$17.76. The MWS5001 gives you 150 ns with only 4 mW of operating power.

Key to 5001 performance is our SOS structure with a self-aligned silicon gate. It virtually eliminates overlap of the gate onto source and drain areas. Which greatly reduces interelectrode capacitances compared to aluminum gate SOS.

### Cost effectiveness

Our revolutionary low introductory price of \$17.76 is only part of the cost story. When all factors are considered –

| Type         | Technology | Voltage | Access from address | Power @ 1 MHz |
|--------------|------------|---------|---------------------|---------------|
| RCA MWS5001  | SOS/CMOS   | 5 V     | 150 ns              | 4 mW          |
| Compet. 6508 | Bulk CMOS  | 5 V     | 400 ns              | 8 mW          |

including capability, power and parts-count savings – overall system savings can turn out to be even more dramatic. Since it's static, the 5001 saves on parts by requiring no memory refreshing, no clock, no pulsing. And it has a 3-state output, which allows power savings from common busing.

### Design flexibility

CMOS on sapphire gives the 5001 wide usefulness, with its  $-20^{\circ}\text{C}$  to  $+85^{\circ}\text{C}$  temperature range and  $+4.5\text{ V}$  to  $+6\text{ V}$  voltage range. Bear in mind, too, this is only an early shot in the SOS revolution. Following the 1024 x 1-bit RAM, RCA will announce one with 256 x 4-bit organization. Then, higher performance versions of both, providing even faster access

time. To less than 100 ns. With very little increase in power. You'll also have a choice of open drain or 3-state output.

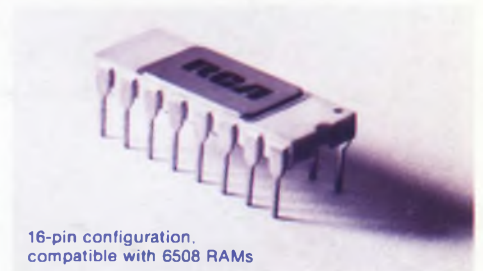

16-pin configuration,  
compatible with 6508 RAMs

For more information and your \$17.76 samples, use the coupon below.

# RCA

## JOIN THE REVOLUTION NOW!

To purchase sample(s) of the MWS5001 for \$17.76 each, send this coupon to RCA, Box 3200, Somerville, N.J. 08876; or check your local distributor. In Europe, mail the equivalent of \$17.76 each to: RCA Solid State, Sunbury-on-Thames, England TW16 7HW.

This coupon good for up to 10 RCA MWS5001 Random Access Memories. Offer good until January 31, 1976.

Please send me \_\_\_\_\_ of your MWS5001 for \$17.76 each. Enclosed is my  check  money order for \$\_\_\_\_\_  Please send me more information only.

Name \_\_\_\_\_ Title \_\_\_\_\_

Firm \_\_\_\_\_

Address \_\_\_\_\_

City, State, ZIP \_\_\_\_\_

Distributor \_\_\_\_\_

ED1122

RCA. First house in CMOS adds SOS.