

# Electronic Design<sup>®</sup> 12

VOL. 23 NO.

FOR ENGINEERS AND ENGINEERING MANAGERS

JUNE 7, 1975

**Inside sweep generators:** Better components have boosted the performance of sweepers. But frequencies still drift and power still varies over the band. Should

you buy a narrow-band unit or one that covers a wide range in one swoop? Either way, you can expect problems. Stay level with sweepers, starting on p. 54.

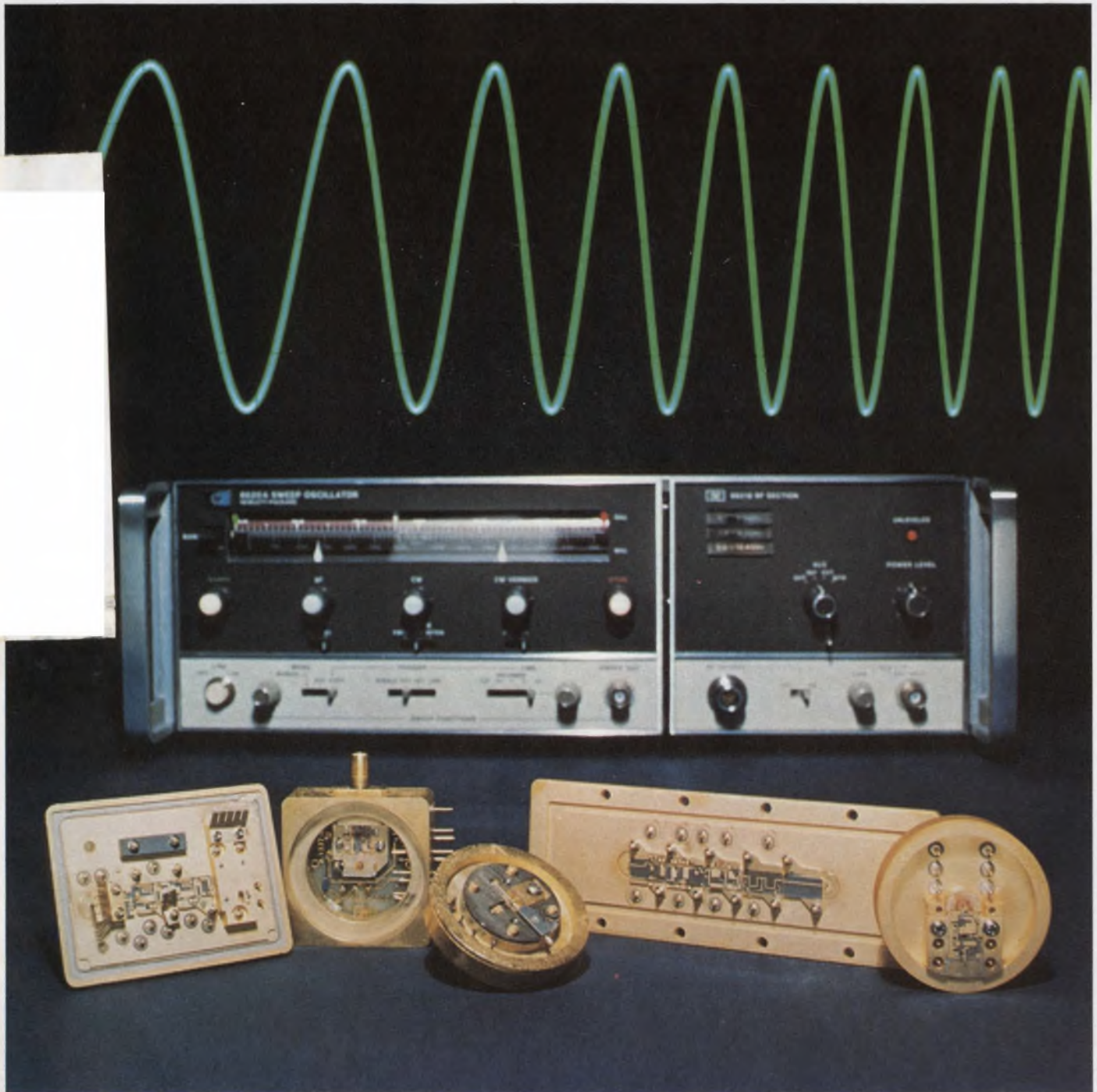



**Because  
you  
only have  
two hands.**

**AMPLIMITE high-density connectors**

come with our exclusive, one-piece plastic strain relief/shield. You can't get one that's easier or less complicated to put on.

Hold the joined "clam-shell" in one hand. Turn the screw with the other. It's that simple to cut into your handling costs.

In addition, you have a highly versatile line of reliable and economical AMP high-density connectors.

With rack and panel interconnections as well as posted configurations. Straight as well as right-angle post contacts. And a variety of contact styles including some with insulation support features. Sizes are 9, 15, 25, 26, 37, 44, 50, 62, 78 and 104 positions.

Of course AMPLIMITE connectors are intermateable with existing high-density types.

For immediate information, call (717) 564-0101. Or write AMP Incorporated, Harrisburg, Pa. 17105.

AMP and AMPLIMITE are trademarks of AMP Incorporated

**AMP**  
INCORPORATED

INFORMATION RETRIEVAL NUMBER 246

# The most accurate word in function generators is XCG.

When we introduced the first of the 180 Series last month, we said we hadn't told you everything. What we didn't tell you about is XCG.

## Now it can be told [or XCG revealed]

XCG stands for xtal-controlled-generator — which stands for a degree of accuracy never before found in any function generator. In both the Models 181 and 183, generator output is locked to a crystal at up to 25 discrete points on the frequency dial. This means they will produce waveform frequencies with synthesizer accuracy of 0.01% of dial setting. When you dial a frequency, you know it's precise, and you don't need a counter to prove it.

## The Model 181 XCG/Sweep Generator \$495

Besides being the most accurate function generator ever, the 181 is also a full sweeper — from 0.1 Hz to 2 MHz, with internal 1000 to 1 sweep. It provides sine, square, and triangle wave outputs (20V output p-p), as well as dc voltage, dc offset, and separate TTL output. And with full

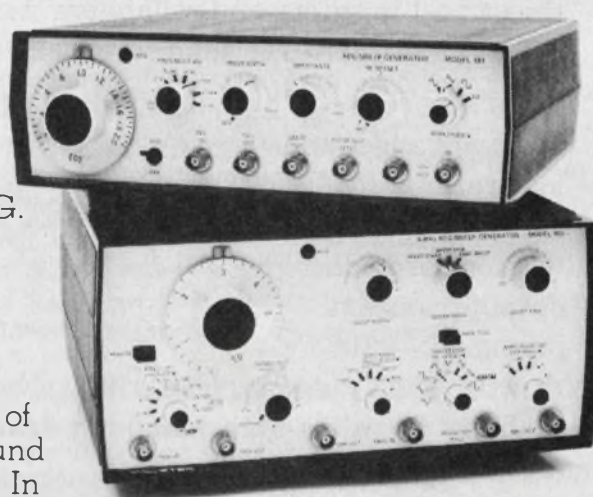

## More 180s from Wavetek.

attenuation, you get ultra-clean signals down to  $-50\text{dB}$ . The only way you can come close to this performance is to buy the Model 180, which gives you everything but XCG for only \$275.

## The Model 183 5 MHz XCG/Sweep Generator \$695

As you can see, the Model 183 is a couple of hundred bucks more than the 181. Here's what that buys you: The 183 has a top frequency of 5 MHz, and provides continuous, triggered, and gated operation. For precise adjustment of continuous sweep, there's a control to individually set start and stop points. There's also a variable symmetry control and another for amplitude — down to  $-60\text{ dB}$ . All of this, plus XCG, add up to the most versatile and accurate function generator ever produced.

## Our Conclusion

Now that you know something about the Wavetek 180s, you'll want to know more. So for complete specs or demonstration, just contact Wavetek, P.O. Box 651, San Diego, CA 92112. Or call (714) 279-2200.

# WAVETEK®

# An extra our 611 S AC solid



U.L. recognized

$\mu$ sec guaranteed minimum  
**600-volt transient withstand**  
caused by over-voltage transients.  
All Teledyne 611s are optically isolated  
feature zero voltage turn-off  
For added safety, we've enclosed  
a rugged, high-impact package  
connections that include both  
and screw terminals. And in  
heard, we're not the only one  
package configuration.

All in all, if it's true reliability  
there's a Teledyne 611 ready  
... in medical electronics, control  
tool or process controls. For  
assistance and fast delivery.



3155 West El Segundo Boulevard  
Telephone (213) 973-4545

Burgstrasse 6-8, 62 Wiesbaden, West Germany  
Telephone: 06121-30231/2 Telex: 04-18

# How to buy

Which comes first—the hardware or the software? You must decide how to create new products with microcomputers. The tougher question is how to assure product profitability? That gets you into questions of hardware availability, software support, design assistance, and reputation in your supplier. When an electronics magazine recently asked readers to rank their microcomputer buying criteria, it came as no surprise to Intel that hardware availability, software support and supplier reputation topped the list.

Intel can supply you today with five general-purpose CPUs, supported by numerous peripheral, I/O and memory components, software packages and development manuals, and the industry's largest library of users' applications programs. Our five microcomputers span a 1000:1 performance range and include the lowest cost, highest performance and most popular designs available today. Their applications are

INTEL MICROCOMPUTER SYSTEM FAMILIES					
MICROCOMPUTER SYSTEM	MCS™ 4	MCS™ 40	MCS™ 8	MCS™ 80	Series 3000
<b>CENTRAL PROCESSOR</b>	4004	4040	8008	8080	3001, 3002, 3003
Technology	PMOS	PMOS	PMOS	NMOS	Schottky Bipolar
Parallel Bits	4	4	8	8	2 per 3002 CPE
Instruction Cycle	10.8 $\mu$ S	10.8 $\mu$ S	12.5 $\mu$ S	2 $\mu$ S	100nS
<b>SUPPORT COMPONENTS</b>					
RAMS (including CMOS)	4	4	5	5	8
PROMS	3	3	3	4	7
ROMS	4	4	3	3	6
*Peripheral Interfaces	6	6	6	6	8
Interrupt Unit			1	1	1
Clock Generator	1	1	1	1	TTL
*I/O Units	5	5	3	3	3
Total Component Choices	23	23	22	23	33
<b>SYSTEMS SUPPORT</b>					
Software Packages					
Microassembler					1
Assemblers	2	2	2	2	
Compiler			1	1	
Monitor	1	1	1	1	
Simulator	1	1	1	1	
Text Editor			1	1	
Manuals	6	6	5	6	1
User's Library	Yes	Yes	Yes	Yes	Yes
Intellec® Development System	Yes	Yes	Yes	Yes	In development

\* Five additional I/O and peripheral devices will be available in 2nd half of 1975.

equally broad  
from electron  
to high speed  
lers and proc  
want to make  
our customer  
begin designi  
pieces of the  
puzzle missin  
development  
cost, each CP  
more than a s  
matched syste  
advanced pro

# icrocomputer.

subsystems, peripheral interfaces, clock generators, priority interrupt and other control units, and the broadest selection of erasable and bipolar PROMs, compatible metal mask ROMs, CMOS and NMOS RAMs.

Moreover, Intel software packages include resident monitors, assemblers and text editors available on Inteltec® microcomputer development systems. Assemblers, simulators and compilers

are also available as cross products on magnetic tape or on leading time share networks. With these aids programs can be written and debugged in a fraction of the time required a few years ago.

You may need design assistance before the meter starts running in the research and development lab. Intel has the industry's most experienced microcomputer field applications engineering group. If your staff needs help to get started, we have regional training centers, workshops, seminars and on-site training courses available.

With Intel, there's no shell game about hardware or software delivery, no guessing whether the supplier can handle all your production commitments. Intel has been

delivering microcomputers in volume since 1971. Our reputation speaks for itself. We've already delivered more general-purpose microcomputers than the rest of the industry combined.

If you have tough questions about which microcomputer will make your new products most profitable, call or write Intel for our solutions. Intel Corporation, 3065 Bowers Avenue, Santa Clara, California 95051 (408) 246-7501.

**intel**® Microcomputers. First from the beginning.

INFORMATION RETRIEVAL NUMBER 4



**Any design—Ribbon Cable, IC Interconnects, Custom Harnesses.** Woven Electronics produces flat woven cable assemblies to your specs for conductors, spacing, insulation, color coding, marking, all requirements including special features such as breakouts, fold lines, tinning, connectors.

Don't accept cable compromises. Let us assist in design stages and get the exact interconnect your system needs.

## **WOVEN ELECTRONICS**

P.O. Box 189/Mauldin, South Carolina 29662  
(803) 963-5131

# **FLAT CABLE**

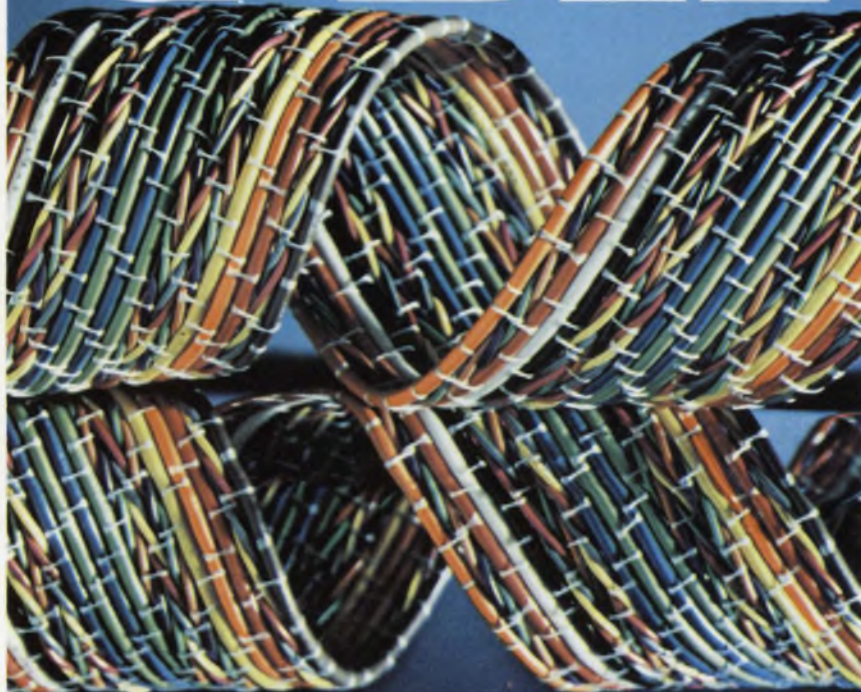

### **Sr. Vice President, Publisher**

Peter Coley

### **Editors**

Editorial Offices  
50 Essex St.  
Rochelle Park, NJ 07662  
(201) 843-0550  
TWX: 710-990 5071  
Cable: Haydenpubs Rochellepark

**Editor-in-Chief** George Rostky

### **Managing Editors:**

Ralph Dobriner  
Michael Elphick

### **Associate Editors:**

Dave Bursky  
Jules H. Gilder  
Morris Grossman  
Seymour T. Levine  
John F. Mason  
Stanley Runyon  
Edward A. Torrero

### **Contributing Editors:**

Peter N. Budzilovich  
Alberto Socolovsky  
Nathan Sussman

### **Editorial Field Offices**

#### **East**

Jim McDermott, Eastern Editor  
P.O. Box 272  
Easthampton, MA 01027  
(413) 527-3632

#### **West**

David N. Kaye, Senior Western Editor  
8939 S. Sepulveda Blvd.,  
Suite 510  
Los Angeles, CA 90045  
(213) 641-6544  
TWX: 1-910-328-7240

### **Editorial Production**

Marjorie A. Duffy

### **Art**

**Art Director,** William Kelly  
Richard Luce  
Anthony J. Fischetto

### **Production**

**Manager,** Dollie S. Viebig  
Helen De Polo  
Anne Molfetas  
Maxine Correal

### **Circulation**

**Manager,** Evan Phoutrides

### **Information Retrieval**

Peggy Long

### **Promotion**

**Manager,** Walter G. Salm  
Karen Kerrigan (Reprints)

### **Creative Layout Services**

**Manager,** Albert B. Stempel

## Across the Desk

### Article on modems prompts a critique

The article "Build Compact Modems" (ED No. 1, Jan. 4, 1975, pp. 74 to 81) discussed a design approach to implement FSK modems. Since the Vadic Corp. is the largest supplier of such modems in the U.S., we feel impelled to comment on the technical merits of the design. Although the article did not state what modems or lines would be connected, it did leave the reader with the false impression that the design would be compatible with Bell 103 modems over the telephone company network.

The Bell 103 modem operates full duplex and requires 70-dB rejection of the local transmit carrier. The proposed design provides 45 dB of rejection. The measured error probability stated in the article approaches 0.5 dB of theoretical; however, this number is very theoretical, since it does not take into account distortions (frequency translation, impulse noise, jitter, etc.), other than white noise on the dial network. The hybrid (duplexer) used does not take into account reactive components in the telco network, and therefore offers generally less rejection than noted.

*Ken Krechmer*

*OEM Marketing Manager*

Vadic Corp.  
505 E. Middlefield Rd.  
Mountain View, CA 94043

### The author replies

The objective of the article was to provide the basic fundamentals

and guidelines for building FSK modems with LSI techniques. Consequently various connecting arrangements and optimum design specifications for specific systems were not detailed.

I agree with Mr. Krechmer's comment on Bell's 103 filtering level. This is identified in the article on p. 77 as follows: "Modems that are designed for a wide dynamic range of input signal levels (-15 to -55 dBm) require better than 70-dB rejection of the local transmit carrier."

I also agree with his statement that the duplexer does not take into account reactive components in the telephone network. This is pointed out on p. 76: "In practice, the line impedance can have reactive as well as resistive component variation."

Mr. Krechmer points out that the article did not take into account many of the distortions on the dial network. System tests have proven that performance for a worst-case 3002 line is degraded typically by 2 to 3 dB when the line specs are 10-Hz frequency translation and 15° p-p phase jitter at a 180-Hz rate.

Another disturbance that reduces data throughput is line dropouts. Such occurrences, up to 32 ms, are bridged by the MC-6860, so that channel establishment is maintained and data transmission can continue.

Modems using the MC6860 are compatible with Bell's 103, in that the handshaking protocol requirements are met, the Tx-Rx frequencies are common and data transmission can occur.

Modems designed to be equivalent  
*(continued on page 8)*

# Thin-Trim<sup>®</sup> capacitors



Tucked in the corner of this Pulsar Watch is a miniature capacitor which is used to trim the crystal. This Thin-Trim capacitor is one of our 9410 series, has an adjustment range of 7 to 45 pf., and is .200" x .200" x .050" thick. The Thin-Trim concept provides a variable device to replace fixed tuning techniques and cut-and-try methods of adjustment. Thin-Trim capacitors are available in a variety of lead configurations making them very easy to mount.

A smaller version of the 9410 is the 9402 series with a maximum capacitance value of 25 pf. These are perfect for applications in sub-miniature circuits such as ladies electronic wrist watches and phased array MIC's.

Johanson Manufacturing Corporation,  
Rockaway Valley Road., Boonton, N.J.  
07005. Phone (201) 334-2676, TWX 710-  
987-8367.

*Johanson*

Electronic Design welcomes the opinions of its readers on the issues raised in the magazine's editorial columns. Address letters to Managing Editor, Electronic Design, 50 Essex St. Rochelle Park, N.J. 07662. Try to keep letters under 200 words. Letters must be signed. Names will be withheld on request.

**ACROSS THE DESK**  
(continued from page 7)

lent to a Bell 102, however, must contain more selective filters than those shown in the design example.

*Garth Nash*

Motorola Semiconductor  
Products Inc.  
5005 E. McDowell Rd.  
Phoenix, AZ 85008

**Throw-away calculator viewed as practical**

Your Jan. 18, 1975 issue was a great boon to the scientist/engineer still trying to decide on buying a scientific calculator—or, indeed, to those of us considering a second calculator (“Special Report on Scientific Calculators,” ED No. 2, pp. 24-30). I recently had to get my 1972 scientific calculator repaired. Compared with the original cost of the machine, the factory’s minimum repair charge didn’t appear large, but when compared with the current price of the machine or brand X’s equivalent cost, the repair charge took “an arm and a leg.”

It may be that with today’s high labor costs, we’re rapidly approaching the time that it will be uneconomical to repair calculators. They may become “throw-aways,” just as transistor radios have become.

With this in mind, the engineer/scientist may well want to pass up his first-choice machine, with its many “convenience” features, for one with less convenience but a substantially lower price. By the time the unit needs repair out of warranty, it will truly be a throw-away.

*Justin Whitney*

6920 E. 17th St.  
Tulsa, OK 74112

**Author corrects an Idea for Design**

In my Idea for Design, “Optical Coupler Helps Transmit Data

and Clock Signals on Single Wire Pair” (ED No. 26, Dec. 20, 1974, p. 104), the optical couplers in the text, to be consistent with the diagram, should be labeled OC3 and OC4 rather than G3 and G4. The polarity of the input diode on OC4 should be reversed, so it is opposite from the polarity of the input diode on OC3.

The circuit will not work as published without the above corrections.

*Richard Gunderson*  
Senior Project Engineer

ADC Telecommunications  
Div. of Magnetic Controls Co.  
4900 W. 78th St.  
Minneapolis, MN 55435

**Parentheses called simple to use**

MOS Technology, Inc., pioneered the two-parentheses, hand-held scientific calculator and was a source of chips for almost all such units delivered in 1974. Thus I thought that you might be interested in an example of the calculating power of a two-parentheses machine, an RPN machine and a machine identified as AESH in the article written by John A. Ball. Memory register is not used but reserved for getting out of trouble in tough problems.

It is our contention that the two-parentheses machine is the simplest to use in complex problems and does not require the

**Misplaced Caption Dept.**



Sorry. That’s Salvador Dalí’s “The Persistence of Memory,” which hangs at the Museum of Modern Art in New York City.

special training referred to by Mr. Ball. The problem solved four ways in the figure is

$$\frac{a + b}{c + d} + (e + f)(g + h).$$

One of the sequences for the two-parentheses machine is a brute-force approach, whereas the other is a knowledgeable approach that omits unnecessary parentheses. We believe that ease of use is more important in reducing errors than key stroke count. The AESH machine not only requires auxiliary memory to solve this problem but also calls for the use of paper and pencil.

*John Paivinen*  
President

MOS Technology, Inc.  
Valley Forge Corporate Center

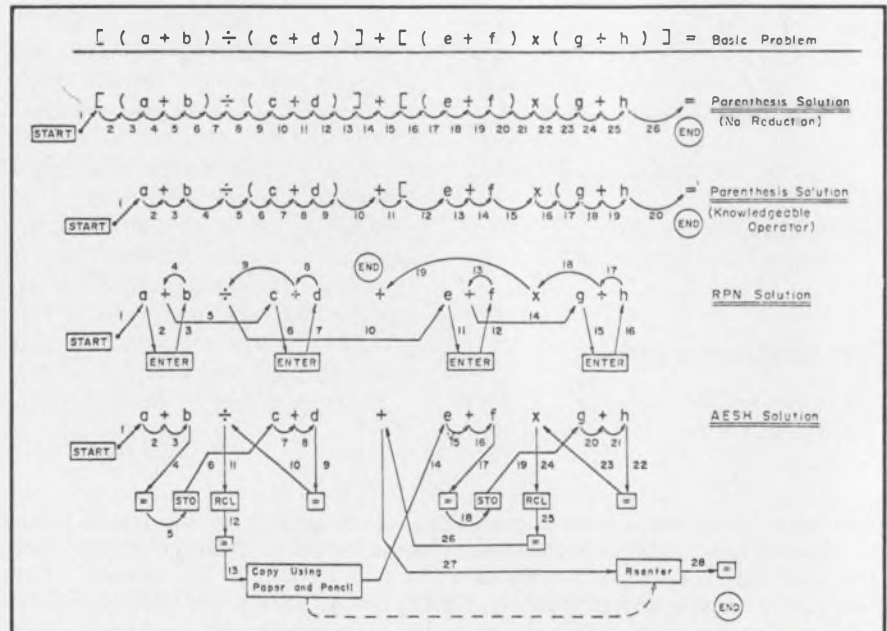





# MEASUREMENT COMPUTATION

innovations from Hewlett-Packard

# NEWS

JUNE, 1975

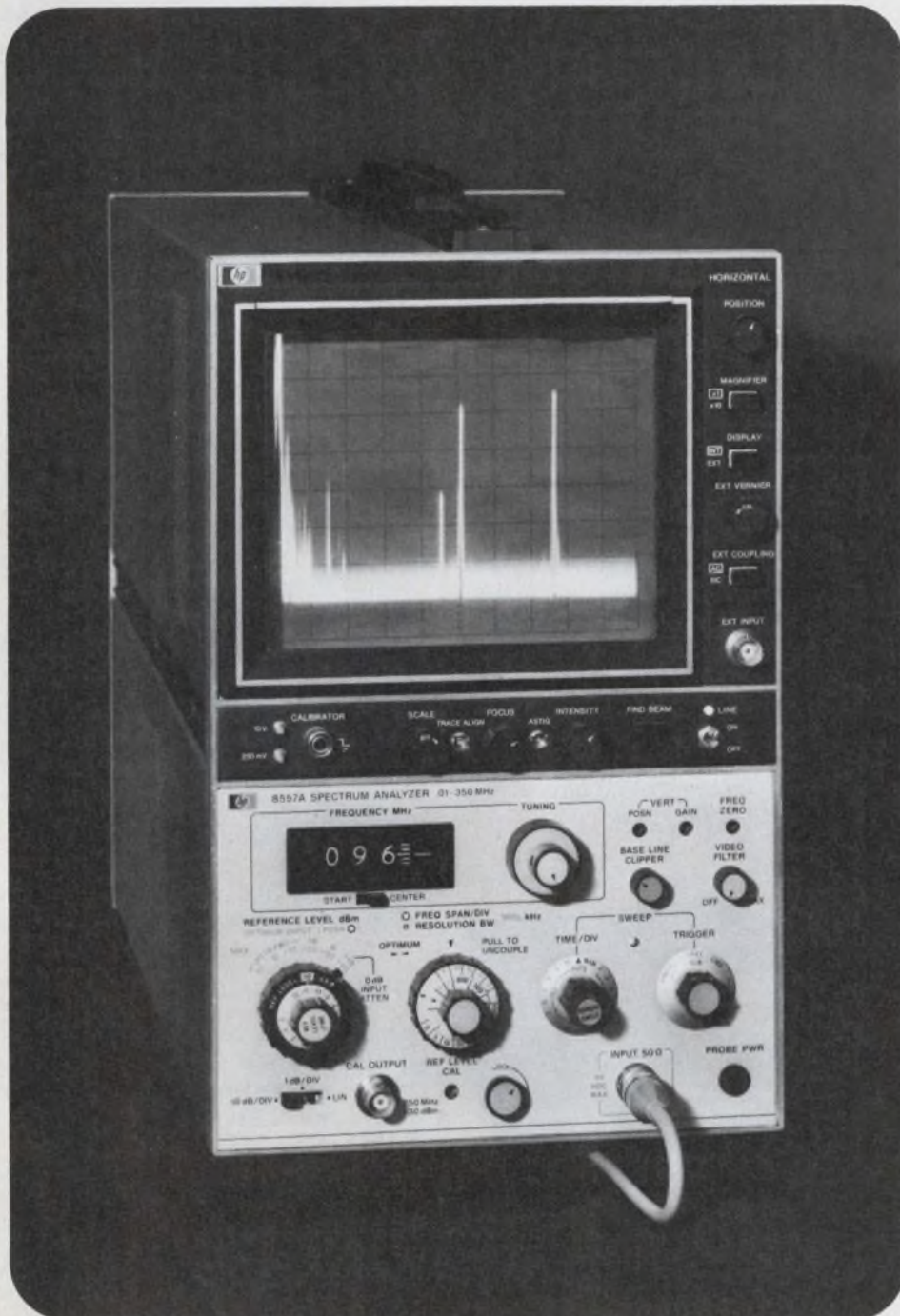

## in this issue

HP-46 desk-top electronic slide rule with printer output (page 5)

New phase modulation capability in 1-2600 MHz signal generator (page 2)

10,000 component measurements per hour with LCR meter (page 7)

## New VHF Spectrum Analyzer Offers Lab-Grade Performance at a Low Price

New 350 MHz Spectrum Analyzer plug-in is accurate, easy to use, and economical.

In the past, engineers usually time-shared one expensive spectrum analyzer, even though most of their measurements did not require high resolution. Now comes an analyzer priced for every bench, so the expensive analyzer can be reserved for more demanding measurements.

The new HP 8557A Spectrum Analyzer, a plug-in for HP 180-series scopes, features performance and accuracy that qualify it for lab use. Yet its ease of operation and economy make it attractive for such cost sensitive applications as production test, service, maintenance, and education. With 10 kHz to 350 MHz range, it's well suited for CATV, telecommunications, mobile radio, broadcast systems, navigational aids and telemetry measurements.

(continued on third page)

## Direct counting up to 520 MHz with NEW low cost counter



Simple, virtually error-free operation complements the 5383A's high accuracy.

Low cost counters generally use pre-scalers (input frequency dividers) to get up to 500 MHz. Unfortunately, pre-scalers impose a resolution or speed penalty—usually a decrease of 4 to 10 times. Now, however, by borrowing unique circuitry from our sophisticated higher priced counters, we're able to offer the HP 5383A, a new, laboratory quality, low cost model using the speedy, accurate, direct counting technique. This technique gives 1 Hz resolution up to 520 MHz using a 1 second gate time.

You're likely to find the 5383A close to ideal for production line testing, communication, navigation and telemetry equipment servicing and R&D since it offers a host of useful features such as:

- 10 Hz to 520 MHz, direct counting
- Nine digit readout
- Accuracy of  $\pm 1$  count  $\pm$  time-base error
- Time base aging rate  $< 0.3$  ppm/month
- Optional TCXO time base for high accuracy calibration needs
- 1 megohm, or fuse protected 50 $\Omega$  input
- 25 mv to 50 mv sensitivity
- Gate times of 0.1, 1.0, 10 seconds
- Rugged aluminum case.

Start on your way to speedier, more certain frequency measurements by looking into the 5383A today.

For a data sheet, check J on the HP Reply Card.

## New 4-Channel Recorder with Interchangeable Plug-ins offers greater versatility

Now you can record one to four input signals against time with the new HP 7404A oscillograph recorder. You can adapt this new recorder to your varied applications including the capability to amplify and measure dc signals with a broad range of sensitivities, or record transducer outputs with ac or dc excitation supplied.

With the choice of plug-ins, you can measure parameters such as voltage, pressure, flow, force, displacement and temperature with respect to time.

The 7404A is a four-channel recorder but will also record on two 80 mm-wide channels.

Clear traces that dry immediately upon contact with the paper are produced by the pressurized ink system of these units. The pens are designed to last the life of the instrument, and will not be damaged by any input signal frequency.

Twelve chart speeds are front-panel selectable as standard on the 7404A. Remote operation is also possible by contact closure or TTL.

To help you choose the recorder for your needs, find out more by checking L on the HP Reply Card.



New 4-channel recorder with easy paper loading, rugged stainless steel pens, modular construction.

## New 1-2600 MHz signal generator features phase modulation, is HP Interface Bus compatible



L-Band communications and telemetry applications now have a new precision signal source.

The new HP 8660C synthesized signal generator spans the range 1 MHz to 2600 MHz in steps as small as 2 Hz. Also being introduced are two new modulation plug-ins which offer HP's first calibrated phase modulation capability.

This added frequency range and phase modulation capability provides precision signals needed to test satellite and space telemetry receivers or communications links. Or, it can serve as a local oscillator in certain frequency-agile transmission systems. The phase modulation also permits comprehensive analysis of phase-lock loop circuits.

The new plug-in modules include an RF Section (86603A) which generates output from 1 MHz to 2600 MHz at levels from +7 dBm to -136 dBm. Model 86634A is a phase modulation plug-in which provides calibrated, linear phase modulation at rates to 10 MHz. Another new modulation plug-in (86635A) provides phase modulation plus frequency modulation.

The 20-key mainframe keyboard provides digital entry of center frequencies, steps, or sweeps. The synthesizer's digital sweep mode is particularly useful in testing extremely stable or sharply tuned components, such as crystal filters.

With the HP-IB (Interface Bus), the generator may be connected as a programmed signal source for a variety of user-assembled mini systems for lab and production uses. (Option 005)

To receive more information, check Q on the HP Reply Card.

## New Bench Supplies for MOS, CMOS and Linear IC Designs

Now there are two low-cost bench supplies designed specifically for industrial and educational labs working with MOS, CMOS and Linear integrated circuits. The HP 6237A delivers three outputs: 0 to 18V, up to 1A; and dual-tracking 0 to  $\pm 20V$ , 0 to 0.5A.

The Model 6237A, and the 6236A shown below, are compact, easy to use and incorporate the key performance and safety features needed in the lab environment.

The complimentary Model 6236A has outputs: 0 to 6V, up to 2.5A; and 0 to  $\pm 20V$ , 0 to 0.5A, and is intended primarily for use with TTL/Linear IC designs.

Each supply can be powered from a nominal 100V, 120V, 220V, or 240V, 47-63 Hz ac input. Both the single and dual-tracking outputs are protected from overloads by fixed current limiting circuits.

For more information, check K on the HP Reply Card.

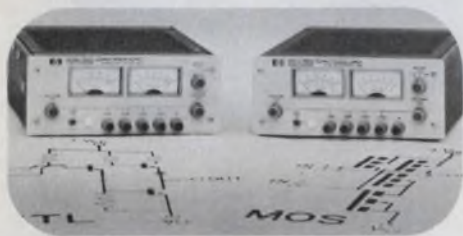

What every industrial and educational lab needs: convenient, low-cost dc power for TTL, MOS, CMOS and Linear IC test and development.

## New VHF Spectrum Analyzer

(continued from page one)

Signal amplitudes from +20 dBm to -117 dBm may be measured and viewed over sweep widths ranging from 350 MHz down to 50 kHz. Eight resolution bandwidths from 1 kHz to 3 MHz permit a wide variety of measurements, such as viewing modulation or analyzing pulsed RF spectra.

Impressive, also, is the 8557A's ease of operation. Most measurements are a simple three step process:

1) Tune the inverted marker to the signal to be measured and read its frequency on the digital readout.

## Why you should consider spectrum analysis

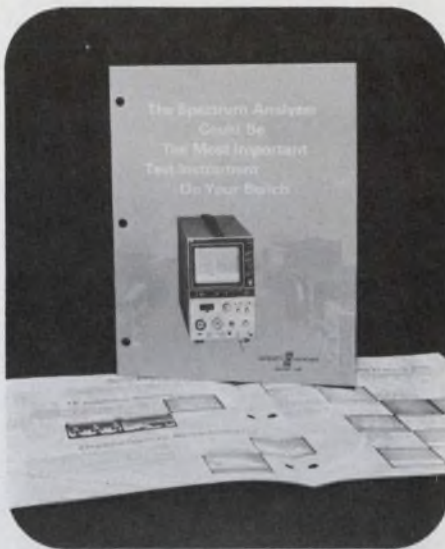

Our new spectrum analysis brochure shows the spectrum analyzer's versatility in making RF signal measurements such as field strength, power, noise, frequency, distortion and modulation. The brochure demonstrates these measurements as they may apply to your work: in powerful techniques for component evaluation, equipment testing and system performance verification.

In addition, the brochure is a guide to help you select the right analyzer for your application by defining critical spectrum analyzer specifications such as resolution bandwidth and amplitude measurement range.

For your copy of the brochure, check U on the HP Reply Card.

- 2) Zoom-in on the signal by decreasing the frequency span (bandwidth, sweep time, and video filtering are set automatically).
- 3) Raise the signal to the top of the CRT and read its amplitude (in dBm) from the reference level control.

Versions of the 8557A for measurements in 75 ohm systems are also available.

For more information, check O on the HP Reply Card.

## New automatic receiver system for versatile communication uses

The HP ARS-400 is a fully automatic precision receiver for signal detection and analysis in the 100 kHz to 18 GHz frequency range. It has many useful applications including satellite system monitoring, spectrum management, site surveillance, electronic intelligence, and EMI testing.

The system consists of reliable, field-proven commercial equipment under program control. The high-speed precision receiver features IF bandwidth from 10 Hz to 3 MHz, multiple detectors for AM, FM and SSB detection.

Specially designed calls have been included to allow the receiver to tune and measure at very fast rates.

Application programs can be created by the user and stored on the disc unit for future use. Output data is written on the IBM-compatible, 9-track magnetic tape for later analysis on the ARS-400 or larger computer systems.

Critical signal parameters such as power, or modulation levels, signal bandwidth, carrier-to-noise ratio, etc. can be provided on-line.

The ARS-400 is capable of gathering significant amounts of usage information over several communications channels. This data can be analyzed on-line or stored on magnetic tape.

The ARS-400 is a totally integrated system, providing a fully characterized precision receiver, data processing capability, interactive graphics, and mass storage devices.

For details, circle P on the HP Reply Card.



New fully automatic precision receiver for spectrum management, electromagnetic interference, site surveillance, or system monitoring.

## New RTE-III Operating System manages up to 512K bytes of memory, up to 64 partitions

Hewlett-Packard's new RTE-III is a disc-based real-time operating system that manages up to 512K bytes of memory, organized in partitions, using the Dynamic Mapping System in 21MX M20 or M30 Computers. Up to 64 multi-user partitions can be defined for simultaneous use such as executing and developing programs, and managing data in a variety of high-level languages that can include FORTRAN IV, Multi-User Real-Time BASIC, and ALGOL. RTE-III supervises execution of many different user's programs in a multi-programming mode; programs may be scheduled by time, events, other programs, or operator command. Software includes a file manager for easy access to random or sequential files. Disc storage can start at 5M bytes, and can be expanded to 118M bytes.

With RTE-III, users at multiple terminals may be developing interactive programs while other user's terminals are engaged in data management. Multi-stream batch processing can be used to provide job control over program development and other background operations. Optional distributed multi-processing software provides for real-time program scheduling and file management functions from remote satellite computers. RTE-III can support a variety of peripherals, including mag tapes, line printers, card readers, plotters, and analog and digital I/O interfaces. System integrity is safeguarded; system software provides for power-fail restart with intact programs and data; a watchdog timer calls the user when I/O devices fail to respond. There are now two levels of memory protection, one by hardware fences and the other by the Dynamic Mapping System.

*For full details about this new operating system, check R on the HP Reply Card.*

## Two new OEM CRT displays feature high resolution with numerous options



Fine image detail and a well-focused spot at all intensity levels make the 1335A ideal for use in analytical and automatic test system applications.

Two new HP CRT displays offer exceptional picture quality and resolution, uniform focus with wide changes of intensity, and X-Y amplifiers with 70 ns rise times. These displays are ideal for use in systems for Spectrum, Fourier, Network and Chemical analysis, as well as in automatic test systems.

Model 1335A, shown above, is a variable persistence, storage, and non-storage CRT display with excellent performance. Persistence is continuously variable from about 0.2 seconds to full storage. The totally new CRT design offers a high resolution image with excellent contrast and uniformity for many applications.

Model 1332A has a standard CRT with a spot of 0.305 mm (0.012 in.) diameter at high intensity levels which remains extremely well-focused over a wide range of intensity levels. The high resolution makes the display ideal for applications requiring sharp focusing

on multiple gray shades or varying writing speeds with frequent video drive level changes.

Numerous options are available to tailor the displays to fit a specific application. These factory-installed options include:

- (1) For the X-Y amplifiers: deflection factor, polarity, input impedance, and rise time;
- (2) Z-axis amplifier: blanking range, polarity input impedance, gain, and digital input;
- (3) for the CRT: graticule, phosphor (on the 1332A), and contrast filter; and
- (4) for the mechanical frame: covers, controls, line voltage, and tolerance, and special ac cords.

*For more information on these two new displays, check B on the HP Reply Card.*

## For improved lab productivity, HP Calculator family now interfaces with many instruments



Instrumentation control from a desk-top programmable calculator.

Now, assembling a custom calculator-controlled instrumentation system is fast and easy because of interfacing cables that allow you to connect multiple instruments.

Digital voltmeters, electronic counters, waveform analyzers and synthesizers, scintillation counters, clocks, capacitance meters and other instruments can be interfaced directly to a 9800 series calculator which can then operate as both a controller or a data logger.

HP interface cards accommodate instruments using 8-4-2-1 BCD output, 8-bit parallel codes in any input and output formats, and bit-serial data.

The new Hewlett-Packard Interface Bus (HP-IB) provides a byte serial interface system that offers plug-to-plug compatibility between common instruments.

For more information on how to interface an HP 9800 series programmable calculator to your instrumentation, check S on the HP Reply Card.

## The HP-46, a desk-top slide rule with LED display and printer output

Since its introduction nearly two years ago, thousands of scientists, engineers, and educators have purchased the HP-46. Applications range from the various engineering disciplines through biology and chemistry, to math, stat, medical research, navigation, even surveying.

The desk-top HP-46 has 48 preprogrammed scientific functions and operations. If you choose, it also prints a functional notation for each operation so you know what was done and when it was done. Thus, you can achieve the most effective use of the nine storage registers, three angular modes, and metric conversions.

The HP-46 reduces intricate and extensive calculations to a series of quick key strokes. And, you can combine arithmetic operations. Serial calculations, chain calculations, and mixed chain calculations are uncomplicated without the need of reference tables.

Put the HP-46 on your desk simplifying calculations, eliminating tedious recalculations, and saving your valuable time.



For details, check A on the HP Reply Card.

Select either scientific or fixed point display to match your calculations with up to 10-digit accuracy.

## Retrofit kits boost accuracy, stability and reproducibility of Cesium Beam frequency standards

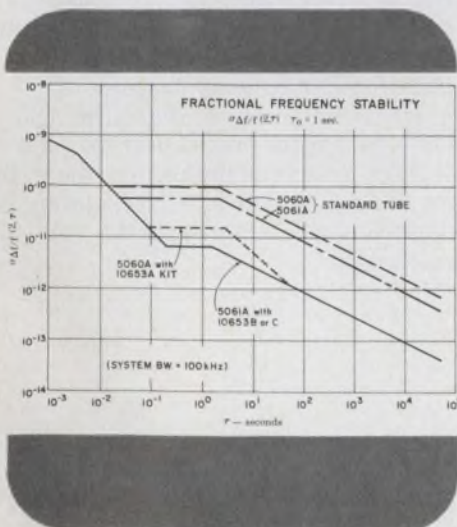

Newly available retrofit kits give present owners of HP's 5060A and 5061A Cesium Beam Frequency Standards an order of magnitude improvement in short term stability. This improvement was formerly only available in newly-ordered 5061As as Option 004. The state-of-the-art performance improvements were attained through major design changes in the cesium beam tube: increased length of the microwave cavity results in higher accuracy, which was achieved without increasing tube size; increased cesium beam flux and a unique HP design of multiple beams results in better short-term stability and greater immunity to shock and vibration; more effective

magnetic shielding reduces effects of external magnetic fields and improves settability.

See the graph to the left for performance characteristics. Other principal specifications of instruments upgraded by the kits are:

Accuracy	$\pm 7 \times 10^{-12}$
Reproducibility	$\pm 3 \times 10^{-12}$
Settability	$\pm 1 \times 10^{-13}$
Long Term Stability	$\pm 3 \times 10^{-12}$

To receive complete technical data, check T on the HP Reply Card.

## New 4.5 GHz Counter offers highest performance in its frequency class.

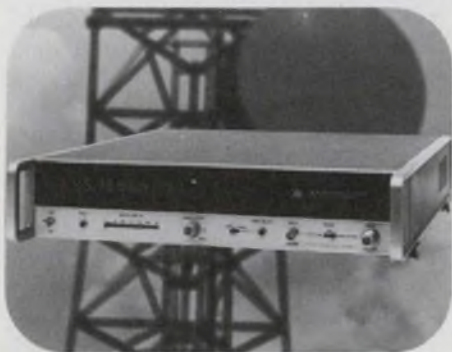

The 5341A Counter offers "best case" performance gems like 30 MHz peak-to-peak FM tolerance, -20 dBm sensitivity, 100  $\mu$ sec acquisition time and +30 dBm damage level on its microwave range.

For cost-effective UHF and microwave equipment production testing, as well as lab troubleshooting from 10 Hz to 4.5 GHz, the new HP 5341A Automatic Frequency Counter is close to ideal.

Compare its range, sensitivity, FM tolerance, speed, accuracy, resolution, overload tolerance, systems compatibility and built-in diagnostics—the new 5341A is unexcelled in the "up to 4 GHz" class of automatic counters today. Its unique "switchable filter" heterodyne technique allows a much faster signal acquisition than other methods. The 5341A can acquire and begin measurement of any frequency to 4.5 GHz within 600  $\mu$ seconds (100  $\mu$ sec in MANUAL mode). Operator convenience is a key feature of the 5341A, with a choice of automatic or manual operation and a unique self-troubleshooting technique.

The ten-digit LED display provides 1 Hz resolution all the way to 4.5 GHz. The 5341A may be purchased with frequency range limited to 1.5 GHz at a reduced price. If desired, you can later upgrade it to 4.5 GHz.

We welcome your comparison of the price-to-performance ratio with other microwave counters.

For more information, check I on the HP Reply Card.

## New capabilities added to bit-error-rate measurement system

Hewlett-Packard's 3760A Data Generator and 3761A Bit Error Rate (BER) Detector provides more flexibility and convenience for communication testing in such areas as fiber optics, digital radio, digital cable and millimeter wave transmission systems. The 3760A/3761A are also useful in applications such as digital multiplex and digital tape and disc recording.

HP's measurement system operates between 1 Kb/s and 150 Mb/s, providing a broader operating range than previously available. Both mean signal and dc triggering are available as a switch selectable option in the 3761A Error Detector. This allows the equipment to be used in either continuous or burst (e.g., time division multiple access transmission systems) signal modes. A second data output, delayed from the primary output by eight bits, is available on the 3760A Data Generator. This effectively provides two uncorrelated outputs for such test applications as four-phase, phase-shift-keyed transmission systems, and cross-talk interference tests. Fixed crystal clock speeds are available for the 3760A Data Generator. This provides the user added convenience where frequent testing at specific speeds is required.

The 3760A Data Generator is also very useful as a stand-alone instrument. It provides flexible pattern (i.e., PRBS, 1010 sequence) and word generation signals with pulse generation quality.

For technical information on the 3760A, 3761A and the new options, check C on the HP Reply Card.



For design, development, commissioning and maintenance of pulse code modulation, PCM, systems, data generator and error detector provide a complete local or remote bit error rate measuring system.

## New detectors and step attenuators for microwave measurements

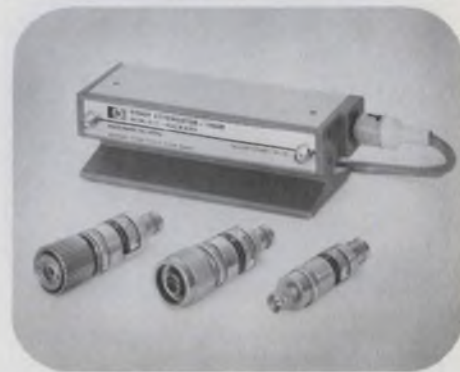

### Detectors

Low barrier hot carrier diode technology (LBHCD) has permitted a new family of microwave detectors covering the 10 MHz to 18 GHz range; HP 8470B (APC-7 or Type N), 8472B (SMA) and 423B (Type N, 12.4 GHz). These detectors have much flatter frequency response than previous point-contact types:  $\pm 0.2$  dB over any octave to 8 GHz;  $\pm 0.3$  dB, 10 MHz to 12.4 GHz;  $\pm 0.6$  dB, 12.4 to 18 GHz.

Microwave detectors are general purpose components, widely used for CW or pulsed power detection, leveling of sweepers, and frequency response testing of other microwave components. Thus, improved flatness and SWR are highly desirable and directly yield more accurate measurements.

### Programmable Attenuators

Models 8495 G/H and 8496 G/H programmable microwave attenuators offer 70 dB or 110 dB range in 10 dB steps from DC - 18 GHz. Models 8494G/H offer 11 dB range in 1 dB steps. Programmability makes the attenuators particularly well-suited for mini-system use under Interface Bus control, using the HP 59306A Relay Actuator.

The design uses an innovative self-latching magnet mechanism for each section. Switching time is less than 20 ms and momentary actuation current is approximately 100 mA for the 25V solenoids.

For detailed information on the detectors, check M; for the attenuators, check N on the HP Reply Card.

# HEWLETT-PACKARD COMPONENT NEWS

## High speed measurements of low-value components with digital meter

If you're testing diodes and capacitors or trimming IC capacitors and resistors, you need fast precise inductance, capacitance, resistance and loss measurements. Plug the HP 4271A Digital LCR meter into your system and you get 10,000 measurements or more per hour.

Using a four-pair measurement technique that reduces stray capacitance and residual inductance, this 1 MHz digital meter measures capacitance from 0.001 pF to 19.000 nF with an accuracy of 0.1%, and inductance from 0.1 nH to 1900.0  $\mu$ H. Capacitance loss components are measured as parallel conductance or as dissipation factor (as

low as 0.0001). Inductance loss components are measured as series resistance (10  $\Omega$  to 10 K $\Omega$ ) or dissipation factor (as low as 0.0001). And you can vary dc bias from 0 V to 39.9 V in 0.1 V increments.

The LCR meter has a four-digit LED display with 90% overrange, and it interfaces easily with HP computers, calculators, and digital recorders.

*For information on improving component testing, check D on the HP Reply Card.*



Typical uses for the 4271A LCR meter include: testing discrete components and varicap diodes, checking semiconductors, and L or C examinations of delay lines.

## Stripline Schottky Diode Quads for Double Balanced Mixers

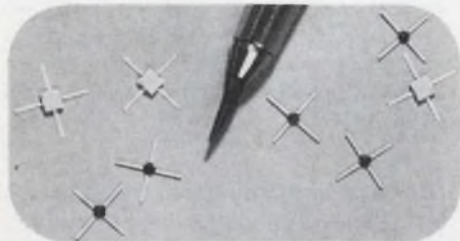

For the first time, Schottky diode quads designed for use in microwave integrated circuits, microstrip or stripline, from 1 to 8 GHz, are available in hermetically sealed packages.

The 2.54 mm (0.10 in) square package, 5082-2261/62/63, contains a monolithic array of Schottky diodes interconnected in ring configuration. Uniform electrical characteristics among the four diodes result in a tightly matched quad.

Broadband quads, 5082-2291/92/93/94, for applications to 18 GHz, are available in a sub-miniature 1.27 mm (0.05 in) square ceramic package whose leads are brazed to the substrate for maximum package ruggedness.

*For details, check F on the HP Reply Card.*

## Guaranteed ruggedness in new beam lead PIN diode

Each lead of these new beam lead PIN diodes will survive a two gram pull. This high lead strength is achieved by a new process enabling Hewlett-Packard to guarantee the ruggedness of this Model 5082-3900.

Breakdown voltage of the new diodes is a guaranteed minimum of 150 volts, and 200 volts is typical. Capacitance ( $C_0$ ) is a low 0.02 picofarads, resulting in isolation equal to or better than other presently available PIN diodes.

These diodes are for use in strip-line or microstrip circuits using welding, thermocompression or ultrasonic bonding techniques. Applications include switching, attenuating, phase shifting, limiting and modulating at microwave frequencies.

*For detailed specifications, check G on the HP Reply Card.*

## New common cathode .43" display

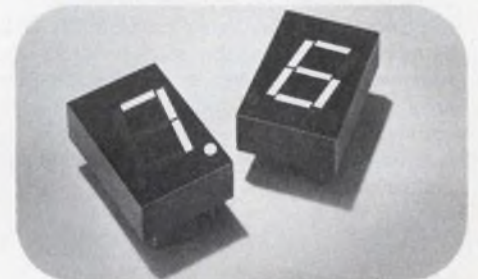

.43" display offers a bright, continuously uniform seven segment display in a 0.3" dual-in-line configuration.

A new, common cathode 0.43-inch (11 mm) high LED display is low cost and easy to interface. The new direct-drive MOS clock circuits interface directly with this new HP 5082-7760 indicator. It is expected to be widely used in many consumer applications, including clock radios, business machines, TV channel indicators and low-cost electronic instruments.

Designed for viewing distances of up to 20 feet, these single digit displays provide a high contrast ratio and a wide viewing angle.

*For more details, check H on the HP Reply Card.*

# The IC Troubleshooters show it like it is... at new reduced prices

Originated by HP, the Logic Probe, Logic Pulser, and Logic Clip have seen widespread use where digital circuits are designed, built or serviced. Their popularity stems from their rapid, simple, virtually error-free operation, coupled with ruggedness. Now, these new low prices will further enhance their popularity.

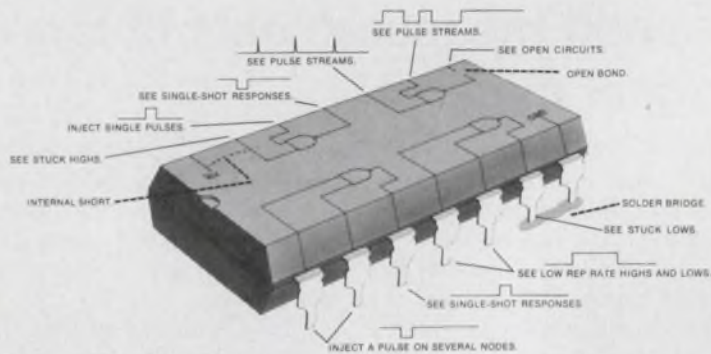

Using the 10526T Logic Pulser and 10525T Logic Probe you can inject pulses into TTL/DTL gates directly and see the results—without unsoldering or trace cutting. Simply press the Pulser's button to inject a pulse and the Probe quickly verifies gate operation—high, low or bad level. It'll read single pulses down to 10 ns and pulse trains up to 50 MHz.

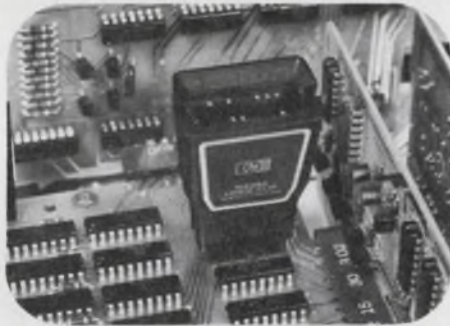

The 10528A is an easy-to-use tool for viewing all the pins of 14- or 16-pin IC's simultaneously. When used in conjunction with the 10526T Pulser, sequential logic circuits like shift registers come alive—each state change is immediately visible—and circuit analysis achieves new meaning.



The 5015T Mini-Kit puts it all together—for less. Order the Probe, Pulser, and Clip in this convenient kit with carrying case provided. Get all of the stimulus-response capability of our popular troubleshooters in this fully integrated kit for the lowest price we've ever offered.

*For more information on the latest techniques in digital troubleshooting, check E on the HP Reply Card.*



East-4 Choke Cherry Road, Rockville, MD 20850  
Ph. (301) 948-6370.  
South-P.O. Box 28234, Atlanta, GA 30328,  
Ph. (404) 434-4000.  
Midwest-5500 Howard Street, Skokie, IL 60076,  
Ph. (312) 677-0400.  
West-3939 Lankershim Blvd, North Hollywood, CA  
91604, Ph. (213) 877-1282.  
Europe-P.O. Box 349, CH-1217 Meyrin 1, Geneva,  
Switzerland, Ph. (022) 41 54 00.  
Canada-6877 Goreway Drive, Mississauga, Ontario,  
L4V 1L9, Ph. (416) 678-9430.  
Japan-Yokogawa-Hewlett-Packard Ltd., Ohashi  
Bldg., 59-1 Yoyogi, 1-chome, Shibuya-ku,  
Tokyo 151, Ph. 03-370-2281/92.



# New socket cards for microprocessors.

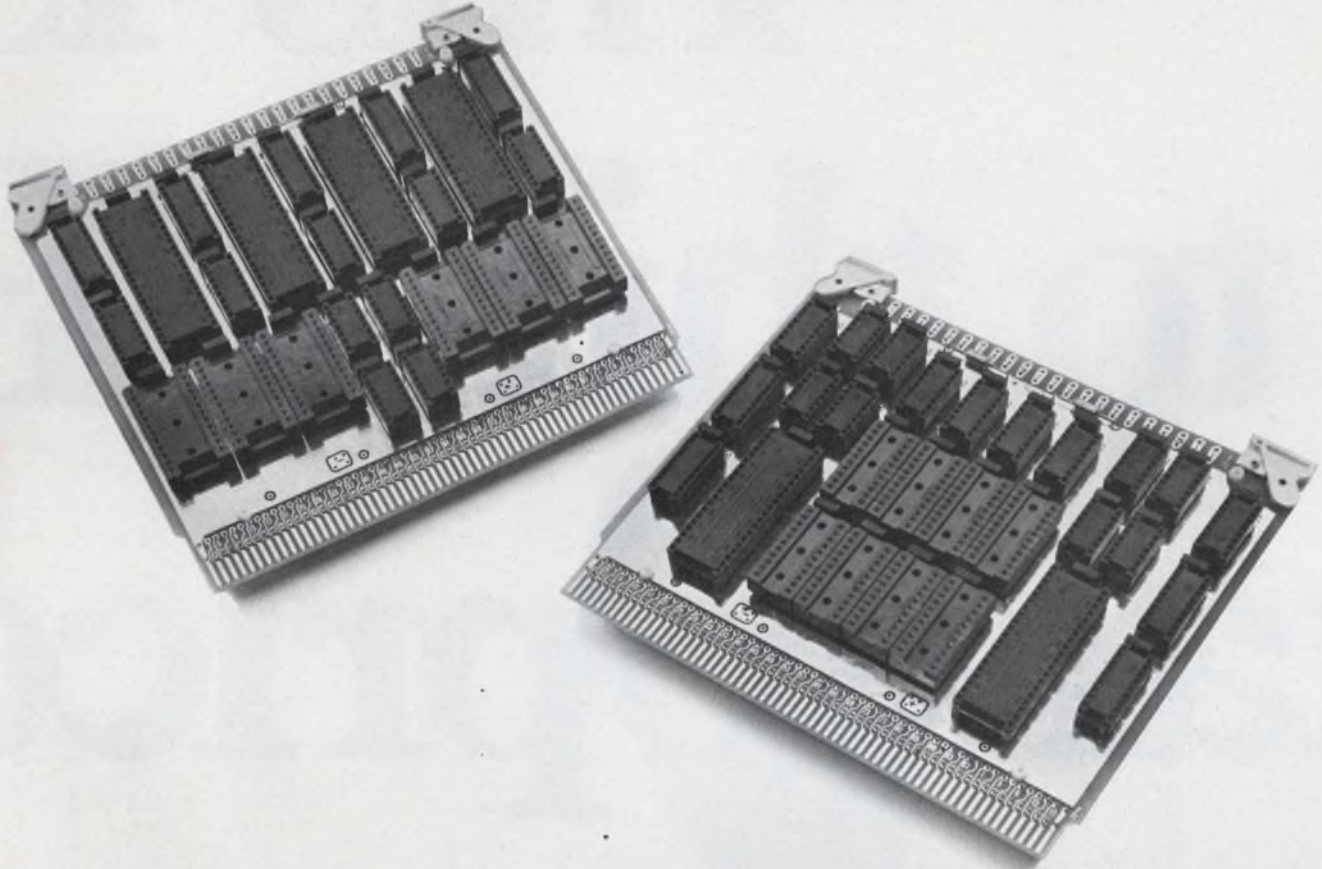

Instantly available, these two new cards are your answer to second-source problems. They enable you to change ICs and wiring for new pin patterns with great ease.

They are designed specifically for microprocessor applications, including controllers, random access memories, and erasable programmable memories. As such they are the newest in our line of 3D socket cards:

**3D2017** Four 40-pin sockets, six 24-pin sockets, five 18-pin sockets, five 16-pin sockets, and four 14-pin sockets. \$124.70.

**3D2018** Two 40-pin sockets, eight 22-pin sockets, four 18-pin sockets, six 16-pin sockets, and eight 14-pin sockets. \$140.70.

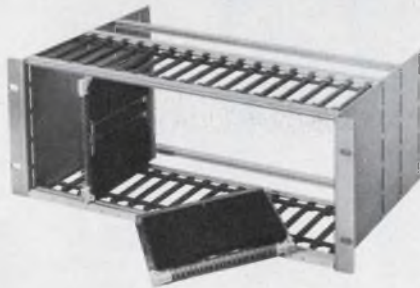

In addition, both cards provide a good ground plane for high-speed operation. They include a ceramic monolithic bypass capacitor at every socket, and provision for bypassing other voltages that may be required for chips. Power can be connected to various pins on LSI chips by means of solder tabs. And each card includes 22 built-in test points.

These cards are complemented by our line of Card-Pak card files, and our automated wiring service.

We're ready for you right now. And so is our nationwide distributor, G. S. Marshall. So call either of us today. Or, tear out this page and keep it handy until you are ready for us.

## EECO

FOR PACKAGING

1441 East Chestnut Avenue, Santa Ana, California 92701  
Phone 714/835-6000

# “This is to think P talk price”

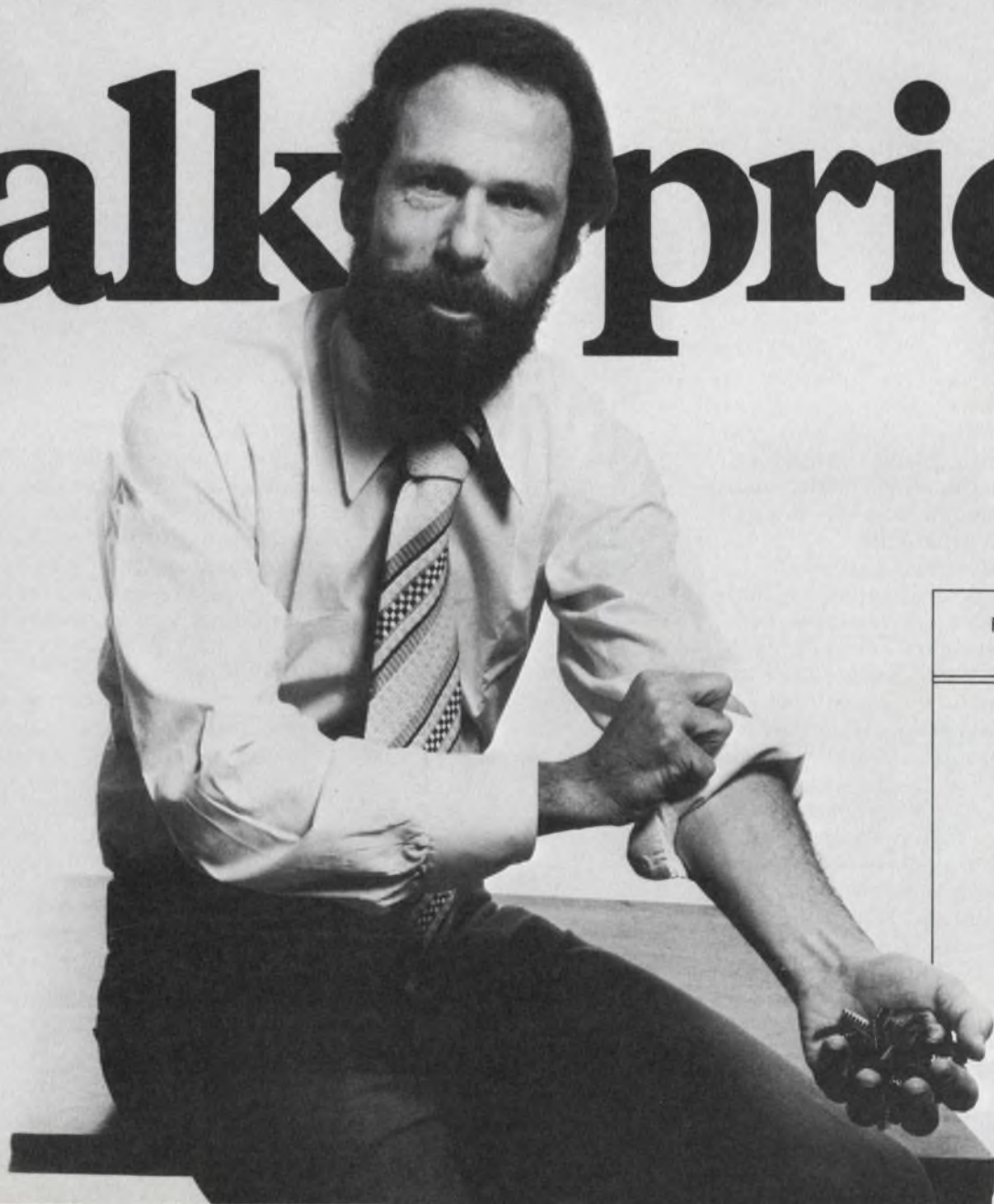

PROM SIZE	ORGANIZATION
<b>1k</b>	256 x 4
	256 x 4
	256 x 4
	256 x 4
<b>2k</b>	512 x 4
	512 x 4
	512 x 4
	512 x 4
<b>4k</b>	512 x 8
	512 x 8
	512 x 8
	512 x 8

# the year ROMs and

You have every right to look to MMI for price and performance leadership; we're the biggest bipolar memory company in the world.

Since we were the first to design and produce 1K, 2K and 4K PROMs (and compatible ROMs) you'll recognize our part numbers; but the price and power figures are happy news. (And this is a year we can all use some good news.)

We've completely redesigned our PROM line. The Schottky process we're using has already been proven on our 8K, 9K, and 10K bipolar ROMs. On our new *Dash One* PROMs it not only cuts power requirements by 30% **without any loss of speed**, but it also yields good parts in quantities that

allow **dramatic price reductions**. All major characteristics are improved. Fan-in is .25mA max. **Grow-back is virtually eliminated**. And we've added extra fuses to give you **superior programming yield**. **At least 95% of all units will program to completion** in 2 seconds or less. And we fully test every part for programmability before we ship it.

The results: MMI gives you better prices. Better performance. Better programmability. Better reliability.

Looks like a better year all around. Please compare the numbers on the OLD and NEW chart. Then get the product and prove it for yourself. The industry is getting moving again. And we can help in lots of ways. Try us.

Call, telex or write our Marketing Department. Monolithic Memories, Inc., 1165 East Arques Avenue, Sunnyvale, California 94086. Phone: (408) 739-3535. Telex: 910 339 9229. In Europe, contact Monolithic Memories, Inc., Amsterdam, Holland, Phone: 100727. Telex: (844) 16365.

INFORMATION RETRIEVAL NUMBER 8

**mmi**  
This is our year.

PROM PART NOS.		(100-999) PRICE		OUTPUT	MAX ICC		OPERATING TEMPERATURE	ROM INTERCHANGEABLE PART NUMBER
OLD	NEW	OLD	NEW		OLD	NEW		
6300	6300-1	\$ 17.00	<b>\$ 5.95</b>	Open Collector	120mA	105mA	0°C to 75°C	6200*
6301	6301-1	17.00	<b>5.95</b>	Tristate	120mA	105mA	0°C to 75°C	6201*
5300	5300-1	44.00	<b>11.95</b>	Open Collector	120mA	105mA	-55°C to 125°C	5200*
5301	5301-1	44.00	<b>11.95</b>	Tristate	120mA	105mA	-55°C to 125°C	5201*
6305	6305-1	45.00	<b>13.95</b>	Open Collector	130mA	105mA	0°C to 75°C	6205*
6306	6306-1	45.00	<b>13.95</b>	Tristate	130mA	105mA	0°C to 75°C	6206*
5305	5305-1	58.00	<b>24.95</b>	Open Collector	130mA	105mA	-55°C to 125°C	5205*
5306	5306-1	58.00	<b>24.95</b>	Tristate	130mA	105mA	-55°C to 125°C	5206*
6340	6340-1	70.00	<b>33.00</b>	Open Collector	140mA	140mA	0°C to 75°C	6240*
6341	6341-1	70.00	<b>33.00</b>	Tristate	140mA	140mA	0°C to 75°C	6241*
5340	5340-1	100.00	<b>54.00</b>	Open Collector	140mA	140mA	-55°C to 125°C	5240*
5341	5341-1	100.00	<b>54.00</b>	Tristate	140mA	140mA	-55°C to 125°C	5241*

\*Pin-compatible ROM-mates are available for all MMI PROMs. Electrical specs are identical. MMI ROMs always cost substantially less than our PROMs, and now our PROMs are the least expensive in the industry.

# Intersil's new FPLA.

## The first PLA that can be programmed electrically in the field.

### The PLA Unmasked!

Programmed Logic Arrays make translation of Boolean logic into hardware much easier than ever before. They simplify design, reduce parts count, cut assembly time, use less power and are more reliable than discrete logic.

Until now programming a PLA required preparation of a mask, with delays and added cost. But no more.

The mask is eliminated in Intersil's IM5200. Electrically programmable in seconds, it's the first **Field Programmable Logic Array (FPLA)**.

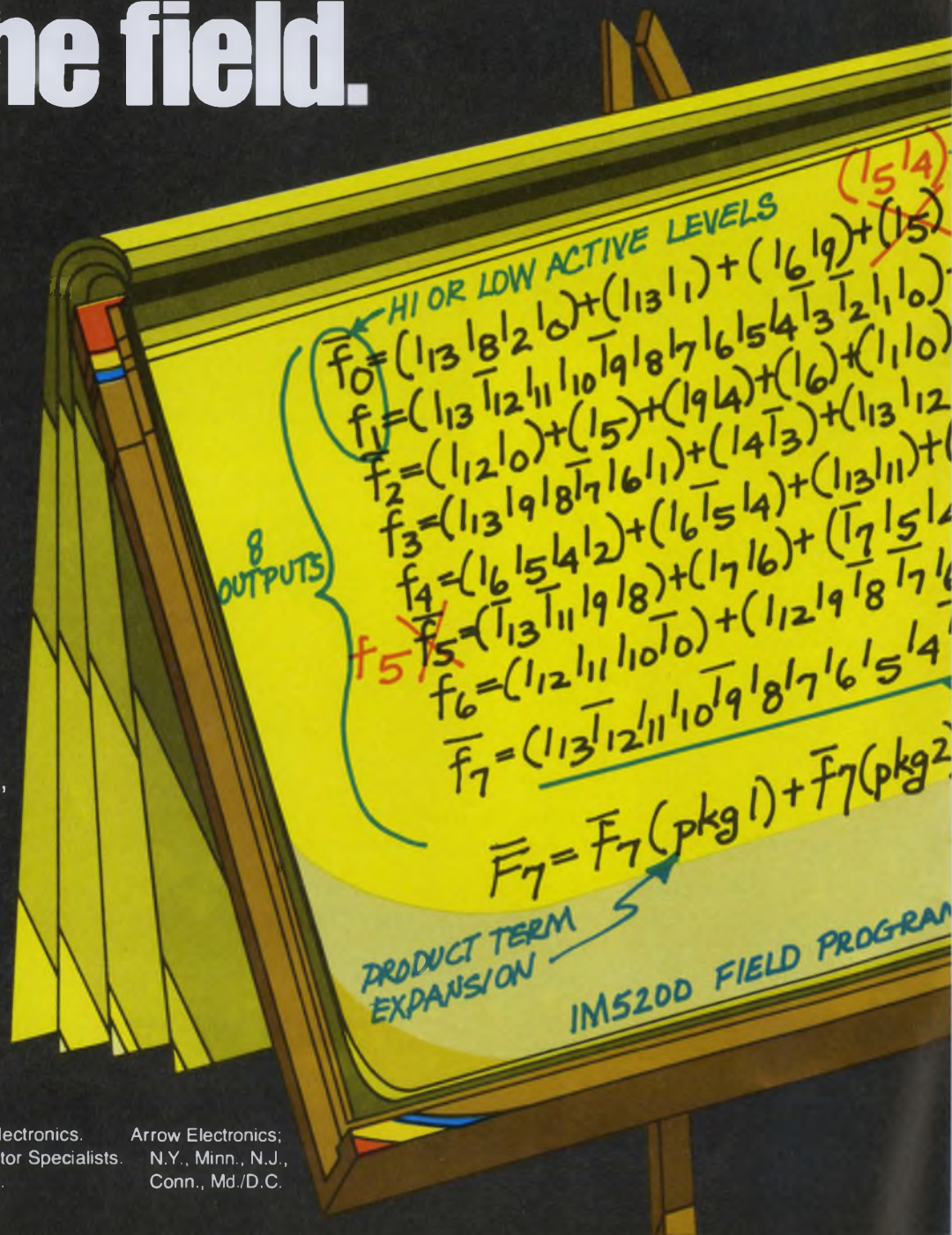

Intersil stocking distributors.  
Elmar/Liberty Electronics.  
Kierulff Electronics; Mass.

Schweber Electronics.  
Semiconductor Specialists.  
Weatherford.

Arrow Electronics;  
N.Y., Minn., N.J.,  
Conn., Md./D.C.

## FPLAs in production and available now.

The IM5200 is equivalent to a group of AND gates which may be ORed at any output. With 14 inputs, 8 outputs and 48 product terms, it provides the complexity of up to 500 4-input logic gates for applications such as random combinatorial logic, code conversion, microprogramming, sequential control and others.

A TTL device, the IM5200 comes in a 24 pin DIP, with typical propagation delay of 65 nanoseconds. Price in 100-999 quantities is \$25.00. Setup charge is \$25.00 per program, with nominal per-unit programming cost.

### And flexible? You bet.

For representing functions in true or complement form, the output level is programmable to high or low active levels. Passive pullup outputs are useful for product term expansion by wire-ORing the outputs of different IM5200s.

Even after programming, there are provisions for editing. Entire product terms may be added or deactivated, new input variables added, or outputs changed from low level to high.

### Proven AIM programming.

Programming is done with Intersil's Avalanche Induced Migration process, U.S. patent No. 3,742,592. AIM has created more than 3 billion memory bits in over 4 years' use with Intersil P/ROMs . . . without a single bit failure!

Reliability is outstanding because the entire process takes place beneath the surface of the silicon, hermetically sealing it from the environment. In addition, programming is much faster than with other methods.

Send for complete product data, including applications. From Intersil, 10900 North Tantau Ave., Cupertino, CA 95014.



Intersil area sales offices.  
Boston (617) 273-2055.  
Chicago (312) 371-1440.  
Dallas (214) 387-0539.

Los Angeles (213) 532-3544.  
Minneapolis (612) 925-1844.  
San Francisco Bay Area.  
(408) 984-2170.

New York (201) 567-5585.  
Upstate New York/Canada.  
(315) 463-3368.  
Representatives in all major cities.

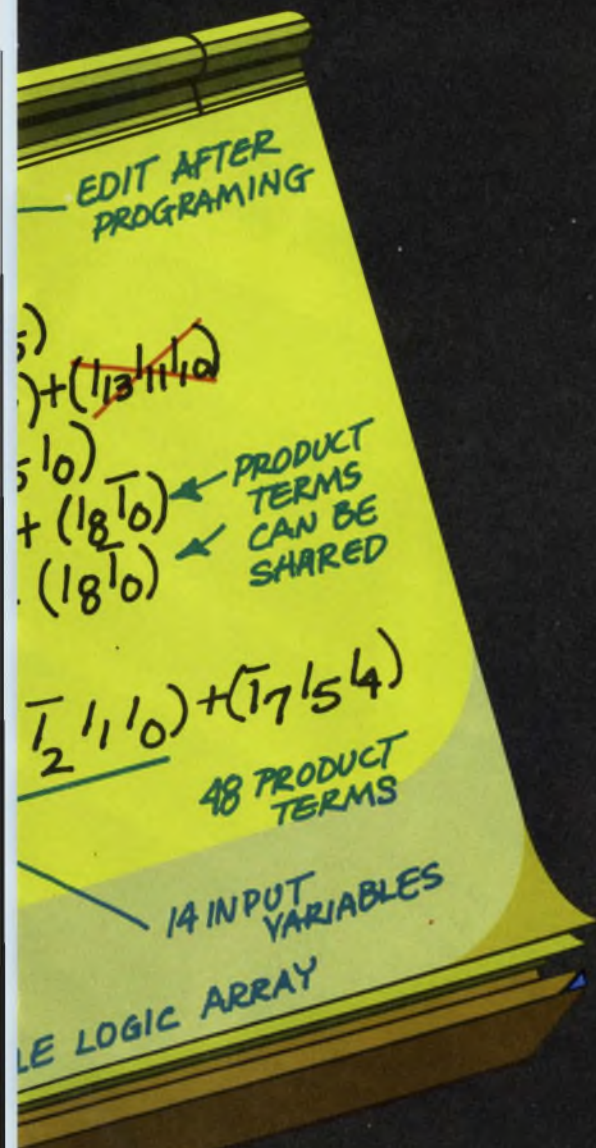

There's Plenty More Where These Came From...

# DIP'S BY PYROFILM

Thick Film Networks ... Hundreds of Values ...  
Hundreds of Thousands In Stock ... 14 and 16 Pin  
... Standard and Custom Circuits ... Available Now

*Setting New Standards in Reliability*

**PYROFILM**

60 S. Jefferson Road • Whippany, N. J. 07981 • (201) 887-8100

INFORMATION RETRIEVAL NUMBER 10

JUNE 7, 1975

## Motorola processor to have 55-ns micro-instruction time

A new microprocessor that is to be at least twice as fast as any other available is under development at Motorola Semiconductor, Phoenix, AZ. Known as the MC10800, the 4-bit slice processor is being made with emitter-coupled logic and is to have a micro-instruction cycle time of 55 ns.

It will be the first of a set of five related parts—designated M10800—that are being designed for high-performance applications, such as top-of-the-line minis, large mainframe computers, numerical and industrial control and digital communication systems.

According to William Blood, Motorola's manager of memory and logic systems, samples of the new micro will be available in the first quarter of 1976. Other parts in the set are to be offered six to eight weeks after that.

All circuits in the M10800 set, Blood notes, will be logic-level, power-supply and noise-immunity-compatible with the company's standard MECL 10k circuits, so that existing memory devices can be used.

The new microprocessor set is designed to overcome the limitations of currently available devices, according to Blood. Micros on the market today, he says, can be classified as either single-chip processors or 2-bit and 4-bit slice-oriented sets.

The single-chip processors, while ideal for many applications, have limited word lengths, fixed instruction sets and MOS speeds that often make them too slow to be useful.

The slice-oriented sets are better, in that they permit expansion of word length and microprogramming to instruction requirements. However, existing devices may have any or all of the follow-

ing limitations: a minimal ALU function set, restrictive data routing and inadequate I/O ports.

Of course, these disadvantages can be overcome by the addition of MSI circuits, Blood notes, but that reduces the advantages of LSI.

The MC10800 will overcome these disadvantages by providing a powerful function set with over 200 instructions, Blood says. In addition, the versatile data-routing paths and I/O ports, will allow numerous options when a system is designed. The MC10800, Blood continues, will make it possible to accomplish in a single operation what would require several operations with other ALUs.

The MC10800 chip contains a latch mask block, the arithmetic logic unit, an accumulator, the shift network, input and output bus controls and associated interconnections. It is designed so it can be expanded laterally to any bit length in increments of 4 bits and expanded vertically to permit pipelining for increased data throughput rates.

The MC10800 will come in a new package—a 48-pin, quad in-line package. This will be the same size as the standard 24-pin DIP. The difference between the two is that the quad in-line package has twice the number of pins, with each alternate one offset from the preceding one. This results in a compact package that is pluggable, wire-wrappable and capable of being used with automated equipment.

Other devices from the five-chip set include the MC10801 control register function chip, which contains the logic for microprogram control; the MC10802 timing-function chip, which ties the system function blocks together; the MC10803 slice/memory in-

terface chip, which contains memory data and address storage, and the MC10804, which is the slice look-ahead carry chip.

Prices for the new micro, Blood says, will be competitive with other available ECL devices.

## Superconducting wire gives 'superior' results

A superconducting wire described as "superior in critical-current carrying density to any known superconductor" has been tested at the Naval Research Laboratory in Washington, D.C.

Critical current density is the maximum current per unit of cross section that a superconductive material can carry and still retain its superconductivity.

Superconductors, which operate at cryogenic temperatures, can carry heavy currents with little resistance loss. As a result, the wires and the system itself can be smaller than with conventional conductors. And, more importantly, the systems can operate with vastly improved efficiencies.

According to the developer of the improved critical-current density capability, D. G. Howe, a ceramics research engineer in the Navy laboratory's Material Sciences Div., the new capability could play an important role in the advancement of power generation, such as in large conventional generators, magneto-hydrodynamic (MHD) generators and controlled thermonuclear fusion reactors.

One of the main technical difficulties still preventing the successful development of efficient MHD generators, Howe says, is the absence of a superconductor capable of handling the necessary current density that the powerful MHD channel magnets require. The laboratory's new superconducting wire, he says, should meet this demand.

The improvement was made by an increase in the gallium content of an earlier Naval Laboratory alloy—vanadium-gallium. Laboratory scientists report that the best critical-current density observed so far at 4.2 K was 1 million amperes per cm<sup>2</sup> of a superconductor in a transverse magnetic field of 100 kilogauss.

## Portable X-ray 'lifts' fingerprints from victim

Rapists and murderers may find themselves behind bars with increasing swiftness because of a portable X-ray machine that "lifts" faint, smudged fingerprints from a victim's body.

The machine, developed jointly by the Police Dept. of San Jose, CA, and Hewlett-Packard's division in McMinnville, OR, is the first portable unit designed to photograph faint prints. The unit weighs 60 lb. including the battery. Portability is important, because such prints usually fade within 24 hours.

In operation, a user first dusts with a lead powder the portion of the body to be X-rayed. Then he straps a special, small cassette to the body over the lead dust. The cassette, which holds the film plus copper and plastic filters, is applied with the film emulsion facing the skin.

The filters remove the soft, or low-energy, X-rays that emanate from the machine's source and that would inadvertently expose the film. Hard X-rays—those of high energy, to which the film is insensitive—pass through the filter and film, strike the lead dust and knock out electrons from the lead atoms. It is these electrons that actually expose the film, which is then developed to get a clear negative of positive photo.

## Waveguide transmitting speed boosted threefold

While AT&T is testing its super-fast microwave circular waveguide system, capable of transmission at 274 Mb/s, the Japanese are testing a system three times as fast—800 Mb/s.

The Japanese system, described at the recent IEEE International Microwave Symposium in Palo Alto, CA, operates at 43 to 87 GHz over a test link 22.7 km long. A repeater station is 15.3 km from the terminal.

The test link was described by Kazuhiro Miyauchi of the Yokosuka Electrical Communication Laboratories, Nippon Telegraph and Telephone Public Corp., Yokosuka-Shi, Japan.

The follow-on system, to be

designated by the Japanese as W-40G, will extend 2500 km and have an end-to-end error rate of better than  $10^{-7}$ . Error rate on the test link was  $10^{-9}$ . Average repeater spacing will be 15 km. The system will consist of 28 800 Mb/s channels, making a total transmission capacity of over 22 Gb/s.

Miyauchi feels confident the future operational systems will be successful. He bases this on the good performance of the test link. As for cost, he notes: "The estimated cost is about half that of the most economical existing large-capacity analog system."

Meanwhile AT&T's new high-speed coaxial cable between New York City and Newark is operating well, according to a Bell Laboratories spokesman. The cable, which was built with a transmission speed of 274 Mb/s for compatibility with the microwave link, was pressed into service ahead of schedule because of a series of fires in New York Telephone Co. buildings that put other links out of commission.

AT&T's conventional short-distance digital transmission system is the T1, consisting of plain copper wires in a cable. Each cable contains 900 pairs of wire, making 48 T1 links. Transmission speed is 1.55 Mb/s.

## Transient suppressor protects RF lines

A subnanosecond metal-oxide transient suppressor that will protect rf transmission lines from fast-rise-time, high-energy electromagnetic pulses has been developed jointly by researchers at the Army Electronics Technology and Devices Laboratory, Ft. Monmouth, NJ, and the Yeshiva University Graduate School of Science in New York City.

The development was described at the Electronic Components Conference in Washington, DC. In a paper on "Metal-Oxide Subnanosec Transient Suppressors," the researchers noted that transient suppressors had been in use for some time in power and low-frequency circuits. These same devices, however, could not be used in rf transmission lines because of their lack of speed and their large off-state capacitance.

The new devices are made from niobium dioxide and housed in standard microwave diode packages. When inserted across a 50- $\Omega$  transmission line, the suppressors can clamp 2-kV pulses to 200 V within 0.7 ns. Thus the bulk of the pulse energy cannot pass the metal-oxide switch.

Where clamping to even lower voltages is required, the researchers noted that a low-power diode could be inserted after the suppressor.

## Alexanderson, pioneer of voice radio, is dead

Dr. Ernest F. W. Alexanderson, whose high-frequency alternator made voice radio possible and whose later developments paved the way for television, died in Schenectady on May 14. He was 97 years old.

Born in Sweden in 1878, Alexanderson studied engineering there and in Germany and then came to the U.S. in search of a more creative atmosphere. He found it in Schenectady in the highly innovative group of engineers led by General Electric's dynamic and somewhat eccentric mathematician, Charles P. Steinmetz.

"Inventors cannot be put in narrow compartments and told what to invent," Alexanderson once said. "It requires the atmosphere of liberty traditional with the old universities, which has been carried over in the GE research laboratory and was in the early days the dominant attitude of engineering. I believe it is very important for the company that such academic freedoms be maintained."

Alexanderson worked at GE throughout his long and fruitful career, from 1902 to 1948, except for a few years as chief engineer at the then Radio Corp. of America, which was formed by GE to handle trans-Atlantic communications.

His ability to find new, practical solutions to problems yielded 322 patents for Alexanderson. Among them—after the alternator—were the magnetic amplifier, the electronic amplifier, the multiple tuned antenna, the anti-static receiving antenna and the directional transmitting antenna. He also devised a radio altimeter.



# TAKE FIVE

# FREE

Now you can sample and evaluate ITT's plastic transistors absolutely free! Select any type from the list below, identify your preferred ITT distributor and send us the completed coupon. You will receive five free devices for evaluation in your own shop. You'll be glad you discovered ITT plastic transistors — they're competitively priced and highly reliable.

Best of all, they're available now. ITT has the lead-forming capability to make plastic transistors interchangeable with most popular metal can configurations. Save money and save time by switching to ITT plastic transistors for general purposes of both polarities and other transistor applications. Start by taking five. Free. Today!

## ITT PLASTIC TRANSISTORS

2N3903  
2N3904  
2N3905  
2N3906  
2N4123  
2N4124  
2N4125  
2N4126  
2N4400  
2N4401

2N4402  
2N4403  
2N5086  
2N5087  
2N5209  
2N5210  
MPS706  
MPS706A  
MPS834  
MPS2222  
MPS2222A

MPS2369  
MPS2369A  
MPS2711  
MPS2712  
MPS2713  
MPS2714  
MPS2907  
MPS2907A  
MPS2924  
MPS2925  
MPS2926

MPS3392  
MPS3393  
MPS3394  
MPS3395  
MPS3638  
MPS3638A  
MPS3693  
MPS3702  
MPS3703  
MPS3704  
MPS3705

MPS3706  
MPS3709  
MPS3709  
MPS3709  
MPS3710  
MPS3711  
MPS5172  
MPS6530  
MPS6531  
MPS6532  
MPS6533  
MPS6534

MPS6535  
MPS6565  
MPS6566  
MPS6571  
MPSA05  
MPSA06  
MPSA10  
MPSA20  
MPSA65  
MPSA66  
MPSA70

Please send me five free transistors of the following type

Name \_\_\_\_\_ Title \_\_\_\_\_  
 Company \_\_\_\_\_  
 City \_\_\_\_\_ State \_\_\_\_\_ Zip \_\_\_\_\_  
 My preferred ITT Distributor is \_\_\_\_\_ City \_\_\_\_\_

CRAMER ELECTRONICS  
Nationwide  
HAMILTON-AVNET  
Nationwide

SEMICONDUCTOR SPECIALISTS  
Elmhurst, IL  
MILGRAY ELECTRONICS  
Freeport, N. Y.

GREEN SHAW  
Newton, Ma.  
WESTATES  
Chatsworth, Ca.

BELL INDUSTRIES  
Sunnyvale, Ca  
CAMGUARD  
Winnipeg, Man.  
Canada

# semiconductors

ITT Semiconductors is a division of International Telephone and Telegraph Corporation, 74 Commerce Way, Woburn, Ma. 01801. Phone 617/935-7910. Factories in West Palm Beach, Florida • Lawrence, Massachusetts • Footscray, England • Colmar, France • Freiburg, Germany • Cascais, Portugal • Taipei, Taiwan • Sydney, Australia

# ITT



OEM Referral Program

OEM Referral Program  
Enrollment Form

# "If you're an OEM, I'd like you to join in an exciting new sales building program."

William Long  
VP OEM Group  
Digital Equipment Corporation

It's our brand-new catalog of OEM systems.

A book Digital salesmen will be using regularly to point out Digital OEMs to potential users of OEM systems.

A book which should mean bigger sales for everyone who's in it — and one of them can be you.

The OEM catalog is the key to a massive new program. Its whole intent is to help our OEMs sell computerized systems to end users. It's the OEM Referral Program. Here's how it works.

We're compiling a catalog of information supplied by our OEM customers on their systems.

With the total support of our worldwide sales force, backed by an advertising campaign in industrial magazines, we're offering help to anyone contemplating the purchase of major equipment.

That help takes the form of detailed suggestions on how to buy

computerized equipment. Suggestions on where to buy the type of equipment they need, and who they can buy it from.

The systems we suggest, of course, are systems sold by Digital OEMs.

What the catalog does is to categorize these systems (which span virtually the entire spectrum of OEM systems on the market today) so our salesmen can match prospects' needs with appropriate OEM systems.

The catalog, like the whole program, is serious business. It has only one purpose: to help your sales effort. After all, every system you sell to your customers is one more computer we sell to you.

But while the OEM Referral Program will be an increasingly important part of our own marketing strategy, it's not the whole story by any means.

We will continue to come out

with new breakthroughs in the areas of price and performance.

And we will continue to work with our OEMs in every way we can to help keep us both profitable in these profit-squeezed times.

In short, we will continue the policies that have kept us the leader in the OEM computer field ever since it started. Because in all that experience, we've learned something about the OEM marketplace:

**We're a success only if you are.**

For more information, write Digital Equipment Corporation, Maynard, Massachusetts 01754. (617) 897-5111. European headquarters: 81 route de l'Aire, 1211 Geneva 26. Tel: 42 79 50.

Digital Equipment of Canada Ltd., P.O. Box 11500, Ottawa, Ontario K2H 8K8. (613) 592-5111.

**digital**

# EEG unit worn by patient records data for 12 hours at 7000 bpi

An electroencephalograph unit that can be worn by a patient and work continuously for 12 hours has a cassette drive that runs at 1/6 ips and records data at 7000 bpi on four channels.

A standard C-120 cassette with chromium-oxide tape has been used by the designer, the Stanford Research Institute of Menlo Park, CA.

"We believe that this is the densest digital recording ever accomplished on a Philips cassette," says Charles S. Weaver, a senior research engineer at SRI.

Developed for the monitoring of EEG patterns from epileptic children, a single C-120 cassette can store 180 Mb. The system, built under contract to the National Institute of Neurological Diseases and Stroke, Bethesda, MD, consists of two major parts.

The first has a cap containing four preamplifiers, which are attached to scalp electrodes and four post amplifiers. The rest of the electronics is in a vest that the patient wears.

## High-speed playback used

A separate system can be used to transcribe data from the cassette to a standard 1/2-in. IBM-compatible reel of computer tape. The playback subsystem contains a cassette playback transport, playback-head amplifiers, digital decoding and reformatting circuits, an IBM-compatible tape transport and d/a converters.

The cassette is played back at 45 times normal speed. John Yarborough, senior research engineer at SRI, points out: "By operating at many times normal recording



**EEG digital monitoring** of epileptic children will be done with this system from Stanford Research Institute. Scalp electrodes feed four channels of EEG data to a data-acquisition system in a lightweight vest worn by the child.

speed when playing the tape back, we can transcribe 12 hours of recording in about 16 minutes."

## What's in the vest?

Ideally the EEG waveforms from the post amplifiers should not contain any signal spectral components outside the 1-to-40-Hz frequency

band. Therefore the signals from the cap go first through a set of 40-Hz low-pass filters. From there they go to a four-channel analog multiplexer and then to a sample-and-hold circuit.

From the sample-and-hold, the signal is digitized in an analog-to-digital converter and fed into a



# How do you connect round cable to flat?

Now it's easier than ever to connect round cable to flat. Or flat cable to flat. Or round to round.

Because now Hughes introduces the HAC-PAK Connectors—a whole new connector family offered in three types of contacts: crimp/removable rear-release (non-environmental, environmental or potted); RFI/EMI fixed filter contacts; and fixed solder-tail contacts.

HAC-PAK Connectors are intermateable and intermountable with one another—and with Hughes front-release subminiature rectangular connectors. (W and WSS Series.)

Our exclusive PolarHex™ center jackscrew coupling assures alignment, provides positive polarization with a choice of keying

## It's a snap.

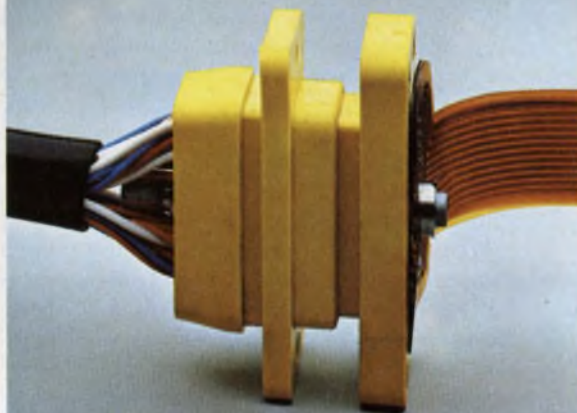

The new Hughes  
**HAC-PAK™ Connector.**  
(MIL-C-28804)

positions, and prevents mismatching.

HAC-PAK subminiature connectors have the highest density of number 22 contacts in the industry. (.085" centers.)

To get all the details, make a connection with Ron Ross at (714) 549-5701, or write: Hughes Connecting Devices, 17150 Von Karman Avenue, Irvine, CA 92705.

#### HUGHES MICROELECTRONICS LTD.:

UNITED KINGDOM — Clive House, 12-18  
Queens Road, Weybridge, Surrey, England.  
Telephone Weybridge 47262

EUROPE — Res Hera Apartment 64, Passage  
International 29, Brussels 1000, Belgium.  
Telephone 17.91.72

### HUGHES

HUGHES AIRCRAFT COMPANY  
CONNECTING DEVICES DIV.

**We crack the tough ones.**

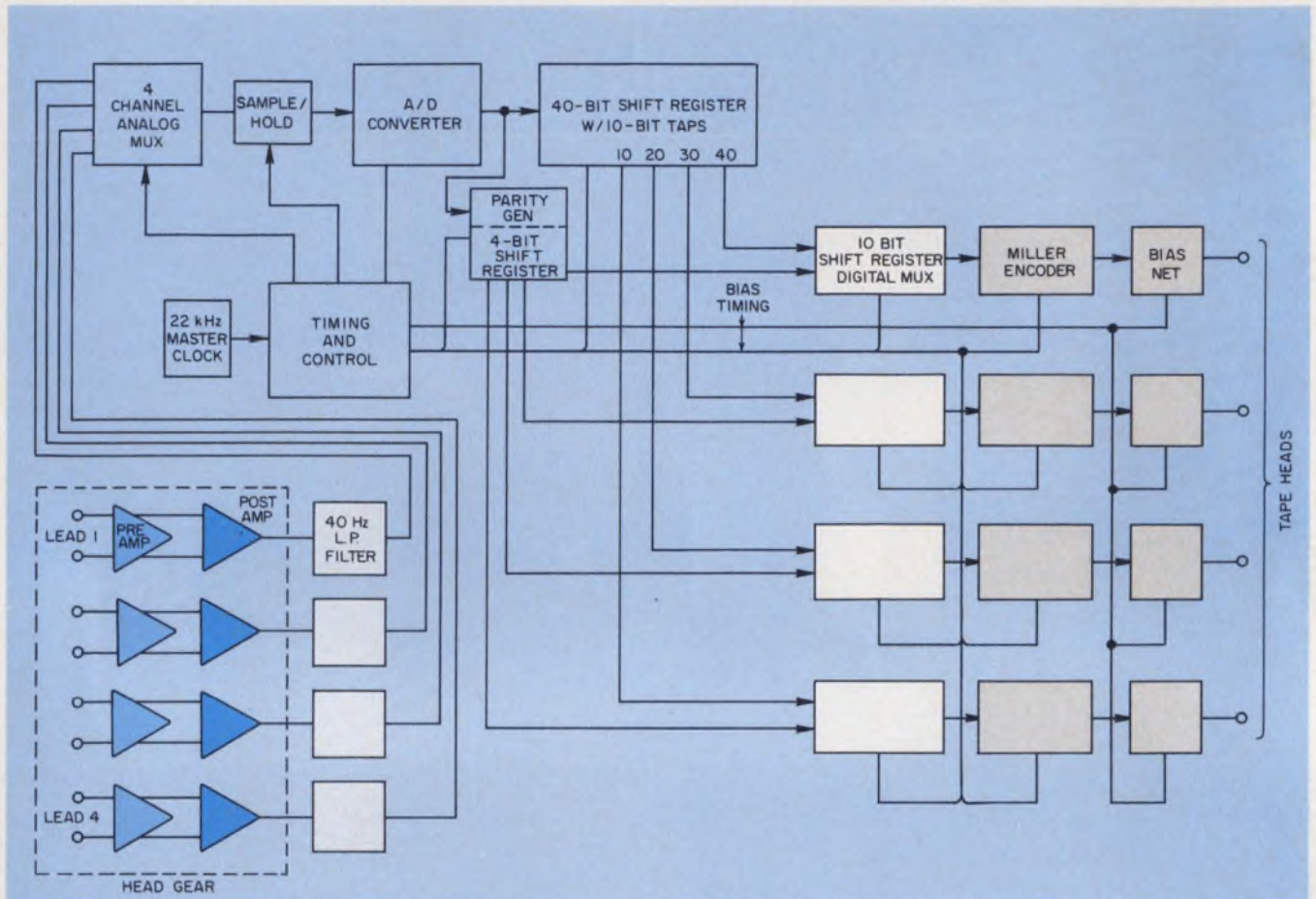

Four channels of analog EEG information are digitized and Miller-encoded. The coded signals are recorded on a Philips type of cassette at a density of 7000 bpi. The

cassette is played back at 45 times normal speed making it possible to transcribe 12 hours of recording in 16 minutes.

40-bit shift register. This shift register has taps at the 10th, 20th, 30th and 40th bits. Four sets of 10 bits each correspond to the four signals from the differential pre-amps in the cap.

The signals go from the four taps on the shift register into four 10-bit shift registers. At this point a parity bit is inserted into each bit stream, and the resulting signal is Miller-encoded.

### Miller coding explained

Miller coding is a self-clocking scheme that allows for very dense data recording. There is a flux transition in the middle of a bit cell if the bit is a ONE. But when the bit is a ZERO, there is no transition. However, if two or more ZEROs occur in a row, there is a flux transition at the end of the bit cell for the second ZERO and for every ZERO until the next logic ONE. The Miller encoded signal then goes through a bias net-

work and to the recording heads.

Floyd Brown, a research engineer at SRI, notes that, for maximum density, bias recording is used instead of saturation recording.

Brown and Yarborough report that the main design problems remaining center on the recording head design. The four-track head must be very accurately aligned.

"Now we have six minutes of head misalignment," Yarborough says. "This limits the frequency response of the system by making the head gap look a lot wider than it is."

SRI is looking for a supplier that can provide four-track heads with much better alignment for a Philips cassette recorder.

Weaver says that further increases in data density could be achieved through the use of data compression. "With data compression," he notes, "we feel that we can at least double the capacity of the tape."

SRI is also working on a lighter

version of the recorder—3-1/2 pounds instead of 5. And while the first version was powered by a lithium battery pack with a life of about 75 hours, a later model will use lightweight conventional batteries with a life of 20 hours. That is all that is needed for most tests, Weaver says.

### Other uses foreseen

SRI looks to other applications for the recording scheme.

"Although the system has been optimized as an EEG recorder," Weaver notes, "the digital recording techniques employed allow the system to be easily modified to meet the requirements for other applications. For example, the drive speed could be altered to permit higher or lower a/d conversion rates than the 100 samples per second used here. It would also be possible to decrease the number of channels digitized and increase the a/d conversion rate." ■■



**I've got D.R.\***  
**AND YOU CAN GET IT TOO!...**  
**in connectors with**  
**dielectric retention from Bendix**

**D.R. GIVES YOU**

- rear release crimp contacts—minimizes potential interfacial seal and contact damage during contact removal
- increased dielectric separation between contacts
- greater reliability plus weight savings—fewer components per connector
- hard-faced chamfered socket inserts assuring positive mating pin alignment
- improved temperature-life capability at 200°C
- optimum fuel and fluid resisting capabilities

\***dielectric retention** (re-ten'shun), n: an innovative method of retaining removable contacts in an electrical connector, incorporating a single dielectric wafer rather than individual metal contact retention clips

**D.R. CONNECTOR DESIGNS**

- are offered in MIL-C-26482, 38999 and 83723 types
- utilize common application tooling
- intermate and intermount with existing series
- are tooled in over 30 arrangements

**GETTING D.R. IS EASY.**

Just contact The Bendix Corporation, Electrical Components Division, Sidney, New York 13838, your nearest Bendix sales office or authorized Bendix distributor.



# Engine sensor-telemetry system hailed as the new racer's edge

Johnny Rutherford, who entered his new Gatorade-McLaren racer in the Indianapolis 500 last week, didn't ride completely alone. His car was equipped with an elaborate telemetry system that told the boys back in the pit just about everything that was going on in the car's engine as well as information on its driving characteristics. Such information had never before been available during a race.

Sensors in the system monitored temperatures, pressures, rpm and fuel flow. The data were relayed to the pit crew by a 14-channel, FM multiplexed telemetry system.

The sensor devices were built by AST/Servo Systems, Inc., Newark, NJ, a subsidiary of Vernitron Corp. The telemetry system was supplied by EMR Telemetry of Sarasota, FL, a subsidiary of Schlumberger. EMR developed the electronics package along with Data General, Southboro, MA, and Bruce McLaren Motor Racing Ltd., known as Team McLaren, in Colnbrook, England.

When all this equipment is in operation, telemetry signals received in the pit are fed into a Data General Nova 2 computer with a 32-k memory, which makes comparisons between various readings and presents significant conclusions to the pit crew. The computer output is displayed either on a CRT or printout from a teletypewriter.

"This prototype system," says McLaren's director of engineering, Tyler Alexander, "will offer the most sophisticated instrumentation package of its kind ever associated with a high-performance vehicle.

**John F. Mason**  
Associate Editor

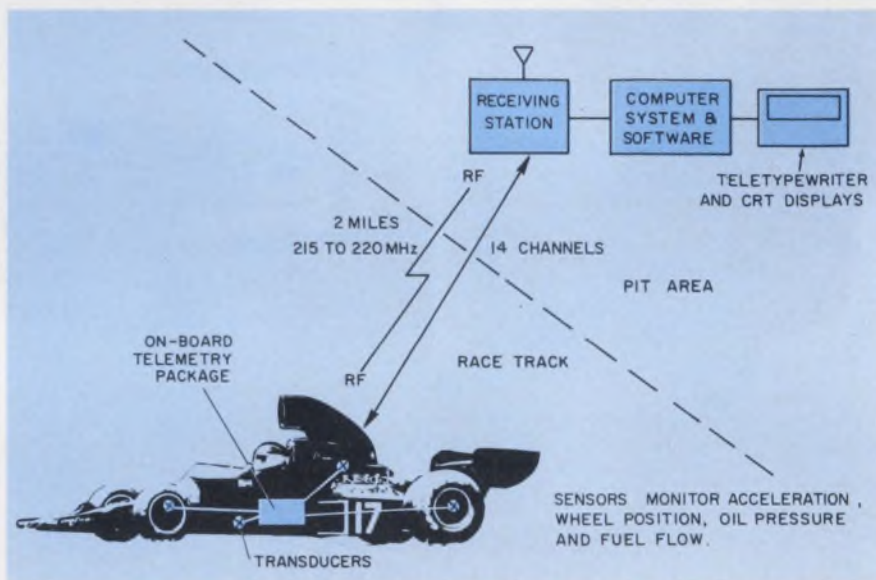

**Real-time measurements** of the performance of the engine and the car itself are displayed in the crew's pit in one second.

"The system will bring economies to the team, improve over-all performance and give us a safer car. And, for the first time, we'll know exactly what the car is doing at any given point. Additionally it will relieve the driver of any anxieties, allowing him to concentrate better on the profession of driving.

"The car will have 14 of its functions monitored. The computer will track the ride height of each of the four wheels, the forward and sideward acceleration, the oil and water temperature, oil and water pressure, manifold pressure, air inlet temperature, turbocharger air flow and fuel flow."

Alexander notes that some of the measurements can be used when a car is being prepared for a race, and others play an important role during a race.

"Readings such as wheel riding height and forward and lateral acceleration will help us get a car ready for a race," Alexander says.



In the pit, a Nova 2 computer examines data telemetered in from the racing car and either displays anything relevant on a CRT or prints it.

"During practice runs we use the driver's evaluations of the car's handling to make adjustments in the suspension, and to adjust the car's air flow for the best amount of downward force. The acceleration and ride height data, which



# If anybody can hand you the ready-made P/C connector you need,

## we can.

That's because we have more of them on the shelf than anybody else we know. We have them from .050 contact centers through .156, from 6 to 210 contacts, with full bellows, semi-bellows and cantilever designs, with gold saving AuTac™ plating, low insertion force contacts, in micro miniatures, dual and single read-outs... and on and on and on.

We've been at this 23 years. And — because we don't compromise on quality

when we make our connectors — we don't like to see your P/C designs compromised by a make-do connector. So, we have a lot of them.

They're all cataloged in our latest 44-page brochure. Send for your free copy so you'll have it when you need it.

Or, if you need help right now, just pick up your phone and call Customer Service. (213) 341-4330.

**Ok. Send me:**  Details on your line of P/C connectors.  
 and, come to think of it, your low cost circular connectors, too.

Name \_\_\_\_\_

Title \_\_\_\_\_

Company \_\_\_\_\_

Address \_\_\_\_\_

City \_\_\_\_\_

State \_\_\_\_\_

Zip \_\_\_\_\_

 **Viking**  
**CONNECTORS**

Viking Industries, Inc./21001 Nordhoff St./Chatsworth, Calif. 91311



## NEWS CONT.

were never available before, will give us scientific measurements."

During a race the computer keeps track of the fuel that the car uses. "Previously," Alexander says, "there was no way to accurately measure the amount of fuel in the car. During a race we can only estimate how much fuel is left, based on the approximate mileage the car gets at race speeds."

Now, the small, propeller-like flowmeter, inserted in the fuel line, monitors the amount of fuel that goes to the engine. Sensors count the flowmeter's revolutions and radio the information to the computer, which converts the revolutions into fuel consumption.

"This will avoid calling a car in for unnecessary refueling and prevent a car from running out of fuel because its consumption was higher than our estimates," Alexander notes.



Johnny Rutherford's racer is loaded with sensors and telemetry to give the pit crew real-time engine readings never before available.

The computer can also count the number of laps the car has made around the track, by counting the times the transmitter in the car goes by.

"The transmitter signal is strongest then," Alexander says, "and the computer can tell when that happens, because it monitors the signal 100 times every second. The computer also can time the

laps by counting the interval between the signal peaks."

The telemetry transmitter is one of two radio transmitters in the Gatorade-McLaren car. The other is used for two-way radio communication between the pit crew and the driver.

The telemetry transmitter operates in the vhf band from 215 to 220 MHz. The minimum power output of 2 W is considered adequate when used with an omnidirectional antenna system over a line-of-sight distance of 1.5 miles.

EMR selected a rugged omnidirectional antenna both for use on the vehicle and at the monitor station. The coaxial antenna may be mounted on the rear bumper or at any convenient spot on the vehicle, and it will provide a low radiation angle without using the roof or trunk lid as a ground plane. The radiated signal is vertically polarized. ■■

## E beam tested as nuclear-power trigger

Can an electron beam powerful enough to produce fusion be focused small enough to irradiate a typical pellet of nuclear fuel?

Sandia Laboratories in Albuquerque, NM, believes that it can be and has built an accelerator to prove it. If the tests are successful, an accelerator 15 times the size of the new machine, called Proto 1, will be built. Ultimately, such an accelerator would be used for a nuclear fusion power plant to generate electricity.

Sandia and other laboratories are interested in electron-beam accelerators because theoretically they are capable of converting up to 75% of their input energy into beam energy, compared with 1% or less that the more conventional short-pulse lasers produce.

The problem with the E beam is in focusing. The laser can be focused relatively easily by optical means, with lenses. But the electrons have a space charge, which means they tend to repel each other.

Sandia scientists hope to focus the E beams by injecting plasma (ionized gas) to neutralize the

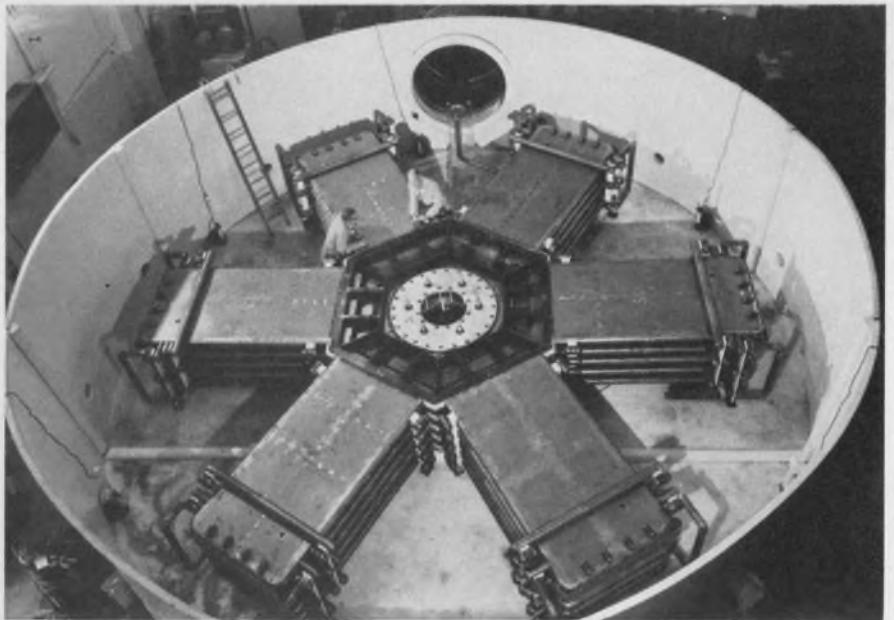

Proto 1 electron-beam accelerator makes use of 12 transmission lines (two in each of this six-segment array) to generate pulsed electromagnetic energy. This energy discharges onto two cathodes that ring the hole in the center of the array. The cathodes create electron beams, which irradiate a fuel pellet placed along the cathode's axis.

electron space charge, so that magnetic forces squeeze the electrons into a small-diameter beam.

In focusing experiments to date,

researchers have been able to focus a 7-in.-diam beam down to about a 10th of an inch—about the diameter of BB pellets. ■■

# SELECTION:

With KEMET Monolithic Ceramic Capacitors, you get a wide range of types, sizes and capacitances from a single, reliable source—to make specification and selection simpler and faster for you.

Take your choice of CK05-CK16, CKR05-CKR16, CDR Established Reliability Chips, MIL-C-20, Dipped, "Solder Guard" and "Gold Guard" Chips, or KEMET BX and NPO Monolithic Ceramic Capacitors.

Name the dielectric—Ultra-Stable NPO, Stable BX or General-Purpose Z5U—with radial or axial leads in the size you need.

Get complete selection data. Write today for your free copy of the KEMET Monolithic Ceramic Capacitors Catalog.

Components Department, Union Carbide Corporation, P.O. Box 5928, Greenville, SC 29606; phone (803) 963-6300, TWX: 810-287-2536, or Telex: 57-0496.



## KEMET<sup>®</sup> OFFERS YOU MORE.

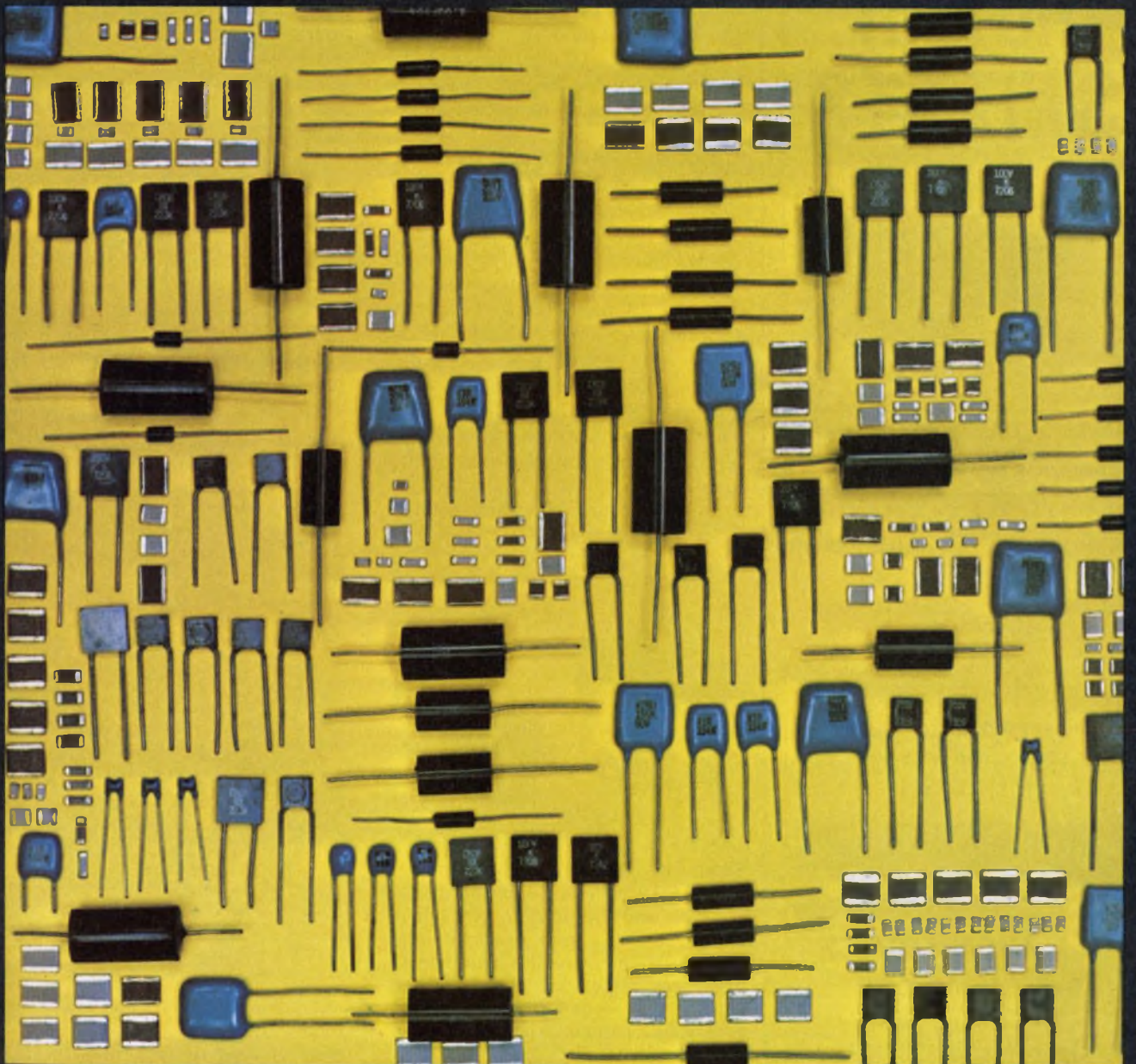

**UNION CARBIDE** COMPONENTS DEPARTMENT

KEMET is a registered trademark of Union Carbide Corporation.

In Europe: Union Carbide Europe, S.A. 5, Rue Pedro Meylan,  
Geneva 17, Switzerland. Phone: 022 47 4411 Telex: 845 22253.

# \$1.14 EACH

## PRINTED CIRCUIT MINIATURE ROTARY SWITCHES

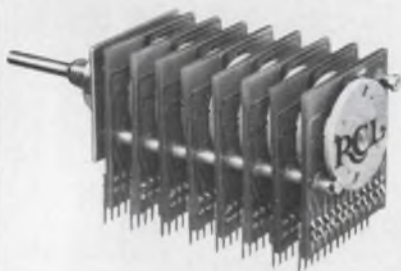

**CHOICE OF TRUE PRINTED CIRCUIT BOARD MOUNTING OR EDGEBOARD CONNECTOR MOUNTING.**

Costs far less than regular miniature Rotary Switches, maintaining RCL's high quality standards.

(Edgeboard type available in production quantities at \$1.14 each.)

(Comparable low costs available on Printed Circuit Board Mounting Type)

**Call our hotline for prompt service and delivery.**

**(201) 374-3311**

**AMF**

**RCL Electronics**

**General Sales Office:  
700 So. 21st Street  
Irvington, N. J. 07111**

### NEWS

## Welded wire chassis keeps CRT terminal light and cool

A number of manufacturers of television units, oscilloscopes and other CRT terminals are now housing their CRTs in open wire frames instead of the conventional metal enclosures.

A chassis made simply of welded wire automatically eliminates heat problems, explains its manufacturer, E. H. Titchener Co., Binghamton, NY. No fans are needed. And the frame weight is cut by approximately a third—the wire chassis usually weighs two to three pounds. Testing and maintenance are made easier and quicker, too.

Manufacturers already using the wire chassis include Hazeltine Corp., Greenlawn, NY, for terminals used in business offices; Raytheon, Norwood, MA, for clerk-to-computer airline reservations systems; Bunker-Ramo, Trumbull, CT, for desk-top terminals used in brokerage firms, and Computer Optics, Bethel, CT, and Redac-tron Corp., Plainview, NY, for warehouse inventory control displays and word-processing equipment.

In most cases, the parts-holding

chassis is manufactured of wire, 1/8-in. to 3/16-in. in diameter, either AISI 1008 or 1010 low-carbon steel. The wire is coated with zinc and bleached chromate, electrolytically applied, to afford corrosion protection and a chrome-like surface.

In addition to the frame, cold-rolled strip steel and stampings are welded onto the chassis to provide mounting studs and screw holes for holding the electronic gear—printed-circuit board cards, transformers, condensers, knobs and dials, lights and the picture tube.

Hole-to-hole dimensions, critical in an assembly of closely packed electronics, can be kept to a tolerance of  $\pm 0.010$  in., the company says. Circuit boards are mounted with permanent fasteners or plastic snap locks to permit the boards to be popped out conveniently and replaced. The picture tube is normally bolted to four stampings with weld studs, and the power transformer is affixed to a heavier stamping on the bottom of the frame, for a lower center of gravity. ■■

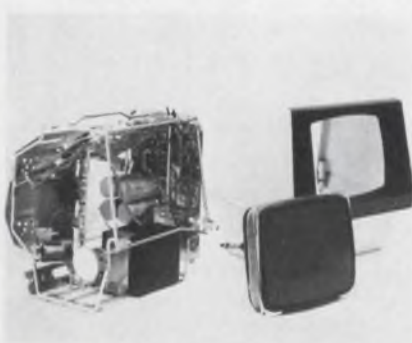

Steel wire chassis for this Bunker-Ramo CRT terminal eliminates heat build-up and the need for fans. It is lighter, cheaper and easier to test and maintain. Once the components have been placed on the chassis, the cabinet is dropped over it and the assembly finished. Manufacturer of the open wire frames is the E. H. Titchener Co., Binghamton, NY.

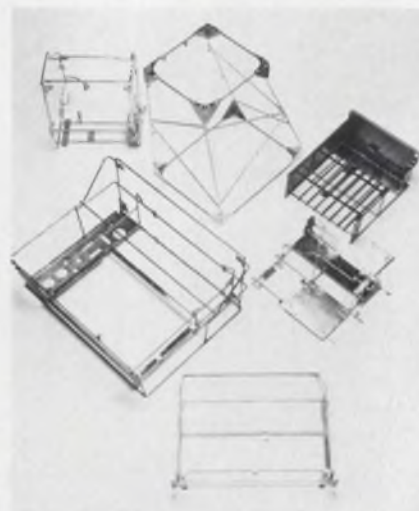

Wire chassis shapes can be built in any design a CRT user requires.

## NEWS

# MW system to help space shuttle land

When the first space-shuttle landing tests are made—now scheduled for September, 1976, at Edwards Air Force Base, CA—they will use a microwave landing system.

Designed by Cutler-Hammer's AIL Div., Deer Park, NY, the system is based on off-the-shelf hardware originally developed for the Federal Aviation Administration. The signal-in-space characteristics, for example, are identical to those of the Navy's C-SCAN system.

The system consists of a scanning beam localizer and glide path and a precision DME (distance measuring equipment) system, all sharing the same channel at K<sub>u</sub> band. Dual redundancy will be provided on the ground and triple in the air. Each ground station will have a monitoring system to detect malfunctions in signal format, rf drift or fade, or any misalignment. It will also test-interrogate the DME function.

Any detected discrepancy will cause a switchover to standby equipment without interruption of service. Both ends of the shuttle landing runways will be equipped.

The antenna scanning mechanisms are of the torsion-bar resonant type, oscillating at 2-1/2 Hz. Transmissions take place on both to and fro scans, resulting in five beam scans per second. The glide-path antenna has a 1.3-degree beamwidth and is slightly under 4 ft long. The localizer antenna has a 2-degree beam and is about 2 ft wide. ■■



Helping the space shuttle land will be AIL's microwave scanning-beam landing system. The azimuth/DME sites are at 1 and the elevation sites at 2.

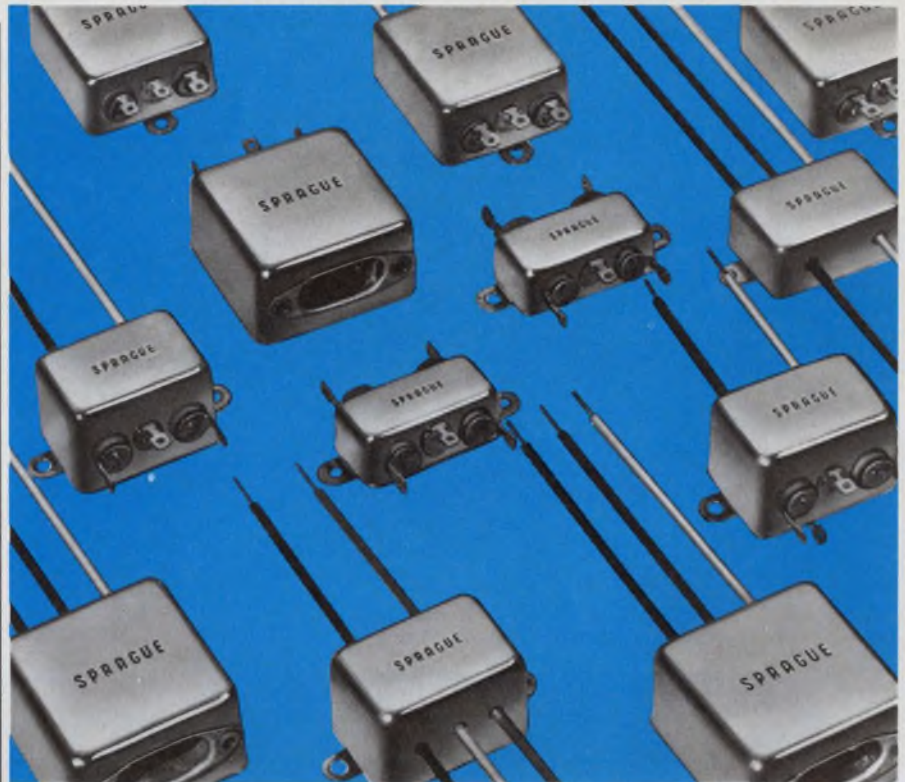

## FILTERS THAT WORK. FILTERS THAT FIT. FILTERS YOU CAN AFFORD.

**Sprague JX5100 Series EMI Powerline Filters give you the right blend of efficiency/size/cost.**

The lower cost of these general-purpose filters makes them especially suitable for higher-volume production-assembled equipment such as computer peripherals, cash registers, credit card verifiers, electronic service instruments, etc.

Series JX5100 Filters are designed to protect equipment from line noise as well as to protect the line from equipment noise, particularly equipment with high impedance loads. Smaller in size than many filters with comparable performance, they control line-to-ground interference with a high degree of efficiency. Filtering both sides of the line, the need for two filters is eliminated.

Available in a wide variety of current ratings (1 to 30 amps) and several different terminal configurations, Series JX5100 Filters withstand a test voltage of 2100 VDC, assuring protection against high-voltage transients. Line-to-ground capacitance is only .01  $\mu$ F, and maximum leakage current (each line to ground, @115V, 60Hz) is 1.0mA.

Sprague maintains complete testing facilities for all commercial, industrial, and government interference specifications.

*For complete technical data, write for Engineering Bulletin 8210.11 to: Technical Literature Service, Sprague Electric Company, 347 Marshall Street, North Adams, Mass. 01247.*

45F-4109R1

# SPRAGUE

THE MARK OF RELIABILITY

THE BROAD-LINE PRODUCER OF ELECTRONIC PARTS

INFORMATION RETRIEVAL NUMBER 18

# The SR-50. The SR-51.

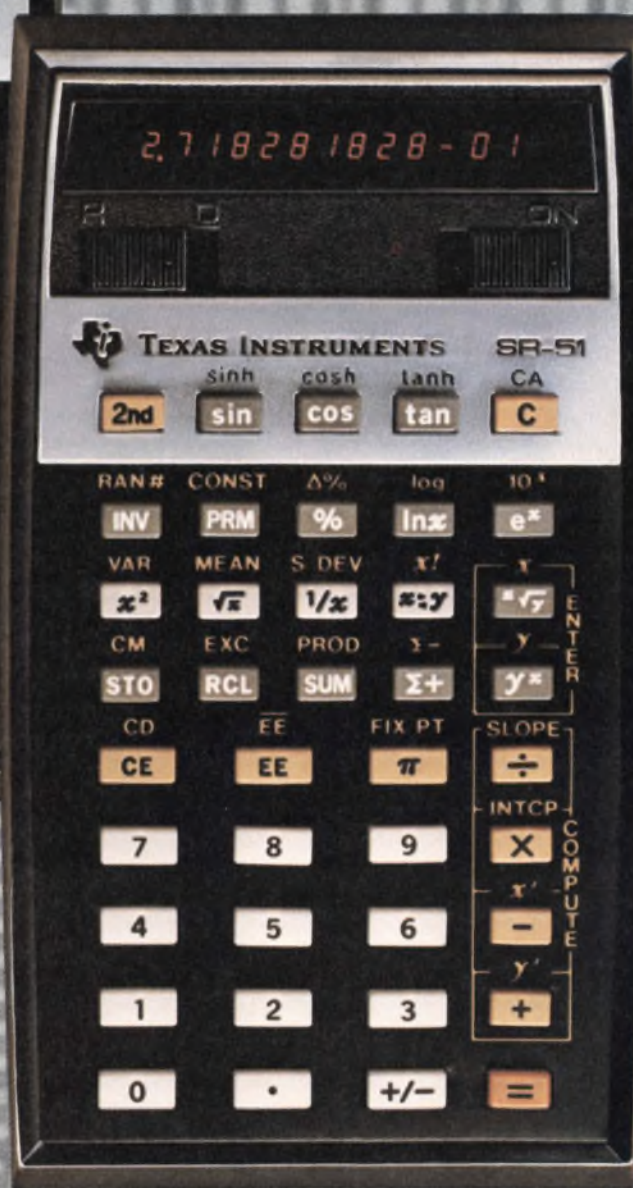
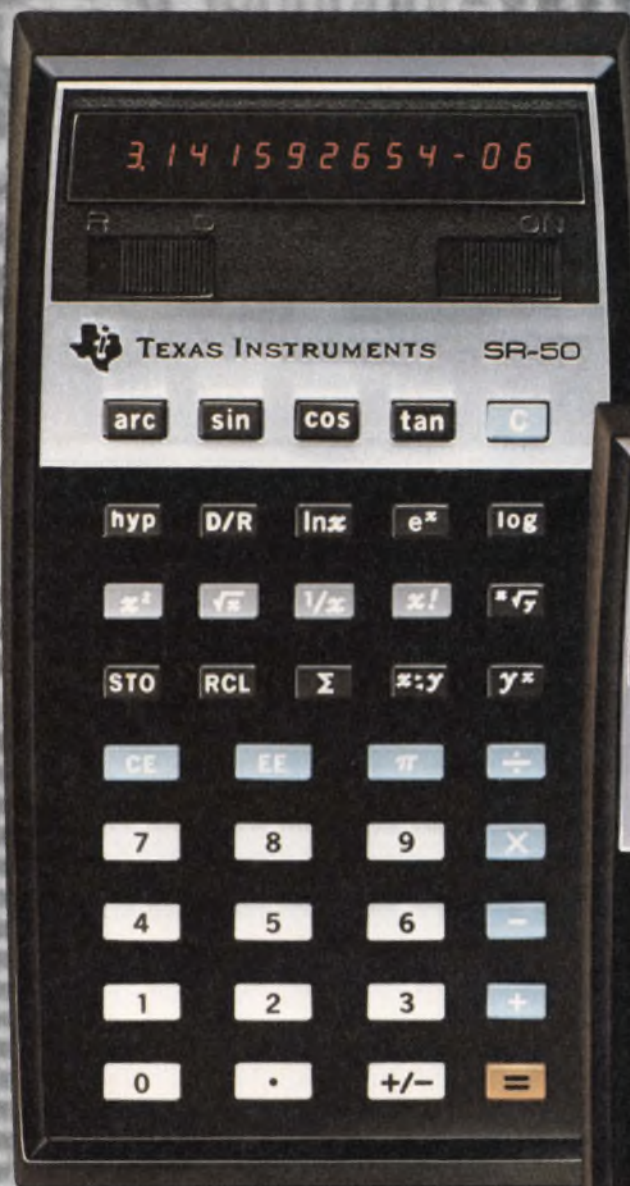

Texas Instruments is steeped in calculator technology from start to finish. We make all critical parts, and control quality every step of the way. This is the key to the exceptional quality and value of TI's professional calculators.

# Capability. Quality. Value.

The technological achievement under the keyboard is still the reason TI's professional calculators offer so much quality and math power for the money.

Engineer. Scientist. Businessman. Student. If you're doing more than basic mathematics in your field, consider an SR-50 or SR-51 from Texas Instruments.

Both deliver answers you can trust—quickly and efficiently—to problems ranging from simple arithmetic to highly complex calculations. You don't have to learn special entry methods or difficult-to-master key sequences. There's a better way—TI's algebraic entry system lets you key your problem just the way you would say it. Naturally. You don't worry about losing data in stacks, or keeping track of what is in each stack, or remembering if the stack is full. The way you learned math is the way it's done. On both the SR-50 and SR-51—you can command tremendous math power with confidence—from the beginning. Power and accuracy you can really put to work.

Answers are calculated to 13 significant digits, rounded off and displayed to 10. And for maximum accuracy, all 13 are held inside for subsequent calculations.

Scientific notation is automatic when you need it. For numbers as large as  $\pm 9.999999999 \times 10^{99}$ . Or as small as  $\pm 1. \times 10^{-99}$ .

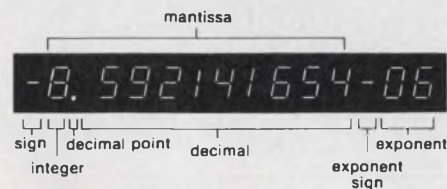

For a closer look at real math power, delve into the list. You'll see for yourself the SR-50 is a lot of calculator for the dollar. And the SR-51 does everything the 50 does and a lot more: Mean, variance and standard deviation. Linear regression. Percent and percent difference. Has a random number generator. And, offers 20 preprogrammed conversions and inverses.

Quality—it's built in right from the start. Texas Instruments designs and manufactures every critical component. From high-purity silicon semiconductor materials to

integrated circuits to light-emitting-diode displays to circuit boards to keyboards. So, we design-in and control quality—not just monitor it—at every level: Materials. Components. The complete system.

FUNCTION	SR-51	SR-50
Log, ln x	yes	yes
Trig (sin, cos, tan, INV)	yes	yes
Hyperbolic (sinh, cosh, tanh, INV)	yes	yes
Degree-radian conversion	yes	yes
Deg/rad mode selection switch	yes	yes
Decimal degrees to deg. min. sec.	yes	no
Polar-rectangular conversion	yes	no
$y^x$	yes	yes
$e^x$	yes	yes
$10^x$	yes	no
$x^2$	yes	yes
$\sqrt{x}$	yes	yes
$\sqrt[y]{x}$	yes	yes
$1/x$	yes	yes
$x!$	yes	yes
Exchange x with y	yes	yes
Exchange x with memory	yes	no
% and $\Delta$ %	yes	no
Mean, variance and standard deviation	yes	no
Linear regression	yes	no
Trend line analysis	yes	no
Slope and intercept	yes	no
Store and sum to memory	yes	yes
Recall from memory	yes	yes
Product to memory	yes	no
Random number generator	yes	no
Automatic permutation	yes	no
Preprogrammed conversions	20	1
Digits accuracy	13	13
Algebraic notation (sum of products)	yes	yes
Memories	3	1
Fixed decimal option	yes	no
Keys	40	40
Second function key	yes	no
Constant mode operation	yes	no

strength, injection-molded plastic designed to take a beating. It's a quality calculator. And you know it as soon as you get your hands on one. The heft and solid feel tells you it's a fine-quality instrument even before you press a key.

The SR-50 and SR-51 are human engineered, too, for maximum comfort and efficiency. For a hand or a desktop. Keys have positive-action, tactile feedback. And the bright, wide-angle displays are easy to read at your desk or on the go. Slim. Compact. Light. In your briefcase or on your belt, you'll hardly notice just 8.3 ounces.

Technological leadership and quality craftsmanship are why Texas Instruments can offer so much value at such low prices: \$109.95 for the SR-50. \$179.95 for the SR-51.

## 20 Preprogrammed Conversions

FROM	TO
mils	microns
inches	centimeters
feet	meters
yards	meters
miles	kilometers
miles	nautical miles
acres	square feet
fluid ounces	cubic centimeters
fluid ounces	liters
gallons	liters
ounces	grams
pounds	kilograms
short ton	metric ton
BTU	calories, gram
degrees	gradients
degrees	radians
°Fahrenheit	°Celsius
deg. min. sec.	decimal degrees
polar	rectangular
voltage ratio	decibels

To assure you reliable performance, every calculator is subjected to severe environmental and reliability testing prior to release to production. In production, every one is thoroughly tested, then "burned-in", then thoroughly tested again. If there's any problem, we want to find it before it gets to you.

Inside, steel machine screws anchor all important structural elements—plastic welds and glue fastenings aren't good enough. A double-tough Mylar\* barrier keeps dust and moisture from getting under the keyboard. The case is high-

See them at your nearest TI calculator retailer. Or, send for our new fact-filled color brochure. It details the outstanding capability of both the SR-50 and SR-51 with full feature descriptions, sample problems, entry-method considerations and more. Circle the reader service number. Or write, Texas Instruments, M/S358, P.O. Box 22013, Dallas, Texas 75222



TEXAS INSTRUMENTS  
INCORPORATED

INFORMATION RETRIEVAL NUMBER 20

# Be prepared...



Kit includes  
Original  
Swiss Army  
knife at no  
extra cost

for emergency needs...and design improvements

3 KHz - 750 MHz

## Double-Balanced Mixer Kit \$79.95

SAVE \$41.75 AND ALSO GET AN ORIGINAL SWISS ARMY KNIFE

### Be prepared to . . .

- ... meet emergency customer needs
- ... outfit breadboards and prototypes overnight
- ... customize designs without delay
- ... retrofit and update designs
- ... modify and substitute for better performance or price
- ... and to cut, skin, slice, sever, snip, saw, screw, scribe, shape, scrape, strip, pick, pry, punch, trim with the Swiss Army knife included in kit.

There's an analogy between the popular Swiss Army knife and Mini-Circuits Laboratory's new double-balanced mixer kit (DBK-4). Both have been designed to serve their owner when the need arises . . . and both products should be on hand when the need arises.

### Double-balanced mixer kit (DBK-4)

**BE A PLANNER AND SAVE \$41.75.**

Order now and receive six double-balanced mixers (2)SRA-1, (2)SRA-1W, (1)SRA-3, (1)SRA-6 and one Swiss Army knife for only \$79.95. (A \$121.70 mixer value if purchased separately.)

MODEL	Frequency Range (MHz)	Conversion Loss (dB) Total Range	Isolation (dB)					
			Lower band edge to one decade higher		Mid range		Upper band edge to one octave lower	
			LO-RF	LO-IF	LO-RF	LO-IF	LO-RF	LO-IF
SRA-1	LO-0.5-500 RF-0.5-500 IF-DC-500	6.5 typ 8.5 max	50 typ 35 min	45 typ 30 min	45 typ 30 min	40 typ 25 min	35 typ 25 min	30 typ 20 min
SRA-1W	LO-1-750 RF-1-750 IF-DC-750	6.5 typ 8.5 max	50 typ 45 min	45 typ 30 min	45 typ 30 min	40 typ 25 min	35 typ 25 min	30 typ 20 min
SRA-3	LO-0.025-200 RF-0.025-200 IF-DC-200	6.5 typ 8.5 max	60 typ 50 min	45 typ 35 min	45 typ 35 min	40 typ 30 min	35 typ 25 min	30 typ 20 min
SRA-6	LO-0.003-100 RF-0.003-100 IF-DC-100	6.5 typ 8.5 max	60 typ 50 min	60 typ 45 min	45 typ 30 min	40 typ 25 min	35 typ 25 min	30 typ 20 min

## Mini-Circuits Laboratory

OUR NEW ADDRESS IS: 837-843 Utica Avenue, Brooklyn, NY 11203 (212) 342-2500 Int'l Telex 620156

Foreign Sales Representatives:  AUSTRALIA General Electronic Services, 99 Alexander Street New South Wales, Australia 2065;  ENGLAND Dale Electronics, Dale House, Wharf Road, Frimley Green, Camberley Surrey;  FRANCE S.C.I.E.-D.I.M.E.S., 31 Rue George - Sand, 91120 Palaiseau, France;  GERMANY, AUSTRIA, SWITZERLAND Industrial Electronics GMBH, Klüberstrasse 14, 6000 Frankfurt/Main, Germany;  ISRAEL Vetricons, Ltd., 69 Gordon Street, Tel-Aviv, Israel;  JAPAN Denso Kaisha, Ltd., Eguchi Building, 8-1-1 Chome Hamamatsucho Minato-ku, Tokyo;  EASTERN CANADA B. D. Hummel, 2224 Maynard Avenue, Utica, NY 13502 (315) 736-7821;  NETHERLANDS Coimex, Veldweg 11, Hattem, Holland

US Distributors:  NORTHERN CALIFORNIA Gain-White & Co., Foothill Office Center, 105 Fremont Avenue, Los Altos, CA 94022 (415) 948-6533;  SOUTHERN CALIFORNIA, ARIZONA Crown Electronics, 11440 Collins Street, No. Hollywood CA 91601 (213) 877-3550



# Washington Report

## **Pentagon surviving budget-cutting fray**

The Pentagon is going to make out well next fiscal year, despite cuts by the Senate and House Armed Services Committee. The House Committee chopped \$3.7-billion out of a total request of \$29.8-billion, and the Senate group voted for a cut of \$4.8-billion. But already in the Pentagon's coffers are \$1.3-billion that had been requested for military aid to South Vietnam and \$902-million the Navy had asked for to cover anticipated inflationary shipbuilding costs.

All of the Pentagon's really high-priority projects seem to be relatively intact. The B-1 program won't move as fast as the Air Force wanted, but it is still very much alive. The same goes for the Navy's Trident program.

The Senate committee did vote to reduce the number of shipbuilding starts next year, but it left intact the funds requested for other programs, including the six AWACS (Airborne Warning Control System) aircraft the Pentagon wants. The House committee had cut that program in half. Final details will be worked out in conference.

Efforts are expected in both houses of Congress to make further trims, but considering the reverses in Southeast Asia and the fragile detente with the Soviet, the experts don't think the final figure will be lower than \$25-billion, the amount the Senate committee arrived at.

## **COMSAT seeking to sever Government apron strings**

Contending that it is a mature, viable commercial enterprise, the Communications Satellite Corp. (Comsat) is asking Congress to amend the act that created it in 1962 so it can operate much like any other common carrier, not tied to the Government.

A bill introduced by Sen. Warren G. Magnuson, Democrat of Washington, and Sen. James B. Pearson, Republican of Kansas, would authorize the creation of a new corporation for profit that would not be an agency of the Federal Government. As a communications common carrier, Comsat still would be subject to regulation by the Federal Communications Commission, as it is now, but the FCC wouldn't have the approval authority it holds today on efforts to obtain additional capital.

## **FAA to choose aeronautical satellite contractor**

The Federal Aviation Administration expects to request bids by mid-year for the space segment of its Aeronautical Satellite Program and to select a prime contractor towards the end of the year, says James E. Dow, acting administrator. In recent testimony before the House Appropriation

Subcommittee on Transportation, he requested a total of slightly over \$1.9-billion for his agency—which is \$179-million more than was authorized last year.

For facilities and equipment, the FAA is requesting \$250-million, of which \$43.9-million would be for navigation aids, instrument landing systems and visual aids. Included are funds for replacing 10 obsolete long-range radars and 18 obsolete ASR-8 radars, now used for airport surveillance, and the acquisition of 17 solid-state Direct Access Radar Channels to complete the outfitting of all en-route centers.

Under research, engineering and development, the agency is asking for \$80.4-million. Included, Dow says, are programs for discrete-address radar beacons and the Intermittent Positive Control ground-based collision avoidance system; experimental communications/surveillance satellites; advanced air-ground communications systems and other systems to improve air traffic control.

## **New source of RFI: aquarium thermostats**

The Federal Communications Commission is drawing a bead on another source of rf interference that is plaguing electronics engineers—aquarium thermostats. Agency experts say undesirable radiation is emitted at the thermostats, or from power lines supplying other buildings from the same transformer. So far, commercially available power-line filters have not been effective in eliminating the interference.

The FCC's position on such possible radiation devices as electric shavers, mixers, vacuum cleaners and thermostats has been that of merely requiring such equipment to be operated without interference with other electronic equipment. But, because of growing concern, the commission says now that it expects manufacturers to take measures to eliminate or substantially reduce interfering radiation before the equipment leaves the factory. If voluntary efforts by industry aren't satisfactory, the FCC says it will initiate rule-making procedures.

**Capital Capsules:** The loss of 140,000 jobs in U.S. industry and \$2-billion in export sales may result if the Commerce Dept.'s export promotion program is cut, the Electronic Industries Association has warned. The Office of Management and Budget has ordered cuts. . . . **The outlook for foreign military sales is bright again this year, but not quite as good as it was last year.** In 1974, sales on a government-to-government basis were \$8-billion, plus another \$1-billion transacted on a commercial basis. Defense officials believe the Government sales will run between \$7-billion to \$8-billion this year. If some pending aircraft sales come through before June 30, sales for 1975 could outstrip the 1974 total. . . . **A radar that will not only tell the number of vehicles in a convoy but also their types** is on the shopping list of the Army Mobility Equipment Center. Wanted is a sensor system for the Remotely Monitored Battlefield Sensor System. The capability sought includes detection of number, type, location, speed and heading of mixed targets. . . . **An electrically powered wheelchair that responds to 32 voice commands** is the latest development of the NASA Jet Propulsion Laboratory. Developed under a Veterans Administration program, the wheelchair is for quadriplegics and others severely handicapped. Not only do voice commands control chair movements; they also operate a manipulator arm on the chair that can be extended from one to four feet to pick up objects with two pincer fingers.

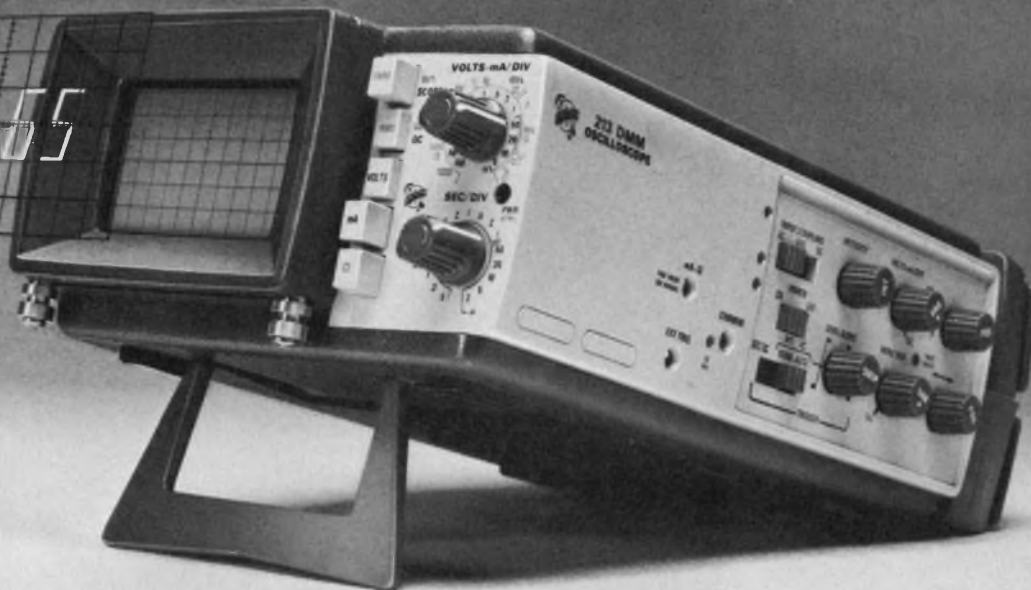
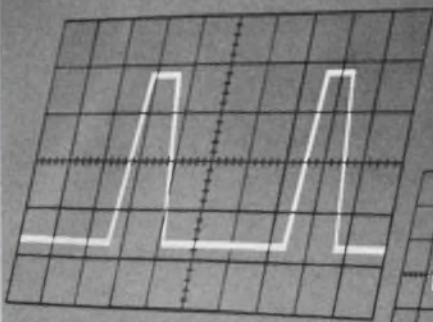

# DMM.... Miniscope.... both in one handheld unit

You no longer have to settle for only a DMM or suffer the inconvenience of carrying two separate instruments. The new TEKTRONIX 213 DMM/Oscilloscope provides the instrumentation needed to reduce service costs by performing more of your servicing on site, on the first call. And it weighs only 3.7 lbs. This precise, full function, 3½ digit DMM and 1 MHz oscilloscope in one compact (3.0 × 5.2 × 8.9 in.) package fits easily in your briefcase or tool kit. During operation the 213 can be hand held, rested on the equipment under test, or even carried on a convenient neck strap.

Included in the extensive measurement capabilities of the 213 are precise dc voltage from 0.1 V to 1000 V full scale, dc current from 0.1 mA to 1000 mA, true rms voltage and current over the same ranges, and resistance from 1 KΩ to 10 MΩ full scale. In the oscilloscope mode, the 213 displays both voltage (5 mV/div to 100 V/div) and current (5 μA/div to 1000 mA/div) waveforms.

With its easy portability and internal battery power (3.5 hours operation), the 213 DMM/Oscilloscope is equally at home at the top of a ladder, on a catwalk in a processing plant, in a

moving vehicle, in an office environment, or at a remote field location. And rugged construction insures that the 213 will withstand rough handling.

At only \$1200, the 213 adds outstanding versatility to the Tektronix 200 Miniscope Series. Other instruments in this line include both single and dual-channel 500 kHz oscilloscopes, a dual-channel 500 kHz storage oscilloscope and a 5 MHz oscilloscope for higher frequency applications. All of these Miniscopes share the 213's advantages of small size, light weight, internal battery power, rugged construction, double insulation, and integral voltage probes and power cord.

For detailed information on this complete DMM and Oscilloscope in one small, handheld package, contact your local Tektronix Field Engineer, or write Tektronix, Inc., P.O. Box 500, Beaverton, Oregon 97077. In Europe, write: Tektronix Ltd., P.O. Box 36, St. Peter Port, Guernsey, Channel Islands.

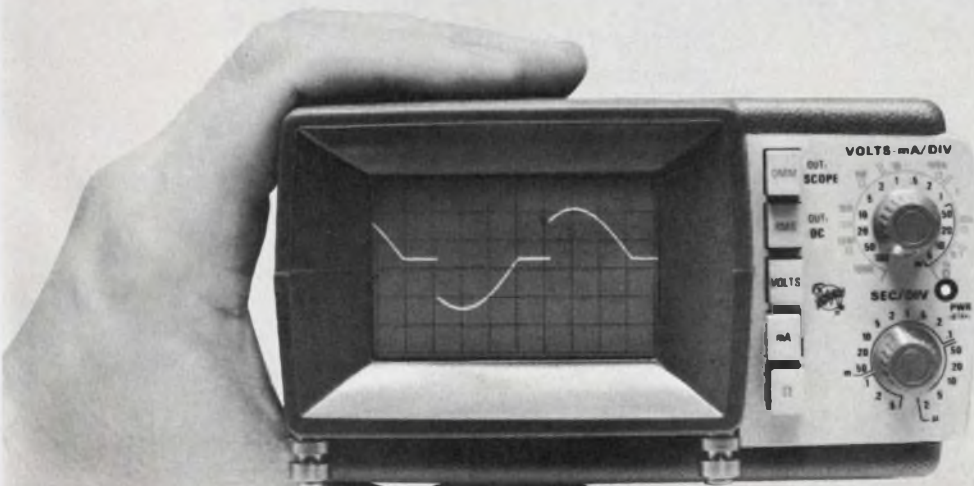

**TEKTRONIX®**  
committed to  
technical excellence

RIGHT ON TARGET AGAIN



Bearing it well!

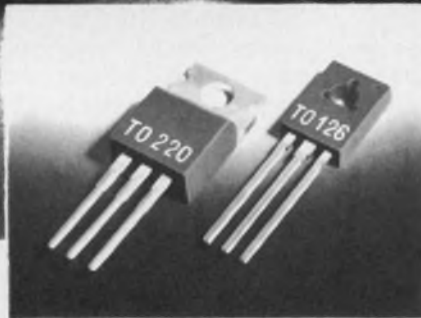

## Complementary power pairs in plastic

### Epibase-darlington

#### 4 Amperes - TO 126 pack

NPN	PNP
2N 6037	2N 6034
2N 6038	2N 6035
2N 6039	2N 6036
SJE 800	SJE 700
SJE 801	SJE 701
SJE 802	SJE 702
SJE 803	SJE 703

#### 8 Amperes - TO 220 pack

NPN	PNP
BDX 53/A/B/C	BDX 54/A/B/C

### Epibase-transistors

#### 2 Amperes - TO 126 pack

NPN	PNP
2N 4921/22/23	2N 4918/19/20
SJE 720/21/22	SJE 710/11/12

#### 4 Amperes - TO 126 pack

NPN	PNP
2N 5190/91/92	2N 5193/94/95
SJE 220/1/2/3/4/5	SJE 230/1/2/3/4/5

#### 4 Amperes - TO 220 pack

NPN	PNP
2N 6121/22/23	2N 6124/25/26
SIP 31/A/B	SIP 32/A/B

SGS - ATE Semiconductor Corporation - **Newtonville, Mass.** 02160 - 435 Newtonville Avenue - Tel 617-9691610 - Telex 922428  
**Stocking Distributors:** Edmar Electronics Co. **Des Plaines, ILL.** (312) 298-8580 - Energy Electronic Products. **Los Angeles, CA.** (213) 641-9020 - Esco Inc. **Dayton, OHIO.** (513) 226-1133 - KA Electronic Sales. **Dallas TX.** (214) 634-7870 - Radar Electric Co. **Seattle, WA.** (206) 282-2511 - Rosyl Electronics. **Bayshore, NY.** (516) 586-1800 - Wilshire Electronics. **Burlington, MASS.** (617) 272-8200 - Prelco Electronics Ltd. **Montreal 357, Quebec.** (514) 389-8051

# DELAY BY EVENTS, STABLE DISPLAYS, AND EASY-TO-USE CONTROLS: HOW DO YOU GET ALL THIS IN AN INEXPENSIVE LABORATORY OSCILLOSCOPE WITH DELAYING CAPABILITY?

The TEKTRONIX 5B31 Digitally Delaying Time Base has a delay-by-events mode in addition to delay by time (up to 99,999  $\mu$ s in 1- $\mu$ s increments). In the delay-by-events mode, you can synchronize the delay to a specific event and then trigger the sweep up to 99,999 events later.

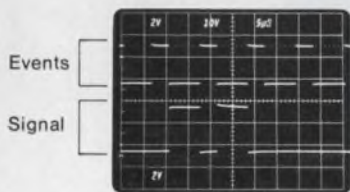

The 5B31 has a digital delay system—a crystal-controlled clock, a digital counter, and a circuit that eliminates 1-count ambiguity—that introduces no more than 20 ns of jitter at any sweep speed. So the 5B31 will have little effect on the stability of your display, even at very high sweep speeds.

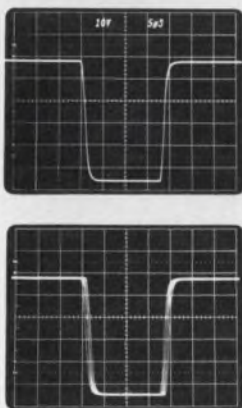

The 5B31 has easy-to-use controls: thumbwheels and pushbuttons instead of dials. You can set and read out the

delay from the 5-digit thumbwheel to the nearest  $\mu$ s or event, select the delay mode by pushing the  $\mu$ s or events button, and trigger at the beginning of the delay by pushing the DLY'D button.



Then you can study any portion of the waveform in detail by adjusting the thumbwheels and increasing the sweep speed.

You can choose a 5400-Series laboratory oscilloscope with this digital delaying capability for less than \$2000. This oscilloscope system gives you the basic performance and capability you need now and the potential to expand for your future measurement needs.



How can we offer you this flexibility? The 5400-Series, a comprehensive group of plug-ins and store and non-store mainframes, can be combined to make up just the right oscilloscope measurement system for you.

We'd like to help you select the right system for your needs. Let us send you all the technical details on the 5400-Series Oscilloscopes and the 5B31 Digitally Delaying Time Base. Write Tektronix, Inc., P.O. Box 500, Beaverton, Oregon 97077. In Europe write Tektronix Limited, P.O. Box 36, St. Peter Port, Guernsey, Channel Islands. For a demonstration, contact your nearest Tektronix Field Office. U.S. Sales Prices F.O.B. Beaverton, Oregon.

**DIGITAL DELAY/ANOTHER 5000-SERIES SYSTEM.**



**TEKTRONIX®**  
committed to technical excellence

## OUR NEW DIGITALLY DELAYING TIME BASE

INFORMATION RETRIEVAL NUMBER 24

FOR DEMONSTRATION, 152

# Meet the 1500W zener.

## The zener with the specs of a surge suppressor.

If you're using power zeners as surge suppressors, you need to know whether the zener will protect your circuit. And the usual specs aren't much help.

Here's the zener you've been waiting for. It's designed and spec'd as a suppressor, with 1500W peak pulse power capability — higher than any

conventional zener. And it's available at a very reasonable price — about a third of what you'd pay for a 50W zener.

Circle our number on the reader service card — we'll send you the whole story on our 1N5629A-1N5650A series of power

zeners. And you'll never have to guess about surge suppression again.

Unitrode Corporation, 580 Pleasant Street, Watertown, Massachusetts 02172.

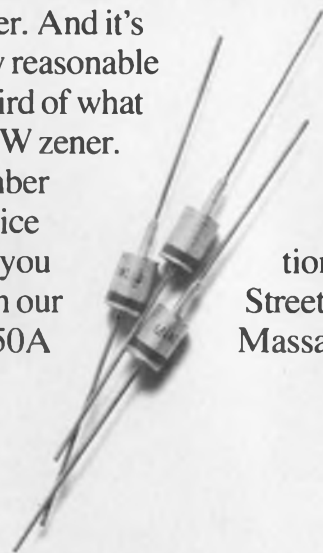

UNITRODE

# Genius to bum

Jack's company is taking a bath this year. Last year, continuing its annual growth rate of about 17% a year, Jack's company hit a record sales volume of some \$35,000,000. So everybody knew that Jack was a genius, a man so capable and so shrewd that he never made a mistake. Or, a least, he didn't make serious mistakes.

When you visited his company you could sense the high morale, the spirit of enthusiasm. You could smell the odor of success. And when his employees spoke of Jack, they did so with a certain reverence. But this year Jack's a bum.

Sales have plunged to an annual rate of some \$13,000,000. And earnings have plummeted even more precipitously. Further, some of Jack's bold and brilliant ventures of past years have turned out to be duds. So, in keeping with the popular business practice of burning up all the bad news in a bad year, Jack is writing off some huge losses.

If you visited Jack's company now, you'd find that morale stinks; people have forgotten his past glories and they talk (well, they really whisper) about his blunders. You get the feeling he's pretty stupid. Those people are wrong again.

There are lots of star performers in our industry, loads of brilliant engineers and managers. But nobody bats 1000. The only folks who don't make mistakes are dead. If we want to evaluate live people properly, we'd better recognize that they're going to make mistakes—some of them serious. As observers, the most serious mistake that *we* can make is to assume that the past is a perfect indicator of the future.

Sure, the fellow who pulls one blooper after another is likely to goof again in the future. And the fellow who has scored many brilliant achievements in the past is more likely to score again. But there are no guarantees. For most companies in our industry 1975 has been an unhappy year. But not a terminal year. There will be plenty of terrific years in the future—even for those who took a bath in 1975.



A handwritten signature in dark ink, which appears to read "George Rostky". The signature is fluid and cursive.

GEORGE ROSTKY  
Editor-in-Chief

# We made them first. To last.

Available now from Singer: Size 8 and 11 Bu/weps synchros designed to meet the latest requirements of MIL-S-20708C specifications.

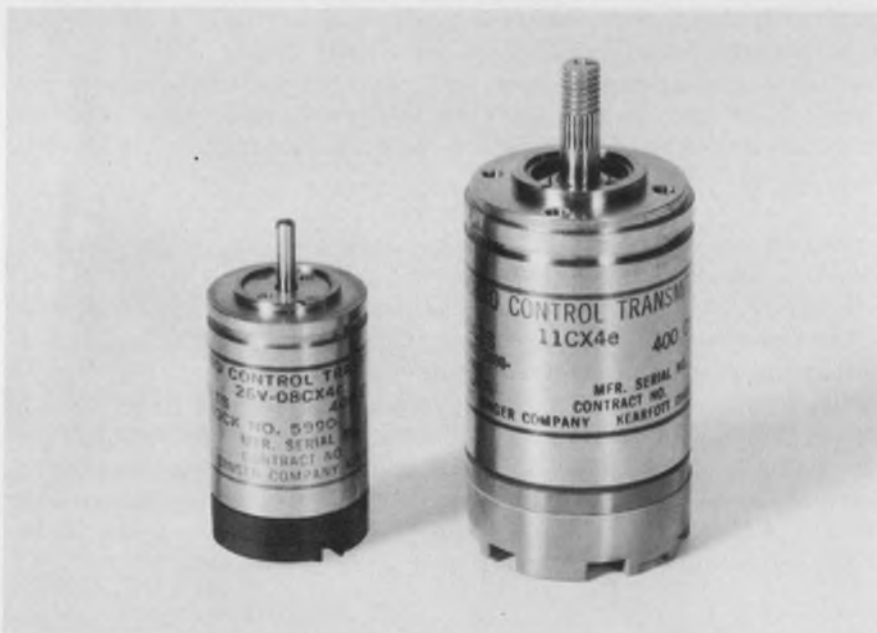

Kearfott, the first to design Bu/weps size 5, 8 and 11 synchros, has over the years constantly made them better. These units are used in fire control systems, radar, navigation, missile functions and other applications requiring a high level of precision, endurance and reliability.

These Kearfott synchros operate over the entire temperature range of  $-55^{\circ}\text{C}$  to  $+125^{\circ}\text{C}$ . They are DOD qualified and listed in the QPL.

(They can also meet reasonable cost requirements in computers, electronics and other types of business equipment.)

You can get these synchros in the following Bu/weps types:

Size 8	Size 11
26V 08CX4c	26V 11CX4c
26V 08CDX4c	11CX4e
26V 08CT4c	26V 11TX4c
	26V 11CDX4c
	11CDX4b
	26V 11CT4d
	11CT4E

We'll be happy to send you drawings and technical details on request. Also for Kearfott Size 5 Bu/weps CX, CDX and CT units, and Size 11 and 15 resolvers. Units with the same characteristics but different Bu/weps shaft variations are also available. Write for information to the Singer Company, Kearfott Division, 1150 McBride Avenue, Little Falls, N.J. 07424.

**SINGER**  
AEROSPACE & MARINE SYSTEMS



OEM buyers:  
**Ask**  
**Control Data**  
 for increased cartridge disk  
 drive capacity.

**We have it.**



**9427 H CDD**  
 12 MB capacity standard,  
 6 MB or 3 MB optional  
 200 or 100 TPI  
 Average access 35 ms  
 Data Rate: 312 K bytes/sec.



**9747 DSU with Cartridge  
 Disk Drive interface**  
 60 MB capacity  
 Industry standard 11 high pack  
 Average access 35 mc  
 Data Rate: 312 K bytes/sec.

21 OEM offices, in 11 countries,  
 specializing in service to the mini OEM.

Call (612) 830-5624 or return coupon.

Bruce Bergman, Product Sales Manager  
 Control Data Corporation, Dept. ED-675  
 7801 Computer Ave. So., Minneapolis, MN 55435  
 Please send information on your Cartridge Disk Drives.

NAME		TITLE	
COMPANY		ADDRESS	
CITY			
STATE	ZIP	PHONE	



**CONTROL DATA  
 CORPORATION**

The Total Services Company



GRANDMA'S GRACIOUS GRAPESHOT  
(Always The Right Gesture)  
GOLDEN SHAFT  
ARROW WORKS

OL' STANDEY  
POWDER  
797-4486  
343-9602  
(411)

GOODEN-CHEAPE  
ARMS  
SCAR  
DEAD'S

DID YOU  
SELL TO  
CUSTER?

KEN  
WINGFIELD

# Peace at any price in silicon power



This isn't a shootout about new product so if you're expecting the latest bullets on the latest gizmo, move on now.

If, however, you want to see us take a stand on pricing your next silicon power transistor you'll have to continue to the bitter end.

Simply stated our policy is this: *we'll be competitive on 99.9% of the power transistors in our broad line.*

Sounds simple but it isn't.

We think a fair price for a good product is the only way to last. So do you.

Used to be you knew us as the me-too in discretos. Others innovate, Motorola follows.

That held true 'till we decided the only way to capture first place in silicon power was to become the technological leader. So we started a technology war that scored like:

Motorola	Competition
Aluminum TO-3, TO-66	..... Copied it
EpiBase* technology	..... Copied it
EpiBase	
Darlington	..... Copied it
Annular† Darlington	..... Copied it
Thermopad II*	
Plastic	..... Uncopied
Power Regulators	..... Copied it
HV Darlington	..... Copied it
Switchmode* Power	..... Copied it

We won hands down. And more to come.

Former leaders are cutting prices now.

There's a price war going on. And everybody expects us to be in it.

We are.

But we won't degrade total service because prices are lower. That's shoot-from-the-hip bs.\*\*

If you want fair and square prod-

uct at competitive cost you'll be forced to recognize Motorola still offers more than anyone who waves their latest red-inked price sheet at you.

Straight arrow stuff. Clean neat devices . . . Easy to find specs . . . Low failure rates . . . Many salesmen . . . Few service hassles . . . Volume . . . Applications help . . . Good literature . . . Ready to assemble parts . . . Standards.

Things real leaders have to have to last. Things most of you want for long term peace of mind.

Things wheeler-dealers *never* have — now or after their bubbles burst.

In the meantime we'll meet them, and you, on any battleground in the USA at high noon or otherwise.

And when the chips are down we know you'll be on our side.

Or else.



New.  
Send for it.  
Box 20912,  
Phoenix 85036.

## Drive a real bargain



# MOTOROLA SILICON POWER

# VECTOR FITS IT ALL TOGETHER, BETTER

## MODULE CAGES



CMA SERIES

Strong, rugged all aluminum units supplied assembled for slide-in EFP modules in 3 1/2", 5 1/4", 7" and 8 3/4" heights and up to 15 3/4" deep.



EFP MODULES

Sleek aluminum cases with slide-off side covers, extruded top and bottom rails hold cards 2.73", 4.5" and 7.98" wide and 4.5", 6.5", 9.6" and 11.31" long. 59 models available in widths from 1" to 4 1/2".

## CARD FILES AND CAGES



CCK-13 SERIES

Rugged all aluminum, card height adjustable card files supplied assembled ready for connectors which mount on 4-way adjustable struts. The cages are designed for cards with width ranges of 1.0" to 2.73"; 2.73" to 4 1/2"; 6.2" to 7.98"; and lengths up to 9.6". Plastic or metal guides available. *Continuous extruded aluminum plate style* has 106-0.075" wide continuous grooves on 0.150" centers for cards allowing maximum flexibility.

## MULTI-USE CAGE KITS



CA-HP SERIES

Supplied unassembled in 11 different models for maximum flexibility to house cards and/or modules. Order card and module guides separately. Slotted side walls and bracket-mounted connector mounting struts provide wide adjustability. Available in 3 1/2", 5 1/4", 7" and 8 3/4" heights and 9", 12", and 15 3/4" depths. All parts and hardware of any Vector cage are available separately. For custom card or module cages, request our "design your own" form drawing.

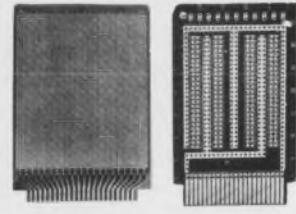

- PLUGBORDS
- TERMINALS
- CONNECTORS

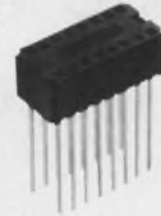

See **EDM** vol. 3, pg. 722-726

## PACKAGING HARDWARE FROM:



ELECTRONIC CO., INC.

12460 Gladstone Ave. Sylmar, California 91342



Phone (213) 365 9661

TWX (910) 496 1539

34113

INFORMATION RETRIEVAL NUMBER 123

# Do you train or retrain employees? Consider these famous courses...

## BASIC ELECTRICITY

By Van Valkenburgh, Nooger & Neville, Inc.

This simplified illustrated course is the civilian version of the Basic Electricity course used for years by the U.S. Navy and requires no previous background in electricity and little mathematics. The step-by-step approach covers basic concepts from electromagnetism to AC and DC circuits and motors. Frequently only one new concept is introduced on each page and it is amplified by at least one illustration per page. Each topical section concludes with helpful review pages. In five volumes, 624 pages.

- Paperbound set, #0033-2, \$18.40
- Combined Cloth Edition, #0039-1, \$16.70



**HAYDEN BOOK COMPANY, INC., 50 Essex St., Rochelle Park, N.J. 07662**

Please send me the book(s) checked above on 15-day free examination. At the end of that time, I will remit payment, plus postage, or return the book(s) with no further obligation. **Save Money!** Payment enclosed. Publisher will pay all shipping and handling charges—same 15-day guarantee.

## BASIC ELECTRONICS

By Van Valkenburgh, Nooger & Neville, Inc.

Any trainee with a basic knowledge of electricity (equivalent to *Basic Electricity* study) can master the fundamentals of electronics with this progressive course. *Basic Electronics* explains all vital concepts in a logical, step-by-step sequence — from power supply elements and circuits through amplifiers, transmitters, receivers and transistors. In six volumes, 680 pages.

- Paperbound, #0048-0, \$22.15
- Combined Cloth Edition, #0049-9, \$19.50

Tests (and answers) for both courses are available for group and self-study applications.

Prices subject to change without notice.

Name \_\_\_\_\_  
Firm \_\_\_\_\_  
Address \_\_\_\_\_  
City/State/Zip \_\_\_\_\_

# Heath sets a new performance level for laboratory recorders

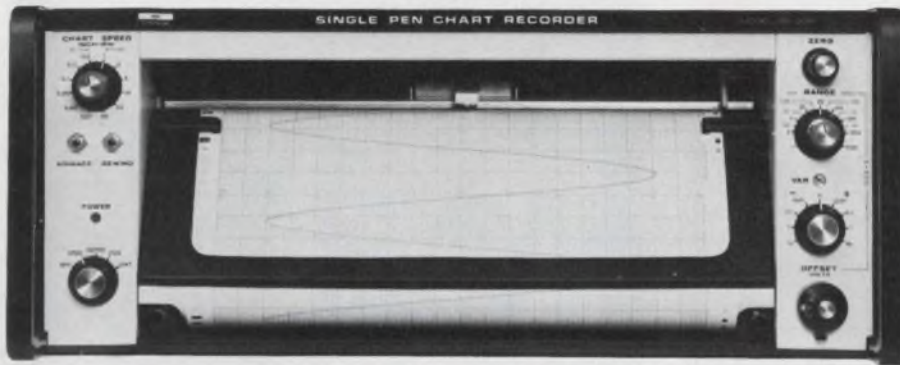

Our new single-pen SR-205 has many standard features that are available only as extra-cost options with other manufacturers. Like front panel zero controls for pen placement anywhere with zero input...full scale input ranges of 1, 2, 5, 10, 20, 50, 100, 200 & 500 mV or volts...calibrated positive & negative offset for input signal suppression...pushbutton chart advance and rewind...12 chart speeds from 50 in/min to 0.01 in/min in a 1-2-5 sequence...remote control capability for all functions. Balance time is only 250 msec for accurate response to fast-changing signals. Maximum error is  $\pm 0.2\%$  of full scale. A great recorder value—only \$995\*.

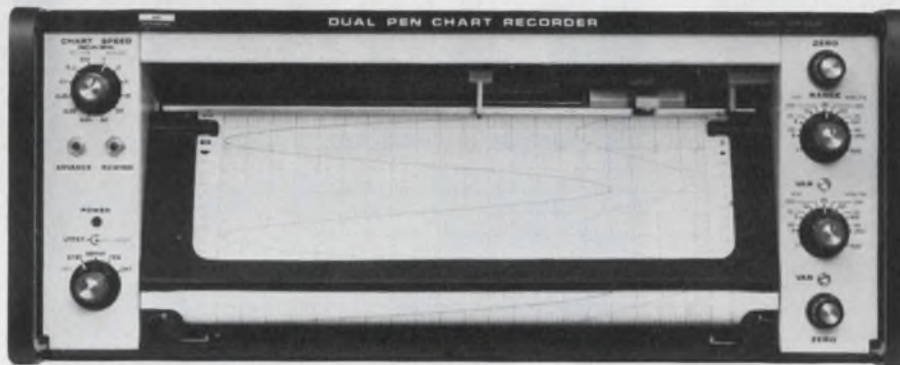

The new SR-206 brings dual-pen recording to the Heath/Schlumberger recorder line. Both channels offer the same capability as the SR-205 above, except for calibrated offset...both inputs provide 18 calibrated ranges from 1 mV to 500 V full scale...pens are separated by one large division on the chart for easy comparison...remote control includes separate pen lift and events marker for each channel...disposable, nylon-tipped pens for sharp, distinct traces at any chart speed. The SR-206 is the most complete recording system in its price class. Only \$1395\*.

Heath/Schlumberger has engineered precision and performance into two new strip chart recorders that are probably all the lab recorder you will ever need. Each recorder is a complete system — there are no extras to buy. The price even includes events markers, electric pen lift, necessary hardware for rack mount and easy conversion to metric operation. Chart drive is quartz crystal controlled for stable chart operation regardless of line frequency. Front panel pushbuttons provide two-speed chart advance and rewind. Remote control by TTL-level signals for pen

lift, chart drive, events marker and servo mute is possible through a connector on the rear panel (mating connector supplied). An enclosed conductive plastic slideware is used for long life without periodic cleaning. Pen motor current limiting circuitry allows the pen to be driven continuously off scale with no audible noise and no possibility of damage to the recorder.

The precision and versatility of the SR-205 & SR-206 will make them the most-used instruments in your lab.

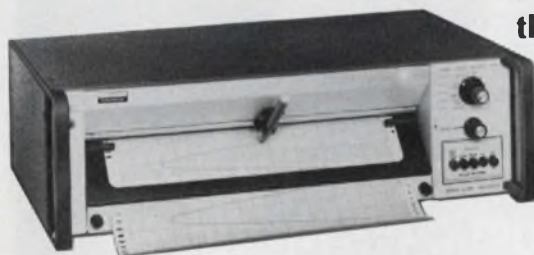

## Research-quality performance on a low budget... the SR-255B only \$365\*

The SR-255B is our best recorder value. It offers a full 10-inch chart width...pushbutton selection of 10 mV, 100 mV, 1 V and 10 V full scale spans with variable control for expansion to 100 V full scale...10 digitally-derived chart speeds from 10 to 0.01 in/min with accuracy to 0.5% or better...floating input with better than 10 megohms input impedance to minimize source loading...complete remote control capability for all functions. Only \$365\*, calibrated and ready for use.

### Send for your free Heath/Schlumberger Catalog



The latest Heath/Schlumberger Assembled Instruments Catalog has complete specs and descriptions for all of the above recorders — along with many other high performance, low cost instruments for industrial, research and educational applications. Send for your free copy today.

Please send my free copy of the latest Heath/Schlumberger Assembled Instruments Catalog.

HEATH/SCHLUMBERGER INSTRUMENTS  
Dept. 511-070  
Benton Harbor, Michigan 49022

HEATH  
Schlumberger

NAME \_\_\_\_\_

TITLE \_\_\_\_\_

COMPANY/INSTITUTION \_\_\_\_\_

ADDRESS \_\_\_\_\_

CITY \_\_\_\_\_ STATE \_\_\_\_\_ ZIP \_\_\_\_\_

MAIL ORDER PRICES F.O.B. FACTORY.  
PRICES AND SPECIFICATIONS SUBJECT TO CHANGE WITHOUT NOTICE.

EK-462

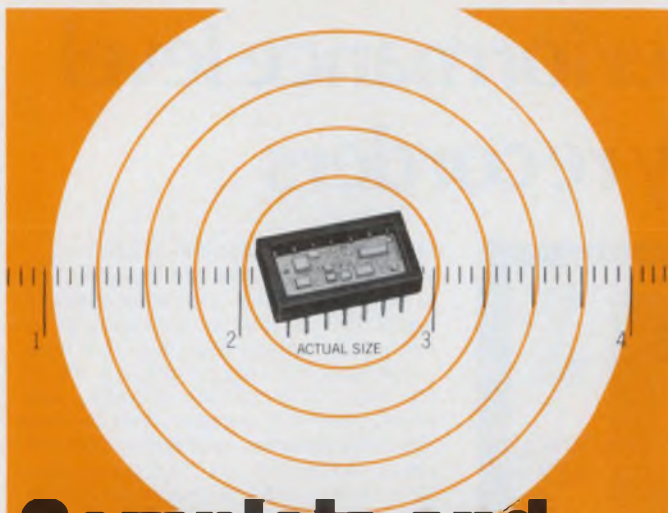

# Complete and Adjustment-Free Sample/Hold

Model MN343 S/H in a dip features:

- HIGH SPEED... 7.5  $\mu$ sec acquisition time.  
... 60 nsec aperture time.
- LOW DROOP RATE... 100  $\mu$ V/msec.
- GUARANTEED ACCURACY...  $\pm .02\%$  at 25C.  
...  $\pm .05\%$  (0 to 70C and -55 to +125C).
- SMALL SIZE... 14 pin hermetic dip.

Micro Networks continues to lead the field in the engineering and production of complete, adjustment free conversion products.

Model MN343—with internal holding capacitor—is the first complete and adjustment free S/H in a dip. It is laser trimmed for offset and gain, eliminating the need for external components and trim pots. Because of its high speed and low droop characteristics it is a perfect match to the 12 bit high speed A/D converters such as Micro Networks' MN5200. For the operating range -55 to +125C, the MIL-range unit MN343H will lose only 1 mV—or less than  $\pm 1/2$  LSB out of 12 bits in 50  $\mu$ sec.

For additional information, prices and specifications, write or call.



**Micro Networks Corporation**  
324 Clark Street • Worcester, Mass. 01606/Tel:617-852-5400

INFORMATION RETRIEVAL NUMBER 125

## TEKELEC HAS THE SPIRIT OF '76



The \$76 Digital Panel Meter



**\$76.00** 100 Quantity  
**3 1/2 Digits**



**\$125**  
**4 1/2 Digits**

100 QUANTITY

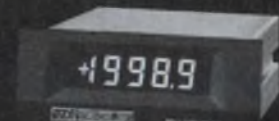

**3 YEAR WARRANTY ON LIQUID CRYSTAL DISPLAY**

- 14 Voltage and current ranges
- Sensitivity to 1  $\mu$ V/digit
- Shielded transformer power supply
- 220 V RMS Common mode voltage
- Overrange indication
- Bi-polar operation with automatic polarity indication
- All metal case for better noise immunity
- Available for DC power
- Power consumption 1 1/2W nominal
- Isolated parallel BCD output

**TEKELEC, INC. TA**

2623 Saddle Ave., Oxnard, CA 93030 • (805) 485-5445

INFORMATION RETRIEVAL NUMBER 126

# ANOTHER DIMENSION

has been added to the world famous family of

**Simpson®**  
260 VOMS

## the SERIES 6XL



### FOR THE SPECIAL NEEDS OF THE SOLID STATE ELECTRONICS INDUSTRY

- Extra shock and drop-resistant construction, high impact, custom-molded panel and case
- Extra large viewing area with four-color (Red, Green, Blue and Black) scales, keyed to matching range panel
- 33 ranges with extra voltage, current, resistance and low-power ohms functions
- Plus — all the features of the time-honored, ever popular 260-6

260-6XL, Complete with batteries, test leads and manual ..... **\$90.00**  
260-6XLM, with mirror scale ..... **\$93.00**

#### 260-6XLP WITH CIRCUIT OVERLOAD-PROTECTION

Reset pushbutton releases when overload exists. Will not reset until overload condition is eliminated.

260-6XLP, complete with batteries, test leads and manual . . . **\$125.00**

260-6XLPM, with mirror scale ..... **\$128.00**



#### RANGES:

DC Volts .....	0-0.25; 0-1; 0-2.5; 0-10; 0-25; 0-100; 0-250; 0-500; 0-1000
AC Volts .....	0-2.5; 0-10; 0-25; 0-100; 0-250; 0-500; 0-1000;
DC Microamperes .....	0-50 (250 MV Drop)
DC Milliampères .....	0-0.5; 0-5; 0-50; 0-500
DC Amperes .....	0-5 (250 MV Drop)
AC Amperes .....	6 ranges from 0-5 to 0-250 with optional Model 150 Amp-Clamp adapter.
DB Scale (1 MW 600 Ω Reference) .....	-20 to +10; -9 to +21; -1 to +29; +11 to +41; +19 to +49
Resistance (Standard Power) .....	Rx1 (6 Ω center scale), Rx100 (600Ω center scae), Rx1K (6000 Ω center scale), Rx10K (60,000 Ω center scale)
Resistance (Low Power) .....	Rx1 (20 Ω center scale) Rx10 (200 Ω center scale) Max. open circuit voltage only 100mV! Max. measuring power only 0.125 mW!
Size .....	5¼ x 7 x 3⅞" (133 x 178 x 79 mm)
Weight .....	2.5 lbs. (1.14 kg)

#### ACCESSORIES

Model 150 Amp-Clamp, Catalog No. 00532 complete with a No. 00533 test lead .....	<b>\$29.50</b>
30 kV DC Probe, Catalog No. 00509 .....	<b>\$22.00</b>
Grip-Tip Extension Probe, Catalog No. 00118 .....	<b>\$ 4.75</b>
Rigid Case, Catalog No. 00805 .....	<b>\$20.50</b>
Sheath Case, Catalog No. 01818 .....	<b>\$16.75</b>
5 kV DC Probe, Catalog No. 00506 .....	<b>\$ 5.25</b>
5 kV AC Probe, Catalog No. 00505 .....	<b>\$ 5.25</b>

Available Now at Leading Electronics and Electrical Equipment Distributors • Write for Complete Specifications



## SIMPSON ELECTRIC COMPANY

853 Dundee Avenue, Elgin, Illinois 60120 • (312) 697-2260  
CABLE: SIMELCO • Telex: 72-2416

IN CANADA: Bach-Simpson, Ltd., London, Ontario  
IN ENGLAND: Bach-Simpson (U.K.) Ltd., Wadebridge, Cornwall  
IN INDIA: Ruttonsha-Simpson Private, Ltd., Vikhroli, Bombay



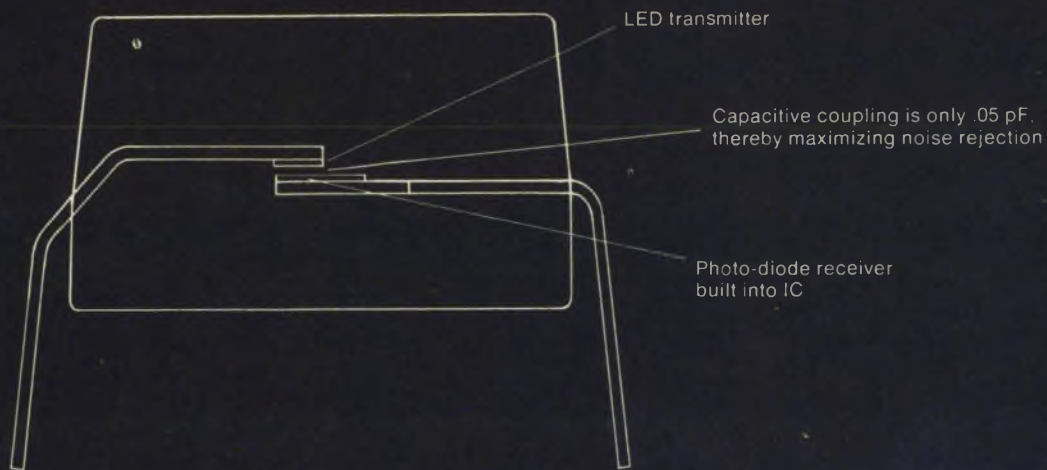

# Ultra fast opto-isolator cuts noise pick-up 100,000 times

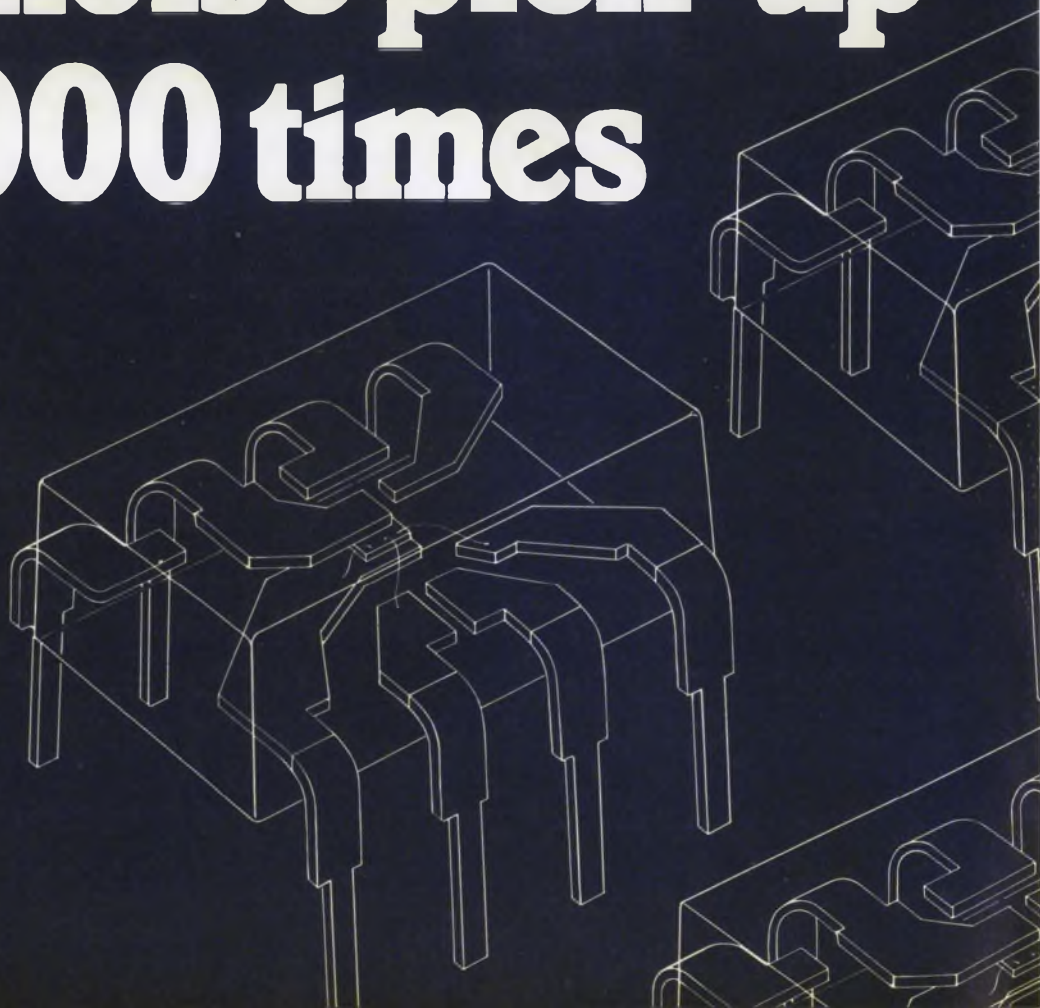



The specs are startling. Our IL-100 Isolite can transmit data at rates up to 5 megabits per second. And with common mode rejection of 50 db. That's better than any opto-isolator ever made, regardless of speed.

This performance is good enough to eliminate noise pick-up problems in nearly all hard-wired data transmission applications.

Such a state-of-the-art breakthrough means you can tie together computer and peripherals without resorting to brute force techniques for eliminating noise pick-up—such as laying in conduit and shielding systems, all of which are highly expensive.

And it means you save countless hours when a system is installed, modified or moved.

The IL-100 is a true solid-state device. It is DTL/TTL compatible, so it can be designed into your next solid-state system without the extra components required by pulse transformers.

It has an unusually versatile Schottky-clamped 3-state output that gives you built-in multiplexing capability without extra parts.

And its built-in Schmitt trigger virtually eliminates chance of oscillation, making your designs less critical and more reliable.

With propagation delay of only 75 nanoseconds, there is no opto-isolator made that offers comparable performance.

Don't use yesterday's technology to protect today's solid-state circuits. For details on the IL-100 ultra high-speed opto-isolator, contact Litronix, Inc., 19000 Homestead Road, Cupertino, Calif. 95014. Phone (408) 257-7910.

**No wonder  
we're No.1  
in LEDs**

**litronix**



# INVISIBLE LIGHT from General Electric

## 6 NEW INFRARED LEDs

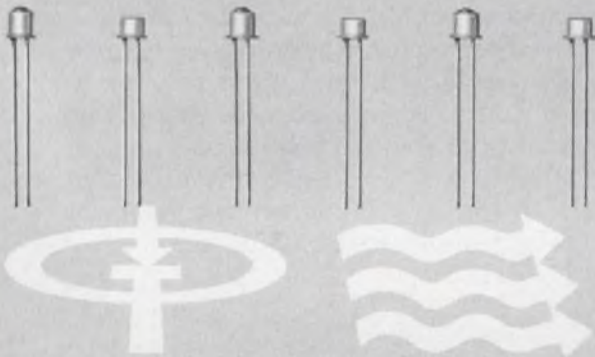

- High non-coherent power out @ 9400Å from GaAs liquid epitaxial pellet
- LED55C series offers guaranteed 5.4mW output @ 100mA
- Available in hermetic TO-46 type packages...choice of lens or flat cap
- Exact replacements for SSL55 & 56 series
- Suggested resale prices start @ \$1.56 in 1K lot quantities

## ....AND DON'T FORGET OUR DETECTOR LINE

- 11 models feature either ultra sensitive Darlington or transistor inputs
- Complements General Electric LED55 & 56 series infrared emitters
- Choice of top viewing hermetic TO-18 type or side viewing plastic packages

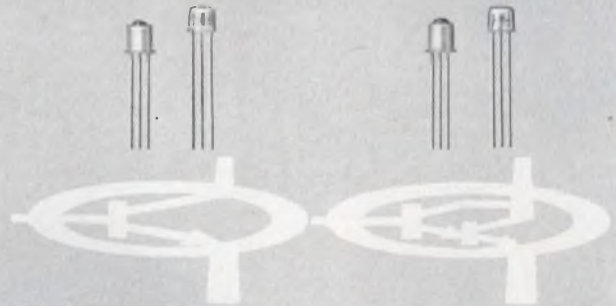

Competitively priced and available thru authorized General Electric Electronic Components Distributors

Semiconductor Products Department, Electronics Park, 7-49,  
Syracuse, N.Y. 13201

GENERAL  ELECTRIC

What's your design problem...  
Unit-size? Complexity? Reliability?  
Packaging? Field service?  
Multi-component handling?

**Garrett hybrid  
microcircuits are  
the solution.**

Garrett custom engineering can meet your requirements with hybrid microelectronic technology, performance-proved in consumer, industrial, and military products.

Our high-volume production capability, which encompasses thick film, thin film, component attach of discretes or chips, and automated testing, allows you to order just one micro device instead of many separate components. Reduces your material-handling and labor costs. And increases efficiency.

Whatever your hybrid microcircuit requirements, contact the one reliable source that offers maximum performance at minimum cost. Garrett. Send us your design specs for fast response on price quote and delivery. Contact: Manager, Microelectronic Sales, Garrett Manufacturing Ltd., 40 Voyager Court North, Rexdale, Ontario, Canada. M9W 4Y3. Tel. (416) 677-9790.



**The Garrett Corporation** One of The Signal Companies

**GARRETT**  
**MICROCIRCUITS**  
They solve the problem

# FOCUS

## on Sweep generators

If collision with error heightens truth, prepare for dizzying altitudes in your search for the right sweep generator.

It is true that the sweeper has improved enormously since its early days. Outputs are flatter. Residual fm and drift have been cut. Distortion and noise are down. But sweepers still aren't perfect, and if the instrument itself has come a long way, the manner of its specification hasn't.

Look at flatness. It's one of the most important sweeper specs—and one of the most ambiguous. If you're testing wideband devices, you'd like the sweeper's output amplitude or power to stay level as the frequency skims along. If the output doesn't stay flat, you can't distinguish the device's response from that of the sweeper. Your results are meaningless, unless you somehow compensate.

So you're relieved when you see a tiny  $\pm 0.2$ -dB variation listed for a unit's flatness. But your smiles turn to gloom pretty fast when your test amplifier's response comes out looking like a roller-coaster course. What went wrong? Perhaps that  $\pm 0.2$ -dB sweeper isn't so flat after all.

### Flat is beautiful

What you weren't told is that flatness isn't an absolute, intrinsic quality—far from it. Flatness depends on so many variables, it's doubtful that it can ever be fully stated.

Touch the variable attenuator or vernier: There goes the flatness. One setting of this control may hurt the spec, another can iron out the wrinkles. Boost your sweep speed to, say, beyond 10 sweeps per second to get a flicker-free scope display. What happens? If the leveling loop's bandwidth isn't wide enough—and chances are it isn't—forget about leveled power.

**Stanley Runyon**  
Associate Editor



Various plug-ins for the TF2361 sweep generator—backbone of the Marconi line—convert the unit from a general purpose to a specialized instrument. Shown is the video plug-in: 25 kHz to 30 MHz in one sweep.



Multiplexed, multiband sweeper systems, from Weinschel, give continuous coverage from 0.01 to 18 GHz. A single p-i-n device performs leveling and multiplexing.

Shove a high-directivity coupler between the sweeper and load to get a good source match and, you guessed it, the coupler digs into the flatness. Connect the load at the end of long cables, and the same thing happens. Change detectors and—ditto.

Even when a power meter or wideband detector tells you the output is reasonably level, don't count on it. Every sweeper output contains distortion products that can invade the leveling loop and affect flatness. Consequently if the vendor measures flatness with wideband detectors, the distortion comes through; if he uses a narrowband or frequency-selective device, the unwanted signals are dumped.

The upshot of all this is: Distortion limits flatness, and the two specs must be compatible. If the data sheet highlights a flatness of  $\pm 0.25$  dB—but spurious signals are only 20-dB down—



Single, dual or multiband plug-ins can fill the hole in Wiltron's 610C solid-state mainframe, a 100-kHz to 22-GHz box. Optional harmonic markers are provided in the video output, rather than the rf output.

watch out. Those two numbers don't mix. To approach the 0.25-dB figure, look for spurious levels at least 30 dB below the fundamental.

Peer deeply into leveling specs to get answers to other questions: Does the figure cover the entire range or just a narrow sliver? Is the leveling internal? External? Both? Perhaps it's neither.

Don't forget that even automatic leveling loops have limitations. How well the loop regulates depends on gain, bandwidth, detector characteristics, coupler response and other factors. Negative peak detectors can give results that differ widely from those of positive detectors. For this reason, some units provide a manual polarity switch to select the proper phase. Other sweepers do this automatically.

To keep output power constant, loop gain must be high. To respond to rapid variations, so must

the loop bandwidth. But if the gain is too high, you're likely to get some rather neat—but unwanted—oscillations. If too low, you get something else: no leveling.

Some sweepers need a manual gain readjustment to maintain optimum leveling each time you change your power level. Others do this automatically. With still other sweepers, you don't have to worry about it—you can't get the power level you thought you would.

### Power to the people?

Everybody wants to know how much power he's going to get in a sweeper, especially leveled power. And manufacturers will gladly tell. Unfortunately the phrase "maximum leveled power" means different things to different people. To some, it means that the minimum power you'll get within a band will exceed the stated value when at the highest leveled power setting (if you went 'Wha?' you're not alone).

To others, the MLP is the nominal value around which a plus or minus figure spells out the level variations. And then there are those who say that the maximum leveled power is the minimum power in a band when the unit is leveled. Who's right? Take your choice.

Most buyers look for high power. Indeed, sweepers over the years have pushed for even higher power, until today 10 mW out of 18-GHz, solid-state units is typical, and you can get even more at lower frequencies. But the cost for each extra decibel of power above 10 mW is staggering. And though you need high power to drive some loads, often the extra power is wasted. Generally the more a sweeper designer pushes his source for power, the more harmonics and noise he gets. No matter how much power you've got—or extra detector sensitivity for that matter—harmonics or noise are what limit many measurements.

What's needed in most cases is dynamic range, not high power. This means you've got to check a sweeper's output for its bottom end, too—something that's often forgotten. Dynamic range can be limited by the external detector, of course. Remember, though, that you've got still another way to stretch the range: Opt for a more sensitive receiver or a network or spectrum analyzer that's matched to the source. (Some spectrum analyzers offer a tracking-generator output that can be used as a swept source to give a wide dynamic range display.)

Signal purity must be watched closely. With enough harmonics, reflection measurements can be off by 20 or 30%. You can easily filter harmonics in an octave-band or narrow-bw sweeper. Many vendors do. But with broadband sweepers, you'll need tracking YIG filters to keep har-

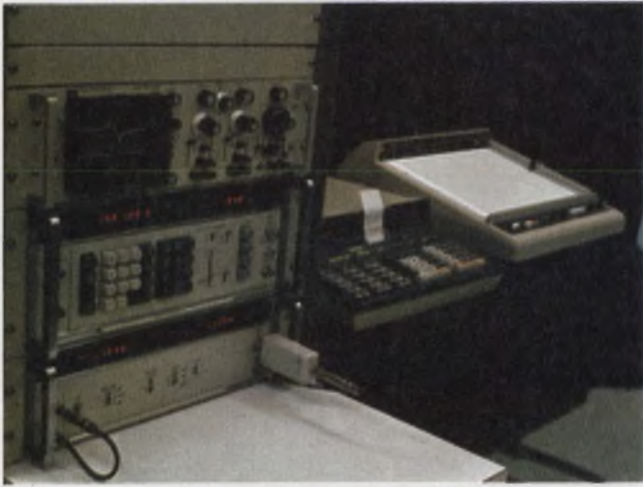

Team a synthesized sweeper, such as Hewlett-Packard's 3330B, to a programmable calculator and a network analyzer, and you can automatically plot amplitude and phase curves or print out circuit characteristics.



Systron-Donner's low-cost sweeper is the 540A multi-band unit. The \$1195 mainframe accepts all plug-ins from the company's two other sweeper series.

monics to the lowest achievable today—rarely better than 30 dB. When you add filters to the output, don't forget to account for the insertion loss.

Peek around corners to look for harmonics. That's what you literally must do in some cases. Why? Because the harmonic spec doesn't include the band edges—where, as you may guess, the harmonics are the worst.

#### A new sweeper may not sweep clean

Even when you think you've got the spurious spec trapped, it can slip away from you. Just twirl the attenuator knob, and up goes the distortion. You may have started with the rated nonharmonic spurious level of  $-45$  dB, but reduce the output power by 10 dB, and your unwanted level climbs to only  $-35$  dB.

Don't search for a phase-noise number when you evaluate a sweeper's purity. Almost nobody specifies it. However, if you intend to use the

sweeper in its cw mode, you just might be interested in phase noise. If you are, ask for a figure.

Keep in mind that the wider the bandwidth, the wider the door is open to noise, instability and drift. Sure to lead the pack is another shaky spec: residual fm.

Every sweeper has unavoidable frequency modulation. The question is how much, relative to the bandwidth of the test device. With poor fm, the best you can hope for are ragged response curves. At worst, fm can wipe out all definition in narrowband devices. If you try to sweep slowly, you can't with too much fm. So you've got to know how much residual fm to expect. Finding out isn't easy.

You might see a statement that says "residual fm: 500 Hz." That sounds pretty good. But is it? Is the figure in rms, peak or peak-to-peak? You don't know. What bandwidth was used to measure the modulation? 10 kHz? 100 kHz? Don't try to compare two units unless you know. But do compare a sweeper's minimum sweep-width spec with its residual fm. If the fm isn't at least 10 times less (preferably 100), forget the minimum width.

Don't forget that when you buy greater frequency capability for future use, you also buy more residual fm. You can't very well test 10-kHz filters when that 500-MHz sweeper has 10 kHz of unwanted frequency swing. Better stick to a 20-MHz box, with about 200 Hz of residual. Or you can look for sweepers with switchable bandwidths. In some, you set a narrowband position manually. In others, automatic circuitry sets optimum bandwidths to keep residual fm down.

Frequency instability can smear your trace all over the screen. And residual fm isn't the only culprit. Change the temperature by just one degree, and frequency can easily get knocked down or up by 500 kHz in a 300-MHz instrument—100 times more than the residual fm. Let the line voltage vary by 10% and—bingo—another  $\pm 30$  kHz. Reach over and twiddle the rf or power level. Guess what? Lop off or tack on another 30 kHz.

None of this means that sweepers can't do the job. They can. But you must know the limitations—even if it takes a little arm-twisting to get the facts.

Don't turn your back once you pin down the effects of tempco, line voltage and residual fm. If you do, the trace may not be there when you return. "What happened now?" Drift.

#### Enter drift, exit response

All sweepers drift. The data sheet may not say so. But with time, the center frequency will wander away from its setting. If the short-term drift isn't good, you'll have to glue your fingers



Part of Tekscan's VS series, the Model 80 covers 1 to 1200 MHz in two overlapping bands and offers five different sweep-rate modes.



In Singer's 6600 Series of microwave units, all frequency indicators are located on the lone 13-in. scale. Thus plug-in panels are uncluttered.

to the frequency control. Long-term drift, on the other hand, may not be a problem unless, say, you're testing stacks of filters. By the time you plug in the last filter, you may not see a response. Is the filter bad? Or did the frequency drift?

Unless the vendor tells you what he means by short and long-term, you can't really pin down drift. Short, to some, is one to five minutes, while long means one to eight hours. Others call 10 to 15 minutes "long." Whatever the definition, a drift spec without time is meaningless.

Remember, the wider the bandwidth, the more likely the drift. Remember, too, that drift is crucial in testing narrow-bandwidth circuits and components. Instability in a sweeper can discourage you to the point where you'd like to give the unit a good smack. Don't do it. Some sweepers are sensitive to shock.

Try giving it a light tap or two instead before you buy the instrument. If it sweeps up a few megahertz, you'll have learned something about how vibrations can affect the output. Can an internal fan, or fans on surrounding equipment, have an effect? While you're at it, check other environmental specs—like humidity—to see what these can do.

Even before you worry about annoying departures from the center frequency, ask yourself: What is my center frequency?

When you bought that sweeper with 1% accuracy, you felt pretty good. And when you added a second unit with a 4-digit counter to set and read center frequency, you felt even better. Unfortunately neither may be quite as accurate as you expected.

In the first unit, you forgot to ask an important question: Percentage of what? Bandwidth? Indicated value? Full scale? Another parameter? And though 1% sounds great, with a 1% 1000-MHz box, you can't trust the dial to identify a device's tuned frequency by better than 10 MHz. In this case, you'll need more accurate dial calibration (if you can get it) or markers. In cw mode, you can always use an external counter.

The vendor also forgot something with that first sweeper. He didn't say that you couldn't dial better than a few hundred kilohertz. So you may well ask: How can I get 5-kHz accuracy if I can't adjust any finer? The answer is you can't.

With the second unit—the digital dialer—the manufacturer didn't specify dial accuracy at all. He hoped the supposed unambiguous readout would cloud the issue.

The moral is: Insist on both frequency accuracy—preferably in units of hertz—and resolution. But don't stop there. Get the accuracy for all modes of operation, both cw and sweep. Get the accuracy as a function of sweep speed—especially in YIG-tuned sources. At the faster speeds, accuracy can plummet by a factor of five. Does the spec sheet say so?

If your unit has a cw mode, do this: Zero in on a frequency, starting from the high end of a band. Then shoot over to the low end and approach the frequency from that direction. The difference between the readings (you didn't expect them to coincide, did you?) is the unit's hysteresis.

You won't find hysteresis on many sweeper brochures. Another spec you might not see—one that can be important in the cw mode—is residual a-m, distributed sidebands caused by noise. Or if a-m is mentioned, other items needed to make the spec meaningful are nowhere in sight. Needed here are at least the measurement bandwidth and, preferably, how the residual a-m was measured.

### Sweeping specs under the rug

Of all sweeper characteristics, linearity may cause the greatest confusion. Some vendors say it's important. Others deny it. And then there are those for whom linearity poses no problem at all—they simply ignore it.

Disagreement even extends to the definition of



The 162C is Kay Elemetrics' wideband, 1-to-1000 MHz generator. A summation sweep mode is offered as an option to test CATV amplifier trunk lines.

linearity. A sweeper is perfectly linear if its incremental change of frequency with respect to time ( $\Delta f/\Delta t$ ) is perfectly constant. But other manufacturers' definitions link linearity to internal sweep voltages or other parameters. None of the variations may be strictly incorrect. But are you getting the information you really need—how the spec affects your measurements?

What you should know is this: Where and at what frequencies is linearity measured? If it's expressed as a percentage, find out: Percentage of what? If expressed as a ratio, remember that 1.2:1 is a linearity (or nonlinearity) of 20%.

Is linearity really important? Not if you've got accurate markers to tell you where you are, says one school of thought. Not if your dial or frequency-accuracy spec tells you what you need to know, says another. And not unless you're going to control frequency with an external voltage, a third group contends.

Who is right? Everybody and nobody.

If you're using a scope to see a device's response, it would be nice if you could calibrate frequency along the X axis. And you can if the linearity is good enough. Markers can do the job, of course, but they're not without problems, and they cost extra in some cases. However, if you want to identify frequencies more accurately, then you'll probably need markers.

Another reason why linearity can be important: You turn your sweep speed up to get the best, flicker-free picture, then you use the picture to tune a filter. Satisfied, you slow the sweep to plot a curve. Hey, what's that extra bow in the curve? Is it the filter? Maybe. But chances are the sweeper's linearity changed when you slowed the sweep. In fact, it probably improved. But you tuned the filter at the fast sweep, remember, where you thought the linearity was good. Better retest the filter.

Chances are, the linearity spec will be tied to the maximum frequency, rather than the sweep width. Consequently, as you squeeze the width down, the nonlinearity—as a percentage of the width—gets worse. Now suppose you've got a 500-MHz box with a linearity of 1%, or

5 MHz. You confidently dial a narrow width of 10 MHz, with 100 MHz on the left edge of the screen and 110 MHz on the right. Where's 105 MHz? In the center, where you'd like it to be? Possibly. In fact, 105 MHz can be anywhere on the screen—yet the sweeper still meets its published specs.

The lesson here is: Find out how linearity varies, not just with sweep speed but with width and other parameters. And while you're at it, dig into sweep width, rate, range and markers, too. Surprises await you.

### Mark these words

When linearity is really bad, you'll probably need markers to tell you where you are. Various types are available, including pips, birdies, combs and, more recently, intensity-modulated dots and even horizontal markers. But step gingerly. Markers aren't a panacea; they can bring their own set of troubles. For instance, markers can be rich in harmonics. Will you be sacrificing signal purity for extra markers?

Then again, how accurate are markers, anyway? If the marks are derived from the internal sweep-drive voltage, then they will be only as accurate as the proportionality between the frequency and voltage. This may not be better than about one-half to 1%.

Of course, you can opt for crystal-controlled pulses or birdies—frequency bursts—to improve accuracy by up to two orders of magnitude. But you may need one crystal oscillator per marker frequency or range of frequencies. This can add up to big bucks. And accuracy isn't always guaranteed. A marker isn't infinitesimally narrow—it has width. If the marker is much wider than the sweep width—a condition easily attained—the CRT will show nothing but marker. Where's your accuracy then? Another question: What's the marker amplitude and how flat is it with frequency? Get the answer.

You might have to lean on markers for another reason: There's no other way to tell how wide your response curve is. You've got a width control, all right. But it isn't calibrated, or it reads in percent of band. The data sheet didn't tell you this, of course. It listed minimum and maximum sweep widths, so you assumed you'd be able to set anywhere in between. You can't without markers. In keeping with its penchant for mystery, the specs sheet didn't reveal one thing you inadvertently could do with the sweep-width knob—change the center frequency.

Similarly, we've already seen that the sweep-speed control can affect other parameters. Some instruments, though, have one preset rate, synchronized to the line frequency. You can save money with a fixed-rate unit. But you'd better



be sure that the response of present or future circuit or devices is compatible with the rate. Otherwise you won't be able to live with it. Life can be a bit uncomfortable with yet another incompatible duo: the mismatched load and source.

### Opposites don't attract

If a sweeper's output impedance doesn't equal that of the load and connecting cables, you'll have reflections. And reflections lead to measurement errors. You may start with a nominal 50- $\Omega$  system. But as the frequency varies, so does the impedance of both the load and the sweeper—and so does the load voltage, for even more errors.

So you can't ignore mismatch. External leveling can help smooth changes at the load. So can a front-panel slope adjustment offered in some units. And so can the vendor, by telling you at least what impedance the output voltage comes from—zero, 50  $\Omega$ , or what—and across what load you get the rated voltage. If you can get the vendor in an informative mood, slip this one to him: Exactly what happens to the output frequency as the VSWR varies?

If the vendor's really being candid, he might even tell you how much stray radiation spews from his box and how he measured it. Or how somebody else's garbage riding on the power line affects the sweeper (perhaps it just shoots through and pours from the sweeper output jack). He might even tell you how accurate his output meter is and exactly what the meter monitors.

Such moments of candor may not last long. Even so, listen attentively. Perhaps you'll learn something that will help you in one decision you're sure to make. That's whether to buy a plug-in or all-in-one unit.

Until recently, you had to choose either a narrowband sweeper (usually one octave) or you bought a mainframe controller with plug-ins for each band of interest. Or you selected a sweeper with bandswitching—four or five manually switched bands without plug-ins. Today the movement toward broadband sweeps continues, and you can get multi-octave plug-ins or units that automatically switch between internal oscillators to cover, say, 1 to 1000 MHz or 100 MHz to 18 GHz in one sweep.

The arguments for plug-in expandability vs less expensive all-in-ones are well known. With the arrival of the broadbander, however, new pros and cons must be weighed.

First, many broadband designs use heterodyning or multiplication to generate frequencies in the region below about 2 GHz. While newer designs offset many of the limitations of the heterodyne approach—like higher spurs, broadband



Low frequencies down to 0.035 Hz are the forte of the 965A from Vibration Instruments. The unit delivers squares and triangles, as well as sinusoids.

noise, less stability and frequency accuracy—you've still got to watch these areas carefully. Second, in sequentially switched sweepers, with multiple oscillators, you've got an entirely new problem area: the switching points.

### Block that gap

If the top frequency of a lower-range oscillator doesn't coincide exactly with the bottom frequency of the next higher one, you'll get either a gap or an overlap in frequency. In a broad sweep maybe you won't care if a few points are missing. In a narrow sweep such discontinuities are intolerable.

Moreover if you phase-lock the sweeper to another box and go through a frequency break point, you'll probably lose lock for at least 2 to 10 ms. You can skirt such problems if you look for a sweeper that automatically avoids bandswitching in narrow sweep modes.

You'll probably look for other things you'd like the sweeper to avoid—like transients at the switching points, extra long switchover time intervals with an accompanying loss of output power, leveling-loop glitches and the like. One feature you might like, though, is a blanking pulse at the switch points. With blanking, you can modulate the Z axis so you don't see the switching points on the CRO screen. One more point: Don't expect phase continuity at the switching points. You won't get it.

To avoid transients, sequential sweepers with multiple sources keep the oscillators on all the time. This means you'll have to wait perhaps a half hour for warmup if you unplug the unit. It also means that the instrument consumes more power, which creates heat. This isn't necessarily bad if the manufacturer is successful in getting rid of the heat. If he isn't, reliability will suffer.

Some vendors use fans to get rid of heat. Those that don't are quick to point to potential problems with fans: reliability, noise, vibration, EMI and extra power consumption. But as in every design tradeoff, it's results that count, not "potential" problems.

Tugs-of-war between vendors occur in many other design areas. One such conflict plants YIG-

tuned oscillators at one end and varactor-tuned units at the other. You, of course, serve as the rope.

### No clear winner

Sure, YIGs with the right design can beat varactors in purity, stability, linearity and other areas. But there's no guarantee. And, of course, varactors have their own potential assets: higher power, faster tuning, reduced power consumption and less weight compared with YIGs. Again, check for results, not just components.

Don't let such controversies steer you away from other important areas—like the specs that describe a sweeper's modulation characteristics or programmability, for example.

Concentrate on such items as modulation bandwidths in both a-m and fm modes. Check modulation sensitivity: Is the MHz/V spec constant or does it vary with the band and even with frequency? If it isn't constant, you'll be constantly twiddling the modulation source.

Is the programming analog or digital? What inputs are needed to program the sweeper? What levels? What impedance will the input see? Pin these down exactly.

Instrument options run a close second to stock-market options for risks to the buyer. Watch for this ploy: The performance data listed includes specs of options, but the listed price covers the stripped instrument. Another: Bold print proclaims a super five-year warranty. What happens when you get out your magnifying glass? The most expensive component—the YIG oscillator—isn't covered. P.S.: The five year warranty may not be free; sometimes you've got to buy it.

Though advice freely given may be freely ignored, heed this warning: Take nothing for granted with sweepers. You can easily pay \$20,000 for a good microwave instrument. For that kind of money, you may not expect the unit to quit oscillating at the upper 20% of its range. But it can happen. You won't be looking for frequency discontinuities when sweeping backward. But gaps can appear. And you may not believe your eyes the first time you see the frequency backtrack, instead of changing smoothly and monotonically. But it's a possibility.

Perhaps none of these things will happen. But sweepers aren't easy to design, especially above 8 GHz. Units may meet the letter of the spec sheet but not the intent, so caution is the watchword. The first question to ask is: Do I really need a sweep generator?

### Sweeper or synthesizer?

If your application calls for very narrow sweep widths—1% of center frequency, or less—

or if you need extreme stability and resolution, then perhaps a frequency synthesizer will do a better job. Indeed, a significant trend today is toward synthesized sweepers for use in narrow-band automatic test equipment. For instance, with Hewlett-Packard's 3330A/B automatic synthesizer hooked up to a programmable calculator, network analyzer and X-Y plotter, you can sweep out a crystal response with resolutions of 0.01 dB for amplitude and 0.01 degrees for phase.

Hewlett-Packard, of course, is the industry leader in sweeper shipments. Latest in HP's line is the 86290A, a 2-to-8-GHz plug-in for the company's 8620A mainframe, and the 86222A plug-in, a 10-MHz-to-2.4 GHz unit. The 5-1/4-in.-high 86290A weighs just 33 lb, yet gives frequency accuracy of  $\pm 20$  MHz at 18 GHz. Drifts are less than 50 ppm in 10 min, and linearity is about 0.05% of output frequency.

The HP 86222A delivers 20 mW with  $\pm 0.25$ -dB flatness over the full sweep and features intensity-modulation markers rather than the traditional birdie types. Both plug-ins are matched to HP's network analyzers, such as the 8410B, so that you can make, for instance, multi-octave vector measurements.

For even higher power, HP's 8690B family includes both solid-state and BWO plug-ins, with outputs exceeding 100 mW, depending on the band.

Also marketing units that extend from the audio to the microwave regions is Kay E-metrics. Its line comes in three package sizes: 19-in. rack, compact bench units with built-in markers and oscilloscope plug-ins. The company's 162C sweeps from 1 to 1000 MHz in one band. With a flick of a knob, the 162C becomes a narrowband sweeper.

Those in the TV industry might be interested in Marconi's TF 2361, a plug-in unit that goes up to the vhf bands. The video plug-in covers 25 kHz to 30 MHz in one sweep and, with a blanking and sync mixer plus a differential-probe unit, you can build up a complete video measuring system.

### Frequencies hit the stratosphere

Need a millimeter wave sweeper? Micro-Now Instrument Co. is a specialist in this area. And you'll probably need an expert, since specs for these units aren't as well defined as the lower frequency generators. Micro-Now's sweepers cover 33 to 110 GHz and provide power to 100 mW using BWOs.

Not to be confused with Micro-Now is the Micro-Tel Corp., manufacturers of an unusual sweeper, the SG-800. What makes this 0.1 to 18-GHz unit unique are specs like -60-dB harmonics, 99-dB calibrated output attenuator and a



Internal switching in the Telonic 1210 couples two sweep sources and delivers a continuous band of frequencies from 200 kHz to 1000 MHz.



At just \$495, the Wavetek 1050 is one of the most economical vhf generators around. Despite the low price, the unit provides  $\pm 0.25$ -dB flatness.

pulse-modulation on/off ratio of 65 dB. Unusual, too, is the unit's removable and remotely controlled rf assembly, which can be placed up to 500 feet away. For all of this, however, be prepared to pay a high price. Many of the features and specs are optional.

For more conventional instruments, the 9500 series from Narda Microwave covers 1 to 18.5 GHz without plug-ins. One of the first broadbanders, this series offers four digital frequency selectors that can be programmed with resolution of 100 kHz over the entire range. And pushbuttons give the user six different sweep combinations. Latest developments at Narda include a high-speed YIG multiplier for flicker-free displays and a boost in power level to 10 mW.

Three instruments form the present line at Philips Test and Measuring Instruments. The PM 5164 ranges from 0.1 Hz to 100 kHz, costs just \$1135 and delivers four simultaneous outputs: a sine, square and triangle of fixed amplitude plus any one of the three with adjustable amplitude. Both sweep speed and width are variable. The PM 5324 covers the hf range, and the PM 5334 the TV, i-f and rf frequencies. Both cost under \$1000.

If it's power you need over the range from 25 to 1000 MHz, Rohde & Schwarz can give it to you. The company's SMLU sweeps this entire range or any part and delivers up to 2 W. And harmonics are down more than 30 dB (typically 40 to 50 dB). Another swept power generator is Ailtech's 50-watter, the Model 473, which goes from 225 to 400 MHz.

#### Pioneers still active

Competing strongly in the microwave market is Singer Instrumentation, a pioneer in sweepers through its Alfred line. Singer's 6600/9514/9515

series forms the backbone of the company's multirange, continuous-sweep system. Though the series features a wide line of plug-ins, including new models that deliver 40 mW in the 1-to-2 and 2-to-4-GHz bands, Singer is moving away from octave units toward broadband, completely integrated units. In keeping with another strong trend, the company emphasizes programmability of all major functions.

Another "old timer" and significant force in the sweeper business is Systron-Donner. Three basic families cover the spectrum from 100 kHz to 18 GHz with a selection of plug-ins and options. Model 50520, for instance, accepts up to eight plug-ins and, depending on the controller, can sweep sequentially among the eight. Another model, the 5000A, takes just a single plug-in.

Markers can be a headache to use, but Systron has come up with an intensity modulated marker system to relieve the pain. Move the intensified dot anywhere on the screen, and a counter automatically tracks and displays the dot's position, even in the swept mode.

Moving down in frequency, you'll find a number of outfits competing in the uhf/vhf range and below. Telonic Altair's 1210/1240 uses internal switching to go from 1 to 1000 MHz in one shot. The company's dedicated sweepers (uhf and vhf TV) can be set with digital inputs that control a phase-locked synthesizer. Features of most Telonic units include 1-dB attenuation steps, buffer amplifiers to minimize frequency pulling, and up to seven birdie markers in PC-card form.

Almost nobody has a more complete line than Texscan, with six broad series spanning the spectrum from 500 Hz to 6500 MHz. From dedicated TV units to high-power (20 W) to sophisticated laboratory instruments, Texscan's sure to have an appropriate model. Use of ICs and im-



Digital tuning and frequency readout characterize the 9535 from Narda. This solid-state broadband sweeper continuously from 1 to 18.5 GHz.

proved mixers and amplifiers have allowed the company to offer units such as the VS-90B—a 5-to-2350-MHz box with no plug-ins—and the WB series, a 10-pounder with programmability, -40-dB distortion, countdown or horizontal markers, and other goodies.

For really low frequencies, check into the VIC 965A, from Vibration Instruments. With it, you can go as low as 0.035 Hz and sweep to 35 Hz—a 1000:1 range. In fact, you can set the upper and lower limits anywhere over a 1000:1 range up to 35 kHz. And you can dial in exact rates, either linear (3% accuracy) or logarithmic (5%), from 0.001 Hz/s to 10,000 Hz/s in the former and 0.1 to 99.9 Oct/min. in the latter. But you can't get all rates on all frequency ranges.

Eminent in the vhf/uhf market from 1 to 1500 MHz is Wavetek Indiana. Brand new is the company's fixed-rate Model 1050—a 1-to-400-MHz

box that sells for the remarkable price of \$495, yet still boasts -30-dB harmonics, ±0.25-dB flatness and a display linearity of 2%. Wavetek's most popular sweeper is the programmable 2001, covering 1 to 1400 MHz in three bands and offering start-stop, cw and  $\Delta f$  modes, as well as many other features. Other popular units include the 2000, a low-priced version of the 2001, and the 1801A, targeted for the CATV industry.

Back in the higher frequency bands, you're sure to run into Weinschel Engineering's plug-in, 0.01-to-18-GHz Model 430A or its multiplexed, multiband sweeper, the 4310A/k. The Weinschel line boasts a number of automatic functions—like a YIG lag compensation network that maintains accuracy at even the highest sweep speed and circuits that keep residual fm low and the output leveled regardless of sweep rate.

Other unique Weinschel features include automatic polarity selection in the external-leveling mode and a single level control with automatic loop-gain adjustment.

Over 20 plug-ins for Wiltron's 7-in.-high 610C mainframe make it one of the most versatile in the industry. And Wiltron is right at the top of today's sweeper technology with a plug-in that zips from 10 MHz to 18.5 GHz in a single sweep and weighs 14 lb. Other plug-ins cover 100 kHz to 22 GHz, and all units provide a front-panel slope adjustment to compensate for the frequency response of the external circuitry.

You can take your choice of several different markers in the Wiltron line, from the standard patented intensity dot, rf or video pips to optional birdies, harmonic combs and fixed-frequency markers.

Finally, you may decide that what you really need is a sweeping function generator. If you do, look into those offered by Clarke-Hess, Dana/Exact and Interstate Electronics. ■■

## Need more information?

The products cited in this report don't represent the manufacturers' full lines. For additional details, circle the appropriate information retrieval numbers. For data sheets and more vendors, consult ELECTRONIC DESIGN'S GOLD BOOK.

- Ailtech Cutler Hammer Co., 815 Broadhollow Rd., Farmingdale, NY 11735. (516) 595-6471. (Richard T. Knadle Jr.). Circle No. 401
- Clarke-Hess Communication Research Corp., 43 W. 16th St., New York, NY 10011. (212) 255-2940. (Kenneth K. Clarke). Circle No. 402
- Dana Exact Electronics Inc., 455 S.E. Second Ave., Hillsboro, OR 97123. (503) 648-6661. (Joe Foster). Circle No. 403
- Hewlett-Packard, 1501 Page Mill Rd., Palo Alto, CA 94304. (415) 493-1501. Circle No. 404
- Interstate Electronics Corp., 707 E. Vermont Ave., P.O. Box 3117, Anaheim, CA 92803. (714) 772-2811. (Pat O'Leary). Circle No. 405
- Kay Elemetrics Corp., 12 Maple Ave., Pine Brook, NJ 07058. (201) 227-2000. (Jim Connors). Circle No. 406
- Marconi Instruments, 100 Stonehurst Ct., Northvale, NJ 07647. (201) 767-7250. (Keith Elkins). Circle No. 407

- Micro-Now Instrument Co., Inc., 6104 N. Pulaski Rd., Chicago, IL 60646. (312) 478-1151. (Clarence L. Arnow). Circle No. 408
- Micro-Tel Corp., 6310 Blair Hill Lane, Baltimore, MD 21209. (301) 823-6227. (Richard S. Finke). Circle No. 409
- Narda Microwave Corp., Plainview, L.I., NY 11803. (516) 433-9000. (Eugene Kushner). Circle No. 410
- Philips Test & Measuring Instruments, Inc., 400 Crossways Park Dr., Woodbury, NY 11797. (516) 921-8880. (William E. Keller). Circle No. 411
- Rohde & Schwarz, 14 Gloria Lane, Fairfield, NJ 07006. (201) 575-0750. (Allen Freeland). Circle No. 412
- Singer Instrumentation, 5340 Alla Rd., Los Angeles, CA 90066. (415) 493-3231. (Al Hart). Circle No. 413
- Systron-Donner, 735 Palomar Ave., Sunnyvale, CA 94086. (408) 735-9660. (J. Johnson). Circle No. 414
- Telonic Industries, 21282 Laguna Canyon Rd., Laguna Beach, CA 92652. (714) 494-9401. (Bruce Brazelton). Circle No. 420
- Texscan Corp., 2446 N. Shadeland Ave., Indianapolis, IN 46219. (317) 357-8781. (Bob Shevlot). Circle No. 415
- Vibration Instruments Co., 1614 Orangethorpe Way, Anaheim, CA 92801. (714) 879-6085. (Marvin P. Marsh). Circle No. 416
- Wavetek Indiana, Inc., 66 N. First Ave., Beech Grove, IN 46107. (317) 783-3221. (Ed McDonald). Circle No. 417
- Weinschel Engineering, 1 Weinschel Lane, Gaithersburg, MD 20760. (301) 948-3434. (Andrew Belski). Circle No. 418
- Wiltron Co., 930 E. Meadow Dr., Palo Alto, CA 94303. (415) 321-7428. (Walter L. Baxter). Circle No. 419

## New from Potter & Brumfield



### The lowest profile 3 amp relay we've ever offered!

The P&B T10 Series relay is lower than many other circuit board components. Only 0.375" high, it's ideal for high-density applications. Permits pc boards to be mounted on 0.5" centers!

T10 relays provide 0.1 to 3 ampere switching @ 30VDC. Coil ratings are 6, 12, 24, and 48VDC. Permissive make, gold-flashed silver contacts are noted for low contact bounce, long operating life. Bifurcated contacts for low level switching are available on special order.

Designed for low cost general purpose applications, the T10 is ideal for use in tele-communications, copy and reproduction machines, computer and peripheral equipment.

For additional information, contact the Potter & Brumfield sales representative or authorized distributor nearest you, or write Potter & Brumfield Division AMF Incorporated, Princeton, Indiana 47671. Telephone 812 385 5251.

  
**Potter & Brumfield**



Solving switching problems is what we're all about.

# Your Frequency Spectrum of Noise or Vibration is MEANINGLESS

... UNLESS you remember how it was taken!

**Our new analyzer writes it down.**

Our new real-time spectrum analyzer, the 440A Mini-Ubiquitous®, never forgets. It "writes" electronically all control settings, cursor amplitude and frequency readings, and scale factors. A photo of the CRT preserves complete information. Even the graticule is self-generated for perfect alignment and intensity — no parallax.

The Mini-Ubiquitous® is specifically designed to be easy to use . . . no calibration adjustments, no CRT controls, no guessing what is being analyzed. Because you can view and plot the time function, it can also be used as a "transient recorder." It has the minimum number of controls for the maximum number of features. Plug-in design adapts it to special applications now or in the future. Typical applications are:

- rotating machine signatures
- noise source location
- product noise reduction
- on-the-road, in-the-air, or on-ship analysis
- transient recording and analysis
- reactor monitoring
- on-line machine diagnosis

**ADDED FEATURES:**

- High resolution 400-line analysis
- Ranges from 0-20 to 0-20,000Hz (extended with optional translators)
- Precision, stability and a dynamic range greater than 60 dB (1000:1) due to all-digital design
- Digital frequency readout directly in RPM (as well as Hz) and digital amplitude measurement both simultaneously written on the CRT
- Automatic background noise cancellation with "subtraction" averaging
- Harmonics identified with unique harmonic markers
- Capture and recording of transients (time signals) as well as their spectra . . . true transient spectra with flat weighting
- Complete X-Y plotter set-up and control

Models from \$6950 to \$9450.

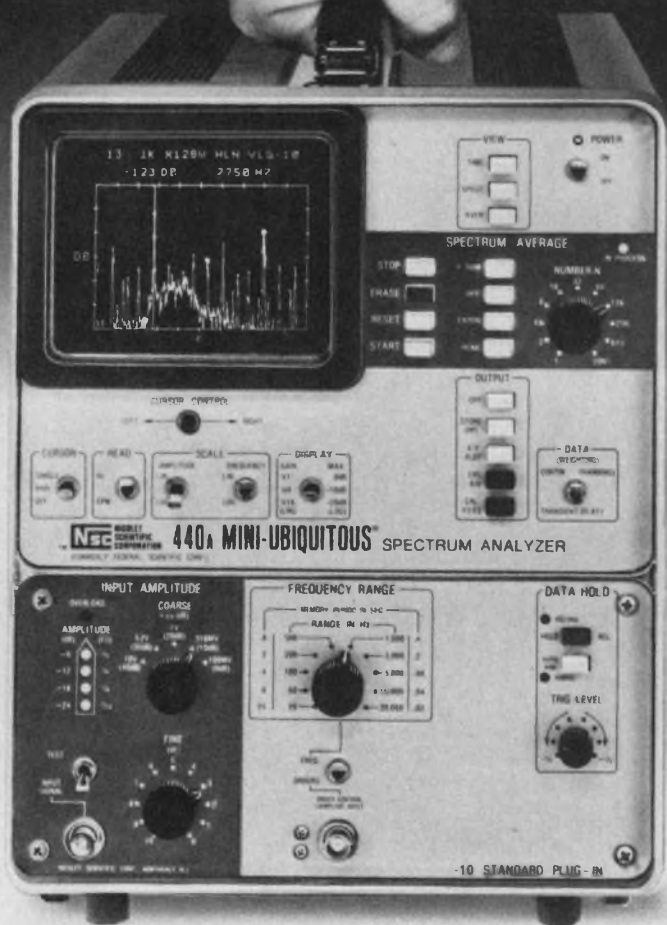

Call or write Dick Rothschild for detailed specs and/or a demonstration at your facility analyzing your data.

**Nsc** NICOLET SCIENTIFIC CORPORATION  
(formerly Federal Scientific Corp.)

Manufacturers of  
**UBIQUITOUS®**  
real-time signal processors.

245 Livingston St., Northvale, N.J. 07647, (201) 767-7100 TWX: 710 991 9619

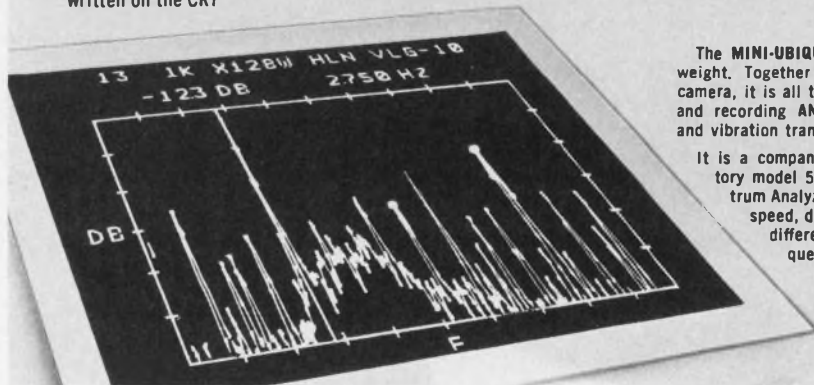

The MINI-UBIQUITOUS® is small, lightweight. Together with a simple polaroid camera, it is all that's needed for analysis and recording ANYWHERE! (Transit cases and vibration transducers are optional.)

It is a companion to our larger laboratory model 500A-1 Ubiquitous® Spectrum Analyzer, which features higher speed, dual-memory averager, and differential amplitude and frequency measurements.



# SIEMENS

## Introducing the 203 Test System. Total semiconductor memory testing at true 20 MHz speed.



The 203 Semiconductor Memory Device Test System is a new, powerful tool for evaluating the performance of RAM's, ROM's and Shift Registers in production, engineering, and incoming inspection. The system satisfies all aspects of high-speed functional and DC-parametric testing requirements to provide total test flexibility and lowest cost-per-unit throughput.

The microprogrammable processor in the 203 generates address sequences and data patterns at true 20MHz test rates, enhancing its use for future high-speed devices. Multi-cycle timing is provided by 16 independently programmable channels. A high resolution 1ns clock permits meaningful time-related device tests, ensuring accurate, repeatable test results.

A minicomputer controller in the 203 provides system control and data retrieval. Flexible, task-oriented software using a macro-language simplifies programming. The 203 is available as a single station or may be used in a parallel or multiplex operation with up to four handlers or wafer probers.

The 203 Test System is totally unique in the semiconductor memory test field. It offers an unmatched test capability to the user at the least overall cost. Today and tomorrow.

**Siemens Corporation**  
**Computest Products**

3 Computer Drive, Cherry Hill, N.J. 08002 (609) 424-2400

## Get to know the optocoupler and you'll eliminate problems caused by misapplication. And, careful definition of critical specs will cut costs.

Even the best-made optocouplers can prove troublesome in high-volume applications if you fail to specify them accurately and to control the quality of incoming devices. Out-of-tolerance couplers may cause reduced circuit performance, haphazard performance or outright circuit failure.

Five different types of optocoupler outputs are available—transistor, Darlington, SCR, diode/amplifier and diode/gate (see table). But no matter which you use, there are two basic ways to guarantee optimum performance:

1. Identify all the critical parameters—leakage, lifetime, bandwidth, coupling efficiency, speed, cost—and specify the tolerances needed.

2. Control the critical factors through a combination of tests and vendor selection.

Since requirements vary with application, so will quality control methods. Don't expect the same test procedure to be optimum for both under-the-hood automotive applications and office machine equipment. And, don't demand unnecessarily tough specs from a supplier. You may find that in production the resulting device is of such low yield that the manufacturer can fill only half your needs—or worse, can only supply the couplers spasmodically when he gets yield.

### Tips for specifying tests

When special performance measurements are required, keep in mind the following:

- Most static parameters can be measured automatically and inexpensively.

- Dynamic parameters, high dielectric stresses and very low leakage currents require expensive manual testing.

- Destructive testing—which includes most burn-in, mechanical, environmental and some high-stress dielectric testing—costs even more.

Some rules of thumb that can keep costs down and performance consistent include these:

- Use standard second-sourceable parts when possible.

- When forced by technical or economic reasons to deviate from standard parts, tighten the specs only on parameters that can be tested automatically and loosen them on all other parameters.

- If a tight tolerance on some parameter is required, ask your first and second-choice suppliers what absolute limits they would prefer, given a spec "X" percent wide.

- Some dynamic parameters, such as switching speeds, correlate well with static terms, such as  $h_{FE}$ . Know which ones they are, since static screening costs much less than dynamic testing.

Define these tradeoffs in the initial design stages, where you can evaluate the costs of a premium-spec device against the cost of components needed to design around it. Otherwise you may be mired down in hardware problems at the production stage. The solutions then may require premium devices and end up costing you both time and extra money per unit.

Manufacturers will generally not allow themselves to be tied to fixed, tight limits on optocouplers without imposing price penalties. The only other way a user can control quality is to determine the best manufacturers on the basis of the construction techniques used (the manufacturer will advertise them if they are good) and the ready availability of data on stress-test results. Most data will provide single-stress, worst-case failure rates and thus supply a basis for estimating device stability.

### Evaluate the useful coupler lifetime

The light output of the LED in a coupler decreases as the LED is operated.\* This is not normally expected of semiconductors, and you're asking for trouble if you don't evaluate the effects of such a fall-off on your system. When you evaluate a coupler for light fall-off (loss of

---

William Sahn, Consulting Applications Engineer, General Electric, W. Genesee St., Auburn, NY 13022.

---

\*The March, 1974, issue of "Elteknik Med Aktuell Elektronik" contains a detailed comparison of LEDs and couplers. This article, "Hur Lang Lever Lysdioden," was written by Hans Nettel. The article provides a greater insight into stress/degradation and manufacturer variability than is possible in the scope of my article.

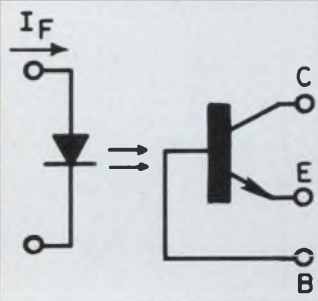
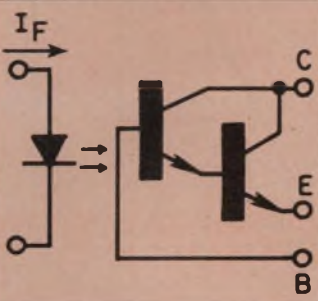
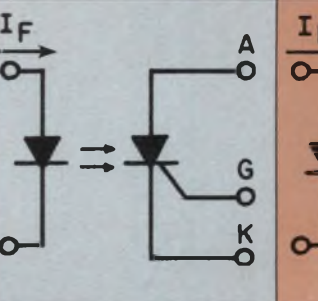
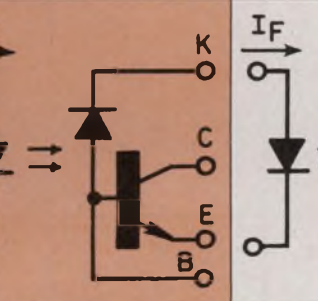
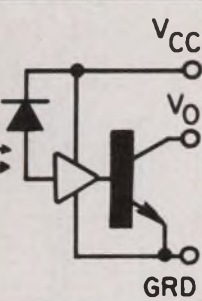

## Comparison of different optocoupler types

Parameter	Discrete			IC	
	Transistor	Darlington	SCR	Diode/Amplifier	Diode/Gate
					
Efficiency	$CTR = I_C/I_F$ 10% to 100% min	$CTR = I_C/I_F$ 100% to 500% min	$I_{FT} = f(R_{GK})$ 20 mA max	$CTR = I_C/I_F$ 7% to 500% min	$CTR = I_O/I_F$ 600% min
Speed	$t_{on}, t_{off}$ 1 to 5 $\mu$ s	$t_{on}, t_{off}$ 50 to 200 $\mu$ s	$t_{on}$ 5 to 20 $\mu$ s typ	$t_{pd}$ 0.5 to 60 $\mu$ s	$t_{p1h}, t_{p1l}$ 50 to 100 ns
Parasitics	$C_{ISO}$ $R_{ISO}$ 1 to 3 pF, 10 to 100 G $\Omega$	$C_{ISO}$ $R_{ISO}$ 1 to 3 pF, 10 to 1000 G $\Omega$	$C_{ISO}$ $R_{ISO}$ Coupled 100-500 V/ $\mu$ s dv/dt 1 to 3 pF, 10-1000 G $\Omega$	CMRV 20-60 V rms @ 2 MHz	CMRV <sub>H</sub> CMRV <sub>L</sub> 2-60 V rms @ 2 MHz
Off voltage	$B_{VECO}$ $BV_{CEO}$ typ 5-7 V min, 25 V min	$B_{VECO}$ $BV_{CEO}$ typ 5-7 V min, 25 V min	$V_{DM}$ $V_{RM}$ 200-400 V min	$V_{KB(max)}$ $V_{CE(max)}$ 7 to 18 V	$V_{OC(max)}$ $V_{O(max)}$ 7 V
On voltage	$V_{CE(SAT)}$ typ. 0.1 V	$V_{CE(SAT)}$ typ. 0.7 V	$V_{TM}$ 1.3 to 1.5 V max	$V_{CE(SAT)}$ 0.1 to 0.2 V typ	$V_{OL}$ 0.6 V max
Leakage	$I_{CEO}$ 50-500 nA max	$I_{CEO}$ typ 100 nA max	$I_{DM}$ typ 50 $\mu$ A max	$I_{CEO}$ 0.5 to 250 $\mu$ A max	$I_{OH}$ 250 $\mu$ A max
Maximum power input or output	$P_{do}$ typ 400 mW max	$P_{do}$ typ 400 mW max	$P_{do}$ typ 400 mW max	$P_{do}$ typ 100 mW max	$N_{(FAN OUT)}$ 8 max
Reverse voltage (min)	$V_{R(MAX)}$ 3 to 6 V	$V_{R(MAX)}$ 3 to 6 V	$V_{R(MAX)}$ 3 to 6 V	$BV_R$ 5 V	$BV_R$ 5 V
$V_F$ (max forward voltage)	1.5 to 2 V	1.5 to 2 V	1.5 to 2 V	1.7 to 1.8 V	1.7 to 1.8 V
Maximum power $P_{dl}$ input or output	100 mW	100 mW	100 mW	35 mW	$I_{F(MAX)}$ 10 mA
Typical cost (1000 pcs)	\$0.75 to \$2	\$1.35 to \$2	\$2.70 to \$3.50	\$1.80 to \$4.50	\$1.95 to \$5

coupling efficiency), bear in mind the following:

- Rates of fall-off vary widely from manufacturer to manufacturer.
- Liquid epitaxial processed material is much superior to any other process.
- Tight process control is required both in chip manufacture and in packaging to provide consistently good results.
- In a good device, stress—temperature and bias current—must be increased greatly to produce appreciable acceleration of the phenomena.
- Short, high-current pulse operation causes much less fall-off of output than expected.

For a benchmark, a good product design will normally have less than 10% of the device population drop more than 20% in light output after 1000 hours of steady-state, maximum-rating testing. This extrapolates to about a 100-year half-life at maximum ratings for 90% of the units (Fig. 1).

Another life effect to be wary of is familiar to most SCR users: Due to voltage acceleration of inversion-channel formation, high-voltage (> 100 V) device ratings should be based on the life-test results of high-temperature blocking tests, not on breakdown voltage. Devices made by vendors who should have known better have been specified as superior but haven't been able to survive a weekend under testing at maximum temperature and half-rated voltage. Obvious problems like this are easily found in cursory evaluations, but if not found, they can be deadly in production.

#### Isolation: Will it hold up?

Isolation voltage and maximum dielectric capability are well specified when tested on a one-shot basis. But which of these should be used on a transient repetitive basis and which for steady-state? The answers depend on the voltages at which corona initiates and extinguishes. Since the corona is not easily detected and it bears no strong correlation with the maximum spec value in different mechanical designs, you must lab test it yourself.

Environmental effects can normally be handled with straightforward design procedures—good temperature control, clean circuit-board construction and careful circuit layout. Also there are two commonly unforeseen problems. First, leakage current increases faster than expected for semiconductor devices since a base-to-emitter resistor usually isn't used in transistor and Darlington coupler applications. Second, coupling temperature coefficients aren't always the same for different manufacturer's devices at low current levels. Both of these potential problems are easily avoided when known (Fig. 2).

Logic applications of couplers are widespread,

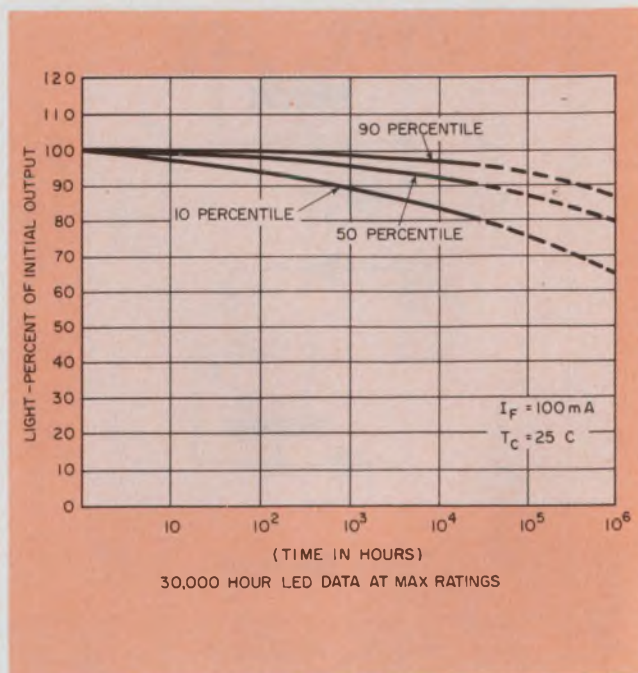

1. After 30,000 hours of testing, the light output of a LED decreases. The percentile curves indicate the statistical distribution of changes in LED output.

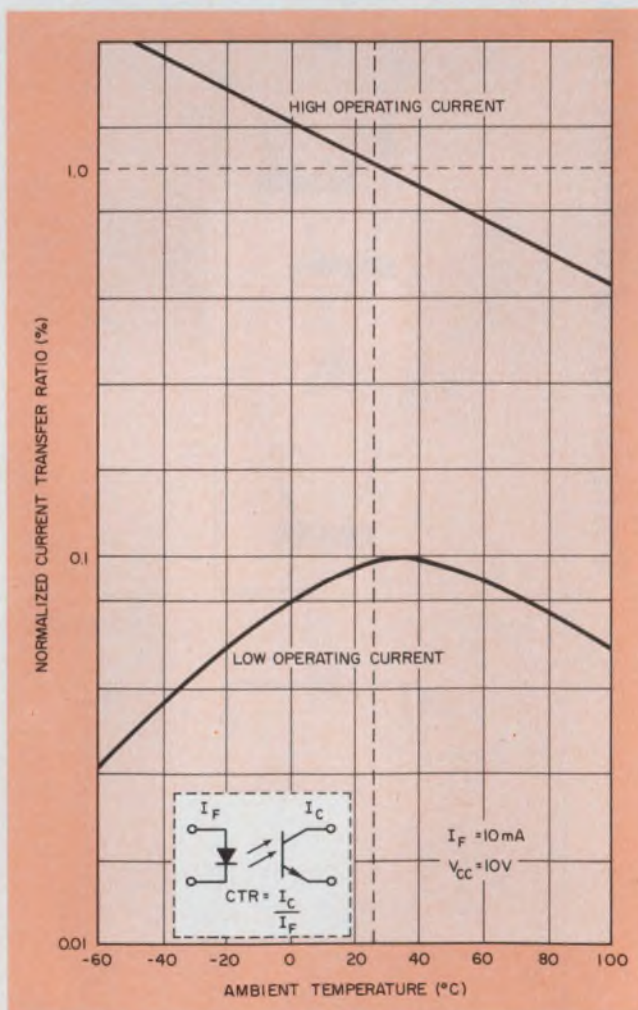

2. The normalized current-transfer ratio of a coupler changes rapidly with temperature because of leakage-current changes, especially in Darlington couplers.

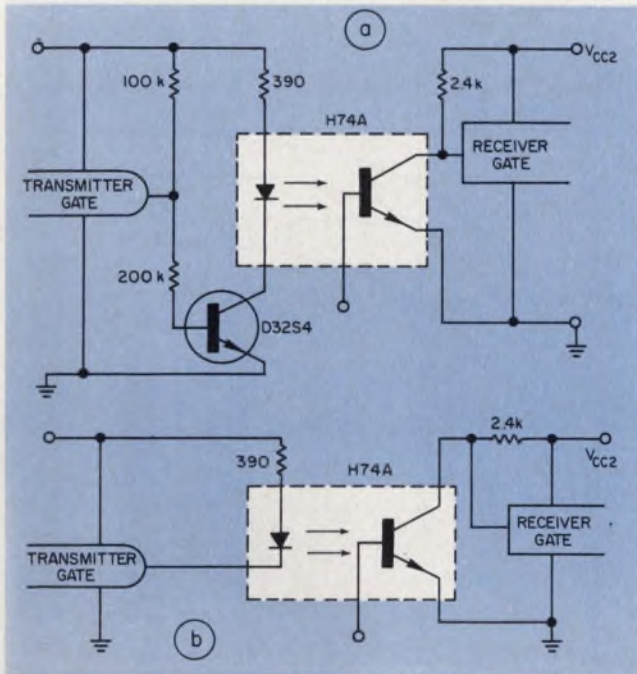

3. Logic-compatible couplers require additional circuitry to obtain drive current from CMOS levels (a). However, they can be driven from TTL directly (b).

as is a largely undefined but highly touted TTL compatibility. When a coupler is TTL-compatible, it must operate with standard tolerance pull-up resistors, over standard supply-voltage tolerances, over required temperature ranges and at worst-case logic levels. To date, only some couplers, made by GE, Hewlett-Packard, Litronix, and Monsanto appear specified to meet these constraints over the 7400 logic series temperature range of 0 to 70 C.

The IC gates have a vast speed advantage (although they're still slower than IC logic), but they cost more and need careful stabilization to avoid latch-up or oscillation at high temperatures. The transistor-output coupler, which costs less, has very slow switching speeds. And, no coupler is truly CMOS compatible (this would require LED operation at 30  $\mu$ A), although under special conditions with certain gates, coupling may be achieved with some of the IC and Darlington output couplers (Fig. 3).

Use of a transistor buffer biases the LED up to the current where efficient light generation takes place (Fig. 3a). Common-mode noise rejection (where the slowness of the phototransistor becomes an asset for high-frequency noise immunity) must also be evaluated in the design of logic coupling circuits.

#### Choose couplers carefully for power control

Control of power circuits with logic requires isolated devices both to provide logic-level inputs from power and mechanical sources and to control power sources from logic outputs. Fig. 4

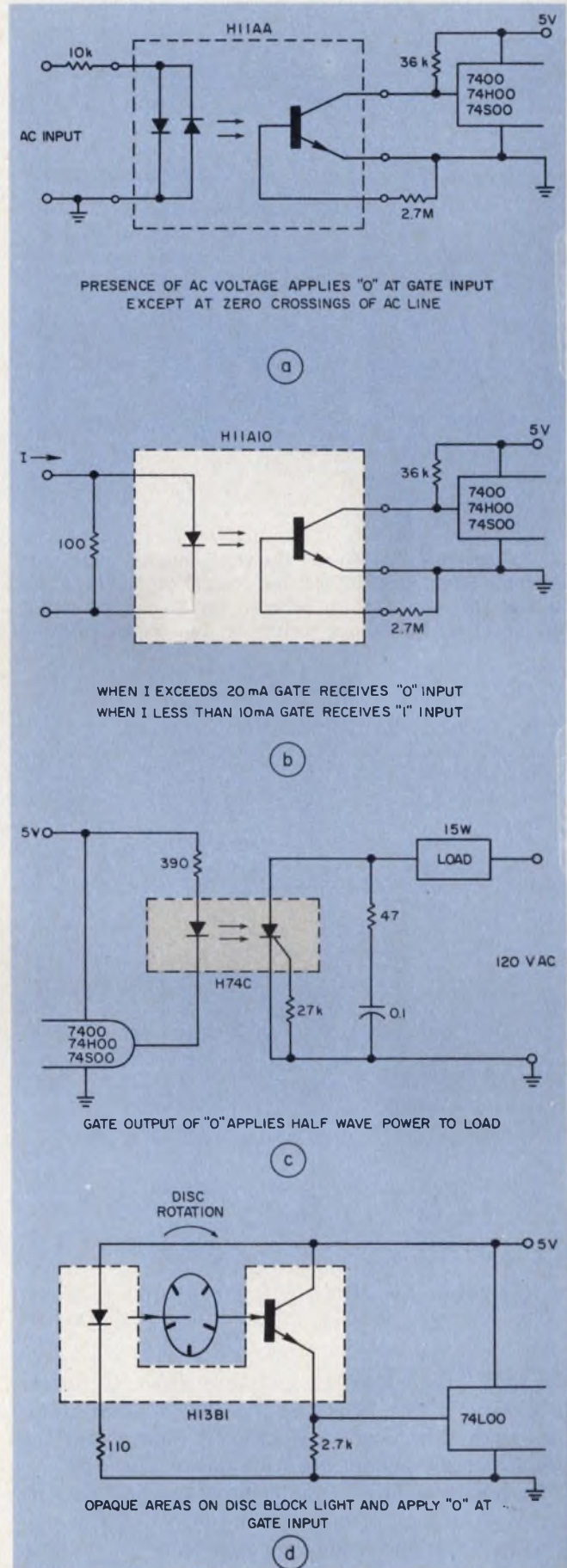

4. Optocouplers can do many jobs. They can sense ac power (a) and dc power (b). You can also use couplers to control power (c) or sense motion (d).

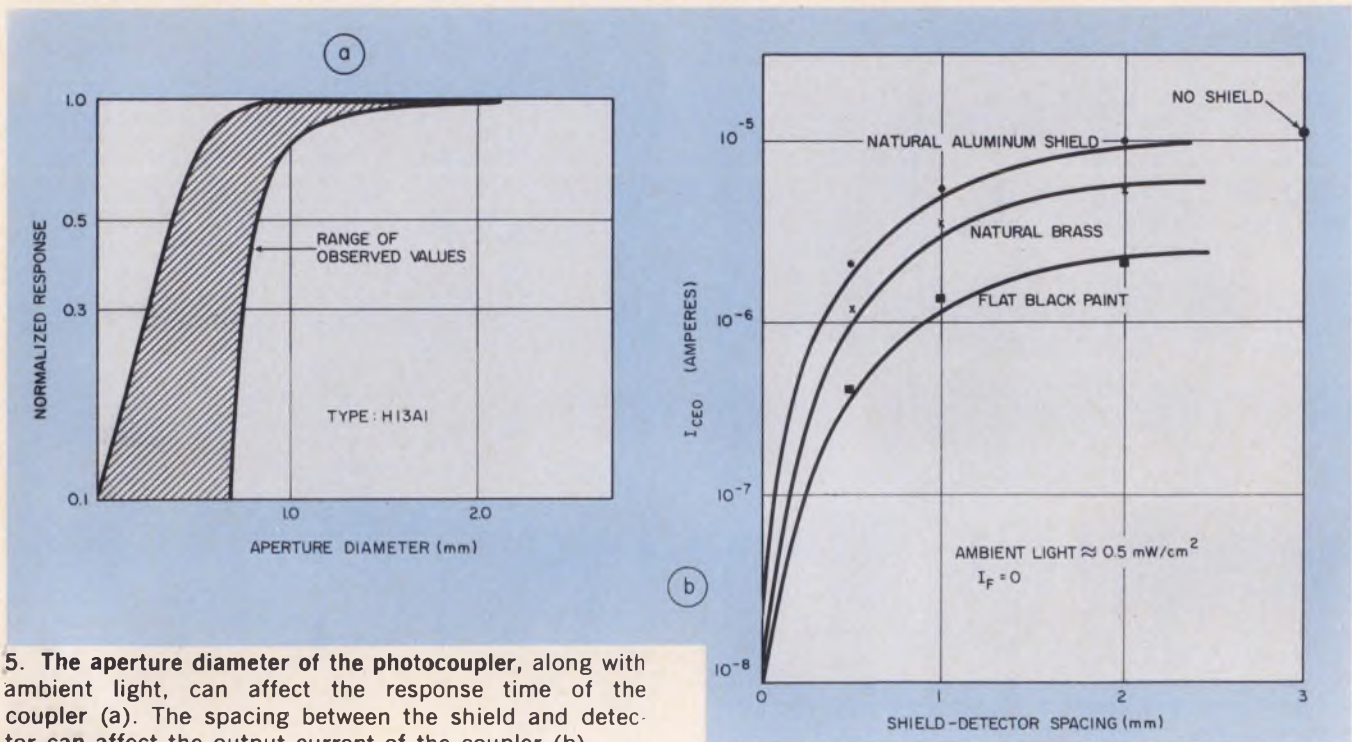

5. The aperture diameter of the photocoupler, along with ambient light, can affect the response time of the coupler (a). The spacing between the shield and detector can affect the output current of the coupler (b).

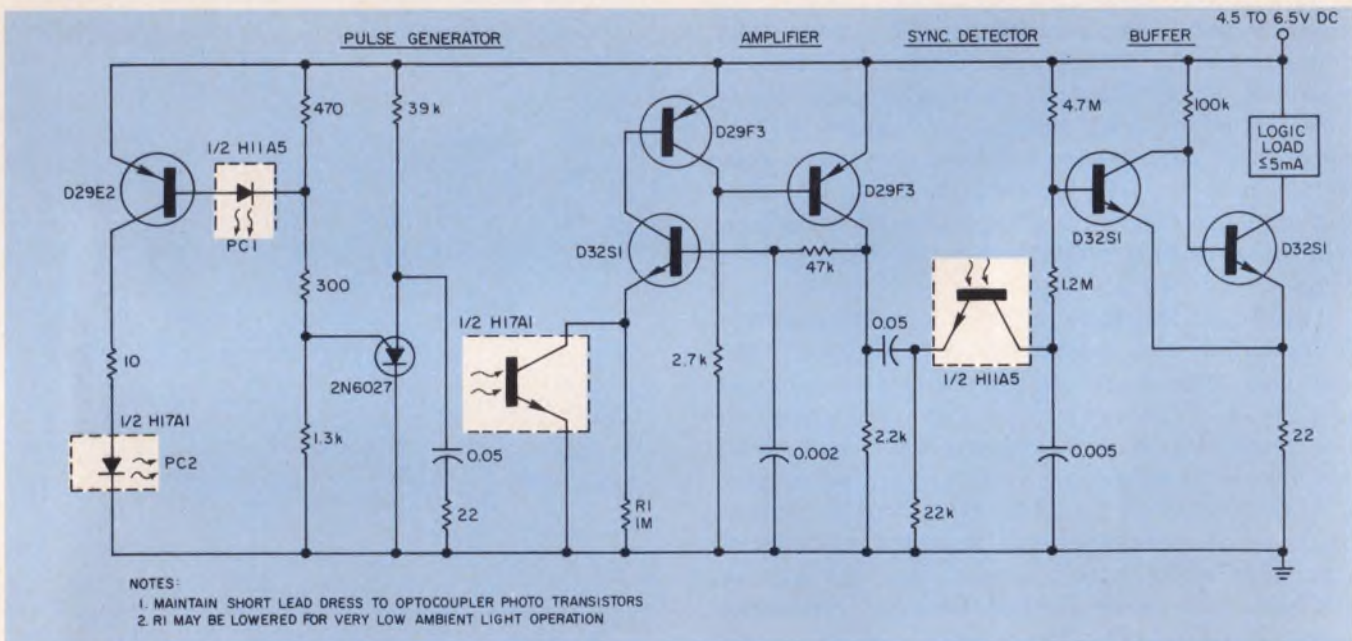

6. This circuit can detect objects moving along a production-line belt. Detection ranges of up to 3 ft are possible if you use different LED and phototransistor combinations to get more sensitivity.

shows TTL-compatible couplers used to interface logic with power circuits. The system monitors both power and mechanical inputs and the common-logic output controls power circuits.

In power-to-logic coupler applications the effects of the huge transients on power lines, which feed through the isolation capacitance, must also be considered.<sup>1</sup> For the SCR coupler (Fig. 4c), false triggering could result from these transients, since they have a high  $dV/dt$  that can

couple into the input circuit.

The interrupter coupler for sensing mechanical motion (Fig. 4d) is affected by two external sources. Fig. 5a shows the effect of aperture (window) size on coupling efficiency and indicates that reflection and diffraction effects roughly double the apparent light path width. This effect can sometimes be minimized at very low cost if you mask the light-detector device, although it will cost in output where lenses are

used. Ambient light also plays a part in choosing the surface finish of the light shield (Fig. 5b). Also, certain materials are opaque to the eye but are infrared transparent—and thus make poor light shields.

A typical industrial application (Fig. 6) required a circuit that could reliably and rapidly sense the presence of small parts on a 1.5-in.-wide moving belt and provide an output to 5-V logic. Cost of the control circuit, both initial and life cycle, is also important. Basically this is an interrupter module application. The relatively long distance that must be spanned and a high long-term reliability indicate the LED should operate in a pulse mode. Speed of response then dictates use of a phototransistor detector biased from a very low source impedance.

Pulse operation permits use of the low-cost plastic interrupter module, and it eliminates the need for an expensive optic system and assembly alignment. Synchronous detection of the phototransistor output prevents leakage current, ambient light and temperature from degrading system performance.

A phototransistor coupler provides an ideal switch for synchronous signal detection. A programmable unijunction transistor (PUT) oscillator provides the least expensive pulse generator to drive both the interrupter and the coupler LEDs. A cascode-input amplifier, with heavy low-frequency negative feedback, provides the required low source impedance bias for the interrupter phototransistor, as well as regulating the dc bias point to minimize ambient light, leakage and temperature effects. Three plastic-cased transistors provide the amplification. The amplifier output, synchronously detected by PC<sub>1</sub>, provides a negative output when the interrupter module's light path is unblocked. The system is fail-safe, since any malfunction will cause a zero or positive output signal. A simple two-transistor buffer amplifier with hysteresis provides the 5-V logic output, while permitting the use of a small detector capacitor to preserve system speed.

The cost of components for the system is less than \$5 at the 1000-piece level. Compared with the simple combination of a 10,000-hour, 5-V lamp and a photo-Darlington needed to guarantee TTL compatibility, this system saves about \$2. It provides better resolution, minimal ambient light problems, longer life, comparable speed and is more fail-safe than the lamp system. You can upgrade the interrupter module to a LED55C and a L14G1, or add lenses to the H17A1, and increase the range to about 3 ft. ■■

#### References

1. Martzloff, F., "Surge Voltages in Residential and Industrial Power Circuits," *IEEE*, July/August, 1970.

# Dialight sees a need:

(Need: The widest choice for your every application.)



**739 SERIES** Save design time and installation costs . . . this LED display assembly is attractively designed in a convenient package with bezel and is ready for instant panel mounting. Available in groups of one or more characters, with or without decoder/driver . . . characters are 0.625" and come with either green or red LEDs in seven-segment format. Read-out offers lowest cost per character for comparable size.



**755 SERIES** High brightness planar gas discharge displays in a 0.550" character. Orange color gives high contrast ratio and allows readability to 40 feet even in high ambient lighting. Designed for interfacing with MOS/LSI, displays have an expected life of 100,000 hours or more.



Dialight, the company with the widest choice in switches, LEDs, indicator lights and readouts, looks for needs . . . your needs . . . and then they develop solutions for your every application. No other company offers you one-stop shopping in all these product areas. And no other company has more experience in the visual display field. Dialight helps you do more with these products than any other company in the business, because we are specialists that have done more with them. Talk to the specialists at Dialight first. You won't have to talk to anyone else. Send for your free new copy of Dialight's current catalog.

## **DIALIGHT**

Dialight, A North American Philips Company  
203 Harrison Place, Brooklyn, N. Y. 11237  
(212) 497-7600

# See Dialight.

# Think of yourself as a heart specialist

The system is your patient and its power supply is your responsibility. For a long, happy system life, prescribe Sorensen STM modular switchers.

Compared to equivalent series-pass power supplies, STMs are twice as efficient, less than half the size, and price competitive. Yet they offer all of the inherent advantages of series-pass.

We've got a catalog that describes all 40 models, from 3.0 to 56 Vdc. It even has a prescription form ready to fill out. Simply circle the inquiry number. Sorensen Company, a unit of Raytheon, 676 Island Pond Road, Manchester, N.H. 03103. (603) 668-4500.

**Sorensen**  
**POWER SUPPLIES**

INFORMATION RETRIEVAL NUMBER 35



OUTPUT

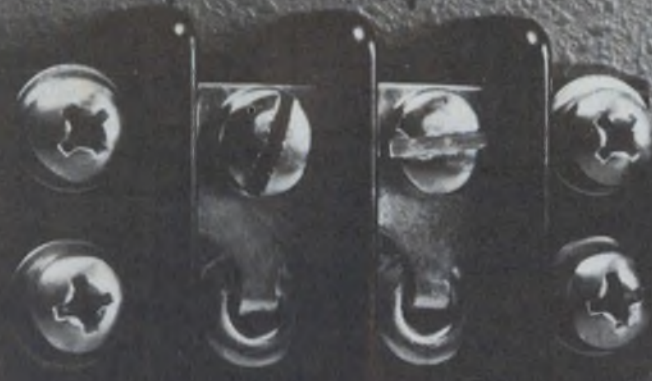

6A

**CORRESEN**  
POWER SUPPLIES  
SIM  
12-12



GROUND INPUT



VOLT

# Debug that microcomputer system with a mini.

With the mini acting as an artificial memory, you can probe the microcomputer conveniently while it operates.

Small memory and a lack of peripheral equipment often hinder applications software development for microprocessor-based microcomputers. You can overcome the problem with hardware simulators, or you can use software tools, such as cross assemblers and editors on large machines—but all of these will add to the development cost. If a minicomputer is available, why not build a hybrid simulator and give the microcomputer an artificial memory?

It will not only simulate the memory functions but will also leave the hardware functions intact. The microcomputer has controlled access to the mini's memory and the user can view the result (Fig. 1).

Thanks to the mini's high-speed peripherals and the fact that most microcomputer activity centers on the memory, a good deal of the step-by-step diagnostic and debugging capability inherent in hardware or software simulators is retained. In addition there is no need to buy PROM and RAM chips, which, in small quantity, often exceed the cost of the microprocessor by several times.

Because the hybrid simulator is a compromise between a hardware and software model, it has some disadvantages. The simulated memory is quite slow. When testing real-time routines, the programs run slow and the processor under simulation may not keep pace with external events.

Another disadvantage is that software access to CPU internal registers is complicated. The data can be saved for analysis only if you write special register-saving routines in the microcomputer language, and integrate them in the simulated memory. Finally the function of the interrupt system can be supervised only to the extent allowed by memory access.

The interface that couples the mini and microcomputer enables data and address transfers between both devices. The type of mini used is not too important. However, since most microcom-

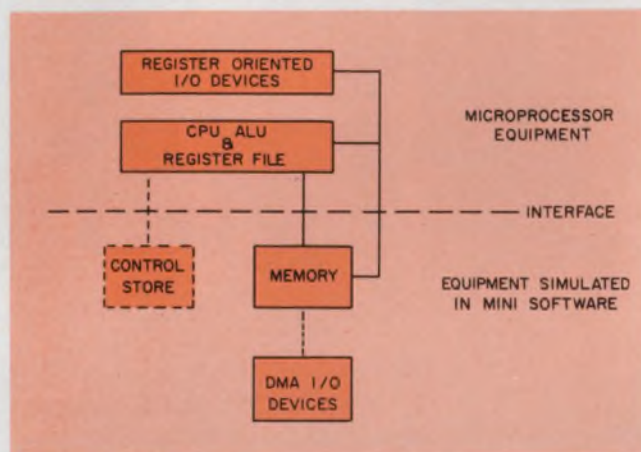

1. Simulator for a microcomputer memory permits system development without resort to emulators. The microprocessor chip is connected to its intended peripherals so its action remains realistic.

puters are byte-oriented, a 16-bit host can simplify the address mapping. Each microcomputer address must be mapped to a new available address in the mini. With 16-bit machines, a single word holds two microcomputer bytes.

## Mini determines interface needs

The actual interface design depends largely on the type of mini used. The following mini I/O operations are necessary:

INPA—Read address, 12 bit word for a 4-k simulation.

INPD—Read data and R/W request, 10-bit word formed by 8-bit data and 2-bit R/W request indicator.

OUTD—Output data (8 bit word).

OUTE—Ready output pulse; one bit indicates the end of a read or write operation.

The structure of the interface between an 8008-based microcomputer and a PDP-8 minicomputer is shown in Fig. 2. The read/write request line connected to the minicomputer input synchronizes operations between the two processors.

Open-collector devices capable of sinking 25 mA drive the input lines of the PDP-8. Either discrete transistors or high-current ICs will do the job.



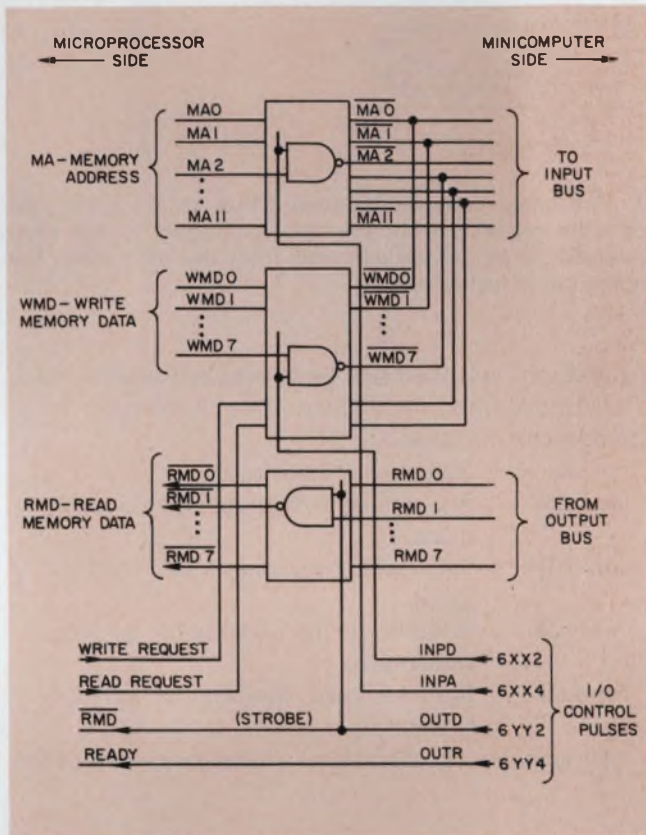

2. The mini senses microcomputer addresses and supplies the necessary data. The mini response is slow compared with that of the microcomputer; hence the two must operate asynchronously. Read/write request lines provide the controls. Signals at the microcomputer side are latched.

The 8008 microprocessor requires additional circuits for normal operation. These circuits provide address latching, multiplexing and bus drive.<sup>1,2,3</sup> Universal I/O drivers (Intel 8212) perform the functions (Fig. 3). Also used are outputs from a two-phase clock and internal state decoder, both normally associated with the microprocessor.

The simulator, which operates on a request-sampling basis, leaves the minicomputer's interrupt system free for other purposes. In addition to simplifying the simulator coding, this design also makes the simulator independent of the minicomputer operating system.

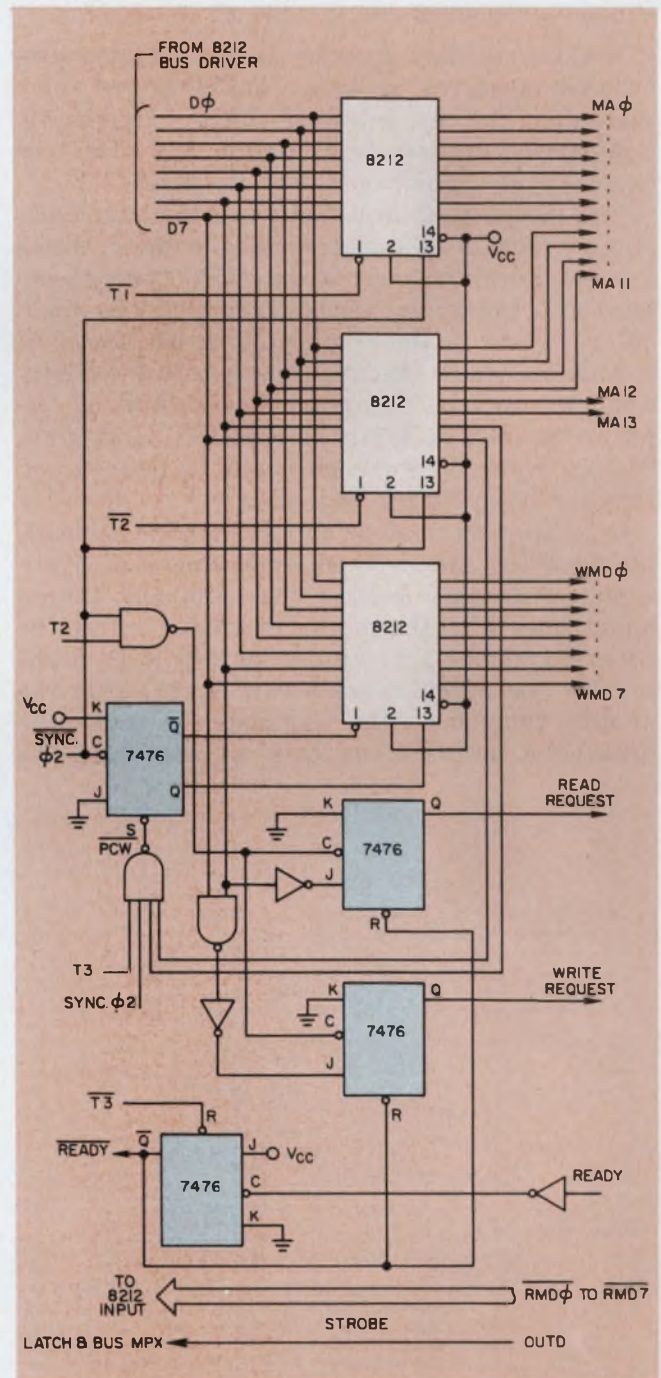

3. Address and data latches permit normal operation of the 8008 CPU when attached to the PDP-8 mini. The inputs from the 8008 include the clock ( $\phi 1$ ,  $\phi 2$ ) and decoded processor state ( $T1$ ,  $T2$  and  $T3$ ).

Since the simulated memory is slow, the microcomputer should be able to communicate with the memory asynchronously. In the case of the Intel 8008, this is achieved by a "ready" pulse from the mini that tells the processor that the memory operation has been completed. The simulator first reads the read/write request bits to see what is to be done. If there is no request, it waits in an endless loop. In the case of a request, it performs the appropriate memory action and ends with the issuance of the ready (OUTR) pulse (Fig. 4).

### Dynamic debugging can be built in

Besides standard memory load and dump procedures, features such as masking and byte searching can be initiated during simulation. Comparison of data fields before and after the execution of a program is also possible.

The insertion of breakpoints in the microcomputer program is undoubtedly the most useful feature. Every memory-access (MA) address defined as a breakpoint temporarily halts the simulation. While in the stopped state, all keyboard commands can be executed to test both the microcomputer data and program. Breakpoints can be for write-only, read-only or both write and read. Sixteen different breakpoints can be defined and removed at arbitrary addresses.

Once simulation stops on a breakpoint address, the operator can proceed by typing a C (continue) command or have the simulator iterate nnnn times with the nnnnC command. After the C command, the simulator stops whenever it encounters the specified breakpoint again. After the nnnnC command, the simulator counts the breakpoint accesses but does not stop until the

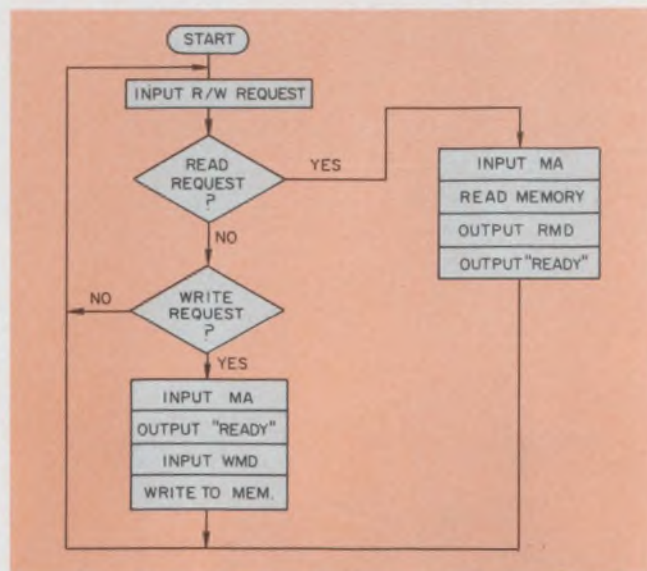

4. The basic dialogue between CPUs consists of read or write requests from the microcomputer to the mini followed by an acknowledgment from the mini when the operation is completed.

breakpoint specified has been reached nnnn-times. For breakpoint definitions, the following commands can be used:

- Z Remove all breakpoints.
- nnnnW+ Set write breakpoint at location nnnn.
- nnnnR+ Set read breakpoint at location nnnn.
- nnnnW- Remove write breakpoint at location nnnn.
- nnnnR- Remove read breakpoint at location nnnn.

All address specifications (locations) are given

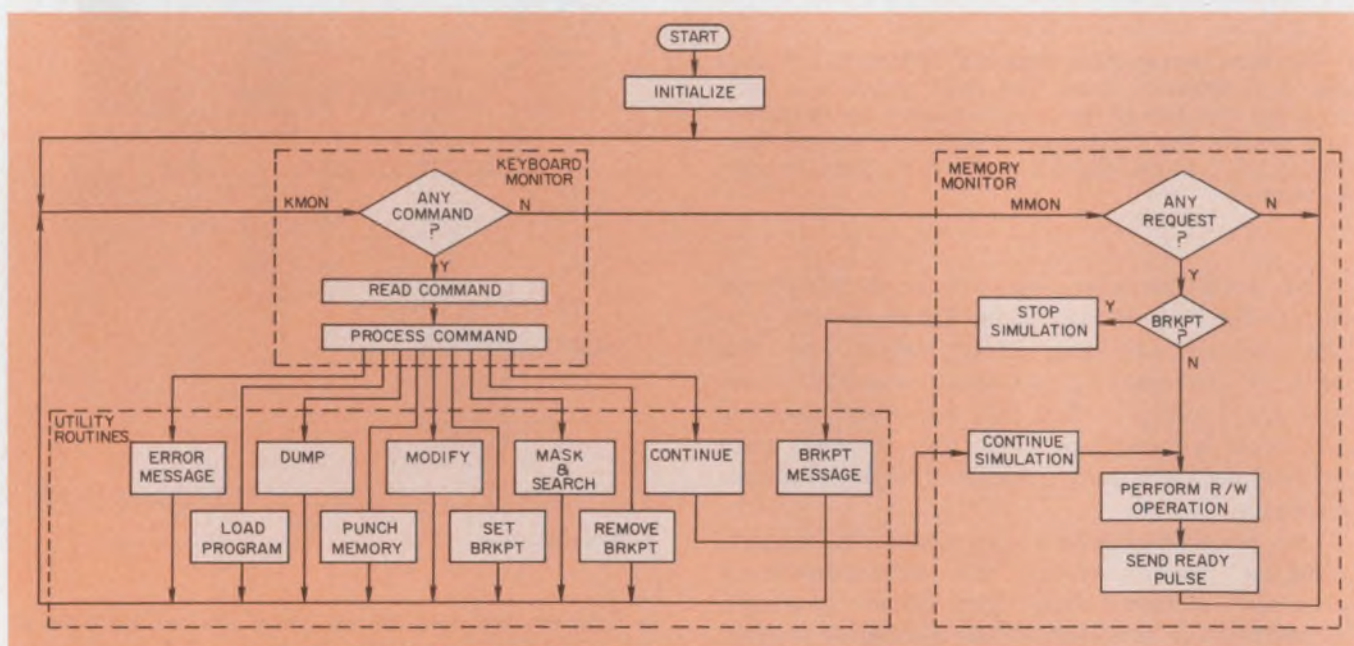

5. The program loops between keyboard and memory monitor. Most of the keyboard monitor routines and

utilities come from the mini's debugging routines. The memory-monitor program is written.

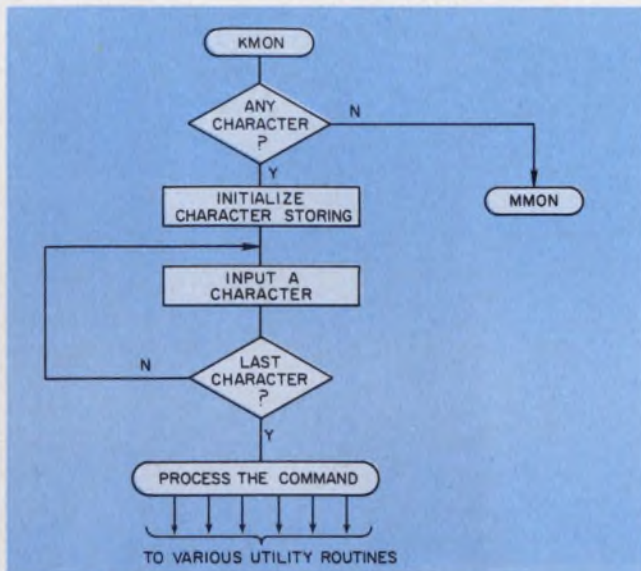

6. The keyboard monitor, upon receiving control, decodes an input string (if present) and performs the desired action. Following execution of the command, a jump back to the loop starting point completes the cycle.

in original address space (MA) of the microcomputer and are mapped to mini addresses when executed in the simulator.

#### Mini's software speeds implementation

The software part of the simulator (Fig. 5) is made up of three components: keyboard monitor, memory monitor and utility package. You can build a keyboard monitor and the majority of utility routines by small modifications to an existing debugging routine for minicomputer programs. Nearly every type of minicomputer has some software package of this type. For the PDP-8, the ODT-8 routine is used. The format of the simulator is nearly the same as that of the ODT. Programs for the memory monitor and some utility routines associated with it are the only ones that must be written.

The software operation is as follows: After the initializing sequence, the program starts to loop between the keyboard and the memory monitor. At the keyboard side, the loop is interrupted by the first character to be entered (Fig. 6). Characters are read one after another until some terminating character ends the string and passes control to the command-processing routine. The appropriate utility action, called from this routine, executes the command and then ends with a jump back to the starting point of the loop.

On the memory-monitor side, the loop is interrupted by memory read/write requests issued at the microcomputer side (Fig. 7). Each request is tested in the breakpoint table. When its address is found to have been defined as a breakpoint, the

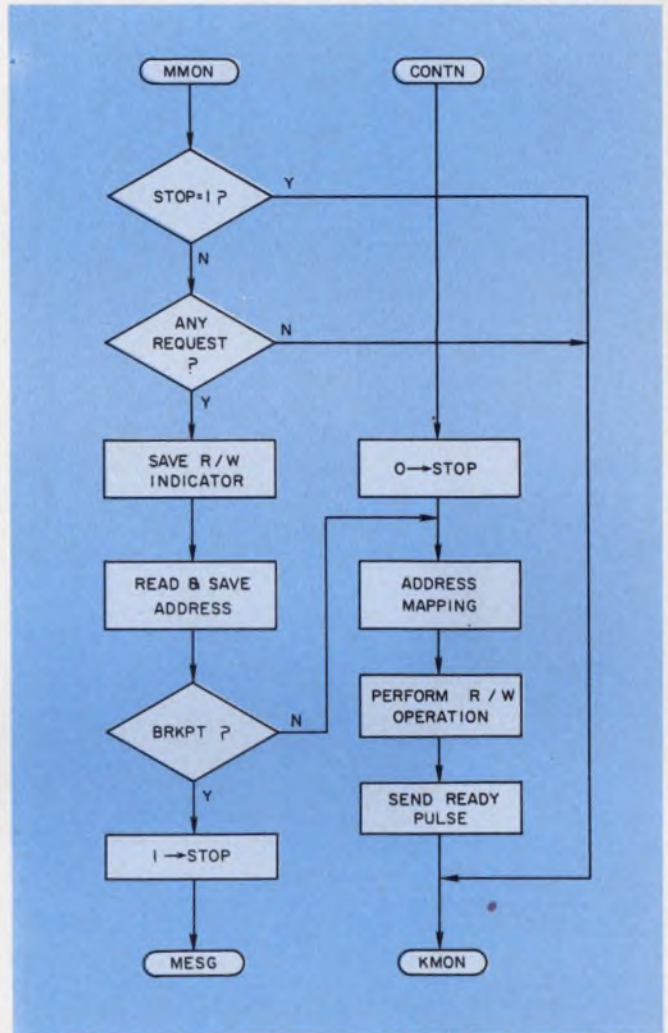

7. The memory monitor, which simulates the microcomputer memory, loops until it receives a read/write request. The monitor converts microcomputer addresses to mini locations.

memory monitor proceeds to the stopped state (STOP = 1). Meanwhile the loop keeps running, and all keyboard commands can be issued. The memory monitor does not leave the stopped state until some "C" command is given.

Written in PAL-3 assembly language, both monitors require about 80 locations. Some of the most useful utility routines require 300 core locations. ■■

#### Bibliography

- "DEC-08-COCO-D," A description of ODT-8, Digital Equipment Corp., 1968.
- Schultz, G. W., Holt, M. R., McFarland, H. L., "A Guide to Using Microprocessors," *Computer*, June, 1973.
- "Small Computer Handbook," Digital Equipment Corp., 1973.
- Weiss, C. D., "MOS/LSI Microcomputer Coding," *Electronic Design* No. 8, April, 1974, pp. 66-71.

#### References

1. "8008 8-Bit Parallel Central Processor Unit, User's Manual," Intel Corp., 1973.
2. Lewis, D., Siena, W., "How to Build a Microcomputer," *Electronic Design* No. 19, Sept., 1973, pp. 60-65.
3. "8212 Eight-bit I/O Port," Intel Corp., 1974.

A beautiful put-up  
can wrap up a great saving

**BELDEN** 

*...new ideas for moving electrical energy*

INFORMATION RETRIEVAL NUMBER 234



To us, put-ups are more than shipping containers that get our wire, cable, and cords to you in performance shape.

Put-ups are also a potential source of cost reduction at your end. The "right" put-up usually pays off via reduced assembly time, longer runs, storage efficiencies, or less spoilage.

For example, there's our new cost-cutting UNREEL™ put-up.\* A packaged wire dispenser. Wire flows freely stops instantly when pulling stops. No reel inertia to overcome. No snarls or backlash. No need for tensioning devices. No reels or spools to return or dispose of. Saves man hours.

With Belden, put-up analysis is part of our total engineering approach to the applica-

tion of wire, cable and cords.

When you're ready to explore the potential cost reduction of put-ups with Belden, you can benefit from our comprehensive applications support. We not only have the capability to provide all the standard forms where they work best, we also have developed proprietary techniques to meet a variety of usage needs. And if we can't optimize a put-up from standard and proprietary methods, we'll innovate one for you. For answers right now, phone:

(317) 966-6681, Electronic Division

(312) 887-1800, Transportation Division

(312) 681-8920, Electrical Division

Or write Belden Corporation, 2000 South Batavia Ave., Geneva, Illinois 60134.

\*Available on a widening selection of Belden wire, cable and cordage.

H-3-4



# Look at calculator languages.

You'll find algebraic notation easier to use, but with practice you can work faster with a reverse-Polish machine.

There's more to evaluating a calculator language than mere counting of key strokes. Any realistic evaluation must take into consideration the answers to questions like these:

- Is it easy to learn the language?
- In long calculation sequences, are the language rules likely to confuse?
- Are you only an occasional calculator user or do you use one continually?
- Is speed important and are you willing to devote the effort to attain high speed?
- Are there special features needed for your work?

A recent study that compares the key-stroke requirements of calculator languages appears to give reverse-Polish notation (RPN) a slight edge.<sup>1</sup> However, mere analysis of the number of key strokes needed for relatively simple arithmetic operations is not by itself conclusive.

Consider the three calculator languages that are generally available: reverse-Polish notation, used almost exclusively by the Hewlett-Packard family; algebra-with-hierarchy, as used on the Texas Instruments SR-50, and ordinary algebra, as used on most other calculators. Which is best?

New users usually find algebra systems easier to learn than RPN. With algebra systems, you present numbers and operations to the calculator in the way you learned them when you studied algebra. This is a major selling point of manufacturers that make algebraic calculators.

But don't conclude that RPN is difficult to learn. It takes only a little skill and some practice. If you use the calculator more than occasionally, you will have no trouble. RPN follows the "computer-way" of calculating; thus experienced machine-language computer programmers have little trouble with it.

As an occasional calculator user, however, you are more likely to work your way out of a problem with an extra pair of parentheses, which costs only two extra key strokes. Though this is equivalent to the use of an extra **ENTER** fol-

lowed by a **ROLL** key stroke in RPN, the RPN procedure is not as "natural" to an untrained operator as the use of parentheses.

## Making a valid comparison

Of course, for a valid comparison, all the systems must be well-designed. For example, in an RPN system the stack registers should be at least four levels deep, and these registers should be used only for arithmetic functions. In both ordinary and hierarchic algebraic systems, at least two levels of parentheses or their equivalents should be available. And for all systems, no operation should require more than one key stroke. Single-stroke capability is commonly available in moderately priced calculators.

Once an arithmetic system is learned, short sequences and expressions almost never cause confusion. But a long sequence may force you to break it into small parts to get the answer.

The ordinary algebra system is the least likely to get you into trouble. Operations are performed in the order that you put them in. There is little possibility to mistake what's going to happen next. At most, to avoid confusion, extra parentheses may be needed when they are not in the written expression. However, extra key strokes will also be needed then. Or a slight rearrangement of the equation may help some other sequences.

Algebra-with-hierarchy systems can be just as easy to work with as ordinary algebra after you develop the confidence that the calculator is following your instructions. The hierarchy, in which multiplications and divisions are done first, causes delayed operation. An expression such as  $2 + 3 \times 4$  can be done without putting parentheses around  $3 \times 4$  or without rearranging the equation, as ordinary algebra systems require. But in longer sequences—especially those that involve the function  $a^x$ , which is a level of hierarchy above multiplication and division—the calculator can at times fall considerably behind the key strokes, but it will catch up. And if you're not confident about how the calculator works, you can become confused.

---

Thomas S. Budlong, Director Product Planning, Compu-corp, Los Angeles, CA 90064.

RPN usually requires some prior thought to plan the order of operation for long sequences (Table 1). In the example in the table, three numbers are keyed in before a single operation key is used. Though some sequences are naturals for RPN, others can defy your best efforts. This often happens when all levels of the stack are filled. Part of your calculation can be lost in overflow if you then attempt to enter more data.

Of course, the quickest way out of such a situation is to break the expression into smaller parts and save the intermediate answers for later recombination.

Experienced RPN users can move numbers through the system quite rapidly. But this requires practice—sometimes several months of it. With experience, an RPN operator can expect ultimately to go faster than the skillful algebra

## Some calculator language details

### How RPN works

As numbers are keyed into an RPN calculator, they enter a so-called push-down stack of registers. A common configuration has a four-level stack. The top level is connected to the display. Numbers already in the registers move down one level when a special **ENTER** key is pressed. A number in the lowest level overflows and is lost.

The four basic function keys are **+**, **-**, **×** and **÷**. Sometimes  $a^x$  and other two-variable functions are also provided. When pressed, they cause the following actions:

- The designated function is performed on the number in the display with the number in the second level of the stack.
- The result of the operation is displayed, and the numbers in the lower stack levels each move up one level.

For continuous sequences, the result of an operation should enter the second stack level to allow a new number to be keyed into the display. Though this can be done by pressing **ENTER**, a well-designed RPN system automatically does this when the next number is keyed in (See Table 1).

Because numbers are entered first and the function to be performed last, the designation "reverse" is used. And "Polish" comes from the system's inventor, a Polish logician, Jan Lukasiewicz.

### How algebraic systems work

The algebraic systems use an **=** instead of

**ENTER** key. Numbers and functions are keyed in the same sequence as they appear in equation form. And parentheses keys separate strings. For example  $2 \times 3 + 5 \div 4 - 7 =$  would be keyed in as

2 **×** 3 **+** ( 5 **÷** 4 **)** **-** 7 **=**.  
 Parentheses also can be nested several levels deep.

In ordinary algebra systems the functions are carried out in the same order that they are presented to the calculator—which can give incorrect results if parentheses are not used.

Algebra-with-hierarchy systems, however, assign a lower hierarchic level to **+** and **-** functions than to **×** and **÷**. The latter two, in turn, are lower than  $a^x$ . When an add command is followed by a multiply command, the multiplication is done first, then the addition. However with an ordinary algebra system, the add command would be carried out as soon as the multiply was keyed.

For example, for entry of 2 **+** 3 **×** 4 **=**?, ordinary algebra would add the 2 and 3 as soon as **×** was keyed, and this sum would then be multiplied by 4 when **=** was pressed; an incorrect result, 20, would be obtained. Algebra-with-hierarchy, however, holds the **+** operation when **×** is pressed and waits for the completion of the multiplication. Thus 3 **×** 4 is done first, and the 2 is then automatically added; the correct result, 14, is then obtained.

To obtain the correct answer with ordinary algebra, the key sequence would have to be rearranged to 3 **×** 4 **+** 2 **=**, or expanded to include parentheses:

2 **+** ( 3 **×** 4 **)** **=**.

**Table 1. Solve  $(7 + 8 \times 4)/5$  by RPN**

Key strokes	Stack level				Comments
	Display	2	3	4	
7	7	0	0	0	Key 7 into the display.
ENTER	7	7	0	0	Copy the display into the next level of the stack.
8	8	7	0	0	Key in 8.
ENTER	8	8	7	0	Enter the 8 into the stack.
4	4	8	7	0	Key in 4.
$\times$	32	7	0	0	Multiply the two top stack levels and move the stack up one level. The 7 is now in place to be added to the display.
$+$	39	0	0	0	Add the two top stack levels. The stack again moves up one level.
5	5	39	0	0	Keying in a number after $+$ , $-$ , $\times$ , or $\div$ automatically puts the display in the stack.
$\div$	7.8	0	0	0	Divide the display by the next level. This is the answer.

user. However, the occasional user probably will not acquire enough practice to become fast with RPN.

**Special features can be important**

Most algebra systems offer one or more special features. The most common and useful is "constant operation." In the simple sequence  $7 \times 8 =$ , the  $7 \times$  is retained after the initial calculation. To multiply 7 by another number, say 5, requires entry of only  $5 =$ . For multiplication of a long string of numbers by the same number, this feature can be a big timesaver.

**Table 2. Author's subjective evaluation**

	RPN	Ordinary algebra	Algebra with hierarchy
Learning ease	5	10	8
Confusion avoidance	7	10	8
Speed of calculation	10	8	8
Special features	10	10	10
Number of key strokes	10	9	9
Total	42	47	43

For simple addition of a list of numbers, RPN is best. After the first **ENTER** key stroke, subsequent entries are simply followed by  $+$ . No other key is required to display the result.

If there are enough stacks in RPN—or parentheses levels in algebraic—long sequences can be interrupted to obtain intermediate calculations. In RPN you roll the stack down one level, and in algebraic you open a level of parentheses. When you complete the intermediate calculation, you then roll the stack back up or close the parentheses. But take care not to exceed the limits on available stacks or parentheses levels. For such cases, a stack or parentheses-level indicator is a valuable convenience.

But only your personal requirements can tell you whether a particular special feature makes one system a better choice over another.

Confused? Too much to consider? Then fill out a table and score the factors on a scale from 1 to 10. The author's subjective preferences are shown in Table 2.

Usually the over-all differences are small. A system seldom wins decisively. The final choice is still based on your own judgement. ■■

**Reference**

1. Ball, John A., "Reverse-Polish or Algebraic Entry—Which Is Best?" *Electronic Design*, Jan. 18, 1975, pp. 50-52.



# You won't get a better DAC deal. Anywhere.

Because Teledyne Philbrick offers you the broadest line. The tightest specs. The best price/performance.

We're talking about our economy line DACs, for starters. The 4020 Series of 8, 10, and 12-bit DACs feature adjustment-free high performance at very low cost.

And our 4039QZ general purpose 12-bit DAC gives you a pin-for-pin, price-for-price edge in second sourcing the DAC-12QZ.

Our 4060 Series high speed current DACs have a guaranteed settling time of 60 nsec. to  $\pm 0.1\%$  and give you a competitive and compatible option to Analog Devices and Datal.

Still not convinced? Our 4070 Series high speed multiplying DACs are unmatched in terms of specs and performance. Our 4072 is a 12-bit MDAC, the fastest in the industry with 500 nsec. at .01% accuracy.

In the high reliability, guaranteed performance area, we'll soon be announcing a 12-bit micro-circuit DAC which will be the fastest and most accurate for MIL-STD applications.

At Teledyne Philbrick you don't have to sacrifice spec for price. Or vice versa. We give you both.

For complete information, write for our Application Bulletins today. Or "DIAL" (our Direct Information Access Line) 617-329-1600. Teledyne Philbrick, Dedham, MA 02026. In Europe, Tel. 673.99.88, Telex: 25881. Or write, 181 Chaussee De La Hulpe, 1170 Brussels.



# Use low-cost IR detectors to solve many tough temperature-measurement problems. These sensors allow noncontacting measurement of hard-to-reach hot spots.

Available low-cost infrared detectors give the engineer many sensing options for industrial measurements. With these IR elements and fairly simple signal-conditioning circuitry, you can design reliable and economical measuring instruments for remote monitoring and control.

Applications range from noncontact temperature sensing of inaccessible targets and remote counting of moving objects to detecting intruders for security alarms and locating optical telemetry paths. IR detectors are also useful to analyze gases, such as engine exhausts, based on absorption of infrared radiation, and they can measure power in laser beams.

IR sensors are generally either photon counters or heat-sensitive materials. Table 1 describes some of the more common performance specifications.

Photon detectors fall into three family types

C. S. Molee, Engineering Manager, Mark Muller, Product Engineer and Alan Eschbach, Senior Project Analyst, Victory Engineering, Victory Rd., Springfield, NJ 07081.

(Table 2). They count energy in terms of the free electron currents created when radiation from a heat source interacts with the semiconductor crystal lattices.

Photon detectors are very sensitive with specific detectivities of typically  $10^8$ . They also have fast time constants, typically measured in microseconds. But they are only sensitive to a narrow range of wavelengths at the low end of the IR spectrum, they require cryogenic temperatures during operation and are relatively expensive, typically—\$400 to \$600.

Thermal detectors can be divided into five general types (Table 3). They absorb infrared energy, and the resulting temperature rise changes an electrical property, such as resistance or capacitance.

## Thermal detectors respond slowly

Traditional thermal detectors have slow responses, typically measured in milliseconds. Sensitivities are only moderate, with specific de-

**Table 1. Common detector terms and definitions**

Term	Symbol	Definition
Responsivity	$\rho$	The ratio of output signal to incident radiation; usually expressed in volts per watt.
Noise	$V_n$	Extraneous voltage generated by a detector.
Johnson or thermal noise	$V_j$	Noise due to random motion of electrons in a resistance element. The root-mean-square Johnson noise can be approximated as $V_j = \sqrt{4KTR\Delta f}$ . Boltzman's constant, K, is $1.38 \times 10^{-23}$ joules/kelvin, T is the absolute temperature in degrees kelvin, R is the resistance in ohms, and $\Delta f$ is the electrical bandwidth of the circuit in Hz.
Noise equivalent power	NEP	The incident radiation in watts required to produce an output signal equal to the detector noise.
Detectivity	D	The reciprocal of NEP.
Specific detectivity	$D^*$	Detectivity normalized for a detector area of $1 \text{ cm}^2$ and a bandwidth of 1 Hz. It is equal to $D/\sqrt{A\Delta f}$ , where A is the detector active area in $\text{cm}^2$ and $\Delta f$ is the bandwidth in hertz. When reporting $D^*$ , the wavelength or the black-body temperature and chopping frequency at which the data are taken must be specified.
Time constant	$\tau$	The period required for a detector to reach 63.2% of its final output value following the application of steady-state incident radiation. The time constant equals $1/2 \pi f_c$ , where $f_c$ is the chopping frequency in Hz at which the frequency response begins to roll off at 3 dB/octave.

**Table 2. Types of photon IR detectors**

Type	Material
Photovoltaic detectors	Silicon (Si) Gallium arsenide (Ga As) Germanium (Ge) Indium arsenide (In As)
Photoconductive detectors	Silicon (Si) Lead sulfide (Pb S) Lead selenide (Pb Se) Indium antimonide (In Sb) Germanium—Gold doped (Ge:Au) Germanium—Cadmium doped (Ge:Cd) Mercury—Cadmium-telluride (Hg:Cd:Te)
Photoelectromagnetic detectors	Indium antimonide (In Sb)

**Table 3. Types of thermal IR detectors**

Detectors Type	Materials
Thermocouple and thermopile detectors	Various metallic alloys Nickel (Ni) Bismuth (Bi) Antimony (Sb) Various semiconductors
Thermistor detectors	Mixtures of metal oxides, such as those of nickel, cobalt and manganese
Ferroelectric detectors	Barium-strontium titanate
Golay Cell detectors	Xenon gas
Metal strip detectors	Blackened strips of thin metal

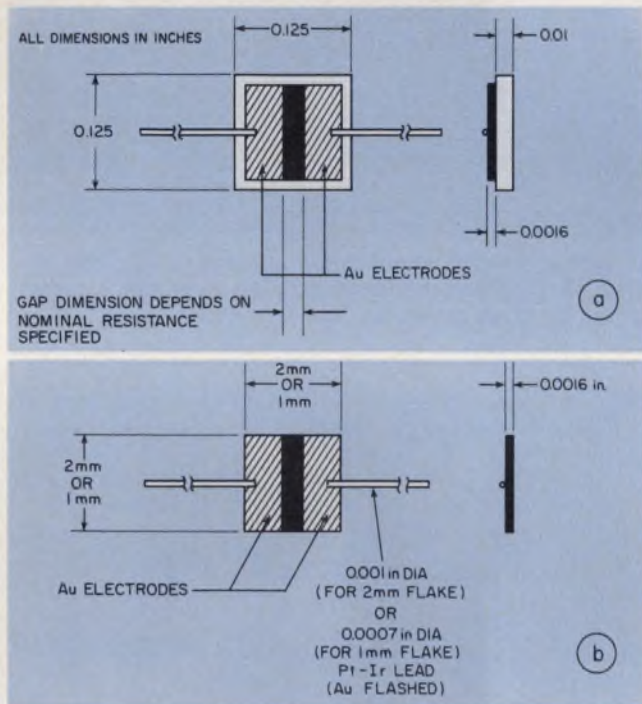

1. Typical thermally sensitive flakes of metal oxides are only 0.125 in. square when mounted on a ceramic substrate (a) and only 2 or 1 mm square, free-standing (b).

tivities of about  $10^7$ . They can, however, respond to the full infrared spectrum, and their cost is moderate, typically—\$100 to \$300.

A newer series of thermal IR detectors can be formed from thick-film thermistor flakes composed of metal oxides such as manganese, nickel, cobalt and titanium. The resistance of these flakes decreases sharply with absorbed energy. They offer high sensitivity along with low cost (typically \$40 to \$60), high mechanical durability and good electrical characteristics. These sensors can be used for IR detection in applications that previously required more sophisticated and expensive transducers.

For instance, applications that call for high

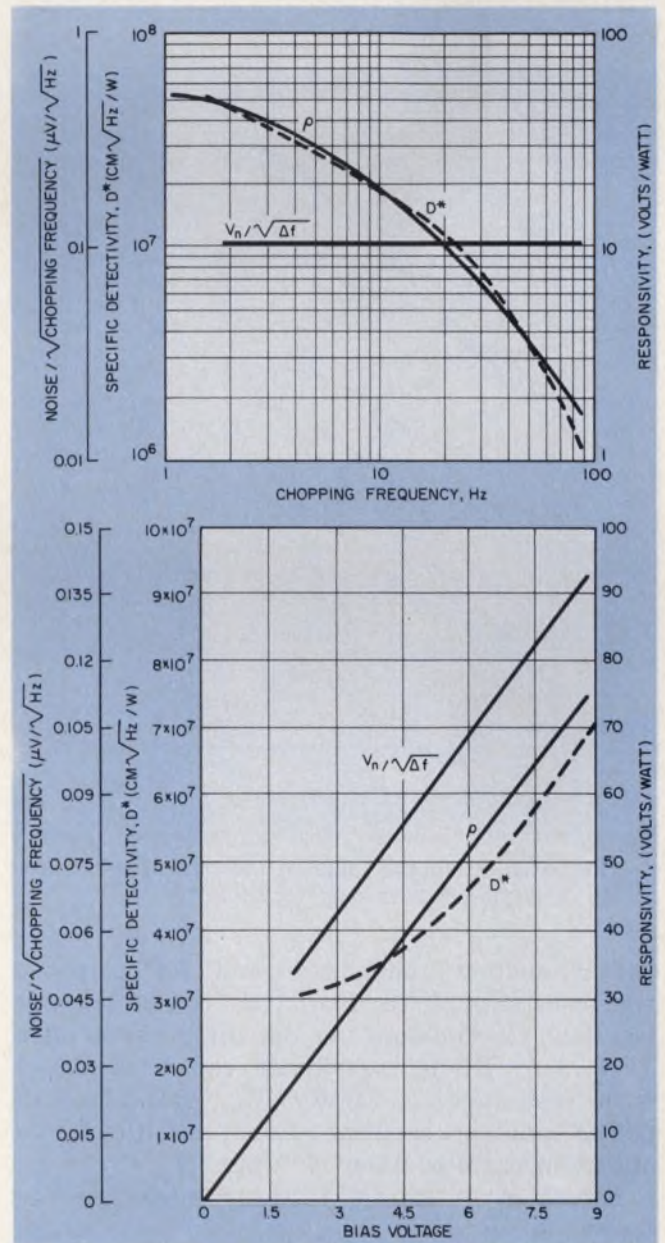

2. Responsivity, noise and specific detectivity are shown as functions of the chopping frequency (a) and as functions of the bias voltage (b).

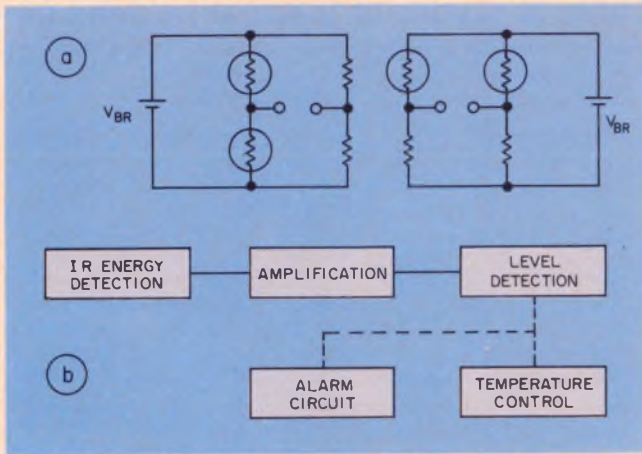

3. Matched sensors can be used as adjacent arms of a balanced bridge to reduce drift or provide high sensitivity (a). Bridge outputs can be conditioned to serve many alarm and control functions (b).

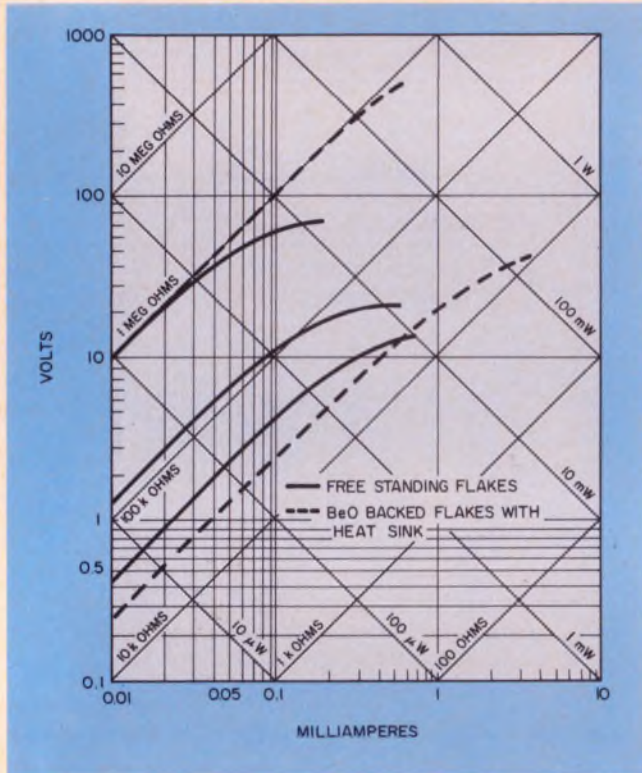

4. The initial-resistance value of the heat-sensitive elements determines power-handling capacity.

power-handling capabilities and for response time-constants of less than 1 ms can be handled by flake thermistors on beryllium substrates (Fig. 1a). Higher sensitivity can be achieved with free-standing flakes (Fig. 1b), although power-handling capacity drops and time constants increase to about 300 ms.

Fig. 2 gives typical infrared properties for free-standing flake detectors. Substrate-backed elements have similar characteristics, except that responsivity decreases at low chopping frequencies. The noise characteristics of both types ap-

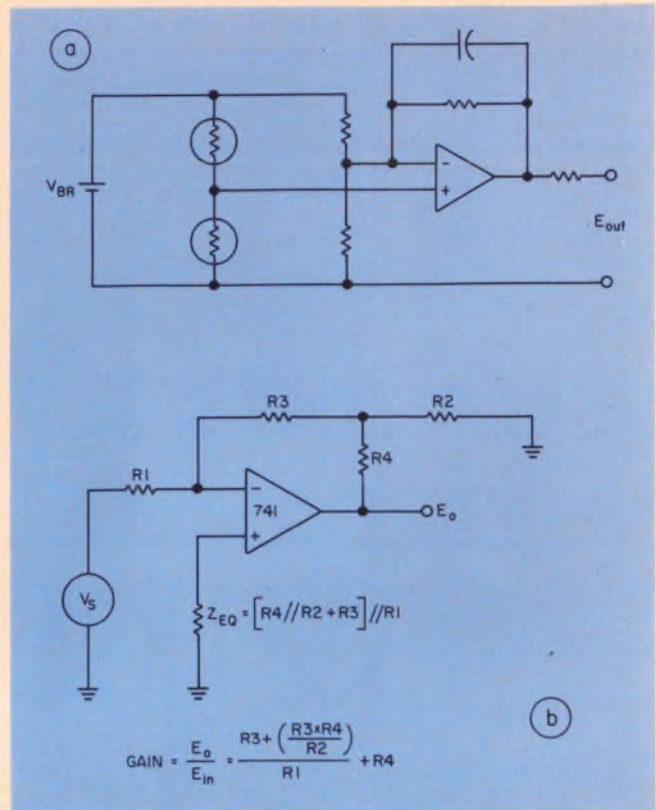

5. Typical bridge amplification circuits sometimes include capacitors in the feedback loops to minimize errors caused by noise picked up from external sources.

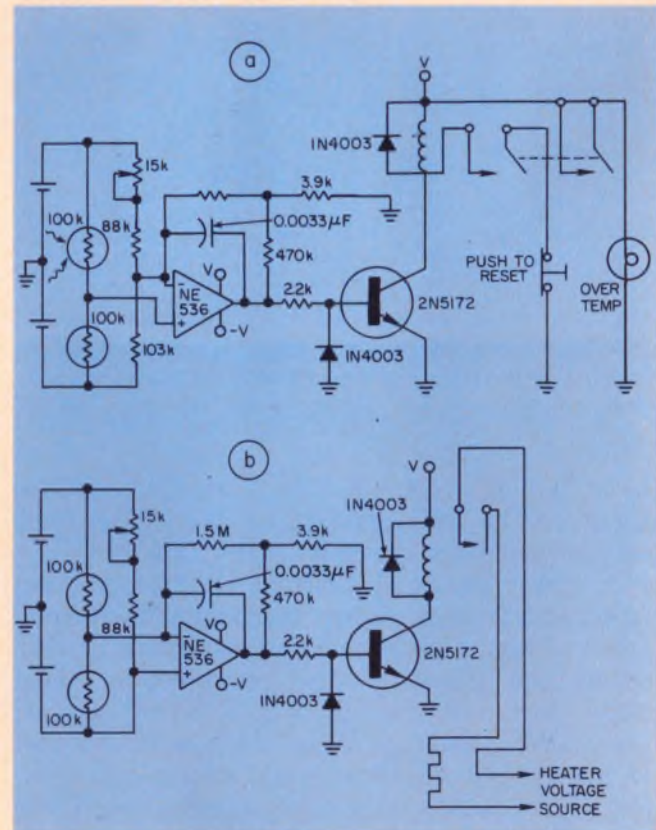

6. An overtemperature alarm circuit (a) and a temperature-control circuit (b) can be built with very few components, since the heat-sensitive elements don't need any critical conditioning.

proach the Johnson level.

IR detectors, used in systems to detect and process IR energy, can be connected in balanced-bridge circuits that are part of more complex signal-processing circuits (Fig. 3).

IR energy detection can be accomplished if you use a single thick-film flake, apply a bias voltage and monitor the output current. More often, though, dual matched thermistors in common headers are used. For applications such as counting or temperature measurement, one of the two flakes is exposed to the IR radiation, while the other is shielded from impinging energy and used to compensate for ambient effects.

For gas analysis, a light beam can be split, with the two thermistors used to sense rays passing through and bypassing the sample. Composition can then be inferred from calibration of the bridge unbalance that results from the difference in optical absorption. In either case, the magnitude of the bridge voltage,  $V_{BR}$ , can be determined from the voltage-current curves for the elements (Fig. 4). Avoid excessive bias voltage, though, or self-heating of the flakes can invalidate any reading.

#### Amplify weak detector signals

You can use amplifiers, such as the one in Fig. 5a, to provide a useful output voltage based on the low-level bridge imbalance, which occurs when the active flake is exposed to IR radiation. If you need additional sensitivity, a differential amplifier (Fig. 5b) can be used. Along with increased gain from the differential amplifier circuit you can use more realistic resistor values in the feedback network.

Level detection circuits that sense IR radiation can include a transistor switch, which triggers any type of control element when the magnitude and polarity of the amplifier output voltage reach predetermined values. For instance, if the transistor turns on a latching relay, the circuit can operate as an over-temperature fail-safe device.

A practical over-temperature alarm circuit and a simple temperature-control circuit use capacitors in the amplifier feedback loops to reduce circuit noise (Fig. 6). Higher resistance flakes can be used to increase sensitivity to IR energy. However, when the high resistance flakes are used in this type of circuit serious noise problems may develop. The IR-sensitive resistances in the bridges will be functions of the IR source temperature, the distance to the source.

For best results, choose stable, low-drift components to minimize drift. In many cases, you may need special optics to increase the over-all sensitivity. The optics can range from simple reflective mirrors to lens and filter systems. ■■

## What's Practical Automation Doing With Digital Printers?



## Everything New!

When we designed our new miniature Matri-Dot Series of alphanumeric digital printers, we dedicated them to you and your customers. Matri-Dot printers represent a significant breakthrough in design, performance, and price.

### Built like a Practical Automation Printer means . . .

1. **Smallest Size** . . . only 3½" W x 3" H x 9" D
2. **Lowest Price** . . . \$140 in 100 unit quantity
3. **Full Alphanumerics** . . . a complete 63 character set
4. **Ribbonless Printing** . . . unique inked platen lasts for 75,000 lines
5. **Standard Interfaces** . . . RS232C and others
6. **18 Columns** . . . 110 character per second print rate

Six sound reasons to take the next important step . . . ask for a demonstration and become convinced!



**PRACTICAL  
AUTOMATION,  
INC.**

Trap Falls Road ■ Shelton, Connecticut 06484  
Tel: (203) 929-5381

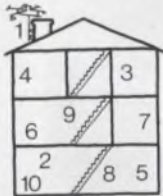
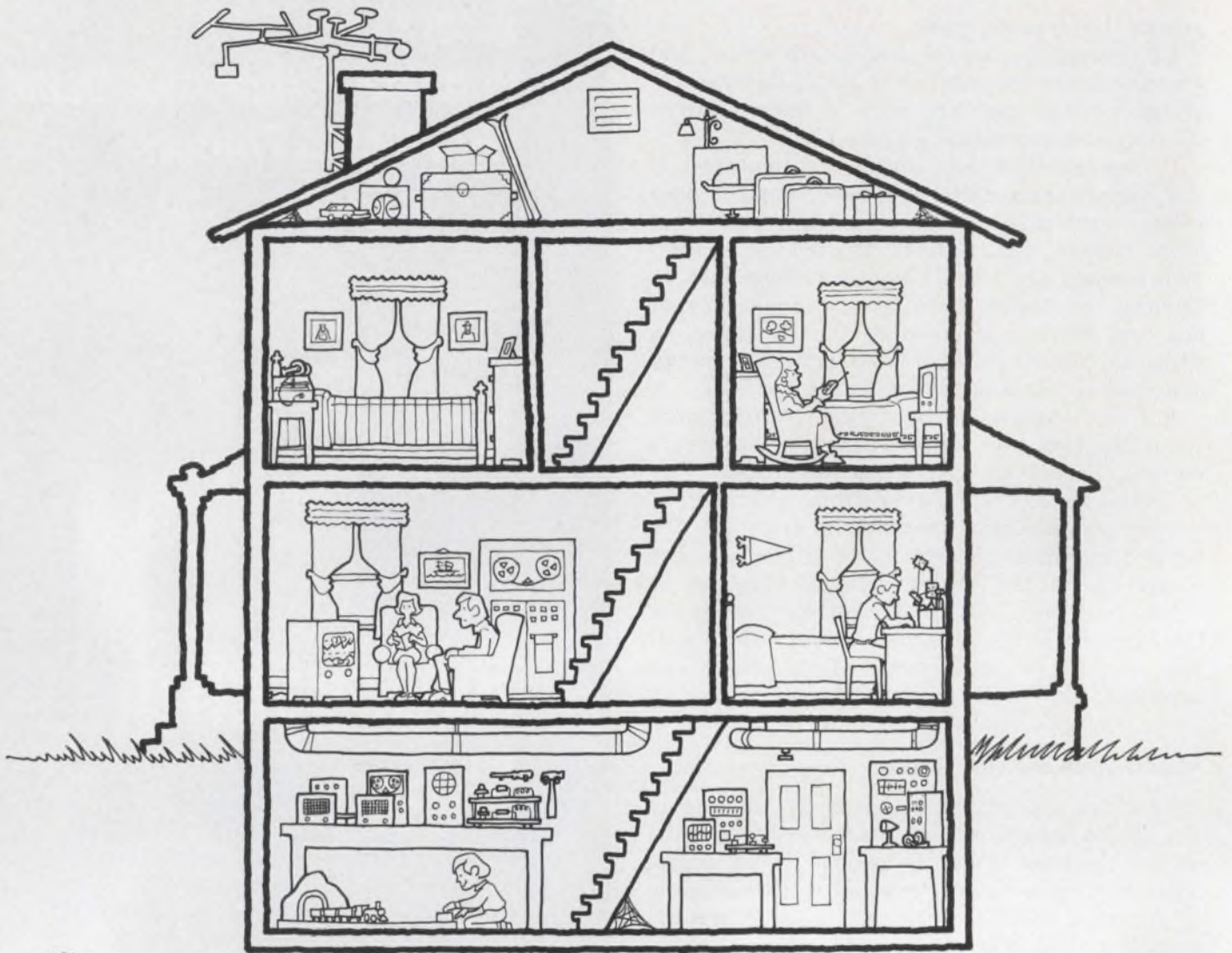

## Engineers gotta have fun, too!

Here are 10 hobby and project books that let the engineer use his special talents for improving his home or just having fun.

1. **HOW TO SELECT AND INSTALL ANTENNAS**, #0786-8, \$4.90. All aspects of antenna selection and installation. Instructions for putting up UHF, VHF, FM antennas or complete master TV systems.
2. **20 SOLID-STATE HOME AND HOBBY PROJECTS**, #0134-7, \$4.55. Two-station intercom, electronic siren, power regulator, metal detector, water-operated alarm, etc. Complete instructions, parts lists, diagrams.
3. **25 SOLID-STATE PROJECTS**, #5881-0, \$4.90. Auto burglar alarm, programmable auto-speed-minder, indoor-outdoor electrothermometer, telephone call timer, electronic dice, TV remote-sound system, etc., etc.
4. **50 IC PROJECTS YOU CAN BUILD**, #0723-x, \$4.55. Hi-fi headphone amp, auto tachometer, intercom, TV commercial killer, etc. Each project can be put together in one night with these simple instructions.
5. **BUILDING THE AMATEUR RADIO STATION**, #0709-4, \$4.30. Complete construction of amateur radio station. Schematic and wiring diagrams and chassis layouts for Novice and General Class stations.

6. **COLOR TELEVISION: Principles and Servicing**, #5929-9, \$5.70. Receiver troubleshooting and servicing techniques. Charts listing trouble symptoms, causes, and remedies. Instructions for using the latest test instruments.
7. **HOW TO BUILD A LOW-COST LASER**, #5934-5, \$4.55. How to build a laser at home, from readily available parts, for approximately \$100! Includes a collection of laser experiments.
8. **BENCH-TESTED COMMUNICATIONS PROJECTS**, #0788-4, \$3.75. Telephone broadcaster, party line listening, canned light music, rollaway ham

shack, VHF extender, 6-meter solid-state transmitter, etc.

9. **HOW TO BUILD A WORKING DIGITAL COMPUTER**, #0748-5, \$5.45. Step-by-step instructions for building an inexpensive digital computer simulator. Includes parts lists, theory of operation, and fundamental programming techniques for solving simple problems.

10. **110 THYRISTOR PROJECTS USING SCR'S AND TRIACS**, #5096-8, \$4.30. Burglar, fire and water level alarms, power control devices for electric tools, and other useful projects built and fully evaluated by the author.



**Hayden Book Company, Inc., 50 Essex St., Rochelle Park, N.J. 07662**

Please send the books I have circled on 15-day free examination. At the end of that time, I will remit payment, plus postage, or return the book(s) with no further obligation. (SAVE MONEY! Payment enclosed. Publisher pays all shipping and handling charges. Same 15-day return guarantee.)

Name

Address

City  State  Zip

Prices subject to change without notice.

75-42

# ±15 VOLT POWER MINI'S FOR OP AMPS

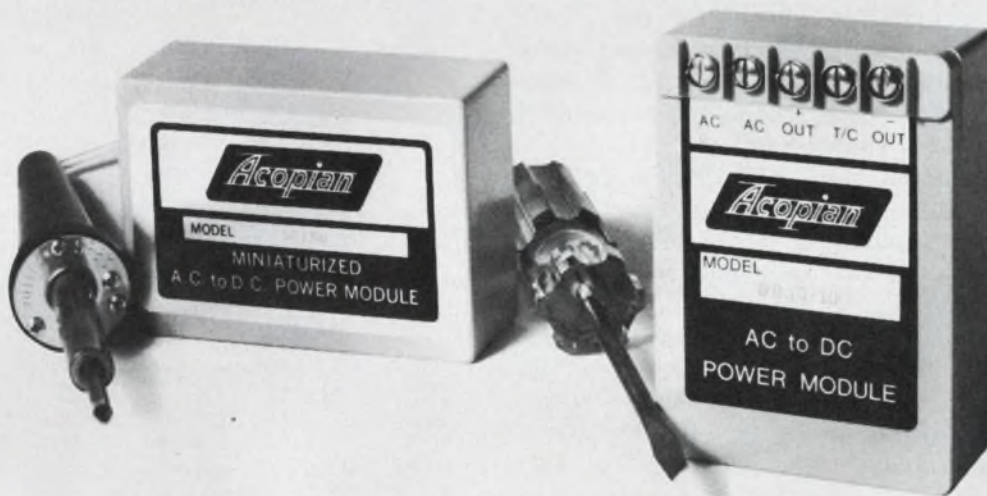

ALL MODELS U.L. RECOGNIZED

PC-BOARD MOUNTING			
OUTPUT CURRENT MA	SIZE INCHES	PRICE	MODEL
25	2.3 x 1.8 x 1.00	\$24	D15-03
50	2.3 x 1.8 x 1.00	39	D15-05
100	3.5 x 2.5 x 1.00	49	D15-10A
200	3.5 x 2.5 x 1.00	69	D15-20
300	3.5 x 2.5 x 1.25	105	D15-30
500	3.5 x 2.5 x 2.00	130	D15-50

CHASSIS MOUNTING			
OUTPUT CURRENT MA	SIZE INCHES	PRICE	MODEL
100	3.5 x 2.5 x 1.38	\$55	DB15-10
150	3.5 x 2.5 x 1.38	65	DB15-15
200	3.5 x 2.5 x 1.38	75	DB15-20
300	3.5 x 2.5 x 1.63	105	DB15-30
350	3.5 x 2.5 x 1.63	110	DB15-35
500	3.5 x 2.5 x 2.38	135	DB15-50

Line/load regulation,  $\pm 0.1\%$  or better; ripple, 1 mv; input, 105-125 VAC. Other single and multiple output models from 1 to 75 volts, to 2.5 amps. Liberal quantity discounts. Three-day shipment guaranteed.

Complete details on these plus a comprehensive line of other power supplies and systems are included in the Acopian 74-75 catalog. Request a copy.



Corp., Easton, Pa. 18042. Telephone (215) 258-5441.

## Inexpensive TTL chip makes a versatile oscillator circuit

Three of the four gates in an SN7403 chip can be connected with a few RC elements to construct a free-running, adjustable square-wave generator (Fig. 1a). The SN7403 is an inexpensive TTL chip with four open-collector, two-input NAND gates.

The repetition rate of the generator can cover a range from a few pulses per second to megahertz. The rise and fall time of the pulses are measured in nanoseconds, which is characteristic of the TTL family. The repetition rate is dependent on the values of both the potentiometer and the capacitor (Fig. 1b).

The open-collector gate can directly drive a low-power speaker of the type used in pocket radios. And when combined with a LED, the circuit also can give useful visual effects for use in the lab.

Possible applications for the generator (Fig. 2) include use as a low-cost square-wave test generator (a) or as a circuit continuity tester (b) or circuit-breaker audio or intruder alarm (c). With small changes, the generator can also serve as a code-practice oscillator or metronome.

*Stamatios V. Kartalopoulos, The University of Toledo, Dept. of Electrical Engineering, Toledo, OH 43606.*

CIRCLE No. 311

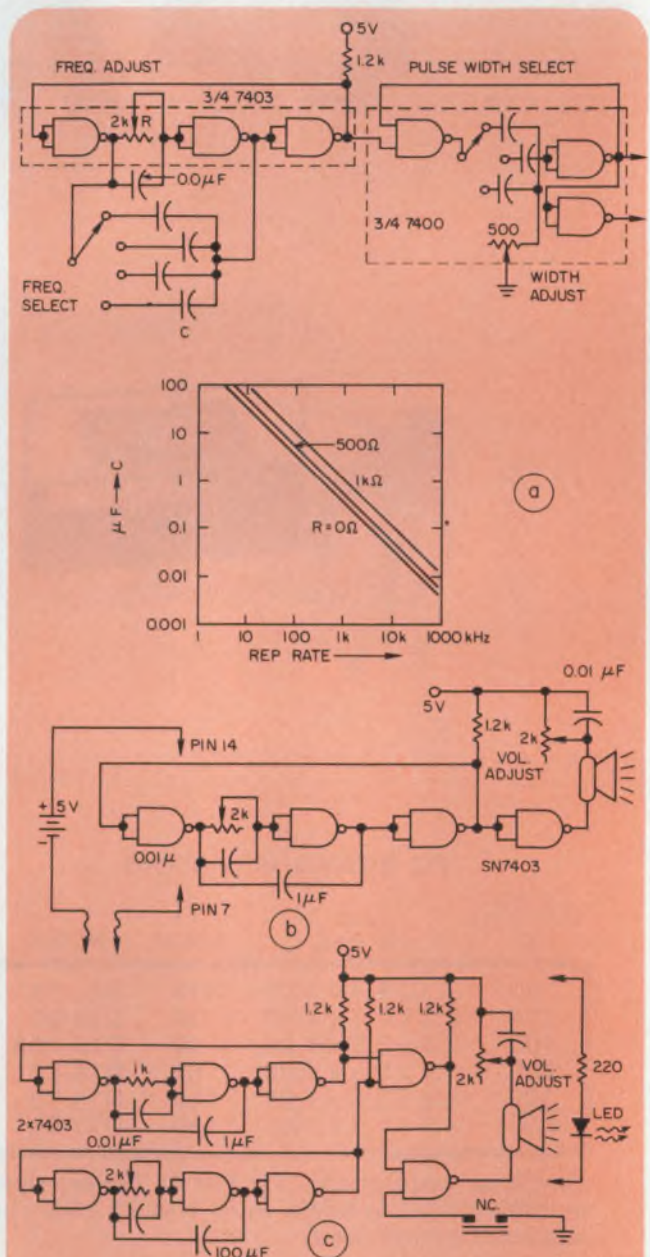
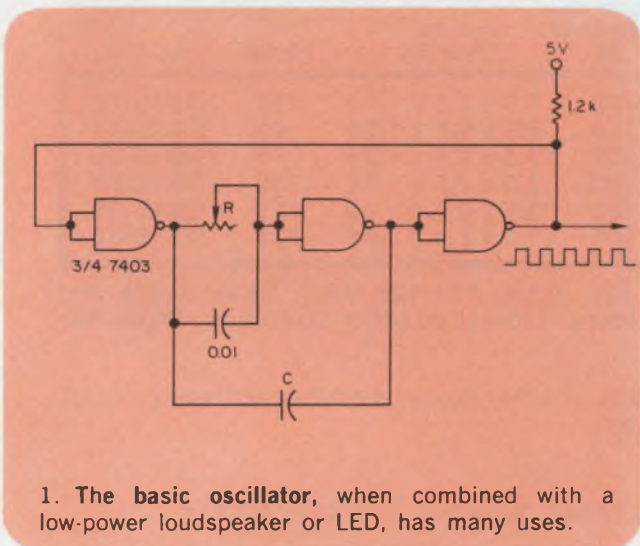



# The sub-priced subminiature: TRW/Cinch Burgun-D<sup>®</sup> connector



You'll have to look closely to tell a TRW/Cinch Burgun-D<sup>®</sup> Subminiature Connector from the other four types of D-Subminiatures in our line. But there's a whale of a difference in price.

Crimp removable selectively gold-plated contacts and a glass-filled nylon insulator with a unique molded-in contact retention system substantially reduce the total connector cost. For non-military applications, you can't beat the TRW/Cinch Burgun-D for price and performance.

The new Burgun-D series comes in 6, 15, 25, and 51

contact sizes which are intermateable with all D-Subminiatures of the same size. A variety of selective gold-plated stamped and solid-plated machined contacts are available in bulk or on reels to satisfy your design requirements. They all utilize standard assembly and crimping equipment.

Don't fish for additional information on TRW/Cinch Burgun-D's, phone your nearest stocking distributor or TRW/Cinch Connectors, 1501 Morse Avenue, Elk Grove Village, Illinois, 60007, (312) 439-8800.

\*Trade Mark ITT Cannon CC-7503

**TRW<sup>®</sup> CINCH CONNECTORS**

# Analog-input multiplier/divider provides 3-1/2-digit output

A simple two-quadrant multiplier/divider accepts analog inputs and provides a 3-1/2-digit BCD output. It features input impedances of 10 MΩ or greater on all inputs. The circuit uses only three ICs and is easy to adjust. The accuracy in the multiplier mode is 0.2%, and for the combined multiplication/division operation ( $XY \cdot k/Z$ ) is better than 0.5%.

Input Z is scaled by a factor  $k = 0.6$ , and it can be used as reference for the multiplication ( $XY$ ) or as a one-decade divider with a range of 0.6 to 6.0 V. Input X can range from +2 to -2 V, and Y must be limited to negative voltages with a -1-V maximum.

An LD110/111 a/d converter chip set, IC<sub>1</sub> and IC<sub>2</sub>, forms two-thirds of this circuit. The additional LD111, IC<sub>3</sub>, converts it to a multiplier/divider (Fig. 1). In IC<sub>1</sub>, the X analog input determines the average height,  $V_{in}$ , of pulses of fixed width,  $T_m$ , which are digitized by IC<sub>3</sub>. And IC<sub>2</sub> effectively modulates  $T_m$  with  $-Y \cdot k/Z$  analog voltages to provide a digital output equal to  $XY \cdot k/Z$ . The modulation is performed with a gate circuit external to IC<sub>1</sub>.

In the analog-processor circuit, IC<sub>1</sub>, signal X is applied to an integrator during  $T_m$ —the so-called measurement interval—which alternates with a time interval called the fixed-zero interval that equals  $2048/f_{in}$  (Fig. 2). Module IC<sub>2</sub> uses its integrating amplifier in a dual-ramp mode. The Y signal causes the IC<sub>2</sub> integrator to ramp up during the zero interval, and the Z signal causes it to ramp down during the measurement interval.

When the down slope reaches a comparator threshold, the signal path between the analog input X and IC<sub>1</sub> is opened by the 3N164 analog gate. Thus the pulse width of  $T_m$  is, in effect, modulated by the variable ratio  $-Y \cdot k/Z$ .

To obtain the 0.2% accuracy, four calibration steps are needed (Fig. 3):

1. Apply  $X = 2$  V,  $Z = 0.6$  V and  $Y \cong -0.9$  V and adjust the full scale trimmer,  $R_{11}$ , so the circuit output is equal to  $-2Y$  volts.
2. Keep voltage on X and Z, as in step 1, and apply approximately 0.02 V to the Y input. Adjust the zero trimmer,  $R_{10}$ , so the circuit output reads the new value of  $-2Y$  volts.
3. Repeat step 1.
4. Repeat step 2.

The combined resistance of  $R_9$  and zero-trimmer  $R_{10}$  provides a small amount of charge to the IC<sub>2</sub> integrator, because the integrator is clamped below 0 V.

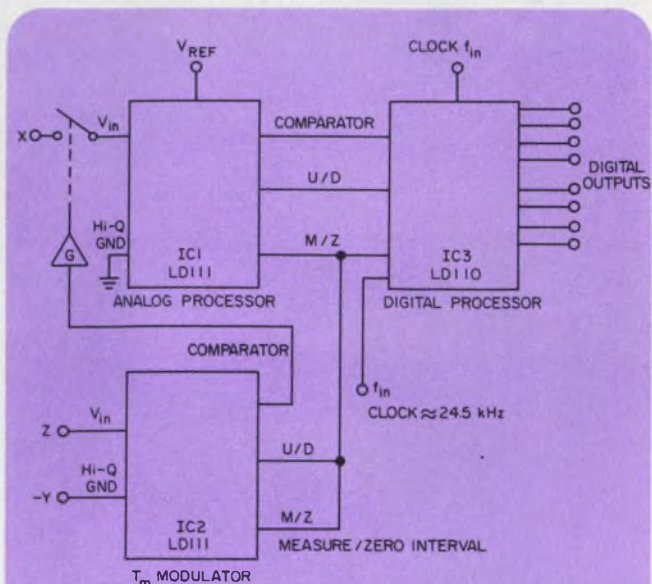

1. This multiplier/divider consists of a simple a/d converter plus a modulator. IC<sub>1</sub> and IC<sub>2</sub> form the converter. IC<sub>3</sub> is the modulator.

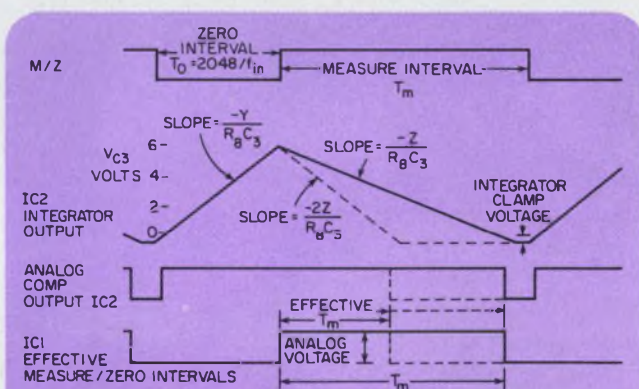

2. The  $-Y/Z$  factor controls the effective  $T_m$  value of IC<sub>1</sub>.

If an input voltage,  $U$ , is applied to pin 2 of IC<sub>1</sub> and  $V_{ref}$  is made a variable,  $W$ , the transfer function would become

$$\frac{XY}{Z} \cdot \frac{2U}{W} \cdot 4096 \cdot \frac{R_1}{R_2}$$

This modification can provide extra flexibility for data reduction without need for additional circuitry.

Gary Grandbois, Siliconix Inc., 2201 Laurelwood Rd., Santa Clara, CA 95054.

CIRCLE NO. 312

(continued on page 94)

# Gates introduces the future in energy cells.



There's now a new energy source that's a superb alternative: Rechargeable, sealed lead-acid batteries from Gates.

We call these batteries the future in energy cells. And for good reason.

They have all the product advantages you need plus economic advantages that may well give a new dimension to your product pricing.

Advantages: Gates Energy Cells are as compact as nickel cadmium or gelled type cells. And they are completely sealed, so that no acid vapor can leak out (they also include a self-sealing vent for extra safety). Gates Energy Cells provide low internal impedance for high discharge rates (more than 100 amps from the D cell and 200 amps from our X cell for short periods of time). And can be operated or stored in any position.

Gates Energy Cells offer great packag-

ing flexibility. In fact, our individual cell availability allows you to choose your own specific voltage (in 2-volt increments) and current, as well as configuration.

Just as important as what Gates Energy Cells have to offer is what they don't have to offer. Like outgassing problems. Or cell reversal. Or "memory" problems.

Because Gates Energy Cells are made from low-cost materials that are readily available, they're very high in watt-hr. per dollar value. Which means that if you specify them, you'll probably save your company more than a few dollars. And make yourself into something of a hero in the bargain.

To find out more about the future in energy cells, circle our reader service number or write us. We'll send you *free* literature containing features, application information, ratings and specifications. George Sahl, Gates Energy Products, Inc., 1050 S. Broadway, Denver, CO 80217.



**Energy Products**

*Where the  
energy future is now*

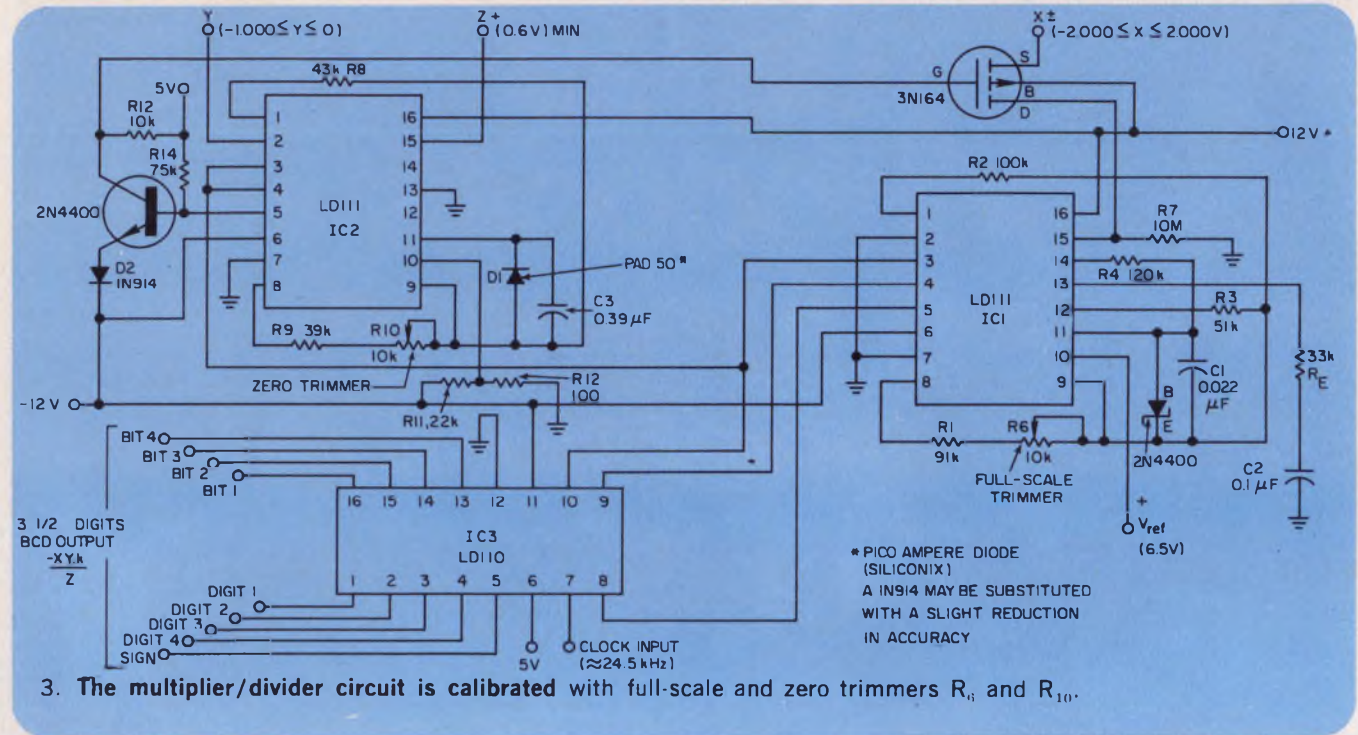

## Audible alarm tells when car lights are on and ignition switch is off

A reliable solid-state circuit provides an audible warning whenever the automobile ignition is off and the headlights or parking lights are on.

The circuit uses a unijunction transistor oscillator that is biased on when the ignition is off and the lights are on. The oscillator drives an 8- $\Omega$  speaker. The time constant of  $R_1C$  determines the frequency of oscillation. Many unijunction transistors will work in this circuit, including the 2N2160, 2N1671 and TIS43. The circuit, as shown, is intended only for vehicles with the battery negative at ground.

The input that goes to the lights can be connected at the light switch or to the instrument-panel fuse terminal. The input from the ignition can be connected to the ignition switch or to any fuse that is live only when the ignition switch is on, such as the radio or heater fuses. In most vehicles the fuse panel is more accessible than the switches. Solderless connections to the fuses can be made if wires are wrapped around the load end of the fuses and the fuse clips are used to hold the wires in place.

*Jack Elias, Senior Development Engineer, Honeywell Inc., 1100 Virginia Dr., Fort Washington, PA 19034.*

CIRCLE No. 313

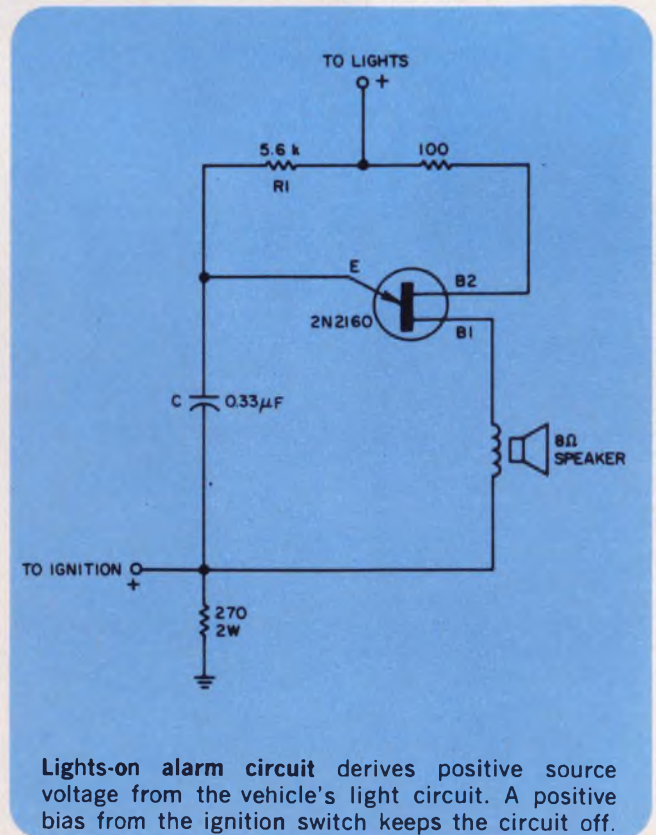

# If your bench scope says your ECL logic looks like this...

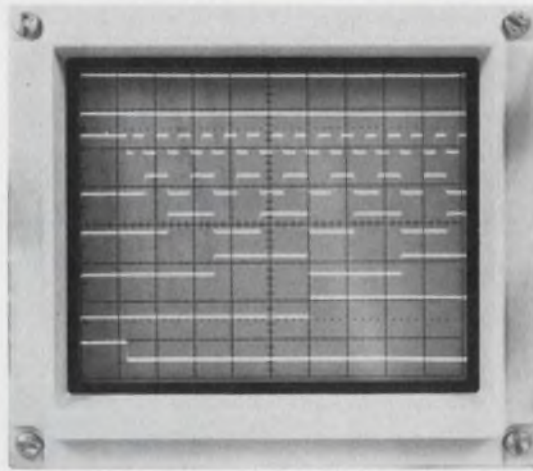

## ...you're using the new 100MHz 8100-D Digital Logic Recorder from Biomation.

**Introducing the new 100MHz Glitch Fixer: Biomation's 8100-D puts a faster fix on faster glitches.**

The original Glitch Fixer, Biomation's 810-D, has been helping a lot of engineers study timing relationships of 8-bit signals at speeds up to 10MHz.

But because the world's going faster—with MECL, ECL II, ECL III and Schottky-clamped I<sup>2</sup>L parts in your boards—we've built a new digital logic recorder, the 8100-D, with speeds up to 100MHz.

It's the new-and-faster way to turn your ordinary bench scope into a data stream display. It records 8 data channels at once and presents them in the same format you're used to seeing on data sheets.

The 8100-D features built-in combinatory logic setting to help you isolate your problem event *fast*. It has a big memory, too; can store up to 2,048 8-bit data words, including the often critical information that lies *just ahead* of the

triggering event. And it also provides digital output for computer analysis or mass storage.

The 8100-D is a piece of diagnostic instrumentation that circuit designers and troubleshooters have been asking us for. We will be glad to send you all the splendid details. Just use the reader service number or get in touch with us directly. Biomation, 10411 Bubb Road, Cupertino, CA 95014. (408) 255-9500. TWX 910 338 0226.

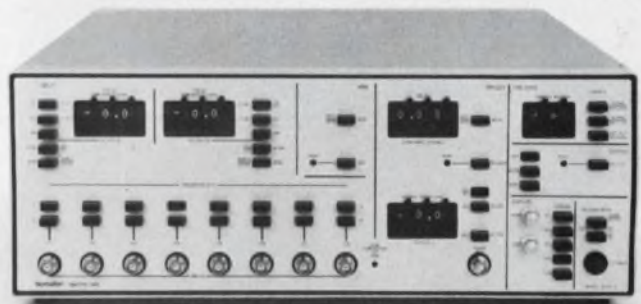

# biomation

INFORMATION RETRIEVAL NUMBER 45

# Wide-range voltage-to-frequency converter uses only one dual op-amp IC

A voltage-to-frequency converter (Fig. 1) can be built with only one IC, five resistors and, surprisingly, no external capacitors. The cost: less than \$15.

The circuit uses a programmable op amp, whose slew rate and other parameters vary linearly with a so-called set current (Fig. 2).

Several such programmable op amps are available. Of these, the HA2730—a two-amplifier monolithic chip with independent programming ports for each amplifier—can achieve 4-to-5 decades of programming range.

The converter circuit uses one amplifier,  $A_1$ , as a slewing amplifier and the other,  $A_2$ , as a comparator function. The output of  $A_2$  applies large positive and negative voltage steps to  $A_1$  to alternate the direction of  $A_1$ 's output waveform. Amplifier  $A_2$ 's positive-feedback network produces hysteresis, which controls the absolute value of  $A_1$ 's output. And for optimum step response  $A_2$ 's set current to pin 13 is statically programmed for maximum slew rate.

The control voltage,  $V_c$ , however, determines  $A_1$ 's slew rate. And because  $A_1$ 's output voltage swing is constant, modulation of its set current results in direct control of the circuit's frequency. Actually,  $A_1$ 's internal compensation capacitor acts as the timing component. And an in-

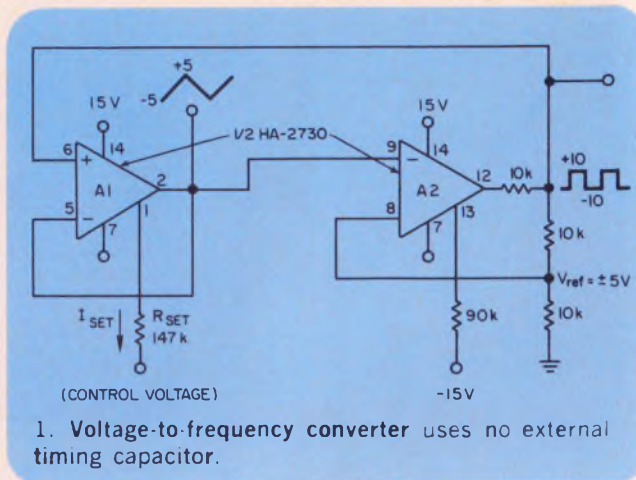

ternal bipolar current source, whose current magnitude is directly proportional to the set current of pin 1, then determines the charge-discharge rate.

An experimentally determined curve (Fig. 3) shows a conversion nonlinearity of less than  $\pm 0.03\%$  of full scale over 3 decades and  $\pm 1.5\%$  of full scale over 4.3 decades of frequency. The frequency range is adjustable by a change in the resistance of  $R_{set}$ . Amplifier  $A_1$ 's output

(continued on page 98)

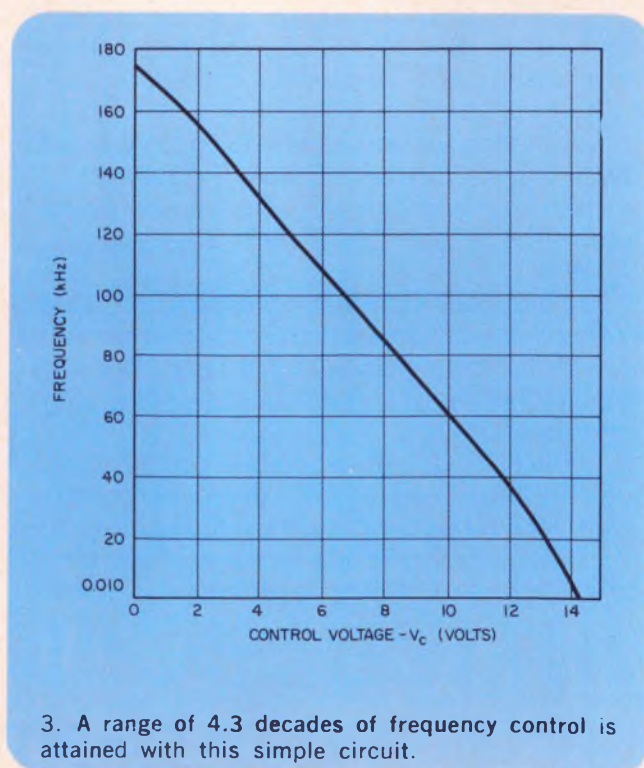
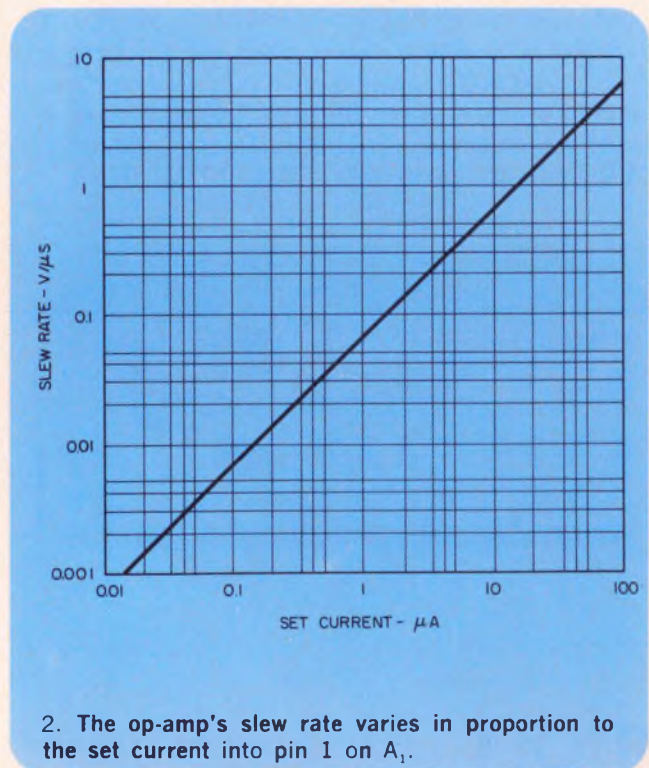

# And now, for debugging serial data,

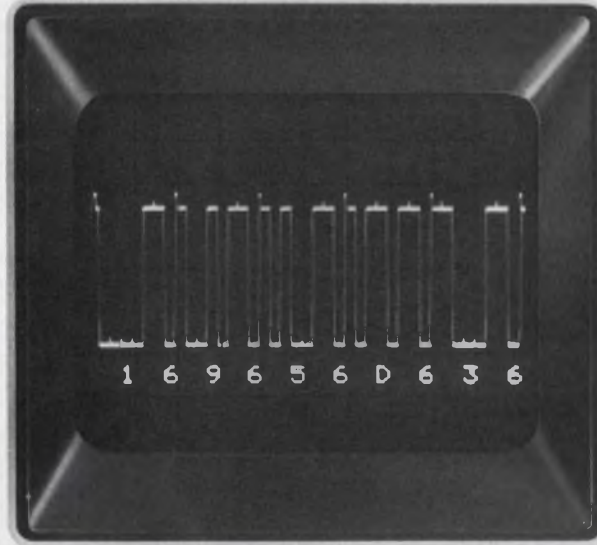

## Biomation brings you the 110-D.

Not just a new product. An entirely new kind of data recorder. From the folks who brought you the Glitch Fixer.

The best way to tell you about the Biomation 110-D's dramatic new way of debugging serial data is to show you the memo from our own engineering staff that sold us on the concept.

### Purpose

Designed to monitor, store, and display serial data, either synchronously or asynchronously. Major uses as follows:

#### 1. High speed synchronous data (up to 10MHz)

- Rotating memories (drums, disks, floppy disks).
- Digital tape decks—up to and including high performance 3200 bpi reel-to-reel decks.

*110-D will "snapshot" data and display it free of the jitter normally seen when using scope.*

- Shift register and delay line memories (MOS shift registers, magnetostrictive delay lines, glass delay lines, etc. such as found in CRT-type data communications terminals and other video-refresh applications).

*110-D will snapshot changing data patterns and allow stored analysis, otherwise impossible with scope.*

#### 2. Low speed synchronous data

110-D utilizes static RAMs to prevent data loss at low speeds.

- Synchronous modem channels—data between modem and terminal, between modem and computer front-end, etc. Includes Bell 201-type modems and other proprietary synchronous modems.

*Using a scope has same problems as above: changing data patterns and channel jitter makes analysis difficult or impossible.*

#### 3. Low speed asynchronous data

- Asynchronous modem channels—Bell 103- and 202-type modems and equivalent units from independent suppliers. **110-D has switchable internal clock for sampling data at normal data baud rates.** Also has start-bit validation logic, for "framing" the data in start-stop data.

- RS232 data channels—includes nearly all computer terminals, both video and hard-copy. Teletype KSR-33 and Dataspeed 40 terminal are typical examples.

*Asynchronous data is not only changing and jittering, but is coming in asynchronous bursts. The 110-D will time-compress the data to permit whole message groups to be easily observed.*

*Data from low speed computer peripherals—printers, card readers, card punches, paper-tape readers, etc. are often transmitted serially between them and the host main-frame. The 110-D is useful in developing and trouble-shooting these peripherals.*

There isn't enough room on this page to give you the whole story. Please call or write us for all the technical data and for a "hands-on" demonstration of a whole new solution to serial data problems. Biomation, 10411 Bubb Road, Cupertino, CA 95014. (408) 255-9500. TWX 910 338 0226.



# biomation

INFORMATION RETRIEVAL NUMBER 46

swing can be varied by a change in positive feedback in A. This change also affects the frequency range.

Additional circuit specs include an input volt-

age range of  $\pm 15$  V, outputs of  $\pm 5$ -V-triangular and  $\pm 10$ -V-square waves, an input control response of  $5 \mu\text{s}$  and an FM bandwidth of 60 kHz.

Ernie Thibodeaux, Senior Applications Engineer, Harris Semiconductor, P.O. Box 883, Melbourne, FL 32901. CIRCLE No. 314

## Build a linear, high-frequency detector with low offset and wide dynamic range

To get low dc offset drift over a wide temperature range in a detector circuit, plus good linearity, the diodes need not be used in the feedback loop. Thus the frequency range of the detector circuit is not limited by the gain-bandwidth of the op amp, but rather mostly by capacitance associated with the diodes. Such a detector circuit (see figure) can handle up to 5-MHz video bandwidth with a simple diode balancing and biasing technique.

The circuit's op amp inverting and noninverting gains are the same. Therefore input offset voltages from diode-resistance variations with temperature are amplified equally by both inputs. The result is very little net-offset change at the output.

A plot of change in output offset voltage vs temperature for various output levels shows that for output levels of less than 100 mV, where output offset is usually critical, offsets are held to less than 3 mV over a 50-C temperature range.

Good linearity is achieved by the use of low forward-drop, hot-carrier diodes that have been biased on slightly by the voltage across  $D_1$ . Better

than 3-dB linearity can be obtained over a 50-dB dynamic range from 25 to 70 C.

Christopher B. Schwerdt, Receiver Design Engineer, and Camie S. Marie, Westinghouse Electric Corp., Friendship International Airport, Box 746, Baltimore, MD 21203. CIRCLE No. 315

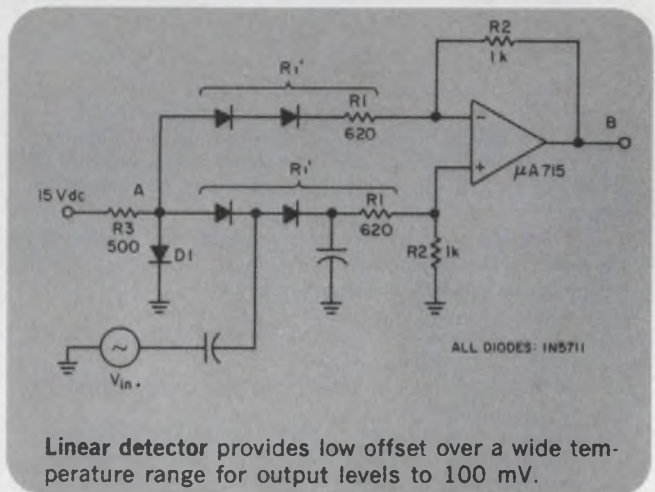

### IFD Winner of February 1, 1975

**Robert C. Dobkin**, National Semiconductor Corp., 2900 Semiconductor Dr., Santa Clara, CA 95051. His idea "Function Generator Produces Sine, Square and Triangular Waves" has been voted the Most Valuable of Issue Award.

**Vote for the best Idea in this issue** by circling the number for your selection on the Information Retrieval Card at the back of this issue.

**SEND US YOUR IDEAS FOR DESIGN.** You may win a grand total of \$1050 (cash)! Here's how. Submit your IFD describing a new or important circuit or design technique, the clever use of a new component or test equipment, packaging tips, cost-saving ideas to our Ideas for Design editor. Ideas can only be considered for publication if they are submitted exclusively to ELECTRONIC DESIGN. You will receive \$20 for each published idea, \$30 more if it is voted best of issue by our readers. The best-of-issue winners become eligible for the Idea of the Year award of \$1000.





# Save 40 to 60% on our "Gold Plate Special"

Nine times out of ten, barrel plating electronic contacts with gold or other precious metals means waste. Waste of material. Waste of money.

Our special SELECT-O-PLATE process, on the other hand, means practically no waste and money savings of 40 to 60%. SELECT-O-PLATE deposits precious metals (in thicknesses as thin as .000005") precisely where function requires and no place else; on the tips of contact points, or the center of lead frames, or on continuous coil-stripe or spot. We take every possible step to assure that plating quality matches your specifications. And your product's performance reliability either stays the same or improves.

There's a great deal more to tell you about SELECT-O-PLATE and how it can benefit your profit picture. If you'll call us or drop us a line, we'll send it to you.



## SELECT-O-PLATE

... Makes a little bit of gold go a long, long way.

## PRECISION PLATING COMPANY, INC.



Precious metal plating since 1904  
4123 West Peterson Avenue  
Chicago, Illinois 60646  
Tel: 312/583-3333

INFORMATION RETRIEVAL NUMBER 47

## Water pump driven by solar-cell panel

To demonstrate that solar cells can be used to drive mechanical equipment, a solar-energy water pump at the Laboratoires d'Electronique et de Physique Appliquee at Limeil-Brevannes, near Paris, was built in co-operation with the Philips research organization.

A solar-cell panel, which is 5 m<sup>2</sup>, delivers a maximum of 300 W to power an experimental pump that can raise water from a depth of 15 m. This is a situation comparable with that prevailing in the dry areas of many countries. With 3000 hours of sun per year, the pump is expected to deliver 1000

cubic meters of water a year for each square meter of solar panel. In the laboratory the pump delivered about half this amount.

This project also developed a new concept of handling power fluctuations in solar-cell installations. The short-term energy storage uses storage batteries, while the long-term storage uses the potential energy of water pumped into a tank. Solar cells have previously been used to provide power for isolated electronic equipment, such as radio and television relay stations and beacons for air traffic control.

## Bandwidth increased on waveguide horn

A new slot pattern that increases the bandwidth of a waveguide horn for the fast-wave balanced-hybrid mode (HE<sub>11</sub>) has been developed by Eljim in Nes

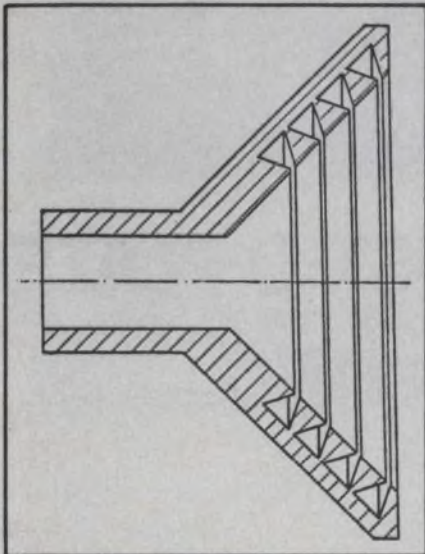

Ziona, Israel.

The design, using tapered slots (see illustration), has demonstrated a low standing-wave ratio from 7.5 to 18 GHz and a bandwidth of 2.4:1. This is in contrast with the usual bandwidth of 2:1 for a shuttered horn. In theory, the bandwidth can be 3:1. The researchers intend to extend the band characteristics of the feed section behind the horn in an effort to achieve a practical 3:1 design.

## Fused-silica device replaces lithium-niobate

Fused silica, a new substrate material for surface acoustic-wave devices, has been used by the Thomson-CSF ASM Div., Cagnes-sur-Mer, France, in a reflective-array signal compressor incorporating edge-bonded transducers.

The fused silica is low in cost, isotropic in nature and can easily

be machined. It compares favorably with lithium niobate, the usual material used for this application.

By profiling the depth of grooves that form the reflective grating of the surface-wave device, a flat amplitude response has been obtained over a 60-MHz bandwidth at a 100-MHz center frequency.

Thomson researchers have determined that edge-bonded transducers, which generate the Rayleigh waves on the silica substrate, have a low conversion loss that makes these transducers competitive with interdigital types.

## Liquid crystal stores high-contrast images

High-resolution, high-contrast images have been reproduced and stored for up to six months on a smectic liquid-crystal display at the Thomson-CSF research laboratories in Orsay, France.

The image was stored in a 16 × 14-mm cell made up of a 10- $\mu$ m film of smectic liquid crystal sandwiched between a 10- $\Omega$ -per-square of conductively coated, transparent glass. The smectic liquid crystal is one in which the material is initially in an anisotropic state but is charged to an isotropic state when heated locally—in this case, by a laser beam. Upon cooling, the cell acquires a stable, scattered anisotropic texture.

The image was impressed on the cell by scanning with an IR laser. The optical transmission of the beam-addressed point was controlled by variations in the voltage applied to the crystal. A continuous gray scale was reproduced. Total erasure was produced in less than 100 ms by application of an ac voltage to the cell.

Images have been synthesized on the cell by application of an amplitude-modulated, 40-kHz carrier voltage.

# SIEMENS

## Low profile relays Space savings in a proven design.

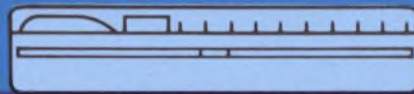
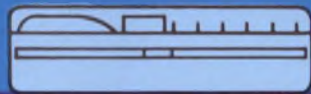
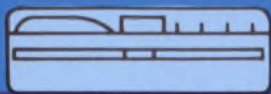

Siemens low profile relays permit nearly double the PC board mounting density compared to standard height relays. And only the Siemens design covers the full range—1, 2, 4 and 6 PDT contacts, with a uniform height of only 0.4 inches. Space savings that add up to greater dollar savings through better cabinet utilization.

Bifurcated contacts (standard) of fail-safe design assure maximum reliability over a long electrical life. Millions in use over the past four years confirm this proven design. Typical applications include communications systems, data processing and automatic control systems.

Delivery is assured as Siemens-designed low profile relays are available from more than one source.

Siemens low profile relays. Space savings in a proven design. Write for detailed literature.

**Siemens Corporation**  
**Special Components Division**

186 Wood Avenue South, Iselin, New Jersey 08830 (201) 494-1000

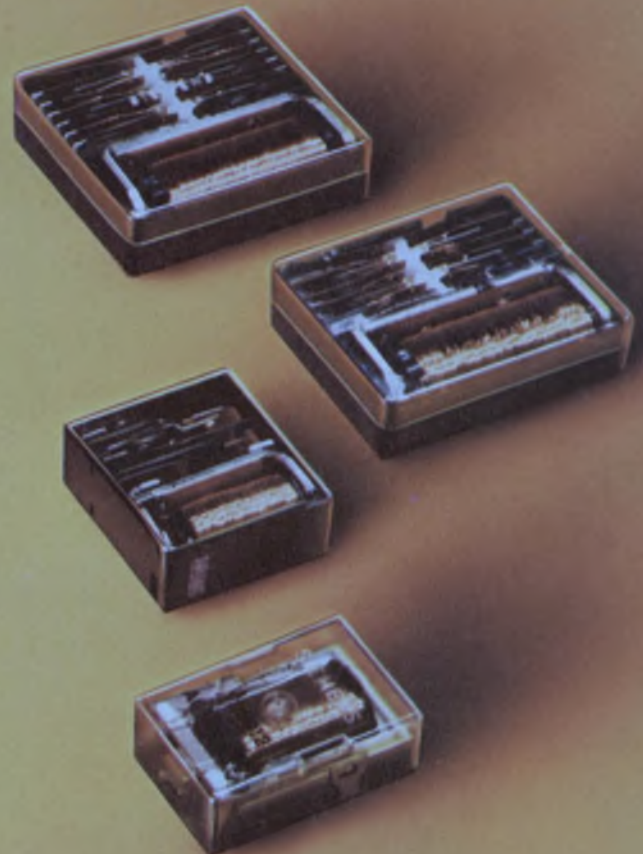

# Reliability is staggered steps and a hunk of DAP.

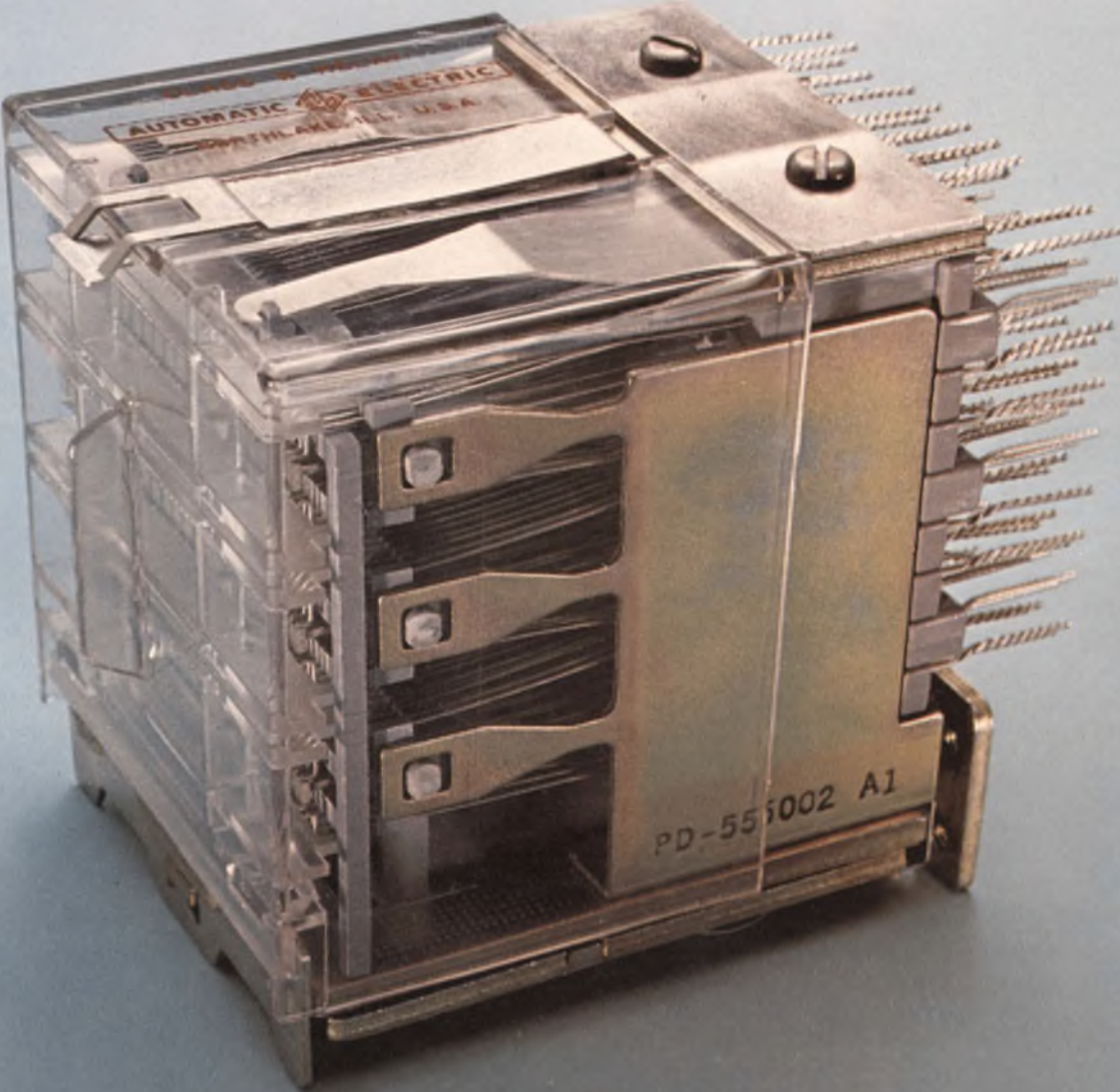

### Over a billion operations from 51 poles.

Our Class W wire-spring relay is different. In fact, there's nothing like it in the entire industry. Where else can you find a relay with 51 poles for transferring circuits and a mechanical life of more than a billion operations! That's about two and a half times the life of the best conventional relay around.

Another nice thing about our Class W is that it takes up a lot less space and costs less than using a bunch of other relays. That's because we build our Class W relay with one, two or three levels of contact assemblies, with 17 form C combinations per level. By the way, they're available with gold contacts for low-level switching.

### Making it tough on creepage.

All those staggered steps you see on the side were put in to raise the breakdown voltage between terminals. These molded steps add extra creepage distance between the terminals. This really counts for high voltage testing, or when using our Class W in unfavorable ambient conditions.

These steps, and all the molding compound used for insulating the contact springs, are made from

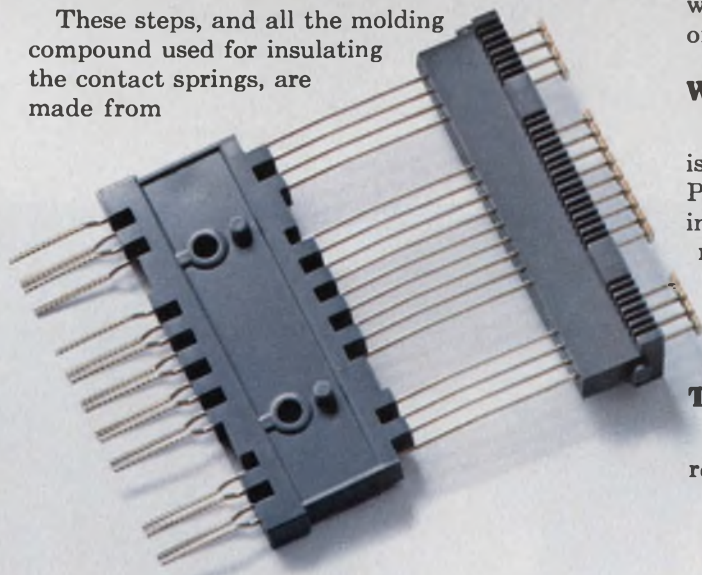

diallyl phthalate. (They call it DAP for short.) It has great insulating properties and it wears like iron. Even if the humidity is high, you have excellent protection.

### Redundancy—two springs are better than one.

Each of our long wire-spring contacts has an independent twin with the same function. One tiny particle of dust could prevent contact on other relays. Not with our Class W. You can be sure one of the twins will function. That's back-up reliability.

The twin contacts are twisted together at the terminal end. Then we give them a spanking (you might call it swedging) to provide solderless wrap.

### We're for independence.

Our springs are longer, because the longer the spring, the more independent they get. And the better contact they make. Don't forget, the wire-spring relay is the most reliable way to get a permissive make or break contact. You can rely on it.

The middle contact springs have to be stationary. To make sure they stay that way forever, we actually mold them between two thick pieces of DAP on both ends. Just try to move one.

### When we say flat, it's flat.

Each frame, banged out by a gigantic machine is extra thick and extra flat. Then they're planished. Planishing is another step we go through in forming the frame to add strength and stability by relieving surface strain.

We've made our spring-loaded pile-up clamp extra thick, too. Once it's tightened down, the whole pile-up is nice and tight, and stays tight.

### There's more.

We could tell you a lot more about our Class W relays. Like how the tough high-temp molded

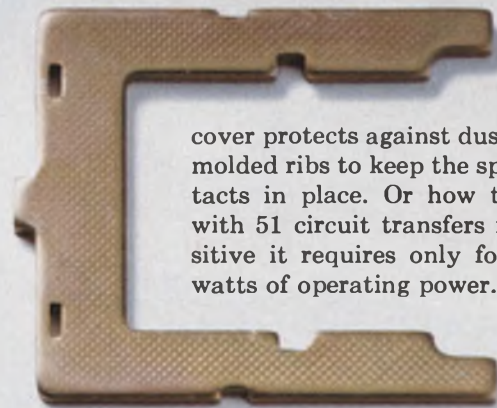

cover protects against dust and has molded ribs to keep the spring contacts in place. Or how this relay with 51 circuit transfers is so sensitive it requires only four to six watts of operating power.

But why don't you let us prove how much reliability we put into our Class W? We'll be waiting to hear from you. Government Industrial Sales Division, GTE Automatic Electric, Northlake, Illinois 60164.

**GTE AUTOMATIC ELECTRIC**

INFORMATION RETRIEVAL NUMBER 49

# Assemble prototype pots instantly.

New MOD POT Instant Prototypes equips you to put together virtually any pot you could want. And when you're ready for production, our distributors can quickly supply volume quantities to factory standards. Order a MPIP from your Allen-Bradley electronics distributor. \$97.50 apiece. Or, ask him for complete information on MOD POT... publication 5217.

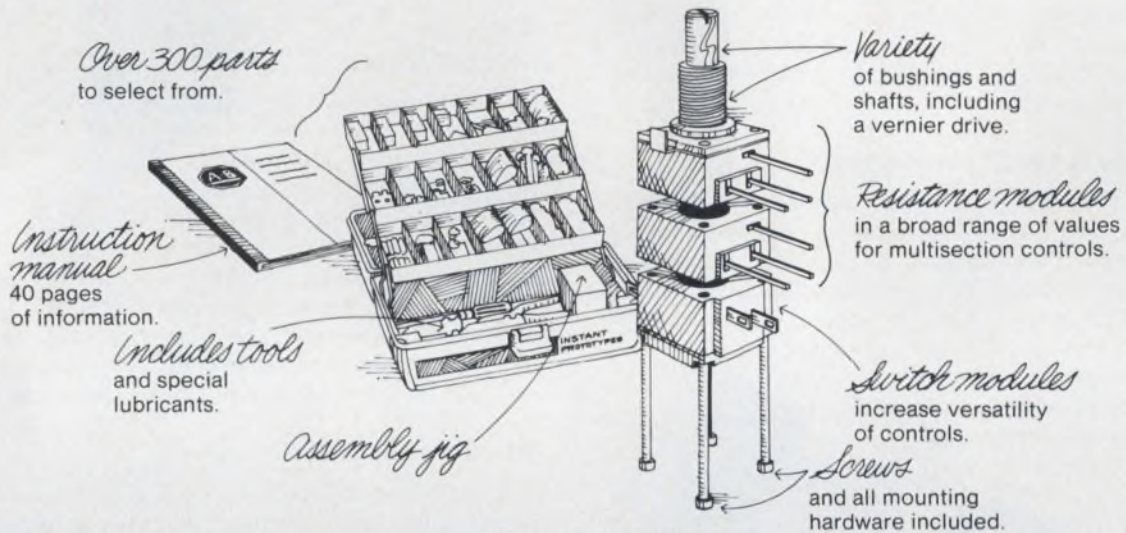

## Quality in the best tradition.



**ALLEN-BRADLEY**

Electronics Division  
Milwaukee, Wisconsin 53204

# Active-probe system adds new dimension to time-interval studies

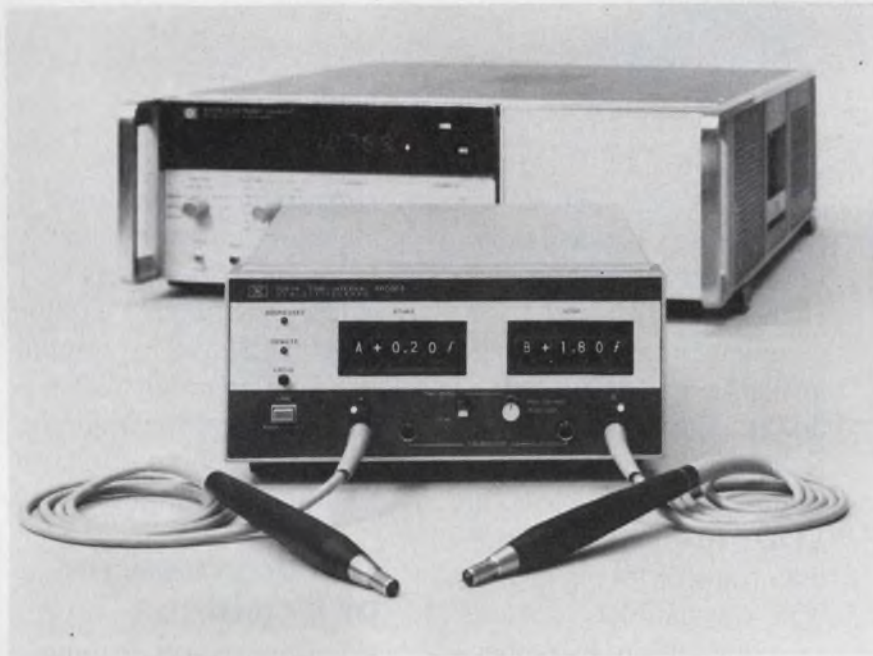

Hewlett-Packard, 1501 Page Mill Rd., Palo Alto, CA 94304. (415) 493-1501. \$1500; 30-60 days.

With a new piece of measurement gear, you bring a time-interval meter or counter to the signal, rather than the other way around. Hewlett-Packard's Time-Interval Probes, Model 5363A, sits between a signal and a counter and shrinks trigger-level errors, cuts signal loading and distortion, stretches the counter's dynamic range and brings other benefits.

It all adds up to more accurate measurements of rise time, propagation delay, pulse width and other time intervals.

The instrument consists of two active probes and what HP calls "a support box." The probes hook to your signals, and the box delivers outputs to your counter or scope. With this arrangement, the signal sees a high-impedance, low-capacitance front end (1 M $\Omega$ /10 pF), while the counter looks at a 50- $\Omega$  transmission line coming

from the support box.

On the box are two digital thumbwheels that let you move the trigger levels up and down along the input signals in 10-mV steps from -9.99 to 9.99 V. You know that the trigger point corresponds to the dial setting because the 5363A calibrates itself—all you do is flip a CAL switch.

The unit runs through the calibration process in about 1 s, then lights an indicator to signal that it's finished. If you change the slope or the probe for some reason, just hit the CAL switch again.

Each thumbwheel can be set to work with either probe so you can use one wheel for "start" and the other for "stop" to make A-B measurements. Or you can use both thumbwheels with one probe to accurately measure a signal's transition times. Thus counters that couldn't do so before, can now measure rise and fall times. Signal slope—positive or negative-going—is also selected with the

front thumbwheels.

Another feature of the HP 5363A—one that eliminates one source of error in start-stop measurements—is variable time delay. By insertion of a variable delay in the stop channel, with the delay adjustable by  $\pm 2$  ns, you can dial out unwanted differential delays. Or you can use the delay to add offset so that you can measure down to zero ns.

For an extra \$250, you can buy the HP interface bus option and let a processor or calculator control all of the 5363A's functions, except delay adjust. If the time-interval meter or counter is also programmable, you've got a complete time-interval system.

The Time-Interval Probes system isn't perfect, of course. Because of energy considerations, the input signal must remain above or below the trigger level for at least 5 ns. This limits the maximum input rate to 100 MHz. After calibration, the ambiguity in the trigger level is  $\pm 8$  mV  $\pm 0.2$  mV/ $^{\circ}$ C.

Accuracy of the unit is the ambiguity divided by the input slew rate (at the trigger point) plus 1 ns. The accuracy spec doesn't hold in the regions within 8% from the signal's top or bottom or within 100 mV from the top or bottom, whichever is greater. With both thumbwheels set to the same value, the trigger points will be within  $\pm 3$  mV of each other in a differential measurement.

Rise time of the HP 5363A is 1 ns. Counter outputs swing from -0.5 to +0.5 V into 50  $\Omega$ , with less than 2-ns rise time. Trigger-level outputs—useful for oscilloscope observations—are dc values that equal the level setting plus the ambiguity plus or minus 75 mV.

CIRCLE NO. 301

# Introducing 5 new LSI reasons to choose Isoplanar CMOS.

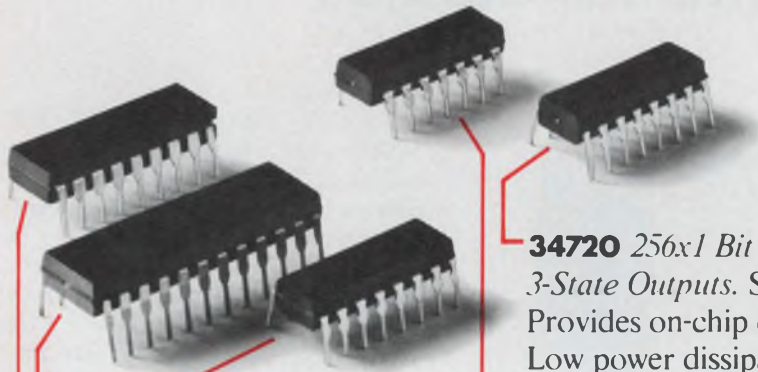

Now you can get five new LSI CMOS devices from Fairchild you just can't get from anyone else.

All five are the product of Fairchild's Isoplanar process.

And all five are available in quantity today:

**34702 Programmable Bit Rate Generator:** Controls up to 8 transmission channels. Provides all 13 popular bit rates. Conforms to EIA RS-404. With on-chip pull-up circuitry. And TTL compatibility.

**34703 16x4 Parallel/Serial FIFO:** Provides serial or parallel input and output. With 3-state fully-buffered outputs. New slim 24-pin DIP. Expandable without any external logic.

**34710 16x4 Bit Clocked RAM with 3-State Output Register:** Features full buffering. Edge-triggered. Optimized for register stack operation.

**34720 256x1 Bit RAM with 3-State Outputs.** Static. Provides on-chip decoding. Low power dissipation. High-speed. True and complementary outputs available. Fully-buffered.

**34731 Quad 64-Bit Shift Register:** Handles shift frequencies up to 4 MHz at VDD=10V. Serial-to-serial data transfer. 14-pin package. TTL compatible.

In addition, five other LSI CMOS circuits will be available soon.

## LSI, MSI or SSI. The choice is all yours.

If you like our new LSI, of course, you'll love our whole CMOS family.

*Fact. We've got what you want.* Fairchild offers all of the CMOS devices most popular today. Altogether, 65 devices available now in quantity.

*Fact. We've got it your way.* Ceramic and plastic DIP, Flatpaks, Chips, Commercial or Mil Spec with 38510 or our special Matrix VI processing. Any way you want it, we're ready to deliver it.

*Fact. We're more compatible.* While other manufacturers are busy redesigning their lines to catch up with our Fairchild 34000 Series, we're compatible with *all* other CMOS—and we've got the high performance and standardization you want *now*.

## The advantages of Isoplanar.

Here's another thing to remember.

LSI, MSI or even SSI—no matter what Fairchild CMOS you buy, you get the full advantages of our Isoplanar technology:

1. Highest guaranteed noise immunity.
2. Fully-standardized drive outputs for direct interface with low power TTL and low power Schottky TTL.
3. Propagation delay that's less dependent on loading—for increased system speeds.

And what makes it all extra nice, Fairchild's Isoplanar CMOS can replace any 4000 Series CMOS pin-for-pin.



## INSTRUMENTATION

### Need a midget DPM? It's line powered

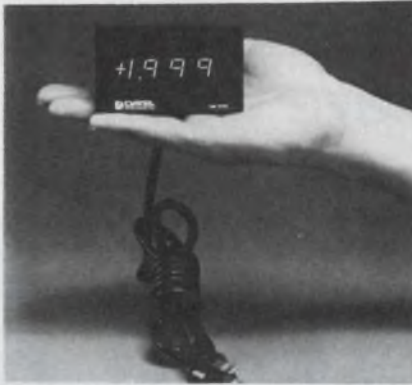

Datel Systems, 1020 Turnpike St., Canton, MA 02021. (617) 828-8000. \$159.

This miniature 3-1/2-digit DPM, which runs on 115 V ac and is dubbed the Model DM-2115, is claimed to be the world's smallest line-powered DPM. The unit measures 1.75 x 2.25 x 3 in. and accepts true differential inputs within  $\pm 1.999$  V. CMR is 70 dB up to 60 Hz and differential input impedance is 100 M $\Omega$ , min. Accuracy of the DM-2115 is within 0.05% of the reading,  $\pm 1$  count, tempo is within 50 ppm/ $^{\circ}$ C max or only five counts over the temperature range of 0 to 50 C. The unit has automatic polarity and overflow display and selectable decimal points. Power consumption is 3-1/3 W. Display is 0.43-in. LEDs.

CIRCLE NO. 304

### Unit monitors transients on 3-phase lines

Micro Instrument Co., 580 Opper St., Escondido, CA 92025. (714) 746-2010. \$3750; stock.

With three differential input circuits capable of either line-to-line or line-to-ground measurements, Model 520 SCR transient recorder measures peak transients and surges from dc to 1  $\mu$ s. The new instrument has a fourth recording channel to give the user a selection of measurements including frequency, undervoltage and current. Accuracy is +3% fs. Signals are preconditioned through memory circuits and presented on a four-channel strip-chart recorder having speeds for 1, 7 or 30 days continuous monitoring.

CIRCLE NO. 305

### 6-digit unit counts directly to 600 MHz

Ballantine Labs, P.O. Box 37, Boonton, NJ 07005. (201) 335-0900. \$795; 2-4 wks.

Model 5760A 6-digit counter weighs only 6-1/2 lb. and direct counts to beyond 600 MHz, said to at least halve the time required for full resolution. The display (0.43-in., 7-segment LEDs) holds the counter's last reading while the next one is being made. The high-impedance input (1 M $\Omega$ /25 pF) covers the range from 10 Hz to 180 MHz with a sensitivity of 35 mV rms up to 40 MHz, increasing to 100 mV rms at 180 MHz. The 50- $\Omega$  input is used from 10 to 600 MHz with a sensitivity of 35 mV rms up to 400 MHz and 65 mV rms up through 600 MHz.

CIRCLE NO. 306

### Burst noise test set has 4 input channels



Quan-Tech Div. of Scientific-Atlanta, Randolph Park West, Route #10, Randolph Township, NJ 07801. (201) 887-5508. \$9700; 12 wk.

The Model 2494 burst (popcorn) noise test set detects the presence of "popcorn" noise. It provides the threshold circuitry needed to segregate units on the basis of average noise voltage levels as well as peak voltage to average voltage ratio. Since the detection of burst noise requires a relatively long observation period, the 2494 is designed to measure four devices simultaneously in order to provide reasonable operator productivity. In addition to the GO, NO-GO information, a two-digit LED readout reads average noise voltage or the number of times the noise voltage exceeds the ratio threshold for each of the four test channels.

CIRCLE NO. 307

Send for your free  
CMOS Data Book  
today.



If you drop us a note, we'll be happy to send you our new Fairchild CMOS Data Book with complete information on 98 devices—available now or coming soon.

Or just write or call your Fairchild Sales Office, Distributor or Representative today.

Semiconductor Components Group, Fairchild Camera & Instrument Corp., 464 Ellis St. Mountain View, CA 94040  
Telephone (415) 962-5011  
TWX: 910-379-6435

**MADE IN**  
**FAIRCHILD**  
**No. 1 for logic and memory.**

**5PPM/°C  
and a  
20 year  
end-of-life...  
all in  
Angstrohm's  
new  
SAR  
precision  
metal film  
resistors!**

And that's not all! The new SAR Series of precision resistors is backed by Angstrohm's 15 year old reputation for providing a quality product that will outlast the equipment it's used in. Write, for complete technical specifications today!



**angstrohm  
precision, inc.**

one precision place  
hagerstown, maryland 21740  
telephone: 301-739-8722  
1wx: 710-853-6834

INTEGRATED CIRCUITS

**Data-communication ICs  
have 500-MHz bandwidth**

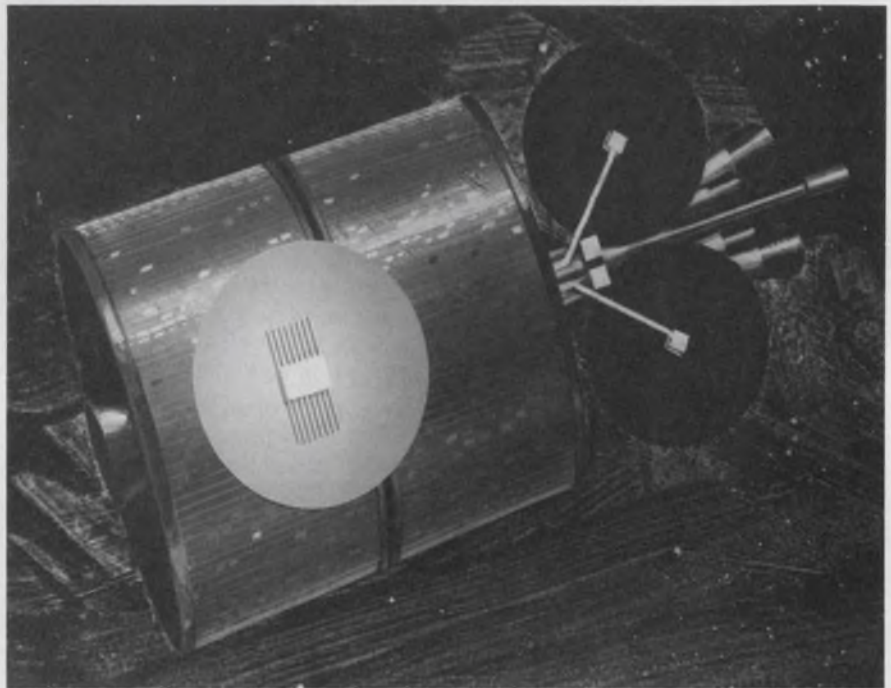

*Motorola Semiconductor Products, 5005 E. McDowell Rd., Phoenix, AZ 85008. (602) 244-6900. See text: stock.*

Whereas propagation delay and toggle rate have always been the key specs defining the speed of digital ICs, bandwidth becomes important if the application is data communications. The first logic-function ICs for data communications are now available from Motorola. They all have a bandwidth of at least 500 MHz. Bandwidth here is defined as the highest rep-rate signal that a circuit can pass while maintaining a specified minimum output logic swing.

Called the MC1601-1605, the five chips are all compatible with both the MECL III and MECL 10K logic families. The 1601, 1602 and 1603 are multiple-input OR/NOR gates. They have typical rise and fall times of 0.75 ns. The propagation delay for all three is also 0.75 ns, typical. Power dissipation ranges from 600 mW for the 1601 down to 320 mW for the 1603.

Similar rise and fall times and

propagation delays hold for the MC1604, a triple line receiver. Dissipation runs 460 mW, and, as with the three other chips, the 500-MHz bandwidth is specified for an output logic swing of 600 mV.

The MC1605 is a type D master-slave flip-flop. It toggles at 500 MHz and also has rise and fall times of 0.75 ns. Propagation delay increases to 1.2 ns on set or reset. With a clock input, the propagation delay is typically 1.4 ns and dissipation 525 mW.

Unlike those of other MECL III and MECL 10K devices, the outputs of the 1601-1605 cannot be wire-OR'd without significant loss of bandwidth.

Packaging is in the standard MECL III/10K 16-pin ceramic flat pack. At the high frequencies for which the chips are designed, DIP packaging is not satisfactory. Flat packs have shorter leads and hence lower inductance and reduced cross talk.

All of these circuits are also available in unpackaged chip form. When chips are used, optional pads

are included on chip to permit use of an additional  $-3.2\text{-V-dc}$  supply voltage. This can reduce on-chip power consumption by roughly 25%.

These circuits are the first of a new family of high-bandwidth functions, to be expanded during the next several months. They are expected to find application not only in data communications but also in such high bit-rate applications as real-time analyzers, oscilloscopes and laser systems.

Pricing of the 1601-1604 is \$16.90 (1-24) down to \$14.50 (100-999). The MC1605 costs \$24.60 (1-24) and \$22.40 (100-999).

CIRCLE NO. 303

## Instrumentation amp has FET input

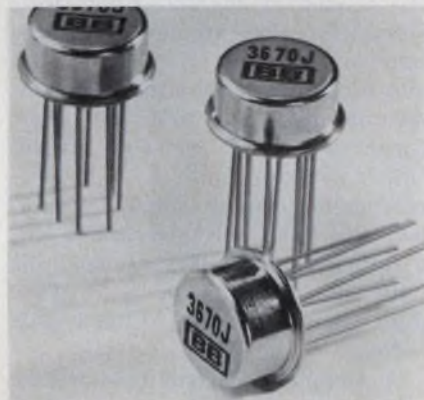

*Burr-Brown, International Airport Industrial Park, Tucson, AZ 85734. (602) 294-1431. \$26.60 to \$14.70 (100); small quantity from stock.*

The 3670—the first FET-input IC instrumentation amplifier—allows gain adjustments of 1 to 1000 V/V to be made with a single resistor. The amplifier has a maximum input bias current of 10 pA, an input impedance of  $10^{13} \Omega$  and CMR ranges from 60 to 100 dB. Three models are offered. The lowest cost unit is the 3670J which has a gain nonlinearity of 0.2% at a gain of 1000 and an offset voltage drift of  $50 \mu\text{V}/^\circ\text{C}$  (RTI). The 3670K and 3670S have a gain nonlinearity of just 0.1% at the same gain, and a voltage drift of  $25 \mu\text{V}/^\circ\text{C}$ . The J and K versions are specified for a 0 to  $+70^\circ\text{C}$  temperature range while the S version is specified at  $-55$  to  $+125^\circ\text{C}$ . All three models deliver a rated output of  $\pm 10 \text{ mA}$  at  $\pm 10 \text{ V}$ , and they come in a TO-100 package.

CIRCLE NO. 308

## 256-bit bipolar RAMs cut dissipation

*Advanced Micro Devices, Inc., 901 Thompson Pl., Sunnyvale, CA 94086. (408) 732-2400. \$13.50 to \$35.00 (100 up).*

A pair of 256-bit bipolar RAMs—the Am27LS00 and Am27LS01—employs low-power Schottky processing to reduce power requirements by 50 to 60% while main-

taining top speeds. The ICs have a guaranteed access time of 45 ns over the commercial temperature range, and 55-ns access over the military-temperature range. Typically, devices dissipate 275 mW compared with 500 to 700 mW for competitive units. Organized  $256 \times 1\text{-bit}$ , the RAMs come either with a three-state output (27LS00) or with an open-collector output (27LS01).

CIRCLE NO. 309



## Let's face it. People do judge by the cover.

Even the most sophisticated customers can't help being influenced by the way a product looks. That's why we're so careful about the design of our Optima enclosures. Because first impressions count.

Of course, we think about more than styling when we build our enclosures. We also design them with enough strength to last indefinitely. And we provide for just about any optional feature you might want. Detachable panels, chassis slides, hinged doors and the like.

The point of it all is real, honest quality. Optima enclosures are probably the very best you can buy. And they look it. And most important, that's how they can make your product look.

For a better idea of the broad range of Optima enclosures, ask for our color catalog.

**OPTIMA**

Write Optima Enclosures, a division of Scientific-Atlanta, Inc.  
2166 Mountain Industrial Blvd., Tucker, Georgia 30084 or call (404) 939-6340

INFORMATION RETRIEVAL NUMBER 54

**WERTRONIX**

**NO. 1 IN FHP MOTORS.**

OUR AD MANAGER ASKED US NOT TO MAKE THIS CLAIM. SO WE FIRED HIM.

He said we needed statistical data. We say we prove it with action.

You need a special motor fast? Call us. We zoom a sketch to our Small Quantity Department and ship in a day or two.

That's action.

Wertronix is a big company, too. We can get those 1,000 motors on your dock in 8 to 10 weeks.

That's action!

Anyone want to argue who's No. 1? The hell with loaded statistics... Call us and we'll prove it. With action.

**WERTRONIX**

2673 CULVER AVENUE  
DAYTON, OHIO 45429  
PHONE 513-299-5586

FREE NO. 1 BOOK: Full range of permanent magnet motors & gearmotors, 1/100-1/4 HP, military & commercial. Also tachometers, blowers, actuators, etc., design data.

INFORMATION RETRIEVAL NUMBER 55

# 17,568 design possibilities

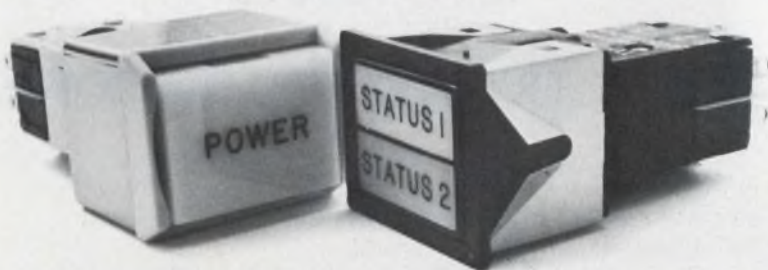

That's how many combinations you can have with Illuminated Products' new Series 700/800 Presslite switches.

Nine vivid colors. With barriers or without. Black or light grey housings. Snap-in or hard mount versions. One or two lamps. Split or single legend. One or two poles. Single or double throw. Alternate or momentary action. All this in a 10.5 amp switch that's impossible to tease. Write or call: Illuminated Products Inc., 207 S. Helena St., P.O. Box 4011, Anaheim, CA 92803. (714) 535-6037.

**ILLUMINATED PRODUCTS INC.**

A Subsidiary of OAK Industries Inc.



One innovation in a series.

INFORMATION RETRIEVAL NUMBER 56

## INTEGRATED CIRCUITS

### Calculator chips simplify designs



National Semiconductor Corp., 2900 Semiconductor Dr., Santa Clara, CA 95051. (408) 732-5000. \$16.25 to \$22.50 (1000); stock.

A series of programmable ICs simplifies the design of business and scientific calculators. The new ICs consist of the following: four special-function single-chip calculator circuits (the MM5760, 62, 63 and 64) and a calculator programmer circuit (the MM5765) that converts any of the new single-chip calculators into a fully programmable "learn mode" calculator. For each special-function IC, a complete calculator can be built with the addition of a display, digit driver, keyboard and 9-V battery.

A complete electronic slide-rule calculator with a three-level stack and a complete set of log and trig functions employs the MM5760 chip. If a programmable version is required the addition of the MM5765 calculator programmer circuit to the MM5760 slide-rule circuit produces a programmable machine with a 102 step memory.

The MM5762 business and financial calculator circuit offers single-key computation of present and future value of compound interest, deposit or sinking-fund amounts, payment or loan installments, and sum-of-the-digits calculations.

The MM5763 statistical calculator circuit includes linear correlation and regression, y-intercept, mean and standard deviation, summation of X or Y values, and other single-key functions.

The MM5764 international conversion calculator chip automatically converts from one measuring system to another for length, volume, area, or temperature—a total of 96 different functions.

CIRCLE NO. 310

## DATA PROCESSING

### Portable instrument recorder responds to mV



Spence Systems, 425 E. Green St., Pasadena, CA 91101. (213) 684-2246. \$3200 to \$5200.

The Microlog is an instrument grade four-channel recorder. Dimensions of the portable unit are less than 4-1/2 x 3-1/2 x 1-1/2 in. and the weight is 14 oz. Recordings of millivolt analog signals can be made onto any high quality cassette tape at frequencies down to dc. The recorder is powered by four small mercury batteries, which give a running time of 24 hours continuously or up to 30 days incrementally with a C120 cassette. The user can choose specifications for each channel such as FM, direct recording, timing pulser, event marking, incremental operation, etc., through use of small plug-in modules. S/n exceeds 30 dB. Playback is on a separate rack-mounted unit at up to 60 times recording speed for rapid data retrieval.

CIRCLE NO. 320

### Scanner-digitizer offers 400-line resolution

Celco, 70 Constantine Dr., Mahwah, NJ 07430. (201) 327-1123. From \$175,000; 6 mos.

A scanner called Masterscan can digitize images of up to 14 x 14 in. while scanning the area with 16 M points. The unit will calibrate itself and reduce an artwork master of 14 x 14-in. to a digital record in 16 s. The system offers 4000-line resolution. Automatic lens selection is available for different output formats, and 10 x 10-in. coverage. Masterscan includes machine-language software, computer selection and interfacing by the manufacturer.

CIRCLE NO. 321

### Core memory includes reconfiguration control

EMM Commercial Memory Products, 12621 Chadron Ave., Hawthorne, CA 90250. (213) 644-9881. \$3315; June.

Standard capacity for the Micro-memory 3000QD is 32 k words by 16, 18, or 20 bits per word. This can be altered to 64 k x 8, 9 or 10 bits by use of an external control signal. The three-wire, 3D core memory offers an access time of 300 ns. A plug-in card measuring 11.75-by-15.4 in. includes memory and support circuits. Only external power (15 V, 5 V and -15 V) is needed.

CIRCLE NO. 322

### Wang Basic computer comes in a faster model



Wang Laboratories, 836 North St., Tewksbury, MA 01876. (617) 851-4111. \$5800; 4 to 6 weeks.

The System 2200C computer boasts greater throughput than its predecessor, the System 2200B. As before the unit has rapid access to its 4 to 32k working memory; uses simple Basic language; and interfaces with a complete line of peripherals. Faster program overlays at double the tape loading speed make disc loading six times faster. A number of new Basic statements add to the system's already extensive vocabulary. The CRT screen can prompt the operator on how to recover from errors in application programs with the ON ERROR GOTO statement. COM CLEAR optimizes use of memory space. RETURN CLEAR improves subroutine efficiency. With DEFFIN'HEX, the user can enter customized codes for special characters directly from the keyboard. Older system 2200A and 2200B CPUs can be field-upgraded to a System 2200C for a retrofit charge.

CIRCLE NO. 323

## Advertisement

## ELECTRONIC PACKAGING

### Cabinet racks: upright, inclined, big, deep



Bud Radio, Inc., 4605 E. 355 St., Willoughby, O. 44094, (216) 946-3200. Shipped ready for use.

Series 2000 cabinet racks from Bud. Standard uprights, 16 sizes. Clear inside depths, 20 1/2", 24". Eight extra-deep units have 29 1/2" clear inside depth. Outside heights, 30 1/2" to 88". Mounting rails adjusted horizontally. Six inclined units. Clear inside depths, 20 1/2", 29 1/2". Front panel, 20° off vertical. Compare value, shipping economies. For the name of your local Bud Rep or Distributor —

PHONE (800) 645-9200, TOLL FREE

### Special fabrication of electronic housings



Bud Radio, Inc., 4605 E. 355 St., Willoughby, O. 44094, (216) 946-3200. Get what you want for less.

Bud designs and fabricates racks, cabinets, enclosures for new or re-designed electronic instruments or systems. Standard Bud housings can be altered to fit many applications. Original housings can be designed and produced. In addition, Bud's Imlock system can be used for short runs, test or pilot models. For the name of your local Bud Rep or Distributor —

PHONE (800) 645-9200, TOLL FREE

## Standard enclosures with custom features



Bud Radio, Inc., 4605 E. 355 St., Willoughby, O. 44094, (216) 946-3200. Your Bud Distributor has it.

Compucab by Bud. Dual-slope, off-the-shelf enclosures with custom-designed configurations. Use for a range of instruments. Maximum visibility — no fasteners on panel area. All aluminum. Cover and back in smooth white enamel. Base and sides, black textured enamel. Knockouts in rear panel. Rubber feet furnished. Two styles. Shipping economies. For the name of your local Bud Rep or Distributor —

PHONE (800) 645-9200, TOLL FREE

## Compact enclosures, versatile, economical

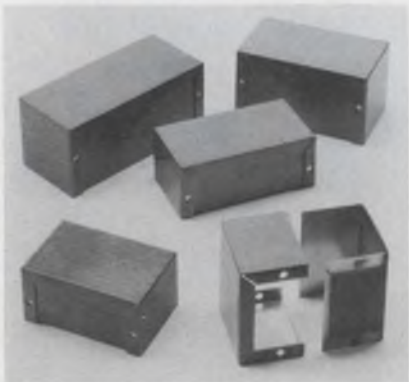

Bud Radio, Inc., 4605 E. 355 St., Willoughby, O. 44094, (216) 946-3200. Available in 18 sizes.

Miniboxes from Bud. Use as separate housings or as part of a larger assembly. Flanges give assured shielding. Projecting covers on cowl-type units minimize glare, protect controls, dials. .040 and .050 aluminum alloy. Immediately available. Shipping economies. One of nearly 3000 products from Bud Radio. For the name of your local Bud Distributor or Rep —

PHONE (800) 645-9200, TOLL FREE

## DATA PROCESSING

### Rf modems provide coax cable links

Catel, 1400-D Stierlin Rd., Mountain View, CA 94043. (415) 965-9003. See text; stock.

An rf modem, the FMTT 2200, provides a pair of channels in the 2-to-300-MHz range for coaxial cable links. The unit accepts inputs from modems, facsimile devices or voice multiplexers and provide the necessary modulation and demodulation. Units are available for audio or TTL modes and come in rack or flat-mount configurations. A modem pair for audio use costs \$845; for TTL data at 75 kbit/s the price is \$895.

CIRCLE NO. 324

### PC board acquisition systems plug into minis

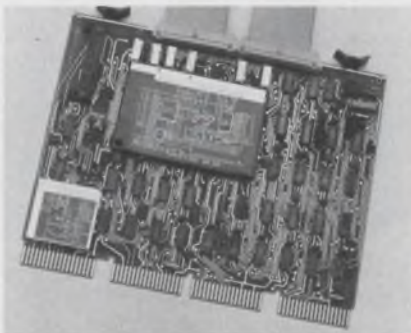

Adac Corp., 29b Cummings Park, Woburn, MA 01801. (617) 935-6668. See text; 6 to 8 wks.

The Model 600-11 data-acquisition system for the PDP-11 series computers is contained on a single 8.5 x 15-in. PC board. The Model 600-11 has a high speed (100 kHz throughput rate) 12-bit a/d converter, high speed sample and hold and 16 channels of multiplexer that can be expanded to 64 channels. Program interrupt is also included. The unit needs no external power supply, as it takes the 5 V which is available from the computer, and converts it to  $\pm 15$  V with a dc to dc converter. An optional programmable gain amplifier with gains of 1, 2, 5 and 10 extends the effective, dynamic range to over 40,000 to 1. The Model 600-11 is priced at \$1800 for the 16-channel version. The Model 600-8E, also card mounted, provides equivalent performance for PDP-8e minis and costs \$1900.

CIRCLE NO. 325

## digital pyrometer for \$146<sup>25\*</sup>



### LINEARIZES OUTPUT OVER THERMOCOUPLE RANGE 0° TO 2400°F WITH 1° RESOLUTION

- J, K, T, E, B, R & S Thermocouple Models with 0.2% Conformity
- Open Thermocouple Indication
- RTD Model with 0.1° Resolution
- Pre-Calibrated Plug-in Sensor Modules
- Dual Slope, Automatic Zero
- 13mm (1/2 inch) LED Display
- Parallel BCD Output
- Automatic Cold Junction Compensation
- Remote Control of HOLD and BLANKING
- DIN Case with Screw Terminal Inputs
- 500V Analog to Digital Isolation (Option)
- Digital Set Point Alarm (Option)
- 0 - 1V Linearized Analog Output (Option)
- 2 Year Warranty

\*OEM quantities

### FOR IMMEDIATE RESPONSE

Write: Newport Laboratories, Inc., 630 E. Young St., Santa Ana, CA 92705  
Call Collect: (714) 540-4686  
In Netherlands, Call:  
Amsterdam (20) 45-20-52  
In W. Germany, Call:  
Spremlingen 6103-63041

**NEWPORT**

## Data interface analyzer shows status of all lines



*International Data Sciences, 100 Nashua St., Providence, RI 02904. (401) 274-5100. \$160; stock.*

The Model 60 test set provides access to all 25 conductors of the EIA RS-232 interface. Twelve LEDs monitor the status at the source of 12 primary signals and two additional LEDs sense either positive or negative voltage levels greater than  $\pm 3$  V. Twenty-four miniature switches allow all interface conductors (except frame ground on pin 1) to be individually interrupted for isolated testing and observation of terminal or modem signals. Pins on each side of each switch and small jumper cables are provided to allow cross-patching and monitoring of signals. The Model 60 is self-contained in its own metal case. Two penlite batteries provide over 100 hours of continuous operation.

CIRCLE NO. 326

## Now a 'millicomputer' overlaps mini and micro

*Computer Automation, 18651 Von Karman, Irvine, CA 92664. (714) 833-8830. See text.*

Neither micro nor mini, the NAKED MILLI is almost micro size yet has almost mini performance. The NAKED MILLI has a large instruction set (93) and can perform a 16-bit add function in 6 microseconds. Standard features include programmed I/O, Direct Memory Address (DMA) and Direct Memory Channel (DMC). Optional features are real time clock, power/fail restart, autoload and Teletype/CRT serial interface. The processor uses bipolar TTL, and is available with core, RAM, ROM and PROM memories in sizes from 1k bytes to 32k bytes per memory module. In large quantities, the processor plus 1 kbyte of memory sells for \$560; the processor alone costs \$275.

CIRCLE NO. 327

INFORMATION RETRIEVAL NUMBER 60 ►

MARKING DATA  
SYNTRONIC INST INC  
ADDISON, ILL  
C9370-( ) 822

# A LOT MORE FOR A LITTLE MORE



## OUR NEW C9370 DEFLECTION YOKE

*gives you a lot more performance for just a little more money.*

Instead of a TV yoke that was designed for someone else—or even for another type of tube—and is limited by that design, now you can get a custom yoke to match your drive circuitry. You can get better resolution, superior geometry correction and 100% reliability, since every yoke we ship has been tested and approved.

In addition, you'll save money during assembly because our yoke does not require magnet adjustments to correct geometry. So the yoke that gives you a lot more, may be surprisingly economical.

Our engineers are ready to customize a C9370 for your precise needs. Call us for engineering service and design advice, or send for information about the Syntronic Instrument yoke that gives you a lot more for only a little more money.



## syntronic

SYNTRONIC INSTRUMENTS, INC.  
100 Industrial Road, Addison, IL 60101  
Phone: (312) 543-6444

### Single local device replaces two modems

*Computer Transmission Corp., 2532 Utah Ave., El Segundo, CA 90245. (213) 973-2222. Under \$300; 30 to 45 days.*

A dial-up data set simulator can now eliminate two data sets and provide direct communication between local terminals and computers or communications devices. Called Connectran, this low-priced device can, under operator control, link a central computer, concentrator node, packet node or multiplexer with a terminal located within a range of up to 1250 ft by means of an 11-pair twisted cable. Only one unit is needed at the terminal end. The Connectran emulates all originating and answering data set functions and operates at data rates up to 9600 bit/s depending on distance. Simple pushbutton operation enables the terminal operator to access a computer port. At the same time the unit notifies the operator if the port is busy.

CIRCLE NO. 328

### CRT terminal price drops below \$1000



*Lear Siegler, Electronic Instrumentation Div., 714 N. Brookhurst St., Anaheim, CA 92803. (714) 774-1010. See text.*

Designed to sell for less than \$1000, the ADM-3 CRT terminal displays a 12 x 80 line and can operate at rates up to 19,200 baud. The terminal has 53 keys, plus a special shift key, and can generate up to 128 ASCII codes. The display set is 64-character ASCII on a 5 x 7 matrix; capacity is expandable to 1920 characters, and data rates are switch-selectable. A rear-panel switch selects either an RS-232 or a current-loop interface. Quantity discounts are available.

CIRCLE NO. 329

### Small column printer is also reliable

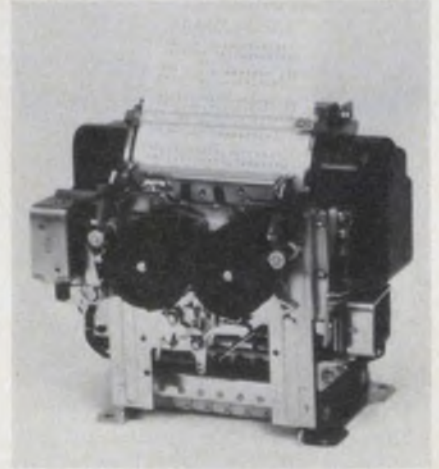

*C. Itoh Electronics, Inc., 280 Park Ave., New York, NY 10017. \$50 (qty); 3 to 3-1/2 mos.*

Designed for a MTBF of 5M lines, the AN-101F prints up to 21 columns at approximately 1.2 line/s. The drum mechanism used has a 42-character font and prints from a black-and-red inked ribbon. Signal inputs must be in parallel form. The over-all unit weighs 6.7 lbs. and operates from 17 V dc.

CIRCLE NO. 330

**When you consider "thumbwheels" ...**

**CONSIDER JOINING THE "ROTARY REVOLUTION" WITH JANCO EXPLOSION-PROOF PUSH BUTTON ROTARY SWITCHES**



BI-directional



UNI-directional

COMPARE with any thumbwheel... "Mil Spec Qualified" Janco Push Button Rotary Switches feature explosion-proof, totally enclosed construction, total environmental seal and EMI shielding. Adaptable to high density packaging it is engineered to function accurately, quickly and positively, at high switching speeds. Available in 8, 10, 12 and 16 positions in all standard coded outputs... truly a switch with "no hang-ups."

**Janco CORPORATION**

3111 WINONA AVE., BURBANK, CALIF. 91504  
PHONE 213-845-7473 • TWX 910-498-2701

INFORMATION RETRIEVAL NUMBER 62

# STABILITY YOU CAN COUNT ON...

**MURATA'S TEMPERATURE COMPENSATING CERAMIC CAPACITORS.**



- NPO TO N4700
- ALL STANDARD VOLTAGES
- FAST DELIVERIES
- RELIABILITY BACKED BY 30 YEARS OF EXPERIENCE

**muRata CORPORATION OF AMERICA**  
Rockmart Industrial Park, Rockmart, Georgia 30153  
Phone: 404-684-7143 Telex: 54-2999

INFORMATION RETRIEVAL NUMBER 64



### Chip thermistors come with leads and coating

Western Thermistor Corp., 303 Via El Centro, Oceanside, CA 92054. (714) 433-4484. Under \$1.00: 1 M  $\Omega$  (100 up); 4 wks.

Low-cost chip thermistors with leads and phenolic coating have resistance of over 1 M  $\Omega$ . The unit's nominal temperature coefficient (NTC) is  $-5.4\%/^{\circ}\text{C}$  at 25 C with a  $0^{\circ}/50^{\circ}\text{C}$  ratio of 14.3. Maximum diameter over coating is 0.1 in. Thermistors with 10 M  $\Omega$  at 25 C are expected to be in production in March, 1975. NTC will be as high as  $-5.8\%/^{\circ}\text{C}$  and Betas to approximately 5800 K.

CIRCLE NO. 331

### Cermet-film resistors available to 10 M $\Omega$



Allen-Bradley Co., 1201 S. Second St., Milwaukee, WI 53204. (414) 671-2000. \$0.17 (1000 up); 6 wks.

The maximum resistance value of the new Type CC cermet-film resistor has been extended from 1 to 10 M  $\Omega$ —in the same 0.250 L  $\times$  0.090 D-in., capless, 1/4-W package. Allen-Bradley claims that no other metal-film resistor is offered in so wide a range in this single small size. Standard tolerance is 1%. Temperature coefficient is  $\pm 100$  ppm/ $^{\circ}\text{C}$ . Recent developments in Allen-Bradley resistive inks have made it possible to provide this higher resistivity without a sacrifice in performance. The resistors have baked on alphanumeric markings with the resistance value shown in two places for easy identification. Performance characteristics are substantially superior to the established reliability specification MIL-R-39017 and the high-stability specification MIL-R-10509, according to Allen-Bradley.

CIRCLE NO. 332

# 3 HIGH VOLTAGE IDEAS FROM VICTOREEN.

#### TRANSIENT VOLTAGE MEETS ITS MASTER: VICTOREEN SPARK GAPS.

If you're looking for a way to capture line transients that could damage sensitive solid state power supplies or other circuitry which is easily damaged by transients, our SGL spark gap is your answer. Excellent primary protection can be achieved without a need for complicated line conditioners. Line transients with pulse widths of 75 nsecs to 1 msec will be detected. Nominal firing voltage is 215VAC peak with ramp rates of 100V sec. Energy dissipation capability of a single pulse is 65 joules. Try it our way. Victoreen spark gaps are available with DC firing voltages from 150-25kV.

#### HOW TO SIMPLIFY HIGH VOLTAGE REGULATION IN POWER SUPPLIES.

A need for fewer components is always appreciated. So, when regulating circuits where high voltage and current are required, try the excellent performance of Victoreen's HV Regulating Diodes. By combining a Victoreen 7235 triode with a GV3A-1200, a regulated range of 3-5 milliamps is achieved. Regulation of better than 0.2% is obtainable over the usable current range. Reliable regulation over a wide temperature span can be expected with a maximum temperature coefficient of 0.015%/ $^{\circ}\text{C}$  from  $-65^{\circ}\text{C}$  to  $+125^{\circ}\text{C}$ . High voltage regulation is simple, our way.

#### MINI-MOX CAN TAKE IT. FROM $-55^{\circ}\text{C}$ to $+125^{\circ}\text{C}$ .

The Explorer 'C' satellite is now analyzing ultraviolet absorption in the upper atmosphere. Aboard are a Magnetic Ion Mass Spectrometer and a Retarding Potential Analyzer. In the RPA, Victoreen Mini-Mox resistors provide feedback in an auto-ranging electrometer where temperatures can vary an incredible  $-55^{\circ}\text{C}$  to  $+180^{\circ}\text{C}$ . But performance over a wide temperature range is only one of the many outstanding characteristics of the Mini-Mox resistor. For new design freedom in stable and dependable high voltage circuitry, explore Mini-Mox. Off-the-shelf from Victoreen.

Victoreen Instrument Division,  
Sheller-Globe Corporation,

10101  
Woodland Avenue,  
Cleveland,  
Ohio 44104  
WATS Line:  
1-800-321-9990



SG SHELLER-GLOBE CORPORATION

115VAC  
R1  
AC SECONDARY  
NO  
\*PREVENTS TRIPPING AT TURN-ON

7235  
1200V UNREGULATED  
1M  $\Omega$   
VARYING LOAD  
GV3A-1200

1:1 5000megs  
10:1 500megs  
100:1 50megs  
GAIN 100  
AUTO RANGING ELECTROMETER

# Isolate your power supply problems...

## with Intronics' DC to DC Power Converters

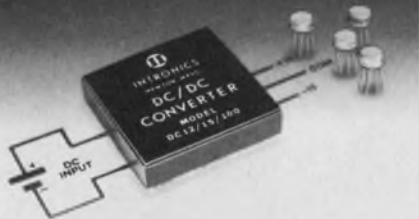

Intronics offers a high efficiency line of modular, compact DC to DC Power Converters, specifically designed for high input/output isolation. Each unit will convert a single unregulated DC voltage source to dual regulated output voltages and can be used to replace a separate AC input power supply many times its size. The compact design also ensures convenient circuit card mounting near the point of application, thus eliminating ground loop problems. Floating, tracking outputs with excellent regulation, low temperature coefficient, low output noise, current limiting to 150% of full load current and maximum power source protection are additional advantages you can expect from these Intronics' models, all at a competitive price.

### Features include:

- 5, 12, 28VDC Inputs
- $\pm 12$ VDC,  $\pm 15$ VDC Outputs, at 25 or 100mA
- 10 $\Omega$  ohms Input/Output Isolation
- 1% Preset Output Accuracy
- .02% Line/Load Regulation

Whether your design is for medical electronics, portable test equipment, ocean going or other mobile applications, specify Intronics' DC to DC Converters.



# intronics

57 Chapel Street, Newton, Massachusetts 02158 U.S.A.  
617-332-7350. TWX 710-335-6835

### Overseas call:

Brussels, Belgium 13-73-84  
Maidstone, England 54224  
Helsinki, Finland 11-123  
Paris, France 9077844  
Munich, Germany 524181  
The Hague, Holland 678380  
Milan, Italy 9043983  
Zurich, Switzerland 93-31-61

## COMPONENTS

### Slide switches come in multiposition versions

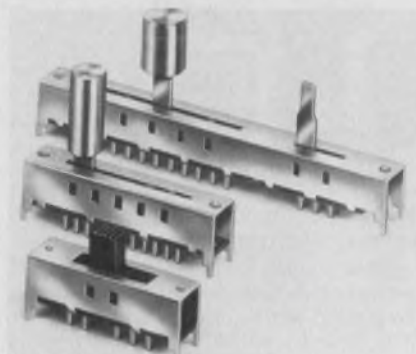

Alco Electronics Products Inc., 1551 Osgood St., North Andover, MA 01845. (617) 685-4371. \$0.60: Mod. SS-24 (500 up); stock.

Multiposition slide switches complement other slide components on PC boards and eliminate wiring errors. They are available in three styles: SS-24 (DP4T) with black phenolic actuator and SS-110-13 (SP10T+3) and SS-111 (SP11T) with aluminum or anodized, black, detachable knobs and with or without hairline indicator. Knobs must be ordered separately. All styles feature make-before-break action. Minimum life expectancy is 20,000 operations. Rated load is 300 mA at 30 V dc.

CIRCLE NO. 333

### Breadboard socket uses solderless connections

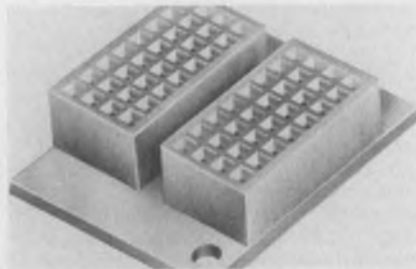

Vector Electronic Co., Inc., 12460 Gladstone Ave., Sylmar, CA 91342. (213) 365-9661. \$2.63 (unit qty); stock.

A new DIP socket for breadboarding allows convenient interconnection without soldering. The socket, Model 570G-1, consists of two nylon-based 0.85 x 0.47 x 0.30-in. termination blocks spaced to accommodate any standard 14 or 16-pin DIP component. Four tie-points per contact allow solderless interconnections with ordinary 22-AWG hook-up wire.

CIRCLE NO. 334

### Tachometer assembled into customer's product



Renco Corp., 26 Coromar Dr., P.O. Box 246, Goleta, CA 93017. (805) 968-1525. From \$47.36 (OEM qty).

The KT23A modular tachometer is available in resolutions from 100 to 1000 counts per revolution. The tachometer/encoder is supplied in three subassemblies: code disc and hub, light source and sensing electronics. The customer assembles and integrates these elements onto the shaft within the casing of his final manufactured product. The modular elements are prealigned to minimize the time and expense of final integration. The tachometer is 2-1/4 in. in diameter and 3/4-in. high. It can be supplied for shaft diameters from 1/4 to 5/8 in.

CIRCLE NO. 335

### Joy stick operates in up to 9 positions



Square D Co., Dept. SA, 838 W. National Ave., Milwaukee, WI 53201. (414) 384-8100.

Class 9001 Type M miniature joy-stick operators are available in three, five or nine-position models. The nine-position type uses the 45 degree diagonal as well as the vertical and horizontal positions. These devices can be obtained with momentary or maintained contacts and with or without a latch. Devices with a latch cannot be operated until the latch button in the center of the handle is depressed. Up to four contact blocks can be mounted on the back of the operator with either NO or NC contacts. Pressure wire or slip-on terminals are used.

CIRCLE NO. 336

## DIGITAL SENSOR improves resolution

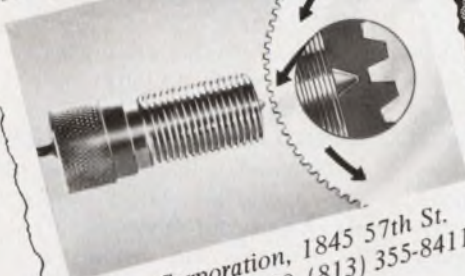

Electro Corporation, 1845 57th St.  
Sarasota, Fla. 33580. (813) 355-8411  
\$49 list: Stock to 4 weeks.

Send for complete catalog

Model 58413 Di-Mag® Digital Magnetic Sensor is designed for applications requiring very high resolution. Geometrically matched sensing tip (pole-piece) allows maximum resolution when used with fine toothed gears. Unit has self-contained signal conditioning circuitry and produces outputs compatible with TTL, DTL or HTL logic.



**YES... WE'VE BEEN BUSY!**

*This honey of a new product is but one of many — look for more in the New Product Sections of your favorite publications.*

INFORMATION RETRIEVAL NUMBER 74

From the people at Bodine and Bodine Distributors

## New PM drive systems

BODINE  
ELECTRIC  
COMPANY



1/8 thru 1/2 HP systems

Type DPM permanent magnet SCR adjustable speed/torque drive systems, for demanding applications. Available from stock.

**Built for rugged, long term use**—controls feature circuitry with wide degree of flexibility for end-use convenience. Chassis-type controls adaptable to any type sub-system.

**Our proven single source systems approach**—Bodine designs and manufactures both the control and drive units. Results: Perfect matching of controls with motors or gearmotors. You get high performance—more reliability.

Get the facts on Bodine DPM Control Systems.

Bodine Electric Company, 2528 W. Bradley Place, Chicago, IL 60618

INFORMATION RETRIEVAL NUMBER 75

ELECTRONIC DESIGN 12, June 7, 1975

## Now... AC MEASUREMENTS GO DIGITAL!

- True RMS Volts
- True RMS Current
- AC Watts

... all in YEW's new 2504 AC DMM!

The new 2504 digital AC instrument offers unexcelled accuracy and versatility for the measurement of sinusoidal and non-sinusoidal waveforms and for measurements at low power factors. Flexible design allows optional purchase of just the measuring functions required while push-button controls provide ease of operation.

The YEW 2504 is the AC DMM. Its 0.25% accuracy and 0.01% resolution, standard analog output, and low cost (Prices start at \$1,590.) make it the ideal instrument for quality control, lab, field maintenance, and instrument calibration applications. Write for details.



Standard ranges (Multirange Model):  
30V/60V/100V/150V/300V,  
0.5A/1A/2A/5A/10A (15W to 3,000W)  
Frequency range: 25 Hz to 1 kHz

**YEW**

Yokogawa Electric

**YEWTEC CORPORATION**

1995 Palmer Avenue  
Larchmont, N.Y. 10538

Telephone: 914-834-3550

60 Years of Measuring and Recording Instrumentation

INFORMATION RETRIEVAL NUMBER 76

## Dual-slope a/d's run from 5-V logic supplies



Datel, 1020 Turnpike St., Canton, MA 02021. (617) 828-8000. From \$79 (1 to 9); stock.

A series of modular, dual-slope, a/d converters has ratiometric operation and can operate from 5-V-dc supplies. The ADC-ER series modules produce either parallel binary or BCD outputs as well as -5 V dc power for driving transducers. Four-wire ratiometric operation lets you make accurate measurements with external references that could vary as much as 50% from nominal. Five models are available: 2-1/2 and 3-1/2 digit BCD versions and 8, 10 and 12-bit binary units. All modules give sign-magnitude coding with automatic polarity. Accuracy is 0.05% of reading  $\pm 1$  count and resolution is 1 mV for BCD outputs and 250  $\mu$ V for binary outputs. Temperature coefficient of gain is  $\pm 35$  ppm/ $^{\circ}$ C and offset TC is  $\pm 30$   $\mu$ V/ $^{\circ}$ C. Conversion time is 76.7 ms for binary outputs and 43.3 ms for BCD. All modules have differential inputs with a 100-M $\Omega$  input impedance and a 70-dB common-mode rejection. The high normal-mode rejection of 40 dB for line frequency is achieved by use of a signal integration time equal to a multiple of line frequency. The modules measure 4  $\times$  2  $\times$  0.4 in. (10.16  $\times$  5.08  $\times$  1.02 cm), consume 1.25 W and operate over 0 to 70 C.

CIRCLE NO. 337

## Electronic tach delivers control signal to 50 mA

Electro Corp., 1845 57 St. Sarasota, FL 33580. (813) 355-8411. \$275; 4 to 6 wk.

The Series 76600 Electro-tach controller is a fast response frequency-to-dc converter. It provides outputs of up to 50 mA and has a separate 0-to-1-mA meter output. Four full-scale frequency ranges that span 45 Hz to 25 kHz are available. Both low (10 mV rms) and high-level (5 V dc) inputs are accepted by the tach. High level signals may also be used to gate low-level input signals. Plug-in modules simplify frequency selection and spares requirements. Internal jumper-zero and span controls permit wide selection of outputs.

CIRCLE NO. 338

## Active bandpass filter has wide dynamic range

A. P. Circuit Corp., 865 West End Ave., New York, NY 10025. (212) 222-0876. \$650; 2 wk.

A variable-frequency tuned bandpass filter, Model 301, offers a typical dynamic range of 90 dB, a tuning range extending from 0.1 Hz into the audio frequency spectrum, and a low noise level. The frequency can be adjusted continuously in five decade steps. A single potentiometer continuously controls each decade of frequency. The bandwidth is set by another potentiometer within a range of Q from 5 to 100. Very low signal levels can be amplified up to 40 dB ( $\times 100$ ), or strong signals attenuated, by a variable-gain input amplifier.

CIRCLE NO. 339

## F/v converter delivers 0.05% linear signals

Richard Lee, Box 724, New Providence, NJ 07974. (201) 665-1333. \$37 (100-up).

The Model 713 frequency-to-voltage converter produces 0 to 1 mA for operating panel meters, I to F converters, etc., and simultaneously provides 0 to 1 V across 1000  $\Omega$  for operating DPMs, recorders, etc. Low-level, repetitive signals of 10 mV rms will produce a 0.05% linear output from the 713. Full scale is determined and set by the user over any input frequency range to 15 kHz. Only one supply voltage (+12 V dc) is required for operation. The unit measures only 1.5  $\times$  1.5  $\times$  0.6 in.

CIRCLE NO. 340

## Watt transducers have optical isolation

Macrodyne, 1900 Maxon Rd., P.O. Box 1079, Schenectady, NY 12301. (518) 342-5619. From \$150.

The WTM series of optically isolated watt transducers provides complete isolation with wide frequency response. Input signals are derived from current shunts and resistor dividers, completely eliminating transformer inputs and elements sensitive to magnetic fields. The units have an input frequency range that spans from dc to 2 kHz without loss of accuracy. The voltage and current product is computed through an optical isolator for each phase. The results are summed and filtered to yield instantaneous power. Power factor, reactive power and peak power may also be calculated.

CIRCLE NO. 341

**intech** INCORPORATED  
(408) 244-0500  
1220 COLEMAN, SANTA CLARA CA. 95050

## High voltage amplifiers handle up to 290 V pk-pk

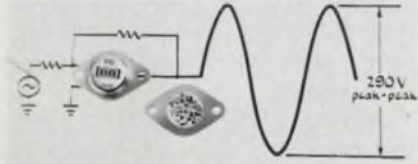

*Burr-Brown, International Airport Industrial Park, Tucson, AZ 85706. (602) 294-1431. From \$27 (100-up); stock.*

The 3580 series of FET-input operational amplifiers provides output voltage swings of up to  $\pm 145$  V. That's up to 290 V pk-pk from a TO-3 package. These new amplifiers are claimed to be the first high voltage units, either modular or IC, to have their own self-contained automatic thermal protection. Another feature of the 3580 series is that all units will dissipate over 3 W without a heat sink. Add a suitable heat sink, and they'll go up to 4.5 W. Depending upon model, CMRR varies from 86 to 110 dB and slew rate from 15 to 20 V/ $\mu$ s. The three models available include the 3580J ( $\pm 18$  to  $\pm 35$  V dc supply), 3581J ( $\pm 32$  to  $\pm 75$  V dc) and the 3582J ( $\pm 70$  to  $\pm 150$  V dc).

CIRCLE NO. 342

## Track/hold amplifier has teraohm input Z

*ILC Data Devices, Airport International Plaza, Bohemia, NY 11716. (516) 567-5600. From \$200 (unit qty); 4 to 8 wk.*

The DTH-8111 hybrid differential track-and-hold amplifier has an input impedance of  $10^{12}$   $\Omega$ . Additional features are low hold drift of 0.25 mV/ms and an acquisition time of 10  $\mu$ s. Its high input impedance makes it directly compatible with the company's 1507 series of eight-channel dual-input multiplexers. The unit can be supplied with selected accuracies to 0.01% and in track-to-hold steps of 0.02%. The amplifiers are designed to meet MIL-M-35810 and are processed to MIL-STD-883. Model DTH-8111 is guaranteed for operation from  $-55$  to  $+85$  C with operation to  $+125$  C available on special order. The units are housed in  $1 \times 0.8 \times 0.2$  in. hermetically sealed DIPs.

CIRCLE NO. 343

# The Sure Cure for HYBRID TENSION from Raytheon/Quincy

When hybrid problems cause hybrid tension, our custom hi-rel capability can cure it. We're the hi-rel hybrid specialists... in chip-and-wire and beam lead units... for military and medical electronics exclusively. Where a cure *has* to be sure, you can rely on Raytheon/Quincy to provide the custom hybrid you need. Just contact Mr. K. Singh at Raytheon. He'll make you feel better right away. Raytheon Company, Industrial Components



Operation,  
465 Centre  
Street,  
Quincy, Mass.  
02169.  
(617) 479-5300.

RAYTHEON



**our products  
are more fully  
developed...**

Standard Condenser capacitors are indeed fully developed to produce the optimum in performance and durability. Standard is in one business only, the design and manufacture of the world's finest capacitors. We have designed and delivered thousands of specialized capacitors for industry. In fact, what you think of as "special" may be among the many designs already available from stock at Standard. However, if you require capacitors of unusual shape, size, value and material, our engineering department will help you design and produce them to your exact specifications at stock prices. For immediate action, send us a sketch and complete details.

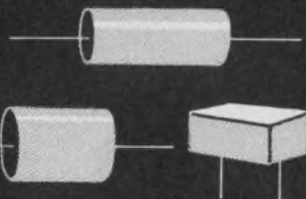

Write or phone for catalog and details.

**Standard**

**CONDENSER CORPORATION**

Dept. ED-6 1065 West Addison Street  
Chicago, Illinois 60613 • (312) 327-5440

INFORMATION RETRIEVAL NUMBER 73

**DISCRETE SEMICONDUCTORS**

**High voltage transistors  
designed for CRT use**

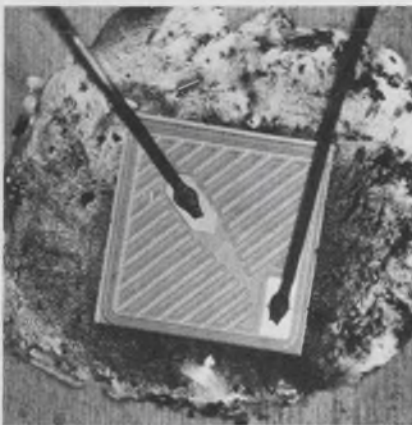

SGS-ATES Semiconductor, 435  
Newtonville Ave., Newtonville, MA  
02160. (617) 669-1610. 100-up  
prices: \$2.40 (406); \$2 (407);  
stock.

The BU 406 and BU 407 are npn transistors designed specifically for CRT horizontal deflection circuits. The BU 406 has a breakdown voltage of 400 V and a peak repetitive collector current of 10 A, while the BU 407 has a 330-V breakdown. These transistors are housed in TO-220 plastic cases.

CIRCLE NO. 344

**Optoelectronic switches  
available in two models**

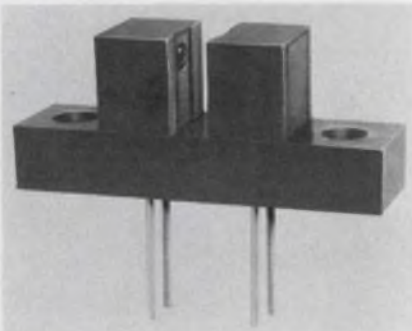

Spectronics, 830 E. Arapaho Rd.,  
Richardson, TX 75080. (214) 234-  
4271. \$1.45 (1000-up); stock.

Two optoelectronic switches, designated SPX 1874 and SPX 1873, are direct electrical and mechanical replacements for General Electric types H13A1, H13A2, H13B1 and H13B2 and Monsanto MCA8/81 and MCT8/81 types, respectively. The switches are available in both phototransistor and photo-Darlington versions.

CIRCLE NO. 345

**Power-switching  
transistors handle 25 A**

General Semiconductor Industries,  
P.O. Box 3078, Tempe, AZ 85281.  
(602) 968-3101. From \$7.50 (100-  
up); stock.

A family of npn high-current, fast-switching transistors has a 25-A maximum collector current. The 2N6338 through 2N6341 transistors can dissipate 200 W, have rise times of less than 0.3  $\mu$ s and turn-off times of less than 1.25  $\mu$ s.  $V_{(E(S))}$  ranges from 100 V dc in the 2N6338 to 150 V dc in the 2N6341. The transistors are housed in TO-3 metal packages.

CIRCLE NO. 346

**Hyperabrupt diode  
series handles 25 V**

MSI Electronics, 34-32 57 St.,  
Woodside, NY 11377. (212) 672-  
6500. \$4.90 (100-up); 2 wk.

In the ZC800 through ZC806 series of hyperabrupt tuning diodes, the characteristics of these 25-V devices are preserved even for the large area 100 pF types. The diodes have capacitance values from 10 to 100 pF when measured at 2 V. The capacitance tuning ratio measured from 2 to 20 V is a minimum of 5:1. At 3 V and 8 pF, the Q is a minimum of 300 while at 3 V and 85 pF, the Q is 100 minimum when measured at 50 MHz. The diodes are packaged in DO-7 glass cases and meet or exceed the environmental specifications of MIL-S-19500. The ZC800 series is available in matched pairs and quads for preselector, synthesizer and electronic tuning applications.

CIRCLE NO. 347

**Fast recovery diodes  
handle up to 60 A**

Sescosem, 101 boulevard Murat,  
75781 Paris Cedex 16, France.

The ESM 243, 244 and 245 series of fast recovery power diodes are available in the TO-126, DO-4 and DO-5 packages, respectively. The diodes recover in 100 to 500 ns and can handle loads of 60 A. The ESM 243 series handles from 50 to 400 V and has a 100 ns recovery time. The 244 units handle to 600 V and recover in 200 ns. The 245 series diodes handle up to 1000 V and can recover in 500 ns.

CIRCLE NO. 348

# Portable Digital Multimeter at an Analog Price

MODEL 280  
\$99<sup>95</sup>



Enjoy the benefits of auto-polarity digital read-out plus full overload protection and high-low power ohms for accurate tests in solid-state circuits.

**Accuracy better than analog VOM's!**

**22 RANGES**

Reads in decades: AC and DC volts and mA, 1-1000; ohms, 100-10 meg. Resolution: 1mV, 1mA, 0.1 ohm.

Accuracy: DC typically  $\pm 1\%$  F.S.; AC and ohms typically  $\pm 2\%$  F.S. except  $\pm 2.5\%$  on highest range. Uses "C" cells. Optional AC adapter/charger.

**In stock at your local distributor**

**B+K PRECISION**

PRODUCTS OF DYNASCAN  
1801 W. Belle Plaine Avenue Chicago, IL 60613

INFORMATION RETRIEVAL NUMBER 67

# Reliable dual-trace scope useful to 30MHz.



MODEL 1472  
\$599

We nominally rate the 1472 at 15MHz (-3dB), but it easily syncs and displays a 30MHz signal with sure triggering. It automatically selects chopped or alternate trace display to avoid flickering at any sweep speed . . . so even with 11 sensitivity ranges from 10mV to 20V/cm and 19 sweep ranges from 0.5 $\mu$ SEC to 0.5SEC/cm, it's easier to use than most scopes. The 1472 has 24nSEC risetime and can be used in X-Y mode with matched phase-shift and sensitivity inputs.

**In stock at your distributor.**

**B+K PRECISION**

PRODUCTS OF DYNASCAN  
1801 W. Belle Plaine Avenue - Chicago, IL 60613

INFORMATION RETRIEVAL NUMBER 68

APPLIANCE & INDUSTRIAL MAINTENANCE TESTERS • OSCILLOSCOPES • PICTURE TUBE TESTERS • VOM'S • AMPLIFIERS • AF, RF & SWEEP GENERATORS • AC LEAKAGE TESTERS • SOLID STATE TESTERS • VOLTOHM METER • ISOTAPS • GENERATORS • BATTERY CHARGERS • PORTABLE AC VOLTMETERS • TESTERS



## RCA Test Instruments... The broad line for a wide range of applications.

Whether it's for use in consumer or industrial electronics, laboratories, schools, safety tests or for everyday electrical or electronic maintenance, there's an RCA Electronic Instrument for your application.

And you can find out about them all in the new 1975 RCA Electronics Instruments Cata-

log. It's yours free for the asking. Just contact any one of the more than 1,000 RCA Distributors worldwide. Or write RCA Distributor and Special Products Division, Cherry Hill Offices, Camden, N.J. 08101.

**RCA Electronic Instruments**

INFORMATION RETRIEVAL NUMBER 69

ELECTRONIC DESIGN 12, June 7, 1975

# Sturdilite ELECTRONIC WORK STATIONS



- RUGGED QUALITY
- PLANNED FLEXIBILITY

STURDILITE SYSTEMS combine the look of quality furniture with the ruggedness of industrial equipment . . . and provide *true economy* and *efficiency*, no matter how large or small your work area may be!

Unique combinations of work surfaces, riser shelves, electrical outlets, and pedestal bases with innumerable drawer/door arrangements, provide the maximum in *planned flexibility*.

STURDILITE engineers will gladly prepare detailed room layouts to meet your specific requirements . . . at *absolutely no cost to you!* Send for free catalog, or . . . better yet, call us at (616) 685-6400.

**Sturdilite**

ANGLE STEEL DIVISION  
KEWAUNEE SCIENTIFIC EQUIPMENT CORP.  
PLAINWELL, MICH. 49080 (616) 685-6831



INFORMATION RETRIEVAL NUMBER 70

121

## BUTTON UP SHIELDING, GROUNDING & CONTACTING PROBLEMS

Wherever you need very low surface-to-surface resistivity—grounding p.c. cards, completely removable ground-plane connection paths, providing static-electricity discharge paths, maintaining high conductivity despite changing contact geometry, pressure, or alignment, etc.—consider low-cost Metex mesh buttons.

Available in many different wire formulations, sizes, shapes, and geometries. The simplest button is a cylinder of resilient wire mesh (providing hundreds of surface contacts, and thousands of parallel internal paths). For special applications, we make a sophisticated hybrid—an elastomer core, surrounded by resilient mesh, partially recessed in a metal cup.

We can control almost any parameter: dimensions, compressibility, resilience, conductivity, corrosion resistance, etc.

Call or write, for full data and free representative samples. Metex Corp., 970 New Durham Rd., Edison, N. J. 08817, (201) 287-0800 or Cal-Metex Corp., 509 Hindry Ave., Inglewood, Calif. 90301, (213) 641-8000.

## ...WITH NEW MESH BUTTONS FROM METEX.



We call the signals in shielding  
**METEX**

INFORMATION RETRIEVAL NUMBER 77

## DISCRETE SEMICONDUCTORS

### IR emitting diodes deliver 7.5 mW

RCA Electronic Components, 415 S. Fifth Street, Harrison, NJ 07029. (201) 485-3900. \$3.50; stock.

The SG1009A IR emitting diodes have a typical power output at 940 nanometers of 7.5 mW at a dc drive current of 100 mA. The emitting source of the diode is a gallium arsenide pellet. The IR diode is supplied in a hermetically sealed two-lead TO-18 case.

CIRCLE NO. 349

### Complementary pair now a monolithic

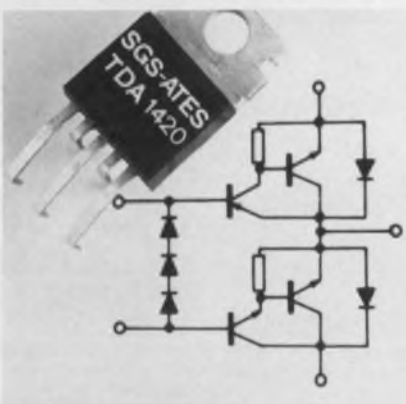

SGS-ATES Semiconductor, 435 Newtonville Ave., Newtonville, MA 02160. (617) 969-1610. From \$1.60 (100-up); stock.

The TDA1420, a quasi-complementary Darlington pair, with biasing system is housed in a Pentawatt (five lead TO-220) package. Each Darlington can deliver a current of over 3 A and can withstand a supply voltage of 44 V. In addition to the 44 V, TDA1420, a 36-V version, the TDA1410, is also available.

CIRCLE NO. 350

### 30-A triac handles PIVs of 1100 V

AEG Telefunken, D 6000 Frankfurt, 70 AEG Hochhaus, West Germany.

The TW 12 N triac has a maximum admissible peak inverse voltage of 1100 V. The high PIV permits the triac to be connected directly to 380-V system supplies. The maximum admissible effective forward current is 30 A, and the surge current can reach 110 A.

CIRCLE NO. 351



## hot stuff

or cold, CHR's family of TEMP-R-TAPE of Kapton provides outstanding endurance. They retain their excellent mechanical and electrical properties over a wide temperature range, -100 to +500F.

Available in thicknesses from .001" to .0045" with a choice of several adhesive systems including adhesive two sides.

Find your CHR distributor in the Yellow Pages under "Tapes, Industrial" or in industrial directories. Or write for complete specification kit and sample. The Connecticut Hard Rubber Company, New Haven, Conn. 06509.

## CHR

an ARMCO company

INFORMATION RETRIEVAL NUMBER 78  
ELECTRONIC DESIGN 12, June 7, 1975



## Optical switch modules have four sensor models

HEI, Jonathan Industrial Center, Chaska, MN 55318. (612) 448-3510. From \$6.

A series of optical switch modules use separately packaged sensor and emitter units. The sensor module is available in four versions: phototransistor, photo-Darlington, photosensor with an amplifier and photosensor followed by a Schmitt trigger. There is only one emitter version available, and that uses a LED. Sensor modules may be purchased separately or in combination with the LED module. All units are prewired and have recessed mounting holes. The Schmitt trigger sensor version uses a hybrid circuit which can drive additional logic and/or low-level relays.

CIRCLE NO. 352

## TC reference diodes function at 100 $\mu$ A bias

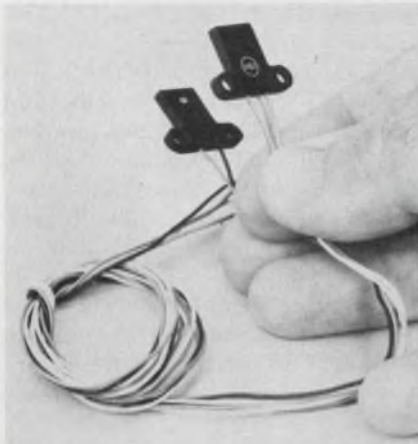

Codi Semiconductor, Pollitt Dr., Fair Lawn, NJ 07410. (201) 797-3900. From \$3.60 (100-up); stock to 3 wk.

A C8000 series of ultra-low, multicurrent, temperature compensated reference diodes operates at currents as low as 100  $\mu$ A. The temperature coefficients of these devices are as low as 5 ppm/ $^{\circ}$ C over an operating temperature range of  $-55$  to  $+100$  C. Since the devices are current regulated, shifts in the operating current by as much as  $\pm 50\%$  cause very small changes in the temperature coefficient. The diodes are encapsulated in hermetically sealed DO-7 glass packages and can be supplied with long term stabilities as low as 10 ppm/year.

CIRCLE NO. 353

# THE POWER SUPPLY A MANAGEMENT TEAM COULD LOVE



If you're an engineer, or in engineering management, you might find our new SCR Series Single Phase Input Power Supplies very attractive. They provide 800, 1600 or 2400 watts of power and precise 0.1% regulation in both voltage and current modes (for higher power ask about our three phase input SCR units). All offer the highest power output per mechanical volume in the industry.

### Check these superior benefits:

- \* High Efficiency
- \* Remote Sensing
- \* Remote Programming
- \* Series or Parallel Operation
- \* 5 Year Warranty
- \* Rack or Bench Mount
- \* Overvoltage Protected (optional)
- \* Constant voltage or current with automatic crossover
- \* Optional Input Voltages

For applications assistance and technical information, phone TOLL FREE (800) 631-4298

VOLTAGE	CURRENT	CV rms RIPPLE	CC rms RIPPLE	% EFF.	AC input I NOM E	PRICE \$
0-7.5	100	75 mv	1000 ma	63	13	650
	180	80 mv	1920 ma	65	26	850
	250	80 mv	2990 ma	66	20	1100
0-10	80	75 mv	600 ma	65	13	600
	150	80 mv	1200 ma	68	26	850
	210	80 mv	1680 ma	69	19	1100
0-20	40	60 mv	120 ma	67	13	600
	80	80 mv	320 ma	70	25	800
	120	80 mv	480 ma	73	18	1000
0-40	20	60 mv	30 ma	68	13	500
	40	100 mv	100 ma	75	24	750
	60*	100 mv	150 ma	80	18	900
0-60	13	70 mv	15 ma	70	13	500
	26	90 mv	39 ma	81	23	850
	40	90 mv	60 ma	81	18	1000
0-80	10	80 mv	10 ma	77	12	500
	20	120 mv	30 ma	83	21	850
	30**	100 mv	35 ma	82	18	1000
0-150	5	150 mv	5 ma	80	10	500
	10	200 mv	13 ma	87	20	850
	15	200 mv	20 ma	84	18	1000
0-300	3	250 mv	3 ma	85	6	550
	5	300 mv	5 ma	87	20	850
	8	300 mv	8 ma	85	17	1000
0-600	2	700 mv	2 ma	87	6	650
	3	700 mv	4 ma	88	20	850
	4	750 mv	5 ma	85	17	1100

\*Specify Model No. SCR40 58

\*\*Specify Model No. SCR80 28



### ELECTRONIC MEASUREMENTS INC.

405 Essex Road, Neptune, N. J. 07753

Phone: (New Jersey) 201 - 922-9300 • (Toll-Free) 800 - 631-4298

Specialists in Power Conversion Equipment

## Planar triode aims for airborne use

Varian, 1678 Pioneer Rd., Salt Lake City, UT 84104. (801) 487-7561.

The Y-540 high-voltage planar triode can be used for switch or series regulator service in either radar or general-purpose airborne

applications. Essentially a uhf triode, the tube can be operated in the nanosecond region. The Y-540 features an extended grid-anode insulator for 10-kV operation at sea level, and an arc-resistant extended interface matrix cathode. The new unit has an average transconductance of 30 mmhos (at  $I_b = 100$  mA) and average amplification factor of 145. Maximum operating temperature is 250 C.

CIRCLE NO. 354

## Diode switch/driver works from 3 to 300 MHz

Vitek Electronics Inc., 200 Wood Ave., Middlesex, NJ 00846. (201) 469-9400. \$55; stock.

An rf/i-f diode switch/driver combination—the SDR-24-50—covers the 3-to-300-MHz frequency range. The SPDT operates from a 24-V supply, offers a minimum isolation of 60 dB and has a typical insertion loss of 0.75 dB. Connectors are BNC female types.

CIRCLE NO. 355

## Ion laser uses 115-V supply

Lexel Corp., 928 E. Meadow Dr., Palo Alto, CA 94303. (415) 328-3466. P: See text.

A compact ion laser operates from a single-phase, 115 or 220-V, 50/60-Hz supply. The new unit is reportedly the only cw ion laser of its type that can be operated from standard supplies. The Model 75 laser comes in two versions: The krypton model offers up to 100 mW of red power, and the argon model offers 400 mW of blue and green power. The laser head weighs only 36 lb and measures 4.85 × 7.19 × 28.20 in. The single-phase power supply weighs 75 lb and measures 8.0 × 16.6 × 19.0 in. Available options include light regulator, rack-mounted power supply, automatic starting and remote turn-on. Cost of the Model 75 argon version with single-phase power supply is \$6035.

CIRCLE NO. 356

## 0.5-5-GHz crystal sig sources output 5-20 mW

Mik-Beth Electronics, Inc., 210 S. 31st St., Kenilworth, NJ 07033. (201) 241-8831. \$575 (1-4); 8 weeks.

The MBE-S-FOX series of crystal-controlled signal sources covers the frequency range of 500 MHz to 5 GHz with output powers of 5 to 20 mW. Spurious rejection exceeds 65 dB for in-band and harmonic signals. Over the 0-to-60-C temperature range, stability is better than ±0.003%. Units operate from -20 V dc supplies and draw 80 mA. Output impedance is 50 Ω, and load VSWR is 1.5:1.

CIRCLE NO. 357

Three decades of design experience and demonstrated performance has led to one of the most versatile photometer systems today: the Spectra® Pritchard 1980. Offering *high sensitivity*, interchangeable optics, zero polarization and *automatic* readout, our 1980 has become the industry standard for measurement of luminance (brightness), uniformity, contrast and MTF of all kinds of displays — including CRT's, liquid crystals, LED's and gas discharge.

The 1980 can measure displays as fine as 0.0001" (0.0025mm) diameter — from pitch-dark ( $10^5$  fL) to sun-bright ( $10^7$  fL). NBS-traceable calibration is maintained by a built-in, highly stable calibration light source.

For full data, write for brochure. Or call collect.



3000 No. Hollywood Way, Burbank, CA 91505  
(213) 849-6017 • Telex 69-1427

### The 1980 Pritchard®



The light measurement people

INFORMATION RETRIEVAL NUMBER 80

## Mm antenna has dual polarization



Alpha Industries Inc., 20 Sylvan Rd., Woburn, MA 01801. (617) 935-5150.

A horn-lens millimeter antenna—Model A858-6/881/884—features dual polarization and a frequency range of 33 to 40 GHz. The new antenna has a sidelobe level of -25 dB and beam efficiency in excess of 90%. Half-power beamwidth is 4 degrees, nominal gain is 32.5 dB and VSWR doesn't exceed 1.3:1. The antenna can accommodate standard TE<sub>11</sub> circular waveguides.

CIRCLE NO. 358

## Diplexer has low loss and sharp selectivity

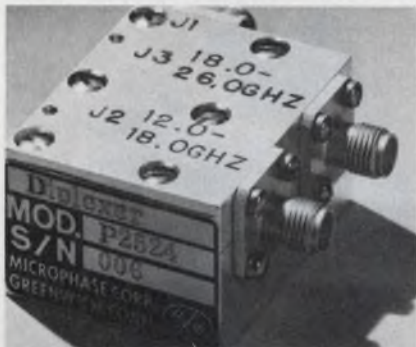

Microphase Corp., Box 1166, Greenwich, CT 06830. (203) 661-6200.

The Model P2524 diplexer features low insertion loss, sharp skirt selectivity and high interchannel isolation. The P-K band diplexer operates in severe military environments and at temperatures up to 125 C. Frequency coverage is 12.0 to 26.0 GHz, with crossover frequency at 18.0 GHz. Insertion loss at crossover frequency is 4.8 dB max. The unit has a crossover region of  $f_{co} \pm 3\%$  and a passband insertion loss of 1.0 dB max. Selectivity is 60 dB min with  $f_{co} \pm 15\%$ . Channel-to-channel isolation is 60 dB min from dc to 26 GHz, except in the crossover region.

CIRCLE NO. 359

## Mixer/preamp holds noise to 9 dB max



Frequency Engineering Laboratories, Farmingdale, NJ 07727. (201) 938-9221.

938-9221.

A mixer/amplifier combines low noise with broadband frequency coverage. The MA-1200 series has an operating range of 100 to 1300 MHz, an over-all noise figure of 9.0 dB max and a gain of  $46 \pm 0.5$  dB. The unit's i-f response is 3 kHz to 3500 MHz and it outputs  $\pm 2$  V into a 100- $\Omega$  load. The flat-pack mixer employs special ferrite-core techniques.

CIRCLE NO. 360

## You know our reputation in DC to DC

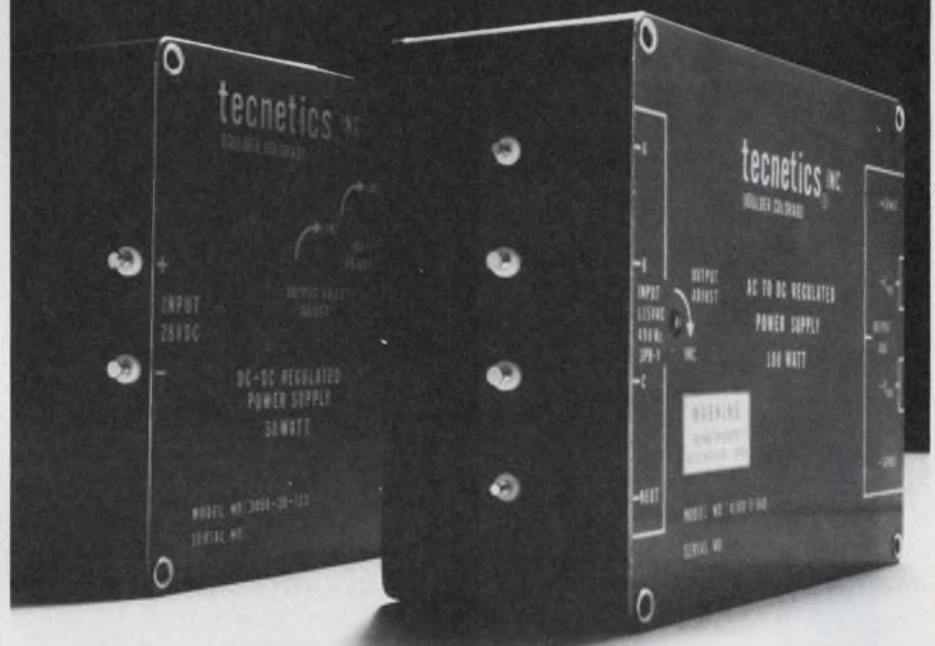

## Wait till you see Tecnetics' new 400 Hz AC power supply

We earned a reputation with our line of DC to DC power supplies. Now, we add to it with a new 400 Hz AC power supply. Like our 28VDC power supplies, the AC model features extremely high packaging density, high efficiency and reliability. Most important, it's small, measuring in at only 4x4x2 inches and weighing 36 ounces fully encapsulated.

These power supplies are designed to meet

the rugged vibration, shock, humidity and altitude specs of the aerospace industry (Mil-E-5400). They also have separate, remote error-sensing terminals to compensate for voltage loss, assuring that the voltage level remains constant at the load.

Write for our 26-page catalog that gives full specs and prices on these and over three hundred other power supplies.

SPECIFICATIONS	3000 SERIES - DC TO DC	4000 SERIES - 400 Hz AC TO DC
Output Power	150, 100, 50, & 25 watt models	100, 50, & 25 watt models
Output Voltages	13 standard outputs from 5 to 48V	13 standard outputs from 5 to 48V
Input Voltages	28VDC or 48VDC (48VDC only on 150 w units)	115VAC $\pm 10\%$ , 400 Hz (Single or 3 phase)
REGULATION		
Line	(LL to HL) 0.3%	(115V $\pm 10\%$ ) 0.2%
Load	(1/2 to FL) 0.1%	(1/2 to FL) 0.1%
Load	(NL to FL) 0.4%	(NL to FL) 0.5%
Temp	0.01%/°C	0.1%/°C

**tecnetics**® The Power Conversion Specialists

P.O. Box 910, 1625 Range Street, Boulder, Colorado 80302 (303) 442-3837 TWX 910-940-3246

# 2000 pole double throw switch

How do you direct 2,000 low level transducer lines into a back-up computer without changing 200 cables? Easy. T-Bar® 48-pole latching relays. T-Bar makes high density switches and relays... designs and fabricates special switching systems... reliably and economically. If you switch a lot of lines — all at once or a few at a time — write or phone today for complete T-Bar literature.

**T-Bar** INCORPORATED  
SWITCHING COMPONENTS DIV.

146J Danbury Road  
Wilton, CT 06897  
Phone: 203/762-8351



(4966) SWITCHING COMPONENTS DIVISION AD #1

INFORMATION RETRIEVAL NUMBER 82

## MICROWAVES & LASERS Gunn osc modulates at 10-MHz rates



Varian, 611 Hansen Way, Palo Alto, CA 94303. (415) 493-4000.

The 9082 series of Gunn oscillators provides FM capabilities—deviation exceeds 300 MHz pk-pk—at rates in excess of 10 MHz over the -40 to +85 C temperature range. The 9082 series features two tuning inputs, which reportedly provide the wide tuning ranges and high linearity normally achievable only with YIG devices. The slow tuning port of the VSX-9082N1, for example, has a linearity of  $\pm 0.2\%$  maximum over the 8-to-12.4-GHz range. Hysteresis is 10 MHz maximum. The fast tuning port features a frequency range of  $\pm 155$  MHz minimum, 3-dB bandwidth of 10 MHz minimum and 10-MHz sensitivity of 55 kHz/ mA minimum.

CIRCLE NO. 361

## Acoustic delay line meets MIL specs



Walter M. A. Andersen & Associates, 4 Main St. Extension, Tariffville, CT 06081. (203) 658-7666.

An acoustic delay line, the Model CR02, can be obtained in a version that meets full MIL-spec requirements. The new unit offers a delay of 1.5 to 10  $\mu$ s and delay tolerance of  $\pm 5$  ns. Measuring  $1.5 \times 0.5 \times 0.5$  in., the delay line has a center frequency of 60 MHz, minimum bandwidth of 15 MHz and maximum insertion loss of 23 dB. Spurious signals are 26 dB below the fundamental frequency.

CIRCLE NO. 362

## Compact transfer switch handles 1 W rf

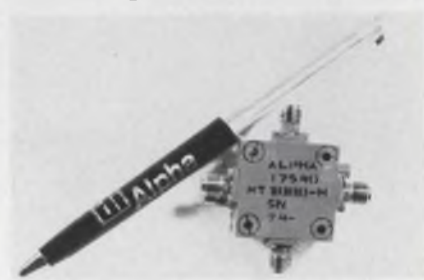

Alpha Industries, Inc., 20 Sylvan Rd., Woburn, MA 01801. (617) 935-5150. \$273 (1-9); 4-8 weeks.

The MT3888 solid-state transfer switch with driver—measuring  $1.0 \times 1.0 \times 0.75$  in.—can reverse the order of connections between two input and two output ports. Operating from 0.5 to 18 GHz in decade bandwidths, the unit has a typical insertion loss of 1.4 dB and typical isolation of 40 dB. Switching speed is 800 ns, and 1-W rf powers can be handled. The unit operates from 5-V supplies and draws 85 mA maximum.

CIRCLE NO. 363

## Antenna system yields 37-dB gain



Watkins Johnson Co., 3333 Hillview Ave., Palo Alto, CA 94304. (415) 493-4141.

A directional antenna system, Model WJ-8332, covers the 1-to-18-GHz frequency range with gains of 23 to 37 dB, corresponding to a minimum beamwidth of about 2 degrees. The antenna can be positioned in elevation from -3 to +90 degrees and in azimuth from 0 to  $\pm 200$  degrees. A control unit provides digital readouts of azimuth and elevation angles, and of the polarization angle of any individual band antenna.

CIRCLE NO. 364

### Bellows allow component adjustment

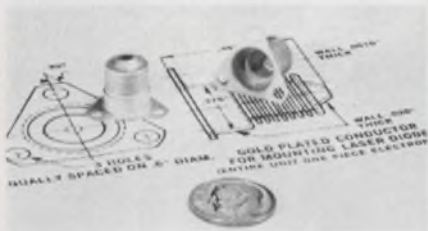

Servometer Corp., 501 Little Falls Rd., Cedar Grove, NJ 07009. (201) 785-4630.

Electronic designers may now adjust components in sealed enclosures via bellows that have a wall thickness that varies from 0.0005 to 0.020 in. The bellows are available in diameters from 0.125 to 1.25 in. Extension strokes equal to 80% of the bellows free length are available, if constant pressure on the component is required. The parts are produced by electroforming, and thus, internal dimensions can be held extremely close. Conical interface surfaces can be produced where components with whisker type contacts must be self-aligning. The bellows can be clamped by a flange, solder assembled or welded in place. Gold plating is available where high conductivity is required.

CIRCLE NO. 365

### Desoldering tip fits small 50-W iron



Micro Electronic Systems, Inc., 8 Kevin Dr., Danbury, CT 06810. (203) 746-2525. \$15 (unit qty); stock.

The DIL-16-UN desoldering tip works with an Ungar 50-W-element iron. The tip desolders all the leads of a 14 or 16-pin IC simultaneously, and it enables the user to remove the IC without damage.

CIRCLE NO. 366

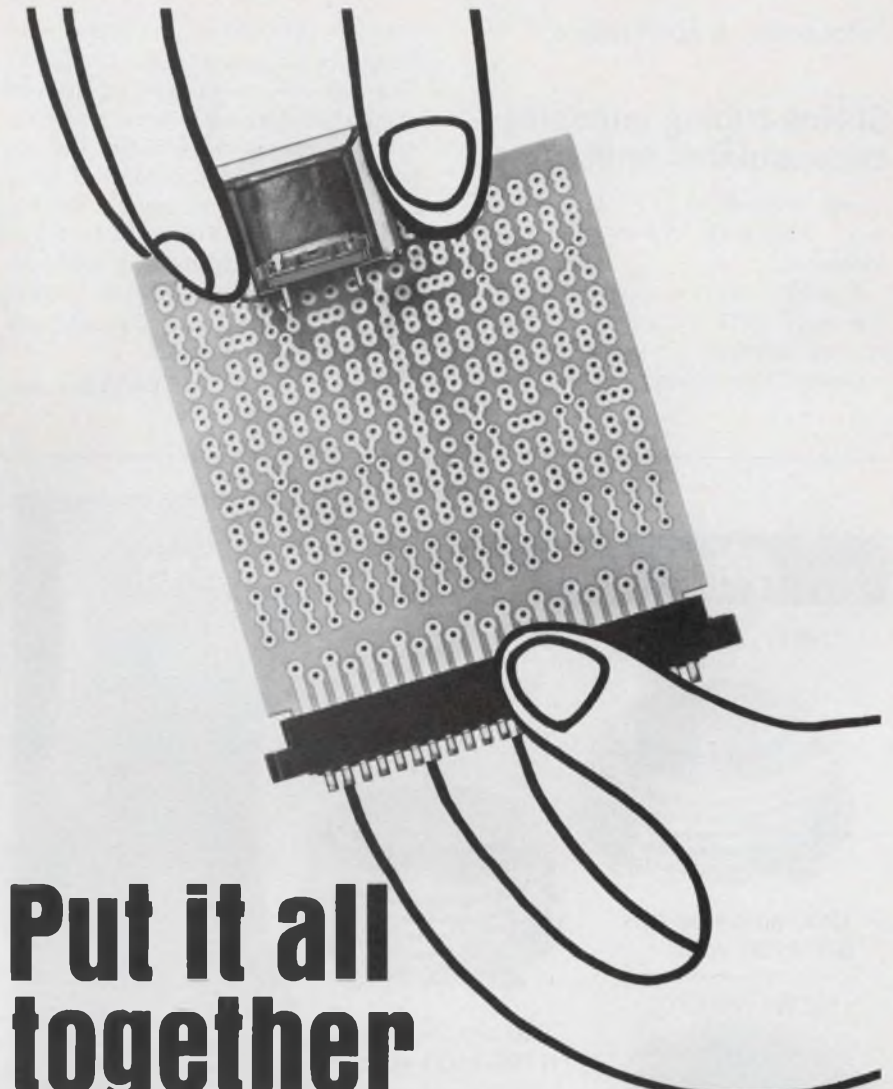

# Put it all together with TRIAD

Who else but Triad has the printed circuit cards, the plug-in transformers and inductors, and the right connectors in stock at your industrial electronic distributors—ready for you to use? Triad's new standard series of plug-in telephone coupling transformers are designed particularly to interconnect remote data entry and display terminals to computers over voice grade telephone lines. Useful for impedance matching, isolation, line balance, bridging, hybrid and holding coil applications. Other plug-ins for transistorized control and instrumentation include units for both power and audio use.

All Triad plug-ins fit precisely into standard grid patterns on our versatile line of integrated and universal circuit cards. And—when you put a "CO" prefix ahead of the card number, you'll get the applicable Winchester connector in the same package with the card—ready for you to put together. Call your distributor for Triad's latest catalog. Triad Distributor Services, 305 North Briant Street, Huntington, Indiana 46750.

 **TRIAD-UTRAD**  
Litton Distributor Services

INFORMATION RETRIEVAL NUMBER 83

## Shrink-tubing adhesive encapsulates splices

Alpha Wire Corp., 711 Lidgerwood Ave., Elizabeth, NJ 07207. (201) 925-8000.

Fit-750 is new polyolefin tubing lined with an adhesive, which can encapsulate and protect components. The tubing is positioned

over a component or splice and heated with a heat gun to 135 F. The adhesive melts and the tubing shrinks to force adhesive into even microscopic crevices. When the adhesive cools, it provides a bond that seals out moisture. Tubing diameters range from 1/4 to 1-1/2 in. and tensile strength is 1500 psi. Flexibility is maintained to -55 C and the material is water, fungus and chemical resistant.

CIRCLE NO. 367

## Epoxy system stakes parts to PC boards

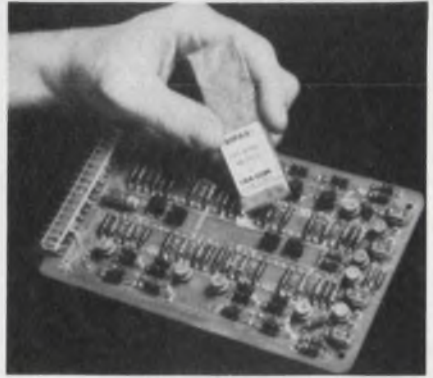

Tra-Con, Inc., 55 North St., Medford, MA 02155. (617) 391-5550. Stock.

Tra-Bond 2111 is a convenient way to "stake" delicate electronic components to chassis parts or PC boards. It's a specially formulated epoxy system with thixotropic additives. Tra-Bond contains no solvents, has a long pot life and cures at room temperature. It adheres to metals, ceramics, glass, wood, leather and many plastics. It is electrically insulating, and offers resistance to weathering, petroleum products, salts, mild acids and alkalis and many organic solvents.

CIRCLE NO. 368

## New SCRs FOR YOUR DESIGNS

NEW NL-C601



1200 amperes rms  
800-1700 volts

NEW NL-C602



950 amperes rms  
1700-2500 volts

NEW NL-F701



1600 amperes rms  
500-1700 volts

### POINT THE WAY TO PROFITS

- Power and inverter SCRs available in assembled Heat Exchangers.
- Other SCRs available from 16 amps and 25 volts.
- Call or write for full details



**NATIONAL ELECTRONICS**

a varian division

geneva, illinois 60134 (312) 232-4300

## Knitted-wire filter material resists 2000 F



Metex Corp., 970 New Durham Rd., Edison, NJ 08817. (201) 287-0800.

Knitted-wire air filters can be made of any wire alloy. Materials that are resilient and can resist corrosion, vibration and heat up to 2000 F are available. The mesh is made with controlled filtration and pressure-drop characteristics to accommodate a wide range of applications, from tiny instrumentation to large gas turbine inlets.

CIRCLE NO. 369

DIRECT FROM STOCK

# 5V3A

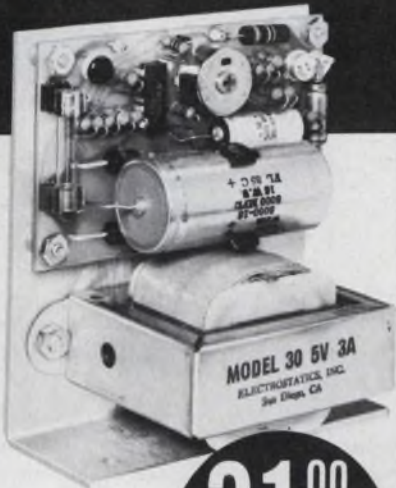

**31<sup>00</sup>**  
(1-9)

\$23.70 - 100 pcs.

**Excellent regulation and ripple.**

## SPECIFICATIONS

Size: 4 x 4.5 x 2.75 overall  
 Input: 105-125V, 47-420 Hz  
 Output: Any DC voltage 3 to 30  
 Regulation: Line — 0.005%  
                   Load — 0.05%  
 Ripple: Less than 250 Microvolts  
 Temp: Operative —40 to +71°C  
       Storage —65 to +85°C  
       Coefficient —0.01%/°C Max.  
 Current Limiting: Fixed Foldback Type  
 Overvoltage: Optional

MODEL	VOLTAGE	AMPS
30-5	5.0	3.0
30-10	10.0	1.8
30-12	12.0	1.5
30-15	15.0	1.2
30-24	24.0	1.0
30-28	28.0	1.0

## ORDERING INFORMATION

QUANTITY	PRICE	WITH O.V.
1-9	\$31.00	\$36.00
10-24	29.20	33.70
25-49	26.60	29.90
50-99	25.10	28.20
100-	23.70	26.90

CALL (714) 279-1414 FOR DELIVERY

**Electrostatics, inc.**  
 7718 CLAIREMONT MESA BLVD. • SAN DIEGO, CA 92111

**Wrapping tool operates from battery**

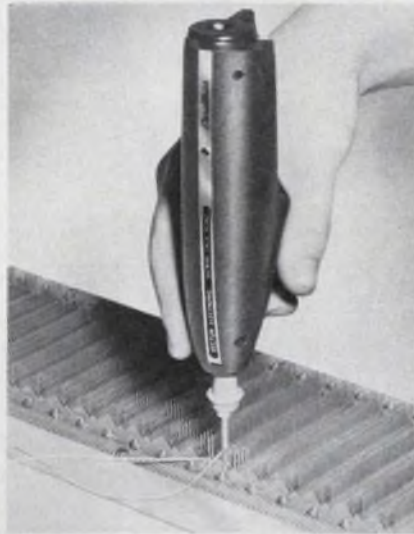

Vector Electronic Co., Inc., 12460 Gladstone Ave., Sylmar, CA 91342. (213) 365-9661. See text.

Designed for prototype or low-volume production, Vector's new P160-4 wrapped-wire tool and P160-2 wrapping bit is delivered from stock for \$59.69, including battery, line cord and recharging unit. Typically competitive units sell in the \$90-to-\$125 range. Balanced for easy operation, the unit weighs only 9 oz. The tool wraps 0.025 to 0.028-in.-square posts with 26-to-30-AWG wire. The 0.070-in. bit radius allows wrapping posts spaced on 0.10-in. centers. A 0.590-in. bit depth permits multilevel wrapping. A Ni-Cd battery has a nominal duty cycle of 8 h without charging. Recharging time is 14 to 16 h.

CIRCLE NO. 372

## Insulated wire meets UL and IPCEA standards

Haveg Industries, Inc., P.O. Box 7, Winooski, VT 05404. (802) 655-2121.

Exar cross-linked polymeric insulated wire is now UL listed for SIS and switchboard applications. Exar 250, and the more flexible Exar 350, both rated at 125 C and 600 V, are available in sizes 14 through 4 AWG as SIS-designated wire. In sizes 24 through 16 AWG, switchboard wire is supplied with a UL 3271 listing. The insulation also conforms to the vertical flame-resistance requirements of IPCEA standard S-19-81.

CIRCLE NO. 373

## ATC 100 SERIES QPL CAPACITORS



**NOW HEAR THIS..**

ATC 100 UHF/Microwave Capacitors have been QPL approved since June 1974 in the following types:

- CY81** -Case A chip
- CY82** -Case A pellet
- CY83** -Case B chip
- CY84** -Case B pellet
- CY85** -Case B microstrip
- CY86** -Case B axial ribbon
- CY87** -Case B radial wire
- CY88** -Case B radial ribbon
- CY89** -Case B axial wire



**FOR INFORMATION...**

just circle the number below.

For samples of any ATC 100 UHF/Microwave Capacitors, call Ralph Wood (516) 271-9600.

**american technical ceramics**

ONE NORDEN LANE,  
 HUNTINGTON STATION, N.Y. 11746  
 (516) 271-9600 • TWX 510-226-6993

INFORMATION RETRIEVAL NUMBER 87

# RF detectors fast delivery

Quantities to 200  
from stock

You get fast delivery on WILTRON's quality RF detectors whether your needs are large or small.

And with discounts of up to 15% in quantity.

These are WILTRON's time-proved quality detectors with field-replaceable diodes. Diodes are field-replaceable even in 18.5 GHz models.

Call Walt Baxter at WILTRON now for details.



Model	Range	Connectors In	Out	Flatness	Price \$
71B50	100 kHz- 3 GHz	BNC Male	BNC Fem.	±0.5 dB	70
73N50	100 kHz- 4 GHz	N Male	BNC Fem.	±0.2 dB	75
74N50	10 MHz- 12.4 GHz	N Male	BNC Fem.	±0.5 dB	145
74S50	10 MHz- 12.4 GHz	SMA Male	BNC Fem.	±0.5 dB	165
75A50	10 MHz- 18.5 GHz	APC-7	BNC Fem.	±1 dB	190
75N50	10 MHz- 18.5 GHz	N Male	BNC Fem.	±1 dB	170
75S50	10 MHz- 18.5 GHz	SMA Male	BNC Fem.	±1 dB	170



930 E. Meadow Drive • Palo Alto, Ca. 94303 • (415) 494-6666 • TWX 910-373-1156

INFORMATION RETRIEVAL NUMBER 88

# NEW DIP TRIM- MER

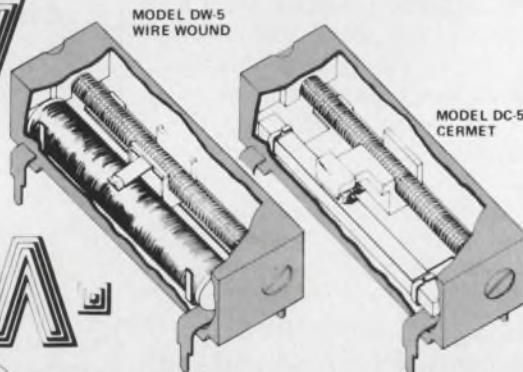

ACTUAL SIZE

Minelco's new Dual In-Line Potentiometer is a low cost trimmer specifically designed for PCB automatic insertion equipment.

- HIGH-IMPACT PLASTIC HOUSING RESISTS CLEANING AGENTS
- LOW INDUSTRIAL PRICING
- DESIGNED FOR DIP AUTOMATIC INSERTION EQUIPMENT
- AVAILABLE IN SINGLE OR MULTIPLE LOADING MAGAZINES.

The DW-5 wire-wound model offers low TC to  $\pm 50$  PPM and resistance values up to 25K

The DC-5 model with CERMET element and multiple point wiper contact for stability and reliability will retain accurate settings within 0.5% of desired voltage. TC of  $\pm 100$  PPM; resistance range up to 2 megs. infinite resolution.



**MINELCO**

Division General Time Corp  
A TALLEY INDUSTRIES COMPANY

135 SOUTH MAIN STREET • THOMASTON, CONN. 06787  
PHONE: 203/283-8261 • TWX: 710/475-1091

Send for  
free brochure.

INFORMATION RETRIEVAL NUMBER 89

## POWER SOURCES

### Industrial power units offered at lower cost

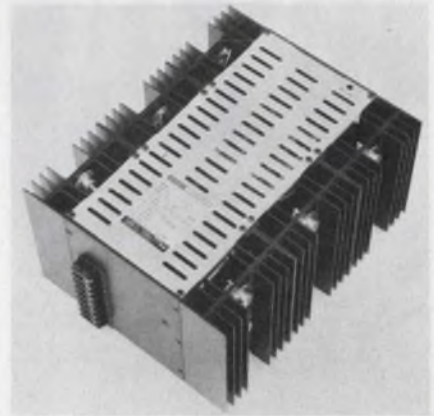

Abbott Transistor Labs Inc., 5200 W. Jefferson Blvd., Los Angeles, CA 90016. (213) 936-8185. \$249 (1-4); stock.

Model RN20 Series, 60-Hz-to-dc industrial power modules, incorporates the same electrical performance and mechanical construction as the company's "R" series but at 20% less cost. The RN20 family provides 20 A at various voltages between 4.5 and 13 V dc. Line and load regulation are 0.1% and ripple is less than 0.02%. Standard features include short-circuit protection, input transient protection and remote error sensing. Tempco is 0.03%/°C.

CIRCLE NO. 374

### Source powers self-scan displays

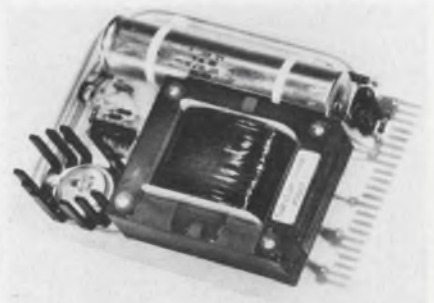

Modular Power, Inc., 4818 Ronson Ct., San Diego, CA 92111. (714) 279-1641. \$52.50; 4 wk.

PCS-250/DI is designed specifically for self-scanning type visual displays. The unit provides up to 100 mA at 250 V dc. Ripple and noise specifications are 200 mV rms and tempco is 0.2%/°C. The supply features automatic current foldback. Size is only 4.5 × 5.95 × 2.25-in. and weight is 2.75 lb.

CIRCLE NO. 375



# Triple-output dc source protects against brownouts

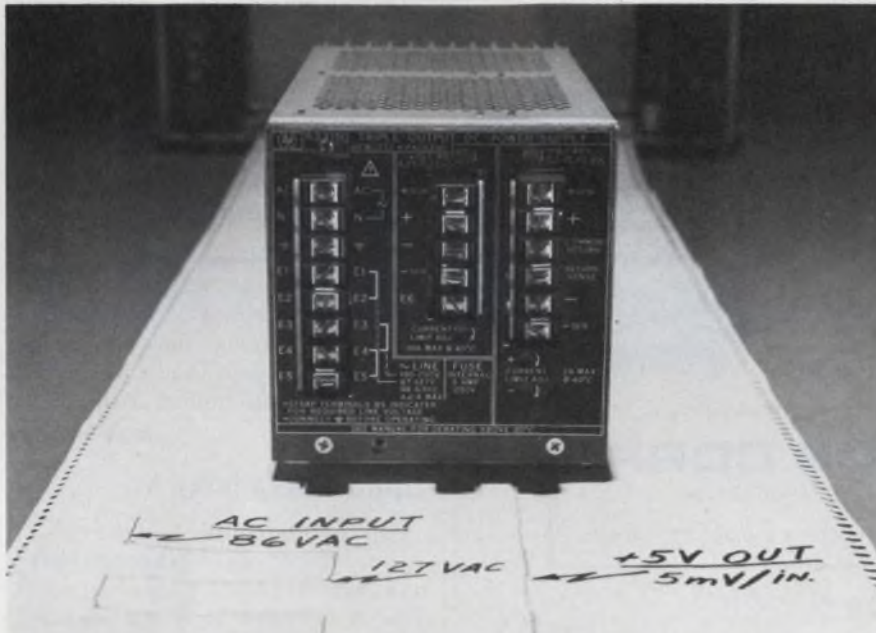

Hewlett-Packard, 1501 Page Mill Rd., Palo Alto, CA 94304. (415) 403-1501. \$415 (25); 6-8 weeks.

Don't worry if your ac power line dips by 20%. Hewlett-Packard's new triple-output ac-to-dc supply will keep your load going. Don't sweat if the line voltage goes out completely—at least not for the first 20 ms. That's how long the HP 63315D will carry the load with no ac input.

More and more, memories in computers and terminals face loss of valuable data as the stability of prime power increasingly worsens. And, more and more, power supplies like the HP unit are being offered for brownout or blackout protection.

Both  $\pm 15$  and 5 V are delivered by the 63315D, which lists its normal operating range as 87 to 127 V ac or 180 to 250 V dc, and which keeps the output steady even in the face of a 600-V line transient.

The dc load current is shared by the 5, 15 and  $-15$  V terminals. Any combination can be selected from 18 A at 5 V and 0.67 A at  $\pm 15$  V, to 10 A at 5 V and 2 A at  $\pm 15$  V. One caution in selec-

tion is to stay below the 110-W maximum rating of the HP source.

All outputs are regulated to 0.12%, with ripple and noise of 5 mV rms, 40 mV pk-pk, from 20 Hz to 20 MHz. Outputs are adjustable: 4.75 to 5.25 V for the 5-V level, and  $\pm 11.4$  to  $\pm 15.75$  V for the  $\pm 15$  V.

Standard in the 63315D is current limiting of transient inrush currents and overcurrent, and protection against overtemperature, overvoltage and reverse voltage.

Self-restoring foldback is the method used to limit the current for shorts or overloads, and you can set the limits anywhere from 50% to 150% of rated value. A crowbar circuit watches for excessively high output voltages (6 to 7 V on the 5-V output; 16 to 18 V on the  $\pm 15$ ). When tripped, the crowbar drops the outputs to less than 2 V.

Weight of the HP unit is just 10 lb. and size is  $4.96 \times 4.76 \times 10.82$  in. Cooling is by convection but you can remove the finned heat sink and mount the power supply against other structural surfaces if desired.

CIRCLE NO. 302

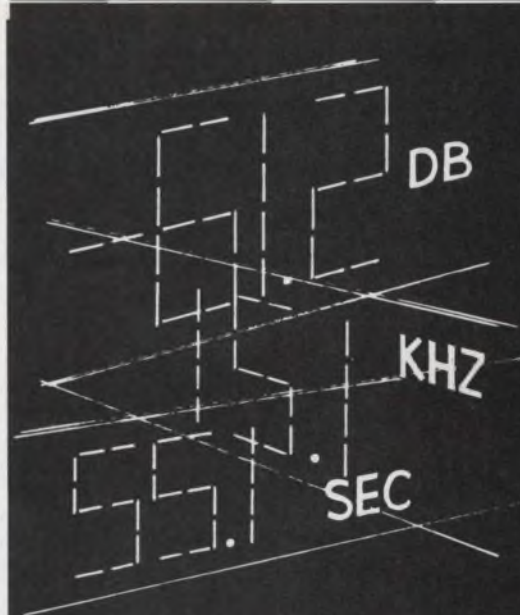

## Only with an EMR Real-Time Spectrum Analyzer..

### All digital Fourier analysis at a price you can afford

The New EMR 1510 represents a significant breakthrough in the field of Real-Time Spectrum Analysis . . . Using Fourier techniques the analysis is all digital. Digital analysis requires no calibration. Gain and offset errors are contributed by only the very stable input amplifier and aliasing filter. Result: you get greater than 60 dB dynamic range,  $\pm 0.1\%$  frequency accuracy, a well defined window function and resultant analysis bandwidth . . . not possible with analog techniques.

Take the first step and write . . . we'll also tell you about our unique LED display of Frequency/Amplitude/Averaging Time, complete programmability, and much more!



Only From EMR!



EMR Telemetry  
Weston Instruments, Inc.  
Box 3041, Sarasota, Florida 33578  
813-371-0811

# IMC FAN FACTS

## Our Super Boxer Fan delivers more

New aerodynamic impeller design gives this IMC fan about  $\frac{1}{3}$  more air delivery than other fans of its class\* This super airmover is a natural for efficient and economical cooling in tightly packed card racks, cabinets and other enclosures. Literature on request! For immediate service please call Fred Taylor, Sales Manager at (603) 332-5300 or write:

\*88 CFM at .15" Static Pressure.



4-11/16" square by 1-1/2" deep.

**IMC MAGNETICS CORP.**  
NEW HAMPSHIRE DIVISION

ROUTE 16B, ROCHESTER, NEW HAMPSHIRE 03867.



INFORMATION RETRIEVAL NUMBER 91

## Why Decitek's low cost 150 cps Sam tape reader is so accurate and reliable.

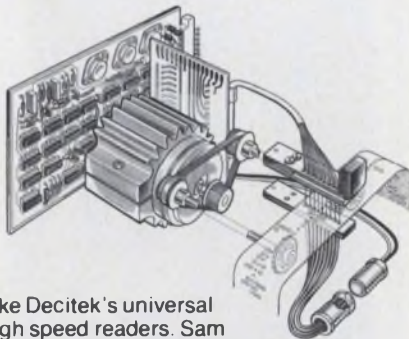

Like Decitek's universal high speed readers, Sam has our patented dual sprocket drive that starts, steps and stops accurately every time, eliminates tape wear. A highly stable fiber optic-photo transistor array reads 5, 6, 7, and 8 level advanced and center feed hole tapes interchangeably without adjustment. For more features that make Sam more than a match for any other low cost reader, write for our brochure.



When reading matters

**DECITEK**

A DIVISION OF JAMESBURY CORPORATION

250 CHANDLER STREET, WORCESTER, MASSACHUSETTS 01602. U.S.A. (617) 798-8731

INFORMATION RETRIEVAL NUMBER 92

## Application Notes

### Contact materials

A four-page reprint points out the electrical and thermal conductivities of the most popular contact materials as well as their corrosion resistance and mechanical wear properties. Deringer Manufacturing, Mundelein, IL

CIRCLE NO. 376

### Equalizers and filters

"Group Delay Equalization in Communications Systems" features useful applications information as well as a tutorial look at the design of equalizers and filters. SEG Electronics, Richmond Hill, NY

CIRCLE NO. 377

### Optical data links

Optical data link system parameters, fiber optic characteristics and typical performance capabilities are covered in a six-page bulletin. Meret, Santa Monica, CA

CIRCLE NO. 378

### Wrought nickel silvers

Physical, mechanical and chemical data on wrought nickel silvers are provided in a 12-page catalog. The International Nickel Co., New York, NY

CIRCLE NO. 379

### Electronic counters

Five application notes have been added to the series that detail how specific, frequently encountered measurement tasks can be performed by the company's Model 5345A 500-MHz electronic counters. An index to the series of 13 notes is also available. Hewlett-Packard, Palo Alto, CA

CIRCLE NO. 380

### Pick the right capacitor

A simplified method of determining the proper capacitor for low-voltage dc power supply input filter applications is described in a bulletin. Sprague Electric, North Adams, MA

CIRCLE NO. 381

## New Literature

shelly associates  
leader in...



Multi-  
Message  
Displays

### Multimessage displays

Three families of multimessage displays, the SRO-64, SRO-90 and SRO-600 series, are described in a four-page bulletin. Electrical and mechanical characteristics are included. Shelly Associates, Santa Ana, CA

CIRCLE NO. 382

### Data conversion products

Detailed specifications on data conversion products are given in a six-page foldout. Teledyne Philbrick, Dedham, MA

CIRCLE NO. 383

### Resistors

Precision and power wirewound resistors are covered in a 36-page handbook. Included is a MIL style cross-reference chart. RCL Electronics, Irvington, NJ

CIRCLE NO. 384

### Connectors and terminals

Solderless connectors and terminals are featured in a four-page brochure. Hoffman Industrial Products, Farmingdale, NY

CIRCLE NO. 385

### Fire safety catalog

A redesigned catalog lists 600 publications and visual aids on fire safety, NFPA Publications, Boston, MA

CIRCLE NO. 386

### Tape readers

Ruggedized punched tape readers for airborne, shipboard, mobile van, flight line and military applications are shown in a 36-page catalog. EECO, Santa Ana, CA

CIRCLE NO. 387

### Epoxy adhesive

Two pieces of literature describe Ready-Bond JR 228. One provides technical specifications; the other features. Chomerics, Irvine, CA

CIRCLE NO. 388

### Heaters and controls

A 120-page, four-color catalog contains a complete description of over 66 product lines of heaters, controls and accessories. Illustrated photos, diagrams, cross-sections and specifications are included. General Electric, Scotia, NY

CIRCLE NO. 389

### Beryllium rings

Electronic and electrical applications of beryllium copper contact rings and springs are shown in an eight-page catalog. Instrument Specialties, Little Falls, NJ

CIRCLE NO. 390

### Amateur radio equipment

Amateur radio equipment, including cw and SSB audio filters, electronic keyers, frequency standards, audio amplifiers, active filters, PC boards and components, are highlighted in a 16-page catalog. MFJ Enterprises, Mississippi State, MS

CIRCLE NO. 391

### Components

System components for high-speed functional and dynamic testing are covered in an eight-page brochure. Tau-Tron, North Billerica, MA

CIRCLE NO. 392

### IC industry report

Just off the press, a 76-page publication presents a clear unbiased picture of what happened in the integrated circuit industry in 1974, and what is in store for 1975. It costs \$75 a copy; to order send check or company purchase order to Integrated Circuit Engineering, 6710 E. Camelback Rd., Suite 211, Scottsdale, AZ 85251

INQUIRE DIRECT

# MEASURE BURST (POPCORN) NOISE

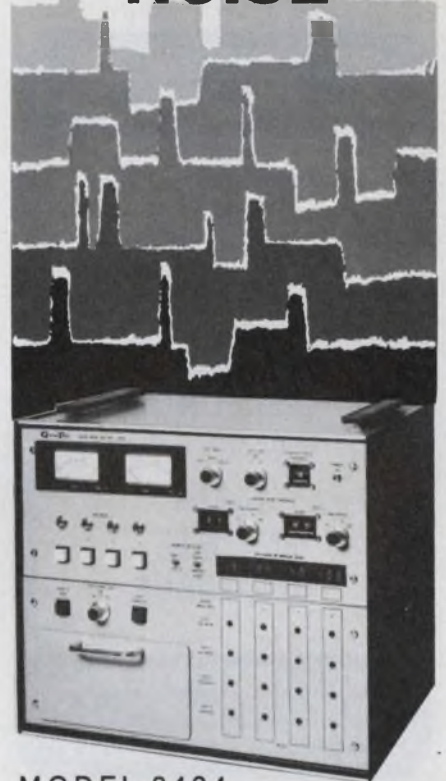

## MODEL 2494 BURST NOISE TEST SET

The Quan-Tech Model 2494 is a unique test set primarily oriented to the detection and measurement of "Popcorn" (Burst) noise characteristics of linear integrated circuits and bipolar transistors.

- RAPID TEST TIME PER DEVICE
- TESTS 4 DEVICES SIMULTANEOUSLY
- AVERAGE AND PEAK NOISE INDICATIONS
- COUNTS "POPCORN" IMPULSES OF EACH DEVICE INDEPENDENTLY
- ADJUSTABLE THRESHOLD SETTINGS FOR GO-NO-GO INDICATORS
- MEASUREMENT AT BOTH LOW AND HIGH SOURCE RESISTANCE
- DIGITAL READOUT
- ADJUSTABLE POSITIVE AND NEGATIVE POWER SUPPLIES
- INTERNAL CALIBRATION
- CONFORMS TO ESTABLISHED INDUSTRY STANDARDS AND RECOMMENDED PRACTICES

46

**Quan-Tech**®

Division of SCIENTIFIC ATLANTA, Inc.

Randolph Park West, Route 10, Randolph Township, N.J. 07801 • (201) 361-3100

INFORMATION RETRIEVAL NUMBER 93

## recruitment and classified ads

**nce**

**MINICOMPUTERS  
AND  
PERIPHERALS**

BOUGHT • SOLD • RENTED

**SUBSTANTIAL  
DISCOUNTS**

*Everything fully guaranteed*

Send for  
**FREE  
CATALOGUE**

**NEWMAN COMPUTER EXCHANGE**  
3960 Varsity Dr. Ann Arbor, Mi. 48104  
**(313) 973-1230**

**THIS IS A GREAT MIC!... ROGER!**

The MP Series is the latest advancement in zone paging systems. Available with two thru twelve paging zones.

**SES** Quality Engineered Sound Products  
**COM** SESCO, INC.  
P. O. Box 590, Gardena, CA 90247 U.S.A.  
(213) 770-3510 • TWX 910-346-7023

**STRETCH YOUR BUDGET!**

Reconditioned Scopes, SS Power Supplies, Freq. Counters & Generators - Many others. Send for our: "Bargain Bulletin"

Lawrence Instruments, Sunbury PA

CIRCLE NO. 291

**FREE ALARM CATALOG**

Full line of professional burglar and fire alarm systems and supplies. 96 pages, 450 items. Off the shelf delivery, quantity prices.

 mountain west alarm  
4215 n. 16th st., phoenix, az. 85016

CIRCLE NO. 292

**RENT a MINI**

1 DAY DELIVERY  
DEC PDP 8I (4K)  
DEC PDP 8L (8K)  
ASR 33

**FOR SALE**

MINIS DEC • DG • CAI • GTE  
HP • HIS • IBM • INT  
LOCK • MICRO • SEL  
VARIAN • XLO

PRINTERS MDS 4330 ..... \$2950  
CDC 9322 ..... \$2500  
DP 2440 ..... \$7500

CARD DOC M200 ..... \$950  
READERS GDI 100 ..... \$450

PAPER DIGITRONICS 2500 ..... \$350  
TAPE CHALCO • BRPE21 ..... \$250

MAG PERTEC • WANGCO  
TAPE POTTER • AMPEX

**617-261-1100**  
**AMERICAN USED COMPUTER CORP.**  
P.O. Box 68, Kenmore Sta., Boston, MA 02215  
member COMPUTER DEALERS ASSOCIATION

CIRCLE NO. 293

**HERMETIC SEALING**

Connectors • Headers • Relay Bases  
Terminals • Custom Seals • Testing  
Glass/Ceramic To Metal • Since 1959

**DETORONICS CORPORATION**  
10660 E. Rush • S. El Monte, CA 91733  
(213) 579 7130 • TWX 910 587-3436

CIRCLE NO. 294

**Help your  
Heart...  
Help your  
Heart Fund**

American Heart Association



## NEW LITERATURE

### Thumbwheel switches

A 40-page catalog summarizes standard switches. Specifications, features, applications, photographs, outline drawings and prices are included. The Digitran Co., Pasadena, CA

CIRCLE NO. 393

### Turns-counting dial

A two-page data sheet describes the Model 16 turns-counting dial. A photo, dimensional drawing, specifications, reference chart for a complete line of multidials and ordering information are included. Spectrol Electronics, City of Industry, CA

CIRCLE NO. 394

### Power supplies

A 48-page designer's handbook and catalog of power supplies and line conditioners contains imaginative solutions to conventional power conditioning and ac-dc conversion problems. Tele-Dynamics, Fort Washington, PA

CIRCLE NO. 395

### IEEE standards catalog

A 32-page IEEE standards catalog lists more than 350 standards publications by subject as well as in numerical sequence. Included are American National Standards published by IEEE. IEEE, New York, NY

CIRCLE NO. 396

### Punched tape readers

Design features and specifications of dual-sprocket drive, photo-electronic punched tape readers with reading speeds from 100 to 600 characters per second are given in an eight-page bulletin. Decitek Div. of Jamesbury Corp., Worcester, MA

CIRCLE NO. 397

### Solid-state replacements

An updated 156-page guide to RCA solid-state products lists more than 103,000 types which can be replaced with only 250 SK devices. Ratings, characteristics, dimensional outlines, terminal diagrams and a revised semi hardware replacement directory are included. RCA Solid State, Somerville, NJ

CIRCLE NO. 398

## Vendors Report

Annual and interim reports can provide much more than financial-position information. They often include the first public disclosure of new products, new techniques and new directions of our vendors and customers. Further, they often contain superb analyses of segments of industry that a company serves.

Selected companies with recent reports are listed here with their main electronic products or services. For a copy, circle the indicated number.

**The Foxboro Co.** Instruments and systems for process management and control.

CIRCLE NO. 421

**Altair.** Electronics, instrumentation and industrial process and control systems.

CIRCLE NO. 422

**Franklin Electric.** General-purpose motors.

CIRCLE NO. 423

**Royal Industries.** Automotive electronics, nuclear-energy products and plastic products.

CIRCLE NO. 424

**Teleflex.** Aircraft controls, monitoring and measuring devices for nuclear reactors, protective coatings and plastic extrusions.

CIRCLE NO. 425

**Western Union Corp.** Information networks, teleprinter networks, computer-communications networks, terminals for systems and communications satellite systems.

CIRCLE NO. 426

**Nippon Electric.** Communications, electronic data processing, components and consumer electronics.

CIRCLE NO. 427

**Fairchild Camera & Instrument.** Semiconductor components, integrated circuits, discrete products, communications equipment, audio-visual equipment, transducers, magnetic recording and reproducing systems, space and defense systems and automatic testing equipment.

CIRCLE NO. 428

## Introducing The "No Hardware" THUMBWHEEL SWITCH



- Five parts per switch
- Matte finished
- U.L. fire retardant
- Variety of colors
- Low cost

### SAVE UP TO 35% ON YOUR SWITCH COSTS

IMC thumbwheel switches are the result of months of design -- to bring you a more reliable switch that can be mounted without hardware. Molded-in snap studs enable the switch banks to be assembled without bands or clamps -- saves you up to 25% of the switch cost. Standard black matte finish saves an additional 10%.

Front mount or rear mount with only five parts per switch, and only 8mm (0.315") wide, makes it the smallest thumbwheel switch on the market.

IMC switches also provide conversions from dial settings to coded outputs -- decimal or binary coded decimal are off-the-shelf. OEM prices start at \$1.25.

**IMC** INTERNATIONAL MICROTRONICS CORPORATION  
4016 E. TENNESSEE STREET / TUCSON, ARIZONA 85714  
(602) 795-9440 TWX 910-952-1170

INFORMATION RETRIEVAL NUMBER 101

## Telonic re-invents the Sweep Generator.

Our new Model 1210 is capable of sweeping a full 1 to 1000 MHz without manual band switching. It's done internally, electronically by a patented circuit. Now you can see a continuous frequency sweep as wide as 1000 MHz or as narrow as 200 kHz, with no interruptions. This solid-state, modular instrument is one of our Series 1200 sweepers covering 2 kHz to 1.5 GHz. They're an investment in dependable instrumentation. And when your equipment dollars are hard to come by, you'd better make the right buy. Right?

The Series 1200 Sweep Generator catalog is free. Write us.



**TelonicAltair**

2825 Laguna Canyon Rd. · Box 277 · Laguna Beach, California 92652  
Tel: 714 494-9401 · TWX: 910 596-1320 · Cable: TELENG

The No. 1 name in Sweep Generators



INFORMATION RETRIEVAL NUMBER 102

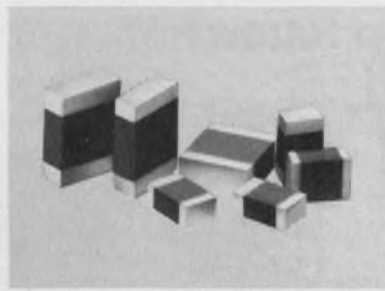

**HIGH Q MULTILAYER CAPACITORS** feature very high quality factors at microwave frequencies. Offered in three standard sizes: .050 x .040, .080 x .050, .125 x .095. Capacitance values from 0.1 pf to 1000 pf with close tolerance and voltages to 1000 VDCW. Johanson/Monolithic Dielectrics Div., Box 6456, Burbank, Ca. 91510, (213) 848-4465.

INFORMATION RETRIEVAL NUMBER 601



**Rugged and low-cost 36-pin connector.** Suberly designed and produced with simplified construction. Cut your costs up to 50%. Moisture-resistant glass-filled nylon insulator Recessed contacts in both male and female housings. Hood provides positive cable strain relief. Interchangeable. E. F. Johnson Co., Waseca, MN. (507) 835-2050.

INFORMATION RETRIEVAL NUMBER 604

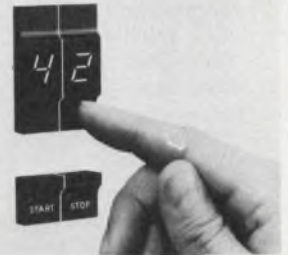

**Solid-State Digital Advance Switch—** The thumbwheel switch you activate with only a TOUCH! No rotating of cumbersome ratchet wheels. Simply touch the "touch plate" and the switch advances, step-by-step, until you remove your finger. Stepping rate 0.3 seconds/digit. Master Specialties, 1640 Monrovia, Costa Mesa, Calif. 92627.

INFORMATION RETRIEVAL NUMBER 607



**Free catalog of 34,500 power supplies** from the worlds largest manufacturer of quality Power Supplies. New '74 catalog covers over 34,500 D.C. Power Supplies for every application. All units are UL approved, and meet most military and commercial specs for industrial and computer uses. Power Mate Corp. (201) 343-6294.

INFORMATION RETRIEVAL NUMBER 602

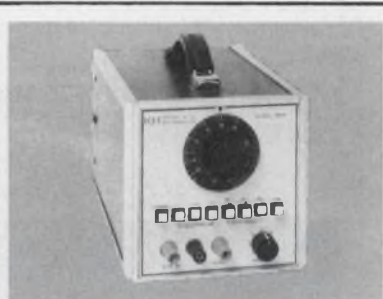

**Low Cost Function Generator, Model 5800;** sine, square and triangle waveforms from 0.2Hz to 2MHz. 15 volts p-p outputs, 50 ohm output. Distortion typically less than .3%. 1000:1 tuning dial covers audio range on one band. Aux. output square wave. Price \$245. Stock delivery. Krohn-Hite Corp. 580 MA Ave., Cambridge, MA 02139 (617) 491-3211.

INFORMATION RETRIEVAL NUMBER 605

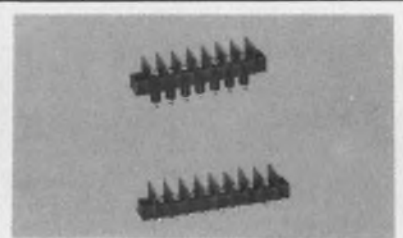

**Compact Curtis Terminal Blocks of** Unbreakable Thermo-Setting Plastic feature ultrasonically welded terminal inserts and full mechanical thread system. High-barrier CB/CFT blocks are rated 15 amp/300 volt with 5,500 volt breakdown. Feed-thru and surface-mount designs available. Curtis Industries, Inc., 8000 West Tower Avenue, Milwaukee, Wisconsin 53223, (414) 354-1500 or toll free (800) 645-9200 — New York call collect (516) 294-0990.

INFORMATION RETRIEVAL NUMBER 608

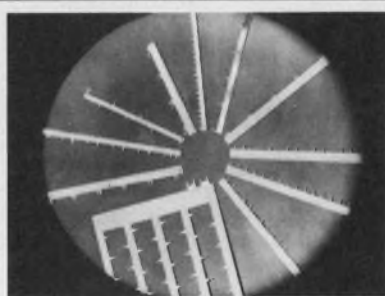

**Mini/Bus® Evaluation Kit, \$25,** in stock. Lets you try Rogers' low-cost, noise attenuating, high packaging density power distribution system for PC boards. Millions in use. Standard parts on 2 weeks delivery, or less! Customer parts 4 to 6 weeks delivery. Rogers Corporation, Chandler, Ariz. 85224. Phone (602) 963-4584

INFORMATION RETRIEVAL NUMBER 603

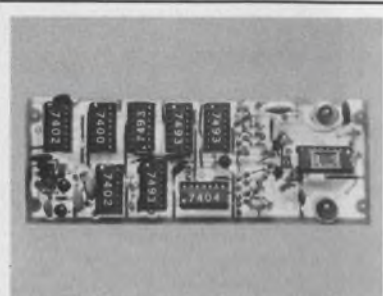

**Low Cost Image Sensing Module** contains a 1024 element (32-by-32) image sensor and all support circuitry on a single pc board. Digital video output may be displayed directly on an oscilloscope. Complete module (SE1024W) is \$150. Kit (SE1024K) is \$90. Cromemco, 26655 Laurel, Los Altos, CA 94022.

INFORMATION RETRIEVAL NUMBER 606



**NEW TOPAZ AC LINE REGULATORS**  
**FEATURE:** • 98% efficiency • Small size and weight • Very low distortion • Wide input voltage range • Excellent response Prices start at \$245. Models from 500 VA to 24 kVA. Delivery from stock. TOPAZ ELECTRONICS, 3855 Ruffin Road, San Diego, CA. 92123

INFORMATION RETRIEVAL NUMBER 609



CONVERTER  
OUTPUT SCOTT T

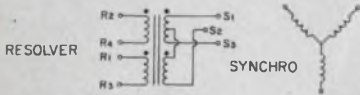

**SCOTT T. TRANSFORMER:** MAGNETICO Synchro driver is 7/8 x 1-5/8 x 11/16 high, rated at 1 volt amp., 2 arc minutes accuracy. P.N. 52155 is 5.9 sine and cosine to 11.8 v. L-L Synchro. P.N. 52156 is 5.9 sine and cosine to 90 v. L-L Synchro. MAGNETICO, 182 Morris Avenue, Holtsville, N.Y. 11742—516-654-1166.

INFORMATION RETRIEVAL NUMBER 610

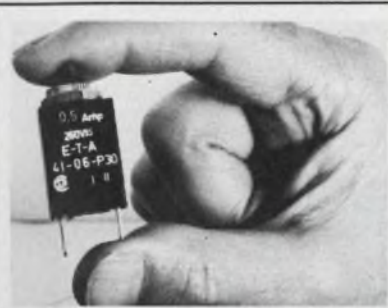

**Overcurrent Protector**, manual reset eliminates fuse replacement. Convenient panel mounting. 15 fractional ratings from 0.1 to 3 amp. Other models up to 400 amp. Trip-free and fool-proof, UL and CSA approved. High quality, low cost \$1.29 ea. in 1000 lots. E-T-A Products Co. of America, 7400 N. Croname Rd., Chicago, Ill. 60648. Tel: (312) 647-8303. Telex: 253780.

INFORMATION RETRIEVAL NUMBER 613



**MALE & FEMALE HEADERS.** Straight and right-angle male headers provide economical attachment of complete matrices of .025" square posts to PC boards. Female headers provide economical interconnecting to matrices of square or round posts. Off-the-shelf up to 36 contacts/row. Custom shapes: 4-6 wks A P PRODUCTS INC, Bx 11-D, Painesville Oh 44077

INFORMATION RETRIEVAL NUMBER 611

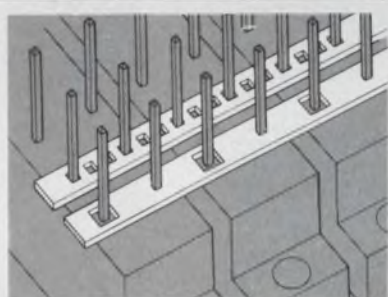

**STRIP/BUS BY ROGERS.** Low Cost Bussing Systems; easy installation, reliable solder joints; greater pin exposure. Write or call for details. Rogers Corporation, Rogers, Connecticut 06263. Phone (203) 774-9605.

INFORMATION RETRIEVAL NUMBER 614



**30 amp bridge rectifiers** for UL applications from Tarzian has exceptionally long creepage path (1/4"+), aluminum base for rapid heat dissipation. 400 Amp surge rating. 50-1000 PIV. Center hole or stud mount case \$3.42 and up in 25 quan. Sarkes Tarzian, Inc., Semiconductor Div. 415 College Ave., Bloomington, IN 47401, 812-332-1435.

INFORMATION RETRIEVAL NUMBER 612

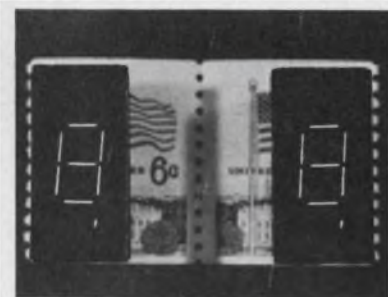

**The Proven Incandescent Readout** Standard 16 Pin DIP Flat Pack. All units 5 Volt 100,000 hrs. plus 3015F-BM 08ma/seg 700 ft/lam 3015F-BM10 10ma/seg 1700 ft/lam 3015F-BM15 15ma/seg 4500 ft/lam Field tested over 4 years in many applications. READOUTS, INC. P.O. Box 149, Del Mar, Ca. 92014 Tel. 714-755-2641 Telex 69-7992.

INFORMATION RETRIEVAL NUMBER 615

Advertisers wishing to reserve Quick Ad units should note the following mechanical requirements: Specs—Supply glossy photo of product and approximately 40 words which will set no more than 10 lines of 34 characters each. AFTER SUBMISSION NO COPY CHANGES CAN BE ACCEPTED. Quick Ads cost only \$325 per insertion, less for frequency advertisers.

**RATES:**

1x  
\$325

7x  
\$300

13x  
\$275

19x  
\$270

26x  
\$265

39x  
\$260

52x  
\$255

104x  
\$250

# Compare for Yourself...



## You'll See Why 99% of Users Rate Electronic Design's **GOLD BOOK** Equal or **SUPERIOR** to Other Industry Directories

A comparison of 1974-75 electronics industry directories reveals the GOLD BOOK'S superiority at a glance. It is the largest, most complete, most comprehensive one-step purchasing and reference tool ever produced in this industry. Its *Product Directory* contains more than twice the number of editorial pages as EEM; 50 percent more than EBG. There are more manufacturers, more products, more cross references; more than twice the number of distributors. There are eleven times more catalog pages for user reference than contained in EBG. AND, the GOLD BOOK is the only major electronics directory that goes overseas in quantity. Analysis of rating cards returned by users reveals that 99% rate the GOLD BOOK equal or superior to other industry directories. If you're looking for catalog data, product or supplier information . . . the place to look *first* is the GOLD BOOK.



## COMPARISON OF ELECTRONICS INDUSTRY DIRECTORIES

(1974-75 editions)

	Electronic Design's GOLD BOOK	EEM Electronic Engineers Master	EBG Electronics Buyers Guide
<b>CIRCULATION</b>			
Total	Over 90,000	85,993 <sup>1</sup>	30,017 <sup>1</sup>
Non-U.S. <sup>2</sup>	13,200	None <sup>1</sup>	1,339 <sup>1</sup>
<b>CATALOG PAGES</b>			
Number of pages	2,820	2,752	257 <sup>3</sup>
<b>PRODUCT DIRECTORY</b>			
Total number of pages	469	195	305
Total number of products listed	4,799	3,235	4,267
Number of direct products listed	2,925	2,250	2,479
Number of cross-reference products listed	1,874	985	1,788
Is complete mailing address given each time a company is listed?	Yes	No	No
Is telephone number given each time a company is listed?	Yes	No	No
<b>TRADE NAME DIRECTORY</b>			
Total number of pages	28	19	18
<b>MANUFACTURERS DIRECTORY</b>			
Total number of pages	341	200	260
Number of manufacturers listed	7,528	3,165	5,800
Are distributors listed for manufacturers free of charge?	Yes	No	No
Does manufacturers listing include FSCM numbers?	Yes	No	No
Does manufacturers listing show facsimile equipment by make and call number?	Yes	No	No
<b>DISTRIBUTORS DIRECTORIES</b>			
Number of distributors listed in alphabetic section	5,780	1,720	None
Number of distributors listed in geographic section	5,780	1,720	None

**NOTES:**

<sup>1</sup> Standard Rate & Data; Oct. 24, 1974

<sup>2</sup> Includes Canada

<sup>3</sup> Includes fractionals

ELECTRONIC DESIGN's function is:

- To aid progress in the electronics manufacturing industry by promoting good design.
- To give the electronic design engineer concepts and ideas that make his job easier and more productive.
- To provide a central source of timely electronics information.
- To promote communication among members of the electronics engineering community.

**Want a subscription?** ELECTRONIC DESIGN is sent free to qualified engineers and engineering managers doing design work, supervising design or setting standards in the United States and Western Europe. For a free subscription, use the application form bound in the magazine. If none is included, write to us direct for an application form.

If you do not qualify, you may take out a paid subscription for \$30 a year in the U.S.A., \$40 a year elsewhere. Single copies are \$1.50 each.

If you change your address, send us an old mailing label and your new address; there is generally a postcard for this bound in the magazine. You will have to requalify to continue receiving ELECTRONIC DESIGN free.

**The accuracy policy** of ELECTRONIC DESIGN is:

- To make diligent efforts to ensure the accuracy of editorial matter.
- To publish prompt corrections whenever inaccuracies are brought to our attention. Corrections appear in "Across the Desk."
- To encourage our readers as responsible members of our business community to report to us misleading or fraudulent advertising.
- To refuse any advertisement deemed to be misleading or fraudulent.

Microfilm copies are available of complete volumes of ELECTRONIC DESIGN at \$19 per volume, beginning with Volume 1, 1952 through Volume 20. Reprints of individual articles may be obtained for \$3.00 each, prepaid (\$.50 for each additional copy of the same article) no matter how long the article. For further details and to place orders, contact the Customer Services Department, University Microfilms, 300 North Zeeb Road, Ann Arbor, Michigan 48106 telephone (313) 761-4700.

**Want to contact us?** If you have any comments or wish to submit a manuscript or article outline, address your correspondence to:

Editor  
ELECTRONIC DESIGN  
50 Essex Street  
Rochelle Park, N.J. 07662

## Dual Hi-Speed FFT Processor Easy to Operate



Conceived from the point of view of the operating engineer rather than the computer programmer, the new Omniferous™ FFT Analyzer operates like an instrument, calculates like a computer. This Series OF-400 Analyzer is a universal digital signal analysis system for real-time viewing of changing functions, a complete instrument with all signal conditioning and display calibration built-in. For the first time an operator can observe transfer function, cross-spectra or coherence as the signal is changing without waiting for the analyzer to perform successive laborious calculations.

Features include high speed of 68,000 samples/sec throughput, and high resolution with a 2048 transform size and extra-sharp input anti-aliasing filtering. Calculates FFT, IFFT, power spectra, auto-correlation, cross correlation, and signal enhancement (time averaging), as well as the averaging of any calculated function in sum, peak or exponential mode.

The system excels in high dynamic range, ease of use, display flexibility with two simultaneous display outputs, frequency coverage to 100 kHz, and reasonable cost. Designed by the originators of the famous Ubiquitous® family of real-time spectrum analyzers.

**Nicolet Scientific Corp.** (formerly Federal Scientific Corp.)

245 Livingston St., Northvale, New Jersey 07647  
(201) 767-7100. TWX: 710-991-9619

IMMEDIATE, CIRCLE NO. 170  
ROUTINE, CIRCLE NO. 171

## UNDERSTANDING CHIP CAPACITORS

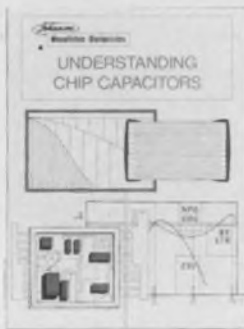

This new thirty-two page reference book covers all phases of chip capacitor technology. The introductory section explains and illustrates in basic terms what chip capacitors are, their properties and how they operate. Included, as well, are six other chapters covering electrical properties, general classes of dielectrics, testing parameters, high reliability testing, general testing and quality conformance requirements, some answers on chips, and how to select the proper chips for specific requirements.

This handbook is generously illustrated with twenty-two graphs and seven comprehensive tables covering a wide variety of data and performance characteristics.

CIRCLE NO. 172

## JOHANSON/MONOLITHIC DIELECTRICS DIV.

P. O. Box 6456  
Burbank, California 91505 Phone: (213) 848-4465

## MATERIALS FOR MAGNETIC FUNCTIONS

by Fennimore N. Bradley

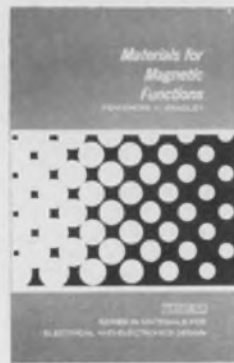

This valuable reference provides a thorough background as well as practical design techniques for the materials needed for magnetic functions. Included in its exhaustive coverage is detailed treatment of key parameters of about 30 classes of ferrite materials relating processing to costs and design trade-offs . . . and equally thorough coverage of about 40 classes of both conventional and exotic magnetic metals and processes. The book focuses on design problems encountered in a wide range of permanent-magnet applications . . . pinpoints design problems in nearly 30 categories of electromagnetic devices . . . and concludes with coverage of environmental influences such as corrosion, magnetic field, temperature, stress, etc. 360 pp., 6 x 9, illus., cloth, \$17.20. Circle the reader-service number to order a 15-day examination copy.

CIRCLE NO. 173



HAYDEN BOOK COMPANY, INC., 50 Essex St., Rochelle Park, N.J. 07662

# Manufacturers

Advertisements of booklets, brochures, catalogs and data sheets. To order use Reader-ServiceCard (Advertisement)



## GIANT FREE CATALOG

New 180-page catalog! Packed with 1,000's of hard-to-find buys in Optics, Science, Electronics. Loaded with optical, scientific, electronic equipment available from stock. Rare surplus buys. Many "one-of-a-kinds". Ingenious scientific tools. Components galore: lenses, prisms, wedges, mirrors, mounts, accessories. 100's of instruments: pollution test equipment, lasers, comparators, magnifiers, microscopes, projectors, telescopes, binoculars, photo attachments, alternate energy sources. Shop, save by mail! Request free Catalog "DA".

CIRCLE NO. 174

### Edmund Scientific Co.

America's Largest Science-Optics-Electronics Mart  
300 Edscorp Bldg., Barrington, New Jersey 08007 (609) 547-3488

Share in the nation's top managerial policies, strategies, techniques . . .

## MANUFACTURING MANAGEMENT SYSTEMS

New Challenges and Opportunities Edited by Fred Gruenberger



By crystallizing the results of the 1973 Informatics/UCLA Symposium, this book offers a powerful blend of technical and managerial expertise for enhancing the overall success and profitability of today's manufacturing management systems. Some of the nation's top industrial and technical leaders speak freely and in depth of their organization's objectives and specific operations, as well as their personal strategies and methods. You'll find the newest computerized tools available to manufacturers . . . crucial managerial skills for directing progressive systems . . . the tact and care needed for the sensitive human problems of system implementation, and more. #5940-x, 160 pages, \$10.50. Circle the Info Retrieval No. to order a 15-day exam copy. When billed, remit or return book. No obligation.

CIRCLE NO. 175

Hayden Book Company, 50 Essex St., Rochelle Pk, N.J. 07662

## VERSATILE VECTOR VOLTMETER



The Princeton Applied Research Model 129A Two Phase Lock-in/Vector Voltmeter permits simultaneous measurement of magnitude and phase angle even if the signal is masked by background noise. Flip a switch and measure the I and Q components of the vector; independent output expansion, offsetting, and filtering of each component are also provided. Full scale sensitivity ranges from 1 microvolt to 0.25 volts and is extendable to 25 volts with the optional compensated attenuator. Model 186/41. The Model 129A reference channel has fully automatic reference tracking capability and is phase matched to the signal channel over the operating range 0.5 Hz to 100 kHz. Complete specifications are contained in our Lock-in Amplifier Catalog No. T218.

CIRCLE NO. 176

### Princeton Applied Research Corporation

P.O. Box 2565, Princeton, New Jersey 08540  
609/452-2111. See us at the CLEA Show, Booth #760 & #770 in Washington, D.C. May 28-30

# Electronic Design

## Advertising Sales Staff

Tom W. Carr, Sales Director  
Rochelle Park, NJ 07662  
Robert W. Gascoigne  
Daniel J. Rowland  
(Recruitment, Quick Ads, Classified)  
50 Essex Street  
(201) 843-0550  
TWX: 710-9990-5071

## Philadelphia

Thomas P. Barth  
50 Essex Street  
Rochelle Park, NJ 07662  
(201) 843-0550

## Boston 02178

Gene Pritchard  
P.O. Box 379  
Belmont, MA 02178  
(617) 489-2340

## Chicago 60611

Thomas P. Kavooras  
Berry Conner, Jr.  
200 East Ontario  
(312) 337-0588

## Cleveland

Thomas P. Kavooras  
(Chicago)  
(312) 337-0588

## Los Angeles 90045

Stanley I. Ehrenclou  
Burt Underwood  
8939 S. Sepulveda Boulevard  
Suite 510  
Los Angeles, CA  
(213) 641-6544

## San Francisco 94022

Robert A. Lukas  
Box 126  
3398 El Camino Real  
Highway 82  
Palo Alto, CA 94306  
(415) 965-2636

## London, Amsterdam, Tokyo, Seoul

John Ashcraft  
12, Bear St.  
Leicester Square  
London WC2H 7AS England  
Phone: 01-930-0525

W. J. M. Sanders  
John Ashcraft & Co.  
Herengracht 365  
Amsterdam C., Holland  
Phone: 020-24-09-08

Haruki Hirayama  
Electronic Media Service  
5th Floor, Lila Bldg.,  
4-9-8 Roppongi  
Minato-ku, Tokyo, Japan  
Phone: 402-4556

Cable: Electronicmedia, Tokyo  
Mr. O-kyu Park, President  
Dongbo Int'l Corp.—  
World Marketing  
C.P.O. Box 4010  
Seoul, Korea  
Tel. 76-3910/3911  
Cable: DONGBO SEOUL  
Telex: EBKOREA K27286

ABP

BPA

# Advertiser's Index

Advertiser	Page	Advertiser	Page	Advertiser	Page
AMP, Incorporated	Cover II	GTE Automatic Electric	102, 103	Master Specialties	136
AP Products	137	Garrett Corporation, The	53	Metex Corporation	122
Acopian Corp.	89	Gates Energy Products, Inc.	93	Micro-Line, Division of	
Allen Bradley Co.	104	General Electric Company	52	Bausch & Lomb	146
American Technical Ceramics	129	Gold Book, The	50F, *102, *103, *104, 138, 139, 146	Micro Networks Corporation	50F
Angle Steel	121	Gould Inc.	143	Minelco Division/General	
Angstrom Precision, Inc.	108	Hayden Book Co.,		Time Corp.	130
Bafco, Inc.	146	Inc.	50D, 88, 140, 141	Mini-Circuits Laboratory	42
Belden Corporation	78, 79	Heath Company	50E	Monolithic Memories, Inc.	20, 21
Bell, Inc., F. W.	143	Hecon Corporation	143	Motorola Semiconductor	
Bendix Corporation	33	Hewlett-Packard	9 thru 18	Products, Inc.	50B, 50C
Biomation	95, 97	Hughes Aircraft Company	31	MuRata Corporation of America	114
Bodine Electric Company	117	IMC Magnetics Corp.	132	National Electronics, A	
Bud Radio, Inc.	111, 112	ITT Semiconductors	27	Varian Division	128
Connecticut Hard Rubber Co.	122	Illuminated Products Co.	110	Newport Laboratories, Inc.	112
Control Data Corporation	50A	Industrial Timer	145	Nicolet Scientific Corp.	64, 140
Cromemco	136	Intech, Incorporated	118	Optima Enclosures, A Division	
Curtis Industries, Inc.	136	Intel Corporation	4, 5	of Scientific Atlanta, Inc.	109
Decitek, A Division of		International Microtronics Corp.	135	*Philips Industries, Test and	
Jamesbury Corp.	132	Intersil	22, 23	Measuring Instruments Dept.	40, 41
Dialight Corporation	71	Intronics Industries, Inc.	116	Photo Research, a Division of	
Digital Equipment Corporation	28, 29	Janco Corporation	114	Kollmorgen Corporation	124
Dynascan Corporation	121	Johanson Manufacturing Corp.	7	Potter & Brumfield, Division of	
EECO	19	Johanson/Monolithic		AMF, Incorporated	63
EMR Telemetry	131	Dielectrics Division	136, 140	Power Mate Corp.	136
ETA Products	137	Johnson Co., E. F.	136	Practical Automation Inc.	87
Edmund Scientific Co.	141	Krohn-Hite Corp.	136	Precision Plating Company, Inc.	99
Elec-Trol, Inc.	145	Kurz-Kasch, Inc.	146	Princeton Applied Research Corp.	141
Electro Corporation	117	Litronix, Inc.	50H, 51	Projects Unlimited	145
Electronic Design	*46, 89	Litton Triad-Utrad	127	Pyle Industries	143
Electronic Measurements, Inc.	123	MCG Electronics	144	Pyrofilm Corporation	24
Electrostatics, Inc.	129	Magnecraft Electric Company	Cover III	Quan-Tech, Division of	
Fairchild Semiconductor, A Division		Magneto	137	Scientific Atlanta, Inc.	133
of Fairchild Camera and				RCA Electronic Instruments	121
Instrument Corporation	106, 107			RCA Solid State	Cover IV

## NEW 1000:1 SWEEP GENERATOR (It's a function generator too!)



The VIC 965A is a new sweep generator covering a wide 1000:1 continuous frequency sweep range and combines the functions of a sweep generator, and a function generator in one small compact unit only 3½" high and 12" wide. It provides a wider sweep frequency range, greater stability, and accuracy than commonly available. Five frequency ranges, 0.035 Hz - 35 Hz; 0.35 Hz - 350 Hz; 3.5 Hz - 3500 Hz; 35 Hz - 35,000 Hz; and 350 Hz - 350,000 Hz.

The upper and lower frequency limits may be set (screwdriver) to cover a lesser range

than the 1000:1 range normally covered. The generator can be manually tuned, can be swept with a SINGLE SWEEP UP, SINGLE SWEEP DOWN, and AUTOMATIC continuous sweep. The sweep rate is determined by a digital dial providing a wide range of sweeps either linear in Hz/sec or log in Oct/min. Both linear and logarithmic D.C. voltages proportional to frequency are provided at the back of the unit. For more details contact: Vibration Instruments Company, 1614 Orangethorpe Way, Anaheim, California 92801 — 714/879-6085.

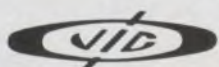

VIBRATION INSTRUMENTS CO.

INFORMATION RETRIEVAL NUMBER 103

\*Advertisers in non-U.S. edition.

ELECTRONIC DESIGN 12, June 7, 1975



Pyle Industries can provide highly efficient midrange or tweeter horns to meet almost any sound requirement. Our horns can be used in either bass reflex or acoustic suspension systems . . . and all of them are competitively priced.

Here at Pyle, speakers are our only business. Our personnel have over two centuries of combined experience designing, engineering, and manufacturing high quality hi-fi speakers.

If you need horns, we've got plenty. Call or write for complete information.

**PYLE INDUSTRIES**  
2050 U.S. 24 East • Huntington, IN 46750  
219-356-1200

INFORMATION RETRIEVAL NUMBER 104

## Introducing the Brush 110 strip chart recorder—with a thermal writing pen guaranteed for life.

There isn't another strip chart recorder on the market today that can match the Brush 110's performance, ruggedness, versatility and writing dependability.

The new hot-tip thermal writing system produces clear, sharp, highly reproducible blue traces **with no smudges, no smears, no skips and no puddles.**

Before you buy, check out the remarkable Brush 110. Contact your nearest Gould sales engineer for a demonstration. Or write Gould Inc., Instrument Systems Division, 3631 Perkins Avenue, Cleveland, Ohio 44114.



**GOULD**

INFORMATION RETRIEVAL NUMBER 106

## We started a counter revolution

... in 1964, when we introduced the Hecon line ... every kind of electro-mechanical, electronic and pneumatic/fluidic counter imaginable, from totalizing to predetermining to batching ... *every single one tested before it leaves our plant.*

Find out for yourself. Contact us for free catalog today.

**HECON CORPORATION**  
P.O. Box 247  
Eatontown, N.J. 07724  
Phone (201) 542-9200

**HECON OF CANADA, LTD.**  
80 Galaxy Blvd.  
Rexdale, Ontario M9W-4Y8  
Phone: (416) 678-2441

**HECON**



INFORMATION RETRIEVAL NUMBER 105

ELECTRONIC DESIGN 12, June 7, 1975

## New Bell Magnetic Sensors do things nothing else can do!

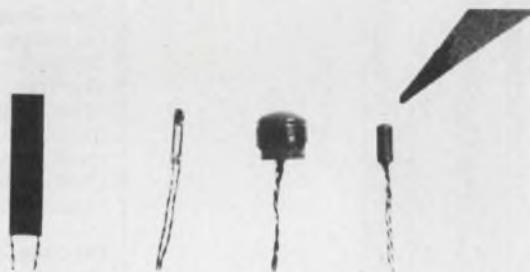

Bell Hall effect generators are unique solid state components. They provide a voltage output proportional to ambient magnetic flux density. Their operating characteristics permit virtually any application: frequency, dc to MHz; magnetic flux density, milligauss to kilogauss; linearity, to 0.1%; temperature,  $-269^{\circ}\text{C}$  to  $+100^{\circ}\text{C}$ .

Take advantage of the circuit saving (**money saving**) benefits of non-contact Bell Hall generators. Application information will get you started solving design problems in totally new, efficient ways.

**Some present applications are:** current sensors, guidance systems, brushless dc motors, magnetic field measurements, proximity sensors, power transducers. Hall effect experimental kits are available.



4949 Freeway Drive East  
Columbus, Ohio 43229  
614/888-7501  
TWX: 810-337-2851

A subsidiary of The Arnold Engineering Company

INFORMATION RETRIEVAL NUMBER 107

143

# Circuit Savers

DC **95¢** 1000 pcs.

**TRANSIENT SUPPRESSOR**



The TSD-1.5 Series are ideal for protection of long signal lines from damage from induced lightning etc. Reaction time is in nanoseconds.

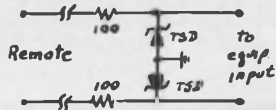

2 units (back to back) will protect sensitive components from a 5KV, 1ms duration transient. Clamp voltages from 5V to 200V. Call Mike Coyle for applications assistance. Full line of protection modules for every hi-lo voltage/current requirement. Write or call for Catalog 749.

279 Skidmore Road  
Deer Park, New York 11729  
Telephone: 516 - 586-5125

# MCG Electronics

INFORMATION RETRIEVAL NUMBER 108

**SUBSCRIBER SERVICE** For prompt service include the addressed label when writing about your subscription.

## CHANGE OF ADDRESS

city	company address	division/departement	company	name	NEW ADDRESS
state				title	
zip					

If you're moving, please let us know six weeks before changing your address. If you have a question, place your magazine address label here and clip this form to your letter.

MAIL TO: ELECTRONIC DESIGN Circulation Dept. Hayden Publishing Co., Inc., 50 Essex Street, Rochelle Park, NJ 07662

# Product Index

**Information Retrieval Service.** New Products, Evaluation Samples (ES), Design Aids (DA), Application Notes (AN), and New Literature (NL) in this issue are listed here with page and Information Retrieval numbers. Reader requests will be promptly processed by computer and mailed to the manufacturer within three days.

Category	Page	IRN	Category	Page	IRN
<b>Components</b>			photometer systems	124	80
battery	93	44	response analyzer	146	114
capacitors	37	16	scales	146	115
capacitors	120	73	scope, dual-trace	117	68
capacitors, ceramic	145	112	spectrum analyzer	64	281
capacitors, chip	7	6	spectrum analyzer	131	90
dc transient suppressor	144	108	strip-chart recorder	143	106
DIPs	53	30	test instruments	117	69
filters	39	18	test set, noise	107	307
potentiometers	104	50	time-interval meter	105	301
rf detectors	130	88	timer, time-delay	145	109
relays, solid-state	145	110			
resistors, metal-film	108	53	<b>Integrated Circuits</b>		
sensors, magnetic	143	107	amp, instrumentation	109	308
sound device, solid state	145	111	antenna system	126	364
spark gaps	115	65	CMOS data book	107	51
switch	135	101	calculator chips	110	310
switches	38	17	ICs, data communication	108	303
switches	110	57	RAM, 250-bit	109	309
switches	126	82	switch	126	363
switches, rotary	114	62	switch/driver	124	355
switches, slide	116	333	triode	125	354
transformers	127	83			
trimmer, cermet	115	332	<b>Modules &amp; Subassemblies</b>		
trimmers	130	89	a/d converter	118	337
			amp, sample/hold	119	343
<b>Data Processing</b>			amplifiers, high-V	119	342
cartridge, disc drives	89	41	filter, bandpass	118	339
computer, Basic	111	323	hybrid circuits	119	72
digitizer	111	321	hybrid microcircuits	24	10
drive systems, PM	121	74	tach, electronic	118	338
memory, core	111	322	transducer, watt	118	341
minicomputer	113	327			
OEM systems	29	12	<b>Packaging &amp; Materials</b>		
tape readers	132	92	bellows	127	365
			cable	6	5
<b>Discrete Semiconductors</b>			connectors	31	13
Darlington,			connectors	33	14
complementary	122	350	connectors	11	246
diodes, fast recovery	120	348	DIP socket, breadboard	116	334
diodes, IR	122	349	enclosures	109	54
diodes, tuning	120	347	fans	132	91
modules, optical switch	123	352	filter, dust	128	369
power transistor	120	346	gold plating	99	47
SCRs	128	85	knobs	146	113
switches, optoelectronic	120	345	PC connector	65	33
transistors	27	11	packaging hardware	52	29
transistors	40	19	socket cards	19	7
transistors, high-V	120	344	tapes, industrial	122	78
triac, high voltage	122	351	wire, cable and cord	79	234
			wire-wrapping tool	129	372
<b>Instrumentation</b>			work stations	117	70
burst noise test set	133	93			
counters	143	105	<b>Power Sources</b>		
DMM, ac	88	40	modules	130	374
DMM/oscilloscope	45	22	power converters	116	66
DPM	107	304	power source	131	302
data recorder	97	46	power supplies	41	20
digital logic recorder	95	45	power supplies	73	35
digital printer	87	38	power supplies	129	86
multimeter	117	67			

## FOR THE UTMOST IN RELIABILITY

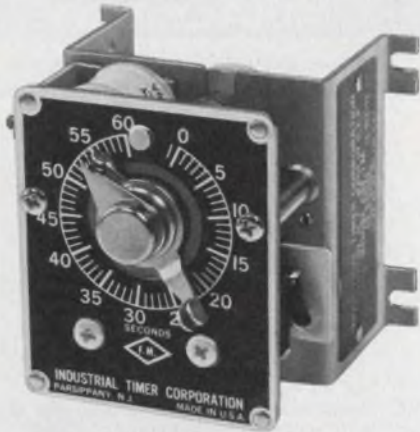

### TIME DELAY TIMER Series CSF

It is one of industry's most versatile compact delay timers, offering dial adjustability, automatic reset, external clutching and 10 amp. SPDT snap action load contacts. Repeat accuracy is 1 1/2%. Resets in 1/2 second at maximum settings. Voltages: 120, 240/50-60 hertz. All of our timers are made to give you service far beyond what you'd reasonably expect. Our line consists of 17 basic types, each available in various mountings, voltages, cy-

cles, circuits and load ratings... and with whatever special wrinkles you may need. Bulletin 305 tells all about our reliable Delay Timers. Write for it or a catalogue of the entire line. If you have an immediate timer requirement, send us your specifications. Or for fastest service call (201) 887-2200.

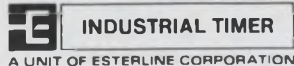

Industrial Timer Corporation, U.S. Highway 287, Parsippany, N.J. 07054

INFORMATION RETRIEVAL NUMBER 109

## DIP-ALARM<sup>TM</sup>

Unique, miniature solid state sound device with unlimited applications



- Plugs into DIP sockets or PC boards
- Rugged, reliable, loud
- Models for 3, 5, and 12 VDC, 35 mA
- Dependable solid state construction means no mechanical contacts, arcing or RF noise.
- 76 dB at 400 Hz tone radiates in all directions for positive alarm, warning, fault detection
- Use in conjunction with DIP-FLASH<sup>TM</sup> for pulsing operation.



projects<sup>®</sup>  
unlimited

3680 Wyse Road  
Dayton, Ohio 45414  
Tel. 513-890-1918  
TWX 810-450-2523

IN EUROPE  
B.P. 15  
B-6100 Mont-Sur-  
Marchienne, Belgium  
Telex 51-390  
Tel. (071) 36 64 86

INFORMATION RETRIEVAL NUMBER 111

## SOLID STATE RELAYS WITH SOMETHING EXTRA

From Elec-Trol, a complete line of 6, 10 and 25 Amp. AC and DC input Solid State Relays and custom designs to meet your needs. All feature: **Zero Crossover Switching** to eliminate RF noise and load current or voltage surges. **Photo Isolation between Input & Output** - 1500 VRMS FET Input Current Limiter on all DC models prevents relay closure by input transients & increases LED life. **Built-in Snubber Network in Output** prevents uncontrolled operation due to load-line transients. **IC Compatibility and Reverse Polarity Protection** on all DC models. Call or write for complete information today.

26477 N. Golden Valley Road • Saugus, Calif. 91350  
(805) 252-8330 • (213) 788-7292 • TWX 910-336-1556

### ELEC-TROL, INC.

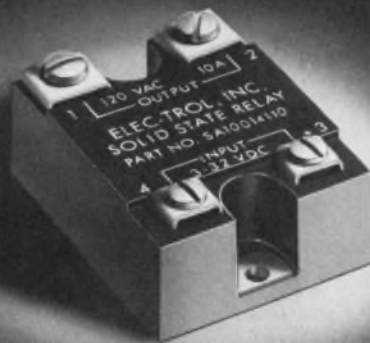

INFORMATION RETRIEVAL NUMBER 110

ELECTRONIC DESIGN 12, June 7, 1975

## Noise sensitivity problems go away- we guarantee it!

Topaz Ultra-Isolation Transformers provide an inexpensive and reliable way to supply clean, noise-free AC power to sensitive equipment such as computers, instrumentation, communication and process control equipment.

Ultra-Isolation Transformers offer the industry's best noise attenuation:

- Common-mode noise rejection greater than 145 dB.
- Transverse-mode noise rejection greater than 125 dB at 1 kHz.
- Standard models 125 VA to 45 kVA.
- Priced from \$64.



**Our guarantee:** A Topaz Ultra-Isolation Transformer will solve your noise sensitivity problems to your complete satisfaction or we'll take it back—no questions asked.

### TOPAZ ELECTRONICS

SOLUTIONS TO  
POWER PROBLEMS

3855 RUFFIN ROAD, SAN DIEGO, CA. 92123 • (714)279-0831

INFORMATION RETRIEVAL NUMBER 112



# 1,500,000

## KNOBBS TO CHOOSE FROM...

and they're "Warranted for Life"

Kurz-Kasch has over 1½ million low cost, high quality knobs in inventory, ready to ship to you. (You save . . . no tooling cost on stock knobs, specials 4 to 6 weeks delivery.) Your local distributor's stock is available at factory prices. Select instrument and control knobs from 24 families with 367 basic sizes and shapes in general purpose phenolics, melamines and ureas. All Kurz-Kasch knobs are warranted for the life of the product on which they're used. Send now for free 20 page catalog. (Also found in THOMAS REGISTER "THOMCAT.")



**Kurz-Kasch, Inc.**  
711 Hunter Avenue  
Wilmington, Ohio 45177  
513/382-0966

INFORMATION RETRIEVAL NUMBER 113

**ABSOLUTELY** the world's most accurate rulings using vacuum deposit chrome, etch and fill or emulsion processes. They're produced on the world's largest 1 micro inch numerically controlled ruling engine with interferometric feedback controls. Need precision scales, grids, slits, reticles, Ronchis numbers, letters, circles, dots, or nickel mesh? We stock many items for immediate delivery. Send for brochure No. 38-36.

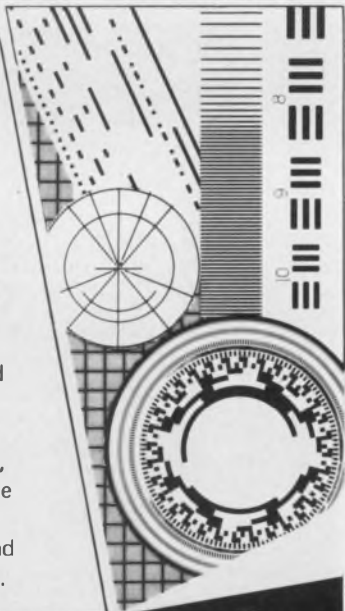

**SCALES RULINGS RETICLES & GRIDS FROM THE WORLD'S LEADING SCALE MAKERS.**

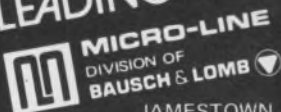

JAMESTOWN, NY 14701 716/488-1958

INFORMATION RETRIEVAL NUMBER 114

## TWO CHANNEL SWEEP FREQUENCY RESPONSE ANALYZER

TWO COMPLETE CHANNELS OF FREQUENCY RESPONSE MEASUREMENT

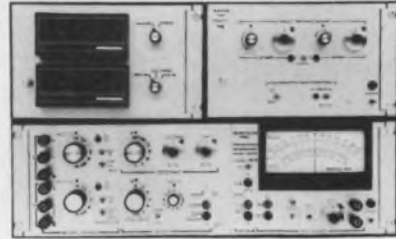

MODEL 913-72

**TO GIVE:** Open-loop measurement across any block in the system while in closed loop operation. Direct reading of amplitude ratio (DB) & phase shift.  
AC coupled inputs (automatic rejection of up to 200 volts DC).  
Automatic gain control over 80 DB dynamic range in each channel.  
Automatic high noise and harmonic rejection.  
**SWEEP:** Continuous log sweep from any start frequency to any stop frequency in the 6 1/2 decade frequency range.

### FREQUENCY RANGE

MODEL 913-72 - .005 thru 10,000 Hz.

MODEL 913H-72 - .025 thru 50,000 Hz.

SEND FOR COMPLETE CATALOG OF ALL MODELS

**BAFCO, INC.**

717 MEARNS ROAD  
WARMINSTER, PENNSYLVANIA 18974  
TEL: (215) 674-1700 • TWX No. 510-665-6860

INFORMATION RETRIEVAL NUMBER 115

## WHO MAKES WHAT & WHERE TO FIND IT

Volume 1 of **Electronic Design's GOLD BOOK** tells all. And, when you look up an item in its **PRODUCT DIRECTORY** you'll find each manufacturer listed **COMPLETE WITH STREET ADDRESS, CITY, STATE, ZIP AND PHONE.** Save time. There's no need to refer elsewhere to find missing information.

**IT'S ALL THERE**  
in  
**Electronic Design GOLD BOOK**



# Just How Broad is the MAGNECRAFT Stock Relay Line?



**free  
wall  
chart!**

Magnecraft's stock relay line consists of 1200 versions derived from 17 categories - - - - that is the largest and broadest line in the industry.

Oh? Did I read that correctly?

Yes, Magnecraft Electric provides 1200 relay versions in stock through our nationwide distributor network. Those 17 categories include; low profile, general purpose, power, mercury displacement, sensitive, coaxial, telephone type, air dashpot time delay, solid state, latching types, high voltage, mercury wetted reeds, dry reeds, and dip reed relays.

Magnecraft can offer you the design engineer, a quality product, local distributors, and the broadest relay line in the industry to choose from. If we don't have the relay in stock we will custom design a relay to meet your requirements.

Full color 22" x 34" relay specification chart.



**Magnecraft** ELECTRIC COMPANY

5575 NORTH LYNCH AVENUE • CHICAGO, ILLINOIS 60630 • 312 • 282-5500 • TWX 910 221 5221

What's new in solid state...

# RCA "Gold CHIP" LICs. Hermeticity in plastic at plastic prices.

Plastic LICs may have caused you some worries about field failures, actual or potential. But you didn't want to pay the price of ceramic or frit seal. Or, maybe the expensive hermetic packages you did use were damaged during insertion.

Now, the solution. RCA "Gold CHIP" linear integrated circuits. With gold metalization plus Chip Hermeticity In Plastic (CHIP). For reliability *plus* the economy and ruggedness of plastic.

Gold CHIP LICs have noncorroding gold metalization and leads. No aluminum with its potential problems. We make the chip itself hermetic. And put it in our advanced plastic package

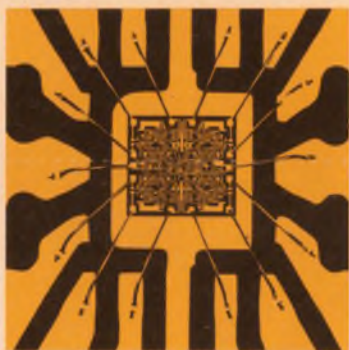

with proven outstanding reliability. Result: truly cost-effective hermetic LICs at the price of standard plastic LICs.

How reliable are they? We experienced zero failures in the following tests (data available): Temperature/Humidity/Bias, Operating Life, Thermal Fatigue, Pressure Cooker, Thermal Shock, Temperature Cycle.

#### Free Gold CHIP Sample

Evaluate them yourself! We'll send you one of the 6 off-the-shelf "G" standards listed here, free: CA741CG op amp; CA747G dual op amp; CA324G quad op amp; CA339G quad voltage comparator; CA3724G high voltage transistor array; CA3725G high voltage transistor array. Just specify which one, on a self-addressed label.

To find out more, contact your local RCA Solid State distributor. Or RCA.

Write: RCA Solid State, Box 3200, Somerville, New Jersey 08876; Ste. Anne de Bellevue 810, Canada; Sunbury-on-Thames, U.K.; Fuji Bldg., Tokyo, Japan.

# RCA

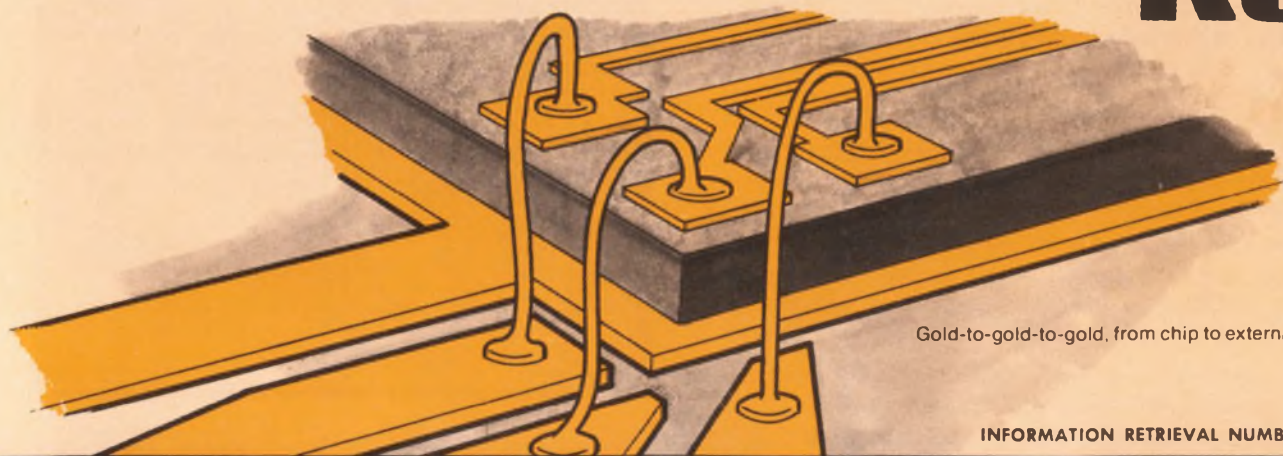

Gold-to-gold-to-gold, from chip to external world.

INFORMATION RETRIEVAL NUMBER 248

RCA. Full house in Linear ICs.