

# Electronic Design<sup>®</sup> 10

VOL. 23 NO.

FOR ENGINEERS AND ENGINEERING MANAGERS

MAY 10, 1975

A multifaceted computer world confronts today's designer. He's got to keep up with progress in architecture made possible by improved chip technology. He

has to consider the growing list of non-traditional peripherals. And he must recognize new computer uses such as in robotics and numerical control. Turn to P. 32.

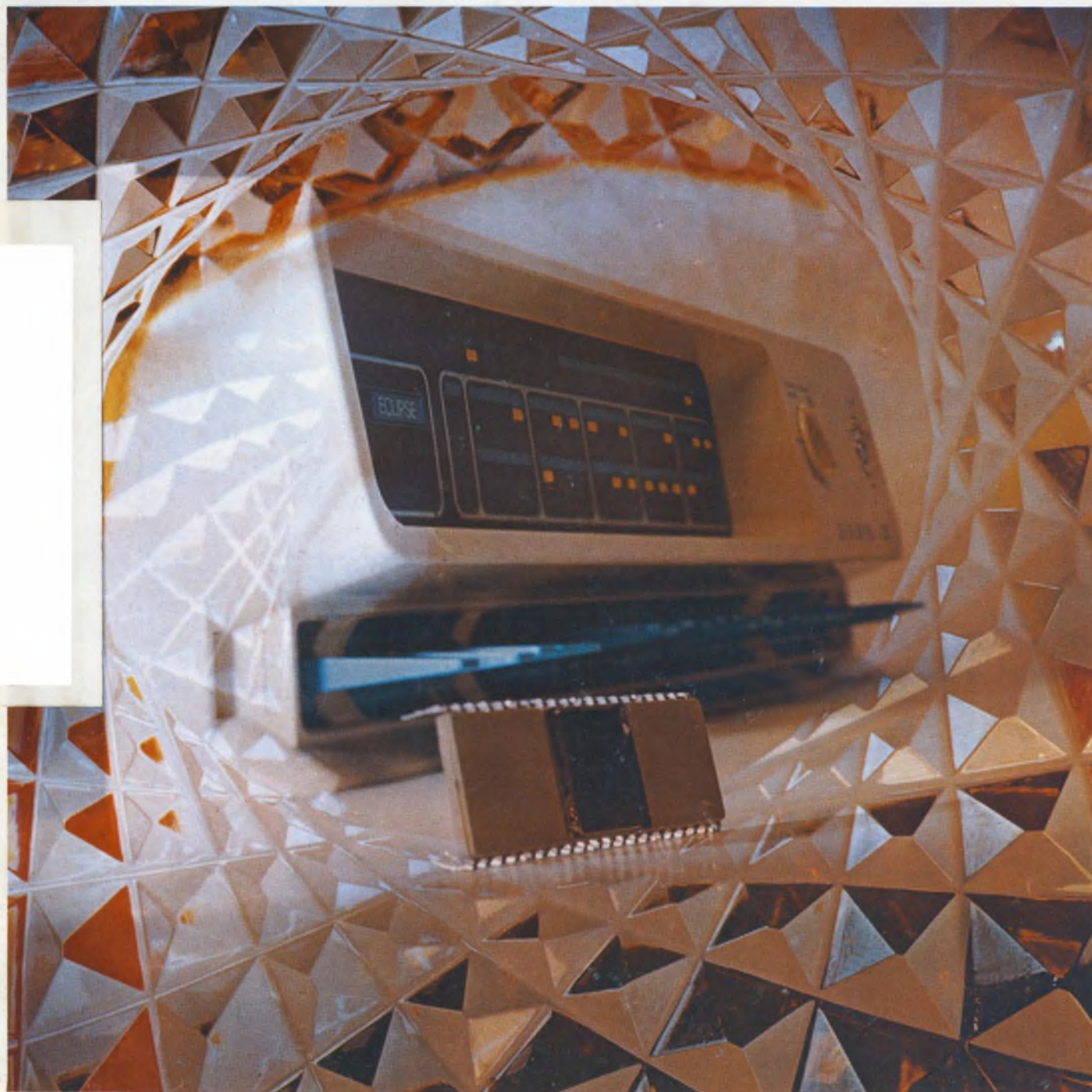



# UNIVERSAL MODEMS



Universal makes modems any way you want them — as OEM cards, rack-mountable units or free-standing packages. In a word, we combine the latest in modem technology with the ultimate in personalized service and personalized applications engineering.

For example, using CMOS technology, we've put a whole 201 modem on a single card in less than 50 square inches. Of course we also offer many choices of 103s and 202s.

Our custom design capability offers you the performance options you need, as well as complete compatibility with your mechanical layout. Besides cards, rack-mounted or free-standing units, Universal also provides multi-channel packages, with modems in any frequency mix up to 2400 bps.

In addition to our products, we're awfully proud of our customer service. Check us out: Call us on the telephone. You'll like what you hear.



Anaheim Convention Center,  
Anaheim, Calif.  
May 19-22, 1975

See us at Booth 2467



# universal data systems

2611 Leeman Ferry Road • Huntsville, Alabama 35805 • Telephone (205) 533-4500 • TWX 810 - 726-2100

Created by Hill & McKenzie Advertising, Winter Park, Florida

INFORMATION RETRIEVAL NUMBER 246





INFORMATION RETRIEVAL NUMBER 2

SPECIFICATIONS

- Frequency Range: 1 – 520 MHz
- Frequency Accuracy:  $\pm 0.001\%$
- Resolution: 1 kHz
- Stability: Less than 0.2 ppm per hour
- Output Range: +13 dBm to -137 dBm
- Flatness:  $\pm 0.75$  dB
- AM Modulation Range: 0 – 90%
- FM Deviation: 0 – 5 kHz and 0 – 500 kHz
- Internal Modulation Rates: 400 Hz and 1 kHz
- Dimensions: 12" wide x 5½" high x 13¾" deep
- Price: \$1,975

Note: In addition, the entire frequency range is remotely programmable in 1 kHz steps using six lines of BCD programming.

We'll remember your impressive bulk, your incredible weight, the glow of your vacuum tubes burning into the night. Whenever anyone said "signal generator" we thought of you.

But someone new has come along—from Wavetek. Slim, attractive, a mere twenty-five

pounds of solid state ingenuity. Yet the phase-locked Wavetek 3000 can do everything you used to do. (Some things a little better.) All the while consuming less than a tenth the power and a fraction the bench space. Even the price is a little lower.

We could go on, but that

would be cruel. So we'll just print the Wavetek 3000's specifications for you to read . . . and weep.

**WAVETEK®**

INDIANA INCORPORATED  
 P.O. Box 190, 66 North First Avenue  
 Beech Grove, Indiana 46107  
 Tel. (317) 783-3221 TWX 810-341-3226

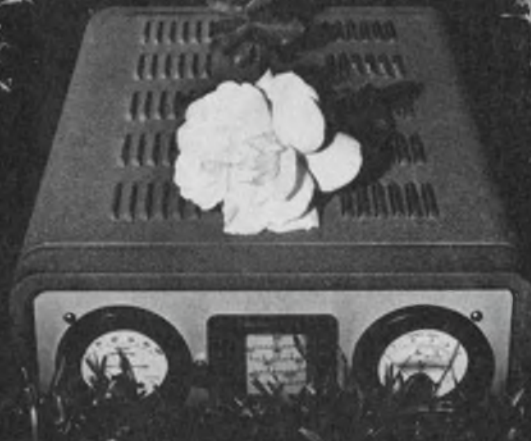

**So long, fatso.**



# Gates introduces the future in energy cells.



There's now a new energy source that's a superb alternative: Rechargeable, sealed lead-acid batteries from Gates.

We call these batteries the future in energy cells. And for good reason.

They have all the product advantages you need plus economic advantages that may well give a new dimension to your product pricing.

Advantages: Gates Energy Cells are as compact as nickel cadmium or gelled type cells. And they are completely sealed, so that no acid vapor can leak out (they also include a self-sealing vent for extra safety). Gates Energy Cells provide low internal impedance for high discharge rates (more than 100 amps from the D cell and 200 amps from our X cell for short periods of time). And can be operated or stored in any position.

Gates Energy Cells offer great packag-

ing flexibility. In fact, our individual cell availability allows you to choose your own specific voltage (in 2-volt increments) and current, as well as configuration.

Just as important as what Gates Energy Cells have to offer is what they don't have to offer. Like outgassing problems. Or cell reversal. Or "memory" problems.

Because Gates Energy Cells are made from low-cost materials that are readily available, they're very high in watt-hr. per dollar value. Which means that if you specify them, you'll probably save your company more than a few dollars. And make yourself into something of a hero in the bargain.

To find out more about the future in energy cells, circle our reader service number or write us. We'll send you *free* literature containing features, application information, ratings and specifications. George Sahl, Gates Energy Products, Inc., 1050 S. Broadway, Denver, CO 80217.



**Energy Products**

**Where the  
energy future is now**



---

## NEWS

- 19 **News Scope**
- 32 **Computer '75 special issue**, featuring current trends in computer technology. Topics covered include: Radically improved machines resulting from advances in ICs; nontraditional peripheral devices; 'far out' applications of dedicated computer systems; test equipment aimed at computers; an interview with Paul Ely of Hewlett-Packard; automated industrial control systems; powerful new computer software for the designer and a preview of the National Computer Conference.
- 25 **Washington Report**

---

## TECHNOLOGY

- 100 **FOCUS on uninterruptible power supplies and inverters:** Explores the benefits and limitations of such power sources and guides the specifier through the claims, counterclaims and pitfalls.
- 114 **Explore microcomputer I/O capabilities** and then select the chips. Here are pointers on what to expect from different input/output architectures.
- 122 **Simplify add-on peripheral controllers** with LSI data-communications circuits. A mini-to-terminal interface provides one practical example.
- 130 **Keeping fast minis busy** is a job for stack architecture. One computer can serve several users and make efficient use of virtual memory.
- 138 **Uncover data-acquisition errors** despite complex specs. An error budget prepared from the data sheet verifies the performance directly from system printouts.
- 146 **Ideas for Design:** Power op amp provides  $\pm 100$ -mA output and up to 100-V/ $\mu$ s slew rate . . . Voltage comparator circuit gives audio alarm when tripped . . . Monitor circuit detects and shows voltage excursions outside set limits.
- 152 **International Technology**

---

## PRODUCTS

- 164 **Components:** DIP relay is small in size and price.
- 168 **Modules & Subassemblies:** Programmable shaft-angle encoder works with any rotating shaft.
- 170 **Modules & Subassemblies:** Data-acquisition card handles 16 channels.
- 176 **Discrete Semiconductors:** Caseless thyristors slash cost, ease assembly.
- |                           |                         |
|---------------------------|-------------------------|
| 157 Data Processing       | 184 Integrated Circuits |
| 162 Packaging & Materials | 188 Microwaves & Lasers |
| 180 Instrumentation       |                         |

---

## DEPARTMENTS

- |                                |                                |
|--------------------------------|--------------------------------|
| 97 Editorial: Stepping outside |                                |
| 7 Across the Desk              | 198 Vendors Report             |
| 192 Evaluation Samples         | 204 Advertisers' Index         |
| 193 Application Notes          | 206 Product Index              |
| 194 New Literature             | 208 Information Retrieval Card |

**Cover:** Photo by Jean-Pierre Ragot, Golddust Exchange, Boston, MA, courtesy of Data General Corp., Southboro, MA



# Intel announce recyclable PRO

The new Intel 2708 is the first 8K erasable and electrically programmable read only memory (EPROM). With a guaranteed access time of 450 nanoseconds from 0°C to +70°C, the 2708 is twice as fast as any previously available EPROM. Intel is now the first supplier with a complete family of 2K, 4K, & 8K EPROMs and 2K, 8K, & 16K interchangeable metal mask programmable ROMs.

The significance of the 2708 is best illustrated by comparing it with the industry standard, Intel's 1702A.

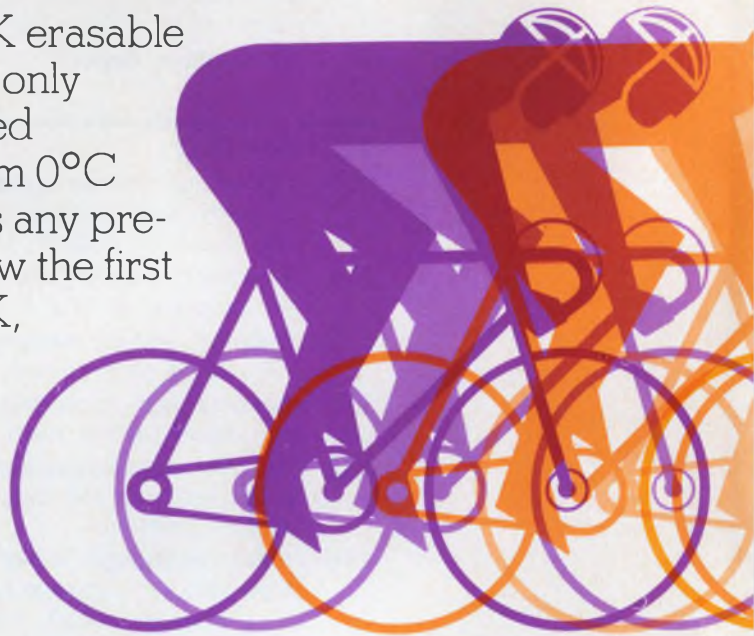

The 2708 has four times the density (8192 bits vs 2048), twice the speed (450 ns vs 1  $\mu$ sec), consumes one third the power (95  $\mu$ w/bit vs 300  $\mu$ w/bit) and the 2708 programs almost five times as fast as the popular 1702A (12 ms/bit vs 58 ms/bit). All 8192 bits in the 2708 can typically be programmed in 100 seconds on any one of several commercially available programmers. With an order of 10,000 or more Intel EPROMs, we'll provide the programmer.

All Intel EPROMs have interchangeable metal mask programmable ROMs. For example, the 2708 can be interchanged with the 8K, 2308 ROM. For systems requiring higher ROM densities, two 8K, 2708 PROMs can be replaced with the new 16K, 2316A ROM.

If you're working on ROM pattern development or designing systems where the bit patterns may change, you'll save time and money using

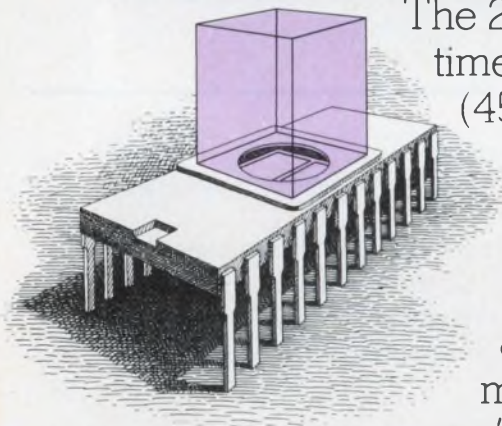



# ces the first 8K M.



EPROMs. They can be erased and reprogrammed again and again. To erase simply illuminate the die by shining a shortwave ultraviolet lamp through the transparent lid.

You can use Intel EPROMs for micro-program control, read-mostly memories, code conversions, lookup tables, random logic simulation, secure communications, etc. Their static operation, TTL compatibility, standard +5, -5, +12V supplies, chip-select control, and three state outputs make system design easy and economical.

Intel's complete family of EPROMs and

bipolar PROMs are available from distributor stock. Most Intel distributors also offer free programming for prototype quantities. Contact: Almac/Stroum, Component Specialties, Inc., Cramer, Hamilton/Avnet, Industrial Components, Inc., Sheridan and L.A. Varah Ltd. For more information call any Intel regional office: West, (714) 835-9642; Mid-America, (214) 661-8829; Great Lakes, (513) 890-5350; East, (617) 861-1136; Mid-Atlantic, (215) 542-9444. For your copy of the new application note AP-6 "Designing with Intel PROMs & ROMs" write Intel Corporation, 3065 Bowers Avenue, Santa Clara, California 95051.

INTEL BIPOLAR PROMS						
SIZE	PART NUMBER	ORGANIZATION	PINS	WORST-CASE ACCESS TIME (0° TO +75°C)	OUTPUT OPEN COLLECTOR OR THREE STATE	INTEL INTERCHANGEABLE ROM
1K	3601-1	256x4	16	50 ns	OC	3301A
	3601			70 ns	OC	3301A
	M3601			90 ns*	OC	M3301A
2K	3602	512x4	16	70 ns	OC	3302
	3602-4			90 ns	OC	3302-4
	3602L-6**			120 ns	OC	3302L-6
	3622			70 ns	TS	3322
	3622-4			90 ns	TS	3322-4
3622L-6**	120 ns	TS	3322L-6			
4K	3604	512x8	24	70 ns	OC	3304A
	3604-4			90 ns	OC	3304A-4
	3604L-6**			120 ns	OC	3304L-6
	3624			70 ns	TS	3324A
	3624-4			90 ns	TS	3324A-4

\*\* -55° to +125°C \*\*Low Power

INTEL EPROMS						
SIZE	PART NUMBER	ORGANIZATION	PINS	WORST-CASE ACCESS TIME (0° TO +70°C)	OUTPUT OPEN COLLECTOR OR THREE STATE	INTEL INTERCHANGEABLE ROM
2K	1702A	256x8	24	1.0 μs	TS	1302
	1702A-6			1.5 μs		1302
4K	2704	512x8	24	0.45 μs	TS	2308
8K	2708	1024x8	24	0.45 μs	TS	2308 or 2316A

**intel® delivers.**



# FLATWIRE

Simple jumpers to massive power signal assemblies. Flat ribbon form or programmed, multi-purpose, multi-layer. Machine made or hand-tied. Delivered in absolute conformance to your system requirements and ready for drop-in. Flat woven cabling gives you broadest design capability, superior control and performance characteristics of individually insulated leads and precise positioning.

For maximum benefits, let us assist in planning. End those harness hang-ups. Think Woven—your complete source for flat interconnects.

## WOVEN ELECTRONICS

P.O. Box 189/Mauldin, S.C. 29662  
(803) 963-5131

### Sr. Vice President, Publisher

Peter Coley

### Editors

Editorial Offices  
50 Essex St.  
Rochelle Park, NJ 07662  
(201) 843-0550  
TWX: 710-990 5071  
Cable: Haydenpubs Rochellepark

**Editor-in-Chief** George Rostky

### Managing Editors:

Ralph Dobriner  
Michael Elphick

### Associate Editors:

Dave Bursky  
Jules H. Gilder  
Morris Grossman  
Seymour T. Levine  
John F. Mason  
Stanley Runyon  
Edward A. Torrero

### Contributing Editors:

Peter N. Budzilovich  
Alberto Socolovsky  
Nathan Sussman

### Editorial Field Offices

#### East

Jim McDermott, Eastern Editor  
P.O. Box 272  
Easthampton, MA 01027  
(413) 527-3632

#### West

David N. Kaye, Senior Western Editor  
8939 S. Sepulveda Blvd.,  
Suite 510  
Los Angeles, CA 90045  
(213) 641-6544  
TWX: 1-910-328-7240

### Editorial Production

Marjorie A. Duffy

### Art

**Art Director**, William Kelly  
Richard Luce  
Anthony J. Fischetto

### Production

**Manager**, Dollie S. Viebig  
Helen De Polo  
Ann Molfetas  
Maxine Correal

### Circulation

**Manager**, Evan Phoutrides

### Information Retrieval

Peggy Long

### Promotion

**Manager**, Walter G. Salm  
Karen Kerrigan (Reprints)

### Creative Layout Services

**Manager**, Albert B. Stempel



## Across the Desk

### More talk about torque

It is curious that some companies seem to take pride in a "me too" attitude. One letter to the editor recently bragged about the manufacture of a torque transducer like that of another manufacturer, but it omitted covering important differences in this field ("Acurex Corp. Sets the Record Straight," ED No. 26, Dec. 20, 1974, p. 7).

Apparently reference was made to a transducer type based on electromagnetic transmission of the torque signal from a rotating shaft. A good deal more was left to the imagination. Readers interested in torque-transducer application could be confused by the implication that a coupling is directly convertible to a torque transducer merely by addition of an electromagnetic signal path. A fundamental requirement is incorporation of a torque-detection element, which was prominent by its absence.

Conventionally torque transducer signals have been transmitted from rotating systems by means of slip rings (a feature incorporated in one torque-measuring system produced by West Coast Research). Contrary to the disclaimer of knowledge in the Dec. 20 letter, slip rings have proved reliable for signal transmission for many years. In fact, we have achieved speeds from 1 to 60,000 rpm with negligible noise, using the slip-ring technique. It is a surprise that others in the business do not know that this is a most reliable method, since it is

the most widely accepted technique.

To join the "me too" ranks, let me state that West Coast Research can also employ other methods of signal transmission from rotating shafts—namely, FM wireless link or an electromagnetic (transformer) coupling and even an optical signal link.

Getting back to the torque detector: Probably still the most reliable and accurate, as well as straightforward, method of sensing torque is by means of a bonded strain-gauge bridge. Many torque-transducer manufacturers have not mastered this technique but employ other sensing methods, including variable-reluctance, differential-transformer and a variety of optical techniques.

Further, the measurement of power is not a direct measurement, as stated in the letter, but is derived from the torque signal and a rotational speed signal. It is necessary to combine angular rate measurement with torque to obtain a rate of energy input to the system.

*H. M. Spivack*

West Coast Research Corp.  
P.O. Box 25061  
Los Angeles, CA 90025

### Parking-meter sensor makes him blow fuse

I note with alarm that a company is making a Hall-effect parking-meter sensor ("CMOS Parking Meter Eliminates Dead Time," ED No. 25, Dec. 6, 1974, p. 23). Aside from the fact that a less noble use

*(continued on page 14)*

# Thin-Trim<sup>®</sup> capacitors



Tucked in the corner of this Pulsar Watch is a miniature capacitor which is used to trim the crystal. This Thin-Trim capacitor is one of our 9410 series, has an adjustment range of 7 to 45 pf., and is .200" x .200" x .050" thick. The Thin-Trim concept provides a variable device to replace fixed tuning techniques and cut-and-try methods of adjustment. Thin-Trim capacitors are available in a variety of lead configurations making them very easy to mount.

A smaller version of the 9410 is the 9402 series with a maximum capacitance value of 25 pf. These are perfect for applications in sub-miniature circuits such as ladies electronic wrist watches and phased array MIC's.

Johanson Manufacturing Corporation,  
Rockaway Valley Road., Boonton, N.J.  
07005. Phone (201) 334-2676, TWX 710-  
987-8367.

MANUFACTURING CORPORATION

Electronic Design welcomes the opinions of its readers on the issues raised in the magazine's editorial columns. Address letters to Managing Editor, Electronic Design, 50 Essex St. Rochelle Park, N.J. 07662. Try to keep letters under 200 words. Letters must be signed. Names will be withheld on request.



# Industry standards... Seven cermet trimmers that can

## How?

- Through design versatility
- Fast delivery
- Excellent quality

## Necessary Decisions:

1. Single vs. multiturn
2. Sealed vs. not sealed
3. Size
4. Resistance
5. Pin spacing
6. All-important, PRICE

**Take a close look before you select your next trimmer. Call your local Beckman Helipot distributor for free evaluation samples, or immediate technical literature.**

**Beckman**  
HELIPOT DIVISION



## Single-turn

### Model 91

- High quality – low price
- Unique brush contact
- Excellent setability
- 100% inspected
- Protective dust cover
- Top or side adjust
- Screwdriver or hand adjust
- Standoffs prevent rotor binding and permit board washing
- Small  $\frac{3}{8}$ " dia. size
- 12 pin configurations
- Wide resistance range: 10 $\Omega$  to 2 meg $\Omega$

**Price: \$0.42\***



### Model 72

- Sealed for board washing
- Available in VALOX 420-SEO housing
- Top or side adjust
- Brush contact
- Excellent setability
- Only 2 ohms of end resistance
- $\frac{3}{8}$ " square
- 100% inspected
- 7 pin configurations
- 19 resistance values

**Price: \$0.54\***



### Model 82

- Lowest profile trimmer in industry
- $\frac{1}{4}$ " dia. by 0.150" max. height
- Sealed for board washing
- Flame-retardant design
- 82P – top adjust
- 82PA – side adjust
- 100% inspected
- Brush contact provides excellent setability
- A cermet benefit that wirewound can't approach: resistance range 10 $\Omega$  to 1 meg $\Omega$

**Price: \$1.12\***



**★ Still waiting for delivery on trimmers from another manufacturer?**

**Call your local Beckman Helipot distributor for a convenient cross reference from stock.**



# handle 95% of your applications.

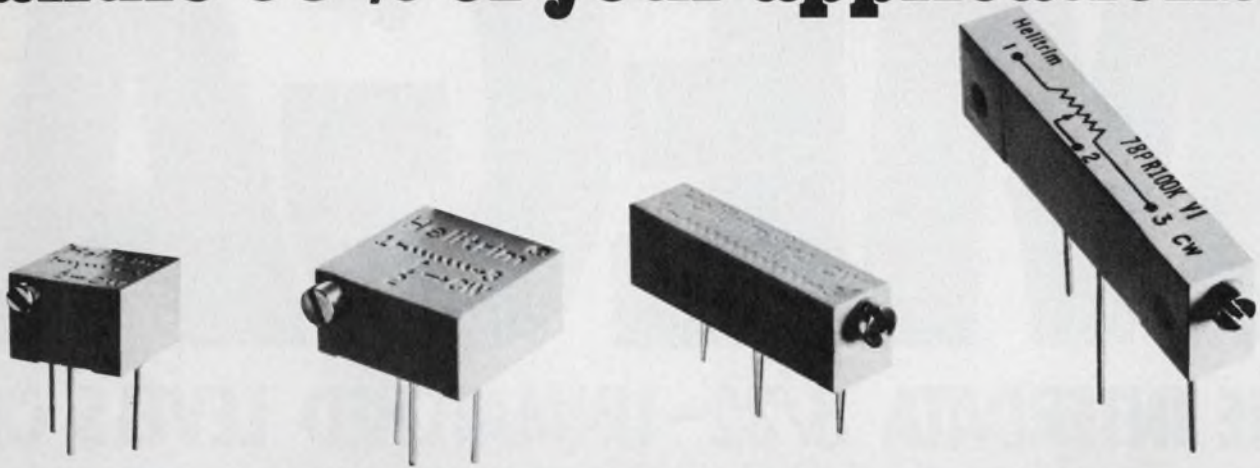

## Multiturn

### Model 64

- Miniature, sealed trimmer
- 22 turns of adjustment
- Operates with 0.25 watt at 85°C derating to zero watts at 150°C
- 100% inspected
- 18 resistance values: 10Ω to 1 megΩ
- ¼" square size is excellent for P.C. board packaging
- Uses Beckman's unique brush contact design
- Adjustability – voltage ratio within 0.01%

**Price: \$4.20\***



### Model 66

- Low-cost, multiturn with benefits of more costly trimmers
- Sealed for board washing
- 20 turns for adjustment accuracy
- Compact ¾" square housing
- Brush contact
- 3 pin styles for efficient space utilization
- Broad resistance range: 10Ω to 2 megΩ
- Operates with ½ watt at 25°C
- 100% inspected

**Price: \$2.70\***



### Model 89

- Our lowest cost multiturn
- Sealed for board washing
- ¾" rectangular trimmer just 0.250" high
- Needs no O-ring because of our unique ultrasonic sealing technique
- Only 2 ohms of end resistance
- 15 turns for accurate and quick adjustment
- 3 pin styles for mounting versatility
- Panel mount available
- 100 ppm/°C tempco
- 19 resistance values available
- 100% inspected

**Price: \$1.05\***



### Model 78

- Military performance at industrial prices
- 1¼" rectangular only 0.195" wide
- Sealed
- 3 terminal styles: Flex leads, Printed circuit pins, Solder lugs
- Panel mount available
- Power rating 0.75 watt at 70°C
- 100% inspected
- 22 turns of adjustment
- Resistance range: 10Ω to 2 megΩ
- 100 ppm/°C tempco

**Price: \$2.28\***



\*1,000-piece price



# INTRODUCING THE WORLD'S FIRST

# MEGA

## THE INTERDATA 8/32—UNMATCHED LEVELS OF PERFORMANCE IN A MINICOMPUTER SYSTEM.

### MEGAMINI ARCHITECTURE: AN ABUNDANCE OF SHEER POWER.

Interdata's new 8/32 Megamini has performance characteristics found only on large scale computers. Like direct addressing to one million bytes. Full 32-bit hardware with performance enhancers such as dual instruction

look-ahead stacks, multiple register sets, interleaved 32-bit memory, and fast floating-point hardware. What our 8/32 Megamini means to you is an unequalled combination of power, flexibility, and reliability in a compact package. All at a price that's fully competitive.

### MEGAMINI SOFTWARE: POWERFUL, FLEXIBLE, EASY-TO-USE.

Today's hardware must be designed to ease your software effort. You shouldn't have to spend a lot of expensive programming time trying to figure out how to get around minicomputer hardware limitations. With the 8/32 Megamini you don't — because there are none.

For example. The direct addressing capability of the 8/32 Megamini allows you to build programs and data arrays in any size up to the amount of memory you have — no more 64K limits.

It also means we can give you versatile and powerful software to help lower the cost of building your system. Software with a multi-tasking operating system, OS/32MT, with unique multi-user



The 8/32 MEGAMINI — with a full Megabyte.

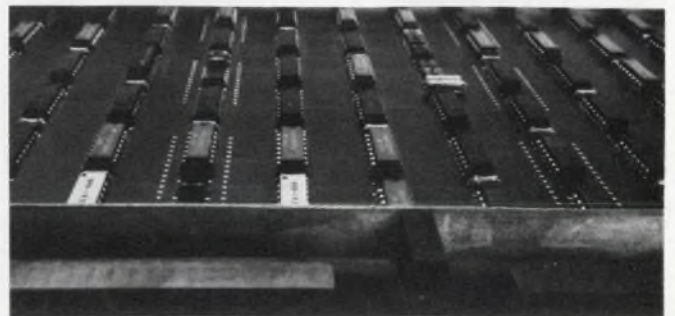

Multi-Wire Technology — a key to MEGAMINI performance.



# MINI<sup>TM</sup>

COMPARE: THE INTERDATA 8/32 MEGAMINI VS. THE-LESS-THAN-MEGAMINI COMPETITION.

	INTERDATA 8/32	XEROX 550	IBM 370/158	DEC 11/70	DG Eclipse
<b>WORD LENGTH</b>	32 bits	32 bits	32 bits	16 bits	16 bits
<b>INSTRUCTION TIMES</b> (Register to Memory)					
Integer Add	1.25	1.8	.9	1.8	2.5
Multiply	3.54	6.2	2.0	3.9	8.8
Divide	5.8	14.4	9.9	8.3	11.2
Floating Point Add	2.3	6.1	2.4	8.25	5.5
Multiply	3.0	9.1	2.3	11.25	7.2
Divide	5.35	23.3	8.9	12.25	7.9
<b>HARDWARE I/O</b>	Yes	Yes	Yes	No	No
<b>MAX. DMA RATE/SECOND</b>	6MB	4MB	6.7MB	4MB	2MB
<b>DIRECT ADDRESSING RANGE</b>	1MB	1MB	16MB	64KB	64KB
<b>GENERAL PURPOSE REGISTERS</b>	2 stacks 16 each*	4 stacks 16 each	1 stack 16 each	2 stacks 8 each	1 stack 4 each
<b>PRICING (Basic Configuration)</b>					
CPU + 128KB Memory	\$51,900	\$128,700	N/A	\$54,600	\$32,500
CPU + 1048KB Memory	\$179,400	\$478,700	\$1,905,700	\$163,800	N/A

\* (6 Additional Stacks Optional)

program development capabilities. Software that has an optimizing macro assembler, MACRO CAL. And software with a sophisticated telecommunications access package, ITAM, that allows you to treat remote communications terminals and computers as if they were simply local devices.

Now, with all of this available, you can concentrate your efforts on the real problem at hand – your application.

### THE MEGAMINI: NOT JUST A COMPUTER – BUT A SYSTEM.

The Interdata 8/32 Megamini gives you a full range of peripherals, software and advanced features to choose from in tailoring your system: 166MB disc systems, fast line printers, 1600 BPI tapes and graphic CRT's. Plus software modules like FORTRAN, BASIC, EDIT, AIDS and many more.

### FOR MORE MEGADATA, CLIP AND MAIL.

Interdata, Inc., Oceanport, N.J. 07757

- All that power sounds marvelous. Send me more information on the Interdata 8/32 Megamini.
- You may have hit on the solution to my megaproblem. Have a representative call me.

Name \_\_\_\_\_ Title \_\_\_\_\_  
 Company \_\_\_\_\_  
 Address \_\_\_\_\_  
 City \_\_\_\_\_ State \_\_\_\_\_ Zip \_\_\_\_\_  
 Telephone \_\_\_\_\_



Subsidiary of Perkin-Elmer ED-5-10-75  
 Oceanport, N.J. 07757. (201) 229-4040



# End switching puzzles

## with Switchmode silicon power

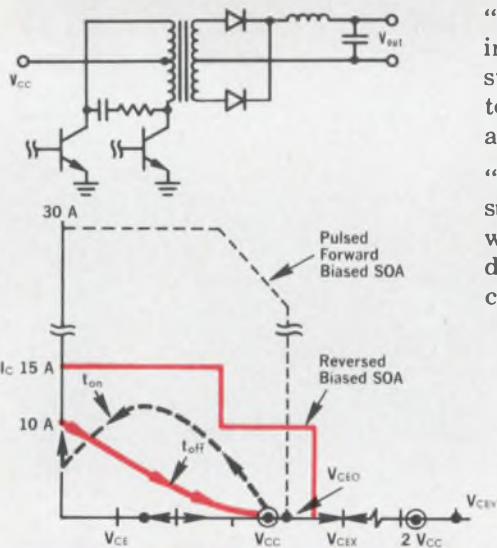

“... both blocking voltage and sustaining voltage are important in switch-mode applications. The circuit illustrated requires high blocking capability since the transistor is subjected to a substantially higher voltage than  $V_{CC}$  after turn-off . . .”

“... for inductive loads, high voltage and current must be sustained simultaneously during turn-off, in most cases with E-B junction reverse biased. The safe level for these devices is specified as  $V_{CEX(su)}$  at given high collector currents as shown on the reverse biased SOA curve . . .”  
(from Switchmode *Designers Data Sheet*)

## The jigsaw's complete.

It's finally been done.

Motorola did it in '72 by introducing the now industry-standard 2N6306-6308 switches . . . we're doing it again in '75 with the 2N6542-6547 Switchmode family.

SWITCHMODE	$V_{CEV}$ V	$V_{CE(su)}^*$ @ 100°C V	$I_c$ Cont. A	$V_{CE(sat)}$ max @ $I_c$ , 100°C	$t_r^*$ (max) @ $I_c$ , 100°C	PRICE
2N6542/3	650/850	350/450	5	2/3	800ns	\$2.25/ 2.85
2N6544/5	650/850	350/450	8	2.5/5	900ns	3.75/ 4.75
2N6546/7	650/850	350/450	15	2.5/10	1500ns	7.50/10.75

\*Clamped inductive load

What you've had in specs up to now doesn't get you there. It might even lead you astray with incomplete info.

For example, when all you've got is forward bias SOA limits (and that's all you get from everyone else) and you need to know what happens in reverse or OFF-biased for clamped inductive loads, you've got a square peg for a round hole.

Same thing when you're trying to match a high-temperature inductive load to low-temperature resistive switching specs.

Apples and oranges.

That's when all your guesswork starts — cutting and fitting that finally leaves you at a workable, but fuzzy, point in the picture . . . a design without specs. An engineering never-never land.

Switchmode's\* the name from now on.

Switchmode silicon power is completely spec'd to tell you exactly how the device will operate under all operating conditions; forward, reverse, clamped inductive or resistive. Actual use conditions and real-world situations. You know how far your load lines can go and still be safe. You know what  $V_{CEX(su)}$ ,  $V_{CE(sat)}$  and



“... in most applications, a large percentage of total device power dissipation occurs during turn-off time and  $t_f$  is normally used as a figure of merit. There are, however, two portions of the turn-off waveform that can add losses and in some cases can be significant. The interval  $t_v$  is part of total storage time  $t_s$  and is defined as voltage switching time. During  $t_v$ , the  $V_{CE}$  voltage changes from saturation to clamp voltage while collector current has only decreased by 10%. The time  $t_f$  occurs after fall time and appears as a “tail” on the collector current waveform. Significant dissipation occurs during the total period  $t_v + t_f + t_f$ ...”

(from *Switchmode Designers Data Sheet*)

2N6546 TYPICAL TURN-OFF WAVEFORM  
Clamped Inductive Load

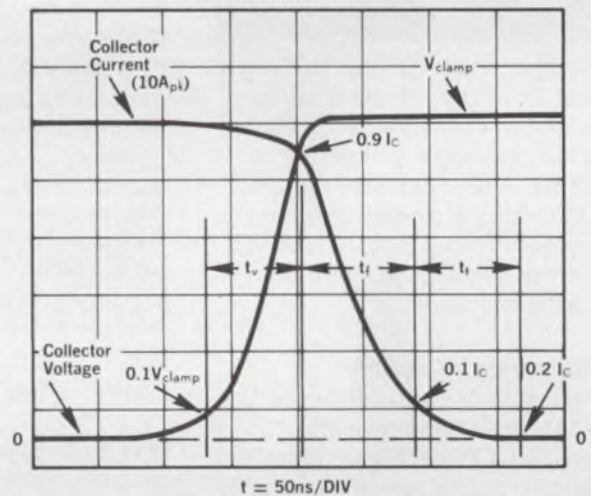

$I_{CEV}$  are at 100° case. You know  $t_s$  and  $t_f$  performance as a function of collector current and temperature at high inductive energy. You know precisely where you stand with secondary breakdown . . . before it happens. The unknown is known.

No guess work. No empiricals. No unspc'd performance.

Just solid, practical data from a pragmatic, comprehensive Designers Data Sheet. A real “first”.

These premier Switchmode units are nanosecond

fall-time fast in clamped inductive loads. 450 V sustaining at 100° C case. Up to 15 amperes continuous. Triple-diffused rugged.

The world's moving faster to lighter, quicker, efficient switching power supplies. Find out how you can move with it — send for new Switchmode data sheets, Application Notes AN588, AN719 and AN737 and Engineering Bulletin EB-39 on new approaches to switching regulators. Box 20912, Phoenix, AZ 85036.

©Trademark of Motorola, Inc.

# Switchmode

You'll never go back to linear or series-pass again.

*Imaginative*  
from Motorola, the power producer



# Meet Shelly's LED-EYE

Industry's first  
complete line of  
LED indicators  
in standard  
T1 packages.



## Wide range of colors



Another first for Shelly. Industry's first T1 LED package. They're bright! In red/2.5 MCD @ 20 ma; green, orange & yellow/2.0 @ 20 ma. Also a current regulated LED which provides constant intensity from 4.5V to 11V. And a voltage sensing LED for battery status indication.

## Just snap into panel

Easiest to use too. Just insert into 0.191" hole and press into position. LED-EYES are ideal for modern panels where space is at

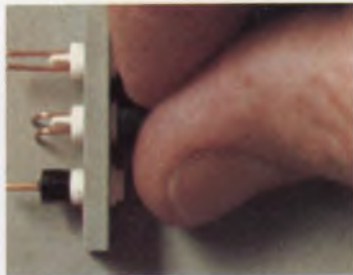

a premium. Mounting on 0.225" centers they offer clean design and high illumination.

## Digi-caps, too

Cap styles include Ball End and our unique Digi-cap, a LED-EYE imprinted with 1 or 2 letters, numerals or symbols to give added dimension to a display.



## Shelly — The T1 specialists

**With Brite-Eyes — T1** incandescents in 7 cap styles & 7 colors. Front relampable without tools.

**With Trans-Eyes — A Brite-Eye** with built-in hybrid amplifier. Eight base/circuit configurations.

**With LED-Eyes — The first LED** in a standard T1 package. 4 colors and 2 cap styles.



Send for our free "How To Order" brochure or phone 800-645-9200 EEM Dial-A-Source.

# shelly associates

A Subsidiary of Datatron, Inc.

1562 REYNOLDS AVENUE, SANTA ANA, CALIFORNIA 92705  
PHONE (714) 540-9330 • TWX 910-595-1859  
MAILING ADDRESS: P.O. BOX 11427, SANTA ANA, CALIFORNIA 92711  
INDICATORS • MULTI MESSAGE DISPLAYS • FIBER OPTICS • ANNUNCIATORS

ACROSS THE DESK  
(continued from page 7)

of electronics is hardly imaginable, I object to the idea that a gizmo like that could be made sufficiently reliable so it could be used by untrained city employees.

If the device were sensitive enough to detect the presence of a motorcycle or a fiberglass car (Corvette, Avanti), it would also be decoyable. Taping a magnet onto the meter would be another effective countermove.

What knowledgeable individual would want to take the time to try to explain to a law officer that the parking meter had reset for unknown reasons, even though he did everything right? What officer would believe him?

Having been robbed over the years by vending machines that do things a human would never have the chutzpah to do, and having had my long-distance phone calls answered by machines that never reply, I believe there are areas where technology has no business. Adding machines and color TV, yes; parking meters, no.

James Rieger  
Engineer

Naval Weapons Center  
Code 3735  
China Lake, CA 93555

## Misplaced Caption Dept.





"Engineering said it wouldn't leak."

Sorry. That's Rembrandt's *Woman Bathing in a Stream*, which hangs at the National Gallery in London.

(continued on page 16E)

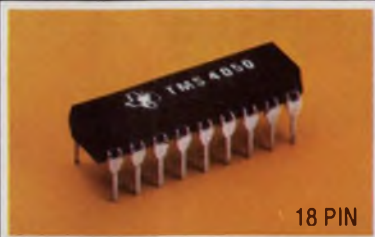

DEVICE TYPE	PACKAGING	ACCESS TIME (NS)	POWER SUPPLIES
TMS 4030	 22 PIN	300	-3V,+5V,+12V
TMS 4030-1		250	-3V,+5V,+12V
TMS 4030-2		200	-3V,+5V,+12V
TMS 4050	 18 PIN	300	-5V,+12V
TMS 4050-1		250	-5V,+12V
TMS 4050-2		200	-5V,+12V
TMS 4060	 22 PIN	300	$\pm$ 5V,+12V
TMS 4060-1		250	$\pm$ 5V,+12V
TMS 4060-2		200	$\pm$ 5V,+12V

# MOS memories

## Design Flexibility.

Texas Instruments 4K RAM family.

Helps you achieve optimum cost/performance designs.

When the design objective is to save space by increasing part density, the compact 18-pin TMS4050 may well be your best choice. You'll get 200ns performance and lower cost too—compared to 16-pin 4Ks, this is a 40% speed improvement and a 30% lower cost.

On the other hand, when separate data inputs and outputs are a design must, then the 22-pin TMS4030 or TMS4060 is the perfect choice.

Now with nine new 4K RAMs available, in plastic or ceramic, you can tailor the memory system performance to CPU needs. And you can design with

confidence. Because TI has more experience in building 4K RAMs than any other manufacturer. In

- First to combine the single transistor cell with the reliable N-channel silicon gate process.

- First to have an 18-pin 4K.
- First to offer a 200ns 18-pin 4K.

All TI 4K RAM types are in volume production. Availability is off-the-shelf through TI's authorized distributors in plastic (NL) or ceramic (JL).

For a Reliability Report or data sheets (indicate by type and number), write on your company letterhead to Texas Instru-

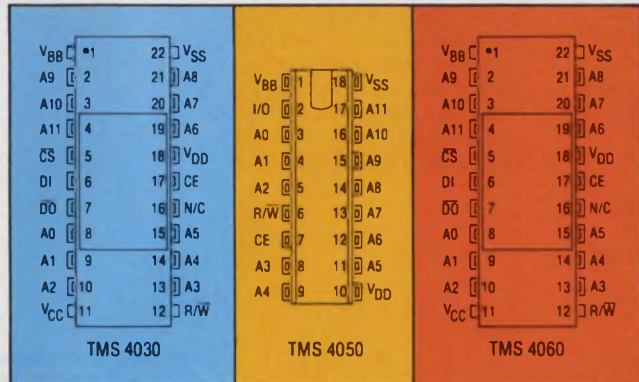

fact, TI can claim four big firsts in 4K technology:

- First to offer a 4K RAM.

ments Incorporated, P.O. Box 5012, M/S 308, Dallas, Texas 75222.

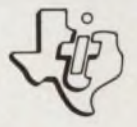



# This Data Acquisition System is the Best Alternative to Building Your Own

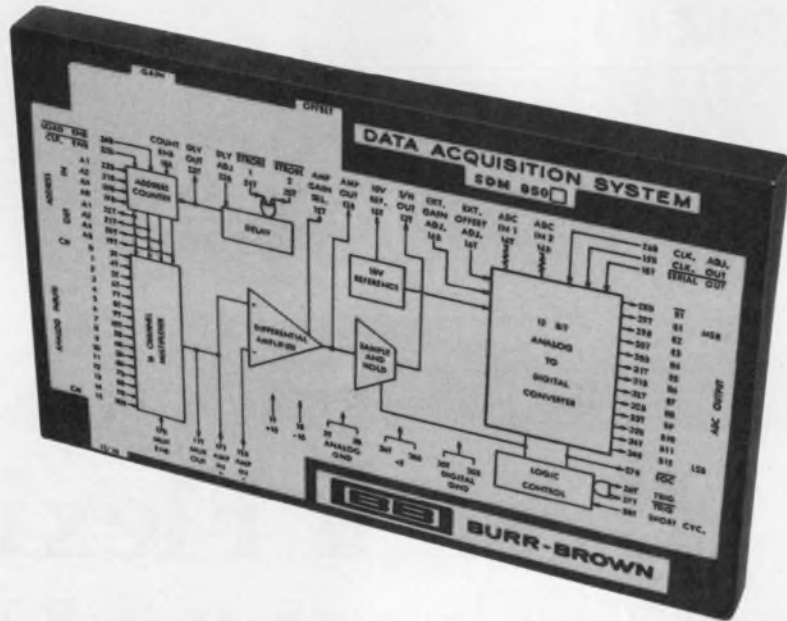

Here's why. First, it's pre-engineered to save you design time and money. Then, we've put everything together for you, including a few very neat Burr-Brown microcircuits, to save your purchasing, production, and test time. All components are performance matched to offer low-cost, accurate, and reliable data acquisition. You eliminate a lot of hassle, and, in turn, you get a complete, high performance 12-bit, 8- or 16-channel modular analog data acquisition system that's ready to plug in. Your total cost is just our low price for the system plus the cost of your purchase order.

Designed to accept either 16 single ended (SDM850), or 8 differential (SDM851) analog data channels, each model contains its own Burr-Brown multiplexer, differential amplifier, sample/hold, 12-bit successive approximation A/D converter, and programming sequence logic. All working together to multiplex and convert up to  $\pm 10$  volt analog data signals into 12-bit digital samples with guaranteed accuracies of  $\pm 0.025\%$  at throughput sampling rates of up to 50kHz per second without the use of any external components. Throughput of up to 100kHz is possible in an "overlap" mode.

And, a complete set of compatible multiplexer expanders and a DC/DC converter are available to let you configure your system to accept up to 128 differential or 256 single-ended analog signals.

Each system module is 100% tested for every channel and burned in for 168 hours to assure that key system parameters are met and premature component failures are eliminated. Each is housed in a 0.375" H x 4.6" W x 3.0" L steel case designed to minimize space requirements while providing electromagnetic shielding.

You could build one of these modules yourself, but your parts cost alone would probably equal or exceed our unit price for either model of just \$595. When you add your costs for design, documentation, purchasing, production, and testing, we're convinced you'll think a "buy" decision is the best alternative... especially when you see our OEM pricing. Burr-Brown, International Airport Industrial Park, Tucson, Arizona 85734. Telephone (602) 294-1431.







## Give us one of these. And we'll give you a magnetically operated solid state proximity switch and some change.

The advantage of a mechanical proximity switch is its low price.

The advantage of a solid state proximity switch is its reliability.

The advantage of a MICRO SWITCH 103SR is that it gives you both.

For under \$10, the 103SR offers you the almost infinite cycle life of solid state design. Because its design is based on the Hall-effect chip.

And, because the 103SR is magnetically operated, you get added design flexibility. It senses only magnetic targets, not other metals.

The bushing is threaded aluminum, for easy mounting and adjustment. And the aluminum housing is environmentally sealed.

It's built to handle two

different voltage ranges: 5 VDC; or 6 to 16 VDC with a built-in voltage regulator. Also, it provides sensing speeds from 0 to in excess of 10 KHz—in a temperature range from  $-40^{\circ}\text{C}$  to  $+150^{\circ}\text{C}$ .

Each unit comes with six inches of lead wire and is available with either digital or analog output. There's a choice of various magnetic targets, including multiple pole, or ring magnets. Special magnet mounting hardware is also available.

If you'd like to find out how the 103SR can lower your costs and increase your productivity, call your nearest MICRO SWITCH Branch Office. Or write for literature.

**MICRO SWITCH**

FREEMONT, ILLINOIS 61032  
A DIVISION OF HONEYWELL

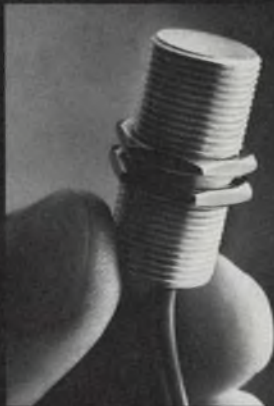

MICRO SWITCH products are available worldwide through Honeywell International.

Circle #289 for Data, #290 for Salesman to call.



# New low prices and Texas Instruments 900

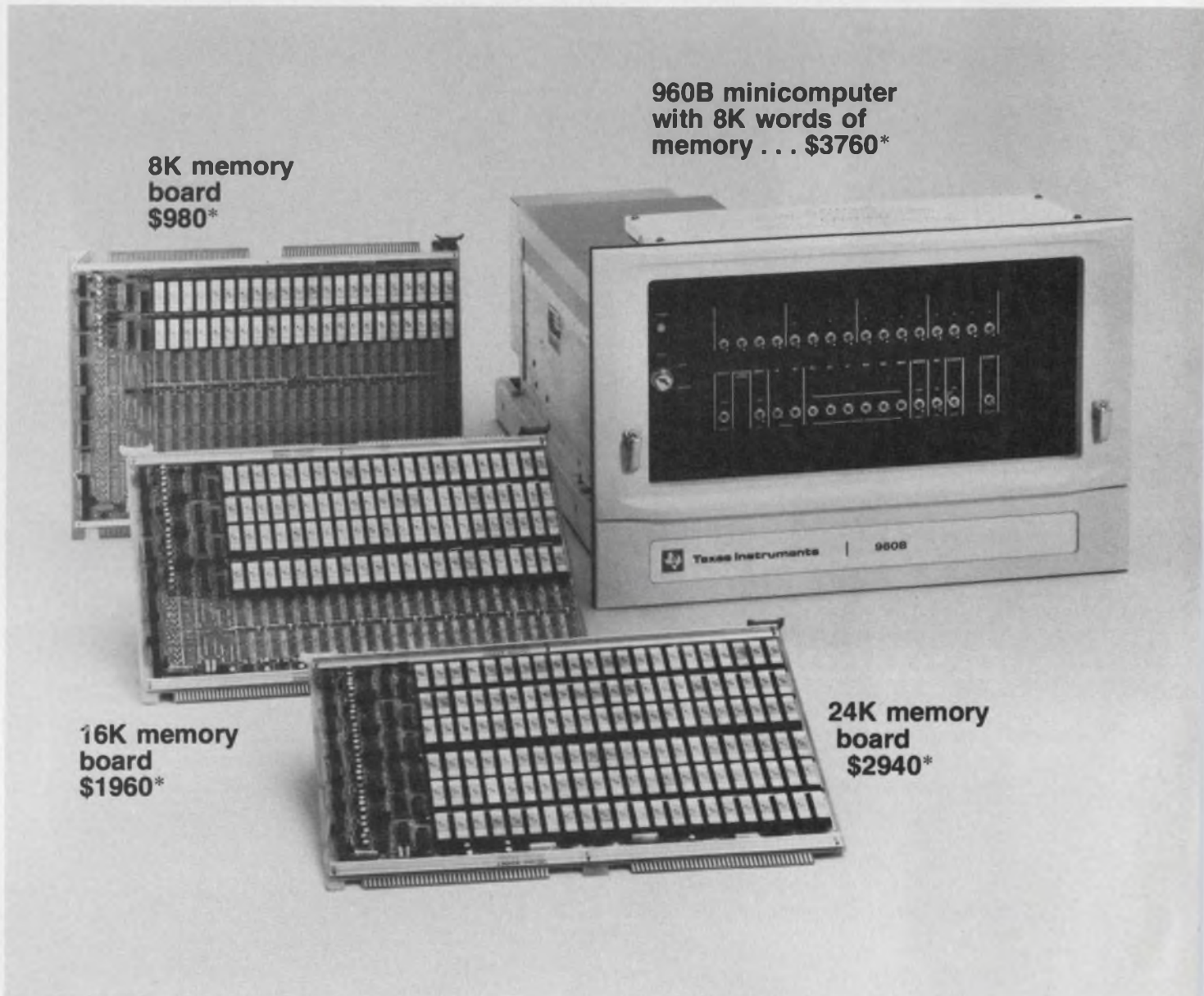

\*Prices quantity 100 OEM, USA only.

**Improving man's effectiveness through electronics**



# proven reliability for series computer memories

**Now, semiconductor memories with built-in error-correction circuitry and 100,000 hours MTBF... for as low as \$980 for 8K 16-bit words.**

TI's 900 series minicomputers offer users memory features that yield reliability . . . 100,000 hours MTBF . . . unsurpassed by any other minicomputer memory design.

## New low prices

As has always been the case at TI, improved performance and reliability have continued to come down in price. The trend continues . . . with new reductions in memory prices up to 38%.

Each 8K increment of memory for TI's minicomputers is now only \$1400 in CPU quantity one. With attractive end-user and OEM discount schedules, this price drops to as low as \$980 for OEM CPU quantity 100.

## Reliability features

TI's computer memories are designed using reliable 4K RAM devices. Multi-bit error detection and single-bit error correction are standard features of these memories. With these features, if a single-bit failure should occur, the memory controller corrects the error and transfers valid data to the CPU so that valuable processing can continue. Also, light emitting diodes indicate the exact location of a faulty memory device.

	TI 960B	TI 980B	HP 21-M/10	DEC PDP-11/05	DG Nova 1210
	S/C memory w/error corr.	S/C memory w/error corr.	S/C memory w/parity	Core memory w/o parity	Core memory w/o parity
CPU w/8K words	\$4,700	\$5,075	\$6,150	\$ 5,995	\$5,800
CPU w/16K words	6,100	6,475	7,650	7,495	7,400
CPU w/24K words	7,500	7,875	9,150	12,195	9,400
<i>Price includes:</i>					
ROM loader	Yes	Yes	Yes	No	No
Power fail protect	Yes	Yes	No	Yes	Yes
Hardware Mult./Div.	No	Yes	Yes	No	No

All prices quantity one, USA only.

Innovative features such as these provide significant reliability benefits for users. MTBF, for instance, is 100,000 hours for an 8K word board . . . which means increased uptime.

## Density . . . an attractive feature

Increased density is another very important benefit. Because of TI's 4K RAM, users can have 8K, 16K, or 24K 16-bit words of memory on a single board, and can get as much as 65K words of memory in the main CPU. Significant? Indeed it is . . . because this

increased density, along with built-in reliability, comes at very low prices.

What's more, TI backs these products with a network of sales and service offices across the U.S. and in major countries overseas.

For the full story, contact the nearest sales office listed below. Or, write Texas Instruments Incorporated, Digital Systems Division, P.O. Box 1444, M/S 784, Houston, Texas 77001. Or call (512) 258-5121, Computer Systems Marketing.



Arlington, Va. (703) 527-2800 • Atlanta, Ga. (404) 458-7791 • Boston, Mass. (617) 890-7400 • Chicago, Ill. (312) 671-0300 • Clark, N.J. (201) 574-9800 • Cleveland, Oh. (216) 464-2990 • Dallas, Tx. (214) 238-5318 • Dayton, Oh. (513) 253-6128 • Denver, Co. (303) 751-1780 • Detroit, Mich. (313) 353-0830 • Houston, Tx. (713) 777-1623 • Minneapolis, Minn. (612) 835-5711 • Orange, Ca. (714) 547-9221 • Orlando, Fla. (305) 644-3535 • San Francisco, Ca. (415) 392-0229 • Sunnyvale, Ca. (408) 732-1840 • Amstelveen, Holland 020-456256 • Bedford, England 58701 • Beirut, Lebanon 353188/353189 • Cheshire, England 061 442-8448 • Copenhagen, Denmark (01) 917400 • Essen, Germany 02141/20916 • Frankfurt, Germany 0611/39 9061 • Freising, Germany 08161/801 • Milano, Italy 683034 & 6899215 • Montreal, Canada (514) 332-3552 • Paris, France (1) 630-2343 • Slough, England 33411 • Stockholm, Sweden 62 71 59/62 71 65 • Sydney, S. Australia 831-2555 • Toronto, Canada (416) 889-7373

**TEXAS INSTRUMENTS**  
INCORPORATED

INFORMATION RETRIEVAL NUMBER 152



# SHIFT INTO HIGH PERFORMANCE WITH A 4K STATIC RAM

**FULLY STATIC:** The SEMI 4402 is a fully static 4K RAM. That's important. For one thing, it means you can now design a 250 nsec MOS memory system around a 4K device without worrying about refresh or charge pump circuitry. For another, static RAMs are inherently less susceptible to soft bit error problems than comparable dynamic devices.

**350 NANOSECOND CYCLE:** The SEMI 4402 4K static RAM has a complete cycle time of just 350 nsec and 200 nsec maximum access time. That makes it the fastest 4K static RAM in production. Now you can design a truly high performance MOS memory around a static 4K device.

**AVAILABLE NOW:** The SEMI 4402 4K static RAM is here now. We're already delivering it to customers at the memory system level. And it is second sourced by a major supplier of MOS devices.

**LOW POWER:** The SEMI 4402 4K static RAM has similar power levels to comparable dynamic devices. However, power conservation is achieved by the Chip Select Input, which causes the 4402 to enter a low power standby state whenever it is unselected. Normal  $V_{DD}$  is 12 Vdc, but  $V_{DD}$  can also be reduced to 5 volts without risking loss of stored data. And the 4402's differential output results in inherently high noise immunity memory systems.

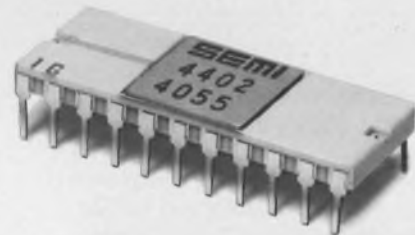

**PERFORMANCE TESTED:** Like all SEMI NMOS components, the 4402 4K static RAM must meet our own tough test standards, since we use it in our memory systems — for example the MICRORAM 3400N. With our reputation riding on its performance, you may be sure the acceptance standards are high indeed. In fact we 100% ac and dc test our components twice — at wafer and again in the package.

**MODEL SELECTION:** In addition to the 4402, EMM SEMI offers you a complete line of static NMOS RAM and ROM components to meet your design needs. Make your selection from the adjacent chart.

Part No.	Bit Org.	Access Time
<b>RAMS</b>		
SEMI-1801	1024 x 1	90 nsec.
SEMI-1802	1024 x 1	70 nsec.
SEMI RA-3-4256	256 x 4	1 usec.
SEMI RA-3-4256B	256 x 4	1 usec.
<b>ROMS</b>		
SEMI RO-3-4096	512 x 8	500 nsec.
SEMI RO-3-5120	512 x 10	500 nsec.
SEMI RO-3-16384	4096 x 4	1.0 usec.

More new products to come... additional 4K static RAMs, ROMs.

**PROVEN TRACK RECORD:** At EMM we've been making memory components and systems since 1961. Unlike memory suppliers who market components only, all EMM components are all performance proven in our own systems. When you buy from EMM, you get the benefit of the unusually high acceptance standards we

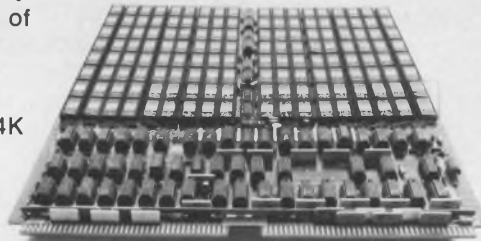

impose on ourselves, as well as our years of experience in meeting the needs of the memory marketplace. If you'd like further information about any of the products featured here, or any other EMM components or systems, contact your local EMM office today.

**EMM SEMI**

A division of Electronic Memories & Magnetics Corporation  
3883 North 28th Avenue, Phoenix, Arizona 85017  
Telephone (602) 263-0202

INFORMATION RETRIEVAL NUMBER 153





*(continued from page 14)*

## Liquid-crystal supplier lets us in on 'secret'

We found "Focus on Displays" (ED No. 26, Dec. 20, 1974, pp. 52-62) to be very interesting, well-written and an accurate reflection of the current status of this industry. We were disappointed, however, in not finding Ashley-Butler listed among the companies at the end of the article.

Ashley-Butler is the world leader in the design, development and manufacture of large-area liquid-crystal displays. Most of our business has been in the area of custom displays, ranging from 3 × 5 to over 12 × 12 in. Unfortunately our name and capability seem to be a secret throughout much of the industry.

We hope that situation will change, as Ashley-Butler has recently designed, developed and delivered a liquid-crystal digital clock for the home and office market. This clock reached the market before Christmas and has sold extremely well. The clock's appeal rests in the unique appearance made possible by the dynamic-scattering liquid-crystal displays.

*Richard Klein*

*Director of Engineering*

Ashley-Butler, Inc.  
208 U. S. Highway 206 S.  
Somerville, NJ 08876

## Right facts, wrong pic

In the new-product item "Micro-programmed Minis Are 32-bit Machines" (ED No. 4, Feb. 15, 1975, p. 112), the wrong picture accompanied the description of the SEL 32/50 and SEL 32/55 minicomputers from Systems Engineering Labs, Fort Lauderdale, FL. The photo was that of the Connectran data-set simulator from Computer Transmission Corp., El Segundo, CA. Here is the correct picture of the SEL 32/50 and 32/55 minis.

The Connectran incidentally is a dial-up data set simulator that eliminates two data sets and phone line. A single unit gives local data



service at distances up to 1200 feet via 11-pair twisted cable. For Systems Engineering Labs

**CIRCLE NO. 318**

For Computer Transmission

**CIRCLE NO. 319**

## Astrodata reports it's alive and well

I have read with interest your article on Disney World in the Feb. 15 edition ("That Dazzling Dizzy Disney World Is Run by Computer," ED No. 4, p. 24). I was shocked by the reference to Astrodata as a company that is "now defunct." I wish to advise that Astrodata is a viable company located in Anaheim, CA.

I am pleased to report that the formation of a single division for manufacturing and marketing telex switching systems under the sponsorship of the Plessey Co., Ltd., is proceeding as scheduled.

A retraction of the statement contained in your article would be in order.

*Leo F. Imhoff*

*Vice President of Administration*  
Astrodata Inc.

270 E. Palais Rd.  
Anaheim, CA 92803

*Ed. Note: Astrodata reports that it filed for reorganization under Chapter 11 but was rescued from bankruptcy by a financial house in New York on Aug. 17, 1972. The company was forced to abandon the Disney computer project before its completion and no longer makes computers.*

## There's an EMM office near you.

### WESTERN REGION

*Regional Office*  
SAN FRANCISCO  
(408) 247-9711

LOS ANGELES AREA  
(213) 644-9881

ORANGE COUNTY AREA  
(714) 639-5811

MINNEAPOLIS AREA  
(612) 941-2404

PHOENIX AREA  
(602) 968-2492

DALLAS AREA  
(214) 231-7207

### EASTERN REGION

*Regional Office*  
BOSTON  
(617) 861-9650

CHICAGO AREA  
(312) 297-7090

WASHINGTON, D.C. AREA  
(703) 941-2100

NEW YORK AREA  
(516) 423-5800

CLEVELAND AREA  
(216) 842-8920

### INTERNATIONAL OFFICES

*European Headquarters*  
BELGIUM  
(031) 76.69.75

UNITED KINGDOM  
(01) 751-1213

WEST GERMANY  
(089) 74.30.40

### SALES REPRESENTATIVES

FLORIDA, ALABAMA,  
GEORGIA, NORTH CAROLINA,  
SOUTH CAROLINA, MISSISSIPPI,  
TENNESSEE, LOUISIANA  
Gentry Associates  
(305) 894-4401  
(205) 534-9771  
(919) 227-3639

AUSTRALIA, NEW ZEALAND,  
HONG KONG, SINGAPORE  
Delairco Industries Pty. Ltd.  
Sydney 29-2863

FINLAND  
Digelius Electronics Finland OY  
(90) 650-995

CANADA  
Megatronix  
(416) 742-8015  
(514) 488-0404  
(613) 729-4004  
(604) 526-3312

INDIA  
Southern Electronics  
442-397, 445-983

ISRAEL  
S.T.G. International Ltd.  
(03) 53459

JAPAN  
Nissho Electronics Corporation  
(03) 542-2351

**EMM** ELECTRONIC MEMORIES &  
MAGNETICS CORPORATION  
12621 Chadron Avenue  
Hawthorne, Calif. 90250  
(213) 644-9881





## MEASURES REAL POWER

**N  
E  
W**

This unique new electric power sensor is finding success in an amazing number of worthwhile applications. And many more are yet to benefit! The reasons are clear.

The new real power sensors have qualities ideally suited to contribute to the solutions of today's energy and economic situations. The modules accurately measure real electric power ( $\pm 0.25\%$ ). They are simple, reliable, and reasonably priced. F. W. Bell, Inc. real power sensors are versatile, rugged, and easily applied to single phase, three phase, 60 Hz to 10 kHz sinusoids and non-sinusoids, and any power factor operation.

Here are some application examples of PX series transducers which are now in use.

### ACTUAL PERFORMANCE vs. REAL POWER:

Bell real power sensors provide the information necessary to rate electrical equipment performance versus real power consumption. An example would be gallons per kilowatt for a pump, or cubic feet capacity versus watts for refrigerators.

### BENEFITS:

- Accurate
- Low loading, one watt
- Simple, reliable
- Inexpensive
- Used to save energy and money

### TORQUE MEASUREMENTS:

Bell real power sensors are in use measuring motor torque. Shaft torque is real power divided by shaft angular velocity. The real power sensor provides the accurate power signal for the torque computation.

### VISCOSITY SENSOR:

Bell real power sensors are used on pump motors to sense and measure the viscosity of the pumped fluids.

### POWER DRAW MEASUREMENTS:

Bell real power sensors are employed in portable and fixed energy management systems. The real power sensor can be used with recorders, PT's, CT's, and related equipment to measure the power consumed within a manufacturing or other facility. The results are used in energy management to reduce power bills and maintain operation with reduced energy consumption.

For complete application and technical details, use the inquiry card.



from  
Bell

The  
Gaussmeter  
People

4949 Freeway Drive, East  
Columbus, Ohio 43229

A Subsidiary of  
The Arnold Engineering Company

Fw-BELL  
INC.



# If anybody can hand you the ready-made P/C connector you need,

## we can.

That's because we have more of them on the shelf than anybody else we know. We have them from .050 contact centers through .156, from 6 to 210 contacts, with full bellows, semi-bellows and cantilever designs, with gold saving AuTAC™ plating, low insertion force contacts, in micro miniatures, dual and single read-outs . . . and on and on and on.

We've been at this 23 years. And — because we don't compromise on quality

when we make our connectors — we don't like to see your P/C designs compromised by a make-do connector. So, we have a lot of them.

They're all cataloged in our latest 44-page brochure. Send for your free copy so you'll have it when you need it.

Or, if you need help right now, just pick up your phone and call Customer Service. (213) 341-4330.

**Ok. Send me:**  Details on your line of P/C connectors.  
 and, come to think of it, your low cost circular connectors, too.

Name \_\_\_\_\_

Title \_\_\_\_\_

Company \_\_\_\_\_

Address \_\_\_\_\_

City \_\_\_\_\_

State \_\_\_\_\_

Zip \_\_\_\_\_

 **Viking**  
**CONNECTORS**

Viking Industries, Inc./21001 Nordhoff St./Chatsworth, Calif. 91311





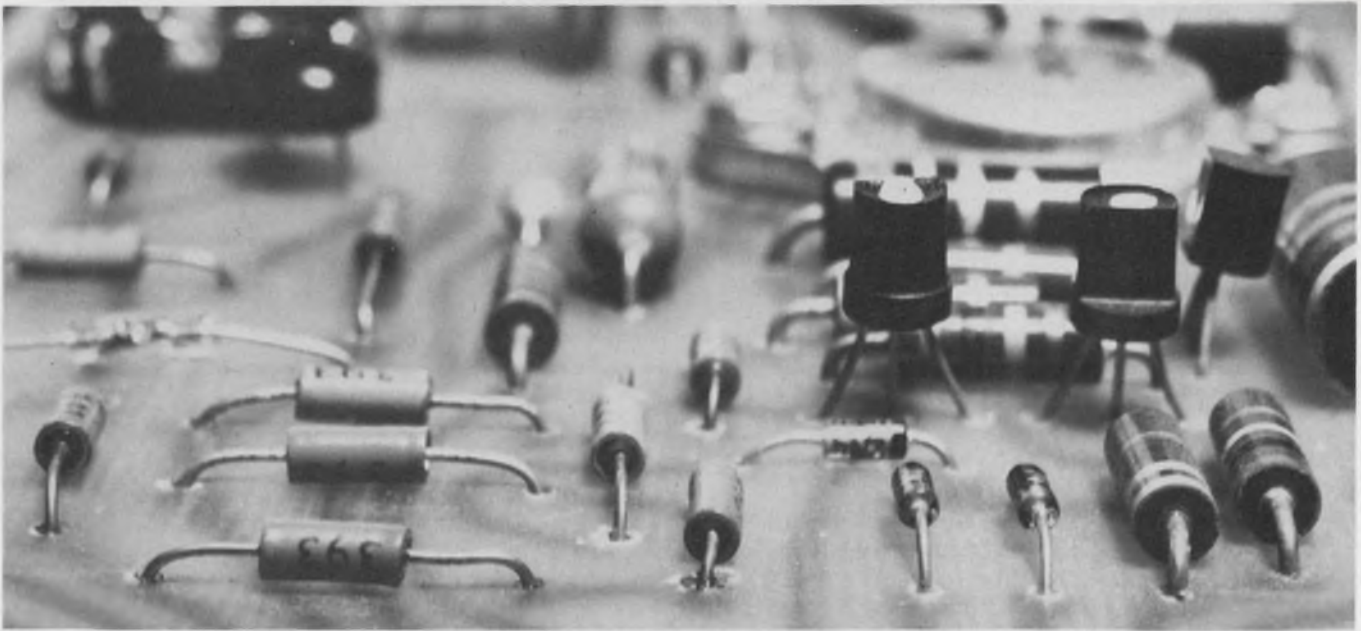

# Superautoinsert density

Pronounce it super-auto-inser-density. It's the good thing that happens to your costs when you switch over to GTI/Tensor's axial-leaded ceramic capacitors.

For starters, axial-leaded capacitors can be automatically inserted in your circuit boards. Our 0.065-inch-diameter by 0.150-inch-long type C150 can be automatically inserted at the same machine setting used for diodes. Tensor's C150 has a range of 100 pf to 22,000 pf at 25V in temperatures from  $-55^{\circ}$  to  $+125^{\circ}\text{C}$  (X7R characteristics).

You get maximum capacitance in a small package for greater component density on your cards. And low-profile from axial-leaded capacitors for maximum cards per drawer. Some big

potential cost savings there, too.

Tensor's caps are hermetically sealed in glass. We process them with unique and proprietary techniques that give them longer life and greater stability.

While concentrating on your higher productivity, we haven't neglected our own. We've automated our processing, sealing, testing and sorting, device marking, and taping and reeling operations. So we can make 'em as fast as you can use 'em.

Get superautoinsert density in your assembly line and good things will happen to your bottom line. Write or call: Tensor Electronics, Inc., 11558 Sorrento Valley Rd., San Diego, Calif. 92121, (714) 453-7262/Telex 69-5056.



 **tensor**  
**electronics, inc.**  
A SUBSIDIARY OF GTI CORPORATION



# Stripswitch™

## Not much to you.

## But big to us.



If we had to design a new switch for circuit board applications, we'd design Stripswitch again.

Not some other switch. Stripswitch.

The one with coded output—decimal, BCD, complimentary, special binary, and 1-, 2-, 3-, and 4-pole.

The one with 1 to 11 stations, each with 8, 10, 12, or 16 positions, actuated by thumb, finger, or screwdriver.

The one that mounts both horizontally and vertically, and reads out on the front or the side.

The one you wave-solder to your



Actual size.

board, or plug into DIP sockets and strips.

The one made of durable Valox\*, with lots of legends and markings, color codings, and rotation limit stops.

The one that costs less than \$1.00 per station if you order enough stations.

That's little enough, whether you buy Stripswitch from us or our distributors—G. S. Marshall, Hall-Mark, or Schweber.

And that makes it big.

# EECO

## FOR SWITCHES

1441 East Chestnut Avenue, Santa Ana, California 92701  
Phone 714/835-6000

\*Registered General Electric trademark



# Some people just won't operate by the book.

Fortunately, we have our share of those people — Bill Herbert for example. One of our customers discovered they had a serious shortage of ceramic cylinders used in an electronic assembly. They needed additional parts... and fast. Using normal channels, it just wasn't possible to fabricate them on such short notice.



Bill took the challenge. He figured out a way to take existing cylindrical parts, and with a special grinding operation, meet the specs for the assembly. It worked. And

we were able to deliver enough parts so our customer avoided a costly delay.

Not exactly a conventional solution. But then we've never been able to convince Bill to operate that way. He continues to browse through his private ceramic stock, operate a lathe, push trays of parts, load a kiln, and just about everything else outside of his job description to help a customer out of a jam.

Scrambling, discovering, expediting... everyday Bill Herbert and people like him are helping our customers solve problems. It's a Coors speciality. Put us to the test.

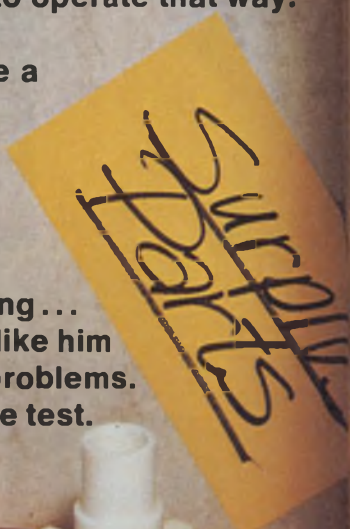

**Coors Porcelain Company**

600 Ninth Street / Golden, Colorado 80401 / (303) 279-6565 / Telex 45-593

INFORMATION RETRIEVAL NUMBER 16



MAY 10, 1975

## Laser and radar systems speed pinpointing of targets

A hand-held laser system that can determine the range of a target in one second is being built for the Army by the RCA Government Communications and Automated Systems Div. in Burlington, MA.

Meanwhile in nearby Wayland, MA, Raytheon's Equipment Div. has developed a radar that pinpoints the site of a mortar or artillery emplacement after one shell has been fired.

The RCA laser system, being developed for the Army Electronics Command, Fort Monmouth, NJ, resembles field binoculars. The system measures the range and displays it in meters in the sighting eyepiece. The unit, designated the AN/GVS-5, weighs only 5 lb.

The user sights the target and activates the system by pushing a "fire" button. The laser emits a narrow beam at the target, and a receiver collects the reflection. The time delay is converted to distance in meters.

The laser transmitter incorporates a chemical Q switch wafer—a saturable absorbing dye in acrylic—that costs only pennies to produce. The Q switch is packaged in a compact, sealed resonator subassembly about the size of a cigarette. The subassembly consists of a rod coated at one end to provide a mirror that gives partial reflections, a cylindrical filter to keep ultraviolet light away from the Q switch and a mirror that gives total reflections.

The complete module mounts directly to the transmitter telescope. If a failure occurs, the entire assembly can be removed and replaced with a new one.

The unit's receiver elements consist of a detector/preamplifier module, video amplifier, range counter and display module.

The Raytheon radar system pin-

points mortar or artillery emplacements with a minicomputer and a digital Doppler signal processor. It is a completely redesigned, solid-state version of a mortar-and-artillery-locating radar that saw action in Vietnam, according to H. H. Thomas, program manager at Raytheon.

The detection range is 24 km, as opposed to 12 km in earlier systems. The advance has been achieved with all-solid-state design and an electrostatically focused klystron. Full coverage of 360 degrees is provided as opposed to earlier units that could monitor only one sector at a time.

Designated the AN/TPQ-31, the radar is reported to have achieved 98% average probability of detection on the first round fired during field tests of 1000 rounds.

During the first few weeks of the tests at a Marine Corps base in 29 Palms, CA, the firings were used to refine signal and target data-processing algorithms. Very high subclutter visibility—the ability to see through ground clutter caused by reflections from bulbs and other obstructions—is attained with a fast-Fourier-transform signal processor, Thomas points out. This is necessary, he says, because the artillery and mortar shells have such small cross-sections.

The detected targets are fed to a Univac 1616 minicomputer, which is to be placed by the UYK-20, a standard Univac military version. The computer takes the two-dimensional data of the target and infers the third dimension by adding the most probable parabolic trajectory.

From the velocity projected, the computer also predicts what type of projectile the incoming target is, as well as the launching and impact points.

## Transducer simplifies image processing

The development of a unique optoelectronic image transducer has led to simple, image-processing devices.

The transducer consists of a thin cadmium-sulfide layer deposited on a substrate that is excited with hf or vhf surface acoustic waves. It was developed by Philip Kornreich and Stephen Kowel, associate professors in the Dept. of Electrical and Computer Engineering, Syracuse University, NY.

According to the inventors, conventional image processors are complex and require computer systems. In their device, image processing is done as an integral function of the device itself.

The following devices have been built:

- A focus detector for still and movie cameras.
- A simple motion detector for optical surveillance or motion compensation systems.
- Pattern recognition of simple forms.

The image transducer works, Kornreich explains, because the conductivity of the cadmium-sulfide layer is altered by two phenomena: light falling upon it and mechanical deformation of the film caused by the passage of surface acoustic waves through the layer.

The coupling of light and sound produces signals that represent the spatial Fourier transforms of an image on the surface. The opto-transducer output is taken from the cadmium-sulfide layer. The electrical output is the equivalent of the Fourier transform of the image.

The transform signal—unlike that of a TV camera—cannot be directly processed to give a recognizable image, Kornreich notes. However, he points out, the inherent characteristics of these transform signals make them useful where conventional image-device signals are not.

As an example, Kornreich points to the focus detector, recently patented, which could be used in home movie cameras to keep the scene in focus, despite camera or subject movement.

This is a simple form of the



device, Kornreich notes. The cadmium-sulfide layer is deposited on a lime-glass substrate and is excited by the sine-wave output of a single discrete surface-acoustic-wave transducer. The transducer is fed from a 20-to-30-MHz source.

When an image is focused onto the opto transducer, high-frequency components appear at the opto-transducer output, Kornreich explains. These sine-wave components are largest when the image contains the sharpest edges—at the point of sharpest focus.

The opto-transducer output is fed to a tuned network to improve the signal-to-noise ratio.

The latest device under development gives a two-dimensional scan of the image surface, Kornreich says, as contrasted with the in-focus device, which scans in only one direction. The new device, which has a 17-by-17-mm photosensitive surface deposited on a 20-mil-thick lithium-niobate crystal, has two interdigital transducers mounted on the niobate substrate, with one at right angles to the other.

These interdigital transducers are fed sine-wave signals at 140 MHz, Kornreich says, and when the signals are applied in the proper phase relationship, it is possible to scan the sensitive sulfide in any desired fashion, such as in rasters or circles.

Where the X and Y acoustic scans meet on the cadmium-sulfide surface, Kornreich says, inherent nonlinearities in the electrical characteristics produce a mixing effect and beat frequencies appear, which can be monitored.

The niobate device is suitable for detecting motion in a scene, Kornreich points out, because when the image moves, the phase of the Fourier transform signal shifts, while the magnitude remains constant.

## Harris offers new line of 24-bit computers

Harris Corp. has developed a family of six packaged, virtual-memory, 24-bit computers ranging in size from 96,000 to 768,000 bytes. The machines are aimed at

the growing big-mini market already supplied by such companies as Interdata, DEC, Data General, Systems Engineering Laboratories, Computer Automation and Hewlett-Packard.

Besides virtual memory, the new line's competitive features include bundled software, compatible across all six machines; remote job entry capability for use with large host processors and a scientific arithmetic unit that provides floating-point hardware for fast calculations. All systems are supported by the Vulcan operating system, which permits concurrent time-sharing, multibatch and real-time processing.

Other major software packages include Fortran IV, Cobol, RPG II and extended Basic.

Shipments of the computer system will begin in the fall.

CIRCLE NO. 315

## Switch inside knob saves valuable space

As instruments shrink, space behind the front panel becomes more valuable. So much so that designers at Tektronix in Beaverton, OR, have designed a special knob that contains the electronics for a 32-position switch. It requires virtually no space behind the panel.

The first use of the new switch/knob is in the 7L5 spectrum analyzer module that Tektronix recently introduced. The device mounts on the panel with two screws and has seven wire leads coming out of it.

In describing it, Carlos Beeck, a senior engineer at the company, notes that 5 LEDs and five photosensors, along with a coded shutter, are mounted inside a 1-in.-diam-knob. Also included in the knob is an internal shaft, on which the knob can rotate, and a mechanical detent mechanism. By coding of the shutter and selection of the right detent mechanism, it is possible to produce a switch with as many as 32 positions, Beeck says.

The switch/knob is said to give higher reliability because it eliminates mechanical switching. The output from the device is either a ONE or a ZERO. Darlington drivers are used to provide higher current-handling capability.

## Advanced sensing used to study causes of fog

Using three advanced remote-sensing techniques, researchers at the Naval Electronics Laboratory Center in San Diego are investigating how and why fog forms.

The approaches are these:

- A frequency-modulated, continuous-wave radar that senses moisture fluctuations in the atmosphere.

- A sound-detection and ranging system (Sodar) that gives a picture of the thermal structure of the atmosphere.

- A light-detection and ranging system (Lidar) that senses particulate matter in the air.

According to Ray Noonkester, a research physicist on the project these sensing systems, when used together, provide an accurate picture of the thickness and structure of the part of the atmosphere in which the fog forms.

The radar-sensing system, he notes, produces a swept S-band signal that ranges from 2.8 to 3 GHz. This system is capable of sensing air-turbulence structures as small as 5 cm. It can indicate small moisture fluctuation in the atmosphere and rainfall rates as low as 0.01 mm an hour. Drizzle or rain can be sensed aloft, even if it doesn't reach the ground. This is important, Noonkester says, because drizzle that does not reach the ground may be responsible for some types of fog.

The acoustic sensing system uses bursts of audible acoustic energy that are scattered by temperature fluctuations in the atmosphere.

The system consists of a 2-kHz source, audio power amplifiers and a 3-by-3 array of Altec Lansing speakers. The electrical input power to the system is 1350 W. However, since the transmitter and transducer are only 27% efficient, the radiated acoustic power is only 365 W.

To detect small particles in the air, such as those found in fog and clouds, the Navy researchers are using a light-detection and ranging system that contains a GaAs laser diode array. This system can determine the location of the lower boundary of clouds, while the other systems determine the upper boundary.



ANOTHER REASON HEINEMANN IS NO. 1 IN OEM CIRCUIT BREAKERS

# THE INTEGRATED CIRCUIT BREAKER

## THREE TECHNOLOGIES— ELECTROMECHANICAL, HYBRID, AND SOLID-STATE—TO MATCH YOUR GROWING PROTECTION REQUIREMENTS

You'll always need overcurrent and short-circuit protection. But with the vulnerability of solid-state circuits and the increasing threat of brownout, that alone may not be enough.

For example, if you're designing with integrated circuits and other semiconductor components, you've got to guard against overvoltage as well as overcurrent. Transient overvoltage protection requires nanosecond response; overcurrent for semiconductors may require microseconds. Sometimes conventional circuit breakers simply aren't fast enough.

And if you're designing equipment to be used on a typical ac line—motors that can burn up, instruments that can become inaccurate, and computers that can garble—you've got to watch out for brownout. But undervoltage protection is something else you can't get with conventional breakers.

These are tough problems. But Heinemann can solve them all—often with a single device combining several protection functions. We have three kinds of breakers—electromechanical, hybrid electromechanical/solid-state, and all solid-state—so we're not committed to selling you any one technology that may have limitations.

Our highly experienced field representatives and factory application engineers can apply any or all of these technologies to solving your protection problem. Whether you make computers or coffee machines. Whether you make them in South Bend or Singapore. Heinemann has representatives in all major industrial areas. And factories in the U.S., Canada, West Germany, South Africa, and Australia.

Send for our electronic protection literature package. It'll tell you what you're up against. And what kind of protection you need to safeguard your circuits and your company's reliability reputation. Heinemann Electric Company, Trenton, NJ 08602. Phone (609) 882-4800.



# HEINEMANN

**We keep you out of trouble.**

INFORMATION RETRIEVAL NUMBER 17

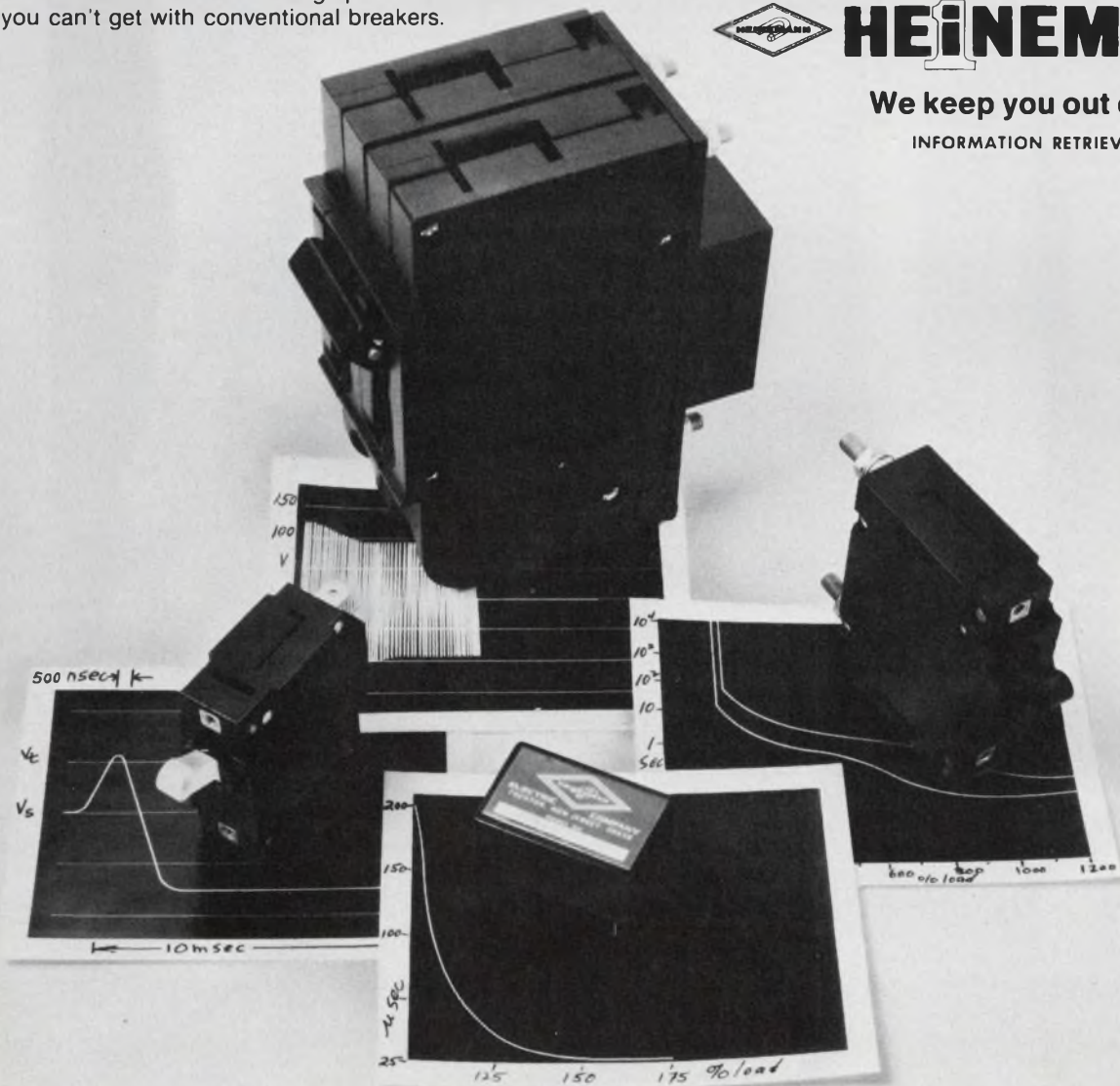



When it comes  
to wire processing  
we won't  
leave you stranded

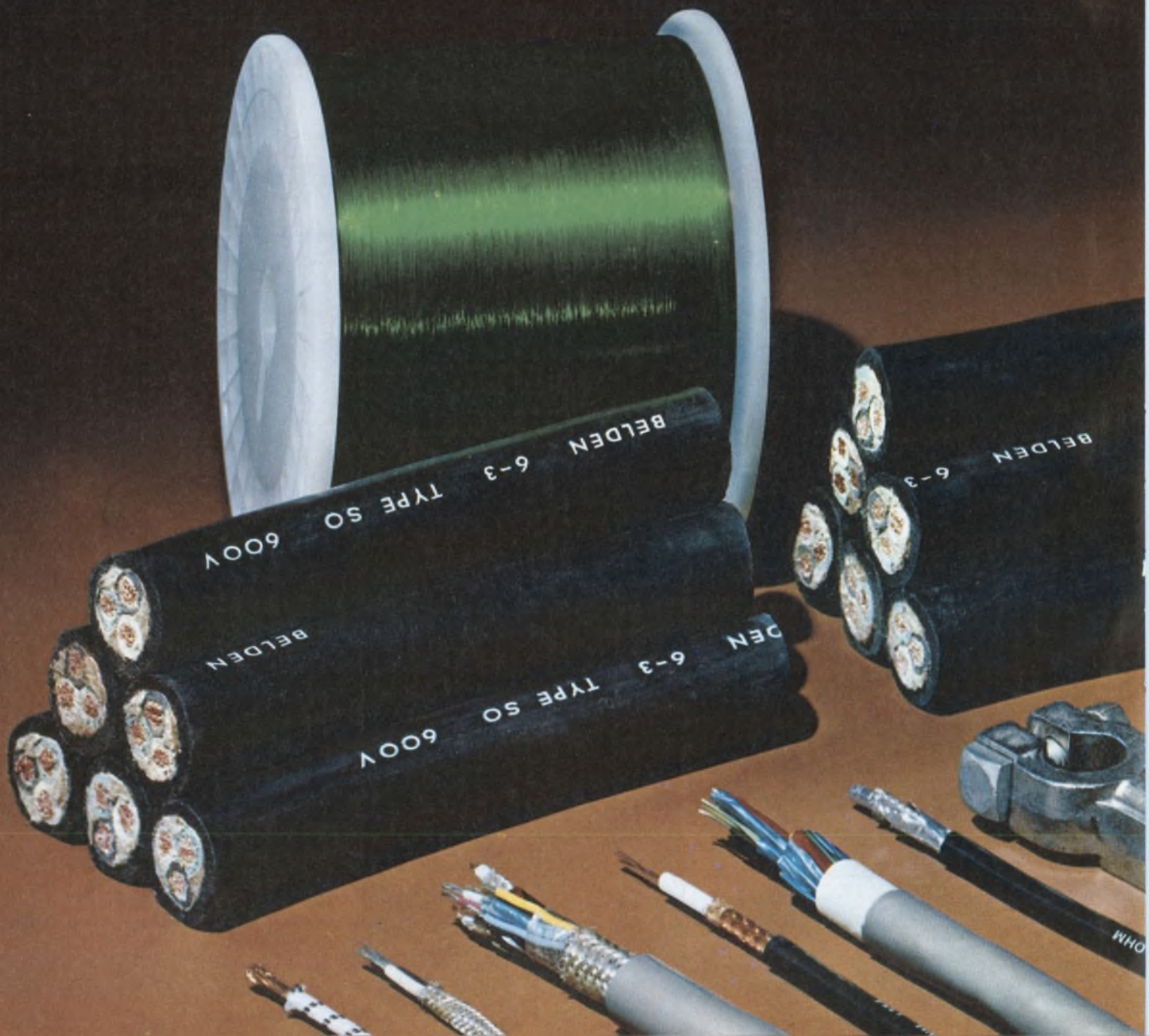



Your design is set. The components are on hand. The line is starting to roll. All of a sudden wham! That essential wire connection cannot be controlled. Your production schedule is "bottlenecked," and more importantly, your costs have skyrocketed.

While such situations are difficult to avoid completely, most wire processing problems can be foreseen if you take advantage of Belden's "total engineering view" to wire, cable, and cord applications.

Not only will it foresee a fabricating problem, for example, it can also uncover opportunities for cost reduction without hurting performance.

Consult Belden specialists when you get ready to look into the fine points of wire feeding, cutting, stripping, terminating, and

assembly. Our wire specialists and engineers will meet with your people, at your plant, to discuss a wire problem. Helping solve customer problems has always been our long suit. It still is.

We not only have the capability to provide standard techniques, we also have developed proprietary technology to anticipate your needs.

When we can't help you "get it all together" using standard procedures, we'll innovate a solution for your problem! For answers right now, phone:

(312) 887-1800, Transportation Division

(312) 681-8920, Electrical Division

(317) 966-6681, Electronic Division

Or write Belden Corporation, 2000 South Batavia Ave., Geneva, Illinois 60134.

**BELDEN** 

*... new ideas for moving electrical energy*

INFORMATION RETRIEVAL NUMBER 234

H-5-4

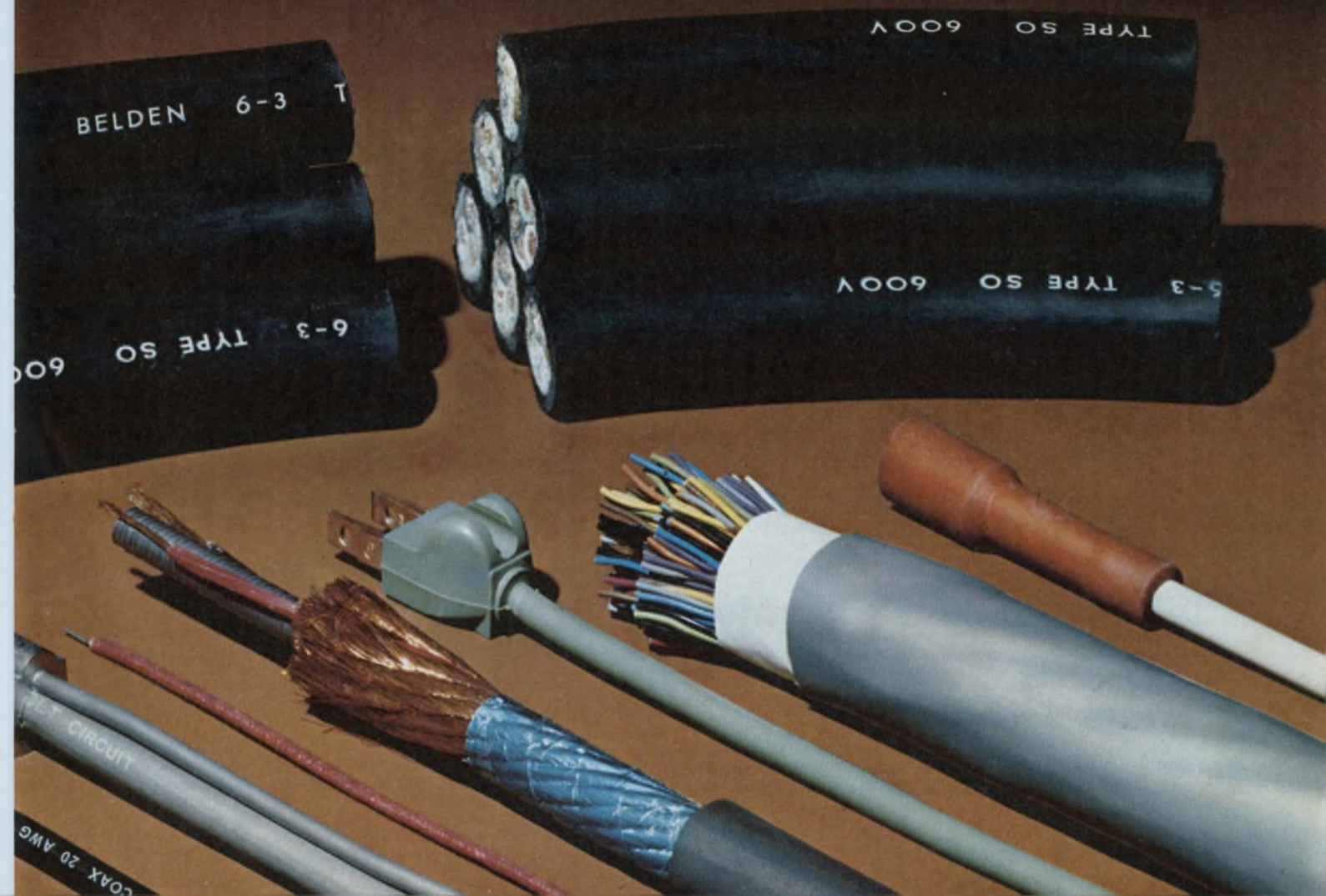



# SURPRISE! \$9.95

## DIRECTIONAL COUPLERS

- Frequency 10 KHz - 1000 MHz
- High directivity to 35 dB
- Wide selection of coupling
- From \$9.95
- Low main line loss from 0.1 dB
- One week delivery

Mini-Circuits ships thousands of signal processing components each week to more than 500 companies throughout the world. These units are included in over 300 critical military programs as well as communications, medical, CATV, telephone transmission and instrumentation applications.

Our years of experience in high-volume production result in high reliability units with guaranteed repeatability of performance at lowest cost. That's why more and more systems engineers are specifying Mini-Circuits' directional couplers, mixers and power splitter/combiners as the industry's standard.

For complete specs, performance curves and application notes, see MicroWaves 1974 Product Data Directory (p. 187-311) or circle Reader Service No. for your 132-page catalog.

Model	Coupling, dB	Freq. MHz	Price	Qty.
PDC 10-1	11.5 ± 0.5	0.5- 500	\$11.95	(5-49)
ZDC 10-1			\$26.95	(4-24)
ZMDC 10-1			\$36.95	(4-24)
PDC 10-2	10 ± 0.5	250-1000	\$15.95	(5-49)
ZDC 10-2			\$30.95	(4-24)
ZMDC 10-2			\$40.95	(4-24)
PDC 15-6	15 ± 0.5	0.01- 35	\$19.95	(5-49)
ZDC 15-6			\$34.95	(4-24)
ZMDC 15-6			\$44.95	(4-24)
PDC 20-3	19.5 ± 0.5	0.2- 250	\$11.95	(5-49)
ZDC 20-3			\$26.95	(4-24)
ZMDC 20-3			\$36.95	(4-24)
PDC 20-1	21 ± 0.5	25- 400	\$19.95	(5-49)
ZDC 20-1			\$34.95	(4-24)
ZMDC 20-1			\$44.95	(4-24)
*PDC 10-1B	11.5 ± 0.5	1- 400	\$ 9.95	(6-49)
*PDC 20-1B	19.2 ± 0.5	0.5- 200	\$14.95	(5-49)

\*Bidirectional

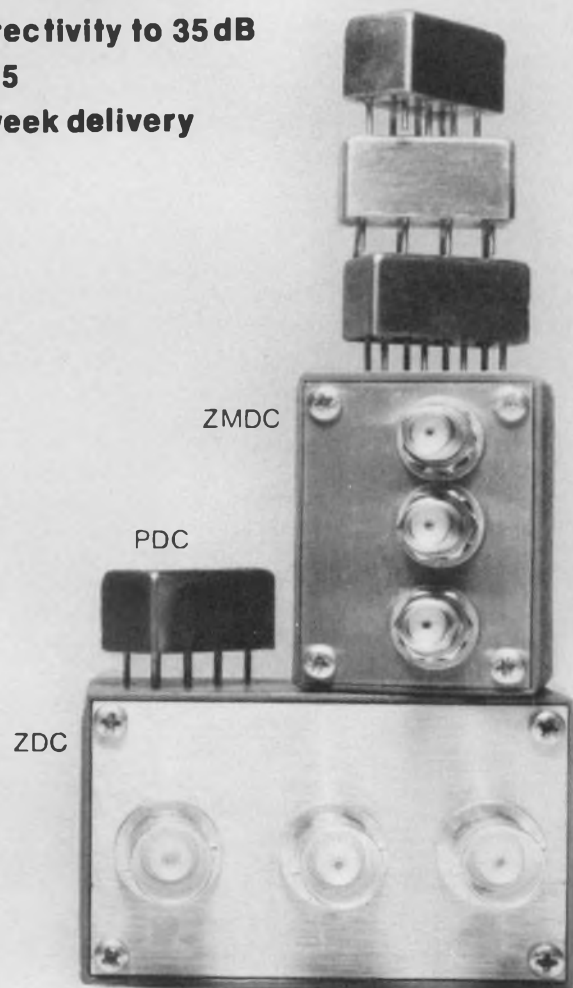

**Mini-Circuits Laboratory**  
A Division Scientific Components Corp.

**Foreign Sales Representatives:**  AUSTRALIA General Electronic Services, 99 Alexander Street, New South Wales, Australia 2065;  ENGLAND Dale Electronics, Dale House, Wharf Road, Frimley Green, Camberley Surrey;  FRANCE S. C. I. E. - D. I. M. E. S., 31 Rue George - Sand, 91120 Palaiseau, France;  GERMANY, AUSTRIA, SWITZERLAND Industrial Electronics GMBH, Klüberstrasse 14, 6000 Frankfurt/Main, Germany;  ISRAEL Verctronics, Ltd., 69 Gordon Street, Tel-Aviv, Israel;  JAPAN Densho Kaisha, Ltd., Eguchi Building, 8-1 1 Chome Hamamatsucho Minato-ku, Tokyo;  EASTERN CANADA B. D. Hummel, 2224 Maynard Avenue, Utica, NY 13502 (315) 736-7821;  NETHERLANDS Coimex, Veldweg 11, Hallem, Holland

**US Distributors:**  NORTHERN CALIFORNIA Cain-White & Co., Foothill Office Center, 105 Fremont Avenue, Los Altos, CA 94022 (415) 948-6533  
 SOUTHERN CALIFORNIA, ARIZONA Crown Electronics, 11440 Collins Street, No. Hollywood, CA 91601 (213) 877-3550

For complete U.S. Rep listing and product line see MicroWaves' Product Data Directory

**OUR NEW ADDRESS IS: 837-843 Utica Avenue,  
Brooklyn, NY 11203 (212) 342-2500  
Int'l Telex 620156**



# Washington Report

## **Solar energy program planned by U.S.**

The Energy Research and Development Administration is planning an ambitious solar energy program, starting with a 10-MW solar power plant that it hopes to have in operation somewhere in the Southwest in four to five years. It is seeking proposals from industry for the design of a plant that would use the central-receiver concept with four basic sub-systems: a field of solar-radiation collectors, a radiation absorber and boiler heat exchanger, a thermal storage unit and a heat-to-electricity conversion cycle. The collector field will consist of an array of controlled heliostats that will reflect radiation to an absorber boiler atop a tall tower.

In another move, the agency has awarded three contracts for nine-month studies of energy-storage concepts involving flywheels, compressed air and thermal. Rockwell International has the flywheel project and General Electric the two other studies.

## **Increase in defense R&D sought**

The Defense Dept.'s Advanced Research Projects Agency will try to match Soviet defense-related R&D with a \$226.6-million request for fiscal 1976, a boost of \$24.3-million over last year's appropriation.

With this money, the agency will break new ground in work on "organic superconductivity and new semiconductor materials to perform new tasks at microwave, submillimeter and optical wavelengths," George H. Heilmeier, director of the agency, told a Senate Armed Services Committee's subcommittee on R&D.

Among the major thrusts will be the development of charge-coupled technology applications to satellites, advanced air defense radar and higher-powered chemical lasers. To solve the problem of locating hostile weapons, the agency envisions a small remotely piloted vehicle (RPV) equipped with a lightweight, low-cost, high-performance radar, or a laser line scanner.

## **New radio service for offshore drillers proposed**

Because of growing offshore drilling activity, particularly in the Gulf Coast region, the Federal Communications Commission is proposing a new radio network—Offshore Radio Telecommunications Service. At present there are some 2200 platforms in the Gulf, and the number is expected to reach 5000 within two to three years. Businesses operating drilling and other operations maintain communications through the common-carrier Rural Radio Service and the private Petroleum Service.



The FCC considered a number of frequencies, from below 100 MHz to above 900 MHz, before finally deciding to allow shared use of the uhf-TV Channel 17 (488-494 MHz). Major factors in the decision were the off-the-shelf availability of a complete line of equipment for this frequency band and the fact that use of Channel 17 in the Gulf offshore area would have "only minimal impact on future television service." While awaiting public comment, the FCC has already frozen the TV assignment table for Channel 17 in the region.

The agency will likely have a similar problem to solve on the West and East Coasts in the future when more areas of the Continental Shelf are opened for petroleum exploration.

## **NASA and NSF expecting full budgets for 1976**

Although the Senate has yet to act, both the National Aeronautics and Space Administration and the National Science Foundation are likely to get the funding authorization they want, pretty much as requested by the President.

The House has authorized \$3.59-billion for NASA fiscal 1976. The agency had asked for \$3.54-billion. On the other hand, the House reduced the three-month transition budget (July 1 to Sept. 30, 1976) request of \$959-million to \$922-million. Some \$30-million is to be deferred from research and development and used for construction of facilities.

The National Science Foundation's request for \$755.4-million has been approved to the dollar by the House, but a number of Congressmen have been sharply critical of some social-research aspects, particularly a program called "Man: A Course of Study." That program, funded at \$7-million, has been called objectionable because of sections dealing with sex and violence among Alaskan Netsilik Eskimos. The NSF has agreed to stop funding the program.

**Capital Capsules:** In the interest of increasing competition, the Coast Guard has announced that it is willing to test and evaluate 400-kW (minimum) solid-state Loran-C transmitters, although it has one in hand developed under contract by Megapulse, Inc. The Coast Guard wants three transmitters now, with a total purchase in the future of up to 20 units. . . . Companies with research and development capabilities in modular infrared, IC video amplifier modules and visible light-emitting diode arrays are being invited by the Army Electronic Command to make their capabilities known. **The Army has a need for high-density infrared detector FLIR arrays and video-processing integrated circuits, to be used in thermal imaging systems. . . . Westinghouse, in a project funded by the Air Force, has built and tested a prototype rotor that will be the heart of a new kind of electrical generator that could supply an aircraft with 5 million kW of power.** Based on superconductivity, the generators are to weigh less than a third of what conventional generators now weigh. The needed low temperature is maintained by circulating liquid helium through the rotor, which is an electromagnet mounted in a thermally insulated vacuum vessel. . . . A "wrist worn personal fitness monitor" is being sought by the Law Enforcement Assistance Administration to be worn by law enforcement and other public service personnel whose work involves periods of stress. **The device would provide a readout of pulse rate, body temperature and blood pressure.** Currently available electronic components must be used.



The background of the entire page is a photograph of a tropical island at sunset. In the foreground, several palm trees are silhouetted against the bright orange and yellow sky. In the background, the dark silhouette of a mountain range is visible, with a prominent, sharp peak. The overall mood is serene and exotic.

# RUNAWAY TO TAHITI ...WITH BOURNS

Sound pretty good? Well, we're not kidding. Bourns is giving away an all-expense ten day holiday-for-two to that Polynesian paradise, Tahiti. Turn the page and see how you might **RUNAWAY TO TAHITI!**



# RUNAWAY TO TAHITI ... WITH BOURNS

## THE PRIZE...

Runaway to the fabled Polynesian islands of Tahiti, Moorea and Bora Bora. Ten days of fun, adventure . . . and relaxation on the crown jewels of the Pacific. All expenses paid — deluxe hotels, air travel (from U.S.), inter-island travel, introductory island excursions, Tahitian feast, personal guide service . . . plus spending money. You can go marketing, paddle an outrigger canoe, do your own bicycle or motor scooter exploring, go sailing, take a glass bottom boat ride, water ski, snorkeling . . . or, go deep sea fishing, if you like. Above all, soak up the sun and relax.

## OTHER PRIZES...



### LASER . . . INTERNATIONAL CLASS SAILBOATS

The next best thing to sailing to Tahiti . . . is sailing in your home waters. So . . . Bourns is giving away two LASER sailboats to the next two winners (after 1st). The LASER — world's most successful new one-design — is 14-feet of cartoppable fun and speed. Class fleets everywhere.

### NEW HP-55 PROGRAMMABLE CALCULATORS

HP's new Model 55 scientific calculator does about everything but whistle for a cab. Besides all the mathematical stuff . . . the HP-55 also has 20 addressable storage registers, built-in digital timer (stopwatch) . . . and it stores and runs up to 49-step programs. Bourns is awarding two of these beauties.



### TEXAS INSTRUMENTS SR-50 ENGINEERING CALCULATORS

The ultimate engineering "slide rule" calculator . . . squares, roots and reciprocals, quadratic equations,  $n^{\text{th}}$  power and roots, sines, cosines, tangents, exponentials, logarithms. Ten-digit display, 2 digit exponent, plus 2 signs. We're giving away TEN.

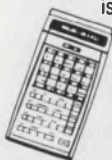

### NEW POTENTIOMETER HANDBOOK

McGraw-Hill and Bourns have collaborated to produce THE comprehensive handbook on variable resistive components. Over 320 pages, extensively illustrated, covers everything from design, applications, explanations of performance specifications and test methods . . . and much, much more. McGraw-Hill will sell them for \$13.50. We're giving away ONE-HUNDRED.



NOTE: Delivery of above prizes free within continental U.S. only.

Photo by Irwin Christian

## CONTEST RULES

All you have to do to enter . . . is complete the questionnaire below. To answer the questions correctly, you must read and comprehend the information contained in the eight mini-ads on the next two pages. This questionnaire is no gimmick . . . if you want a chance to RUNAWAY TO TAHITI, you will have to answer every question . . . and answer each correctly. This gives serious contestants improved odds over those who are only casually interested. However . . . everyone has an equal opportunity to win. You may enter as many times as you wish . . . BUT ONLY ON QUESTIONNAIRES CLIPPED FROM ACTUAL TRADE MAGAZINE ADS. Winners will be drawn from all correctly answered questionnaires. All prizes will be awarded. Only one prize per entrant (one per family). If you wish to have a list of the actual winners, simply send a self-addressed, postage paid envelope with your entry. Bourns employees, and employees of Bourns advertising agency, authorized reps, distributors, and trade magazines are ineligible for this contest.

### READ THE MINI-ADS ON THE NEXT TWO PAGES, THEN COMPLETE THIS QUESTIONNAIRE AND MAIL TO: RUNAWAY TO TAHITI, C/O BOURNS, INC., 1200 COLUMBIA, RIVERSIDE, CALIFORNIA 92507.

1. Bourns gives you a choice in low-cost  $\frac{3}{4}$ " rectangular trimmers. How many adjustment turns variations are offered? \_\_\_\_\_
2. What is the 1000-pc. price of the Model 3006 trimmer? \_\_\_\_\_
3. Did you know Bourns makes a  $\frac{3}{8}$ " square multi-turn trimmer that sells for only \$1.10 ea.? What is the Bourns Model No.? \_\_\_\_\_
4. Who offers the widest selection in square multi-turn trimmers? \_\_\_\_\_
5. The power rating of the 3352 single-turn trimmer is \_\_\_\_\_. The 1000 pc. price is \_\_\_\_\_.
6. What Bourns Division offers "Free Lunches For a Week . . . if"? \_\_\_\_\_
7. Did you know that Bourns can now deliver special thick-film networks (with chip capacitors, special circuits, etc.) in 5 to 8 Weeks? \_\_\_\_\_
8. Bourns Model 3540 \_\_\_\_\_-turn,  $\frac{3}{4}$ " x  $\frac{7}{8}$ " Diam. Precision Potentiometer sells for \_\_\_\_\_ in 1000 piece quantities, \_\_\_\_\_ section configurations are offered as standard option.
9. Bourns Magnetics Division manufactures audio, power and pulse transformers in sizes up to \_\_\_\_\_ pound(s).
10. How many standard, off-the-shelf resistor networks are available from Bourns? \_\_\_\_\_
11. Does Bourns Model 3680 Pushbutton potentiometer need adjustment or phasing before installation? \_\_\_\_\_
12. Bourns  $\frac{3}{4}$ " cermet panel controls have the most \_\_\_\_\_ - for-size.
13. Do you have an application for Bourns 3680 Pushbutton Potentiometer? \_\_\_\_\_  
If yes, what \_\_\_\_\_
14. Did you know Bourns new 3851 and 3858 conductive plastic panel controls are direct replacements for the Allen-Bradley Model J . . . but require only  $\frac{1}{2}$  as much behind-the-panel space? \_\_\_\_\_

Name \_\_\_\_\_

Address \_\_\_\_\_

City \_\_\_\_\_ State \_\_\_\_\_ Zip \_\_\_\_\_

Company \_\_\_\_\_ Phone \_\_\_\_\_



TRIMPOT PRODUCTS DIVISION  
1200 COLUMBIA AVENUE, RIVERSIDE, CALIFORNIA 92507  
PHONE 714 684-1700, TWX 910 332-1252 CABLE: BOURNSINC



# RUNAWAY TO TAHITI ...WITH BOURNS

SECRETS REVEALED

be choosy  
about  
trimmers  $\frac{3}{4}$ "

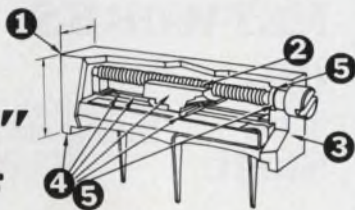

Bourns gives you a choice in high-quality, low-cost  $\frac{3}{4}$ " rectangular, multiturn trimmers . . . so you can tailor performance more closely to your specific application needs . . . and your budget. ① If you need a thin  $\frac{3}{4}$ " trimmer, we have the 3005 wirewounds at .17" thin . . . if you need a short one, our 3006 cermet unit stands only  $\frac{1}{4}$ " high ② For tailored adjustability choose 7½-, 10-, 15-, 20-, or 30-turn versions . . . in either solid or transparent cases ③ for panel mounting requirements, choose factory installed or flexible do-it-yourself options ④ Performance? How about 1% CRV • electrical adjustability of  $\pm 0.05\%$  VR • Mil-Grade environmental specs • power handling from .5 to 1 watt • TC of  $\pm 100$ PPM/°C for all resistance ranges. ⑤ Plus all the nice technological advances like: press-fit lead screws that eliminate o-ring windup and backlash . . . yet seal against humidity and board washing processes; multi-wire wipers for improved CRV; end-adjustment idling to prevent overtravel damage; swagebond termination for long-term stability, reliability; one-piece high temp thermo-plastic cases; wide choice of pin configurations ⑥ Price? How about \$.93 ea. (1000 pc. quantities, Model 3006) ⑦ Availability is off-the-shelf at 97 distributor locations . . . plus an extensive factory stock.



NOBODY KNOWS MORE ABOUT TRIMMERS THAN BOURNS

SQUARE  
SHAPE,  
COOL  
PRICE!



Pick your package . . . pick your price . . . in square, WGAP multi-turn trimmers . . . and still get the best — BOURNS! Choose from 6 cermet and 5 wirewound models . . . at super competitive prices. Our  $\frac{3}{4}$ " square Model 3299 cermet unit has the lowest price we know of (\$1.10 in 1000 pc. quantity) and still outperforms comparable units. If you need wirewound element performance, you can get it from Bourns . . . from \$2.16 (Model 3255, 1000 pc. quantity). We've got QPL mil-spec models (RT-24, -26 and RJ-22, -24, -26) and sizes and pin styles to suit your requirements. Same superb construction features as our rectangular lead-screw trimmers.

COMPARE . . . you'll understand why Bourns is still No. 1

	Size	Res. Range	Res. Tol.	Power	CRV	Adj Turns	Max Temp	Vib-ration	Price
BOURNS 3299	$\frac{3}{4}$ " sq.	10-1 Meg	$\pm 10\%$	$\frac{1}{2}$ W 70°C	3%	25	125°C	20G	\$1.10/1000 pc.
BECKMAN 66	$\frac{3}{4}$ " sq.	10-2 Meg.	$\pm 20\%$	$\frac{1}{2}$ W 25°C	No Spec	20	105°C	10G	\$2.70/1000 pc.

Availability is off-the-shelf at 97 distributor locations . . . plus an extensive factory stock. For a free sample, contact your local authorized Bourns representative or distributor.

small  
size,  
low cost,  
BIG  
PERFORMANCE...



Bourns Model 3540 family of 3-, 5-, and 10-turn potentiometers incorporate all the precise electrical specs of larger military grade pots . . . in a compact  $\frac{7}{8}$ " Diam.-by- $\frac{3}{4}$ " long package. Dual-ganged and dual-concentric shaft units available as standards. Availability is OFF-THE-SHELF at over 97 distributor locations, and from our extensive factory stock.

If you're now using one of the following parts . . . switch to the BOURNS Model 3540 family . . . and be SURE.

AMPHENOL: 2131B, 2151B, 4101B, 4201B, 4301B, MF-78  
HELIPOT: 7216, 7246, 7266, 7276, 7366, 7466  
SPECTROL: 502, 510, 520, 530, 532, 533, 534, 535, 550  
TRW/IRC: 1000, 1005, 7500, 7505, 8400, 8403

Yes, we have custom options . . . like rear shaft extensions, hi-torque, special linearity and resistance tolerances, triple sections, centertap, etc. Our 3540's work great with a BOURNS turns-counting dial, too!!

### FREE SAMPLE

Tell us about your application. Call 714-684-1700 and ask for a PANEL POWER Engineer.

\*\$3.97 ea. (single unit, 10-turn style) in 1,000 pc. quantity.

single-turns  
with  
singular  
performance



If you have a single-turn application, Bourns can cover you every-way from Sunday. You can choose wirewound or cermet element models with superlative performance and reliability . . . priced from 43¢ each (Model 3352, 1000 pc. quantity). You can have top adjust, side adjust, Mil-Spec units . . . in all kinds of pin styles. For example, our little  $\frac{3}{8}$ " square Model 3386 single-turn is available in 12 different terminal styles. If size is your prime concern . . . our little  $\frac{1}{4}$ " Diam. Model 3329 stands only .18" high. If you want just a little more adjustability . . . Bourns unique Model 3339 gives you four-turns in a single-turn package.

Compare Bourns performance and reliability . . . and you'll understand why Bourns trims more circuits than anyone else in the world!

Model Element	Power	CRV	Adjust-ability	Res. Range	Term. Styles	Shock Vibration	Price 1000 pcs
3352 Cermet	$\frac{3}{4}$ W @ 40°C	1%	$\pm .05\%$ VR	10-5 Meg.	12	100/30G's $\frac{3}{8}$ " Dia.	.43
3386 Cermet	$\frac{1}{2}$ W @ 85°C	1%	$\pm .03\%$ VR	100-2 Meg.	8	100/30G's $\frac{3}{8}$ " Dia.	.49
3329 Cermet	$\frac{1}{2}$ W @ 85°C	3%	$\pm 0.1\%$	10-1 Meg.	3	100/30G's $\frac{1}{4}$ " Dia.	1.22
3339 Cermet	$\frac{1}{2}$ W @ 85°C	3%	$\pm 0.03\%$	10-1 Meg.	3	100/30G's .30" Dia.	1.46

Available off-the-shelf at 97 distributor locations . . . plus an extensive factory stock.



# RUNAWAY TO TAHITI ...WITH BOURNS

## Update Your PANEL with the NEW BOURNS® PUSHBUTTON POTENTIOMETER

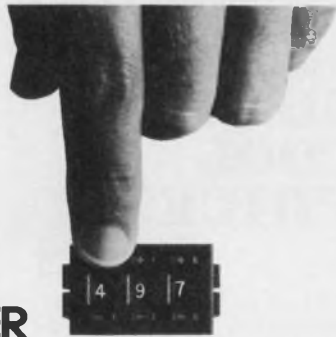

The new Model 3680 Pushbutton Potentiometer integrates a precision incremental decade potentiometer with an easy-to-read digital display. AND a speedy pushbutton control action. It is handsome, accurate, and a "snap" to install. Everything is INSIDE the Model 3680 . . . no resistors or mini-PC boards are required . . . nothing clutters the back of the unit to steal precious space. No pot-to-dial phasing required . . . it's ready to install when you open the box.

### FEATURES SUMMARY

- 0% to 100% capability by 0.1% steps
- In-Line Digital readout
- Accuracy (Dial Reading to Output Ratio)  $\pm 0.5\%$
- Convenient snap-in mounting with bezel
- Rear solder lug terminals fit AMP series 110 receptacles (dual purpose solderable)
- 100 PPM/°C tempo
- 2 watts power rating
- Rectangular to match other panel components

For more information, call your local Bourns representative, distributor, field sales office . . . or call the factory direct and ask for a PANEL POWER engineer.

## NETWORKS...

### Off- The- Shelf



We've got over a quarter-of-a-million standard resistor networks on the shelf . . . in your favorite Beckman, CTS, Dale and Allen-Bradley part numbers . . . we can ship in 24 hours. Call your friendly Bourns rep or distributor today for a quote! Our pricing-pencil is super sharp these days!

### ... or Made- To- Order

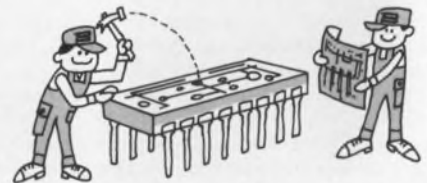

WE'LL BUILD TO YOUR PLANS — Last year was Bourns "start-up" year in networks . . . and our reputation for "quality, service and value" got us more custom networks opportunities than we could handle. Well . . . our operation is up-to-speed now. We are in production on many kinds of complex specials . . . including resistor/capacitor combinations. We can deliver special circuits to your requirements—prototype quantities in 5 weeks, production quantities in 8 weeks. Our price is right, and Bourns stands behind every part.

## Switch to BOURNS and get the most power-for-size in low-cost PANEL CONTROLS

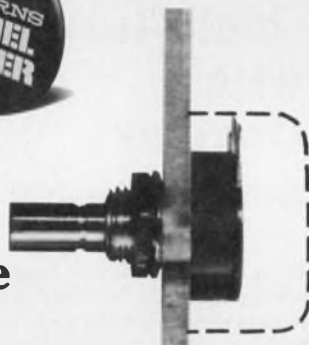

Save valuable "real estate" behind the panel . . . switch to BOURNS® unique SPACE SAVER controls design. Extends only  $\frac{1}{4}$ " behind your panel, yet handles as much power as bulkier alternatives.

Choose Bourns CERMET CONTROLS for maximum power-for-size and optimum stability.

Choose Bourns NEW CONDUCTIVE PLASTIC CONTROLS for low noise and long life. Ideal replacement for bulky carbon controls.

Bourns controls are available off-the-shelf at 97 distributor locations nationwide. Standards can be shipped direct from factory stock in 24 hours.

### FREE SAMPLE

Call "CONTROLS" at 714-684-1700 and tell us about your application. We'll send you the Bourns Control that best suits your needs. Pronto.

## FREE LUNCH...

if our standard pricing  
can't beat the price  
you're now paying for  
Transformers,  
Inductors  
or Delay Lines\*



...we'll buy your lunch FOR A WEEK!

Try us. Simply send a letter telling us (1) what you're buying and how many (2) price you're paying (3) technical specifications. SEND ACTUAL SAMPLE OF WHAT NOW BUYING. We'll respond in one week . . . with a better price on a better product (our return rate is less than  $\frac{1}{2}\%$ ) . . . or a FREE LUNCH ticket!

\* specifically, audio or power transformers and inductors (20hz to 500 khz) and pulse transformers in quantities of 10,000 or more . . . and delay lines in quantities of 1000 or more. Sizes up to  $\frac{1}{2}$ -lb.

BOURNS INC., MAGNETICS DIVISION  
28151 HIGHWAY 74, ROMOLAND, CA 92380 PHONE: 714 657-5195 TELEX: 67-6446



OEM buyers:  
**Ask**  
**Control Data**  
 for double density core memory,  
 32K x 18 in 16K x 18 space...  
 at a lower cost per bit!

**We have it.**

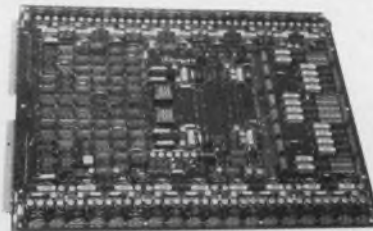

The CDC 94200 core memory:

CAPACITIES	SPEEDS
16K x 18	350 NS access
16K x 36	850 NS cycle
32K x 18	

ALSO AVAILABLE:  
 256K Bytes—Rack Mounting  
 512K Bytes—Rack Mounting  
 Power Supply Module

21 OEM offices in 11 countries  
 specializing in service to the mini OEM.

Call (612) 830-6135 or return coupon.

Richard E. Sakowicz, OEM Product Sales Manager  
 Control Data Corporation, Dept. ED-5105  
 3857 Louisiana Avenue  
 St. Louis Park, Minnesota 55426

NAME

TITLE

COMPANY

ADDRESS

CITY

STATE

ZIP

PHONE



**CONTROL DATA  
 CORPORATION**

The Total Services Company

See us in Booth #2441 at the NCC  
 INFORMATION RETRIEVAL NUMBER 23



# COMPUTER '75

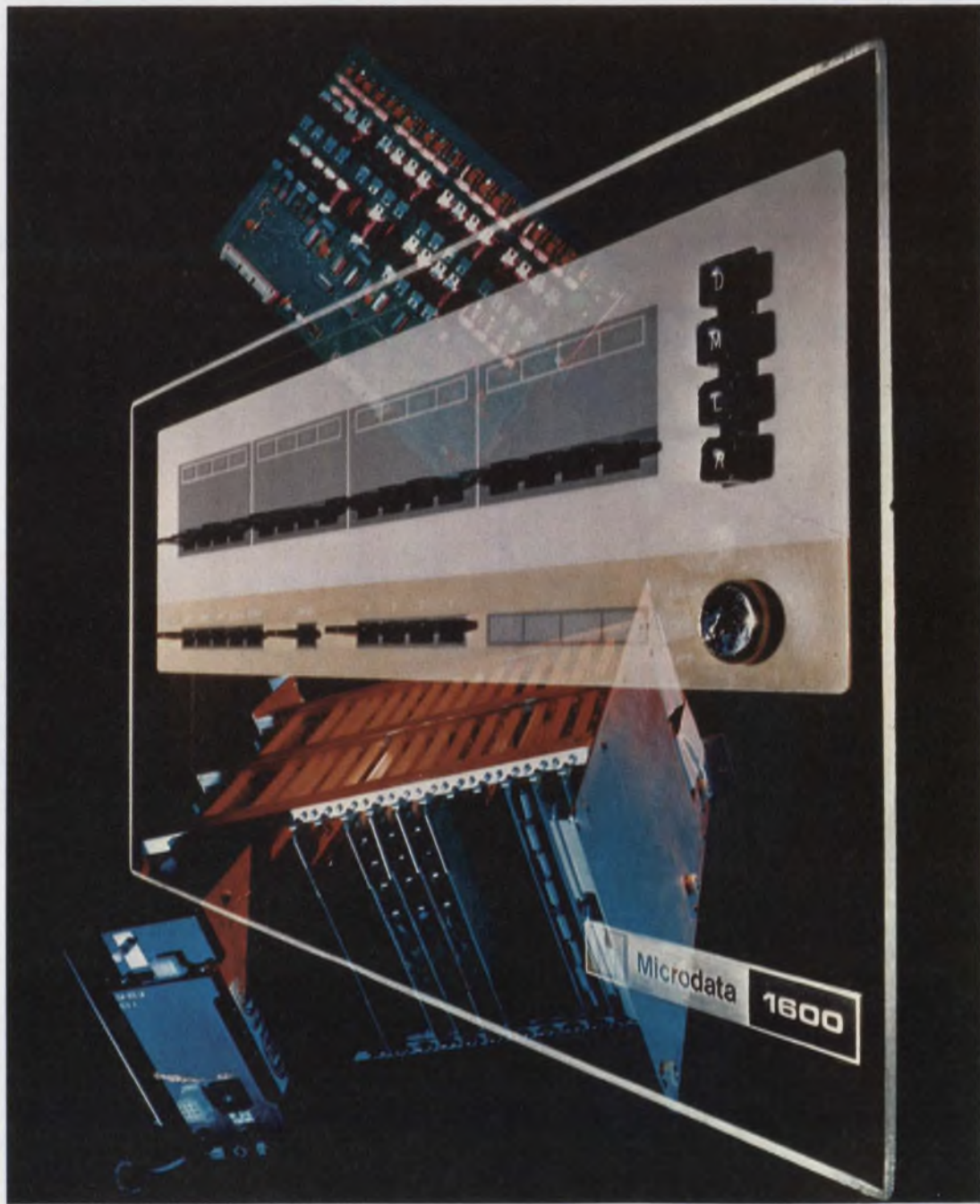

**From micro to maxi,  
it's the era of change**



**P**rogress in solid-state, as reflected in the latest LSI microprocessors and semi memories, is producing a new generation of computers, from micros to large mainframes.

Microcomputers have borrowed such features as microprogramming and pipelining from large systems, thereby speeding some operations and permitting faster entry of instructions.

Built-in MOS/LSI microprocessors are drastically reducing the size and cost of established minicomputer lines.

Finally, even the structure of large computer systems is changing. Solid-state RAMs—consisting of magnetic bubbles, MOS shift registers or CCDs—are expected to produce substantial architectural changes.

Solid-state progress is not only changing the shape of computer hardware but it is also altering the traditional roles of the computer in data processing and number crunching. The emergence of mini and microcomputers is sparking a growing army of what would have been considered “far out” applications only a few years ago.

Dedicated systems are turning up in sports-stadium scoreboards, electronic games, intelligent street and highway traffic controls, musical synthesizers and vending-machine coin changers.

Not only are computers being applied to non-traditional uses but peripheral equipment itself

is also becoming nontraditional, spurred in large part by semiconductor progress. The Termiflex hand-held computer terminal, for example, looks like a calculator but it's a lot more complex. It's got a 20-switch keyboard that can generate and display all 128 ASCII characters. Then there's the new line of visual computer peripherals that enable computers to “see” as well as hear and speak. One example is a digital line-scan camera from Reticon that looks like a camera, except that the film plane is replaced by a linear array of photosensing diodes.

As LSI devices, computers and computer systems increase in complexity so do the requirements for test and measuring equipment. For troubleshooting a high-speed digital system, the oscilloscope just won't do the job. The growing family of logic analyzers can often do what the conventional scope can't. “Intelligent” machines to diagnose ailments or to self-program are another response to increasing circuit complexity.

Software, too, has kept up with the increasing complexity of computer hardware. Powerful programs now enable designers to “see” a system work before it's actually built. These programs need minimal computer background; the computer does most of the translation from engineering notation to computer-usable form. Analog design programs range from dc to microwaves, and digital design covers gates to microprocessors.

For a fast look at changes in computer technology, turn the pages of this special section.

---

**Semiconductor ROMs form the control memory for Microdata's 1600, an 8-bit microprogrammable mini.**

## Contents

<b>Micros or large mainframes, advances in ICs are producing radically improved machines.</b> .....	34
<b>Novel ways of entering data are under study, including the power of positive thinking.</b> .....	46
<b>Dedicated systems giving rise to once 'far out' applications, from sports scoring to security.</b> .....	56
<b>Test and measuring equipment growing in complexity to keep pace with brainier computers.</b> .....	62
<b>Will the micro KO the mini? Not if the mini manufacturers counterpunch, says Paul Ely of HP.</b> .....	68
<b>Automated industrial controls not yet ready to go it alone without guidance of humans.</b> .....	72
<b>With new, powerful software, designers can 'see' a system work before it's actually built.</b> .....	80
<b>Top computer show unfolds in Anaheim with spotlight on new directions in design.</b> .....	90



# Micros or large mainframes, advances in ICs are producing radically improved machines

Edward A. Torrero, Associate Editor

**M**any of the improved capabilities of today's computers can be traced directly to solid-state advances. Increased speeds, heightened component densities and lowered costs resulting from new monolithic circuits are helping computer architects build new and better machines.

Advanced integrated circuits in the form of LSI microprocessors and microcontrollers—and especially the latest memories—are turning up in virtually every kind of computer from micro to large mainframe. In the process, traditional distinctions are becoming blurred as computers take on features usually associated with their larger—or, in some cases, smaller—cousins.

A new generation of minicomputers provides a vivid example. Here are some of the major trends:

- Low-end minis that use MOS/LSI microprocessors are being offered as smaller and cheaper versions of established models. In addition bipolar/LSI microcontrollers and bit-slice processors are providing architects with the tools to maintain both the speed and structure of earlier models in newer low-cost versions.

- Steadily falling IC-memory costs have accelerated the use of high-density MOS dynamic RAMs for main memory and high-speed and bipolar RAMs for cache, or buffer, storage. Cache memories increase over-all system speed when the relatively slow MOS RAMs are used for main memory. At present MOS RAMs offer a top storage capacity of 4096 bits, and available 1024-bit bipolar RAMs have an access of about 50 ns.

- An increasing number of capabilities hitherto associated with large mainframes are being incorporated into high-end minis. Features like virtual memory and virtual machine, and stacks for instructions and data are being tailored for



A 32-bit minicomputer with 1 Mbyte of core cycles at 450 ns average, 300 ns minimum. Interdata's 8/32 Mega-mini uses high-speed Schottky-TTL circuits.

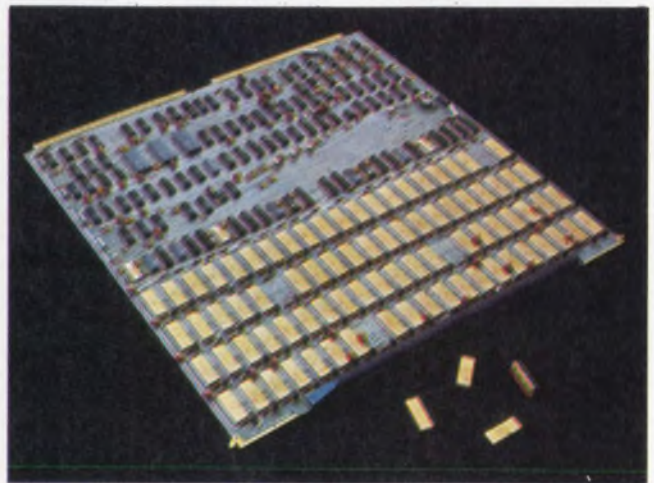

A semiconductor memory module from Data General has correction circuitry that can run without an error, even though four chips have been removed.



minis. And 32-bit architectures are supplanting the established 16-bit structures for newer models.

### Micros on the move, too

Similarly microcomputers have borrowed from larger systems such features as microprogramming and pipelining, with the latter independently speeding some serial operations to allow faster entry of instructions. Moreover improved MOS techniques have led to 16-bit microprocessors on a single chip for a dramatic reduction in parts count.

With the Pace chip from National Semiconductor, Santa Clara, CA, for example, a single IC can replace the 15 to 20 packages used in the company's older, but faster and more flexible, 16-bit multichip processor. Also, Pace provides an improved interrupt structure consisting of six vectored levels. And it simplifies data processing involving 4-bit BCD and 8 and 16-bit binary operations.

Like most other new LSI microprocessors, the Pace chip seeks to fill a host of applications. But even newer versions in development could mark

a departure from the wide-ranging role that earlier "computers on a chip" had sought.

"We believe the market has matured so that we no longer have to make a processor all things to all people," says George Reyling, a project manager at National. The company is working on a dedicated microprocessor called the CMP-8, intended essentially for communications. "Specialized markets," Reyling observes, "may dictate specialized architectures."

The benefits of a dedicated approach would include specialized instructions and interface characteristics. The number of components would also be less. And memory costs would be down, since an application program could be shortened.

In a data-handling and routine application, for example, a dedicated approach would de-emphasize arithmetic capabilities, Reyling explains. "It would improve addressing modes and probably have memory-to-memory instructions rather than memory-to-accumulator." As a result, data could be moved from one memory directly to another, bypassing the microprocessor.

"But it's not clear one answer is the best," Reyling points out. A dedicated system could be

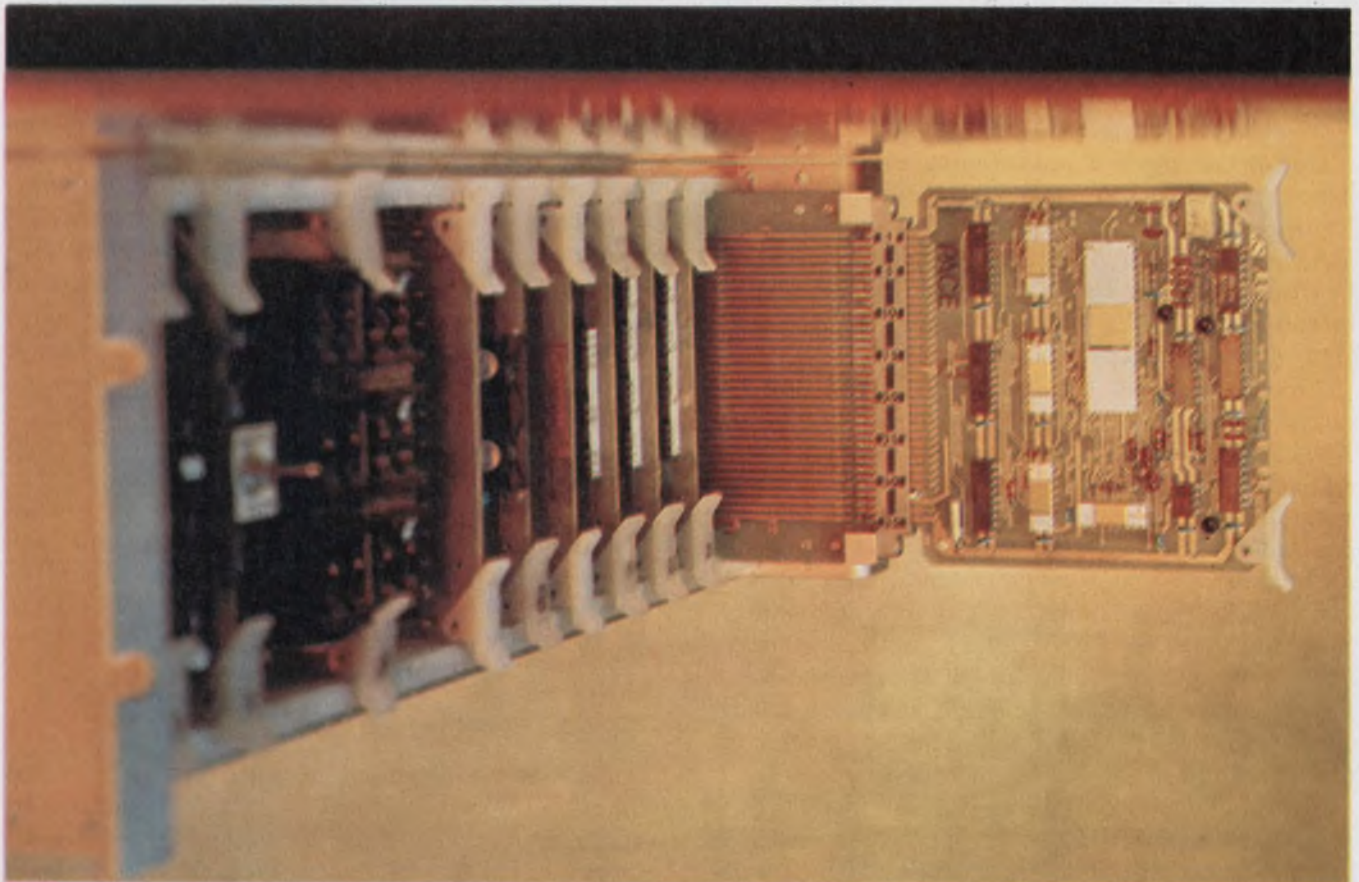

**A 16-bit microprocessor on a single chip** replaces the 15 to 20 ICs of older multichip versions. National Semi-

conductor's Pace microprocessor chip uses p-channel MOS/LSI techniques.





A single system processor controls input/output and arithmetic processors in the hierarchical architecture of the Xerox 560 computer, a 32-bit mini. Independent

processors can simultaneously access memory. And input/output transfers can take place simultaneously with computing operations.

achieved with a specialized microprocessor architecture or specialized support chips that could be developed to have increased intelligence.

#### Minis use micros

One minicomputer manufacturer that has embraced custom LSI microprocessors is Digital Equipment Corp. The mini maker in Maynard, MA, uses custom chips manufactured by Western Digital, Newport Beach, CA, in DEC's recently introduced LSI-11. This is a smaller-sized version of the company's popular PDP-11.

"We have taken the original PDP-11 and reduced package size by a factor of 20 in five years," says Robert Van Naarden, DEC's product manager for the LSI-11. Other benefits of large-scale integration include reduced costs and increased capabilities, "but with no real change in architecture," Van Naarden points out.

The first PDP-11, with 4-k words of memory, sold for \$10,000. An LSI-11 with the same amount of memory sells for \$990. And the basic LSI-11 comes as a single module, in contrast with the original PDP-11 box that housed power supply, fans and a number of modules.

The single 8-1/2 × 10-in. LSI-11 module contains a 16-bit MOS LSI microprocessor on three basic chips: a chip that emulates the larger mini's data path, another that provides instruction decoding, and two Microm chips that contain the machine's microcode. The entire chip set imple-

ments the instruction set of a PDP-11 35—a medium-range model in the PDP-11 series. The board also contains 4-k × 16 bits of memory and an I/O channel.

The microprocessor chip set provides DEC with a microprogramming capability. So the same processor hardware can be used to develop new models. A change in the mini's microcode—involving a simple change of Microms—would result in a machine with different capabilities.

In the LSI-11, DEC has used this flexibility to add features not found in the mini that it emulates. The new model, for example, has a microcoded ASCII-console routine that avoids the programmer's usual panel of lights and switches. Instead, a designer can employ the same terminal used for program development. Similarly a microcoded octal debugging technique—an aid in testing and troubleshooting—circumvents the usual practice of manually loading paper tape. One benefit of these two features is that the micro-based mini can be loaded from a remote location.

#### 4-k MOS RAMs reduce costs

Another minicomputer with a 16-bit word length—Hewlett-Packard's 21MX—benefits directly from the increasing availability of 4-k-bit dynamic RAMs. "IC manufacturers have been able to increase production and decrease costs," says Bob Frankenberg, a section manager at HP's Data-Systems Div. in Cupertino, CA. "We



have passed the savings on," he adds in reference to recent price cuts.

Besides decreasing over-all hardware costs, Frankenberg says, lower-priced RAMs are leading to increasing use of high-level languages, such as Fortran. "And they offer 50 to 60% greater reliability than core," he adds.

The use of low-cost 4-k RAMs made possible such architectural changes as a dynamic mapping system—a memory management scheme that expands address space from 32 k words to 1 million words. The expanded space is divided into four spaces: one is for the system, another for the user, and the rest are for direct-memory-access channels.

Available microprogrammed instructions allow access of one memory space to another. A "dirty-page" indicator tells which memory spaces have already been written into. And a parity-error indicator permits a page with "bad" bits to be eliminated.

System speed can be maintained at 650 ns—the memory-system cycle—through the use of 64-bit TTL RAMs in the mapping system. The high-speed memories have 35-ns access. "We couldn't have achieved the system speed with slower memories," Frankenberg reports.

In addition the HP mini employs the clock-off time of 4-k RAMs to perform address translation. During this period the bipolar memories are accessed. "It's a down time anyway, so we make use of it," Frankenberg says.

Refresh requirements for the dynamic RAMs can pose problems, especially in real-time processes. "A DMA transfer from a peripheral disc, for example, can't wait for the memory to do its thing," Frankenberg observes. The HP solution structures the system to ensure the transfer without recourse to a cost-increasing FIFO, or first-in, first-out stack. In essence, "we move refresh slightly out of the way, but never in a way that loses data."

High-speed memories also show up in the microprogrammable mini's control store. The HP 21MX uses 256-bit RAMs manufactured by Fairchild, Mountain View, CA. Once a microprogram has been developed in the volatile control store, 256 × 4-bit bipolar PROMs can be used to store the program permanently. The PROMs come from Harris Semiconductor (Melbourne, FL) and Monolithic Memories (Sunnyvale, CA).

### Minis move up to 32-bits

In an effort to cut software costs while taking advantage of low-cost ICs, Interdata offers mini-computers with a 32-bit architecture. The latest model from the Oceanport, NJ, manufacturer is the 8 32, which the company calls Megamini.

"Unlike competing units that claim a 32-bit

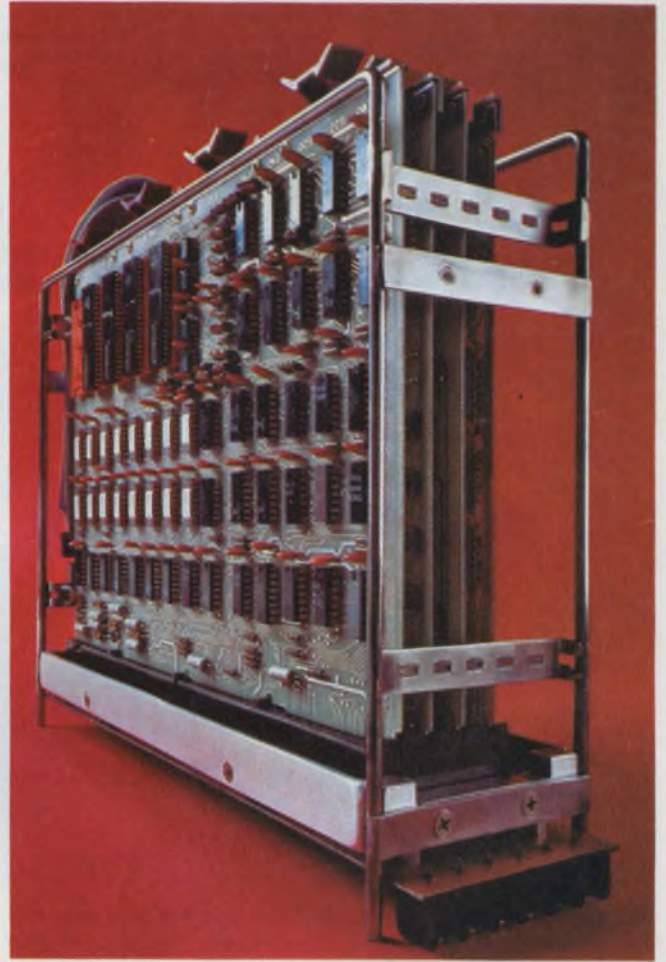

An 8-1/2 × 10-in. board contains the major elements of a mini. The Digital Equipment Corp. LSI-11 board uses a multichip, n-channel microprocessor.

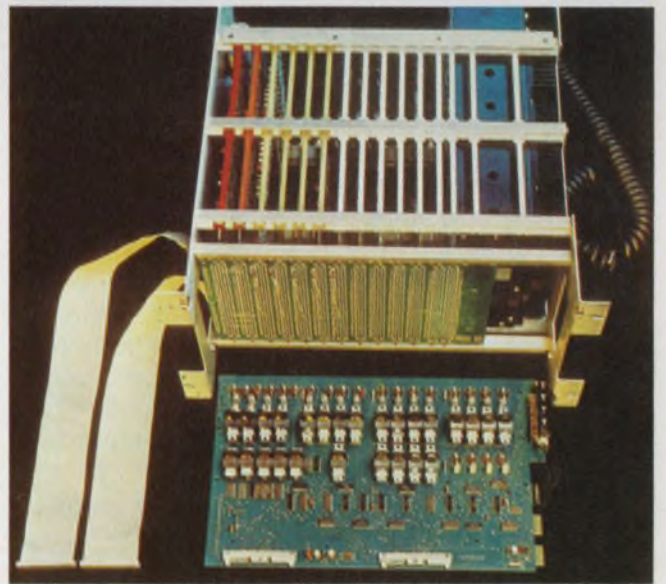

A microprogrammable mini from Interdata employs a push-down—or last-in, first-out—stack architecture to simplify use of high-level language and its compiler.





Aiming for users who need special memory and security features, Honeywell offers the 68/80, the top of the Series 60 computer line. The latest advance in the

Multics system, the 68/80, provides up to 6 billion bytes of addressable virtual memory. Multics can accommodate up to 10 processors on one system.

architecture," says William Sweet, Interdata's product line manager, "we have it."

To a programmer, each part of the Interdata machine—instructions, registers and data—looks 32-bits long. "When a programmer sees 16-bit registers," Sweet asserts, "he sees a 16-bit machine."

For Sweet, 16-bit machines imply limitations on software. "Programs can live with 16 bits," he says, "but programs have to live with other things too—like data, which can become larger than the program."

For example, an operating system—the control software that acts like a "traffic cop"—may require over 64-k words of space. And a large optimizing compiler allowing simultaneous, multi-user operation can require 100-k to 200-k bytes, Sweet points out. However, 16-bit machines tend to be limited to 64-k-word chunks.

Sweet attributes much of the speed improvement of the minicomputer's architecture to improved ICs.

High-speed, Schottky-TTL circuits are employed in the mini's processor for a cycle time of 240 ns. And while core is used for memory, interleaving techniques with 32-bit modules achieve an ef-

fective 32-bit cycle time of 450 ns. The speedy 8/32 executes a floating-point multiply in 3  $\mu$ s, and it has a DMA burst transfer rate of 6 Mbytes/sec.

As impressive as the specs are, Sweet points to the machine's optimizing compiler for perhaps the single best example of the power of the 32-bit machine. Besides increasing the speed of a designer's Fortran program, the compiler automatically produces re-entrant code. As a result, many users can interact with the compiler at the same time. With a 16-bit machine, Sweet notes, the compiler must be segmented and users don't have the same simultaneous access.

#### Increasing word size further

For some proponents of increased word lengths, even 32 bits isn't long enough. "Some say you need 36 bits," says Bill Poduska, vice president of engineering at Prime Computer, Framingham, MA. Mainframe computers, which established the 32-bit word standard, also employ 36-bit—the IBM, Honeywell and Univac machines, for example. And 64 bits are offered by computers from Control Data Corp.



# Who's who in high performance linear I.C.'s? We are.

Teledyne Philbrick. The ones who started it all some 29 years ago. Today we have the best line of bipolar and FET input high performance linear I.C.'s. Some 17 different I.C. families in all . . . general purpose, wideband, high speed/fast settling and ultra-low drift bipolar I.C.'s. General purpose, low cost, high accuracy, ultra-low bias current, ultra-fast and wideband/fast settling FET I.C.'s.

Linear I.C.'s that give you low-cost, high reliability and high performance without any of the usual trade-offs. So you get all the performance you need at competitive prices that will surprise you. Dependable I.C.'s with the experience to back them up.

We've got a wideband bipolar I.C., our 1321, that boasts a settling time of 500 nsec. to 0.1%, better than any competition and sells for \$6 in 100's.

Or we'll give you the same specs in a FET input I.C., our 1433, for \$9.50 in 100's.

How about our 1340, an ultra-low drift bipolar I.C. with  $0.2 \mu\text{V}/^\circ\text{C}$   $E_{osTC}$  and  $5 \mu\text{V}/\text{year}$  long-term stability that sells for \$25 in 100's.

Or the fastest FET I.C. op amp on the market, our 1430, that gives you a settling time of 200 nsec. to 0.01%, max. and 10 V @ 50 mA output.

We could go on and on. But you get the idea. If you want the best high performance linear I.C.'s check us first.

Write for our new Linear/ Nonlinear Catalog. Or "DIAL" (our Direct Information Access Line) 617-329-1600.

Teledyne Philbrick, Dedham, MA 02026. In Europe, Telephone 673.99.88, Telex: 25881. Or write 181 Chaussee De La Hulpe, 1170 Brussels.

 **TELEDYNE  
PHILBRICK**

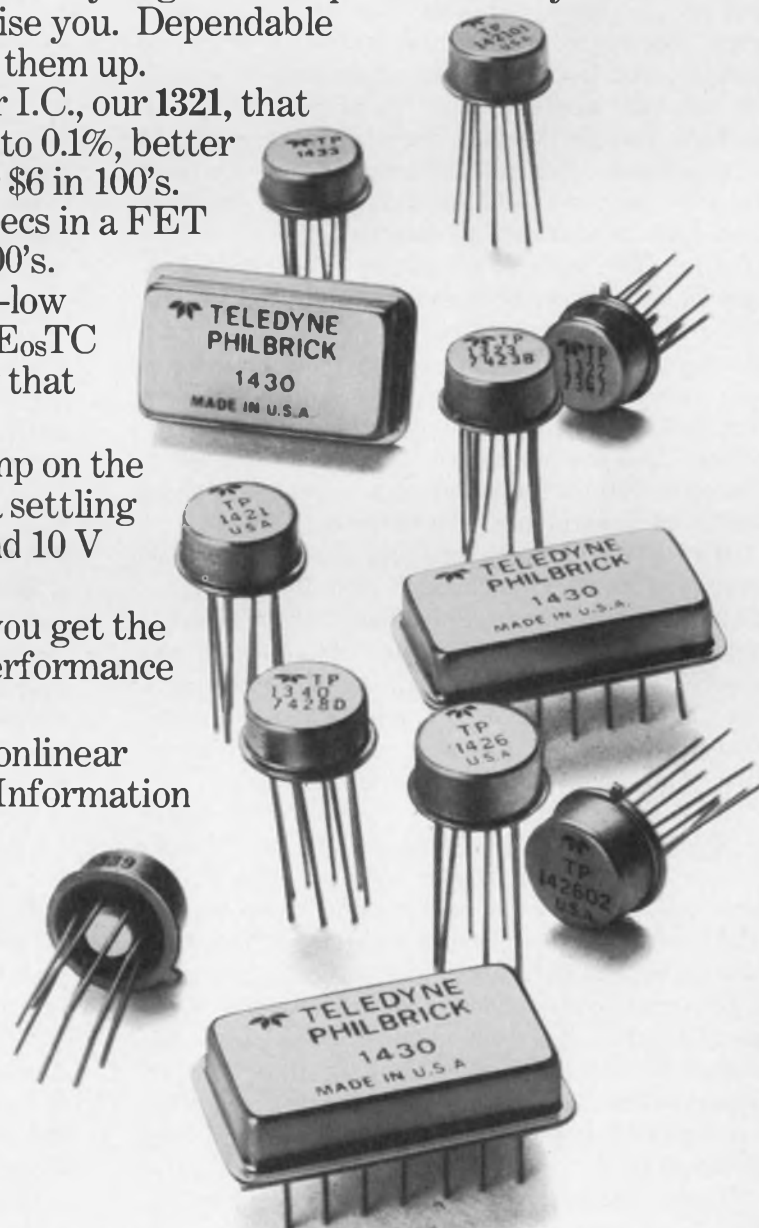



"It's not really a matter of precision any more," Poduska asserts, "because the 32 and 36-bit word lengths are so close." Instead the argument is either for four 8-bit characters (32 bits total) or four 9-bit characters (36 bits total).

"We originally got 8-bit characters basically because IBM said so in the 360," Poduska reflects. Display considerations led to 7-bit plus parity-bit character codes.

Meanwhile Prime Computer is taking advantage of lower-priced IC memories by incorporating error-correcting codes in such machines as its 300 series. "Adding, say, 5 bits for checking to 16 bits of information could make for a 33% cost penalty in memory," Poduska says. However, prices are low enough so manufacturers are willing to absorb the incremental costs.

In addition Poduska sees increasing use of virtual memory and virtual-machine techniques. Memory systems, already up to 1/2-million bytes, can go to 250 million words in a virtual memory, and it also has the advantage of simplified software and increased reliability. A virtual machine implies virtual memory and more. It maps memory plus instructions. So when a user executes, say, an I/O instruction, the machine traps and implements it directly.

Cache, or buffer, memories and microprogrammable central processors—traditional mainframe features—are catching on fast with mini manufacturers. The Eclipse line from Data General, Southboro, MA, combines these features with 200-ns cycle times and single-bit error correction. And the machine can operate with 800-ns core or a 700-ns semiconductor memory without additional controllers or interfaces.

"Microprogrammable machines are sometimes thought of as slow machines," says Ron Grunner, Eclipse system manager. "They often need a large number of instructions." In the Eclipse, however, the architecture allows several operations to be performed in parallel. A writable control store gives users access to 256 instructions. And each instruction is 56 bits long.

The Eclipse cache memory consists of a cluster of 200-ns bipolar units arranged in four blocks of four words each. Each memory board contains one cache. When addressing memory, the CPU checks cache and main memory. If the work is in cache, the data are transferred in 200 ns.

An error check doesn't require extra CPU time; it takes just 300 ns. Error-detection/correction memories use 5 bits more than noncorrecting units. The extra bits are for a computation made by both memory and CPU when they exchange data.

Error-correcting circuitry is also used in the 980B mini from Texas Instruments. Aiming for control applications, this mini combines a bit-handling capability with a dual architecture that

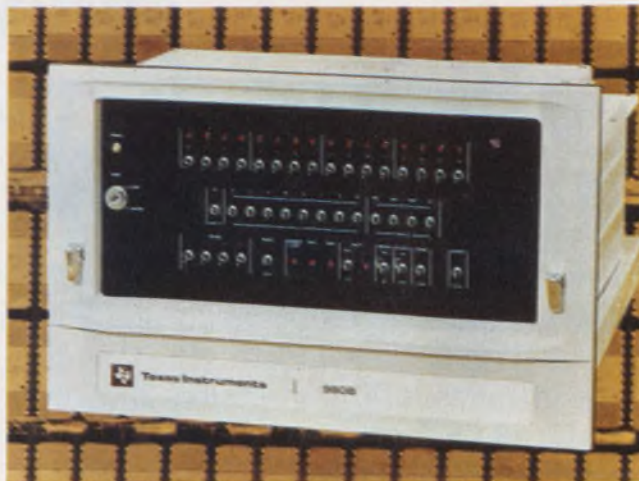

Incorporating MOS memory elements with single-bit error correction and multibit error detection, TI's 980B mini-computer allows single-bit manipulation.

seeks to overcome so-called context switching.

The most far-reaching changes, however, will probably appear in large computer systems. Already solid-state memories, like the charge-coupled-device, are expected to improve data-access times now limited by electromechanical storage units. Moreover block-oriented solid-state RAMs—consisting of magnetic bubbles, MOS shift registers or CCDs—will undoubtedly produce substantial architectural changes.

#### LSI processors are changing mainframes

But the greatest impact is expected from LSI microprocessors. Within a few years, computer architects believe they will be able to build new machines using standard, off-the-shelf micro chips and related ICs. Several little processors would be microprogrammed and put together in a configuration that is controlled by software. With these multiprocessing computers, large-system CPUs could be altered or upgraded without significant changes in hardware.

However, major system problems remain to be solved. "On one level, there's the problem of interference between several processors accessing a commonly shared memory," says Dr. Ugo O. Gagliardi, director of Honeywell Information Systems Technical Office in Waltham, MA. "And if you don't go with a common memory, you have the problem of proper utilization of each private memory."

But that's a simple matter compared with software control, the complex problem of controlling several processors that are fairly asynchronous and independent, Gagliardi explains. ■■



Fairchild introduces  
 a universal standard 8-bit microprocessor  
 that's simple to configure,  
 easy to program,  
 handles more than half  
 of all small systems applications  
 and costs less to use.

# THE F8.

**MADE IN  
 FAIRCHILD**

Fairchild's new 8-bit F8 microprocessor is simply the best ever.

Because basically, it's the most *simple* to use.

And one look at our before-and-after comparison shows why.

## The first complete microprocessor system on 2 chips.

Now for the first time, you can build a functionally complete, self-contained, practical 8-bit microprocessor system using just two chips.

*Two chips.*

For the first time, you don't need additional packages for I/O logic and latches, address logic, clock generation,

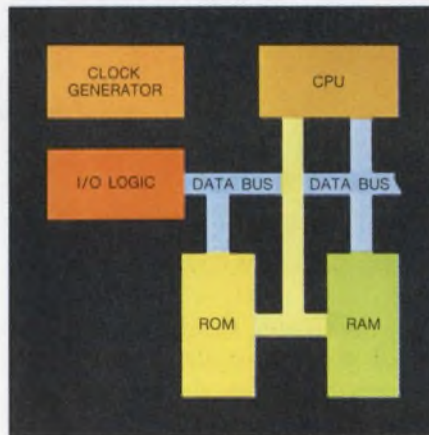

Minimal microprocessor system before the Fairchild F8.

RAM storage or power-on reset.

Because they're already there—tucked right on our two basic chips.

The F8 CPU.

And the F8 ROM.

## The F8 supercontroller. How simplicity was achieved.

To reach the functional densities and speed of the F8, we turned to our proven Iso-

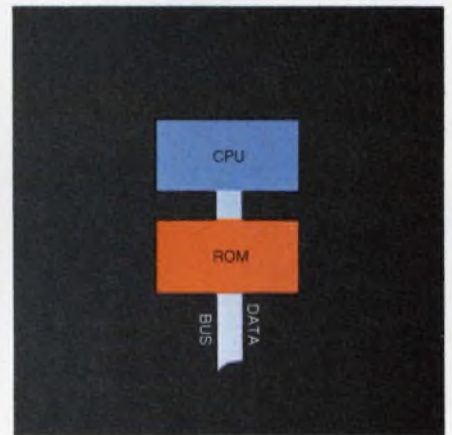

Minimal microprocessor system after the Fairchild F8.

planar, ion-implanted, N-channel technology, which allows up to 40% more function per unit area.

This permitted added functions to be included on both CPU and ROM chips. Yet, the F8's CPU remains the smallest 8-bit, N-channel chip in the business.

With lower power. And high speed.

Continued.



## Introducing the basic F8 system. And 5 key changes.

In developing the new F8, Fairchild designers have introduced a number of important hardware features available with no previous system.

Changes inspired by the hard-earned experience of users themselves:

1. Two 8-bit I/O ports on the CPU chip. And two more on the ROM chip. 32 bidirectional lines in all.

2. 64-bytes of fast RAM scratchpad *built into* the CPU chip.

3. A clock generator and power-on reset *built into* the CPU chip, too.

4. A programmable interval timer *built into* the ROM chip.

5. 60% of the 70 instructions are 1-byte.

Other F8 features and refinements include:

A speedy 2  $\mu$ s minimum instruction execution time.

Direct TTL I/O compatibility.

A typical power dissipation of less than 300 MW per chip.

Local interrupt with automatic address vector.

And much more.

Result—a complete 2-chip microprocessor system that's really *just 2 chips*. Easier to handle, much more versatile,

generally less expensive and just a pleasure to use.

### 3 additional devices for mid-size, memory-intensive or multiprocessing systems.

Along with the basic 2-chip configuration, Fairchild has designed three additional F8 devices for easy system expansion:

1. *The 3852 Dynamic Memory Interface Circuit* allows the user to expand his system using standard dynamic memory—such as the Fairchild 4096-bit RAM.

In addition, synchronous DMA channel control signals are generated by the 3852.

2. *The 3853 Static Memory Interface Circuit* permits the

user to expand his system using standard static memories including Fairchild's 2102 and 3538 RAMs, and 3514 and 3515 ROMs.

The 3853 also features interrupt control circuits and a programmable timer.

3. *The 3854 DMA Direct Memory Access Circuit* provides a fast, direct data path between a high-speed peripheral device and F8 processor memory without tying up and slowing down the CPU.

The 3854 can also be used to provide a synchronous data path between multiple processors.

All three additional F8 chips are in final development or production now.

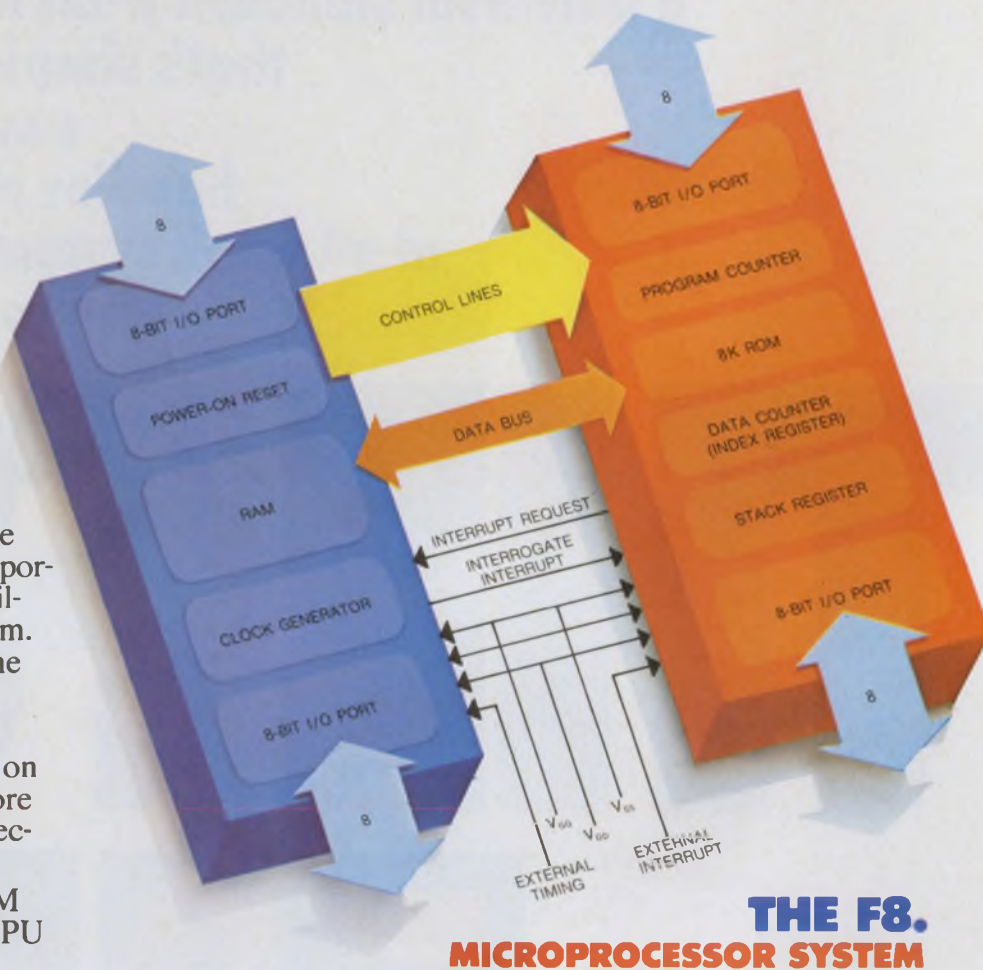



**F8 applications.**  
**The first standard super-controller goes to work.**

The advantages of the F8 design become still more evident when its range of applications is considered.

In fact, the new F8 covers a broader spectrum of applications than any other microprocessor. (See chart.)

Applications which the chart indicates are cost-sensitive are ones in which total system performance is limited by the fact that data is entered manually (like cash registers and calculators).

In these applications, the reduced parts count of the 2-chip F8 system will usually be the lowest cost solution.

For applications requiring fast data processing or numerical analysis, benchmark performance of the economical F8 generally meets or exceeds

that of other microprocessors.

For the designer whose primary concern is economy in one application and performance the next, the F8 provides one system for virtually every need.

Because of the breadth of F8 applications, it is a logical candidate to become an industry standard.

**Traffic-light controller.** Designed around a basic 2-chip system, the F8 traffic light controller handles crosswalk lights, crosswalk button interrupt, street signal lamps and road traffic detectors. The controller automatically adjusts signals for optimum flow for different traffic conditions throughout the day

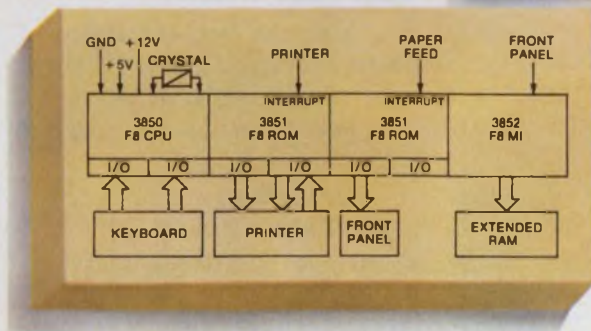
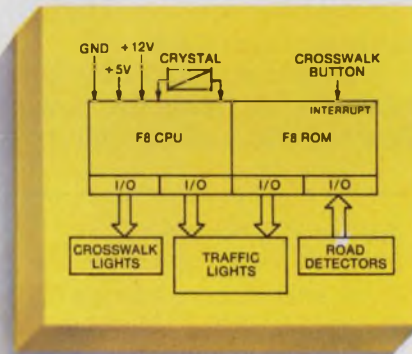

**Intelligent terminal.** Only four F8 chips are required to handle this smart terminal's keyboard input and printer, as well as provide memory interface for external RAM storage

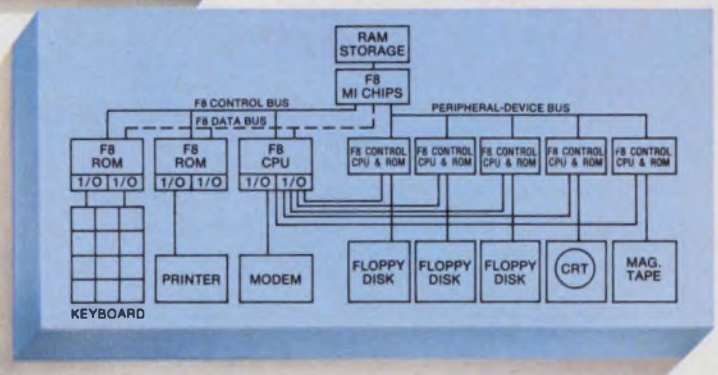

**Key-to-floppy-disk.** Multiple F8 processors are used in this key-to-floppy-disk system. Each controller consists of a CPU and a ROM. The processors are linked through a multiplexed memory channel provided by a DMA chip. This system illustrates the modular approach to expansion achievable with the F8. Because all controllers can operate simultaneously, total system throughput is increased.

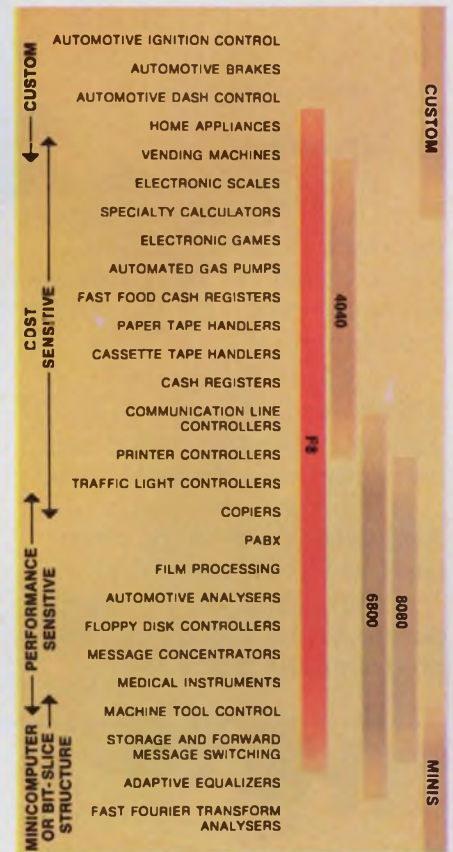

Microprocessor Application Spectrum





Fairchild's F8 system is supported by extensive software and hardware aids.

**F8 software.**

1. *The F8 User's Manual.*  
The User's Manual provides chip specifications, defines Cross Assembler and Cross Simulator programs and covers the instruction set in detail.

2. *Cross Assembler.*  
Accessible now on the G.E. Timeshare Network. Additional networks available as required.

3. *Cross Simulator.*  
Accessible now on the same basis as Cross Assembler.

Plus additional software developed for our special F8 programming hardware.

**F8 program development hardware.**

To make F8 program development even easier, Fairchild has developed three hardware subsystems.

1. *F8M Program Development Module.* Available now, the F8M offers a basic devel-

opment system for microprocessor programs.

The module features teleprinter interface capability, 32 I/O lines, external interrupt, 1024 bytes of RAM and 2048 bytes of plug-in PROM, full operator controls and display.

The F8M is also available in kit form.

2. *F8S Program Development Module.* Available in 3rd Quarter, this PDM will provide expanded capability for memory-intensive applications.

3. *F8C Microcomputer.* Available in 4th Quarter, the F8C is a complete microcomputer system including power supplies and control panel housed in a bench-top cabinet. I/O ports are brought out to connectors, ready to interface with user peripheral equipment. The F8C is provided with a native Assembler.

**Take your choice.**

You can find out more about Fairchild's new F8 super-controller several ways.

For general data, you can mail our coupon.

Or for more specific F8 facts, you may elect to write to us on your company letterhead, describing your particular needs in detail.

Or you may call your Fairchild Sales Office, Representative or Distributor today.

Semiconductor Components Group, Fairchild Camera & Instrument Corp., 464 Ellis St., Mountain View, CA 94040. Telephone (415) 962-5011. TWX: 910-379-6435.

**THE F8.**  
**MADE IN FAIRCHILD**

Send to: P.O. Box 880A,  
Mountain View, California 94042

Please send me more information on Fairchild's new F8 Microprocessor System. My specific area of application:

---

Products are manufactured at my location in the following categories:

Industrial    Government/Military    Instruments  
 Communications    Consumer    Computer    Business Machines

---

NAME \_\_\_\_\_ TITLE \_\_\_\_\_

---

COMPANY \_\_\_\_\_

---

ADDRESS \_\_\_\_\_ PHONE \_\_\_\_\_

---

CITY \_\_\_\_\_ STATE \_\_\_\_\_ ZIP \_\_\_\_\_



# When the Ramada Inn makes a promise, we put it in writing.

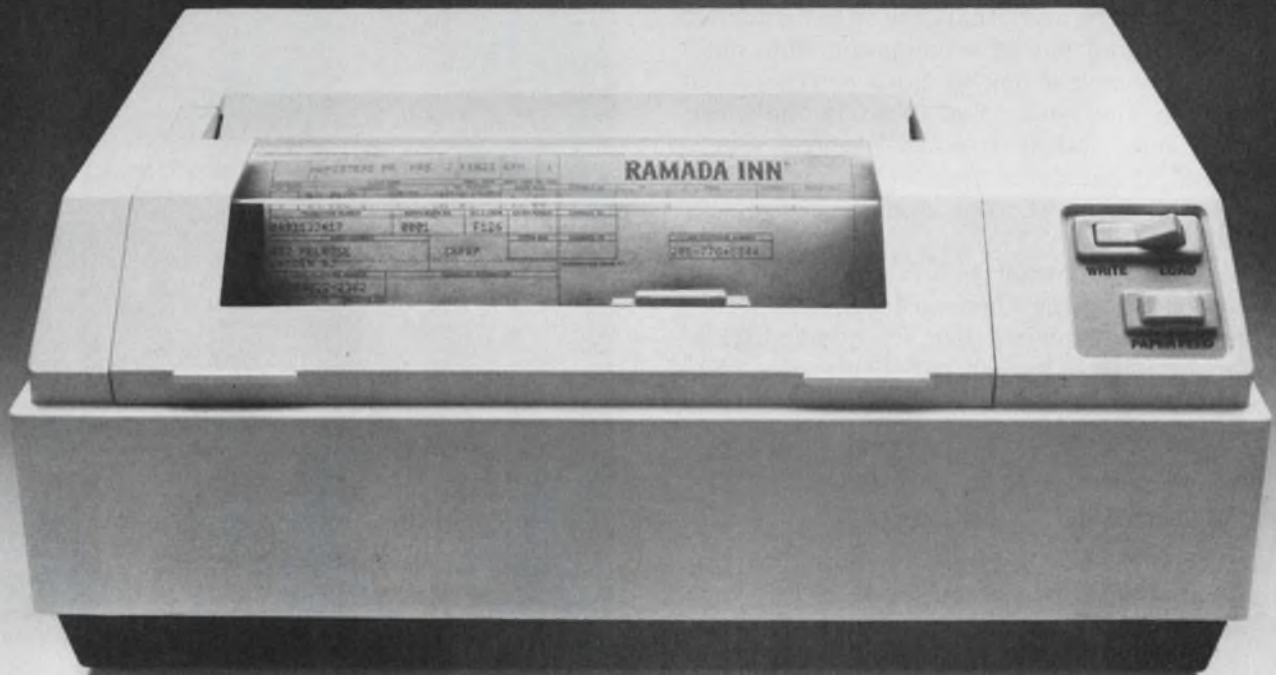

Any one of our competitor's page printers can print Ramada Inn's reservations.

And some of them can do it faster than ours.

But Ramada Inn chose our 4553 that operates at 15 ch/s. Because what we don't offer in speed, we offer in reliability. Which makes this specific machine perfect for their needs. But if you need something faster, we also offer our 4554 that operates at 60 ch/s.

Both machines are of relatively simple design and very inexpensive. Also, neither machine requires a ribbon when they print information. Our use of helix and hammer design to form the 5 x 7 dot matrix produces an extremely clear and easy-to-read print out.

And we're even easy to interface. The Facit 4553 and 4554 are obtainable for bit parallel (USASC II) data transmission and serial data transmission.

At Facit, we put a lot of work into our machines so you can get a lot of work out of them.

The Facit 4553 and 4554—we don't have any reservations about them. For more information, just write to Facit—O.E.M. Division, 501 Winsor Drive, Secaucus, New Jersey 07094.

 **FACIT**  
Dedicated to Efficiency

Look for us at the NCC show  
May 19-22 Anaheim CA booth 2734-36-38



## Novel ways of entering data are under study, including the power of positive thinking

Jules H. Gilder, Associate Editor

**T**here are more ways than one to get information into and out of a computer. You don't have to punch it out on cards or type it out on a printer, you know. You can talk the information in and listen to it when it comes out, if you're tired of humdrum approaches. Or you can even "think" it in, if your system is properly equipped.

These techniques exist today. And some commercial systems using them are available. They are part of a growing list of nontraditional peripherals. Besides speech and brainwave techniques, at least a half dozen other nontraditional peripherals are available.

### 'Think' your data in

The "mind-reading" system for thinking data into a computer is being developed at the Stanford Research Institute, Menlo Park, CA. According to Dr. Lawrence Pinneo, head of the project, it is an automatic biologically controlled communications system.

Pinneo notes that there are certain patterns in human electroencephalographic and electromyographic signals that are associated with language. By using pattern-recognition techniques, these patterns can be identified and correlated with specific words.

So far Pinneo and his researchers have been working with a limited vocabulary of between seven and 15 words. In describing how the system works, Rebecca Mahoney, a member of the research team, notes that the EEG pattern associated with a specific word for a particular person is recorded and stored in the computer memory. This record is called a template, and each time a word is to be recognized, the EEG

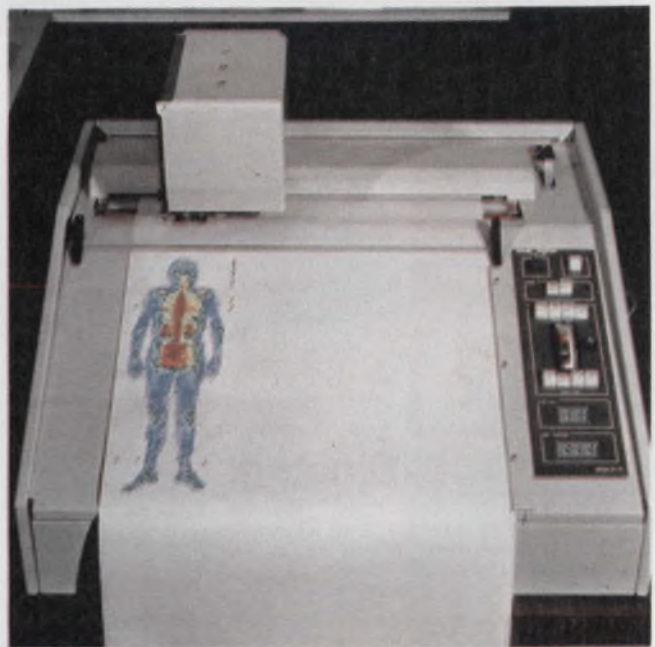

Multicolor printouts are possible with the CPA-1, a nine-color image printer from Elscint

pattern associated with that word is compared with the different templates in the computer until a match is found. If a match is made, information in the EEG pattern in question is added to the old template and a new updated template is produced. Once a word is recognized, it can be read out or used by another part of the system.

Recent advances in the mind-reading interface have made it possible to reduce the memory required by the system. The latest version uses a LINC 8 computer with 8 k of memory to produce on-line recognition accuracy of 50 to 53%. While this is still not good enough for direct



brain-to-computer communication, it's a big step in that direction. Accuracy can be increased if more than the present seven electrodes are used to pick up information or if the system is given more time to analyze the data.

The ultimate goal of this project is to minimize the need for slow, conventional input devices, such as punch cards and teletypewriters.

### Voice systems are here

An equally interesting system that has already advanced to a state of practicality is the voice data-entry systems. Several organizations have developed these peripherals, and others are trying to advance the state of the art.

The two major developers of commercial voice-input devices are Threshold Technology Inc. of Cinnaminson, NJ, and Scope Electronics Inc. of Reston, VA.

Threshold offers the VIP 100, an isolated-word recognizer that responds to individual words or carefully articulated phrases. According to Marvin Herscher, vice president of Threshold, the VIP 100 is an adaptive system that recognizes spoken words from a wide variety of speakers, regardless of vocabulary, dialect or acoustic environment. The standard system comes with enough memory to store 32 words or phrases, but with optional equipment it can be expanded to 100 words.

The machine must first be trained to recognize the speaker's voice. This is done simply by having the user repeat to the machine several times the words to be recognized. The machine automatically analyzes the audio and stores a reference pattern.

Once the VIP 100 recognizes a spoken word or phrase, it generates a digital code that identifies the sound. This code can then be used to enter data into a computer, retrieve stored information or control machine operations.

Herscher points out that the use of voice input for computers eliminates a lot of potential sources for error and speeds up the over-all system. In fact, he notes, with voice input, it is possible to reduce systems that previously required the handling of data by three or four people to systems where data are entered by the originator.

Citing an example of how the VIP 100 works, Herscher notes that Continental Can Co. uses it for quality control. An inspector measures certain critical dimensions on the lid of "pull tab" cans and simultaneously enters the information by voice into the VIP 100 system. The output from the VIP 100 is fed to a tape machine, where the data are collected. The tape is then taken to a computer for analysis.

In addition to speeding data entry, voice-input systems also make it possible for handicapped

people to program computers. Work in this area is being done by Scope Electronics. According to Wally Birdseye, technology applications manager, a system has already been set up that permits a handicapped person to program a mini remotely by voice.

A more advanced system is being developed and should be ready for use by late fall. It would allow several quadriplegics to time-share a DEC-10 computer remotely over telephone lines.

Scope is also tackling the problem of recognizing continuous speech instead of just individual words or phrases, Birdseye says. This is more difficult to do, because some way of determining where one word ends and the next begins must be determined.

Another system developed by Scope not only lets the user talk to it, but answers him right

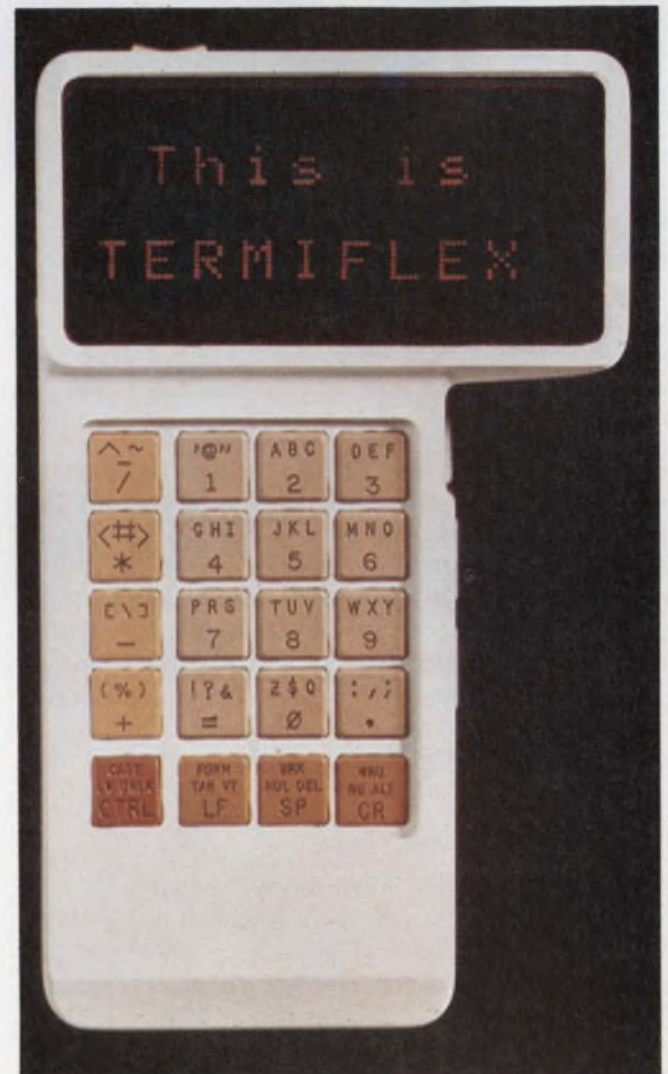

Termiflex hand-held computer terminal can generate all 128 ASCII characters and display them in two lines of 10 characters each. An internal 1000-character memory automatically stores incoming and outgoing data. The terminal weighs only 1.5 lb.





Voice-input systems are being used at Continental Can Co. to enter quality-control data into computers. An inspector makes several measurements on pull-top lids

and enters the data by voice into Threshold's VIP 100 system, which prepares punched tapes. A computer then determines if quality control is satisfactory.

back. It's known as VRASS (voice-recognition and synthesis system), and it was developed for the Naval Air Development Center, Warminster, PA. VRASS, says Birdseye, can recognize and synthesize up to 150 individual words and phrases. In operation, spoken messages are entered into the system, and a complex message decoder, using up to 18 levels of syntax control, determines the message content. Information is outputted by a synthesized voice.

### The talking computer

Talking systems have been available for a while. You may have been involved with them indirectly if you've ever gone to a bank and the teller has verified the balance in your account. Many banks have a system that simply requires the teller to punch in your account number. The balance in your account is then checked by computer and a voice synthesizer tells the cashier on the telephone how much money you have in your account.

Many of the voice synthesizers are nothing more than sophisticated tape or disc recorders,

where basic sounds, words or even phrases are individually recorded and played back under computer control.

Some voice synthesizer manufacturers have taken advantage of semiconductor memory technology and produced all-solid-state synthesizers such as the Expandable Voice Annunciator from Master Specialties Co., Costa Mesa, CA.

According to Ken Renard, product manager for voice systems, words or phrases that take a maximum of 0.5 sec to pronounce are digitized by a four-bit analog-to-digital converter and stored in a read-only semiconductor memory that is between 2 k and 16 k in size. The larger the size of the memory, the higher the fidelity of the output.

To output a message, ROMs are addressed in the correct sequence, and the digital information is fed to a digital-to-analog converter to get back the analog audio signal. The signal then goes to an amplifier and speaker.

This approach to voice synthesis is limited, because it requires a memory chip for each word in vocabulary. A better approach, which is being investigated, is to store the basic speech sounds



in ROMs. This would make it possible to construct any word.

### Cameras give a computer 'eyes'

Not only are computers capable of hearing and speaking, but with the availability of semiconductor image-sensing arrays, they are now capable of "seeing" as well. Digital cameras using photodiode arrays can feed data into computers so that noncontact inspection, process control and measurements can be made.

An example of this type of visual computer peripheral is the LC600 digital line scan camera from Reticon Corp., Mountain View, CA. The LC600 looks like an ordinary photographic camera, except that the film plane is replaced by a linear array of small photodiodes. Array lengths vary from 64 to 1024 diodes long, and center-to-center spacing as small as 1 mil is possible, notes Reticon's president, John Rado.

A lens images an object onto the array, which is electronically scanned to produce a train of analog electrical pulses having an amplitude proportional to the light intensity of the diodes. The analog pulses are then compared with preset back-and-white thresholds and are converted into digital pulses. The digital pulses can then be fed to a computer, where they can be counted to determine the position of an edge, or the pulses between two transitions can be counted to measure a diameter, Rado points out.

The video system is being used in several production systems for measuring and sorting objects. In the sorting operation, Rado explains, the image of the various objects are fed into a computer and form what is called a signature. As an image passes in front of the camera, its signature is compared with those in the computer memory. When a match is made, appropriate action is taken.

A more advanced computer video system is available from Dicomed Corp., Minneapolis. This system is capable of much higher resolution than the Reticon, and it can also be used for full color applications. A drawback, however, is that it is primarily designed to be used with a film input.

The input image is broken down to as many as 16 million array elements for the highest resolution version. Each element can have one of 256 intensity levels. An 8-bit code indicates what the intensity level for each element is.

The data are fed into a computer, where they are processed for either enhancement or recognition of a particular feature and then read out onto a color film recorder. The recorder consists of a CRT display with a moving spot whose intensity varies according to the 8-bit code and a special camera. To produce a color picture, sequential recording with red, green and blue



Brain-to-computer interface system being developed at Stanford Research Institute allows a person to enter data into a computer by "thinking" it in. Accuracy and system vocabulary have to be significantly increased to make thought input a viable method of entering data into a computer.

filters is used. Three times more memory is required than for black and white pictures. A typical 2000-by-2000 full-color array takes about 5 min to record.

### Printer gives nine colors

For lower-resolution output applications that require color capability, a nine-color printer from Elscint Inc., Palisades Park, NJ, can be used. Originally developed for nuclear medicine applications, the CPA-1 printer accepts BCD input signals to produce nine-color prints on ordinary printer paper.

Color is achieved in the CPA-1 through use of a nine-color ribbon, and a picture is composed of rectangular segments that measure 0.4 mm in width and from 1 to 6 mm in length. The rectangles are printed at a density of 3 per millimeter. This results in a continuous pattern that looks very much like a brush painting.

The printed color is changed by the BCD input. The highest BCD number represents the highest intensity, which is red, and the lowest number indicates the lowest intensity, violet. The color brown is used to indicate an overrange condition.



The contrast range of colors is controlled by pushbuttons. For example, by selection of the proper button, it is possible to make yellow the highest intensity color and blue the lowest.

While the CPA-1 can be used with computers to clarify output data, the software to control it has to be in the computer. The reason for this is that the nuclear scanning system it was originally designed for has the control software built into the image processor.

### Try a hand-held terminal

An unusual peripheral that seems to be an extension of the portable terminal and calculator technologies is the Termiflex hand-held computer terminal from Termiflex Corp., Nashua, NH.

Although it looks an awful lot like a calculator, the Termiflex is far from being a simple computing device. It features a 20-switch keyboard that, along with three shift keys, can generate and display all 128 ASCII characters.

The 1.5-lb terminal also has several selectable parameters. These include communication speed, which can be 10, 15, 30 or 120 characters per sec. Parity can be chosen as either odd, even, mark or space. And the transmission mode can be selected as either half or full duplex. Other programmable features include upper or lower-case characters and line justification.

William Turner, vice president of the company, notes that data are displayed on 10 5-by-7 LED dot matrices. There can be up to two of these 10-character lines in the terminal. When a line is filled, the Termiflex automatically transfers the data in the first line to the upper display line and continues writing data in the lower. As this, too, fills up, data in the upper display are placed into memory and the data from the lower display move up again. This is known as scrolling. The unit has a scrolling memory of 100 lines, for a total storage capacity of 1000 characters. Data can be recalled by operation of a single switch that causes the data in memory to move forward or backward.

Applications for the hand-held terminal are many, Turner notes. It can be used as a control device for automated equipment or as an auxiliary terminal for debugging computers. It is particularly suited for field-service use, because with its power supply and acoustic coupler, it takes up only half the space of a standard attache case.

### Write the data into a computer

Instead of punching data into a computer via a keyboard, you can write the data in if you use

the Alphabec-75 pen from Xebec Systems Inc., Sunnyvale, CA.

The Alphabec-75 is a computerized pen that converts handwritten copy directly into ASCII coded data. In addition the pen's ballpoint or fiber tip creates hard copy, so that no special forms or data tablets are needed.

Data entered via the pen are limited to 16 characters—10 digits and 6 control symbols. As data are entered, they are displayed on a read-out unit; verification of the data is immediate. If an error occurs, you can erase it simply by drawing a line from right to left over the wrong character.

At the heart of the ASCII pen are small motion transducers that sense the direction of movement. This information is sent to a control module that contains pattern-recognition circuitry, which defines each character.

If desired, the ASCII-coded data generated by the pen can be stored on a cassette tape with a density of over 145,000 characters per cassette. Or it can be sent via a built-in RS-232-C interface to a computer. Asynchronous transmission can occur at rates between 110 and 2400 baud. Synchronous transmission can take place at between 1200 and 4800 baud.

### Smart cable eases connection

The newest of the nontraditional peripherals is the intelligent cable from Computer Automation of Irvine, CA. The smart cable is part of a universal interfacing system that makes it possible to bring together processors with up to eight standard and custom input/output devices.

The brain of the intelligent cable is the PicoProcessor—a small microprogrammed processor optimized to control I/O devices. It is capable of transferring data, manipulating device control signals, monitoring status and generating and responding to computer interrupts.

In use, the PicoProcessor is placed near the peripheral of interest. This eliminates the problem of special cabling to different peripherals with different electrical characteristics. The intelligent cable provides fast and convenient data transfer without the high cost of many direct-memory-access controllers or selector channels, which can service only one or two devices at a time.

Input and output operations and word and byte transfers can take place concurrently in any mix on all channels. Once an I/O operation is begun by the outputting of a single control word to the desired channel, data transfers are completely automatic and require no program intervention until the required words are transferred



# VACTEC brings you BLUE



Unlike our little Japanese friend, photodetectors have always been insensitive to blue. Until now.

Vactec's latest development is a new Blue Enhanced Silicon (BES) photodiode with exceptionally low dark current for efficient response in the blue region (200 - 400 nm). Made in Missouri, U.S.A., it performs equally well in an expensive Japanese SLR camera or in an American-made colorimetric analyzer as well. And you'll like the price, which could be as big a breakthrough as blue sensitivity.

Vactec also introduces a new line of PIN photodiodes that operate at high voltages, low noise levels, and fast rise times, with about half the blue sensitivity of the BES photodiode. For larger areas, Vactec offers a complete range of Blue Enhanced Silicon photovoltaic cells up to 1 1/8" diameter.

Vactec now supplies the broadest line of photodetectors in the industry, including:

- silicon solar cells
- hi-speed/low-leakage silicon cells
- NPN phototransistors
- NPN photodarlingtons
- CdS & CdSe photoconductors
- CMOS & bi-polar custom ICs
- opto-couplers
  - a) LED/photoconductor
  - b) LED/phototransistor or darlington
  - c) lamp/photoconductor
- selenium photovoltaic cells

*Call or write today:*



**Vactec, Inc.**

**2423 Northline Industrial Blvd.  
Maryland Heights, Mo. 63043  
(314) 872-8300**







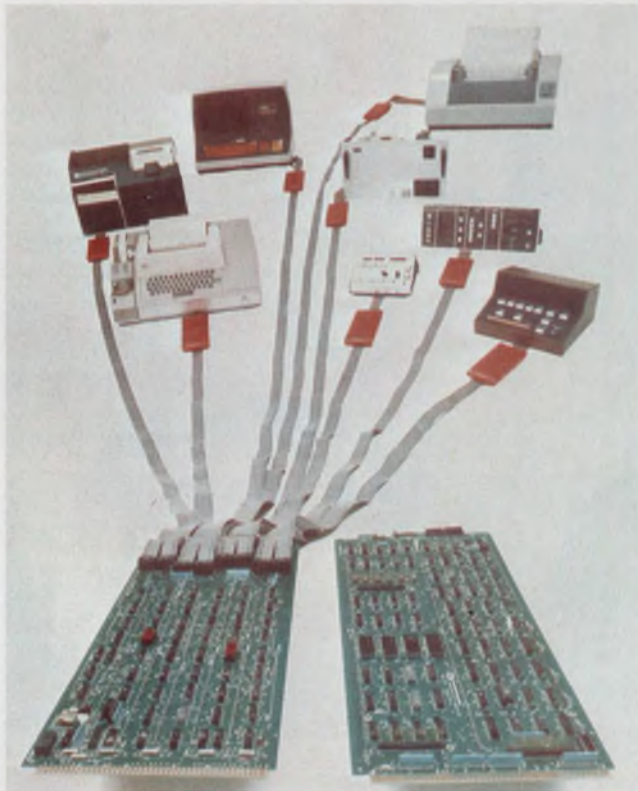

The intelligent cable, from Computer Automation, contains a PicoProcessor that makes it possible to bring together a processor with up to eight peripheral devices. It can manipulate data and respond to control signals.

or an error condition is detected by the Pico-Processor.

Although most telephone data-entry techniques require the use of Touch Tone telephones, the latter are not absolutely necessary. A dial-pulse interpreter, developed by Goldmark Communications Corp., makes it possible to use an ordinary rotary dial telephone to enter data into a computer.

The advantage of having a rotary dial interface is that if you want to enter the data from a remote location, you don't have to hunt for a Touch Tone phone. In addition many telephone exchanges still do not have Touch Tone capability.

The dial-pulse interpreter attaches to the telephone line and samples the dial-generated pulses that occur after completion of the telephone connection. Specially designed chirp detectors, storage registers and word comparators are used to allow accurate interpretation.

The output signals available include four lines of BCD TTL, optional single-relay contact closure and optional TTL one-of-10 output. In addition a LED display will show the dialed digits. ■■



Digital cameras can feed data to computers so that noncontact inspection, process-control and size and position measurements can be made. This system—the LC600—is from Reticon.

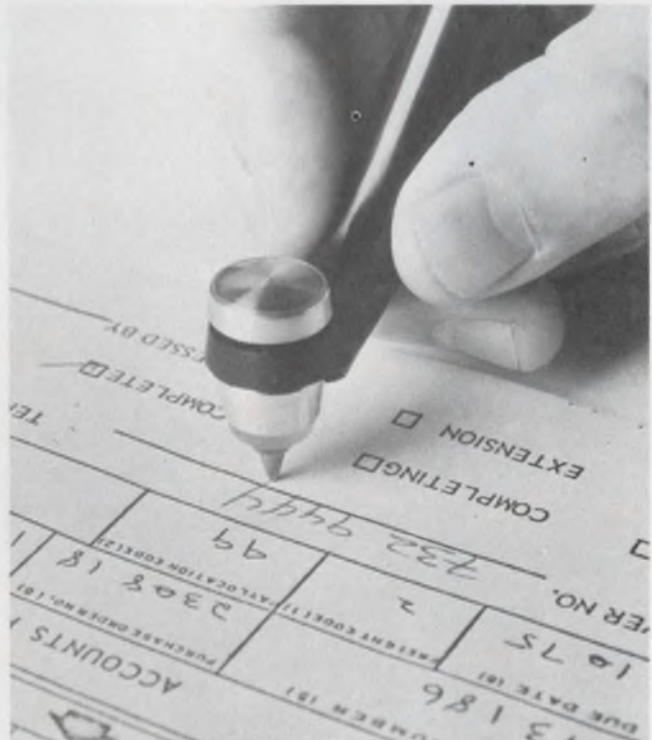

Written data can be entered directly into a computer with the Alphabec 75 ASCII pen from Xebec Systems. Sensors in the head of the pen determine the direction of motion and produce signals that are used to identify the number being written.



# Design with the complete flat cable/connector system.

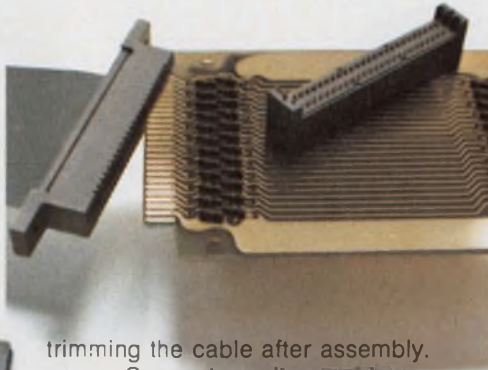

trimming the cable after assembly.

Connector units provide positive alignment with precisely spaced conductors in 3M's flat, flexible PVC cable. The connector contacts strip through the insulation, capture the conductor, and provide a gas-tight pressure connection.

With cable, connectors and assembly tools from one design and manufacturing source, you have added assurance the connection will be made surely, with no shorts or "opens."

And "Scotchflex" now offers you more design freedom than ever. From stock you can choose shielded and non-shielded 24-30 AWG cable with 10 to 50 conductors, and an ever-increasing variety of more than

The 3M DELTA pin and socket connector.



Assembly-cost savings are built in when you design a package with "Scotchflex" flat cable and connectors. But more important, 3M Company offers you the full reliability of a one-source system: cable *plus* connectors *plus* the inexpensive assembly aids that crimp the connections quickly and securely (with no special operator training required).

The fast, simple "Scotchflex" assembly sequence makes as many as 50 simultaneous multiple connections in seconds, without stripping, soldering or

100 connectors to interface with standard DIP sockets, wrap posts on standard grid patterns, printed circuit boards, or headers for de-pluggable applications. 3M's DELTA "D" type pin and socket connectors are now also available. For full information, write Dept. EAH-1, 3M Center, St. Paul, MN 55101.



# 3M's "Scotchflex" line.

"Scotchflex" is a registered trademark of 3M Co.



A black AMP shuttle tool is shown in use, terminating a flat-cable connector. A hand is holding the tool, which is mounted on a base. The tool has a cylindrical shuttle mechanism. A multi-colored flat-cable is being inserted into the tool. The AMP logo is visible on the side of the tool. The background is a plain, light color.

# Nobody has an easier to apply line of no-strip, no-solder, round- conductor flat-cable connectors than AMP.

**Quick, easy terminating.** The new AMP shuttle-tool is designed for reliable and repeatable production. Loading is easy. The operator simply pulls out the shuttle to load the cable and housing, and then pushes the shuttle in, to terminate. Alignment is automatic and positive. Pneumatic tooling is also available.



AMP Latch connectors terminate 10 through 60 leads on multi-conductor flat cable. Simultaneously. They mate with two rows of .025 posts on .100-inch centers. Our 14- and 16-position AMP Latch connectors mate with standard DIP sockets. There's also a family of edge connectors in the line.

**Fail-safe.** Dual camming and latching ears on the unique AMP Latch folding contacts provide a four-point electrical contact and mechanical grip for each conductor—not just two points—to provide true redundancy. You can inspect the termination itself before the cover is applied. After termination, inspection ports in the connector cover allow visual checkout of each fork-type contact for proper locking and latching. The latching of individual contacts prevents bowing or parting of the covers. The connectors can also be probed under electrical load via the inspection ports. To insure integrity, the cover also locks to both ends of the connector housing with auxiliary latches.

**Connects three ways.** With AMP Latch, you can interconnect to pc board spring sockets, directly to the board itself, or to DIP sockets—anywhere you want to interface on high-density, .100-inch patterns.

Ask your AMP representative for an in-plant demonstration. Or write for AMP Latch connector literature. AMP Incorporated, Harrisburg, Pa. 17105.

AMP is a trademark of AMP Incorporated.

# AMP INCORPORATED

INFORMATION RETRIEVAL NUMBER 30





## Dedicated systems giving rise to once 'far out' applications from sports scoring to security

Jim McDermott, Eastern Editor

The traditional roles of computers in data processing and number crunching are being overshadowed by a growing army of dedicated systems for what a few years ago would have been considered "far out" applications. Sparked by the emergence of the minicomputer, and now the microcomputer, these dedicated systems are turning up in the following:

- Sports stadium scoreboards with TV.
- Error-free fire engine dispatching.
- Automatic point-of-sale transactions.
- Personnel identification by physical features and voice.
- Electronic games.
- Intelligent traffic controls.
- Automatic vending-machine coin changers.
- Talking computers.
- Musical synthesizers.
- Laboratory-animal motion analyzer.
- Computer-generated horoscopes.

The most advanced sports stadium scoreboard and its controlling system, built by Conrac for the Buffalo Bills football team at the Erie County Stadium near Buffalo, uses a computer to store or display messages on a matrix of 9600 (80 × 120) incandescent lamps. While this has been done before, the principal advance is in the fact that TV pictures can also be shown.

"We can take any video signal from a camera or tape recorder or TV network and convert this to digital information to control each of the matrix lamps," says Ken Epple, general manager of Conrac Media Corp., Duarte, CA.

The computer used is a Computer Automation Alpha 16 with a 24-k memory. The video image produced is 27 feet high and 47 wide, he notes, and the system works well for closeups.

Small, specialized computers have made their



Pictures from a local portable TV camera or from network stations are processed by computer and projected from a computerized football scoreboard by Conrac.



A dogfight flight training system for the Navy pits pilot against pilot in mock air-to-air combat. The computer-based system, by Cubic Corp., provides mission replay.



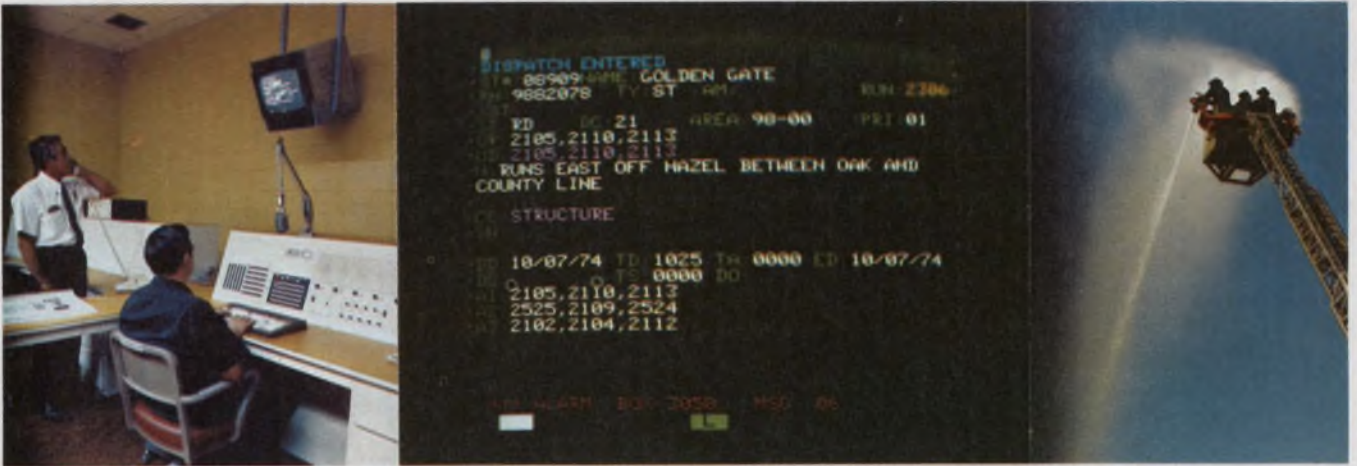

Community safety is improved by this computer-operated fire-engine dispatching center in Citrus Heights, CA. Mistakes formerly introduced by handwritten mes-

sages and look-up of fire locations in a hand-file are automatically sensed by the computer, a Xerox 530. The errors are instantly flagged on the CRT terminal readout.



Speedup of checkout at these supermarket lines is improved substantially by National's Datachecker electronic checkout system. The electronic cash-register

terminals at each stand are linked to a backroom micro-computer consisting of an IMP-16 microprocessor and a disc file, where product data are stored.

way into the \$3-billion amusement-game industry with the advent of a rash of electronic coin-operated games. Most use a TV screen as the display and playing field. Probably the most familiar is the electronic ping-pong game, in which the players bat a dot of light back and forth across a net on a TV tube.

Leading the field here is Pong, developed and produced by Atari Corp., which was founded by Nolan K. Busnell, a 31-year old engineer who worked his way through the University of Utah

by managing games at a Salt Lake City amusement park. Some 65 ICs are used for the computer and sound effects in this game.

Dedicated computers are promoting public safety in such areas as law enforcement and fire fighting. A prime example of computer benefits is the Xerox Dispatch System for Fire Agencies, a computer-assisted approach to vehicle dispatching using the Xerox 530 computer.

Installed in Citrus Heights, a suburb of Sacramento, CA, the dispatch system provides





This security system uses the unique geometry of a human's hand to verify or deny entry to employees at My Toy Corp. The handprint is scanned by an Identimat machine and is compared with the digital description on a magnetically encoded card.



An instant check on baggage handled by the automated system at Eastern Airlines' Miami Terminal is made at the computer. The DEC computer, laser optical readers and conveyors are linked in this Bendix system. The optical baggage tag is a coded bullseye.

faster and more accurate information to fire stations. In its present configuration it has 32-k words of core memory and 24.5 million bytes of disc storage.

Before the computer was installed, a fire dispatcher would answer a phone call, write down the information, look up the street involved on a Roladex file card and finally write the dispatch information on an Electrowriter that transmitted the message to the fire stations.

"With the new system," says Donald Larson, assistant chief of communications, "the dispatcher types in the street address of the fire, and it appears on a CRT screen. The computer then supplies all the data for dispatching units to the blaze. This includes the nearest cross street, the availability of fire hydrants and items like who to contact for the key to a building."

A hard copy of the CRT screen data is rapidly sent to the fire stations via a Xerox Mobile Printer.

"This system eliminates error—mistakes in dispatching the wrong units or sending them to a wrong street or wrong address," says Larson.

The computer also serves as a double check in detecting and rejecting many errors that might be introduced by the dispatcher or by an excited caller. For example, if the dispatcher types in a nonexistent address, misspells the street name or inputs an address and telephone number that do not match, the computer prints out on the CRT:

"Record not found."

Computers that can identify a person by his handprint or by his voice are being used to provide improved plant security as well as to eliminate time-card cheating in which one person checks in another's time card.

An automatic palm reader, produced by Identification Corp. of Northvale, NJ, and controlled by a Nova 1200 minicomputer, is installed at each of seven employee entrances at My Toy Corp., a Brooklyn, NY, toy manufacturer. An employee who wants to enter the plant inserts an encoded plastic identification card into the identification unit and then lays his palm on top of the reader.

The unit scans the size and shape of the hand and obtains a digital readout that is compared with that in the plastic card. If the readings agree, the computer checks further to verify that the individual has access to the department. If the check is positive, the computer records the time of entry in a payroll file. If the check is negative, an alarm sounds.

### Electronic checkout speeds marketing

A prime example of the use of microcomputers to speed personal marketing chores is National Semiconductor's supermarket electronic checkout system. The full 800 CS Datachecker system includes multiple checkout stands. Each stand has an electronic cash-register, an elec-



tronic scale, an electronic coin dispenser and an optical scanner. Checkout, says National, is speeded up to 45% when the optical reader is used. Without it an improvement of 25% is still obtained.

Data from the checkout stand are fed to a backroom system comprised of the IMP-16 microprocessor and a disc store. The IMP-16 provides full 16-bit parallel processing capability. The scanner reads the standard optically coded label and transmits the product description to the microprocessor. The processor matches the description to pricing information in the disc memory. The entry is recorded by the system, registered on the terminal display and printed on the customer tape.

The computer also monitors item movement and updates store inventory automatically. Also, totals are available by department, terminal, clerk or item to help in labor scheduling and sales evaluation.

A "way out" application of minicomputers is the calculations, for astrologers, of the orbital positions of the sun, moon and planets, along with other astrological data, such as nodes, planetary distances and daily motion.

The results of such calculations are presented in both graphic and printed-report form for interpretation by the astrologer, says Neil Michelsen, founder of Astro Computing Services, Pelham, NY.

The computer used is a 64,000-bit Interdata with a 10-megabyte disc, a 400-cpm card reader, a 33 ASR Teletype and a Versatec 1200A printer-plotter.

A computer-operated system that collects and interprets visual data about laboratory-animal behavior has been installed at the University of Kansas Medical Center, Kansas City. It recognizes acts the researchers want identified, including resting, rearing, sitting, grooming, walking, smelling or looking.

The system, produced by Kantronics, Lawrence, KS, uses a TV camera that looks at the lab animals and feeds the video output into a quantizer. This unit converts the analog information to binary data for computer use.

### The talking computer

A computer that talks to its users eliminates the need for costly, space-consuming data terminals; it requires only a Touch-Tone telephone, for access to information. The audio response system, part of a Honeywell 3200 computer, is used by the EDP Corp., in Detroit to serve its largest customer, the Ferndale Cooperative Credit Union.

Tellers call the computer, identify the credit union, the transaction to be made and the cus-



This traffic controller is a key element in a Connecticut system by Automatic Signal, Norwalk, that cut travel time by 45% through a high-traffic shopping district. Local intersection control is exercised by a CMOS microcomputer that talks to the system computer.



Microprocessors monitor marine-engine performance for maintenance and failure prevention. This diesel generator is watched by an Advanced Electronics Development Corp. system using gas, water and oil sensors.

tomer by Touch-Tone button entry. The computer responds with a vocabulary designed to handle withdrawals, payoffs, account information, fast-cash credit and management reports.

For example, if a teller is processing a withdrawal, the computer tells him how much money is in the account. Since the Ferndale Co-op requires a minimum balance, the system also states the maximum a customer may take out.

The voice response is on a cylinder containing 63 sound tracks, like those on movie film. The computer program selects the words, recorded in a woman's voice, in the order that provides a sensible response to the query. ■■



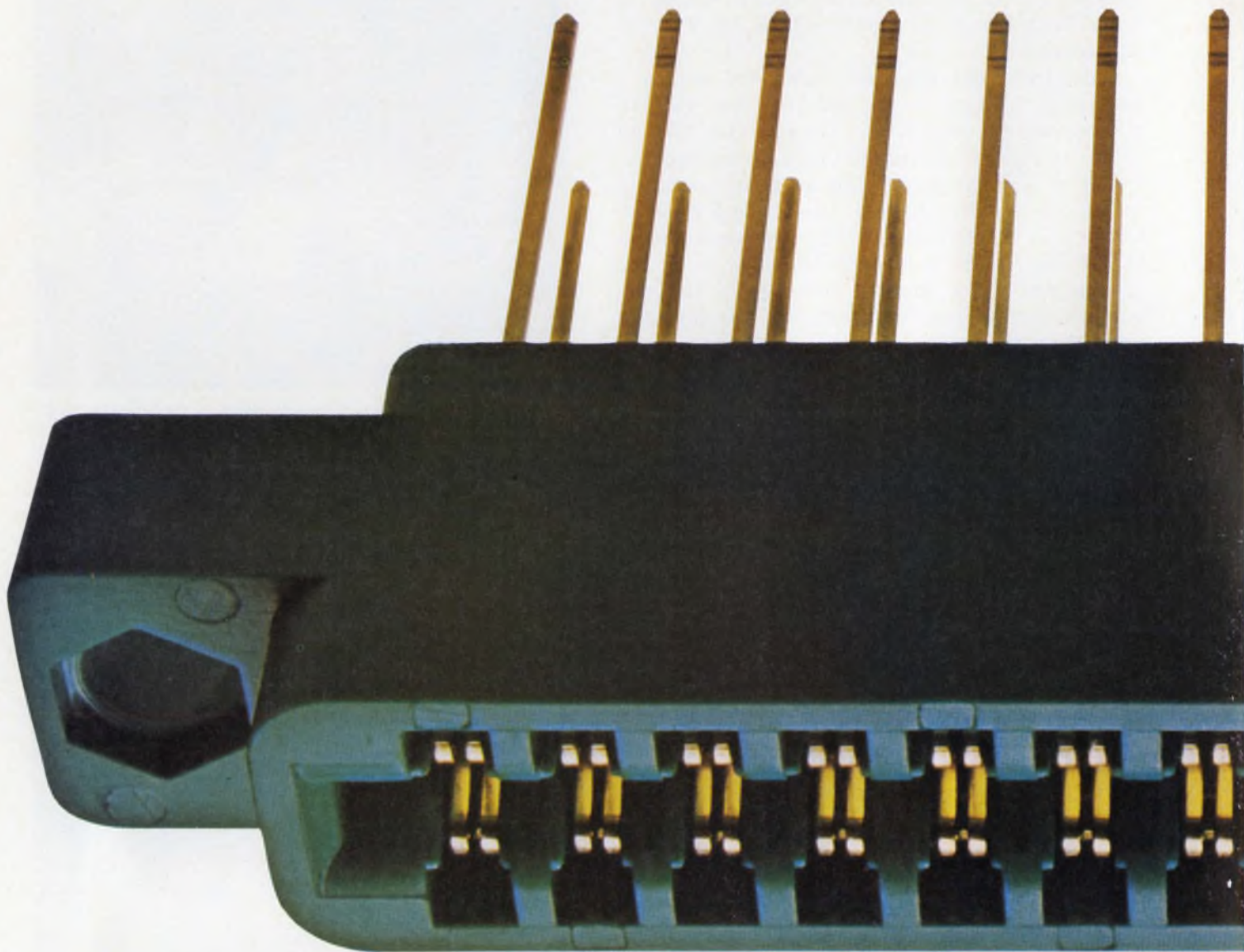

# Sylvania connects

Our printed-circuit edge board connectors make contact with the outside world in almost any way you want. You can get gold-dot or gold-plated contacts in bellows or bifurcated styles, designed for crimp or point-to-point wiring, and in a choice of plastic bodies.

In manufacture, we control the complete operation from stamping and plating, through plastic molding and assembly.

Right up to the finished product.

When it comes to custom work, our engineers and designers bring this same high quality control to your own specific design.

Control of materials, production and quality inspection is one of the key features of our connector program.

(It's that ability to control quality all the way that helped us develop the most reliable gold-dot



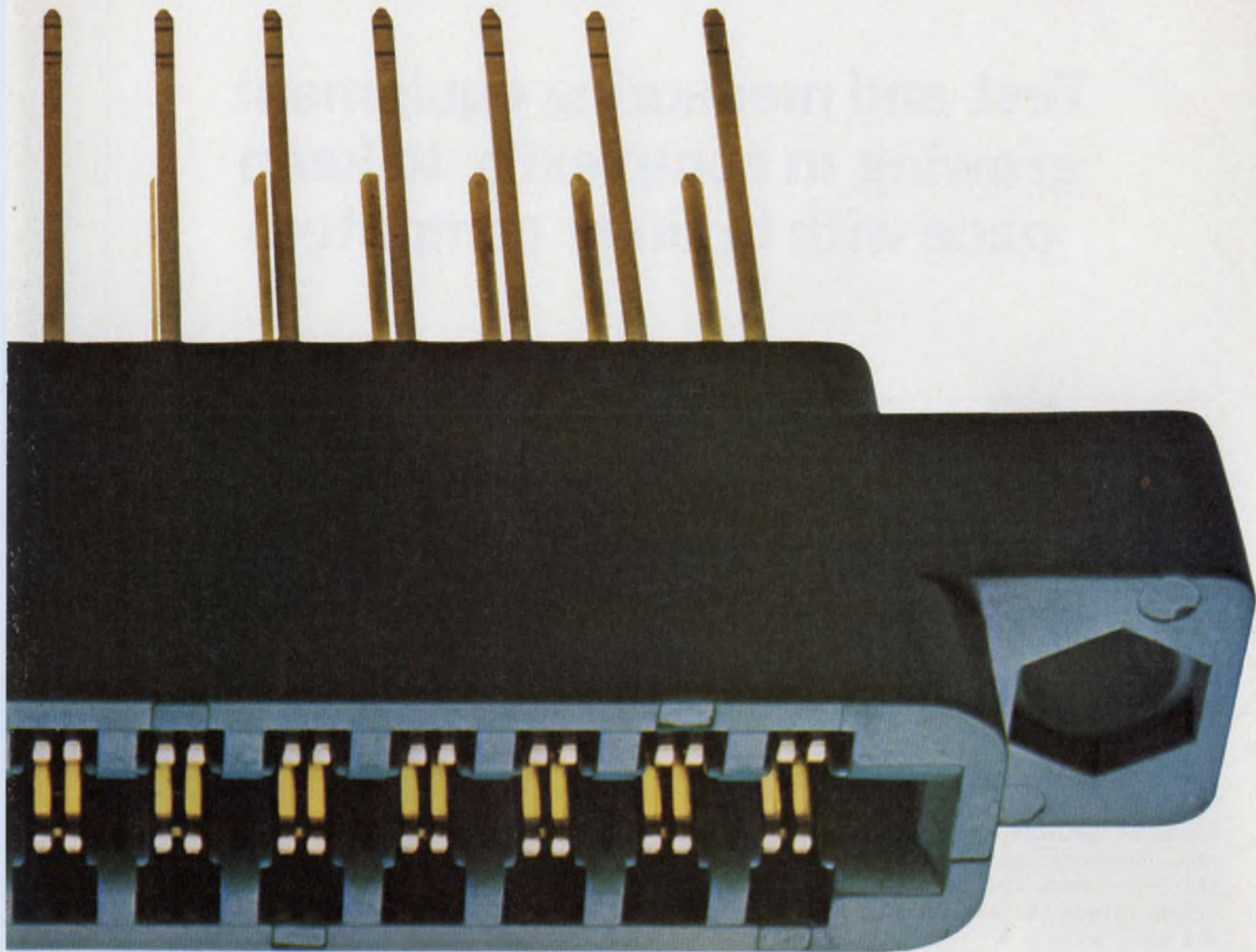

# with the outside world.

contact on the market.)

We maintain this quality control and precision manufacture in high-volume production. We have to, since we supply the largest users of circuit connectors in the country.

What we've done for them, we can do for you.

When you need circuit board connectors that have to talk to the outside world, talk to somebody who's wise in the ways of the outside world

—Sylvania.

For more information, get in touch with: GTE Sylvania, Parts Division, 816 Lexington Ave., Warren, Pa. 16365.

We're helping you make it.

**GTE SYLVANIA**



# Test and measuring equipment growing in complexity to keep pace with brainier computers

Stanley Runyon, Associate Editor

**W**hen it comes to test equipment, the oscilloscope remains king. But as LSI devices, computers and computer systems move up in complexity, so do the requirements for test and measuring equipment. New and different test gear is needed: equipment that can handle mixed analog and digital circuitry, instruments that can wade into long data streams and pick out a preselected pattern, and testers that can simulate logic, analyze faults and then guide test personnel right to the trouble spot.

All these capabilities, and more, are the hallmarks of test equipment today. And the venerable, 40-year-old scope—though faster and better than ever—must find other roles to play or must change to meet the new demands. As it turns out, it's doing both.

When you need to look at complex or super-fast analog signals, practically nothing can beat the real-time scope. But when you troubleshoot a digital system that spews out a 50,000-word sequence, how do you zero in on a few needed words? Or suppose you must look at sixteen 12-bit words simultaneously. You've got a problem if you try to do it with a standard scope. With a new class of instrument—the logic analyzer—it's a snap.

## The new breed for the new need

Children of necessity, logic analyzers do what the conventional scope can't: They store and display simultaneously many data channels, let you look forward or backward in a bit stream with respect to a trigger, and recognize and trigger from a preset combination of bits.

While these are the attributes shared by the analyzers now available—from Biomation, E-H



**Diagnosis by computer:** Teradyne's L100 automatic test system checks arithmetic boards for the company's M365 computing controller, and it pinpoints any faults.

Research Laboratories and Hewlett-Packard—the resemblance doesn't go much further. Whereas the HP unit, the 1601L, accepts 12 parallel inputs and displays the bits as 16 consecutive words in numeral ONE and ZERO form, both the AMC 1320 from E-H and Biomation's 8200 display eight parallel signals in true time relationship—that is, they use pseudo-voltage levels





A computer-directed halo of light shines through a PC board and shows an assembler where to place the next wire. The computer then tests the connection (IBM).



Computerized checkout of an Interdata 7/32 minicomputer processor board. The terminal displays input data plus expected and actual output data.

to represent ONEs and ZEROs.

Thus the 1601L answers functional questions exclusively: Which loop is hung up? What RAM bit isn't right? Why does the counter skip? By contrast, the 1320 and 8200 perform timing and voltage measurement as well—but with nowhere near the resolution of a conventional scope.

Other differences exist between the three units.

For example, Biomation's 8200 zips along at a hefty 200-MHz data rate, while the AMC 1320 places second at 50 MHz. Trailing, but still sucking in data at a brisk clip, is the 10-MHz 1601L. And while the 1601L needs an external clock and the 1320 works only from its own, the 8200 can use either.

Of all the attributes of this new line of test equipment, perhaps the most important is pattern recognition. With it, you can page through a long sequence, say 100,000 words, and pull out one slice of bits. So useful is this feature that it has formed the basis for an entirely new piece of test gear: the pattern analyzer.

Modeled after a widely used software debugging tool (stop on address *n*), the pattern analyzer—also called a word recognizer, event trigger or logic trigger—has opened new doors for conventional scopes. For instance, with the HP 1620A, you set 16 toggle switches to ONE, ZERO or a don't-care position. The unit then sits back to wait for the preselected word. When the word arrives, the 1620A delivers a fast pulse that can trigger a standard scope or other device.

Jitter-free scope triggering is made possible by another box—the Tektronix 821 word recognizer. Though the 821 handles just four bits, you can cascade units to build up a 16-bit capability. Tektronix also offers a digital-delay unit and a digitally delayed time base, plug-ins for the company's scope and TM500 modular instrument line. Both units are diagnostic tools for scope analysis of high-jitter data streams.

Stable scope triggering is also offered by Philips. A trigger-circuit modification of the company's PM3260 scope, plus a special probe, slashes loading down to a wee 1-pF. Both ECL and TTL options are available.

While the new crop of diagnostic hardware can make life a bit smoother in the lab or field, an entirely new class of testing tool takes over in production. In this area, automatic test equipment (ATE) reigns.

### Put your tester to the test

To run sequences of tests on thousands of devices, logic PC cards or systems requires automation. On that, everyone agrees. But when it comes to where to test, what tests to run and how many of each kind, you'll get 30 different responses from as many ATE vendors. And users of ATE voice their opinions, too.

There's no doubt that the earlier you catch a bad device or manufacturing defect, the less you'll spend for test and repair. Incoming inspection therefore plays a key role in the test process, and practically all computer vendors and users of digital ICs run at least go/no-go checks on all devices at this stage. For this purpose, equip-



ment traditionally ranges from small benchtop testers to large, computer-controlled machines. In between these extremes, you'll find a host of intermediate testers—dedicated units, fixed-pattern testers and other approaches.

Which tester to buy has always been a problem. And with the arrival of built-in microprogrammed processors in the newest small testers—such as those from Mirco Systems, Phoenix, AZ—the line between benchtop units and computer-based systems is becoming blurred.

One problem tackled by some of the newer testers is that of programming. Traditionally program entry is done by software, front-panel switches, pattern generators or with personality cards. But benchtop machines like Fairchild's Qualifier 901 attempt to cut through programming complexity and expense with new methods. With the Qualifier, the user inserts a plastic card, optically encoded for each device to be tested. The 901 then does the rest.

At the PC-card level—another crucial point in the test process—you'll also find numerous testers in fierce competition, with as many test approaches as there are machines. Which is best? As usual, it depends on your application.

Major areas to investigate include test speeds, accuracy, voltage and current range and resolution, software or other programming, patterns available, data collection and analysis, devices handled and timing capabilities. These are all traditional areas of ATE capability. But as the latest products in ATE reflect, there are new areas to investigate too.

As ICs grow more complex, as more and more devices are squeezed onto a single chip, and as newer and tougher-to-test memories—like the 4-k RAM—appear, testing headaches grow, and ATE must do more. How do you check quickly complex logic boards with thousands of devices per board? How do you rapidly pin down the trouble spot in, say, a 5000-device IC when only 18 pins are accessible? The answer is, you probably can't—unless your ATE can automatically detect, isolate or guide you to the fault.

### Tracking down footprints

Practically every card tester introduced in recent years offers some form of guided-fault isolation. For instance, models in the just-unwrapped series of capable testers from Computer Automation, Irvine, CA, automatically direct the operator to the fault's origin. This fault diagnosis is similar to that in systems built by such tester outfits as Data Test, Faultfinders, Fluke/Trendar, General Radio—a pioneer in guided fault—Hughes Aircraft, Instrumentation Engineering, Macrodata, Siemens/Computest, Teradyne, and others.

In Data Test's 5700, a computer tells the operator to touch a probe to a given point and start a test sequence. The computer then digests the logic transitions at that point and diagnoses the problem, if any. When logic functions aren't accessible through input pins, the 5700 can direct the user to the right spot.

Still another board tester, the Shortfinder FF202 from Faultfinders Inc. of Latham, NY, programs itself, then uses a microprocessor to test between nodal points for shorts, opens, leakage and the like. The unit then automatically isolates circuit defects and prints data for repair. The 202 handles both bare and loaded PC boards, a unique feature says the company.

"Intelligent" machines, ones that diagnose ailments or that self-program, are one response to increasing circuit complexity. Yet another approach is to test while you design or while you build. That testing is becoming more intertwined with the actual development and production processes is revealed by two systems, one in use at IBM and the other commercially available from Computer Automation.

In the IBM system—called STEP (system for test and plug)—a computer directs light probes along three orthogonal axes to identify connecting pins on circuit boards for the company's 370 computers. A halo of light shows the operator exactly where a wire should be connected out of the thousands of possible connections.

The STEP system then performs a 100% electrical test of the insertion. Only if the connection is correct will the light probe move on.

BigSim, a simulation software system for Computer Automation's 4900 tester, takes testing out of the production arena and moves it into the design lab. In fact, no hardware need be built at all. With simulation, it's all done on paper and in the machine: The ability to design, verify, locate test points, configure multiple cards, produce test programs—like those for go/no-go and automatic/guided-fault isolation—and then run all tests. Simulation can save many hours later on, when hardware is finally produced.

Software, of course, occupies a key spot in systems test, where the complete, functional computer is wrung out by diagnostic routines. And with the rise of mixed, or hybrid, analog and digital circuit boards, software and test hardware are working harder than ever.

One example of this is CAPS VII, a software package developed by General Radio, Concord, MA. With the package, GR's 1792D logic-board tester can measure such analog parameters as voltage, current, frequency and transition times. The program can then shift to the digital mode and run through all logic tests.

Diagnosis by software forms the core of in-house testing of computer systems, especially peri-





Logic analyzers form a new class of test instrument to meet the needs of digital-logic troubleshooting. The main features of the class include the ability to display many

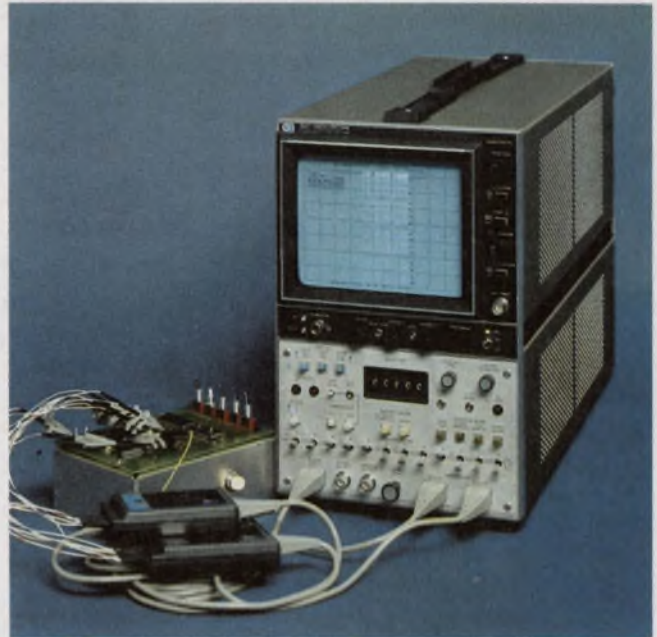

signals simultaneously, to single out a grouping of bits and to look forward or backward along a bit data stream. Left: Biomation's 8200. Right: the HP 1601L.

peripheral equipment. Computer systems, however, have a habit of failing in the field, no matter how thoroughly tested before shipment. How to service and maintain equipment in the field poses a problem that calls for new test methods—and new types of test instrumentation.

#### The demise of house calls?

To service equipment on site requires portable testers—lots of them. A data-communications center, for example, may include terminals, modems, interfaces, printers, tape and disc memories and other peripherals, all of which will need servicing at one time or another.

To fill the need, test gear is offered by such companies as Atlantic Research of Alexandria, VA, Nu Data, Little Silver, NJ, International Data Sciences, Providence, RI, Pulsecom in Falls Church, VA, and Tau-Tron of N. Billerica, MA.

Tau-Tron's line of equipment includes units for bit-error-rate testing that blaze along at up to 1 GHz—the fastest rate available today.

Atlantic Research markets Intershake, a portable instrument that can analyze, simulate and generate practically any signal condition needed to check all data-communication system components, including software. Intershake works on-line or off-line and stores tests internally or in spare pop-in PROMs.

Both International Data Science's Model 60 and Nu Data's 921-S interface test set can be shoved into a pocket, and both units test interconnections

between a modem and terminal to ensure conformity to EIA 232, the Electronic Industries Association standard for data transmission. The Model 505-2 from Pulsecom performs similar troubleshooting.

Such "line snoopers" and other portable test gear can literally fill a service van or station wagon. But add such extensive gear to the cost of house calls today, and field service becomes a very expensive proposition. So much so, in fact, that an increasing number of computer vendors are looking into remote call-up diagnostics to examine terminals or other devices.

Already in use at Datapoint, IBM, GTE Information Systems, Sycor and Western Union Data Services, remote call-up automatically dials a processor in the field and then transmits test routines when the processor answers the phone. Test results are analyzed and displayed either on site or at the remote test center. The idea, of course, is to avoid a service call, if possible.

Whether remote testing will eliminate such calls entirely remains to be seen. One thing that won't be eliminated by remote diagnostics, ATE or logic analyzers, however, is the oscilloscope.

As evidenced by such new performers as Hewlett-Packard's microprocessor-based scope, the Tektronix digital-processing unit and the Philips line of multiplying scopes, and also by the programmable, calculating oscilloscope from Norland Instruments of Fort Atkinson, WI, scopes are taking on a new look. And they are gaining a foothold in the world of digital measurements. ■■



Even after you buy it, HP's 182 Mainframe keeps on giving you a choice. A choice of other plug-ins as measurement needs change . . . a choice to update as new plug-ins are developed . . . a choice of three entirely separate modes of measurement.

**LOGIC ANALYSIS (Data Domain)** – To watch your digital logic circuits step through their operations, our Logic Analyzer plug-in gives you a direct readout of one's and zero's . . . in hexadecimal, BCD, or octal. It shows

you 16 words at a time, 12 bits wide so you can see logic state flow with respect to both positive and negative time.

**FREQUENCY DOMAIN** – To see amplitude as a function of frequency, there's a plug-in for spectrum analysis between 0.1 and 1500 MHz. It gives you signal range greater than 70 dB and selectable resolution bandwidths from 1 kHz to 3 MHz. Choose the dual-channel Frequency Response Test Set, and you can do simultaneous

# Choose the keeps you a



**Logic Analysis  
(Data Domain)**

**Time Domain  
(Multi-channel  
timing measurements)**



swept-frequency display of insertion gain/loss and return loss (SWR) from 15 MHz to 18 GHz.

**TIME DOMAIN** – For real-time measurements, choose from seven vertical and four time-base plug-ins. Choose single, dual, or four-channel verticals. Select high sensitivity or high bandwidth... or both with two separate plug-ins. Perhaps time-domain reflectometry will solve your problem. Choose from two plug-ins. If you're

beyond real-time capabilities, select from three plug-ins for sampling up to 18 GHz.

And there's an even wider choice when you look into our other 180 Scope Systems. You can choose from a number of fast-writing or storage mainframes, plus dozens of plug-ins. To find out more about the scope family that keeps on giving you a choice, write or contact your local HP field engineer.

#284 for Technical Information  
#285 for Immediate Applications Assistance

# scope that giving choice



Sampling  
up to 18 GHz

Spectrum Analysis

HEWLETT  PACKARD

Sales and service from 172 offices in 65 countries  
1501 Page Mill Road, Palo Alto, California 94304



## One man's view

# Will the micro KO the mini? Not if the mini manufacturers counterpunch, says Ely of HP

John Mason, Associate Editor

**F**irst there was the giant computer. The data processor to end all data processors. Centralization was the answer. One big machine would do the brain work for an entire facility.

Then came the smaller machines. Decentralization became an acceptable concept. But was it really the way to go?

Then the minicomputer arrived. This was real revolution! Decentralization was right, after all. And the mini was king!

And then—and who was ready for this?—the microprocessor appeared.

Will there be a battle? Is it curtains for the mini? For Digital Equipment Corp. For Data General? For Hewlett-Packard?

Hewlett-Packard's Paul C. Ely Jr. says there will be a battle but the mini will survive—if the manufacturer knows what he's doing. Ely is general manager for the company's Computer Systems Group in Cupertino, CA.

Changes are taking place in the computer industry all right, Ely agrees. The microprocessor is having an impact.

"But fortunately," Ely explains, "the minicomputer has always enjoyed the advantage of having a very broad base, as far as applicability is concerned. As industry grows and makes new demands, the minicomputer moves in to fill them.

"The microprocessor and the minicomputer aren't at war but the microprocessor has captured some territory and is forcing the mini to move. The mini has consistently come down in price and up in performance. So the microprocessor is simply taking over the smaller, cheaper jobs that the mini is now too big to handle. Together, the microprocessor and the mini have expanded the market."

Ely sees three important trends in the giant minicomputer companies:

1. Manufacturers rarely sell someone a bare CPU these days. They provide the mini in a complete system with integrated peripherals. "Even the OEMs want complete systems," he says. This trend, which actually started about three years ago—before microprocessors—is evident in many product lines: "DEC's PDP-11/70, Data General's Eclipse, and HP's 3000 CX," Ely notes.

2. A system's software is more powerful than it used to be. "You give them really comprehensive operating software that will solve their problems," Ely says. As a result, less money is spent for developing custom software and a better, more reliable software results.

3. Manufacturers have got to build their own peripherals. This gives the systems manufacturer a chance to make a unique performance contribution to his product at the systems level. It also gives him control of his reliability and costs.

### How to stay alive

Some minicomputer houses will be around two years from now and some won't, Ely says, adding: "HP and apparently DEC are actually experiencing a period of growth during these generally bad economic times. To survive, you have to move forward into systems integration and peripherals. And you must also move backward into IC technology."

As an example, Ely notes: "In the past almost any group of engineers with a bright idea could buy logic from Fairchild or Texas Instruments or Motorola, build a CPU, put together a simple, though perhaps clever, software package to run it, and they were a 'mini supplier.'

"These are the people who may be replaced by the microprocessor companies," Ely predicts.

To survive in the long run, he says, manufac-





**Paul C. Ely, Jr.**, general manager of Hewlett-Packard's Computer Systems Group, Cupertino, CA, is responsible for the company's newly consolidated computer and computer system's operations. Previously, he was general manager of the Data Systems Div.

---

turers must know how to build electromechanical devices and at least the main systems peripherals, such as discs and tapes, for mass storage and for line printers and terminals to interact with the system.

"This is where the money in a system is," Ely says, "not in the CPU.

"Apart from cost," he adds, "reputation is at stake. If you buy your discs, you won't be able to differentiate them from those of your competitors. And you can't claim that your discs are better unless, in fact, they are and unless you make them. As the industry matures, the ones who have developed their own capabilities in these key peripherals will be successful.

"This doesn't mean that we're going to stop buying all peripherals. But we do plan to build a large share of the ones that represent the essential performance limitations in our systems."

Expertise in LSI design is also required, Ely says. Minis of the future won't be built with standard circuits from a semiconductor house; they'll be custom-designed, he predicts.

"Some of the minicomputer companies are vertically integrating backwards into IC technology by working closely with a supplier," the HP manager points out. "That's what DEC has done with Western Digital to make their LSI-11. This is an LSI version of the DEC PDP-11. We in HP have invested in an in-house LSI capability and Data General has bought an LSI facility."

Ely feels strongly enough about the need for expertise in IC technology to predict: "The extent to which we are successful in this will determine our competitive success in the long run."

Will the IC houses become systems producers?

"Microprocessor companies don't at this point have the software capability to become a systems house," he says. "They can, however, acquire this by first recognizing the need for it, hiring a competent staff and gaining experience.

"Developing a peripheral capability, on the other hand, is more difficult. This requires both an engineering and a manufacturing capability—something that's very different from manufacturing ICs and that calls for a substantial investment. Making a good disc is a sophisticated electromechanical job which requires major machine-shop facilities."

More uses are being found for the minicomputer because new industrial areas are discovering its applicability, and also because it's now being offered as a more complete, practical system, Ely says.

"OEMs, who began buying relatively simple CPUs to use as controllers, now frequently put a whole computer system in their product. They build sophisticated computer-controlled systems into products that formerly would have received no more than a simple disc-based unit.

"We see a lot of new business in the energy-related industries. We are selling computers to OEMs who sell to exploration companies, service companies and manufacturers of drilling equipment. There are a large number of small technically based companies that serve the energy field that are in a rapid state of growth today.

"A great deal of training and patience are required by the user of today's minicomputers," Ely says. "I personally think that HP has done a good job in this area, but we're going to do even better." ■■



# Now from International Rectifier.

## “Extra Margin” Fast Switching Power Transistors.

If you're chopping line voltages at 20 KHz or inverting and stepping down at high frequency, you should consider IR's two new families of fast switching, glass passivated power transistors. They can mean better reliability and lower cost in line operated power supplies.

**Fast Switching Speed—Cooler Operation** . . . the oscillograph shows typical fall times in the sub-micro-second range. Gives extremely low switching losses for cooler operation and higher reliability.

**Lower Leakage — High Temperature Stability** . . . with ICEO in the micro-amp range, IR devices are about one-tenth the accepted leakage rates of others. Provides the higher stability important for high performance at elevated temperatures.

**High Second Breakdown — High Reliability** . . . adds to our broad safe-operating area for an extra margin of safety.

**Glass Passivation — Long Term Reliability** . . . high reliability and long term stability is achieved by hard glass passivation. Also, if you're using chips to make your own circuits, IR's glass passivation gives you the most stable, easy to assemble chips you can start with, making your yields higher.

If you are paralleling devices, the tight gain, switching time and saturation voltage control of these transistors make the job easier. And through 100% testing of key parameters we can provide even closer matching if necessary.

JEDEC types listed are immediately available, so contact your local IR salesman, rep or distributor today for samples. Also, ask for data on IR's other series of high gain/high voltage power transistors and power Darlington.

International Rectifier, 233 Kansas Street, El Segundo, California 90245. (213) 678-8261.

New International Rectifier Fast Switching Power Transistors								
IR Part No.	V <sub>CEO</sub> (sus) (Max V)	I <sub>C</sub> Peak (A)	h <sub>FE</sub> (min/max)	@ I <sub>C</sub> (A)	V <sub>CE</sub> (sat) (Max V)	@ I <sub>C</sub> (A)	P <sub>d</sub> (W)	t <sub>r</sub> /t <sub>f</sub> (μs)
2N6306	250	16	15/75	3.0	0.8	3.0	125	6/4
2N6307	300	16	15/75	3.0	1.0	3.0	125	6/4
2N6308	350	16	12/60	3.0	1.5	3.0	125	6/4
2N6542	300	10	7/35	3.0	1.0	3.0	100	7/8
2N6543	400	10	7/35	3.0	1.0	3.0	100	7/8
2N6544	300	16	7/35	5.0	1.5	5.0	125	1/1
2N6545	400	16	7/35	5.0	1.5	5.0	125	1/1

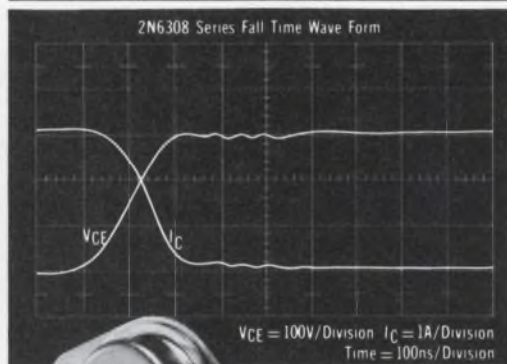

**INTERNATIONAL RECTIFIER**  
the innovative power people



SEMICONDUCTOR DIVISION, 233 KANSAS STREET, EL SEGUNDO, CALIFORNIA 90245, PHONE (213) 678-6281

INFORMATION RETRIEVAL NUMBER 35

INFORMATION RETRIEVAL NUMBER 36 ►



# Just as you can count on 24 hours in a day,



## you can count on Synchron motors.

We custom-make every Synchron motor. Every one. Because it's almost impossible to stock ready-made synchronous motors exactly right for your needs.

Perhaps the motor you need for your product calls for a little more speed than the motor that's letter perfect for someone else. Or you need a little less torque. Or a threaded output shaft instead of a knurled one.

If we say we'll ship in 5 weeks, we'll do it. At a fair price.



And if we've approved your application we'll stand behind our motor 100%.

Stated simply: You can rely on Synchron motors to be designed and built right, to do the job right. That's the only way we do business.

Call or write for our specification sheets and the name and location of our representative in your area.

Choose from five principal styles of Synchron motors—60 or 50 Hz—from one revolution per week to 900 rpm—from 8 thru 98 oz-in torque at 1 rpm—from hundreds of different outputs.

**MALLORY**



**HANSEN MANUFACTURING CO.**  
a division of P. R. MALLORY & CO. INC.  
Princeton, Indiana 47870

We make every Synchron motor as if our name were on your product



# Automated industrial controls not yet ready to go it alone without guidance of humans

Morris Grossman, Associate Editor

**C**an man be designed completely out of automated industrial systems?

From the standpoint of hardware, there are no insurmountable obstacles. But from the standpoint of practicality, it does not appear feasible today.

As Ed Aldredge, manager of process computer systems of Union Carbide, South Charleston, WV, explains it: "An operator is usually required for start-up and shut-down procedures. Further, a human observer is better able to head off trouble by anticipating trends and interpreting relationships not defined in a computer's program. He is also concerned with adjustments for subtle changes in raw materials and unprogrammed deviations of operating conditions."

For example, a baking ingredient such as yeast may vary with season and the supply source. Sara Lee's engineering department head, B. L. Weller at Deerfield, IL, says that these variations can't be predicted by computer. Dough twisting continues to demand human control, though Sara Lee's baking facilities are otherwise highly automated with a Honeywell 610 computer control for batching and other baking processes.

Since humans are still essential, even with computer control, the man/machine interface must be designed to accommodate man's limitation and strengths. A display must show all critical variables, but at the same time it must avoid overloading the operator.

Alarm priorities must be clearly defined and corrective actions unambiguously indicated. A primary failure can cause many other variables to exceed their limits. But only the most critical should be displayed at first by a well-designed control panel. To show all could confuse the operator and lead to incorrect reactions.



As logs are measured in a sawmill, a PDP-8 tells an operator of a four-blade saw which sizes and lengths to select to get the maximum yield of usable lumber.

Similarly for trend evaluation. The challenge is to provide sufficient information, but not too much. Excessive signals can easily hide significant variations, because there is just too much to watch.

## Help for the man/machine interface

For operations likely to occupy the eyes and hands of an operator fully, Threshold Technology



Inc., Cinnaminson, NJ, provides its VNC-100, a voice-input control system. The desk-top-sized VNC-100 can be "taught" to recognize and identify an assigned operator's voice. And this voice data can be stored in tape off-line. The voice converter is trained simply by repetition of each word in a vocabulary about five to 10 times.

Unskilled factory personnel can read data into a computer, direct the operation of a computer-controlled manufacturing or testing process. And skilled machine programmers can prepare programs in ordinary English for, say, a numerically controlled (NC) machine tool. All this while the programmer is making observations, adjustments, calculations or handling prints, charts or tools.

"Future shock" is another serious man/machine problem to confront automation designers and vendors, especially in the conservative

English; not in a computer code.

"The microprocessor is going to play an increasingly important role in the lower levels of hierarchical control systems," explained Conley. "The slow speed and limited memory in microprocessors are adequate for a small number of control loops. The 1050 is configured as a distributed processor, where several microprocessors work together, each on a specific task. However, all microprocessors share one data bus and main memory system. But in spite of advances in CNC equipment, the tape and hard-wired controller are going to be around for a long time," he predicted.

DNC, in its ultimate implementation, is a hierarchy of computers from large central general-purpose machines to individual NC, CNC or merely controller-equipped machines. Such a



A large milling machine is controlled by a PDP-14 mini-computer at the Toulouse factory of Aerospatiale, France's largest aircraft maker.

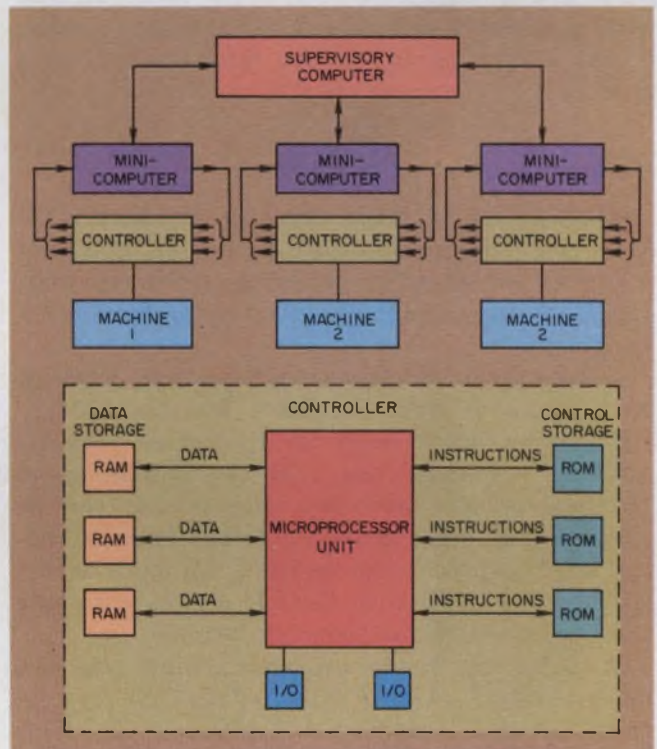

The hierarchy of computers in a fully automated system ranges from a large central unit to local smaller units and microprocessors within controllers.

machine-tool industry. Paper-tape numerical control (NC), the newer computerized numerical control (CNC) and its hierarchical superior, direct numerical control (DNC), have induced "computerphobia" among machine operators, according to GE's, NC manager, James Conley. "GE's cure for these fears," says Conley, "is to make the control interface to at least look familiar as in its Mark Century 1050 Microprocessor CNC. Also the diagnosis software is in

system is the control of a fully automated factory. A master library of parts-making programs, stored in a central memory bank, is distributed, when directed by the central computer, to individual machine controls. Even the conveyor system that moves the parts between machine stations is centrally controlled.

This ultimate implementation does not yet exist, but Ingersoll-Rand Co.'s heavy machining center in Roanoke, VA, comes close. Six NC



machine tools—multi-axis milling and drilling machines—arranged around a conveyer transfer system, under control of an IBM 360/30 computer, can make as many as 16 different kinds of metal parts. Just three operators and a supervisor run the entire complex. An equivalent conventional machine shop would need about 30 manual machines and 30 operators to do the same job.

However, there are few such installations. The main reason lies in the economics of parts manufacturing. Few companies are willing to risk the huge amount of money needed to find out if large DNC systems are reliable, economical and flexible enough to accommodate future changes.

In the meantime low cost systems, such as GE's Mark Century 550 Series, are the trend. The 550M, for instance, can be fitted to a three-axis tool like a Bridgeport milling machine. Most small machine shops have at least one Bridgeport. And this familiar mill, even when outfitted with the 550M's closed-loop NC and tape reader, is not likely to upset the most conservative operator.

#### Hierarchical steps up and down

Allen-Bradley's Mike Gregory, product manager for numerical-control equipment does not expect to see extensive growth in DNC this year, although Allen-Bradley continues to build such systems.

A step up in hierarchy from a single-machine NC system is Allen-Bradley's Bulletin 1795, a DNC supervisory computer. It comes with all essential software. The 1795 can handle up to 16 CNC or NC machines, and it also can be coupled into other manufacturing, process control or data-processing systems. Its modular design is said to make it flexible and to eliminate the need for custom-designed systems.

A step lower on the hierarchic totem pole is a machine such as the Adapt-A-Path CNC system from General Automation, Anaheim, CA. This system, too, comes complete with software. "The Adapt-A-Path, for continuous profile milling, is directed by an SPC-16 minicomputer. The software can perform all the mathematical computations needed to define even the most complex three-dimensional cam surface. The operator need only call it into use," according to Raymon J. Noorda, executive vice president of General Automation. "In addition, the system can match control signals to the characteristics of a retrofitted machine tool's drive system; it can sense tool errors and correct them smoothly; it can drive tools directly from its memory and eliminate paper-tape handling; it can match most program formats, and it allows on-site programming and editing."

But true adaptive control—much publicized at the last three Machine Tool Shows in Chicago—has a long way to go and is not yet off the ground, according to Charles F. Carter, director of product development of Cincinnati Milacron, Cincinnati, OH. However, he sees practical technical gains in all levels of numerical-control hierarchy in 1975, even in hardwired NC. "CNC still offers more than NC. But, meanwhile, many of the sophisticated features of CNC are filtering down to NC. Also programmable controllers are starting to be improved by the use of microprocessors."

#### Minis in the hierarchy

The direct centralized control system can suffer from a host of problems. Some of these are:

- Widely dispersed operations. The plant might be spread over a large area, and data communications equipment is expensive and error prone.
- Changes are difficult. The addition or modification of a process requires a lot of reprogramming and possible downtime.
- Vulnerability to catastrophe. A breakdown of the central computer can stop all operations, despite major efforts to prevent them.

By contrast, a system that is designed around independent minicomputer-controlled subsystems can carry on, even if a central control might be down. Also, in the initial design and build up of such a large system, the use of minicomputers makes it easier to concentrate on one section at a time. As each subunit is made to function properly, it can be tied to the central computer. Further, with a hierarchy using minicomputers, the software for the central-computer can be much simpler than with DNC. The minicomputers al-

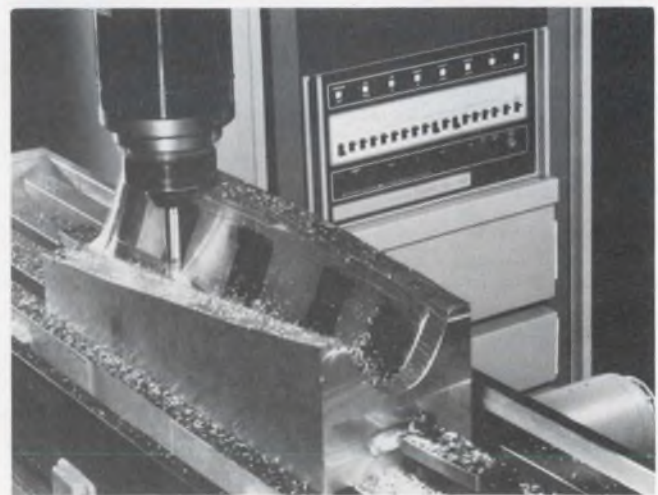

Three-dimensional contour cutting with hyperbolic interpolation is directed by General Automation's Adapt-A-Path and its SPC-16 minicomputer.





**Computerized numerical control**, as represented by GE's 8500 Series, provides a programmable and solid-state output to previously relay-sequenced machines.

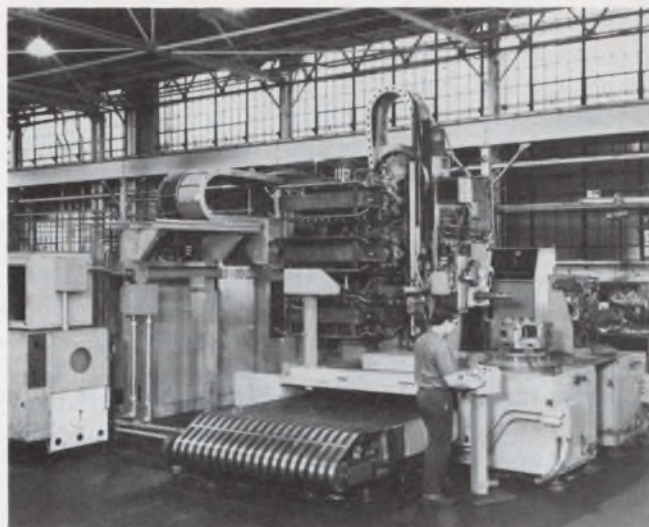

**Computer numerical control** directs Cincinnati Milacron's CIM-Xchanger Series 25HC machine, which carries 90 tools that can be randomly accessed by the program.

low distribution of a great amount of the control intelligence to the local level.

The Inland Steel Co. has taken this approach. It uses PDP-11/45s at local process-control levels. All software development is being done with the view of a future interface to an IM 370 central-control computer.

The computer system is designed to monitor the furnaces. Weighed raw materials, temperature, exhaust-gas composition, level of furnace charge and other parameters are monitored and controlled. Hot spots are detected and corrected, and the composition of the steel produced is predicted and controlled.

The Rock Island Refinery, Indianapolis, also has chosen PDP-11s. But its oil refinery operation, for the present, uses the minicomputers only as process monitors. Operator interaction is via several video and hard-copy terminals.

Again, system designers have taken the step-by-step approach to build the over-all system in small, manageable bits. Rock Island's future plans include an expansion to a hierarchical computer system eventually to perform over-all control over the oil refinery. Controls to be added include those for the tank farm, loading docks, a maintenance work-order system, warehouse inventory and lab instrumentation.

### Low end of the totem pole

"The programmable controller, at the simplest end of the machine-control spectrum, is expected to outstrip its past growth in 1975," reports Allen-Bradley's Mike Gregory, product manager for NC equipment, Cleveland. And he foresees that "the programmable controller is a perfect

application for the microprocessor. Their computing and sequencing capabilities will make them cheaper and more powerful in the 1975 to 1980 period."

But the microprocessor is not a minicomputer. It isn't a number cruncher. It has comparatively long instruction times (0.5 to 5  $\mu$ s for minis vs 10 to 30  $\mu$ s for micros) and short instruction sets (to 150 instructions for minis vs 50 for micros).

"Nevertheless they add a new dimension to the availability of 'intelligence' at the controller level of machines," explains John Underwood of Industrial Nucleonics, Columbus, OH. "We have taken advantage of microprocessors in our thickness controller, the AccuRay 510, a radioactive isotope based thickness gauge. It uses an Intel 8008 microprocessor in the initial field-test units, though future versions may use the 8080. Desired thickness is preset with dials, and the controller's output regulates the thickness of sheet metal during the rolling process."

Many more announcements of such microprocessor applications can be expected in 1975. In particular, solid-state controllers for NC machine tools are ripe for conversion to the use of microprocessors. However a very large population of machine tools have yet to be changed from electromechanical-relay to solid-state controllers.

### Conversion to solid-state controllers

Computers can be made to interface with relay controllers. "But a controller made of the same components as computers—logic gates and solid-state or magnetic memories—can do a better job," according to Kenneth Jannotta, product ad-



administrator of the Eagle Signal Div. of Gulf & Western Industries, Inc., Davenport, IA. "And the same solid-state controller can be used on many different machines, or sequences can easily be changed merely by a change in program."

"Eagle Signal's Controlpac 600 can be thought of as a logic system with many solid-state logic gates, instead of relays, which can be arranged in almost any desired order," he says. "The size of its program memory and the number of required inputs and outputs are the only limiting factors. And the 600 can be expanded to meet almost any requirement."

Allen Bradley's Bulletin 1755 Mini-PMC controller is in many ways similar to the Eagle Signal unit. The 1755 provides a maximum capacity of 62 input/output functions and also features pushbutton programming that can edit, search and clear. An option is available to print or punch hard-copy outputs. The memory-loader unit displays system status, and it also serves to diagnose problems.

With controllers such as these, computers can now interface machine tools with mutually compatible circuits. And because of the controllers' programmable features, machine manufacturers no longer need specialized controllers for different machines, nor do they have to rewire a machine's controller when sequence, interlock or other changes must be made.

### Computers control power networks

Power utilities use computers to help control their networks. Again, the system is usually not under direct computer control, except for special, well-defined routines. In a peak-load period, a dispatcher may be called upon to make as many as 20 decisions an hour. He may have to start or shut down a generator, redistribute the load among several generators, or be required to take a transformer out of service for inspection or repair. A computer can clearly help, but it also needs human guidance.

To take a transformer out of service with the help of a computer, the dispatcher calls up a diagram of the section of the network involved on a cathode-ray display. He checks the load flow and availability of reserve transformers or load paths. A light pen directed at the displayed equipment symbols can select the switches to be open or closed and the transformers to be used. The dispatcher uses an alphanumeric keyboard to direct specific actions.

The operation is protected by the computer with security, logic and load-limit checks. The computer determines the consequences of all directed actions. If the computer approves, an appropriate display gives the go-ahead, and only then is an execute command effective.

The desired sequence—disconnect of a given transformer—is then automatically carried out in proper sequence by the computer program. The successful conclusion of the operation is logged on printed records, filed in the computer memory and indicated on a screen.

### Electricity users need computers

Both users and producers of electricity can employ computers to optimize their systems. Nick Wells, product manager of Digital Equipment Corp., Maynard, MA, estimates that "you can cut your plant's electric bill by 10 to 20% without any effect on your manufacturing capacity or efficiency." In dollars, this can be very con-



Programmable controllers, such as this Eagle-Signal CP600 with solid-state circuitry, are replacing the conventional relay-sequencing controller.

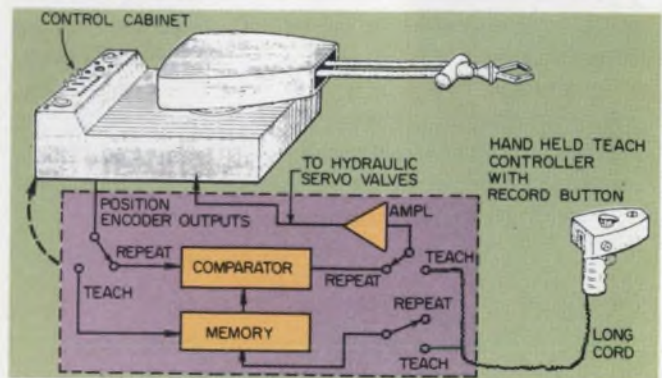

Today's robots must be "taught." A skilled worker must take them through the paces. Future robots will be "choreographed" by software.



siderable, with today's high kilowatt-hour costs.

Power companies determine their customer rates both by power consumption and peak demand. High demand for only a half hour can raise the power charges for the whole month. And unusually high peak demand in one month may influence the charges for the next 11 months. The high-demand rate can cost as much as four times the rate for uniformly distributed power.

"A computer-directed power-demand control system that can cost between \$20,000 to \$60,000 can save its cost in six to eight months in a plant with about a \$200,000 electric bill, especially if it is subject to highly fluctuating power demands," according to Wells.

Such a system can be programmed to shed and restore loads automatically. Certain heavy loads, such as those associated with air-conditioners, space heaters, some fans and lights, can be safely interrupted for 15-to-30-minute intervals on a priority basis. Of course, operator intervention can modify the program on-line to change shed/restore priorities and on/off time limits.

### The robots are coming

While some system designers are deliberately designing man into their system, others are diligently trying to design him out.

A new bulletin of the National Bureau of Standards, *Dimensions*, says that the 1980s promise to be the decade of the robot. Today they can perform only very simple things.

"The industrial robots in use today are only pick-and-put devices," C. A. Rosen and D. Nitzan of Stanford Research Institute, Menlo Park, CA, note in a paper. "They are limited to simple activities, such as loading and unloading presses, stacking parts, spot-welding or paint-spraying. A major limitation of these robots is their lack

of anything but the most primitive sensory feedback. No commercially available industrial robot has visual-ranging or tactile-force sensors."

Thus today's robots can't determine the position or orientation of parts for inspection or assembly tasks. Many laboratories in addition to SRI, such as the Charles Stark Draper Laboratory, Cambridge, MA, and IBM's Thomas J. Watson Research Center, Yorktown Heights, NY, are engaged in research and development work in this area. SRI is working to develop computer programs that can control manipulators with visual and tactile sensors to perform tasks of simple inspection and assembly.

Two IBM researchers, David D. Grossman and Peter M. Will, report that no language exists for describing the choreography of part motions or operations, especially to direct assembly tasks.

"We fail to realize the subtle complexity of moving," they say in a paper. "There is evidence that these difficulties may be fundamental, because motion is controlled by the right-hand functions of the human brain, and language and logic by the left-hand. Thus there is a schism between language and nonlinguistic motion—at least in human terms." Of course, some existing computer languages do control motion, but they are restricted to the limited motions of numerically controlled machine tools or handling equipment.

"At the present time, to get around this lack of language, a "robot" is "taught" a job, instead of being preprogrammed with a computer language," says J. Engelberger, president of Unimation, Inc., Danbury, CT. "The machine is led through the operation by skilled operators and the motions digitally recorded. Then the recorded behavior can be played back repeatedly."

Unimation produces such teachable programmable machines—loosely called robots. The wrench-articulated arm of a \$20,000 to \$50,000 Unimation robot can be taught to perform up to 1000 steps.

Unimation also is studying tactile sensors and the use of a TV camera or laser range-finder to tell the robot the shape, orientation and distance of objects.

No major technical barriers are apparent to building, in the near future, robot factories that can build robots.

"But the potential for major social disruption by such an advance could be far more profound than was the original Industrial Revolution," according to Engelberger. "Between now and 1984 a 50 to 80% reduction in the number of needed factory metal workers can be expected. However, industrial robots also will create new and better jobs. Workers' jobs will not be merely eliminated, but rather redesigned to be less routine, tedious and dangerous." ■■

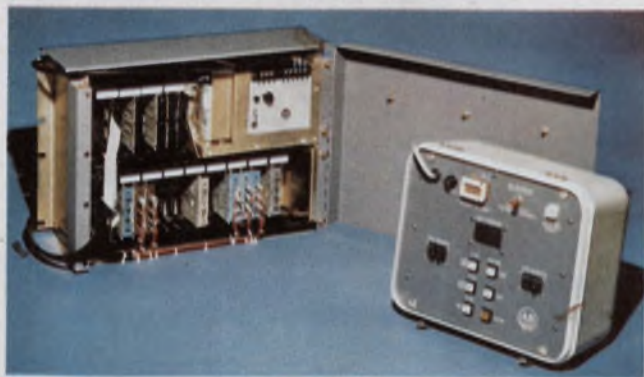

Pushbutton programming on this programmable controller made by Allen-Bradley, the Bulletin 1755-Mini-PMC, can sequence 62 input/output functions.



# Sprague puts more passive component families into dual in-line packages than any other manufacturer.

## Call Sprague First!

					HIGHER PACKAGING DENSITY
				LOWER PRODUCTION COSTS	
plus improved performance and compatibility with DIP microcircuits					

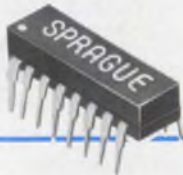

**DIP  
MULTIPLE  
TANTALUM CAPACITORS**

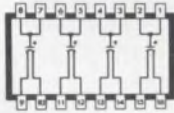

Solid-electrolyte tantalum capacitors with 2 or 4 sections per package. 8- or 16-pin configurations. Standard ratings are 6.8  $\mu\text{F}$  @ 35V, 15  $\mu\text{F}$  @ 20V, 22  $\mu\text{F}$  @ 15V, 33  $\mu\text{F}$  @ 10V. Capacitance tolerance,  $\pm 20\%$ . Operating temperature range,  $-55^\circ\text{C}$  to  $+85^\circ\text{C}$ . Write for Bulletin 3542 or circle 291 on reader service card.

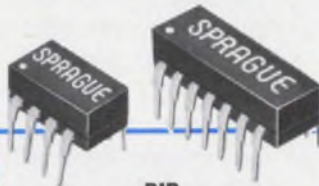

**DIP  
MULTIPLE  
CERAMIC CAPACITORS**

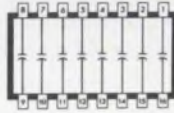

Monolithic<sup>®</sup> construction . . . alternate layers of ceramic dielectric material and metallic electrodes are fired into a solid homogenous block. 2, 4, 7, or 8 capacitor sections per package. Standard ratings, 18 pF to 0.1  $\mu\text{F}$  @ 100V. Capacitance tolerance,  $\pm 20\%$ . Write for Bulletin 6242 or circle 292 on reader service card.



**DIP  
MULTIPLE  
TANTALUM/CERAMIC  
CAPACITOR ASSEMBLIES**

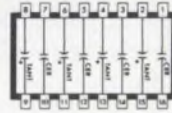

Solid tantalum and Monolithic<sup>®</sup> ceramic alternating isolated sections. Choice of 4 or 8 sections per package. Standard tantalum ratings, 6.8  $\mu\text{F}$  @ 35V, 15  $\mu\text{F}$  @ 20V, 22  $\mu\text{F}$  @ 15V, 33  $\mu\text{F}$  @ 10V. Ceramic ratings .01, .047, .1  $\mu\text{F}$  @ 100V. Cap. tol.,  $\pm 20\%$ . Write for Engineering Bulletin 6642 or circle 293 on reader service card.



**DIP  
RESISTOR/CAPACITOR  
NETWORKS**

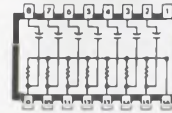

(1 of 3 designs)

Metanet<sup>®</sup> metal-film resistors and Monolithic<sup>®</sup> ceramic capacitors in bypassed pull-up, R-C coupling, speed-up, and active terminator networks. Resistor ratings, 100 to 6800  $\Omega$  with 125 mW power dissipation. Capacitor ratings, 100 pF to .01  $\mu\text{F}$  @ 100V. Write for Engineering Bulletin 6612 or circle 294 on reader service card.

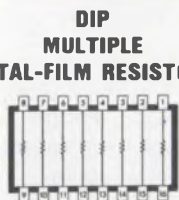

**DIP  
MULTIPLE  
METAL-FILM RESISTORS**

Noble metal film resistors encased in protective glass. Choice of 7 or 8 resistors per 14- or 16-pin package. Resistance values, 50  $\Omega$  to 100,000  $\Omega$ . Power dissipation, 125 mW. Standard resistance tolerance,  $\pm 5\%$ . Operating temperature range,  $-55^\circ\text{C}$  to  $+70^\circ\text{C}$ . Write for Bulletin 7042 or circle 295 on reader service card.

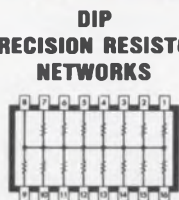

**DIP  
PRECISION RESISTOR  
NETWORKS**

(1 of 5 designs)

Noble metal film resistors in pull-up, pull-down, interfacing, and terminating configurations, for applications requiring repetitive resistance patterns. 14- or 16-pins. Up to 28 resistors per package. Individual resistors from 50 to 100,000  $\Omega$ . Dissipation, 125 mW. Write for Bulletin 7042 or circle 296 on reader service card.

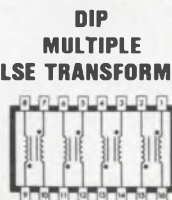

**DIP  
MULTIPLE  
PULSE TRANSFORMERS**

(1 of 2 designs)

Four transformers in 16-pin package. All cores have exclusive protective coating. Inductance values from 10 to 1000  $\mu\text{H}$ . ET product values of 5 volt- $\mu\text{sec}$ . Choice of four turns ratios . . . 1:1, 2:1, 3:1, 4:1. Operating temperature range, 0  $^\circ\text{C}$  to  $+70^\circ\text{C}$ . Write for Engineering Bulletin 40400 or circle 297 on reader service card.

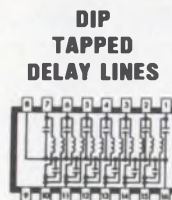

**DIP  
TAPPED  
DELAY LINES**

Lumped constant delay lines . . . ideal for timing and pulse synchronization circuits. 14- or 16-pin packages with delays of 50, 100, or 150 nanoseconds at a characteristic impedance of 100  $\Omega$ . Working voltage, 50 VDC. Operating temperature range, 0  $^\circ\text{C}$  to  $+70^\circ\text{C}$ . Write for Bulletin 45004 or circle 298 on reader service card.

**Popular Types Now Available OFF-THE-SHELF From Your Sprague Industrial Distributor.**

For complete technical data, write for any of the above-mentioned Engineering Bulletins to: Technical Literature Service, Sprague Electric Company, 347 Marshall Street, North Adams, Mass. 01247.

**THE BROAD-LINE PRODUCER OF ELECTRONIC PARTS**





# CAUTION: 50,000 VOLTS



## LET ERIE DESIGN and BUILD YOUR HIGH VOLTAGE POWER SUPPLIES and VOLTAGE MULTIPLIERS

When you talk about designing and packaging miniature, low current High Voltage Power Supplies and Voltage Multipliers, the name ERIE should come to mind first. Why? *No other manufacturer of these sophisticated devices has its own capacitor and rectifier technology in-house.* Only ERIE does it all. Our many years experience in producing State of the Art high voltage capacitors and high voltage silicon rectifiers — plus an unsurpassed technology in circuit designing, packaging and encapsulation, makes ERIE an ideal source for your high voltage component needs. From very low input voltages, ERIE can produce output voltages up to 50,000 volts. Application for these compact, high reliability devices includes night-vision image intensification systems. Apollo TV cameras. CRT displays. Avionics systems exposed to rugged environments. Industrial, commercial and military equipments . . . an almost infinite variety of applications. So bring ERIE in early. Let us design and build *your* High Voltage Power Supplies and Voltage Multipliers. We're equipped to handle large or small volume orders . . . in-house.

Write for our 32-page catalog  
High Voltage Components and  
Devices . . . or for technical  
assistance, call

613/392-2581

ERIE TECHNOLOGICAL PRODUCTS, INC.  
Erie, Pennsylvania 16512

**ERIE**



## With new, powerful software, designers can 'see' a system work before it's actually built

Seymour T. Levine, Associate Editor

**T**oday's computers allow designers to conceive, analyze, test, troubleshoot and even lay out an entire system without leaving their terminals.

Most of these computing systems include conversational programs—almost all of which discourse with the designer in his own terms: nodes, branches, gates, currents, semiconductors, even whole chips. This powerful software needs minimal computer background; the computer does most of the translation from engineering notation to computer-usable form. Analog design programs range from dc to microwaves, and digital design covers gates to microprocessors.

Admittedly the best available programs empha-

size coverage of analog circuits more than digital. But a designer has many alternatives from there. For those with some computer-programming experience, the enhancements for the latest dialects of Fortran, Basic and APL make it easy to write your own analysis routines. A recent innovation of most of these languages is their ability to operate on input data that resembles English-like statements and turns them into mathematical variables needed for solutions.

Another useful tool, especially for the designer of digital systems, is simulation language, such as IBM's GPSS V (General Purpose Simulation System V) and Rand Corp.'s Simscript II. These languages are more abstract than circuit-design languages, but they can easily represent, trace and catalog sequences of events in a complex digital



Computer-aided designs often start with a spec and end with complete PC board layouts. RCA uses Applicon graphics terminals to master the layout problems associated with complex MSI and LSI components, after CAD programs verify the design.



Service centers with multiple computer systems form the backbone of Control Data's Cybernet. The computer network offers time-sharing access to design programs on user terminals, as well as allowing user computers to augment their processing power with the network.



## Common terms

**Assembly language**—A machine-oriented language based primarily on a one-to-one relationship between machine instructions and user-supplied source code.

**Batch Environment**—A situation in which the computer receives instructions and program(s) from a terminal or other peripheral device, then executes the requested operations at its own convenience.

**Breakpoint**—A place in a computer program where the program can be stopped by external intervention during execution, such as from the operating system. The user can then examine registers and memory locations, alter data generated by the program and even request that execution resume from that point.

**Compiler**—A computer program that translates source program statements to executable machine code.

**Delimiter**—Any means used to separate data items at input. Most frequently used are spaces or commas. The delimiter for the two integers 123 678 is the space between them.

**Interactive environment**—A situation in which a computer continually responds to the user upon receipt of directives from his terminal.

**Interpreter**—A computer program that translates and executes each source instruction separately.

**Microprogram**—Stored routines in CPU control memory that define machine instructions as a series of elemental steps to be executed by the processor's control section.

**Operating system**—A collection of software that schedules jobs, assigns resources such as peripherals, manages all data transfers between computer and its peripherals, and then performs various housekeeping functions.

**Source program**—The statements written by the programmer, usually in a language convenient to the expression of the problem.

**String**—A contiguous set of memory addresses each of which contains a single alphanumeric character. The string "TODAY IS COLD" occupies 13 bytes in IBM equipment, which includes the two spaces between words. Strings are often enclosed in quotes when written in program statements.

controller or even a bipolar CPU module.

The wide availability of advanced microprocessors has created a need for software tools to accelerate their programming. Often referred to as assemblers or cross assemblers, these run on large computers and are neither logic design programs nor languages. And each assembler is tailored to a specific microprocessor. The assembly language text is inputted in the same form used by the microprocessor. The program then permits editing of the text and simulation of the action of the processor.

### Gather your data together

Engineers may also benefit from software designed to help business cope with ever increasing amounts of data. This need has spurred the development of management systems for organization, maintenance and retrieval of data in large computer data bases. Data-base systems allow the designer to collect data from many simulations. The computer can then be directed to organize the data by specific characteristics or to report exceptions to expected results.

In choosing design programs, you will find that the most comprehensive packages work with the largest systems—either in-house or at service bureaus. But bigger is not always better. Large computers have complex operating systems. In the event of an error, the diagnostic messages require considerable software expertise to inter-

pret, and the time spent in debugging can outweigh the time saved in problem preparation.

On the other hand, minis and calculators feature simple user commands and responses that sharply reduce debugging time. However, the problem must be inputted and solved in more piecemeal fashion than with the maxi. Many engineers find this a very cost-effective approach.

In a sense, time-sharing services offer the best of both worlds—simple conversational debugging combined with access to large computers that can handle the advanced packages. The penalty, of course, is price. This is not the cheapest way to do things; but it can serve as a good introduction to what's available. Convenience is another factor. Widely separated users of time-sharing can jointly participate in a problem's solution over the vendor's national or even international computer network.

### Analog circuits are easiest to analyze

Applications software for the designer covers a broad spectrum. Continuous systems, as represented by analog circuits and microwave networks, present little difficulty. The algorithms are fast, thorough and highly developed.

Digital systems programs, while effective, usually work on a gate-by-gate level. And a large board of MSI can easily saturate the facilities provided. But work on discrete simulation is progressing. Some of the newer programs can deal





Flexible high-level languages can be used to design computers. Algol-based assemblers written on the HP 2100

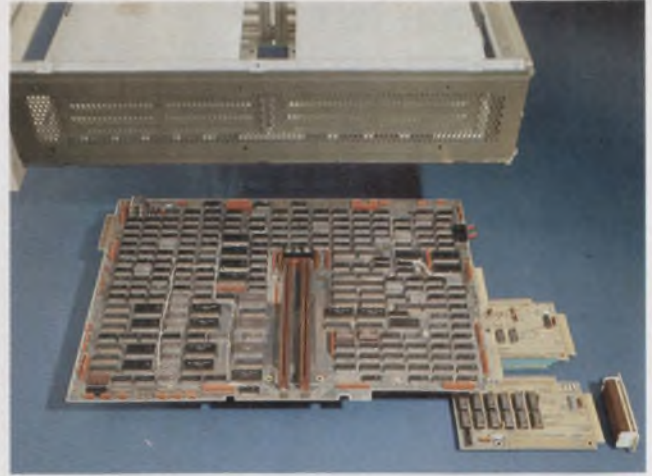

were used to develop the microcode for the HP 21MX. String processing is an important feature.



The arithmetic prowess of programmable calculators makes them a natural for CAD. HP's 9830A (left) executes a comprehensive microwave design program called BAMP, and Tektronix offers microwave software on its



Model 31 (right). The use of graphical peripherals plus programming ease help make calculator systems popular design tools. Graphics tablets can also be used with some of these units.

with these circuits on a higher level—namely on the basis of register-to-register data transfers. It is on this level that one usually designs controllers and CPUs.

Analog circuit analysis programs for large machines have a common input language and can perform dc, ac and transient analysis in a single program. Although all these capabilities existed even in 1969, the user had to provide separate descriptions to several programs to obtain the same results, and the number of elements seldom exceeded 200. Today's programs offer rapid execution of networks of up to several thousand elements. With IBM's ASTAP (Advanced Statistical Analysis Program), a 1041-element network executed on a System/360 Model 85 uses a total of 180 s, of which the setup accounts for 162 s.

Most circuit analysis programs perform time analysis through state-space techniques. To gain

speed, the associated matrices are handled with sparse-matrix techniques—that is, the program skips over zero elements in the state matrix instead of computing with them.

Another technique—implicit integration—permits the use of large time steps, if the necessary integrations converge. Together these techniques often boost execution speed by a factor of 10, compared with the speeds attainable with ECAP and SCEPTRE, which, incidentally, still find wide use.

Circuit-analysis programs work well with nodes and branches—but what about servo mechanisms? IBM's CSMP III offers input descriptions in terms of integrators, summers and other analog-computer paraphernalia. Like ASTAP, the program performs time analysis with state-space methods; however, the sparse-matrix and implicit-integration techniques are not available.



Thanks to a head start on computer analysis plus ready availability of good algorithms, single analog circuit packages can perform a broad variety of analyses (see "Linear Systems Analysis Simplified," ED No. 11, May 24, 1974, pp. 70 to 78).

Commercial packages, especially on time-sharing services, go even further. Tymshare's version of SPICE adds dc analysis, white-noise generation, transient analysis, sensitivity and temperature variations. General Electric's version of ECAP includes ac, dc and transient analyses, as well as sensitivity. IBM's ASTAP includes most of these features and adds Monte Carlo statistical analysis. The analysis helps predict changes in network performance with variations in component values.

SPICE is a very unusual circuit design program offered by National CSS, Stamford, CT. The program features a miniature operating system that allocates and releases memory dynamically. Combined with virtual memory, the program allows the user to simulate circuits of staggering complexity. The largest to date had 2000 bipolar active elements. The original version of SPICE, written at the University of California at Berkeley, had a capacity of 400 nodes and 100 transistors.

Computer optimization of circuit parameters is another feature that helps smooth the design procedure or, at the very least, assists in choosing component values. As a rule, the optimization procedures prove most effective in the frequency domain. The mathematics is straightforward and the computer does not have to calculate an entire transient response for each iteration. Also, some of the algorithms used for linear programming carry over, since the entire system can be described in matrix form with constant coefficients.

Practically all programs for CAD offer built-in models for bipolar transistors, FETs, diodes, JFETs and MOSFETs. SPICE offers the user Ebers-Moll or Gummel-Poon for bipolars; Hodges and Schichtman for MOSFETs and junction diode or Schottky-barrier versions for diodes.

### Know the circuit model used

For critical simulations, you will have to know which model best describes the device to be analyzed. Spec sheets for the various semiconductors do not provide numerical values for use with the models. If you can't get values for the 10 to 24 parameters involved, the vendor's software will insert default values. It's up to you to know if these serve your application.

As a rule, the algorithms used work very well with nonoscillatory circuits. However, bilevel

circuits, such as Schmitt triggers, can cause the program to hang up. Dc analysis can be stymied by bilevel circuits as well. Ask the vendor what the program action is, in this event. In some cases you can intervene and adjust the time step or initialize the circuit to a stable state. In other cases the program stops execution, and the values obtained are not guaranteed as to accuracy.

As the chart shows, many CAD programs run on large mainframes, often in a batch mode. These require slightly greater programming skill on the part of the user than similar products on time-sharing services. For example, ASTAP provides for the insertion of user defined functions, to be written as Fortran function subprograms—thus implying some skill with that language. Tymshare lets you define models in component blocks. Another language, CSMP III, accepts modules in the form of Fortran subroutines when in a batch mode, but it has been adapted by Tymshare to accept input in the form of a connection list and description of blocks made up of CSMP elements.

Logic design programs are not quite as sophisticated. Despite wide use of MSI and LSI devices, most of the programs treat logic on a gate-by-gate basis when in fact a single MSI chip accounts for hundreds of gates. There are several reasons why. For one thing, time-sharing vendors say most programs offered to them are not debugged enough for general use. Some engineers feel they can visualize the operation of complex logic without a computer because only ONES and ZEROS are involved. Finally, analog theory predates digital by 10 years and is well publicized.

The Logcap simulator is probably one of the most advanced. Instead of using collections of gates, it permits the insertion of transfer-function macros for shift registers. The program is available from National CSS in time-sharing and from RRC International in package form (see chart). As a rule, the logic simulators can produce timing diagrams, mimic propagation delay and detect spikes. University Computing Co., Dallas, TX, series of programs includes test-pattern generation and fault isolation.

Test programs such as CAFIG from Bendix Corp. make use of Eichelberger's theorems (see "Algebra Finds Logic Circuit Glitches," ED No. 4, Feb. 15, 1974, p. 90) to check for logic glitches. Three-valued representations of logic—ZERO, ONE and Indeterminate—figure prominently in many checkout algorithms. CAFIG which stands for Circuit Analyzer and Fault Isolation Generator, finds digital input patterns with which to test a given logic board. In addition, the program computes the output pattern for each input pattern and specifies a replacement fault output for a given simulated fault. The program handles 1000 gates on a 20-bit mini, the BDX



# Sampling of commercially available design programs

Category	Program name	Type of analysis performed	Models used	Source	Language and Machine	Time-sharing vendor
Circuit modeling and analysis	OPTINET	Ac steady-state analysis; sensitivity analysis; circuit optimization	Network elements; cataloged circuits	RRC International, Troy, NY	Fortran IV; IBM 360/67	Request from originator
	UCCAP/SCEPTRE II	Dc failure analysis; transient analysis; nuclear environment simulation; worst-case and others. Keeps up with Air Force Sceptre II releases	Ebers-Moll nonlinear semi model; passive circuit elements	University Computing Co., Dallas, TX		
	I/TRAC3	Transient, dc, radiation and ac analysis; optional worst-case and Monte-Carlo	Ebers-Moll semi models; passive circuit elements	Berne Electronics, White Plains, NY	Fortran IV IBM 360/67; DECsystem 10; CDC 6600 and others	—
	Digital Filter Design program (24 programs)	Determines coefficients for low-pass, bandpass, band-stop and high-pass digital filters. Produces closed loop designs from one of three Z transforms	Five prototypes: Butterworth Bessel Butterworth-Thompson Chebyshev Elliptic	Technology Service Corp., Santa Monica, CA	Fortran IV; CDC 6000 XDS Sigma 5/7 DECsystem 10	—
	ASTAP	See text	Network elements and stored models	IBM (contact local sales rep)	Fortran IV IBM/360 and 370 series	—
Logic	LOGCAP-2	Simulates logic networks with up to 30,000 nodes. Handles rise and fall delays. Has three-state simulation; generates test programs	Gates; one-shot high-level algorithmic models MSI/LSI library	RRC International, Los Altos, CA	Fortran IV IBM/360 and 370	National CSS, Norwalk, CT
	I/LOGIC	Simulates logic networks. Produces timing diagrams at point of charge or at equal intervals. Detects races and hazards	Blocks that include FF's one-shots and gates. Up to eight inputs per block	Berne Electronics, White Plains, NY	Fortran IV IBM 360/67 CDC 6000 DECsystem 10 and others	—
	LOGSIM III	Simulates logic networks; detects spikes; has on-off delay option; simulates stuck at ONE or ZERO	Gates, shift registers r/w memories, flip-flops, etc.	Software Products Co., Hope, MI	Fortran IV	LOGSIM II available from University Computing Co., Dallas, TX
	CAFIG*	See text	Logic diagram	Bendix, Teterboro, NJ	Assembly; BDx 6200 mini	—
	D-LASAR	Generates test patterns that detect 95% of failures	Input schematic internally exploded to NAND gates	University Computing Co.	Fortran and assembly	University Computing Co.
	DLG	Evaluates stimulus patterns to generate fault dictionary with resolution to 1.2 ICs	—		Univac 1108	University Computing Co.
Microwave	COMPACT	Optimizes microwave passive and active circuits; works in frequency domain; manipulates up to 15 parameters. Provides circuit analysis, stability analysis and sensitivity analysis	Two-port scattering or Y parameters	Compact, Los Altos, CA	Fortran IV; IBM 370/158 CDC 6600 DECsystem 10	United Computing Systems, National CSS, Tymshare
	MAGIC (useful from near dc to microwave)	Performs constrained optimization with element values adjusted between specified minimum and maximum size	Resistors, capacitors, inductors stubs and transmission lines. Present limits—100 branches, 50 variable elements, 100 constraints, 40 frequencies	—	Univac 1108 Fortran and assembly	University Computing Co., Dallas, TX
	BAMP	See text	Two-port scattering matrices	Hewlett-Packard	HP-2100 (mini) HP-9830A (calculator)	General Electric Mark II
	TWA-3	Traveling-wave multi-signal operation in two dimensions. Includes multisignal effects and harmonics	—	Shared Applications, Ann Arbor, MI	Fortran IV DECsystem 10, IBM 360/67 CDC 6600	—

Note: Abbreviated descriptions of many of the programs in this table were abstracted with permission from the ICP Software Directory, Vol. 2, Jan., 75, publ. by International Computer Programs, Carmel, IN



6200, and uses 16-k of core.

BigSim, a program used with Computer Automation's Capable 4900 tester (which uses a 64k Alpha LSI-2 mini), similarly takes a description of the circuit in terms of logic elements and gates, then generates random input patterns to be used for acceptance testing and fault isolation. The system will accept algorithms for registers.

Specific programs for large machines that perform these and similar feats include Logcap-2 from RRC International and D-Lasar from University Computing Co. (see table).

### Microprocessor design thrives interactively

The newer class of logic programs and languages don't deal with logic at all. And they work almost exclusively in a time-sharing environment. They mimic microprocessors and permit the user to view the effects of his programs in advance. These vendor-supplied programs consist of two major subdivisions: assembler and simulator. Initial input consists of assembly-language statements for the target microprocessor inputted from a user terminal. Mainframe programs allow editing of the source text and then pass the code to a simulated assembler, where the user receives useful error messages. Once the errors are corrected, the user can have his code executed by a simulated microprocessor. The simulator permits examination of the simulated processor registers and selected memory locations. And the simulator usually offers instruction traces, while the simulated processor executes and permits the user to have the simulation stop at prearranged breakpoints. Peripheral-device simulation is limited.

Once the designer is satisfied that his program performs its intended tasks, he can request a binary tape for transfer to the microprocessor chip programmer.

One thing to remember is that the time-sharing vendor did not write the program the microprocessor vendor supplied; hence there is a surcharge for use of the packages. At present such packages are available for a number of chips, including the Intel line (4000 and 8000 Series), National Semiconductor (IMP 8, 16), Rockwell International (PPS Series) and RCA (Cosmac). Time-sharing vendors that offer this service include Tymshare, General Electric and National CSS. Zeno Systems of Santa Monica, CA, offers the assembler portion for the Intel chips to use on the DECsystem 10. An assembler from Innovonics of Silver Spring, MD, handles the Intel 8008, 8080 and DEC's MPS series with a PDP-11 mini. Both the Innovonics and Zeno programs are interactive.

The trend to minicomputer and even calculator-based design algorithms is particularly notice-

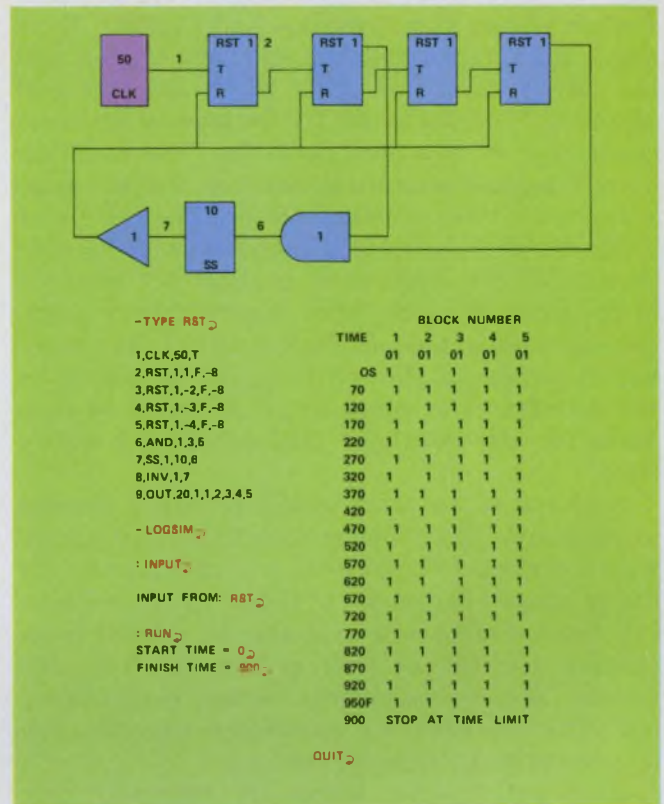

A conversational environment geared to the needs of the engineer helps make CAD cost-effective. An almost 1:1 translation of circuit to computer input takes place with the LOGSIM program, shown executed on the Tymshare network.

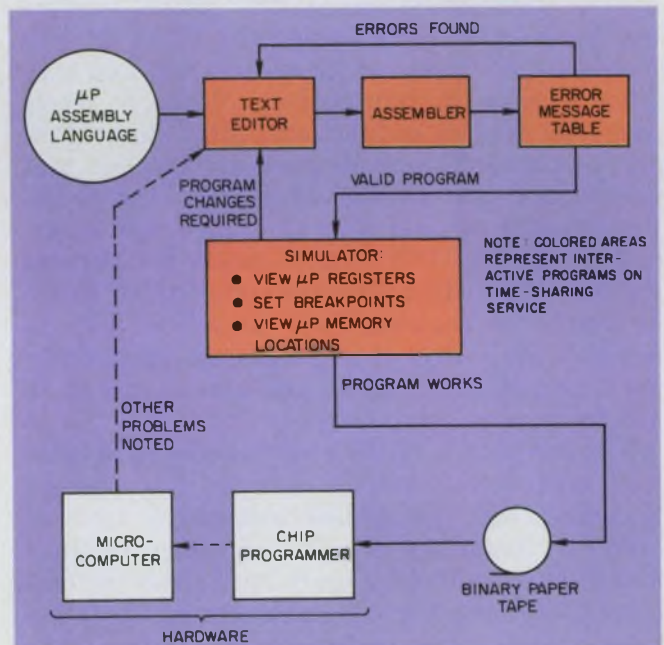

Microprocessor assembler simulators offer 60 to 80% assurance that the final product will work. These interactive programs accept microprocessor assembly language, permit editing of the text and then let you debug the software on a simulation of the microprocessor. A binary tape of a successful program is burned into PROM or ROM.



able in microwave design. BAMP, a Hewlett-Packard algorithm executes on General Electric's Mark II service, the HP 2000/S mini and the 9830A calculator. This Basic Analysis and Mapping Program treats the problem as an interconnection of two port networks. The resulting output includes scattering matrices, S-Plane mapping, and circuit stability factor. The calculator easily matches mainframe accuracy with its nine digits. But the speed ratio is about 5:1 in favor of the mini. When the mini is servicing 10 users, the speed advantage drops to 2 or 3:1. The number of two-ports allowed is almost unlimited on the mainframe or mini, but it drops to 60 two-ports for the calculator because of its memory size.

A glance at the chart will show that a number of programs also perform optimization of microwave networks. The reasons are the same as for linear lumped parameter systems. Of the optimizing types, Compact is available on several time-sharing services as well as directly from the vendor. Magic goes slightly beyond conventional optimization, since its parameter selection can be constrained to specific limits.

Once the designer leaves the relatively cozy world of electronics-oriented languages, he can still select from the major high-level languages or from a class of specialized languages designed for multi-discipline use.

Simulation languages, such as Simscript II or GPSS, tend to come with much more comprehensive diagnostics than do the general-purpose languages, such as Fortran and PL/I. If you have the facility to run these, you will find both quite suitable in representing logic or whole computer systems in functional form. Both GPSS and Simscript II provide an event monitor that keeps track of events and advances a clock to the next instant of time when a change may occur.

With IBM's GPSS, which stands for General Purpose Simulation System, transactions (such as data through a computer) move from point to point in the system mode, make use of facilities such as arithmetic units, and can be stored in queues such as cache buffers.

Persons with a fairly good knowledge of Fortran will find Simscript akin to the Fortran language, with augmented statements such as PERFORM (transfers control to a named routine) and IF THEN ELSE (if a condition is true perform some operation otherwise do something else). The remaining features include statements for time advance, event-processing and accumulation of analysis of statistical data. Incidentally, GPSS also provides for similar analysis.

The latest release of Simscript comes from Rand Corp. as Simscript II (1968). GPSS V, the latest IBM version, uses disc-based swapping to ease memory requirements and can interface

with PL/I.

Computer buffs continually predict the demise of Fortran and cite its machine dependence, lack of powerful string manipulation statements and awkward use of subroutine statements. But the language is improving. Recent enhancements include the ability to accept strings of characters and to form them into numerical variables and vice versa. For file handling, the user can have the program terminate when it runs out of data cards or when erroneous data are supplied. To further simplify card-data entry unformatted read statements allow integers and alphanumeric characters to be entered in free style with spaces or commas between each. IBM refers to this as list-directed input; the list is the set of variables named at the READ or WRITE statement.

### ANSI keeps languages stable

In addition to periodic enhancements, the Fortran language is one of three supported by the American National Standards Institute; the others are PL/I and Cobol. BASIC is now under consideration. Support by the institute, headquartered in New York, NY, ensures coordination of language changes with continuing review of updates. In some measure this minimizes the effects of moving programs between various machines or the need to rewrite them frequently.

The ability to express strategy with the IF THEN ELSE statement together with string-handling capability and in-house availability made ALGOL the language used to develop microcode for Hewlett-Packard's 21MX minis. A microcode assembler spends much of its time manipulating symbols and specifying the actions to take. The 2100 mini was used as the tool in developing the Writable Control Store Routines for the 21MX. Note that Fortran is only recently acquiring some of this capability, and even now cannot perform comparisons on character strings.

APL deserves much wider use in the engineering community. This gut feeling of APL users stems from the language's origins. Kenneth Iverson originally developed the language, not for computers, but as a means to convey mathematical algorithms more efficiently than is possible in algebraic notation. What Iverson wrote in 1969 was based on elementary matrix multiplication—namely, the product of sums.

Matrix operations make extensive use of two operands—addition (+) and multiplication (×). A typical matrix operation resembles  $a \times b + c \times d + e \times f \dots$

But you can substitute max and min for + and ×, and the procedure results in the shortest path through a set of nodes. Look a little closer, suggests Alan Rosen, vice president and technical adviser of Scientific Timesharing, and you can



see row or column vectors that represent processor registers, and then you can define operations that represent functional data transfers.

As to its logic power, Iverson did a complete description of the System/360 computer in 1964, published under the title "A Formal Description of System 360" in the IBM Systems Journal, Vol. 3, No. 3. Also, since the language is matrix-oriented, it's small wonder that MARTHA, a linear frequency-analysis program was written in APL. The program handles microwave circuits and is available in Scientific Timesharing's system.

The type of computer support available can often prove decisive when you're choosing a language or design technique.

With larger time-sharing vendors, such as General Electric, National CSS, Tymshare and Rapidata, the machines form a shared network in which several users in different areas can work on the same problem or segments of it. There is one precaution: FCC regulations prohibit the use of these facilities purely for message transfer.

If you give your imagination free rein, you can easily simulate a network of CPUs. The idea, says Alan Rosen, is to have several people each simulate one CPU at their terminals in APL language. But Scientific Timesharing Co. also allows several users to share a common file simultaneously. Thus, in effect, these people simulate CPUs and the intercommunication between them.

Present Fortran programs tend to be very fast, thanks to optimizing compilers such as IBM's Fortran IV (H Extended) compiler or those available from mini houses like Data General, Computer Automation, and Varian. The IBM diagnostics, however, are best suited for an experienced programmer. Universities use friendlier compilers designed to get students on and off line rapidly. Waterloo University in Waterloo, Canada, offers WATFIV, which returns very descriptive diagnostics that really boost debugging speed. However, these compilers cost about \$5000 a year for private use, but are available at a nominal charge to universities.

### Microprogramming can influence run times

The advent of microprogrammed computers can play hob with a common argument against interpretive languages like Basic and APL. The argument states that interpreters run slowly because they execute in piecemeal fashion, statement-by-statement. Compiler-based languages such as Fortran run fast because the source statements are converted to machine instructions before execution.

But with microcode, the machine instructions are themselves interpreted through microprograms—so why use compilers?

On current IBM equipment, which is micro-coded, APL tends to run three to five times slower than Fortran. However, on the IBM 370/145 users can obtain an APL Microcode Assist. The execution speeds of the APL and Fortran are often equal; sometimes APL outspeeds Fortran by 2:1. But even so, Fortran still affords greater input-output efficiency on mass-storage devices like tape and disc.

If you happen to use Control Data's CYBER 70 or CYBER 170 computers, you can gain expanded processing capability by hooking into the company's CYBERNET services, which offers a very wide variety of circuit-analysis programs. For example, TESS handles up to 601 nodes and 600 elements and performs worst-case, as well as nonlinear transient, analyses. CC-TEGAS3, developed by comprehensive Computer Systems and Simulation of Austin, TX, offers test-generation for digital systems, fault-tolerance analysis and detection of races, hazards and spikes.

The ever increasing processing power of the newest minis has not been overlooked by the software vendors. Interdata's new 8/32, with its megabyte of memory, will shortly house the program called CYCARDS. This is available on Control Data, GTE-Sylvania and National CSS time-sharing services, and it does single or multi-layer PC board routings. The program, written by Scientific Calculations, Rochester, NY, handles some 400 components and 3000 pins. Subroutines at widely spaced core addresses communicate easily, thanks to the mini's 32-bit memory-address range.

Calculators are also beginning to get their share of some of number-crunching design algorithms. Like the minis, they present the user with a very friendly environment in which to develop programs. In fact, their low cost, ease of use and excellent numerical prowess often overshadow the simple language offered, such as BASIC or algebraic notation. In addition the calculators readily interface with graphics plotters. The plotting speed often exceeds that of a time-sharing service that is sending at the customary 300-baud rate. ■■

### Need more inputs?

For more information on software or time-sharing vendors, the following organizations offer publications and directories:

Auerbach Publisher's Inc., 121 N. Broad St., Philadelphia, PA 19107. (215) 491-8200.

Datapro Research Corp., 1805 Underwood Blvd., Delran, NJ 08075. (609) 764-0100.

International Computer Programs, 1119 Keystone Way, Carmel IN 46032. (317) 844-7461.



# Compare TI's NEW SR-51....

- Mean, variance and standard deviation.
- Automatic linear regression. ● 20 programmed conversions. ● Percent and percent difference.
- Random number generator.
- 3 accessible memories. And much more for only

**\$179.<sup>95</sup>**



More math power for the money. More than log and trig and hyperbolics and functions of  $x$  . . . the SR-51 has these and also has statistical functions... like mean, variance and standard deviation, random numbers, factorials, permutations, slope and intercept, and trend line analysis. Check the chart above—compare it. With the HP-45 or any other quality calculator. Then try it—at no risk. We're sure you'll agree that the SR-51 offers extraordinary value.

FUNCTION	SR-51	HP-45
Log, ln	yes	yes
Trig (sin, cos, tan, Inv)	yes	yes
Hyperbolic (sinh, cosh, tanh, Inv)	yes	no
Degree-radian conversion	yes	yes
Deg/rad mode selection	yes	yes
Decimal degrees — deg-min-sec	yes	yes
Polar-rectangular conversion	yes	yes
$y^x$	yes	yes
$e^x$	yes	yes
$10^x$	yes	yes
$x^2$	yes	yes
$\sqrt{x}$	yes	yes
$\sqrt[y]{x}$	yes	no
$1/x$	yes	yes
$x!$	yes	yes
Exchange $x$ with $y$	yes	yes
Metric conversion constants	13	3
% and $\Delta\%$	yes	yes
Mean and standard deviation	yes	yes
Linear regression	yes	no
Trend line analysis	yes	no
Slope and intercept	yes	no
Store and recall	yes	yes
$\Sigma$ to memory	yes	yes
Product to memory	yes	yes
Random number generator	yes	no
Automatic permutation	yes	no
Preprogrammed conversions	20	7
Digits accuracy	13	10
Algebraic notation (sum of products)	yes	no
Memory (other than stack)	3	9
Fixed decimal option	yes	yes
Keys	40	35
Second function key	yes	yes
Constant mode operation	yes	no

**Test the SR-51 at no risk. Full refund if not satisfied. Master Charge or Bank Americard accepted.**



TO: Texas Instruments Incorporated  
P.O. Box 22013, M/S 358, Dallas, Texas 75221

Try it 15 days. Return with all accessories if not satisfied.  
Enclosed is my  check,  money order,  company purchase order for \$ \_\_\_\_\_ for the purchase of \_\_\_\_\_ SR-51(s).

Please add state and local taxes where applicable.\*  
Please charge this order to my  Master Charge. Or,  BankAmericard

My Card Number is:

With the expiration date: \_\_\_\_\_

If Master Charge is used indicate 4-digit Bank Number appearing on card just above your name:

Name \_\_\_\_\_

Street \_\_\_\_\_

City \_\_\_\_\_

State \_\_\_\_\_

ZIP \_\_\_\_\_

Authorizing Signature (If billed to Credit Card Must be signed by card holder)

\*AL, AZ, CA, CO, CT, FL, GA, IA, IL, IN, KY, MA, MD, MI, MN, MO, NC, NM, NJ, NY, PA, TN, TX, UT, VA, WA, WI. Offer good only in U.S.

**TEXAS INSTRUMENTS**  
INCORPORATED

© 1975 Texas Instruments Incorporated  
13500 North Central Expressway  
Dallas, Texas

83016



# This one resistor can shrink your inventory costs

Type CC. It's a 1/4w size 1% cermet film resistor that far exceeds RN55D specs. Use it for your needs from 1/8w at 125° to 1/2w at 70°C (max. 250 V) and 10 ohms to 10 megs.

TCR is well below 100 PPM/°C. Now available from A-B distributors: 10 ohms to 10 megs off the shelf. Write for publication EC33.



**Quality in the best tradition.**



**ALLEN-BRADLEY**

Electronics Division  
Milwaukee, Wisconsin 53204



# Top computer show unfolds in Anaheim with spotlight on new directions in design

It's called the world's largest show for the computer industry—the annual National Computer Conference—and it's rallying May 19-23 in the Anaheim Convention Center around the theme "Challenges in a New Era": the era of the microprocessor, with its impact on computer architecture . . . of new mass-memory systems offering low-cost, on-line storage of a trillion bytes of data . . . of simplified programming that even a non-Ph.D. can understand.

More computer organizations will be represented in the California city this year than were on hand for last year's show in Chicago. The sponsor, the American Federation of Information Processing Societies, says that 269 organizations will occupy 796 booths, against 246 in 812 booths in 1974. Thirty-thousand visitors are expected to attend, compared with 25,909 last year.

Of the 89 technical sessions, about two-thirds are applications-oriented to the end user. The rest are for computer designers.

Topics of particular interest at this year's show include architecture, storage and microprocessors.

Computer architectures that once would have been economically impossible to develop are becoming feasible with emerging microprocessors, the ris-

Jules H. Gilder, Jim McDermott and David N. Kaye, Associate Editors

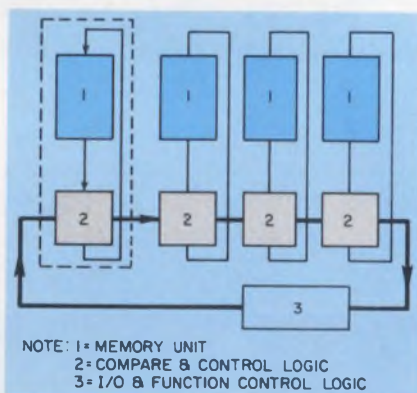

A simple arrangement for a sorting memory is shown above. A segment of the bus is extended to become a memory segment. This consists of a memory unit and the compare and control logic. An additional segment is used as the input-output unit.

ing level of integration of memories and the rapidly falling cost of memory devices, according to Dr. Ugo Gagliardi, director of Honeywell Information Systems Technical Office, Waltham, MA.

Gagliardi, chairman of Session 70, "Impact of New Technologies on Computer Systems Architecture," points out that one of the newer architectures that has become practical is the multiple processor structure.

An excellent example of this architecture is given in a Session 76 paper by researchers from Bolt Beranek & Newman, Inc., Cambridge, MA. A paper, "Pluribus—a Reliable Multiprocessor," is co-authored by S. M. Orenstein, W. R.

Crowther, M. F. Krale, R. D. Bressler, A. Michel and F. E. Heart.

Bressler, a senior computer scientist, points out that to exploit the decreasing cost of system components, researchers have assembled collections of units into multiprocessor systems. The Pluribus line of machines, developed as a switching node in the ARPA network, uses 13 Lockheed minicomputers in the largest configuration assembled to date, he reports.

"In this architecture, multiprocessors are used in a network where all the processors are equal with each other. And each can service any job," Bressler says.

He points out that the processors are treated as equal, both in hardware and in software. Consequently there is no assignment of priority among the processors.

The identity of the processor performing a particular task is of no importance, Bressler notes.

The machine software consists of a single conventional program run by all processors. About one-quarter of the program is stored in each processor, with the remaining three quarters in a common memory.

Bressler sees the system, which has a bandwidth of 7.5 Mbits, as suitable for communication schemes, where the computer power is not directed towards extended computations but where modularity and reliability are important. In this system, he points out, no one



piece is vital to any given task. If one piece breaks, another takes over.

With this architecture, Bressler comments, the machine can be built in a small configuration to handle small bandwidths, or in a very large configuration for large bandwidths, without any significant change in the program.

A somewhat different architecture is discussed in a Session 76 paper, "Microprocessor-Based Multiprocessor Ring-Structured Network," by Hoo-min D. Toong, assistant professor of electrical engineering and computer sciences at the Massachusetts Institute of Technology.

"The microprocessor has really opened up the area of intelligent networks with data base and resources that are truly shared," Toong says.

"The ring structure is a totally different architecture. In contrast to structures like trees and graphs, it provides for communications applications, reliability, simplicity of design and relatively low cost.

"We're implementing a ring network now in which, in this case, Intel 8080 microprocessors are used as intelligent nodes on a ring structure. But the scheme is independent of the type of microprocessor used."

The microprocessors give a great deal of flexibility in the type of resources that can be interfaced into such a network, Toong says. One resource category is peripherals. Other computers can even be connected into the ring. The "resource" doesn't necessarily have to be a hardware device.

But some of the problems of the ring structure under study are programming language and the operating system in such structures, Toong reports.

At present, he notes, software is a bottleneck. This was true with minicomputers, he observes, and it's now true of microprocessors.

In another paper, Prof. P. M. Thompson of the University of Ottawa, Canada, points out that in a system organized to sort data according to any set of descriptors, the main limitation to speed lies in communication between the parts of the store.

A solution to the communication problem is provided by the

segmented bus, Thompson points out in the Session 82 paper, "A Data-Sorting System Using a High-Speed Bus." The segmented bus is used in its simplest form for the sorting array, he notes.

Words are transmitted by being clocked from segment to segment in "carriers" along the bus. If there is an empty carrier, Thompson says, words can be entered at the input-output segments.

If empty carriers are present at appropriate ports, it is possible to enter several words at the same time, Thompson says. And in like fashion, several words can be put out at the same time.

However, Thompson points out, as a word is sent out, its place can be taken by a new input word.

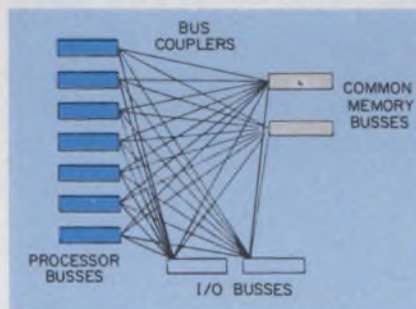

In the Pluribus multiprocessor architecture a novel feature is treatment of all processors as equal units. The hardware is joined together by special bus couplers that permit units on one bus to access those in another.

The advantage of this operating structure, Thompson says, is that the segmented bus permits communication between one pair of ports without preventing it between another pair. Or it can provide communication between several pairs at the same time.

Thompson notes that the whole system, including bus and input/output units are clocked at the same speed. ■■

There long has been a need for a peripheral system with low-cost, on-line storage of a trillion bytes of data, with no manual intervention. With the recent announcement of IBM's 3850 mass-storage system and a new mass-memory about to be unveiled by

Control Data Corp., the impact of such huge storage systems is about to be felt throughout the computer industry.

Control Data's hopes for success of the new memory system are based not on parity, but on tangible advantages over the 3850. These include:

- Faster average access to any byte of information.
- Faster transfer rate of data.
- Plug compatibility with existing IBM hardware.

Information on the new memory system will be spelled out in presentations in Session 48. William F. Morgan, Control Data's executive consultant for peripheral products, points out why a mass-memory system is desirable and what characteristics it should have. A key point he brings out is that it is not at all uncommon for a system to require 2000 magnetic-tape reel mounts a day. This is very costly and time-consuming, he points out, and makes attractive the use of some mass-memory systems that make data automatically available.

Details of the new memory are given by Gary E. Puffett, manager of mass-storage systems at Control Data, in his paper, "A Mass-Storage Facility."

The new system has total capacity of about 21 trillion bytes and average access time of only 7 sec to any byte of information, compared with the 10 sec needed by the 3850.

C. T. Johnson of IBM in Boulder, CO, counters the Control Data assault on IBM's three-month reign by presenting the good points



Vast amounts of data can be stored on data cartridges housed in the honeycomb storage compartments of the IBM 3850 mass storage system. Two cartridges can store the same amount of data as one disc pack.



of its 3850 mass-storage system.

Among the things Johnson notes is that the 3850 has total storage capacity of 35 trillion bytes—14 trillion more than the capacity of the Control Data memory.

And the IBM data-transfer rate is 874 kilobytes/sec, Johnson says. At first glance, this rate looks like an advantage over the Control Data unit. But because of lower reliability of the helical-scanning technique used to read out data,

the IBM system needs a lot of error correction. This slows the system to an actual transfer rate of about 200 kilobytes/sec.

The Control Data system doesn't have this problem, and its 806-kilobyte transfer rate is the actual transfer speed.

Another interesting feature of the Control Data unit relates to the interfacing of the memory. IBM's 3850 requires a new controller—the 3803. The Control

Data memory doesn't. It can plug right into the 3832 controller, which is existing IBM hardware.

The race between IBM and Control Data is only the beginning. Other companies are working to develop mass-memory systems that will eliminate the need for people to handle memory media. Both the IBM and Control Data systems make possible on-line storage at off-line cost.

### Enter electron-beam memories

Another mass-memory discussed at Session 48 is an electron-beam memory from Micro Bit Corp., Lexington, MA. In a paper on "Bridging the Memory Access Gap," Dennis Speliotis, manager of advanced systems, describes a prototype system that was delivered for evaluation to Control Data three months ago and a product line that will be introduced by the end of the year.

According to Speliotis, an electron beam is used to read and write data into a specially designed storage tube. The prototype system consists of nine tubes, each with a capacity of 128 kilobits, for total storage of 1.2 megabits. It is being used with a Star 1B computer, a scaled-down version of the Control Data Star computer.

The product to be introduced by the end of the year is known as the System 7000, Speliotis notes. It will consist of 18 parallel storage tubes, each with a capacity of 4 million bits, for total system storage of 75 megabits.

Speliotis points out that the electron-beam memory has six extra tubes, used to accommodate a 6-bit Hamming code that can correct a single error and detect double errors.

The access time of the electron-beam memory is  $5 \mu\text{s}$  to a block of data. Once at the correct block, the system requires only  $0.5 \mu\text{s/bit}$  to read out data. Thus, for the 18-tube system, data can be read out at 36 megabits/sec. Writing, Speliotis says, is four times slower than reading.

Discussing costs, Speliotis points out that the OEM price for a plug-compatible system is only 0.04 cent/bit.

Applications for electron-beam memories, he says, include replace-

Three decades of design experience and demonstrated performance has led to one of the most versatile photometer systems today: the Spectra® Pritchard 1980. Offering *high sensitivity*, interchangeable optics, *zero polarization* and *automatic readout*, our 1980 has become the industry standard for measurement of luminance (brightness), uniformity, contrast and MTF of all kinds of displays — including CRT's, liquid crystals, LED's and gas discharge.

The 1980 can measure displays as fine as 0.0001" (0.0025mm) diameter — from pitch-dark ( $10^{-5}$  fL) to sun-bright ( $10^7$  fL). NBS-traceable calibration is maintained by a built-in, highly stable calibration light source.

For full data, write for brochure. Or call collect.

**PHOTO RESEARCH**  
The light measurement people

3000 No. Hollywood Way, Burbank, CA 91505  
(213) 849-6017 • Telex 69-1427

A Division of Kollmorgen Corporation

### The 1980 Pritchard®





ment of head-per-track discs and main-memory add-on, if a cache memory is used with them.

The head-per-track disc replacement looks particularly attractive, Speliotis notes. Current discs, such as the IBM 2305, have an average access time of 2.5 ms and an OEM cost of between 0.12 and 0.2 cent/bit. This doesn't compare very well with the 5  $\mu$ s and 0.04 cent/bit of the electron-beam memory.

In the main-memory add-on application, Speliotis notes that by use of a cache memory, the electron-beam can match the performance of the IBM 370/158 memory.

### Novel memories described

At Session 55, electron-beam memories are also being discussed, along with other "novel memories," such as holographic and Josephson.

In a paper on "BEAMOS—A New Electronic Digital Memory," William C. Hughes, a program manager at General Electric's R&D facility in Schenectady, NY, discusses an electron-beam memory that uses a target constructed from four pieces of silicon. Unlike the two memories described by Micro Bit's Speliotis, the GE system is capable of storing 32 million bits per tube. The access time is 30  $\mu$ s, and the cost for storage on a systems level is only 0.02 cent/bit.

According to Hughes, the basic storage principles are the same for both systems, but GE uses a different technique for reading out data. This accounts for the higher storage capability.

The large quantity of data, he



**Holographic techniques** can be used to permit 4-by-6-inch microfiche cards to replace 2400 ft reels of tape. A prototype of the system has been delivered to the Air Force's Rome Air Development Center.

notes, is accessed by a matrix lens. This consists of an 18-by-18 array of electronic lens-deflection systems that divide the 32 megabit array into that many parts. Each lens thus has access to a smaller area of the total storage plane.

Hughes indicates that the 32-megabit module has been successfully constructed and tested and that commercial development is close at hand. Hughes indicates that it will take at least another

year until a final memory system will be commercially available.

### Film is better than tape

Some companies looking at the mass-memory market believe that film is a better storage medium than tape.

One of these is Harris' Electro-Optics Operation in Melbourne, FL. In a paper on "Holographic Memories: Fantasy or Reality?"

**OptimaDesk...  
the data console  
with the one thing you've  
been waiting for.**

**Everything.**

Every feature you'll ever conceivably want, including the ones that cost extra in other data consoles (rolled front edge, chrome legs and the like.) Every color from Burnt Orange to Sky Blue to Black; fourteen standard colors in all. Standard widths are 24", 45" and 66", each in a choice of keyboard or desk heights. And the two styles you see here are just the beginning.

Above all, the OptimaDesk is the finest quality furniture ever built for electronic instruments. And the price is right. The 45" model is around \$239, for instance.

Write to us for complete information.



**OPTIMA<sup>®</sup>**

Optima Enclosures, a division of Scientific-Atlanta, Inc. 2166 Mountain Industrial Blvd., Tucker, Georgia 30084 or call (404) 939-6340



A. Knox Gillis points out that magnetic-tape memories have a tendency to degrade with time. To make sure that the stored data remains retrievable, it is necessary to re-record it every few years.

In contrast with this, Gillis notes, data recorded on film are permanent and need not be refreshed.

But the availability of holographic memories to the computer industry will be limited during

the next 10 years to archival read-only types, Gillis says. The reason, he adds, is that there are still many problems to the production of read/write holographic memories, including the perfection of light valves and page compositors to organize the data.

In the meantime, read-only holographic memories are close to commercial application, Gillis reports, with Harris already having delivered a working memory to

the Air Force. It uses a synthetically fabricated hologram (see "Optical Data Systems Find a Niche in the World of Fast, Fast Computing," ED No. 9, April 26, 1974, p. 126).

With this approach, it is possible to store all the data normally held on a 2400-ft magnetic tape on a single microfiche card. If improved interferometric recording techniques are used, that same amount of data can be stored on a square centimeter of film, Gillis says. ■■

## The inside story of the amazing new \$31 Compact 1.

Take a close look.

Beneath the handsome exterior of Zero's new VIP Compact 1 you'll find a feature you've never found on a \$31\* instrument enclosure before. Those rugged steel and aluminum panels are hiding a removable chassis. Which means you can now easily build up your equipment on the free chassis, and then simply re-assemble the enclosure around it.

A result of thorough design, Compact 1 delivers an amazing new level of quality, strength, efficiency and economy. If these are your requirements for a small instrument enclosure, you've found what you've been looking for. We're ready to ship any of the twelve standard sizes to you within two weeks.

Write for your free catalog today.



The Final Touch

\*From \$30.80 to \$38.65 in quantities of 50.



ZERO MANUFACTURING CO.  
Burbank, CA 213/846-4191 · Monson, MA 413/267-5561 · Clearwater, FL 813/531-8991

**H**ow do you use microprocessors efficiently? Four sessions at the conference—11, 17, 23 and 29—are devoted to this topic, with heavy emphasis on improved software.

A Session 11 paper describes how the use of 16-bit instructions and address-word lengths, plus multiple accumulator architecture, can make programming easier and more efficient. In this presentation, Alan Weissberger of National Semiconductor, Santa Clara, CA, uses the company's Pace—the industry's first 16-bit microprocessor—as an example.

With the Pace, Weissberger notes, the instructions and operands are fetched in single memory cycles rather than the multiple memory references required for byte-oriented data or instructions.

"This enhances system throughput and improves program execution time," he says.

The need to develop more and better software for microprocessors is also emphasized in two Session 29 papers. Louise H. Jones of the University of Delaware, looks at instruction sequencing in a variety of microprogrammed computers. She considers both microprocessors and minicomputers and concludes that most current microprogrammed computers use inefficient instruction sequencing routines. She calls for a more structured technique of microprogramming to allow easier implementation of control logic.

In another Session 29 paper, Gary A. Kildall of the Naval Postgraduate School in Monterey, CA, reviews microcomputer software design. He notes a trend toward higher-level languages, such as



PL/M from Intel and PL/M+ from National Semiconductor, to make the programming of microcomputers easier. He also sees a trend away from external cross-assemblers and toward inexpensive internal assemblers.

The fastest and most efficient method of transferring data between a microprocessor and external systems is analyzed in a Session 11 paper by Gary Sawyer, an applications engineer with Motorola Semiconductor, Phoenix, AZ.

For the transfer of data within microprocessors, Sawyer points out, the most commonly used technique is to send the data from the memory through the processor and then to the outside.

A second technique, direct-memory address, transfers data directly between memory and external systems, Sawyer explains, thereby bypassing the processor. This method is always faster, but it requires more hardware.

### Bipolar slices for speed

When speed is of primary importance, bipolar microprocessors are the choice of many designers over the MOS variety.

In a paper in Session 23, Marcian E. Hoff Jr. from Intel Corp., Santa Clara, CA, tells how to make a central processor from bipolar microprocessor components.

The company uses two-bit slice processors. Each slice contains arithmetic, logic, register and data-bus portions of a computer central-processing unit. These slices can be used together to form a computer of a desired word length.

David C. Wyland of Monolithic Memories, Sunnyvale, CA, describes a 4-bit slice bipolar processor made by his company. He also compares alternatives to choose microprocessors.

"The single-chip microprocessor has the lowest system cost, along with moderate performance," he says. "The multiple-chip design, with a dedicated instruction set and dedicated control chip design, results in high performance at moderate chip count and price. The multiple-chip design, using general-purpose control and data-flow chips, results in high performance and a flexible design

with somewhat higher chip count than the custom multichip approach. However, it has similar system costs, due to the use of high-volume chips."

### Putting them to work

The first microprocessor-based oscilloscope was the 1722A from Hewlett-Packard, Colorado Springs, CO. Walter A. Fischer, in a Session 17 paper, "The Syn-

ergistic Combination of an Oscilloscope and a Microprocessor," describes the 1722A.

"The microprocessor adds an order of magnitude more accuracy to the standard oscilloscope, by providing greater resolution and readability than had previously been possible," Fischer notes. "Specifically, better than 1% measurements can be made on time intervals as small as 30 ns or 4% of full scale." ■■

## This is a rack-full of counter capability.



HP's new 75 MHz Timer/Counter is easily held in your hands. Take a look at the front panel: Never before has there been so much counting capability in such a small package at such a small price. Seven other modules snap on to convert to other instruments — including a DMM — or to connect to the HP Interface Bus.

Features include: 1 nsec time interval averaging • autoranging of frequency, frequency ratio, period average, time interval average • full complement of triggering controls, monitor LEDs • preset ECL and TTL thresholds • an astonishingly low price of only \$910\* total for 5308A module with 5300B mainframe. \*Domestic USA price only.

**HEWLETT**  **PACKARD**

Sales and service from 172 offices in 65 countries.  
1501 Page Mill Road, Palo Alto, California 94304

02503



# Our plastic 400V TO-92 SCR.

**We'll help you put it to work,  
even if you've never used  
an SCR before.**

Meet our new plastic TO-92 SCR:  
800mA RMS, 400V, with  
200 $\mu$ A gate sensitivity and a  
maximum holding current of  
5mA. It sells for less than 50¢  
in quantities of ten thousand.

If you know SCRs, you know you  
can't get anything like it at the price.  
(Except our plastic 300V SCR,  
which is even less expensive.)

If you don't know SCRs, we'll  
introduce you. Our introductory kit  
includes dozens of designs and  
descriptions for a variety of SCR  
applications. It'll help you take  
advantage of the fast, low-cost  
power-handling capability that SCRs  
deliver in high voltage circuits.

Just fill out the coupon at right.



I'm using SCRs now, and I'd like to evaluate your new low-cost 400V SCR.

I've never used an SCR before, but I sure am interested in them. Please send me your introductory kit.

Name \_\_\_\_\_

Title \_\_\_\_\_

Company \_\_\_\_\_

Address \_\_\_\_\_

City \_\_\_\_\_ State \_\_\_\_\_ Zip \_\_\_\_\_

Mail to: Mr. V. Savoie  
Unitrode Corporation,  
580 Pleasant St., Watertown, Mass. 02172.



**UNITRODE**



# Stepping outside

When visitors would arrive a few minutes late for an appointment with Joe Fleet, he would refuse to see them—regardless of how much they could help him or his company. In Joe's mind this taught them a lesson—just as one teaches a lesson to naughty schoolchildren. In the process, and Joe probably wasn't aware of this, it established his authority and made him feel important. The psychology books I used to read would probably suggest that Joe was misdirecting hostility and compensating for deep-seated inferiority feelings.

Joe works hard for his company. Building it is one of his passions. Yet he has hurt his company on many occasions because engineers who can get other jobs prefer not to work with him; customers who can find alternate suppliers prefer to avoid him (though he's nicer to customers than to vendors and co-workers); and suppliers (whom he tries to eat for breakfast) turn him off at the first sign of a seller's market.

Joe is by no means stupid. So he senses a lot of the hostility and sees it as further proof that "people are no damn good." Most people who know him feel it's a pity Joe has that hang-up—that need to put other people down all the time. Wouldn't it be great, they say, if Joe could step outside himself for a while and see himself as others do. It probably would be.

But very few of his observers suspect that their vision of themselves might be imperfect. Possibly because nature tries to protect us from unpleasantness, most of us can't see our own hang-ups. It's easy for us to see how Joe's behavior hurts Joe and his company. Joe can't see it. But Joe can see us. He may wonder sometimes if it wouldn't be wonderful if we could step outside ourselves and see ourselves as others do. Would it?



A handwritten signature in cursive script that reads "George Rostky". The ink is dark and the signature is fluid and somewhat stylized.

GEORGE ROSTKY  
Editor-in-Chief



# Don't forget NITRON for off-the-shelf ROMs. At competitive prices.

If you're a communications or computer equipment manufacturer, you should know more about NITRON. We're a high-volume producer of a broad line of N-channel read-only memories (ROMs). We can meet your needs with a completely new line of off-the-shelf or mask-programmable

devices (all exact replacements for Motorola units) that represents state-of-the-art technology at competitive prices.

Before you forget, check the items that interest you in the coupon below. We'll supply the facts you need, promptly and with no obligation.

**NITRON** A division of **MCDONNELL DOUGLAS**



NITRON  
10420 Bubb Road, Cupertino, CA. 95014

Please tell me more about the ROMs I've checked below,  
each corresponding to the Motorola MCM series number.

NAME \_\_\_\_\_ COMPANY \_\_\_\_\_

TITLE \_\_\_\_\_ ADDRESS \_\_\_\_\_

CITY \_\_\_\_\_ STATE \_\_\_\_\_ ZIP \_\_\_\_\_

High-speed, low-power, N-channel, 8K and 16K ROMs:

- NCM6560 Series 1Kx8 or 2Kx4 (mask programmable) ROM
- NCM6570 Series 128x7x9 row character generator (mask programmable)
- NCM6580 Series 128x7x9 column (mask programmable)
- NCM6590 Series, our *all-new* 2Kx8 (mask programmable)



ITEMS SHOWN AT APPROXIMATELY THREE TIMES ACTUAL SIZE

PC BOARD TO MOTHER BOARD (OR CHASSIS)

## choose your terminals

On most all AirBorn subminiature connectors for printed circuit board or conventional inter-connection applications, you can choose soldercup, dip terminal, Wire-Wrap\* post, or crimp barrel terminations. For information on AirBorn's entire subminiature line, call 214/233-2000 or write our Dallas plant at 4321 AirBorn Drive, Addison, Texas 75001.

\*Registered trademark of Gardner-Denver Company

# AirBorn, Inc.

# Dialight sees a need:

(Need: The widest choice for your every application.)

**513 SERIES** With bezel for snap-in panel mounting. Alternate, momentary and snap-action contacts with ratings to 5 amps. N.O., N.C. and two circuit (one N.O., one N.C.). Low level switches also available. Round, square and rectangular bezels in four colors; caps from 1/2" to 1 1/2" in more than 12 colors. Illuminated caps with or without legends. **UL listed.**

**PUSH BUTTON CAPS** Round, square and rectangular shapes in wide variety of sizes and colors. With hot stamped, engraved or film legends.

Dialight, the company with the widest choice in switches, LEDs, indicator lights and readouts, looks for needs . . . your needs . . . and then they develop solutions for your every application. No other company offers you one-stop shopping in all these product areas. And no other company has more experience in the visual display field. Dialight helps you do more with these products than any other company in the business, because we are specialists that have done more with them. Talk to the specialists at Dialight first. You won't have to talk to anyone else. Send for your free new copy of Dialight's current catalog.

**DIALIGHT**  
Dialight, A North American Philips Company  
203 Harrison Place, Brooklyn, N. Y. 11237  
(212) 497-7600

# See Dialight.



# FOCUS

on  
Uninterruptible  
power supplies  
and  
inverters

Few spec sheets contain all the information you'll need to specify the right inverter or to put together a trouble-free UPS (uninterruptible power supply) system. The problem exists not just because of the pressures of competitive spec writing—of which there are plenty—but because vendors can't characterize a UPS or inverter completely without knowledge of the application. And, of course, the applications are limitless.

Like a piece in a jigsaw puzzle, an inverter/UPS must be a perfect fit with its adjoining sections—the prime power source and load. If it doesn't fit, you've got trouble. To avoid a migraine, take this advice: Don't start selecting a unit until you've investigated both your source and load and know both intimately. What you'll uncover may surprise you.

## A source of trouble

Brownouts . . . blackouts . . . dips . . . surges . . . EMI . . . spikes . . . fast transients. More and more, these are some of the unwanted extras that come with power, be it utility, battery, system source or whatever.

Indeed it's because of the increasingly poor quality of the ac power mains that the UPS has become essential for computers and other critical loads. And even battery sources—which power inverters in portable and other equipment—are subject to voltage dips, noise and spikes fed back from other loads hooked to the common system line.

Surprisingly, many users of ac line power don't realize how unconstant the line actually is or what undervoltage, overvoltage or transient con-

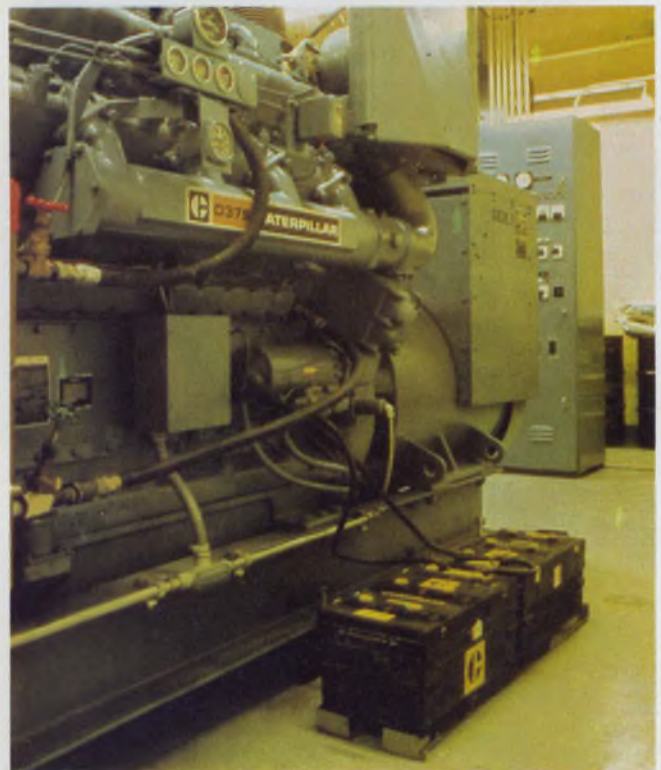

After providing 15 minutes of protection, the battery bank for a 360-kVA UPS from Cyberex Inc. has done its job, and a back-up engine generator takes over.

ditions can do to equipment.

Because of drops in the distribution system from the source to the point of use, the steady-state voltage can be cut by up to 12% under normal conditions. Add to this the dynamic loading effects caused by start-ups, shutdowns, load switching, lightning and other problems, and you get this typical picture:

In a metropolitan area, expect major faults

Stanley Runyon  
Associate Editor



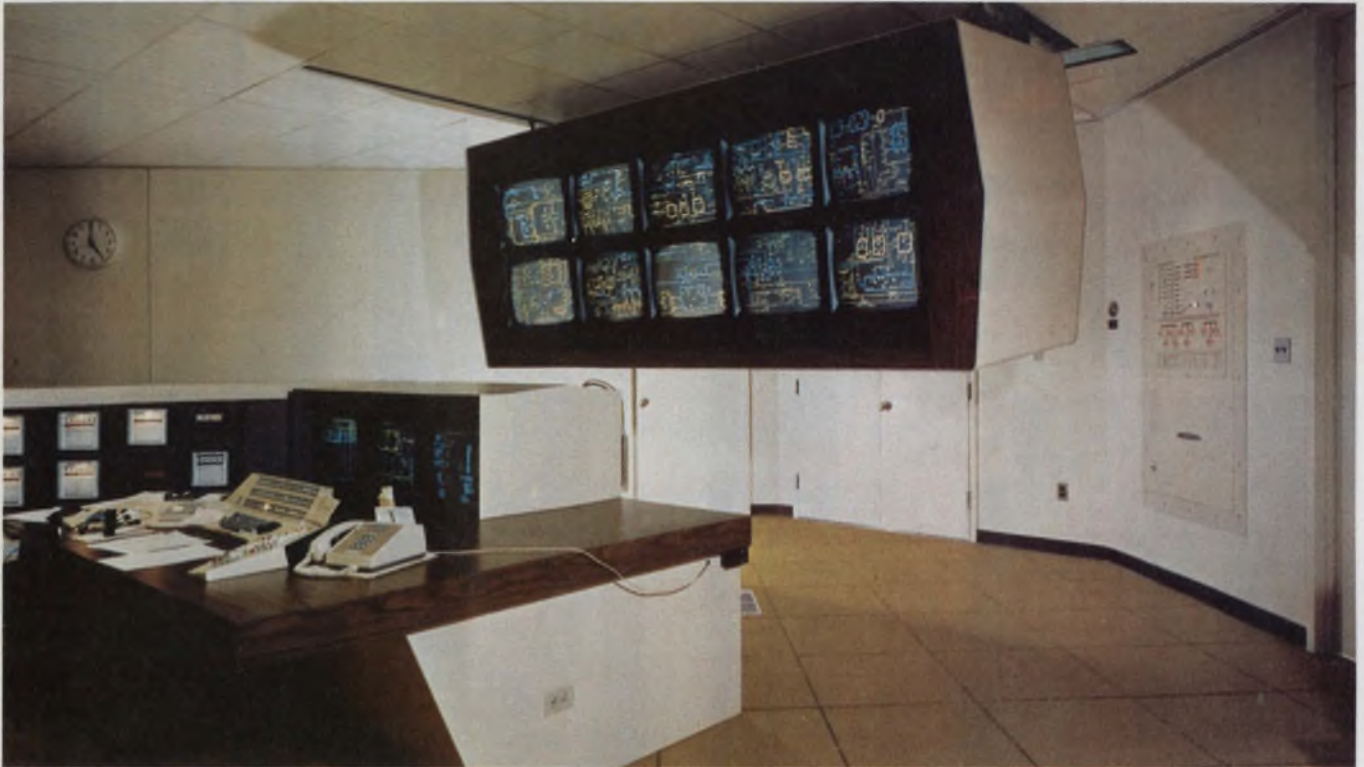

To ensure no power failures at an electric utility's control center, an Exide Superguardian UPS powers the crucial computer. A remote-control console displays the UPS system status (top), while three rectifier/chargers form the heart of the supply, backed up by two 192-cell lead-acid batteries (left).



do so on undervoltage. Still other machines are sensitive to transients.

Generally computers can stand  $\pm 8$  to  $\pm 10\%$  variation in line voltage and  $\pm 0.5$  to  $\pm 3\%$  in frequency, but this depends on the computer. Based on the experience of IBM, you can expect from 25 to several hundred processing errors yearly from power-line disturbances in some installations.

with a 75% voltage drop—or more—about 10 times a year. Minor faults, with drops to 25%, will occur 500 to 1000 times a year. And transients and spikes will occur more than 10,000 times yearly, with surges zooming to 2000% and lasting up to 10 ms.

To top it off, countless smaller fluctuations can also be expected, and like the other dynamic faults, they are unpredictable and difficult to measure. These are the “normal” line conditions—excluding brownouts, which can snip up to 8% more from the normal level.

What are the effects of momentary dropouts or voltage deviations? In computers, look for malfunctions, processing errors and loss of valuable memory if the failure lasts for more than a few cycles. A slight overvoltage will cause some computers to malfunction, while others will

#### Low line can flatten the load

In other types of equipment, let the line drop just 10% below the 120-V nominal and these things can happen: Motors give 19% less torque, run almost 10 degrees hotter and burn out faster. Solenoids take 20% more time to actuate and give 20% less holding power. A battery's charging rate drops 20%—as does the output of electrical heaters. Grinders remove 25% less metal, and fluorescents put out 15% less light—and can be damaged. The list goes on and on.

The moral is this: Know your source. You can't specify a UPS adequately until you've pinned down all the line conditions that the UPS will see at its input end. To do this, you'll have to chart a history of disturbances at your equipment's power input over a fairly long period of



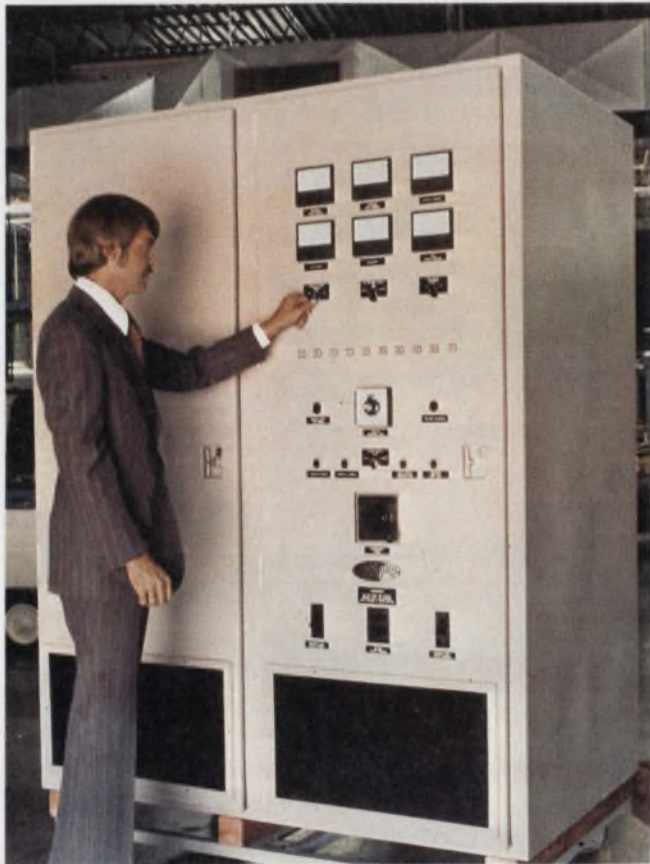

Meters keep track of voltages, currents, frequency and other parameters in International Power Machine's 125-



kVA UPS (left). The system includes a rectifier/charger, inverter and static and manual switches (right).

time—say, at least a year.

This requires monitoring equipment—not just chart recorders or voltmeters, but high-speed recording voltmeters or transient recorders—instruments that can grab and hold split-second fluctuations. When you're through, you should have numbers for nominal line voltage and frequency, a history of dropouts and variations, including amplitudes and durations, and a description of noise or distortion on the line.

Other information may be needed, especially in large-scale installations. Included here is the current capacity of the prime power source, the maximum available short-circuit current at the UPS input terminals, the impedance of the source (to determine input harmonics) and other factors—in short, a complete power profile.

No less important to a UPS (or inverter) is what it sees at its delivery end—at the load. You can't rate a UPS or define its operating characteristics until the load is completely defined. This means going beyond a simple match of the load's kVA rating to that of the UPS. It means that you've got to know the load's power factor and magnitude, as well as what the load can tolerate in voltage and frequency variations, harmonic distortion, noise, transients and the like.

The "load," of course, means all equipment that will be tied to the UPS or inverter. Com-

puters, peripherals, cooling systems, relays, motors—all should be included. Remember that the power factor of a typical equivalent load is usually around 0.8 lagging—not 1.0 as is commonly supposed. If the figure drops below 0.8, you'll probably need some correction for power factor.

#### Curiosity doesn't kill

To define the load fully, ask some additional questions: Is my load nonlinear? Is it fixed or does it vary? What about current in three-phase loads—is it unbalanced? What is the maximum down time my load can stand? Does the load pull a high in-rush current at start-up? If it does, for how long?

In-rush current can pose a particularly sticky problem to a UPS or inverter. If in-rush is forgotten—as it often is—you'll end up with a supply that can't handle the load. When you turn on the power, the supply will probably go into a current-limiting mode and drop the output voltage.

You can get around the in-rush problem in a number of ways. You can spend a lot more and get an oversized system that can handle the peak currents. Or you can use a switching scheme in which the load starts from a higher



current source—like the utility line—and then transfers automatically to the UPS/inverter when the current falls to its nominal operating level.

Such transfer is usually accomplished by what UPS vendors term a static transfer, or bypass, switch. The switch, which can do the job in 4 ms or less, can have other duties as well.

When you consider in-rush, don't forget that of the UPS itself. When ac power returns after an outage, current can zoom to full value in a short time. If the surge is too fast or severe, it can disturb other equipment on the utility line. If you're really unlucky, the surge will trip a circuit breaker or knock out a standby generator—and there goes your critical load. The solution here is a power "walk-in" or current-limiting circuit.

After you've learned both your source and load—especially what the former can do and what the latter can take—check into the UPS/inverter itself. When you do, be prepared for an uphill specifying job.

### Spec it, don't design it

You may think that a product that can cost as much as \$250,000 or even more is bound to be fully and accurately specified. Don't count on it. In specs like efficiency, transient response, regulation and even power rating, there are traps for the uninitiated. Other specs hurt in another way: by their omission.

If manufacturers "inadvertently" underspec, engineers tend to do the opposite—perhaps because they've been burned before. Be cautious. But don't try to design the UPS. It'll be hard enough to determine performance, much less tell a vendor how many SCRs to use or what battery bus voltage.

The heart of any UPS is its inverter. Consequently most important UPS specs center on the inverter. In general, most inverters fall into three major categories, depending on the end use: (1) The OEM, limited-power (< 200 W) inverter; (2) The high-power inverter built specifically for a UPS system, and (3) The static inverter aimed primarily at airborne, mobile and military markets.

All inverter types change dc to ac. Of the three types, the OEM often delivers square waves, while the high-power and static, by and large, provide 60 or 400-Hz sinusoidal power. But regardless of type, all inverters are power supplies and must be specified as such.

As in any supply, regulation is a key spec. It can be defined as in PY1-1972, the NEMA standard for dc power supplies. But many vendors have their own approaches. Regulation is often given for variations other than full to no

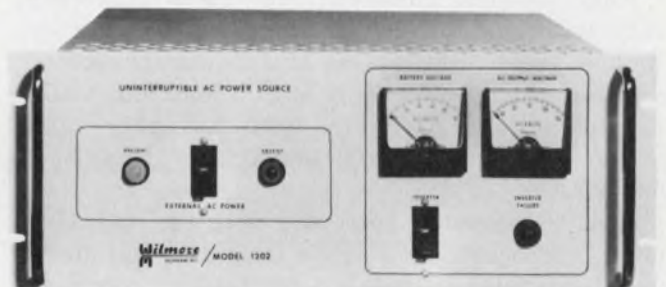

Interest in UPS protection is growing, not just for high-power uses but for smaller loads, too. Fulfilling that need are such units as Wilmore's 1202 (bottom)—at 250 VA one of the smallest UPS units around—the Topaz 3-kVA unit (center) and Elgar's UPS-252-1 (top), a 2.5-kVA supply.

load, or regulation is listed without stating other necessary conditions.

As a result, you can't compare competitive products safely for regulation. To do so, you must know this: What is the regulation for full load and line variations? Does frequency alter regulation? How is regulation affected by temperature? What load power factor was used to measure regulation? (Some units don't regulate well at < 0.8 factors.) Exactly what is the worst-case regulation?

On the other hand, bear in mind the common tendency to buy more regulation than your load



actually needs, just to be "safe." This can turn out to be costly in terms of money, equipment size and cooling requirements. So avoid extra tight regulation.

One spec you shouldn't avoid, even if the vendor does, is efficiency. Though the definition of efficiency is simple (power out over power in), it's tough to find out how efficient a supply is.

### Keep cool with high efficiency

Obviously the higher the efficiency ( $\eta$ ), the less the drain on the battery for the inverter or UPS. Conversely, the higher the  $\eta$ , the smaller the battery needed for a back-up period. Perhaps most important, a highly efficient supply needs less cooling or heat sinking, lasts longer and is generally more reliable.

So vendors like to boost efficiency as much as possible. But watch out. If they can't do it technically, they may try to jack it up with a pencil. Some deceptions are obvious; others aren't.

First, efficiency should be calculated by division of output watts by input watts—not volts-amps. Second, a lone figure for  $\eta$ , without qualifications, can mislead. The listed value may be that of the inverter alone. But what about the rest of the system? Static switches, rectifier banks, charging circuits—all of these dissipate power and cut into the  $\eta$ . Are they included in the figure?

Ask another question: How does efficiency vary with line and load changes? An  $\eta$  of 85% sounds great. But unless stated otherwise, the number usually holds only at full load and nominal line voltage. At lighter loads or higher input levels,  $\eta$  is sure to drop appreciably. Just how much? Ask.

Because efficiency does vary with the operating point, and because it's easier to define than measure, be careful in making competitive comparisons. Measurements of  $\eta$  can be way off because current waveforms aren't necessarily sinusoidal. This leads to large errors in average-responding instruments that are calibrated in rms value. In fact, one inverter vendor claims that when source impedance is considered along with complex current, only a thermodynamic (calorimetric) measurement of power loss can give a true picture.

If you buy a unit that has more capacity than you now need—in anticipation of future load growth—remember this: Since the system won't be working at capacity, it probably won't be as efficient. This leads to more source drain than you expected and increased heat—which must be removed.

Some inverter vendors don't spec efficiency at all. With the  $\eta$  missing, a potential user may think he can bury the inverter in a dead airspace



**Massive power source on wheels:** one of three Teledyne Inet inverter switching sections, mounted on rollers for maintenance convenience.

with little or no heat sink. But  $\eta$  isn't 100%, and you've got to remove the heat or risk a frizzled inverter. Other vendors are more generous: A fine-print spec in the footnote tells you to stay below a base-plate-mounting temperature. How do you do it? That's left to your imagination.

Heat removal in any supply is not easy. But keep in mind that a 10-C increase in temperature can double the failure rate of SCRs or other semiconductors. Batteries also wince at temperatures other than 25 C. Lower temperatures cut into capacity, while elevated ambients ( $> 30$  C) slash battery life expectancy. Besides temperature, look into altitude, humidity, vibration, shock and potentially corrosive atmospheres. All can affect performance.

Batteries can cause their share of problems in other ways, especially in large UPS systems that literally need a room full of them. The first problem with batteries is how to specify one.

### Powering a flashlight is one thing . . .

Sizing battery systems can become so complex, in fact, that at least one vendor uses a computer to do the job. Besides battery type (the most commonly used are lead-calcium, lead antimony and nickel cadmium), you've got to establish ratings for such parameters as ampere-hours,



end, float and equalization voltages, full-rated and short-circuit (overload) currents, projected life, charging times and other factors. No less important are the requirements for battery connections, protective circuits and personnel safety.

Perhaps the best approach is to ignore the details. Tell the vendor how long the battery must support the load—the full load—and let him do the rest. Then hold him to the contract.

Remember that as the back-up time goes up, so does the battery and charger size, cost and the electric bill. Large battery systems are also potentially dangerous and require preventive maintenance.

So keep back-up to a minimum. For a computer, the usual battery capability runs between five minutes and one hour—enough time to sew up the computer, ride through the outage, or connect to standby motor-generator power if a sustained loss is expected. For other applications, like phone exchanges, batteries can work for up to eight hours. (Battery chargers are usually sized for 8, 12 or 24-h recharge.)

Be aware that if the vendor can't maintain the battery float voltage for any reason—like scrimping on charger design so that at low-line voltages the battery isn't kept fully charged—you probably won't get the specified back-up time. Take a good look at the charger's capabilities.

Remember, too, that UPS or inverter specs can change as the battery runs down. Overload rating, for instance, may be given at full output voltage, with no mention of dc input voltage. But overload rating can plunge significantly as the battery discharges—and in some designs can disappear completely. Where is this stated on the data sheet? In many cases, it isn't.

Overload, current-limiting, fault-clearing protection and start-up in-rush are all related, of course. Check them all out together.

Overload is one area to be watched, for other reasons. Many inverters are touted to be current-limiting at some overload point—say, 125 or 150%. What you aren't told, though, is that the inverter can't deliver the overload current long enough to clear the fault—that is, to trip or blow the protective device. Watch for this.

With some equipment, not only may specs be missing but hardware, too. To get the rated performance, you have to add external components—such as filters, transformers, fans and other goodies. Even when you seem to be getting something, you may not be. One inverter vendor has generously provided extra windings on his output transformer in case the input drops to 20 V or less. But in his eagerness to give more, not less, this vendor forgot to mention that the user must add switching circuits to ensure continued operation at low input voltage.

Another unfulfilled promise: static switches that aren't. A true static switch should be solid-state. But some manufacturers use semiconductor switch sections on the ac-line side and substitute electromechanical contacts on the inverter side. Consequently you can't switch fast to clear a fault or if the inverter fails. Check for this. While you're at it, check into another area often ignored by inverter suppliers: transient performance.

### It's a dynamic world

Though you may find it tough to determine an inverter's dynamic characteristics, don't give up. One vendor candidly admits that transient or dynamic behavior can make or break system performance.

What you have to pin down are such specs as dynamic impedance and regulation, damping, recovery characteristics, duration and amplitude of voltage excursions (max and min), and other factors. When you do, watch for deceptions. For instance, transient response, or regulation, during a load change can be made to look good simply by limits on the specified change. Thus while some vendors list a 100% step load variation, others use 50% or even 20%.

Games are played with recovery time, too. A unit that settles within a few microseconds or recovers to 0.1% in 5  $\mu$ s sounds pretty good. But ask: To 0.1% of what, for what load change and exactly what happens to the output during that "few" microseconds?

Protection from transients can be important. Line-generated impulses can zap a sensitive input circuit. And don't forget that switching spikes or noise can be generated internally and radiate or feed back to the power source and its other loads. To avoid interference troubles later, look into the inverter (or UPS) EMI specs and protective filtering, if any. Look also for transients that occur during a transfer mode.

Spikes and noise (and EMR, too) don't play favorites, of course. These unwanted signals would like nothing better than to get into your load and change a few ONES to ZEROS. And all too often they do. The reason is simple: You weren't told that the spikes existed—at least not outright.

Ripple and noise may have been specified, all right. But the vendor lumped the hash together with distortion and listed it all as an rms figure. Since spikes contribute little to an rms value, the vendor has succeeded in hiding their existence. One thing he probably won't hide, though, is his equipment's output distortion.

A sinusoid with high purity—one low in harmonics—would seem to be desirable. So engineers tend to look for it. But what does total



harmonic distortion (THD) of 1% really buy?

Remember that the utility line's THD probably runs around 2 to 3% anyway and that most loads don't complain at the figure. Some loads don't wince at a THD of 10% or even higher (many inverters offer square-wave outputs). So see what your load can tolerate and avoid overspecifying distortion.

You should also realize that a source's output harmonics are related to its output impedance and that the harmonics depend greatly on the load—and also the input voltage, in some cases. Thus you may get an excellent sinusoid at nominal line. But when the inverter's input drops, say hello to your new square wave.

The load can drastically distort a sine wave. Inverter manufacturers usually measure distortion into a linear load. However, in most cases the UPS or inverter sees a transformer and choke or a capacitor-input rectifier circuit—a highly nonlinear load. Though you started with 5% distortion (the linear-load spec), you can easily end up with 15% with the filter-rectifier load.

To minimize the problem, look for units with low output impedance. This will also help improve regulation and transient performance. Another point: While distortion is measured in rms, the load may care more about peak or average values (power-supply inputs, for instance). So don't ask just for THD but for form and crest factors, too.

How much harmonic distortion a given unit produces depends also on the basic inversion technique. Some methods yield little or no harmonics. Others need heavy filtering or shaping to arrive at the final sinusoidal shape. And here lies the basis for a controversy—the “my-way-is-best” syndrome.

While it's true that inverter design has progressed significantly since the 1960s, no single existing method has the edge over any other in all areas. Each has advantages, each limitations. In the end it's performance that counts, not internal design or the fact that a unit is a “third or fourth-generation” design. So don't get sucked in by these arguments.

Other areas of controversy are sure to pop up in the search for the right unit—power transistors vs SCRs, for instance, or single-phase UPS systems vs three-phase. Again, there are relative virtues and weaknesses to be considered—not just labels. Consider this, too: Is that UPS system really uninterruptible?

### Even a UPS has its downs

A UPS is more than a product. It's an insurance policy. And like most policies, the system will pay off—but only to the extent you don't forget or violate the fine-print limitations. Since

no UPS is failure-proof, any system is bound to develop a problem sooner or later. Obviously you'd like this to be later.

Vendors also want to offer reliable products—to stay in business, if nothing else—so most will promote reliability. To do this, they point to MTBFs, understressed components, conservative design, satisfied customers, reputation, financial stability, longevity of the company and other criteria. Our advice: Take MTBFs with a grain of salt, listen politely to the design talk, then go out and check the rest.

If an inverter does fail, most systems will automatically transfer the load to the ac line (called a reverse-transfer system). If an electro-mechanical relay does this, you can expect a dropout of about 50 to 150 ms. If your load can't be out that long, remember, a static switch can do the job in less than 4 ms.

For the ultimate in reliability, partial or total redundancy is necessary. But watch out. Paralleled inverters don't ensure failure-proof operation. One inverter can fail and take the others down, unless a switching arrangement is used to isolate the defective unit. Since redundant operation costs a lot more; you'll have to make sure you really need it. As you mull it over, think about this: Do you really need a UPS at all?

If the problem is just noise on the ac line, a UPS is an expensive way to isolate the load. Instead, check into isolation transformers specifically made to attenuate common-mode and other noise. If brownouts or wide line fluctuations are the culprit, investigate ac line regulators or pre-regulators, which can cut variations by a factor of 5 or more. Preregulators bring another benefit: You can relax the power-supply specs on your own equipment.

Still another option is to not use an inverter at all but a dc/dc converter. After all, if you're going to drive a dc power supply anyway, why not skip the extra step of inversion—with its extra energy loss—and go right to a converter and battery charger? This makes sense to some extent. But don't forget that all dc/dc converters must first invert to ac, then proceed to transform, rectify and filter to get the final dc levels.

### Who's who in UPS/inverters

Many other tradeoffs must be made with inverters and UPS systems, some of which you may not think of—and which the vendor may strangely forget to mention. Keep in mind the following: acoustical noise and possible structural loading problems; stability of the output frequency; grounding, maintenance, safety and engineering support; potential inverter start-up problems. And don't forget to find out how the



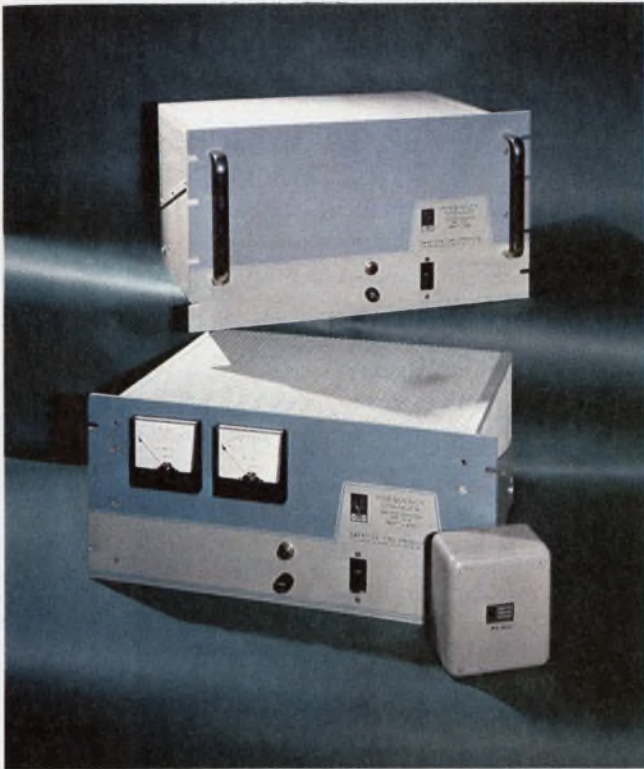

Frequency changers and inverters from Bulova are intended for synchronous motor drives, chronographs, timers and other precision applications.

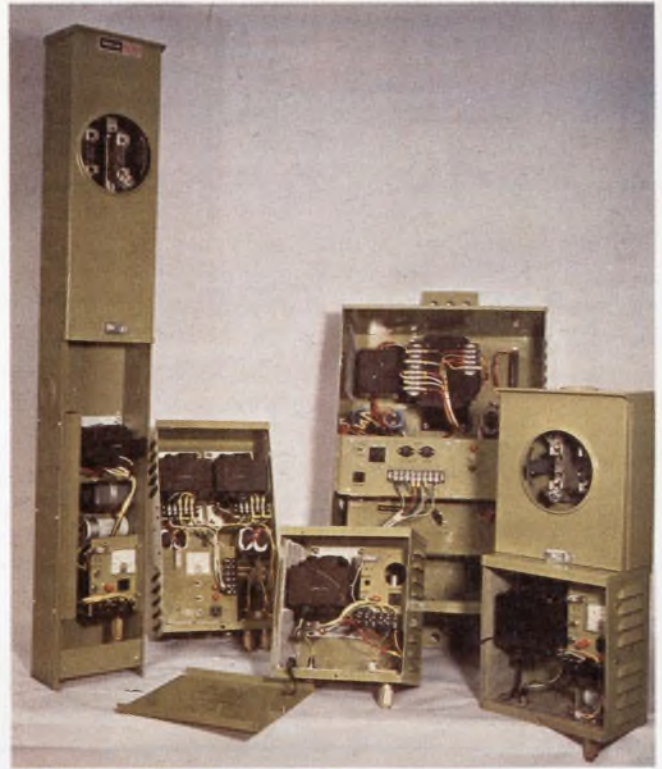

Various standby systems and ac power supplies marketed by Sola Electric show the great variety in packaging of such units. Sola also makes line regulators.

vendor tested his system.

But once you're clear on your needs and what to expect when you enter the marketplace, the next step is to ask: What's new and who's who in inverters and UPS systems?

Probably the most significant movement over the years in such power sources has been toward all-solid-state designs. Faster and higher-power transistors and other semiconductors have teamed up with ICs to give more power in smaller and lighter packages. And with PROMs, LSI and other digital logic, vendors like Abacus Controls and others have come up with digitally synthesized waveforms, to cut weight even more.

Other trends include crystal control of output frequency, fault protection with automatic reset and, at last, a movement toward standardization of specs (ISA, NEMA). Today vendors put systems together for you so that you don't have to select individual batteries, inverters, control circuits and the other necessary units that make up a UPS.

Generally suppliers can be grouped according to output power, application or expertise in a specialized area. For example, if you need an inverter to power fractional-horsepower motors—say, for fans or blowers—check into the Power Conversion Operation of Rotron, Inc. Since Rotron also markets the motor, the company will match exactly the motor load to the inverter (to 1000 W).

For high-voltage inverters to drive rectifiers or voltage multipliers, Advanced High Voltage Corp. offers units that change 28 V dc to 7.5 or 15 kHz at up to several thousand volts and 45 W. Inverters for rugged mobile and marine environments are the specialty of Advance Conversion Devices, while Bulova's Electronic Div. concentrates on stable frequency sources rather than power.

To survey your input line properly, you'll need special equipment, such as the Model 3401 power-line disturbance monitor from Programmed Power Inc. The unit keeps track of and measures such things as frequency error, under and over-voltages and transient magnitudes.

Inverters for military, airborne and aerospace applications demand stringent specifications. Such units are the forte of Aerospace Avionics, Avionic Instruments Inc. (AI<sup>2</sup>) and Unitron Inc. Each offers a fairly wide line with a broad range of individual features.

Need a small dc-to-ac power source for laboratory or field use? Companies such as Terado, Topaz, Tripp Lite and Wilmore offer them up to about 1500 W. Terado and Topaz also sell UPS systems, the former to 1500 W and the latter to 10 kVA. Intended for emergency lighting and alarm systems are UPS systems made by Exide Lightguard Div. Various models deliver up to 1350 W for a minimum of 90 minutes.

Manufacturers offering complete UPS systems



are numerous indeed. In power ranges up to about 50 kVA, you'll run into outfits like Deltec, which offers single and multiphase systems, static transfer and partial or total redundancy; and Elgar, a company that builds to its own industry forecasts, not to order, so you can get fast delivery.

When you get up into the really large-scale systems—50 to 2000 kVA—other names pop up. Atlantic Research's modular concept allows the company to deliver up to 75 kVA in 25-kVA steps, or to provide up to 450 kVA in 75-kVA steps. Cyberex Inc. will parallel modules to get you up to the higher powers. The Exide Power Systems Div. of ESB Inc. guarantees an over-all system efficiency of 86% (it says it will sign a penalty clause). And International Power Machines, formerly Static Products, markets 3- $\phi$  units that deliver to 250 kVA. Need 415-Hz power for your computer? International can supply it.

Well known in the large-scale UPS/inverter field are Solidstate Controls, Teledyne Inet, and Westinghouse. Each has the resources and experience to deliver uninterruptible power to practically any load, and to provide just about anything in the way of protection, redundancy, controls, maintenance—you name it.

Finally, if you decide that line regulators are all you need, check into those made by Sola Electric, Tele-Dynamics, TDC Div. of Frequency Technology, Topaz and others. MCG Electronics specializes in ac transient suppressors. And if you go the dc/dc converter route, instead of dc/ac, vendors abound. Check out RO Associates' line, for one. Sorensen's STM series works from ac or dc, and automatically switches to the dc source if the ac fails.

Another option: Acopian Corp. supplies ac-to-dc systems with built-in, redundant power modules. Hook one to your battery operated inverter and you've got reliable power. ■■

## Need more information?

The products cited in this report don't represent the manufacturers' full lines. For additional details, circle the appropriate information retrieval numbers. For data sheets and more vendors, consult ELECTRONIC DESIGN's GOLD BOOK.

- Abacus Controls Inc., 65 Fourth St., Somerville, NJ 08876. (201) 526-6010. (George A. O'Sullivan). **Circle No. 401**
- Acopian Corp., P.O. Box 585, Easton, PA 18042. (215) 258-5441. (Thomas E. Skopal). **Circle No. 402**
- Advance Conversion Devices Co., 109 Eighth St., Passaic, NJ 07055. (201) 778-0707. (Stanley W. Feltman). **Circle No. 403**
- Advanced High Voltage Co., Inc., 14532 Arminta Ave., Van Nuys, CA 91402. (213) 997-7222. (Michael J. Alexander). **Circle No. 404**
- Aerospace Avionics Inc., Airport International Plaza, 110 Wilbur Pl., Bohemia, NY 11716. (516) 589-9200. (Steve Summer). **Circle No. 405**
- American Vector Inc., 59 Brown Ave., Springfield, NJ 07081. (201) 379-7806. (Ted Gordon). **Circle No. 449**
- Atlantic Research, 5390 Cherokee Ave., Alexandria, VA 22314. (703) 354-3400. (Ralph Blair). **Circle No. 406**
- Avionic Instruments Inc., 943 E. Hazelwood Ave., Rahway, NJ 07065. (201) 388-3500. (Peter Wicinski). **Circle No. 407**
- Bulova Watch Co., Inc., 61-20 Woodside Ave., Woodside, NY 11377. (212) 335-6000. (Joe Bodow). **Circle No. 408**
- Christie Electric Corp., 3410 W. 67th St., Los Angeles, CA 90060. (213) 750-1151. **Circle No. 409**
- Cyberex Inc., 7171 Industrial Park Blvd., Mentor, OH 44060. (216) 946-1783. (David C. Griffith). **Circle No. 410**
- Deltec Corp., 3849 Gaines St., San Diego, CA 92110. (714) 297-4466. (Gary M. Thomas). **Circle No. 411**
- Electronic Measurements Inc., 405 Essex Rd., Neptune, NJ 07753. (201) 922-9300. (Robert Hill). **Circle No. 412**
- Elgar Corp., 8225 Mercury Ct., San Diego, CA 92111. (714) 565-1155. (John J. Waterman, Jr.). **Circle No. 413**
- Emerson Controls, 3300 Halladay St., Santa Ana, CA 92702. (714) 545-5581. **Circle No. 414**
- Emerson Electric Co., 3300 S. Standard St., Santa Ana, CA 92702. (714) 545-5581. **Circle No. 415**
- Era Transpac Corp., 311 E. Park St., Moonachie, NJ 07074. (201) 641-3650. **Circle No. 416**
- Exide Power Systems Div., ESB Inc., Rising Sun & Adams Ave., Philadelphia, PA 19120. (215) 342-8000. (J. J. Drummond). **Circle No. 417**
- Garrett/Airesearch Mfg., 2525 W. 190th St., Torrance, CA 90509. (213) 323-9500. **Circle No. 418**
- General Electric/GPCBD, P.O. Box 2913, Bloomington, IL 61701. (309) 662-4311. **Circle No. 419**
- Glentronics, 748 E. Alosta Ave., Glendora, CA 91740. (213) 963-1676. **Circle No. 420**

- Gould/Industrial Battery Div., 467 Calhoun St., Trenton, NJ 08607. (609) 392-3111. **Circle No. 421**
- Gulton Industries Engineered Magnetics Div., 13041 Cerise St., Hawthorne, CA 90250. (213) 679-0111. **Circle No. 422**
- Instrument and Control Systems, Inc., 129 Laura Dr., Addison, IL 60101. (312) 543-6200. (Marion Servos). **Circle No. 423**
- International Power Machines Corp., 3328 Executive Blvd., Mesquite, TX 75149. (214) 288-7501. (Michael L. George). **Circle No. 424**
- Kaylor Energy Products, 1918 Menalto Ave., Menlo Park, CA 94025. (415) 325-9255. (Roy Kaylor, Jr.). **Circle No. 425**
- Lorain Products, 1122 F St., Lorain, OH 44052. (216) 288-1122. **Circle No. 426**
- Moxon Inc./SRC Div., 2222 Michelson Dr., Irvine, CA 92664. (714) 556-6500. **Circle No. 427**
- Nife Inc., Copiague, NY 11726. (516) 842-5240. **Circle No. 428**
- Nova Electric Manufacturing Co., 263 Hillside Ave., Nutley, NJ 07110. (201) 661-3434. **Circle No. 429**
- Power Applications, Inc., 581 W. Merrick Rd., Valley Stream, NY 11580. (516) 872-6336. (E. F. Kober). **Circle No. 430**
- Power Systems & Controls, P.O. Box 27306, Richmond, VA 23261. (703) 355-2803. **Circle No. 431**
- Powertec, Inc., 9168 DeSoto Ave., Chatsworth, CA 91311. (213) 888-0004. (John Poturny). **Circle No. 432**
- Programmed Power Inc., 141 Jefferson Dr., Menlo Park, CA 94025. (415) 323-8454. (R. L. Cooper). **Circle No. 433**
- RO Associates, Inc., 3705 Haven Ave., Menlo Park, CA 94025. (415) 322-5321. (Frederick S. Kamp). **Circle No. 434**
- Rotron, Inc., 7-9 Hasbrouck Lane, Woodstock, NY 12498. (914) 679-2401. (Bill Fisher). **Circle No. 435**
- Sola Electric, 1717 Busse Rd., Elk Grove Village, IL 60007. (312) 439-2800. (Irving W. Roane). **Circle No. 436**
- Solidstate Controls, Inc., 600 Oakland Park Ave., Columbus, OH 43214. (614) 263-1886. (John N. Holscher). **Circle No. 437**
- Sorensen Power Supplies, Div. of Raytheon, 676 Island Pond Rd., Manchester, NH 03103. (603) 668-1600. (Ken Lent). **Circle No. 448**
- Static Power, 3800 Campus Dr., Newport Beach, CA 92660. (714) 546-4731. **Circle No. 438**
- TDC Div. of Frequency Technology, Inc., Box 365, Whitcomb Ave., Littleton, MA 01460. (617) 456-3374. (Emil B. Rechsteiner). **Circle No. 439**
- Tele-Dynamics, 525 Virginia Dr., Fort Washington, PA 19034. (215) 643-6161. (Murray Kraus). **Circle No. 440**
- Teledyne Inet, 711 W. Knox St., Gardena, CA 90248. (213) 327-0913. (Hal Proppe). **Circle No. 441**
- Terado Corp., 1068 Raymond Ave., St. Paul, MN 55108. (612) 646-2868. (Wayne M. Sorenson). **Circle No. 442**
- Topaz Electronics, 3855 Ruffin Rd., San Diego, CA 92123. (714) 279-0111. (Dick Wheelock). **Circle No. 443**
- Tripp Lite, 133 N. Jefferson St., Chicago, IL 60606. (312) 346-3040. (Larry Goodman). **Circle No. 444**
- Unitron Inc., 1624 N. First St., Garland, TX 75040. (214) 276-8591. (D. E. Davis). **Circle No. 445**
- Westinghouse Electric Corp., Box 225, Buffalo, NY 14240. (716) 631-2600. (C. G. Helmick). **Circle No. 446**
- Wilmore Electronics Co., Inc., Box 2973, West Durham, NC 27705. (919) 489-3318. (J. L. Harris). **Circle No. 447**



# Still fighting snap, crackle and pop?



Noise has a way of showing up in circuits. Bendix has a way of preventing it. Filter connectors. Boasting some of the best attenuation curves available, Bendix filter connectors solve a wide range of low-pass filter problems. Small wonder Bendix is first choice in the fight against snap, crackle and pop.

These versatile connectors, production tooled, are available in a wide range of cylindrical and rectangular configurations designed to meet most any industrial, commercial and military application.



Configurations that can be intermateable with most MIL-Spec and popular commercial connectors and special designs for advanced state-of-the-art equipment. There's sure to be one that meets your attenuation and frequency requirements. You'll like what you hear when it comes to the price, too. And that goes for delivery as well.

Write for our new catalog. It's yours for the asking. The Bendix Corporation, Electrical Components Division, Sidney, New York 13838.

**Bendix**

INFORMATION RETRIEVAL NUMBER 49



# Nothing spoils computer data like cardiac arrest

If watts stop flowing in the system, bad things happen — like illogical behavior, like complete lapse of memory. Sorensen STM power supplies assure your computer of a strong heart to guard against these unwanted things.

STMs are more than reliable. Being modular switchers they are twice as efficient as series-pass types, less than half their size, and price competitive. But they have all of the advantages inherent in series-pass design.

There are 40 STMs in the series, from 3.0 to 56 Vdc, in four modular sizes. Our catalog, written especially for heart specialists, tells all about them. Simply circle the inquiry number. Sorensen Company, a unit of Raytheon, 676 Island Pond Road, Manchester, N.H. 03103. (603) 668-4500.

**Sorensen**  
**POWER SUPPLIES**

INFORMATION RETRIEVAL NUMBER 51





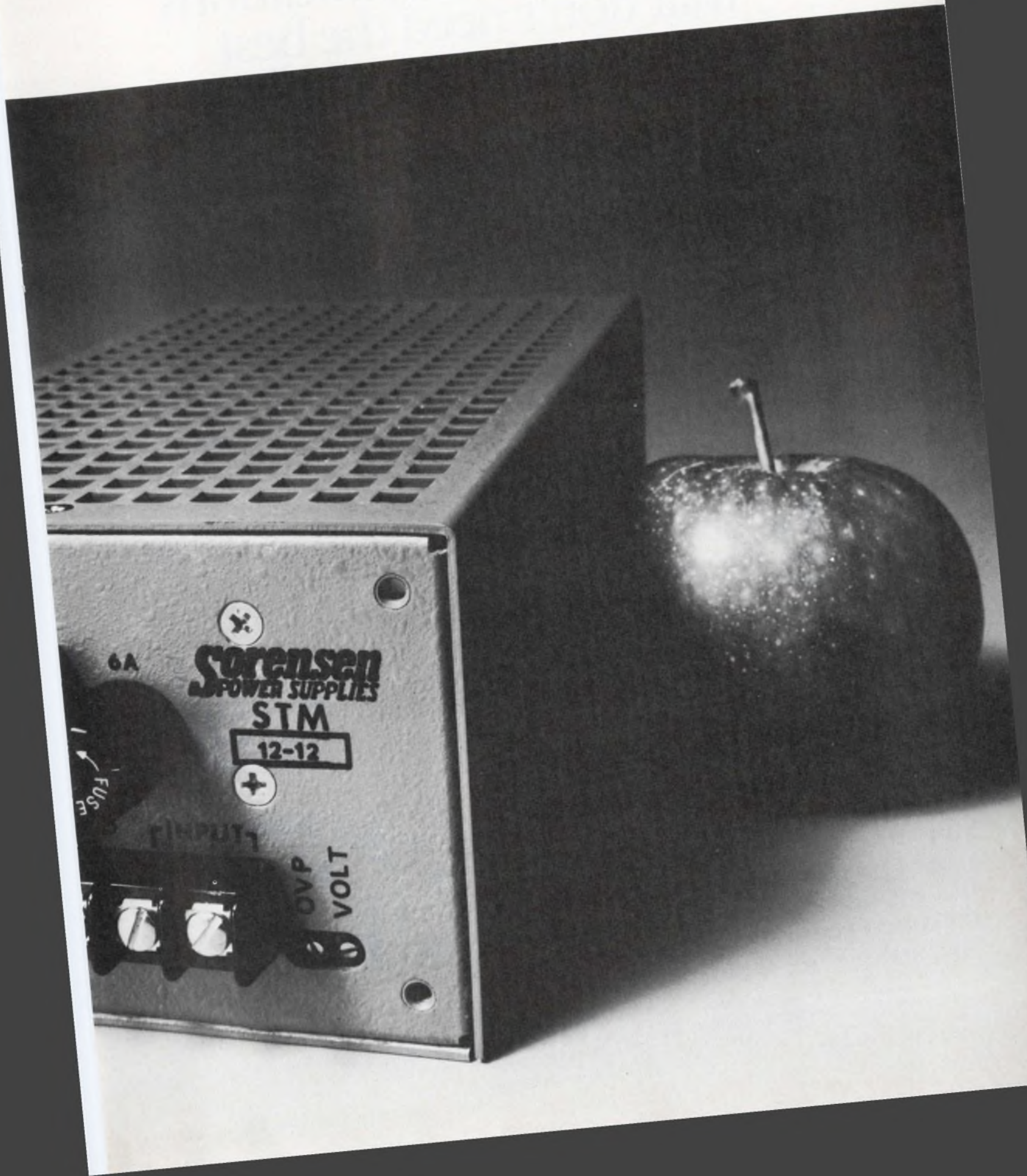



# The best power supplies you can buy for applications that don't need the best power supply you can buy.

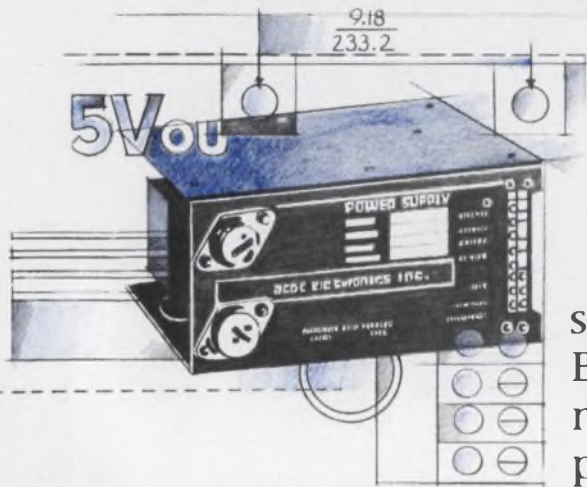

Sure, you can buy cheaper power supplies... and more expensive ones, too. But ACDC's OEM series gives you the most for your dollar... modestly priced power supplies with high priced performance... power supplies that will give you just what you need... at a price you can afford.

Compare our OEM series with the highest priced supplies on the market. We offer 0.1% regulation instead of 0.01% and open frame construction instead of a closed black box. Aside from that, you might never notice any other difference. The OEM series features the same excellent stability, same dependable overload protection, same versatile mounting capability and the same long term performance guarantee. The only conspicuous difference is the price.

There are over 100 U.L. recognized models in the series from 4 to 36 volts, up to 36 amps. They're detailed in our new 72-page Product and Application Guide. Forty-eight pages crammed with specifications, dimensions and technical information on these and 300 other standard power supplies, plus rack systems and custom designs. And, there's another 24 pages of engineering data... information that will make it easier for you to choose the correct power supply for your system. The catalog is free. Just write for it.

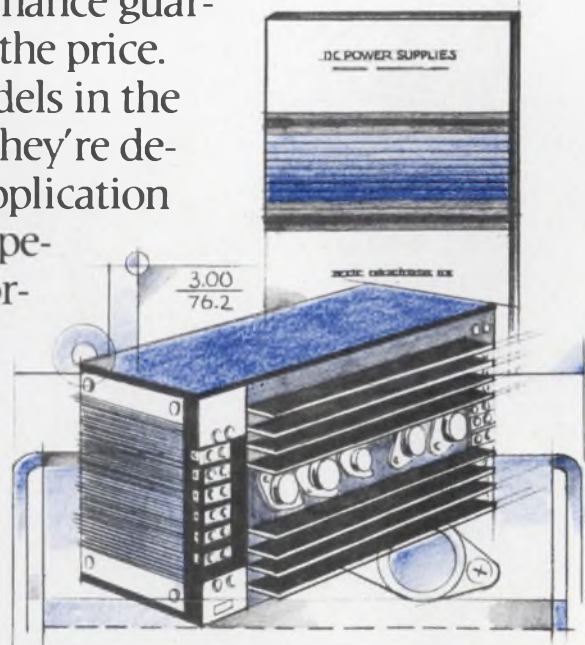

## acdc electronics inc.

401 Jones Road, Oceanside, CA 92054 (714) 757-1880, TWX: 910-322-1470

INFORMATION RETRIEVAL NUMBER 52





# Hughes image memory systems are used by more people, for more applications, than any other image memories in the world.

A lot of people must be happy with Hughes image memories. Because they're used in many ways, by thousands of people every day—helping them do their jobs better and quicker.

Like doctors, commercial airline pilots, blood analysts, production inspectors, baggage

inspectors, quality control technicians, teachers, ship-board fire controllers, medical technicians (ultrasound, x-ray, thermography), aircraft radarmen, records management personnel,

and many, many more.

If you'd like literature or application assistance, call (714) 729-9191. Or write: 6855 El Camino Real, Carlsbad, California 92008.



**HUGHES**  
HUGHES AIRCRAFT COMPANY  
 INDUSTRIAL PRODUCTS DIVISION  
 IMAGE DEVICES

**Creative Image Processing.**

INFORMATION RETRIEVAL NUMBER 53



## Explore microcomputer I/O capabilities

and then select the chips. Here are pointers on what to expect from different input/output architectures.

Most buyers of microcomputers are dazzled by the intricacies of CPU-chip design, but the usefulness of a microcomputer depends closely on its ability to exchange data with peripheral devices. A word to the wise: Explore the I/O architecture before you buy.

A microcomputer's I/O architecture breaks down into these areas:

- Transfer techniques.
- Instruction formats.
- Busses.
- Bus structures.
- Interrupt schemes.
- Memory-access techniques.

### Three kinds of I/O transfer techniques

Most microprocessors allow for three types of I/O transfer techniques—programmed transfer, interrupt-program control and hardware control. In the first two cases, found in most simple applications, the microprocessor controls the transfer. In the third case, system hardware controls transfer.

When all I/O operations are under program control—with all instructions to receive or transmit information included in the program—data are transferred whenever the corresponding instruction is executed.

To transfer data, the program addresses a peripheral device with an input or output command. In some cases the program must first check the availability of the peripheral by checking its status and waiting until it is ready. Typical of this approach are applications where information is entered one character at a time—as from a keyboard. In such cases the microprocessor must spend significant “overhead time” waiting for the data to be entered. This isn't a disadvantage in desk-calculator applications, in which the CPU does not have other functions to perform. But it might not be ac-

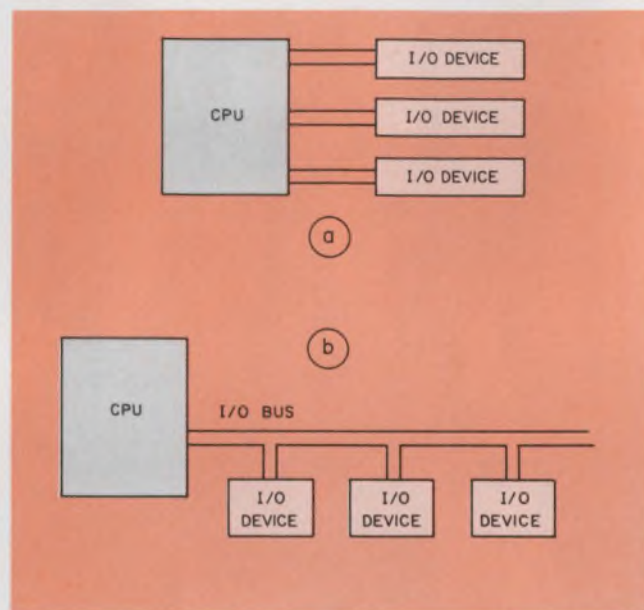

1. I/O bus structures employ several schemes. A radial system is the simplest, but it limits the number of I/O units (a). A party-line system reduces the number of lines needed for a distributed system (b). The latter system also comes in a daisy-chain version, which connects devices serially.

ceptable in a real-time monitoring system.

The interrupt-program approach requires a smaller I/O overhead than that of programmed transfer. I/O devices can signal the microprocessor by an Interrupt whenever they are ready to transmit or receive information. When information is received and identified, the microprocessor interrupts its normal program, stores its state and jumps to a subroutine that allows it to perform the transfer operation. Once the interrupt has been serviced, the microprocessor returns to the state at which it was interrupted or some other predetermined state, and it resumes its normal operation.

This approach allows the microprocessor to spend a minimum of time servicing an I/O device. Hence it can perform more operations or handle more peripherals.

Hardware control of information transfer was not used much in early microprocessor applications, but most newer CPUs can accommodate it.



The method requires a significant amount of additional hardware, since the I/O device must initiate and control the data transfer directly into or from microcomputer memory.

But the software support is minimal. It is limited to the initiation, termination and recovery aspects of the transfer. These aspects are performed automatically without microprocessor intervention.

The hardware-control approach, also known as direct-memory access or data break, can be used to transfer blocks of characters directly between a peripheral device—such as tape, cassette or floppy disc—and the main microprocessor memory.

#### I/O instruction formats differ

The handling of programmed I/O operations varies significantly from one microprocessor to another. Most microprocessors have special I/O instructions of varying length. But some don't have any; the I/O ports are treated as if they were RAM locations.

One of the simplest examples of a special I/O instruction is that of the single-byte instruction, with a different word for each I/O port. Typical is the I/O instruction format of the Intel 8008:

01 RRM MM1.

The five RRMMM bits define 1 of 32 ( $2^5$ ) possible I/O operations, where RR = 00 implies one of eight input operations and RR  $\neq$  00 one of 24 output operations.

The Mostek 5065 has two types of single-byte instructions. One provides the usual I/O operations for 16 input and 16 output ports:

Input accumulator command 01 10 XXXX

Output accumulator command 01 00 XXXX

The second type has this form:

Input accumulator skip 01 11 XXXX

Output accumulator skip 01 01 XXXX

During the execution of these I/O instructions (which can be used to access either the same or different I/O ports, depending on system configuration), the CPU tests a flag bit, which may be controlled by the addressed peripheral. Whenever the flag bit is a ONE, the next two bytes of

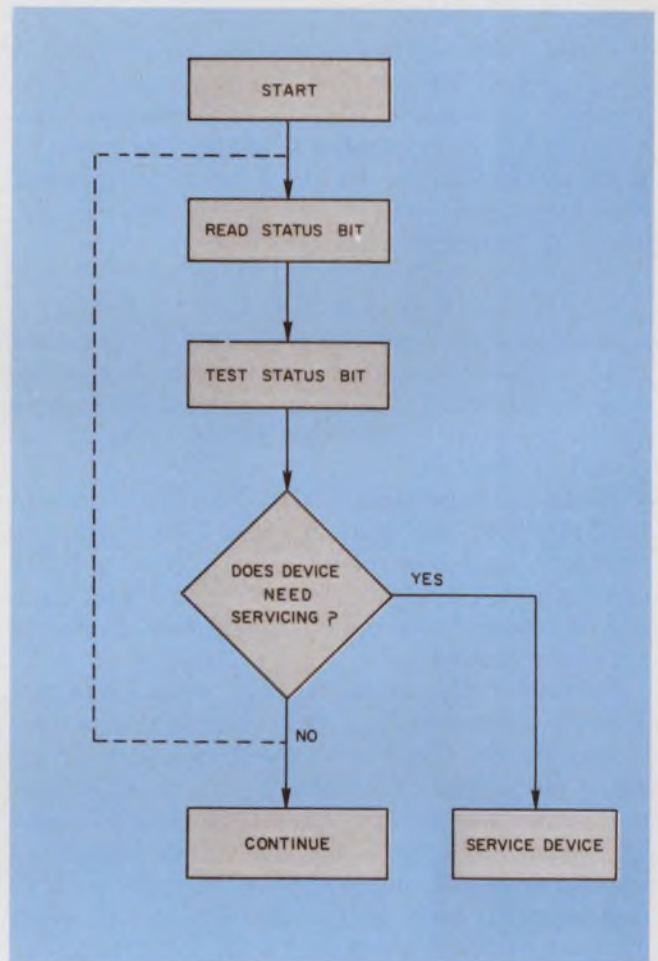

2. Peripheral devices can be polled periodically to find if any need service. However, this simple technique can be time-consuming.

instruction are skipped. This option simplifies the dialogue between CPU and peripheral. Depending on a peripheral's state of readiness, the program can perform an immediate branch.

Despite the extreme simplicity of the I/O instructions for the Intel 8008 and Mostek 5065, this approach limits the number of I/O ports that can be addressed. With the 8008, the number is 32; with the 5065, it's 64. In addition, 1/8 (32/256) or 1/4 (64/256) of the possible instruction words are used for I/O alone. Hence few combinations are left for other purposes.



Some microprocessors use a multibyte I/O instruction, although here, again, there are significant variations. Intel's 8080, for example, employs a 2-byte I/O instruction with the following form:

```
1 1 0 1 X 0 1 1
A A A A A A A A
```

The first byte specifies an input or output instruction (depending on the value of X). The second byte distinguishes between as many as 256 input or output devices. Hence a few combinations of instructions allow the use of many I/O ports. However, twice as many bytes of control memory are needed.

A different 2-byte I/O instruction is found in the Rockwell PPS-8. The microprocessor is designed to operate with up to 16 performance-enhancing I/O devices, each of which has two 8-bit ports. Software controls the devices, and internal registers store control and status information. The I/O instruction has this form.

```
0 1 0 0 1 1 1 0
A A A A X C C C
```

where the first word indicates an I/O operation, AAAA defines one of 16 I/O devices, X specifies an input or output operation and CCC determines which register within the device is being accessed by the CPU.

From a comparison of the I/O instructions of the Intel 8080 and the Rockwell PPS-8, you can see that there is a tradeoff for a given number of instruction bits. The tradeoff is the total number of I/O ports vs the intelligence built into the interface devices.

However, it's almost always possible to use memory addresses for I/O devices. I/O ports are considered as if they were RAM locations; an input is performed by reading memory and an output by writing into it. Though a program may look somewhat more obscure (I/O operations become more difficult to spot if the program isn't documented), operations performed on input data can be those associated with RAM data. For example, add, compare and test bits. This technique also allows for a number of I/O devices, limited only by the size of the memory that can be addressed by the microprocessor.

This approach has been chosen by Motorola for its M6800 microprocessor, which doesn't have any instructions reserved for I/O. The number of bytes for I/O operations—typically one to three—depends on the type of operation and on the addressing mode. Special peripheral circuits in the M6800 family—such as the Peripheral Interface Adapter or the Asynchronous Communications Interface Adapter—are designed to be compatible with this approach.

The new National PACE processor doesn't have any special I/O instructions either. Like the Motorola M6800, it relies entirely on the address-

ing of I/O ports as if they were memory locations. Hence all memory-reference instructions can be used to perform I/O operations.

### Information travels on busses

Parallel lines and control logic, referred to collectively as the I/O bus, transfer information between microprocessor and I/O devices. The bus contains three types of lines: data, device address and command.

Data lines consist either of one bidirectional set or two unidirectional sets. In the latter case, one set is used exclusively for inputting of data to the CPU and the other for outputting of data. In most cases the width of the bus—number of lines—equals the word length of the microprocessor.

Device-address lines are used to identify I/O devices. The theoretical maximum number of available address lines changes significantly from one microprocessor to another. It depends on the way I/O operations are handled. The number of I/O ports can vary from 32 (or  $2^5$ , as in the Rockwell PPS-8 or Intel MCS-8) to 65 k (or  $2^{16}$  as in the Motorola M6800 or National IMP-16).

Command lines allow a peripheral to indicate to the CPU that it has finished its previous operation and is ready for another transfer.

Other lines are also present. You can find interrupt lines on which devices request service, enable or disable lines that can be used to control the interrupt, as well as lines that provide timing whenever required.

The different busses are frequently combined on the same lines to simplify construction and, in some cases, to reduce costs. However, this may increase the number of control lines. The extra lines are needed to extract the necessary information from the common bus.

### Three ways to structure the I/O bus

I/O bus structures can take three different forms: radial, party-line or daisy chain (Fig. 1).

A radial-bus system connects each I/O device to the microprocessor through a dedicated set of lines. It does not allow the connection of more than one I/O unit. Because of its simplicity, a radial bus provides a convenient solution, although it isn't usually compatible with the limited number of CPU pins. However, it is a possibility with the Rockwell PPS-4 system.

A party-line bus is time-shared for data transfers between the CPU and many I/O devices. It must provide means of identifying which device is being called on at a given instant. It does not allow the simultaneous use of more than one I/O unit. All devices are accessed in parallel, and the choice of one or another is controlled entirely by



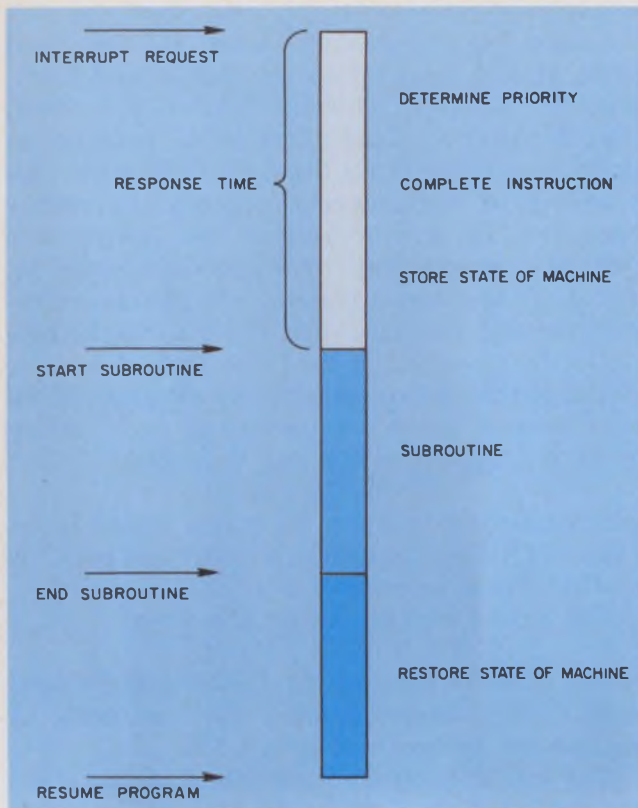

3. An ideal interrupt-service routine automatically saves the state of the microcomputer and then restores it after the interrupt has been handled.

the microprocessor. This bus structure would be justified mainly in the case of a distributed system, since it would significantly cut the number of required lines.

A daisy-chain bus is very similar to the party-line, except that the connections are made in serial fashion. Each unit can modify the signal before passing it on to the next device. This approach is used mainly for signals related to interrupts or polling circuits. Whenever a device requires service, it blocks the signal. A priority is thus established, since the devices that are closest to the microprocessor have the first chance to request service.

The Fairchild F-8, for example, uses the daisy-chain concept to organize its interrupt priorities. Each RAM or ROM chip—which also provides I/O ports—can accept one interrupt input. And each chip can connect to its neighbors to establish priorities. The daisy-chain technique is also used in the Rockwell PPS-8.

Generally a system's bus structure depends on the CPU used. Pin-limited, first-generation CPUs have a single bus that must be time-shared between memory addresses, instructions, input and output data, device addresses and control signals. This time-sharing requires involved peripheral circuitry, consisting of numerous latches, multiplexers and timing circuits. Also, output information has to be latched before it can be directed

toward the appropriate output device—usually another latch. Hence output bus structures usually have to be of the party-line type.

In second-generation microprocessors more than twice as many pins are available. Typically there is a bus for addresses and another for instructions and data, and most control signals are directly accessible. Although some time-sharing still is needed, there's no need for two-stage buffering between the CPU and output device. Nevertheless I/O busses employ a party-line configuration.

Moreover more microprocessors are allocating one or more pins for external flags. For example, the National IMP-16 has two flag bits, while the newer PACE chip offers four external flags. The Mostek 5065 has one external flag. All of these flags simplify programming when a single bit of information has to be exchanged.

### Interrupts need servicing

Some applications require that a peripheral device be serviced as soon as possible after some external condition has occurred. In some cases, especially when the microcomputer is not very busy, this can be done by program control. But most frequently it's necessary to establish some sort of interrupt structure that allows asynchronous external events to change the processing sequence.

When interrupt facilities are not available, the only way to find out whether a device requires servicing is to interrogate it periodically by inputting a status bit and testing it. When the need for service is identified, the program branches to a special subroutine, at the end of which the program returns to its regular operation.

This technique is quite easy to implement (Fig. 2). But significant time could elapse between the moment service is requested and the moment the processor recognizes it. The time can be lessened if the program sits on a small interrogating loop (dashed line in Fig. 2) or, if the microcomputer is programmed to interrogate the inputs frequently. Neither case, however, represents efficient use of a microcomputer.

To eliminate wasteful loops without sacrifice in speed, most microprocessors have at least one interrupt input. Whenever an interrupt occurs, the microprocessor terminates the instruction it is executing and branches immediately to a service subroutine (Fig. 3). Ideally the subroutine should do the following:

- Save the microprocessor "state"—all the information contained in the accumulator, the registers and the internal flag flip-flops. (This operation isn't always simple.)
- Acknowledge the interrupt signal on a special line, when it is available.



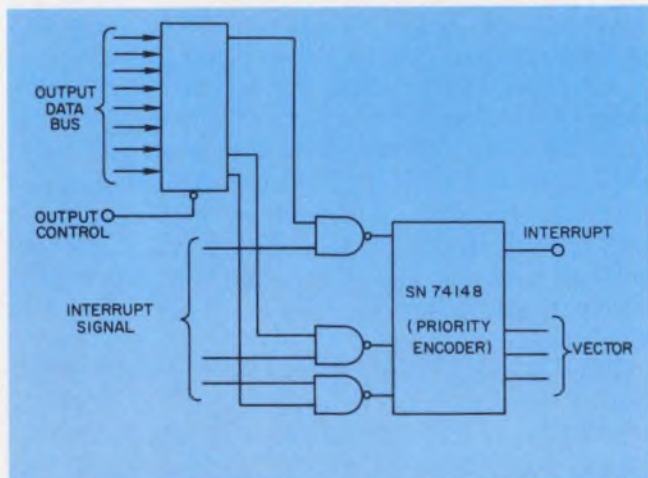

4. Either an enable/disable function or a priority structure can be obtained readily for a microprocessor that has neither. A conventional input port can be used to control the interrupt input.

- Perform the operation called for by the interrupt.

- Restore the state of the machine.
- Resume execution of the program.

The elapsed time between interrupt and the start of the interrupt-handling subroutine is called the "response time." The difference between the total time elapsed and the actual execution time is referred to as the "overhead." Both times should be kept as low as possible.

#### Interrupt capabilities vary

The capabilities of microprocessors can vary considerably in the way they save the state upon receipt of an interrupt request and restore this state upon completion of servicing. For the Intel 8008, for instance, an extensive amount of software is required. And additional hardware is necessary for saving, at least temporarily, the accumulator and one of the registers. You could avoid the external circuitry by reserving two of the seven internal registers exclusively for status saves. But speed and program efficiency probably would be impaired.

Newer microprocessors, such as the Intel 8080, Motorola M6800 and National PACE, have special instructions that save the state of the microcomputer by pushing status information into a push-down, or last-in first-out, stack.

For those applications that have few interrupt sources, the Mostek 5065 offers a unique solution: It incorporates three independent sets of accumulators, program pointers and link flip-flops. Whenever an interrupt occurs, the processor can simply shift from one level of operation to the next, thus making status saves and restorations unnecessary.

Recent microprocessors—such as the Intel 8080, Mostek 5065, Motorola M6800 and Rockwell PPS-8—have Interrupt Enable and Interrupt Disable instructions that set or reset an internal interrupt-control flip-flop. These allow the disabling of the interrupt request, whenever necessary. In microprocessors not having this feature, the only way to achieve the same result is to use external hardware to gate the interrupt signals. The hardware, in turn, can be controlled by a conventional output (Fig. 4).

The Mostek processor employs two special instructions to control the enabling or disabling of its interrupt. The first has the form

$$0\ 0\ 0\ 0\ 1\ 0\ M_1\ M_0,$$

which allows a designer to enable either Interrupt 1 ( $M_1$ ) or Interrupt 2 ( $M_0$ ) or both, by making the appropriate bit a ONE.

The second instruction has the form

$$0\ 0\ 0\ 0\ 1\ 1\ M_1\ M_0,$$

which allows a designer to disable either Interrupt 1 ( $M_1$ ) or Interrupt 2 ( $M_0$ ) or both, by making the appropriate bit a ONE.

The PACE microprocessor has a status register that reserves 6 of its 16 bits for interrupt control. One of these bits can disable all of the interrupts. It is automatically set to a ZERO by the interrupt service routine, but it can be reset by software. The five other interrupt-control bits each enable or disable one of the four interrupt inputs or a built-in interrupt that is generated when the stack is full or empty.

To control the status bits, however, you must use a few instructions. These load one of the accumulators or registers with the information and then duplicate it in the flag registers.

Each source of an interrupt signal is usually associated with a program-controlled Arm flip-flop. A programmer can enable (Arm) or disable (Disarm) one interrupt source without affecting the others. Until the recent introduction of improved support circuitry, this feature could be implemented only with external hardware under output control.

#### Assigning priorities to interrupts

Interrupt requests are frequently assigned priorities. Whenever two interrupts occur simultaneously, the one with the higher priority is considered first. Furthermore a higher-priority interrupt can interrupt the service routine of a lower-priority interrupt. Most microprocessors don't have built-in priorities, and these must be handled either with software, external hardware, or both.

Among the exceptions are the Mostek 5065, which obtains two levels of interrupts through two pins. Also, National's PACE assigns priori-



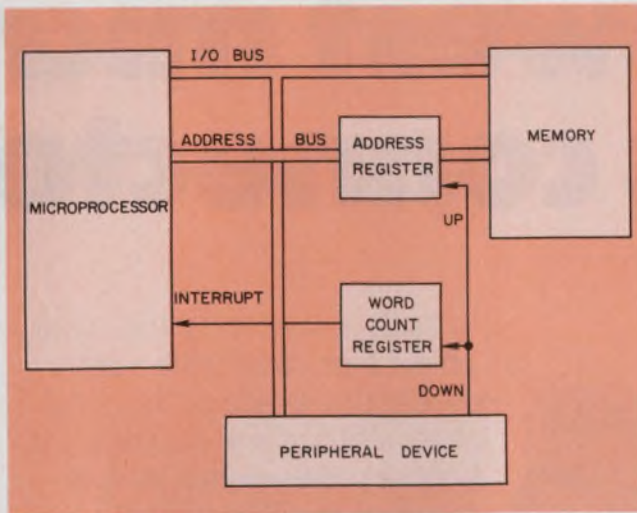

5. A direct-memory access facility permits efficient transfer of large blocks of data between memory and peripheral device.

ties to its four interrupt inputs, and so does the Toshiba TLCS-12 to its eight interrupt inputs. Of course, the daisy-chain structure in Fairchild's F8 or Rockwell's PPS-8 automatically provides priorities.

Most microcomputers have a single-level interrupt: The interrupt causes a transfer of control to a preassigned memory location that contains the beginning of the programmer's interrupt-processing routine. When more than one device may cause the interrupt, the program must poll all possible sources to determine which requires servicing.

For some microprocessors—for example, Intel's 8008 and 8080—the interrupt is "vectored." Whenever these units receive an interrupt request, the microprocessor immediately interrogates a few input bits (the vector). These bits specify one of several addresses—typically eight—and the program jumps to these to find the appropriate service subroutine. Vector interrupt makes polling unnecessary whenever the number of interrupt sources is smaller than the number defined by the vector.

In some cases—the Intel 8008 and 8080—the vector must be constructed with external hardware that encodes the eight interrupt conditions. This can be achieved easily with priority encoders like the SN74148. In other cases—such as the National PACE—the vector is automatically constructed within the CPU.

Multiple-level interrupts are not found very frequently in presently available microprocessors. The exceptions include the Rockwell PPS-8, with three levels (one of which is dedicated); the Toshiba TLCS-12, with eight levels; the Mostek 5065, with two levels, and the National PACE, with four levels. Multiple-level interrupts allow the microprocessor to determine immediately

which device is requesting an interrupt. At the same time multiple levels simplify assignment of interrupt priorities by eliminating the need for special hardware or software.

Many applications require the fastest possible transfer of large amounts of data between the microcomputer memory and peripheral devices. System efficiency can be increased by avoidance of time-consuming programmed word transfers in which the microprocessor supervises each operation.

Increased efficiency can be achieved by addition of a direct-memory access (DMA) facility. It allows an I/O device interface to "steal" a memory cycle from the program and transfer a word of data directly from or to a memory address specified in a special address register. With an automatic increment of the address register after each word transfer, successive words of data can be transferred into successive memory locations.

A separate, word-count register keeps track of the progress of the transfer. Typically the register is loaded at the beginning of the operation with the number of data words to be transferred and decremented after each transfer. On reaching zero, the word-count register signals the completion of the transfer operation by generating an interrupt signal.

#### Circuitry initiates memory cycle

Additional control circuitry is also required to initiate the memory cycle, once the data are ready to be transferred (Fig. 5). This circuitry depends on the CPU used. Although most 8-bit CPUs have DMA capabilities, the problems of implementation can vary significantly from one unit to another.

Direct-memory address can be initiated either by a peripheral device or by the microprocessor. In either case programmed control loads the address register with the address of the first memory location, and the word count register with the total number of words to be transferred.

With the Intel 8080, a Hold input can be used to request the CPU to enter a state in which the following occurs: The data bus and the address bus go to their high impedance state, thus allowing an external device to gain control of that bus. The CPU acknowledges the Hold input with an acknowledge signal on its HLDA pin.

In the Mostek 5065, the same result is obtained, respectively, with WAIT (input) and DMA (output).

The most efficient way to implement DMA is given by the Rockwell PPS-8. A special, additional chip can be used to control up to seven independent DMA operations. ■■



# Our newest micro device is connected

## Lectures.

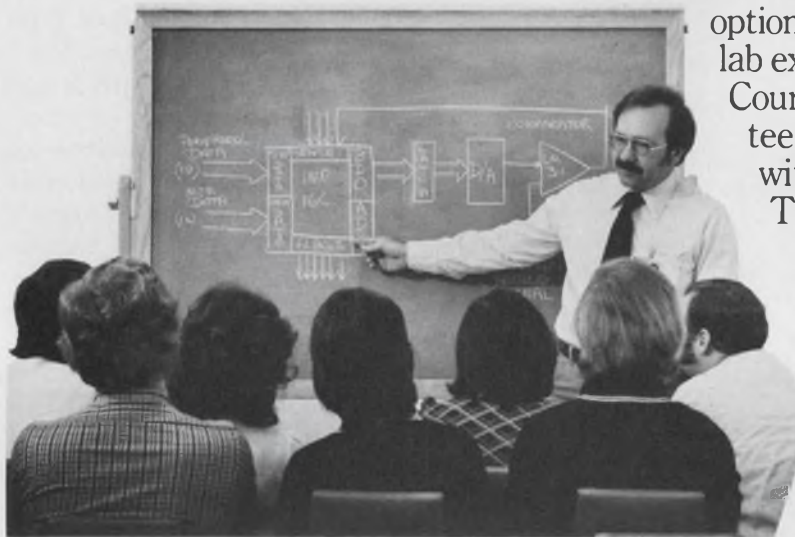

Introducing National's new microprocessor schools.

These aren't your sales-oriented "seminars" that various manufacturers hold on occasion at hotels. These are permanent, fully-equipped training centers dedicated to the thorough, systematic education of the engineering community to the ins and outs of microprocessing.

Located in Miami, Dallas, and Santa Clara, our Training Centers will offer extensive hands-on training to reinforce class lectures. There'll be at least one lab station for every two students (consisting of a microcomputer, Disc Operating System, terminal, and experimental peripheral devices for solving class problems).

In each course we'll work your tail off for four days, with a fifth, optional day available for extra lab experience and consultation.

Course prerequisites guarantee that you'll be working with others at your level.

The courses cost \$395 each.

### **Microprocessor Fundamentals.**

Stored program concepts, logical functions, basic stuff like that.

You can be dumb as a turnip about microprocessing, but it'd help if you know something about digital design

techniques, binary numbers, hexadecimal numbers, and Boolean algebra.

### **Programmable Systems Design.**

An in-depth course on IMP-16 and PACE applications and interfaces.

For this one you should either have taken our basic course or otherwise have a basic grounding in microprocessor concepts, software, programming and interfacing.

**Advanced Programming.** This one's for the guy who'll write complex applications software.

It'll cover hairy stuff like fixed frequency events, real time software design, and system timing considerations.

Prerequisites are considerable ...check with our Training Center.



# processor input to your brain.



**Microprogramming.** This course covers the use of National's Microprogram Development System in developing instruction sets, modifying standard instruction sets, and developing totally new instruction sets for our IMP series of microprocessors.

Prerequisites are pretty stiff... check with our Training Center.

**For Further Information:** Call or write the Training Center nearest you:

Eastern Microprocessor Training Center, National Semiconductor Corp., 2721 Bayshore Drive South, Suite 121, Miami, Florida 33133. (305) 446-8309.

Central Microprocessor Training Center, National Semiconductor Corp., 13773 North Central Expressway, Suite 1132, Dallas, Texas 75231. (214) 690-4552.

Western Microprocessor Training Center, National Semiconductor Corp., 2900 Semiconductor Drive, Santa Clara, Calif. 95051. (408) 732-5000, ext. 7183.

#### CLASS SCHEDULE

SCHOOL LOCATION	MICRO-PROCESSOR FUNDAMENTALS	PROGRAM-MABLE SYSTEMS DESIGN	ADVANCED PROGRAMMING	MICRO-PROGRAMMING
Miami	May 5-8 June 16-19, August 11-14.	April 7-10, May 12-15, June 23-26, August 18-21.	May 19-22, July 14-17, August 25-28.	July 21-24.
Dallas	April 21-24, July 14-17.	March 24-27, April 28- May 1, June 2-5, July 21-24.	July 28-31.	
Santa Clara	April 28- May 1, June 9-12, July 28-31.	March 24-27, May 5-8, June 16-19, August 4-7.	May 12-15, June 23-26, August 11-14.	October 27-30.

**National**  
There's more to microprocessing  
than microprocessors.

See us at the NCC, booth #2305-7



# Simplify add-on peripheral controllers

with LSI data-communications circuits. A mini-to-terminal interface provides one practical example.

With available LSI data-communication circuits, it's possible to cut costs and simplify the design of peripheral controllers for minicomputers. And the same design techniques can be extended to microprocessors.

Peripheral controllers interface minis or microprocessors (which use a parallel-data format) and peripheral equipment (which employs a serial format). Hence controllers perform serial/parallel data conversions, and they contain interface, timing and synchronizing circuitry. Many of these features have been incorporated into two LSI data-communication circuits: the UART (Universal Asynchronous Receiver/Transmitter) and ACIA (Asynchronous Communications Adapter).

Either LSI circuit can be used in applications involving such peripheral equipment as teletype-writers and terminals. Typically such applications call for low transmission rates—below 1200 bps or 120 char/sec—and operation in an asynchronous mode. A teletypewriter, for instance, operates asynchronously at 10 char/sec maximum rate.

The design of a peripheral controller conveniently breaks down into these three phases:

- Interface and control logic.
- Data conversion.
- Software.

Let's see how a design proceeds with the following example: a controller for a popular mini-computer must transmit and receive data from a TI ASR 700 tape-cassette terminal.

## Consider the system basics

The terminal uses an asynchronous serial bit stream consisting of data bits that are preceded by a Start bit and followed by one or more Stop bits (Fig. 1). The Start and Stop elements don't contain information, but they do establish bit and character synchronization at the receiving device. Also some mechanical teletypewriters—and some recent integrated terminals—require more than

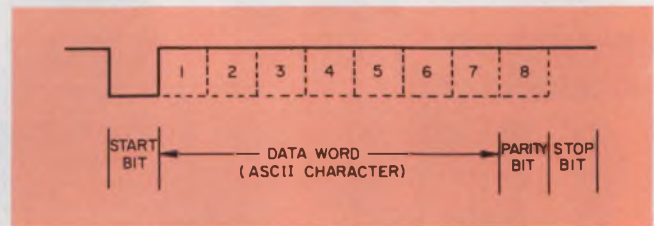

1. Peripheral devices use asynchronous formats.

one Stop bit, due to the mechanical response time of the unit.

The TI terminal also uses the ASCII (American Standard Code for Information Interchange) code for representation of alphanumeric information. In the transmission of data, a clock signal is not transmitted along with the data, and gaps (idling) between the characters may result. Therefore the receiving device must generate a clock that is synchronized to the data for purposes of data sampling.

In the mini, data are handled in a 16-bit parallel form without Start and Stop elements. The mini uses 16 address lines to select the peripheral device for data transmission. Under program control, the mini asserts a peripheral address, and parallel data either transfer to or from the peripheral controller—a "write" or "read" operation, respectively. Then the controller converts the parallel data to serial form for use by the terminal, or vice versa.

The peripheral controller consists of six sections (Fig. 2): Address and Control Logic, I/O Interface Circuitry, Multiplexer, Transmitter, Receiver and Status-and-Control Storage.

Again under program control, an 8-bit character (in ASCII code) is loaded into the transmitter portion; Start and Stop bits are added to the character and it is transmitted in serial form to the terminal. Likewise in the receiver section, the incoming serial character has its Start and Stop bits stripped, and the character becomes available to the mini in parallel form.

Either the UART or ACIA can be used to perform the serial/parallel conversions.

The transmitter portion of the UART adds a Start and one or two Stop bits to the character

Karl Fronheiser, Computer Applications Engineer, Motorola, Inc., Semiconductor Products Div., Phoenix, AZ 85008.



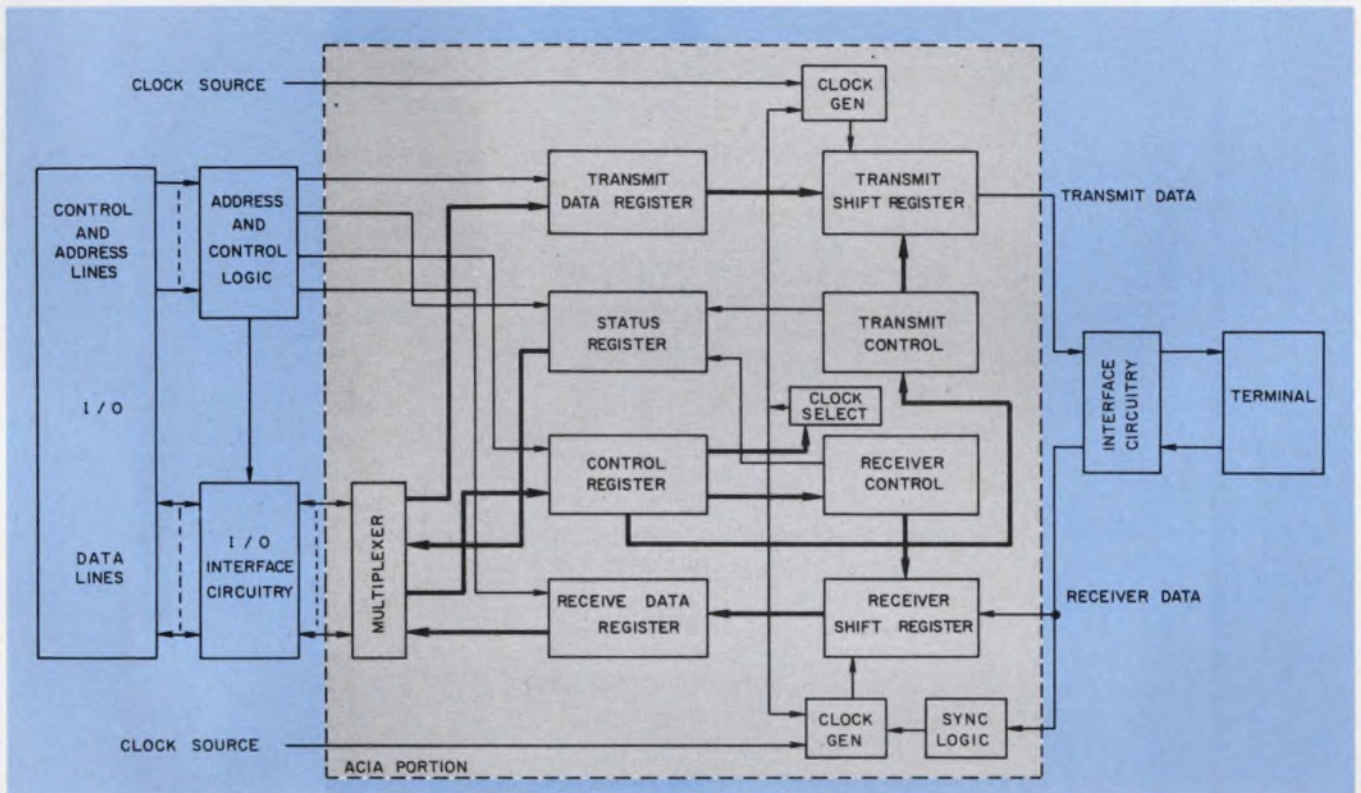

2. A peripheral controller consists of the blocks shown. An ACIA incorporates much of the circuitry needed.

as it shifts out serially. If internal parity generation has been selected, a parity bit also is inserted in the last data-bit position (the 8th bit in ASCII). The transmitter's input data storage has double buffering, so that one character can be loaded into a buffer as another character transmits out of a shift register.

Detection of the Start bit—logic ZERO—initiates the UART's receiver cycle. The Start bit's leading transition synchronizes an internally generated clock to the data. Sampling is enabled at the approximate midpoint of the bit times. The Start-bit detection circuitry latches when the Start bit remains low for half a bit time. Then remaining data bits can be sampled at their approximate midpoints.

The UART's receiver also has double buffering, so that one character can be read from a buffer as a shift register receives another. The status

of each incoming character is checked for parity and framing and overrun errors. A framing error indicates the absence of a Stop bit, and an overrun indicates that a character previously received has not been read by the mini.

#### UART and ACIA differences

Thus far, the characteristics of a UART are identical to that of an ACIA. With a UART, however, control inputs, status outputs and data buffers are accessible through unidirectional lines. Thus the I/O bus of the mini requires additional multiplexing for read or write operations. The ACIA incorporates the multiplexing circuitry, so that status, control and data registers are accessible through a single bidirectional bus.

A schematic of the peripheral controller appears in Fig. 3. Bus drivers and receivers must



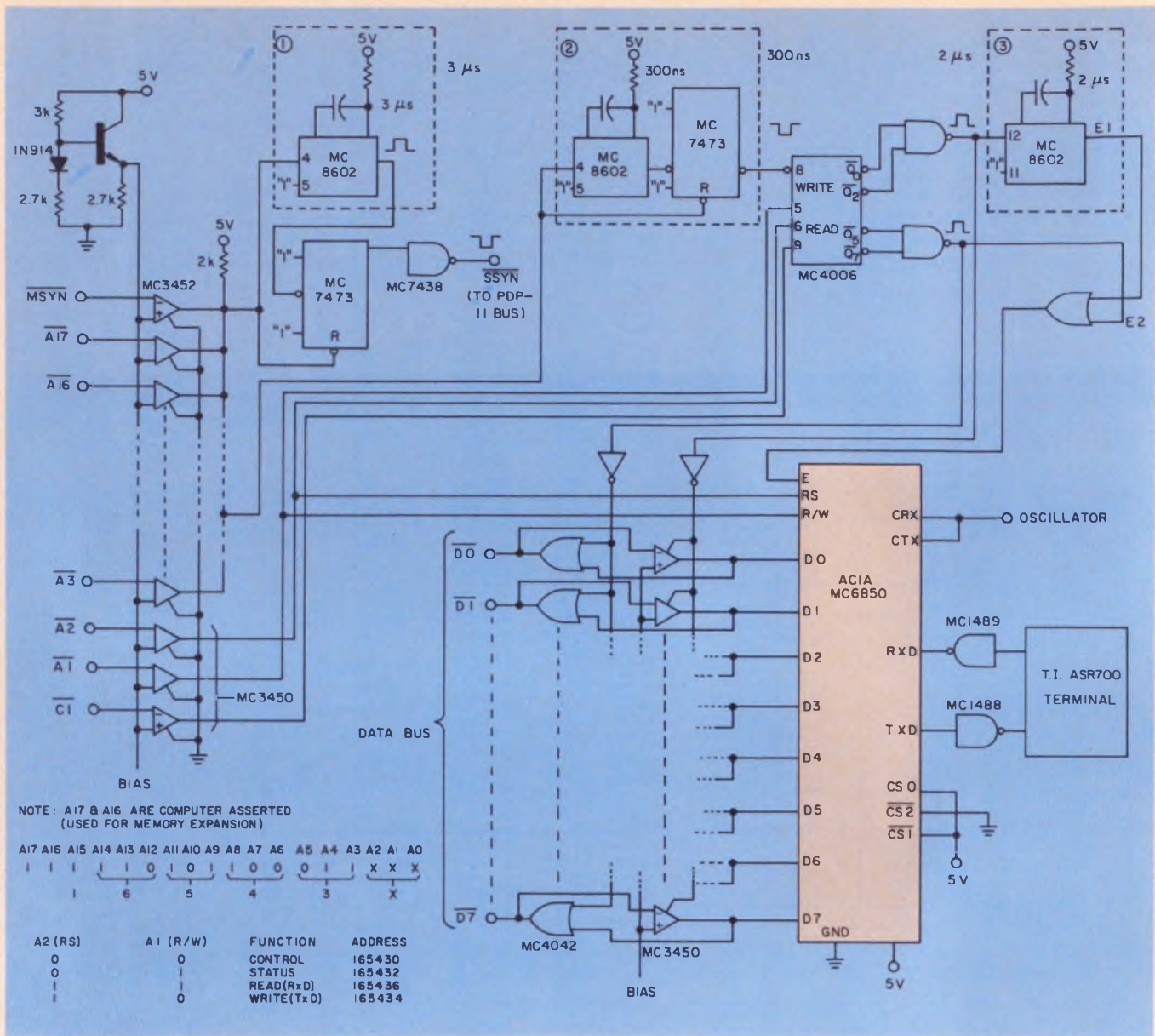

3. The hardware requirements for the controller are indicated in this schematic.

meet the mini's I/O interface specifications, shown in the table.

From Fig. 3, an open-collector quad line receiver (MC3452) decodes the mini's address bus. The address and data bus of the mini are in complemented form. A biasing network connected to appropriate address-receiver inputs simplifies the address decoding. Also, the biasing network sets the threshold level of the receiver.

Address lines  $\overline{A}_{02}$ ,  $\overline{A}_{01}$  and control line  $\overline{C}_1$  use an active pull-up, TTL-compatible receiver (MC3450) to drive other TTL-compatible logic in the controller. And the bidirectional data bus employs both a driver (MC4042) and receiver (MC3450).

During the read and write operations, the PDP-11 places the controller address on the address bus, along with control bits and a Master Sync (MSYN) command (Fig. 4). The MSYN signal

allows for the skew between the address and control bits; it indicates to the peripheral that the address and control bits are present.

Once an MSYN signal is asserted, the peripheral controller has a maximum time—up to 20  $\mu$ s, depending on the mini model—to respond with a Slave-Sync (SSYN) signal. This signal can be delayed by the one-shot (1) in Fig. 3 to allow for data processing within the controller. The response of an SSYN signal indicates to the mini that the address has been recognized by the controller and performance of the request has taken place. After MSYN is cleared, the controller clears SSYN to free the bus for other purposes. One MSYN is generated for a read operation and two for a write operation.

The mini treats a peripheral address the same as it does a core-memory address. This address requires a clear (destructive read) com-



## Table. Mini interface requirements

DRIVER (OPEN-COLLECTOR OUTPUT)	50 mA AT 0.8V	LOGIC "0"
RECEIVER	2.5V AT 160 $\mu$ A	LOGIC "1"
	1.4V AT 0.0 $\mu$ A	LOGIC "0"

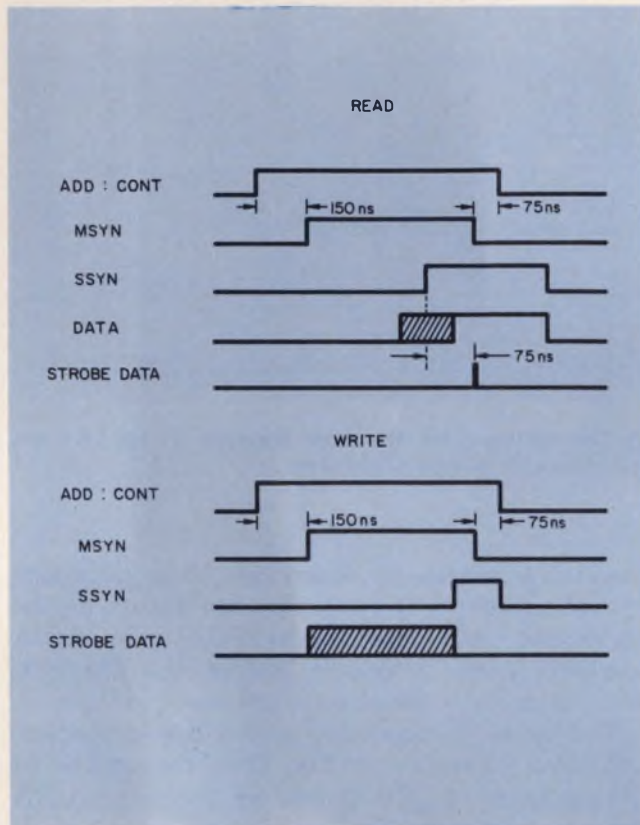

4. The mini establishes these timing requirements for read and write operations.

mand before data can be written into core. But unlike core memory, data can be written into the peripheral controller without the need for a clear operation. Therefore the read command must be ignored by use of the  $C_1$  control bit, which indicates either a read or write operation.

The ACIA's four registers—control, status, receive data and transmit data—require four separate addresses that must be in even numbers, since the mini's  $A_{00}$  bit is used to indicate a byte operation. And for simplified decoding logic, address bits  $A_{01}$  and  $A_{02}$  select one of four registers. For example, address 165430 (octal notation) can access the control register while addresses 165432, 165434 and 165436 can access the status, transmit-data and receive-data registers, respectively.

To prevent "glitches" during register access, the Read/Write (R/W), Register Select (RS)

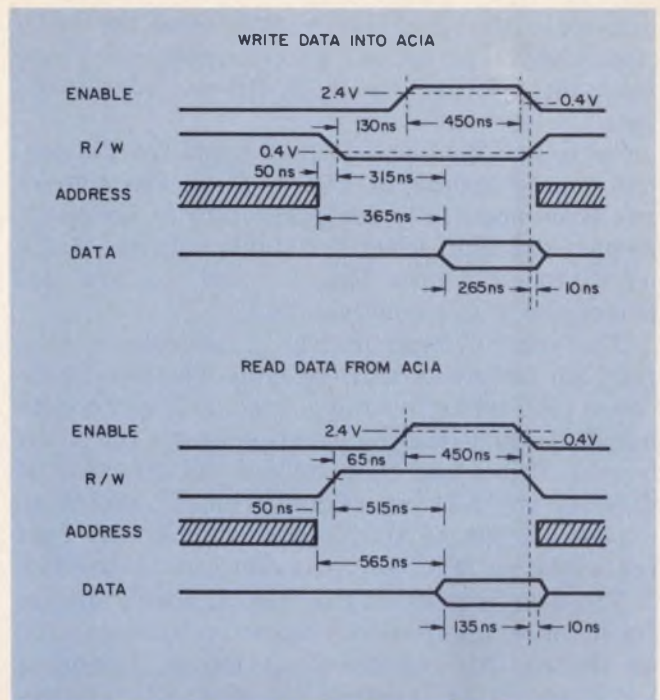

5. The ACIA has setup and hold timing relationships that must be observed in the controller design.

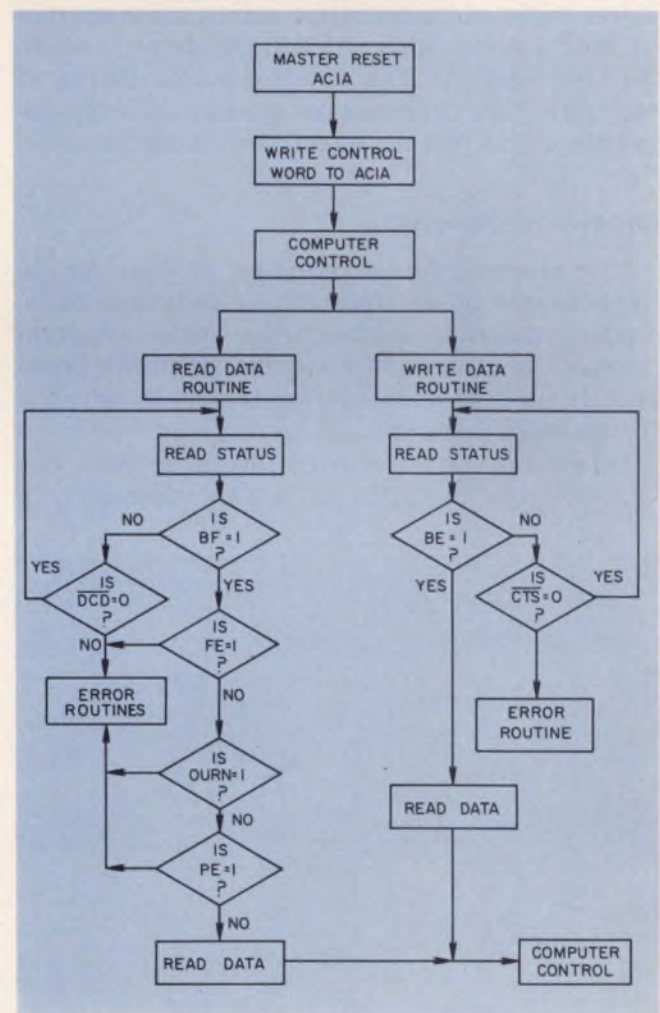

6. Read and write operations for the minicomputer are outlined with the flow diagram.



and address inputs must be stable when the ACIA enable input is active. This requirement stems from the fact that the R/W, RS and address inputs are level-sensitive.

Setup and hold-time requirements for the control inputs appear in Fig. 5. Since the address bus is decoded fully for generation of an S<sub>SYN</sub> signal, the chip-select capability of the ACIA isn't needed. Hence C<sub>S0</sub>, C<sub>S1</sub> and C<sub>S2</sub> are tied permanently to an active state.

The control logic in Fig. 3 provides timing for both the ACIA and the mini. The 4-to-10 decoder (MC4006) generates read and write commands. In turn, the commands generate the ACIA enable strobe, and they control the direction of data on the I/O bus. Control bit C<sub>1</sub> selects an unused output of the decoder during the read command, so that the command can be ignored.

The delay circuit (2) in Fig. 3, which enables the decoder, also provides the setup time required by the ACIA's register-select inputs. During a write operation, another one-shot (3) ensures that enable setup and hold-time requirements are met.

Finally the controller-to-terminal interface employs standard RS232 devices. The ACIA receiver input and transmitter output are converted to RS232 levels with an MC1488 driver and an MC1489 receiver. The data input and output of the ASR 700 terminal is already RS232-compatible, so no further interfacing is needed.

### Software requirements

The minicomputer's reception of data can be implemented on an interrupt or dedicated basis. Under interrupt control, the main program "jumps" to an interrupt routine. Then the interrupt is serviced and program control is returned to the main program.

Interrupts can occur from several sources. For example, the reception of a data character in

```

ACIAC = 165430 CONTROL REGISTER
ACIAS = 165432 STATUS REGISTER
ACIADT = 165434 TRANSMITTER REGISTER
ACIADR = 165436 RECEIVER REGISTER

• INITIALIZATION
  MOVW #263, ACIAC ;MASTER RESETS ACIA
  MOVW #261, ACIAC ;Control Word - Selects word length,
  etc.

• READ ROUTINE
  READ1 : MOVW ACIAS, R1 ;GET STATUS OF ACIA
          COMB R1 ;TRUE FORM
          BITB #001, R1 ;CHECK BUFFER FULL
          RNE 2 FRAM ;BRANCH IF BUFFER IS FULL
          BITB #010, R1 ;CHECK DCD
          BEQ READ1 ;READ STATUS AGAIN

          BR ERROR ;BRANCH IF CARRIER IS LOSS
          FRAM : BITB #020, R1 ;CHECK FOR FRAMING ERROR
                BEQ OVRN ;BRANCH IF NO FRAMING ERROR
                BR ERROR ;BRANCH FOR FRAMING ERROR
          OVRN : BITB #040, R1 ;CHECK OVERRUN ERROR
                BEQ PAR ;BRANCH IF NO OVERRUN
                BR ERROR ;BRANCH IF OVERRUN
          PAR : BITB #100, R1 ;CHECK PARITY ERROR
                BEQ DATA ;BRANCH IF NO ERROR
          ERROR : (ERROR ROUTINE) ;ERROR ROUTINE
          DATA : MOVW ACIADR, R1 ;GET DATA
                  COMB R1 ;TRUE FORM (NON COMPLIMENTED)
                  RTS ;RETURN FROM SUBROUTINE

• WRITE ROUTINE
  READ2 : MOVW ACIAS, R1 ;GET STATUS OF ACIA
          COMB R1 ;TRUE FORM
          BITB #002, R1 ;CHECK BUFFER EMPTY BIT
          RNE DATA2 ;BRANCH IF BUFFER IS EMPTY
          BITB #010, R1 ;CHECK CTS BIT
          BEQ READ 2 ;BRANCH IF CTS IS ACTIVE
          (ERROR ROUTINE) ;ERROR ROUTINE
  DATA2 : MOVW R2, ACIADT ;LOAD DATA IN TRANSMITTER
          RTS ;RETURN FROM SUBROUTINE

```

7. The software for the flow diagram in Fig. 6 uses minicomputer source statements.

the ACIA causes an interrupt. In a dedicated system, a subroutine samples the status of the peripheral until data are available. The ACIA works in either interrupt system, but the software example is based on a dedicated system.

The ACIA incorporates power-fail protection and power-on reset circuitry. These features avoid the reception of false indicators from the ACIA during a power-on sequence. But they don't eliminate the need for initialization after power-on. Initialization begins with a master reset of the ACIA. Then the control registers are used to program such parameters as word length and

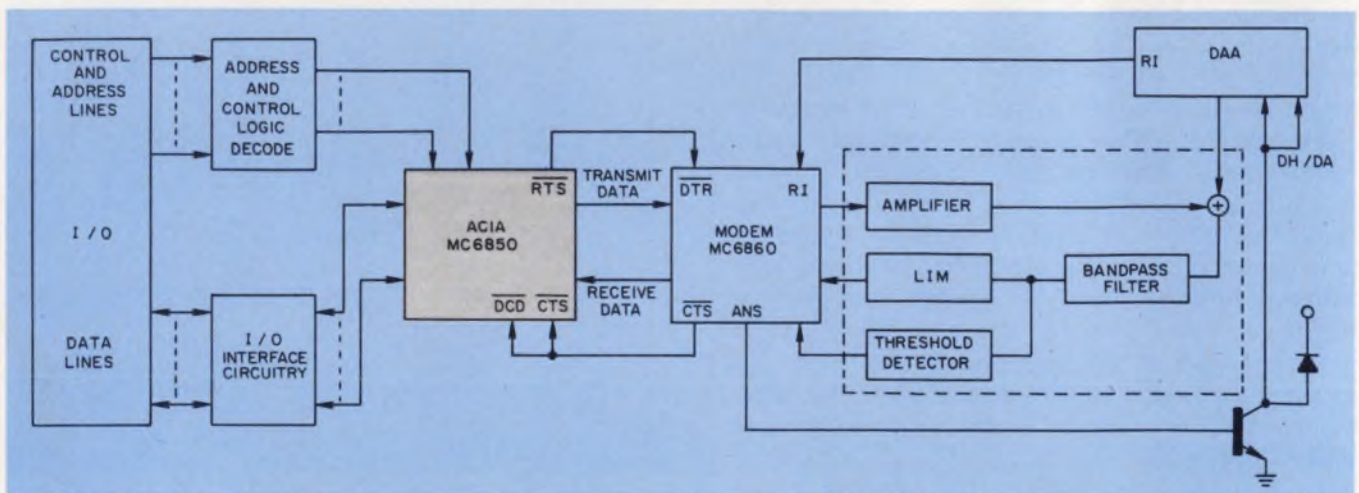

8. With a modem interface, remote data entries can be achieved.



counter-divider ratios. The flow diagram of the read and write routines appears in Fig. 6.

In a read operation, the ACIA's buffer-full status bit is checked continually until data have been received. Then remaining status bits are checked for data errors due to parity, framing or overrun. A data error causes a jump to an error routine (not shown), which can cause retransmission of the previous character or can cancel the erroneous data. If no errors occur, the controller reads the data and program control returns to the main program.

In a write operation, the buffer-empty status bit is checked to see if data may be loaded into the buffer. After a character is loaded into the controller, the program control returns to the main program. An example of source statements—in the mini's language—for the read and write routines appears in Fig. 7.

#### Modem extends controller range

With the addition of a modem, the controller can transmit or receive data from remote locations over telephone lines. The ACIA can initiate the handshaking requirements between the local and remote locations through the chip's internal control functions. Fig. 8 shows a typical example that uses a low-speed modem (MC6860).

The modem converts the digital transmitted data from the ACIA into an analog form for transmission. Likewise, analog data received by the modem are converted to digital form for use by the mini. Telephone companies require the Data Access Arrangement (DAA) for protection of their equipment. The remote site also requires a modem to convert the data from analog form to digital form and vice versa.

The following procedure achieves "handshaking" between the ACIA and modem after the telephone channel has been established: The local modem (in Originate mode) is enabled via the Request to Send (RTS) output of the ACIA. The remote modem, upon answering the phone, transmits back its carrier frequency. Upon detection of this carrier, the local modem enables its Clear-to-Send (CTS) output, which is detected by the ACIA. Then data can be transmitted and received under computer control.

The CTS input of the ACIA is available as a status bit in the status register, and it also disables the transmitter portion when inactive. The Data Carrier Detect (DCD) input of the ACIA is available as a status bit and it also disables the receiver portion when inactive. In this example, the low-speed modem has only a CTS output. Therefore the CTS output of the modem is tied to both the CTS and DCD inputs of the ACIA to disable the transmitter and receiver simultaneously. ■■

# Over 10 years ago Globe brought out the first maintenance-free rechargeable battery.



## Today Globe's the most proven one.

# gel/cell<sup>®</sup> the rechargeable with experience!

- emergency lighting
- security systems
- memory standby
- portable instrumentation
- telecommunications
- medical electronics
- sport and recreation

*Write for the complete maintenance-free story!*



**GLOBE BATTERY**

DIVISION OF GLOBE-UNION INC.

Gel/Cell Marketing

5757 N. Green Bay Avenue

Milwaukee, WI 53201 — (414) 228-2394

INFORMATION RETRIEVAL NUMBER 50



First came Remex flexible disk drives.

## Now, the whole, compact, IBM-compatible, data-packin' system

The new Remex RFS7400 flexible disk system offers all of the high-speed, high-capacity attributes inherent in this technique, plus many outstanding performance advantages unique to the Remex design.

Naturally, the Remex systems are IBM 3740 compatible. We test each system to prove it. They read diskettes prepared in a 3740 system, or write and initialize diskettes that can be read on a 3740 system. The RFS7400 also offers a unique write enable option that gives foolproof operation without modification on any standard IBM compatible media.

Among the many other features, the RFS7400's fail-safe drive design offers Tracks "00" and "76" sensing to prevent machine damage and loss of data at both ends of the media. It offers approximately 50% longer life than competitive drives. And average random access time is more than 30% faster.

The system includes formatter electronics, with up to four separate drives, and power supply. Diagnostic software, I/O drivers and computer compatible interface controllers are available as options for PDP-11 and NOVA minicomputers. Like all other Remex computer interface packages, we guarantee system compatibility.

The Remex flexible disk system offers:

- Multiple drive read-write/seek operation
- File Unsafe
- Write protect
- High data reliability (Read Error Rate:  $1 \times 10^9$  bits Read/Error, nominal;  $1 \times 10^{12}$  bits Read/Hard Error, nominal)
- Storage capacity:  $246 \times 10^3$  bytes per diskette
- Transfer rate:  $31.25 \times 10^3$  bytes (8-bit) per second
- Available for 115 VRMS, 60Hz, 230 VRMS, 50Hz.
- DMA and Programmed I/O interface controller (option)

ASK FOR AN EVALUATION UNIT: Write Remex, Ex-Cell-O Corporation, 1733 Alton St., P.O. Box 11926, Santa Ana, Cal. 92711. Or call:

BOSTON: (617) 784-8380 • NEW YORK: (212) 947-0379  
ORLANDO: (305) 894-4401 • CHICAGO: (312) 359-1310  
DALLAS: (214) 661-0300 • PHOENIX: (602) 946-4215  
LOS ANGELES: (714) 557-6860 (Orange County)

We work with you

# REMEX



Peripheral  
Products

Ex-Cell-O Corporation

INFORMATION RETRIEVAL NUMBER 55

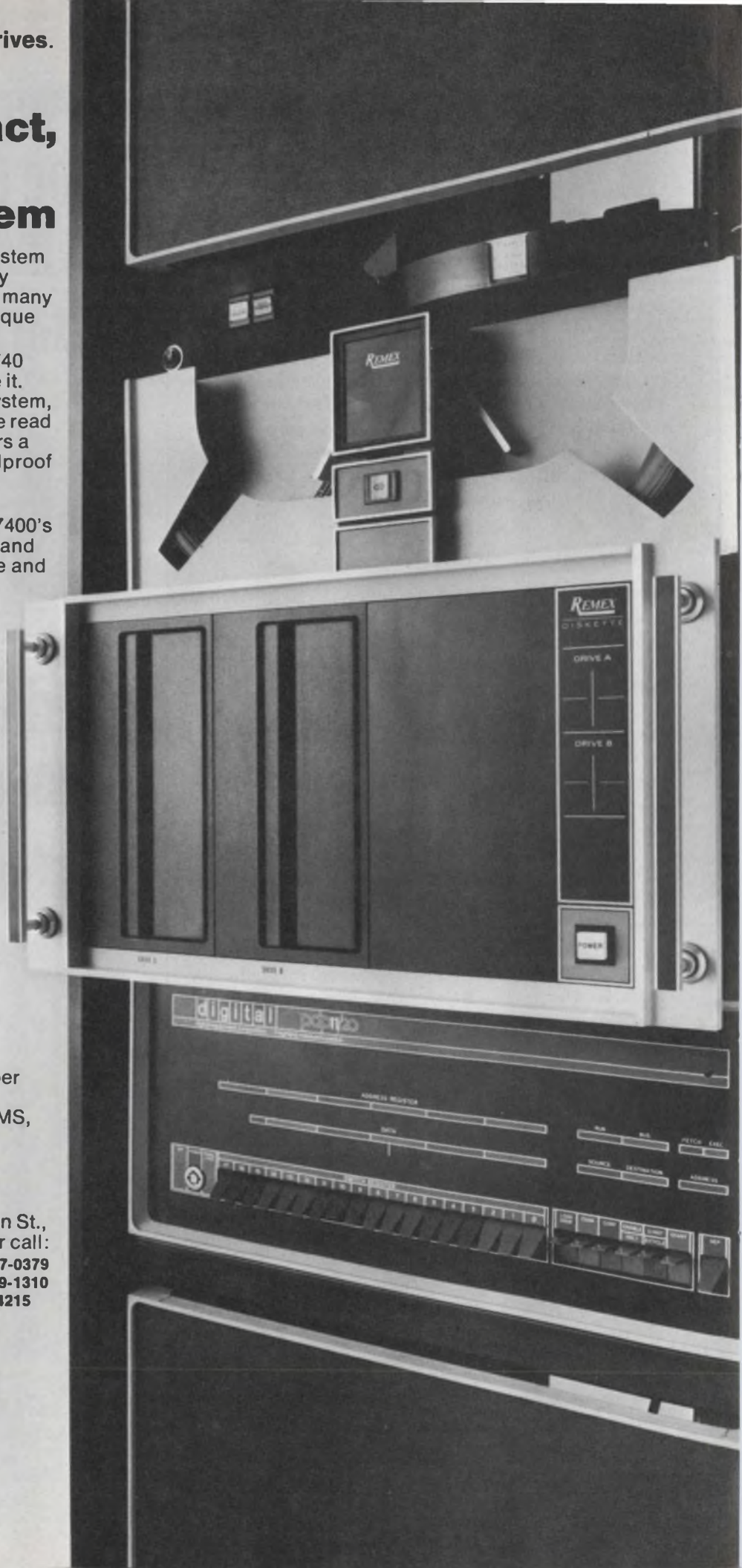



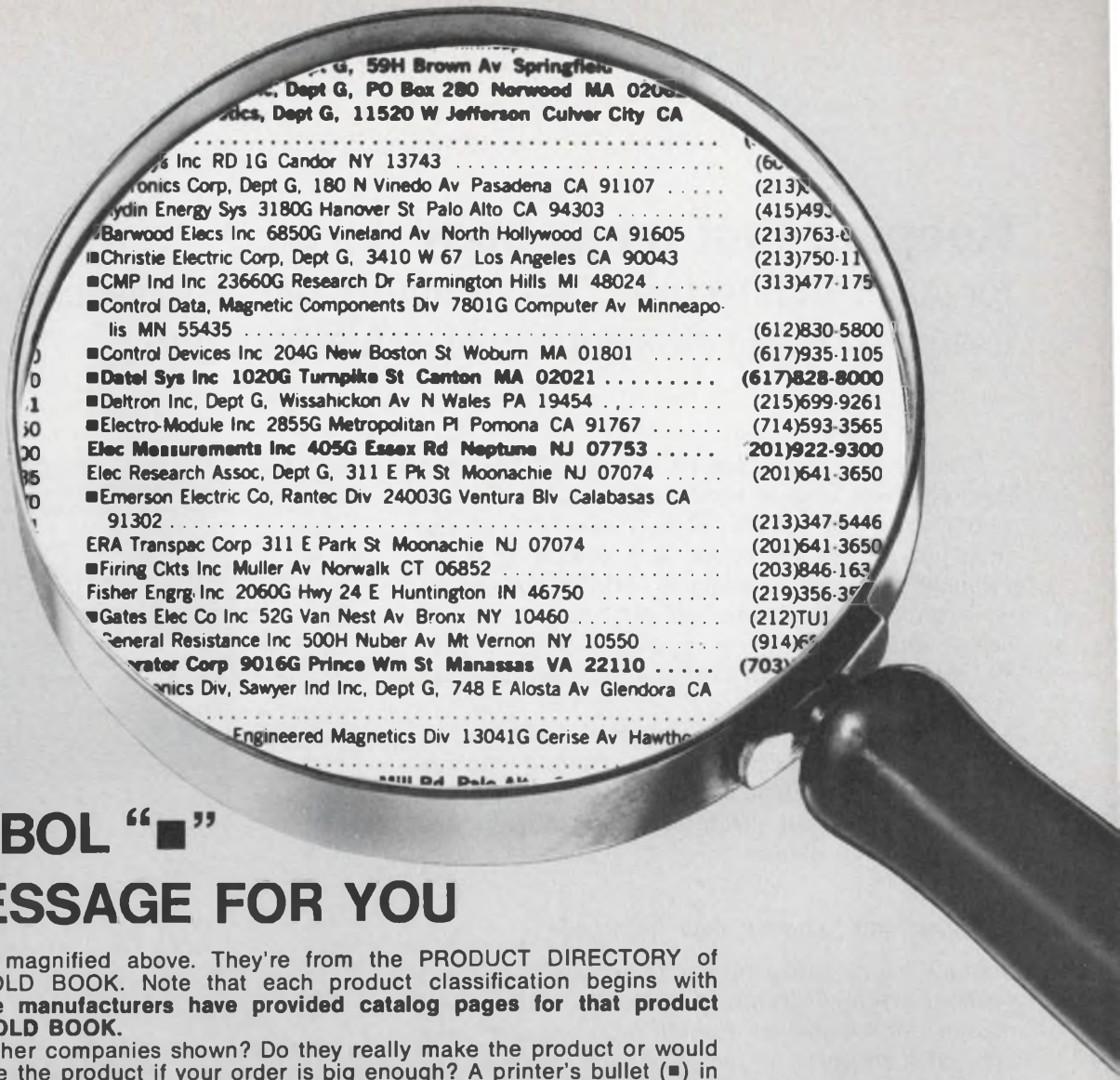

## THIS SYMBOL "■" HAS A MESSAGE FOR YOU

Look at the listings magnified above. They're from the **PRODUCT DIRECTORY** of *Electronic Design's* **GOLD BOOK**. Note that each product classification begins with boldface listings. **These manufacturers have provided catalog pages for that product in vols. 2 or 3 of the GOLD BOOK.**

But what about the other companies shown? Do they really make the product or would they merely *like* to make the product if your order is big enough? A printer's bullet (■) in front of its name means that the company has submitted printed literature on that product to the editors of the **GOLD BOOK**. It's reasonable to assume that these suppliers actually make the product, for it's not likely that a supplier would prepare literature for a product he can't ship. The bullet ■ gives you a measure of verification.

Manufacturers listed in boldface in the second sub-group have provided catalog pages, but not for the specific product heading the list.

In a constantly moving industry, these measures of verification are of course subject to change. Yet they can be helpful guides as you seek out potential suppliers.



Electronic Design's  
**GOLD BOOK**  
 BIGGEST AND BEST ELECTRONICS MASTER CATALOG  
 & DIRECTORY IN THE WORLD



# Keeping fast minis busy is a job for stack architecture. One computer can serve several users and make efficient use of virtual memory.

Fast minis are becoming a way of life, but keeping them busy is something else. It's not uncommon to find a CPU that is idle 80% of the time but spends the other 20% compiling a developmental Fortran problem. Multiprogrammed operation, in which one machine serves several users simultaneously, is a good solution. And stack architecture can create a suitable machine environment.

Important capabilities supported include: re-entrant coding, time-sharing, dynamic storage allocation and efficient use of virtual memory. As a side benefit, the architecture also enhances compiler performance.

## Stack systems separate data from code

Stack architecture differs from the traditional register-oriented design. A program in the main memory of a register-oriented minicomputer consists of a mixture of two elements: machine instructions and program data (Fig. 1). The machine instructions are usually *static*, while the data and return addresses *change* during the life of the program. And herein lies the problem: A program in a register-oriented computer consists of elements that change as well as elements that remain fixed. Therefore it is difficult to implement multiprogramming on traditional systems, because the programs cannot efficiently be made re-entrant.

Consider the case of two users, one with an active program, the other waiting (Fig. 2). The active program calls a commonly used routine, say Subroutine A. But in the middle of execution, the operating system interrupts the program of User 1 for a higher priority job from User 2. Assume that User 2's program also calls Subroutine A and completes execution. When User 1's program resumes at the point of interruption, all variable elements, such as data and return addresses, will have been destroyed.

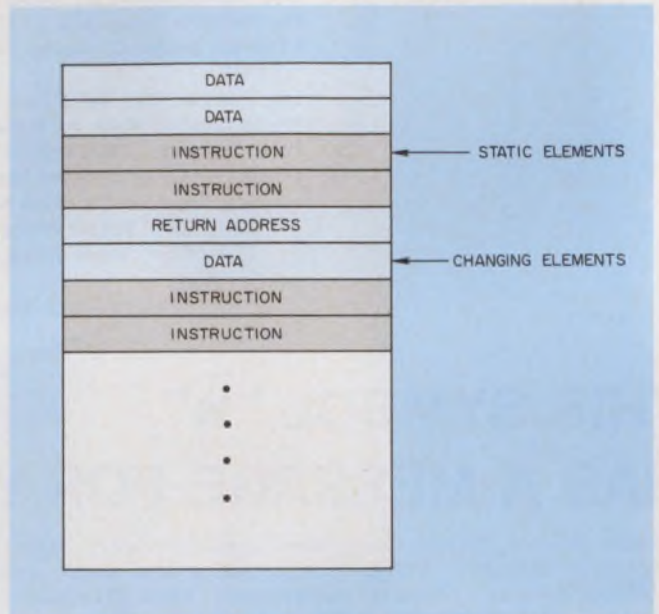

1. Data and instructions for a given program are usually combined in a multiprogrammed computer.

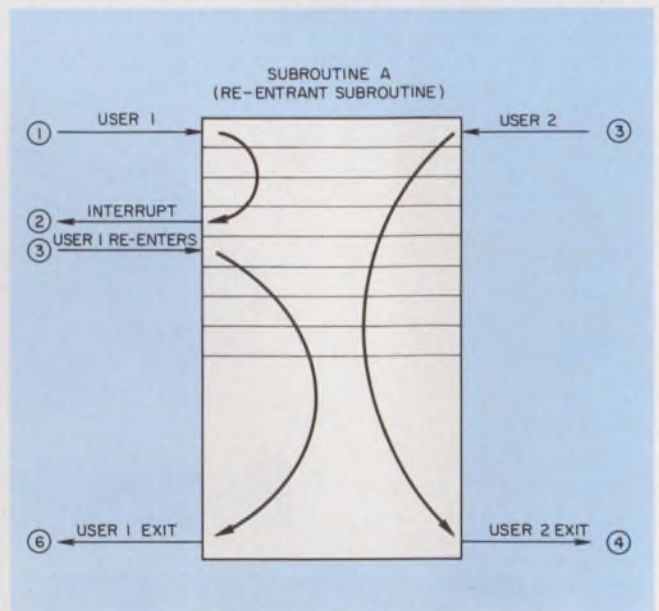

2. When several persons must use the same program, the mixture of instructions with calculated results makes for difficult bookkeeping, especially if the routine can be interrupted then re-entered.

William E. Foster, Computer Systems R&D Manager, Hewlett-Packard Data Systems, 11000 Wolfe Rd., Cupertino, CA 95014.



There are four possible solutions to this problem:

1. Restart User 1 at the beginning of the subroutine. This has the obvious disadvantage of poor performance, along with the possibility that User 1 will never finish because of frequent higher-priority interrupts.

2. Provide multiple copies of the common subroutines, one for each user. This solves the re-entrance problem but is inefficient use of memory, because of duplication of programs (in our example, Subroutine A could have been a 30,000-word Fortran compiler).

3. Provide a software solution, where all variable data are moved to a protected area of memory at the beginning of the subroutine and restored at the end. This is the approach that some real-time operating systems use, but, again, it has the disadvantage of poor performance, due to the overhead of moving data to and from the subroutine each time it is called. For commonly used functions, such as sine and square root, this could easily double their execution time.

4. Provide a design where programs are divided into two classes of elements: machine code that never changes, and variable elements, such as data arrays, temporary storage locations and return addresses. This is precisely the principle of stack architecture.

Stack architecture provides an efficient implementation of re-entrant programming (Fig. 3). In a stack machine, programs consist of *separate* code and data segments. It is not possible for a user to modify a code segment; therefore all programs are automatically re-entrant. It is never necessary to have more than one copy of any program or subroutine, even if many simultaneous users are accessing it. However, each user has his own unique data area. Data segments contain all information that changes as the program executes—such as variables, arrays and return addresses. Code segments contain all of the information that remains fixed—machine instructions and program constants.

In a multiprogrammed minicomputer system, programs should be shared among all active users; unnecessary duplication of code severely restricts the number of users that can execute concurrently. The example shows just one subroutine being shared, but in reality the system could be sharing compilers, libraries, application programs and even parts of the operating system itself, such as the file system.

Time-sharing is a subset of multiprogramming (the term, when applied to minicomputers, usually means a multiterminal system with just a single language available, such as BASIC). Shared code isn't necessary because just one program runs on the system—the BASIC interpret-

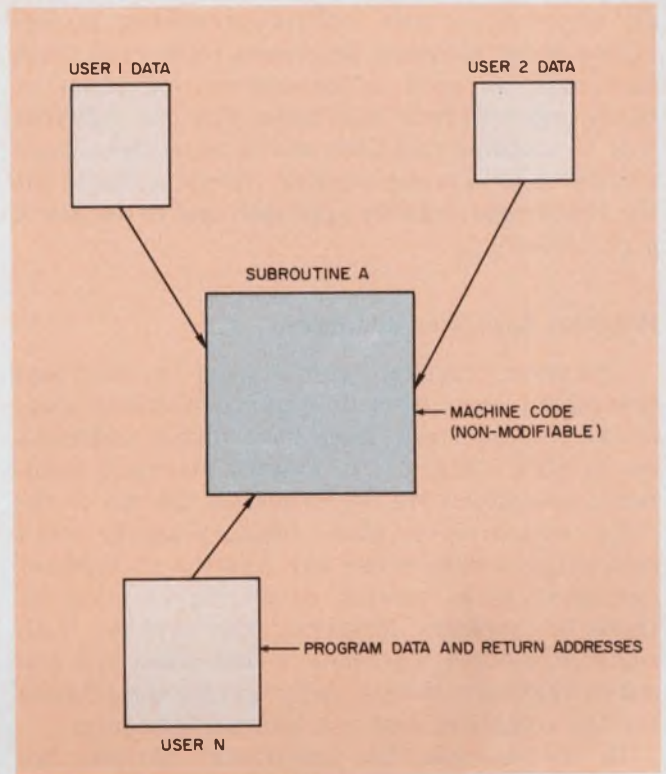

3. Separation of code and data, as with a stack machine, allows each user to work with any portion of the same re-entrant routine. There is need to save only the data calculated by the program and return addresses.

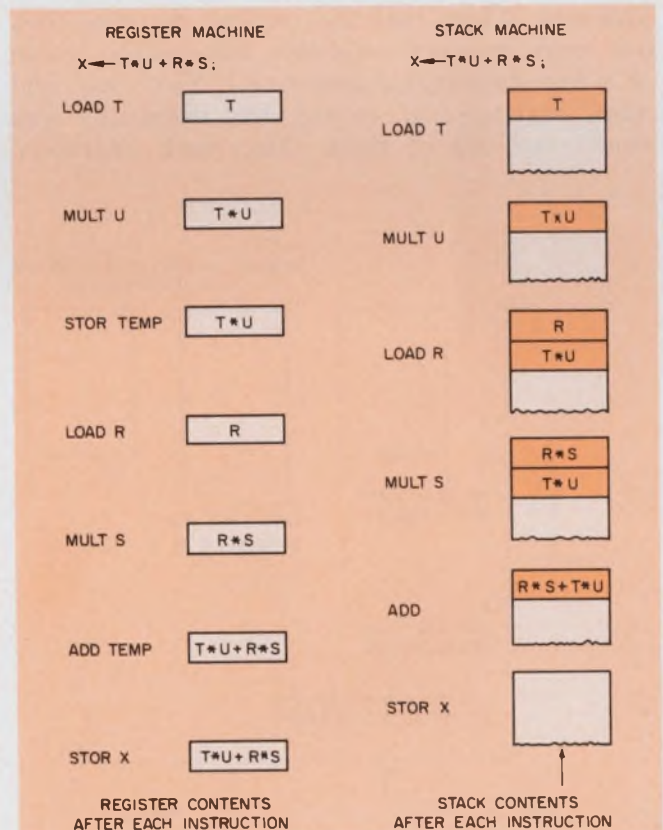

4. A stack machine has virtually an unlimited number of addresses, but a register machine must store to temporary locations.



er. However, a true multiprogramming system allows many different languages to be used from terminals, as well as concurrent execution of batch and real-time programs. The only efficient way to combine real-time multilingual time-share and batch on a minicomputer system is throw out the traditional register approach and to use stack architecture.

### Registers have fixed addresses

The term "register" comes from the fact that traditional computers do their arithmetic operations in registers that have fixed addresses in the CPU (Fig. 4). In a stack machine, arithmetic operations are performed on the top of the stack, which moves about memory as the stack size changes. Therefore any location in memory can serve as a register, producing as many as there are memory locations. The problem with register-oriented machines is that when you run out of registers, things really become complicated for the compilers and you lose performance.

In the example, the traditional machine has only one register. The compiler must allocate a temporary location in the program and store the intermediate result ( $A*B$ ) into it to evaluate the expression. This complicates the design of the compiler, wastes memory (for both the temporary cell and the program steps necessary to access it), and degrades the performance of the program. (Note that the register machine took one more memory reference instruction, which is a time-consuming operation.) You could add more registers, of course, but eventually you would run out of them. Also, each additional

register slows the "context switching" time—the time when the system switches from one user to the next—because each register must be saved in memory and later restored if it is going to be used by the next user.

In the stack machine there is no need for temporary storage of intermediate results; arithmetic operations use the top-most elements in the stack. LOAD instructions "push" data onto the top of the stack, and STORE instructions "pop" data from the top of the stack. Intermediate results are automatically pushed deeper into the stack as new data are loaded, and the results are in place, ready for operation, without additional memory fetches.

### Storage can be allocated as needed

Stack instructions can be added to traditional, register-oriented minicomputers. And these instructions help in expression evaluation. However, a true stack machine—one designed with the stack in mind—uses the stack in many other ways. One is through dynamic storage allocation, which greatly reduces the total memory required to execute a program. In a traditional computer, storage for all the data requirements of a program is allocated when the program is loaded, because the data are embedded in the program itself. More efficient use of memory results if the storage is allocated on an as-needed basis, and pooled when no longer required (Fig. 5).

With stack architecture, when the program is first loaded, memory is allocated for the minimum requirements of the program, such as COMMON blocks in a FORTRAN program.

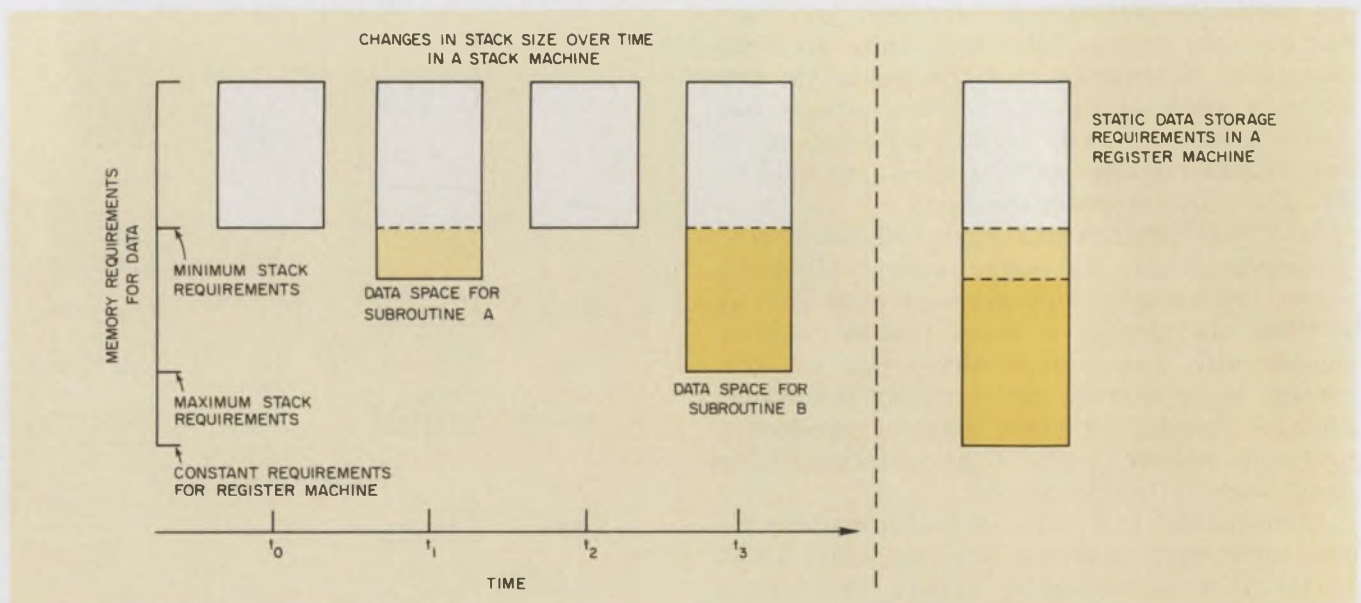

5. Dynamic memory allocation becomes automatic with a stack, since each subroutine uses only the amount of data space needed to perform calculations. In a regis-

ter machine the maximum space is allocated at execution time, and it remains fixed. Hence a stack machine makes efficient use of memory.



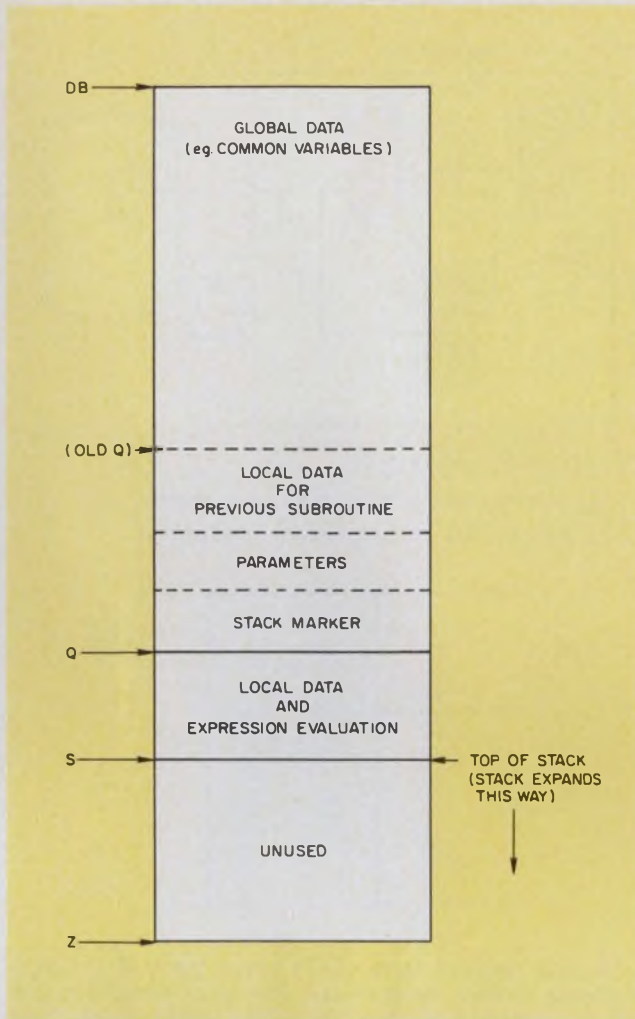

6. Four registers control stack boundaries. DB and Z limit the stack to prevent interference between users. Q indicates the data base for a currently executing routine, and S follows the changing stack size.

Then, as subroutines are called, the stack is expanded to meet their requirements. When a subroutine terminates, the stack is cut back to its original size so the memory can be used by the next subroutine. Generally the maximum amount of storage required at a single time is less than the amount required for the entire life of the same program on a register machine.

Four registers control the stack boundaries in the CPU (Fig. 6). DB points to the beginning of the stack, and Z to the limit of the stack. These registers provide the protection required in a multiprogrammed system so that a user cannot get outside of his assigned boundaries. S points to the current top of stack, and it continually changes as expressions are evaluated and storage is allocated. Q points to the base of data for the currently executing subroutine. Just below Q there is a stack marker that contains return addresses and information on how far to cut back the stack when the current subroutine is finished. Below this are the parameters that have been

passed to the subroutine by the calling program. A by-product of the stack that is very useful to systems programmers is that it permits all subroutines in any language to be recursive. When a subroutine contains a call to itself, the parameters are loaded on the top of the stack, Q is reset, and the process repeats.

The area between Q and S is for local storage of the currently executing subroutine and for storage of expression evaluation. The space above DB is used by global data, such as COMMON blocks. If S tries to expand beyond Z, the CPU interrupts the operating system and lets it make the decision whether or not to expand the stack beyond its current limit.

Because code and data are separated in a stack machine, it is relatively easy to implement an efficient virtual memory scheme. The machine code can be divided into variable length segments, so only that part of the program currently executing needs to be in main memory (Fig. 7a). The location of each code segment (either memory location or disc address) is kept in a resident table called the Code Segment Table (CST). The process of linking a segmented program together during execution is as follows:

1. Whenever a subroutine call statement is encountered in a program, the compiler emits a PCAL (procedure call) machine instruction. If the call is to be a subroutine within the currently executing code segment, the CPU merely branches to the beginning of the subroutine, with the return address left on the top of the stack (in the "stack marker" described previously).

2. If the call is to a subroutine that is external to the code segment, PCAL examines the CST to determine the location of the code segment. If the code segment is in main memory, the CPU branches to the appropriate location within that code segment.

3. If the CST indicates that the called code segment is not in main memory, the CPU performs an internal interrupt, branches to the operating system, and provides the disc address and length of the required code segment. It is now up to the operating system, through decisions made by the memory manager and the scheduler, to decide when to bring in the code segment.

This process makes it extremely easy to develop programs that are much larger than available memory. At any point in time it is only necessary for one code segment and the stack of the currently executing program to be in main memory. This makes more memory available to other users so that fast context switching between users can take place. Each time a PCAL is executed, the instruction sets a bit in the appropriate CST entry. These bits in the CST are periodically scanned by the operating system to determine which are the most frequently used



# 12 Bit A/D in a dip...



**1  $\mu$  sec  
per bit**

The MN5210 Series of 12 bit A/D converters guarantees total conversion time of 13  $\mu$ sec maximum...a clock rate of 1 MHz.

Micro Networks 12 bit A/D's are:

- Totally adjustment free and factory trimmed. The need for range and zero adjustments is totally eliminated, thereby effecting savings in space, component count, assembly, and test labor.
- Hermetically sealed 24-pin dip package—guarantees high reliability and space savings.
- Low power (700 mw)—reduces system power drain.
- Guaranteed  $\pm 1/2$  LSB linearity over the full temperature range—assuring no missing codes.
- Available to the full MIL temperature operation of  $-55$  to  $+125^{\circ}\text{C}$ .
- Optionally available processed to MIL-Std-883, Class B.

Prices: MN5210 (1-24)...\$275  
MN5210H (1-24)...\$425



Available from stock.  
Technical data available  
on request. Write or call  
...today.  
Tel: 617-852-5400

**MICRO NETWORKS  
CORPORATION**

324 Clark Street • Worcester, Mass. 01606

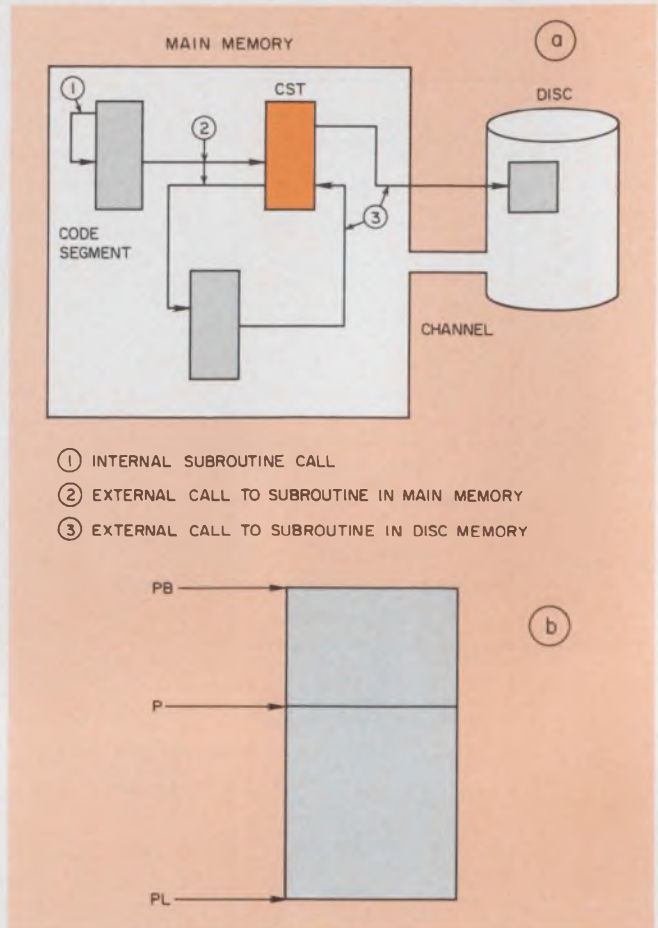

- ① INTERNAL SUBROUTINE CALL
- ② EXTERNAL CALL TO SUBROUTINE IN MAIN MEMORY
- ③ EXTERNAL CALL TO SUBROUTINE IN DISC MEMORY

7. A code segment table (CST) keeps track of program segments in main memory (a). The stack simplifies this virtual memory operation, because program and data are separate. Three registers, PB, P and PL, protect and manage the code being executed (b).

code segments. The least used are swapped out to make room for the most-used segments.

Three registers are used to point to the currently active code segment: PB, P, and PL (Fig. 7b). PB points to the base of the code segment, while PL points to the end of it. P points to the currently executing instruction. PB and PL provide protection in code segments in the same way that DB and Z provide protection in data segments. This protection is critical for multiprogrammed environments. Another requirement for a system where use of main memory is very dynamic is ease of relocation of code and data. All instructions are PB or P-relative, and all data are relative to the stack registers (DB, Q, and S).

Q and S are relative to DB, and P is relative to PB. Therefore only one register has to be set when code or data are loaded into memory: PB for code and DB for data. It is not necessary for the operating system to patch the address portions of memory reference instructions or to change indirect pointers in the data segments. The relocation of code and data is very fast and efficient in a stack machine. ■■



Inherently rugged, these triple-diffused devices permit circuit operation directly from rectified 117V or 220V line — eliminating transformers. Ideally suited for inverters, convertors, switching regulators, motor controls and wherever there's hi-rel applications. The exploded view demonstrates our single chip design and packaging

TYPE #	(pk.) I <sub>c</sub>	V <sub>CE</sub>	h <sub>FE</sub> @ I <sub>c</sub>	Switching Speed (Typ.)
PT-3512	70A	325	10 @ 30A	t <sub>r</sub> = .5 μs
PT-3513	70A	400	10 @ 30A	t <sub>s</sub> = 1.2 μs
PT-3522	90A	325	10 @ 50A	t <sub>r</sub> = .5 μs
PT-3523	90A	400	10 @ 50A	
350 Watt Power Rating		Guaranteed SOAR		

concept which makes high-voltage, high-current transistors off-the-shelf availability possible. Pre-rating and pre-testing techniques of chip allows choice of solid copper packages. For further information

and application assistance, call Sales Engineering, PowerTech, Inc., 9 Baker Court, Clifton, N.J. 07011. (201) 478-6205.

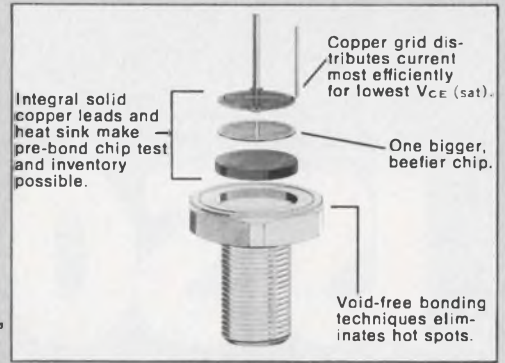

**PowerTech, Inc.**

"BIG IDEAS IN  
BIG POWER"

# 400v90AMP



NPN Silicon  
Power Transistor  
Switch — Highest KVA  
at lower cost,  
weight & space.



# IF OUR IS SO MUCH BET WHY IS IT \$100



Face it, the big guy always gets to charge more than the little guy.

But does Dana really make a better counter than H-P?

Compare our 8010B with the H-P 5326A. Our frequency is three times

better than theirs. Our sensitivity is two times better. Our basic model gives you eight digits. Theirs gives you seven.

Our counter has a 100-second time base. Theirs, a 10-second time base. We use standard TTL plug-in IC's.



# COUNTER BETTER THAN H-P'S, CHEAPER?



H-P doesn't. So we're easier to service.

The H-P stripped model costs \$1,595. Ours is \$1,495.

Buy our counter.  
Before we get to be the big guy.

Call our Sales Department  
at (714) 833-1234 for your nearest Dana

representative, or  
write to us at 2401  
Campus Drive, Irvine,  
California 92664.

**DANA**®

**Others measure by us.**



# Uncover data-acquisition errors despite complex specs. An error budget prepared from the data sheet verifies the performance directly from system printouts.

A precalculated error budget, plus an assist from the systems computer, provides fast check-out of a computer-based data-acquisition system design. The resulting test is easy to apply, yet it takes full account of the complex specifications for individual analog-input devices, such as multiplexers and digitizers.

With the error budget, you predict the allowable mean and rms errors of the entire system. The computer calculates mean and rms values from data samples collected while operating with a calibrated input source. Comparison of computed values with calculated maximum sample means and standard deviations tells the tale. In a few minutes, thousands of samples on many channels can be taken, digitized and printed out.

## Plan the test approach

The errors may be divided into two types: systematic and random. The systematic are identifiable quantities, such as the settling error of a zeroing potentiometer.

**Ware Myers**, Senior Engineer, Xerox Corp., 9920 La Cienega Blvd., Inglewood, CA 90301.

Random errors occur because of electrical noise. Typically the probability density of this random noise has the customary gaussian or bell-shaped curve centered on the systematic error mean. In some instances less random forms of electrical noise, such as power-supply ripple, may cause systematic errors. In the present analysis this effect is ignored.

The computer calculation consists simply of the sample mean and standard deviation for N measurements. Along with the sample of N measurements, you also program channel gain, sample rate and other system variables. The equations to use with the acquired data are straightforward:

$$\text{Sample mean} = \frac{1}{N} \sum x_i = \bar{X}$$

and

$$\text{Sigma} = \left( \frac{1}{N} \sum_{i=1}^N (x_i - \bar{X})^2 \right)^{1/2},$$

in which  $x_i$  is a single sample. The unit for  $x_i$  is the digital count as presented to the computer from the a/d converter.

Systematic errors fall into two classes: zero and reading errors. Zero errors represent inaccuracies

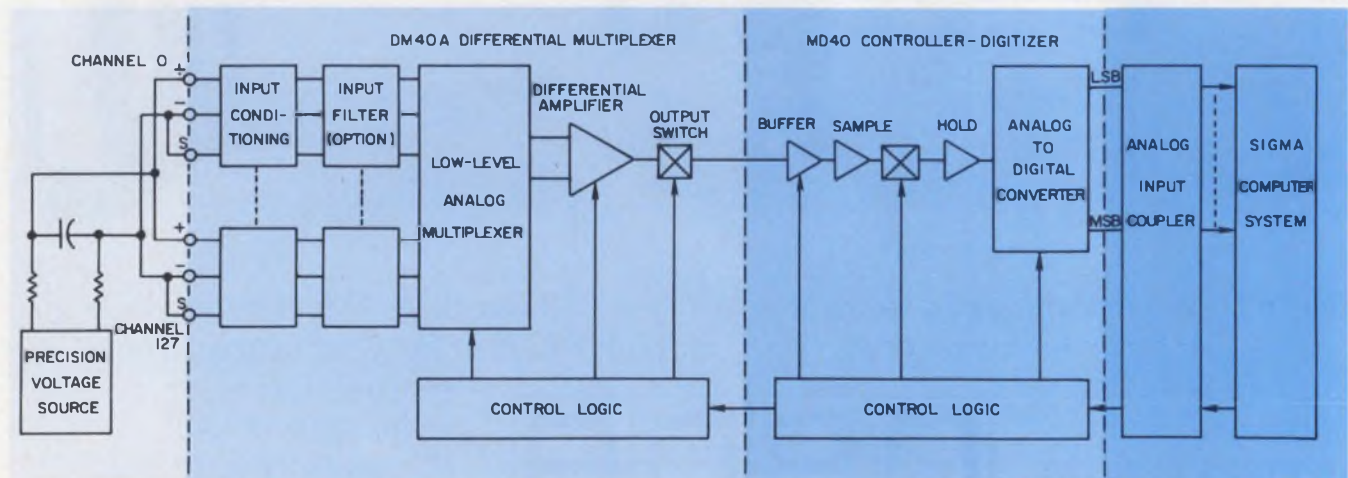

1. To check out a data-acquisition unit, set up a simulated system configuration and apply a precision voltage

source. The computer can provide outputs to verify over-all performance as calculated from subsystem specs.



racies present during the processing of a zero input signal. Reading errors are additional inaccuracies present in the processing of a nonzero signal. Reading errors are directly proportional to the signal and usually are listed on spec sheets as a percentage of full scale.

Zero errors fall into two further spec categories: referred-to-input (rti) and referred-to-output (rto). For unity channel gain, simply add values. For higher gains, multiply rti by gain and add to rto value.

Specs for temperature-related errors, which are sometimes zero errors, are given as a value per degree C. Include these for a range of  $\pm 3$  C within the assumed temperature range of the test itself. As used in this report, the temperature error is zero if the test is conducted at the vendor's calibration temperature. But even in a controlled environment, an allowance of 3 C (more in an uncontrolled environment) is advised.

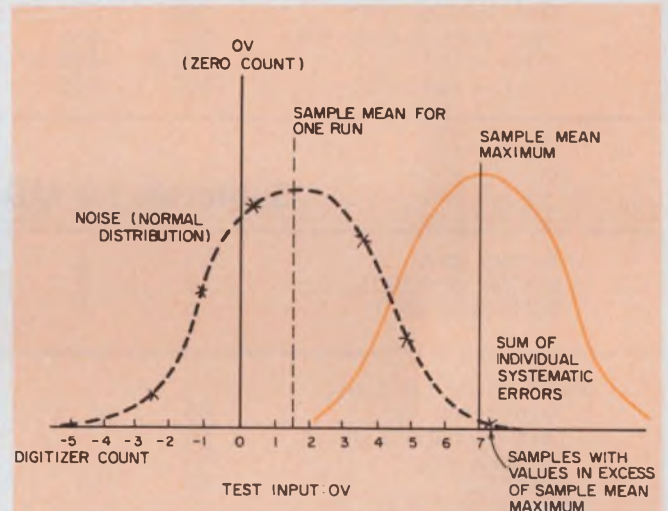

2. Performance capability is bounded by two main factors: cumulative systematic errors and random electrical noise. The computer calculates the mean and standard deviation to compare with calculated values.

Table 1. Analog subsystem—zero error specs

DM40A Differential Multiplexer		MD40 Controller-Digitizer (with buffer input)	
Zero trim resolution:	$0.5 \mu\text{V rti} + 70 \mu\text{V rto}$	Zero resolution:	$60 \mu\text{V rti} \pm 100 \mu\text{V rto}$
Dynamic offset:	$0.65 \mu\text{V rti}$ at 10 sample /s (filtered channels only)	*Zero stability tempco:	Single-ended input; $20 \mu\text{V rti} + 50 \mu\text{V rto} / ^\circ\text{C}$ , or $60 \mu\text{V rti} + 150 \mu\text{V rto} / 3 \text{ C}$
*Zero stability tempco:	$1 \mu\text{V rti} + 20 \mu\text{V rto}$ per $^\circ\text{C}$ ( $3 \mu\text{V rti} + 60 \mu\text{V rto}$ for 3 C range)	Differential input:	$30 \mu\text{V rti} + 50 \mu\text{V rto}$ per $^\circ\text{C}$ , or $90 \mu\text{V rti} + 150 \mu\text{V rto} / 3 \text{ C}$
Input current On:	$0.1 \mu\text{V rti}$ based on 0.1 nanoamp per leg input current multiplied by $R_{s1} + R_{s2}$ or $(100 + 0)$ .	MD40 digitizer:	Zero setting resolution; $\pm 0.002\%$ FS (10V) maximum, or $200 \mu\text{V}$
Input current Off:	$3 \mu\text{V rti}$ (filtered only); computed as $0.1 \text{ nA} \times (R_{s1} + R_{s2})$ plus $0.5 \text{ nA} \times (1020 + 1020)$ plus $2 \mu\text{V}$	Zero stability, tempco:	$\pm 0.001\%$ FS per $^\circ\text{C}$ , or $100 \mu\text{V}$ per $^\circ\text{C}$ or $300 \mu\text{V}$ for 3 C
Input Settling Time: 1000 or 10,000 sample/s	$\pm 0.01\%$ FS or $5 \mu\text{V rti}$ , whichever is greater	†Dynamic error at 13 bits.	$\pm 0.01\%$ FS, maximum, or $100 \mu\text{V}$
15,000 sample/s	$\pm 0.01\%$ FS or $15 \mu\text{V rti}$ , whichever is greater		

\* Based on a calibration temperature of 25 C  
 † Full scale is 10 V



## Subtotals for DM40A

	1	8	64	512	1024	2048	4096	Units
System gain	1	8	64	512	1024	2048	4096	
DM40A gain (G1)	1	8	64	512	512	512	512	
MD40 gain (G2)	1	1	1	1	2	4	8	
<hr/>								
DM40A (rti)								
Zero Trim Resolution	0.5						0.5	μV
Zero Stability (3 C)	3.0						3.0	
Input current ON	0.1						0.1	
Subtotal (rti)	3.6						3.6	
rti × G1	3.6	28.8	230.4	1843	1843	1843	1843	
Input settling error (rti)	—	—	—	5	5	5	5	
Input settling error × G1	—	—	—	2560	2560	2560	2560	
<hr/>								
DM40A (rto)								
Zero trim resolution	70						70	μV
Zero Stability (3 C)	60						60	
Input settling error (rto)	500	500	500	—	—	—	—	
Σ (rti + rto)	633.6	658.8	860.4	4533	4533	4533	4533	
Σ (rti + rto) × G2	634	659	860	4533	9066	18,132	36,264	

## Subtotals for MD40 and system total

	1	8	64	512	1024	2048	4096	Units
System gain	1	8	64	512	1024	2048	4096	
DM40A gain (G1)	1	8	64	512	512	512	512	
MD40 gain (G2)	1	1	1	1	2	4	8	
<hr/>								
MD40 Buffer Input (rti)								
Zero Resolution	60						60	μV
Zero Stability (3 C)	90						90	
Subtotal (rti)	150						150	
rti × G2	150	150	150	150	300	600	1200	
MD40 Buffer Input (rto)								
Zero resolution	100						100	μV
Zero Stability (3 C)	150						150	
Subtotal (rto)	250						250	
Σ (rti × G2 + rto)	400	400	400	400	550	850	1450	
MD40 Digitizer								
Zero setting resolution	200						200	μV
Zero Stability (3 C)	300						300	
Dynamic error—13 bits	1000						1000	
Subtotal	1500						1500	
MD40 zero error	1900	1900	1900	1900	2050	2350	2950	μV
DM40 error	634	659	860	4533	9066	18,132	36,264	
Total system	2534	2559	2760	6433	11,116	20,482	39,214	
÷ 2441 μV	1.04	1.05	1.13	2.64	4.55	8.39	16.06	

3. Specs that define system errors are complex, and an error budget helps translate them to allowable measurement limits. Values referred to device inputs

are multiplied by the gain and summed. The spec shown governs zero error—the case when the input signal is zero.

To perform the test, we calculate the allowable ranges for three quantities:

- Zero error.
- Zero error plus reading error ( $\pm 80\%$  FS).
- Noise with zero input.

The computed means taken with zero input and at 80% FS are compared with the allowable values. Finally the computer-calculated value of sigma is checked against the allowable range.

Consider the following configuration: a precision voltage source, differential multiplexer, controller-digitizer, analog input coupler and computer (Fig. 1). The differential multiplexer,

Xerox Model DM40A, acquires up to 128 differential low-level signals. It conditions and optionally filters each channel, then multiplexes them into a single programmable-gain differential amplifier. The output switch can time-division multiplex up to eight DM40As to a common analog output bus. A programmable-gain buffer amplifier (part of the MD40 controller-digitizer) accepts the multiplexed analog signal and applies it to a sample-and-hold circuit. The a/d circuit provides sign plus 12 bits, which the analog input coupler applies to a Sigma-Series computer.

The computer controls the operation of the



## Table 2. Reading errors with $\pm 80\%$ FS input

Subsystem	Error Source	Specification	$\mu\text{V}$ at $\pm 80\%$ FS
DM40A	Gain trim resolution (all gains)	$\pm .01\%$ FS, max	$\pm 800$
	Gain accuracy between any two steps†	$\pm .02\%$ FS, max	$\pm 1600$
	Linearity, referred to straight line thru zero and FS	$\pm .005\%$ FS, max	$\pm 500$
	Extra Linearity (filtered channels)*	$\pm .01\%$ Reading	$\pm 800$
	Gain Stability all gains	$\pm .002\%$ / °C	$\pm 480$ (3 C)
MD40	Buffer Input		
	Gain Accuracy (X1)	$\pm .01\%$ FS max	$\pm 800$
	Gain Accuracy (X2, X4 X8)	$\pm .02\%$ FS max	$\pm 1600$
	Gain Stability	$\pm .0005\%$ / °C max	$\pm 120$ (3 C)
	Linearity (at X1)	$\pm .003\%$ FS max	$\pm 300$
	Digitizer		
	FS setting resolution	$\pm .01\%$ max	$\pm 800$
FS stability	$\pm .001\%$ / °C max	$\pm 240$ (3 C)	
	Static linearity	$\pm .01\%$ FS max	$\pm 1000$

\* Not used for calculations without filters  
 † Omit for unity gain

System gain	1	8	64	512	1024	2048	4096	Units
DM40A gain (G1)	1	8	64	512	512	512	512	
MD40 gain (G2)	1	1	1	1	2	4	8	
$\pm 8\text{V}$ input error (unfiltered)	5040	6640	6640	6640	11620	18380	31900	$\mu\text{V}$
Zero Error 1000 or 10,000 Samples/s	2534	2559	2760	6433	11116	20482	39214	$\mu\text{V}$
Total	7574	9199	9400	13073	22736	38862	71114	$\mu\text{V}$
$\div 2441 \mu\text{V}$	3.10	3.77	3.85	5.36	9.31	15.92	29.13	Count

4. Add the allowance for reading error in Table 2 to the zero error to get the total systematic error.

test through the analog input coupler. Controlled items include buffer and differential amplifier gain and selection of the analog channel. With four gain settings for the buffer amplifier and differential amplifier, 16 gain settings are possible. Eight combinations suffice to test each gain value. Input filters to the differential mux are optional, as is digitizer resolution of 8 to 13 bits; use 13 bits for best results.

Without systematic errors, the probability distribution of the system outputs resembles a gaussian curve centered at zero counts on the digitizer. A given sample mean can lie anywhere between the limits set by the sum of the individual systematic errors (Fig. 2), yet it will have a variance equal to that calculated for the noise components. The limits used equal the expected mean plus or minus the sum of the systematic errors. If the computer-calculated sample mean lies in this range, the result is acceptable for systematic or calibration error.

The DM40A's contribution to zero errors is calculated as follows:

- List referred-to-input (rti) error specifica-

tions in microvolts separately.

- Sum all rti errors.
  - Multiply the rti error sum by the DM40A gains.
  - List and sum referred-to-output error specifications.
  - Sum rti errors times gain and rto errors.
  - Multiply this final sum by the MD40's gain.
- The MD40 calculations for zero error follow a similar pattern.

Transferring detailed specs (Table 1) to the actual worksheets (Fig. 3) is a straightforward chore if you use the aforesaid steps. Calculations are performed separately for each unit then added together to provide the over-all system error.

After summation, the errors for the DM40A and MD40 are converted to digitizer counts through division by  $2441 \mu\text{V}$ . Each count has the value given by

$$\frac{\text{Volts FS}}{\text{Counts FS}} = \frac{10 \text{ V}}{2^{12}} = 2441 \mu\text{V}.$$

Reading error plus zero error equals the sys-



tematic error near full scale—or, as used here 80% of full scale. Reading errors for each unit are listed and summed in essentially the same way as for zero errors. Gain-related errors must be selected for the system gain used in each set of test samples. The subtotal of DM40A reading errors (Table 2) is multiplied by the MD40 gain and added to the total MD40 errors. These results plus zero errors from the worksheet (Fig. 3) give the total systematic error (Fig. 4).

### Use rms addition for noise

Noise contributions add in an rms rather than algebraic sense, as shown in the worksheet for the calculation of rms noise (Fig. 5). The voltage standard introduces 50  $\mu\text{V}$  at 80% of full scale and 1  $\mu\text{V}$  at zero output. Additional calculations are supplied for grounded input, in which case the source does not contribute noise error.

Account must also be taken of the discrete nature of the data supplied to the computer. The computer cannot resolve 1- $\sigma$  noise values of less than one or two counts. If the mean signal value happens to equal 0.5 count, even the slightest noise will produce a sigma of 0.5. Why? Out of 1000 values, 500 give a count of -1 and 500 a count of +1; none falls on the boundary.

The corrections in Table 3 account for a/d resolution and apply to converters with any number of bits. For sigmas of greater than two counts, the corrections needed are negligible.

For quickest results, program the computer for short-form output (Fig. 6a). Include pro-

**Table 3. Correction factor for digitizer count**

Calculated mean square count	Corrected count
under 0.20	0.5
0.23	0.52
0.40	0.68
0.60	0.80
1.00	1.10
1.20	1.37
1.33	1.45
1.50	1.61
2.00	2.08
Above 2.00	Use calculated value

gram control of the number of samples digitized for each channel, the channel gain and sample rates. Then compare computer-calculated sample means and sigma with the chart values for volts and counts. Values for 0 V, 8 V (80% FS) and standard deviation should fall within the calculated limits (Figs 6b and 6c).

For further information, program a bar-chart histogram. Make the height proportional to the number of times a given count occurs. If more than three out of 1000 samples fall outside the 3- $\sigma$  limits, the noise probably contains systematic error components. ■■

## Worksheet for rms noise at 1000 sample/s

System gain	1	8	64	512	1024	2048	4096	
DM40A gain (G1)	1	8	64	512	512	512	512	Units
MD40 gain (G2)	1	1	1	1	2	4	8	
<hr/>								
Voltage standard rms, (max rms)	50	50	50	1	1	1	1	$\mu\text{V}$
DM40A at sample/s (max rms)	3.2						3.2	$\mu\text{V}$
$\Sigma (VS^2 + DM40A^2)^{1/2} = r_{ti}$	51	51	51	3.36	3.36	3.36	3.36	$\mu\text{V}$
$r_{ti} \times G1$	51	408	3264	1720	1720	1720	1720	$\mu\text{V}$
$r_{to}$ , rms, max	100						100	$\mu\text{V}$
$\Sigma (r_{ti}^2 \times G1^2 + r_{to}^2)^{1/2}$	112	420	3265	1723	1723	1723	1723	$\mu\text{V}$
$\Sigma (r_{ti}^2 \times G1^2 + r_{to}^2)^{1/2} \times G2$	112	420	3265	1723	3446	6892	13784	$\mu\text{V}$
<hr/>								
MD40 buffer input								
$r_{ti}$ (max rms)	60						60	$\mu\text{V}$
$r_{ti} \times G2$	60	60	60	60	120	240	480	$\mu\text{V}$
$r_{to}$ (max rms)	260						260	$\mu\text{V}$
Digitizer (max rms)	167						167	$\mu\text{V}$
$\Sigma (r_{ti}^2 \times G2^2 + r_{to}^2 + \text{Dig.}^2)^{1/2}$	315	315	315	315	332	392	571	$\mu\text{V}$
$\Sigma (DM40A^2 + MD40^2)^{1/2}$	334	525	3280	1751	3462	6903	13796	$\mu\text{V}$
$\div 2441 \mu\text{V}$	.14	.22	1.35	.72	1.42	2.83	5.65	Count
With grounded input	.14	.14	.16	.72	1.42	2.83	5.65	Count

5. Random-noise specs cumulate in rms fashion and include the effects of channel gain.



### Short-form printout

CHAN	EXPECTED VOLTS	GAINS		N	SAMPLE MEAN		STD DEVIATION	
		MUX	ADC		VOLTS	COUNTS	VOLTS	COUNTS
0128	000.0000V	0064	0001	01000	000.0000V	00000.0	0.0002V	000.1
0129	000.0000V	0064	0001	01000	000.0000V	00000.0	0.0004V	000.2
0130	000.0000V	0064	0001	01000	000.0000V	00000.0	0.0004V	000.2
0131	000.0000V	0064	0001	01000	000.0000V	00000.0	0.0002V	000.1
0132	000.0000V	0064	0001	01000	000.0000V	00000.0	0.0002V	000.1
0133	000.0000V	0064	0001	01000	000.0000V	00000.0	0.0002V	000.1
0134	000.0000V	0064	0001	01000	000.0002V	00000.1	0.0007V	000.3
0135	000.0000V	0064	0001	01000	000.0004V	00000.2	0.0009V	000.4

CHAN	EXPECTED VOLTS	GAINS		N	SAMPLE MEAN		STD DEVIATION	
		MUX	ADC		VOLTS	COUNTS	VOLTS	COUNTS
0128	008.0000V	0064	0001	01000	007.9995V	03276.6	0.0024V	001.1
0129	008.0000V	0064	0001	01000	007.9995V	03276.6	0.0026V	001.1
0130	008.0000V	0064	0001	01000	007.9995V	03276.6	0.0024V	001.0
0131	008.0000V	0064	0001	01000	007.9995V	03276.6	0.0024V	001.0
0132	008.0000V	0064	0001	01000	007.9995V	03276.6	0.0024V	001.0
0133	008.0000V	0064	0001	01000	007.9995V	03276.6	0.0024V	001.0
0134	008.0000V	0064	0001	01000	007.9997V	03276.7	0.0002V	000.1
0135	008.0000V	0064	0001	01000	008.0002V	03276.9	0.0026V	001.1

(a)

### Summary noise specification compared with test results

	1	8	64	512	1024	2048	4096	Units
System gain	1	8	64	512	1024	2048	4096	
DM40A gain (G1)	1	8	64	512	512	512	512	
MD40 gain (G2)	1	1	1	1	2	4	8	
Grounded Input								
Calculated (one sigma)	.14	.14	.16	.72	1.42	2.83	5.65	Count
Corrected (one sigma)	.50	.50	.50	.78	1.45	2.83	5.65	
Test Run, Range	.0-.1	.1-.1	.1-.4	.4-.6	1.0-1.2	2.0-2.4	3.8-5.2	
±8V Input								
Calculated (one sigma)	.14	.22	1.35	.72	1.42	2.83	5.65	Count
Corrected (one sigma)	.50	.50	1.38	.78	1.45	2.83	5.65	
Test Run: Range +8V	.2-.3	.3-.4	1.0-1.1	.6-.8	1.1-1.3	2.0-2.5	4.1-4.6	
-8V	.1-.1	.1-.1	1.1-1.2	.6-.8	1.1-1.3	2.1-2.4	4.1-5.2	

(b)

### Systematic error allowance at 1000 samples/s

Input	Volts ( $R_s < 100\Omega$ )	Gain setting	Sample Means (Limits)			Std. Dev. (Limits)		
			Volts	Counts	Counts	Volts	Counts	
zero	zero	x1	0.0000	±.0026	±1.1	.0012	.5	
		x8		±.0026	±1.1	.0012	.5	
		x64		±.0028	±1.2	.0012	.5	
		x512		±.0064	±2.7	.0019	.8	
		x1024		±.0111	±4.6	.0036	1.5	
		x2048		±.0205	±8.4	.0069	2.9	
		x4096	0.0000	±.0392	±16.1	.0138	5.7	
±8.0000	±.0005	x1	8.0000	±.0076	3277	±3.1	.5	
		x8		±.0092	±3.8	.0012	.5	
		x64		±.0094	±3.9	.0034	1.4	
		x512		±.0131	±5.4	.0019	.8	
		x1024		±.0228	±9.3	.0036	1.5	
		x2048		±.0389	±16.0	.0069	2.9	
		x4096	8.0000	±.0712	3277	±29.2	.0138	5.7

(c)

6. The computer provides values for sample mean and standard deviation (a). Values for the standard deviation

fall within corrected calculated values (b). Sample means easily meet the limits shown for mean values (c).





## OEM Referral Program

### OEM Referral Program Enrollment Form

Enrollment Form

Name: \_\_\_\_\_

Address: \_\_\_\_\_

City: \_\_\_\_\_ State: \_\_\_\_\_ Zip: \_\_\_\_\_

Phone: \_\_\_\_\_

Business Title: \_\_\_\_\_

Company Name: \_\_\_\_\_

Product Line: \_\_\_\_\_

Referral Source: \_\_\_\_\_

Signature: \_\_\_\_\_

Date: \_\_\_\_\_



# "If you're an OEM, I'd like you to join in an exciting new sales building program."

William Long  
VP OEM Group  
Digital Equipment Corporation

It's our brand-new catalog of OEM systems.

A book Digital salesmen will be using regularly to point out Digital OEMs to potential users of OEM systems.

A book which should mean bigger sales for everyone who's in it — and one of them can be you.

The OEM catalog is the key to a massive new program. Its whole intent is to help our OEMs sell computerized systems to end users. It's the OEM Referral Program. Here's how it works.

We're compiling a catalog of information supplied by our OEM customers on their systems.

With the total support of our worldwide sales force, backed by an advertising campaign in industrial magazines, we're offering help to anyone contemplating the purchase of major equipment.

That help takes the form of detailed suggestions on how to buy

computerized equipment. Suggestions on where to buy the type of equipment they need, and who they can buy it from.

The systems we suggest, of course, are systems sold by Digital OEMs.

What the catalog does is to categorize these systems (which span virtually the entire spectrum of OEM systems on the market today) so our salesmen can match prospects' needs with appropriate OEM systems.

The catalog, like the whole program, is serious business. It has only one purpose: to help your sales effort. After all, every system you sell to your customers is one more computer we sell to you.

But while the OEM Referral Program will be an increasingly important part of our own marketing strategy, it's not the whole story by any means.

We will continue to come out

with new breakthroughs in the areas of price and performance.

And we will continue to work with our OEMs in every way we can to help keep us both profitable in these profit-squeezed times.

In short, we will continue the policies that have kept us the leader in the OEM computer field ever since it started. Because in all that experience, we've learned something about the OEM marketplace:

**We're a success only if you are.**

For more information, write Digital Equipment Corporation, Maynard, Massachusetts 01754. (617) 897-5111. European headquarters: 81 route de l'Aire, 1211 Geneva 26. Tel: 42 79 50.

Digital Equipment of Canada Ltd., P.O. Box 11500, Ottawa, Ontario K2H 8K8. (613) 592-5111.

**digital**



## Power op amp provides $\pm 100$ -mA output and up to $100\text{-V}/\mu\text{s}$ slew rate

A power driver for complementary output transistors can be used as a power op amp, if proper compensation techniques are used. Slew rates to  $100\text{ V}/\mu\text{s}$  and output currents of  $\pm 100\text{ mA}$  are also easily obtained.

Two methods of compensation are used. For gains of five and higher, a single capacitor from the output to ground can stabilize the amplifier (Fig. 1). The table in the figure relates gain to power bandwidth, slew rate and the required capacitor size. Note that a closed-loop gain of five yields characteristics similar to the 741, but with the important advantages of  $\pm 100$ -mA output and little parametric change with capacitive loads up to  $50,000\text{ pF}$ .

Because only small input-signal levels are normally present with input compensation, high slew rates and wide bandwidths can be obtained even at unity gain (Fig. 2). The slew rate at unity gain is  $50\text{ V}/\mu\text{s}$ , and the 3-dB power bandwidth is  $600\text{ kHz}$ . Slew rates and bandwidths are higher for higher gains. Although  $47\ \Omega$  for  $R_c$  is adequate at unity gain, higher gains need slightly larger resistor values. Capacitor  $C_c$  increases for lower gains.

*Jim Wyland, Signetics Corp., 811 E. Arques Ave., Sunnyvale, CA 94086.*

CIRCLE No. 311

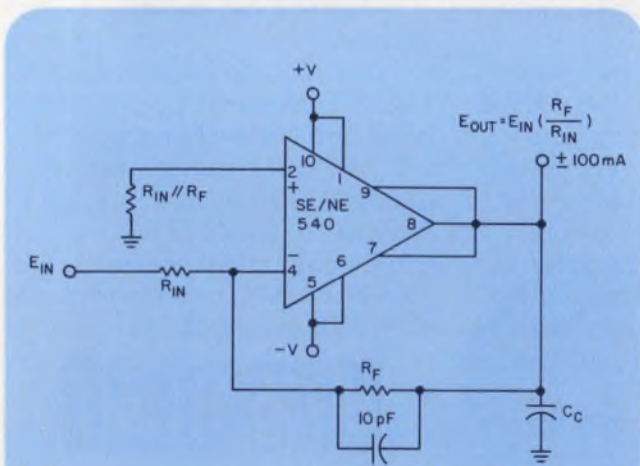

GAIN	$C_C$	SLEW RATE $\text{V}/\mu\text{s}$	POWER BANDWIDTH
100 UP	0.01	15	240 kHz
50	0.02	7.5	120 kHz
10	0.1	1.5	24 kHz
5	0.2	0.75	12 kHz

1. Output compensation of a power driver provides high-current output.

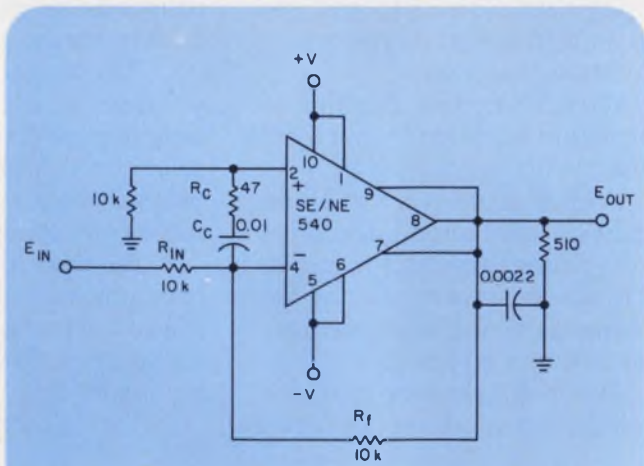

GAIN	$C_C$	$R_C$	SLEW RATE $\text{V}/\mu\text{s}$	POWER BANDWIDTH
1	0.01	47	50	600 kHz
10	0.0047	100	80	600 kHz
100	0	$\infty$	100	800 kHz

2. Input compensation allows a high slew rate and wide power bandwidth.



# another Simpson first!

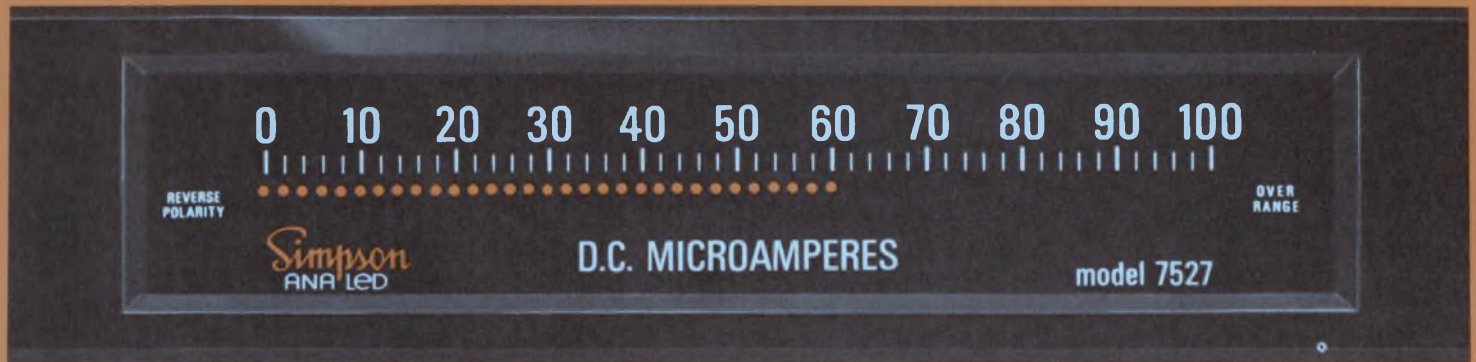

## Simpson® ANA LED

**SURPRISINGLY VERSATILE, EXTREMELY RUGGED, TOTALLY SOLID-STATE . . .** A new display concept combining the best of analog and digital panel meters . . . Opens a whole new world of application possibilities . . . Limited only by your imagination.

Light Emitting Diodes give pinpoint indication — no parallax, no guessing. Input changes are shown instantly in corresponding display changes, making it easy to spot trends and fluctuations. No response delays, no overshoot, no tracking error, plus near-perfect repeatability. ANA-LED is capable of operating under severe environmental conditions and still give years of accurate, trouble-free service.

Less than 8 x 2 x 3/4 inches size, including display and drive electronics, ANA-LED is available in horizontal or vertical style; with linear or non-linear conversion and display; expanded scale; zero left, right or center. Recorder and reference signal outputs included for driving digital set-point control modules which are also available from Simpson.

Need a special ANA-LED? Let Simpson help you design it. Send us your specifications and we'll return a quotation promptly. Check our catalog first, however — that special ANA-LED may be a standard Simpson stock item.

Get off-the-shelf delivery from your local electronics and electrical equipment distributors.

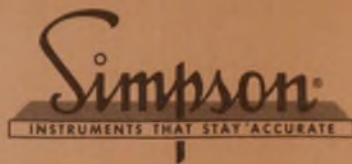

### SIMPSON ELECTRIC COMPANY

853 Dundee Avenue, Elgin, Illinois 60120 • (312) 697-2260  
CABLE: SIMELCO • Telex: 72-2416  
IN CANADA: Bach-Simpson, Ltd., London, Ontario  
IN ENGLAND: Bach-Simpson (U.K.) Ltd., Wadebridge, Cornwall  
IN INDIA: Ruttonsha-Simpson Private, Ltd., Vikhroli, Bombay

KATY INDUSTRIES



INDUSTRIAL  
EQUIPMENT  
GROUP

Manufacturers of over 2,000 styles, sizes and ranges of analog, digital and ANA-LED panel meters



1 1/2, 2 1/2  
3 1/2, 4 1/2,  
4 x 6, 8"



1 1/2, 2 1/2  
3 1/2, 4 1/2"



2 1/2, 3 1/2"

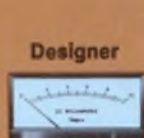

3 1/2, 4 1/2"



2 1/2, 3 1/2"



2 1/2  
3 1/2, 4 1/2"

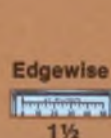

1 1/2  
2 1/2, 3 1/2"



8"



4 1/2"



3 1/2"







# The way our distributors stock Wood Mini-Mag Circuit Breakers, they're practically on their way to you right now.

Say you need a supply of circuit breakers, the kind that trips instantaneously on short circuit. And you need them installed now.

Call your authorized Wood Electric Circuit Breaker distributor. He's nearby to give you quick delivery. And chances are he has what you need, right in stock: Mini-Mag compact magnetic-hydraulic circuit breakers. Ratings from 0.5 to 30 amperes.

Voltages from DC to 400 Hz. Trip times from .009 to 10 seconds at 200% of rated load.

In single, double and 3-pole units.

He also has a complete line of other magnetic-hydraulic models, plus thermal types.

For technical literature, call the Wood Electric Circuit Breaker distributor or our sales representative nearest you, or write Potter & Brumfield Division AMF Incorporated, Princeton, Indiana 47671. Telephone 812-385-5251.

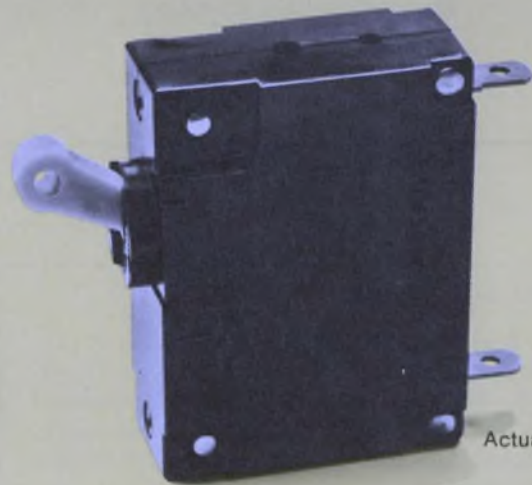
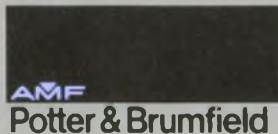

Actual Size



# Monitor circuit detects and shows voltage excursions outside set limits

Expensive, bulky strip recorders are usually used to monitor dc levels for changes in amplitude from some nominal value and to record the event. Here is a simple circuit that can detect a change in voltage outside of a set range and provide a permanent indication of the event, as long as the monitored level does not drop to zero. The circuit is powered from the monitored source.

Zener diodes  $D_1$  and  $D_2$  are selected to provide the desired window above and below the nominal value of the monitored voltage,  $V_{in}$ . The H15A1 is an optical coupler with very low ON resistance, and  $Q_1$  and  $Q_2$  are inexpensive general-purpose transistors, such as 2N3393.

If  $V_{in}$  is within the window,  $Q_2$  conducts and the SCR does not fire. If  $V_{in}$  increases above  $V_{z1}$ ,  $Q_1$  will also conduct, the optical coupler turns OFF, and the SCR fires to latch the LED and thus record the event. If  $V_{in}$  decreases below  $V_{z2}$ , both  $Q_1$  and  $Q_2$  are cut off and, again, the optical coupler is off and the SCR fires to record the event.

The values and component types have been chosen to monitor a nominal 12-V level with upper and lower set points of 14 and 10 V. Other set points can be determined as follows:

$$\text{upper set point} = V_{z1} + 2e_{bc}$$

$$\text{lower set-point} = V_{z2} + e_{bc}$$

where  $e_{bc}$  = transistor base-to-collector voltage

drop. For the components shown:

$$e_{bc} = 0.4 \text{ V,}$$

$$V_{z1} = 14 - 0.8 = 13.2 \text{ V,}$$

$$V_{z2} = 10 - 0.4 = 9.6 \text{ V.}$$

The zeners in the figure meet these values within normal zener tolerances.

*Robert A. Sullivan, President, Engineering Services, P.O. Box 6216, Shirlington Station, Arlington, VA 22206.*

CIRCLE NO. 313

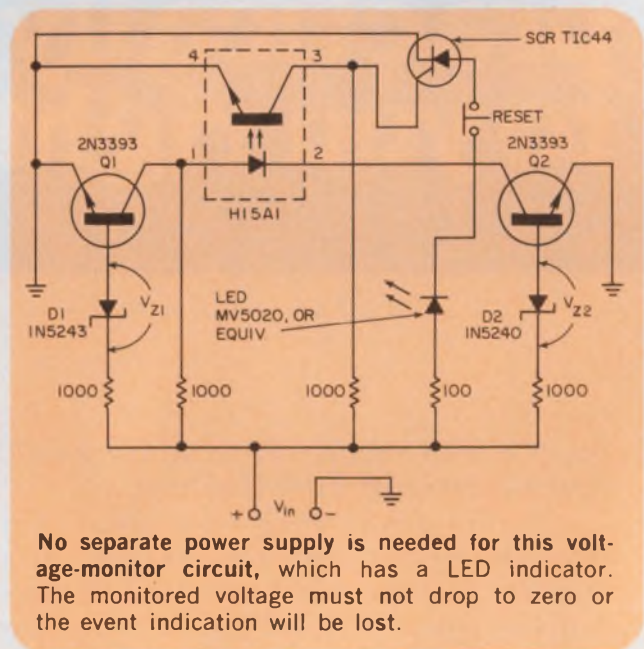

No separate power supply is needed for this voltage-monitor circuit, which has a LED indicator. The monitored voltage must not drop to zero or the event indication will be lost.

### IFD Winner of January 4, 1975

**James deHaan**, Design Engineer, Barber Colman Co., Park Plant, 1354 Clifford Ave., Rockford, IL 61111. His idea "Circuit Eliminates Switch Bounce in Keyboards and Gives Latched Output" has been voted the Most Valuable of Issue Award.

**Vote for the Best Idea in this issue** by circling the number for your selection on the Information Retrieval Card at the back of this issue.

**SEND US YOUR IDEAS FOR DESIGN.** You may win a grand total of \$1050 (cash)! Here's how. Submit your IFD describing a new or important circuit or design technique, the clever use of a new component or test equipment, packaging tips, cost-saving ideas to our Ideas for Design editor. Ideas can only be considered for publication if they are submitted exclusively to ELECTRONIC DESIGN. You will receive \$20 for each published idea, \$30 more if it is voted best of issue by our readers. The best-of-issue winners become eligible for the Idea of the Year award of \$1000.

ELECTRONIC DESIGN cannot assume responsibility for circuits shown nor represent freedom from patent infringement.



# THE TRIMLINE SERIES

DISTINCTIVE ELECTRONIC ENCLOSURES



**PREMIER METAL PRODUCTS COMPANY**

A DIVISION OF SUNSHINE MINING COMPANY  
337 MANIDA STREET, BRONX, N. Y. 10474 (212) 991-6600



INFORMATION RETRIEVAL NUMBER 62



## Ring hybrid junction operates at broadband

The ring stripline hybrid junction, a narrow-band device, has been redesigned at the Philips Research Laboratories, Aachen, West Germany, to form a broadband microwave balun.

The conventional ring hybrid junction gives balun action by coupling a single input to port 1 (Fig. 1). A split output is obtained at ports 2 and 4 with components of equal magnitude but  $180^\circ$  out of phase. This configuration has a disadvantage: It can be

used only at or very near its design frequency. (Note that the dimensions of R are governed by the frequency and desired output impedance.)

The experimenters found that the addition of an extra loop (Fig. 2) gives the ring a broadband characteristic. However, the added loop must have an optimized length. A computer program modeling the stripline as a two-port network, described by the equations of a lossless line, gave the researchers the modified ring in Fig. 2.

A practical stripline balun for a midband frequency of 2 GHz was formed on an alumina substrate less than  $1 \text{ cm}^2$  (Fig. 3). For the configuration shown, a bandwidth ratio of 0.5 was obtained ( $\Delta f$  divided by the midband frequency).

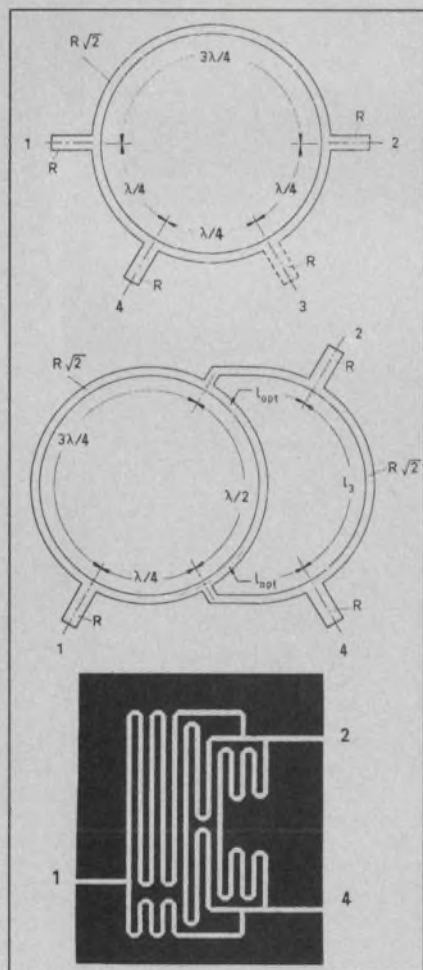

## GaAs Impatt diodes use ferrite bias lines

Undesired high-frequency bias oscillations and other noise components, produced by high-efficiency gallium-arsenide Impatt diodes when they are operated as free-running oscillators or saturated amplifiers, have been suppressed by special filters designed at the Royal Radar Establishment in Worcestershire, England.

Gallium-arsenide Impatt oscillators and amplifiers used by the experimenters were uniformly doped n-type and read-type diodes, with broadband rf coaxial circuits having distributed-line bias arms. The difficulty encountered in bias-line design, the researchers report, is to keep shunt capacitance to a minimum and

thus ensure that any series resonance across the line is well above the cutoff frequency of the diode's induced negative resistance. The resonances can be damped by the inclusion of a high-inductance element—namely, ferrite beads, which were used in a prototype four-stage bias filter.

The filter elements tried for the first stage were a helical stripline spiral and a winding of fine copper wire on a 1-mm-diam plastic rod. This first stage is a choke for the signal frequency. The researchers then suppressed intermediate components in two stages, using ferrite beads threaded over the rod and also over the fine wire. The high impedance of the ferrite beads makes them suitable for use in bias-line filters at frequencies up to at least 2 GHz.

Low frequencies were filtered with a conventional low-frequency filter.

## Low VSWR achieved in X-band amplifier

A two-stage GaAs FET amplifier has been designed to give 9.5-dB gain over the 6.5-to-12-GHz frequency band. The amplifier, developed at the Plessey Co. in England, has a VSWR of less than 2.5:1 at the input and output.

The GAT3 Schottky-barrier FET used as the active device in this amplifier has a gate that is  $120\text{-}\mu\text{m}$  wide and  $1\text{-}\mu\text{m}$  long. There is a buffer layer between the epilayer and the gallium arsenide.

The first amplifier stage was biased for minimum noise, and the second stage for maximum gain. Careful attention was given to the input matching network design. For example, the wire bonds from the transistor chip to the microstrip circuit were included in the network, since such bonds can behave as  $200\text{-}\Omega$  transmission lines at X band.



# welcome addition to the family



## TRW/Cinch low cost Series 90 P.C. edge connectors

These TRW/Cinch Edge Connectors were created to beat rising material costs while maintaining product performance. Designed with 20 microinches of gold—at the contact areas only, over 30 microinches of nickel underplate—with high capability, glass-filled polyester insulators, they cost about 20% less than our standard commercial units, 50% less than our military types. The use of nickel, an effective barrier to base metal migration, rather than copper underplate, provides a longer wearing, more stable gold layer.

CC-7508

As with other members of TRW/Cinch Edge Connector family, you have a choice of seven sizes from 6 to 25 positions, in both dip solder and solder tab terminations—and delivery is when you expect it, from TRW/Cinch Connectors or its distributors.

For more information call your nearest sales office or distributor (listed in EEM)—or contact TRW/Cinch Connectors, An Electronic Components Division of TRW, Inc., 1501 Morse Avenue, Elk Grove Village, Illinois 60007, (312) 439-8800.

**TRW**® **CINCH CONNECTORS**

INFORMATION RETRIEVAL NUMBER 64



# There's nothing semiconductor ex

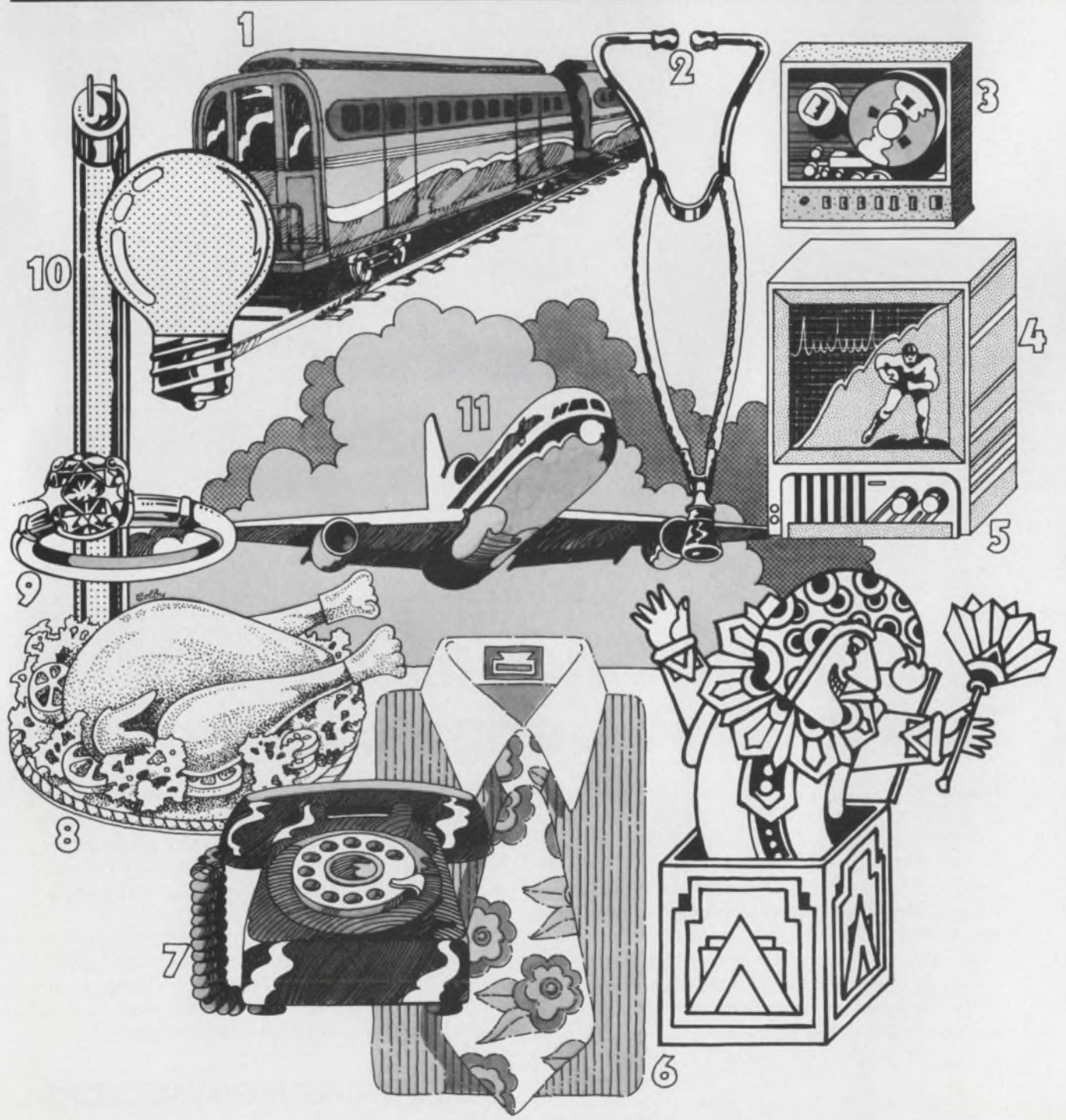



# semi about Delco's perience.

**1 Transportation**—Rail Locomotive Power, Electrostatic Painting, Signal Systems, Switches, Ignition Systems, Charging Systems, Heater/AC Controls  
**2 Medical**—Electrosurgery, Forceps, Coagulators, Cutters, Nebulizers  
**3 Power Supplies**—Linear Regulators, Switching Regulators, Capacitive Discharge Ignition, Battery Chargers  
**4 Monitoring**—Displays, Video Remote Sensing, CRT Readout, Television  
**5 Entertainment**—Audio Systems, Television  
**6 AC Motor Speed Controls**—(used in the production of:) Clothing, Food, Drink, Toys, Light Machinery, Furniture, Packaging, Paper  
**7 Communications**—Telephone, CRT, Audio Amplifiers, Computers, Video Cameras  
**8 Induction Ranges**  
**9 Ultrasonics**—Cleaning (industrial, jeweler, dentures), Welding, Emulsification  
**10 Lighting**—Strobe, Fluorescent, Mercury Vapor, Emergency Switches, Timing  
**11 Navigation**—Flight Simulators, Sonar Buoys, VLF Transmitters, Phased Array Radar.

You'd be surprised to know in how many industries Delco Electronics has firsthand power semiconductor application experience. They include, among others, transportation and medical, computers and communication, with products that range from motor speed controls to ultrasonic equipment. And the list goes on.

But we realize that you're most interested in how your new product should be designed, how your equipment is functioning and how your business is going. That's where Delco comes in personally.

You see, Delco Electronics has a staff of application engineers available to assist you when you're

developing new designs. They have a wide range of application experience to draw from and a wide range of dependable Delco high-energy

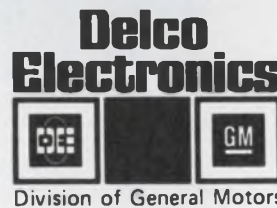

power semiconductors to work with. Power semiconductors that have been meeting tough government and industrial specifications for years.

Put the two together, and chances are you'll end up with a well-designed, reliable piece of equipment, sooner.

Call us or your local Delco semiconductor distributor

and ask about our full line of reliable semiconductors. And how Delco Electronics engineers may assist you.

**DELCO  
ELECTRONICS**—  
Regional Sales Offices

Box 1018  
Chestnut Station  
Union, New Jersey  
07083  
(201) 687-3770

Box 2968  
Van Nuys, California  
91404  
(213) 988-7550

General Sales Office  
700 E. Firmin  
Kokomo, Ind.  
46901  
(317) 459-2175

## **Delco Electronics. The Power Specialists.**



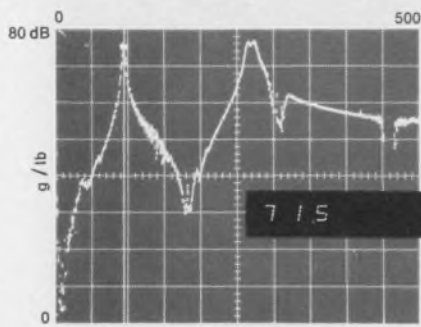

Transfer Function Magnitude with cursor measuring Magnitude directly.

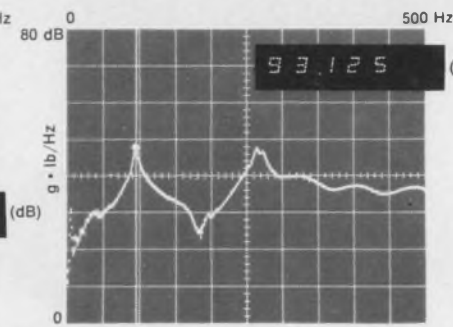

Cross-Spectrum Magnitude with cursor measuring frequency.

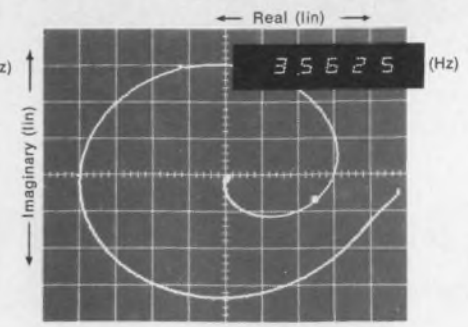

Nyquist diagram of transfer function real vs. imaginary with cursor dot measuring frequency.

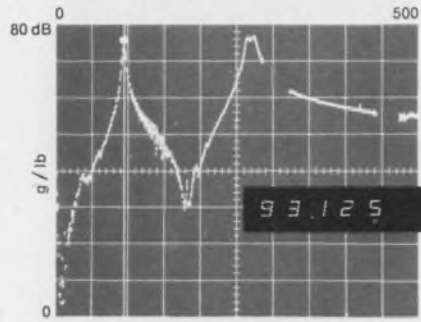

Edited Transfer Function Magnitude with invalid data blanked, and cursor measuring frequency.

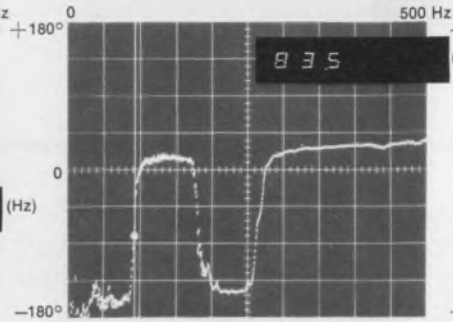

Transfer Function Phase with cursor measuring phase angle (-83.5°).

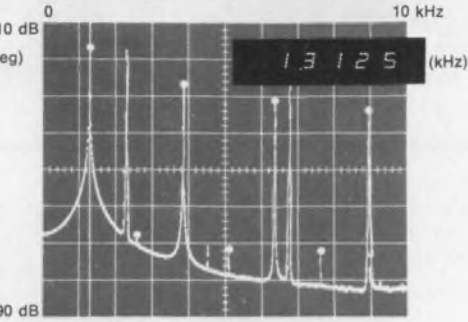

Power spectrum with markers identifying harmonics of the selected fundamental.

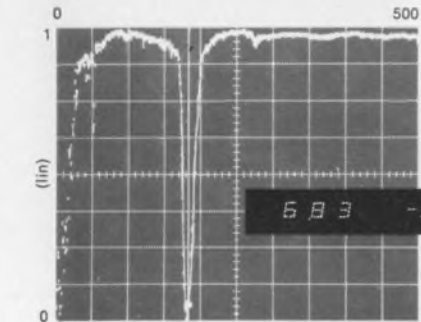

Coherence Function with cursor measuring degree of coherence ( $6.83 \times 10^{-3}$ ).

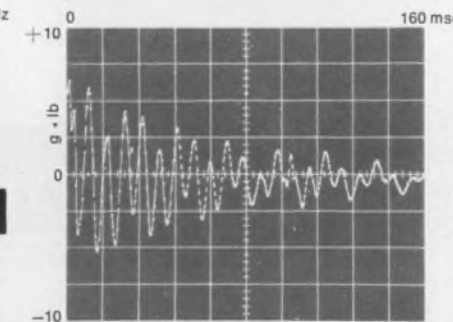

Cross-correlation with zero time at left.



## Solve practical Noise/Vibration Problems faster, easier with new 400A Omniferous<sup>®</sup> Real-Time FFT Analyzer.

The 400A Analyzer is a universal dual-input signal processor, which gets answers to real problems fast and accurately on-line — particularly for the dynamics of structures, nuclear reactor noise, machine vibration, and ship, aircraft or vehicle noise.

Not only is the 400A fast — real time to 10kHz — but all frequency functions are available for display at any time during or after the event without rerunning the data. This insures that the calculated functions are truly meaningful but different views of exactly the same data ... power spectra, transfer and coherence functions, Nyquist diagrams, correlation.

Pushbuttons select functions and their scales. It's impossible to make a programming error, since no programming is needed to operate the Analyzer. It is a true "instrument" (even though it calculates digitally) with safeguards to insure "good" data: automatically set anti-aliasing filters insure a pure spectrum, the coherence function validates the transfer function, edit blanking eliminates questionable regions of the transfer and coherence functions.

Simple digital measurement of any output allows use of the Analyzer's very high resolution (800 frequency elements) and wide dynamic range (70-80 dB). Display expansion vertically and horizontally reveals significant detail. Readings are calibrated and referenced either to full scale or to operator-set reference points. Differences in amplitude or frequency may be read directly. Harmonic markers (with automatic alignment) identify related frequency peaks. Pairs of functions can be viewed simultaneously on two separate CRT's, each with its own gain and offset for optimizing each display individually. Any displayed data may be recorded on an X-Y plotter, at the push of a button, or digitally recorded.

Call George Lang, Manager Application Engineering, for a demo at your facility analyzing your data, and see for yourself.



FFT Analyzer with add-on mini-computer for post-processing.

**Nsc** NICOLET SCIENTIFIC CORP

(formerly Federal Scientific) Manufacturers of UBIQUITOUS<sup>®</sup> real-time signal processors.

245 Livingston Street Northvale, N.J. 07647  
(201) 767-7100 TWX: 710-991-9619

For Demo Circle Reader Service #282

For Literature Circle Reader Service #283



## New Products

### Monitor captures data at trigger midpoint



Universal Data Systems, 2611 Lee-man Ferry Rd., Huntsville, AL 35805. (205) 533-4500. See text; 45 days.

Data Trap is the name of a monitoring device designed to trigger on a given character or series of characters and trap up to 256 characters on either side of the pattern. With an optional RS-232 interface the user can operate with rates up to 9600 baud. Trigger sequences up to 70 hex (4-bit) characters in length can be used. The price without CRT is \$4000; an optional CRT adds \$1500 to the price or the user can use an existing one.

Booth No. 2267 Circle No. 305

### Cost plummets with 1200-baud PC modem



Vadic Corp., 505 E. Middlefield Rd., Mountain View, CA 94043. (415) 965-1620. See text.

A 1200-baud modem in module form performs the functions of a Bell 202D for \$120. In quantities of 100 or more the price of the Model 81094 drops to \$95. Operation at 1200 baud is half duplex over a two-wire leased line, or full duplex over a four-wire leased line for multipoint polled data communication networks.

CIRCLE NO. 306

### Interfaces between mini and IBM/370 offered

Interdata, Inc., 2 Crescent Place, Oceanport, NJ 07757. (201) 229-4040. \$3500 or \$5000; stock.

Two programmable interfaces link the manufacturers minicomputers to IBM System/360 and 370 mainframe processors. The units transmit data at rates up to 500 kbyte/s and operate on the IBM multiplexer, block multiplexer or selector channel in single or multi-address configurations. One unit priced at \$3500, recognizes a single IBM device address. The other interface, priced at \$5000, recognizes up to 256 IBM device addresses.

CIRCLE NO. 307

### Automated drafting done by computer

Dimensional Systems, 31 Hartwell Ave., Lexington, MA 02173. (617) 852-2700. \$125,000.

Datadraft, a computerized drafting system, produces finished, detailed drawings from engineering sketches in one-fifth the time required for manual drafting. A typical "E" size drawing can be generated in about six hours. The operator enters the drawing information by placing a stylus on the various symbols and lines on the sketch. For each location a symbol or line type is designed by pointing the stylus to one of a variety of types on a user specified symbol "menu." Words and numbers are entered on an integral alphanumeric keyboard and are automatically positioned on the drawing. The information provided by the operator is processed and stored as a final drawing on removable or disc packs (100 to a pack) or magnetic tape. Drawings can be provided by the system plotter in any desired size. In addition, the processing system performs routine drafting tasks such as: straightening and orthogonalizing lines; text justification and insertion; and alignment of symbols horizontally and vertically.

CIRCLE NO. 308

### Top-of-line mini added to 21MX series

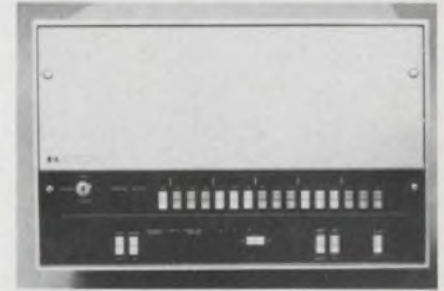

Hewlett-Packard, 1501 Page Mill Rd., Palo Alto, CA 94304. (415) 493-1501. From \$8382 (32 k words); August.

The M/30 leads the 21MX computer series in memory size and powered I/O accommodations. With twice the memory capacity and 50% more I/O space, it is priced only 17% higher than the next smaller model in the line. A processor package can contain up to 128-k words (256 k bytes) of semiconductor memory, and 14 powered I/O channels. Like all 21MX minis, the M/30 has 128 instructions that include floating point firmware, memory parity, extended arithmetic unit (EAU), a bootstrap loader and operator panel. The CPU is fully user-microprogrammable. A new real-time executive, HP RTE-III, can manage 250 k (512 k bytes) of memory. RTE-III allows HP 21MX minis to operate as multiprogramming, multilingual machines with input-output spooling and multi-terminal monitoring capabilities.

Booth No. 1437 Circle No. 309

### Low-cost printer/plotter offers 100 point/in.

Gould Inc., Instrument Systems Div., 20 Ossipee Rd., Newton, MA 02164. (617) 969-6510. See text; 45 days.

The 5010 printer/plotter operates with a resolution of 100 dot/in. vertically and horizontally. It is designed for slower speed use at reduced cost than other members of the Gould family. The unit prints 132 char/line at a speed of 600 line/min and plots at 1.2 in/s. The unit is said to be 200 times faster than drum and pen plotters. The 5010 is available in three versions; plotter only for \$6000; as a printer for \$5000, or both at \$6500.

CIRCLE NO. 310



# SUPER SWITCH



## **100 NANO second Trr DO-5**

FMC has developed a very fast switching, high power diode, having a low  $V_f$  of .90\* volts at 60 amp peak. Designed specifically for UPS systems requiring reliability and high efficiency operation.

For detailed information, contact:  
FMC Corporation  
Semiconductor Products Operation  
Homer City, Penna. 15748  
(412) 479-8011

**FMC** Special  
Products

\* at 150°C



## Formatter makes disc easy to interface

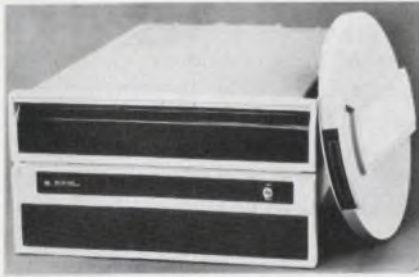

Hewlett-Packard, 1501 Page Mill Rd., Palo Alto, CA 94304. (415) 493-1501. See text.

A 15-Mbyte moving-head disc drive that uses cartridges, the Model 7905A with associated formatter, easily interfaces to any processor. The formatter also allows for error correction, multiprocessor access and automatic macro I/O operations. The disc is rack-mountable and measures 10.5-in. (26.7-cm) high, including power supply. Usable data capacity is 10 Mbytes on the front-loading cartridge and 5 Mbytes on the resident disc. Seek time for the 7905A is 5 ms track-to-track, 25 ms average. Average latency is 8-1/3 ms. Data transfer rate is 7.5 megabits per second. The disc drive and 13097 controller sell as a unit, disco/15 for under \$8400; additional drives are priced under \$5900.

Booth No. 1437 Circle No. 320

## Semi-memory boards replace 16-k core units

National Semiconductor Corp., 2900 Semiconductor Dr., Santa Clara, CA 95051. (408) 732-5000. 1¢/bit; stock to 3 days.

The MOSRAM 104 is a complete memory with 16,384 words of 8 bits on a single 8.3 × 13.5-in. board. Access time is 500 ns; cycle time 750 ns and faster versions are available. The "104" directly replaces Dataram Model DR-104 core memory; a depopulated version 8192 × 8-bits replaces 8-k × 8 core memories. These are general-purpose boards suitable for use in mini mainframes and intelligent terminals. The units also offer low power drain, 6 W.

CIRCLE NO. 321

## Core memory comes in compact 16-k modules

Control Data Corp., 3857 Louisiana Ave., St. Louis Park, MN 55435. (612) 830-6135. See text; 60 days.

The Model 94200 core memory module with a density of 2215 bit/in<sup>2</sup> offers expandable memory design in 64-k byte increments on a single card. A single card decodes up to 512-k bytes. The basic 16 k × 36-bit module has an access time of 350 ns. Options include 32-k × 18 and 16-k × 18 organizations. Quantity prices of 16-k × 36-bit units range from \$1975 each to \$2175 each.

CIRCLE NO. 322

## Speedy 32-bit mini keeps pace with maxis

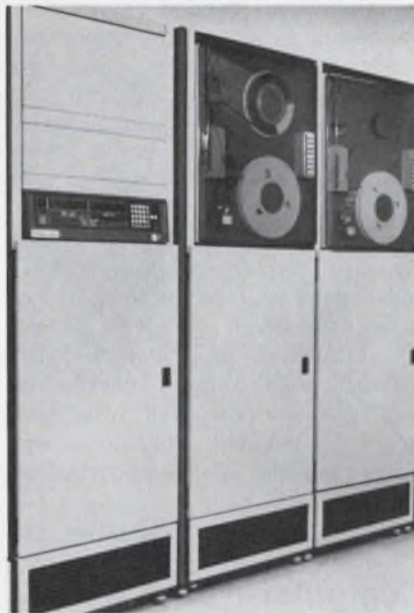

Interdata, 2 Crescent Pl., Oceanport, NJ 07757. (201) 229-4040. \$179,400 (1 Mbyte memory).

The Model 8/32 Megamini, which highlights this exhibit, offers instruction execution times comparable to those of an IBM 370/158. Salient features include 32-bit architecture with up to one million bytes of directly addressable memory, supported by a multitasking operating system, OS-32/MT. Interleaved core modules offer a cycle time of 450 ns; Schottky logic gives a 240-ns processor time. Floating point hardware is available. Other products include a 30 char/s serial impact printer, dubbed the Carousel, and the Model 7/16 mini.

Booth No. 2337 Circle No. 323

## ELECTRONIC PACKAGING

## Rack panels removed; inside not disturbed



Bud Radio, Inc., 4605 E. 355 St., Willoughby, O. 44094, (216) 946-3200. Panels, door 18 ga. steel.

Classic II cabinet racks from Bud. Brushed aluminum extrusion frames front panel. Sides removed from outside. Mounting rails adjustable front to rear. Rear door can be mounted to open right or left. Supports more than average load. All-steel, extra-rigid frame. Comes assembled. Compatible with Classic II cabinets. For further information phone —

1-800-321-1764, TOLL FREE

IN OHIO, 1-800-362-2265, TOLL FREE

## Special fabrication of electronic housings



Bud Radio, Inc., 4605 E. 355 St., Willoughby, O. 44094, (216) 946-3200. Get what you want for less.

Bud designs and fabricates racks, cabinets, enclosures for new or re-designed electronic instruments or systems. Standard Bud housings can be altered to fit many applications. Original housings can be designed and produced. In addition, Bud's Imlok system can be used for short runs, test or pilot models. For further information phone —

1-800-321-1764, TOLL FREE

IN OHIO, 1-800-362-2265, TOLL FREE

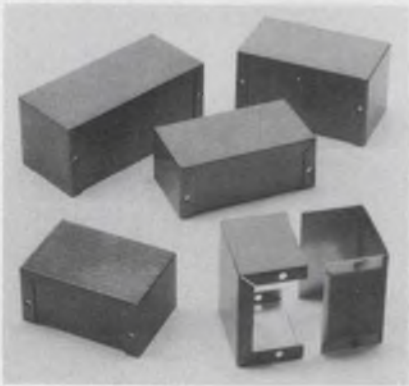

## ELECTRONIC PACKAGING

**Compact enclosures,  
versatile, economical**

*Bud Radio, Inc., 4605 E. 355 St., Willoughby, O. 44094, (216) 946-3200. Available in 18 sizes.*

Miniboxes from Bud. Use as separate housings or as part of a larger assembly. Flanges give assured shielding. Projecting covers on cowl-type units minimize glare, protect controls, dials. .040 and .050 aluminum alloy. Immediately available. Shipping economies. One of nearly 3000 products from Bud Radio. For further information phone —

1-800-321-1764, TOLL FREE

IN OHIO, 1-800-362-2265, TOLL FREE

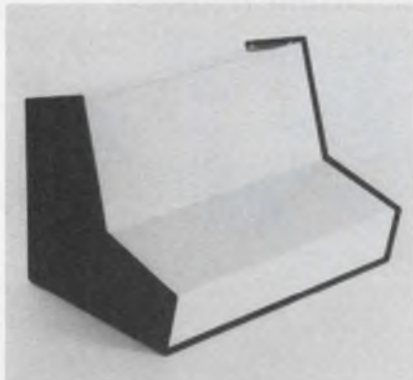
**Standard enclosures  
with custom features**

*Bud Radio, Inc., 4605 E. 355 St., Willoughby, O. 44094, (216) 946-3200. Your Bud Distributor has it.*

Compucab by Bud. Dual-slope, off-the-shelf enclosures with custom-designed configurations. Use for a range of instruments. Maximum visibility — no fasteners on panel area. All aluminum. Cover and back in smooth white enamel. Base and sides, black textured enamel. Knockouts in rear panel. Rubber feet furnished. Two styles. Shipping economies. For further information phone —

1-800-321-1764, TOLL FREE

IN OHIO, 1-800-362-2265, TOLL FREE

## DATA PROCESSING

**Quiet thermal printer  
has control capability**

*Hewlett-Packard, 1501 Page Mill Rd., Palo Alto, CA 94304. (415) 493-1501. \$800; 30 days.*

A quiet thermal printer, Model 5150A, accepts data from BCD (binary coded decimal) or ASCII sources and prints up to 20 columns of alphanumeric information. Of modular construction, it is available in various configurations including some as a system controller. The unit prints 5 × 7 dot-matrix characters at faster than three lines per second on heat-sensitive paper (available in rolls or fan-folds). Reliability and light weight result from design simplicity—thick-film thermal print head; no inking systems. The paper advance mechanism has only two moving parts. The mainframe contains a power supply, control logic, and print mechanism. Input interfaces are provided by plug-in circuit boards. Option 001 interfaces the printer to the HP Interface Bus (or directly to most ASCII-coded data sources) with a 20-column, 64-character readout. Option 002 interfaces BCD ±8421 coded instruments through 10-column inputs; up to two such interfaces may be installed. Additional options include a data-acquisition package.

CIRCLE NO. 324

**Computer-type terminal  
performs control tasks**

*Electronic Associates, West Long Branch, NJ 07764. (201) 229-1100. Under \$13,900.*

Uses for the Spacer-75 terminal include data communication, data acquisition, computer-aided instruction and word processing. The MOS/LSI system is in an integrated package, containing alphanumeric and graphic CRT, ASCII or customized keyboard, an 8k to 32k word 16-bit minicomputer, and a floppy disc bulk storage unit. Options include 64 a/d channels, data acquisition modules and a full line of standard peripherals. Software support includes a Fortran IV compiler, Real Time Basic, text editor and debug routines.

CIRCLE NO. 325

**Fast printers  
controlled by  $\mu P$** 

*Applied Computing Technology, 17961 Sky Park Circle, Irvine, CA 92707. (714) 557-9972. \$1945 (25 qty).*

A microprocessor controlled printer is capable of printing 120 char/s bidirectionally. The series 900 achieves an effective speed of over 160 char/s. Standard features include 132 columns, multiple copies, horizontal tab, vertical formatting and forward-reverse line feed. The model printer forms characters in a 7 × 9 dot matrix. The unit can print 96 different characters. With keyboard input you can send or receive at speeds of 10, 30 or 120 char/s. Other features included are a 320-character buffer and a character view.

CIRCLE NO. 326

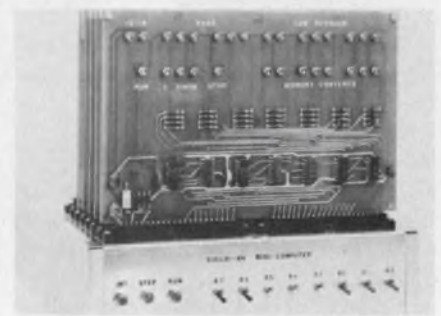
**Kit-style microcomputer  
supports peripherals**

*Scelbi Computer Consulting, 1322 Rear, Boston Post Rd., Milford, CT 06460. (203) 874-1573. See text; third quarter '75.*

The Selbi-8H is a modular computer based on the Intel 8008 microprocessor. It is constructed from a basic set of PC cards and can operate in conjunction with a wide variety of peripheral interfaces and devices. Among these are an oscilloscope display driver, ASCII keyboard interface and an interface for use with audio-type recorders. Instruction times vary from 11 to 44  $\mu s$ . Chassis kits start at \$440 which includes five boards: CPU, data buffer, input card front panel controller, and a 256-word memory card. The unit allows up to 4 k of memory or 16 k with an expander box. Available programs include peripheral support, calculator packages, assemblers and editors.

CIRCLE NO. 327



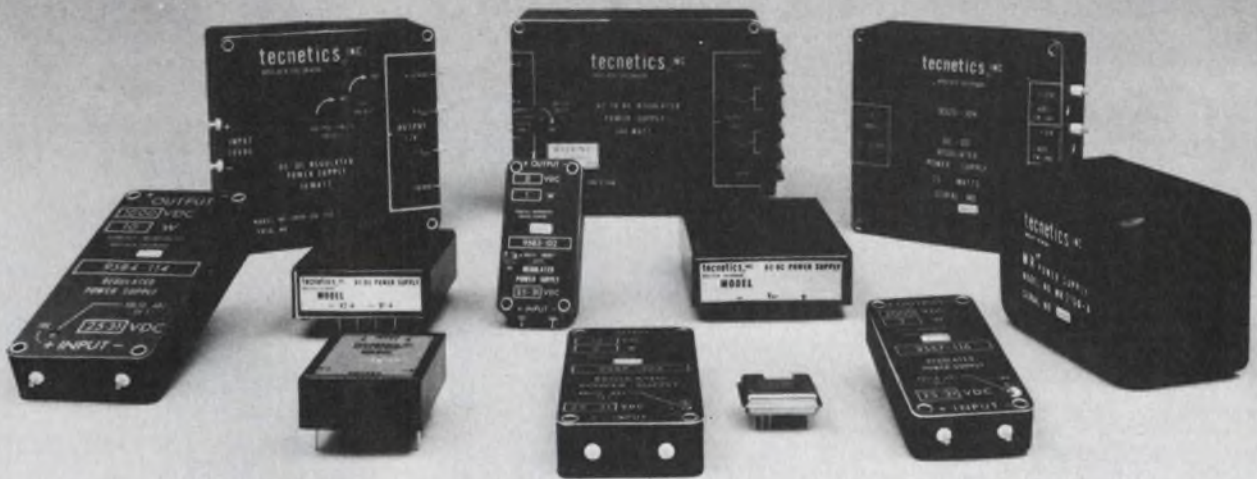

# Your house or ours.

Why it is better to buy DC-to-DC power supplies.

Sure, you can probably build that power supply yourself. First you get out the old breadboard and start designing. When you think you have it, you start testing and compiling reliability data. Then you assemble a load of components. Maybe you have some, maybe you wait for purchasing to buy them. Finally, you set up inventory, inspection, quality control and manufacturing procedures.

All time consuming, and surprisingly expensive. Probably more expensive than you anticipated. Especially when you consider valuable engineering time which could have been put to more creative use.

There's another way. You call up Tecnetics and tell us what you need. And you've got it. Ready to go. You see, we've already done all the designing, engineering, testing, and purchasing. We've been doing it since 1959.

So by now, most of the power supplies you need are in our catalog. Regulated and unregulated, commercial and mil type, hybrid and modular, even our new DC high efficiency types. But if it's something unique, we have the expertise to make it for you. To your specifications.

Quickly, with fully documented reliability, and at a price that's more than competitive with in-house production.

Because that's all we do. You see, they don't call us "The Power Conversion Specialists" for nothing. Reputations like ours don't come easy.

So send for our 26-page power supply catalog. It has all the specs, plus prices. And we'll send along an analysis of the economics inherent in the make or buy decision.

**tecnetics®** The Power Conversion Specialists

Please rush me your catalog plus an analysis of the "Make or Buy" decision.

Name

Company

Address

City  State

P.O. Box 910, 1625 Range Street, Boulder, Colorado 80302  
(303) 442-3837 TWX 910-940-3246



# a little A-300 goes a long way.



In high frequency transmission. RF power generation for industrial and research processes. RF/EMI and general laboratory applications, too.

The Model A-300 is a totally solid state power amplifier, covering the frequency range of 0.3 to 35MHz with a gain of 55dB. Capable of delivering 300 watts of linear Class A power and up to 500 watts in the CW and pulse mode, the A-300 is the ultimate in reliability.

Although the unit is perfectly matched to a 50 ohm load, it will deliver its full output power to any load (from an open to a short circuit) without oscillation or damage.

Complete with power supply, RF output meter and rack mount, the A-300 weighs a mere 89 pounds and operates from ordinary single phase power.

High power portability goes a long way for \$5350.

For further information or a demonstration, contact ENI, 3000 Winton Road South, Rochester, New York 14623. Call 716-473-6900 or TELEX 97-8283 E N I R O C

## ENI

The World's Leader  
in Solid State  
Power Amplifiers

SEE  
Electronic Design's  
**GOLD BOOK**  
FOR COMPLETE  
PURCHASING  
INFORMATION

INFORMATION RETRIEVAL NUMBER 73

## PACKAGING & MATERIALS

Field tool kit contains  
120 tools and parts



Jensen Tools and Alloys, 4117 North St., Phoenix, AZ 85018. (602) 959-2210. \$245 (unit qty).

A new field-engineer tool kit, the JTK-77, contains virtually everything needed to service complex electronic and data-processing equipment and office machines. The JTK-77 contains more than 120 tools and work accessories plus an optional test meter. Three pallets hold most of the tools securely and conveniently, and present the tools in an orderly fashion to the user. The attache case is of hardwood construction with brass fittings and a walnut-brown scuff-proof Marvelon covering. It measures 17-1/4 x 12 x 6 in. with room to accommodate test equipment and extra parts.

CIRCLE NO. 328

## Card extenders fit five-layer boards

Mupac Corp., 646 Summer St., Brockton, MA 02402. (617) 588-6110. \$70 (10 up); stock.

A family of multilayer card extenders for five layer boards contains two ground planes to prevent adjacent high-frequency signals from coupling to each other. Quality pin and socket connectors on opposite ends of the extender ensure a long life of many insertions with high reliability, according to Mupac. As many as 216 signal lines are available on the large extenders of the family. Panels come 1/16 or 1/8-in.-thick, G-10, epoxy-glass material.

CIRCLE NO. 329

## NEW DPVM's FROM NEWPORT



## BRIGHT 13MM LED DISPLAY, BCD OUTPUT, RATIO AND 2-YR WARRANTY

FOR **\$8100\***  
3 1/2 DIGIT MODEL 203

- Four full scale ranges
- Auto-Polarity  $\pm$  1999 counts
- Voltage, Current and Ratio measurements
- Automatic Zero-Front panel F.S. adjust

(Model 2003, 4 1/2 digit \$139\*)

Whether you need 3 1/2 or 4 1/2 digits, Newport will deliver the most reliable and versatile Digital Panel Volt Meter (DPVM) available. With a great reduction in parts and the addition of the new 1/2-inch LED display, we can now increase our warranty to a full 2 years. The life expectancy of the display is greater than 11 years. Full scale ranges are 200 millivolts, 2, 20, and 200 volts. . . and BCD output comes free. Newport now has worldwide stocking representatives providing off-the-shelf deliveries and local support. For complete data, call or write: Newport Laboratories, Inc., 630 East Young Street, Santa Ana, CA 92705.

For immediate response, CALL COLLECT  
(714) 540-4686  
(In Europe-Tele. Amsterdam [20] 45-20-52)

\*Quantities of 100

## NEWPORT

INFORMATION RETRIEVAL NUMBER 74  
ELECTRONIC DESIGN 10, May 10, 1975



## Conductive adhesive holds rf gaskets



Emerson & Cuming, Inc., Canton, MA 02021. (617) 828-3300.

When gaskets must provide electrical contact between mating surfaces, it is very important that adhesives used to bond the mating surfaces also be a good electrical conductor. Eccoshield VCA is first applied to all mating surfaces—both the gasket and the waveguide flange. The adhesive is pressure sensitive. Thus the flange connection may be taken apart repeatedly without need to change the gasket or adhesive. And the rf seal is not impaired. The volume resistivity of this adhesive is less than 0.001  $\Omega$ -cm, equivalent to the gasket material.

CIRCLE NO. 330

## PC-board holder stacks assorted board sizes



Manix Manufacturing, Box 496, Mann Rd., Huntingdon Valley, PA 19006. (215) 355-7200. OP251: \$4.50; OP261: \$6.

PC boards of different sizes can be simultaneously stored and stacked on the new E-Z-Stack holder. The product is molded of lightweight polypropylene. Its L-shape design permits boards either larger or smaller than the holder itself to be stored efficiently. Each holder is grooved to accommodate up to 25 boards with a maximum of 3/32-in. thickness. The space between grooves is 3/8 in. Two models are available—OP251 for boards to 6  $\times$  9 in. and OP261 for large boards to 12  $\times$  15 in.

CIRCLE NO. 331

# The Sure Cure for HYBRID TENSION from Raytheon/Quincy

When hybrid problems cause hybrid tension, our custom hi-rel capability can cure it. We're the hi-rel hybrid specialists... in chip-and-wire and beam lead units... for military and medical electronics exclusively. Where a cure *has* to be sure, you can rely on Raytheon/Quincy to provide the custom hybrid you need. Just contact Mr. K. Singh at Raytheon. He'll make you feel better right away. Raytheon Company, Industrial Components



Operation,  
465 Centre  
Street,  
Quincy, Mass.  
02169.  
(617) 479-5300.





# TEC-LITE™

THE SMALLEST LED SWITCH/INDICATOR ON THE MARKET



AVAILABLE IN RED, GREEN AND YELLOW

Low As **\$3.00** Each in 500 Qty's.

Subminiature SSBL Series combines long life LED and SPST-NO-DB switch in a low cost, highly reliable unit that fills a variety of display and control functions—especially where space is limited. Projects only 5/8" behind panel with turret lug terminals (as shown) or 1" with .025" square Wire-Wrap terminals. Mounts in 1/4" hole on 3/8" centers.

Momentary contact pushbutton switch has rating of 100 mA @ 115 VAC and life exceeding 1 million operations at rated current. The SSBL operates from a 5 VDC supply and can accommodate up to 28 VDC by adding an external series resistor.

## MATCHING LED INDICATOR



Low As **\$1.75** Each in 500 Qty's.

The SSIL Series has all the outstanding features of the SSBL, but is an indicator only. Built-in resistor adapts unit for 5 to 28 VDC operation. Device is also available with RFI shielding.

TEC also has a low-priced matching switch only—the SBS—plus subminiature indicators and switch/indicators with neon and incandescent lamps.

### DISTRIBUTORS:

Audio Electronics, Inc., Canada	(416) 495-0720
Bodelle Co., Inc., Chicago	(312) 323-9670
Bordewick Co., New England	(617) 659-4915
Century Aero Corp., So. Cal.	(213) 772-1166
Peerless Radio Corp., Florida	(305) 566-5966
Ratel Electronics, No. Cal.	(415) 965-2010



TEC, Incorporated

9800 NORTH ORACLE ROAD  
TUCSON, ARIZONA USA 85704  
(602) 297-1111  
TWX 910-952-1377

## COMPONENT

# DIP relay is small in size and price

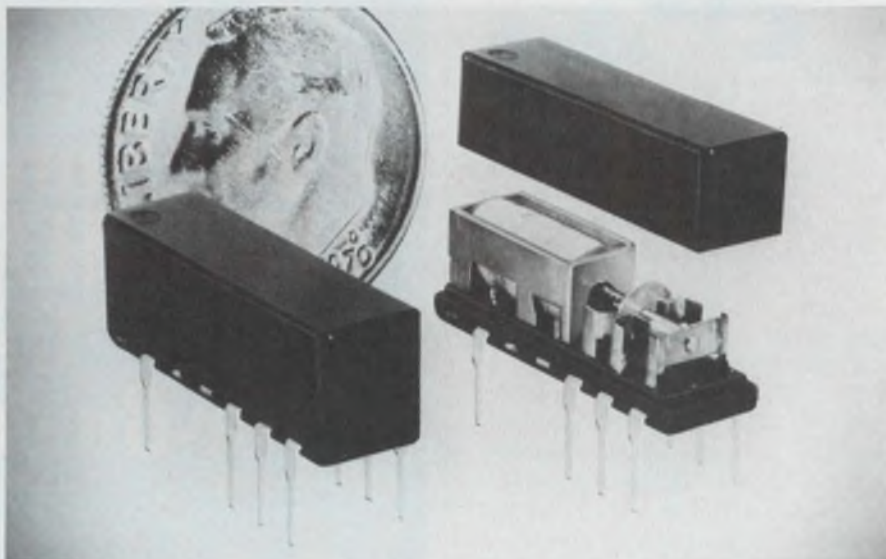

*Babcock, Div. of Esterline Corp., 3501 Harbor Blvd., Costa Mesa, CA 92625. (714) 540-1234. P&A: See text.*

The smaller the relay, the more expensive it is, right? Wrong, says Babcock. Its series BC74 electromechanical relays are housed in dual-in-line packages and cost \$1.65 when purchased in 1000 unit lots.

Not only are the relays small, but you have a wide choice of contact styles. You can choose from a one-form A, B, C (single or double break), U, V, W, X, Y and Z or a two-form C (common movable blade). Any of these styles is available in an 8-pin DIP that measures 0.78 × 0.27 × 0.3 in.

All contact forms except X, Y and Z have a maximum dielectric strength of 500 V rms at 60 Hz; for the X, Y and Z at 60 Hz, the dielectric strength is 1000 V rms.

Similarly all but the X, Y, Z forms have contact ratings of 0.5 A for 100,000 operations or 0.25 A for 500,000 operations. The X, Y, Z ratings are 2 A for 100,000 operations and 1 A for 500,000. All units are specified for operation from 0 to 70 C.

The relay operate time of 3 ms for all forms includes any contact bounce. Release time is 4 ms, including any bounce. You can

get the relay with nominal coil voltages of 5, 6, 12 and 24 V. Drop-out voltages for the BC74 relays are 10% of the nominal coil voltages.

Coils can be ordered with resistance values of 306, 441 and 1806 Ω for a 40-mW coil power requirement, or you can get coil resistances of 122, 176, 722 and 2890 Ω for 100-mW operation. All resistances are ±10%.

The closest competition to the Babcock BC74 is the Model 53451 dual electromechanical relay manufactured by AMP (Harrisburg, PA). The 53451 relays are housed in 16-pin DIPs that measure 0.9 × 0.36 × 0.5 in., not including pin height. The package, though, contains two independent relays, each with two-form C contacts.

The AMP units have only one coil voltage, nominally 4.5 V, and require more power—about 135 mW per coil, as opposed to 40 or 100 mW for the Babcock relays. They also have a lower dielectric strength—only 300 V rms at 60 Hz.

Both the Babcock and the AMP relays have similar switching times and operating temperature ranges. However, the AMP unit costs about four times more than the Babcock relay.

For Babcock  
For AMP

CIRCLE NO. 302  
CIRCLE NO. 393



# Now, 4 times the memory on the same size card.

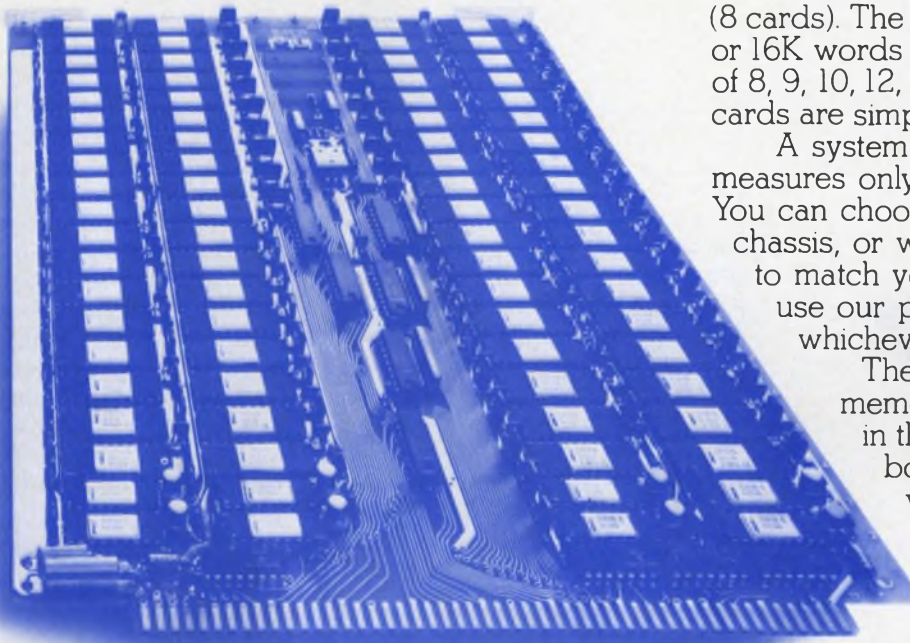

(8 cards). The standard options are 4K, 8K or 16K words per board and word lengths of 8, 9, 10, 12, 16 or 18 bits. For longer words, cards are simply combined.

A system expanded to 256 kilobytes measures only 8.175 x 10.5 x 5.0 inches. You can choose one of our standard card chassis, or we can make a custom chassis to match your requirements. You can use our power supplies or yours, whichever you prefer.

There probably never was a memory system as easy to expand in the field or in your factory. The boards are also interchangeable with our in-10 1103 systems—10,000 of which have already been shipped. Just allow 0.5 inch for each board. The universal control unit provides byte control, module select, address register, optional data register and control and data I/O and automatic refresh capabilities.

**But your options on the in-40 and all other important semiconductor memory technologies are really unlimited. Intel also has the customizing expertise that comes from doing work for most of the industry's leading OEM's.** And our billion-bit production plant gives quick delivery on standard or custom designs.

Call us if you want to store more words on fewer cards at lower cost.

Intel Memory Systems, 1302 North Mathilda, Sunnyvale, California 94086 (408) 734-8102

Regional offices:

Boston (617) 861-1136;  
Philadelphia (215) 542-9444;  
Dayton (513) 836-2808;  
Dallas (214) 661-8829;  
Los Angeles (714) 835-9642.

The most compact and most expandable low-cost memory system you'll probably see for years to come is Intel's in-40 dynamic RAM system. It's a true new generation design, available right now in standard models from 16K words to 256 kilobytes or in custom configurations with quick delivery.

Besides highest density, the in-40 assures you higher performance than previous low-cost systems, whether solid-state or core. Built with Intel's newest 4K n-channel MOS RAMs, the in-40 provides an access time of 350 ns, cycle time of 550 ns, low power dissipation and TTL compatibility with very solid margins.

**One single in-40 memory board stores 16,384 18-bit words or 32,768 9-bit words.** One single control unit board runs any system up to 128 kilowords or 256 kilobytes



Memory Options Unlimited

## intel memory systems

A DIVISION OF INTEL CORPORATION

INFORMATION RETRIEVAL NUMBER 77



# With MINI BUS<sup>®</sup>

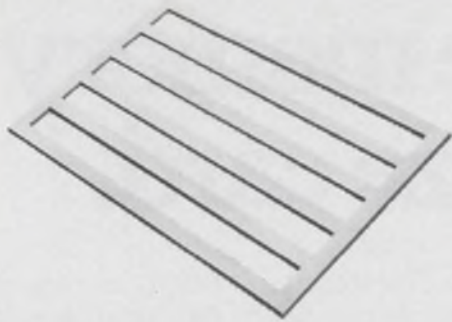

It's the PC card bus bar that saves space on a PCB. Saves money too. Makes board design and layout easier.

## all these DIPs



How can you put 36 DIPs on a 30 sq. inch board without using costly multi-layer PCBs?

## go on a 5" x 6" 2-sided PCB

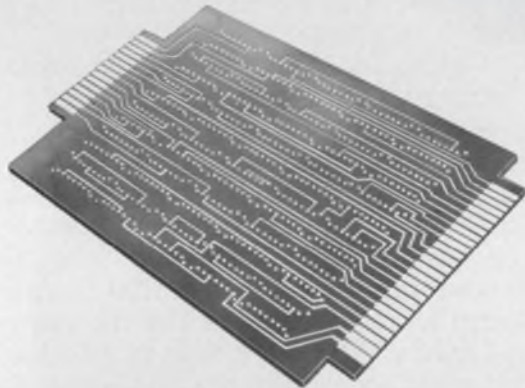

Take Voltages and Grounds **off the board** with MINI/BUS. Use all the board geometry for interconnecting DIPs.

## like this

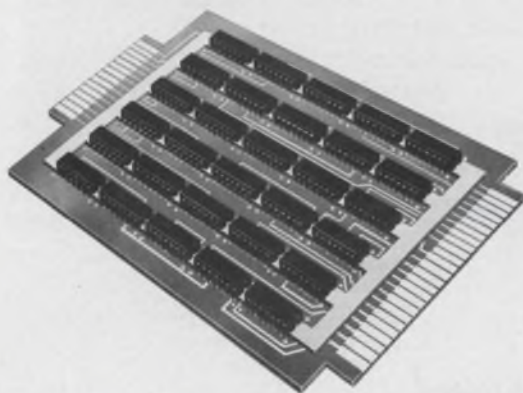

With MINI/BUS, you'll save design and layout time. You'll save space on the board. And **you'll save money** — up to half the cost of a typical 4-layer PCB.



**Rogers Corporation** Chandler, Arizona 85224 Phone: (602) 963-4584

Represented in Canada by LLOYD A. MEREDITH,  
1560 Watersedge Road, Clarkson, Ontario L5J 1A4 Phone: (416) 533-2367

## COMPONENTS

### Kit contains \$69 worth of switches for only \$17

*Cherry Electrical Products Corp., P.O. Box 718, Waukegan, IL 60085. (312) 689-7702. See text.*

Cherry offers a switch prototype kit that contains 32 switches for only \$17. This is a substantial reduction from the \$69 the switches would cost if purchased individually. The kit provides a handy supply of basic switches for prototype work. It contains two thumbwheel switch assemblies, three keyboard switches and 27 snap-action switches. The snap-action units include five subminiatures, five miniatures, two low torque, four for panel mounting, nine assorted types and two units for low-energy applications. They are mounted in neat recesses of a 16 x 24 plastic board that can stand on a desk or hang on the wall. A special \$50-off coupon gives complete details and contains a handy postage-free order card.

CIRCLE NO. 332

### Small chips provide high capacitance

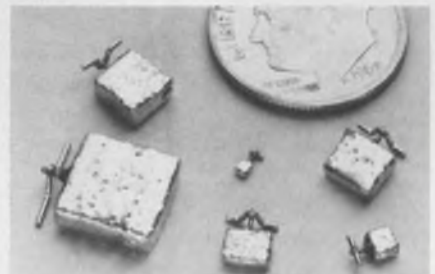

*Corning Glass Works, Corning, NY 14830. (607) 962-4444.*

High capacitance-to-volume ratios in forms specially designed for hybrid, thick-film and micro-circuit use are the features of Corning's new MC, microminiature, chip, tantalum capacitors. The capacitor bodies are the negative terminals. And the positive terminals are solder-coated nickel wires. The six sizes offered range from 0.060 x 0.056 x 0.155 in. to 0.170 x 0.355 x 0.460 in. and provide capacitances from 0.1 to 100  $\mu$ F. The smallest size has a +40%, -20% standard tolerance. All others have standard tolerance of  $\pm$ 20%. Tolerances of  $\pm$ 10% are available in all sizes.

CIRCLE NO. 333



# You can measure the quality of Hoffman Enclosures



Being close isn't good enough in lots of electrical enclosure applications. It either fits or it doesn't. Hoffman quality assures a proper fit. One of our customers put it this way: "What Hoffman says in its catalog is true. Hoffman Electrical Enclosures are consistently well built, and tolerances are what Hoffman says they'll be."

Hoffman is proud of its reputation. We guard it by making numerous checks for dimensional accuracy during our quality control inspections. As one of the country's major manufacturers of electrical enclosures we have a reputation to protect.

We can help you protect your reputation too, with over 1,700 high quality electrical enclosure products. For a copy of our free, problem-solving catalog, call or write:

**Hoffman** **ELECTRICAL ENCLOSURES**  
HOFFMAN ENGINEERING COMPANY  
 Division of Federal Cartridge Corporation  
 ANOKA, MN 55303 DEPT. E2B41

INFORMATION RETRIEVAL NUMBER 79  
 INFORMATION RETRIEVAL NUMBER 80 ►

## What's Practical Automation Doing With Digital Printers?



## Everything New!

When we designed our new miniature Matri-Dot Series of alphanumeric digital printers, we dedicated them to you and your customers. Matri-Dot printers represent a significant breakthrough in design, performance, and price.

### Built like a Practical Automation Printer means . . .

1. **Smallest Size** . . . only 3½"W x 3"H x 9"D
2. **Lowest Price** . . . \$140 in 100 unit quantity
3. **Full Alphanumerics** . . . a complete 63 character set
4. **Ribbonless Printing** . . . unique inked platen lasts for 75,000 lines
5. **Standard Interfaces** . . . RS232C and others
6. **18 Columns** . . . 110 character per second print rate

Six sound reasons to take the next important step . . . ask for a demonstration and become convinced!



Trap Falls Road ■ Shelton, Connecticut 06484  
 Tel: (203) 929-5381



# Programmable shaft-angle encoder works with any rotating shaft

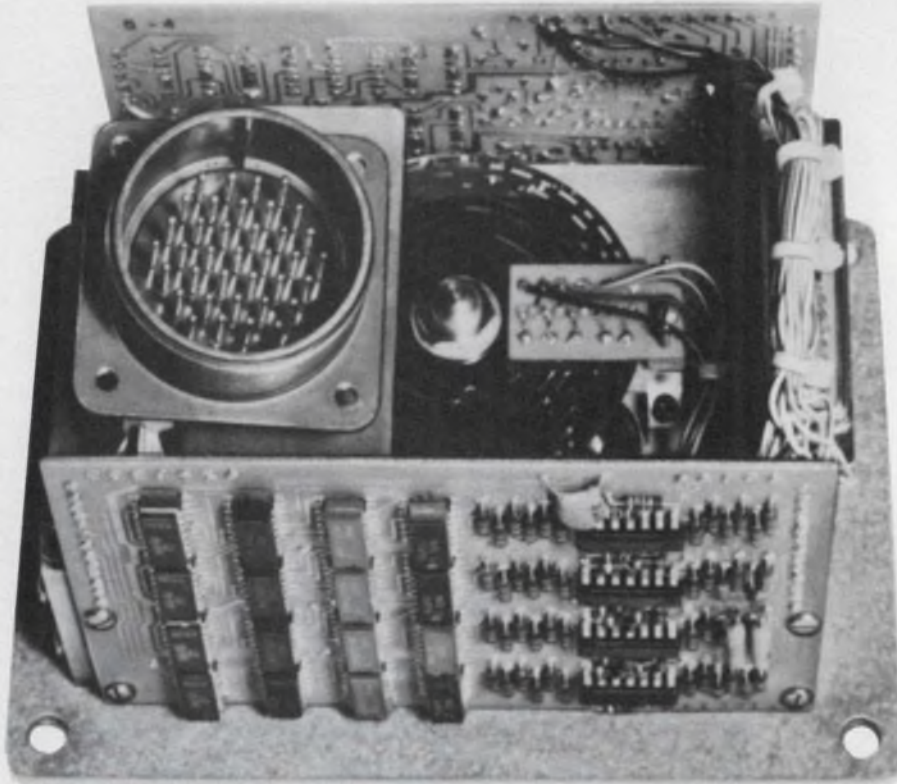

Theta Instrument Corp., Fairfield, NJ 07006. (201) 227-1700. P & A: See text.

In the past, optical encoders had to be specially coded for each category of machine application. Now Theta Instrument Corp., with its Decitrak POE series of programmable optical

encoders, has eliminated the need for custom encoder discs. Thus if your application changes, you can just reprogram the internal circuitry rather than replace the expensive encoder disc.

Theta's POE absolute encoders provide a parallel BCD TTL output that can be electronically

modified to suit almost any shaft application. The output code can be multiplied by any three-decade programming that has a value between 0.001 and 0.999. The constant can be set by external thumbwheel switches or hand-wired as a permanent setting.

Encoders in the POE series are available with ranges from 999 to 999999, full scale. Maximum output error for any of the encoders is  $\pm 1$  count over the entire operating range. The encoders operate at a max speed of 3000 rpm.

Only 0.2 oz-in. of breakaway torque is needed to start the encoder disc rotating from a dead stop. This force is less than a tenth that required by most contacting encoder types.

The encoder power requirement is only 5 V dc at 1 A. The operating temperature range spans 0 to 50 C. To connect the encoder to external equipment, an MS-3102A multi-pin connector is required. The POE encoders are housed in heavy gauge, 5.5 x 6.5 x 4.6-in. metal cases, which can protect the devices from severe industrial environments.

Prices for the POE series start at \$995 for single quantities of the three-decade version. Delivery is from 60 to 90 days.

CIRCLE NO. 304



**ANALOGY**  
WHEN SLOW, BULKY INTERFACES BUG YOUR CONTROL SYSTEM, UPDATE FAST WITH INTECH'S NEW A/D AND D/A CONVERTER MODULES. THE A-867 DAC FOR ONE, GIVES 16-BIT RESOLUTIONS IN 30.4 SEC AT CURRENT OR VOLTAGE OUTPUTS WITH ONLY 4 PPM/°C OFFSET TEMP/CO. IT COSTS LESS AND MEASURES ONLY 2x4x0.4. SAME GOES FOR A-868 14-BIT DAC.

**intech** INCORPORATED  
(408) 244-0500  
1720 COLEMAN, SANTA CLARA CA 95050



## Consider all the ins and outs of your new circuit design. Then consider Curtis® Terminal Blocks.

Tangled, twisted, and loose wires can snarl up even the best circuit design. So don't tangle with trouble. Curtis offers 19 electronic and electrical terminal blocks with hundreds of model variations available to straighten out almost any wiring layout problem.

Here are just a few of the features offered----

- capacities ranging from 5 amps/300 volts to 250 amps/600 volts
- modular, channel-formed, closed-back, feed-thru and fully insulated feed-thru designs offered
- choice of tab, screw, clamp, PC pin or taper pin termination
- heavy duty lug and tubular, high pressure solderless types available for high current applications
- full mechanical thread system incorporated in many units

Specify Curtis electronic and electrical terminal blocks and you'll have the best line in the industry to work with. Specify anything less and you may be tangling with trouble.



### CURTIS INDUSTRIES, INC.

8000 West Tower Avenue, Milwaukee, Wisconsin 53223

Call (414) 354-1500 for the name of a representative or distributor near you.

In Canada: A.C. Simmonds & Sons, LTD, Willowdale, Ontario.

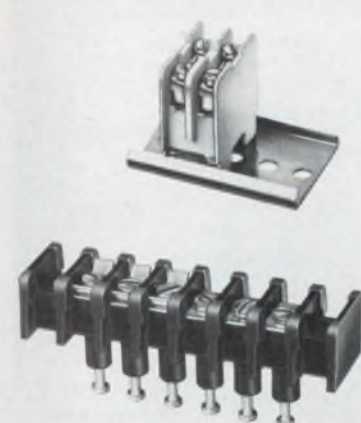

INFORMATION RETRIEVAL NUMBER 82

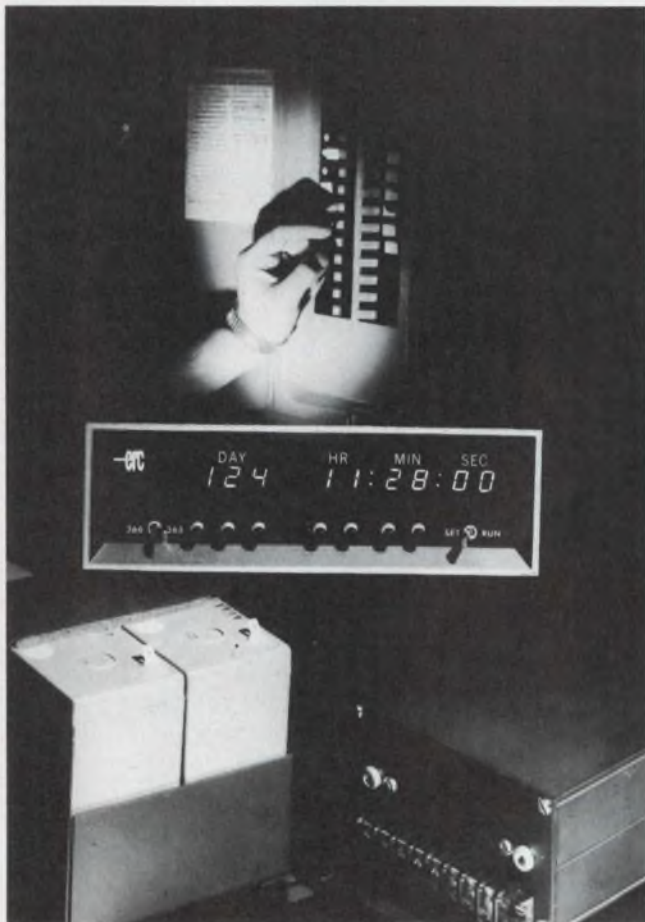

## Uninterruptible BCD real-time data . . .

for computers and instrumentation systems is provided by ERC Calendar Clocks with Battery Backup systems.

Battery Charger/Switchover Unit charges batteries between outages and when line power fails, instantly switches battery power to clock logic circuits. Three models of battery packs provide backup power for 8, 16, or 24 hours. Recharge time is approximately 3½ times discharge time.

Clocks available for use with Battery Backup Systems have crystal timebases and BCD outputs and remote control inputs and outputs for systems use. Models available include 12-hr. w/AM-PM indicator and 24-hr. clocks and month-day and day-of-year Calendar Clocks.

For full information circle the reader service number or call Bill Cook at 913-631-6700.

electronic research co. • a TRAMCO div.



7618 Wedd  
Overland Park, Kansas 66204  
Mail to: P.O. Box 913  
Shawnee Mission, Kansas 66201  
TWX: (910) 749-6477  
Telephone: (913) 631-6700

INFORMATION RETRIEVAL NUMBER 83



# Beat the Brownout\* Blues

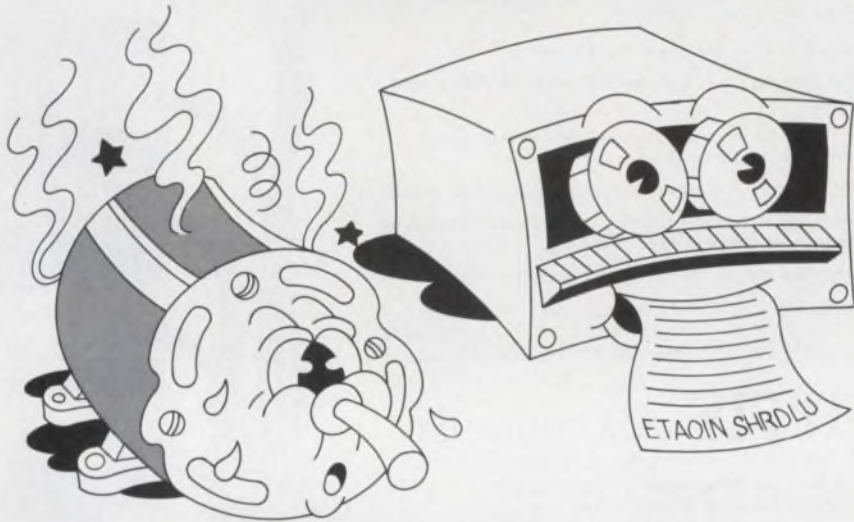

## No more computer garble, instrument error, or overheated motors.

\*Uncontrolled line-power reductions or in-plant voltage fluctuations can ruin performance, shorten equipment life. Patented Varax® line regulator maintains nominal voltage for extreme line swings. For 115 V models, output stays at 115 Vac even when line drops to 90 V.

Varax protects better than ferroresonant devices. Available in low-cost OEM or new enclosed versions for in-plant use. 100, 115, and 230 V models in 500 and 1500 VA ratings.

Off-the-shelf delivery from 110 stocking distributor locations.



**TELE-DYNAMICS** DIVISION OF **AMBAC**  
WANLASS POWER SUPPLIES AND  
LINE CONDITIONERS

525 Virginia Drive, Fort Washington, PA 19034 • (215) 643-3900

An equal opportunity employer M/F

©Tele-Dynamics

6165A

## MODULES & SUBASSEMBLIES

### Data acquisition card handles 16 channels

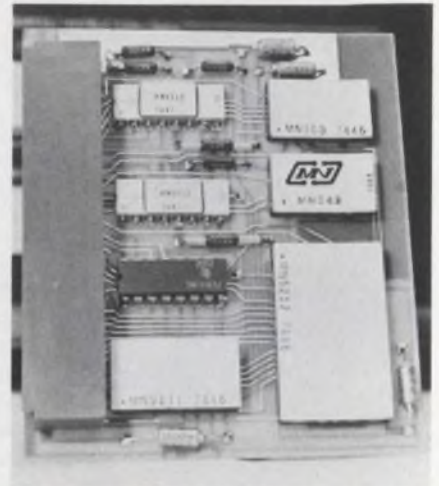

Micro Networks Corp., 324 Clark St., Worcester, MA 01601. (617) 852-5400. For 1 to 9 units: MNA-7000, \$595; MNA7000H, \$1195; 2 to 4 wk.

The MNA7000 and MNA7000H are adjustment-free 16 channel data acquisition systems. Both units resolve input data to 12-bit words and measure only 3.15 × 2.75 × 0.45 in.

The MNA7000 is rated for 0 to 70 C operation, while the 7000H is rated for the full -55 to +125 C MIL temp range—an industry first. Both units, though, have a guaranteed linearity to ±1 LSB over their full operating temperature ranges, as well as ±1/2 LSB linearity at 25 C.

A fully differential instrumentation amplifier is provided in both units to buffer the selected signal. The amplifier's input impedance is 100 MΩ min., and its common-mode rejection is 72 dB min. from dc to 1 kHz.

In the single-ended mode, and the "pseudo" differential mode, 16 data input channels are available and, in the differential mode, you have eight channels with a common-mode range of ±10 V.

Several input range options are available: 0 to ±10, -10 to +10, and -5 to +5 V. Coding is straight binary (for 0 to +10 V) and offset binary (for bipolar ranges). Conversion time is 25 μs per channel (overlap mode) including the sample-hold delay. Power requirements are ±15 and +5 V.

CIRCLE NO. 301



Reliable dual-trace scope useful to 30MHz.



MODEL  
1472  
\$599

We nominally rate the 1472 at 15MHz (-3dB), but it easily syncs and displays a 30MHz signal with sure triggering. It automatically selects chopped or alternate trace display to avoid flickering at any sweep speed . . . so even with 11 sensitivity ranges from 10mV to 20V/cm and 19 sweep ranges from 0.5 $\mu$ SEC to 0.5SEC/cm, it's easier to use than most scopes. The 1472 has 24nSEC risetime and can be used in X-Y mode with matched phase-shift and sensitivity inputs.

In stock at your distributor.

**B-K PRECISION**

PRODUCTS OF DYNASCAN

1801 W. Belle Plaine Avenue · Chicago, IL 60613

INFORMATION RETRIEVAL NUMBER 85

Affordable frequency counter for jobs that have always needed one

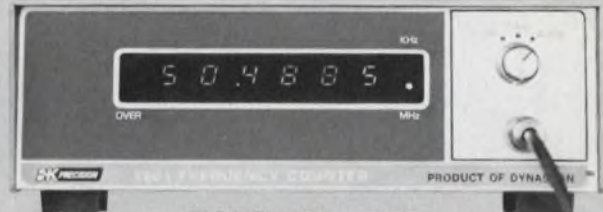

MODEL 1801 \$230

With a good autoranging frequency counter you can watch oscillator adjustments, monitor RF and audio frequencies precisely, do fast production testing, check critical countdown chains, calibrate signal generators, check pull-in range of AFT circuits and CB frequencies accurately. The 1801 is good because its accuracy is typically better than 10PPM; it typically reads 10Hz-60MHz and is guaranteed to read 20Hz-40MHz. It's automatic—there's just one control and gate times, decimal points and scalings are automatically selected for best speed and accuracy. And it's fast—the display is refreshed up to 5 times per second.

In stock at your distributor.

**B-K PRECISION**

PRODUCTS OF DYNASCAN

1801 W. Belle Plaine Avenue Chicago, IL 60613

INFORMATION RETRIEVAL NUMBER 86

You don't have to buy a new car to get an electronic ignition.

Let's face it. After 37 years, even a Phantom III can use a lift. That's why I put a Delta Mark Ten B Capacitive Discharge Ignition on my Phantom . . . to give her a spark I'd pit against any '75 model car. I went to Delta because they aren't Johnny-come-latelys. Delta's been making electronic ignition systems for over a decade.

Whatever kind of car you drive, you can give it the same great Delta performance I gave mine.

- Mark Ten B Capacitive Discharge Ignition Systems are manufactured by Delta Products, Inc., a company with a conscience, and with a proven record of reliability both in product and in customer relations.

- The Mark Ten B really does save money by eliminating the need for 2 out of 3 tune-ups. Figure it out for yourself. The first tune-up or two saved pays for the unit, the rest is money in your pocket. No bunk!

- Because the Mark Ten B keeps your car in better tune, you actually can save on expensive gasoline.

- With a Mark Ten B, spark plugs stay clean and last longer . . . fouling is virtually eliminated.



I want to know more about Mark Ten B CDI's. Send me complete no-nonsense information on how they can improve the performance of my car.

Name \_\_\_\_\_

Address \_\_\_\_\_

City \_\_\_\_\_ State \_\_\_\_\_ Zip \_\_\_\_\_



**DELTA PRODUCTS, INC.**

P.O. Box 1147, Dept. ED, Grand Junction, Colo. 81501  
303-242-9000

Mark Ten B,  
assembled . . . . \$64.95 ppd  
Mark Ten B, kit . . . . \$49.95 ppd

Standard Mark Ten,  
assembled . . . . \$49.95 ppd  
Deltakit@ . . . . \$34.95 ppd

INFORMATION RETRIEVAL NUMBER 87





# It also comes assembled.

If you need dials, we have dials. If you need handsets, we have handsets. If you need Touch Calling keysets, we've got 'em by the thousands. Ringers and hook-switches, too. Or, if you need complete telephones, we have them for you in all the latest styles and colors.

You get communications components faster from GTE Automatic Electric because, outside of the Bell System, we're the largest manufacturer of telephone equipment in the U.S. If you need it, we have it.

Use the coupon below for a complete

catalog. Or if you're in a real hurry, call John Ashby at (312) 562-7100, extension 250.

When it comes to quality components, call **THE SOURCE:** GTE Automatic Electric.



- Please send your catalog of communications components.
- Please send more information and prices on \_\_\_\_\_ of \_\_\_\_\_  
(Quantity) (Product)

Name \_\_\_\_\_ Title \_\_\_\_\_  
 Company \_\_\_\_\_  
 Address \_\_\_\_\_  
 City \_\_\_\_\_ State \_\_\_\_\_ Zip \_\_\_\_\_  
 Telephone \_\_\_\_\_

Mail to: Mr. J. D. Ashby, B-4, GTE Automatic Electric, Northlake, Illinois 60164.

**GTE AUTOMATIC ELECTRIC**



RIGHT ON TARGET AGAIN



A perfect match when things get hot.



# 1st monolithic complementary darlington pair

TDA 1420/1410  
Equivalent circuit

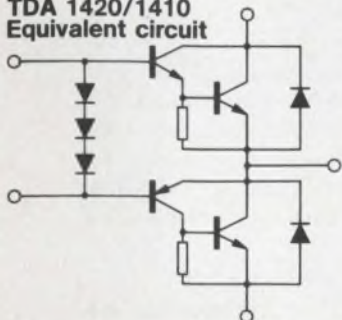

The TDA 1420 integrates a quasi-complementary (NPN/PNP) darlington pair and biasing diodes for perfect electrothermal matching. Applications for this versatile power IC include DC or stepping motor drivers, op amp power boosters, audio output stages, etc.

All this in Pentawatt<sup>®</sup>, the rugged 5-pin plastic pack.

For lower voltages try the TDA 1410.

Key parameters	TDA 1420	TDA 1410
$V_{CEO}$	44 V	36 V
$V_{CES}$	60 V	50 V
$I_C$	3 A	3 A
$P_{tot} @ T_c \leq 60^\circ C$	30 W	30 W

SGS-ATES Semiconductor Corporation - Newtonville, Mass. 02160 - 435 Newtonville Avenue - Tel: 617-9691610 - Telex: 922482

Stocking Distributors: Energy Electronic Products, Los Angeles, CA, (213) 641-9020 - KA Electronic Sales, Dallas, TX, (214) 634-7870 - Radar Electric Co., Seattle, WA, (206) 282-2511  
Rosyl Electronics, Bayshore, NY, (516) 586-1800 - Wilshire Electronics, Burlington, MASS, (617) 272-8200 - Prelco Electronics Ltd., Montreal 357, Quebec, (514) 389-8051

INFORMATION RETRIEVAL NUMBER 89



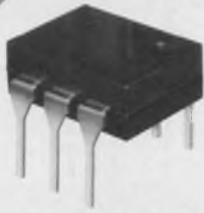

### SPECTRONICS 5KV OPTICAL ISOLATORS IN 6-PIN DIPS

Spectronics offers the first 5KV isolator in the popular 6-pin dual in-line package. These components are directly interchangeable with standard industrial 6-pin isolators.

### LOW-COST PHOTODETECTORS & LEDs

Spectronics provides industry's largest selection of standard off-the-shelf detectors and LEDs. Direct replacements for such popular industrial types as GE, TI, Monsanto and Motorola.



### STANDARD OPTICAL SWITCHES

Six, low-cost off-the-shelf optical switches are available as direct replacements for such popular devices as the H13A1, A2; H13B1, B2; MCA 8, 81 and MCT 8, 81. Both phototransistor and photodarlington versions are furnished.

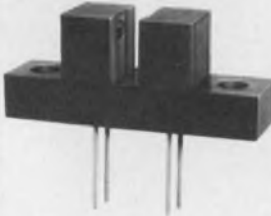

Call Spectronics for everything you need in opto. We make optoelectronics work... for you!



830 E. Arapaho Rd.,  
Richardson, Texas 75080  
(214) 234-4271

INFORMATION RETRIEVAL NUMBER 90

### MODULES & SUBASSEMBLIES

### Pre-settable timer has 2, 3 or 4-digit accuracy



Kessler-Ellis Products, Atlantic Highlands, NJ 07716. (201) 291-0500. From \$210; stock.

A solid state, electronic pre-settable timer is available with 2, 3 or 4-digit setting accuracy. The user can simply dial in a desired number of milliseconds, activate the start circuit and after the given pre-set time has expired, a normally open 9-A triac will fire, passing 110 V ac to a load. Timed increments from 1 ms to 1 min. are available either by use of an RC time constant circuit or a CMOS digital divider.

CIRCLE NO. 334

### Breadboard amplifier allows easy, quick test

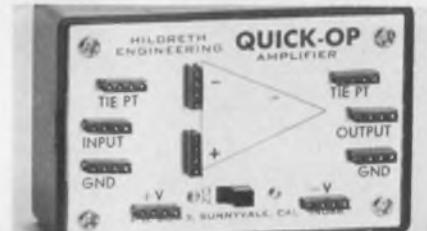

Hildreth Engineering, P.O. Box 3, Sunnyvale, CA 94088. (408) 245-3279. \$11.95 (unit qty); stock to 2 wk.

The Quick-Op Amplifier lets you develop, test or experiment with a wide range of op-amp circuits. Forty solderless connectors are located on a function identified panel—just plug in resistors, capacitors, diodes, etc. A 741C op-amp is internally wired, offset nulled and tested, and two 9-V batteries mount inside the case to make a self-contained unit. Quick-Op can also be powered from external supplies through solderless tie points. The unit measures only 3.25 x 2.125 x 1.375 in. and weighs 4.5 oz.

CIRCLE NO. 335

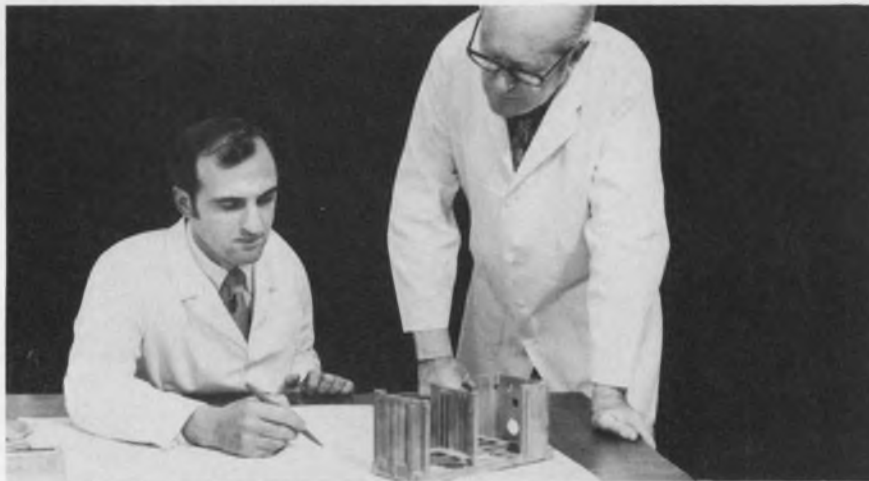

### "Check Atlantic for Investment Castings.. they deliver in 3 to 5 weeks"

Atlantic's patented planar investment casting process provides high production rates and true precision control.

The process combines the best features of Plaster Mold and traditional Investment Casting. Almost any shape or

contour is possible.

No order is too big or too small. Delivery in 3 to 5 weeks from Atlantic... the only producer of both investment castings and plaster mold casting serving the industry today—Literature available.

# Atlantic Casting

and Engineering Corporation

EIGHT TEN BLOOMFIELD AVENUE / CLIFTON, NEW JERSEY 07012  
201 / 779-2450

INFORMATION RETRIEVAL NUMBER 91



# Capability in Design and Production of Customized Power Transformers

Whatever your requirements for custom transformers INELCO can simplify your purchase.

Within 10 days from receipt of your specifications, a Prototype Transformer is on its way for your approval. It will further assure you of the perfection in the mass-produced units. Limited production runs are available to Test Market your prototype.

Our Engineering Department is always available for consultation on design or production needs. Because your requirements change, INELCO can organize flexibility in production scheduling. Another big plus for our ever growing list of customers.

Write today for our brochure, "Taking the confusion out of specifying power transformers".

## INGLOT ELECTRONICS CORPORATION

4878 NORTH ELSTON AVENUE • CHICAGO, ILLINOIS 60630  
phone 312/286 5881



INFORMATION RETRIEVAL NUMBER 92

# dB Multimeter...

The only low cost full function digital multimeter with 120 dB range.  
Operates on battery or line.

### Model 2180 (shown)

Six functions, 31 ranges, AC-DC Volts, AC-DC Current, Ohms plus dB, integral battery charger standard. Basic DC accuracy 0.1%, 100µV resolution, dB accuracy, 0.5dB, 600 & 900 ohm termination standard, 3½ digit LED display. Compact and rugged enough to stand on! Only ...

**\$395.**

Don't need dB?  
Compare the Model 2120; identical to the 2180 less dB with five functions, 26 ranges.

**\$295.**

Don't need dB or current? The Model 2110 offers three functions, 15 ranges. Delivery is from stock.

**\$245.**



All Models  
Delivery from stock.

Your local United Systems representatives can supply full specifications.  
List of International Sales and Service Centers available.

**Digitec**

UNITED SYSTEMS CORPORATION

a subsidiary of

**Monsanto**

818 Woodley Road • Dayton, Ohio 45403 • Ph: (513) 254-6251 • TWX: (810) 459-1728



DIRECT FROM STOCK

# 5V3A

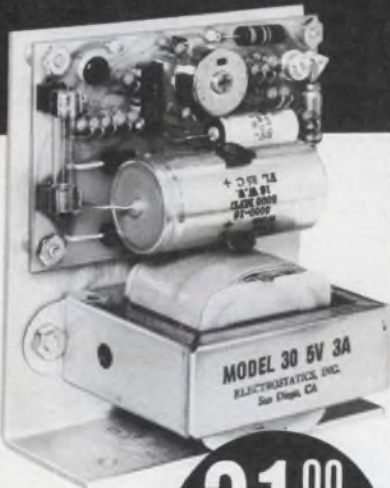

**31<sup>00</sup>**  
(1-9)  
\$23.70 - 100 pcs.

**Excellent regulation and ripple.**

### SPECIFICATIONS

Size: 4 x 4.5 x 2.75 overall  
Input: 105-125V, 47-420 Hz  
Output: Any DC voltage 3 to 30  
Regulation: Line — 0.005%  
Load — 0.05%  
Ripple: Less than 250 Microvolts  
Temp: Operative —40 to +71°C  
Storage —65 to +85°C  
Coefficient —0.01%/°C Max.  
Current Limiting: Fixed Foldback Type  
Overvoltage: Optional

MODEL	VOLTAGE	AMPS
30-5	5.0	3.0
30-10	10.0	1.8
30-12	12.0	1.5
30-15	15.0	1.2
30-24	24.0	1.0
30-28	28.0	1.0

### ORDERING INFORMATION

QUANTITY	PRICE	WITH O.V.
1-9	\$31.00	\$36.00
10-24	29.20	33.70
25-49	26.60	29.90
50-99	25.10	28.20
100-	23.70	26.90

CALL (714) 279-1414 FOR DELIVERY

**Electrostatics, Inc.**  
7718 CLAIREMONT MESA BLVD. • SAN DIEGO, CA 92111

INFORMATION RETRIEVAL NUMBER 99

## DISCRETE SEMICONDUCTORS

# Caseless thyristors reduce cost and ease assembly

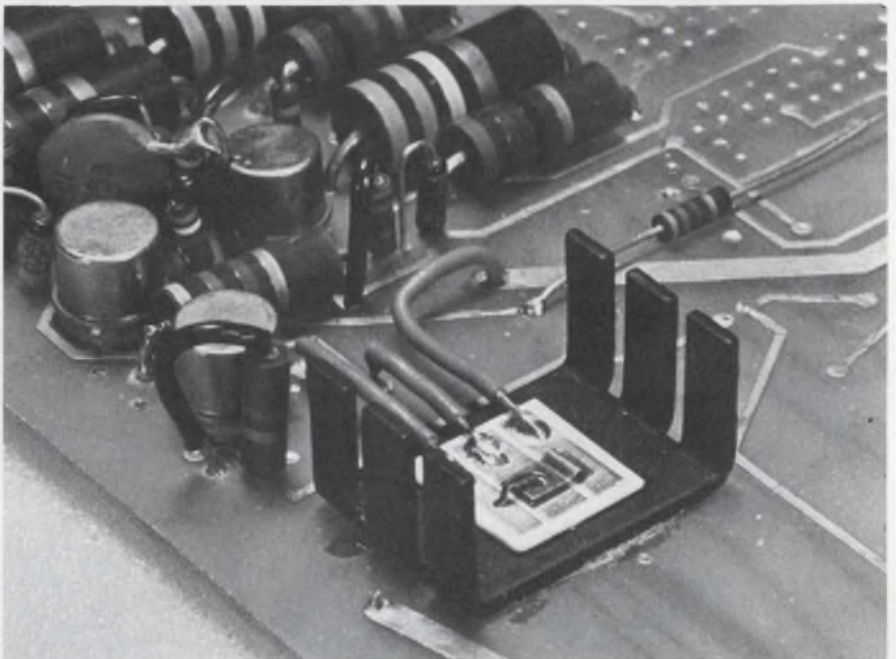

Unitrode, 580 Pleasant St., Watertown, MA 02172. (617) 926-0404. P&A: See text.

Chip thyristors mounted on ceramic substrates can save you money while still retaining the benefits of conventional packages. So says Unitrode in offering its Chipstrate caseless thyristors.

Basically a Chipstrate consists of a glass-passivated, solderable power thyristor chip mounted on a thin square piece of alumina ceramic. Conductive paths are provided from the cathode, gate and anode of the chip to contact pads on the ceramic.

Since there are no cases, the devices cost, typically, 20 to 40% less than equivalent packaged units.

Chipstrates are available in SCR and triac versions that can handle from 10 to 55 A at voltages from 200 to 600 V. For elements with ratings of less than 30 A, the ceramic base is 0.5 in. on a side and 0.025 in. thick. Units rated for currents above 30 A measure 0.65 in. on a side and are also 0.025 in. thick.

All metallization is kept at least 0.05 in. from any edge of the ceramic base material. This simplifies compliance with the

over-the-surface spacing requirements of Underwriters' Laboratories for certain applications.

Chips and contacts are mounted onto the substrate at 325 C, typically. A coating of silicone compound protects the mounted chip from physical damage. This permits subsequent circuit connection using 60/40 solder.

The alumina Chipstrate has a thermal resistance of about 0.7 C/W when used with the recommended mounting method. You can, though, optionally get the Chipstrate with a beryllia substrate. The beryllia has a lower thermal resistance of 0.14 C/W.

Also, you can get the Chipstrate with metallization on the bottom of the ceramic as well as on top—a possible simplification for some interconnect problems. You can get the Chipstrate with 95% of the commercial thyristor types available.

Prices in 5000-piece lots, with an alumina substrate, range from \$0.60 to \$4, depending upon voltage and current ratings. The beryllia substrates add about 10% to the cost. Delivery is from 2 to 3 weeks for small quantities and 8 to 10 weeks for big orders.

CIRCLE NO. 303



# NEW from HEI...



## a low cost optical switch

### Compensates for drift and ambient light problems.

Now, for approximately \$1.50, in quantities, you can get a precision-made HEI optical switch that won't give you drift or ambient light problems. But, this new reliable switch will give in excess of 10,000 operations per second for a minimum of 10,000 hours... the work life of 10,000 mechanical switches... 10 times the accuracy with less power requirements than a mechanical switch. And, it's a quality switch that's ideal for counting, sensing, sequencing, indexing, positioning and linear measurement. In short, this new EOS switch line gives you a lot for very little.

#### GENERAL SPECIFICATIONS (25°C)

EOS MODEL	2A2	2A1	8B2	8B1
LIGHT CURRENT (MIN)	50 UA	200 UA	1000 UA	2500 UA
DARK CURRENT (MAX)	100 NA	100 NA	100 NA	100 NA
SWITCHING SPEED				
RISE TIME	5 USEC	5 USEC	150 USEC	150 USEC
FALL TIME	5 USEC	5 USEC	150 USEC	150 USEC

To get all the facts on HEI's new optical switch line, just write: HEI inc., Jonathan Industrial Center, Chaska, Minnesota 55318



**HEI inc.**

Jonathan Industrial Center  
Chaska, Minnesota 55318 (612) 448-3510

# TWO HEADS ARE BETTER THAN ONE.

Especially when they save you money.

Our unique Sycor 145 Dual Diskette Recorder costs considerably less than two ordinary IBM compatible single-head models.

But price isn't the only reason our recorder is head and diskette above the crowd.

Take storage. With the Sycor 145, you have four times the storage capacity of the usual single head recorder. Because its two heads have the capability of writing on either side of the diskette.

And when it comes time to access that data, our recorder is even more impressive.

Being 3740-compatible, the Sycor 145 handles the same 77-track diskette as other recorders, but its track to track access time of 2.5 msec is the fastest in the industry.

Four times faster than the others.

But don't just take our word for it. Check out the competition. Then look at the Sycor Model 145. We think you'll prefer ours.

Now that there's two sides to the story.

## SYCOR

Contact OEM Department, Sycor, Inc.,  
Ann Arbor, Michigan 48104. Telephone (313) 971-0900.

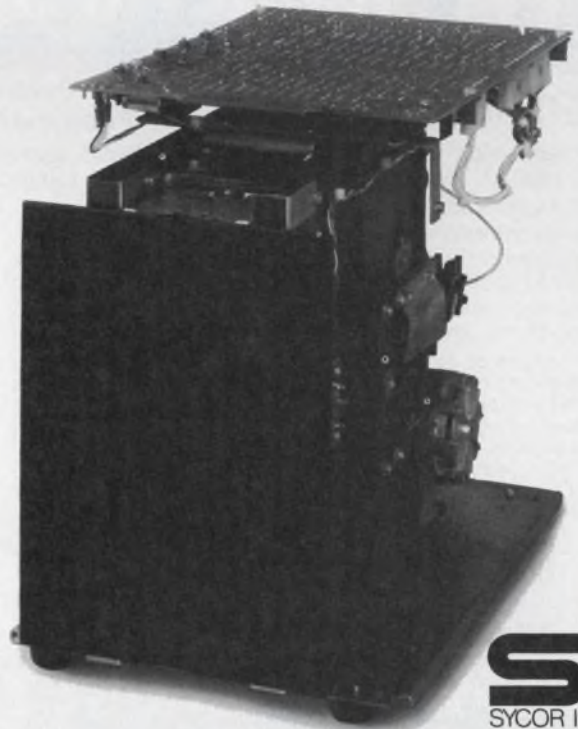

**SI**  
SYCOR INC

Internationally represented by  
Munzig International in London, Paris, and Geneva;  
by CORE, GmbH, in Copenhagen, Hamburg, and Frankfurt;  
by Mitsui & Co., Industrial Machinery Dept., Tokyo;  
and by STG International in Tel Aviv.



# MAG TAPE FOR HP2100



A great minicomputer deserves a great mag tape transport! Don't hang second-rate peripherals on your top-notch HP2100. Digi-Data offers you the finest quality tape-handling equipment available anywhere at any cost.

Phase-encoded, NRZI, or both together, and tape speeds to 45 ips. Prices start at \$5,750 for complete systems which are thoroughly checked-out on our own HP2100's and supplied with diagnostic software.

Digi-Data also manufactures mag tape systems for D.E.C.'s PDP-11 and Data General's NOVA series.

SEE THE REEL EXPERTS FOR YOUR MAG TAPE NEEDS NOW.



## DIGI-DATA CORPORATION

8580 Dorsey Run Road, Jessup, Md. 20794 (301) 498-0200

Digi-Data Europe

Fluestrasse 632 5313 Klingnau Switzerland TELEX: 845-58555

INFORMATION RETRIEVAL NUMBER 102

# PM MAGNETIC SHIELDS

**Immediate Delivery-**

**For Over 90% Of Current  
Photomultiplier Tube Types**

These high permeability AD-MU magnetic shields are fully hydrogen annealed, ready for use. Already tooled—no tooling cost.

For your special application or specific environment, our Problem Solving Magnetic Shielding Specialists can either modify a stock shield, or custom design a shield to your exact requirement.

18 pages of advanced shielding techniques and components.

Also 4-Page Reprint from Electronic Design. Yours for the asking.



## AD-VANCE MAGNETICS, INC.

226 E. SEVENTH ST., ROCHESTER, IND. 46975

(219) 223-3158 TWX 810 290 0294

Our 3rd Decade of Magnetic Shielding Leadership



INFORMATION RETRIEVAL NUMBER 103

## DISCRETE SEMICONDUCTORS

### Rf transistor delivers 5 W at 2 GHz

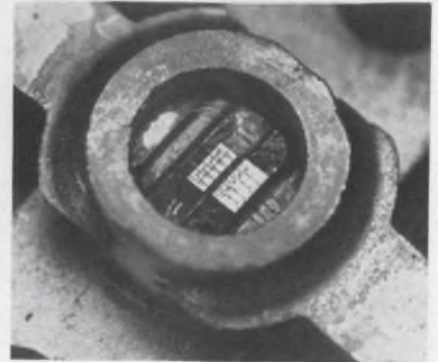

*Amperex Electronic Corp., Hicksville Div., Hicksville, NY 11802. (516) 931-6200. From \$75; stock.*

An rf power transistor, the 2005BLY, can deliver 5 W at frequencies up to 2 GHz with a 9-dB gain when operated from a supply voltage of 28 V. This transistor, designed for operation at 1636.5 and 1645 MHz, is a common base device with internal input matching networks and operates in a class "C" mode. The 2005BLY is an epitaxial npn planar transistor packaged in an hermetically sealed HLP-8 package. The transistor has gold metalization and diffused ballast resistors to increase transistor life over devices using the older aluminum metalization systems.

CIRCLE NO. 336

### Quad-FET demodulator designed for vhf use

*Siliconix, 2201 Laurelwood Rd., Santa Clara, CA 95054. (408) 246-8000. \$12.40 (100-up); stock.*

A quad-ring-demodulator, the U350, is designed for vhf balanced mixer and analog multiplier applications. The device has four matched U310 junction FET chips in a single TO-99 package. In active mixer applications, the demodulator has a two-tone intermodulation product—as high as +34 dBm—and a conversion gain of +4 dB. Transconductance of the U350 is 15 mmho typical and capacitance is as low as 10 pF with drain current of 10 mA. Noise figure is 8 dB at a frequency of 100 MHz. In multiplier applications, the device has only a 90  $\Omega$  maximum turn-on resistance.

CIRCLE NO. 337



## DIGITAL SENSOR improves resolution



Electro Corporation, 1845 57th St.  
Sarasota, Fla. 33580. (813) 355-8411  
\$49 list: Stock to 4 weeks.

Send for complete catalog

Model 58413 Di-Mag® Digital Magnetic Sensor is designed for applications requiring very high resolution. Geometrically matched sensing tip (pole-piece) allows maximum resolution when used with fine toothed gears. Unit has self-contained signal conditioning circuitry and produces outputs compatible with TTL, DTL or HTL logic.



**YES . . . WE'VE BEEN BUSY!**

*This honey of a new product is but one of many — look for more in the New Product Sections of your favorite publications.*

INFORMATION RETRIEVAL NUMBER 104

## Power Distribution Blocks With Built-In Time and Cost Savings



They're especially designed to simplify installation and assembly . . . speed up wiring . . . and provide a secure connection to prevent possible slip-out.

You don't have to wait, either. You get quick delivery on a wide range of sizes and types—at nominal piece prices.

Most blocks are UL recognized and certified by CSA.

Request Bulletin PT-300. If you have a special requirement, give us the specs. We'll design a block to your need.



## Underwriters Safety Device Company

7300 W. Wilson Ave., Chicago, Ill. 60656 • 312-867-4600

INFORMATION RETRIEVAL NUMBER 105

ELECTRONIC DESIGN 10, May 10, 1975

# THIS MAKES 40,000 CASSETTE RECORDERS. WHEW!

When it comes to cassette recorders, who you buy them from is as important as what you buy.

And when you buy the Sycor Model 135, you're dealing with a company that already has 40,000 recorders in service worldwide.

The popularity of our cassette recorder isn't really surprising.

The Sycor 135 is the ANSI compatible cassette drive with record overwrite capacity that lets you edit a whole data block without disturbing so much as a character on adjacent records.

The recorder that reads/writes at a fast 12.5 ips with quick starts and stops for high throughput. With a dual-gap head for Read-After-Write verification.

The recorder that accesses data at a clip of 60 ips.

For more information on our Model 135, or for help on any design or application problem, give us a call.

A company that's made 40,000 cassette recorders ought to be pretty good at finding solutions.

# SYCOR

Contact OEM Department, Sycor, Inc.,  
Ann Arbor, Michigan 48104. Telephone (313) 971-0900.

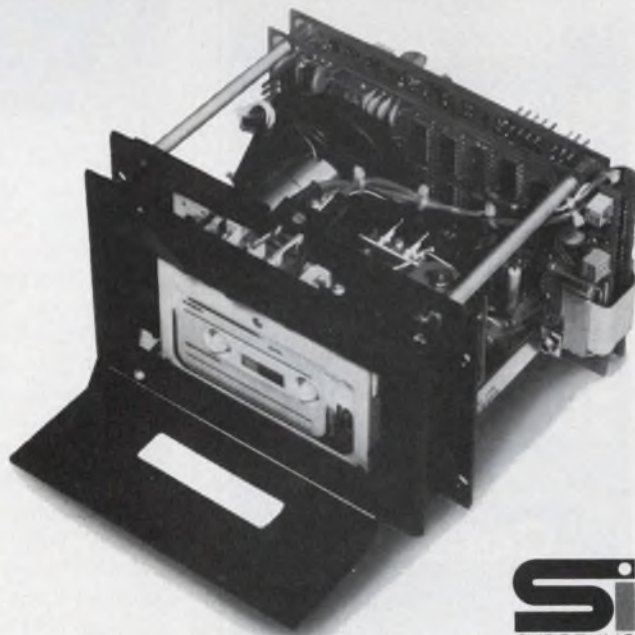

Internationally represented by  
Munzig International in London, Paris, Munich, Tokyo, and Geneva;  
and by STG International in Tel Aviv.

INFORMATION RETRIEVAL NUMBER 106



**EAGLE**  
**EP**  
 SINCE 1843  
**PICHER**

**Carefree**  
 RECHARGEABLES

## LEAD-ACID BATTERIES

- SEALED ● RUGGED
- NO MAINTENANCE
- SAFE ● SPILL-PROOF
- WIDE TEMPERATURE OPERATING RANGE
- LONG LIFE



**RELIABLE ECONOMICAL RECHARGEABLE POWER**  
 for

- Alarm Systems
- Emergency Lighting
- Electromedical Apparatus
- Telephone Carrier Equipment
- Portable Television
- Communication Equipment
- Portable Instrumentation
- Computer Standby Systems
- And Many More

To Find Out How to Make  
 Your Battery System

**Carefree**<sup>®</sup>

Call or Write

**EAGLE-PICHER INDUSTRIES, INC.**  
 Commercial Products Dept. ED  
 P.O. Box 130, Seneca, Mo. 64865  
 Telephone (417) 776-2258

## INSTRUMENTATION

### 3-digit DPM comes in 3 models at \$62 (100 up)



Analogic, Audubon Rd., Wakefield, MA 01880. (617) 246-0300. \$62 (100).

A new series of 3-digit, universal DPMs, the AN2530, features true floating, high-Z input (1000-M $\Omega$  nominal, 100 dB CMR, 300 V peak CMV) and resistor programmed gain to 50  $\mu$ V per count. The series comes in three versions: The AN2530-L (LED display), the AN2530-S (gas plasma) with accessory programmable connector AN86 and the AN2330-L (PC-card unit), a pin-compatible model. All three models use 5-V power, display three decimal digits and consume 3 W.

CIRCLE NO. 338

### DMM guarantees accuracy over lifetime



Philips Test & Measuring Instruments, 400 Crossways Park Dr., Woodbury, NY 11797. (516) 921-8880. \$335.

MOS circuitry is used throughout in the PM2522 multimeter. During the lifetime of the instrument, the specified accuracies (0.2% on dc) are guaranteed, and there is no need to recalibrate. CMR is 100 dB and input impedance is 10 M $\Omega$ . The 3-1/2-digit LED display has an automatic decimal point as well as polarity and overrange indication. All functions and controls are pushbutton selected and there is no need to change leads from voltage to resistance measurements.

CIRCLE NO. 339

## Why are GENERAL SCANNING OPTICAL SCANNERS



Because our complete line of optical scanners use the proven moving-iron galvanometer as the basic component. Patented technological designs, using this principle, make it possible for General Scanning to offer optical scanners unequaled in the speed and accuracy of mirror deflection. Many models available in the following series:

#### Series G-100 PD

- position transducer for closed loop operation
- flyback times of less than 1 ms.
- drives mirrors up to 0.05 gm-cm<sup>2</sup> inertia
- mechanical rotations up to 20° peak-to-peak
- linearity of 0.3%, peak-to-peak

#### Series G-300 PD

- position transducer for closed loop operation
- flyback times of less than 5 ms.
- drives mirrors up to 50 gm-cm<sup>2</sup> inertia
- mechanical rotations up to 25° peak-to-peak
- linearity of 0.2%, peak-to-peak

#### NEW "S" Series

- fixed frequency resonant scanners 400 to 4000 Hz
- mechanical rotations from 10° to 30° peak-to-peak
- integral tachometer for amplitude control and synchronization
- torsion bar suspension — no bearings

We offer precision pen motors and strip chart recorders, too. Be "right on the beam", call or write for specs or details.

The general awaits your orders.

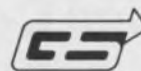

**GENERAL SCANNING INC.**  
 150 Coolidge Avenue  
 Watertown, MA 02172  
 TEL: (617) 924-1010

INFORMATION RETRIEVAL NUMBER 108  
 ELECTRONIC DESIGN 10, May 10, 1975



Compact counter/timer  
is just 2 × 3 × 3 in.



Kessler-Ellis Products, Atlantic Highlands, NJ 07716. (201) 291-0500. Approx. \$200; stock.

This solid-state counter/timer combination has the following standard features: compact size of 2 × 3 × 3 in.; built-in 110-V-ac power supply; unique "touch to reset" circuit eliminates all moving parts; display hold circuit for reading the display while it continues to count or time; optional BCD output; and a built-in crystal time base or 60-Hz divider for timing in seconds or hundreds, minutes and seconds or other combinations.

CIRCLE NO. 340

## Analyzer diagnoses microprocessors

Motorola Inc., 455 E. North Ave., Carol Stream, IL 60187. (312) 690-1400.

MPA-1 logic analyzer is a completely new diagnostic tool specifically designed to analyze both hardware and software operations of microprocessors. The unit displays 32 words of 24 bits each in hexadecimal characters on a 9-in. CRT screen. The characters are arranged in groups of four and two, representing a 16-bit address and 8 data bits. Any location within 65 k addresses may be selected as the trigger address with preset hex switches. The MPA-1 will display 32 consecutive addresses and the associated data. The display can be set to start or end with the trigger address; the starting or ending address can also be delayed from the selected address. Price and delivery are not yet available says Motorola at press time.

Booth No. 1222-1224

Circle No. 341

# Problem solving... with Victoreen High Voltage Technology

## 1 UNORTHODOX CRT DRIVE

How did we meet ever-expanding requirements for increased bandwidth and lower power consumption, coupled with the availability of high-voltage zener-type diodes (Victoreen Corotrons)? With an unorthodox drive scheme for CRT's.

Instead of supplying the CRT anode with very high voltage, we ground the anode and supply a drive signal, riding at approximately —1800 volts, to the grid. The advantages? Being direct-coupled there are no reactive components to limit high-end frequency response or cause roll-off at the low end.

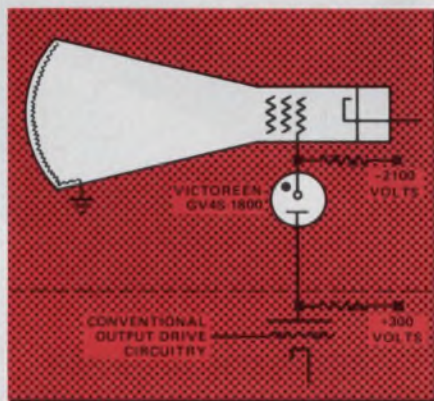

Even though the Corotron operates in the corona mode of discharge, it has no voltage jumps or jitters. Corotrons are not tied to "natural" operating voltages and are adjustable in manufacture from 350 to 30,000 volts.

## 2 FROG MUSCLES TO BRAIN WAVES

Colleges and universities, medical research laboratories and R&D firms need amplification of low level signals. Such signals are derived from frog-muscle experiments, brain-wave measurements, cardiac research, avalanche-breakdown, currents in ionization chambers as well as from a range of constant-current sources.

Victoreen MINI-MOX resistors are used widely to modify op-amp characteristics to:

1. Stabilize output and eliminate oscillation.
2. Define gain so measurements can be quantified.
3. Restrict bandwidth to the region of specific interest.

They typically have a voltage coefficient of —5 ppm/volt, full-load drift of less than 2% in 1000 hours, temperature coefficient of 100

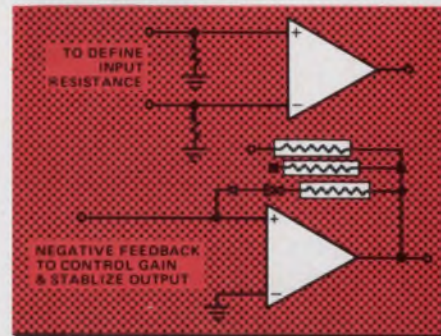

ppm, and a Quantech noise of less than 1.5 V/volt at 20M ohms. They are available in values from 100K to 10,000M ohms in 1, 2, 5 and 10% tolerances.

## 3 A PROBE FOR HIGH POTENTIAL

Two Victoreen MAXI-MOX resistors used in series can serve as a probe in radar circuitry capable of measuring voltages up to 60,000 volts. The probe, compatible with a number of voltmeters of different manufacture, has both short- and long-term stability. Short-term stability assures negligible drift and fluctuation during measurement, while long-term stability maintains the original calibration accuracy of the probe.

Each MOX-5 resistor used in the probe has a maximum operating voltage of 37,500 volts with a power rating of 12½ watts. The voltage coefficient is 1 ppm/volt over the complete voltage range of the MOX-5, while the temperature coefficient is better than 300 ppm for —55° to 125°C.

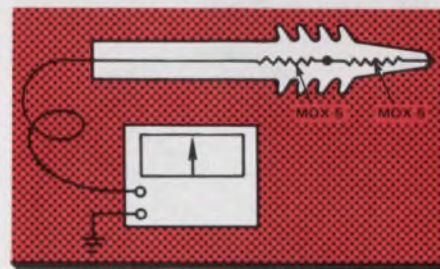

MAXI-MOX resistors have full-load drift less than 1% in 2000 hours of operation, and are available in tolerances of 1, 2, and 5% in values from 10K to 2,500M ohms. A silicone varnish conformal coating provides environmental protection while allowing a maximum hot-spot temperature of 220°C.

Victoreen Instrument Division  
of VLN Corp.  
10101 Woodland Avenue  
Cleveland, Ohio 44104



INFORMATION RETRIEVAL NUMBER 109



# QUALITY IN VOLUME

When you achieve it, you can offer true competitive value. That's just what we're doing at USCC/Centralab for 1975. MONO-KAP™ radial, and MONO-GLASS axial monolithic ceramic capacitors are now available to volume users *from stock* to eight weeks. Our investment and "learning curves" last year guarantee competitive responsiveness — USCC will welcome your specials and non-stock orders. Here's an offer you haven't heard lately — your money is going to buy more at USCC. Cash in on the best values in monolithic ceramic capacitors.

## DISCRETE ASSEMBLY

MONO-KAP™ radial-leaded epoxy coated capacitors are reliable performers; they're rugged enough to work in MIL environments. 4.7 pF to 10 Mfd., 50 to 200 WVDC in 4 dielectrics, including Z5U, in a variety of case sizes featuring meniscus control to 0.032 inches. Large quantity orders from stock.

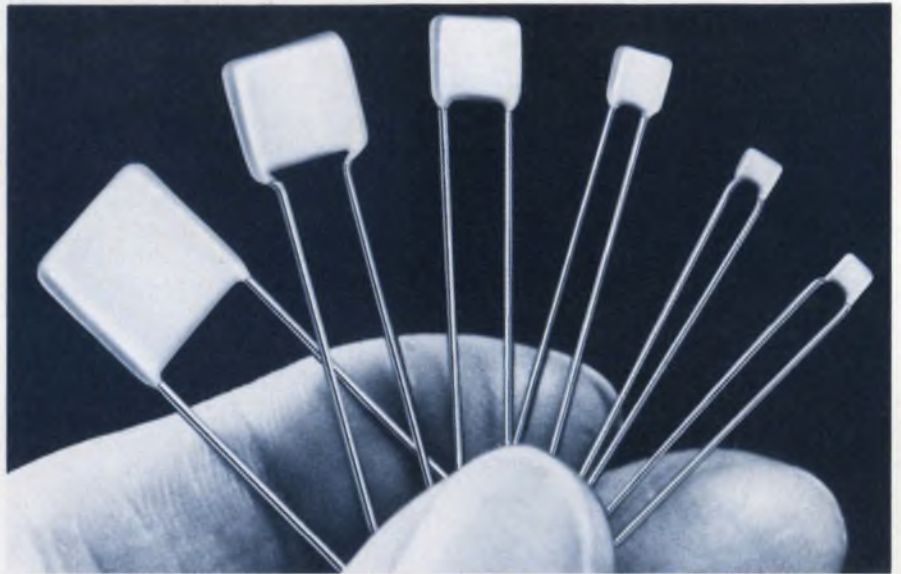

## AUTOMATIC INSERTION

MONO-GLASS axials are glass encapsulated, designed for automatic PCB insertion; furnished reel-packed for high volume applications. They're available in 50 and 100 WVDC from 1 pF to 1.0 Mfd.; four dielectrics: COG, X7R, Z5U and Y5V.

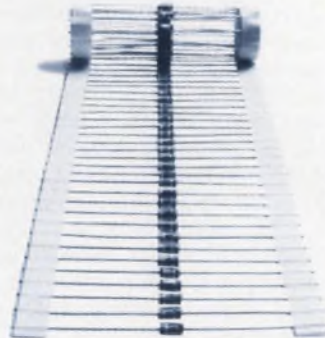

## CUSTOM DESIGN

We're responsive to your design requirements; get USCC's new expanded 1975 catalog.



If you need a special, call (213) 843-4222 or your nearest overseas location for assistance or evaluation samples.

Remember. USCC/Centralab. Value.

FOR QUICK REFERENCE, SEE OUR PRODUCTS IN YOUR EEM, GOLD BOOK OR EBG PAGES.



**USCC/Centralab**

Electronics Division • Globe-Union Inc.

2151 North Lincoln Street • Burbank, California 91504

(213) 843-4222 • TWX: 910-498-2222





### Miniature DPMs give big 0.3-in. display



Velonex Div. of Varian, 560 Robert Ave., Santa Clara, CA 95050. (408) 244-7370. \$132 (3-1/2 digits); 8 wks.

Impac B Series of miniature DPMs features a 0.3-in. LED display. The meters are available in models with 3, 3-1/2, 4 or 4-1/2 digits. Dimensions of all units in the series are identical: Front panel area is less than 4.4 in.<sup>2</sup> and behind-panel volume is less than 5.3 cubic in. Power consumption is less than 1 W.

CIRCLE NO. 342

### Six-hole mainframe added to modular line



Tektronix, Inc., P. O. Box 500, Beaverton, OR 97005. (503) 644-0161. \$395.

Those who have discovered the company's TM 500 system of instrumentation, including DMMs, counters, signal sources, power supplies, and breadboard modules, can now put six plug-in modular instruments in a single, portable power module/mainframe. The TM 506 occupies only 17-1/2 in. of bench space. The unit is 20-in. deep and, like all TM 500 mainframes, only 6-in. high, including feet. The unit is also available in a rack-mounted version, which includes mounting ears and slide-out tracks. It is designed for installation and operation in standard 19-in.-wide racks.

CIRCLE NO. 343

### Waveform generator imitates drawn patterns

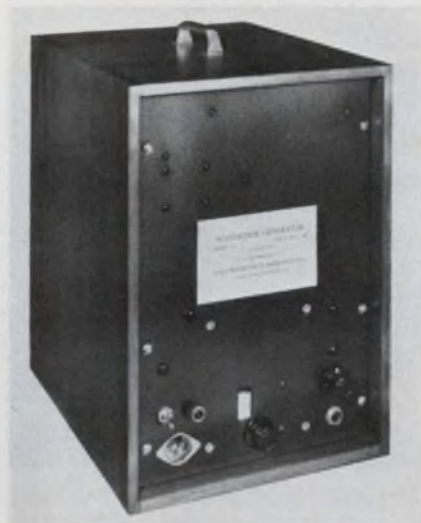

Electro-Physical Research, Inc., P.O. Box 817, Sandy Hook, CT 06482. (203) 426-0148. \$1725.

Waveform generator, Model CS-1, produces an electrical signal that is a faithful reproduction of the waveform drawn or photographed on a small glass slide. The pattern on the slide is electronically scanned, amplified and made available at the output terminals. The unit will produce the sound of any musical instrument or human voice, including short words; any combination of fundamental and harmonics in any phase and/or amplitude relationship; tone bursts and other transients; sine, square, and triangular waveforms; neural pulses and other waveforms. Normal frequency range is from 40 to 250,000 Hz; however, pulse times may be made as short as desired.

CIRCLE NO. 344

### PROM duplicator handles 256-bit memories

Curtis Electro Devices, Box 4090, Mountain View, CA 94040. (415) 964-3136. \$499.50; stock to 2 wks.

PR-2300S is a production programmer for the new 256-bit (32 × 8) 82S23 and 82S123 Schottky PROMs. The compact, table-top instrument will duplicate from a pin-compatible ROM, ROM simulator or computer with an average programming time of 1 s. Just insert the blank PROMs, press the START button and watch for a PASS or FAIL indication.

CIRCLE NO. 345

# Large Lens LED's

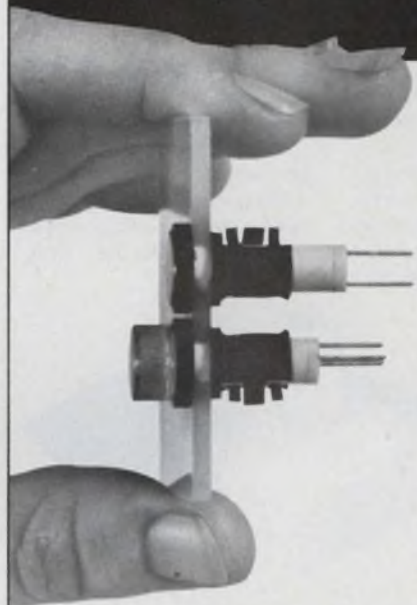

## Green, Yellow, Amber, Red

- With or without built-in resistors.
- Large, bright viewing area (.4" diameter).
- Ideal for backlighting (dead front panels etc.) or hot stamped legends.
- Can be PCB mounted.
- Small mounting diameters (.250" or .290") for easy wiring and close spacing.
- 2 to 28V models.
- Optional built-in drivers.
- Low cost, immediate availability.

And we've got more! LED, Incandescent and Neon sub-miniature panel lights . . . PCB lights. We're your "one-stop-shop" for indicator lights.

The "original" little light people!

# DATA DISPLAY PRODUCTS

5428 W. 104th St., Los Angeles, Ca. 90045  
(213) 641-1232



# the facts about E.M.I. SHIELDING

Design information from Mag-Shield's 30 years experience in E.M.I. shielding.

## IS THERE A QUICK WAY TO SOLVE A SHIELD DESIGN PROBLEM?

Use Mag-Shield's new lab kit to construct and evaluate an experimental shield. Each kit contains an ample supply of high saturation Netic material, high permeability Co-Netic material, double-adhesive shield construction tape, and an A.C. field evaluator probe... all for only \$99.50!



Here's everything you need to construct and evaluate prototype shield designs.

## HOW DO I USE THE KIT MATERIALS?

Comprehensive instructions are furnished with every shielding lab kit. Complete information on magnetic shielding parameters, properties of Netic and Co-Netic shielding alloys, the elements of a basic shield, and examples of how to use the kit materials and magnetic pick-up probe are included.

## WHAT ABOUT PRODUCTION RUNS BASED UPON MY EXPERIMENTAL SHIELD?

Contact Mag-Shield before tooling is begun. Our many years experience in the design and manufacture of magnetic shields will provide important cost savings to you.

For further information, just circle the reader service number, or write Mag-Shield direct to receive a copy of brochure LK-101.

MAGNETIC SHIELD DIVISION



Perfection Mica Company  
740 Thomas Drive  
Bensenville, Illinois 60106  
(312) 766-7800 TWX (910) 256-4815

## INTEGRATED CIRCUITS

### 8-k ROM holds control programs

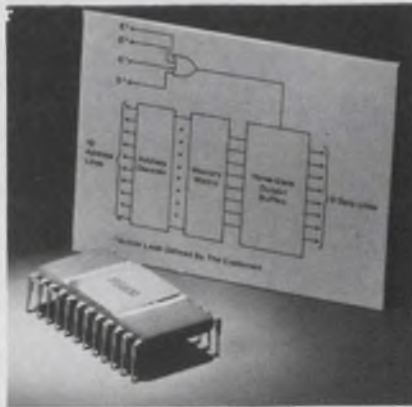

Motorola Semiconductor Products, Inc., P.O. Box 20294. (602) 244-3466. P&A: See text.

A  $1024 \times 8$ -bit ROM, the MCM-6830L, constitutes one of the memory components in Motorola's microcomputer chip set. The NMOS silicon-gate circuit stores the microprocessor's control programs, and it can be used in other bus-organized applications. The MCM-6830L is fully TTL compatible, and it operates from a single 5-V supply. Maximum read-access time is 575 ns. Housed in a 24-pin, ceramic DIP, the price of the ROM is \$35.00, in 1-24 quantities, with a design-aid program stored in the memory.

CIRCLE NO. 346

### Bucket brigade IC has dual 512-bit stages

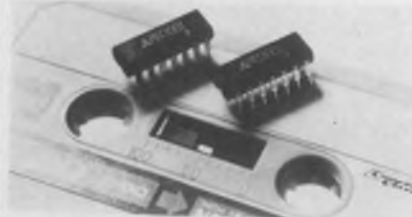

Panasonic, Div. of Matsushita Electric, Pan Am Bldg., 200 Park Ave., New York, NY 10017. (212) 973-4980. Under \$10 (1000-up).

A bucket brigade IC, the MN-3001, delays analog signals in the audio frequency range. The dual 512-stage BBD uses silicon-gate technology and has applications such as in playing a record where a time delay of tens of milliseconds is required for reverberation.

CIRCLE NO. 347

◀ INFORMATION RETRIEVAL NUMBER 112

### Amplifier simplifies microphones

N.V. Philips Gloeilampenfabrieken, Elcoma Div., P.O. Box 523, Eindhoven, the Netherlands.

The TCA980 monolithic amplifier is intended primarily for telephones and intercom systems. In a telephone handset, a capsule assembly containing the TCA980, a low-impedance dynamic microphone and a  $0.22\text{-}\mu\text{F}$  capacitor can directly replace the carbon microphone. When used with a microphone having an impedance of  $200 \Omega$  and a sensitivity of  $100 \mu\text{V}/\mu\text{bar}$ , the output of the amplifier is  $22 \text{ mV}/\mu\text{bar}$ . The output impedance of the TCA980 is typically  $150 \Omega$ . The new IC requires a supply current of 10 to 100 mA, and it comes in a TO-12 package.

CIRCLE NO. 348

### 256-bit CMOS RAM has 150-ns access

Solid State Scientific Inc., Montgomeryville, PA 18936. (215) 855-8400. \$12.00 (1000).

An improved version of the company's 256-bit CMOS RAM is being offered. Organized 64 words by 4 bits, the new version has a typical access of 150 ns. Standby power is typically less than  $0.2 \mu\text{W}/\text{bit}$ . The new memory comes in either epoxy or ceramic 24-pin DIP or flat pack.

CIRCLE NO. 349

### 1-k MOS RAM has 145-ns max access

Synertek, 3050 Coronado Dr., Santa Clara, CA 95051. (408) 241-4300. \$10.80 (100-999).

A fully decoded 1024-bit dynamic, silicon-gate MOS RAM—the SY1103A-1—uses ion-implantation techniques to achieve worst-case access times of 145 ns. By using ion implanted load devices, the SY1103A-1's chip-enable capacitance has been reduced to 18 pF. This reduces clock power dissipation by 35% and cuts the number of clock drivers required at the system level. Also, the precharge clock required with standard 1103-type RAMs is not needed with the new RAM. The memory has a  $1024 \times 1$ -bit organization and it comes in an 18-pin ceramic DIP.

CIRCLE NO. 350



# POWER MINI'S FOR CHASSIS MOUNTING

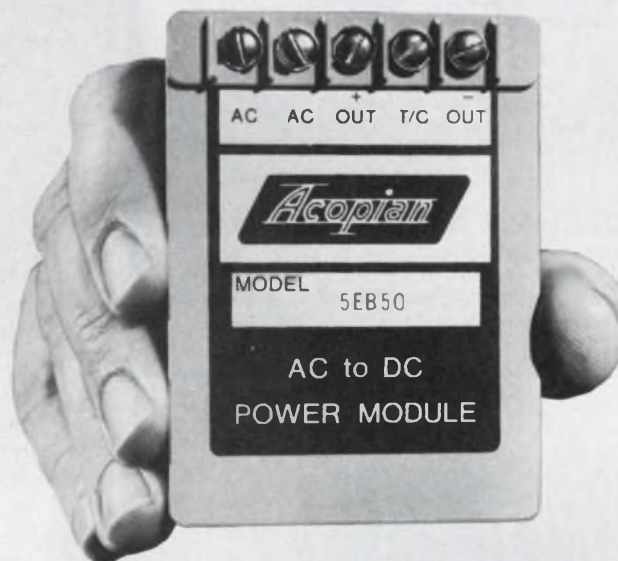

## ALL MODELS U.L. RECOGNIZED

OUTPUT VOLTAGE	OUTPUT CURRENT AMPS.	REGULATION LOAD $\pm\%$	REGULATION LINE $\pm\%$	RIPPLE MV RMS	SIZE INCHES LxWxH	PRICE	MODEL
5	.500	.15	.05	1	3.5x2.5x1.38	\$ 55.00	5EB50
5	1.0	.25	.05	1	3.5x2.5x1.63	75.00	5EB100
5	1.5	.35	.1	1	3.5x2.5x1.63	105.00	5EB150
5	2.0	.25	.05	1	3.5x2.5x2.38	115.00	5EB200
5	2.5	.25	.05	1	3.5x2.5x2.38	130.00	5EB250
$\pm 15$	.100	.05	.05	1	3.5x2.5x1.38	55.00	DB15-10
$\pm 15$	.150	.05	.05	1	3.5x2.5x1.38	65.00	DB15-15
$\pm 15$	.200	.05	.05	1	3.5x2.5x1.38	75.00	DB15-20
$\pm 15$	.300	.05	.05	1	3.5x2.5x1.63	105.00	DB15-30
$\pm 15$	.350	.05	.05	1	3.5x2.5x1.63	110.00	DB15-35
$\pm 15$	.500	.1	.05	1	3.5x2.5x2.38	135.00	DB15-50

Input, 105-125 VAC. Other mini power supplies from 1 to 75 volts. Three day shipment guaranteed. Complete details on these plus a comprehensive line of other power supplies and systems are included in the Acopian 1974-75 catalog. Request a copy.



Corp., Easton, Pa. 18042. Telephone: (215) 258-5441.

INFORMATION RETRIEVAL NUMBER 113



**CONDUCTIVE  
ELASTOMERIC  
CONNECTORS**

- Conductive and resilient elastomeric contact elements •
- Low cost • Variable contact sizes, spacing, and configurations •
- Compensates for surface irregularities • Isolates vibration •
- No soldering required • Built-in stops • Speeds assembly and reduces package volume •
- Free sample available upon request.

**TECKNIT®**

**Technical Wire Products Inc.**  
 Eastern Division • 129 Dermody St., Cranford, NJ 07016 (201) 272-5500  
 Western Division • 427 Olive St., Santa Barbara, CA 93101 (805) 963-1867

INFORMATION RETRIEVAL NUMBER 114

At last...  
circuit  
design  
answers

The PC boards shown above are just a few of the answers Douglas has for your design problems. Choose from a complete line of more than 50 off-the-shelf PC boards. Then select the card rack, case, and connectors that are best suited to your needs. Douglas has everything you'll need for prototype design and limited production. Singly or in quantities, you'll get total, off-the-shelf assistance. Next time you have a design problem, check with the people who have the answers. Write for your free copy of our catalog today.

**DOUGLAS  
ELECTRONICS, INC.**

718 Marina Boulevard, San Leandro, California 94577 (415) 483-8770

INFORMATION RETRIEVAL NUMBER 115

INTEGRATED CIRCUITS

**Single chip  
holds modem**

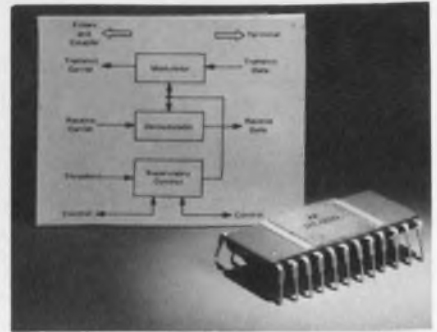

*Motorola Semiconductor Products, Inc., P.O. Box 20924, Phoenix, AZ 85036. (602) 244-3466. \$75 (1-24).*

A 0-to-600-bps digital modem, the MC6860L, provides modulation, demodulation and supervisory control functions necessary to implement a serial data-communications link. The NMOS circuit employs frequency shift keying (FSK) modulation, and it permits data transfer via standard, voice-grade telephone channels. The MC6860L is compatible with the company's M6800 microcomputer family and interfaces directly with the MC6850 asynchronous adapter. Modes of operation for the MC6860L include full duplex, half duplex, simplex, automatic answering, automatic disconnect, originate only, answer only and answer/originate.

CIRCLE NO. 351

**Calculator performs  
360 conversions**

*MOS Technology, Inc., Valley Forge Corporate Center, 950 Rittenhouse Rd., Norristown, PA 19401. (215) 666-7950. Under \$20 in high volume.*

The MPS 2529-104 single-chip calculator array can perform 360 different pre-programmed unit conversions or up to three user-programmable conversions. The array also includes such basic features as algebraic entry, two parentheses levels, scientific notation and natural logarithms. Three full-feature accumulating memories are accessible to a user. Each is separately addressable from a keyboard with Store, Recall and M+ keys. The calculator array operates with a 40-key board and a 12-digit display.

CIRCLE NO. 352



# FULL CIRCLE SURGE PROTECTION

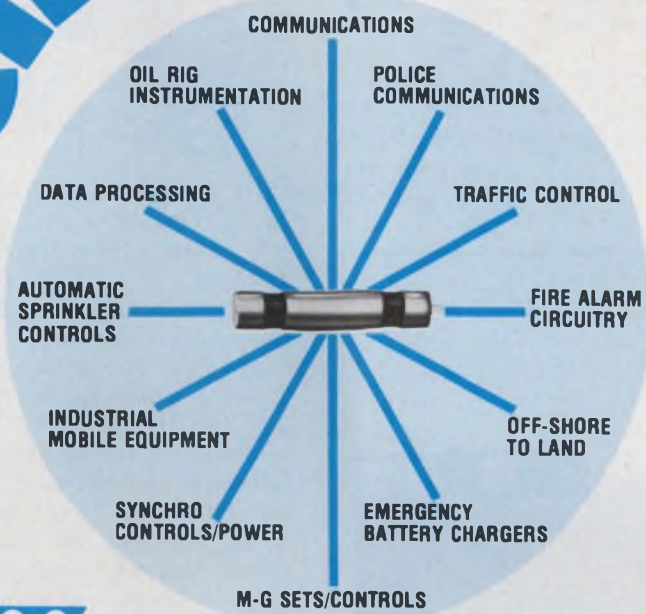

Protect your solid state equipment from junction damage caused by high-current surges due to power switching and lightning transient induction. Ordinary protective devices ground only one wire, allowing currents to reach your equipment through the "other" wire. TII 3-Electrode Gas Tube Surge Arresters simultaneously ground both wires of a signal or power pair. TII protection can end unnecessary service calls and customer complaints. To learn more about surge and how to



protect against it, write for your free copy of "Surge Protection for Solid State Circuitry" or circle the appropriate reader reply number.

Worldwide Patents:  
 • J.P. 2,088,111 • J.P. 2,088,112 • U.S. Pat. 3,811,339 • U.S. Pat. 3,811,340  
 • U.S. Pat. 3,811,341 • U.S. Pat. 3,811,342 • U.S. Pat. 3,811,343 • U.S. Pat. 3,811,344  
 U.S. Pat. 3,811,345 • U.S. Pat. 3,811,346 • U.S. Pat. 3,811,347 • U.S. Pat. 3,811,348

U.S. Listed and  
 REA-Accepted  
 Models Available

Licensed by M-O Valve Co., Ltd.,  
 and by Western Electric Co.  
 Made in U.S.A.



**TELECOMMUNICATIONS INDUSTRIES, INC.**  
 More than 2,000,000 TII Gas Tube Surge Arresters in Service.

1375 Akron Street  
 Copiague, New York 11726  
 (516) 842-5000 • Telex: 144631

INFORMATION RETRIEVAL NUMBER 116

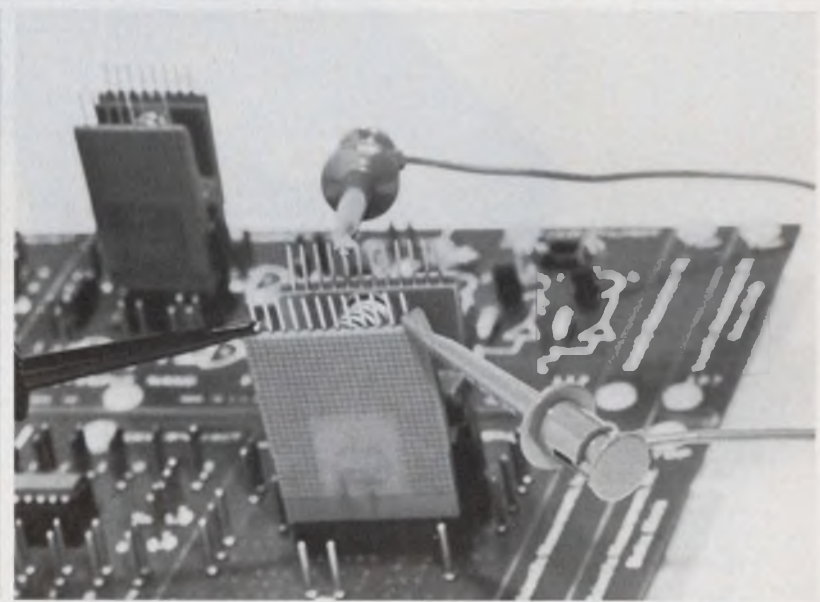
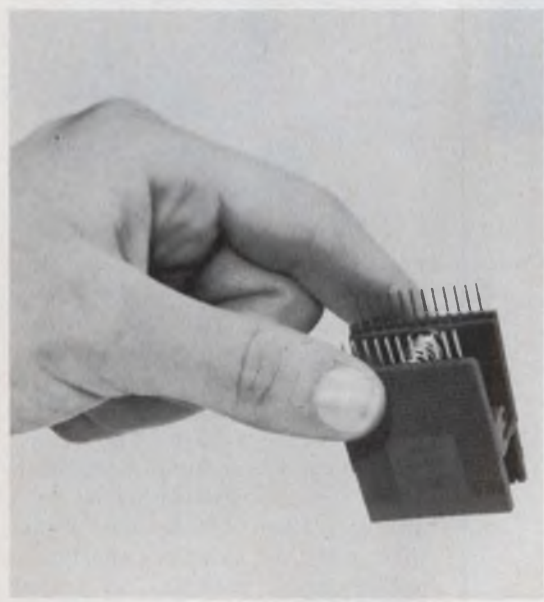

## dip clip & 1/2

24-pin dual in-line packages can now be quickly and easily tested with the new Model 4124 24-lead Dip Clip. Test contacts are elevated for easy attach-

ment of test probes, and separated to greatly reduce the possibility of accidental shorting while testing live circuits.



**POMONA ELECTRONICS**

1500 East Ninth St., Pomona, California 91766 Tel: (714) 623-3463

A Division of ITT

INFORMATION RETRIEVAL NUMBER 117



MICROWAVES & LASERS

180° hybrid covers 2 to 12.4 GHz



Norsal Industries, Inc., 34 Grand Blvd., Brentwood, NY 11717. (516)

231-4040. \$450.

The Model 4834, a 180-degree hybrid, spans the frequency range of 2 to 12.4 GHz. The unit offers an isolation of 17 dB, a VSWR of 1.4 and insertion loss of 1.7 dB. Amplitude and phase unbalance are  $\pm 0.5$  dB and  $\pm 7$  degrees, respectively. The 4834 comes in a 3-1/2 x 1-1/2 x 1/2-in. package, and it has an input power rating of 20 W average and 2 kW peak.

CIRCLE NO. 353

2-to-18-GHz mixer uses -10 dBm LO

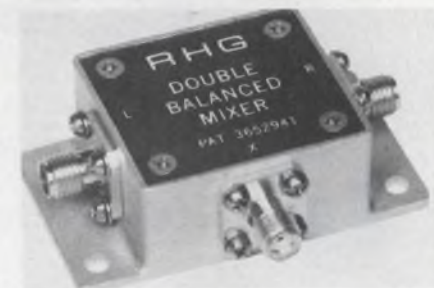

RHG Electronics Laboratory Inc., 161 E. Industry Ct., Deer Park, NY 11729. (516) 242-1100. \$625; 30 days.

Only -10 dBm of LO power is needed for the Model DMB-18 multi-octave double-balanced mixer. The new mixer has an rf range of 2 to 18 GHz and its i-f range of 1 to 350 MHz can be extended to 18 GHz with an external diplexer. Isolation from the rf to LO is typically 25 dB over the 12-to-18-GHz range. And conversion loss is typically 13 dB at -10 dBm LO.

CIRCLE NO. 354

PLUG UGLY.™

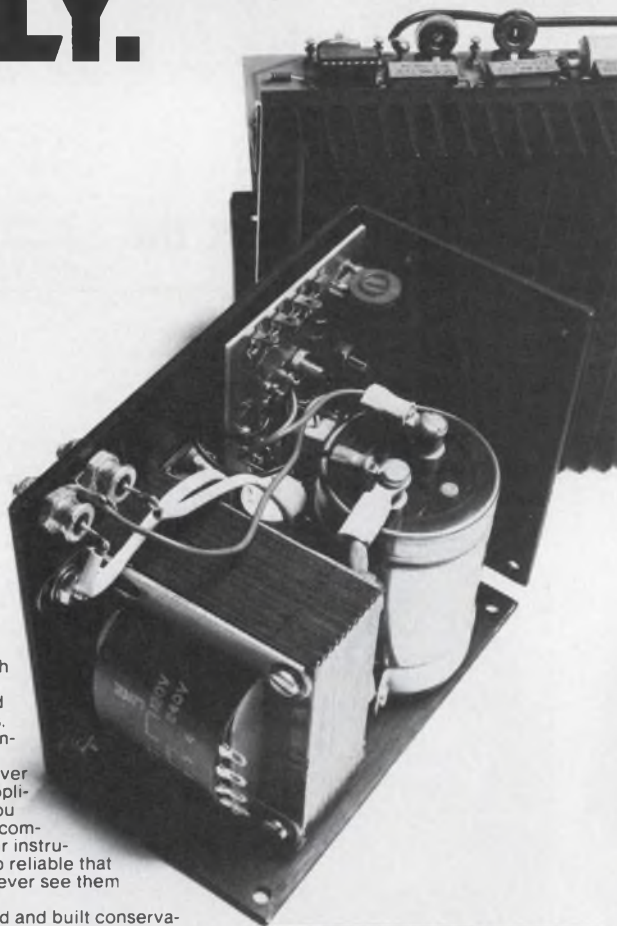

\$49 (unit qty.)  
5V, 6A

They're not much to look at.

Because instead of fancy front panels, we designed our standard open-frame dc power supplies to cover 90% of your OEM applications. And once you plug them into your computers, peripherals or instrumentation, they're so reliable that chances are you'll never see them again.

They're designed and built conservatively so you get full rated power all the way up to +55°C. Regulation, ripple and noise are specified by the book. And with no expensive options, you can now get your dc power for as little as 60¢/W (unit qty).

If you've looked at the competition, we know that has to be a sight for sore eyes.

For more info, use the bingo card or call 714/979-4440. Or call your local Cramer or Newark distributor and get UGLY today

OPEN-FRAME OLV SERIES: 4-28 Vdc, 15-250 W

STANDARD FEATURES: Choice of 16 voltages adjustable  $\pm 5\%$ . Currents to 50A; no derating to +55°C.  $\pm 0.1\%$  IC regulation.  $\pm 0.1\%$  ripple and noise. Remote sensing/programming. Spike suppression. Foldback current limiting. 120/240 Vac. 50/60 Hz inputs.

OPTIONS: OVP crowbar. PRICES: \$29.00 to \$219 (unit qty)

Elexon Power Systems

Get UGLY wherever you are: New England: Coakley, Boyd & Abbott 617/444-5470 □ Upstate N.Y. Kehoe Component Sales 315/524-2491 □ N.Y. Metro, New Jersey: Ed Glass Assoc. 201/592-0200 □ Penn., Del., So. N.J.: T O E Sales 215/348-2212 □ Va., S.C., Md., N.C.: Component Sales, Inc. 301/484-3647 □ Kentucky, Ohio, Ind.: Frank J. Campisano Co. 513/662-1616 □ Michigan: Viliani-Pitcher, Inc. 313/271-4600 □ No. Carolina: Component Sales, Inc. 919/782-9433 □ Ga., Ala.: BJR Manufacturing Repts 205/881-3569 □ Florida: Orbe, Inc. 813/894-0687 □ Ill., Wisc.: Iowa: Baihorn & Welch 312/889-5011 □ Utah: Minn., N. & S. Dakota: Lew Cahill & Assoc. 612/646-7217 □ Mo., Kansas: K & M Sales Co. 816/471-2355 □ Colo.: Utah: J. S. Heaton Co., Inc. 303/758-5130 □ Texas: La.: Carter Assoc., Inc. 214/276-7151 □ Okla., Ark.: Hugh J. Daly Co. 918/627-4159 □ Arizona: J. S. Heaton Co. 602/264-7887 □ New Mexico: J. S. Heaton Co. 505/293-3900 □ Wash., Ore.: Blum & Associates 206/782-1600 □ N. Calif.: J. S. Heaton Co. 415/369-4671 □ S. Calif.: RLS Associates 714/644-7497



ELPAC © Copyright 1974 Elopac, Inc.

INFORMATION RETRIEVAL NUMBER 118

Doppler module increases sensitivity



Plessey Semiconductor, 1674 McGaw Ave., Santa Ana, CA 92705. (714) 540-9979. \$85 (100); stock.

A doppler module for intruder alarms achieves increased sensitivity by using separate transmitter and receiver cavities. The transmitter cavity is a Gunn-diode oscillator, and the receiver cavity is a mixer/receiver. A return signal that is 100 dB less than the transmitted signal produces an output of at least 40  $\mu$ V. This is equivalent to the typical signal produced by a moving person 50 meters distant, assuming an antenna gain of 15 dB. Modules are available for frequency ranges of 8.8 to 9.9 GHz and 10.2 to 11.0 GHz, and units supplied can be pretuned to any frequency within their range. Minimum transmitter power output is 10 mW.

CIRCLE NO. 355



## He-Ne laser costs \$10 in volume

Hughes Aircraft Co., P.O. Box 9515, Los Angeles, CA 90009. (213) 670-1515. P&A: See text.

A new type of helium-neon laser, designed for emerging high-volume applications such as the video disc player market, will eventually cost about \$10 in quantities of 100,000. The company expects to have the laser available as a standard product by mid-1975. The new He-Ne laser has internal mirrors and features Hughes' patented cold-cathode coaxial construction. It will be available either polarized, or randomly polarized, with power outputs up to 2-1/2 mW. Beam diameter is about 0.7 mm. Input power requirement to the laser is less than 6 W, which reportedly represents a 35% reduction from current models. Length of the unit is less than 10-1/2 in. It will be available either as a laser tube alone with a diameter of approximately 1 in. or in a pre-aligned package with a diameter of 1-3/8 in.

CIRCLE NO. 356

## 1-18 GHz couplers offer $\pm 0.2$ -dB sensitivities

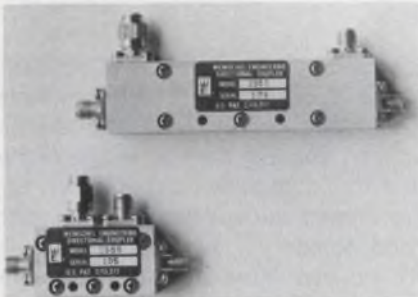

Weinschel Engineering, P.O. Box 577, Gaithersburg, MD 20760. (301) 948-3434. \$125 to \$150; stock to 30 days.

The Models 1551 through 1557 directional couplers cover the 1-to-18-GHz frequency range with frequency sensitivities of  $\pm 0.2$  dB (Models 1551 through 54) and  $\pm 0.3$  dB (Models 1555 through 57). Directivity is 20 dB minimum, 24 dB typical for Models 1551 through 54; 19 dB minimum, 23 dB typical for Models 1555 through 57. Insertion loss (excluding coupled power) is 0.3 dB maximum to 4 GHz, 0.4 dB maximum to 12.4 GHz, and 0.7 dB maximum to 18 GHz.

CIRCLE NO. 357

## Downconverter yields 10-2000-MHz output



Miteq Inc., 100 Ricefield Lane, Hauppauge, NY 11787. (516) 543-8873. \$1875; stock to 60 days.

The DN8006A downconverter can

be used with either a 2100-to-4090-MHz or 4100-to-6100-MHz swept signal input to produce a 10-to-2000 MHz output. A power input of  $-10$  dBm typically gives  $+10$  dBm minimum output. In-band spurious rejection is typically 40 dB, with a harmonic rejection of 30 dB typical. An internal sampler when used with an external sweeper provides  $\pm 0.2$ -dB power flatness.

CIRCLE NO. 358

# MEAN AND UGLY.™

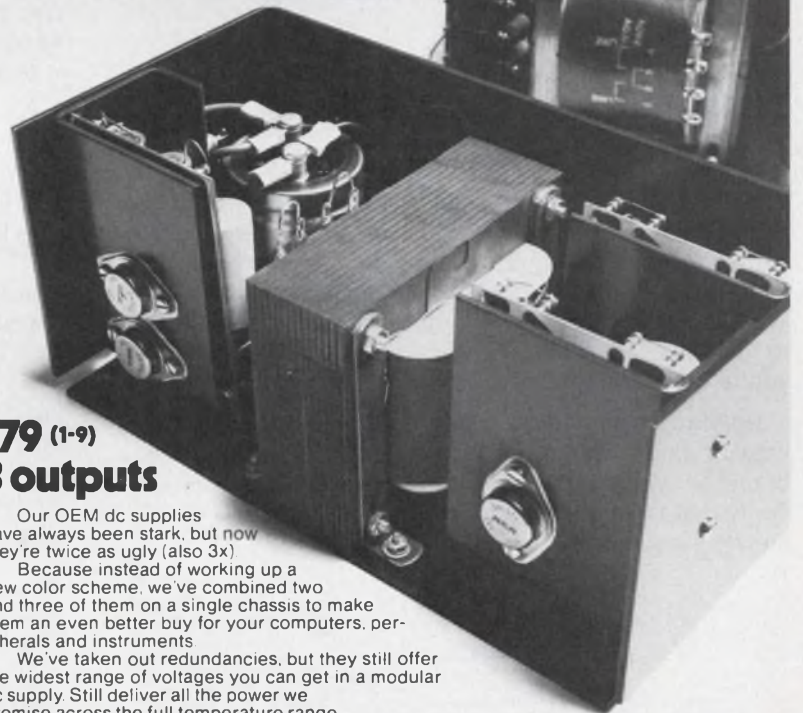

## \$79 (1-9) 3 outputs

Our OEM dc supplies have always been stark, but now they're twice as ugly (also 3x)

Because instead of working up a new color scheme, we've combined two and three of them on a single chassis to make them an even better buy for your computers, peripherals and instruments

We've taken out redundancies, but they still offer the widest range of voltages you can get in a modular dc supply. Still deliver all the power we promise across the full temperature range (even with 50 Hz inputs). And still include all the features you need as standards, not expensive options.

So that now if you check us out against the competition, they're liable to tell you that we're not just ugly.

We're downright mean.

For more info, use the bingo card or call 714/979-4440 Or call your local Cramer or Newark distributor and get UGLY today

MULTIPLE OUTPUT DLV/TLV SERIES: 1st output: 5 V at 3-15 A. OVP standard. 2nd and/or 3rd outputs: each 4-28 V, 6-15 W. OVP optional. All outputs isolated, may be used as positive or negative supplies.

STANDARD FEATURES: Choice of 16 voltages, adjustable  $\pm 5\%$ . Currents to 15 A, no derating to  $\pm 55^\circ\text{C}$ ,  $\pm 0.1\%$  regulation,  $\pm 0.1\%$  ripple and noise. Remote sensing/programming. Spike suppression. Foldback current limiting. 120/240 Vac. 50/60 Hz inputs.

OPTIONS: Enclosure PRICES: \$29 to \$151 (1-9)

## Elexon Power Systems

Get UGLY wherever you are: New England: Coakley, Boyd & Abbott 617/444-5470  Upstate N.Y.: Kehoe Component Sales 315/524-2491  N.Y.: Metro, New Jersey: Ed Glass Assoc. 201/592-0200  Penn., Del., So. N.J.: T.O.E. Sales 215/348-2212  Va., S.C., Md., N.C.: Component Sales Inc. 301/484-3647  Kentucky, Ohio, Ind.: Frank J. Campiano Co. 513/662-1616  Michigan: Wilan-Pitcher, Inc. 313/271-4600  No. Carolina: Component Sales, Inc. 919/782-8433  Ga., Ala.: BUR Manufacturing Repts 205/881-3569  Florida: Orbe, Inc. 813/894-0587  Ill., Wisc., Iowa: Balhorn & Welch 312/889-5011  Minn., N. & S. Dakota: Lew Cahill & Assoc. 612/646-7217  Mo.: Kansas: K & M Sales Co. 816/471-2355  Colo.: Utah: J. S. Heaton Co., Inc. 303/758-5130  Texas: La.: Carter Assoc., Inc. 214/276-7151  Okla., Ark.: Hugh J. Daly Co. 918/627-4159  Arizona: J. S. Heaton Co. 602/264-7887  New Mexico: J. S. Heaton Co. 505/293-3900  Wash., Ore.: Blum & Associates 206/782-1600  N. Calif.: J. S. Heaton Co. 415/369-4671  S. Calif.: RLS Associates 714/644-7497



© Copyright 1974 Elpac, Inc.

INFORMATION RETRIEVAL NUMBER 119



# Electronic Design's

## YOUR OWN INSTANT

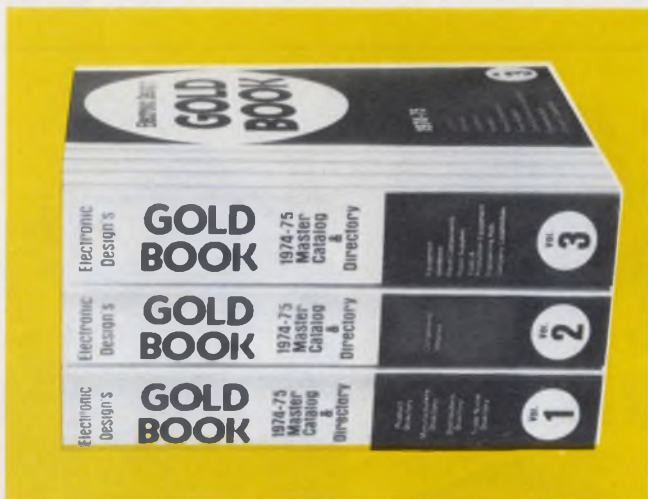

### WANT TO KNOW MORE ABOUT A COMPANY?

You'll find 7,528 manufacturers listed in *Electronic Design's* GOLD BOOK — more than twice the number contained in EEM. But there's more, too. In addition to complete address and phone number, whenever provided by the company you'll find:

TWX  
TELEX  
CABLE ADDRESS  
FACSIMILE EQUIPMENT  
(make and call number)  
QPL DESIGNATION  
FEDERAL STOCK CODE  
NUMBER

NUMBER OF ENGINEERS  
NUMBER OF EMPLOYEES  
DOLLAR VOLUME  
KEY OFFICIALS  
SALES OFFICES  
FOREIGN OFFICES  
U.S. & FOREIGN REPS  
U.S. DISTRIBUTORS

### SIMPLIFIES AND SPEEDS PRODUCT SEARCH

Want to know who makes what? Just turn to the GOLD BOOK's *Product Directory*. Each manufacturer's complete street address, State, zip, and phone is given every time it's listed. Contact is simplified . . . you (or your secretary) don't have to go to any other directory to get missing address information — a big help if you're contacting many suppliers at the same time.

**Boldface type** and page references steer you toward catalog pages on the products you're seeking that are bound in Volumes 2 or 3. And there are symbols to verify that the company really makes the product — not merely says it does.

### LOOKING FOR A DISTRIBUTOR NEAR YOU?

Check the Geographical Section of the GOLD BOOK's *Distributors Directories*. You enter the section by state, then find your city — or one nearby — and the distributors located in that city. You can then go to the Alphabetic Section to find the complete address, zip, and phone. In most cases annual sales volume or net worth, year established, and names of key officials are included. (Distributors are also listed after the companies they represent in the *Manufacturers Directory*.)



### LOOKING FOR A FOREIGN REPRESENTATIVE?

A good rep nowadays is hard to find. It's even harder to know where to start, especially if your company is looking for a rep overseas. Do your sales manager a favor and tell him that foreign reps are listed after each company in the *Manufacturers Directory*. (If you are an overseas subscriber, chances are you've already found this section very useful.)



# GOLD BOOK

## INFORMATION SYSTEM

**KNOW THE TRADE NAME BUT  
NOT THE MANUFACTURER?**

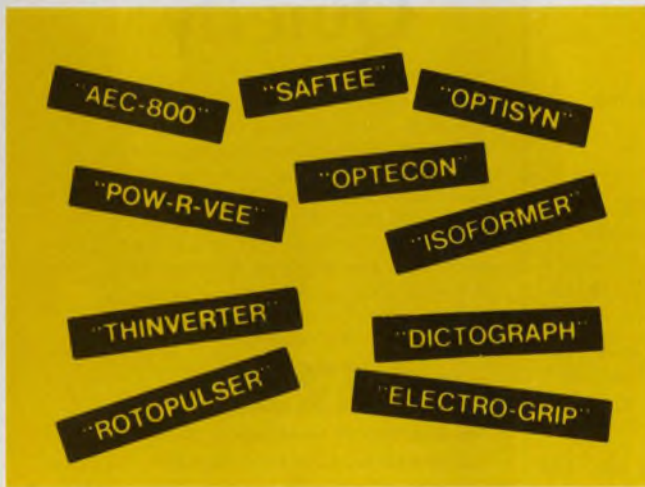

If you've always thought of a product in terms of its trade name, there's an easy way to find out what it is and who makes it. Check the GOLD BOOK's *Trade Names Directory*. Over 4,600 trade names are included from "A. P. Bondeze" to "Zoomator." You can then turn to the *Manufacturers Directory* for more information.

### **DID WE MISS SOMETHING? LET US KNOW ABOUT IT**

The 1975-76 GOLD BOOK directories will be even more complete; more useful than our first edition. Has your company changed its address, phone, product lines or reps? Be sure your ad manager up-dates your listings. Better yet, if you know of any changes that should be made, drop a note to:

**George Weingarten, Editor**  
**Electronic Design's GOLD BOOK**  
**50 Essex Street, Rochelle Park,**  
**New Jersey 07662**



### **CATALOG DATA FOR IMMEDIATE ACTION**

Before you contact a supplier, check the catalog pages in the GOLD BOOK. The product information you need may already be at your fingertips. There are 2,820 catalog pages in all—more than any other industry directory. In some cases the specification data included in these pages may be sufficient to enable you to place your order. In others, the information can shorten the time required for you to discuss your specific needs.

### **WHEN YOU HAVE THE GOLD BOOK YOU DON'T NEED ANY OTHER INDUSTRY DIRECTORY**

Research studies show that 99% of your fellow engineers rate the GOLD BOOK equal or *superior* to other industry directories. It's the "in" directory—the one that's being used and referred to. It's clearly the choice of engineers throughout the U.S. and overseas.

## **LOOK FIRST IN ELECTRONIC DESIGN'S GOLD BOOK**

**BIGGEST, MOST COMPREHENSIVE  
ELECTRONICS MASTER CATALOG  
& DIRECTORY IN THE WORLD**



DIRECT FROM STOCK

SINGLES  
**72<sup>00</sup>**

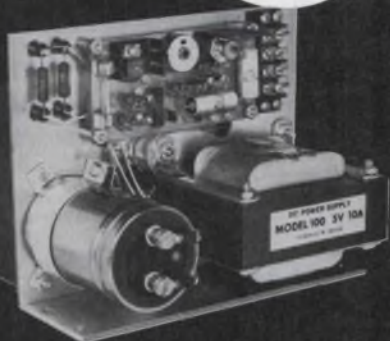

**5V10A**

SINGLES AND DUALS  
FULL RATING AT 71°C

**SPECIFICATIONS**

Size: 7 x 5.5 x 5.5 overall  
 Input: 105-125V, 47-420 Hz  
 Output: Any DC voltage 3 to 30  
 Regulation: Line — 0.005%  
 Load — 0.05%  
 Ripple: Less than 500 Microvolts  
 Temp. Operative — 20 to +71°C  
 Storage — 65 to +85°C  
 Coefficient — 0.01%/°C Max.  
 Current Limiting: Fixed Foldback Type  
 Overvoltage: Optional

SINGLE OUTPUTS			DUAL OUTPUTS		
Model	Voltage	Amps	Model	Voltage	Amps
100-5	5.0	10.0	100-0505	5.0	5.0
				5.0	5.0
100-10	10.0	8.0	100-1212	12.0	3.5
				12.0	3.5
100-12	12.0	7.0	100-1515	15.0	3.0
				15.0	3.0
100-15	15.0	6.0	100-2424	24.0	2.0
				24.0	2.0
100-24	24.0	4.0	100-2828	28.0	2.0
				28.0	2.0
100-28	28.0	4.0			

**ORDERING INFORMATION**

Quantity	With O.V.*		With O.V.*	
	Singles	Duals	Singles	Duals
1-9	\$72 ea	\$78 ea	\$85 ea	\$97 ea
10-14	68	73	81	91
25-49	62	67	73	83
50-99	57	61	67	76
100-	53	57	63	72

\*O.V. = Overvoltage protection

CALL (714) 279-1414

**Electrostatics, Inc.**  
 7718 CLAIREMONT MESA BLVD. • SAN DIEGO, CA 92111

**Evaluation Samples**



**Cable pack**

A sample pack features selected ribbon cable products including standard configuration, laminated, bonded flat and twisted cable. Spectra-Strip.

CIRCLE NO. 359

**Electrical tubing**

Dielectric plastic tubing rated for 600 V at 105 C comes in A.W.G. sizes from 24 up to 2-1/2 in. and in standard wall thicknesses from 0.03125 to 0.01 in. It meets ASTM and MIL specs, has CSA approval and meets the FR-1 flame test, U.L. Subject 224. Dielectric Materials.

CIRCLE NO. 360

**Nylon spacers**

Molded nylon spacers come in lengths of 1/16-in. increments from 1/8 to 1 in. and outside diameters of 3/16, 1/4, 5/16, 3/8 and 1/2 in.

CIRCLE NO. 361

**Interconnection material**

A sample kit contains three 1-1/2 in. x 3 in. metal-filled elastomeric sheets, one each in thicknesses of 5, 10 and 20 mils, and complete instructions on the use of the material. The kit is priced at \$10. Chomerics, 77 Dragon Ct., Woburn, MA 01801

INQUIRE DIRECT

**PC board switches**

Series RK8000 subminiature PCB rocker-actuated switches are intended for solder pin insertion into 1/16, 1/32 and 1/8 in. PC boards. Request sample on company letterhead, indicating the expected end use. Control Switch, 1420 Delmar Dr., Folcroft, PA 19032

INQUIRE DIRECT

**Plug Us In**



**Turn Us On**



**Quietly**

Measuring low level signals is tough enough without adding noise—so our preamplifiers are quiet. To find out more about our wide range of quiet preamps, write or call for our handy full color wall chart; it will help you in selecting the best preamp for your application. Princeton Applied Research Corporation, P.O. Box 2565 Princeton, New Jersey 08540, 609/452-2111. In Europe, contact Princeton Applied Research GmbH, D8034 Unterpfaffenhofen, Waldstrasse 2, West Germany.

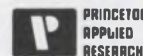

286

See us at the CLEA Show Booth # 760 and # 770.  
 INFORMATION RETRIEVAL NUMBER 121



Designing a microcomputer around the 8008? You need *Microcomputer Design*. Over 300 pages of hardware design ideas simplify the tangled TTL in the published circuits. Helps build increased performance and lower cost into your system. Great for OEMs evaluating the 8008. Ideal for college-level study.

- Book with 8008 for \$100.
- With 8008-1 (60% faster) \$110.
- Book with 8080 for \$200.
- Book alone, \$75. Quantity discounts are available. (U.S. prices; Ill., + 5%) WE HONOR



**MARTIN RESEARCH**  
 Suite 330/1825 South Halsted St.  
 Chicago, Ill. 60608/312. 829. 6932

INFORMATION RETRIEVAL NUMBER 122  
 ELECTRONIC DESIGN 10, May 10, 1975



# POWER FOR RAMS



Eliminate extra power supplies in your random access memory designs

RAM-PAC\* power sources use +5v DC main bus voltage to provide the voltages needed to operate all 4K RAMs. As many as 55 RAMs can be powered by a single source, small enough to be mounted on the same PC card that holds the ICs. Outputs are short circuit protected.

Input: 5v ± .25v DC

Output voltages:

RP 12-3/5 ..... +12v, -3v  
 RP 12-5/5 ..... +12v, -5v  
 RP 12-9/5 ..... +12v, -9v

Output voltage tolerances:

+12v = ±5%;  
 negative voltages = ±10%

Maximum output power:

+12v = 550 ma;  
 negative voltages = 10 ma

Temperature coefficient:

±3mv per degree C, nominal

Output ripple:

150 mv max. P-P, over 20 mHz bandwidth

Line regulation:

+12v = ±50 mv; negative voltages = ±150 mv

Load regulation:

+12v = <175 mv; negative voltages = <100 mv

Package size: 2.8 × 2.8 × .4 inches

Price, one to nine quantity: \$64.50 each



## Reliability, Inc.

5325 Glenmont

Houston, Texas 77036, U.S.A.

713-666-3261 TWX: 910-881-1739

\*Trademark, Reliability, Inc.

INFORMATION RETRIEVAL NUMBER 123  
 ELECTRONIC DESIGN 10, May 10, 1975

## Application Notes

### CAD of microwave circuits

How microwave circuit designers can simplify their calculations using a desktop calculator is the subject of an application note. A new software package, Microwave Pac Volume 1, is described. Hewlett-Packard, Palo Alto, CA

CIRCLE NO. 362

### FFT processing

"Theory and Application of Fast Fourier Transform Processing" discusses the system parameters involved in defining a Fast Fourier Transform requirement, as well as Fourier methods: the Fourier Transform, the Discrete Fourier Transform (DFT) and the Fast Fourier Transform (FFT). Spectra Data, Northridge, CA

CIRCLE NO. 363

### Semiconductor fuses

Factors which should be considered in selecting semiconductor fuses are explained in a reprinted article. International Rectifier, Semiconductor Div., El Segundo, CA

CIRCLE NO. 364

### Interfacing CMOS

Examples of practical circuits for a wide variety of interfacing situations between CMOS and other technologies and design constraints for each circuit are given in an eight-page catalog. Logic diagrams and tables of characteristics supplement the text. RCA Solid State, Somerville, NJ

CIRCLE NO. 365

### Gear train system

"Gear Train System Studies for Use with Synchronous Timing Motors" covers tooth form proportions, wear and materials, surface endurance data, safe cyclic bending stress data and miscellaneous tabulated data. The book has a marked price of \$2.50. General Time, Industrial Controls Div., Thomaston, CT 06787

INQUIRE DIRECT

INFORMATION RETRIEVAL NUMBER 124 ►

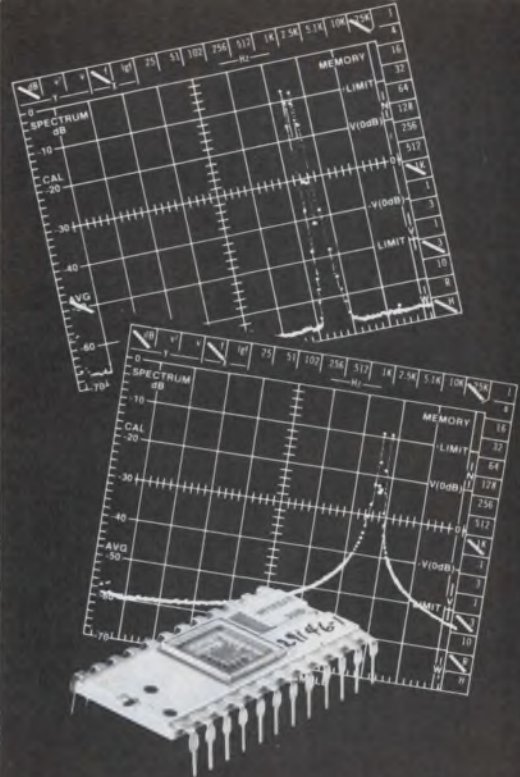

## Only with an EMR Real-Time Spectrum Analyzer...

## Change a PROM, Change a Window Function

In a spectrum analyzer, the shape of the window function is an important factor affecting resolution and measurement accuracy. In the EMR 1510 Real-Time Spectrum Analyzer, the window function is digitally defined by a field replaceable PROM. Rectangular and Hanning windows are standard and switch selectable. Need a Lehmann or other special functions? Add or change a PROM.

That's not all... 60dB dynamic range, LED readout, computer interface, CRT status display, and much more!

Only From EMR!



**EMR** Schlumberger

EMR Telemetry  
 Weston Instruments, Inc.  
 Box 3041, Sarasota, Florida 33578  
 813-371-0811



# DIT-MCO WIRE/CIRCUIT ANALYSIS SYSTEMS...THE ULTIMATE TEST!



## Computer Controlled System 823 Tests Backplanes, Multilayer Boards, Cable Networks, Wired Racks . . .

And performs the tests accurately with a wide range of substantially superior test parameters. Distributed solid state switching eliminates adaptor cables. System 823 is pluggable directly to the product or fixture.

System 823: Computer Control, solid state switching, test speed, superior test parameters, testing at higher voltage, a complete standard software package, and a variety of standard and special hardware/software options.

CALL OR WRITE: A DIT-MCO representative can show you how the System 823 relates to your test needs. He'll show you how to perform tests faster, more simply, and save money too!



## The Difference in Testing!

### DIT-MCO INTERNATIONAL

A Division of Xebec Corporation  
5612 Brighton Terrace, K. C., Mo 64130  
Telephone (816) 444-9700  
Telex Number 42-6149

European Technical Representative, Radix House,  
Central Trading Estate, Staines, Middlesex,  
TW18-4-XA, England, Telephone (0784) 51444  
Telex Number 935023

INFORMATION RETRIEVAL NUMBER 125

## New Literature



### Readouts

A 60-page "Readout Product Selector Guide" details readouts made to accommodate incandescent, neon, gas discharge and light-emitting diode light sources. Dialight, Brooklyn, NY

CIRCLE NO. 366

### Data systems

A 16-page brochure on the company's chromatography data system, PEP-2, includes descriptions of both the hardware and software for accomplishing a wide variety of laboratory chromatographic tasks. Perkin-Elmer, Norwalk, CT

CIRCLE NO. 367

### Thick-film materials

Characteristics and typical applications of thick-film materials are presented in an eight-page brochure. Methode Development, Chicago, IL

CIRCLE NO. 368

### Printer/plotters

High-speed electrostatic printer/plotters for graphic and alphanumeric presentations are described in a 12-page brochure. Gould, Instrument Systems Div., Cleveland, OH

CIRCLE NO. 369

## VIDEO AMPS

### C-COR VIDEO Amplifiers are the most versatile!

DC and AC Coupling  
Laboratory or Modular  
Single or Multiple Output

FOR EXAMPLE

MODEL	4392	3567	3334
BW	DC to 20 MHz	DC to 20 MHz	DC to 20 MHz
Gain	6 to 20dB	20dB	X1 to X100 in steps
Z In/Out	50/5 ohms	1k/50 ohms	50/50 ohms
Output	+32dBm into 50 ohms	+19dBm scope preamp	+21dBm into 50 ohms

For a complete amplifier catalog  
call, wire, or write:

**C-COR**  
*Electronics, Inc.*

60 Decibel Road  
State College, PA 16801  
814-238-2461  
TWX 510-691-1933

Call Toll Free 800-458-3751

INFORMATION RETRIEVAL NUMBER 126

## TAURUS

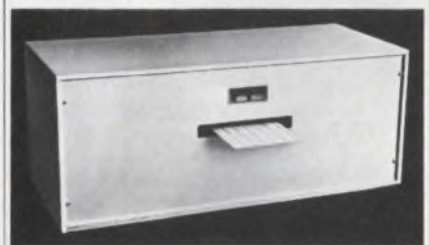

### HEAVY DUTY INDUSTRIAL CARD READERS for OEM and Systems Applications

**APPLICATIONS:** Warehousing, Process Controls, Manufacturing, Data Handling, etc.

**SELF-CONTAINED:** Plug in and operate. Various output formatting. Wide number of options.

Send for 1975 Catalog.

ACADEMY HILL  
LAMBERTVILLE  
NEW JERSEY  
08530  
609-397-2390



INFORMATION RETRIEVAL NUMBER 127  
ELECTRONIC DESIGN 10, May 10, 1975



about  
**5¢/yr.\***  
 buys a lot  
 of reliability  
 with  
 Angstrom's  
 new  
 SAR,  
 20 year  
 end-of-life  
 precision  
 metal film  
 resistors!



\*Based on a typical cost of \$1.00 each.



**angstrom  
 precision, inc.**

one precision place  
 hagerstown, maryland 21740  
 telephone: 301-739-8722  
 twx: 710-853-6834

INFORMATION RETRIEVAL NUMBER 128  
 ELECTRONIC DESIGN 10, May 10, 1975

### Electronic project kits

Solid-state Modukit electronic project kits are featured in a four-page catalog. The catalog includes power supplies (factory assembled) and environmental lighting, which includes strobes, color organs, etc. Bowman Electronics, Garwood, NJ

CIRCLE NO. 370

### D/a and a/d converters

Over 100 data conversion products are described in a 12-page catalog. Micro Networks, Worcester, MA

CIRCLE NO. 371

### Linear ICs

A Linear IC Product Guide covers communications, controls, instrumentation, information systems, federal applications and consumer applications. The guide provides fingertip accessibility and selection of bipolar, MOS and CMOS ICs characterized for linear operation. RCA Solid State Div., Somerville, NJ

CIRCLE NO. 372

### Relays and accessories

Over 1100 stock relays and accessories are shown in a 32-page catalog. Potter & Brumfield, Princeton, IN

CIRCLE NO. 373

### Transistors chips

Silicon transistor chips, available in over 2000 2N types, are featured in a catalog. The catalog illustrates basic sizes and configurations, and presents specifications in tabular form. Semico, Costa Mesa, CA

CIRCLE NO. 374

### Instrumentation

Descriptions and selection criteria for DPMs, linear ICs, thin-film resistor networks and substrates, function modules, a/d and d/a converters, power supplies, amplifiers, dual monolithic transistors, s/d converters and monolithic analog CMOS multiplexers, switches and converters are given in a 272-page guide. Analog Devices, Norwood, MA

CIRCLE NO. 375

INFORMATION RETRIEVAL NUMBER 129 ▶

# picture this...

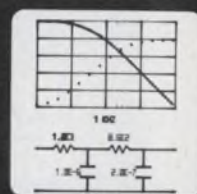

# with our Graphics Interface

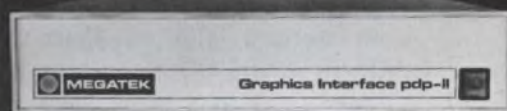

STARTING AT **\$1095.**

#### APPLICATIONS:

Fast-Fourier-Transform or Multichannel Analyzer Display ■ Computer-Aided Design, Layout, and Instruction ■ True Perspective Presentations ■ Stimuli Pattern Generation for Retinal Research ■ Dynamic Simulations ■ Graphical Display Monitor for Real-Time Processes

In just a few seconds you can convert your X-Y scope into a graphics display. We've got parallel interfaces for NOVA, ECLIPSE, PDP-11, ALPHA-16/LSI, and HP-2100 minicomputers as well as serial interfaces for remote timeshare terminals. No modifications are required to existing equipment. Simply connect one of our economical interfaces and you're in business. A built-in 50 Hz refresh memory assures flicker-free displays and eliminates the need for CPU cycle stealing. Software is provided which permits you to plot vectors and/or points directly from simple BASIC language commands. And we've got light pens and hard copy adapters, too! Call or write for complete details.



**MEGATEK**  
 BUDGET PERIPHERALS

1055 Shafter Street, San Diego, CA 92106  
 Telephone (714) 224-2721

Announcing our newest at NCC Booth 1550



# CUSTOM POWER SUPPLIES FROM OFF-THE-SHELF SUB-MODULES



Over 1200 configurations of miniaturized, high efficiency AC-DC & DC-DC Regulated Power Converters using standard sub-modules . . . only from Arnold Magnetics!

Our exclusive off-the-shelf thin-mods let you design your own custom power conversion systems as you order. There's no engineering cost, no lost design time, and no long delivery schedules.

All this, plus super performance. AC (115 VAC, 50-500 Hz) and DC (12, 28, 48 and 115 VDC) inputs . . . multiple isolated and regulated (to .1%) outputs . . . up to 120 watts per output . . . 3.9 watts delivered per cubic inch . . . efficiencies to 85% . . . short circuit and transient protection.



Your complete Power Conversion System is provided in a tested and encapsulated miniaturized, conduction cooled package.

Call us collect . . . ask for Mark Warren. We'll have our easy-to-use Specification Form and our new Catalog in the mail to you today!



## ARNOLD MAGNETICS CORPORATION

11520 W. Jefferson Blvd.  
Culver City, Ca. 90230 • (213) 870-7014

## NEW LITERATURE



### Tantalum capacitors

A set of specifications and application notes for solid tantalum capacitors includes information on standard MIL metal case, non-polar, subminiature and extended range hermetically sealed axial lead capacitors. Union Carbide, Components Div., Greenville, SC

CIRCLE NO. 376

### Ferrite materials & cores

Catalog sheets on molded ferrite parts cover coil forms, sleeves, toroids and beads. The data sheets contain magnetic and physical specifications. Krystinel Corp., Port Chester, NY

CIRCLE NO. 377

### Communications processor

An eight-page brochure presents an overview of the COPE 1600 remote communications processor's design features, performance capabilities, operating characteristics and general specifications. Harris Data Communications Div., Dallas, TX

CIRCLE NO. 378

### Solid-State Databooks

The SSD-200C seven-volume, 4482-page set of 1975 Databooks covers RCA's standard line of ICs, discrete MOS devices, CMOS digital integrated circuits, power transistors, thyristors, rectifiers, diacs, rf and microwave devices and high-reliability ICs and discrete devices. Databooks may be ordered by individual volume at \$3 each or the seven-volume set is available for \$19. RCA Solid State Div., Box 3200, Somerville, NJ 08876

INQUIRE DIRECT

### Motor relay

The PMS solid-state motor protection relay for large/critical ac motors is described in a six-page foldout. Weston Instruments, Sarasota, FL

CIRCLE NO. 379

### Deviation controllers

Analog-digital indicating deviation controllers for process control systems are described in an eight-page booklet. Included are dimensional drawings, specifications, available options and ordering information. Beckman Instruments, Process Instruments Div., Fullerton, CA

CIRCLE NO. 380

### Dielectric capacitors

A 116-page catalog on wound film dielectric capacitors includes capacitor basics and even points out some real pitfalls that some of the experts are reluctant to discuss. And for anyone with questions, they are readily answered by information on an application chart. Elpac Components, Santa Ana, CA

CIRCLE NO. 381

### Integrated circuit modules

Abacus 1-100 series circuit modules are highlighted in an 18-page catalog. Specifications, characteristics, parameters and application information are included. Information Control Corp., El Segundo, CA

CIRCLE NO. 382

### PC terminal switches

An illustrated 20-page catalog describes miniature toggle, push-button, slide, keyboard and rotary PC terminal switches and accessories. Engineering diagrams are tabulated for easy reference and identification of critical dimensions. Alco Electronic Products, North Andover, MA

CIRCLE NO. 383

### Dc micromotors

Diagrams, photos and tables supplement an 8-page text describing dc micromotors. Portescap, U.S., New York, NY

CIRCLE NO. 384



# Think Large. Think Small. Think Ise

Think our three jolly green giants for desk-top electronics. Our two pint-size pigmies for carry-in-the-pocket display designs. But don't stop there. Think low operating voltages, low power consumption, glass encapsulation all around, and wafer-thin thickness and dip clip pins for fast efficient mounting.

**itron**<sup>®</sup>

## FG-159A2

ec = eb = 35Vp-p  
ic = 4.5mA<sub>p-p</sub>  
ib = 3.5mA<sub>p-p</sub>

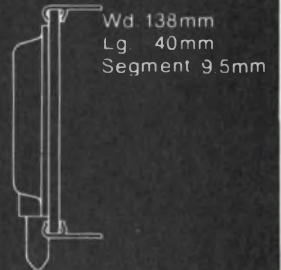

## FG-139A2

ec = eb = 30Vp-p  
ic = 3.6mA<sub>p-p</sub>  
ib = 2.8mA<sub>p-p</sub>

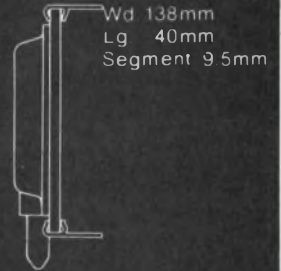

Our jolly  
green giants

## FG-99A2

ec = eb = 24Vp-p  
ic = 3.5mA<sub>p-p</sub>  
ib = 2.5mA<sub>p-p</sub>

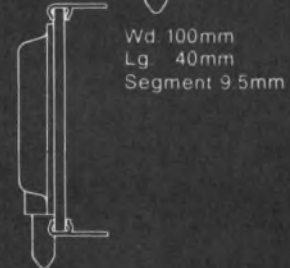

## FG-125A2

ec = eb = 24Vp-p  
ic = 2.0mA<sub>p-p</sub>  
ib = 2.0mA<sub>p-p</sub>



Our pint-size  
pigmies

## FG-95A

ec = eb = 24Vp-p  
ic = 2.0mA<sub>p-p</sub>  
ib = 1.5mA<sub>p-p</sub>



### Something else to think about

Think Ise for digital readouts for instruments, clocks and other products, too.

The Brighter Side of Electronics

## ISE ELECTRONICS CORP.

Main Office:

P.O. Box 46 Ise City Mie Pref. Japan  
Tel: (05963) 5-2121 to 4. Telex: 4969523

Tokyo Office:

2-7-7 Shigashi Shinbashi Minato-ku Tokyo Japan  
Tel: (03) 433-6616 to 9. Telex: J26546

Noritake Electronics Office:

22410 Hawthorne Blvd. Torrance California 90505 U.S.A.  
Tel: (213) 373-6704 Telex: 230674910

INFORMATION RETRIEVAL NUMBER 131



# Look what \$595 buys!

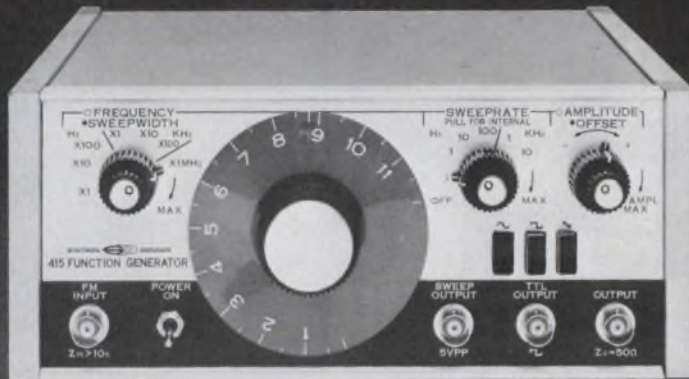

## New 11 MHz sweep/function generator

Only Systron-Donner offers a 11 MHz sweep function generator at such an inflation-defying price. Inexpensive, yes, but look at these Model 415 features: **Frequency** in 7 decade ranges from 0.01 Hz to 11 MHz • **Dial accuracy** 1% of full scale typical • **Waveform outputs:** sine, square, triangle, ramp and a T'L compat-

ible sync pulse square wave. **Plus:** The same instrument without internal sweep (Model 405) costs just \$495. Of course, it can still be swept externally. For details, contact your nearest Scientific Devices office or Systron-Donner at 1 Systron Drive, Concord, CA 94518. Phone (415) 676-5000.



INFORMATION RETRIEVAL NUMBER 132

# Vendors Report

Annual and interim reports can provide much more than financial-position information. They often include the first public disclosure of new products, new techniques and new directions of our vendors and customers. Further, they often contain superb analyses of segments of industry that a company serves.

Selected companies with recent reports are listed here with their main electronic products or services. For a copy, circle the indicated number.

**Thomas & Betts.** Connectors and terminations, fittings and accessories, wire harnessing devices and accessories, flat cable and connectors, telecommunication test equipment and cable-tie installation tools.

CIRCLE NO. 385

**Union Carbide.** Batteries and related products, polyethylene and chemicals.

CIRCLE NO. 386

**Honeywell.** Control systems and information systems.

CIRCLE NO. 387

**Bausch & Lomb.** Electro-optics, scientific instruments and consumer products.

CIRCLE NO. 388

**Conrac.** Communications, controls, information displays and automated assemblies.

CIRCLE NO. 389

**Comsat.** Communications satellites.

CIRCLE NO. 390

**RCA.** Electronic commercial products and services, consumer products and services, broadcasting, communications, government systems.

CIRCLE NO. 391

**Raytheon.** Government systems, consumer electronics, semiconductors, MSI/LSI ICs, medical electronics, microwave products, wire and cable, radar and minicomputers.

CIRCLE NO. 392

# Circuit Savers

DC **95¢** 1000 pcs.

**TRANSIENT SUPPRESSOR**

The TSD-1.5 Series are ideal for protection of long signal lines from damage from induced lightning etc. Reaction time is in nanoseconds.

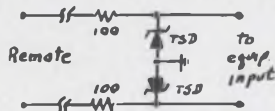

2 units (back to back) will protect sensitive components from a 5KV, 1ms duration transient. Clamp voltages from 5V to 200V. Call Mike Coyle for applications assistance. Full line of protection modules for every hi-lo voltage/current requirement. Write or call for Catalog 749.

279 Skidmore Road  
Deer Park, New York 11729  
Telephone: 516 - 586-5125

# MCG Electronics

INFORMATION RETRIEVAL NUMBER 133

**SUBSCRIBER SERVICE** For prompt service include the addressed label when writing about your subscription.

CHANGE OF ADDRESS

city	company address	division/department	company	name	NEW ADDRESS
state				title	
zip					

If you're moving, please let us know six weeks before changing your address. If you have a question, place your magazine address label here and clip this form to your letter.

MAIL TO: ELECTRONIC DESIGN Circulation Dept. Hayden Publishing Co., Inc., 50 Essex Street, Rochelle Park, NJ 07662



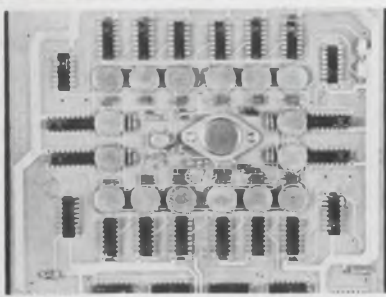

The 5 bit converter constructed on single printed circuit card. Total thruput time 50 n sec, with 20 MHz update rate. Temperature stability over full mil range, -55°C to +125°C with drift less than ±1 bit over entire range. M.S. Kennedy Corp; Pickard Dr, Syracuse, NY 13211 (315) 455-7077.

INFORMATION RETRIEVAL NUMBER 601

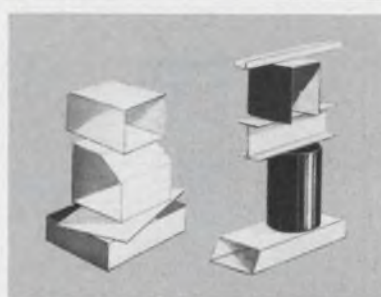

Glass laminated epoxy 155°C cases for component and circuit packaging are available in thousands of sizes. Thin wall tubes and headers offer optimum protection in all applications. Literature and samples available. Stevens Tubing Corp., 128 North Park Street, East Orange, New Jersey 07019. Telephone 201-672-2140.

INFORMATION RETRIEVAL NUMBER 604

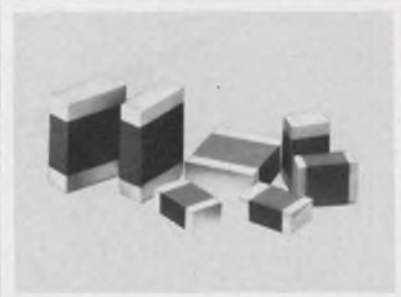

**HIGH Q MULTILAYER CAPACITORS** feature very high quality factors at microwave frequencies. Offered in three standard sizes: .050 x .040, .080 x .050, .125 x .095. Capacitance values from 0.1 pf to 1000 pf with close tolerance and voltages to 1000 VDCW. Johanson/Monolithic Dielectrics Div., Box 6456, Burbank, Ca. 91510, (213) 848-4465.

INFORMATION RETRIEVAL NUMBER 607

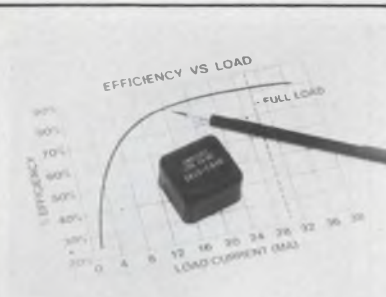

Activate gas discharge readouts! DC-to-DC power supplies convert low DC line voltages of 5, 9, 12 or 15 volts to nominal 200 and 250 volt DC levels required to run gas discharge information displays. Ideal for battery powered applications! Free literature. Endicott Coil Co., Inc., 31 Charlotte Street, Binghamton, N.Y. 13905

INFORMATION RETRIEVAL NUMBER 602

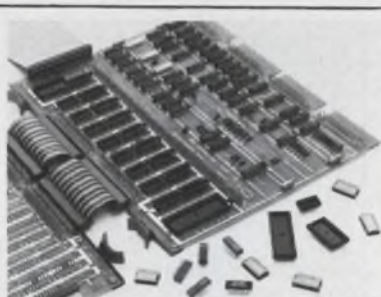

**PDP-11 General Purpose Interface.** The MDB-11C provides all features of a DEC DR11C plus additional 16 bit register, 4 selectable interrupt control levels, 16 decoded device addresses, takes only one quad slot, has maximum Unibus load of 1. Also, 20 wirewrap positions are provided. \$390. MDB Systems, Inc., 981 N. Main Street, Orange, CA 92667.

INFORMATION RETRIEVAL NUMBER 605

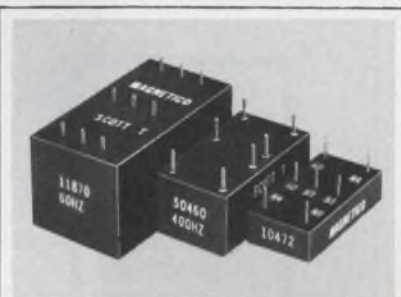

**Scott T Transformer.** 11870: 60HZ, 90v, L-L in. 1.1x2.1x1.1. 50460: 400HZ, 90v, L-L in. 7/8x1-5/8 x11/16. 50642: 400HZ, 11.8v, L-L in. 7/8x1-5/8-11/16. 10472: 400-HZ, 11.8v, L-L in. 3/4x1-1/2x3/8. All with 6v RMS sine & cosine output. MAGNETICO, INC., 182 Morris Ave, Holtsville, N.Y. 11742 516-654-1166.

INFORMATION RETRIEVAL NUMBER 608

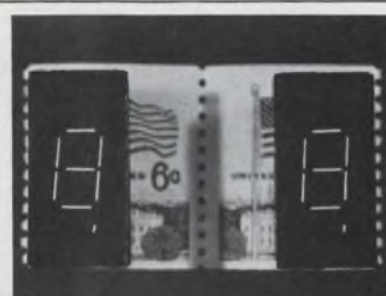

**The Proven Incandescent Readout Standard 16 Pin DIP Flat Pack.** All units 5 Volt 100,000 hrs. plus 3015F-BM 08ma/seg 700 ft/lam 3015F-BM10 10ma/seg 1700 ft/lam 3015F-BM15 15ma/seg 4500 ft/lam Field tested over 4 years in many applications. READOUTS, INC. P.O. Box 149, Del Mar, Ca. 92014 Tel. 714-755-2641 Telex 69-7992.

INFORMATION RETRIEVAL NUMBER 603

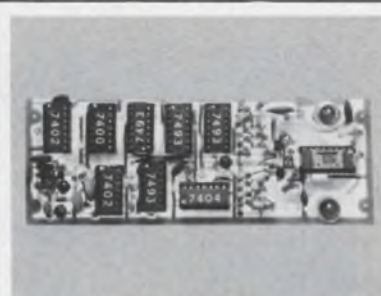

**Low Cost Image Sensing Module** contains a 1024 element (32-by-32) image sensor and all support circuitry on a single pc board. Digital video output may be displayed directly on an oscilloscope. Complete module (SE1024W) is \$150. Kit (SE1024K) is \$90. Cromemco, 26655 Laurel, Los Altos, CA 94022.

INFORMATION RETRIEVAL NUMBER 606

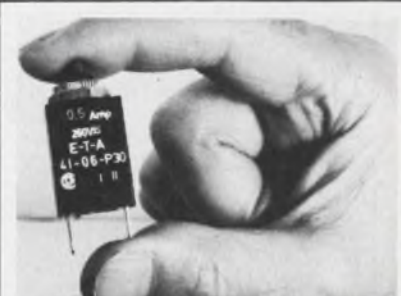

**Overcurrent Protector, manual reset** eliminates fuse replacement. Convenient panel mounting. 15 fractional ratings from 0.1 to 3 amp. Other models up to 400 amp. Trip-free and fool-proof, UL and CSA approved. High quality, low cost \$1.29 ea. in 1000 lots. E-T-A Products Co. of America, 7400 N. Cromame Rd., Chicago, Ill. 60648. Tel: (312) 647-8303. Telex: 253780.

INFORMATION RETRIEVAL NUMBER 609



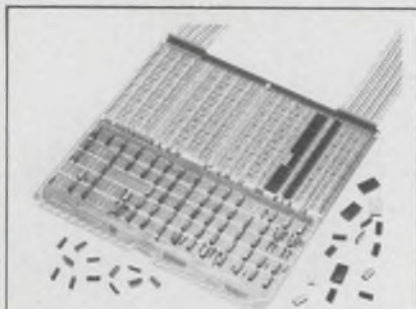

**NOVA/DCC-116** general purpose interface board provides: multiple device selection, 4 I/O registers, DMA zero word count detect, 105 socket positions for 14, 16, 24 & 40 PIN IC's. Basic board (all features of data general 4040 plus multiple device select) \$350. MDB Systems, Inc., 981 N. Main St., Orange, CA. (714) 639-7238.

INFORMATION RETRIEVAL NUMBER 610



Free catalog of **34,500** power supplies from the worlds largest manufacturer of quality Power Supplies. New '74 catalog covers over 34,500 D.C. Power Supplies for every application. All units are UL approved, and meet most military and commercial specs for industrial and computer uses. Power Mate Corp. (201) 343-6294.

INFORMATION RETRIEVAL NUMBER 613



**Series "E" Electro-Pac Inverters**, designed for heavy duty operation, provide a source of highly-reliable well-regulated ( $\pm 2\%$ ) pure sinewave power from inputs of 48, 120, or 240 volts DC. ICS offers inverters from 0.5 kVA to 25 kVA, with 120, 240, 60 Hz or 50 Hz outputs. ELECTRO-PAC Div., ICS Inc. 129 Laura Dr., Addison, Ill. 60101

INFORMATION RETRIEVAL NUMBER 616



**Synchro to Linear DC Converter:** Infinite Resolution. Full ( $\pm 180^\circ$ ) or Limited Angle DC Output ( $\pm 90^\circ$ ),  $\pm 6$  or  $\pm 15$  minute accuracy at input rates up to 1440°/sec., 60 or 400 Hz input. Custom Output scaling available. Module 2.6" x 3.1" x .82" H. Price from \$350 in quantity. Computer Conversions Corp., East Northport, N.Y. 11731—(516) 261-3300.

INFORMATION RETRIEVAL NUMBER 611



**Introduction To Defense Radar Systems Engineering.** Excellent introduction and practical reference to radar systems design and applications. #9194, 260 pp., \$22.95. Circle the Info Retrieval No. to order 15-day exam copy. When billed, remit or return book with no obligation. Hayden Book Co. 50 Essex St. Rochelle Park, N.J. 07662

INFORMATION RETRIEVAL NUMBER 614



**SCADA 80** - reliable, low cost, compact (20" x 20" x 8") remote control and data acquisition terminal with many computer interfaces; data speeds of 300/600/1200/9600 Baud; power consumption of 0.5 watt; analog status, accumulator I/O options; OEM discounts. F & M Systems Co., 2525 Walnut Hill Lane, Dallas, TX 75229—(214) 241-4242.

INFORMATION RETRIEVAL NUMBER 617

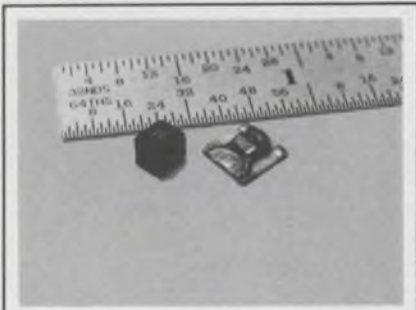

**High-Q Microminiature Chip Inductors**, LC Tuned Circuits have wide inductance range, good stability. MIL-C-15305/commercial version, magnetically shielded/unshielded. Inductance .01 uH to 10,000 uH. LC factory-tuned circuit .25" square by .125". Vanguard Electronics Co., Inc., 930 W. Hyde Park Blvd., Inglewood, CA 90302/(213) 678-7161

INFORMATION RETRIEVAL NUMBER 612

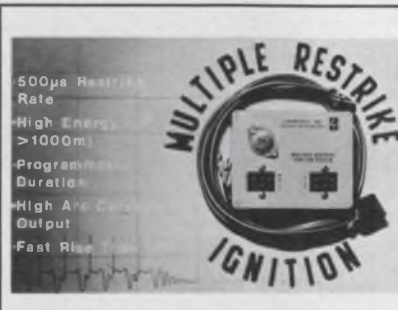

**LABTRONICS' Multiple Restrike (M-R) Ignition** produces high energy repetitive spark on each power stroke for effective ignition of air/fuel mix. Increase mileage up to 40%, longer points/plug life. Model VI \$79.95, VI-B \$59.95 1 yr warranty, 30 day guaranteed refund. Check, M.O. (postpd US) Labtronics, Inc. 3835 Hillside, Ypsilanti MI 48197

INFORMATION RETRIEVAL NUMBER 615

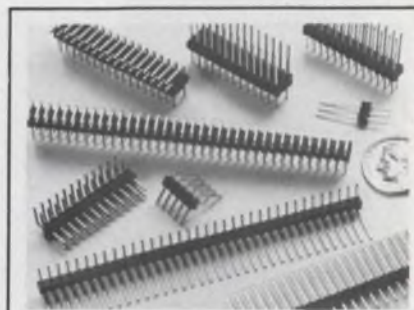

**Straight & Right-Angle Headers** provide an economical method of attaching complete matrices of .025" square posts to PC boards to serve as male contacts for interconnection systems. Available with up to 36 pins per row in several popular pin lengths, A P Products Inc., Box 110, Painesville, Ohio 44077.

INFORMATION RETRIEVAL NUMBER 618



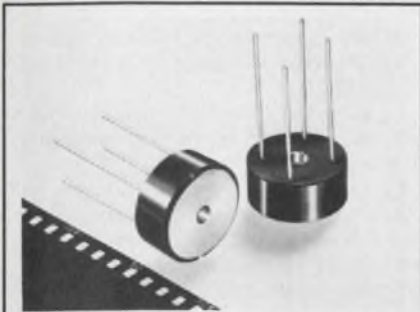

**3/4" Diam 10 amp Bridge Rectifiers** from Tarzian with heat dissipating aluminum base. 240 amp surge rating. Heat dissipation is 25W@10A. Max case temp is 150° C. H-FB Series supplied as standard avalanche, fast recovery or with special terminals. Sarkes Tarzian, Inc., Semiconductor Div., 415 College Ave., Bloomington, Ind. 47401, 812-332-1435.

**INFORMATION RETRIEVAL NUMBER 619**

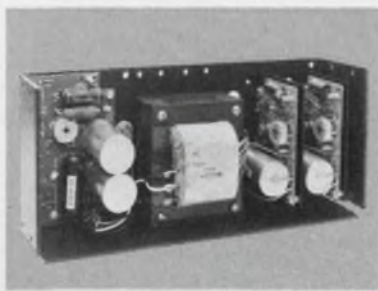

**OPEN FRAME POWER SUPPLIES**

If you are using micro processors, you'll need special voltages for the chips and for rams and other companion devices. We'll supply the special voltage combinations in single, dual, or triple output units. Dynage, Inc. 1331 Blue Hills Avenue, Bloomfield, Conn. 06002 203-243-0315

**INFORMATION RETRIEVAL NUMBER 622**



**Static Power Conversion & Line Isolation.** Unitron offers precision static power equipment for military and industrial applications. 50/60 Hz to 50 Hz, 60 Hz or 400 Hz; 400 Hz to 50 Hz, 60 Hz, or 400 Hz; 28 VDC to 50 Hz, 60 Hz, or 400 Hz. Available in ratings from 250 VA to 25 KVA. Unitron Inc., 1624 N. First St., Garland, TX 75040. (214) 276-8591

**INFORMATION RETRIEVAL NUMBER 620**



**MP12 Small Computer System.** Configure your own application system with 4k MP12 CPU with programmed I/O, interrupts, DMA. Interface cards for teletype, modems, floppy disk, paper tape, A/D, printer, card reader, mag. tape. Real-time operating system, full supporting software. Fabri-Tek, Inc. 5901 S. Cnty. Rd. 18, Mpls, MN 55436 (612) 935-8811

**INFORMATION RETRIEVAL NUMBER 623**

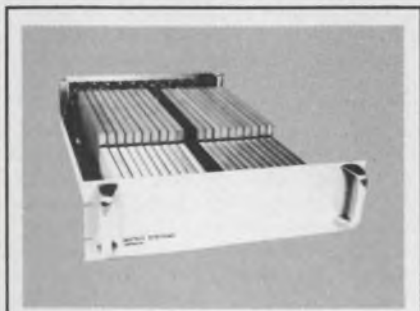

**Programmable Audio Switching System** features up to 400 Two Wire Switchpoints. It may be interconnected in nearly any configuration ie, Multipole, Multithrow, Matrix or Scanner. System may be controlled by 16 bits TTL compatible I/O Buss or 28 VDC. MATRIX SYSTEMS CORPORATION (213) 882-2008.

**INFORMATION RETRIEVAL NUMBER 621**

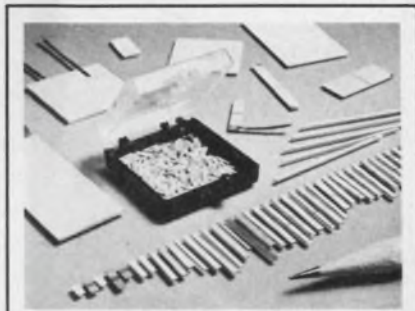

**Low Power Electromechanical And Acoustic Transducers** convert mechanical or acoustic to or from electrical energy. Applications include phono cartridges; microphones; head phones; delay lines; micropositioning and relays. E. Hanson, Gulton Industries Inc., Electronic Components Div., 212 Durham Ave., Metuchen, NJ 08804 (201) 548-2800

**INFORMATION RETRIEVAL NUMBER 624**

Advertisers wishing to reserve Quick Ad units should note the following mechanical requirements: Specs—Supply glossy photo of product and approximately 40 words which will set no more than 10 lines of 34 characters each. AFTER SUBMISSION NO COPY CHANGES CAN BE ACCEPTED. Quick Ads cost only \$325 per insertion, less for frequency advertisers.

**RATES:**

1x  
\$325

7x  
\$300

13x  
\$275

19x  
\$270

26x  
\$265

39x  
\$260

52x  
\$255

104x  
\$250



## recruitment and classified ads

### RENT a MINI

1 DAY DELIVERY  
DEC PDP 8I (4K)  
DEC PDP 8L (8K)  
ASR 33

#### FOR SALE

MINIS DEC • DG • CAI • GTE  
HP • HIS • IBM • INT  
LOCK • MICRO • SEL  
VARIAN • XLO

PRINTERS MDS 4330 .....\$2950  
CDC 9322 .....\$2500  
DP 2440 .....\$7500

CARD DOC M200 .....\$950  
READERS GDI 100 .....\$450

PAPER DIGITRONICS 2500 .....\$350  
TAPE CHALCO • BRPE21 .....\$250

MAG PERTEC • WANGCO  
TAPE POTTER • AMPEX

617-261-1100

AMERICAN USED COMPUTER CORP.

P.O. Box 68, Kenmore Sta., Boston, MA 02215  
member COMPUTER DEALERS ASSOCIATION

CIRCLE NO. 271

#### STRETCH YOUR BUDGET!

Reconditioned Scopes, SS Power Supplies, Freq. Counters & Generators - Many others. Send for our: "Bargain Bulletin"

Lawrence Instruments, Sunbury PA

CIRCLE NO. 272

#### FREE ALARM CATALOG

Full line of professional burglar and fire alarm systems and supplies. 96 pages. 450 items. Off the shelf delivery, quantity prices.



mountain west alarm  
4215 n. 16th st., phoenix, az. 85016

CIRCLE NO. 273

#### IT'S A SMALL WORLD!

SMALLER AUDIO TRANSFORMERS  
Sizes: 1-3/8" x 1-15/16", 15/16" x 1-1/4",  
9/16" x 5/8" (Send for complete catalog)



Quality Engineered Sound Products  
SESCOM, INC.  
P. O. Box 590, Gardena, CA 90247 U.S.A.  
(213) 770-3510 • TWX 910-346-7023

CIRCLE NO. 274

UNUSED WIRE AVAILABLE ON ORIGINAL REELS  
NATIONAL CABLE CO.  
3800' NX 1524J 700' NX 5245J

CAROL  
2500' 16-3 STO 600V E-27520 VINYL  
750' 16-3 600V RUBBER COVERING  
IF INTERESTED CALL  
GREYHOUND COMPUTER CORP.  
EL PASO, TEXAS • 915-544-2700

#### \$ DOLLAR POWER \$

SAVE MONEY ON RECONDITIONED SIG.  
GENERATORS-SCOPES-SS POWER SUP-  
PLIES-FREQ. COUNTERS-OVENS

WALLEN ELECTRONICS  
BROCKTON, MA.

617/588-6440 617/472-0244

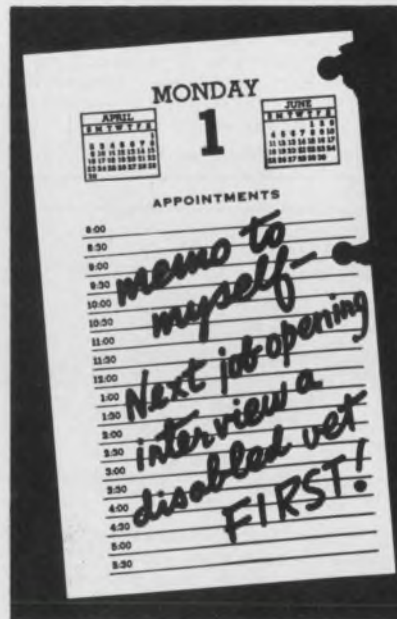

The President's Committee  
on Employment of the Handicapped  
Washington, D.C. 20210

ELECTRONIC DESIGN's function is:

- To aid progress in the electronics manufacturing industry by promoting good design.
- To give the electronic design engineer concepts and ideas that make his job easier and more productive.
- To provide a central source of timely electronics information.
- To promote communication among members of the electronics engineering community.

Want a subscription? ELECTRONIC DESIGN is sent free to qualified engineers and engineering managers doing design work, supervising design or setting standards in the United States and Western Europe. For a free subscription, use the application form bound in the magazine. If none is included, write to us direct for an application form.

If you do not qualify, you may take out a paid subscription for \$30 a year in the U.S.A., \$40 a year elsewhere. Single copies are \$1.50 each.

If you change your address, send us an old mailing label and your new address; there is generally a postcard for this bound in the magazine. You will have to requalify to continue receiving ELECTRONIC DESIGN free.

The accuracy policy of ELECTRONIC DESIGN is:

- To make diligent efforts to ensure the accuracy of editorial matter.
- To publish prompt corrections whenever inaccuracies are brought to our attention. Corrections appear in "Across the Desk."
- To encourage our readers as responsible members of our business community to report to us misleading or fraudulent advertising.
- To refuse any advertisement deemed to be misleading or fraudulent.

Microfilm copies are available of complete volumes of ELECTRONIC DESIGN at \$19 per volume, beginning with Volume 1, 1952 through Volume 20. Reprints of individual articles may be obtained for \$3.00 each, prepaid (\$5.00 for each additional copy of the same article) no matter how long the article. For further details and to place orders, contact the Customer Services Department, University Microfilms, 300 North Zeeb Road, Ann Arbor, Michigan 48106 telephone (313) 761-4700.

Want to contact us? If you have any comments or wish to submit a manuscript or article outline, address your correspondence to:

Editor  
ELECTRONIC DESIGN  
50 Essex Street  
Rochelle Park, N.J. 07662



## Advertising Sales Staff

Tom W. Carr, Sales Director

Rochelle Park, NJ 07662

Robert W. Gascoigne

Daniel J. Rowland

(Recruitment, Quick Ads, Classified)

50 Essex Street

(201) 843-0550

TWX: 710-9990-5071

## Philadelphia

Thomas P. Barth

50 Essex Street

Rochelle Park, NJ 07662

(201) 843-0550

## Boston 02178

Gene Pritchard

P.O. Box 379

Belmont, MA 02178

(617) 489-2340

## Chicago 60611

Thomas P. Kavooras

Berry Conner, Jr.

200 East Ontario

(312) 337-0588

## Cleveland

Thomas P. Kavooras

(Chicago)

(312) 337-0588

## Los Angeles 90045

Stanley I. Ehrenclou

Burt Underwood

8939 S. Sepulveda Boulevard

Suite 510

Los Angeles, CA

(213) 641-6544

## San Francisco 94022

Robert A. Lukas

Box 126

3398 El Camino Real

Highway 82

Palo Alto, CA 94306

(415) 965-2636

## London, Amsterdam, Tokyo, Seoul

John Ashcraft

12, Bear St.

Leicester Square

London WC2H 7AS England

Phone: 01-930-0525

W. J. M. Sanders

John Ashcraft & Co.

Herengracht 365

Amsterdam C., Holland

Phone: 020-24-09-08

Haruki Hirayama

Electronic Media Service

5th Floor, Lila Bldg.,

4-9-8 Roppongi

Minato-ku, Tokyo, Japan

Phone: 402-4556

Cable: Electronicmedia, Tokyo

Mr. O-kyu Park, President

Dongbo Int'l Corp.—

World Marketing

C.P.O. Box 4010

Seoul, Korea

Tel. 76-3910/3911

Cable: DONGBO SEOUL

Telex: EBKOREA K27286

# Design Data from Manufacturers

Advertisements of booklets, brochures, catalogs and data sheets. To order use Reader-Service Card (Advertisement)

## "THE HOW AND WHY OF REAL-TIME SPECTRUM ANALYSIS OF NOISE AND VIBRATION"

500-line UBIQUITOUS real-time  
SPECTRUM ANALYZER  
CALCULATOR  
with built-in dual memory averager



New 16-page brochure on latest Ubiquitous® 500-line Real-Time Spectrum Analyzer/Calculator UA-500A-1 contains complete application data & a "how to" section. The "why" explains the need for resolution, real time, & averaging. The "how to" section solves typical analysis problems: "how to be sure correct data is being analyzed," "how to analyze transients," "how to interface to a computer," "how to cancel background noise," "how to analyze rotating machinery."

Model UA-500A-1 is specifically designed to simplify machine diagnosis, rotating machine analysis, noise source identification, mechanical signature comparisons, underwater signal analysis, & noise reduction. Includes such features as automatic harmonic identification, direct digital readout in RPM, & the ability to make relative amplitude & frequency measurements digitally.

Demo, circle 171  
Lit., circle 172

**Nicolet Scientific Corp.** (formerly Federal Scientific)  
245 Livingston Street, Northvale, New Jersey 07647  
(201) 767-7100. TWX: 710-991-9619

## GIANT FREE CATALOG



New 180-page catalog! Packed with 1,000's of hard-to-find buys in Optics, Science, Electronics. Loaded with optical, scientific, electronic equipment available from stock. Rare surplus buys. Many "one-of-a-kinds". Ingenious scientific tools. Components galore: lenses, prisms, wedges, mirrors, mounts, accessories. 100's of instruments: pollution test equipment, lasers, comparators, magnifiers, microscopes, projectors, telescopes, binoculars, photo attachments, unique lighting. Shop, save by mail! Request free Catalog "DA".

CIRCLE NO. 173

## Edmund Scientific Co.

America's Largest Science-Optics-Electronics Mart

300 Edscorp Bldg., Barrington, New Jersey 08007 (609) 547-3488

Share in the nation's top managerial policies, strategies, techniques . . .

## MANUFACTURING MANAGEMENT SYSTEMS

New Challenges and Opportunities Edited by Fred Gruenberger

By crystallizing the results of the 1973 Informatics/UCLA Symposium, this book offers a powerful blend of technical and managerial expertise for enhancing the overall success and profitability of today's manufacturing management systems. Some of the nation's top industrial and technical leaders speak freely and in depth of their organization's objectives and specific operations, as well as their personal strategies and methods. You'll find the newest computerized tools available to manufacturers . . . crucial managerial skills for directing progressive systems . . . the tact and care needed for the sensitive human problems of system implementation, and more. #5940-x, 160 pages, \$10.50. Circle the Info Retrieval No. to order a 15-day exam copy. When billed, remit or return book. No obligation.

CIRCLE NO. 174



Hayden Book Company, 50 Essex St., Rochelle Pk, N.J. 07662



# Advertiser's Index

Advertiser	Page	Advertiser	Page	Advertiser	Page
ACDC Electronics, Inc.	112	Fabritek, Inc.	201	Perfection Mica Company	184
AMP, Incorporated	54, 55	Facit-Addo, Inc.	45	*Philips Industries, Test and Measuring Instruments Dept.	172, 173
AP Products	200	Fairchild Semiconductor		Photo Research, A Division of Kollmorgen Corporation	92
Acopian Corp.	185	Components Group, Fairchild Camera & Instrument Corp.	41, 42, 43, 44	*Pihner International Corp.	89
Ad-Vance Magnetics, Inc.	178	GTE Automatic Electric	172	Pomona Electronics Co., Inc.	187
Advance Conversion Devices Company	205	GTE Sylvania, Parts Division	60, 61	Potter & Brumfield, Division of AMF, Incorporated	149
AirBorn, Inc.	99	GTI Tensor Electronics, Inc.	164	Power/Mate Corp.	200
Allen Bradley Co.	89	Gates Energy Products, Inc.	2	Power Tech, Inc.	135
American Optical Corporation	207	General Scanning, Inc.	180	Practical Automation Inc.	167
Angstrom Precision, Inc.	195	Globe Union, Gel/Cell Division	127	Premier Metal Products Company	151
Arnold Magnetics Corp.	196	Gold Book, The *8, 129, *185, 190, 191		Princeton Applied Research Corp.	192
Atlantic Casting and Engineering Corporation	174	Gould Inc., Instrument Systems Division	207	RCA Solid State	Cover IV
Atlantic Research Corporation	208	Gulton Industries, Inc.	201	Raytheon Company, Industrial Components Operation	163
Beckman Instruments Inc., Trimpot Division	8, 9	HEI, Inc.	177	Reader Service Card	208A 208B
Belden Corporation	22, 23	Hansen Manufacturing Co.	71	Readouts, Inc.	199
Bell, Inc., F. W.	16F	Hayden Book Company, Inc.	*15, 200, 203	Reliability, Inc.	193
Bendix Corporation, The, Electrical Components Division	109	Heinemann Electric Company	21	Remex, Ex-Cello Corporation	128
Bodine Electric Company	205	Hewlett-Packard	66, 67, 95	Rogan Corporation	208
Bourns, Inc., Magnetics Division	29, 30	Hoffman Engineering Company	167	Rogers Corporation	166
Bourns, Inc., Trimpot Products Division	27, 28	Hughes Aircraft Company, Industrial Products Division	113	SGS Ates Semiconductor Corporation	173
Bud Radio, Inc.	159, 160	ISE Electronics Corp.	197	Sarkes-Tarzian Inc.	201
Burr-Brown Research Corporation	16	Ingot Electronics Corporation	175	Sensors, Inc.	205
C-Cor Electronics, Inc.	194	Intech Incorporated	168	Shelly Associates	14
Chicago Dynamic Industries, Inc.	207	Intel Corporation	4, 5	Simpson Electric Company	147
Chrono-Log Corporation	208	Intel Memory Systems	165	*Sodeco	9
Computer Automation, Inc.	64 A, B, C, D	Interdata, Subsidiary of Perkin-Elmer	10, 11	Sorensen Company, A Unit of Raytheon Company	110, 111
Computer Conversions Corporation	200	Interface Technology	199	Spectronics, Incorporated	174
Computer Survey Card	128A, 128B	International Rectifier	70	Sprague Electric Company	78
Control Data Corporation	31	Johanson Manufacturing Corp.	7	Stevens Tubing Corp.	199
Coors Porcelain Company	18	Johanson/Monolithic Dielectrics Division	199	Systron-Donner	198
Cromemco	199	Kennedy Corporation, M. S.	199	Sycor, Inc.	177, 179
Curtis Industries, Inc.	169	Labtronics Inc.	200	TEC, Incorporated	164
Dana Laboratories, Inc.	136, 137	3M Company	53	TRW Cinch Connectors, an Electronic Components Division of TRW, Inc.	153
Data Display Products	183	MCG Electronics	198	Taurus Corp.	194
Data Technology Corporation	136, 137	MDB Systems	199, 200	Technical Wire Products, Inc.	186
Delco Electronics, Division of General Motors Corporation	154, 155	Magnecraft Electric Company	Cover III	Tecnetics, Inc.	161
Delta Products, Inc.	171	Magneto, Inc.	199	Telecommunication Industries, Inc.	187
Dialight, A North American Philips Company	99	Martin Research	192	Teledyne Philbrick	39
Digi-Data Corporation	178	Matrix Systems Corporation	201	Tele-Dynamics, Division of Ambac	170
Digital Equipment Corporation	144, 145	Megatek	195	Texas Instruments, Incorporated	15, 88
Dit Mco International	194	Micro Networks Corporation	134	Texas Instruments, Incorporated, Digital Systems Division	16B, 16C
Douglas Electronics, Inc.	186	Micro Switch, A Division of Honeywell	16A	USCC/Centralab Electronics Division, Globe-Union, Inc.	182, *183
Dynage Inc.	201	Mini-Circuits Laboratory, A Division of Scientific Components Corp.	24	Underwriters' Safety Device Company	179
Dynascan Corporation	171	Monsanto, United Systems Corporation Subsidiary	175	United Systems Corporation, a Subsidiary of Monsanto	175
EECO	17	Motorola Semiconductor Products, Inc.	12, 13	Unitron Inc.	201
EMR Telemetry, Weston Instruments, Inc.	193	MuRata Corporation of America	208	Unitrode Corporation	96
E-T-A Products Co. of America	199	National Semiconductor Corporation	120, 121	Universal Data Systems	Cover II
Eagle-Picher, Inc.	180	Newport Laboratories, Inc.	162	Vactec, Inc.	51
Edmund Scientific Company	203	Nicolet Scientific Corp.	156, 203	Vanguard Electronics	200
Electro Corporation	179	Nitron, A Division of McDonnell Douglas	98	Victoreen Instrument Division, Shellar-Globe Incorporated	181
Electro-Pac	200	Optima Enclosures, a Division of Scientific Atlanta, Inc.	93	Viking Industries, Inc.	16G
*Electronic Design	8, 88	*Oscilloquartz S. A.	185	Wavetek Indiana Incorporated	1
Electronic Memories & Magnetics Corp.	16D, 16E	Panduit Corporation	205	Weston Components	207
Electronic Navigation Industries	162			Woven Electronics	6
Electronic Research Co.	169			Zero Manufacturing Co.	94
Electrostatics, Inc.	176, 192				
Elexon Power Systems	188, 189				
Endicott Coil Co., Inc.	199				
Erie Technology Products, Inc.	79				
F & M Systems	200				
FMC Corporation	158				

\*Advertisers in non-U.S. edition.



# UPS

## ACDCO UNINTERRUPTIBLE POWER SYSTEMS



*in terms of time & money . . .*

### UNINTERRUPTIBLE POWER SYSTEMS end the high cost of any degree of lost power!

Whatever or wherever the application a dependable line of ruggedly built, Solid State Power Protection equipment is available for Fixed base, Portable, Mobil or Marine use from ACDCo.

- 36 VA to 5 KVA • 50/60/400 Hz • Single or three phase
- UPS SYSTEMS • STATIC INVERTERS
- FREQUENCY CHANGERS • ENGINEERING SERVICES

Product information available on request

Send us your requirements or call for applications assistance

**ADVANCE CONVERSION DEVICES COMPANY** 

109 EIGHTH STREET PASSAIC NEW JERSEY 07055 Phone (201) 778-0707

INFORMATION RETRIEVAL NUMBER 134

*this  
costs you--*

*and your customer*

After Delivery Economies (ADE) are the reason Bodine fhp motors and drive systems have become the power behind the leading products.

Bodine motors perform. Reliably. Run stronger and last longer. You have fewer rejects. Less service problems. Far fewer downtime complaints from customers. You get consistent quality—motor to motor, lot to lot. It all helps protect your bottom line profitability, reputation and tomorrow's repeat sales.



If you're concerned about costs and profit take a close look at Bodine.  
(1/2000 thru 1/4 Hp).

ADE (After Delivery Economies)  
make Bodine a better fhp buy

**BODINE  
ELECTRIC  
COMPANY**

Bodine Electric Company, 2528 W. Bradley Place, Chicago IL 60618.  
INFORMATION RETRIEVAL NUMBER 136

# THE DETECTORS

Tough infrared measurement problems are no match for The Detectors . . . Sensors' rugged, low cost thermopile detectors.

Whatever your application . . . from temperature monitoring, spectrophotometry or pollution monitoring to intrusion and fire detection, horizon sensing instrumentation or laser power measurement, The Detectors are ready to help you solve it.

One of The Detectors has the precise combination of high D\*, convenient resistance range, excellent responsivity, fast time constant and broad spectral response for your specific application.

Learn about the entire Sensors' line of thin film thermopile detectors. Ask for the free brochure now.



 **sensors, inc.**

3908 Varsity Dr., Ann Arbor, MI 48104  
Tel: (313) 973-1400

INFORMATION RETRIEVAL NUMBER 135

ELECTRONIC DESIGN 10, May 10, 1975

## NEW PANDUIT® FLAT CABLE MOUNT

**Economical, versatile method of  
mounting or bundling flat cable**

- Secures stacked cables, folds and breakouts
- Maintains flat cable's inherently uniform transmission characteristics
- Mount to any surface using screws or commercial adhesive
- Low profile
- Removable and reusable
- Stacking up to 5 1/4" high; cable widths to 3".



Installed with PAN-TY®  
Intermediate Cross-section  
Cable Tie

**FREE  
SAMPLES**

Sold through Authorized  
Panduit Distributors

**PANDUIT** CORP.

Tinley Park, Ill. 60477  
Phone: (312) 532-1800  
In Canada: Panduit (Canada) Limited

INFORMATION RETRIEVAL NUMBER 137



# Product Index

**Information Retrieval Service.** New Products, Evaluation Samples (ES), Design Aids (DA), Application Notes (AN), and New Literature (NL) in this issue are listed here with page and Information Retrieval numbers. Reader requests will be promptly processed by computer and mailed to the manufacturer within three days.

Category	Page	IRN	Category	Page	IRN	Category	Page	IRN
<b>Components</b>			LEDs	183	111	electronic ignition	171	87
capacitors	182	110	power semiconductors	155	65	encoder	168	304
capacitors, chip	166	333	power transistor switch	135	58	hybrids	163	75
circuit breaker	21	17	power transistors	70	35	system, data acq.	170	301
circuit breakers	151	63	switch, optical	99	47	timer, presettable	174	334
communication			switching diode	158	71			
components	172	88	thermopile detectors	205	135	<b>Packaging &amp; Materials</b>		
digital sensor	179	104	thyristors, caseless	176	303	adhesive, conductive	163	330
fiberscope	207	138	transistors, rf power	178	336	bus	166	78
fuse	208	142				cable	6	5
indicators	99	48	<b>Instrumentation</b>			cable/connector system	53	29
indicators	164	76	counter	137	59	card extenders	162	329
motors	71	36	counter/timer	181	340	card readers	194	127
motors and drive			DMM	180	339	castings	174	91
systems	205	136	DPM	180	338	connectors, elastomeric	186	114
passive components	79	291	DPM	183	342	DIP clip	187	117
photodetectors	51	28	DPVMs	180	108	EMI shielding	184	112
potentiometers	89	40	data console	93	42	enclosures	15	13
potentiometers	207	141	digital clocks	208	144	enclosures	94	43
power transformers	175	92	dual-trace scope	171	85	enclosures	167	79
readouts	197	131	frequency counter	171	86	flat cable mount	205	137
relay, DIP	164	302	instrument mainframe	183	343	holder, PC-board	163	331
relays	III	247	logic analyzer	181	341	knobs	208	143
resistors	181	109	PROM duplicator	182	345	PM magnetic shields	178	102
resistors	195	128	photometer systems	92	41	PM magnetic shields	178	103
surge arrestors	187	116	power amplifier	162	73	terminal blocks	169	82
switch	17	15	preamplifiers	192	121	terminal blocks	179	105
switch	207	140	real-time analyzer	156	283	tool kit	162	328
switch kit	166	332	scopes	67	34	wire, cable & cord	23	18
switches	149	289	signal generator	1	2			
transient suppressor, dc	198	133	spectrum analyzer	193	124	<b>Power Sources</b>		
			strip-chart recorder	207	139	batteries	2	3
<b>Data Processing</b>			test equipment	194	125	batteries, lead-acid	180	107
core memory	31	23	timer/counter	95	44	battery	127	50
data acquisition system	16	14	waveform generator	183	344	line regulator	170	84
drafting, automated	157	307				power supplies	110	51
graphics interface	195	129	<b>Integrated Circuits</b>			power supplies	185	113
image memory systems	113	53	amplifier	184	348	power supplies	188	118
interface, IBM 370	157	307	bucket brigade	184	347	power supplies	189	119
memory, core	159	322	calculator chip	186	352	power supplies	192	120
memory, disc	159	320	ICs, linear	39	24	power supplies	196	130
memory, semiconductor	159	321	modem	186	351	power supplies, dc-dc	161	72
memory system	165	77	op amps	IV	248	power supply	176	99
microcomputer	160	327	PROM, 8-k	5	4	UPS	205	134
microcomputer book	192	122	RAM	184	350	UPS	208	145
minicomputer	11	9	RAM, 256-bit CMOS	184	349			
minicomputer	157	309	ROM	184	346	<b>new literature</b>		
minicomputer	159	323	ROMs	98	46	communications		
modem, asynchronous	157	306				processor	196	378
monitor, data	157	305	<b>Microwaves &amp; Lasers</b>			d/a and a/d converters	195	371
OEM systems	145	60	couplers	189	357	dc micromotors	196	384
optical scanners	162	74	downconverter	189	358	data system	194	367
page printer	45	27	hybrid	188	353	deviation controllers	196	380
printer, column	160	324	laser	189	356	instrumentation	195	375
printer/plotter	157	310	mixer	188	354	linear ICs	195	372
printer, serial	160	326	module, Doppler	188	355	motor relay	196	379
terminal, intelligent	160	325				PC terminal switches	196	383
			<b>Modules &amp; Subassemblies</b>			printer/plotters	194	369
<b>Discrete Semiconductors</b>			a/d converter	134	57	readouts	194	366
Darlington pair	173	89	amplifier, breadboard	117	335	relays and accessories	195	373
demodulator, FET	178	337	converters, a/d and					
LED indicators	14	12	d/a	168	81			



## Remote viewing at a price competitive models can't even approach.

This new, low-cost FS-100 Fiberscope with a 24" flexible length can reveal hidden flaws, peer into recesses, and trace vibrations to their source. Built with AO quality throughout, this battery-powered unit features a high resolution fiber bundle with a wide angle fixed focus objective lens and an adjustable eyepiece. For further information on the entire Fiberscope line, write or call American Optical Corporation, Fiber Optics Division, Southbridge, Massachusetts 01550. Tel. (617) 765-9711 Extension 2445.



**Only \$295**

Model FS-100  
Fiberscope

**AO**  
American  
Optical

INFORMATION RETRIEVAL NUMBER 138

## Introducing the Brush 110 strip chart recorder—with a thermal writing pen guaranteed for life.

There isn't another strip chart recorder on the market today that can match the Brush 110's performance, ruggedness, versatility and writing dependability.

The new hot-tip thermal writing system produces clear, sharp, highly reproducible blue traces with no smudges, no smears, no skips and no puddles.

Before you buy, check out the remarkable Brush 110. Contact your nearest Gould sales engineer for a demonstration. Or write Gould Inc., Instrument Systems Division, 3631 Perkins Avenue, Cleveland, Ohio 44114.



INFORMATION RETRIEVAL NUMBER 139

ELECTRONIC DESIGN 10, May 10, 1975

## MINI-THUMBWHEEL SWITCH

FOR  
COMPUTERS.  
NUMERIC CONTROLS.  
IN-FLIGHT GEAR.  
MANY OTHER  
SMALL-SPACE  
INPUT SWITCHING  
OPERATIONS.

RETROFITS MOST  
MINIATURE  
THUMBWHEEL  
SWITCH PANEL  
OPENINGS.

CDI Series TSM mini-thumbwheel switches mount on 1/2-inch centers . . . can be furnished with decimal, binary, or binary with complement output—or with specified code characters. Available with extended PC boards for mounting additional components if desired. Large, easily-read numerals . . . positive detent . . . 8, 10 and 12 positions. Completely O-ring sealed against hostile operating environments.



.900" x .980"  
FRONT PANEL SIZE  
FOR SINGLE  
MODULE ASSEMBLY.



**CHICAGO DYNAMIC INDUSTRIES, INC.**

PRECISION PRODUCTS DIVISION  
1725 Diversey Blvd., Chicago, Illinois 60614  
Phone (312) 935-4600

INFORMATION RETRIEVAL NUMBER 140

## NEED A COMPETITIVE EDGE?

# CHECK OUT WESTON POTS

FOR COST  
DELIVERY • PERFORMANCE

### EXAMPLE:

Model #830P

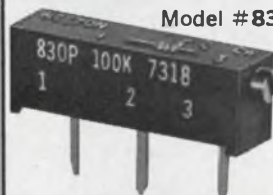

**WESTON  
RECTILINEAR  
3/4" CERMET  
TRIMMER**

**PRICE** (1000 Piece Orders) **\$ .97** EA.

Comparable prices — all sizes — Square  
• Round • Cermet • Wirewound

WESTON

**Schlumberger**

WESTON COMPONENTS  
ARCHBALD, PENNSYLVANIA 18403  
TEL. (717) 876-1500  
TWX 510 656-2902  
TELEX 83-7443

INFORMATION RETRIEVAL NUMBER 141



# THE FUSE THAT NEVER BLOWS!

MURATA'S POSISTOR®



- SELF-RESTORING
- REPLACES FUSES
- PROVIDES OVERCURRENT PROTECTION FOR:  
TRANSFORMERS, SOLENOIDS,  
SMALL MOTORS, NI-CAD CHARGERS...

**muRata**

CORPORATION OF AMERICA  
2 Westchester Plaza, Elmsford, New York 10523, U.S.A.  
Phone: 914-592-9180 Telex: 137332

INFORMATION RETRIEVAL NUMBER 142

# If you need DIGITAL CLOCKS

look to  
**Chrono-log**

for

the features you need at off-the-shelf prices.

LED, NIXIE® or BCD displays.

Time ranges from milliseconds to years. Outputs can be parallel and or serial BCD, modulated carrier, level shift or video. DC, AC or internal battery operation. "Naked" cards for OEM's.

For Digital Clocks, Time Code Generators and Readers, write or call Chrono-log Corp., 2 West Park Road, Havertown, Pa. 19083 Phone: (215) 853-1130



**CHRONO-LOG**  
CORPORATION

INFORMATION RETRIEVAL NUMBER 144

## Rogan knobs look better and are built better,



## and we'll prove it with a free sample.

After you receive our catalog, send us a note outlining your specific requirement and the quantity involved.

Or furnish us with our competitor's part number and we will cross-reference it.

Our samples and quotation will be returned promptly.



3455 Woodhead Drive, Northbrook, Illinois 60062 (312) 498-2300

INFORMATION RETRIEVAL NUMBER 143



*You may be whistling  
in the dark  
If you think  
power failures  
only happen  
to the other guy*

Protect your equipment  
with an ARC  
Uninterruptible Power System

Contact:

Energy Conversion Dept



**ATLANTIC RESEARCH  
CORPORATION**

5390 Cherokee Avenue  
Alexandria, Va 22314  
703 354 3400

INFORMATION RETRIEVAL NUMBER 145

ELECTRONIC DESIGN 10, May 10, 1975



# Introducing, a New Design Spectrum\* of Low Profile Relays.

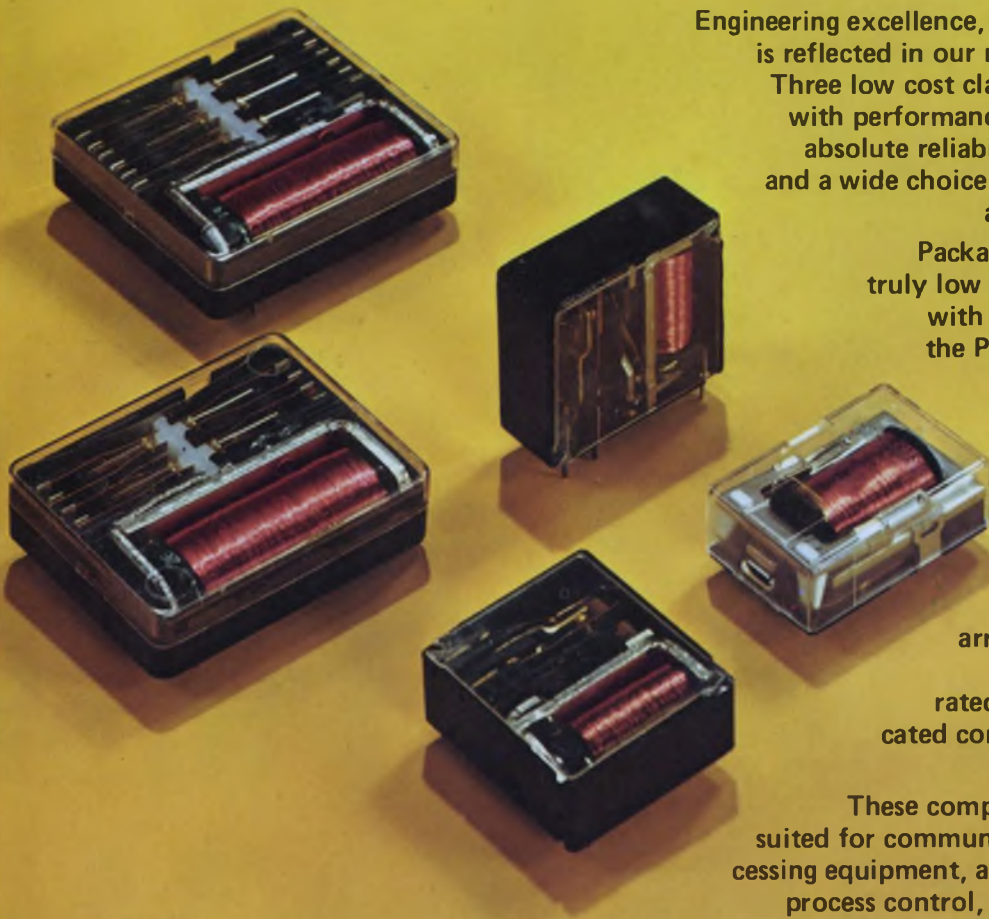

Engineering excellence, a tradition at Magnecraft, is reflected in our new printed circuit relays.

Three low cost classes are available in stock with performance specifications including absolute reliability, long mechanical life, and a wide choice of contact configurations and switching capabilities.

Packaging flexibility includes, a truly low profile dust proof design, with a minimum height above the P.C. board, and a vertically mounted space saving version. The relays feature industry standard .1 inch grid spacing for terminals, and high density center to center board spacing. Contact arrangements include SPDT, DPDT, 4PDT, and 6PDT rated from 1 to 8 amps. Bifurcated contacts are optional on certain configurations.

These compact relays are particularly suited for communication systems, data processing equipment, automatic control systems, process control, automotive and consumer electronics.

\*Family of Relays



## Free!

LOW PROFILE  
RELAY BROCHURE

Specifications, photos, and line drawings are included in Magnecraft's latest 4 page bulletin, number 750. A 36 page stock relay catalog will accompany the bulletin for all your relay applications.

Find Magnecraft Relays in EEM and the Gold Book

**Magnecraft** ELECTRIC COMPANY

5575 NORTH LYNCH AVENUE • CHICAGO, ILLINOIS 60630 • 312 • 282-5500 • TWX 910 221 5221



What's new in solid state...

# Four RCA op amps that make the CA3130 what it is.

Our CA3130 gets many of its winning ways from four very capable relatives. Four RCA op amps that can fill special requirements you may have. If you need programmable linear gain control, check the CA3080. For high crossover frequency plus high slew rate, there's the CA3100T. For high output current and easy programmability, the CA3094E. For low power supply drain, the CA3078T.

The CA3130 is the ideal choice when you're looking for a good measure of all of these characteristics in one device. That's what makes the CA3130 so great. Its versatility comes from the unique combination of MOS/FET, bipolar and COS/MOS on the same chip. And its surprisingly low 1K price of 75¢ makes it a

natural for your high-volume products.

Beyond the table, here's more typical data about the CA3130:

Input Impedance:  $1.5 T\Omega$  ( $1.5 \times 10^{12} \Omega$ ).

Input Current: 5 pA.

Input Offset Current: 0.5 pA.

Input Offset Voltage: 0.8 mV (CA3130B).

Settling Time: 1.2  $\mu$ sec.







An output voltage swing to within 10 mV of either supply rail.

Strobing terminals.

If you are interested in one or all of these op amps, contact your local RCA Solid State distributor. Or RCA.

Write: RCA Solid State, Box 3200, Somerville, New Jersey 08876; Ste. Anne de Bellevue 810, Canada; Sunbury-on-Thames, U.K.; Fuji Bldg., Tokyo, Japan.

# RCA

	CA3080E	CA3100T	CA3094E	CA3078T	CA3130
Gateable plus programmable gain control	> 60 dB				Gateable
Unity gain crossover frequency, MHz		40			15
Slew Rate, V/ $\mu$ sec		25 			10 
Output, mA (peak)			300		22 
Power consumption, mW				.0015	2.5
Single supply voltage required, V				1.5	5.0
Price (1K), \$	0.55	1.50	0.90	1.25	0.75

RCA. A full house in linear ICs.