

## Coax termination difficulties?

Now you can mass-connect flat, multiple-conductor cables. Gang operations strip and terminate up to 26 precision-spaced coax

lines. Compact and inexpensive, the cables come in 50, 75, 93 or 95-ohm impedance styles. To terminate your transmission problems, see story on page 95.

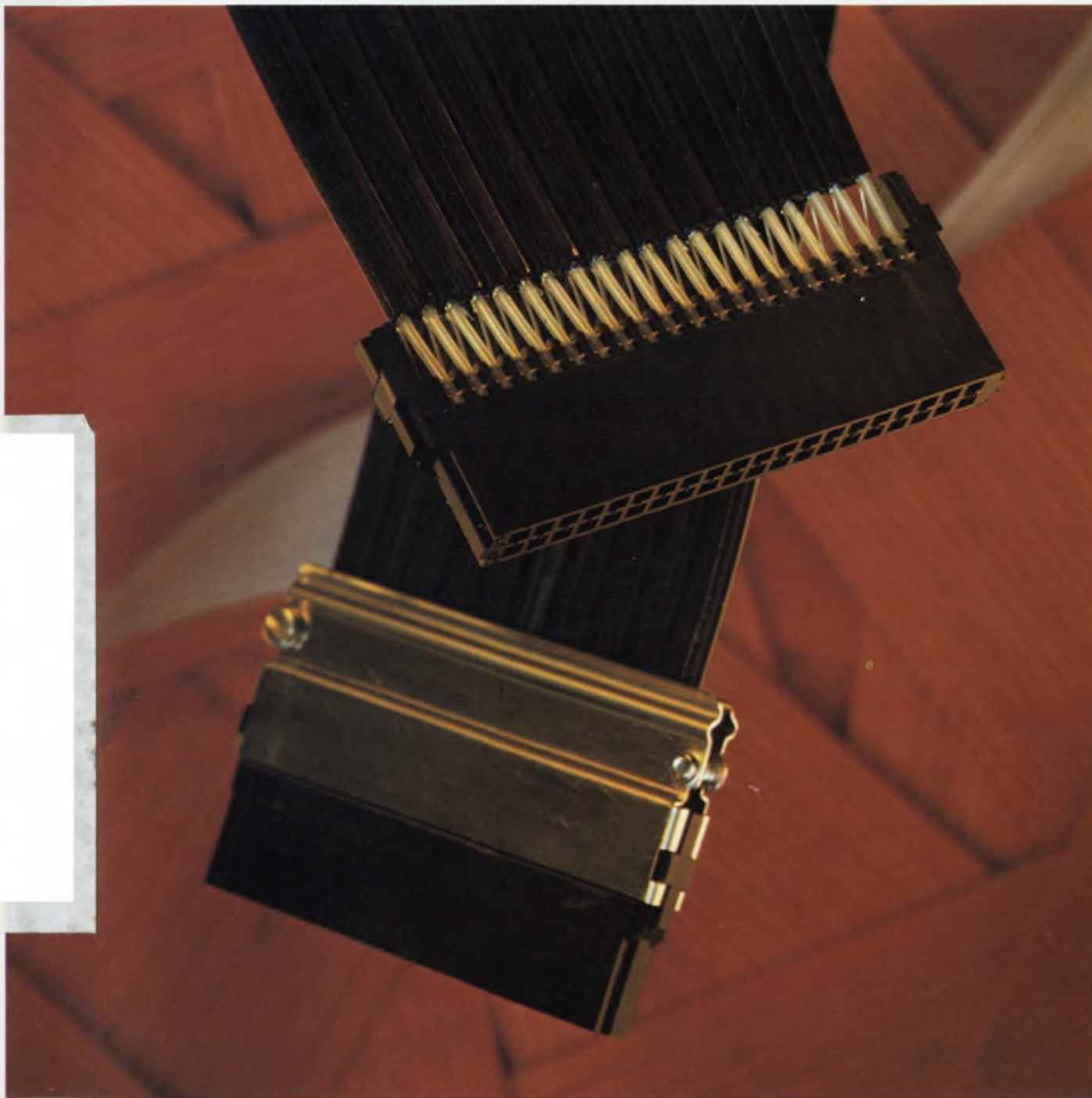

# Don't cheat yourself on trimmer performance.

Compare element size and see why Dale gives you better value!

Low profile doesn't have to mean low performance. The larger cermet element in Dale Low Profile Trimmers gives you extra value for your money. Extra assurance of trouble-free performance. You get: **More Power** 1 watt at 70°C lets you derate for assured long-term stability. **Better Adjustability** —  $\pm 0.10\%$  output resistance,  $\pm 0.05\%$  output voltage ratio. **Low Noise** 1% Contact Resistance Variation standard. **Low T.C.**  $\pm 100$  PPM standard.

Immediate delivery from stock...

Cermet Models  
(781, 783, 784)

Wirewound Models  
(721, 723, 724)

Phone 402-564-3131  
today for complete details.

DALE ELECTRONICS, INC., 1300 28th Ave., Columbus, Nebr. 68601  
In Canada: Dale Electronics Canada Ltd.  
In Europe: Dale Electronics GmbH  
8 Munchen 60, Falkweg 51, West Germany  
A subsidiary of The Lionel Corporation



DALE  
780  
Low  
Profile



Brand H



Brand B



Brand I

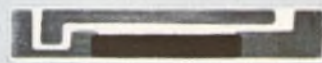

Brand E

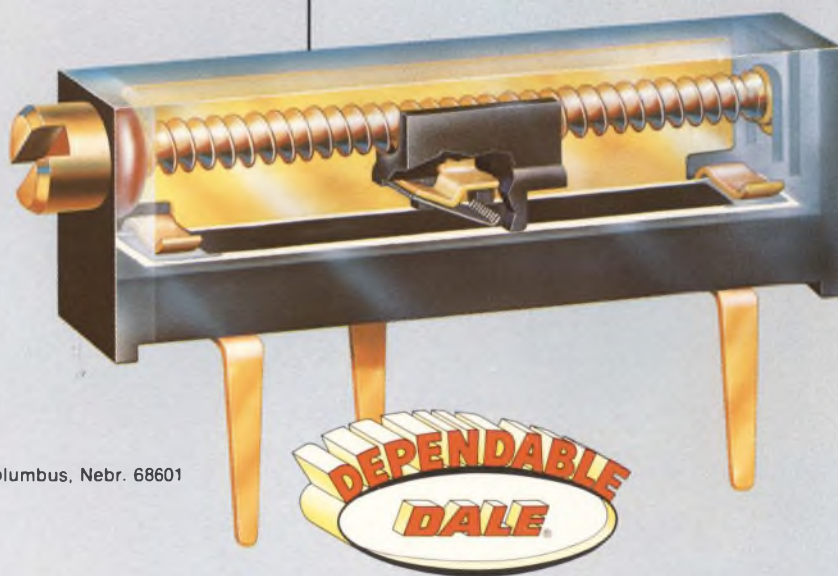

INFORMATION RETRIEVAL NUMBER 252

Our complete product line can be found in *Electronic Design's GOLD BOOK*.

# Meet the Unbelievable Datagraph

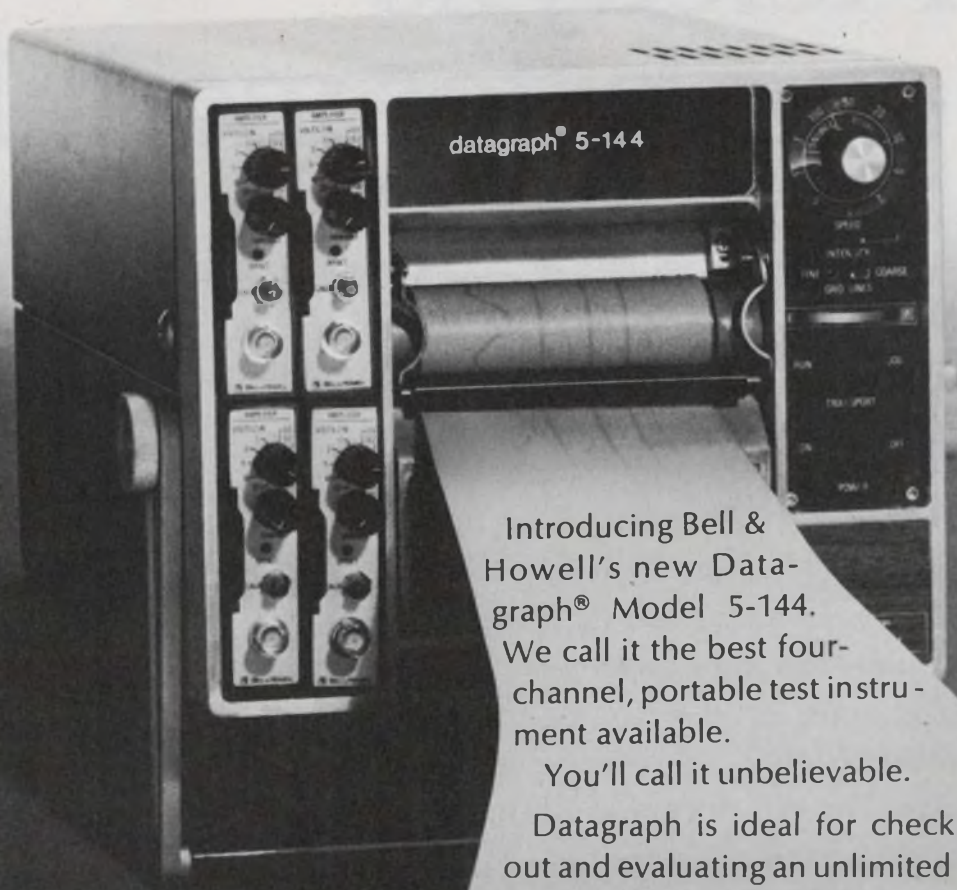

Introducing Bell & Howell's new Datagraph® Model 5-144. We call it the best four-channel, portable test instrument available.

You'll call it unbelievable.

Datagraph is ideal for checking out and evaluating an unlimited variety of both analog and digital systems, components and circuits.

It'll handle four tests at once, and give you the answers now, in real time.

Datagraph is as easy to use as an oscilloscope, but it'll give you a hard-copy record up to 200 feet long for further study. Its four channels have a wider frequency response, higher accuracy and provide more flexibility than strip-chart recorders.

Like all Bell & Howell products, Datagraph comes backed by more than 35 years of experience in the development of quality, dependable precision instrumentation. To see Datagraph, contact us for a demonstration.

We think we'll make a believer out of you.



## BELL & HOWELL

For more information, write the CEC/Instruments Division at 360 Sierra Madre Villa, Pasadena, California 91109 or circle the reader service number below.

# Get on board with Teledyne I/O converter modules



Now Teledyne Relays offers its proven I/O converter modules in low profile packages for direct PC board mounting. The versatile Teledyne 675 series allows you to design programmable controllers, process and machine tool controls with flexible and economical I/O interface circuitry. The full line includes both ac and dc, input

and output modules. All versions are optically isolated, with 1500 VRMS isolation, to protect logic lines from ac or dc power circuits. The AC output modules feature zero voltage turn-on to reduce switching noise and high dv/dt ratings to prevent false triggering in tough industrial environments.

Get on board with Teledyne Relays. We've got thousands of I/O modules at work in the field. Call your nearest Teledyne Relays office for location of your local representative or distributor.

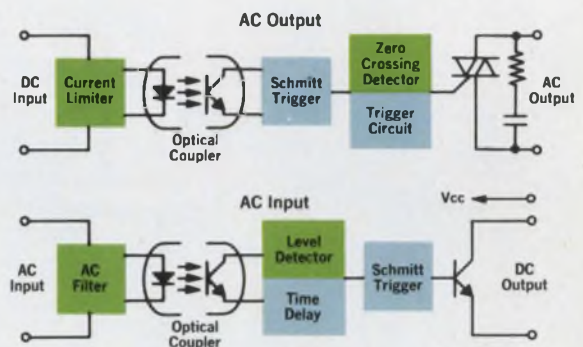

Typical Functional Diagrams



## TELEDYNE RELAYS

3155 West El Segundo Boulevard, Hawthorne, California 90250  
Telephone (213) 973-4545

Photo courtesy of Datametrics  
a subsidiary of ITE Imperial Corporation.

Burgstrasse 6-8, 62 Wiesbaden, West Germany  
Telephone: 06121-30231/2 Telex: 04-186851 (Trel-D)

Heathrow House, Bath Road, Cranford, Hounslow, Middlesex, U.K.  
Telephone: 01-8972501 Telex: 935008

---

## NEWS

- 21 **News Scope**
- 24 **Circuits and substrates separated** to make bigger, cheaper hybrids.
- 26 **Launch control for space shuttle** to lean heavily on minicomputers.
- 31 **Want to buy a \$20,000 minicomputer for \$5000?** Or a \$750 scope for \$550? Roll your own electronics can cut costs.
- 45 **Washington Report**

---

## TECHNOLOGY

- 54 **FOCUS on Graphic recorders:** Zeros in on the major elements that make up a recorder—pen drives, paper systems and writing methods—and attempts to clear the fog in terminology, lack of standards, tradeoffs and limitations.
- 68 **Program multichannel audio gain** with FETs in the feedback paths of op amps. Quad chips allow up to 60 dB of control range with good tracking.
- 76 **Know your a/d converter's dynamic range.** There are three basic definitions, but you had better consider your application before trying to interpret them.
- 80 **Recognize hand-printed characters** with a simple algorithm. Only a small amount of hardware is needed to identify a full set of numbers.
- 86 **Ideas for Design:** Current limiter added to power supply protects sensitive circuits . . . Programmable unijunction transistor protects op amp from overvoltages . . . Function generator produces sine, square and triangular waves.
- 92 **International Technology**

---

## PRODUCTS

- 95 **Packaging & Materials:** Ribbon coax-cable design allows gang stripping and easy assembly.
- 98 Data Processing
- 101 Integrated Circuits
- 106 Components
- 108 Instrumentation
- 112 Discrete Semiconductors
- 114 Modules & Subassemblies
- 116 Power Sources
- 117 Microwaves & Lasers

---

## DEPARTMENTS

- 49 **Editorial:** Haven't we been on this trip before?
- 7 Across the Desk
- 120 New Literature
- 126 Advertisers' Index
- 128 Product Index
- 130 Information Retrieval Card

**Cover:** Photo by J. H. Troupe courtesy of AMP Incorporated, Harrisburg, PA

# Choose any speed from Intel's new colle

We have expanded the 2102 series into a first-class family of versatile, easy to use, n-channel static RAMs. These new 1024-bit RAMs add very high speed and 256x4 modularity to the family. Our advanced 2102A series delivers a variety of very fast military and industrial RAMs. The 2101, 2111 and 2112 RAMs save packages in small, expandable memory systems.

The 256x4 organization is available in three package options: 22-pin 2101, 18-pin 2111 and 16-pin 2112. The 2101 has separate input and output lines while the other two have common I/O lines. Both the 2101 and 2111

have an output disable pin for controlling the state of the I/O bus. Both also have two chip enable inputs, whereas the 2112 has

a single chip enable input. Like the 2102, these new RAMs dissipate only 150 mW, typically.

The world's fastest static RAMs are in Intel's 2102A series of 16-pin, 1024x1 RAMs. The 2102A-2's worst case access time is 250 ns. Like all the family's commercial RAMs, its speed is guaranteed from 0 to 70°C.



INTEL'S 1K STATIC RAM FAMILY			
PART	WORST-CASE SPEED*	SIZE	PINS
2102A-2	250 ns	1024x1	16
2102A	350 ns	1024x1	16
2102A-4	450 ns	1024x1	16
MC2102A-4	450 ns	1024x1	16
2101-1	500 ns	256x4	22
2102-1	500 ns	1024x1	16
2111-1	500 ns	256x4	18
2101-2	650 ns	256x4	22
2102-2	650 ns	1024x1	16
2111-2	650 ns	256x4	18
2112-2	650 ns	256x4	16
MC2102A-6	650 ns	1024x1	16
2101	1 μs	256x4	22
2102	1 μs	1024x1	16
2111	1 μs	256x4	18
2112	1 μs	256x4	16

\*Worst case access time and minimum cycle times are guaranteed over full operating temperature range (-55 to +125°C for MC2102A-4 and MC2102A-6; 0 to 70°C for all other types)

# and configuration ction of static RAMs.



For military temperature range operation, two worst case speed options are offered, 450 ns for the MC2102A-4 and 650 ns for the MC2102A-6.

Every member of the family is as easy to use as the 2102. They operate on a single +5V supply at TTL logic levels and have three-state outputs for easy OR-tying. They need absolutely no MOS/TTL interface circuitry. And all are fully static — no clocks or refresh.

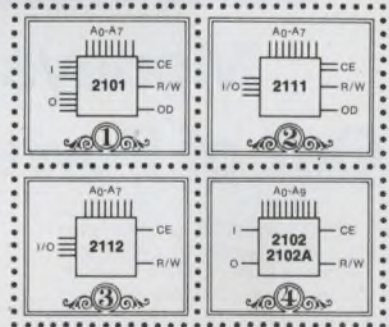

The new series are as easy to get, from stock at your local distributor, as the 2102. See him now and choose these first-class RAMs in whatever variety you need to optimize system cost, performance, and modularity.

All of Intel's static RAMs are available now from Almac/Stroum, Cramer, Hamilton/Avnet, Sheridan Sales, Industrial Components, and L.A. Varah. Or write Intel for the n-channel static RAM information package.

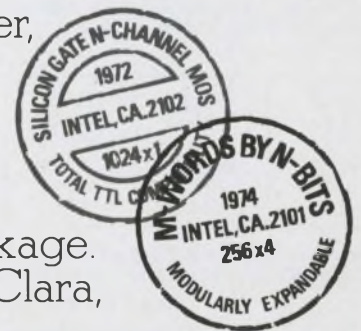

Intel Corporation, 3065 Bowers Avenue, Santa Clara, California 95051 (408) 246-7501.

**intel<sup>®</sup> delivers.**

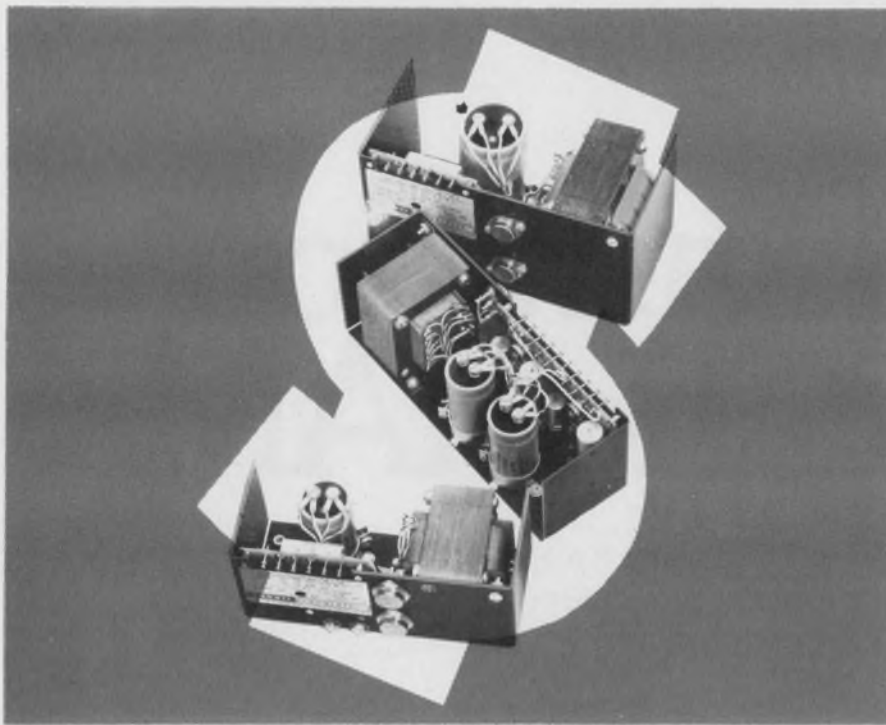

# Start Getting Your Money\$worth Out of Power Modules





Now, you can really start getting your moneysworth out of power modules with Abbott's new LOW COST series. Designed to give you 100,000 hours of trouble-free operation (that's 11½ years), these reliable units meet the needs of OEM engineers. Their purchase price is about \$7 per year of service. The model LC series feature:

- 47-420 Hz Input Frequency
- 0.1% Regulation
- +50°C. Ambient Operation
- Single and Dual Outputs
- 1 Day Stock Delivery

These units provide more quality per dollar compared to similar items on the market. See table below for prices on some of our LC models. Many other LC models are listed in our catalog.

If analyzing the many similar power supplies on the market is confusing; if you are concerned about the long-term reliability of those units, then decide on an Abbott power supply for your system. Your best buy in OEM power modules is ABBOTT.

Abbott also manufactures 3,000 other models of power supplies with output voltages from 5 to 740 VDC and with output currents from 2 milliamps to 20 amps. They are all listed with prices in the new Abbott Catalog with various inputs:

60  to DC  
 400  to DC  
 28 VDC to DC  
 28 VDC to 400   
 12-38 VDC to 60 

5V @ 6 Amps	5V @ 10 Amps	12V @ 10 Amps	15V @ 4 Amps	28V @ 1 Amp	±12V @ 1.2 Amps	±15V @ 4 Amps
LC5T6	LC5T10	LC12T10	LC15T4	LC28T1	LLC12T1.2	LLC15T4
\$72	\$81	\$99	\$81	\$72	\$99	\$135

Please see pages 307-317 Volume 1 of your 1974-75 EEM (ELECTRONIC ENGINEERS MASTER Catalog) or pages 853-860 Volume 3 of your 1974-75 GOLD BOOK for complete information on Abbott Modules.

Send for our new 60 page FREE catalog.

**abbott transistor**

INDUSTRIAL PRODUCTS DIVISION  
 general offices eastern office  
 5176 W. Jefferson Blvd./Los Angeles 90016 1224 Anderson Ave./Fort Lee, N.J. 07024  
 (213) 930-1040 Telex: 69-1398 (201) 224-6900 Telex: 13-5332  
 INFORMATION RETRIEVAL NUMBER 5

## Vice President, Publisher

Peter Coley

## Editors

Editorial Offices  
 50 Essex St.  
 Rochelle Park, NJ 07662  
 (201) 843-0550  
 TWX: 710-990 5071  
 Cable: Haydenpubs Rochellepark  
 Editor-in-Chief George Rostky

## Managing Editors:

Ralph Dobriner  
 Michael Elphick

## Associate Editors:

Dave Bursky  
 Jules H. Gilder  
 Morris Grossman  
 Seymour T. Levine  
 John F. Mason  
 Stanley Runyon  
 Edward A. Torrero  
 Richard L. Turmail

## Contributing Editors:

Peter N. Budzilovich  
 Alberto Socolovsky  
 Nathan Sussman

## Editorial Field Offices

### East

Jim McDermott, Eastern Editor  
 P.O. Box 272  
 Easthampton, MA 01027  
 (413) 527-3632

### West

David N. Kaye, Senior Western Editor  
 8939 S. Sepulveda Blvd.,  
 Suite 510  
 Los Angeles, CA 90045  
 (213) 641-6544  
 Northe K. Osbrink, Western Editor  
 112 Coloma St.  
 Santa Cruz, CA 95060  
 (408) 426-3211

## Editorial Production

Marjorie A. Duffy

## Art

Art Director, William Kelly  
 Richard Luce  
 Anthony J. Fischetto

## Production

Manager, Dollie S. Viebig  
 Helen De Polo  
 Anne Molfetas  
 Christopher G. Hill

## Circulation

Manager, Evan Phoutrides

## Information Retrieval

Peggy Long

## Promotion

Manager, Walter G. Salm  
 Karen Kerrigan (Reprints)



## George A. Philbrick: Gentleman, innovator

George A. Philbrick is dead. A pioneer in electronic analog computing and a devotee of feedback, he is generally acknowledged to have been the originator of the modular operational amplifier, which is today so important to electronic circuit designers.

Scholar, gentleman, mathematician, writer, artist, teacher, poet, his fertile mind produced many innovations in automatic control and electronic circuit design. Moreover his every accomplishment evoked a feeling of style of unusually high order, that left an indelible impression on all who came in contact with him.

We who have had the experience of more extended acquaintance with him have known him to be a person of infinite complexity, yet of unexpected simplicity, too. An immensely private person, his thoughts were nevertheless global; no aspect of the world nor of humankind escaped his interest. Impressive in size and appearance, as well as in intellect, he was by no means perfect: He had friends and enemies, those he had befriended and those he had wronged. Yet all would agree that he was a special person.

Those in our field who did not know him (or even about him)—and there were many, in view of his retirement during the 1960s—should be aware of our generally unrecognized debt to him. Perhaps someone else would have proposed the operational amplifier as a circuit component if he hadn't. But only he could have originated it (as an outgrowth of the modular unit operator, of which he was an

early advocate), recognized its implications, communicated them to a technical world with verve and authority, built up a successful amplifier business (virtually unchallenged for 10 years) and nearly made "phil-brick" a synonym for modular operational amplifier (instead of "op amp"). Imagine what the world would be like today without the operational amplifier—if you can!

His presence has enriched all of technology, and his departure is a matter of regret for all of us, his beneficiaries.

*Daniel H. Sheingold*

Analog Devices Inc.  
Route 1 Industrial Park  
P.O. Box 280  
Norwood, MA 02062

## 'Nice' engineer finds editorial is 'sexist'

I read your editorial from the Dec. 6, 1974 issue ("Nice Young Girls and Consultants," ED No. 25, p. 51), and I think that it is in very poor taste to make the analogy you made between prostitution and electronics. Isn't it bad enough that your magazine uses the bustline to sell electronic equipment (same issue, p. 126). Do you also have to relate your experiences in the red-light districts of other countries to make your not-too-interesting points?

I suggest that before you write your next editorial you consider the fact that more and more women are entering the field of electronics and that your sexist attitudes are outdated and offensive to some of the "nice young girls" who are

*(continued on page 8)*

Electronic Design welcomes the opinions of its readers on the issues raised in the magazine's editorial columns. Address letters to Managing Editor, Electronic Design, 50 Essex St. Rochelle Park, N.J. 07662. Try to keep letters under 200 words. Letters must be signed. Names will be withheld on request.

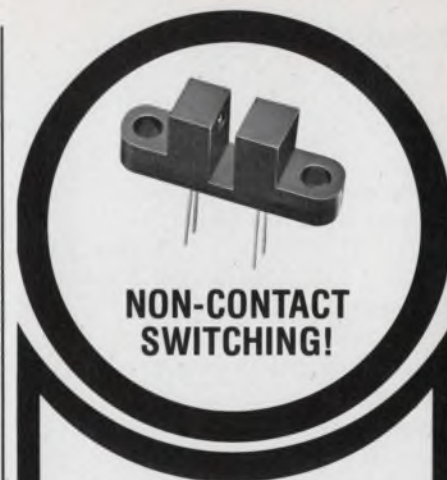

## OPTICALLY COUPLED INTERRUPTER MODULES

OPTRON OFFERS IMMEDIATE DELIVERY OF NEW, LOW COST SERIES

OPTRON's new, low cost optically coupled interrupter module series combines non-contact switching and solid state reliability for applications requiring sensing of position or motion of an opaque object such as motion limit, paper edge or shaft encoding.

The new OPB 800 and OPB 803 consist of a gallium arsenide infrared LED coupled with a silicon photosensor in a plastic housing. The OPB 800 with a phototransistor sensor has a typical unblocked output of greater than 0.75 mA with a LED input of 20 mA. Typical output of the OPB 803 with a photodarlington sensor is 3 mA at an input of 10 mA.

Both devices are available from stock and offer design flexibility with the following options:

- High resolution aperture for shaft encoder or strobe bar applications
- Infrared transmitting filter for applications in high ambient light applications
- Alternate pin separation to fit standard DIP socket

New OPTRON optically coupled interrupter modules are interchangeable with similar products as follows:

OPTRON	GE	Monsanto
OPB 800	H13A1	—
OPB 800	H13A2	—
OPB 803	H13B1	MCA 8
OPB 803	H13B2	MCA 81

Detailed technical information on these and other OPTRON standard interrupter and reflective modules, as well as versions for specific applications is available on request.



**OPTRON, INC.**

1201 Tappan Circle  
Carrollton, Texas 75006  
214/242-6571

(continued from page 7)  
reading your magazine.

Phyllis Kos  
Production Engineer

University of Illinois Chicago  
Circle  
Small Groups Laboratory  
Box 4348  
Chicago, IL 60680

## The editor replies

I don't feel my attitudes are sexist. I feel instead that any field of human endeavor, including prostitution, is fair game for analogy. Incidentally, in walking down one of Hong Kong's main thoroughfares, I didn't know that it was a "red-light district." Nor did anyone else.

George Rostky

## Hooker's technique called ad success

I would say that the charming Tokyoan ("Nice Girls and Consultants," ED No. 25, Dec. 6, 1974, p. 51) followed your lessons to a T:

1. She knew her customer, on the basis of visual market research: Well-dressed Western businessman type.

2. Her interception of you "on the way to your hotel room" certainly testifies to her efficiency.

3. She projected her intended client's needs by admiring a receding hairline—a well-known testimony to an active social life.

4. She accomplished much more than a transistory transaction? You needed an editorial subject, which she furnished, in return for which you advertised her services to 334,585 prime and pass-along readers.

By the way, what was the name of your hotel?

Herbert H. Heller  
Senior Staff Engineer  
Information Services

Bird Electronic Corp.  
30303 Aurora Rd.  
Solon, OH 44139

## Open-loop measurement rates compliments

The method brought out by Dr. Pierce (see "Measure Open-Loop Servo Response," ED No. 24, Nov. 22, 1974, p. 170) is excellent. This approach has been in wide use in feedback control system work.

The two-channel sweep frequency-response analyzer (Model 913) manufactured by Bafco, Inc., is a much better instrument to use than the one mentioned, as it has built-in noise and harmonic rejection resulting from the internal mechanization of Fourier integral analysis. Open-loop results are obtained readily from closed-loop tests at signal-to-noise ratios up to 1 to 10. With some external equipment, measurements have been accomplished accurately at an s/n of 1/1000.

Abraham M. Fuchs  
Vice President

Bafco, Inc.  
717 Mearns Rd.  
Warminster, PA 18974

*Ed Note: The Hewlett-Packard gain-phase meter referred to in Dr. Pierce's article was mentioned as a representative instrument. It was not offered as the only or best possible choice. For more information on the Bafco instrument, Circle No. 316.*

## Let's get it right for CellMate

In the "Focus on DC/DC Converters" (ED No. 23, Nov. 8, 1974, pp. 70-78), we listed the old address and phone number for CellMate Div. of Seven Sciences Inc. The company is now located at 1405 Civic Center Dr., Santa Clara, CA 95050. (408) 249-8400.

## Job hopping viewed as involuntary evil

In "Meet' the Applicant Before Talking to Him" (ED No. 25, Dec. 6, 1974, p. 86), Alan J. Rider refers to a government manpower study, which states that two to seven years is ideal length of service for an engineer with any one employer. The study is referenced casually, then used as a basis for

statements concerning the personal lives of the entire engineering community.

The engineer has throughout the 1960s been characterized as a nomad, following the jobs, living under feast or famine, depending on contracts that will either be canceled or simply fulfilled. Since when is the engineer voluntarily job-hopping for the purpose of becoming a better engineer? Excessive disruption of engineering families has been caused by the breadwinner trying to head off the layoff.

Sure, there's usually been an increase in pay accompanying moves, but that's only because there is a tradeoff between salary, security and convenience. In the engineering world, security is zilch; hence the community of technological nomads.

I hope Mr. Rider doesn't think poorly of me if I happen to have satisfied my employers for a great number of years.

D. J. Sweeney  
Air Traffic Systems Div.

Mitre Corp.  
Bedford, MA 01730

## V/f converter supplier sets record straight

I have read with considerable interest the product descriptions of v/f converters that have appeared in recent issues of your magazine, in particular since North Hills Electronics, Inc., has been a pioneer in the development and application of these units. I feel that you are performing an important service in making the capabilities of these modules known to your audience, and I appreciate the inclusion of North Hills among the suppliers of such units. However, there is one error in the prices quoted for our units in ED 21, Oct. 11, 1974, p. 138.

Our unit, which is the equivalent of the one described, is the DF-20-310, not the DF-10-310, and it sells at \$58 in unit pricing, which is competitive with the comparable units.

Sol Sherr  
Executive Vice President  
North Hills Electronics, Inc.  
Glen Cove, NY 11542



# MEASUREMENT COMPUTATION

innovations from Hewlett-Packard

# NEWS

FEBRUARY, 1975

## in this issue

New programmable pocket calculator with timer

Intelligent CRT—low price, high performance

New triple-output bench supply

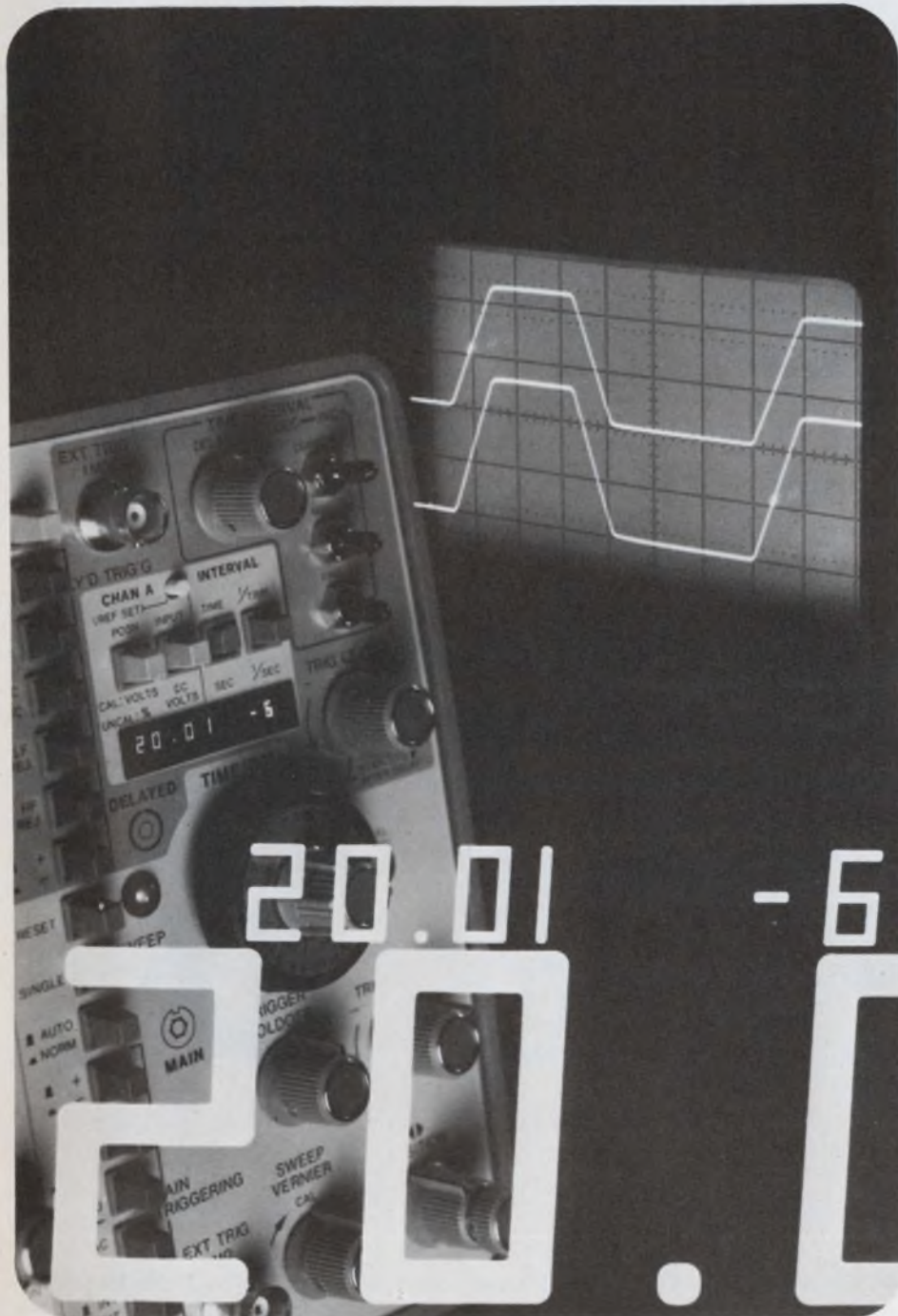

## New smart oscilloscope with built-in microprocessor gives you answers

HP has combined a high-performance 275 MHz scope, a microprocessor, and LED display to put an end to graticule counting, mental calculations, and most conventional scope errors. The new 1722A gives you a quantum leap in measurement accuracy and convenience. It's a working lab partner that speeds measurements of time intervals, frequency, instantaneous or dc voltage levels, and relative amplitude expressed in percentage. And, instead of conventional reading errors, the 1722A gives you a 3½-digit LED reading of your measurements...in seconds, Hz, volts, or percent.

The microprocessor takes over several tasks you used to perform. It keeps track of dial settings, automatically

*(continued on page 3)*

## Measure wideband microwave networks— in one sweep

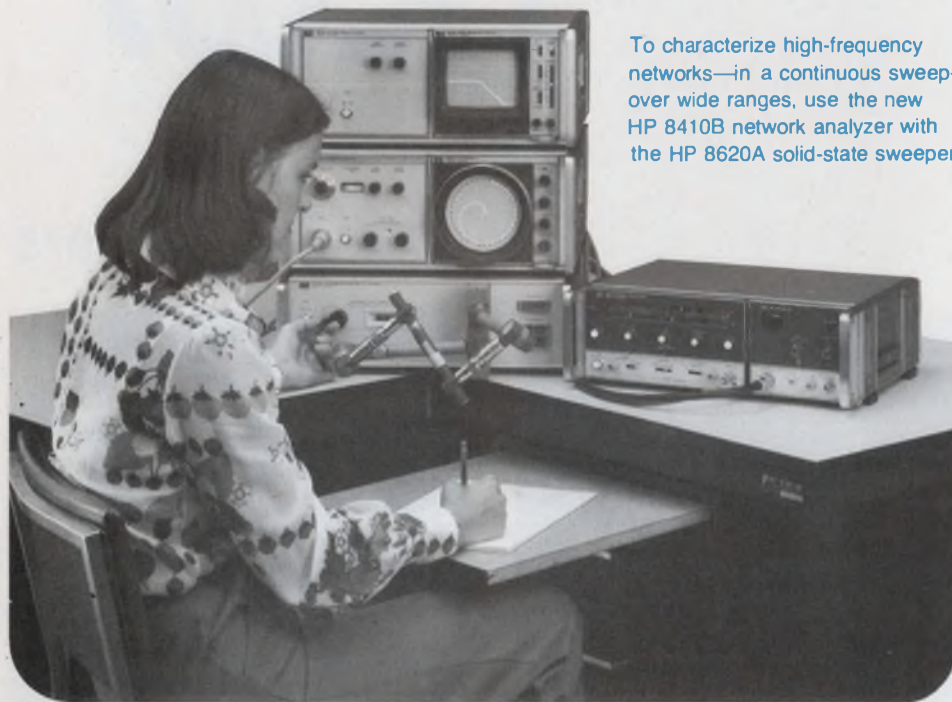

To characterize high-frequency networks—in a continuous sweep—over wide ranges, use the new HP 8410B network analyzer with the HP 8620A solid-state sweeper.

Two dramatic examples of continuous-sweep multi-octave measurements made with the new HP 8410B network analyzer:

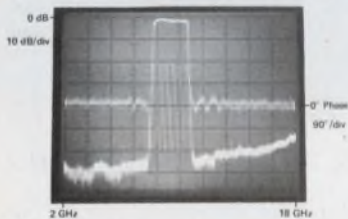

Transmission characteristics (magnitude and phase) of 8-10 GHz bandpass filter, shown over 2 to 18 GHz range. Note that insertion Loss Trace (10 dB/div) is free from harmonic responses.

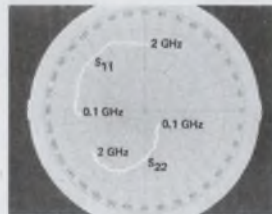

Polar plots of transistor s-parameters from 100 MHz to 2 GHz.

Frequency band switching is a thing of the past when multi-octave range networks are measured with the new HP 8410B network analyzer. The 8410B, successor to the popular HP 8410A\* (which was limited to octave-wide sweeps), measures both the magnitude and phase of network parameters, vital data for microwave designers. Test configurations covering from 100 MHz to 40 GHz are offered.

Multi-octave measurements in one continuous sweep are possible when the 8410B is used with the HP 8620A sweep oscillator. For example, with the new HP 86290A sweeper plug-in, you can sweep test from 2 to 18 GHz. Or the HP 86320A RF plug-in and the

8410B cover from 100 MHz to 2 GHz, more than four octaves.

The 8410B network analyzer is a frequency-selective system that tracks the sweeper, resulting in a full 60 dB spurious-free dynamic range. Other multi-octave measurement schemes using broadband detection are typically limited to 20 or 30 dB range because of source harmonics.

\*Existing 8410's can be retrofitted for automatic tuning.

For your copy of the Data Sheet, check L on the HP Reply Card.

## Up to 24 Millicandelas from new high-efficiency RED, YELLOW, and GREEN LEDs

A new series of high-intensity, solid-state LED 'illuminators' are now available from HP. The new high-efficiency Red LEDs have an intensity of 24 mcd at a forward current of 10 mA.

Packaged in the T-1 $\frac{3}{4}$  outline, the lamps come in both wide and narrow beam types; the wide beam lamps using a diffused lens and the narrow beam lamps with a clear lens. These lamps have long general purpose leads to facilitate all types of mounting.

Four lamps of each color are being introduced, two light output categories for each beam angle. High intensity is obtained using a new HP technology employing a transparent gallium phosphide substrate and adding a reflector in the package. Higher Intensity is possible under "pulsing" conditions (or up to 20 mA dc) as these LEDs do not saturate. These lamps are rugged and are ideal for use in high ambient light conditions. The narrow beam, high output models are used as pushbutton switch illuminators and "Dead Front" panel annunciators. The wide beam models are used for low power panel indicators or backlighting.

For more information, check F on the HP Reply Card.



Red (5082-4650), Yellow (5082-4550) and Green (5082-4950) LED lamps.

## NEW high-efficiency step recovery diodes



Special introductory price.

Our new high-efficiency step recovery diodes maximize cutoff frequency while maintaining a fast transition time. Thus, they provide excellent performance in low or high order multipliers and in comb generators.

The new 5082-0800 series diodes are passivated with a thermal oxide for maximum stability. You can buy them in chip form, in low-cost glass packaging, or in hermetically sealed metal-ceramic packages. Test data is supplied with each ceramic packaged device.

As an introductory offer, these devices are available in prototype quantity at the 100 piece price (offer good until April 30, 1975).

For more information, check *E* on the HP Reply Card.

(continued from page one)

## New scope with microprocessor

computes time intervals and voltage levels, converts time measurements to frequency, and calculates percent. It even signals if you make an erroneous setting.

HP's dual delayed sweep gives you two adjustable intensified markers for displaying the start and stop points of a time interval. The microprocessor automatically computes and displays the time interval between the markers. This speeds digital timing measurements, reduces errors, and simplifies the adjustment of circuits to meet a timing spec.

The 1722A makes waveform measurements faster, more accurately, and more completely than conventional scopes costing up to twice as much.

For details on HP's microprocessor oscilloscope, check *B* on the HP Reply Card.

## NEW HP-55 scientific pocket calculator offers 86 keyboard functions, programmability and built-in timer



HP introduces an extraordinary new programmable scientific pocket calculator. With all of the pre-programmed functions and operations of our popular HP-45, plus 38 new ones including statistical functions.

You can perform circular trigonometry in degrees, radians or grads and convert among any of them. Also, compute two-variable mean and standard deviation, linear regression, linear estimate, curve plotting and four simultaneous linear equations with four unknowns.

The HP-55 has 20 addressable storage registers—more than twice as many as any other scientific pocket calculator on the market.

And, the HP-55 is the only pocket calculator in the world with a built-in digital electronic timer with 100-hour

capacity—a stopwatch that times and stores up to 10 events within the same experiment, accurate to 0.01%.

Whenever you wish to write a program to solve your particular calculations, just set the program switch, enter a program of up to 49 steps, then run it... as often as you wish. Meanwhile, you still have access to all 86 keyboard functions plus the 20 register memory.

And, with the HP four-register stack, enter the most complicated equations without having to keep track of the parentheses and brackets.

To learn more about the amazing new HP-55, check *A* on the HP Reply Card.

## Faster graphs with new high-speed time-share plotter



Fast digital X-Y plotter accepts bit-serial ASCII at 10 or 30 characters per second.

Now you can plot up to seven vectors per second in any direction using the new 7203A high-speed graphic plotter.

Vectors of any length are plotted in any direction and the resulting graph appears as a smooth line, in contrast to the staircase often drawn by incremental plotters.

Check numerical control tapes, display statistical data, quickly analyze engineering designs or use this plotter for any application you have that requires fast graphics.

Four colors of ink are available in disposable pens. Pens are changed quickly and easily so that plots may

be superimposed in color for comparison.

Each plot coordinate is expressed with a Binary number represented by the bit pattern of two successive ASCII characters. Thus, only 4 characters are required to define any move.

The 7203A operates in parallel with data communication terminals. Easy to use software subroutines are available for many time-share systems.

Plots are front panel scalable from  $0 \times 0$  up to  $10 \times 15$  in. ( $25 \times 38$  cm) using paper up to  $11 \times 17$  in. ( $28 \times 43$  cm).

Check *J* on the HP Reply Card.

## NEW HP display terminal offers an intelligent addition to your computer

HP's new 2640A display terminal with built-in microprocessor is the intelligent, cost-effective answer to your data entry and information handling needs.

The 2640A operates either on-line or in stand-alone mode, with full editing capability. You can write 24 lines with 80 characters per line on the 5 by 10 in. (127 by 254 cm) rectangular display. High resolution ensures clear, precise character definition. You can also plug in three additional character sets, such as a line drawing set or a math set, and use them concurrently with the standard character set.

The 2640's dynamically allocated memory lets you store 8 to 50 lines or add optional memory modules and store over 400 lines depending upon line length. Memory protection is standard on all 2640A terminals.

Should the modular 2640A need repair, just lift up the top and replace the necessary printed circuit cards. And, thanks to a universal interface, the 2640A works with a wide variety of computers.

For more information or a demo, check *C* on the HP Reply Card.

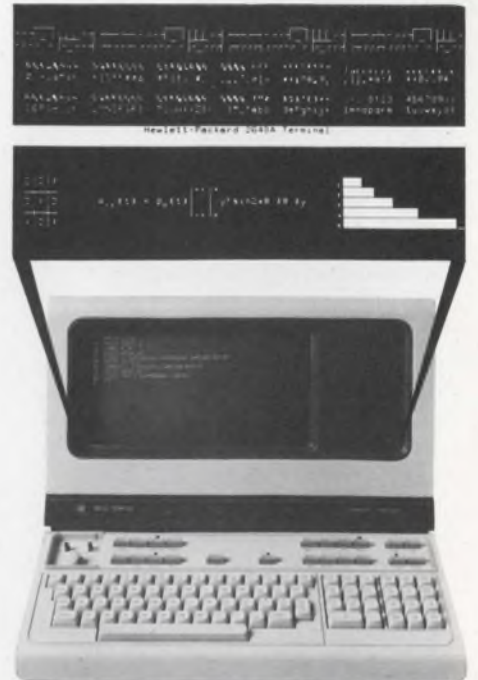

New Hewlett-Packard Model 2640A CRT Terminal is microprocessor controlled. Model 9866A Line Printer (left) is optional.

## 21MX computer with new Dynamic Mapping System plug-in gives you million word addressing space



Programmable DMS for 21MX computer expands address space.

A new Dynamic Mapping System (DMS) devised by HP for its 21MX series user-microprogrammable 4K RAM semiconductor memory minicomputer allows access to four independent memory spaces.

The 12976A DMS expands the memory address size to 20 bits, thereby providing a maximum main memory addressing space of 1,048,576 16-bit words. It does this without adding to the 650-nanosecond cycle time.

Accounting for the compactness and low prices of the new large-memory models, HP cites features common to the whole 21MX line. For example, all 38 of the new instructions are contained in a single 265 word module of microcode. Also included is read and or write protection on an individual 1K-page basis. All these instructions are on half of a single small circuit board. These new capabilities are plug-in installable.

The HP Dynamic Mapping System functions with main memory somewhat as "virtual memory" schemes function with disc memory.

The 38 new microcoded instructions in DMS firmware, including cross map moves and block transfers, give extensive control over memory allocation and protection. In addition to these 38 supplied by HP, the user can generate his own unique memory management and protection instructions using the standard microcode capability.

For more info on this new Dynamic Mapping System, check **O** on the HP Reply Card.

## HP interface bus enhances signal generator

Joining the growing list of HP-IB compatible instruments is the HP 8660A/B synthesized signal generator. It's a fully programmable signal generator with .01 to 1300 MHz frequency coverage,  $3 \times 10^{-8}$ /day frequency stability ( $3 \times 10^{-9}$ /day optional), +13 to -146 dBm output level, and AM, FM and pulse modulation capabilities.

When installed, the HP interface bus allows programming of:

- Frequency, in 1 Hz steps over the entire 1300 MHz range.
- Output level, in 1 dB steps over the entire 160 dB range.
- Modulation mode, either AM or FM.
- Modulation source, either internal 400 or 1000 Hz tone or external source.
- AM depth, in 1% steps from 0 to 99%.
- FM deviation, in 3 overlapping ranges, either 50 or 100 steps per range, from 0 to 1 MHz.

The HP-IB interface is available as option 005 on new instruments or as a field-installable kit 08660-60189 for instruments already equipped with the standard BCD interface.

To learn more, check **M** on the HP Reply Card.



Now, you can run a precision signal generator under calculator control.

## Helpful techniques for using VHF signal generator



New application information available for 8640A/B.

Three new application notes show you how to extend the usefulness and accuracy of HP's 8640A/B VHF signal generator (450 kHz to 1100 MHz).

AN 170-1 explains how to improve the specified output level accuracy over narrower frequency limits—i.e., how to operate the generator for optimum accuracy. Also, special calibration can be used to minimize effects of frequency response, temperature, detector and meter linearity, and vernier error.

AN 171-1 describes a method for improving crystal filter measurements when using an HP vector voltmeter and the 8640A/B. This technique optimizes frequency tuning sensitivity by using a feedback signal from the phase meter to the generator external FM input.

AN 171-2 describes how to build a simple heterodyne circuit that extends the frequency down range to dc-450 kHz. The circuit mixes the rear-panel fixed 5 MHz crystal output with the tuned output signal and provides a stable frequency that can be read directly on the digital readout.

For your copies, check **P** on the HP Reply Card.

## New capabilities, more options for HP-5300 measuring system

Now there is a high resolution 8-digit display mainframe (Model 5300B) with temperature-compensated crystal option in the HP-5300 series of electronic counters and digital multimeters.

New snap-ons for the system include an 1100-MHz counter and a bus interface.

In the 5300 system, a complete instrument consists of two halves that snap together in about 15 seconds. The width of these units is a very compact 6¼ inch (160 mm). The upper half, or mainframe, contains the readout and associated circuitry. The instrument's measurement functions are determined by the lower half, or "snap-on", of which there are now 7 models for measuring frequency, time interval, ac and dc volts and ohms. The new 5312A ASCII "snap-between" module allows all of the 5300 functions to interface with data acquisition systems via the HP Interface Bus.

With the new 5305A 1100-MHz frequency counter snap-on, you get a sensitivity of 10 mV to 500 MHz and better than 25 mV to 1100 MHz, automatic gain control and manual attenuator to measure noisy or modulated signals, plus a front panel accessible input fuse to prevent costly front end damage.

With the new 5312A ASCII "snap-between" module you can mate other instruments and controllers to the 5300 series via the HP Interface Bus.

*For more information, just check H on the HP Reply Card.*



HP 5300 Measurement System adds 5300B 8-digit module, 5305A 1100-MHz counter, and 5312A ASCII interface to HP Interface Bus.

## Now debug your control system design before you build it

New software for design engineers using 9830A calculator in BASIC language.



With HP's powerful 9830A programmable calculator and state-variables software, you now can know exactly how your control system will perform long before you've committed time, materials, and manpower to an expensive prototype.

The new state-variable software provides a complete transient response solution for control systems, whether for mechanical, electronic, hydraulic, optical, or hybrid systems. It's a carefully developed set of programs that will assure you a stable system in a minimum amount of time. There's no hassle with computer programming and interfacing. You just key in the values directly from your block diagram, and the 9830A does the rest automatically.

In 10 minutes or less, you get a high resolution plot of transient response and printed list of system parameters. If you want to adjust your design, you simply key in different values. Thus, you can explore alternatives—right at your desk—to find a better design or solution.

An extensive library of engineering and design programs are available from HP.

*To learn more, check N on the HP Reply Card.*

## Low frequency spectrum analyzer offers unmatched resolution

Up until now, the biggest problem analyzing low frequency signals has been the display. Now, you can get a clear picture of mechanical vibrations, audio filters, or data communication channels with HP's 3580A spectrum analyzer, covering 5 Hz to 50 kHz. The trace appears on a CRT with 1 Hz bandwidth—that's the best resolution of any low-frequency spectrum analyzer on the market.

You can also store your trace in the CRT's digital storage. In fact, store two traces, and compare them on the CRT. You can study and interpret spectral information easily and quickly.

Dynamic range is 80 dB. HP offers unique adaptive sweep that speeds up your measurements and reduces analysis time. The 3580A weighs just 35 lbs (16 kg) and operates on batteries, as well as line power.

*For more information, check D on the HP Reply Card.*



There are many variables in a sound system; thus, instrumentation is needed to track down problems. HP's 3580A Spectrum Analyzer has the range and visual display necessary to analyze audio problems. With this unique instrument, distortion hum, equalization and reverberation can be quantified far better than even the best ear.



## For versatility, ease of operation and wide applications, 50 MHz pulse generators



What every Logic laboratory needs: versatile, easy to operate 50 MHz generator.

The 8012B and 8013B pulse generators are ideally suited to the requirements of a general digital logic laboratory where ease of operation and wide range of applications are essential.

Their 10V outputs and fast transition times (3.5 ns on the 8013B and 5 ns on the 8012B) enable you to dynamically test TTL, ECL and even the latest CMOS logic. You can simulate noise patterns and, in double pulse mode, test device recovery times and make noise immunity measurements. You can also use them as amplifiers when generating worst case data patterns.

These instruments not only enable you to set up pulses more easily, but also much more quickly. One big time-saving feature is the unique front panel layout; the slider controls provide a simple, straightforward design that enables

you to set up your pulses very quickly and with a minimum risk of incompatible pulse settings. They also greatly improve the readability of the pulse parameters. Another time-saver is the square wave mode which enables you to set up pulses very rapidly without having to worry about pulse width or delay.

In addition, the variable transition times of the 8012B enable you to generate any triangular or trapezoidal waveforms, and the two independent outputs of the 8013B enable you to test circuits designed with bipolar supplies.

For more information on these extremely flexible pulse generators, check K on the HP Reply Card.

## A 20 column low-cost printer that really is quiet

At last: a quiet printer that's really quiet. The new 5150A thermal printer prints faster than 3 lines per second, without any noisy impact mechanisms. It accepts data from BCD or ASCII sources and can list 20 columns of alphanumeric information, yet the price is extremely reasonable.

The 5150A uses heat-sensitive paper and a thermal print head, so you don't have to bother with ink spills or refills. Don't let simple design or light weight fool you—the 5150A is a high technology peripheral that can interface with minicomputers, any Interface Bus (HP-IB) instrument system or other digital data sources having acceptable codes and voltage levels. Available options include clock, BCD or ASCII interface and scanner—whereupon it can serve as an HP-IB controller.

For more information, check G on the HP Reply Card.



The 5150A printer is available in several different configurations to fit your system; here, it logs data from a 5345A Electronic Counter.

## New triple-output bench supply for IC test and development

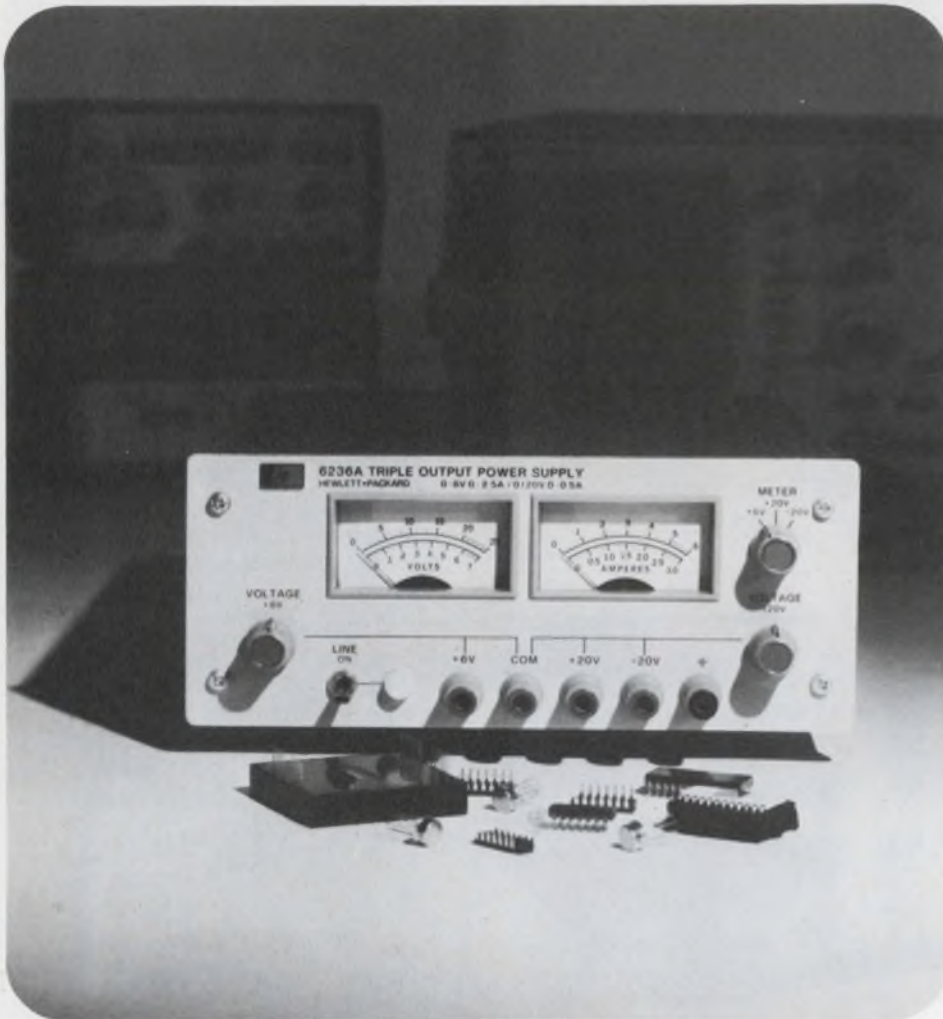

Separate voltage controls adjust the 0 to 6V and 0 to  $\pm 20V$  outputs, while the meter switch selects the desired V and I range for display on the panel meters.

Low cost, small size, and outstanding performance, make this new three-in-one lab supply a valuable aid to anyone designing or testing equipment using integrated circuits. Model 6236A delivers three outputs: 0 to 6V, up to 2.5A; and dual-tracking 0 to  $\pm 20V$ , 0 to 0.5A. The 0 to +20V and 0 to -20V outputs track one another within 1% to supply the symmetrical voltages needed by op amps and similar balanced-voltage-source applications. A single 0 to 40V @ 0.5A output can also be obtained by connecting across the -20 and +20V terminals.

All outputs are regulated to 0.01% +2mV, with ripple and noise of 0.35mV rms/1.5mV p-p. The dc outputs have smooth turn-on and turn-off characteristics so that no output voltage overshoot is produced when the ac line switch is operated. Both the 6V and  $\pm 20V$  outputs are protected from overloads by fixed current limiting circuits.

Model 6236A can be powered from a nominal 100V, 120V, 220V, or 240V, 47-63 Hz ac input. The supply weighs only 9½ lbs. (4.3 kg) and is 3½ in. high (8.9 cm), 8½ in. wide (21.6 cm), and 12½ in. deep (31.8 cm). Single and dual-unit rack-mounting kits are available.

*For more information on the three-in-one power supply, check 1 on the HP Reply Card.*

HEWLETT  PACKARD

East-20010 Century Blvd., Germantown, MD 20767, Ph. (301) 428-0700.

South-P.O. Box 2834, Atlanta, Ga. 30328, Ph. (404) 436-6181.

Midwest-5500 Howard Street, Skokie, Ill. 60076, Ph. (312) 677-0400.

West-3939 Lankershim Boulevard, North Hollywood, Calif. 91604, Ph. (213) 877-1282.

Europe-Post Office Box 85, CH-1217 Meyrin 2, Geneva, Switzerland, Ph. (022) 41 54 00.

Canada-6877 Coreway Drive, Mississauga, Toronto, L4V 1L9, Ph. (416) 678-9430.

Japan-Yokogawa-Hewlett-Packard, 1-59-1, Yoyogi, Shibuya-ku, Tokyo, 151.

# The "Above-Average" Sub-System by Celco

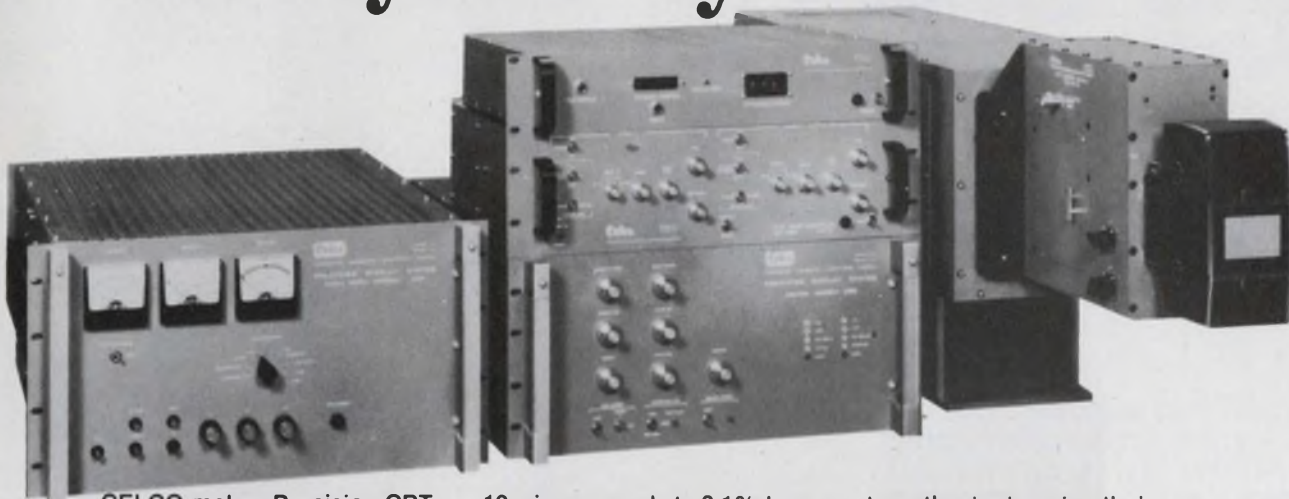

CELCO makes Precision CRT Displays for your "above-average" CRT requirements.

Need a CRT spot-size as small as 0.00065"? This standard CELCO 5" CRT display is being used for Satellite Photography. They needed the best they could get. You can get performance like that too with CELCO's DS5-065 Precision CRT Display.

A CELCO DS5-08 with 0.1% linearity, and spot size of 0.0008" is being used by another CELCO customer for Nuclear Photography Film Recording. Special features include programmable Raster Generators, and triple-layer and articulated shielding for ambient fields from earth's field and from dc to RF fields.

Fingerprint Scanning is the job of CELCO's DS5-10 Optical Character Recognition System for one of our customers. They needed that wide 2.5 MHz deflection bandwidth for high-speed scanning of vast amounts of data. And the DS5-10 has a settling time of

10 microseconds to 0.1% large signal, and 350 nanoseconds to 0.02% small signal settling time. Spot-size is 0.001".

One CELCO customer is using our 5" Color Display System for color separation and color photo scanning. One display does all that!

If your needs are "above-average" but your budget is below-average, CELCO also makes a 5" Precision CRT Display System especially for you that's ideal for your Low-Cost Film-Scan applications. Or if your display needs are larger, CELCO makes standard precision 7" and 9" CRT displays.

Our DS5-075 provides NASA with a 0.00075" spot-size for their Viking Orbiter and Viking Lander satellite photography. They needed 0.01% repeatability too. And they got it. From CELCO.

Two different customers with "above-average" display needs are using CELCO CRT Display Systems for Astronomy Research. One is an observa-

tory; they're keeping their eye on the Sun. The other is recording their Stellar Observations with a CELCO CRT Display System.

High-speed map making is the task of another CELCO customer using a CELCO precision display for topographical projects.

CELCO displays are helping a leading Oil Company in their oil explorations. While another CELCO display is being used in Eye Research.

Maps and satellites, eyeballs and oilwells. All "above-average" display requirements. If your needs are ABOVE-AVERAGE, you need a CELCO "above-average" Precision CRT Display System.

(Don't you think so too?)

Call CELCO for your "above-average" CRT Display System.

UPLAND CA 714-982-0215  
MAHWAH NJ 201-327-1123  
(average is so . . . ho-hum to us.)

CONSTANTINE ENGINEERING LABORATORIES COMPANY  
1150 E. Eighth Street, Upland, CA 91786

70 Constantine Drive, Mahwah, NJ 07430

INFORMATION RETRIEVAL NUMBER 7

# CUTLER-HAMMER'S BIG LINE OF COMMERCIAL MINIATURES.

Toggles. Pushbuttons. Rockers. Rotaries. Available in a vast array of operator styles, colors, and shapes. Including illuminated pushbuttons and rockers. Many featuring snap-in mounting. And all in stock for fast delivery!

Now the same great quality, service and availability you've come to expect from Cutler-Hammer is available in miniature size—at a competitive price!

Make your selection. Standard or watertight. Single or multiple pole. A wide range of decorator caps, buttons, bezels that extend application flexibility. And for their size, hefty electrical/mechanical ratings.

Before you place that next order, check with your source for commercial miniature switches—your nearest Cutler-Hammer Sales Office or Authorized Stocking Distributor.



**CUTLER-HAMMER**

SPECIALTY PRODUCTS DIVISION, Milwaukee, Wis. 53201



Switch  
to No. 1

More than just switches;  
prompt availability,  
field help, innovation,  
quality assurance, too.

## Analog signal processing moving to challenge digital

With recent developments in charge-coupled devices and MOS diode arrays, analog signal-processing techniques are being considered as replacements for some digital techniques now in use.

Engineers will learn of the latest advances in analog signal processing at the International Solid-State Circuits Conference in Philadelphia later this month.

Among the developments to be discussed will be these:

- An MOS diode array that does the same processing as CCD equivalents.
- A CCD that performs a 500-point Fourier transform.
- An analog CCD delay line that has parallel input taps.

While most of the progress in analog signal processing has been in CCDs, some work has been done with MOS diode arrays. Some of this work will be described by Gene Weckler, an engineer for the Reticon Corp. of Mountain View, CA, in a paper on "The Analog Signal Processor." Weckler notes that by using standard MOS technology, it is possible to signal correlators and delay lines. It is not necessary to go to CCDs, he says.

The device to be described by Weckler is a 128-bit serial-in, serial-out analog delay line. The circuitry, he notes, is actually a group of sample-and-hold circuits on a single chip. Each of the 128 stages of the device is made up of an input MOSFET, a diode whose capacitance is used to store charge and a MOSFET output buffer. In addition there are input and output shift registers that control the gating of the FETs.

Information is read in and out of the device by input and output scanners, and no transfer of charge is needed.

As with CCDs, signals can be read in and out at different rates.

The delay possible with the MOS array is limited to 40 ms, Weckler notes. But work is under way to use thin-film capacitors instead of diodes to store information. This could increase storage time by as much as two orders of magnitude.

A more sophisticated device that does use CCD technology will be discussed by Robert W. Brodersen of Texas Instruments. This is a 500-point Fourier transform chip that was originally developed for the Army's Electronics Command at Fort Monmouth, NJ, for remote target-surveillance pattern-recognition systems.

According to Dennis D. Buss, a co-author of the paper, the single chip device uses the chirp-Z transform algorithm to implement the discrete Fourier transform. The device, he notes, can be used in the audio and video frequency ranges, and it competes head-on with digital fast-Fourier-transform processors.

It's possible that some sort of Fourier-transform device will be among the first analog CCDs commercially available. Buss indicates that TI is working on a small modular device that can be used to make transformers of arbitrary length.

"We're thinking along the lines of a 64-point transform chip, but that's only a goal. We are not there yet," he cautions.

Another CCD device to be discussed at the conference will be a 64-bit analog delay line with multiple input taps. According to Roger Melen, a researcher at Stanford University, the device—known as a "razorback" CCD—can be used either to provide a selectable bit delay or to perform delay-sum and multiplexing operations. The device was developed for an acoustic imaging system so an electronic lens could be rapidly scanned

while producing a three-dimensional image of an object.

The razorback CCD is not limited to this application, however. Melen notes that at least one semiconductor manufacturer—AMI—is interested in offering a device like this as a building block.

Describing some of the characteristics of the device, Melen reports that it has a bandwidth of 1.3 MHz, a delay that is adjustable from 3 to 8000  $\mu$ s and has delay taps at 16, 32, 48 and 64 bits.

## Standard CMOS ICs due for custom designs

With CMOS already a standard logic family and also a tool for custom designs, the next step in evolutionary development is about to take place: standard CMOS ICs to satisfy a variety of custom applications.

Motorola in Phoenix, AZ, plans to introduce the first dozen circuits over the next 12 months with the MC14400 series. According to Bob Berner, manager of CMOS product planning: "We will be introducing parts that will be directed at computer peripherals, appliances, watches, telephony and a variety of other specific markets."

The process used will be low-power metal gate and will be the same as the standard CMOS logic family. The parts will usually be available in both plastic and ceramic packages.

Typical of the products to be introduced this year are a pair of binary-to-phone pulse converters, a 2-of-8 keyboard to binary encoder, a liquid-crystal watch circuit, a quad precision timer/driver and a pair of oscillator/divider circuits. Other products in the series include modems, tone encoders, a/d logic subsystems and a hex contact bounce eliminator.

## 'Smart' cable links computer to peripherals

First the intelligent terminal, then the intelligent instrument, and now—the intelligent cable.

Announced by Computer Automation, Irvine, CA, the "smart" cable consists of a ribbon that goes from a minicomputer to a periph-

eral device, such as a printer, terminal or memory. Imbedded in the cable near the peripheral is a small processor that provides most of the electronics to interface the computer to the peripheral.

Most minicomputer systems require a separate peripheral interface card that costs several hundred dollars for each peripheral. In some cases the card might handle two peripherals.

In Computer Automation's approach, a single half card—called an input-output distributor—and a set of intelligent cables, allow the computers to communicate with up to eight parallel or serial peripheral devices. The I/O distributor costs \$380 in single quantity, and the cables are \$145 each.

CIRCLE NO. 317

## IBM desk computer designed for novices

Ease of use, low-cost comprehensive software and intersystem compatibility are keynotes of IBM's new System/32 small computer. The over-all system is designed for users with no prior experience in data processing.

The basic desk-sized unit, which rents for as low as \$770 a month, offers the following:

- Visual display.
- Simple operator commands and visual prompting.
- Two types of disc storage.
- Communications compatibility with many IBM terminals and systems, including other System/32s and the System/360 or 370.

Applications programs are supplied, at extra cost, for such industries as the construction, wholesale-food and paper and office-products and also for hospitals and membership organizations.

The basic computer is equipped with 5 Mbytes of fixed-disc storage, a six-line CRT display, 16 kbytes of main storage, a 40-char/serial-impact printer (7 × 7 wire matrix), an IBM Diskette read/write facility and a typewriter keyboard with numeric pad. All information is supplied by the Diskette rather than a card reader.

Extensive use of advanced MOSFET technology is responsible for the machine's small size. The density is 40 times that of the IBM

370. The average internal instruction time is 1  $\mu$ s, and an interpretive user instruction averages 60  $\mu$ s.

The read/write mechanism for fixed-disc storage uses a pivoting arm instead of the in-out movement of more conventional systems.

The main processor capacity can be increased from 15-k-bytes to 24 or 32 k, and the 5-Mbyte disc to 9.1 Mbytes. The average access time is 70 ms for 5-Mbyte storage to 72.5 ms for 9.1 Mbytes. And the data rate is 889 kbytes. Except for Diskette read/write operations, the System/32 overlaps all I/O.

Optional communications devices are available to support binary synchronous communications, and Synchronous Data Link Control (SDLC) can be ordered for interface with larger systems. In addition the processor can act as a direct-entry disc system or read Diskettes prepared on data-entry systems.

Buying prices for the System/32 start at \$33,100, with the largest unit selling for \$40,800.

## 9216-bit CCD memory a market trail blazer

The first production charge-coupled-device memory is available in prototype quantities—a serial storage memory organized in a 1024-word-by-9-bit format.

Designed by Fairchild Semiconductor, Mountain View, CA, the memory is for use in terminal buffers, display refresh and peripheral equipment as well as other buffer applications.

Packaged in an 18-pin DIP, the CCD unit contains TTL-to-MOS level conversion, timing and I/O control circuitry using the N-MOS process. The architecture uses nine 1024-bit shift registers shifted in parallel, so nine-bit bytes are stored or retrieved in a byte-serial mode. Each memory cell has 1.3 mil<sup>2</sup> area.

Input and output is via bidirectional three-state data lines, and a single two-phase external clock supplies timing. The operating frequency is 3 MHz, and power dissipation is 250 mW while reading or 30 mW during 50 kHz standby periods.

The unit is called the CCD 450, and the initial price is \$90 in

single quantities. The large-quantity production price is projected at \$9 by late 1975.

According to Dr. Thomas A. Longo, vice president and general manager of the Fairchild Integrated Circuits Group:

"We will be introducing four other CCD memory products in the coming two-year period, particularly for mainframe computer applications. Each of the products will use our N-MOS process, making them practical to produce at high volume with a low cost per bit.

CIRCLE NO. 318

## Serial printer shuns the costly electronics

A 30-character-per-second serial-impact printer with an integral microprocessor control and high-speed digital stepper motors eliminates costly front-end electronics and analog-to-digital conversion circuitry.

Announced by the Terminal Products Group of Interdata, Inc., Randolph, NJ, the combination of print-cup design, the microprocessor and the stepper motors gives high print quality, according to the company's president, Daniel Sinnott.

Called the Carousel for its print cup, the printer has two paper paths—one around the platen for cut forms, the other for feeding continuous form sheeting up from the rear of the machines and over the platen.

The Carousel, which will cost \$1500 in quantities of 50, is priced below the Diablo high-type printer, James Brennan, sales director for the Carousel, notes. A Carousel 300 terminal—which includes the printer, keyboard, communications interface, molded cover, power supply and forms-handling accessories—will sell for \$2460 in quantities of 50.

Production deliveries of both the printer and terminal are scheduled to begin in May.

The Carousel print cup rotates during character selection at up to 2100 rpm. It has 94 fingers that contain the alphanumeric of the ASCII set. Six more fingers on the wheel are shortened to let the operator see the copy as it is printed.

CIRCLE NO. 319

# It doesn't matter that Mini-Circuits' mixers are used in more systems than any other.

## What matters is why.

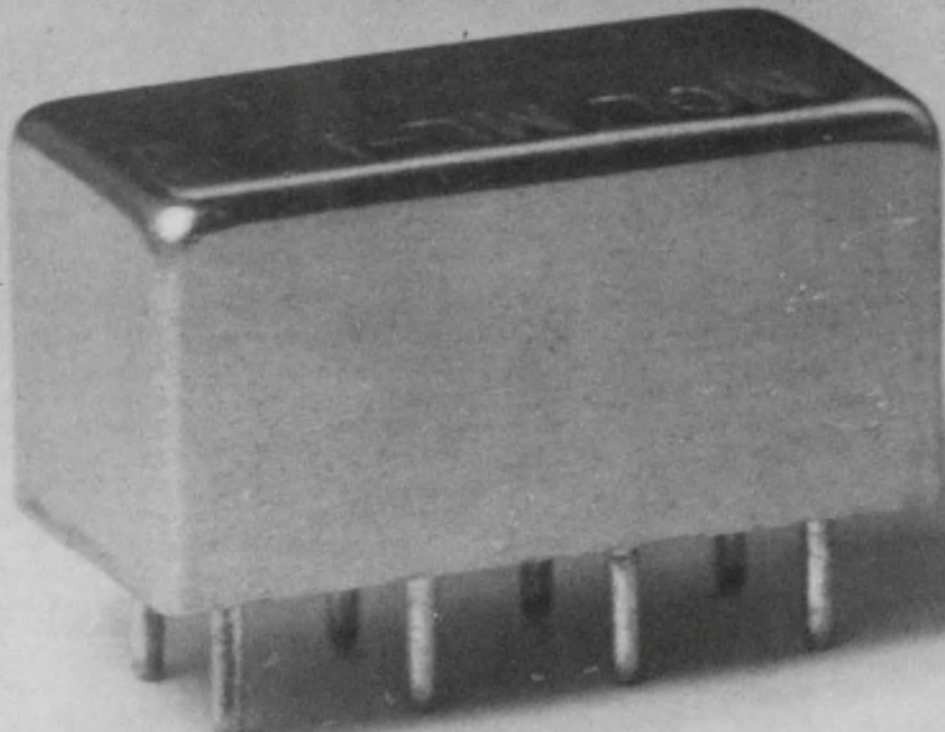

Mini-Circuits ships thousands of units each week to more than 500 companies throughout the world. These mixers are included in over 300 critical military programs as well as communications, medical, CATV, telephone transmission and instrumentation applications.

Our years of experience in high-volume production result in high reliability units with guaranteed repeatability of performance at lowest cost. That's why more and more systems engineers are specifying Mini-Circuits' mixers, directional couplers and power splitter/combiners as the industry's standard.

For complete specs, performance curves and application notes, see MicroWaves 1974 Product Data Directory (p. 187-311) or circle Reader Service No.9 for your personal 132 -page catalog.

### WE'VE GROWN

*Customer acceptance of our products has been so overwhelming, we've been forced to move to larger facilities — THANKS.*



**Mini-Circuits Laboratory**

A Division Scientific Components Corp

MCL

**OUR NEW ADDRESS IS: 837-843 Utica Avenue, Brooklyn, NY 11203 (212) 342-2500**

**Foreign Sales Representatives:** □ **AUSTRALIA** General Electronic Services, 99 Alexander Street, New South Wales, Australia 2065; □ **ENGLAND** Dale Electronics, Dale House, Wharf Road, Frimley Green, Camberley Surrey; □ **FRANCE** S. C. I. E. - D. I. M. E. S., 31 Rue George - Sand, 91120 Palaiseau, France; □ **GERMANY, AUSTRIA, SWITZERLAND** Industrial Electronics GMBH, Klüberstrasse 14, 6000 Frankfurt/Main, Germany; □ **ISRAEL** Vectronics, Ltd., 69 Gordon Street, Tel-Aviv, Israel; □ **JAPAN** Densho Kaisha, Ltd., Eguchi Building, 8-1 1 Chome Hamamatsucho Minato-ku, Tokyo; □ **EASTERN CANADA** B. D. Hummel, 2224 Maynard Avenue, Utica, NY 13502 (315) 736-7821; □ **ITALY** Microel Italia s. r. l. via M. Loria 50, 20144 Milano & via Senafe 27, 00199 Roma; □ **NETHERLANDS** Coimex, Veldweg 11, Hatterm, Holland

**US Distributors:** □ **NORTHERN CALIFORNIA** Cain-White & Co., Foothill Office Center, 105 Fremont Avenue, Los Altos, CA 94022 (415) 948-6533; □ **SOUTHERN CALIFORNIA, ARIZONA** Crown Electronics, 11440 Collins Street, No. Hollywood, CA 91601 (213) 877-3550

*For complete U.S. Rep listing and product line see MicroWaves' Product Data Directory*

# Circuits and substrates separated to make bigger, cheaper hybrids

Need a hybrid circuit larger than  $2 \times 2$  in.? Till now you couldn't buy a standard alumina substrate that was much larger. It was also difficult to find a package to put it into. But a new multi-layer hybrid technology from Northrop Electronics, Hawthorne, CA, will let hybrids grow much larger.

According to Arthur Friedman, the company's microelectronics engineering manager, "We have already prototyped hybrids that are  $4 \times 6$  in., and we could go much larger if needed."

Dr. Robert F. Vieth, chief of the Northrop microelectronics development group, adds: "Not only can we make the package larger, but we can do it at a reasonable cost. Even for standard-size hybrids, we are 10 to 20% cheaper. As the size goes up, the cost savings increases dramatically."

The key to the technology is separation of the substrate from the interconnecting circuitry. Northrop calls this Thinc-Pak construction. ICs are mounted on metal pads on a substrate. The circuitry is fabricated separately on an epoxy-glass material. Then the whole thing is laminated together.

The circuitry is thin film and is applied by photolithography. Density runs 20 to 40% higher than it does in silk-screened, thick-film hybrids. Friedman reports that ICs can be spaced approximately 30 chips/in<sup>2</sup>. Lines can be deposited with 2-mil widths on 4-mil centers, maintained over a 6-in. span. Conventional thick film is not much better than 4-mil lines on 8-mil centers.

To construct a hybrid, Northrop starts with a 2.5-mil-thick epoxy-glass board coated on both sides with 0.7-mil copper. It then em-

ploys the following procedure:

- Chemically thins the copper to 0.3 mil.
- Coats both sides with DuPont Riston photoresist.
- Positions the pattern mask, exposes, develops and etches. This makes vias and cavities through the epoxy-glass.
- Coats with Riston again for the conductor pattern, and processes with a mask.
- Plates up conductors and vias.
- Prepares a substrate (ceramic or metal), with metal pads placed to fall under the cavities in the epoxy-glass.
- Places the epoxy-glass circuit of interconnections on top of the substrate, with the metal pads showing through the cavities.
- Laminates together.
- Places the IC chips in cavities and bonds them to the pads.
- Bonds the chips to the printed circuit either by wire bond or beam leads, if that type of chip is used.
- Coats with a conformal coating.
- Covers with an hermetically sealed top.

Friedman notes that an interface connector can be constructed on the edge of the board to make the hybrid into a plug-in module.

So far the technique has only been tried with two layers. However, Northrop sees no reason why more layers could not be constructed with the same technique.

The most significant application for the technology, says Friedman, is in dense, compact semiconductor memory systems. Other appropriate areas are in microprocessor systems, automotive electronics, aircraft systems, digital watches and military systems with low weight, small sizes and low cost. ■■

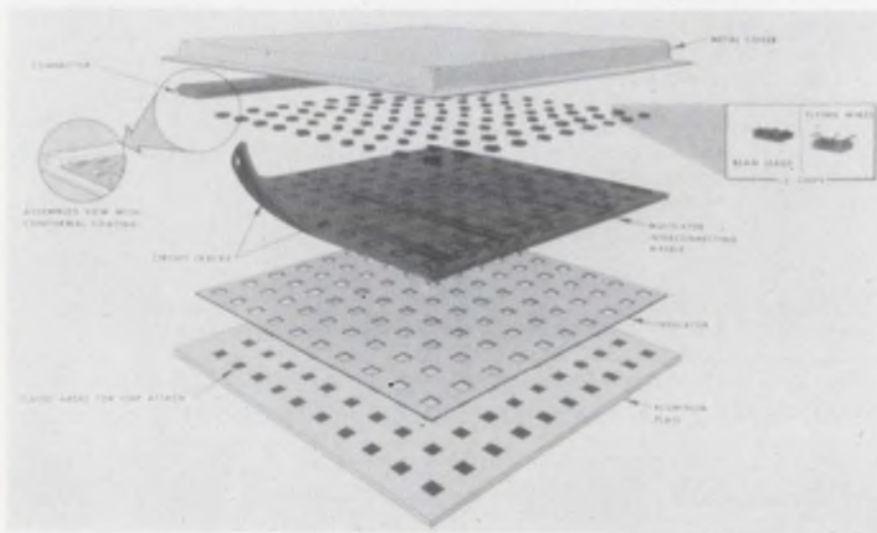

A two-layer printed pattern is fabricated on an epoxy-glass substrate. The IC chips fit in cavities through the interconnect matrix and are bonded to the plated areas on the aluminum substrate. With wire bonds or beam leads, if available, the chips are connected to the interconnect matrix. The whole assembly is finally laminated together, coated and covered.



Want high-volume component production?



# Consider the capacity of 34 electronic plants in a company called TRW.

The fourteen Electronic Components Divisions of TRW, Inc. can supply virtually any component in almost endless quantities. One of our divisions, for instance, has the capacity to produce 375,000 resistors an hour. Another can produce 15 million connectors a month. If you need a source with high-volume capability, you've just found it in a company called TRW.

## **TRW**® **ELECTRONIC COMPONENTS**

**TRW**. CAPACITORS

**TRW**. CINCH-MONADNOCK

**TRW**. GLOBE MOTORS

**TRW**. IRC POTENTIOMETERS

**TRW**. IRC RESISTORS

**TRW**. SEMICONDUCTORS

**TRW**. CINCH CONNECTORS

**TRW**. CONSUMER INTERNATIONAL

**TRW**. HOLYOKE WIRE & CABLE

**TRW**. SUPERMET PRODUCTS

**TRW**. CINCH-GRAPIK

**TRW**. ELECTRONIC FUNCTIONS

**TRW**. IRC NETWORKS

**TRW**. UTC TRANSFORMERS

INFORMATION RETRIEVAL NUMBER 10

# Launch control for space shuttle to lean heavily on minicomputers

The smooth launch-control system that got all the Apollo flights off the ground and to the moon is antiquated compared with the system being developed for the space shuttle, which is scheduled to make its first flight in 1979.

The Apollo system was partly computerized, but there were also a number of preflight ground operations that were monitored by personnel who watched meters.

For the shuttle, each function will be monitored by a minicomputer that has all the tolerances stored in its memory. It will warn the operator when something isn't right, and will refuse to proceed with an operation if it's given improper commands.

Preflight tests that took the Apollo crews two hours will be

done by the shuttle system's computer in seconds.

For instance, the propellant console will contain everything to command and monitor discrete and analog functions associated with that operation. The console will contain subprograms to test and check out the propellants' transfer system during prelaunch activities and other subprograms to operate the system during tanking or detanking. If the operator's commands are out of proper sequence, the computer will immediately tell him so.

Why wasn't Apollo computerized?

"Computers were too slow then," says Frank Griffin, technical assistant to the associate director of the Launch Processing Develop-

ment Center at the Kennedy Space Flight Center, Cape Canaveral, FL, where the system was conceived.

"There wasn't the sophisticated software we have now, and the older machines simply couldn't handle multiple tasks," Griffin says.

The shuttle is being designed for crews to fly satellites into low earth orbit, leave the satellites there and return to earth again. The shuttle will eventually take robot tugs into low earth orbit and release them to go on, on their own, up to satellites in higher, synchronous orbit (22,000 miles) and bring them back.

The Launch Process Control Room will contain 15 consoles, each of which will command and monitor test and checkout functions for a particular operation.

Overseeing the minicomputers that will run the consoles will be a large-scale data-processing machine as large as the IBM 360—in which all the programs will be stored. If it's desired to change a mini's program, the big machine will do it. A second identical machine, with shared, direct-access storage capability, will be on hand as a backup and for noncritical functions.

One big difference in the system being developed for the shuttle and the old Apollo complex is the use of a data bus. Two wideband cables will carry one complete data bus, which will take care of up to eight systems.

"This means two wires will replace 640 wires," Griffin says.

The contract awards for the system, which will be made by the Kennedy Space Flight Center, will probably be divided into three major categories: one contract for approximately 60 minicomputers, one for the two big computers and a third for the rest of the system. All requests for proposals to bid will go out this year. ■■

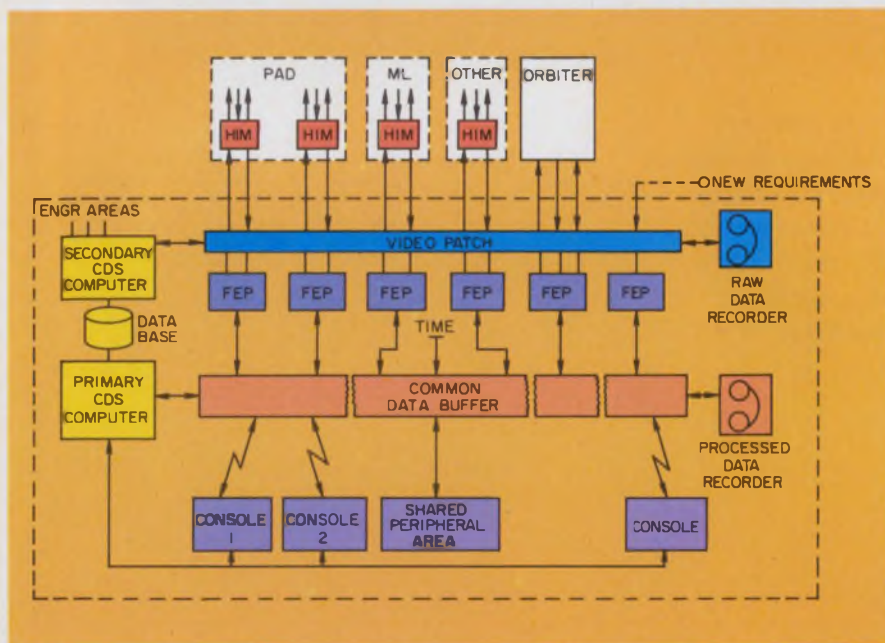

Each computer-driven console will command and monitor a particular operation to get the space shuttle ready for launching. Status readings will go to the launch control center via hardware interface modules (HIM), which will pass them on to front-end processors (FEP) or minicomputers. The minicomputers, or FEPs, will produce a compact measurement list that will be sent on to the common data buffer. The buffer will send the information to the console and to two large central data subsystems (CDS).

**Gates  
introduces  
the  
energy  
future.**

# Comparing Gates' the other two There's no

Gates Energy Cells give you everything you want in a rechargeable battery and less. Less, because these sealed lead-acid batteries present fewer design problems

Gates Energy Cells are not position-sensitive. They can be operated, charged or stored in any position.

Gates Energy Cells provide over 200 deep discharge cycles—gelled batteries typically provide only about 50 to 200.

Gates rechargeable batteries are sealed and safety-vented, eliminating the acid vapor outgassing problem of gelled batteries.

Gates Energy Cells can be floated or cycled or both. One cell does it all.

Gelled type cells can have a self-discharge rate as high as 12% per month. Gates Energy Cells offer a very low rate of about 5% per month.

Gates Energy Cells offer you great flexibility. Individual cell availability allows great configuration flexibility. You're not confined to the rigid configurations of gelled type cells.

The electrolyte in Gates batteries is not gelled.



# Energy Cells with kinds is easy. comparison.

and fewer operating problems. Yet, they give you all the power, the durability and dependability you could ever need at a cost that makes solid sense.

In the Gates Energy Cell, there is virtually no risk of thermal runaway. Normal overcharge creates no hazards as it can in nickel-cadmium cells.

Gates Energy Cells cost less. Lead and acid are cheaper than nickel and cadmium. Just as important, lead and acid are readily available.

Gates Energy Cells can be used in series or parallel with no cell reversal problems . . . even if they are completely discharged. Nickel-cadmium can't provide this advantage.

Nickel-cadmium batteries often take on a "memory" if floated. Gates Energy Cells will never give you this kind of effect.

The self-discharge rate of Gates batteries is so low they can be confidently stored for approximately two years . . . this versus the 20% to 30% per month rate of most nickel-cadmium cells.



# Now there's another alternative - a new third-generation energy cell designed to power anything - especially your imagination.

This new energy source is the Gates rechargeable, sealed lead-acid battery. And what it can do for your work from concept, to design, to pricing is nothing short of amazing.

Consider size. Gates Energy Cells are every bit as compact as nickel-cadmium or gelled type cells. They're completely sealed, too, so there is no acid or acid vapor leakage.

Gates Energy Cells provide low internal impedance for high discharge rates — up to 100 amps from our D cell and 200 from our X cell for short periods of time. And they can be operated, charged or stored in any position. That's right. Any position.

Packaging flexibility? Gates Energy Cells give you all the flexibility you could imagine. In fact, our individual cell availability allows you to



choose your own voltage and current, as well as package configuration.

But the important thing about Gates Energy Cells isn't just what they have to offer.

It's what they don't offer. Like outgassing. Or cell reversal. Or "memory" problems. Ever.

Because these energy cells are made from low-cost materials that are readily available, they're very high in watt-hour per dollar value. Which means that if you specify them, chances are you'll save your company more than a few dollars. And make yourself into something of a hero in the bargain.

Discover for yourself what a number of America's leading manufacturers have already discovered. Get more information on the energy future. Fill out and mail our coupon today.



## Yes!

I want to see the energy future. Please send me your *FREE* brochure containing battery features, application information, ratings and specifications.

Name \_\_\_\_\_

Title \_\_\_\_\_

Company \_\_\_\_\_

Address \_\_\_\_\_

City/State/Zip \_\_\_\_\_

Mail coupon to: George Sahl, Gates Energy Products, Inc.  
1050 S. Broadway, Denver, CO 80217

ED-25

**Energy Cells**  
EXCLUSIVE FEATURES  
APPLICATION INFORMATION  
RATINGS & SPECIFICATIONS

# Roll-your-own electronics can cut costs of high-quality equipment

Want to buy a \$20,000 minicomputer system for \$5000? Or a \$750 dual-trace scope for \$550?

How about a \$250 power supply for \$90?

These are only hints of the savings available when you purchase electronic equipment in kit form. And today, when money is tight, many companies are buying kits.

Kits provide an inexpensive way to test-market products and to help build the markets for assembly-line units.

## Quality computer performance

One of the most impressive kits to appear in a long time is the minicomputer from MITS Inc., Albuquerque, NM. Known as the Altair 8800, the mini kit, when put together, becomes a full-blown, high-quality computer that rivals commercially available units in performance.

The heart of the Altair 8800, Intel's 8080 NMOS microprocessor, is the reason why this minicomputer is equal to, and in many cases superior to, commonly used minis today. According to Ed Roberts, president of MITS, the Altair is a parallel, 8-bit-data-word, 16-bit-address computer with a cycle time of 2  $\mu$ s.

The performance characteristics of the mini are basically those of the 8080. It has a 78-instruction repertoire, including some instructions for double precision. This, says Roberts, is almost twice the number of instructions found in comparable processors. While the basic cycle time of the Altair is slightly slower than that of some competitive computers, the Altair



The Altair 8800 computer kit uses Intel's 8080 processor and is said to offer performance equal to that of computers costing six times more.



This solid-state camera kit uses a 32-by-32 array of MOS photodiodes to produce a low-resolution picture.



The IO-4510 dual-trace scope kit from Heath features a 15-MHz bandwidth and an input sensitivity of 1 mV/cm.

may still outperform them.

Explaining how, Roberts notes that if a particular problem requires decimal arithmetic and much I/O capability, the Altair has the advantage. The 8080 contains a decimal converter that makes it easy to perform arithmetic on BCD numbers.

In addition, Roberts goes on, the 8080 has a very powerful I/O structure. It can connect to 256 input and 256 output devices. Most small computers available today can directly address 64 or fewer input/output channels.

Roberts admits, however, that the Altair may not look as good if it has to solve a CPU-related problem that requires considerable speed. In such cases, he says, a mini with a faster cycle time would look better.

"It's difficult to compare performance, because there isn't any software system—like Fortran—that's sophisticated enough to do benchmarks with," Roberts notes.

Another indication of mini per-

Jules H. Gilder  
Associate Editor

formance is the amount of memory it can directly address. The Altair, he says, can directly address 65,000 8-bit words. By contrast, most other minis directly address only about 500 words of data. For larger memories, it is usually necessary to address them indirectly through a base page.

### Instant market survey

The Altair computer made its debut in a construction project featured on the cover of the January issue of *Popular Electronics*. Roberts notes that when the company offers a kit and features it in an article in a hobby magazine, it gets an instant market survey.

"Within two weeks after the project appeared, we had already sold 115 units," he says. An unusually high number of these orders were placed by industrial customers, many of whom are interested in buying between 10 and 20 machines. A few industrial buyers are even considering buying between 50 and 100.

In explaining why there is so much interest in this mini kit, Roberts notes that the cost of the kit is less than that of the components by themselves. MITS buys the components in large quantities at a saving.

Roger Melen, a researcher at Stanford University and one of the first customers for the Altair mini, says: "If I go to buy the Intel 8080 in unit quantities, it's going to cost \$350. For \$45 more, I can go to MITS and purchase a complete kit that includes the power supply, case and associated circuitry. I get a proven, tested design."

Melen notes that if he adds up just the cost of the critical ICs, he's far beyond the cost of a MITS kit.

### Cyclops: The solid-state camera

Another kit that has just become available and is already finding use in industrial applications is a solid-state camera. It is called Cyclops and uses a  $32 \times 32$  element MOS photodiode array. The kit is being produced by Roger Melen and several other Stanford University researchers who have formed a company known as Cromenco, based in



Slightly lower performance is offered by the Heath IP-27 power supply when compared with commercial units. But it costs \$90, while others cost \$250.

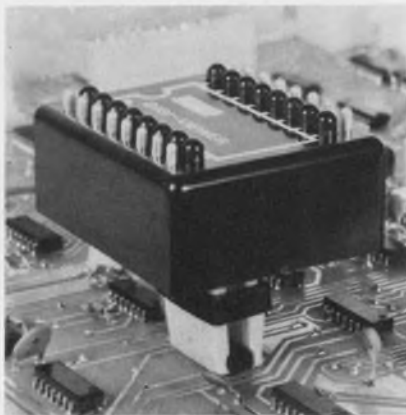

Static and dynamic operation of ICs can be checked with this \$20 in-circuit IC tester from Southwest Technical.

Palo Alto, CA.

The most startling thing about the camera kit is its price—\$90. A  $32 \times 32$ -element-array camera from Reticon, a leader in photodiode array cameras, costs \$2250.

When asked to explain the tremendous difference in price, Melen cited several factors that help keep the cost low. First, he admits, the Cyclops is a lower-performance camera than the Reticon.

"Reticon's image sensors have no defects on them; ours have a few," Melen continues, adding: "The defects don't affect operation of the camera for the majority of the applications."

If you have an application that requires a lot of sensitivity or many levels of gray—between 64 and 128—the defects will cause problems, Melen says.

Most industrial applications, however, require only a low-resolution, inexpensive image sensor, he contends, and the Cyclops is designed to fill that need.

Another factor that makes the Cyclops cheaper than a Reticon is that much of the processing circuit is on the imaging chip. The output

of the chip consists of a series of digital ONE or ZERO signals, while the Reticon device has a video output that uses extra circuitry to convert the signals to digital form.

In addition Cromenco offers very little customer support. The kit is provided so that a customer can build the camera and see that it works. If he wants to modify it, he has a working base to start from, Melen says.

Another kit offered by Cromenco is called the Altair Cyclops. This is a \$155 camera designed to operate with the MITS minicomputer for motion-detection and servo-feedback applications.

Melen calls the kit approach valuable both from the user and manufacturer's point of view. As a user who has purchased several Altair computer kits, he notes that a kit is a learning experience. It shows how a set of components designed to work together can be reduced to circuit boards.

As a manufacturer, he notes that it is a way of getting sophisticated devices into the hands of many people at minimal cost. Citing an example, Melen says that a customer in the glass industry bought one of the camera kits because he was interested in monitoring a glass-pulling operation to see if the glass broke. That one kit has now generated interest by that customer for 300 wired units.

### Save \$200 on a scope

If you want to add equipment to your inventory and you happen to have a few technicians who periodically run out of work, the new IO-4510 dual-trace oscilloscope may be for you. It can be assembled by a technician in about 20 hours and can save you \$200 over comparable instruments.

Of course, if you're going to have to hire a technician just to put it together, it probably won't pay. The IO-4510 is competitive with the 1220A from Hewlett-Packard, and if you buy it wired from Heath, it will cost you about the same as the 1220A—\$750. But in kit form it's only \$550.

According to Charles Gilmore, manager of Heath's instrument group, a lot of companies are



# ASSISTANCE:

Your fellow engineers at KEMET firmly believe that complex decisions and computations don't have to be difficult, too.

That's why we devised this new wheel-type calculator that can simplify sampling and reliability determination for all types of electronic components.

One side is a Sampling Procedures Calculator that conforms to MIL-STD-105D. It's invaluable for receiving inspections and QC product analyses. Component and design engineers can also use it to prepare and analyze their specifications.

The reverse side is a Reliability Calculator — which is useful to designers, specifiers and inspectors of components.

And the best news is that this Sampling/Reliability Calculator is free. Ask your KEMET Capacitors representative for one—or send us the coupon below.

Components Department, Union Carbide Corporation, P.O. Box 5928, Greenville, SC 29606; phone: (803) 963-6300, TWX: 810-287-2536, or Telex: 57-0496.



**COMPONENTS DEPARTMENT**



## KEMET OFFERS YOU MORE.



I need assistance. Send me your free KEMET Sampling/Reliability Calculator pronto.

Name \_\_\_\_\_  
Title \_\_\_\_\_  
Firm \_\_\_\_\_  
Street \_\_\_\_\_  
City \_\_\_\_\_  
State \_\_\_\_\_ Zip \_\_\_\_\_

# Grayhill quality in 1/4 amp lighted switches



- **Self-cleaning wiping contacts for logic circuits**

- Momentary and alternate actions—SPST, SPDT, and DPDT circuitry—operates in any position or attitude.

- Shown actual size—decorator-designed for compact panels—wide color choice—matching unlighted switches and indicator lights.

- Choice of mountings— front panel bezel, sub-panel or bushing.

Not all lighted push-button switches are created equal! Grayhill's low-level lighted switches are designed for applications where *switch* quality is what really counts. They out-perform butt contact or snap action switches... yet offer the style and appearance options you need, competitively priced. Write for complete technical data on these switches, and consult EEM for data on other Grayhill switches.



561 Hillgrove Avenue • LaGrange, Illinois 60525  
(312) 354-1040

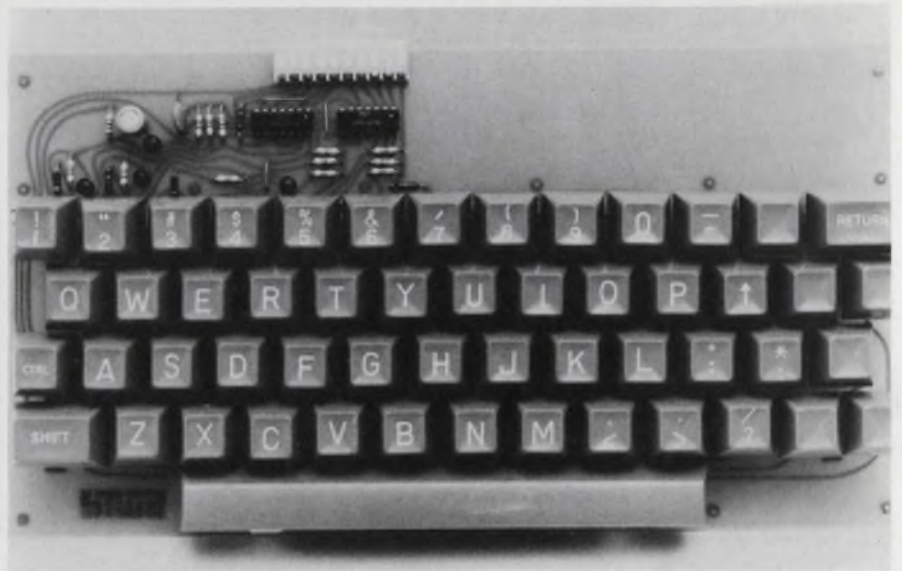

Computer keyboards are also available in kit form. This 53-character unit from Southwest Technical includes an internal ASCII encoder.

switching to kit instruments. There is interest not only in the scope kits, he says, but in power supplies and ac VTVMs as well. In fact, about 50% of some of the Heath power-supply kits being sold go to industrial customers.

Gilmore notes that the Heath IT 27 power supply costs \$90. The nearest competition for this 50-V, 1.5-A supply comes from wired units that cost between \$200 and \$250. But, as with the solid-state camera, the performance of the kit unit is slightly lower. However, not all applications require super regulation or super temperature stability, Gilmore notes.

"Many times a little bit less regulation and a little less stringent requirements on the nitty-gritty specs are completely acceptable," he says. "And we're doing a whopping business because of that."

### It's not all good

Not all kit manufacturers agree that kits are the way to go for industrial applications. One kit manufacturer—Dan Meyer, president of Southwest Technical Products Co., San Antonio, TX—contends that it just doesn't pay an electronics company to buy a kit. He points out that he has advertised ASCII keyboard kits in the trade press and has received very poor results, even though the unit costs only \$40 in kit form.

A lot of companies outside of

the electronics industry have, however, purchased kits. Meyer reports. He attributes this to the need to acquire instruments in the cheapest way possible.

### More to come

Plenty of kit developments are waiting in the wings. MITS has kits of peripherals for the Altair 8800. One is a disc-operating system for the computer. The controller for the disc will cost about \$400, while the disc drive itself will be about \$700.

Two other peripherals, both terminals for the Altair 8800, have left the drawing board at MITS. One is a CRT unit that will display 16 lines of information with 64 characters on each line. The terminal's memory will be able to hold four of these 16-line pages. The cost of the kit will be \$600. This includes a built-in acoustic coupler, RS 232 modem interface and a Motorola or Miratel monitor.

A gas-discharge display terminal that uses a single 32-character Burroughs display has also been designed by MITS. Like the CRT unit, it has a built-in modem and acoustic coupler.

By building all of these units, the designer can put together a system that will consist of a processor, terminal and several disc drives for about \$3000, MITS reports. That's comparable to a system that now costs between \$15,000 and \$20,000. ■■

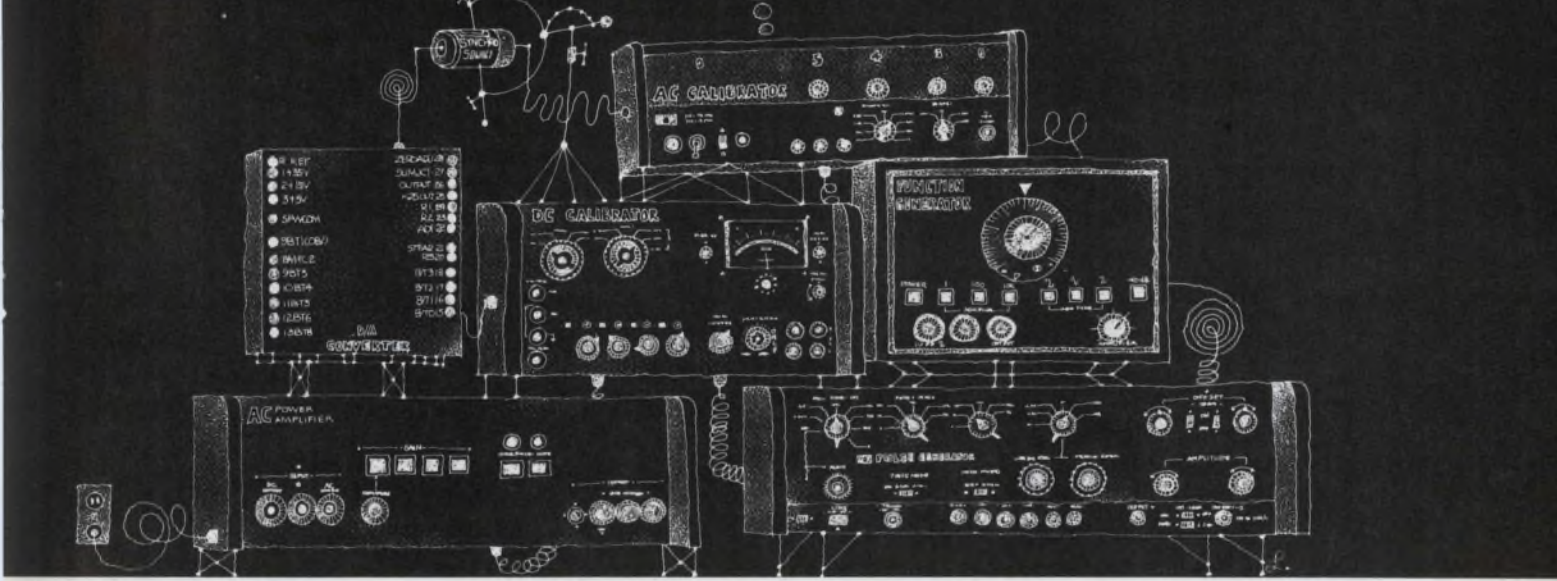

## Problem: design a programmable stimulus that's seven signal sources in one

**We did it. Our power-DAC is a whole test lab in one box.**

If you're concerned with automatic testing, the Fluke power-DAC is everything you need.

It's a fast bipolar D-to-A converter with plenty of output power for any application up to 110 volts at 0.5 amp.

Using the external reference option, you can program it as an AC/DC calibrator to test DVM's or as an AC/DC stimulus and load for printed circuit board testing.

Use it as a power amplifier in conjunction with an external reference for acoustic power testing.

Program it as a pulse or function generator for shake tests.

Use it as a source to confirm that synchros track over specified voltage limits.

Response is not only fast, but clean. Settling time is 30 to 110  $\mu$ s depending on model. Programming

noise is only 50 mV and 100 mV peak on low and high ranges respectively. It has a 100 KHz usable frequency range. Basic output accuracy is 0.01% with 30 ppm stability over a temperature span of 15-35°C for 90 days.

All units have current limit (and current sink too) so they can be operated in parallel or series—just like batteries. Or, choose programmable current limit option, available for some units.

Fully guarded, isolated control logic is standard and can be programmed with a single 24-bit word or optionally with a 16-bit/8-bit word multiplexed on a common data bus.

Your choice of programming. BCD with 4 decades standard and 5 optional. Or binary with 14 or 16-bit programming.

Resolution is 1 mV standard. 100  $\mu$ V optional.

Six different models start at just \$1445.

Brief specs	4210A/4216A	4250A/4265A	4270A/4275A
V <sub>o</sub> low range	16V	16V	16V 32V
V <sub>o</sub> high range	—	65V	110V 110V
I <sub>o</sub>	100 mA	1A	0.5A
Resolution	1mV 1mV 100 $\mu$ V*	1mV 1mV 100 $\mu$ V*	1mV 0.5mV 100 $\mu$ V*
Programming	BCD binary	BCD binary	BCD binary
Settling time	30 $\mu$ s	100 $\mu$ s	110 $\mu$ s
Programming noise (PK)	—	100mV**	100mV**
Price (basic)	\$1445	\$1795	\$1895
*optional			**high range



For data out today dial our toll free hotline 800-426-0361

John Fluke Mfg. Co., P.O. Box 7428, Seattle, WA 98133  
For a demo circle 201 . For literature only, circle 14

For information on the rest of the Fluke line see our ad in EEM or the Gold Book.



# there **is** a difference in monolithic ceramic capacitors!

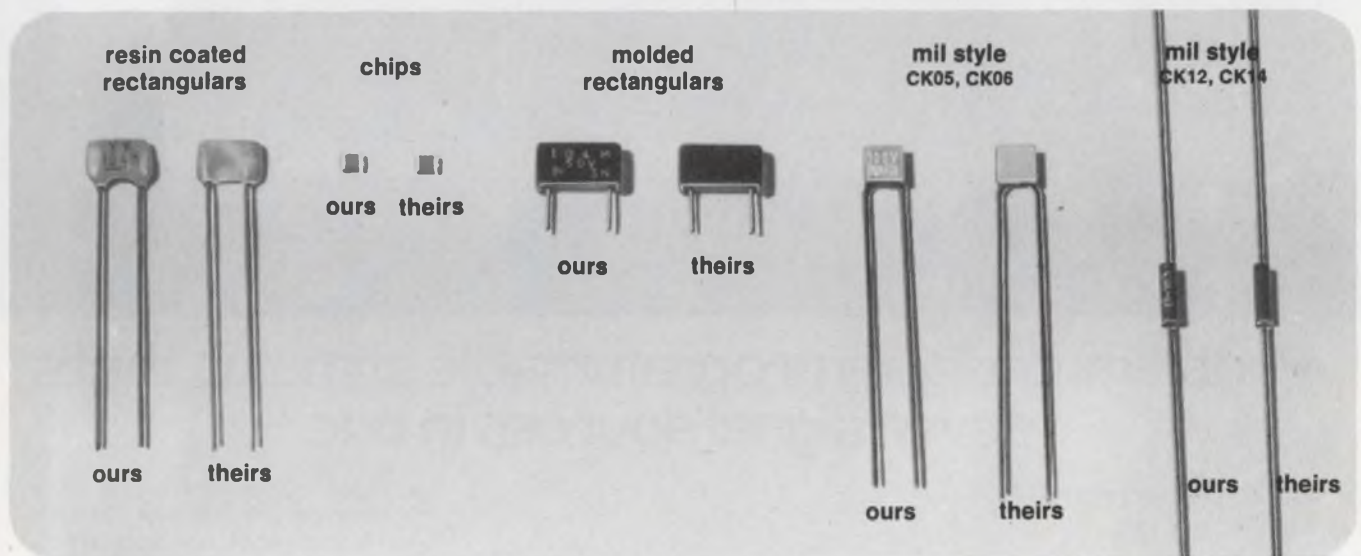

But, you'll never find it in a photo! The difference that counts is inside . . . performance and reliability backed by over thirty years of experience in the design and manufacture of ceramic capacitors and materials. This is the difference that makes Murata monolithics different. What's more there's a capacitor in our line for virtually every application requirement . . . our deliveries are on time . . . *and* our prices are competitive. Write or call our brand new Georgia capacitor facility and we'll be happy to send you everything you need to know about Murata monolithics.



Rockmart, Georgia 30153 • Phone: 404-684-7143 Telex: 54-2999

INFORMATION RETRIEVAL NUMBER 15

# Nylon. Everything you want for electrical applications.

Connectors, switches, terminal blocks—just about everything electrical or electronic—gets a head start on performance and economics when you mold in Celanese Nylon.

For good reasons. Like the fact that Celanese Nylon has U/L rating on electrical properties of 105°C. Great me-

chanical strength and toughness. Plus high dielectric properties, so you can design more compact units with thinner walls. Good thermal properties. And fine processability.

There are many formulations of Celanese Nylon, including fast-cycling, high-flow grades, super mold re-

lease grades, glass-reinforced and heat-stabilized. We'll be glad to help select the best one for your electrical or electronic application.

Write for a copy of our brochure on Celanese Nylon. And a U/L Yellow Card. Celanese Plastics Company, Dept. N-507, 550 Broad Street, Newark, N.J. 07102.

Celanese Plastics Company is a division of Celanese Corporation. Canadian Affiliate: Celanese Canada Ltd. Export: Amcel Co., Inc., and Pan Amcel Co., Inc., 522 Fifth Ave., New York 10036



**A TOUGH TEAM FOR TOUGH TIMES: CELCON, CELANEX, CELANESE NYLON.**

acetaldehyde-free thermoplastic polyesters



**CELANESE  
ENGINEERING  
RESINS**

INFORMATION RETRIEVAL NUMBER 16



**Modular versatility.  
Zero entry force.  
And low cost.**

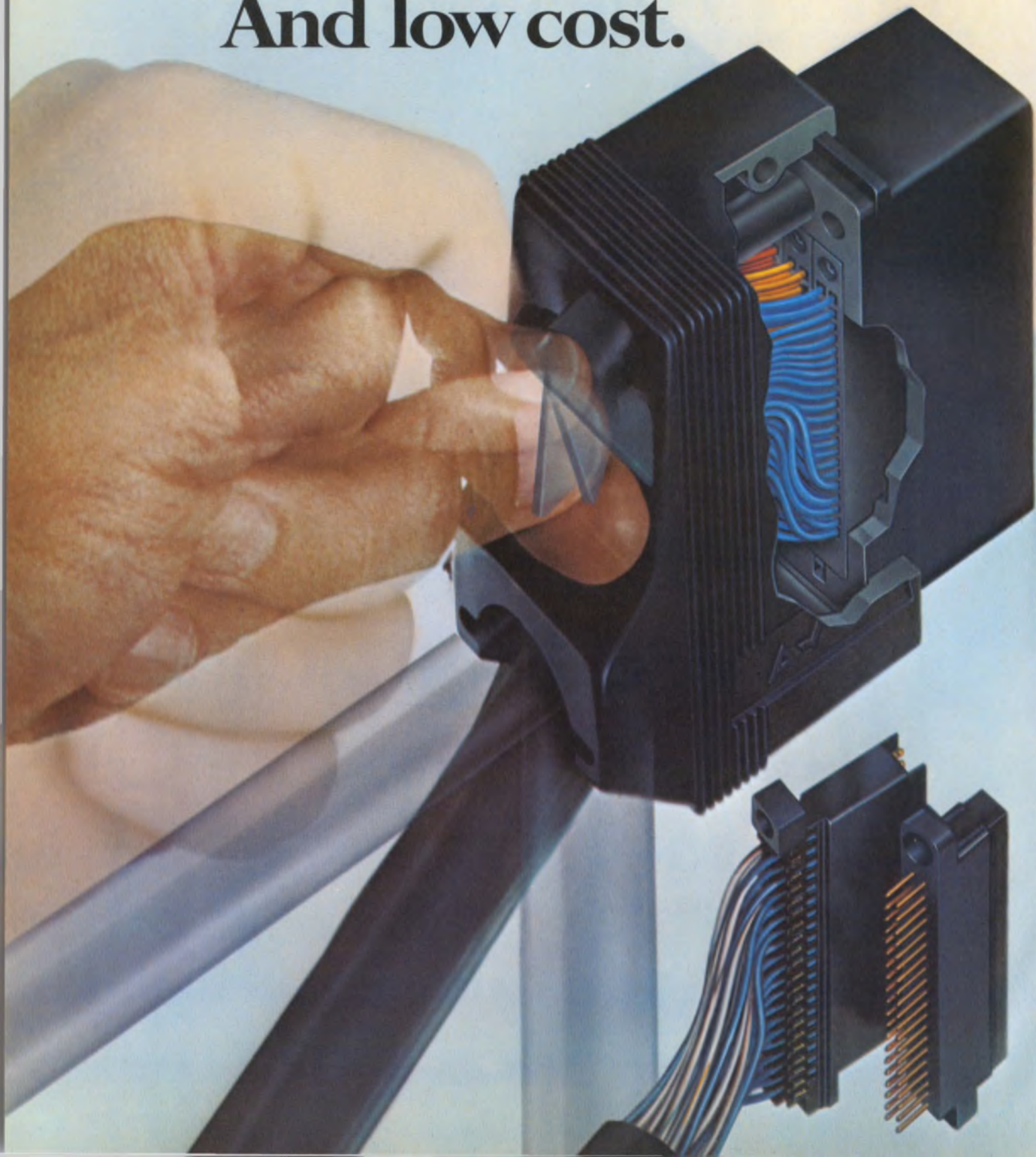

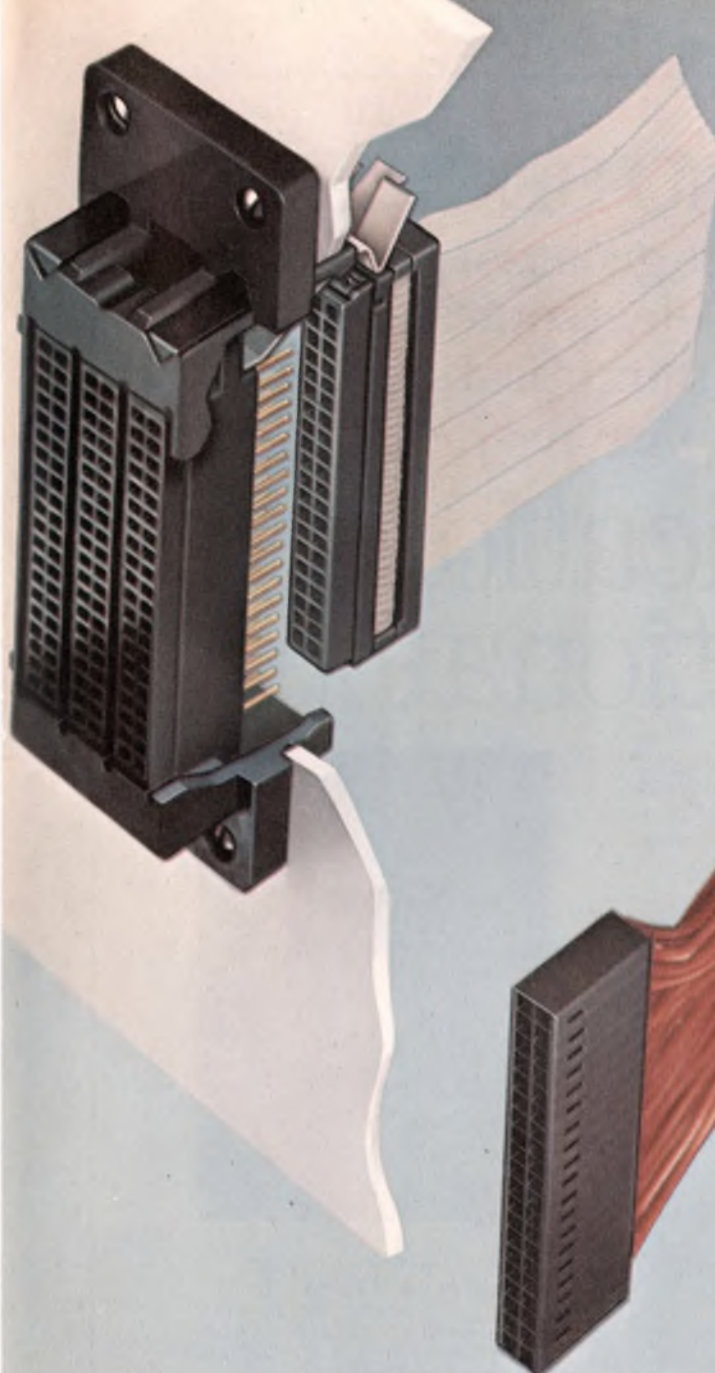

## New AMP CR Series I/O terminator

Just turn the cam 90° clockwise, and 120 or 156 contacts come together instantly. Connections are self-made with wipe and back-wipe actions.

With zero entry force. When the CR is closed there are over 150 grams of force on each contact. Yet there is virtually no contact wear for well over 5,000 cycles.

The new AMP CR Series connectors are designed for cable-to-cable, cable-to-board, and cable-to-panel applications. The Versatile CR is built of modules of your choice to accept connectors for ribbon cable, discrete wires and flat flexible cable. Additional economy is realized in the all-plastic construction which includes cable clamps and jack-screws, requiring no retaining hardware.

For easy, fast, zero-entry-force mating of large numbers of contacts, the new AMP CR Series is unequaled. For more information call (717) 564-0100, circle the Reader Service Number, or write AMP Incorporated, Harrisburg, PA 17105.

AMP is a trademark of AMP Incorporated.

Versatile AMP CR uses connector modules for ribbon cable, discrete wires, flat flexible cable. Connections include wrap types, and the recently introduced mass termination technique—displacement.

# AMP

INCORPORATED

INFORMATION RETRIEVAL NUMBER 17

# IT'S REALLY NO SECRET-

But did you know that the greatest growth in the world's professional electronics industry is in the sector of communications?

We did, and that is why we have produced-

# communications international

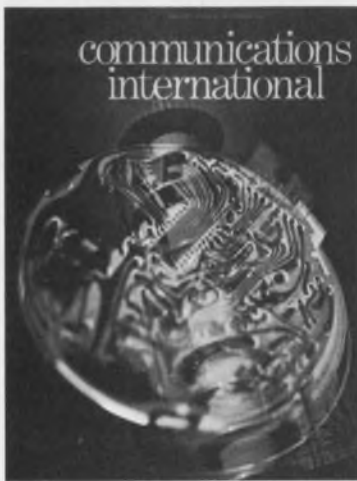

the new monthly journal for the world's manufacturers, designers & users of systems, equipment & components in the field of communications.



**Circulation:** Communications International has a circulation of 5,000 copies in the UK, 9,000 copies on the mainland of Europe and 4,000 copies are sent to countries throughout the rest of the world.

**Advertising:** The Publication offers highly competitive advertisement rates ranging from £340 for a whole page black and white to £94 for a quarter page in black and white. Series discounts are available and colour is charged extra. Communications International is published from the UK but its readership is global and its editorial coverage is carefully

selected from material provided by a worldwide network of foreign correspondents and articles from eminent international technologists. Communications International concerns itself with four broad editorial areas of communication and these are line and data, mobile radio, fixed radio and defence. Within these

areas it provides up-to-the-minute news of the world industry, its business aspects and in depth technical information aimed at aiding engineers to solve specific problems. Communications International also presents regular international features on the most technically efficient and economic options available to managers and purchasers of communications equipment and it includes a meticulously screened and researched section which every month is devoted to new products appropriate to the communications industry.

Mail this form today to: The Publisher, COMMUNICATIONS INTERNATIONAL  
49-50 Hatton Garden London EC1N 8XS ENGLAND. Telephone: 01-278 6571

Please send:

- Advertisement Rates & Data  
 Subscription Details

Name \_\_\_\_\_

Status \_\_\_\_\_

Company/Address \_\_\_\_\_

Country \_\_\_\_\_ ED



# MEXICO PLANT OPEN

## FERRITE MAGNET

Ferrite magnet delivery times slashed  
by opening TDK MEXICO PLANT



TDK introduces a line of powerful, compact ferrite magnets which are available in various multi-pole configurations. The simplified molding process also allows a variety of shapes to be produced at low cost.

Optimum composition, together with optimum shape have been realized to provide perfect matching

in situations requiring strong magnetic fields. These TDK ferrite magnets are ideal for a broad range of applications, starting with motors and speakers, and extending into large size machine tools and compact electronic watches.

Now TDK adds vastly reduced delivery time to these merits. The

renowned TDK production line was transported en masse to Mexico. Smooth product supply is assured from the specialized plant that's as close as your next door neighbor.

For ferrite magnet requirements, check TDK first.



TDK CORPORATION OF AMERICA 931 South Douglas Str., El Segundo, Ca. 90245 Phone: (213) 644-8625 CHICAGO BRANCH 2906 West Peterson Av., Chicago, Ill. 60659 Phone: (312) 973-1222  
NEW YORK BRANCH 755 Eastgate Blvd., Garden City, N.Y. 11530 Phone: (516) 746-0880 EL PASO BRANCH Room 6, 8201 Montana Place, El Paso, TX 79925  
TDK ELECTRONICS CO., LTD. 14-6, 2-chome, Uchikanda, Chiyoda-ku, Tokyo 101, Japan

INFORMATION RETRIEVAL NUMBER 19

# Introducing the expensive curve tracer that doesn't cost a lot.

The B&K Model 501A.

It hooks up to any scope, old or new. (Like our Model 1460 triggered-sweep scope.)

And it analyzes all semi-conductors including J-FET's, MOS-FET's, signal and power bipolar transistors, SCR's, UJT's and diodes. Fast and easy.

Constant current and voltage steps with 3% accuracy make the Model 501A an exceptional value. In fact, it performs like \$2,000 units. Yet you can afford one on each engineer's bench. And another for incoming quality control.

Call your B&K distributor. Or write Dynascan Corporation.

In stock at your parts distributor.



**\$163<sup>00</sup>**



Product of Dynascan Corporation  
1801 West Belle Plaine Avenue, Chicago, Illinois 60613

INFORMATION RETRIEVAL NUMBER 85

You'd probably expect a portable oscilloscope as rugged and reliable as this one to cost a lot.

You'd be wrong.

Introducing the B&K Model 1403 3" Solid-state oscilloscope. It's so compact, reliable, and inexpensive that it's the perfect scope for most on-the-line monitoring applications. Look at its specs: DC to 2MHz bandwidth at 20mV/cm. Recurrent sweep speeds from 10Hz to 100k Hz. New wide-angle CRT to reduce case depth to a minimum. Direct-deflection terminals for waveforms up to 150 MHz. Weighs only 8½ pounds. And has a smoked acrylic graticule for trace sharpness and easy reading. All the reliability and accuracy you need in a monitor scope — at a surprisingly low price.

Contact your distributor, or write Dynascan Corporation.

**\$189<sup>00</sup>**



Very good equipment at a very good price.

Dynascan Corporation  
1801 West Belle Plaine Avenue, Chicago, Illinois 60613

INFORMATION RETRIEVAL NUMBER 86

## VERO ... A COMPLETE ELECTRONIC PACKAGING CAPABILITY

# Frames and Module Racks

A total and versatile packaging capability for every application from a connector to a case ... and everything in between!

- Standard EIA Rack Mounting, 5.25", 7", 8.75" panel heights
- 10" and 13" deep end plates
- 1", 2", 3", 4", 5", 6", and 8" wide modules
- All modules can be fully screened
- Verolock® system retains all modules with one push/pull action
- Extremely rigid construction
- FREE design service to your specifications
- Off-the shelf delivery

We make your job easier...

Call or write today for more information:

**Vero Electronics, Inc.**

171 Bridge Road, Hauppauge, N.Y. 11787

Tel.: 516-234-0400 TWX: 510-227-8890

In Canada Call: EPS, 613-389-1025

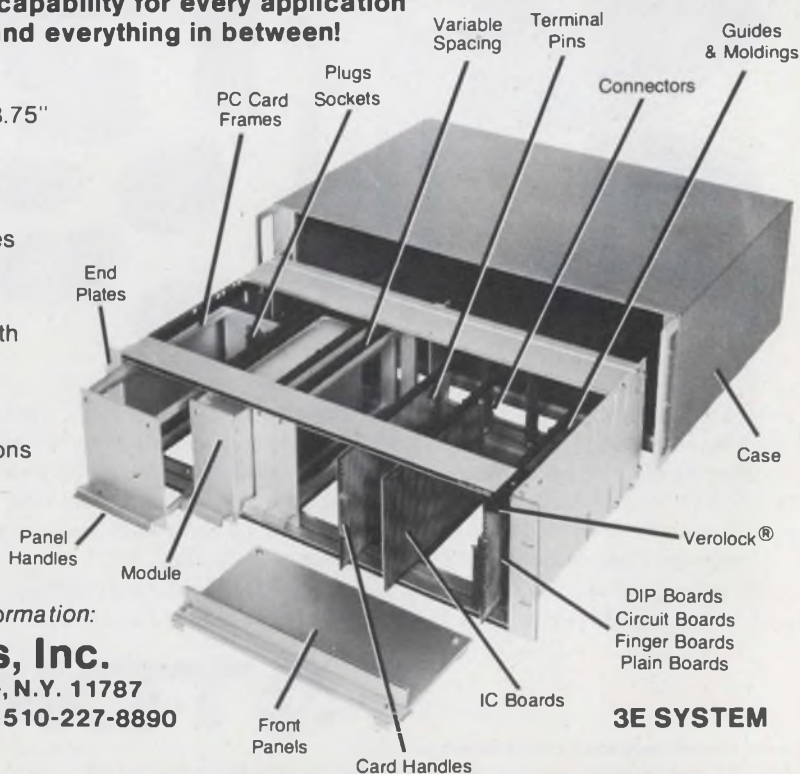

**3E SYSTEM**

**vero**

INFORMATION RETRIEVAL NUMBER 87

**SPECIAL OFFER  
TO ELECTRONIC DESIGN  
SUBSCRIBERS**

# Now \$49.95

## The scientific calculator that has just solved your biggest problem--price

The Sinclair Scientific was originally introduced at \$119.95 and was recently advertised at \$99.95. Now under a special arrangement, the same calculator is available in limited quantities to ELECTRONIC DESIGN subscribers at \$49.95. This is half the cost of most other scientific calculators. Additionally, each purchase of a \$49.95 calculator brings you a \$5 bonus certificate good toward the purchase of any other Sinclair calculator.

The Sinclair performs logarithmic and trigonometric functions, as well as displaying scientific notation on all calculations. What's more, the Sinclair Scientific isn't just portable. It's pocketable. Less than 3/4 inch thin. And 3 3/4 ounces light. It's the world's thinnest, lightest scientific calculator. Just look at some of its essential functions, and you may never use your slide rule or log tables again:

- |                            |                                          |
|----------------------------|------------------------------------------|
| log and anti-log (base 10) | automatic doubling                       |
| sin and arcsin             | $x^y$ , including square and other roots |
| cos and arccos             | plus the four basic arithmetic functions |
| tan and arctan             |                                          |
| automatic squaring         |                                          |

### What makes a scientific calculator scientific?

There are many calculators that call themselves "scientific." But most, frankly, don't measure up. To be a really valuable tool for engineers, scientists, technicians and students, a calculator must provide all of the following: Log functions. And trig functions. And scientific notation ( $10^{-99}$  to  $10^{99}$ ).

### Specifications

- |                                                                                                                       |                                                                                                                    |
|-----------------------------------------------------------------------------------------------------------------------|--------------------------------------------------------------------------------------------------------------------|
| <b>Functions:</b><br>4 arithmetic<br>2 logarithmic<br>6 trigonometric                                                 | <b>Logic:</b><br>Reverse Polish, with post-fixed operators for full flow chain calculations                        |
| <b>Keyboard:</b><br>19 key format with 4 "triple-action" function keys using standard, upper and lower case operation | <b>Power Source:</b><br>Battery operated with 4 inexpensive AAA penlight batteries, providing over 25 hours of use |
| <b>Display:</b><br>5-digit mantissa<br>2-digit exponent (both signifiable)                                            | <b>Size:</b><br>4 1/2" high<br>2" wide, 1 1/8" thick                                                               |
| <b>Exponent:</b><br>300-decade range, from $10^{-99}$ to $10^{99}$                                                    | <b>Weight:</b><br>3 3/4 oz.                                                                                        |
|                                                                                                                       | <b>Warranty:</b><br>1 year                                                                                         |

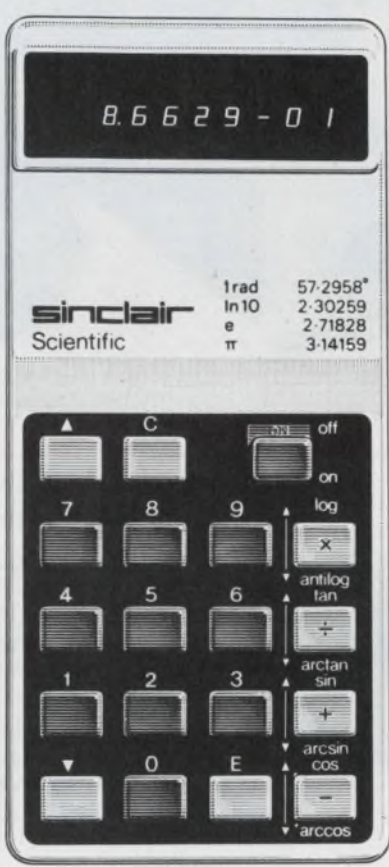

actual size

Clearly, a scientific calculator without scientific notation severely limits the size of numbers with which you can work easily. And scientific notation without transcendental functions is little more than window dressing on an arithmetic calculator.

What it all adds up to is this: Only Sinclair provides truly scientific capability at a truly afforded price.

### What makes the Sinclair Scientific so inexpensive?

Two important technological breakthroughs. First, the British-built Sinclair Scientific has a single integrated circuit. Engineered by Sinclair. And exclusive to Sinclair. (Competitive units require more than one chip. Their chips are larger. And also more expensive.)

Second, Sinclair's exclusive keyboard has only four function keys, which provide "triple-action" by changing from standard to upper or lower case mode.

Extra keys mean extra cost. (Not to mention size and weight.) And fewer keys mean a simpler format to memorize—for increased speed and fewer entry errors.

### Old hands at small miracles.

Sinclair has been an innovator in calculator miniaturization right from the start. And it's now Europe's largest manufacturer of pocket calculators.

Naturally, Sinclair maintains a service-by-return mail operation in the U.S. (and everywhere else in the world) to handle any product problems, should they develop. And the Sinclair Scientific is backed by an unconditional one year replacement warranty.

### How to get your Sinclair Scientific.

To order your Sinclair Scientific today, just fill out the coupon below.

**sinclair™**  
**SCIENTIFIC**  
**The logical choice.**

**ORDER FORM**

To: Hayden Mall Order  
50 Essex St., Rochelle Park, N.J. 07662

Individual Orders must be accompanied by check or money order.

Please send me \_\_\_\_\_ Sinclair Scientific(s) at \$49.95 (plus \$3.50 per unit, shipping and handling) including batteries, carrying case, instruction booklet and warranty. (New Jersey residents add sales tax.)

Enclosed is my check or money order for \_\_\_\_\_

Signature \_\_\_\_\_

Name \_\_\_\_\_

Company \_\_\_\_\_

Address \_\_\_\_\_

City \_\_\_\_\_ State \_\_\_\_\_ Zip \_\_\_\_\_

Company Purchase Orders for 6 or more calculators are accepted for D&B rated accounts.

# the KEPCO **JMK**

is the best system power supply you can buy

It's not (hardly) a stripped-down 'OEM module' and we didn't really design it as just another lab-bench supply (though lots of people use them that way).

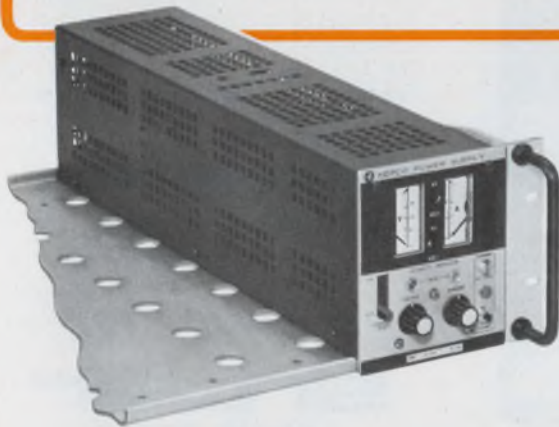
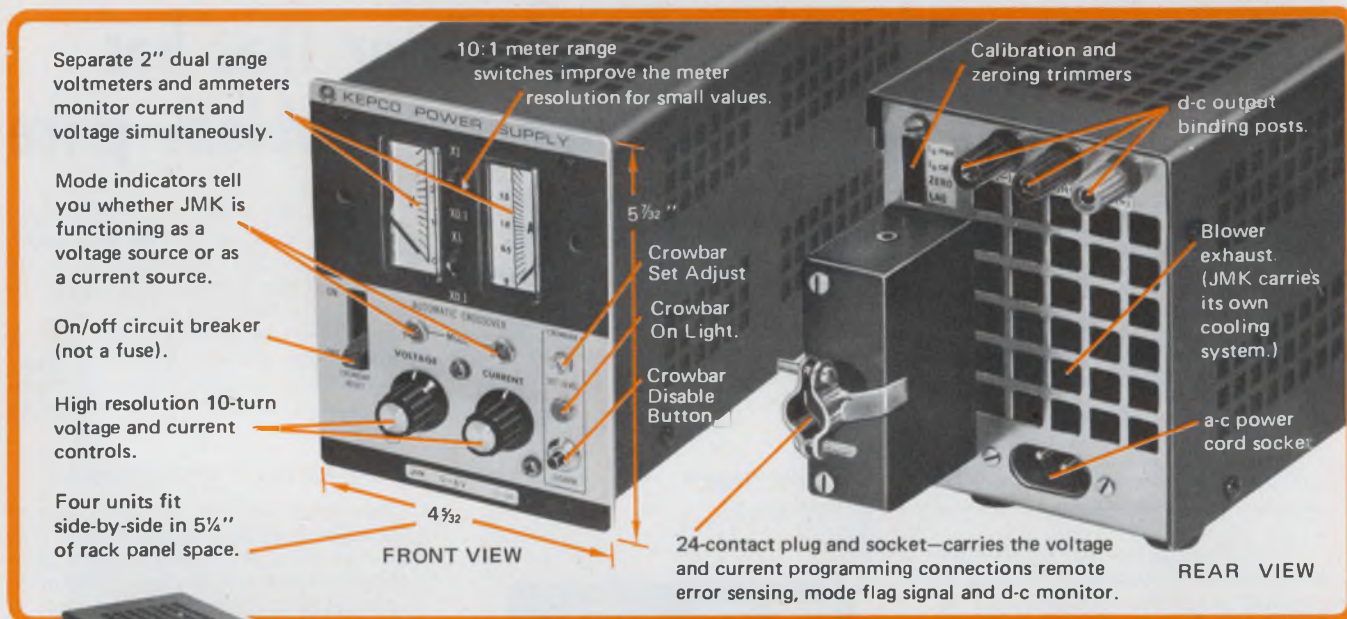

Kepeco designed JMK to answer the special needs of the system designer for practical rack-mount systems power supplies.

The shape of JMK, for example, minimizes precious panel space—four of them will fit in a 5 1/4" high drawer (Model RA-24) which has provision for slide mounting. The connections to JMK are all at the rear so they don't clutter your panel—moreover, they're all *plug-in*. That means you don't need to fool with a screwdriver and wire-list to mount or remove a JMK. Just plug it into its prewired cable connector.

Kepeco's JMK doesn't have hot radiator fins protruding in all directions—nor does it require elaborate derating for the elevated temperature of jammed systems racks. JMK has its own built-in blower system exhausting air (heated only about +15°) directly to its rear. You'll get *full output* from your JMK from -20°C to +71°C, no derating, no baking the equipment above.

JMK is fully programmable, you can control it with resistance, analog signals, or digital instruction with up to 12-bit resolution.\* JMK, as an automatic crossover power supply, can be controlled in either mode with a degree of precision and stability that is close to standards-lab performance (5 ppm source effect, 50 ppm load effect, 50 ppm temperature effect coefficient. . .).

Kepeco designed JMK for the systems man who needs a full-performance, programmable power supply to run his test program (on instructions from the computer) or a stable current source to energize sensitive circuits, or perhaps an ultra-stable voltage supply to which repeatable measurements can be referred.

Kepeco's catalog contains the full specifications for the 14 JMK models ranging from 0-6 volts at 5 and 10 amperes to 0-100 volts at 0.5 and 1 ampere. Write to Dept. EK-5 for your free copy.

\*Using a low-cost digital programming accessory.



**KEPCO**®

KEPCO, INC. • 131-38 SANFORD AVENUE • FLUSHING, N.Y. 11352 • (212) 461-7000 • TWX # 710-582-2631 • Cable: KEPCOPOWER NEWYORK

INFORMATION RETRIEVAL NUMBER 22

# washington report

## **The Democratic Congress: Changes, but not upheavals**

Observers of the Washington scene are still hedging their estimates of how the new, heavily Democratic Congress will go about the nation's business. Undoubtedly it will be more liberal in political perspective and, because it's younger in average age, less prone to rubber-stamp defense proposals. But past experience has shown that initial zeal and pledges of reform have a tendency to mellow after Congressional sessions get under way.

Yet changes are already here, as witnessed in the House Ways and Means Committee, where one-man rule is apparently over. Other entrenched committee chiefs are threatened, and seniority alone isn't going to assure them of their lofty spots. In the House Committee on Armed Services, Rep. F. Edward Hebert (D-LA) is expected to retain the chairmanship but not be as all-powerful as he was in the last Congress.

In sum, expect changes, but no convulsions. The liberals and Southern conservatives may not even get it all together to ensure a cohesive Democratic majority.

## **AEC declassifies laser-fusion research**

In hopes of developing usable fusion power more quickly, the Atomic Energy Commission has declassified additional aspects of its laser-fusion research. Now about 95% of the information in the field is available to the public.

The most recent declassification permits publication of theoretical and experimental studies of microscopic fuel pellets, which are filled with heavy hydrogen and used as targets in the laser-fusion process. This will allow studies of the design and performance of these targets and multiple-dimension calculations of them. The AEC, which becomes part of the new Energy Research and Development Administration, says the action was taken to allow free discussion of work in progress.

## **Environmental impact affecting electronic installations**

The Federal Government is proposing some tough rules to implement the National Environmental Policy Act of 1969 that will affect the design of electronic systems. One major change would be in the definition of what constitutes a "major" facility. Before such facilities can be built, the builder must submit a statement detailing its potential impact on the environment.

Originally the thinking was to use a dollar figure—\$100,000—as the threshold point for mandatory submission of the environmental-impact statements. But inflation and recognition of possible “visual pollution” from different construction prompted a new look. Now the Federal Communications Commission says it considers the following as “major”: All underground cable or waveguide routes and aerial transmission lines for *long-distance* telecommunications; private and common-carrier microwave relay antenna towers or supporting structures exceeding 100 ft; AM, FM, television and international broadcast antenna towers or supporting structures exceeding 300 ft, and all AM broadcast directional arrays whatever their height; other antenna towers or supporting structures, including pole-mounted microwave antennas that exceed 300 ft and are not in areas devoted to heavy industry or agriculture; satellite earth stations having an antenna of 30 ft or more in diameter; and communications facilities in areas designated as wilderness or wildlife preserves or in areas recognized either nationally or locally for special scenic or recreation value.

Even facilities that would affect districts, sites, buildings, structures or objects significant in American history, architecture, archeology or culture would be classified as “major.” And the birds are not forgotten. Antennas over 500 ft high “should be avoided if possible” along migration routes, the FCC specifies.

## Vhf replacing mf on the Great Lakes

Medium frequency (mf) will give way to vhf on May 6 as the mandatory radiotelephone system on Great Lakes vessels. On that date, says the Federal Communications Commission, use of mf in the safety system will be discontinued under a 1973 agreement with Canada.

Vhf equipment will be required on every vessel over 65 ft long and on those engaged in towing, except where the total length of the units is less than 65 ft. Exempted are ships of war, troopships, ships in tow, sail-powered vessels and Government-owned ships.

The primary frequency will be 156.8 MHz. Also reserved are 156.7, 156.6 and 156.3 MHz. Transmitters will be limited to no more than 25 W and no less than 15.

**Capital Capsules:** The Air Force is seeking sources for development, fabrication and flight-testing of an imaging reconnaissance radar for remotely piloted vehicles. Modification of an existing, lightweight, low-cost radar is highly desirable. . . . Systems that will permit the development of a cannon-launched, beam-rider projectile are under investigation by the Army. . . . The Office of Telecommunications Policy has extended for two years its two advisory councils—one on frequency management and one on electromagnetic radiation management. . . . The Army Electronics Command is looking for a developer of a multistage transistor amplifier that would operate at 12 to 15 GHz under small-signal conditions by utilizing microwave integrated-circuit techniques and GaAs or InP FETs. . . . The National Aeronautics and Space Administration's compilation of research and technology activity for fiscal 1975 is now available as the NASA Research and Technology Operating Plan Summary (RTOP-75). Included are summary portions that spell out objectives and identify installations of primary interest. NASA officials predict the plan will be particularly helpful to small R&D companies. A copy costs \$3 and can be obtained from the National Technical Information Service, Springfield, VA 22151.

# If you design with ECL or TTL, You need to know about Tektronix TM 500

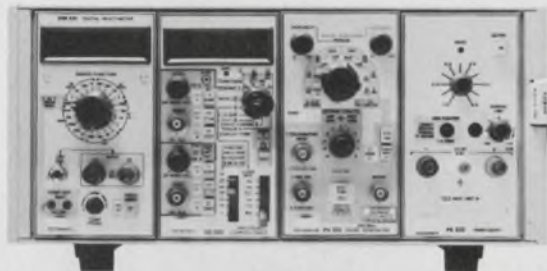

## If You're into High Speed Logic,

the Tektronix TM 500 High Speed Logic Instrumentation plus the Tektronix 485 Oscilloscope (350 MHz) or 475 Oscilloscope (200 MHz) provide all the instrumentation you need for TTL or ECL up to 250 MHz. The four plug-ins of the TM 500 High Speed Logic system are a PG 502 Pulse Generator (\$1195) with 1 ns rise time and independently variable logic 1 and 0 levels... a DC 505 Digital Counter (\$1395) with 10 ns single shot resolution and averaging to 100 ps... A DM 501 Digital Multimeter (\$550) with temperature measurement capability added to all its conventional functions (so you can verify operating temperatures of logic IC's and detect hot spots in tightly packed circuitry)... and the PS 505 Power Supply (\$175) with the 3.0 to 5.5 V dc high-current (4 A) output essential for breadboarding or testing TTL and ECL devices. Also, you can expand the capabilities of the system to provide jitter-free oscilloscope triggering for viewing any segment of long pulse sequences by including the DD 501 Digital Delay (\$495). The 485 Oscilloscope features dual trace, 1 ns rise time, and delayed sweep.

**Whatever Pursuit in Electronics You're Into**, you should learn more about TM 500 instrumentation. A particular group of plug-in modules in a four-hole mainframe provides the instruments most often needed in telecommunications, another fulfills the needs of industrial instrumentation calibration and troubleshooting, another for medical instrumentation, others for education, and so on.



## The TM 500 Concept,

TM 500 is a growing, compatible family of 29 plug-in modular instruments, accessories, and one, three, and four-hole mainframes providing the common power supply. *It's multifunctional:* The plug-ins include 11 signal sources, 5 counters, 2 digital multimeters, 5 power supplies, 3 signal processors, 1 oscilloscope, 1 X-Y monitor and even a blank plug-in kit, so you can assemble the specialized circuits you require. *It's versatile:* You can select from general-purpose instruments, such as the DM 501 Multimeter, or highly specialized instruments such as the TG 501 Time Mark Generator. You can select a system of instruments exactly tailored to your needs. *It's synergistic:* The instruments can "work together" through a common interface circuit board, so your lab bench needn't be cluttered with interconnecting cables. *And it's neatly configurable:* The TM 501 (one), TM 503 (three), and TM 504 (four-compartment) mainframes are attractive and compact. Since the typical four-instrument system only weighs about 20 pounds, it can be hand-carried as easily as it goes onto a bench. The TM 504 (\$225) is only 11" W x 6" H x 20" D. In rack mounting, each bay contains six instruments. And Tektronix SCOPE-MOBILE® carts let you put your entire instrumentation requirements on wheels.

**Find Out What TM 500 Can Do For You.** Get the new TM 500 Booklet A-3072 with full specifications and suggested package configurations, or contact your local Tektronix Field Engineer for a demonstration. Or write to Tektronix, Inc., P.O. Box 500, Beaverton, Oregon 97077. In Europe, write Tektronix Limited, P.O. Box 36, St. Peter Port, Guernsey, Channel Islands



# Just as you can count on Newton's law,



## you can count on Synchron<sup>®</sup> motors.

The synchronous motor you install in your product is likely to be the most important single component. So everything about that motor should be exactly right for your product. The speed, the torque, the price and the delivery, of course. The performance, the quality and the dependability. But, especially, its rightness for you.

What's exactly right for someone else may be exactly wrong for you. That's why it's almost impossible to find a ready-made synchronous motor



that meets your specs in every way.

We custom-make every Synchron motor. At a competitive price. To fit your needs, not ours. Delivered on time. Designed and built right, to do the job right. That's the only way we do business.

Call or write for our specification sheets and the name and location of our representative in your area.

Choose from five principal styles of Synchron motors—60 or 50 Hz—from one revolution per week to 900 rpm—from 8 thru 98 oz-in torque at 1 rpm—from hundreds of different outputs.

**MALLORY**



**HANSEN MANUFACTURING CO.**  
a division of P. R. MALLORY & CO. INC.  
Princeton, Indiana 47670

We make every Synchron motor as if our name were on your product



## Haven't we been on this trip before?

Remember the component shortages? And 40-week deliveries? Remember when we had to plead with vendors for delivery of capacitors, resistors, TTL ICs? Remember when we took the component salesman to lunch and sent him Christmas gifts so his company would keep us in mind at the shipping dock? It's all going to happen again.

We're doing just what we did several years ago. We're talking up gloom. We're highlighting despair. Through word of mouth and through our mass media, we're promoting the idea that the world is going to end tomorrow.

We're convincing ourselves and others that consumers are not going to buy radios, televisions and calculators any more; that companies aren't going to buy control systems and computers; that airlines aren't going to buy any more electronics-laden airplanes; that governments aren't going to buy any more defense equipment. And once we've convinced ourselves of that, it's a short step to assume that the electronics industry is finished and that we'll all be out of jobs tomorrow.

So we cancel all but the most urgent orders and we delay others. We start getting tough with our vendors and, sure enough, we kill some of them. Others cut back production, close down lines and lay off skilled people. Then one day, probably much sooner than any of us think, we find that we've burned up our inventory and our customers want some of our products.

So we call a vendor for immediate delivery of something, and he can't give us immediate delivery. He needs two weeks. Another customer asks for immediate delivery, and he has to wait three weeks. Our vendor can't build up capacity fast enough because it takes time to start up production lines again. The skilled people he fired now have jobs pumping gas or selling life insurance. And pretty soon our vendor increases prices. And we can't go to too many competitors because we've killed some of them off. And. . . .

Haven't we been on this trip before?



A handwritten signature in dark ink, appearing to read "George Rostky". The signature is fluid and cursive, written in a professional style.

GEORGE ROSTKY  
Editor-in-Chief

# Seven cermet trimmers that

## How?

- Through design versatility
- Fast delivery
- Excellent quality

## Necessary Decisions:

1. Single vs. multiturn
2. Sealed vs. not sealed
3. Size
4. Resistance
5. Pin spacing
6. All-important, PRICE

**Take a close look before you select your next trimmer. Call your local Beckman Helipot distributor for free evaluation samples.**

**To get his phone number, or immediate technical literature, call toll-free (800) 437-4677.**

**Beckman**  
HELIPOT DIVISION



## Single-turn

### Model 91

- High quality — low price
- Unique brush contact
- Excellent setability
- 100% inspected
- Protective dust cover
- Top or side adjust
- Screwdriver or hand adjust
- Standoffs prevent rotor binding and permit board washing
- Small  $\frac{3}{8}$ " dia. size
- 12 pin configurations
- Wide resistance range:  $10\Omega$  to  $2\text{ meg}\Omega$

**Price: \$0.42\***



### Model 72

- Sealed for board washing
- Available in VALOX 420-SEO housing
- Top or side adjust
- Brush contact
- Excellent setability
- Only 2 ohms of end resistance
- $\frac{3}{8}$ " square
- 100% inspected
- 8 pin configurations
- 19 resistance values

**Price: \$0.54\***



### Model 82

- Lowest profile trimmer in industry
- $\frac{1}{4}$ " dia. by 0.150" max. height
- Sealed for board washing
- Flame-retardant design
- 82P — top adjust
- 82PA — side adjust
- 100% inspected
- Brush contact provides excellent setability
- A cermet benefit that wirewound can't approach: resistance range  $10\Omega$  to  $1\text{ meg}\Omega$

**Price: \$1.12\***



# handle 95% of your applications.

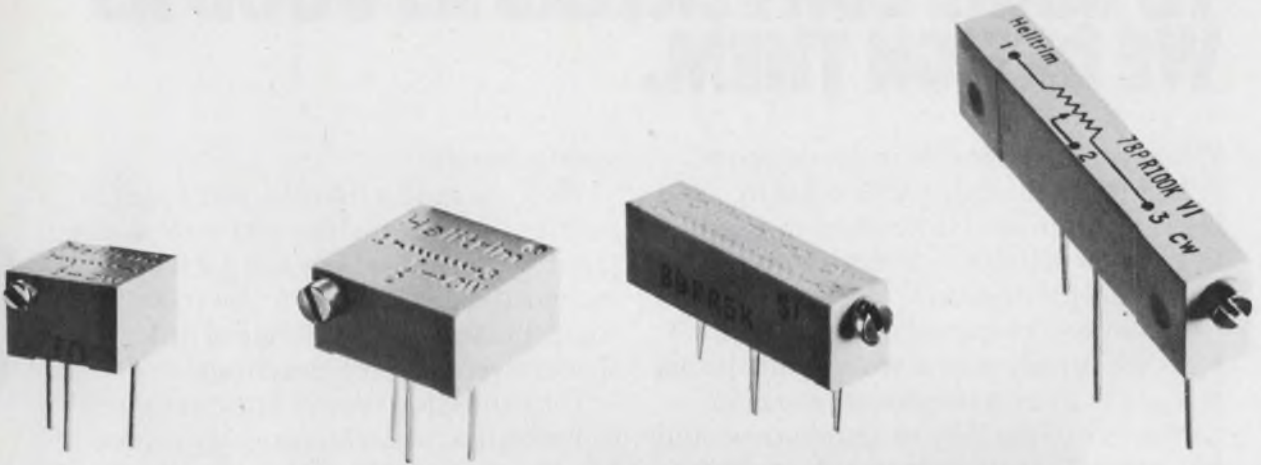

## Multiturn

### Model 64

- Miniature, sealed trimmer
- 22 turns of adjustment
- Operates with 0.25 watt at 85°C derating to zero watts at 150°C
- 100% inspected
- 18 resistance values: 10Ω to 1 megΩ
- ¼" square size is excellent for P.C. board packaging
- Uses Beckman's unique brush contact design
- Adjustability – voltage ratio within 0.01%

**Price: \$4.20\***



### Model 66

- Low-cost, multiturn with benefits of more costly trimmers
- Sealed for board washing
- 20 turns for adjustment accuracy
- Compact ¾" square housing
- Brush contact
- 3 pin styles for efficient space utilization
- Broad resistance range: 10Ω to 2 megΩ
- Operates with ½ watt at 25°C
- 100% inspected

**Price: \$2.70\***



### Model 89

- Our lowest cost multiturn
- Sealed for board washing
- ¾" rectangular trimmer just 0.250" high
- Needs no O-ring because of our unique ultrasonic sealing technique
- Only 2 ohms of end resistance
- 15 turns for accurate and quick adjustment
- 3 pin styles for mounting versatility
- Panel mount available
- 100 ppm/°C tempco
- 19 resistance values available
- 100% inspected

**Price: \$1.05\***



### Model 78

- Military performance at industrial prices
- 1¼" rectangular only 0.195" wide
- Sealed
- 3 terminal styles: Flex leads, Printed circuit pins, Solder lugs
- Panel mount available
- Power rating 0.75 watt at 70°C
- 100% inspected
- 22 turns of adjustment
- Resistance range: 10Ω to 2 megΩ
- 100 ppm/°C tempco

**Price: \$2.28\***



\*1,000-piece price

INFORMATION RETRIEVAL NUMBER 25

# WE GO TO A LOT OF EFFORT TO MAKE CONVERTERS AS GOOD AS WE DESIGN THEM.

When you're the leader in the design of A/D and D/A modules, you've got to break some ground in manufacturing, too.

Take our active abrasive trimming operation, for instance. (That's one of our trimmers on the opposite page.) We put it together ourselves, and we're pretty proud of it. It lets us trim resistor networks in converters while they're under power and operating. This gives us an extremely precise trim, in a fraction of the time it would take to hand select and install discrete resistors. That means we can give you very good performance in a budget-priced module. And we can give you that performance consistently, from order to order, in high volumes.

We also design and build a lot of our own test equipment for incoming inspection, in-process testing and final testing. Our QC and testing groups have a workload you wouldn't believe.

We take a lot of extra care with our individual components, too. We've got an automatic operation for transistor selection and matching. The most stringent PC board requirements in the field. And sophisticated material handling and production scheduling, controlled by a large-



scale computer.

With converter circuitry, you've got to build in the performance you want or you just don't get it. And you can get it, from our most basic converter to our most sophisticated. Plus a full line of mil-spec converters if you need them.

The extra effort we put into our manufacturing has made our general purpose line of converters the standard of the industry. You know them as ADC-10Z, ADC-12QZ, DAC-10Z, and DAC-12QZ. Even if you buy them from somebody else.

And our brand new DAC1118 and DAC1009 are coming on fast.

When you're looking for a modular converter, look beyond the specs. And if you're ever in the neighborhood, drop in. We'll show you the muscle behind our data sheets.

Analog Devices Inc., Modular Instrumentation Division,  
Norwood, Massachusetts 02062.  
East Coast: (617) 329-4700.  
Midwest: (312) 297-8710.  
West Coast: (213) 595-1783.





# Focus

## on Graphic recorders

No chart recorder can reproduce exactly the waveform at its input. Since the ideal recorder doesn't exist, the relevant question is: How faithful a reproduction can you get? The question is simple. The answers may not be.

Each of the major components that make up a recorder can contribute an error. The pen-drive mechanism, input attenuators or amplifiers, paper drive—and even the paper itself—all have limitations. What you'd like to know is to what extent and under what conditions.

To find out, you'll have to pore over a slew of electrical and mechanical specs. In the electrical department, specs like accuracy, frequency response, linearity and stability must be pinned down; in the mechanical, you'll need to check into such items as chart-drive accuracy, line width and even paper stretch. And these aren't all.

Unfortunately you may have to stretch yourself before you finally get satisfactory answers. More than a few recorder brochures are long on photos of intricate, delicate curves to show off the recorder, but short on clear, practical performance data. The curves—while lovely to look at—are usually unrelated to real-life situations. Some specs that are needed are nowhere to be seen.

Adding to the problem is the lack of a universal standard to spell out definitions, specs and tests. Consequently when a vendor talks about linearity, for instance, which of the numerous definitions is he using? You really don't know. But you can be sure it's the one that puts his product in the best light.

To spotlight the one recorder that's best for you out of the thousands available, first shine some light on your exact needs. Look at your signal: What frequency range will it cover? What ampli-

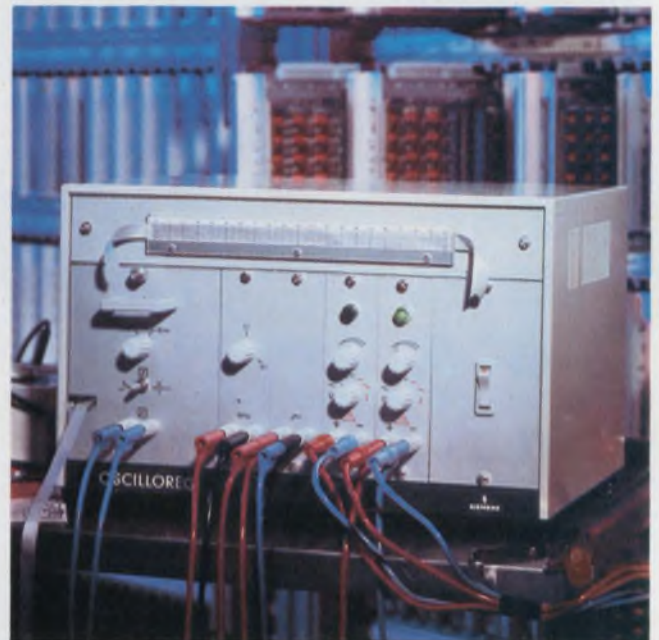

Thermal writing on a 10-mm-wide metallized paper strip characterizes this pulse recorder, the Oscilloreg, from Siemens. The unit shows pulse time relationships.

tudes and waveshapes? What temperatures and humidities will the recorder see? Is the application primarily one of low speeds and unattended operation or must you monitor fast changes? How accurate must the trace be?

### The movement toward standards

Only after these and other questions are satisfied can the right stylus-drive mechanism, writing method, paper type, input conditioners, chart drive and necessary options be selected. The writing mechanism is a good place to start.

Stan Runyon  
Associate Editor

In general, accuracy and frequency response are limited by a recorder's writing mechanism, which also loosely defines the instrument's classification. Here, again, no standards exist and categories are vague. With vendors disagreeing about which recorder belongs in which category, and with the writing mechanism details often missing or stated vaguely, it's easy to compare apples and oranges unknowingly. To make matters worse, the terms accuracy, linearity, reproducibility, resolution and other forms are often interchanged.

Thus one major manufacturer splits recorders into three groups: strip-chart, direct-writing oscillographs and light-beam oscillographs. In this breakdown, X-Y recorders are listed as strip-chart units, with the time (T) axis replaced by a second (Y) variable.

The physical distinction between the three categories apparently rests with the pen (or stylus) mechanism. Strip-chart recorders, in this classification, use dc drive motors and pulleys, or cables, to position the stylus. A potentiometer or slide-wire element senses stylus position and feeds the information back to the input, where it is compared with the signal to be reproduced. Hence the strip-chart, in this definition, is a closed-loop servo system.

But another well-known vendor distinguishes between servo and oscillographic types, and lists servo, direct writing and other types as strip-chart recorders. Since many oscillographic units are also operated closed-loop, confusion results.

In general, strip-chart recorders are instruments intended to portray phenomena that vary with respect to time. The word "servo" refers to a servomotor-driven, null-balancing, closed-loop system characterized by the highest accuracy (at best, about  $\pm 0.1\%$ ), lowest frequency response (10 Hz, at most) and widest chart width (to about 11 in.) of the various recorder types. But you don't necessarily get the best of all three specs simultaneously. Strip-chart units are usually limited to two channels, but the traces can be overlapped.

Direct-writing oscillographs, by one definition, are moving-coil (D'Arsonval) or moving-iron galvanometers with the stylus attached directly to the movement (or penmotor) without intermediate gears or pulleys.

But a quick survey of recorder literature reveals that the meaning of the term "direct writing" depends on who's talking. One brochure states, "A direct-writing recorder writes the measured data 'directly' on a paper chart."

Another source of recorder information says that direct-galvanometer drive refers to the "direct" application of the signal to the coil, with no preamplification. The same source also talks about pens that are "directly" driven from the

information being recorded—for example, temperature or pressure sensors that are mechanically linked to the pen motion.

Position, velocity or acceleration feedback can all be found in galvanometer recorders. For the galvanometric types, accuracy hovers, at best, around 0.5% full-scan; frequency response is limited to about 250 Hz and chart width to roughly 4 in. The number of channels can range to eight, and even more. In general, traces can't overlap in a galvanometer unit.

The light-beam oscillograph is the least accurate (about  $\pm 2\%$ ), but it can handle frequencies to 10 kHz and even higher, plotted on a chart up to 12 in. In the light-beam scheme a mirror attached to a galvanometer movement deflects a light spot across photosensitive paper, which is then developed to get the final trace.

Still another light-beam unit deflects a CRT beam to generate the moving spot. A fiber-optics bundle then transfers the light to photosensitive

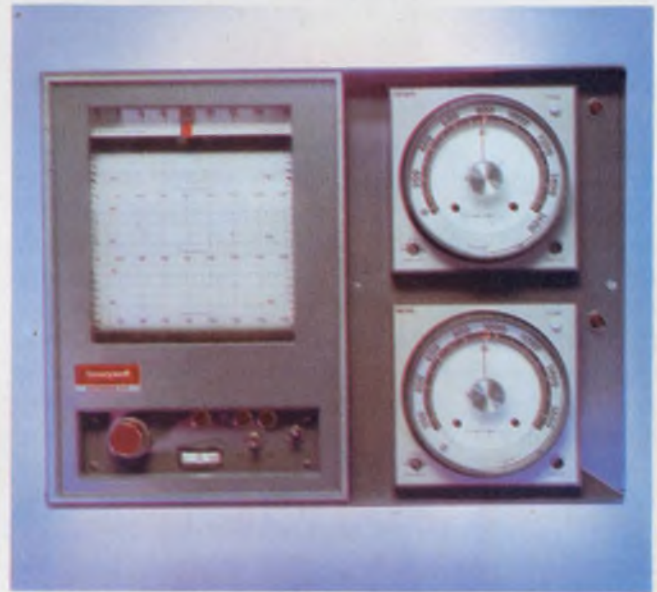

Industrial recording and control packages are assembled to a customer's specifications by Honeywell's Process Control Div. The strip-chart unit is an Electronik III.

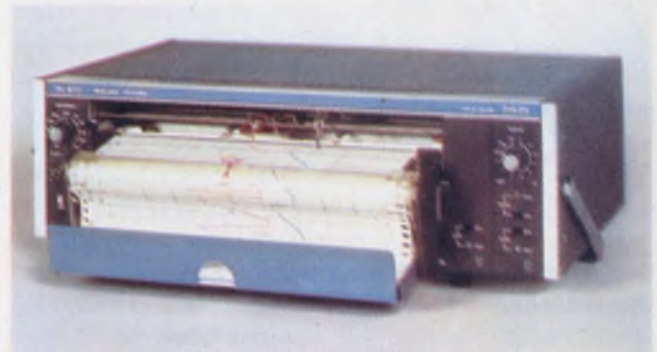

Double-pen recording with a 0.25-s full-scale (250 mm) deflection is offered by the Philips PM 8222, an OEM servo unit. Also featured is a Z-fold chart system.



If it's an industrial recorder you need, check into Leeds & Northrup's wide line of 11 basic models with over 140 options. The company makes laboratory units, too.

paper. The result: a frequency response of greater than 5 kHz.

Other drive mechanisms with many variations can be found in commercial recorders. Some use stepping motors to position the stylus. Others don't write continuous lines at all but use print heads to bang out a series of sequential points on the chart paper. Still others are one-moving-part linear servos without gears, cables, pulleys, clutches or slide wires. And you can get analog recorders that scan dry electrosensitive paper, line by line, to give a facsimile-like presentation.

Whatever the type of recorder, it's the in-use accuracy that counts, not the inherent or theoretical capabilities of the mechanism. So many factors can combine to assault accuracy that it's probably the toughest to specify of all recorder parameters. And this is often reflected in the spec sheet.

### Illusive accuracy specs

When a vendor states his instrument's accuracy as a percentage of full scale—and most do—how much trust can you place in the figure? A spec of 0.2% sounds pretty good. But does it account for the width of the line, which can easily approach the same percentage? You don't know.

Perhaps the figure represents the accuracy of the chart drive and not the indicating portion of the recorder. Or does it include both? Of course, when you plot a variable against time, you'll also want to know how steady the chart is. This depends not just on the chart motor, its drive frequency (if any) and gear train, but on the



Up to 24 variables can be intermixed on the Telmar 6000 multipoint recorder, which displays in color on multiple frames arranged on a single sheet of paper.

sprockets, guides or any other arrangement that can affect the position of the chart beneath the stylus.

What about the chart itself? Since no printing process is perfect, it's reasonable to expect some errors in the grid lines. For that matter, the chart paper itself can stretch or shrink with changes in temperature and humidity. Are these included in the accuracy spec? Since the paper dimensions can vary by  $\pm 1\%$ , the answer is obvious.

Accuracy can also vary with the range setting of the input attenuator, and the figure may depend on how well you set the initial calibration adjustments—something the vendor can't control. Time, temperature and line-voltage variations are also out of the vendor's hands. But does he tell you how the changes affect the instrument? Probably not.

Whatever the stated accuracy does include, you can be almost certain that the spec in most cases is valid at just one temperature: 25 C. But temperature can and does affect recorder operation, as can humidity and line voltage. Thus gains can vary, zero settings can drift—and accuracy suffers.

Time is also unkind to recorder accuracy. Even



at constant temperature, recorders often drift over the short term (8 h or less). And since friction and mechanical wear build with time, accuracy over the long term will certainly degrade.

Where can you find this information on the spec sheet? In most cases, you'll have to ask for it. Even when listed, the drift figure may be referred to the input and specified at just one sensitivity. To get the actual drift—which can be 100 times higher—you'll have to determine the basic drift and then multiply it by the gain factor.

Particularly in servo-driven units, you may find an accuracy statement, but often tacked on alongside—or buried in the back—are numbers for such related items as deadband, hysteresis, repeatability and linearity. Sometimes deadband and hysteresis are lumped into the number for accuracy, repeatability or even linearity. How can you tell when this is done? You can't.

#### A loose servo is a dead servo

In a servo system, deadband is the amount the input signal must vary to get the motor going—that is, to overcome the friction of the stylus on the paper, and that of the drive train, and to accelerate the load. If a potentiometer serves as the feedback element, its resolution also affects the deadband.

A related effect—labeled hysteresis—can be traced to backlash or elasticity within the drive train, which limits the fidelity with which the stylus can follow the input signal.

Nonlinear frictional forces in galvanometers also represent a form of hysteresis and keep the galvanometer from moving until sufficient signal has been applied. The presence of nonlinear forces also means that removal of the signal doesn't guarantee that the stylus will return exactly to its starting point.

Another effect that points to frictional nonlinearities: waveshapes that change when their amplitudes are gradually reduced.

Various repeatability tests can sum up such errors. One method applies a deflecting signal in alternate directions, with rest periods (zero signal) between reversals. A low-pass filter ensures that the signal is applied and removed gradually, with no overshoots. In the ideal recorder the rest periods all occupy the same level. Practical recorders exhibit some small offset.

Since galvanometers are basically rotating devices, curved grid paper must be used to match the radius of the stylus. Alternately—and this is usually more desirable—rectangular-coordinate paper can be used if the pointer arc is converted to rectilinear motion by a mechanical linkage. (In frequency response, however, curvilinear motion may have a slight edge over rectilinear.)

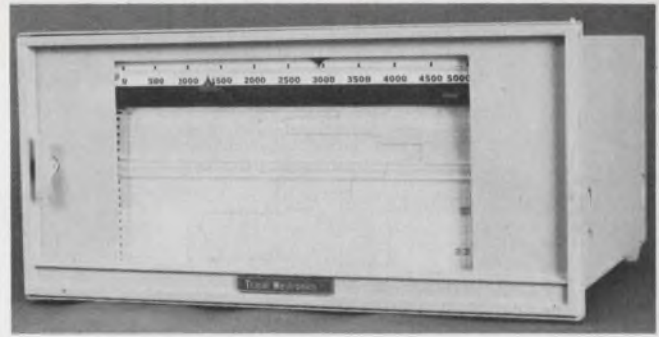

With 11 in. of chart width, the D11E, from Tracor Westronics, provides a resolution of 0.1% of span. The dual-pen unit's front-panel size is only 8-1/2 × 17-3/4 in.

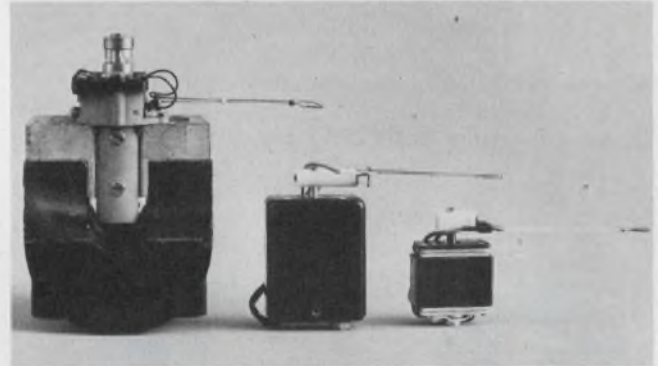

Evolution of the pen motor (left to right): D'Arsonval (circa 1950), moving-iron movement (1962) and moving-iron designed around 1972 (General Scanning).



The Simpson 604 Multicorder can be likened to a multimeter with a recording device instead of a meter. The unit measures volts, amps, millivolts and milliamps.

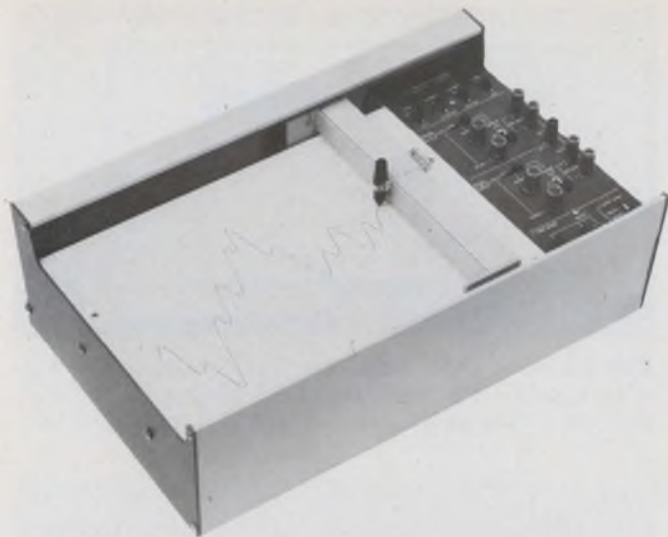

For the general-purpose laboratory user, Hewlett-Packard's 7015A X-Y recorder features electrical and mechanical flexibility to fit various applications.

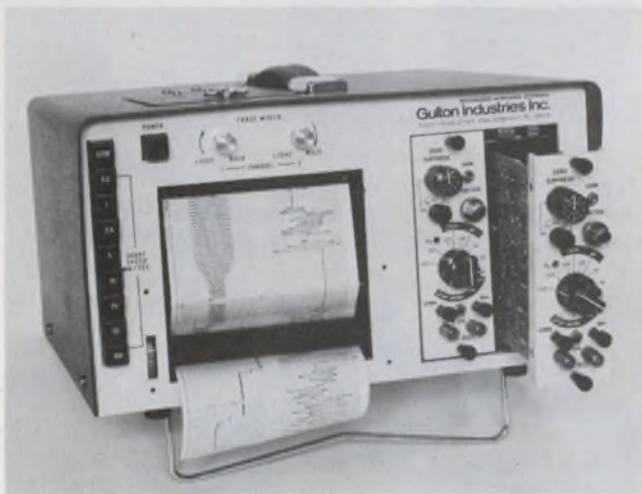

Features normally found only in laboratory units—such as interchangeable plug-in signal conditioners—are offered in the TR-222, Gulton's portable recorder.

Unfortunately the sliding or rotating bearing contacts of the linkages increase the friction and inertia and contribute an additional area for wear.

Still another method of polar-to-rectangular conversion holds a long, hot element in contact with heat-sensitive paper. The paper is pressed between the element and a knife edge, over which the paper passes. With a sufficiently long tip, as the pointer rotates, one part of the element always maintains contact with the paper along the knife edge and thereby traces a straight line. This, of course, doesn't mean that the recorder performance is linear—just that the stylus writes a straight line as the coil rotates. The departure from linearity depends on the angle of rotation since the length of the visible paper mark is proportional to the tangent of the angle.

In galvanometers, as in most recorders, the



Electrosensitive recording paper with a 23-dB tonal range from white to black is used in the EPC line to provide a facsimile-type presentation.

quality of the trace improves as the contact pressure between stylus and paper increases. But increased pressure means increased friction—which is to be avoided.

To offset the effects of friction from contact pressure, linkages and other sources—and to improve linearity—some galvanometers are designed with position-feedback. In effect, the feedback increases the apparent torsional stiffness of the suspension for small deflections. In null-balancing servos most of the nonlinearity stems from that of the feedback element. But, though linearity may be improved by feedback, the method of specifying it isn't.

### Walking the straight and narrow

A perfectly linear recorder would have an output (deflection) that is directly and linearly proportional to its input (voltage or current) across the entire chart span—that is, equal increments of input produce equal deflections, or amplitude changes, at any spot on the chart. (This, of course, is aside from linearity based on stylus-geometry considerations.)

Perfection doesn't exist in practical recorders. But the gap can be considerably narrowed—at least on paper—by auspicious selection of the method by which nonlinearity is specified.

Numerous methods exist, all based on variations of how a straight line can be drawn through an arbitrary series of points. The straight line, which represents the ideal input-output relationship, can be moved for a "best fit" to the curve connecting the actual input-output points.

The best fit obviously is the one that gives the smallest number for nonlinearity.

Actually any of the methods—of which the most popular are the least squares and end-point—is legitimate, at least mathematically. But 99 times out of 100 you're not told which method the manufacturer used. And even when you are, how do you relate the stated linearity to actual

individual errors—which can easily exceed the given value? You can't—at least not on paper.

Perhaps the best approach is to apply a small, constant-amplitude, sinusoid to the recorder and then move the resulting trace to various positions on the chart—especially the chart edges. Changes in the peak-to-peak amplitude of the trace will expose nonlinearities.

Some manufacturers feel that all errors should be lumped into one over-all accuracy spec. Others say that in many cases absolute accuracy isn't the most important spec, since other portions of a measuring system—such as transducers—contribute far greater inaccuracies than the recorder. More important, this school of thought says, is repeatability, or reproducibility—the ability to get the same result over a period of time. Thus drift and nonfixed errors—such as deadband—should receive greater emphasis. But whatever the emphasis, one item everyone agrees is important is frequency response, or bandwidth.

All recorders are limited in frequency response. The trick is to find out how much. Unfortunately the best place to do this is not always the spec sheet.

### A tricky spec

How a deflection system reacts with changes in the frequency of an input signal is what you'd like to know. But to really pin it down, you have to find out where you're operating on the chart, what your signal looks like and what input amplitudes to expect.

Each of these factors will affect the frequency response. And that's why many spec sheets tend to forget one or more factors. If no qualifiers are tacked on, forget the figure altogether and start asking questions.

Ask the vendor if the spec holds only at the chart center. In most cases, it does. Ask what amplitude the vendor used when he measured the response. What waveshape did he use: Sinusoid? Square wave? Triangle? Or what? And where were the damping and gain pots set at the time?

Remember that as frequencies go higher, a point is reached at which response begins to drop. This means that you won't necessarily get a full-scale swing at high input frequencies. More likely, you'll get a third or a fourth of the total chart width. This is a limitation you may be able to live with—as long as you know about it.

You can be pretty sure that most unqualified frequency-response specs are for small signals. What you can't always be certain of is exactly what the spec means when it's fragmented. For instance, when a statement says that frequency response is flat within  $\pm 1/2$  dB, 0 to 50 Hz, and  $-3$  dB to 100 Hz, does this mean that the re-

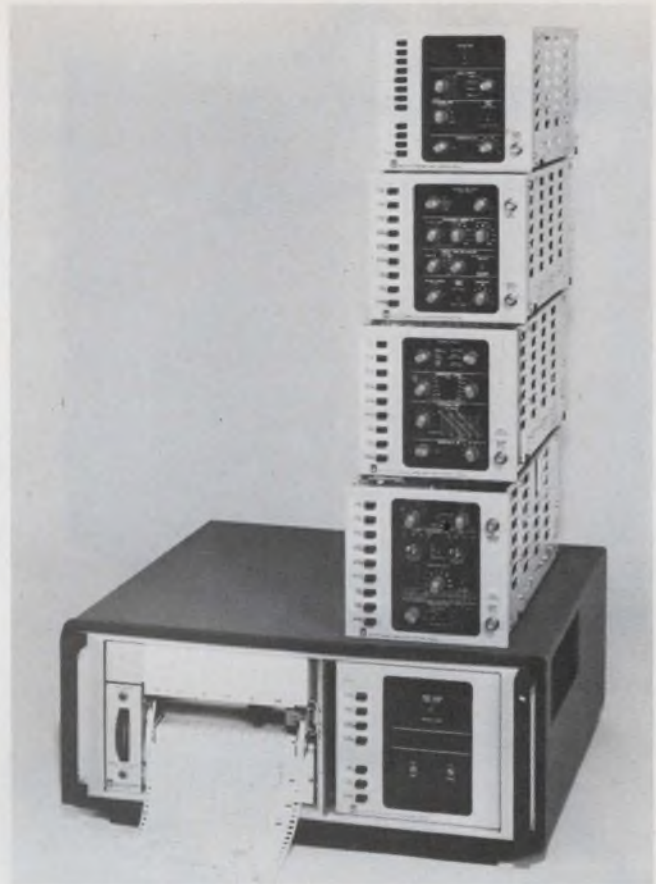

Slide in the right plug-in and General Radio's 1523 becomes a wave analyzer, sweep oscillator or other measurement/recording instrument.

sponse at 100 Hz is 3 dB below that at dc? It might.

But somewhere else on the document, you spot a fine-print clause that implies a signal other than dc was used as a reference. Now it looks as though the over-all deviation from flatness may not be 3 dB at all—it depends on where the reference point falls on the response curve with respect to the dc level.

In motor-driven servo units—where reaction is relatively slow—bandwidth and frequency-response specs are dropped for other terms: response time, slewing speed (or rate), acceleration and writing speed.

Because of its slow response, a servo recorder is usually used for static or slowly changing phenomena—temperature changes with long thermal time constants, for example. Most servos excel in these applications. But when it comes to dynamic performance, life isn't so easy.

Under dynamic conditions—important in X-Y units—a servo can slew just so fast and no more. When the velocity limit is reached, the servo will be unable to track the input signal, and errors will result. This limit is reached when a sinusoid's peak amplitude equals  $V_m/2\pi f$ , where  $V_m$  is the servo's maximum velocity.

Peak acceleration limits also exist, beyond

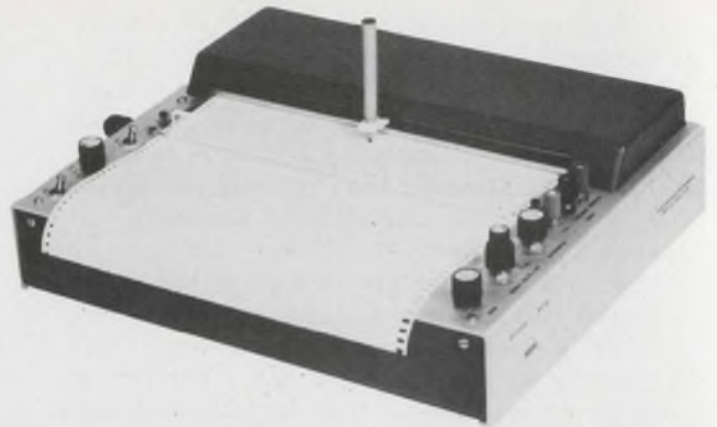
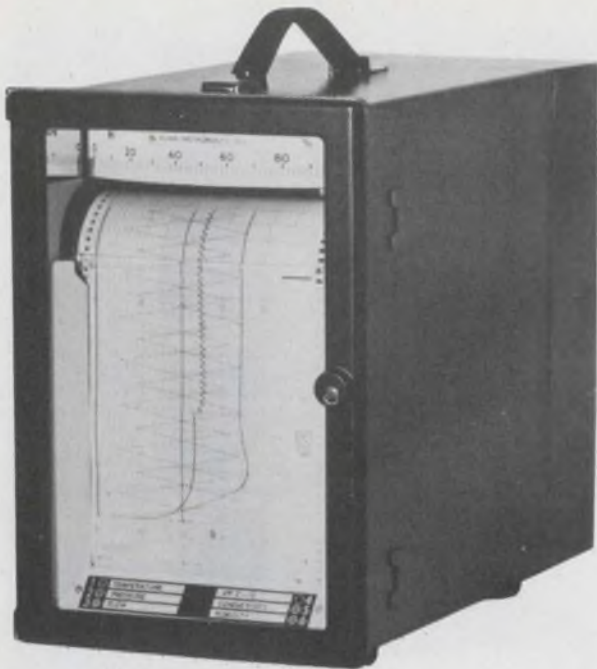

The many forms recorders take today are demonstrated by these units. Clockwise from top left: Elnik's multipoint unit records up to six channels in separate colors. MPI's 1027 Y-T unit offers 16 ranges. A miniature recorder from Fischer & Porter measures only 6 × 6 in. And Linear Instruments makes a two-pen integrating unit.

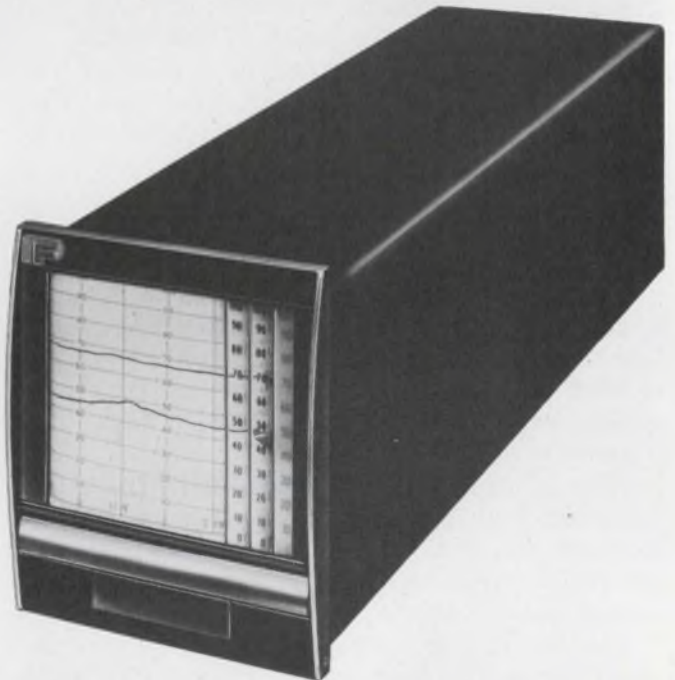

which the servo can't follow the signal's rate of change. As in velocity limited operation, the servo saturates or becomes nonlinear, and errors result.

To specify servo response, many vendors list a response time—the time the stylus needs to cover the full chart distance after a full-scale step is applied. Others give slew rate instead, usually in inches per second. Whatever the method, make sure that settling time is included in the response spec. Make sure the response holds for both directions—some units are slower going one way than the other. And in ink-pen systems, note this: If the reservoir can't deliver ink fast enough, that impressive high-speed slew may be useless.

As in any moving system governed by the differential equation for balanced torques or forces, a recorder's response to a step or triangular input tells you how well it can reproduce an input waveshape.

Thus a step input will reveal oscillatory behavior or it will show that the instrument is underdamped, critically damped, or whatever. A

triangle will establish the recorder's phase lag in addition to the amplitude distortion: Depending on the instrument's damping coefficient, square waves will exhibit rounded-off corners or overshoots; triangles will start to look like sinusoids with rounded, instead of sharp, peaks.

What damping level produces the best fidelity of response is a matter of opinion among vendors. Most recorders have 60 to 100% of critical damping. Some offer adjustable damping.

In galvanometer movements frequency response can be stretched, and damping controlled, by use of driving amplifiers and also by feedback loops with equalizing networks. To get the widest response, look for recorders that use both techniques.

Though galvanometers top motor-driven in-

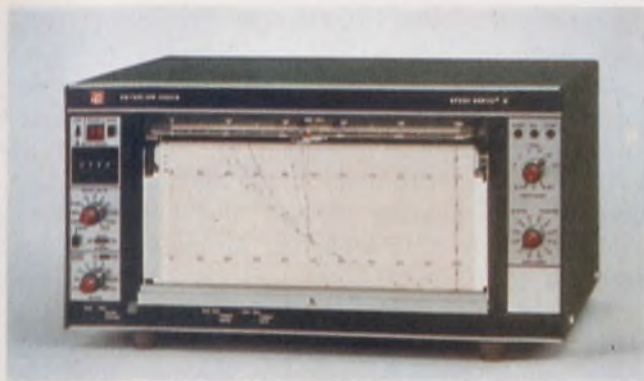

In the Speed Servo II multipoint unit from Esterline Angus, a thermal matrix print head records up to 24 channels. Format is user programmable.

struments in frequency range, the motor drive is generally more sensitive. Sensitivity—a spec most recorder users are interested in—tells you how much voltage or current you'll need to move the stylus across the full chart span.

Some caution is needed to evaluate a unit's sensitivity. One recorder will list it as so many volts per millimeter, another as volts per inch, and still another as volts per division. You'll have to dig to find out how big a division is. Or you might see something that says "sensitivity: 0.1 mV." This can mean 0.1 mV will drive the stylus full span, or it can be the amount needed to move 1 mm. Find out.

For a unit to be very sensitive—that is, to move relatively large amounts with small inputs—the deadband must be negligibly small. So watch out when the recorder maker brags about microvolt sensitivities but lists millivolt deadbands: Like pickles and ice cream, the two don't go together. While you're at it, look for other "indigestible combinations"—noise rejection and response, for one.

### Sensitivity can hurt

Like other instruments with sensitive front ends, recorders are susceptible to conducted or radiated noise. And since many recorders chop the dc input and use ac amplifiers to minimize drift, spurious ac signals are amplified along with the legitimate dc levels.

Unwanted signals that get by the front end can shift calibrations (zero level), produce deadbands, spikes and nonlinearities, and affect damping.

To avoid or reject noise, a number of techniques are available, including filtering, grounding, shielded and guarded construction, and physical isolation of circuits. Any or all of these may be used within one unit, and the resulting immunity is split into two specs: one for normal-mode rejection (NMR) and the other for com-



Flat-bed laboratory units, such as this one from Fisher Scientific, let the user write notes conveniently. The pen lifts electrically or manually, depending on model.

mon-mode (CMR).

But straight numbers for NMR and CMR—no matter how high—may not tell what rejection you'll get in your own setup. Both figures depend on such items as source impedance, frequency, waveshape, input-circuit imbalance and external grounding methods. Since the vendor can't measure the rejection for all possible combinations, he settles for one. If you're lucky, he'll at least tell you which.

Take CMR. In a perfectly balanced differential-input circuit—one in which the impedance from source to recorder to ground is equal in both the high and low legs—the CMR is infinite. Of course, some imbalance always exists, and the CMR spec will depend on the amount. Since no universal standard exists for the amount of imbalance, vendors can choose any value. Most have settled for a 1-k $\Omega$  imbalance. If no figure is given at all, be suspicious.

With NMR, other problems can arise. To boost NMR, vendors offer units with fixed input filters. Or you can get preamps with switchable filters. This is all well and good—until you remember that filters need time to settle. Thus that high-frequency response you expected may not be realizable unless you switch the filter out—at the expense of NMR.

Other recorder input characteristics may be important: The input impedance, for example, shouldn't be so low as to load your source. Remember that in some null-balanced units, the input impedance can plunge drastically as the servo moves off null; the faster the servo can follow the input signal, the closer it will remain

toward balance—and high impedance. At any rate, you should be told the minimum impedance (at the point of maximum imbalance).

Protection—for both the machine and the user—may be a must. High common-mode voltages can burn the instrument, and ungrounded or nonisolated instruments, the user. If a high CMR attached to a weak common-mode voltage is thrown at you, duck. The high/low combination is a clue that something in the input circuit may not be so desirable.

In some cases the recorder's motor may need burnout protection—say, if the recorder will

operate in a remote, unwatched site and at full-scale settings.

And as anyone who's ever used a sensitive recorder can attest, the stylus can also be damaged by off-scale slams or mishandling. Thermal stylii have been known to open at the element, thereby breaking the heating circuit. Perhaps the best protection here is to look for the latest in stylus designs.

The old truss-work stylus that dominated the industry for many years has been replaced by more rugged designs: tubular, coaxial construction and folded-blade units made of titanium or

## Who makes what in recorders

Company	Types offered L = lab I = industrial	Formats		Drive types		Writing system					Paper system F = Folded R = Rolled C = Circular	Remarks	
		Strip C = continuous line M = multipoint	X-Y	Nulling servo	Galv- anometer	Ink	Thermal	Pressure	Light	Electro			
Beckman (Dynograph series)	L	C			✓	✓	✓ (option)					F, C	Biomedical units. Change input coupler to vary function.
Data Technology	L, I	C		✓		✓						F, R	Flat bed or vertical. Charts: 4 to 10 in.
Elnik	I	C, M			✓	✓						R	Functions changed with plug-in cards. Colored ribbon prints dots in multipoint units.
EPC Labs	L, I	see remarks								✓		R	Line-by-line scan (XYZ) units. Analog or digital inputs. Tonal response of paper gives "Z" axis.
Esterline Angus	L, I	C, M	✓	✓	✓	✓	✓					F, R	Broad line spans all types. Multipoint unit thermally brands up to 24 channels.
Fischer & Porter	I	C		✓		✓						R, C	Dc torque motor with contactless feedback. Up to three pens.
Fisher Scientific (Recordall line)	L	C		✓		✓						R	Sprocketless paper. Two pens. Electric pen lift.
General Radio	L	C		✓		✓						R	Graphic measurement center. Plug-ins vary function. Many automatic features.
General Scanning	L, I	C			✓		✓					F, R	Miniature units. Open or closed loop. Battery operation, low power.
Gould Instrument Systems Div. (Brush)	L, I	C, M	✓		✓	✓	✓		✓	✓		F, R	One of the widest lines available. Many "firsts," including closed- loop moving-coil penmotor.
Gulton (Measurement and Control Systems Div.)	L, I	C			✓		✓					R	OEM building blocks, alphanumeric thermal printing. Complete line of portable units.
Hewlett- Packard	L, I	C	✓	✓	✓	✓	✓					R, C	Fast response X-Y units. Reliable die-cast mainframes. One-moving-part linear servos. Worldwide service.

stainless steel. Other designs prolong stylus life, improve performance or make maintenance easier—replaceable tips, ball tips, indirect heating elements, ceramic thermal tips are all available today. Before you buy, however, you'll first have to decide which writing method to opt for.

### Drawing the line on drawing the line

Fluid flow . . . heat . . . pressure . . . light . . . electrons. Sounds like a course in basic physics, doesn't it? But each really is a way to draw a line on a piece of paper. And which to choose

depends heavily on the application. Paper costs, trace permanence, reliability and convenience all play major roles in selection.

Of all the methods, capillary-ink writing is the simplest and most economical. Chart paper is the least expensive—no minor consideration where reams of data are to be taken. Lines are usually crisp and dark and can be easily copied, if desired.

The disadvantages of capillary flow are similar to those of the old fountain pen. To start the flow, some sort of priming system is usually needed. At higher writing speeds, ink may not

Company	Types offered L = lab I = industrial	Formats		Drive types		Writing system					Paper system F = Folded R = Rolled C = Circular	Remarks	
		Strip C = continuous line M = multipoint	X-Y	Nulling servo	Galv-anometer	Ink	Thermal	Pressure	Light	Electro			
Honeywell	L, I	C, M	✓	✓	✓	✓	✓	✓	✓			R, C	Extensive line ranges through all types. CRT and light-beam units with response to 25 kHz.
Houston Instrument	L, I	C	✓	✓		✓						F, R	Specialist in X-Y and combined X-Y/strip chart units. Model 6450 can work in eight modes.
Incor	L, I	C			✓		✓					R	Plug-in signal conditioners. Each plug-in has own isolated supply.
Leeds & Northrup	I	C, M		✓		✓						R, C	Industrial units. Over 140 standard options. Die-cast aluminum cases & mainframes.
Linear Instruments	L	C		✓		✓						R	Flat-bed, log, linear and integrating recorders. Remote-chart option.
McKee-Pedersen	L	C	✓	✓		✓						R	Input impedance > 50 MΩ off balance. Chart can be turned back for multiple traces.
Philips	L, I	C, M	✓	✓		✓						F	Wide line. Compact unit combines flat bed and vertical profile, can be stacked or rack mounted.
Siemens	L, I	C	✓	✓	✓	✓	✓		✓	✓		F, R	Broad line includes light, laser-beam and liquid-jet recorders. Laser unit also has large-screen display.
Simpson	L, I	C (see remarks)	✓	✓	✓			✓				R	Miniature & battery units. Clamp mechanism makes sequential impressions on pressure-sensitive paper.
Telmar	I	M										Rectangular sheet	Unusual unit uses typewriter ribbon to record up to 24 inputs on separate frames.
Tracor Westronics	L, I	C, M		✓		✓						R	Offers certified units for hazardous areas. Computer compatibility; variable print rates.
Yewtec	L, I	C	✓	✓	✓	✓			✓			F, R	Wide range spans all types. Scratch system draws 0.01-mm-wide line on roll of film.

flow fast enough, and skipping results. At low speeds, too much ink may flow. If the pen stops momentarily, get out the ink remover. (But if the pen stops long enough, don't worry about flooding. The quick-drying ink used to prevent smudges will probably clog the pen.)

To get around the problems of capillary flow, recorder designers have come up with the pressurized-ink approach—a completely enclosed hydraulic system that pumps ink to the pen at a rate determined by chart and pen speeds. Because of the optimized variable pressure, uniform lines over a wide speed range are produced. Ink blobs don't occur because the pump stops when the pen does.

Pressurized systems are generally smudge-proof, since the ink is literally forced into the special coating of the chart paper. Contrast and paper gloss are usually high, and the resulting trace is probably the most permanent of all writing types. Because of the special coating, the paper for pressurized writing costs about 50% more than the plain paper used for capillary flow. And, of course, you've got to pay extra for the hydraulic system.

If you don't want to fill reservoirs or periodically change pressurized cartridges (some can last a year or more), check out the host of dry

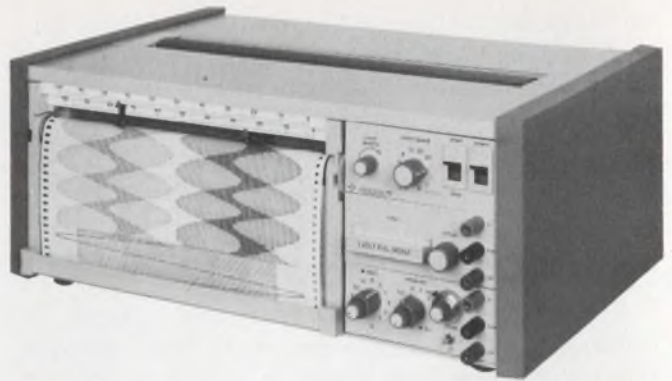

Recently introduced, the Gould 110 is a thermal writer that uses a new type of paper to produce blue traces with a thermally fast-acting ceramic pen tip.

writing schemes. You'll avoid ink problems. But the tradeoffs are usually higher paper costs, less contrast and definition, and possibly reduced paper stability. And most dry-writing chart paper doesn't take well to handling: unwanted smudges and marks are common.

Heat, electrosensitive and photosensitive papers cost roughly 4, 6 and 10 times more, respectively, than plain ink paper. For very high chart speeds, however, you may have no choice but to go to one of the more expensive recording methods.

Tradeoffs (other than economic) exist within

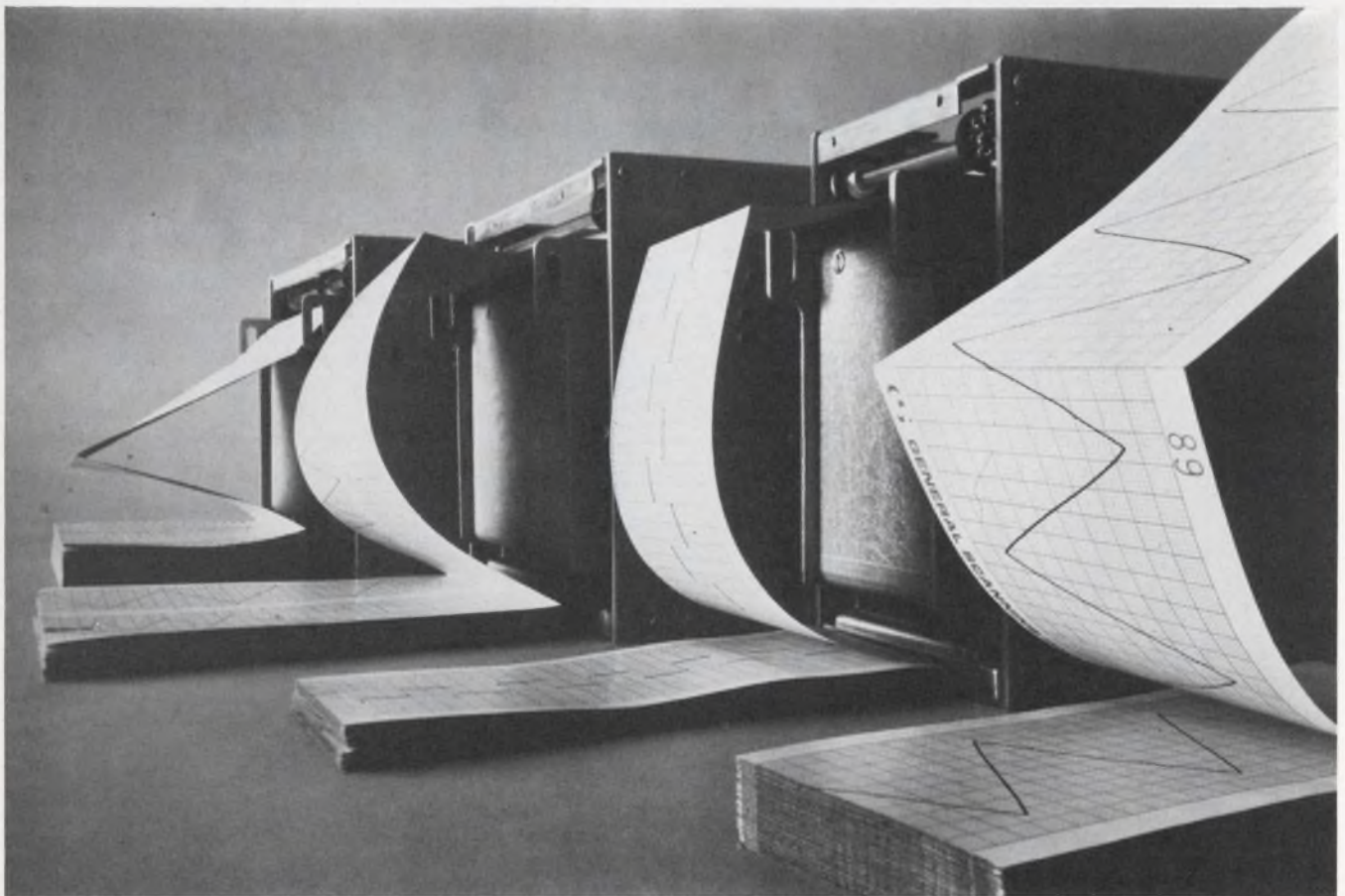

Typifying the latest trend in paper systems are these Z-fold OEM units, manufactured by General Scanning.

Z-fold systems offer a number of advantages over roll paper, including no threading or spills.



the many dry-writing schemes. Thermal stylii don't have to press as hard against the paper as pressure-sensitive ones, so thermal pens can usually write faster. Heat-sensitive paper is also less susceptible to accidental marking.

Older electrosensitive schemes use a high-voltage stylus to break down a carbon-impregnated paper. The process leaves a carbon residue that must be removed. Newer, low-voltage units use a different form of paper to avoid this problem.

Not only the paper type, but how the paper is handled by both the machine and user, is an important consideration. Anyone who's spent a frustrating half hour trying to load a difficult machine appreciates one in which paper changing is fast and easy. Ditto with pen servicing.

Equally appreciated are units that don't spill streams of paper all over the floor during recording, and ones that let you write information alongside the trace without becoming a contortionist. Storing stacks of recordings can also be a problem. For these reasons, Z-fold (or fan-fold) recorders are becoming increasingly popular. Z-fold gives the user easy storage and handling, instant access to down-the-line data and convenient space to write notes. The machine doesn't spill paper all over the floor, either.

But watch out. The Z-fold unit is harder to design than the standard roll-chart recorder, and performance may suffer for it. This is because some mechanisms used for standard rolls tend to remove the fold in Z-fold paper. Thus the paper may not stack as it leaves the machine. To avoid this, designers must come up with alternate mechanical arrangements. This isn't easy, and friction, inertia, pen pressure and rigidity can all be adversely affected.

Other features besides Z-fold, can make life easier or are even necessary for a job. Let's look at some.

### Options galore

Perhaps in no other measuring instrument can you find the variety and quantity of options, features and type variations that you can in recorders.

Whatever recorder you need—industrial, OEM, military or laboratory—you're sure to find one among the many offered by dozens of vendors. Some make them, some import them and a few offer "private-label" recorders bought from others.

Industrial units are generally large-quantity items that are built up with options and features for a single-purpose job. By contrast, lab recorders are usually general-purpose machines and, as such, come with interchangeable front ends and selectable speeds and sensitivities.

Features and options range from integral disposable pen-cartridges to stepping-motor chart drives to alphanumeric edge printing. Some units offer automatic ranging and automatic gain or damping. Retransmitting devices are available to provide output control signals, if needed.

If the thousands of features and options don't do the job, many vendors will customize special units. Just ask. ■■

## Need more information?

The products cited in this report don't represent the manufacturers' full lines. For additional details, circle the appropriate information retrieval numbers. For data sheets and more vendors, consult ELECTRONIC DESIGN's GOLD BOOK.

- Beckman Instruments, 2500 Harbor Blvd., Fullerton, CA 92634. (714) 871-4848. (Dick Bresen). **Circle No. 420**
- Data Technology Corp., 2700 S. Fairview Rd., Santa Ana, CA 92704. (714) 546-7160. (R. Gaskill). **Circle No. 421**
- Elnik Instruments Inc., 410 Garibaldi Ave., Lodi, NJ 07644. (201) 779-7388. (C. J. Loens). **Circle No. 422**
- EPC Labs Inc., P. O. Box 97, Beverly, MA 01915. (617) 927-2523. (Michael J. Stewart). **Circle No. 423**
- Esterline Angus Div., Esterline Corp., P. O. Box 24000, Indianapolis, IN 46224. (317) 244-7611. (Paul Lawall). **Circle No. 424**
- Fischer-Porter Co., 48 Warminster Rd., Warminster, PA 18974. (215) 675-6000. (E. W. Grien). **Circle No. 425**
- Fisher Scientific Co., 711 Forbes Ave., Pittsburgh, PA 15219. (412) 562-8479. (Phil Hunsucker). **Circle No. 426**
- Fitchburg Coated Products (Recorder Paper), Box 1106, Scranton, PA 18501. (717) 347-2035. **Circle No. 448**
- Foxboro Co., 86 Neponset Ave., Foxboro, MA 02035. (617) 543-8750. **Circle No. 449**
- General Scanning Inc., 150 Coolidge Ave., Watertown, MA 02172. (617) 924-1010. (R. L. Hubbell). **Circle No. 427**
- Gould, Inc., Instrument Systems Div., 3631 Perkins Ave., Cleveland, OH 44114. (216) 361-3315. (Joseph F. Swyt). **Circle No. 428**
- Hewlett-Packard, 1501 Page Mill Rd., Palo Alto, CA 94304. (415) 493-1501. **Circle No. 430**
- Honeywell, Process Control Div., 1100 Virginia, Fort Washington, PA 19034. (215) 643-1300. (H. F. Davis). **Circle No. 431**
- Honeywell, Test Instrument Div., P. O. Box 5227, Denver, CO 80217. (303) 771-4700. (Bob Shipman). **Circle No. 432**
- Houston Instrument Inc., Div. Bausch & Lomb, 4950 Terminal Ave., Bellaire, TX 77401. (713) 667-7403. (L. C. Bower). **Circle No. 433**
- Incor Instrumentation Inc., 144 Lamar St., West Babylon, NY 11703. (516) 643-7070. (T. Swift). **Circle No. 434**
- Leeds & Northrup Co., Sumner Pike, North Wales, PA 19454. (215) 643-2000. (W. S. Mahle). **Circle No. 435**
- Linear Instrument Corp., 17282 Eastman, Irvine, CA 92705. (714) 546-6776. (P. R. Peek). **Circle No. 436**
- McKee-Pedersen Instruments, Box 322, Canville, CA 94526. (415) 937-3630. (R. G. McKee). **Circle No. 437**
- Measurement and Control Systems Div./Gulton Industries, Inc., Gulton Industrial Park, East Greenwich, RI 02818. (401) 884-6800. (C. H. Eckert). **Circle No. 429**
- Philips Test & Measuring Instruments Inc., 400 Crossways Park Dr., Woodbury, NY 11797. (516) 921-8880. (Stewart Rausch). **Circle No. 438**
- Philips Gloeilampenfabrieken, Industrial and Scientific Equipment Div., Eindhoven, the Netherlands. 040-788620. (Stanley Lodder). **Circle No. 439**
- Siemens Aktiengesellschaft, Werner-von-Siemens Strabe 50, D-8520 Erlangen 2. (09131) 7-33940. (Joachim Ullmann). **Circle No. 440**
- Siemens Corp., 186 Wood Ave. South, Iselin, NJ 08830. (201) 494-1000. (B. Mayer). **Circle No. 441**
- Simpson Electric Co., Div. of AGM, 853 Dundee Ave., Elgin, IL 60120. (312) 695-1121. (J. M. Petroselli). **Circle No. 442**
- Telmar Inc., 1150 W. Third Ave., Columbus, OH 43212. (614) 299-2165. (G. R. Scott). **Circle No. 443**
- Texas Instruments, Digital Systems Div., P.O. Box 1444, MS 784, Houston, TX 77001. (713) 777-1301. **Circle No. 446**
- TPI Div. of Graphic Control Corp. (Marking-system components manufacturer), 2 Springdale Rd., Cherry Hill, NJ 08003. (609) 424-2200. (Thomas Schwanda). **Circle No. 447**
- Tracor Westronics Inc., 5050 Mark IV Parkway, Fort Worth, TX 76106. (817) 625-2311. (D. L. Clarke). **Circle No. 444**
- Yewtec Corp., 1995 Palmer Ave., Larchmont, NY 10538. (914) 834-3550. (G. R. Johnson). **Circle No. 445**

# The choice is yours...

## for image storage

- Air traffic control ● Harbour and river traffic control ● Remote display
- Image offset and Zoom ● Multisensor displays ● TV image freeze
- Banking, luggage check ● Scan conversion (PPI, random, TV standards)
- Signals handling ● Low light level imaging. Integration.

We offer the widest choice of storage tubes to solve your problems: permanent recording or progressive erasure, single or dual-gun for sequential or simultaneous write and read-out, full grey scale capability, rugged, compact and high resolution types.



**THOMSON-CSF**

MARKETED IN NORTH AMERICA BY DUMONT ELECTRON TUBES & DEVICES / CLIFTON N.J. / TEL (201) 773-2000

FRANCE - THOMSON-CSF GROUPEMENT TUBES ELECTRONIQUES / 8, RUE CHASSELOUP-LAUBAT / 75737 PARIS CEDEX 15 / Tél. (1) 566 70 04

Germany - THOMSON-CSF Elektronenröhren GmbH / Am Leonhardsbrunn 10 / 6 FRANKFURT/MAIN / Tel. (0611) 70 20 99

Italy - THOMSON-CSF Tubi Elettronici SRL / Viale degli Ammiragli 71 / ROMA / Tel. (6) 38 14 58

Japan - THOMSON-CSF Japan K.K. / Kyosho Building / 1-9-3 Hirakawa-cho / Chiyoda-ku / TOKYO 〒102 / Tel. (03) 264 6341

Sweden - THOMSON-CSF Elektronrör AB / Box 27080 / S 10251 STOCKHOLM 27 / Tel. (08) 22 58 15

United Kingdom - THOMSON-CSF Electronic Tubes Ltd / Bilton House / Uxbridge Road / Ealing / LONDON W 5 2TT / Tel. (01) 579 55 11 / Telex 26 659

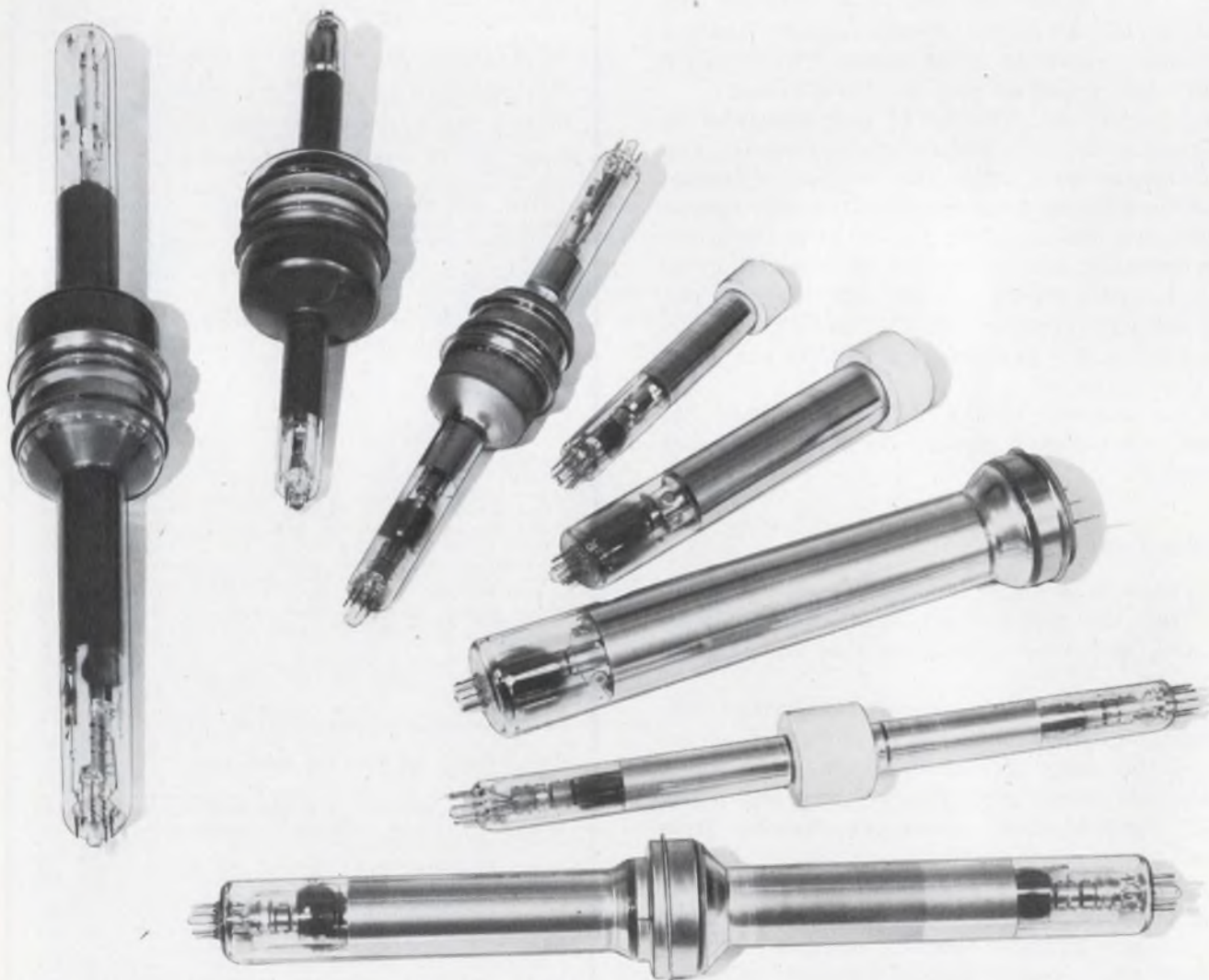

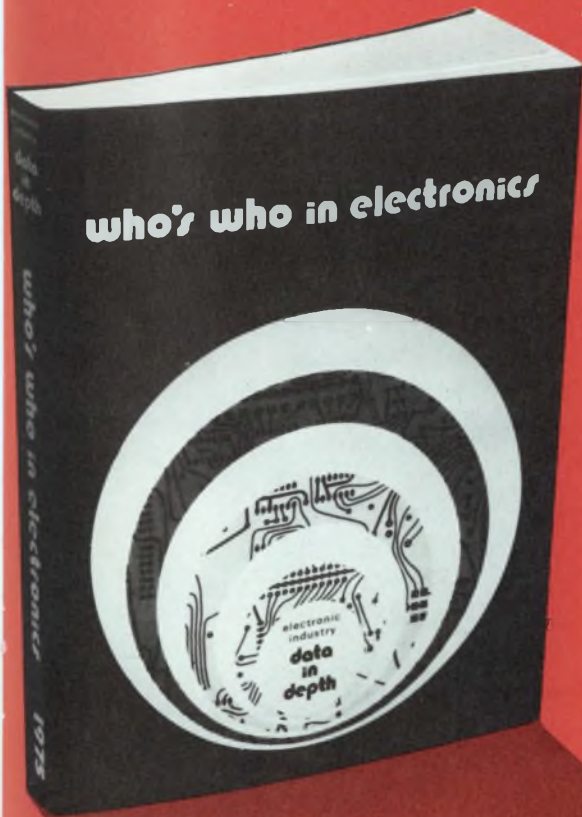

An Industry **FIRST...**

Have all the facts  
on electronic firms  
at your fingertips

**data in depth**

...7,500 Manufacturers  
...2,500 Distributors  
...3,500 Representatives

**who's who  
in electronics**

The most comprehensive directory  
in the electronic industry.

**exclusive!**

**Manufacturers Section**

Companies are listed in alpha sequence under city headings within states. More information is shown on these manufacturers than all other industry directories combined.

- Division
- Toll free phone  
TWX, Telex
- Key personnel
- Number of employees
- Annual sales
- Plant size
- Foreign trade
- S.I.C., major products

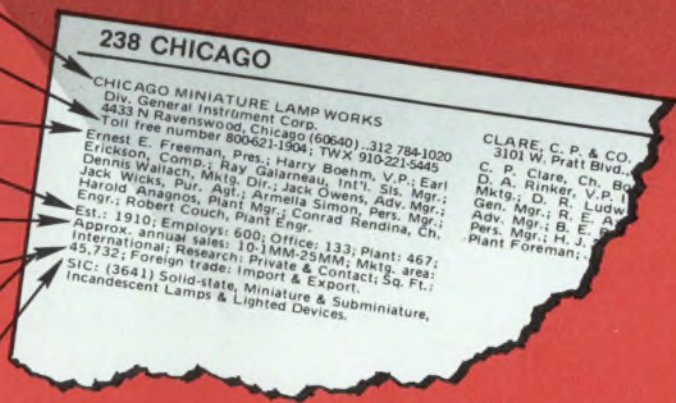

**Alpha & Geo Sections**

Each major section is organized into alpha-  
betic and geographic segments. Data-in-Depth  
appears in geographic, while alpha contains:  
name, address and direct dial phone number.

**Purchasing Index**

Contains over 600 separate product classi-  
fications. Listings include: name, address and  
telephone number.

**Distributors Section**

Lists over 2,500 electronic industrial distri-  
butors. Data include: key personnel, number  
of employees, annual sales, major lines stock-  
ed and much more.

**Representatives Section**

Over 3,500 electronic representatives are list-  
ed with: lines handled, territory covered, type  
of industry served and much more.

- Vastly expanded data (750 pages)
- Dozens of uses by: buyers, sellers,  
& marketing oriented management.
- Accurate & authoritative.
- Easy to use

**\$49.50**  
Plus \$2.50 for postage and handling.

Send Check Today To...

**hp harris publishing co.**

33140 AURORA ROAD • CLEVELAND, OHIO 44139  
PHONE 216 248-8540

# Program multichannel audio gain

with FETs in the feedback paths of op amps. Quad chips allow up to 60 dB of control range with good tracking.

A field-effect transistor in the feedback path of a noninverting amplifier allows you to design gain-control circuits with a three-decade range. Besides the circuit's simplicity, it lends itself—with dual or quad op amps—to multiple-channel operation with tracking gain control. Since the FET is used as a voltage-controlled resistor, a single potentiometer or digital-to-analog converter can control any number of channels.

The gain-control range can be designed for values from below 2:1 to above 1000:1. Input voltage levels are limited by allowable distortion, and the bandwidth of the complete circuit depends on the maximum gain and the unity-gain bandwidth of the op amp.

## Control FET channel resistance

The reciprocal relationship between FET channel resistance  $r_d$  and  $V_{GS}$  is used for the linear gain control. The ac resistance of the FET is given by

$$r_d = r_o \frac{V_p}{V_p - V_{GS}} \quad (1)$$

in which  $V_p$  is the pinch-off voltage. As  $V_{GS}$  approaches  $V_p$ , the  $r_d$  approaches infinity.

In fact, the FET is often used this way as a simple voltage-controlled attenuator (Fig. 1a). But you can consider  $V_p - V_{GS}$  as a control voltage  $V_c$  and therefore

$$r_d = r_o \frac{V_p}{V_c} \quad (2)$$

The gain of an op-amp circuit and FET (Fig. 1b) is given by

$$A_v = 1 + \frac{R_1}{r_d} \quad (3)$$

Or, with  $r_d$  expressed as in Eq. 2,

$$A_v = 1 + \frac{R_1}{r_o} \cdot \frac{V_c}{V_p}, \quad (4)$$

which proves that the gain is a linear function of  $V_c$ .

When  $V_c = 0$ , the gain is unity; as  $V_c$  approaches  $V_p$  the gain increases to

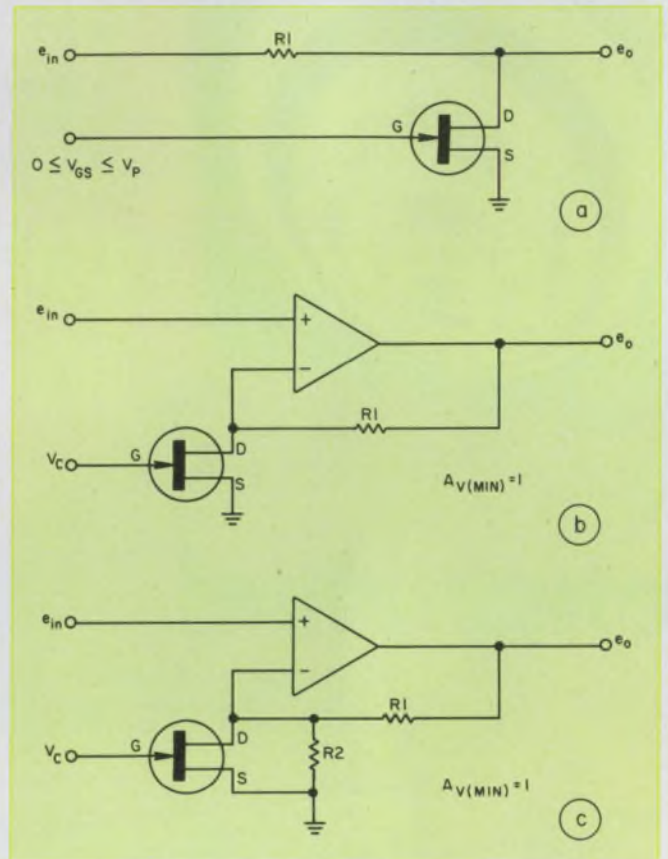

1. The FET as a voltage variable resistor easily controls the gain of an op amp. While the unit is often used as a simple attenuator (a), it provides linear control when used in conjunction with an op amp (b, c).

$$A_v = 1 + R_1/r_o.$$

The gain values of such circuits can be as high as 1000.

The addition of resistor  $R_2$  will limit the minimum gain to some value greater than unity (Fig. 1c). The gain equation becomes

$A_v = 1 + R_1 / [(R_2 r_o (V_p/V_c)) / (R_2 + r_o (V_p/V_c))]$ , or more simply,

$$A_v = 1 + \frac{R_1}{R_2} + \frac{R_1}{r_o} \cdot \frac{V_c}{V_p},$$

which remains linear with  $V_c$ .

The actual circuits exhibit linear gain change with the control voltage; except near minimum gain (Fig. 2). Finite contact resistances at the source and drain cause the FET to act in a non-

James Sherwin, Linear Applications Manager, National Semiconductor Corp., 2900 Semiconductor Dr., Santa Clara, CA 95051.

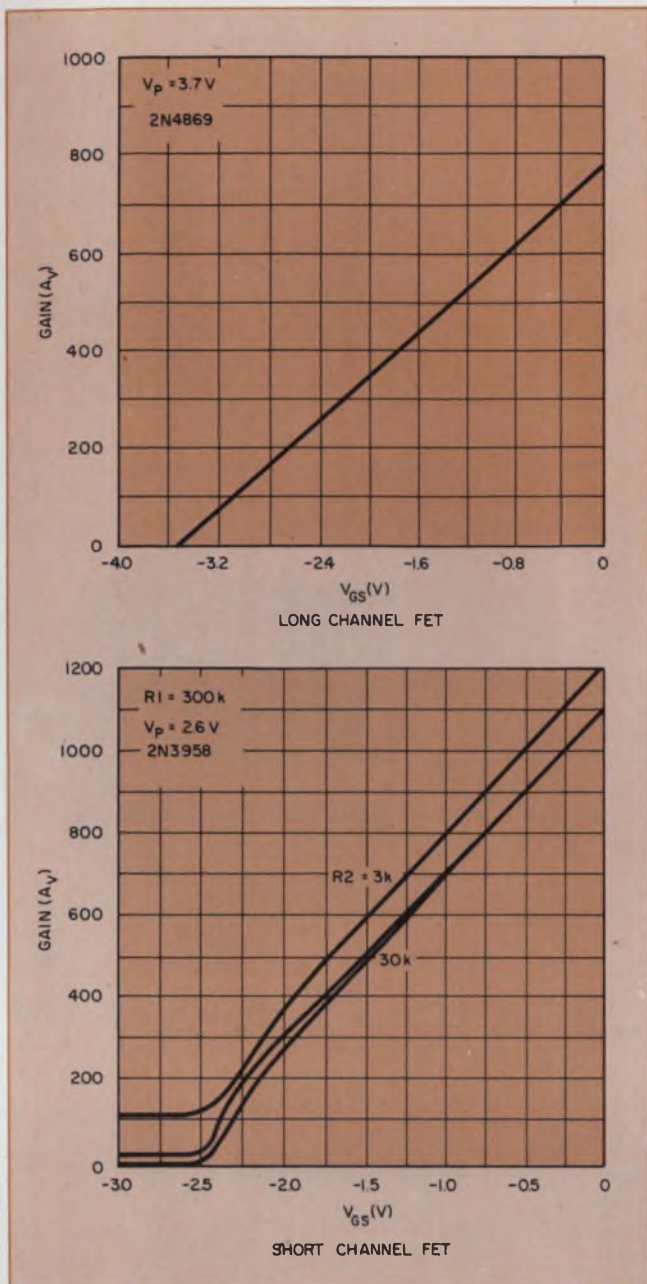

2. The linearity of gain control depends on the channel length of the FET. Long channels are better because the controlled resistance is a larger percentage of the total FET channel resistance.

ideal way. However, for FETs with longer channels, the gain curve is more linear. For these units the controlled-channel resistance is a larger percentage of the total source-drain resistance. And where precise control is required, the long-channel device is desirable.

### Signal distortion can be minimized

The value of  $r_d$  is not constant with the ac signal across the FET. And this form of nonlinearity can introduce distortion. The effect is most pronounced as  $V_{GS}$  approaches  $V_p$ . There are two simple ways to minimize this distortion: Limit  $V_{DS}$  to small values when  $r_d$  is large or use FETs that have large values of  $V_p$ .

The linearity of  $r_d$  can be improved somewhat by feedback of a portion of  $V_{DS}$  in series with  $V_{GS}$ . About half of  $V_{DS}$  is applied to the gate (Fig. 3a). All that is required is the addition of two resistors and a capacitor. The capacitor blocks the control voltage from the drain and op-amp input. The addition of an emitter follower (Fig. 3b) prevents abrupt changes in  $V_i$  from being coupled to the op amp.

The improvement in measured distortion with and without feedback is very significant (Fig. 4). Measured distortion at low signal levels is actually the result of noise, not circuit distortion. The plots are given for a maximum gain of 100 to avoid regions of low S/N. The total noise is that of the op-amp input stage plus the contribution from the FET—essentially the thermal noise of  $r_d$ .

The signal bandwidth of the circuit equals that of the op amp's closed-loop bandwidth. The control time constant depends on the FET input circuit (the value of R) and is limited by the slew rate of the op amp. The FET can react almost instantaneously to produce a step change in the feedback ratio.

There are numerous applications for these circuits; for example,

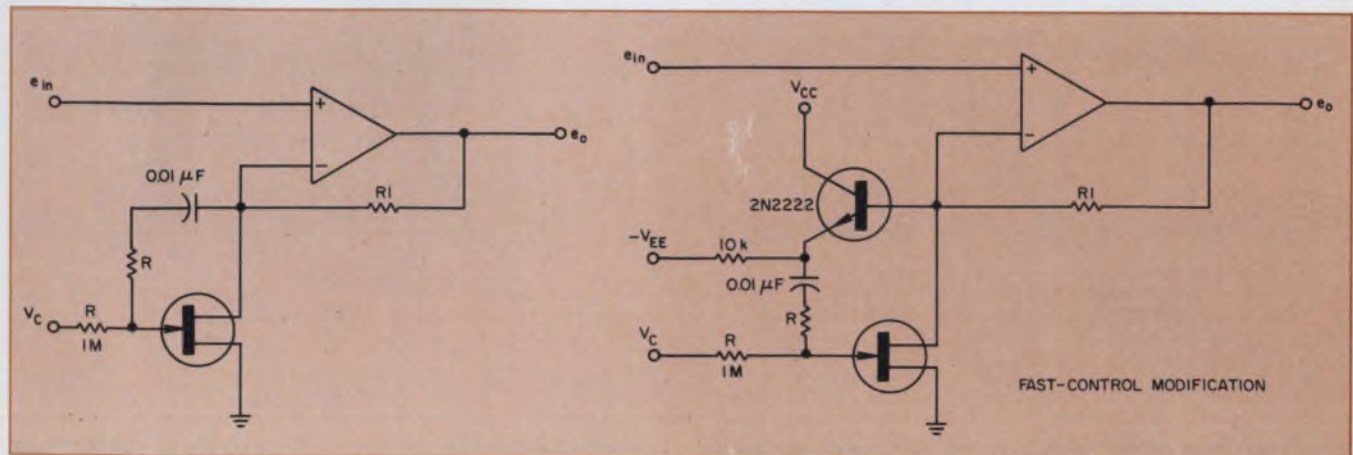

3. Series feedback of  $V_{DS}$  with  $V_{GS}$  improves gain-control linearity.

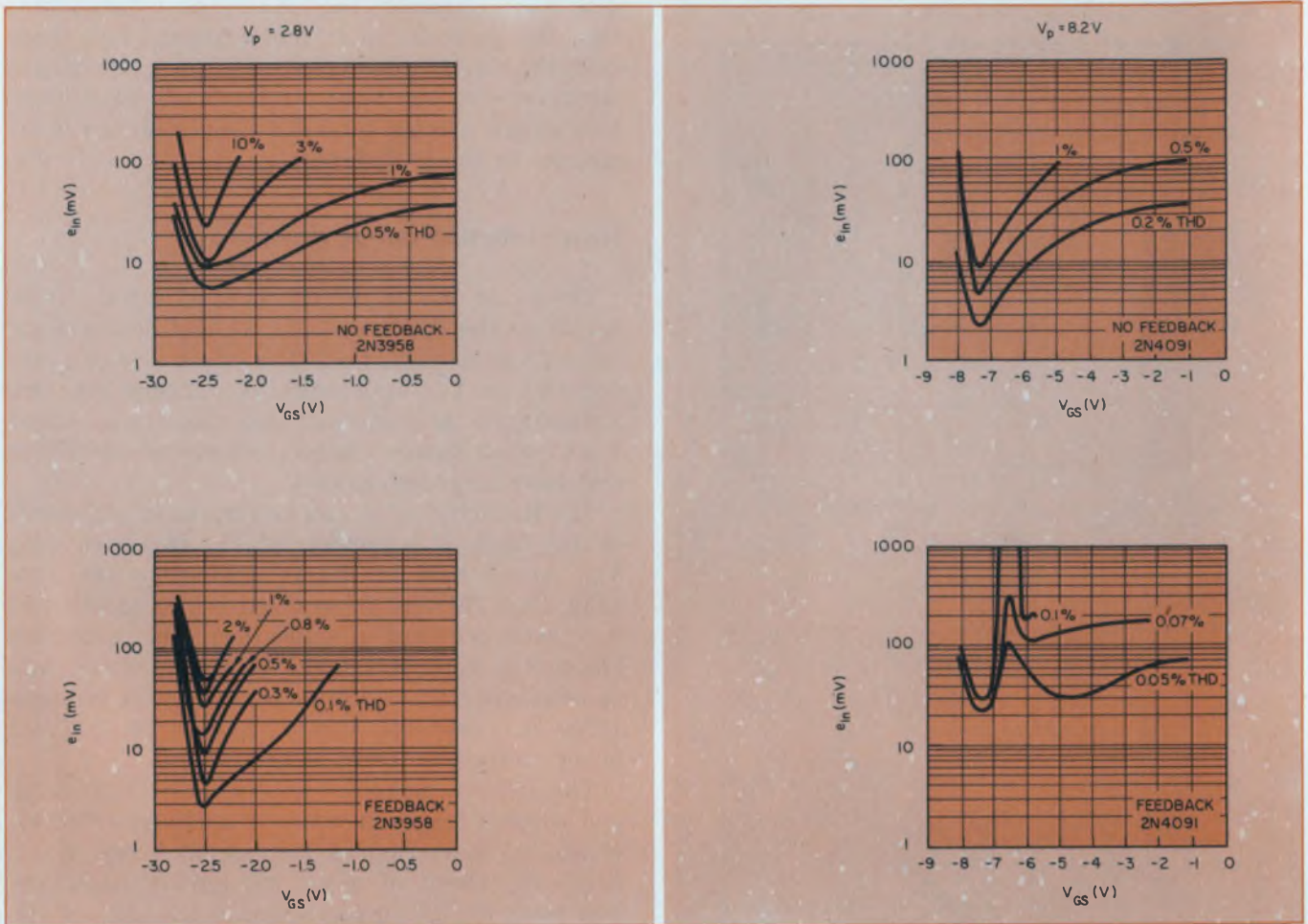

4. Large values of pinch-off voltage,  $V_{p1}$ , as well as feedback (shown in Fig. 3), reduce signal distortion as

shown by the curves on the lower right. Gain control range is from 1 to 100 for all four curves.

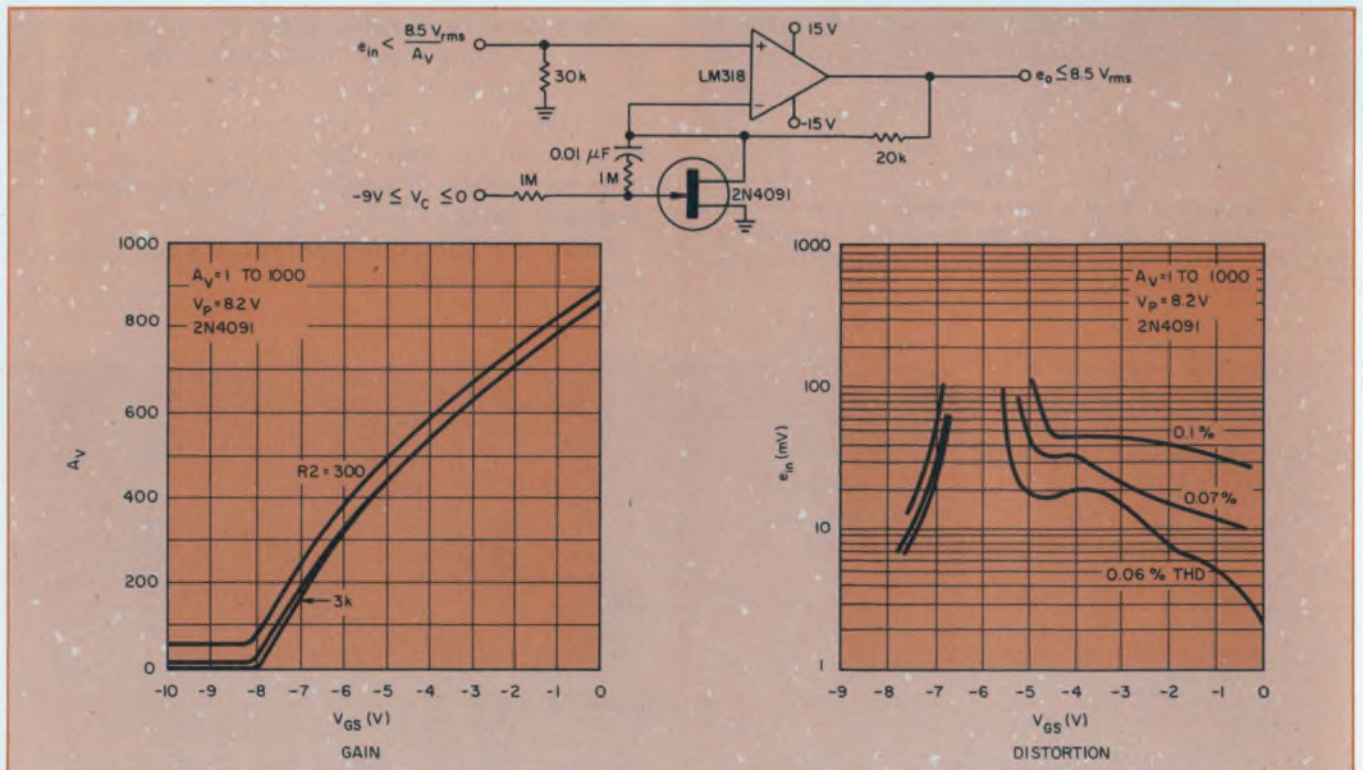

5. A maximum output of 8.5 V rms and a gain range of 1000:1 are readily achieved. Distortion is low, but the

short-channel FET forces the gain curve to deviate from linearity with respect to  $V_G$ .

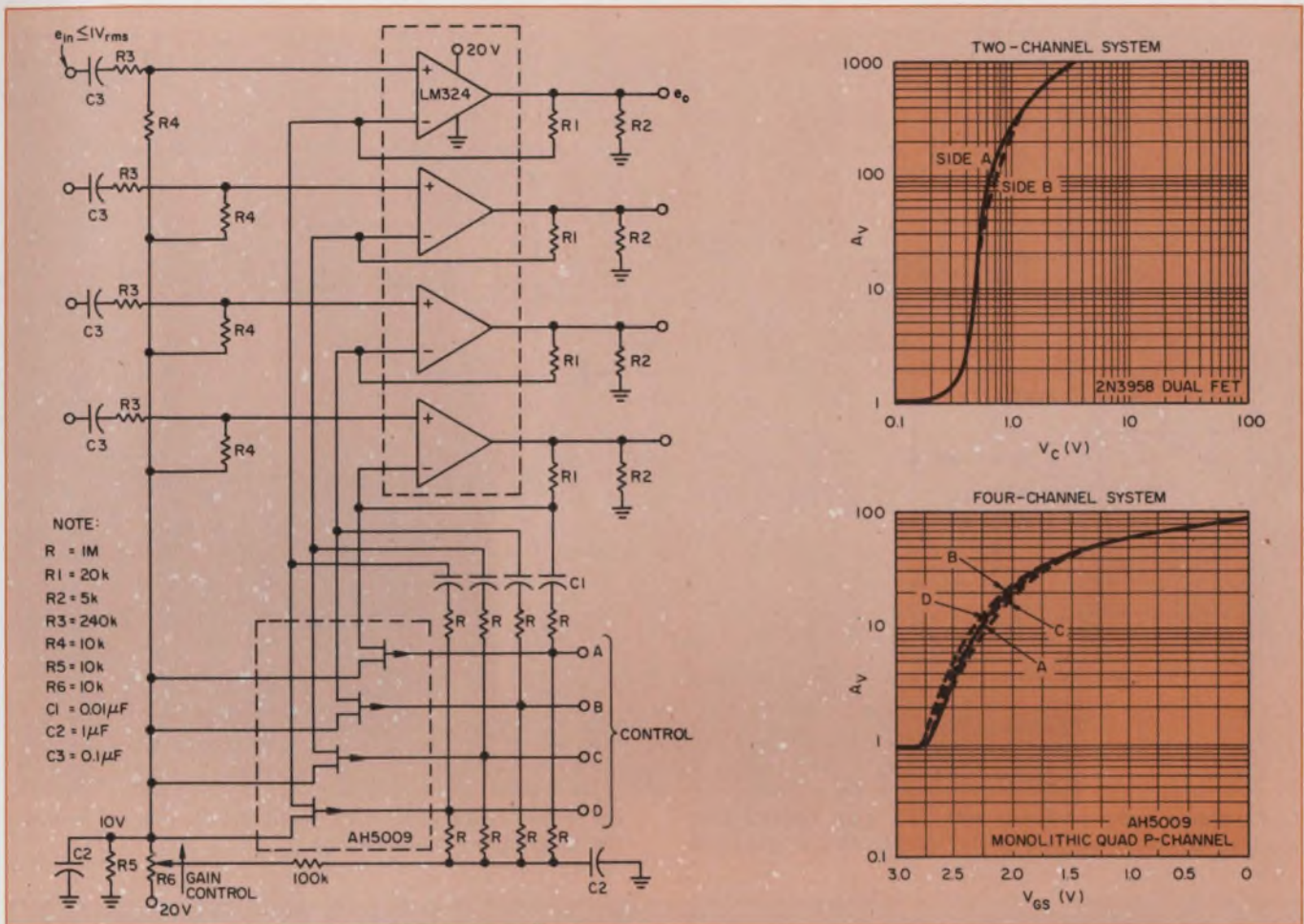

6. Multiple-channel operation with excellent gain tracking is readily achieved by use of dual or quad monolithic

FET chips. Monolithic FETs are recommended for a close match of  $V_p$  on all channels.

- Remote or multichannel gain control.
- Volume expansion.
- Volume compression.
- Quad sound control.

At maximum gain, the circuit shown in Fig. 5 has a bandwidth of 20 kHz, a maximum output level of 8.5 V rms and a gain range of 1 to 1000. The FET has a large  $V_p$  (8.2 V) to minimize distortion. The FET used is a short-channel type. Hence the circuit has a nonlinear gain-control characteristic.

The op amp used provides wide frequency range at maximum gain. The input voltage must be less than 8 mV rms at maximum gain to prevent output saturation. And the circuit provides an S/N of 60 dB measured with a 10-kHz bandwidth.

For a gain range of 1 to 100, an LM301A could furnish a 10 kHz bandpass, handle 80 mV signals and provide 80 dB of S/N.

### Monolithic FETs ensure gain match

Any dual op amp used in conjunction with a monolithic dual FET (NSC 2N3958) can provide tracking gain functions. Alternatively, the

LM324 quad op amp and AH5009 quad FET will provide four tracking channels (Fig. 6). The gain is variable over a range of 100:1 (40 dB), and you get a minimum S/N of 70 dB with 4.3 V rms output. And excellent gain tracking is possible, as shown by the curves. Monolithic dual (quad) FETs ensure a close match of  $V_p$ .

Noise is an important consideration for these gain-control circuits. For a 40-dB attenuator, you may have to add fixed attenuation at the amplifier input and perhaps at the output. Thus a low-noise amplifier is desirable. Low source resistance also helps. With an LM381 you can achieve about 100 dB of S/N with a 40-dB gain range or 80 dB S/N with a 60-dB attenuator.

To reduce sensitivity with temperature, use a silicon resistor for  $R_1$ . This will compensate for FET temperature sensitivity. If the FET were integrated on the op-amp chip,  $R_1$  could also be included.

The linear characteristic of the FET gain control is ideal for use in volume expanders. The required control range is about 1:4, and the input signal level is low. Other requirements include these:

- Linear slope of log gain (dB) with respect

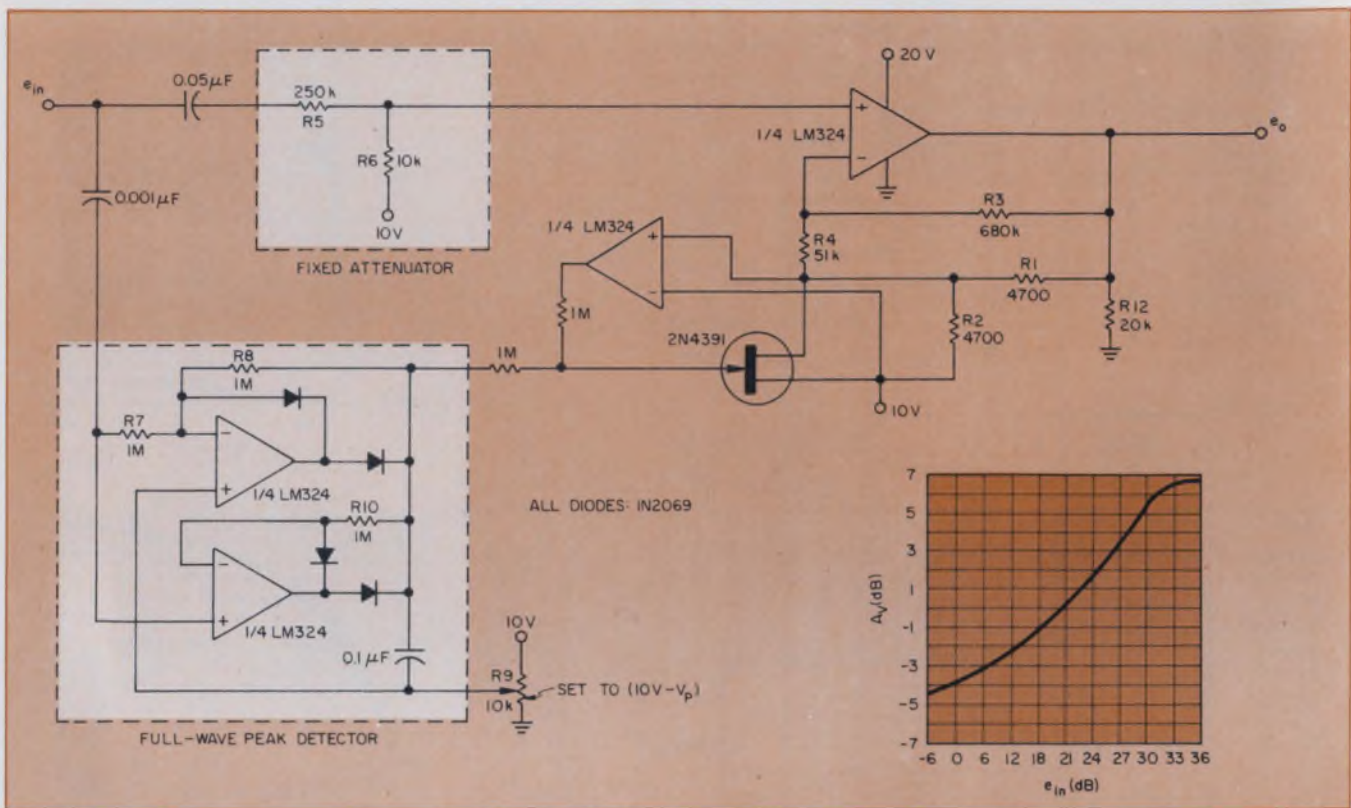

7. A volume expander built with FET gain control also has the necessary log-gain characteristic. Circuit gain is 0

dB at mid range (100 mV). Resistors  $R_3$  and  $R_1$  furnish the logarithmic characteristic.

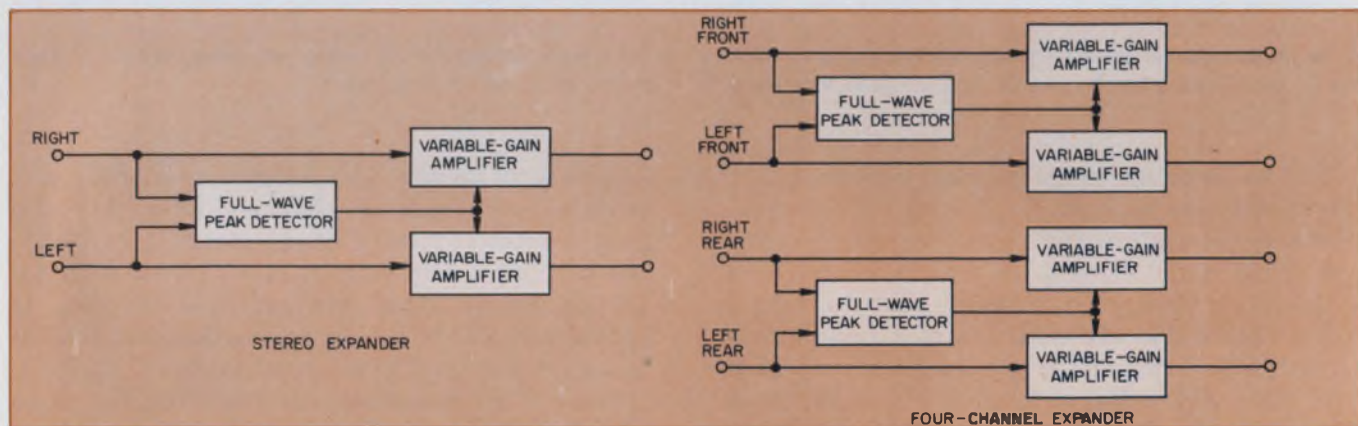

8. The expander circuit is readily adaptable to stereo or quad sound systems.

to signal level (dB).

- 12-dB gain change for 30-dB input signal range.

- Linear peak detector with fast attack (1 ms or less) and discharge time of about 2 s.

A circuit built around a quad op amp achieves all these design goals (Fig. 7). Resistors  $R_3$  and  $R_1$  modify the linear gain curve to a logarithmic one. Half of the quad performs as a full-wave peak detector. The FET is biased off (minimum gain) for small signals and biased on progressively for large signals (maximum gain).

Resistors  $R_5$  and  $R_6$  attenuate the input signal before amplification. This reduces distortion (0.1% at all signal levels) and provides over-all

gain of 0 dB at the mid-range of expansion. The S/N is a function of signal level, but the maximum is 80 dB.

The circuit technique is extended readily for use with stereo or quad applications (Fig. 8). You can choose to expand all channels together, derive individual control signals from each channel or obtain the signal from a summation of two to four channels.

If volume compression is needed, bias the FET on for low signals and let increasingly larger signals bias the FET off. The distortion is greatest at large signal levels (low gain) but still acceptably low, usually less than 0.1%. And the circuit is a logical mate to the expander. ■■



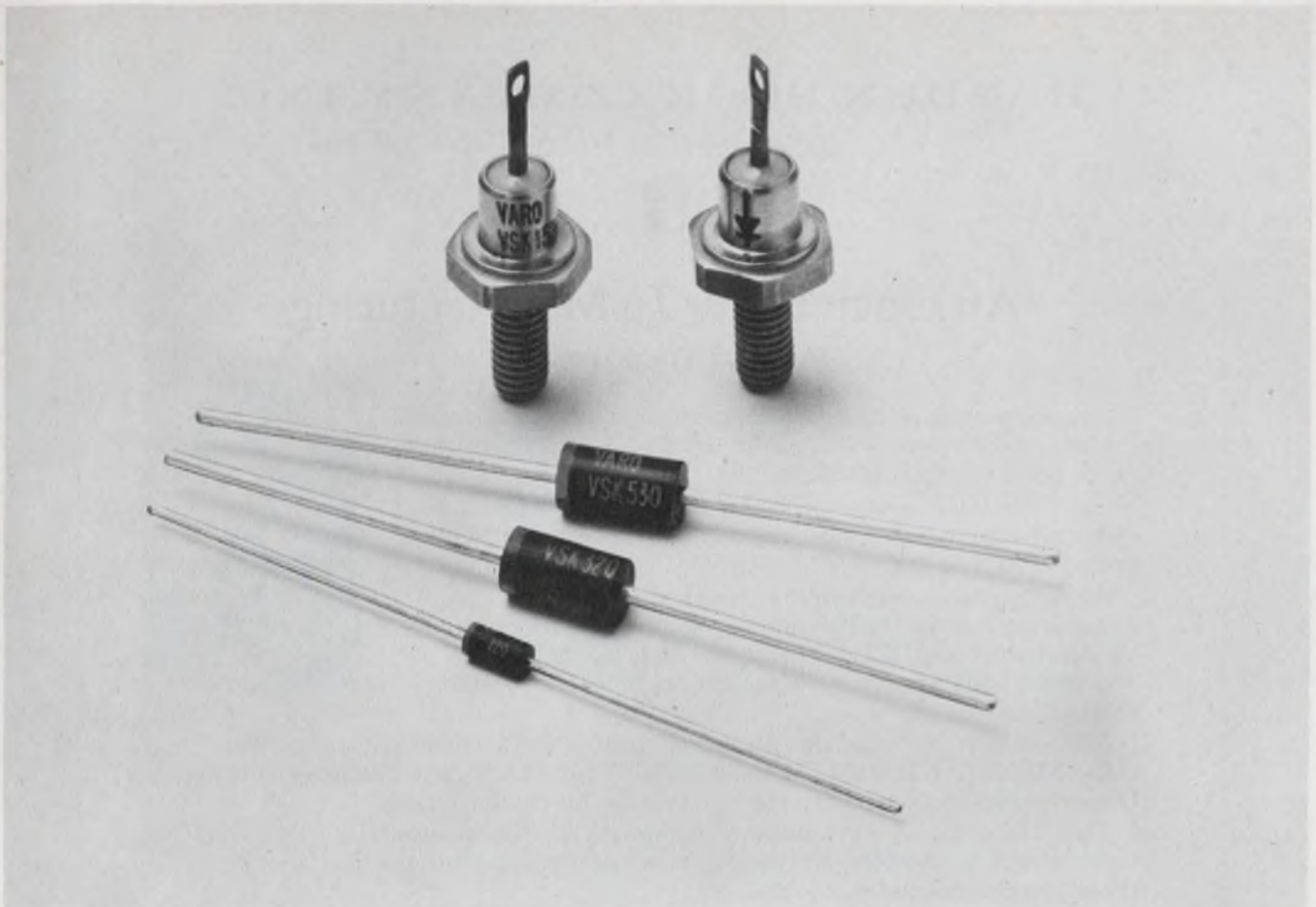

# SCHOTTKY BARRIER RECTIFIERS

*A new series from the advanced rectifier technology  
of Varo Semiconductor, Inc.*

Four new series of Schottky Barrier Rectifiers are now available from Varo Semiconductor, Inc. They are rated at 1A, 3A, 5A, and 15A ( $I_o$ ) with 20V and 30V ( $V_{RRM}$ ).

Features are: Extremely fast recovery ( $t_{rr}$ ), very low forward voltages ( $V_F$ ), high reliability and low cost.

The 1A series (VSK 120 & 130) in DO-41 packages have 450 & 550 mV ( $V_F$ ); 40A peak  $\frac{1}{2}$  cycle surge ( $I_{FSM}$ ) and 10mA ( $I_R$ ) at 100°C.

VSK 320 & 330, the 3A devices have 475 and 500mV ( $V_F$ ); 150A peak  $\frac{1}{2}$  cycle surge ( $I_{FSM}$ ) and 30 mA ( $I_R$ ) at 100°C.

VSK 520 & 530 — 5A Schottkys have 380mV ( $V_F$ ); 250A peak  $\frac{1}{2}$  cycle surge and 75 mA ( $I_R$ ) at 100°C. Both the 3A and 5A series are in axial lead, epoxy packages.

The VSK 1520 & 1530 — 15A series are in DO-4 metal stud cases and have 550mV ( $V_F$ ); 300A peak  $\frac{1}{2}$  cycle surge and 75mA ( $I_R$ ) at 100°C.

All devices have a junction operating temperature range of -65°C to +125°C.

Typical pricing in 1000 qtyts range from \$1.38 ea. (VSK 120) to \$3.67 ea. (VSK 1530).

VARO SEMICONDUCTOR, INC.  
P.O. Box 676 • Garland, Tex. 75040

*Please send free evaluation samples on your  
new Schottky type no. \_\_\_\_\_*

Name \_\_\_\_\_

Title \_\_\_\_\_

Company \_\_\_\_\_

Address \_\_\_\_\_

City \_\_\_\_\_ State \_\_\_\_\_ Zip \_\_\_\_\_

**SEND COUPON OR WRITE ON  
YOUR LETTERHEAD FOR  
FREE SAMPLES.**



*Design us in . . . we'll stay there*

**VARO**

**VARO SEMICONDUCTOR, INC.**

P.O. BOX 676, 1000 N. SHILOH, GARLAND, TEX. 75040 (214) 272-4551 TWX 910-860-5178

**Varo Sales Representatives**

AL Buchanan & Abrams Assoc. 305-898-7444 • AZ W. W. Posey Co. 602-949-5873 • AR Whiteside Sales 214-231-9771 • CA (NO) W. W. Posey Co. 415-948-7771 • CA (SO) Corcoran Assoc. 213-823-4859 • CO Sage Sales 801-531-0531 • CT Comp Rep Assoc., Inc. 203-239-9762 • DE Tom Davis Marketers 302-998-0123 • FL Buchanan & Abrams Assoc. 305-898-7444 • GA Buchanan & Abrams Assoc. 305-898-7444 • IA Coombs Assoc. 312-298-4830 • IL (NO) Varo Semiconductor, Inc. 312-627-3802 • IL (SO) Beneke & McCaul 314-434-6242 • IN Technical Reps., Inc. 317-849-6454 • KS Beneke & McCaul 816-765-2998 • KY Technical Reps., Inc. 317-849-6454 • LA Whiteside Sales Co. 214-231-9771 • ME Comp Rep Assoc., Inc. 617-444-2484 • MD Tom Davis Marketers 703-591-7390 • MA Comp Rep Assoc., Inc. 617-444-2484 • MI Davis Martensen Co. 313-474-8300 • MN Loren F. Green Assoc. 612-781-1611 • MS Buchanan & Abrams 305-898-7444 • MO Beneke & McCaul, Inc. 314-567-3399 • NB Beneke & McCaul 816-765-2998 • NJ (NO) Cooper-Simon & Co. 516-487-1142 • NJ (SO) Tom Davis Marketers 302-998-0123 • NM W. W. Posey Co. 602-949-5873 • NY (METRO) Cooper-Simon & Co. 516-487-1142 • NY (UPST) Bob Dean, Inc. 607-272-2187 • NC Buchanan & Abrams Assoc. 704-332-4974 • OH (NO) J. C. Hofstetter Co. 216-241-4880 & 216-725-4477 • OH (SO) J. C. Hofstetter Co. 513-296-1010 • OK Whiteside Sales Co. 214-231-9771 • OR C. K. Shanks & Assoc. 503-292-5656 • PA (E) Tom Davis Marketers 302-998-0123 • RI Comp Rep Assoc., Inc. 617-444-2484 • SC Buchanan & Abrams Assoc. 704-332-4974 • TX Whiteside Sales Co. 214-231-9771 • UT Sage Sales 801-531-0531 • VA Tom Davis Marketers 703-591-7390 • WA C. K. Shanks & Assoc. 206-632-4290 • WI Varo Semiconductor, Inc. 414-782-7590 • CANADA • ONT Cantronics, Ltd. 416-661-2494 • QUE Cantronics, Inc. 514-341-5207

INFORMATION RETRIEVAL NUMBER 29

# HAYDEN BOOK COMPANY, INC.

50 Essex Street, Rochelle Park, New Jersey 07662



## An Open Letter To Manufacturing Managers.

Are you putting off reliable and promising systems innovations because of the money involved? Or the time? Or maybe because of the painful "people problems" you can foresee?

You probably face these problems constantly because as systems technology expands, it demands radically new talents and skills from management.

Recently, professionals from industry, education and government met for the 10th annual symposium co-sponsored by Informatics and UCLA. Their goal? To bring *clarity* and *profitability* to today's new manufacturing methods—for *you*, the *manager*.

Now we have compiled the proceedings into a compact management handbook, called **MANUFACTURING MANAGEMENT SYSTEMS: New Challenges and Profit Opportunities**. As a manager, you couldn't ask for anything more.

This handbook is the symposium and *more*. We've cut away all the extras—the repetitions, the mumblers and the chit-chat—leaving you with the clear and uninterrupted essentials.

The result is an unparalleled, personalized handbook of guidelines, solutions and solid information from some of the nation's most successful industrial leaders.

You'll hear the vice-president in charge of technical affairs at Ford Motor Company tell how an American institution computerized its vast and complex production lines (and battled equally monstrous supplier foul-ups, record problems, etc. along the way).

An executive from a major R & D firm outlines what he has discovered to be the vital managerial skills and essentials for directing progressive operations.

One of Informatic's key men spells out some of the latest and most worthwhile computerized tools available to manufacturers.

The president of a manufacturing firm offers 16 pages of realistic guidelines for handling the sensitive problems of system implementation (without any of the current psycho-social jargon).

There's one corporation president whose share of this handbook is frankly titled "Making Sure You Really Get a Payoff From Your Manufacturing System." It amounts to nothing less than a proven master plan for doing just that.

There are ten sections in all, each one more helpful and informative than the next. Every page is sharp and direct, yet conversational, as if it were being spoken. For the manager, there's a perfect balance of technical information and the wisdom and common sense for using it.

*You can now examine, read and use the handbook free, for 15 days, just by circling the information retrieval number shown below. At the end of that time, just send in a check for \$10.50, plus postage and handling, or return the book with no further obligation.*

You won't run across many opportunities to hear this kind of straight talk. Try to imagine a symposium where you sit right up front and write down every single word because you know you can use it all.

P.S. Remember—it's easy to order. Just circle the *Information Retrieval No.* shown below!



**AIMING for BETTER TRIMMER PERFORMANCE?**

**SETABILITY  $\pm 0.05\%$**

**ZERO in with VISHAY 1/4" TRIMMERS**

BULK METAL<sup>®</sup> set on Compatible Substrate results in:

- TCR: 10ppm/°C
- Setability:  $\pm 0.05\%$
- Low noise: 10 ohm ENR max.
- Uniform surface for low noise
- Mechanical resolution: 21 $\pm$ 2 turns
- Redundant current paths for higher reliability
- Multiple etch lines for improved setability
- Meets or exceeds most military specifications

VISHAY'S unique process of Bulk Metal<sup>®</sup> set on ceramic brings to 1/4" trimmers a combination of stability, TCR, resolution, and setability never before available . . . and they exceed most Mil specs!

**STYLES AVAILABLE**



Model 1240X  
(RJR26X)



Model 1240W  
(RJR26W)



Model 1240P  
(RJR26P)



**VISHAY RESISTIVE SYSTEMS GROUP**

OF VISHAY INTERTECHNOLOGY, INC.

63 LINCOLN HIGHWAY MALVERN, PA. 19355 PHONE: (215) 644-1300

®

INFORMATION RETRIEVAL NUMBER 91

**LOOKING FOR  
A  
DISTRIBUTOR  
NEAR YOU?**

Electronic Design's GOLD BOOK lists 5,700 distributors with access both alphabetic, by distributor name, and geographic by location.

When you need information . . .

**Electronic Design's  
GOLD BOOK  
IS THE PLACE  
TO LOOK**

**TURNED ON TONES!**

**MURATA SUBMINIATURE  
PIEZOELECTRIC  
TUNING FORKS  
FOR TONE SIGNALING  
AND CONTROL**



- CODING AND DECODING
- 288.5 TO 3,000 Hz
- -20°C TO +60°C
- 1.260" X .307" X .307"
- 0.16 oz

**muRata**

**CORPORATION OF AMERICA**

2 Westchester Plaza, Elmsford, New York 10523, U.S.A.  
Phone: 914-592-9180 Telex: 137332

INFORMATION RETRIEVAL NUMBER 92

# Know your a/d converter's dynamic range.

There are three basic definitions, but you had better consider your application before trying to interpret them.

If you select an analog-to-digital converter based on the manufacturer's specification of dynamic range, be careful. Manufacturers use three different definitions to specify dynamic range. One highlights linearity, another sensitivity and the third distortion. Each is correct, but which will be useful to you depends entirely on your application.

The differences may be summarized as follows:

*Linearity* is important when precise arithmetic processes must be performed, such as in digital filtering. One actual instance is in the moving target indicator filter, or "clutter canceler," used in some radar systems. Insufficient dynamic range cuts into the subclutter visibility—the ability to detect a small signal that has doppler offset in the presence of large stationary signals.

*Sensitivity* is vital in ensemble arithmetic processes, such as correlation. One example of this is digital pulse compression or matched filtering. Each individual arithmetic calculation may be buried in noise, but the ensemble of all calculations provides the correlation gain.

*Distortion* is critical in frequency-sensitive arithmetic processes, such as transform algorithms. One of these is the inherently high-dynamic-range fast-Fourier transform. Spurious output products generated in the a/d conversion appear as artifacts (internally generated signals) aliased into the data.

## Linear range: What is it?

What is linear dynamic range? It can be defined as the range of input values over which the digitized output value does not depart by more than 3 dB (Fig. 1). The input-voltage samples quantized by a/d converters are usually transformed into a binary output. A converter that delivers  $n$  bits can resolve an input voltage into  $2^n$  discrete equally spaced values. Each bit output from the converter represents a doubling of the input voltage or a 6-dB change. The least-significant bit (LSB) is usually ambiguous—the accu-

racy of conversion is limited digitally to  $\pm 0.5$  LSB.

The LSB error is only the quantization error and does not include analog errors due to a/d converter component tolerances or sampling errors due to aperture time (sampling gate uncertainty times the highest radian frequency present). Since the maximum signal error is  $\pm 0.5$  LSB, the true signal value is equally likely to be found anywhere within the error band. Thus we can say that the average error will be  $\pm 0.25$  LSB.

## Sensitivity given in decibels

The sensitivity of an a/d converter is always 1 LSB, since an analog input voltage change equivalent to 1 LSB must occur to change the output state. The dynamic range of a converter is the span of signal amplitudes that the converter will quantize to within a predetermined accuracy.

As the input voltage decreases, the converter's binary count output decreases. It drops to the next lower number as the input passes the halfway point between the nominal voltage steps. For a 10-bit bipolar converter that is designed to digitize a voltage span from  $-5$  to  $+5$  V, the changes in output codes occur at 10-mV intervals. For the plot in Fig. 1, the  $\pm 3$  dB departure occurs between the first and second bits, with an input voltage of  $-51$  dB relative to full amplitude.

At the full-scale positive end, the digital output count should not exceed binary 511, since 512 would appear as the two's-complement form of the full-scale negative value. A well-designed a/d converter uses "saturation arithmetic" and will hold its plus sign (ZERO) and all ONEs for inputs that exceed full-scale positive. And likewise for the minus sign (ONE) and all ZEROs for inputs exceeding full-scale negative.

This overrange capability allows another 3 dB for excursions and justifies a 54-dB rating for the a/d converter's linear dynamic range. A handy method of computing the linear range of a converter that resolves to  $n$  bits is

$$\text{Dynamic range} = 6(n-1) \text{ dB.}$$

---

John D. Fogarty, P.E., 5130 Rondel Pl., Columbia, MD 21043.

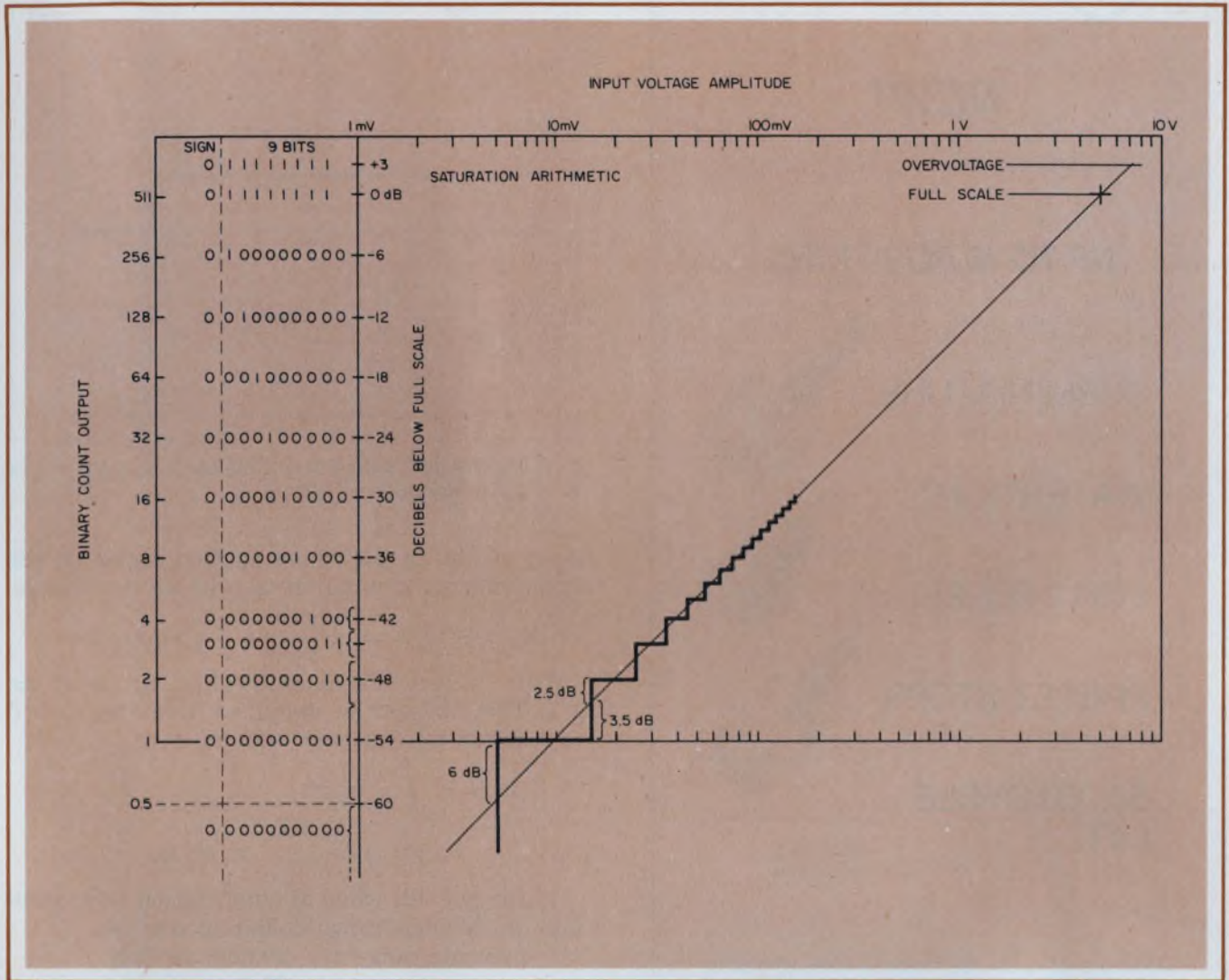

1. The binary count output vs the input voltage amplitude is easily converted into a decibel scale.

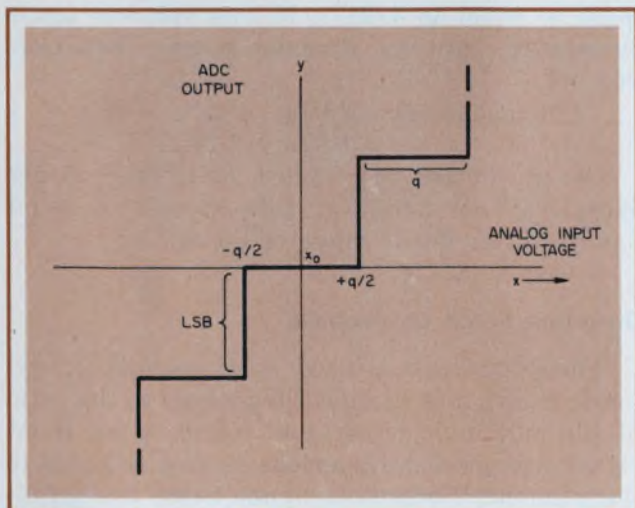

2. Quantization of the a/d converter's input voltage creates a staircase effect, since the input can change by a quantum step,  $q$ , before the output changes.

Only unipolar converters with no sign bit can produce a true 6n-decibel linear dynamic range.

The sensitivity dynamic range is expressed in decibels and is the ratio of the full-scale output to the minimum discernible signal. In a converter this signal is limited by the quantization noise or uncertainty in the LSB. If you use the conventional definition of tangential sensitivity, found in noise-figure analysis, the minimum signal equals the noise power. Thus the dynamic range equals the signal-to-noise ratio of the full-scale output to the quantization noise:

$$\begin{aligned} \text{Dynamic range (dB)} &= 10 \log_{10} (1/N_q) \\ &= -10 \log_{10} N_q. \end{aligned}$$

To derive the quantization noise power,  $N_q$ , assume that the input signal has uniform distribution (equally probable) and the converter output can change only in steps of the least significant bit. Thus the analog excursion that causes an output change of 1 LSB is  $q$  (Fig. 2). The



**NEW!**

## ROTARY SWITCHES

**UP TO 16 POSITIONS**

- SUBMINIATURE
- WATERTIGHT
- 1 OR 2 POLES
- PRESET STOPS
- 50,000 CYCLE LIFE



All Shown  
Actual Size

Nonshorting, low-profile rotary switches with positive detent feature low contact resistance and long life — ideal for hand-held communications or virtually any application that requires a compact, highly reliable, watertight switch.

Contact resistance is 10 to 50 milliohms (max), depending on model. Contact rating for all models is 100 mA @ 120 VAC, and insulation resistance is 10,000 megohms (min) between adjacent terminals @ 100 VDC initial.

Stainless steel shaft is slotted and flatted for screw-driver adjustment or knob. Versatile devices can be PCB or panel mounted. For detailed information, contact TEC or the TEC-REP nearest you.

**DISTRIBUTORS:**

Audio Electronics, Inc., Canada	(416) 495-0720
Bodelle Co., Inc., Chicago	(312) 323-9670
Bordewick Co., New England	(617) 659-4915
Century Aero Corp., So. Cal.	(213) 772-1166
Peerless Radio Corp., Florida	(305) 566-5966
Ratel Electronics, No. Cal.	(415) 965-2010



**TEC, Incorporated**  
9800 NORTH ORACLE ROAD  
TUCSON, ARIZONA USA 85704  
(602) 297-1111  
TWX 910-952-1377

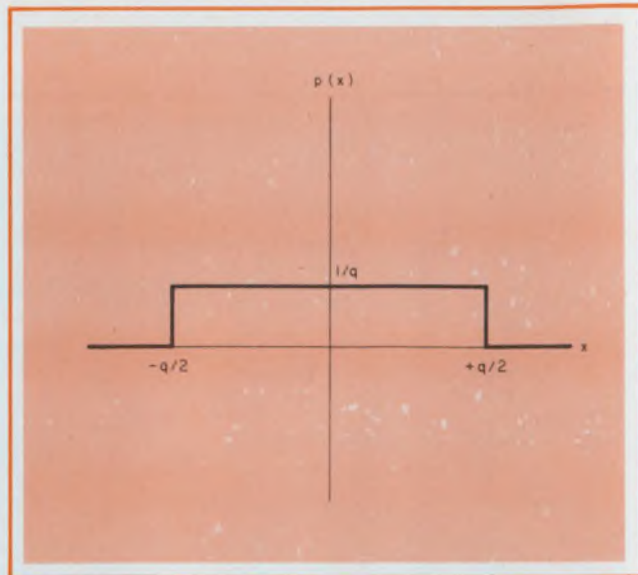

3. A uniform distribution is rectangular and spans  $-q/2$  to  $+q/2$  when  $p(x) = 1/q$ .

noise power is the mean-squared value of the input voltage,  $x$ , required to produce the change.

$$N_q = \langle n^2 \rangle = \int_{-q/2}^{+q/2} (x - x_0)^2 p(x) dx.$$

For uniform distribution (Fig. 3),  $p(x) = 1/q$ . This can now be simplified if you let  $x_0 = 0$  to result in the expected value of  $n^2$  of

$$\begin{aligned} \langle n^2 \rangle &= \int x^2/q dx \\ &= (1/q) \left[ \frac{x^3}{3} \right]_{-q/2}^{q/2} = q^2/12. \end{aligned}$$

If you put this value of quantization noise back into the dynamic-range definition, you get

$$\begin{aligned} \text{Dynamic range} &= -10 \log_{10}(q^2/12) \\ &= -20 \log_{10}q + 10.8. \end{aligned}$$

An  $n$ -bit a/d converter (including sign bit) has  $2^{n-1}$  possible output magnitude states. Therefore, for unity full-scale output, the smallest step,  $q$ , must be equal to  $1/2^{n-1}$ . If this value is again substituted into the dynamic-range definition, you get:

$$\begin{aligned} \text{Dynamic range} &= 20 \log_{10} 1/2^{n-1} + 10.8 \\ &= 6.02n + 4.78. \end{aligned}$$

This result can be rounded off to  $6n + 5$  dB. With this new definition, for example, a 10-bit a/d converter has a range of 65 dB.

### Distortion based on overload

When distortion is used as a measure of dynamic range, it is specified in decibels as the ratio of the minimum discernible signal to an input signal that produces spurious responses equal to the minimum discernible signal. Since this definition is based on experimental measurements of a system in overload, the results are not generally calculable. ■■

**Welded switch terminals assure flaw-free connections.**

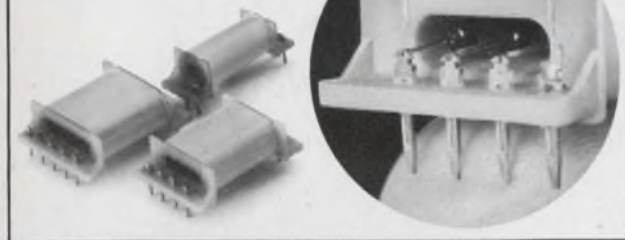

**Series 46 reed relays. Built better to perform better.**

Welded switch terminals prevent damage during assembly and handling and prevent softening and failure of connections when Series 46 open type miniature reed relays are soldered to PC boards. As a result, you get better performance and lower reject rates. Both dry and mercury wetted switches are available. Dry reed models employ NV Philips high reliability reed switches which give the extremely stable contact resistance desired in logic circuit applications. Five different coil forms offer many contact combinations in A, B or C forms. Contact ratings range from 2.8 to 50 watts, 3-48 vdc. Terminals are spaced on 1" centers in the popular .150" grid.

**Send for information now!**

**NORTH AMERICAN PHILIPS CONTROLS CORP.**

Frederick, Md 21701 • (301) 663-5141

INFORMATION RETRIEVAL NUMBER 34

**Discover new performance and economy for your stepper applications.**

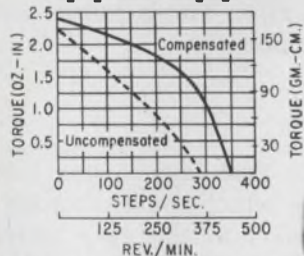

**4-phase PM logic motors for under \$9ea.\***

Get information today on our new low cost 82401 Series reversible permanent magnet logic stepper motor. It will achieve an optimum cost vs. performance ratio for you. End uses include analytical instrumentation and computer peripheral applications such as printer drives, X-Y plotter drives and chart drives.

Coil design assures low wattage operation.....3.5 watts for both 5 vdc and 12 vdc models. Stable stepping operation is achieved by using a permanent magnet construction. Maximum pull-in/out torque is 2.4 oz-in. with a compensation network. Also a maximum pull-in rate of 350 steps/sec and pull-out rate of 480 steps/sec can be attained. Basic step angle is 7.5°, but integral gearing can be furnished to provide a variety of stepping angles and torques.

*\*In 500 quantities*

**Send for information today!**

A. W. HAYDON CO. PRODUCTS

**NORTH AMERICAN PHILIPS CONTROLS CORP.**

Cheshire, Conn 06410 • (203) 272-0301

INFORMATION RETRIEVAL NUMBER 35

ELECTRONIC DESIGN 3, February 1, 1975

**Our \$365\* strip chart recorder includes EXTRAS like these...at no extra cost**

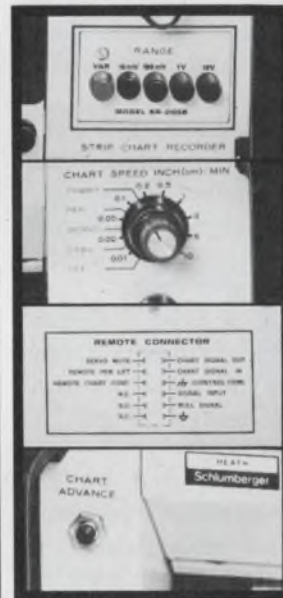

... pushbutton selection of four input spans from 10 mV to 100 V full scale

... ten digitally-controlled chart speeds from 10 to 0.01 inches or cm per minute

... rear panel connector for remote control of all recorder functions (including electric pen lift)

... front panel pushbutton chart advance

**The Heath/Schlumberger SR-255B. You don't have to pay extra for the extras.**



Send for your free copy of the latest Heath/Schlumberger Assembled Instruments Catalog and discover our complete line of high performance, low cost strip chart recorders — and a complete line of precision instruments for industrial, research and educational applications.

**Heath/Schlumberger Instruments  
Dept. 511-02  
Benton Harbor, Michigan 49022**

**HEATH  
Schlumberger**

Please send the latest Heath/Schlumberger Assembled Instruments Catalog.

Name \_\_\_\_\_

Title \_\_\_\_\_

Company/Institution \_\_\_\_\_

Address \_\_\_\_\_

City \_\_\_\_\_ State \_\_\_\_\_ Zip \_\_\_\_\_

\*MAIL ORDER PRICES; F.O.B. FACTORY.  
PRICES & SPECIFICATIONS SUBJECT TO CHANGE WITHOUT NOTICE

EK-447

INFORMATION RETRIEVAL NUMBER 36

# Recognize hand-printed characters with a simple algorithm. And only a small amount of hardware is needed to identify a full set of numbers.

It's easy for a logic circuit to "recognize" hand-printed characters. Surprised? The algorithm is extremely simple when the system is limited to numbers and a few other symbols.

The circuit need only record the regions where a hand-printed character begins and ends. These first and last regions, properly encoded, then address a PROM look-up table to provide the ASCII code for the hand-printed number. The characters are drawn on a standard data-tablet input system.

Consider a paper form preprinted with boxes, in which the characters are hand-printed. The dimensional aspect ratio of each box is  $3 \times 4$ , but each box is divided into nine areas, numbered as in Fig. 1a. Though the recognition task could include the direction, sequence and other characteristics of each stroke, not all of this information is needed for capturing only numbers from zero to nine plus four other symbols. Only the starting and ending points are needed (Figs. 1b and 2).

Conventional written symbols are used, unlike those in optical character-recognition systems (OCR), and little training in recognizing or writing the characters is needed. Surprisingly, the only instance where an ambiguous result is likely to occur—but is easily avoided—is in the case of the number 4.

Note that an "open" number 4 can be confused with the number 7, if the 4 is started in area 2 and ended in area 8 (Fig. 2). An open 4 must begin with the down stroke first—start in region 4 and end in 8 for the first stroke. Then a number 4 with an 8-6 or 4-6 code (for the complete character) is uniquely recognized by the circuit. This is the only special "training" needed to use this algorithm.

The preprinted paper form is placed on a standard data tablet, available from several manufacturers. The data-tablet system converts pen position to binary-coded coordinate outputs

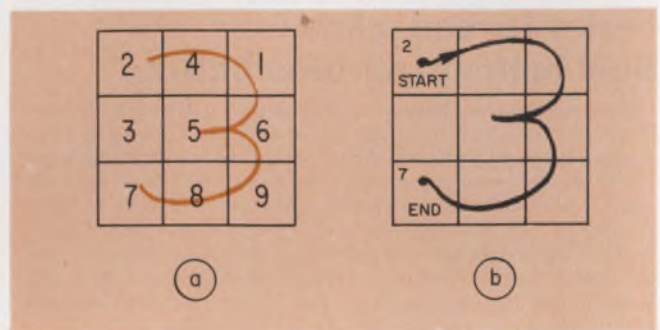

1. Characters are printed within a "macro" box that is subdivided into nine "micro" parts. The parts are numbered (a), and only the start and stop micro numbers (b) are significant in identifying the hand-printed character.

(Fig. 3). The form contains the boxes within which the characters are printed with the pen.

Let's call the boxes on the form "macro boxes." A movement of the pen from one box to another is a macro jump. Within each box, the nine numbered regions are called micros. As the pen is moved within a macro box to create a character, it makes micro jumps. These jumps are analyzed to identify the character.

## Data tablet reads the writing

The data tablet divides each macro box into  $128 \times 64$  position outputs, which the accompanying logic circuit partitions into the nine active micro regions surrounded by dead zones (Fig. 4). The over-all size of the macro box is arbitrary, and boxes can be placed throughout the page in any regular pattern.

Lines delineating the micro regions within each macro box need not be included on the preprinted form, though the lines are useful during the first minutes of training.

The system recognizes the completion of a character when it detects a transition from one preprinted box to another—a macro jump. A 1-s interval with no macro jump is also a signal for a character's completion.

The logic circuit for this character-recognition method uses a relatively small amount of TTL hardware. The operation of the circuit can be

Albert Whetstone, Technical Director, and Stephen Domyan, Design Engineer, Summagraphics Corp., 35 Brentwood Ave., Fairfield, CT 06430.



# State flow chart for hand-printed number recognition

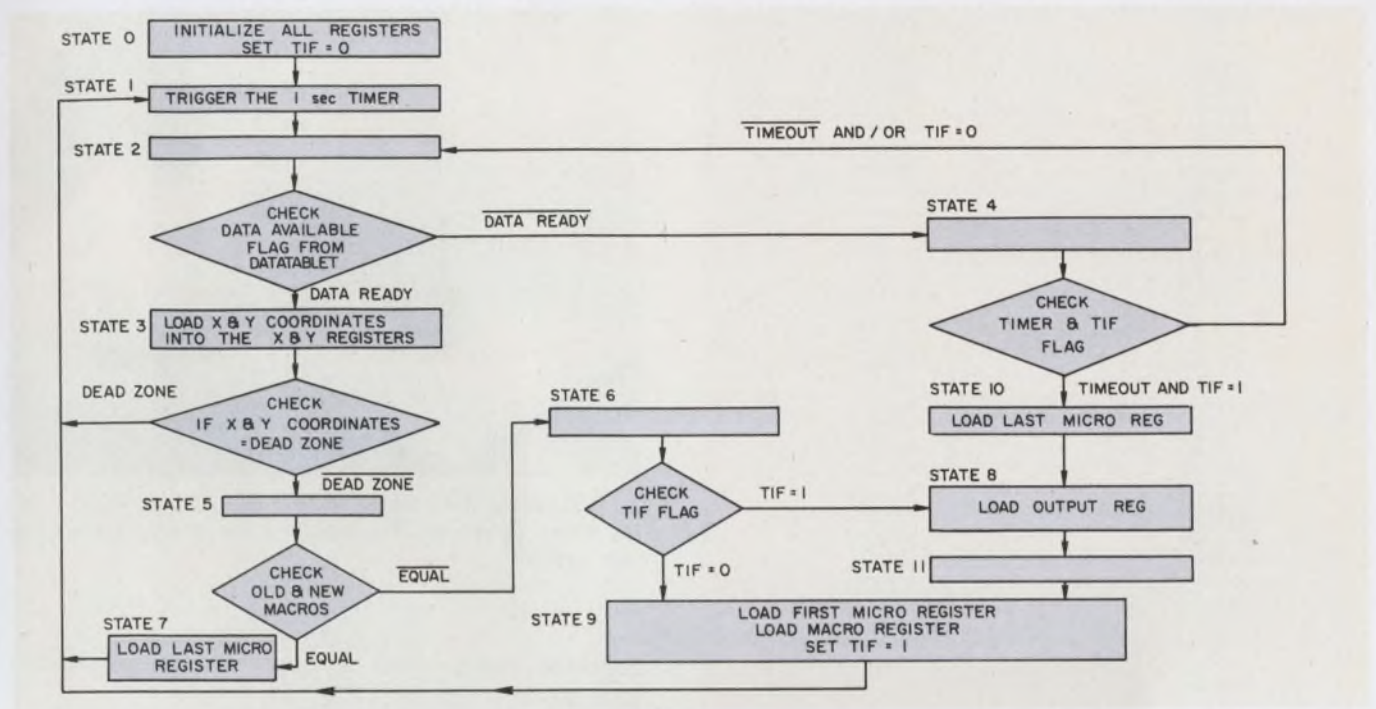

## PROM truth tables

S/C converter PROM							
ADDRESS				OUTPUTS			
X	Y			B <sub>1</sub>	B <sub>2</sub>	B <sub>3</sub>	B <sub>4</sub>
A <sub>1</sub>	A <sub>2</sub>	A <sub>3</sub>	A <sub>4</sub>	B <sub>1</sub>	B <sub>2</sub>	B <sub>3</sub>	B <sub>4</sub>
0	0	0	0	0	0	1	0
0	0	0	1	0	0	1	1
0	0	1	0	0	1	1	1
0	1	0	0	0	1	0	0
0	1	0	1	0	1	0	1
0	1	1	0	1	0	0	0
1	0	0	0	0	0	0	1
1	0	0	1	0	1	1	0
1	0	1	0	1	0	0	1
ALL OTHERS				0	0	0	0

Y-micro PROM		
ADDRESS	OUTPUT	
	O <sub>2</sub>	O <sub>1</sub>
0—4	1	1
5—28	0	0
29—35	1	1
36—59	0	1
60—66	1	1
67—90	1	0
91—127	1	1

X-micro PROM		
ADDRESS	OUTPUT	
	O <sub>2</sub>	O <sub>1</sub>
0—4	1	1
5—17	0	0
18—24	1	1
25—38	0	1
39—45	1	1
46—58	1	0
59—63	1	1

Micro-to-ASCII converter PROM												
ADDRESS								OUTPUT				CHARACTER
A <sub>1</sub>	A <sub>2</sub>	A <sub>3</sub>	A <sub>4</sub>	A <sub>5</sub>	A <sub>6</sub>	A <sub>7</sub>	A <sub>8</sub>	O <sub>1</sub>	O <sub>2</sub>	O <sub>3</sub>	O <sub>4</sub>	
0	1	0	0	1	0	0	0	0	0	0	1	ONE
0	0	1	0	1	0	0	1	0	0	1	0	TWO
0	0	1	0	0	1	1	1	0	0	1	1	THREE
1	0	0	0	0	1	1	0	0	1	0	0	FOUR
0	1	0	0	0	1	1	0	0	1	0	0	FOUR
0	1	0	0	0	0	0	1	0	1	0	1	FIVE
0	0	1	0	0	0	0	1	0	1	0	1	FIVE
0	0	0	1	0	0	1	1	0	1	1	0	SIX
0	1	0	0	0	0	1	1	0	1	1	0	SIX
0	0	1	0	1	0	0	0	0	1	1	1	SEVEN
0	0	0	1	0	0	0	1	1	0	0	0	EIGHT
0	0	0	1	1	0	0	1	1	0	0	1	NINE
0	1	0	0	0	1	0	0	0	0	0	0	ZERO
0	0	1	1	0	1	1	0	1	1	0	1	=
0	1	0	1	1	0	0	0	1	0	1	1	;
1	0	0	0	1	0	0	0	1	1	1	0	.

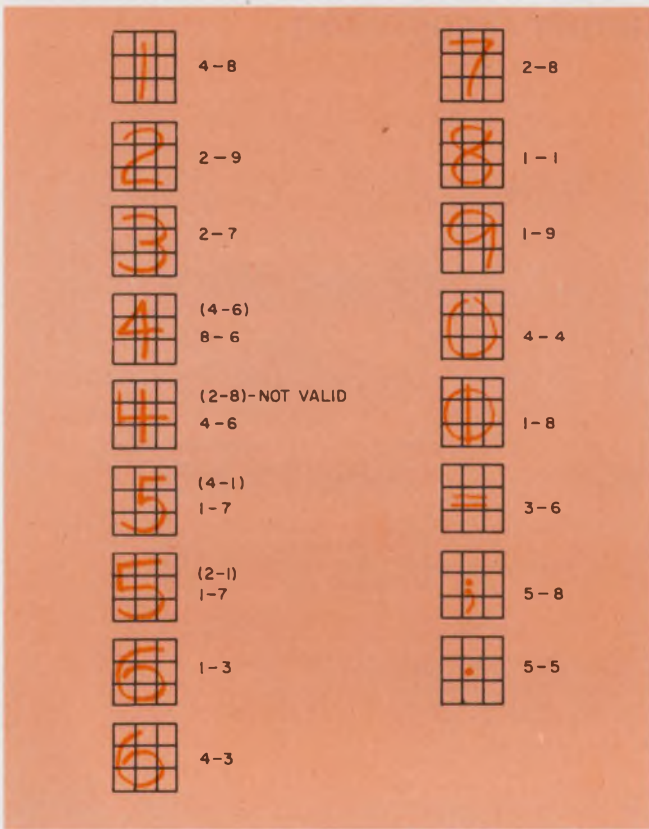

2. All the standard numerals plus four other symbols can be identified by a two-number begin/end code. Only the open number 4, if improperly drawn, can confuse the system. It will have the same code as number 7.



3. A standard data-tablet system with a preprinted overlay sheet serves as the input to the character-recognition system.

followed easily with a flow chart (see chart) and block diagram (Fig. 5).

#### Following the logic

In the data-tablet system used, the pen position is sampled about 30 times a second, and 10-bit binary X and Y coordinates of the pen enter the recognition electronics for each sample. A translate-initiate flip-flop (TIF) in the character-recognition sequential circuit starts the cycle. A data-available flag from the data-tablet circuit loads the 10-bit X and Y coordinates into the X and Y registers. The six least-significant bits (LSBs) of the X coordinate form the X-micro word, and it addresses the X-micro PROM. Seven Y LSBs address the Y-micro PROM.

Output codes of the two micro PROMs provide the address for the S/C (stroke-code) PROM. Note that all ONE outputs of the two micro PROMs are Ored and designate a dead zone. And the S/C PROM converts its 4-bit sequentially numbered inputs into a special code (see PROM truth tables).

S/C codes of the first and last stroke positions are stored at the proper time in the sequence in corresponding registers. These two registers—the first and last micro registers—then form the 8-bit address for the micro-to-ASCII code-converter PROM. This PROM needs to provide only four of the seven bits used in an ASCII character code, because in the numbers and the four other characters recognized by the system (Fig. 3) the remaining 3 bits are identical. Thus these bits can be hard-wired at the output connector to provide the full code.

The X and Y coordinates' most-significant bits (MSBs)—four X bits and three Y bits—form

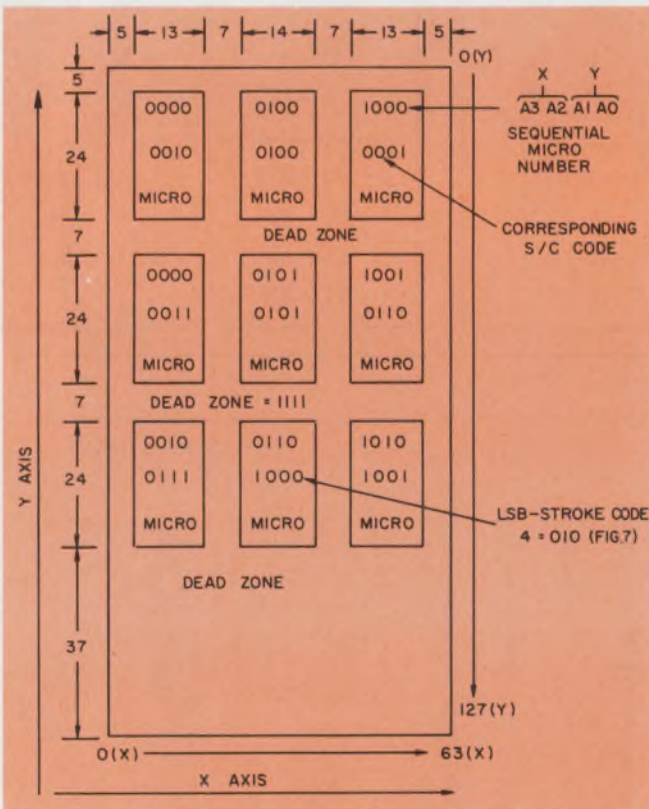

4. Each macro box on the preprinted form is scanned by the data tablet, and the pen's coordinates are identified by the codes shown in each micro box. The dead zone corresponds to the 1111 code.

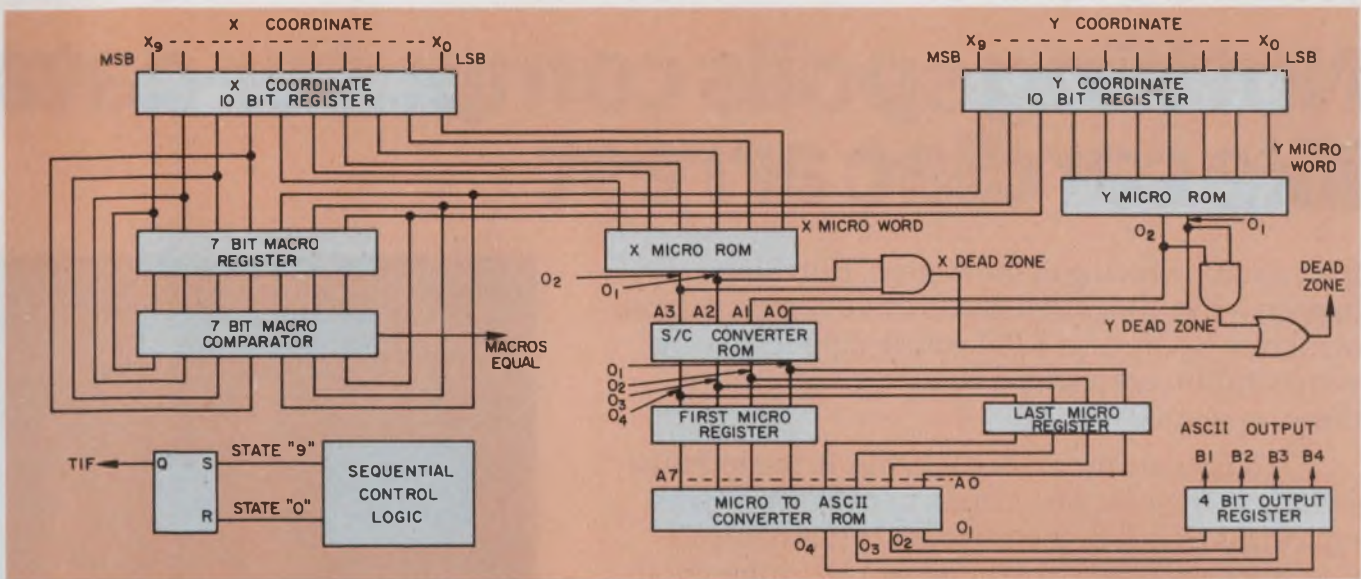

5. Character-recognition block diagram shows how the coordinates of a character's start and end regions are

combined to address character-recognition PROMs. The output words then address a micro-to-ASCII ROM.

a 7-bit macro word. The word has sufficient capacity to allow the identification of eight rows of 16 boxes each. This word is compared with a previous 7-bit word. If the two are not identical, the circuit concludes that the pen moved from one macro region to another—that is, a character has been printed and another started—and an output of the character in ASCII code results.

### Expanding the system

Additional characters can be included in the recognition repertoire, but confusion soon sets in with this simple approach. More powerful discriminants must be used to handle the entire ASCII set. Since characters are created dynamically in real time with a data tablet, many character-formation features can be analyzed:

- The sequence in which the parts of the character are created.
- The speed of each character stroke.
- The number of direction reversals in the X or Y coordinates.
- Whether the Y velocity is high or low when X changes direction, and vice versa.

And many other discriminants can be added to this list.

The dynamic nature of a data-tablet input contrasts with OCR, where a static character is scanned and merely analyzed into black and white areas. No history of the way the character is created can enter the OCR analysis.

An extension of the character-recognition system to the full ASCII set is under study. Preliminary experimental results indicate that the location of the first stroke of a character is an additional excellent discriminator. The five most

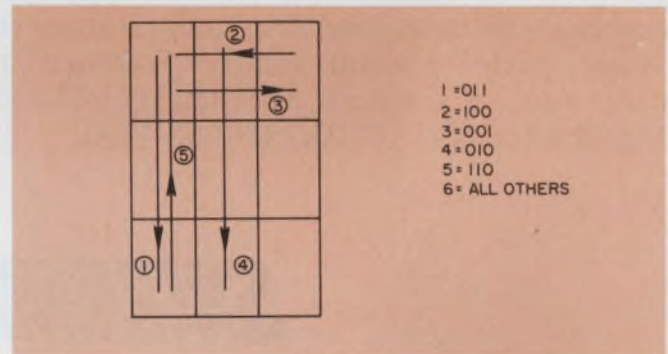

6. All but seven of the ASCII alphanumeric begin with these five strokes. Only a 3-bit code—the LSBs of the S/C micro-region codes—is needed to identify the strokes (see Fig. 4).

common first strokes are shown in Fig. 6. These encompass all but seven characters of the ASCII alphanumeric set.

An expanded system could make use of the S/C PROM's special output code to identify the strokes. The code provides a form of data compression. Since each micro box is labeled with four bits, it seems at first that a three-box stroke would need 12 bits to label it. However, the five strokes of Fig. 6 can be identified by only a 3-bit code. The three LSBs of the S/C output for each micro box provide unique 3-bit combinations for each stroke.

Thus five 3-bit words can divide the total character set into five groups, or dictionaries. A sixth dictionary would contain those few characters that do not use the five common initial strokes. Thereafter, within each dictionary, other discriminants would identify the character uniquely.

The same discriminants need not be used in each dictionary; one may be more effective than others in a particular dictionary. ■■

# Nothing spoils computer data like cardiac arrest

If watts stop flowing in the system, bad things happen – like illogical behavior, like complete lapse of memory. Sorensen STM power supplies assure your computer of a strong heart to guard against these unwanted things.

STMs are more than reliable. Being modular switchers they are twice as efficient as series-pass types, less than half their size, and price competitive. But they have all of the advantages inherent in series-pass design.

There are 40 STMs in the series, from 3.0 to 56 Vdc, in four modular sizes. Our catalog, written especially for heart specialists, tells all about them. Simply circle the inquiry number. Sorensen Company, a unit of Raytheon, 676 Island Pond Road, Manchester, N.H. 03103. (603) 668-4500.

**Sorensen**  
**POWER SUPPLIES**

INFORMATION RETRIEVAL NUMBER 31



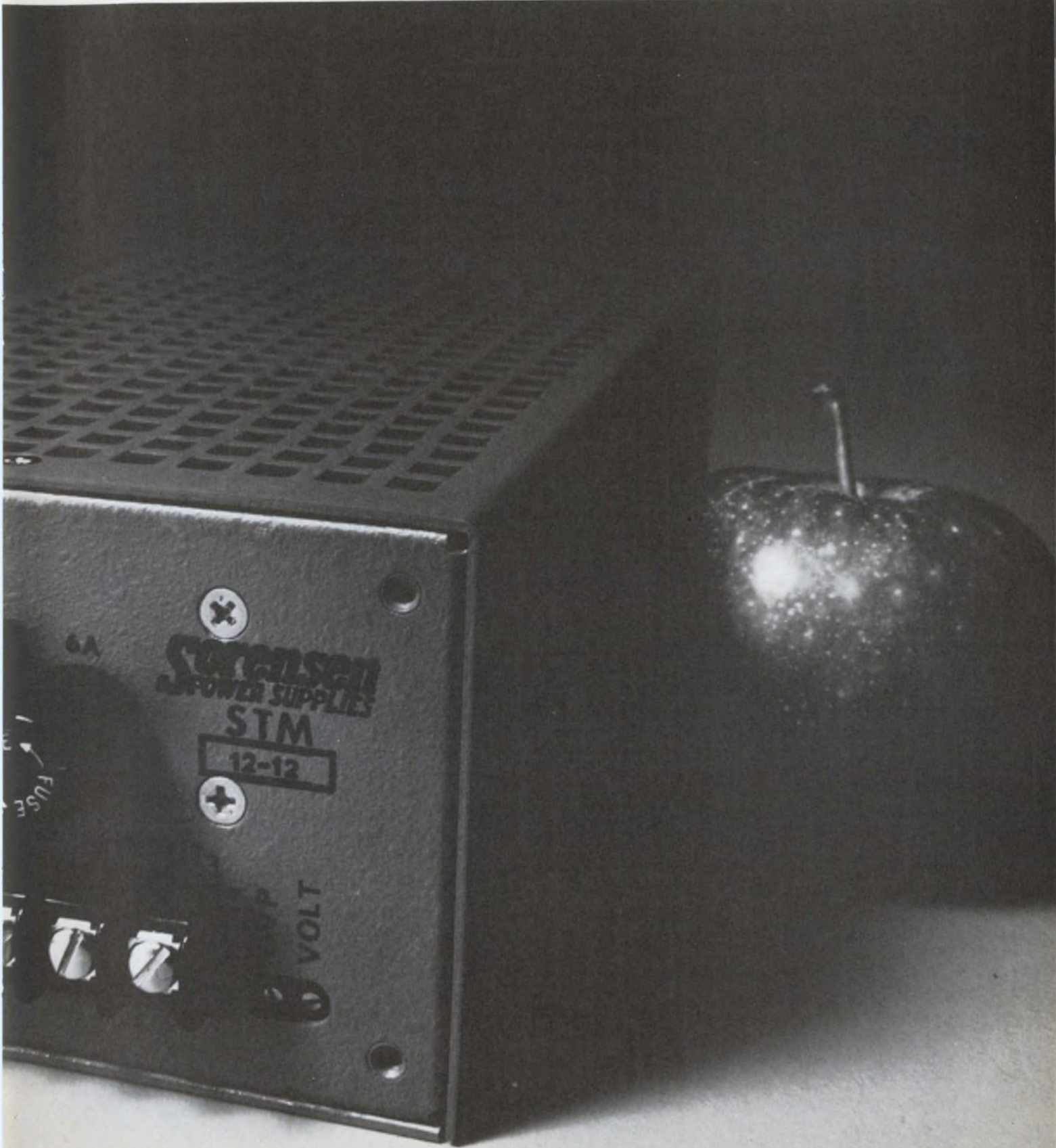

CORNING  
POWER SUPPLIES

STM

12-12

6A

FUSE

AMP  
VOLT

6

## Current limiter added to power supply protects sensitive circuits

A low-current limit circuit added to a standard power supply can protect expensive, difficult-to-replace parts from damage in an accidental misconnection or short-circuit. Though most power supplies are current-limited to protect their own internal circuitry, many can't limit to the low value of 5 mA. And those that can, often don't show when they are in overload condition.

The limit circuit in the figure can be patched in series with almost any dual power supply to provide dual current ( $\pm V$ ) limiting, selectable at value of 5 or 25 mA. Two LEDs each independently display an overload condition in a section of the supply. This feature is particularly valuable during breadboard and prototype testing. The limit circuit can be used on variable supplies from  $\pm 5$  to  $\pm 22$  V. The limiter requires no other power. The small voltage drop of about 0.3 V in each line caused by the limit circuit is negligible for most applications.

Since both halves of the circuit work in the same way, let's consider only the top half. Transistor  $Q_2$  and  $R_2$  form a bipolar current source, which is biased into operation by  $Q_1$  and  $R_1$  and the constant current delivered by the FET current source,  $Q_5$  and  $R_3$ . The FET current is held constant to within 10% over the entire voltage range of the circuit. The output current is selected with  $R_2$ . The values of  $R_2$  ( $R_{2n}$  or  $R_{2i}$ ) provide limits of approximately 5 or 25 mA. Other values can be used to provide different limits.

When  $Q_2$  is not in a current-limit condition, its  $V_{ce}$  is low. When  $Q_2$  goes into current limit,  $V_{ce}$  increases, which turns on the Darlington-connected  $Q_3$ ,  $Q_4$  combination and LED 1 to show the overload condition.

Transistor  $Q_2$  is a large-geometry transistor that provides minimal saturation voltage and adequate worst-case power dissipation. Transistor  $Q_1$  is identical to  $Q_2$ , so that accurate biasing of  $Q_2$  can be achieved with minimal voltage drop across resistors  $R_1$  and  $R_2$ .

For a fixed voltage supply, the constant-current source,  $Q_5$  and  $R_3$ , can be replaced by a

single resistor. For 5 mA, its value would be approximately

$$(2 V_{in} - 1.9) / 0.005 = R.$$

Mark Stitt, Burr-Brown Research Corp., International Airport Industrial Park, Tucson, AZ 85706.

CIRCLE NO. 311

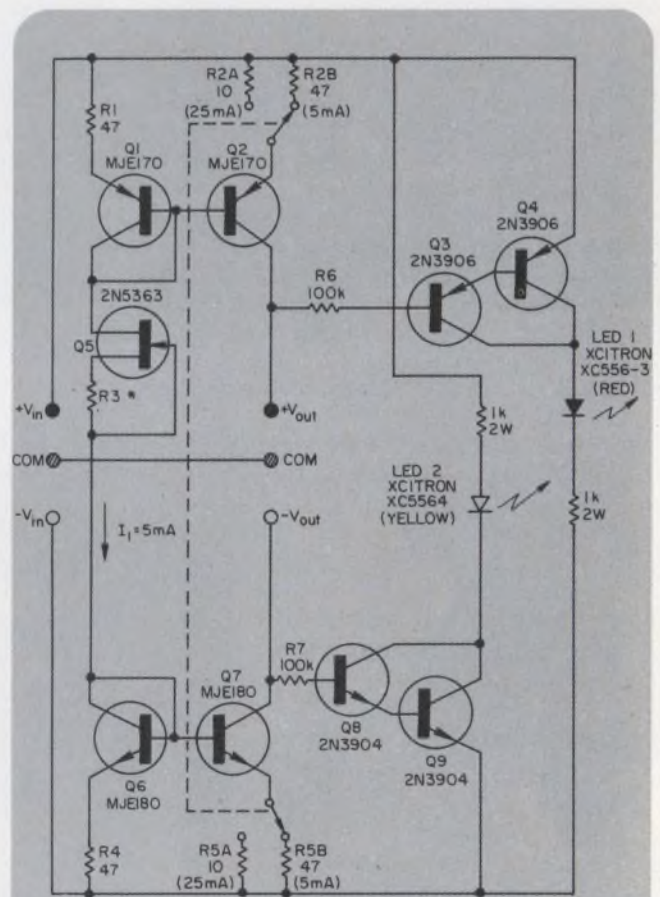

**Current-limiting circuit** allows selection of limits of 5 or 25 mA. A change of resistors  $R_2$  and  $R_5$  can alter these limits.

If you need  
**top-quality**  
**panel**  
**instruments**  
 with a clean,  
 modern look...



GL

Buy  
**Triplet's**  
**Series GL**  
**or GL/B**

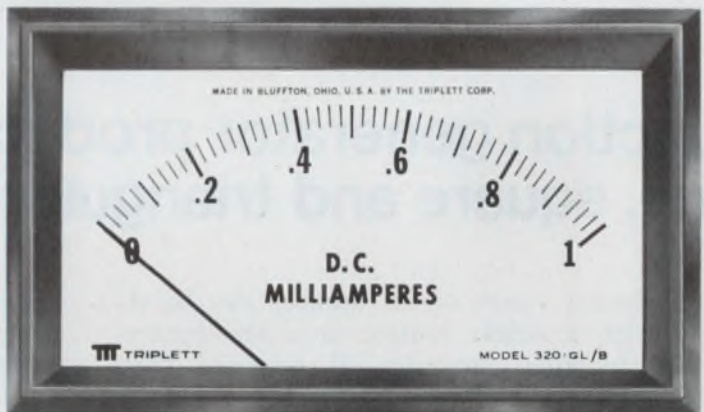

GL/B (mounted appearance)

Triplet's newest panel instruments, the Series GL and GL/B, feature glass windows, matte-finish phenolic cases and a dial design that can readily accommodate multiple scales. They are available in 3½", 4½" and 5½" sizes.

The GL Series features a standard 2-stud mount with 3- and 4-stud mounts available.

The feature of the GL/B Series is behind-the-panel mounting with a bezel which is an integral part of the case.

There's a choice of more than 275 stock sizes and ranges — in DC microammeters, milliammeters, ammeters, millivoltmeters and voltmeters; AC milliammeters, ammeters, and voltmeters; RF thermoammeters; dB meters and VU meters. For those who need special instruments . . . custom dials, pointers, scales, accuracy, tracking, resistance, response time or practically any combination of unusual specs can be put into these new cases. For quick, dependable delivery

of small quantities of these adaptable new instruments, contact your Triplet Sales/Service/Modification Center or distributor. For prototypes or production quantities, contact your Triplet representative. Triplet Corporation, Bluffton, Ohio 45817.

**TRIPPLET**  
 BLUFFTON, OHIO 45817  
 Manufacturers of the World's  
 most complete line of V-O-M's

INFORMATION RETRIEVAL NUMBER 32

# Programmable unijunction transistor protects op amp from overvoltages

To protect an op-amp input from overvoltages, zener diode clamps often are used. But this solution doesn't work in high-impedance applications where the zener's reverse current may be too high. A programmable unijunction transistor (PUT) can solve this problem.

The leakage current of an MPU-131 PUT is only 5 nA in the unfired state. This makes the PUT suitable to protect even FET input circuits, without a substantial effect upon the input characteristics.

In the figure, the MPU-131 protects an LM-311 comparator against voltages higher than  $V_p$ . A 7400 gate drives an overvoltage-indicator LED. Adjustment of  $R_2$  can vary  $V_p$  from 1 V to  $V_{CC}$ . Removal of input overvoltage restores circuit.

*H. Thomas, Zurich, Switzerland.*

CIRCLE NO. 312

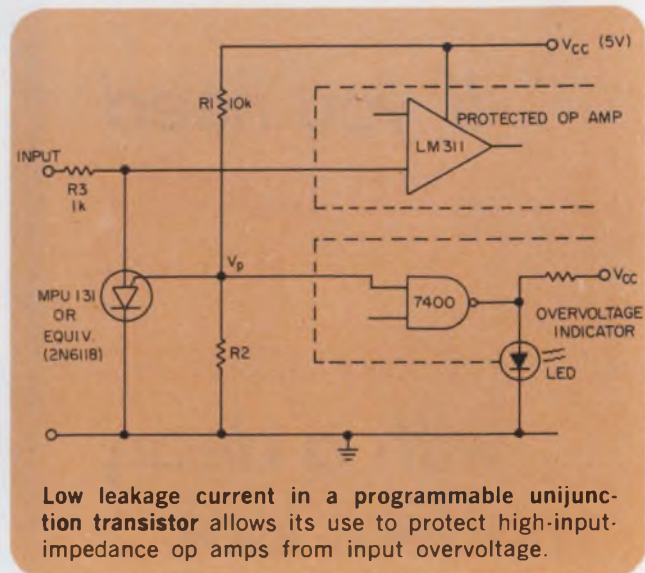

## Function generator produces sine, square and triangular waves

A frequency range of six decades can be obtained with a single control in a sine-square-triangle function generator. It operates from below 10 Hz to 1 MHz with usable output to about 2 MHz.

The triangle wave is generated when switched current-source transistors  $Q_1$ ,  $Q_2$ ,  $Q_3$  and  $Q_4$  alternately charge and discharge timing capacitor  $C_1$ . This action generates a linear triangle wave follower without use of an op-amp integrator. A FET voltage follower, LH 0033C, buffers the triangle wave and drives the comparator, output amplifier and sine converter.

A precision dual comparator, LM319, sets the peak-to-peak amplitude of the tri-wave. It's essential to accurately control the tri-wave amplitude, since the sine converter requires close amplitude control to produce a low distortion output. The tri-wave is applied to the comparator inputs via divider network,  $R_8$ ,  $R_9$ ,  $R_{10}$  and  $C_2$ . The comparators switch when the amplitude of the tri-wave is  $\pm 2.5$  V. Capacitor  $C_2$  compensates for delays in the comparator at high frequencies.

A square-wave output from the comparator ap-

pears at the emitter of  $Q_5$ , which drives the current switches and, when selected, the output amplifier. The current switches provide a 5-nA-to-5-mA current to timing capacitor  $C_1$ . The maximum output current is set by  $R_{15}$  and  $R_{17}$ . It appears when the arm of the frequency control,  $R_{11}$ , ties all four emitters together. About 380 mV is developed across  $R_{11}$ , and this voltage corresponds to over a  $10^6$  change in charging current.

Transistors  $Q_6$  and  $Q_7$  form a differential amplifier with emitter degeneration. The triangle wave is attenuated by  $R_1$  and  $R_2$  to about 450 mV and applied to  $Q_6$ . This drives the transistors nonlinearly to produce a sine-wave output current at the collector of  $Q_7$ , which then drives the output amplifier.

The output amplifier, an LM318, with feedforward compensation to maximize bandwidth and slew rate, scales all three waveforms to  $\pm 10$  V. But even with the feedforward there is not enough bandwidth for good reproduction of the triangle or square wave at frequencies over 1 MHz. If the higher frequencies are of major



# Here's a plastic, low-noise 5 GHz transistor that sells for only \$2.95...

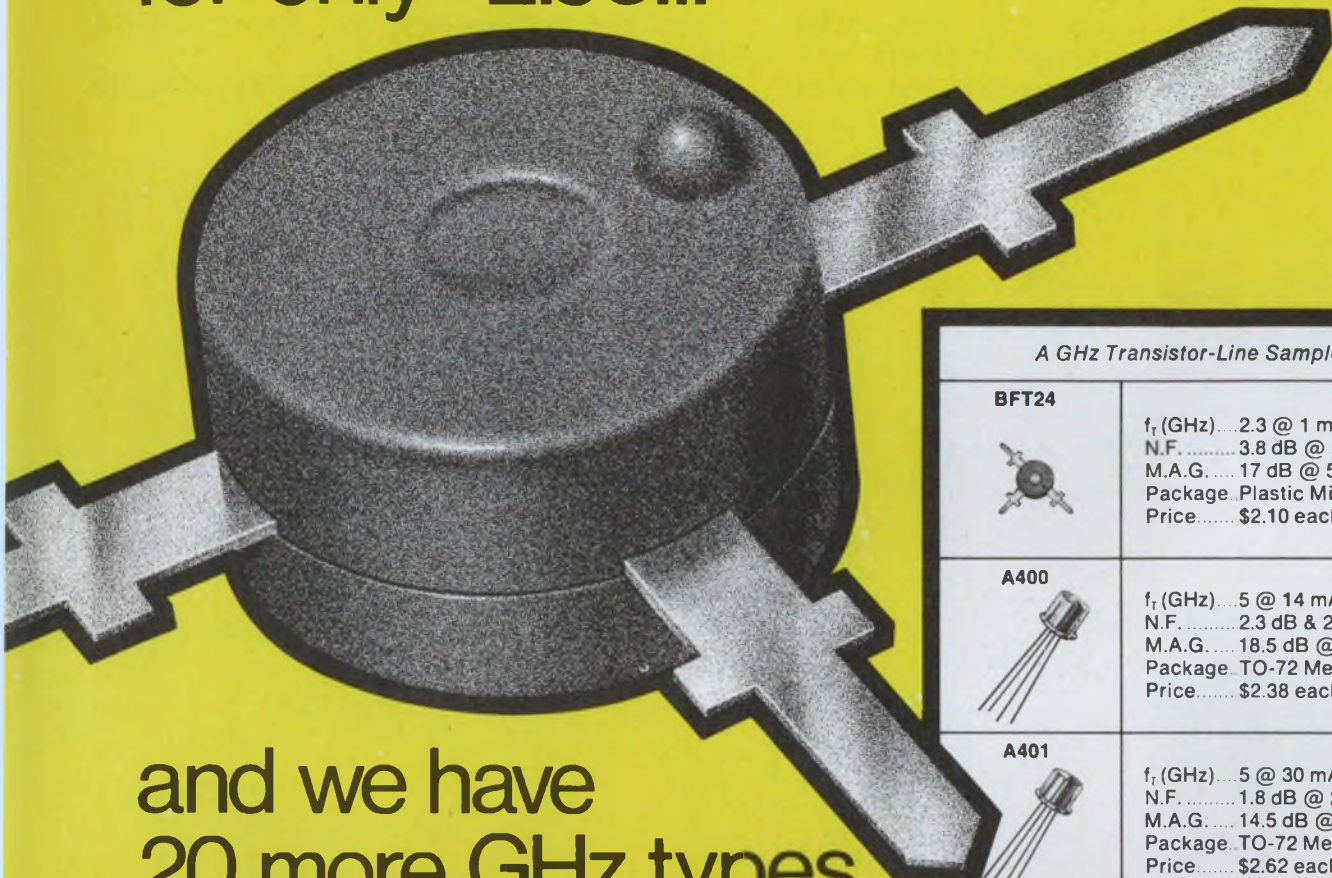

## and we have 20 more GHz types priced from \$1.05 to \$3.95





Now you don't have to pay \$9.00 for a low-noise GHz transistor... nor do you have to settle for gain-bandwidth product of only 1 GHz.

Our \$2.95 high-performance BFR91 gives  $f_T$  of 5 GHz at 30 mA of collector current... and its noise figure is only 1.9 dB at 500 MHz.

Best of all, this BFR91 is only one of a growing line of small-signal RF transistors that are establishing Amperex as an outstanding leader in the field. We are combining the world's most advanced shallow diffusion technologies with unsurpassed packaging skills so that we may offer you the best overall combination of GHz transistor specifications, packages and prices available today.

There's an Amperex GHz transistor for virtually every small-signal application up to 2 GHz... CATV/MATV amplifiers, portable pagers and transceivers, high bit-rate communications equipment, frequency counters and high frequency oscilloscopes, to name but a few.

For further information on the Amperex line of high-performance, GHz-range transistors, write: Amperex Electronic Corp., Solid State and Active Devices Div., Slatersville, Rhode Island 02876, or phone (401) 762-9000.

A GHz Transistor-Line Sampler	
<b>BFT24</b> 	$f_T$ (GHz)....2.3 @ 1 mA N.F. ....3.8 dB @ 500 MHz M.A.G. ....17 dB @ 500 MHz Package..Plastic Micro-T Price.....\$2.10 each*
<b>A400</b> 	$f_T$ (GHz)....5 @ 14 mA N.F. ....2.3 dB @ 200 MHz M.A.G. ....18.5 dB @ 500 MHz Package..TO-72 Metal Price.....\$2.38 each*
<b>A401</b> 	$f_T$ (GHz)....5 @ 30 mA N.F. ....1.8 dB @ 200 MHz M.A.G. ....14.5 dB @ 500 MHz Package..TO-72 Metal Price.....\$2.62 each*
<b>BFR91</b> 	$f_T$ (GHz)....5 @ 30 mA N.F. ....1.9 dB @ 500 MHz M.A.G. ....16.5 dB @ 500 MHz Package..Plastic Micro-T Price.....\$2.95 each*
<b>BFR94</b> 	$f_T$ (GHz)....3.5 @ 90 mA N.F. ....5 dB @ 500 MHz M.A.G. ....13.5 dB @ 500 MHz Package..Stripline Stud Price.....\$7.25 each*

\* In 1000 piece quantities

# Amperex®

TOMORROW'S THINKING IN TODAY'S PRODUCTS

Sold through  
North American Philips Electronic Component Corporation

## IDEAS FOR DESIGN

interest, a faster output amplifier is necessary.

The transistors that determine the timing current should be made to track with temperature changes. Small heat sinks should be used to thermally couple  $Q_1$  and  $Q_2$  to  $Q_3$  and  $Q_4$ . Temperature differences between the pair will cause the wave symmetry to change.

To adjust the system, first set  $R_{11}$  for a 1-MHz output. Then adjust the output symmetry with  $R_{16}$ . Now reset  $R_{11}$  to a 10-Hz output and adjust

the symmetry again, but this time with  $R_{14}$ .

Other adjustments may be necessary in the sine converter. Resistor  $R_7$  can be trimmed if the sine output from the LM318 has a dc offset. Also, it may be necessary to adjust  $R_2$  to minimize distortion. There can be considerable distortion if the tri-wave is not symmetrical and does not have equal slopes.

*Robert C. Dobkin, National Semiconductor Corp., 2900 Semiconductor Dr., Santa Clara, CA 95051.*

CIRCLE NO. 313

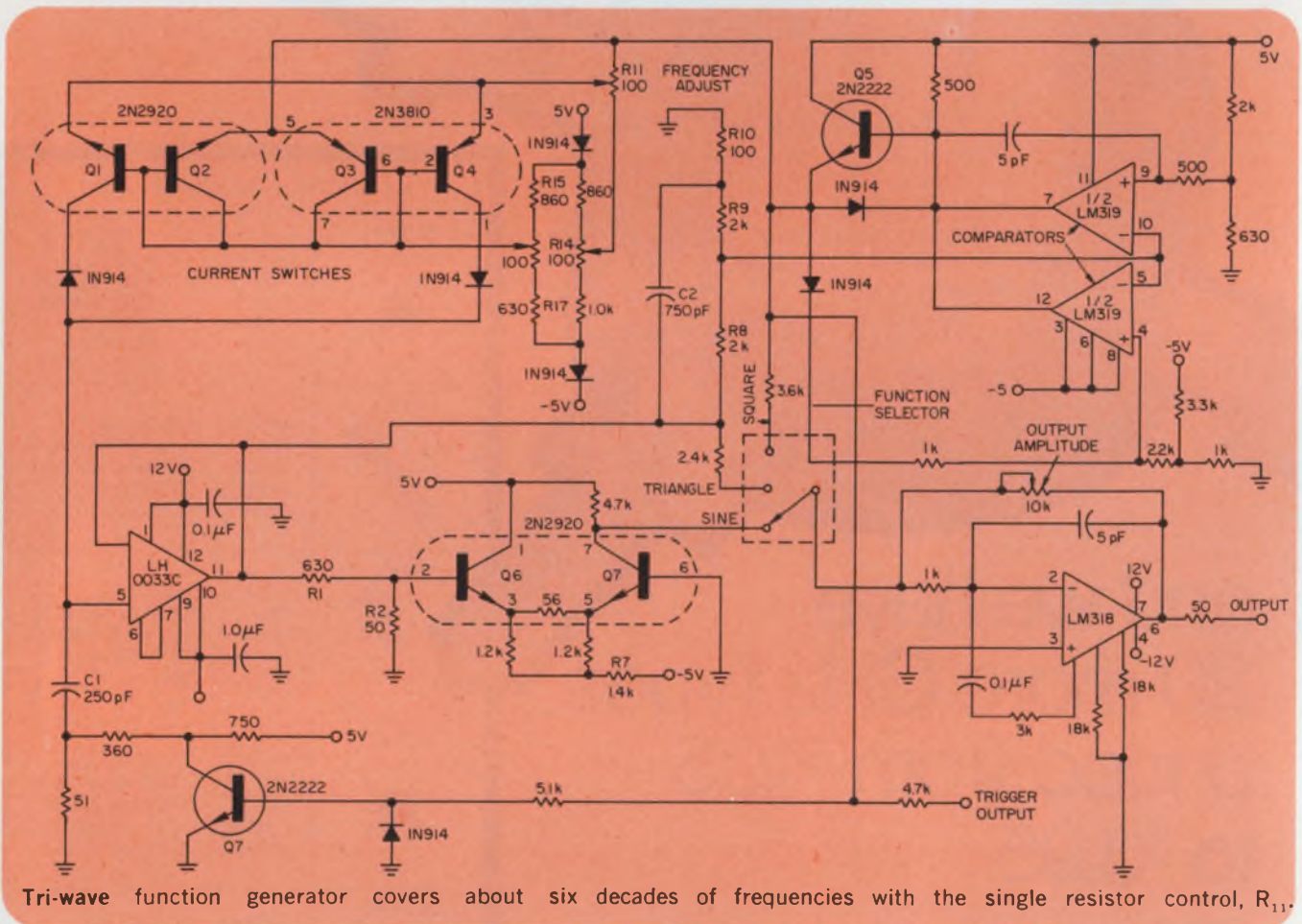

### IFD Winner of September 27, 1974

**Penn Clower**, Design Engineer, Charles Stark Draper Laboratory, 68 Albany St., Cambridge, MA 02139. His idea "Inexpensive AM Modulator Replaces Clipping Type and Gives Less Distortion" has been voted the Most Valuable of Issue Award.

**Vote for the best Idea in this issue** by circling the number for your selection on the Information Retrieval Card at the back of this issue.

**SEND US YOUR IDEAS FOR DESIGN.** You may win a grand total of \$1050 (cash)! Here's how. Submit your IFD describing a new or important circuit or design technique, the clever use of a new component or test equipment, packaging tips, cost-saving ideas to our Ideas for Design editor. Ideas can only be considered for publication if they are submitted exclusively to ELECTRONIC DESIGN. You will receive \$20 for each published idea, \$30 more if it is voted best of issue by our readers. The best-of-issue winners become eligible for the Idea of the Year award of \$1000.

ELECTRONIC DESIGN cannot assume responsibility for circuits shown nor represent freedom from patent infringement.

# The perfect atomic frequency standard

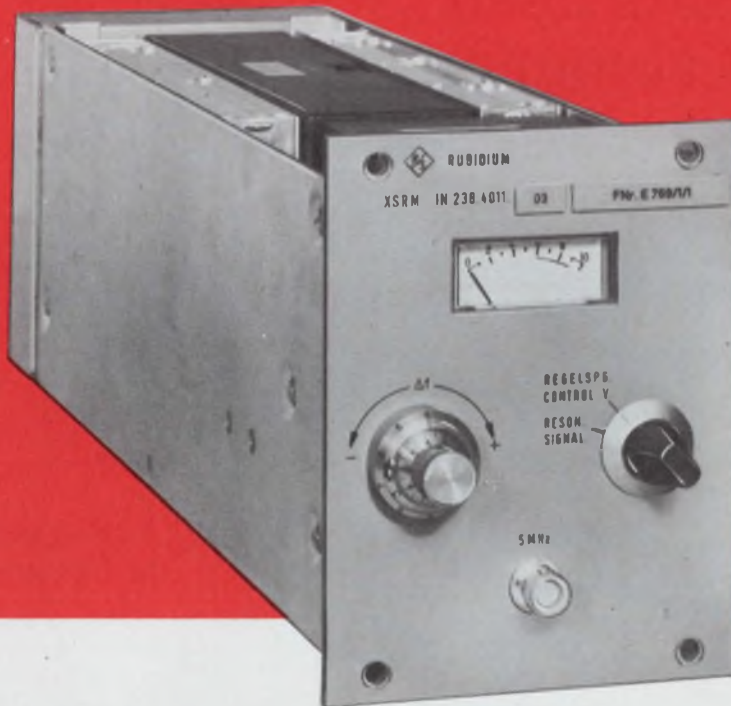

**For Economical Navigation, Standards Lab, Bench and Airborne Applications.**



Two accessories provide even greater usability: (1) Line/Battery Power Supply with automatic change-over; (2) Frequency Converter providing 10 MHz, 5 MHz, 1 MHz and 100 kHz locked-in phase. These modules and the XSRM are available in a single cabinet or in a 19" rack mount package.

The R&S Type XSRM Rubidium Frequency Standard has more features and benefits than any other standard.

- No daily adjustments necessary as there are for crystal-type units
- Package size is very compact — only 4 x 5 x 13.5 (inches)
- It's flyable — weighing only 11.5 lbs.
- Power consumption is exceptionally low — a mere 18.5 W min.
- Warm-up time is rapid — just 35 minutes.
- Spectral purity is very high — > 120 dB (spurious suppression and S/N)
- Frequency stability is superior — typically <  $2 \times 10^{-11}$ /month

Send for our complete descriptive brochure and/or to schedule a demonstration.



*World Leader in Test Inst. + Communications for Over 40 Years*

**ROHDE & SCHWARZ**

14 Gloria Lane, Fairfield, N.J. 07006 ■ (201) 575-0750 ■ Telex 133310

## 'Bucket' circuits used for weighted summing

Transversal filters using bucket-brigade circuits in a new weighted-summation technique have been developed at the Technical University of Budapest. The new technique is reported to be an improvement over the more usual methods for weighted summing, such as capacitance-splitting or gate-tapping with a FET source-follower network.

The Hungarian circuit uses a passive network and a node-tapping summation procedure. The simplest version is shown in Fig. 1. A simplified schematic is given in Fig. 2. Here the large rectangle is a capacitive m-pole passive network. The filter design satisfies the following general requirements:

1. The charge is retained by the capacitances.
2. There is no stray coupling between elements of the array to make the filter dispersive.
3. Multiple-outputs with differ-

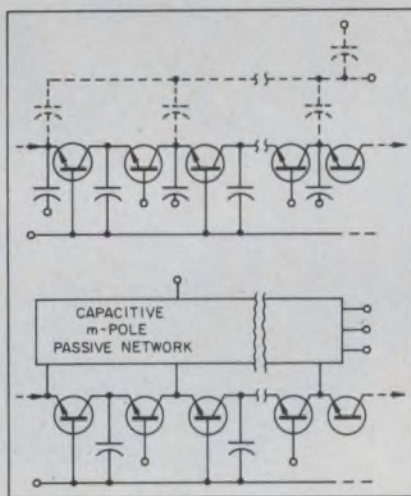

ent weightings are available.

4. The output level is independent of the driving-signal frequency.
5. Rectangular output pulses are produced.

## Timing circuit uses step-recovery diodes

Step-recovery diodes have been used in a new circuit for short-delay timing in high-speed signal-processing, such as in a/d converters. Variable timing is an important advantage of the new circuit over the use of fixed delay lines. Timing pulses of 2 to 100 ns can be generated with very short rise and fall times and at pulse repetition rates between 1 and 140 MHz.

The practical monostable circuit was developed by Cambridge Consultants Ltd., Cambridge, England.

A shortcoming of the step-recovery diode—recovery delay when the current though it is reversed—is eliminated by the back-to-back juxtaposition of recovery diodes,  $D_2$  and  $D_3$ . The charge built up during the forward-current phase is passed back and forth between the diodes on current reversals. Thus the output-pulse rise and fall times can be kept very small.

The input applied to  $Q_1$  has a minimum duration of 5 ns. The pulse turns off emitter-follower  $Q_2$  and causes current to flow through

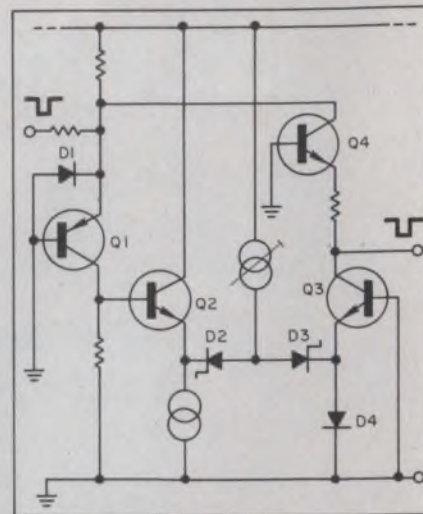

$D_2$ ,  $D_3$  and  $Q_3$ . The current also flows through  $Q_4$ , latching the input for the duration of the output pulse that appears at the collector of  $Q_3$ . The pulse duration is determined by the charge stored in  $D_3$ .

## A no-energy approach to frequency modulation

Frequency modulation that requires no energy to shift the frequency has been achieved at Philips Research Laboratories in Eindhoven, the Netherlands. Normally the variation of capacitance in a harmonic oscillator requires energy to change the signal frequency. The Philips device avoids this by using a gyrator circuit that, in oscillation, has energy flowing back and forth between two capacitors.

As a result, no energy is stored or lost. Varying the gyration transconductance gives frequency variation without change of phase or amplitude—that is, ideal frequency modulation.

The Philips gyrator circuit is a conjuctor oscillator (described by S. Duinker in Philips Research Reports, 1962, pp. 1 to 19). Amplitude control is possible through instantaneous feedback in proportion to the signal, which is compared with a reference. The Q factor of the resonant circuit is made to be almost infinite by a difference-signal feedback. In practice, the measured performance has shown that neither large frequency deviations nor high modulating frequencies result in distortion.

# After all the noise, the quiet logic of HiNIL and 74C CMOS keeps you on the right track.



May 10, 1869. Promontory, Utah. The rumble of wheels, the hiss of escaping steam, the shouts of the celebrating crowd filled the skies with a deafening roar when they drove the golden spike that joined the Central Pacific and Union Pacific Railroads.

But today, when you link Teledyne's high noise immunity logic, HiNIL, and our 74C CMOS together in your digital or analog/digital control designs, you'll no longer have to worry about spikes or noise. Teledyne invented HiNIL to meet the need for high noise immunity found in practically all digital systems. The success of this large and still growing family has made Teledyne a leading supplier of logic for high noise applications.

Just put HiNIL on input-output lines to block heavy noise transients and drive high current peripheral devices. And use CMOS in the middle to minimize power dissipation and increase speed and circuit density. The combination of HiNIL's guaranteed 3.5V noise margin and 74C's low power dissipation lets them quiet almost any kind of system with high noise problems.

Our two logics interface directly, too. Standard 74C drives HiNIL directly and HiNIL drives more than 50 CMOS loads. Simply connect both to an inexpensive 12 or 15V  $\pm 1V$  power supply. You can even connect linear circuits to the same supply for extra savings.

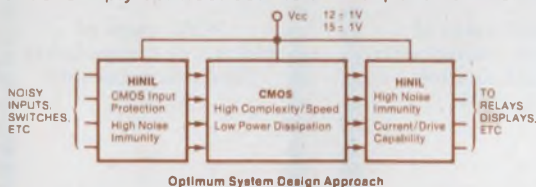

HiNIL eliminates the need for drivers because it sources up to 15mA and sinks up to 65mA. That's ample capability for display tubes, LEDs, lamps and relays.

And with HiNIL you save on filter capacitors, get the extra flexibility and economies of diode-expandable inputs, and have a choice of active or passive pullup and open collector outputs. There's plenty of board-shrinking MSI in both families, too.

So write or call Teledyne today to find out about our HiNIL and 74C CMOS lines. We'll show you how easy it is to block out all the noise and stay on the right track.

## **TELEDYNE SEMICONDUCTOR**

1300 Terra Bella Avenue, Mountain View, California 94043 Tel: (415) 968-9241 TWX: 910-379-6494 Telex: 34-8416

ENGLAND: Heathrow House, Cranford, Hounslow, Middlesex, Tel: (44) 01-897-2503 Telex: 851-935008

FRANCE: 90, Avenue Des Champs Elysees, 75008 Paris, Tel: 2563069 Telex: 842-29642

WEST GERMANY: Albert Gebhardtstrasse 32, 7897 Tiengen, Tel: 7741-5066 Telex: 841-792-1462

JAPAN: Nihon Seimei-Akasaka Bldg (3F), 1-19, Akasaka 8-chome, Minato-ku, Tokyo 107, Tel: 03-405-5738 TWX: 781-2424241

Additional offices in West Germany, Hong Kong and the United States. Representatives and distributors worldwide.

**new**  
**C/MOS**  
**Logic Probes**  
**Available Now**



New Model LP-576 tells you everything you need to know in 5 through 15V COS/MOS circuits: lows, highs, open circuits and pulses are all indicated. Send for free literature. For a 30 day Free trial Probe or special information, telephone Tom Barth, Kurz-Kasch, Inc., Electronics Division, 2876 Culver Avenue, Dayton, Ohio 45401, Telephone: (513) 296-0330.

Free test data



**Kurz-Kasch, Inc.**  
 ELECTRONICS DIVISION  
 2876 Culver Avenue  
 Dayton, Ohio 45401  
 Telephone 513/296-0330

INFORMATION RETRIEVAL NUMBER 37

**LOCK, LOCK...**

WITH  
**TIP**  
 AND  
**TAB**

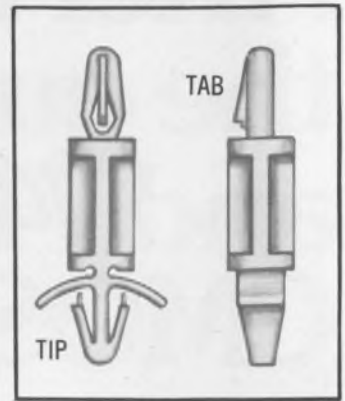

For A  
**DOUBLE LOCKING**  
 Circuit Board Support

Richlok's Series LCBS circuit board supports plug into the chassis and lock themselves into position. Permanently, thanks to a "Barbed Arrow" locking tip.

Snap the board on and a tension tab expands to lock it to the support. The locking tab withstands up to 100 lbs. of pull, yet allows removal of the board with finger tip pressure. Which is just what you want, isn't it?

A double locker from Richlok. In 12 spacing heights from 3/16" to 1-3/8". High dielectric strength nylon or flame retardant material.

**FREE**  
**Samples**

**RICHLOK® CORPORATION**

5835 N. Tripp Ave. • Chicago, Ill. 60646 • (312) 539-4061

INFORMATION RETRIEVAL NUMBER 39

**FREE**  
**TEST**



shows you how to save costs  
**SUPERIOR NO. 30 FLUX**  
*prevents corrosion when soldering*  
 Ideal for printed circuit boards

Why take chances that corrosion from soldering will cause rejects and unnecessary expense? Use the same flux that hundreds of our customers all over the world are using — Superior No. 30 NON-CORROSIVE SOFT SOLDER LIQUID FLUX. We'll sample it to you at no cost to prove that it will end corrosion problems! It's positively non-corrosive. No zinc, ammonium chloride, resin or gum. Non-hygroscopic, non-conductive, no fumes or disagreeable odors. Residue is water soluble. Makes soldering easier and faster!

Send coupon below or check reader service card for free sample now. After you've tested it, you'll be mighty glad you did.

**SO SUPERIOR THAT IT IS PATENTED**  
 Meets U.S. Army Sat. Com. Agency Spec. SM-A-571678

send for **FREE** sample **TODAY!**

**SUPERIOR FLUX COMPANY** • Est. 1932  
 653 Alpha Drive, Cleveland, Ohio 44143—Dept. ED

Send free sample No. 30 FLUX  
 Send prices and details

FIRM \_\_\_\_\_  
 ATTN OF \_\_\_\_\_  
 ADDRESS \_\_\_\_\_  
 CITY \_\_\_\_\_ STATE \_\_\_\_\_ ZIP \_\_\_\_\_

INFORMATION RETRIEVAL NUMBER 38



16.665 users of electronic components for automation in 1974.

Salon international des **composants électroniques 75**

Paris 2-8 April

For you, this year again, Paris is a must

French Trade Shows  
 1350 Av. of the Americas  
 New York N.Y. 10019  
 ☎ (212) 582.49.60



9083 users of electronic components for data processing in 1974.

Salon international des **composants électroniques 75**

Paris 2-8 April

For you, this year again, Paris is a must

French Trade Shows  
 1350 Av. of the Americas  
 New York N.Y. 10019  
 ☎ (212) 582.49.60

INFORMATION RETRIEVAL NUMBER 40

ELECTRONIC DESIGN 3, February 1, 1975

# Ribbon coax-cable design allows gang stripping and easy assembly

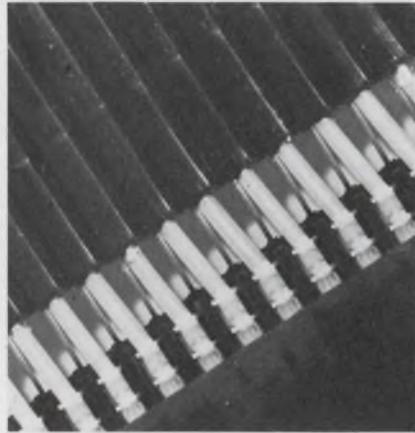

AMP Inc., Harrisburg, PA 17105.  
(717) 564-0100. See text.

Engineers need no longer accept degraded performance in high-speed and high-frequency systems because conventional coaxial cable is costly, bulky and difficult to terminate. AMP's new flat-ribbon, flexible, multiple-coaxial-cable assemblies meet most all of these objections.

The new coax cable is precision-made and designed for easy, mass termination. The bulk is reduced, since individual cables are spaced accurately—only 0.1 in. apart for presently available 50, 75 or 93- $\Omega$  assemblies, or 0.125 in. on a larger 95- $\Omega$  ribbon, available soon.

Coax cable, in both conventional single and flat multiple-conductor form, has been available for many years. But all of the previous multiple forms have been only ribbonized constructions of individual cables. And whether they were woven, laminated, chemically or heat bonded to make a flat package, the termination of the cables was still an individual, tedious operation.

In AMP's new cable assembly, each cable in a ribbon has its own

center conductor, dielectric and shield. The center-conductor size, dielectric material and dielectric outside diameter are varied to provide the different characteristic impedances. But each center conductor is located on a predictable centerline-to-centerline spacing. The solid-wire center conductors are used for ease of wire stripping and termination.

The shield, a foil and drain-wire construction of aluminized Mylar totally covers the coax core. And

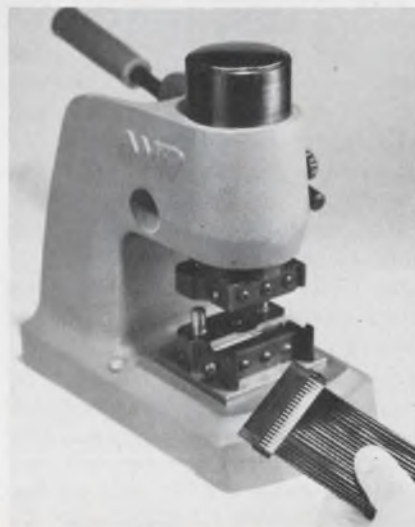

the solid drain wire acts as a low-resistance path and way to terminate the shield.

The drain wires are also located on predictable spacings. Because both center conductors and drain wires are in known locations, mass stripping and terminating is possible.

The stripping action removes the foil shield together with the cable jacket to expose the drain wire and center conductor. The dielectric on the center conductor may be stripped or left in place.

Braid is not used because it is not easily gang-stripped or terminated. Also, braid uses an expensive form of copper and is bulky. And a single, solid wire at a known location can be controlled more readily. In addition the foil is removed easily with the jacket during stripping.

The cable design is an optimized compromise of factors such as size, mass-termination requirements, efficiency and economics. Losses in the dielectric and center conductor are major considerations. The larger the center conductor, the lower the resistive and skin-effect losses. Below 1 GHz, attenuation is mainly due to resistive loss. Skin-effect becomes increasingly important at higher frequencies. A good balance for the 0.1-in. center-to-center distances is a 28-AWG wire for 50- $\Omega$  cable and a smaller 30-AWG wire for the 75 and 93- $\Omega$  cables. The conductor material is tin-plated solid copper.

The dielectric for the higher impedance cables is a foamed polypropylene or polyethylene. The 50- $\Omega$  cable uses solid polypropylene. The use of a low dielectric-constant material for high-impedance designs

*(continued on page 96)*

# Isolate your power supply problems...

## with Intronics' DC to DC Power Converters

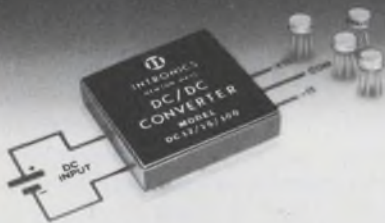

Intronics offers a high efficiency line of modular, compact DC to DC Power Converters, specifically designed for high input/output isolation. Each unit will convert a single unregulated DC voltage source to dual regulated output voltages and can be used to replace a separate AC input power supply many times its size. The compact design also ensures convenient circuit card mounting near the point of application, thus eliminating ground loop problems. Floating, tracking outputs with excellent regulation, low temperature coefficient, low output noise, current limiting to 150% of full load current and maximum power source protection are additional advantages you can expect from these Intronics' models, all at a competitive price.

#### Features include:

- 5,12,28VDC Inputs
- $\pm 12$ VDC,  $\pm 15$ VDC Outputs, at 25 or 100mA
- 10 $\Omega$  ohms Input/Output Isolation
- 1% Preset Output Accuracy
- .02% Line/Load Regulation

Whether your design is for medical electronics, portable test equipment, ocean going or other mobile applications, specify Intronics' DC to DC Converters.

57 Chapel Street, Newton, Mass. 02158 U.S.A.  
617-332-7350, TWX 710-335-6835

INFORMATION RETRIEVAL NUMBER 41

## PACKAGING & MATERIALS (continued from page 95)

and high dielectric-constant for low impedance keeps the cables a common size and spaces the drain wire within a small tolerance zone area. The foamed material has a propagation delay time about 13% less than Teflon and the solid polypropylene is about 5% greater. Nominal time delay for the solid material is 1.54 ns/ft, and 1.29 for the foamed.

The dielectric loss is dominant in lengths of 3 ft or less. In lengths over 30 ft, resistive loss is primary. Between 3 and 30-ft lengths, the cable loss is a combination of both. The dielectric power factor is very close to that of Teflon.

The electrical specifications for a 20-conductor, 75- $\Omega$  cable include: a characteristic impedance tolerance of  $\pm 3 \Omega$  when measured with

a 150-ps rise-time pulse with up to a 90° flat bend; capacitance of 17 pF/ft; crosstalk between adjacent pairs of less than 0.1% and less than 0.05% between all other lines; rise-time decay of less than 30 ps/10 ft, measured at 20 and 80% levels; and an attenuation at 100 MHz of less than 8 dB/100 ft. All these specs are based upon tests on 10 ft of cable.

AMP can supply now a 20-position connector (WLS 4-15-74) for its 0.1-in.-spaced cable. And a family of connectors to handle from 6-to-26-wide cables will soon be available. Also AMP is supplying completely assembled cables. Currently, a typical 20-conductor, 50- $\Omega$  coax cable, with connector-terminated leads at both ends, sells for between \$8 and \$12 for lengths of 2 to 6 ft in OEM quantities.

CIRCLE NO. 301

## Engraving tool uses solid carbide tip



Mountain West Alarm Supply Co., 4215 N. 16th St., Phoenix, AZ 85016. (602) 263-8831. \$15.75 (unit qty).

The D12 electric engraver permanently marks valuables to permit fast identification and quick recovery in case of theft. The engraver permanently marks steel, plastic, copper, brass, wood, or glass. A replaceable carbide tip is driven by a high-speed reciprocating motor at 7200 strokes per minute. The solid carbide tip is practically wearproof. A calibrated stroke-adjustment dial regulates length of stroke. The depth of engraving can be set from fine lines to deep marks. For continuous duty, a diamond point is available. The unit weighs just 2 lb and operates from 115 V ac at 60 Hz.

CIRCLE NO. 302

## Set lead bender size with micrometer screw



Harwil Co., 903 Colorado Ave., Santa Monica, CA 90401. (213) 394-4710. Stock.

Model N-300 lead bender is now equipped with a fine-pitch adjusting screw for smooth micrometer adjustment of bend spacing. The adjusting screw is permanently dry lubricated. Standard features include strain relief between component and bend, replaceable plastic guides and a rigid hard anodized aluminum frame. The unit eliminates measurement and trial-and-error bending of component leads. You match the pointers with eyelet holes in the circuit board and spin the knurled wheel with the thumb to automatically space the bends. All axial lead components to 1/2-in.  $\times$  1-1/2-in. long with maximum distance between inside of bends of 1.725 in. are accommodated.

CIRCLE NO. 303



## Learn digital design with instruction kit

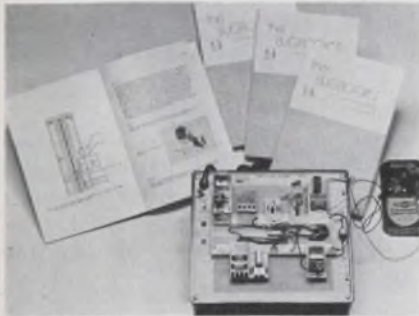

E&L Instruments, Inc., 61 First St., Derby, CT 06418. (203) 735-8774.

The LR Innovator series, for teaching digital electronics, includes modular hardware, called Outboards. The modules plug directly into an SK-10 solderless breadboarding socket. This allows the student to experiment with different digital-logic components. Over 750 pages of instructions and 90 experiments are supplied for self-programmed study. As new developments in digital electronics become available, the manufacturer will provide new modules and software to cover them.

CIRCLE NO. 304

## Instrument knobs fasten without set screws



Interlock, 770 Airport Blvd., Burlingame, CA 94010. (415) 348-5625.

The Collet Knob has no set screw. This new knob is secured by means of a collet that tightens around the entire shaft to provide a tight-fitting, perfectly-aligned knob. The knobs are available in two styles, five sizes and hundreds of combinations of pointers, figure dials, stators and colored caps. The sizes available are 10, 14.5, 21, 28 and 36 mm. Different colored caps can be used to identify knobs. The basic knob can have different components added with ease.

CIRCLE NO. 305

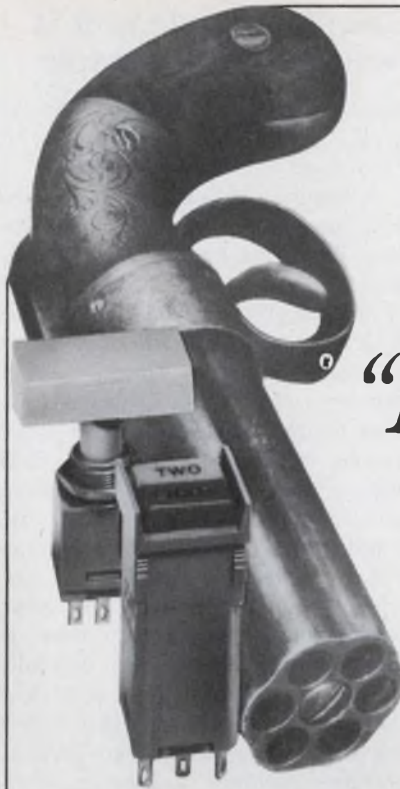

Before you order switchlights, we challenge you to compare our low cost

# "Persuader Line"

feature for feature with other leading brands

We're the kind of firm that believes in more than one gun barrel and plenty of ammunition. So when you add our familiar S410\* series to our new S190\* series, you'll find we have a very convincing line of general purpose switchlights indeed. It's "The Persuader" —the line we invite you to compare for low cost, quality and versatility with that of any other manufacturer. Just check the list below, then get in touch with your local distributor for exact specifications. And we're easy to find . . . located in major cities world wide.

Standard Features	Clare-Pendar "Persuader"	Micro	Diallight	Other
1. Low Cost	YES			
2. Distributor Stock	YES			
3. U.L. Listed	YES			
4. 2 Form C	YES			
5. Wiping Contacts	YES			
6. Snap Action Contacts	YES			
7. 10 amp Rated	YES			
8. 2 amp Rated	YES			
9. 100,000 Cycle Life	YES			
10. 6 Lens Shapes	YES			
11. Split Lens Displays	YES			
12. Solid/Proj. Displays	YES			
13. 5 Adapter Shapes	YES			
14. Barrier Adapters	YES			
15. Snap-In Mount	YES			
16. Rear Panel Mount	YES			
17. Gang Frame Mount	YES			
18. Quick Connect Trmls.	YES			
19. Engraved Legends	YES			
20. Alt. Remain-In	YES			
21. Mom./Alt./Indicator	YES			

\*S190 \$1.62 in quantities of 1000

\*S410 \$2.53 in quantities of 1000

See distributor listing Vol 1/568

SEE  
Engineering Design's  
**GOLD BOOK**  
FOR COMPLETE  
PURCHASING  
INFORMATION

**CLARE-PENDAR**



CLARE-PENDAR  
a GENERAL INSTRUMENT CO.  
Box 785, Post Falls, Idaho 83854  
(208) 773-4541

## Add-on memory for mini uses 4-k RAM on a board

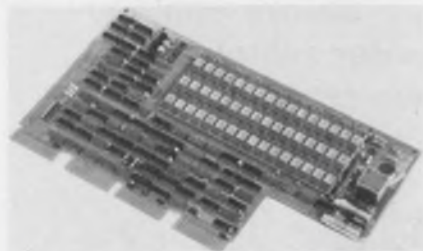

Monolithic Systems, 14 Inverness Dr., Englewood, CO 80110. (303) 770-7400. \$1995; 3 wk.

The Monostore VII/Planar is a single-board semiconductor memory system, with 12k × 16 organization, that fits a PDP-11 small-peripheral slot. Based on a 4096 × 1 NMOS RAM, the memory is hardware and software compatible with the PDP-11. It operates from the small-peripheral-slot power sources of 5 V and -15 V. Access time of 500 ns and cycle time of 700 ns allows maximum use of the bus speed. Existing programs can be used without modification. The small-peripheral-slot compatibility simplifies machine organization since the minicomputer can be ordered with minimum memory and all slots wired for small peripherals. The Monostore VII/Planar memory can then be added as required for a particular application. Two Monostore VII boards give more capacity than that given by four conventional boards. Power dissipation is 22 W at full speed, and 15 W in standby.

CIRCLE NO. 306

## Pipelined array device does FFTs in 250 μs

Spectra Data Inc., 18758 Bryant St., Northridge, CA 91324. (213) 993-1622. \$50k to \$250k; 120 to 150 days.

Model 2000 array processor uses pipeline operation and can transform 1024 complex points in 250 μs. The unit also does forward or reverse FFT. To attain these high speeds circuits are dedicated to a stage of the FFT algorithm; each stage sends results to the next until the results pour out of the last stage. The unit accepts analog or digital data and handles arrays as large as 8192, 32-bit words.

CIRCLE NO. 307

## Calculator-style unit is remote PDP-8 console

Douglas Electronics, 718 Marina Blvd., San Leandro, CA 94577. (415) 483-8770. \$700; stock.

A small calculator-type keyboard with seven segment LED octal display performs remotely all of the standard functions of the PDP-8/e programmer's console. The Model RFP-80 operates with or without the standard front panel. Current memory address and selected register contents are continuously displayed. Choice of display, data entry and various instructions are rapidly accomplished with simple push-key operation. Debugging programs and temporary control of turnkey systems are therefore easier. Additional time is saved by not having to mentally convert from binary to octal and then back to binary when entering or reading data. The RFP-80 package includes a plug-in interface board, a thin 10-foot interconnecting cable and plexiglass front panel to replace the PDP-8/e front panel.

CIRCLE NO. 308

## A/d converter sends results over phone line

Elographics, Data Systems Div., P. O. Box 388, Oak Ridge, TN 37830. (615) 482-4038. See text; 60 days.

The Datamat 11A analog-to-serial-data converter connects any analog output device to existing data transmission lines. The stand-alone unit accepts the analog voltage then formats, encodes and serializes it. Outputs are Serial ASCII with EIA RS-232C current loop, and parallel BCD; all provided simultaneously at rear panel connectors. Baud rate is selectable from 110 to 1200. The 11A can optionally accept data from several sources. In addition the unit can be inserted between existing communications components (e.g., between TTY and minicomputer or TTY and modem) without interfering with prior data transmissions. The standard Datamat 11A is equipped with its own 3-1/2-digit LED display or optionally with a four-digit display. The 11A with 3-1/2 digits costs \$1395 or \$1495 for four digits.

CIRCLE NO. 309

## Acquisition system has amp on each channel

Tustin Electronics Co., 1431 E. St. Andrews Pl., Santa Ana, CA 92705. (714) 835-0677. \$300 to \$400 per channel; 60 to 90 days.

System 2400 for data acquisition features a digital gain-controlled amplifier for each channel. The unit provides 1 to 10,000 in decade ranges. CMRR is 160 dB and 140 dB at gains of 10,000 and 1000, respectively. Amplifier bandwidth is 100 kHz for all values of gain. Input offset voltage is 1 μV and offset current is 1 nA at 25 C. Two to six-pole filters are optional. System throughput rates are 650 kHz, 275 kHz and 100 kHz for 12-bit systems and 500 kHz, 200 kHz, and 75 kHz for 15-bit systems.

CIRCLE NO. 310

## Buffer memory doubles PDP-11/45 speed



Fabri-Tek Inc., 5901 S. County Rd. 18, Minneapolis, MN 55436. (612) 935-8811. See text; 45 days.

The Model 4511 Memory Buffer is designed to increase the effective speed of PDP-11/45 main core memory. Processing time can be reduced by as much as one-half depending on the program used. The Model 4511 buffers the entire 124k words of main core memory of the 11/45, to achieve an effective speed of 450 ns. The unit uses bipolar technology and is contained on three PC cards which can be installed in minutes on the PDP 11/45 Fastbus. The memory buffer has 512 words by 16 bits of available storage and comes with a 5-V power supply. The Model 4511 with 8 k words of Fabri-Tek Model 11 Core Memory sells for approximately \$11,810 (unit qty). Model 11 add-on core memory systems range in size from 8 k to 128 k words.

CIRCLE NO. 320

XENON corporation

# FLASHTUBES and RELATED EQUIPMENT

Lamps and Equipment for the Generation of Light.

FEATURES: High Volume Production Reliability

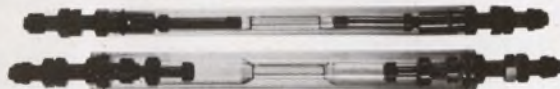

We can deliver a reliable product in the quantities required by the OEM user. Our lamps have consistently higher quality, with longer and more uniform life.

In addition, we can solve the problem of having to build your own circuitry with our:

- Trigger Transformers
- Chokes
- Trigger Modules
- Power Modules

All are part of the engineering and manufacturing package Xenon can deliver and we can offer the most advanced technical assistance in the industry.

### NEW PRODUCT ANNOUNCEMENT

Contact our factory for information on our new inner seal design. Its unique insulating and cooling properties have solved problems in many OEM application areas:

SEND FOR OUR COMPLETE PRODUCT CATALOG. XENON ASSURES QUICK DELIVERY.

39 Commercial St., Medford, Mass. (617) 395-7634.

INFORMATION RETRIEVAL NUMBER 44

# PHOTO ETCH PRINTED CIRCUIT KIT

Makes circuits THREE WAYS

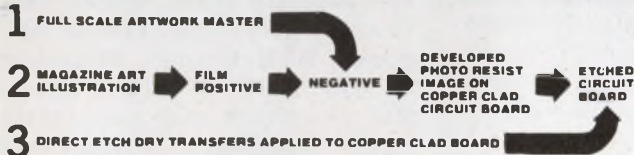

**NO** CAMERA DARKROOM FILM CUTTING TRACING

**USES DATAK'S POS-NEG PROCESS**  
The revolutionary photographic way that makes PERFECT printed circuits from original art or a printed page.

KIT CONTAINS: 5' x 6' steel printing frame, 4 sheets 5' x 6' photocopy film, yellow-tinted chemicals for 1 pint film developer and 1 pint film fixer, 5' x 6' copper clad board, 3' x 4' copper clad board, spray can of photo etch resist, 1 pint resist developer, 2 sheets 8 1/2" x 11" layout film, 1 roll 1/16" printed circuit tape, 1 roll 1/32" printed circuit tape, 8 sheets dry transfer direct etch PC patterns including pads, transistors, round cans and flat pack ICs, DIP ICs, edge card connectors, lines, circles, jags etc. 1/2 lb anhydrous ferric chloride to make 1 pint etchant, instructions.

ER-4 COMPLETE PHOTO ETCH SET	.....	\$24.95
ER-2 PC patterns and tapes—refill	.....	3.39
ER-3 1/2 pound dry etchant—refill	.....	1.25
ER-5 6 sheets photocopy film—refill	.....	3.39
ER-6 Film process chemicals—refill	.....	1.79
ER-7 Photo resist spray, 2.5 oz.—refill	.....	2.95
ER-8 Resist developer, 16 oz. can—refill	.....	2.95

AT YOUR DISTRIBUTOR OR DIRECT

the **DATAK** corp.  
65 71st St. • Guttenberg, N. J. 07093

INFORMATION RETRIEVAL NUMBER 45

ELECTRONIC DESIGN 3, February 1, 1975

# NOW... AC MEASUREMENTS GO DIGITAL!

- True RMS Volts
  - True RMS Current
  - AC Watts
- ... all in YEW's new 2504 AC DMM!

The new 2504 digital AC instrument offers unexcelled accuracy and versatility for the measurement of sinusoidal and non-sinusoidal waveforms and for measurements at low power factors. Flexible design allows optional purchase of just the measuring functions required while push-button controls provide ease of operation.

The YEW 2504 is the AC DMM. Its 0.25% accuracy and 0.01% resolution, standard analog output, and low cost (Prices start at \$1,590.) make it the ideal instrument for quality control, lab, field maintenance, and instrument calibration applications. Write for details.



Standard ranges (Multirange Model):  
30V/60V/100V/150V/300V,  
0.5A/1A/2A/5A/10A (15W to 3,000W)  
Frequency range: 25 Hz to 1 kHz



Yokogawa Electric

**YEWTEC CORPORATION**  
1995 Palmer Avenue  
Larchmont, N.Y. 10538  
Telephone: 914-834-3550

60 Years of Measuring and Recording Instrumentation

INFORMATION RETRIEVAL NUMBER 46

at prices from \$50  
Hipotronics offers you  
delivery from stock  
on over 800 standard  
models of

# hv dc power supplies

... with output voltages  
from 1 to 1000 KV and  
current outputs from  
2 ma to 50 amperes.



model 860-6.5  
60 KV, 6.5 ma.

## ALSO:

■ **Custom design units:** for wide range of applications — electrostatics, accelerators, lasers, monocyclic charging, high power radars, high voltage testing, and more.

■ **HV power packs:** wide range of compact, miniaturized power packs, with output voltages from 2.5 to 100 KV and current ratings of 2 to 10 ma. Also, standard 5-ma and 2-ma HV power packs with simplified controls.



model R-30B

Send for our 24-page catalog, "High Voltage DC Power Supplies and Components," or call our Sales Department and ask for the Power Supplies Manager.



**HIPOTRONICS, INC.**

Brewster, N. Y. 10509 / (914) 279-8091  
TWX: 710-574-2420

## DATA PROCESSING

### Mag tape replaces paper with boost in speed

Dicom Industries, 715 N. Pastoria Ave., Sunnyvale, CA 94086. (408) 732-1060. From \$1760 (qty).

The Model 330 digital tape cassette can replace paper tape readers and punches. Speed increases of 33 times over synchronous units and 8333 times over asynchronous units are claimed. The Model 330 simultaneously emulates both paper tape punch and reader. Data storage capacity is 10 times that of a 1000 foot paper tape roll. A standard ANSI/ECMA cassette is used. Several standard versions of the Model 330 are available. These include: single or dual transport, FIFO buffer for 128 or 256 characters, and ANSI/ECMA format.

CIRCLE NO. 321

### Paper-tape reader loads microcomputer faster



Intel Corp., 3065 Bowers Ave., Santa Clara, CA 95051. (408) 246-7501. \$975; 2 wks.

The imm 8-90 is a high-speed paper tape reader for Intellec 8/MOD 8 and 8/MOD 80 microcomputer development systems. The reader transfers data 20 times faster than a standard TTY, tape reader. An asynchronous data transfer rate of 200 char/s allows an 8-kbyte program to be loaded in the Intellec memory in 1.5 min. Moreover, the new reader is completely software and hardware compatible with all Intellec 8 systems. Intellec 8 resident monitor software includes a general-purpose tape-reader driver that enables all system software to use the imm 8-90 features. The driver is also callable by user-written applications programs. In addition, the monitor provides dynamic I/O reconfiguration, for instantaneous reassignment of peripherals. Interface cables and documentation are supplied.

CIRCLE NO. 322

### Cassette reader mates with mini or terminal

Datel Systems, 1020 Turnpike St., Canton, MA 02021. (617) 828-8000. \$2095 to \$2795.

The LPR-16 Cassette Reader accepts tapes written in Datel's complementary NRZI digital format and converts them to serial or parallel format. Two interface boards can be used with the LPR-16 Reader. The RS-232-C interface connects directly to many ASCII devices. The minicomputer interface transforms serial digital information recorded on the cassette (at 1700 bit/s) into parallel logic levels to be transferred on command to an external computer or processor.

CIRCLE NO. 323

### Distributed industrial network uses minis

Hewlett-Packard, 1501 Page Mill Rd., Palo Alto, CA 94304. (415) 493-1501. See text; 120 days.

Three models of control satellites and a central computer unit are part of the industrial distributed network designated the 9600MX. Each control satellite contains a minicomputer interfaced to analog and digital I/O. The input-output segment can be separated up to 10,000 ft. from the control satellite mini (a 21MX). Model 9611A satellite offers a full line of industrial signals that include 50 V dc outputs, 117 V ac input and 250 V ac. Model 9603A offers the same capability but does not include terminal strips and signal conditioning. The Model 9602A provides an integrating DVM for data acquisition use only. The Model 9700 is a mini plus peripherals that acts as the central computer. The controllers become satellites to the 9700 and can communicate at rates to 1 Mbit/s over wire links up to 10,000 ft. The software executive RTE-II provides remote access to program and data files, task scheduling and peripheral sharing. Real-time programs can be written in Fortran or Basic. A spooling feature improves system throughput. Communications packages cost \$6000 for the first link and \$4000 for each additional link. Prices for the hardware units are 9700A: \$37,300; 9611A: from \$31,000; 9602A: \$50,000; 9603A: \$24,400; 9604A: \$24,400.

CIRCLE NO. 324

## INTEGRATED CIRCUITS

### Eight CMOS ICs keep time

*Solid State Scientific, Inc., Montgomeryville, PA 18936. (215) 855-8400.*

Eight standard CMOS circuits are offered for digital watches and clocks. The SCL5440 and SCL5445 are single-chip time base, LED decoder drivers for displaying hours, minutes, seconds and date. The 5440 has outputs compatible with common-anode LEDs, and the 5445 has outputs compatible with common-cathode LEDs. The SCL5441 is an upgraded design of the previous SCL5424 circuit for LCD displays showing hours and minutes. This decoder driver has switch anti-bounce inputs. Operating current is guaranteed to be less than  $1 \mu\text{A}$ . The SCL5442 is a decoder driver for LCD displays showing hours, minutes, seconds and date, with AM-PM indication. It has an improved time setting technique, with seconds hold and advance capability. Operating current is less than  $1 \mu\text{A}$ . A new single-chip low-voltage time base and LCD decoder driver, the SCL5443, reportedly has the lowest cost of any similar circuit. A second device is the SCL5447 time-base circuit, which would be teamed with the 5441 or 5442 decoder-driver. The SCL5419 digital-clock time base is an oscillator and 23-stage divider, with integrated oscillator and digital frequency trim. It is designed for use with a 4-MHz crystal. Digital frequency select permits factory adjustment of frequency without need for a trimming capacitor, over a range of 0 to 250 pulses per million.

CIRCLE NO. 325

### 1-k SOS RAM accesses in 120 ns

*RCA, Route 202, Somerville, NJ 08876. (201) 722-3200.*

A  $1\text{-k} \times 1\text{-bit}$  silicon-on-sapphire (SOS) RAM has an access time of about 120 ns at 10 V, with cycle times of 150 ns. Operating dissipation is about 20 mW at 1 MHz and 10 V. The chip employs a 16 row decoder, rather than the conventional 32, for increased speed.

CIRCLE NO. 326

## Sprague Delivers!

# YOU DON'T HAVE TO TAKE A SUBSTITUTE.



### THE CAPACITOR:

Sprague's Type 192P Pacer<sup>®</sup>...  
The Dependable Low-Cost  
Miniature Polyester Film Capacitor.

### THE DELIVERY CYCLE:

Large Production Quantities  
4 – 8 Weeks ARO on All Popular  
Ratings. Off-the-Shelf Delivery from  
your Sprague Industrial Distributor.

### THE CATCH:

None.  
Sprague Delivers Film Capacitors.

Call your nearest Sprague district office or  
sales representative for complete information.

Sprague Electric Company,  
North Adams, Mass. 01247  
Tel. 413/664-4411

4SP-4142

# SPRAGUE

THE MARK OF RELIABILITY

THE BROAD-LINE PRODUCER OF ELECTRONIC PARTS

INFORMATION RETRIEVAL NUMBER 48

# IT'S CLEARLY THE CHOICE OF ELECTRONICS ENGINEERS – WORLDWIDE



PLEASE HELP US

Kindly judge Electronic Design's GOLD BOOK in relation to other similar directories by answering the first two questions with a tick (✓) or a cross (✗). Complete all other questions, then adding any comments you wish to offer. Thank you.

Overall usefulness (Scale of 1-5) of including the information you need: 5

Comprehensiveness (Availability of information of products included in the book): 5

How many colleagues use your GOLD BOOK? 5

Comments: I like the book very much. It is very useful and contains a lot of information. I will be ordering a copy for my office.

Name: J. P. ...

Company: ...

Address: ...

City: ...

PLEASE HELP US

Kindly judge Electronic Design's GOLD BOOK in relation to other similar directories by answering the first two questions with a tick (✓) or a cross (✗). Complete all other questions, then adding any comments you wish to offer. Thank you.

Overall usefulness (Scale of 1-5) of including the information you need: 5

Comprehensiveness (Availability of information of products included in the book): 5

How many colleagues use your GOLD BOOK? 5

Comments: I like the book very much. It is very useful and contains a lot of information. I will be ordering a copy for my office.

Name: J. P. ...

Company: ...

Address: ...

City: ...

PLEASE HELP US

Kindly judge Electronic Design's GOLD BOOK in relation to other similar directories by answering the first two questions with a tick (✓) or a cross (✗). Complete all other questions, then adding any comments you wish to offer. Thank you.

Overall usefulness (Scale of 1-5) of including the information you need: 5

Comprehensiveness (Availability of information of products included in the book): 5

How many colleagues use your GOLD BOOK? 5

Comments: I like the book very much. It is very useful and contains a lot of information. I will be ordering a copy for my office.

Name: J. P. ...

Company: ...

Address: ...

City: ...

PLEASE HELP US

Kindly judge Electronic Design's GOLD BOOK in relation to other similar directories by answering the first two questions with a tick (✓) or a cross (✗). Complete all other questions, then adding any comments you wish to offer. Thank you.

Overall usefulness (Scale of 1-5) of including the information you need: 5

Comprehensiveness (Availability of information of products included in the book): 5

How many colleagues use your GOLD BOOK? 5

Comments: I like the book very much. It is very useful and contains a lot of information. I will be ordering a copy for my office.

Name: J. P. ...

Company: ...

Address: ...

City: ...

PLEASE HELP US

Kindly judge Electronic Design's GOLD BOOK in relation to other similar directories by answering the first two questions with a tick (✓) or a cross (✗). Complete all other questions, then adding any comments you wish to offer. Thank you.

Overall usefulness (Scale of 1-5) of including the information you need: 5

Comprehensiveness (Availability of information of products included in the book): 5

How many colleagues use your GOLD BOOK? 5

Comments: I like the book very much. It is very useful and contains a lot of information. I will be ordering a copy for my office.

Name: J. P. ...

Company: ...

Address: ...

City: ...

# WHEN YOU HAVE Electronic Design's GOLD BOOK YOU DON'T NEED ANY OTHER INDUSTRY DIRECTORY

In just a few months, the first issue of *Electronic Design's* GOLD BOOK has become the leader among all directories used in this industry. Engineers have responded enthusiastically throughout the U.S. and from all over the world — especially in Europe where they've never seen anything like it before. The GOLD BOOK has become number one almost overnight.

## HERE'S HOW YOUR FELLOW ENGINEERS RATE THE INDUSTRY ANNUALS

	Annals Consulted Within Past Month	Annals Preferred
Electronic Design's GOLD BOOK	85%	60%
Electronic Engineer Master (EEM)	63%	42%
Electronic Buyer's Guide (EBG)	32%	8%
Thomas Register	16%	7%
Conover-Mast Purchasing Directory	2%	1%

SOURCE: Study by Dr. Eugene D. Jaffe, Associate Professor of Marketing, St. John's University, Nov. 1974. Base: respondents using directories. Totals exceed 100% due to multiple mentions.

The GOLD BOOK has revolutionized directory use patterns in this industry. Here's why: The GOLD BOOK is by far the largest, most complete one-step electronics purchasing and reference tool ever produced. And it's far easier to use. Look at these comparisons:

## COMPARISON OF ELECTRONICS INDUSTRY DIRECTORIES (1974-75 editions)

	EBG ELECTRONICS BUYERS' GUIDE	EEM ELECTRONIC ENGINEERS MASTER	ELECTRONIC DESIGN'S GOLD BOOK
<b>Number of manufacturers listed</b>	5,800	3,165	<b>7,528</b>
Total number of products listed	4,267	3,235	4,799
Number of direct products listed	2,479	2,250	2,925
Number of cross-reference products listed	1,788	985	1,874
Number of distributors listed in Distributors Directory — Alphabetic	0	1,720	<b>5,780</b>
Number of distributors listed in Distributors Directory — Geographic	0	1,720	<b>5,780</b>
Is complete mailing address given each time a company is listed in product directory?	No	No	<b>Yes</b>
Is telephone number given for each company listed in product directory?	No	No	<b>Yes</b>
Are distributors listed for each manufacturer?	No	Partial <sup>1</sup>	<b>Yes</b>
Does manufacturers listing include FSCM numbers?	No	No	<b>Yes</b>
Does manufacturers listing include facsimile equipment by make and call number?	No	No	<b>Yes</b>
Total Circulation	30,017 <sup>2</sup>	89,169 <sup>2</sup>	<b>Over 90,000</b>
Overseas Circulation <sup>2</sup>	1,339 <sup>2</sup>	0 <sup>2</sup>	<b>13,200</b>
Number of ad pages	590 <sup>4</sup>	2,752	<b>2,820</b>

<sup>1</sup> Paid listings only  
<sup>2</sup> Includes Canada

<sup>3</sup> Standard Rate & Data, Oct. 24, 1974  
<sup>4</sup> Includes fractionals

**MOST THOROUGH, MOST COMPLETE, EASIEST-TO-USE  
ELECTRONICS INDUSTRY DIRECTORY IN THE WORLD**

INTEGRATED CIRCUITS  
**Standard 74C CMOS  
 extends temperatures**

*Harris Semiconductor, Melbourne, FL 32901. (305) 727-5407.*

Having alternate sourced the basic 74C CMOS line introduced by National Semiconductor, the company is now also accompanying National in extending the temperature range of the 74C commercial line. The new range is -40 to 85 C—up from a range of 0 to 70 C.

CIRCLE NO. 327

**1-k NMOS static  
 RAM accesses in 60 ns**

*RCA, Somerville, NJ 08876. (201) 722-3200. \$10.50 (1000); stock.*

An NMOS memory, the MW-7001ID 1024 × 1-bit static RAM has pin compatibility with the AMS 7001L. The new RAM has a 60-ns maximum access time, 180-ns maximum cycle time and TTL-compatible inputs. Maximum dissipation is 0.5 μW/bit standby and 640 μW/bit operating. The RAM comes in a 22-lead ceramic DIP.

CIRCLE NO. 328

**CMOS IC offers  
 basic functions**

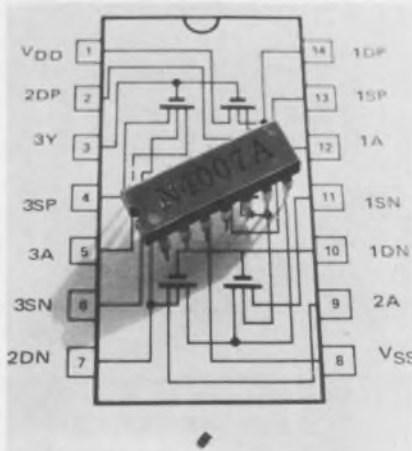

*Signetics, 811 E. Arques Ave., Sunnyvale, CA 94086. (408) 739-7700. 47¢ (1000).*

A CMOS dual complementary pair plus inverter is offered in the Model N40007A. The IC, which is interchangeable with a like-numbered RCA version, accepts supply voltages in the range of 3 to 15 V. Input resistance is greater than 10<sup>12</sup>Ω, and input current is less than 10 pA. All inputs have over-voltage protection.

INQUIRE DIRECT

**Compact module  
 improves watch designs**



*American Microsystems, Inc., 3800 Homestead Rd., Santa Clara, CA 95051. (408) 246-0330.*

The company's latest digital watch module features decreased thickness, complexity and power requirements. Called the Compact Watch Module, or CWM, the new unit is only 0.25-in. thick. The CWM achieves a 49% reduction in the number of component elements and a 60% reduction in the number of electrical connections, when compared with the company's previous model, the HMM. In addition, a special liquid-crystal material in the display allows operation from supplies of only 3 V. As a result, a number of discrete components, including a voltage converter, are eliminated. Current consumed is 7 μA.

CIRCLE NO. 329

# JAN & JANTX 2N4150 SWITCHING TRANSISTORS

are now  
 available for your  
 MILITARY SYSTEMS.

**GENERAL SEMICONDUCTOR INDUSTRIES**  
 Manufactures Over 200 Types of  
**HIGH SPEED, HIGH POWER**  
 NPN Switching Transistors  
 Ranging From 1 To 60 AMPS.



**GENERAL SEMICONDUCTOR INDUSTRIES, INC.**

2001 West 10th Place, Tempe, Arizona 85281 • (602) 968-3101 • Mailing Address: Post Office Box 3078



## 8-bit micro set has 12 LSI I/O options

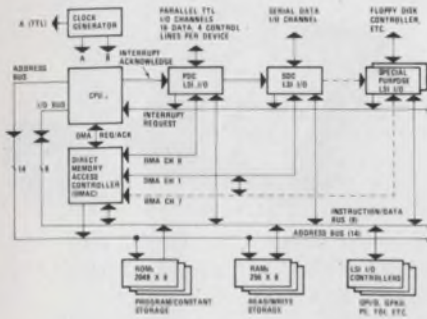

Rockwell International, P. O. Box 3669, Anaheim, CA 92803. (714) 632-3729. P: See text.

The PPS-8 family of 8-bit micro-computer circuits provides 12 LSI input/output controller options and a full complement of memories. The PPS-8 system architecture is based on a set of more than 90 expandable instructions, and the chips employ established p-channel MOS fabrication techniques. Memory circuits include  $256 \times 8$  RAM,  $1\text{-k} \times 8$  ROM,  $2\text{-k} \times 8$  ROM, and, in development, an electrically erasable  $256 \times 8$  ROM.

Main elements of the PPS-8 CPU are: 8-bit parallel adder accumulator for logic and arithmetic operations, five 8-bit registers for memory addressing and data manipulation, a pointer for a RAM data stack, processing logic for a priority interrupt structure, and logic for direct memory access.

The CPU can directly accept three levels of priority interrupts. More than 15 independent I/O circuits may be serviced for each priority level.

A load or store instruction can perform transfer, increment or decrement, and compare functions in  $4 \mu\text{s}$ . Such multifunction instructions perform decimal arithmetic at the rate of  $12 \mu\text{s}$  per digit. A table search takes  $12 \mu\text{s}$  per byte and a block data transfer—moving bytes from one memory location to another—can also be done at a  $12\text{-}\mu\text{s}$  byte rate.

For prototyping, available evaluation boards are priced at \$600 to \$700. A minimum PPS-8 micro-computer circuit set including CPU, a  $2\text{-k} \times 8$  ROM, a  $256 \times 8$  RAM, DMA controller and clock in 1000 quantities costs about \$125 per set, including ROM encoding.

CIRCLE NO. 330

## With MINI BUS<sup>®</sup>

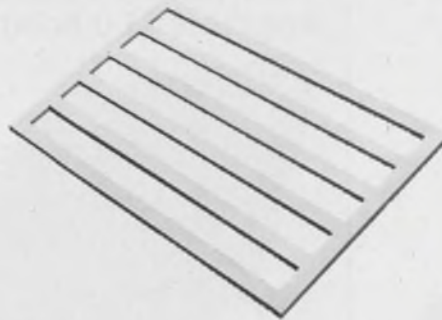

It's the PC card bus bar that saves space on a PCB. Saves money too. Makes board design and layout easier.

## all these DIPs



How can you put 36 DIPs on a 30 sq. inch board without using costly multi-layer PCBs?

## go on a 5" x 6" 2-sided PCB

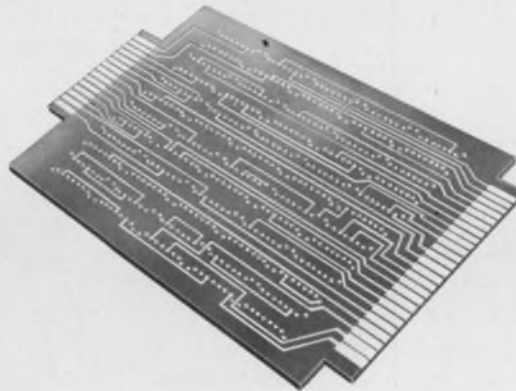

Take Voltages and Grounds **off the board** with MINI/BUS. Use all the board geometry for interconnecting DIPs.

## like this

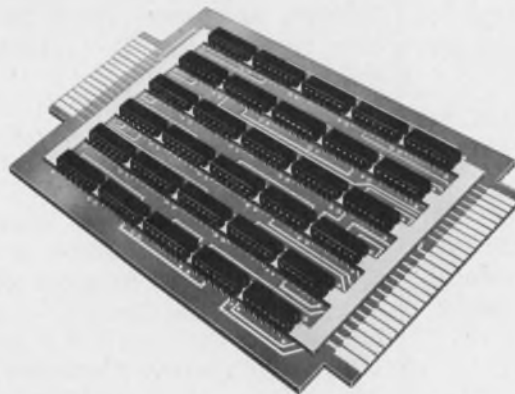

With MINI/BUS, you'll save design and layout time. You'll save space on the board. And **you'll save money**—up to half the cost of a typical 4-layer PCB.



Rogers Corporation Chandler, Arizona 85224 Phone: (602) 963-4584

Represented in Canada by LLOYD A. MEREDITH,  
1560 Watersedge Road, Clarkson, Ontario L5J 1A4 Phone: (416) 533-2367

INFORMATION RETRIEVAL NUMBER 52



## hot stuff

or cold, CHR's family of TEMP-R-TAPE of Kapton provides outstanding endurance. They retain their excellent mechanical and electrical properties over a wide temperature range, -100 to +500F.

Available in thicknesses from .001" to .0045" with a choice of several adhesive systems including adhesive two sides.

Find your CHR distributor in the Yellow Pages under "Tapes, Industrial" or in industrial directories. Or write for complete specification kit and sample. The Connecticut Hard Rubber Company, New Haven, Conn. 06509.



an ARMCO company  
INFORMATION RETRIEVAL NUMBER 53

### COMPONENTS

#### Cross-patch module programs 100 points

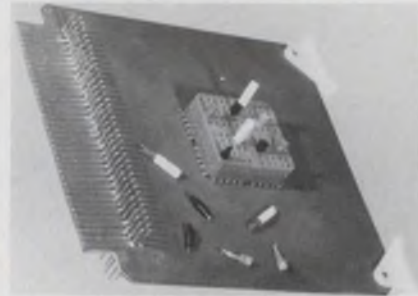

Aries Electronics, Inc., P.O. Box 231, Frenchtown, NJ 08825. (201) 996-4096. \$40 to \$60 board mounted; 2 to 6 wks.

Aries cross-patch is a miniature XY programmable module with 100 interconnection points on a 10 x 10 grid configuration. The grid dimension is 0.100 in. Any X point may be connected to any Y point by the use of bifurcated shorting plugs. Also, two sizes of diode interconnection plugs can switch functions. With shorting plugs installed, the height of the module is only 0.480-in. high. Both plugs and cross patch are available with color codes.

CIRCLE NO. 331

#### Varistors available down to 20 V rms



General Electric Co., Semiconductor Products Dept., Building 7, MD#49, Electronics Park, Syracuse, NY 13201. (315) 456-2021. \$0.41 (1000 up); stock.

New GE-MOV varistors are capable of both dc and ac operation and voltage ratings for the new series are now as low as 26 V dc, or 20 volts rms. Higher voltage ratings are available to 81 V dc, or 60 V rms. Response time is less than 1 ns. Energy ratings range from one to 15 W-s with 1-A transient currents. Compared to zener diodes, these varistors are capable of handling 2 to 4 times as much current and up to 15 times the peak power.

CIRCLE NO. 332

#### Tactile-tape keyboard switches with feeling



Clare-Pendar Co., P. O. Box 785, Post Falls, ID 83854. (208) 773-4541. See text.

Softac, an 18-station keyboard, features soft-stroke, tactile-feel switching and low cost—less than \$2 per assembly, less bezel, in low quantities and \$1.60 in quantities of 50,000. The keyboard interfaces with conventional MOS, CMOS and TTL circuits. The tactile-tape technology allows the construction of arrays in single, double, triple and quadruple rows. A life of 10-million cycles is assured by sealing the contacts. Keys have an over-all travel of 0.050 in. and provide a positive switch-make feel. An integral ON/OFF slide switch is included.

CIRCLE NO. 333

#### Custom assemble small motors to any need



General Time, 135 S. Main St., Thomaston, CT 06787. (203) 283-5881.

The H4 motor system uses a modular design and assembly technique. This enables the company to manufacture and stock large quantities of motor components for assembly and delivery in a matter of days. The H4 motor system consists of four basic building blocks—the prime mover, the speed reduction unit, the output shaft and a pair of detachable leads. Combined, the components form an advanced 40 oz-in. torque timing/work motor. The H4 system's prime movers and gear trains are completely interchangeable. They are stocked separately and easily mated to meet specific motor voltage, frequency and output speed requirements.

CIRCLE NO. 334

## Storage capacitors use single-anode foil



International Importers, Inc., 2242 South Western Ave., Chicago, IL 60601. (312) CL-4-4252. \$1.20: type FO (1000 up); stock.

A broad line of low-cost Rubycon aluminum electrolytic discharge capacitors features low-leakage current and a single-anode foil design that replaces conventional double-anode foil constructions. Advantages claimed for the single foil include a small leakage current equal in microamps to the  $\mu\text{F}$  value, low dielectric loss and an improved pulse-rise characteristic to allow a short recharge time. Operating temperature is  $-10$  to  $40$  C and tolerance  $-10$  to  $+30\%$ . Type FO capacitors are rated for 330 and 360-V operation, with surge voltage ratings of 350 and 380 V, respectively. Type SF capacitors operate at 450 V with a 500-V surge. Capacitance values range from 200 to 2000  $\mu\text{F}$ , in 100  $\mu\text{F}$  increments.

CIRCLE NO. 335

## Control motor designed with hollow rotor

Micro Switch, Div. of Honeywell, 11 W. Spring St., Freeport, IL 61032. (815) 232-1122. See text.

Miniature high-performance dc control motor, the 26EM, is smaller than a standard flashlight battery. Primarily designed for digital cassette recorders and cartridge drives, it will sell for about \$10 in quantity orders. The motor features a hollow-rotor design, which makes possible an 18-ms response time and a rated torque of 1.65 oz-in. The rotor is epoxy coated. Standard models operate on 12 V dc, but options also include 6 and 24-V-dc models, ball bearings, two-hole mountings and lead wires.

CIRCLE NO. 336

# The Servo-Tek World of DC Servomotors



Wide range of permanent-magnet dc models available.

Servo-Tek's Permanent-Magnet DC Servomotors are precision made to give highly reliable performance. Their stability, high output-to-size ratio and speed range from 0-10,000 rpm with output torques to 2.0 oz-in make them ideal as prime movers in servomechanisms. Diameter 1.135 in. lengths up to 3.253 in. A unique field structure of Alnico VI results in minimized cogging (slot lock), a prerequisite to optimum servo performance. Models are available with a variety of operating voltages and with various mountings and integral gearing. Moderately priced with quantity discounts.

FREE CATALOG of rotating components available.

Be Selective. Turn To...

**SERVO-TEK**  
PRODUCTS COMPANY

1086 Goffle Road, Hawthorne, NJ 07506 · 201-427-3100

Servo-Tek of California, Inc.

8155 Van Nuys Blvd., Van Nuys, CA 91402 · 213-786-0690

INFORMATION RETRIEVAL NUMBER 54

## Decitek gives you accurate, reliable tape reading whatever your reader requirements.

Regardless of what reader you select from the Decitek line, you will be assured of proven reliable performance.

A patented dual sprocket drive gives consistently accurate character registration

up to 600 cps without tape wear.

The fiber optic-photo transistor read system provides highly stable error-free reading.

Write for brochure giving details on the full

Decitek line of high-performance punched tape readers.

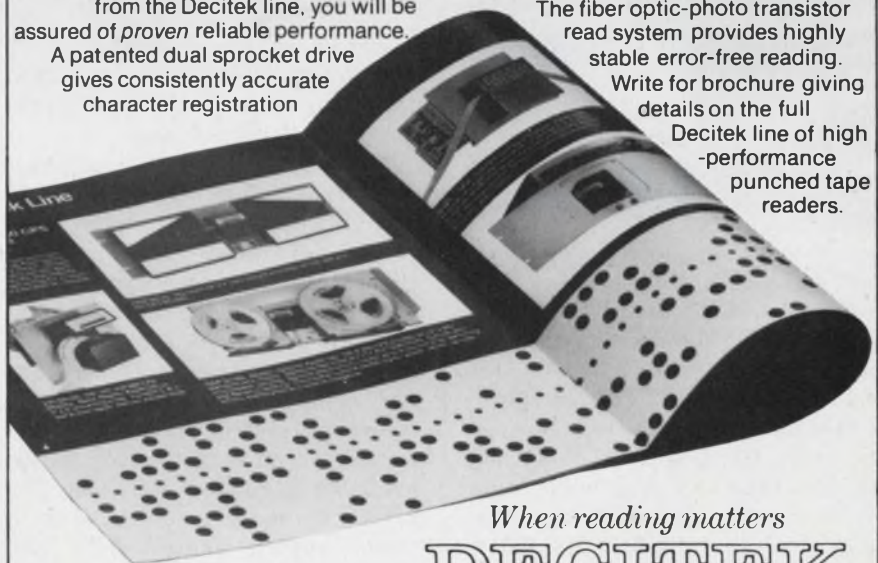

When reading matters

**DECITEK**

A DIVISION OF JAMESBURY CORPORATION

250 CHANDLER STREET, WORCESTER, MASSACHUSETTS 01602, U.S.A. (617) 798-8731

INFORMATION RETRIEVAL NUMBER 55

### Photometer offers any measurement units



Alphametrix, 532 Berry St., Winnipeg, Canada. (204) 786-1476. \$1095.

Model 1020 lab/industrial photometer/radiometer is designed for applications where single parameter measurements are made on a repeated basis. Display is 3-1/2 digits plus any desired units of measurement. Controls include full-scale offset and seven decades of ranging. Analog output is standard. Sensitivity:  $10^{-12}$  W/cm<sup>2</sup>,  $10^{-6}$  FC,  $10^{-4}$  FL. Spectral range: 200 nm to infrared. Options are BCD interface, automatic ranging and pulse mode.

CIRCLE NO. 337

### Logic probe handles all CMOS voltages

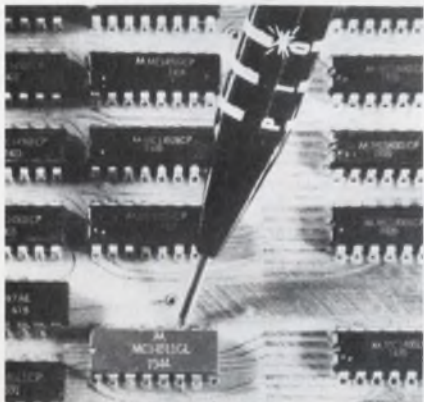

Questronics, Inc., 3598 S. 300 West, Salt Lake City, UT 84115. (801) 262-9923. \$25; stock.

This CMOS logic probe operates on all logic voltages (3 to 18 V dc) and indicates "1", "0" or pulse conditions with LEDs located near the probe tip. Logic "0" is a voltage less than 45%  $V_{DD}$  while logic "1" is greater than 55%  $V_{DD}$ . The pulse indicator flashes for 0.2 s each time a pulse of 500 ns duration or greater is present. Input impedance is 2 M $\Omega$ .

CIRCLE NO. 338

### Rms/dc converter works to 0.25%

UFAD Corp., 700-36th St. S.E., Grand Rapids, MI 49508. (616) 241-6000. \$795; 30 days.

Programmable true-rms-to-dc converter unit, Model 732, converts any waveform, including white noise, to a dc voltage proportional to the rms value of the input. Accurate to  $\pm 0.25\%$ , the unit has a 1-MHz bandwidth, 6:1 crest factor, two remotely selectable response times and two time-delay outputs preset to user requirements. Input range is programmed by an external 3-bit BCD code and covers a 90-dB range in eight steps. The output is analog, 0 to +10 V dc. Three versions are available with input ranges of 100 mV to 300 V, 3 mV to 10 V, or 30 mV to 100 V, fs.

CIRCLE NO. 339

### Quiet thermal printer accepts BCD or ASCII



Hewlett-Packard, 1501 Page Mill Rd., Palo Alto, CA 94304. (415) 493-1501. \$800; 30 days.

Model 5150A quiet thermal printer accepts data from BCD or ASCII sources and prints up to 20 columns of alphanumeric information. Modular in construction, it is available in many different configurations and can function as an instrument system controller. The unit prints 5  $\times$  7 dot-matrix characters at faster than three lines per second on heat-sensitive paper, available in rolls or fan-folds. The printer's mainframe contains a power supply, control logic and print mechanism. Input interfaces are provided by the use of plug-in circuit boards.

CIRCLE NO. 340

### Time-interval meter resolves 100 fs



United Systems Corp., 918 Woodley Rd., Dayton, OH 45403. (513) 254-6251. \$5500.

Model 8330 time-interval counter provides single-shot measurements with 100-ps resolution, time-interval averaging with 100-femtosecond resolution, along with period and period average measurements to the same high resolution. Arming is provided for selection of a particular signal to be measured from a sequence of signals. Full remote programmability and parallel BCD output are standard, as well as a variety of input/output control signals. Front-panel controls are single point programmed and trigger levels use BCD 8-4-2-1 code.

CIRCLE NO. 341

### Compact DMM built around LSI



Philips, P. O. Box 523, Eindhoven, the Netherlands. \$225.

The heart of the PM 2513 DMM is an LSI circuit that performs part of the analog circuit functions, the a/d conversion and the digital signal evaluation. The IC drives directly a 3-1/2-digit, seven-segment LED display with automatic decimal point. It also displays polarity, overload and low battery. Five ranges of ac and dc voltages cover 0.1 to 600 V and 0.1 to 1000 V, respectively. Basic accuracy is  $\pm 0.2\%$ . Also handled are ac and dc current and resistance.

CIRCLE NO. 342

**Sweep gen offered  
for 75-Ω applications**



Wavetek Indiana Inc., 66 N. 1st Ave., Beech Grove, IN 46107. (317) 783-3221. 1001A: \$1100; 1002: \$1150; stock.

Series 1000 is a 75-Ω general-purpose, sweep/signal generator. Model 1001A covers a frequency range of 0.5 to 300 MHz and Model 1002 covers 1.0 to 500 MHz. Sweep linearity is 2%. Flatness of ±0.25 dB is accomplished with pin diode leveling. Output amplitude is +60 dBmV max, with total attenuation range of 90 dB. Attenuation accuracy is ±0.5 dB. These units also feature AM and FM capability and remote programming for center frequency, sweep width and attenuation over a 20-dB range.

CIRCLE NO. 343

**Electronic load  
handles up to 750 W**



ACDC Electronics, Oceanside Industrial Center, Oceanside, CA 92054. (714) 757-1880. \$850; 6-8 wks.

EL-750 programmable electronic load can simulate up to 750 W of dc power. The portable instrument operates in either a constant-resistance or constant-current mode. A dynamic switching mode is built into the units. A square-wave generator enables the load to switch between two adjustable current levels. Two frequency rates are selectable by a front panel switch: two times the input line frequency or 1 kHz, both 50% duty cycle. The unit provides a meter shunt output that can be used as a calibration check or for a digital meter readout.

CIRCLE NO. 344

# A logical test for Digital Logic Test Systems.

1. Can response be measured 100 nanoseconds after simultaneous applications of stimulus?

**Yes**   **No**

2. Are clocks programmable for frequency, pulse width and number of pulses?

**Yes**   **No**

3. Is it economically expandable to three work stations with 1024 two-way interface lines in each station?

**Yes**   **No**

4. Does the system software provide a debug feature which allows the operator to monitor and control the test?

**Yes**   **No**

5. Does it provide File Management, guided-probe fault isolation and complete self-test to the card level?

**Yes**   **No**

Hughes 1024 Digital Logic Test System.



Hughes 1024 Digital Logic Test System answers yes to all the questions above. It also provides an optional simulation system, Digital Fault Analysis (DFA), which generates a logic model; simulates the unit under test; verifies using fault insertion techniques; and generates fault isolation data for the automatic guided probe. Time independent gate level simulation identifies "race" conditions and traces them to their origin.

Write for our new brochure: Hughes Automation Analysis, 2020 Oceanside Boulevard, Oceanside, CA 92054. Or call (714) 757-1200, Extension 336.



INFORMATION RETRIEVAL NUMBER 57

# LOOK FIRST IN

## FOR POWER SEMICONDUCTORS

### ■ WHO MAKES THEM

You'll find 97 manufacturers of power semiconductors beginning on pages 353, 428 and 457 of *Electronic Design's* GOLD BOOK (Volume 1—Product Directory). For your convenience, each manufacturer is listed with complete street address, city, state, zip and phone number.

### ■ SALES OFFICES—REPS DISTRIBUTORS

To find information about each power semiconductor manufacturer, turn to the *Manufacturers Directory*. Whenever possible it lists names of key officials, sales offices, export offices, foreign offices, U.S. and foreign reps followed by a list of U.S. distributors. In many cases there is additional data, when provided by the company: TWX, TELEX, cable address, facsimile equipment (make and call number), 800 (toll-free numbers) as well as number of engineers, number of employees and financial data.

### ■ CATALOG PAGES

Here's a rundown of the catalog pages you'll find on power transistors in *Electronic Design's* GOLD BOOK.

Manufacturer	Starts in Vol. 2, Page:	Manufacturer	Starts in Vol. 2, Page:
DELCO ELECTRONICS	379	RCA SOLID STATE	511
GENERAL ELECTRIC	414	RSM SENSITRON	537
INTERNATIONAL		SEMTECH	542
RECTIFIER	451	SOLITRON	545
MOTOROLA	471	TEXAS INSTRUMENTS	547
POWER TECH, INC.	507	TRW	554

KEEP *ELECTRONIC DESIGN'S* GOLD BOOK  
HANDY WHEN YOU CALL

Refer to your copy of *Electronic Design's* GOLD BOOK before you dial your next vendor. Referral to specific product pages can shorten your long distance phone calls. LOOK FIRST in *Electronic Design's* GOLD BOOK.



# Electronic Design's

# GOLD BOOK

## FOR COOLING EQUIPMENT

### ■ WHO MAKES IT

You'll find eleven categories of cooling equipment and related products listed in the *Product Directory of Electronic Design's GOLD BOOK*. For blowers and fans 38 manufacturers are listed. For thermoelectric cooling/heating modules, 17; circulating liquid cooling units, 21; heat sinks and dissipators, 50; thermal conductive coatings, 23; insulators and insulating hardware, 52; transistor mounting pads, 23; epoxy potting compounds, 41; silicone greases, 17; and washers, 18. As with power semiconductors, data about each manufacturer, his reps and distributors can be found by referring to the *Manufacturers Directory*.

### ■ HERE'S A RUNDOWN OF THE CATALOG PAGES YOU'LL FIND ON HEAT SINKS AND DISSIPATORS ALONE

Manufacturer	Number of Catalog Pages	Starts On Page:
AHAM	3	Vol. 2, 1286
Hughes Aircraft Co.	4	Vol. 2, 1289 Vol. 3, 1264
Hughes Connecting Devices	2	Vol. 3, 1442
Intl. Elec. Research	4	Vol. 2, 1291
Intl. Rectifier	2	Vol. 2, 458
Jermyn	1	Vol. 2, 1295
Thermalloy Inc.	1	Vol. 2, 1304
Unitrack	1	Vol. 3, 271
Wakefield Engrg. Inc.	42	Vol. 2, 1307

### ■ TAKE WAKEFIELD ENGINEERING, FOR EXAMPLE

Wakefield Engineering's 42 page catalog of semiconductor cooling products begins on page 1307 of Vol. 2. In addition to detailed specs and information about its heat sinks and thermal cooling products (most show curves of natural and forced convection characteristics) the pages include diagrams of 99 heat sink extrusion shapes with dimensions, surface area, and thermal characteristics. Wakefield's unit also provides guides on HOW TO SELECT HEAT SINKS, ENGINEERING DATA, HEAT SINK MOUNTING SPECIFICATIONS, HOLE PATTERNS, U.S. DISTRIBUTORS, EUROPEAN SALES AGENTS, U.S. FIELD SALES ENGINEERS, and lists other available Wakefield catalogs.

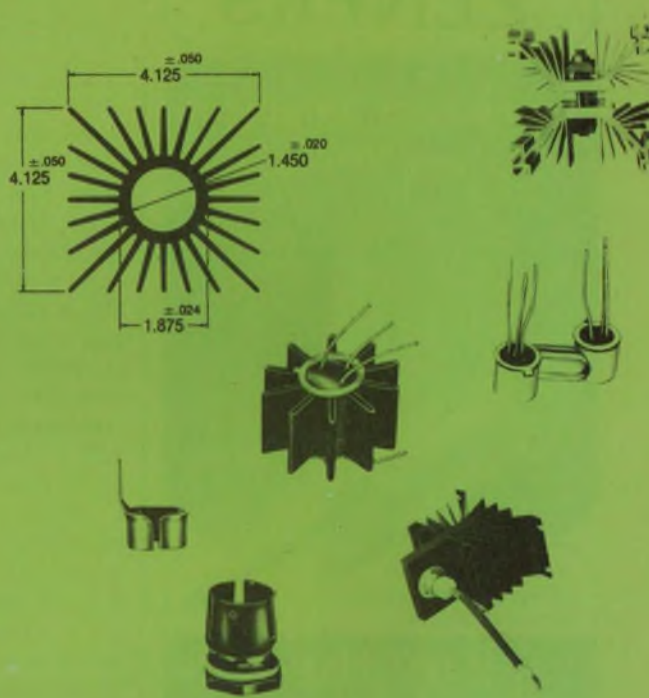

1  
AMERICAN MADE  
Tolerance  
**SCHAUER**  
1-Watt  
**ZENERS**

**Immediate Shipment  
Low Prices**

ANY voltage from 2.0 to 16.0

Quantity	Price each
1-99	\$1.07
100-499	.97
500-999	.91
1000-4999	.86
5000 up	.82

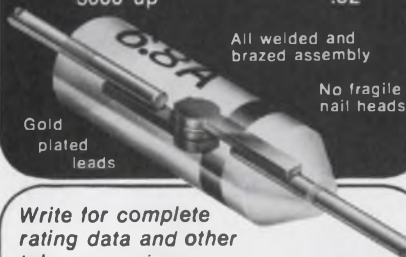

All welded and  
brazed assembly

No fragile  
nail heads

Gold  
plated  
leads

Write for complete  
rating data and other  
tolerance prices.

**Buy the kit-  
Save  
a lot**



Kit contains a 51-piece assortment of SCHAUER 1% tolerance 1-watt zeners covering the voltage range of 2.7 to 16.0. Three diodes of each voltage packaged in reusable poly bags. Stored in a handy file box. Contact your distributor or order direct.

A \$54.57 value for  
**ONLY \$24<sup>50</sup>**

Semiconductor Division

**SCHAUER**  
Manufacturing Corp.

4511 Alpine Ave. Cincinnati, Ohio 45242  
Telephone: 513/791-3030

DISCRETE SEMICONDUCTORS

**Power transistor made  
for switching circuits**



Semicoa, 333 McCormick Ave.,  
Costa Mesa, CA 92626. (714) 979-  
1900. \$70.

An npn switching power transistor, Model SCA100-120, appears as only a 0.002- $\Omega$  resistance with a 100-A collector current. The device has a saturation voltage of 1.7 V at rated maximum collector current. The transistor is intended for high-speed switching operation at 120 V. Its  $F_T$  is 50 MHz at an  $I_C$  of 10 A and beta is typically 40 at a collector current of 50 A. The transistor characteristics show broad safe operating areas, with  $E_{S/B}$  of 200 millijoules, and  $I_{S/B}$  of 40 A. The unit can be operated continuously at 40 A, 100 V and 70 C. It is available in TO-3, TO-61, or TO-63 packages or as a molybdenum-mounted chip.

CIRCLE NO. 345

**Rf power transistors  
operate from 16 V**

Communications Transistor Corp.,  
301 Industrial Way, San Carlos,  
CA 94070. (415) 591-8921. \$39  
(BM70-12); \$21.50 (BM40-12);  
stock.

The BM70-12 and BM40-12 rf power transistors can simplify amplifier design. The units make it possible to design a 100-W amplifier with only three transistors instead of the customary seven. The transistors are guaranteed to withstand infinite VSWR at all phase angles when operated at rated power with a 16-V supply (dc). Both units have internal matching and are designed for operation in the 138-to-174-MHz frequency range.

CIRCLE NO. 346

**Darlington photodetector  
has two sensitivities**

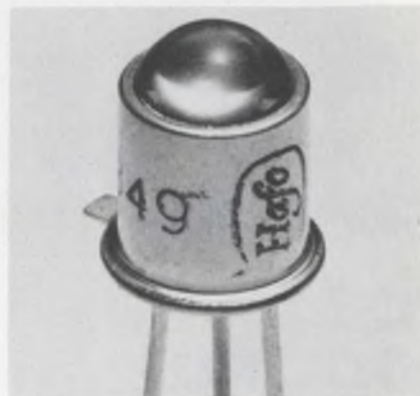

Asea-Hafo AB, Siktgatan 5, S-162  
26 Vällingby, Sweden.

The 6B82, a silicon photodetector with a very high sensitivity, consists of a photodiode and a three-transistor Darlington amplifier. It is hermetically encapsulated in a TO-18 case with a lens cap. When using only two transistors, the detector works like a conventional photoDarlington and its sensitivity is typically 150 mA/(mw/cm<sup>2</sup>) at a wavelength of 940 nm. The main advantage of 6B82 is, however, its third transistor, with which the sensitivity can be further increased more than 100 times. As an example, an irradiance of only 5  $\mu$ W/cm<sup>2</sup> is sufficient to give an output current of approximately 100 mA. Typical values of 6B82 when using two and three transistors are as follows: saturation voltages 0.8 and 1.4 V, rise times 30 and 500  $\mu$ s and fall times 25 and 350  $\mu$ s, respectively.

CIRCLE NO. 347

**Switching diode has  
135-V breakdown voltage**

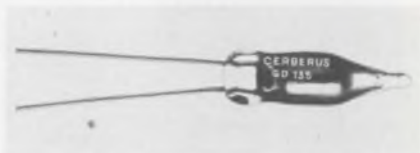

Cerberus Ltd., CH-8708 Mannen-  
dorf, Switzerland.

The GD 135 switching diode is designed for dc and trigger circuits. The uniform breakdown voltage of 135 V and the current input of 0.1 to 2 mA make this diode useful for such applications as measuring circuits, automatic control systems and trigger circuits.

CIRCLE NO. 348



## Metal oxide varistors come in many models



General Electric, Electronics Park, Bldg. 7, Mail Drop 49, Syracuse, NY 13201. (315) 456-2021. \$0.25 (10,000 pcs); stock.

The "MA" series of MOV varistors is designed for automatic insertion. These units are capable of both dc and ac operation. Voltage ratings range from 121 to 365 V dc, 88 to 264 V ac rms. The metal oxide varistors are voltage dependent, symmetrical resistors which perform in a manner similar to back-to-back zener diodes. There are seven models available in each of two selections. Selection A is classified at RETMA voltages  $\pm 15\%$  at 1 mA dc. Selection B is classified at RETMA voltages  $\pm 10$  mA dc. Energy ratings range from 100 to 700 milli-Joules, operating temperatures from  $-40$  to  $+125$  C. The molded axial-lead package has a diameter of 3.68 mm (0.145 in.) and is 8.5 mm (0.335 in.) long, excluding leads.

CIRCLE NO. 349

## Rectifier stacks come in two versions

Semtech Corp., 652 Mitchell Rd., Newbury Park, CA 91320. (213) 628-5392. From \$1 (100-up); stock.

A rectifier stack, claimed by the company to be the smallest in the industry, can meet or exceed the environmental requirements of current military and space programs. It measures  $0.215 \times 0.07$  in. The stack is available in two different types, with specifications as follows: General purpose,  $t_{rr}$  of 2  $\mu$ s, PIV of 2 to 4 kV, average current of 125 mA at 55 C, maximum reverse current of 100 nA at 25 C, and one cycle surge current of 7 A. The fast recovery stack has a  $t_{rr}$  of 250 ns (300 ns for 4000 to 6000 kV units), a PIV of 1500 to 3000 V, an average current of 100 mA at 55 C, a max reverse current of 100 nA at 25 C and a one cycle surge current of 5 A.

CIRCLE NO. 350

# NEW NEW NEW

## STRIP CHART ADAPTER FOR X-Y RECORDER

Model 2000 Recorder  
\$890 plus modules

Model SCA-1 Strip Chart Adapter  
\$765

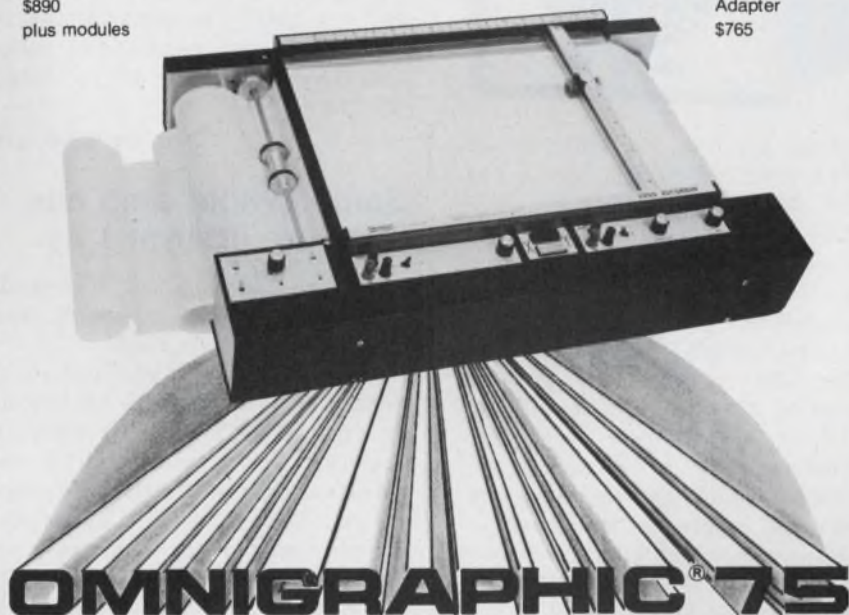

### PRESENTS NEW VERSATILITY FOR YOUR 2000 X-Y RECORDER

- Converts any Omnigraphic 2000 X-Y into a Strip Chart Recorder.
- Provides single sheet advance (local or remote control) thus eliminating manual single sheet changing.
- Bi-directional chart drive
- Easily installed in the field
- Adapter only \$765 complete

Send for brochure today.

houston  
instrument

THE  
RECORDER  
COMPANY

ONE HOUSTON SQUARE (at 8500 Cameron Road) AUSTIN, TEXAS 78753  
(512) 837-2820 TWX 910 - 874-2022 cable HOINCO

EUROPEAN OFFICE Rochesterlaan 6 8240 Gistel Belgium  
Phone 059/27445 Telex Bausch 19399

® A registered trademark of Houston Instrument

INFORMATION RETRIEVAL NUMBER 61

### Temperature controller setpoint is 1%



Thermo Electric, 109 5th St., Saddle Brook, NJ 07662. (201) 843-5800. \$137; 3 to 5 day.

The Model 32126 temperature controller is specifically designed for use with resistance temperature detector inputs. The controller provides on-off proportional control. The proportional band is centered about the setpoint and fixed at 3% of full scale. Self-adjusting on-off cycle time compensates for rapid temperature variations due to process load changes. Potentiometric setpoint accuracy is 1% of full scale span. A tamper-proof setpoint knob is used to prevent accidental changes of temperature settings. Direct temperature indication is provided by a built-in meter with an effective width of up to 30% of full scale span. Indication and setpoint are on the same scale to eliminate dual meter confusion, yet provide indication independent of control action.

CIRCLE NO. 351

### S/d converter provides $\pm 5^\circ$ offset null

Transmagnetics, 210 Adams Blvd., Farmingdale, NY 11735. (516) 293-3100. \$595 (1 to 9); stock to 4 wk.

The Model 1623F is a miniature, 14-bit s/d converter that has an internal  $\pm 5^\circ$  null offset capability. This model can be supplied to convert either the standard frequencies of 60 or 400 Hz, or special frequencies as low as 30 Hz or as high as 10 kHz. Output is either 14-bit binary parallel, four decade BCD or both. The Model 1623F is supplied in an encapsulated package that measures  $2.625 \times 3.125 \times 0.82$  in.

CIRCLE NO. 352

### Sample/hold amp has aperture jitter of 1 ns

Analogic, Audubon Rd., Wakefield, MA 01880. (617) 246-0300. \$39 (100-up); stock to 2 wk.

The MP240 sample-and-hold module has an aperture uncertainty (jitter) of  $\pm 1$  ns. Its transfer accuracy is within  $\pm 0.01\%$  of specified gain of 1, and the linearity is  $\pm 0.005\%$  of FSR. The signal feedthrough in the hold mode is  $-90$  dB and the unit has an acquisition time of  $5 \mu\text{s}$  to acquire a 10-V step to within 0.01%. The s/h amplifier contains a high-impedance input buffer for minimum loading of analog signal sources, TTL/DTL/CMOS compatible switching control, proprietary signal-guarded and signal-compensated acquisition and disconnect switching circuits.

CIRCLE NO. 353

### Retro-reflective control has max range of 30 ft



Mektron, 2728 N. Jessup St., Portland, OR 97217. (503) 285-3681. \$155 (1 to 9).

The Model 220-20 retro-reflective infrared limit switch is a completely self-contained unit. It measures  $2 \times 6 \times 6.5$  in. and is housed in a NEMA 4/12 extruded aluminum enclosure with an internal ambient light shield. Operating range of the standard 220-20 unit is 30 ft when a 3 in. dia. reflective disc is used and 5 ft with low cost reflective tape. Multiple units can be mounted on 2 in. centers for conveyor and log measuring applications. Each switch contains a pulsed, solid-state, infrared transmitter; tuned receiver; power supply; input transformer; heavy-duty, 10-A relay; sensitivity adjustment; time delay (adjustable 0 to 9 s); alignment indicator; and a programmable mode select to ease compatibility of the standard unit to a variety of applications.

CIRCLE NO. 354



ANALOG  
STAY IN CONTROL WITH INTECH'S INDUSTRIAL CONTROL ICs THE 3050 AC DETECTOR DIFFERENTIAL OR SINGLE ENDED TO 1MHZ. 3040 QUAD MONITOR ALARM DRIVES EXTERNAL SPEAKER DIRECTLY. 3030 TEMPERATURE ALARM SETS OFF BELLS AND WHISTLES. EXCELLENT REPEATABILITY. THE 3020 TRI-STAGE ALERT/ALARM AND 3010 TONE ALARM DRIVE LEDs OR LAMPS. ALL 14-PIN DIP. TTL COMPATIBLE. STOCK DELIVERY. LOW PRICES. WRITE US!

**intech** INCORPORATED  
(408) 244-0500  
1720 COLEMAN, SANTA CLARA CA 95050

## Photoelectric controls use modulated LEDs

Warner Electric Brake and Clutch, 449 Gardner St., Beloit, WI 53511. (815) 389-3771. MCS143: \$105, MSC144: \$112; stock.

Two self-contained LED modulated photoelectric sensors are designed for controlling a wide range of packaging applications and industrial functions. The MCS-143 LED scanner comes complete with infrared light source, sensor, power supply, amplifier and plug-in output relay contained in one housing. A modular version, MCS-144, offers a choice of four-time-delay modules and three output switching devices: relay, hybrid switch or logic output, in addition to the standard MCS-143 features. The light is modulated at a high-frequency in order to operate effectively over long distances—up to 30 ft. The light receiver circuitry is also modulated synchronously with the LED, thus making the unit immune to all other light and environmental conditions. The enclosures for both controls are of high impact strength plastic, completely gasketed and designed to meet NEMA 1, 3, 4, 12 and 13 standards. Total weight is 25 oz. maximum.

CIRCLE NO. 355

## Microphone preamp has low distortion

Custom Sound Productions, P.O. Box 54, Village Station, New York, NY 10014. (212) 691-8754. \$160 (8-up).

A microphone preamplifier is designed for ultra-low noise and low distortion operation. The amplifier uses all tantalum capacitors and carbon film resistors mounted on a G-10 glass-epoxy circuit board. It features adjustable gain operation from a single 40-V power supply or battery and a single-ended output up to 24 VU. Specifications include a balanced input; a 3-pin XLR-type locking connector; an unbalanced output; up to 13 V into 8 k $\Omega$  (or greater); a power supply ripple voltage rejection of 120 dB; a noise of 0.5  $\mu$ V typical and a total harmonic distortion of 0.1%.

CIRCLE NO. 356

## MAGNETIC SHIELDING FOR ANY CONFIGURATION

Ad-Vance reduces your shield costs because it already owns tooling for most standard shields. Or, our Magnetic Shielding Specialists will custom fabricate shields to your exact specifications.

- Magnetic Shields for 312 Types of Photomultiplier Tubes.
- AD-MU Sheet Stock.
- AD-MU Tape Data Protectors assure full fidelity of valuable tapes.
- Unequaled engineering & design service.
- In-house quality control.
- Fast delivery, competitive pricing.



2 Modern Plants with complete facilities for quality shield manufacturing

Ad-Vance Magnetics, Inc., the Old Firm with the New Name, is the industry's largest, oldest and most experienced independent firm exclusively manufacturing magnetic shielding.



AD-MU Folts Cut, Wrap Easily & Quickly



Typical Custom Fabricated Shields For Components & Systems



Send for 16-page catalog

## AD-VANCE MAGNETICS, INC.

226 E. SEVENTH ST., ROCHESTER, IND. 46975

(219) 223-3158 TWX 810 290 0294

The Magnetic Shielding Specialists

INFORMATION RETRIEVAL NUMBER 63

# NEW DIP TRIM POT



ACTUAL SIZE

MODEL DW-5  
WIRE WOUND

MODEL DC-5  
CERMET

- HIGH IMPACT PLASTIC HOUSING RESISTS CLEANING AGENTS
- LOW INDUSTRIAL PRICING
- DESIGNED FOR DIP AUTOMATIC INSERTION EQUIPMENT
- AVAILABLE IN SINGLE OR MULTIPLE LOADING MAGAZINES

Minelco's new Dual In-Line Potentiometer is a low cost trimmer specifically designed for PCB automatic insertion equipment.

The DW-5 wire-wound model offers low TC to  $\pm 50$  PPM and resistance values up to 25K.

The DC-5 model with CERMET element and multiple point wiper contact for stability and reliability will retain accurate settings within 0.5% of desired voltage, TC of  $\pm 100$  PPM, resistance range up to 2 megs, infinite resolution.



**MINELCO**

DIVISION  
GENERAL TIME CORP.  
A Talley Industries Company

135 SOUTH MAIN STREET • THOMASTON, CONN. 06787  
PHONE: 203/283-8261 • TWX: 710/475-1091

Send for  
free brochure.

INFORMATION RETRIEVAL NUMBER 64

# Switch switches fast

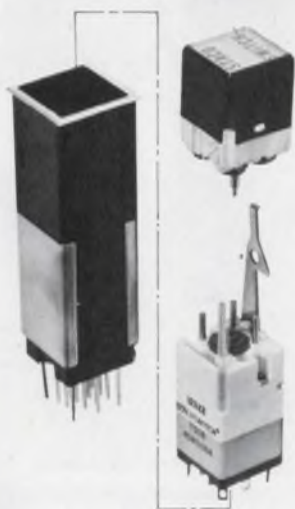

On those rare occasions when a switch malfunction shuts down equipment, STACO's Model 49 Illuminated Push-button Switch, with its plug-in switch module, can have things running again in less than 60 seconds. Simply flip a lever to remove the display pushbutton, and pull out the toilworn switch module. Slip in the plug-in replacement unit and reinsert the display pushbutton. It's that simple... and that fast!

No need to touch the behind-the-panel wiring. Once terminations are wired into the system, plug-in modules can be removed and replaced from front of panel. Choice of economical, dependable solder or wrap type terminations.

If your operation cannot tolerate downtime, then STACO's Model 49 can help keep the wheels turning. Its proven switch mechanism assures long service life and when at long last it needs replacing, a new module quickly plugs in. There's a choice of switch action and circuitry to meet your requirement.

When you think switch... think STACOSWITCH.



1139 BAKER STREET, COSTA MESA, CALIF. 92626  
(714) 549-3041 TWX: 910-595-1507

Other STACO Company products: Fixed Ratio Transformers, STACO, INCORPORATED, Richmond, Indiana; Variable Transformers, STACO, INCORPORATED, Dayton, Ohio.

INFORMATION RETRIEVAL NUMBER 65

## POWER SOURCES

### Compact UPS is self-contained



Deltec Corp., 3849 Gaines St., San Diego, CA 92110. (714) 297-4466. \$1425.

The DSU 710 uninterruptible power system (UPS) maintains conditioned ac power to critical computer systems and other electrical and electronic equipment. The unit is self-contained and includes battery charger, battery reservoir and output inverter regulator. Output from the DSU 710 is an isolated 117-V-ac  $\pm 5\%$  sine wave. Standard accessories are alarm indicators and remote signals for loss of utility ac and battery low, ac current and voltage output meters and reverse transfer switch which automatically switches the critical load to utility power should an unexpected failure occur in the system.

CIRCLE NO. 357

### Voltage reference lists low 1-ppm/ $^{\circ}$ C tempco



Codi Semiconductor, Pollitt Dr., Fair Lawn, NJ 07410. (201) 797-3900. \$46 to \$275 (10 pc. qty); 4 to 8 wks, some stock.

This series of precision voltage references offers tempcos as low as 1 ppm/ $^{\circ}$ C. Standard "Certavolt" models feature a short-circuit-protected output of 10,000 V, with tempco specified from 15 to 55 C and long-term stability as low as 10 ppm/year. The units are said to be ideal voltage references for precise (12 to 16-bit or better) a/d and d/a converters, inertial guidance platforms and precision analog computation.

CIRCLE NO. 358

### Battery charger ends charge at any voltage



Alpha Components Corp., 115 Eucalyptus Dr., P. O. Box 947, El Segundo, CA 90245. (213) 322-7780. \$48.50 (10); stock.

Model 20BC12, OEM open-frame battery charger, will deliver 20 A to a 12-V discharged battery and senses voltage to automatically reduce charging current. Designed for 115 V dc, the charger is voltage regulated for 100-to-125-V input. Output is protected from continuous overloads by a dc circuit breaker, and the charger design is inherently protected from short circuits and accidental battery reversals. A control provides full adjustment to end charge at any desired voltage.

CIRCLE NO. 359

### Constant-current source offers hefty output

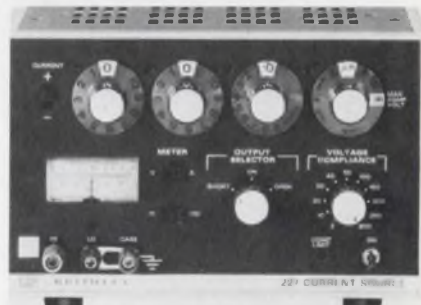

Keithley, 28775 Aurora Rd., Cleveland, OH 44139. (216) 248-0400. \$925; 30 days.

Model 227 constant-current source offers outputs to 1.1 A at a compliance voltage of 50 V, and even higher compliance voltage (300 V) at lower currents. The unit features an output range of 1  $\mu$ A to 1.1 A in four decade ranges. The current level is selected digitally through the use of three in-line dials on the front panel. The compliance voltage limit is selected via front-panel control from 3 V to the maximum. Output resolution is 50 ppm.

CIRCLE NO. 360

### Adjust bandwidth of L-band klystron

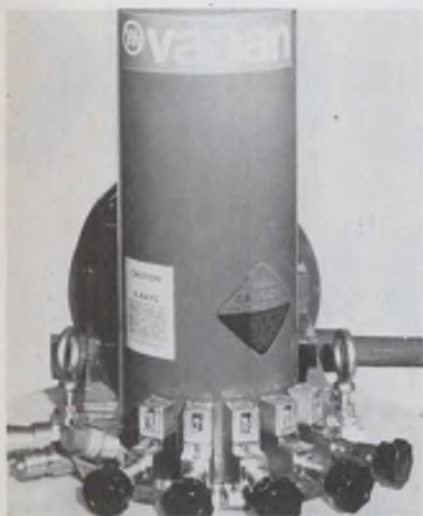

Varian, 611 Hansen Way, Palo Alto, CA 94303. (415) 493-4000.

The Model VA-963A L-band klystron provides either broadband or narrowband operation from the same tunable tube. Individual cavity tuning knobs can be quickly set in the field to factory determined positions using digital counters. Curves of tuner setting versus frequency are supplied with each tube, and the basic frequency range is 1250 to 1350 MHz.

CIRCLE NO. 361

### Switch/comparator tests two loads



Telonic Altair, 21282 Laguna Canyon Rd., Box 277, Laguna Beach, CA 92652. (714) 494-9401. \$295; 30 days.

An rf switch/comparator permits the simultaneous testing of two loads with a single sweep or signal generator. Called the Model 701, the new unit can test devices over a frequency range of dc to 300 MHz. Insertion loss is 0.3 dB up to 50 MHz and 1.0 dB beyond. Isolation is 80 dB, up to 50 MHz and 40 dB over 50 MHz. The difference between detected levels with identical loads is 0.1 dB max over the entire frequency range.

CIRCLE NO. 362

### Compact module simplifies radars

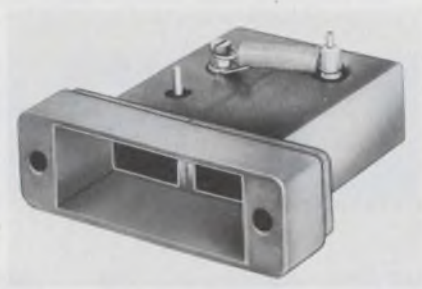

Amperex Electronic Corp., 230

Duffy Ave., Hicksville, NY 11802. (516) 931-6200. \$47.50; stock.

The DX-489 compact radar module includes an integral antenna, gunn-oscillator transmitter and Schottky-barrier diode detector. According to the company, the module conforms to FCC regulations for 10.525-GHz Field-Disturbance Sensors. The gunn-oscillator transmitter section typically consumes less than 1 W from a 7-V-dc supply, and it radiates about 8 mW of 10.525-GHz power.

CIRCLE NO. 363

## You know our reputation in DC to DC

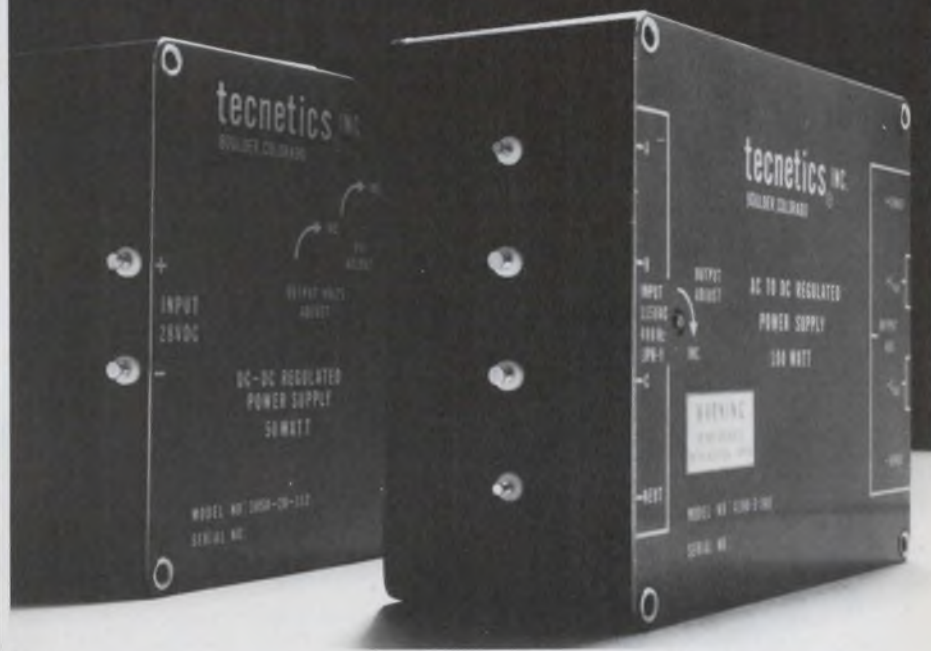

### Wait till you see Tecnetics' new 400 Hz AC power supply

We earned a reputation with our line of DC to DC power supplies. Now, we add to it with a new 400 Hz AC power supply. Like our 28VDC power supplies, the AC model features extremely high packaging density, high efficiency and reliability. Most important, it's small, measuring in at only 4x4x2 inches and weighing 36 ounces fully encapsulated.

These power supplies are designed to meet

the rugged vibration, shock, humidity and altitude specs of the aerospace industry (Mil-E-5400). They also have separate, remote error-sensing terminals to compensate for voltage loss, assuring that the voltage level remains constant at the load.

Write for our 26-page catalog that gives full specs and prices on these and over three hundred other power supplies.

SPECIFICATIONS	3000 SERIES - DC TO DC	4000 SERIES - 400 Hz AC TO DC
Output Power	150, 100, 50 & 25 watt models	100, 50 & 25 watt models
Output Voltages	13 standard outputs from 5 to 48V	13 standard outputs from 5 to 48V
Input Voltages	28VDC or 48VDC (48VDC only on 150 w units)	115VAC ± 10%, 400 Hz (Single or 3 phase)
REGULATION		
Line	(LL to HL) 0.3%	(115V ± 10%) 0.2%
Load	(½ to FL) 0.1%	(½ to FL) 0.1%
Load	(NL to FL) 0.4%	(NL to FL) 0.5%
Temp	0.01% / °C	0.1% / °C

**tecnetics**®

The Power Conversion Specialists

P.O. Box 910, 1625 Range Street, Boulder, Colorado 80302 (303) 442-3837 TWX 910-940-3246

# Electronic Design's GOLD BOOK IS READY



## VOLUME 1 DIRECTORIES

### • PRODUCT DIRECTORY

Want to know who makes a given product? *Electronic Design's* GOLD BOOK is the first place to look. Manufacturers are listed under almost 5,000 product headings or cross references. You'll find everything an electronics manufacturer would require — components, computers, hardware, test equipment, instrumentation, systems and services — they're all there, from "Abrasives" through "Zone Boxes."

Knowing only a name or state isn't much help if you or your secretary want to contact several manufacturers at once for information or a quote. That's why *Electronic Design's* GOLD BOOK repeats each manufacturer's full name, street address, city, state, zip and phone number every time the manufacturer is listed.

### • MANUFACTURERS DIRECTORY

You'll find 7,528 manufacturers listed in *Electronic Design's* GOLD BOOK — more than twice the number contained in "the other industry directory." In addition to complete address and phone number, whenever provided by the company you'll also find:

TWX  
TELEX  
CABLE ADDRESS  
FACSIMILE EQUIPMENT  
(make and call number)  
800 (TOLL-FREE) NUMBER

QPL DESIGNATION  
FEDERAL STOCK CODE NUMBER  
NUMBER OF EMPLOYEES  
NUMBER OF ENGINEERS  
DOLLAR VOLUME  
KEY OFFICIALS

SALES OFFICES  
FOREIGN OFFICES  
U.S. AND FOREIGN REPS  
U.S. DISTRIBUTORS

### • DIRECTORIES OF DISTRIBUTORS

Want to find a distributor near your town? Use the geographic Directory of Distributors. Access is by State, then City. 5,700 distributors are listed. The same distributors are also listed alphabetically for your convenience, often with additional information about their business volume, key personnel, etc.

### • TRADE NAME DIRECTORY

If you've heard the trade name, but can't remember who makes it, here's the place to look. Over 4,600 industry trade names are included. Listing includes brief description of item and company name.

---

**TOTAL DISTRIBUTION: 91,000 — 13,200 COPIES OVERSEAS,  
INCLUDING 11,000 COPIES IN EUROPE**

# WHEN YOU ARE



## VOLUMES 2 & 3 CATALOGS

- 520 CATALOG PAGES ON ICs AND SEMICONDUCTORS
  - 300 CATALOG PAGES ON INSTRUMENTS
  - 290 CATALOG PAGES ON POWER SUPPLIES
- 210 CATALOG PAGES ON WIRE AND CONNECTOR PRODUCTS
  - 150 CATALOG PAGES ON SWITCHES

Volumes 2 and 3 of *Electronic Design's* GOLD BOOK are filled with manufacturers' technical data and product catalogs — a gold mine of information for the engineers, engineering and purchasing managers of this industry. Products are classified by related families and are organized in 52 product categories, over 2,800 catalog pages in all.

Volume 2 contains *Components and Materials*; Volume 3 contains *Equipment, Hardware, Panel Components, Power Supplies, Tools and Production Equipment, Engineering Aids*, and "Company Profiles and Capabilities."

*Electronic Design's* GOLD BOOK is READY WHEN YOU ARE. Keep it on hand for product search, sourcing, or for instant technical and specifying data. It puts the entire electronics industry at your fingertips.

*Electronic Design's* GOLD BOOK is the largest, most complete, most comprehensive one-step purchasing and reference tool ever produced in this industry. Its PRODUCT DIRECTORY contains more than twice the number of editorial pages than the other industry directory; almost 50% more pages of TRADE NAMES; half again the number of pages in its MANUFACTURERS DIRECTORY; almost twice the number of pages in its DISTRIBUTORS DIRECTORIES. It's far and away the biggest and best electronics directory in the world.

### BETTER BY EVERY MEASURE

	The Other Industry Directory	<i>Electronic Design's</i> GOLD BOOK	
Total manufacturers	3,165	7,528	+ 4,363
Direct product codes	2,250	2,925	+ 675
Cross-reference product codes	985	1,874	+ 889
Total product codes	3,235	4,799	+ 1,564
Overseas circulation	Nil	13,200	+ 13,200

Send today  
for your  
**FREE**  
brochure,  
price list and  
dealer list.



Model 5112-1  
Single Pen  
Recorder with 1, 2,  
5, 10 in/min. chart  
speeds and 10 mv  
fixed input spans  
\$395

# OmniScribe™ 75

TOP SELLING STRIP CHART RECORDER \$395

Here's America's number one strip chart recorder for 1975! And for a \$395 rock bottom price in an age of inflation. Yet look at these features:

- Multi-speed chart drive — field adjustable for English/Metric scaling
- Self-aligning sprocketless paper drive
- New patented transducer eliminates troublesome slide wire.
- Two-pen models available at \$595 up

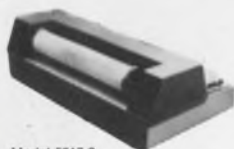

Model 5212-2  
Dual channel recorder  
with 1, 2, 5, 10 in/min.  
chart speeds and 5 in-  
put spans of 10 mv up  
\$690



Model 5210-14  
1 mv dual channel re-  
corder with electronic  
integrator, 2.5, 5, 10, 20  
cm/in chart speeds.  
\$945

Pick a winner for 1975! Write for details today.

**houston  
instrument**

**THE  
RECORDER  
COMPANY**

ONE HOUSTON SQUARE (at 8500 Cameron Road) AUSTIN, TEXAS 78753  
(512) 837-2820 TWX 910 - 874-2022 cable HOINCO  
EUROPEAN OFFICE Rochesterlaan 6 B240 Gistel Belgium Phone 059/27445 Telex Bauach 19399  
**TM** trademark of Houston Instrument

INFORMATION RETRIEVAL NUMBER 69

# Make the big change-over to the new DMM from T.R.I.

High performance, low cost (\$279) and compact size, 10 $\mu$ V Resolution.

### 10 $\mu$ V resolution, \$279

Model 6355 is a portable DMM having a 10 $\mu$ V (DC voltage) resolution. It is comparable to DMM's for laboratory use, priced at an economical \$279, and sets a new standard of performance for portable DMM's.

### Fully automatic

Operation is as simple as selecting the function and signal connection. The measured value is displayed

through the automatic selection of 5 functional modes: range selection, unit display, polarity, over-range indication and overload protection.

### True portability

It measures 4-3/8" (W) x 2-7/8" (H) x 6" (D) and is a light-weight 1.8 lbs for complete portability. The shock-resistant design even protects the unit against accidental drop damage.

### Rechargeable battery (Option)

Besides the AC power supply, the standard composition includes an alkaline battery. Optionally available is a rechargeable battery. Standard accessories include a battery charger.



505 West Olive Avenue  
Sunnyvale, CA 94086  
(408) 733-9080

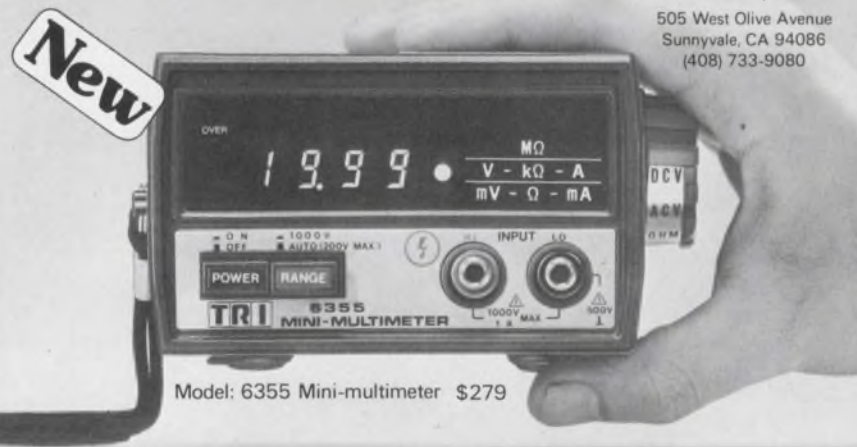

Model: 6355 Mini-multimeter \$279

INFORMATION RETRIEVAL NUMBER 70

## new literature

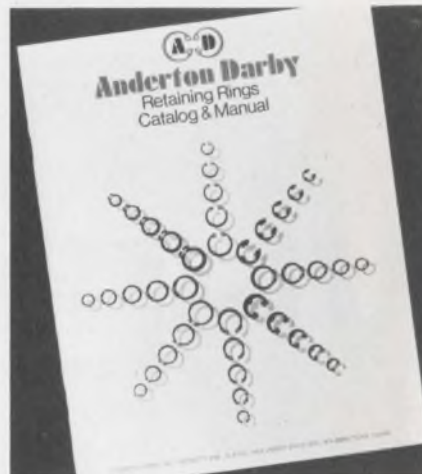

### Retaining rings

A 44-page edition of a retaining rings catalog and manual features sections on metric retaining rings, retaining and snap rings for bearing retention and wire rings. Accessories, including pliers, dispensers and applicators, are covered. Anderton Darby, Clifton, NJ

CIRCLE NO. 364

### SCR power supplies

Over 50 models of single-phase and three-phase SCR power supplies are detailed in a six-page data booklet. Covered are specifications for the units as well as price information. Electronic Measurements, Neptune, NJ

CIRCLE NO. 366

### 3-digit universal DPM

A universal three-digit digital panel meter and its supporting accessories are detailed in a brochure. Analogic, Wakefield, MA

CIRCLE NO. 367

### Pot and trimmer standards

A revised version of this Variable Resistive Components Institute's standards for wirewound and non-wirewound precision potentiometers and trimming potentiometers may be purchased at \$5 a copy. Complimentary copies may be obtained by companies that are members of VRCI. Variable Resistive Components Institute, 1717 Howard St., Evanston, IL 60202

INQUIRE DIRECT



## Data logger

A 52-page brochure describes the Digitrend 220 "smart" data-acquisition system. A system description is presented, with photographs, as well as options, specifications and prices. Doric Scientific, San Diego, CA

CIRCLE NO. 371

## Microwave switches

A series of p-i-n diode switches, which provide ultra-broadband operation from 1 to 18 GHz in a single unit, are described in a four-page brochure. GHZ Devices, Chelmsford, MA

CIRCLE NO. 372

## Signal processors

Real-time signal processors and accessories—for on-line instant analysis of noise and acoustics, pass-by tests of vehicles and air-

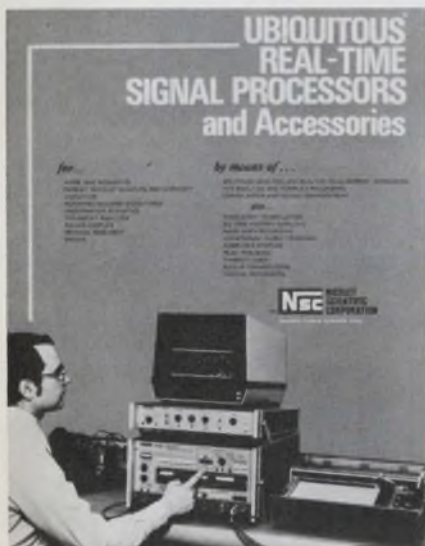

craft, vibration, rotating machine signatures, underwater acoustics, transients, radar doppler, medical research and speech—are detailed in an eight-page catalog. Nicolet Scientific, Northvale, NJ

CIRCLE NO. 373

## Radiotron handbook

F. Langford-Smith's "Radiotron Designer's Handbook" contains 1500 pages of comprehensive vacuum tube theory and practical application information and is written in an easy-to-understand style with many illustrations. It is available in limited supply at \$15 a copy. RCA Commercial Engineering, Harrison, NJ 07029

INQUIRE DIRECT

## Paper Tape Handler

### Model 650

**A new low-cost spooler for use with the Addmaster 601 Tape Reader**

Fully self-contained, including power supply for reader.

Reads "step by step" on external command or runs on internal clock at 150 characters per second.

Bi-directional, both read and high speed slew mode.

Needs only two control lines.

Stops on character.

Automatic end of tape/broken tape sensing.

Fully proportional servos.

Standard 19" rack mounting, 5¼" high panel.

Uses 5¼" diameter reels.



Write for catalog of Addmaster computer peripherals.

416 Junipero Serra Drive • San Gabriel, California 91776

INFORMATION RETRIEVAL NUMBER 71

## A complete line of CUSTOMIZED ROTARY CERAMIC SWITCHES ...

### For RF and POWER APPLICATIONS

RSC switches are available in a variety of switching models. RSC high precision, quality built units are designed for applications requiring long life maintenance-free service. Types include shorting and non-shorting, single and multi-deck, up to 18 pole positions. Features include, 10 to 100 amp current carrying capacity, 20° to 90° detents, 2000 to 24000 volts flashover and corrosion-proof construction.

Write for catalog no. 960 and complete information.

## RADIO SWITCH CORPORATION

Rt. 79, Marlboro, N. J. 07746

MODEL 65

MODEL 80

MODEL 78

MODEL 86

MODEL 88

MODEL 85

MODEL 90

MODEL 92



**NEW!** Larger Page Size  
**NEW!** More Full Color  
**NEW!** Easy-Read Type

**SAVE ON LAFAYETTE PRODUCTS PLUS BEST MAJOR BRAND NAMES**

The catalog you NEED if you're interested in electronics! Filled with colorful, accurate, interesting descriptions of all the latest electronics products, plus the "bits and pieces" you need to keep everything in top shape. It's the "energy saving" way to shop too—order by mail from your easy chair!

**Lafayette**

Listen to us, you can't go wrong.

Mail this coupon today **FREE!**

DEPT 45025

Lafayette Radio Electronics  
 111 Jericho Tpk., Syosset, LI, NY

Send me your **FREE** 1975 Catalog

Name ..... Apt. ....  
 Street .....  
 City ..... State .....  
 Zip

Send a 1975 Catalog to my friend

Name ..... Apt. ....  
 Street .....  
 City ..... State .....  
 Zip

INFORMATION RETRIEVAL NUMBER 72

NEW LITERATURE



**Rotary switches**

Rotary, lever, ganged and PC board switches for low-current applications are covered in a 32-page catalog. The catalog contains illustrations, a cross-reference guide to comparable military switches and is fully indexed. Standard Grigsby, Aurora, IL

CIRCLE NO. 374

**Voltage standard**

Accuracy, resolution, range and stability of the Model AN3100 secondary dc voltage standard are given in a six-page catalog. Another brochure provides 31 useful applications for the instrument. Analogic, Wakefield, MA

CIRCLE NO. 375

**Tools and safety equipment**

An 80-page catalog of specialized professional hand tools and safety equipment is organized for easy referenced and fully indexed—both alphabetically and by product number. Tools and safety equipment are illustrated with photographs and drawings. Mathias Klein & Sons, Chicago, IL

CIRCLE NO. 376

**Microminiature switches**

Electrical and general data, dimensional drawings and ordering information on microminiature switches for PC-board mounting are given in a 12-page catalog. Included is a price list. Centralab, Milwaukee, WI

CIRCLE NO. 377

**R-2R ladder networks**

High-precision TaNFilm R-2R 12-bit binary ladder networks are featured in a bulletin TRW/IRC Resistors, Philadelphia, PA

CIRCLE NO. 378

**Indicating devices**

A 96-page catalog covers indicating devices—readouts, indicators, switches and information display/control systems. TEC, Tucson, AZ

CIRCLE NO. 379

**Servo systems**

Engineering characteristics for over 30 different amplifiers for driving dc and ac motors, dc torquers, clutches and resolvers are given in a four-page catalog. Parameters shown are output power, output voltage, input impedance, gain and power required. On the last page is a compilation of frequently used conversion factors helpful when designing servo systems. Control Technology, Long Island City, NY

CIRCLE NO. 380

SUBSCRIBER SERVICE For prompt service include the addressed label when writing about your subscription.

CHANGE OF ADDRESS

NEW ADDRESS	name	company	division/department	company address	city	state	zip

If you're moving, please let us know six weeks before changing your address. If you have a question, place your magazine address label here and clip this form to your letter.

MAIL TO: ELECTRONIC DESIGN Circulation Dept. Hayden Publishing Co., Inc., 50 Essex Street, Rochelle Park, NJ 07662

# DO COLLEGES HELP BUSINESS AS MUCH AS BUSINESS HELPS COLLEGES?

Yes, they do. But not in the same proportion.

Business contributes about 15% of the total voluntary support received by colleges.

But today, business gets half the college-trained people who are employed. Tomorrow, it will need even more.

As a result, businessmen should think seriously about increasing the level of corporate giving to education. Can you, as a businessman, think of a better investment?

For the latest national figures on corporate giving to higher education, write on your letterhead for "CFAE Survey of Corporation Support of Higher Education," and enclose \$2.00 to help cover costs. Mail to: Council for Financial Aid to Education, 6 East 45th Street, New York, N.Y. 10017.

Give to the college of your choice. Now.



Advertising contributed for the public good

## Electronic Design

### Advertising Sales Staff

Tom W. Carr, Sales Director

### Rochelle Park, NJ 07662

Robert W. Gascoigne  
Daniel J. Rowland

(Recruitment, Quick Ads, Classified)

50 Essex Street  
(201) 843-0550  
TWX: 710-990-5071

### Philadelphia

Thomas P. Barth  
50 Essex Street  
Rochelle Park, NJ 07662  
(201) 843-0550

### Boston 02178

Gene Pritchard  
P.O. Box 379  
Belmont, MA 02178  
(617) 489-2340

### Chicago 60611

Thomas P. Kavooras  
Berry Conner, Jr.  
200 East Ontario  
(312) 337-0588

### Cleveland

Thomas P. Kavooras  
(Chicago)  
(312) 337-0588

### Los Angeles 90045

Stanley I. Ehrenclou  
Burt Underwood  
8939 S. Sepulveda Boulevard  
Suite 510  
Los Angeles, CA  
(213) 641-6544

### San Francisco 94022

Jerry D. Latta  
P.O. Box 1248  
Los Altos, CA  
(415) 965-2636

### London, Amsterdam, Tokyo, Seoul

John Ashcraft  
12, Bear St.  
Leicester Square  
London WC2H 7AS England  
Phone: 01-930-0525

W. J. M. Sanders  
John Ashcraft & Co.  
Herengracht 365  
Amsterdam C., Holland  
Phone: 020-24-09-08

Haruki Hirayama  
Electronic Media Service  
5th Floor, Lila Bldg.,  
4-9-8 Roppongi  
Minato-ku, Tokyo, Japan  
Phone: 402-4556

Cable: Electronicmedia, Tokyo

Mr. O-kyn Park, President  
Dongbo International  
Corporation  
1.P. O. Box 4010  
Seoul, Korea  
Phone: 28-1911

Cable: Dongbo Seoul



The Ultimate in Ignition Systems!

★ **ELIMINATES BREAKER POINTS.**  
Perfect Timing and Dwell never change!

★ **Eliminates Tune-ups.**  
Never wears out or needs any Maintenance.



★ **The Most Advanced**  
"OPTO-ELECTRIC SYSTEM"

● The Allison Breakerless System eliminates the Points and Condenser, replacing them with an Opto-Electronic Trigger, using a Light-Emitting Diode and Phototransistor. Also completely eliminates wiper-arm "friction" wear. The only "TRUE" Electronic Ignition that you can install for under \$100. Gives 40-times more Timing Accuracy than ANY system using mechanical Breaker-Points! Unlimited RPM. Smoother running (No timing fluctuation as with Magnetic units). Unaffected by Temperature, Moisture, or Vibration! All Solid-State Components. Easier Starting under any condition! Increased Horsepower. Sparkplugs last longer. Perfect timing increases engine Efficiency and Gas Mileage up to 30%!

● **Quick and Easy Installation!**

★ **Tested and Proven reliability.**

Only \$49<sup>95</sup> ● **SATISFACTION GUARANTEED!**

● Complete. ● **1-YEAR FACTORY WARRANTY.**

(State Make, Year, Engine Size). (Calif. Res. add Tax).

● **CONVERT YOUR "C-D" UNIT TO BREAKERLESS!**  
"TRIGGER-UNIT" ONLY \$34.95

★ **Send Postcard for FREE BROCHURE Today.**

**ALLISON AUTOMOTIVE CO.**

P.O. Box 881-F, TEMPLE CITY, CAL. 91780

INFORMATION RETRIEVAL NUMBER 75

**WHEN  
THE BLOCK  
READS  
"DIGITAL DISPLAY"**

**...don't get  
involved!**

**Let us fill the block for you.**

When your lead time is short, our off-the-shelf PDC series display modules can save you time and money on moderate volume or prototype applications. We have modules in a wide range of digit sizes. They include LED, incandescent, and seven-segment numeric as well as dot-matrix alphanumeric. They're pre-wired for BCD logic and are ready to mount to your panel with just two screws. Ask for our catalog.

In fact, contact us whatever the requirements of that digital display block may be; we also design and produce custom systems. We are digital display specialists and thrive on involvement.

**Precision Dynamics Corporation**  
3031 Thornton Ave. - Burbank, CA. 91504  
(213) 845-7606

INFORMATION RETRIEVAL NUMBER 74

## "Zoom In" on Closely Spaced Peaks In Real Time with 0.1 Hz Resolution

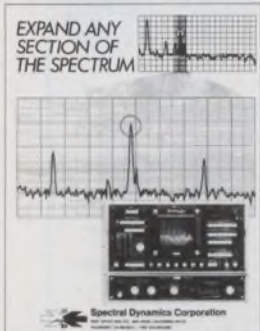

Need an accurate way to detect low-level signals buried in noise or crowded by other spectral components? An SD330A Real Time Analyzer and SD332 Spectrum Translator will analyze frequencies up to 150 kHz with narrowband resolution. . . . narrow as 0.1 Hz with no loss of frequency accuracy! (You can also look at bands as wide as 20 kHz for quick surveys to 150 kHz). For detailed examination of a given area—just like a zoom lens—simply dial in the center frequency of the "window" to be expanded. The scope will display a spectrum of the selected width centered on the chosen center frequency, and the RTA's digital cursor reading shows the exact frequency of any point of interest.

CIRCLE NO. 171

**Spectral Dynamics Corporation**  
P.O. Box 671, San Diego, CA 92112  
(714) 565-8211. TWX 910-335-2022

## PRACTICAL RELAY CIRCUITS

By Frank J. Oliver



Uniquely groups various relay circuits according to the functions they perform, enabling the systems designer to quickly select the best circuit for his specific purposes. Includes arc and RFI suppression systems; time delay function; audio tone control and resonant-reed relays; sequential relays; protective functions of relays against overload overvoltage, and overcurrent, pulse generation and detection; logic circuits; and more. Particularly important is coverage of pulse-operated relay systems now extensively used with automated control systems. Illustrated with many circuit diagrams using the latest American National Standard graphical symbols. 363 pp., 6 x 9¼, illus., cloth, \$17.20 **Circle the reader-service number to order a 15-day examination copy.**

CIRCLE NO. 172

**HAYDEN BOOK COMPANY, INC., 50 Essex St., Rochelle Park, N.J. 07662**

## MATERIALS FOR MAGNETIC FUNCTIONS

by Fennimore N. Bradley



This valuable reference provides a thorough background as well as practical design techniques for the materials needed for magnetic functions. Included in its exhaustive coverage is detailed treatment of key parameters of about 30 classes of ferrite materials relating processing to costs and design trade-offs . . . and equally thorough coverage of about 40 classes of both conventional and exotic magnetic metals and processes. The book focuses on design problems encountered in a wide range of permanent-magnet applications . . . pinpoints design problems in nearly 30 categories of electromagnetic devices . . . and concludes with coverage of environmental influences such as corrosion, magnetic field, temperature, stress, etc. 360 pp., 6 x 9, illus., cloth, \$17.20. **Circle the reader-service number to order a 15-day examination copy.**

CIRCLE NO. 173

**HAYDEN BOOK COMPANY, INC., 50 Essex St., Rochelle Park, N.J. 07662**

# Electronic Design

ELECTRONIC DESIGN's function is:

- To aid progress in the electronics manufacturing industry by promoting good design.
- To give the electronic design engineer new concepts and ideas that make his job easier and more productive.
- To provide a central source of timely electronics information.
- To promote communication among members of the electronics engineering community.

**Want a subscription?** ELECTRONIC DESIGN is sent free to qualified engineers and engineering managers doing design work, supervising design or setting standards in the United States and Western Europe. For a free subscription, use the application form bound in the magazine. If none is included, write to us direct for an application form.

If you do not qualify, you may take out a paid subscription for \$30 a year in the U.S.A., \$40 a year elsewhere. Single copies are \$1.50 each.

**If you change your address,** send us an old mailing label and your new address; there is generally a postcard for this bound in the magazine. You will have to requalify to continue receiving ELECTRONIC DESIGN free.

**The accuracy policy of ELECTRONIC DESIGN is:**

- To make diligent efforts to ensure the accuracy of editorial matter.
- To publish prompt corrections whenever inaccuracies are brought to our attention. Corrections appear in "Across the Desk."
- To encourage our readers as responsible members of our business community to report to us misleading or fraudulent advertising.
- To refuse any advertisement deemed to be misleading or fraudulent.

Microfilm copies are available of complete volumes of ELECTRONIC DESIGN at \$19 per volume, beginning with Volume 1, 1952 through Volume 20. Reprints of individual articles may be obtained for \$3.00 each, prepaid (\$.50 for each additional copy of the same article) no matter how long the article. For further details and to place orders, contact the Customer Services Department, University Microfilms, 300 North Zeeb Road, Ann Arbor, MI 48106 telephone (313) 761-4700.

**Want to contact us?** If you have any comments or wish to submit a manuscript or article outline, address your correspondence to:

Editor  
ELECTRONIC DESIGN  
50 Essex Street  
Rochelle Park, NJ 07662

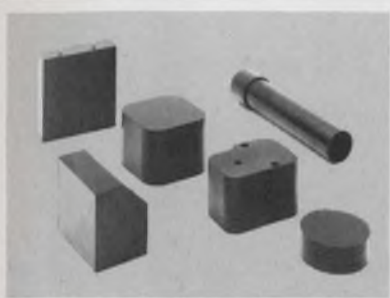

**Glass laminated epoxy 155°C cases** for component and circuit packaging are available in thousands of sizes. Thin wall tubes and headers offer optimum protection in all applications. Literature and samples available. Stevens Tubing Corp., 128 North Park Street, East Orange, New Jersey 07019. Telephone 201-672-2140.

INFORMATION RETRIEVAL NUMBER 601

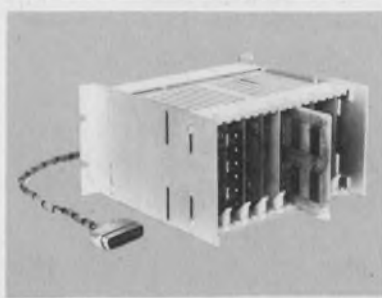

**Expandable Voice Annunciator.** Now your electronic equipment can speak out—just give it a solid-state voice! Whole words stored in OMs provide natural sounding synthesized voice. Capable of being expanded modularly from 10 to 30 words. First 10 words are zero to nine. Master Specialties, 1640 Monrovia, Costa Mesa, Calif. 92627. (714) 642-2427.

INFORMATION RETRIEVAL NUMBER 604



**Thin-Trim variable capacitors** provide a reliable means of adjusting capacitance without abrasive trimming or interchange of fixed capacitors. Series 9401 has high Q's and a range of capacitance values from 0.2-0.6 pf to 3.0-12.0 pf and 250 WVDC working voltage. Johanson Manufacturing Corporation, Boonton, New Jersey (201) 334-2676.

INFORMATION RETRIEVAL NUMBER 607

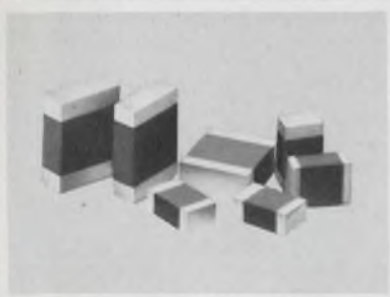

**HIGH Q MULTILAYER CAPACITORS** feature very high quality factors at microwave frequencies. Offered in three standard sizes: .050 x .040, .080 x .050, .125 x .095. Capacitance values from 0.1 pf to 1000 pf with close tolerance and voltages to 1000 VDCW. Johanson/Monolithic Dielectrics Div., Box 6456, Burbank, Ca. 91510, (213) 848-4465.

INFORMATION RETRIEVAL NUMBER 602



**Basic Engineering Sciences & Structural Engineering for E-I-T Exams.** Sampling for test problems makes the best preparation yet for exams. #5712-1, 424 pp., \$17.20. Circle the Info Retrieval No. to order 15-day exam copy. When billed, remit or return book with no obligation. Hayden Book Co., 50 Essex St., Rochelle Pk., N.J. 07662

INFORMATION RETRIEVAL NUMBER 605

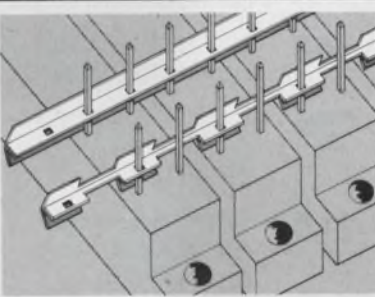

**STRIP/BUS** has low profile, high current-carrying capacity, and low cost. Provides easy installation and removal. For details, write Rogers Corporation, Rogers, Connecticut 06263, or call Chet Platt at (203) 744-9605.

INFORMATION RETRIEVAL NUMBER 608



**Free catalog of 34,500 power supplies** from the worlds largest manufacturer of quality Power Supplies. New '74 catalog covers over 34,500 D.C. Power Supplies for every application. All units are UL approved, and meet most military and commercial specs for industrial and computer uses. Power Mate Corp. (201) 343-6294.

INFORMATION RETRIEVAL NUMBER 603

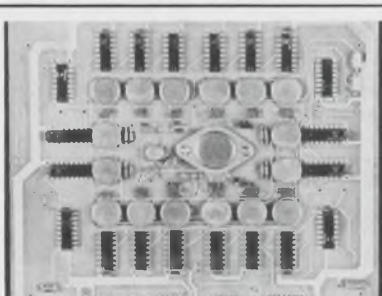

**The 5 bit converter** constructed on single printed circuit card. Total thrupt time 50 n sec, with 20 MHz update rate. Temperature stability over full mil range, -55°C to +125°C with drift less than ±1 bit over entire range. M.S. Kennedy Corp; Pickard Dr, Syracuse, NY 13211 (315) 455-7077.

INFORMATION RETRIEVAL NUMBER 606



**"Synchro to digital converters** - 10, 12, or 14 bit output, errorless tracking up to 4 r.p.s., accuracy ±4 min. of arc ±.9LSB, resolution - 1.3 minutes, 60 or 400 Hz input, Module 2.6 x 3.1 x .82" H, Price From \$350 in qty. Computer Conversions Corp., East Northport, N.Y. 11731 (516) 261-3300."

INFORMATION RETRIEVAL NUMBER 609

# A GOLD MINE OF INFORMATION & DATA

- **520** CATALOG PAGES ON ICs & SEMICONDUCTORS
- **300** CATALOG PAGES ON INSTRUMENTS
- **290** CATALOG PAGES ON POWER SUPPLIES
- **210** CATALOG PAGES ON WIRE & CONNECTOR PRODUCTS
- **150** CATALOG PAGES ON SWITCHES
- **2800** CATALOG PAGES ALL TOLD IN 52 PRODUCT CATEGORIES

*Electronic Design's* GOLD BOOK puts the entire electronics industry at your fingertips. Use it for product search, selection, specification and purchase. It's the most thorough industry master catalog & directory ever compiled.

When you need Information . . .

Electronic Design's

## GOLD BOOK IS THE PLACE TO LOOK

## advertiser's index

Advertiser	Page	Advertiser	Page
AMP, Incorporated	38, 39	Kennedy Corporation, M. S.	125
Abbott Transistor Laboratories, Inc.	6	Kepeco, Inc.	44
Ad-Vance Magnetics, Inc.	115	Keystone Electronics Corp.	130
Addmaster Corporation	121	Kurz-Kasch, Inc.	94
Allison Automotive Co.	123	Lafayette Radio Electronics	122
Amperex Electronics Corporation	89	Master Specialties	125
Analog Devices, Inc.	52, 53	Minelco Division, General Time Corp.	115, 129
B & K Product of Dynascan Corporation	42	Mini-Circuits Laboratory, A Division of Scientific Components Corp.	23
Beckman Instruments, Inc. Helipot Division	50, 51	MuRata Corporation of America	36, 75
Bell & Howell	1	North American Philips Controls Corp.	79
CELCO (Constantine Engineering Laboratories Company)	19	Optron, Inc.	7
Celanese Plastics Company	37	Pomona Electronics	129
Chrono-Log Corporation	130	Power/Mate Corp.	125
Clare-Pendar	97	Precision Dynamics Corporation	123
Communications International	40	RCA Solid State	Cover IV
Computer Conversions	125	RFL Industries, Inc.	129
Connecticut Hard Rubber Co., The	106	Radio Switch Corporation	121
Constantine Engineering Laboratories Company (CELCO)	19	Reader Service	130A, 130B
Cutler-Hammer, Specialty Products Division	20	Richlok Corporation	94
Dale Electronics, Inc.	Cover II	Rogers Corporation	105, 125
Datak Corporation, The	99	Rohde & Schwarz	91
Decitek, A Division of Jamesbury Corporation	107	Schauer Manufacturing Corp.	112
Dynascan Corporation	42	Servo-Tek Products Company	107
*Electronic Design	37, 51	Sinclair Scientific	43
Fluke Mfg. Co., Inc., John French Trade Shows	35 94	Sorensen Company, A Unit of Raytheon Company	84, 85
Gates Energy Sources	27, 28, 29, 30	Spectral Dynamics Corporation	124
General Semiconductor Industries, Inc.	104	Sprague Electric Company	101
Gold Book, The	75, 102, 103, 110, 111, 118, 119, 126, 130	Stacoswitch	116
Grayhill, Inc.	34	Stevens Tubing Corp.	125
Hansen Manufacturing Co.	48	Superior Flux Company	94
Harris Publishing Co.	67	TDK Electronics	41
Hayden Book Company, Inc.	74, 125	TEC, Incorporated	78
*Hayden Book Company, Inc.	50	T.R.I. Corporation	120
Hayden Mail Order	43	TRW, Electronic Components	25
Heath/Schlumberger Instruments	79	Tecnetics, Inc.	117
Hewlett-Packard	9 thru 18	Tektronix, Inc.	47
Hiptronics, Inc.	100	Teledyne Semiconductor	93
Houston Instruments, A Division of Bausch & Lomb	113	Teledyne Relays, A Teledyne Company	2
Houston Instrument, The Recorder Company	120	Thomson CSF	66
Hughes Aircraft Company, Industrial Products Division	109	Triplett Corporation	87
Hughes Aircraft Company, Connecting Devices	Cover III	Union Carbide, Components Dept.	33
Intech, Incorporated	114	Varo Semiconductor, Inc.	73
Intel Corporation	4, 5	Vero Electronics, Inc.	42
Interface	130	Vishay Resistor Products, a division of Vishay Intertechnology, Inc.	75
Intronics	96	Xenon Corporation	99
Johanson Manufacturing Corp.	125	Yewtec Corporation	99
Johanson Monolithic Dielectrics	125		

\*Advertisers in non-U.S. Edition.

**FREE ALARM CATALOG**

Full line of professional burglar and fire alarm systems and supplies. 96 pages, 450 items. Off the shelf delivery, quantity prices.



mountain west alarm  
4215 n. 16th st., phoenix, az. 85016

CIRCLE NO. 291

**HERMETIC SEALING**

Connectors • Headers • Relay Bases  
Terminals • Custom Seals • Testing  
Glass/Ceramic To Metal • Since 1959

**DETORONICS CORPORATION**

10660 E. Rush • S. El Monte, CA 91733  
(213) 579-7130 • TWX 910-587-3436

CIRCLE NO. 292

**OVER 500 SCIENTIFIC BOOKS  
AT INCREDIBLE DISCOUNTS**

Catalogue 1975-A lists hundreds of books on Electronics, Engineering, Physics, Chemistry, Mathematics, and other scientific disciplines. All books are new, and typical discounts range from 40% to 60% of list price. Stretch your budget with books from:

**HERBERT SHPRENTZ COMPANY**  
BOX 83-HB, IRVINGTON, NY 10533

CIRCLE NO. 293



The President's Committee  
on Employment of the Handicapped  
Washington, D.C. 20210

**SENIOR COST  
ESTIMATOR  
CONTROL &  
INSTRUMENTATION**

Five-ten years experience in cost estimating Nuclear Power Plant Control and Instrumentation Systems. Applicant should have experience in determining labor hours associated with assembly of control consoles and signal processing racks. EE degree preferred.

To apply, send resume to Manager of Employment, Dept. 656.

**GENERAL ATOMIC COMPANY**  
P. O. Box 81608  
San Diego, CA 92138

An Equal Opportunity  
M/F Employer

**PERSONNEL  
RECRUITMENT  
ADVERTISING  
IN  
Electronic Design**

**REACHES THE  
RIGHT PEOPLE  
AT A LOWER COST  
PER THOUSAND**

*Call the  
HOTLINE  
today  
for complete  
information:  
(201) 843-0550  
extension 246*

# product index

**Information Retrieval Service.** New Products, Evaluation Samples (ES), Design Aids (DA), Application Notes (AN), and New Literature (NL) in this issue are listed here with page and Information Retrieval numbers. Reader requests will be promptly processed by computer and mailed to the manufacturer within three days.

Category	Page	IRN	Category	Page	IRN	Category	Page	IRN
<b>Components</b>			<b>Instrumentation</b>			<b>Packaging &amp; Materials</b>		
bite indicator	129	78	CMOS logic probes	94	37	circuit board supports	94	39
capacitors	101	48	counter	108	341	coax cable	95	301
capacitors, storage	107	335	curve tracer	79	86	connectors	III	253
cross-patch module	106	331	DMM	108	342	digital instruction kit	97	304
DIP potentiometer	115	64	DMM, ac	99	46	electronics catalog (NL)	120	69
display modules	122	73	digital logic test system	109	57	engraving tool	96	302
electronics catalog (NL)	120	69	electronic load	109	344	ferrite magnets	41	19
electronics show, French (NL)	94	40	electronic catalog (NL)	120	69	industrial tape	106	53
flashtubes	99	44	electronics show, French (NL)	94	40	knobs, instrument	97	305
I/O converter modules	2	3	generators	100	47	lead bender	96	303
indicating devices (NL)	122	379	high-speed logic instrumentation	47	23	liquid flux	94	38
keyboards	106	333	Lab Coat Courier (NL)	120	367	magnetic shielding	115	63
load cells	130	80	logic probe	108	338	mini bus	105	52
logic motors	91	35	oscilloscope	79	87	molded plastic parts (NL)	120	368
microminiature switches (NL)	122	377	panel instruments	87	32	nylon	37	16
motor, control	107	336	photometer	108	337	PC connectors (NL)	120	370
motors	48	24	power-DAC	35	14	PC kit	99	45
motors, small	106	334	printer	108	340	retaining rings (NL)	120	364
R-2R ladder networks (NL)	122	378	rms/dc converter	108	339	standoffs and spacers	130	82
reed relays	91	34	sampling/reliability calculator	33	12	test clip	129	79
rotary switches (NL)	122	374	servo systems (NL)	122	380	<b>Power Sources</b>		
servomotors, dc	107	54	strip-chart recorder	121	70	battery charger	116	359
switches	20	8	strip-chart recorders	91	36	current source	116	360
switches	116	65	sweep generator	109	343	power modules	6	5
switches, lighted	34	13	test clip	129	79	power supplies	85	31
switches, rotary	78	84	time code generator/reader	130	81	power supplies	96	41
switchlights	97	42	5-1/2-digit multimeter (NL)	120	369	power supplies, hv dc	123	74
test clip	129	79	<b>Integrated Circuits</b>			power supply, ac	117	66
trimmers, cermet	51	25	CMOS, 74C series	104	327	UPS	116	357
varistors	106	332	circuit, watch	104	329	voltage reference	116	358
<b>Data Processing</b>			electronics catalog (NL)	120	69	voltage standard (NL)	122	375
calculator, scientific	43	21	electronics show, French (NL)	94	40	<b>new literature</b>		
console, programmer	98	308	ICs, CMOS	101	325	data logger	121	371
converter, serial a/d	98	309	microcomputer	105	330	electronics catalog	120	69
cross-patch module	106	331	monolithic ICs (NL)	120	365	electronics show, French	94	40
data acquisition	98	310	RAM, 1-k NMOS	104	328	indicating devices	122	379
data logger (NL)	121	371	RAM, 1-k SOS	101	326	Lab Coat Courier	120	367
electronics show, French (NL)	94	40	<b>Microwaves &amp; Lasers</b>			microminiature switches	122	377
memory, add-on	98	306	comparator	117	362	microwave switches	121	372
memory, buffer	98	320	microwave switches (NL)	121	372	molded plastic parts	120	368
memory, cassette	100	321	klystron, L-band	117	361	monolithic ICs	120	365
network, industrial	100	324	radar module	117	363	PC connectors	120	370
processor, FET	98	307	<b>Modules &amp; Subassemblies</b>			R-2R ladder networks	122	378
punched tape readers	107	55	ac detector	114	62	retaining rings	120	364
reader, cassette	100	323	a/d and d/a modules	53	26	rotary switches	122	374
reader, paper tape	100	322	amplifier, s/h	114	353	SCR power supplies	120	366
signal processors (NL)	121	373	control optical	114	354	sampling/reliability calculator	33	12
<b>Discrete Semiconductors</b>			controller, temp	114	351	servo systems	122	380
diode, switching	112	348	controls, photoelectric	115	355	signal processors	121	373
electronics catalog (NL)	120	69	converter, s/d	114	352	tools and safety equipment	122	376
photodetector	112	347	I/O converter modules	2	3	voltage standard	122	375
rectifiers, Schottky	73	29	ignition systems	122	72	Who's Who in Electronics	67	28
stacks, rectifier	113	350	preamplifier, mike	115	356	5-1/2-digit multimeter	120	369
transistor, power	112	345	servo systems (NL)	122	380	<b>design aids</b>		
transistors, rf power	112	346				sampling/reliability calculator	33	12
transistors, 5-GHz	89	33						
varistors	113	349						
zeners	112	60						



# GAUSSMETERS



	ANALOG MODEL 750A	DIGITAL MODEL 750D
High Accuracy (up to)	±1.5% FS	± [0.2% of reading ±1 Digit]
Ranges (as high as)	50,000 Gauss	100,000 Gauss
Readouts	5½" Taut-band Meter	Four Digit (BCD output available)
Measurements	Permanent Magnet and DC Fields; AC Fields from 20 to 800Hz	
Internal Calibration	No Reference Magnet Needed	
Probes	Transverse, Axial and Tangential Available	
Power Req.	115/230V, 50/60Hz	
Price (less probe)	\$865.00	\$1,180.00

An optional (Model ID75) Differential and Incremental Adaptor is available.

RFL offers other models of magnetic measuring equipment, write for free technical booklet.

**RFL Industries, Inc.**  
Boonton, N. J. 07005

Tel: 201-334-3100/TWX: 710-987-8352/CABLE: RADAIRCO, N. J.



EST. 1922

INFORMATION RETRIEVAL NUMBER 77

# MINELCO C180 BITE INDICATOR

\*BUILT-IN TEST EQUIPMENT

## A low cost, reliable circuit condition indicator.



Actual size

### Features:

- Magnetic Latching
- Negligible Power Drain
- Operates on 25 Millisecond Pulse
- Sealed



Send for free brochure.



**MINELCO**

Division General Time Corp.  
A TALLEY INDUSTRIES COMPANY

135 SOUTH MAIN STREET • THOMASTON, CONN. 06787  
PHONE: 203/283-8261 • TWX: 710/475-1091

INFORMATION RETRIEVAL NUMBER 78

ELECTRONIC DESIGN 3, February 1, 1975

# DO-IT-YOURSELF grabber



- Simplified Assembly
- Versatile
- Comfortable Finger Grip Action
- Completely Field Serviceable
- Molded of Tough Lexan\*

Model 3925  
Mini Test Clip  
Shown Actual Size

This test clip with gold plated hook is excellent for rapid testing of components and Wire Wrap† pins. Clip is completely insulated to point of connection. Build any combination of test leads with wire up to .090 dia. Easy and comfortable to operate. Molded of rugged Lexan to resist melting when soldering. Write for literature and prices.

### SIMPLIFIED ASSEMBLY

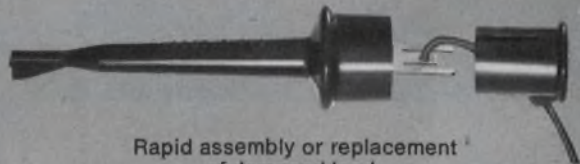

Rapid assembly or replacement of damaged lead.

### MODEL 3925

hooks onto components or slips over square Wire-Wrap pins

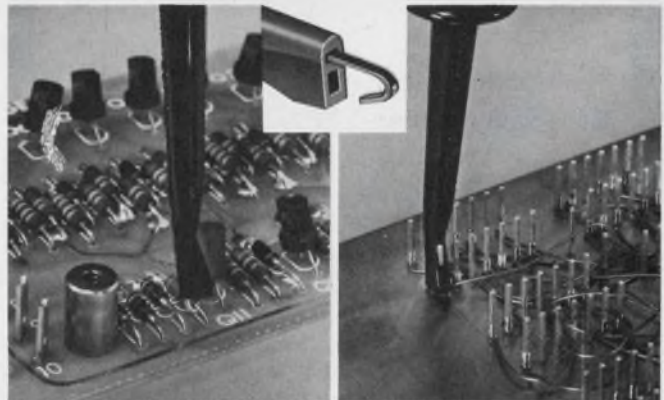

\*Lexan is a General Electric trade-mark. †Registered trade-mark of Gardner - Denver Co.



**POMONA ELECTRONICS**

A Division of ITT

1500 East Ninth St., Pomona, Calif. 91766  
Telephone (714) 623-3463

INFORMATION RETRIEVAL NUMBER 79

## LOOKING FOR LOW RANGE LOAD CELLS?



## INTERFACE HAS THEM!

When your requirements call for load cells in a 5, 10, or 25 pound range, and your specifications demand high accuracy, better contact interface. We've just introduced a new version of our proven Minibeam series that's low range, high performance, and affordable.

What about performance? Non-linearity, hysteresis, and non-repeatability combine to a total error band, based on a straight line through zero, of less than  $\pm 0.04\%$ . That's performance. All three ranges carry a list price of only \$225.00. That's less than half of what you'd pay for competitive units, and the performance is substantially better. The other plus features include a rated output of 3mV/V to simplify instrumentation, off-the-shelf small quantity delivery to ease your production scheduling, and proven reliability.

For complete information on these load cells and others in ranges up to 100 tons, call or write Ted Johnson at Interface, today.

### interface

7401 East Butherus Drive/Scottsdale, Arizona 85260  
Telephone: (602) 948-5555

INFORMATION RETRIEVAL NUMBER 80

## STANDOFFS AND SPACERS



Over 200 assorted sizes and styles cataloged for you to choose from. Available in Aluminum, Brass and Phenolic, tapped or thru-hole. Immediate delivery from stock. Free engineering service for your special requirements.

NEW FREE CATALOG ON REQUEST



Manufacturers of Standardized Hardware for Electronics

## KEYSTONE

ELECTRONICS CORP.

49 Bleecker Street • New York, N.Y. 10012

INFORMATION RETRIEVAL NUMBER 82

## New Low Cost TIME CODE GENERATOR/READER



Time Code Reader ..... \$890.

Generator/Reader ..... \$1265.

The new LOW COST Series 9000 Time Code Units generate and read serial IRIG Time Codes used in analog magnetic tape instrumentation, hard wire transmission and telemetry systems. In addition, they provide buffered parallel BCD outputs, TTL compatible, for digital storage devices and computer inputs. Options include Multi-code units, Day-of-Year Calendars and Millisecond BCD outputs.

Write or call Chrono-log Corporation, 2 West Park Road, Havertown, Pa. 19083, (215) 853-1130



INFORMATION RETRIEVAL NUMBER 81

## WHO MAKES WHAT & WHERE TO FIND IT

Volume 1 of **Electronic Design's GOLD BOOK** tells all. And, when you look up an item in its **PRODUCT DIRECTORY** you'll find each manufacturer listed **COMPLETE WITH STREET ADDRESS, CITY, STATE, ZIP AND PHONE.** Save time. There's no need to refer elsewhere to find missing information.

**IT'S ALL THERE**  
in  
**Electronic Design  
GOLD BOOK**

ELECTRONIC DESIGN 3, February 1, 1975



# How do you connect round cable to flat?

## It's a snap.

Now it's easier than ever to connect round cable to flat. Or flat cable to flat. Or round to round.

Because now Hughes introduces the HAC-PAK Connectors—a whole new connector family offered in three types of contacts: crimp/removable rear-release (non-environmental, environmental or potted); RFI/EMI fixed filter contacts; and fixed solder-tail contacts.

HAC-PAK Connectors are intermateable and intermountable with one another—and with Hughes front-release subminiature rectangular connectors. (W and WSS Series.)

Our exclusive PolarHex™

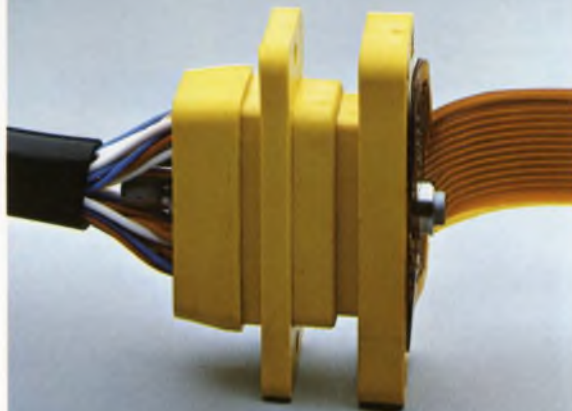

The new Hughes  
**HAC-PAK™ Connector.**  
(MIL-C-28804)

INFORMATION RETRIEVAL NUMBER 253

center jackscrew coupling assures alignment, provides positive polarization with a choice of keying positions, and prevents mismatching.

HAC-PAK subminiature connectors have the highest density of number 22 contacts in the industry. (.085" centers.)

To get all the details, make a connection with Ron Ross at (714) 548-0671, or write: Hughes Connecting Devices, 500 Superior Avenue, Newport Beach, CA 92663.

**HUGHES**  
HUGHES AIRCRAFT COMPANY  
CONNECTING DEVICES

**We crack the tough ones.**

Digital IC news from RCA...

# High Rel COS/MOS is winning over T<sup>2</sup>L logic users.

The chart below is merely a partial representation of the broad variety of military and aerospace programs where RCA High-Rel COS/MOS circuits are being used, instead of T<sup>2</sup>L and other logic. It shows both wide acceptance and confidence. Not only in RCA technology. But in the COS/MOS devices that technology has produced.

If your digital system can be improved by taking advantage of the performance characteristics of CMOS, you can now start incorporating RCA COS/MOS with confidence. All RCA COS/MOS circuits are available in High-Rel Mil-38510/883 specs from a Mil-M-38510 approved production facility in Findlay, Ohio. And all are available through your local RCA distributor. The fact is,

we already have a most comprehensive line of High-Rel COS/MOS ICs and, as new RCA COS/MOS products are developed, they'll become available in High-Rel versions soon after commercial announcement.

To order your High-Rel COS/MOS devices and the free High-Reliability Integrated Circuit brochure, contact your local RCA Solid State distributor. Or RCA.

Write: RCA Solid State, Box 3200, Somerville, New Jersey 08876; Ste. Anne de Bellevue 810, Canada; Sunbury-on-Thames, U.K.; Fuji Bldg., Tokyo, Japan.

# RCA

## PROGRAMS USING HIGH REL COS/MOS

### GENERAL GOVERNMENT

TOW COBRA  
S 3A AIRCRAFT  
LANS PROGRAM  
D-106S COMMUNICATIONS  
AIRS  
ARC-150  
ARC-164  
PRC-85  
STINGER  
AN/ALE 139  
DMD/PLARS  
AFSCS  
FAA VOICE SWITCH  
MULTI ROLE COMBAT  
AIRCRAFT (EUROPE)  
AN-TPN-19  
AN-ASQ-119  
ARTIC  
AWA

MK 46  
CAPTOR  
MANPACK  
SKIRU  
NYVO  
BISS

### ARMING DEVICES

XM-56  
SM-70  
ADAM  
FMU-128  
FMU-129

### SATELLITES, AEROSPACE

ATMOSPHERIC EXPLORER  
HEAO  
SPACE SHUTTLE  
ITOS  
B-SAT  
SAT COM  
NIMBUS  
HELIOS  
OSCAR-6  
PIONEER F  
ATS  
IMP SATELLITES  
MJS-77  
(MARINER, PIONEER-SATURN)  
CTS  
VELA

INFORMATION RETRIEVAL NUMBER 254

RCA. The first house in CMOS.