

Electronic Design[®] 24

FOR ENGINEERS AND ENGINEERING MANAGERS

VOL. 22 NO.

NOV. 22, 1974

The magic word in instruments continues to be digital. Spectrum analyzers, oscilloscopes and other analog machines are using digital techniques for storage and

signal processing. Also, more microprocessors are turning up in instruments for internal control and computation. This report on instruments starts on page 40.

INSTRUMENTS



74



Ultra reliability in
ultra-miniature
transformers...

...and they're off the shelf!

PICO Electronics' patented construction combines mass production with the utmost in reliability to produce the smallest possible transformer.

These little giants handle up to 600 milliwatts at 1 KHz and 1.5 watts at 10KHz. They cover the frequency range of 300Hz to 250KHz. Primary or Secondary impedances of 3.2 ohms to 250K ohms. Pulse applications .05 μ s to

100 μ s. Construction can be TO-5 plug-in, insulated flexible leads or flat pack ribbon style.

Size variations from 1/4" dia. x 1/4" ht. to 1 1/32" dia. x 1/2" ht. Special designs with 1/4" dia. and .180" ht.

Pico Electronics is a Q.P.L. source. All transformers are hermetically sealed in a metal case and in strict compliance with MILT-27 specifications. Every Pico device has the added reliability feature of being

guaranteed for 25 cycles of thermal shock (MIL-STD-202D, method 107C).

Industrial and Commercial designs are also available for maximum economy.

Over 600 standard transformers to choose from... Delivery—stock to one week... specials take a little longer—9 days.

Send for free 36 page catalog.

PICO Electronics, Inc.

50 South MacQuesten Pkwy., Mt. Vernon, New York 10551 • Telephone 914-699-5514

THE FIRST OF THE BIG COUNT TIMERS

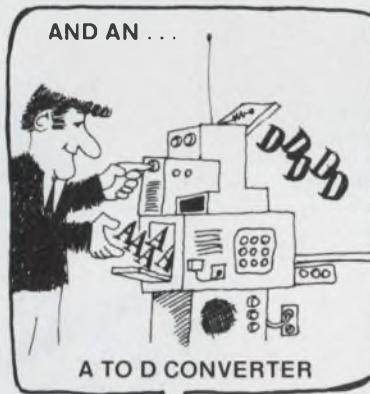
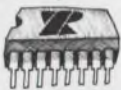
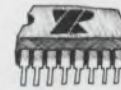
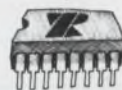
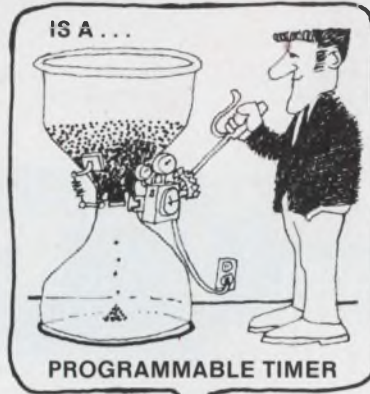
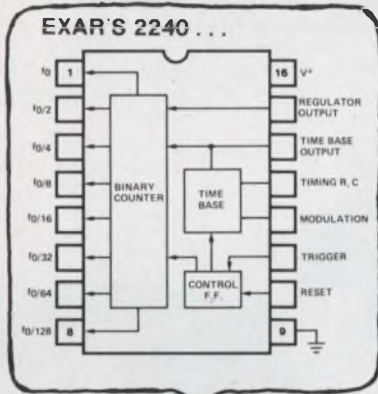

- AND AN ...
- ULTRA-LONG DELAY GENERATOR
 - DIGITAL SAMPLE AND HOLD
 - FREQUENCY SYNTHESIZER
 - PULSE COUNTER
 - BINARY PATTERN GENERATOR
 - PRECISION OSCILLATOR
- ... ALL IN ONE.



Exar's new XR-2240 counter/programmable timer solves so many tough problems that designers will unanimously agree that it's really the universal timer.

With its unique combination of analog and digital timing methods, you can now replace inadequate and complex assemblages of monolithic and electromechanical timers with the much simpler XR-2240. As a bonus, you get greater flexibility, precision operation, and a reduction in components and costs for most applications.

Because of built-in programmability, you can also use the XR-2240 for frequency synthesis, electronic music synthesis, digital sample and hold, A to D conversion, binary counting and pattern generation, and more.

With a single XR-2240 you can now generate

precision time delays programmable from 1RC to 255RC, a range of microseconds to 5 days. By cascading only two XR-2240 timers, you can extend the maximum delay by a factor of 2^N , where $N = 16$ bits, resulting in a total delay of 3 years!

The XR-2240 operates over a 4V to 15V supply range with an accuracy of 0.1% and an $10 \text{ ppm}/^\circ\text{C}$ temperature stability. It's available in either a 16-pin ceramic or plastic dual-in-line package for military or commercial applications. Prices start at \$4.50 in 100 piece quantities.

For the more conventional timing applications, look to our other timers: the XR-320 timing circuit and the XR-2556 dual timers. Call or write Exar, the timer leader, for complete information.

EXAR SPEAKS YOUR LANGUAGE

R-OHM CORPORATION
EXAR INTEGRATED SYSTEMS
P.O. BOX 4455, IRVINE, CA 92664
TELEPHONE: (714) 546-8780
TWX: 910-595-1721

Rohm
QUALITY · RELIABILITY

R-OHM ELECTRONICS GMBH
EXAR INTEGRATED SYSTEMS
MÜHLENSTRASSE 70
4051 KORSCHENBROICH
FEDERAL REPUBLIC OF WEST GERMANY

Members of the International R-OHM Group

INFORMATION RETRIEVAL NUMBER 2

FOR NEW STANDARDS IN SPECTRUM ANALYZERS, THINK HP

8556A Tuning Section,
20 Hz—300 KHz,
with built-in tracking
generator, \$2150.

8553B Tuning Section,
1 KHz—110 MHz,
\$2850.

8443A 110 MHz Tracking
Generator/Counter,
\$4100.

8444A 1300 MHz
Tracking Generator,
\$3300.

Tracking generators for wide dynamic range,
swept frequency response measurements.

The Widest Choice in Spectrum Analyzers.

With HP's neatly-interrelated spectrum analyzers, you choose tuning sections, displays and companion instruments to tailor a system for your measurement needs all the way from 20 Hz to 40 GHz. Then, as your requirements expand, re-configure your system simply by adding the related piece of equipment. For example, when you need to cover a new frequency range simply add that tuning section.

By themselves, any of the 4 spectrum analyzers give you tremendous signal analysis capability made possible by absolute amplitude calibration, low distortion, high resolution, and wide frequency scans coupled with the ability to zoom down to a narrow scan.

Value really multiplies when you add the companion instruments. For example, the tracking generators combined with the analyzers make swept measurements over a 120 dB range thus forming precision swept frequency test systems.

And our automatic preselector for the microwave tuning unit does away with virtually all image, multiple and spurious responses.

All in all, HP's family of spectrum analyzers gives you the greatest depth and breadth of performance and the best value in signal analysis equipment available anywhere. For more information, call your local HP field engineer or write.

HEWLETT *hp* PACKARD

Sales and service from 172 offices in 65 countries.
1501 Page Mill Road, Palo Alto, California 94304

8554B Tuning Section,
0.1—1250 MHz, \$3825.

8555A Tuning Section,
10 MHz—40 GHz, \$7100.

8445B, 18 GHz Auto-
matic Preselector, for
wide scans, free from
unwanted responses,
\$2500. (\$3170 with
LED frequency readout
option.)

8552B High Resolution
IF Section has 10 Hz
bandwidth, manual
scan, two log plus
linear scales, \$3475.
Lower cost unit (8552A,
\$2775) also available.

141T Variable
Persistence and Stor-
age Display Section. Gives
bright, high-resolution traces
at slow scans, \$2100. Also available:
economical normal persistence and
large screen displays.

NEWS

- 27 **News Scope**
- 40 **Instrument '74 special issue**, featuring current trends in instrumentation. Topics covered include: Inside the instrument; instrument packaging; instrument advances; calculator and computer-compatible instruments; pulse and word generators; wave and spectrum analyzers; microwave instrumentation; temperature measuring instruments; laboratory power supplies and interviews with industry pioneers.
- 33 **Washington Report**

TECHNOLOGY

- 150 **Choose the right storage oscilloscope** to capture both super-slow and ultra-fast events. New technology in storage has boosted the number of options.
- 162 **Measure time interval precisely.** Recognize the common pitfalls in counter measurements and eliminate potential errors.
- 170 **Measure open-loop servo response** without saturation problems. Just open the loop, drop in an auxiliary op-amp computing chain, then reclose the loop.
- 176 **Team calculators with instruments** to direct the test sequence, acquire and process data, and deliver output results. Cheaper than minicomputers, too.
- 182 **Untangle automatic test equipment** to find the right system for the job. A review of the relative merits of available ATE schemes helps untie the first knot.
- 190 **Design a low-cost pH meter.** Match a sensor to a suitable amplifier and DPM to get a digital unit that resolves 0.01 pH units with an accuracy of 0.02 pH.
- 196 **Ideas for Design:** Slave clock can run free at center frequency and lock in within one cycle . . . Electronic ignition system uses standard components . . . Programmable sine-wave oscillator uses only one CMOS IC . . . Improve interrupt-handling capability of microprocessor with a few ICs.
- 206 **International Technology**

PRODUCTS

- 209 **Modules & Subassemblies:** 12-bit hybrid a/d converters designed for high performance by two companies.
- 220 **Power Sources:** 3-output variable supply regulates to within 0.01%.
- | | |
|-----------------------------|---------------------------|
| 215 Components | 264 Packaging & Materials |
| 224 Instrumentation | 276 Integrated Circuits |
| 234 Discrete Semiconductors | 280 Microwaves & Lasers |
| 246 Data Processing | |

Departments

- | | |
|--------------------------------------|--------------------------------|
| 147 Editorial: The way to die | |
| 7 Across the Desk | 300 Advertisers' Index |
| 284 Application Notes | 302 Product Index |
| 286 New Literature | 304 Information Retrieval Card |
| 294 Bulletin Board | |

Cover: Designed and illustrated by art director Bill Kelly.

Build faster systems Intel's microcomp

You can now build a limitless variety of high speed, high performance

INTEL'S SERIES 3000 SCHOTTKY LSI	
3001	MICROPROGRAM CONTROL UNIT
3002	CENTRAL PROCESSING ELEMENT
3003	LOOK-AHEAD CARRY GENERATOR
3212	MULTI-MODE LATCH BUFFER
3214	INTERRUPT CONTROL UNIT
3226	BIDIRECTIONAL BUS DRIVER
3601	1024-BIT BIPOLAR PROM (256X4)
3604	4096-BIT BIPOLAR PROM (512X8)
3301A	ROM (COMPATIBLE WITH 3601)
3304A	ROM (COMPATIBLE WITH 3604)
3106A	256-BIT RAM (THREE STATE)
3107A	256-BIT RAM (OPEN COLLECTOR)

logic systems at low cost with a handful of Intel's new Schottky LSI microprogrammable computing elements. This is the first bipolar family with a total systems concept built into every part. Your system will be faster

and far more universal than hard-wired TTL, when you choose the right Series 3000 configuration for your product line. Our flexible, microprogrammable architecture lets you tailor system speed, size, logic functions, bus structures and data paths to your own needs.

And your design will cost much less than hard-wired TTL. Series 3000 LSI computing elements inexpensively replace 60 to 80 percent of the MSI/SSI components previously required in peripheral controllers, large computer channel controllers, minicomputer and

midcomputer central processors, data communications concentrators and processors, industrial machine and process controls, and other high-speed systems.

Each Central Processing Element is a complete 2-bit data processing slice with built-in functions that simplify system operation. The Microprogram Control Unit is a powerful state sequencer, used to select microinstruction sequences from microprogram memory.

More than 6.5 million microinstructions per second can be executed by the typical 16-bit central processor shown here. To further enhance throughput, multiple-bit data shifts, masking and bit testing, macroinstruction program counter maintenance, and basic register-to-accumulator operations have all been reduced to one microcycle.

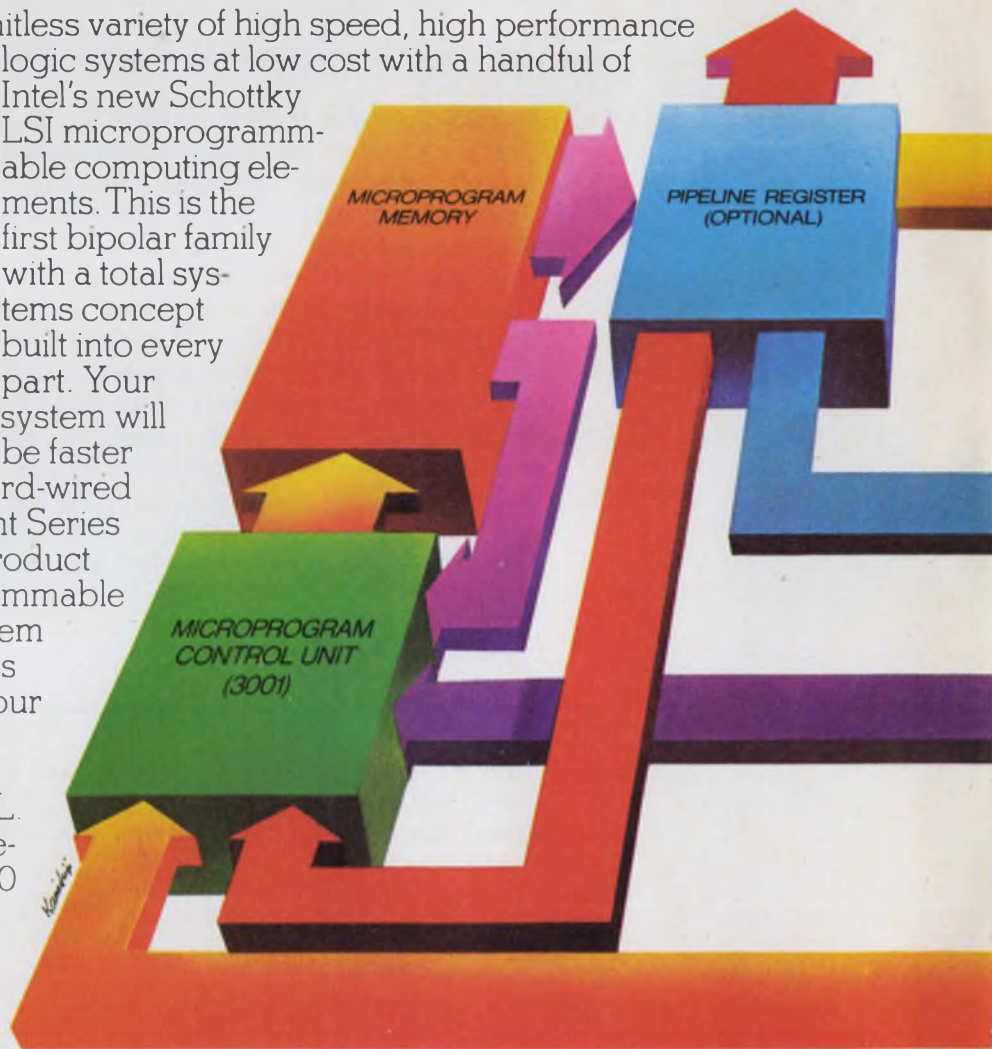

at half the cost with using bipolar LSI.

No external buffers or multiplexers are shown in the data bus structure because none are needed. The bus structure is variable and the Central Processing Array, microprogram memory, interrupt and I/O structure can be tailored to suit the application.

Start exploring your own logic universe with Intel's WF 3000 Bipolar System Development Kit.

It contains design aids, two Microprogram Control Units, ten Central Processing Elements and ten 3601A PROMs—more than enough Schottky LSI building blocks for a typical system. Our kit updating program also entitles you to receive, without further charge, selected samples of new Series 3000 family members as they are announced in 1975 and priority mailings of additional design aids.

The kit is available from your local Intel distributor for only \$720. We'll send you a Look-ahead Carry Generator,

Interrupt Control Unit, Multi-mode Latch Buffer and Bidirectional Bus Driver directly and follow up with more samples later. Or, you can buy our Series 3000 computing elements in production



volume and build high performance systems for as little as half the cost of TTL. All elements are in stock now except the 3304A which will be available First Quarter, 1975.

For more information on Series 3000, write Intel Corporation, 3065 Bowers Avenue, Santa Clara, California 95051.

intel® Microcomputers. First from the beginning.

INFORMATION RETRIEVAL NUMBER 4

FLAT INTERCONNECTS YOUR COMPLETE SOURCE

Ribbon Cable / IC Interconnects / Custom Harnesses

You're sold on flat cable, now buy it at its best. Precise, compact cable packages to fit your specifications perfectly, computer-loomed for unmatched versatility by Woven Electronics.

Handling ease of independent non-bonded leads speeds production, cuts cost, while technical characteristics outrank other flat cable forms.

Make Woven your source for jumpers, continuous rolls, special harnesses, all your interconnect needs.

WOVEN ELECTRONICS

P.O. Box 189 Mauldin, South Carolina 29622
803/963-5131

Vice President, Publisher

Peter Coley

Editors

Editorial Offices
50 Essex St.
Rochelle Park, NJ 07662
(201) 843-0550
TWX: 710-990 5071
Cable: Haydenpubs Rochellepark

Editor-in-Chief George Rostky

Managing Editors:

Ralph Dobriner
Michael Elphick

Associate Editors:

Dave Bursky
Jules H. Gilder
Morris Grossman
Seymour T. Levine
John F. Mason
Stanley Runyon
Edward A. Torrero
Richard L. Turmail

Contributing Editors:

Peter N. Budzilovich
Alberto Socolovsky
Nathan Sussman

Editorial Field Offices

East

Jim McDermott, Eastern Editor
P.O. Box 272
Easthampton, MA 01027
(413) 527-3632

West

David N. Kaye, Senior Western Editor
8939 S. Sepulveda Blvd.
Suite 510
Los Angeles, CA 90045
(213) 641-6544
Northe K. Osbrink, Western Editor
112 Coloma St.
Santa Cruz, CA 95060
(408) 426-3211

Editorial Production

Marjorie A. Duffy

Art

Art Director, William Kelly
Richard Luce
Anthony J. Fischetto

Production

Manager, Dollie S. Viebig
Helen De Polo
Anne Molfetas
Christopher G. Hill

Circulation

Manager, Evan Phoutrides

Information Retrieval

Peggy Long

Promotion

Manager, Walter G. Salm
Karen Kerrigan (Reprints)

across the desk

Typo deflates price of high-power pulser

In the Velonex new-product account on p. 120 of the July 5 issue, the price of our high-power pulse generator is wrong. Our release gave the price as \$1990, not \$1190. And since your publication of the item, the price has been raised to \$2090.

Roy C. Martens
President

Martens & Associates
135 Waverly Pl.
Mountain View, CA 94040

A bilingual approach to electronics defended

Just read your July 19 editorial, "Too Many Foreigners," with mixed emotions. I agree it would be nice if communications could be handled with universal engineering precision, as an ideal objective. The trouble is that engineers, regardless of nationality are creatures of their particular upbringing and cultural fabric. They ultimately relate information to their particular environment and aspirations.

What I'm trying to suggest is that I believe the emotions still play a major role in our international technical relations. So I hope your editorial will not be interpreted by our various Hewlett-Packard (and other U.S. company) managers in such a way that local language concessions are ignored.

After all, if "engineers can understand each other with little difficulty," there's seemingly no need for HP or others to stray from the English language in

communicating with them. And while that kind of thinking is a comfortable balm for our U.S. frustrations over foreign tongues, it is ultimately a pretty arrogant position that has long-term vulnerabilities.

Carl W. Anderson
Manager, Advertising & Sales Promotion

Electronic Products Group
Hewlett-Packard
1501 Page Mill Rd.
Palo Alto, CA 94304

We win some, we lose some

For the first time, I want to congratulate you on your editorial in ELECTRONIC DESIGN, Aug. 2, 1974, ("The Good Boss," ED No. 16). You really surprised me. It was well written and meaningful.

It's too bad I can't say the same about the quality of the power-supply editorial content of your magazine. Cheers!

Robert H. Okada
President

RO Associates, Inc.
3705 Haven Ave. P.O. Box 2163
Menlo Park, CA 94025

A plea for recycling our nuclear wastes

In reply to Ralph Gobel's letter in the Aug. 2 issue suggesting rocketing radioactive waste into the sun:

Such a narrow-minded "let's engineer a solution to this problem" approach is typical of those who are ill at ease or untutored

(continued on page 10)

giga-trim capacitors for microcircuit designers

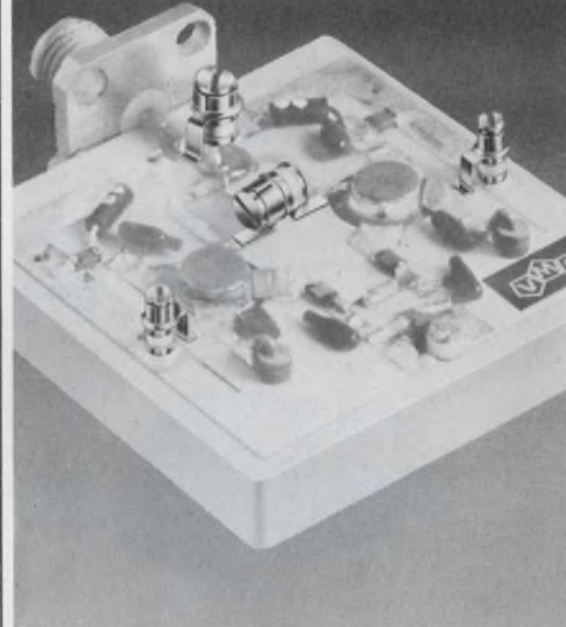

7261 SL 7263 7264 7265

Giga-Trim[®] (gigahertz-trimmers) are tiny variable capacitors which provide a beautifully straight forward technique to fine tune RF hybrid circuits and MIC's into proper behavior. They replace time consuming cut-and-try adjustment techniques and trimming by interchange of fixed capacitors.

Applications include impedance matching of GHz transistor circuits, series or shunt "gap-trimming" of microstrips, external tweaking of cavities, and fine tuning of crystal oscillators.

Johanson

MANUFACTURING CORPORATION

BOONTON, NEW JERSEY 07005
201 / 334-2676

Electronic Design welcomes the opinions of its readers on the issues raised in the magazine's editorial columns. Address letters to Managing Editor, Electronic Design, 50 Essex St. Rochelle Park, N.J. 07662. Try to keep letters under 200 words. Letters must be signed. Names will be withheld on request.

Three New REED RELAYS from CLARE

Perfect blend of economy and reliability in a dry reed relay

Clare's new 951 dry reed relay is a product of Clare's automated manufacturing process that combines economy with reliability. This epoxy molded PCB relay houses the popular Picoreed capsule which gives you from 100 million operations at signal level loads to 5 million operations at 10 volt-amps. It's an excellent, rugged relay for telecommunications, process control and general electronic applications where reliability and long life is critical. Available in 1, 2 and 4 form A configurations.

951



Longer life than a dry reed; less expensive than mercury wetted contact

The new 851 mercury wetted reed relay gives you as much as a billion bounce-free operations, plus switching capabilities from signal level to 50 volt-amperes. The epoxy molded PCB relay is in performance and price, somewhere between the popular dry reed and the more expensive mercury contact relays. And that makes it ideal for applications in telecommunications, computer peripherals, data acquisition and industrial control. Available now in 1, 2 and 4 form A configurations.

851



A new kind of self-latching reed relay

Clare's new relay is the 961 self-latching PCB dry reed relay which features a unique switch that provides the magnetic memory function without the external biasing magnets

961



found in conventional latching relays.

It is designed to operate on one millisecond pulse, but the pulse duration is limited only by coil heating. Once pulsed, the relay remains in that state until the opposite mode is selected.

Ideal for complex automatic test equipment or telecommunications systems, they're available in 1 to 6 pole configurations and have 5 volt-ampere contact ratings.

Availability? Right now!

All three relays are in production and in stock right now. For full technical specifications contact your nearest Clare Distributor. For more comprehensive application information, contact C. P. Clare & Company, 3101 W. Pratt Avenue Chicago, Illinois 60645 or phone (312) 262-7700.

QUALITY, SERVICE, RELIABILITY

C. P. CLARE & COMPANY a subsidiary of
GENERAL INSTRUMENT CORPORATION



NEW GE-MOV™ VARISTORS BETTER THAN ZENERS FOR TRANSIENT PROTECTION

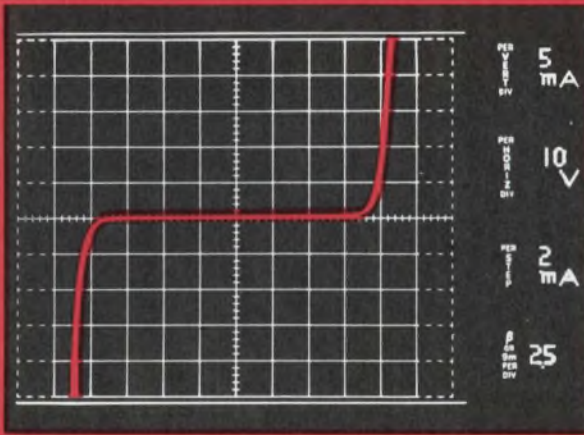

Actual photograph of V33ZA1 Characteristic

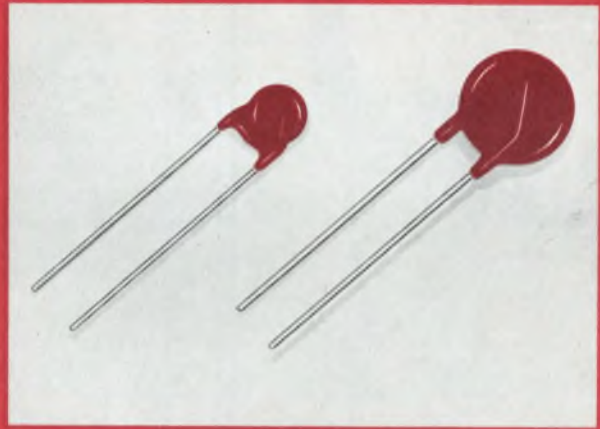

Actual Size

NEW "ZA" Series GE-MOV™ metal oxide varistors are voltage dependent symmetrical resistors which....

- Exhibit characteristics similar to back-to-back zeners when used for transient protection
- Offer up to 10X improvement in peak pulse current capabilities compared to zeners
- Are characterized to $\pm 10\%$ RETMA values at 1 mA DC
- Offer better characteristics than zeners, silicon carbide, selenium or R-C networks when used for transient protection

NEW 26V DC "ZA" SERIES

- 26-81V DC, 20-60V RMS
- Up to 250A peak pulse current
- 1-15 Joules energy absorption
- 14 Types, 2 package sizes
- 41¢ each, suggested resale 10,000 lot quantities
- New "ZA" Series complements over 100 other GE-MOV™ varistor types offering transient protection up to 1000V RMS, up to 2,000A peak pulse current
- Available now from any authorized GE Electronics Component Distributor
- For free sample, write on letterhead to: General Electric Semiconductor, Electronics Park, Bldg. 7-49, Syracuse, N.Y. 13201 stating desired voltage—AC or DC and application

GENERAL



ELECTRIC



**AT YOUR
FINGERTIPS**

**Industry's Best
Delivery On Every**

**Precision/
Power
Wire-wound
Resistor**

In Our Catalog

Call our hotline for prompt
service and delivery.
(201) 374-3311

RCL
ELECTRONICS, Inc.

General Sales Office:
700 So. 21st Street
Irvington, N. J. 07111

ACROSS THE DESK

(continued from page 7)

in whole-systems thinking. This attitude, together with the "what would they say at the lab if I stepped out of my field" syndrome, continues to stifle the conceptual leaps now necessary if we are to apply technology in humane, life-enhancing ways. We must now begin to avoid problems, not solve them.

In the energy field this means we must move to renewable solar sources (including windpower, ocean thermal gradients and bipolar conversion) while we still have the fossil energy we will need to make the transition.

The nuclear-fission age is already over. Fission electricity now equals in capital cost per installed kilowatt hour the cost of power provided by large wind plants. Nuclear fission, like oil shale, is a net energy loser; the gross energy output is less than the gross energy input.

Rather than "waste" our deadly wastes by rocketing them into the sun, let's develop the massive technology that will recycle such valuable by-products.

These views do not reflect those of my organization, but they are generally those of students in Oregon Museum of Science & Industry courses on the theory, design and construction of wind generators, solar flat-plate collectors and methane digesters.

Lee Johnson
On-Site Energy Systems Consultant
Energy Center
Oregon Museum of Science & Industry
4015 S.W. Canyon Rd.
Portland, OR 97221

**Statek quartz crystals
are uniquely small**

I read with interest the article in the July 19 issue on "Inflation, Energy, Semiconductors to Dominate Tomorrow's Electronics." The information in Table 1, concerning quartz crystals for watches, is inaccurate. The dimensions of the Statek WX-2CF crystal currently in production is 0.4 (1.016 cm) x 0.15 (0.3010 cm) x 0.07 in. (0.1778

cm), for a volume of 0.0042 in.³ (0.0688 cm³). The table value for the minimum dimension is 57% too large, and the volume is 89% too large. Statek manufactures the smallest high-quality watch crystal presently available.

The Statek design is unique and offers a considerable improvement in size, high-volume producibility (cost), accuracy and ruggedness.

Richard J. Nelson
Applications Engineer

Statek Corp.
1200 Alvarez Ave.
Orange, CA 92668

**Arthur D. Little
88 years young**

Though we very much sympathized with Mr. Rostky's sense of editorial sorrow at what he implies is an inevitable hardening of corporate arteries ("Growing Old Youthfully," ED No. 14, July 14, 1974, p. 59), we feel we must point to ourselves as a conspicuous exception to the statement that "it's probably impossible to escape the encumbrances of age and size."

In fact, Arthur D. Little—founded in 1886 and a venerable corporate octogenarian with 1600 employees—exhibits many of the traits you would attribute exclusively to frisky, lean, young corporate colts:

1. We are open 24 hours a day, 365 days a year. Arthur D. Little keeps its doors open all night, so engineers and researchers can come in at any hour to try out ideas—and they do.

2. Though we do permit ourselves a few coming-of-age privileges—such as employing technicians—you're as likely as not to find our most senior professionals wiring and debugging their own breadboards.

3. Far from being enmeshed in tiers of managers, ADL's organizational chart is flat and is comprised of management, professional consultants and support personnel. This encourages professionals to become enmeshed in finding the best solution to problems of clients by quickly fielding a team of people with the needed skills from anywhere in the company.

The results of maintaining this

(continued on page 16)

SOLID ROCK

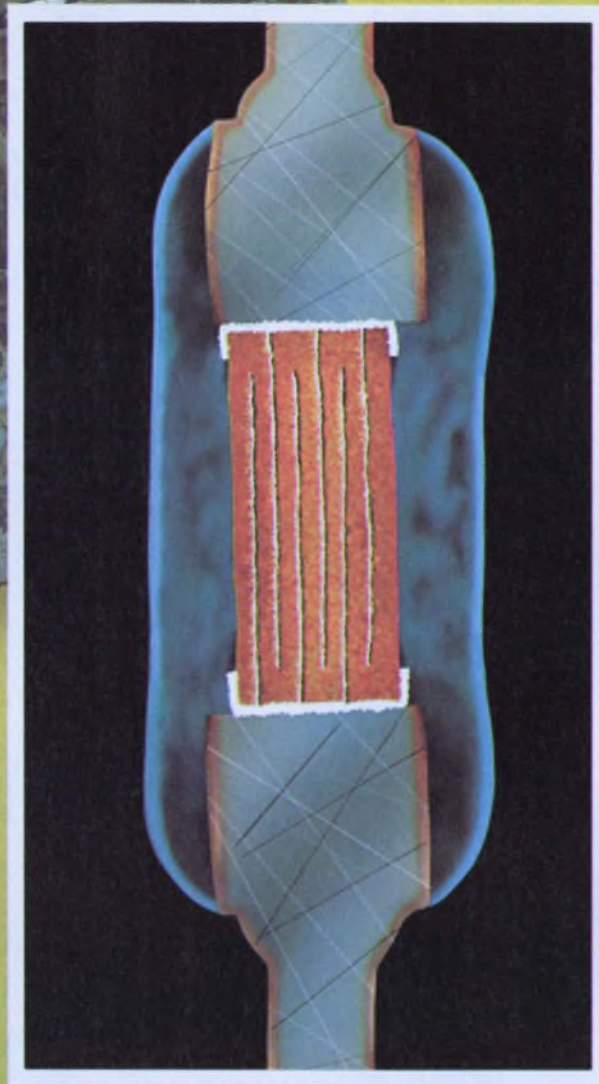
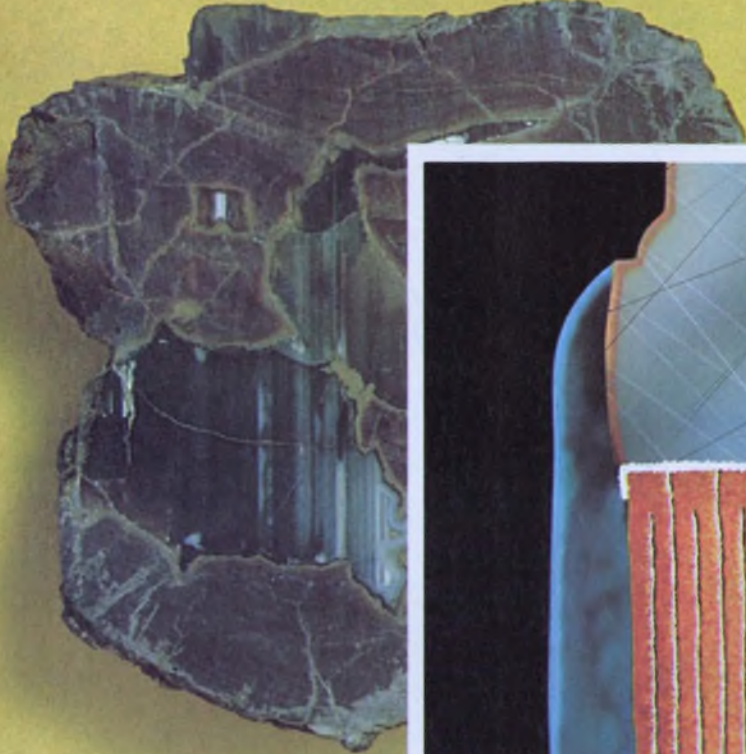

ROCK SOLID

The most solid, stable glass-sealed ceramic capacitors around. Processed with unique and proprietary techniques (patents pending). That's what makes GTI/Tensor's glass-sealed ceramic capacitors as solid and tough as a rock. Results:

- No point contact resistance
- 50% lower ESR
- Dielectric stability
- Higher insulation resistance
- Greater volumetric efficiency
- Smaller size (resulting in greater component density on the board)

Body characteristics available: NPO (COG), X7R (BX) and Z5U (GP).

GTI/Tensor tapes and reels your order for automatic insertion.

For hard facts and rock-solid deliveries, write or call us or one of our representatives; while you're at it ask for our new catalogs on Glass Sealed Ceramic Capacitors and Monolithic Chip Capacitors.

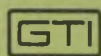

tensor
electronics, inc.

A SUBSIDIARY OF GTI CORPORATION

11558 Sorrento Valley Road
San Diego, California 92121
(714) 453-7262 Telex: 69-5056

Gate	MC10104L	MC10104P	MC10504L	MC10504F	PERIPHERALS — Add-On Memories / Multiplexers / Sample Data Systems / High Speed Discs / Laser POS Scanners / Preprocessors / Holographic Memory Systems / Hard-Wired Programmers / OEM & End-User Minicomputers	MC10118L	MC10118P	MC10518L	MC10518F
Gate	MC10105L	MC10105P	MC10505L	MC10505F	Dual 2-Wide 3-Input OR-AND Gate	MC10119L	MC10119P	MC10519L	MC10519F
Gate	MC10106L	MC10106P	MC10506L	MC10506F	4-Wide 4-3-3-Input OR-AND Gate	MC10121L	MC10121P	MC10521L	MC10521F
Gate	MC10107L	MC10107P	MC10507L	MC10507F	4-Wide OR-AND; OR-AND-INVERT Gate				
Gate	MC10109L	MC10109P	MC10509L	MC10509F	MILITARY — Countermeasures Equipment (ECM) / Ground Support Equipment (GSE) / Frequency Synthesizers (PLL) / Phase-Array Radar (PAR) / Airborne Computers / Guidance Systems / Tracking Systems / Coding Systems For Secure Communication / Missile Electronics / Weapons Systems / Image Recognition / Laser Range Finders / Multiplexers / Fire Control Systems / Target Acquisition Systems / Digital Delay Lines				
Gate	MC10110L	MC10110P	—	—	Triple 4-3-3-Input Bus Driver	MC10123L	MC10123P	*	*
OR Gate	MC10111L	MC10111P	—	—	Quad TTL-To-MECL Translator	MC10124L	MC10124P	MC10524L	MC10524F
	MC10113L	*	*	*					

14 new reasons why your next design should include

MC10158 Quad 2-Input Multiplexer (Non-inverting Output)
Includes common clock and common data select inputs. Ideal for economical multiplexing.

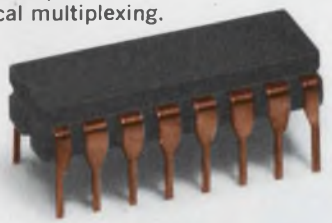

MC10150AL 256 x 4 Factory PROM
Largest ECL ROM available today. Novel programming offers low cost and short turn-around time.

MC10195 Hex Inverter/Buffer
Intended for MSI-rich designs for high-fanout clock driving and reducing stub lengths on long bus lines.

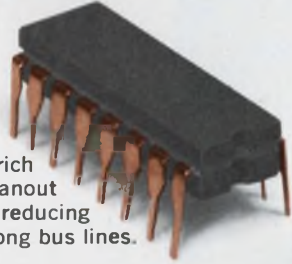

MC10194 Dual Simultaneous Bus Transceiver
Designed for high speed data transfer over multiport bus lines, increases message density.

MC10159 Quad 2-Input Multiplexer (Inverting Output)
A quad two channel multiplexer with enable. Input levels are inverted at the output.

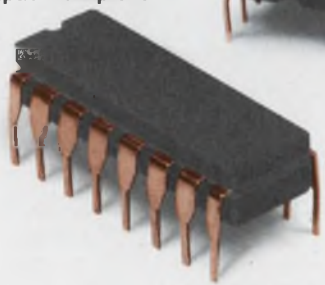

MC10166 5-Bit Comparator
Compare two 5-bit binary words. Connect multiple devices for comparing longer words.



MC1696 ÷ 10, 1-GHz BCD Counter with Reset
An industry first, a natural for front-ends of high performance counters and prescalers.

MC10287 High-Speed 2-Bit Multiplier Useful as an array multiplier block. Two 4-bit words can be multiplied in 14 ns (typical).

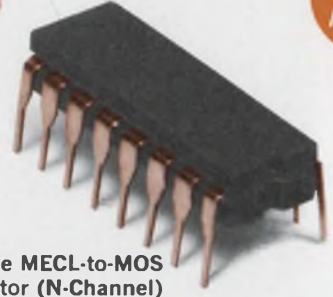
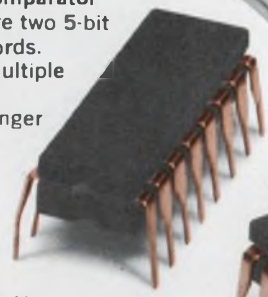

MC10177 Triple MECL-to-MOS Translator (N-Channel)
Designed for NMOS memory systems as a read/write data/address driver. Drives high capacitive loads.



er (Non-Inverting Output)	MC10158L	*	*	*	Quad 2-Input MUX W/Latch	MC10173L	MC10173P	*	*
er (Inverting Output)	MC10159L	*	*	*	Dual 4-to-1 Multiplexer	MC10174L	MC10174P	MC10574L	MC10574F
/Checker	MC10160L	MC10160P	MC10560L	MC10560F	Quint Latch	MC10175L	MC10175P	MC10575L	MC10575F
ort Equipment / Satellite Computers / Communications Processors / Radio-Systems / Tracking Systems / Rocket Electronics / Deep Space Satellites / Sound Stations / Digital Correlators	MC10161L	MC10161P	MC10561L	MC10561F	Hex D Flip-Flop	MC10176L	MC10176P	*	*
oder (Low)	MC10162L	MC10162P	MC10562L	MC10562F	Triple MECL-to-MOS Translator (N-Channel)	MC10177L	*	*	*
oder (High)	MC10163L	*	*	*	Binary Counter	MC10178L	MC10178P	*	*
tion Ckt. (IBM Pattern)	MC10164L	MC10164P	MC10564L	MC10564F	Look Ahead Carry Block	MC10179L	MC10179P	*	MC10179F
	MC10165L	MC10165P	*	*	CONSUMER — FM Tuner Phase-Locked Loops / Private Aircraft Radio Equipment / CB and Marine				

Quad Bus Receiver
 Dual D Latch
 Dual D Flip-Flop
 Dual MUX W/ Latch (Common Reset)
COMMUNICATION — TDMA (Time-Division Multiple-Access) / High Speed Modems / Satellite Communications / Microwave Communications / Frequency Synthesizers / Data Delay Lines / Telemetry (PCM) / Real-Time Signal Processors / Digital Filtering / Data Communications / Radar / Error Detection and Correction Systems / Message Scramblers / Switching Systems / Video Signal Processors / Data Compressors / Telephone Computers

MC10129L	—	—	—	—
MC10130L	MC10130P	MC10530L	MC10530F	—
MC10131L	MC10131P	MC10531L	MC10531F	—
MC10132L	MC10132P	—	—	—
MC10133L	MC10133P	MC10533L	MC10533F	—
MC10134L	MC10134P	—	—	—
MC10135L	MC10135P	MC10535L	MC10535F	—

64-Bit RAM (64 x 1) (90 ohm Drive) (15 ns max)	MC10140L	—
4-Bit Universal Shift Register	MC10141L	MC10141P
64-Bit RAM (64 x 1) (10 ns max)	MC10142L	—
INSTRUMENTATION — Frequency Meters / Counting Meters / Nuclear Instrumentation Equipment / Medical Electronics / Laser Circuitry / Precision Timing / Oscilloscopes Generators / Radar Systems / Correlators / Walsh Generators and Filters / Logic Test Pulse Generators / Distance Measuring Equipment / Memory Testers / Mass Spectrometer Prescalers / Spectrum Analyzers	—	—
8 x 2 Multiport Register File (RAM)	MCM10143L	—
256-Bit RAM (256 x 1) (30 ns max)	MCM10144L	—
64-Bit RAM (16 x 4)	MCM10145L	—
128-Bit RAM (128 x 1) (12 ns max)	MCM10147L	—
64-Bit RAM (64 x 1) (50 ohm Drive) (15 ns max)	MCM10148L	—
256 x 4 Factory PROM	MC10150AL	—
Quad Latch (Negative Clock)	MC10153L	—

MECL

New product innovations are only one reason for the growing popularity of MECL. In addition to high speed capabilities, MECL offers design techniques that may lead to more competitive designs in lower speed regions.

Designers now have a choice of 96 basic devices in MECL 10,000 and compatible MECL III, available in 230 package options. For complete details, write to Motorola Semiconductor Products, Inc., P.O. Box 20912, Phoenix, Arizona 85036.

Exactly why should your next design include MECL? We have the answers in an audio/visual seminar covering the use of MECL, design advantages, and comparison of 10K and Schottky TTL. For a presentation at your facility, just call your local Motorola Distributor or OEM Sales Office. You'll see first hand what MECL can do for you.

MC10182 16-Pin 2-Bit ALU
 Capable of performing 4 logic operations and 4 arithmetic operations on two 2-bit words.

MC10190 Quad IBM-to-MECL Translator A quad translator for interfacing from IBM MST-type logic signals to standard MECL 10K levels.

MC10186 Hex D Flip-Flop with Common Reset Supplies an MSI answer for fast D flip-flop requirements. Clocking common to all six flip-flops.

MC10197 Hex AND Gate Provides a high speed hex AND function with strobe capability for a variety of applications.

MC10191 Hex MECL-to-IBM Translator The inverse of 10190. Ideal for peripherals and add-ons where interfacing to IBM computer is required.

MOTOROLA MECL

... new logic capabilities for the 70's!

INFORMATION RETRIEVAL NUMBER 10

MECL, MECL 10,000, and MECL III are trademarks of Motorola Inc.

Hex D Flip-Flop W/ Common Reset	MC10186L	*	*	*
Quad IBM-to-MECL Translator	MC10190L	*	*	*
Hex MECL-to-IBM Translator	MC10191L	*	*	*
LINEAR — Video Gates / Video Amplifiers / Schmitt Triggers / Balanced Modulators / Commutating Filters / Limiters	—	—	—	—
Error Detection/Correction Ckt. (Motorola Pattern)	MC10193L	*	*	*
Hex Inverter/Buffer	MC10195L	*	*	*
Hex AND Gate	MC10197L	*	*	*
High-Speed Dual 3-Input 3-Output OR Gate	MC10210L	—	—	—
High-Speed Dual 3-Input 3-Output NOR Gate	MC10211L	—	—	—
High-Speed Dual 2-NOR 1-OR Gate	MC10212L	—	—	—
High-Speed Triple Line Receiver	MC10216L	MC10216P	MC10616L	MC10616F

* Indicates scheduled package additions

Binary Counter (325 MHz typ)	MC1654	—	—	—
Voltage Controlled Multivibrator	MC1658	—	MC1658P	—
Dual 4-Input OR/NOR Gate	MC1660	—	—	—
Quad 2-Input NOR Gate	MC1662	—	—	—
Quad 2-Input OR Gate	MC1664	—	—	—
Dual Clocked RS Flip-Flop	MC1666	—	—	—
Dual Clocked Latch	MC1668	—	—	—
Master Slave Type D Flip-Flop (350 MHz typ)	MC1670	—	—	—
Triple Exclusive-OR Gate	MC1672	—	—	—
Triple Exclusive-NOR Gate	MC1674	—	—	—
Bi-Quinary Counter (350 MHz typ)	MC1678	—	—	—
INTERFACE — A to D Converters / D to A Converters / Line Driving/Receiving In TTL	—	—	—	—
IBM Bus Drivers/Receivers / MOS RAM "Sense" Amplifiers / Bus Driver/Receivers /	—	—	—	—
NMOS Memory & Controls	—	—	—	—
Dual 4/5 Input OR/NOR Gate	MC1688	—	—	—

CELCO can make an "Above-Average" Scanner & Printer System for your Image Processing Application.



CELCO's Large-Format Scanner is a unique solution for automating the production of master fonts for a manufacturer of computer typesetting equipment. Scanning a 16-million point area, this system calibrates itself and reduces an artwork master 14 inches x 14 inches to a digital record in 16 seconds.

Our Precision Printer is designed to automatically access the digital records created by the Scanner, and reproduce high-resolution photo-reductions on a master plate.

CELCO has led the field in producing High-Resolution CRT Scanning Systems for applications in Satellite Image Recording, Nuclear and Astronomical Research, Pattern Recognition, Medical Research, high-speed Map-Making, Automatic Inspection Systems, and other "Above-Average" requirements.

This "Above-Average" Scanner and Printer System represents a combination of CELCO's unique in-house

capabilities. From long experience in analog electronics and display engineering, to a broad achievement in both digital hardware and software systems, CELCO can offer a "state-of-the-art" approach to your most unusual problems.

If you have an image processing application, look to CELCO for the "Above-Average" solution.

CONSTANTINE ENGINEERING LABORATORIES COMPANY
1150 E. Eighth Street, Upland, CA 91786

70 Constantine Drive, Mahwah, N J 07430





Fresh off the shelf. Ribbon cable from Hughes.

It could be as good an idea as penny candy: getting your ribbon cable from the same people who crack your tough flat conductor-cable problems.

We offer it by the foot, or as you like it. We not only make it, but we cheerfully cut it, strip it and terminate it for you.

Our new ribbon cable comes in widths from two to 100 conductors. The conductors are round (solid or stranded),

and have color-coded PVC insulation. You can get 22 to 28 AWG.

Of course, all our cable comes with Hughes quality built-in. And we handle your order with the helpful attitude of one of the most competitive companies in the cable business.

So write us soon. Hughes Connecting Devices, 500 Superior Ave., Newport Beach, Ca. 92663. Or call (714) 548-0671.



HUGHES
HUGHES AIRCRAFT COMPANY
CONNECTING DEVICES

We crack the tough ones.

(continued from page 10)

kind of atmosphere speak for themselves. Among some of the more notable inventions that have bubbled up recently are a reliable, accurate, competitively priced, all-electronic speedometer; a digital microwave transceiver that costs less than any other on the market; a distinctively low-cost word processor; a microfiche reader noteworthy for its low cost, high performance and light weight; a compact, rugged, accurate digital compass; an alpha particle detector, compact enough to be mounted on a miner's helmet; a facsimile machine that won an IR new-product award; and a rugged, stackable chair for use in sports arenas.

In other words, we believe companies *can* grow old very youthfully. We are.

David A. Curtis

Electronic Systems Section

Arthur D. Little, Inc.

Acorn Park

Cambridge, MA 02140

Class-D amplification? It's an old idea

Please be advised that the Class-D audio amplifier ("Boost Audio-Amplifier Efficiencies," ED No. 8, April 12, 1974, pp. 96-98) is hardly new. The U.S. Marine Corps is now in production on the AN/UIQ-10, a fully qualified 250-W system that has evolved over the years and is based on pulse-width modulation (Class D). As the former project engineer, I assure you there is no question in my mind that the AN/UIQ-10 does everything Class D.

M. Keller

1935 Hawthorne Ave.
Alexandria, VA 22311

Ed. Note: The author of the article did not contend that the technique was new. On the contrary, he pointed out that the Class-D approach is "a design introduced about a decade ago but then rarely used." From time to time ELECTRONIC DESIGN reviews old techniques that have attained new significance. The editors felt

that readers would find an article on the Class-D amplifier useful because of the growing emphasis on energy conservation and portability in audio designs.

They don't live there anymore

In a product feature on Simpson Electric's new solid-state panel meter, the ANA/LED ("Solid-State Panel Meter Fills the Gap Between Analogs and Digitals," ED No. 15, July 19, 1974, p. 126), an old Chicago address was given for the company. Simpson's correct address is 853 Dundee Ave., Elgin, IL 60120. Phone: (312) 695-1121.

Sharp eyes pick up a flaw in our LVDT

I was reading your article "Sensors in 5 Areas Are Getting Tinier, Cheaper and More Precise" (ED No. 15, July 19, 1974 pp. 30-38), and I came across two instances where you called an LVDT a linear velocity displacement transformer (pp. 34 and 36). As is correctly stated on pg. 32, it is a linear *variable differential* transformer.

John R. Malin, Physicist

Corning Glass Works
Finishing Research Dept.
SP-PR-I
Corning, NY 14830

Dial 1391 for iCOM

A garble in transmission resulted in a wrong phone number for iCOM in the Sept. 27 issue ("First Floppy Disc Peripheral Made for Minicomputers," ED No. 20, p. 138). The correct phone number of the Canoga Park, CA, company is (213) 348-1391. A little old lady at 1291 has been getting a slew of calls and is tiring of forwarding them to iCOM. For further information,

CIRCLE NO. 319

**If your
copy of the
Laboratory
Power
Supply
brochure
from Lambda
has been
removed...**

**please check
the proper
number on the
reader service
card for your
free copy.**

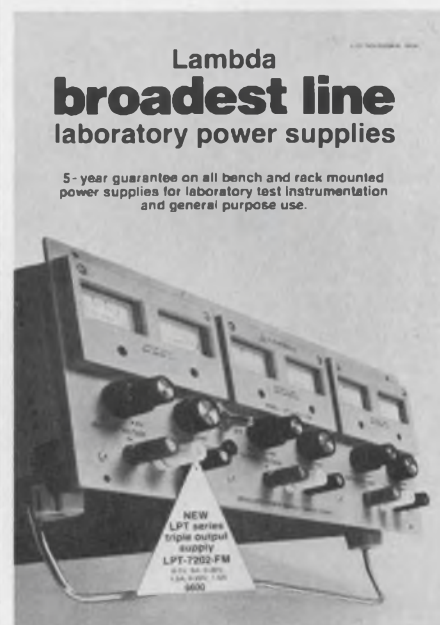

**LAMBDA
ELECTRONICS CORP.**

A **Veeco** Company

515 BROAD HOLLOW RD. MELVILLE, N.Y. 11746

INFORMATION RETRIEVAL NUMBER 246

ELECTRONIC DESIGN 24, November 22, 1974

If these new testers do **half** what we promise, it'd be well worth your time and effort to prove it.

These testers cost tens of thousands less than other production test systems. They fit under an airline seat, travel easily to field applications. They enable drastic reductions in set-up costs by combining normal programming with psuedo-random patterns, by being compatible with other logic testers. They dramatically increase throughput on even the most complex boards by automatic testing up to 100 times faster than other computer-controlled testers. They significantly reduce troubleshooting costs by providing many more fault-isolation techniques.

See? Half that would be extraordinary.

All that is ordinary — with the new MIRCO 500-Series Logic-Circuit Testers.

Join the growing list of companies who've put these testers to the test. Then bought.

**The most incredible
logic testers
ever devised?
Put your best hands
on them.**

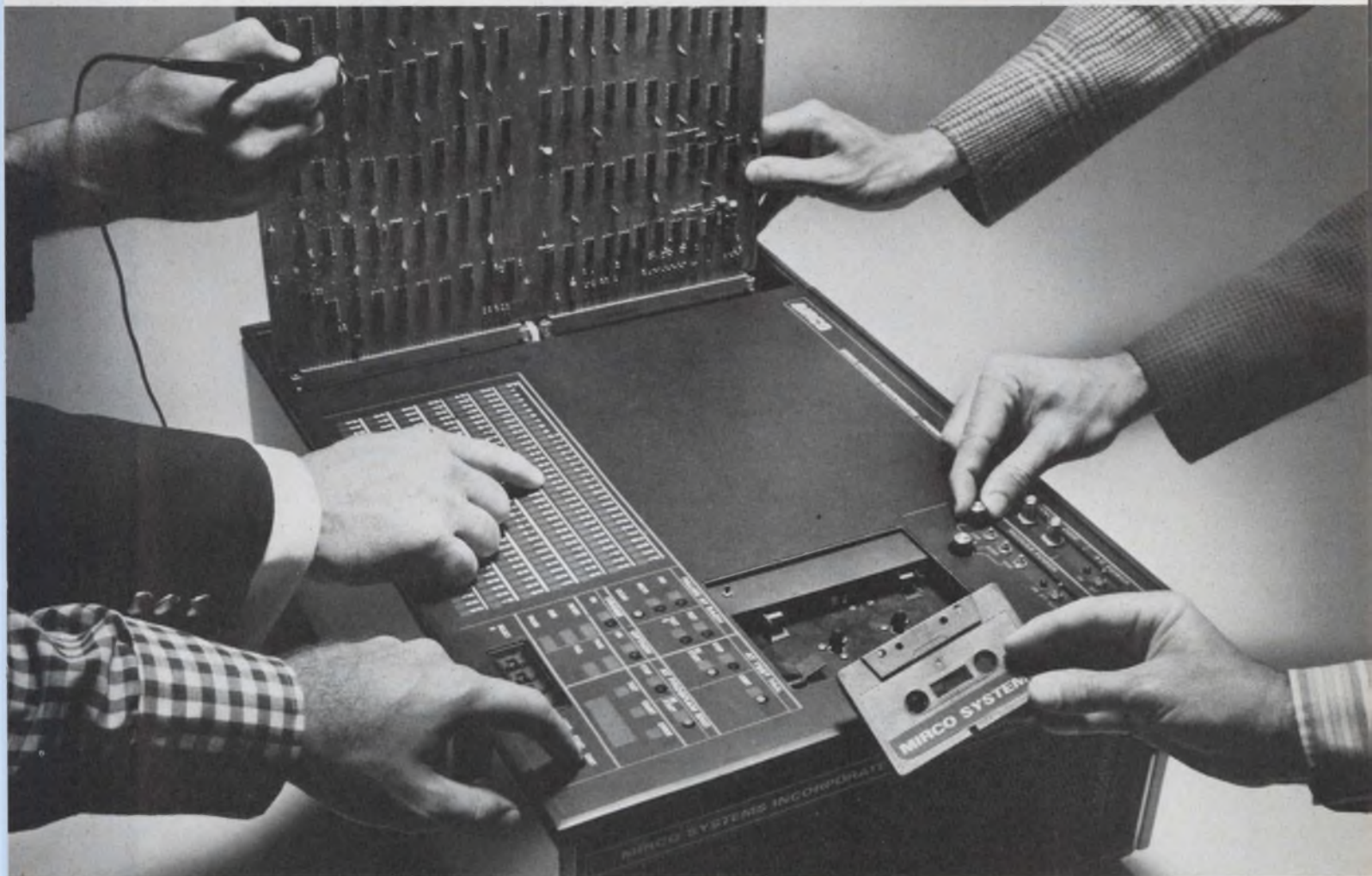

MIRCO MIRCO SYSTEMS
INCORPORATED

2106 WEST PEORIA AVENUE • PHOENIX, ARIZONA 85029 • (602) 944-4691 • TELEX 668-403

THE RACK-A-TIERS



An open-and-shut case for BUD RELAY RACKS.

When an installation calls for one relay rack or a series of open, closed, small, medium or large relay racks, Bud has them! Better yet, your Bud Distributor has them. In stock! Versatile, economical relay racks . . . designed and built to give you that value and quality synonymous with every one of Bud's nearly 3,000 products. For the name of the Bud Distributor or Representative in your area, call (800) 645-9200, toll free.

OPEN RELAY RACKS.

Four types. Eleven sizes. Strong, solid structures for mounting equipment when a complete enclosure isn't required or when easy access to components is a must.

RR-1263 Series has chassis-type base with supporting angles. Uprights, $\frac{1}{4}$ " steel channels 3" deep. Top plate, $1\frac{1}{8}$ " x $3\frac{1}{8}$ ".

RR-1265 type . . . a heavy-duty relay rack . . . is usually bolted to floor. Base, two $\frac{1}{4}$ " steel angles each $3\frac{1}{2}$ " x 5" x $20\frac{3}{8}$ ". Cross bars, $\frac{1}{8}$ " x $2\frac{3}{32}$ " x $1\frac{1}{16}$ " steel angles.

RR-1367 Series has 8"-deep welded "U" member and triangular brackets that hold uprights to base. Integral panel mounting rails on both sides tapped 10-32. Racks may be bolted together in Add-A-Rack fashion.

TABLE-TOP OPEN RELAY RACKS.

Chassis-type base holds heavy components where table mounting is required. Supporting angles provide strength, rigidity. Panel mounting rails recessed; 19" panels fit flush with front.



CR-2174

SUPER DELUXE TWO-DOOR RELAY RACK.

This unit has a solid front door, louvered rear door and sides. Adjustable panel mounting supports may be moved back to a point where distance between rear and front panel is from 9" to 15".



RR-1248



CR-1774

DELUXE RELAY RACKS.

Can be used to house a wide variety of electronic equipment and control systems. Well ventilated; take 19" panels. Contoured front vertical members have integral $\frac{1}{4}$ " panel mounting supports, drilled and tapped 10-32. Two-flush-type snap action catches secure rear door.



AR-1778

PRESTIGE BALL CORNER RELAY RACKS.

Contoured upright members plus ease of assembly make this Bud unit distinctive and economical. Clearance of door and sides permits installation over panels without damaging knobs, switches and controls. Take 19" panels. Panel mounting rails are adjustable to a depth of $6\frac{1}{2}$ " from the front. Can be combined into a series using the Add-A-Rack system.



CR 2280

ADD-A-RACK SYSTEM.

System can be used to join Deluxe or Prestige ball cornered relay racks. By combining several Add-A-Rack assemblies, any number of racks may be coupled for maximum use of lateral space.

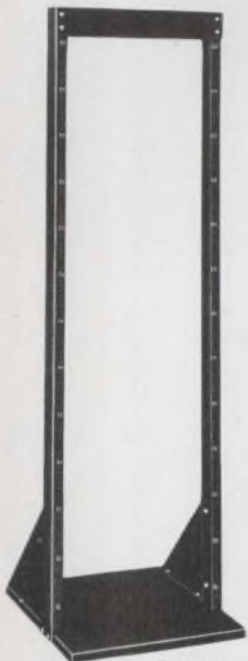

RR-1263

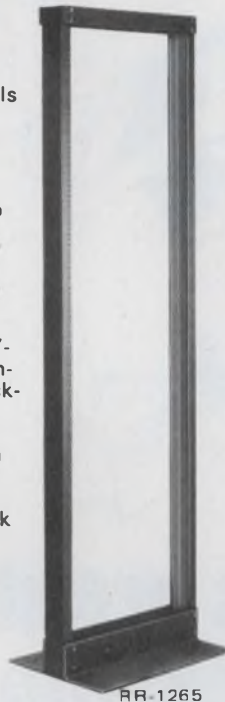

RR-1265

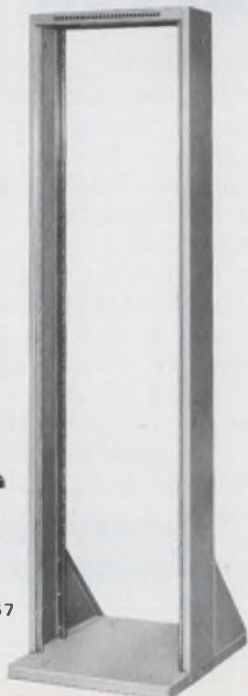

RR-1367

BUD

"The Housing Authority"

BUD RADIO, INC.
4605 E. 355th St. Willoughby, Ohio 44094
216/946-3200 TWX 810-427-2604

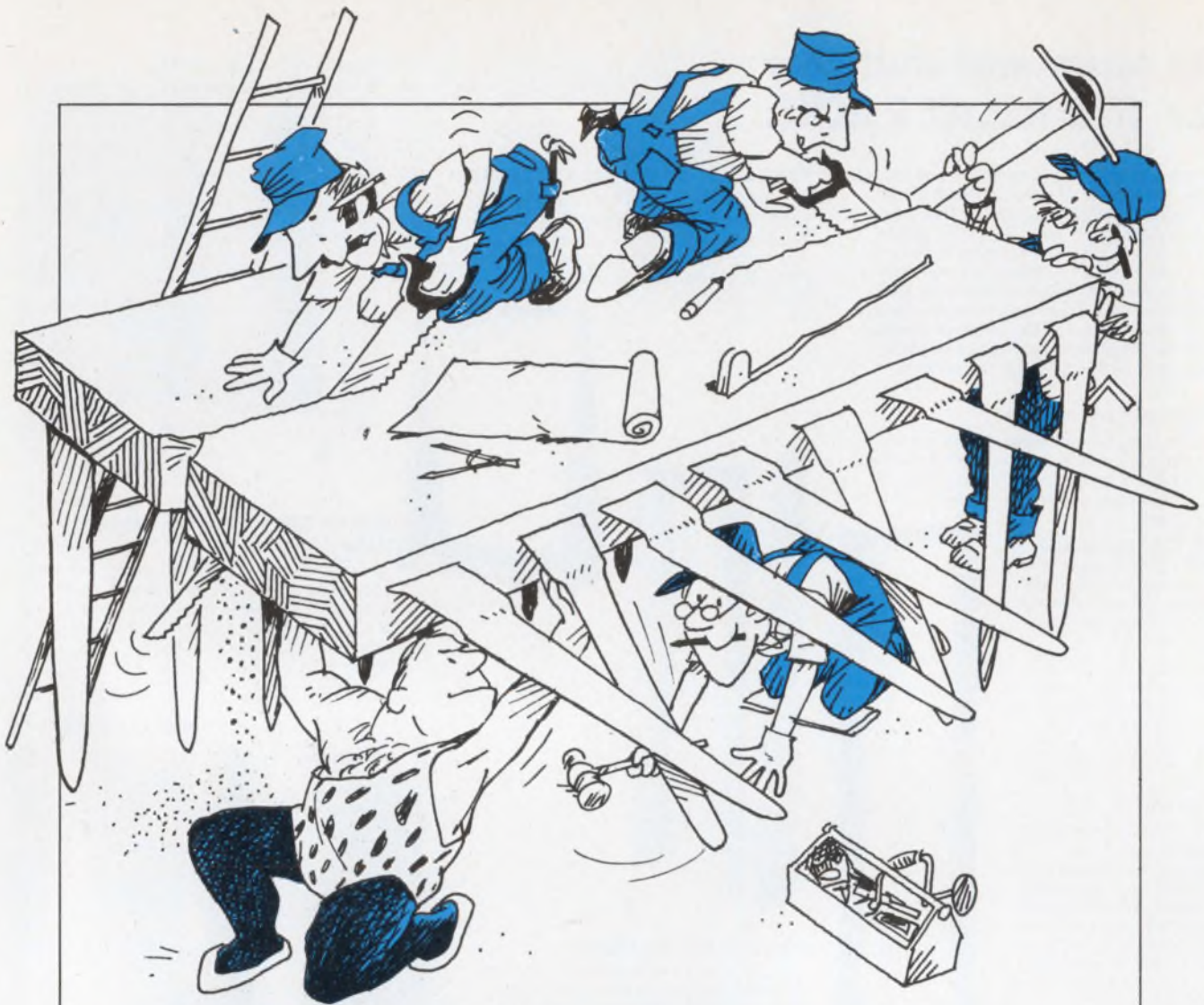

Our DIP crew makes great SIP resistor networks, too.

Leave it to our guys. They know you need a variety of space-stretchers to make your circuit-board packaging easier. And that's why these DIP experts also make Beckman RESNET™ standard SIP networks in 28 popular varieties.

These thick-film, cermet SIPs (.780" wide, .350" high, .090" thick) are standard 8-pin types, dimensionally uniform and ideal for automatic insertion techniques. Laser-tailoring assures precise resistance values, and every part is 100% tested.

Two convenient networks (see schematics)

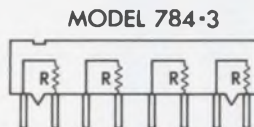

give you a 7-resistor model for applications like pull-up or pull-down networks, and a 4-resistor model for such typical uses as line termination and LED current limiting.

Resistance values available in both versions are 100, 150, 220, 330, 470, 680, 1K, 1.5K, 2.2K, 3.3K, 4.7K, 10K, 15K, and 22K.

And now for more good news. They're all stocked locally by your Beckman/Helipot distributor, ready for immediate delivery.

Cost? Truly competitive, actually giving you cermet quality at plastic prices.

Why wait? Let the new Beckman SIP line start making things a lot easier for you. For immediate literature or the phone number of your Beckman/Helipot representative, call toll-free (800) 437-4677. Right now.

Beckman®
HELIPOT DIVISION

A new digital phasemeter that's accurate to .05°?

.05° accuracy and .01° resolution
continuous precision measurement
from 0°–360.00°

no 0/360° ambiguity, right down
to readings as small as .01°

5 digit Sperry readout

accuracy unaffected by amplitude differences

frequency range 10Hz to 5MHz

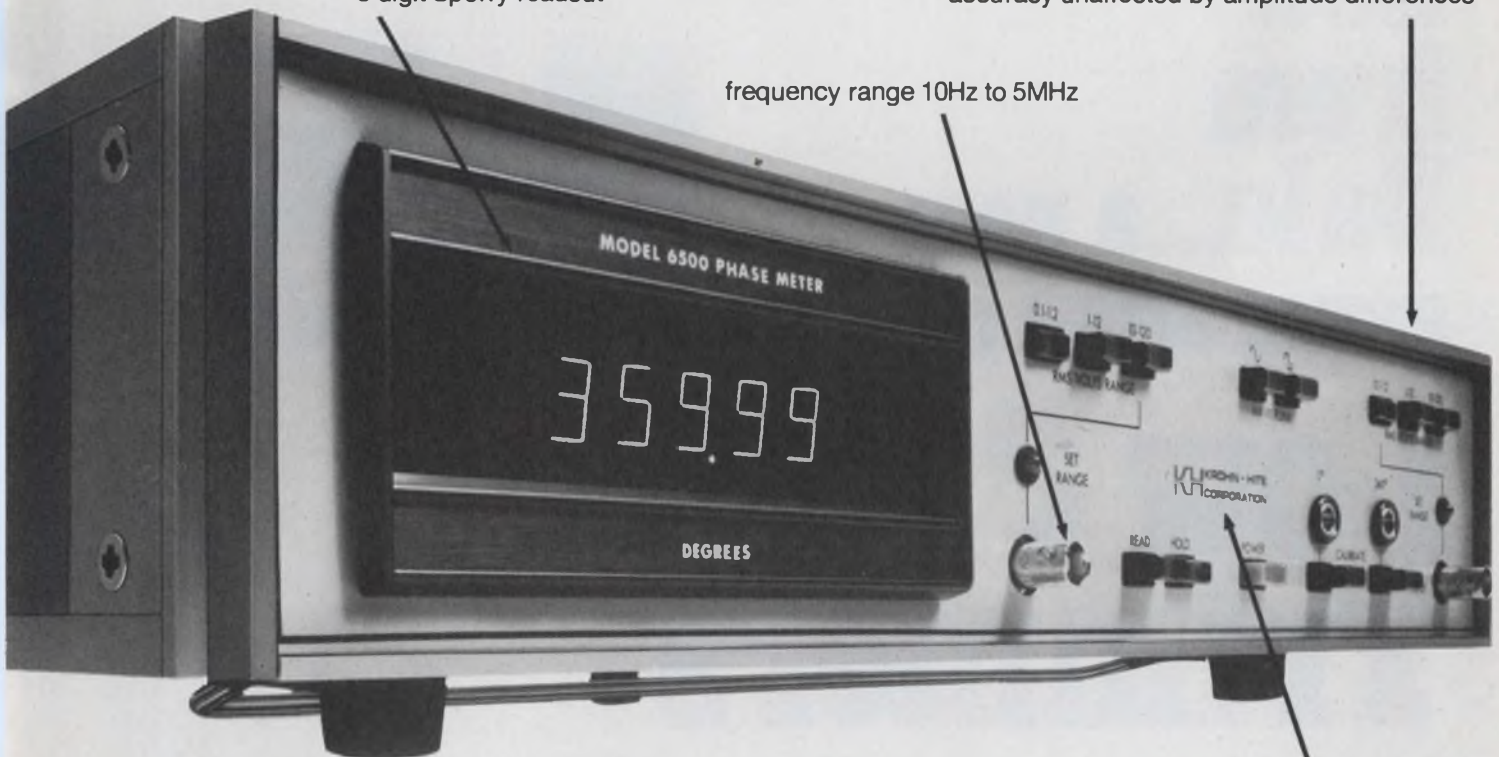

Precisely.

and the best performance
at the best price,
only \$1995.—

for immediate action call
(617) 491-3211, TWX 710
320 6583, or contact your
local KH representative,
listed below.

**KH KROHN-HITE
CORPORATION**

580 Massachusetts Avenue, Cambridge, Massachusetts 02139

SALES OFFICES: ALA, Huntsville (205) 534-9771; ARIZ, Scottsdale (602) 947-7841; CAL., San Jose (408) 292-3220, Inglewood (213) 674-6850; COLO., Denver (303) 934-5505; CONN., Glastonbury (203) 633-0777; FLA., Orlando (305) 894-4401; HAWAII, Honolulu (808) 941-1574; ILL., Des Plaines (312) 298-3600; IND., Indianapolis (317) 244-2456; MASS., Lexington (617) 861-8620; MICH., Detroit (313) 526-8800; MINN., Minneapolis (612) 884-4336; MO., St. Louis (314) 423-1234; N.C., Burlington (919) 227-3639; N.J., Haddonfield (609) 795-1700; N.M., Albuquerque (505) 299-7658; N.Y., E. Syracuse (315) 437-6666, Rochester (716) 328-2230, Vestal (607) 785-9947, Elmont (516) 488-2100; OHIO, Cleveland (216) 261-5440, Dayton (513) 426-5551; PA., Pittsburgh (412) 371-9449; TEX., Houston (713) 688-9971, Richardson (214) 231-2573; VA., Alexandria (703) 354-1222; WASH., Seattle (206) 624-9020; CANADA, Montreal, Quebec (514) 636-0525, Toronto, Ontario (416) 444-9111, Stittsville, Ontario (613) 836-4411, Vancouver, British Columbia (604) 688-2619.

Now from Dale...a new generation of Low Profile Trimmers

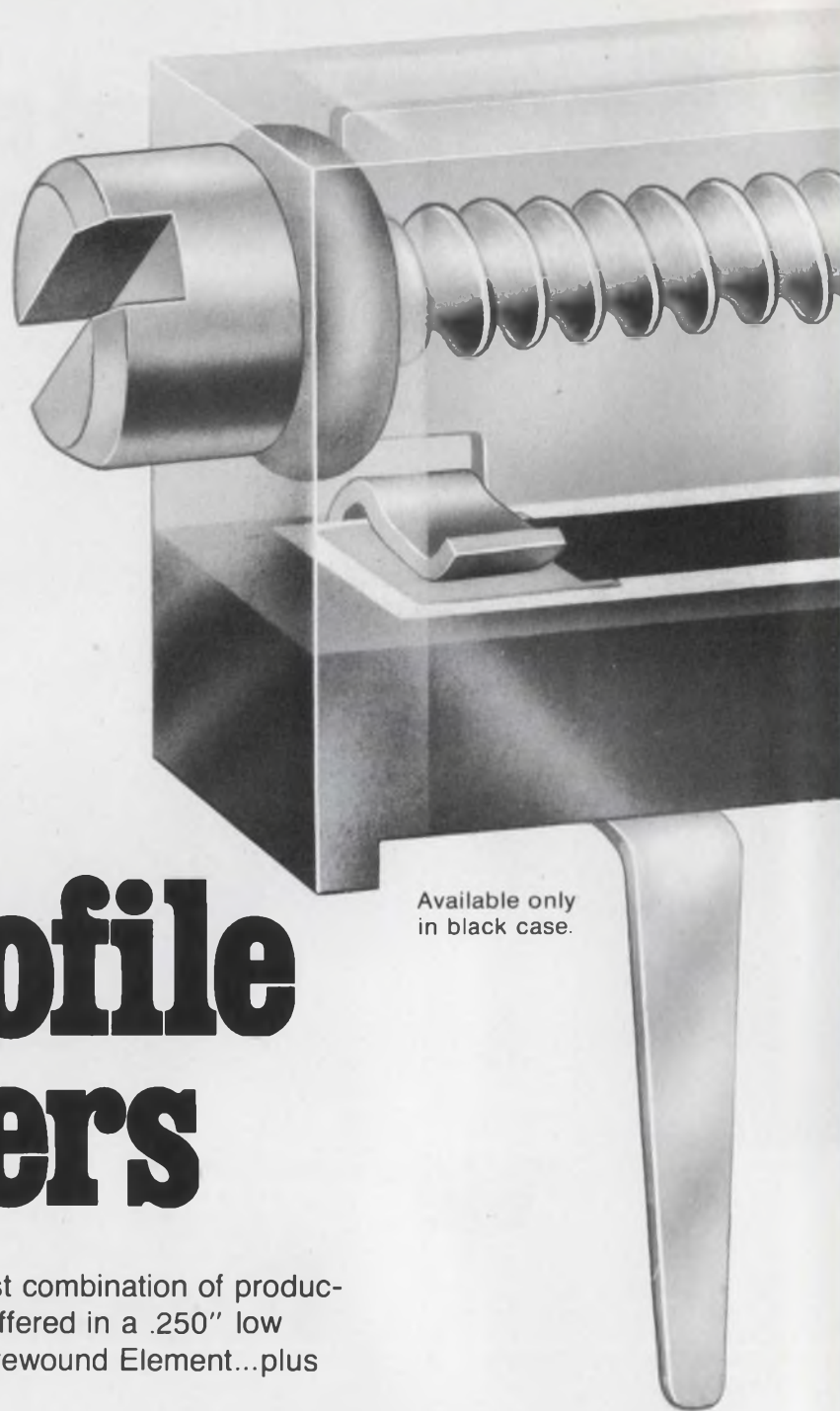

Dale's new 700 Series gives you the best combination of production and performance advantages ever offered in a .250" low profile package. Choice of Cermet or Wirewound Element...plus good delivery and low price.

Better Adjustability: Cermet models provide output resistance of $\pm 0.10\%$ and output voltage ratio of $\pm 0.05\%$.

Higher Power: All models offer 1 watt power dissipation at 70°C .

Low T.C.: 100 PPM for all cermet models, 50 PPM for wirewound.

Low Noise: Cermet models with 3% contact resistance variation standard (1% available). Wirewound models have equivalent noise resistance of 100 ohms max.

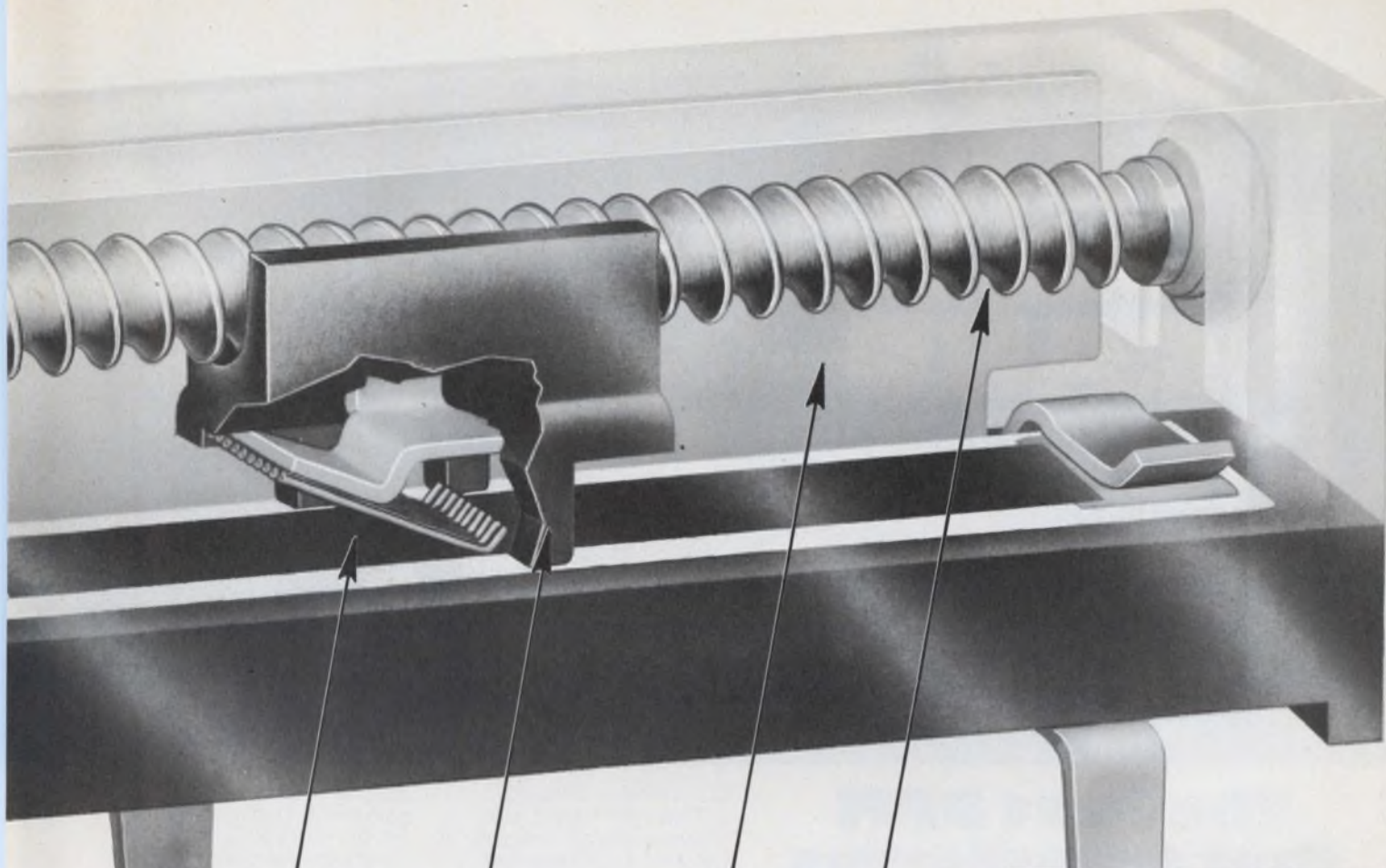

Largest Cermet Element

covers nearly entire substrate. Enhances setability and CRV. Provides 1 watt at 70°C.

Solid Wiper Block

with wire spring-finger contacts. Maintains optimum interface with resistance element. Provides low contact resistance variation and reduces backlash.

Patented Side Collector

provides excellent setting stability by allowing use of broader element.

All Metal Screw.

25-turn adjustment. One-piece clutch prevents overtravel damage.

Improved Package Density

3 standard pin spacings allow fast interchange with many larger models.

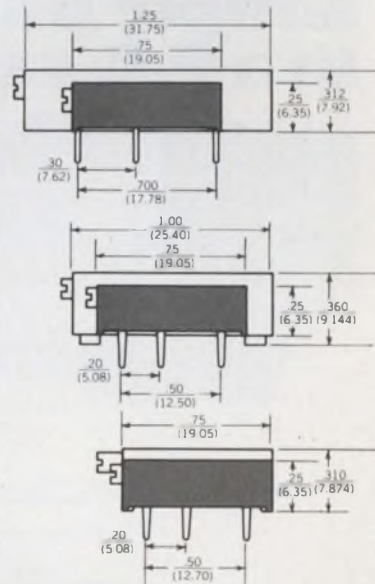

99 cents each in 1,000 quantity

Samples available. Write today on company

letterhead describing application...or call

402-564-3131



DALE ELECTRONICS, INC.
 1300 28th Avenue, Columbus, Nebr. 68601
 In Canada: Dale Electronics Canada Ltd.
 In Europe: Dale Electronics GmbH
 8 Munchen 60, Falkweg 51, West Germany
 A subsidiary of The Lionel Corporation

D-2 Our complete product line can be found in *Electronic Design's GOLD BOOK*.

INFORMATION RETRIEVAL NUMBER 17

ADD A CARD, ANY CARD

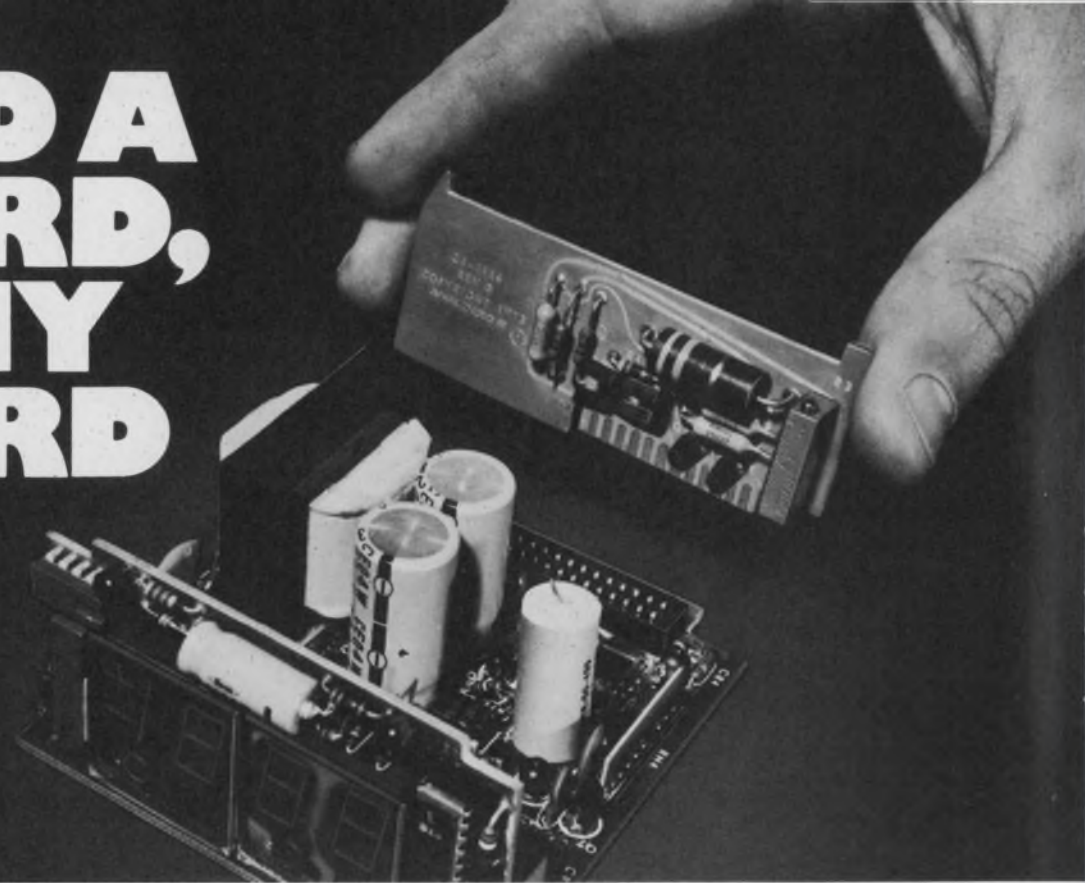

**The first DPM
that transforms
into your own
product by
simply plugging
in a P.C. card.**



AN2553/AN2533 DESIGN SPECIFICATIONS

ANALOG INPUT	
Configuration:	Bipolar balanced symmetrical differential inputs
Dynamic Input Impedance:	1000 megohms nom
Common Mode Rejection Ratio:	80 dB standard, up to 160 dB optional
ACCURACY/STABILITY	
Accuracy:	0.05% of reading ± 1 count
Range Tempco:	35 ppm of reading
CONVERSION TECHNIQUE	Dual-slope integration
DISPLAY	.55" 7 seg. Sperry or .5" L.E.D.
DIGITAL SIGNALS	
Logic Levels (all inputs and outputs):	External Blanking, Hold, Overload, Clock, Latch, Carry, EOC, Polarity
UNIVERSAL POWER INPUTS:	100, 117, 220, and 240 VAC
Operating Temperature:	RMS $\pm 10\%$ 49 to 63Hz @ 2W -10°C to +60°C
Dimensions:	DIN-STANDARD: 96mm bezel width, x 48mm bezel height; 95.4mm max depth

NOTE: Model AN2553 offers additional capabilities
\$89.00 Base Price AN2533 quantity 100

- Universally powered
- True differential inputs
- Low power consumption
- DIN Int'l Std. case size
- Surprisingly low cost
- Bright self-illuminating display
- High reliability

Build any required circuit on the uncommitted analog interface card we furnish. Then just plug it into the special powered signal interface connector in our AN2553 3½-digit DPM. It's that easy to incorporate the value-added options that make your product more profitable...or specify application requirements, and we'll build them in before shipment.

Either way, you can get interface and signal conditioning flexibility never available before—including linearized thermocouple cold-junction compensation, load cell transducer excitation, auto ranging, current shunts, active multiple filtering—virtually any functional add-on, in fact, that you need. And, because the circuit card fits right in the internationally accepted DIN standard package your system or instrument is simplified and much more economical and there's less to debug.

We've put in power and space for an optional digital circuit card, too. So you can

add isolated and buffered parallel BCD output, linearization, and set point control...go all the way and expand the basic DPM up to the subsystem level—at the lowest cost.

Don't need all the flexibility? Order the even more economical, general-purpose, basic AN2533. Fill *all* your 3½ digit DPM needs with the exceptionally high quality and reliability ensured by premium-components, worst-case design techniques, low parts count, and the cool-running generously derated operation that has made Analogic the number one supplier of OEM digital panel instrumentation in the whole world.

Write for more information: Analogic, Audubon Rd., Wakefield, Mass. 01880; phone (617) 246-0300.

Northeast, 617-235-2330, 203-966-2580,
315-466-0220, 201-652-7055,
212-947-0379

Mid Atlantic, 215-272-1444,
215-687-3535, 703-790-5666,
301-252-8494

Midwest, 314-895-4100, 913-362-0919,
216-267-0445, 513-434-7500,
313-892-2500, 412-892-2953,
312-283-0713, 414-786-6950,
317-844-0114

South, 713-785-0581, 214-620-1551,
305-894-4401, 919-227-3639,
205-534-9771, 305-773-3411,
813-867-7820

West, 303-744-3301, 505-523-0601,
602-946-4215, 505-292-1212,
714-540-7160, 415-398-2211,
206-762-7664, 503-643-5754

Canada, 613-836-4411, 604-688-2619,
416-499-5544, 514-636-0525,
902-434-3402

ANALOGIC

... The Digitizers



CENTRALAB

Electronics Division

GLOBE-UNION INC.

5757 NORTH GREEN BAY AVENUE
MILWAUKEE, WISCONSIN 53201

Centralab perspectives

FOR USERS OF ELECTRONIC COMPONENTS

To get the latest generation component, engineers are saying Selectashaft® before they say rotary switch.

Distributor assembly of this mechanically superior rotary switch gives them instant delivery on over 100,000 custom assemblies and eliminates secondary modification costs.

If you're specifying or buying rotary switches, your Centralab Selectashaft Distributor would like to let you compare this totally new switch with any old style switch. One sample is all you'll need to see how it can meet custom specifications yet save from 3% to 17% on total cost, depending on switch type and quantity.

Selectashaft is the first name for rotary switch. Electrically equivalent to our famous PA-Series switches, it's the latest generation component. Mechanically superior to any old style rotary, it gives you adjustable torque, better feel and longer life. It uses a new dual ball, side-thrust index, and incorporates an adjustable stop ring instead of the old style stop tabs. There are no modification problems — no bare metal to rust or corrode, no scrap, no loss of warranty and no secondary modification cost. You get everything you need — exact shaft length, end detail and shaft flat angle without modification. And, when you consider the cost savings, the reasons to say Selectashaft — before you say rotary switch — are clear. Ask for a sample and see.



THIS CATALOG, available from your Distributor, gives complete specs, dimensional drawings, circuit diagrams and easy ordering instructions. Ask for it. You'll find the answers to your design and delivery problems.

THE SELECTASHAFT SYSTEM consists of preassembled standard rotary switches and a series of individual exact shafts. Factory trained Distributors, using specially designed equipment, assemble these parts to meet custom requirements. You choose from three shaft styles — .250" plain round, .218" and .156" flat. There are 24 shaft lengths, .687" to 2.375" and 24 shaft flat angles in 15° increments. You select from 92 subminiature and miniature switches — 1", 1.325" and 1.500" diameters; diallyl phthalate, phenolic or ceramic sections. You have your choice of knobs, dial plates, index assemblies and hardware. You get the design freedom of over 100,000 possible custom switch combinations.

ASK FOR SELECTASHAFT ROTARY SWITCHES AT THESE CENTRALAB DISTRIBUTORS:

CALIFORNIA

Abacus Electronics
Mountain View 94040
415/961-1500

Elmar Electronics Inc.
Mountain View 94041
415/961-3611

Kieruff Electronics Inc.
Los Angeles 90022
213/685-5511

COLORADO

Acacia Sales, Inc.
Lakewood 80215
303/232-2882

FLORIDA

Electronic Equipment Co.
Miami 33142
305/871-3500

Hammond Electronics
Orlando 32802
305/241-6601

INDIANA

Radio Distributing Co., Inc.
South Bend 46624
219/287-2911

Ra-Dis-Co, Inc.
Indianapolis 46202
317/637-5571

KANSAS

Radio Supply Co., Inc.
Wichita 67211
316/267-5214

MASSACHUSETTS

Wilshire Electronics/N.E.
Cambridge 02138
617/491-3300

MICHIGAN

RS Electronics
Detroit 48227
313/491-1012

MINNESOTA

Gopher Electronics Co.
St. Paul 55113
612/645-0241

NEW YORK

Peerless Radio Corp.
Lynbrook, L.I. 11563
516/593-2121

Summit Distributors
Buffalo 14202
716/884-3450

NORTH CAROLINA

Kirkman Electronics
Winston-Salem 27108
919/724-0541

OHIO

Esco, Incorporated
Dayton 45403
513/226-1133

Pioneer-Standard Electronics
Cleveland 44105
216/587-3600

Stotts-Friedman Company
Dayton 45402
513/224-1111

PENNSYLVANIA

Cameradio Electronics
Pittsburgh 15222
412/288-2600

Herbach & Rademan, Inc.
Philadelphia 19134
215/426-1700

Philadelphia Electronics Inc.
Philadelphia 19107
215/568-7444

TEXAS

Harrison Equipment Inc.
Houston 77004
713/224-9131

Texas Instruments Supply
Dallas 75235
214/238-6811

Southwest Electronics Inc.
Stafford 77477
713/494-6021

WASHINGTON

Almac/Stroum Electronics
Seattle 98108
206/763-2300

Acre's'n Acres of Clover Caps



Radial leaded monolithic ceramic epoxy coated capacitors designed for maximum performance . . . at low cost

Blue Ribbon Quality



Expanded production lines rush even the largest orders through — without losing any of the award winning quality that has given Varadyne top production honors in the capacitor field.



We Deliver Lickety-Split!

You name the date and you'll get off-the-line delivery — as we promise it — when we promise it. And we cut standard part delivery time to an absolute minimum through our network of 13 nationwide distributors.

Clover Caps

Rugged capacitors . . . Mass produced by our proprietary manufacturing process and completely sealed in epoxy.

Harvest time at Varadyne! Plenty of varieties to please even the most finicky engineer. Prices that will appease the toughest purchasing agent's craving for savings. Millions, stamped "Grade A" by Varadyne Quality Control inspectors, in stock, now!

Capacitances range from 2.2 pF to 4.7 mFd and meet applicable requirements of MIL-C-11015.

Available in 50 and 100 volt configurations in three ceramic formulations: Type BN (Ultra Stable NPO); Type BR (Stable 15% TC); Type GM (General Purpose X5V-Z5U).

In six sizes, ranging from the smallest capacitor, measuring only .100 x .100 x .100 to the largest, .500 x .500 x .200 in size. Solder coated, copper clad steel leads. 1.25" min. length.

Complete electrical and physical interchangeability with all other radial leaded monolithic coated capacitors.

Harvest our Literature

Gather sheaves of technical data describing our radial leaded Clover Caps, axial leaded G-2 Caps, and a passel of other chip capacitors and resistors.

Tell us your special requirements and we'll send you applications information and evaluation samples of our products that will meet your needs. Just write Varadyne Industries, Inc., 1547 18th St., Santa Monica, Calif. 90404, or phone: (213) 829-2984



Get Lucky! Free 4-Leaf Clovers

An honest-to-gosh 4-leaf clover, preserved in a plastic thing-a-ma-bob that sticks to your telephone base. Keeps a genuine dialer knob topped pen within easy grabbin'. Sent to qualified engineers who ask for it — long as we got a supply!



We're on the move!

VARADYNE

Varadyne Industries, Inc.
1547 18th St., Santa Monica, California 90404
Phone: (213) 829-2991 • TWX (910) 343-6856

INFORMATION RETRIEVAL NUMBER 20

Clues to next IBM computer point to major advances

A picture of IBM's next major computer system has, according to IBM watchers, been pieced together from two sources: information revealed in Telex Corp.'s antitrust suit against the computer giant and evaluation of IBM's own announcements over the last three years.

The IBM system that will follow the 370 will have substantial changes and will include the following features, it is believed:

- A distributed architecture.
- Multiple processors.
- A hierarchal memory system.
- A virtual system throughout.
- A very broadband data bus, with possible use of fiber optics for the bus.
- Bubble memories or charge-coupled devices as backing stores for the main memory.
- Advanced silicon technology in the form of substantially higher-density chips using merged transistor logic (MTL)—a low-cost bipolar concept—and integrated injection logic (I²L)—a new approach to LSI.
- Substantially higher levels of redundancy and diagnostics.

Distributed architecture

"We see, in the follow-on system to System 370, a distributed architecture," says Lee H. Walther, director of the computer equipment group at Quantum Science Corp., Palo Alto, CA. "The new system will have a very wide-band I/O bus, which will be the primary element within the system. Essentially everything in the system is connected to this, including a number of different processors.

"One processor would be the instruction processor, with its own memory of 256-k bytes. The memory would be extremely fast and use either bipolar or I²L technology. These instruction processors would

be microprogrammable in order to execute higher-level languages.

"Another class of processor is called the file processor, which will be the primary means for staging of data in another feature—the hierarchal memory system."

The file processor would contain a 5-MHz, 256-k byte buffer, probably using 4-k chips, Walther says. Attached to the file unit will be a bubble memory with a capacity of five million bytes, block-addressable in 256-k bytes, Walther believes. Access time, he says, will be between 300 and 600 μ s.

The next staging device in the hierarchal memory system is code-named the Apollo disc, Walther reports. It would store one million bytes of data, with an access time of between 10 and 20 ms. And the final stage in the hierarchy is expected to be the IBM 3850 mass-storage system, which can retain 472 million bytes with access time from 2 to 8 sec.

Walther sees the main system memory as a very large, principally MOS store, block-addressable in 256-k-byte blocks. It would use from 32 to 64-k chips.

The main memory, Walther says, will be the final staging position for data and program storage prior to the passage of a block to several individual processors that are part of the system.

The operating system is expected to be resident in a master-control processor. Other system processors, according to Walther, include a 370 emulator, a sensor processor to handle the conversion and processing of analog signals to digital form, and a communications processor.

User maintenance seen

A. G. W. Biddle, executive director of the Computer Industry Association, Encino, CA, sees the

future IBM systems as containing distributive computing on a network style, using multiple parallel processors.

"It will probably be designed to be relatively easy to add increments of memory or computing capacity on a customer's site," Biddle says.

"A significant portion of computer maintenance will be shifted to the user. IBM will probably link the user to a sophisticated diagnostic system operated from one of IBM's facilities."

The user, in effect, will be able to dial into the center, Biddle says.

IBM's announcements of overall architecture and software have defined its next systems, says Frederick G. Withington, senior staff member at Arthur D. Little, Cambridge, MA.

IBM's recent announcement of the 3850 file-storage system revealed a self-contained file subsystem with virtual file management, plus the software to make it possible, Withington points out.

"This subsystem is a part of IBM's future system, either exactly as is or with some new hardware," he asserts.

An IBM announcement on "systems network architecture," relating to communications and terminals, revealed a complete subsystem of software and machinery from the software section of the central computer out through the controller and its software, the line disciplines and some of the terminals. Withington notes that IBM promises that if the network architecture is adopted for communications by a customer, it will remain essentially unchanged down through the next line of computers.

32-k words squeezed into one core memory

A look at the first memory to pack 32-k words of core into a single module should remove any doubt about the vitality of core memories.

Developed by Modular Computer Systems (Modcomp), Ft. Lauderdale, FL, and unwrapped at the recent Instrument Society of America show in New York, the new memory not only cuts space by a factor of 2, according to its de-

signer; it reduces the cost of mini-computers by 18 to 27% and offers potentially greater reliability.

The designer, Thomas Hughes, notes that until now, 16 k was the largest-core memory available on one board. But Modcomp saved real estate and boosted density by developing a double-sided planar stack and using a single X-Y drive and a unique dual-inhibit scheme for the sense windings.

With 32-k words on one board, the number of interconnections are cut, and auxiliary electronics are reduced substantially. For example, only 28 X-Y drivers are needed, compared with 80 for two 16-k boards. Thus, says Hughes, money is saved and the reduction in components and connections increases inherent reliability by a factor of 2.

The benefits of the new memory are realized in six new Modcomp minicomputer systems that have been built around the module and in a software package called Maxnet, which enables computers to be linked in distributed networks.

CIRCLE NO. 318

A White House office of science backed

A raft of bills to reinstate a science and technology office in the White House have been introduced in Congress, and finally one has surfaced from committee and been approved by the Senate—S. 32.

In addition to offering a framework for coordination of the nation's research and development activities, the measure would authorize the creation of a three member council of advisers by the President. The advisers would be full-time.

Four-in-one calculator has pROM modules

A "design-it-yourself" scientific calculator comes with four plug-in pROM modules. By inserting a module in a receptacle at the bottom of the machine, the user can convert the calculator into an electrical engineering tool. Remove it and replace it with another module, and the machine becomes a surveyor's slide rule.

The calculator, the PC-1002, was

introduced recently by Sharp Electronics Corp., Paramus, N.J. The pROM module incorporates a 256-bit custom-designed chip from National Semiconductor whose program is controlled by four extra-function calculator keys. When installed, the pROM becomes part of the calculator's hard-wired system. With different modules, the functions of the special keys are changed, converting the calculator to any user-specified application.

Sharp says it will design and manufacture special pROM modules to order. Standard chips are now available for four applications: statistics, mathematics, metric conversion and surveying. Currently in preparation are additional applications covering structural and electrical engineering and machine design.

Apart from the pROM function, the PC-1002 can be keyboard-programmed up to 64 steps. The 15 functions provided by the calculator include trigonometric, inverse trigonometric, hyperbolic, exponential, factorial, logarithmic, power, azimuth and area calculations.

The three-pound PC-1002, which comes with one standard pROM module, sells for \$645. Each additional module costs \$75.

CIRCLE NO. 317

2 new RCA RAMs to use SOS/CMOS

RCA plans to introduce two 1024-bit static RAMs that employ silicon-on-sapphire (SOS), complementary-MOS (CMOS) technology as a low-power alternative to higher-speed bipolar memories.

According to Hank Miiller, director of MOS IC products in Somerville, NJ, the SOS/COSMOS (RCA's name for the ICs) memories will dissipate only 15 mW when operating at 1 MHz from a 10-V supply. Comparable bipolar memories can yield higher speeds, Miiller says, but they consume about 500 mW, or 30 times more than the SOS device.

The two new memories differ in organization. The first, which is to be offered next June, has a 1024 × 1-bit scheme, while the second—targeted for an August debut—has a 256 × 4-bit scheme. Both units have a typical access time of 125

ns when operated from 10-V supplies. Shorter access times will be offered with different output-structure options, Miiller says, and samples will be available early next year.

The new memories will also have pinout compatibility with some popular bipolar memories. The SOS/COSMOS RAMs will feature single-supply operation over a wide range, and they will permit simplified memory expansion through the use of chip-select lines, which won't have to be clocked.

An unusual feature of the ICs' fabrication is the use of silicon-gate techniques in addition to SOS. Both approaches reduce parasitics, and hence increase speed. However, with self-aligning silicon gate Miiller explains, the product has increased reliability and yield.

Flat-panel displays due in 1980 cockpits

Air Force requirements for instrumentation in the cockpits of 1980 aircraft call for a flat-panel multifunction display. Light-emitting-diode matrix displays are a leading contender.

The first such prototype display has been delivered to the Flight Dynamics laboratories at Wright-Patterson AFB, OH, by Litton Data Systems, Van Nuys, CA. It is 1/2 by 3/4 in. and contains a matrix of 32 × 48 diodes. According to the Air Force, the program goals are a 5 × 6-in. display, 200 ft-L brightness, low-power operation and maximum panel thickness of 2.5 in.

Current requirements also call for a single color (green) and digital addressing.

Litton's approach, according to Alvin L. Riggs, manager of display technology, is to build the display from 1 × 1-in. modules, placed side by side to create a display of any desired size. Each module has 64 × 64 diodes on it.

"We are currently using gallium-phosphide diodes from Monsanto in St. Louis," Riggs noted. "Each array is monolithic on a single substrate."

Addressing of the matrix is one column at a time in steps across the module. The scan rate is 400 Hz.



**Put it all together
with Buchanan
Printed Circuit Board
Connectors – and
eliminate 4 connection
points per circuit!**

Here's a new solderless printed circuit connector that eliminates hybrid interfaces between electrical and electronic circuitry. It replaces costly interwiring between terminal blocks, barrier blocks, and internal electronics... saves you up to 4 or more separate connection points per circuit!

With only a screwdriver and this new Buchanan one-piece connector, you can quickly connect solid or stranded wires, #12 through #30 AWG, to standard .200" contact-spaced printed circuit boards. The connector block is available for 12, 18, 24, 30 and 36 circuits; provides 300V insulation spacing between circuits; can carry up to 5 amperes per circuit; and is flame-retardant.

A unique right-angle design provides mounting flexibility and increased density, and the block can be mounted against any two adjacent panel sides if desired, since wire entry is all on one side. You can even "daisy chain" two or more conductors!

For complete engineering, pricing and ordering information, write us at Dept. ED-4.



**CONTROL PRODUCTS
DIVISION**

Amerace Corporation
Control Products Division
2330 Vauxhall Road

**Announcing
the 120-
nanosecond
1103 with
a 7-day
access time!**

We took the most popular 1K semiconductor RAM ever built and made it smaller and faster.

The result is the S1103-X. At 120 nanoseconds, it's the fastest member of the world's quickest 1103 family.

And it has another feature that's unique to our RAMs: guaranteed 7-day delivery! Within a week, you can start putting more speed into your systems.

Guaranteed quantity, too!

Our production lines in Santa Clara and Pocatello are turning out 1103 circuits so fast that we can ship any number you need. This year, we have already produced millions of them.

And our whole 1103 RAM family has several unique characteristics that are worth remembering.

If your system has trouble with pattern sensitivity like the Bodio effect, our circuit will eliminate it. It automatically solves t_{CW} problems, too, which gives you more flexibility in systems design.

And having the largest and most experienced RAM testing capacity in the industry, we cut down your incoming test problems.

Our spectacular specs!

In addition to the super-fast S1103-X, there are three RAMs in this AMI line—the S1103, S146 and S1103-1. The difference between them is speed. They

have access times of 300/205/150 ns respectively and fast cycle times of 580/390/360 ns.

Other memorable features of our 1103 family are:

- Full internal decoding
- Or tie capability
- Chip enable for low power distribution
- Simple memory expansion
- Input protection against static charge
- 2 msec refresh period
- 18 pin plastic or ceramic dual-in-line package

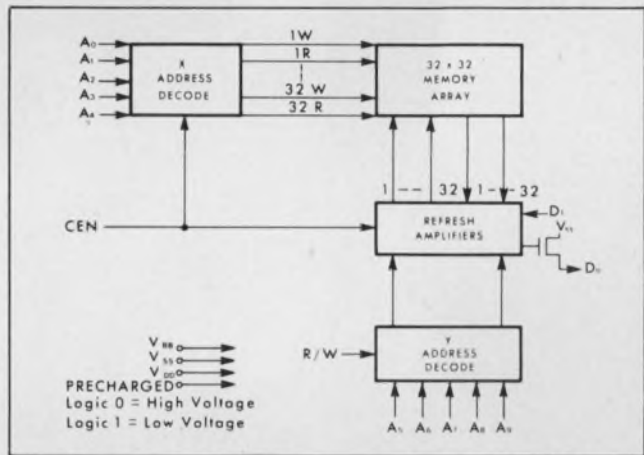

S1103-X Block Diagram

Call now for immediate delivery!

For fastest possible access to our 1103 RAMs, call or write Frank Rittiman, AMI, 3800 Homestead Road, Santa Clara, CA 95051. Phone (408) 255-3651. Or get your distributor to truck some over. He's got all you can handle.

More good news from AMI

AMERICAN MICROSYSTEMS, INC.

a great new way to "pick" CHERRYS



**this new 72-page
Cherry Products Handbook is actually
five catalogs in one.**

Packed in a unique new "tell-all" format is everything you could possibly want to know about Cherry's: 1. Unique Snap Switch Selector-Locator that lets you choose—in seconds!—the right switch for any application. 2. Thumbwheel and Leverwheel Switches in nine basic series available in hundreds of variations and specials. 3. Keyboards . . . Keyboard Switches . . . and unique new Matrix Keyboards. 4. Matrix Selector Switches for rapid circuit selection and programming. 5. Gold "Crosspoint" Contact Switches for low energy circuits.

... and it's yours for the asking: Just TWX 910-235-1572...

... or PHONE 312-689-7702 and ask for Frank

CHERRY

CHERRY ELECTRICAL PRODUCTS CORP.
3600 Sunset Ave., Waukegan, Ill. 60085



Cherry affiliates worldwide • Hirose Cherry Precision Co., Ltd., Tokyo • G. W. Engineering Pty. Ltd., Sydney
Cherry Electrical Products (U.K.) Ltd., St. Albans, Herts • Cherry Mikroschalter GmbH, Bayreuth, Germany

washington report

A bigger EIA sees defense spending rising

The electronic industry will have a stronger voice by the turn of the year when the Association of Electronic Manufacturers merges into the Electronic Industries Association. The signing ceremony took place at the final convention of the AEM in Miami, and the merger becomes effective Jan. 1. At that time the approximately 100 company members of AEM automatically become members of the EIA.

At the EIA's recent 50th annual meeting, members were advised that total Dept. of Defense spending would increase 33% between 1975 and 1980 to total approximately \$16.7-billion. The largest gains, the EIA predicted, will go to ships and operations and management areas. Inflation is expected to account for approximately \$4-billion of the increase.

Electronic markets for Federal agencies involved in civilian affairs, such as the Dept. of Health, Education and Welfare, the Federal Aviation Administration and the Environmental Protection Agency, will increase by 88% between 1975 and 1980, the EIA forecasts.

Proposal would help military attract engineers

An assist proposed for the All-Volunteer Armed Forces could swell the ranks of engineers and scientists by opening up educational opportunities for young people.

Sen. W. E. Brock (R.-T.N.) has introduced a bill to create a Reserve Enlisted Training Corps. It would set up technical academies in the armed forces that would be essentially two-year junior colleges. Students would be able to study electronics, aviation mechanics, space sciences, nuclear energy and other fields. Graduates would serve four years in the armed forces. As a further incentive towards training more degreed engineers and scientists, the bill would provide a scholarship service similar to that now used to obtain personnel for health services.

Air Force to scrutinize its avionics

The Air Force can be expected to look even more closely at the avionics it buys, for the simple reason that's where it is increasingly putting its shrinking money. The Secretary of the Air Force, John L. McLucas, says that recent studies have shown that 30% of a new aircraft's procurement cost can be attributed to its electronics configuration. Over \$3-billion annually is now devoted to development, procurement and maintenance

of electronic systems for aircraft, missile and space applications.

For decades, military applications have been the driving force for industrial technology in many areas, but the Secretary notes that the civilian world is going increasingly electronic. As an indication of the impact of the consumer market, he points out that the Federal Government's share of the electronics market has dropped from two-thirds in 1960 to one-third this year.

Avionics now represent 4% of the total market, and the Air Force is revising its development and procurement strategies. Along with the quest for performance, the USAF will emphasize reliability. Electronic systems have become more costly, the Secretary notes, but there hasn't been an equivalent increase in reliability. Although component reliability has increased, over-all reliability hasn't, largely because of greater system complexity.

When is a grant really a contract?

Federal financial finagling is under fire. The Senate recently passed a bill designed to discipline and control the way Federal agencies spend about \$100-billion annually through direct contracts, grants and grant-in-aids. At issue are practices under which the agencies, faced with deadlines for spending budgeted funds before a fiscal year expires, may award grants to manufacturers instead of obligating them under contracts. Sponsored by Sen. Lawton Chiles (D-FL) the legislation aims at eliminating such abusive practices by setting up standards under which a contract, a grant or grant-in-aid agreement could be employed.

Senator Chiles says: "Federal agencies admit that they arbitrarily swap contracts for grants to beat the system, to avoid the requirements of law placed on contracts and to get rid of their budgeted funds before the fiscal year runs out. There are good and valid reasons for using both contracts and grants, but we are long past due ending the purposeful misuse of these procedures and the waste of funds that has resulted."

Capital Capsules: The Air Force, which has set new standards for electronic connectors and multiplex busses, is now focusing on standardization of microcircuits. With the Navy, the USAF is working on a Standard Electronic Module program, electronic building blocks, to simplify logistics and gain economies through volume buying. . . . NASA officials say that the communications requirements for the joint U.S.-Soviet space mission next year will include nine voice circuits and three teletypewriter circuits, with the ATS-6 satellite serving as the space link. . . . The Federal Communications Commission has turned the spotlight on manufacturers of electromagnetic-radiation sensors. Seems that in a recent check, the products of seven of 10 manufacturers didn't comply with the requirements in effect at the time they were certified. The FCC has issued an order to the seven to show cause why their authorization for the devices shouldn't be pulled. . . . The National Science Foundation is looking for firms or organizations to do solar photovoltaic energy research in two areas. One would be a broad evaluation of potential terrestrial applications, including selection of optimized systems having greatest potential; the second would be the design of an experimental state-of-the-art multikilowatt solar electric generator.

Time Interval Readout, a Digital Multimeter, and Your Choice of Oscilloscopes--- All in One Portable Instrument

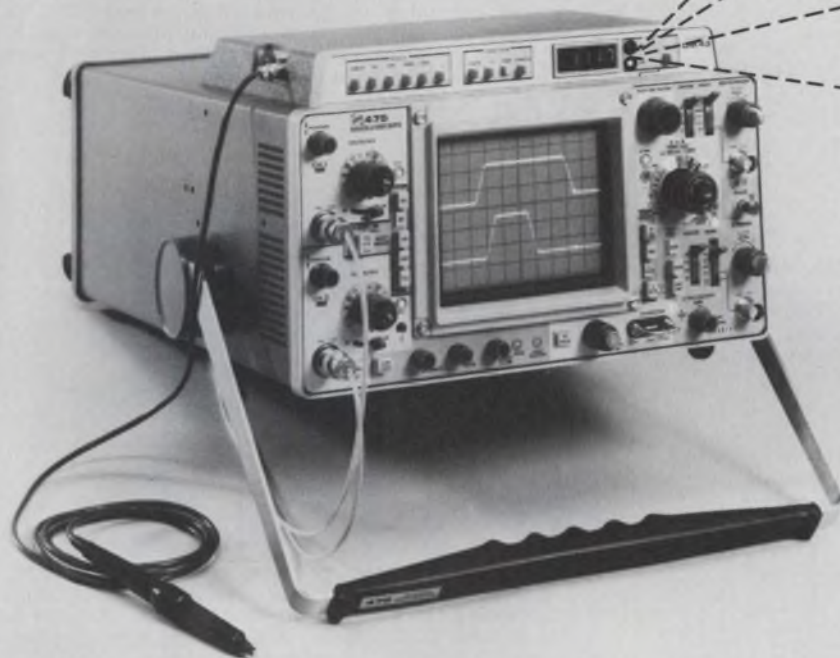

11.18

ms

Time Interval

067.8

Temperature

05.08

Voltage

17.37

Resistance

Complete Measurements

Direct digital readout of time intervals with improved resolution, 1% accuracy, increased freedom from error, and greater operator convenience. Dc voltage measurements with an accuracy of 0.1%. Resistance measurement with 0.75% accuracy. Temperature measurement from -55°C to $+150^{\circ}\text{C}$. A built-in DMM adds all of these capabilities to the Tektronix laboratory quality, dual channel, delayed sweep Portable Oscilloscopes.

Since the DMM operates independently of the oscilloscope, you can monitor temperatures or dc voltages while simultaneously displaying waveforms.

Price/Performance and Choice

You can select the optimum Portable Oscilloscope/DMM for your application from four high performance models. They all provide outstandingly cost-effective measurements in the laboratory, in production, and in the field.

100 MHz bandwidth, 5 mV/div vertical sensitivity, and a built-in DMM make the 465 DM43 a price/

performance leader at \$2470. The 475 DM43 extends these capabilities to 200 MHz at 2 mV/div for only \$3225. The unique 466 DM43 combines fast transfer storage to 100 MHz (1350 cm/ μs stored writing rate) and variable persistence storage with a built-in DMM in one rugged portable instrument for \$4555. If your application doesn't require the full 1350 cm/ μs stored writing rate, the 464 DM43 offers all other features of the 466 DM43 for only \$3925.

More For Your Money

Prices for all of these instruments are for complete functioning units including probes. And Tektronix extras such as precision dc voltage measurement, temperature measurement, resistance measurement, trigger view, and scale factor readout add still more value for your instrumentation dollar.

To find out more about these innovations in portable instrumentation, contact your local Tektronix Field Engineer or write: P.O. Box 500, Beaverton, Oregon 97077. In Europe write: Tektronix, Ltd., P.O. Box 36, St. Peter Port, Guernsey, C.I., U.K.



TEKTRONIX®

committed to
technical excellence

Dialight sees a need:

(Need: The widest choice for your every application.)

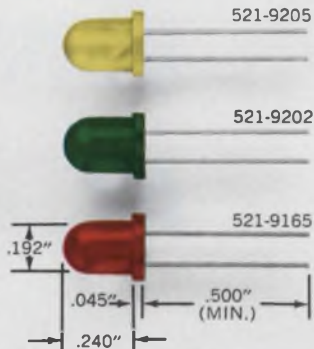

Now available in green, yellow and red. Mini-sized for maximum front panel density and easy panel mounting. High luminous intensity, low cost. Vibration/shock resistant. Solid state for long life. Wide viewing angles. Ideal for applications like panel lighting, film annotation and alpha-numeric displays.

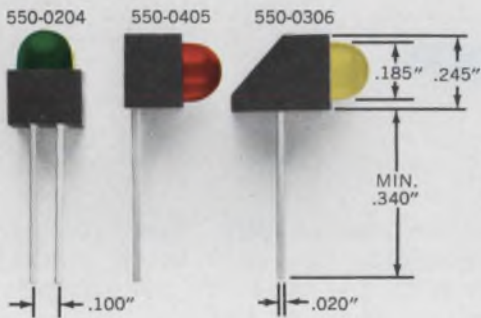

Mix 'em or match 'em. LED logic state fault indicators are available in red, yellow and green, in a variety of shapes, some with a built-in integral resistor. Can be driven from DTL and TTL logic. Designed for easy alignment on PC boards so that multiple functions can be displayed.

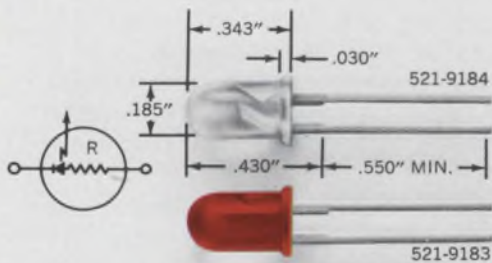

Available in red or clear LED packages with or without a built-in current limiting resistor. Red LED is also made without resistor. Suitable for circuit status indication, alpha-numeric displays and visual indicators. Features long wire-wrappable leads. IC compatible with solid state reliability. High luminous intensity, low power consumption, low cost.

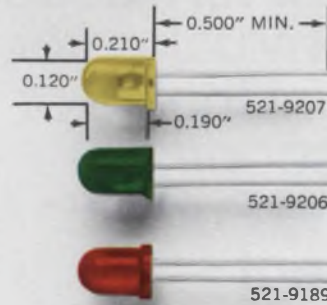

Your choice of green, yellow and red, with axial leads for dense packaging requirements. Wide viewing angle for easy readability. Low power consumption, low cost, IC compatible. 10mA operation for typical brightness. Size is identical to the most popular red LEDs.

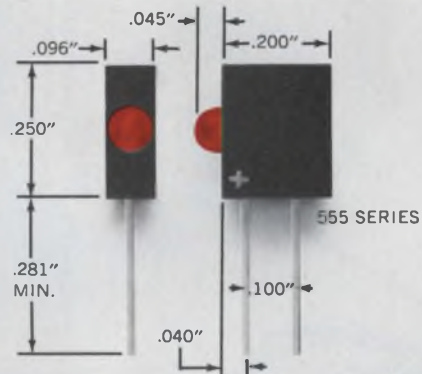

LED logic state fault indicators available in 14 models with voltage ratings from 1.7 to 14. Suitable for dense packaging on printed circuit boards—up to 10 units to the inch—IC compatible. With built-in series resistor. Polarity identified. Low power consumption.

Dialight, the company with the widest choice in switches, LEDs, indicator lights and readouts, looks for needs . . . your needs . . . and then they develop solutions for your every application. No other company offers you one-stop shopping in all these product areas. And no other company has more experience in the visual display field. Dialight helps you do more with these products than any other company in the business, because we are specialists that have done more with them. Talk to the specialists at Dialight first.

DIALIGHT
 Dialight, A North American Philips Company
 203 Harrison Place, Brooklyn, N. Y. 11237
 (212) 497-7600

You won't have to talk to anyone else.

See Dialight.

STABLE DIGITAL DISPLAYS-

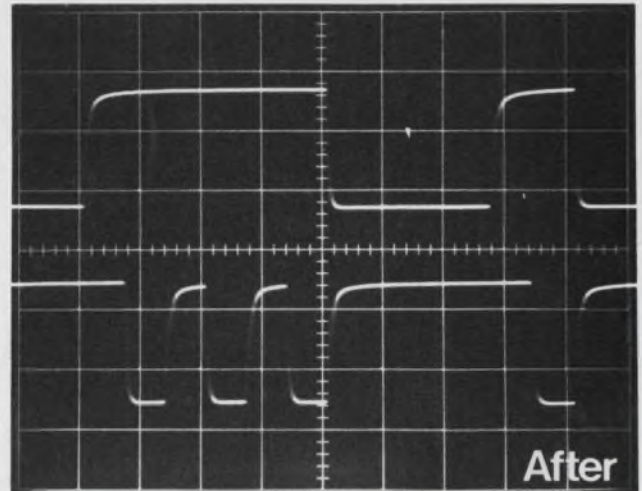
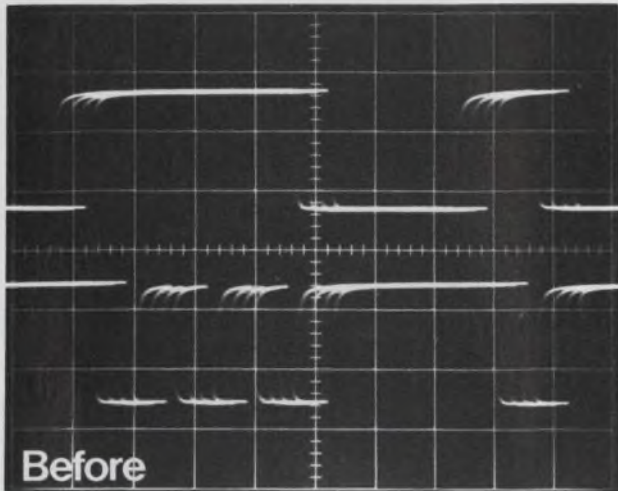

**TWO
EASY
WAYS**



Logic

Triggered Displays

Stable oscilloscope displays of asynchronous logic sequences are easily achieved with a trigger from the 821 Word Recognizer. And the 821 will work equally well with synchronous sequences that have no single unique sync point. As a trigger generator the 821 combines your choice of input logic signals to produce a single output pulse. Appearance of a specific op code in an instruction register, a predetermined count from a digital counter, or the occurrence of a special set of logic levels at your system inputs can all be used for jitter-free oscilloscope triggering.

And the versatile 821 serves as a logic "babysitter" to indicate whether a selected combination ever occurs, as an indicator of word presence or absence at strobe time, as a strobed four channel logic probe, and as a four channel logic level driver for troubleshooting static logic. All of these valuable logic diagnostic aids are offered in one pocket-sized unit for only \$200.

Delay By Events Trigger

Select and display any data segment in a disc, drum, or tape memory. Examine serial data transfers. Study serial transmission. Jitter-free, delayed oscilloscope triggers for all of these applications, and many more involving long pulse trains, are easily obtained with the TEKTRONIX DD 501 Digital Delay. By basing the delay on a count of input digital events rather than an analog time, the DD 501 eliminates jitter due to mechanical speed variations or other clock irregularities.

Easy thumbwheel selection of any delay count from 0 to 99,999 provides quick positioning of the desired data segment on the oscilloscope screen. Versatility has been assured by making the DD 501 compatible with all logic families. The DD 501 plug-in can be housed in any TM 500 Series Power Module. It is priced at only \$495 plus the Power Module (\$125 for the TM 501 shown above).

For more information on stable digital triggering the easy way contact your local Tektronix Field Engineer or write: P.O. Box 500, Beaverton, Oregon 97077. In Europe write: Tektronix, Ltd., P.O. Box 36, St. Peter Port, Guernsey, C.I., U.K.



TEKTRONIX®

committed to
technical excellence



**Commercial gold—
lowest price**

20 microinches of gold. Amphenol has a full line of 225 Series edgeboard connectors. Some manufacturers offer a similar connector with a 10 or 15 microinch gold flash at comparable prices. But if you need gold, make sure you get at least 20 microinches of gold plate. Amphenol's got it.

**Industrial gold—
medium price**

30 microinches of gold. More critical industrial applications may need a heavier gold plating on the contacts and a stronger dielectric material, like our industrial grade 225 Series connectors. Gold plated beryllium copper contacts and a glass fiber reinforced diallyl phthalate body make this the connector for all but your toughest jobs.

Strike gold

Amphenol has a printed board connector priced for your application. That's because we offer the same connector line with 20, 30 or 50 microinches of gold plating. Our 225 Series bellows contact edgeboard connectors let you design to the price level that best suits your needs.

Whether your application calls for a cost-saving commercial connector, or the very best connector money can buy, we've got you covered. From six to 100 contacts. In five different

contact configurations. Four mounting types. And seven tail styles for solder or wrapped terminations. Taper pin and Crimp Poke Home® terminations give you additional versatility where you need it.

Amphenol 225 Series connectors are available in more places than any other brand, too. Because Amphenol has the largest network of stocking distributors in the industry. There's one nearby waiting for your call. Delivery is now.



**Military gold—
premium**

50 microinches of gold. Your toughest jobs may require a connector qualified to MIL-C-21097 C/21—like our military grade 225 Series connector line. A full 50 microinch gold plating over beryllium copper contacts and our best dielectric means this connector will stand up to the most severe operating conditions. It's our best connector for your toughest jobs.

at your price.

Or strike bright tin/lead.

If economy is most important, find out about our bright tin/lead contact plating. Performance compares favorably with light gold, but the price is lower. Eliminating gold plating on your printed boards will cut costs even further.

Find all the options. Write or call for our 36-page catalog (PC-6). Amphenol Industrial Division, 1830 S. 54th Ave., Chicago, Ill. 60650—312/242-1000.



**BUNKER
RAMO**

AMPHENOL

INSTRUMENTS 74

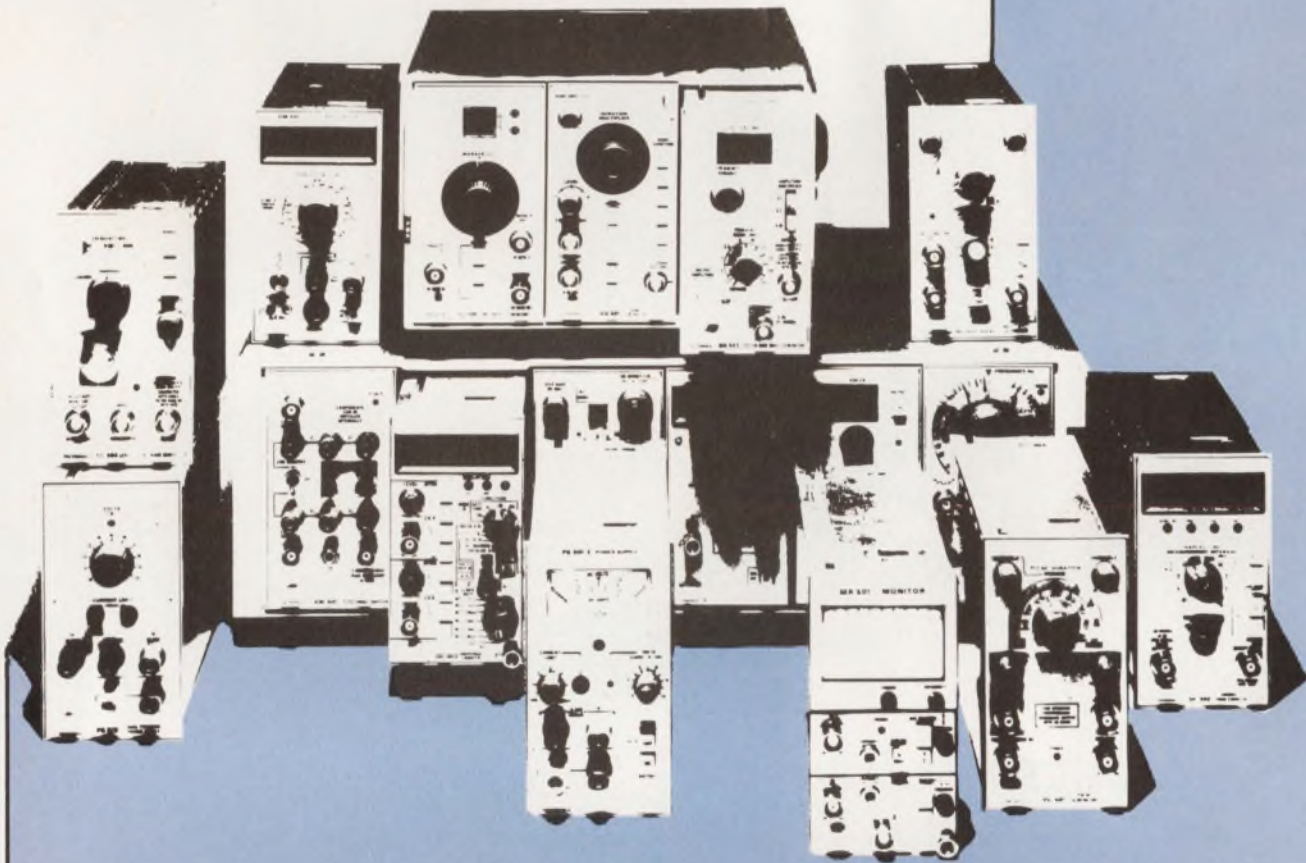

***Faster and smarter
measuring tools ease
the designer's load***

The single, most pervasive influence on instrument design and selection today is the increased use of digital IC technology. Although most front-end operations continue to be performed by traditional analog circuitry, the invasion of SSI, MSI and LSI devices are making possible classes of instruments that are orders of magnitude better in performance, smaller in size and smarter than their predecessors.

Such digital ICs as ROMs, microprocessors and PLAs are creating instruments with internal memory, numerical readout of key measurements and capability for real-time analysis. A whole new class of smart instruments has emerged that not only perform traditional measurement functions but that also store data, compute averages and provide summary results.

Among the new instruments that have been developed in the last year and a half are logic analyzers, pattern analyzers and word recognizers. These instruments are designed to do one job: to monitor and troubleshoot logic systems.

Another trend is the redesign of instruments that once were BCD (binary-coded-decimal) programmable to be ASCII (American Standard Code for Information Interchange) programmable. In fact, a new

worldwide standard is being devised to specify the protocol and define system criteria for hooking together programmable instruments and controllers, such as calculators, minicomputers and microprocessors.

But despite the digital onslaught, analog technology is very much alive. Analog ICs, including op amps and function generators, are going into medium-performance, low-cost instruments. Improvements in mixers and narrow-band crystal filters have sharply boosted wave and spectrum-analyzer performance.

And despite improvements in instrument performance, some problems remain—most notably in the packaging area. A serious difficulty here is panel clutter. In certain scopes the electrical and physical constraints of the circuitry conflict with human-factors principles. Some instrument manufacturers have tried to ease the sensory overload on the user—but only a relatively few. More human engineering studies are needed here.

Another problem is difficulty in servicing some instruments because of insufficient test points and failure to label parts.

For a fast, incisive look at how bench and laboratory instruments are changing—and what the changes mean to designers—turn the pages of this special report.

Contents

- 42 **Inside the instrument**—Performance soars as digital LSI moves to center stage.
- 56 **Instrument packaging**—A new problem rises to plague users: panel clutter.
- 64 **Instrument advances**—Troubleshooters for logic emerge as digital trend gains.
- 74 **Programmable instruments**—Look for changes in compatible equipment.
- 84 **Industry profile**—Today's mature designs, as seen by a young 'old-timer.'
- 90 **Pulse and word generators**—ICs demand new highs in instrument accuracy.
- 100 **Wave and spectrum analyzers**—Analyze signals as never before.
- 114 **Microwave instrumentation**—It's a new world of measurement at 1 GHz and higher.
- 124 **Industry profile: European**—Remember testing in 1844? Siemens Corp. can.
- 130 **Temperature-measurement**—It's a wide field, with some 'standards' challenged.
- 140 **Laboratory power supplies**—To find the new, turn the package inside-out.

INSIDE THE INSTRUMENT

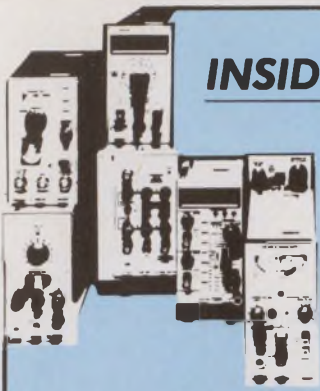

Performance soars as digital LSI moves to center stage

Solid-state technology—particularly digital bipolar and MOS medium and large-scale circuitry—is producing new and better instruments and doing it in a cost-effective way.

Functions that were historically performed with analog devices—such as test, measurement and signal generation—are now being done with digital techniques. And functions that were impossible to achieve with analog techniques, like the extended storage of waveforms, are now available.

Almost hidden by the focus on mass application of digital technology is the fact that a variety of MSI analog circuits—like op amps and function generators—are being produced. These devices are turning up in lower-cost instruments of moderate performance. For costly, high-precision instrumentation, high-quality discrete components are still the designer's choice.

The types and numbers of SSI, MSI and LSI circuits used in today's instruments vary widely. An instrument may comprise many MSI bipolar devices or a few LSI bipolar or MOS packages. While the choice of solid-state devices is strongly dependent upon instrument specifications as well as the number of instruments to be produced, ICs invariably are incorporated to achieve one or more of the following design tasks:

- Reducing cost.
 - Improving performance.
 - Making the instrument smarter.
 - Lowering component counter.
 - Reducing power consumption.
 - Improving reliability.
 - Shrinking package size.
- Cost, performance, and size are prime design



A microprocessor in this automatic capacitance bridge, by Boonton, eliminates the use of error-correction charts by calculating and compensating for instrument errors.

targets in the highly competitive digital-voltmeter, multimeter and panel-meter industry. Consequently the use of solid-state technology is widespread.

"Through the use of LSI in our line of measuring instruments," says John Watson, digital instrument product manager at Weston Instruments, Newark, NJ, "we obtain a reduction in cost as well as an improvement in performance.

"The second big influence on our class of instruments is the reduction in component density, which, again, simplifies manufacturing and gives you the benefit of improved quality and reliability.

"At present we have two Mostek digital LSI-MOS chips doing counting, decoding and all the control logic for analog-to-digital conversion in a 3-1/2-digit multimeter and in two digital panel

Jim McDermott
Eastern Editor

meters. By the end of next year we'll have a new generation of instruments similarly equipped."

With the downward trend of digital instrument prices, especially among the lower-cost instruments, John Kong, chief engineer of digital products at Simpson Electric Co., Elgin, IL, says: "We cannot afford to have discrete components. To cut down the piece-part count, to achieve compact size and to get better reliability—especially in the panel-mount instruments—we're using a standard set of two PMOS LSI chips: an analog and a digital device. But we're also working on a custom LSI chip that will have added functions, such as autoranging. And a reduction in power of our portable equipment is a No. 1 target."

Robert Boole, director of modular instruments at Analog Devices, Norwood, MA, agrees with Kong. He notes: "The major trend occurring at the moment is the adoption of LSI chips in place of T²L MSI packages to make panel meters even smaller or to make meters of typical sizes perform more complex functions. Also, emphasis is on the use of CMOS LSI to reduce power dissipation."

Analog's latest DPM, the Model 2008, is a 4-1/2-digit unit that uses a CMOS device—a single chip that performs the same a/d functions as 20 or 30 TTL chips—to keep heat rise to a minimum. Over-all component count is reduced by more than 30%, Boole points out, and the unit uses only 4 W.

Instrument manufacturers are going to employ more and more MOS LSI, predicts Richard Van Saun, engineering manager for John Fluke Mfg. Co., Seattle. This exploitation of CMOS, PMOS, NMOS—and "probably QMOS and ZMOS in the future"—Van Saun points out, is riding the coattails of semiconductor memories, watch chips and calculator ICs.

To date, the digital multimeter that consumes the least power—less than 1 mW, including the display—is the Dana Laboratories Danameter 2000. The meter can operate from as low as 6 V and it can run off a standard 9-V transistor battery for a year.

While the display is field-effect liquid crystal using less than 1 μ W, a major contribution to meeting the low-power design target is in the use of two custom chips—one a CMOS, the other low power bipolar.

"This is the only instrument that has all the active circuitry in MSI," says John Crosby, development manager at Dana Laboratories, Irvine, CA. "Looking at the PC board, there are only the two packages—no transistors or other active components of any type.

"The bipolar chip, which requires less than 100 μ W, performs the a-to-d conversion, as well as signal conditioning, such as ohms-to-dc and ac-to-dc conversions.

"The CMOS chip is high-density, low-threshold [1 to 2 V] design that does the counting and decoding and provides the control logic."



A digital processing oscilloscope and a programmable calculator, by Tektronix, talk to each other a

microprocessor interface. Here, dimensional tolerances and hardness of parts are being evaluated.

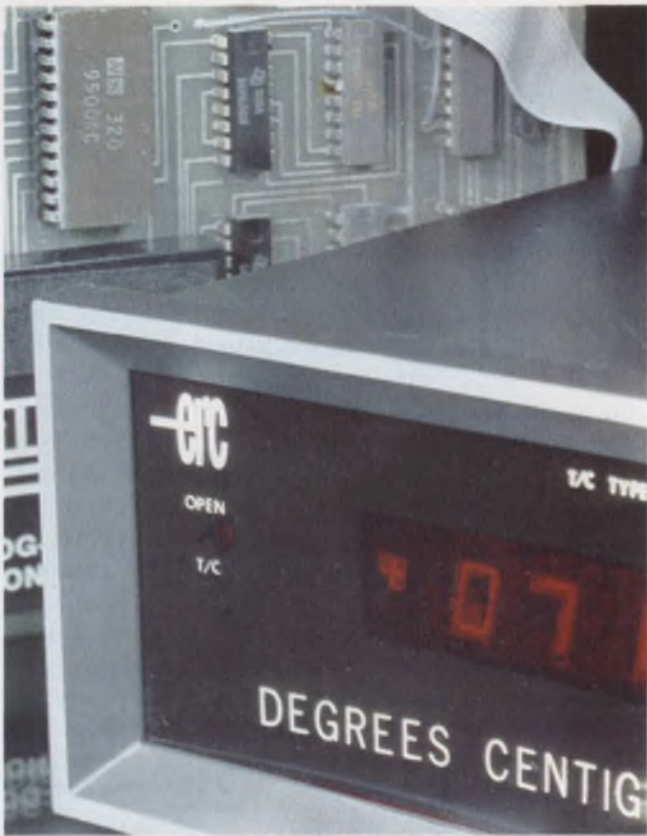

A ROM in this thermocouple indicator, by Electronic Research, stores factory-programmed data that provide a 512-segment linearization of thermocouple outputs.

The CMOS chip uses about 800 μW . And the bipolar chip is an advance over previous designs, Crosby says. Each transistor functions at significantly less than 1 μA . Most transistor performance is degraded at those levels, Crosby points out.

As yet, no one has developed a single-chip digital panel voltmeter. But Don Kesner, manager of industrial systems engineering at Motorola Semiconductor, Phoenix, AZ, predicts they will appear in late '75 or early '76. And when they do, he says, the voltmeter market will be radically altered.

The single chip will simplify panel meters to the point where they will become just an assembly operation, he says. "Consequently this will spawn a group of garage operations, just as happened with calculators. Also, companies making panel meters for their own use will probably decide to produce them externally as well."

Kesner also sees the same generic single-chip device being used on counters as well. In counter chips, the main technology advance will be in increased CMOS density, he notes. The fairly slow three and four-decade counters presently used will be supplanted by faster and denser five and six-decade NMOS counters. And general-



A two-chip monolithic waveform generator is incorporated in the prototype instrument by Exar, at right. A single-chip device is used in the other instrument, produced in kit form by Electronic Kits and Components.

purpose n-channel ICs, like fairly fast shift registers, will become predominant, Kesner believes.

Instruments get smarter

Probably the most significant trend in instrument design is the incorporation of solid-state circuitry to make instruments smarter. The solid-state intelligence performs calculations upon the electrical quantities being processed by the instrument and then displays the answers. This relieves the operator of the need to use charts and error-correction tables.

Although calculator chips and even microprocessors are available for calculating functions, they are seldom used today in smart instruments, primarily because of their slow operating speeds. In many cases instrument designers have chosen to incorporate their own bipolar computational systems into the devices because of the superior performance of such circuitry.

An example of this is found in the UA-500 spectrum analyzer produced by Nicolet Scientific Corp., Northvale, NJ. The UA-500, which is used for real-time analysis of noise and vibration data in the 0.02-to-100-kHz operating range, is a real-time spectrum analyzer and averager. It has a digital MSI-TTL memory that provides a wide range of transient capture.

"An instrument should be easy to use," says Rheinhold Vogel, Nicolet's chief engineer. "In viewing the spectrum on an oscilloscope, it is rather difficult to evaluate both amplitude and frequency by counting centimeters and multiplying on a slide rule or a calculator. So what we've done is include an arithmetic unit within the instrument. This permits you to read out the amplitude and frequency of any spectrum line by means of a front-panel cursor control. The answer appears in a LED display."

Standard TTL logic was used, Vogel points out, because of its low cost and fast performance. Also, it has a compatible interface with the other

hard-wired MSI-TTL logic, adders, counters and parallel loaders in the machine.

Computing capability and intelligence is available today in instruments that cost several thousand dollars. But Watson at Weston Instruments feels that the next big step—to make lower-cost digital multimeters smart—will occur in the next 18 months. Special LSI chips that provide computational functions will increase the meter's intelligence, he predicts.

Examples of the added capability that Watson sees include calculation of dB and other ratios between two measured points.

The most recent development in smart instruments is the incorporation of microprocessors either within the instrument or as an interface between the instrument and remote intelligence. In the case of Tektronix, its WP1100 digital processing oscilloscope, which contains binary storage of waveform data in a 4096-by-10-bit core memory, converses with a programmable calculator that operates in binary-coded decimal format.

Tektronix uses an Intel 8008 to provide a microcomputer interface between the scope and the calculator. The calculator can perform all sorts of arithmetic manipulations on the stored waveforms, according to Tim O'Toole, marketing staff engineer.

"Waveforms and readout scale factors are stored in the scope core memory." O'Toole points out. The scope, which has a digitizer in it, has some 30 plug-ins, including those for voltage and current. With the plug-ins, both voltage and current waveforms can be digitized. The microcomputer interface permits the calculator to read into and write out of that core memory in any fashion.

Two key buttons on the face of the digital processing oscilloscope are STORE and HOLD. O'Toole explains. When the STORE button is pushed, the waveform on the scope screen is stored and continually updated. If the trace moves up or down or sideways, the waveform is digitized as it moves. But the instant the HOLD button is pushed, the image on the scope face is put into core memory and can then be accessed with the calculator.

Software allows the programmable calculator to access the waveforms and perform operations on them, such as multiplying voltage by current to obtain power. Or the entire waveform can be differentiated to get the energy spectrum.

The microprocessor was used for the interface, O'Toole says, because it would require an excessive amount of TTL or other circuitry to do the same task. Neither the room nor the power was available.

Among the more advanced instruments that have incorporated a microprocessor is Boonton

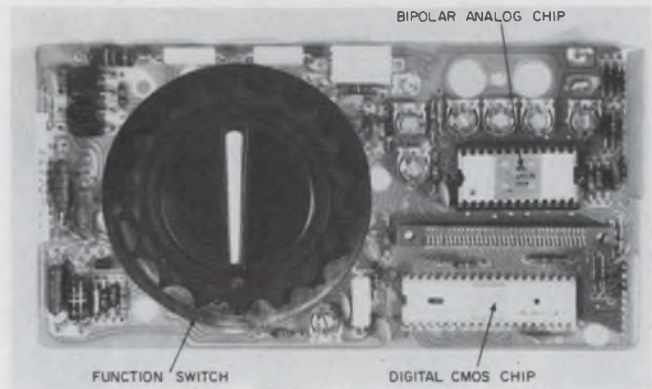

All active circuitry is incorporated in the bipolar analog and the digital CMOS packages of this Danameter 2000. A field-effect display is mounted over the CMOS device.

Electronic Corp.'s 76A automatic capacitance bridge.

"The main reason we used the microprocessor was for its arithmetic capabilities," says Dick Lee, head of Boonton's development engineering in Parsippany, NJ. "It allows transforms of the basic capacitance measurement into other more useful forms, such as dissipation and Q. The instrument measures capacitance and conductance, and with these two quantities, you can, from front-panel control, calculate the equivalent parallel resistance. The dissipation or Q of the test specimen can be transformed into equivalent series-circuit values of R_s and C_s ."

"The microprocessor solved another problem. We're using a modified Young bridge, which is not a four-wire technique. The basic measurement is very clean at the instrument terminals. But it is often necessary to extend the bridge terminals, using special cables that add a loss to the measurement. Measurement of a capacitance attached to the far end of the cable can be converted to its equivalent at the bridge terminals themselves.

Processor solves complex functions

"The transforms to convert the measurement are complicated. But since they are arithmetic in nature, the processor can do them without any difficulty. Formerly we provided error-correction and other charts which the operator had to use to obtain the answer.

"Another advantage to using the microprocessor is that we were able to take care of, by programming, all of the random logic and decision loops required for operation of a complicated instrument. As a result, there is no sequencing logic of any consequence.

"In another area, if we discover that there are limitations in the way we implemented a certain logic function, we can change it by reprogramming. In addition the processor also allows us to



The use of dc logic switching in this Philips PM 3260 120 MHz oscilloscope provides more efficient location of operator controls. Simplified servicing also results.



Dc logic switching in the Philips PM 3260 120-MHz oscilloscope provides more efficient placement of operator controls. Simplified servicing is an added bonus.

use special test programs for diagnostics.

"Because the 76A is programmable, the microprocessor is useful, in that all the information involved in data transfer passes through it. The microprocessor has the logic for the interface and data transfers as well. The interface is the general-purpose, 16-line, byte-serial ASCII bus that is the standard Hewlett-Packard calculator interface."

The microprocessor from the Hewlett-Packard HP-35 hand-held calculator is incorporated in HP's new 1722A 275-MHz oscilloscope to provide computational intelligence. With this oscilloscope, readout of time intervals, frequency, dc

voltage, peak or instantaneous voltage and percent difference between trace amplitudes are presented on a front-panel digital LED display.

Using a new HP technique—dual delayed sweep—both the start and stop points of a time interval measurement can be displayed as intensified markers on the traces while the instrument is in a TIME mode. The interval between is then calculated by the processor chip and digitally displayed. Desired time intervals can be set into the LED readout and the circuit under test may be adjusted.

The scope has a 1/TIME mode in which the microprocessor computes the reciprocal of whatever was set in the TIME mode and displays the answer. If the TIME measurement was the period of a waveform, the display is a direct readout of frequency or repetition rate.

The 1772A may be set so that the LED display shows the average dc voltage at the Channel A input, and in this case the scope functions as an autoscoping 3-1/2-digit DVM.

With the scope in a POSITION mode, the amplitude of any point on the display may be measured, giving instantaneous voltage levels. The measurement may be relative or absolute.

The unit can function as a differential voltmeter by first establishing a reference level and then comparing any other displayed level with it.

Joining the trend to incorporate microprocessors in test equipment, the Fairchild Systems Technology Div., Palo Alto, CA, is using an Intel device in the Fairchild Qualifier 901, a new digital IC tester designed to check DTL, TTL and CMOS. The tester was designed with simplified operation as a goal. The microprocessor permits dispensing with PC board programming and inconvenient program entry methods, like switches, keyboards and paper tape.

"The 901 is totally controlled with a QUAL-CARD—a plastic card that has all the data needed to operate the microprocessor encapsulated in the card," says Terry Beers, manager of market development for small systems. "To get on the line, you press a LOAD button, shove in the card and go—which is the innovation due to the microprocessor."

The QUAL-CARD, Beers explains, contains the software control. Competing systems, he points out, use a PC board, plus a reference unit and compare the unit under test with the reference. But the reference unit can develop a fault.

Use of the microprocessor in the Qualifier 901 has reduced system cost substantially.

"It's the first computer-controlled tester on the market for less than \$10,000," Beers reports. "The nearest computer-controlled system that I'm aware of is somewhat like a Sentry 100, which is \$80,000. A library of program QUAL-CARDS is available at \$20 to \$30 per program—in contrast

to the traditional \$200 to \$300."

For instruments that measure functions with linearity that varies over a broad range, the use of ROMs as look-up tables to provide linearity compensation is substantially superior to the older analog methods that used curve-shaping with diodes or other nonlinear devices.

One example of the use of ROMs for linearizing measurements is found in digital thermocouple indicators such as Electronic Research Co.'s series 9500 thermocouple meter.

According to Allen Sohl, chief engineer of the Digital Instrument Div., the 9500 incorporates 512 ROM segments of linearization. The meter, which is used with standard type J or K thermocouples, measures from 0 to 1200 C for type J and 0 to 1371 deg for type K.

The ROM has a look-up table that is programmed with nonlinear data corresponding to the thermocouple type in use. A prime advantage is that the ROM is factory programmed, and never needs to be adjusted to give a curve fit. The ROM correction conforms to the linearity curve within $\pm 0.25^\circ$.

7400 T²L still a favorite choice

Despite the widespread publicity attached to MOS-LSI and to microprocessors in general, the series 7400 TTL MSI logic remains a low-cost, high-performance choice of many designers, even for the newest instruments.

Burnell West, engineering manager of instruments at E-H Research Labs, Oakland, CA, reports that its new Model 1320 Digiscope "is loaded with over 700 ICs. Over one third of these are 7400 series and Schottky TTL devices."

The Digiscope, which was designed for the analysis and testing of digital systems, has eight independent channels. The data in each channel are stored in registers and are displayed on eight traces—one above the other—on the face of a scope. The logic levels versus time are thus presented for operational checks and trouble analysis.

Alphanumerics are presented on the scope along with digital timing waveforms. The characters are generated by modulating a video raster with the contents of an MSI ROM, West points out.

"We have very little MOS in our circuits," West says, "because of the speed problem and also reliability. We aren't yet totally satisfied that it is reliable enough," he says.

The low price and fast speed of the 7400 series convinced the Heath Co., Benton, MI, to incorporate a considerable amount of that logic in a fast time-base for the company's new dual-trace, 15-MHz oscilloscope, the SO 4510. The TTL time-base trigger circuit has a typical speed of 45 MHz, says Charles Gilmore, instrument product

line manager.

The SO 4510 scope has a mix of 7400 and 7400H to give a low-cost (\$750 assembled, \$550 in kit form) scope with exceptionally high performance specs, Gilmore says.

There is a design trend towards the use of low-power, high-speed logic families, particularly with small instruments where packaging space is tight, and where cooling is a problem. The growing solid-state contender here is low-power Schottky TTL (7400LS).

"Low-power Schottky probably offers the lowest cost approach," says Stan Bruederle, marketing manager for these devices at Signetics, Sunnyvale, CA. "At present, Schottky is somewhat lower in price than CMOS and costs considerably less than low-power T²L 7400L."

Bruederle predicts that 7400L will be eventually pushed out of the market by 7400LS. While 7400L is a 1 mW-per-gate logic, the Schottky 7400LS consumes only 2 mW, as contrasted with 10 mW for the 7400 series.

"If the designer wants to go to the ultimate in low power, yet retain speed, he can design with a combination of CMOS and Schottky," Bruederle points out.

While microprocessors are attracting considerable attention for use in future instrumentation, the opinion of potential users is not all favorable.

"I think the microprocessor market has to stabilize," comments Vogel of Nicolet Scientific. He feels that an industry standard, like the 1 k-by-1 k static ROM is needed.

"Where there are many microprocessors around, and each chip is different," Vogel points out, "you don't know whether they're going to be compatible. And if you lock yourself into one, what happens a month from now?"

"We're looking towards designing instruments making heavy use of microprocessor technology," says E-H Research's Burnell West. "They will be in different instruments doing different things. In each case we'll evaluate the existing technologies and pick the optimum one."

Dale Mrazek, head of digital applications at National Semiconductor, Santa Clara, CA, issues a note of caution regarding microprocessors.

"Anytime you're going to design a dedicated, fixed instrument, I don't think you should use a microprocessor. Because microprocessors are general-purpose solutions to a variety of problems, rather than specific solutions, I think it will be more cost-effective to handle a specific function with a standard or custom design.

"Remember, even if a microprocessor drops to zero in cost, it still requires a ROM and a RAM to make it work. What the microprocessor gives you is flexibility of change—a faster turn-around time. If that's not a requirement, you're wasting money." ■■

CONTINENTAL CONNECTOR'S

SELECTIVE PLATING

... or how to reduce
your connector cost
without sacrificing reliability



CONTINUOUS STRIP OF CONTACTS WITH SELECTIVE PLATING



ENLARGED VIEW
OF SINGLE CONTACT
WITH SELECTIVE PLATING

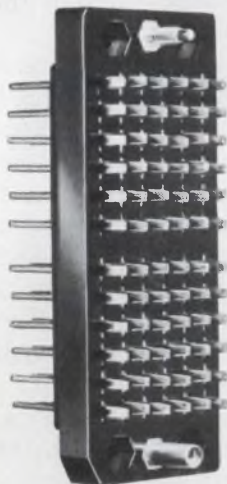

TWO
TYPICAL
CONNECTOR
TYPES
SUITABLE
FOR
SELECTIVE
PLATING



Continental's continuous process selective plating deposits an equal amount of gold on each contact. The contacts pass through various cleaning and plating baths, resulting in a controlled amount of gold uniformly deposited on the critical contact area.

By plating gold on the contact surface only, selective plating automatically brings down your connector cost enormously. This is especially true on high density connectors using the selective plating method.

NOTE: Selective plating equipment was designed and built by Continental Connector in its' own facilities.

Send your quotation request for comparison costs.

Contact our Engineering Department for new designs such as back panel or any connector-to-wire packaging.

For the Sales Representative Nearest You, See Our Listings in EEM and Gold Book Directories

CONTINENTAL CONNECTORS

CONTINENTAL CONNECTOR CORPORATION ■ WOODSIDE, NEW YORK 11377

INFORMATION RETRIEVAL NUMBER 28

INFORMATION RETRIEVAL NUMBER 232 ►

Electronic Design 8

VOL. 22 NO.

FOR ENGINEERS AND ENGINEERING MANAGERS

APRIL 12, 1974

Marconi's State-Of-The-Art Analyzer. This 110MHz Spectrum Analyzer was featured on this cover of Electronic Design. Model 2370 is one of the new

Marconi products detailed in the following pages. Let Marconi Instruments, their rep. team and varied publications solve your measurement problems...

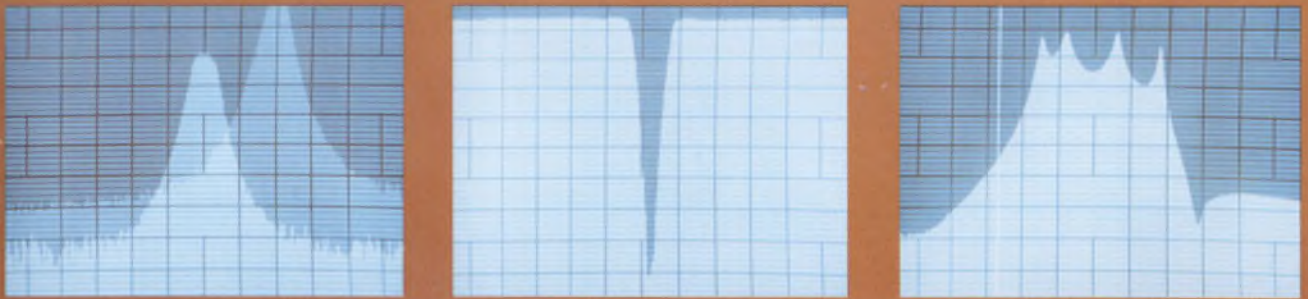



Model 2012
Low noise, highly stable generator for receiver testing



Model 2015
Low cost, high performance AM/FM generator

FM/AM SIGNAL GENERATORS

DESCRIPTION	FREQUENCY	FEATURES
FM/AM SIGNAL GENERATOR Model 2002B	10KHz to 88MHz	0.1 μ V to 1V \pm 1dB, fully solid state, AM variable to 100%, FM deviation \pm 1KHz to \pm 50KHz max. dependent upon range. Incremental frequency controls with discrimination of 0.025% and direct readout in KHz. Xtal calibrator. External frequency shift permits phase mod. or phase locking. Digital Synchronizer available.
FM/AM SIGNAL GENERATOR (6625-913-7223) Model 995B/Series	200KHz to 220MHz	0.1 μ V to 100mV. Calibrated Δ F. Step attenuator, Crystal standardized; extremely stable. Deviation \pm 600KHz on top bands. Has simultaneous FM & AM. Also available for narrow band working FM spurious less than 25Hz. Model 995B/5.
FM SIGNAL GENERATOR (6625-937-2801) Model 1066B/6	10MHz to 470MHz	Similar to 1066B/1 but, wider deviations to 400KHz f_m 30Hz to 100KHz, also incorporates xtal calibrator.
FM/AM SIGNAL GENERATOR Model 2015	10MHz to 520MHz	Covers 10MHz to 520MHz in 11 bands with discrimination permitting tuning to narrow band (\pm 3KHz) receivers. FM deviation 10KHz and 100KHz. AM to 80%. Precision ALC eliminates need for external set carrier control. Fundamental signal with low spurious content. Will also operate from external 24VDC. Portable, 5 1/2" high 11" wide. Lowest cost for performance generator on USA market today.
DIGITAL SYNCHRONIZER Model 2171	10MHz to 520MHz	Used with Model 2015 to set frequency to stability of \pm 2 in 10^7 to resolution of 100Hz. Once locked frequency may be digitally tuned to at least 1% from center frequency, with full modulation capabilities retained.
LOW NOISE VHF/UHF FM SIGNAL GENERATORS Models 2011-2012-2013	130MHz to 180MHz 400MHz to 520MHz 800 MHz to 960MHz	Highly stable low noise unit for testing narrow band mobile receivers. Velvet vernier tuning. Infinitesimal leakage. Noise less than -140dB/Hz, VHF/UHF; -125dB/Hz, 800 - 960MHz, 20KHz from carrier. Output level 0.01 μ V to 100mV into 50 Ω FM deviation to \pm 30KHz f_m 300Hz to 3KHz.
AM/FM SIGNAL GENERATOR AND SWEEP GENERATOR Model 2008	10KHz to 510MHz	This unique combination Generator/Sweeper provides both facilities without sacrifice to the precision quality of either function. Eleven bands with 1 : 1.5 cover span from VLF thru UHF. Output 0.1 μ V to 100mV into 50 Ω . Stability 5 p.p.m. FM deviation \pm 3KHz \pm 10KHz \pm 30KHz \pm 100KHz and above 45MHz \pm 300KHz. Mod. frequency to 125KHz. AM to 80%. Comprehensive sweep facilities on all bands. Full Modulation facilities may be retained in sweep mode. Xtal calibrator and markers. Counter readout of carrier frequency available on model 2008/1.
SOLID STATE PRECISION FM SIGNAL GENERATOR (6625-491-7755) Model 2006	4MHz to 1000MHz	Solid state precision FM unit accepts any 4 of 5 oscillators with bands 4 to 10MHz; 10 to 90MHz; 88 to 220MHz, 215 to 500MHz and 440 to 1000MHz. Output 0.1 μ V to 100mV into 50 Ω . FM \pm 100KHz to \pm 300KHz max. dependent on frequency. Mod frequencies 20Hz to 125KHz internal or external. Synchronized version 2006/1 available.

FM DEVIATION METERS

FM DEVIATION METER (6625-060-3320) Model 791D	4MHz to 1024MHz	Deviation ranges, \pm 5, \pm 25, \pm 75 and \pm 125KHz full scale. Accuracy 3%. Crystal standardized. Local oscillator can be xtal controlled for measuring deviations down to 10Hz.
FM DEVIATION/ AM MODULATION METER Model 2300A (USA) (6625-480-8706)	4MHz to 1000MHz to 2500MHz using ext. oscillator	Wide range, mod. freq. up to 200KHz; deviation ranges \pm 1.5, \pm 5, \pm 15, \pm 50, \pm 150, \pm 500KHz. Local oscillator can be xtal locked, external oscillator can be used. De-emphasis 50 μ sec. 75 μ sec. switch selected. FM accuracy \pm 3% for deviation up to \pm 500KHz f_m 30Hz to 150KHz. AM modulation two ranges 30% and 100% mod. freqs. 30Hz to 50KHz (carrier 4 to 350MHz).
FM DEVIATION/ AM MODULATION METER Model 2300B	4MHz to 1200MHz	Measures FM deviation to 500KHz, AM depth to 95% at carriers up to 400MHz. Very low internal noise allows narrow deviation measurements. Filter for noise measurement. De-emphasis 50 μ S, 75 μ S and 750 μ S. Distortion and channel separation on FM stereo meets FCC testing requirements.
PORTABLE MODULATION METER Model 2303	25 to 520MHz	Measures FM on all mobile bands thru 520MHz deviations 15, 5 and 1.5KHz. Accuracy 3%. Low noise. AM measurements to 225MHz. 95% depth. 3% accuracy. AC or battery operated. 13 lbs.
PROGRAMMABLE FM/AM MODULATION METER Model 2301A	4MHz to 1000MHz	FM deviation in six ranges from \pm 1.5KHz to \pm 500KHz FS. f_m 30Hz to 200KHz demodulated output distortion 0.25%. AM 30% and 100% FS. Automatic internal carrier level setting.

MICROWAVE SIGNAL SOURCES

DESCRIPTION	FREQUENCY	FEATURES
Model 6055	0.85 to 2.15GHz	A unique series of transistor and gunn diode microwave signal sources covering 400MHz to 18.0GHz. Digital display of frequency, accuracy typically $\pm 1\%$. Variable output levels typically 10mW on gunn diode sources. Up to 150mW on transistor models, Gunn Diode Models are 6057, 6058 and 6059. Model 6551 has FM. Special frequency coverages on request.
Model 6056	2.0 to 4.0GHz	
Model 6057	4.5 to 8.5GHz	
Model 6058	8.0 to 12.5GHz	
Model 6059	12.0 to 18.0GHz	
Model 6070	0.4 to 1.2GHz	
Model 6551	1.4 to 1.7GHz	

COMMUNICATIONS RECEIVERS

Model 1830	120 KHz to 30MHz	A unique series of communications receivers covering 10KHz thru 870MHz. All feature superb construction and top performance. Low frequency models provide AM/CW/SSB. 990 series offer AM/FM. Xtal locking facility optional on all models to enhance stability.
Model 990R	27MHz to 240MHz	
Model 990S	230MHz to 870MHz	



Model 2910 series
Non Linear Distortion Analyzer with Sampler



Model 2914/15
TV Automatic Monitoring System

TV TRANSMISSION TEST EQUIPMENT

TV SIDEBAND ANALYZER Model 2360R	Provides a symmetrical or asymmetrical swept video signal for testing video amplifiers or transmission networks using 625, 525 or 405 line systems, positive or negative modulation. Uses Converter TM6936 for 405 channels.
TV SWEEPER Model 2361	Main sweep unit has internal rep. rate 0.01Hz to 100Hz with linear, semi log, CW, single shot and many other modes. TV field lock, blanking and phase shift controls and alternate trace separation. Produces uniform, flat, low distortion sweep. Plug-ins available: Video 25KHz to 30MHz. VHF 1 to 300MHz, UHF 220MHz to 1000MHz.
TV SWEEP ANALYZER Model 2900	Comprehensive frequency sweep analyzer combines Model 2361 Sweeper and video unit, Blanking and Sync Mixer Model 2908 and Differential Probes unit, Model 2907. Measures response of active or passive transmission networks. Differential measurements on composite signal to an accuracy of 0.01dB. Also measures termination impedance and return loss.
LUMINANCE/CHROMINANCE GAIN & DELAY TEST SET Model 2904/1	Measures gain and delay inequality with gain discrimination 0.5dB, delay discrimination 2 nanoseconds. Visible display of misalignment with scope.
NON-LINEAR DISTORTION ANALYZER with SAMPLER Model 2910	Makes accurate, simultaneous measurements of differential gain, differential phase and luminance non-linearity, even in the presence of noise. Gain and phase can be directly measured against a calibrated pulse which can be varied over the ranges of 0 to 11% in .1% steps and 0 to 11° in .1° steps respectively, with the luminance non-linearity being resolvable down to 0.1% using an external scope display.
TV AUTOMATIC MONITORING SYSTEM Models 2914 and 2915	Automatically analyzes and displays all essential parameters including: amplitudes of bar, sync, various T pulses, and noise; luminance linearity, chrominance gain, chrominance/luminance crosstalk, etc., all measured in the most suitable units of measure and presented digitally when under manual control (see also illustration above). Versions for national and international systems.

BRIDGES AND Q METERS

UNIVERSAL BRIDGE Model 1313A	1KHz and 10KHz 20Hz to 20KHz External	0.1 μ h to 110h, 0.1pf to 100 μ f, 0.003 Ω to 110M Ω . Accuracy 0.1%. Built-in osc. and detector. Direct reading; simplest possible operation. Uses adapter TM6113 for biasing inductors to 200mA.
PORTABLE UNIVERSAL BRIDGE Model 2700	1KHz internal 20Hz to 20KHz External	0.2 μ h to 110h, 0.5pf to 110 μ f, 0.01 Ω to 11M Ω . Accuracy 1%. Transistorized simple. Measures incremental L, electrolytics & non-linear resistance using external bias supplies.
Q METER Model 1245A	1KHz to 300MHz	Q ranges 5 to 1000, ΔQ 25-0-25. Accuracy 5% to 100MHz, 20% to 300MHz. Calibrated capacitor 7.5 to 500pf, ΔC ranges ± 1 and ± 5 pf. Extremely stable and easy to operate. Uses separate oscillators. Dielectric and Series Loss Test Jigs available. Also HF & LF inductors.



Model 2303
Mobile Radio Deviation Meter



Model 2090B
Noise Loading Test Set

MOBILE RADIO TEST GEAR

DESCRIPTION	FREQUENCY	FEATURES
PORTABLE MODULATION METER Model 2303	25 to 520MHz	Measures FM on all mobile bands thru 520mHz deviations 15, 5 and 1.5KHz. Accuracy 3%. Low noise. AM measurements to 225MHz. 95% depth. 3% Accuracy. AC or battery operated. 13 lbs.
PORTABLE COUNTER Model 2424A	10Hz to 512MHz	A 10Hz resolution to 500MHz and a 10mV sensitivity over entire frequency range make this eight digit battery operated counter ideal for field testing of mobile transmitters. 6½ lbs.
MOBILE RADIO SIGNAL GENERATORS	All Mobile Bands	Special low noise signal generator series for all bands. 130MHz thru 960MHz. See Signal Generator Section, Models 2011, 2012, 2013, and general purpose 2015.
AUTOMATIC DISTORTION METER Model 2337	20Hz to 20KHz	Simultaneous indication of level down to 3mV, distortion down to 0.1% without tuning adjustments. With external filter, the unit becomes ideal for SINAD testing.

DIGITAL COMMUNICATIONS – P.C.M. TEST GEAR

MULTIPLEX TEST SET Model 2807	Voice Channel	Both sinewave and pseudo random noise stimulus available to measure channel gain, frequency response, idle channel noise, gain linearity, quantization distortion and interchannel crosstalk. National and International models available.
PATTERN GENERATOR AND ERROR DETECTOR Model 2808	1.536 to 8.448 Mbit/s	Generates pseudo random test signal in AMI, RZ or NRZ formats. Errors and blanking can be introduced to test regenerator clock recovery. Automatic locking of pseudo random signal in receiver. Performs bit by bit analysis of received signal.
DATA LINE ANALYZER Model 2809	300Hz to 3400Hz	Used for testing data transmission lines and links; measures peak-to-average rating (PAR), frequency response and system noise level. Has correction for phase-intercept distortion.

PROGRAMMABLE ATTENUATORS

UHF ATTENUATOR Model 2168	DC to 1000MHz	Attenuation range 0 to 139 dB in 1 dB steps. Accuracy $\pm 0.5\%$, ± 0.1 dB at 1KHz, $\pm 1.5\%$, ± 0.2 dB at 1GHz.
MF ATTENUATOR Model 2165	DC to 500KHz	Attenuation range 0 to 99.9 dB in 0.1 dB steps. Accuracy 1% of setting ± 0.01 dB. Output/input impedance 600 Ω unbalanced. Usable to at least 1MHz.

INTERMODULATION AND BASEBAND TEST GEAR

NOISE LOADING TEST SET TRANSISTORIZED (6625-965-8625) (AN/GSM 161A) Model 2090A	12KHz to 12.388MHz (i.e. up to 2700 channels)	Solid state unit has built-in standardizing noise source in receiver for gain setting, out-of-band testing, etc. Includes noise generator, receiver and a choice of many different filters. NPR measurements can be made up to 75 dB.
NOISE LOADING TEST SET Model 2090B	12KHz to 12.388 MHz	Designed to meet latest CCIR and CCITT requirements (Recommendation 399-1 Oslo 1966). Operation similar to model 2090A.
Model 2099AB		This filter extension box can be added to any 2090A or 2090B system to provide accommodation for up to nine extra high, low or band stop filters and six extra band pass filters with oscillators. Minor modification required to existing generators and receivers to provide access. Simple field modification kits available.
AUTOMATIC NOISE RECEIVER Model 2092C	12KHz to 12.388MHz	The Automatic noise receiver automatically adjusts its sensitivity to the incoming noise level, intermodulation noise level, or residual noise level. The noise power ratio (NPR) of a microwave system or component under test, is automatically determined and the result displayed digitally. A three digit display will give direct readout of NPR, dBm, dBmO, dBmN or dBmNO with or without 'C' message or psophometric weighting. Can be used with any current noise generator.
HF SPECTRUM ANALYZER Model 2370	30Hz to 110MHz	Comprehensive spectrum analyzer system with dispersion from 20Hz/div to 100MHz full width, resolution 0.1 dB, filter bandwidths from 5Hz to 50KHz, displayed dynamic range 100dB, 10 x 12 cm flicker-free digitally stored display, frequency measurement to counter accuracy.
TWELVE CHANNEL NOISE GENERATOR (6625-948-4724) Model TM7816A	300Hz to 3400Hz	Generates twelve non-related channels of Gaussian noise from twelve separate solid state sources. Output: each channel 1mW in 600 Ω balanced, 300Hz to 3400Hz. Attenuation to -32 dbm in 2 db steps. Spurious noise in OFF channel (all other channels ON) is less than 10 dba (-75 dbm FIA weighted).
TV AUTOMATIC MONITORING SYSTEM Model 2914/15		See television section overleaf.

New

X-Y Display Memory
Model 2214

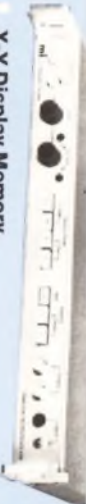

New

Digital Synchronizer
Model 2171



New

FM/AM Modulation Meter
Model 2300B



New

Automatic White Noise
Loading Receiver
Model 2092C

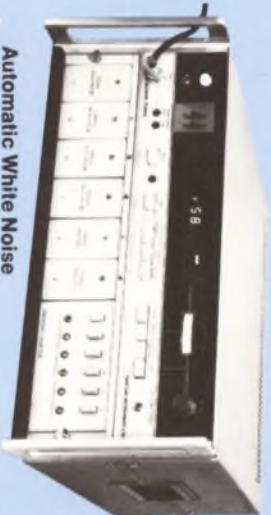

New

H. F. Spectrum Analyzer
Model 2370

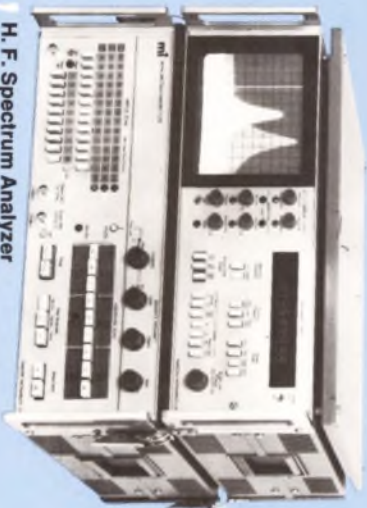

New

TV Automatic Monitoring System
Model 2914/15



**We've
moved!**

Note Our
New Address
and
Telephone Number
(201) 767-7250

FIRST CLASS
Permit No. 100,
Northvale, N.J. 07647

BUSINESS REPLY MAIL

No Postage Stamp Necessary If Mailed In The United States
Postage will be paid by:

mi MARCONI
INSTRUMENTS
DIVISION OF MARCONI ELECTRONICS INC.

100 STONEHURST COURT,
NORTHVALE, NEW JERSEY 07647

mi publications



Full Marconi Instruments Catalog NA7
(Available on request.)



Noise Loading Test Set Applications Kit



Marconi Instrumentation
(Check mailing list to receive your free copies of this House Technical Journal issued four times per year.)



"Quiet Ones" kit for Mobile Radio Testing Notes



Automatic Monitoring of Television Signals



Contact
Issued six times a year. This journal keeps you informed on the new products and the world of Marconi. Issued free to all on our mailing list.



PCM Measurements Explained

Use this Reply Card to receive this information or contact your mi rep.

mi Please send me . . .

- NA7 General Catalog
- Current Price List
- GSA Contract Price List
- White Noise Applications Kit
- Mobile Radio Testing
- T.V. Signal Monitoring Package
- PCM Measurements
- Reprint of Spectrum Analyzer Article
- Full specifications on the following **mi** products

- Add my name to the mailing list to receive **Instrumentation and Contact**
- My application/problem is _____

Telephone _____ Ext. _____

Name _____

Title _____

Company _____

Address _____

City _____

State _____ Zip _____

Bradenco	Texas, Okla., Ark., La.	214-358-3278
Rush S. Drake Associates	Washington, Oregon, W. Idaho	206-763-2755
Ken Corporation	New England States	617-438-5464
L & M Associates	New Jersey New York City Philadelphia Area & South N.J. Long Island	201-843-8700 212-675-7486 215-639-3100 516-231-8363
Lee Associates	Ala., Miss. Florida Georgia, Tenn. North & South Carolina	205-533-5896 813-294-5815 404-457-7117 919-787-5818
Kenneth W. Meyers	Ill., Wisc., Iowa Ind., W. Kentucky Minnesota	312-774-6440 317-243-6681 612-920-7080
Moxon Electronics	Central Calif., L.A. Northern Calif., Nevada San Diego, S. Calif. Arizona	714-556-6500 408-734-4352 714-292-4820 602-273-7363
Ohio Instrument Company	Ohio, Mich., E. Ky., W. Pa.	614-885-0743
PLS Associates Inc.	Colorado New Mexico Utah, Wyoming, East Idaho	303-771-0140 505-255-2330 801-272-3681
S & S Associates	Wash., D.C., Md., Va., Del.	301-654-1434

mi MARCONI INSTRUMENTS
DIVISION OF MARCONI ELECTRONICS INC.

NEW Address

100 STONEHURST COURT, NORTHVALE, NEW JERSEY 07647
TELEPHONE: 201/767-7250



“A good general purpose signal generator should handle most of your bench needs and be cheap enough to fit every budget. That’s why we designed the HP 8654A”

Frequency range: 10-520 MHz
Calibrated
output level: +10 to -130 dBm, leveled
Modulation: AM & FM,
internal & external
Stability: 20 ppm/5min
Price: \$1700. Domestic USA price only.

But you'll want to evaluate the 8654A for yourself. A call to your local HP field engineer will put one in your hands. Or for more information just write.

HEWLETT  PACKARD

Sales and service from 172 offices in 65 countries.
1501 Page Mill Road, Palo Alto, California 94304

INSTRUMENT PACKAGING

A new problem rises to plague users: panel clutter

Compared with those of a decade ago, today's instruments are Buck Rogers marvels—more functions, increased ranges, tightened tolerances. But the improvements have raised several new problems: perhaps the most serious is panel clutter. Some instrument manufacturers—but unfortunately, only a few—have attempted to ease the sensory overload of the user.

Human-engineering studies provide some of the characteristics that lead to good control-panel design. These include:

- Similarity—color, size and shape can emphasize particular knobs, indicators and switches to make them stand out, or to tie them together so they relate to a certain function.
- Proximity—spaced groups and clusters can relate controls and displays.
- Territoriality—drawn lines, to bracket and frame functions, and elevated, dished or sloping surfaces can blend related items into distinct groups.
- Automaticity—manual controls can be eliminated by automatic circuits, such as those in polarity and voltage-range selection.

The application of these principles allows the user to cut through the clutter that a complex front panel might otherwise present. The user is helped to locate quickly areas of immediate interest.

Applications of the principles

A laboratory power supply made by the Trygon Division of Systron Donner, Westbury, NY, the TL 8-3, illustrates the use of three contrasting colors to identify the unit's three power supplies

Morris Grossman
Associate Editor



The well-organized flight engineer's controls in this Lockheed 1011 of the Trans World Airlines fleet avoid the sensory overload that could result from large amounts of data on a cluttered panel.

and relate them to corresponding output terminals. Note how the color keying is quicker and more effective than the letter designations A, B and C to tie the terminals to the supply.

In a somewhat more sophisticated way, Tektronix 7000 series scopes make use of color to classify the functions. Green identifies all trig-

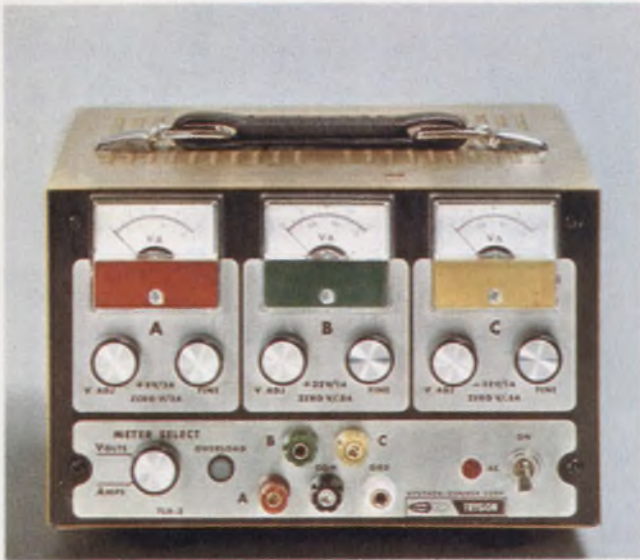

Color coding ties the power supplies and output terminals in Trygon's TL8-3 triple-output power supply.

ger controls—source, level, coupling, etc. The user only concerns himself with green colored areas when triggering decisions are made. Blue identifies controls that affect the CRT display, such as alternate, chop, add or channel. And red marks those controls that permit the user to operate the oscilloscope in an uncalibrated condition.

Yellow designates controls to be used with caution and black and shades of grey define function boundaries and for use in printing nomenclature. Some miscellaneous functions use orange. All plug-in modules of the series use this color code without exception. And, once the user has familiarized himself with the color coding, he is greatly helped in operating the scope, no matter what combination of plug-ins he uses.

Another quite good example of panel design is the 102A FM/AM signal-generator, made by Boonton Electronics, Parsippany, NJ. This instrument uses seven knobs of different shapes and sizes. These separate and identify the various controls.

Some human-factors studies show that about 45 knob variations—in 15 different knob shapes, each in three sizes—can be readily distinguished by feel alone. Each size must differ from the next by at least 50%, however. Thus Boonton could have used greater knob variations, but probably at the expense of symmetry and panel appearance.

The Boonton function generator also makes full use of the principles of proximity and territoriality. The three functions—modulation, frequency selection and output level—are clearly separated by space and demarcation.

And note the distinctive gradation of lettering sizes. Labels should be large enough for comfortable viewing at normal operating distances—

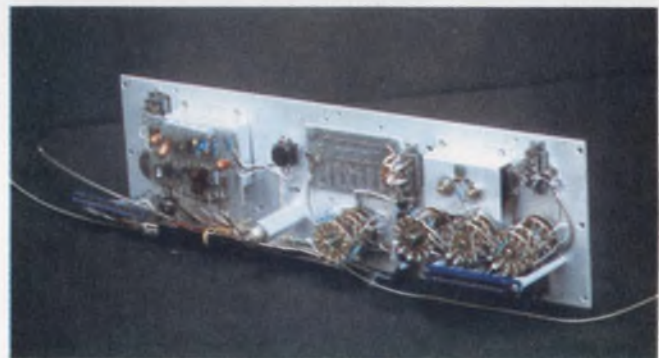
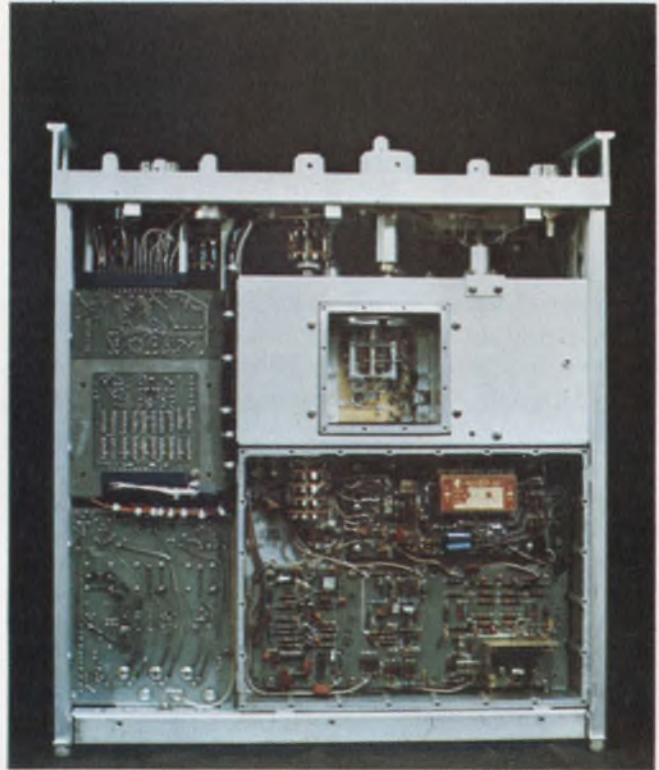

The principles of proximity, territoriality, knob configuration and letter-size gradation are well applied in Boonton's 102A FM/AM signal generator. Bottom and behind-the-panel views show easy access to all parts.

usually about 20 in. And letter-size variations should have minimum increments of about 25% to provide a clear distinction.

Where there is a need for many controls and functions in a small space—as in some general-purpose oscilloscopes—the result often is a cluttered control panel. The circuit's electrical and

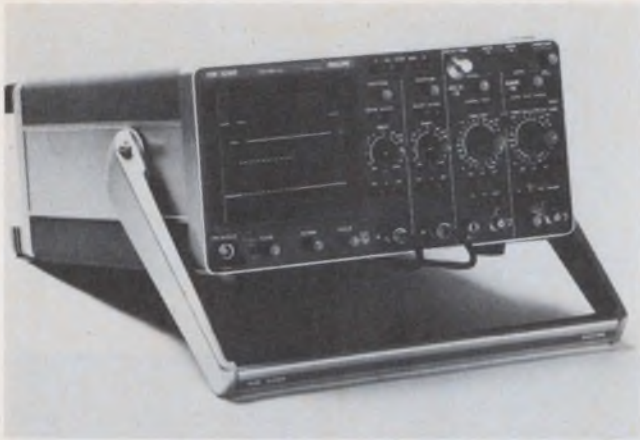

Phillip's PM 3260 120-MHz oscilloscope has a very clear and uncluttered, easily used control panel. Cold switching enables the designer to place the controls for best layout.

physical constraints conflict with the application of human-factors principles. You can't always place a control for greatest clarity and ease of use, because the leads may become too long, undesired feedback and coupling may result, or physical obstacles may interfere.

But so-called cold switching—where the controls switch secondary dc logic signals instead of the actual signal that's being controlled—allows freedom for human-factors engineering. The circuit can then be designed to optimize both the electrical and mechanical requirements, without electromechanical restrictions. Thus maintenance is simplified and the controls can be separated for a superior panel layout.

Cold switching is an important feature of the PM3260 oscilloscope, made by Philips Test and Measuring Instruments, Woodbury, NY. The scope is a 120-MHz, dual-trace instrument. Its IC amplifiers allow a low over-all power consumption of only 45 W, and the power supply can operate over 90 to 250 V and frequencies of 46 to 440 Hz. This low-power consumption allows the omission of a fan with its problems of noise, filters to be changed and louvers in the case.

Compared with many popular scopes of equivalent capabilities, the Philips unit presents a very clear and uncluttered, easily used control panel, because cold switching allows easy application of proximity and territoriality.

In addition to the arrangement of controls and displays, the ability to adjust the viewing angle for a panel can be of primary importance. Old and heavy instruments generally present a fixed viewing angle. This often forces the user into an awkward, uncomfortable position. Human-factors engineers, in extensive measurement surveys, have established a chart for preferred and maximum viewing angles.

Modern, lightweight bench instruments are

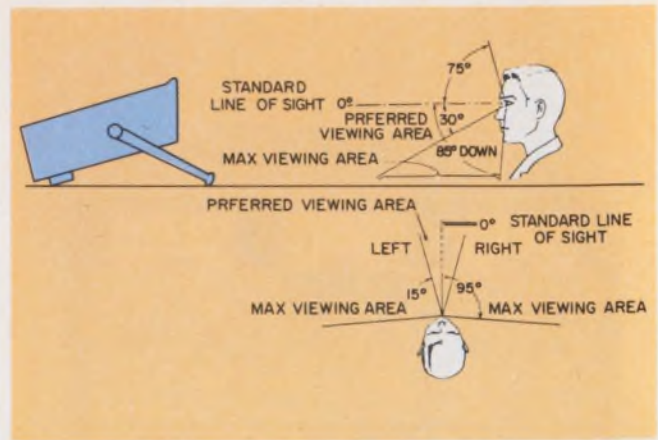

The ability to adjust the viewing angle of an instrument for comfortable use is of primary importance. Human engineering provides the preferred range of angles that most people can accommodate to.

often supplied with a multipositional tilt bail that allows an optimal viewing angle. For example, the Model 168 digital voltmeter from Keithley Instruments, Cleveland, incorporates a 16-position tilt stand. The stand doubles as a convenient carrying handle.

The Keithley housing, which has soft rubber feet on the bottom for slip-free positioning, holds the coiled-up line cord. The power plug fits unobtrusively into an opening in the case.

Many other instrument makers have adopted the carrying-handle tilt stand. Two examples are John Fluke's (Seattle) 8800 digital multimeter and Philips PM 3260 scope.

For a handy help in viewing on the Hewlett-Packard, Model 970A, hand-held digital multimeter, you can invert the numerical display with the flick of your thumb. Also, the unit's designers take full advantage of automaticity. The digital meter has automatic ranging, polarity indication and decimal-point placement. Only the functions—volts, ac or dc, or kilohms are manually selected.

Are repairs easy?

Maintainability is as important to the electronic-instrument user as ease of use. To avoid excessive instrument down time, the design should include:

- Modular packaging.
- Sections and components that are identical circuits and can be interchanged.
- Easy accessibility to test points while the unit is operating.
- Self-checking features.
- Adequate labeling of parts and test points.
- Quick-opening covers with captive screws, and preferably no need for disassembly tools.

Three digital multimeters show different approaches to packaging. The Series 350 DPM from



Keithley's designers preferred pushbuttons for the Model 168 digital multimeter. And autoranging eliminates the need for a range-selection switch.

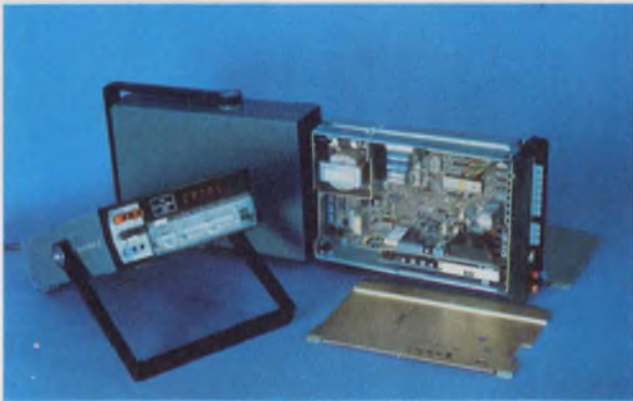

Fluke's 8800 digital multimeter uses lever switches because its designers say that lightweight instruments are pushed backwards when pushbuttons are actuated.

Electronic Research Co., Shawnee Mission, KS, comes apart readily. It has a separate PC board mounted to the unit's backplate to hold the heavier components of the power supply. This is intended to reduce damage to the main-circuit PC board—damage that could be caused by the mass of a transformer, say—when the unit is dropped. A separate power-supply board makes it easier to offer a large variety of optional voltage-source ranges—115 or 220 V ac, 5 or 10 to 30 V dc, etc.

Pushbuttons vs levers

According to Indle King, an industrial-design manager at John Fluke, that company's 8800 digital multimeter is designed with lever switches instead of pushbutton units. The reason, King says, is that lightweight instruments, like digital meters, tend to be pushed back when buttons are actuated. And the lever keys themselves serve as clear mechanical displays of the selected functions. This eliminates the extra cost of an electronic-function indicator.

The Keithley Model 168 digital multimeter, on

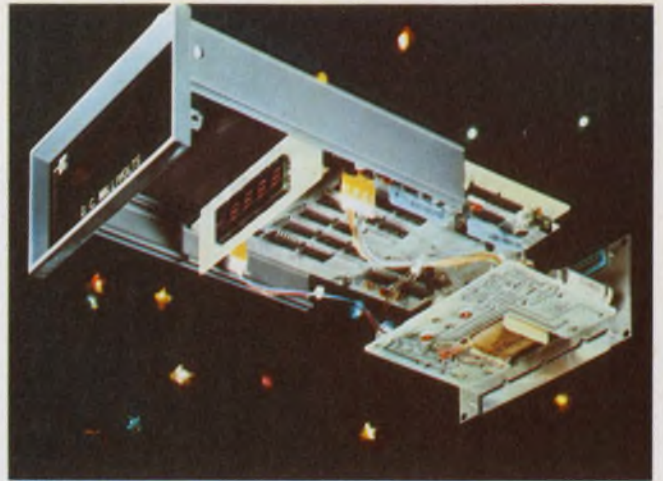

Heavy components can damage a complex PC board when the board is subjected to shock or vibration. ERC's 350 DPM features a separate board for the power supply to protect the main board.

the other hand, uses pushbuttons. Keithley says they're easier to use. And autoranging on each function eliminates the need for a range-selection switch; but, of course, the decimal must be placed automatically. Furthermore, the function—volts, milliamps, ohms, ac, dc, etc.—is displayed electronically so that the user doesn't have to peer at the pushbuttons.

Like the Philips' PM3260 oscilloscope, the Model 700 frequency counter from Newport Laboratories, Santa Ana, CA, also uses cold-switching for all mode and time-base functions. But in this case cold switching chiefly improves maintainability. A single LSI chip avoids the use of two eight-wafer rotary switches—with the attendant mess of wires that would be required between the control panel and the main PC board. Two simple PC rotary switches, which require no hand wiring, are all that are needed.

Maintenance problems in Newport's Model 700 are minimized by elimination of the hand wiring that a large switch would require. It's hard to change an inner wafer on a complex ganged rotary switch. The simple wafers on the PC board of the Newport Instrument are easy to fix.

Though many manufacturers advocate soldered-in IC chips because, they contend, IC sockets are a source of possible failure, Newport Laboratories provide sockets for its chips. Of course, easy IC replacement is a decided advantage when a chip fails. The socket vs no-socket controversy hinges on the reliability of the ICs.

Most instrument designers use at least some of the techniques that human-factors engineers consider desirable for easy maintenance. But in many cases the methods are introduced mostly to enhance the manufacturing or assembly processes. No longer can this be left to chance. Engineers should consider maintainability in the conceptual stage and design phases. ■■

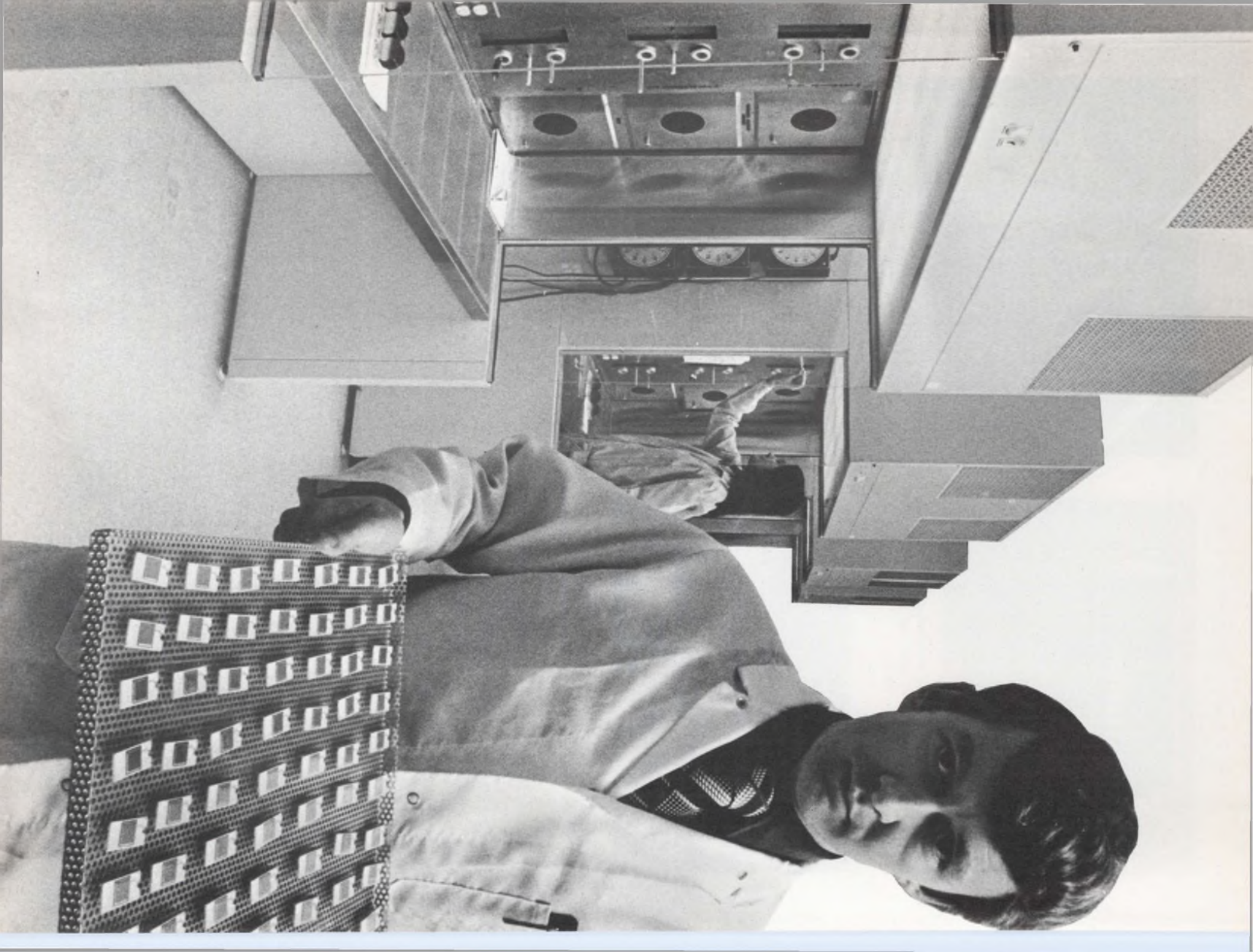

IT'S HERE. ANALOG DEVICES' \$39 12-BIT IC DAC.

No other 12-bit DAC-IC or module — gives you greater accuracy. Or a lower cost.

Introducing the AD562 — the revolutionary IC from Analog Devices Semiconductor that outperforms every other 12-bit DAC on the market.

Simply stated, the AD562 is a 12-bit IC digital to analog converter in a hermetically sealed, 24-pin DIL package.

It gives you guaranteed monotonicity over the full operating temperature range, with a maximum total error as low as $\frac{1}{4}$ LSB (0.006%) at 25°C, and a 3ppm/°C maximum gain temperature coefficient.

The logic inputs are positive-tri-state, and are specifically designed to be both TTL and CMOS compatible. In addition, both binary and BCD versions are available.

How the AD562 came about. The state-of-the-art AD562 could only come from a company like Analog Devices.

After all, we're the world's leading manufacturer of A/D and D/A converters for test and measurement instrumentation. And with converter products like the AD562, we're extending that leadership in integrated circuit form.

CMI — the new technology that made it possible. To give the AD562 its unmatched accuracy, we developed a process called CMI-Compound Monolithic Integration.

CMI is the partitioning of a complex function into a minimum number of monolithic chips, each specifically designed to work with the others, and assembled in a single package.

For greater performance, the AD562 features two chips. A monolithic, 12-bit precision, bipolar transistor current switch and control amplifier chip. And a compatible silicon-chromium thin-film resistor network containing the DAC bit-weighting and range resistors.

First, they're internally connected. Then, while the AD562 is powered, all the resistors are trimmed by a computer-controlled automatic laser trimmer.

The result is outstanding resolution and scale factor calibration. And state-of-the-art performance at a very low price.

The AD562 does even more for you. You'll find that the AD562 gives you a lot of operating advantages.

Like providing five pin-programmable output ranges, both bipolar and unipolar.

Acting as a two-quadrant multiplier when you apply a variable external reference voltage.

And offering a newly developed current switching cell structure which provides superior immunity to supply voltage variation, and reduces nonlinearities due to thermal transients as the bits are switched.

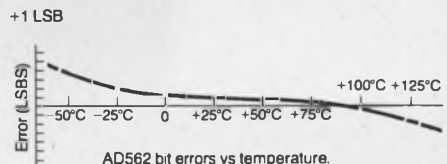

Three temperature ranges to choose from. You can specify the AD562 guaranteed for operation over three temperature ranges. The model K: 0 to +70°C. The model A: -25 to +85°C. And the model S: -55 to +125°C.

And best of all, prices start as low as \$39 in hundreds.

If you'd like more information on the AD562, call Analog Devices Semiconductor, Norwood, MA. 02062.

East Coast: (617) 329-4700

Midwest: (312) 297-8710

West Coast: (213) 595-1783

 **ANALOG
DEVICES**

INFORMATION RETRIEVAL NUMBER 30

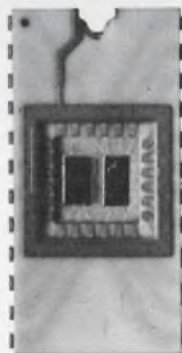

Resistor networks: we deliver through thick and thin.

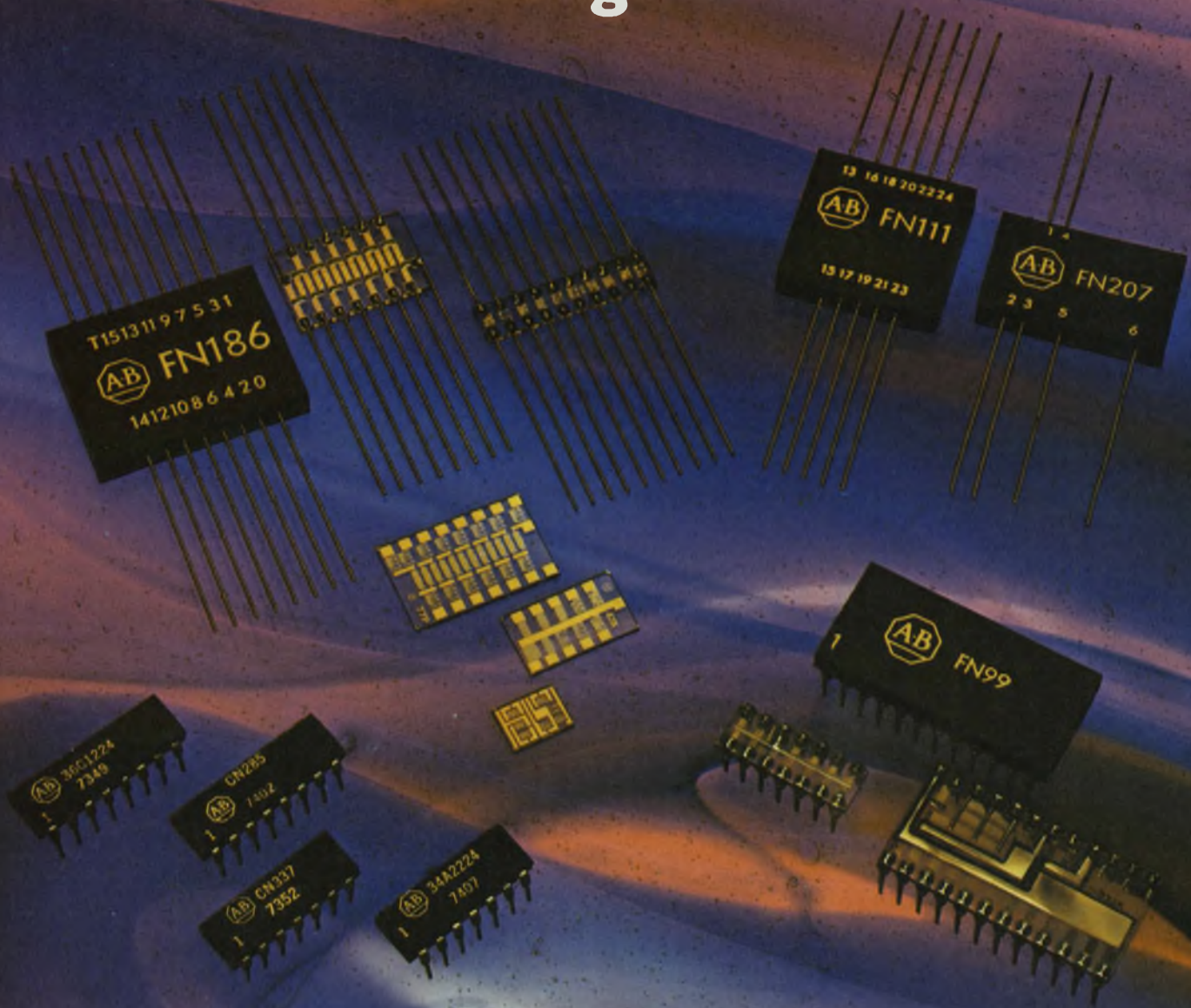

Seventeen years of film resistor experience combined with quality production capabilities give you prompt solutions to your network needs. Whether you require precision thin film or semi-precision thick film in prototype or mass production quantities. Thin film in chip, conformal coat, flat pack and DIP. Thick film in standard 14 and 16 pin DIPs with resistor or resistor/capacitor configurations. Popular pull-ups and terminators off-the-shelf. Contact your local A-B sales office or write for our 5800 series publications. Allen-Bradley Electronics Division, 1201 South Second Street, Milwaukee, WI 53204. International Division, Milwaukee, WI 53204. Canada: Allen-Bradley Canada Limited, Cambridge, Ontario. United Kingdom: Allen-Bradley Electronics, Limited, Jarrow, County Durham NE32 3EN.

SELECTED SPECIFICATIONS

	Thin Film	Thick Film
TCR	± 10 to ± 25 ppm/ $^{\circ}$ C	± 100 and ± 250 ppm/ $^{\circ}$ C
TCR tracking	± 5 ppm/ $^{\circ}$ C	± 50 and ± 100 ppm/ $^{\circ}$ C
Absolute tolerance	as low as $\pm 0.1\%$	as low as $\pm 1.0\%$
Matching or ratio tolerance	as low as $\pm 0.05\%$	as low as $\pm 2.0\%$
Resistance range	1K to 10 Megs (special 10 ohms to 50 Megs)	10 ohms to 1 Meg

If you're really serious about cost, be serious about quality.



ALLEN-BRADLEY

Milwaukee, Wisconsin 53204

INFORMATION RETRIEVAL NUMBER 31

EC85

**RF Microwattmeters—
Analog and Digital—
FS Sensitivities from
10 nW to 10 mW**



MODEL
42B/42BD

Boonton rf microwattmeters offer unrivalled sensitivity: 10 nW fs to 10 mW fs; from 200 kHz to 18 GHz, at highest stability ever attained at these sensitivities. Analog (42 B) or digital (42 BD) versions, both with linear DC outputs and logic-level programmability. BCD outputs are standard on digital version, auto-ranging and dB display (0.01 dB resolution) optional. Boonton Electronics, Parsippany, N.J. 07054

INFORMATION RETRIEVAL NUMBER 255

**Wide-Range
Programmable
Capacitance Meters**



MODEL
72B/72BD

Boonton analog (72B) and digital (72BD) provide rapid, accurate, 3-terminal and differential measurements, at 1 MHz, from 1 pF fs. Measures semiconductor-junction capacitance at low (15 mV) test level, with provision for external DC bias. Phase-sensitive detector measures accurately even at Q=1. Logic-level range programmability and fast-tracking DC output are ideal for ATE. Model 72BD has standard BCD output and autoranging. Boonton Electronics, Parsippany, N.J. 07054

INFORMATION RETRIEVAL NUMBER 256

**Direct Capacitance Bridge
0.00005 to 1000 pF
and 0.01 to 1000 mho**



MODEL
75D

Boonton Model 75D Direct Capacitance Bridge is designed for 1 MHz capacitance and loss measurement. Capacitance range, 0.00005 pF to 1000 pF; basic accuracy, 0.25%. Conductance range: 0.01 mho to 1,000 mho, basic accuracy, $\pm 5\%$. Internal bias from -6 V to +150 V. Adjustable test level, 1 mV to 250 mV, at 1 MHz. Two modes of operation allow either conventional capacitance and loss measurements or one-control balance for capacitance only. 3-terminal input configuration. Boonton Electronics, Parsippany, N.J. 07054

INFORMATION RETRIEVAL NUMBER 257

INFORMATION RETRIEVAL NUMBER 258 ▶

Happy birthday, price-less.

Introduced just one year ago, our 102A FM/AM Signal Generator is celebrating a well-earned sales success against the HP8640B that once had the market sewn up. It's no wonder when you can save thousands of dollars and still get all you really need.

With our generator you get a well shielded, low noise source from 4.3 to 520 MHz that is both stable in frequency and accurate in level. We've shrunk warmup to 15 minutes and weight to 30 lbs.

We have the best residual FM spec around: 100 Hz resolution with a 6-digit display, individual metering of modulation and RF output, true peak monitoring, and 0-300 kHz internal FM deviation on all bands—external FM deviation can be as wide as 2 MHz peak-to-peak even at the lowest frequencies.

The 102A is engineered for your convenience. That's why we've designed a front panel that is easy-to-use and understand, why we have the specifications decaled on the top of the instrument in plain view, why we've added a unique adjustable "feel" main drive mechanism for easy narrow-band receiver setting, and why we have a full list of optional goodies—like a detected AM output to verify our negligible phase-shift for VHF omnitesting, fused RF output with replaceable elements, and external clock input.

Call or write today for data and/or a demo and you'll call the 102A price-less, too. Boonton Electronics Corp., Rt. 287 at Smith Rd., Parsippany, N. J. 07054; (201) 887-5110.

Price \$3575.

BOONTON



Do they
love you for your
performance...
or is your
\$2200 price edge
the frosting on
the cake?



Troubleshooters for logic emerge as digital trend gains

The increasing use of digital logic and the growing complexity of logic circuitry has spurred the development of instruments geared to one job: the monitoring and troubleshooting of logic systems.

Some of these new instruments, which have started to appear in the last year, are logic analyzers, pattern analyzers and word recognizers.

Another trend, the digital conversion of existing instruments, has continued at a rapid pace. Not only are many instruments that previously had analog meters being redesigned to accommodate digital, but instruments that never had meters before are being redesigned with additional logic and digital displays to produce more powerful units. This is being made possible by semiconductor manufacturers, who are able to put more processing power in smaller packages.

Examples of how LSI logic and digital readouts are being combined to improve existing instruments are a microprocessor oscilloscope from Hewlett-Packard and a digital multimeter oscilloscope from Tektronix.

Keeping pace with logic

To tell what's happening in the world of digital logic, it's necessary to look at the outputs of the logic elements. In the past this has been done by logic probes and clips and oscilloscopes. But with logic systems becoming more sophisticated, instruments to examine them must grow in sophistication, too. It's no longer enough to check the output of a few logic elements. Often it's necessary to monitor as many as eight or 12 inputs. To fill the more complex needs, the

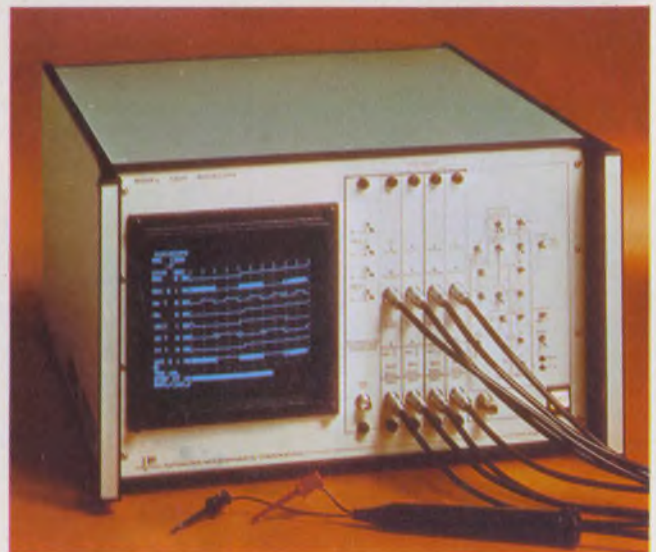

The AMC 1320 logic analyzer is capable of displaying the simultaneous time relationships of up to 8 parallel channels of data.

logic analyzer was born.

Three logic analyzers have been introduced in the last year and a half. They are the 1601L from Hewlett-Packard, the AMC 1320 from E-H Research Laboratories and the 8200 from Bionation. The machines can be classified into two categories: The 1601L as a functional analyzer and the 1320 and 8200 as electrical analyzers.

In functional analysis the aim is to examine the device, subassembly or system to see if it works. Does the counter count? Does the microprogram follow the flow chart? Points like these are checked.

Electrical analyzers on the other hand, not only determine if the device or subsystem works, but also are capable of timing measurements, glitch detection and analysis, and voltage measurements. Examples of electrical analysis might

Jules Gilder
Associate Editor

include determining how fast the counter counts, how much noise immunity there is and whether there are adequate margins for error in both voltage swing and time.

As a functional analyzer, the 1601L collects data from the circuits under test and displays them as ONES and ZEROS in truth-table format on a CRT. It accepts data at rates as high as 10 Mbits per second and can handle as many as 12 parallel inputs. Data are displayed as 16 consecutive 12-bit words and can be presented in either BCD or octal format.

The 1601L has no internal clock, and thus is only good for synchronous operation. Also, since you can't see what's going on between clock pulses, the analyzer cannot directly show glitches or other spikes. However, a trigger output sig-

nificantly converted to a binary sequence and then shifted into a data-acquisition register at a selected clock rate of up to 50 MHz.

Upon occurrence of a trigger pulse, which can be derived from a combination of the logic inputs, acquisition stops and the accumulated data are transferred into the display register. Because the trigger can be used to stop acquisition, it's possible to look back in time and see the events that took place before the trigger as well as after it. Thus it's possible to compare the timing diagram presented by the instrument with the one originally drawn by the engineer when he designed the system.

All logic analyzers use comparators to decide if a logic level is a ONE or a ZERO. The threshold setting of the comparator is critical. If, as



Oscilloscopes are getting smarter and the latest entry is the 1722A microprocessor scope from HP. It uses the micro from the HP-35 calculator.

nal is provided that can be used to trigger a regular oscilloscope. Thus glitches can be spotted indirectly.

If you're more interested in looking at the simultaneous time relationships of multiple signals, the AMC 1320 or the Model 8200 logic analyzers are best.

Both have overcome a very serious problem encountered with the oscilloscope—that of simultaneous stored sweep of many channels of data. One drawback, however, is that the new logic analyzers cannot offer on any one channel the resolution of an oscilloscope in either time or voltage. But they do display as voltage levels, representing ONE and ZERO, eight parallel logic signals with their true time relationships.

The AMC 1320 can store up to 100 8-bit words. During acquisition all channels are first simul-



High speed logic can be analyzed with the 8200 logic analyzer from Biomation. It can accept 8 channels of data at a rate of 200 megabits/s.

in the Biomation and HP devices, the threshold is a single level set between the ZERO and ONE levels, abnormalities will be missed—like low ONES, high ZEROS, glitches and ringing. The AMC 1320 overcomes this problem by using two threshold levels, one each for ZERO and ONE.

For those high speeds

For really high speeds, like those encountered in ECL logic systems, there is no choice. The only analyzer that can do the job is the Biomation 8200, with its 200-MHz data rate. It also has more memory capability than the AMC 1320,

being able to store 2048 words of 8 bits each.

The 8200 combines some of the good points of both the E-H and HP units. One place where this is evident is the clock system. While the 1601L works only with an external clock and the AMC 1320 only with an internal clock, the 8200 can use either. However, the designers neglected to include a useful feature that is present in both the HP and E-H units—a pattern trigger. The pattern trigger capability is so desirable that a recent check with Biomation revealed that the 8200 is being modified to include it.

With a pattern trigger, a digital word is preset into the analyzer by switches that select either a ONE, a ZERO or a don't-care mode. The analyzer then cycles through until it recognizes the word that has been preset. At that point it triggers the display.

Hand-held units available, too

Logic analyzers do not necessarily have to be large, expensive bench instruments. Hand-held units that use light-emitting diodes to indicate logic ONEs and ZEROs are also becoming popular. One of these is the BD-0617B from CPSR Instruments, Inc., Bluebell, PA.

This \$475 unit contains a 32-bit memory whose contents are displayed on 32 LED indicators. The LEDs are arranged in two rows of 16. Data are entered into the unit in either a serial or parallel mode and can either be split into two 16-bit channels or entered as a single 32-bit sample.

In the serial mode, data are entered through the serial input probe on the upper end of the unit. Data are shifted into the analyzer's memory by an external clock, which is provided by the system being examined.

For entering parallel data, it is necessary to interface with two 16-pin DIP connectors on the rear of the analyzer. Data appearing on these 32 inputs will be transferred to the internal memory and displayed on the first clock edge after the trigger point.

Like the more expensive bench-top analyzers, the hand-held CPSR unit can display both pre-trigger and post-trigger data. The data appearing on the display can be delayed from the trigger point in increments of 10 clock cycle periods up to a maximum of 2550 cycles.

Another hand-held logic analyzer, the MS-416 from MITS, Inc., Albuquerque, NM, comes in kit form and costs \$127.50. Assembled units cost \$189.50. Like the CPSR device, the MS-416 displays data on LEDs. But where the CPSR unit has 32 LEDs and only two-channel capability, the MITS device has 64 LEDs and four-channel capability.

Clocking of data is done by an internal clock



Pattern analyzers that trigger scopes on the occurrence of a specific bit pattern, are becoming popular because they provide jitter-free traces.

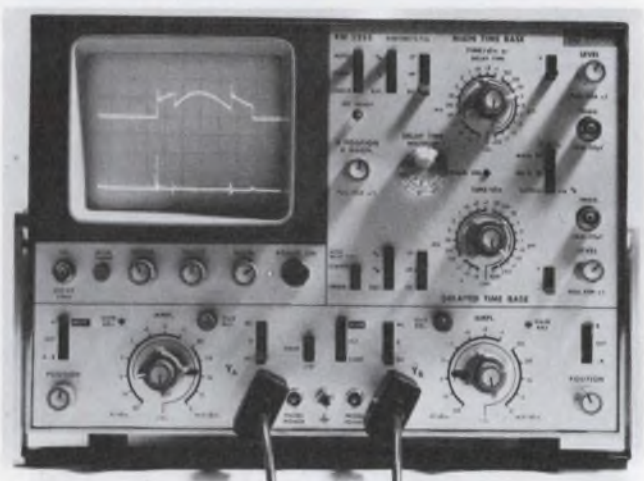

By adding multipliers to a scope, engineers at Philips came up with the PM 3252, which can display the product of two input signals.

that provides an adjustable time base from 0.5 μ s to 200 ms. This means that the maximum frequency of the unit is 2 MHz. Power for the MS-416 is provided by an internal nickel-cadmium battery, which will last 1.5 hours between charges.

Logic triggers improve scopes

Logic triggers are not limited in their application to logic analyzers. Because the triggering circuits in conventional oscilloscopes leave much to be desired when used with digital signals, logic triggers are ideal for jitter-free scope triggering. Tektronix of Beaverton, OR, has come out with a device it calls the 821 word recognizer.

The 821 is a 4-bit logic trigger. Its 50- Ω TTL output, however, makes it possible to cascade four 821s to achieve a word length of 16 bits. Like the logic triggers in the analyzers, the Tektronix device allows each of the inputs to be set to either a ONE, a ZERO or a don't-care condition. The don't care position is used for applications that require less than four inputs.

By flipping a switch, the user can convert the 821 from a logic trigger to a driver. In the driver mode, the input probes become output drivers, each capable of driving up to six TTL loads. This feature is useful where inputs are to be manually stepped through their logic truth tables.

Another logic trigger that has been introduced is the HP 1620A pattern analyzer. Like the 821, the HP unit can recognize synchronous or asynchronous patterns. But unlike the 821, it can accommodate up to 16 parallel input channels.

Upon recognizing the preset pattern in an onrushing stream of data, the 1620A produces a 2-V, 30-ns pulse that can be used to trigger any oscilloscope, data analyzer or other device. In the parallel asynchronous mode a special filter is automatically engaged to eliminate glitches that could cause spurious triggering. The filter tells the instrument to ignore glitches if their duration is shorter than that set by any of the pushbuttons—20, 50, 100 or 200 ns. If no buttons are pushed glitches of less than 10 ns are ignored.

Oscilloscopes that multiply

In the last two years instrument designers have gradually been adding more and more processing power to oscilloscopes. One of the early additions came from N.V. Philips Gloeilampenfabrieken, Eindhoven, the Netherlands. In the PM 3252 and 3253 Philips scopes there is now multiplication capability, which permits the product of two input signals to be displayed simultaneously with one of the original signals.

This feature allows these instruments to be used for transient-power measurements in semiconductor development, for high-accuracy phase measurements and for direct measurement of physical properties that can be converted to electrical signals through transducers. By displaying one of the original signals simultaneously with the product, the user can see the correlation between the two.

Another important characteristic of the multiplying scopes is a special output jack at the rear of the instrument that allows either the instantaneous or average value of the displayed product to be shown on an indicating device or to be used for further processing. Any dc voltmeter connected to this output can be used as a wattmeter. The output, which is derived from the



The fastest storage scope around is the 466 from Tektronix. It has a writing speed of 1350 cm/ μ s and a viewing time of from 15 s to 6 minutes.



The first digital phase angle voltmeter is the 225 from North Atlantic Industries. A ratio-metric option displays ratio of input to a reference.

multiplier, is calibrated in terms of the oscilloscope display (100 mV/division).

It is also possible, by adjustment of front-panel controls, to change both the oscilloscope display and meter sensitivity from the low-micro watt to the kilowatt range.

The two-in-one instrument

Since the oscilloscope and the digital multimeter are probably the most important instruments to the engineer, it is only natural that some manufacturer would offer an instrument that combines the two. Tektronix did it originally with its 7000 series plug-in oscilloscope. Now the digital multimeter has been added to the portable oscilloscope family in the form of the DM 43.

The DM 43 is a module that attaches to Tek's 464, 465, 466 and 475 scopes and lets them measure temperature, time, resistance and volt-



The 6500 digital phasemeter from Krohn-Hite features an accuracy of 0.05° with a 0.01° resolution. The fre-

quency range of the meter is from 10 Hz to 5 MHz and inputs can range from 0.1 to 120 V rms.

age. The module also makes it easier to measure delay sweeps, and it does it more reliably. The conventional method of making such measurements requires several manual manipulations and calculations. With a digital multimeter, the manual calculations are eliminated.

The DM 43 consists of three basic sections: converters for temperature, time and resistance; a digital voltmeter and a 3-1/2-digit readout.

Temperature measurements are made with a probe that has a silicon npn transistor in the tip. (The emitter-base voltage of the transistor is a measure of temperature because one characteristic of a forward biased p-n junction is that the voltage drop across it is temperature-dependent.) With the probe, temperatures can be measured within 2 C from -55 C to $+125$ C and within 3 C from $+125$ C to $+150$ C.

Another example of more processing power in an oscilloscope is the Tektronix 7704A digital-processing oscilloscope. It combines the following: a processor and software optimized for waveform processing, a general-purpose oscilloscope and a minicomputer.

In addition to displaying a signal as a conventional scope does, the 7704A can also average the signals to eliminate noise, can display the signal in the frequency domain by calculating its Fourier transform, can correct for signal errors caused by impedance mismatches, can automatically scale displayed waveforms to any convenient form and can correlate and convolute signals. All of this is made possible by the 7704A's ability to add, subtract, multiply, divide, differentiate and integrate.

Hewlett-Packard has taken the Tektronix idea of adding a computer to an oscilloscope and carried it one step further. Instead of using a minicomputer, it has used a microcomputer. The result is the 1722A, a 275-MHz, dual-channel microprocessor oscilloscope.

In designing the 1722A, HP engineers capitalized on the time and effort already put into the HP 35 scientific calculator and included that

device's microprocessor into the scope. The HP 35 processor enables the new scope not only to display waveforms, but also to provide a digital LED readout of time interval, frequency, dc voltage, peak voltage and percent difference in amplitudes.

In another area of the technology—storage scopes—Tektronix has taken the lead with its Model 466. At a writing speed of 1350 cm/ μ s (3000 divisions/ μ s), the 466 can grab and hold single-shot pulses with no tradeoff in the unit's 100-MHz bandwidth. What is traded off, however, is scanning size. The top speed comes with a reduced scan of 3.6 by 4.5 cm. The full scan of 5.4 by 7.2 cm is only achieved once the writing speed drops to 135 V/ μ s.

The instrument features multi-mode storage capability that provides:

- A variable persistence mode with a bright trace for both slow and fast repetitive signals.
- A fast-transfer mode for high-frequency signals and single-transient analysis.
- A nonstore mode for conventional oscilloscope displays.

Viewing time varies from 15 s at full stored intensity to about 6 minutes for reduced intensity.

The 466 also has a push-to-view trigger switch that automatically routes the trigger signal from the Channel A time base to the vertical deflection amplifier. Thus without disconnecting leads or re-setting controls, the operator can quickly check his trigger source.

Meters continue to go digital

In a continuation of the trend to digital meters, Krohn-Hite has come out with a phase meter, the Model 6500, that offers phase-angle measurements with $\pm 0.05^\circ$ accuracy and 0.01° resolution. An interesting feature of the five-digit 6500 is that its phase accuracy is unaffected by unequal signal input levels, which can range from 0.1 to 120 V rms.

The Krohn-Hite unit also overcomes an am-

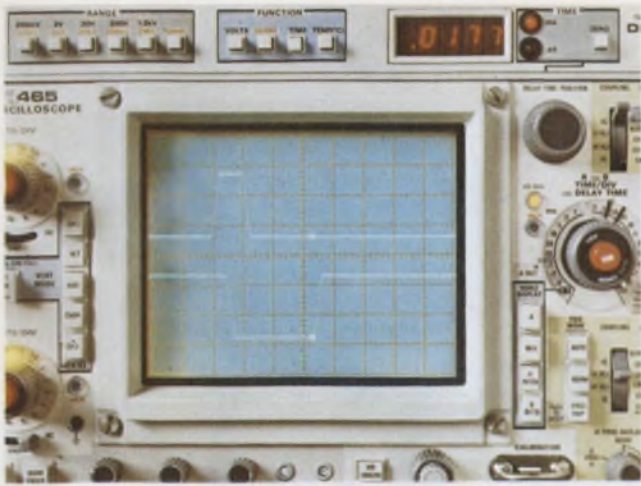

The DM 43 digital multimeter from Tektronix can be used with the 464, 465, 466 or 475 scopes to measure temperature, time, voltage or resistance.

biguity problem that generally plagues other meters. With most meters, when the angles are close to 0, 180 or 360°, it's necessary to switch ranges to avoid erratic reading or discontinuities. But the 6500 reads directly from 0 to 360° and can measure phase differences as small as 0.01° without meter fluctuations or repeatability errors.

If voltages as well as phase angles are to be measured, the new digital phase-angle voltmeter from North Atlantic Industries, Plainview, NY, is the instrument to use. Called the Model 225, it is the first digital phase-angle voltmeter to be announced.

The 225 measures total voltage over 10 Hz to 100 kHz and provides phase-sensitive voltage and phase-angle measurements at any two spot frequencies within the 30-Hz-to-30-kHz band. When operated in the phase-sensitive mode, the unit provides 0.1% voltage measuring accuracy and 0.25° phase-angle accuracy at frequencies around 400 Hz.

These accuracies compare favorably with analog phase-angle voltmeters that provide 2% voltage accuracy and 1° phase-angle accuracy. The increased accuracy of the digital unit results from use of phase-locked-loop digital filters, which permit the signal and reference channels to be filtered by matched two-pole filters instead of hard-to-match five-pole filters.

The 225 handles a maximum input voltage of 500 V rms, with intermediate ranges down to 10 mV, full scale. An optional feature is a ratiometric configuration that displays the ratio of signal input to reference input levels. Ratios can be measured and displayed for in-phase, quadrature and total voltage. The ratiometric mode can be used for amplifier-gain measurements, direct reading of transfer function and

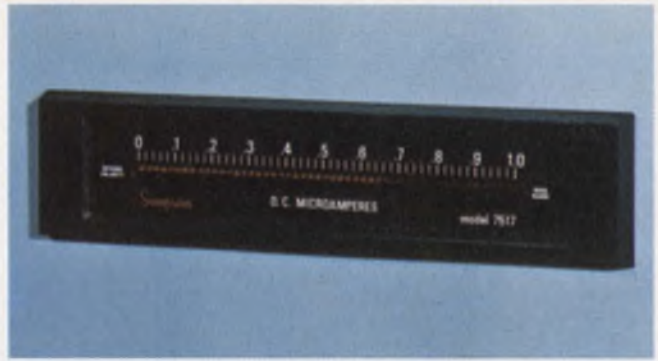

The ANA/LED panel meter from Simpson combines the advantages of both analog and digital meters. It has no moving parts but can show trends.

direct measurement of transformer ratio and transmission-line loss.

Bridging the analog-digital gap

A meter that bridges the gap between analog and digital panel meters, by combining the best of both worlds, is Simpson Electric's ANA/LED panel meter. Like digital meters, the Simpson unit is all-solid-state—it contains no moving parts. But like an analog meter, information is read out by an indicator on a meter face scale.

An unusual feature of the ANA/LED is that electrical signals do not actuate a conventional pointer mechanism, but rather a linear array of light-emitting diodes. The 5-in.-long array of discrete LEDs is positioned next to a calibrated scale. When an input is applied, all the LEDs below the signal level light up in thermometer-like fashion.

The new meter accepts the same type of analog signal that a D'Arsonval meter does, and by means of internal conversion circuitry, it produces a proportional signal that drives the output display.

Unlike analog meters—but like digital ones—the ANA/LED requires external power: about 2.4 W from a dual 6-V supply. Because of this requirement, the Simpson unit does not directly replace the D'Arsonval meter. It provides an alternative in areas where certain characteristics of the moving coil instrument are undesirable.

Another virtue of the Simpson meter is its fast response time—15 ms. This is possible because there are no inertia-producing mechanical components and no analog-to-digital conversion circuits. Since there are no pivots and jewels, vibration damage is no longer a problem. It can also be subjected to oil-bearing or dust-laden atmospheres without concern for friction.

The ANA/LED has an amplified signal output and a reference voltage, which, when combined with voltage-comparator circuits and auxiliary power supplies, can provide 50 set points. ■■



The WJ-1250 Modular Synthesizer System

1 to 18 GHz Coverage Provided in a 13 inch high configuration

The WJ-1250 Modular Synthesizer System pictured above provides a minimum of 5 mW across the full 1 to 18 GHz frequency range. The desired frequency may be commanded via the front panel keyboard or the rear panel BCD input connector, and the synthesized frequency is provided at the appropriate RF Source port.

By employing other available units, a minimum of 10 mW can be supplied across the full 0.5 to 18 GHz range in a

20 inch high configuration and still have room to accommodate a future 18–26 GHz RF Source. Lesser frequency coverage may of course be provided using fewer modular units, while programmable attenuation, modulation, single-port output, etc. can be accomplished through additional units.

With the output signal achieved directly from YIG-tuned oscillators, maximum power and spectral purity are maintained over the full range. Maximum full range

switching time is 100 msec, and long-term stability is ± 3 pp 10^7 /day or that of an external reference.

For specifications on the WJ-1250 Modular Synthesizer System, its component modules, and other related products, contact the Watkins-Johnson Field Sales Office in your area or Systems Applications Engineering at the Palo Alto address and phone number below.

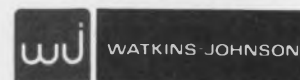

Watkins-Johnson—U.S.A.: 3333 Hillview Ave., Palo Alto, CA 94304 • (415) 493-4141 • TWX: 910-373-1253 • Telex: 34-8415 • Cable: WJPLA • 700 Quince Orchard Rd., Gaithersburg, MD 20760 • (301) 948-7550 • TWX: 710-828-0546 • Telex: 89-8402 • Cable: WJCEI • **United Kingdom:** Shirley Ave., Windsor, Berkshire SL4 5JU. England • Tel: Windsor 69241 • Cable: WJUKW-WINDSOR • Telex: 847578 • **West Germany:** 8033 Planegg, Muenchenerstr. 17 • Tel: (089) 859-9441 • Cable: WJDBM-Muenchen • Telex: 529401 • **Italy:** Piazza G. Marconi, 25 00144 Roma-EUR • Tel: 59 45 54 • Cable: WJROM-ROMA • Telex: 60117

INFORMATION RETRIEVAL NUMBER 32

INFORMATION RETRIEVAL NUMBER 236 ►

A 5-digit multimeter at a 3-digit price.

\$995. That's the basic price of the 5000. And that's the lowest price we've ever had for a 5-digit multimeter.

\$375 adds true RMS.

This converter can measure signals with crest factors ranging up to 22. All with typically 0.1% accuracy and settling times of less than 600 milliseconds. AC or AC+DC mode operation is also provided.

When you consider the

5000's total performance, there's really nothing comparable for the money. You get delayed dual slope integration for increased accuracy and linearity at a reduced cost, 100% over-ranging and autoranging to ensure complete flexibility in use. And a large LED display with leading zero blanking for easy viewing.

The 5000 is truly a classic technical achievement. Improved performance at lower cost.

Contact your Dana sales representative by calling toll-free 800-645-9200. In New York, phone 516-294-0990. In Europe, call 02-241 4550.



DANA

Others measure by us.

It's so accurate, no other 5-digit multimeter can check its performance.

In order to check the readings of our 5900, you'll need a more accurate 5-digit multimeter. And no such instrument exists.

Because of its high stability, there is a minimum of recalibrations to ensure its .001% accuracy.

That's impressive enough. But the 5900 has a lot more going for it.

It provides true systems capability. The standard digital output and optional remote programming in

every 5900 are fully isolated and buffered. More than 20 readings per second can be made on all measurements. And there is a super-fast mode that allows 100 readings per second.

It has 5 DC ranges, 60% over-range and full ratio capability. Plus 350 volts RMS protection on all ohms measurements. Now it even has a true RMS converter.

The basic 5900 price is \$1,995. And at that price, nothing else is really comparable.

Contact your Dana sales representative by calling toll-free 800-645-9200. In New York, phone 516-294-0990. In Europe, phone 02-241 4550.



DANA
Others measure by us.

A low-cost scope should offer more than a low price.

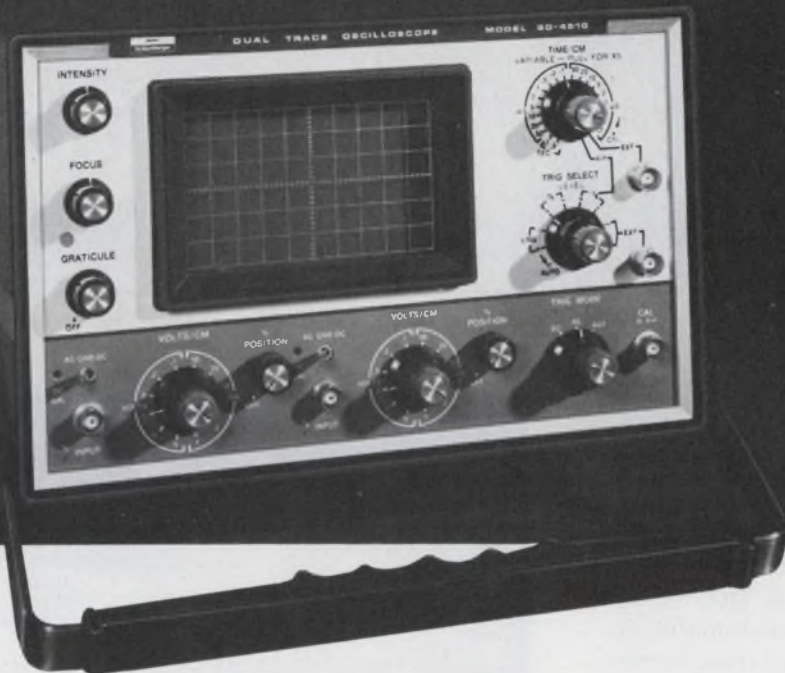

The new Heath/Schlumberger dual-trace SO-4510 has DC-15 MHz bandwidth, 1 mV sensitivity, post-deflection accelerated CRT, vertical amplifier delay lines & more . . . for only \$750*.

The actual value of any oscilloscope is really how much it benefits the user in price, or performance, or both. Our SO-4510 offers a low price plus DC-15 MHz bandwidth, vertical sensitivity of 1 mV/cm, time base sweep to 100 nsec/cm and complete dual-trace capability. And it also offers many features that other manufacturers don't provide at anywhere near our low price.

Like **post-deflection acceleration** for a brighter trace and faster writing speeds. Many input signals that wouldn't be visible on a mono-accelerated CRT are presented in a sharp, bright trace on the SO-4510. Think of your applications for an oscilloscope. Can you really do without our additional brightness?

Trigger bandwidth — is it specified? The SO-4510 will typically trigger on signals up to 45 MHz and is guaranteed to 30 MHz. And there's no stability control needed with the digitally-controlled triggering circuits. In the automatic mode, a reference baseline is generated even when the trigger signal is absent. Complete triggering controls are provided with choice of AC or DC coupling, triggering at any point on the vertical signal. An AC fast coupling mode is provided to reject low-frequency components of the trigger waveform for accurate scope triggering. Choice of automatic or normal sweep uses any one of 22 time bases from 0.2 sec/cm to 0.1 μ sec/cm.

Vertical input sensitivity of 1 millivolt — over the full bandwidth. Think of this in terms of the way you're most likely to use an oscilloscope — with a X10 probe. With the SO-4510 and a X10 probe, you can still read waveforms to 10 mV/cm, not the 50 or 100 mV/cm found on other scopes. We also offer a companion high impedance isolating probe with 10:1 attenuation for only \$23.95*.

Internal delay lines for the vertical amplifier insure start of the horizontal sweep prior to the beginning of the vertical signal. They allow display of at least 20 nanoseconds of the pre-triggered waveform, insuring that the complete waveform will be displayed. Can you really do without this pulse analysis capability?

True X-Y capability. X-Y operation uses Channel 1 for horizontal deflection and Channel 2 for vertical deflection. Phase measurements can be made using the standard vertical inputs, not the horizontal input as other scopes require.

Dependable, rugged design with easy-to-service construction. The SO-4510 was designed by service-oriented engineers who have been designing low cost scopes for a long time. The SO-4510 is remarkably easy to service. All major circuitry is located on five circuit boards for easy trouble-shooting. Push-on connectors permit fast removal of any board. Even the CRT can be removed and replaced in a matter of minutes.

Most important, the SO-4510 is designed and built by Heath — specialists in high performance, low cost instrumentation. We know how to provide good instrument value for the money, not merely another low-price instrument. And we're not just entering the low-cost instrument market, we've been here for years. The SO-4510 was designed for a maximum of performance at the lowest possible cost. And if you're interested in saving even more, our IO-4510 offers the same performance and features in an easy-to-assemble kit for only \$549.95*.



The latest Heath/Schlumberger catalog features a complete line of high performance, low cost instruments for industrial and educational applications. Our '75 Heathkit Catalog describes the world's largest selection of electronic kits — including a full line of lab and service instruments. Send for your free copies today.

Heath/Schlumberger Instruments Dept. 531-269 Benton Harbor, Michigan 49022		HEATH Schlumberger
<input type="checkbox"/> Please send the 1975 Heathkit catalog.		
<input type="checkbox"/> Please send the latest Heath/Schlumberger catalog.		
Name _____		
Title _____		
Company/Institution _____		
Street _____		
City _____		
State _____		Zip _____
*Mail order prices; F.O.B. factory. Prices & specifications subject to change without notice.		
		EK-435

PROGRAMMABLE INSTRUMENTS

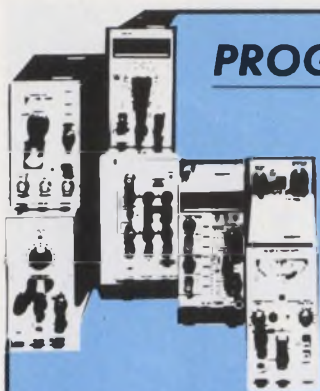

In 3 major ways look for changes in compatible equipment

Instruments that once were BCD-programmable only are being redesigned to be ASCII-programmable. . . . Calculators and microprocessors are eating away at the controller market that once was the sole domain of the minicomputer. . . . And a standard is being developed that specifies the protocol and system criteria for hooking together programmable instruments and controllers, such as calculators, minicomputers and microprocessors.

It's apparent that programmable instrumentation systems are undergoing significant changes.

Many instruments are being offered today by manufacturers as "computer-compatible." Are they programmable? Maybe—but not necessarily. Computer-compatible usually means that the instrument has a BCD (binary-coded-decimal) output connector that feeds the reading, in bit-parallel form, to a controller (programmable calculator, minicomputer or microprocessor). Most often the instrument also has a digital display of its reading. The BCD output is taken directly from the display decoder.

To be programmable, the instrument must do far more. According to Tom Coates, research and development engineer at Hewlett-Packard in Santa Clara, CA:

"The instrument must not only be able to feed readings to the controller; it must also be manually controlled and the front panel locked out when the instrument is under the influence of the controller. The controller must be able to return local control to the instrument. And the controller must be able to instruct the instrument when to take measurements, when to out-

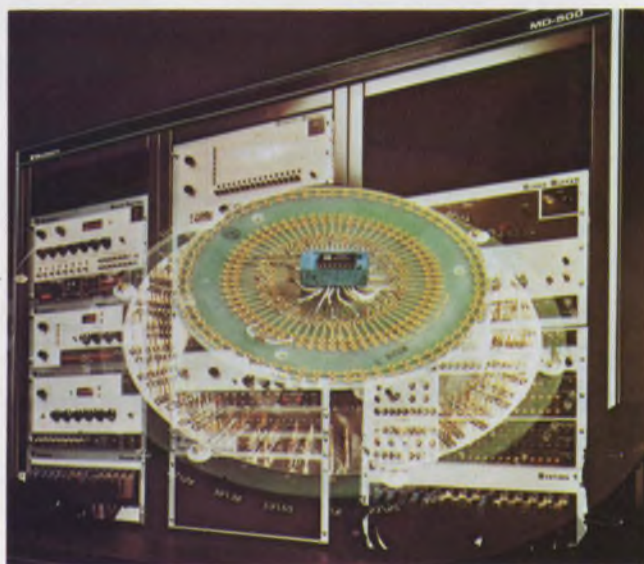

Macrodata's MD-500 is a large-scale, general-purpose LSI test system. It is controlled by an Interdata 70 minicomputer and contains primarily test instruments designed in-house at Macrodata.

put the data and at what speed to take the measurements."

In other words, the controller and the instrument must have a hand-shaking link. Often the relationship goes further.

The instrument might have a program memory or even an internal microprocessor to help with local computation. The instrument might have a range of status flags or signals that help the controller keep track of what's going on. These might be messages such as: out of calibration; power on; busy; measurement complete; phase lock obtained; finished calibrating; overload; out of range; illegal range for the function selected; ready for orders.

Traditionally minicomputers have been the controllers in automatic measurement systems.

Dave Kaye
Senior Western Editor

These minis like to see data in an 8, 12 or 16-bit, fully parallel mode. Since most instruments have been BCD-programmable, the mini has required an interface that converts from BCD to straight binary, so the instrument language can be translated to mini language.

Why haven't instruments been developed to communicate directly in straight binary? Some have. But it is so much easier to take the already existing BCD signal out of the instrument. And, besides, less than 20% of the instruments sold are used in automatic measurement systems. It is usually considered not worth the cost of development to have a separate line of binary programmable instruments.

Even if the instruments were to converse in straight binary, that wouldn't be enough. Most minis require their own unique communications protocol. There is no standard, no common ground upon which controllers and instruments can meet on equal and interchangeable terms. But this major problem is near solution.

The formidable job has been taken on by the International Electrotechnical Commission (IEC). In a meeting in Bucharest recently, a proposed standard was almost entirely agreed upon. Such a standard, once accepted by the member nations of the IEC, would be worldwide in scope. For an American manufacturer to sell programmable equipment anywhere in the world, the equipment would have to conform to the standard.

The proposed standard is based to a large extent on the suggestions of Hewlett-Packard, Palo Alto, CA. HP has incorporated its suggestions in a product called the Hewlett-Packard Interface Bus. The bus can handle up to 15 interconnected devices, distances of less than 20 meters, data rates of less than 1 Mbyte/s and a variety of short hand-shaking messages.

Data on the bus are transferred in bit-parallel, byte-serial fashion. Many engineers feel that the most desirable information code to use is ASCII (American Standard Code for Information Interchange). However, that is not mandated by the proposed IEC standard. The interface system contains 16 signal lines to carry all information (addresses, universal commands, measurement data, program data and status data) among the interconnected devices.

At any one time, one device may be talking into the bus and one or more devices may be listening to the talker. Eight DIO (data input/output) signal lines carry coded messages from the talker to the listeners. Data flow is bidirectional, in that the same signal lines are used both to input program data and to output measurement data from an individual device. Data are exchanged asynchronously between devices on the bus, which makes for compatibility be-



The first system to use the HP Interface Bus is the 3042A network analyzer from Hewlett-Packard. This system is a calculator-controlled frequency synthesizer and network analyzer for measuring amplitude and phase from 50 Hz to 13 MHz.



Under control of a Tektronix 31 programmable calculator, the 31/53 system can process data from a variety of instruments in the TM-500 series of plug-in devices.



The 1010 programmable waveform analyzer from E-H Research has a program storage register within it and can be interfaced to the Tektronix 31 and HP 9821 programmable calculators.



The DMM-42 from California Instruments is a 4-1/2-digit programmable digital multimeter. It is BCD-programmable with a high degree of isolation between the unit's analog and digital sections.

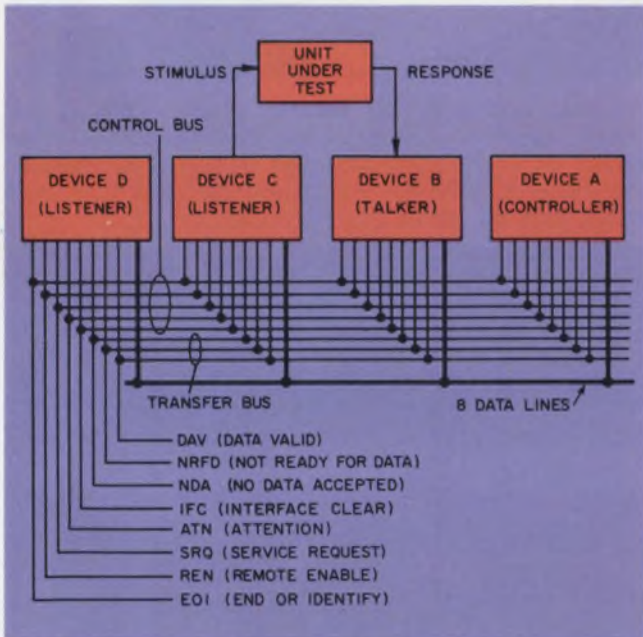

Hewlett-Packard's Interface Bus is being considered by the IEC for use as an international interface standard for automatic test systems. Up to 15 devices can be attached to the bus asynchronously with data rates of up to 1 Mbyte/s.

tween devices with varying data rates and transmission characteristics.

Special control and status messages are carried on the other eight lines. Three of these dedicated lines—DAV (data valid), NRFD (not ready for data) and NDAV (no data accepted)—are used to transfer each byte of coded data on the eight DIO signal lines. The five remaining dedicated signal lines—IFC (interface clear), ATN (attention—used to describe the type of data to be transmitted), SRQ (service request-

ed), REN (remote enable) and EOI (end or identify)—are used to manage an orderly flow of information across the interface.

Proposed standard ignores minis

Some engineers contend that the proposed IEC standard ignores minicomputers as controllers, because a byte serial mode of data transfer has been selected rather than a fully parallel system. However, the best mode is influenced by the size and speed of the instrumentation system being developed. By limiting the elements of the system to 15 and specifying byte serial, the standard's framers acknowledge that large, fast systems would have to go another route. But for smaller systems, any controller could be used. Minicomputers could interface to the bus as well as calculators. The standard, however, appears oriented primarily toward use of calculators as the controllers. Zoltan Tarczy-Hornoch, director of research with Systron-Donner in Concord, CA, says: "Minicomputers are pretty well out for small programmable systems. Calculators and microprocessors will dominate this field."

John Fluke Jr., technical director of the Automatic Test Group at John Fluke Manufacturing Co., Seattle, is in favor of the standard, but he notes one weakness:

"We feel that the standard misses character sequence requirements. Thus 'standard' instruments will not all be compatible with one another. For example, one instrument might return the most significant bit of the data word first, and another might transmit the least significant bit first. No software convention has been included in the standard to cover data format."

Tarczy-Hornoch of Systron-Donner says: "The

proposed IEC standard might be too rigid if the data format and code were specified. In addition it would be much more difficult to get a world-wide forum, such as the IEC, to agree to it."

Fluke hopes that in this country at least, the IEEE will specify data format in a standard of its own.

Nonetheless Fluke and most other major instrumentation companies are busily developing ASCII programmable instruments that will be compatible with the proposed IEC standard.

At the moment the only companies with IEC-compatible instruments are HP and Wavetek, San Diego. Tarczy-Hornoch of Systron-Donner says: "All of our new programmable instruments will be IEC-compatible and ASCII-programmable."

Programmable sources are limited

Programmable instruments can be thought of as coming in two classes: signal sources and measurement devices. Some engineers call them stimulus and response devices. Although many manufacturers make measurement devices—such as digital voltmeters, waveform analyzers, frequency counters—very few make sources. Sources are such devices as power supplies, signal generators, frequency synthesizers and waveform generators.

Many systems houses develop their own programmable power supplies because of a limited selection on the market. Hewlett-Packard and John Fluke both have large, fairly expensive programmable dc power supplies. Kepco, Flushing, NY, makes less expensive and less sophisticated units.

Fluke's 4200 series of Programmable Power-DACs are actually digital-to-analog converters with a power-amplifier output. They come with either BCD or binary TWOs complement programming. Outputs are available to 65 V at 1 A, or 110 V at 1/2 A, with 100- μ V resolution.

Similar units from HP also come in either BCD or straight binary, with outputs available from ± 16 V at 12.5 A to ± 100 V at 1/2 A. In addition HP has programmable current sources called the 6140A and 6145A, which provide ± 160 mA at 100 V and ± 100 mA at 100 V, respectively. Most of these large programmable power sources cost from \$1500 to \$3000.

A wide selection of small, inexpensive supplies that are resistance-programmable is available from Kepco. These are often an order of magnitude cheaper than the large units from HP and Fluke, but they require an external digital-to-analog converter to interface with a minicomputer or a programmable calculator. Kepco sells the d/a converter as a separate unit.

Often a test system will have to simulate ac

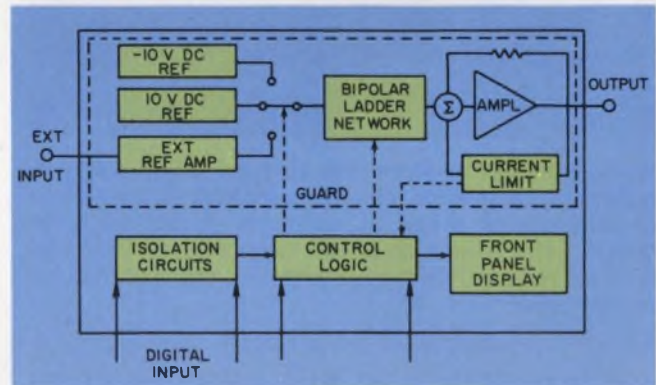
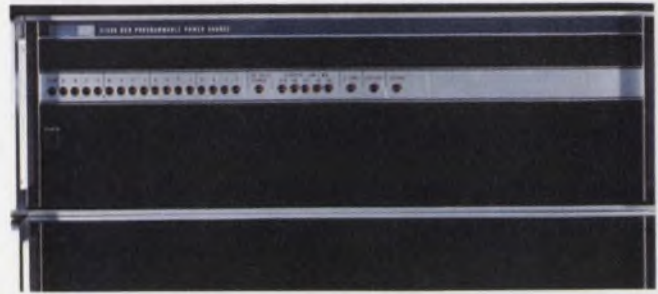

Fluke's programmable power DAC uses a bipolar ladder network digital-to-analog converter, connected through a power amplifier, to provide precision programmable power. Outputs are available at 65 V and 110 V.

power-line disturbances, such as transients. In this case a programmable ac power source is needed. One of the more unusual instruments available for this function is the series 830T Programmable Oscillator from California Instruments, San Diego. It can, under program control, set individually the frequency, phase and amplitude of its output. Frequency can be adjusted from 45 Hz to 9.99 kHz, phase from 0 to 360 degrees in 1-degree increments and amplitude from 0.5 to 135 V rms in 0.1-V steps. For higher power levels, the programmable oscillator would be connected to a power amplifier.

Very few programmable signal generators are available. Programmable frequency synthesizers are more widely used. Examples of these are a set of instruments that HP has adapted to be both ASCII-programmable and compatible with the proposed IEC standard: the 3320A/B and 3330A/B, covering 0.01 Hz to 13 MHz. For higher frequencies, the older 8660A/B covers from 10 kHz to 2.6 GHz.

Programmable pulse generators are available from several companies, including HP, Systron-Donner and E-H Research Laboratories, Oakland, CA. Missing from most of the programmable pulse generators, says Coates of HP, is programmable pulse width. No ASCII-programmable pulse generators are currently available.

One of the most versatile pulse generators is the Series 150 from Systron-Donner. Serial or parallel programming is available with repetition



The only non-HP instruments that are ASCII-programmable and compatible with the proposed IEC interface standard are a series of waveform generators from Wavetek. This model, the 159, works to 3 MHz and can also be controlled by a keyboard on the front of the instrument.

rates from 10 Hz to 50 MHz, pulse delays from 10 ns to 10 ms and pulse width from 10 ns to 10 ms. Depending upon options, units in the 150 series sell for \$3000 to \$5000.

An offshoot of the pulse generator, for testing digital systems, is the word generator. The only ASCII-programmable and IEC-compatible word generator is the 8016A from HP. It has a 9×32 -bit memory and a variable 0.5-Hz-to-50-MHz bit rate.

The only ASCII-programmable and IEC-compatible waveform generators come from Wavetek. They are the 152, 158 and 159, selling for \$4995, \$1245 and \$1495, respectively. Remote control of phase angle is a unique feature of the 152, which has a frequency range of 1 Hz to 100 kHz.

Measurement instruments abound

Most manufacturers of response or measurement instruments make a programmable version of one or more of their products. In a few isolated cases instruments have been specifically designed for systems applications. More often, programming is an option on a standard bench instrument.

Digital voltmeters and multimeters are the most common of the programmable measurement devices. HP has the 3490 Digital Multimeter, the only DMM that is ASCII-programmable and IEC-compatible. This is a five-digit unit with a unique self-test feature. At the flip of a switch, the 3490 sequences itself through 10 tests that check timing signals, autoranging circuits, the LED display and many of the digital ICs in the instrument.

California Instruments has a BCD-programmable DMM called the DMM 42. This 4-1/2-digit

instrument has a high degree of isolation between the analog and digital portions of the box, and it automatically protects against selection of an incompatible function and range.

Fluke has one of the largest selections of programmable DMMs and DVMs (digital voltmeters). All of these instruments are BCD-programmable. John Fluke Jr. acknowledges, though, that IEC standard interfaces are being developed for Fluke's systems instruments.

A useful feature of the Fluke meters that very few other programmable instruments have is a set of output lines that indicate such status indications as range, function, overload, data ready and busy.

Most DMMs are programmed very simply. A single data word indicates function, range, filter-in and remote. Remote is a command that usually locks out the front panel with the exception of the power-on switch. Coates of HP notes that several different techniques are used to lock out the front panel in programmable instruments.

An HP technique that is newly designed has been implemented in the 5345, a 500-MHz digital counter. A pair of busses is used in the 5345. One bus is connected to the front panel and one to the remote controller. When the remote command is given, the instrument merely switches from one bus to the other.

Roger Jennings, president of Fluidyne Instrumentation, Oakland, CA, and the designer of many calculator-based instrumentation systems, reports that many programmable instruments, notably DMMs, suffer from common-mode noise problems. This is usually caused by insufficient isolation between the analog and the digital portions of the system. The noise is most detrimental when low-level signals are to be measured or acted upon.

The noise problem has been keenly noted by Keithley Instruments, Cleveland. William Nichols, chief engineer, explains: "For a very sensitive instrument, such as our 180, 4-1/2-digit nanovoltmeter or our 616 digital electrometer/multimeter very high isolation is needed. From the low input to the chassis ground, we have better than $10^{10} \Omega$ shunted by less than 700 pF."

The 180 is one of the few instruments that output a good range of status indications. Polarity, range and overload, as well as data, are available on output lines.

Although the Keithley instruments are BCD-programmable, they have an unusual outputting scheme that provides serial as well as parallel data streams. The output lines can be strobed. Each line controls 4 bits of output data, so the output can be easily set for 8, 12 or 16-bit computers.

If the computer can't handle the output in parallel, serial activation of the strobe lines al-

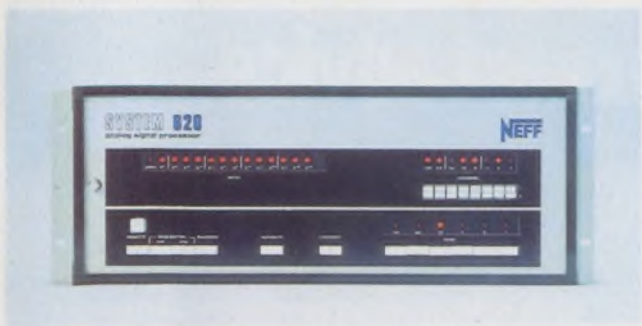

Neff's Model 620 data-acquisition system is compatible with Digital Equipment's PDP-11 computers and has a programmable channel address, gain and sample rate.

lows the output to be interrogated in any multiple of 4 bits. In addition isolated range control lines provide the option of selecting a desired range by remote control while retaining the autoranging capability of the instrument. Remote programming is provided over five decades on each range function.

Not too many programmable counters are on the market. The only ASCII-programmable, IEC-compatible counters are from HP. They are 5345 dc-to-500-MHz counter, the 5340A and 5341A microwave counters and the 5300B electronic counter system—a snap together, counter display system with a variety of modules that cover various frequencies. The 5345A is the world's first direct-counting, dc-to-500-MHz counter.

One of the more sophisticated programmable measurement instruments is the 1010 waveform analyzer from E-H Research Laboratories. According to Burnell West, engineering manager for instruments, "It uses a programmable sampling scope and a processor to measure such things as rise time, fall time and propagation delay." The instrument is ASCII-programmable. A 56-character program sets the machine. It has a program register that can be interrogated to read back and check the program. Very few instruments have a program register. However, more and more instruments are being designed with memory registers. In the case of programmable instruments, the register can be used to store a reading until the controller is ready for it. The instrument is free to take another reading while it stores the first one. Systron-Donner also makes an ASCII-programmable waveform analyzer. However, only the inputs are ASCII, while the outputs are BCD.

Systems, systems everywhere

Many automatic test systems have been developed over the last few years. Most have been under minicomputer control and a few have been

calculator based. Automatic test systems have been widely used for IC and semiconductor testing. Generally most of the instruments that make up the blocks in an IC tester are custom designed rather than off-the-shelf. William Mandl, director of program management at Macrodata, Woodland Hills, CA, points out:

"Regular minicomputers and calculators are not fast enough to check a fast IC at operating speed. We only use a minicomputer for executive functions in the test system, while a specially designed fast controller handles the real-time test operations."

Of the calculator-based systems, the best known is the 31/53 from Tektronix, Beaverton, OR. This system couples the Model 31 programmable calculator with part of the TM-500 series of modular instruments. John David, calculator product specialist at Tektronix, admits that the system is neither fully programmable nor complete.

"We have no stimulus instruments or programmable power supplies in the system yet," he says. And the calculator can act only upon the data from the instruments but cannot give commands to the instruments. The instruments used are counters and DMMs with BCD outputs.

"We are actively designing instruments that will be ASCII-programmable and compatible with the IEC standard," David says. One additional system that Tektronix offers is a Model 31 calculator-based digital-processing oscilloscope.

The first HP system to use the HP interface bus was the 3042 calculator-controlled network analyzer, according to Roger Youngberg, systems product manager at the company's Instrument Div. in Loveland, CO. This system contains a 3330B frequency synthesizer and a 3570A network analyzer. It measures amplitude and phase over a frequency range of 50 Hz to 13 MHz and costs about \$23,000.

More recent systems out of HP have been the 3571 digital spectrum analyzer and a calculator-based data-acquisition system.

Fluidyne has shipped many systems that use Wang calculators. They have been process-control systems and data-acquisition systems primarily. Fluidyne makes an interface for connecting up to 10 instruments to a calculator. Jennings notes that the interface is a multiplexer that strobes the instruments on the bus. He says that with a simple modification, the interface could be made compatible with the proposed IEC standard.

In addition to interface subsystems, interface ICs are now on the market to ease the job of the system designer. Motorola Semiconductor, Phoenix, AZ, has introduced the MC3440 family of quad interface bus transceivers. These chips are designed to meet the requirements of the IEC standard interface. ■■

Our little Pixie got expert advice.

8 years ago we introduced Pixiepot®... the **only** 10-turn miniature precision wirewound pot for the commercial market. Just $\frac{3}{4}$ " long x $\frac{7}{8}$ " diameter, with a mechanical life of 500,000 revolutions. She was totally unique for her small size, low cost and high performance features.

Since then, our 'Elite Design Team' has continued to expand her overall performance capabilities by offering many new custom features. Today the Pixiepot line, in 3, 5 and 10-turn models (available with metric shafts and bushings), is among the most complete and versatile on the market.

Our engineering expertise is backed by the finest quality and manufacturing facilities second to none. Together, they're your assurance of our meeting realistic delivery schedules for 'specials' at the most competitive prices. Call or write us direct for technical literature and the location of your nearest rep.

DUNCAN ELECTRONICS

SUBSIDIARY

SYSTRON  DONNER

2865 Fairview Road • Costa Mesa, California 92626
PHONE: (714) 545-8261 □ TWX 910-595-1128



**Duncan: Your prime source for
custom designed pots.**

Introducing the ALC-5.



The hardworking connector that's easy on your pocket.

Now you can truly reduce your cost of interconnecting by designing in the new ALC-5.* It represents a new concept in subminiature coaxial connector design that will yield the best cost-to-performance ratio of any connector available today.

Unshielded hookups can be risky.

The ALC-5 economically provides RF shielding in computer applications where high speed or close proximity prevent the use of unshielded, single conductor interconnects. Where the new FCC 900 MHz reallocations have put higher frequency demands on vehicle monitoring and communications systems, the ALC-5's hard working VSWR virtue shines (1.1:1 at 1GHz, 1.2:1 at 4GHz, 1.4:1 at 6GHz with RG-58 C/U cable).

Crimp-crimp assemblies assure the repeatable performance required for navigational equipment, biomedical monitoring systems and professional

broadcast and recording gear. Everything from marine radar systems to microwave ovens can use these tiny, low-cost, reliable RF connections. And crimp-crimp assembly also keeps your production costs low.

A fresh, new answer for today's interconnection needs.

The ALC-5 is a contemporary line designed around today's demands for lower price, better performance, smaller size and faster delivery and assembly. Rather than a revamp of one of yesterday's solutions, we've invented something totally new. We've taken the first bold step. Why don't you take the next. Specify ALC-5. Amphenol RF Division, Bunker Ramo Corporation, 33 E. Franklin Street, Danbury, Connecticut 06810, (203) 743-9272. *U.S. Patent No. 3,282,303



AMPHENOL

MOS ANOTHER FIRST!!!!

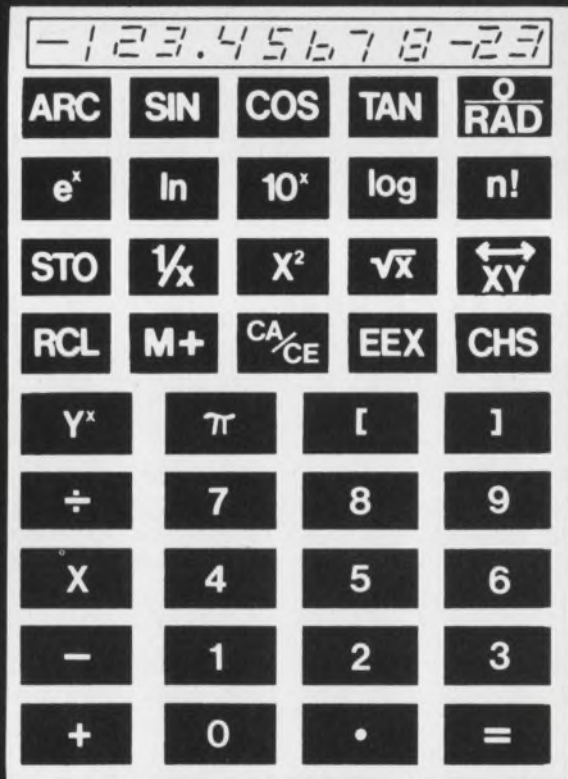

HEADQUARTERS-
Applications Mgr.: Mr. Julius Hertsch;
MOS Technology, Inc., Norristown, Pa. 19401

CENTRAL REGION-
MOS Technology, Inc., 838 S. Des Plaines St.
Chicago, Illinois 60607 (312) 922-0288

EASTERN REGION-
Mr. William Whitehead, Suite 307-
88 Sunnyside Blvd., Plainview, N.Y. 11803 (506) 822-4240

WESTERN REGION-
MOS Technology, Inc., 2172 Dupont Dr., Suite 221
Patio Bldg., Newport Beach, Calif. 92660 (714) 833-1600

a proud affiliate of **ALLEN-BRADLEY**

The First Single Chip Scientific Calculator Arrays

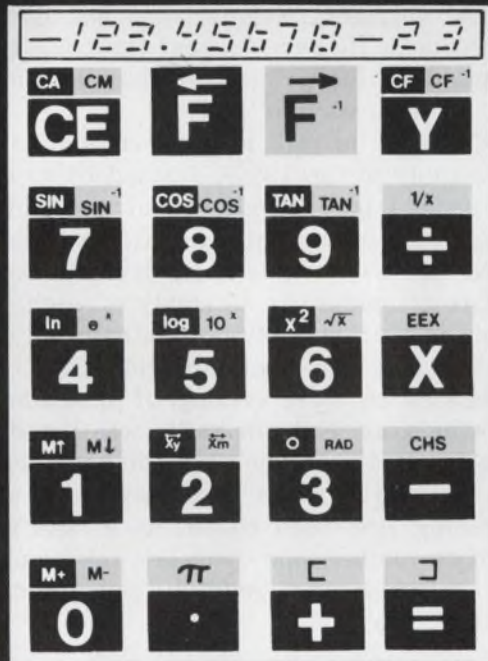

With...

- FULL SCIENTIFIC FUNCTIONS
- ALGEBRAIC ENTRY
- TWO PARENTHESIS LEVELS
- FULL SCIENTIFIC NOTATION
- 12 DIGIT DISPLAY (S,8,S,2)
- FULL FEATURE MEMORY

And

- REDUCED POWER
 - DIRECT SEGMENT DRIVE
 - NO EXTERNAL COMPONENTS
- FOR
- POWER-ON-CLEAR
 - CLOCKS
 - DISPLAY CUTOFF
- ONE 28 PIN DIP

INFORMATION RETRIEVAL NUMBER 37

WE'VE TURNED
A TECHNOLOGY
INTO A COMPANY

MOS

MOS TECHNOLOGY, INC.
VALLEY FORGE CORPORATE CENTER, NORRISTOWN, PA. 19401 (215) 666-7950



INDUSTRY PROFILE

Today's mature designs, as seen by a young 'old-timer'

One of the nicest things about being an "old-timer" in the electronics instrument industry is that you don't have to be very old to be one. After only a score of years at General Radio Co., Harold McAleer, 44-year-old v.p. of engineering, is already a veteran of three generations of technology, including vacuum-tube, transistor, and LSI.

Noting how rapidly the electronic instrument industry has matured in his brief career, McAleer says he's amazed when he realizes he once worked with germanium point-contact transistors and stepping relays and is now involved with TTL and CMOS logic, PDP-11 computers, op amps and integrated phase-locked loops.

He's quick to point out that by industry maturity, he doesn't mean age.

"I mean youth and vigor and strength, as opposed to callowness," he says. The industry's maturity shows up in product design and in the processes we use to decide what products to produce and how to produce them."

McAleer believes that in the last 20 years changes in philosophy and technology have caused industry shifts in the following ways:

- From how to design a product to what product to design.
- From the engineer/inventor as a central figure to the engineer/inventor as a team player.
- From instruments for product design to instruments for product manufacture to instruments for product maintenance and repair.
- From designing products for capability to designing products for application.

Bostonian by birth and an MIT graduate with an MSEEE, McAleer worked his way up at General Radio as a cooperative student employee, development engineer, designer, and manager of custom products. He believes that the company's growth parallels the growth of the instrument industry. In some ways it does.

General Radio helped to pioneer single operator assembly in the 1930s. Instead of moving the instruments past a number of assemblers, as in the usual production line, General Radio moves the assemblyman from instrument to instrument to complete the assembly of each.

Founded in 1915 by Melville Eastham, an avid experimenter in radio communications, the company published its first catalog of instruments the following year. Not one radio was listed. In fact, General Radio has never made a radio. At the time the word "radio" was new and interesting, having just been coined as a substitute for the more cumbersome "wireless telegraphy." "Radio" in 1915 was roughly equivalent to "electronics" today.

Venerable instruments at low cost

Among the products listed in the General Radio catalog in 1916 were a Precision Variable Air Condenser (\$25), a Decade Resistance Box (\$19), a Precision Variable Inductance (\$24), and an Absorption Wavemeter (\$60).

Harold McAleer never has worked on products that cost so little, but he did work on a 10-MHz counter once that had 100 double-triode vacuum tubes and sold for \$2500. He thinks it would sell for \$10,000 today.

"In the old days we talked about the big vacuum-tube counters," he says "and the manufacturers entered a horsepower race, very similar to the one that was going on in the auto-

Richard L. Turmail
Associate Editor

mobile industry: Who can produce the highest frequency range for the user—1 MHz, 20, 100, 500?"

Improved technology has brought higher performance and lower prices.

According to McAleer, the early orientation of the instrument industry was internal. Designers would apply in-house design to venerable products in an attempt to make them more marketable.

Now, he says, the view is much more external: Not how to do a thing or what material is available to make circuits, but rather what is the need in the marketplace? The emphasis is not on how to do a particular job but what is the job to be done.

This means that the bench engineer must be



Harold T. McAleer, V.P. of Engineering at General Radio Co. is, at 44, an instrument industry veteran.

more attuned to some of the nonengineering aspects of his job. The engineer/inventor is no longer the central figure he was in the very early days. He is now part of the team, along with marketing and production.

Designing for the repairmen

As the industry matured, McAleer says that more time and money were spent, first, on product design and then on product manufacture. He now thinks that the emphasis will soon shift to product maintenance and repair.

"A man will walk into your house or company one of these days with a little suitcase," he says. "He'll electronically test your facility and say, 'Hey your oil burner needs recharging and your computer needs a new battery, and you'd better reshingle the roof.'"

What does this mean to the engineer? Designers will have to design products for maintenance men. They'll have to be more and more aware of the application areas.

"In the early days of instrument application," McAleer says, "designers would design a product that they'd like to use—they were designing for themselves or for the man in the next office. Today they'll have to design for the ultimate user."

One of the most interesting product evolutions, says McAleer, is in the test area. He says that automatic test systems don't represent a new generation in the history of test and measurement; they are a culmination of test methods.

"Automatic testing is big this year," he notes, "because it cuts the cost of testing products, which lowers their price and expands their market. These concepts feed back into the test-bench instruments whence they came, which I find intriguing."

But with all this maturity, McAleer admits that mistakes are also part of the game. He concedes that every once in a great while the company produces a turkey. We facetiously call this a "prestige product," to soothe the feelings of the people involved.

"Once we developed a beautiful rectifier test set that was perfect for testing all of the parameters of selenium rectifiers," he says.

"The only problem was that the whole world was swinging to the use of germanium and silicon rectifiers—the product was too late."

McAleer also mentions a multiple pen recorder, developed a decade ago, that was capable of recording very fast phenomena.

"Our problem was that the technology to support it wasn't there," he notes. "We were too soon. We developed it with a vacuum tube, and it was too big and too hot. The idea was right, but the technology was wrong." ■■

If anybody can hand you the ready-made P/C connector you need,

we can.

That's because we have more of them on the shelf than anybody else we know. We have them from .050 contact centers through .156, from 6 to 210 contacts, with full bellows, semi-bellows and cantilever designs, with gold saving AuTac™ plating, low insertion force contacts, in micro miniatures, dual and single read-outs... and on and on and on.

We've been at this 23 years. And — because we don't compromise on quality

when we make our connectors — we don't like to see your P/C designs compromised by a make-do connector. So, we have a lot of them.

They're all cataloged in our latest 44-page brochure. Send for your free copy so you'll have it when you need it.

Or, if you need help right now, just pick up your phone and call Customer Service. (213) 341-4330.

Ok. Send me:

- Details on your line of P/C connectors.
 and, come to think of it, your low cost circular connectors, too.

Name _____

Title _____

Company _____

Address _____

City _____

State _____

Zip _____

 **Viking**
CONNECTORS

Viking Industries, Inc./21001 Nordhoff St./Chatsworth, Calif. 91311



"The end" had a fantastic beginning.

Never before has a laboratory tape recorder gained acceptance as rapidly as the Model Ninety-Six. It was recognized as the industry leader within a year after we introduced it as "the end" . . .

. . . **The end of head wear worries.** Superb, trouble-free performance in dozens of labs has proven how right we were, how reliable our patented solid ferrite heads really are.

. . . **The end of spectral pollution.** The Model Ninety-Six gives you super-clean data. A wideband servo produces absolute minimum TBE and virtually eliminates recorded flutter.

. . . **The end of configuration problems.** Users have told us omniband electronics make sense. Only six plug-in assemblies support any configuration.

Users have also told us about other great Model Ninety-Six features: selective track recording capability, 100% digital electronic shuttle, and non-contacting, optic-free end-of-tape sensing system. You can learn about these and other superior features when you talk to a man who's used the Model Ninety-Six. Or call or write our expert, Ed Haines, (303) 771-4700. Honeywell Test Instruments Division, P.O. Box 5227, Denver, Colorado 80217.

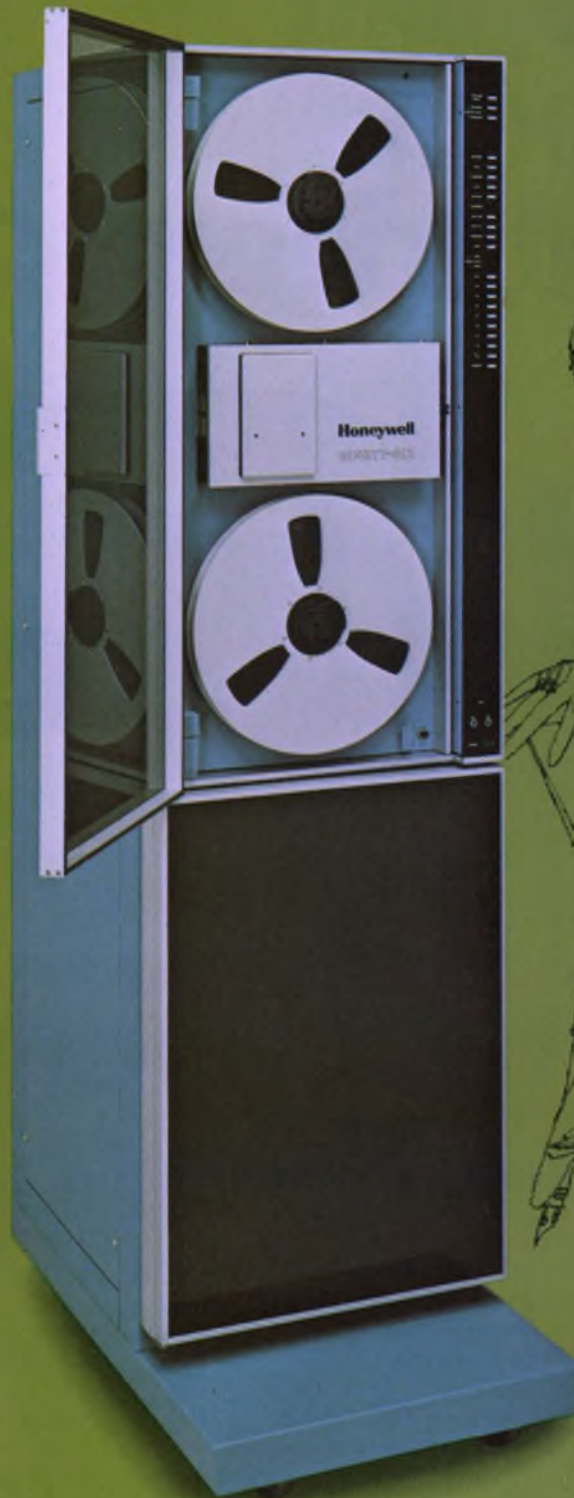

INFORMATION RETRIEVAL NUMBER 38

Honeywell

TEST INSTRUMENTS DIVISION

Give your scope a word trigger



For easier logic design and debugging

With HP's new 1620A Pattern Analyzer and your present scope you can trigger on any digital word up to 16 bits. Whether your data is serial or parallel, synchronous or asynchronous. You simply preset the trigger word you want, and the pattern analyzer gives you a 2V, 25 nsec pulse when that word appears in the data stream.

The 1620A, with its pattern recognition ability, provides a dynamic window for viewing any digital circuit—at clock speeds up to 20 MHz. You can make real-time measurements on any part of your system... whether you're analyzing the data following the trigger word, another data stream, or some other event at that particular point in time.

You can also delay the trigger point up to 999,999 clock pulses after the word—in either serial or parallel mode. And if you have a long serial word to interrogate, the 1620A,

with its qualifier input, lets you window on any portion of that word.

A threshold-level switch allows you to select TTL input levels or vary the input threshold over a $\pm 10V$ range for use with other logic families. And a selectable asynchronous filter prevents your scope from triggering on glitches due to differences in pulse timing (skew) among the various channels.

For only \$1,750* (including probes), you can turn your present scope into a digital troubleshooter and simplify your digital analysis problems. For more information about this newest member of HP's growing digital analyzer family, call your local HP field engineer. He can also give you information on HP's 4-bit AND-gate Trigger Probes for TTL, MOS, and ECL. Priced at just \$150* each, they give you pattern recognition on four parallel events to trigger scopes, logic analyzers, or other digital test equipment.

* Domestic USA price only.



Sales and service from 172 offices in 65 countries.
1501 Page Mill Road, Palo Alto, California 94304



The No Gold Adder Edgeboard Connectors.

The only extra is the designed-in reliability.

Gold inlay bonding allows Texas Instruments to deliver edgeboard connectors with gold only where you need it. At the point of contact. We use less gold, so you get *no gold adders*. The TI quote is the price you pay!

Conventional gold plating is wasteful because you pay for gold in noncontact areas. And if the plating is too thin, the surface can become porous enough to cause intermittencies.

At TI, we metallurgically bond a

thick inlay of gold right on the contact area. A full 50 microinches of gold on wire wrap configurations and 100 microinches on solder tail. (Compare this with the industry plating standard of 30 microinches. You may be paying more for less.)

TI uses high quality spring material, too. Copper Alloy 725. It provides the spring and conductivity of phosphor bronze — and has superior corrosion resistance and better solderability.

TI edgeboard connectors are

available in a choice of 6-50 positions, .100" or .125" centers, wire wrap or solder tail.

For more information, and the name of your nearest stocking distributor, call Texas Instruments Incorporated, Connector Systems, (617) 222-2800 Ext. 268 or 7216.

(Be sure to ask about our cost-saving gold inlay DIP sockets, too.) For literature write Texas Instruments, Mail Station W-1, Attleboro, Mass. 02703.

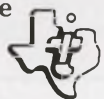

TEXAS INSTRUMENTS
INCORPORATED

Putting new technologies at your fingertips.

PULSE AND WORD GENERATORS

IC applications demand new highs in instrument accuracy

Under pressure from IC users for equipment with accuracy and versatility, manufacturers of pulse and word generators have begun to meet their demands.

Since current IC designs make extensive use of TTL, ECL, MOS and high-threshold (noise-immune) circuits, the pulse equipment must often provide precise timing, sharp rise times and high speed. The new units deliver large voltage swings (≈ 16 V), well-defined pulse shapes, high rep rates (to hundreds of MHz) and clean transitions (to evaluate propagation delay). And all these parameters can be placed under operator control.

Large-scale memory devices, computer peripherals and other digital subsystems require complex data patterns, often with specific time relationships, for diagnostic stimuli. This is the domain of the word or data generators.

Even more time-critical are laser systems and nuclear experiments. Generators that serve this field can provide nanosecond resolution between pulses, long interpulse delays and pulses with stable flat tops. Representative flat-top pulses often spec out at less than 0.02% droop with 10- μ s width.

Versatile generators obviate kluges

Test-equipment manufacturers let you meet most of these requirements without need for breadboard kluges. The pulse generators provide waveshape controls that include transition time, interpulse delay, amplitude, and repetition rate. Dials can be trusted to give repeatable patterns without the need for oscilloscope monitors.



The pulse generator and scope are well-known design aids. But their speed and versatility are greater than ever. The generators from E-H Research Laboratories include a 50-MHz fully programmable unit, the 1501A (top right); a laboratory version, the 135A (lower left), and the EH-129, a 500-MHz unit. An AMC 1100 sampling scope (1 GHz) is an appropriate display unit.

And there are the modular systems. With these you can repeatedly assemble or disassemble setups that provide pulse sequences for a variety of projects.

Digital circuits are checked at both functional and parametric levels. The functional tests operate on a go/no-go basis. Bit patterns exercise the circuit, and monitors or displays check the final outcome against expected results. With complex digital circuits the test parameters, especially pulse-to-pulse timing—become very important. The final state of the circuit depends upon waveform timing and bit pattern.

Word generators provide the source for most functional tests. These units issue pulse patterns that correspond to digital words or even pseudo-

Seymour Levine
Associate Editor



Word generators exercise complex digital gear with pre-set digital pulse streams. The Model 912CR from SRC Moxon operates at clock pulse rates to 10 MHz (serial output) and to 5 MHz (12 parallel bits). A card reader facilitates rapid changes of programmed data—up to 960 bits—with a single IBM card.



A hand-held pulser and logic probe locate stuck nodes quickly. The Model HL-583 stimulator (left) operates at 5 Hz or in a one-shot mode. The unit can supply up to 1 A for 1 μ s with CMOS or TTL amplitude levels and takes its power from the circuit under test. The resultant logic state is shown in the probe (Model LP-575). Both units are from Kurz-Kasch, Dayton, OH.

random sequences. Rates up to 1 GHz can be obtained—for pseudorandom sequences—with instruments such as MN-3, from Tau-Tron, North Billerica, MA. One distinction: A word generator issues prestored bit patterns; a pseudorandom unit supplies a pattern that appears random but actually repeats after n pulses (usually 512 or more).

Pulse-generator users often single out one node—such as an input to an op amp or a gate—and view the result on a conventional scope. Therefore overshoot, rise time, fall time and other pulse aberrations count. For example, even pulse amplitude levels become critical if a precision comparator is involved.

But there are common grounds between the

functional or go/no-go tests and the node tests. When the user tests a digital circuit functionally, he often finds that the observed patterns of ONES and ZEROS are not what he expected.

The point where deviations between expected and actual patterns exist is where parametric tests take over. In one approach the user attaches a digital trigger. The device provides an output when a given bit pattern occurs. The trigger, in turn, is applied to a conventional scope so the analog waveforms that follow can be observed. The observation of the actual waveform constitutes a parametric test.

The field serviceman also has a powerful tool with pulsers and their mates, the logic probes and clips. Together, they provide a functional test that detects bad nodes, one at a time.

Circuit families shape generator capabilities

Not all pulse and word generators strive for universality. The units are often tailored to the logic families used. At present the subdivisions are MOS and TTL. Generators suitable for MOS applications deliver higher voltages than do those for TTL and ECL. CMOS and PMOS circuits usually require 16 V into 50 Ω ; NMOS requires -16 V pulses. Repetition rates for MOS average 20 MHz; those for ECL and TTL are 50 MHz and more. Generators for TTL and ECL have maximum output levels of ± 5 V (into 50 Ω) with ± 2 V offset. Pulses for ECL and Schottky TTL must be especially well-defined, with transition times of less than 1 ns.

Generators that provide widths and rise times in the nanosecond region, and must drive several feet of coaxial cable, often cannot provide precise signals at the input to the device under test (unless the device is also terminated at 50 Ω). With the better generators, line reflections that cause the error are minimized. The generator uses current drivers that feed a 50- Ω internal impedance. This ensures a sufficient generator match with the coaxial cable.

Medium-priced generators omit frills

Medium-speed pulse generators offer repetition rates up to 20 MHz, with rise and fall times of about 10 ns. Prices for this class of instruments average \$500.

The Model 8011A from Hewlett-Packard (\$435) is a specific example. You get bipolar, positive-going or negative-going pulses with pk-pk amplitudes of 16 V. Transition times are below 10 ns. According to the manufacturer's pulse delay, variable dc offset and gated operation are omitted to keep the price down.

You can also use the 8011A for limited functional tests on MSI devices like counters. A



Color these pulse generators flexible. The HP Model 8082A (left) provides variable transition times down to 1 ns. The 250-MHz generator also provides adjustment of pulse delay, width and two output levels. Similar parameters are controllable either remotely or by thumbwheel switches on the Model 1501A from E-H.



counted-burst option (\$300) enables the generator to output 1-to-9999 pulses on receipt of a trigger, and the same number of pulses occur regardless of the rep-rate setting.

Also in the medium-speed range are two generators by Philips Test and Measuring Instruments, Woodbury, NY: the PM5704 (\$380), a 5-V unit for TTL use; and the PM5705 (\$390), a 15-V unit. The generators provide 0.1-to-10-MHz coverage with complementary pulse outputs. The 5704 also supplies 5 V dc to power TTL circuitry.

Instruments with similar performance include the Model 88 and Model 99 from Systron-Donner, Concord, CA. These provide 2-to-20-MHz operation with 5-ns rise time and generate 1 to 5-V pulses. The Model 101 (\$395) provides complementary pulses from 10 Hz to 10 MHz with single or double-pulse operation. Other manufacturers include Chronetics, Mt. Vernon, NY, with Models PG-10 and PG-11A; Dytech, Santa Clara, CA, with Models 850 and 852. At \$895 Interstate Electronics, Anaheim, CA, offers a combination pulse and function generator. The F74 provides 20 MHz rep rates, adjustable width (down to 30 ns) and 1000:1 rep-rate variation.

For the user with a limited budget, Dytech offers a high-performance unit for \$185—the Model 750. This pulse generator covers 10 Hz to 10 MHz with 50-ns-to-100-ms pulses (rise and fall times of less than 5 ns). And the unit accepts a synchronous gate input.

But how low can prices go? For \$159, the Model 1101 pulse generator from Interdesign, Sunnyvale, CA, provides 0.1-MHz-to-2-MHz operation with 10-ns rise time and 50-ns fall time, as well as continuously variable pulse width. Of course, the minimal pulse generator (a square-wave unit) costs even less. Dytech's Model 701 (20 Hz to 50 MHz) provides 4-ns transition times and costs \$124.

Rise time, amplitude, pulse width and duty

cycle are interdependent. And these tradeoffs become apparent at high speeds. The first tradeoff is usually amplitude for rise time and rep rate. For example, it's almost impossible to get 16-V pulses at rep rates above 50 MHz. But you can expect 5-V amplitudes with 20-ns rise times at rates from 100 to 250 MHz, and 2 V from 500 MHz to 1 GHz—all into 50 Ω loads.

The recently announced HP Model 8082A is a formidable entry for use with Schottky TTL and ECL. The unit can generate 5-V pulses and provide control of period, delay, polarity, width, transition time, amplitude and base line. The transition time is controllable to below 1 ns, and the pulse width is adjustable from below 2 ns to 0.5 ms. The rep rate can be adjusted from 1 kHz to 250 MHz in six ranges.

The Model 113 from Systron-Donner also attains a 250-MHz rep rate, provides a 4.5-V pulse between 220 and 250 MHz and 5 V rep rates below 220 MHz.

At the border line of the range; namely, 100 MHz, Philips PM5770 and PM5771 offer 10-V pulses with 4 ns and 2.4-ns transition times that are adjustable. In addition Chronetics offers its Model PG-16 that provides 20-V pulses with 2-ns transition time.

Modular units generate complex sequences

Modular pulse generator systems tend to emphasize high performance (100 MHz and up). Most offer digital programming and digital-delay controls.

Tau-Tron offers the TMI Series, which covers a frequency range from dc to 100 MHz. Individual units provide up to eight channels on a single frame with adjustable pulse widths over the 5-ns-to-10-ms range. The output format is NRZ (nonreturn-to-zero). Each pulse remains on or off for a full clock cycle.

The 1900 Series from HP provides rep rates

to 125 MHz with rise times down to 350 ps (at 25 MHz with the 1920A). At 125 MHz you get 2-ns rise time. T.R.I. Corp. (Takeda Riken), Sunnyvale, CA, offers the 4220/30 Series with speeds up to 500 MHz. Rise and fall times are adjustable continuously from 500 ps to 4 ns. Outputs are available with RZ and NRZ formats.

Tektronix TM 500 Series features plug-in units that operate in TM 501, TM 503 and TM 504 power modules. The generator modules which include 50 MHz and 250-MHz pulse generators—are connected by a common board to the power unit's intra-compartment interface.

The T.R.I. 4200 pulse generator forms part of a modular system and also acts as the main-frame. The generator provides NRZ format at rep rates of 100 MHz to 1 GHz at output levels to 2 V. Plug-in units provide width control (0.5 to 3.4 ns in 100-ps steps) as well as a pulse-burst capability.

Generators that simulate nuclear events

Many pulse generators—both conventional and modular versions—offer unusual waveform combinations that almost rival those of data generators. (The modular systems often include data or word generators to complement the pulse generators.)

Berkeley Nucleonics, Berkeley, CA, features NIM modules based on standards for dimensions and power-supply requirements of the U. S. Atomic Energy Commission (Standard Nuclear Instrument Report, TID 20893). These scientific instruments, also available with portable power

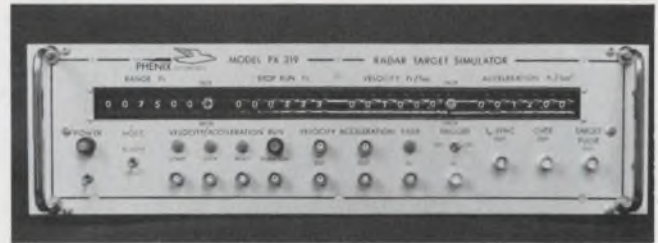

A simulator for radar range provides a target pulse at a precise time after a trigger pulse. The output pulse is controlled to simulate target velocity and range. Model PX 219 provides use times under 5 μ s for a 400- μ s target pulse. The PX 219 from Phenix Electronics can be programmed remotely.

racks, include digital-delay generators, precision pulse generators and reference modules. Berkeley's Model LG-1 provides a linear ramp to modulate the amplitude of the Model PB-2 or GL-3 pulse generators. One purpose is to test pulse-heights analyzers. If the analyzer is linear, the so-called sliding pulses will deposit an equal number of pulses in each channel.

Digital-delay generators provide stable precision delays after the occurrence of an input pulse and are often used for sonar, radar and delay-line tests. Models like the 7050 and 7055 from Berkeley Nucleonics provide delays to 1 s in 10-ns increments. Berkeley's Model 7030 features remote programmability and provides delays and gates to 100 μ s in 1-ns increments.

Other manufacturers of these precision units include: Cordin, Salt Lake City, UT, whose Model 438 provides six channels; HP with the Model 1910A that provides 5-to-100-ns delay; Tau-Tron's

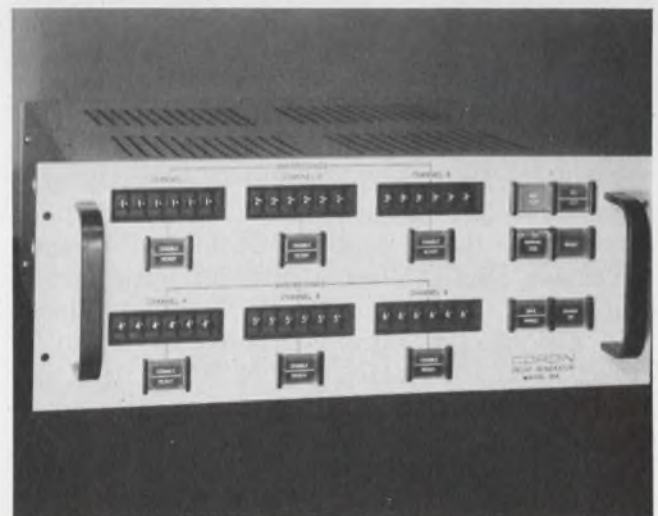
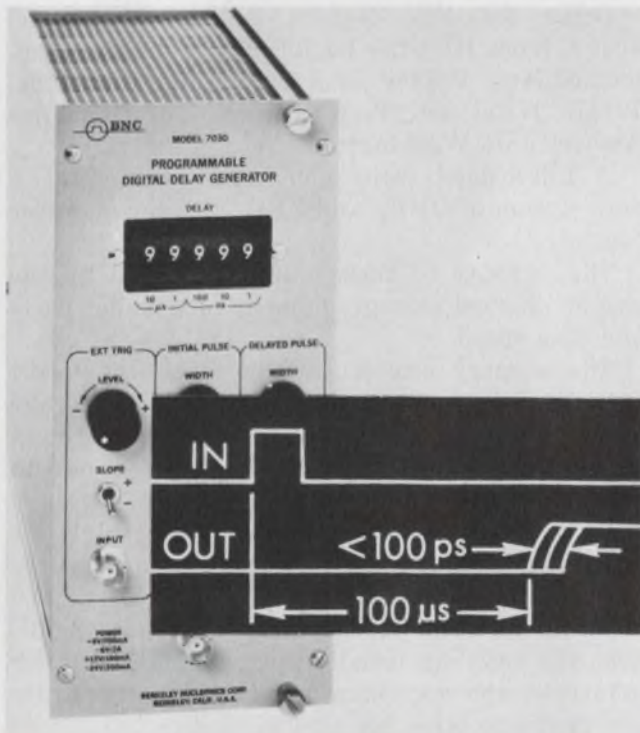

Time-delay generators provide delayed triggers calibrated to nanosecond increments. The Model 438 from Cordin (right) provides delay from 0 to 999.999 μ s with outputs to 40 V into 50 Ω . Model 7030 (left), part of Berkeley Nucleonics modular system, offers 1-ns increments to 100 μ s. These devices are often used in the operation of Image Converter Laser Diagnostic Cameras and flash X-ray analysis.



High-power pulse generators deliver 31 kW per pulse with amplitudes to 2500 V and 20-ns rise time. These units find use in EMI tests, magnetic component tests and laser pulsing. The Velonex Model 660 features BCD-programmable width, prf and amplitude.

Model MD-4 and MD-5 (10 ns to 1 s with 1-ns increments), and T.R.I.'s Model 4221/N delay unit. Be sure to check that the allowable rep rate of the delay generator meets your requirements.

Radiation detectors, such as scintillation counters, often output pulses at randomly spaced intervals. These pulses rise rapidly but decay slowly. Under high count rates these so-called tail pulses pile up into one another. Model DB-2 from Berkeley Nucleonics provides such pulses for count rates from 10 Hz to 1 MHz with Poisson-distributed intervals. The Model PB-4 provides flat-top or tail pulses. Droop is less than 0.02% with 10 μ s width. The decay time constant (100 to 37% amplitude) of the tail pulse is adjustable from 0.5 μ s to 1 ms.

Phenix Electronics, Hawthorne, CA, provides radar target pulses with a range from 0 to 999,999 ft. The Model PX 219 is remotely programmable for range, velocity and acceleration. Jitter is less than 2 ns or 0.0005% of set range.

Velonex Div. of Varian provides pulse generators that deliver up to 31 kW per pulse (Model 360) and rise times of under 20 ns. Pulse widths are continuously variable from 50 ns to 3 ms. Maximum power is delivered at rep rates up to 0.3 MHz and reduced power to 1 MHz. With auxiliary output units, the generator can furnish up to 30 kV or currents to 750 A. A particularly important application for high-current units is for low-voltage impulse testing of power transformers.

For those applications that require test and characterization of MOS circuits, there are the Model 601 and Model 610 pulse generators from the Comaltest Division of Data-Control Systems,

Danbury, CT. Model 601 provides four-phase pulses from 60 Hz to 10 MHz; Model 610 provides two-phase operation. Both units have adjustable transition times (10 ns to 100 μ s), amplitudes from -30 to 12 V and clock delays from 30 ns to 100 μ s.

Word generators emphasize data patterns

Word generators simulate binary patterns of sufficient complexity to test large-scale digital systems.

Important specs include clock rate, word length, size of data storage; and for random data, the length of the sequence. Precise control of pulse characteristics is secondary, but be sure to check for amplitude, rise time, impedance and other key characteristics.

Single-channel units are used to check serial data channels. If the channel is for data communications, the format is important. Asynchronous channels require Start and Stop bits. (For more about asynchronous channels see "Focus on Modems and Multiplexers," ED No. 22, Oct. 25, p. 68.) The widely accepted test input for synchronous channels is a pseudorandom bit pattern, which is usually generated by a linear shift register.

The Model 1310 TDM-Modem Test Set from International Data Sciences, Providence, RI, formats data with one Start bit and 1, 1.4 or 2 Stop bits. In between these, the unit inserts between five to eight pseudorandom bits. For synchronous links the unit provides rates of 0.5 Mbit/s. In addition the Model 1310 furnishes bit and block error counts and has standard modem control lines.

Other data-link testers include the Model 1645A from HP; the BERT 901 from I.I. Communications, Willow Grove, PA, and the Model 7914B Data Set Tester from Tele-Dynamics Ambac, Fort Washington, PA.

A full-fledged word generator can output a data stream of ONEs and ZEROs under operator control.

The capacity of these units is gauged by the size of internal storage, number of parallel ports and data speed.

The memory size is usually given in words. HP's Model 8006A generator provides storage of two 16-bit words. There are two ports through which the 16-bit words can be shifted out in parallel, so it is a 2×16 bit unit.

More recent word generators sport high bit rates (50 MHz), large numbers of ports (9 to 48) and large memories (as large as 24,576 bits). In addition to the large capacities available, the user can usually put channels in series to increase the word length or to parallel separate generators to boost parallel-word size.



The E-H 1604 word generator generates simultaneous pulses for up to 48 pins (at rates to 20 MHz) and compares the measured output with expected levels stored in its own memory. Each pin can provide 512 bits. And all the parameters on this device are programmable.

The most sophisticated generator is the E-H 1604 from E-H Research Labs, Oakland, CA, with a capacity of 48 ports by 512 bits (24,576 bits). All ports receive data within a few nanoseconds of one another at rates to 20 MHz. Also you can reorganize the generator (port \times bits) as 12×2048 , 6×4096 or any other combination. And the generators can be paralleled. Each pin can be inputted or outputted, because the generator will compare the DUT output with an expected sequence also stored in the unit.

Any disparities between data and reference are stored in an "error" memory. A computer provides all information to the generator and can access the error memory. The E-H 1604 sells for \$60,000 and is primarily for automated testing.

Among the fastest generators are those from Tau-Tron. The Model WG-305 provides 18,432 bits with up to 36 parallel bits/word at rates from under 1 Hz to 100 MHz. The memory is divided into two halves and the output can be generated from subsets of each.

For off-line use, the Model 8016A from HP offers 9×32 organization (288 bits) and can be programmed from a punch card or bit by bit from the front panel. And 288 bits, in contrast with 24 kbits, can be set by hand in a reasonable period of time.

Digital generators from SRC Moxon, Newport Beach, CA, provide up to 960-bit capacities (12×80) at 15-MHz rates with parallel operation for more than 12 channels. A three-dimen-

sional pin matrix speeds manual programming.

There are even combinations of pulse and word generators. The Model RS-648 from Interface Technology, South Pasadena, CA, is one example. The unit can provide multiple pulses per period with independent control of interpulse spacing. And the individual pulse widths can be set from 50 ns to 0.999 s. All this is done with stored program words. With its eight channels, the unit can simulate easily the I/O timing of a mini. And as a word generator, the Model RS-648 furnishes capacities to 1024 bits (8×128) at 14-MHz rates.

Combinations of pulse and word generation are available on a reduced scale from some of the modular systems. Tau-Tron's TMI series includes word generators, delay modules, wave-shape conditioners and bit-error detectors. T.R.I.'s 4220/30 series (500-MHz rate) includes the Model 4225 word generator that has up to 15 channels with storage of 1 kbit. The T.R.I. 4200 system, which operates at 1 GHz, includes a plug-in word generator (Model 4202) that can generate a 15-bit serial output. And HP's 1900 series includes a 50-MHz, 16-bit word generator, the Model 1925A, as well as a bit-error detector (Model 1930A).

More and more, many pulse generators, and practically all of the word generators, feature remote operation. HP supplies the General Purpose Interface Bus for the word generator but uses analog programming (from a d/a converter) to set pulse-generator verniers. Interface Technology supplies programmable ROMs. Others such as Tau-Tron use binary-coded lines. Phenix, as well as E-H Research, provide control of all parameters. Phenix uses ASCII format in the form of seven data lines and one strobe. E-H Research Labs uses bit parallel, ASCII or 16-bit words to program its 1501A generator. ■■



For more information

For a list of manufacturers of pulse and word generator products, refer to the following sections in the Product Directory of ELECTRONIC DESIGN's Gold Book:

Generators, Impulse	Vol. 1, p. 177
Generators, Gate	Vol. 1, p. 177
Generators, Pulse	Vol. 1, p. 178
Word Generators	Vol. 1, p. 483

The new Keithley Model 168 autoranging DMM... ...vive la différence!

There really is a difference in Digital Multimeters, and once you've experienced Keithley's 168 you'll know why we say *vive*! If you're tired of "general-purpose" promises that turn into run-of-the-mill

performances; if you want that bit extra that'll make your job easier, then *vive la différence*... here's the DMM for you! Send for our DMM Selector Guide or call us for demo now. Phone (216) 248-0400.

AC VOLTS
DC AMPS
OHMS

5 functions
100 μ V to 1000 V dc
100 μ V to 500 V ac
0.1 μ A to 1 A dc
0.1 μ A to 1 A ac
100 m Ω to 20 M Ω

price
Enough said? Order one... or two... or three now!

\$299⁰⁰

two-terminal input

Simple to connect. You can't get it wrong. Eliminates the word "whoops" from your vocabulary. Saves temper, too.



hi-lo ohms

Select either of two voltage levels, 1 V or 100 mV, for ohms measurements. You can have your PN junctions either way you want 'em... on or off.



options & accessories

Rechargeable batteries that you can install anytime. An RF probe for high frequencies. Test leads. A 50-amp current shunt too.



automatic ranging

You just connect the signal and push the function. The decimal point pops into position automatically and the display is direct reading. That does save time!



KEITHLEY INSTRUMENTS
U.S.A.: 28775 AURORA ROAD, CLEVELAND, OHIO 44139
EUROPE: 14, AVENUE VILLARON, 1009 PULLY, SUISSE

**Christmas could come early for
designers using this
versatile switch from Spectrol...**



The Model 87 Half-inch Switch

- Up to 3 poles and up to 10 positions — a total of 18 switching combinations to choose from
 - Mounts directly on a printed circuit board
 - Design versatility permits unlimited applications and many cost saving benefits: logic switching, internal switching device for optional equipment add-ons, test point switching, adapting main-frame computers to peripheral equipment, standardizing printed circuit boards, selecting operational voltages, selecting calibration resistors, etc.
- Send for literature, and ask about free samples.

Spectrol

SPECTROL ELECTRONICS GROUP

UNITED STATES Spectrol Electronics Corporation 17070 E. Gale Avenue, City of Industry, Calif. 91745, U.S.A. • (213) 964-6565 • TWX (910) 584-1314
 UNITED KINGDOM Spectrol Reliance Ltd. Drakes Way, Swindon, Wiltshire, England • Swindon 21351 • TELEX: 44692
 ITALY SP Elettronica spa Via Carlo Pisacane 7, 20016 Pero (Milan) Italy • 35 30 241 • TELEX: 36091

INFORMATION RETRIEVAL NUMBER 42

Here's a recording swept-frequency-response system you can expand to include:

- narrow-band-wave analysis
- 1/3-octave-band analysis
- level-vs-time recording

GR's 1523 plug-in approach lets you put together a complete graphic-level measurement system as your needs and budget dictate. Start with the mainframe/recorder and the plug-in that satisfies your immediate measurement requirements, the 1523-P2 Sweep Oscillator, for example. Other plug-ins can be added anytime in the future.

The recorder in the mainframe is automatically synchronized to every plug-in and each plug-in has time-saving automatic features. One that's common to all plug-ins, for example, is the automatic repeat

chart mode. This feature provides automatic rewind of the chart paper at the conclusion of a plot so the next plot can be superimposed on the first for easy comparison. Easily interchangeable red, green, and blue pens facilitate plot identification.

Take a look at all the plug-ins and some of the tasks they'll do for you. Then call your GR sales engineer or write to E. G. Rahaim, General Radio, Concord, Mass., for full particulars on the versatile 1523 Graphic-Level Measurement System.

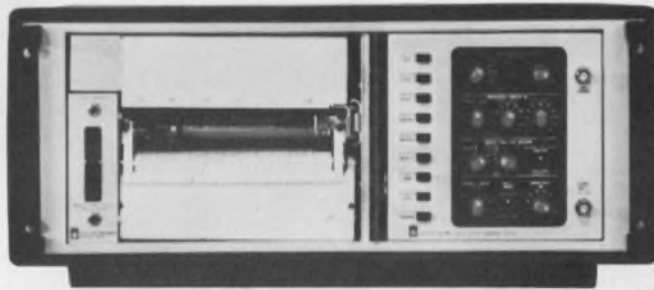

-P2 Sweep Oscillator

- filter-and network-response testing
- loudspeaker, amplifier, and tape-recorder evaluation
- performance tests for microphones, hydrophones, and hearing aids



-P4 Wave Analyzer

- swept-frequency-response measurements
- distortion measurements
- noise-floor measurements



-P3 1/3-Octave Analyzer

- speaker testing
- auditorium frequency-response measurements

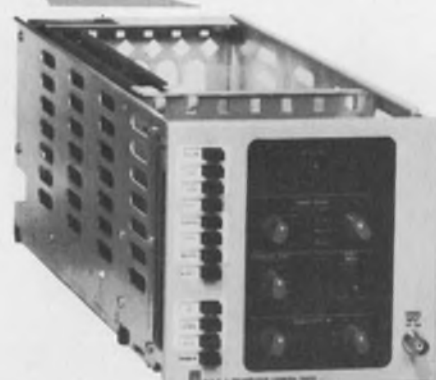

-P1A Level-vs-Time Recorder

- reverberation decay measurements
- general level-vs-time recordings



300 BAKER AVENUE, CONCORD, MASSACHUSETTS 01742 • NEW YORK (N.Y.) 212 964-2722, (N.J.) 201 791-8990 • BOSTON 617 646-0550 • WASHINGTON, D.C. 301 948-7071 • DAYTON 513 294-1500
 ATLANTA 404 394-5380 • CHICAGO 312 992-0800 • DALLAS 214 234-3357 • LOS ANGELES 714 540-9830 • SAN FRANCISCO 415 948-8233 • TORONTO 416 252-3395 • ZURICH (01) 55 24 20
 • GR COMPANIES • Grason-Stadler • Time Data • Techware Computing Co.

vactec phototransistors

VACTEC, INC.

2423 Northline Industrial Blvd.

Maryland Heights, Mo. 63043

Phone (314) 872-8300

Vactec npn epitaxial large chip, high sensitivity phototransistor. An enlarged section of the wafer forms the colorful background.

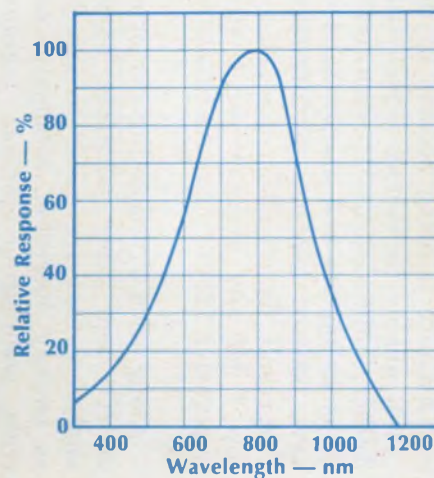
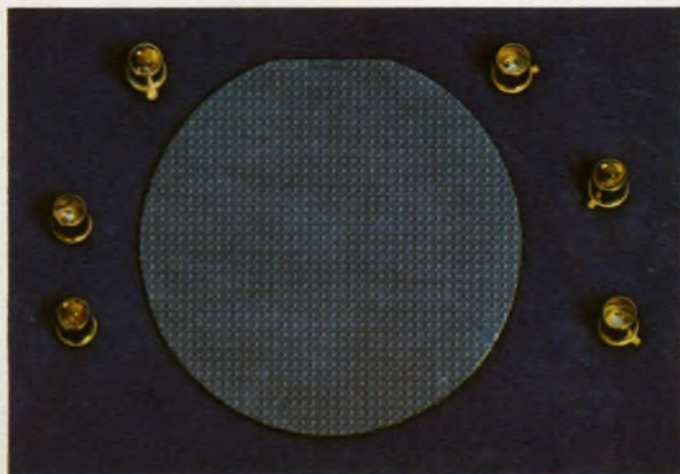

Standard Vactec phototransistors provide very high sensitivity and good blue response. Liberal design flexibility is also offered with trade-off for some characteristics, including: light current; response time; spectral sensitivity; and breakdown voltage. Selection of packages are TO-18, co-axial, pill, non-hermetic TO-18 size and special arrays on 50-mil or 25-mil centers.

Custom design is practical for quantities as low as 10M per year. Masking charges are nominal. Our automatic test capability includes 100% sort (with light applied) for I_{CEO} , breakdown voltage and dark current. Vactec can also second-source practically anyone's phototransistors. Write for Bulletin VTTA-1 today.

WAVE AND SPECTRUM ANALYZERS

Analyze signals as never before with digital methods

If there's one word to describe the exciting things happening to wave and spectrum analyzers today, that word would be "digital." From internal memory to numerical readout of key measurements to real-time analysis, analyzer performance is being boosted by digital ICs.

But analog techniques aren't fading just yet. Rather, improvements in such analog-dominated areas as mixers and narrow-band crystal filters have boosted analyzer performance even more. The result: bandwidths squeezed to a super-narrow 1 Hz and dynamic range stretched to an impressive 120-dB span. And these benefits aren't all.

Along with skyrocketing performance, the use of ICs and other advances have resulted in analyzers that are easier to use. Features such as battery operation, automatic setting of controls, pushbutton controls, absolute calibration of CRT displays and dials, and digital computation and display of amplitudes and frequencies—all are moving the spectrum analyzer out of the engineering lab and into production, test and field maintenance. These areas traditionally have been manned by semiskilled or unskilled personnel.

Even more amazing, the advances have been accompanied by a phenomenon not usually associated with boosts in performance—falling prices. Today spectrum analyzers sell for as low as \$2500. And even though you can still spend \$12,000 or more, you get a lot more for your money than you did a few years ago.

Why, after many years of hibernation, has the spectrum analyzer suddenly awakened in a frenzy of activity? The answer: it's needed.



Clear, steady displays of slow sweeps are possible without storage tubes. The secret? Refresh the display at high speed from a digital memory as does this unit from Hewlett-Packard, the 3580A.

As frequencies go higher and higher, it becomes increasingly difficult to work in the time domain. Measurements that involve Fourier analyses, noise, power spectra, random signals and correlation are best made in the frequency domain—the realm of the spectrum analyzer.

And with the increase in activity in CATV, with the push to ever higher communications frequencies, with new and more stringent Federal Communications Commission rules to guard the already overcrowded frequency spectrum and with the new OSHA requirements for limiting audible noise, the spectrum analyzer has become the instrument of the hour. Today over 50% of

analyzer sales are for microwave units, and 90% of all units sold are for use above 30 MHz.

Actually Hewlett-Packard, Palo Alto, CA, blew the cobwebs off the all but dormant analyzer industry and changed the complexion of the market when the company introduced a really practical unit in 1964. For the first time, an analyzer offered a wide frequency range—20 times greater than that of existing units—a stabilized front end and calibrated displays and controls.

The new analyzer made HP the industry leader in spectrum analyzers, a position the company still holds, with 50% or more of the market. Hewlett-Packard maintains its dominance with such equipment as the newly unwrapped 3580A.

Innovations—and lots of them—make the low-frequency (5 Hz to 50 kHz) 3580A a standout:



Real-time analyzers use digital algorithms to perform a Fourier-transform analysis of incoming signals. The unit shown is Nicolet Scientific's UA500A, an analyzer that performs digital calculations.

digital storage, adaptive sweep, battery operation and a resolving power of 1 Hz—the narrowest bandwidth of any spectrum analyzer. These features aren't just window dressing but get around problems that have constantly plagued the analyzer and limited its use. Look at what digital memory does.

To resolve closely spaced spectral components, an analyzer must use narrow-band filters—the closer the frequencies of interest, the narrower the filter must be. But as a filter's 3-dB bandwidth gets squeezed down, its equivalent rise time—and hence its transient response time—gets pushed up. Since the analyzing filter, in

effect, sweeps across the frequency range (in a swept analyzer), the rate of sweep must be slow enough to accommodate the filter's rise time.

In effect, the filter must linger at each frequency for a period determined by the 3-dB bandwidth. Since the CRT sweep in conventional analyzers runs at the same rate, the trace motion can be painfully slow. In fact, the sweep can be so sluggish that standard CRT phosphors can't retain enough information to provide a meaningful display.

Digital memory replaces storage tubes

To get around the slow sweep problem, vendors have traditionally used storage tubes or long-persistence phosphors. But these solutions have brought other problems: fading, blooming and burning.

Digital storage, on the other hand, solves most—if not all—of the problems of analog displays. With it, the CRT can be swept at an independent—and faster—rate than that of the frequency scan. Thus the trace is refreshed at a constant high speed from memory, resulting in a flickerless, bright display. And, as in the HP 3580A, the display doesn't have to be adjusted whenever the sweep speed is changed. Once set, intensity and focus remain fixed.

Other benefits accrue from internal memory: A trace can be stored and recalled later. In the \$3800 HP unit, memory can be split so a stored trace can be superimposed on a subsequent spectrum for comparison.

To further alleviate the problem of snail-paced sweep speeds—especially a problem with low-frequency units—HP has come up with something it calls adaptive sweep. In the 3580A, whenever the spectrum amplitude is below a selected threshold, the sweep speeds up by a factor of about 20. Where spectral components exceed the threshold by 6 dB, the sweep drops back to the selected rate. Thus adaptive sweep cuts the time needed to scan low-frequency signals with high resolution.

That digital storage is fast becoming an important trend in spectrum analyzers is demonstrated by another recent unit—the TF2370 from Marconi, Englewood, NJ. The MOS memory of this 110-MHz unit provides an infinite-persistence, bright, flicker-free image on a TV-like display. And like the HP unit, the Marconi memory can be split in half: Two images can be superimposed, with one image dimmed relative to the other, and either image can be kept indefinitely while the other is refreshed.

But the TF2370's performance doesn't stop with digital storage. A multitude of outstanding specifications and features reveal what analyzers can do today. Together they catapult the TF2370

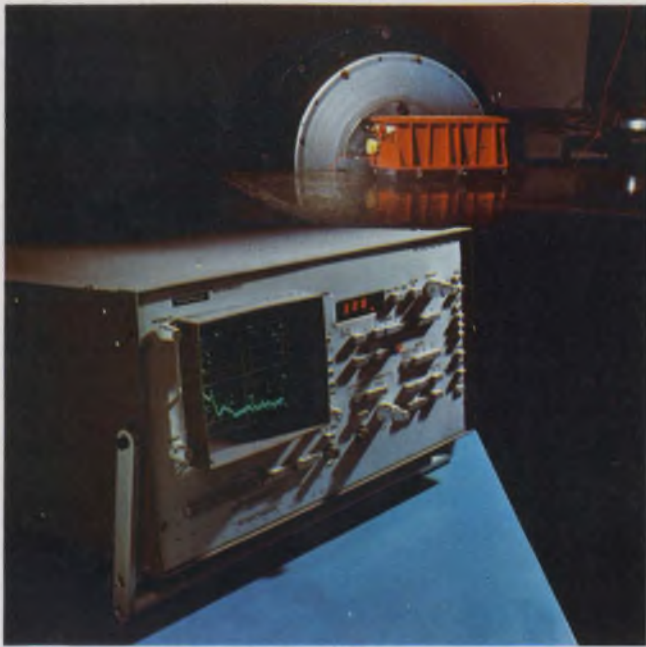

Unlike swept analog analyzers, digital units, such as the EMR 1510, display an unconnected series of dots, one dot per spectrum.

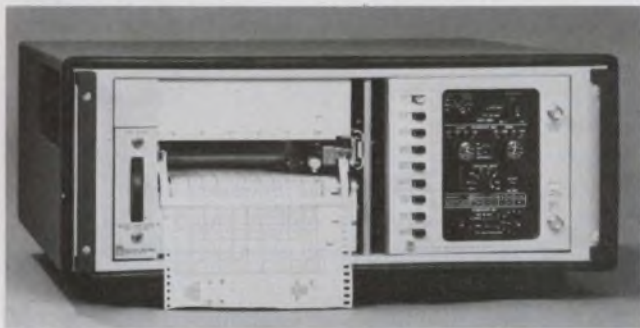

Records of wave analyses are made by General Radio's 1523 P4, a plug-in system that starts, sweeps, and stops at specific dialed-in frequencies.

to the top of its class.

The performance offered by Marconi—such as a 5-Hz minimum bandwidth, 100-dB displayed dynamic range, and -159 -dBm minimum input—just couldn't be achieved a few years ago. And despite its high sensitivity and wide coverage, the TF2370 has been made fairly easy to use: Just set the center frequency, sensitivity and sweep width (dispersion or scan), and the unit automatically computes and sets the optimum sweep rate, filter bandwidth and rf/i-f gain ratio.

Finally, an easy-to-use analyzer

Thus a user of the TF2370 doesn't have to make calculations or worry about improper control settings destroying valid results—long a thorn in the side of analyzer users.

Unique to the Marconi is its display. Stored data are displayed at a 76-Hz rate and vertically

scanned by a 513-line interlaced raster. Spectral information is conveyed by brightness modulation of appropriate lines to a height that represents the input amplitudes.

Superimposed on the display is a projected electronic graticule that can be moved by the operator and a bright-line cursor that can be set on any spectral line. The graticule—which gives a parallax-free readout—can be shifted vertically or horizontally to fit selected spectra. And the cursor, which is coupled to a 9-digit counter, can be moved to any line to display the line's frequency automatically on the counter.

Another feature of the 2370 shows that the spectrum analyzer is becoming a precise measuring tool, rather than just a frequency-selective display. All the front-panel controls, most of which are pushbuttons, are digital in nature—that is, rather than switch signals, the controls apply a logic level in on/off fashion to logic gates.

Coupled with storage—which can supply digital outputs—digital switching implies that an instrument can be remotely and automatically controlled. Thus it shouldn't be surprising if the spectrum analyzer soon turns up in an automatic test rig or in an automatic surveillance—electronic countermeasures system. And with the trend toward internal digital computation and control, it won't be surprising if a microprocessor soon surfaces in an analyzer.

Instruments like the Marconi TF2370 aren't inexpensive. The unit sells for about \$15,000. But you could have easily paid that much for a basic machine a few years ago, with none of the improvements of the Marconi.

Dynamic range stretches

But no matter what you paid, one thing you couldn't get in the early days of spectrum analyzers was wide dynamic range. At that time 40 dB was about all that could be mustered. Today 80 dB is common, and at least one unit—the 11-MHz 6303 from Adret Corp., Lancaster, PA—soars to the lofty peak of 120 dB of dynamic range. With that range, you can simultaneously (a key word when you evaluate a unit for dynamic range) look at two signals with an amplitude ratio of 1 million to 1.

An interesting feature of the 6303 is its ability to change roles. By substitution of modules, the unit becomes an 8-digit, programmable frequency synthesizer with a range of 10 kHz to 110 MHz. The analyzer also operates to 110 MHz but at a reduced—but still high—100-dB dynamic range.

Apparently to hold down the cost—the unit sells for about \$10,000—the 6303 doesn't have a built-in display. Instead, the instrument pro-

vides outputs for use on an external scope or X-Y plotter.

Actually the idea of spectrum-analyzer plug-ins isn't new. Nelson-Ross Electronics, Lake Success, NY, has offered them for years, mostly as modules for Tektronix and Hewlett-Packard scopes. For instance, the company's Model 236 can plug-in to an HP 140A/141B scope and provide a quick look at an over-all 25-MHz scan or resolve 100 Hz on a narrow scan.

Nelson-Ross also makes self-contained units—such as the CSA 290, a 400-MHz communications-oriented analyzer whose built-in frequency counter provides $\pm 0.1\%$ tuning accuracy. Unusual is the unit's self-test and self-calibration features, which eliminate the need for external equipment.

Another plug-in, the P9040 from Kay Elemetrics, Pine Brook, NJ, fits the company's 9000AS scope or comes completely self-contained for use with any commercial storage scope. The \$2390 P9040—which covers the video-through-vhf range—also exemplifies the trends toward simplicity and digital design: Both center frequency and attenuation can be digitally read out, and signals are calibrated directly in dBmV.

While the plug-in analyzer's necessarily small size once severely limited its performance, a look at some outstanding units offered by Tektronix (the Beaverton, OR, company that "immortalized" the plug-in in its scope line, and continues to do so in its TM500 series of measuring instruments) reveals that the plug-in has become a factor to be reckoned with.

Consider the Tektronix 5L4N—a low-frequency (0 to 100 kHz), swept-front-end unit that fills two of the three holes in any of the company's 5000 series scopes. Among other things, the unit offers 80 dB of dynamic range, resolution down to 10 Hz, a built-in tracking generator and front-panel selectable impedance. With the latter feature, you can match the analyzer to your source impedance, be it 50 Ω , 600 Ω or 1 M Ω . And the calibration of the 5L4N automatically follows the impedance you select—goodbye mental arithmetic and conversions.

All of the 5L4N's performance, plus a mainframe storage scope than can also be used for time-domain measurements, can be bought for \$3045.

Another Tektronix spectrum analyzer—the 7L13—works at the forefront of analyzer performance in a number of key areas. Made to fit any of the company's 7000 series scopes, the 1800-MHz 7L13 mirrors the design advances that have revolutionized analyzer performance and ease of use: Just one tuning knob on the 7L13 handles both coarse and fine frequency adjustments. Center frequency can be read on a 4-digit LED display or directly on the CRT screen. And

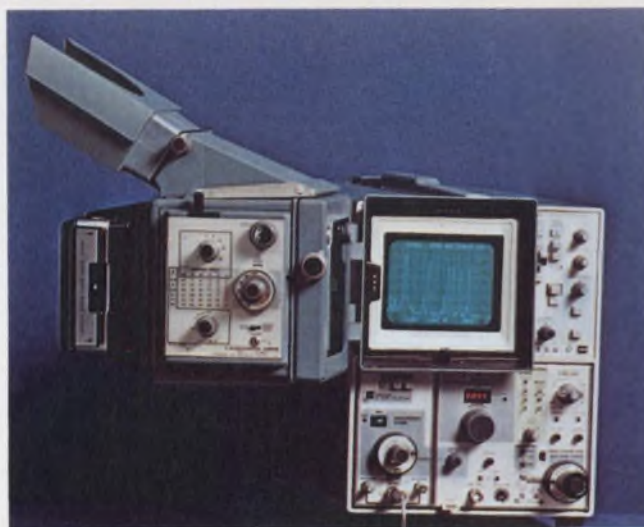

A resolution of 30 Hz out to 1800 MHz marks the Tektronix 7L13. Part of the company's 7000 Series CROs, the unit is shown in a variable-persistence storage mainframe.

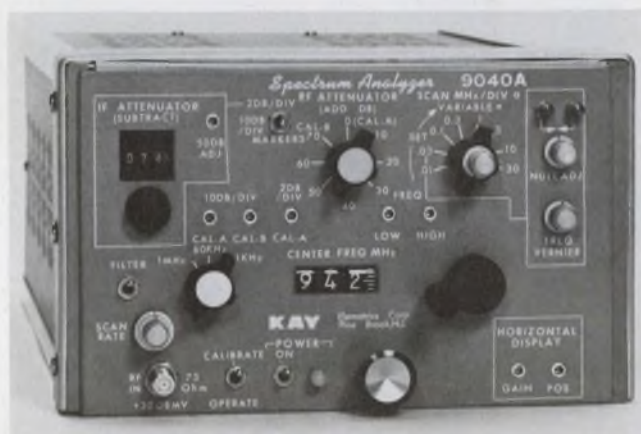

Available as a self-contained unit or for use with an available storage scope is the 300-MHz P9040 from Kay Elemetrics. The unit costs just \$2390.

the screen also shows alphanumeric displays of reference level, resolution, span and other parameters.

All of this makes the unit easy to use. But it's in performance that the 7L13 really excels. Low incidental FM (less than 10 Hz), low drift (2 kHz per hour) and low noise and intermodulation distortion have combined to give the 7L13 a narrow, 30-Hz resolution bandwidth and a super-sensitive -125 -dBm response.

Narrower filters bring better resolution

With such resolution, the Tektronix instrument can clearly display 50-Hz sidebands 125 dB below a carrier of, say, 1476 MHz. And with low drift and distortion products, a sweep lasting, say, 20 seconds will show a clean, jitter-free display.

Part of the credit for the 7L13's performance,



Dual-channel analysis is performed by Honeywell's SAI-470, an instrument that exemplifies the newest trends: RAMs, LED readouts, digital circuitry.



Microwave units comprise the largest market for analyzers. Systron-Donner's microwave unit, the 4809 system, works to 40 GHz at high resolution and sensitivity.



Recently unveiled at Wescon, this unit from Ailtech offers built-in YIG preselection out to 20 GHz. Outstanding is the unit's 100-dB dynamic range and 5:1 shape factor.

says Tektronix, goes to the unit's excellent filter shape factor—an important and often spotlighted analyzer performance factor. Actually it's the shape factor, among other things—and not solely the 3-dB bandwidth of the filter—that eventually determines an analyzer's in-use resolution.

Shape factor—defined as the ratio of the filter's 60-dB to 3-dB bandwidths—tells you how steep the filter's skirts are: The sharper the skirts, the better the resolution of two closely spaced signals of widely different amplitudes.

Thus though one of two competing analyzers may have a superior 3-dB filter bandwidth, that unit may not have better resolving power if its filter response shows a wide spread at the 60-dB-down points.

But remember that even a narrowly shaped filter doesn't guarantee outstanding resolution. If drift or residual FM causes frequency variations of greater than the 3-dB bandwidth, that narrow filter spec is all but meaningless.

Ease of use is increasingly the hallmark of new analyzers today. Take Hewlett-Packard's 8558B. In this 0.1-to-1500-MHz unit, which can be plugged into any HP 180 scope, about 90% of all measurements can be made with just three controls: frequency tuning, span width and amplitude. Once you set the span width, the optimum i-f bandwidth, sweep time and video filtering are all automatically selected. And sure to appeal to nonengineering personnel are the unit's digital frequency readout and direct readout of signal level in dBm.

Another HP unit, the 40-GHz 8555A, now dominates the microwave market with such features and performance as 100-Hz resolution bandwidth, -125-dBm sensitivity, direct coaxial input to 18 GHz, a built-in calibrator, coupled rf and i-f attenuators, and a two-step phase lock (advantageous above 18 GHz, but costly).

But companies such as Ailtech, Farmingdale, NY, and Systron-Donner, Concord, CA, are actively competing for larger shares of the estimated \$30-million market in microwave analyzers.

Microwaves: the big analyzer market

Like the HP unit, Systron's 40-GHz 4809 is a tuning section that forms part of a larger analyzer system. Various displays, sweep and tuning sections and accessories can be plugged in or bolted on to form a complete analyzer tailored to individual needs. Though the HP unit has the edge on resolution—Systron's minimum bandwidth is 300 Hz—and though HP offers more features, the Systron system sells for \$2500 less.

Both the HP and the Systron units are traditional analyzers, in that both use slide-rule



That analyzers are getting easier to use is demonstrated by Hewlett-Packard's 8558B. Just three controls are needed to make practically all measurements.

tuning dials. By contrast, Ailtech's new 727 follows the digital trend with a 5-digit frequency readout.

Like the aircraft of the same designation, the 20-GHz 727 soars high in performance: You'll have to look hard to find another unit that can beat the 727's 100-dB, on-screen dynamic range, its 5:1 filter shape factor and its 10-GHz maximum span width. And if these aren't enough, Ailtech throws in single-knob tuning, automatic bandwidth select (minimum bw = 1 kHz) and an internal YIG preselector. But for such performance, with standard persistence, the 727 sells for \$14,900.

Preselection, or prefiltering, is offered as an option on most microwave analyzers. With it, spurious, harmonic and image responses that can clutter the screen and mask valid spectra are slashed. And preselection can reduce intermodulation distortion and stretch dynamic range.

False displays in an analyzer stem mainly from the type and quality of the unit's mixer and from the basic harmonic mixing used to extend a unit's frequency range on the high end. Doubly balanced mixers cost more, but they can just about eliminate internally generated harmonics and intermodulation products. It isn't surprising, therefore, that the manufacturers of some analyzers—units that use single-ended mixers to keep the cost down—don't spec these re-



Analyzers from Texscan fall in the remarkably low price range of \$2500 to \$4500. The units use a unique marker system to identify frequencies to within 0.005%.

sponses or are rather vague on spectral-purity specs.

Harmonic mixing, on the other hand, can cause multiple and image responses, and these are best removed by a preselector—usually an electronically tuned bandpass filter that automatically tracks the analyzer's tuning.

Besides a clean mixer and preselectors to keep false screen images out, analyzer designers try to make the first i-f frequency as high as possible so images are kept far from the desired signal. Certain analyzers from Texscan, Indianapolis, IN, for example, use a 2000-MHz image separation.

The Texscan units are also good examples of how standard ICs have enabled analyzers to do more at less cost. The company's line carries some of the lowest price tags around. For \$1695, you can literally walk off with a 4-to-300-MHz AL-50: The unit is battery-operated and weighs 25 lb. And the companion AL-51, also portable, covers 1 GHz for \$3300.

Texscan's highest-priced unit—the 1-MHz-to-3-GHz AL-60—sells for \$3360. Like all Texscan units do, the AL-60 offers a unique marker system that can pinpoint frequencies to 0.005%. In the system—called the birdy bypass—harmonics of a crystal oscillator are mixed with those of the first local oscillator. The output beats—or birdies—go directly to the display vertical, bypassing the rest of the analyzer chain. In effect, the unknown is compared with a 0.005% harmonic comb.

Another unit than can be battery-operated, but that can hardly be considered lightweight, is the Analyskop EZF/EZFU from Rohde & Schwarz, Passaic, NJ. Though the unit weighs 114 lb, it's also a heavyweight in performance. Covering the range of 6 kHz to 2700 MHz, the Analyskop's 2.5:1 filter factor may be the lowest of any commercial analyzer. Such a low factor not only implies better separation of frequency components, but makes it possible to speed the sweep at narrow bandwidths. The result: Storage tubes aren't needed.

The Rohde unit is capable of a number of un-

usual tricks. Among other things, it automatically identifies internally generated spurious frequencies, automatically optimizes the ratio of span width to resolution, and it substitutes an electronically superimposed and automatically controlled marker scale for the usual graticule.

The level measurement of the Rohde unit is also automatic, with a calibrated, movable horizontal-reference line. All this, and much more, comes at a rather rich price: \$28,120. However, you can cut the price by \$8570 if you don't need the EZFU uhf tuner and 7-digit counter. The frequency range is then 6 kHz to 130 MHz.

Enter the real-time unit

Swept-spectrum analyzers like the Rohde & Schwarz unit now dominate the communications and general-purpose laboratory arenas. But in a swept analyzer, what happens if your signal decides to change just as the instrument gets to the middle of its frequency sweep? You can try to catch the change on the next sweep—that is, if the signal stays put until then. But it may not. In short, if you expect your signal to vary, look into real-time analyzers, instead of swept.

What the real-time analyzer can do that the swept unit can't is look at all frequency components simultaneously. Thus if the signal changes, the analyzer will spot it (assuming that the rate of change is within the analyzer's limitations).

To look at all frequencies at once, earlier real-time instruments used multiple filters, with the bandpass characteristic of each filter set to overlap that of adjacent filters. In this arrangement the output of each filter is proportional to the amplitude of any frequency component present within the filter's bandpass. The outputs of the filter bank can be scanned as fast as needed to catch the signal variation. If the entire bank is scanned within the time constant of one filter, real-time operation results.

But multiple-filter instruments need hundreds of channels to get decent resolution, and all channels must have identical response. That this isn't easy to do is obvious.

Starting in the mid-60s, and up until recently, most real-time analyzers used the time-compression method of analysis. In this technique an analog-to-digital converter samples the signal and passes the information in parallel binary form to a recirculating digital memory. The output from the memory is fed back to the memory input and sequenced (with respect to newly arrived samples) so that the memory contains all samples in the order of arrival.

Because of the feedback, the time interval between adjacent samples at the memory output is considerably shorter than the intervals of the



Battery operation for field use is another trend in spectrum analyzers. Though it can be used outdoors, Rohde & Schwarz's Analyoskop gives laboratory performance.

input-signal samples. In effect, the signal's time base has been contracted.

The memory output is next fed to a digital-to-analog converter and then to a low-pass filter. The converter's output is an accelerated version of the original signal; the low-pass filter eliminates the sampling frequency. Finally the compressed analog signal is applied to a swept-spectrum analyzer for conventional analysis.

Time compression thus expands a signal's spectrum and allows it to be analyzed at extremely fast rates. And the effective analysis range and bandwidth can be easily changed—just vary the input sampling rate. With the digital memory, if new data are cut off, the compressed signal continues to circulate in the memory. A portion of a signal—or a transient—can thereby be captured and continuously displayed and analyzed.

Other analog techniques are used to design real-time units. But the analyzer that catches the eye today is the all-digital processor—a unit that uses Fourier or Fast-Fourier Transforms (FFT) not only to perform spectrum analyses, but also to determine power spectral density, auto and cross-correlation functions, transfer functions and other characteristics.

Fourier transforms without computers

Initially these analyzers used digital computers to find the Fourier transform of a signal

in real time. But the emergence of the FFT algorithm, along with digital ICs and RAMs, allowed designers to eliminate the computer and build hard-wired, stand-alone analyzers that don't need software. Be careful, though. Some units promoted as "stand-alone" aren't—they're really peripherals.

The engineer used to the terminology and front-panel controls of conventional swept analyzers will find little that's familiar in all-digital instruments. He'll have to learn a new language, based on sampling theory and Fourier analysis, to evaluate these units—a language that includes such terms as "Hanning window," "line or point number" and "aliasing."

Because discrete Fourier processors sample the incoming signal (the integral is replaced by a summation over n samples), an error can occur that is unique to sampled machines. The error—called aliasing—occurs when the signal contains frequencies that are too high relative to the sampling frequency.

For a fixed sampling rate, as the input frequency increases, the number of samples per cycle decreases (assuming the input is a pure sinusoid) until the so-called Nyquist rate is reached at exactly two samples per cycle. Below the Nyquist rate, the sinusoid becomes "under-sampled"—that is, the sampled points of the high-frequency input appear to the digital system exactly the same as would those of a sinusoid of much lower frequency.

Two frequencies are said to be aliases if sinusoids at those frequencies can't be distinguished by the sampled values. Once a signal is sampled, the analyzer can't resolve the ambiguity between a valid low frequency and a spurious alias.

Consequently the Fourier unit must use anti-aliasing filters prior to the a/d conversion to attenuate frequency components beyond the range of the unit. How much attenuation a unit offers depends, of course, on the filter design.

Finding resolution with real-time machines

Since digital units don't otherwise use filters in the analysis process, the resolution of the digital instrument depends, by and large, on the number of points, or lines, sampled (a function of memory capacity). To get the approximate resolution at a given analysis frequency range, or width setting, you can divide the setting by the unit's line capacity (it goes as high as 2048 lines in present units). But this procedure may not be valid with all instruments.

Some units spell out the resolution right on the front panel, so you can select resolution rather than range. Other units are rather vague on resolution, or they cite the number of lines.

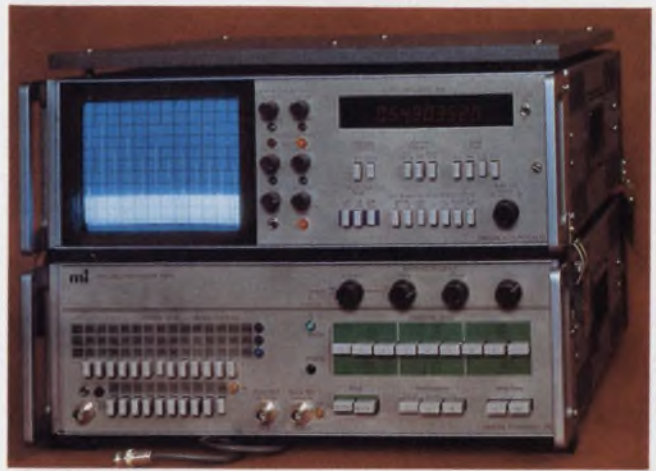

A TV-like display, split digital memory, automatic computation of settings and other fine features set the Marconi TF2370 apart from other analyzers.

Some digital instruments are also vague when it comes to maximum input frequency, and this points to the reason that these sophisticated instruments aren't yet ready to replace the swept analyzer: Digitals, with few exceptions, can now handle only relatively low frequencies (about 50 kHz) in real time.

Time is an important factor in Fourier analyzers for another reason. In the rigid mathematical Fourier transform, the function to be transformed is multiplied by a weighting function ($e^{-j\omega t}$) and integrated over all values of time from minus to plus infinity.

Obviously a practical instrument must operate on finite-length data limits. If the interval—called a frame, block or window—starts and ends abruptly, the window is said to be unweighted, unity weighted or rectangular. The effect of this sharp truncation is to cause numerous unwanted side lobes to appear along with the correct spectral display.

To reduce the discontinuity effects, various tapered windows, or weighting functions—sometimes referred to as the analyzer's filter characteristics—are used. Since any weighting function will also affect the main lobe of a spectral display, windows are chosen to reduce the side lobes without seriously broadening the main lobe.

The most commonly used window is the Hanning function, a cosine-bell weighting curve that theoretically reduces the maximum side lobe by 40 dB. However, the Hanning window broadens the main lobe by a factor of 1.41.

Note that such windows can be implemented in either domain—time or frequency. In the former, the window shapes data for digital processing. In the latter, a "smoothing" effect occurs.

With the window in the time domain—such as provided by the unique 1510 analyzer from EMR/Schlumberger, Sarasota, FL—special win-



With a dynamic range of 120 dB, the Adret 11-MHz 6303 holds the title for this spec. With a substitution of plug-ins, the unit becomes a synthesizer.

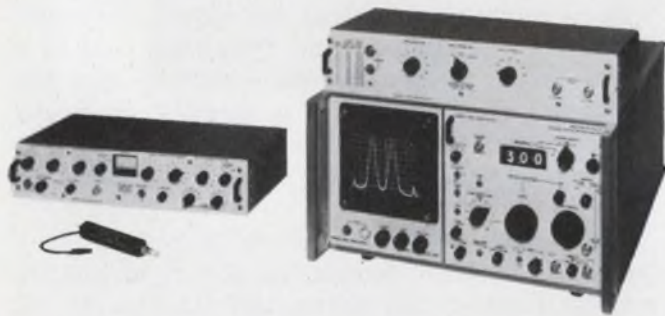

Communications signal analysis is the forte of this unit, the Nelson-Ross CSA-290. The 43-MHz analyzer can handle inputs to 400 MHz with a range extender.

dows can be provided. To do this, the 1510 comes with a programmed, field-installable ROM that holds the special weighting function.

For example, the 1510 offers a Lehmann window—a function that gives equal-amplitude side lobes said to be below the noise level of any signal within the unit's dynamic range (60 dB). The Lehmann window, says EMR, resolves components at odd spacings from the main spectrum—components that the Hanning would miss.

The EMR 1510—which performs a single-channel 256-point analysis in real time to 2.56 kHz (high speed to 25.6 kHz)—typifies what is being done in analyzers today. Digital ICs have allowed EMR to pack the Fourier analyzer plus multispectra averaging and a CRT display into one 8-3/4-in. chassis. And a LED readout displays the frequency or amplitude of any selected line, or the averaging time remaining.

But the 1510 doesn't stop there. The instrument shows on the CRT the status of all major front-panel controls, has a built-in self-test system, and shows normalizing information so that various bandwidths can be referenced to 1 Hz. The price for all this? \$8800.

Another unit that spotlights the latest design

techniques, with its digital algorithms, RAMs and hard-wired preprogramming, is the SAI-470 from Honeywell's Signal Analysis Operation (SAO) based in Hauppauge, NY. A pioneer in real-time analyzers, SAO (formerly Saicor) has unwrapped a number of digital correlators and analyzers since 1967, and the 470 is the company's most recent.

Designed to be used with any of SAO's correlators, the 470 features all-pushbutton operation—there are no tuning or gain adjustments—and LED readout of key parameters. When used with the SAI-43A correlator, the 470 performs a dual-channel analysis, with 400-point resolution, on frequencies up to 2.5 MHz—probably the highest of any real-time unit. And like other real-time instruments, the SAO 470 gives a choice of pushbutton-selectable weighting functions, either rectangular or Hanning.

Both the input data and the analyzed components are available at the 470's output, and they can be simultaneously viewed on any scope or X-Y plotter. The transform can be presented along either the vertical or horizontal axis in any of a number of forms: real, imaginary, phase, log magnitude, log frequency and more. And a movable marker can be set on any point and the X-axis location of the marker read out digitally. The SAI-470/43A combination sells for approximately \$15,000.

That even the sophisticated real-time spectrum analyzer is becoming easier to use is demonstrated by still another remarkable unit—the Nicolet Scientific, Northvale, NJ, UA-500A.

Combining a 500-line real-time analyzer with a dual-memory averager and a built-in calculator, the UA-500A makes digital calculations on the spectrum. The unit calculates absolute frequency and amplitude in dB or percentage of full scale, relative amplitude above and below a reference signal and frequency deviation from a reference frequency.

The readout on the Nicolet is a 4-digit LED. All the user need do is set a cursor line on the spectrum of interest and frequency is automatically displayed in hertz (or multiplied by 60 for rpm measurements). And relative measurements are just as easy with the use of the cursor and a "set reference" pushbutton.

The dual-memory feature of the 0.02-Hz-to-100-kHz UA-500A allows the user to compare two sets of data on one scope, separated or overlaid. When multiple signals are present, the harmonics of one signal are identified by a mode that marks intensified dots. The UA-500 series starts at \$11,300.

For higher resolution, the SA-240 from Sanders Associates, Nashua, NH, uses 1024 lines to analyze signals from dc to 40 kHz. The unit offers 12 selectable resolutions from 0.01 to 40 Hz.

From its input translator and FFT processor to filtering, post-processing and storage, the SA-240 uses all-digital circuitry.

Like many of its fellow real-time analyzers, the Sander's unit, which costs \$19,800, has a digital display of a cursor frequency and outputs analog data for display on a CRT or plotter. The unit also averages spectra in powers of two up to 1024 times. And in case of trouble, the SA-240 tests itself and points to the faulty module.

Prior to real-time instruments, low frequencies (low rf down to audio) were handled mostly by wave analyzers—a special class of analyzer.

Wave and other analyzers

Basically the wave analyzer is a tuned, narrow-passband voltmeter, similar to a superheterodyne receiver. Unlike the superheterodyne spectrum analyzer, however, the wave analyzer usually has a meter readout instead of a CRT, and it is manually tuned through the frequency span, not swept. Thus an analyzer can't give the broad, simultaneous view of a spectral range that the swept unit can.

But most scanning analyzers can't give the resolution of a wave-type unit, or they would need such a slow sweep to do so that the simultaneous broad view would be lost.

Some wave analyzers can be swept slowly, though, and the output recorded on a plotter for an overview of the spectrum. One such instrument is the 1523-P4 wave analyzer plug-in, marketed by General Radio, Concord, MA.

One of a family of plug-ins to General Radio's 1523 Graphic Level Recorder, the P4 automatically sweeps between start and stop frequencies dialed into the front-panel controls. At the completion of a chart, the recorder automatically advances to the next chart or rewinds for an overlay.

Analysis with the P4 can be performed on frequencies from 10 Hz to 80 kHz and over an 80-dB dynamic range. Bandwidths are 10 and 100 Hz at rates from 0.1 Hz/s to 100 Hz/s. The P4's scale factors range from 50 to 5000 Hz/in.

One nice feature of many wave analyzers is automatic frequency control (afc). With afc, the instrument locks onto signals that tend to drift out of the set passband—even the widest available to the unit. For instance, the D2040 60-kHz analyzer from Siemens (Iselin, NJ) will hold signals that vary up to ± 100 Hz at 60 kHz, and ± 20 Hz at 1 kHz. And the unit will pull in frequencies up to ± 15 Hz.

Another such unit is the 980M from Vibration Instruments Co. of Anaheim, CA. The 980M is a multichannel (up to six) tracking analyzer that locks and tracks a component despite changes in both frequency and amplitude. The

instrument can be set so its narrow-bandwidth filter (as low as 0.5 Hz) is phase-locked to an arbitrarily shaped reference, which can vary from 3 Hz to 1 kHz and from 10 mV to 100 V.

Some instruments that bear the label of wave or spectrum analyzer are not analyzers in the classic sense. Instead, these units measure harmonic distortion or analyze input signals for properties other than frequency components.

Vu-Data Corp., San Diego, CA, for example, offers a harmonic analyzer, the 101B, that reads, among other things, either the second or third harmonic of inputs to 1 MHz. Sound Technology, Inc., Cupertino, CA, markets the 1700A—a unit that measures total harmonic distortion down to a super low 0.002%. And the 1700A takes just 5 s to do the job. Analyzers from Ortec Inc., Oak Ridge, TN, display histograms of a signal's amplitude or time-interval characteristics.

And a unit from Ufad Corp., Grand Rapids, MI—the Lab-All—may be the universal analyzing instrument of the year: All rolled into one is a wave and spectrum analyzer; a tracking and tunable filter (bandpass/band-reject); a servo, network and distortion analyzer; a demodulator; a phase-sensitive and phase-angle voltmeter; and a Nyquist and Bode plotter.

Add a couple of attachments, and the Ufad unit turns into a Fourier analyzer, three-phase oscillator and a 360-degree phase shifter. ■■



For more information

For a list of manufacturers of spectrum and other analyzers, refer to the following sections in the Product Directory of ELECTRONIC DESIGN's Gold Book:

Analyzers, A-F	Vol. 1, p. 32
Analyzers, Harmonic	Vol. 1, p. 33
Analyzers, Interference	Vol. 1, p. 33
Analyzers, Intermodulation	Vol. 1, p. 33
Analyzers, Microwave	Vol. 1, p. 33
Analyzers, Noise	Vol. 1, p. 34
Analyzers, Phase & Voltage	Vol. 1, p. 34
Analyzers, Probability Density	Vol. 1, p. 34
Analyzers, Pulse	Vol. 1, p. 34
Analyzers, Radar	Vol. 1, p. 34
Analyzers, Sonic & Subsonic	Vol. 1, p. 34
Analyzers, Spectrum	Vol. 1, p. 35

how 80%
of \$2,000
is only

\$580⁰⁰

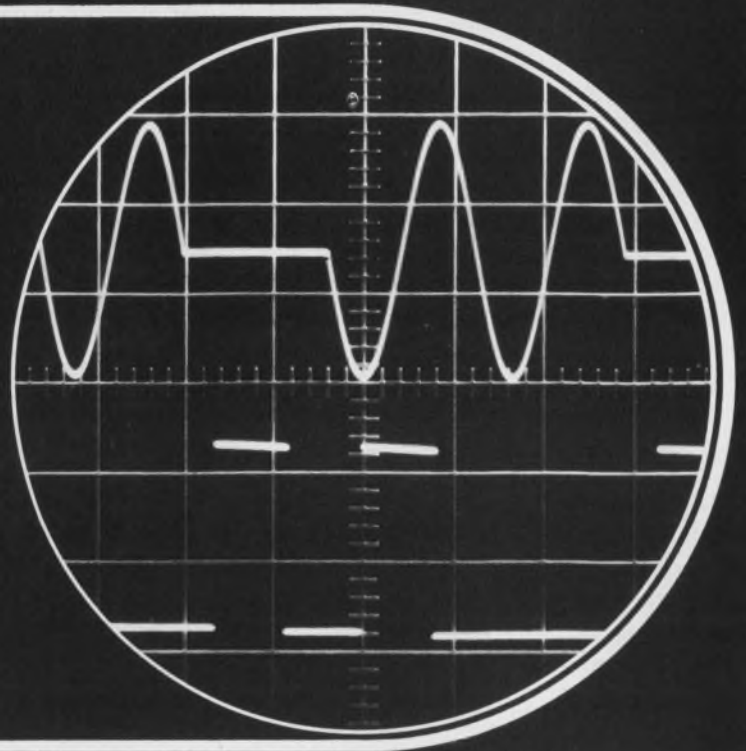

Oscilloscopes for most production, inspection, QC and lab applications are not used to their full capability.

In fact their full capability in bandwidth may even need to be limited by an external bandpass filter for easier trace readability. In one electronics manufacturing facility a survey of 22 applications discovered 19 applications which were appropriately served by our least expensive \$179.95 oscilloscope with recurrent sweep and 2MHz bandwidth. A survey of your facility may reveal similar opportunities for saving. Our triggered sweep scopes with 10MHz bandwidth and 35 nanosecond rise time answer the needs of more than 80% of all applications. Sensitivity of 10mV/cm offered by both our single and dual trace triggered sweep scopes is similarly suitable for over 80% of all applications.

Why overspecify your oscilloscopes? It's not necessary if the intent is to be sure you get the repeatability, reliability, ruggedness and versatility that is characteristic of every B&K oscilloscope. Move your ultra-wide bandwidth scopes to other applications where you need them. You'll find the B&K scopes easier to use with their simplified, human-engineered panels and controls.

10 Day Free Trial

With more than 20 years successful experience in manufacturing fine test equipment at competitive prices, Dynascan has the confidence in its new B&K instruments to offer them on a 10 day free trial basis. Just properly identify yourself, your company and your application and we'll supply a new oscilloscope that will prove our claim to quality and value. Write on your letterhead for complete specifications and Free Trial.



Model
1470

CONDENSED SPECIFICATIONS

B&K Model 1470 Dual Trace Triggered Sweep Scope
DC to 10MHz at 10mV/cm. Two separate vertical amplifiers. 35 n sec rise time. Six dual pattern modes including chopped, alternate, add and Channel 2 inverted. Auto and triggered sweep 1 usec/cm to 0.1 sec/cm. 5X magnification. **\$580.00**

B&K Model 1460 Triggered Sweep Scope
DC to 10MHz at 10mV/cm. 35 n sec rise time. 0.5 usec/cm to 0.5 sec/cm auto and triggered sweep. 5X magnification. 5V p-p 1 KHz calibration voltage. **\$450.00**

B&K Model 1431 3" Triggered "Mini-Scope"
As above, but 1/3 the size. **\$399.00**

B&K Model 1403 Portable 3" "Mini-Scope"
3" solid state scope only 5 1/4" x 7 3/8" x 11 1/4". DC to 2MHz bandwidth and 20mV/cm sensitivity. Recurrent sweep 10Hz to 100kHz. Weighs only 8 1/2 pounds. **\$189.00**

B&K PRODUCTS OF
DYNASCAN

1801 W. Belle Plaine Ave. • Chicago, IL 60613 • Phone (312) 327-7270

Complete Line of Analog and Digital Multimeters, Oscilloscopes, Signal Generators, Semiconductor Testers, Power Supplies, Probes, Tube Testers and Substitution Boxes.

INFORMATION RETRIEVAL NUMBER 45

INFORMATION RETRIEVAL NUMBER 46 ►

NO CASUAL CONTACTS.

We don't treat connectors casually.

And neither should you.

With our connectors, the gold is exactly where you want it.

You can get a completely gold-coated contact or our reliable gold-dot type. Both types are available custom or off-the-shelf.

High quality connectors are our business. And business is something we don't treat casually.

GTE Sylvania, Parts Division,
Warren, Pa. 16365

GTE SYLVANIA

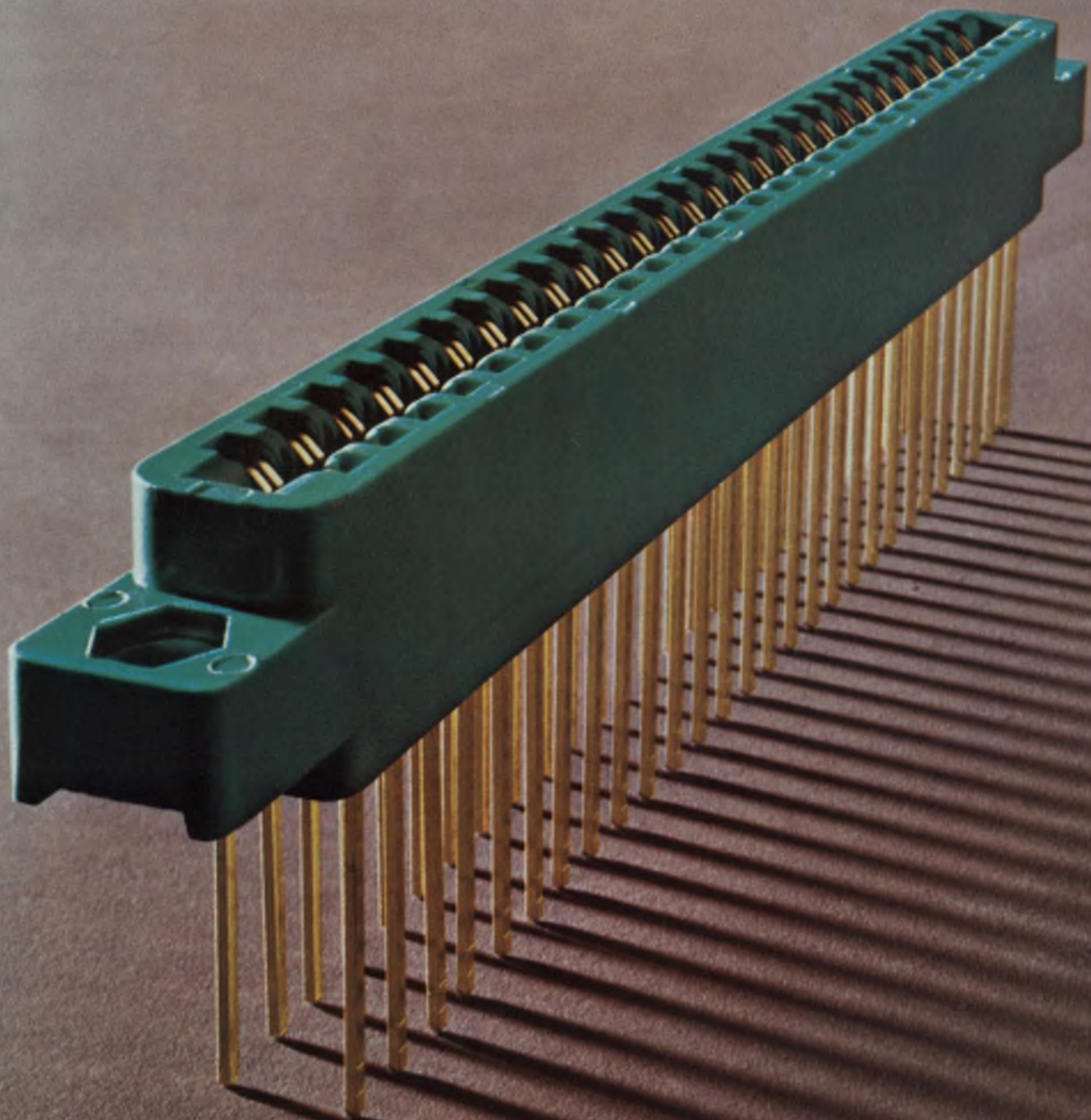

New generation of high-performance, low-cost, ultra-precision resistors

Tolerances: .01% to 1%
Temp. Coeff.: 5 to 25 PPM/°C
T.C. Matching: to 1 PPM/°C

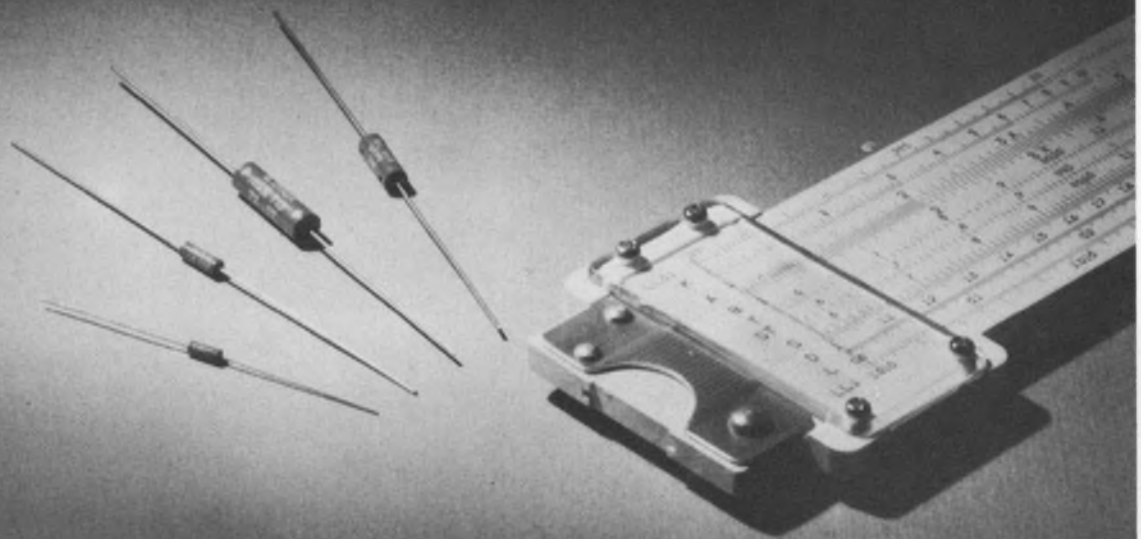

Caught in a cost/performance bind on precision resistors? Solve the problem with TRW/IRC's new MAR Series of ultra-precision metal film resistors. Where speed and precision count, they offer the ultimate in cost/performance ratio. And by "performance," we mean *better* than premium wirewounds.

With the MAR Series, you get an ultra-stable, ultra-precision resistor with an extremely low temperature coefficient. You also get the non-measurable noise, low voltage coefficient and stress stability previously available only in pre-

cision wirewounds. Yet you still have the high-frequency response, reliability, pulse stability and resistance/size ratio of metal film.

Also available as part of the MAR technology are resistor matched sets and modules providing additional performance and cost advantages. For comprehensive technical data and MAR samples, contact your TRW representative. Or write TRW/IRC Fixed Resistors, 2850 Mt. Pleasant St., Burlington, Iowa 52601. Phone: (319) 754-8491.

IRC TYPE	RESISTANCE RANGE (Ohms)	TEMPERATURE COEFFICIENTS -20° C to +85° C (± ppm/°C)	TOLERANCES (± %)	POWER RATING (@ 85° C) (Watts)	VOLTAGE RATINGS (Volts)	DIMENSIONS IN INCHES		
						Body Length (L Max)	Body Diameter (D Max)	Lead Gage (A)
MAR3	20-100K	T10 = 15	1.00, 0.50, 0.25,	1/20	200	.191	.082	≠ 26 .016 [⊛]
MAR5	20-250K	T13 = 10	0.10, 0.05, 0.02,	1/10	250	.281	.102	≠ 22 .025
MAR6	20-500K	T16 = 5	0.01	1/8	300	.425	.155	≠ 22 .025
MAR7	20-1 Meg			1/4	500	.650	.195	≠ 22 .025

[⊛]Wider ranges available. Contact factory. [⊙]Lead length 1.00 ± .062.

TRW[®] IRC RESISTORS

ECL design just became a three-layer piece of cake.

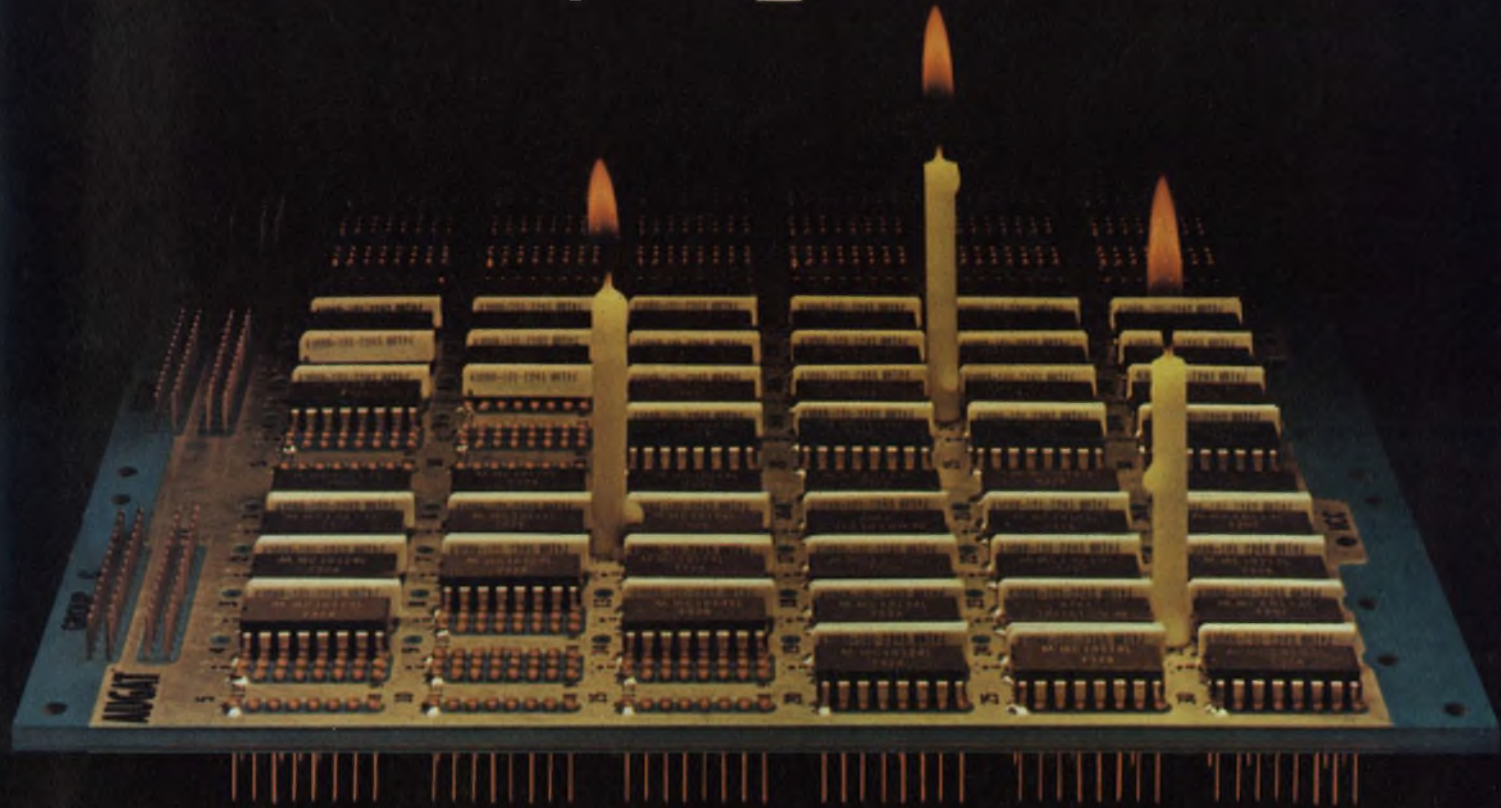

Augat ECL Board with -2 volt bus for terminating single in-line package (SIP) resistor network.

Compared to methods of the past, the Augat series of socket, Wire-Wrap® ECL boards makes ECL design a piece of cake. Even for circuits in the 125 to 500+ MHz range.

They can save you 90 percent or more in breadboarding and prototyping time. Tens of thousands of dollars in start-up costs. And many costly hours in field maintainability.

With this proven advance in three-layer interconnection technology you don't have to design in controlled impedance interconnections, mess around with transmission lines, or commit power connections for different ECL logic modules. All of which frees you to concentrate on the partitioning of logic functions and the preparation of a wiring list.

And unlike a multi-layer P.C. board, there is no loss in planar density. Two 16-pin ECL and associated pull down and decoupling components fit into one square inch on every Augat ECL board.

The nice thing, too, is that Augat ECL boards are standard catalog items available in any quantity at any time from Augat distributors around the world. You can contact them directly or write Augat, Inc., 33 Perry Avenue, Attleboro, Mass. 02703. Tel. 617-222-2202. TWX 710-391-0644.

AUGAT®

Registered TM of Gardner-Denver Company

Europe - Augat N.V., Boulevard A. Reyers, 103, 1040 Brussels, Belgium, Tel. (021) 7369399.

Japan - Kyokuto Bocki Kaisha Ltd., New Otemachi Bldg. 2-1, 2-Chome Otemachi, Chiyoda-Ku, Tokyo 100-91, Japan, Tel. (03) 244-3788.



MICROWAVE INSTRUMENTATION

It's a new world of measurement at 1 GHz and higher

Remember when slotted lines and couplers were used for most measurements at 1 GHz and higher? Klystrons, stabilized by blowers, had to be tuned continually. Measurements had to be performed step by step at the discrete frequencies indicated by cavity wavemeters.

Now vector voltmeters and network analyzers can obtain the characteristics of units under test in a fraction of the time. Sweepers with bandwidths extending over several bands allow data to be obtained automatically for a complete impedance plot, and the plot can be displayed on analyzers.

Signal generators and synthesizers provide rf signals with increased purity, heightened stability and improved resolution. Moreover the signal frequency can be measured automatically and displayed digitally with frequency counters, which don't require a cw input. Similarly the signal power can be measured and displayed digitally.

Many of the improvements have resulted from the increasing use of solid-state circuitry. Thin-film hybrid assemblies and microwave ICs have brought compact, lightweight units with decreased dissipation. High-speed emitter-coupled-logic circuitry has proved particularly useful for front ends of frequency counters. But the impact of solid state has been just as dramatic in i-f or lower frequency sections, which handle much of the data processing.

However, tubes are still very much in the picture, especially where maximum power is a key requirement. They are also the major active component at frequencies around 18 GHz and above.

At these high frequencies, there isn't the wide

variety of instruments that you find at lower frequencies. Less demand is cited by manufacturers as a major reason. Another is the requirement for waveguide plumbing, rather than coax, with associated problems.

Where commercial equipment isn't available, designers are building their own. Even at microwave frequencies, the requirements for super accuracy may force designers to develop special equipment. However, commercial components are often used as the building blocks.

Regardless of the equipment, the limitations on measurement accuracy and repeatability remain the same. Finite mismatches and insertion losses in passive components cause errors in expensive test gear just as easily as they do in minimal, basic fixtures. Hence vendors often supply special hardware accessories for their models. And efforts to improve passive components continue.

Network analyzer forms basic tool

One of the most useful microwave instruments is the network analyzer. "It offers the only practical way of characterizing magnitude and phase of devices and networks, short of going to slotted-line techniques, which are time-consuming and require a cw signal," asserts Scott Wright, product marketing manager for network measurement instruments at Hewlett-Packard, Santa Rosa, CA.

The analyzer can test any type of active or passive network, from cables to transistors to amplifiers. It can measure both amplitude and phase of the network. It displays the results on polar or rectangular coordinates, or on analog meters that give magnitude in dB and phase in degrees. Wright notes that the data measured provide impedance, transmission loss or gain,



Improved instruments simplify tests and measurements. Here are units offered by Hewlett-Packard, a major supplier (clockwise, starting at the top left): the HP 8410 network analyzer, displaying the input impedance of a 2-to-18-GHz attenuator; the HP 8620 solid-state sweep oscillator, covering the 2-to-18-GHz band and, with a version of the company's network analyzer, permitting continuous measurement over its band; the HP 435A power meter; and the HP 8640B vhf signal generator, containing frequency counter plus phase-lock for synthesizer-type stabilities to 1.1 GHz.

phase linearity through the network as well as basic linear characteristics, such as S parameters.

A typical setup employs a swept oscillator that supplies the signal for the network under test. The network alters the signal and then passes it along to a two-channel receiver that converts its rf input to i-f for the magnitude. Phase difference results from a comparison of the signal phase and a reference phase.

Network analyzers don't come cheaply. HP's basic unit costs \$10,000 to \$15,000, which doesn't include the source but does include test fixtures, such as directional couplers. Compared with a reflectometer setup, which measures magnitude only, the network-analyzer setup costs about three times more.

"But you get much more than just phase with a network analyzer," Wright notes. Sensitivity increases, as does measurement bandwidth. Also, amplitude-measurement capability is greater, according to Wright.

The HP 8410 analyzer has a 60-dB measurement range that extends from -10 to -70 dBm.



This "window" represents a key spec for the measurement of small-signal devices. For a valid measurement, the device must not be driven with so high a signal that it distorts.

Bandwidths depend mainly on the signal source. Up to 18 GHz, standard sweepers for the 8410 provide octave bandwidths, and data obtained can be displayed at the same time. With one test fixture the 2-to-12-GHz range can be covered. Above 18 GHz the need for waveguides tends to limit bandwidths to narrower waveguide bands.

The sweep range of HP's analyzer has recently been extended with the introduction of a multi-octave sweeper plug-in (HP 8620A). The new unit can interface with a version of HP's basic network analyzer (8410B) to display 2-to-18-GHz measurement data in one continuous sweep.

Measurement limitations

Analyzers do have limitations. For example, they can't be used to test nonlinear networks.



A solid-state sweeper/signal-generator provides full coverage from 1 to 18.5 GHz in a single range. The multi-octave Model 9535 is offered by Narda.

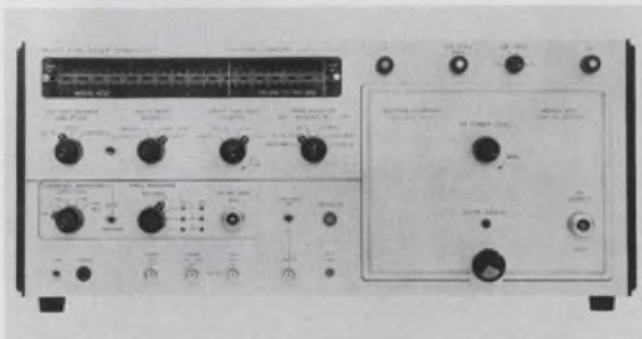

With a plug-in, the 7.9-to-18.5-GHz countermeasures band can be swept in the Model 610C Sweeper Series from Wiltron (Palo Alto, CA). Leveled output is 5 mW.

These circuits present several sine-wave components to an analyzer, which primarily responds to the fundamental. Hence the data obtained won't be relevant.

Rf hardware—such as various transmission lines and directional couplers—ultimately limits the accuracy. This applies not only to network analyzers but also to microwave tests and to measurements.

The finite input/output SWRs of transmission lines and the directivities of couplers present major sources of error. A coupler's directivity indicates how well signals can be separated. At low frequencies, 40-dB directivities are typical. But this parameter decreases with increasing frequency, dropping to 30 dB at 12 GHz and 26 dB at 18 GHz. The effect of couplers can be as great as the network under test.

Klystrons for signal generators

In contrast to sweepers, which have gone solid-state, signal generators have stayed with tubes. Two major suppliers of these generators are Hewlett-Packard and Polarad, Lake Success, NY.

"We have a growing line of klystron units, which may seem anomalous," says Ed Feldman, marketing manager at Polarad.

However, cavity-tuned klystrons offer several advantages over, say, the voltage-tuned YIG oscillators commonly used in sweepers. Though the latter feature all the advantages of solid-state devices, "klystron units have better spectral purity and calibrated outputs that extend over a 100-dB range," Feldman asserts.

Typically harmonics from klystron units are 60 dB below the peak of the fundamental frequency. By comparison, solid-state units suppress these unwanted frequencies by only 20 dB, according to Feldman. Also, the frequency of klystron units can be determined on a digital readout to an accuracy of typically 0.5%. Feldman contrasts this value with typical 1% accuracy for analog meters in solid-state units.

The advantages of klystron units result naturally from their construction. Cavities have high Qs, and they can be operated at frequencies well below those of the next higher propagating modes. Moreover klystrons generate far more power than is actually tapped, so loose coupling can be employed to obtain the output signals. Hence distortion can be held to a minimum.

Also, the use of a waveguide-beyond-cutoff in the coupling structure yields the broad calibrated output simply. It involves just a waveguide with no propagating modes and a coupling probe. Linear motion of the probe gives the calibration directly.

In addition klystrons have a built-in modulation capability because of their control grids, which are similar to the grid found in low-frequency vacuum tubes. As a result, units can be turned on and off completely, without the residual leakage found in solid-state devices. The feature becomes important in pulsing applications.

A typical unit in the Polarad signal-generator line is the 1607A, which covers the 3.7-to-8.4-GHz frequency range. The unit costs \$3300 and includes pulse-modulation capability. All units in the Polarad line provide a minimum of at least 10 mW. Polarad klystron sources—signal generators without the calibrated output—provide over 100 mW.

Synthesizers have improved specs

Some applications require rf signals whose frequencies can be determined to high resolution and can be made extremely stable. For these cases, designers can turn to frequency synthesizers.

Among recent improvements in synthesizers are broader bandwidth and increased spectral purity. "Spectral purity used to mean narrower



Attenuation calibrator spans the broad range of 10 MHz to 40 GHz. The Model 915-B from PRD (Syosset, NY) measures up to 110 dB in a single step and accepts levels as low as -120 dBm.

bandwidth and high-Q, mechanically tuned cavities," says Paul Tipon, project engineer at Systron-Donner, Concord, CA. "Now with phase-locked YIG oscillators, we can achieve octave bandwidths, compared with bandwidths of 3% or less before."

Newer models have reduced phase noise, Tipon notes. Excessive noise, which is particularly troublesome from about 1 kHz to 100 kHz away from the fundamental frequency, can seriously limit high-sensitivity measurements.

Tipon points out that typical phase noise was about 90 dB below the fundamental frequency 100 kHz away. Now units have minimum phase-noise levels of 115 dB. Beyond 100 kHz from the fundamental, spurious signals are suppressed to at least 90 dB.

Between about 1 kHz and the fundamental, stability plays the major role. However, various references can be used to limit drift. Typically a stability of ± 3 parts in 10^9 per day can be achieved. And with very stable references, stability can be held to ± 5 in 10^{13} per day.

"Phase noise has been improved by varying the coupling to the YIG sphere," says Tipon, who also sees further improvements coming shortly. "A year ago people were talking about YIG-tuned Gunn oscillators that could output 10 to 20 mW. Now they're talking about 50 to 100 mW at 20 GHz."

The new units should also have low phase noise, he says, since the same coupling techniques can be used.

Systron-Donner offers the 1600 series of synthesizers for the microwave frequency range. For example, the Model 1603 covers the 2-to-4-GHz range, and the Model 1617 spans 12 to 18 GHz. Units cost from \$12,000 to \$17,000, and all are programmable. A digital BCD input permits

remote control of the unit.

Some features of synthesizers are finding their way into signal generators. Ned Barnholt, product marketing manager for HP's Stanford Park Div., sees the trend in signal generators going toward more units with programming and frequency synthesizing capabilities.

"Internal circuitry contains many phase-locked loops for the synthesis of many individual frequencies," he explains.

The stability of these signal generators can be set by external references. For example, "1 Hz at 1 GHz is common now," says Barnholt. Also, the units allow remote data entry for the programming, with ASCII or BCD signals, of such functions as power level and modulation in addition to frequency.

HP—a major supplier of synthesizers—also offers the newer signal generators. The HP 8660 A/B, for example, operates up to about 1 GHz.

Counters expand capabilities

As synthesizers have moved up in frequency range and capability, so also have frequency counters. Commercially available units permit automated measurements up to 18 GHz, and they have options for tests to 23 GHz. Resolutions of 1 Hz are offered, and counter sensitivities have improved to -25 dBm at 18 GHz.

These features can be found in HP's popular 5340A counter, which sells for \$6200. It uses proprietary thin-film hybrid assemblies for a high-frequency sampler and its driver—the two critical components in the unit's internal phase-locked loop.

In operation, the PLL locks a voltage-controlled oscillator to the incoming signal. Further processing, with multiples of the VCO's output frequency and another PLL, yields the incoming frequency in this so-called transfer-oscillator technique. The technique has also been widely used by Systron-Donner under the tradename ATCO.

Before counters became automated, a "designer normally had to tune a dial and maybe do some mathematics," says Duncon MacVicar, HP's product manager for microwave frequency counters. In essence, the designer had to lock the VCO to the signal.

MacVicar attributes the improved sensitivity to the use of transfer-oscillator techniques, rather than heterodyne methods. "The technique has a narrow-band i-f—hundreds of kilohertz," he says. "But that's all that's needed. Since the VCO is tracking the signal, a lot of noise doesn't get in." With heterodyne methods, the i-f bandwidth is about 200 MHz.

HP's newer counter, the 5345A, combines with the 5354A Heterodyne Converter plug-in to per-



More than 10-dBm output and a calibrated range of +6 to -130 dBm can be obtained from the 1106B-L signal

generator from Polarad. The 1.8-to-4.6-GHz klystron unit features leveled cw and modulated outputs.

mit the latest advance: automatic measurement of pulsed rf signals to 4 GHz. With this unit, designers can obtain the frequency of carrier signals that make up rf pulse bursts. Proprietary thin-film hybrid circuits and a "frequency-averaging" technique produce automatic averaging of a series of pulsed-carrier measurements. The complete unit sells for about \$6000.

The new counter can handle automatically pulses as narrow as 250 ns. For even narrower pulses, a manual or programmed mode is available for pulse widths smaller than 100 ns.

The 4-GHz counter employs special switchable filters to achieve an acquisition time of 160 μ s—an indication of the speed of measurement. With earlier models, the time was typically 10 ms.

In addition the HP counter can accept signals with a large amount of FM. It can tolerate up to 500-MHz pk-pk deviation. At band edges, at least 20 MHz, pk-pk, can be accepted.

Meter accuracy increases

For some instruments, improvements in a passive component results in a significant increase in measurement accuracy. The venerable power meter is a case in point.

HP's latest, the 435, employs a thermocouple sensor rather than the thermistor type used in previous models. Thermistor mounts have a reflection coefficient of typically 0.230, compared with 0.123 for the thermocouple. These values assume an input SWR of 2:1.

"The difference makes for a dramatic improve-

ment in measurement uncertainty," says HP's Barnholt.

With the thermistor values, uncertainty can be $\pm 17\%$ of the measurement. But with corresponding thermocouple values, the reduced SWR yields a lower uncertainty of $\pm 9\%$, according to Barnholt.

In earlier models an input rf signal heats a thermistor. Bridge techniques are then used to determine the input rf power. Since these techniques can be designed for high accuracy, the detection scheme becomes the major limitation on accuracy. Hence the switch from thermistor to thermocouple sensor leads to improved accuracy.

An additional advantage of thermocouples, according to Barnholt, is a 10-to-15-dB wider dynamic range.

HP's 435 operates up to 18 GHz, and it can accept signals on 50 or 75- Ω lines. A complete unit, consisting of meter and mount, costs about \$1000—somewhat lower than an equivalent thermistor unit. The 435 meter also features a built-in reference oscillator and auto-zero capability. The thermocouple employs special thin-film circuitry.

Read power digitally

A similar power meter is manufactured by General Microwave. The Farmingdale, NY, company offers the Model 476, which has a conventional analog readout, and the Model 475 with a digital readout—a unique feature for power

meters. The 475's readout is a 3-3/4 digit display.

In addition the General Microwave digital model has a 60-dB direct-reading single range that extends from about -40 to +20 dBm. Its rated accuracy is ± 0.05 dB. With the 476 analog meter, the sensitivity reaches -45 dBm, or $0.03 \mu\text{W}$, and readings are accurate to $\pm 1\%$ of full scale.

The unit typically operates to 18 GHz. However, with an SMA-connector power head, the frequency range can be extended to 22 GHz (the General Microwave 440B).

For instant calibration, the meter contains an internal 10-kHz, +5-dBm reference. The standard can be employed without a disconnect of the power head. A simple flip of a switch engages the reference.

Designers build their own

As impressive as available instruments are, some applications require designers to develop special equipment. The need for extreme accuracy, for example, could dictate this course in any frequency band. However, the difficulties in selecting suitable test equipment—like measurement problems at high frequencies—tend to worsen as frequency increases.

For Tom Abele, department head of microwave components and apparatus at Bell Laboratories, North Andover, MA, the need for special equipment arose because of "the lack of a really good sweeper." Abele's group must perform precision measurements at millimeter wavelengths, and it often needs data in the 40-to-110-GHz range.

Now, he says, "we are using backward-wave tubes and bulky power supplies." The tubes are foreign-made and expensive. They cost \$10,000 to \$11,000, which doesn't include the supplies or other equipment, Abele says. Moreover outputs must be leveled with additional circuitry.

The requirement for super-accuracy in the 1-to-20-GHz range motivated a group at Bell Laboratories in Holmdel, NJ, to build an extremely accurate computer-controlled network analyzer that uses commercially available components.

As described by G. D. Haynie, head of the measuring system dept., the test equipment had to check repeater units in a 4000-mile system. Because of the great length, tolerances for the repeaters become extremely tight.

According to James G. Evans, a supervisor in the Bell group, the test equipment had to measure group-delay distortion of about 0.1 ns. And the shape of the loss characteristics had to be determined to about 0.01 dB. These values translate into a test system with accuracies of 0.01 ns and 0.001 dB. ■■



Direct reading from 10 nW to 3 W on a digital display is possible with the Model 467A meter from General Microwave. The unit employs a thermocouple sensor.



The latest automatic 18-GHz counter costs less than \$4000. Standard minimum sensitivities are -20 dBm at 12 GHz and -15 dBm at 18 GHz. The unit, from EIP (Santa Clara, CA) also has a 40-MHz, pk-pk, FM tolerance to 10-MHz modulation.



For more information

For a list of manufacturers of microwave and millimeter-measuring products, refer to the following sections in the Product Directory of ELECTRONIC DESIGN's Gold Book:

Analyzers, Network	Vol. 1, p. 34
Counters, Instruments, Microwave	Vol. 1, p. 128
Generators, Frequency Synthesizer	Vol. 1, p. 176
Generators, Sweep, rf & Microwave	Vol. 1, p. 179
Meters, Power Microwave	Vol. 1, p. 251

Introducing the V-71. 32K for 8 grand.

Incredible. Getting 32K out of an off-the-shelf mini. Plus the option of a power fail/restart, teletype controller, automatic bootstrap loader for TTY's and real-time clock for only \$800 more*.

It gives us the distinction of being the cheapest computer in the world delivering 32K. And gives you the chance to get a lot more power for your money.

But the V-71 is more than just another piece of bare metal selling at a rock-bottom price (we leave that specialty to others). It—like the entire Varian V-70 family—has been elegantly designed by Varian engineers who think in terms of systems and total concepts.

With additions, the V-71 is capable of a powerful blend of hardware, systems software (the VORTEX operating system), and extensive peripherals. And Writable Control Store if that's what you need.

How much of a system you want to make out of the V-71 is up to you. The raw power is there. And Varian's open-ended architecture makes it easy to add whatever building blocks you need.

If you want more power for less money, check out the new V-71. For further information, write Varian Data Machines, 2722 Michelson Drive, Irvine, CA 92664. Or call 833-2400.

*V-71 price and options based on orders of a dozen.



 **varian
data machines**

New snap-in rockers with Cutler-Hammer reliability.

Here's a completely new line of snap-ins, each engineered with the kind of solid dependability you expect in Cutler-Hammer Rockette® switches. Bright metal bezels, illuminated and non-illuminated, A-c and D-c capabilities up to 20 amps.

Sub-panel rockers in a variety of colors, rocker or paddle designs in standard, special, or proprietary models.

Switches snap in and stay in permanently. Speed up assembly time, cut costs.

Flush-mounted rockers in the same wide range of designer-oriented colors and styles. One- and two-pole models.

Illuminated single-pole rockers. Choice of red, green, amber, white, or clear. Hot-stamped legends indicate switch functions.

For more information, call your Cutler-Hammer Sales Office or Switch Distributor.

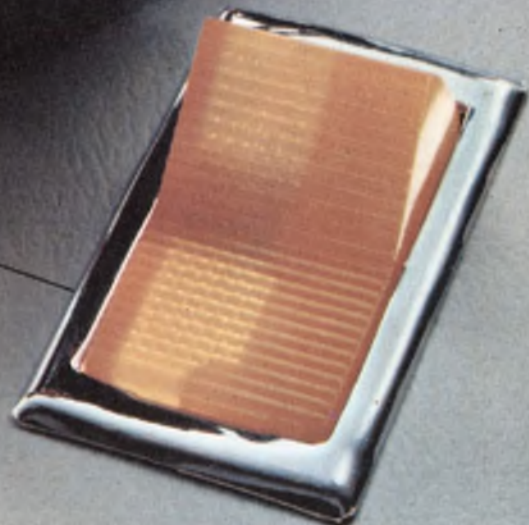

CUTLER-HAMMER
SPECIALTY PRODUCTS DIVISION, Milwaukee, Wis. 53201



PRODUCTS FROM H·S·I

... A Concise Listing



HIGH SPEED DIGITAL PULSE COUNTERS

with 4, 6, 8 digits; 12, 24 VDC, 115 VAC, 60 Hz; response rates of 0-100 pps; 2 or 3 wire stepper or synchronous motor. Extremely long life and extraordinary reliability. Available with BCD readout capability.

HIGH SPEED DIGITAL STOP CLOCKS

with 4, 6, 8 digits; 12, 20, 115 VAC, 50 or 60 Hz; 1.5 watt max.; readout in sec., min. or hrs.; increments of 1/10 or 1/100 of a sec. or a min. or an hour; manual or electric reset. Quiet, dependable and accurate. Available with BCD readout capability.

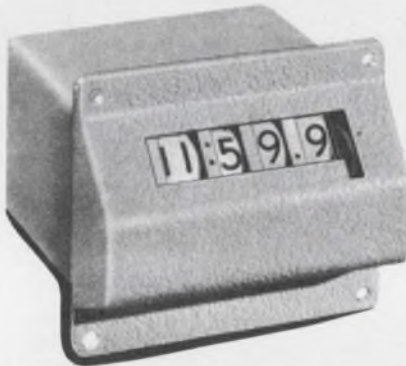

DIGITAL PANEL MOUNT CLOCKS

with readout in 12 or 24 hours, mins., 1/10 min. or 0-55 sec.; calendar (Gregorian month/day/hour/min./sec. or Julian 1-366 day/hour/min./sec.); 12, 20, 115 VAC, 50 or 60 Hz; driven by BIG INCH synchronous motors. Rapid transfer, reliable, long life, extremely accurate. Available with BCD readout capability.

PRECISION SWITCHES

Resilient or hermetic seal, high and low temperature switches and switch assemblies for applications where optimum performance is the criteria. SPST, SPDT, DPDT, etc. Push button, plunger, roller, toggle actuated. Many types, styles, sizes.

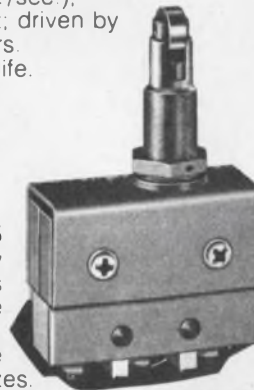

BIG INCH® PRECISION MINI-MOTORS

One watt synchronous, 2-wire and 3-wire stepper, step-servo, brushless DC; uni-directional, bi-directional; 1-1/16" dia.; instant (1/100 sec.) stop/start/reverse; integral gear train. Powerful, efficient, dependable.



HAYDON SWITCH & INSTRUMENT, INC.

1500 Meriden Road, Waterbury, Conn. 06720
(203) 756-7441

SEND FOR LITERATURE ON ANY OF THE ABOVE PRODUCTS.

INFORMATION RETRIEVAL NUMBER 51

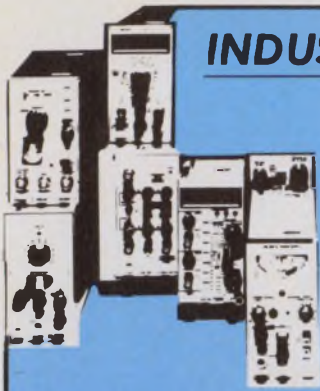

Remember testing in 1844? If you can't, Siemens Corp. can

It's folly to talk about the evolution of electronic instruments in Europe without mentioning the three largest native European producers: Philips, Rohde & Schwarz, and Siemens Corp. They've all played major parts in perfecting the Continent's electronic instrumentation.

Take Siemens. Its origin goes back almost as far as the electromagnetic telegraph. Soon after that invention, Werner Siemens founded his concern, in 1844, and set out to develop test methods and equipment for ocean and overland lines that would carry telegraphy.

"Thus our experience in communications testing goes back practically as far as the history of that art," says Alfred Heindl, Siemens' manager of domestic and worldwide export activities.

Heindl worked his way up to his present position from checking to servicing to developing test equipment, switching to sales in 1961. He lives with his wife and two daughters near Munich and has lately developed a taste for mountain hiking in the nearby Alps. He has been a Siemens employee for over 20 years; he knows much of the history of electronic instrumentation in Europe just by knowing his own company's diversified history.

Seven decades of test-gear evolution

For example, Heindl knows that by the turn of the century, highly accurate measuring bridges for inductance and dissipation and also audio frequency generators were available in Europe. By 1910, a number of test sets for voice-frequency measurements on telephone lines were on



Alfred Heindl of Siemens Corp. talks about the past, present and future of European instrumentation.

the way. In 1925, he says, manufacturers began to develop test bays for all voice-frequency, ac and dc measurements in repeater stations. In 1930, there was test equipment for repeater broadcast transmission lines.

Heindl can attest to the ruggedness of the 1930 line of test gear.

"In the 1950s," he notes, "some well-preserved specimens could still be found in repeater stations, and we revived a number of them with surprisingly good results. They were built like battleships, and with the modern test gear we

had at hand, we could adjust them to much better than the original specification."

Also in the 1930s, high-frequency test gear for use up to 2 MHz—and a little later, 4 MHz—came out. An advanced system of voice and broadcast line test bays was developed and installed in repeater offices throughout Germany. The system used motor-driven sweep generators and automatic synchronization to the distant receiver, with the line's frequency characteristics automatically recorded on a chart at the unattended remotely located test bay.

By 1935, according to Heindl, carrier-frequency instruments, selective receivers with multiple-frequency conversion, were built.

"Siemens' catalog of communications test equipment already had some 300 pages, listing more than 120 instruments and test bays, including hf test gear operating up to 20 MHz," Heindl says.

Through the 1940s the frequency limits were continuously pushed upwards, beyond a gigahertz and more. In the 1950s, with the second birth of television (World War II had stopped the first birth) TV test equipment flourished in Europe.

"Later in the 50s, as the bands of radio-transmission systems moved up in frequency," says Heindl, "so did our test gear." Slotted lines, power meters and microwave sweepers to 10 GHz and higher were developed. And vast amounts of symmetrical carrier-frequency cable were installed during that decade.

In the 1960s, instruments for broadband transmission, both coaxial and on radio system basebands, came to the forefront.

"Second-generation semiconductors are still the market leaders," Heindl says, "with the third generation making extensive use of integrated techniques."

Problems faced in development

The problems in developing test gear are about the same in Europe as they are in the U.S., which means they're difficult. Test equipment ought to be more accurate than the system being tested. This makes it very difficult to develop, since much of the gear is designed at an earlier stage with an earlier technology.

Innovations come so thick and so fast today, Heindl says, that "the lifespan of an instrument is beginning to be no longer than five years—it's becoming very difficult to cope with the high cost of development."

He adds that to develop a new carrier test system of some complexity to today's standards costs \$1.16-million and up, and only a few thousand will be sold, at best. No company can af-

ford to develop the wrong system or to experiment too much. The product must reach as many users as possible to spread the high cost, and this means it must often be a compromise among the user's wishes.

"We attempt to cope with this problem by building just that compromise," Heindl says. "By close cooperation between customers and our local organizations in different countries, we add special options, tailored to the local requirements. This gives us production runs that are both large enough for the factory and flexible enough to meet changing local needs."

Trend to automation seen

Heindl sees more automation in all areas of instrumentation as the future trend. The higher accuracy requirements will be unobtainable by manual methods, he believes, because well-trained personnel are becoming increasingly scarce. In addition the complexity of systems under test is growing, and this also will foster automation, Heindl says.

Automation will bring increased speed and economy to testing, but the manual, portable instrument won't die, the Siemens executive stresses. He believes it will always have its place.

But it is going to be easier to operate and carry in future years, he says. And with microcomputers and more integrated logic in portable instruments, accuracy will rise.

"Of course, if you go just a little further," he says, "the categories, 'automated test system' and 'manual instrument,' may lose their present meaning, and the difference may just be in whether it's a stationary or a portable automated tester."

Heindl feels that the customer's approach is largely: "What's new?" But he says that most customers know what the problems are.

"That doesn't mean you can sell him a bad instrument," Heindl emphasizes, "but if something goes wrong, he's willing to give you a second chance because, most likely, he's been in the same position before with his product or development."

To illustrate his point, Heindl recalls a "funny" experience he once had. He was demonstrating the only model of a new instrument at a military site when the instrument broke into flames and burned to a crisp. The fuse was about the only thing that remained intact.

"They were very sympathetic", he says, "fed us a good lunch and sent us back home with the remains. Two weeks later we received an order for 60 sets from the same people, and the incident was never mentioned. We were dumbfounded. You can't ask for much better customer relations, can you?" ■■

Some of the best things about our new Digivac[®] 1000 are what you can't see.

When you look at our vacuum fluorescent readout, you won't see the low voltage requirements making it directly compatible with available MOS IC logic packages.

You won't see the exclusive mica substrate which supplies mechanical strength and helps emphasize lighted segments through a desirable halo effect.

You won't see the low cost, lower than competing readouts with fewer customer advantages.

Of course, there are things about our Tung-Sol[®] Digivac 1000 you can see.

Like the Digivac 1000's brightness. 50% more brightness and greater uniformity than ever before.

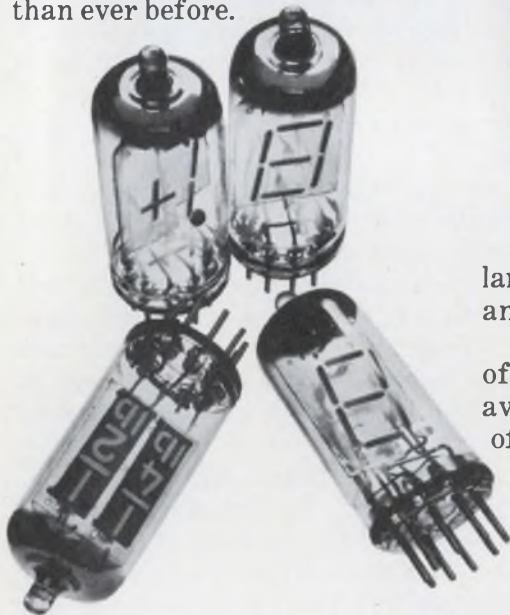

You can see the flexible language with alpha, numerical and symbolic figures.

You can see the wide range of colors, including white, available with common types of filters.

And because of the unique construction, you can see the accurate viewing assured from virtually any angle.

With the Digivac 1000 readout, whether you see it or you don't... it's still nice to know it's all there.

For additional information on the Digivac 1000, write to: Wagner Electric Corporation, 1 Summer Avenue, Newark, New Jersey 07104.

Wagner makes other quality products in volume for the electronics industry, including bridges, power supplies and subsystems, silicon rectifiers, resistors, miniature lamps and status indicators. And Wagner offers contract manufacturing.

WAGNER[®]

We've got a lot more riding for you.

©Trademarks Wagner, Tung-Sol and Digivac, Reg. U.S. Pat. Off. and Marcas Registradas

SEE
Electronic Design's
GOLD BOOK
FOR COMPLETE
PURCHASING
INFORMATION

INFORMATION RETRIEVAL NUMBER 53

LITTELITES

**We're out to win you over
with top quality, fast service,
and hard facts.**

FACT 1. Our new Littelites line includes Cartridge Lamps and Lampholders, Subminiature Lampholders, Miniature Lampholders, and Snap-mount Plastic Lites. Now you can buy them all from one manufacturer and save time, paperwork, and money.

FACT 4. Total in-house production capabilities, new tooling, and new molds make Littelites the finest quality lights on the market today.

FACT 6. Our Littelites team of R&D and sales engineers is ready to assist you with standard or special application technology.

FACT 2. To meet your individual requirements, all four Littelites product groups are available in a wide variety of lens styles and colors, lamps, voltage ratings, finishes, and terminations.

FACT 5. Our Littelites program features a computerized service center that can cross reference, price, and provide availability information . . . all within seconds.

FACT 7. Our Littelites program offers the widest selection of packaging available.

FOR MORE INFORMATION

Contact Littelfuse or your local Littelfuse Representative and ask for our Littelites Product Guide.

LITTELFUSE

Your indication of quality and service

800 E. Northwest Highway
Des Plaines, Illinois 60016
(312) 824-1188

Subsidiary of Tracor



KEMET FLAT KAP vs. NPO CERAMICS

Win the cost battle. Specify new KEMET Flat Kap Parylene Thin-Film Capacitors. They're now available in extended values from .001 uF to .22 uF for applications requiring small size, exceptional stability, and 0 ± 50 PPM/ $^{\circ}$ C. temperature coefficient of capacitance.

Reliability? They're built to meet MIL-C-55514 specifications. And designed for an operating temperature range of -55° C. to $+125^{\circ}$ C.

Choice? They're available for prompt delivery in three tolerances — $\pm 10\%$, $\pm 5\%$ and $\pm 1\%$.

Price? Above .01 uF, they're much lower in cost than NPO Ceramic Capacitors having essentially the same performance characteristics (see charts below).

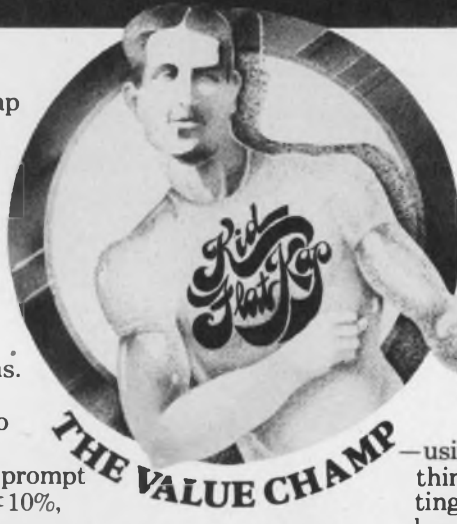

And their small, rectangular cases — with radial or axial leads — give you greater volumetric efficiency. Think how KEMET Flat Kap Capacitors can save you space and money in circuits where close tolerance, repeatable temperature coefficient and capacitance stability are essential.

You're not giving up a thing in quality. The secret is the unique KEMET Flat Kap construction — using Union Carbide's Parylene ultra-thin dielectric film; special thermosetting resins; and precision, high-purity aluminum foil electrodes.

For high-reliability performance at lower cost, specify the value champ — new KEMET Flat Kap Parylene Precision Thin-Film Capacitors.



COMPONENTS DEPARTMENT

P.O. Box 5928, Greenville, S.C. 29606 Phone: (803) 963-7421 TWX: 810-287-2536

PERFORMANCE CHARACTERISTICS		
	FLAT KAP	NPO
Operating Temperature Range	-55° to $+125^{\circ}$ C.	-55° to $+125^{\circ}$ C.
Temperature Coefficient of Capacitance	0 ± 50 PPM/ $^{\circ}$ C.	0 ± 30 PPM/ $^{\circ}$ C.
Voltage Coefficient	Negligible	Negligible
Dissipation Factor @ 1 kHz	0.30% Max.	0.15% Max.
Insulation Resistance: Megohm-uF at 25° C. Megohm-uF at 125° C.	10,000 100	1,000 100
Dielectric Absorption	1% Max.	0.5% Max.
Volume (0.05 uF Capacitor)	0.045 In. ³	0.0625 In. ³

KEMET is a registered trademark of Union Carbide Corporation
In Europe: Union Carbide Europe, S.A. 5, Rue Pedro-Meylan, Geneva 17, Switzerland Phone: 022/47 4411 Telex: 845-222 53

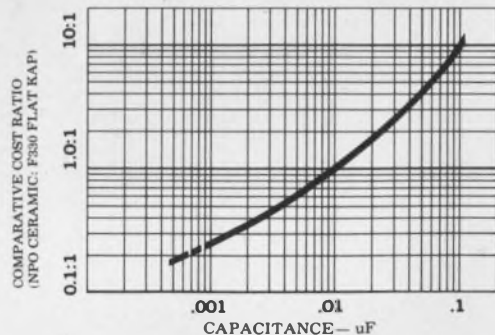

CERAMIC
AIR
GLASS
QUARTZ
PLASTIC

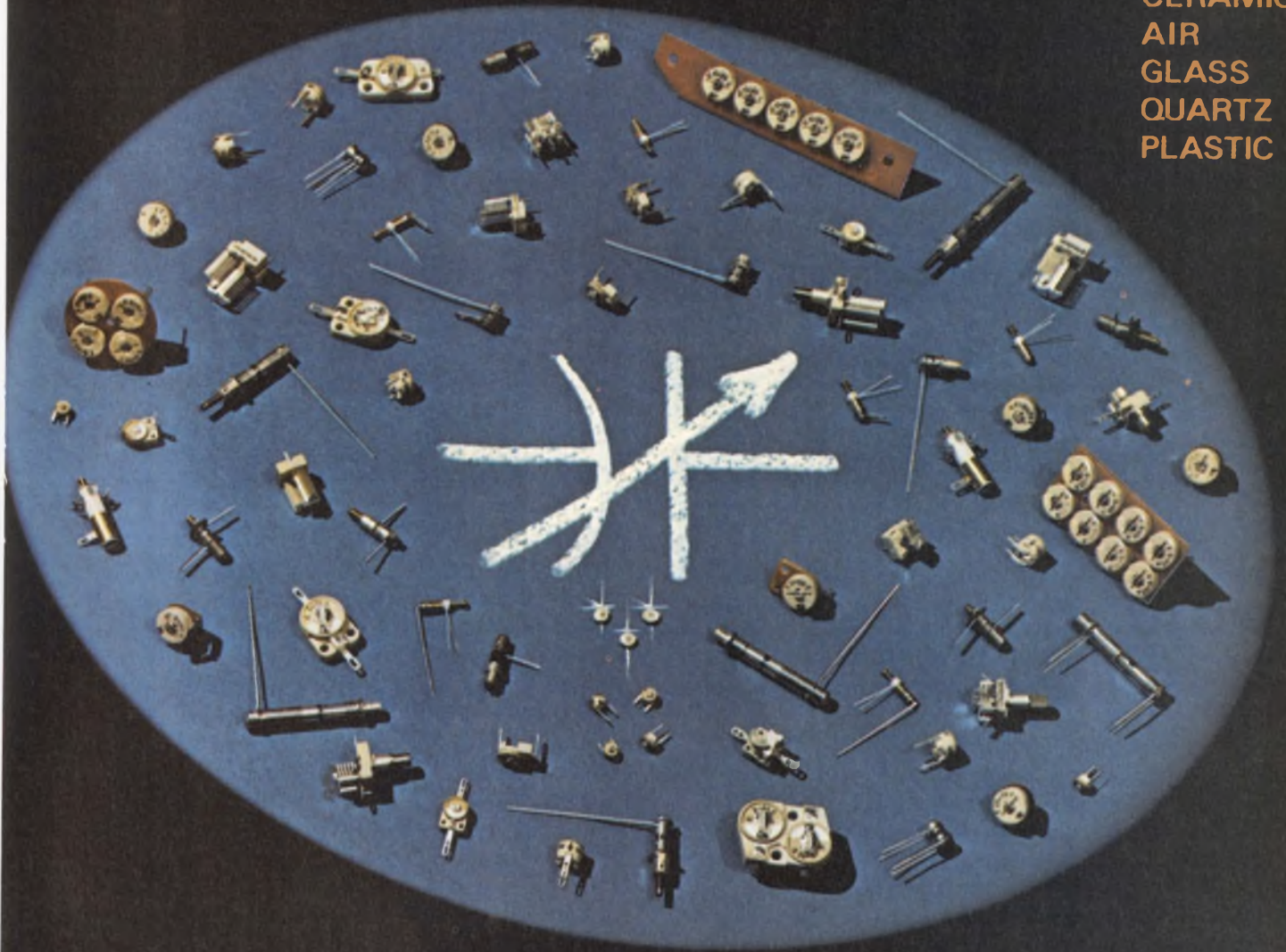

THE TRIMMER CAPACITOR YOU NEED APPEARS SOMEWHERE IN THIS SPOTLIGHT

MORE THAN 1,000 VARIATIONS TO CHOOSE
FROM . . . AND ERIE DELIVERS ON TIME

When engineering and purchasing people need Trimmer Capacitors, most look to ERIE first. And for good reason. It's easy to find the trimmers they need. The price is right . . . the quality is typically ERIE . . . and they know ERIE delivers on time to meet production schedules.

ERIE Trimmer Capacitors range in size from the tiny new "Vari-Thin" 515 Ceramic Trimmer for quartz watches and other miniature circuits . . . up to a variety of larger sizes and assemblies. Whether you need ceramic, air, glass, quartz or plastic, we have the dielectric, capacitance range and mounting arrangement to meet your requirements. If you have the application . . . ERIE has the Trimmer Capacitor. In the spotlight above, can you find the Trimmer best suited to your current bread-board circuit?

Let ERIE serve as your one-stop source for quality Trimmer Capacitors.

WRITE TODAY FOR OUR
TRIMMER CAPACITOR
CATALOG . . . 500
OR CALL 814/453-5611

ERIE TECHNOLOGICAL PRODUCTS, INC.
Erie, Pennsylvania 16512

ERiE

TEMPERATURE-MEASURING INSTRUMENTS

It's a wide, wide field, with some 'standards' challenged

Choosing the best electronic temperature-measuring instrument for the job is tougher than it used to be. There's such a wide selection of instruments to choose from today: thermocouples; thermistors, or metal-resistive sensing elements, and infrared pyrometers, which require no physical contact with the object being measured.

In addition each instrument class has units with a digital readout (with or without BCD output) and analog-meter indicators (with or without outputs to drive a chart recorder).

The choice becomes even more difficult because some well-known instruments—widely accepted as industry standards for years—are being challenged by newer designs. The semiconductor technologies—LSI, MOS and low-power circuits—are causing the same stir in temperature instruments that they did in many other fields. The result is newer instruments that are either cheaper, with the same performance as some of the old stand-bys, or that offer more features and better performance at the same price level.

The first decision is the type of sensing element best suited for the application. Each technology has advantages and limitations; the choice is a tradeoff between accuracy, repeatability of results, long-term stability and size.

The temperature-sensing element used most widely in industry and laboratories is the thermocouple. It consists of two wires of dissimilar metals that are soldered, twisted or fused to form a junction. In operation, the system uses two of these junctions—the measuring,

or "hot," junction and the reference, or "cold," junction. A voltage is generated that is proportional to the temperature difference between the two junctions.

In the laboratory, the reference junction can be submerged in an ice bath to hold it at 0 C, or placed in an oven in which the temperature is controlled. In most other applications, the ice bath is replaced with some form of compensated cold junction that permits the reference junction to remain at ambient room temperature and



Digital thermometers, like this Model 811 from IVAC Corp. in San Diego, provide greater accuracy than analog temperature-measuring devices.

Northe Osbrink
Western Editor

compensates for any variations. In fact, in some instruments there is no physical cold junction at all but an electronic circuit.

Although analog meters may seem outmoded because of today's digital readouts, they do have an important advantage over digital displays. Ray Heggemann of Yellow Springs Instruments (YSI-Sostman Div., Yellow Springs, OH) explains: "Many engineering applications require looking at a rate of temperature change—sometimes more important than absolute temperature. To watch a component heat up or to look for a failure accompanied by a sudden heat rise, the analog meter is invaluable. And the curves plotted on a chart recorder can often tell a great deal about the performance of a system—better than columns of tabulated numbers."

One example of a laboratory, analog thermocouple thermometer is the BAT-4 from Bailey Instruments, Saddle Brook, NJ. The \$295 unit uses copper/constantan thermocouples exclusively, including some microprobes with a tip diameter of 0.008 in. (33 gauge). The unit covers -100 to $+175$ C in four ranges, with an accuracy of 0.1 C. And it can be used with two probes to measure a temperature differential of up to ± 20 C. Other versions of the BAT thermometer, including one with digital readout, cover -200 to $+400$ C. An important feature in the BAT meters is that they require no calibration and can accept microprobes with a tip

diameter of 0.013 in., bead thermocouples with a diameter as small as 0.009 in., and larger "workhorse" probes that are sturdier.

Thermocouples range in price from less than \$8 each to well over \$50, depending on size, materials and packaging. With care, a user can make his own thermocouples from appropriate wires and find them very accurate.

High-accuracy thermometers

For users who need greater accuracy than that provided by an analog meter, or who need to interface temperature information into a digital-processing system, the digital thermocouple thermometer comes in a wide variety of sizes, shapes, prices and performance levels.

Because the output of a thermocouple is a very nonlinear curve, a digital instrument must be able to correct for this. The National Bureau of Standards provides correction charts for all metal combinations, so the correction factors are well-known. Most digital thermocouple thermometers take advantage of the bureau's curves and correct the output of the thermocouple digitally at a number of points on the curve.

According to Al Frowiss, vice president of marketing for Doric Scientific, San Diego: "Actually the required number of correction points varies with the number of digits that must be displayed and the accuracy of the thermocouple



The HP 2801A quartz thermometer (shown with a d/a converter and analog recorder) is a precise laboratory instrument priced at over \$3000. Covering the -80 to

$+250$ C range, it measures temperature by the change in frequency of an oscillating quartz crystal. The thermometer has a six-digit readout.



The Triplet Model 615 is a 20,000 ohms-per-volt multi-tester with a -50 to $+1500$ F thermocouple thermometer. Accuracy is $\pm 3\%$ of full scale.

itself. Since a thermocouple might have a practical 0.1-F limit of accuracy, there is no reason to linearize any more than is required to get the reading inaccuracies down to the last displayed digit. This can make the accuracy of an instrument substantially better than errors caused by interchangeability of the thermocouples themselves."

Doric Scientific manufactures a wide range of temperature instrumentation and has what appears to be the largest selection of digital thermocouple indicators. They range in price from the \$300 DS-530-T3, which offers basic accuracy of ± 5 F or ± 4 C with a resolution of 1° and a repeatability of 1° , to the DS-100-T3, a unit starting at about \$1300 with a basic accuracy of ± 0.2 F or ± 0.2 C and resolution and repeatability of 0.1° .

Another laboratory digital thermocouple thermometer is the Model 2100 from John Fluke Manufacturing, Seattle. It can accept any of six different thermocouples or 10 different thermocouple inputs of one type. The unit price starts at about \$1000 and includes several options.

There is also a variety of less-expensive digital thermocouple meters, both panel-mounted and mounted in a case for desktop use. A new unit in the U.S. is the tt400 panel meter, made by Schneider Electronics, Medford, MA. It is produced in four configurations to accept J, N, K and T thermocouples (see table), and it offers an unusually large number of linearization points—54 for the type-T and 157 for the type-K thermocouples. Part of the meter is a separate, cold-junction compensation box, which can be mount-



Digitrend 210, a digital multipoint recorder from Doric Scientific of San Diego, scans, conditions, logs and alarms outputs from thermocouples and platinum RTDs.

ed either on the back of the meter or close to the actual measurement thermocouple.

There is a real advantage to the Schneider system. Normally the cable connecting the hot and cold junctions must be made of a pair of metals with the same thermoelectric properties as the thermocouple junctions over a reduced temperature range. This cable, though less expensive than actual thermocouple wire, is still costly and can introduce another source of inaccuracy into the readings.

Thermocouple extensions also require the use of specially designed connectors, which carry the two different conductors through the contacts. The temperature-measurement handbook-catalog from Omega Engineering, Stamford, CT, shows the wide choice of special thermocouple conductors, connectors and switches that are available for accurate thermocouple extensions.

If the cold-junction compensator is placed next to the measurement junction, the connection to the indicator can be made from copper wire. Normal low-level, dc-signal transmission methods are used. The various versions of the Schneider indicator run in price from \$425 to \$470. And the units offer accuracy of 2.1 to 3 ± 1 C at 23 C, with 1% resolution and 1% conformity to the National Bureau of Standards reference.

Platinum resistors are favorites

Of the common methods to measure temperature electronically, the use of a resistance element made of pure platinum, nickel or copper is the most inherently accurate. The purity of the metal is important, since only then can the temperature characteristics of individual probes be made close enough to permit easy interchangeability.

Platinum is the most commonly used metal because it can be made very pure, will not corrode or oxidize under most conditions and covers a wide temperature range, from about -220 to

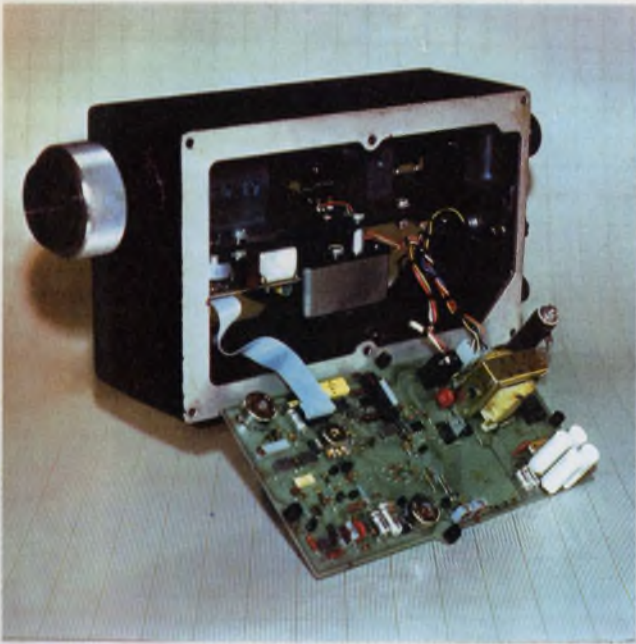

Infrared thermometer from E² Thermodot of Carpinteria, CA, measures temperature by optically sensing the intensity of radiant energy emitted by a warm surface.

+1100 C. The resistance curve of a platinum sensor is also quite linear over a useful temperature range, varying less than 2% from 0 to 500 C.

Nickel is also used—because it is less expensive—for temperatures up to about 300 C. But is not as linear as platinum. Copper, which has a linear curve, is rarely used because it is subject to rapid oxidation.

Although accurate, metallic-resistor temperature detectors (RTDs) are more expensive than thermocouples, they also tend to be much larger, and small probes cost least—\$100. With a relatively large physical mass, RTDs also tend to take longer to stabilize at the measurement temperature than thermocouples do; they often take 8 sec or longer, depending on size.

Unlike thermocouples, resistance elements can be connected to instruments using copper cables, and since they are resistance-variable, they can be measured by use of two, three or four-wire techniques. The elements can be cylindrical or flat and encased in glass or ceramic, usually with a stainless-steel sheath and handle. The smallest typical commercial probes have a diameter of about 0.1 in.—too large for measurements on some electronic components and semiconductor chips.

The Hewlett-Packard thermometer, the 2802A, is part of the 5300A measurement system and costs \$700 with display and thermomodule, but without probe. Probe prices range from \$150 to \$180. The 5300A will measure temperatures from -200 to +600 C with ± 0.5 -C accuracy and 0.1-C resolution. And the unit has a special -100-to-



The series 582 indicators from Fenwal are available in six ranges (from -50 to +750 F) with a $\pm 0.7\%$ accuracy. They accept up to 10 inputs.

+200-C range with $\pm 0.25\%$ accuracy and 0.01-C resolution; it comes with a 4-1/2-digit display. A standard feature is an analog output that will drive a chart recorder or analog meter indicator, and the options include a battery-pack BCD output.

A pocket-sized digital RTD thermometer, only $6 \times 1 \times 3$ in. and weighing 10.5 oz, is the new Model 395 digital heat probe from William Wahl Corp., Los Angeles. The unit costs \$395. It displays temperatures from -50 to 500 C or -50 to 900 F on a three-digit LED display. Accuracy is $\pm 0.5\% \pm 1$ digit, and repeatability is $0.2^\circ, \pm 1$ digit.

This thermometer uses LSI technology and draws only 70 mA from a set of rechargeable NiCd batteries. This gives it a 4.5-hr operating period between charges. A selection of probes, from \$60 to \$180, includes tips as small as 0.25 in. for measurement on flat surfaces and a 0.084-in.-diam penetration probe for use in semi-solids. Wahl also produces a similar digital heat probe that uses thermistor probes.

Thermistors getting better

Thermistors are resistance elements with large negative temperature coefficients—that is, when the temperature rises, the resistance decreases. The thermistor element is usually a mixture of

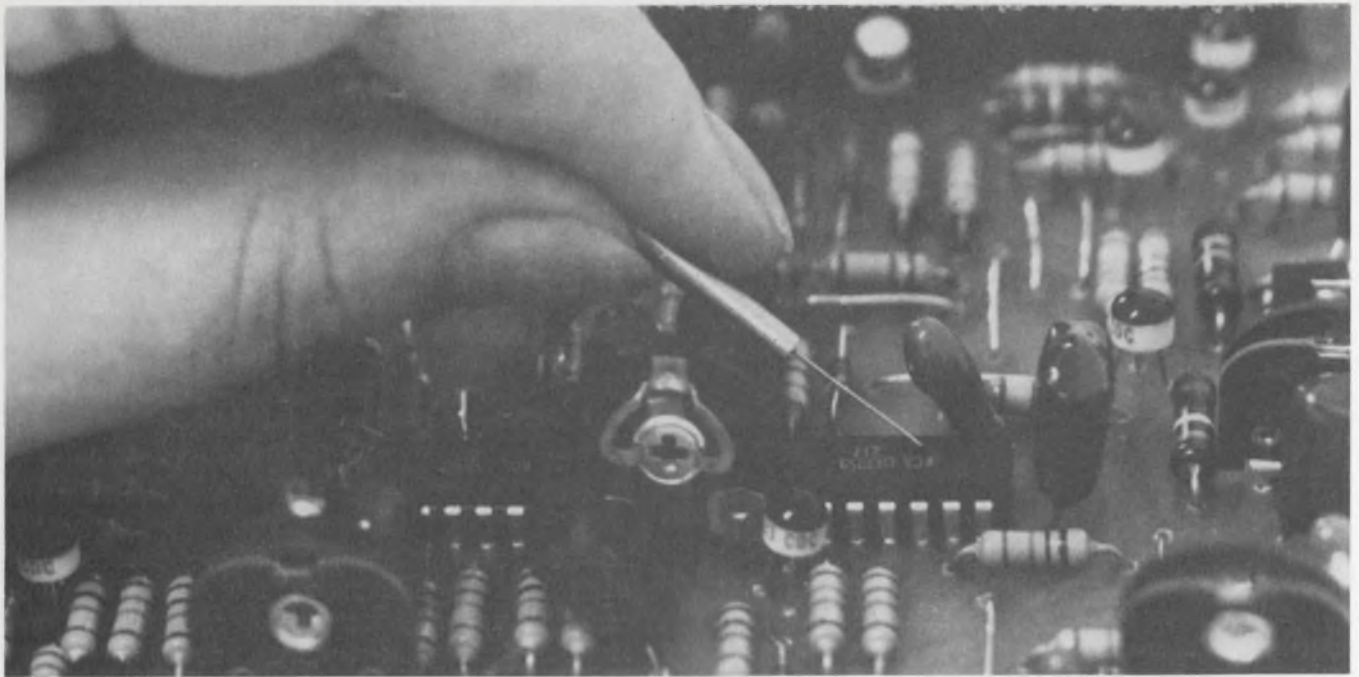

Thermocouples are among the smallest temperature-sensing elements in use today. This microprobe, used

with BAT thermometers from Bailey Instruments, has a 0.013-in. diam tip.

a ceramic with metal oxides of manganese, nickel, iron or cobalt—pressed, baked and finally sintered. They exhibit a change in resistance per °C that is at least 10% more than that of RTDs and equivalent to 400 times more than that of most thermocouples.

The use of thermistors in precision-measurement equipment has been somewhat limited because of the variable nature of the thermistor. Interchangeability has been poor (or very expensive), and the thermistors themselves have not been stable for long-term use. But this picture is changing, with dependable products from such companies as Yellow Springs Instruments. Ray Heggemann of Yellow Springs says:

“Making thermistors is an art closely akin to the art of making transistors a few years ago. It requires almost a magic touch in doping, choosing the base material, controlling the temperature at which the material is sintered. Other factors, such as the method of connecting leads—and particularly the treatment that the thermistors receive after manufacture, in terms of aging and thermal shock—all determine the final characteristics and reliability of a thermistor.”

The basic temperature-vs-resistance curve of a thermistor is not really linear. So instruments that use them must usually be compensated either with a nonlinear temperature scale on an analog meter or with some kind of gain compensation on a digital instrument. The Yellow Springs Thermilinear probe shows an interesting approach to linearization. It consists of two thermistors mounted in a bead; they exhibit different resistance-vs-temperature curves. This active

element is combined with a pair of resistors and the whole network serves as a voltage divider. Thus the over-all output is linear. Note that it is not necessary to change resistors when replacing Thermilinear probes with others of the same type.

The main advantage of this approach is that with a linear change in resistance, temperature can be determined by measurement of voltage drop across the network, current through the network or network resistance. And the indicator can be a relatively inexpensive instrument, like a \$95 DVM panel meter.

Another temperature sensor found in a few instruments is the silicon semiconductor. Tektronix, Beaverton, OR, uses such a device in a probe for use with its DM43 and other digital meters. The DM43 is optional on the company's 464 and 466 portable oscilloscopes.

According to Allen Sohl, chief engineer, instruments for ERC (Electronic Research Corp.), Shawnee Mission, KS: “A silicon probe contains a diode or transistor. By providing a constant current to the diode junction, we can measure the forward voltage drop, which has a nearly linear relationship to the junction temperature.”

ERC uses this method in its Series 9300 digital panel thermometer. It covers -60 C to $+160\text{ C}$ or -76 F to $+320\text{ F}$. The accuracy is $\pm 0.5\text{ C}$, with repeatability of 0.05 C and resolution to 0.01 C . The base price of the instrument varies from \$495 to \$595, depending upon scale and resolution (three, four or five digits). Some options include differential probe input and green LEDs.

The infrared thermometer collects radiation from an object and focuses it with an optical

Common thermocouples used in electronic equipment

Thermocouple type	Nominal temp range (°F)	Nominal error	Nominal output $\mu\text{V}/^\circ\text{F}$ (32 F-1000 F)	*Nominal cost
Chromel/Constantan (Type E)	32 to 600 600 to 1600	$\pm 3 \text{ F}$ $\pm 0.5\%$	30-40	\$5 to \$15
Chromel/Alumel (Type K)	32 to 530 530 to 1400	$\pm 2 \text{ F}$ to $\pm 4 \text{ F}$ $\pm .37\%$ to $\pm .75\%$	20-25	\$5 to \$20
Copper/Constantan (Type T)	-300 to -75 -150 to -75 -75 to +200 200 to 700	$\pm 1\%$ $\pm 1\%$ to $\pm 2\%$ $\pm .75\%$ to $\pm 1.5\%$ $\pm .37\%$ to $\pm .75\%$	21	\$5 to \$15
Iron/Constantan (Type J)	32 to 530 530 to 1400	$\pm 2 \text{ F}$ to $\pm 4 \text{ F}$ $\pm .37\%$ to $\pm .75\%$	30-40	\$5 to \$15

*Nominal cost for simplest thermocouple.

system onto a detector, commonly a mercury-cadmium-telluride cell. Instruments vary greatly. Some measure a carefully limited range of infrared frequencies; others pass a wide band; some are expensive laboratory instruments; others are hand-held and relatively inexpensive.

Among the most recently introduced hand-held models are the digital Heat Spy infrared thermometers from William Wahl. The DHS-8E is designed to measure the temperature of small areas in electronic equipment. The target size is .01 in. when the thermometer is held 1 in. away from the object.

The unit will indicate temperatures from 100 to 999 F on a three-digit LED display, with repeatability of $\pm 0.5\%$, 1% full-scale accuracy and 1-sec response time. The calibration is automatic, and the only user adjustment needed is an emissivity control (0.2-to-1.0 range).

This thermometer projects a light beam that illuminates the target area. The spectral range is 2 to 20 μ . The model sells for \$1595.

Other infrared thermometer manufacturers include Fenwal, Ashland, MA; and E² Thermodot, Carpinteria, CA.

Combination instruments and adapters

For occasional temperature measurements in the shop or lab—when the expense of a temperature-only instrument is not justified—there are many digital or analog instruments that combine a temperature scale with a VOM. For quick measurements, rather than laboratory accuracy, Triplett, Bluffton, OH, produces a maintenance tester with VOM functions and a -50 F to +1500 F scale. Called the Model 615, it costs \$137.

Another multipurpose analog instrument is the TMVO from Amprobe, Lynwood, NY, which sells for \$59.85 and combines a millivolt/ohmmeter with a thermocouple meter.

Schneider Electronics makes the Digitest 610 DMM with 4-1/2-digit readout; it measures ac/

dc voltage, current and ohms, as well as temperatures from -50 C to +200 C with an optional nickel RTD probe. Resolution is 0.1 C; accuracy is $\pm 2 \text{ C}$. The unit sells for \$295 and the probe for \$85 more.

Thermal sensors can also be used with an adapter, or a meterless thermometer system. A digital indicator already in the lab can be used to display temperature.

A very accurate platinum resistance-thermometer adapter is the Model PRT-1000 from Julie Research Laboratories, New York City. The unit costs \$350, complete with a platinum RTD sensor. It provides an analog output of 10.00 mV per $^\circ\text{F}$ or $^\circ\text{C}$, with an output impedance of 10 M Ω and a 10-mA max output current. It is designed to measure -85 to +200 C with an accuracy of $\pm 0.2\%$ of reading and a stability of $\pm 0.15 \text{ C}$ for one year without calibration. ■■



For more information

For a list of manufacturers of temperature measuring products, refer to the following sections in the Product Directory of ELECTRONIC DESIGN's Gold Book:

Monitors, Temperature	Vol. 1, p. 273
Indicators, Temperature	Vol. 1, p. 203
Probes, Temperature	Vol. 1, p. 340
Pyrometers	Vol. 1, p. 343
Thermocouples	Vol. 1, p. 426
Thermometers, Electronic	Vol. 1, p. 426
Thermistors	Vol. 1, p. 425

**Quick
delivery**

Fujitsu Quality on Sale in

ALOXCON

Aluminum Solid Electrolytic Capacitor

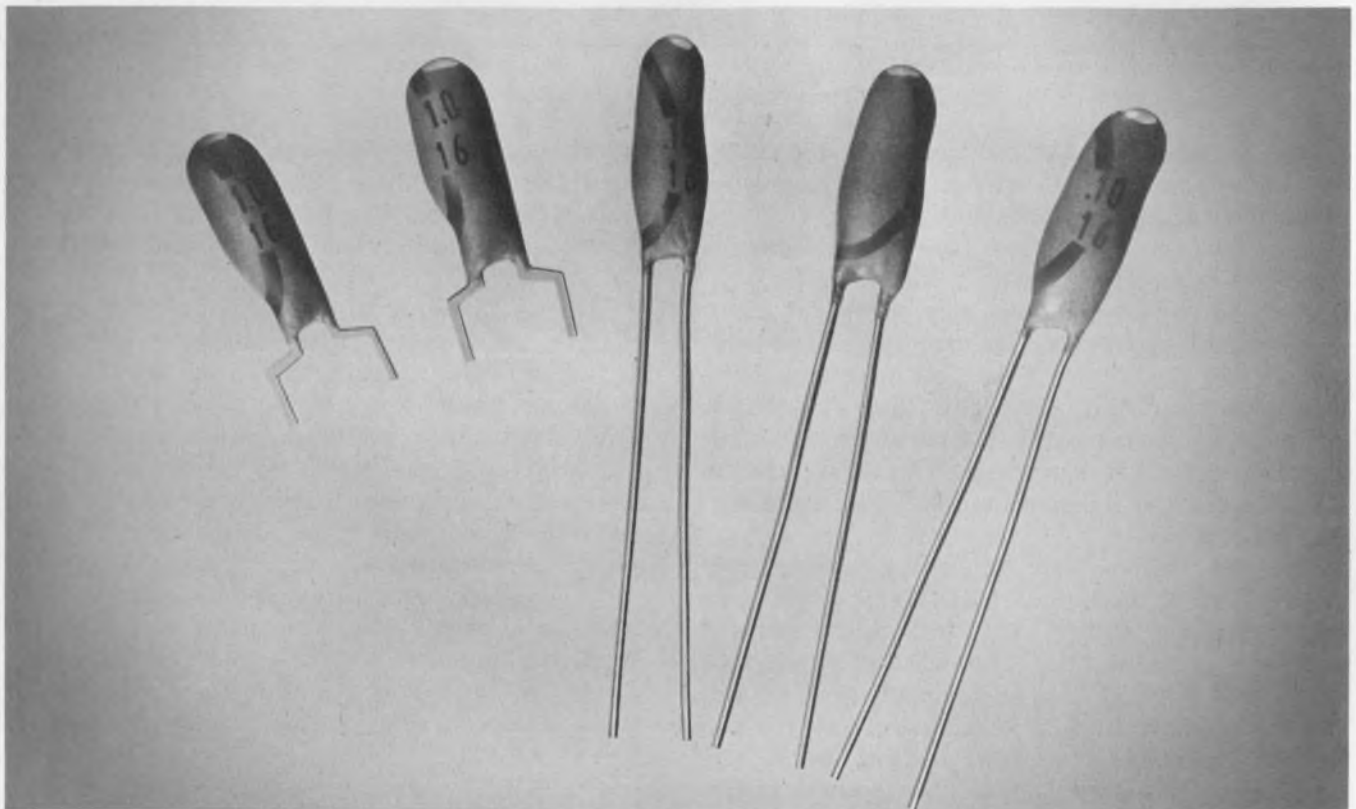

The ALOXCON, developed with Fujitsu's special product techniques, is designed for use in general electronic equipment.

Features include:

- ① High backward breakdown voltage (small backward leakage current)
- ② Excellent temperature & frequency characteristics (Resonant frequency: 1 ~ 10 MHz)
- ③ Special safety structure, which eliminates possibility of explosion or burning down.
- ④ Space-saving flexible mounting

Item		Specifications			
Operating temperature range		-55 ~ 85°C			
Leakage current		Below the larger value of either 0.06 CV or 3 μA			
Capacitance		0.1 μF ~ 10 μF Tolerance: +40% (±20%) *negotiable			
Loss tan δ		10% max.			
Working voltage (WV) and surge voltage (SV)	Working voltage (V)	6.3	10	16	25
	Surge voltage (V)	8	13	20	32

* If required, capacitors with higher performance characteristics are available.

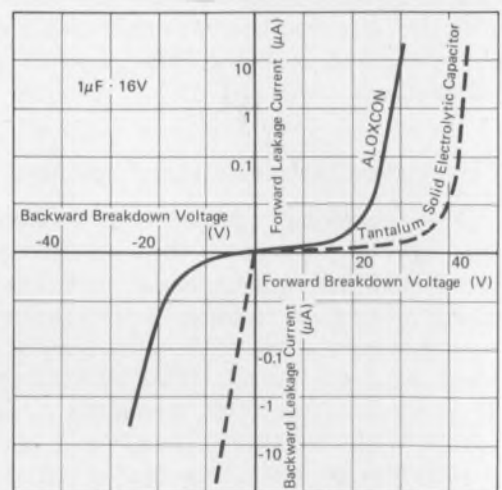

E-1 Characteristics

FUJITSU LIMITED
Communications and Electronics
 Marunouchi, Tokyo, Japan

For further information, please contact:
 Head Office: 6-1, Marunouchi 2-chome, Chiyoda-ku, Tokyo 100, Japan Telex: J22833
 New York Office: 680 Fifth Avenue, New York, N.Y. 10019, U.S.A. Phone: (212) 265-5360
 Fujitsu California Inc.: 1135 East Janis Street, Carson, California 90746, U.S.A. Phone: (213) 636-0858, (213) 537-8930

MAIN PRODUCTS □ Telephone Exchange Equipment □ Carrier Transmission Equipment □ Radio Communication Equipment □ Space Electronics System □ Electronic Computers & Peripheral Equipment (FACOM) □ Telegraph & Data Communication Equipment □ Remote Control & Telemetry Equipment □ Electronic Components

INFORMATION RETRIEVAL NUMBER 57

Buying a function generator isn't a big deal.



Using one every day is!

Because there's not much difference in function generator prices, there is often a tendency to specify the "name" brand. But **handle-ability** can be an essential factor. When a basic signal-source goes into your lab, consider first the **day-to-day efficiency** of the instrument and its effect on the real cost of ownership.

For example, with sweep width a critical factor in testing network frequency response or developing a response plot, INTERSTATE's F34 allows you to precisely dial the controlled starting and end points. This, coupled with a Sweep Limit Indicator that won't let you dial an invalid output, puts it miles ahead of Wavetek's 134 for accuracy and ease-of-use.

This, and many other human engineering and price/performance differences that exist between the two function generators reflect INTERSTATE's continuing concern for the user, and are factually catalogued in our FREE specifier guide. Check the number below to receive it, or for more direct information, call John Norburg, (714) 772-2811.



"THE \$495 COMPARISON:
INTERSTATE F34, WAVETEK 134 FUNCTION GENERATORS."

 **INTERSTATE
ELECTRONICS
CORPORATION**
Subsidiary of A-T-O Inc.

U.S. HEADQUARTERS: Dept. 7000, Box 3117, Anaheim, CA. 92803. **OVERSEAS SALES OFFICES:** AUSTRALIA, Parameters Pty., Ltd.; AUSTRIA, Ing Otto Folger; BELGIUM-LUXEMBOURG, Regulation-Mesure S.P.R.L.; FINLAND, Havulinna Oy; FRANCE, Tekelec Airtronic, S.A.; ITALY, Tekelec Airtronic; ISRAEL, Radat International Company Ltd.; JAPAN, Asahi & Co., Ltd.; NETHERLANDS, Tekelec Airtronic, N.V.; NEW ZEALAND, David J. Reid, Ltd.; REPUBLIC OF CHINA, Bons International Co., Ltd.; SPAIN, Unitronics, S.L.; SOUTH AFRICA, S'technics (Pty) Limited; SWEDEN, M. Stenhardt AB.; SWITZERLAND, Traco Trading Co., Ltd.; UNITED KINGDOM, Euro Electronic Instruments, Ltd.; WEST GERMANY, Tekelec Airtronic GMBH; CANADA, Radronics, Ltd.
TWX U.S.A. 910-591-1197 TELEX U.S.A. 655443 & 655419

INFORMATION RETRIEVAL NUMBER 58

Please don't call our lamps lights



You wouldn't think something as rugged and reliable as our neon lamps would be sensitive about a name. But they have a point. Glowlite neons do more than illuminate functions in appliances, commercial and industrial equipment. They activate, too, as circuit components like transient suppressors, triggering devices, voltage regulators, oscillators and lots of other things. That's because Glowlite has the design versatility and production capability to meet most any specification. So, whether you need a standard indicator or special component, ask for our low-cost, long-life neons. But, please, remember to say lamps and not l-i-g-h-t-s!

ELT GLOWlite
INC. DIVISION

PAULS VALLEY, OKLAHOMA 73075
405/238-5541 • TWX 910-830-6590

INFORMATION RETRIEVAL NUMBER 59

RCA's versatile WO-535A... DC to 10 MHz response for only \$349.*

1. Operates in either triggered or recurrent sweep mode.
2. Vertical sensitivity of 5.9 mV p-p/cm (15 mV/in).
3. Simplified calibration for p-p voltage measurements.
4. All solid state.
5. DC/AC input.
6. Preset TV, "V" and "H" frequencies for instant lock-in.
7. Flat-face 5-inch CRT.
8. Illuminated graph screen calibrated directly in volts.
9. Regulated power supply prevents trace bounce; excellent stability.
10. Return-trace blanking.

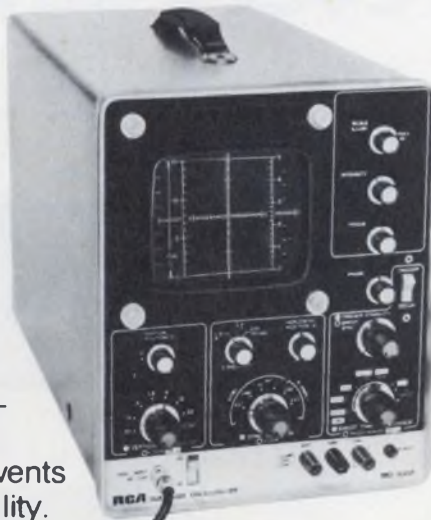

11. Terminals for direct connection to the CRT.
12. Camera mounting studs.
13. Phase control for sweep alignment.
14. Includes WG-400A shielded Direct/Low-Capacitance Probe and Cable.

For complete information and fast delivery on the versatile WO-535A, Dual Mode Oscilloscope, contact any one of the more than 1,000 RCA Distributors worldwide. Or write: RCA Electronic Instruments Headquarters, Harrison, N.J. 07029.

*Optional price including probe.

Specialists demand the best tools of their trade

RCA Electronic Instruments

INFORMATION RETRIEVAL NUMBER 60

Join 'em... the growing crowd using MOSTEK's 16-pin 4K RAM!

The crowd of MOSTEK's 4K RAM users continues to grow. Why this preference for MOSTEK's 16-pin MK4096 over 22-pin alternates? Let's review a few of the reasons:

MOSTEK saves you memory board space. You can pack over twice the memory in the same board space as the 22-pin designer, without increasing power dissipation. The result is a more compact and efficient system.

MOSTEK leads in 4K performance. Check the comparative performance table for proof!

MOSTEK gives you direct compatibility with TTL, DTL, ECL and CMOS. The MK4096 will interface

directly with these popular logic families *without* the special high-voltage clock drivers required by 22-pin RAMs. Fewer address drivers are required also.

COMPARATIVE PERFORMANCE—16-PIN VS 22-PIN RAMs

PARAMETER	MOSTEK	2107	4030
Power Diss.	375 mW	425 mW	690 mW
Input Levels			
Input 0 (Max)	0.8	0.8	0.6
Input 1 (Min)	2.4	3.0	2.2
Output Levels			
Output 0 (Max)	0.4 at 2 mA	0.45 at 1.8 mA	0.4 at 3.2 mA
Output 1 (Min)	2.4 at 5 mA	2.4 at 100 μ A	2.4 at 2 mA
Access Time	300 ns	300 ns	300 ns
Read Cycle Time	425 ns	500 ns	470 ns
Write Cycle Time	425 ns	700 ns	470 ns
Output Data			
Hold Time	260 ns	40 ns	30 ns
Clock			
Characteristics	2 TTL Clocks 7 pF	One 12V Clock 21 pF	One 12V Clock 27 pF

MOSTEK's 4K RAM is easy to use. You can use readily available automatic handlers both for incoming test operations and in circuit board assembly. Not so with 22-pin versions!

Want still more reasons to join the MOSTEK 4K RAM team? Then contact MOSTEK at 1215 West Crosby Road, Carrollton, Texas 75006, (214) 242-0444—or your local MOSTEK distributor or representative. In Europe contact MOSTEK GmbH, TALSTR 172, 7024 Bernhausen, West Germany, Tel. (0711) 70 10 96.

MOSTEK

INFORMATION RETRIEVAL NUMBER 61

MOSTEK moves forward...in memories.

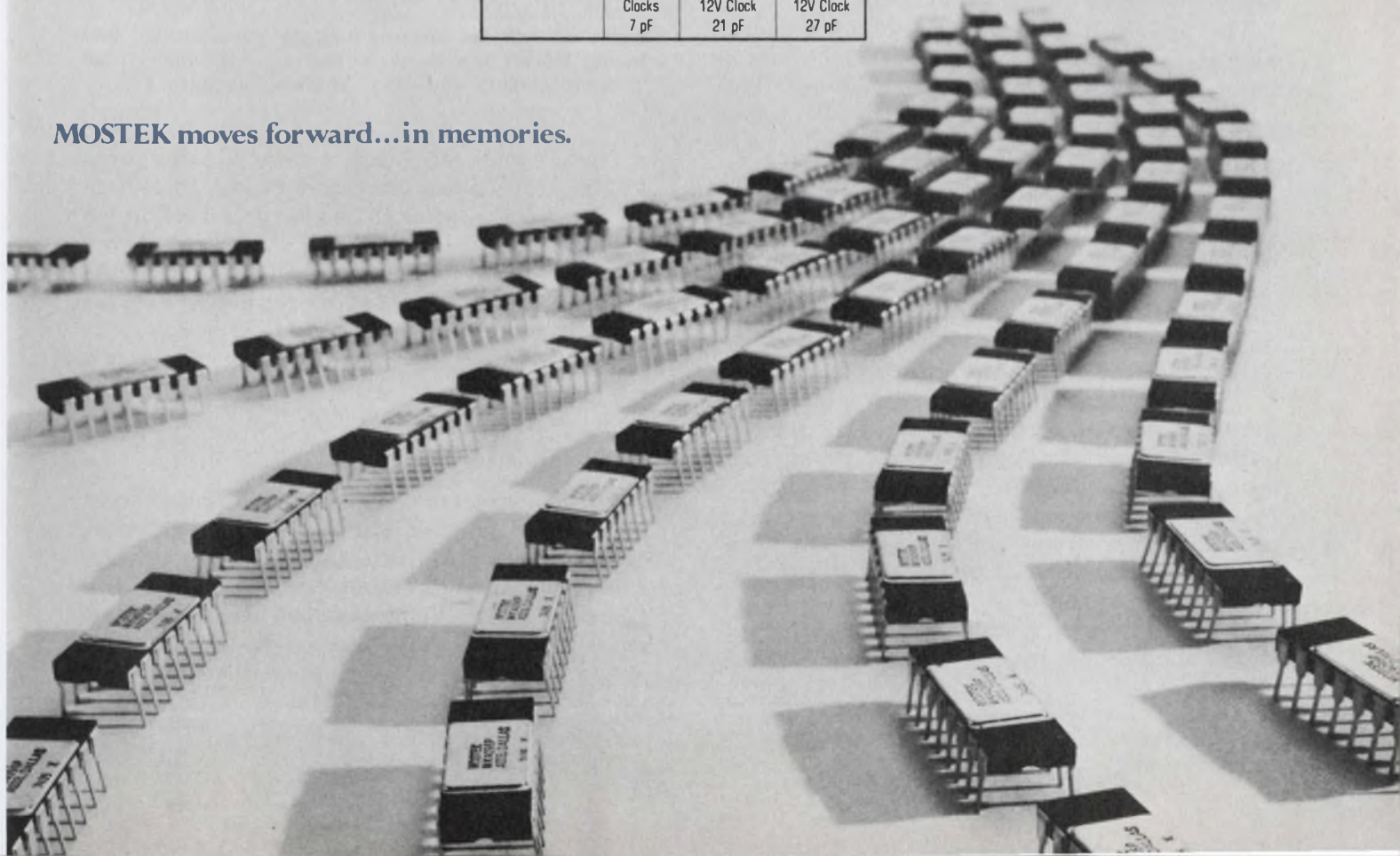

LABORATORY POWER SUPPLIES

To find the new
and different, turn
the package inside-out

Outwardly, laboratory power supplies have changed little over the last few years. They're a bit smaller, a bit prettier and probably weigh less. Dial markings have changed, along with the voltage and current ranges needed by today's circuit designer, but power supplies for the lab bench still have meters, knobs and binding posts. Inside the power supply, however, there have been some radical changes.

New circuits, new devices, new heat-sinking techniques and better magnetics design have helped make lab supplies more efficient, less costly and more flexible than ever.

The use of ICs is growing. Many manufacturers are using IC operational amplifiers in series-pass control circuits, but they are reluctant to switch to an all-IC design; IC voltage regulators are not stable enough to build a precision lab supply, they feel.

On the other hand, some companies say that there is a distinct advantage—low cost—if IC regulators are used in the lab supply. And this may be true, because there is an intermediate class of supplies—units that are better than battery eliminators but not quite as precise as the ultrastable, 0.01%-or-better, regulated lab supply.

Hybrid power circuits provide a compromise in the IC-vs-discrete component tradeoff. One company that chose the hybrid packaging approach is Lambda, Melville, NY. The company offers a full line of hybrid power subassemblies. These provide the key circuit functions within Lambda's lab supplies, or you can use them as local regulators with a separate power source. On the hybrid substrate are discrete components and IC chips, combined to bring out the best features.

Dave Bursky
Associate Editor



Modular plug-in power supplies are part of the TM-500 series of modular test instruments designed by Tektronix. Models are available that provide single, dual or triple outputs and also calibrated voltages.

Power-supply efficiency, a more pressing problem, has caused manufacturers to look to switching regulators. So far the major drawback in lab applications is the conducted and radiated energy caused by the switching circuits in the supply. As shielding and filtering techniques improve, or as new shielding materials become available, the switching supply will appear on the designer's workbench.

Ample regulated supplies

Circuit designers can choose from many types of regulated supplies. For the designer who does a lot of work with both digital and analog circuitry, the multiple-output, variable supply is a necessity. These supplies usually include at least one low-voltage output that might span 0 to 10 V and at least two other outputs (usually identical) that might span 0 to 20 V.

Powertec in Chatsworth, CA, may have cornered the market on versatility with its Model



High-voltage laboratory power supplies, like this model RHR40P120 from Spellman High Voltage Electronics (top), are not made to fit the smallest space. Inside the unit (bottom) open space is needed for cooling.

6D6000—a six-output variable, metered supply. This unit delivers 0 to 6 V at 5 A for logic circuits and has two 0-to-18-V outputs at 2 A each, two 0-to-36-V outputs at 1 A each and one 0-to-200-V output at 40 mA. The supply has a switched meter arrangement so that one voltmeter and one ammeter cover all voltage and current outputs. It sells for \$495—not bad when you look at what you're getting.

The triple-output supply appears to be the type most in demand by circuit designers. These units are usually regulated to within 0.05% of the desired voltages, but some of the newer units are producing better performance while holding the line on price.

Some of the new units include the LPT-7202-FM from Lambda at \$600, the TP-325 from Power Designs (Westbury, NY) at \$375, the TLB7-20 from Acopian (Easton, PA) at \$225, the TL8-3 from Trygon (Westbury, NY) at \$275 and the PS-503 from Tektronix (Beaverton, OR) at \$195. Of course, the specifications of these

units are not the same. Some deliver higher power than others, some are better regulated, and some may not be quite as versatile as others.

Lambda, probably the largest U.S. manufacturer of standard power supplies, has just introduced a high-regulation, triple-output supply—the Model LPT-7202-FM (see product feature, this issue, p. 220). This unit provides a 0-to-7-V output at 5 A, along with two 0-to-20-V outputs at 1.5 A—all regulated to within 0.01% and simultaneous voltage and current metering.

Power Designs has the Model TP-325, which provides a 0-to-6-V output at 5 A and two 0-to-32-V outputs at 1 A. But the dual outputs are not completely independent; they can't be paralleled for extra current, since the positive output of one is tied to the negative output of the other to produce a permanent positive and negative output about a common point. The power supply, though, has many significant features. The dual output can be made to track by the flick of a switch. Each of the three supplies has its own trip set point, and each unit has its own meter and current-limit control. Also included are fault-indicator lights that let you know when trip points are exceeded. Load regulation is a good 0.01% + 1 mV/A for any of the outputs.

The Trygon unit has similar ratings to Power Designs'; it has two 0-to-32-V outputs at 1 A and a 0-to-8-V output at 3 A. The Acopian supply delivers less power—0 to 7 V at 2 A and ± 10 to ± 20 V at 500 mA.

Tektronix, in developing the TM-500 series of plug-in instruments, has included several power-supply units. One is the PS-503 plug-in. It requires one of the power mainframes for its raw supply, but it can deliver two 0-to-20-V outputs at 400 mA each and a fixed 5 V at output 1-A. The supply is unmetered, though, and it has only dial panel markings as a guide.

Metering can cause problems. Since analog meters are accurate to within only 2% or so, small voltage changes usually go undetected. If you're trying to measure a circuit's reaction to millivolt changes in power-supply levels, you will probably connect a digital voltmeter to the supply terminals.

Dial for precision

Some of the newer supplies have eliminated the need to measure either by including a digital panel voltmeter within the supply or by letting you "dial" in the desired voltage with a row of decimal decade switches. These precision power supplies, once called calibration standards, are now growing rapidly in current output capability as the designer's need for large amounts of precisely set power increases.

Most of the new precision supplies have con-



Long, skinny, rack-mounting lab power supplies, such as the JMK series from Kepco, are also widely used on the designer's work bench.



For precision power, calibrated laboratory power supplies use digital readout switches and resistive dividers to deliver levels with millivolt accuracy. This unit is from Trygon.



Triple-output power supplies like the Lambda LPT-7202-FM unit are intended for the designer who must bread-board large digital and analog systems. This unit provides regulation to within 0.01% of desired setting.

trols that let you set the output voltage to within 1 mV, or better, of the desired level. Until recently, current outputs of about 100 mA were considered more than adequate. But now designers need more precision power, and manufacturers are developing units that can deliver in excess of 0 to 20 V at 1 A—in some cases up to 5 A over 0 to 50 V—of precision, settable current or voltage.

For instance, Trygon's Model PLS50-1 can deliver digitally programmable 0 to 50 V at 1 A. The output is set by five decade switches on the front panel to an accuracy of 0.1% +1 mV. Load regulation is a high 0.001% +100 μ V, while the stability is a comfortable 0.002% +100 μ V after an 8-hour warmup. The unit can also be controlled remotely by an analog voltage, current input or resistance. The price for all this is a reasonable \$375.

Power Designs has a competing unit—the 2005A. It can handle loads of up to 500 mA over 0 to 20 V. Instead of multiple decade switches, however, the 2005A uses multiturn dual verniers for adjustment. The unit has an internal temperature-controlled chamber to keep the reference voltage for the regulator stable.

Lambda's LR-DM series of half-rack digital readout supplies provides currents of up to 2.8 A and voltage spans of 0 to 10 V to 0 to 250 V. The output is set via decade switches and is monitored for both voltage and current. Regulation is 0.0005% + 100 μ V, and prices start at \$445.

Computer control on the lab bench

Takeda Riken, Sunnyvale, CA, has introduced several unusual precision current/voltage sources. One, the Model 6120 generator, uses a pulse-width modulation technique to produce calibrated voltages and currents settable in 1 μ V or 0.1 μ A steps on the lowest range.

Over-all accuracy of the 6120 is a high 0.001% of setting \pm 0.0001% of range. Output stability stays at an almost unbelievable 0.0005% of setting \pm 0.0004% of range. Full-scale range can be set to 1.199999, 119.9999 or 1199.999 V, and except for the highest range, the same scales for current.

The calibrator has a built-in memory; this permits up to 14 commonly used voltages or currents to be "preset" and then called up either in sequence or at random for test applications. The unit has a built-in digital display.

This precision supply sells for \$2995—capability doesn't come cheap.

Some of the other precision supplies have bypassed the temperature-sensitivity problem by using a circuit that has temperature-compensated semiconductors instead of an oven. This newer



Dual-output power supplies, like this unit made by Acopian, are used extensively in linear-circuit design, since they deliver positive and negative voltages.

method also eliminates the constant power drain for the temperature control and the usually long warmup time. Costs have also been kept down through circuit modifications—and with the same or better performance of earlier models.

The digitally programmable power supply has grown to be a formidable unit. Most have both manual and digital logic inputs, and some a digital display of the output voltage (usually optional). Some of these units are meant to be built into processor-controlled instrumentation, but are often in a rack right next to the bench.

One such unit, the 6141 from Takeda Riken, is a voltage/current generator that can be digitally controlled by TTL level signals. Accuracy—only $\pm 0.03\%$ of setting, plus or minus several microvolts—isn't as good as that in its big brother, the 6120. Stability is about 0.015% , plus or minus several microvolts—also much looser than that in the 6120. But the less you get, the less you pay—the price for the 6141 is \$890.

The digital programming time—for the output to reach within 99.9% of the set level—is a reasonable 50 ms. The 6141 output level can also be



One of the most versatile units is the 6D6000 made by Powertec. This unit delivers six variable outputs.

stepped up and down at preset time intervals by the flick of a switch. This unit, like the 6120, uses pulse-width modulation to produce its output voltage or current.

Digital programming via a rear panel connection makes the 6141 ideal for link-up to automatic test systems.

Hewlett-Packard (Rockaway, NJ), Kepco (Flushing, NY), Trygon and several other companies also have programmable supplies.

The Hewlett-Packard units—the 6128, 6129, 6130, 6131, 6145 and 6140—can be programmed to deliver power to loads of several hundred watts. Kepco offers a series of lab supplies that have an add-on capability, whereby the user adds a module (SN series) that provides three-digit BCD or 12-bit binary programming capability.

The digital programming option doesn't come cheap—HP charges a minimum of \$1500 for its programmable units, Kepco a minimum of \$370, not including the cost of the supply, and Trygon \$1295 for its programmable supplies. Trygon offers single and dual-output programmable versions of its DPS-50 with a polarity-reversal option and 0-to1-A output capability at 0 to 50 V. For another unit, DPS-100, the figures are 0 to 0.5 A at 0 to 100 V.

Single-output supplies for simple jobs

For the engineer who has a simple application, there are an enormous number of single-output variable supplies. Some, intended for rack mounting, are long, narrow and skinny (quarter or half rack), while others, designed specifically for the lab bench, are short, compact and stackable. Still others are large; they take up a 6-by-19-in.-square rack area and are almost unmanageable on the lab bench.

Modular Power, San Diego, makes the SL series of 1/5th rack power supplies which let you put five variable output units in a one-rack-wide space. For bench use, Modular Power offers the Model 1500—a dual-output unit.

Hewlett-Packard and Lambda have single-output variable bench supplies that are almost palm-sized. These units—the 6211 series from HP and the LL-900 series from Lambda—start at about \$99 and have load regulation to within 4 mV of setting.

The engineers' dream—a power supply that spans an extremely wide range and maintains high efficiency over its entire output scale—is obtainable. One such unit is the Model 6050A Uniply dc supply from Power Designs. This single-output power supply automatically switches internal circuits to operate efficiently.

The 6050A delivers 0 to 7 V at 5 A, or 0 to 15 V at 3 A, or 0 to 25 V at 2 A or 0 to 60 V at 1 A—all from the same set of output terminals



Laboratory power supplies like the triple output TP-325 from Power Designs (left), the Keithley 245 high voltage supply (top, right) or the high power Electronic Measurements SCR series supplies come in many ratings, shapes and sizes.



and without need to turn a switch. The patented circuit uses multiple-output unregulated supplies connected via a series of OR gates to a group of series-pass regulators—the regulator used is determined by the load requirement. Thus you have at your fingertips a power supply that retains the same efficiency at 10 V as it does at 60 V. And you don't sacrifice anything in doing this—regulation is a comfortable 0.01% +1 mV. And the cost is only \$229 for the four-in-one supply.

High-efficiency supplies needed

High-current, single-output supplies are needed more than ever, since many large systems are now being breadboarded. Several companies have strived to keep the power dissipation down when the power supplies are not operated at their optimum levels. A conventional 0-to-20-V supply is only 10 to 20% efficient if operated at 5-V.

One of the several methods rapidly being adopted to boost efficiency is SCR pre-regulation. This is a switched method of limiting the input voltage to the regulator circuit, so that the larger power dissipation when a wide-range supply is used as the lower output levels doesn't occur.

Electronic Measurements, one of the many companies using this approach, has power supplies that deliver 600, 1200, 2000, 2500, 5000 and 10,000 W of 0.1% regulated power. These units start at \$425 for a unit that delivers 0 to 20 V at 30 A—the Model SCR 20-105.

Because the supply uses a switching pre-regu-

lator, some of its uses are limited, but typical applications might include lasers, accelerometer focusing coils, electroplating, semiconductor aging racks and cryogenic magnets.

The upper limit of series-pass regulators seems to be about 500 W. Above this, the switching SCR regulator takes over. The regulating technique actually limits the ac input power to the transformer, thus reducing the raw dc voltage seen by the power semiconductors in the regulator. This reduces strain on the devices and also the amount of heat that must be dissipated.

Lambda, in its LB series, has convection-cooled units with 5-kW adjustable outputs that require only 12-3/16 in. of rack panel height. Prices, though, aren't cheap—starting at \$1100 for the LB-703-FM-OV, which delivers 0 to 36 V at 80 A.

From high current to high voltage

Over the last decade power-supply performance demands have become more stringent, especially in the high-voltage area. The key requirements are a trilogy: size, price and performance.

Two major methods are used by manufacturers to generate the high voltages: line frequency step-up transformers, combined with series-pass regulators, and dc-to-dc converters that use high-frequency switching techniques.

The step-up transformer method takes line-frequency ac signals and increases their value to

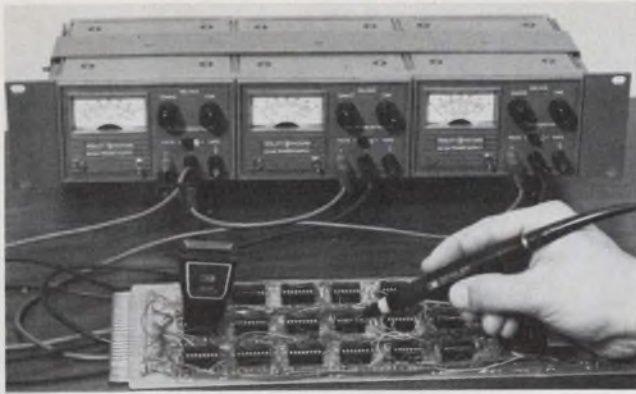

Single-output mini power supplies for the lab bench, including these units in the 6200 series from Hewlett-Packard, are available in many ranges.

the level desired, rectifies the voltage and then regulates the raw high voltage by use of tube-type series-pass regulators. This method doesn't generate any RFI, and it provides much better regulated and faster-responding high voltages than the switching supply.

On the other hand, the switching supply requires less magnetic material—for example, smaller transformers and thinner wire. This permits more compact units to be built, and there is less heat to be dissipated. Along with the reduced magnetics, smaller capacitances can be used, since the frequency is high. Typical switching frequencies range from about 15 to 60 kHz.

High-voltage power supplies are coming of age on the lab bench. New units include such features as remote voltage or resistance programming, BCD digital remote programming and parallel or slaved operation.

Spellman High Voltage Electronics offers a line of high-precision, high-regulation supplies, the RHSR series, that span 5 to 60 kV with current outputs of 1 to 10 mA. These units have a load regulation to within 0.001% +0.1 V and a ripple of only 0.001% +0.1 V rms. Prices for the RHSR supplies start at \$865.

Other companies have similar units—for instance, Bertan Associates has the 205 series. These units have the same regulation but a slightly higher ripple specification, starting at 10 mV, pk-pk, for a 0-to-1000-V unit. Bertan's supplies are priced at \$450 and up.

Additional precision supplies are available from companies like Keithley, Kepco, Hewlett-Packard, Advanced High Voltage, Power Designs and Voltek. All also make units that are intended for less demanding operating conditions. Many units are regulated to within 0.01%.

Prices average about \$400 for units with voltage outputs around the 2-to-5-kV level. There are units in this 0.01% regulation area that can provide outputs as high as 400 kV, although their prices reach well over \$5000.

Overload protection for high-voltage supplies is necessary, although several companies offer this only as an option. Different companies use different methods for indicating an overload. For instance, Power Designs, in its 1500 series of supplies, uses a pulsating needle in the meter movement to indicate the danger. The internal-protection circuits sense the output about once a second when overloads of more than 120% occur. Keithley, in its 244 supply, uses a flashing light to do the same job.

Prices for the 1500 series units start at \$575, while those for the 244 start at \$395.

Where do we go from here?

Specialty bipolar supplies—units that can swing from negative to positive voltage levels at speeds as high as 1 V/ μ s—are a growing area. These bipolar or operational power supplies can handle voltages from several hundred volts negative to several hundred positive for such applications as high-voltage semiconductor testing and insulation testing of wire and cable.

Kepeco and Hewlett-Packard are two of the leading manufacturers of these supplies, which functionally resemble giant high-power op amps. The BOP units from Kepeco, for instance, provide voltage swings from ± 15 to over ± 72 V at current loads of up to ± 20 A. Prices start at \$649.

The HP power-supply amplifiers, the 6800 series, include dual range outputs, constant voltage/constant current operation and metering of the ac and dc output voltage and current. The supplies operate either as a power amplifier or as a dc supply. Prices range from \$260 to \$900. ■■



For more information

For a list of manufacturers of laboratory power supplies, refer to the following sections in the Product Directory of ELECTRONIC DESIGN'S Gold Book:

Power Supplies, ac input, 0 to 100 V dc output	Vol. 1, p. 316
Power Supplies, ac input, 101 to 1000 V dc output	Vol. 1, p. 317
Power Supplies, over 1000 V dc output	Vol. 1, p. 318
Standards, Current	Vol. 1, p. 392
Standards, Voltage	Vol. 1, p. 393



This is the county seat, home of the Freeport High Pretzels, and where a new miniature DC motor with low inertia is being made.

One of the advantages of our new 26EM miniature motor has to do with where it's made: in the U.S.A.

So if there's ever a service or application problem, there's no problem. You dial an area code. Not another country.

The other advantage of our new miniature motor has to do with who makes it. MICRO SWITCH. So it has the same innovative technology we build into all the other MICRO SWITCH high-performance DC control motors.

And that includes a hollow rotor to provide the lowest possible rotor mass, resulting in very low inertia. And to give you an extremely fast response time—the mechanical time constant is just 18 ms.

Competitively priced, its form, fit and function make the 26EM completely interchangeable with miniature motors made outside the U.S.A.

And ideally suited to applications that include digital cassette recorders and cartridge drives; advanced instrumentation; servo-drive systems; X-Y recorders; print head positioning; and virtually anywhere else there's a need for a high performance DC control motor of this size.

Especially one that can offer you service and application assistance in Freeport, Illinois. Plus a nationwide network of branch offices.

If you'd like more information on the 26EM or any of our other high-performance DC control motors, call toll-free, 800/645-9200 (in N.Y. 516/294-0990, collect) for the location and telephone number of your nearest MICRO SWITCH Branch Office.

This is the new MICRO SWITCH 26EM DC control motor. Smaller than a cassette, but with a lot of big advantages.



MICRO SWITCH

FREEPORT ILLINOIS 61032

A DIVISION OF HONEYWELL

The way to die

There's more than a chuckle in the tale of the two oldsters discussing the best way to die. Jeb, age 83, wanted to die, painlessly and quietly—perhaps in his sleep. But Zeke, 87, wanted to die abruptly—shot by an irate husband.

In a way all of us must make the decision on how to die—professionally as well as personally. Though few of us give it much thought, there's little doubt that we're going to leave. But most of us give no thought to our manner of departing.

I'm reminded of this when I think of two companies who, years ago, found themselves as world leaders in dying markets. The approaches they took to impending death were as disparate as those of Jeb and Zeke. The Jeb-like company, a computer manufacturer, saw its market vanishing, did some flailing about, then without knowing it, resigned itself to a slow and quiet death. It appeared to have opted for dying in its sleep and, at least from the outside, it now appears to be very much asleep.

The Zeke-like company, an instrument manufacturer, seemed to stand up and confront the grim reaper with "We're not ready." It jumped into the digital voltmeter field at a time when the world seemed least likely to need another DVM manufacturer. Its management turned an ailing company into one that's bursting with vitality. The company became a dominant factor in the DVM marketplace. Its decision to enter the DVM business was extremely daring and perhaps desperately foolish. But it was a conscious decision—a considered, deliberate and, it turned out, a successful, grasping for life.

Managers in both the computer and instrument companies made decisions—the former unwittingly, the latter very deliberately.

We, too, as managers of our personal and professional lives, must often make how-to-die decisions. When misfortunes or opportunities arise—we lose a job, or we lose a contract, or our chief competitor introduces a fantastic product—we react. Some of us react by doing nothing—not deliberately (which is sometimes wise), but aimlessly. We opt to sleep our way to the grave—like Jeb and the computer company. Others fight back, grasping always for what's left of life.

One approach is no more virtuous than the other. But each of us—as individuals, as engineers, as managers—must make the choice.



A handwritten signature in dark ink that reads "George Rostky". The signature is fluid and cursive, written in a professional style.

GEORGE ROSTKY
Editor-in-Chief

We couldn't have said



"Standing out among the industry giants—in both analogs and digitals—is Weston, a company that pioneered many of the advances in APMs. From optical indicators, to p & j's, to taut band; and from commercial to aerospace, you'll find it at Weston.

it better.



"If it's a DPM you're looking for, chances are you'll also find it at Weston: The company kicked off the industry when it introduced the first DPM just seven years ago."

Electronic Design, August 2, 1974

INFORMATION RETRIEVAL NUMBER 63

We're either first or best. Or both.

WESTON



Weston Instruments, Inc.

614 Frelinghuysen Ave., Newark, N.J. 07114

In Europe: Schlumberger Instruments and Systems,
12 Place Des Etats Unis, 92120 Montrouge, France

I want to know more about:

Weston APMs Weston DPMs

I'm also interested in:

Weston DMMs Weston VOMs

Weston Frequency Counters

Name _____

Company _____

Address _____

City _____ State _____ Zip _____

Phone _____ Have salesman call.

Choose the right storage oscilloscope to capture both super-slow and ultra-fast events. New technology in storage has boosted the number of options.

Very low repetition-rate signals . . . super-fast single-shot events . . . random transients . . . slowly changing inputs. These are just a few of the many applications for which the modern storage cathode-ray oscilloscope (CRO) is the most practical way to view and measure electronic waveforms.

To get the most out of a storage CRO in your own work, you have to start with an understanding of what current instruments of this type can do. With this in mind, you can go on to select one of the several available storage technologies that best meets your own needs.

From single-shots to spectrum analysis

Unlike conventional CROs, which display the signal only while it is occurring, storage CROs can also capture fleeting single-shot events and hold the traces for analysis long afterwards. Some storage units can be set to wait for the trigger signal, generate a single stored sweep, and then lock out future sweeps until reset. Digital storage can go even further, and store parts of the signal that precede the trigger.

Working with repetitive signals, conventional CROs can't generate a good display once the repetition rate of the waveform goes below 20 to 50 Hz. When the time interval between events is longer than the persistence of the CRT phosphor, the display on a conventional CRO appears to flicker on and off. Here too, storage makes it possible to see and measure the waveform. Since the trace stays on the screen, the user doesn't have to keep vigil for each pulse.

Transients can be treated as still another type of one-shot event, and both repetitive and random signals of this class can be captured for analysis in the storage mode. This includes signals with rise times from several seconds to those in the nanosecond range or beyond (Fig. 1). The use of a storage CRO can save incalculable hours when you look for glitches, one of the most dif-

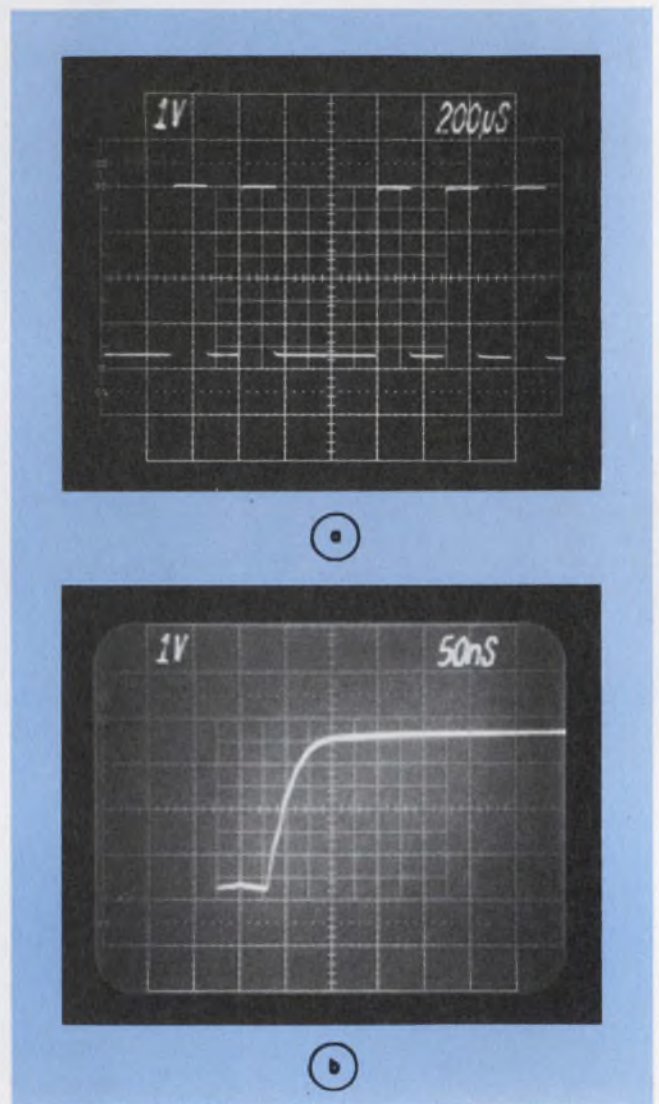

1. With storage, you can study nonrepetitive waveforms, such as digital words (a). With fast-transfer storage, rise times are easily measured (b).

ficult of all troubleshooting procedures (Fig. 2).

In many applications—such as digital-equipment servicing—triggered storage is the only practical way to identify seemingly random events, or to check the exact timing and wave-shape of critical signals and transitions.

At the other end of the time spectrum, storage CROs make it possible to examine signals that

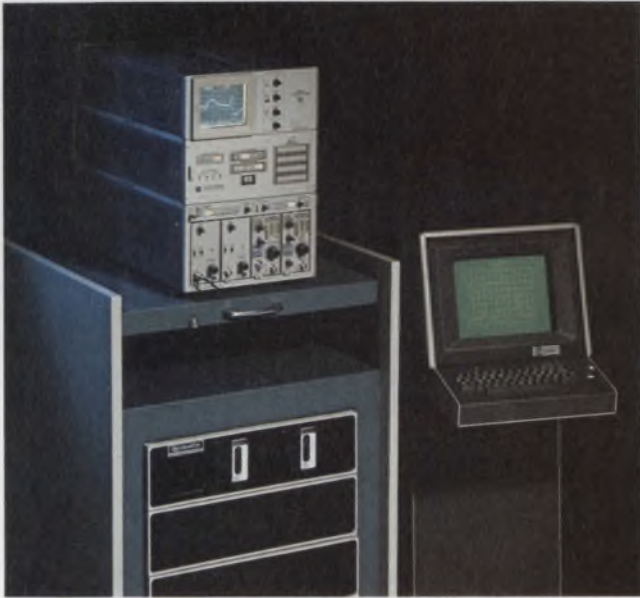

Available storage oscilloscopes today range from a 3.7-pound, battery-powered, bistable miniscopes (below) to a sophisticated digital-processing unit (left). The miniscopes will hold a signal for hours so that you can bring the unit to the job and even carry the trace home. With the digital system you can calculate data and hook up a computer for further analysis.



change too slowly to be seen as waveforms on regular CROs (Fig. 3). Such signals are not at all uncommon in mechanical systems and in transducer-based applications, where standard CROs can't meet the measurement demands. The auto makers, for example, are one of the largest users of storage CROs, with most of their applications involving mechanically generated signals.

Spectrum analysis and time-domain reflectometry both produce traces that represent a system state at one moment in time. A storage CRO can display this transformed signal. Or it can display the input waveform in the conventional mode. Digital-storage systems make extensive processing of both the original and transformed signal possible when matched with an appropriate computer.

Another entire range of storage applications stems from the ability of some storage systems to partially erase the signal after each sweep. In this arrangement, any repetitive signal capable of actuating the trigger circuit can be reinforced constantly, while all other signals fade from the screen. In effect noise and extraneous signals are integrated out.

In all of these applications, of course, the

storage CRO gives the user a chance to inspect the signal visually and, in many cases, to make quantitative measurements of the signal's characteristics. Other people can be called in to give advice or inspect the waveform, and permanent photographic records can be made if necessary.

Split-screen storage enhances the direct inspection capability, since direct comparisons can be made between a signal and a stored reference, between two stored signals or even of the same signal captured at two different points of time.

The trouble with photos

In some cases it is possible to photograph the trace on a conventional CRO and thus capture a waveform. Before the advent of storage units, this was the only practical way to save CRO images. But direct-trace photography has many limitations which can become so burdensome that vital traces are often missed or large amounts of time are used just to find the right camera settings.

The uncertainty of the photographic outcome can become crippling when the needed record is of an event that cannot be run repetitively to get

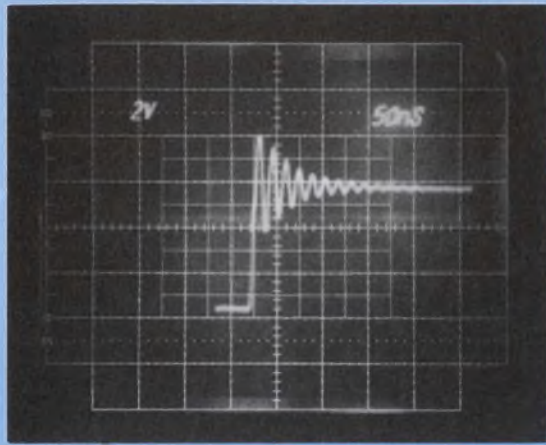

(a)

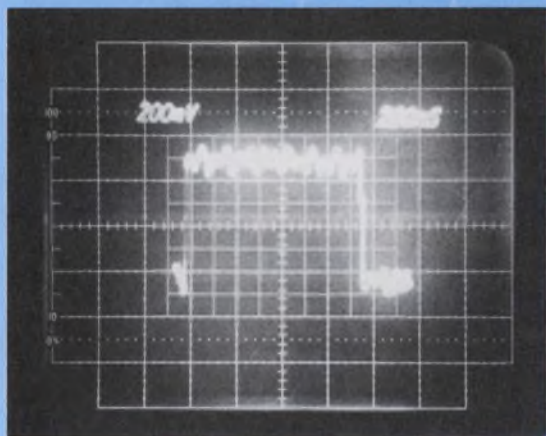

(b)

2. Single-shot, stored traces capture difficult signals such as switch bounce (a) and elusive amplifier ringing (b). Storage shows all details.

the camera adjusted properly—in satellite launches or nuclear tests, for example.

Surprisingly photographic recording is often much more costly than use of a storage CRO. Film costs, as well as the expenses to set up each photograph, are frequently overlooked—but they are often quite significant. One laboratory found that the purchase of a storage CRO reduced film costs by \$800 per month. Most cases will not be as dramatic, but nevertheless a careful look at most applications will show a significant saving with storage.

For long-term storage, it is obviously uneconomical to dedicate a CRO to each signal. But unlike photography with conventional scopes, pictures of a stored trace are easily taken with a simple, inexpensive camera.

Several systems are available which can take a photographed trace—or even one on a storage-CRO screen—and reduce it to digital coordinates.

The advantage of a two-stage digitizing system

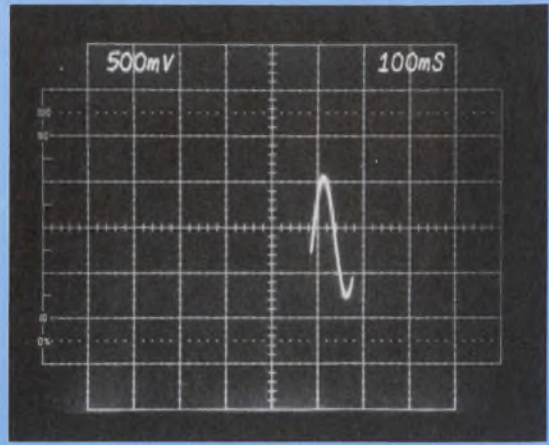

(a)

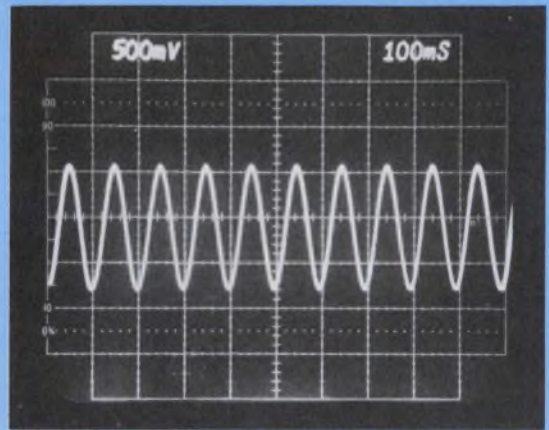

(b)

3. Phosphors in nonstorage CROs show only part of a slow trace (a). By contrast, a storage oscilloscope gives the complete picture (b).

(analog storage plus digitizer) is that it adds computer compatibility to the power and flexibility of general-purpose analog instruments. Direct digitizing systems—with no analog capability—are also available, both in CRO form and in more specialized configurations.

Key specs to look at

Once it is clear that an application calls for a storage CRO, a choice must be made between the various available types. These can range from miniature CROs weighing under 3 lb, to laboratory and digital-processing units. There are several factors (in addition to those applicable to all CROs) that are of special importance in the selection process.

One factor of prime importance is stored writing speed. This figure tells how fast the electron beam can draw a usable picture across the CRT faceplate in the storage mode, and it is usually

given on the data sheet in either divisions or centimeters per length of time.

Older storage CROs were quite limited in writing speeds. This meant that a fast changing signal could not be successfully stored. But stored writing speeds are now available that match or exceed the speed of many CRO amplifiers. For a 100-MHz sine wave, this calls for a speed of about 1000 cm/ μ s. At this writing rate, you can easily store a single-shot pulse with a 3.5-ns rise time (Fig. 4).

Many applications, of course, don't require such high stored writing speeds. For these tasks, speeds as slow as 1 cm/ms are also available.

Recent improvements in writing speed anticipate that even as CRO amplifiers get faster, storage won't be far behind. Thus fast storage should be available for almost any use where the additional cost is worthwhile—both in analog and digital storage systems.

Storage-retention time is another important consideration in storage-CRO selection. Present capabilities range from fractions of a second to weeks, depending on the CRT type and how the operating parameters are set. Digitized signals can be stored indefinitely.

In most applications the needed retention time will depend on what must be done with the image before it is lost. The requirements may call for a mere notation of the approximate shape of the trace or may dictate time-consuming measurements. During the retention time, it may be necessary to display the image continuously or it may be acceptable to save the image in latent form, provided it can be retrieved when desired.

In some storage techniques, latent storage time and actual view time are inversely related. Display of the stored trace in these systems causes the image to decay, with the rate of loss related to the display brightness and the rate with which the trace was written. For some CROs, stored view time can be as short as several seconds for extremely fast input signals. This may or may not be a problem, depending on the use and times involved.

Given the limitations of the CRT, a tradeoff exists between writing speed and brightness. The electron-beam current is limited by desired emitter life and by focusing considerations. Use of the maximum current can cause excessive heating and phosphor burning on slow portions of the trace. This forces the use of a smaller current value in many cases. When the maximum usable current is spread over a large area of the screen, as happens with fast signals, the brightness at these points is reduced proportionally.

The range of acceptable trace brightness and contrast ratios depends, of course, on the application. Production-line work and field service may dictate more stringent specifications than

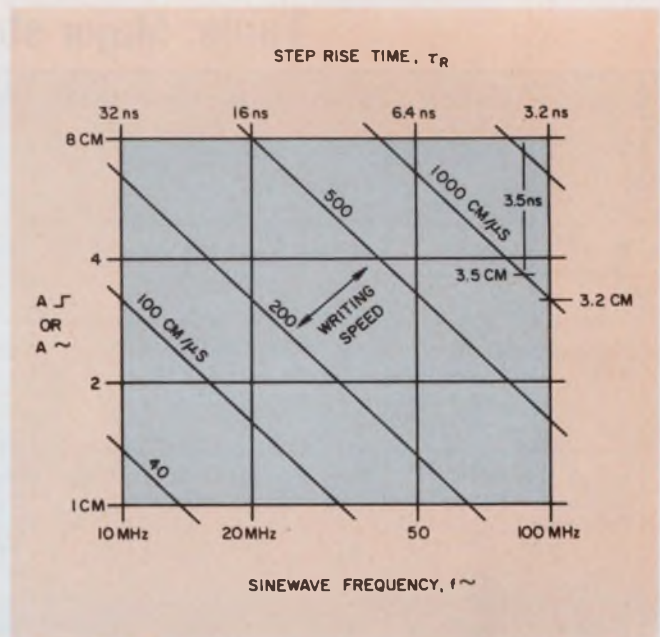

4. What stored writing speed do you need? Nomograph relates speed to step rise time, sine wave frequency and trace amplitude.

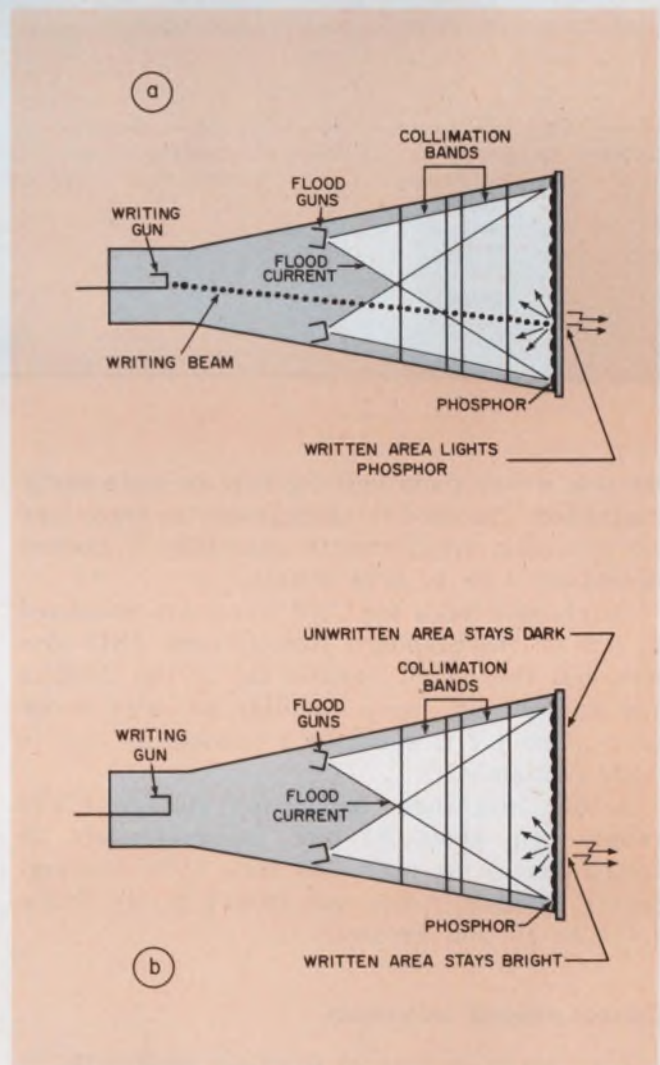

5. In bistable storage, the writing beam traces the waveform on a target (a). Flood guns reinforce the written portions to keep those areas bright (b).

Table: Major storage techniques

	Maximum writing speed	Storage duration	Approximate brightness	Contrast	Grey scale	Ease of operation	Available configurations	Special capabilities	Typical signals that call for this type	Rough cost of simple instrument type
Bistable phosphor	Above 5 cm/μs	Hours	34 nits (10 ft/cd)	4:1	None	Easiest	Miniscope portable lab bench	Split screen; long view time	Extremely slow; step responses	\$1100 to \$3500
Bistable mesh	Above 25 cm/μs	Days	340 nits (100 ft/cd)	2:1	None	Easy	Lab, bench, rack	Long view time	Complex waveforms; mixed fast and slow	\$600 to \$3500
Variable persistence (halftone)	Above 400 cm/μs	Seconds to minutes	170 nits (50 ft/cd)	Above 10:1	More than 5 levels	Easy	Portable lab, bench, rack	Making traces brighter; pictorial images	Noisy, repetitive	\$1500 to \$3500
Transfer to variable persistence	Above 1300 cm/μs	Seconds to minutes	170 nits (50 ft/cd)	Above 10:1	None	Moderate	Portable lab, bench, rack	Fastest oscilloscope writing speed	Fast step response; high frequency	\$3300 to \$4000
Transfer to bistable	Above 180 cm/μs	Days	340 nits (100 ft/cd)	2:1	None	Moderate	Lab, bench, rack	Fast writing speed with long view time	Fast signals requiring long view time	\$3300 to \$4000
Digital	Depends on technique, ranges from 10 to 8000 cm/μs	Indefinite	Depends on monitor	Depends on type and monitor	Depends on type and monitor some allow more than 8 levels	Easy to difficult	Bench rack separate components; large systems	Pretriggering; numerical processing; data logging	Extremely fast transients; inputs to be digitized; long digital sequences	\$2000 to \$200,000

lab use, where room lighting may be more easily controlled. The need to photograph the trace may set minimum requirements, especially if camera operation is to be kept simple.

Brightness levels for CRT traces are measured in nits in the Standard International (SI) system, but the metric candela/m² or the English footlambert are more familiar to most scope users. One nit is equal to 1 candela/m² and to 0.292 footlamberts.

Actual brightness levels for storage CRTs range from about 34 nits (approximately 10 footlamberts) to over 343 nits (100 footlamberts). Contrast ratios vary from a barely visible 1.1:1 to 10 and greater.

Current storage techniques

Four major techniques to retain waveforms in CROs are currently available (see table). The four are: bistable storage, variable persistence, transfer and digital conversion. A few more

methods find application in more specialized display instruments. These include photochromic, chemical, and infrared. None of these are now suited for CRO use.

Bistable storage is one of the simplest of the CRT techniques (Fig. 5). In this system the electron beam writes a pattern on a target material with two stable states. The written portions permit low-energy electrons from a second electron gun (flood gun) to hit the phosphor at moderate speeds and keep the screen bright at those points. The unwritten parts repel further electrons from the flood guns, and slow the arriving particles below the speeds needed to excite the phosphor.

Bistable-storage CRTs offer clear images and require relatively simple external circuitry. Since each storage point acts like a miniature multi-vibrator that moves to a stable point when partially charged to the written level, the display is uniform and needs little adjustment in everyday use. Since each point reaches a stable state, the

display lasts for many hours without any significant accumulation of error.

Two different types of bistable-storage CRTs are now being manufactured. The first of these is the bistable-phosphor CRT, which uses the tube phosphor itself as the storage target. Points on the phosphor that are not written repel the low-energy electrons and keep the points dim. The written areas attract low-energy electrons and consequently stay bright.

An extra feature with bistable-phosphor storage is split-screen operation: Each half of the screen can be controlled independently, and each can store, erase or run in the conventional mode.

The second type of bistable CRT is the bistable transmission type, which stores the image on a coated fine-wire mesh suspended between the electron guns and the phosphor inside the tube. The low-energy electrons pass easily through the mesh at the written points but are retarded in the blank portions. While this arrangement is more expensive than the bistable-phosphor type, the display is brighter, and operation is just as simple.

A recent innovation is the appearance of bistable systems that can display single composite images made up of a changing, nonstored image and a constant stored trace. To do this, the system writes the stored trace at a sufficient intensity to store, and writes the nonstored trace at a level sufficient to excite the phosphor but below the stable point needed to store.

Writing speeds for bistable storage CROs range from about $0.01 \text{ cm}/\mu\text{s}$ to $10 \text{ cm}/\mu\text{s}$. Brightness and contrast levels generally surpass 34 nits (10 footlamberts) at about 4-to-1 contrast ratios.

Variable persistence offers grey scale

Variable-persistence tubes also store the image on a dielectric fine-wire mesh in the electron path. But variable-persistence CRTs permit each target point to assume any value in a continuous range between zero and complete charge. The electron transmission at each target point, and therefore the corresponding screen brightness, is proportional to the amount of charge (Fig. 6). Unless optimized for contrast, a variable-persistence tube can produce more than five distinguishable brightness levels. This is why this CRT is sometimes known as a halftone-transmission tube (Fig. 7).

Variable-persistence is potentially the fastest storage technique. But high speeds are possible only at the expense of storage-retention time: Displaying the resulting trace also shortens the storage time below the value for latent retention.

This is because storage in a variable-persistence CRT is not stable. Electron leakage and ion

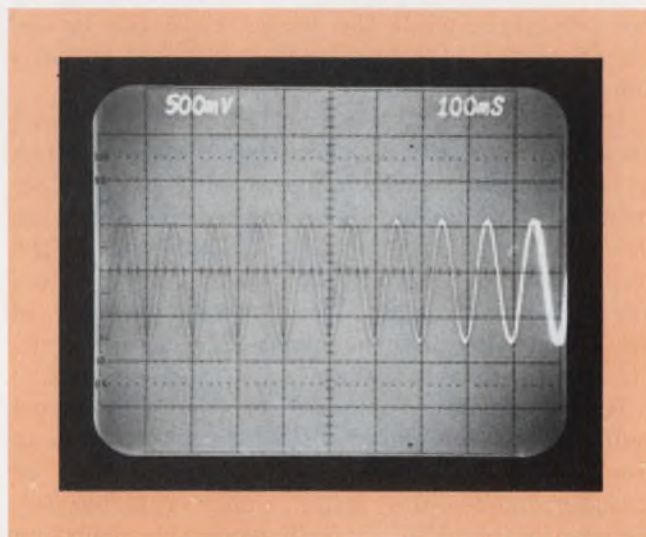

6. Variable persistence—or halftone storage—can display a range of brightness from dark to light.

currents begin to degrade the image as soon as it is formed, and the effect increases with high display brightness levels. When the beam writes the image quickly, the charge on each point is small, and it may be only seconds before the image begins to fade. This effect may be slowed somewhat with a reduction in image brightness. Most variable-persistence CROs provide a means to turn down the display intensity until the image is needed.

Image fading can also be used to advantage, however. Variable-persistence units are often set deliberately to speed the fading process: If the CRO is set to erase at a rate equal to the signal-repetition rate, a low rep-rate signal will appear continuous—yet changes will be shown as they are detected.

For repetitive signals with clear trigger points, variable-persistence displays can eliminate the masking effect of noise or asynchronous interference. In this application the controls are set so that the erase pulse wipes out all images over a period of several sweeps. The image of the desired signal is reinforced with each sweep and remains quite visible. All other points are not written as often and are erased.

Writing speeds for variable-persistence units go beyond $500 \text{ cm}/\mu\text{s}$. Although brightness varies with writing speed, 170 nits (50 footlamberts) at specified speed are not unusual.

Transfer: the fastest analog storage

In transfer storage, two storage systems are cascaded within a single tube to increase writing speed vastly without the sacrifice of brightness or view time (Fig. 8). The first storage target is a variable-persistence mesh, which is optimized for extremely rapid writing speed and short im-

age retention; while the second mesh can be operated either as a long-lasting bistable or variable-persistence storage.

In effect the first mesh acts as a writing-speed amplifier, and the second mesh behaves either as a standard variable-persistence or bistable transmission element. The image is captured on the first mesh and quickly transferred to the second mesh. The technique gives transfer-storage CROs—with the second mesh operating in the variable-persistence mode—the fastest writing speed of any of the analog storage systems.

By appropriate settings of the front-panel controls, some transfer CROs can be operated in single bistable, single variable-persistence, or transfer mode—the latter either variable-persistence or bistable. In each mode the operating parameters can be varied to give the best performance. The transfer CRT is by far the most flexible of all types.

Flexibility, however, usually entails some sacrifice in operating simplicity, and while the transfer CRO is not inordinately difficult to use, it is a bit more complex than the other varieties. Most of the controls are the same as those for the nonstorage equivalent (time base, vertical deflection, and triggering), but transfer also requires a set of adjustments for the element voltages.

Another tradeoff in present transfer CRTs is in the erase-cycle timing. The two meshes used to store the image must both be erased for each complete transfer-storage cycle.

In some applications different erase cycles are needed. Several fast sweeps of the first storage target can be transferred at one time to the second target. And several transfer cycles can be accumulated on the second storage as well.

Writing speeds for transfer units have surpassed $1000 \text{ cm}/\mu\text{s}$ in the fast, variable-persistence mode. Brightness and contrast levels are comparable with the corresponding single-stage bistable and variable-persistence systems.

Digital techniques are beginning to find applications in the storage-CRO field. These systems combine some degree of analog signal conditioning, analog-to-digital conversion, and digital signal-output or display. Most are rack or cabinet-mounted, but there are also portable systems as well as those tied to large computer systems.

And now, digital storage

Digital systems have two significant advantages: First, the numerical output from a digital CRO can be fed to numerical processing systems for further calculations, including sophisticated techniques such as fast-Fourier transforms. The output can also be connected to automatic data-collection and logging systems for future use.

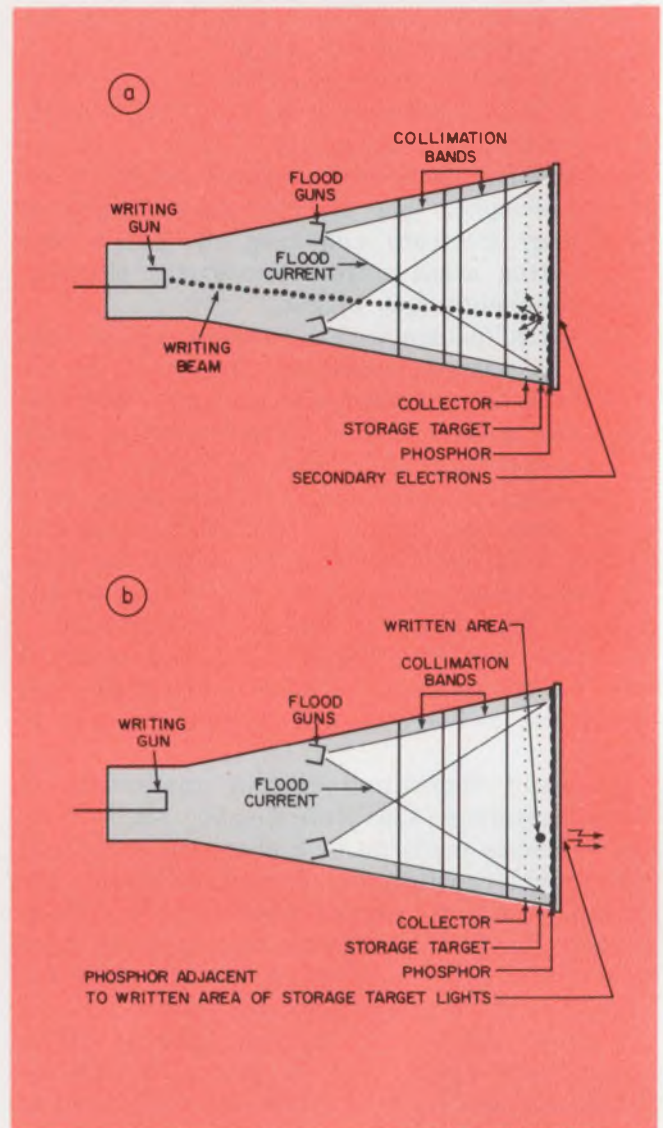

7. With variable persistence, the writing beam charges the target positively at the points of contact (a). Flood-gun electrons pass through the written areas to light corresponding screen points (b).

The second major advantage of the digital CRO is its pretrigger storage capability. Because a digital system can be set to refill its memory continuously, it can freeze any combination of time segments within its range—regardless of whether the segments occur before or after the trigger signal.

In applications comparable with those of the analog storage CRO, the digitized points are displayed on a CRT, which may be either built into the instrument or available separately. The quality of the trace depends on how many sample points in each time frame are available, but the display picture quality in itself is limited only by the capabilities of the monitor.

On the other hand, digital systems are more limited than analog units as general-purpose storage instruments. Maximum bandwidths are several orders of magnitude smaller for digital

units than for comparable analog instruments. Costs are substantially higher for equivalent performance in other areas. As of yet, there are no equivalents to many analog configurations, and the depth of coverage, by application, is limited. For these reasons digital systems have proven successful in more specialized applications.

Scan conversion, a digital-storage technique with an equivalent stored writing speed greater than 8000 div/ μ s, finds use in laser research, nuclear experimentation, and nondestructive testing. In these applications the subnanosecond rise time justifies the cost, which can equal that of 50 analog units.

Digital processing CROs use standard CRO front ends and active analog-to-digital conversion. Their controllers can be simple front-panel controls or sophisticated computers. Their equivalent stored writing speed is limited by their sampling rate and by how few points the user will accept to define the waveform.

A 10-ns sample—a rate available on faster systems—yields 10 points for each cycle of a 10-MHz signal, enough to detect waveshape but not to follow harmonic distortion or nonlinearity. For most uses, 100 to 1000 points per cycle is desirable.

Note that digital storage, in most cases, should not be considered as an alternative to analog methods but as a complementary technique.

Some final factors and case histories

No matter what method is chosen as the storage technique, remember that the factors that influence the choice of a conventional CRO still must be considered in the selection of a storage unit. These include configuration, versatility, portability, bandwidth, sensitivity, and triggering—as well as the more general considerations of value reliability, quality and manufacturer's support.

Here are some examples of how others have gone about selecting their storage CRO.

A manufacturer of electronic systems needed to run a series of destructive tests on proposed components to see the reactions at the actual point of failure. Both voltage and current waveforms were required—the frequencies and peak values involved were known only roughly.

A storage CRO was obviously called for, since an unknown number of test runs would have to be performed on each component before failure occurred, and each trace had to be recorded in case of failure. To photograph each trace would have been prohibitively expensive.

Since a range of components was involved, and the frequencies and voltages at failure uncertain, a laboratory CRO scope was desirable. This would allow the test group to select various plug-ins

Writing speed and input slew rate

Writing speed, the maximum rate of beam movement that gives a usable display, can be calculated as follows:

The total beam velocity, V_{tot} , is the square root of the sum of the horizontal and vertical components squared,

$$V_{tot} = (V_x^2 + V_y^2)^{1/2},$$

where V_x is the velocity of the sweep and equals:

$$\frac{1}{\text{sweep time per cm}}$$

and V_y is the signal's up-and-down spot velocity.

Since V_x is usually much smaller than V_y , we can consider $V_{tot} = V_y$ for practical purposes.

For a sine wave corresponding to the equation $y = A_{max} \sin 2\pi ft$, vertical velocity, V_y , equals $dy/dt = 2\pi fA_{max} \cos 2\pi ft$. The cosine function reaches a maximum of 1 when the sine function crosses the $y = 0$ line. This gives a maximum $V_y = 2\pi fA_{max}$.

For a step response,

$$W_s = k \cdot A_{max} / T_r,$$

where T_r is the 10-to-90% rise time, A_{max} is the maximum amplitude, and k is a factor dependent on the waveshape. Values of k in this equation range from 0.8 for a linear ramp to 2.2 for a single-pole RC response. A k of 1.0 is typical for a step response limited by a few poles.

for the differing signals and provide the maximum range of measuring capabilities for the dollar. Portability was not felt to be a significant factor.

Writing-speed requirements, also dependent on the input-output characteristics, were indeterminate. The test group felt that high-frequency transients were likely to be important. Therefore a decision was made to go to the fastest available CRO.

Storage duration needed was not long. Failure was usually quite evident and a camera would be set up to immediately capture the image. A simulated run convinced the company that only a few seconds were required to make the determination that failure had occurred and to trigger the camera.

Fast-transfer storage was the most appropriate for the conditions. Besides meeting all their requirements, the transfer CRO had the additional advantage of multitrace mode operation, where several traces are transferred onto the same image, to give a standard of comparison for

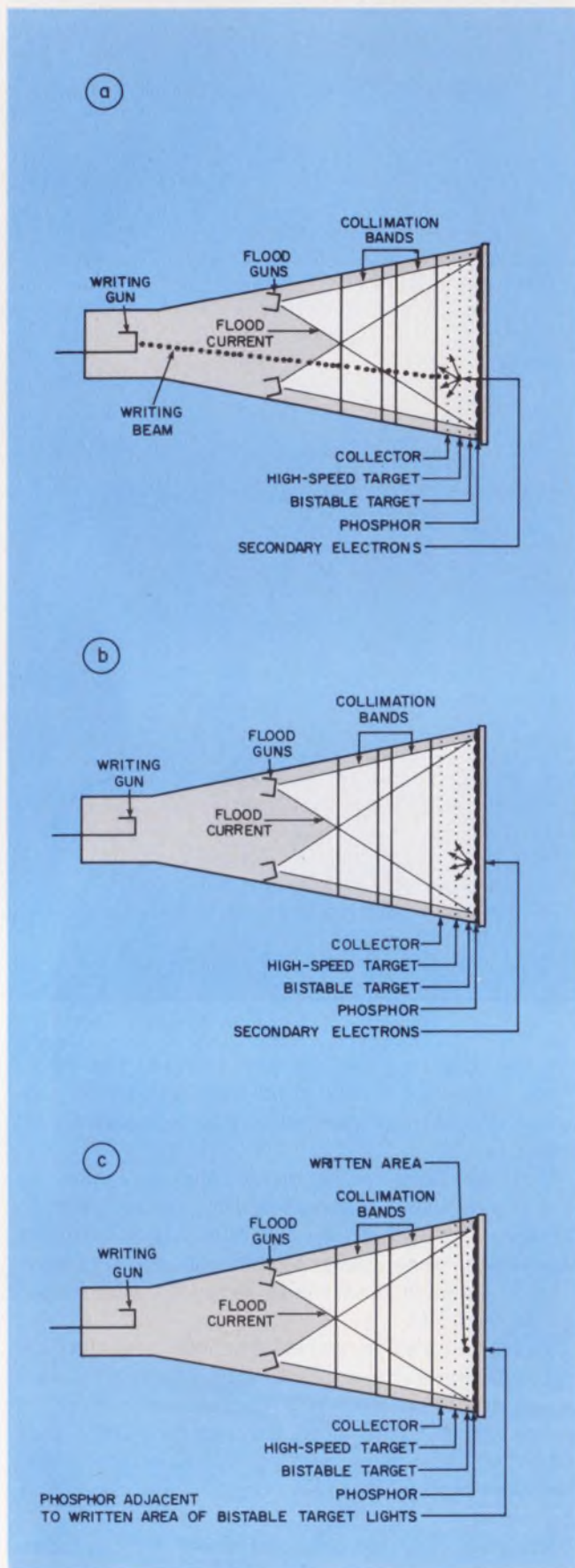

8. In transfer storage a high-speed target is charged positively by the writing beam (a). Flood-gun electrons pass through written area only and strike a second target (b). Written areas of second target pass more electrons than unwritten areas to produce a trace (c).

each new run. A decision was made to recommend a laboratory, plug-in, fast-transfer unit.

In another case, that of the service department of an industrial-equipment company, the choice was relatively easy. Only very small, battery-operated CROs were even considered, and simplicity of operation and ruggedness were primary considerations. Signals were all relatively slow, and voltages high. A highly insulated case was required for safety.

Storage was selected for this application because the size of the equipment and location of the parts made it frequently difficult for the service person to see the CRO from all positions. This meant that the image had to last longer than it took to make the adjustments and return to the CRO. This can take many minutes.

A bistable mini-CRO was the overwhelming choice. It offered the required portability, ruggedness and ease of operation. With battery operation the CRO would be floated above ground for examination of signals referenced to high voltages. The image lasted for hours, and the single-sweep feature permitted the CRO to trigger on the incoming signal and to store the image. This proved to be an invaluable aid in troubleshooting. Reports from the field indicate that the department made a wise choice.

A not-so-wise choice

Less fortunate was a small producer of telephone equipment. The engineering department, working with low-repetition-rate dialing pulses, decided for various reasons to select a variable-persistence laboratory CRO.

Although this type was adequate for measurements on the system when all went well, it soon became obvious that the CRO couldn't show what was going wrong. A quick demonstration by the CRO vendor's local office showed that a faster unit was needed. The apparent source of difficulty was a large glitch in a leading edge with 65-ns rise time. For the faster speed requirements, transfer storage appears to be best.

The company already owned a laboratory bistable storage CRO, which performed very well in making measurements on relay and contactor circuits and was well suited to store low rep-rate pulses where exact waveshape was not critical.

With a single product line and repetitive measurements, the company realized that a monolithic nonplug-in CRO had sufficient flexibility and could reduce costs sufficiently. Not only that, but the CRO could be used in the field to test the equipment under actual operating conditions. Consequently a new order was placed for a portable, fast-transfer oscilloscope. In practice the new unit and the existing bistable storage CRO have proved complementary. ■■

Introducing the new 4½-digit DPM from WESTON®



Weston, the first to introduce DPM's, completes their third generation product line.

Users of the Weston 2½ and 3½ digit units are well aware of Weston quality. The new Model 1234 provides the same outstanding price/performance, this time with 4½ digits and 10 microvolts sensitivity.

Outstanding accuracy and stability are provided through use of the Weston patented Dual Slope Integration* technique. Accuracy and stability specifications extend over operating temperatures of 0 to 50°C.

Display readout is a seven segment gas discharge planar packaged in the Weston "industry standard" high impact glass reinforced case.

Basic ranges are 100 mV through 1000V with sample speeds variable to 30 per second. Other standard options are BCD, remote decimal point positioning and line voltage operation for worldwide use. If you have been looking for a 4½ digit DPM, it will be worth your time to take a minute and return the coupon. We will send you everything you need to know about our new Model 1234. For the sales office closest to you, dial toll free (800) 645-9200, or in New York State, call collect (516) 294-0990.

In Europe: Schlumberger Instruments and Systems, 12 Place Des Etats Unis, 92120 Montrouge, France.

*U.S. Patent #3,051,939

Weston Instruments
614 Frelinghuysen Ave.
Newark, N. J. 07114

Tell me more about Weston Model 1234 DPM.

I also want to know about

- Weston APM's
- Other Weston DPM's
- Weston DMM's
- Weston VOM's
- Weston Frequency Counters

Name _____

Company _____

Address _____

City _____ State _____ Zip _____

Phone _____

Have a salesman call.

We're either first or best. Or both.

WESTON® Schlumberger

Announcing the first 0.5" multi-digit LEDs

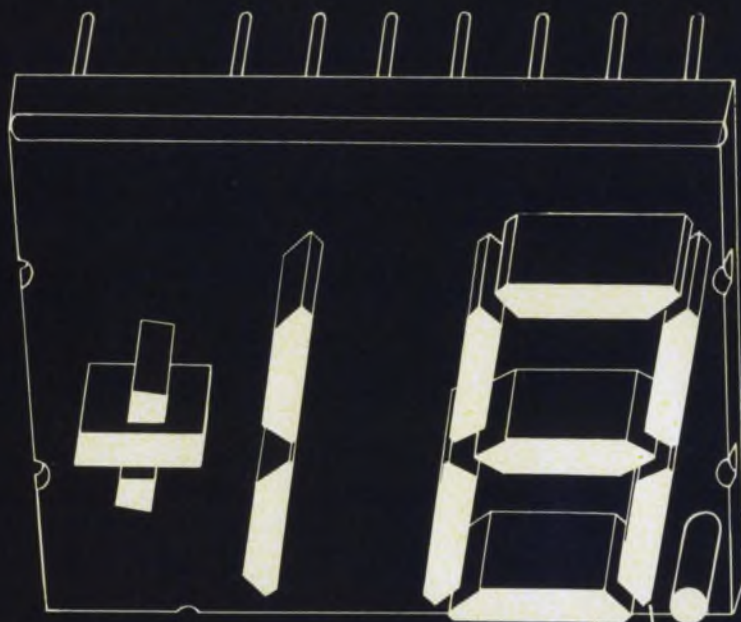

One DIP
handles
two digits

Mitered corners
increase
eye appeal

Light pipes spread
illumination evenly
over broad segments



Here we go again. It's another first from Litronix: multi-digit 0.5"-high LEDs.

These two-in-one packages are tailor made for anyone who wants to save money in lower production costs. They require only half the inventory. Half the handling. Half as many components to assemble and test.

Makers of digital time pieces will find them ideal, as will those who manufacture point-of-sale terminals. FM digital readout tuning systems. TV channel tuners, and instrumentation.

The modules are end-stackable to produce any combination of 0.5" digits on 0.5" centers. The DL-727 is a two-digit module that's ideal for clocks. And our DL-721 module offers a \pm sign and a "1" for polarity and over-range indications on instruments.

Each module has the same drive requirements. Power required is only 30 to 40 mW per segment from standard logic voltage supplies. Modules are packaged in standard DIPs.

Naturally, you enjoy all the solid state advantages of LEDs. They're compatible with today's IC circuits. Rugged. Easy to multiplex. And offer fast response.

In any business lower costs make a difference. Our dual 0.5"-high digits help your products keep a competitive edge.

Our data sheets tell all. Contact Litronix, 19000 Homestead Road, Cupertino, Calif. 95014. Phone (408) 257-7910.

**No wonder
we're No.1
in LEDs**

litronix

Measure time interval precisely.

Recognize the common pitfalls in counter measurements and eliminate potential errors.

Although conventional analog and sampling oscilloscopes are often used for precise time-interval measurements, a time-interval counter offers potentially greater accuracy and resolution. Yes, the oscilloscope offers a distinct advantage by permitting the operator to observe the waveform under measurement. But counters can measure the time between two events to 100 ps or better. And the counter is better suited to add to a computer-controlled system.

Precise measurements like that are essential in nuclear and ballistic time-of-flight tests, radar ranging and in the characterization of active components, such as integrated circuits.

But a number of factors can produce considerable errors when the time-interval meter is used. Let's examine the causes of error and inconsistency, and consider methods to minimize their effects on measurement.

What is measurement accuracy?

Measurement accuracy is given by the following:

$$\begin{aligned} \text{Time-interval measurement accuracy} = \\ \pm 1 \text{ count} \pm \text{time-base error} \pm \text{trigger error} \\ \pm \text{trigger-level settability.} \end{aligned} \quad (1)$$

Now let's examine each of the error-producing factors in Eq. 1:

- **±Count.** This refers to the internal counted clock and is also a measure of the resolution. The measurement always provides this inherent uncertainty, since there usually can be no guarantee of coherence between the input frequency and the counted clock. A 500-MHz counted clock represents state of the art, and for such a clock frequency the ± 1 count becomes ± 2 ns. Several techniques that increase this resolution are available.

- **Time-base error.** Factors in the time base that can affect measurement accuracy include the oscillator's short-term instability and long-term drift. The quality of the oscillator required de-

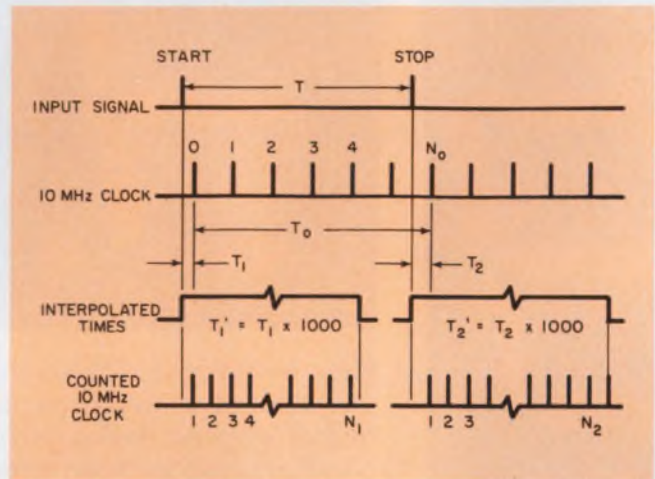

1. By analog interpolation, 100-ps resolution can be achieved with a clock frequency of only 10 MHz.

pends on the measurement to be made—in general, the shorter the times to be measured, the less demanding the performance requirements on the oscillator. For example, if $1 \mu\text{s}$ is the maximum time to be measured and the instrument provides an absolute resolution of 1 ns, the oscillator need only be better than 1×10^{-3} both in long-term drift and short-term stability (for a $1\text{-}\mu\text{s}$ averaging time). An air crystal will suffice for such measurements. On the other hand, if the application lies in frequency standards where measurements of one second or longer are needed, a high-stability oven oscillator is required. But bear in mind that high-stability time-base oscillators are quite expensive.

- **Trigger error.** Any amplitude on the input signal will cause an error at the point where triggering occurs; incorrect triggering directly translates to a measurement error. For precision measurements, the input signals are assumed to be high speed (nanosecond rise times), in which case trigger error is rarely a factor.

- **Trigger-level settability.** Any error in the absolute level at which the triggers are set translates directly to a measurement error.

The measurement resolution obtained with a conventional time-interval meter is limited to the period of the internally counted clock. To achieve 1-ns resolution, for example, 1-GHz

David Martin, Product Marketing Manager, Counters and Printers, Hewlett-Packard, 5301 Stevens Creek Blvd., Santa Clara, CA 95050.

counting circuits must be used. Such a speed not only pushes the state of the art but is an expensive solution.

Fortunately alternative techniques can provide the resolution for precision timing measurements. Three popular approaches are (1) time-interval averaging, (2) analog interpolation, and (3) startable oscillators.

Time-interval averaging is based on the fact that if the \pm count error is truly random, it can be reduced when a number of measurements

are averaged. But the time interval must be repetitive and have a repetition frequency that is asynchronous to the instruments' clock. Under these conditions, the resolution is given by:

$$\text{Time-interval average resolution} = \frac{\pm \text{count}}{\sqrt{N}}, \quad (2)$$

where N = number of time intervals averaged and ± 1 count = single-shot resolution limit.

The absolute improvement in resolution is limited only by noise inherent in the instrument and should be less than 100 ps.

How a time-interval meter works

In a simplified block diagram of the time-interval meter (Fig. A), the main gate is opened by the START input (output from START AMP-TRIGGER) and closed by the STOP (output from STOP AMP-TRIGGER). During the time the gate is open, the internal clock is counted into the decade counting assembly and then displayed. The total count, with appropriate positioning of the decimal point, is the elapsed time between START and STOP. If, for example, the counted clock is 100 MHz, each count represents 10 ns of time.

Inputs are provided for measurements between two points on the same waveform or for separate inputs. Some instruments offer switchable input impedances. Input signal-conditioning circuits and their associated controls are of critical importance in the measurement process. A typical arrangement for the input signal-conditioning controls is shown in Fig. B. An attenuator is used to contain the input signal within the dynamic range of the input. For time-interval measurements, the input should be dc-coupled; however, since most time-interval meters also have provision for frequency measurement, an ac-coupled position is also made available.

A SLOPE switch allows the counter to trigger on either the positive or negative slope of the input signal. Finally a LEVEL control allows triggering to occur at any amplitude point on the signal that is within the dynamic range of the counter input. This control essentially sets the reference voltage level at which the input amp-trigger will fire.

If we assume the input signal-conditioning circuits have been set correctly (and we ignore trigger settability and energy considerations), the outputs from the amp-triggers reflect the precise points on the input waveform(s) between which the time measurements are to be made (Fig. C).

Fig. C also illustrates that time interval has two dimensions, time and voltage. If the user recognizes this at the outset, the chances for accurate and reliable measurements improve greatly. More often, however, the measurement

is approached as a simple frequency measurement on a sinusoidal signal. Lack of attention to the input signal-conditioning circuits and measurement setup is the prime source of measurement error and the major reason why the instrument's potential accuracy is sometimes not achieved.

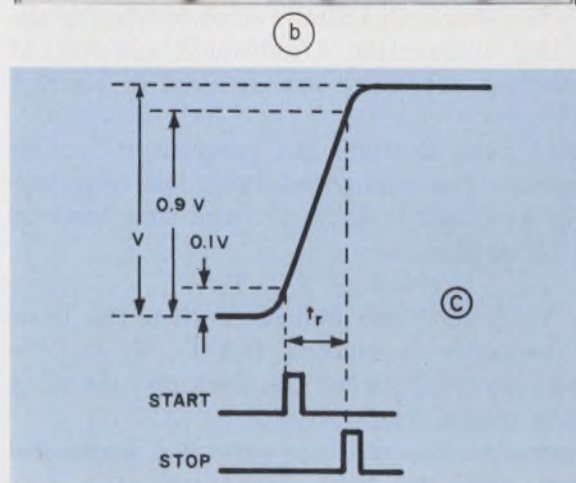
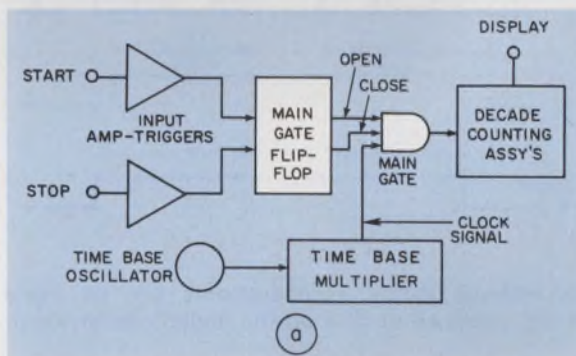

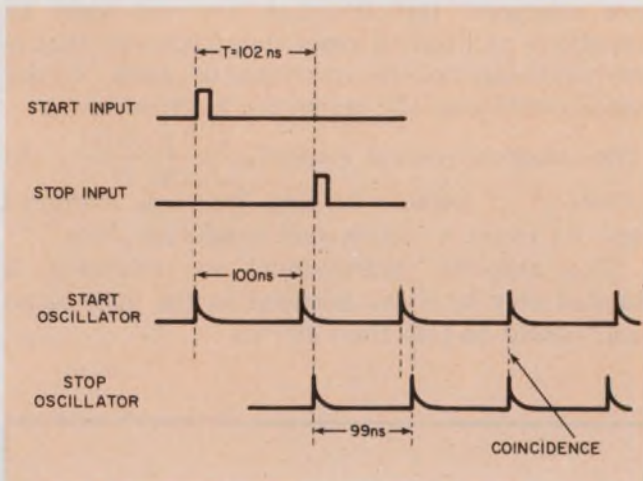

2. Two startable oscillators, one for START and one for STOP, give high-resolution, single-shot measurements.

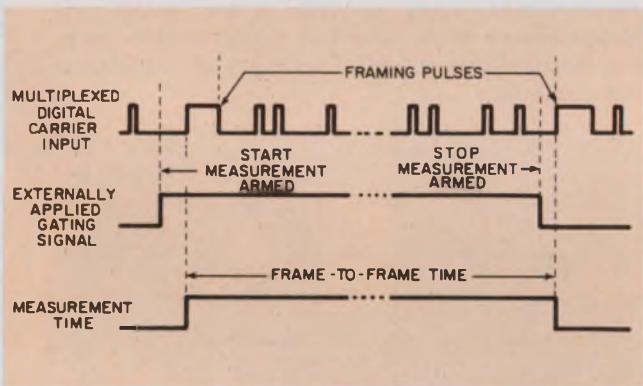

3. With external gating, measurements can be made despite the presence of data on the digital carrier input.

The major advantage of time-interval averaging is the relatively low cost at which subnanosecond time-interval resolution can be achieved. The disadvantage is the requirement of a repetitive input, at least to the extent that N measurements can be made. In addition statistical measurements—such as peak-to-peak, rms jitter or histograms—cannot be performed for resolutions beyond the single-shot limit, since averaging destroys this information. (Additional subtleties of time-interval averaging are detailed in Refs. 1 and 2.)

Rather than average the inherent ± 1 count uncertainty, the analog interpolation technique actually measures it (Fig. 1). And time interval T can be written as

$$T = T_0 + T_1 - T_2,$$

where T_0 is the time indicated when the basic clock frequency is counted and T_1 , T_2 are the time ambiguities between the clock and the start and stop pulses, respectively.

To measure interval T_1 , a capacitor is charged for this time and then discharged at a rate 1000 times slower. During the discharge time the

clock is again counted, resulting in N_1 counts. Interval T_2 is measured in a similar fashion, resulting in N_2 counts. With T_0 represented by N_0 counts, the time T becomes

$$T = 1000 N_0 + N_1 - N_2.$$

The resolution of the measurement has been increased 1000 times by interpolation, and the instrument behaves exactly as if the counted clock were 1000 times faster (except that resolution is ± 2 counts because of the two interpolators).

Thus the disadvantages of time-interval averaging are overcome. Moreover it can be seen that negative, as well as positive, time intervals can be measured. This technique is ideally suited therefore for coincidence measurements. Resolutions of 100 ps, single-shot, can be achieved with analog interpolation.

The startable oscillators technique is also an interpolation process and offers advantages similar to those of analog interpolation. The process is illustrated in Fig. 2, where a 102-ns time interval is measured to 1-ns resolution.

Two startable oscillators are used with this technique, one for the START input signal and one for the STOP. The START oscillator in this example has a period of 100 ns, while the STOP oscillator has one of 99 ns.

At receipt of the START input pulse, the START oscillator begins, and 100-ns clock pulses are accumulated in a register. As soon as the STOP input pulse is received, the accumulation process ceases; however, the START oscillator is not turned off. At the same time the STOP oscillator begins delivering 99-ns clock pulses into another register until coincidence between the two clock trains is detected. It can be seen that this occurs just two clock pulses later.

The contents of the START register contain the time-interval information to 100-ns resolution, while the STOP register contains the remaining two decades of resolution. This measurement is therefore made to 1-ns resolution.

Note that this technique can also be extended to perform coincidence measurements.

Some instruments provide an operational mode of external gating that greatly increases measurement versatility. The terminology of this mode is by no means standard, but, in essence, external gating allows the operator to arm both the start and stop of the measurement.

External gating extends versatility

Consider a multiplexed digital communications channel and a requirement to measure the frame-to-frame time (the time between one given framing pulse and another), with two framing pulses

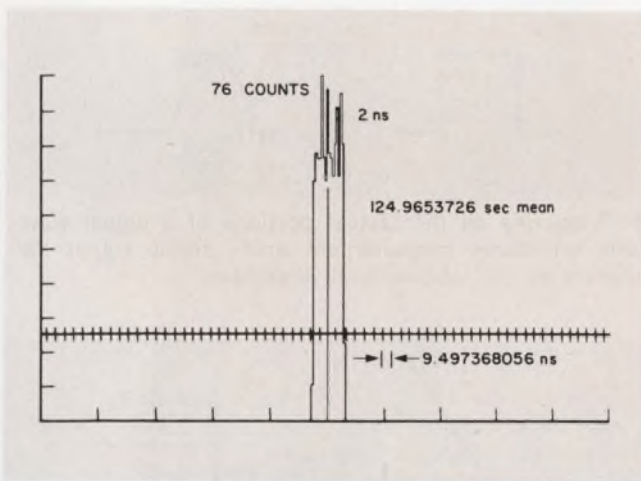

4. Histogram of frame-to-frame jitter obtained in real time, with use of a programmable calculator as the data-reduction element.

encompassing one channel, or frame, of information (Fig. 3). The problem is to start on the first frame pulse and stop on the next, ignoring the potential interference from the digital data preceding or occurring within the given frame.

This requirement is achieved when an external gating signal is applied to the counter so the start of the measurement is armed just prior to the first frame pulse and the stop is armed just prior to the second frame pulse. As shown in Fig. 3, the frame-to-frame time is now measured despite the presence of data on the carrier.

If a programmable calculator is added to the system, the peak-to-peak jitter of the frame time can be computed. With the calculator connected to the digital I/O of the counter, the measurement can be performed in real time. An example of such a measurement is shown in Fig. 4, with the data reduced by the calculator plotted in the form of a histogram.³

The versatility that external gating provides is particularly applicable to the complex digital signals commonly found in computer and digital communication systems. External gating can also be used to prevent the counter from triggering on noise spikes.

Input circuits face critical demands

Most users of time-interval instrumentation get into trouble because they fail to consider all the facets of the counter input and signal-conditioning circuits, as well as the errors created by these oversights. Critical factors include bandwidth, differential delay, sensitivity, dynamic range and trigger level. Let's look at them:

- **Bandwidth.** The fastest signal that will be seen by the input amplifiers is limited by the rise time of the amplifier. Thus it is useless to try to measure a 10-ns rise time with a 100-ns ampli-

fier. Moreover the time interval resolution offered by many counters is in excess of the rise-time capability of the amplifiers. This is particularly true where special techniques are used to increase the resolution, as previously described. Thus many properly functioning instruments may display erroneous answers because of their bandwidth-limited input amplifiers. This potential error can be minimized in most cases by adjustment of the counter's trigger controls, so that triggering occurs on the fastest part of the waveform as seen by the input amplifiers (Fig. 5).

- **Differential delay.** The finite bandwidth of the input amplifier implies a finite propagation delay of the input signal through the amplifier. Since two amplifiers are always involved and since it is virtually impossible to achieve perfect matching, a finite differential exists in the propagation delay between the two channels. This can create significant errors, particularly where resolution-increasing techniques are used. However, it is relatively simple to calibrate this delay out. Just input a pulse train of an accurately known period, measure the pulse-to-pulse time and note the difference between this measured time and the period. If this difference—the differential delay—is significant, it can be eliminated by insertion of a length of cable that matches the delay between the appropriate input channel and the signal to be measured.

- **Sensitivity.** The sensitivity of the counter should be chosen so it will handle the minimum level input signal. Excessive sensitivity can create problems, especially with wideband inputs, since false triggering on random noise or noise spikes can occur.

- **Dynamic range.** The linear range of the input amplifier is referred to as the dynamic range. If the input signal exceeds the dynamic range of the counter, distortion, at best, and amplifier damage, at worst, will occur. Attenuation should therefore be used, as necessary, to maintain the signal within the dynamic range. Note that the attenuators themselves can create an additional source of error, depending on their accuracy. In addition attenuation decreases the effective input sensitivity. If the full measurement flexibility is to be achieved, the dynamic range should be as wide as possible. A dynamic range that is 20 dB larger than the sensitivity is considered barely adequate; 26 dB is desirable.

- **Trigger level.** To maintain the full flexibility achieved by the wide dynamic range, the trigger-level control should allow the operator to trigger the counter from any point on the signal that is within the dynamic range.

For some measurements—such as rise time, slew rate or propagation delay between 50% amplitude points—the determination of the absolute input voltage level at which triggering of

the counter occurs is of critical importance. Any error in triggering level translates directly to a measurement error.

Trigger level determination

The popular technique to determine trigger level has been to use Z-axis modulation of an oscilloscope. The inevitable propagation delay plus the inherent speed limitation of this technique make it impractical for the precision measurements under discussion. It has been found that the most reliable technique is to measure the actual dc voltage level, V_t , of the input signal at which triggering occurs. To do this, measure the dc reference, V_t' , applied to the counter's input trigger (Fig. 6).

The difference between V_t and V_t' arises because of the hysteresis level of the input trigger plus the finite imbalance between the two sides of the trigger circuit. The counter's input sensitivity is determined by the hysteresis level, and both the hysteresis and the finite imbalance are affected by time and environmental changes.

It is, however, a relatively simple matter to determine this differential. Apply a slow square wave (10 kHz) of accurately known amplitude to the counter. Adjust the counter trigger level until triggering just occurs. The reference voltage, V_t' , can be measured (usually at the rear panel of the counter), and V_t is then also known. The process can be repeated for various input signal amplitudes, thus allowing the differential between V_t and V_t' to be determined across the entire dynamic range of the counter input (Fig. 7).

The accurate determination of square-wave amplitude can be obtained by means of a comparison technique, with a variable-voltage dc standard as the reference. If the input signal to the counter has a high slew rate, an additional error can arise, since it takes a finite charge for a trigger circuit to fire.

Charge starts to accumulate when the input signal crosses the trigger point set at V_t . By the time sufficient charge has accumulated, however, the input signal has moved to V_{t1} , and it is at this voltage level that triggering occurs. The charge is related to the gain-bandwidth product of the amp trigger and can be expressed as a constant, $K = Vt$ in mV-ns.

A typical value for K is 100 mV-ns; however state-of-the-art design can provide a figure almost 10 times higher. Use of this value for K and a 2-V input signal with 1-ns rise time (input slew rate = 2000 mV-ns) provides a trigger settability error of 0.22 ns (Fig. 8).

If the preceding factors are considered in the time-interval measurement, errors will be minimized. These same precautions apply as well

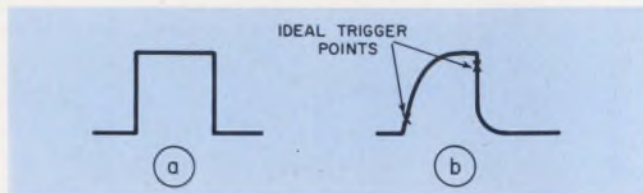

5. Triggering on the fastest portions of a signal waveform minimizes measurement error. Input signal "a" appears as "b" at the input amplifiers.

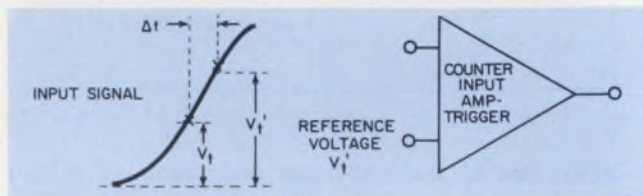

6. Setting reference voltage V_t' via the counter trigger-level control establishes the voltage level, V_t , of the input signal at which the counter triggers.

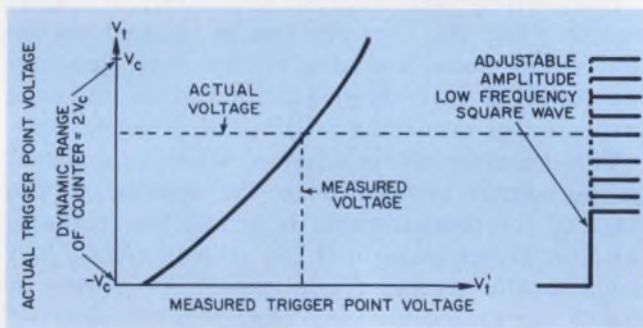

7. Determining settability error over the dynamic range of the counter input.

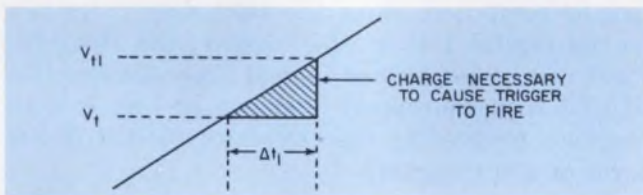

8. Although charge starts to accumulate at V_t , triggering does not occur until V_{t1} , when the input signal has a high slew rate.

to oscilloscopes. In fact, the tendency is to overlook these error factors even more when oscilloscopes are used.

Feeding the signal into the counter

Failure to consider how the signal is carried to the input can also be responsible for large errors. The basic cause of error is mismatch between the signal impedance and the counter input impedance. Reflections can occur when the two points are connected by a line of finite length, resulting in waveform distortion and consequent error. In addition the impedance presented by the counter to the signal could cause enough

loading to change the waveform—or, in an extreme case, cessation of operation.

For measurements such as those in digital communication or computer-system checkout, the problem of signal transportation can be alleviated with relative ease, since the signal is usually preconditioned and available at a relatively convenient impedance level. In this case, errors can be minimized if the counter is terminated to create a matched system.

In addition, as with all time-interval measurements, line lengths should be kept equal and as short as possible. It is also good practice to trigger the counter as close to the base line of the pulse input as possible. This reduces errors caused by stray shunt capacitance throughout the connecting cable and the counter input.

The problems with signal transportation are more severe, however, when measurements are performed on active components, such as integrated circuits. Here no convenient BNC or type N connectors are available, the signal is not preconditioned, and rise time or slew rate—the most difficult measurements of all—are generally demanded.

The ideal solution is to connect the signal to the counter with a line of zero-length and zero-distributed capacity and to use a counter with infinite input resistance and zero-shunt capacity. This can be approximated with high-impedance passive oscilloscope probes. The shunt capacity at the point under test is reduced by the amount of attenuation provided by the probe. This attenuation does, of course, reduce the effective sensitivity of the counter.

The use of probes also reduces errors caused by reflection, provided the impedance presented to the counter by the probe is matched by a like impedance at the counter input. Since the input impedances for counters and oscilloscopes are similar, this usually poses no problem. It is important to note that the measurement techniques for counters apply equally to oscilloscopes.

Time-interval measurements can be performed on TTL, MOS and CMOS with a minimum of error. ECL is the most difficult of all logic families to measure, since it is low-level, fast and extremely sensitive to capacitance; thus shunt capacity should be kept to an absolute minimum. This suggests the use of more attenuation in the probe, which in turn, implies higher sensitivity from the counter. ■■

References

1. Application Note 172, "The Fundamentals of Electronic Frequency Counters," Hewlett-Packard, Palo Alto, Calif.
2. Application Note 162-1, "Time Interval Averaging," Hewlett-Packard, Palo Alto, Calif.
3. Application Note 174-5, "Determining Probability Densities with the HP 5345 Electronic Counter," Hewlett-Packard, Palo Alto, Calif.

Get CUSTOM MOS in any quantity

(and we mean **ANY** quantity
—starting from 1 piece)

LSI Computer Systems, an experienced MOS company, will supply your custom MOS circuits in any process using the latest design techniques for highest reliability at the lowest cost. MOS circuits can be supplied to commercial or military specifications.

PARTIAL LIST OF CUSTOM CIRCUITS SUPPLIED

- Industrial Controls
- Juke Box Logic
- Digital Instrument Controls and Display
- Electronic Organs
- Data Communications
- Counter/Display
- Crystal Oscillator/Dividers
- Editing Typewriter
- Computers

MULTI PROCESS CAPABILITY

for

HIGH SPEED • LOW POWER • LOW VOLTAGE
HIGH DENSITY • NOISE IMMUNITY
SINGLE POWER SUPPLY

LSI computer systems, inc.
22 Cain Drive, Plainview, N.Y. 11803
(516) 293-3850

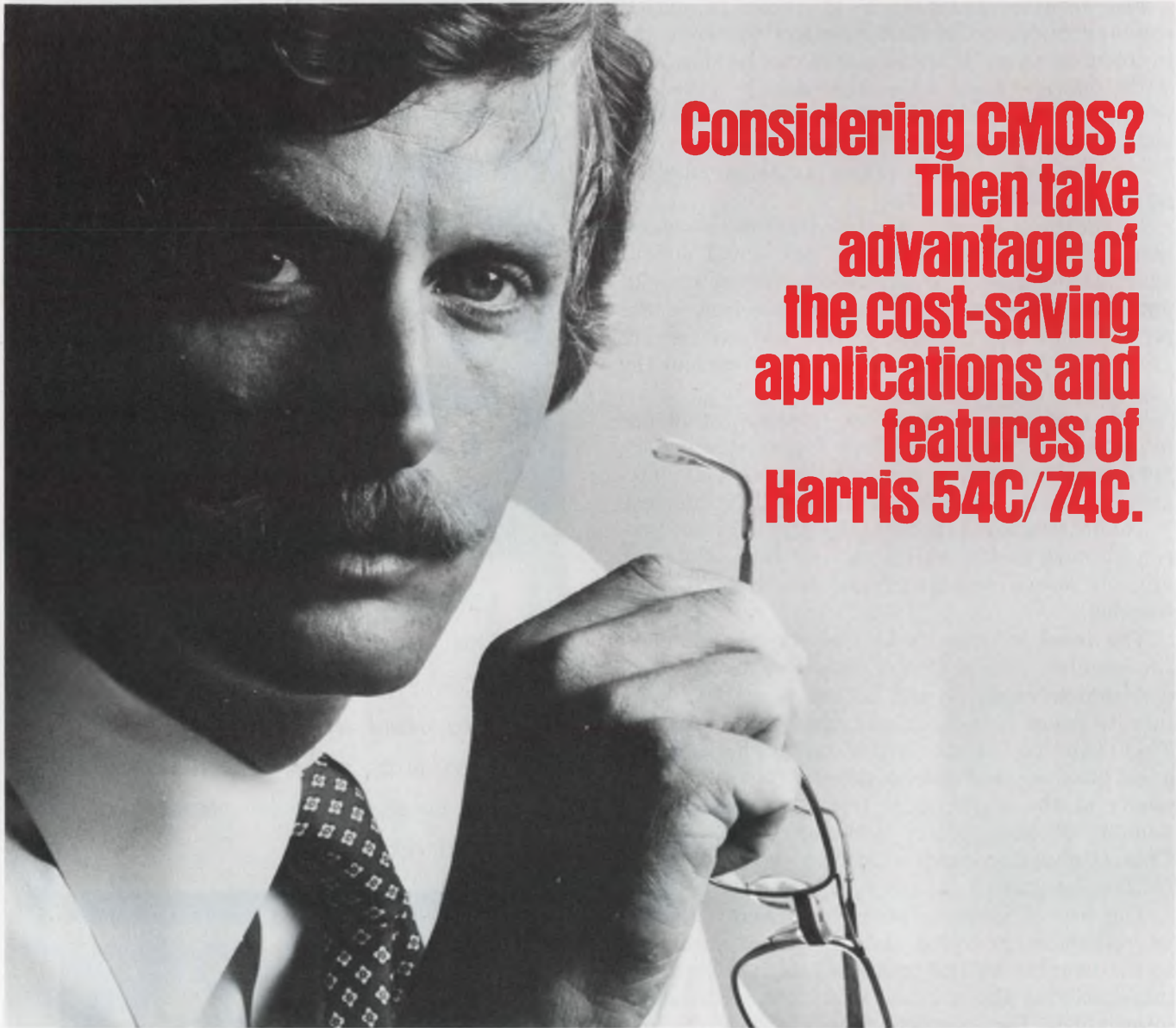

**Considering CMOS?
Then take
advantage of
the cost-saving
applications and
features of
Harris 54C/74C.**

You can apply it now and without reservation.

Harris supplies the identical 54C/74C devices that National does. And our product line is complete. We have 23 in the family now, and 14 more on the way. Specifications are written for the system designer and are consistent across the line. Units in quantity are available from distributors, and constitute a complete compatible family. The software you need to design 54C/74C into your system is available now.

The series is pin-for-pin and function-for-function equivalent to T²L 7400. Cost-savings include low power supply requirements, less

power supply regulation, fewer bypass capacitors, easier design and simplified power distribution. The units also offer high noise immunity—typically 45% of supply voltage.

Experience gained from using the 7400 series can be applied directly to 54C/74C's, and your applications are easy, too, with standardized input and output characteristics.

For a copy of our new 54C/74C handbook, write Marketing Communications, Harris Semiconductor, P.O. Box 883, Melbourne, Florida 32901.



**HARRIS
SEMICONDUCTOR**
A DIVISION OF HARRIS CORPORATION

P.O. Box 883, Melbourne, Florida 32901 (305) 727-5430

WHERE TO BUY THEM: ARIZONA: Phoenix—Hamilton, Liberty Weatherford; Scottsdale—HAR (602) 946-3556 CALIFORNIA: Anaheim—Weatherford; El Segundo—Liberty; Glendale—Weatherford; Long Beach—HAR (213) 426-7687; Mountain View—Elmar; Palo Alto—Weatherford; HAR (415) 964-6443; Pomona—Weatherford; San Diego—Liberty; Weatherford; COLORADO: Commerce City—Elmar; Denver—Hamilton; Englewood—Weatherford; CONNECTICUT: Danbury—Schweber; Norwalk—Harvey; FLORIDA: Hollywood—Hamilton; Schweber; Melbourne—HAR (305) 727-5430; GEORGIA: Atlanta—Schweber; Norcross—Hamilton; ILLINOIS: Elk Grove Village—Schweber; Schaumburg—HAR (312) 894-8824; Schiller Park—Hamilton; INDIANA: Indianapolis—Pioneer; KANSAS: Lenexa—Hamilton; MARYLAND: Baltimore—Hamilton; Rockville—Schweber; MASSACHUSETTS: Burlington—Hamilton; Lexington—Harvey; Wellesley—HAR (617) 237-5430; MICHIGAN: Livonia—Hamilton; Troy—Schweber; MINNESOTA: Edina—Hamilton; Schweber; Minneapolis—HAR (612) 432-6111; MISSOURI: Hazelwood—Hamilton; NEW JERSEY: Cedar Grove—Hamilton; Mt. Laurel—Hamilton; Somerset—Schweber; NEW MEXICO: Albuquerque—Hamilton; Weatherford; NEW YORK: East Syracuse—Hamilton; Melville—HAR (516) 249-4500; Syracuse—HAR (315) 463-3373; Rochester—Schweber; Westbury—Schweber; Woodbury—Harvey; NORTH CAROLINA: Raleigh—Schweber; OHIO: Beachwood—Schweber; Cleveland—Pioneer; Dayton—Pioneer; HAR (513) 226-0636; PENNSYLVANIA: Wayne—HAR (215) 687-6680; TEXAS: Dallas—Hamilton; Weatherford; HAR (214) 231-9031; Houston—Hamilton; Weatherford; UTAH: Salt Lake City—Hamilton; WASHINGTON: Seattle—Liberty; Weatherford; WASHINGTON, D.C.: HAR (202) 337-3170; CANADA: Mississauga—Ontario—Hamilton; Montreal—Quebec—Hamilton; Ottawa—Ontario—Hamilton

LEGEND FOR HARRIS SALES OFFICES & DISTRIBUTORS: Elmar Electronics (Elmar); Hamilton Avnet Electronics (Hamilton); Harris Semiconductor (HAR); Harvey Electronics (Harvey); Liberty Electronics (Liberty); Pioneer Standard Electronics (Pioneer); Schweber Electronics (Schweber); R. V. Weatherford Co. (Weatherford)

If You Use, Maintain, Specify, or Authorize Instrumentation,

You Need to Know About Tektronix TM 500



it's multifunctional—

a continually growing family of 29 modular plug-in instruments

- digital multimeters
- counters to 550 MHz
- generators
- amplifiers
- power supplies
- oscilloscopes
- a blank plug-in kit for your custom circuitry ... and more ...

Whatever your field of electronics, whatever your responsibility, you need to know about Tektronix TM 500 Test and Measurement Instruments.

Send for the new 56-page TM 500 Booklet . . . includes full specifications on 29 modular plug-in instruments and three power mainframes, an explanation of the product line concept, and examples of special configurations and applications in high demand. Your Tektronix Field Engineer will assist you in selecting instruments to meet your needs.

Ask for **TM 500 Booklet, A-3072**. Contact your local Tektronix Field Engineer, or write to Tektronix, Inc., P.O. Box 500, Beaverton, Oregon, 97077. Telephone: (503) 644-0161 TWX: 910-467-8708. In Europe, write Tektronix Ltd., P.O. Box 36, St. Peter Port, Guernsey, Channel Islands.

INFORMATION RETRIEVAL NUMBER 68
FOR DEMONSTRATION, 286

it's multiconfigurable—

compact one, three, and four-hole mainframe enclosures

- bench-top
- portable
- rack mounting
- SCOPE-MOBILE® mounting

it's versatile—

you can group instruments that fulfill your needs

- Digital Logic High Performance System for TTL or ECL
- Audio Frequency Instrumentation System
- Industrial Instrumentation System
- Medical Instrumentation Calibration System
- Educational System
- Portable System for Computer Service
- (Your System)

Special Handling

Please rush me the TM 500 Booklet, A-3072.

I would like to discuss grouping instruments for the following application:

I want a demonstration of TM 500 Instruments.

NAME _____ COMPANY _____

TEL. NO. _____ EXT. _____

ADDRESS _____

CITY _____

STATE _____ ZIP _____



TEKTRONIX®

committed to

technical excellence

Measure open-loop servo response

without saturation problems. Just open the loop, drop in an auxiliary op-amp computing chain, then reclose the loop.

By breaking a closed servo loop at the right place and introducing an auxiliary chain of op-amp computing elements at the broken points, you can measure immediately both the closed and open-loop response of the servo.

The method solves the problem that constantly plagues servo designers: how to quantify a control system's open-loop response. In many servos, direct measurement is difficult; in others, it's impossible.

For example, when you break the loop of an integrating or high-gain servo, an amplifier or other element immediately saturates and makes measurements impossible.

To get around this, you can measure the transfer function of each element in the loop, then multiply all the individual responses to get the over-all transfer function. But this indirect and time-consuming method doesn't always give valid results—first, because the method ignores the effects of element interactions and second, because noise often limits the accuracy of the test data.

Open-loop response is hard to get

Consider a typical position servo in which the position of the load is controlled with a command input, normally a dc voltage (Fig. 1). To obtain the closed-loop response, you normally connect a sinusoidal signal to the input and use a scope to compare the output of the position sensor with the input reference signal.

To get the open-loop response of the position servo, you could try to break the loop, inject a sinusoid, and then measure the signal that zips around the loop and returns to the break point. In practice, however, an amplifier will probably saturate when you break the loop.

Suppose you now add two unity-gain op amps to the position servo (Fig. 2). With no reference signal applied at point R, the original servo is unchanged. Introduce a sinusoidal signal at point A. The sine wave starts at point A, transmits

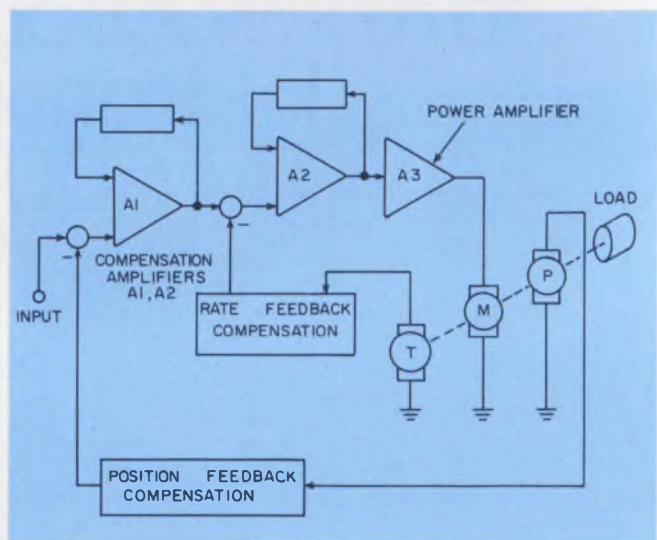

1. Typical position servo has two feedback loops: one to carry back the load position and the other to adjust the servo damping. When the main loop is broken at any point, one of the servo amplifiers usually saturates, which makes measurements impossible.

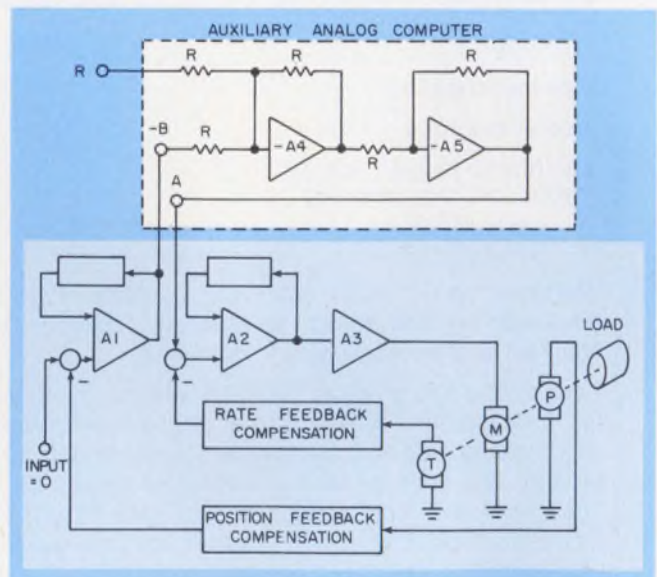

2. To measure open-loop (and closed-loop) response with the loop closed, a break is made at the summing junction between amplifiers A_1 and A_2 , and an auxiliary computing chain is inserted at the break. With zero reference signal, the servo-loop gain remains unchanged.

Dr. Bill D. Pierce, PE, Staff Engineer, Hughes Aircraft Co., P.O. Box N, Aurora, CO 80011.

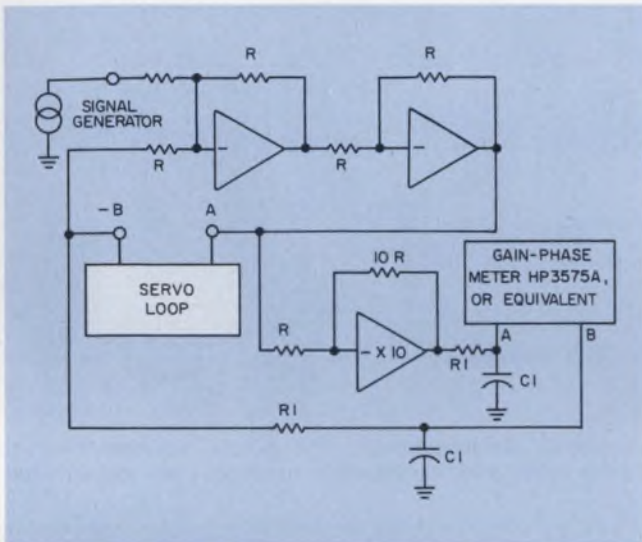

3. Two improvements make low-frequency measurements easier: noise blocking low-pass filters in series with the leads of the gain-phase meter, and a loop-gain booster amplifier that precedes the meter.

through the servo and comes back to the auxiliary amplifiers at point B. The open-loop gain and phase are now immediately available. Just measure the voltage at B with respect to the negative voltage at A (negative because of the feedback).

Furthermore to get the closed-loop response, measure the voltage at B with respect to the negative voltage at R. To quantify the complete open and closed-loop response, just vary the frequency of the signal at R and repeat the measurement at each frequency.

The measurements are simplified with a gain-phase meter, such as the Hewlett-Packard Model 3575. This instrument readily handles large dynamic ranges of both frequency and signal magnitude, and it's capacitively coupled so dc bias is not a problem. An additional benefit is that measurements can be made even with noisy signals. Consequently data which normally require hours of effort (if at all possible to get) can be obtained in just a few minutes.

Certain precautions are necessary with the auxiliary-chain technique: The magnitude of the

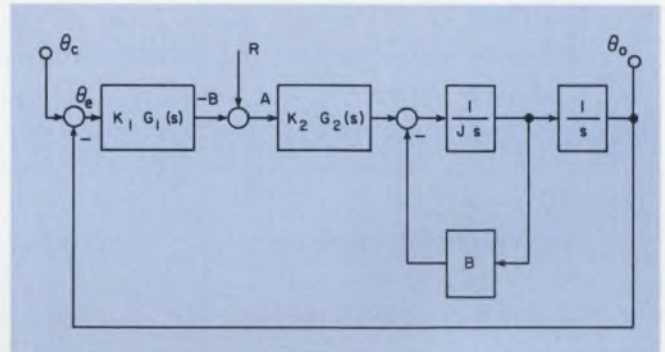

4. Both the closed and open-loop transfer functions of a typical position servo can be written to demonstrate analytically the validity of the auxiliary-chain method.

voltage at R must be adjusted to prevent saturation of any of the servo-loop elements. But V_R should be kept as large as possible to improve the signal-to-noise ratio. Ideally the two impedance levels at the point where the loop is broken should be matched to prevent changes in the loop dynamics.

Where to break the loop

Normally it's best to break the loop at a point of low-impedance and of high signal magnitude. If the servo doesn't have a rate loop, the best break point is usually at the input to the power amplifier (to A_3 in Fig. 2).

However, a few quick calculations show that measurements will be erroneous if the break is made within a minor loop. As a final precaution, voltage and power levels at the break point must be compatible with the ratings of the auxiliary amplifiers.

Many improvements in the basic technique are possible. When signals are extremely noisy, low-pass filters should be placed in series with the two inputs of the gain-phase meter. (Series connection is possible because you measure gain and phase by comparing one signal with respect to another.)

An alternative is to place a $\times 10$ (+20 dB) amplifier in series with one input of the meter. The amplifier boosts the signal over certain frequency

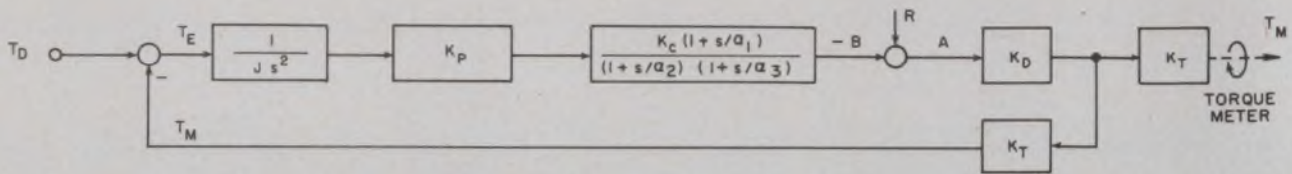

(Load damping and high-frequency terms neglected)

- | | | |
|-----------------------------|---------------------------------------|--|
| Load inertia | $J = 1.38 \text{ oz-in-sec}^2$ | $\alpha_1 = 200 \text{ sec}^{-1}$ |
| Proximity detector constant | $K_P = 300 \text{ volts/rad}$ | $\alpha_2 = 2200 \text{ sec}^{-1}$ |
| Compensation amp. | $K_O = 8 \text{ volts/volt}$ | $\alpha_3 = 3000 \text{ sec}^{-1}$ |
| Driver amp. | $K_D = 2.5 \text{ amps/volt}$ | $T_D = \text{Bearing friction torque}$ |
| Motor torque constant | $K_T = 40 \text{ oz-in./amp}$ | $T_M = \text{Motor torque}$ |
| Acceleration constant | $K_A = K_D K_T K_P K_C / J = 174,000$ | |

$$G_{ol}(s) = \frac{T_M(s)}{T_E(s)} = \frac{B(s)}{A(s)}; \quad G_{cl}(s) = \frac{T_M(s)}{T_D(s)} = \frac{B(s)}{R(s)}$$

Open-loop transfer function: $G_{ol}(s) = \frac{174000(1 + s/200)}{(1 + s/2200)(1 + s/3000)s^2}$

Closed-loop transfer function: $G_{cl}(s) = \frac{(1 + s/200)}{(1 + s/265)(1 + s/3855) \left[1 + s \frac{2(.51)}{1062} + \left(\frac{s}{1062} \right)^2 \right]}$

5. Response of a bearing-torque tester can be determined analytically and the results compared with measurements performed on the actual servomechanism.

Both open and closed-loop functions are determined.

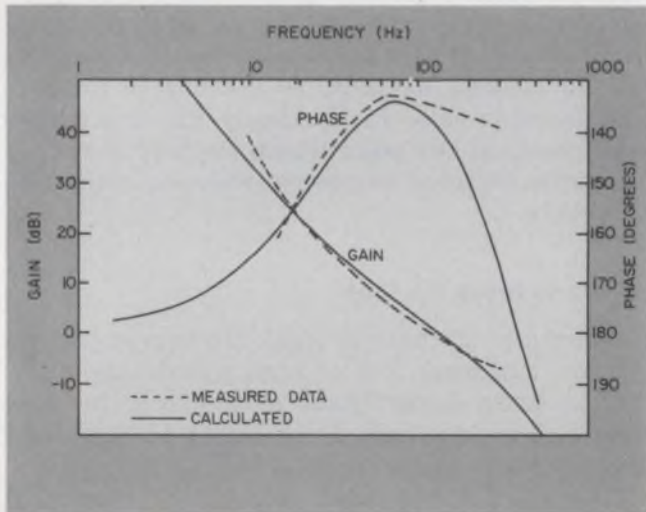

6. Open-loop response of the bearing-torque tester: Measured gain and phase agree closely with the calculated data for the frequencies of interest.

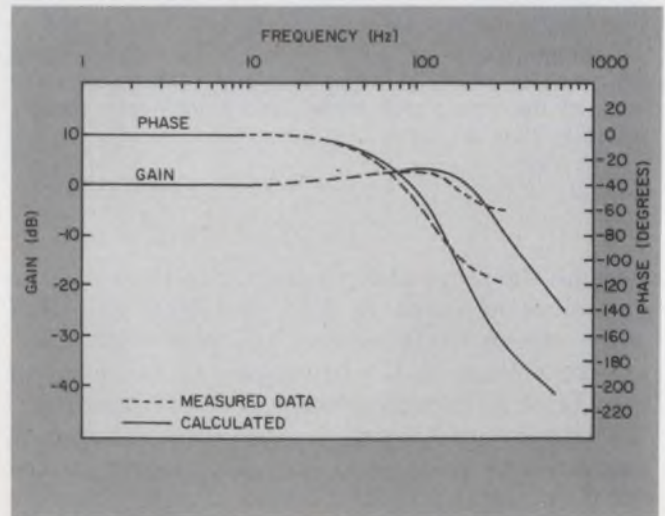

7. Closed-loop response of the torque tester also shows a close correlation between the experimental and theoretical data over most of the frequency range.

ranges. (The signal must always be larger than the noise on the system grounds.)

You can improve low-frequency open-loop measurements when you insert an amplifier at point A (Fig. 3). Similarly since loop gain is low at high frequencies, the $\times 10$ amplifier should be used at point B for high-frequency measurements. Note that the magnitudes of the signals at A and B (meter input terminals) are equal at

the gain-crossover frequency.

Note that the auxiliary-chain technique is not necessarily limited to electromechanical servos. You can also use the method to measure the characteristics of electronic amplifiers. And the technique is especially useful to test analog-computer simulations. As a design aid, of course, the method is invaluable: System performance is immediately available whenever you change the

value of a parameter.

To demonstrate the test method analytically, look at a compensated position servo (Fig. 4). The summing junction with inputs R and B, and output A, is formed when you break the loop and insert the auxiliary op-amp circuit of Fig. 2.

Calculation verifies method

With $R = 0$, the original servo remains unchanged, and the open-loop transfer function is given by

$$G_{OL}(s) = \frac{\theta_o(s)}{\theta_e(s)} = \frac{K_1 K_2 G_1(s) G_2(s)}{J s(s + B/J)}$$

The closed-loop transfer function is:

$$G_{CL}(s) = \frac{\theta_o(s)}{\theta_e(s)} = \frac{G_{OL}(s)}{1 + G_{OL}(s)}$$

Now consider the case when $\theta_c = 0$. Both the open and closed-loop transfer functions can be written in terms of A, B and R as follows:

$$\frac{B(s)}{A(s)} = G_{OL}(s); \quad \frac{B(s)}{R(s)} = G_{CL}(s)$$

Hence both the open and closed-loop responses of any control system are easily measured when you add an auxiliary summing point to the loop. Note also that you can easily measure the transfer functions of the individual elements of the system—just insert the two input leads of the gain-phase meter in the right place.

As a practical example of the technique, look at a bearing torque tester built by Hughes Aircraft Co. and used in the Intelsat IVA bearing-retainer stability verification program (Fig. 5). The outer race of the test bearing is belt-driven at a constant speed. The inner race is mounted on an air bearing and its position controlled by the servo loop of Fig. 5.

The inner-race position error signal—sensed by a proximity detector—controls the brushless dc torque motor of the inner race. The motor current, proportional to the motor torque, is a measure of the bearing's friction torque. In Fig. 5 the summing junction with signals A, B and R corresponds to the auxiliary amplifier circuit used for the frequency-response measurements. The open and closed-loop transfer functions of the servo are given in the figure.

Results of the open and closed-loop tests are given in Figs. 6 and 7. The responses, as calculated from the transfer functions, are also shown. The close correlation between the theoretical and experimental results demonstrates the validity of the new technique.

Note that the results should be compared only over the frequency range for which the transfer functions are valid. Note also that the accuracy of the test data (especially phase angle) usually degrades at high frequencies. This can be traced to the low signal-to-noise ratio at the loop output (point B in Fig. 5). ■■



KOOLER-KROWN

FOR TO-5, TO-8, TO-66
Power Transistors



Extend the life and useful power range of transistors with low-cost Kooler-Krown Heat Dissipators. The engineered design combines a large heat dissipation area with good natural air flow. Heat is effectively transferred by circumferential, intimate fit of heat dissipator to transistor case. Heavy gauge formed metal gives sufficient mass for heat dissipation, and acts as a firm spring to hold the Kooler-Krown onto the case. Ease of assembly, exceptional performance characteristics and low cost (only 24¢ each in quantity) are provided by Kooler-Krown heat dissipators. Best of all, get a sample and try it!



TRIAC-KOOLER

For Triac Packages



The Triac-Kooler is a low cost (only 17¢ each in quantity) heat dissipator that effectively levels excessive heat rise in triacs, affording greatly prolonged usefulness to the triac. A push-in rivet firmly assembles the Triac-Kooler to the base of the triac. The multiple finned area disperses the heat. The small size of the Triac-Kooler permits dense packaging. The attaching push-in rivet is supplied with each Triac-Kooler. Nothing else is needed. No tools. Send for your sample . . . try it.



Another Heat Dissipator!
The well known metal UNITRACK card guide affords heat dissipation or grounding for your "hot" boards right into the chassis.

UNITRACK®

UNITRACK Division Calabro Plastics, Inc.
8738 West Chester Pike, Upper Darby, Pa. 19082
Telephone (215) 789-3820

INFORMATION RETRIEVAL NUMBER 69

AVX puts class



under glass.

It's GlasGuard.™ A quality AVX axial monolithic capacitor. Encapsulated in a glass package. GlasGuard lets you afford excellence. It costs less than a molded capacitor yet it provides the environmental protection required in demanding commercial applications.

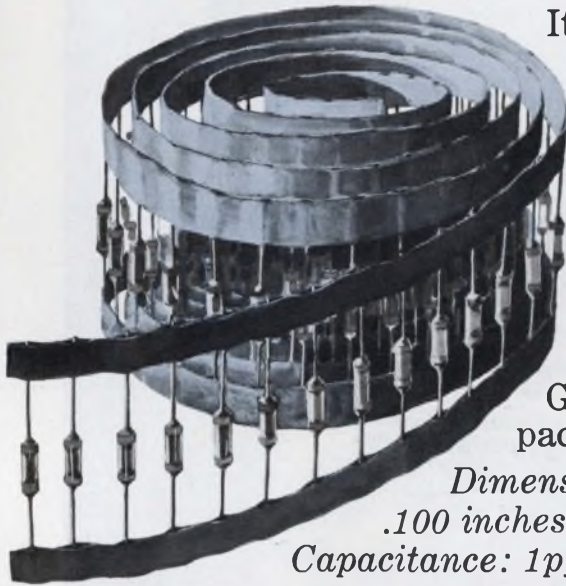

It's also a thoroughly modern component.

Axial leaded. Packaged in reels for automatic insertion allowing fast, economical, up-to-date assembly. Using the same equipment you use for your other axial parts.

Best of all, underneath it's an AVX capacitor. A precision component. Carefully manufactured and tested to provide you with greater reliability. By AVX. The industry leader in ceramic capacitors.

GlasGuards are available in three case sizes, reel packaged for automatic insertion.

*Dimensions: Length .170 to .260 inches, Diameter .065 to .100 inches, Lead diameter standard size .020 inches
Capacitance: 1pf to 120,000pf, Voltage: 25, 50, 100, 200VDC
Four temperature characteristics.*

AVX Ceramics, Department C-2, P.O. Box 867, Myrtle Beach, S.C. 29577

Send me detailed specifications of GlasGuard capacitors along with free sample.

Name _____

Title _____

Company _____

Address _____

Zip _____

Telephone _____

For faster delivery call AVX Ceramics directly: 803-448-3191 TWX: 810-661-2252

AVX: The Insiders

AVX Ceramics Division, P.O. Box 867, Myrtle Beach, S.C. 29577 803-448-3191 TWX 810-661-2252

AVX Distributors: Cramer Electronics Inc./Jaco Electronics Inc.
Newark Electronics/Texas Instrument Supply/Weatherford Co.

INFORMATION RETRIEVAL NUMBER 70

Team calculators with instruments to direct the test sequence, acquire and process data, and deliver output results. Cheaper than minicomputers, too.

Unsure whether to combine a minicomputer or a calculator with your instrument setup? Price, memory size and systems speed are the key factors to consider. Sure, the minicomputer is faster. But most small instrument systems are restricted by the speed of the instrument or the response of the devices under test; so computational speed is not that significant.

As for memory size, calculators with 4-k and 8-k capacity are now commonly available, and selected models can be extended with disc memory, if necessary. When it comes to price, a calculator system will generally cost 30 to 40% less than a comparable computer.

Calculators differ from computers, in that their language is built into the hardware. Thus when a calculator is turned on, it is ready to operate instantly; the computer must have a compiler loaded into memory. This also means that the calculator offers more useful storage than a minicomputer with equivalent memory. The mini must sacrifice memory to use a high-level-language compiler (or resort to assembly language). The disadvantage of the calculator is that the language is not changeable.

Three types of calculator language are available:

1. Keystroke, which resembles assembly language, since the housekeeping functions of moving information into and out of registers must be programmed.

2. Algebraic, which has a resemblance to high-level languages and is programmed much the same as a mathematical expression is written.

3. High-level, such as BASIC.

The least expensive calculators have the keystroke language; however, users of systems will find the higher-level language easier to learn and use.

Systems using calculators can perform data acquisition, frequency testing, network analysis and spectrum and distortion analysis (Fig. 1). And these systems can take data from a variety



1. Systems using calculators can take data from a variety of instruments, process the data and output the results to an assortment of peripherals.

of instruments, process the data and output the results to an assortment of peripherals, including plotters, printers and tape cassettes.

Interfacing is a serious factor

One problem with interfacing an instrument to a calculator is the need for a set of control lines and a set of data lines. This requires two I/O slots and the ability to communicate in parallel with from 40 to more than 100 separate lines. A typical 4-1/2-digit voltmeter is likely to require 10 to 15 control lines and 25 data lines. Furthermore each instrument requires a different number of lines, different logic senses and so on.

The result is that the interfacing capability

Roger Youngberg, Product Manager, Hewlett-Packard, Loveland Instrument Div., Loveland, CO 80537

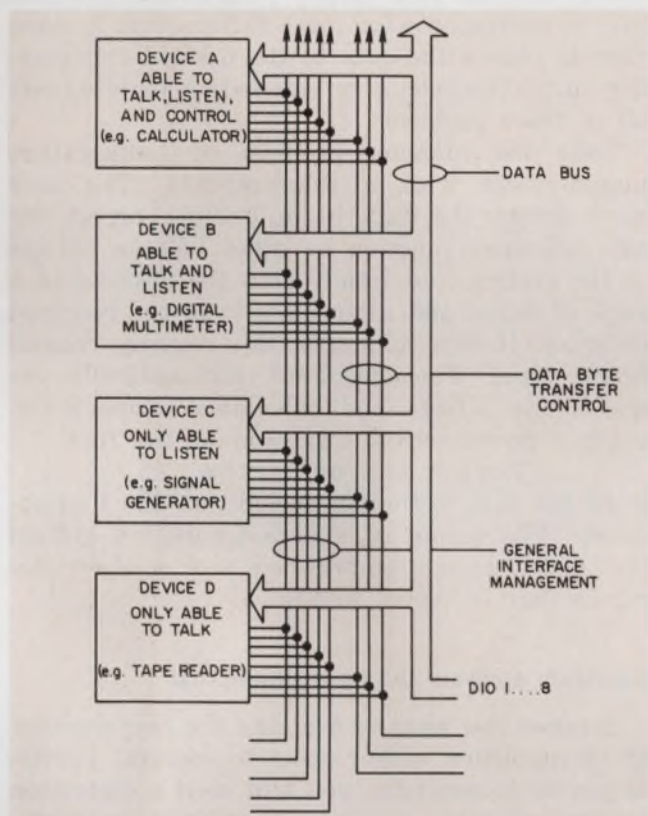

2. The Hewlett-Packard Interface Bus includes 16 signal lines to convey addresses, commands and data to the various interconnected devices.

is usually limited to a very few instruments, and the control and interface hardware is unique to each instrument. This drawback is responsible for the limited use of calculator-instrument systems.

Of course, all calculators offer a wide variety of dedicated peripherals, each occupying its own I/O slot. These are usually very flexible and well interfaced. Even though measuring instruments have not typically been so well equipped for calculator compatibility, the recent development of a standardized interface bus has changed this picture.

The International Electrotechnical Commission (IEC) is presently considering the interface definition for ratification as in the IEC standard

recommendation. It is an attempt to eliminate the hardware incompatibilities between instruments and to simplify the software necessary for intercommunication among devices.

The key advantages of the proposed IEC system include: (1) Ability to handle asynchronous communications between devices; (2) Capability to transfer data at any rate suitable for the devices, and (3) Provision to interconnect devices with differing I/O speeds.

A commercial version of this standard interface concept is now available and called the Hewlett-Packard Interface Bus. The interface focuses on the most frequent common needs within instrumentation systems—15 or less interconnected devices, distances shorter than 20 meters, data rates of less than 1 megabyte per second and relatively short messages between system components.

A key objective of the interface system is to permit interconnection of a broad spectrum of instruments with a wide variety of capabilities, including measurement, stimulus, display, storage and processor-related activities. The system must be effective in interconnecting a simple device, such as a 10-digit remote display, or a complex computer used to control a large system.

The HP interface system contains 16 signal lines to carry all information (addresses, universal commands, measurement data, program data and status data) among interconnected devices (Fig. 2). Eight signal lines (Data Input Output 1 through 8) carry coded messages in bit-parallel, byte-serial form to and from devices. Another eight dedicated signal lines carry special control and status messages. Three of these dedicated signal lines are used to effect the transfer of each byte of coded data on the D101 through the D108 signal lines. The remaining five dedicated signal lines are used to manage an orderly flow of information across the interface.

The interface system accommodates up to 15 devices (voltmeter, counter, power supply, controller) interconnected via a passive cable network. Interconnecting cables are available in 1, 2 and 4-meter lengths for ease in system assembly.

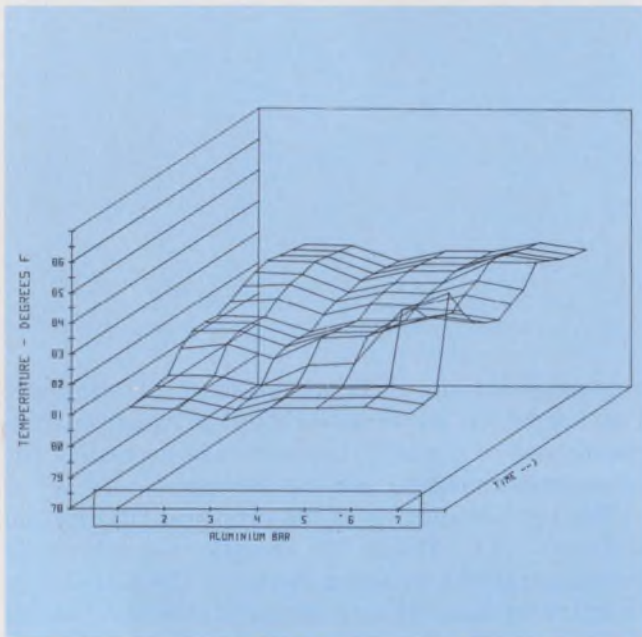

3. The temperature profile of an aluminum bar is displayed at the output of an HP data-acquisition system. The time scale represents 10 seconds between plots.

Information flow over the data signal lines is exchanged in byte-serial fashion, with each byte being transferred from one "talker" to one or more "listeners." The data flow is bidirectional, in that the same signal lines are used both to input program data and to output measurement data from a device. Data are exchanged asynchronously between devices to enable compatibility among a wide variety of instruments.

Since the bus structure permits communication between as many as 15 devices and uses one calculator interface card, it eliminates the pressure on the I/O structure of the calculator. Furthermore, since communication with the bus follows a well-defined set of rules, the system user no longer has to struggle with the idiosyncracies of each individual instrument's I/O structure.

Putting the combination to work

Measurement readings and calculations that formerly demanded hours of manual effort or the use of expensive computer time can now be performed by a desktop calculator at modest cost. These systems do not require specially trained personnel for programming, and they permit relatively unskilled operators to be assigned to production testing. In some cases the production test time has been decreased by a factor of 10 or more, and hardware costs have risen only to the extent of the cost of the calculator.

An area where the calculator has made one of its greatest contributions is that of data ac-

quisition. Here the measurement signal values are typically furthest removed from the actual measurement information desired. Rarely does the user want data in millivolts or ohms. Rather, it is micro-inches of strain, pounds per square inch of stress, temperature in degrees, pounds of weight or some other physical parameter that is sought.

The output of most transducers is in millivolts or ohms rather than physical parameters. In addition, the output is often nonlinear, needs to be scaled and has zero offsets. Hardware is necessary to compensate for these factors, and it takes time to reduce the data to the desired engineering units. The calculator can reduce or eliminate all of these problems.

Take the common problem of temperature measurement with a thermocouple. The user must accept the data in millivolts, correct for any reference junction or other voltage offsets in the system, and finally find the reading in a book of tables and interpolate it to the required accuracy. If done manually, this requires considerable time. The calculator automatically removes the offsets and calculates temperature, using a power-series expansion of the form

$$\text{Temp} = az = bx^2 + cx^3 + \dots$$

to fit the data to the nonlinearity of the thermocouple. The output of a data-acquisition system that measures the temperature profile of an aluminum bar is shown in Fig. 3.

Spectrum analysis can be a simple task

Suppose you want to evaluate the performance of an amplifier with respect to spectral purity. If you do it manually, you will need a distortion analyzer for the harmonic-distortion measurements, a spectrum or wave analyzer for intermodulation-distortion tests and some type of voltmeter for gain and bandwidth tests. And all this testing will chew up considerable time. The calculator can eliminate the need for much of the hardware and time. A typical spectrum-analysis system is shown in Fig. 4. The calculator can be programmed to do the following:

- Measure all the signal harmonics and calculate total harmonic distortion.
- Apply stimulus and measure intermodulation distortion.
- Control the vhf switch and analyzer to measure gain.
- Sweep the source and analyzer together to gather frequency response data.

In addition other tests that normally are tedious to perform—such as constant power bandwidth and distortion vs power—are done simply and rapidly because of the system's ability to control stimulus as well as to measure response.

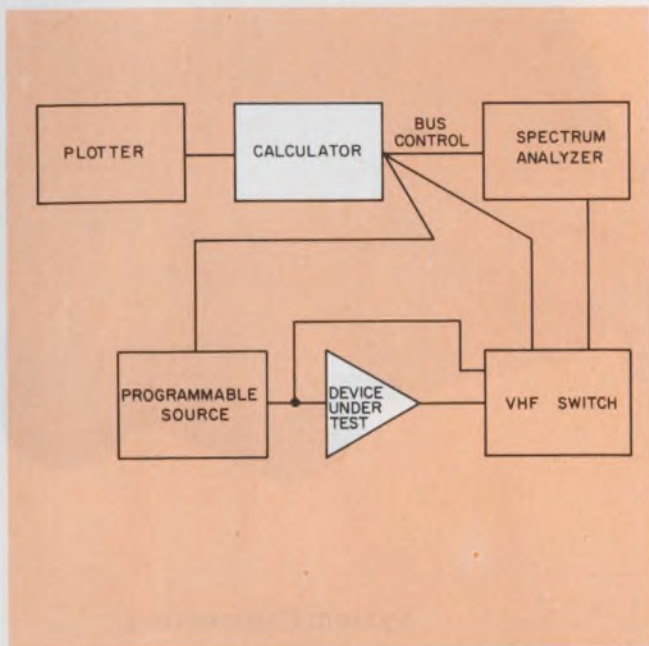

4. A typical spectrum analysis setup, with bus controls to connect the instruments to the calculator.

The fast-growing communications industry demands a wide variety of filters with tight specs. A number of major producers of such communications filters are using calculator-controlled network-analysis systems to control and test the production output. Among the complex series of tests to characterize the filter are these

- Insertion loss.
- -3-dB points and bandwidths.
- -60-dB points.
- Passband ripple.
- Passband group delay.
- Out-of-band rejection.

This variety of tests, performed manually, would demand extensive time and make high-volume production and testing costly. The calculator permits well over 100 measurements to be taken in less than 20 sec to characterize a filter fully; manual evaluation of the same filter could take 20 minutes or more.

The ability of the calculator to control the measurements and make pass-fail decisions allows a series of tests to be performed in seconds. The calculator is an ideal and cost effective controller for testing of this kind, since the response of the device being tested is typically in the 1-to-100-ms region, a speed easily handled by most calculators.

Systems with calculator control will be used more and more as hardware costs drop and speeds and capability rise. Standardization of interfaces will end equipment obsolescence caused by I/O incompatibilities. This, in turn, will put systems into the hands of many more users. ■■

BERG Minisert™

... Low-Profile P.C. Socket provides repeated pluggability for IC's, DIP's, etc.

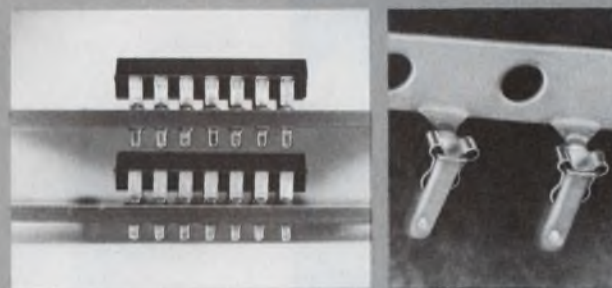

For use where space is restricted; extends just .030" above and .088" below board, allows .400" board-to-board spacing. One size MINISERT® socket fits wide range of hole sizes—.050" to .058" in diameter. RTV diaphragm seals foreign matter out of the socket. MINISERT socket accepts round or flat leads of DIP's, LED's and LSI's. Free-standing design can be used in any socket pattern. Semi-automatic machine inserts at rates up to 2000 per hour. Write for Bulletin 120, or call:



BERG
ELECTRONICS
Division E. I. du Pont de Nemours & Co. (Inc.)

New Cumberland, Pa. 17070 Phone: (717) 938-6711

*Terminals sell for \$20 to \$30 per thousand in volume quantities.

INFORMATION RETRIEVAL NUMBER 71

QUICKIE® CONNECTOR...

FOR THE RAPID, RELIABLE TERMINATION OF FLAT FLEXIBLE CABLE.

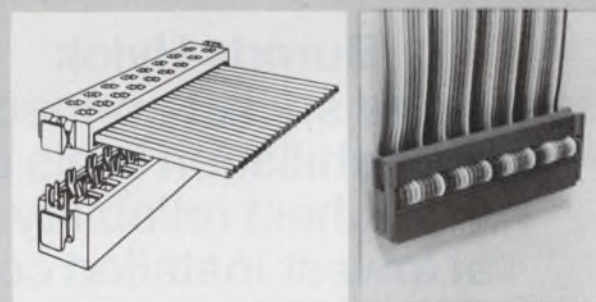

The Berg QUICKIE, a female connector, simultaneously terminates multi-lead flexible round cable *without* pre-stripping. The askewed tines of the contact effect a stripping action which terminates virtually any brand of cable, regardless of insulation material, in about 10 seconds. Design assures redundant electrical contact, and allows for visual inspection *before* assembly. QUICKIE can be used to interface cable on .050" centers to .025" square wire-wrapping posts on .100" sq. grid. Write for Catalog 125 or call:

*Berg Electronics Trademark



BERG
ELECTRONICS
Division E. I. du Pont de Nemours & Co. (INCORPORATED)

New Cumberland, Pa. 17070 Phone: (717) 938-6711

INFORMATION RETRIEVAL NUMBER 72

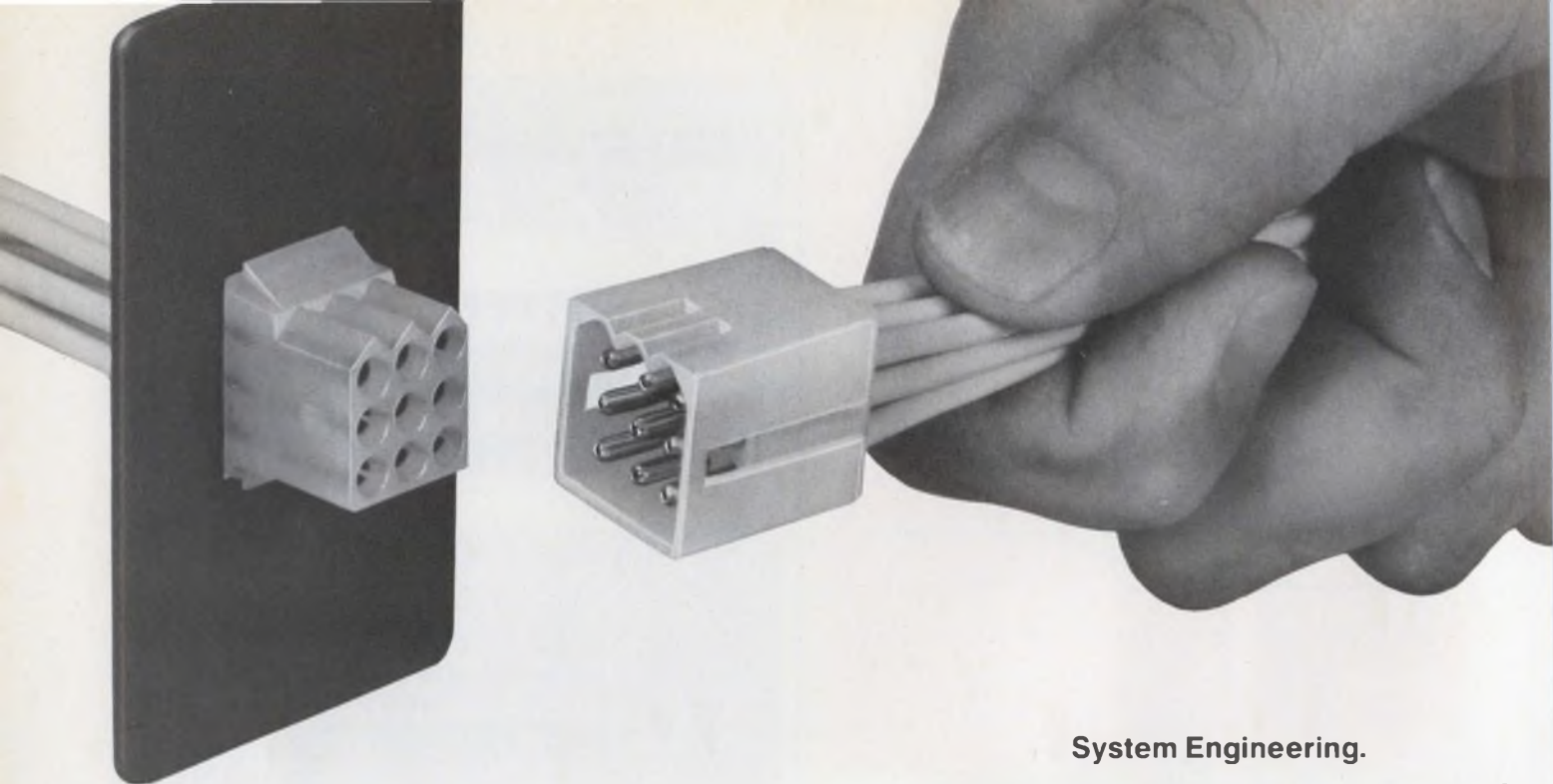

You can't beat "the system."

**Burndy Hylok[®]
pin and socket connectors
and installation tools offer
highest reliability
at lowest installed cost.**

System Engineering.

That's what makes the Burndy Hylok[®] pin and socket connector system perform at the lowest installed cost. Our contacts are specifically designed to be terminated in our rugged, automatic tooling and installed reliably and easily in our connector housings. It's a system that's designed to work together to give you trouble-free and faster assembled connectors. The result is lower installed cost because assembly is faster and easier at every step.

The Housings.

They're available in either panel mountable or free hanging styles and are made of tough flexible nylon. The housings have positive polarizing keys to eliminate

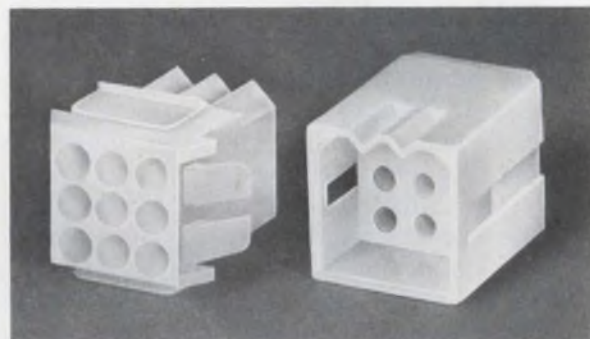

mis-mating. Low profile mounting ears make Hylok[®] fast and easy to install, and resilient take-up springs hold the housing securely over a wide range of panel thicknesses. Hylok[®] housings are available in 2,3,4,6,9,12 and 15 positions to cover virtually every application.

The Contacts.

Burndy Hylok[®] contacts feature a three point stabilizer and three positive

BURNDY CONNECTS

International Sales and Manufacturing Brussels Barcelona, Paris Rotterdam, Stockholm, Stuttgart, Turin, Zurich, St. Helens (Eng.), Toronto, Sydney, Tokyo, Mexico, Sao Paulo

forward stops. The result is an accurate, precise contact "float," so mating is always fast, easy and smooth. Never a contact out of alignment. Our contacts

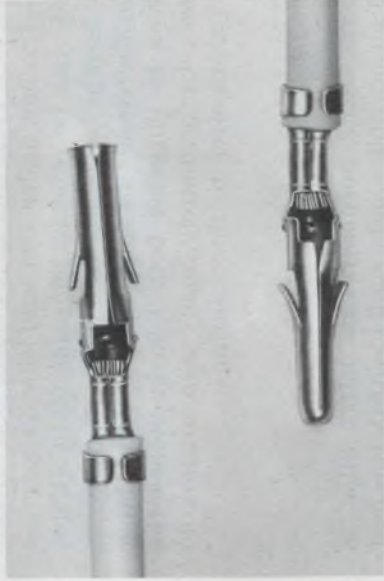

cover the full range of wire sizes. Number 24 to 16 AWG and .040" to .130" insulation diameter. They also feature serrated wire barrels to break up surface oxides and a stepped insulation barrel to keep the conductors in perfect alignment with the contacts.

The Tooling.

There's a complete line of Burnndy installation tooling to match every production requirement. The Burnndy UTM Universal Terminating Machine is a rugged 5-ton bench press that delivers the quietest, most consistently reliable crimps in the business. For larger runs, choose the Burnndy automatic wire processing machines ADET or ASET that cut the leads to length, mark them, strip them to length and terminate one or both ends. All at speeds up to 4,000 leads per hour! Burnndy installation tooling is as versatile as it is fast. Both pin and socket contacts are terminated in the same mechanisms to reduce change-over time and all



machines feature easy-to-set dial adjustments for wire size and insulation size.

Compatibility.

Burnndy Hylok® pin and socket connectors are interchangeable and interchangeable with other standard pin and socket connectors.

It all adds up to the finest system of pin and socket connectors ever made. A system that can't be beat for dependability and total value. For more information on Burnndy Hylok® pin and socket connectors, write Burnndy Corporation, Norwalk, Connecticut 06856. And see why you can't beat our system.

 **BURNDY**
Offices in principal cities throughout the United States

Untangle automatic test equipment

to find the right system for the job. A review of the relative merits of available ATE schemes helps untie the first knot.

With the wide variety of automatic equipment available for electronic circuit testing—of both commercial and in-house origin—the designer is faced with a tough selection process. Hardware organization schemes for automatic test equipment (ATE) vary widely from manufacturer to manufacturer. Specifications of commercial ATE are voluminous and direct comparison seems impossible.

To penetrate the fog, let's try to identify the basic types of ATE and discuss the capabilities and drawbacks of each.

Fundamentally, ATE hardware can be placed into two basic classes: fixed program and variable, stored program. Combinations or variations of these configurations are also available.

Fixed-program ATE

In the fixed-program type using comparators (cost: between \$1000 and \$30,000), circuits under test (CUTs) are inserted one at a time into the test equipment, and random signals are fed to the input pins. Signal values on the output pins of the CUT, and possibly some internal nodes, are compared with the values measured on the corresponding pins and nodes of a known-to-be-good circuit, used as a reference (Fig. 1).

The advantages of the fixed-program are twofold: (1) no programming is required; therefore, there's no software overhead; and (2) such a system can be built at low cost.

But the fixed program has a number of problems. First, it's not suited to test sequential circuits that have no reset lines. The CUT is likely to power up in an internal state that's different from that of the reference circuit. Second, because of the random inputs used as test signals, fault coverage is usually incomplete.

Another problem: Since a known good board is used as a standard for each of a number of different types of CUTs, and since at least one board of each type must be kept at each test loca-

tion, a high inventory of good boards must be kept.

Finally, comparators have limited capability to make analog measurements and to switch measuring devices from pin-to-pin of the CUT. These capabilities are usually found only in systems of far greater cost.

There are ways to get around these problems. For example, in sequential circuits—which can power up in unpredictable states—it's possible that good circuits will be accidentally rejected. However, if a reset line is provided, both circuit boards—the one under test and the comparison standard—can be reset to the same state. Otherwise, a homing sequence (an input sequence to initialize the circuit to some known state) must be derived to initialize both boards before the actual test. Unfortunately, many comparators do not lend themselves to this solution.

Fault simulator sidesteps problems

Random inputs normally can detect 30% to 60% of all possible single faults within the first few input steps. However, because so many additional random inputs are required to ensure complete fault coverage, the process almost becomes one of exhaustive trial and error. With se-

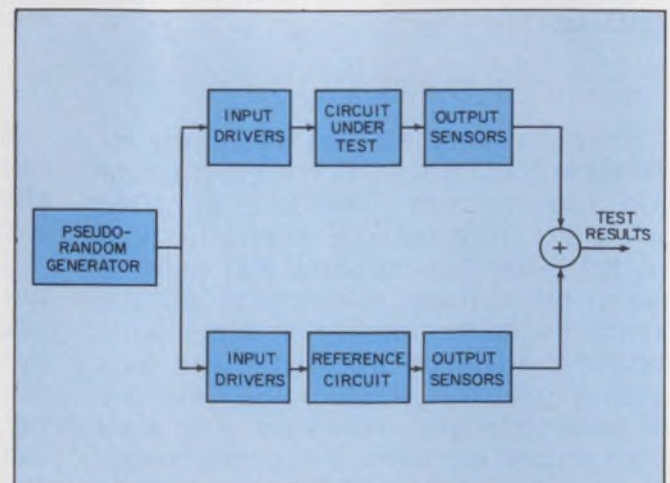

1. A fixed-program, comparator-type ATE compares the circuit under test with a reference circuit.

K. To and R. E. Tulloss, Members of the Research Staff, Western Electric Co., Engineering Research Center, Princeton, NJ 08540.

This Christmas, ask for a gift for a lifetime.



quential circuits, this problem is further compounded since the sequence of the tests is also important. This problem can be side stepped if a fault-simulator program is available. Tests can be generated manually or by one of the known algorithms—such as the path sensitization method, the D-algorithm or the Boolean difference method—and checked for completeness with the fault simulator. Again, most comparators do not permit this solution.

With respect to the inventory problem, known-good circuits need not be kept and used as standards. The values of good circuits can be predicted—either by a fault simulator or by actual measurement of a known good circuit. These values can be retained in a computer readable medium such as paper tape, cards, etc. An additional benefit is that there need be no fear of deterioration of the good circuit.

Another basic fixed-program ATE method is the pattern generator approach (cost: \$500 to \$15,000). In this method, a pattern generator sends a test vector into a good board and either records the subsequent output vectors or counts the number of transitions from ONE to ZERO and ZERO to ONE for each output pin. Any CUT that does not have the same output vectors or transition counts on corresponding output pins can then be labeled faulty (Fig. 2).

For fault location, transition counts of internal nodes are also recorded. To avoid race conditions, one input pin is changed at a time by use of a Gray code or 1-out-of-n code.

The advantages of the pattern generator are these:

1. Because of its fixed test procedure, it is considerably less expensive than computerized testers; and its associated software cost is nil.
2. The code generator can run tests at high speed.
3. The test sequence is exhaustive if the CUT

is combinational or if all of its flip-flops can be externally set, reset and sensed.

But the pattern generator technique has inherent deficiencies: initialization problems, faulty circuits with correct counts and incomplete test sequences. Let's look at them.

Sequential circuits need special care

Initialization problem: The pattern-generator method is applicable to combinational circuits since these do not have initialization problems. However, with sequential circuits, random starting will cause rejection of fault-free CUTs.

To avoid the initialization problem, a homing sequence must be used to reset the CUT for those sequential circuits that have no reset lines. But this may be impossible in many pattern generators.

Faulty circuits with correct transition counts: Undetected errors are possible when transition counts are used instead of the actually received vectors. This is because, in some circuits, the transition count is not unique. That is, the total count can be realized from more than one combination of inputs.

To verify whether the transition count is unique to the good circuit, a fault simulator can again be put to use. Fault simulation is usually overlooked for this purpose, nevertheless it can prove quite useful.

Incompleteness of test sequence: Since a fixed pattern is used as the test sequence, it may not be possible to detect all faults in sequential circuits. Again, this may lead to acceptance of bad circuits.

Solution: The completeness of the fixed test pattern for a particular circuit can be verified—again by a fault simulator.

In general, instead of a fixed pattern generator we can use a pROM (Programmable Read Only

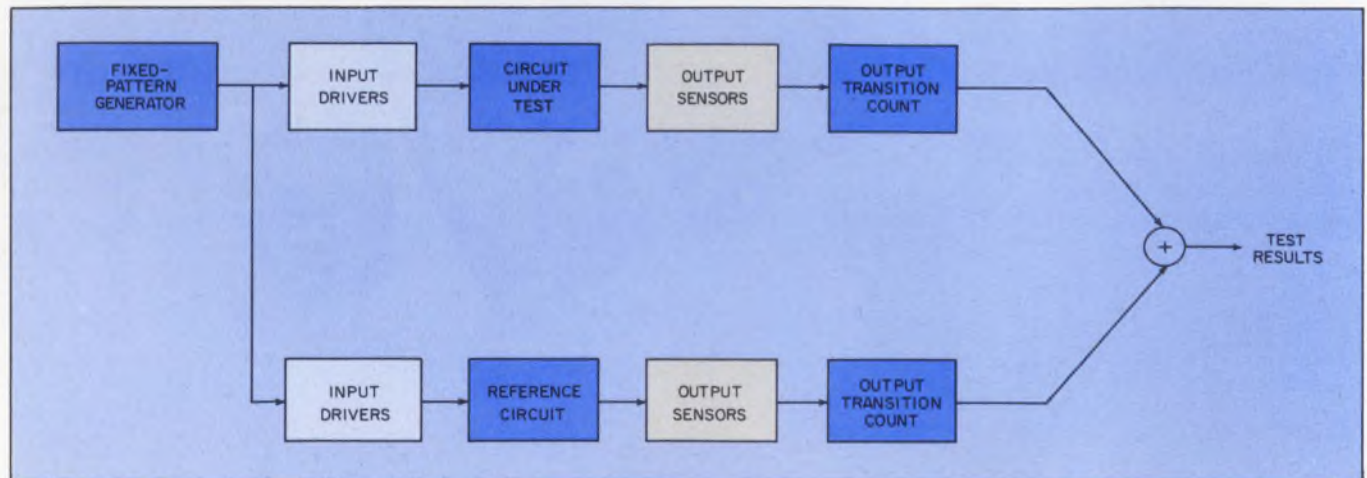

2. With the pattern-generator approach to testing, the ATE counts ONE-to-ZERO and ZERO-to-ONE transitions,

instead of checking the output functions. The total count is then compared with that of a good board.

A Hewlett-Packard pocket calculator is a gift for a lifetime.

The HP-35 Electronic Slide Rule.

Performs *all* basic arithmetic, trig and log calculations automatically. Has an Addressable Memory, displays 10 digits in fixed decimal or scientific notation, automatically positions decimal point throughout its 200-decade range. Cost, \$225*

The HP-45 Advanced Scientific.

Performs 44 scientific functions including vector arithmetic, rectangular to polar conversion, mean and standard deviation. Has 9 Addressable Memories. At \$325* it's *the* pre-programmed calculator for *all* scientists, engineers and students of science and engineering.

The HP-65 Fully Programmable.

The world's only fully programmable pocket calculator. You can write, edit and record programs up to 100-steps long. You can take advantage of HP pre-recorded programs, so you gain the speed/accuracy benefits of programming without writing your own. Performs 51 pre-programmed functions. Cost, \$795*

The HP-70 Business.

Performs all sorts of general business, interest, financial management, lending, borrowing and saving calculations—precisely, quickly, easily. A Financial Memory Bank lets you enter numbers in any order and change them anytime. Has 2 Addressable Memories and a very affordable price. \$275*

The HP-80 Financial.

Performs virtually *all* time/money calculations in seconds. Has a 200-year calendar, an Addressable Memory. Lets you make new kinds of management calculations that enable you to make better decisions. Cost, \$395*



Make this a special Christmas. Ask for an instrument crafted to last your working lifetime and designed to solve the problems you can expect to encounter throughout that lifetime.

Circle the HP pocket calculator that's right for you, then slip this ad to you-know-who. They can call us toll-free at (800) 538-7922 (In Calif. call (800) 662-9862) for the name, address and telephone number of a nearby HP dealer.

***All HP pocket calculators have Hewlett-Packard's patented RPN logic system with 4 Memory Stack and carry a one year warranty on parts and labor. Prices exclude state and local taxes.**

HEWLETT  PACKARD

Sales and service from 172 offices in 65 countries
Dept. 232N, 19310 Pruneridge Ave., Cupertino, CA 95014

INFORMATION RETRIEVAL NUMBER 75

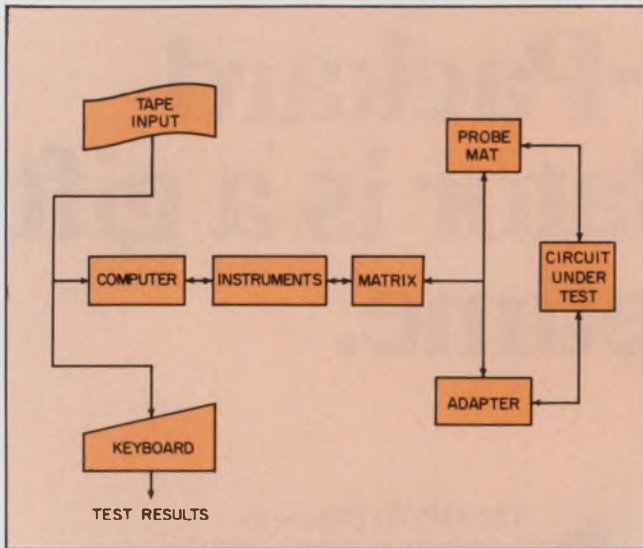

3. Still another approach to ATE for components is the computer-controlled stored program tester.

Memory) as a pattern generator. The complete test sequence (produced and verified by a fault simulator) can be put into the pROM. This means building your own pattern generator or doing some careful shopping.

Faults can be located by repeated execution of the complete test sequence while you trace back from the bad output pin, probe each stage and compare with precalculated values until a correct value is measured. The fault must then reside in the stage last measured.

Most versatile: variable, stored program

The variable, stored-program type is still another ATE method to be explored (cost: \$50,000 and up, and still rising). There are two approaches to the method: those of component and functional testing.

In the former, each of the components in the CUT is measured to determine if it is within tolerance. Access to the components is made via a mat of fixed-position probes (Fig. 3). Advantages are that a component tester can locate multiple faults; and fault location is simple and immediate: The faulty component is the one that's out-of-tolerance or nonfunctional.

One disadvantage is that each of the components must be probed, and the cost to construct and maintain the required large number of probe mats is excessive. Of course, all the components in the circuit must be easily accessible—not always possible. Another disadvantage: Circuits whose components are out of tolerance in such a way as to compensate one another may work, but they would not pass component-tolerance tests.

Once we leave the realm of discrete-component circuits and look at those with ICs, the boundary

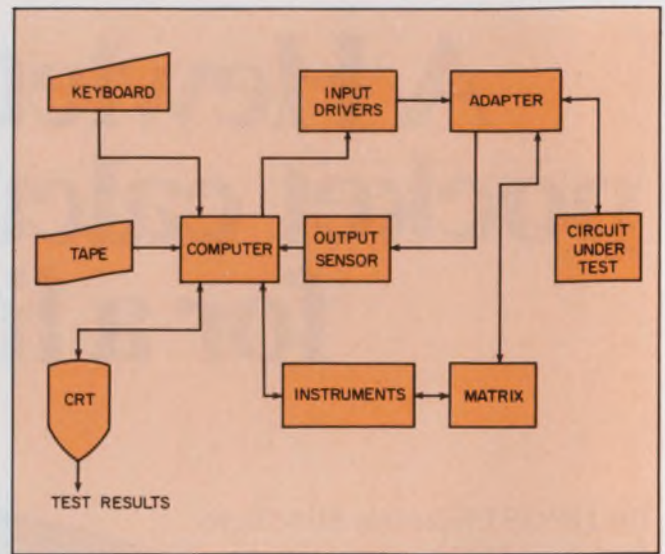

4. For functional testing, the most versatile—and most expensive—configuration uses diagnostic software.

between discrete-component and other modes of testing blurs. One variation is to use IC clips and pattern generators to check the ICs, with conventional probe mats for discrete components.

Functional testing—the second approach to variable, stored-program ATE—is the most flexible and most expensive of all the types. Here, test sequences are usually verified for completeness by a fault simulator, and faults are located by a fault-dictionary look up or other on-line diagnostic software (Fig. 4).

Flexibility is the strong point of variable, stored-program test equipment because of (1) stored-program control; (2) a switching system that routes the instrument connections; (3) accessibility of the computer for any required data processing; (4) the wide selection of vendors who offer the test-equipment building blocks; and (5) the possibility of re-configuration through the addition or deletion of software or hardware building blocks.

The major disadvantage is a management problem: Operation and maintenance of a sophisticated, complex test system is not unlike that of a computer center.

With the varieties of hardware that are available, potential users must be fully aware that though they may buy a half-million-dollar system, they still may be forced to spend that much—or more—on software development. To produce quality test programs to drive a sophisticated ATE involves high costs; and additional cost is incurred every time an engineering change goes through on a product to be tested.

The manpower to design and prove-in test programs is likely to be expensive too—both because of the engineering talents required and because of the sheer bulk of work needed to analyze today's complex digital designs. ■■



I've got D.R.*

AND YOU CAN GET IT TOO!...
in connectors with
dielectric retention from Bendix

D.R. GIVES YOU

- rear release crimp contacts—minimizes potential interfacial seal and contact damage during contact removal
- increased dielectric separation between contacts
- greater reliability plus weight savings—fewer components per connector
- hard-faced chamfered socket inserts assuring positive mating pin alignment
- improved temperature-life capability at 200°C
- optimum fuel and fluid resisting capabilities

***dielectric retention** (re-ten'shun), n: an innovative method of retaining removable contacts in an electrical connector, incorporating a single dielectric wafer rather than individual metal contact retention clips

D.R. CONNECTOR DESIGNS

- are offered in MIL-C-26482, 38999 and 83723 types
- utilize common application tooling
- intermate and intermount with existing series
- are tooled in over 30 arrangements

GETTING D.R. IS EASY.

Just contact The Bendix Corporation, Electrical Components Division, Sidney, New York 13838, your nearest Bendix sales office or authorized Bendix distributor.



Watch Out.

The volts are out to ruin your computer, maybe your entire system!

Nobody needs to remind you that the erratic demand on electric power these days has created a potential "brownout" condition in just about every major industrial area. Protecting your computer or system from the crazy dips and surges in voltage is critical. A slight dip can cause a computer to drop a few digits, lose parity, distort information, or lose its memory entirely. A surge damages delicate components and ruins printed circuits.

Sola Electric's "brownout insurance" comes in the form of highly reliable constant voltage transformers and Solatron® Voltage Regulators

—in a wide range of specifications. Most are standard units and immediately available for off-the-shelf shipment. And our applications engineering people are ready to help right now —whether you're designing voltage regulation into your equipment or adding protection to an existing system.

Protect yourself. Contact your local Industrial Distributor or the AC Products Group at Sola Electric. Call (312) 439-2800 or write Sola Electric, 1717 Busse Rd., Elk Grove Village, Illinois 60007.

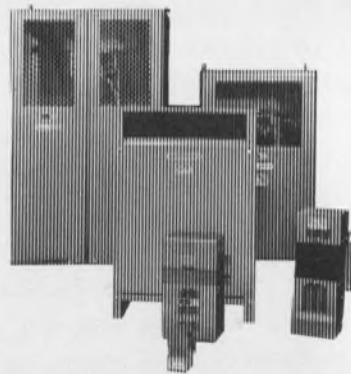

Get brownout "insurance" from SOLA

SOLA ELECTRIC

SIB
SOLA BASIC

INFORMATION RETRIEVAL NUMBER 77

Here are our thirteen new Data Converters.

We don't have to say how great they are. We'll just say that they'll solve a lot of your data conversion problems. That the price is good in singles. Great in 100's. And that they're available now. But that's

what you expect from Teledyne Philbrick. New data converters that speak for themselves.

TELEDYNE PHILBRICK **4070**
high speed
8-bit multiplying
D/A converter

TELEDYNE PHILBRICK **4131**
1 μ s. 10-bit A/D converter

TELEDYNE PHILBRICK **4133**
2.5 μ s. 12-bit A/D converter

TELEDYNE PHILBRICK **4060**
8 bit
high speed current
D/A converter

TELEDYNE PHILBRICK **4072**
high speed
12-bit multiplying
D/A converter

TELEDYNE PHILBRICK **4130**
750ns 8-bit A/D converter

TELEDYNE PHILBRICK **4129QZ**
12-bit A/D converter

TELEDYNE PHILBRICK **4071**
high speed
10-bit multiplying
D/A converter

TELEDYNE PHILBRICK **411710**
buffered 2 5 digit
bcd A/D converter

TELEDYNE PHILBRICK **411610**
buffered 8-bit
A/D converter

TELEDYNE PHILBRICK **4061**
10-bit
high speed current
D/A converter

TELEDYNE PHILBRICK **4132**
3.5 μ s. 12-bit A/D converter

TELEDYNE PHILBRICK COUPON

If you'd like complete specs on any or all of our thirteen new data converters, circle the number(s) below and mail the coupon today,
4060 4061 4070 4071 4072 4039QZ 4129QZ
4130 4131 4132 4133 411610 411710.

Name _____ Title _____
Company _____
Address _____
City _____ State _____ Zip _____

ED

Telephone (617) 329-1600. Or write, Dedham, Mass. 02026.
In Europe, Tel. 673.99.88, Telex: 25881. Or write, 181 Chaussee De La Hulpe, 1170 Brussels.

Design a low-cost pH meter.

Match a sensor to a suitable amplifier and DPM to get a digital unit that resolves 0.01-pH units with an accuracy of 0.02 pH.

With the availability of relatively inexpensive digital panel meters (DPMs) and high-impedance op amps, it's now possible to design a low-cost, digital-readout pH meter with resolution of 0.01 pH units and accuracy of 0.02 units.

High input impedance—and, hence, low bias current—are important, because the internal resistance of the glass-calomel probe commonly used to sense pH is high—in the range of 10^8 to $10^{11} \Omega$. Thus an electrical model of the probe looks like a high-resistance voltage source (Fig. 1).

Ideally a pH meter should have the following characteristics:

- *High input resistance*— $10^{13} \Omega$ or greater.
- *Offset control*—to balance out the natural offset voltage of the glass electrode, as well as the IR drop of the op amp's bias current across the electrode's internal resistance.
- *Voltage scaling*—to adjust the slope of the probe function at 25 C from 59.13 mV/pH to either 10 mV/pH or 100 mV/pH for a correctly scaled digital reading.
- *Gain control to maintain the output at either 10 mV/pH or 100 mV/pH*—to compensate for probe output variations with temperature. The output varies from 54.17 mV/pH at 0 C to 74.00 mV/pH at 100 C.
- *Operating temperature range of 15 to 35 C*—usually sufficient if the pH meter is to be used in an indoor laboratory.
- *Power requirements of ± 15 V, 25 mA, with a line and load regulation of 0.5% or better.* Many suitable commercial modular supplies are available.

Just two stages needed

Two op-amp stages form the basic pH circuit (Fig. 2). High input resistance is achieved in the first stage with a FET or varactor-bridge op amp, used in a noninverting configuration. The gain of this stage sets the voltage scaling, and at 25 C a gain of 1.69 gives a factor of 100

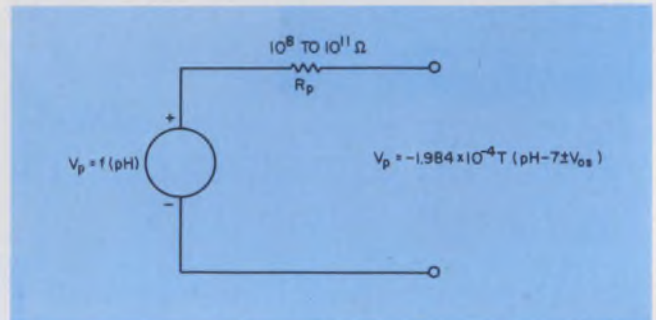

1. Model of a glass calomel pH probe appears as a voltage source in series with a high resistance.

mV/pH. Since the gain is given by $1 + (R_f/R_7)$, resistor R_f can be made variable to provide the range to compensate for temperature excursions between 0 and 100 C.

Note that the temperature under consideration here is that of the glass electrode probe—which is not necessarily that of the room ambient. First-stage design parameters for various temperatures are given in the table.

To change the slope of the probe function—that is, to make the output voltage increase in a positive direction with increasing pH value—the second stage is hooked up as an inverter. This stage also has a variable offset (provided by R_{12} and R_{13}) sufficient to drive the output to any value between -1400 and $+1400$ mV. Thus the pH meter is equipped for use in potentiometric titrations. With the gain and offset controls in separate stages, interaction between these parameters is eliminated.

The direct output will drive a DPM with a full scale of 1.999 V. With a voltage divider (R_{20} and R_{21}), a DPM with a full-scale voltage of 199.9 mV can be used. As an alternative, a wide-scale—at least four inches—1-mA moving-coil meter, calibrated linearly from 0 to 14, can be used as a readout. However, the meter resistance plus the sum of resistors R_{18} and R_{19} must total 1400 Ω .

Switch S_1 is the amplifier input control. In position 1 of S_1 , the probe connects directly to the input. If the probe is not in a solution, or is not connected to the input terminals, position

Robert J. Dugan, Instrumentation Engineer, Dept. of Chemistry, University of Florida, Gainesville, FL 32611

2 can be used to ground the op-amp input to prevent amplifier drift. In this position the meter reads approximately pH 7.

Positions 3 and 4 of S_1 are for testing and calibration. In position 3 a voltage divider—set as close to +295.6 mV as its trimpot allows—forms the input. This value corresponds to pH 2 at 25 C. Position 4 connects to a fixed value of -295.6 mV and corresponds to pH 12 at 25 C.

To adjust the meter, first allow 15 minutes for warmup. Then set S_1 to position 2 and adjust trimpot R_{11} for zero volts at the output of stage 1. Monitor the voltage on the wiper of R_{12} and set to zero volts; then adjust R_{17} for zero volts at the output of stage 2. Finally adjust R_3 for +295.6 mV at terminal 3 of S_1 and R_4 for -295.6 mV at terminal 4.

Built-in calibration and test

To calibrate for operation at 25 C, short the input (S_1 at position 2) and adjust the offset control (called Standardize) to a reading of pH 7. Then set S_1 to position 3 and adjust the gain control (called Temperature Compensation) for a reading of pH 2. Switch position 4 should now give a pH 12 reading.

This procedure also confirms that the circuitry is working properly. (Users of pH meters commonly fault the electronics for bad operation, though most problems originate with the probe or the solution.)

To use the meter, go through the 25-C calibration check: Put the probe in a buffer solution of known pH at 25 C, set S_1 to position 1 and turn the Standardize pot until the pH reading is that of the buffer. The meter is now ready to use.

To keep errors down, examine carefully the changes in bias current and offset voltage with ambient temperature fluctuations. In laboratories the maximum temperature change can be assumed to be about ± 10 C.

Note that errors caused by bias-current drift exceed those of offset-voltage: With a V_{os}/T of $20 \mu\text{V}/^\circ\text{C}$, the error is $200 \mu\text{V}$ for a 10 C change, which corresponds to a reading error of 0.003 pH units. But with an initial bias cur-

pH theory: A refresher

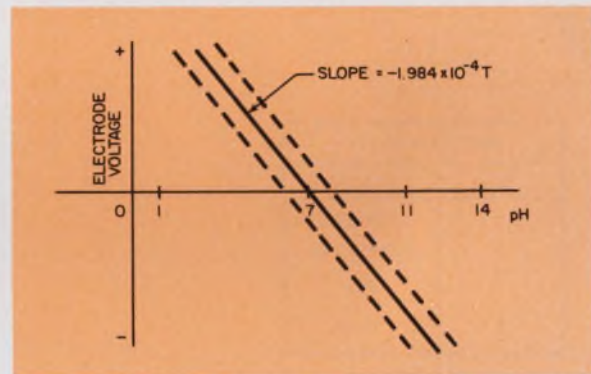

In a neutral solution—one that is neither acidic nor basic—the pH is 7.0 at 25 C. This decreases for acidic solutions and increases for basic solutions. Each unit change in pH number represents a tenfold change in hydrogen-ion activity, a_{H} , which is related to the concentration of hydrogen ions in a solution—specifically $\text{pH} = -\log a_{\text{H}}$.

Most pH measurements use a glass-calomel electrode probe to provide a linear voltage as a function of pH over most of the pH range—pH 1 to pH 11. Modified glass-calomel electrodes are used to cover the strong base end of the scale—from pH 9 to pH 14.

The voltage-pH relationship is described by the equation

$$V = - \frac{RT (\ln 10)}{F} [\text{pH} - 7 \pm V_{os}] ,$$

where R is the gas constant ($8.314 \text{ J}^\circ\text{K}^{-1}$), F is the Faraday constant (96487 coulombs/mole), T is the probe temperature in degrees Kelvin, and V_{os} is a small offset voltage, which has a different magnitude for each probe.

With the constants inserted, the equation becomes

$$V = -1.984 \times 10^{-4} T (\text{pH} - 7 \pm V_{os}) ,$$

and, when $T = 25 \text{ C}$ (298 K),

$$V = -0.05913 (\text{pH} - 7 \pm V_{os}) .$$

The figure shows the probe characteristics. The dotted lines indicate the range in which the actual curves can fall, depending on offset voltage.

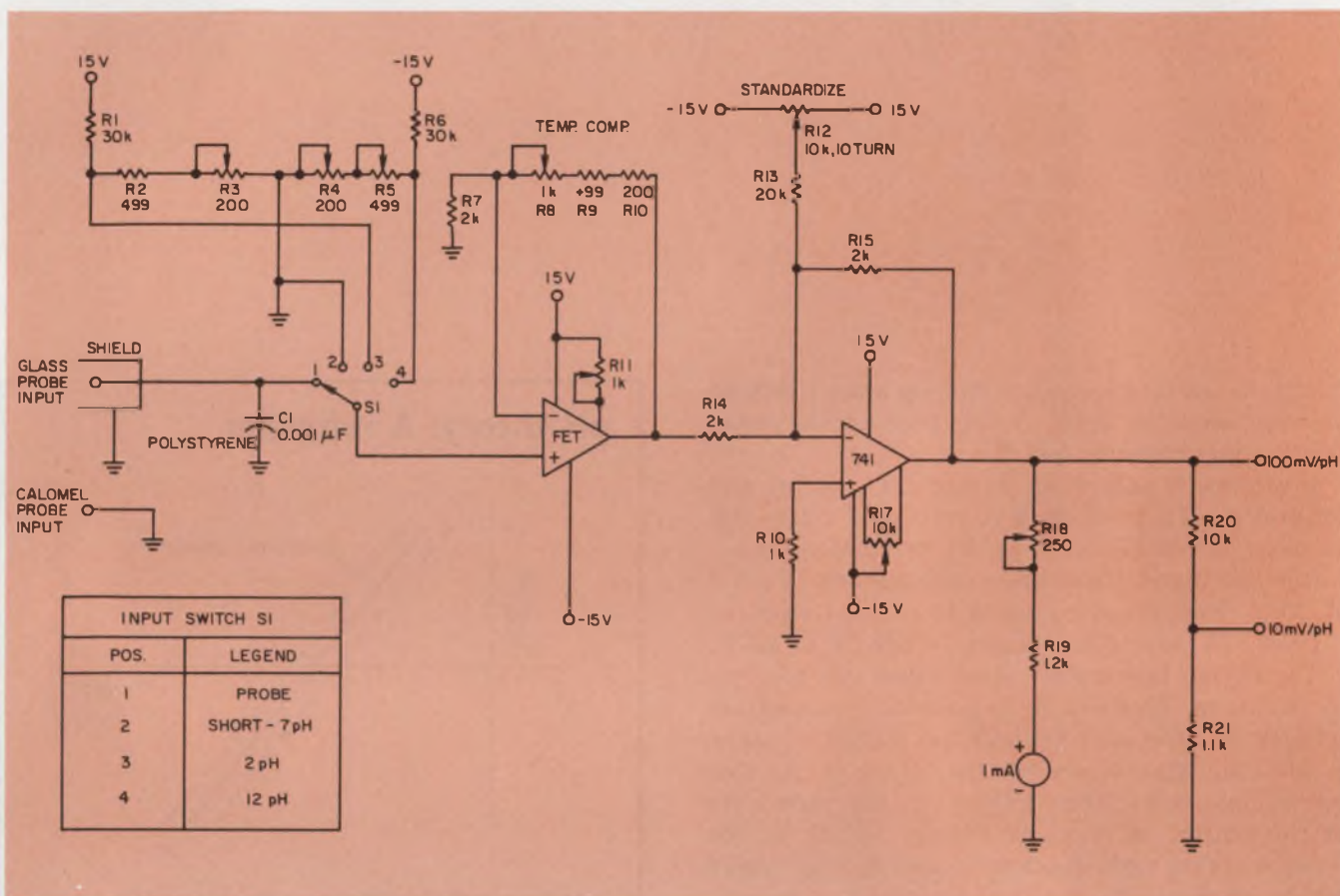

2. Just two op amp stages are needed to design an accurate pH meter. The first stage, a FET, provides high input impedance to prevent loading of the probe; while

the last stage inverts the probe's output to give a positive slope of voltage vs pH. Independent gain and offset controls are provided.

rent of 1 pA and a probe resistance of $10^{11} \Omega$, the error is 100 mV for a 10-C change. This corresponds to a reading error of 1.69 pH units—obviously unacceptable.

Two op amp choices possible

There are two ways to avoid large errors: (1) Use a high-cost, varactor-bridge op amp—such as the Burr-Brown 3339/27, with a maximum bias current of 10^{-14} A. Or (2) Use a low-cost op amp—such as the Analog Devices 40J, which has a rather loose spec of 50 pA but usually measures about 1 pA.

With the varactor bridge, the maximum error will be 0.017 pH. With the low-cost op amp, the room temperature must be reasonably stable while the pH measurements are taken (about ± 2 C) and the initial error must be balanced out with the Standardize pot.

For best long-term stability, resistors should be 1% wire-wound or metal film. These provide a tempco of 100 ppm or better. Common 5% carbon-composition resistors can be used, but calibration will be more difficult and more fre-

First-stage parameters

Temperature	Slope of probe function	First-stage gain	$R_f = (R_x + R_y + R_{10})$
0 C	54.167 mV/pH	1.85	1693 Ω
25	59.13	1.69	1382
50	64.08	1.56	1121
100	74.00	1.35	703

quent. Note that switch S_1 must have an insulating material of $10^{14} \Omega$ or greater; ceramic and most phenolic materials are suitable.

The final choice of op amps depends, of course, on the budget. With all parts purchased at single-unit prices, the cost of the pH meter is \$75 with the AD 40J and a 4-1/2-inch, 1-mA analog readout. With the varactor-bridge op amp, add \$55.

A 3-1/2-digit DPM, instead of the analog meter, adds \$120 to the cost, for a total of \$195 or \$250. Of course, the best resolution, accuracy and stability is achieved with the DPM and varactor-bridge combination. ■■

Front panel components should look good.

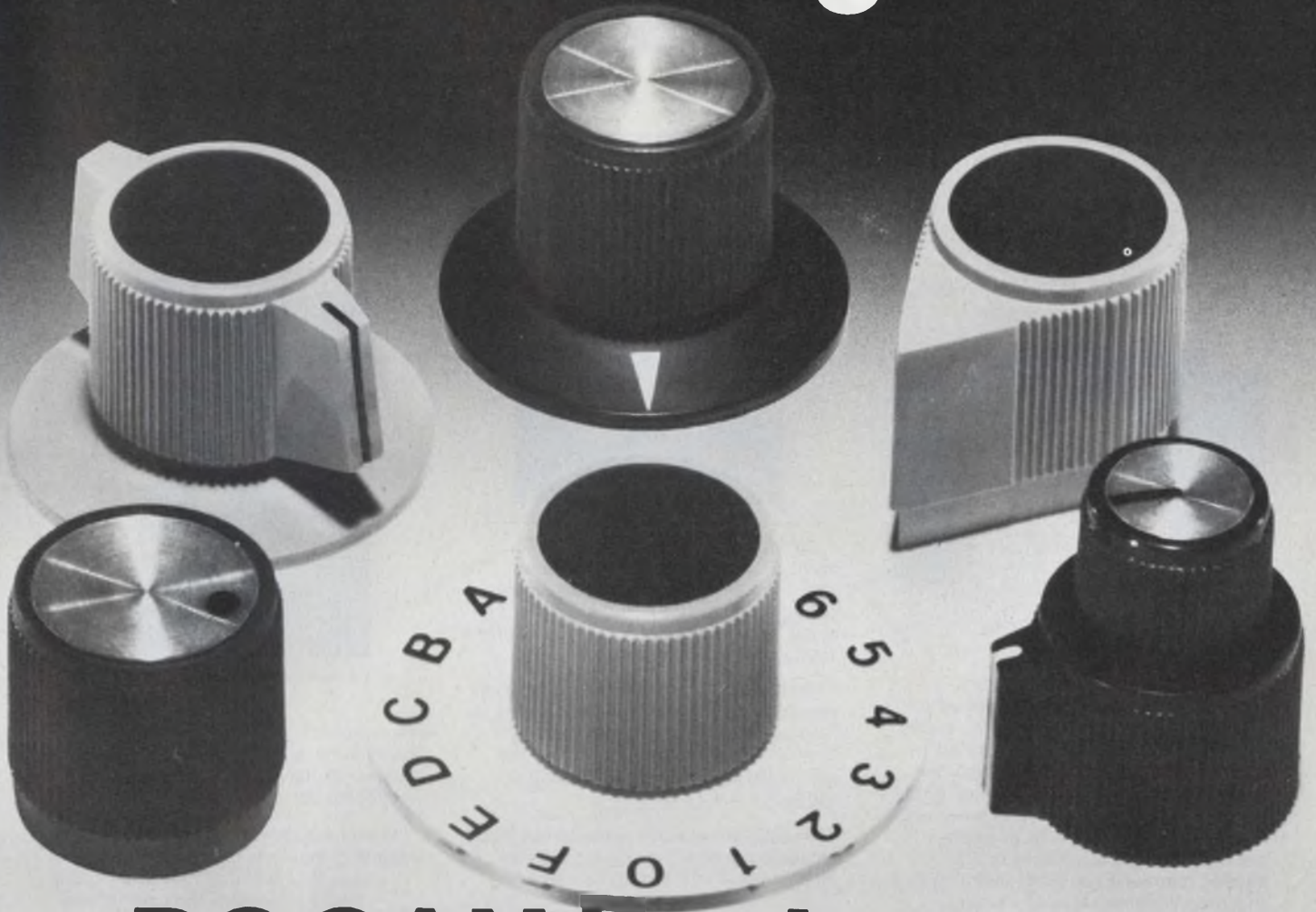

ROGAN knobs and dials do.

Today's market is aesthetics-conscious. An attractive front panel adds to the acceptance of your product. Front panel components, including control knobs and dials, must contribute to the overall design. Some knobs and dials simply look better than others. We think that the Rogan line illustrates superior styling details, while offering the largest selection of functional shapes and sizes available.

Obtain a copy of our catalog by contacting Rogan . . .
the control knob and custom dial company.

ROGAN

C O R P O R A T I O N

3455 Woodhead Drive, Northbrook, Illinois 60062
Phone: (312) 498-2300 • TWX: 910-686-0008

Missing some test data?

Are you missing some test data because you don't have an instrument that can capture it . . . or one that can adequately read it out?

The missing link may well be a Nicolet 1090 digital oscilloscope.



There are many good laboratory measuring instruments that suffer either from lack of adequate speed or from their inability to retain a signal for detailed analysis. For instance, an X-Y recorder may not react quickly enough to record all the transitions in your signal of interest. By the same token a voltmeter or analog oscilloscope typically makes only a fleeting readout. Even those instruments that have the ability to hold a reading usually cannot read it out as a permanent record, nor can they present it for more detailed analysis.

This is one area where the 1090 really shines. You can record two waveforms simultaneously, and display up to four waveforms simultaneously for easy comparison. Since waveforms are stored digitally you may retain them until you wish to store new information.

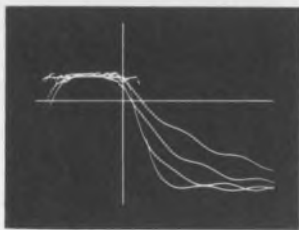

The 1090 offers numerical readout of any selected data point. Selection is made with an easily moved cursor. Wherever the vertical cursor intercepts the waveform the alphanumeric readout on the CRT displays time from trigger and voltage

recorded at that point in time. Both values are calculated by the 1090 so that the CRT alphanumeric are in actual time and voltage. (You don't have to multiply a number times a switch setting.)

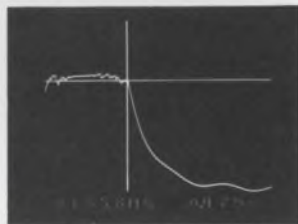

So you can closely inspect any particularly interesting portion of your signal the 1090 offers expansion of the stored waveform up to 64 times on both X and Y axes revealing selected detail of the 4096 x 12-bit word memory.

The 1090 also offers mid-signal trigger capability so you can "look backwards" in time as well as forward from the trigger. This feature permits you to inspect the events leading up to, and following, a trigger.

Besides being much easier to use than an analog 'scope, the digital 1090 also offers hardwired interface to magnetic

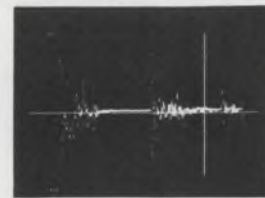

A. An unexpanded view of a signal from an accelerometer. Vertical marker shows center of region which will be shown when display is expanded.

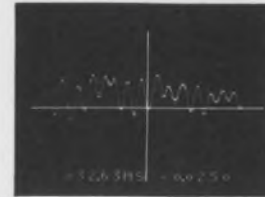

B. Fig. A with X and Y scale magnification of 8.



C. Fig. A with X and Y scale magnification of 32.

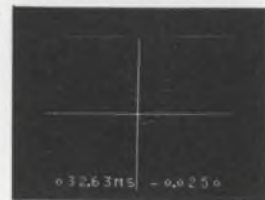

D. Fig. A with X and Y scale magnification of 64.

tape recorders, programmable calculators, and X-Y recorders. Some customers have interfaced it to a minicomputer.

Waveforms previously stored on digital magnetic tape may be recalled from your tape library and examined using the 1090's expansion and comparison features.



Phone or write for details on the 1090 and its plug-ins and how they might apply to your measurement needs in the frequency range of d.c. to 1 MHz.

NICOLET INSTRUMENT CORPORATION

5225 Verona Road
Madison, Wisconsin 53711
Telephone: 608/271-3333

INFORMATION RETRIEVAL NUMBER 80

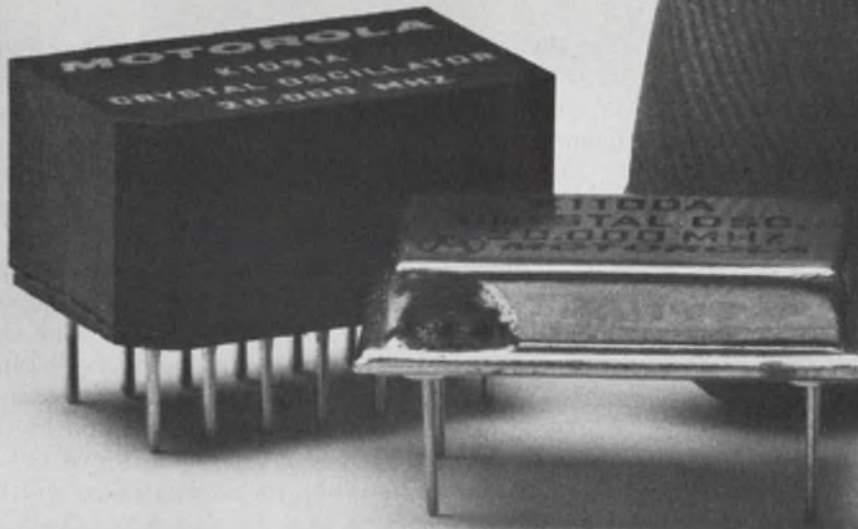

Think *hybrid* **small.**

Here's a crystal clock oscillator that's even smaller than our K1091A. Fits the same circuits, same sockets. And even costs less in volume quantities. The K1100A is available from 250 kHz to 20 MHz, and, like the K1091A, is TIL compatible, has $\pm 0.01\%$ stability from 0°C to $+70^{\circ}\text{C}$, and uses the standard +5V dc input.

Rush delivery now available.

Now you can take advantage of 4-week

volume delivery of the K1100A in stock frequencies (4.0, 4.9152, 5, 10, 20 MHz). 6 week delivery for any discrete frequency from 4 to 20 MHz. And 8 week delivery for any discrete frequency from 250 kHz to 4 MHz.

For full specifications and prices on both the K1091A and K1100A, write Motorola, Component Products Department, 2553 N. Edgington, Franklin Park, Illinois 60131.

Or call (312) 451-1000.



MOTOROLA
Communications and Electronics Inc.

ideas for design

Slave clock can run free at center frequency and lock in within one cycle

Unlike the conventional phase-locked-loop circuit (PLL), the slave clock in the figure can run free at the normal lock frequency. It can achieve synchronism with a reference in less than one cycle and slip phase by less than a cycle when incoming signals are lost.

The circuit's free-running frequency can be adjusted to slightly above or below the lock frequency, as well as to "dead-on," without interference with the lock, free-run or acquisition modes. Though this slave clock is not a true PLL circuit, it will replace and outperform the PLL in many applications.

In the free-running mode, the collector of Q_2 remains low. As a result G_3 enables the one-shot OS-2. The Q output of OS-2 is inverted by G_1 and G_2 and applied to OS-1. Thus OS-1 is triggered by each leading edge of OS-2 output, and OS-2 is triggered by each trailing edge of the OS-1 output.

The pulse width of OS-1 approximates the desired free-running period as set by C_2 , R_9 , and R_5 .

The pulse width of OS-2 is set to about $3/4$ that of OS-1 by R_6 , R_{10} and C_3 , so that OS-1 output is asymmetrical and at the free-running frequency.

OS-3 has a pulse width half that of OS-1 and thus can restore the symmetry of the output. Symmetry is adjusted by R_7 .

In the slave mode, the master-clock signal appears at the collector of Q_5 , which on rising edges triggers OS-2 via G_3 and OS-1 via G_1 and G_2 . Thus OS-1 receives a trigger at both the beginning of each master clock cycle and a second trigger from OS-2, via G_1 and G_2 , about $3/4$ of the way through the cycle of OS-1. Since OS-1 is retriggered in less than its normal pulse width, its Q output remains low. In this way, OS-2 is continuously enabled and triggered by each master clock pulse to keep its output in phase with the master clock.

If a master-clock signal fails to arrive on time, OS-1 will not be kept triggered, and its enabling signal to OS-2 will end approximately $3/4$ of the

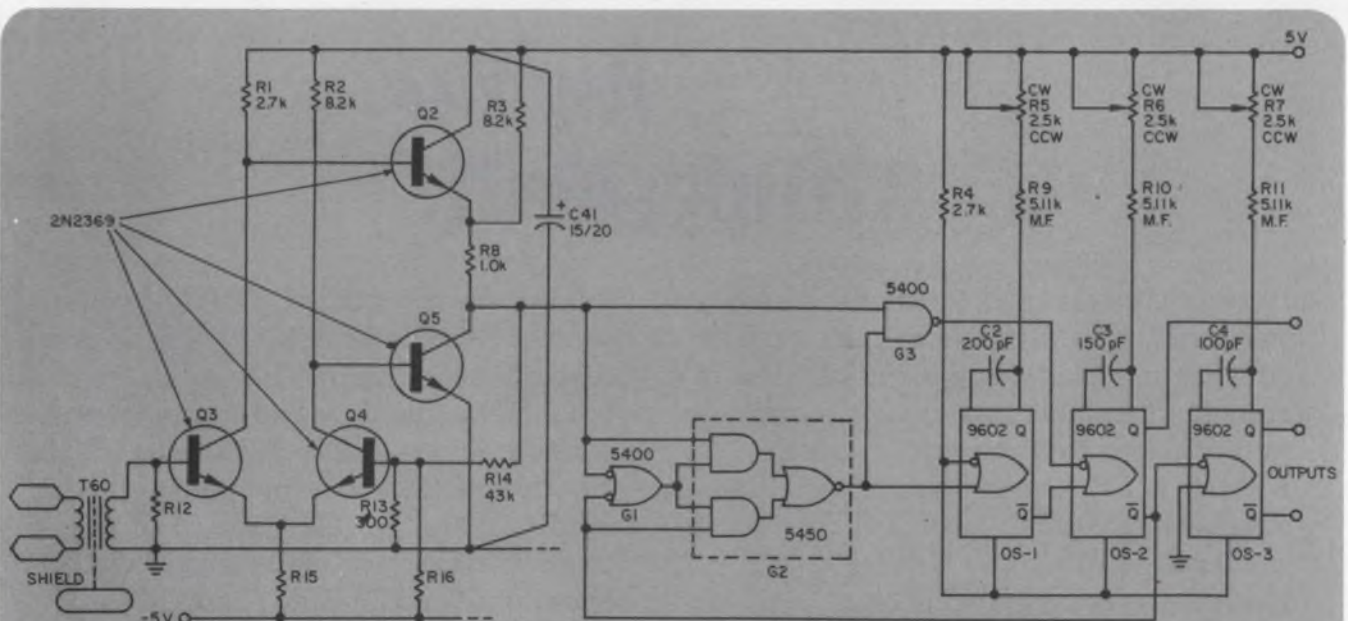

The timing of this slave clock circuit is controlled by RC time constants. The component values

shown are for 1.5-MHz operation. Capacitor scaling can change the frequency range.

If you need panel instruments with **custom** dials, cases, accuracy, tracking, resistance, response time, or practically any combination of unusual specs...

Buy
Triplett's
designed-for-you
Panel
Instruments

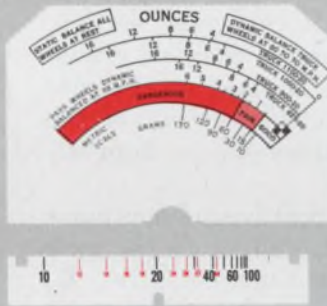
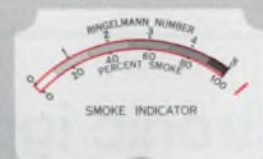
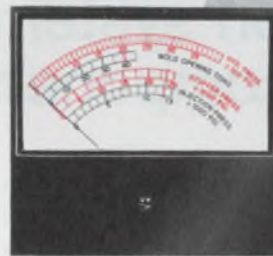
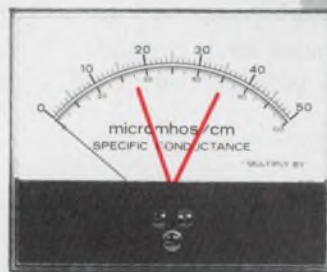
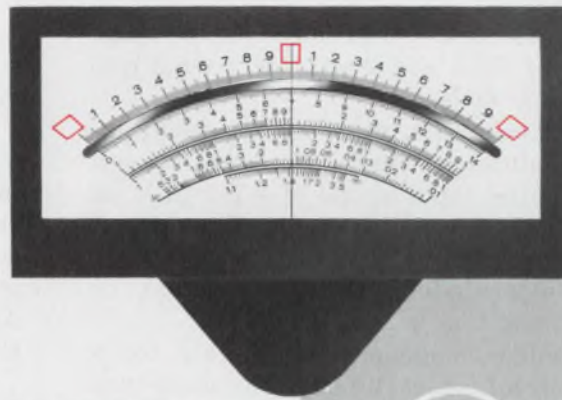

Although we stock some 1369 different styles, sizes and types of standard panel instruments, a very large proportion of our customers buy custom instruments.

Because they need:

custom dials

reading in such units as pH, roentgens, mm Hg, rpm, %, inches.

custom cases

square, round, rectangular, edge-wise (horizontal and vertical), wide, narrow, shallow.

custom accuracy

to within 1/2% with mirror scales and knife-edge pointers.

custom tracking

to match the specific needs of existing or new instrument designs.

custom resistance

for low circuit loading with tolerances as low as $\pm 1\%$.

custom damping

to meet stringent electrical and vibration requirements.

For instance, one of our customers had us design and manufacture a custom instrument to replace — in every detail of physical and electrical specifications — one which he was using on a delicate piece of medical instrumentation. Rejects from his previous source had risen to over 20%. He rejected only 3 of the first hundred we shipped — with almost negligible rejections from the many hundreds we've shipped since.

What custom panel instrument specifications do you need to make your

product more reliable, more accurate, more rugged and — in the long run — less expensive? For quick, dependable delivery of small quantities of Triplett's "designed-for-you" panel instruments, contact your Triplett Sales/Service/Modification Center. For prototypes or production quantities, contact your Triplett representative. He'll put you in touch with our Instrument Designers/Engineers who'll help you analyze the problem and suggest the optimum cost/result solution.

TRIPLETT
BLUFFTON, OHIO 46817
Manufacturers of the World's
most complete line of V-O-M's

IDEAS FOR DESIGN

way through the next "scheduled" clock cycle. The resetting of OS-1 will then trigger OS-2 into the free-running mode.

The circuit includes a discrete-component input-signal conditioner that can transform a bipolar differential input signal of 0.2 to 2 V pk to pk into a TTL-compatible signal. This circuit is not required where TTL-compatible levels are already available so long as the no-signal, or free-running condition is a ZERO state.

The RC timing components shown are for a clock frequency of about 1.5 MHz as used in a T₁ telephone carrier system. The circuit can be adapted easily to other frequencies by a proportional adjustment of the values of capacitors C₂,

C₃ and C₄.

A typical application of the slave-clock circuit is in satellite digital processors, where one or more processors are slaved to a master clock in a central controller. The satellites must continue to operate independently at the center frequency in case of planned or accidental loss of the master-clock signal. But most simple digital PLL circuits are fundamentally limited to run free substantially above or below the lock frequency. Also PLL circuits contain a time constant that slows the acquisition rate.

A. Paul Brokaw, Director of Advanced Prod. Development, Analog Devices Inc., Route 1 Industrial Park, P.O. Box 280, Norwood, MA 02062.
CIRCLE NO. 311

Electronic ignition system uses standard components

A capacitive-discharge automobile ignition system can be built with commonly available components. The system employs a 555 timer, which operates in an asynchronous square-wave mode to drive the system's converter section. Thus a common 6.3-V center-tap filament transformer of good quality can be used as the converter transformer. The rectified output of the converter transformer charges C₂ to approximately 500 V dc.

When the points open, a positive-voltage pulse is coupled through R₁₀, CR₆, and C₄ to the gate of the 2N4444 SCR. When the SCR fires, C₂ discharges through the spark coil and starts to recharge with the opposite polarity. This polari-

ty reversal provides a negative charge through R₈ and CR₅ to the SCR gate to prevent its re-triggering after the SCR turns off.

When the points close, they discharge C₃ through R₉ and R₁₀, so the SCR can be retriggered. The time required for this discharge provides delay to prevent erratic SCR firing caused by point bounce at high engine rpm.

This circuit is in actual use and has been bench-tested to an equivalent of 15,000 rpm on an eight-cylinder engine. With careful shopping, the entire system can be built for less than \$15.

L. G. Morgan, Associate Engineer, Singer Co., 833 Sonora Ave., Glendale, CA 91201.

CIRCLE NO. 312

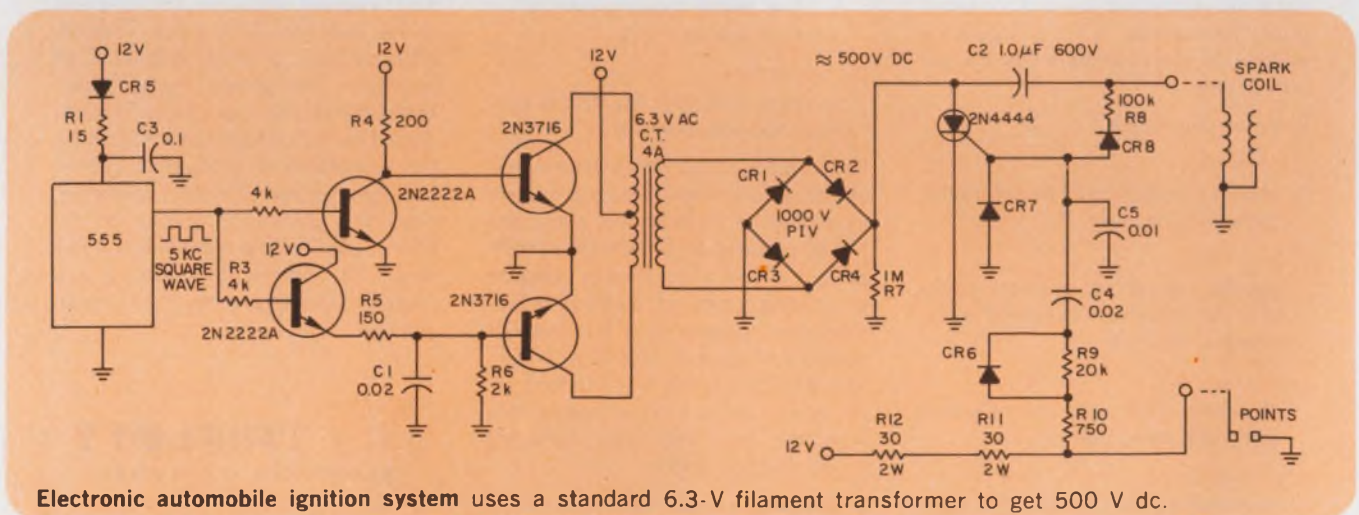

Electronic automobile ignition system uses a standard 6.3-V filament transformer to get 500 V dc.

here's a low-cost sweep/function generator

that doesn't act like one

price

- Model 196 \$350 (f.o.b. Hillsboro, Oregon).

performance

- Output amplitude 20V p-p open circuit, 10V p-p into 600 Ω .
- Frequency range 0.1 Hz to 1 MHz in 7 ranges with a frequency multiplier for continuously variable (1000:1) control.
- Sine, square, triangle, ramp, pulse and swept waveforms.
- Pulse output sufficient to sink 20 TTL loads.

internal sweep

- Internal sweep generator permits sweeping the frequency of the main generator.
- Sweep width continuously variable from 0 to 1000:1 (3 decades).
- Sweep rate continuously variable from 100 ms to 10 sec in two ranges.

application

- Audio testing . . . sweep the full range of amplifiers and other equipment without twisting a knob.
- Bench use . . . the Model 196 is an ideal signal source for bread-boarded circuits or any applications to 1 MHz. Low frequency end (down to 0.1 Hz) opens up new applications not possible with sine-square oscillators.
- Teaching . . . if you want your students to learn about signal sources with the kind of laboratory instrumentation they'll use later on, the Model 196 offers complete features at a price your budget can afford.

features

- VCF (voltage controlled frequency) input for frequency control from an external AC or DC source.
- Main output attenuation 30 db, continuously variable.
- DC offset . . . variable from +10 to -10 volts open circuit.
- Continuously variable amplitude control of output voltage.
- Ramp/pulse invert control to switch polarity.
- Continuously variable control for pulse and ramp duty cycle.

DANA EXACT
electronics, inc.

(A subsidiary of Danalab, Inc.)

BOX 160, HILLSBORO, OREGON 97123
(503) 648-6661 TWX 910-460-8811

In Europe, Africa and the Middle East, contact
Danalab International s.a. 119/121 Rue Anatole
France 1030, Brussels, Belgium Tel: 2414550.
Telex: 846-23662.

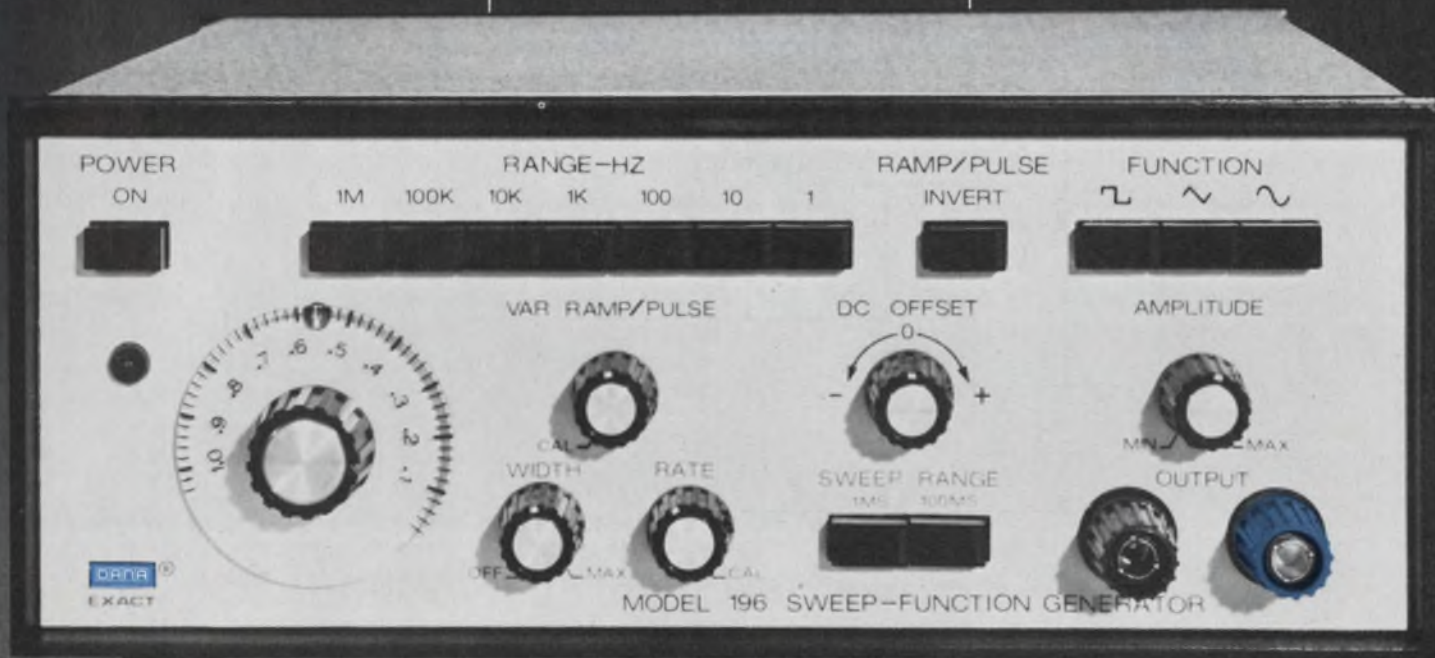

ACTUAL SIZE

Programmable sine-wave oscillator uses only one CMOS IC

CMOS logic gates can be used to produce a programmable sine-wave oscillator for use in such applications as frequency-shift keying, audio testing and remote-control signaling. The circuit is based on a Wien-bridge configuration and needs only two CMOS NAND gates for selectable linear operation. Thus a single CMOS IC and a few passive components become an economical, stable oscillator whose frequency can be dynamically chosen from four discrete values. The control inputs are CMOS-compatible.

With input 1 at logic ZERO and the other inputs at logic ONE, frequency f_1 is determined by the Wien network according to the equation

$$f_1 = \frac{1}{2 R_1 C_1}, \text{ where } R_1=R'_1 \text{ and } C_1=C'_1;$$

similarly for f_2, f_3 and f_4 .

When no frequency is desired, all inputs are maintained at logic ONE. A logic ONE equals 10 V. NAND gate G_1 's output is then at or near ground potential, or logic ZERO.

The gain of the G_1 and G_2 inverter stages provides sufficient regenerative feedback to cause the circuit to oscillate. The two 1N914 diodes around G_2 stabilize the output amplitude and help avoid clipping. Also, G_2 is biased as a linear inverter.

Resistors should be metal film, or some other

low TC types. The lowest resistor value for the frequency-selective bridge should be 50 k Ω , to avoid loading the output of G_1 . Capacitors with a mica or polystyrene dielectric are recommended. Resistor R_5 , which determines the output amplitude, should be set between 500 k Ω and 1 M Ω for best output waveform.

Oscillation frequencies can extend from the subaudio to ultrasonic range. Extremely low-frequency oscillators with moderate-valued capacitors are made possible by the high input impedance—roughly $10^{12} \Omega$ —of the CMOS gates, because then large bridge resistance values can be used. A maximum of 10 M Ω is safe.

The maximum operating frequency of the oscillator is 40 kHz, although best performance is obtained at or below 20 kHz. At the low extreme, the circuit has been tested to 0.008 Hz (125 seconds/cycle). There is no theoretical lower frequency limit since the gain stages are dc-coupled.

As an added feature, the output may be gated OFF by application of a ZERO to one or more of the unused inputs of G_2 , shown connected to V_{DD} .

Max W. Hauser, 1712 Francisco St., Berkeley, CA 94703.

CIRCLE No. 313

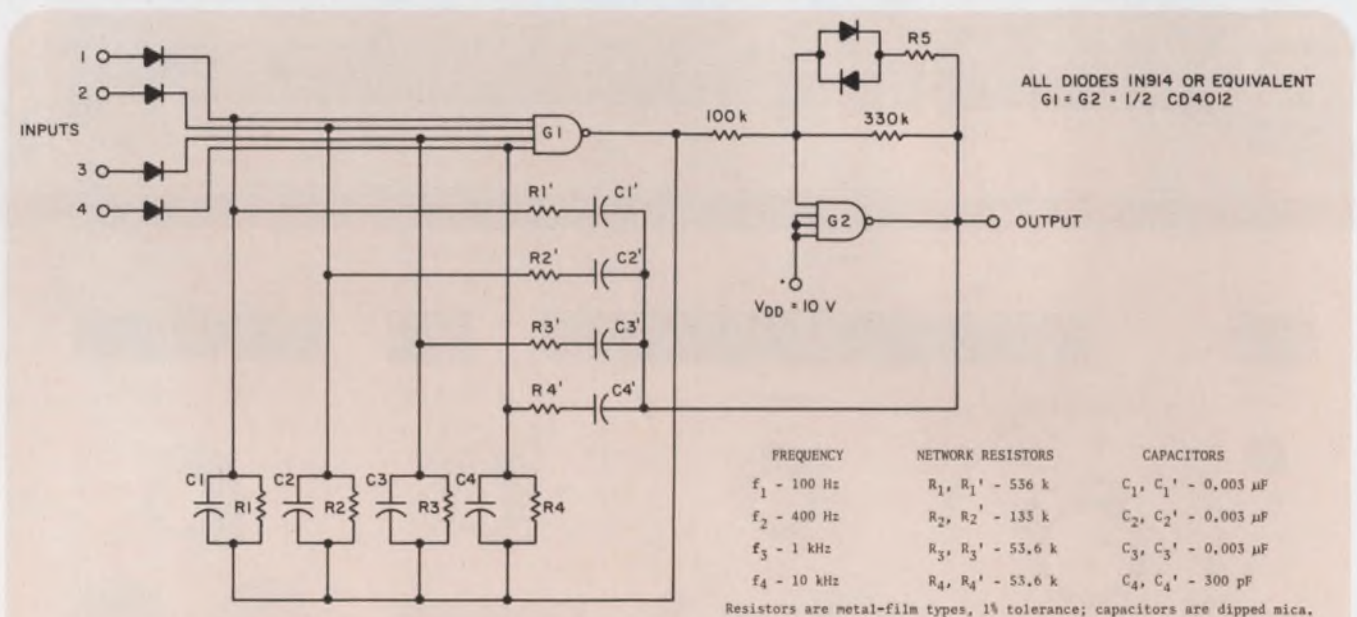

A sine-wave oscillator can be built with linearly biased CMOS gates and a Wien-bridge network.

COMPLETE

10 BIT DAC

ON A SINGLE CHIP!

SIMPLIFIED SCHEMATIC AND PIN CONNECTION DIAGRAM

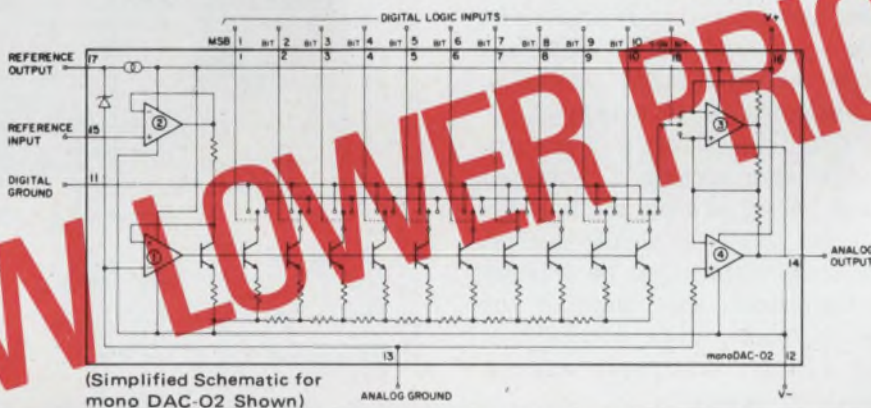

NEW LOWER PRICES!

A complete 10-Bit plus Sign D/A Converter on a single chip! No need to add complex external precision voltage references or output operational amplifiers . . . it's all there, tested and ready to go . . . and, every device is 100% tested for monotonicity at 0°, 25° and 70°C and receives a 72 hour high-temperature powered burn-in to insure the ultimate in quality and reliability. The monoDAC-02's flexible Sign/Magnitude coding allows use in both unipolar and bipolar applications and the

logic inputs are compatible with TTL and CMOS levels . . . external reference capability further broadens application versatility. The monoDAC-02 provides fast 1.5 μ sec settling, low 225mW power consumption and puts it all together in a compact 18-pin DIP . . . and the best part of the story is monoDAC-02's new, lower prices . . . they're waiting for you at your Precision Monolithics stocking distributor . . . call him today!

	Resolution	Monotonicity (Guaranteed, 0° to 70°C)	Price @ 100 pcs.
monoDAC-02DDU1	10-bits + sign	7-bits	\$15.00
monoDAC-02CCU1	10-bits + sign	8-bits	\$20.00
monoDAC-02BCU1	10-bits + sign	9-bits	\$30.00
monoDAC-02ACU1	10-bits + sign	10-bits	\$60.00



1500 SPACE PARK DRIVE, SANTA CLARA, CALIFORNIA 95050
TEL. (408) 246-9225 • TWX 910-338-0528 • CABLE MONO

AUTHORIZED DISTRIBUTORS:

NEW YORK METROPOLITAN AREA Harvey Radio, Woodbury, N.Y.: (516) 921-8700 • NEW ENGLAND AREA Gerber Electronics, Dedham, Mass.: (617) 329-2400 • UPSTATE NEW YORK Harvey Federal Electronics, Binghamton, N.Y.: (607) 748-8211 • NORTHEAST Newark Electronics, Woburn, Mass.: (617) 935-8350 • BALTIMORE-WASHINGTON Whitney Distributors, Baltimore, Md.: (301) 944-8080 • PENNSYLVANIA Hallmark Electronics, Huntingdon Valley, Pa.: (215) 355-7300 • Pioneer/Pittsburgh: (412) 391-4846 • MICHIGAN RS Electronics, Detroit, Mich.: (313) 491-1000 • SOUTHEAST Kirkman Electronics, Winston-Salem, N.C.: (919) 724-0541 • EAST CENTRAL Pioneer/Cleveland, Cleveland, Ohio: (216) 587-3600 • Pioneer/Dayton, Dayton, Ohio: (513) 236-9900 • CENTRAL Hallmark Electronics, Elk Grove Village, Ill.: (312) 437-8800 • Minneapolis, Minn.: (612) 884-9056 • St. Louis, Mo.: (314) 521-3800 • TEXAS-OKLAHOMA Sterling Electronics, Houston, Texas: (713) 627-9800 • Dallas, Texas: (214) 357-9131 • SOUTHWEST Sterling Electronics, Albuquerque, N.M.: (505) 345-6601 • Phoenix, Ariz.: (602) 258-4531 • WEST Westates Electronics Corp., Chatsworth, Calif.: (213) 341-4411 • Sunnyvale, Calif.: (408) 733-8383 • Intermark Electronics, Sunnyvale, Calif.: (408) 738-1111 • Denver, Colo.: (303) 936-8284 • Salt Lake City, Utah: (801) 486-3411 • San Diego, Calif.: (714) 279-5200 • Santa Ana, Calif.: (714) 540-1322 • Almac-Stroum, Seattle, Wash.: (206) 763-2300 • Portland, Ore.: (503) 292-3534 • CANADA Intek Electronics, Vancouver, B.C.: (604) 324-6831.

INFORMATION RETRIEVAL NUMBER 84

Improve interrupt-handling capability of microprocessor with a few ICs

With about six standard-TTL ICs, the interrupt-handling flaws of the Model 8008 LSI microprocessor can be eliminated.

The chip can recognize interrupts, and can also accept a one-byte instruction to call an interrupt-service routine. But the LSI processor doesn't automatically save and later restore either the contents of CPU registers or the status of condition flags (bits that are set to indicate various conditions).

An external push-down, or last-in first-out stack overcomes the problem with a total overhead time of only 480 μ s (Fig. 1). Without the external stack, two dedicated CPU registers would be needed (the external-stack technique requires none), entailing 680- μ s in overhead.

Two 64-bit RAMs addressed by a 4-bit up-down counter provide the necessary external memory for the stack. Also, a 4-bit latch holds the condition flags from the first to the second Push operations. Up to 16 values can be Pushed without overflow. Generally this number of values is more than adequate, since subroutines for both processing and all interrupts can be nested only to a depth of seven.

Unless it's necessary to detect stack overflow or underflow, neither the counter nor the RAM needs any initialization. Thus only the count-up and the count-down inputs are activated (preset and clear inputs are tied high or low, as appropriate).

The only important design criterion is that the count pulses occur on opposite sides of the read/write strobes for the memory. A Push (write) cycle consists of a count-up operation in state T_3 (of the basic five-state CPU period) and a write into memory in state T_1 . The Pop (read) cycle reads the memory contents during state T_3 (implicitly due to the characteristics of the input instruction), and counts down during T_1 . Both the Push and Pop cycles latch the condition flags during T_1 of input-type instructions.

A minimum of two Push operations are needed to preserve completely the processor state in the interrupt-service routine. The first saves the contents of the accumulator and latches the condition flags. The second preserves half the contents of the memory-address registers in the CPU, while it saves the latched condition flags in the register; thus the accumulator is freed for interrupt processing. Additional Push operations can be used to save other registers, or the condition flags in the stack, when other CPU registers

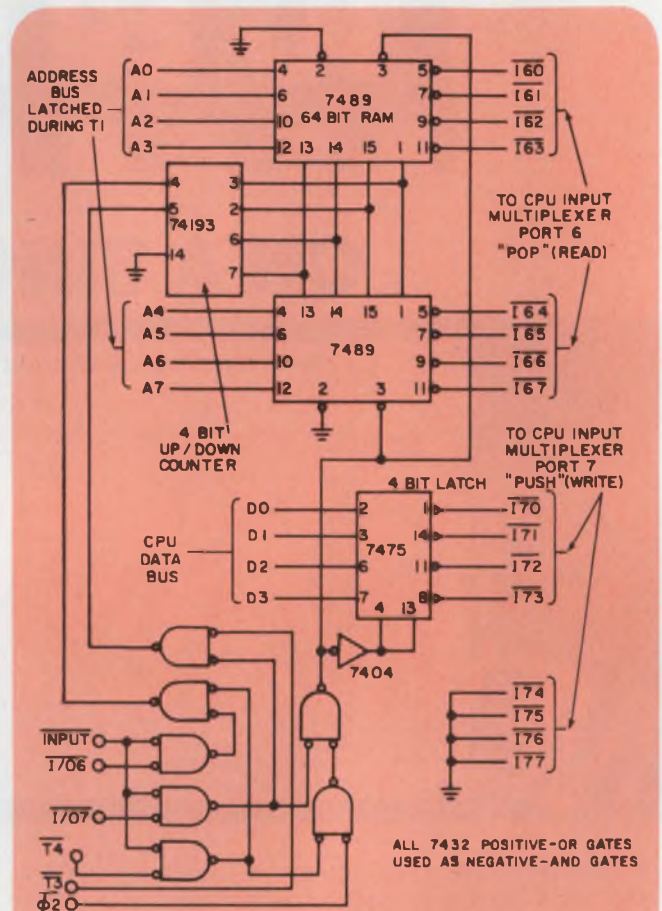

1. A handful of standard ICs form an external push-down stack for the 8008 LSI microprocessor, introduced by Intel and also offered by Microsystems International (Canada). Two of the CPU's eight possible input instructions are reserved for Push and Pop operations, corresponding, respectively, to CPU-input ports 7 and 6.

or memory are used by the interrupt-service routine.

To restore the processor state for the return to the interrupted program, a 16-word table translates the saved condition-flags back into the processor conditions (Fig. 2). If the four unused bits that are input during the Push instruction are all ONEs, this table can be placed at the end of one of the program memory pages.

One of two algorithms can be used to save and restore the processor state. The first shows the minimum requirement for maximum nesting of interrupts (Fig. 3). The second permits interrupt nesting to a depth of three, but renders the accumulator and the memory-address registers—and thus any memory location—available to the

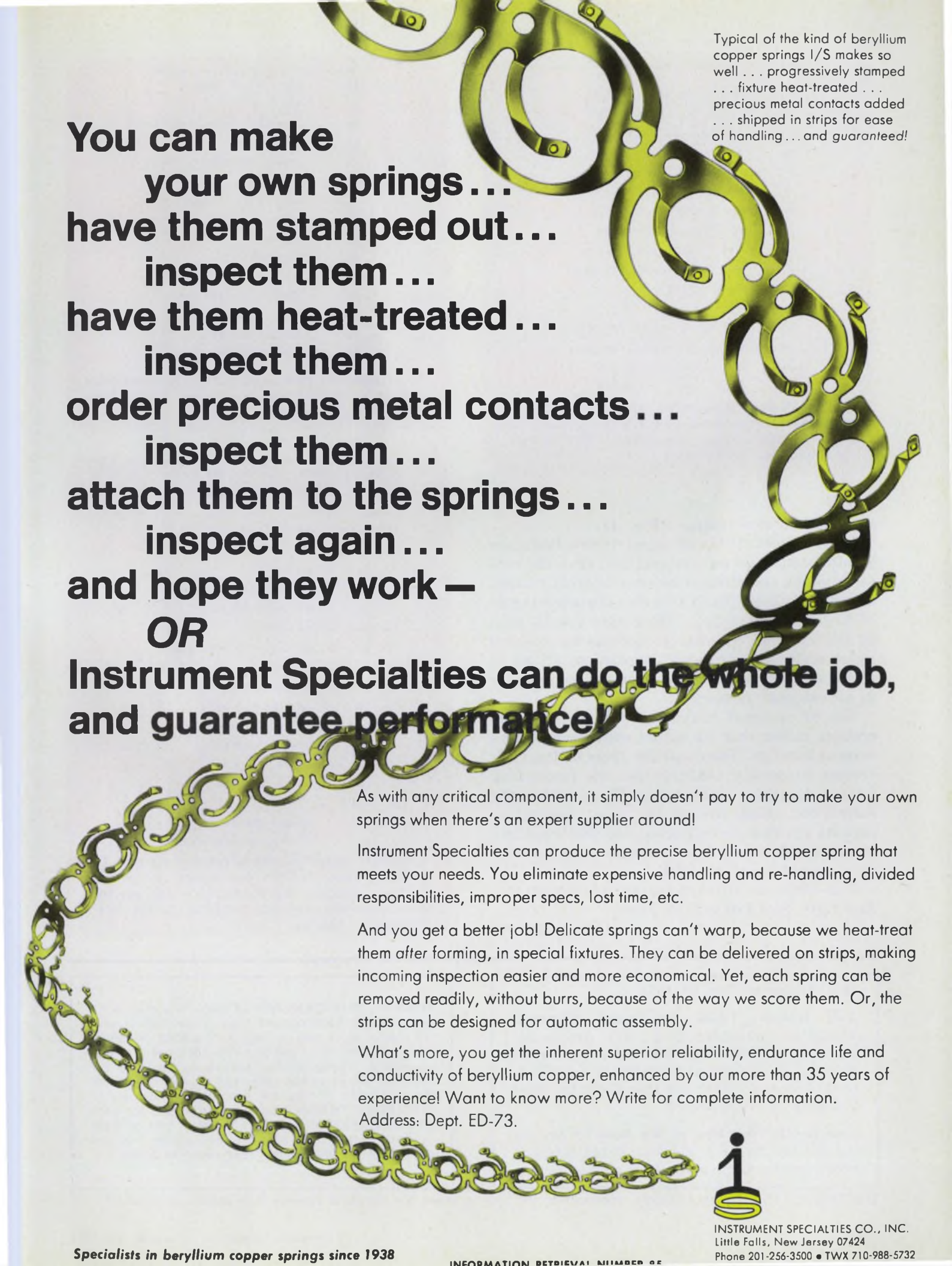

**You can make
your own springs ...
have them stamped out ...
inspect them ...
have them heat-treated ...
inspect them ...
order precious metal contacts ...
inspect them ...
attach them to the springs ...
inspect again ...
and hope they work —
OR
Instrument Specialties can do the whole job,
and guarantee performance!**

Typical of the kind of beryllium copper springs I/S makes so well . . . progressively stamped . . . fixture heat-treated . . . precious metal contacts added . . . shipped in strips for ease of handling . . . and *guaranteed!*

As with any critical component, it simply doesn't pay to try to make your own springs when there's an expert supplier around!

Instrument Specialties can produce the precise beryllium copper spring that meets your needs. You eliminate expensive handling and re-handling, divided responsibilities, improper specs, lost time, etc.

And you get a better job! Delicate springs can't warp, because we heat-treat them *after* forming, in special fixtures. They can be delivered on strips, making incoming inspection easier and more economical. Yet, each spring can be removed readily, without burrs, because of the way we score them. Or, the strips can be designed for automatic assembly.

What's more, you get the inherent superior reliability, endurance life and conductivity of beryllium copper, enhanced by our more than 35 years of experience! Want to know more? Write for complete information.

Address: Dept. ED-73.



INSTRUMENT SPECIALTIES CO., INC.
Little Falls, New Jersey 07424
Phone 201-256-3500 • TWX 710-988-5732

CONDITION FLAG TRANSLATION TABLE (VALUES IN DECIMAL)

32	POSITIVE, ODD, NONZERO, NO CARRY
64	NEGATIVE, ODD, NONZERO, NO CARRY
000	ZERO, ODD, ...NOT POSSIBLE
000	" " " "
48	POSITIVE, EVEN, NONZERO, NO CARRY
96	NEGATIVE, EVEN, NONZERO, NO CARRY
0	POSITIVE, EVEN ZERO, NO CARRY
000	NEGATIVE ZERO ...NOT POSSIBLE
160	POSITIVE, ODD, NONZERO, TRUE CARRY
192	NEGATIVE, ODD, NONZERO, TRUE CARRY
000	ZERO ODD, ...NOT POSSIBLE
000	" " " "
176	POSITIVE, EVEN, NONZERO, TRUE CARRY
224	NEGATIVE, EVEN, NONZERO, TRUE CARRY
128	POSITIVE, EVEN, ZERO, TRUE CARRY
000	NEGATIVE, ZERO, ...NOT POSSIBLE

2. The 16-word table helps return the processor state to the interrupted program. Six of the possible combinations are designated "000" to indicate that they cannot occur.

interrupt-service routine (Fig. 4).

In the 8008 CPU, all input instructions are simultaneously output instructions, since the contents of the accumulator become externally available during T_1 of the PCC cycle—the second cycle of any I/O instruction. These data can be used by the external circuitry to address an external input multiplexer for port expansion, or, as in this case, to save the contents of the accumulator in an external memory.

Use of an input instruction for the Push operation, rather than an output instruction, offers several benefits. The condition flags of the CPU become externally available (as the lower four bits of data bus) during state T_1 of each input instruction. Also, use of the input instruction permits the flags to be latched and then read into the accumulator on a subsequent input instruction—usually another Push.

Tom Pittman, Microprocessor Consultant, P.O. Box 1408, San Rafael, CA 94902

CIRCLE No. 314

INTERRUPT SERVICE ROUTINE STATE SAVE (MINIMUM)

INT	INP 7	SAVE A IN STACK (PUSH)
	LAL	SAVE L
	INP 7	...IN STACK, READING CONDITION FLAGS
	LLA	SAVE PLGAS IN L
	...	(SERVICE THE INTERRUPT)
REST	LAH	SAVE H IN A
	LHI CFTP	CONDITION FLAG TABLE MEMORY PAGE
	LLM	READ THE TABLE VALUE
	LHA	RESTORE H
	LAL	FLAG GENERATOR TO A
	ADA	SET THE CONDITION FLAGS
	INP 6	RECOVER L FROM STACK (POP)
	LLA	
	INP 6	RECOVER A FROM STACK
	RET	RETURN TO INTERRUPTED ROUTINE

3. An algorithm saves and restores the processor state with the minimum requirement for the deepest nesting of interrupts.

INTERRUPT SERVICE ROUTINE STATE SAVE (GENERAL)

INT	INP 7	SAVE A IN STACK (PUSH)
	LAL	
	INP 7	SAVE L IN STACK
	LAH	
	INP 7	SAVE H IN STACK
	INP 7	SAVE CONDITION FLAGS IN STACK
	...	(SERVICE THE INTERRUPT)
	PROCESSOR STATE RESTORATION	
REST	INP 6	RECOVER FLAGS FROM STACK (POP)
	LLA	TO REGISTER L
	LHI CFTP	CONDITION FLAG TABLE MEMORY PAGE TO H
	LAM	READ TABLE VALUE INTO A
	ADA	SET THE CONDITION FLAGS
	INP 6	RECOVER H FROM STACK
	LHA	
	INP 6	RECOVER L FROM STACK
	LLA	
	INP 6	RECOVER A FROM STACK
	RET	RETURN TO INTERRUPTED ROUTINE

4. Another algorithm also saves and restores the processor state. But this one makes any memory location, including the accumulator and external memory-address registers, available to the interrupt-service routine.

IFD Winner of July 19, 1974

Neil Dvorak, Chief Electronics Engineer, Technical Equipment Corp., 917 Acoma St., Denver, CO 80204. His idea "Coupling Circuit Ensures Drive Current from Op Amp to Emitter-Follower Booster" has been voted the Most Valuable of Issue Award.

Vote for the Best Idea in this issue by circling the number for your selection on the Information Retrieval Card at the back of this issue.

SEND US YOUR IDEAS FOR DESIGN. You may win a grand total of \$1050 (cash)! Here's how. Submit your IFD describing a new or important circuit or design technique, the clever use of a new component or test equipment, packaging tips, cost-saving ideas to our Ideas for Design editor. Ideas can only be considered for publication if they are submitted exclusively to ELECTRONIC DESIGN. You will receive \$20 for each published idea, \$30 more if it is voted best of issue by our readers. The best-of-issue winners become eligible for the Idea of the Year award of \$1000.

ASK FOR THE NEW ACOPIAN



POWER SUPPLY CATALOG 1974 *Acopian* 1975

...and when it arrives, take special note of pages 42 and 43. They contain a factual—and useful—discussion of Acopian's long-standing 3-day-shipment policy.

You'll find that "3 days" is not just an advertising slogan. It is a firm commitment that we have *never* failed to meet. You'll learn that, in an emergency, we may be able to do

better than 3 days. We've also commented on the "stock delivery" claims of other power supply manufacturers, and what happens to delivery when the units ordered are out of stock.

The remaining pages provide complete specifications and prices for a comprehensive line of power modules and systems. Included are mini

modules for powering IC's and op amps, as well as other supplies with ratings to 60 Amps and regulation to $\pm 0.005\%$. The Acopian catalog also lists redundant output power systems, narrow profile and plug-in modules, and unregulated supplies.

Ask for the new Acopian 1974-1975 power supply catalog.



Corp., Easton, Pa. 18042. Telephone: (215) 258-5441.

INFORMATION RETRIEVAL NUMBER 86

Thermal body radiation studied as medical aid

The diagnosis of cancerous tumors and circulatory disturbances may be aided by measurements of thermal body radiation in the 0.9-to-1.2-GHz region. The radiation is obtained from a surface layer of the body, with the depth of microwave penetration. Such measurements have been made at the Royal Institute of Technology in Stockholm with a small loop antenna connected to a radiometer—a Dicke type used in radioastronomy.

The antenna is placed on the surface of the body. For most body areas, a good match—VSWR < 1.2—can be obtained. The radiometer is a broadband type used in radioastronomy. The receiver compares the noise from a matched termination at a known temperature with the noise from the an-

tenna placed on the body.

Tests have shown that for a constant temperature gradient perpendicular to the surface, the radiometer temperature agrees with the temperature 4 mm below the surface. The radiometer measurements on the body surface are compared with thermistor measurements. The radiometer readings in tests have been about 1 C higher than the thermistor values.

When the radiometer antenna and the thermistor are placed on a person's stomach and the person drinks a glass of ice water, the radiometer temperature reading drops immediately by about 1.5 C. The thermistor temperature shows a slight, delayed decrease.

To eliminate spurious signals, the experiments have been carried out in a screened room.

4 dB/km loss obtained with optical waveguide

Optical-fiber waveguides with an exceptionally low loss of 4 dB/km have been produced at the Standard Telecommunication Laboratories in Britain.

With use of a core of germanium and silicon dioxide, plus a cladding of fused silica, graded refractive-index profiles at the core/cladding interface have been obtained. The graded index reduces the pulse dispersion previously obtained in practical optical-waveguide applications.

Attenuation and scatter-loss measurements carried out on the graded-refractive-index waveguide at semiconductor-laser wavelengths have demonstrated the 4 dB/km figure.

Pulse-dispersion measurements on the fibers, with use of a modulated semiconductor injection laser,

have shown a significant improvement over fibers that have a step change in the refractive index at the core-cladding interface. Fiber loss is expected to be reduced below 4 dB/km through minimization of scatter loss.

Indium-phosphide Gunns attain high efficiencies

Microwave indium-phosphide, transferred-electron Gunn-effect oscillators with efficiencies of 21% at 11 GHz and 18.5% at 15.2 GHz have been developed at the Royal Radar Establishment in Britain.

The devices, which convert dc to microwave energy, are formed from n-type layers grown by vapor epitaxy on n⁺ indium-phosphide substrates, with layers about 8 to 12 μ m thick. The oscillators have been tested in waveguide cavities that

use pulsed cw frequencies between 10 and 18 GHz.

The research was undertaken to develop the potential of indium phosphide and to demonstrate an optimum process for formation of the cathode contacts, since current limiting at these contacts gives high efficiency. Efficiencies comparable to those of known solid-state microwave sources have been obtained with oxidized silver-gallium-alloy cathode contacts, particularly at frequencies higher than 12 GHz. The effect of the cathode-contact current limiting is complex. Theoretical studies that relate device performance to the energy spectrum of electrons injected at the cathode are being continued.

Paramp built for use with Italian satellite

A parametric amplifier has been designed at the British Post Office Centre in Ipswich, England, for use in earth stations at frequencies of the Italian Sirio experimental satellite. The satellite has yet to be launched.

The paramp operates at 11.3 to 11.9 GHz with a 20-dB gain over a 0.5-dB bandwidth of 600 MHz. It has a measured noise temperature of 47 to 51 K, and that includes the internal feeds.

Each of the amplifier's two stages has a cryogenic four-port circulator and an amplifier module. The modules use balanced gallium-arsenide diffused-mesa varactor diodes having a series loop resonance of 31 GHz. Broadband characteristics are obtained by use of mechanically tunable cavities coupled to the diode idler circuits.

Each amplifier is pumped by a klystron at 42 to 43 GHz. The cryogenic operating temperature is obtained when the device is clamped to the 20-K station of a closed-cycle, helium-gas refrigerator. The complete assembly cools to operating temperature in 3 1/2 hours.

The amplifier's stages are mechanically tuned at this temperature by use of flexible cable. The connections to the input and output of the amplifier are WG16 waveguide. Copper-plated stainless-steel waveguide is used for the amplifier internal feeds.



For the Engineer who needs the best Measuring Instruments...

6 new ideas

■ NEW INSTRUMENTS

- Spectrum Analyzers
- Impedance Plotters
- Sweep Test Systems
- Power Signal Generators
- Frequency Synthesizers
- Selective Microvoltmeters
- Programmable Attenuators
- TV Broadcast Test Equipment
- Semiconductor Test Equipment

■ NEW FACILITY

devoted to Engineering, Manufacturing, Quality Control, Sales and Service.

■ NEW CATALOG

286 pages describing over 1,500 instruments.

■ NEW EXTENDED WARRANTY

up to 3 years on all R&S equipment.

■ NEW DIRECT LEASE PLAN

lease any instrument from R&S.

■ NEW QUICK DELIVERY PLAN

from stock.

Send for your new catalog today and see all our ideas.

World Leader in Test Inst. & Communications for Over 40 Years



ROHDE & SCHWARZ

14 Gloria Lane, Fairfield, N.J. 07006 ■ (201) 575-0750 ■ Telex 133310



SPECIFICATIONS

- Frequency Range: 1 – 520 MHz
- Frequency Accuracy: $\pm 0.001\%$
- Resolution: 1 kHz
- Stability: Less than 0.2 ppm per hour
- Output Range: +13 dBm to -137 dBm
- Flatness: ± 0.75 dB
- AM Modulation Range: 0 – 90%
- FM Deviation: 0 – 50 kHz and 0 – 500 kHz
- Internal Modulation Rates: 400 Hz and 1 kHz
- Dimensions: 12" wide x 5½" high x 13¼" deep
- Price: \$1,975

Note: In addition, the entire frequency range is remotely programmable in 1 kHz steps using six lines of BCD programming.

We'll remember your impressive bulk, your incredible weight, the glow of your vacuum tubes burning into the night. Whenever anyone said "signal generator" we thought of you.

But someone new has come along—from Wavetek. Slim, attractive, a mere twenty-five

pounds of solid state ingenuity. Yet the phase-locked Wavetek 3000 can do everything you used to do. (Some things a little better.) All the while consuming less than a tenth the power and a fraction the bench space. Even the price is a little lower.

We could go on, but that

would be cruel. So we'll just print the Wavetek 3000's specifications for you to read . . . and weep.

WAVETEK®

INDIANA INCORPORATED
 P.O. Box 190, 66 North First Avenue
 Beech Grove, Indiana 46107
 Tel. (317) 783-3221 TWX 810-341-3226



So long, fatso.

12-bit hybrid a/d converters designed for high performance by two companies

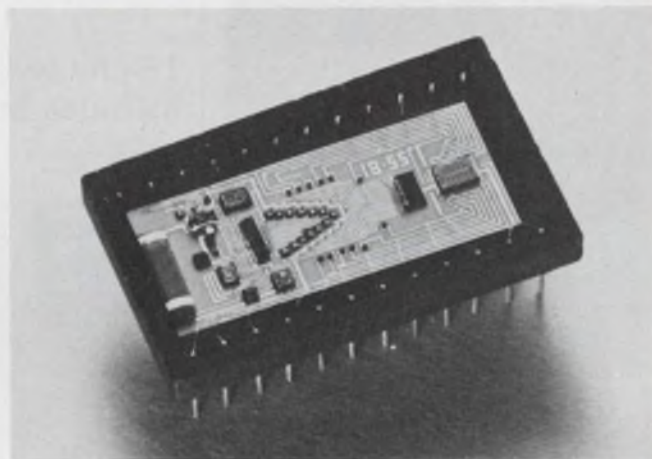
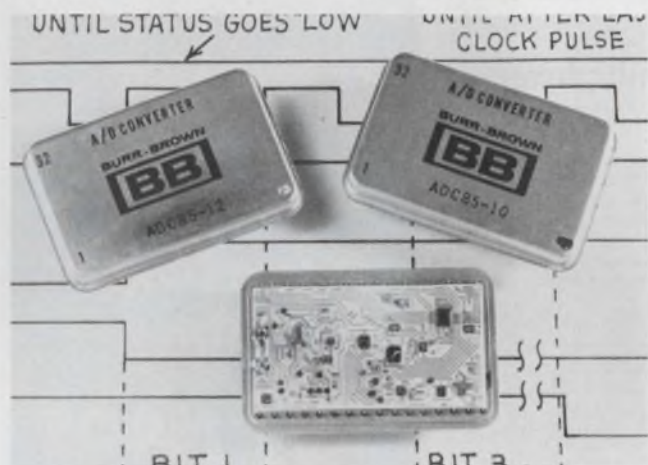

Burr-Brown, International Airport Industrial Park, Tucson, AZ 85706. (602) 294-1431. P&A: See text.

Micro Networks, 32 Clark St., Worcester, MA 01606. (617) 852-5400. P&A: See text.

Hybrid 12-bit analog-to-digital converters have been unveiled simultaneously by two different companies. Both similar, but not identical, specifications.

All versions in Burr-Brown's ADC-85 converter series have a conversion time of 10 μ s for 12 bits. Each unit is housed in a 32-pin, triple-width DIP and dissipates 1.5 W.

The Micro Networks MN5210 converters are a little slower, but they are also more compact and consume less power. They have 13- μ s conversion times, fit in a 24-pin, double-width DIP and dissipate less than 1 W.

Burr-Brown has four units in its series: the ADC-85, in 10 and 12-bit models, and the ADC-85C, in 10 and 12-bit versions. The 85 is rated over an extended range of -25 to +85 C, while the 85C models are specified for 0 to 70 C.

The linearity of the Burr-Brown

converters is specified at ± 0.5 LSB over the full operating range. Gain drift for the expanded-range version is a low 15 ppm for the 12-bit unit and 20 ppm for the 10 bit. The commercial units have drifts of 25 and 40 ppm, respectively. Gain inaccuracy, though, stays at a low 0.09% over the full temp range.

Only two trims—gain and offset—are required on the ADC-85 converters to set the accuracy. Both serial and parallel digital outputs are available simultaneously from the converters. If all the bits aren't needed, the converters can be short-cycled to speed conversion time—you can get 10 bits in 6 μ s and even faster results for 8 bits.

External jumpers between the pins determine the converters' input range. Typical ranges available include ± 10 , ± 5 , ± 2.5 , 0 to 5, and 0 to 10 V.

Micro Networks, on the other hand, offers six converters in its MN5210 series—the MN5210, 11, 12, 13, 14 and 15. The first three units have an internal voltage reference; the latter three require an external reference. Also the first three are identical, except for the

input-voltage range capability. The MN5210 handles 0 to -10 V; the 5211, ± 5 V, and the 5212, ± 10 V. Similar ranges are available in the 5213, 14 and 15, respectively.

The conversion time of these units is just slightly over 1 μ s/bit, while the power dissipation is kept to a low 915 mW for the 10, 11 and 12 and an even lower 815 mW for the other three.

The linearity error of the Micro Networks converters over a 0-to-70-C range is ± 0.5 LSB. Zero error and absolute accuracy are not specified over temperature but are given as worst-case specs of 2 LSB and 0.4%, respectively, for the entire operating range. Absolute accuracy includes such terms as gain, zero and linearity.

Converter input impedance, depending upon the model, ranges from 6.7 to 13.4 k Ω . The digital output is available in both serial NRZ and parallel-binary formats.

Both the Burr-Brown and the Micro Networks lines require the standard three voltages—dual 15 V and a single 5 V.

Prices for the Burr-Brown converters are as follows: ADC-85/10-

(continued on page 210)

AMPERITE

Thermostatic RELAYS

- LONG DELAY -

240 & 300 Seconds



New! For applications requiring long delays. Hermetically sealed — not affected by altitude, moisture, or climate changes... SPST only — normally open or normally closed... Compensated for ambient

temperature changes from -55° to +80°C... Rugged, explosion-proof, long-lived... Standard radio octal base only.

Price, under \$6.00 ea

Write for Bulletin No. LD-73.

DELAYS:
2 to 180
SECONDS*



Same rugged construction, hermetic sealing and stability as the long Delay Relays described above... For standard radio octal and 9-pin miniatures.

Price, standard or min., under \$4.00 ea.

* Miniatures delays: 2 to 120 seconds.

PROBLEM? Send for Bulletin No. TR-81.

All Amperite Delay Relays are recognized under component program of Underwriters' Laboratories, Inc. for all voltages up to and including 115V.

DIFFERENTIAL RELAYS

For automatic overload, over-voltage or under-voltage protection... Made only to specifications for 70V, 80V, 90V and 100V.

Price, under \$6.00 ea.

AMPERITE BALLAST REGULATORS

Automatically keeps current and voltage at a definite value. For AC or DC... Hermetically sealed, rugged, vibration-resistant, compact, most inexpensive.

Price, under \$3.00 ea.

Write for 4-p. Bulletin No. AB-51.



AMPERITE

600 PALISADE AVE., UNION CITY, N.J. 07087

Telephone: 201 UNion 4-9503

In Canada: Atlas Electronics, Ltd.,
50 Wingold Ave., Toronto 19

MODULES & SUBASSEMBLIES

(continued from page 209)

bit, \$185; 85/12-bit, \$225; 85C/10-bit, \$160; and 85C/12-bit, \$195.

All basic models in the Micro Networks MN5210 series cost \$275. The company also has MIL versions (add an H suffix) that cost \$425. Burr-Brown is developing a MIL version.

Burr-Brown CIRCLE NO. 302

Micro Networks CIRCLE NO. 303

16-channel multiplexer includes buffer amp



Datal Systems, 1020 Turnpike St., Canton, MA 02021. (617) 828-8000. \$129 (singles); stock to 5 wk.

The MM-16 analog multiplexer consists of 16 CMOS FET switches with an address selection decoder and an output buffer amplifier. The MM-16 transfer accuracy is 0.01% and the settling time only 3 μ s when the internal output buffer amplifier is used. Without the output amplifier, the switching time is typically 500 ns. A four-bit (8421) input code is used to select the channel address. There is also a fifth "inhibit" input which permits you to connect two MM-16s to provide 32 channels. Input and output signal levels are ± 10 V. The ON impedance of the analog switches is 2 k Ω without the buffer amplifier and 100 M Ω with the buffer. The buffer amplifier delivers ± 5 mA to an input load with a typical 0.05 Ω output impedance. The output offset is adjustable to less than 1 mV. The MM-16 is housed in a 2 x 1.5 x 0.375 in. module with dual in-line spaced gold-plated pins. Power requirement is ± 15 V dc at 6 mA.

CIRCLE NO. 304

THE NEXT GENERATION OF Broadband Power Amplifiers Starts with The *isi* M403



.01-250MHz
100W min.
50db gain

SMALLER
LIGHTER
QUIETER

DESIGNED FOR RELIABILITY AND EASE OF MAINTENANCE

Solid State protection and control circuitry with complete remote control capability. Write or Call



instruments for industry, inc.

151 Toledo Street, Farmingdale, N.Y. 11735
(516) 694-1414

Temperature controller handles many inputs

Sys-Tec, 877 Third St. S.W., New Brighton, MN 55122. (612) 636-6373. \$32.05 (large qty).

The Model TC-190 temperature controller enables the user to apply setpoint resistance to the instrument thus permitting the use of a wide variety of resistance temperature detectors, thermistors, or other resistance-type sensors. Inputs accept positive or negative tempco sensors with resistances from 10 Ω to 10 k Ω . Output capability is 6, 10, or 15 A through one form A relay contact (resistive loads only).

CIRCLE NO. 305

Electrical transducer handles volts or amps

Rochester Instrument Systems, 275 Union St., Rochester, NY 14605. (716) 325-5120. CCC: \$49; VCC: \$49, VCX: \$165; 4-6 wk.

Two transducers, Models CCC-1B and VCC-1B, are designed to accept ac current or voltage inputs, respectively, and provide a proportional dc current output. And expanded scale voltage transducer, Model VCX-1B, also provides the same type of output. The units are designed to respond to the average value of the input signal. However, all models are calibrated to indicate the rms of a pure sinusoid. The input stage consists of a linear transformer coupled with a solid-state amplifier output stage. The CCC-1B and VCC-1B have a basic accuracy of $\pm 0.5\%$, a stability per year of $\pm 0.25\%$ of full scale and a maximum temperature influence of $\pm 0.5\%$ over an operating temperature range of -20 to $+65$ C. They also conform to the IEEE surge withstand capability (SWC) test. All Models are available with a number of options including: nonstandard voltage input range, nonstandard current input range and nonstandard current and voltage output signals. The transducers are housed in heavy-duty steel enclosures with welded-on mounting plates. Their entire circuitry may be removed without dismantling the units from the panel through the removal of two easily accessible screws.

CIRCLE NO. 306

INFORMATION RETRIEVAL NUMBER 91 ►

Rugged...versatile

"The Persuader"

The S190 switchlight outguns everything its size...costs only \$1.62*

In every era, new products come along to keep the competition honest, with all the cards on the table. So we invite you to compare our S190 series with other switchlights. Check our variety of lens colors and easy mount panel adaptors...our wide terminal spacing for easy and fast wiring: solder, quick connect, PCB...our no-tool lamp replacement, long life wiping contacts, rugged molded case. Consider the low cost when you realize that the S190, with its 2 Form C action, has greater circuit flexibility than most switchlights on the market. And it's easily available at your local distributor! Call our sales office in your area for applications assistance...we're located in major cities, world wide. Clare-Pendar Co., Box 785, Post Falls, Idaho 83854, (208) 773-4541.

*In quantities of 1000



CLARE-PENDAR
Switchlights & Keyboards



New!

Four-quadrant drive handles 1/4 to 5 hp

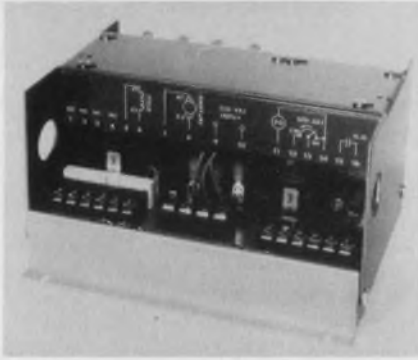

Extron, 5735 Lindsay St., Minneapolis, MN 55422. (612) 544-4197. From \$300 (unit qty); stock.

The Series 140 four-quadrant regenerative SCR drive is designed to control motors in low horsepower ranges (1/4 to 5 hp). Its output is ± 90 V dc for 120-V-ac units and ± 180 V dc for 230-V-ac units. The control mode for the series 140 is selectable via a program switch and consists of the following modes: armature feedback with IR compensation; current feedback; tachometer feedback; and external reference. Other features include adjustable rate loop gain, current loop gain, crossover and selection of either internal or external current limit. Options available on the Series 140 include an isolation card, for external inputs such as instrument followers; linear acceleration and deceleration; and input from encoders or other transducers. All options are available via snap-in option cards.

CIRCLE NO. 307

Crystal oscillator runs from 5-to-15-V supplies

Conner-Winfield, Box L, West Chicago, IL 60185. (312) 231-5270. From \$95, stock to 5 wk.

A CMOS compatible crystal oscillator is available at any fixed frequency from 50 kHz to 20 MHz. The oscillator has a frequency tolerance from $\pm 0.001\%$ to $\pm 0.05\%$ and an operating temperature range from $+20$ to $+40$ C to -55 to $+125$ C. The unit operates at any fixed supply voltage from $+5$ to $+15$ V dc with $\pm 5\%$ regulation. Supply current drain is from less than 1 to about 5 mA.

CIRCLE NO. 308

Sequential timer can have many stages

Minarik Electric, 224 E. Third St., Los Angeles, CA 90013. (213) 624-8876. \$28 per stage.

A solid-state, sequential timer, Model BLC, has two, three or four stages, although any number may be supplied. The stages plug into a base module equipped with a terminal strip, and may be connected for single cycling or recycling. Each stage is independent, and may be adjusted to any time cycle from 0.5 s to 30 min. Delay is set by a pot mounted on each stage. The timer has a repeat accuracy of $\pm 0.5\%$ and temperature drift of only $\pm 0.006\%/^{\circ}\text{C}$. Drift is only $0.01\%/V$, and temperature range spans 25 to 65 C. Assembled height is only 2.25 in., and length, 5.875 in. Over-all width varies with the number of stages: two stages are 3 in., three are 3.75 in., and four are 4.5 in.

CIRCLE NO. 309

Noise generators provide tenfold output increase

CODI Corp., Pollitt Dr., Fair Lawn, NJ 07410. (201) 797-3900. From \$22.70; stock to 6 wk.

A family of white-noise generators and diodes has outputs up to 1 V over a 3-kHz bandwidth. Output of the devices is as much as one order of magnitude above that of those previously available. The increased output of this series is obtained by a proprietary technique for precisely matching the generating diode to its accompanying built-in amplifier. The devices are available over a frequency range of 10 Hz to 1000 MHz, in both industrial-grade plastic encapsulations and in hermetically sealed packages for high reliability military applications. Output is independent of frequency and temperature.

CIRCLE NO. 310

IR transmitter/receiver uses reflective tape

Stevens Associates, P.O. Box 620, Alamo, CA 94507. (415) 837-9164. Dual unit: \$99.50, single unit: \$149.50.

The Big Brother IR transmitter/receiver uses reflective tape to provide a 16-ft range without regard to ambient light. This range, useful for security systems, smoke or fog detection and industrial counting, is available when any 12-V power source is used. Low current consumption of 10 mA allows extended battery life. Size is $2.25 \times 2.125 \times 1.75$ in. Separate sources and receivers are also available for ranges up to 160 ft.

CIRCLE NO. 320



ANALOG STAY IN CONTROL WITH INTECH'S INDUSTRIAL CONTROL ICs THE 3050 AC DETECTOR DIFFERENTIAL OR SINGLE ENDED TO 1MHZ 3040 QUAD MONITOR ALARM DRIVES EXTERNAL SPEAKER DIRECTLY 3030 TEMPERATURE ALARM SETS OFF BELLS AND WHISTLES EXCELLENT REPEATABILITY THE 3020 TRI-STAGE ALERT/ALARM AND 3010 TONE ALARM DRIVE LEDs OR LAMPS ALL 14-PIN DIP TTL COMPATIBLE STOCK DELIVERY! LOW PRICES. WRITE US!

intech INCORPORATED (408) 244-0500
1720 COLEMAN, SANTA CLARA CA 95050

From the
voltmeter
house...

Here's how we tested our 42,386th multimeter.

The world's best-selling 3½ digit multimeter is virtually indestructible.

Recently, two Fluke quality control engineers wanted to know if our 8000A 3½ digit multimeter would survive a fall from a 24-foot rack. We were shipping several to a phone company.

So they tossed one out the window. Two stories up. It still worked.

But 9944/100% of these out-of-the-ordinary tests we **don't** instigate.

They just seem to happen.

Our president talks about the time he picked up an 8000A at a trade show without knowing it was ready for case removal. The works crashed to the floor but it still played perfectly . . . to everyone's delight and the president's relief.

One reason why our DMM is so tough: it only has 99 parts. Major analog and digital circuitry are on LSI chips.

It's also flexible. This DMM has 26 ranges, including five ranges of ac and dc volts, five ranges of ac and dc current, and six ranges of resistance. And it's the only DMM using an A-to-D converter with inherent self-zeroing to completely eliminate offset uncertainty.



But it's the ruggedness that really makes the 8000A a conversation piece. Our sales force still laughs about the Fluke salesman who was so hot to make a sale that he took his Fluke multimeter and brought it down—crash!—right on his prospect's desk.

"See," he said, "it's really tough."

And so it was, but the op amp that was hidden under a pile of papers wasn't. P. S.—our salesman didn't make the sale.

On a more positive note, a UPS truck accidentally backed over an 8000A not long ago . . . without ill effect.

So there you are. The world's largest selling 3½ digit DMM. And the toughest. And for \$299 it could be yours.

For data out today, dial our toll-free number, 800-426-0361

In the continental U.S., dial our toll free number 800-426-0361 for the name and address of your nearest local source. Abroad and in Canada, call or write the office nearest you listed below, John Fluke Mfg. Co., Inc., P. O. Box 7428, Seattle, Washington 98133. Phone (206) 774-2211. TWX: 910-449-2850. In Europe, address Fluke Nederland (B.V.), P. O. Box 5053 Ledeborstraat 27, Tilburg, The Netherlands. Phone 013-67-3973. Telex: 844-52237. In the U.K., address Fluke International Corp., Garnett Close, Watford, WD2 4TT, England. Phone 0923-33066. Telex: 934583. In Canada, address ACA, Ltd., 6427 Northam Drive, Mississauga, Ontario. Phone 416-678-1500. TWX: 610-492-2119.

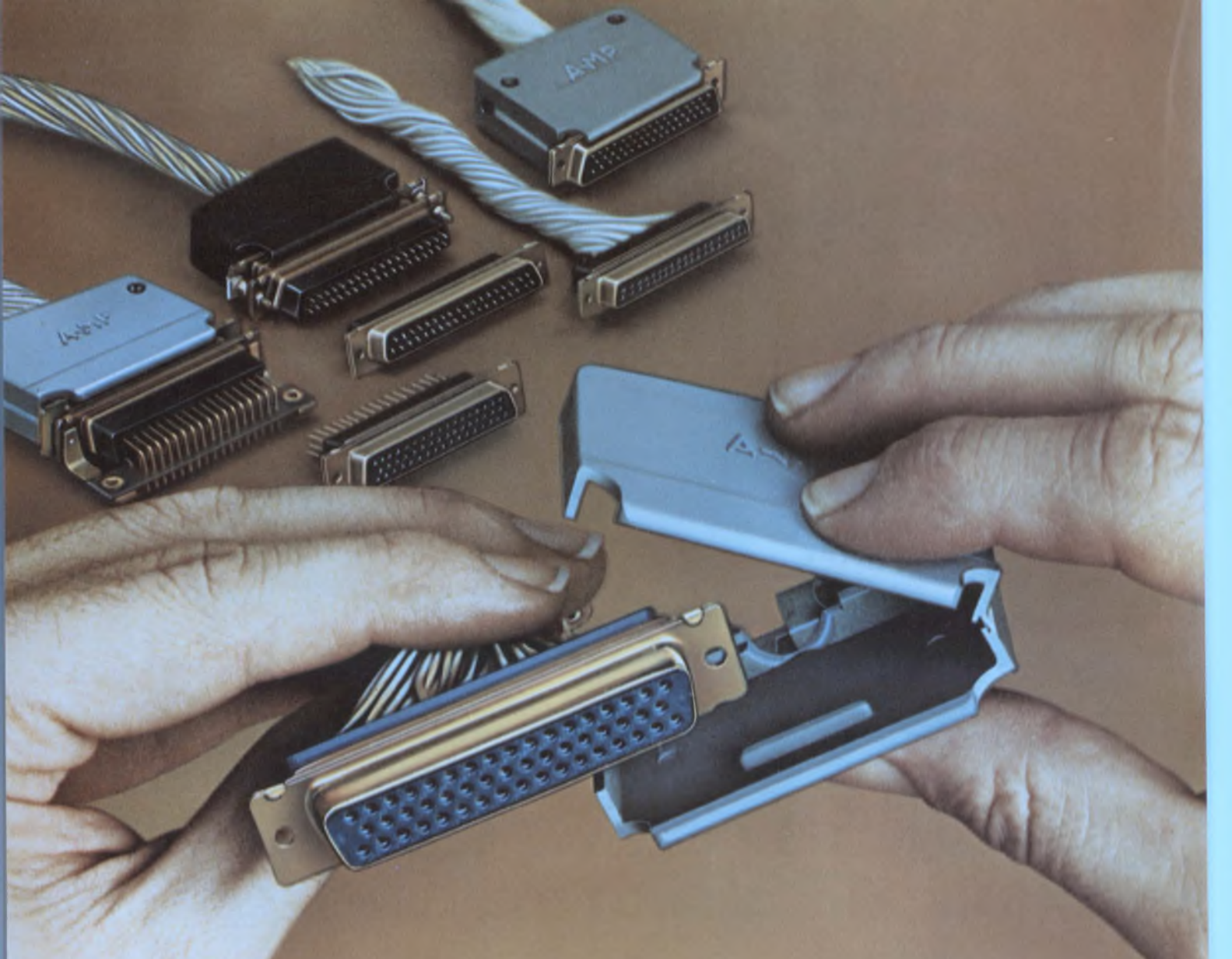

A collection of various AMP high-density connectors is shown in the upper left. In the center, a pair of hands is shown assembling a connector. One hand holds a metal connector housing with a blue contact strip, while the other hand holds a silver plastic clam-shell cover. The hands are positioned to snap the cover onto the housing. The background is a plain, light-colored surface.

**Because
you
only have
two hands.**

AMPLIMITE high-density connectors

come with our exclusive, one-piece plastic strain relief/shield. You can't get one that's easier or less complicated to put on.

Hold the joined "clam-shell" in one hand. Turn the screw with the other. It's that simple to cut into your handling costs.

In addition, you have a highly versatile line of reliable and economical AMP high-density connectors.

With rack and panel interconnections as well as posted configurations. Straight as well as right-angle post contacts. And a variety of contact styles including some with insulation support features. Sizes are 9, 15, 25, 26, 37, 44, 50, 62, 78 and 104 positions.

Of course AMPLIMITE connectors are intermateable with existing high-density types.

For immediate information, call (717) 564-0101. Or write AMP Incorporated, Harrisburg, Pa. 17105.

AMP and AMPLIMITE are trademarks of AMP Incorporated.

AMP
INCORPORATED

INFORMATION RETRIEVAL NUMBER 94

AMP District Offices.

NEW ENGLAND DISTRICT
Suite 107, Riverside Park
Weston, MA 02193. (617) 891-7500

NEW YORK DISTRICT
25 Commerce Drive
Cranford, N.J. 07016
(212) 285-9575 (N.Y.)
(201) 276-4382 (Cranford)

MID-ATLANTIC DISTRICT
400 W. Swedesford Rd.
Berwyn, Pa. 19312
(215) 647-6060

SOUTH ATLANTIC DISTRICT
955 L'Enfant Plaza North, S.W.
Suite 4010
Washington, D.C. 20024. (202) 484-9596

GULF DISTRICT
2220 Parklane Drive, N.E.
Suite 485
Atlanta, GA 30345. (404) 934-6363

OHIO DISTRICT
Landings Office Bldg.—Suite 207
3040 Riverside Dr.
Columbus, OH 43221. (614) 486-0276

LAKE DISTRICT
30555 Southfield Rd.—Suite 440
Southfield, MI 48075. (313) 645-5590

ILLINOIS DISTRICT
1050 Morse Ave.
Centex Industrial Park
Elk Grove Village, IL 60007
(312) 439-5800

NORTH CENTRAL DISTRICT
4600 W. 77th St.—Rm. 319
Minneapolis, MN 55435. (612) 920-8210
TWX (910) 576-2849

SOUTHWESTERN DISTRICT
Frito Lay Tower—Suite 1440
Exchange Park, Dallas, TX 75235
(214) 352-4852-4853
TWX (910) 861-4227

SOUTHERN PACIFIC DISTRICT
1840 S. Wilmington Ave.
Compton, CA 90220. (213) 537-4490
TWX (910) 346-7044

NORTHERN PACIFIC DISTRICT
Vallico Park
10300 N. Tantau Ave.
Cupertino, CA 95014. (408) 255-3830

AMP INCORPORATED

COMPONENTS

Gigahertz trimmers have extended ranges

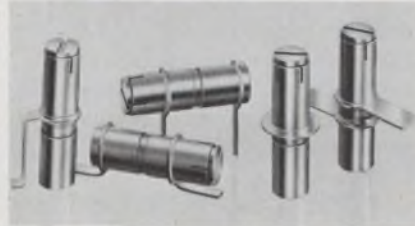

Johanson Manufacturing Corp., 400 Rockaway Valley Rd., Boonton, NJ 07005. (201) 334-2676. \$4.60 (1000 up); 3 wks.

Four new series of Giga-Trim, gigahertz-range capacitors are now available with greatly increased capacitance ranges. The 7260-4 series has a range of 2.5 to 5.0 pF and is 0.21-in. long and 0.07-in. in diameter. Also available are the 7270-4, 7280-4 with intermediate capacitance ranges and the 7290-4 series with an adjustment range of 7.0 to 30.0 pF. The 7290-4 is 0.56-in. long and 0.12-in. in diameter. All series are available in five mounting styles. Their solderless construction allows them to be soldered and resoldered during installation without damage.

CIRCLE NO. 321

Linear motor generates 3 Gs on 11-lb load

Information Magentic Corp., 5743 Thornwood Dr., Goleta, CA 93017. (805) 964-6828.

Model 35-N is a 5-in. stroke linear motor actuator for precise X-Y positioning. The motor is an advanced version of Infomag's Model 35, which is used widely in computer disc-drive positioning systems. It is capable of handling loads to 11 lb with up to 3-G acceleration capability. Maximum force is 32 lb. When operated from Infomag's digital servo system, positioning time for a 2-in. stroke is about 100 ms with a positioning accuracy of better than ± 0.0005 in. The motor is approximately $9.5 \times 5.7 \times 5$ in. and weighs 80 lb. It can be supplied with or without linear velocity and positioning transducers. An electronic control amplifier also is available.

CIRCLE NO. 322

Metal-film resistors precise to $\pm 0.05\%$

TRW/IRC Resistors, P.O. Box 887, Burlington, IA 52601. (319) 754-8491. 3-6 wks.

High resistance, low TCR metal-film resistor, AR-90, is encapsulated in high-temperature epoxy with two solderable, tinned-copper axial leads. Body dimensions are $1 \times 0.4 \times 0.4$ in. They are designed for voltage dividers and input attenuators that require values between 1 and 10 M Ω . The standard tolerances are $\pm 0.05\%$, temperature coefficients are ± 5 , 10 and 15 ppm/ $^{\circ}\text{C}$ and the power rating is 0.5 W at 85 C.

CIRCLE NO. 323

Binary attenuation obtained with thin films

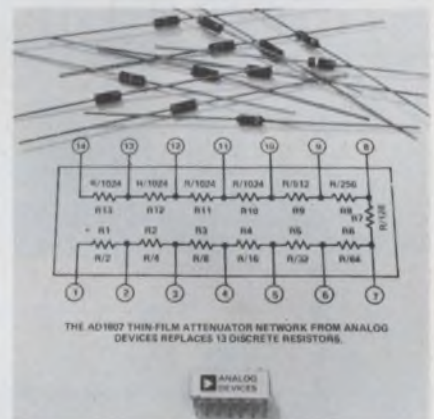

Analog Devices Inc., P.O. Box 280, Norwood, MA 02062. (617) 329-4700. \$6 (OEM qty); stock.

The AD1807 family of 13 thin-film resistor attenuator networks is configured for binary strings. They come in 14-pin DIPs or flatpacks and in chip versions. The networks can provide digitally programmed or discretely switched, binary attenuation from R/2 to R/1024. Resistance values range from 10 k Ω to 1 M Ω . Other properties include: TCR tracking to 1 ppm/ $^{\circ}\text{C}$, noise to -50 dB, long-term stability to $\pm 0.005\%$ /year and response time to less than 10 ns. Optional certification to MIL-STD-883 is available. The resistive elements are made of nichrome. Laser trimming and ratio matching assure accuracies to 0.01% with a resolution to 0.001 R. Standard networks operate from 0 to 70 C, and they are available in -55 to 125 C versions.

CIRCLE NO. 324

COMPONENTS

Aluminum 40% less in solid electrolytics



International Importers Inc., 2242 S. Western Ave., Chicago, IL

60608. (312) 847-6363. \$0.059; 0.22 μ F, at 10 V (10,000 up); stock.

Aluminum solid-electrolytic capacitors are both electrically and physically similar to tantalum capacitors, yet cost up to 40% less for a given capacitance value, according to the manufacturer. The new capacitors are available in nine values, from 0.1 to 2.2 μ F and three working/surge voltages—10/13, 16/20, and 25/32 V. Operating temperature range is -55 to 85 C.

CIRCLE NO. 325

Digital potentiometer resolves 1000 steps



Bourns, 1200 Columbia Ave., Riverside, CA 92507. (714) 684-1700. \$23 (1-9); stock.

Bourns Model 3680 Knobpot digital potentiometer combines an incremental decade potentiometer with a digital display and fast, pushbutton, resistance selection. Resolution of the output is 1-in-1000 discrete steps and repeatability is $\pm 0.1\%$. Each decade has a rated life of 100,000 operations. Snap-in mounting cuts installation time to a minimum and eliminates mounting hardware. An integral bezel covers irregular panel cut-outs and blemishes. The unit's terminals match AMP Series 110 receptacles, or they can be soldered. Resistance elements are Cermet with a tempco of 100 ppm/ $^{\circ}$ C. The power rating is 2 W and the standard resistance range of the 3-decade unit is 5 k Ω to 1 M Ω with a tolerance of $\pm 1.0\%$.

CIRCLE NO. 326

Pendulum replaces gyro for vertical sensing

Humphrey Inc., 9212 Balboa Ave., San Diego, CA 92123. (714) 565-6631.

A highly accurate vertical indicator, Model VI19-0101-V, with a potentiometric output that detects a full 360 $^{\circ}$ roll and $\pm 90^{\circ}$ pitch can replace much more expensive vertical gyroscopes in applications where continuous, high-acceleration fields are not present. The unit does not require power, and it is capable of continuous long-life operation. A vertical gyro is limited by motor life and the necessity for periodic overhaul. The unit is fluid filled for precision damping and is accurate to within $\pm 0.10^{\circ}$. The unit is pressure sealed to withstand 4000 psi. It weighs 3.5 lb and is 3.75 in. in diameter by 6.1-in. high. Other models are available in a wide variety of ranges.

CIRCLE NO. 327

Now you can turn to MCL for reliable high power r-f and microwave testing.

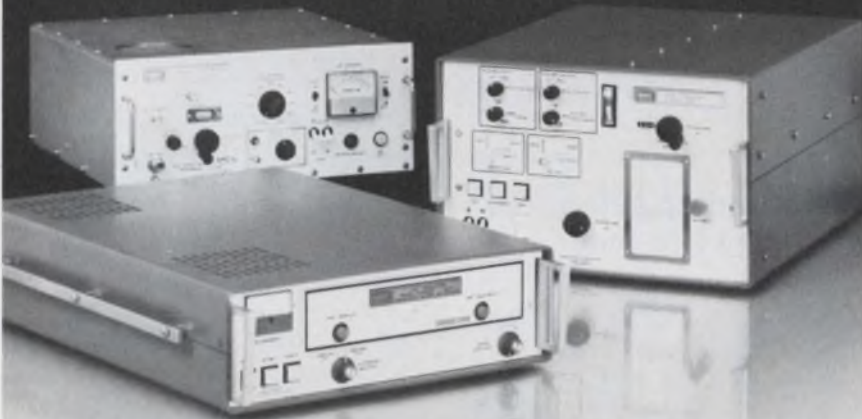

Many customers remember us for the "extras" engineered and built into our microwave cavities, e.g., our potted anode bypass assembly.

But some may not be aware that today MCL also offers one of the industry's largest and most diverse power oscillator, amplifier and systems lines.

The same extra margin of reliability and performance customers have learned to expect from our cavities is also a feature of our instrumentation products.

For a recommended solution to your high power testing problem—without obligation—write us today.

MCL, Inc., 10 North Beach Avenue, La Grange, Illinois 60525. Or call (312) 354-4350.

Now on GSA contract GSOOS-27086 See us in EEM-Vol. 1 pp. 284-291



Complete RF Network Analysis ... **NOW!**



400 kHz to 500 MHz with 115-dB dynamic range and 0.005-dB resolution — these are not design goals of an idealized analyzer; they are performance facts of hundreds of instruments now in the field.

NOW used by a growing list of owners to measure group delay of CATV amplifiers and filters, to determine s-parameters of vhf transistors, to measure crosstalk of multiconductor coaxial cable, to test flatness of telephone filters and equalizers, to check the response of ECM and radar i-f modules . . .

NOW for **your** use to provide fast, accurate measurements of nearly any transmission and reflection property, including magnitude, phase, group delay, and s-parameters — all at the push of a button or the twist of a knob.

NOW with built-in rectilinear and polar display, 50- and 75-ohm capability, two measurement channels for simultaneous displays of two unknowns, and a complete line of accessories to suit your application.

NOW the GR 1710 RF Network Analyzer — only a moment of your time for a demonstration.

LATER, even more.

For High-Frequency Measurements

 **General Radio**

300 BAKER AVENUE, CONCORD, MASSACHUSETTS 01742

NEW YORK (N.Y.) 212 964-2722, (N.J.) 201 791-8990
BOSTON 617 646-0550 • DAYTON 513 294-1500
CHICAGO 312 992-0800 • WASHINGTON, D. C. 301 948-7071 • ATLANTA 404 394-5380
DALLAS 214 234-3357 • LOS ANGELES 714 540-9830 • SAN FRANCISCO 415 948-8233
TORONTO 416 252-3395 • ZURICH (01) 55 24 20

GR COMPANIES • Grason-Stadler • Time/Data • Techware Computing Co.

INFORMATION RETRIEVAL NUMBER 97

Green, Yellow, Amber
or Red . . .



Our LED Panel Light Story is a Lot Brighter!

- LED panel lights brighter than incandescent lamps at 1/2 the current (2.5 mcd @ 10 mA).
- All four colors at the same low price as RED's (\$1.19 in 1000 quantities—includes built-in resistor and mounting hardware).
- Sub-miniature sizes with standard or low profile lens projections.
- Attractively styled and ruggedly built.
- Immediate availability of all colors.

TURN ON THE "LITTLE" LIGHT PEOPLE . . . phone or write for more information today!

DATA DISPLAY PRODUCTS

5428 W. 104th St., Los Angeles, Ca. 90045
(213) 641-1232

INFORMATION RETRIEVAL NUMBER 98

COMPONENTS

DIP-type switch provides
up to 10 contact pairs

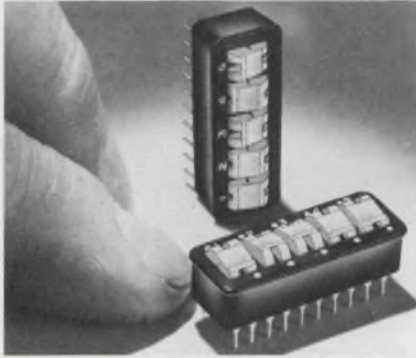

AMP Inc., Harrisburg, PA 17105.
(717) 564-0101.

New multiple rocker switches can contain from four to 10 individual, single-throw, contact pairs with a variety of ganging arrangements. They are housed in a miniature DIP packages and occupy less than 0.11 in³. A seven-contact-pair unit measures 0.38 × 0.78 × 0.35 in. exclusive of leads. Leads are on a standard 0.1 × 0.3-in-DIP spacing. In addition to form A contacts, form Z, make-before-break contacts, are also available. Contact material is beryllium-copper with gold-over-nickel plating. Electrical life is 2000-switch-operations minimum. Each pair of switch contacts is rated 50 V at 100 mA, nonswitching and 5 V at 100 mA, switching. Dielectric breakdown voltage between adjacent switch cells is 500-V-dc minimum.

CIRCLE NO. 328

Dynamic delay lines keep rise time to 1 ns

Technitrol, Inc., 1952 E. Allegheny
Ave., Philadelphia, PA 19134.
(215) 426-9105.

Dynamic delay lines of 25, 50 and 100 ns for high-speed and standard T²L and DTL provide five outputs in equal time increments with a fan out of 10 circuits per tap. Rise time at a V_{cc} of 5 V at 25 C with no load is 1 ns max in the 25 and 50-ns units; 2-ns max in 100-ns units. The three models are compatible and may be cascaded for any combination of delays without deterioration of rise times. Packaging is in a 14-pin DIP with a max 0.4-in. high as standard.

CIRCLE NO. 329

DO YOU HAVE AN electronic display light measurement problem?



A work horse when it comes to measuring the output characteristics of electronic displays; that's the Gamma Scientific Model 2900MR Scanning Microphotometer System.

Its versatility gives it the capability of measuring any type of display; CRT, LED, liquid crystal, gaseous discharge, large screen projection, photochromic, hard copy.

Specific measurements include: contrast, resolution, line width, spot size, persistence, phosphor noise, flare, halation, modulation transfer, radiance, illuminance, candlepower, spectral radiance, specular or diffuse reflectance, chromaticity, correlated color temperature, luminance profiling, integrated luminance, screen brightness, ambient light level, effects of polarizers, filters, etc.

Dynamic or static measurement. Two-slit technique, single-slit, square or circular apertures.

You can tailor the system to your needs simply by selecting the optimum lens-aperture combination.

Spatial or spectral scan capabilities added with either scanning eyepiece or monochromator, both motor driven. Dual channel digital interfacing with computers.

Give us your problem. We're sure we can help.

Call collect.



**GAMMA
SCIENTIFIC
INCORPORATED**

3777 Ruffin Road, San Diego, Calif. 92123
(714) 279-8034 Cable: GAMS1 SDG TELEX: 69 7938

INFORMATION RETRIEVAL NUMBER 99

ELECTRONIC DESIGN 24, November 22, 1974

PM motor line operates on batteries

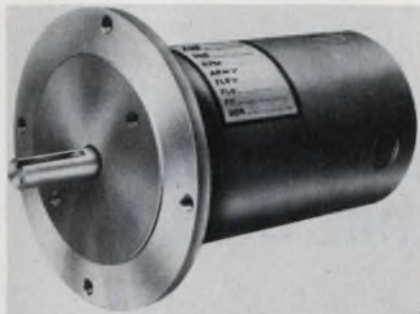

Indiana General, 405 Elm St., Valparaiso, IN 46383. (219) 462-3131.

New Model 45 fractional-to-integral horsepower NEMA PM motors are designed for high efficiency with battery powered systems—typically 10% higher than wound-field designs. Also, the motors feature linear speed/torque characteristics and dynamic braking. Pulse and start-up torque are as much as 20 times the continuous-torque rating. Thus peak-load demands can be met without resorting to large motor sizes. Speeds to 3450 rpm are available in a wide range of sizes and voltage ratings.

CIRCLE NO. 330

Power-line filters are UL recognized



Sprague Electric Co., 347 Marshall St., North Adams, MA 01247. (413) 644-4411.

A new series of low-cost general-purpose EMI power-line filters, Series JX5100, filters both sides of the line and protects equipment from line noise. The filters are UL recognized for 125 or 250-V-ac operation, and they are available in current ratings from 1 to 30 A with several different terminal configurations. The filters withstand a test voltage of 2100 V dc, line-to-ground capacitance is only 0.01 μ F and the maximum leakage current of each line to ground at 115 V, 60 Hz is 0.5 mA.

CIRCLE NO. 331



If you could save up to 30% without losing anything by using this new 10mm ceramic trimmer capacitor, wouldn't you want to know it?

That's exactly what we can promise you for many applications. All the performance you need for about a third less than you've been spending.

These new trimmers have five capacity ranges from 3.0pF min. to 30.0pF max. Their operating temperature range is -30° C. to $+125^{\circ}$ C. And they mount interchangeably with other ceramic trimmers for PC applications. Four dielectric types available.

But check them out for yourself. Get the coupon in the mail today.

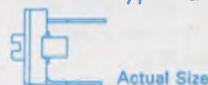

E. F. JOHNSON COMPANY/Waseca, Minnesota 56093. Dept. 3302
You bet I'd like literature and a free test sample of your new low cost trimmer capacitor if it can do what you say!

Check capacitance (pF) range needed:

- 3.0 to 8.0 3.0 to 12.0 5.0 to 13.0
 5.0 to 20.0 5.0 to 30.0

_____ Please send them directly.

_____ Please call me at: _____

Name _____

Firm _____

Title _____



Address _____

City _____

State _____

Zip _____

E. F. JOHNSON COMPANY

INFORMATION RETRIEVAL NUMBER 100

RED =
LOGIC HIGH

F.

WHITE =
LOGIC LOW

A.

BLUE =
PULSE

C.

T. a new,
faster,
low cost, digital
system that cuts
troubleshooting
time to minutes
...or seconds.

You'll reduce setup time, increase field service cost efficiency, reduce training time, relieve documentation worries, and best of all speed analysis time, with the new F.A.C.T. system for digital troubleshooting.

Failure Analysis by Color Tracing is an exclusive Kurz-Kasch system. By comparing the color observed on a logic probe with the color marked on a print, schematic or overlay, anyone can troubleshoot digital logic. No decision making is needed. F.A.C.T. does it all. F.A.C.T. is faster than scopes, clips, meters or comparators and displays more information. Its low cost... \$149.50, includes a Kurz-Kasch logic probe and pulser, a protective pocket pouch and a F.A.C.T. software documenting procedure. For FREE literature, 30 day FREE TRIAL probes, or special F.A.C.T. information, telephone Tom Barth, General Manager, (513) 296-0330, 2876 Culver Avenue, Dayton, Ohio 45401.



Kurz-Kasch, Inc.
ELECTRONICS DIVISION

INFORMATION RETRIEVAL NUMBER 101

220

POWER SOURCES

3-output variable supply regulates to within 0.01%



Lambda, 515 Broad Hollow Rd., Melville, NY 11746. (516) 694-4200. \$600, 4 to 8 wk.

For the designer who breadboards large digital and analog systems, Lambda has developed the LPT-7202-FM triple-output, metered lab power supply. It delivers 0 to 7 V at 5 A and two 0-to-20-V levels at 1.5 A each.

The adjustable outputs are regulated to within 0.01% + 1 mV for line variations from 105 to 125 V ac rms. Load regulation is the same for a 0-to-100% load change. The ripple and noise specs are 500 μ V rms and 1.5 mV, pk-pk, with either the positive or negative terminal grounded.

Front-panel analog metering covers all variables: There are three voltmeters and three ammeters. No switch is needed to read any output variable. Each power supply is completely independent and can be series-connected to the next for wide voltage swings.

The 7202 has constant current with automatic crossover capability. The current range is 1.5 A maximum, and a minimum of 0.1% of max or 45 mA can be obtained.

Voltage outputs can be remotely controlled via resistance programming of 200 Ω /V or voltage programming of 1 V/V. The outputs have temperature coefficients of 0.015% + 300 μ V/ $^{\circ}$ C.

The supply is rated for operation over a wide 0 to 60 C, but above 30 C the output current must be slightly derated by 0.5 A on the 7-V output for every 10-C increase, and by about one-third as much on the dual outputs.

Electronic overload protection, using adjustable current-limiting, can be set over 1 to 105% of the rated current output. The over-voltage protection is an option, and the extra circuits can be mounted on the rear panel. The supply operates to rated specs over line inputs of 105 to 132 V ac and can optionally be ordered for higher line voltages. The V option allows operation from 187 to 242 V or 205 to 265 V.

Three other power supply manufacturers have triple-output supplies with similar ratings. Power Designs in Westbury, NY, has the TP-325, which provides 0 to 6 V

(continued on page 222)

Clean up your act!

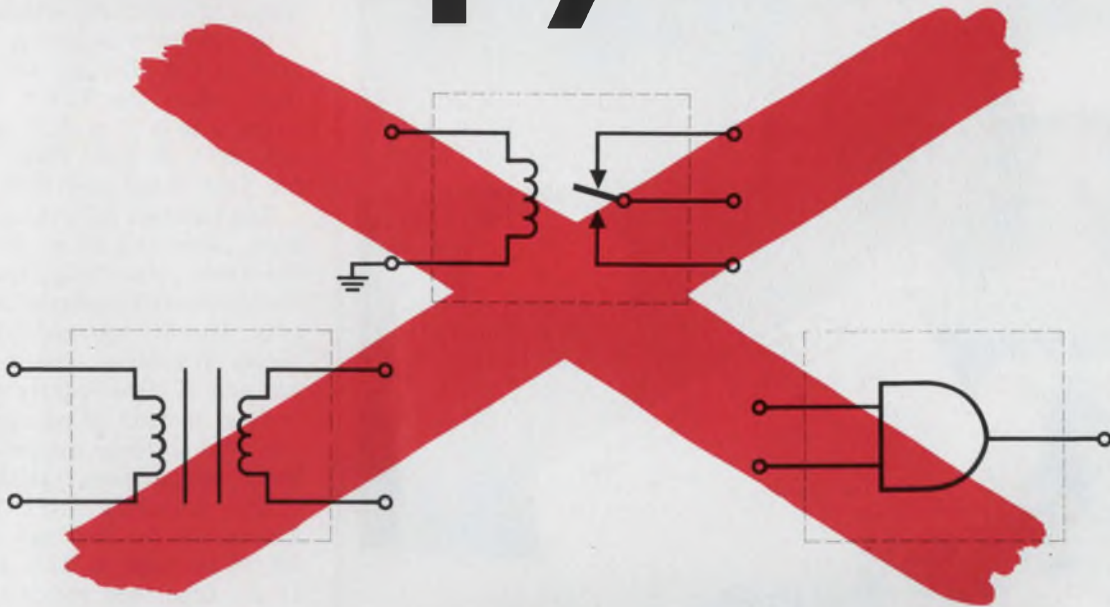

Opto-isolate your critical circuits with Monsanto's MCT2's.

Here's a cost-effective way to get top signal transfer (50% CTR for MCT2's, 250% for MCA 230's), yet isolate critical components against transients of 1.5 to 2.5kV: Put an opto-isolator in the circuit. Switching speeds range from 150kHz (MCT2) to 10kHz (MCA230). Millions of them are in daily use in industrial controls, telephone interfaces, computer mainframes and peripherals. Cleaning the noise out of critical paths.

System interface problems?

We've put together App Notes on sixteen of the thorniest design problems that O/I's can help solve. Includes:

- Input drive circuits.
- Solid-state 125 MA relay.
- Low-cost AC relay.
- O/I's in linear coupling.



- Gated amplifier functions.
- Phone line coupler isolator.
- Logic isolation, line receiver.
- Interfacing Darlington O/I's to TTL logic . . . and more!

We'll be glad to send you a copy of this 64-page applications book. Simply ask for it on your letterhead. And give us an idea of your application, will you please?

And now . . . more!

We've increased our production of these widely accepted components during the past six months and can now deliver the quantities you specify when you need them. Call your Monsanto distributor or **Monsanto Commercial Products Company**, Electronics Division, 3400 Hillview Avenue, Palo Alto, CA. 94304. Phone: (415) 493-3300

Putting innovation to work.

Monsanto

INFORMATION RETRIEVAL NUMBER 102



Read our report card.

The slip packed in each Wesco shipment is your assurance of straight "A" performance from every Wesco capacitor, and we enclose our report card to prove it. Our Quality Control Acceptance Report assures you of top grades for reliability, dependability and performance.

So stop worrying about passing your Q.C. tests. Graduate to the capacitor company that packs its reputation *and* its report card in every shipment.

WESCO

WESCO ELECTRICAL COMPANY
201 MUNSON STREET
GREENFIELD, MASSACHUSETTS 01301
TELEPHONE: 413-774-4358

POWER SOURCES

(continued from page 220)

at 5 A and a dual 0 to 32 V at 1 A. Powertec in Chatsworth, CA, makes the 6C3000, which provides 0 to 6 V at 5 A and a dual 0 to 36 V at 1 A. Trygon, also in Westbury, offers the TL8-3, which delivers 0 to 8 V at 3 A and a dual 0 to 36 V at 1 A. These units sell for \$375, \$350 and \$275.

The Lambda unit, though it costs \$600, gives you more. For a start, the three other supplies are not simultaneously metered on all outputs. The 6C3000 and TL8-3 have poorer regulation specs. The TP-325 and 6C3000 require forced air cooling, instead of convection cooling. And all three competitors have lower temperature ratings.

The Lambda LPT-7202-FM weighs 24 lb. and has a size of 5-3/16 in. high × 12.5 in. wide × 11 in. deep, not including control knobs. The supply can be operated at 50-Hz line frequency if you derate the output currents by 10%.

Lambda	CIRCLE NO. 301
Power Designs	CIRCLE NO. 472
Powertec	CIRCLE NO. 473
Trygon	CIRCLE NO. 474

Modular series includes thermal-barrier models



Analog Devices, Rte. 1 Industrial Pk., P.O. Box 280, Norwood, MA 02062. (617) 329-4700. \$99; stock.

This new series of modular power supplies includes one thermal-barrier, four chassis-mount, and one low-profile model. All the supplies use current limiting for short-circuit protection. Each supply operates from 0 to 71 C, and accepts 105 to 125 V ac, 50 to 400-Hz input. Tempco is 0.015%/°C. The units provide 5 or ±12 or ±15 V at currents ranging from 100 to 1000 mA. Size of the low-profile 902-2 is 3.5 × 2.5 × 0.875 in.

CIRCLE NO. 332

Data Precision Introduces A New 4-1/2 Digit DMM

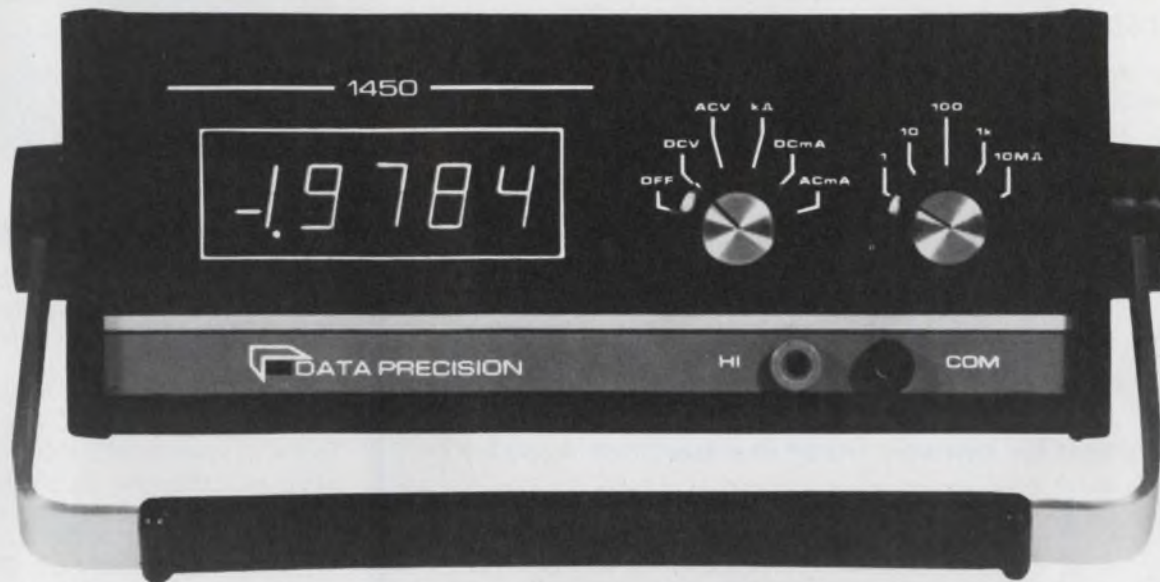

MODEL 1450

only **\$325.** complete

BIG, BRIGHT 1/2 INCH PLANAR DISPLAY
5 FUNCTIONS - 21 RANGES - 100% OVERRANGE
6 MONTH DC ACCURACY OF $\pm 0.02\%$
OF READING, $\pm 0.01\%$ f.s.

Data Precision's newest family member is a 5-function, 21-range, economical, laboratory-precision bench instrument. This low cost/high performance 4-1/2 digit Multimeter features bright 1/2 inch planar display, full electronic overload protection to 1000V on all DC ranges, 500V on AC, 115V on resistance, fuse protection on current. Simple 2-knob operation. Data Precision proven circuitry includes Tri-Phasic™ auto-zeroing A/D converter, Ratiometric™ resistance mea-

surement and the patented high-stability Isopolar™ reference. One year warranty, Certificate of Conformance, Test Documentation, instruction manual and probes.

- DC Volts, 100 microvolts to 1000V
- AC Volts, 100 microvolts to 500V RMS
- Resistance, 100 milliohms to 20 Megohms
- AC and DC Current, 1 microamp to 2 Amps
- AC Voltage/Current response, 30Hz to 50kHz

In-stock availability from our representatives:

AL (205) 533-5896	GA (404) 457-7117	MN (612) 781-1611	NY (N) (315) 446-0220	UT (801) 268-3181
AZ (602) 994-9519	HI (808) 262-6286	MO (W) (816) 737-0066	NY (S) (516) 482-3500	WA (206) 763-2210
CA (N) (408) 733-9000	IL (312) 593-0282	MO (E) (314) 731-2331	OH (N) (216) 725-4560	
CA (S) (714) 540-7160	IN (317) 293-9827	NC (919) 787-5818	OH (S) (513) 885-4171	
CO (303) 449-5294	MA (617) 273-0198	NJ (S) (215) 925-8711	OR (503) 238-0001	CAN (W) (416) 787-1208
CT (203) 525-7647	MD (301) 792-8661	NJ (N) (201) 863-5660	TX (N) (214) 234-4137	CAN (W) (613) 772-5874
FL (813) 294-5815	MI (313) 482-1229	NM (505) 265-6471	TX (S) (713) 461-4487	CAN (E) (514) 731-9328

 **DATA PRECISION**
 ...years ahead

Data Precision Corporation
 Audubon Road, Wakefield, MA 01880
 Phone (617) 246-1600

INFORMATION RETRIEVAL NUMBER 104

Linear-IC tester measures 7 parameters

Delstad Electronics, 861 Revere Ave., Bronx, NY 10465. \$885; 6 to 8 wks.

This linear IC tester measures

plus and minus bias currents, offset currents, offset voltage, bandwidth, open-loop gain, and common-mode voltage. Optional features include programmable power supplies and a built-in oven for temperature drift of the above parameters. Plug-in circuit boards allow simple and rapid testing of most existing ICs, including the new dual and quad op amps.

CIRCLE NO. 333

Triggered-sweep scope comes in compact case



B & K Dynascan Corp., 1801 W. Belle Plaine Ave., Chicago, IL 60613. (312) 327-7270. \$399, less probe.

Model 1431 scope is only 4-3/4 x 7-7/8 x 12-7/8-in. deep, said to be approximately one-third the size of comparably performing scopes. Bandwidth on the vertical amplifier is dc to 10 MHz, with a sensitivity of 10 mV/div. In addition to triggered sweep, sync is fully automatic. There are one, two, and five steps on the calibrated vertical attenuator; TV-H and TV-V sweep selector positions for viewing two horizontal lines or two vertical fields at the flip of a switch. Sweep time is 0.5 μs/div to 0.5 s/div, in 19 calibrated ranges; with 5X magnification, maximum sweep speed increases to 0.1 μs/div.

CIRCLE NO. 334

Digital indicator brags 72 versions



Phillips Industries, Dept. CSA, Postfach 120, 35 Kassel-B./West Germany.

Digital 377 is a panel-mountable digital indicator with 72 versions, so that it can be tailored to user specs. The unit is sized to 144-mm x 48-mm DIN standard front dimensions. Indication is provided by a 3-1/2-digit, seven-segment planar display. Numerals are 14-mm high. Inputs can be voltage or current. Polarity display is automatic.

CIRCLE NO. 335

OVER 120dB

How's that for dynamic range in a spectrum analyzer?

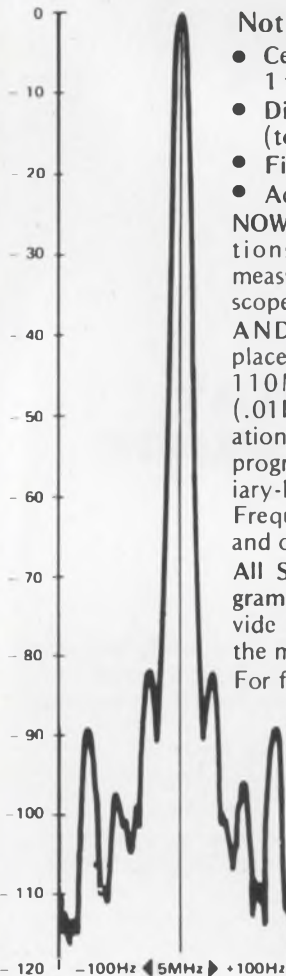

Not to mention . . .

- Center-Frequency, Range 0 to 11MHz, plus 1 to 110MHz (with 100dB dynamic range).
- Dispersion Range, ±200Hz to ±10kHz (to ±100kHz on 110MHz band).
- Fixed Analysis Window, 10Hz
- Accuracy, ±5Hz!

NOW you can go after those elusive low-level modulations and perturbations, and get meaningful, accurate measurements, displayed on an X-Y recorder or storage scope, and on a panel dB meter.

AND that's with just a Model 6303 Plug-In Unit. Replace it with a Model 6300 and you've got a 10kHz to 110MHz Frequency Synthesizer, with 1Hz resolution (.01Hz optional), AM/FM modulation, Search, attenuation from +10 to -115dBm in -1dBm steps, 500 μsec programming speed with no switching transients. Auxiliary-Function Plug-ins offer Sweeps and Markers, Phase/Frequency Comparison, Sine/Square Wave Modulation, and other functions.

All Series 6000 models are manually and remotely programmable. Adret "handshake interface" PC cards provide compatibility with virtually any minicomputer on the market today.

For full details, request Bulletin 3545 today.

1887 Lititz Pike
Lancaster, Pa. 17601
(717) 569-7059



There's nothing new about a 2N3055 but there's a **powerful** difference in this one.

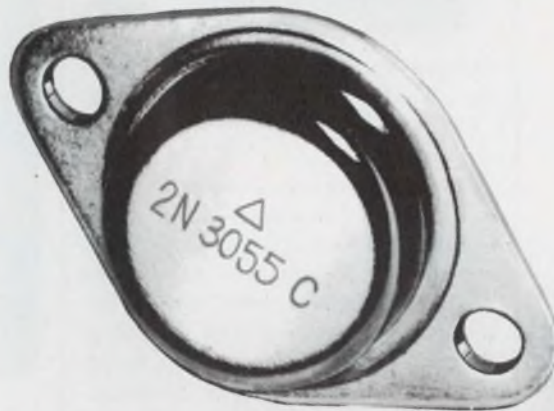

**That's why we call ours the 2N3055C *
*"C" designates it as the Cadillac of power transistors.**

Compare the specs below and see at a glance why Sensitron's up-graded version of the workhorse 2N3055 . . . the 2N3055C . . . is your best bet for a wide range of power transistor applications.

Parameter	Conventional 2N3055	RSM Sensitron "Cadillac" 2N3055C
Chip size	140-175 mil ²	210 mil ²
P _D	115 W @ 25°C case temp.	150 W @ 25°C case temp.
I _{Cmax}	15 A	30 A
BV _{EBO}	7V	10V
BV _{CEO}	60 V	120 V
BV _{CER}	70 V	130 V
I _{CEX}	@ 100 V < 5 mA	@ 120 V < 1 mA
h _{FE}	20 @ 4 A	25 @ 4 A
h _{FE}	5 @ 10 A	10 @ 8 A
V _{CE} (sat)	1.1 V @ 4 A	0.75 V @ 4 A
V _{CE} (sat)	8.0 V @ 10 A	3.0 V @ 10 A
SOAR	60 V @ 1.9 A	70 V @ 2.15 A

Write or call for more information or applications assistance on the 2N3055C and other RSM Sensitron single diffused power transistors.



Sensitron Semiconductor

A DIVISION OF RSM ELECTRON POWER, INC.
221 West Industry Court • Deer Park, N.Y. 11729
Telephone 516-586-7600 • Telex 96-7737

INFORMATION RETRIEVAL NUMBER 106

a little A-300 goes a long way.



In high frequency transmission. RF power generation for industrial and research processes. RFI/EMI and general laboratory applications, too.

The Model A-300 is a totally solid state power amplifier, covering the frequency range of 0.3 to 35MHz with a gain of 55dB. Capable of delivering 300 watts of linear Class A power and up to 500 watts in the CW and pulse mode, the A-300 is the ultimate in reliability.

Although the unit is perfectly matched to a 50 ohm load, it will deliver its full output power to any load (from an open to a short circuit) without oscillation or damage.

Complete with power supply, RF output meter and rack mount, the A-300 weighs a mere 89 pounds and operates from ordinary single phase power.

High power portability goes a long way for \$5350.

For further information or a demonstration, contact ENI, 3000 Winton Road South, Rochester, New York 14623. Call 716-473-6900 or TELEX 97-8283 E N I R O C

ENI

The World's Leader in Solid State Power Amplifiers

SEE Electronic Design's **GOLD BOOK** FOR COMPLETE PURCHASING INFORMATION

INSTRUMENTATION

Counter/totalizer takes inputs to 100,000/s



Durgin & Broune, Inc., 80 Allied Rd., South Burlington, VT 05401. (802) 863-6873. Start at \$110; stock.

The 300 series electronic counter/totalizer totalizes with absolute accuracy a variety of inputs at speeds up to 100,000 counts per second. Standard units will totalize contact closures and dc pulses from 5 to 50 V dc. All 300 series units feature a unique programmable bounce-guard circuit for slow speed totalizing of mechanical switch and relay closures. The digital readouts are 3/8-in. high seven-segment displays. The counter weighs 2.25 lbs, requires a panel cutout of 2.8 x 4.3 in. and has a rear panel depth of 3.5 in.

CIRCLE NO. 336

Probe accepts 4 inputs with variable delay



Electronic Systems and Products, P.O. Box 57822, Webster, TX 77598. (713) 479-6734. \$98; 30 days.

The Model LP-TTL logic probe can acquire, store and display the status of four data input lines at any selectable time from 1 to 10,000 μ s after an input trigger. The trigger can be a plus or minus transition or free run. All inputs and the delayed strobe output are TTL-compatible. External power of 4.5 to 5.5 V at less than 100 mA is required. The unit is 1 x 2 x 4-in., weighs 5 oz and comes complete with test leads.

CIRCLE NO. 337

There's still nothing like them.



The PRD 915-B Attenuation Calibrator has long been in a class by itself.

It measures up to 110 dB in a single step, and achieves an accuracy of ± 0.03 dB/10 dB with only -80 dBm input power. It's the lab/production line instrument for attenuator calibration, extreme VSWR measurements, noise measurements, and sensitive detection in reflectometers, plasma diagnostics, etc.



The PRD 819-A Klystron Power Supply saves a jumble

of power supplies, meters, and haywire connections. It provides universal operating potentials and modulation capabilities for low and medium power microwave and millimeter klystrons to 3,600 volts and 100 milliamperes.

Looking for quality microwave components? Ask for our "Quick Guide" to microwave instruments & components. Call (516) 334-7810. Or write:

PRD Electronics, Inc.

A subsidiary of Harris Corporation
1200 Prospect Ave. / Westbury, L.I., N.Y. 11590



DPMs measure ratios and absolute values



ILC Data Device Corp., Airport International Plaza, Bohemia, NY 11716. (516) 567-5600. 2000: \$79; 2000A: \$89 (100);

These 3-1/2-digit DPMs, Models DDC 2000 and DDC 2000A, perform both ratiometric and absolute value measurements. The DDC 2000 is a digital ratiometer that converts low-level signals directly from transducers without signal conditioning or excitation power supplies. Both units feature independently floated differential inputs (signal and reference channels), LED displays, simultaneous track and hold inputs, require no adjustments, and are powered from a single 5-V dc logic supply. The units are identical except that the 2000A includes an internal reference for absolute value measurements.

CIRCLE NO. 338

Frequency counter gives portable operation



Dymar Electronics Ltd., Colonial Way, Radlett Rd., Watford, Herts. WD2 4La, England.

Model 1680 measures radio frequencies over the 30-Hz-to-600-MHz range in the field or in the laboratory: The unit operates from either ac or from internal, rechargeable batteries. Sensitivity is 10 to 15 mV up to 500 MHz and 20 to 40 mV from 500 to 600 MHz. Featured are a 9-digit LED display and accurate measurements even in the presence of a large proportion of AM on the carrier wave. The unit measures $7 \times 10\text{-}1/2 \times 2$ in., and weight with batteries is 5-1/2 lb.

CIRCLE NO. 339

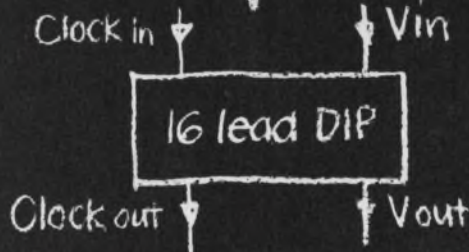

Analog Memory
70 DB S/N
Sample rate: 12 MHz
1 μsec - 40 msec delay
IN PRODUCTION!

Reticon Corporation, a pioneer in solid state image sensing, has now applied its technological leadership to the field of analog memories.

These devices are large scale integrated circuits which sequentially time sample an analog input signal and store each sample as an analog voltage level on one of a series of storage capacitors. The stored samples are then read-out in sequence to reconstruct the original input signal with a new time base. Several device types are available from inventory with up to 128 elements of storage.

Applications include time base correction (expansion or compression), tapped delay lines, correlation, digital filtering, real time Fourier transforms, chirp radars and many others.

Write or call for further information including detailed peripheral circuits.

There are over 60 salesmen and 14 distributors to serve you worldwide.

RETICON®

910 Benicia Avenue,
Sunnyvale, California 94086
Phone: (408) RET-ICON TWX: 910-339-9343

A logical test for Digital Logic Test Systems.

1. Can response be measured 100 nanoseconds after simultaneous applications of stimulus?

Yes **No**

2. Are clocks programmable for frequency, pulse width and number of pulses?

Yes **No**

3. Is it economically expandable to three work stations with 1024 two-way interface lines in each station?

Yes **No**

4. Does the system software provide a debug feature which allows the operator to monitor and control the test?

Yes **No**

5. Does it provide File Management, guided-probe fault isolation and complete self-test to the card level?

Yes **No**

Hughes 1024 Digital Logic Test System.



Hughes 1024 Digital Logic Test System answers yes to all the questions above. It also provides an optional simulation system, Digital Fault Analysis (DFA), which generates a logic model; simulates the unit under test; verifies using fault insertion techniques; and generates fault isolation data for the automatic guided probe. Time independent gate level simulation identifies "race" conditions and traces them to their origin.

Write for our new brochure: Hughes Automation Analysis, 2020 Oceanside Boulevard, Oceanside, CA 92054. Or call (714) 757-1200, Extension 336.

HUGHES
HUGHES AIRCRAFT COMPANY
INDUSTRIAL PRODUCTS DIVISION

INFORMATION RETRIEVAL NUMBER 110

INSTRUMENTATION

Recorder offers a number of 'firsts'



Astro-Med, Atlan-Tol Industrial Park, West Warwick, RI 02893. \$1950; 60 days.

Said to be the world's first inkless high-speed battery-powered two-channel recorder, the Model DASH 2 is also said to be the first to use electro-sensitive recording paper, as well as the first to include a chart-drive mechanism that provides an infinite variety of chart speeds. Weight of the complete unit is less than 25 lbs. Gel-cell batteries are rechargeable without removal from the case and provide up to 8 hours of continuous duty before recharge is required.

CIRCLE NO. 340

Recorder handles up to 14 analog inputs

Vishay Instruments, 63 Lincoln Hwy., P.O. Box 925, Malvern, PA 19355. (215) 644-1300. \$9100 complete pkg. (Model 304-6); 3 to 4 wks.

Model 304 dynamic recording system can simultaneously and continuously record up to 14 channels. The system consists of signal conditioning modules and a multi-channel recorder. The BA-4 signal conditioning module supplies the bridge completion, bridge and amplifier power, bridge balance, calibration and amplification. Another feature is a separate bridge power switch, which enables the operator to cut power on the bridge to validate the recorded data. The recorder used in this system houses an ultraviolet light source and optical system, as well as the galvanometers (light beam).

CIRCLE NO. 341

interface- ability

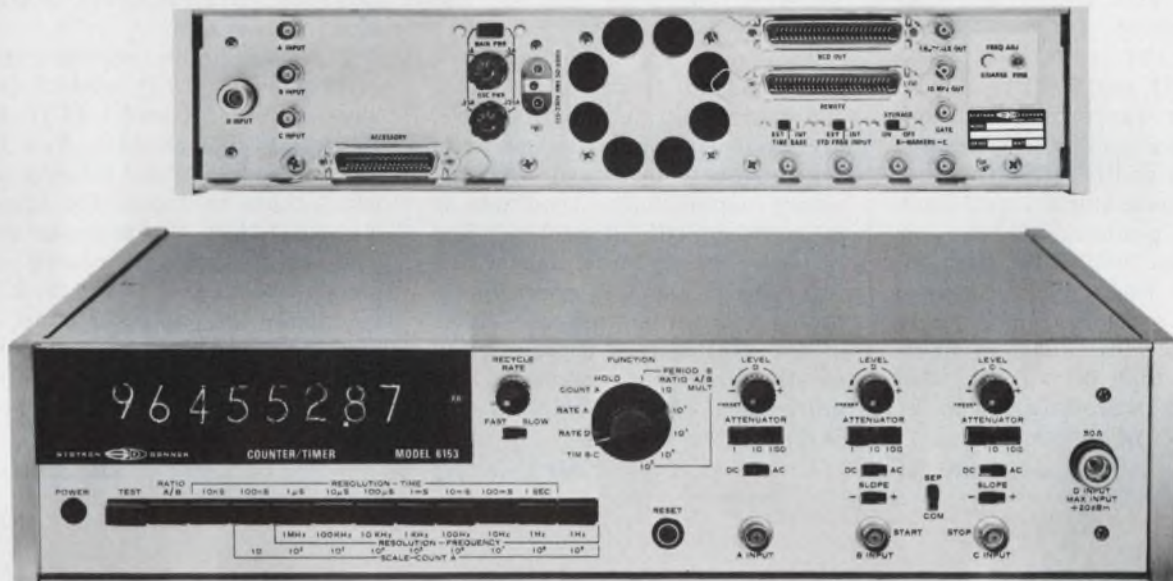

Or why **systems people** buy more S-D counters

- 6 remote **programming** options
- 4 **BCD** outputs (low and high level)
- Special codes, formats, logic levels
- Universal counter / timer functions
- 50, 200, 512 MHz, 3 GHz

For details or a demo on series 6150 counters, call your Scientific Devices sales and service office (listed below). Or contact Concord Instruments Division, 10 Systron Drive, Concord, CA 94518. For immediate details call our Quick Reaction line (415) 682-6471 collect. In **Europe**: Systron-Donner GmbH, Munich, W. Germany; Systron-Donner Ltd., Leamington Spa, U.K.; Systron-Donner S. A. Paris (Le Port Marly) France. **Australia**: Systron-Donner Pty. Ltd., Melbourne.

SYSTRON  DONNER

Albuquerque, (505) 268-6729; Baltimore, (301) 788-6611; Boston, (617) 894-5637; Burlington, NC (919) 228-6279; Chicago, (312) 297-5240; Cleveland, (216) 261-2000; Denver, (303) 573-9466; Dayton, (513) 298-9904; Dallas, (214) 231-8106; Detroit, (313) 363-2282; Ft. Lauderdale, (305) 721-4260; Hamden CT (203) 248-9361; Huntsville, AL (205) 536-1969; Houston, (713) 623-4250; Indianapolis, (317) 783-2111; Kansas City, KS (913) 631-3818; Los Angeles, (213) 641-4800; Minneapolis, (612) 544-1616; New York City area (201) 871-3916; Norfolk, (703) 499-8133; Orlando, (305) 424-7932; Philadelphia, (215) 825-9515; Phoenix, (602) 834-1682; Rochester, NY (716) 334-2445; San Antonio, (512) 694-6251; San Diego, (714) 249-6642; San Francisco area (415) 964-4230; Seattle, (206) 454-0900; St. Louis, (314) 842-2535; Syracuse, (315) 457-7420; Washington, DC area (703) 451-6500.

INFORMATION RETRIEVAL NUMBER 111

INSTRUMENTATION

Units combine pulse and waveform generation



Interstate Electronics, 707 E. Vermont Ave., P.O. Box 3117, Anaheim, CA 92803. (714) 772-2811. F74: \$895; F77: \$1095; 60 days.

Models F77 and F74 are said to be the first waveform generators to integrate a true pulse generator output with width settability into a function-generator format. Each unit offers positive, negative, or bipolar pulses to 20 MHz, with 15-ns rise/fall times and adjustable pulse-width settings from 30 ns to 10 ms. Pulse-width jitter is specified at less than 0.1%, with total pulse/square wave aberration at less than 5% of set amplitude.

CIRCLE NO. 342

Spectrum analyzers resolve to 0.01 dB



Hewlett-Packard, 1501 Page Mill Rd., Palo Alto, CA 94304. (415) 493-1501. \$9000 to \$30,000; December.

Two new spectrum analyzers, one manually operated, the other fully automatic and programmable, are designed for production testing, quality control and for laboratory applications. Amplitude is measured to 0.01-dB resolution and displayed in dB on a digital display. Model 3044A is manually operated and can be used with either of two synthesizers, depending upon the frequency resolution requirement. Model 3045A is the automatic version.

CIRCLE NO. 343

Skinny remote display needs no rear room



Nationwide Electronic Systems, 1536 Brandy Pkwy., Streamwood, IL 60103. (312) 289-8820. Start at \$211. 4 to 6 wks.

The new Slimline remote display gives a bright LED readout from any source of parallel BCD data (TTL/DTL compatible). New features include optional polarity sign and latches to freeze the display without affect on incoming data. The entire display is housed in a metal case only 9/16-in. thick; it mounts on the front of a panel and uses no room in back. The unit operates from 5 V dc power and incorporates MAN-72 seven-segment LED arrays.

CIRCLE NO. 344

Fluke mates

**Advanced L.S.I. multimeter
26 ranges, 5 functions.
\$299**



8000A

- 3½ digit Fluke quality DMM
- Combines analog and digital LSI
- ac and dc volts, amps and ohms measurements
- 0.1% dc accuracy guaranteed for one full year
- Optional battery operation and data output
- Full 12-month guarantee

**Autoranging LSI/MOS multi-function counter
\$349**



1900A

- Autoranging in both frequency and period measurements
- 5 Hz to 80 MHz, high sensitivity — 25 mV
- Event counting to 10⁶ events, automatic overflow
- Six digit LED display with automatic annunciation
- Optional battery operation and data output
- Full 12-month guarantee



John Fluke Mfg. Co. Ltd., P.O. Box 1094, Station "D"
Buffalo, N.Y., 14210. Phone (716) 842-0311. TWX 610-492-3214

INFORMATION RETRIEVAL NUMBER 112

SEE
THIS



DEMO
CASE
IN
YOUR
OWN
PLANT



LET US SHOW YOU – IN PERSON – WHY **TEC-LITE**
INDICATING DEVICES ARE THE BEST, MOST
RELIABLE UNITS THAT YOU CAN BUY!

CALL FOR AN IN-PLANT APPOINTMENT

TEC-LITE... YOUR COMPLETE SOURCE FOR SWITCHES, INDICATORS,
READOUTS AND INFORMATION DISPLAY/CONTROL DEVICES



9800 N. ORACLE RD./TUCSON, AZ. 85704 U.S.A./ (602) 297-1111

datum inc

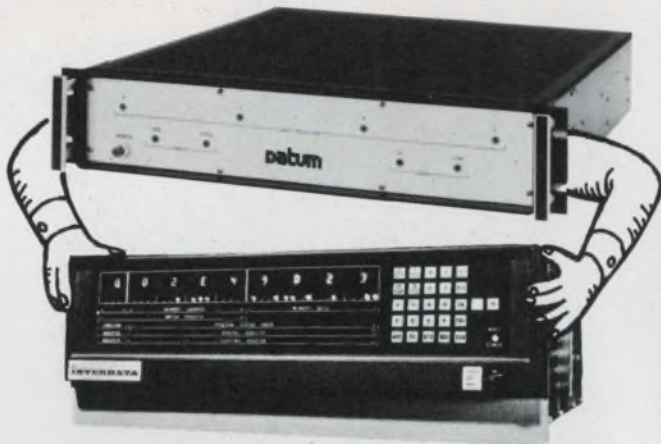

DATUM knows how to control your Interdata

The expert, DATUM, now brings complete mag-tape control to your Interdata minicomputer. Just one DATUM 5091/Interdata controller interfaces and formats up to four 1/2-inch magtape drives of almost any kind... or cassette drives. Each port has its own I.C. drivers for maximum reliability. You control any combination of 7 or 9 tracks, at 12.5 to 125 ips, with odd or even parity. And, with single or multiple data densities of NRZI and PE formats, you still remain ANSI and IBM compatible. Furthermore, software for your mini is software for DATUM. It is features like these plus over 4000 DATUM magtape systems for other minicomputers, that give us the know-how to control your Interdata.

Write for specifications
and prices

Datum inc

1363 S. State College Boulevard, Anaheim, California 92806 ■ 714/533-6333
EUROPE ■ Datum House, Cranford Lane, Harlington, Middlesex, UK ■ 01-879-0456

INFORMATION RETRIEVAL NUMBER 114

INSTRUMENTATION

Function generator offers variable phase

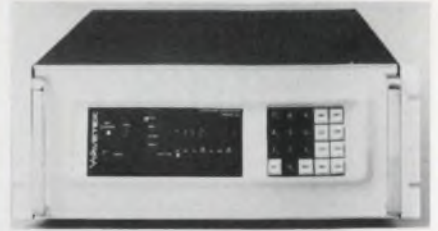

Wavetek, P.O. Box 651, San Diego, CA 92112. (714) 279-2200. \$495; 45 days.

This programmable function generator, the 152, has variable phase outputs with manual or remote control of phase angle. Phase may also be referenced to an external or internal synch and controlled with 4-digit resolution. Each output is independently programmable for sine, cosine, triangle or square waveform or dc voltage, as well as amplitude and offset to ± 9.99 V peak; all with 3-digit resolution. Frequency is common for all channels and programmable with 3-digit resolution. Programming is remote by 7-bit parallel ASCII coded characters or by front-panel keyboard with LED readout. Characters are accepted at a 1-MHz rate. Frequency range is 1 Hz to 100 kHz.

CIRCLE NO. 345

Unit calibrates tape recorders automatically



Vu-Data Corp., 7170 Convoy Ct., San Diego, CA 92111. (714) 279-6572. \$3495; 60-90 days.

Model 101B harmonic-analyzer system is a multifunction instrument that provides automatic calibration of instrumentation or audio tape recorders. The unit measures 2nd or 3rd-harmonic distortion of fundamentals up to 1 MHz and voltage up to 5 MHz. Other specs include: distortion from 0.3% to 100% fs and voltage from 3 mV to 10 V fs.

CIRCLE NO. 346

MORE SWITCH FOR THE MONEY.

NOW YOU CAN SPECIFY PRACTICALLY ANY CUSTOM PUSHBUTTONS ON SWITCHCRAFT'S DW "Multi-Switch®"

There's almost no limit to the variety of pushbuttons you can use on this space-saving, multiple-station pushbutton switch. It has a newly designed "Cross-Rib" actuator located on each module

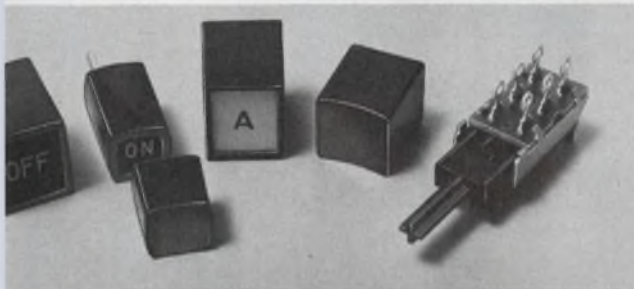

that makes the switch more versatile than ever.

The "Cross-Rib" actuators conform to industry standards and are furnished $\frac{3}{4}$ " and $\frac{1}{2}$ " long to accommodate different size pushbuttons. They solve many operator-machine interface problems

when used with Switchcraft non-illuminated "Dual," "Showcase," concave or convex face, rectangular, round or square pushbuttons, or the unique "Glo-Button" that achieves simulated illumination.

MORE QUALITY FOR THE MONEY.

In a nutshell, the Series 70000, 71000 DW "Multi-Switch®" is an economical 1 to 18 station switch, that offers up to 4 PDT switching per station; Interlock, All-Lock, Non-lock or Push-lock/ Push-release functions, plus an almost unlimited variety of electromechanical and electrical accessory options. These switches are adaptations of the Switchcraft Series 65000 DW "Multi-Switch®" switches that

are noted for their simplicity, economy and reliability.

DW POWER MODULES FOR HEAVY CURRENT SWITCHING

For "on-off" power switching, motor control and a variety of other high-current

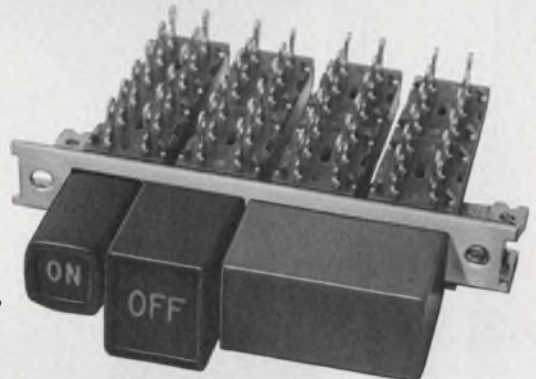

applications, specify a DW Power Module—one per station maximum. Turret terminals are brass with tin-lead coating. The snap-action switch is Form 1-C rated at 11 amps, and is U.L. and C.S.A. listed. The mounting brackets and insulating shields are designed to meet those same requirements.

YOUR FREE DICTIONARY

We publish a handy dictionary of switching and connecting terminology. Write us for your free copy and we'll also put you on the list for TECH-TOPICS. Over 12,000 engineers find the application stories in this technical review extremely helpful. SWITCHCRAFT, INC., 5529 N. Elston Avenue, Chicago, Illinois 60630



SWITCHCRAFT®

INFORMATION RETRIEVAL NUMBER 271

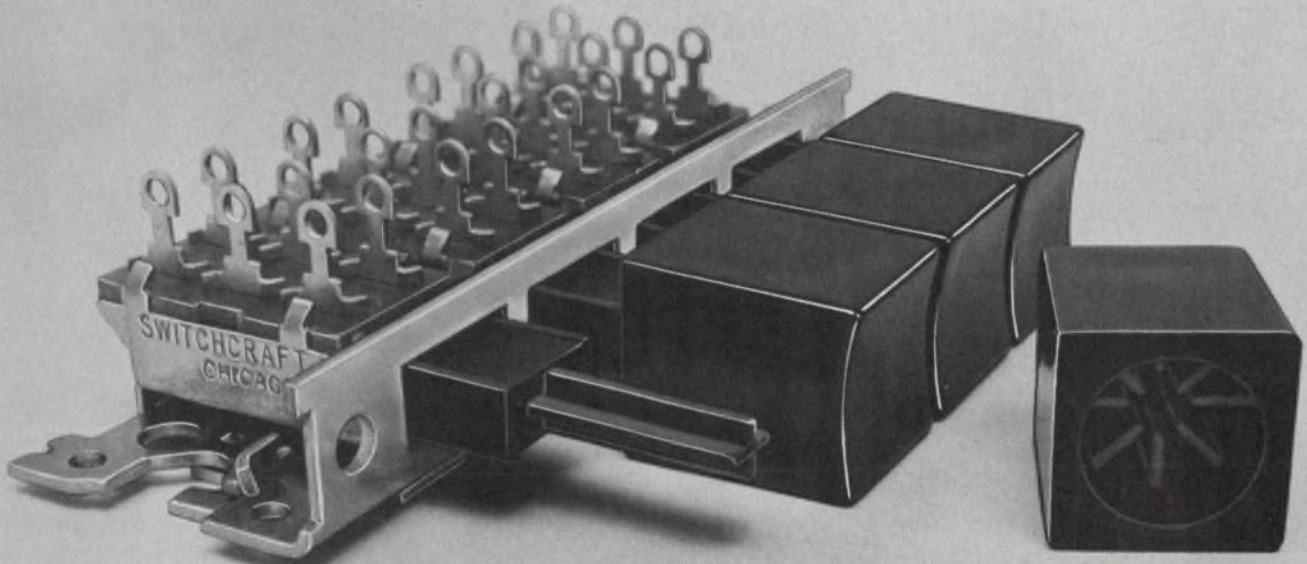

THICK FILM RESISTORS COME IN MANY SHAPES!

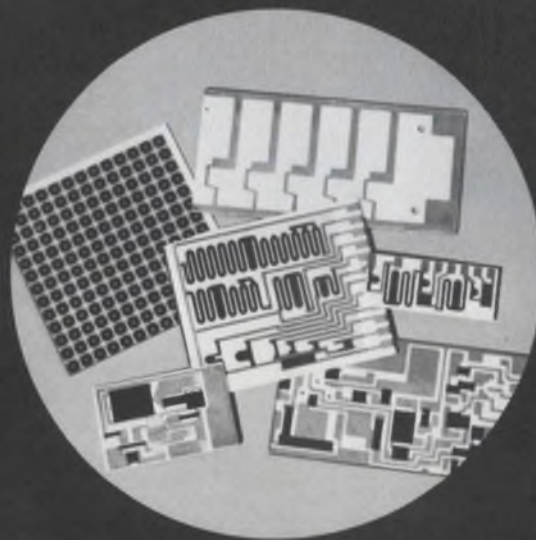
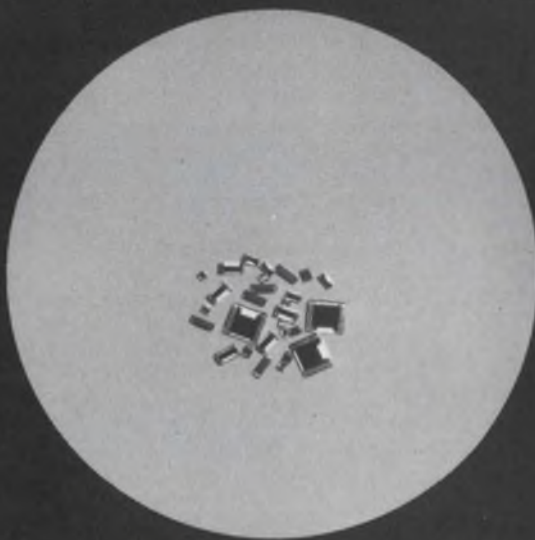
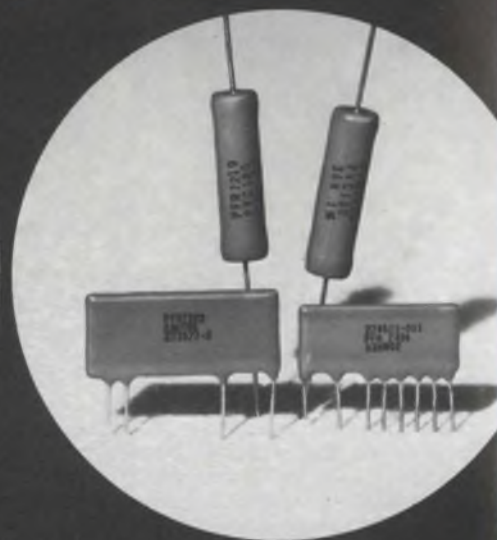
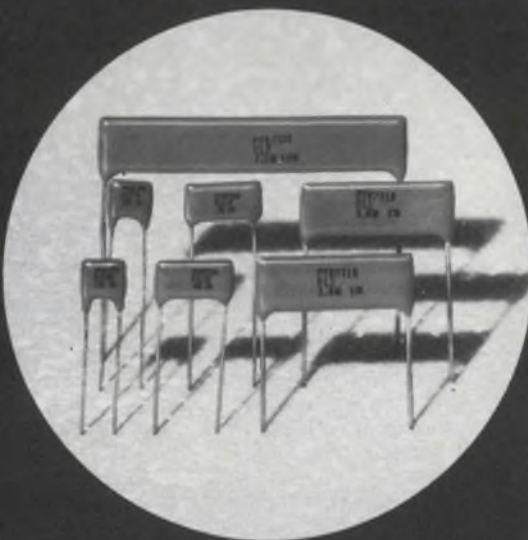

When You Specify Pyrofilm ...

PVC—High Voltage, up to 17.5 KV, up to 1000M, as low as 100 PPM/°C.

FLATSO—4 Sizes up to 10 KV, 100M. 1/2, 1/4, 1 & 2W. Tolerances: 1, 2, 5 & 10.

NETWORKS—Matched in Temp. Coefficient, Ratio and/or Tolerance.

CHIPS—6 sizes with values ranging from 10 ohms to 5 meg. ohms.

CUSTOM NETWORKS—Sure, the Pyrofilm Thick Film Resistor Line is broad... but there are times when you have a unique set of requirements. That, too, is the time to talk to the Pyrofilm people.

Setting New Standards in Reliability

PYROFILM

60 S. Jefferson Road • Whippany, N. J. 07981 • (201) 887-8100

INFORMATION RETRIEVAL NUMBER 291

921

AVAILABLE NOW!

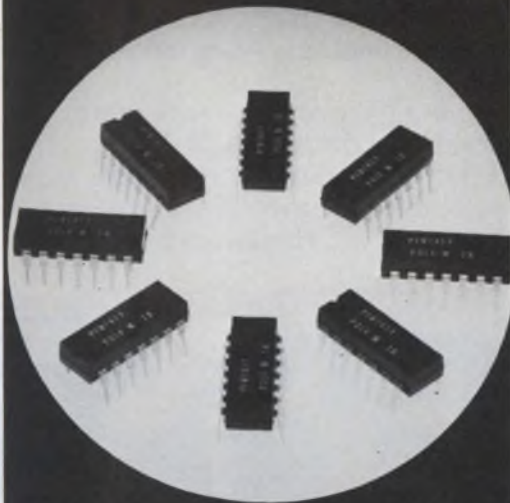

NEW PYROFILM DIPs

Standard Circuits
Custom Circuits



AVAILABLE SOON!

Complete Full Line Catalog
Circle Information Retrieval
Number 290

Setting New Standards in Reliability
PYROFILM

60 S. Jefferson Road • Whippany, N. J. 07981
(201) 887-8100

INSTRUMENTATION

System automatically tests relays



Teradyne, 183 Essex St., Boston, MA 02111. (617) 482-2700. \$58,000 to \$64,000; 20 to 24 wks.

The K167B relay test system is a new configuration of the K167, introduced last year, and is directed toward medium-sized manufacturers and medium to high-volume users of relays. In the K167B, four-station multiplexing and high-voltage dc and ac capability have been removed and are now offered as field installable options. Specs and performance of the K167B are otherwise the same as the K167. The same hard-copy data are available: lot summary sheets, measured parameter values (data logging) and automatic distribution analysis.

CIRCLE NO. 468

Portable unit measures temperature to 1%

Sys-Tec, Inc., 877 Third St., S.W., New Brighton, MN 55112. (612) 636-6373. \$65.

The Model TM-107A temperature meter covers 200 to 400 F. An industry-standard 200 Ω NiFe resistance temperature detector (RTD) is used to provide input accuracy and allows field interchangeability without recalibration. Readout is activated by a pushbutton and displayed on the mirrored scale meter. Accuracy is $\pm 1\%$. The meter is protected against shock and overload, and will read full scale if the RTD becomes disconnected or fails.

CIRCLE NO. 469

Unit checks wiring at 20,000 tests/second

Data Numerics Inc., 141-A Central Ave., Farmingdale, NY 11735. (516) 293-6600. \$1500 (100-point unit); 30 days.

Data Check 200S is a wiring analyzer that has a continuous scan to detect intermittents in cables. The unit operates at the rate of 20,000 tests per second and can check out all wired and unwired conditions in wiring assemblies including test cables, backplanes and PC boards of up to 2000 points. A conto-scan feature permits continuous operation of the testing function to determine intermittent conditions that may be introduced by flexing or vibrating the unit under test.

CIRCLE NO. 470

Process recorder shows trends to 40 feet

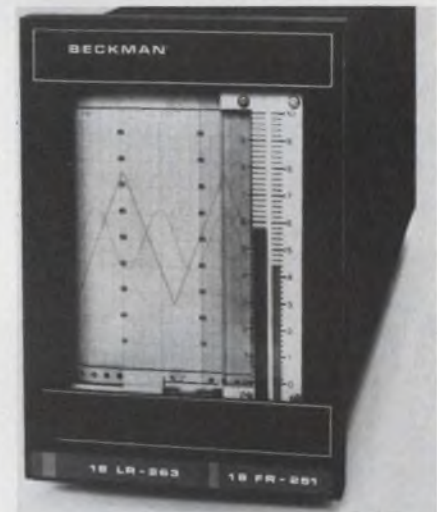

Beckman Instruments, 2500 Harbor Blvd., Fullerton, CA 92634. (714) 871-4848.

A new noninking, dual-channel process recorder offers highly visible trend indicators that can be read at distances up to 40 feet. Model 8720 recorder uses pressure-sensitive writing techniques. Servo-driven tapes provide overlapping traces with less than 0.05-in. displacement along the time axis and activate color-coded indicators of chart reading that can be seen across the room. The gearless, servo-driven stylus system affords full-scale response time of less than 1 s with selectable damping. Accuracy is $\pm 0.5\%$ fs, hysteresis is 0.2% fs and deadband is 0.1% fs.

CIRCLE NO. 471

The OEM Factory Announces the PDP-11/35S Super Savers.

The OEM Factory is now cranking out PDP-11/35S systems at an unprecedented rate and an unprecedented price.

And you can get all the peripherals and software you need right here, in one place, where we do the system's integration.

So the larger, more comprehensive a system you want, the

more savings we can pass along to you and your customers. The OEM Factory makes it happen in a super way.

A typical PDP-11/35S with 16K plus disk and console goes for \$14,847 in quantities of 50. That saves you over 20% on memory alone. And with 32K you're saving over 30%. What's more, we build

our own memories and peripherals, so we can add in all the goodies from the start. Integrated as one system's package. At significant savings.

But if we couldn't save you a nickel, you'd still love the PDP-11/35S. With expansion to 128K words of sense memory. Hardware floating point. Hardware relocation



and protection. Software like the RSX-11M multi-task real-time system, or its big brother, RSX-11D. Plus peripherals, over 60 different ones for every need.

But doing more for less is what you'd expect from Digital. Our PDP-11/35S is supported and serviced by people that can really help in systems planning, integra-

tion, and on-going maintenance. We'll be there when you need us. Which can save a lot of time.

The PDP-11/35S savings plan is all part of Digital's greater plan of offering the most cost-effective OEM systems.

The PDP-11/35S. It's like money in the bank.

Digital Equipment Corpora-

tion, Maynard, Mass. 01754. (617) 897-5111, Ext. 5159. European headquarters: 81 route de l'Aire, 1211 Geneva 26. Tel: 42 79 50. Digital Equipment of Canada Ltd., P.O. Box 11500, Ottawa, Ontario K2H 8K8. (613) 592-5111.

digital

INFORMATION RETRIEVAL NUMBER 275

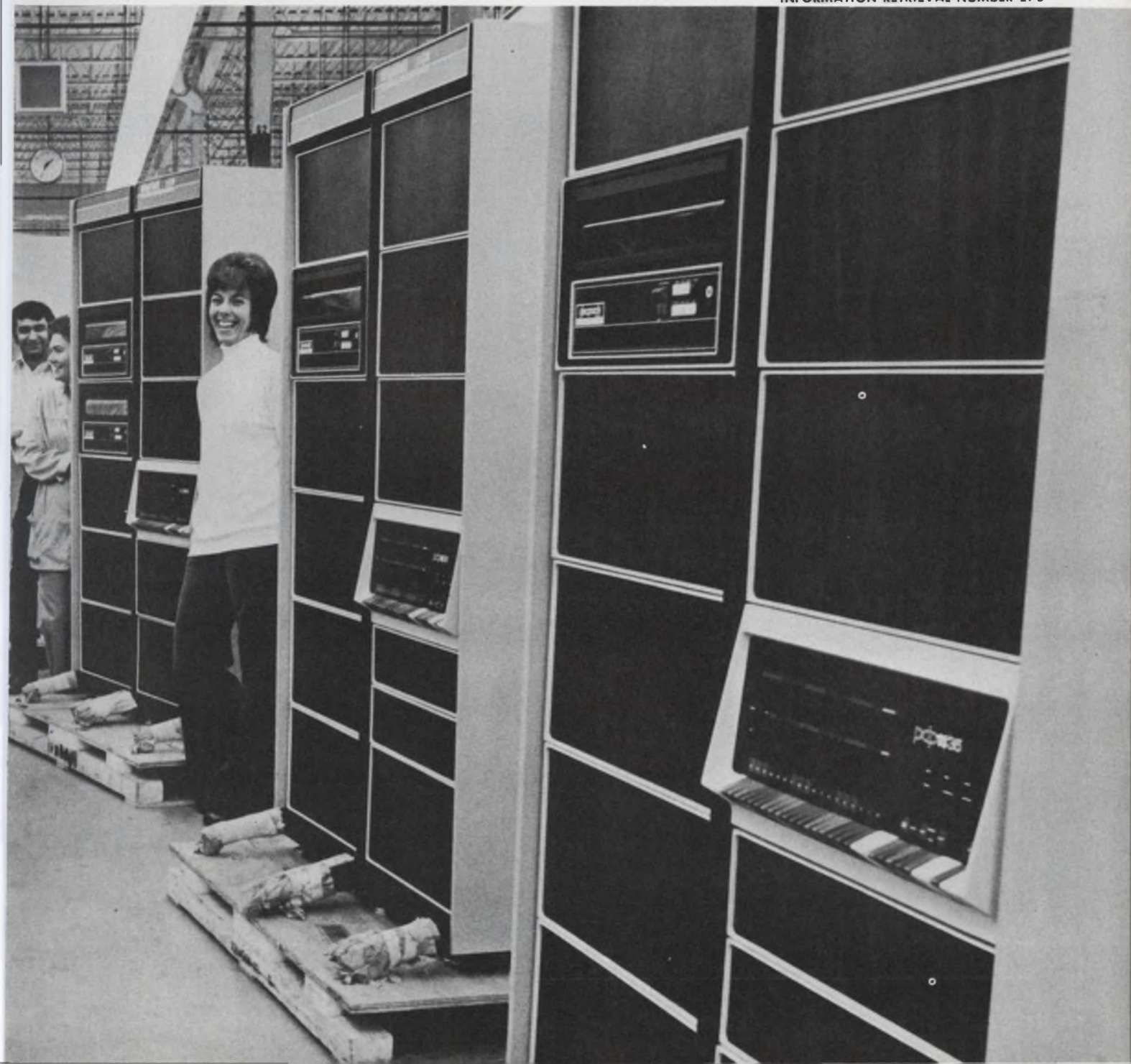

**Domestic or Professional
YOUR potentiometer is here**

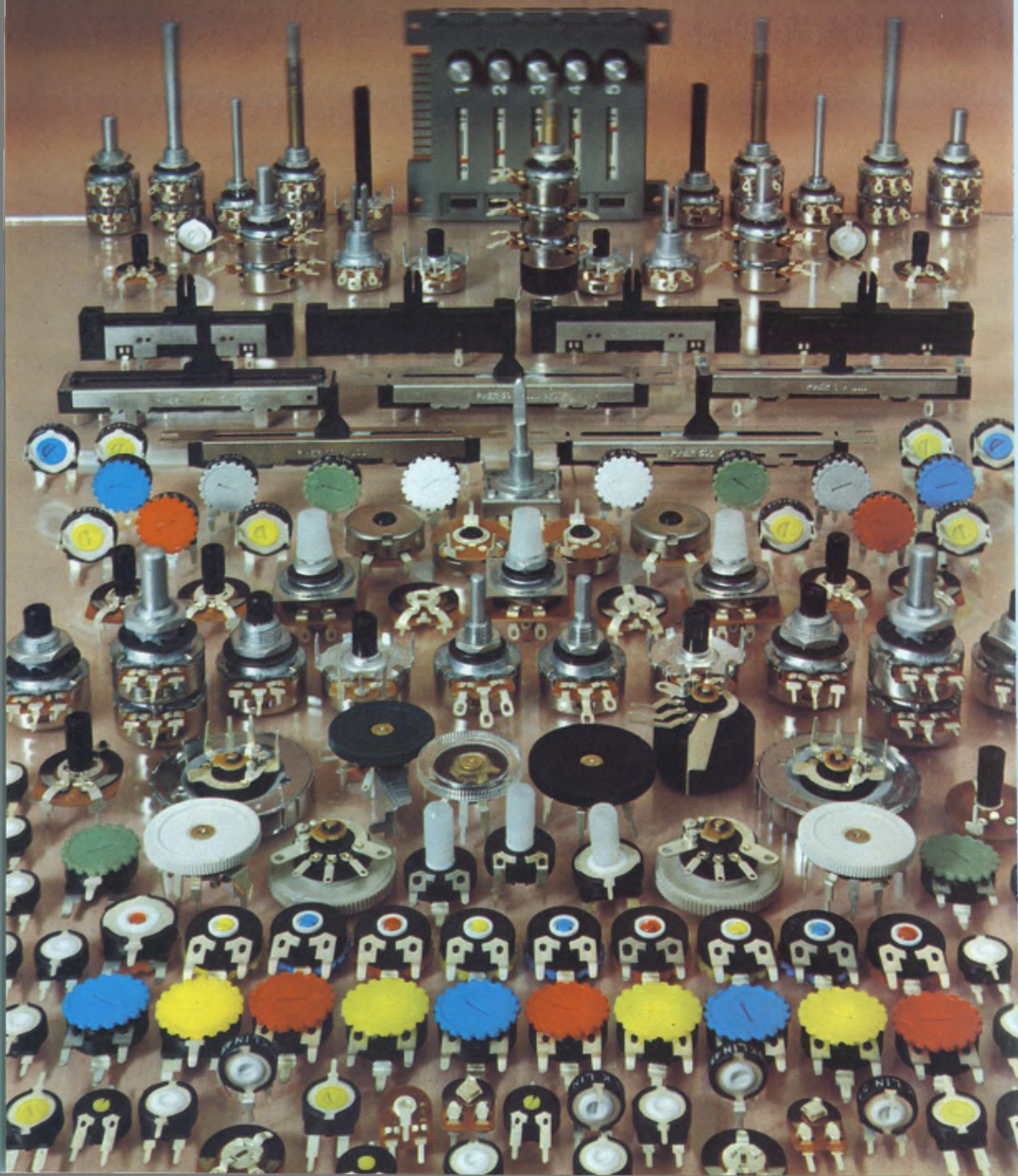

With our range of preset, rotary spindle, slider and rectilinear potentiometers – all designed round the prime requirements of noise-free operation and long life – we have brought new standards of quality and reliability to the potentiometer market for domestic or professional use.

In a technology not normally associated with dramatic breakthroughs we have introduced new ideas to component design and manufacture.

Like our Series PT preset pots which are fully enclosed in flame retardent plastic for protection from environmental factors. And the new PL40 slider pot, with its enclosed track and specially designed wiper movement that eliminates jitter, giving ultra-smooth operation.

Of course we also provide the usual options, like matched pairs for stereo applications, various terminal arrangements, earth screening and mains switches.

There's also the new PL25, a 20-turn rectilinear preset control for radio and tv varicap tuning applications.

In short, in any situation calling for high quality potentiometers, the discerning engineer should turn to Piher.

Write or ring for full details.

U.K. – PIHER International LTD.,
Romar House, The Causeway,
Staines, Middlesex, England.
Tel: Staines 56157. Telex 934167.

U.S.A. – PIHER International Corp.,
1239 Rand Road, Des Plaines,
Illinois 60016, U.S.A.
Tel: 312 297 1560. Telex 282154.

Germany – PIHER International GmbH.,
85 Nurnberg, Tuchergartenstrasse 4,
W.Germany.
Tel: 0911 533 051. Telex 623354.

France – PIHER International SARL,
83, Rue Etienne Dolet, 94230,
Cachan, France.
Tel: 656 26 07. Telex 27107.

Italy – PIHER International S.P.A.,
Via Censio 34, 20154 Milan, Italy.
Tel: 314532/316213.

Head Office – Riera Cañado,
s/n Apartado de Correos 53,
Badalona (Barcelona), Spain.
Tel: 389 03 00. Telex 59521.

 **PIHER**

A GOLD MINE OF INFORMATION & DATA

- **520 CATALOG PAGES ON
ICs & SEMICONDUCTORS**
- **300 CATALOG PAGES ON
INSTRUMENTS**
- **290 CATALOG PAGES ON
POWER SUPPLIES**
- **210 CATALOG PAGES ON WIRE
& CONNECTOR PRODUCTS**
- **150 CATALOG PAGES ON
SWITCHES**
- **2800 CATALOG PAGES ALL
TOLD IN 52 PRODUCT
CATEGORIES**

Electronic Design's GOLD BOOK puts the entire electronics industry at your fingertips. Use it for product search, selection, specification and purchase. It's the most thorough industry master catalog & directory ever compiled.

When you need information . . .

Electronic Design's
GOLD BOOK
IS THE PLACE
TO LOOK

HAYDEN BOOK COMPANY, INC.

50 Essex Street, Rochelle Park, New Jersey 07662



An Open Letter To Manufacturing Managers.

Are you putting off reliable and promising systems innovations because of the money involved? Or the time? Or maybe because of the painful "people problems" you can foresee?

You probably face these problems constantly because as systems technology expands, it demands radically new talents and skills from management.

Recently, professionals from industry, education and government met for the 10th annual symposium co-sponsored by Informatics and UCLA. Their goal? To bring *clarity* and *profitability* to today's new manufacturing methods—for *you*, the *manager*.

Now we have compiled the proceedings into a compact management handbook, called **MANUFACTURING MANAGEMENT SYSTEMS: New Challenges and Profit Opportunities**. As a manager, you couldn't ask for anything more.

This handbook is the symposium and *more*. We've cut away all the extras—the repetitions, the mumblers and the chit-chat—leaving you with the clear and uninterrupted essentials.

The result is an unparalleled, personalized handbook of guidelines, solutions and solid information from some of the nation's most successful industrial leaders.

You'll hear the vice-president in charge of technical affairs at Ford Motor Company tell how an American institution computerized its vast and complex production lines (and battled equally monstrous supplier foul-ups, record problems, etc. along the way).

An executive from a major R & D firm outlines what he has discovered to be the vital managerial skills and essentials for directing progressive operations.

One of Informatic's key men spells out some of the latest and most worthwhile computerized tools available to manufacturers.

The president of a manufacturing firm offers 16 pages of realistic guidelines for handling the sensitive problems of system implementation (without any of the current psycho-social jargon).

There's one corporation president whose share of this handbook is frankly titled "Making Sure You Really Get a Payoff From Your Manufacturing System." It amounts to nothing less than a proven master plan for doing just that.

There are ten sections in all, each one more helpful and informative than the next. Every page is sharp and direct, yet conversational, as if it were being spoken. For the manager, there's a perfect balance of technical information and the wisdom and common sense for using it.

You can now examine, read and use the handbook free, for 15 days, just by circling the information retrieval number shown below. At the end of that time, just send in a check for \$10.50, plus postage and handling, or return the book with no further obligation.

You won't run across many opportunities to hear this kind of straight talk. Try to imagine a symposium where you sit right up front and write down every single word because you know you can use it all.

P.S. Remember—it's easy to order. Just circle the *Information Retrieval No.* shown below!



HISTORY'S GREAT 45'S

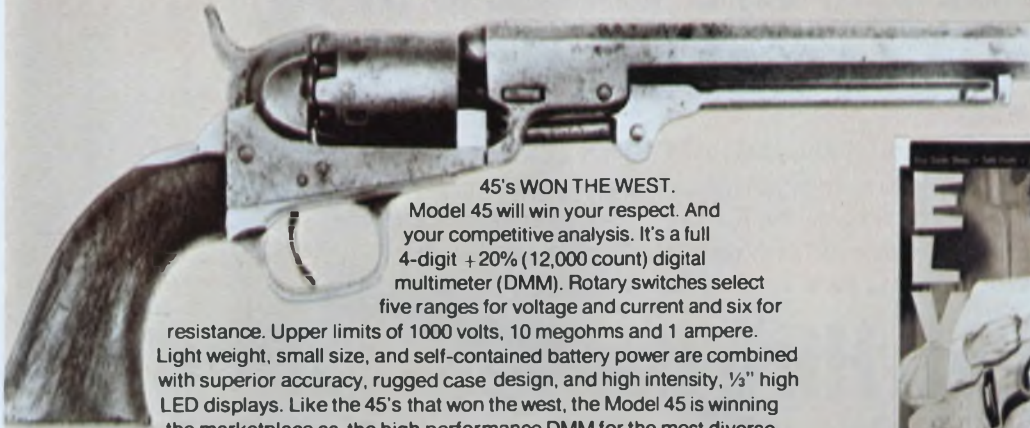

45's WON THE WEST.

Model 45 will win your respect. And your competitive analysis. It's a full 4-digit +20% (12,000 count) digital multimeter (DMM). Rotary switches select five ranges for voltage and current and six for resistance. Upper limits of 1000 volts, 10 megohms and 1 ampere. Light weight, small size, and self-contained battery power are combined with superior accuracy, rugged case design, and high intensity, 1/2" high LED displays. Like the 45's that won the west, the Model 45 is winning the marketplace as the high performance DMM for the most diverse applications and environments.

45 RPM. For kids, 45's meant they could have everything they wanted at the price they could afford. That's Model 45: everything you want in a full 4-digit +20% (12,000 count) DMM for very little money. For the record, we think you'll find the 45 has the best price-performance ratio.



'45 AND VICTORY. Our 45 scores a few victories itself over the competition. You probably won't run out to Times Square, grab and kiss the first girl you see. But, if you spend all day working with a DMM, then resolution of 10uV, 10nA and 10mΩ is significant. And so is the 45's battery-saver circuit. They're the small victories of Data Technology's engineering that'll win you over.



45' SANDWICH.

"Construction is everything," admits Salami Joe, creator of world's longest sandwich. We couldn't agree more, Joe. Model 45 is cased in high-impact-resistant polycarbonate with top and bottom aluminum covers. Disassemble in seconds. 10-step calibration. Our 45's a hero, too.



45 ROCKETTES. What accessories 45 gorgeous gams flashing rhythmically across the stage. Model 45's accessories are just as right. Here's our kickers: High voltage, RF and demodulator probes. Universal lead kit. Carrying case. Rack mounts. Dance your heart out.

"HENRY!
DO YOU HEAR
A FUNNY NOISE?"

"SIGH... ETHEL,
GO TO SLEEP.
IT'S 3:45 IN THE MORNING"

THE 45 MINUTES AFTER THE HOUR SURPRISE. It's usually late and dark. But not always. Too often, it's 3:45 Thursday afternoon on the test bench when your DMM opts for funny noises and funny readouts. That's when you'll wish for Model 45 quality and reliability. 12 month parts and labor full service guarantee, of course.



45 WORDS ABOUT MODEL 45. Many interesting 45's. But if you're looking for a full 4-digit +20% (12,000 count) DMM, then here's the most interesting 45: Data Technology's Model 45. For information write or call: Data Technology Corporation, 2700 South Fairview, Santa Ana, California (714) 546-7160.

data technology corp.

Don't forget...the training, the discipline, the experience, the leadership, the teamwork, the loyalty, the determination.

Don't forget all the assets veterans have. Attitudes that make them highly-motivated, productive individuals. Skills adaptable to a variety of industries and positions. Proven trainability and self-discipline. Don't forget. Don't forget all they learned . . . sometimes the hard way.

For help in hiring veterans, contact your local office of the State Employment Service; for on-the-job training information, see your local Veterans Administration office.

Don't forget. Hire the vet.



**JOBS FOR
VETERANS** 
ADVERTISING
COUNCIL

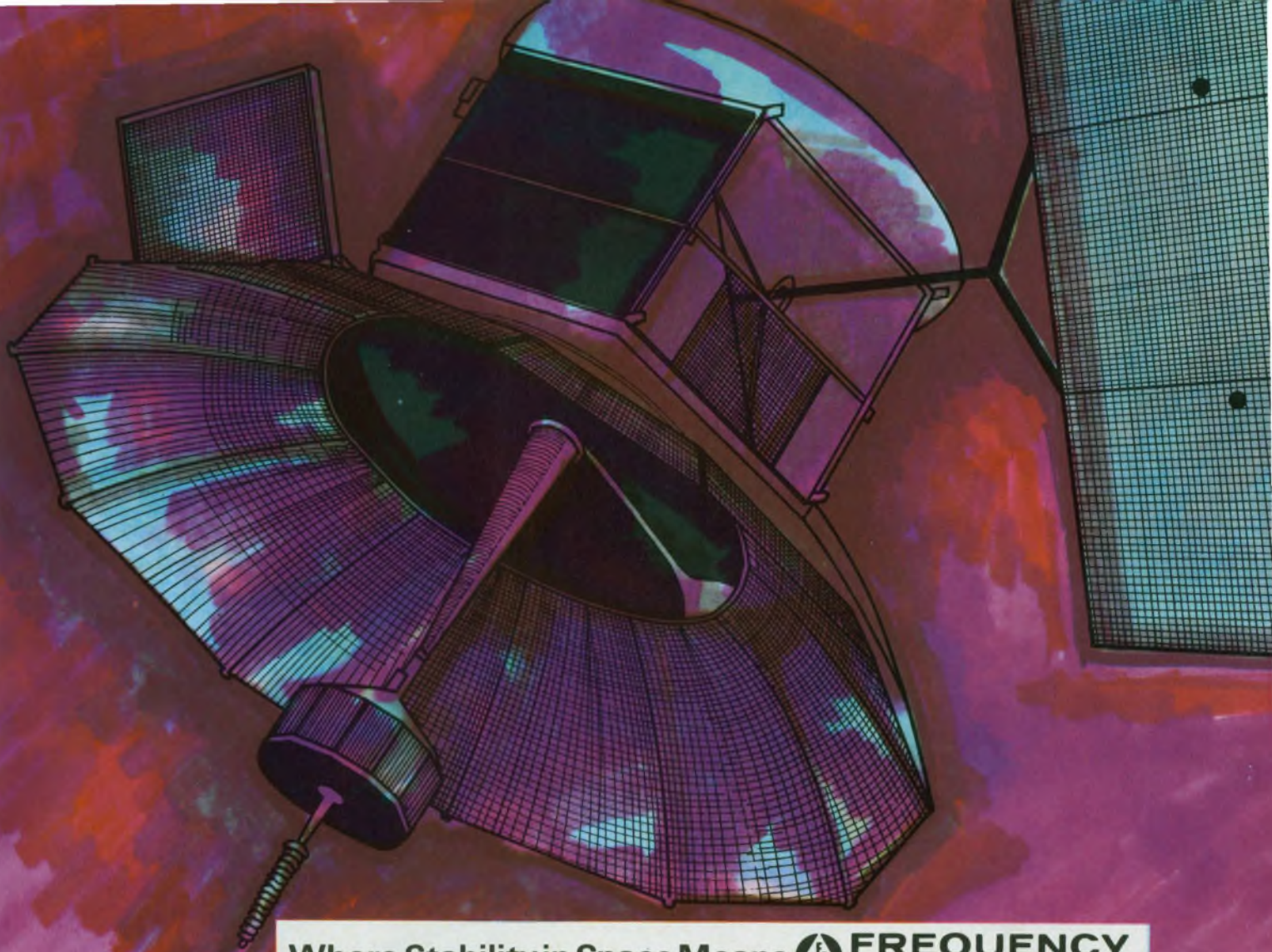

Where Stability in Space Means  **FREQUENCY ELECTRONICS, INC.**

Time and Frequency is our unique dimension . . .
We have contributed with High Stability and Reliability to:

- FLEET-SATCOM
- Manned Space Shuttle
- Apollo-Soyuz
- HEAO (High Energy Astronomical Observatory)
- Timation Satellite
- VIKING Mars Space Probe
- PIONEER Jupiter Probe

Shown here is an exploded view of a typical space-qualified Frequency Standard.



SPECIFICATIONS

PARAMETER	VALUE	PARAMETER	VALUE
Nominal Output Frequency	5.0 MHz	Long term frequency (life) stability over environments	$\pm 1 \times 10^{-7}$ / 5 years
Short Term Frequency Stability		Frequency change due to orientation	1.2×10^{-9} / gauss
0.1 second integration time	3×10^{-11} (1 σ)	Frequency change due to magnetic fields	5×10^{-11} / gauss
1 millisecond integration time	2×10^{-9} (1 σ)	DC Power Consumption	2.5 W maximum (run) 4.0 W maximum (start)
24 hour stability within any 10°F temperature change within the range of 0°F and +110°F	$\pm 1 \times 10^{-11}$ / 24 hrs.	Weight	40 ounces maximum
24 hour stability within any 25°F temperature change within the range of 0°F and $\pm 110^\circ\text{F}$	$\pm 2.5 \times 10^{-11}$	Size	4" diameter x $7\frac{1}{16}$ " length

 **FREQUENCY ELECTRONICS, INC.** 3 Delaware Drive, New Hyde Park, New York 11040 (516) 328-0100

DISCIPLINED TIME FREQUENCY STANDARD • FREQUENCY STANDARDS • PHASE COMPARATORS • FREQUENCY ERROR ANALYZERS • DISTRIBUTION AMPLIFIERS
TIME & FREQUENCY CONTROL SYSTEMS • PRECISION QUARTZ CRYSTAL OSCILLATORS • CRYSTAL FILTERS & DISCRIMINATORS

New economical $\frac{1}{8}$ -watt carbon film resistor

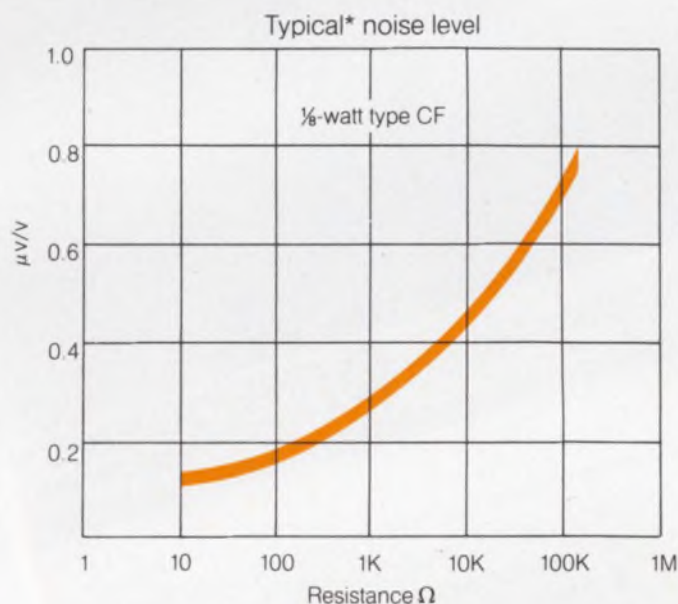

*"Typical" is defined as the maximum value of measurement unit to be expected in 95% of the population of a distribution.

We have the most advanced space-saving $\frac{1}{8}$ -watt carbon film resistor – a superior replacement for the RC 05 – and we'd be delighted to send you samples.

Electrical noise is exceptionally low and is typically less than –20 DB at 10 ohms to –4 DB at 220 K ohms, based on 1μ volt of noise per volt equal to 0 DB.

Load life change for 1000 hours operation at 70° C is typically less than 1%.

Moisture resistance change is also typically less than 1%. Shelf drift is no longer a problem with this new resistor.

Dielectric strength of the jacket is 500 volts RMS.

Temperature coefficient of resistance is typically better than –700 PPM.

Flame retardant coating is another feature of this resistor. Available from 2.2 ohms to 220 K ohms, 5% standard tolerance.

Mechanically interchangeable with both composition and metal oxide resistors of the same wattage. The resistor is only 0.071 inches (1.8mm) in diameter and 0.177 inches (4.5mm) long, maximum.

To get samples and literature, call 814-362-5536, TWX 510-695-5921 or drop us a note at Bradford, Pa. 16701.

AIRCO ELECTRONICS – The Home of the Ω

Bradford, Pa. resistor plant – composition, carbon film, metal film and metal oxide film resistors; fixed composition capacitors; variable, adjustable and fixed shielded inductors. *Nogales, Arizona inductor plant* – molded fixed and conformal coated inductors; peaking coils. *Niagara Falls, N.Y., special components* – precision thin film and semi-precision thick film chip resistors and resistor networks.



KAY's new spectrum analyzer

- 1 — 300 MHz
- Phase locked
- 72 db dynamic range
- 1 KHz resolution
- Compact plug-in
- Low cost: only \$2390

Originally designed to fill the need for a VHF spectrum analyzer for CATV measurements, this new analyzer is receiving wide acceptance to fill the need for a high performance low cost analyzer for spectrum analysis in the HF VHF frequency range.

The 9040 spectrum analyzer is available self contained in the 9011 power supply with X and Y outputs for independent use with any storage oscilloscope. At \$2585.

The unit is also a compatible plug-in for the Tektronix 5103N and 5403 series of oscilloscopes and the Kay 9000AS split screen storage main frame. In addition to the spectrum analyzer plug-in, the Kay 9000AS Test Set main frame is compatible with a series of plug-ins including wideband sweep oscillators, gain loss/return loss measurement devices and the summation sweep receiver widely used in CATV system testing.

The 9040 features **phase locked** operation with 1 KHz resolution in the 1-300 MHz frequency range. The 72 db dynamic range with sensitivity to -50 dbmv's 75 ohm, -100 dbm 50 ohm is displayed in either 10 db/div or 2 db/div. Scan width is variable from 3 KHz per division to 30 MHz per division with excellent linearity. Scan speed is variable from 40 sec. per scan to 60 Hz in addition to a one shot sweep for use with XY plotters.

I.F. filters at 1 KHz, 30 KHz and 1 MHz are manually selected or automatically selected in the **Auto Mode** to reduce scan loss error. The unit also features built in frequency markers for calibration of both amplitude and frequency with cal adjustments readily accessible on front panel. A precision 0-70 db rotary attenuator provides attenuation in 10 db steps with 1% accuracy to 300 MHz. Spurious responses are greater than 72 db down.

New KAY half-rack sweep generator series



9060

Model	Frequency Range	Sweep Width	RF Output	Flatness	Distortion	Price (plus markers)
9054	50 KHz-110 MHz	0-110 MHz	1V RMS	± 25 db	> 35 db down	\$ 995.
9059	.5-300 MHz	0-300 MHz	1V RMS	± 25 db	> 30 db down	845.
9060	.5-500 MHz	.5-500 MHz	1V RMS	± 3 db	> 35 db down	1150.
9062	1-1000 MHz	.5-1000 MHz	.5V RMS	± 25 db	> 30 db down	1395.
9063	1-1500 MHz		.5V RMS		> 30 db down	1495.
	Band 1: 1-900 MHz	Band 1: 500 KHz-1000 MHz		Band 1: ± 25 db		
	Band 2: 800-1500 MHz	Band 2: 200 KHz-700 MHz		Band 2: ± 3 db		

KAY attenuators

- High Accuracy
- Low VSWR
- Minimal Insertion Loss
- 75 Ohm

DC-12.4 GHz
Sliding Block
132 db



\$395.

Miniature
DC-2 GHz
Rotary
70 db



\$125.

Miniature

DC-1 GHz
In-Line Toggle
132 db

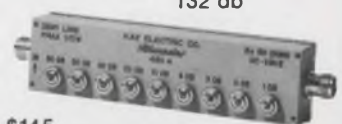

\$145.

Noise Figure Meters • Gain-Loss, Return Loss Bridges
LIN/LOG Amplifiers • RF Detectors
1 GHz Electronic Switch • Test Equipment

KAY Elemetrics Corp

Maple Avenue, Pine Brook, New Jersey 07058/Phone (201) 227-2000

INFORMATION RETRIEVAL NUMBER 115

Power Darlingtons have gains to 10,000

General Electric, Electronics Park, Bldg. 7, MD49, Syracuse, NY 13201. (315) 456-2021. From \$0.60 (1000 up); stock.

Three plastic encapsulated power Darlington transistors have high current gain and good gain hold-up, plus low saturation voltages. Collector-to-emitter voltages range from 30 to 80 V with current ratings from 2 to 10 A. Betas range from 1000 to as high as 10,000. The D41K has a current rating of 2 A, with a minimum beta of 10,000 at 200 mA. It is a pnp complement to the previously introduced D40K. The D44E and D45E npn and pnp types handle 10 A. They have minimum betas of 1000 at 5 A. Each type is color-coded for easy pnp-npn identification. The D41K is in the company's Power Tab package. The D44E and D45E use the higher power Power Pac package.

CIRCLE NO. 347

Schottky diodes handle 30 A at 125 C



TRW Power Semiconductors, 14520 Aviation Blvd., Lawndale, CA 90260. (213) 679-4561. \$5 (large qty); stock.

The SD-41 power Schottky diode is rated at 30-A average forward current. The Schottky diodes are claimed by the company to be the first available in production quantities for operation at a case temperature of 125 C. Diodes have a maximum forward voltage drop of 0.55 V at 30 A with 125-C case temperature. Max reverse voltage is 45 V. The devices handle a nonrepetitive peak forward surge of 500-A single cycle, have a reverse recovery time in inverter circuits of less than 10 ns and are housed in JEDEC DO-4 cases.

CIRCLE NO. 348

Rf power transistor delivers 40 W



Solid State Scientific, Montgomeryville Industrial Center, Montgomeryville, PA 18936. (215) 855-8400. \$29 (100-up); stock.

The SD1089, a 40 W rf power transistor, is designed for use over 450 to 512 MHz. The unit is for rated 40 W at 12.5. Automatic wire bonding maintains tight control over internal inductance. An input impedance transformation is achieved by use of a MOS capacitor chip with the internal and external lead inductances, reducing the Q of the input. The SD 1089 is available in a six-lead, 0.5 in. diameter flange package. It replaces the CM 4012, MRF 621 or JO 3040.

CIRCLE NO. 349

AIMING for BETTER TRIMMER PERFORMANCE?

TC 10 PPM/°C

ZERO in with VISHAY 1/4" TRIMMERS

BULK METAL™ set on Compatible Substrate results in:

- TC: 10ppm/°C
- Setability: ±0.05%
- Low noise: 10 ohm ENR max.
- Uniform surface for low noise
- Mechanical resolution: 21±2 turns
- Redundant current paths for higher reliability
- Multiple etch lines for improved setability
- Meets or exceeds most military specifications

VISHAY'S unique process of Bulk Metal™ set on ceramic brings to 1/4" trimmers a combination of stability, TC, resolution, and setability never before available ... and they exceed most Mil specs!

STYLES AVAILABLE



Model 1240X
(RJR26X)



Model 1240W
(RJR26W)



Model 1240P
(RJR26P)



VISHAY RESISTIVE SYSTEMS GROUP

OF VISHAY INTERTECHNOLOGY, INC.

63 LINCOLN HIGHWAY MALVERN, PA. 19355

PHONE: (215) 644-1300

®

**For PBX, computer memory
and instrument power
supply applications**

turn to CTS

for cermet resistor networks

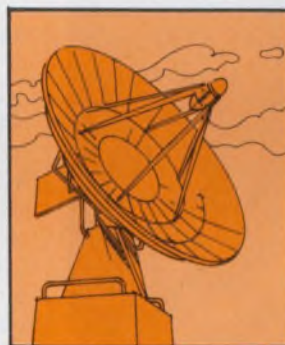
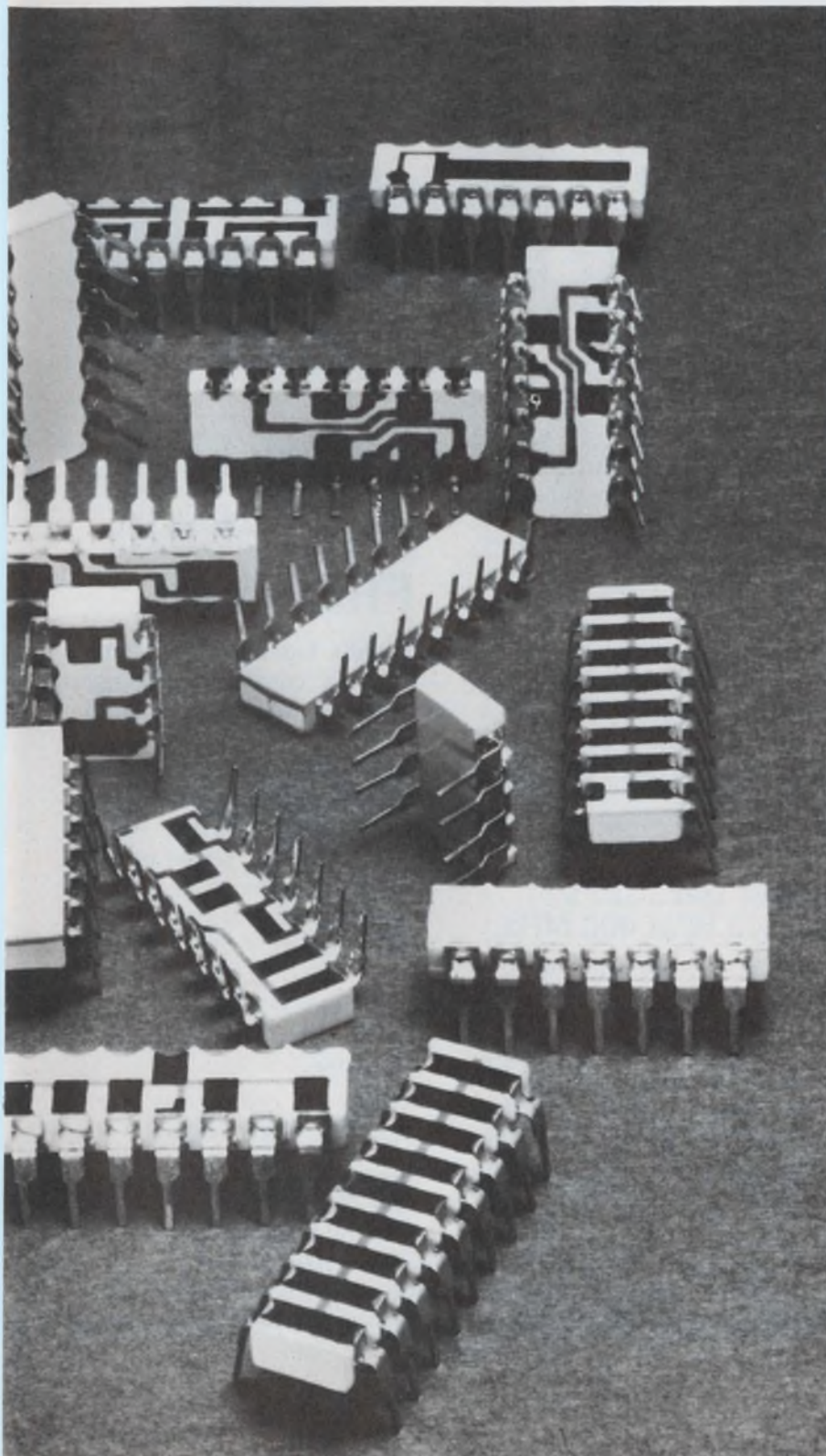

Save Space. Money. Time. It's easy with CTS Series 760 DIP Cermet Resistor Networks. Four popular packages . . . 8, -4, -16 and -18 lead styles . . . provide an infinite number of circuit combinations.

Compact, low profile design puts the squeeze on PCB space. Cost cutters, too. All designs eliminate lead forming and lead trimming for low cost automatic insertion along with IC's and other DIP components. Time saving? One 18-lead CTS 760 Series package can replace up to 32 separate components.

Available without organic cover coat, so you can trim for circuit balance. Precision .100" leads; rated up to 2 watts on 18 lead style; 5-lbs. pull strength on all leads.

Immediate delivery on standards. Custom designs to specifications. Be a saver. Turn to CTS of Berne, Inc., 406 Parr Road, Berne, Indiana 46711. Phone: (219) 589-3111.

CTS CORPORATION
ELKHART, INDIANA



A world leader in cermet and variable resistor technology.

AMERICAN MADE

Tolerance SCHAUER 1-Watt ZENERS

**Immediate Shipment
Low Prices**

ANY voltage from 2.0 to 16.0

Quantity	Price each
1-99	\$1.07
100-499	.97
500-999	.91
1000-4999	.86
5000 up	.82

All welded and brazed assembly

No fragile nail heads

Gold plated leads

Write for complete rating data and other tolerance prices.

Buy the kit- Save a lot



Kit contains a 51-piece assortment of SCHAUER 1% tolerance 1-watt zeners covering the voltage range of 2.7 to 16.0. Three diodes of each voltage packaged in reusable poly bags. Stored in a handy file box. Contact your distributor or order direct.

A \$54.57 value for
ONLY \$24.50

Semiconductor Division
SCHAUER
Manufacturing Corp.

4511 Alpine Ave. Cincinnati, Ohio 45242
Telephone: 513/791-3030

DISCRETE SEMICONDUCTORS

LED 7-segment displays have 0.3 in. digit height

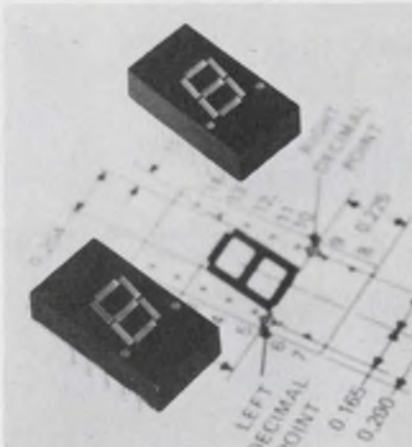

Texas Instruments, P.O. Box 5012, Dallas, TX 75222. (214) 238-3741. \$3 (100-up); 5 wk.

Two visible-LED numeric displays have character heights of 0.3 in. Designated the TIL312 and TIL313, these seven-segment displays are characterized for uniformity of luminous intensity. The TIL312 is designed as common-anode with right and left hand decimals. The TIL313 has common cathode with right hand decimal. Other features include continuous uniform segments, high contrast, and single-plane, wide-angle visibility. The large character height and wide segment stroke width makes the TIL312 and TIL313 useful for desk or panel mounted equipment requiring viewing distances up to 12 ft. These devices are available in matched brightness groups for multidigit applications.

CIRCLE NO. 350

Rf power transistors deliver 40 W at 400 MHz

TRW Semiconductors, 14520 Aviation Blvd., Lawndale, CA 90260. (213) 679-4561. \$92 (1 to 25); stock.

The JO-2015 gold-metalized uhf transistor has an infinite VSWR when operated at 50 W, 400 MHz and 28 V. The JO transistors use a two-section internal input matching network to simplify circuit design and reduce tuning requirements. The units employ diffused emitter ballasted resistors and are housed in a ceramic flange package.

CIRCLE NO. 351



Complete with "drop-in" charging stand.

CORDLESS SOLDERING FREEDOM

Wahl's Iso-Tip® Soldering Iron is cordless, 8" long with tip, weighs 6 oz. and reaches a 700° Soldering temperature in 5 seconds! DC operated to eliminate AC leakage and the need for grounding. Gives up to 150 consecutive joints, depending on wire size, without recharging. Available with five standard tips (from .020" to .187" dia.). Quick Charge model also available.

Write or call today for complete information.

WAHL®

Clipper Corporation
2902 Locust Street
Sterling, Illinois 61081
(815) 625-6525

"Manufacturing Excellence
for over 50 Years"

Germanium transistors handle 3 A up to 40 V

Germanium Power Devices, P.O. Box 65, Shawsheen Village Station, Andover, MA 01810. (617) 475-5982. From \$2; 2 wk.

The 2N1183 to 2N1184B family of pnp germanium power transistors is designed to handle up to 3 A with voltages of 40 V. The transistors are housed in TO-8 metal cans and are suited for computer peripherals, communications equipment and battery operated equipment.

CIRCLE NO. 352

Thermopile detector has 12 V/W responsivity

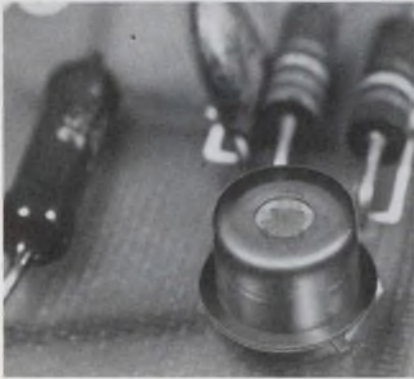

Sensors Inc., 3908 Varsity Dr., Ann Arbor, MI 48104. (313) 973-1400. \$126; stock.

The Model S-15 thermopile detector has a 12 V/W responsivity under standard (500 K blackbody source, 10 Hz chopping frequency) test conditions. The detector active area is a 28-junction square geometry design made by thin-film evaporation techniques, and measures 1.5×1.5 mm. The detector is packaged in a standard TO-5 configuration with three external wire leads. KBr window material and silver internal connecting leads and pads are standard but other window materials, including CaF_2 , BaF_2 , Ge, KRS-5, Irtran-2 and SiO_2 are optionally available. The S-15 is also available, less window material, in which case gold leads and pads are used for internal connections to preclude corrosion. Other S-15 performance specifications include: $D^*(500 \text{ K, dc})$ of 1.5×10^8 cm $\text{Hz}^{1/2}/\text{W}$, time constant of 40 ms, resistance of 10 k Ω and noise equivalent power of 1×10^{-9} W/ $\text{Hz}^{1/2}$.

CIRCLE NO. 353



8 BIT DAC In Stock, In Quantity:

\$12.50 in Singles

This low cost, 8 Bit DAC 371-8 D/A Converter has been field-proven in millions of hours of reliable, trouble-free use. New production capacity now permits us to fill all orders from stock... in quantity. (\$12.50 is singles price.)

The DAC 371-8 incorporates all the standard features—built-in reference, DTL and TTL compatibility, 8-Bit current output, and ready-to-use operation—and plugs into a single 16 PIN IC socket. Contains all hermetically sealed active components (no plastic devices), and incorporates thin film precision resistors for high reliability and long-term stability. For use with +5V power supply, add suffix -LV when ordering.

For Fast Action, Call:

In USA: (617) 272-1522 (or TWX 710-332-7584)

In Europe: Hybrid Systems GmbH, 61 Darmstadt, Luisenplatz 4, Germany

Tel. 6151-291595 TELEX 841-419390

Hybrid Systems Corporation, Burlington, Massachusetts 01803

Hybrid Systems
CORPORATION

Power transistors get JAN and JAN TXV rating

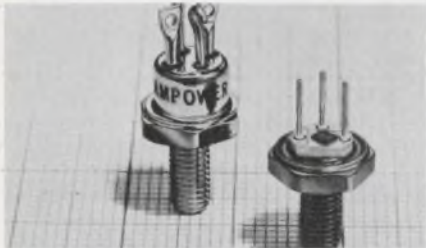

Ampower, 375 Kings Highway, Smithtown, NY 11787. (516) 582-6767. 2N3996: \$16, 2N3997: \$19 (100-up); stock.

JAN, JAN TX, and JAN TXV 2N3996 and 2N3997 power transistors have been qualified to MIL-S-19500/375. The JAN/JAN TX 2N3996 and 2N3997 are silicon npn planar epitaxial process power transistors. They are housed in a TO-111 isolated collector double-ended stud case. Both power devices

have 30-W power dissipation capacities at 100-C case temperature, a 5-A collector current capability as well as sustaining voltages of 80-V minimum. The significant differentiating characteristic between the two types is the dc gain. The 2N3996 has a gain of 40 to 120 at 1 A, 2 V and 15 minimum at 5 A, 5V. The 2N3997 dc gain spec is 80 to 240 at 1 A, 2 V and 20 minimum at 5 A, 5 V.

CIRCLE NO. 354

ECL in St. Petersburg: Where you're not just employed. You're stimulated.

Here you have the opportunity to do what you really want. To continue learning. To pursue your own special areas of interest. To use all your background and experience.

In fact, we encourage our people to be diversified. We won't hold you back.

If you're a creative electronic design or R & D engineer who really wants to produce, ECI is where you can do just that. We're involved with a wide variety of communications and electronic systems ranging from satellite terminals and missile data transmission systems to shipboard radios and thermal printers. We even help move the U.S. mail with advanced mail handling and processing systems.

What we become involved with in the future may well depend on your contribution.

This isn't only a great place to work. It's a great place to live, too. St. Petersburg and the surrounding area of Florida's West Coast offer just about everything you and your family could want in education, recreation and culture.

If ECI and St. Petersburg sound like places you'd enjoy calling home, write in confidence to William C. Peterson, Personnel Manager, Electronic Communications, Inc., Box 12248, St. Petersburg, Florida, 33733.

It could be one of the most creative moves you've ever made.



Subsidiary of NCR



Get all four basic types of fixed resistors from Panasonic.

1. Hot molded carbon composition fixed resistors from Panasonic have an extremely high degree of resistance value stability. They are all uniform so you can design with dependability. Solidly built with superb appearance, Panasonic hot molded carbon composition resists cracking, gives you reliable performance. They are extremely small and light to give you design flexibility. Especially in digital circuitry where good pulse characteristics are necessary.

2. Carbon film resistors have proven stability. The carbon film is formed on the surface of high-grade ceramic cores. These resistors are all grooved and painted according to value. They have long product life and low noise level. Their superior coating provides excellent insulation and protection from humidity.

3. Precision type metal film resistors have a very wide range of operating temperatures. From -55°C to $+150^{\circ}\text{C}$. Panasonic's precision type metal film resistors operate within reliable resistance tolerances, from $\pm 1.0\%$ to $\pm 5.0\%$. Panasonic's newly developed epoxy resin coating gives them excellent resistance to humidity.

4. Flame-proof metal oxide film resistors are made with superior metal oxide film. This film is formed on heat proof, non-alkaline ceramic materials to provide flame-proof insulation. These Panasonic resistors deliver high frequency performance with little current noise. Very stable, they have a maximum operating temperature of 70°C .

All are readily available. All at a reasonable price. All made with the kind of quality that delivers high performance. It's what you expect from Panasonic. For more information on Panasonic fixed resistors, fill out this coupon.

Matsushita Electric Corp. of America, ED-3
Industrial Division, 200 Park Avenue, N.Y., N.Y. 10017

- Please send fixed resistor literature.
 Please have representative call.

Name _____

Title _____

Company _____

Address _____

City _____ State _____ Zip _____

Panasonic Electronic Components
our technology is all around you

Red LEDs available with or without limiting R

Dialight, 203 Harrison Pl., Brooklyn, NY 11237. (212) 371-8800. From \$0.33 (1000-up); stock.

Red GaAsP LEDs are available with a clear diffused (521-9184) or red diffused (521-9183) lens. Both come with a built-in current-limiting resistor. The red diffused is also available without a resistor (521-9179). Operating characteristics at 25 C for the 521-9179 produce the following results: minimum luminous intensity of 0.8 med; typical wavelength of 655 nm; typical response speed of 10 ns; typical forward voltage of 1.6 V; and typical reverse breakdown voltage of 10 V. Operating characteristics at 25 C for the 521-9183 and 521-9184 produce similar results except for the typical forward current of 15 mA, typical speed of response of 15 ns; and a minimum reverse breakdown voltage of 3 V.

CIRCLE NO. 355

Bridge rectifiers handle 400-A surge currents

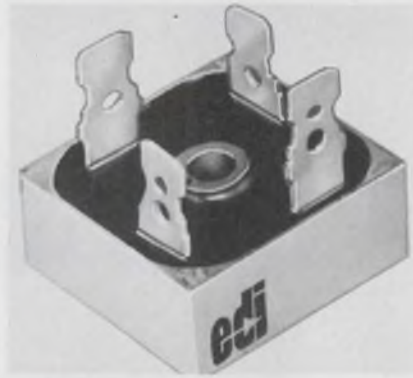

Electronic Devices, 21 Gray Oaks Ave., Yonkers, NY 10710. (914) 965-4400. Typical unit: \$3.40 (1000-up).

The PW and PWL bridge rectifiers have a 400 A surge capability. This unusually high surge rating results from a new diffusion process and larger junction with lower forward voltage drop. The bridges are available in PRV ratings from 50 to 800 V. They are available for heat sink or chassis mounting. The units measure 1.25 in. square x 0.438 in. high.

CIRCLE NO. 356

Mini phototransistors handle 50 mW max



Clairex Electronics, 560 S. Third Ave., Mount Vernon, NY 10550. (914) 664-6602. CLT 5160: \$2.82, CLT 5170, \$3.23; (1-9); stock to 4 wk.

The CLT 5160 and CLT 5170 are silicon, planar epitaxial, phototransistors, in a lensed window, miniature, hermetic package. Each transistor can handle a maximum of 50 mW (derate 0.5 mW/°C). Rise and fall times are typically 1.5 μs. V_{CEO} and V_{ECO} maximum voltage are 40 and 5 V, respectively, for either transistor. The 5160 has a maximum light current of 2 mA while the 5170 has a 6 mA minimum light current. The CLT 5160 and 5170 are suited for mounting on PC boards since the 0.077 in. outside package diameter enables high device density with modest mounting tolerances.

CIRCLE NO. 357

Opti-ranging... a Monsanto exclusive!

Select the Counter or Counter/Timer that provides the functions you need and get AGC and Monsanto's exclusive Opti-ranging for optimum display resolution. AGC prevents erroneous measurements at marginal input amplitudes. Opti-ranging allows the selection of resolution, prevents gate change interruption of display and retains the unit value of any one decade. In contrast to autoranging, Monsanto's unique Opti-ranging offers all the advantages of automatic and manual operation without the inherent disadvantages of both. Contact your nearest Representative or write for full specifications and prices.

Prices start at **\$595.**



SEE ELECTRONIC DESIGN'S GOLD BOOK FOR SALES OFFICES AND REPS.



850 Series — 4 models, Universal Counter/Timers 50 MHz through 1 GHz



870 Series — 3 models, Frequency Counters 150 MHz through 1 GHz

DigiTec

UNITED SYSTEMS CORPORATION

a subsidiary of **Monsanto**

918 Woodley Road • Dayton, Ohio 45403 • Ph: (513) 254-6251 • TWX: (810) 459-1728

Pick your gas-discharge display and leave the driving to us

Use ITT types 504 and 505 to drive popular high voltage gas discharge displays, a job which normally requires either 90V or 180V transistors. The 504, 505 pair contains all the active circuits needed to drive a full eight segment (seven segments plus decimal) display up to ten digits wide. All segment currents are matched and programmable via a single external resistor. The 504 and 505 are supplied in high-reliability ceramic 18 pin DIPs.

Ask your ITT distributor or contact us directly for details. The 504 and 505 are available now; look for the ITT 512, now in development.

ITT...Logically

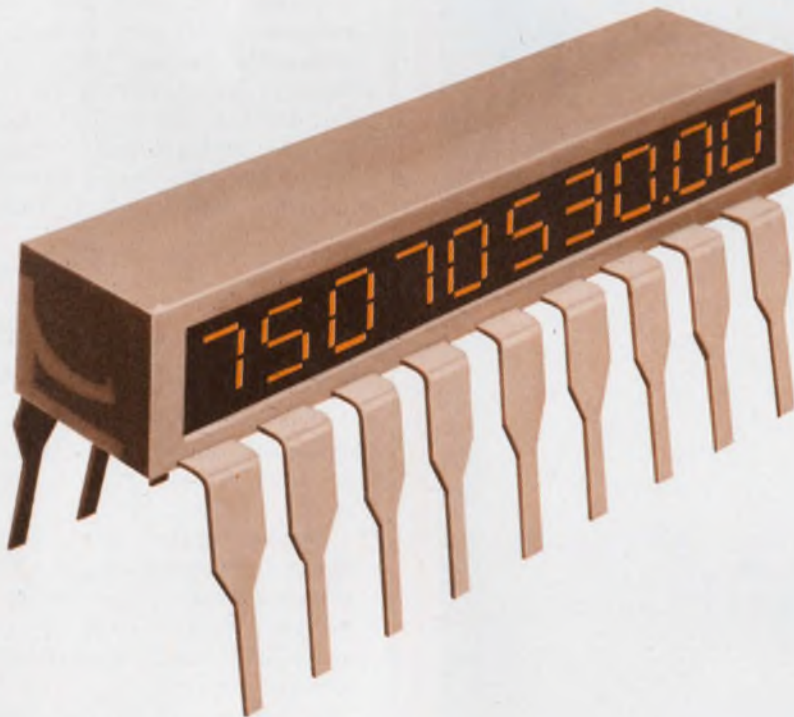

semiconductors

ITT Semiconductors is a division of International Telephone and Telegraph Corporation, 3301 Electronics Way, West Palm Beach, Florida 33407. Phone 305/842-2411. Factories in West Palm Beach, Florida • Lawrence, Massachusetts • Footscray, England • Colmar, France • Freiburg, Germany • Cascais, Portugal • Taipei, Taiwan • Sydney, Australia.

ITT

High voltage rectifiers handle 3 A up to 50 kV

Electronic Devices, 21 Gray Oaks Ave., Yonkers, NY 10701. (914) 965-4400. From \$7.10 (25 pcs.).

The KVP series of high voltage rectifier assemblies is rated to 1 A, has current ratings to 1 A and

voltage ratings from 5000 to 50,000 V peak reverse voltage. Also available is the RVP fast recovery series that has a max switching time of 300 ns. The KHP and RHP Series handle up to 3 A and are otherwise electrically similar to the KVP and RVP types. All the models use matched silicon rectifier elements, meet all applicable MIL-STD-750 tests, and are encapsulated in high thermal conductivity epoxy.

CIRCLE NO. 358

**Capture Signals like a Transient Recorder
Store and Playback Data like a Tape Recorder
with Better Accuracy, Computer Compatibility,
and Portability.**

That's the Beauty of an ERDAC!



COLLECT Several Waveforms Simultaneously
EXAMINE Analog Signals In Real Time
FREEZE and Study the Important Events
MEASURE Time and Amplitude Values Quickly
REMEMBER the Captured Signals for Detailed Analysis
STORE Traces on Computer Quality Tape Cartridges
PLAYBACK Exactly the Record Segment Selected for Review
ANALYZE the Data With Precisely the Time Resolution Desired

Now you can really capture and process data effectively!

Capability to handle electrical and biomedical transients; shock, strain, acceleration, and other dynamic signals can be yours . . . off the shelf!

CALL DAN ANTOS 518 - 372-5619



MACRODYNE INC.

1900 Maxon Rd., P.O. Box 1079
Schenectady, New York 12301

INFORMATION RETRIEVAL NUMBER 125

Low leakage diodes offer seven current values

Siliconix, 2201 Laurelwood Rd., Santa Clara, CA 95054. (408) 246-8000. From \$0.79 (100-up); stock.

The PAD line of low-capacitance, high-impedance diodes is intended for circuits requiring clipping, clamping or overvoltage protection. There are seven devices in the PAD family, with leakage ranging from 1 pA (PAD-1) to 100 pA (PAD-100). Reverse impedance is high, ranging from $2 \times 10^{13} \Omega$ for the PAD-1 to $4 \times 10^{12} \Omega$ for the PAD-5. Capacitance in the diode family ranges from 0.8 to 2 pF. Typical forward voltage drop is 0.8 V. All diodes are housed in TO-18 packages.

CIRCLE NO. 359

Silicon IR sensor has response to 1.1 μm

Spectronics, 830 E. Arapho Rd., Richardson, TX 75080. (214) 234-4271. \$95 (100-up).

The SD-3427s are silicon infrared detectors that use p^+ on n structures. When reverse-biased to -90 V, the depletion region extends throughout the device to the back contact. This results in low capacitance, fast rise and fall times with no slow tail response, high quantum efficiency and spectral response to 1.1 μm . Typical characteristics include NEP (2870, 1000, 1) $2.1 \times 10^{-13} \text{ W Hz}^{-1/2}$; D^* (λ_p , 1000, 1) $1.9 \times 10^{12} \text{ cm Hz}^{1/2} \text{ W}^{-1}$; λ_p , 0.87 μm and total capacitance, 3.5 pF. The detectors are available with lenses or flat windows.

CIRCLE NO. 360

Diode series intended for TV output circuits

AEG-Telefunken, 570 Sylvan Ave., Englewood Cliffs, NJ 07632. (201) 568-8570. From \$0.53 (100-up); stock.

The BY 211/2 to 5 series of diodes are designed for TV-line output circuits. These diodes have a high reverse voltage (F_{RWM}) of up to 500 V and a repetitive peak forward current (I_{FRM}) of 12 A. The maximum reverse recovery time (t_{rr}) when switched from an I_F of 1 A to an I_R of 1 A is 350 ns.

CIRCLE NO. 361

**This
Green
Light
Says,**



**“Go ahead
with
slim trim
display
equipment
ideas.”**



Multi-Digit Display with nine, eleven or thirteen digits. Or the FG type Multi-Digit Display with nine or twelve digits.

Go ahead because Ise lights your way to smaller, snappier equipment with a new wafer-thin multi-digit display. Then in addition to lighting the way, gives you a choice of two displays to work with. The DP-AS



Digits on (FG) models measure a mini 5mm high to help you be as small in your thinking as you want. Both new displays are glass-enclosed all around. And have easy-mounting pin connectors. But mounting isn't the only thing that comes easy with these trimmed-down displays. Reading the indication they give comes easy, also. Because Ise keeps with the past. Gives these new multi-displays the same eye-easy green glow and planer construction that make their forerunners so popular. In addition, they also give you low-voltage advantages for direct LSI drive.



If you've been holding back on a headful of ideas simply because the right multi-digit display wasn't available, it's time to stop.



1. FG95A (NEW)
2. FG125A2 (NEW)
3. DMCL19E1
4. DG12H1
5. DG19E1
6. DP128AS (NEW)

The Brighter Side of Electronics



Creator of Fluorescent Digital Display:

ISE ELECTRONICS CORP. P.O. Box 46 Ise-city, Mie Pref., Japan
Tel: (05963) 5-2121 Telex: 4969523
International Sales Div.:

ISE INTERNATIONAL CORP. 2-7-7, Higashi-Shinbashi, Minato-ku, Tokyo, Japan
Tel: 433-6616~9 Telex: J26546 Cables: "ISEWORLDREP" TOKYO
Sales & Technical Office:

ISE CORP. OF AMERICA 1472 West 178th Street, Gardena, Calif., 90248 U.S.A.
Tel: (213) 532-0470 Telex: 230674910

Representative: Paris, Munich, Amsterdam, Stockholm, Vienna, Milan, Bombay, Hong Kong, Taipei.

INFORMATION RETRIEVAL NUMBER 126

We are FIRST



... with microwave and power hybrid packages, and other new concepts for microcircuitry.

We were first

with the all-metal flat pack
the solid sidewall plug-in
the weldable dip

We will be first . . .

don't put off until tomorrow
what we can do for you today
... call Isotronics.

the microcircuit
packaging specialists



Isotronics

Isotronics, Inc.
12 Coffin Ave., New Bedford, Mass. 02746
(617) 997-4575 TWX 710 344 1961
Cable — ISOTRONICS

Visit us at ISHM

INFORMATION RETRIEVAL NUMBER 127

DISCRETE SEMICONDUCTORS

Common-cathode digit has 0.3 in. height

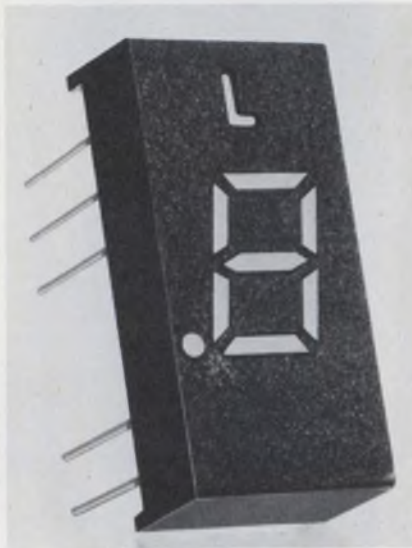

Litronix, Inc., 19000 Homestead Rd., Cupertino, CA 95014. (408) 257-7910. \$2.35; stock.

A 0.3 in. high red LED digit is arranged as a common cathode display with the decimal on the left. The DL-702 has a typical luminance of 0.7 mcd at 10 mA per segment. Satisfactory luminance may be obtained at an average current of 5 mA per segment when pulsed with narrow duty cycle waveforms. Forward voltage per segment is 1.7 V typically and 2 V maximum when operated at 20 mA. The DL-702 is packaged in a standard 14-pin DIP.

CIRCLE NO. 362

Rf power transistors operate up to 900 MHz

Communications Transistor, 301 Industrial Way, San Carlos, CA 94070. (415) 591-8921. From \$5.25 (unit qty); stock.

The DD and DM series of rugged, high-gain rf power transistors are designed for use in the 800-to-900-MHz frequency range. There are six broad-band, common-base devices that provide power outputs ranging from 0.5 to 40 W from a 12-V supply. All are available in both stud and isolated flange packages. The transistors can withstand infinite VSWR at all phase angles when operated at rated output power and supply voltage.

CIRCLE NO. 363

INSPECTION MARKING MAGIC

● Apply a micro-dot of fluorescent color — removable or permanent — for inspection marking of electronic circuit boards with the incredible Metron Marker. Squeeze-type, needle point, disposable pen has 12,000-dot ink capacity, replaces adhesive dots. Many other industrial uses. Thirteen permanent inks: ten military colors plus gold, silver, transparent (fluoresces blue under ultraviolet light); eight removable colors: red, green, blue, orange, yellow, brown, violet, grey. When ordering, specify color(s), removable or permanent ink.

NOW. MORE COLORS.
Five standard colors in
boxed desk stand, \$13.25

Single pens,
\$2.95 ea.

METRON MARKER

METRON OPTICS, Box 690AB
Solana Beach, CA 92075 • 714/755-4477

INFORMATION RETRIEVAL NUMBER 128

WOULD YOU BELIEVE? THE SMALLEST IN THE WORLD!

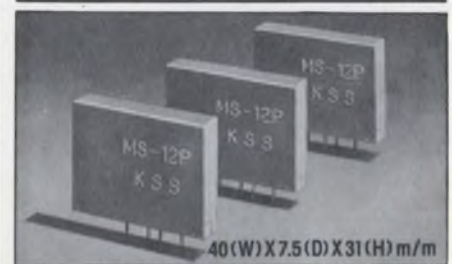

1H SOLID DELAY LINE
The MS-12 delay line is a small 1H type developed for video dropout compensation. The MS-11P is a color television receiver use delay line.

Items	Type	Unit	MS-12P	MS-11P
Nominal frequency	MHz		4 433619	4 433619
Nominal delay time	μS		63.1943	63.1943
Delay tolerance	ns		±30	±5
Bandwidth	MHz		±1	±1
Insertion loss	dB		12±3	8±3
Spurious	dB		20	3rd 22 others 30



House of Crystal...

Kinsekisha Laboratory Ltd.

● Head Office & Plant: 23-17, 2-chome Miyazaki, Setagaya-ku, Tokyo, Japan. Tel: 426-2111
● Mail Address: Central P.O. Box 350, Tokyo, Japan. ● Cable Address: CRYSTAL TOKYO

INFORMATION RETRIEVAL NUMBER 129

IR sensor/emitter pair operate up to 1 in. apart

Optron, 1201 Tappan Circle, Carrollton, TX 75006. (214) 242-6571. OP 160: \$0.85; OP 500, \$49 (1000-up); stock.

An infrared LED source (OP 160) and sensor (OP 500) pair feature high efficiency emission with high sensitivity. The OP 160 emitter has a typical output of 1.5 mW at 20 mA in a concentrated beam at an emission wavelength of 940 nm. The OP 500 npn planar phototransistor has a high spectral sensitivity designed to match that of the OP 160. Typical output of the OP 500 is 10 mA at 20 mW/cm² tungsten lamp irradiance. When operated as a pair, the OP 160/500 provides a typical output of 1 mA with an input of 20 mA at a lens-to-lens spacing of 0.25 in. The identical input at a spacing of 1 in. generates an output of 0.5 mA.

CIRCLE NO. 364

GaP LED indicators claim 100,000 hr life

Leecraft Mfg., 21-16 44th Rd., Long Island City, NY 11101. (212) 392-8800.

LED lamps built with GaP devices for constant optimum light output provide a life expectancy of 100,000 hr. Series L45R (3/16 male tabs), Series L46R (0.04 in. pins for PC and socket mounting) and Series L41 (wire leads) permit friction fit mounting in 0.312 in. holes. Speed nuts are furnished for maximum security. Series L39UR (wire leads or male tabs) provides snap-in mounting for positive positioning, without any additional hardware. The LED source is available in red, green and yellow. Lenses are hi-hat or flush plastic and come in a variety of colors. The standard bezel is chrome or aluminum depending on series. Housing is constructed of durable white nylon. Features include: low power consumption (10 to 20 mA) at approximately 2 V; standard dc operating voltages of 6, 12 and 24 V and ac units include diode rectification for high output and protection against transient reverse pulses.

CIRCLE NO. 365

New and improved General Electric lamps provide for increased design flexibility.

Two new sub-miniature halogen cycle lamps ideal for miniaturization.

These new T-2, 6.3V, 2.1 amps, 75 hour GE halogen cycle lamps are the smallest of their type (.265") and set industry standards for size and light output (16-20 candlepower). They are perfect for miniaturization of equipment such as reflectors, housings and optical systems. They also save on overall cost of equipment and are less than half the cost of the #1973 quartz lamp they replace.

Two terminal configurations are available. #3026 (20 candlepower) has wire terminals. #3027 (16 candlepower) has a new two pin, ceramic base that plugs in to make installation and removal a snap. Samples of the #3027 lamp are available in limited quantities now; production quantities will be available in the first quarter of 1975. These lamps have an iodine additive that creates a regenerative cycle that practically eliminates normal bulb blackening. They will produce approximately 95% light output at 75% of rated life.

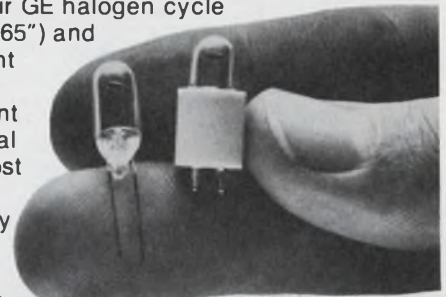

An expanded line of Wedge Base Lamps for simple, low-cost circuitry.

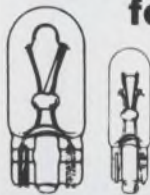

Now you can have greater design freedom than ever before with wedge base lamps. GE now offers six large lamps in its line of T-1 3/4 (.230" max.) all-glass, sub-miniature wedge base lamps. In addition to our three 14V lamps (#37, #73 and #74), we now also offer two 6.3V lamps (#84 and #86) and a 28V lamp (#85).

These lamps are ideal for applications where space is at a premium. Their wedge-based construction allows you to design for low-cost sockets and virtually ends corrosion problems because they won't freeze in the sockets. And the filament, which is always positioned in the same relation to the base, offers more uniform brightness.

Green Glow Lamp has been improved over previous lamp.



Actual Size

Now our G2B Green Glow Lamp, the only domestic green lamp on the market today, gives a more uniform, purer green light than our previous model. It's bright enough for your circuit component applications. With appropriate current limiting resistors, it can be used for 120/240 volt green indicator service. Or used together with our high-brightness C2A red/orange/yellow glow lamps to emphasize multiple functions with color.

All GE glow lamps give the benefits of small size, rugged construction and low cost — 12¢ each for the G2B, 4.4¢ each for the C2A in 100,000 quantities.

Send today for newest literature.

For the most up-to-date technical information on any or all of these lamps, write: General Electric, Miniature Lamp Products Department, # 7411L, Nela Park, Cleveland, Ohio 44112.

GENERAL  ELECTRIC

INFORMATION RETRIEVAL NUMBER 130

GREAT TIMING!



**Series 2200
Precision Timers**
Microseconds to
999.99 Seconds



**Series 2400
Digital Clocks**
12, 24, or 100 Hours



**Series 2440-2450
Calendar Clocks**
Seconds to Months



**Series 2600
Stopwatches**
Microseconds to Minutes



**Series 2500
Comparators**
For timing decisions

All have BCD outputs, all-aluminum enclosures,
and ERC accuracy and dependability.

Telephone: (913) 631-6700
TWX: (910) 749-6477

electronic research co. • a texttron div.

Mail to: P.O. Box 913
Shawnee Mission, Kansas 66201

Visitors welcome at 7618 Wedd, Overland Park, Kansas

erc

DATA PROCESSING

Computer boasts double throughput at old price



Digital Equipment Corp., 200 Forrest St., Marlboro, MA 01752. (617) 481-9511. \$600,000 to \$1,500,000, June.

Designated the DECsystem-1080 and 1090, the newest members of this family offer twice the processing power of current systems at approximately the same price. New hardware and software are compatible with previous generations of Digital's large-scale computers. The computers incorporate three new peripheral subsystems and software extensions. They can perform concurrent processing of time sharing, transaction processing, batch processing, remote batch, and real-time operations. An extended instruction set increases their scope for business and commercial applications. Both systems are built around Digital's newest processor, the KL10, which offers twice the instruction rate of the current processor, the KI-10. A 2048-word cache memory and use of MSI, ECL makes the effective processor cycle time 300 ns. An integral PDP-11/40 mini serves as the machine console, controls internal registers and data paths and provides diagnostic support. Main memory for both systems is expandable from 128K, 36-bit words to over 4 million words of core. Data from magnetic tape are directly accessible to the main memory bus through a data channel controlled by a PDP-8/A mini-computer. New peripheral subsystems complement the processor. A disc system designated the RHP04 allows on-line storage of 3.2 billion characters. In addition there are an industry-standard 200 in/s magnetic tape system (TU70, TU-71) and a fixed-head disc, the RHS04 that can be used as a virtual memory and swapping medium.

CIRCLE NO. 366

The long-billed heat sucker would like you to meet her family.

Our good friend, the Heat Sucker (better known as a Hughes heat pipe), is now the proud mother of an entire flock: round and flat bills, flexible round bills and the cold mounted plate bill. Each variant feels right at home in electronic, chemical and mechanical equipment; industrial processing; and medical applications. Anywhere you might need thermal control.

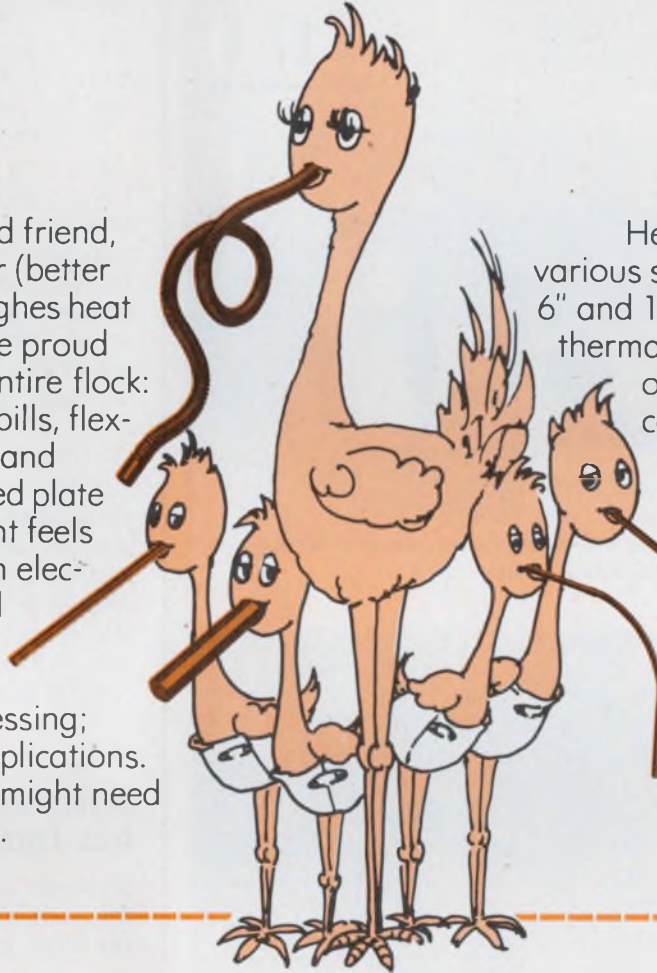

Heat Suckers come in various sizes: $\frac{3}{16}$ " to 1" diameter, 6" and 12" lengths. They have thermal transport capabilities of 10 to 2,000 watts covering temperature ranges from: -90°C to $+200^{\circ}\text{C}$.

Since the birds have mass migrated to our shelves, you can order right off the shelf for as little as \$37.00 (less in quantity).

HUGHES
HUGHES AIRCRAFT COMPANY
ELECTRON DYNAMICS DIVISION

Celebrate along with us. Send the coupon and get a cigar and literature. Hughes Electron Dynamics Division, Advertising Dept., 3100 W. Lomita Blvd., Torrance, California 90509. Or call (213) 534-2121, Ext. 451.

HUGHES
HUGHES AIRCRAFT COMPANY
ELECTRON DYNAMICS DIVISION



Name _____

Company _____

Address _____

City _____ State _____ Telephone _____

Application _____

ED-11

INFORMATION RETRIEVAL NUMBER 133

Make the big change-over to the new DMM from T.R.I.

High performance, low cost (\$279) and compact size, 10 μ V Resolution.

10 μ V resolution, \$279
Model 6355 is a portable DMM having a 10 μ V (DC voltage) resolution. It is comparable to DMM's for laboratory use, priced at an economical \$279, and sets a new standard of performance for portable DMM's.
Fully automatic
Operation is as simple as selecting the function and signal connection. The measured value is displayed

through the automatic selection of 5 functional modes: range selection, unit display, polarity, over-range indication and overload protection.

True portability
It measures 4-3/8" (W) x 2-7/8" (H) x 6" (D) and is a light-weight 1.8 lbs for complete portability. The shock-resistant design even protects the unit against accidental drop damage.

Rechargeable battery (Option)
Besides the AC power supply, the standard composition includes an alkaline battery. Optionally available is a rechargeable battery. Standard accessories include a battery charger.



505 West Olive Avenue
Sunnyvale, CA 94086
(408) 733-9080



Model: 6355 Mini-multimeter \$279

INFORMATION RETRIEVAL NUMBER 134

STACOSWITCH means pushbutton displays

When you think switch, think STACOSWITCH the pushbutton display specialists. Individual or matrix mount; snap-in, dress nut, or clamping bezel mount; QPL reliability and computer-grade low cost. STACOSWITCH offers a wide range of versatile display switches...lighted and unlighted. Choice of circuitry, switch action, legend display style and type to best meet your needs.

Write today for complete catalog and prices. When you think switch... think STACOSWITCH.



Other STACO Company products: Fixed Ratio Transformers, STACO, INCORPORATED, Richmond, Indiana; Variable Transformers, STACO, INCORPORATED, Dayton, Ohio.

INFORMATION RETRIEVAL NUMBER 135

DATA PROCESSING

Multiplexer lets user copy four video signals

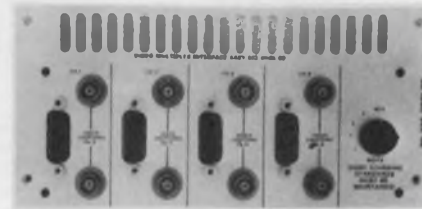

Tektronix, P. O. Box 500, Beaverton, OR 97005. (503) 644-0161. See text; stock.

A four-channel multiplexer enables the manufacturer's 4632 Video Hard Copy Unit to make facsimile copies from up to four standard composite signals and from digital video signals of refreshed alphanumeric/graphic terminals. The user can switch to any one of the four channels for copying from a single terminal or can select the multiplex mode and copy all four in a four-channel queue. The 4632 is plug-to-plug compatible with most alphanumeric and graphic terminals and can produce a clear 8-1/2 x 11 in. copy of a display in 18 s. Price of the 4632 Multiplexer, installed at the factory, is \$500; the Model 4632 copier costs \$3395.

CIRCLE NO. 367

Buffered tape formatter has two memories

Kennedy Co., 540 W. Woodbury Rd., Altadena, CA 91001. (213) 798-0953. \$4000 to \$5500; 60 days.

A buffered formatter for synchronous transports uses a random-access buffer, divided into two independent memories. The 9217/9217B permits uninterrupted recording of asynchronous data received at burst rates to 250,000 char/s. The Model 9217 provides the synchronous tape control and the formatting electronics, while the Model 9217B supplies buffering and memory control. Formatting electronics in the Model 9217—parity generator, cyclic redundancy check, and gap control—are checked by read-after-write circuits. The system is available for nine-track 1600 char/in. tape decks.

CIRCLE NO. 368

If you're tired of the cost of replacing line voltage 6 and 7 watt lamps, consider our 3 watt annunciator cost and energy saver.

Available with voltage ratings from 6 to 120 volts, each lamp has a built-in aluminized reflector to intensify candlepower . . . plus pyrex colored lens caps for unique lighting and signaling effects.

Bases? Take your pick of candelabra screws, miniature bayonets, even PC-card compatible bi-pins.

To see all the ways our advanced product line gives you more, write for our free 56-page Illumination Design Data Handbook and Catalog: Sylvania Miniature Lighting Products Inc., West Main St., Hillsboro, N.H. 03244, phone 603-464-5533

MORE THAN ADVANCED
high-candlepower annunciator lamps meet specialized application needs.



GTE SYLVANIA

INFORMATION RETRIEVAL NUMBER 296

What's the nearest thing to universality in pilot and indicator lamps? Simple—clear cartridge lamps with interchangeable color lenses and standard bi-pin bases that fit all Sylvania lamp assemblies. Easier to buy, easier to store and easier to replace, our 7 pilot cartridge lamps and 15 indicator cartridge lamps give you a complete voltage range, a choice of 10 transparent or translucent color lenses, and the edge of competitive pricing. Find out more, in the 56-page Illumination Design Data Handbook and Catalog available free from: Sylvania Miniature Lighting Products Inc., West Main St., Hillsboro, N.H. 03244, phone 603-464-5533.

MORE THAN VERSATILE
interchangeable cartridge lamps, sockets and lenses keep inventory low.



GTE SYLVANIA

INFORMATION RETRIEVAL NUMBER 297

Buy them with up to 12 sockets . . . cut them to any length you want . . . clip them to a panel in seconds. When you're multiple-mounting T-2 indicator lamps, that's flexibility plus. Plus time-saving and storage convenience. Plus a choice between sockets on 1/2" or 3/4" centers, between common or separate socket connections, and between three optional snap-on color caps for the twin light. And plus competitive pricing, throughout our broad line. See all the ways we give you more, in the 56-page Illumination Design Data Handbook available free from: Sylvania Miniature Lighting Products Inc., West Main St., Hillsboro, N.H. 03244, phone 603-464-5533.

MORE THAN FLEXIBLE
cut-to-size strip sockets make multiple mounting easy.



GTE SYLVANIA

INFORMATION RETRIEVAL NUMBER 298

Why buy just the bulb, when our complete range of pilot and indicator lamp hardware makes it so easy to match whole panel light assemblies to your design and budget requirements. Choose pilot housings with five interchangeable screw-on lens types, round or rectangular single sockets, twin light indicator assemblies, three different types of snap-on color caps for easy circuit coding . . . everything you need for selection without compromise. For more facts, write for our free 56-page Illumination Design Data Handbook and Catalog: Sylvania Miniature Lighting Products Inc., West Main St., Hillsboro, N.H. 03244, phone 603-464-5533.

MORE THAN CONVENIENT
total-assembly backup for every miniature lamp.



GTE SYLVANIA

INFORMATION RETRIEVAL NUMBER 299

ICS, READ-ONLY MEMORY (ROM)

SEE SHAPER—SEE ICS, MULTIVIBRATOR

RANDOM ACCESS MEMORY (RAM)

- Microsystems Inc 3800 GB Homestead Rd Santa Clara CA (408)246-0330
- Vol 2/590,592,593
- Arrays Inc 550G Middlefield Rd Mt View CA 94043 (415)962-4321
- Vol 2/613-617
- Child Semiconductor 464 Ellis Ct Mountain View CA 94042 (415)962-5011
- Vol 2/642-648
- General Instru Corp, Dept G, 600 West John St Hicksville NY (516)733-3333
- 11802 Vol 2/655
- Intel Corp 3065G Bowers Av Santa Clara CA 95051 (408)246-7501
- LSI Computer Sys Inc 22G Cain Dr Plainview NY 11803 (516)293-3850
- Vol 2/759
- Monolithic Memories Inc, Dept G, 1165 E Argues Av Sunnyvale CA (408)739-3535
- 94086 Vol 2/760,761,765
- Mostek Corp, Dept G, 1215 W Crosby Rd Carrollton TX 75006 (214)242-0444
- Vol 2/766-768
- Motorola Semiconductor Prod Inc, Dept G, 5005 E McDowell Rd (602)244-6900
- Phoenix AZ 85008 Vol 2/787,792
- National Semiconductor Corp 2900G Semiconductor Dr Santa Clara (408)732-5000
- CA 95051 Vol 2/807,808
- RCA Solid State Div, Dept G, Box 3200 Somerville NJ 08876 (201)722-3200
- Vol 2/847,849-852
- Signetics Corp, Sub Corning Glass, Dept G, 811 E Arques Av Sunny- (408)739-7700
- vale CA 94086 Vol 2/860,861
- Texas Instrus Inc, Dept G, PO Box 5012 Mail Station 84 Dallas TX (214)238-2011
- 75222 Vol 2/887,889,893
- Adv Memory Sys 1275 Hammerwood Sunnyvale CA 94086 (408)734-4330
- Adv Micro Devices 901G Thompson Pl Sunnyvale CA 94086 (408)732-2400
- Automata Sys Corp 592G Maude St South Hempstead NY 11550 (516)483-5185
- Calvert Elecs Intl, Semiconductor Div, Dept G, 220 E 23Rd St New York (212)679-1340
- NY 10010 (213)644-9881
- EM & M 12621G Chadron Av Hawthorne CA 90250
- Energy Conversion Devices Inc, Dept G, 1675 W Maple Rd Troy MI (313)549-7300
- 48084 (305)727-5407
- Harris Semiconductor, Dept G, PO Bx 883 Melbourne FL 32901 (213)391-0711
- Hughes Aircraft Co Centinela & Teale St Culver City CA 90230 (714)548-0671
- Hughes Aircraft Co, Microelectronic Prods Div 500G Superior Av Newport (408)257-5450
- Beach CA 92663 (303)761-2275
- Intersil Inc 10900G Tantau Av Cupertino CA 95014 (415)968-9271
- Monolithic Sys Corp 2700G S Shoshone Englewood CO 80110 (215)855-7197
- Raytheon Co Semiconductor Div 350G Ellis St Mountain View CA (516)732-2400
- 94040
- Solid State Scientific Inc, Dept G, Commerce Montgomeryville PA 18936
- Standard Logic Inc, Dept G, 2215 S Standard Av Santa Ana CA 92707
- Standard Microsystems Corp 35G Marcus Blv Hauppauge NY 11787
- Standard Semiconductor 1300G Terra Bella Av Mountain View CA
- 1-17 2-Chome Higashi-Yukigaya Ohta-Ku Tokyo Japan 100
- 95051 Vol 2/618-620
- Elect Arrays Inc Vol 2/642-648
- Fairchild Semiconductor Vol 2/654
- General Instru Corp, Dept G, 11-18 2-Chome (516)293-3850
- 11802 Vol 2/716-745
- Intel Corp 3065G Bowers Av Santa Clara CA 95051 Vol 3/448 (408)739-3535
- Vol 2/716-745
- Kyodo Elec Lab Inc, Dept G, 11-18 2-Chome (215)666-7950
- Kanagawa-Ken Japan Vol 2/759
- LSI Computer Sys Inc 22G Cain Dr Plainview NY 11803 (214)242-0444
- Vol 2/759
- Monolithic Memories Inc, Dept G, 1165 E Argues Av Sunnyvale CA
- 94086 Vol 2/760,762,764
- MOS Technology Inc 950G Rittenhouse Rd Norristown PA 19401
- Vol 2/775-778
- Mostek Corp, Dept G, 1215 W Crosby Rd Carrollton TX 75006
- Vol 2/766,769,770

HERE'S HOW
WE MAKE IT
EASIER FOR



See Manufacturers Directory for local offices.

YOU TO CONTACT SUPPLIERS

COMPLETE STREET ADDRESS, STATE, ZIP AND PHONE FOR EACH LISTING SAVES TIME

Knowing only a name and city isn't much help if you or your secretary want to contact several manufacturers at once for information or a quote. That's why *Electronic Design's* GOLD BOOK repeats each manufacturer's full name, street address, city, state, zip and phone number every time the manufacturer is listed in our PRODUCT DIRECTORY. It's all there. You don't have to leaf through other directories to find the missing information.

IT'S ANOTHER REASON TO REACH FIRST FOR ELECTRONIC DESIGN'S GOLD BOOK.



Electronic Design's **GOLD BOOK**

**BIGGEST AND BEST ELECTRONICS MASTER CATALOG
& DIRECTORY IN THE WORLD**

Byte-oriented memory comes in three sizes

National Semiconductor Corp., 2900 Semiconductor Dr., Santa Clara, CA 95051. (408) 732-5000. See text; stock to 90 days.

A memory system called Mosram 410 is TTL-compatible and features tri-state outputs. Designed for use in POS and CRT terminals as well as eight-bit processors, the system is available in three different capacities: 4k-by-8 bits, measuring 4 in. by 6.3 in.; 4k-by-9 bits, measuring 4 in. by 6.75 in.; and 4k-by-10 bits, measuring 4 in. by 7.2 in. Also available are cycle/access times of 550, 700, and 1050 ns. The 4k-by-8-bit Mosram system, which can be configured in a single Eurocard format, is priced at \$400 for unit quantities with an OEM discount of up to 40%.

INQUIRE DIRECT

Low-cost printer delivers eight line/s

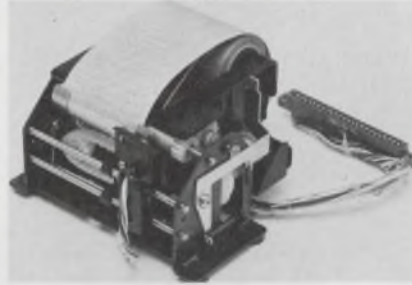

Hycom, 16841 Armstrong Ave., Santa Ana, CA 90705. (714) 557-5252. \$65 (1000 qty).

A 16-column electrostatic printer, the Model DC 1606-B, prints eight lines/s in muted silence. A 5 × 7 dot matrix provides alphanumeric characters as well as mathematical signs and symbols. The printer measures 3.3 × 4.5 × 4.5-in. and weighs 1.8 lb. Mean time between failure (MTBF) has been tested at 5.5 million lines. A 21-column unit that offers the same features and performance characteristics is slated for introduction in early 1975.

CIRCLE NO. 369

Mag tape formatter fits inside drive housing

Microdata Corp., 17481 Red Hill Ave., Irvine, CA 92705. (714) 540-6730. \$640 (qty); 30 days.

Microdata Corp. has introduced the first industry standard formatter designed to mount directly inside tape drives. A single 9.25 × 14-in. PC board contains the tape formatter. The Model 6920 records and reads NRZ1 IBM-compatible 0.5-in., nine-track tapes, with speeds from 12.5 to 45 ips at 800 bpi tape density. Model 6920 serves as a direct replacement of any industry standard formatter and is compatible with industry standard magnetic tape units, including the Microdata Series 6000 and 6800 drives. Up to four drives can be daisy chained. The formatter provides complete drive control and delivers all status information to the controller. Control logic interprets controller commands and generates control signals to time, sequence and carry out the various MTU/formatter operations.

CIRCLE NO. 370

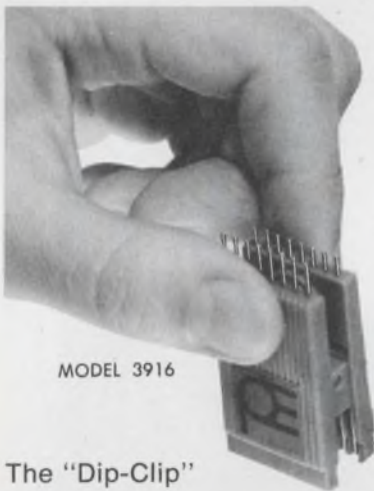

MODEL 3916

The "Dip-Clip" is specially designed to allow the attachment of test probes to 14 or 16 lead DIPs. The unique patented design greatly reduces the possibility of accidental shorting while testing live circuits. Numerous test probes may be quickly connected for hands-free testing.

dip clip

T.M.

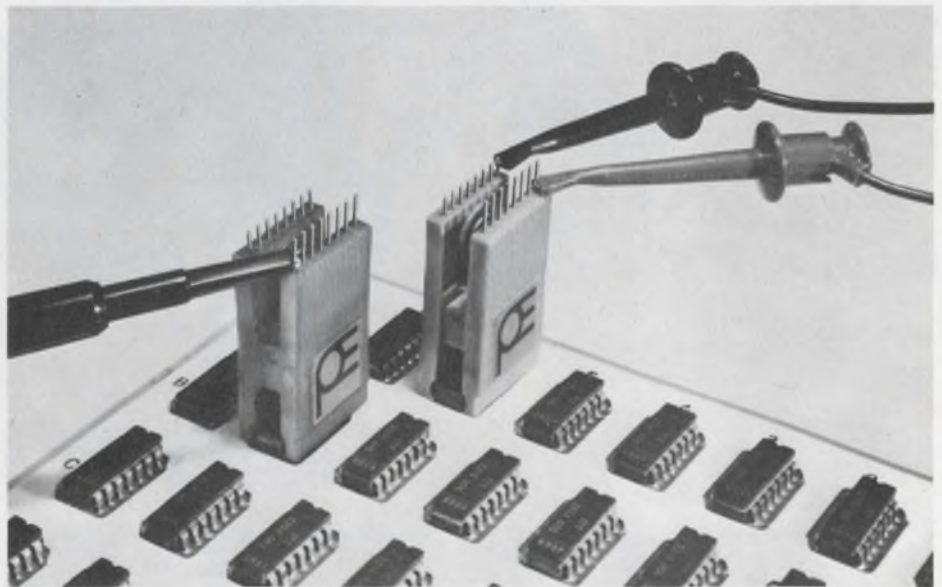

POMONA ELECTRONICS

A Subsidiary of ITT

1500 E. Ninth St., Pomona, Calif. 91766 • Telephone: (714) 623-3463

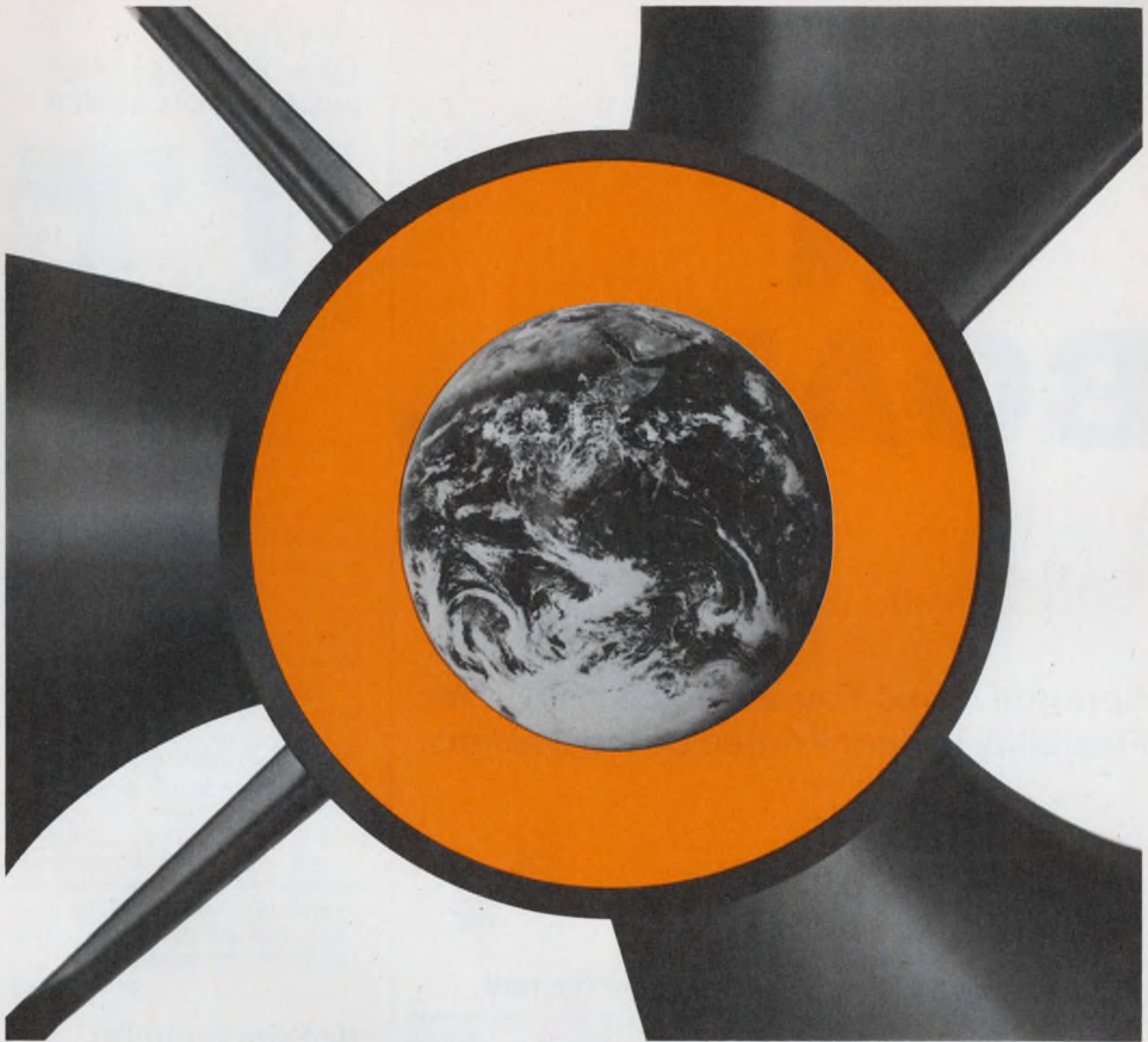

Behind every Rotron® fan and blower... Worldwide Facilities

The world is growing smaller. More and more companies are involved in international sales and international application of their products. Many in manufacturing abroad.

Rotron is such a company. If you are too, or hope to be, you'll be glad to know that Rotron is equipped to serve you throughout the world. With fan and blower manufacturing facilities not only in the U.S.A. but in The Netherlands and Japan as well. With an interna-

tional sales and distributor organization that reaches into all parts of Europe, the Middle East, the Orient, Africa, Australia, and South America.

When you deal with Rotron, you not only receive the best there is in air mover application engineering, in product quality and variety, in distributor service. You get it when and where you need it.

Why settle for less when the best costs no more?



ROTRON INC.

Woodstock, N. Y. 12498 ☐ 914 • 679-2401 ☐ TWX 510-247-9033
Pacific Div., Burbank, Cal. 91506. 213-849-7871 • Rotron B. V., Breda, Netherlands. Tel: 79311. Telex: 844-54074

INFORMATION RETRIEVAL NUMBER 139

18514

GET ON BOARD...

with TANTALEX[®] Low-Cost Solid Tantalum Capacitors

**Sprague Gives You a Choice for
Flexibility in Your Printed Board Designs.**

DIPPED . . .

SPRAGUE TYPE 196D

Small size economical capacitors that utilize high-quality tantalum pellet construction. Conformal epoxy resin coating is highly resistant to moisture and mechanical damage. This capacitor has found wide usage in consumer and commercial electronic equipment. Operating temperature range, -55 C to +85 C. Available in all popular 10% decade values from 0.1 μ F to 330 μ F. Voltage range, 4 to 50 VDC. Standard lead spacing, 0.125" and 0.250". For complete data, write for Engineering Bulletin 3545B.



MOLDED . . .

SPRAGUE TYPE 198D

Economically priced, molded-case Econoline[™] capacitors. Standard lead spacing, 0.100", 0.200", and 0.250". Tough, flame-retardant, crack resistant case has flattened section and polarity indicator for easy-to-read marking and error-free insertion. Fixed external dimensions allow increased productivity during assembly of PC boards. Designed for severe vibration and shock environment, where lead support alone is not adequate. Operating temperature range, -55 C to +85 C. Capacitance values from 0.1 to 100 μ F. Voltage range, 4 to 50 VDC. For complete data, write for Engineering Bulletin 3546.

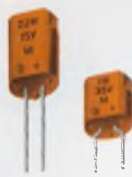

**Call your nearest Sprague district office
or sales representative, or write for the
bulletins mentioned above to Sprague
Electric Company, 347 Marshall Street,
North Adams, Mass. 01247.**

SPRAGUE

THE MARK OF RELIABILITY

THE BROAD-LINE PRODUCER OF ELECTRONIC PARTS

INFORMATION RETRIEVAL NUMBER 138

DATA PROCESSING

Laser beam can send analog signals 2000 ft



*International Laser Systems, Inc.,
3404 N. Orange Blossom Trail, Or-
lando, FL 32804. (305) 295-4010.
\$4995; 90 to 120 days.*

A wideband analog communications link, the Model TL-2, uses an eye-safe laser beam as the carrier. The unit is capable of one-way operation over a clear of sight to 2000 ft and has a bandwidth that extends from dc to 100 kHz. A laser injection diode transmitter and an avalanche photodiode receiver are used. Both units are housed in a rugged steel box that is fitted with a precision alignment bracket. Transmitter beamwidth is 10 mr and the modulator format is pulsed FM. Signal to noise ratio is 55 dB at maximum output. The system can operate over a temperature of -20 to 60 C and a humidity of 99%. Dimensions of the transmitter and receiver are identical—12-in. wide, 16-in. deep and 6.5-in. high. They also weigh the same—35 lb.

CIRCLE NO. 371

Half-size controller handles eight data lines

*The Urban Systems & Services
Co., 3400 Montrose, Suite 216,
Houston, TX 77006. (713) 526-
6243. \$1200; 60 days.*

The Eight-Line Communications Controller interfaces up to eight asynchronous RS-232 or 20-mA lines to the Computer Automation product line. Each separately addressable double-buffered line uses a unique interrupt location for both programmable or Automatic Input/Output. Each line's vector address, baud rate, character length and number of stop bits are switch selectable. And each channel can operate at rates up to 2400 baud. The controller occupies only one-half of an option slot and uses the existing Computer Automation power supply.

CIRCLE NO. 372

IF WE CAN'T MAKE YOUR MINICOMPUTER SYSTEM DO MORE WORK FOR LESS MONEY, NOBODY CAN.

When we introduced the SPC-16, we promised it would be the world's most powerful, versatile, cost-effective family of minicomputers.

It was. It still is.

The SPC-16 isn't the lowest priced hardware you can buy. But it will give you the lowest cost solution.

Through advanced systems architecture, simplified interfacing and a powerful instruction repertoire, the SPC-16 allows you to minimize programming, interfacing and memory costs no matter what size your system is.

Six mighty minis.

The SPC-16 family consists of six minicomputers offering a choice of three memory cycle times (800ns, 960ns and 1440ns), memory expansion to 128K using efficient 16K boards, and two different packaging configurations.

If you build a system around the SPC-16, it will do more work for less money than any other system you could build.

And that translates into more profits.

We know it for a fact. In the past few years, we helped a lot of OEMs get the edge on their competition by designing our product into their products. We helped a lot of end users solve a lot of tough, tight-budget applications. And, we produced some cost-effective systems of our own.

Two hard working systems.

Take RTOS II for example. It's a multi-programming system offering real-time event driven foreground processing concurrent with background job development and computation.

You couldn't buy a better price/performance solution for applications such as process control, data acquisition, laboratory research, material handling, communications or overall manufacturing automation.

We also built a powerful disk-based general purpose system around the SPC-16. DBOS II lets you do more computation with less memory, in far less time, at a lower price than any system on the market. It offers both scientific and commercial languages and a combination of interactive and batch operation.

This system is perfect for service centers, research and development groups and system house dedicated applications.

That's the short form.

To really appreciate how much power we can deliver for your money, write for our book

"The Value of Power." It will give you the facts to back up our claim: If General Automation can't make your system do more work for less money, nobody can.

Write General Automation, 1055 South East Street, Anaheim, California 92805. Or call (714) 778-4800. In Europe, write General Automation, S.A., 24 rue du Sergent Bauchat, 75012 Paris, France. Telephone (1) 346/7973. In Canada, write G.A. Computer Ltd., 880 Lady Ellen Place, Ottawa K1Z5L9, Ontario. Telephone (613) 725-3626.

POWERFUL MINICOMPUTERS BY GENERAL AUTOMATION

INFORMATION RETRIEVAL NUMBER 137

DIB*

DUAL IN-LINE BRIDGE

An integrated bridge rectifier in a miniature dual in-line package

ACTUAL SIZE PACKAGE

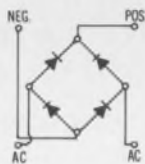

- 4-pin, low-profile DIP
- Leads on standard .10" (2.54 mm) grid
- Compatible with automatic testing, handling and inserting.
- Greatly reduces labor & material costs.
- 100% surge tested at 25A.
- Meets moisture resistant requirements of MIL-STD 2021, 106C
- Two Series: 1 Amp (I_o) at 40°C; ½ Amp (I_o) at 55°C
- 25 to 1000V (V_{RRM})

* TM-Varo Semiconductor, Inc.



Write for free sample

Design us in . . . we'll stay there

VARO SEMICONDUCTOR, INC.

P.O. BOX 676, 1000 N. SHILOH, GARLAND, TEX. 75040 (214) 272-4551 TWX 910-860-5178

INFORMATION RETRIEVAL NUMBER 140

THE WORLD WEIGHS 11 LBS.



New! Tracor Model 900 VLF/LF Receiver. Use it worldwide. Weighs 11 lbs. Costs \$1250.

The lowest-cost, most versatile receiver available. Tunable 10 to 25 kHz in VLF band. Or 60 to 75 kHz in LF band. Worldwide reception includes Paris (16.8 kHz), Japan (17.8 kHz), Australia (22.3 kHz), U.S.S.R. (16.2 kHz) and an increasing number of Omega transmissions in the 11 to 12 kHz band. The 900: offers accuracy of parts of 10¹¹ over 24-hour period; allows traceability to national standards; plots minute-to-minute phase record; provides all that is necessary for frequency comparison to NBS. It comes complete with roof-mounting whip antenna unit, 100 ft. antenna cable and with (or without) panel chart recorder. Write or call for full technical and application information.

Tracor, Inc. Industrial Instruments

6500 Tracor Lane • Austin, Texas 78721 • AC 512/926-2800

INFORMATION RETRIEVAL NUMBER 141

DATA PROCESSING

Concentrator combines six lines to one printer



Honeywell, Inc., 13356 U.S. Hwy. 19, St. Petersburg, FL 33733. (813) 531-4611

The HC-650 Multi-Channel Concentrator (MCC) multiplexes up to six TTY signals to one channel for use by a single high-speed printer. Data from six, five-bit Baudot channels is inputted to the unit at adjustable speeds of 50 to 150 words/min. Output is also continuously adjustable, from 100 to 2000 wpm. Data from each incoming signal are stored in separate channel memories. When a memory accumulates a full page of data, it is triggered automatically for transmission to a high-speed printer or other data sink. Headings identify the time of transmission and channel source and are inserted automatically over each page of data. Conversion of the HC-650 from Baudot to ASCII format is claimed to be relatively simple.

CIRCLE NO. 373

Interface adds 23 Mbytes of tape storage to mini

Qantex, 200 Terminal Dr., Plainview, NY 11803. (516) 681-8350. \$3935; 60 to 90 days.

The Series 2400 Tape Storage System provides 23 Mbytes of mass storage for the PDP-11. An interface card plugs directly into a small peripheral controller slot in the PDP-11. Manipulation of one status/control register and a single data buffer register on the interface card are required for software control. The 2400 uses hardware to do many jobs ordinarily left to the software. The generation and validation of the Cyclic Redundancy Check Character, CRC is one example.

CIRCLE NO. 374

Nowadays, you can't buy immediate delivery.

But you can rent it.

When you order electronic test equipment, you could wait weeks or even months for delivery.

Or, you could rent from REI, and have what you want within hours. With the largest inventory in the business, it's a safe bet that your local REI Instant Inventory Center has exactly what you need. And it's just a phone call away.

Immediate delivery is just one reason for renting from REI. Saving money is another. You pay only for the period you have your instruments, and you can return them anytime... so you get more mileage from your equipment budget.

REI stocks 8,137 fully checked-out test instruments. And they're ready whenever you are. For the full story on renting, as well as prices, send in the coupon for prompt delivery of our free illustrated catalog. Or, call us now for your immediate requirements.

Burlington, MA (617) 273-2770 • Gaithersburg, MD (301) 948-0620 • Oakland, NJ (201) 337-3757 • Ft. Lauderdale, FL (305) 771-3500 • Des Plaines, IL (312) 827-6670 • Dallas, TX (214) 661-8082 • Mountain View, CA (415) 968-8845 • Anaheim, CA (714) 879-0561 • Rexdale, Ontario (PLC Leasing Ltd.) (416) 677-7513

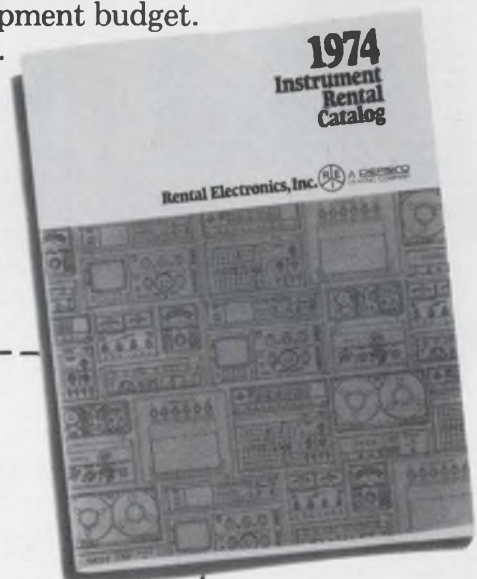

Rental Electronics, Inc.
99 Hartwell Avenue, Lexington, Mass. 02173
Please send me your free, 78-page rental
equipment catalog:

Name _____ Title _____

Company _____

Address _____

City _____ State _____ Zip _____

Rental Electronics, Inc.
A PEPSICO LEASING COMPANY



INFORMATION RETRIEVAL NUMBER 142

Terminate connection problems with Curtis terminal blocks



G Series

Our popular 7/16" center barrier-type blocks are ideal for jobs demanding a variety of terminations at low cost. Tab, screw, clamp, PC pin, solder or taper pin terminals are available. Surface-connect and full feed-thru insulation models are also offered. Available in one thru 26 terminals. G Series feature precision-machined brass inserts, molded in place, for a full mechanical thread system. Rated 20 amps/300 volts.



E Series

Designed primarily for electronic control and low power circuit application, these 3/8" center inexpensive barrier-type blocks are available in one thru 22 terminals. Your choice of screw, clamp, two, four or six tab quick-connect, PC pin or solder terminals. Surface-connect and feed-thru models are offered. Rated up to 15 amps/300 volts.



SE Series

Several terminal variations coupled with miniature size make these 1/4" center blocks ideal for use in tight spaces where versatility must not be sacrificed. These barrier-type blocks are available in screw, clamp, two, four or six tab terminals. Surface-connect and full feed-thru insulation models are also offered. Available in one thru 26 terminals. Rated 5 amps/300 volts.

Send for free engineering catalog No. 1273.



CURTIS INDUSTRIES, INC.
formerly Curtis Development & Mfg. Co.

8000 West Tower Avenue, Milwaukee, Wisconsin 53223. Call (414) 354-1500 for the name of a representative or distributor near you. In Canada: A.C. Simmonds & Sons, Ltd., Willowdale, Ontario

1000

DATA PROCESSING

Video display system includes a mini

Conrac Corp., Datex Div., 1600 S. Mountain Ave., Duarte, CA 91010. (213) 359-914. Under \$10,000 (qty).

With the exception of the keyboard and display monitors, the entire IVIDS display system is housed in an LSI minicomputer chassis. Pages of data composed and edited with the keyboard and edit channel (or pre-stored in extended memory) may be displayed on any display channel. All logical and editing functions are performed in the mini under software control, which makes the system easily reprogrammable and expandable to meet special application requirements. The system, available as a stand-alone display or as a display subsystem to larger-system manufacturers, has four alphanumeric channels. Options include up to 100 channels of video display, special-purpose data manipulation through software control, real-time clock display and floppy-disc extended storage.

CIRCLE NO. 375

Flexible multiplexer designed for entry level

Computer Transmission Corp., 2352 Utah Ave., El Segundo, CA 90245. (213) 973-2222. From \$6350.

For computer users who are just beginning to structure their own data communications networks, the M1215 Multitran can simultaneously accommodate up to four synchronous terminals and up to 12 asynchronous terminals of various speeds over a single voice grade or wideband line. The M1215 supports both time-sharing (dial line) or dedicated (private line) terminals and it is particularly effective in providing high-speed, single-line service between clusters of remote terminals and a distant central processor. This service requires only one data set for the M1215 at the terminal site and another at the CPU. A second M1215 demultiplexes inputs for the processor. The M1215 can be expanded to a maximum of 115 asynchronous channels.

CIRCLE NO. 376

Eliminate Interference-Induced Errors in your Measurements . . .

by removing spurious components from the signal of interest before you measure it. The Model 189 Selective Amplifier provides a choice of narrow-band, lowpass, highpass and notch filtering to eliminate interfering signals and wideband noise. The corner/center frequency is continuously variable between 0.1Hz and 110 kHz with equivalent circuit Q switch-selectable from 1 to 100.



To find out how the Model 189 can eliminate errors from your measurements, write Princeton Applied Research Corporation, P.O. Box 2565, Princeton, New Jersey 08540, or telephone (609) 452-2111. In Europe, contact Princeton Applied Research GmbH, D8034 Unterpfaffenhofen, Waldstrasse 2, West Germany.



PRINCETON APPLIED RESEARCH

259

INFORMATION RETRIEVAL NUMBER 144

FREE CATALOG



Trompeter Electronics announces the publication of a new and revised Catalog T10. It

contains a technical paper 'Noise in Cable Systems'. The section on patching includes panels, jacks, connectors, patch cords and networks. A third section describes 50 and 75 ohm matrices, switches and systems in coax, twinax and triax from DC to 3 GHz.

TROMPETER ELECTRONICS, INC.
8936 Comanche Ave.
Chatsworth, CA 91311
Tel. 213/882-1020

INFORMATION RETRIEVAL NUMBER 145

ELECTRONIC DESIGN 24, November 22, 1974

INFORMATION RETRIEVAL NUMBER 143

CRT terminal offers local or remote use



Pertec Corp., Business Systems Div., 17112 Armstrong Ave., Santa Ana, CA 92705. (213) 882-0030. From \$2025 (100 qty.); 90 days.

A desktop CRT terminal, the Model 7100, provides displays of 12 lines (960 total characters). The 7100 includes a display unit (13 × 19 in.) and a detachable keyboard (18 × 3 × 8-in.). The CRT display uses a 7 × 9 dot-matrix to display the 64-character ASCII set. As an option the display can be expanded from 12 to 24 lines (1920 characters). Available interfaces include synchronous, asynchronous and direct (to computer) with transmission rates to 9600 bit/s. A modem adapter allows a daisy chain of up to 64 terminals. Keyboard functions and communications protocol can be modified by a change of control memory (stored in ROMs).

CIRCLE NO. 377

Intelligent reader processes card data

Bourns Management Systems, 6600 Jurupa Ave., Riverside, CA 92504. (714) 687-7220. Starts at \$6500; 60 days.

Intelligent card readers such as the Series 8000 edit on or off-line and can sort cards into stackers under internal or external program control. The unit reads optically marked cards and uses its internal microprocessor to initiate subsequent actions. These include character suppression, accuracy checks, card classification based on program card and output formatting. The unit operates at rates of 150 or 300 card/min and can output in ASCII or IBM-compatible Bisync formats. Both sides of the card are read and the 80 characters on each side are stored in a 160-character buffer.

CIRCLE NO. 378



See me* for off-the-shelf savings on this and other Tele-Dynamics power supplies ...

Four power supplies in one

- Two 750-mA outputs—each independently adjustable from 11.7 to 15.3 V
- Can be series-connected for double voltage (23.4-30.6 V)
- Can be parallel-connected for double current (1.5 A) utilizing single voltage control
- Master-slave tracking for op-amp applications

Series T12/15-750

QUANTITY	PRICE
1-9	\$51.00
10-24	\$48.50
25-49	\$46.00
50-99	\$43.50

AC input: 105-125/210-250 V, 57-63 Hz, single phase.

Regulation: line and load each ±0.1%. **Ripple:** 0.05% rms.

Overload protection: foldback current-limiting.



TELE-DYNAMICS DIVISION OF **AMBAC**

WANLASS POWER SUPPLIES AND LINE CONDITIONERS

525 Virginia Drive, Fort Washington, PA 19034 • (215) 643-3900

Career opportunities for power supply engineers—an equal opportunity employer M/F

* 110 STOCKING DISTRIBUTOR LOCATIONS

- Allied • Arrow-Angus • Cramer • Newark • Olive Radio • Philadelphia Electronics • Pioneer Standard • RPS Electronics • Ralph's • Stark • Sterling (Calif.) • Summit • Testco • T. I. Supply • Zack • Texas Instruments, Ltd. (Europe) • Tisco (Europe)

Call toll-free (800) 645-9200 for the one nearest you. In N.Y. State, call collect (516) 294-0990.

© Tele-Dynamics

6081

MF ELECTRONICS CRYSTAL OSCILLATORS

MF Electronics produces a broad line of temperature-compensated and clock oscillators for both DIP and PC board use. Any frequency from 4 MHz to 50 MHz may be specified in our low-profile Model 5406 oscillator with a stability of ± 50 ppm or ± 25 ppm from 0° to 65°C. Temperature ranges from -55° to 125°C are also available. Our Model 5401 temperature-compensated oscillator, in flatpack or compact form for PC board mounting, is offered with a stability of ± 1 ppm from 0° to 65°C. Frequencies can be specified from 1 KHz to 10MHz. Alloscillators operate from

a 5V power source for use in standard DTL and TTL. Under MF Electronic's quality control program, every MF oscillator is individually numbered and tested to insure it meets all specifications. The complete range of test results is recorded at the factory, allowing us to guarantee each oscillator and to identify its performance parameters years after its production. Because we make them better and test them better, MF Crystal Oscillators are better for you.



For information and assistance on all your crystal oscillator needs, contact:

MF ELECTRONICS CORP.

118 EAST 25th STREET, NEW YORK, N.Y. 10010 • (212) 674-5360 • TWX: 710-581-4109

INFORMATION RETRIEVAL NUMBER 147

DATA PROCESSING

Remote processor meets demand for data



Harris Corp., Data Communications Div., 11262 Indian Trail, P. O. Box 44076, Dallas, TX 75234. (214) 241-0551.

Total modularity of the COPE 1600 allows the data-communications user to select hardware, software and functional applications according to his specific requirements. The remote processor performs such tasks as data collection inquiry response, satellite processing and data communications. In addition to these multifunction capabilities, the 1600 will perform multitasks (through its operating system software) and interface with multihosts (two different emulators can operate concurrently). The unit's byte-oriented processor is expandable from 16k to 65k in 8-kbyte modules and can support up to 16 asynchronous lines. IBM SDLC hardware is built-in, and Univac's 9000 full-duplex procedure is planned to accommodate future requirements.

CIRCLE NO. 379

Cassette transport has one reel motor

Amilon Corp., 49-12 30th Ave., Woodside, NY 11377. (212) 274-1794. \$80 (1000 qty); 2 weeks.

A cassette tape transport, designated the A9 System, uses a single-reel motor design. The design is said to eliminate back-tension and bearing frictions that cause tape stretch and slippage at the capstan. The Amilon transport also has fail-safe braking. Additional features include a precision-machined head mount, noncontact end-of-tape sensors and single or dual direction play/record. The A9 System is designed to exceed N.A.B. standards. A synchronous capstan motor allows vertical or horizontal operation.

CIRCLE NO. 380

**Three Cheers for
FERRITES
from the Permag Team**

- 1.** With Permag supplying application-rated Indiana General Corp. Ferramics, you'll always get exactly what you need.
- 2.** Complete fabricating facilities. Prototype quantities available. Plus engineering assistance, field testing.
- 3.** Prompt 24-hour delivery. Extensive stock of ferrite parts at all locations. New catalog available. Yea Team!

**FERRAMICS™
FROM PERMAG**

Consult your Yellow Pages for address and telephone number of Permag near you.
Cable Address: MAGNETS NEWYORK

YOUR NO. 1 SOURCE FOR ALL MAGNETIC MATERIALS

PERMAG

Boston New York Chicago Dallas Atlanta
San Francisco Los Angeles Dallas

ALL ACROSS THE COUNTRY

INFORMATION RETRIEVAL NUMBER 148

INTERDATA ANNOUNCES THE INDUSTRY'S FIRST \$3200 MINICOMPUTER TO CHALLENGE THE NOVA.

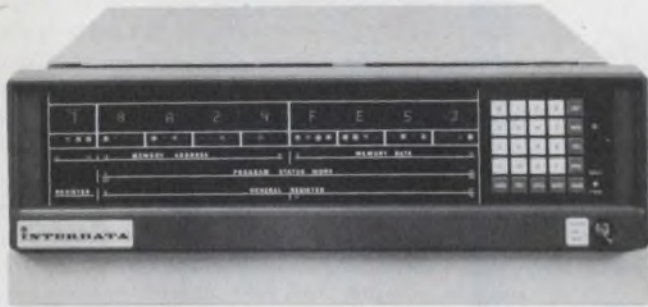

PDP-11 performance at a Nova 2 price.

Minicomputer myths you can live without:

1. There is no such thing as a high-performance, low-cost minicomputer. 2. You have to choose between two extremes — pay a ton for a machine like the PDP-11 and save on software costs, or buy a cheapie like the Nova 2 and pay the price later.

All wrong. Because now there's the Interdata 7/16 — an extremely flexible 16-bit OEM minicomputer that combines the best of both worlds.

It's easier to program than the PDP-11 because it has 16 hardware registers, up to 64K bytes of directly addressable main memory, 255 I/O interrupts with automatic vectoring to service routines and a comprehensive set of more than 100 instructions. That's a lot of muscle.

It's completely modular in design — plug-in options can be installed in the field to meet your specific application requirements.

Options like multiply/divide, programmers' console with hexadecimal display, power fail/auto restart, memory protect and a high-speed Arithmetic Logic Unit that includes floating point hardware. In fact, you can expand the low-cost 7/16 all the way up to the 32-bit Interdata 7/32.

Yet it costs as little as \$3200. Just like the machines that give you the barest minimum. And quantity discounts can reduce that low price by as much as 40%.

Performance	7/16	Nova 2/4	PDP-11/05
Data word length (bits)	4, 8, 16	16	1, 8, 16
Instruction word length (bits)	16, 32	16	16, 32, 48
General-purpose registers	16	4	8
Hardware index registers	15	2	8
Maximum memory available (K-bytes)	64	64	64
Directly addressable memory (K-bytes)	64	2	64
Automatic interrupt vectoring	Standard	Not available	Standard
Parity	Optional	Not available	Special order
Cycle time (usec.)	1.0 or 0.75	1.0 or 0.8	0.9
Available I/O slots	4	2	2

Price	7/16	Nova 2/4	PDP-11/05
8 KB processor	\$3,200	\$3,200	\$4,795
16 KB processor	3,700	3,700	6,495
32 KB processor	5,300	5,300	10,895
Multiply/Divide option	\$950	\$1,600	\$1,800
Floating Point option	\$4,900	\$4,000 plus \$1,000 for 2/10 configuration	Not available

Source: Data General Price List, Copyright 1973, and addendum dated 5/15/73. Nova 2/4 bulletin 012-000060, 1973. DEC OEM & Product Services Catalog, 1972. Auerbach Minicomputer Characteristic Digest, June, 1973. "How to use Nova Computers", 1973.

So you no longer have to make the painful choice between good performance and good price. Or between hardware economy and software efficiency. Now you have a minicomputer that gives you both.

The Interdata 7/16.

We put our muscle where their myth is.

INTERDATA®

2 Crescent Place, Oceanport, New Jersey 07757 (201) 229-4040.
 Boston — (617) 890-0557. Washington — (703) 525-4806. Philadelphia — (215) 436-5579.
 Orlando — (305) 851-6962. Chicago — (312) 437-5120. Detroit — (313) 356-5515.
 Dayton — (513) 434-4193. Kansas City — (913) 384-1606. Houston — (713) 783-3060.
 Dallas — (214) 238-9656. Denver — (303) 758-0474. Los Angeles — (213) 640-0451.
 Phoenix — (602) 968-2477. San Diego — (714) 565-0602. San Francisco — (415) 969-1180.
 Seattle — (206) 455-0680. Toronto — (416) 677-8990. Tokyo — (270) 7711.
 Sydney — 439-8400. London — Uxbridge 52441. Munich — 0811-8543887.

Paper Tape Handler

Model 650

A new low-cost spooler for use with the Addmaster 601 Tape Reader

Fully self-contained, including power supply for reader.

Reads "step by step" on external command or runs on internal clock at 150 characters per second.

Bi-directional, both read and high speed slew mode.

Needs only two control lines.

Stops on character.

Automatic end of tape/broken tape sensing.

Fully proportional servos.

Standard 19" rack mounting, 5 1/4" high panel.

Uses 5 1/4" diameter reels.



Write for catalog of
Addmaster computer peripherals.

416 Junipero Serra Drive • San Gabriel, California 91776

INFORMATION RETRIEVAL NUMBER 152

from SPECTRUM.... for θ mi CONTROL. The 1 MF. FEED-THRU CAPACITOR.



The combined technologies of SPECTRUM CONTROL, INC. and ALLEN-BRADLEY CO. have produced this exciting line of multi-layer feed-thru capacitors. Their tubular design and coaxial construction gives low inductance with capacitance values to 1 MF. The operating temperature range is -55°C to $+125^{\circ}\text{C}$ at 10 amps and 50 VDC. They are ideally suited for bypassing, filtering and coupling applications. Write today for our complete catalog.

Part No. (Threaded) Part No. (Solder-In)	54-785-005 54-785-006	54-786-013 54-786-015	54-786-021 54-786-019	54-786-014 54-786-016
DC Working Voltage	100	50	50	50
Capacitance, MF. at 0.1 VRMS, 25°C, 1 KHz	0.05 GMV	0.3 GMV	0.5 GMV	1.0 \pm 20%
Insertion Loss (db) 1 MHz 1 GHz	16 50	32 70	35 70	40 80
Thread Size - Bolt	8-32	10-32	10-32	10-32
Mounting Hole Size (Solder-In)	.140 \pm .015	.171 \pm .015	.171 \pm .015	.171 \pm .015

Available now from these authorized distributors:

HALL-MARK ELECTRONICS	215-355-7300
METUCHEN CAPACITOR	201-442-0500
MIRCO ELECTRONICS	602-944-2281
ROSE ELECTRONICS	415-697-0224

SPECTRUM CONTROL INC.

152 EAST MAIN ST. • FAIRVIEW, PENNSYLVANIA 16415
PH. 814-474-5593 TWX 510-699-6848



INFORMATION RETRIEVAL NUMBER 153

DATA PROCESSING

Floppy disc system for mini uses IBM format

Remex of Ex-Cell-O Corp., 1733 Alton St., Santa Ana, CA 92705. From \$2695; 60 days.

The RFS 7400 flexible disc system for use with PDP-11 and Nova minis incorporates from one to four disc drives in appropriate enclosure(s), a power supply, cables and formatter electronics. The RFS 7400 uses the IBM 3740 format, thus providing 1.9M bits of data storage per diskette drive or a total of 7.6M bits in a four drive system. Data transfer rate is 250 kbit/s. The system, featuring overlap seek, will simultaneously step four drives to new tracks. Options for the RFS 7400 include driver and diagnostic packages and a program for IBM initialization of diskettes. An option for the interface controller includes both DMA and Programmed I/O, the latter for more efficient diskette initialization.

CIRCLE NO. 381

Printer/plotters go on-line to Univac 11xx

Gould Inc., Instrument Systems Div., 20 Ossipee Rd., Newton, MA 02164. (617) 969-6510. \$6900; 60 days.

The 110X interface puts the company's 4820 and 5000 series electrostatic printer/plotters on-line with Univac 1106, 1107, 1108 and 1110 computers. With it, the computers are said to plot data up to 400 times faster than by pen plotters. The Gould printer/plotters print up to 3000 lines of alphanumeric data/min. and plot graphic material at rates up to 75 sq.-in/s. The standard 110X controller accommodates one Univac channel and one printer/plotter; however, it can be designed to handle up to 14 Gould units. The controller's I/O protocol uses Univac's arbitrary device handler. The software drivers are Gould's Hardware Print and Plot. The interface unit—housed in a 39 x 22 x 14-in. cabinet—comes with a 50-ft. cable for connection to the host computer. Cable lengths up to 1000 ft. long are available as an option.

CIRCLE NO. 382

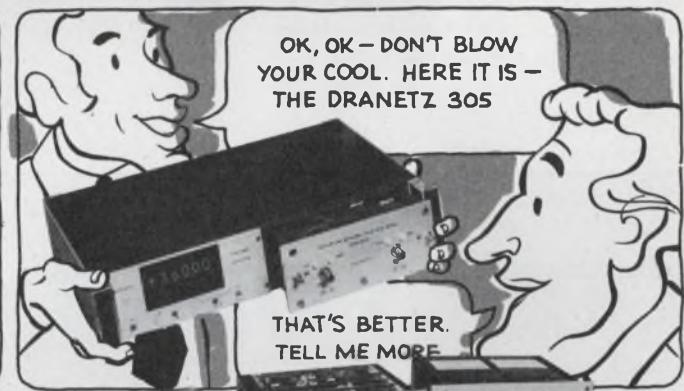
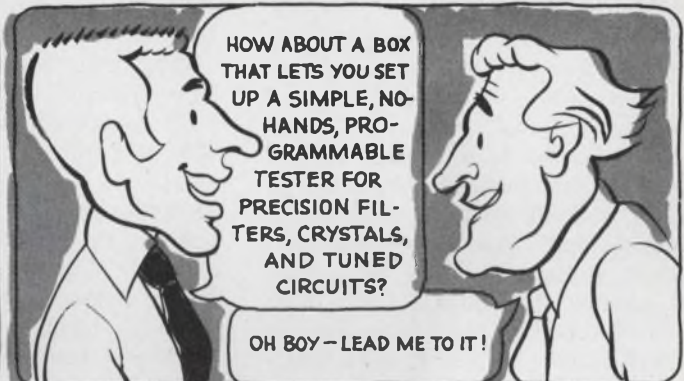
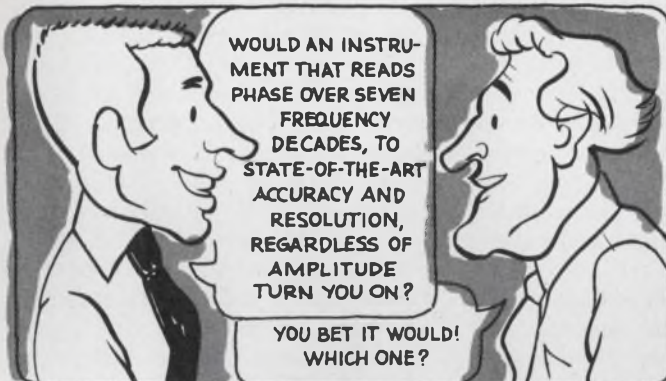
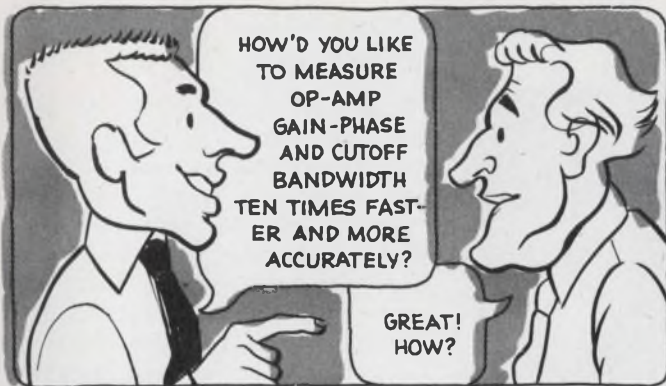

The Dranetz Series 305 Modular Phasemeter is actually a whole family of instruments, selectable to suit your requirements by simple substitution of standard plug-in modules. With it, you can perform the above measurements, and many others, with analog and digital phase accuracies to $\pm 0.05^\circ$, and voltage/ratio accuracies to $\pm 0.2\text{dB}$. You can select frequency ranges up to 11 MHz (higher on special order); operate on signals as low as 1 mV and as high as 3 kV, and measure gain to an accuracy of $\pm 0.5\text{dB}$.

"No-hands" operation is standard. Selection of angle range, sensing of lead or lag angle, selection of output time-constants, and setting of AC gains, are all automatic. For high-speed (computer-controlled) response, a Programmable option permits overriding of these functions. When required,



the 305 can also be equipped with BCD output, for integration into automatic calibration, test, and process control systems.

In both design and construction, nothing has been spared to make the 305 the most accurate, reliable, and foolproof instrument of its kind. All measurements are independent of voltage and frequency levels within the rated ranges. Phase ambiguities in the 0° and 180° regions are automatically locked out. DC stability and immunity to noise in either or both channels are both state-of-the-art. And digital readout eliminates parallax, interpolation, and other operator errors.

The Series 305 enables you to obtain operations and measurements you could never make before, with unprecedented accuracy and stability. For complete details get a copy of Dranetz Catalog F. For a demonstration, just call your local Dranetz Field Representative.

DRANETZ
ENGINEERING
LABORATORIES
INCORPORATED

2385 SOUTH CLINTON AVENUE, SOUTH PLAINFIELD, N. J. 07080, TELEPHONE (201) 755-7080, TWX 710-997-9553

INFORMATION RETRIEVAL NUMBER 154

Platinum/silver paste 1/3 cost of other types

Cermalloy, Cermet Div. of Bala Electronics Corp., 14 Fayette St., Conshohocken, PA 19428. (215) 828-4650. Typical: \$50/oz (1-4 oz).

A new series of platinum/silver conductor pastes for thick-film hybrid microcircuits costs up to one-third less than comparable palladium/silver, palladium/gold and platinum/gold conductor pastes. Four PLS Series conductor pastes are available. Each may be conventionally screen printed and fired for 5 to 10 min at 875 C. The new pastes provide up to 20-lb peel adhesion on a 0.100-in. square pad. For the palladium/silver substitute, leach resistance is greater than 50 s for 0.010-in. wide conductor lines at soldering temperatures of 250 C with 62% tin/36% lead/2% silver-solder. For the platinum/gold substitute, leach resistance is greater than 200 s.

CIRCLE NO. 383

Transmission lines come in flat-cable form



Amp Inc., Harrisburg, PA 17105. (717) 564-0101.

Continuous lengths (to 50 ft) of flat-conductor transmission line have controlled impedance (50 to 125 Ω) throughout the entire length, and terminating pads are placed every 1/2 in. The cable is made with etched-copper circuitry on each side of a 0.005-in. polyester dielectric. Terminals with 0.100-in. centerline spacing fit standard connectors. Connectors for cable-to-cable, cable-to-card, and cable-to-post applications are available.

CIRCLE NO. 384

Cross-linked polymer withstands 750 F

Aremco Products, Inc., P.O. Box 429, Ossining, NY 10562. (914) 762-0685. \$131 per gal. (55 gal up); stock to 4 wks.

Aremco-cast 554 is a high temperature potting compound with capabilities exceeding those of epoxy and silicone material. The compound is a two-part, organic-inorganic, cross-linked polymer which, after a low temperature cure of 275 F, offers temperature resistance to 750 F. The material is virtually impervious to moisture and offers electrical insulation properties comparable with epoxies and silicones. After mixing, the material has the extremely long pot life of 20 days at room temperature. The cured material has a mechanical strength of 10,300 psi in tension and 18,000 in compression. Characteristics can be varied somewhat to meet specific customer requirements, such as by use of fillers like alumina.

CIRCLE NO. 385

TWO GREAT ONES



Texscan's DU-120 oscilloscope is a sensitive, large screen, solid state X-Y display unit designed to satisfy the particular needs of a production or laboratory testing system using sweep generator techniques. The DU-120 incorporates the latest circuitry, including regulation of the high voltage source and a dual packaged FET input. The VS-60 sweep generator is a completely solid state, low distortion, wide sweep instrument covering the frequency range 5 MHz to 1000 MHz with many optional features available from stock.

Texscan

A WORLD LEADER IN ELECTRONICS
"And Coming On Strong"

Texscan Corporation
2446 North Shadeland Avenue
Indianapolis, Indiana 46219
Ph: 317 357-8781
TWX: 810-341-3184 Telex: 272110

INFORMATION RETRIEVAL NUMBER 155

TWO CHANNEL SWEEP FREQUENCY RESPONSE ANALYZER

TWO COMPLETE CHANNELS OF
FREQUENCY RESPONSE MEASUREMENT

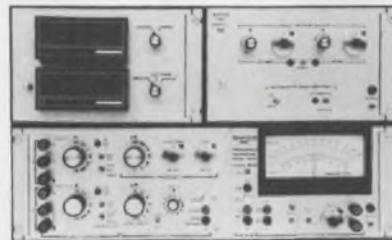

MODEL 913-72

TO GIVE: Open-loop measurement across any block in the system while in closed loop operation. Direct reading of amplitude ratio (DB) & phase shift.
AC coupled inputs (automatic rejection of up to 200 volts DC).

Automatic gain control over 80 DB dynamic range in each channel.

Automatic high noise and harmonic rejection.

SWEEP: Continuous log sweep from any start frequency to any stop frequency in the 6 1/2 decade frequency range.

FREQUENCY RANGE

MODEL 913-72 - .005 thru 10,000 Hz.

MODEL 913H-72 - .025 thru 50,000 Hz.

SEND FOR COMPLETE CATALOG OF ALL MODELS

BAFCO, INC.

717 MEARNS ROAD
WARMINSTER, PENNSYLVANIA 18974
TEL: (215) 674-1700 • TWX No. 510-665-6860

INFORMATION RETRIEVAL NUMBER 156

ELECTRONIC DESIGN 24, November 22, 1974

the biomated scope

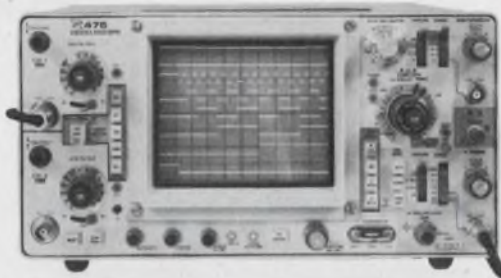

your scope

8 traces of digital logic!

If your world is digital, Biomation's 810-D Glitch Fixer can help you. Mate it to your scope and it captures and displays complex timing events on 8 channels at once. At speeds to 10MHz. *On your bench scope.*

Too many guys have had to sweat out a deglitching problem one line at a time. They asked us to help, and we answered with the 810-D. The unit contains 256 bits of memory per channel—producing a continuous 8-trace timing diagram display on your scope from just one logic stimulus combination of your device. The memory, in conjunction with a novel trigger delay and record control feature also gives you the ability to store a selected amount of the signals which occurred *prior* to the time of the detected trigger. Add to this the unit's 10ns glitchcatching mode and you will know why the 810-D has become a new basic diagnostic tool for designing and debugging digital circuits.



our glitch fixer™

Features:

- Eight logic signal channels with 1M Ohm inputs.
- Presents 8 x 256 bits of recorded data on scope in easily-interpreted timing-diagram form.
- Input latch mode selection provides detection of random pulses—as narrow as 10ns.
- Selectable logic

thresholds include TTL and EIA levels.

- Synchronous clock input to 10MHz.
- Or internal clock selection 20Hz to 10MHz.
- Saves selectable amount of *prior-trigger data*, provides pre-trigger lookback.
- Display expansion gives precise time analysis of data.
- Digital output allows computer analysis or mass storage.

Price: \$1950.

So if you've got a single trace scope and an 8-trace problem, Biomate it with a Glitch Fixer. Get all the glorious details by calling, writing or circling the reader service number. Biomation, 10411 Bubb Road, Cupertino, CA 95014. (408) 255-9500. TWX 910 338 0226.

biomation

INFORMATION RETRIEVAL NUMBER 157

**FROM
BREADBOARD
TO FINAL
PACKAGING
HARDWARE...**

**ALL AVAILABLE
FROM ONE SOURCE**



★ **ADHESIVE BACKED
CIRCUIT SUB-ELEMENTS**
(Over 200 Pre-Drilled component mounting
patterns available "off-the-shelf.")

★ **EPOXY GLASS BOARD
MATERIALS**

- 76 Standard "Off-the-Shelf" Boards.
- Including Unclad, Copper Clad, Cut & Peel Copper Clad, Pre-etched "X-Y" Pattern and Plated thru Hole Copper Clad.
- .100" Grid Hole Pattern or Undrilled.

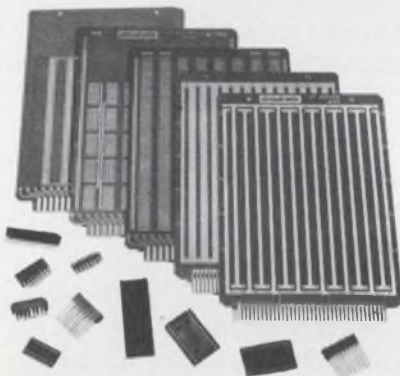

★ **GP CIRCUIT BOARDS and ACCESSORIES**

- Highest Quality — Choose from 74 "Off-the-Shelf" Boards.
- Sockets — Low & Standard Profile, P.C. and Wire Wrap.
- Highest Quality Gold Contacts.
- Adapter plugs • Connectors
- Card Pull Handles.

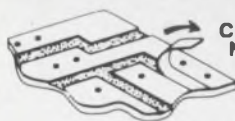

**CIRCUIT-STIK'S
NEW CUT &
PEEL BOARDS**

SEND FOR OUR NEW CATALOGS #502 & #801

circuit-stik

P.O. BOX 3396 • Torrance, California 90510
Phone (213) 530-5530

PACKAGING & MATERIALS

Acrylic coating protects surfaces of work area

*Nalge Co., 75 Panorama Creek Dr.,
Rochester, NY 14602. (716) 586-
8800.*

Nalgene protective laboratory coating, an acrylic-polyethylene coating, goes on clear, and is dry enough to work on in 20 minutes. After a curing period of 24 h, this coating will protect the surface of work areas from stains of almost any sort, including common oil, marking-pen ink and most chemicals. This product can cover masonry, wood, metal, marble, plastic, brick or any painted surface. One gallon covers a maximum of 1500 ft² and can easily be removed with a diluted ammonia solution or commercial wax remover.

CIRCLE NO. 386

Conductive elastomer used in thin keyboards

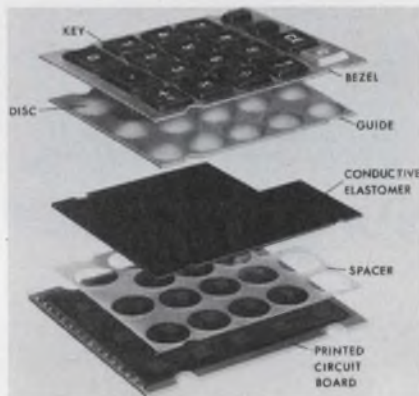

*Technical Wire Products Inc., 129
Dermody St., Cranford, NJ 07016.
(201) 272-5500. \$6 per 12 × 12 ×
0.02-in. sheet (OEM qty).*

Design a low profile keyboard with optional key patterns and maintain compactness and reliability by use of a conductive elastomer called SC-Consil. It is a silicone-based elastomer that contains uniformly dispersed, non-metallic, conductive particles. Holes in a spacer with the same pattern as the keyboard allow contact from a key pad through the SC-Consil to the printed circuit. A 5-to-7-oz actuating force is required to make the key travel about 0.015 in. Standard SC-Consil sheets have a volume resistivity of 10 Ω cm.

CIRCLE NO. 387

Miniature tools in kit fit balanced handles



*Circon Corp., 749 Ward Dr., Santa
Barbara, CA 93111. (805) 967-
0404.*

Circon MicroTools are precision, interchangeable, microminature tools designed for the production and repair of electronic and mechanical instruments. The line consists of 60 screw-based tips that fit either of two delicately balanced handles. Tool tips of special interest are the tungsten MicroNeedle, which has a 0.00025-in. radius point, the MicroScale, which has divisions of 0.002 in. and the Ultra MicroKnife, which has a 0.040 in. cutting edge sharpened to surgical standards. Technicians set contains 23 of the most popular interchangeable tips and three handles.

CIRCLE NO. 388

Core and xformer kit aid circuit design



*Ceramic Magnetics, Inc., 87 Fair-
field Rd., Fairfield, NJ 07006.
(201) 227-4222. \$65 per kit.*

A kit that contains six high-frequency transformers and five ferrite cores enables designers of high-power linear amplifiers, for example, to determine the precise custom configuration of transformers or coils they need. The transformers cover the ranges of 2 to 30 MHz, and 20 to 70 MHz. Designers of communications equipment need no longer settle for off-the-shelf transformer designs. This new series of transformers is flexible and can be custom built for almost any need.

CIRCLE NO. 389

Zero basic boxes cradle the world of industry.

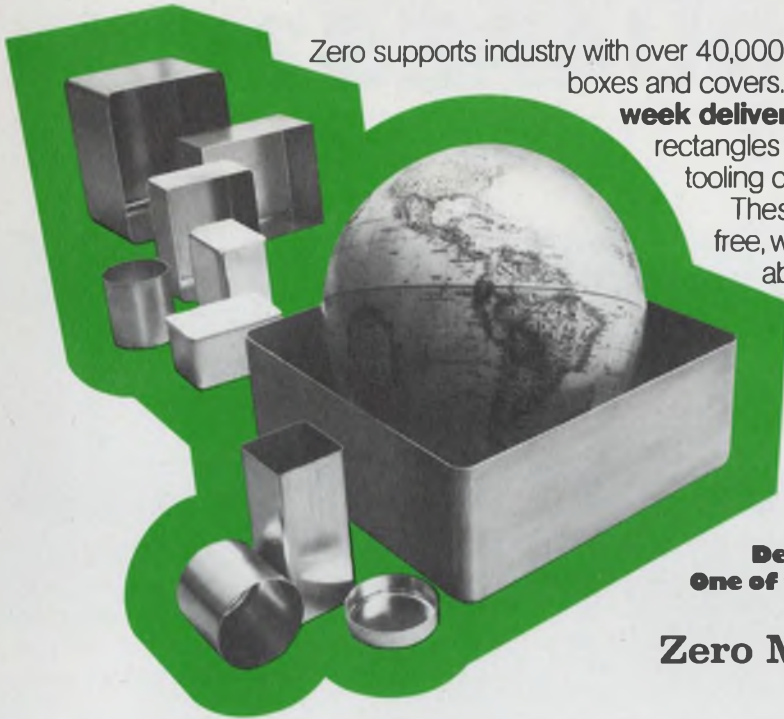

Zero supports industry with over 40,000 standard sizes of deep drawn aluminum boxes and covers. Complete facilities on both coasts mean **two-week delivery** on the most complete size range of rounds, rectangles and squares anywhere. And there's never a tooling charge on standard Zero boxes!

These versatile enclosures are seamless and draft-free, with smooth, wrinkle-free surfaces. And we hold to absolute dimensional integrity, piece after piece.

Contact us in the design stage, and we can save you time and money. If a standard's not the exact answer, Zero has complete facilities for tooling and modifying to match your most exotic designs. Write for your free catalog today, and discover how well Zero supports your world.

**Deep drawn aluminum enclosures.
One of the many ways Zero supports your world.**

Zero Manufacturing Co.

777 FRONT STREET · BURBANK, CALIFORNIA 91503
Design and Manufacturing Facilities | ZERO-WEST · BURBANK, CALIFORNIA
ZERO-EAST · MONSON, MASSACHUSETTS
ZERO-SOUTH · ST PETERSBURG, FLORIDA



FOR IMMEDIATE NEED, CIRCLE 292

FOR INFORMATION ONLY, CIRCLE 293

NO ONE

Customizes Switches Like CDI
Nor Has a More Complete Line

THUMBWHEEL SWITCHES



Completely sealed against hostile environments.



Mounts on 1/2" centers, retrofits most panel openings for miniature thumbwheel switches.

ROTARY SWITCHES

Snap-in, snap-out modules in seconds, eliminating downtime.

Tabet Pat.
2841660,
2971066,
3015000,
2956131,
2988607.



PUSHBUTTON SWITCHES



Miniature add/subtract units retrofit most minithumb-wheel switch panel openings.

CDI earns its reputation every day for Consistently High Quality, Consistently Good Delivery.



CHICAGO DYNAMIC INDUSTRIES, INC.

PRECISION PRODUCTS DIVISION
1725 Diversey Blvd., Chicago, Illinois 60614
Phone: 312, 935-4600

RF WIDE BAND TRANSFORMERS

- 0.1-500 MHz
- 50 ohm impedance
- 1:1 - 16:1 impedance ratio
- Micro-miniature case

\$2.95
10 piece quantities
Some models \$3.45



ONE WEEK DELIVERY!

Impedance ratios of standard models are 1:1, 2:1, 4:1, 9:1 and 16:1. MCL kit TK-1 includes 2 units of each type and sells for \$32.

We invite you to convince yourself. Place your order now and check our delivery, product performance and reliability.

Mini-Circuits Laboratory

A Division Scientific Components Corp.

837-843 Utica Avenue, Brooklyn, N.Y. 11203
(212) 342-2500

INFORMATION RETRIEVAL NUMBER 160

ELECTRONIC DESIGN 24, November 22, 1974

INFORMATION RETRIEVAL NUMBER 161

267

WHO SAYS ENGINEERS ARE SQUARES?



WIN A FREE CARIBBEAN WINDJAMMER CRUISE PLUS \$1,000 CASH

Once again, by reader demand, a week's Windjammer Cruise for two in the fabulous blue Caribbean is waiting for the lucky winner of *Electronic Design's* TOP TEN CONTEST. And that's not all! The first prize winner gets \$1,000 in cash, round-trip air transportation for two, plus a free ad re-run worth thousands of dollars for his company.

Think of it . . . warm sun . . . bright blue water . . . easy carefree days cruising among the Bahama Out-Islands, the Virgin Islands, or the exotic Windward/Leewards. Visit foreign ports. Swim . . . snorkel, or just relax.

IT'S EASY TO ENTER. Nothing to write, nothing to buy, no slogans, no gimmicks. All you have to do is select the TOP TEN ads in the January 4 issue, as measured by *Reader Recall* (*Electronic Design's* method of gaging readership). It's a

*Free reruns awarded only if the company has an advertisement in the January 4 issue.

once-a-year chance to test your skill as well as win valuable prizes for yourself and for your company.

100 PRIZES IN ALL. Portable color TV; Bulova electronic timepieces and technical books broaden your chance to win, make it even more worthwhile to enter.

SEPARATE CONTEST FOR ADVERTISERS

Advertisers, marketing men and advertising agencies can enter too. Duplicate awards are given to the top three winners (Windjammer Cruise, cash, air transportation, free ad re-run; Color TV; Bulova timepiece).

Remind your advertising people that it's the issue of the year for readership . . . the issue of the year for prizes. Put your hard-earned degrees or just plain common sense to work. This year you can be the winner!

THIS YEAR TRY YOUR LUCK!

(Who says engineers are squares?)

**WAKE UP AND JOIN THE
FUN AND EXCITEMENT!**

100 VALUABLE PRIZES!

**ENTER Electronic Design's
1975 TOP TEN CONTEST**



"We enjoyed every minute we were there," writes Paul R. Saunders, winner of last year's Top Ten Contest. "The islands, the people of those islands and the cruise are wonderful . . . the hardest part of the whole trip was returning to reality." Paul and his wife are shown, left, at the end of their trip at English Harbour, Antigua. Paul also won \$1,000 cash and round-trip air tickets for two to the Windjammer Cruise home port. At the time of the contest Paul was associated with Varisystems Corporation, Long Island, N.Y.

**WATCH FOR COMPLETE RULES AND ENTRY BLANKS IN
ELECTRONIC DESIGN'S JANUARY 4, 1975 ISSUE**

**You're Looking At The World's
Smallest Displacement Transducer.
Think of the Possibilities!**

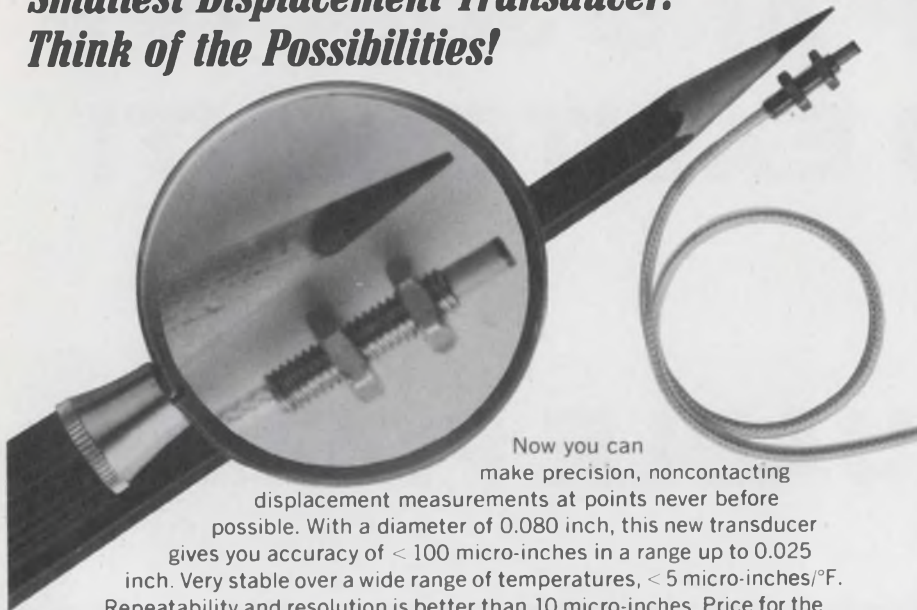

Now you can make precision, noncontacting displacement measurements at points never before possible. With a diameter of 0.080 inch, this new transducer gives you accuracy of < 100 micro-inches in a range up to 0.025 inch. Very stable over a wide range of temperatures, < 5 micro-inches/°F. Repeatability and resolution is better than 10 micro-inches. Price for the KD-2300 - .5 SU is \$445, including associated electronics. (For optional power supply and digital readout, add \$395). Other noncontacting systems with ranges to 3 inches. For facts, contact: Kaman Sciences Corporation, P.O. Box 7463, Colorado Springs, CO 80933. (303) 598-5880.

KAMAN SCIENCES CORP.
A KAMAN COMPANY

INFORMATION RETRIEVAL NUMBER 162

**Decitek gives you accurate,
reliable tape reading whatever
your reader requirements.**

Regardless of what reader you select from the Decitek line, you will be assured of proven reliable performance. A patented dual sprocket drive gives consistently accurate character registration

up to 600 cps without tape wear. The fiber optic-photo transistor read system provides highly stable error-free reading. Write for brochure giving details on the full Decitek line of high-performance punched tape readers.

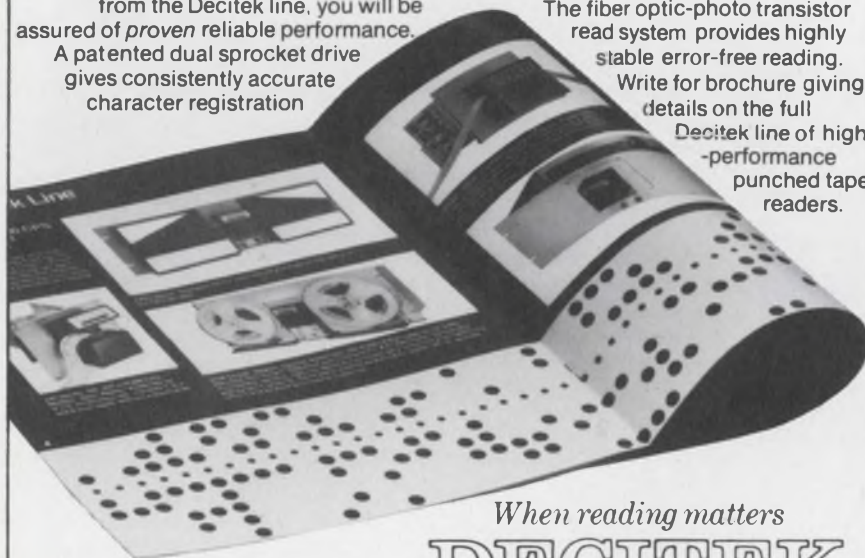

When reading matters
DECITEK

A DIVISION OF JAMESBURY CORPORATION
250 CHANDLER STREET, WORCESTER, MASSACHUSETTS 01602, U.S.A. (617) 798-8731

INFORMATION RETRIEVAL NUMBER 163

PACKAGING & MATERIALS

**Transit cases meet
ATA specifications**



Thermodyne International Ltd., 12600 Yukon Ave., Hawthorne, CA 90250. (213) 679-0411. \$24.84 to \$105.62 (21-50); stock.

A line of high-density polyethylene transit cases, which meet Air Transport Association specification 300-CAT-1, can withstand 100 trips by air. The ATA series containers are a fraction the weight of equivalent metal or wood containers. The ATA specification calls for the case to be weighted with a dummy load, then subjected to 160 drops on corners and faces, 100 tumbles in a test drum, a 2-h vibration test and a 60-min water resistance test. The series includes 56 sizes from 10.7 x 10.7 x 6 in. to 55 x 36 x 25 in. Custom-formed foam cushioning is available for case interiors.

CIRCLE NO. 390

**Card files fit
OEM enclosures**

Mupac Corp., 646 Summer St., Brockton, MA 02402. (617) 588-6110. \$45 (10 up); stock.

A family of small card files is designed for the engineer who must package a small digital box in a larger drawer or OEM enclosure with other electronic hardware. Flush end plates with recessed screws allow either a vertical or horizontal mounting position. PC boards or wire-wrappable panels may be mounted on 0.6 or 1.2-in. centers, respectively. Replaceable snap-in card guides enable expansion of the file from six to 11 positions. The files are available with or without rear power planes.

CIRCLE NO. 391



FREE Fiber Optics Catalog

Features the complete AO line of fiber optics products—from Inspection Fiberscopes and Light Guides to Illuminators, Image Conduits, Faceplates and Custom Components. Includes the four newest remote inspection fiberscopes now available.

Describes the principle, technology and techniques used to make flexible light and image transmissions a proven, practical fact. Write today for your FREE copy of the AO Fiber Optics catalog to American Optical Corporation, Fiber Optics Division, Southbridge, Mass. 01550.

AO
American
Optical

INFORMATION RETRIEVAL NUMBER 177

WHO MAKES WHAT & WHERE TO FIND IT

Volume 1 of **Electronic Design's GOLD BOOK** tells all. And, when you look up an item in its **PRODUCT DIRECTORY** you'll find each manufacturer listed **COMPLETE WITH STREET ADDRESS, CITY, STATE, ZIP AND PHONE.** Save time. There's no need to refer elsewhere to find missing information.

IT'S ALL THERE
in
**Electronic Design
GOLD BOOK**

Welded switch terminals assure flaw-free connections.



Series 46 reed relays. Built better to perform better.

Welded switch terminals prevent damage during assembly and handling and prevent softening and failure of connections when Series 46 open type miniature reed relays are soldered to PC boards. As a result, you get better performance and lower reject rates. Both dry and mercury wetted switches are available. Dry reed models employ NV Philips high reliability reed switches which give the extremely stable contact resistance desired in logic circuit applications. Five different coil forms offer many contact combinations in A, B or C forms. Contact ratings range from 2.8 to 50 watts, 3-48 vdc. Terminals are spaced on 1" centers in the popular .150" grid.

Send for information now!

NORTH AMERICAN PHILIPS CONTROLS CORP.

Frederick, Md. 21701 • (301) 663-5141

INFORMATION RETRIEVAL NUMBER 178

New! Simple, low-cost way to monitor equipment usage time!

Install these new, low cost electrochemical elapsed time indicators in the equipment you design to measure use time of equipment and its components. They are small in size... the size of an ordinary automotive fuse... and easy to install. A snap-in type that fits a standard 3AG fuse clip—or a solder type—are available. They are inexpensive enough to be used in quantity on a single piece of equipment.

The indicator employs a simple coulometry principle. When a controlled DC current is applied across the indicator's terminals, there is a precise buildup of a copper column in the unit's glass tube. The tube, calibrated in hourly increments, provides a direct scale non-reversible readout. Models are available for 1000, 2000, 5000 and 10,000 hours.

**Keeps accurate
time records for
warranty validation,
preventive
maintenance.**



Actual
Size

Send for information now!

A. W. HAYDON CO. PRODUCTS

NORTH AMERICAN PHILIPS CONTROLS CORP.

Cheshire, Conn. 06410 • (203) 272-0301

INFORMATION RETRIEVAL NUMBER 179

Plug in...wire...modify...build...test

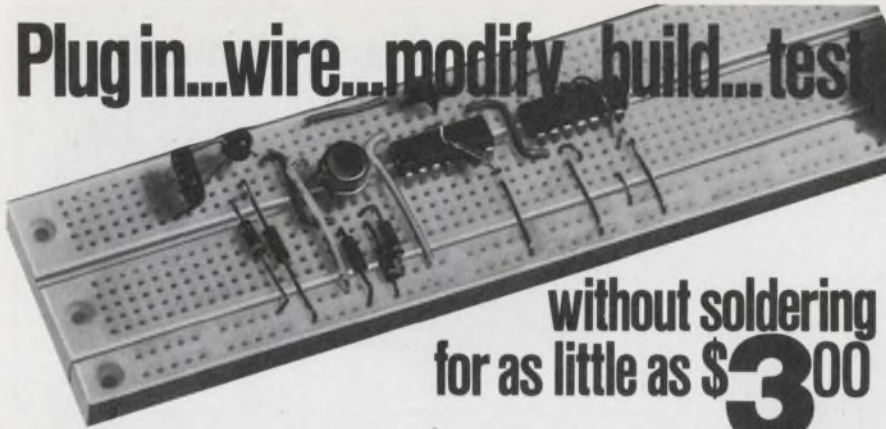

without soldering
for as little as \$3⁰⁰

Introducing QT SOCKETS™ and BUS STRIPS, a flexible new breadboarding system with unique SNAP/LOCK that lets you expand or contract your project by simply snapping together as many QTs as you need. Test ICs, transistors, resistors, capacitors and more. Just plug in, connect with solid #22 AWG hook up wire—no soldering needed! Reuse QTs again and again. No more shorting or burnt fingers! No special patch cords! Available in 10 different sizes, starting as low as \$3 for QT Sockets, \$2 for Bus Strips.

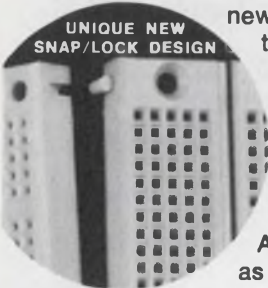

UNIQUE NEW
SNAP/LOCK DESIGN

FREE SELECTION GUIDE

Write or phone today for application and product photos, drawings, specs, socket sizes and ordering information.

Continental Specialties Corp 44 Kendall St., New Haven, CT Tel 203/624-3103

INFORMATION RETRIEVAL NUMBER 165

PACKAGING & MATERIALS

PC-board connector terminates flat cable

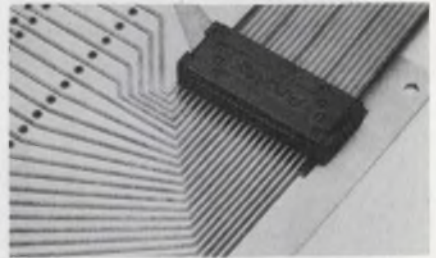

Ansley Electronics Corp., 3208 Humboldt St., Los Angeles, CA 90031. (213) 223-2331.

A new series of one-piece PC transition connectors can terminate up to a 50-conductor flat cable. The solderless Blue Streak flat-cable connectors are available in several pin lengths to accommodate board-thicknesses of 0.031 to 0.094 in. A "tulip" contact design provides contact reliability with four contact points per conductor, according to Ansley. A strain relief is built into both the individual contact and the connector body. The connectors are made of UL-rated 95 VE-O glass-filled nylon with hardened-beryllium-copper contacts to assure superior conductivity and long life. Connectors are rated to carry 1 A at 105 C, and they have a dielectric strength of 1500 V dc. They can terminate 28 to 30-AWG solid wire or 28-AWG stranded wire.

CIRCLE NO. 392

Cut-wire holders stack to dispense wires singly

Marshall Industries, Kinatechnic Systems, 9674 Telestar Ave., El Monte, CA 91731. (213) 686-0141.

Compact cut-wire holders can be individually or securely stacked to any desired height on built-in nesting lugs. The No. 60020 wire holder dispenses wires one at a time. It can hold wire from 3 in. to 6 ft in length. Each dispensing slot is equipped with a foam snubber to prevent the wires from coming out, except when desired. With 14 slots, each one able to dispense up to 50 wires, the individual tray can hold up to 700 wires in a space 12 × 18 × 2 in. A metal dust cover is recommended for the top tray, if wire holders are used for storage.

CIRCLE NO. 393

NEW from IEE

"Displays Galore"



IEE now offers for your convenience, its newest, full color illustrated Product Selector. Designed to assist potential users

in evaluating various alternative solutions to their information display requirements, this eye-catching and informative catalog highlights in descriptive, capsule form the full spectrum of IEE's selection of products—"THE WORLD'S BROADEST LINE OF DISPLAYS".

To obtain your own personal copy, please call, write on your company letterhead, or just circle the number listed below on the information retrieval card at the back of the magazine.

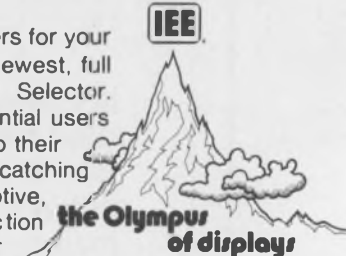

Industrial Electronic Engineers, Inc.

7740 Lemona Ave., Van Nuys, California 91405
Telephone: (213) 787-0311 • TWX 910-495-1707

Our European Office:
6707 Schifferstadt, Eichendorff-Allee 19,
Germany, Tel. 06235-662

DIAL-A-SOURCE: Call toll-free 800-645-9200

INFORMATION RETRIEVAL NUMBER 166

Electronic preset controller offers easy interface and industrial reliability.

- **High noise immunity**
New CMOS circuitry
- **Design flexibility**
Preset up to 6 digits
Presignal up to 6 digits
With or without display
Panel mount & table top versions
- **Input versatility**
Switch closure or electronic
all in one
- **Compact package**
More features per square
inch of panel than any other
industrial controller.

Write for complete information today.

HECON CORPORATION
P.O. Box 247
Eatontown, N.J. 07724
Phone (201) 542-9200
HECON OF CANADA, LTD.
80 Galaxy Blvd.
Rexdale, Ontario M9W-4Y8
Phone: (416) 678-2441



INFORMATION RETRIEVAL NUMBER 167

NEW

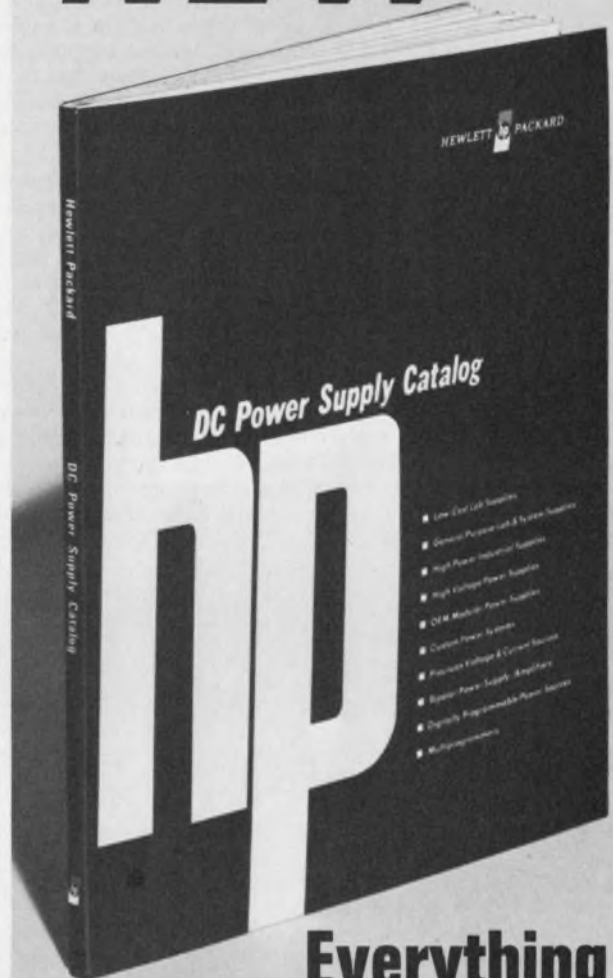

Everything You Need To Know About HP DC Power Supplies

Choosing the right power supply for your application is easy with HP's new DC Power Supply Catalog . . . 120 pages . . . featuring photos, specs, drawings and options on HP's complete line of modular, lab, system and digital power supplies . . . PLUS factual and informative details like: Power Supply Terms and Definitions, How To Select Power Supplies . . . and more . . . yours for the asking.

For your **FREE** copy, write Hewlett Packard, 1501 Page Mill Road, Dept. 21, Palo Alto, California 94304.



Sales and service from 172 offices in 65 countries.
1501 Page Mill Road, Palo Alto, California 94304

21401R

CMOS LOGIC PROBE



\$25

- LOW COST \$25.00 EACH
- USABLE TO 1.5 MHZ
- LED READOUT (0, 1, P)
- HARDENED TIP FOR CONTACT THROUGH OXIDATION AND FLUX
- SLIM, LIGHTWEIGHT
- CMOS COMPATIBLE (3-18V)
- PULSE INDICATOR TO 0.5 μSEC
- REVERSE POLARITY PROTECTED
- COMPLETE ENCAPSULATION FOR TOOL BOX RUGGEDNESS
- LIGHT FLEXIBLE LEADS

DELIVERY FROM STOCK
TTL ALSO AVAILABLE AT SAME PRICE

QUESTRONICS, INC.

P. O. BOX 15803
SALT LAKE CITY, UT. 84115 (801) 262-9923

INFORMATION RETRIEVAL NUMBER 168

INFORMATION RETRIEVAL NUMBER 169



THIS SYMBOL "■" HAS A MESSAGE FOR YOU

Look at the listings magnified above. They're from the PRODUCT DIRECTORY of *Electronic Design's* GOLD BOOK. Note that each product classification begins with boldface listings. These manufacturers have provided catalog pages for that product in vols. 2 or 3 of the GOLD BOOK.

But what about the other companies shown? Do they really make the product or would they merely *like* to make the product if your order is big enough? A printer's bullet (■) in front of its name means that the company has submitted printed literature on that product to the editors of the GOLD BOOK. It's reasonable to assume that these suppliers actually make the product, for its not likely that a supplier would prepare literature for a product he can't ship. The bullet ■ gives you a measure of verification.

Manufacturers listed in boldface in the second sub-group have provided catalog pages, but not for the specific product heading the list.

In a constantly moving industry, these measures of verification are of course subject to change. Yet they can be helpful guides as you seek out potential suppliers.



Electronic Design's **GOLD BOOK** BIGGEST AND BEST ELECTRONICS MASTER CATALOG & DIRECTORY IN THE WORLD

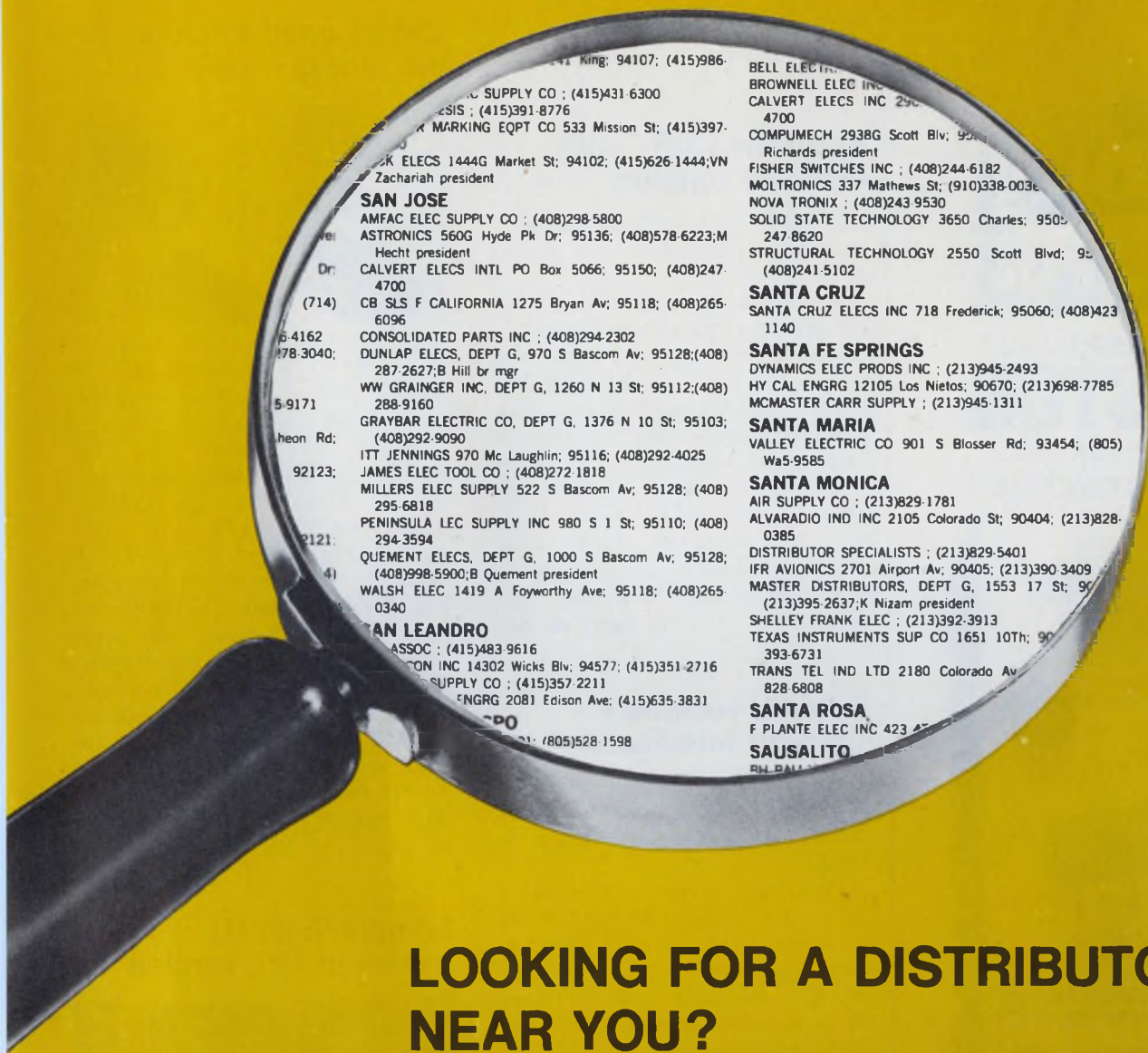

King: 94107; (415)986
 SUPPLY CO.; (415)431-6300
 SIS; (415)391-8776
 MARKING EQPT CO 533 Mission St; (415)397-
 ELECS 1444G Market St; 94102; (415)626-1444;VN
 Zachariah president
SAN JOSE
 AMFAC ELEC SUPPLY CO.; (408)298-5800
 ASTRONICS 560G Hyde Pk Dr; 95136; (408)578-6223;M
 Hecht president
 Dr. CALVERT ELECS INTL PO Box 5066; 95150; (408)247-
 4700
 (714) CB SLS F CALIFORNIA 1275 Bryan Av; 95118; (408)265-
 6096
 CONSOLIDATED PARTS INC.; (408)294-2302
 DUNLAP ELECS, DEPT G, 970 S Bascom Av; 95128;(408)
 287-2627;B Hill br mgr
 WW GRAINGER INC, DEPT G, 1260 N 13 St; 95112;(408)
 288-9160
 GRAYBAR ELECTRIC CO, DEPT G, 1376 N 10 St; 95103;
 (408)292-9090
 ITT JENNINGS 970 Mc Laughlin; 95116; (408)292-4025
 92123; JAMES ELEC TOOL CO.; (408)272-1818
 MILLERS ELEC SUPPLY 522 S Bascom Av; 95128; (408)
 295-6818
 PENINSULA LEC SUPPLY INC 980 S 1 St; 95110; (408)
 294-3594
 2121; QUEMENT ELECS, DEPT G, 1000 S Bascom Av; 95128;
 (408)998-5900;B Quement president
 4) WALSH ELEC 1419 A Foyworthy Ave; 95118; (408)265-
 0340
SAN LEANDRO
 ASSOC.; (415)483-9616
 CON INC 14302 Wicks Blv; 94577; (415)351-2716
 SUPPLY CO.; (415)357-2211
 ENGRG 2081 Edison Ave; (415)635-3831
 PO
 (805)528-1598

BELL ELECT
 BROWNELL ELEC INC
 CALVERT ELECS INC 290
 4700
 COMPUMECH 2938G Scott Blv; 951
 Richards president
 FISHER SWITCHES INC.; (408)244-6182
 MOLTRONICS 337 Mathews St; (910)338-0036
 NOVA TRONIX.; (408)243-9530
 SOLID STATE TECHNOLOGY 3650 Charles; 9505
 247-8620
 STRUCTURAL TECHNOLOGY 2550 Scott Blvd; 951
 (408)241-5102
SANTA CRUZ
 SANTA CRUZ ELECS INC 718 Frederick; 95060; (408)423
 1140
SANTA FE SPRINGS
 DYNAMICS ELEC PRODS INC.; (213)945-2493
 HY CAL ENGRG 12105 Los Nietos; 90670; (213)698-7785
 MCMASTER CARR SUPPLY.; (213)945-1311
SANTA MARIA
 VALLEY ELECTRIC CO 901 S Blosser Rd; 93454; (805)
 W45-9585
SANTA MONICA
 AIR SUPPLY CO.; (213)829-1781
 ALVARADIO IND INC 2105 Colorado St; 90404; (213)828-
 0385
 DISTRIBUTOR SPECIALISTS.; (213)829-5401
 IFR AVIONICS 2701 Airport Av; 90405; (213)390-3409
 MASTER DISTRIBUTORS, DEPT G, 1553 17 St; 90
 (213)395-2637;K Nizam president
 SHELLEY FRANK ELEC.; (213)392-3913
 TEXAS INSTRUMENTS SUP CO 1651 10Th; 90
 393-6731
 TRANS TEL IND LTD 2180 Colorado Av
 828-6808
SANTA ROSA
 F PLANTE ELEC INC 423 A
SAUSALITO
 RH PAUL

LOOKING FOR A DISTRIBUTOR NEAR YOU?

Distributors are listed 3 ways in *Electronic Design's GOLD BOOK*:

1. IF YOU KNOW THE MANUFACTURER, you will find his U.S. distributors included under his listing in the MANUFACTURERS DIRECTORY. Name, city, and phone numbers are provided.
2. IF YOU KNOW THE DISTRIBUTOR'S NAME, you can find his complete address, zip, and phone number in the *alphabetic section* of the DISTRIBUTORS DIRECTORY. In most cases annual sales volume or net worth, year established, and names of key officials are included.
3. IF YOU WANT TO FIND OUT WHICH DISTRIBUTORS ARE LOCATED NEAR YOU, check the *geographical section* of the DISTRIBUTORS DIRECTORY. You enter the section by state, then find your city — or one nearby — and the distributors located in that city. You can then go back to the *alphabetic section* to learn more about them.

Electronic Design's GOLD BOOK

BIGGEST AND BEST ELECTRONICS MASTER CATALOG
& DIRECTORY IN THE WORLD

for
quality
control

STANDARDIZE ON
WESTON
"TOTAL-CONTROL"
POTENTIOMETERS



Weston "Total-Control" Potentiometers are produced under controlled environmental conditions. Step by step the design concept provides for rigid quality requirements beginning with material through parts production, assembly and final test and inspection. Product control for the ultimate in reliability extends even to kilning our own ceramics for the Weston Cermet Line. Custom-design service is available where no Standard Model in any series meets exact individual requirements. Consult your Weston Representative.

Write for Weston Bulletin
"Lots of Pots."

WESTON

Schlumberger

WESTON COMPONENTS
ARCHBALD, PENNSYLVANIA 18403
TEL. (717) 876-1500
TWX 510 656-2902
TELEX 83-7443

INFORMATION RETRIEVAL NUMBER 181

INTEGRATED CIRCUITS

Program UART with external controls

SMC Microsystems Corp., 35 Marcus Blvd., Hauppauge, NY 11787. (516) 231-5151.

The CGM 2017 performs all receiving and transmitting functions associated with asynchronous data communications. The MOS/LSI UART features independently programmable duplex mode, baud rate, data word length, parity mode, and number of stop bits. Through external controls, these may be 5, 6, 7, or 8 data bits; odd/even or no parity; and 1, 1.5, or 2 stop bits when using a 5-bit code.

CIRCLE NO. 394

Drivers, receivers simplify interfaces

Advanced Micro Devices Inc., 901 Thompson Pl., Sunnyvale, CA 94086. (408) 732-2400. \$2.15 to \$5.80.

Two line driver and receiver pairs and a pair of MOS sense amplifiers—the Am55/75107B, 108B and the Am55/75109, 110 and the Am75207, 208—represent pin-compatible replacements for like-numbered units originally offered by Texas Instruments. The Am55/75107B and Am55/75108B dual receivers offer maximum input sensitivity of ± 25 mV and a common-mode range of ± 3 V. The common-mode range can be extended to ± 15 V with an external attenuator. The Am55/75107B offers a standard active pull-up totem-pole output while the Am55/75108B has an open-collector receiver output for bus-organized systems. Specially screened receivers from this pair—the Am75207 and Am75208—offer improved input threshold levels of ± 10 mV maximum. The Am55/75109 and Am55/75110 dual drivers have a common-mode output range of -3 to $+10$ V and offer open-collector differential outputs for bus-organized systems. The Am55/75109 typical output sink current is 6 mA while the Am55/75110 sinks 12 mA.

CIRCLE NO. 395

CMOS quad latches aid storage uses



Siltek International Ltd., Airport Industrial Park, Bromont, Quebec, Canada JOE 1L0. (514) 534-2255. \$1.95 (1000); stock.

CMOS quad latches—the SIL4042B through 4044B—are offered for flexible storage applications. The SIL4042B is a quad-clocked D-latch with clock polarity selection and buffered outputs. The SIL4043B and SIL4044B are quad NOR R/S latch and quad NAND R/S latch, respectively. Each latch has a separate buffered three-state output and individual set and reset inputs with a common output disable. The three latches are capable of 10-MHz operation with $V_{DD} = 10$ V and $C_L = 50$ pF.

CIRCLE NO. 396

Sample/hold IC comes in MIL version

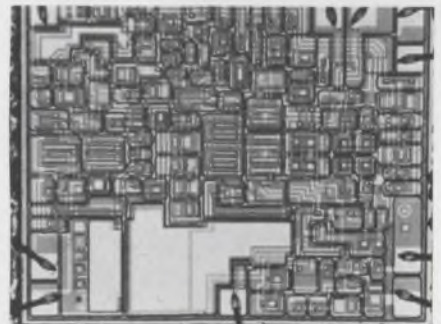

Harris Semiconductor, P.O. Box 883, Melbourne, FL 32901. (305) 727-5407. \$29.70 (100 up).

The HA-2420 monolithic sample-and-hold op amp guarantees characteristics through the full military temperature range of -55 to 125 C. Featuring a slew-rate-to-droop ratio of 5×10^6 , the IC has DTL/TTL-compatible control input, bandwidth of 2 MHz, 50-ns aperture time and a slew rate of 5 V/ μ s. The unit joins the company's previously introduced HA-2425, a commercial temperature-range version.

CIRCLE NO. 397

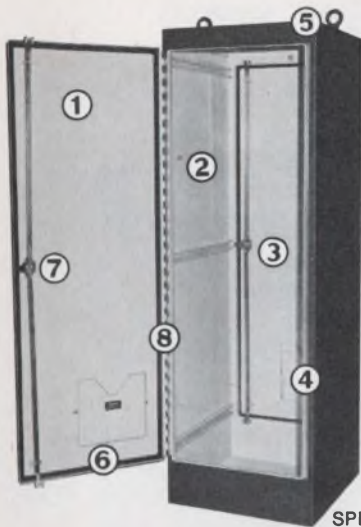

STANDARDS

MEETS
NEMA 12 & 13
SPECIFICATIONS

1. Single door or double doors on front or front and back. 2. Numerous interior panels/relay rack angles available. 3. Heavy gauge steel. 4. All seams continuously welded. 5. Lifting eyes for easy handling. 6. Neoprene door gasket with oil resistant adhesive and steel retaining strips. 7. 3-point latching mechanism, oil tight key locking handle. 8. Heavy gauge continuous hinges. For detailed specifications on over thirty different sizes, write for latest bulletins.

Hoffman® **ELECTRICAL ENCLOSURES**

HOFFMAN ENGINEERING COMPANY
Division of Federal Cartridge Corporation
Anoka, Minnesota, Dept. ED-76

INFORMATION RETRIEVAL NUMBER 182

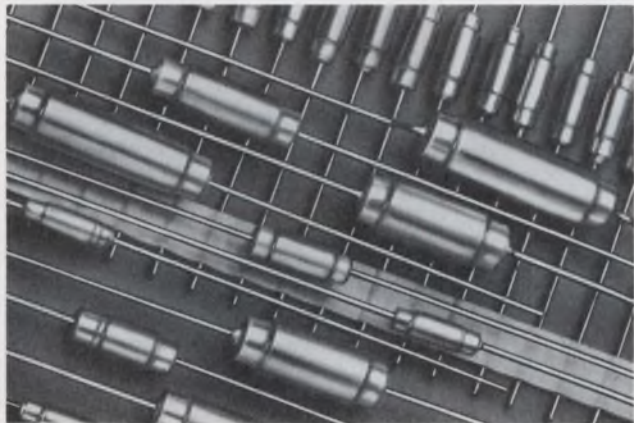

Last year these Paktron® film capacitors were revolutionary. Now they are the standard.

Because our polyester and polypropylene Micromatic® capacitors are uniquely better. Both are self-encased and wound on their own leads—no outside wrapping, no separate lead attachments. Close capacitance tolerances too. Ideal for automatic PC board insertion. For free catalog, write:

PAKTRON, Division Illinois Tool Works Inc.,
900 Follin Lane, S. E., Vienna, Virginia 22180.
Phone (703) 281-2810. TWX 710-833-0682.

PAKTRON
innovators in film capacitors

The Innovative Electronic Group of ITW...
PAKTRON • LICON • EMCON © ILLINOIS TOOL WORKS INC. 1974

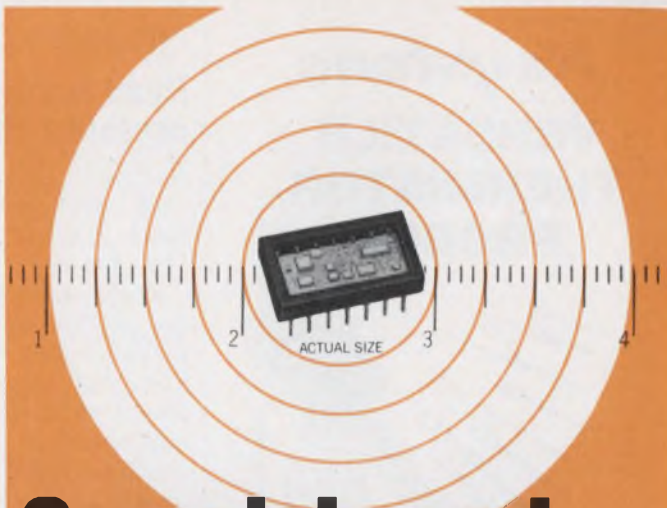

Complete and Adjustment-Free Sample/Hold

Model MN343 S/H in a dip features:

- HIGH SPEED... 7.5 μ sec acquisition time.
... 60 nsec aperture time.
- LOW DROOP RATE... 100 μ V/msec.
- GUARANTEED ACCURACY... $\pm .02\%$ at 25C.
... $\pm .05\%$ (0 to 70C and -55 to $+125$ C).
- SMALL SIZE... 14 pin hermetic dip.

Micro Networks continues to lead the field in the engineering and production of complete, adjustment free conversion products.

Model MN343— with internal holding capacitor — is the first complete and adjustment free S/H in a dip. It is laser trimmed for offset and gain, eliminating the need for external components and trim pots. Because of its high speed and low droop characteristics it is a perfect match to the 12 bit high speed A/D converters such as Micro Networks' MN5200. For the operating range -55 to $+125$ C, the MIL-range unit MN343H will lose only 1 mV — or less than $\pm 1/2$ LSB out of 12 bits in 50 μ sec.

For additional information, prices and specifications, write or call.



Micro Networks Corporation
324 Clark Street • Worcester, Mass. 01606/Tel:617-852-5400

INFORMATION RETRIEVAL NUMBER 183

ELECTRONIC DESIGN 24, November 22, 1974

INFORMATION RETRIEVAL NUMBER 184

277

Keystone

VERSATILE THERMISTOR PROBES



Get quick response for sensing temperatures of gases, liquids and surfaces with 23 thermistor probe styles and configurations. Probes with stainless steel tips can be ordered in lengths from 1" to 4", giving you an extra dimension to customize certain standard probes. Other features include:

Sensitivity . . . highly sensitive to minute temperature changes . . . fast response.

Temperature range . . . can withstand temperatures from -50°C to 260°C .

Resistance values . . . from 1K to 1 meg at 25°C . . . also miniature discs and rods of 100 ohms to 1 meg at 25°C are available.

Tolerance on resistance . . . $\pm 20\%$ at 25°C is standard; $\pm 10\%$ and $\pm 5\%$ or tighter tolerances if desired.

Low-cost series . . . three inexpensive probes to answer many requirements.

Catalog TP-739
... gives details on 23 probe styles and ordering information. Circle reader service card.



Keystone

CARBON COMPANY
Thermistor Division
St. Marys, PA 15857
814/781-1591 • Telex 91-4517

INFORMATION RETRIEVAL NUMBER 185

INTEGRATED CIRCUITS

Read barometric pressure directly

National Semiconductor Corp.,
2900 Semiconductor Dr., Santa Clara, CA 95051. (408) 732-5000. \$76 (100 up).

Eight solid-state barometers—the LX3700 and LX3800 series—permit scaled reading of common units of barometric pressure: inches of mercury (suffix AIM); millimeters of mercury, or TORR (suffix AMM); and millibars (AMB). A digital voltmeter or panel meter, suitably scaled (either X10 or X100, depending on the barometer type), is all that is needed to display local or remote barometric pressure. Specifications common to all barometers include over-all accuracy of $\pm 0.75\%$ of span; repeatability better than $\pm 0.25\%$ of span; and temperature coefficients better than $\pm 0.005\%$ of span/ $^{\circ}\text{C}$.

INQUIRE DIRECT

'Century' calendar circuit uses CMOS

Ragen Semiconductor Inc., 53 S. Jefferson Rd., Whippany, NJ 07981. (201) 887-4141. 6 to 8 wks.

A CMOS watch circuit, the MS-680, can be used to display 12 or 24 hours, minutes, seconds, month and date. The new unit reportedly accounts automatically for leap year to the end of the next century. The MS-680 operates from supplies in the range of 2.2 to 3.0 V and with a 4-digit multiplexed display.

CIRCLE NO. 398

Digit driver simplifies display circuitry

ITT Semiconductors, 3301 Electronics Way, West Palm Beach, FL 33407. (305) 842-2411. \$2.65 (100-999).

The ITT 508 8-digit driver interfaces MOS ICs and LEDs. It contains eight independent drivers, each capable of sinking 40 mA with a maximum input current of $400\ \mu\text{A}$. A combination of the 508 with the 509 eight-segment driver provides the complete interface circuitry for an 8-digit LED display.

CIRCLE NO. 399

FET op amp has 0.1-pA bias

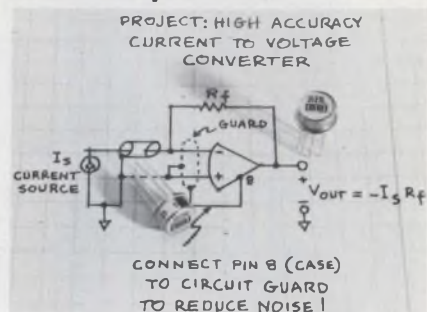

Burr-Brown Research Corp., International Airport Industrial Park, Tucson, AZ 85734. (602) 294-1431. \$16.50 to \$21.50 (100); stock to 4 wks.

The 3523 Series of FET IC op amps achieves sub-picoampere input currents without excessive offset voltage, voltage drift or noise. Maximum bias current for the 3523L is just $\pm 0.1\ \text{pA}$, maximum offset voltage is $\pm 500\ \mu\text{V}$, voltage drift is $\pm 25\ \mu\text{V}/^{\circ}\text{C}$ and current noise is $0.003\ \text{pA}$, pk-pk 0.1 Hz to 10 Hz. The unit has an input impedance of $10^{13}\ \Omega$. Its TO-99 package is connected to pin 8 so that the package itself may be used as part of a shield or guard circuit. All models have a dc open-loop gain of 100 dB, and a unity-gain bandwidth of 1 MHz.

CIRCLE NO. 400

12-bit DAC specs total error of $\pm 1/4$ LSB

Analog Devices P.O. Box 280, Route 1 Industrial Park, Norwood, MA 02062. (617) 329-4700. P&A: See text.

The newest 12-bit DAC—the AD562—boasts an impressive list of specifications. It combines a $\pm 1/4$ -LSB maximum total error (referred to full scale) with guaranteed monotonicity over the full MIL-temperature range. The new unit has a 1 ppm of FSR/ $^{\circ}\text{C}$ differential linearity tempco and 1 ppm of FSR/ $^{\circ}\text{C}$ maximum unipolar offset tempco. Other features include compatibility with TTL/DTL and CMOS, and reduced delay time through the use of a nonsaturating differential current switch. The AD562 comes in a hermetically sealed 24-pin DIP package and costs \$39 to \$100 in hundred quantities. Delivery is from stock.

CIRCLE NO. 401

Keys to higher production, lower cost

ECCOMOLD[®]

Transfer Molding Compounds

Epoxy Powders and Liquids for Electrical/Electronic Encapsulation

Comparative physical, and electrical properties, mold design considerations, processing techniques for both powders and liquids given in new booklet. Send for FREE copy.

EMERSON & CUMING, INC.



CANTON, MA.
GARDENA, CA.
NORTHBROOK, IL.

Sales Offices in Principal Cities

Emerson & Cuming Europe N.V., Oevel, Belgium



INFORMATION RETRIEVAL NUMBER 186

'SNO DRIFT



No temperature drift is just one of a pile of features of PSG

SOLID STATE THERMOSTATS

- NO TEMPERATURE DRIFT FROM SET POINT - SSTC series thermostats drift less than 0.05°C over a minimum life of 2 million cycles.
- ACCURACY - +0.25 to 3°F standard depending on model, other tolerances on request.
- DIFFERENTIAL - 0.25 to 2°F standard depending on model, other ranges on request.
- SHOCK & VIBRATION RESISTANT - Withstand 100 g's shock and 30 g's vibration at 2000 cps.
- LOW COST - Solid state dependability at bimetal prices.

WRITE OR CALL FOR THE SSTC SERIES DATA SHEET.



PSG Industries, Inc.
MANUFACTURER OF PRECISION THERMO AND ELECTRONIC CONTROLS
NINTH & RIDGE AVENUE • PERASIE, PA. 19046
TELEPHONE (215) 257-3621
FORMERLY PHILA. SCIENTIFIC GLASS CO.

INFORMATION RETRIEVAL NUMBER 187

ELECTRONIC DESIGN 24, November 22, 1974

FREE!



SPECIFICATIONS

AC Input	105-125 Vac. 60 Hz.
Line Regulation	±.05%
Load Regulation	±.05%
Ripple	2mv. Pk-Pk, 400 u VRMS
Overload	Current Limit/Foldback
Temp Rating	0-50°C, Derated to 40% @ 71°C
Transient Response	30 u sec. for 50% load change
Temp Coefficient	±.03%/°STD, ±.01% optional
Burn-In	2 hours minimum
Warranty	2 years

When was the last time a manufacturer gave you a power supply free, with no strings attached? Probably never. Well, Power One has a beauty for you to evaluate. FREE with our compliments if you're a qualified OEM user (please, one to a company). Just ask for it with the qualification coupon below.* You don't have to buy anything. It's a 5 VDC, 3 amp power supply from Power One's new "Hi Vol" B&C level power supply line, specifically designed for the high volume OEM user. When you receive it, wring it out. Then compare its price with other supplies. We're confident you'll take care of the rest.

See us in:
EEM, Vol. 1, pgs. 1-586 & 1-587
GOLD BOOK, Vol. 3, pg. 1100

Name _____ Title _____
Company _____
Address _____
City _____ State _____ Zip _____
Buyer's Name _____ Phone _____
Annual Sales \$ _____
Annual Power Supply Requirements \$ _____ Qty _____
Typical Application: Input _____ VAC _____ Hz & 50 Hz
Output(s) _____ Volts _____ AMPS
_____ Volts _____ AMPS
_____ Volts _____ AMPS

*No other liabilities expressed or implied. Offer subject to cancellation without notice.



POWER-ONE, INC.
531 Dawson Drive
Camarillo, Calif. 93010
(805) 484-2806
TWX: 910-336-1297

INFORMATION RETRIEVAL NUMBER 188

syntronic

OPTIMUM CORNER FOCUS

Is a function of ...

- deflection angle
- light output
- yoke impedance
- display speed
- CRT neck diameter
- CRT length
- yoke production capability

To produce one or one hundred yokes having optimum corner focus requires a thorough knowledge of system design trade-offs.

To see the difference our 25 years of experience can make, let us focus on your yoke problem.



SYNTRONIC INSTRUMENTS, INC.
100 Industrial Road, Addison, IL 60101
Phone: (312) 543-6444

MICROWAVES & LASERS

Compact units compare 0-to-360° shifts



Merrimac Industries Inc., 41 Fairfield Pl., West Caldwell, NJ 07006. (201) 228-3890. \$250; 45 days.

Subminiature phase comparators (PCS-3 series), covering the 1-to-160-MHz frequency range, provide two output voltages which, together, permit unambiguous phase comparisons over the entire 0-to-360° phase-shift range. One of the voltage outputs is proportional to the sine of the phase difference between the reference and unknown inputs, and the other output is proportional to the cosine. The comparators exhibit less than 3° phase error at center frequency, and they have a bandwidth of 5%. Input levels are 6 ± 1 dBm for both the reference and unknown signals, and minimum peak output amplitude is 160 mV. The units measure $0.52 \times 1.48 \times 2.05$ in.

CIRCLE NO. 402

Uhf divider specs 2500 W



Transco Products, Inc., 4241 Glencoe Ave., Venice, CA 90291. (213) 821-7911.

Uhf power divider features a 2500-W rating. Covering the 150-to-350-MHz range, the stepped-transformer design (P/N 410C-70900) has a maximum VSWR of 1.25:1 and a maximum insertion loss of 3.25 dB. The unit has HN connectors and measures 35 in. long.

CIRCLE NO. 403

DELAY LINES

NEW



"HI-RATIO" SPIRADEL®

Provides highest ratio of time delay to rise time in Spiradel family. Maintains same excellent electrical specs. for which Spiradel is famous.

NEW



ADDITIONS TO OUR EXTENSIVE 'HF', 'HR' & 'VHR' SERIES

Offers highest ratio of time delay to rise time ever built in a Lumped Constant Line.

NEW



ADDITIONS TO OUR 'MINI' & 'MIDI' SPIRADEL

Affords even greater selection of these high quality, dual-in-line Delay Lines.

L-C FILTERS

FAST PROTOTYPES!

FILTERS OFTEN SHIPPED IN AS LITTLE AS 2 OR 3 DAYS!

NEW



LINEAR PHASE BANDPASS LINEAR PHASE LOWPASS

PLUS extensive listings of typical Lowpass, Highpass, Bandpass & Dip Filters we build.

WRITE FOR NEW CATALOGS

SEE OUR PAGES IN
EEM & GOLD BOOK

VISIT US AT INTERCON



Allen Avionics, Inc.

224 E. 2nd St., MINEOLA, N.Y. 11501
PHONE: 516-248-8080

YIG-tuned filters form MIL-spec preselectors



Watkins-Johnson, 3333 Hillview Ave., Palo Alto, CA 94304. (415) 493-4141.

Two families of YIG-tuned filters, operating over the -54 to 71 C temperature range, cover the frequency range of 0.5 to 18 GHz and supply electronically tunable preselection in MIL-Spec systems. The WJ-61 series, for superheterodyne receivers, has 2 -dB passband windows of ± 7 to ± 20 MHz minimum for 0.5 -to- 1.0 -GHz and 12.4 -to- 18.0 -GHz models, respectively. The 62 series, tailored to the requirements of TRF-type receivers, has narrow bandwidths to allow resolution of multiple signals. All units come in standard 1.4 -in. packages that weigh less than 12 oz.

CIRCLE NO. 404

4-way divider/combiner loses only 0.3 dB



Sage Laboratories Inc., 3 Huron Dr., Natick, MA 01760. (617) 653-0844. \$325; 60 days.

The Model FP1372 four-way matched power divider/combiner features an insertion loss of less than 0.3 dB over the 3.7 -to- 4.2 -GHz frequency range. VSWR is less than $1.2:1$, and isolation between outputs exceeds 20 dB. In combiner applications, the input power rating is 100 mW per port.

CIRCLE NO. 405

THE UN-QUARTZ RESONATOR RMC CERAMIC RESONATOR

WHY pay for quartz, if quartz accuracy is not required in your digital clock generator—USE RMC CERAMIC RESONATORS.

ONLY 50¢ in 100 quantities for any oscillator frequency between 195 KHz and 500 KHz, ± 1 KHz. Temperature stability: $< \pm 0.2\%$ (-20°C to $+65^{\circ}\text{C}$).

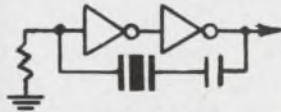

TTL CIRCUITS

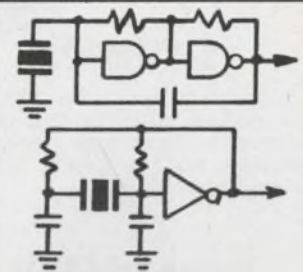

CMOS CIRCUITS



Radio Materials Company

Div. of P. R. Mallory & Co. Inc.

4242 West Bryn Mawr Avenue Chicago, Illinois 60646

(312) 478-3600



INFORMATION RETRIEVAL NUMBER 191

cut costs 40% on parts like this

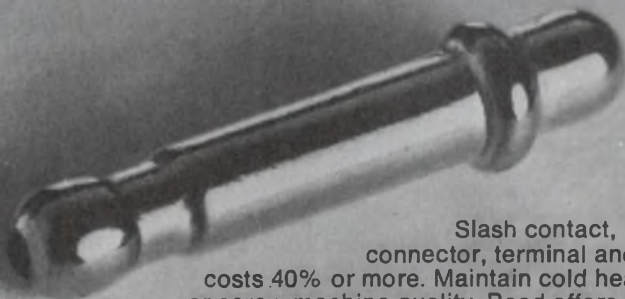

Slash contact, lead, connector, terminal and pin costs 40% or more. Maintain cold headed or screw machine quality. Bead offers a full line of standard products. Formed by our fast, accurate virtually waste free multi-swaging process to give you fast delivery, low prices. We provide custom engineering to meet your special requirements. Write or call for our new catalog.



bead electronics

A Division of Bead Chain Mfg. Co.
58 Mountain Grove St., Bridgeport, Conn. 06605
Phone: (203) 334-4124

INFORMATION RETRIEVAL NUMBER 192

DIT-MCO: The Difference In Testing



SYSTEM 823

A computer-controlled ultra high speed wiring analyzer system for rapid validation of interconnect systems such as computer backplanes, multilayer boards, cable networks, wired racks, etc.

Proven Solid State Switching

Distributed switching and control eliminates the need for massive adaptor cables and is customized to plug directly into your product or access fixture.

Test Parameters

A wide range of substantially superior test parameters insures more consistent, reliable and accurate testing under a variety of conditions.

Test Speed

System 823 is unequaled in test speed and accuracy. Solid state switching and higher test stimuli enable extremely fast and precise insulation and continuity testing — up to several thousand tests per second.

Test At Higher Voltage

High voltage solid state switching permits testing at 24-volt levels. Higher test stimuli result in more reliable error reporting and isolation of real and potential defects.

Software

System 823 comes complete with a standard software package furnished and maintained by DIT-MCO.

The basic set of hardware and software items may be complemented with a large variety of standard and special options.

CALL OR WRITE . . .

We'll send you our new System 823 literature or ask for a DIT-MCO representative to show you how a System 823 relates to your test needs. He'll show you how to perform tests faster, more simply, and save money too!



DIT-MCO INTERNATIONAL

A Division of Xebec Corporation
5612 Brighton Terrace, K. C., Mo. 64130
Telephone (816) 363-6288
Telex Number 42-6149

European Technical Representative, Radix House,
Central Trading Estate, Staines, Middlesex,
TW18-4-XA, England, Telephone (0784) 51444
Telex Number 935023

MICROWAVES & LASERS

Laser welder yields 20-J pulses at 10 pps



Korad Div. of Hadron, 2520 Colorado Ave., Santa Monica, CA 90404. (213) 829-3377. \$41,500.

With the Model KWD-7 laser welder comes the company's KY7 YAG laser—reportedly the most powerful laser available for welding applications. The KY7 produces an average power in excess of 200 W in the form of 20-J pulses at a repetition rate of 10 pulses per second. The KWD-7 consists of the horizontally mounted laser and optics and control console mounted on a stone-topped table. Two electronics consoles containing the power supply and energy storage bank are also included, as well as Korad's Model KWC-9 water-to-water heat exchanger. High-volume applications include relay can welding, hermetic sealing of transducers and electron beam welding where penetration is less than 0.030 inches.

CIRCLE NO. 406

Driver, modulator aid laser-system designs

Harris Corp., 1200 Prospect Ave., Westbury, L.I., NY 11590. (516) 334-7810.

Two products aim for laser systems. The PRD 7801 rf source is designed to be a driver for Q-switch, electro-optical modulators; and the PRD 7803 is an acousto-optical modulator driver. The 7801 provides a 50-W signal source that can be pulsed on and off by a TTL input. Protected against mismatches, it can operate at any center frequency from 10 to 60 MHz. The 7803 driver comes in an integrated package that contains an oscillator, FM and AM modulators and a power amplifier.

CIRCLE NO. 407

Coax detector has 18-GHz range

Weinschel Engineering, P.O. Box 577, Gaithersburg, MD 20760. (301) 948-3434.

Model 1113 coaxial crystal detector features broadband, flat frequency response and a field-replaceable diode element. Flatness is better than ± 1.0 dB over the entire 0.1-to-18-GHz frequency range. Sensitivity is 0.4 mV/ μ W minimum at low levels and 100 mV/0.4 mW at high levels. VSWR is 2.0:1 maximum. The diode element (Part No. B139-522) can be replaced or reversed in the field without the need for special tools and techniques, and the Model 1113 can be ordered with either negative (-1) or positive (-2) output polarity.

CIRCLE NO. 408

Sources feature frequency agility



Communication Techniques Inc., 1279 Route 46, Parsippany, NJ 07054. (201) 263-7200.

Frequency-agile phase-locked signal sources—the CTI series—automatically lock and track the input reference signal over their full output tuning range. Frequency change and lockup time of 100 ms is standard, with 1-ms switching an available option. The use of a high-Q voltage-tunable L-band cavity achieves reduced noise levels. A unique feature of these designs is automatic switching of the phase-lock-loop bandwidth, enlarging it to the rated maximum whenever the loop is stressed, and narrowing the filter bandpass when the oscillator phase-locks to the correct harmonic.

CIRCLE NO. 409

run
long,
strong
and profitably

Bodine FHP motors and gearmotors

Bodine's K-2 line has a history of dependability, long life, and consistent motor-to-motor performance. You get greater economy in the long run. Ball bearing rotors and individual run-in are standard. Performance options include high starting torque for inertia loads, low inertia rotor for fast response in servo applications, dynamic braking capability, torque motor application, and reluctance synchronous operation. Two new bulletins from Bodine covering K-2 motors and gearmotors are now available. Get both from . . .

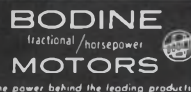

Bodine Electric Co., 2528 West Bradley Pl., Chicago, Ill. 60618
INFORMATION RETRIEVAL NUMBER 194

**The Brush 260
6-channel recorder.
Precise data at low cost
per channel.**

Besides being an accurate, reliable instrument, the Brush 260 is also a real bargain.

You get six 40 mm analog channels and four event markers. Eight pushbutton chart speeds and built-in signal conditioners. Plus Brush exclusives like pressurized ink writing and Metrisite[®] servo-loop feedback system that assures 99½% linearity.

Write Gould Inc., Instrument Systems Division, 3631 Perkins Avenue, Cleveland, Ohio 44114. Or Kouterveldstraat Z/N, B 1920 Diegem, Belgium.



GOULD

INFORMATION RETRIEVAL NUMBER 195

ELECTRONIC DESIGN 24, November 22, 1974

PHILIPS



**Delayed sweep made EASY.
Find out how with the new
Philips PM3260 120MHz
Portable Oscilloscope**

Just dial time and position, then push the delayed timebase pushbutton . . . and read ! That's all there is to it. The Philips PM3260 separate delayed timebase controls afford complete independent settings. Adjustments to usable levels of intensity are automatic and eliminate 'back and forth' control settings at all intensity levels. Pushbutton switching to delayed timebase enables quick measurements.

The PM3260 uses DC switching for all functions. This design feature makes possible the optimum control panel layout for simplicity of operation and maximum electrical and mechanical reliability.

- Separate main and delayed timebase controls
- 120 MHz/5mV
- 20 pounds light
- Bright 20 kV 8 x 10 cm display
- Power consumption a low 45 watts
- Operates over line voltage 90 to 250 volts and 46 to 440 Hz without modification
- PM3260E (Economy model) only \$ 1850.00
Standard PM3260 equipped with probe power is priced at \$ 1950.00

• Special Applications Information
'HOT LINE'

Dial toll free number (800) 645-3043
New York State, call collect (516) 921-8880

FOR SALESMAN CIRCLE NO. 294
INFORMATION RETRIEVAL NO. 295

Philips Test & Measuring Instruments, Inc.
A NORTH AMERICAN PHILIPS COMPANY

application notes

Microprocessors are Logic Elements... and Pro-Log can prove it!

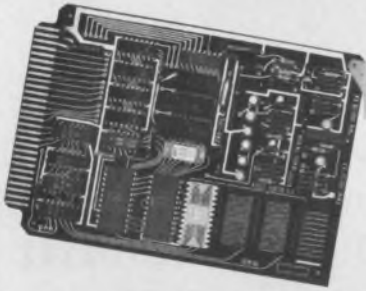

Our 4-bit microprocessor system can replace a rack full of your TTL chips. You'll save design time and production costs. No big redesign jobs for options or changes because the logic is stored in reprogrammable ROMs. Our programmed logic systems are available now, off the shelf.

Our PLS-401 microprocessor system costs less than \$400 in a quantity of one, with substantial OEM discounts. Plus we've got all the support you need: Design manuals, 3-day intensive design course, PROM Programmers, System Testers, special interface cards (including opto-isolator, triac, and driver cards) and support hardware to make your system go together smoothly.

Logic Processor Systems from Pro-Log



Call or write to 852 Airport Boulevard, Monterey, California 93940. (408) 372-4593

INFORMATION RETRIEVAL NUMBER 197

our secret punch



for numerical machine tool control

Our ROYTRON I/O devices punch and read Metalized Mylar Tape (or any tape), reliably, at 50, 60 or 75 cps. How we do that and provide: read stations sealed from dust, corrosion and contaminants; bi-directional feed; adjustable tape guides and over-sized chad boxes . . . desk-top or rack mounted . . . at such low cost, is another secret.

If anyone else could provide the same advantages, it wouldn't be a secret any more.



OEM PRODUCTS DIVISION
LITTON ABS

Automated Business Systems
34 Maple Avenue, Pine Brook, N.J. 07058/(201) 575-8100
IN U.K. — LBS, 27 Goswell Road, E.C.1, London
IN FRANCE — LITTON ABS/OEM, 9/15 Avenue Paul Doumer, 92504 Rueil-Malmaison

INFORMATION RETRIEVAL NUMBER 198

JFETs

An application note identifies and characterizes audio frequency noise in JFETs. Emphasis is placed on basic drive characteristics, rather than on end applications, for those designers who must know the basic noise performance of FETs and how these characteristics may be specified by production-oriented test parameters. Siliconix, Santa Clara, CA

CIRCLE NO. 410

Self-latching reed matrix

The construction, operation and uses of the company's mini memory matrix, an 8 × 8 crosspoint switching assembly using self-latching dry reed relays, are featured in a 21-page booklet. It is fully illustrated with photographs, line drawings and schematics. C.P. Clare, Chicago, IL

CIRCLE NO. 411

Software guide

A 48-page guide contains comprehensive profiles on the company's system software components—operating systems, language processors, utility packages and libraries—and details on exactly what software is supplied with any hardware configuration selected by the user. The guide includes a 14-page software index. Prime Computer, Framingham, MA

CIRCLE NO. 412

Magnetic shielding

Magnetic shielding of computer terminals and other electronic data display equipment is covered in a four-page guide. The guide tells why shielding is needed, suggests when to plan for it and shows how to design a typical shield. Necessary equations are given, along with tables showing the characteristics of the company's shielding material. Eagle Magnetic, Indianapolis, IN

CIRCLE NO. 413

NEED DEPENDABLE PUSHBUTTONS? SWITCH TO CONTROL SWITCH

- High contact pressure for low contact resistance
- Fast make and break to reduce arcing and extend contact life

WIDE RANGE OF STYLES AVAILABLE



UNIFORM PANEL APPEARANCE

- Same external appearance even with different ratings, circuits and other characteristics.
- Building block approach . . . wide variety of mechanisms, adapters, and buttons.

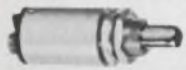

HEAVY DUTY PUSHBUTTON SWITCHES

. . . ratings to 35A



SUBMINIATURE PUSHBUTTON SWITCHES

. . . space saving design

SEND FOR PORTFOLIO OF TECHNICAL BULLETINS



CONTROL SWITCH

A CUTLER-HAMMER COMPANY

1420 DELMAR DRIVE, FOLCROFT, PA. 19032

INFORMATION RETRIEVAL NUMBER 199

The INCREDIBLE FIXIT

?? WHAT IS IT??

- ✓ That SAVES MONEY!
- ✓ Is a PHENOMENAL TROUBLESHOOTER!
- ✓ Works at LIGHTNING SPEED!
- ✓ Has a FANTASTIC MEMORY!
- ✓ Doesn't Take a Coffee Break!

It's The INCREDIBLE FIXIT!

FIXIT #731 — The Automatic
Printed Circuit Board Tester

Systemation Inc.

CLIFTON PARK, ELNORA, N.Y. 12065
(518) 371-3260

The INCREDIBLE FIXIT

INFORMATION RETRIEVAL NUMBER 200

ELECTRONIC DESIGN 24, November 22, 1974

missing links

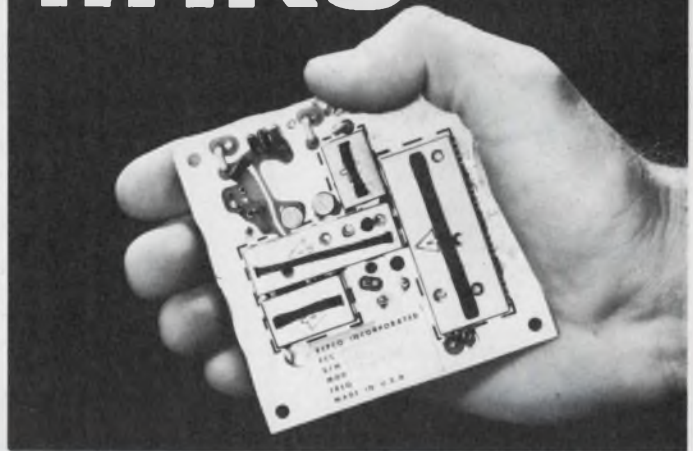

Radio Links...!! We Got 'Em

If you're designing telemetry or data acquisition systems requiring tone, voice, or low-speed digital data transmission . . . or combinations . . . and don't have Repco's modular radio links in the design, you're missing a lot. Low cost, small size, reliability, easy installation, low battery drain, and virtually unlimited design freedom.

These stable, FCC type accepted radio links are made up of plug-in modules, each a complete state-of-the-art circuit. Servicing is as uncomplicated as unplugging a module and re-plugging another.

Take a look at the specs to see what isn't missing:

Transmitters (Typical)

2 millisecond turn on time, .5 up to 25 watt RF output available. Current drain as low as 180 ma.; 12v and 15v models available, size 3.32" x 3.32" x 1".

Receivers (Typical)

12v and 15v models, current drain as low as 4.6 ma. (standby). Frequency stability VHF $\pm .001\%$ — UHF $\pm .00005\%$ (-30 to $+60^{\circ}\text{C}$)
Size 3.32" x 3.32" x 1".

For use under FCC parts 21, 81, 89, 91, 93, 95(A), and U.S. Government Services (non-tactical).

Write today

for complete information on low (25-50MHz), mid (66-88MHz), high band (132-174MHz), and UHF (450-470MHz) transmitters and receivers. All at prices which will surprise you.

REPCO Incorporated

Special Products Department
P.O. Box 7065
Orlando, Florida 32804
Telephone (305) 843-8484

Repco

INFORMATION RETRIEVAL NUMBER 201

new literature

...in test systems where integrity is essential, specify cunningham



Crossbar switches

FROM TEN TO THREE HUNDRED 6 WIRE CROSSPOINTS. EXTREMELY LOW PATH RESISTANCE. LOW NOISE AND MINIMAL THERMAL EMF. MINIMUM OF 20 MILLION OPERATIONS/CROSSPOINT LIFE EXPECTANCY. HANDLES LOW LEVEL AND BROADBAND SIGNALS.



reed matrix

STANDARD 5X10 (50 CROSSPOINT) MATRIX FOR GROUP TO GROUP SWITCHING. INTERMEDIATE FREQUENCY (IF) HANDLES DC TO 4 MHz SIGNALS. HIGH FREQUENCY (HF) CAPABILITY OF 60 MHz WITH SHIELDED SIGNAL PATHS.



matrix controller

INTERFACES A SWITCH MATRIX TO ANY 16 BIT ADDRESS DEVICE. FACILITATES A WIDE VARIETY OF SWITCH MATRIX APPLICATIONS BY PROGRAMMABLE REMOTE AND MANUAL CONTROL. ESPECIALLY USEFUL IN AUTOMATIC TESTING OR TELEMETRY SWITCHING.



scanners

FOR SEQUENTIAL OR RANDOM CONNECTION OF INSTRUMENT LEVEL SIGNALS. REED SCANNERS OFFER HIGH SPEED SWITCHING FOR DATA LEVELS. CROSSBAR SCANNERS BEST FOR LOW THERMAL OR LOW NOISE DATA ACQUISITION SYSTEMS. BOTH FEATURE LOCAL AND REMOTE CONTROL.

applications assistance

FOR ADDITIONAL DATA OR APPLICATIONS ASSISTANCE, CALL THE CUNNINGHAM CORPORATION, HONEOYE FALLS, NEW YORK: (716) 624-2000.

Cunningham Corporation
SUBSIDIARY OF GLEASON WORKS

Digital switch

A miniature lever-operated digital switch with eight, 10 or 12 dial positions is detailed in a data sheet. Photos show both "upper" and "lower" display window locations. Mechanical, electrical, environmental and material specifications and outline drawings are provided. The Digitran Co., Pasadena, CA

CIRCLE NO. 414



Radio Shack catalog

A 164-page catalog has 100 full-color pages featuring the company's stereo and four-channel receivers, automatic turntables, tape recorders and players, speakers, headphones, automotive tape players and CB two-way radios. In addition, the catalog lists tools, tubes and transistors, wire and cable, home security products, intercoms, timers and batteries. Radio Shack, Fort Worth, TX

CIRCLE NO. 415

Special-purpose amps

Fifty-two amplifiers, including general-purpose wideband amplifiers, low-noise preamplifiers, fast rise-time pulse amplifiers, wideband power amplifiers, video amplifiers and multicouplers, are described in a short-form catalog. C-COR Electronics, State College, PA

CIRCLE NO. 416

Magnetic sensors

Information necessary to select the proper magnetic sensor for a given application is contained in a two-page catalog sheet. Dimensions and specifications are provided for sensors including operating criteria. Electro Corp., Sarasota, FL

CIRCLE NO. 417

Stopwatches

A 20-page catalog illustrates and details models for precision timing of sports events, industrial and scientific applications, radio and TV programming. Included are chronographs, tachometers, multiple-dial and multiple-function timers. M. Ducommun, New York, NY

CIRCLE NO. 418

Memory exerciser

Programmable memory exerciser Model 4604, a high-performance, modularly constructed, flexible, English-language test exerciser for diagnostic testing of any complete memory system or integral part, is detailed in a bulletin. Technitrol, Philadelphia, PA

CIRCLE NO. 419

Laser accessories

Laser energy measurement accessories are featured in a 14-page brochure. The brochure provides specifications and applications information on thermopiles, calorimeters, diodes and power monitors as well as alignment and safety accessories. Korad Div. of Hadron, Santa Monica, CA

CIRCLE NO. 420

Cryogenic equipment

A 60-page catalog covers cryogenic standard products, including off-the-shelf cryogenic systems equipment and components. The catalog includes information on heat leak, sizing and pressure ratings. CVI Corp., Columbus, OH

CIRCLE NO. 421

TOM TUMB TACHOMETERS

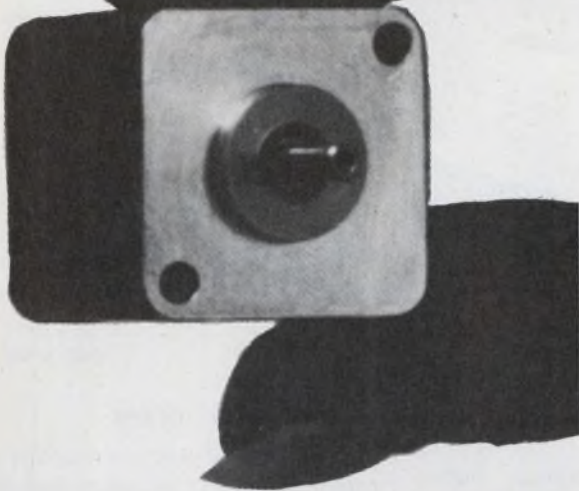

One cubic inch . . . that's all the space it needs. But it sends a strong, reliable signal up to 6.5 V/1000 RPM. Maximum deviation from linearity will not exceed 1% assuring high degree of accuracy. Low friction and rotor inertia will not load down equipment. Speeds to 5,000 RPM.

INLAND MOTOR DIVISION OF KOLLMORGEN CORP.
Radford, Va. 24141 • (703) 639-3973 • TWX 710-875-3740

INFORMATION RETRIEVAL NUMBER 203

Ballantine, 3 to 1 in your favor!

New 15MHz Precision Voltmeter
replaces three old designs
100 μ V sensitivity
unmatchable performance
from \$385

Call your local Ballantine field engineer.



BALLANTINE LABORATORIES, INC.
P.O. Box 97, Boonton, New Jersey 07005
201-335-0900, TWX 710-987-8380



INFORMATION RETRIEVAL NUMBER 206

ALCOSWITCH

Our sub-mini RIGHT ANGLE PC TOGGLE switches may cost a little more, only because they're the best in the industry! Available either as 1 or 2 pole. Most important are our technical features, of which there are far too many to list in this small ad.



Call (617) 686-0126 today and let us tell you why our competitors charge extra for our built-in features.

ALCO ELECTRONIC PRODUCTS, INC.
1551 Osgood St., No. Andover, Mass. 01845

ALCOSWITCH

INFORMATION RETRIEVAL NUMBER 204

ALCOSWITCH

Mustang PUSHBUTTON SWITCHES have Molded-in terminals to prevent contamination. Terminals and contacts are gold flashed at no extra charge. Available with lug or PC terminals. Bushings are 15/32" threaded with all hardware. Push-On/ Push-Off or Momentary action in 1 thru 4-poles.



Call (617) 686-0126 for additional information.

ALCO ELECTRONIC PRODUCTS, INC.
1551 Osgood St., No. Andover, Mass. 01845

ALCOSWITCH

INFORMATION RETRIEVAL NUMBER 205

ELECTRONIC DESIGN 24, November 22, 1974

ALCOSWITCH

FEATURES

- * SPECIFICATIONS FOR ALL CURRENT MICROPROCESSORS
- * ARCHITECTURE OF CPU'S
- * INSTRUCTION SETS
- * LSI TECHNOLOGIES
- * 5 TYPICAL BEACHMARK PROGRAMS FOR 10 CPU'S
- * HARDWARE COMPARISON CHARTS
- * SOFTWARE COMPARISON CHARTS
- * BLOCK DIAGRAMS
- * QUARTERLY UP-DATE SERVICE INCLUDED
- * CONVENIENT 3-RING BINDER FORMAT

WHICH MAN IN YOUR COMPANY WILL SPECIFY THE BEST MICROPROCESSOR FOR YOUR APPLICATION? OR WHICH MICROPROCESSOR?

AH Systems provides the answers in a new service for engineers, product managers and programmers. The Data Book contains a comprehensive survey of all the current microprocessors (over 25 CPU's) and support chips.

A check or purchase order is enclosed for \$495 (additional copies are \$55 each).

Please send me more data on the survey

Please send me data on other AH Systems reports and services.

NAME _____ TITLE _____

COMPANY _____

ADDRESS _____

CITY _____ STATE _____ ZIP _____

ALCOSWITCH



Price \$495

**MICROPROCESSOR
FIELD SURVEY AND DATA BOOK**

**AH SYSTEMS INC. • 9710 COZYCROFT AVENUE
CHATSWORTH, CALIFORNIA 91311 • (213) 998-0223**

INFORMATION RETRIEVAL NUMBER 207

287

the facts about E.M.I. SHIELDING

Design information from Mag-Shield's
30 years experience in E.M.I. shielding.

WHAT IS THE ADVANTAGE OF USING NETIC OR CO-NETIC SHIELDING ALLOYS?

These alloys are especially prepared and treated to attain optimum E.M.I. shielding efficiency. They are available in thicknesses up to .010" for continuous foil, and up to .062" for sheet stock. Shielding foil is easily hand-formed into shields for prototype testing or small production runs. Stress annealed sheet stock has maximum workability properties. Fully hydrogen annealed sheet stock provides maximum permeability.



Netic and Co-Netic foil is easily shaped into simple shield configurations.

HOW DO I KNOW WHICH MATERIAL TO USE?

The high saturation capability of Netic material is ideally suited for attenuating high intensity E.M.I. fields. High permeability Co-Netic material provides maximum attenuation at low field intensities.

CAN YOU SERVICE MY SHIELD DESIGN AND PRODUCTION NEEDS?

Mag-Shield offers complete shield design and fabrication service. And, we can provide immediate delivery on standard shields that will accommodate a wide variety of components. Just circle the reader service number, or write Mag-Shield direct to receive complete information on sample materials and specifications.

MAGNETIC SHIELD DIVISION



Perfection Mica Company
740 Thomas Drive
Bensenville, Illinois 60106
(312) 766-7800 TWX (910) 256-4815

NEW LITERATURE

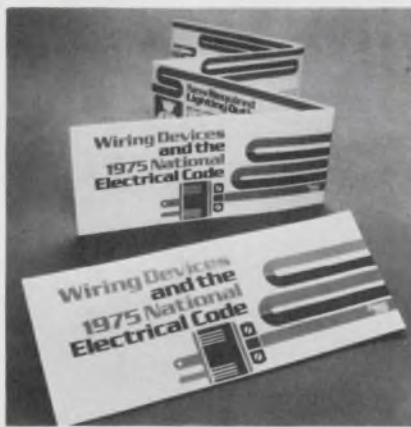

Wiring devices

"Wiring Devices and the 1975 National Electrical Code" provides an explanation of the code's refinements and additions in such areas as ground fault protection, receptacle/outlet locations, lighting outlets, cap and connector requirements. Arrow-Hart, Hartford, CT

CIRCLE NO. 422

Wirewound resistors

Axial lead wirewound resistors are covered in a 14-page catalog. It provides applications, mechanical, electrical and material specifying information. Ohmite Manufacturing, Skokie, IL

CIRCLE NO. 423

LVDT signal conditioner

A linear variable differential transformer (LVDT) signal conditioner is described in a bulletin. Schaevitz Engineering, Camden, NJ

CIRCLE NO. 424

CMOS/PMOS

CMOS and PMOS integrated circuits are described in a catalog. OKI Electronics, Fort Lauderdale, FL

CIRCLE NO. 425

He-Ne lasers

A short-form catalog details helium-neon lasers. The eight-page brochure gives specifications for all models of plasma tubes, internal and external mirror laser heads, power supplies and accessories. Hughes Electron Dynamics Div., Torrance, CA

CIRCLE NO. 426

Cable TV systems

Fifty-five pages describe cable TV systems and products, including trunks, bridgers, distenders, extenders, passives, antenna site and powering equipment. C-COR Electronics, State College, Pa.

CIRCLE NO. 427

Communication instruments

Telecommunications instruments of microwave communications systems, including microwave transmission line test instruments and antenna installation test systems, are described in a catalog. Scientific-Atlanta, Atlanta, GA

CIRCLE NO. 428

Flexible disc drive

The FD400 flexible disc drive is described in a six-page brochure. The FD400 interface requirements are detailed in the brochure, including functional descriptions for all interface signals. Perfect, Chatsworth, Calif.

CIRCLE NO. 429

Aluminum carrying cases

Centurion carrying cases made from deep drawn aluminum are featured in a 12-page catalog. The illustrated catalog provides a listing of models, dimensional data and specifications. Zero Manufacturing, Burbank, CA

CIRCLE NO. 430



Attenuators

Coaxial fixed and variable attenuators are listed in a catalog. Electrical and mechanical data are included. Solitron Devices, Tappan, NY

CIRCLE NO. 431

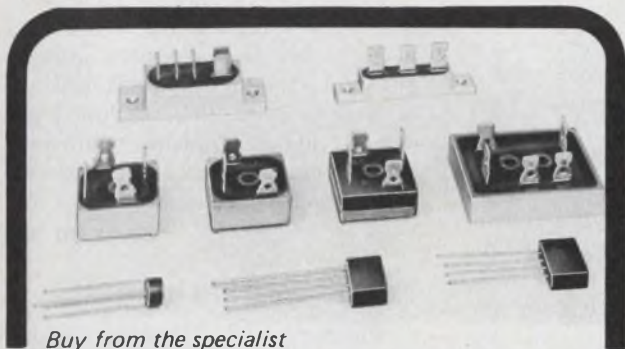

Buy from the specialist

Rectifier Bridges

Peak Reverse Voltages from 50 to 1200 • Currents from 1 to 30 Amp • For P.C. and power terminal mounting • For Heat Sink and Chassis Mounting • Single and 3-phase. Center Tapped and Doubler • Standard and U.L. Component Recognition Types Standard and Fast Recovery • Many unique features Attractive Prices

edi® Free Samples

Write for catalog. Describe application and we will provide free samples and our best low prices.

electronic devices inc.

21 GRAY OAKS AVE., YONKERS, N.Y. 10710
(914) 965-4400 TWX (710) 560-0021 TELEX 13-1580

INFORMATION RETRIEVAL NUMBER 209

automatic transfer standards

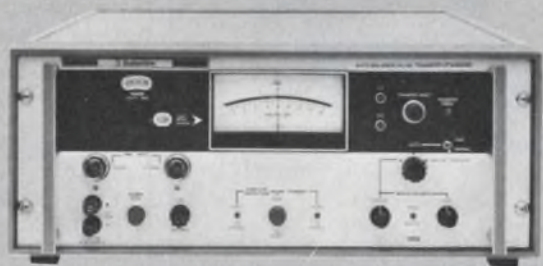

The 1600A Auto-Balance AC/DC Transfer Standard. Precise repeatable measurements every 30 seconds. Traceable to NBS. Takes tedium and guesswork out of 100 ppm transfer measurements in Lab, QA and production.

0.25 V to 1 kV rms, dc to > 100MHz: \$4500



Ballantine Laboratories, Inc.

P.O. Box 97, Boonton, New Jersey 07005
201-335-0900, TWX 710-987-8380

INFORMATION RETRIEVAL NUMBER 211

PRE-PUNCHED, PERFORATED, EXPERIMENTER or PROTOTYPE Boards.

VARIETY OF MATERIALS

GLASS EPOXY
PAPER PHENOLIC
COPPER CLAD
PAPER EPOXY

CHOICE OF THICKNESS

1/32, 3/64, 1/16, 3/32

WE CAN ALSO FABRICATE AND ASSEMBLE TO YOUR SPECIFICATION.

IN STOCK

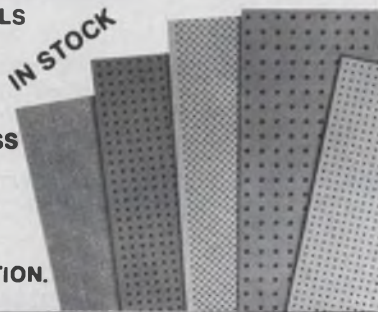

Whatever you call them...We make them!!!

SELECTION OF TERMINALS & HARDWARE

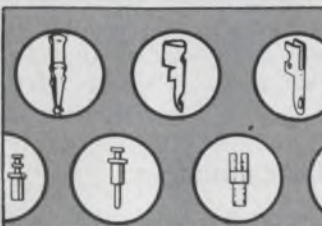

ASSORTED PATTERNS

Pattern	Centers	Hole Dia.
"A"	.265 x .265	.093
"B"	.187 x .187	.062
"E"	.250 x .250	.100
"F"	.200 x .200	.062
"G"	.100 x .200	.062
"H"	.375 x .375	.120
"P"	.100 x .100	.042

Send for new catalog.



KEYSTONE

ELECTRONICS CORPORATION

49 BLEECKER STREET • NEW YORK, N.Y. 10012 • (212) 475-4600

INFORMATION RETRIEVAL NUMBER 210

ELECTRONIC DESIGN 24, November 22, 1974

MINIATURE THERMOCOUPLE REFERENCE JUNCTION

SIGNAL CONDITIONING FOR ALL TYPES OF THERMOCOUPLES

Reference junction offers low cost heated reference with complete isolation



TR34 is designed to provide a highly stable reference unit for thermocouple measurements in applications requiring a small lightweight system. The solid state temperature control circuit, with integral heater and resistance sensor elements, achieves the maximum precision for minimum weight, power and space utilization.

Junction Temperature: 100°C standard

Temperature Stability: ±0.1°C

Power Requirements: 22 to 35 VDC

TR34 12 channel \$370, delivery 4 weeks

TR34 24 channel \$490

TR121 is an 8-channel heated-block type assembly designed for portable applications. The block is electrically heated and proportionately controlled at the reference temperature by a solid state circuit mounted on the block. Thermal insulation isolates the effects of ambient temperature on the reference junctions.



Reference Junction Temperature: +150°F

Temperature Stability: ±0.25°F

Power Supply: 110-220VAC, 50-400 Hz

TR121-8TT \$330, delivery 4-6 weeks



WRITE FOR CATALOG

19414 Londelius Street
Northridge, Calif. 91324
Phone (213) 886-8488
Telex 65-1303

INFORMATION RETRIEVAL NUMBER 212

289

Obsolete Hand Loading (and high prices)

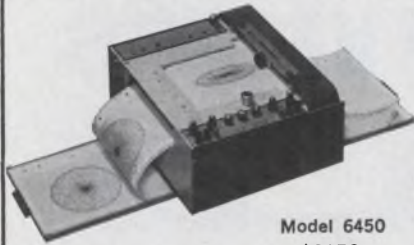

Model 6450
\$2150.

Continuous Chart Supply

X-Y Recording

- Bi-directional Chart Movement
- Z-Fold Paper
- 8½" x 11" Recording Surface (tears out for file use)
- Local or remote control of recording mechanism and pen lift
- English/Metric Scale
- 15 in./sec. slewing speed
- 18 calibrated voltage ranges for each axis—continuously variable in between
- ± .2% Accuracy
- ± .1% Repeatability

Model 6452, X-Y-Y' (two pen)—
\$2950.

houston instrument **THE RECORDER COMPANY**

ONE HOUSTON SQUARE (at 8500 Cameron Road)
AUSTIN, TEXAS 78753 (512) 837-2820
TWX 910-874-2022 cable HOINCO

EUROPEAN OFFICE:
Rochesterlaan 6 8240 Gistel Belgium
Phone 059/27445 Telex Bausch 19399

NEW LITERATURE

Digital instruments

Purchasing digital instruments is simpler and more convenient using the 16-page, two-color digital instrument product index. The mini-catalog lists standard models and prices of the company's instruments as well as optional features. Electronic Research Co., Shawnee Mission, KS

CIRCLE NO. 432

Toggle, PB switches

An illustrated 32-page catalog describes miniature toggle and pushbutton switches. Hardware and accessories are included. Diagrams are tabulated for easy reference and identification of dimensions. Alco Electronic Products, North Andover, MA

CIRCLE NO. 433

Digital instrumentation

More than 20 modular instruments are described in a six-page catalog. Features, applications and specifications are covered. Tautron, North Billerica, MA

CIRCLE NO. 434

Transducer indicators

Series 8000 digital transducer indicators and associated equipment are covered in a 12-page catalog. Specifications and related performance data are included. BLH Electronics, Waltham, MA

CIRCLE NO. 440

HV power supplies

A colorful data sheet describes the SRM line of super-regulated high-voltage power-supply modules. Specifications, features and options are described. Ratings and model numbers for 38 models are listed along with an outline drawing noting size and terminal configuration. Spellman High Voltage Electronics, Bronx, NY

CIRCLE NO. 441

Photoelectric system

A 16-page photoelectric design guide presents a semi-technical, easy-to-understand discussion of photocells and phototransistors. Standard Instrument, King of Prussia, PA

CIRCLE NO. 442

Elapsed time indicators

Subminiature elapsed time indicators for measuring component performance in aerospace, military and industrial equipment are described in a catalog. Included are details about typical mountings and performance data. General Time, Rolling Meadows, IL

CIRCLE NO. 443

Switchboard instruments

Standard and edgewise ac and dc voltmeters, ammeters, wattmeters, varmeters, temperature indicators, frequency meters, synchrosopes, power-factor meters, phase-angle meters and tachometer

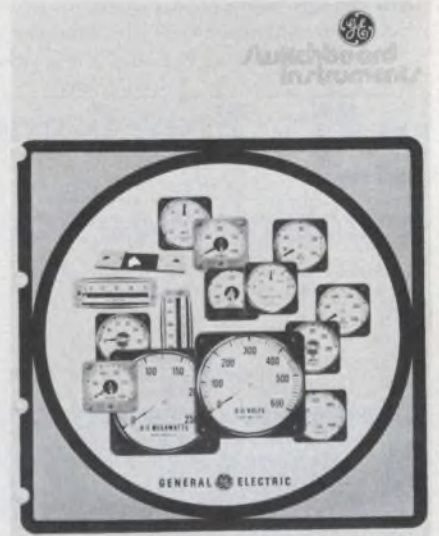

indicators are illustrated in a 36-page catalog. The catalog features simplified price and ordering information, dimensional drawings, principles of operation and a glossary of terms. General Electric, Schenectady, NY

CIRCLE NO. 444

'Y' adapters

Audio "Y" adapters for interconnecting mixers, amplifiers, PAs, lecterns, microphones, phonos, tape decks and cassette recorder/players, tuners and test equipment are described in a bulletin. Switchcraft, Chicago, IL

CIRCLE NO. 445

Ceramic capacitors

Epoxy-coated capacitors with NPO and K1200 characteristics are featured in a bulletin. Bell Industries, Electronic Components Div., Burbank, CA

CIRCLE NO. 446

Vernitorg long life motors should be used for any positioning requirement where continuous rotation is not essential. Infinite resolution and high linearity allow these motors to provide high accuracy in positioning, actuating, tensioning, measuring, and indicating applications. These motors provide smooth operation with no slot effect. They also offer high torque with low input power and high acceleration rates as well as no gears, no mechanical or electrical noise, no explosion hazard, no friction, and no ripple torque. Vernitorg brushless DC torque motors are available in two and four-pole designs, in a variety of sizes and outputs. Peak torque ratings range from 5 to 600 oz-in. Frameless or housed versions are available. Special designs to your requirements also supplied. Vernitron Control Components, A Division of Vernitron Corp., 2440 West Carson Street, Torrance, California 90501, Telephone (213) 328-2504.

Vernitron Limited Rotation Wide Angle Brushless DC Torque Motors

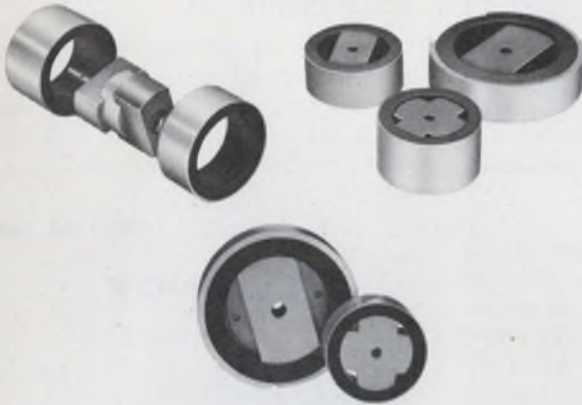

vernitorg

INFORMATION RETRIEVAL NUMBER 214



The Digisec® Encoder keeps little bits from becoming big mistakes.

As some people have found out the hard way, all bits are not of equal length. And what may appear to be just a small error—say a fraction of an arc-second, can lead to a large accumulated error.

As the long recognized leader in encoders, Itek realizes the importance of maintaining accuracy commensurate with resolution. And Digisec Encoders have resolutions and accuracy up to 22 bits/revolution. But that's just part of the story.

Write for our free catalog. Read all about Digisec Encoders. They're more than a bit ahead of their time.

Itek Measurement Systems

A Division of Itek Corporation
27 Christina Street, Newton, Mass 02161

INFORMATION RETRIEVAL NUMBER 216

Ultra-Fast Response THERMISTORS

LARGE VARIETY OF:
CONFIGURATIONS
SIZES
ASSEMBLIES

- RESPONSE TIMES TO 3 MILLISECONDS
- STANDARD RESISTANCES
- BEADS
- PROBES
- FLAKES
- INSULATED MINIATURE ASSEMBLIES



SPECIAL APPLICATIONS INVITED

THERMOMETRICS INC.
15 JEAN PLACE EDISON, N.J. 08817
(201) 548-2299

INFORMATION RETRIEVAL NUMBER 215

ELECTRONIC DESIGN 24, November 22, 1974

At last... a "slide rule" calculator that's big enough to use!



The new Heathkit IC-2100

Because the IC-2100 is larger than pocket calculators, it has contoured, finger-sized keys and bright 1/2"-tall Beckman displays. And it fits where most people use a scientific calculator — on a desk. To make it easier to use, we built in cumulative memory and register exchanges that eliminate scratchpad work. Of course, it performs the functions you need — trig and arc trig in degrees or radians, common and natural logs, powers of e, inverses, square roots, pi and exponential functions. It can even be wired for 120 or 240 VAC. And you can assemble it easily in a few evenings following the illustrated step-by-step instructions. In short, we designed the IC-2100 to help solve all your problems... in a big way.

Kit IC-2100, 4 lbs., available **119.95***

Send for **FREE '75 Heathkit Catalog**



Heath Company, Dept. 60-11
Benton Harbor, Michigan 49022

- Please send my FREE '75 Heathkit Catalog.
 Enclosed is \$_____ for _____
IC-2100's at \$119.95* each, plus shipping.

Name _____
Address _____
City _____ State _____ Zip _____

*MAIL ORDER PRICE, FOB FACTORY. GX-305

PRICES AND SPECIFICATIONS SUBJECT TO CHANGE WITHOUT NOTICE.

INFORMATION RETRIEVAL NUMBER 217

291

There's only 1
low priced
12 bit D/A...



that remains
monotonic over
it's temperature
range.

It takes precision matched ladder resistors that track to 2ppm/°C to achieve 12 bit monotonicity. And all the other low cost D/A's fail to provide sufficient linearity drift to pass the monotonicity test with temperature. In fact most don't even specify linearity drift which is the key D/A performance parameter. At \$59 (1 to 9 pieces) the 411-12 is the lowest cost for the performance.

And they're in stock!

Other 411 Models with corresponding price/performance are available...

Call or write today

FUNCTION MODULES, INC.
711B W. Seventeenth St.
Costa Mesa, CA 92627
Phone: (714) 645-6001

NEW LITERATURE



Instruments

Instrumentation detailed in a six-page catalog includes FM/AM signal generators, FM deviation meters, HF spectrum analyzers, mobile radio test gear, AM/FM/SSB receivers, TV test equipment, intermodulation and baseband test gear, programmable test equipment, microwave instrumentation, bridges and Q-meters and PCM/digital test equipment. Marconi Instruments, Englewood, NJ

CIRCLE NO. 460

Computer systems

Everything you need to get data from you to your computer and back efficiently is highlighted in a 14-page booklet. GTE Information Systems, Stamford, CT

CIRCLE NO. 461

Panel meters

A 44-page illustrated catalog describes analog panel meters for OEM or replacement application. The catalog features easy-to-read price and ordering information, dimensional drawings, an interchangeability guide and a glossary of terms. General Electric, Schenectady, NY

CIRCLE NO. 462

Tools

A 112-page handbook, "Tools for Electronic Assembly and Precision Mechanics," describes over 2500 individual items. Jensen Tools and Alloys, Phoenix, AZ

CIRCLE NO. 463

Gas discharge displays

"Displays and Accessories Short Form Technical Bulletin" presents specifications and color illustrations of information displays, subassemblies and accessories. Schematic drawings present dimensions, configurations and applications. Beckman Information Displays Operations, Scottsdale, AZ

CIRCLE NO. 464

Instrumentation

Details on testing, measuring, monitoring and control with graphic recording instruments are given in a 24-page condensed catalog. Gulton Industries, East Greenwich, RI

CIRCLE NO. 465



Connectors

A 38-page catalog provides information on a contact connector system. Complete sections are included describing the large variety of miniature rectangular and round connectors, special hardware and installation tooling. Burndy, Norwalk, CT

CIRCLE NO. 466

Rf communications products

Communication components are described in a 20-page catalog. Uhf, vhf and microwave discrete transistors and MICRoAMP and rf amplifier modules, amplifier and transistor products for mobile-radio applications, and hybrid amplifiers and discrete transistors for CATV applications are included. TRW RF Semiconductors, Lawndale, CA

CIRCLE NO. 467

THE WORLD'S SMALLEST LATCHING FORM C REED RELAY.

The R-relay is available in hermetically-sealed and magnetically-shielded versions in any of three operating modes: polar single side stable; bistable

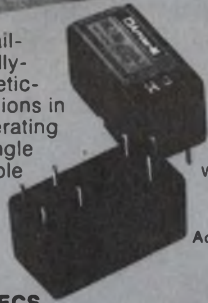

latching single coil; and bistable latching double coil. There's nothing in the world like it. The price is small, too. Call or write for complete data and prices.

Actual size: .394" H x .394" W x .787" L

INCREDIBLE SPECS

Speed: 500 Hz
Low operating power:
40 mW bistable,
80 mW single side stable
DC switching capacity:
Min/max (dry):
100 μ A, 100 mV/0.1 A, 1.2 W
Min/max (power):
40 mA, 1 V/1 A, 20 W
Twin contacts

Contact press: 5 g min.
Shock resist.: >100 G
Vibration resist.:
>10 G @ 10-550 Hz
Operating Temp.: -55 ~ +65°C
Bounce: 0.3 msec, approx.
Long life: >10⁹ mechanical
operations
Weight: 175 ounce
Size: .394" H x .394" W x .787" L

Relays for advanced technology.



Arrow-M Corp. 250 Sheffield St., Mountainside, N.J. 07092 U.S.A.
Telephone: 201-232-4260

INFORMATION RETRIEVAL NUMBER 219

Internal flag, magnetic latching BITE indicator.



ACTUAL SIZE

The MI57D low power drain
(1 watt - 25
milliseconds)
fast response,
high sensitivity

indicator has met the test in both military and industrial applications.

The flag in the MI57D is magnetically held in position and will change color only when the reset coil is pulsed.

Qualified to MIL-I-83287/02.

Further information
and complete
specifications
on request.



MINELCO

Division General Time Corp.

A TALLEY INDUSTRIES COMPANY

135 SOUTH MAIN STREET • THOMASTON, CONN. 06787
PHONE: 203/283-8261 • TWX: 710/475-1091

INFORMATION RETRIEVAL NUMBER 220

PERSONNEL RECRUITMENT ADVERTISING IN Electronic Design

REACHES THE
RIGHT PEOPLE
AT A LOWER COST
PER THOUSAND

Call the
HOTLINE
today
for complete
information:
(201) 843-0550
extension 246

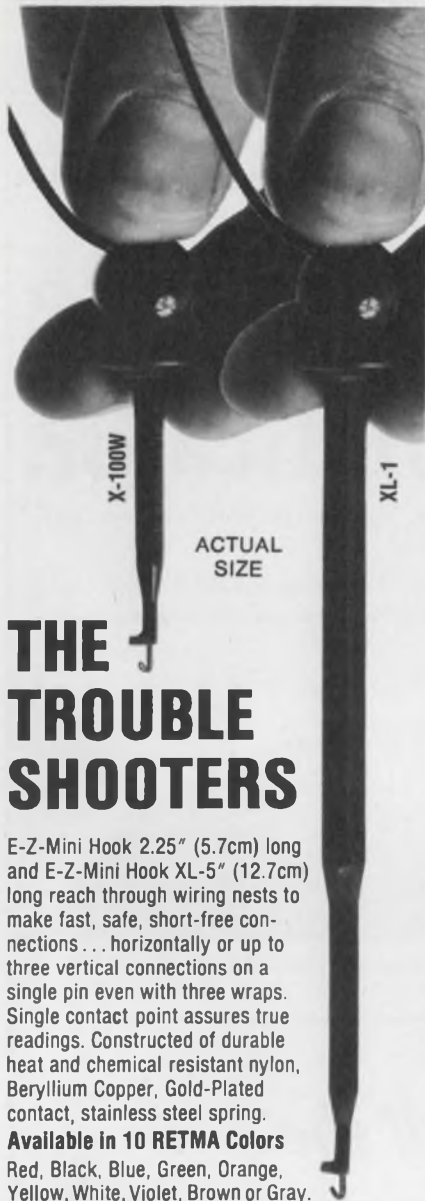

THE TROUBLE SHOOTERS

E-Z-Mini Hook 2.25" (5.7cm) long and E-Z-Mini Hook XL-5" (12.7cm) long reach through wiring nests to make fast, safe, short-free connections... horizontally or up to three vertical connections on a single pin even with three wraps. Single contact point assures true readings. Constructed of durable heat and chemical resistant nylon, Beryllium Copper, Gold-Plated contact, stainless steel spring.

Available in 10 RETMA Colors
Red, Black, Blue, Green, Orange, Yellow, White, Violet, Brown or Gray.

EACH SIZE AVAILABLE IN TWO TIP STYLES



X-100W (2 1/4" long)
XL-1 (5" long)
Square Hole Tip

For lateral or vertical hookups to square wire wrapped pins, or component leads.



X-100W2 (2 1/4" long)
XL-2 (5" long)
Rectangular Hole Tip

For lateral or vertical hookups to rectangular wire wrapped pins or component leads.

EXCLUSIVE FIELD SERVICEABLE FEATURE



Damaged lead wire easily replaced.

Send for complete catalog & price list.

E-Z-HOOK®

114 EAST SAINT JOSEPH STREET
ARCADIA, CALIFORNIA 91006
(213) 446-6175 / TWX 910 582 1614

bulletin board

TRI-DAC Corp. has introduced its first thyristor product line—DIACs with breakover voltages of 32, 40, 50 and 60 V. In addition, the company offers 3-to-40-A TRIACs and 1-to-60-A SCRs.

CIRCLE NO. 447

Beckman Instruments has increased prices up to 10% on laboratory analytical instruments and selected industrial process instruments.

CIRCLE NO. 448

Globe Battery Div. has extended its standby power offerings from 100 to 1680 ampere-hours with the introduction of a new series of Tel/Cell communications and switch-gear batteries.

CIRCLE NO. 449

Five new laboratory computer systems priced up to 37% below its currently available configurations have been announced by **Digital Equipment's Laboratory Data Products Group**. They comprise the DECLAB-11/10 family.

CIRCLE NO. 450

Tektronix' 4013 computer display terminal has been granted approval by Underwriters' Laboratories.

CIRCLE NO. 451

Innovation Data Processing has introduced **FATS (Fast Analysis of Tape Surfaces)**, an OS, DOS or VS tape certification of one to nine tapes, on-line, at tape speed. Most IBM-compatible brand tape drives can be used by FATS.

CIRCLE NO. 452

End users can now purchase **Hewlett-Packard's 21MX mini-computers** in single quantities. Single-unit prices start at \$5950.

CIRCLE NO. 453

Technitrol can handle custom functional testing of memory systems—MOS (n and p channel), bipolar (ECL, TTL), RAMs, plated wire and core memories—at machine speeds to 10 MHz.

CIRCLE NO. 454

Cambridge Memories has increased lease and purchase prices 6 to 8% on its line of 370/STOR computer memory systems.

CIRCLE NO. 456

Hybrid Systems has introduced the **DELTAVERTA** line of system modules for analog data acquisition, transmission and retrieval.

CIRCLE NO. 457

Almost all of the p-channel MOS ICs manufactured by **Signetics**, 811 E. Arques Ave., Sunnyvale, CA 94086 are immediately available in quantity.

INQUIRE DIRECT

Price reductions

Datanetics' ASR-33-type keyboard is being offered at a significantly lower cost—up to 36% in small quantity orders.

CIRCLE NO. 458

Scanbe Manufacturing Corp. has announced a price reduction of 40% on its line of standard PC card ejectors.

CIRCLE NO. 459

SUBSCRIBER SERVICE For prompt service include the addressed label when writing about your subscription.

CHANGE OF ADDRESS

NEW ADDRESS	name	company	division/department	company address	city	state	zip

If you're moving, please let us know six weeks before changing your address. If you have a question, place your magazine address label here and clip this form to your letter.

MAIL TO: ELECTRONIC DESIGN Circulation Dept. Hayden Publishing Co., Inc., 50 Essex Street, Rochelle Park, NJ 07662

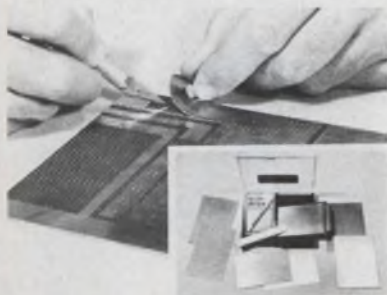

Cut & Peel Circuit Board Kit. Cut prototype boards or ground planes. Assortment of 7 includes one and two sided Cut & Peel Boards on .100" grid drilled and plain epoxy-glass, "X" and "X-Y" Board, a plug-in Cut & Peel GP Board with etched gold/nickel edge connector, and a special knife. Kit #8964 is \$37.00. Circuit-Stik, Inc. Box 3396, Torr., CA 90510.

INFORMATION RETRIEVAL NUMBER 601



Save time! Use Circuit-Stik's Desk Supply Kit to make prototype circuit boards. Keep Circuit-Stik adhesive backed subelements, interconnecting tapes, etched donut pads, and .100" grid drilled epoxy-glass at your desk for use 'When you need it'. #8963 Kit price of \$49.00 save \$7.00. Circuit-Stik, Inc. Box 3396, Torrance, CA 90510 (213) 530-5530.

INFORMATION RETRIEVAL NUMBER 604

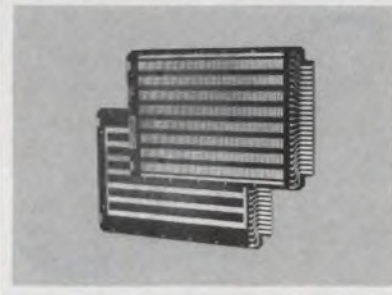

Special 2 for 1 GP board offer. For all DIP's with .300" to .600" lead spacing. Solder I.C.'s directly or plug into sockets. Computer drilled blue FR4 epoxy-glass features high quality gold/nickel plated connector fingers and bright tin plated circuitry. \$15.95 for two GP Boards through Feb. '75. Circuit-Stik, Inc. 24015 Garnier St. Torr., CA 90510.

INFORMATION RETRIEVAL NUMBER 607



3 THINGS MAKE A GREAT TAPE CORE: The proper materials . . . correct engineering . . . Magnetics. Magnetics has been a leading supplier of high permeability tape wound cores and magnetic components since 1949. Our tape cores helped put men on the moon; are used exclusively for Viking Mars Lander. Magnetics, Butler, Pa. 16001.

INFORMATION RETRIEVAL NUMBER 602

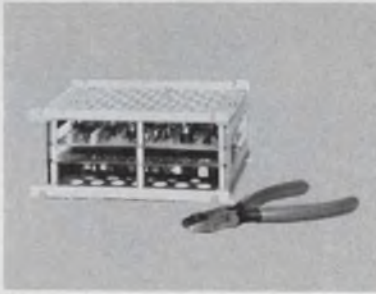

Model MOD-815 A/D Converter. Digital data with 8-bit resolution at any random or periodic word rate from DC through 15 MHz. Only 100 cu. in. Power dissipation approx. 20 watts. Computer Labs, 1109 S. Chapman St., Greensboro, N.C. 27403.

INFORMATION RETRIEVAL NUMBER 605

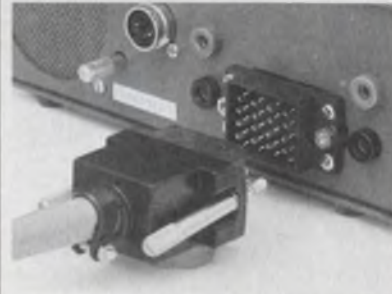

Rugged and low-cost 36-pin connector. Suberly designed and produced with simplified construction. Cut your costs up to 50%. Moisture-resistant glass-filled nylon insulator Recessed contacts in both male and female housings. Hood provides positive cable strain relief. Interchangeable. E. F. Johnson Co., Waseca, MN. (507) 835-2050.

INFORMATION RETRIEVAL NUMBER 608



Free 84-page Printed Circuit Drafting Aids Technical Manual & Catalog contains hundreds of time & money-saving tips, plus details on over 15,000 component symbols & tapes, film, vellum, grids. Bishop Graphics, Inc., 20450 Plummer St., Chatsworth, California, 91311, (213) 993-1000.

INFORMATION RETRIEVAL NUMBER 603

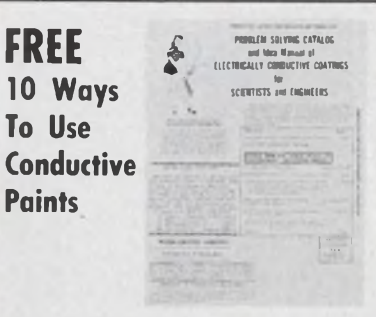

**FREE
10 Ways
To Use
Conductive
Paints**

Our electrically conductive paints are solving "impossible" lab problems and reducing unit production costs. One customer saves a fortune each year PAINTING on four MILLION pin head 1000 meg resistors. Add that up. Why not request "Ten Ways To Use Conductive Paints"? Micro Circuits Co., New Buffalo, Mich. 49117. (616) 469-2727.

INFORMATION RETRIEVAL NUMBER 606

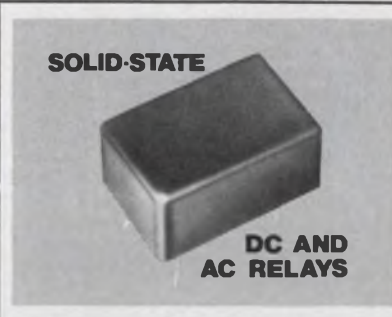

SOLID-STATE

**DC AND
AC RELAYS**

For computer peripherals and other high-speed, high-reliability switching jobs, with either DC or AC loads up to 6 amp, these transformer-coupled Heinemann relays offer highest sensitivity, isolation, accuracy for TTL and other low-level control signals. Heinemann Electric Company, Trenton, NJ 08602.

INFORMATION RETRIEVAL NUMBER 609

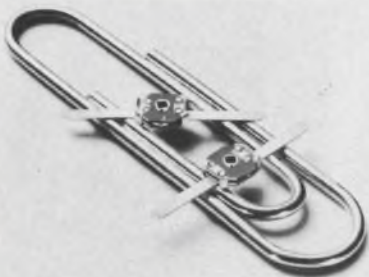

Thin-Trim variable capacitors provide a reliable means of adjusting capacitance without abrasive trimming or interchange of fixed capacitors. Series 9401 has high Q's and a range of capacitance values from 0.2-0.6 pf to 3.0-12.0 pf and 250 WVDC working voltage. Johanson Manufacturing Corporation, Boonton, New Jersey (201) 334-2676.

INFORMATION RETRIEVAL NUMBER 610



Free catalog of 34,500 power supplies from the worlds largest manufacturer of quality Power Supplies. New '74 catalog covers over 34,500 D.C. Power Supplies for every application. All units are UL approved, and meet most military and commercial specs for industrial and computer uses. Power Mate Corp. (201) 343-6294.

INFORMATION RETRIEVAL NUMBER 613

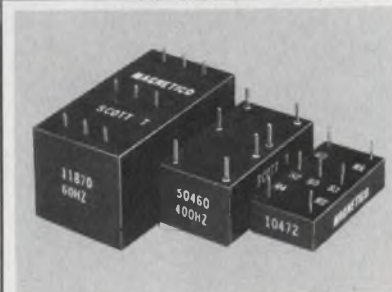

Scott T Transformer. 11870: 60HZ, 90v, L-L in. 1.1x2.1x1.1. 50460: 400HZ, 90v, L-L in. 7/8x1-5/8 x11/16. 50642: 400HZ, 11.8v, L-L in. 7/8x1-5/8-11/16. 10472: 400-HZ, 11.8v, L-L in. 3/4x1-1/2x3/8. All with 6v RMS sine & cosine output. MAGNETICO, INC., 182 Morris Ave, Holtville, N.Y. 11742 516-654-1166.

INFORMATION RETRIEVAL NUMBER 616

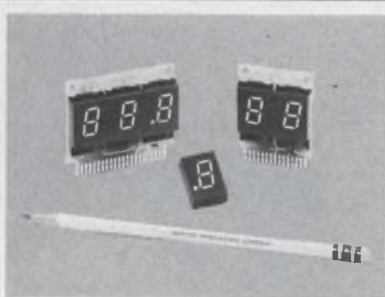

Plug-in LED Display Assemblies with decoder/driver circuits already assembled, ready to plug-in and read-out. Accepts 4-line BCD input. Operates from 5 VDC. Utilizes 0.6" high red numeric LED display. Master Specialties, 1640 Monrovia, Costa Mesa, Calif. 92627. (714) 642-2427.

INFORMATION RETRIEVAL NUMBER 611

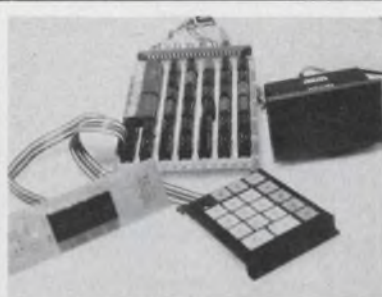

Calculator - BCD Interface. Complete 4 function calculator accepts up to 5 BCD decades from DVM, counter or keyboard. Outputs 7 segment info plus 8 decades BCD. Board TTL compatible - single 5V supply. Many options. \$365. unit quantity. Elcom Ind. Inc., Civil Air Terminal, Bedford, MA 01730 (617) 274-6656.

INFORMATION RETRIEVAL NUMBER 614



LED Digital Displays have attractive one piece bezel constructed of black anodized aluminum. Units employ H.P. 7750 - .43" high char. 2 thru 10 digits are stock. Options include series resistors or decoder drivers. Standard termination is 30" cable or wire wrap pins. Rochester Digital Displays Inc. 120 N. Main St. Fairport, N.Y. 14450 (716) 223-6855.

INFORMATION RETRIEVAL NUMBER 617

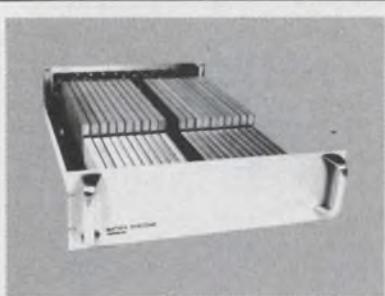

Programmable Audio Switching System features up to 400 Two Wire Switchpoints. It may be interconnected in nearly any configuration ie, Multipole, Multithrow, Matrix or Scanner. System may be controlled by 16 bits TTL compatible I/O Buss or 28 VDC. MATRIX SYSTEMS CORPORATION (213) 882-2008.

INFORMATION RETRIEVAL NUMBER 612



New low profile low cost TTL DIP Crystal Oscillator measures only 0.3" high x 0.49" w x 0.78" L; plugs into single IC socket; available at any fixed frequency from 4 MHz to 20 MHz, with frequency tolerance $\pm 0.01\%$ from -25°C to $+75^{\circ}\text{C}$; fan-out 10 TTL. Supply 5 Vdc $\pm 5\%$. Connor-Winfield Corp., West Chicago, Ill. 60185 (312) 231-5270.

INFORMATION RETRIEVAL NUMBER 615



Basic Engineering Sciences & Structural Engineering for E-I-T Exams. Sampling for test problems makes the best preparation yet for exams. #5712-1, 424 pp., \$14.95. Circle the Info Retrieval No. to order 15-day exam copy. When billed, remit or return book with no obligation. Hayden Book Co., 50 Essex St., Rochelle Pk., N.J. 07662

INFORMATION RETRIEVAL NUMBER 618



STOP WRITING YOUR NAME

IDEAL FOR trade shows & information retrieval cards, this handy professional name and address stamp comes in a convenient, pocket size pack, complete with ink pad. \$4.95 Postpaid. (CA res. add .30 tax.) STAMP-CO, P.O. BOX 942, Los Angeles, CA 90028 or circle number for order form. BankAmerica or Master Charge.

INFORMATION RETRIEVAL NUMBER 619



Digital to synchro converters—14, 12 or 10 bit input, 11.8/90V, 400 or 60Hz transformer isolated output, accuracy ± 4 , ± 15 or ± 30 min. Driving 1VA, 2VA (2.6" x 3.1" x 82"H module) or 5 VA loads (4 1/2" x 9 1/4" pc card). Price from \$350 in qty. Computer Conversions Corp., East Northport, N.Y. 11731. (516) 261-3300.

INFORMATION RETRIEVAL NUMBER 622

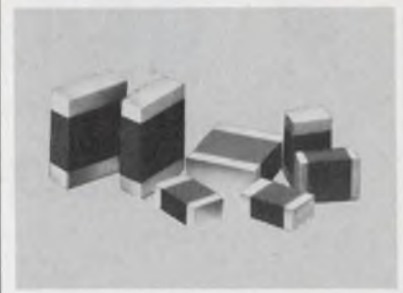

HIGH Q MULTILAYER CAPACITORS feature very high quality factors at microwave frequencies. Offered in three standard sizes: .050 x .040, .080 x .050, .125 x .095. Capacitance values from 0.1 pf to 1000 pf with close tolerance and voltages to 1000 VDCW. Johanson/Monolithic Dielectrics Div., Box 6456, Burbank, Ca. 91510, (213) 848-4465.

INFORMATION RETRIEVAL NUMBER 625



Electrical/Electronics Checklists. 22 detailed checklists to insure complete accuracy and efficiency for a broad array of designs. #9181, 190 pp., \$14.00. Circle the Info Retrieval No. to order 15-day exam copy. When billed, remit or return book with no obligation. Hayden Book Co. 50 Essex St., Rochelle Pk., N.J. 07660.

INFORMATION RETRIEVAL NUMBER 620

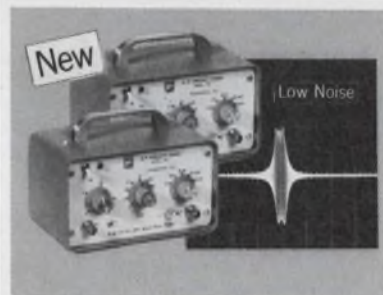

Low cost tuned Band-Pass (Spike) Filter features variable center frequencies and bandwidths. Gain preserved at passband's center frequency independent of frequency and bandwidth settings. Units can be cascaded for staggered tuning effect. Range 0.1 Hz - 10,000 Hz. A. P. Circuit Corp., 865 West End Ave, NY NY 10025 (212) 222-0876.

INFORMATION RETRIEVAL NUMBER 623

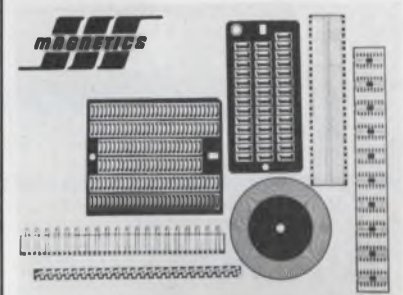

THIN METAL PARTS BY MAGNETICS' PHOTOETCH PROCESS cuts costs and lead time substantially. Photoetching eliminates die costs, assures precise tolerance and uniformity. Ideal for recording head laminations, lead frames, etc. We stock popular alloys, .000125" up. Full plating, selective plating offered. Magnetics, Butler Pa. 16001.

INFORMATION RETRIEVAL NUMBER 626

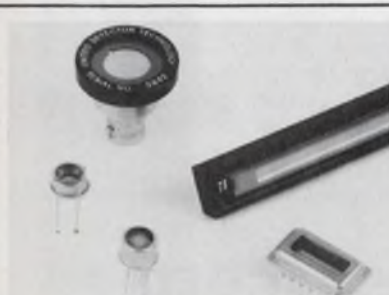

UDT offers a complete line of silicon photodiodes. Schottky for large area and enhanced UV responsivity, planar diffused for low noise and extended responsivity, photops (detector/amplifier combinations), special arrays and detectors to customer specifications. United Detector Technology, 2644 30th St., Santa Monica, Ca. 90405 (213) 396-3175.

INFORMATION RETRIEVAL NUMBER 621

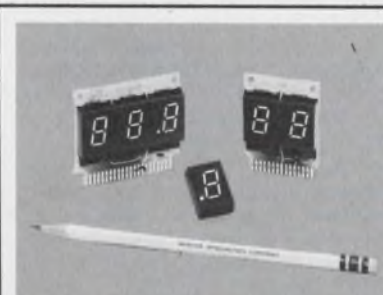

Plug-in LED Display Assemblies with decoder/driver circuits already assembled, ready to plug-in and read-out. Accepts 4-line BCD input. Operates from 5 VDC. Utilizes 0.6" high red numeric LED display. Master Specialties, 1640 Monrovia, Costa Mesa, Calif. 92627. (714) 642-2427.

INFORMATION RETRIEVAL NUMBER 624

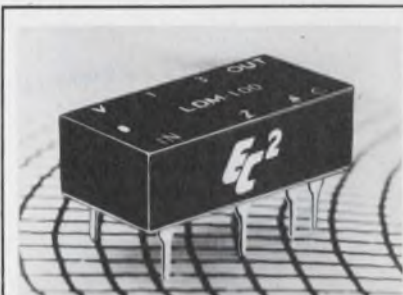

EC's new T-L Compatible Logic Delay Module features 14-pin DIP package (.250 high); precise delays from 25ns to 250ns; with T-L input and outputs; taps at 20% increments, each isolated and with 10 T-L fan-out capability. Engineered Components Company, 3580 Sacramento Drive, San Luis Obispo, CA 93401 (805) 544-3800.

INFORMATION RETRIEVAL NUMBER 627

Circuit Savers

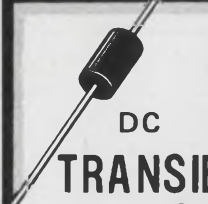

DC **95¢**
1000 pcs.
TRANSIENT SUPPRESSOR

The TSD-1.5 Series are ideal for protection of long signal lines from damage from induced lightning etc. Reaction time is in nanoseconds.

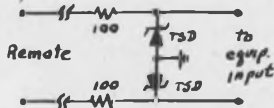

2 units (back to back) will protect sensitive components from a 5KV, 1ms duration transient. Clamp voltages from 5V to 200V. Call Mike Coyle for applications assistance. Full line of protection modules for every hi-lo voltage/current requirement. Write or call for Catalog 749.

279 Skidmore Road
Deer Park, New York 11729
Telephone: 516 - 586-5125

MCG Electronics

INFORMATION RETRIEVAL NUMBER 224

TOYO HCM FILTER T-2 SERIES



TOYOCOM was the first in the world to produce a marketable monolithic crystal filter.

The brand name was designated TOYO HCM FILTER.



EXPORT DEPARTMENT
TOYO BUILDING, NO 8-12-20 JINGUMAE,
SHIBUYA-KU TOKYO, JAPAN
CABLE: EXPORTTOYOCOM-TOKYO
TEL: 03-408-3255
TELEX: 02423001

INFORMATION RETRIEVAL NUMBER 225

Electronic Design

ELECTRONIC DESIGN's function is:

- To aid progress in the electronics manufacturing industry by promoting good design.
- To give the electronic design engineer concepts and ideas that make his job easier and more productive.
- To provide a central source of timely electronics information.
- To promote communication among members of the electronics engineering community.

Want a subscription? ELECTRONIC DESIGN is sent free to qualified engineers and engineering managers doing design work, supervising design or setting standards in the United States and Western Europe. For a free subscription, use the application form bound in the magazine. If none is included, write to us direct for an application form.

If you do not qualify, you may take out a paid subscription for \$30 a year in the U.S.A., \$40 a year elsewhere. Single copies are \$1.50 each.

If you change your address, send us an old mailing label and your new address; there is generally a postcard for this bound in the magazine. You will have to requalify to continue receiving ELECTRONIC DESIGN free.

The accuracy policy of ELECTRONIC DESIGN is:

- To make diligent efforts to ensure the accuracy of editorial matter.
- To publish prompt corrections whenever inaccuracies are brought to our attention. Corrections appear in "Across the Desk."
- To encourage our readers as responsible members of our business community to report to us misleading or fraudulent advertising.
- To refuse any advertisement deemed to be misleading or fraudulent.

Microfilm copies are available of complete volumes of ELECTRONIC DESIGN at \$19 per volume, beginning with Volume 1, 1961 through Volume 20. Reprints of individual articles may be obtained for \$2.00 each, prepaid (\$.50 for each additional copy of the same article) no matter how long the article. For further details and to place orders, contact the Customer Services Department, University Microfilms, 300 North Zeeb Road, Ann Arbor, Michigan 48106 telephone (313) 761-4700.

Want to contact us? If you have any comments or wish to submit a manuscript or article outline, address your correspondence to:

Editor
ELECTRONIC DESIGN
50 Essex Street
Rochelle Park, N.J. 07662

A GOLD MINE OF INFORMATION & DATA

- 520 CATALOG PAGES ON ICs & SEMICONDUCTORS
- 300 CATALOG PAGES ON INSTRUMENTS
- 290 CATALOG PAGES ON POWER SUPPLIES
- 210 CATALOG PAGES ON WIRE & CONNECTOR PRODUCTS
- 150 CATALOG PAGES ON SWITCHES
- 2800 CATALOG PAGES ALL TOLD IN 52 PRODUCT CATEGORIES

Electronic Design's GOLD BOOK puts the entire electronics industry at your fingertips. Use it for product search, selection, specification and purchase. It's the most thorough industry master catalog & directory ever compiled.

When you need Information . . .

Electronic Design's

GOLD BOOK IS THE PLACE TO LOOK

Electronic Design Design Data from Manufacturers

Advertising Sales Staff

Tom W. Carr, Sales Director

Rochelle Park, N.J. 07662

Robert W. Gascoigne
Daniel J. Rowland

(Recruitment, Quick Ads, Classified)

50 Essex Street
(201) 843-0550
TWX: 710-990-5071

Philadelphia

Thomas P. Barth
50 Essex Street
Rochelle Park, N.J. 07662
(201) 843-0550

Boston 02178

Gene Pritchard
P.O. Box 379
Belmont, Mass. 02178
(617) 489-2340

Chicago 60611

Thomas P. Kavooras
Berry Conner, Jr.
200 East Ontario
(312) 337-0588

Cleveland

Thomas P. Kavooras
(Chicago)
(312) 337-0588

Los Angeles 90045

Stanley I. Ehrenclou
Burt Underwood
8939 S. Sepulveda Boulevard
Suite 510
Los Angeles, Calif.
(213) 641-6544

San Francisco 94022

Jerry D. Latta
P.O. Box 1248
Los Altos, Calif.
(415) 965-2636

London, Amsterdam, Tokyo, Seoul

John Ashcraft
12, Bear St.
Leicester Square
London WC2H 7AS England
Phone: 01-930-0525

W. J. M. Sanders
John Ashcraft & Co.
Herengracht 365
Amsterdam C., Holland
Phone: 020-24-09-08

Haruki Hirayama
Electronic Media Service
5th Floor, Lila Bldg.,
4-9-8 Roppongi
Minato-ku, Tokyo, Japan
Phone: 402-4556
Cable: Electronicmedia, Tokyo

Mr. O-kyn Park, President
Dongbo International
Corporation
I.P. O. Box 4010
Seoul, Korea
Phone: 28-1911
Cable: Dongbo Seoul

Advertisements of booklets, brochures, catalogs and data sheets. To order use Reader-Service Card

(Advertisement)

REAL-TIME ANALYZER FOR ROTATING MACHINERY NOISE/VIBRATION MEASUREMENTS

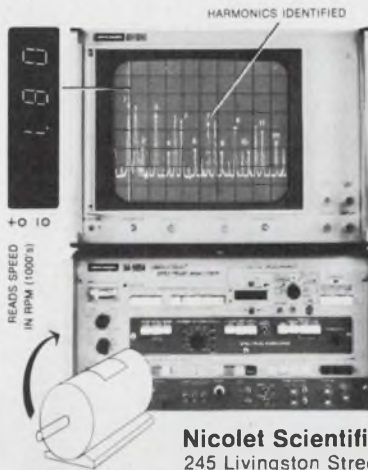

To simplify frequency analysis of noise/vibration in rotating machinery, new Ubiquitous® UA-500A-1 real-time spectrum analyzer with built-in calculator provides: digital measurement of not only absolute frequency, but also difference from a selected reference frequency to read variations from a nominal rotational speed directly; digital measurement of amplitudes in %-full scale (linear scale), dB-below-full-scale (log scales), or difference in dB above & below a selected ref level, so that amplitude of freq peaks (in 3 spectra stored in 3 memories) can be compared; readout of freq in CPM for direct measurement of RPM, (and in Hz or cycles/sec); identification of all spectrum peaks harmonically related to a selected fundamental, such as main shaft rotation, to easily separate them from other signal sources. Built-in dual-memory averager combined with main processing memory of Analyzer provides storage of 3 separate spectra for comparison of standard machine signatures with new ones as they are analyzed.

Demo, circle 170
Lit., circle 171

Nicolet Scientific Corp. (formerly Federal Scientific Corp.)
245 Livingston Street, Northvale, New Jersey 07647
(201) 767-7100. TWX: 710-991-9619

New Precision Low Frequency Analyzer



A new brochure describes Quan-Tech's new Model 2449 Wave and Spectrum Analyzer which covers frequency measurements from 10 Hz to 50 KHz in one range with 1 Hz resolution. Frequency readout: 5 digit LED display. Electronic tuning with sweep increments of 5 or 50 KHz can be initiated at any starting frequency in the spectral range. Selectable sweep periods of 50 or 500 seconds. Select a 7 Hz bandwidth for high precision frequency measurements—a 1000 Hz bandwidth for high scan capability—or a 100 Hz bandwidth for a compromise between resolution and scan speed. Dynamic range greater than 75 dB, full scale input signal voltage from 30 μ V to 300 V in 15 ranges. Priced at only \$2050., the instrument is portable—weighs 20 lbs. Option provides 115 VAC for lab use or 12 VDC for field use. Front and rear covers available. Delivery: 30 days.

CIRCLE NO. 173

Quan-Tech

Div. Scientific-Atlanta, Inc.
Randolph Park West, Route #10
Randolph Township, N.J. 07801, Phone #201-361-3100

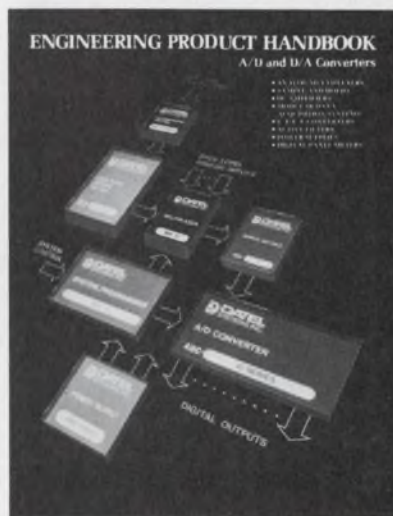

70 page A/D-D/A Engineering Product Handbook

A new 70 page product handbook contains detailed electrical and mechanical information on A/D—D/A Converters, Sample/Hold Amplifiers, Wide Band DC Amplifiers, Instrumentation Amplifiers, Analog Multiplexers, DC-DC Converters and Data Acquisition Systems. Also included are typical applications for Data Conversion Devices.

DATEDL
SYSTEMS, INC.

CIRCLE NO. 174

1020 Turnpike St., Canton, Mass. 02021/(617) 828-8000



advertiser's index

Advertiser	Page	Advertiser	Page	Advertiser	Page
A. P. Circuit Corp.....	277	Datel Systems, Inc.....	299	Hughes Aircraft Company, Connecting Devices	15
A-H Systems	287	Datum, Inc.	232	Hughes Aircraft Company, Electron Dynamics Division.....	247
AMP, Incorporated	214, 215	Decitek, A Division of Jamesbury Corp.	270	Hughes Aircraft Company, Auto Analysis Division.....	228
AVX Ceramics Corporation.....	174, 175	Dialight Corporation	36	Hybrid Systems Corp.....	237
Acopian Corp.	205	Digital Equipment Corporation	232D, 232E		
Addmaster Corporation	262	Dit Mco International.....	282		
Adret Corporation	224	Dranetz Engineering Laboratories Inc.	263		
Advertising Council	232J	Duncan Electronics, Subsidiary of Systron-Donner	80		
Airco Electronics	232L	Dynascan Corporation	110		
Alco Electronic Products, Inc.....	287			ISE Electronics Corporation	243
Allen Bradley Co.....	62	E-Z Hook	294	ITT Semiconductor, a Division of International Telephone and Telegraph Corporation.....	241
Allen Avionics, Inc.....	280	Elcom Industries	296	Industrial Electronic Engineers, Inc.....	272
Amerace Corporation	29	Electronic Design	268, 269, 293	Inland Motor Division, Kollmorgen Corporation	287
American Microsystems, Inc.....	30, 31	Electronic Communications, Inc.....	238	Instruments for Industry, Inc.....	210
American Optical Corporation.....	271	Electronic Devices	289	Instrument Specialties Company, Inc.	203
Amperite Co.	210	Electronic Navigation Industries.....	226	Intech, Incorporated	212
Amphenol Industrial Division, Bunker-Ramo Corp.	38, 39	Electronic Research Corporation.....	246	Intel Corporation	4, 5
Amphenol RF Division, The Bunker-Ramo Corporation	81	Emerson & Cuming, Inc.....	279	Interdata	261
Analog Devices, Inc.....	60, 61	Engineered Components Company.....	296	Interstate Electronics Corporation.....	137
Analogic Corporation	24	Erie Technological Products, Inc.....	129	Itek Measurement Systems Division.....	291
Arrow-M Corp.	293	Esterline Angus Instruments Corp.....	304	Isotronics Inc.	244
Augat, Inc.	113	Exact Electronics, Inc.....	199		
		Exar Integrated Systems.....	1		
Bafco, Inc.	264			Johanson Manufacturing Corp.....	7, 296
Ballantine Laboratories, Inc.....	287, 289	Fluke Mfg. Co., Inc., John.....	213	Johanson/Monolithic Dielectrics Div.	297
Bead Electronics	281	Fluke Mfg. Co., Inc., Ltd., John.....	230	Johnson Company, E. F.....	219, 295
Beckman Instruments, Inc. Helipot Division	20	Frequency Electronics, Inc.....	232K		
Bendix Corporation, The, Electrical Components Division.....	187	Fujitsu Limited	136		
Berg Electronics, Inc.....	179	Function Modules, Inc.....	294		
Biomation	265			Kaman Sciences Corp.....	270
Bishop Graphics, Inc.....	295	GTE Sylvania, Parts Division.....	111	Kay Elemetrics	233
Bodine Electric Company.....	283	GTI Tensor Electronics, Inc.....	10	Keithley Instruments, Inc.....	96
Boonton Electronics Corporation.....	63	Gamma Scientific Incorporated.....	218	Keystone Carbon Company.....	278
Bud Radio, Inc.....	18, 19	General Automation, Inc.....	255	Keystone Electronics Corp.....	289
Burdny Corporation	180, 181	General Electric Company, Miniature Lamp Products Department	245	Kinsekisha Laboratory Ltd.....	244
		General Electric Company, Semiconductor Products Department	9	Krohn-Hite Corporation	21
CTS Corporation	235	General Radio Company.....	98, 217	Kurz-Kasch, Inc.	220
CELCO (Constantine Engineering Laboratories, Inc.)	14	Glowlite Corp.	138		
Centralab, The Electronics Division of Globe-Union, Inc.	25	Gold Book, The.....	250, 251, 232G, 271, 274, 275, 298	LSI Computer Systems, Inc.....	167
Cherry Electrical Products Corp.....	32	Gould, Inc., Instruments Systems Div.	283	Lambda Electronics Corp.	16, 16L1—L16
Chicago Dynamics Industries, Inc.....	267			Litronix, Inc.	160, 161
Circuit Stik, Inc.....	266, 295	Harris Semiconductor, A Division of Harris Intertype Corporation.....	168	Littelfuse, Subsidiary of Tracor.....	127
Clare & Co., C. P.	8	Hayden Book Company, Inc.	232H, 296, 297	Litton OEM Products.....	284
Clare-Pendar	211	Heath Company	291		
Computer Conversions	297	Heath/Schlumberger Scientific Instruments	73	MCG Electronics	298
Computer Labs, Inc.....	295	Hecon Corporation	273	MCL, Inc.	216
Conner-Winfield Corp.	296	Heinemann Electric Company.....	295	MF Electronics, Inc.....	260
Constantine Engineering Laboratories, Inc. (CELCO)	14	Hewlett-Packard	2, 55, 88 183, 185, 273	Macrodyne Inc.	242
Continental Connector Corporation	48	Hoffman Engineering Company.....	277	Magnecraft Electric Company.....	Cover III
Continental Specialties Corporation.....	272	Honywell Test Instruments Division	87	Magnetico, Inc.	296
Control Switch, Inc.....	285	Houston Instruments, A Division of Bausch & Lomb.....	290	Magnetics, Inc.	295, 297
Cunningham Corporation	286			Marconi Instruments	49 thru 54
Curtis Industries, Inc.....	258			*Marconi Instruments, Ltd.....	18
Cutler-Hammer, Specialty Products Division	121			Master Specialties	296, 297
				Matrix Systems	296
Dale Electronics, Inc.....	22, 23			Metron Optics	244
Dana Laboratories, Inc.....	71, 72			Micro Circuits Co.....	295
Data Display Products.....	218			Micro Networks Corporation.....	277
Data Precision Corporation.....	223			Micro Switch, A Division of Honeywell	146
Data Technology Corporation.....	232I			Minelco Division, General Time Corp.	293

recruitment and classified ads

Advertiser	Page	Advertiser	Page
Mini-Circuits Laboratory	267	Spectrum Technology Inc.	304
Micro Systems, Inc.	17	Sprague Electric Company	254
Monsanto, United Systems Corporation Subsidiary	240	Stacoswitch	248
Monsanto Commercial Products Company	221	Stampco	297
Mos Technology	82, 83	Switchcraft, Inc.	232A
Mostek Corporation	139	Sylvania Miniature Lighting Products, Inc.	249
Motorola Components Products Dept.	195	Syntronic Instruments, Inc.	280
Motorola Semiconductor Products, Inc.	12, 13	Systron-Donner	229
MuRata Corporation of America	304	Systemation Inc.	285
Nicolet Instrument Corp.	194	TEC, Incorporated	231
Nicolet Scientific Inc.	299	T.R.I. Corporation	248
North American Philips Controls Corp.	271	TRW/IRC Resistors, an Electronic Component Division of TRW, Inc.	112
PRD Electronics, Inc.	226	Tektronix, Inc.	35, 37, 169
PSG Industries Inc.	279	Tele-Dynamics/Wanlass Division of Ambac	259
Paktron, Division Illinois Tool Works, Inc.	277	Teledyne Philbrick	189
Panasonic Matsushita Electric	239	Texas Instruments, Incorporated	89
Perfection Mica Company	288	Texscan Corporation	264
Permag	260	ThermoMetrics	291
*Philips Electronic Components and Materials Division	19, 20	Toyo Communications Equipment Co., Ltd.	298
*Philips Test and Measuring Instruments	25	Tracor, Inc.	256
Philips Industries, Test and Measuring Instruments	283	Triplett Corporation	197
Pico Electronics, Inc.	Cover II	Trompeter Electronics	258
Piher International Corp.	232F, 232G	Union Carbide, Components Dept.	128
Plessey Semiconductors	120A-H	Unitrak Division, Calabro Plastics, Inc.	173
Pomona Electronics Co., Inc.	252	United Detector Technology, Inc.	297
Power/Mate Corp.	296	United Systems Corporation, a subsidiary of Monsanto	240
Power-One	279	Vactec, Inc.	99
Powertec, Inc.	123	Valdyne Engineering Corporation	289
Precision Monolithics Incorporated	201	Varadyne Industries, Inc.	26
Princeton Applied Research Corp.	252	Varian Data Machines	120
Pro-Log Corporation	284	Varo Semiconductor, Inc.	256
Pyrofilm Corporation	232B, 232C	Vernitron Control Components	291
Quan-Tech, Division of Scientific-Atlanta, Inc.	299	Viking Industries Inc.	86
Questronics, Inc.	273	Vishay Resistor Products, a division of Vishay Intertechnology, Inc.	234
RCA Electronic Components	138	Wagner Electric Corporation	126
RCA Solid State	Cover IV	Wahl Clipper Corp.	236
RCL Electronics, Inc.	10	Watkins-Johnson	70
RSM Sensitron	225	Wavetek Indiana Incorporated	208
Radio Materials Company	281	Wesco Electrical Company	222
Rental Electronics, Inc.	257	Weston Components	276
Repcor, Inc.	285	Weston Instruments, Inc.	148, 149, 159
Reticon	227	Woven Electronics	6
Rochester Digital Displays	296	Zero Manufacturing Co.	267
Rogan Corporation	193		
Rohde & Schwarz	207		
Rotron, Inc.	253		
Schauer Manufacturing Corp.	236		
Sealed Air Corporation	304		
Sola Electric, Division of Sola Basic Industries	188		
Spectral Electronics Corporation	97		
Spectrum Control Inc.	262		

*Advertisers in non-U.S. edition.

SAME DAY SHIPMENT Minis & Peripherals PRINTERS Some "BRAND NEW" DATA PRODUCTS

2440—700 LPM
2470—1250 LPM \$9500
MOHAWK DATA SCIENCES
4320—300 LPM
4330—380 LPM
CONTROL DATA CORP.
9322—200 LPM \$2500
9352—600 LPM

ALSO CENTRONICS, POTTER,
A. B. DICK, IBM, HIS, UNIVAC
617-261-1100

Send for Free Report
"Maintenance of Computers"

AMERICAN USED
COMPUTER CORP.

P.O. Box 68, Kenmore Sta.,
Boston, MA 02215

member
COMPUTER DEALERS ASSOCIATION

CIRCLE NO. 251

FREE ALARM CATALOG

Full line of professional burglar and fire alarm systems and supplies. 96 pages, 450 items. Off the shelf delivery, quantity prices.



mountain west alarm
4215 n. 16th st., phoenix, az. 85016

CIRCLE NO. 252

State Variable Active Filter
Configuration Handbook
\$5.95 plus 85¢ handling and
shipping. (Cal. add 6%)

ESTEP ENTERPRISES

5217 Cangas Drive
Agoura, Ca 91301

CIRCLE NO. 253

HERMETIC SEALING

Connectors • Headers • Relay Bases
Terminals • Custom Seals • Testing
Glass/Ceramic To Metal • Since 1959

DETRONICS CORPORATION

10660 E. Rush • S. El Monte, CA 91733
(213) 579-7130 • TWK 910-587-3436

CIRCLE NO. 254

product index

Information Retrieval Service. New Products, Evaluation Samples (ES), Design Aids (DA), Application Notes (AN), and New Literature (NL) in this issue are listed here with page and Information Retrieval numbers. Reader requests will be promptly processed by computer and mailed to the manufacturer within three days.

Category	Page	IRN	Category	Page	IRN	Category	Page	IRN
Components			sockets	249	298	detector, thermopile	237	353
attenuators (NL)	288	431	solid-state thermostats	279	187	diodes, light-emitting	240	355
bite indicator	293	222	switch	97	42	diodes, low leakage	242	359
capacitor, electrolytic	136	57	switch, DIP	218	328	diodes, Schottky	234	348
capacitor, solid-			switches	232A	271	diodes, switching	242	361
aluminum	216	325	switches	267	160	display, 7-segment	236	350
capacitors	7	6	switches	285	199	display, 7-segment	244	362
capacitors	26	20	switches	286	202	indicators, LED	245	365
capacitors	128	55	switches and keyboards	32	23	LED panel lights	218	98
capacitors	129	56	switches, pushbutton	287	205	LEDs	36	25
capacitors	222	103	switches, rotary	25	19	LEDs	161	65
capacitors, ceramic (NL)	290	446	switches, toggle	287	204	opto-isolators	221	102
capacitors, ceramic	11	9	switchlights	211	91	phototransistors	99	44
capacitors, ceramic	219	100	thermistors	278	185	phototransistors	240	357
capacitors, film	277	183	thermistors	291	215	posistors	304	231
capacitors, monolithic	175	70	thermocouples	289	212	rf communications		
capacitors, tantalum	254	138	transducer	270	162	products (NL)	292	467
capacitors, trimmer	215	321	transformers, ultra-			rectifier, bridge	240	356
ceramic capacitors (NL)	290	446	miniature	II	243	sensor/emitter IR	245	364
delay lines	244	129	trimmer	234	116	transient suppressor, dc	298	224
delay lines, dynamic	218	329	trimmers, low-profile	23	17	transistor, rf power	234	349
digital switch (NL)	286	414	vertical indicator	216	327	transistor, rf power	244	363
displays	243	126	yokes	280	189	transistor, uhf	236	351
displays	272	166				transistors, pnp	237	352
elapsed time indicators	290	443	Data Processing			transistors, power	234	347
encoders	291	216	cable TV systems (NL)	288	427	transistors, power	238	354
ferrites	260	148	calculator, slide rule	291	217	zeners	236	118
filters	298	225	cassette transport	260	380			
filters, power line	219	331	computer system	246	366	Instrumentation		
fluorescent readout	126	53	computer systems (NL)	292	461	amplifier, selective	258	144
gas-discharge display	241	124	computer, 8-k	232	275	CMOS logic probe	273	168
gas-discharge displays			concentrator, data	256	373	communications instru-		
(NL)	292	464	controller, commun.	254	372	ments (NL)	288	428
generators	233	115	data-acquisition system	242	125	counter	226	336
indicating devices	231	113	data-link, laser	254	371	counter/timer	240	123
knobs and dials	193	79	data system	304	228	counters	229	111
lamp hardware	249	299	display data	258	375	DMM	96	41
lamps and lampholders	127	54	flexible disc drive (NL)	288	429	DMM	248	134
lamps, annunciator	249	296	formatter, tape	248	368	DPM	24	18
lamps, cartridge	249	297	formatter, tape	252	370	DPM	227	338
lamps, subminiature	245	130	interface, plotter	262	382	DPM	230	344
magnetic sensors (NL)	286	417	microprocessors	284	197	digital indicator	224	335
mini-motors	122	51	microprocessors	287	207	digital instrumenta-		
motor, linear	215	322	minicomputer	120	49	tion (NL)	290	434
motors	283	194	minicomputer	261	149	digital instruments (NL)	290	432
motors, dc	146	62	multiplexer, data	258	376	digital logic test system	228	110
motors, fractional hp	219	330	multiplexer, video	248	367	digital phasemeter	21	16
motors, torque	291	214	printer, digital	252	369	frequency control		
neon lamps	138	59	processor, digital			devices	304	229
networks, film resistor	215	324	nication	260	379	frequency counter	227	339
potentiometer, digital	216	326	reader, card	259	378	frequency response ana-		
potentiometers	80	34	scanner and printer			lyzer	264	156
potentiometers	276	181	system	14	11	function generator	232	345
pushbutton displays	248	135	software guide (NL)	284	412	function generators	230	342
relay, reed	293	221	storage, floppy disc	262	381	glitch fixer	265	157
relays	III	244	storage mag tape	256	374	IC tester	224	333
relays, thermostatic	210	89	tape punch	262	152	instrumentation (NL)	292	465
resistor network	62	31	tape readers	270	163	instrumentation, portable	35	24
resistor networks	20	15	terminal, CRT	259	377	instruments (NL)	292	460
resistor networks	235	117				logic probe	226	337
resistors	10	8	Discrete Semiconductors			logic probe and pulser	220	101
resistors	112	47	assemblies, rectifier	242	358	logic testers	70	32
resistors, metal-film	215	323	bridges	256	140	memory exerciser (NL)	286	419
resonator, ceramic	281	191	detector, infrared	242	360	multimeter	213	93

Category	Page	IRN
multimeter	230	112
oscilloscope	73	33
oscilloscope	138	60
oscilloscope	224	334
oscilloscope	264	155
oscilloscope, digital	194	80
oscilloscope, portable	283	196
PC board tester	285	200
panel instruments	197	82
pattern analyzer	169	68
phasemeter, modular	263	151
power amplifiers	210	90
power oscillators, amplifiers and systems	216	96
rf network analyzer	217	97
rf power generator	226	107
radio links	285	201
receiver	256	141
recorder	228	340
recorder	228	341
recorder, 6-channel	283	195
recorders, X-Y	290	213
rental equipment	257	142
scanning microphotometer system	218	99
signal generator	208	88
spectrum analyzer	224	105
spectrum analyzer	230	343
spectrum analyzers	2	3
standards	289	211
sweep oscillator	98	43
tape-recorder calibrator	232	346
voltmeter, rms	287	206
wiring analyzer system	282	193
4-1/2-digit multimeter	223	104
Integrated Circuits		
CMOS	168	67
calendar circuit	278	398
DAC	278	401
DAC, 10-bit	201	84
DAC, 12-bit IC	61	30
digit drivers	278	399
drivers, receivers	276	395
ICs, large-scale	227	109
latches, quad	276	396
MOS, custom	167	66
op amp, FET	278	400
RAM, 1-k	31	22
RAM, 4-k	139	61
sample/hold IC	276	397
UART	276	394
Microwaves & Lasers		
detector, coax	282	408
divider	280	403
divider/combiner	281	405
filters, YIG-tuned	281	404
laser welder	282	406
laser driver, modulator	282	407
microwave components	226	108
phase comparators	280	402
sources	282	409
transformers, rf	267	161

Category	Page	IRN
transformers, rf	267	161
Modules & Subassemblies		
ac detector	212	92
amplifiers, s/h	277	184
clock oscillator	195	81
controller interfaces	232	114
controller, temp	211	305
controllers	273	167
converters, a/d	209	302
converters, a/d	209	303
crystal oscillators	270	147
d/a converter, 12-bit	266	158
DAC, 8-bit	237	120
data converters	189	78
drive, SCR	212	307
generators, noise	212	310
multiplexer, analog	210	304
oscillators, crystal	212	308
time delays	280	190
timer, sequential	212	309
timers	246	132
transducer, electrical	211	306
transmitter/rcvr, IR	212	320
Packaging & Materials		
aluminum boxes	267	292
beryllium springs	203	85
cable	6	5
cable, ribbon	15	12
card files	270	391
cases, ATA transit	270	390
coating, protective	266	386
compounds, molding	279	186
conductive elastomer	266	387
connector, flat cable	272	392
connectors	179	72
connectors	187	76
connectors	292	466
connectors, PC	29	21
connectors, PC	86	240
connectors, edgeboard	89	40
connectors, high density	214	94
contacts	111	46
core, xformer kit	266	389
ECL boards	113	48
enclosures	19	14
enclosures	277	182
heat dissipators	173	69
heat pipes	247	137
holder wire	272	393
hooks	292	218
magnetic shielding	288	208
markers	244	128
microwave and hybrid packages	244	130
packaging catalog	258	145
paste, conducting	264	383
pin and socket connectors	181	75
pins	281	192
potting compound	264	385
prototype boards	289	210
sealers	304	230

Category	Page	IRN
socket, PC	179	71
sockets and bus strip	272	165
soldering iron	236	119
terminal blocks	258	143
test clip	252	136
tools, miniature, hand	266	388
transmission lines	264	384

Category	Page	IRN
Power Sources		
modular supplies	222	332
power supplies	16	246
power supplies	123	52
power supplies	205	86
power supplies	279	188
power supplies, dc	273	169
supply, variable	220	301

new literature

aluminum carrying cases	288	430
amplifiers	286	416
attenuators	288	431
CMOS/PMOS	288	425
cable TV systems	288	427
ceramic capacitors	290	446
communications instruments	288	428
computer systems	292	461
connectors	292	466
cryogenic equipment	286	421
digital instrumentation	290	434
digital instruments	290	432
digital switch	286	414
flexible disc drive	288	429
gas discharge displays	292	464
HE-NE lasers	288	426
HV power supplies	290	441
instrumentation	292	465
instruments	292	460
LVDT signal conditioner	288	424
laser accessories	286	420
magnetic sensors	286	417
memory exerciser	286	419
panel meters	292	462
photoelectric system	290	442
rf communications products	292	467
Radio Shack catalog	286	415
software guide	284	412
stopwatches	286	418
switchboard instruments	290	444
toggle PB switches	290	433
tools	292	463
transducer indicators	290	440
wirewound resistors	288	423
wiring devices	288	422
"Y" adaptors	290	445

application notes

JFETs	284	410
magnetic shielding	284	413
self-latching reed matrix	284	411

SMART new data system learns from your finger to do YOUR job



1. Measure up to 248 low level signals accurately, immune from noise—*analog, digital, non linear*. Print them out, tape them, feed your computer (alarms too!).
2. Key program—with one finger—all clock timing, scan intervals, channel gains, I/O, engineering units, powerful subroutines like automatic programming and optional integration. Everything to do your job.

In the new PD-2064, a proven microprocessor, RAMs, and ROMs replace a bushel of expensive circuitry to make a versatile, standardized data acquisition system you can use for general or specific jobs. The big benefit to you is more data *reduced* per dollar. Request Bulletin B110 from Esterline Angus Instrument Corporation, P.O. Box 24000, Indianapolis, IN 46224. 317/244-7611.

 **ESTERLINE ANGUS**
A UNIT OF ESTERLINE CORPORATION

INFORMATION RETRIEVAL NUMBER 228

i'm free



**I'M A
MAIL-LITE®
SHIPPER**

**1 CASE of Mail-Lite FREE when you buy my
\$50 table model heat sealer.**

**2 CASES of Mail-Lite FREE when you buy my
\$100 floor model heat sealer.**



Labor Savings: Can be heat sealed closed in 2 seconds
Postal Savings • Waterproof • Pitterproof • Lightweight • Clean



WRITE TODAY FOR INFORMATION ON OUR
MAIL-LITE SHIPPERS AND THE SPECIAL
HEAT SEALER OFFER.

Sealed Air Corporation

19-01 State Highway 208, Fair Lawn, New Jersey 07410

INFORMATION RETRIEVAL NUMBER 230

THE COMPATIBLES

Spectrum Technology is your one source for frequency control devices that are compatible with the high technology logic of the Seventies. Standard, modified or custom designs include subminiature hybrid circuit crystal oscillators, dual in-line low profile hybrid circuit logic clocks, low cost crystal oscillator IC logic clocks, and TCXO's. Write or call for details.



Frequency Control & Timing Systems Products
Crystal Oscillators • Logic Clocks • TCXO's.

INFORMATION RETRIEVAL NUMBER 229

Murata's Posistors® can.....

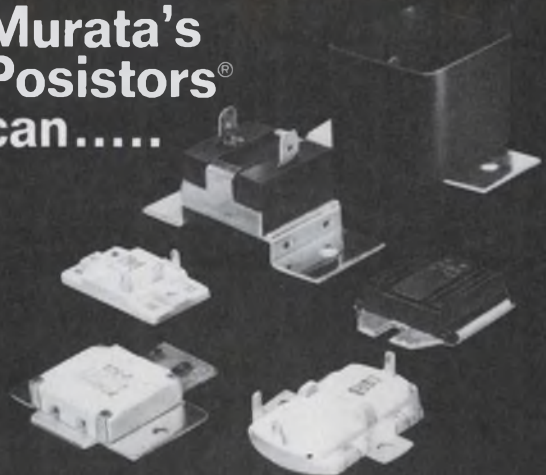

...heat, switch, start motors, control temperature, limit current, sense, aid automotive anti-pollution devices, control and on and on. They're small but powerful positive temperature coefficient devices that can handle hefty loads with a degree of reliability that mechanical switching contacts find impossible to imitate. Let us give you a few ideas as to how Posistors can fit into your scheme of things... just circle the reader service number below.

muRata

MURATA CORPORATION OF AMERICA

2 Westchester Plaza, Elmsford, New York 10523

Telex: MURATA EMFD 137332 / Phone: 914/592-9180

A Subsidiary of Murata Mfg. Co., Ltd., Japan

INFORMATION RETRIEVAL NUMBER 231

ELECTRONIC DESIGN 24, November 22, 1974

BIG TIMERS

Relays That Can Solve Your Time Delay Problems

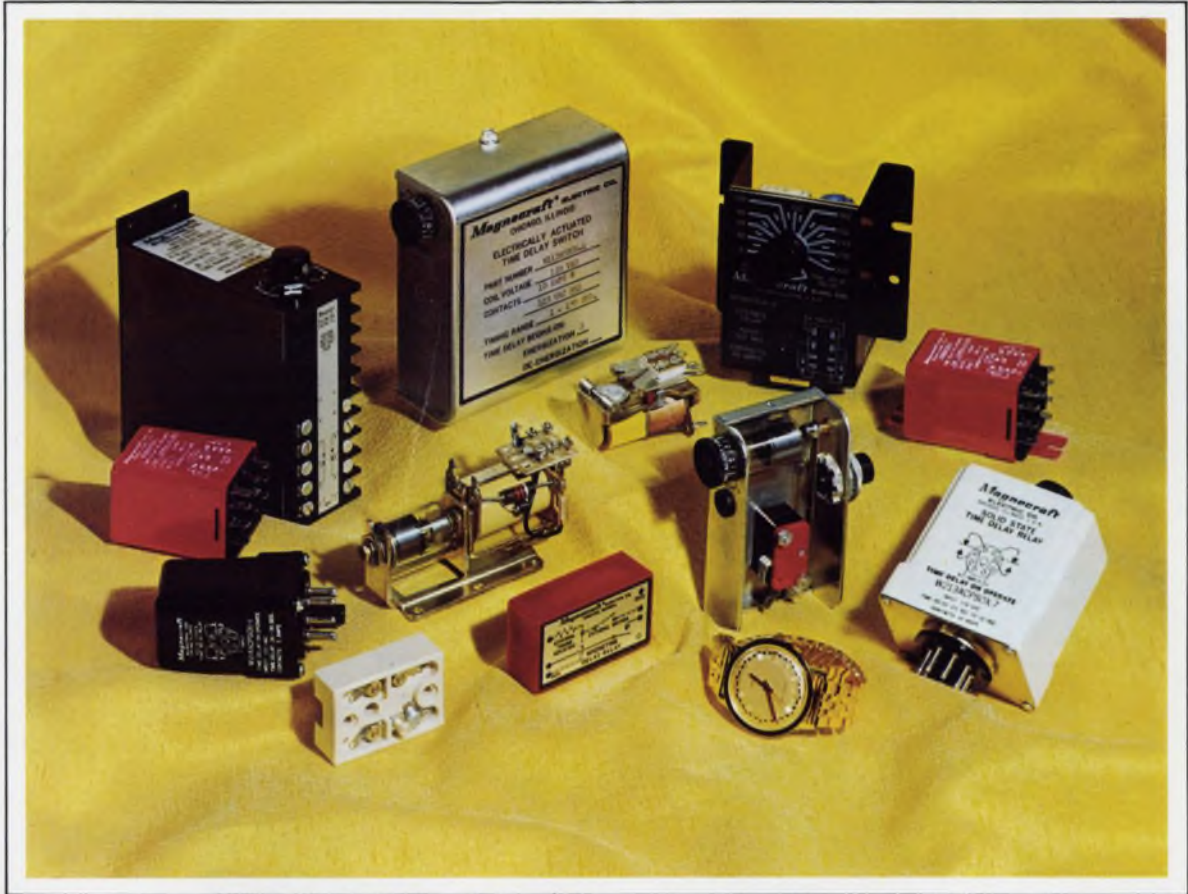

Magnecraft's BIG TIMERS come in all shapes, sizes, and timing ranges for your applications. Time delay relays with slow operate or slow release and time repeat accuracy $\pm 1\%$. Each relay is designed to function with absolute reliability, for long life at lowest cost. Versions offered include: solid state hybrid, copper slug, thermal, air dashpot, telephone type, mercury displacement, and solid state-static output. The photo portrays just some of the endless features, mountings and packaging characteristics available with Magnecraft built-in quality and integrity.

Over 100 different stock time delay relays are available through our nationwide network of distributors. But, if you don't find what you need in stock we will custom build it for you!



- 1) Air Dashpot Class 112M
- 2) Air Dashpot Class 112C
- 3) Solid State (Hybrid) Class 218
- 4) Solid State (Hybrid) Class 388 Flange Mount
- 5) Solid State (Hybrid) Class 388 Plug-In
- 6) Air Dashpot Class 110
- 7) Copper Slug Class 66S
- 8) Air Dashpot Class 113C
- 9) Solid State (Hybrid) Class 211CP
- 10) Solid State (Hybrid) Class 214CP
- 11) Thermal Class 150
- 12) Printed Circuit Class 502
- 13) Our Advertising Manager's Watch



Free!
TIME DELAY
RELAY CATALOG

To help specify your time delay relay needs, ask for Magnecraft's Seventh Edition of the Time Delay Relay Catalog. It offers suggestions on how to specify, testing procedures, comparisons of the types available, principles of operation and a glossary of terms. This super, 52 page catalog is yours for the asking.

Find Magnecraft Relays in EEM sec. 4500
and the Gold Book sec. 1600.

Magnecraft ELECTRIC COMPANY

5575 NORTH LYNCH AVENUE • CHICAGO, ILLINOIS 60630 • 312 • 282-5500 • TWX 910 221 5221

A major breakthrough in op amps...

MOS/FET, Bipolar and CMOS on the same chip.

It's the low-cost CA3130 from RCA. An accurate, easy-to-work-with op amp from the people who first combined PMOS and bipolar technologies in the CA3100T.

Even with three technologies on a single chip, the new CA3130 is simplicity itself. Which is why it costs only \$0.75 at 1K (premium versions are also available). Among its principal features (values shown are typical):

General Purpose

High open loop voltage gain: 110 dB
Low input offset voltage: 8mV
Low input current: 5pA
Input offset current: 0.5pA

FET input

Very high input impedance: 1500 M Ω

Wideband

Unity gain crossover frequency: 15 MHz
High slew rate: 10 V/ μ s
Fast settling time: 1.2 μ s

Micropower

2.5 mW at 5V supply voltage

High current

22 mA output

A voltage swing to within 10 millivolts of either rail on a single power supply is now possible for the first time because of the CMOS output stage.

Available in 8-lead TO-5 ("T") or 8-lead dual in-line ("S") packages off the shelf from your RCA Solid State distributor. Call him or write RCA Solid State, Box 3200, Somerville, N.J. 08876. Phone (201) 722-3200, Ext. 3142.

RCA Solid State

A full house in Linear ICs

INFORMATION RETRIEVAL NUMBER 245

