

# Electronic Design 13

VOL. 22 NO.

FOR ENGINEERS AND ENGINEERING MANAGERS

JUNE 21, 1974

Read phase angle directly with an accuracy of  $\pm 0.05^\circ$  and with  $0.01^\circ$  resolution. Compare two sinusoids with any levels from 0.1 to 120 V rms—even with

unequal amplitudes. Read pulses, squares and triangles, too. No range switching is needed over the full  $0^\circ$  to  $360^\circ$ . Crossover distortion is minimized. P.127.

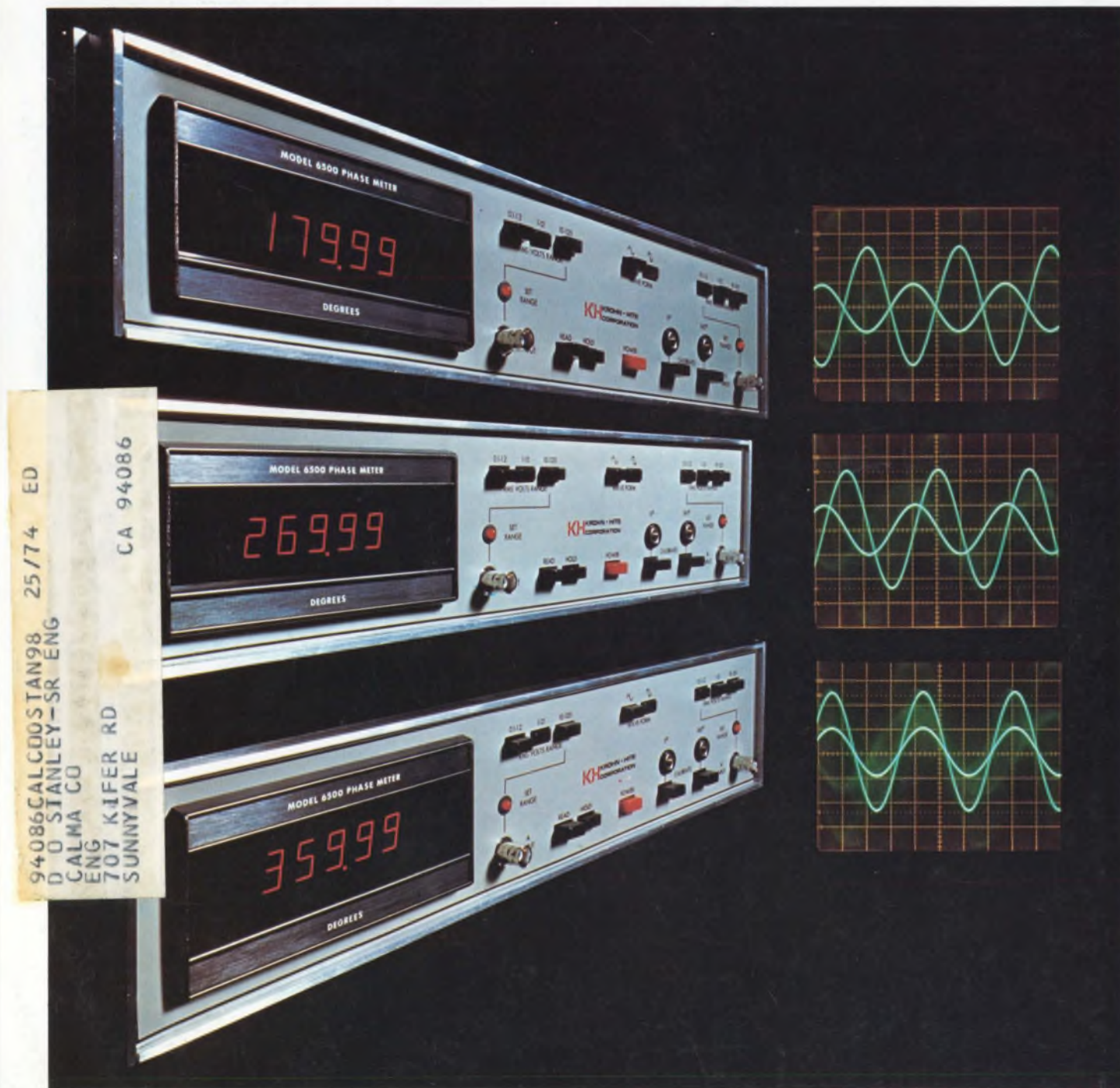





# Start with Dale

...when you need openwound resistors.

There's a Dale wirewound resistor potted inside Chrysler Corporation's unique new electronic ignition control. Openwound models like this are one of our fastest growing product lines. We make them from high quality resistance wire wound on a specially impregnated fiberglass core... with end caps and leads locked on to prevent "opens". The result is nothing fancy. But just the same, you'll find Dale CA and CR resistors in a growing number of high prestige consumer applications. In some, our quality is most important; in others, it's our price. In either case, it's the same Dale resistor. Need openwounds fast... call Dale at 402-564-3131 for complete information.

## OPENWOUND SPECIFICATIONS

**Styles:** Axial (CA) and Radial (CR) leads

**Power:** To 5 watts per inch

**Resistance:** .1 ohm to 7K ohms, depending on core length

**Tolerance:**  $\pm 10\%$  standard,  $\pm 5\%$  available

*(Available with special smokeproof coating for abrasion protection.)*



DALE ELECTRONICS, INC., 1300 28th Ave., Columbus, NE 68601  
A subsidiary of The Lionel Corporation In Canada: Dale Electronics Canada, Ltd.

INFORMATION RETRIEVAL NUMBER 241



# SURPRISE!



**2½ times  
brighter green.**



**6 times  
brighter yellow.**



**6 times  
brighter red.**

HP brings you three new LED's that are many times brighter than our standard T-1 red lamps. All offer a 180° viewing angle, plus high axial luminous intensity and a good on-off contrast ratio. Ideal for front panel applications.

Our new green lamp (5082-4984) uses high-efficiency gallium phosphide to generate a typical luminous intensity of 2 mcd at 20 mA.

Our new yellow LED's are really yellow.

The 5082-4584 lamp offers 2.5 mcd typical at 10 mA.

And red has been dramatically brightened six times in output using non-saturating gallium arsenide phosphide. With a luminous intensity of 2.5 mcd at 10 mA our 5082-4684 high-efficiency red is unbeatable.

Just \$0.80\* in 100 quantities.

Contact Hall-Mark, Schweber or the Wyle Distribution Group for immediate delivery. Or, write us for more details.

They're the brightest way to improve your product.

**HEWLETT  PACKARD**

Sales and service from 172 offices in 65 countries.  
1501 Page Mill Road, Palo Alto, California 94304

01405

\*Domestic USA price only.

INFORMATION RETRIEVAL NUMBER 2

ELECTRONIC DESIGN 13, June 21, 1974

1

# We shaped up DC

## Solid state relay with controlled rise and fall time



Take a good solid state DC relay — Teledyne's 603, for example — add some shaping circuitry so its response waveshape is carefully altered (rise time, turn-off slope, etc.), and something good happens for designers. In-rush currents for capacitive and lamp loads are limited, and so are turn-off transients for inductive loads. Also, controlled rise and fall time minimize EMI and switching transients.

An excellent choice for applications like process control systems, and machine tool controls, the 603 is optically isolated, with sensitive control input (directly compatible with TTL). It's available for loads up to 5 amps, 50 VDC.

The 603 also features Teledyne's exclusive "adaptive" packaging . . . screw or quick-disconnect terminals for chassis mounting, pins for PC boards.

If your application is less critical about in-rush currents and transients, you can order the 603 without controlled rise and fall time; it's identical, with a fast clean conventional waveshape. If you want to switch even higher level loads, shape up and call Teledyne.

 **TELEDYNE RELAYS**

3155 West El Segundo Boulevard Hawthorne, California 90250  
Telephone (213) 973-4545

INFORMATION RETRIEVAL NUMBER 3



---

## NEWS

- 31 **News Scope**  
34 **The rise of active filters:** They're running strong in two major fields.  
46 **Video players for the home** turning to card and disc units to cut costs.  
50 **Nondestructive testing techniques** are advancing with a unique pulse-echo setup.  
55 **Washington Report**

---

## TECHNOLOGY

- 64 **Get high voltage with low-cost multipliers.** If it's a low-current application, simple diode-capacitor networks can be cascaded to deliver any voltage you need.  
72 **Resolve gain/efficiency conflicts** by proper analysis of interstage network components. You'll get higher outputs with minimum VSWR.  
80 **Clean up your logic schematics** so anyone can understand them. It's easy when you put together a consistent set of symbols and names.  
88 **'Flints' that don't wear out:** Piezo-crystals. The 20,000-V sparks from ceramic piezoelectric crystals can replace gas pilot lights in home appliances.  
94 **Get gain control of 80 to 100 dB** by using a two-quadrant multiplier. You can make one from a four-quadrant monolithic multiplier.  
102 **Sharpen active null networks** by use of pole-shift circuit techniques. You'll get networks that yield increased Qs and nulls in excess of -60 dB.  
108 **Every new engineer needs a design guide.** This engineering chief offers a primer checklist that he says will lead to better competitive products quicker.  
114 **Ideas for Design:** Timer/counter chip synthesizes frequencies, and it needs only a few extra parts . . . Fine control of high-power voltage with a low-current variable transformer . . . Single EXCLUSIVE-OR quad produces complementary spikes from clock pulses . . . Op amps multiplex analog signals without need for FET switches . . . Simple circuit tests coaxial cables for opens, shorts and intermittents.  
124 **International Technology**

---

## PRODUCTS

- 127 **Instrumentation:** Digital phase meter gives highest accuracy, at less than \$2000.  
134 **Integrated Circuits:** 256-x-4-bit static RAM simplifies system designs.  
142 **Modules & Subassemblies:** Laser trimmed, 12-bit DACs offer tempcos of 1 ppm/°C.  
160 **Packaging & Materials:** Flexible material changes resistance in one direction.  
152 Data Processing  
166 Components  
173 Microwaves & Lasers  
176 Power Sources  
182 Discrete Semiconductors

---

## Departments

- 61 **Editorial:** Prosperity, the strangler  
7 Across the Desk  
186 Design Aids  
186 Application Notes  
187 Evaluation Samples  
188 Vendor's Report  
190 New Literature  
200 Advertisers' Index  
202 Product Index  
204 Information Retrieval Card

**Cover:** Photo by Bob Morley, courtesy of Krohn-Hite Corp.



# The 2102 to get as it is to

The Intel 2102 n-channel RAM is the most popular 1024 bit static memory available today. It is *the* general purpose RAM with more second sources than any other semiconductor memory component.

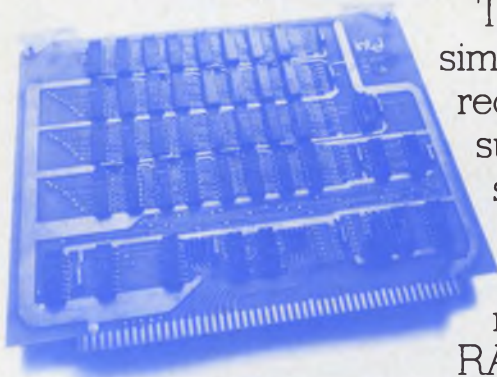

INTEL IN-26 MEMORY SYSTEM

The 2102 is extremely simple to use because it requires no peripheral supporting circuits, no special supplies, nor does it require the extra design effort needed by most RAMs to interface with TTL.

By using the 2102, you can achieve greater system economy because it does not require level shifters, MOS drivers, interface circuits, clocks, refresh and decode circuits, nor even pull-up resistors.

Every pin is TTL compatible, including the +5 volt  $V_{cc}$  supply and the three-state, OR-tie data output that simplifies memory expansion. To connect the 2102 to TTL, just add solder dots. In fact, the 2102 RAM performs exactly as if it were a TTL circuit.

The 2102 speed specs are efficient also. Guaranteed maximum access time is 1 microsecond, typical access time is 500 nanoseconds. Minimum read and write cycle time is also 1 microsecond.

The 2102 costs less per bit in quantity than penny candy. And when you





# RAM is as easy use.

# N-C HANNEL

subtract what you don't spend on design time, other parts, special supplies, boards and labor, the 2102 is easily the most economical static RAM for a wide range of applications.

What's more, the Intel 2102 is easy to get. We have been producing it in volume since early 1972 with the industry's most mature n-channel silicon gate technology. Today, we ship more 2102's than the combined outputs of the dozen or so announced second sources.

The Tektronix 31 Programmable Calculator uses the 2102 and millions of our 2102's are now being used in peripheral equipment, instrumentation and microcomputer

systems. It's a favorite with designers who want to simulate buffer, refresh and variable length registers with something more convenient and less costly than custom MOS registers.



TEKTRONIX 31  
PROGRAMMABLE  
CALCULATOR



EVERY PIN IS TTL COMPATIBLE

The 2102 is only one of Intel's popular MOS RAMs available in volume and from distributor stock. Send for a full catalog of our products including RAMs, ROMs, PROMs, interface circuits and Microcomputers.

Write to: Intel Corporation, 3065 Bowers Avenue, Santa Clara, California 95051. (408) 246-7501.

## intel® delivers.

INFORMATION RETRIEVAL NUMBER 4



# When You Buy a Power Supply, Why Not Get the Best?

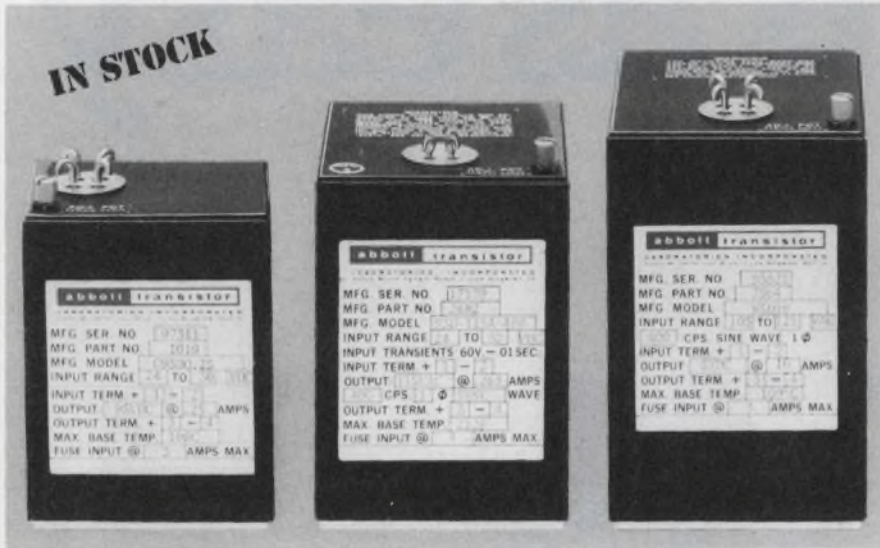

28 VDC to DC  
(55,463 Hrs.)  
Model 95D

28 VDC to 400 A  
(61,387 Hrs.)  
Model 53D

400 A to DC  
(56,148 Hrs.)  
Model W5D

## Abbott's New Hi-Performance Modules

are designed to operate in the stringent environment required by aerospace systems — (per MIL-E-5100K or MIL-E-5272C) and MIL-STD-461 for electromagnetic interference.

**RELIABILITY** — MTBF (mean time between failures) as calculated in the MIL-HDBK-217 handbook can be expected in excess of 50,000 hours at 100°C for all of these power modules. The hours listed under the photos above are the MTBF figures for each of the models shown. Additional information on typical MTBF's for our other models can be obtained by phoning or writing to us at the address below.

**QUALITY CONTROL** — High reliability can only be obtained through high quality control. Only the highest quality components are used in the construction of the Abbott power module. Each unit is tested no less than **41 times** as it passes through our factory during fabrication — tests which include the scru-

tinizing of the power module and all of its component parts by our experienced inspectors.

**NEW CATALOG**—Useful data is contained in the new Abbott Catalog. It includes a discussion of thermal considerations using heat sinks and air convection, a description of optional features, a discussion of environmental testing, electromagnetic interference and operating hints.

**WIDE RANGE OF OUTPUTS** — The Abbott line of power modules includes output voltages from 5.0 volts DC to 3,650 volts DC with output currents from 2 milliamperes to 20 amperes. Over 3000 models are listed *with prices* in the new Abbott Catalog with various inputs:

- 60A to DC, Regulated
- 400A to DC, Regulated
- 28 VDC to DC, Regulated
- 28 VDC to 400A, 1 $\phi$  or 3 $\phi$
- 24 VDC to 60A, 1 $\phi$

Please see pages 581-593 of your 1973-74 EEM (ELECTRONIC ENGINEERS MASTER Catalog) for complete information on Abbott Modules.

Send for our new 56 page FREE catalog.

**abbott transistor**

**LABORATORIES, INCORPORATED**  
5200 W. Jefferson Blvd./Los Angeles 90016 (213) 936-8185  
1224 Anderson Ave./Fort Lee, N.J. 07024 (201) 224-6900

INFORMATION RETRIEVAL NUMBER 5

**Vice President, Publisher**  
Peter Coley

### Editors

Editorial Offices  
50 Essex St.  
Rochelle Park, N.J. 07662  
(201) 843-0550  
TWX: 710-990 5071  
Cable: Haydenpubs Rochellepark  
Editor-in-Chief George Rostky

### Managing Editors:

Ralph Dobriner  
Michael Elphick

### Associate Editors:

Dave Bursky  
Jules H. Gilder  
Morris Grossman  
Seymour T. Levine  
John F. Mason  
Stanley Runyon  
Edward A. Torrero  
Richard L. Turmail

### Contributing Editors:

Peter N. Budzilovich  
Robert Wollins

### Editorial Field Offices

#### East

Jim McDermott, Eastern Editor  
P.O. Box 272  
Easthampton, Mass. 01027  
(413) 527-3632

#### West

David N. Kaye, Senior Western Editor  
2930 West Imperial Highway  
Inglewood, Calif. 90303  
(213) 757-0183

Northe K. Osbrink, Western Editor  
112 Coloma St.

Santa Cruz, Calif. 95060  
(408) 426-3211

#### Washington

Heather M. David, Bureau Chief  
2506 Eye St., N.W.  
Washington, D.C. 20037

### Editorial Production

Marjorie A. Duffy

### Art

Art Director, William Kelly  
Richard Luce  
Anthony J. Fischetto

### Production

Manager, Dollie S. Vieblg  
Helen De Polo  
Anne Molfetas  
Christopher G. Hill

### Circulation

Manager, Evan Phoutrides

### Information Retrieval

Peggy Long

### Promotion

Manager, Jeffrey A. Weiner  
Karen Kerrigan (Reprints)



## across the desk

### Correct that address for Instant Instruments

Instant Instruments greatly appreciates the photoprinting of one of its breadboards on p. 36 in ELECTRONIC DESIGN's April 12 issue ("From \$2.50 to \$1500, Good Systems Can Save You Time in Circuit Design"). This photo shows a Model A-46 PB with a simple electronic thermometer circuit and probe breadboarded to it. The caption below gives a good synopsis on the breadboard's merits; however, in this caption Instant Instruments Inc. has been labeled with an incorrect address of a competitor concern.

The correct address is: 306 River St., Haverhill, Mass. 01830.

*J. Bonfiglio*

*Marketing and Sales Manager*  
Instant Instruments, Inc.  
306 River St.  
Haverhill, Mass. 01830

### HP invites inquiries on its new logic lab

Glad to read your informative special on breadboards ("From \$2.50 to \$1500, Good Systems Can Save You Time in Design," ED No. 9, April 12, 1974, p. 30). The right breadboarding tool can certainly save countless tedious hours for industry EEs working out new designs. And I appreciate the mention of HP's new logic laboratory. Unfortunately the information as given is not exactly correct—the 5035T for breadboarding (including power supply, clocks, data switches, etc.) is only \$295, not \$650 as indicated. The \$650 price is the full-blown training package, including logic probe, logic pulser, logic clip, (see "Report on Portable Circuit Testers," ED No. 5, March

1, 1974, pp. 26-32), new text and lab workbook, components interconnecting wires and carrying case.

The article also omitted Hewlett-Packard from the list of companies at the end, so readers who want more information on our lab might wonder where to address their inquiries.

*Jesse Pipkin*

*Product Manager, Digital Test*  
Hewlett Packard  
5301 Stevens Creek Blvd.  
Santa Clara, Calif. 95050

*Ed Note: Further details on HP's logic lab are available.*

CIRCLE NO. 317

### Correction

The photo caption on p. 119 of ED No. 9, April 26 ("Minis, Minis Everywhere") contained misinformation. The Western Electric plant in Massachusetts does not use a DEC PDP-8 minicomputer. It uses a Fox 1 computer system with (left to right), the disc memory cabinet, the Fox 1 mainframe, the CRT console with a second CRT for remote mounting and a Teletype printer.

### Tree-antenna idea traced to 1904 report

Many thanks for your excellent article on development and applications of the Hemac by the U. S. Army Electronics Command (see "It's a Tree . . . a Pole . . . a Man; No! A Short-Range HF Antenna," ED No. 26, Dec. 20, 1973, p. 52).

I have received many phone calls and letters concerning Hemac applications. One letter, from a Bill Mathews, is of historical interest

*(continued on p. 9)*

Electronic Design welcomes the opinions of its readers on the issues raised in the magazine's editorial columns. Address letters to Managing Editor, Electronic Design, 50 Essex St. Rochelle Park, N.J. 07662. Try to keep letters under 200 words. Letters must be signed. Names will be withheld on request.



## OPTRON OPTOELECTRONIC ASSEMBLIES

LOW PRICED  
IMMEDIATE DELIVERY  
CUSTOM DESIGNS AVAILABLE

OPTRON transmissive optical switch and reflective transducer assemblies consist of infrared LED's coupled with silicon phototransistors or photodarlingtons. Both use discrete hermetically sealed devices for maximum reliability and sensitivity. The assemblies feature non-contact switching, TTL compatibility and fast switching speeds. Low priced standard assemblies are immediately available and custom designed versions for special applications are available on request.



**OPB 120 TRANSMISSIVE OPTICAL SWITCH** uses an infrared LED aligned across a gap with a silicon phototransistor. The

OPB 120 replaces mechanical switching elements with solid state dependability. Typical applications include rotary encoders, tachometers and motion sensors. Standard gap widths are 0.125 and 0.200 inches.



**OPB 125 OPTOELECTRONIC REFLECTIVE TRANSDUCER** consists of a gallium arsenide infrared LED coupled with a silicon phototransistor in compact low-cost molded plastic housing. It has

extremely high sensitivity and is ideal for such applications as EOT/BOT sensing, line finding, and edge and flaw detection.

Detailed technical information on these and other OPTRON optoelectronic products . . . chips, components and PC board arrays . . . is available from your nearest OPTRON sales representative or the factory direct.



**OPTRON, INC.**

1201 Tappan Circle  
Carrollton, Texas 75006  
214/242-6571



# The case for Liquid Crystal Displays

**Liquid crystal displays;** light emitting diodes; incandescent and fluorescent displays and "Nixie" tubes are popping up frequently in circuit designs as the trend to digital readout continues. Each has a purpose and the design engineer should become familiar with all types. We make liquid crystal displays.

## The display of the future?

Our display is a sandwich of two plates, joined and hermetically sealed at the perimeters. A space of about .0005" separates the plates, and this is filled with a nematic liquid crystal solution.

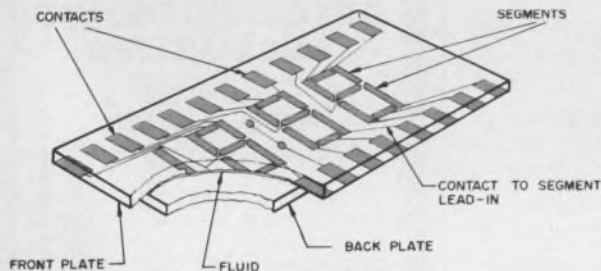

When the liquid is not electrically excited, its long, cigar-shaped molecules are parallel to one another in a position perpendicular to the plates. Thus, the liquid appears transparent. Applying an electric current creates ion activity which leads to turbulence and causes the liquid to scatter incident light. The visual effect is that of a frosted glass. LCD's can be made completely transmissive for back-lighting, reflective for ambient light or semi-reflective for dual mode operation.

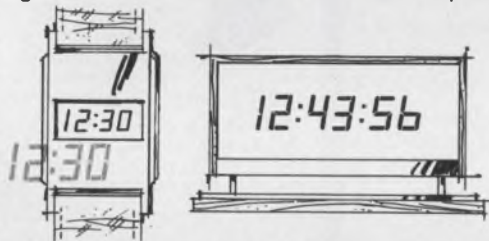

Producing an image — digital or other — simply requires a conductive surface the shape of the desired image on the glass plate toward the viewer. Current flowing from the conductive image on the front plate through the crystal liquid to the common-ground back plate causes the liquid to change from clear to a frosted appearance in the current-carrying area.

These images are almost always in the form of seven segments that make up the numerals 1 through 0. Energizing the proper segments produces the desired numerals. Lead-ins connect the segments to external contacts on the sandwich (display).

## Consider the advantages.

Liquid crystal displays have a number of distinct advantages. Simplicity is the reason for several of these. The elements are few and passive — very little can go wrong with an LCD and this means reliability and long life.

Simplicity means low cost, too — lower than that of most comparable displays. Packaging costs are low because LCD's can be driven directly by MOS and C/MOS circuits. In our dynamic scattering displays very narrow character widths are possible and still provide a good viewing angle — 60 degrees in many cases.

Low power consumption makes the LCD a logical choice where power limitations rule out other display types. Watch type LCD's use only 30  $\mu$ W, for example, with all segments energized at 15 volts.

LCD's offer the greatest flexibility of any display type. Several standard displays are immediately available from Hamlin's stock. Special displays with virtually any type of image can be produced with surprisingly low preparation or "tooling" cost. Because of the LCD's simplicity, lead time on specials is only a matter of weeks.

## A few limitations.

LCD's have limitations, too. Operating temperature range is one. Liquid crystals slow down and may even cease to function at temperatures below 0°C. Above 50-60°C, crystals go into solution and will not function normally.

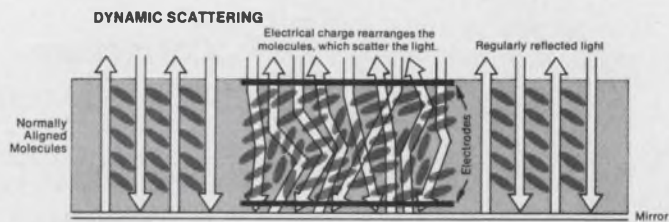

Extremes do not damage LCD's. Once the temperature returns to normal, operation is automatically resumed.

LCD's do not generate light, and they are somewhat difficult to read under low ambient light conditions. (Side or back lighting can remedy this.) Visibility under medium to high ambient light conditions is excellent.

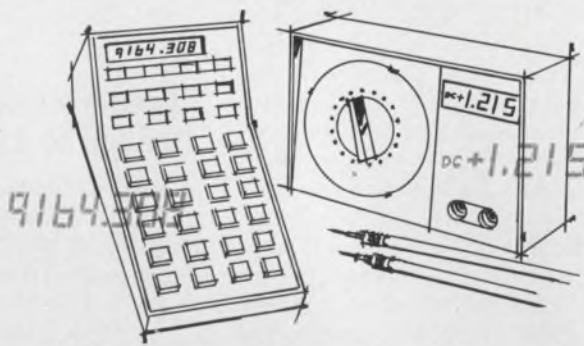

In the majority of display applications, MOS and C/MOS compatibility, reliability, flexibility and low power requirement are important considerations. No other display type can match the liquid crystal display on these jobs. They could become the display of the future. And that's the case for the LCD. For specification and application data, write Hamlin, Inc., Lake Mills, Wisconsin 53551. Or call, 414/648-2361. (Evaluation samples are available at moderate cost.)

# HAMLIN

INCORPORATED

INFORMATION RETRIEVAL NUMBER 7

9791



ACROSS THE DESK  
(continued from p. 7)

Mr. Mathews sent me an original paper by one Major Squire, "Living Trees for Wireless Telegraph Stations," which was published in the February, 1905 issue of *Popular Mechanics*. The article evidently relates to a 1904 report by Major Squire to the U.S. Dept. of War. The response of the department, 70 years ago, confirms that it is easier to get the message out of natural jungle trees than through the man-made bureaucratic jungle.

As for the telephony and telegraphy phenomena, there appear to be differences in the interactions of trees and of human bodies with rf fields. The outer layers of tree trunks, including the cambium layer, are highly conductive relative to the material in the interior. Consequently externally applied rf source fields tend to be reflected and are thus prevented from being absorbed inside the tree trunks.

With the human body, the situation is reversed. The outer, less conductive tissues tend to refract the externally applied rf source fields into the highly inhomogeneous rf absorbent interior of the body. (Ferns, as distinguished from trees, are somewhat similar in this respect.) Tall and fat people are therefore larger rf absorbers and less efficient rf radiators than small and slim ones. This fact puzzled radio engineers who tried to put vhf dipole antennas into garments and field jackets. The effective surface area of a person enters into the rf-absorption-radiation balance of his body.

Unfortunately, by some misunderstanding, the ED article states that fat people make better antennas, which is contrary to the facts.

*Kurt Ikrath*

AMSEL NL-H  
U.S. Army ECOM  
Ft. Monmouth, N.J. 07703

## Prof gives high mark to basement labs

First let me congratulate you on an especially fine issue—ED No. 9, April 26, 1974. The balance of the material that you present meets the needs of the practicing  
(continued on p. 13)

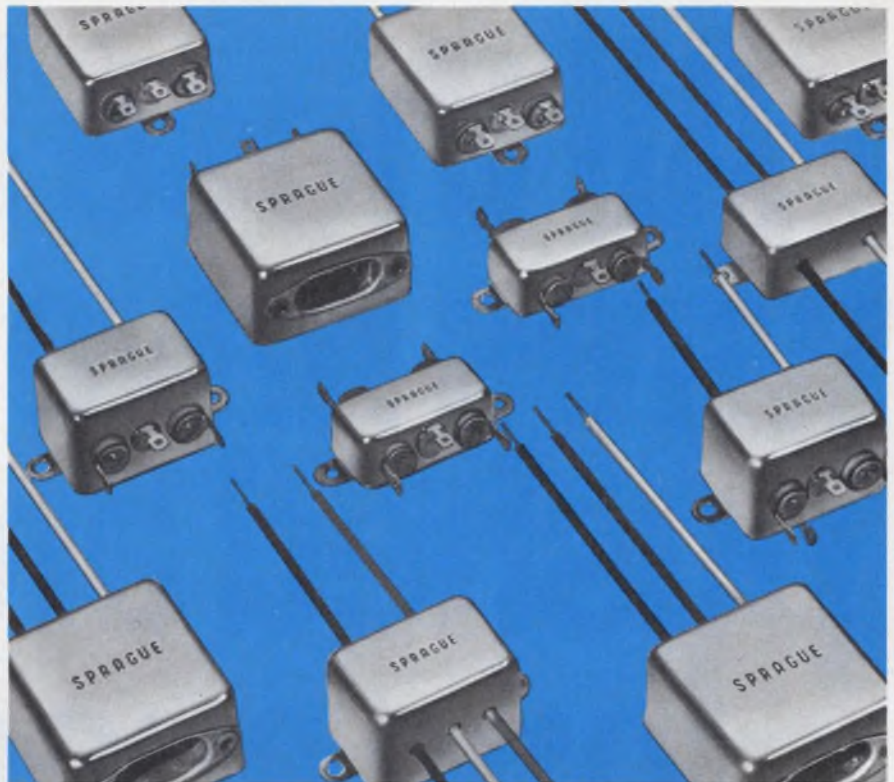

## FILTERS THAT WORK. FILTERS THAT FIT. FILTERS YOU CAN AFFORD.

**Sprague JX5100 Series EMI Powerline Filters give you the right blend of efficiency/size/cost.**

The lower cost of these general-purpose filters makes them especially suitable for higher-volume production-assembled equipment such as computer peripherals, cash registers, credit card verifiers, electronic service instruments, etc.

Series JX5100 Filters are designed to protect equipment from line noise as well as to protect the line from equipment noise, particularly equipment with high impedance loads. Smaller in size than many filters with comparable performance, they control line-to-ground interference with a high degree of efficiency. Filtering both sides of the line, the need for two filters is eliminated.

Available in a wide variety of current ratings (1 to 30 amps) and several different terminal configurations, Series JX5100 Filters withstand a test voltage of 2100 VDC, assuring protection against high-voltage transients. Line-to-ground capacitance is only  $.01\mu\text{F}$ , and maximum leakage current (each line to ground, @115V, 60Hz) is 0.5mA.

Sprague maintains complete testing facilities for all commercial, industrial, and government interference specifications.

For complete technical data, write for Engineering Bulletin 8210.11 to: Technical Literature Service, Sprague Electric Company, 347 Marshall Street, North Adams, Mass. 01247.

THE BROAD-LINE PRODUCER OF ELECTRONIC PARTS

**SPRAGUE**  
THE MARK OF RELIABILITY



**All those little  
wires have been  
pushed around  
long enough.**





Until now, all those wires have been at the mercy of packaging materials that expand when things get hot.

So we developed new Dow Corning® 480 semiconductor molding compound.

Dow Corning 480 has a low coefficient of thermal expansion.

So it virtually eliminates the hot intermittent open. And moisture penetration.

Which means that an integrated circuit stays integrated. Through all sorts of temperature and atmospheric extremes.

But that's not all that's different about 480 molding compound.

Its resistance to salt spray is excellent.

And it reduces your packaging costs because it saves time. Molding times are short—less than one minute for some components. Post curing is unnecessary.

Of course, Dow Corning 480 molding compound also has the advantages of our other silicones. Consistency. Long shelf life. Less cleaning downtime because there's no buildup. Non-flammability. And, because it doesn't irritate skin, there's no need for special handling.

Dow Corning 480 semiconductor molding compound is the kind of improved product you can expect to keep getting from Dow Corning. Our Technical Service and Development Department has more manpower and greater technical facilities than any other in the industry.

If you want to know more about 480, call us at 517 636-8000, or write Dow Corning Corporation, Dept. A-4334, Midland, Michigan 48640.

**DOW CORNING**

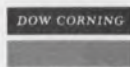







(continued from p. 9)

engineer in many ways. Keep up the good work.

A small point that I feel needs correction: Yes, the space program did many fine things at costs that could never allow survival in the market place. However, the space program would never have been possible without the efforts of many thousands of engineers turning out fine research bits and pieces in low-cost, or basement, laboratories. Let us give credit where credit is due.

On p. 29 ("Heart Monitor Replaces Skin-Piercing Methods") there is mention of a heart monitor that "came from the instrumentation developed to monitor the Mercury astronauts." The truth of the matter is that Dr. Jan Nyboer proposed and used such instrumentation in the early 1940s. His work was followed by many in the medical, engineering and bioengineering disciplines. As a worker in this field, I recall but one or two papers published that related to the space program, while I could submit a list of over 50 publications by civilian workers in labs around the world.

*W. B. Jarzembki, P.E., Ph.D.  
Associate Professor of Biomedical  
Engineering*

The Medical College of Wisconsin  
Div. of Surgery  
8700 West Wisconsin Ave.  
Milwaukee, Wis. 53226

## That editorial on lying has the ring of truth

Your editorial "We Lie a Lot" (ED No. 9, April 26, 1974, p. 51) is most timely. With all the lying going on in our newspapers and on TV by the so-called leaders of our nation, it is indeed refreshing to hear you put it in somewhat of a better perspective.

Unfortunately it is our children today, growing up in this environment, that eventually will be affected most. How do you tell your son and daughter that lying isn't right and yet show them, in black and white, that it's done every day.

I have made a few copies of your editorial and distributed them to some of my friends who, in turn, have shown them to their children—as I have done to mine. It's cer-

(continued on p. 16)

# There's a world of difference between Dow Corning and the other semiconductor packaging-materials suppliers.

The difference is that only Dow Corning has available worldwide a complete line of silicone molding compounds, an accomplished technical service and development team, the advantage of a completely compatible product line, and the convenience of worldwide delivery and service. If you want to give your packaging operation a competitive advantage, just call or write. One of our representatives is nearby.

J. Guillot  
DOW CORNING S.A.R.L.  
140, Avenue Paul Doumer  
92500 Rueil Malmaison  
France  
Telephone: 977.00.40

M. Tedone  
DOW CORNING SpA  
Viale Restelli 3/7  
20124 Milan, Italy  
Telephone: 688 2458

## ASIA

H. Takahashi  
DOW CORNING ASIA LTD.  
P&O Building, 9th Floor  
21 Des Voeux Road, C.  
Hong Kong  
Telephone: 5-258035

H. Hotta  
DOW CORNING ASIA LTD.  
Room 803, Cathay Building  
Mount Sophia  
Singapore - 9  
Republic of Singapore  
Telephone: 321213-5

## AUSTRALASIA

H. Tuynman  
DOW CORNING AUSTRALIA PTY. LTD.  
36 O'Dea Avenue  
Waterloo, N.S.W. 2017  
Sydney  
Telephone: 699 8055

P. Winter  
DOW CORNING AUSTRALIA PTY. LTD.  
103 High Street  
Prahran, Vic. 3181  
Telephone: 51 5450

Dow Corning semiconductor molding compounds...quality and dependability worldwide.

A-4335

## NORTH & SOUTH AMERICA

Resins and Chemicals Marketing  
DOW CORNING CORPORATION  
Midland, MI 48640  
Telephone: 517 636-8682

## EUROPE

R. Hediger  
DOW CORNING INTERNATIONAL LTD.  
Chaussée de La Hulpe 177  
1170 Brussels, Belgium  
Telephone: 73.80.60

B. Sneddon  
DOW CORNING LTD.  
Reading Bridge House  
Reading RG1 8PW  
Berkshire, England  
Telephone: Reading 57251

R. Jones  
DOW CORNING GmbH  
1150 Vienna  
Mariahilferstrasse 180/4  
Austria  
Telephone: 83.85.38

S. Haberer  
DOW CORNING GmbH  
8000 Munchen 50  
Pelkovenstrasse 152  
West Germany  
Telephone: 14 861

# DOW CORNING

DOW CORNING



# More ideas from Amphenol's

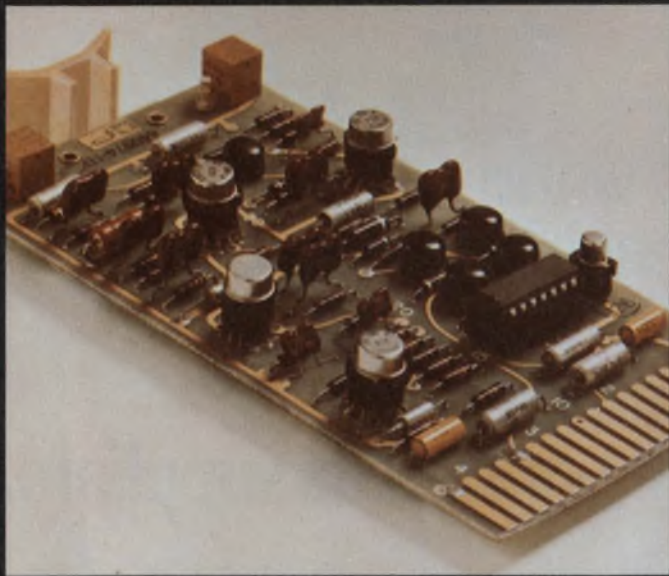

**level 1** Low-cost sockets for transistors in TO packages (above) allow easy replacement and service. ■ New IC sockets are end and side stackable for maximum single board density. Low profile design also allows maximum multi-board density.

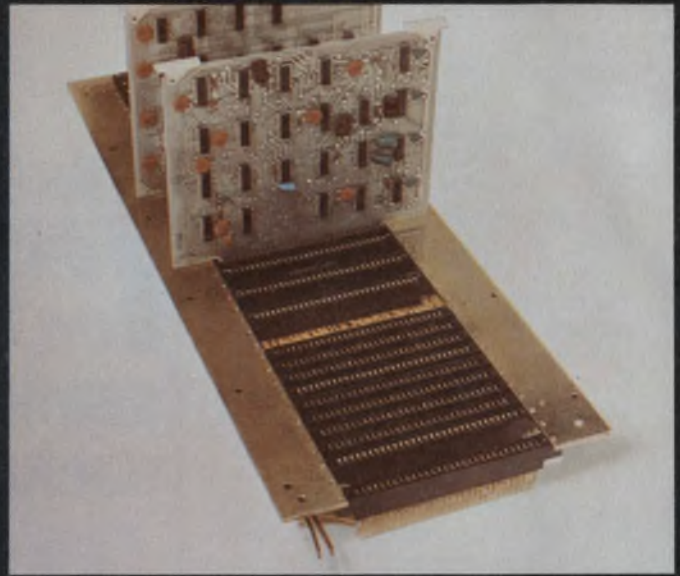

**level 2** Back panel edge board connectors with bifurcated contacts (above) can be wire wrapped or clip-terminated. ■ Bellows contact PC connectors (below) cut interconnection costs without sacrificing performance.

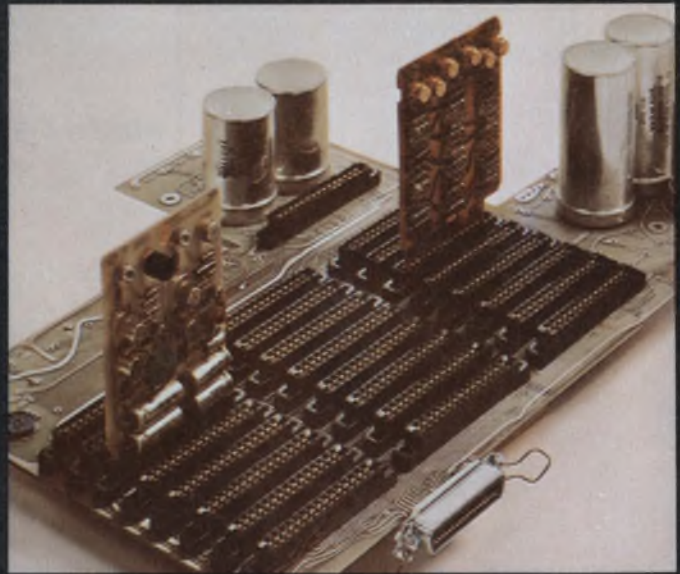
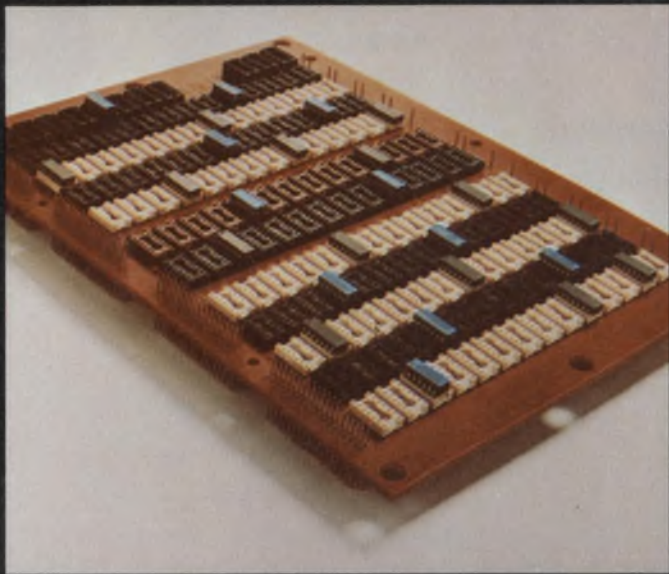

Above are seven new ideas from Amphenol Industrial Division's Spectrum of interconnection capability.

Amphenol's SPECTRUM offers you *all four* levels of interconnections from our unmatched breadth of product line:

**Level 1 . . . DEVICE TO BOARD OR CHASSIS.** We offer interconnections for components such as tubes, relays, transistors, IC packages, trimmers, resistors or capacitors to a PC board or chassis.

**Level 2 . . . BOARD TO MOTHERBOARD OR BACK PLANE.** We offer interconnections for PC boards or

other sub-circuit modules to a motherboard or to a back plane.

**Level 3 . . . MOTHERBOARD OR BACK PLANE WIRING.** We offer interconnections for levels to each other and to other sub-circuits with multi-layer circuit boards, wire wrapping, clip terminations, jumper techniques and dip-soldering.

**Level 4 . . . INPUT/OUTPUT CONNECTIONS.** We offer interconnections for power and signals to and from a system. This interface may be between sub-assemblies within the same enclosure or between individual units.



# Spectrum of interconnections.

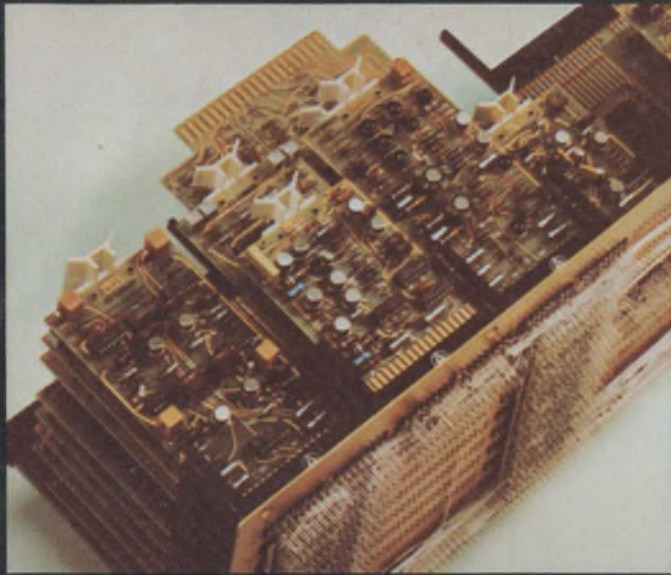

**level 3** Direct entry plate assembly offers modular packaging flexibility. Custom designed plates accommodate any size or style PC board with no tooling cost to you. Rectangular posts are true positioned for automatic wire-wrapping.

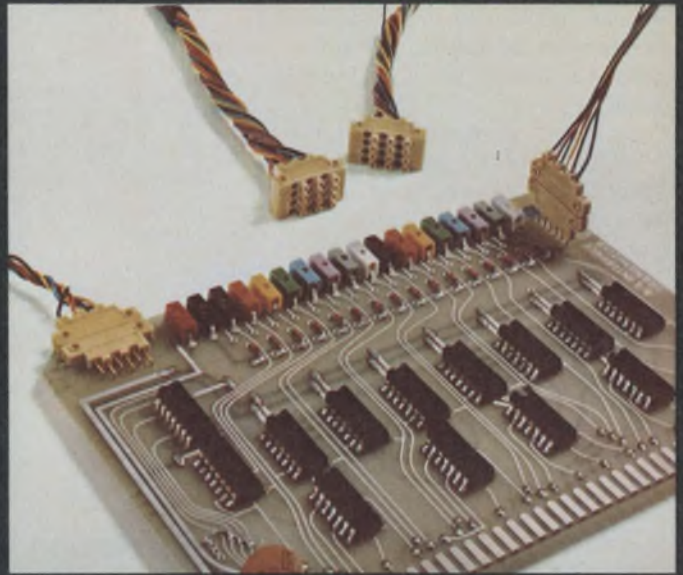

**level 4** Miniature contact (3 input, 3 output) hermaphroditic connectors can be snapped together to connect as many circuits as required. ■ Single finger-tip mounting of low cost connector saves assembly time. Available in UL Class SE-1 flammability rated material.

Write for our Spectrum brochure covering all levels of interconnections.

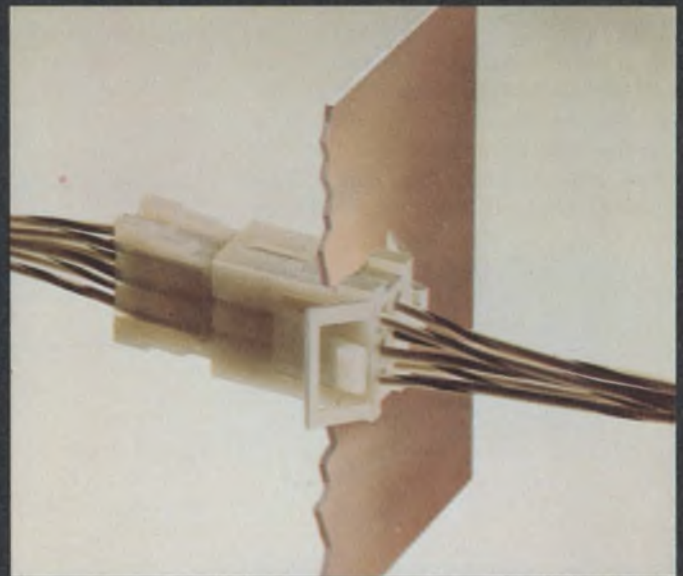

From the simple tube socket—to a myriad of electrical/electronic connectors—to complete and complex termination systems . . . SPECTRUM.

But SPECTRUM is far more than products. It is a depth of capability in engineering, manufacturing and quality control. Amphenol's SPECTRUM is a new height of service, availability and distribution backed by seven Amphenol interconnection-oriented divisions.

Amphenol can fulfill your total interconnection requirements because we are not limited to specifics such as one or two product lines, one or two levels.

Therefore we approach your interconnection needs with complete open-mindedness.

For more new ideas and specific information, write for your copy of "SPECTRUM." Amphenol Industrial Division, Bunker Ramo Corp., 1830 South 54th Ave., Chicago, Illinois 60650.

**BUNKER RAMO** AMPHENOL



tainly not the total explanation, but it does help make us all aware of the present situation.

By all means, keep up the good work.

*Bennett W. Brachman*  
Director of Marketing and Sales  
Spectra-Strip Corp.  
7100 Lampson Ave.  
Garden Grove, Calif. 92642

For your editorial "We Lie a Lot," BRAVO!

And that's no lie.  
Thank you for the generous coverage in this issue. Keep up the excellent work that all your issues reflect.

*Harvey Labban*  
Public Relations

Texas Instruments  
Digital Systems Div.  
P.O. Box 1444  
Houston, Tex. 77001

## Correction

In a New Product mention of Com Dev isolators ("Isolators Cover 12 and 14-GHz Bands," ED No. 6, March 15, 1974, p. 244) the wrong photograph of the product was inadvertently published. The correct photo is shown here. These

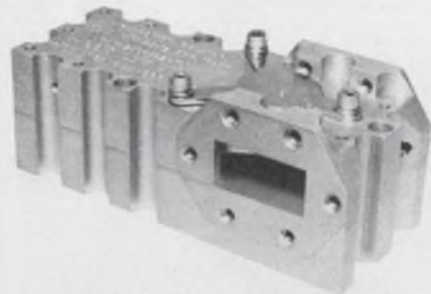

Com Dev isolators have 26-dB of isolation, 0.1-dB insertion losses and input return losses of -30 dB. All models fit the WR-75 waveguide.

## Ion-implanted varactors are two years 'new'

It is encouraging to see ion-implantation techniques used in other than standard IC production ("Triple Varactor IC Promises to

Better the AM Car Radio" ED No. 10, May 10, 1974, p. 38). However, the statement that this is the first application of ion-implantation techniques to varactor diode fabrication is incorrect, to say the least. Alpha Industries has been supplying an extensive line of ion-implanted hyperabrupt tuning diodes to the electronics industry for the last two years. These diodes cover the hf through uhf bands and are used in wideband and linear tuning applications among others.

*Frank A. Leith*  
Manager, Tuning Diodes

Alpha Industries, Inc.  
20 Sylvan Rd.  
Woburn, Mass. 01801

## Correction

There is an error in Fig. 2 in my article "Try Condition/Action Diagrams" (ED No. 5, March 1, 1974, p. 50). One of two side-by-side rectangles labeled "manually selected range" should say instead "manually selected polarity." The corrected portion of the figure appears below:

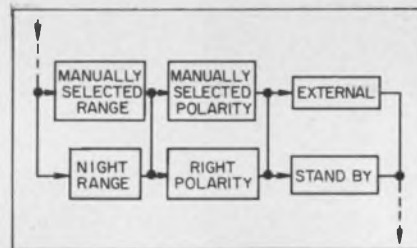

*Robert W. Hofheimer*  
Project Manager

Non Linear Systems, Inc.  
P.O. Box N  
Del Mar, Calif. 92014

## Data on solvent safety yours for the asking

In the article "Choose Cleaning Solvents Carefully," (ED No. 5, March 1, 1974, p. 54) and in some of the letters referring to that article, concern and confusion were indicated about the use of solvents for cleaning in the electronics in-

(continued on p. 24)



## Your closest SIGNETICS distributor is...

ARIZONA  
Phoenix: Hamilton/Avnet Electronics (602) 275-7851  
Phoenix: Kierulff Electronics (602) 273-7331  
CALIFORNIA  
Culver City: Hamilton Electro Sales (213) 870-7171  
El Segundo: Liberty Electronics (213) 322-8100  
Los Angeles: Kierulff Electronics (213) 685-5511  
Mountain View: Hamilton/Avnet Electronics (415) 961-7000  
Palo Alto: Kierulff Electronics (415) 968-6292  
San Diego: Cramer Electronics (714) 565-1881  
San Diego: Hamilton/Avnet Electronics (714) 279-2421  
San Diego: Kierulff Electronics (714) 278-2112  
Sunnyvale: Cramer Electronics (408) 739-3011  
CANADA  
Downsview: Cesco Electronics (416) 661-0220  
Downsview: Cramer Electronics (416) 661-9222  
Montreal: Cesco Electronics (514) 735-5511  
Montreal: Hamilton/Avnet Electronics (514) 735-6393  
Ottawa: Cesco Electronics (613) 729-5118  
Ottawa: Hamilton/Avnet Electronics (613) 725-3071  
Quebec City: Cesco Electronics (418) 524-3518  
Vancouver: Bowtek Electric Co. Ltd. (604) 736-7677  
COLORADO  
Denver: Cramer Electronics (303) 758-2100  
Denver: Hamilton/Avnet Electronics (303) 534-1212  
CONNECTICUT  
Hamden: Arrow Electronics (203) 248-3801  
Georgetown: Hamilton/Avnet Electronics (203) 762-0361  
North Haven: Cramer Electronics (203) 239-5641  
FLORIDA  
Hollywood: Hamilton/Avnet Electronics (305) 925-5401  
Hollywood: Schweber Electronics (305) 927-0511  
Orlando: Hammond Electronics (305) 241-6601  
GEORGIA  
Atlanta: Schweber Electronics (404) 449-9170  
Norcross: Hamilton/Avnet Electronics (404) 448-0800  
ILLINOIS  
Elk Grove: Schweber Electronics (312) 593-2740  
Elmhurst: Semiconductor Specialists (312) 279-1000  
Schiller Park: Hamilton/Avnet Electronics (312) 678-6310  
INDIANA  
Indianapolis: Semiconductor Specialists (317) 243-8271  
KANSAS  
Lenexa: Hamilton/Avnet Electronics (913) 888-8900  
Lenexa: Hall-Mark Electronics (913) 888-4747  
MARYLAND  
Hanover: Hamilton/Avnet Electronics (301) 796-5000  
Rockville: Pioneer Washington Electronics (301) 424-3300  
Rockville: Schweber Electronics (301) 881-2970  
MASSACHUSETTS  
Burlington: Hamilton/Avnet Electronics (617) 273-2120  
Newton: Cramer Electronics (617) 959-7700  
Waltham: Schweber Electronics (617) 890-8484  
MICHIGAN  
Detroit: Semiconductor Specialists, Inc. (313) 255-0300  
Livonia: Hamilton/Avnet Electronics (313) 522-4700  
Troy: Schweber Electronics (313) 583-9242  
MINNESOTA  
Edina: Hamilton/Avnet Electronics (612) 941-3801  
Minneapolis: Semiconductor Specialists (612) 854-8844  
MISSOURI  
Hazelwood: Hamilton/Avnet Electronics (314) 731-1144  
St. Louis: Hall-Mark Electronics (314) 521-3800  
NEW MEXICO  
Albuquerque: Cramer Electronics (505) 265-5767  
Albuquerque: Hamilton/Avnet Electronics (505) 765-1500  
NEW YORK  
Buffalo: Summit Distributors (716) 884-3450  
Farmingdale, L.I.: Arrow Electronics (516) 694-6800  
Rochester: Schweber Electronics (716) 328-4180  
Syracuse: Hamilton/Avnet Electronics (315) 437-2642  
Westbury: Hamilton/Avnet Electronics (516) 333-5800  
Westbury: Schweber Electronics (516) 334-7474  
NORTHERN NEW JERSEY  
Cedar Grove: Hamilton/Avnet Electronics (201) 239-0800  
Saddlebrook: Arrow Electronics (201) 797-5800  
SOUTHERN NEW JERSEY AND PENNSYLVANIA  
Cherry Hill, N.J.: Milgray-Delaware Valley (609) 424-1300  
Moorestown: Arrow/Angus Electronics (609) 235-1900  
Mt. Laurel, N.J.: Hamilton/Avnet Electronics (609) 234-2133  
CENTRAL NEW JERSEY AND PENNSYLVANIA  
Somerset, N.J.: Schweber Electronics (201) 469-6008  
NORTH CAROLINA  
Greensboro: Hammond Electronics (919) 275-6391  
OHIO  
Beechwood: Schweber Electronics (216) 464-2970  
Dayton: Hamilton/Avnet Electronics (513) 433-0610  
Cleveland: Arrow Electronics (216) 464-2000  
Cleveland: Pioneer Standard Electronics (216) 587-3600  
Kettering: Arrow Electronics (513) 253-9176  
TEXAS  
Dallas: Cramer Electronics (214) 350-1355  
Dallas: Hamilton/Avnet Electronics (214) 661-8661  
Houston: Component Specialties (713) 771-7237  
Houston: Hamilton/Avnet Electronics (713) 526-4661  
UTAH  
Salt Lake City: Alta Electronics (801) 486-7227  
Salt Lake City: Hamilton/Avnet Electronics (801) 262-8451  
WASHINGTON  
Bellevue: Hamilton/Avnet Electronics (206) 746-8750  
Seattle: Cramer Electronics (206) 762-5722



# Open up your options in Linear ICs.



What you need, to free up your buying power, is a good strong alternative to single-source linear supplies. Because nothing breaks you out of most price/delivery binds, like that simple basic: freedom of choice.

The key to Buyers' Lib is Signetics. With a major commitment in linear products. For years we've been established in the linear business, in a big, broad-line way.

Volume we've got—our production capacity's doubled in the past year. And variety that just won't stop. A solid line of standard devices to back up a wide range of purchasing requirements. To help you cut delays, wipe out stoppages, and get your system delivered (and paid for) sooner.

But maybe the biggest spread between Signetics and other so-called linear sources is—

service. First, a nationwide network of linear-wise distributors—every region with at least one office within easy call. Second, the industry's most thorough cataloging and applications material. Plus on-the-spot assistance from our traveling platoon of technical specialists—always on the road, for on-site problem solving.

Straight goods, straight talk. And that means anytime we get a sudden run, putting a specific device in short supply, you'll get realistic commitments. Probably the most important option you can pick up from any supplier, when you lift the phone to source linear from Signetics.

Signetics Corporation, a subsidiary of Corning Glass Works, 811 E. Arques Ave., Sunnyvale, California 94086, (408) 739-7700.



Available through your local distributor. Now.

#### Comparators

$\mu$ A710 7520  
 $\mu$ A711 7521  
NE526 7522  
NE527 7523  
NE529 7524  
NE522 7525  
NE521 75S207  
75S208

#### Memory Interface

3207  
3207-1  
3207A  
3207A-1

#### Peripheral Interface

75450

75451

75452  
75453  
75454  
 $\mu$ A733  
75S107  
75S108  
DM8880  
DM7820  
DM8820  
DM7830  
DM8830  
NE501  
NE592

#### Op Amps

$\mu$ A709  
 $\mu$ A740  
 $\mu$ A741  
 $\mu$ A747  
 $\mu$ A748  
LM101A  
LM201A  
LM301A  
LM107  
LM207  
LM307  
LM308  
MC1456

MC1556

NE510  
NE511  
NE515  
NE531  
NE536

#### Voltage Regulators

$\mu$ A723  
NE550

#### Timers

NE555  
NE556

#### PLL's

NE560  
NE561  
NE562  
NE565  
NE566  
NE567

#### Consumer

NE540  
NE546  
ULN2111  
PA239  
MC1496

## Signetics



# SIEMENS

## The unvarying ingredient in every Siemens component: batch-to-batch quality.

Even though Siemens makes 50,000 different shapes and sizes of components, to meet virtually any need *and* the reality of your economics, we're best known for the efforts we devote to quality. Year after year, batch after batch. (We've made 500 million pot cores in the last 5 years alone.)

One of the reasons for our high level of quality and reliability is the two million dollars we invest every working day in research and development. Our R&D program has paid off well—90% of the components we offer today were not available 10 years ago.

R&D has also enabled Siemens to pioneer metallized polyester-film (MYLAR\*) capacitors, tuning-diodes, gas-filled SVP's® and cradle relays. And there are more innovations on the way.

If you depend on electronic components, you can depend on Siemens. Batch after batch, the quality never varies.

\*DuPont registered trademark.

For details, get in touch with your local Siemens specialist, or fill in the coupon below.

Please indicate your specific area of interest and mail to:  
Siemens Corporation, Components Division  
186 Wood Avenue South, Iselin, N.J. 08830

- |  |   |   |
|--|---|---|
| <input type="checkbox"/> BWO's   | <input type="checkbox"/> LCD's          | <input type="checkbox"/> Semiconductors   |
| <input type="checkbox"/> Capacitors                                      | <input type="checkbox"/> LED's          | <input type="checkbox"/> Opto-Electronics |
| <input type="checkbox"/> Ferrites  | <input type="checkbox"/> Planar Triodes |   |
| <input type="checkbox"/> Gas - Filled Surge<br>Voltage Protectors (SVP®) | <input type="checkbox"/> Relays         |   |

Name \_\_\_\_\_ Title \_\_\_\_\_

Company \_\_\_\_\_ Tel. \_\_\_\_\_

Address \_\_\_\_\_

City \_\_\_\_\_ State \_\_\_\_\_ Zip \_\_\_\_\_



SIEMENS  
C42315-A61-A1/1

BC  
309B

B32234  
0,47M100

TBA120 .B12

**Siemens Corporation**  
**Components Division**

186 Wood Avenue South, Iselin, N.J. 08830 (201) 494-1000

INFORMATION RETRIEVAL NUMBER 16



# “Scotchflex” Flat Cable Connector System makes 50 connections at a time.

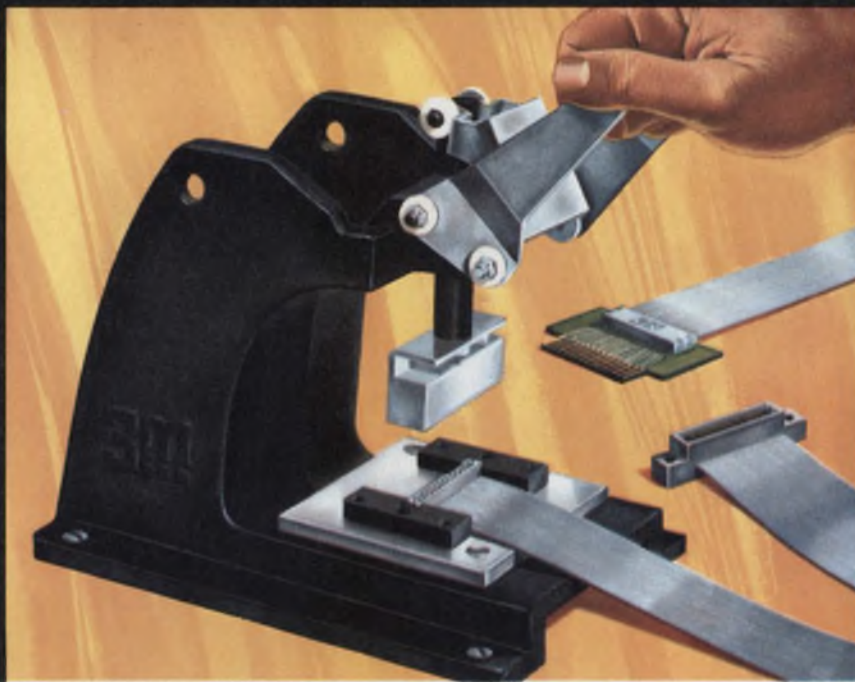

“SCOTCHFLEX” IS A REGISTERED TRADEMARK OF 3M CO.

Build assembly cost savings into your electronics package with “Scotchflex” flat cable and connectors. These fast, simple systems make simultaneous multiple connections in seconds without stripping or soldering. Equipment investment is minimal; there’s no need for special training. The inexpensive assembly press, shown above, crimps connections tightly, operates easily and assures error free wiring.

Reliability is built in, too, with “Scotchflex” interconnects. Inside of connector bodies, unique U-contacts strip through flat cable insulation, grip each conductor for dependable gas-tight connections.

“Scotchflex” offers you design freedom, with a wide choice of cable and connectors. From off-the-shelf stock you can choose: 14 to 50-conductor cables. Connectors to interface with standard DIP sockets, wrap posts on standard grid patterns, printed circuit boards Headers for de-pluggable connection between cable jumpers and PCB. Custom assemblies are also available on request.

For more information, write Dept. EAH-1, 3M Center, St. Paul, Minn. 55101.

**“Scotchflex.” Your systems approach to circuitry.**







# SHOTTKY MSI

## A mini-ALU.

**Delivering basic arithmetic and a little Boolean.  
...in a space-saving 20-pin package.**

TI's new SN74S381 4-bit binary ALU gives you the most useful arithmetic/logic functions in a compact 20-pin, 300-mil-wide plastic package – offering up to a 58% reduction in p-c board area when compared to current 24-pin functions.

And, the 74S381's versatile three-port architecture features full-carry look-ahead. This makes it a basic building block for high density, high performance digital processors in any multiple of 4-bits.

Arithmetic operations include addition and subtraction, (A minus B) and (B minus A)

without external manipulation of operands.

Logic operations are: AND, OR, Exclusive OR. Also,

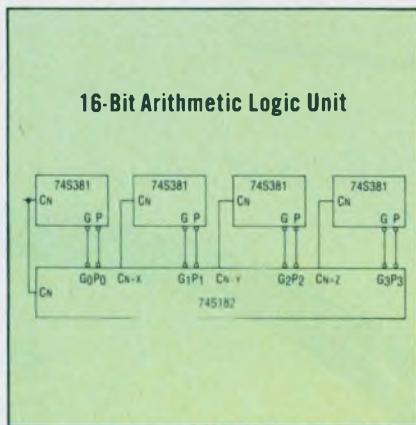

CLEAR (set to minimum) and PRESET (set to maximum).

Couple this functional versatility with a 16-bit typical add time of 25 ns (using a 74S182 look-ahead), a 100-999 piece price of \$4.40, and you have efficiency plus economy.

The SN74S381N is available from your local authorized TI distributor or from TI directly. For data sheets indicate by type number and write: Texas Instruments Incorporated, P. O. Box 5012, M/S 308, Dallas, Texas 75222.



**TEXAS INSTRUMENTS  
INCORPORATED**



# Here's how we help jumbo jets get off the ground.

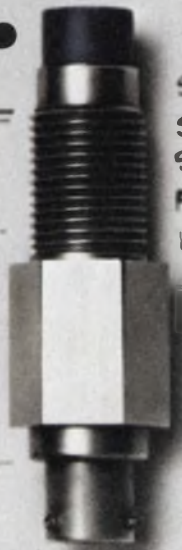
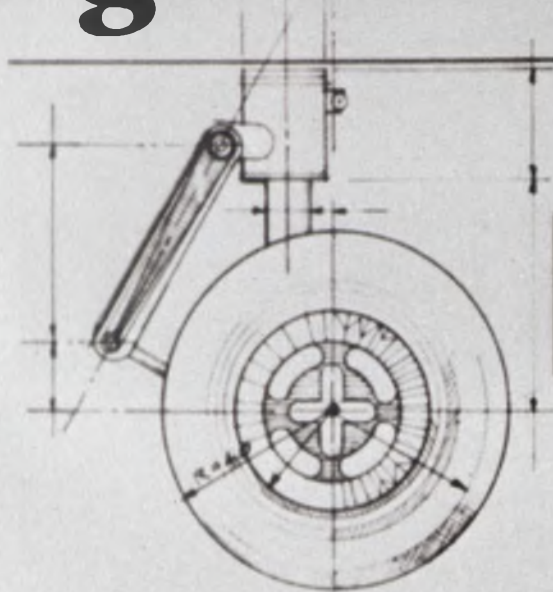

SOLID-STATE FW PROXIMITY HAS SWITCHING & SENSING ELEMENTS SEALED IN SINGLE UNIT. PROVIDES RELIABLE, NO-TOUCH SWITCHING FOR LANDING GEAR AND CONTROL SURFACE POSITION DETECTION. VARIATIONS OFFER SURFACE OR THRU-PANEL MOUNTING, HIGH-SPEED SENSING AND CIRCUITRY OUTPUT OPTIONS.

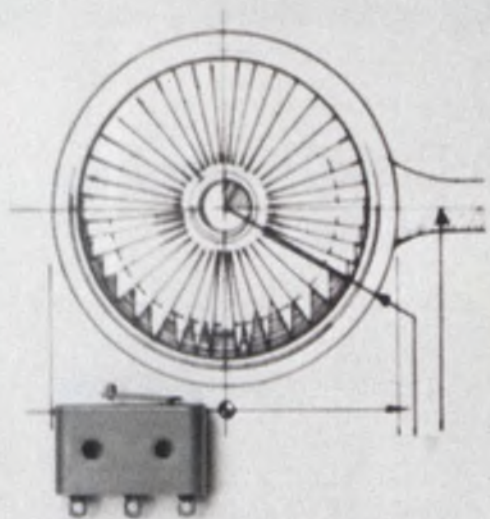

HERMETICALLY-SEALED HM FUNCTIONS IN PRESSURE SWITCH CONTROLS AND CONTROL VALVES. LARGER, HERMETICALLY-SEALED HS OPERATES IN TEMPERATURE RANGE FROM  $-100^{\circ}$  TO  $+500^{\circ}$  F AND TO 25 AMP DC

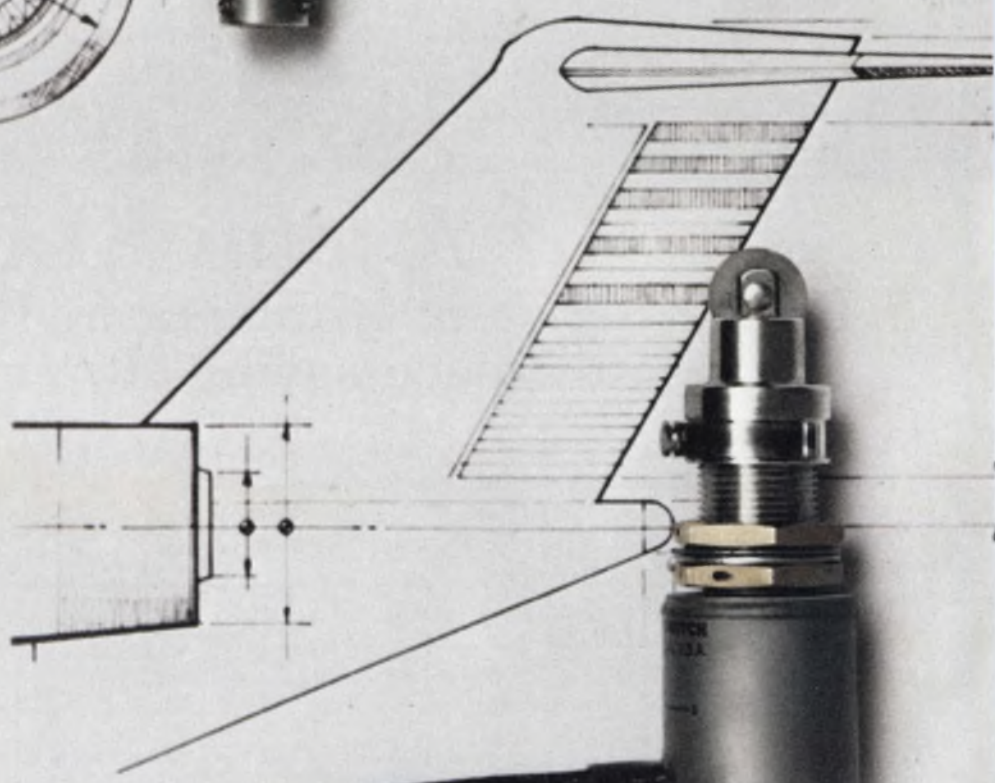

ENVIRONMENTALLY-SEALED EN'S CAN SENSE POSITION OF DOORS & CONTROL SURFACES, INDICATE STATUS OR INITIATE ACTUATOR CONTROL. OFFER WIDE ELECTRICAL RANGE, CHOICE OF TERMINATIONS & OPERATING CHARACTERISTICS. COMPLEMENTARY PRODUCTS OFFER HERMETIC SEALING AND TEMPERATURE RANGES TO  $+600^{\circ}$  F.



TL TOGGLES WORK AS COCK-  
 PIT CONTROLS AND IN MANUAL  
 INPUT PANELS. MEET MIL-S-3950.  
 AVAILABLE WITH UP TO FOUR SPDT  
 CIRCUITS & WITH  
 SCREW, SOLDER,  
 OR INTEGRATED  
 WIRING TERMINA-  
 TIONS. COMPLE-  
 MENTARY TOGGLES  
 OFFER VARIETY  
 OF ACTUATORS,  
 HERMETIC SEAL-  
 ING, UP TO 10  
 POLES, SPECIAL  
 CIRCUITRY AND  
 ROCKER ACTION.

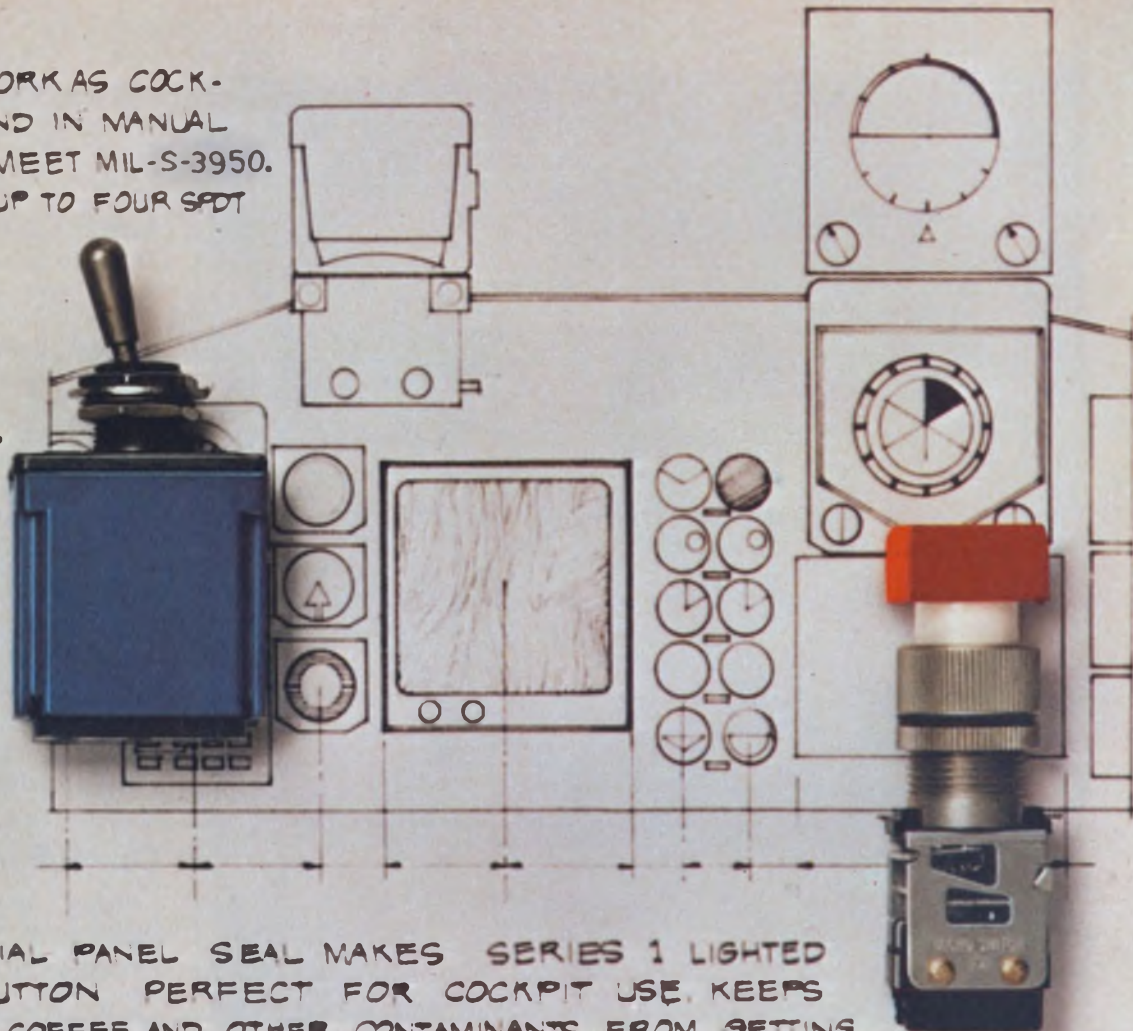

A SPECIAL PANEL SEAL MAKES SERIES 1 LIGHTED  
 PUSHBUTTON PERFECT FOR COCKPIT USE. KEEPS  
 WATER, COFFEE AND OTHER CONTAMINANTS FROM GETTING  
 THROUGH PANEL. MIL APPROVED UNDER M-22885-B1. OTHER MIL  
 APPROVED PUSHBUTTONS OFFER MULTI-POLE,  
 MULTI-LAMP OPTIONS.

ENVIRONMENTALLY-  
 SEALED SE AND  
 XE SWITCHES  
 HANDLE SENSING AND  
 MONITORING FUNCTIONS  
 AT LOW COST. APPLICA-  
 TIONS INCLUDE VALVE  
 MONITORING AND EMER-  
 GENCY EXIT CONTROL.  
 UNSEALED SM AND SX  
 OFFER GREATER COST  
 SAVINGS. UNSEALED  
 HT OPERATES TO  
 +1000°F. IDEAL FOR  
 THRUST REVERSERS  
 AND VALVE CONTROL  
 MONITORING.

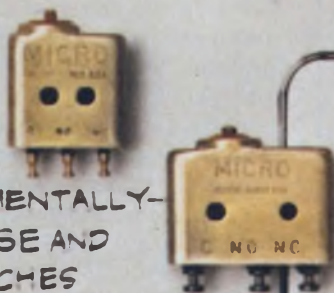

EXIT

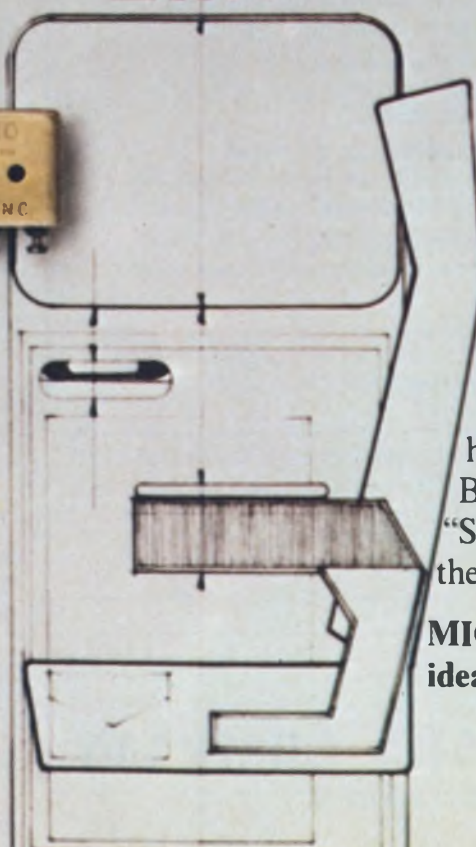

Aerospace applications present  
 special problems.

So MICRO SWITCH has  
 designed entire families of special  
 switches to handle them.

The result is one of  
 industry's most complete lines of  
 rugged high-performance  
 switches for both military and  
 civilian use.

A few examples are shown  
 here. But your MICRO SWITCH  
 Branch Office (Yellow Pages,  
 "Switches, Electric") can provide  
 the full story. Contact them today.

**MICRO SWITCH** makes your  
 ideas work.

**MICRO SWITCH**

FREEPORT, ILLINOIS 61032  
 A DIVISION OF HONEYWELL



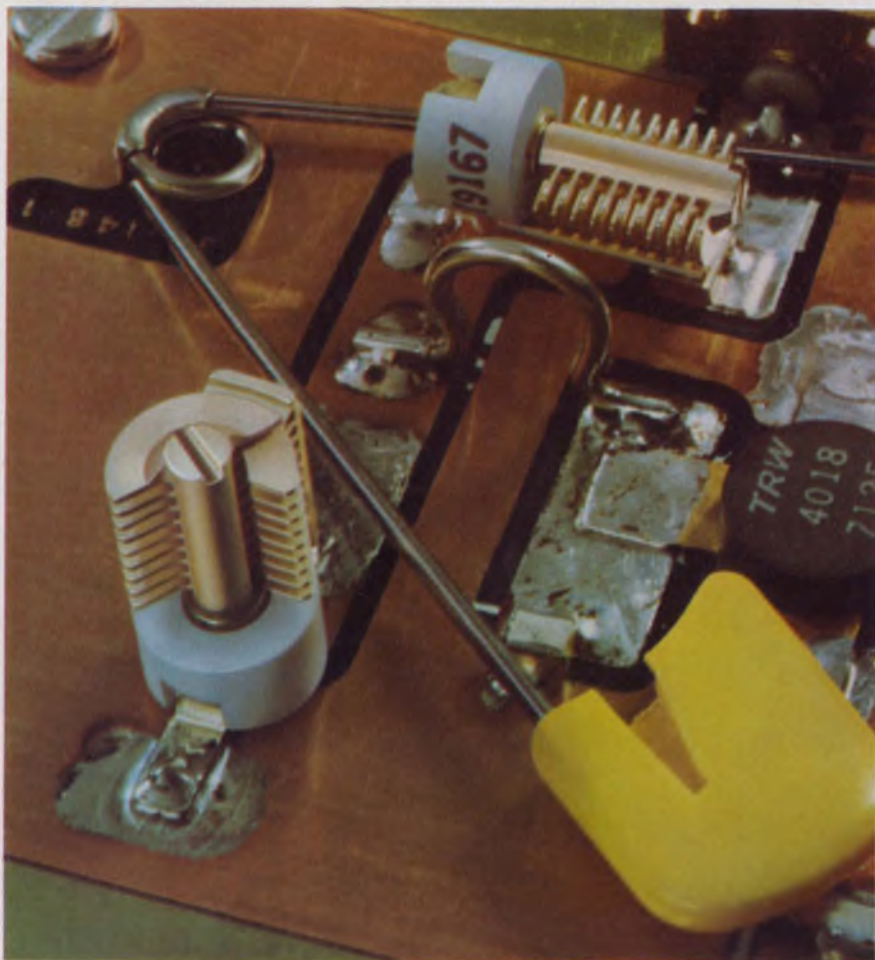

## The smallest 180° tuning air variable capacitors just had babies!

Right. Johnson's exclusive subminiature type "T" air variable capacitors (PC mounts) now come with stripline terminals for microwave applications, either vertical or horizontal tuning.

These space-savers are only about 1/3 the volume of a "U" capacitor, but they offer extraordinarily high mechanical and electrical performance for critical applications.

Rotors and stators are as stable and uniform as precision machining from solid brass extrusion can make them. A high 1 1/2 to 8 ounce-inches torque holds the rotor securely under vibration.

Temperature coefficient is very low plus 30 ± 15 ppm/° C. Q is high, typically 1800 at 200 MHz. Three capacitance ranges span from 1.3 pF to 15.7 pF.

Our 45 years of experience really shows up in these new capacitors. But why take our word for it when a stamp will get you a couple of freebies and you can check them out for yourself.

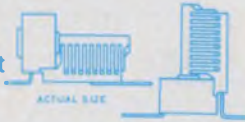

E. F. JOHNSON COMPANY / 3306 Tenth Ave., S.W. / Waseca, Minnesota 56093

Check type and range of sample(s) needed:	Capacitance range	1.3 to 5.4	1.7 to 11.0	1.9 to 15.7
Horizontal tuning		<input type="checkbox"/>	<input type="checkbox"/>	<input type="checkbox"/>
Vertical tuning		<input type="checkbox"/>	<input type="checkbox"/>	<input type="checkbox"/>

Name \_\_\_\_\_ Phone \_\_\_\_\_

Firm \_\_\_\_\_ Title \_\_\_\_\_

Address \_\_\_\_\_

City \_\_\_\_\_ State \_\_\_\_\_ Zip \_\_\_\_\_



**E. F. JOHNSON COMPANY**

INFORMATION RETRIEVAL NUMBER 20

ACROSS THE DESK  
(continued from p. 16)

dustry. A point not mentioned that might be helpful to your readers is the availability of a "Material Safety Data Sheet" for these compounds, published by the U.S. Dept. of Labor as OSHA-20, Rev., May, 1972.

Gas Tech manufactures instrumentation for measurement of both straight hydrocarbon and halogenated hydrocarbon solvents within the toxic ranges. We would be happy to supply information on request.

*Edward F. McFadden*  
Eastern Regional Manager

Gas Tech Inc.  
Eastern Regional Office  
P.O. Box 5649  
Charlottesville, Va. 22903

## Corrections on toxicity

There are serious errors in Table 3 of the article "Choose Cleaning Solvents Carefully." Benzene's TLV (threshold limit value) is listed as 1000 ppm. It should be 25 ppm, and its toxicity should be labeled "extreme"—small quantities are dangerous, cumulative and absorbed through unbroken skin. Toluene and Xylene should have TLVs of 100 ppm, not 200 ppm.

Benzene is an acute poison that produces narcotic effects. Chronic benzene intoxication results in numerous blood changes and, in serious cases, aplastic anemia with frequently fatal outcome. As a myelotoxicant, 140 fatal cases were recorded prior to 1959. Vigliani and Saita in *New England Journal of Medicine*, Vol. 271, p. 873, (1964) reported 26 deaths from chronic benzene poisoning between 1960 and 1963. Eleven of these cases were diagnosed as leukemia, which frequently develops several years after cessation of exposure to benzene.

*Horace F. Adrian, P.E.,*  
Administrator

Occupational Health Branch  
Texas State Dept. of Health  
Austin, Tex. 78756

*Ed. Note: Some of the errors were caused by glitches in printing. Our thanks to the Texas Dept. of Health for calling them to our attention.*



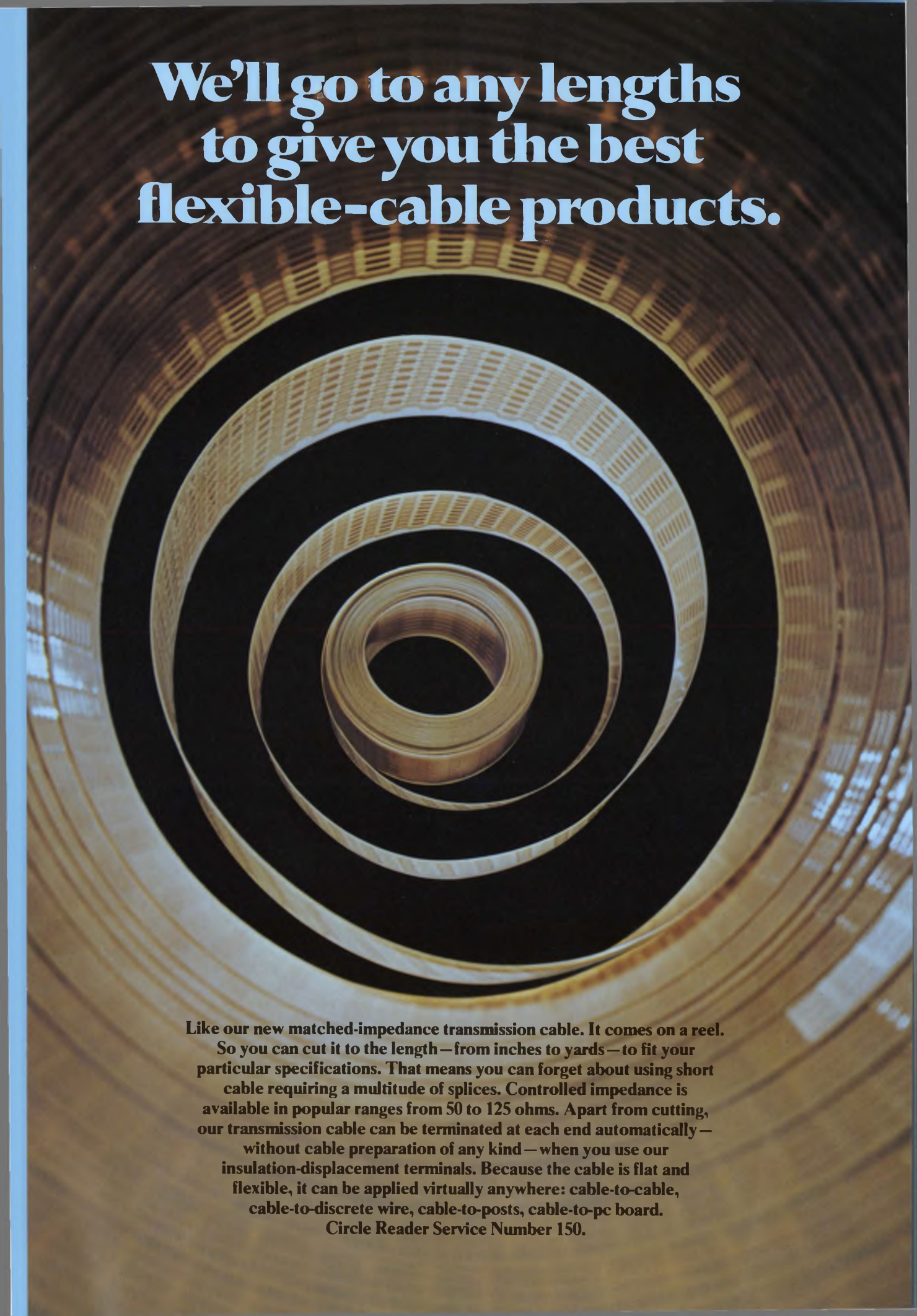

**We'll go to any lengths  
to give you the best  
flexible-cable products.**

**Like our new matched-impedance transmission cable. It comes on a reel.**

So you can cut it to the length—from inches to yards—to fit your particular specifications. That means you can forget about using short cable requiring a multitude of splices. Controlled impedance is available in popular ranges from 50 to 125 ohms. Apart from cutting, our transmission cable can be terminated at each end automatically—without cable preparation of any kind—when you use our insulation-displacement terminals. Because the cable is flat and flexible, it can be applied virtually anywhere: cable-to-cable, cable-to-discrete wire, cable-to-posts, cable-to-pc board.

Circle Reader Service Number 150.



# Total capability: from cable to terminating equipment.

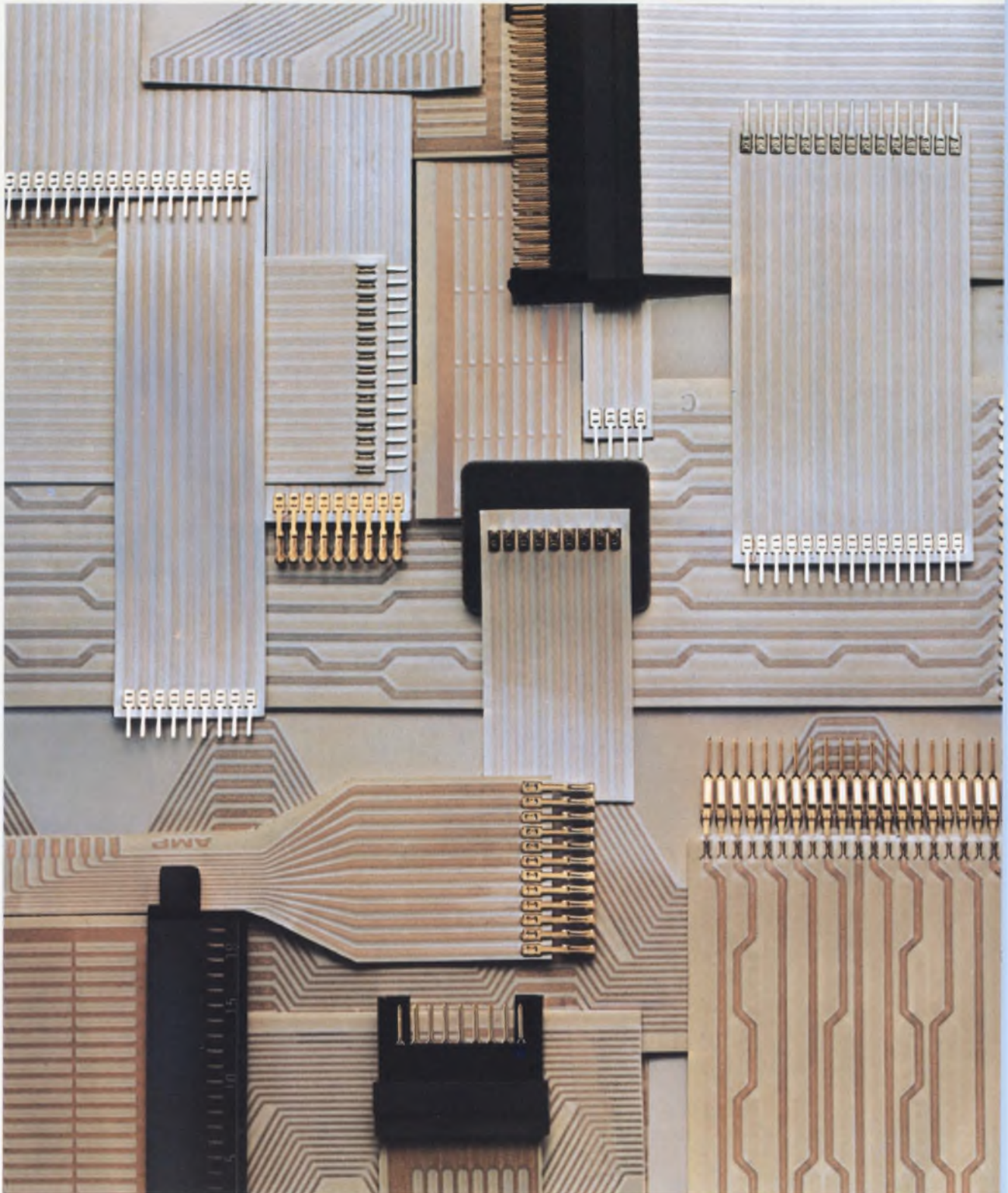



## We do it all, so you can have it all.

From one reliable manufacturer. Whether it's *parallel conductor cable*, pre-terminated jumper assemblies, or *flexible circuit patterns*, which give you compactness plus efficiency. In widths up to 22".

## A totally new idea in cable.

We can also offer power and signal circuits, plus matched-impedance circuitry, on one cable. But best of all, we designed this unique "*combination*" cable to be cut incrementally.

## The automatic way to low applied cost.

We also supply application machines for flat cable assembly in your plant. At the lowest possible applied cost to you. And at the highest production rates possible. They're fast, reliable and easy. No need to prepare the cable. Just cut to length and our machine does the rest—economically.

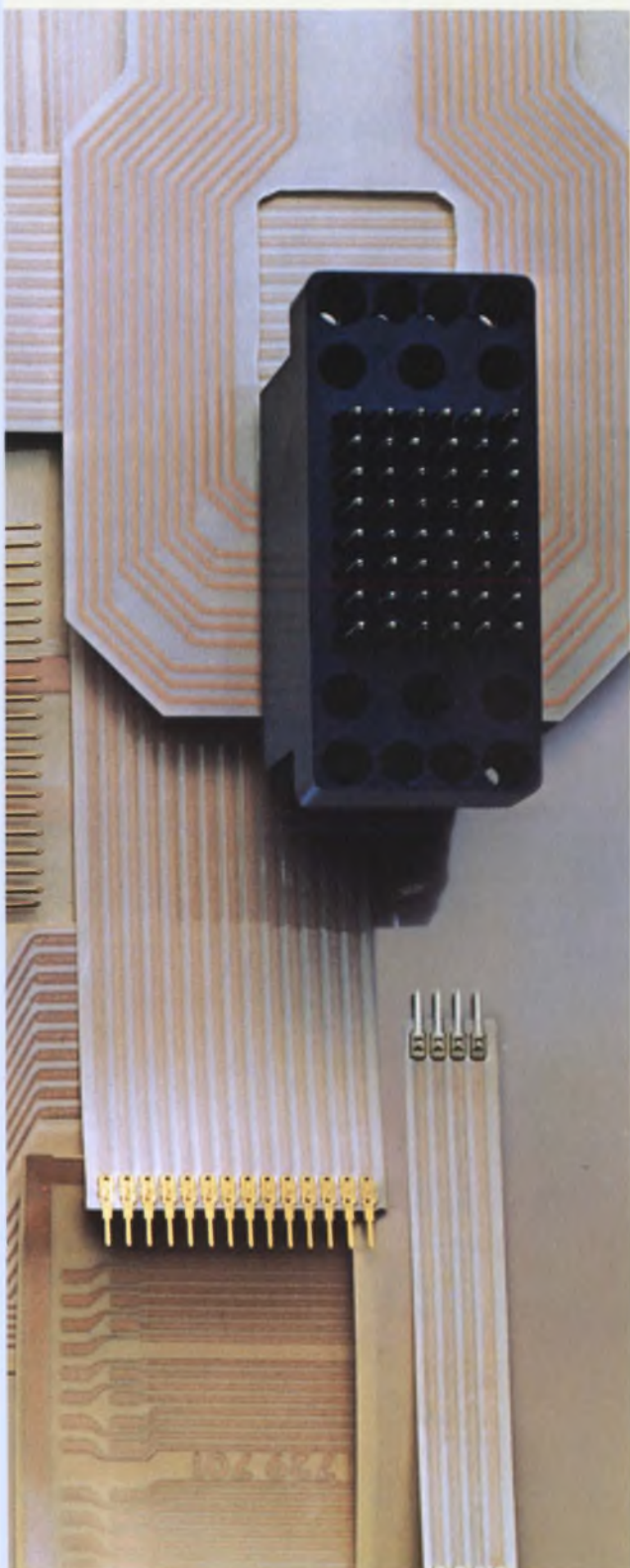



# Are you still terminating leads on round-conductor flexible cable one at a time?

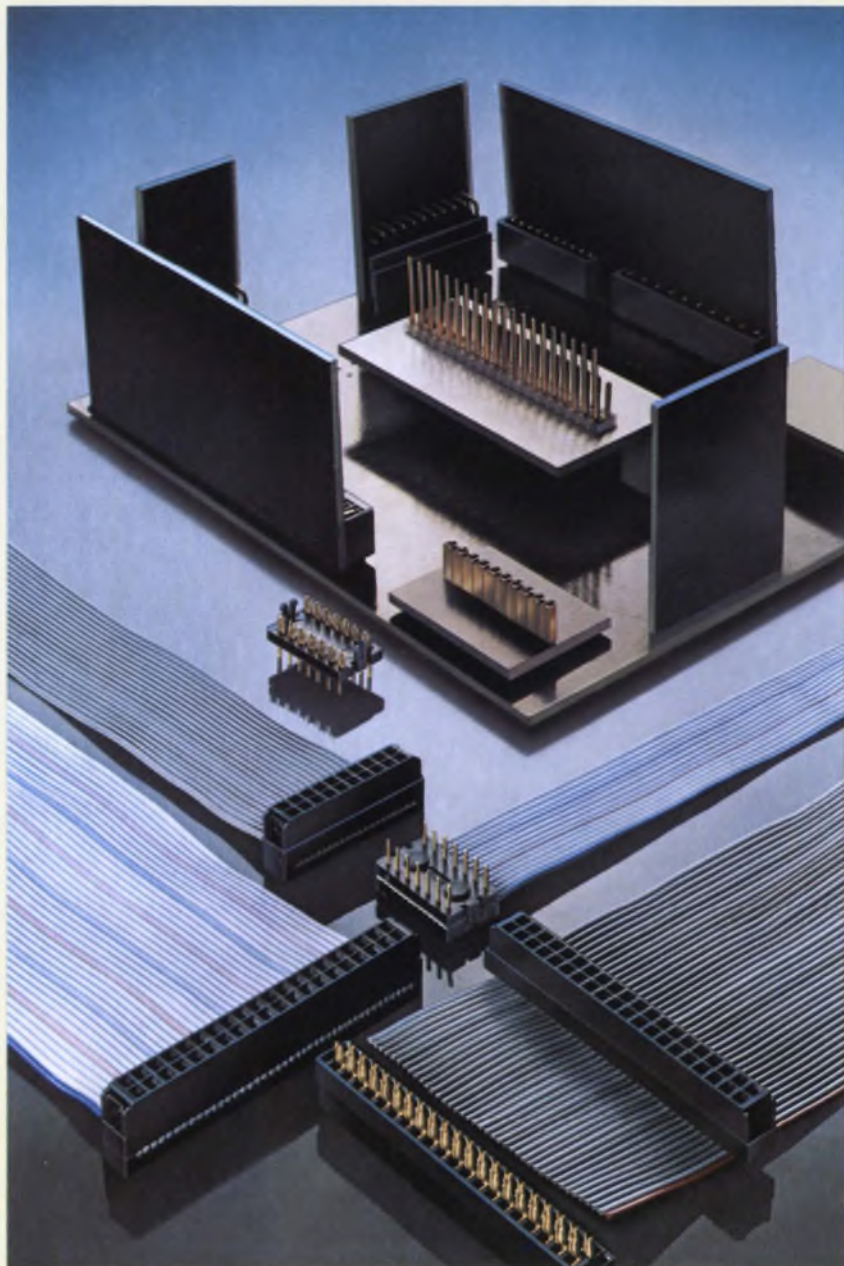

If you are, then it's time to be using AMP latch connectors. They let you terminate all leads simultaneously. Without pre-stripping or soldering.

These connectors are available in 10- to 60-position receptacles. And can mate with true .100 grid, two-row patterns of .025<sup>2</sup> posts. Inspection is simple—even during termination.

Our fork-type contacts provide redundancy and each locks into the cover for maximum point-of-contact pressure and cover retention.

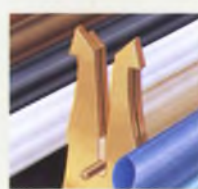

Dual camming and latching beams on AMP contacts provide possible 4-point contact and positive locking for each connector cover.

Our versatile bench press terminates AMP latch connectors (Circle Reader Service Number 151) in seconds. And you can interconnect to pc-board spring sockets, DIP headers, directly to the board itself—or wherever high-density interfacing is required. Strain reliefs can be snapped on after termination and assembly.

AMPMODU post headers are available to accommodate AMP latch connectors. Our complete line includes single- and double-row, straight-through and right angles on .100", .125" and .150" center lines.

All in all, we have the experience and know-how to do just about everything for you. From cable to connectors to headers to terminating equipment. You can even have our cable with all connectors assembled and ready to plug into your equipment. So call (717) 564-0100 for more information. Or write AMP Incorporated, Harrisburg, Pa. 17105.

AMP and AMPMODU are trademarks of AMP Incorporated.

**AMP**  
INCORPORATED



# C.S.S. is computer special systems

## PROJECT MANAGER

### Real Time/Process Control Systems

Assuming software project management responsibility for special purpose real-time and process control systems, you will be actively engaged in marketing, sales and customer interface and design implementation. Working closely with the hardware group you will be involved with unique projects which utilize the PDP-8 and PDP-11 from the initial contact stages through final implementation. You should have a B.S. and 3-5 years real-time or process control systems experience. A knowledge of hardware is most desirable.

## PROJECT MANAGER

### Digital Data Communications

This position involves software project management responsibility for special purpose data communications systems utilizing the PDP-11 with specific activities including marketing, customer and sales interface, design and implementation of communications systems software.

You should be a problem-solver with a BS, 5 years experience, and a demonstrated ability in the following areas: synchronous and asynchronous line protocols, message switch, store and forward, remote job entry and polling. A knowledge of hardware and IBM communications systems is most desirable.

## LOGIC DESIGN ENGINEER

### Special Terminals and Graphics

This position affords an unusual opportunity for the engineer with anywhere from 0-4 years experience to become involved in state-of-the-art design efforts for special terminals and graphics. Working with senior design engineers and applications engineers, you will become heavily involved with design as well as customer interface. Your extensive exposure and developing expertise will present a unique opportunity for advancement.

Digital's Computer Special Systems Group meets the needs of those customers requiring special systems considerations. In a 10 year history, the personnel of C.S.S. have achieved a remarkable record of technological accomplishments and innovative solutions.

C.S.S., a group of approximately 300, works with client-customers seeking solutions to special interfaces, production quantities of unique devices, hardware adaption, product management support or special system software.

If you are a problem-solver, enjoy customer contact, and want to join a spirited group involved in unique special systems designs/applications, then we should get together.

## PROJECT ENGINEER

### For Digital Communication and Multi-Processor Application

This is a challenging opportunity for a professional of demonstrated success to assume a key position within our Computer Special Systems Group involving the direction and design contributions for a unique Digital Communications System. Your responsibilities will not only include design but also the meeting of marketing, budget, and delivery objectives. This multi-faceted position will additionally include the development of unique multi-processor systems for an unlimited variety of applications. You should have a broad background with 4-7 years experience, preferably in the areas of military and non-military communications systems and multi-processor systems.

## PROJECT ENGINEER

This is a unique opportunity for a professional who enjoys and wants the challenge of breaking through existing systems design and applications barriers. If you know how to make computers perform in unique and novel applications that require the utilization of new approaches, this is a position that you will be able to run with. As a member of our Computer Special Systems Group you will be tackling one-of-a-kind systems problems involving the determination of which ones are solvable, and apply the solution. Your background should include a degree in Computer Science, heavy university lab involvement and a record of making computers perform in non-routine applications.

## DESIGN ENGINEERS

Positions are available for design engineers to contribute to Digital Communication, Multi-Processor Application, and unique systems applications.

Please send your resume to Ms. Pat Kress, Digital Equipment Corporation, Dept. 621, 426 Main Street, Maynard, Mass. 01754.

**digital**

digital equipment corporation

The above positions are open for application to women and men regardless of race, national origin, age, religion, or creed.



# BURROUGHS DISPLAYS

## CAN TAKE IT!

Burroughs gas discharge display panels are designed to stand up under the toughest operating conditions of shock, vibration, humidity, and temperature extremes ranging from  $-40^{\circ}$  to over  $+185^{\circ}$  F. Burroughs display panels are capable of withstanding the real-world conditions so often encountered in automotive, aircraft, instrumentation, consumer, and industrial applications.

SELF-SCAN<sup>®</sup>, PANAPLEX<sup>®</sup>, and SELF-SCAN BAR GRAPH displays have no moving parts, no internal welds, and require a minimum of external connections (only 8 connections for a dual SELF-SCAN BAR GRAPH, 16 connections for a 16- or 32-character SELF-SCAN display, and 17 connections for a

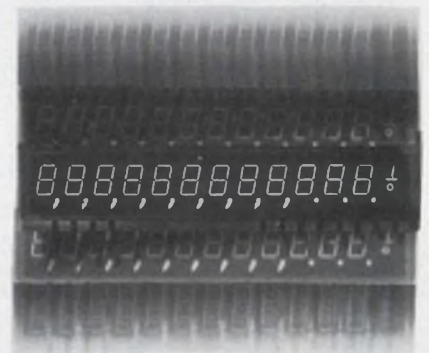

full 9-digit PANAPLEX display). Gas-discharge technology has proven long life through years of rugged use.

These bright, sharp, clear, high-contrast displays are a pleasing neon-orange color, making them a comfortable display to read, even for extended periods of time.

SELF-SCAN display panels are the ideal man-machine links for displaying 16 to 256 alphanumeric characters for information display systems.

PANAPLEX display panels are for 4 to 16 numeric character applications, and can include arithmetic symbols and alphanumeric characters for systems requiring constant or intermittent display of data, such as calculators, clocks, and recording instruments.

SELF-SCAN BAR GRAPH analog displays present information in analog form with digital accuracy for the measurement and display of speed, torque, temperature, pressure, force, acceleration, and other control or information parameters.

SELF-SCAN, PANAPLEX, and BAR GRAPH display components are attractive, easy to read, compact, versatile, and are ideally suited to the new generation of information display requirements.



*For complete technical details and applications engineering recommendations, write or call Burroughs Corporation, Electronic Components Division, P.O. Box 1226, Plainfield, N.J. 07061 or call (201) 757-3400 or (714) 835-7335 in California.*

**Burroughs**





## Digital recording used by home video player

The latest proposed entry in the home video player field—unlike all other systems announced so far—uses digital recording of color television programming on a stationary photographic film plate. The playback optics spin underneath the plate. (See also "Video Players for the Home Turning to Card and Disc Units to Cut Costs," p. 46.)

The digital player, developed at Battelle's Specific Northwest Laboratories, Richland, Wash., has substantial advantages over competing analog systems, according to James T. Russell staff scientist. The record is smaller for given amount of data storage and the digital approach is free of intermodulation distortion and undesirable phase shift encountered with analog systems, he says.

"We take the original color TV signal, which is usually a YIQ standard color signal plus sound, digitize them separately and then spatially multiplex all of the bits on the plate," Russell reports. "Recording and playback are accomplished using a laser and a spinning optical element.

The result, he points out, is a bit stream of 1- $\mu$ m dots with all of the data sandwiched together. Track-to-track spacing is said to be about 2  $\mu$ m in the present prototype model. Tracking of the bit stream is accomplished by use of a mirror that is dithered.

Another advantage, Russell says, is that the vertical and horizontal blanking areas are empty—consequently "we put the audio in there." There is also additional room for four-channel audio plus four more channels for foreign-language sound.

Constant playback speed is listed as another advantage. If the playback motor speed varies, there can be synchronizing problems with some of the other systems, Russell says.

"But with a digital system, he continues, "we can put in a \$2 buffer that clocks the data out at a fixed rate and thus makes the time base correction. That would be prohibitively expensive for analog systems."

Because the record is stationary rather than rotating, the whole disc can be used for playback; with spinning discs, a large area in the middle cannot be used.

"Actually we pick up a factor of 4 in the useful area," Russell says.

The playback system is sealed. The record sits on top of a glass or plastic plate mounted on the top of the player cabinet. The playback optics spin underneath. This prevents dirt from getting into the playback mechanism, Russell says.

In the playback mode, the laser beam is scanned over the record and a photo detector picks up the bit pattern, converting it into a digital signal that relatively simple circuitry reconstructs into a form suitable for display on the TV receiver.

The development of the video player is being pressed by Digital Recording Corp., Scarsboro, N.Y., which has an exclusive licensing agreement with Battelle.

Sarason B. Lebler, president of Digital Recording, indicates that the records can be copied at low cost. A 5 x 7-in. record may cost as little as 25 cents.

Lebler estimates that the manufacturing cost of the home video player in large quantities would be \$108.

### 'Full house' forecast for Wescon show

With less than three months remaining before the Western Electronic Show and Convention opens in the Los Angeles Coliseum, Don

Larson, general manager, predicts a "full house" of exhibitors for the second straight year. Exhibit space is more than 95% committed and should be entirely sold out by July 1, according to Larson.

Final figures are expected to show 280 exhibitors in 537 booths, Larson says. This would compare with 466 booths at last year's sell-out in Brooks Hall, San Francisco.

The show will be held Sept. 10-13. The technical program being assembled consists of 26 or 28 half-day sessions. Among the subjects expected to be covered are charge-coupled devices, microwave and millimeter solid-state components, uninterruptible power supplies, microprocessors and LSI testing.

### TV picture quality adjusted automatically

The 1975 Quasar 100 color TV receiver, recently introduced in New York, senses the ambient light in a room and automatically adjusts the picture quality accordingly.

The light-sensing feature incorporates a color demodulator IC developed by Quasar Electronics and a light sensor. Called Super Insta-Matic, the feature uses a honeycomb lens, similar to a light meter's. Behind the lens is a light sensitive resistor that passes on its information to the IC. The IC increases or decreases the picture brightness, changes contrast and color intensity and keeps them all in balance.

Some of the remote-control systems for color consoles are equipped with a Slumber Sentry, which automatically shuts off the TV when a broadcasting station concludes its transmission.

The "instant-on" feature is built into the new Quasar models with a "vacation switch," which allows the user to turn off the feature if he likes.

Quasar Electronics Corp., formerly a division of Motorola, is now a subsidiary of Matsushita Electric Corp. of America, Franklin Park, Ill. Quasar is now competing for television sales with its sister subsidiary of Matsushita, Panasonic.

Meanwhile, RCA is moving out of the home-audio business, after marketing its new 1975 line, and



will concentrate entirely on "television-related home equipment." This move will leave even more of the consumer electronics market to Japan.

Motorola went out of the phonograph and hi-fi components business in April, 1973, and its home-radio operations in 1972.

Now that Motorola's Quasar is part of Matsushita, however, there has been speculation that the Quasar group will move into the home consumer field.

## Digital storage offered in light-plane radar

A new weather radar for light-to-medium, twin-engine aircraft incorporates digital-information storage and display instead of the real-time analog presentation of competitive radars.

Called the RDR 130 by the developer, Bendix Avionics in Fort Lauderdale, Fla., the unit digitizes, integrates and stores the radar return. From storage, a complete picture is flashed onto a screen at a 60-cycle rate to prevent image flicker. This is unlike other weather systems, which use a high-persistence CRT for image storage, according to Roger D. Stevens, senior staff engineer.

The digital manipulation and presentation of the weather data, says Stevens, offers the following advantages:

- The picture is continuous, like that on a TV screen. It is also brighter because the data is integrated over a number of radar returns. This contrasts with the fairly rapid decay of the picture that follows the radar sweep on high-persistence CRT screens. The pilot can observe the weather picture at any time, regardless of antenna-beam position.

- Storage and integration of the returns minimizes fading and noise interference problems. These features also permit the use of a standard CRT.

- Digital presentation, Stevens notes, allowed Bendix to put in a "display hold" feature that enables the pilot to evaluate a storm's direction and its rate of movement relative to the aircraft. This is accomplished when one image on the CRT is held on the screen for a few moments and then switched

to the updated image. At this point the storm can be observed to jump from one position to another.

- A weather-alert feature warns the pilot of severe turbulence in the center of a storm cell. The turbulence causes the display to blink in the "contour hold" that defines the storm center.

The range of the RDR 130 is 160 miles maximum and one mile minimum, with selectable ranges of 5, 10, 20, 40 and 160 miles. The antenna's horizontal scan is 90°, with a vertical tilt angle of 15° up or down. By depressing the antenna, the system can pick up prominent ground features, such as mountains, rivers and lakes.

The radar has a 7-kW peak power expand transmitter. The system requires 98 W from a 28-V supply.

## Minis monitor weather at nuclear power sites

The Atomic Energy Commission requires that proposed nuclear power-station sites be monitored for weather conditions two years before the start of construction, all during construction and for two years after the beginning of operation. A computer-based system, operated by Digital Graphics Inc., Rockville, Md., has been monitoring five unattended sites since January in accordance with AEC requirements.

At each site 32 weather-monitoring instruments, installed on a 400-ft tower, are sampled once every 15 minutes by an on-site minicomputer—a Varian 620/L. In addition to gathering data, the computer checks the quality of data to indicate instrument malfunctions.

At four-hour intervals, each remote site is contacted via commercial telephone lines by a central Varian 73 minicomputer, which gathers the data. The central computer also resets the clock at the site, clears the memory and can provide program updates. It will print an alarm message if any instruments appear to be malfunctioning.

At infrequent intervals, the central computer serves as a time-sharing terminal for a large computer, transmitting many months' worth of processed weather data. The large computer is then used to

simulate conditions such as probable vapor drift from a cooling tower or accidental nuclear-particle release.

Tom Celi, vice president of technical services for Digital Graphics, says: "We used to use strip-chart recorders, manual data collection and a semiautomatic analysis. By computerizing the whole process, we can now assure the AEC that the data are valid, instruments are working and the site is under continuous observation."

## Second weather buoy being placed in Pacific

A 35-ton automatic weather station, the second in a series that will stretch from the Aleutians to San Diego, is moving to its assigned position some 300 miles west of the Oregon-Washington coast. The first of the large buoys was moored last year in the Gulf of Alaska.

Designated EB-02 by the National Oceanic and Atmospheric Administration Data Buoy Office, the 29-foot buoy was built in the shape of a boat by Lockheed Shipbuilding and Construction Co. in Seattle. It can be moored in water depths of 20,000 ft and operated unattended for a least a year. It is designed to withstand currents up to seven miles an hour, winds to 178 miles an hour and wave heights of 60 ft.

Sensors on the buoy will gather data that will be radioed by three rf transmitters at designated intervals to a Coast Guard station for relay to the National Weather Service.

The sensors will report wind speed and direction, precipitation rate, air temperature and pressure, dew point and global radiation. Hull-mounted sensors will report water-current speed and direction, salinity, temperature and wave height. Before transmission to shore, data collected by sensors are processed by a 1601 computer made by Rolm Corp. of Cupertino, Calif.

The communication system on the buoy is composed of two transceiver sets, which contain three hf transmitters and receivers each, and a common antenna. They receive and demodulate simultaneously on three different rf bands, and modulate and transmit any one of the same bands.



# The last time someone announced 74C, it was a national campaign.

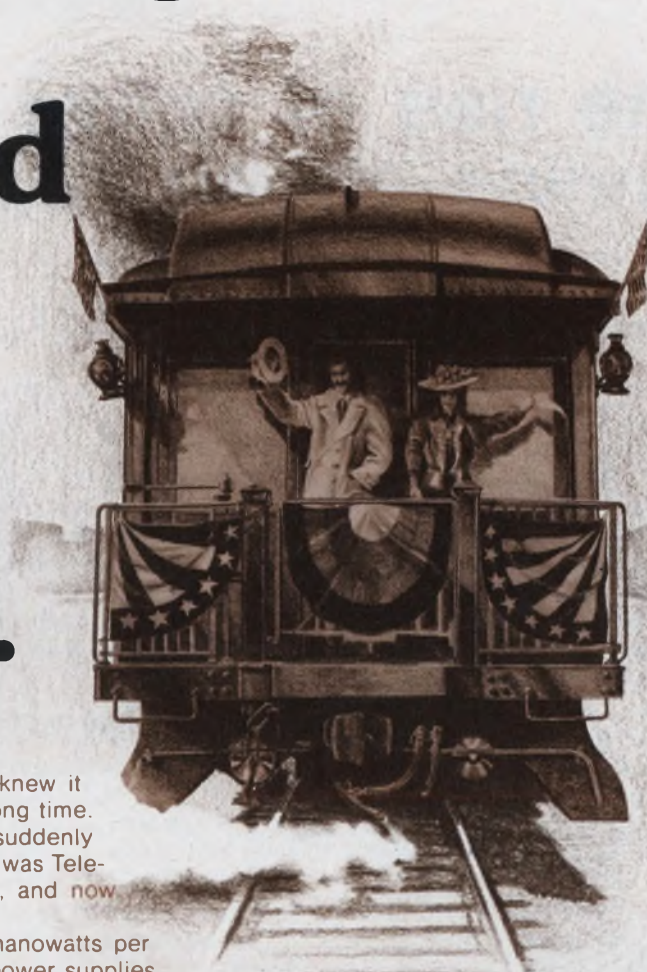

When we saw 74C coming down the tracks, we knew it would be the hottest and most logical CMOS line in a long time. Flags waved, bands played, and thousands of engineers suddenly found CMOS easier to design in. The only thing missing was Teledyne's big production volume and competitive pricing, and now you've got that too.

Here's what Teledyne 74C delivers: A mere 10 nanowatts per gate typical power dissipation. Operation on 3V to 15V power supplies. A big, guaranteed 1V noise margin. Typical noise immunity 45% of the supply voltage. Hefty outputs that drive MOS and bipolar logic (at least two LPTTL loads).

And 74C really simplifies design. 74C logic functions, pinouts and even numbers are identical to 7400 TTL, and every 74C device is compatible with every other 74C device. I/O specs are consistent (no interpreting a pile of data sheets to calculate what's compatible with what). Not to mention drastic cuts in the need for supply regulation, bypass capacitors and noise filtering.

The first batch is available now.

MM74C00	Quad 2-Input NAND Gate	MM74C107	Dual J-K Master-Slave Flip-Flop
MM74C04	Hex Inverter	MM74C160	Synchronous Decade Counter
MM74C20	Dual 4-Input NAND Gate	MM74C161	Synchronous 4-Bit Binary Counter
MM74C42	BCD-to-Decimal Decoder	MM74C192	Synchronous Up/Down Decade Counter
MM74C74	Dual D Flip-Flop	MM74C195	4-Bit Parallel-Access Shift Register

That's our national platform for 74C. But Teledyne's CMOS campaign has just begun. We'll soon be speaking softly about big values in proprietary devices compatible with 74C and custom CMOS for linear and digital applications. All with ultra-low power dissipation and high noise immunity.

 **TELEDYNE  
SEMICONDUCTOR**

1300 Terra Bella Avenue Mountain View, California 94043  
(415) 968-9241 TWX: 910-379-6494 Telex: 34-8416

INFORMATION RETRIEVAL NUMBER 23



# The rise of active filters: They're running strong in two major fields

Analog active filters are replacing conventional passive filters in a variety of applications as the communications and data-acquisition industries seek new ways to help them expand.

And digital active filters are starting to make in-roads, too.

Small, yet often complex active filters are being used in applications like these:

- Line equalization in high-speed modems.
- The decoding of Touch-Tone signals.
- The automatic adjustment of bandwidth in spectrum analyzers.
- The selection of frequency range and rejection of spurious noise in biomedical equipment.

---

**Seymour T. Levine**  
Associate Editor

- Special duties in sophisticated sonar arrays and moving target indicators.

Although the active digital filter has been the subject of considerable research in recent years, most hardware is still in the laboratory stage. So far only two companies are making commercial versions.

On the other hand, no less than 20 companies are making analog filter modules, and this figure rises to 100 if custom units are included.

## Analogs range to 200 kHz

Active analog filters are being used in the 10-Hz-to-200-kHz range, and 500 kHz is in sight.

The upper frequency range is limited by two factors: Passive filters perform similar functions at less cost and size than their active counterparts at 100 kHz or

above. And at frequencies above 200 kHz, the op-amp gain-bandwidth is insufficient to ensure circuit stability and the cost of the amplifiers is high.

Below frequencies of 100 Hz, the active analog filter is the undisputed favorite. Passive inductors capable of operating in this range are very bulky and cannot provide the necessary temperature and component value stability. Also, passive filters cost more than their active counterparts. Typical jobs performed by these filters include electromyograms (EMG), electrocardiogram (EKG) and electroencephalogram (EEG) filtering, geophysical measurements (filtering the outputs of geophone and earthquake tilt sensors) and averaging for spectrum analyzers and rms noise measurements.

Between 100 Hz and 100 kHz, active analog filters compete on the basis of versatility. They are easily tuned by means of external resistors or even a programming voltage. And they can offer high input impedance, low output impedance and circuit gain.

Active analog filters are being commonly used as prefilters of analog-signal inputs for data-acquisition systems (to prevent aliasing), as narrowband tunable filters for spectrum analyzers and as fixed-frequency filters in Touch-Tone decoders. Tunability is useful in feedback-controlled Doppler radars that track moving objects.

The building blocks most frequently offered by the manufacturers like Kinetic Technology, Santa Clara, Calif.; Beckman Instruments, Fullerton, Calif., and Frequency Devices, Haverhill, Mass., are two-pole, op-amp systems of the bi-quad or state-variable type (see box). Both use three op amps, but the state-variable unit,

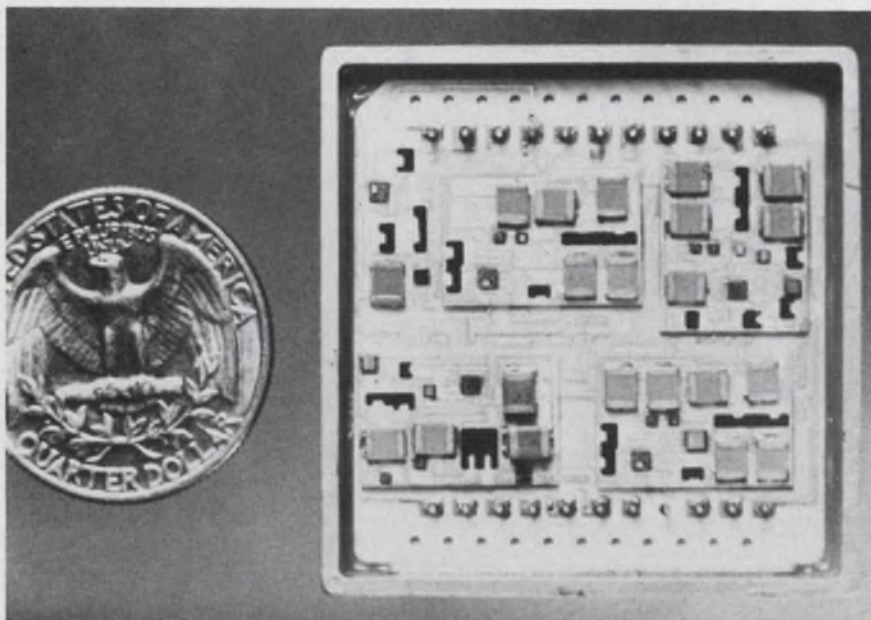

**Hybrid houses have put multiple-pole active filters in small plug-in packages.** Chip components are op amps and capacitors, assembled along with thick-film resistors on a ceramic substrate. This 1.6 x 1.6 x 0.25-in. package from General Instrument contains an eight-pole elliptic filter for operation in the 3-to-50-kHz region.



# THE SUPER SOURCE FOR CAPACITORS

**MEPCO/ELECTRA... the capacitor people**

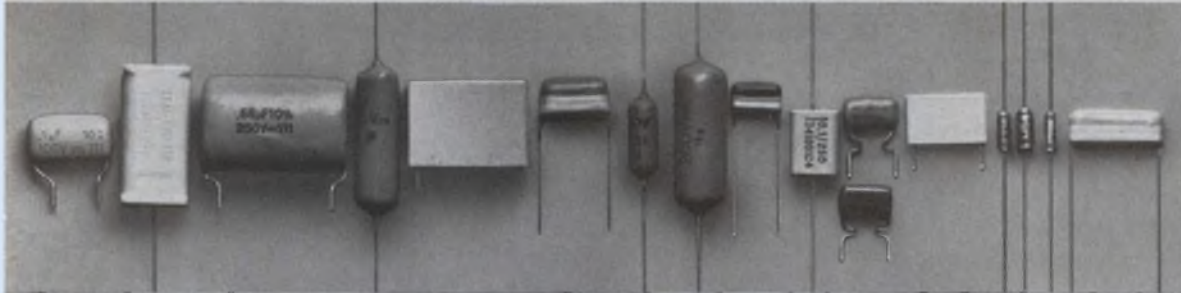

**Film Capacitors**  
 Metallized Polyester & Polycarbonate  
 Polyester & Foil  
 Polystyrene



**Electrolytic Capacitors**  
 Solid Aluminum  
 Dry Aluminum  
 Power  
 Computer

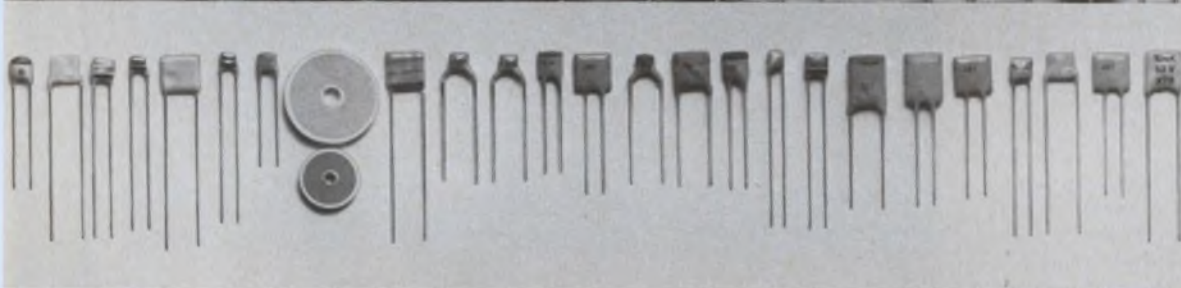

**Ceramic**  
 Microplate Class I & II  
 Monolithic  
 Discoidal

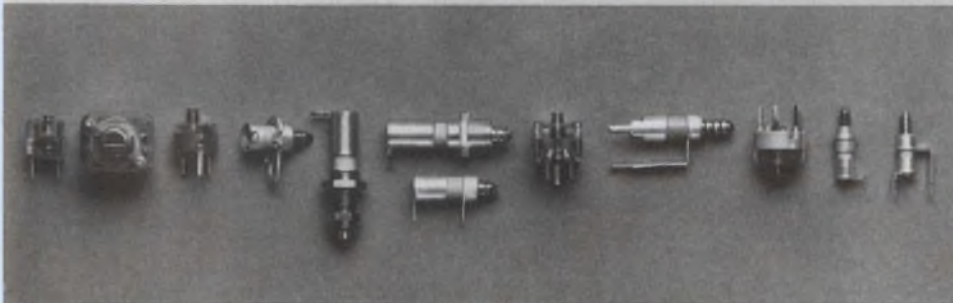

**Trimmers**  
 Film  
 PTFE  
 Polypropylene  
 Ceramic

For more information on the complete Mepco/Electra capacitor line, fill out this coupon and return to:  
 Mepco/Electra, Inc.,  
 Columbia Road,  
 Morristown, N.J. 07960.  
 Attn: Capacitor Marketing or call us at (201) 539-2000.

Send me complete technical information on:

- M/E Film Capacitors**     **M/E Ceramic Capacitors**  
 **M/E Electrolytic Capacitors**     **M/E Trimmers**  
 **Have representative call**

NAME _____	TITLE _____
COMPANY _____	PHONE _____
ADDRESS _____	
CITY _____	STATE _____ ZIP _____



Sold through North American Philips Electronic Component Corporation

**Plant Locations:**  
 Morristown, N.J.  
 San Diego, Calif.  
 Mineral Wells, Tex.  
 Canandaigua, N.Y.  
 Oakland, Calif.



## Building blocks for active analog filters

The gimmick circuits have fallen by the wayside in the active filter world, leaving the field to two major circuits—the state-variable configuration and the bi-quad. Both can be manufactured with readily available op amps, and they have the stability and versatility needed to encourage mass production.

The state-variable circuit is the more flexible of the two and can provide simultaneous low-pass, high-pass and bandpass outputs. The actual configuration is nothing more than an analog computer (a) for the second-order transfer function

$$\frac{k}{s^2 + (\omega_0/Q)s + \omega_0^2}$$

The name state-variable filter refers to the fact that the outputs of the integrators are the state variables for the circuit.

The two integrator-input resistors,  $R_1$  and  $R_2$ , are the main control of the center frequency  $\omega_0$ . Resistor  $R_0$  sets the circuit  $Q$ . To get band-reject operation, sum the high-pass and low-pass outputs. You can also generate all-pass functions with a sum of the low, high and all-pass outputs. In fact, the feedback loops generate the denominator, and sums of the outputs give the numerator.

If you want to voltage-tune the filter, substitute analog multipliers (b) in the circuits for  $R_1$  and  $R_2$ . The center frequency,  $f_c$ , is given by the expression

$$f_c \cong \left(\frac{V_c}{10}\right) \frac{1}{2\pi RC}$$

for the components shown.

Although the state-variable, or universal, filter is less in-

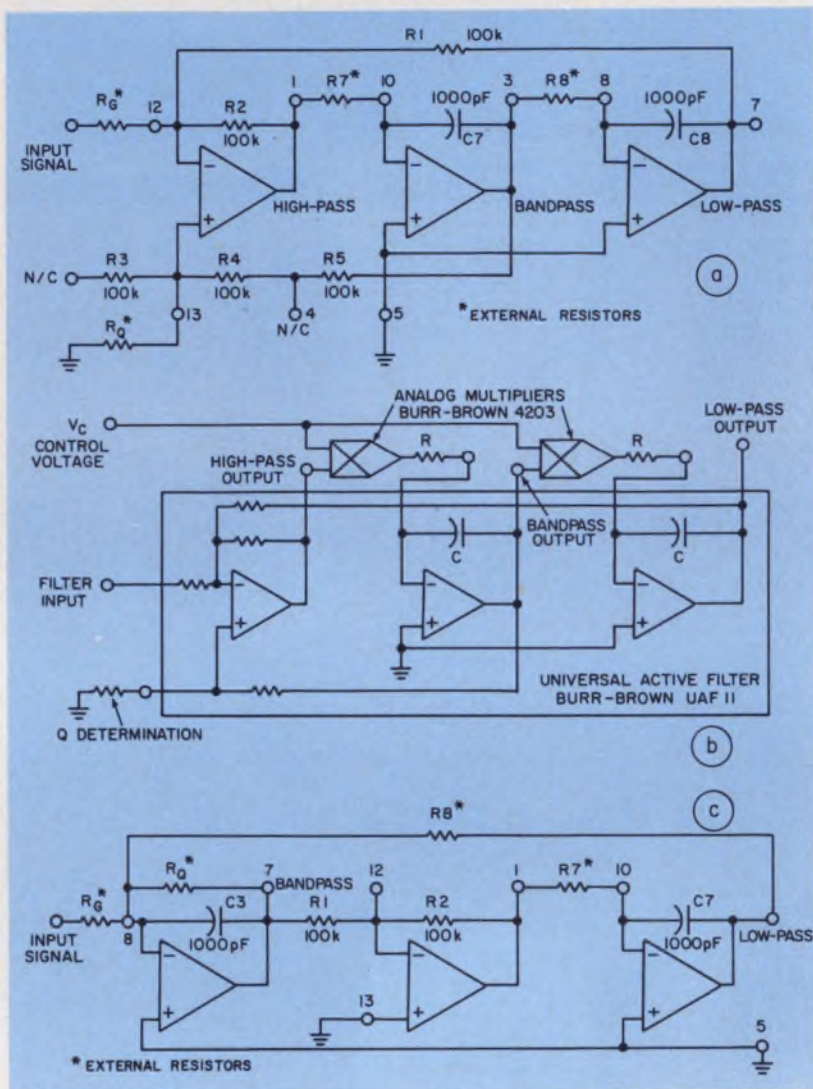

clined to self-oscillation, the bi-quad circuit (c) has more straight-forward design equations. However, only low-pass

and bandpass outputs are available. And variations of the tuning resistor,  $R_1$ , affect  $Q$  as well as frequency.

often called the universal filter, uses two integrators. The bi-quad provides simultaneous bandpass and low-pass outputs, whereas the universal filter provides all three—low-pass, high-pass and bandpass outputs. The bi-quad—sometimes called an active resonator—is often used because the design equations are much simpler. However, the state-variable unit affords the most flexibility and the best stability. The  $Q$  of the root pair and their center frequency can both be set separately by external resistors.

One technique used to make the filter tunable is to interpose analog multipliers in the paths of the frequency-determining resistors of the state-variable unit and then to apply the analog signal to one of the multiplier terminals. Another makes use of FET switches controlled by a variable duty-cycle square wave.

A number of building-block manufacturers also supply cookbook formulas that allow the user to design Butterworth, Chebyshev and Bessel filters in low-pass, high-

pass and bandpass versions. In fact, Burr-Brown tabulates the necessary pole  $Q$  and frequency and provides a 25-line Fortran program listing that transforms the low-pass poles to their bandpass positions. In effect, the user synthesizes his filter: He sets a given pair of pole positions with each module and then cascades the modules.

Kinetic Technology's latest approach is to place multiloop feedback around the modules. Each module's pole pair is tuned to a





**Put it all together  
with Buchanan  
Printed Circuit Board  
Connectors – and  
eliminate 4 connection  
points per circuit!**

Here's a new solderless printed circuit connector that eliminates hybrid interfaces between electrical and electronic circuitry. It replaces costly interwiring between terminal blocks, barrier blocks, and internal electronics...saves you up to 4 or more separate connection points per circuit!

With only a screwdriver and this new Buchanan one-piece connector, you can quickly connect solid or stranded wires, #12 through #30 AWG, to standard .200" contact-spaced printed circuit boards. The connector block is available for 12, 18, 24, 30 and 36 circuits; provides 300V insulation spacing between circuits; can carry up to 5 amperes per circuit; and is flame-retardant.

A unique right-angle design provides mounting flexibility and increased density, and the block can be mounted against any two adjacent panel sides if desired, since wire entry is all on one side. You can even "daisy chain" two or more conductors!

For complete engineering, pricing and ordering information, write us at Dept. ED-4.



**CONTROL PRODUCTS  
DIVISION**

Amerace Corporation  
Control Products Division  
2330 Vauxhall Road  
Union, New Jersey 07083



common center frequency and Q. External feedback loops and op amps set the final frequencies, so the sensitivity of the over-all transfer function is much less than that of the simple cascade.

Not everyone sees these modules as the ultimate for filter designers. For example, G. James Estep, a filter-design consultant for Estep Enterprises, Agoura, Calif., contends that the building block is an excellent prototype tool but does not always give the customer the most value. The module uses three op amps, can come in large packages and requires considerable tweaking if the Q gets too high—say, 25 to 30 at 1 kHz. And extra capacitors are needed at the low frequencies.

The designer has at least two other choices. If the filter is not to be variable, then single-amplifier two-pole circuits, such as the Sallen and Key resonator, will give satisfactory performance, and quad op amps allow for synthesis of eight poles per package. Or if a hybrid facility is available, the designer can often manufacture his own active analog filter circuits. No real proprietary techniques are needed to design state-variable circuits, Estep says.

For sophisticated phase-tracking filters, he notes, the universal modules may not always work. Two channels, built from separate hybrid packages, do not track in



**Benchtop active filters have wider frequency coverage than their state-variable counterparts through use of two tunable channels—one high-pass and one low-pass.** Krohn-Hite's Model 3202 tunes over a range of 20 Hz to 2 MHz with a pair of four-pole filters. Interconnection of the channels furnishes bandpass or band-reject operation.

phase as the temperature changes. For one customer, Estep designed single-resonator sections and placed half the blocks for each of the two channels in one package.

The low-cost modules and DIPs also compete with their passive counterparts. Their stability often exceeds that of filters based on inductors. But price can be a deciding factor. For example, a simple, two-pole LC filter costs about \$6 to build on a PC board, against about \$11 for the active version. However, Cermetek of Mountain View, Calif., plans to offer a DIP similar to the Beckman 881 and the Kinetic Technology FS-50

for less than \$6 in large quantities. Use of a proprietary op-amp quad is expected to make the Cermetek module one of the lowest-powered available— $\pm 15$  V at less than 300  $\mu$ A.

Epitek Electronics in Ottawa, Ontario, with the Model 1881, and Integrated Microsystems, Mountain View, Calif., with the Model  $\mu$ AR 2000, are second sources for the FS-50, as is the Beckman 881. The Epitek 1881 also affords a greater gain-bandwidth product than that of the FS-50.

Where extremely high Q is needed—say, 100 to 200—some of the more recent crystal filters compete nicely. The Vernitron Piezoelectric Div. of Bedford, Ohio, offers a line of ceramic filters that operates in the 7.5 to 60-kHz region. These units fit HP-6 crystal containers, afford Qs of at least 110 and provide the performance of four-pole filters for \$25. These filters find considerable use in narrowband Omega navigation receivers, sonobuoy tone-signaling circuits and in the tone-control systems of remote-controlled warehouse vehicles that pick products to fill orders.

The next step up from building blocks in the active analog-filter field is ready-to-use modules—in fixed and tunable versions.

The filter modules provide Chebyshev, Butterworth and Bessel frequency-response curves designed for low-pass, bandpass, high-pass and band-reject applications. Product lines cover the spectrum from dc to 100 kHz.

Most tunable filters in module or hybrid form—those from Beckman Instruments, Dattel of Canton, Mass., and Frequency Devices—operate with resistive rather than voltage tuning. Of course, the resistors can be switched under computer control to achieve some measure of automatic operation. Frequency Devices, #744 series goes a step further. It uses built-in components and can be tuned by BCD-coded external switches or remotely with relays.

The response curves offered are often related to the ultimate use of the filter (see table). The first three responses are those most often supplied with standard units. The elliptic response is usually a custom item. For example, DeCoursey Engineering Laboratory, Culver

## Commonly used filter responses

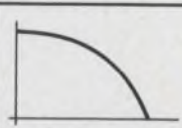
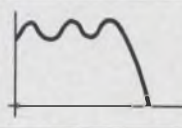
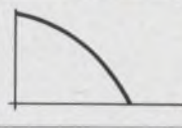
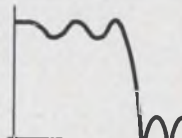
Filter type	Salient Features	Important uses	Shape
Butterworth	Maximally flat amplitude response	Prevent aliasing errors in sampled data systems, general purpose low-pass filtering.	
Chebyshev	Greater selectivity than Bessel or Butterworth, has passband ripple	Audio application since cut-off frequency is more important than gain variations.	
Bessel	Constant time delay, fast settling time and lack of overshoot	Reconstruction of sampled waveforms, averaging, provide fixed-time delay.	
Elliptic or Cauer	Maximum attenuation slope for given no. of poles. Controlled stop-band attenuation.	Telemetry and sonar signal filtering, where sharp attenuation between bands is required.	



# Today's Basic Tool

**COMSTRON'S Model 1013  
Frequency Synthesizer**  
0.1Hz to 13MHz at a Basic \$1595.

*A tool is the extension of man's hand and does his bidding easily... almost by itself. Functional, simple, beautiful... the 1013 is today's Signal Source that meets your every need... on the bench, in your lab, in your system.*

Performance with integrity... the 1013 has all the features and more. Features you'll wonder how you ever did without. A 5+ digit display at full crystal accuracy (no "accuracy stealing" verniers), low spurious and phase noise, high purity sine wave, TTL square wave, metered output, calibrated attenuator and full programmability.

The full 5+ digits are programmed either from the front panel or remotely via a bi-directional I/O bus... the LED display always shows the state of the instrument... accuracy is never compromised! Clean signals... levelled, displayed and settable... with real output power... the COMSTRON 1013—**Today's Basic Tool!**

*Ask for our new brochure or call COMSTRON for a demonstration... today.*

**COMSTRON**

CORPORATION

120-30 Jamaica Avenue Richmond Hill, N.Y. 11418  
Tel: 212-441-3200





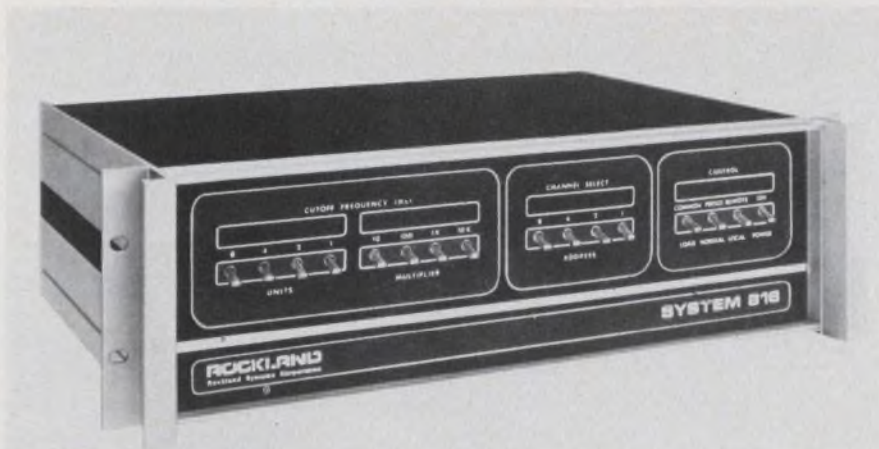

The laboratory analog filter is moving into automated data acquisition. Seventeen lines—each of one bit—select one of 16 channels, the cutoff frequency and the proper range. Each filter channel is an eight-pole Butterworth design, and the user can choose low-pass or high-pass or combined channels for band-pass or band-reject operation. This unit, Rockland's System 816, covers 10 Hz to 15 kHz.

City, Calif., offers active filter modules for the first two responses in the table but will fabricate Bessel or elliptic types. Some additional hybrid manufacturers include the Semiconductor Products Group of General Instrument Corp., Hicksville, N.Y., and Teledyne Microelectronics Co., Los Angeles.

It's no secret that Bell Telephone tried to develop passive filters for use with the Touch-Tone system. But it turned out to be cheaper to buy active filters from an outside vendor—Kinetic Technology.

The frequencies fall within the audio spectrum—697, 770, 852, 941, 1209, 1336, 1477 and 1633 Hz—yet are below the point at which ceramic filters operate. Beckman and Polyphase Instrument Co., among others, also offer filters for these frequencies. Frequency Devices plans to do so shortly.

To suppress unwanted noise, especially spikes, you might try a nonlinear voltage-variable filter. The IPVC-1 from Non Linear Filters, Trumbull, Conn., provides adjustable low-pass cutoff with an external analog signal. The action is nonlinear and also produces zero phase shift in the passband. The external signal sets the limits to the signal slope that the device passes. Linear filters do not remove spikes that are 1% or more of the highest signal frequency period without adding phase distortion.

Universal Filter and Demodulator Corp. (Ufad) of Grand Rapids, Mich., uses a modulation technique

that can provide enormous values of Q. One of its filters, sold to the Navy, has a Q of 10,000,000. A quadrature oscillator drives the unit. The oscillator frequency determines the center frequency of the bandpass function. The shape, including the width of the bandpass function, remains constant with frequency. The operating range of the system is 200 kHz.

Most of the module features—and more—are available with desktop versions of state-variable filters. You get the high, low and bandpass functions, all controlled by switches at the front panel. And quite often a flick of the switch lets you change filter characteristics—say, from Butterworth to RC.

In addition some of these instruments feature low noise (on the order of 10 to 50  $\mu\text{V}$ ) and broad coverage—0.001 to 3 MHz. By comparison, a module's frequency range extends to 200 kHz and the internal noise is higher—usually 50 to 100  $\mu\text{V}$ .

The traditional units, which often find use in checking designs that use active filters, house two adjustable filters in one case—a low-pass and a high-pass. Each one is usable by itself or you can cascade the low and high-pass to get a bandpass. Band-reject or null is obtained by setting the low-pass cutoff at 50% of the notch point and the high-pass at double the notch point. The cutoffs are moved to where phase cancellation produces the null.

Although these are traditional devices, a demand for greater accuracy in frequency setting has arisen. So the dials with accuracy within 5% have given way to decade switches. Most of these units promise accuracy within 2%—as, for example the Model 3320 from Krohn-Hite, Cambridge, Mass., or Rockland Systems, Model 1042 F. The Model 1952 from General Radio, Cambridge, Mass., lists accuracy within 2% with continuous tuning. This model was first announced in 1968.

The latest entry in this class is the Model 4211 from Ithaco, Ithaca, N.Y., that lists accuracy within 1%. The company also claims one of the lowest output noise levels for its unit—about 30  $\mu\text{V}$  in the wideband setting and the unit has a 10 V peak output.

But, the newest wrinkle is the use of programmable analog filters for data acquisition. These filters are controlled by software that selects the frequency segment of interest just prior to a/d conversion of the incoming signal.

Other uses of the programmable filter are with sophisticated fast-Fourier-transform analyzers and spectrum analyzers in which the sampling rate is changed. When the rate of change is not too frequent, a manually controlled filter suffices.

One of these, Rockland Systems Model 1100, even lets you switch-select four-pole Bessel or Butterworth responses. Its Series 1500 offers remote or local programming, while the system 816 is a rack-mounted, multichannel system for computer control.

A number of laboratory filters provides tunable responses similar to those of the state-variable filter. Princeton Applied Research of Princeton, N.J., offers the Model 189 selective amplifier, a two-pole filter that covers 0.1 Hz to 110 kHz in five bands. Calibration accuracy is within 2% of set frequency for a Q of 10. And the unit will also act as an oscillator over the same frequency range.

A. P. Circuit Corp., New York, N.Y., offers a similar unit that covers a smaller frequency range—0.1 to 10 kHz in five bands (filter only). The two-pole bandpass unit allows independent adjustment of Q and center frequency as does the



# POWER FOR YOUR IC'S OR OP AMPS

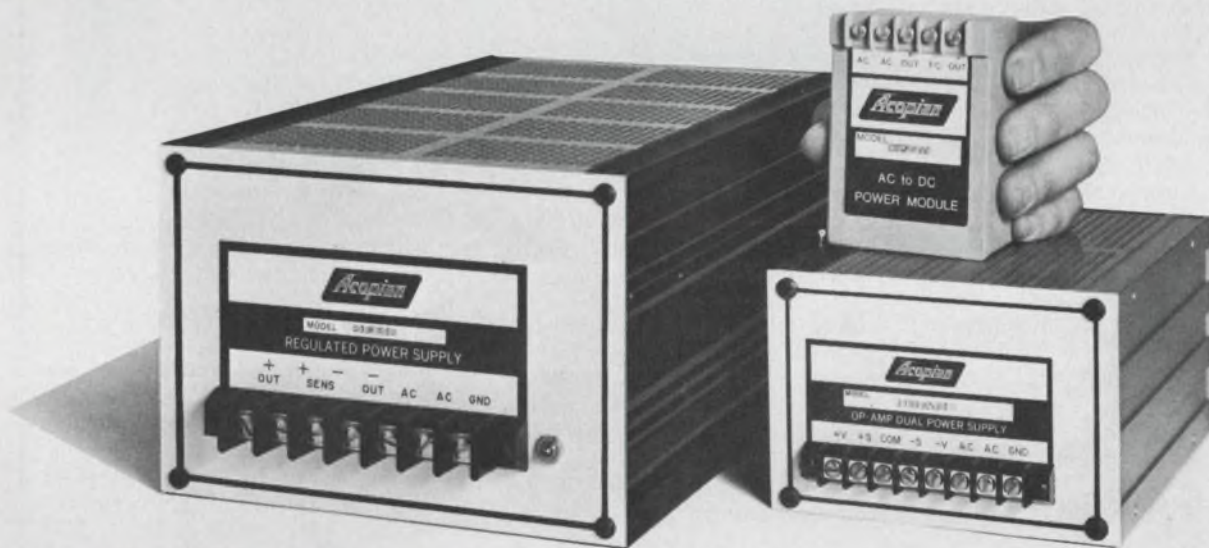

ALL MODELS U.L. RECOGNIZED

## 5 VOLTS

## ±15 VOLTS

OUTPUT CURRENT AMPS	SIZE INCHES	PRICE	MODEL	OUTPUT CURRENT AMPS	SIZE INCHES	PRICE	MODEL
.5	3.5 x 2.5 x 1.4	\$55	5EB50	.1	3.5 x 2.5 x 1.4	\$55	DB15-10
1.0	3.5 x 2.5 x 1.6	75	5EB100	.15	3.5 x 2.5 x 1.4	65	DB15-15
2.0	3.5 x 2.5 x 2.4	115	5EB200	.2	3.5 x 2.5 x 1.4	75	DB15-20
2.5	3.5 x 2.5 x 2.4	130	5EB250	.4	3.4 x 5.1 x 5.1	85	TD15-40
5.1	3.4 x 5.1 x 6.6	150	A5MT510	1.0	3.4 x 5.1 x 5.1	125	TD15-100
9.0	3.4 x 5.1 x 9.3	180	A5MT900	1.6	3.4 x 5.1 x 6.6	150	TD15-160
12.0	3.4 x 5.1 x 13.3	200	A5MT1200	2.5	3.4 x 5.1 x 9.3	160	TD15-250
22.0	5.1 x 7.4 x 11.3	270	A5HT2200	4.5	3.4 x 5.1 x 13.3	225	TD15-450
32.0	5.1 x 7.4 x 16.0	320	A5HT3200	8.5	5.1 x 7.4 x 11.3	299	TD15-850

Line/Load Regulation:  $\pm 0.1\%$  or better; Ripple: 1.5 mv or less; Input: 105-125 VAC

Three day shipment guaranteed. Complete details on these plus a comprehensive line of other power supplies and systems are included in the Acopian 73-74 catalog. Request a copy.



Corp., Easton, Pa. 18042. Telephone: (215) 258-5441.

INFORMATION RETRIEVAL NUMBER 27.



# How a digital filter works

Digital filters work with discrete time samples of the input signal. They output discrete samples at the same rate as the input. They are often thought of as special-purpose computers because the output is based on arithmetic operations—addition and multiplication—performed on stored samples of the input signal.

All quantities used—inputs, outputs and intermediate results—are represented by binary words rather than continuous analog signals. Thus a conventional digital filter can only process an analog signal after it has been converted to digital form.

The sequence of input samples to the digital filter are spaced uniformly in time with period  $T$ . Storage is performed by shift registers that operate with clock period  $T$ . The equations that describe the digital filter and relate their operation to analog filters can be derived from sampled data theory—namely, the Z-transform.

Imagine a set of synchronous sampling switches placed at the input and output of a continuous filter. Let the switches multiply the signal values at their input by unit impulses of weight  $T$ . For this setup, the signal to the continuous filter is

$$x^*(t) = \sum_{n=0}^{\infty} x(nT)\delta(t-nT)$$

and its Laplace transform is

$$X^*(s) = \sum_{n=0}^{\infty} x(nT)e^{-sT}$$

In most literature  $e^{-sT}$  is represented by the symbol  $z^{-1}$ , so that

$$X(z) = \sum_{n=0}^{\infty} x(nT)z^{-n}$$

The equation for  $X(z)$  is the Z-transform of  $x(t)$ .

An important property of the

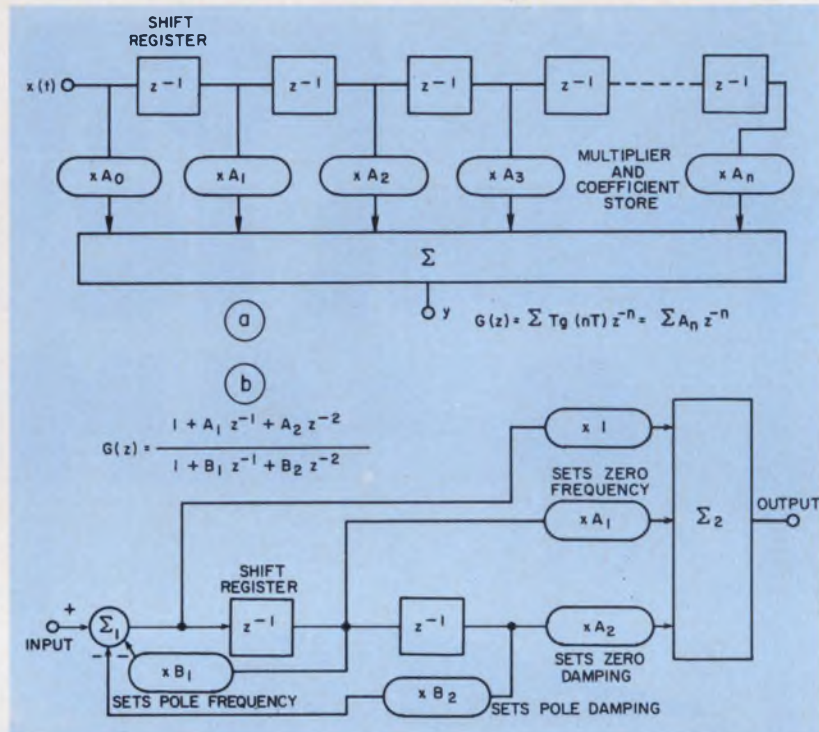

Z-transform is that output  $Y(z)$  is related to the input  $X(z)$  through the Z-transform of the filter,  $G(z)$ . That is,

$$Y(z) = G(z) \cdot X(z)$$

Digital filters are often used to replace tapped delay-line filters for phone-line equalization. The Z-transform of the impulse response of the analog filter—in this case a delay line—provides the approximation. If the line has  $k$  taps, then

$$G(z) = T \sum_{n=1}^k \alpha_n z^{-n} = \sum_{n=1}^k A_n z^{-n}$$

The  $\alpha_i$  are simply the tap weights. The resulting digital filter consists of a series of shift registers with multipliers in place of the tap weights (a). This form of digital filter is called nonrecursive, because the outputs of the shift registers are not fed back to the input. The output of this filter in the

Z-domain is given by

$Y(z) = (\sum A_n z^{-n}) \times X(z)$ , which represents the difference equation

$$y(nT) = \sum_{m=0}^k A_m x(nT - mT)$$

A frequency domain analogy is used if the filter-function cannot be represented by a fixed number of points in the time domain. For instance, suppose  $G(s)$  is the familiar ratio of second-order polynomials. The equivalent digital filter has the appearance of its analog counterpart (b).

This type of digital filter can output an infinite number of samples from a single pulse, since the outputs of the registers are fed back to the input. And the adjustments for poles and zeros are quite similar to those of its analog counterpart, the universal filter.

Princeton Applied Research unit.

Inscoc of Santa Barbara, Calif., offers a dual rack-mounted, four-pole filter, the Model 532, that tunes over a 1-Hz-to-100-kHz range and uses a state-variable design.

Perhaps the most elaborate filter

in the state-variable class is made by United Recording Industries, Hollywood, Calif., for audio work, such as motion-picture sound correction. The instrument contains four tunable filters. Two notch filters let the user remove ac hum, whistles or buzz from tapes, film

or records. And the Qs of the notches are adjustable up to 90 dB, so recorder speed variations do not cause the interference to move out of the notch. Incoherent or broadband noise can be suppressed by adjustment of the low and high-pass filters, respectively.



# Ferrite transformers cost less, increase reliability and eliminate scrap. Broad Band-Rated<sup>™</sup> ferrites replace laminations to 16,000 perm.

## New design solutions

If you're using metal laminations to get high permeability transformers and inductors, take another look at ferrite technology. Our ferrite components now eliminate the high cost of lamination assembly in critical bandwidth applications from 100 Hz to above 250 MHz.

Increased reliability and guaranteed circuit performance of our components end design guesswork and production rework. You design with known circuit parameters and our pretesting program assures that our components will continue to meet your circuit requirements.

## Highest permeability available

Toroidal perm over 16,000 and

effective permeability over 5,000 allows you to use Broad Band-Rated ferrites in a wide variety of new applications. Our full range of shapes includes mated parts in pot core, RM6 and E core configurations to extend your design flexibility.

## Some help from your friends

We'd like to help you apply the latest ferrite technology to your broad band requirements. Our new design guide outlines the improved characteristics of our components and gives you guaranteed specs that make sense. Shunt resistance and reactance per turn squared, temperature coefficient, disaccommodation and hysteresis core constant.

The applications section covers

design of both high and low frequency transformers and shows you how our circuit specifications make your design task easier, more precise.

Circle the Bingo card for your copy of the design guide or call (201) 826-5100 and talk to the engineers who wrote it.

Either way, if you're still gluing laminations to get high permeability, talk to the ferrite experts.

That's us.

Indiana General  
Keasby, NJ 08832

*National distribution through Permagem in Atlanta, Boston, Chicago, Dallas, Detroit-Toledo, Los Angeles, New York and San Francisco.*

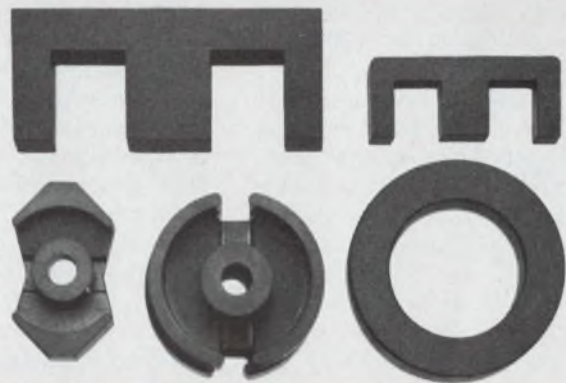
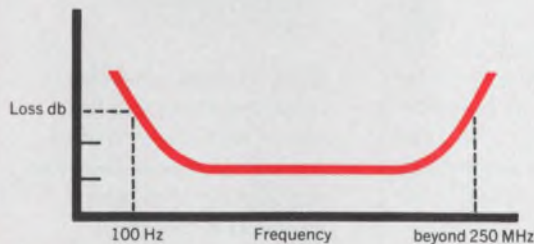

 **indiana general**

a division of Electronic Memories & Magnetics Corporation

INFORMATION RETRIEVAL NUMBER 28



The price of \$515 puts it almost in the instrument bargain class.

### Digital filter demand lags

Why is the digital filter lagging? It certainly has a glamorous reputation: The unit is, in effect, a special-purpose computer that can mimic the action of any analog filter at will. Since everything is digital—including input and output—the characteristics are perfectly reproducible and unaffected by age or ambient conditions. And you can change filters at real-time rates merely by reading in new coefficients.

On the negative side, designers are not as familiar with digital-filter techniques as they are with active analog filters. And until recently no company had built a chip set that could compete in cost with the more mature active analog filter products. The recent announcement of a three-chip filter set from Paradyne Corp., Largo, Fla., could bring increased interest in the digital filter area. But the set is not yet available commercially.

At present, the digital filter user has a choice of only two commercial units—a desk-top version from Rockland Systems Corp., West Nyack, N.Y., and a chip set from Collins Radio, Newport Beach, Calif.

Data communications is one area where digital filters have slowly intruded on the analog domain. For example, Paradyne used digital transversal filters four years ago in place of tapped delay line equalizers on its M-48 modem, a 4800-bit/s unit.

But the M-48, which was full of active filters, has been replaced by a 9600 bit/s modem that processes all signals digitally. A three-chip MOS LSI set provides 26 poles and zeros. The set consists of a ROM sequencer—which programs and controls the filter characteristics—a multiplier chip and a filter structure chip. Now all filters behave alike from modem to modem, and the space savings are considerable. And the ROM, which can provide four different sets of 26-pole filters, lets you have any filter characteristic you want.

Paradyne's chip set has at least one point in common with Bell Telephone's digital filter philoso-

phy—namely the units are most effective when fairly complex functions are implemented. However, the Bell digital filter is still a lab model. The design uses a basic pole-pair computation that is multiplexed to provide a complete Touch-Tone decoder tree.

Another source of digital filters is your own computer, and sometimes it is cheaper to use than available digital filters, if the data rate is low enough. All you do is have the computer perform the required arithmetic with coefficients stored in the main memory.

Computer Signal Processors of Burlington, Mass., uses its 100 ns, CSP-30 mini to perform all the digital filtering for its signal-processing system. These filters select and limit the bands of interest—as, for example, in conjunction with the Fast Fourier Transform. Computation speeds average about 3  $\mu$ s a pole pair. With the CSP-30 alone, the input rate is estimated at 30 kHz.

Charge-transfer technology has a way to go before it can become commonplace in new circuit designs, but it is a potentially strong competitor of the digital filter. The General Electric Research and Development Div. in Schenectady, N.Y., has developed a programmable structure that acts as a transversal filter with variable top weights. For fixed use, a serial-transfer, charge-coupled device will perform the same operation. And the design techniques for digital transversal filters apply to charge-coupled devices.

About the only drawback of the charge-coupled device is that its full bandwidth only extends from dc. Charge-transfer losses set in as the signal's slew rate, rather than the maximum signal-frequency components, increases. In this sense the device behaves somewhat like the op-amp filter from Non Linear Filters. However, the allowable slew rate amounts to several hundred kilohertz.

GE is using charge-coupled devices in developmental military communications systems and in the development of a commercial frequency-division multiplexer. As is to be expected, the multiplexer will beat each channel down to dc before passing the signal through the detector. ■■

**What to do  
if your  
special  
10-page  
Connector  
Selector  
is missing  
from this  
magazine:**

**Write us.**

**We'll send  
you a  
brand new  
copy.  
Free.**



This 10-page connector selection guide will tell you everything you need to know to choose the most popular types of interconnections for most commercial/industrial applications.

The mystery of the Part Number is also revealed.

Write:  
Amphenol Connector Division  
Bunker Ramo Corporation  
2801 South 25th Avenue  
Broadview, Illinois 60153

**BUNKER RAMO AMPHENOL**



# Resistor networks: we deliver through thick and thin.

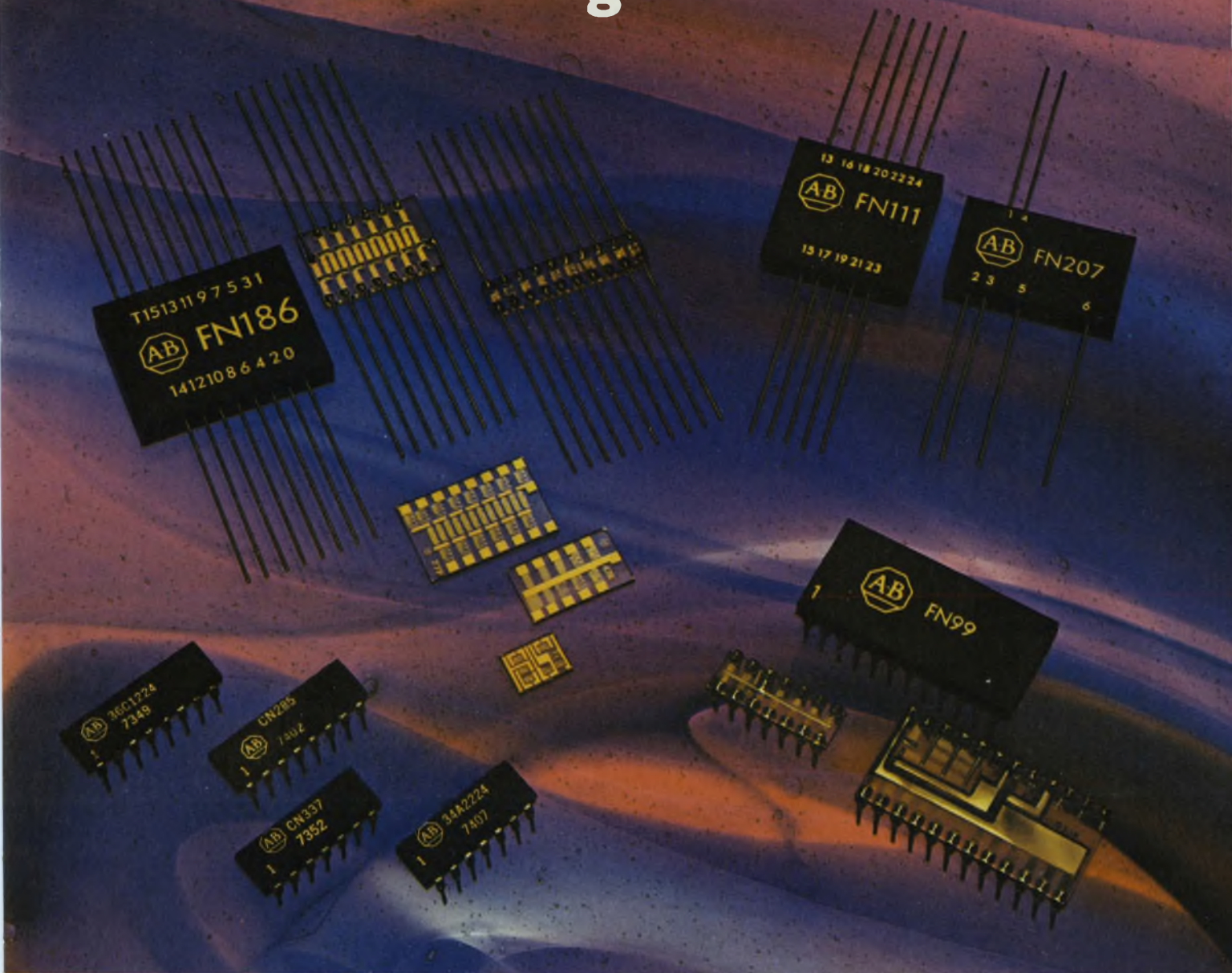

Seventeen years of film resistor experience combined with quality production capabilities give you prompt solutions to your network needs. Whether you require precision thin film or semi-precision thick film in prototype or mass production quantities. Thin film in chip, conformal coat, flat pack and DIP. Thick film in standard 14 and 16 pin DIPs with resistor or resistor/capacitor configurations. Popular pull-ups and terminators off-the-shelf. Contact your local A-B sales office or write for our 5800 series publications. Allen-Bradley Electronics Division, 1201 South Second Street, Milwaukee, WI 53204. International Division, Milwaukee, WI 53204. Canada: Allen-Bradley Canada Limited, Cambridge, Ontario. United Kingdom: Allen-Bradley Electronics, Limited, Jarrow, County Durham NE32 3EN.

## SELECTED SPECIFICATIONS

	Thin Film	Thick Film
TCR	$\pm 10$ to $\pm 25$ ppm/ $^{\circ}\text{C}$	$\pm 100$ and $\pm 250$ ppm/ $^{\circ}\text{C}$
TCR tracking	$\pm 5$ ppm/ $^{\circ}\text{C}$	$\pm 50$ and $\pm 100$ ppm/ $^{\circ}\text{C}$
Absolute tolerance	as low as $\pm 0.1\%$	as low as $\pm 1.0\%$
Matching or ratio tolerance	as low as $\pm 0.005\%$	as low as $\pm 2.0\%$
Resistance range	1K to 10 Megs (special 10 ohms to 50 Megs)	10 ohms to 1 Meg

**If you're really serious about cost, be serious about quality.**



## ALLEN-BRADLEY

Milwaukee, Wisconsin 53204

INFORMATION RETRIEVAL NUMBER 29

EC85



# Video players for the home turning to card and disc units to cut costs

The race to make the video player as much a part of the family scene as color television has heated up considerably with the announcement of new, cheap recording materials and techniques.

Instead of recording on tape and film, three companies are getting ready to offer for home recording magnetic cards, magnetic discs and optical discs that will cost about an order of magnitude less.

Besides this savings, the new recording techniques will permit the use of mechanically simpler playback and recording units. These could be produced for about

half the cost of those now used.

The magnetic card approach is being developed by the Sony Corp. of Japan. In an effort to retain the flexibility of magnetic tape while avoiding its high cost, Sony has developed a unit—known as Mavica—that uses a 176-by-226 mm card to store 10 minutes worth of video and stereophonic information.

The card, called a Mavicard, contains two sheets of magnetic material.

According to Nobutoshi Kihara, director and general manager of Sony, one of the magnetic sheets in the Mavicard is used to store the video information, while the other holds the audio.

In describing the key features of the Mavica system Kihara notes

the following advantages:

- Real-time video recording is possible.
- Slow motion, reverse motion and stop motion can be obtained.
- The Mavicard can be easily and inexpensively manufactured by using high speed contact printing techniques.
- Two sound tracks are provided, giving stereo or bilingual audio. Adding sound to a recorded picture is also simple.
- Centering problems are eliminated since a disc is not used. Complete interchangeability of cards assures a stable playback picture.

The basic unit, Kihara explains, is a playback device. But an adapter that plugs into the playback unit makes it possible to record programs right from a television set.

In describing how the unit works, Kihara notes that when the Mavicard is inserted into the machine, the two sheets of magnetic material are automatically withdrawn from their protective envelope and fed out along the guides of two cylindrical frames which surround two sets of rotating magnetic heads.

When the magnetic sheets are completely threaded around the cylindrical frames, he continues, the heads start rotating while the magnetic sheets advance along the axis of the cylinder. When the record, or playback operation, is completed, says Kihara, the magnetic sheets are pulled back into the envelope and the Mavicard is ejected.

A particularly interesting feature of the Mavica system is that during playback the axial movement of the card can be manually controlled to provide slow or stop motion. The quality of the slow motion image, Kihara says, is comparable to that obtained on commercial television broadcasts.

---

**Jules H. Gilder**  
Associate Editor



Sony Corp.'s Mavica video playback unit uses a 176-by-226 mm magnetic card that can store 10 minutes worth of video and stereophonic information.





**Our gold  
spot  
could be  
your gold  
mine.**

*At today's prices, gold is just too expensive to use where it's not needed.*

*That's why GTE Sylvania developed the technique of putting a circle of gold on lead frames (where it's needed) without coating the whole frame (where it's not needed).*

*Check gold prices in today's*

*paper. You'll see what real savings can be. And you'll see why our method offers the highest quality at a lower price.*

*You'll also see why people like us when we put them on the spot. GTE Sylvania, Parts Division, Warren, Pa. 16355.*

**GTE SYLVANIA**





Outer portion of Bogen's magnetic disc contains a thin coating of  $\text{CrO}_2$ , while the inner portion contains grooves that guide the magnetic pickup head.

In explaining how 10 minutes worth of programming is recorded on one small card, Kihara notes that several techniques were used to increase recording density.

One technique, Kihara explains, is to narrow the width of the recording track and eliminate the guard bands normally used. A problem, however, can arise. Unless the tracking precision is greatly improved, the influence of the adjacent track causes interference during playback. To eliminate this interference, the Mavica system uses a special phase-modulation technique in which the central phase of the carrier in one track coincides with that of the carrier on the adjacent track.

Another technique used to increase density is skip-field recording, Kihara reports. With this method, the video signal is recorded with the frame period aligned on the card, so that slight shifts in tracking cause almost no deterioration of the playback image quality.

### Magnetic disc a possibility

Another entry in the video player-recorder field, the magnetic disc, was invented by Erich Rabe and developed by Wolfgang Bogen GmbH, Berlin.

According to Michael Limburg, marketing manager for Bogen, the new disc system—known as MDR—uses 12-inch plastic discs that are covered with a thin coating of  $\text{CrO}_2$  magnetic material which

is two to three times smoother than the coating on the best known magnetic tapes.

In describing the disc, Limburg notes that it is divided into two distinct areas. The outer portion of the disc contains the magnetic coating, while the inner portion contains grooves, similar to those in normal phonograph records. The grooves, he explains, are used to guide the magnetic pickup head.

The MDR system is very simple, Limburg says, "It's nothing more than a modified recorder changer." In fact, he goes on, models that were built in the laboratory used commercial changers that were modified to rotate at 180 rpm. In addition, the regular stereo cartridge was removed and a special magnetic video head was plugged in to replace it. The head contains a built-in preamplifier so that it is possible to use the existing wiring in the pickup arm to relay the information.

Since magnetic recording technology is used, says Limburg, it is possible to produce a unit that will both record and playback video signals. In contrast, most other disc systems are playback-only devices.

Frequency modulation is used to record both the video and audio signals, reports Limburg. In addition, since they are recorded simultaneously, no synchronization is necessary. Servo controls for accurate tracking of the head are not needed because the grooves on the

interior of the disc provide tracking control.

The grooves are 50 microns apart which results in a density of 500 grooves per inch. This means that 10 minutes worth of programming can be accommodated. Limburg noted, however, that the groove spacing would be reduced to 25 microns and the density would soon be 700 grooves per inch. This would result in 15 minutes worth of recording time.

The MDR system will be on the market by the end of 1975, Limburg says, and sell for between \$350 and \$400.

### Zenith pursues optical disc

Optical technology is being used by the Zenith Radio Corp. of Chicago, to produce a playback only system.

In this approach a transparent, flexible polyvinyl chloride disc is used with a laser to provide 40 minutes of uninterrupted viewing.

The system, notes Phil M. Crosno, a staff engineer on the video player project, is very similar to the one developed by MCA Disco-Vision Inc. of Torrance, Calif., last year (see "It's a 40-Billion-Bit ROM, It's a TV Programmer—It's Disco-Vision!" ED 3, Feb. 1, 1973, p. 35). The major difference between the two, he explains, is that the MCA device uses a reflective detection technique, while the Zenith unit uses a transmissive one.

By detecting information from light transmitted through the disc, says Crosno, it is possible to play both sides of the disc without flipping it over. All that is necessary is to refocus the laser beam on the second surface.

Information is stored on the disc in the form of modulated grooves. The grooves are produced by a pressing operation similar to that used in standard phonograph records. Storage densities as high as  $8 \times 10^6$  bits per square inch can be achieved with this optical approach. The highest density attainable with magnetic technology, he notes, is only  $10^6$  bits per square inch.

Crosno says that the Zenith playback-only system will be on the market in about two years and that a player will probably sell for somewhere between \$400 and \$500. ■■



# BUNDLE WITH **TY-RAP**<sup>®</sup> CABLE TIES



WT-193 Tool

## Cut Costs at Each Step of Harness Fabrication

**1. Tying a large variety of bundle diameters?** The new WT-193 tool gives you an improved level of control and convenience. The accurate preset tension control makes tying uniformity the responsibility of the tool rather than of the installer. The narrow nose and long slim body reaches in, cinches the TY-RAP<sup>®</sup> tie to a preset tension and trims it evenly . . . even in those tough high-density areas.

**2. Repetitious tying in large quantities?** The new TR-300 high-speed tool gives you several benefits. In 8/10th of a second, it installs a TY-RAP tie around a bundle up to 5/8" diameter, cinches and trims evenly.

**3. Here's the most important reduction benefit!** The ultimate key to savings is the locking device in the cable tie. Only TY-RAP ties give you a "grip of steel." A patented, non-magnetic, stainless steel locking wedge is embedded in the nylon cable tie. It's in every self-locking tie, from the miniature 3 inch for 1/16" dia. to the 30 inch tie



for 9 inch bundles. It is used in virtually every modern aircraft, communication, business machine and electrical equipment application . . . in general wherever wire is used.



### 4. Tired of the recurring costs of harness boards?

Our new modular harness board is designed to substantially reduce costs while providing convenience. It is constructed of polyethylene foam sandwiched between two metal screens — the nails can be pushed in by hand. It's reusable. It's reversible. It's modular — boards interlock in seconds to produce any size board needed.



Write for new catalog, The Thomas & Betts Company, Elizabeth, New Jersey 07207 (201) 345-4321. In Canada, Thomas & Betts Ltd., P. Q.

509

Sold Only  
Through  
T&B Distributors



**THOMAS & BETTS**

Division of Thomas & Betts Corporation



# Nondestructive testing advances with unique pulse-echo setup

A marked advance in the design of nondestructive test equipment has been achieved with the development of a pulse-echo, acousto-optical system that does not require immersion of the test object in water or other liquid.

Instead, the specimen is placed against a deformable membrane that comprises one wall of a water-filled Plexiglas tank. The tank also holds a pulsed ultrasonic transducer. An external, pulsed laser and an optical system provide—from the interaction of sonic and optical waves—a Bragg-diffraction image that appears outside the tank. The image can be viewed on a ground glass or picked up by a TV camera.

In addition to nonimmersion of the object under test, other advantages of this relatively simple system include the following:

- Visual images can be obtained of the flaws or discontinuities inside opaque test bodies.
- The visual images appear in real time.

- Contact with only one side of the test object is needed.

- The system is mechanically stable enough to be used in a production environment.

- Trained analytical personnel are not needed, because direct optical images are obtained that do not require data interpretation.

## A military research project

The system, developed by the Advanced Technology Staff of TRW's Space Vehicles Div. in Redondo Beach, Calif., is based on a concept by Otto Gericke, chief of nondestructive testing at the Army Materials and Mechanics Research Center, Watertown, Mass. Gericke was monitor for the Advanced Research Projects Agency.

"This is a real breakthrough," he says, "because in the past we have not been able to obtain pulse echoes in real time. Previous systems transmitted a pulse and picked the echo off of an immersed test object."

In the latter case, Gericke points out, mechanical or ultrasonic scanning is necessary to build up an image, line by line.

By substituting the laser and optical system for the complex scanning system, researchers at TRW, headed by Dr. P. G. Bhuta, manager of the advanced technology staff, have substantially reduced system complexity.

Access to only one surface of the test specimen is needed, Gericke notes, because the image is obtained by the pulse-echo method and not by the transmission of sound directly through the object, as with immersion systems. Use of the single surface, he says, eliminates a problem inherent in through-transmission systems—thickness resonance.

"Because this is a pulsed-laser system, it can be time-gated to eliminate spurious reflections from the test specimen walls," Gericke says.

## It's optically simple

Bhuta points out that a major advantage of the system is its optical simplicity. With the present system, which has verified the feasibility of the concept, the optical images of conventional objects can be readily magnified and projected on a screen. The images can be further improved, Bhuta says, by use of a closed-circuit TV system to pick up and process the images electronically.

Acceptable test results have been obtained, Bhuta points out, by use of 0.002-in.-thick polyethylene and 0.0006-in.-thick aluminized Mylar for the membranes that the specimens are placed in contact with.

With an acoustic power of 200 W, at 15.3 MHz, the experimental setup has detected flaws in aluminum at depths to 3.5 in. ■■

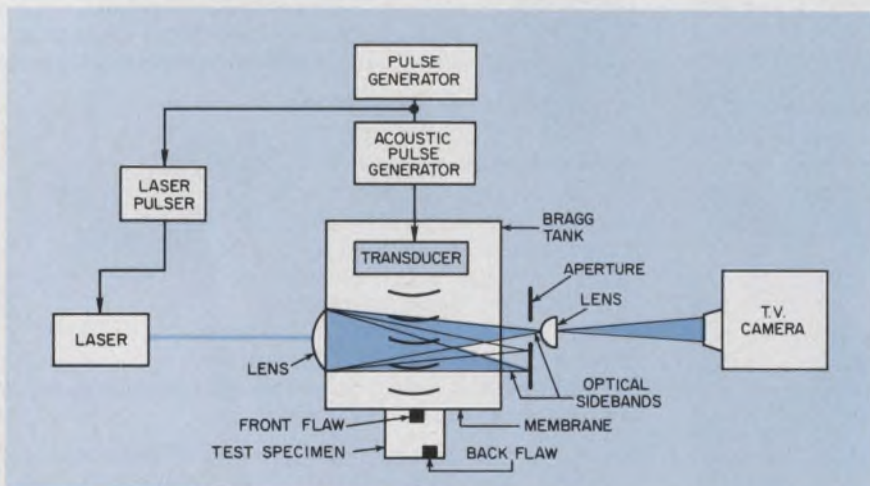

Images of flaws inside test specimens are produced in optical sidebands generated when sonic energy and a laser beam are mixed inside a Bragg tank. The laser is gated to detect flaws at different depths.



Unimax lighted pushbutton controls offer you the broadest variety of styles in a wider choice of displays, colors, illuminations and actuations. From simple pilot light applications to the most sophisticated split face switch or circuit breaker, you'll find a Unimax LPB to meet your requirements—with Unimax quality and reliability built-in. At competitive prices.

**Series 2:** A high-rated (5 amps, 250 volts a-c or 28 volts d-c) lighted or unlighted pushbutton switch, available as momentary or alternate action and offering matching indicators. Small in size and price.

**Series 5:** A versatile two lamp double pole lighted pushbutton switch, momentary or alternate action, that can either transmit or project color in full or split display. High rating. High candlepower. Choice of front panel snap-in or sub panel hard mount. Low price.

**Series 9:** Highest quality 4 lamp switch meeting the requirements of MIL-S-22885. Single screw mounting, simple front of panel relamping and wide choice of lamp circuits. One to four pole switching. Features and options not available in any other switch.

**Series 9C:** All the advantages of the Series 9, with the switching mechanism replaced by a hydraulic-magnetic tripping action circuit breaker.

**EAO Series 01, 02, 03:** Just introduced, these economical products are available in round, square and rectangular styles. Up to three pole switching in momentary or alternate action or as indicators, key lock or mushroom cap models. Ratings and electrical and mechanical performance are uniformly high.

# Unimax Switch CORPORATION

A Riker-Maxson Subsidiary/Ives Road, Wallingford, Conn. 06492

Gentlemen:

I'm impressed.  Please have your representative contact me for a demonstration.  Please send information on the following LPB lighted pushbutton controls: Series \_\_\_\_\_

My application: \_\_\_\_\_

Name \_\_\_\_\_ Title \_\_\_\_\_

Company \_\_\_\_\_

Address \_\_\_\_\_

City \_\_\_\_\_ State \_\_\_\_\_ Zip \_\_\_\_\_

## We have more LPB's going for you than anyone else.

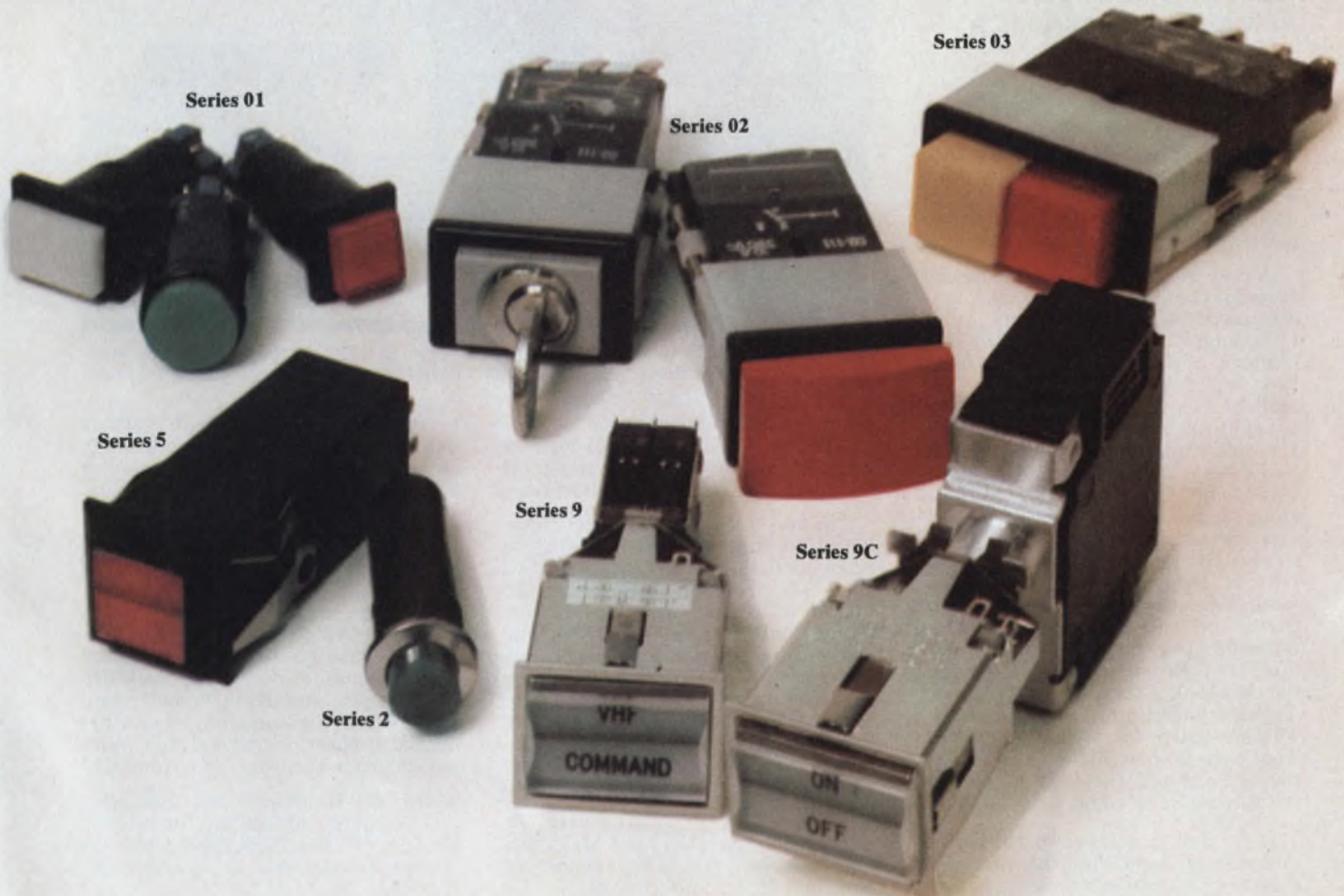



# Centralab perspectives

FOR USERS OF ELECTRONIC COMPONENTS



CENTRALAB

Electronics Division  
GLOBE-UNION INC.

5757 NORTH GREEN BAY AVENUE  
MILWAUKEE, WISCONSIN 53201

## Even if 1975 circuit designs are frozen it's not too late for thick film hybrids.

Centralab can help designers meet the challenge of today's technology changes with two thick film systems. Supplying custom requirements, from quick design to volume production, is a matter of weeks.

Quick turn-around time is only one reason thick film circuits have gained such a strong foothold in many product designs. IC's require longer design lead time. Discretes can't match hybrids for size or reliability.

A case in point. Late in the design cycle for the 1974 passenger cars, governmental safety regulations called for changes in seat belt warning systems. A new seat-belt-ignition interlock would be required on all 1974 models. One major automotive firm brought their problem to Centralab. Hybrids could be the answer. Within two weeks, 8 packages had been designed by Centralab and samples shipped. Both active hybrid and passive circuits were included in the Centralab modules that were a major part of the interlock system. Two weeks later, prototype quantities were furnished and volume production quantities were shipped five weeks after that. From inquiry to mass production took a total of just 9 weeks! Tight scheduling. Exacting specs. Volume orders for millions of pieces. That's the kind of challenge Centralab meets best and the kind of service customers have come to rely upon.

Centralab, a pioneer in thick film circuits, is supplying the needs of automotive, computer, data processing, business machine, point-of-sale,

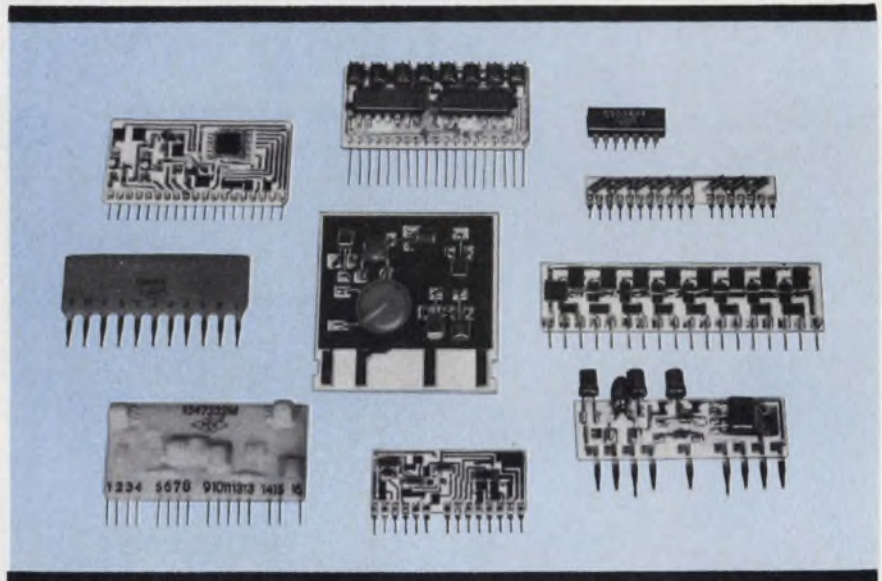

Backed by the experience of designing more than 50,000 custom hybrids, Centralab can supply a wide variety of circuit combinations and package configurations.

consumer and industrial product manufacturers. And they've proven, time and time again, that they can meet the needs for reliable circuits faster.

The two thick film systems Centralab offers means broad flexibility to accommodate custom requirements. Their silver/carbon  $\diamond$ PEC $\diamond$  system offers an economical approach for consumer and industrial applications where tight resistance tolerances are not critical. Used to produce resistor, capacitor or RC networks in a variety of values and package configurations, it also makes possible complete discrete hybrid circuits by adding encapsulated semiconductors to the basic thick film network.

The noble metal/cermet MEC system is ideally suited to commercial and industrial applications — for high stability under extreme environ-

mental conditions, for high voltage and high power applications as well. It is the system used for stable resistor banks and complex hybrid circuits. It meets the need for high-density packaging and is supplied in conformally coated single in-line or plastic molded dual in-line packages.

Customized circuitry is a Centralab specialty. Whether it's staircase networks, passive filters, frequency dividers, pull-up networks, clock drivers, video amplifiers, solid state switches, motor speed control or other special applications for hybrids. Why not consider them for your product?

Write A. R. Wartchow, Manager, Electroceramic Marketing for product data. Or call 414/228-1200. Customers outside U.S.A. write J. H. Meunier, Manager, International Sales.



## Centralab perspective:

### Push button switches. Epoxy sealed terminals.



Centralab push button switches\* feature optional epoxy sealed terminals to prevent flux penetration. No special installation or handling required. Switches deliver peak reliability because soldering problems are eliminated. Available in 2, 4, 6, and 8 poles. Other Centralab advantages:

- Interlock/lockout variations
- Lighted push button options
- Modular LINE SWITCH — mounts in any station
- 26 standard button styles and 18 colors
- Choice of 5 spacing options

Write Centralab for  
Bulletin 1550.

\*Isostat licensed



## Centralab perspective:

### Ceramic Substrates/ ScoreStrates.®



### Get your circuits started right.

Need ceramic substrates for your hybrid circuits? For resistor networks? Capacitor networks? Centralab's got them in every shape and size. In aluminas of 99.5% and 95%. Plain or metallized. With holes, slots, notches, scorelines or plain. With accurate dimensions and a surface finish compatible with your particular needs.

The pay off with Centralab is high performance reliability right from the start. So start right and specify Substrate/ScoreStrate ceramics from Centralab. You'll end up with the same high reliability substrate found in Centralab thick-film circuits.

For assistance on specifications, price and delivery, call Chuck Thompson, 414/228-2942 or write Centralab for Bulletin No. 1057TC.



## Centralab perspective:

### Ultra-Kap™ capacitors. Low dissipation. High insulation.



A dissipation factor as low as 3 percent maximum and high insulation resistance up to 1,000 megohms are only two critical design parameters met by Centralab Ultra-Kap capacitors. Also important is Y5F stability which is a maximum capacitance change of  $\pm 7.5\%$  from  $+25^\circ\text{C}$  over a temperature range of  $-30^\circ\text{C}$  to  $+85^\circ\text{C}$ .

Centralab Ultra-Kap capacitors cost far less than Mylar® and multi-layer monolithic types. With all the function you want. In substantially smaller space, too. For example, you can get a .05  $\mu\text{FD}$ , 16 V capacitor in a .375 diameter disc.

Ultra-Kap capacitors are available in voltage ratings of 3, 12, 16, 25, and 50 V, with a choice of lead size and configuration, and in a selection of coating controls. Ask about the ratings, sizes and shapes you need.

Call Bob Michaels,  
915/779-3964 or write  
Centralab for Bulletin 1106CA





**If your  
present distributor  
can't give you  
metal film resistors,**

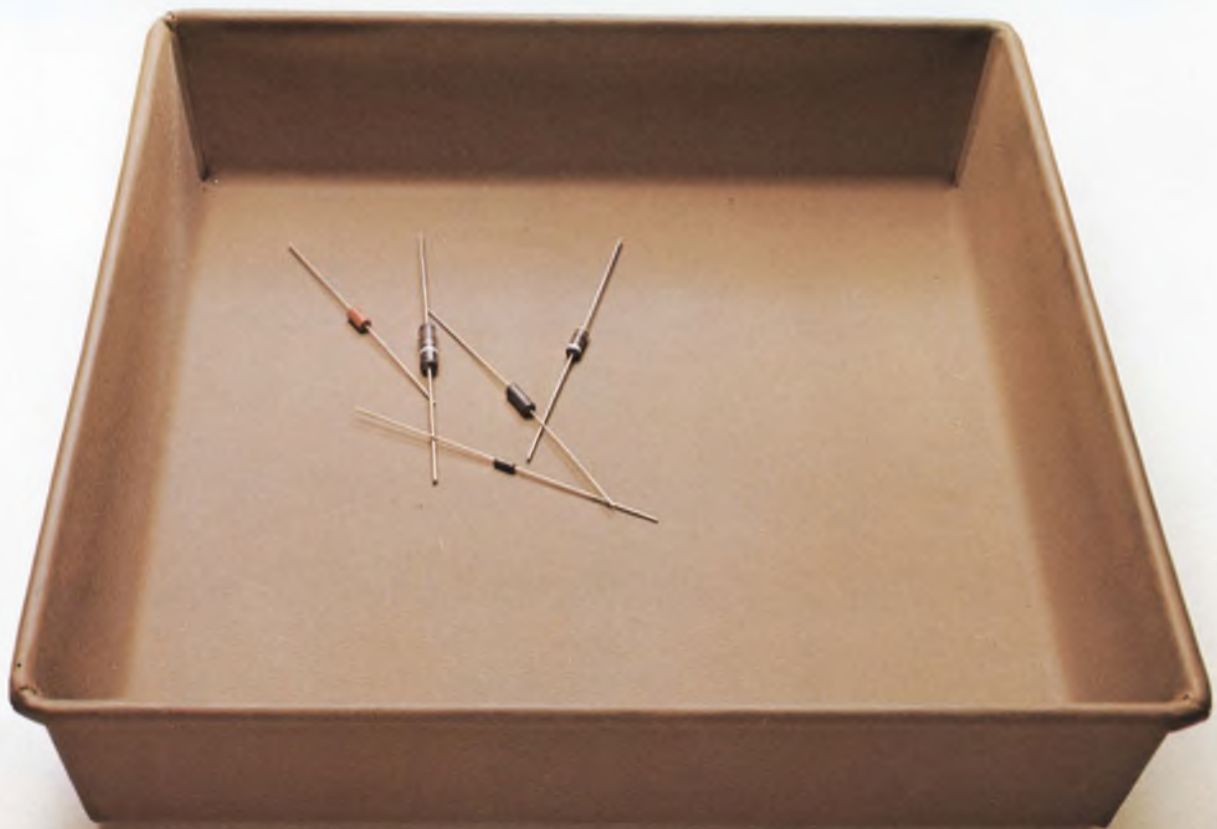



# OURS CAN.

Corning is now shipping more than twice as many metal film resistors as we did in 1970, and we're continuing to increase production capacity. We manufacture more metal film resistors than anyone else in the United States today.

We can meet your demands.

In addition to our present RL, RLR, and RN (C and D) characteristic resistors, we have broadened our line to include the RN55 "E" characteristic 25 ppm precision resistor in 1/2 and 1% tolerances. This product too is now available through your Corning distributor.

We believe the metal film resistor supply

situation will greatly improve in the second half of this year. But we also expect metal films to continue to be the fastest-growing segment of the discrete resistor market.

As the lower power requirements of new designs make wire-wounds less popular, and the needs for greater precision (particularly in automotive and instrumentation applications) make carbon comps less suitable, we expect to see an annual demand growth of at least 10 to 12 percent.

We've geared our production to meet this demand, and our distributors are stocked to supply your requirements.

**ALABAMA:** Huntsville; Cramer/EW (205)539-5722. **ARIZONA:** Phoenix; Liberty Electronics (602)257-1272. **CALIFORNIA:** Gardena; Bell Industries Electronics Corp. (213)321-5802. Los Angeles; Liberty Electronics (213)322-8100. Mountainview; Elmar Electronics (415)961-3611. San Diego; Liberty Electronics (714)565-9171. **COLORADO:** Commerce City; Elmar Electronics (303)287-9611. Denver; Cramer Electronics (303)758-2100. **CONNECTICUT:** North Haven; Cramer Electronics (203)239-5641. **FLORIDA:** Hollywood; Cramer/EW (305)923-8181. Hamilton/Avnet Electronics (305)925-5401. Orlando; Cramer/EW (305)894-1511. **ILLINOIS:** Chicago; Bell Industries (312)282-5400. Schweber Electronics (312)593-2740. **INDIANA:** Indianapolis; Graham Electronics Supply (317)634-8202. **MARYLAND:** Baltimore; Radio Electronics Service Company (301)823-0070. **MASSACHUSETTS:** Watertown; Sterling Electronics (617)926-9720. Newton Centre; Cramer Electronics (617)969-7700. **MINNESOTA:** St. Paul; Ragon Electronics (612)488-0201. **NEW JERSEY:** Cherry Hill; Cramer Electronics (609)424-5993. **NEW MEXICO:** Albuquerque; Cramer Electronics (505)265-5767. **NEW YORK:** Freeport; Milgray Electronics (516)546-6000. Hauppauge; Cramer/Long Island (516)231-5600. Rochester; Cramer/Rochester (716)275-0300. Syracuse; Cramer/Eastern (315)437-6671. Westbury; Schweber Electronics (516)334-7474. Woodbury; Harvey Electronics (516)921-8700. **NORTH CAROLINA:** Winston-Salem; Cramer/EW (919)725-8711. **OHIO:** Cincinnati; Sheridan Associates (513)761-5432. Cleveland; Schweber Electronics (216)464-2970. Columbus; Hughes-Peters (614)294-5351. **PENNSYLVANIA:** Philadelphia; Almo Electronics (215)676-6000. **TEXAS:** Dallas; Solid State Electronics (214)352-2601. Houston; Hamilton/Avnet Electronics (713)526-4661. **UTAH:** Salt Lake City; Cramer Electronics (801)487-4131. **WASHINGTON, D.C.:** Cramer/EW (301)948-0110. Milgray/Washington (301)864-1111. **WASHINGTON:** Seattle; Liberty Electronics/NW (206)763-8200. **CANADA:** Montreal; Cesco Electronics, Ltd. (514) 735-5511. Toronto; Cesco Electronics, Ltd. (416)661-0220.



**CORNING**  
ELECTRONICS

INFORMATION RETRIEVAL NUMBER 37



# Make the Switch

At the Eastern Division of GTE Sylvania, Make The Switch means becoming involved in the development of the most advanced Computer Controlled Circuit and Message Switching System ever conceived.

On April 16, 1974 the Eastern Division, because of its demonstrated superior technical expertise, was awarded a major communications contract to develop a tri-service computer controlled circuit and message switching system that will for the first time ever . . . permit the switching of digital voice communication.

This next generation system will utilize all applicable current, state-of-the-art technology . . . optimize existing design techniques and in fact will be an outstanding system design and integration achievement.

The selection of the Eastern Division to undertake this major long term program clearly establishes our engineering organization as the world leader in this technology, a technology that has practically unlimited future application.

At the Eastern Division "The Switch" represents the beginning of a new era in the field of major electronic systems programs.

We invite professionals of demonstrated ability in computer controlled circuit and message switching systems and data communications to investigate major career opportunities.

The Eastern Division is unquestionably "the place to be."

**Right now, the Eastern Division is seeking highly qualified professionals with experience in the following disciplines:**

**SYSTEM ENGINEERING  
ELECTRICAL ENGINEERING  
MECHANICAL ENGINEERING  
SOFTWARE ENGINEERING  
MATHEMATICS  
INDUSTRIAL ENGINEERING  
MANUFACTURING ENGINEERING**

Technical areas encompass tactical circuit and message switching systems; data and voice transmission and processing; systems engineering and design; real time systems integration, test planning; simulation; traffic analysis; secure digital voice switching; information processing; and LSI including MOS and CMOS.

**Please forward your resume outlining SALARY HISTORY to D. Paul Costello, GTE Sylvania, Eastern Division, 77 "A" Street, Needham, Mass. 02194.**

**Eastern Division**  
**GTE SYLVANIA**  
INCORPORATED

An Equal Opportunity Employer M F



# FUJI

## LEADING MAKER OF FERRITE CORES WIDE RANGE OF CORE FOR POWER SUPPLY

### POT CORES (ROUND)



SP1408 SP1811 SP2213 SP2616 SP3019 SP3622

### POT CORES (SQUARE AND SPECIALITIES)



CP0906 CP1309 CP2014 CP2323 SM-6 CP1715 X-25

### EE CORES



E-10 E-16 E-22 E-30 E-40 E-50 E-60

### UU CORES

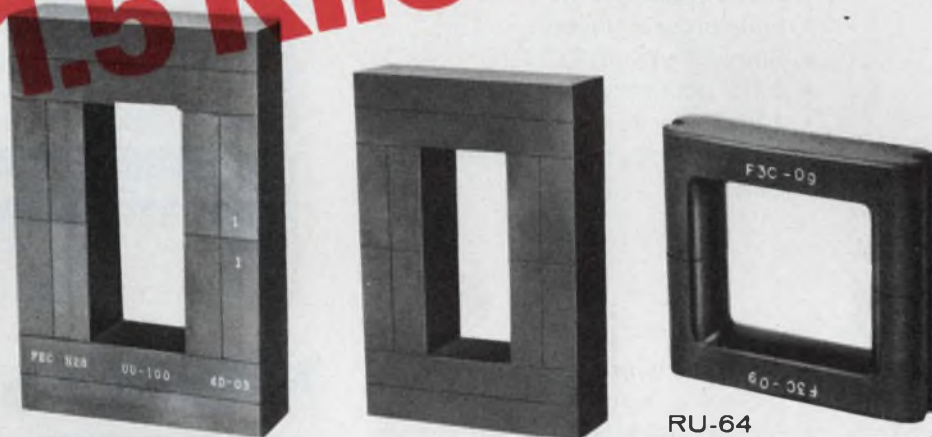

RU-64

Newly developed H28 Material for power rated ferrite cores is best suited for direct-line-switching regulated power supplies. The low-loss, high saturation flux density and superior design of these ferrite cores assure top performance.

Both cores and transformer coils can be manufactured to your specifications.

**FOR YOUR POWER SUPPLY  
STANDARD CORES ARE  
ON OUR SHELF**

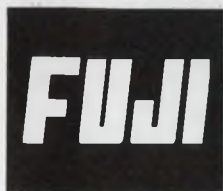

## FERRITE

### FUJI ELECTROCHEMICAL CO.

Head Office: Hamagomu Bldg., 5-36-11, Shinbashi, Minato-ku, Tokyo, Japan  
TEL: 434-1271

Overseas Office: New York, TEL: (212) 532-5630  
Los Angeles, TEL: (213) 620-1640  
Düsseldorf, TEL: (211) 89031

TAD ISHIZUKA  
SAM YOSHINO  
TAD KOMURO



# Don't worry about systems compatibility.

## S-D already has.

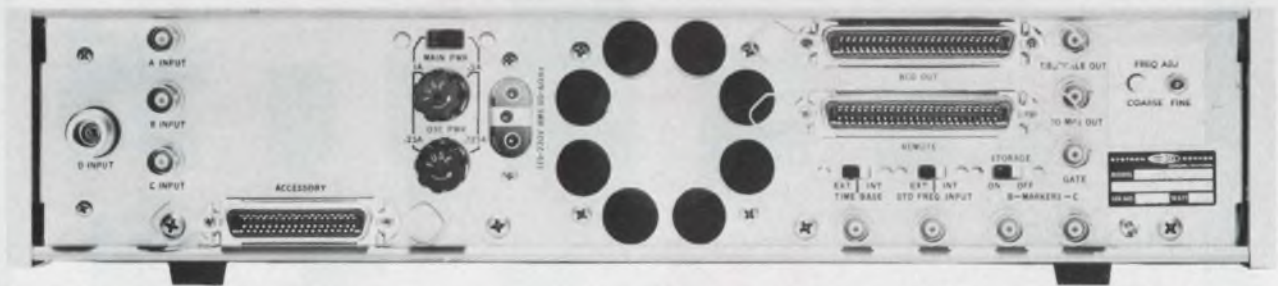

Systron-Donner manufactures a complete line of programmable instruments for systems applications. They were **meant** to be programmable right

from the start. Here are but three of S-D's many easy-to-interface instruments:

### Waveform Analyzers

- Fully programmable
- Single transient to 1 GHz
- 0.1% accuracy
- 1 mv to 2 v voltage measurement
- Search mode and programmable delay

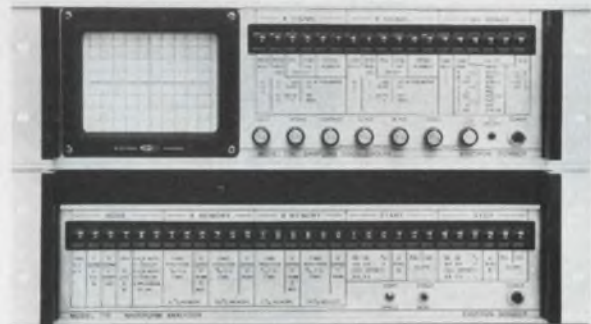

### Counters

- Completely programmable including trigger levels
- 50, 200, 512 MHz or 3 GHz models
- 10 ns one shot T.I.M./period



### Pulse Generators

- All pulse parameters programmable
- 50 MHz repetition rate
- Current sink capability



For immediate information on Systron-Donner's broad line of instruments for systems, call us collect on our Quick Reaction line: (415) 682-6471. Or you may contact your Scientific Devices office or S-D Concord Instruments Division, 10 Systron Drive, Concord, CA 94518. Europe: Systron-Donner GmbH, Munich, W. Germany; Systron-Donner Ltd., Leamington Spa, U.K.; Systron-Donner S.A., Paris (Le Port Marly) France. Australia: Systron-Donner Pty. Ltd., Melbourne.

**SYSTRON**  **DONNER**

INFORMATION RETRIEVAL NUMBER 41



# washington report



Heather M. David  
Washington Bureau

## **Complexity raises cost of Viking spacecraft**

"Sheer complexity" is the stated reason for an almost 20% rise in costs for NASA's program to land two Viking spacecraft on Mars in 1976. Described as the most complicated craft the space agency has ever built, the cost of the two Vikings is now put at \$920-million—\$170 million more than the original estimate. The heart of the Viking is a biological identification experiment that will collect soil samples and subject them to various tests. The device has 40,000 electronic parts, including 22,000 transistors, and 40 thermostats, each controlling a different temperature.

## **Commission to investigate raw-material shortages**

Congressional-executive cooperation has resulted in the swift creation of a temporary National Commission on Supplies and Shortages. The idea, put together by Treasury Secretary William Simon and the Congressional leadership headed by Senate Majority Leader Mike Mansfield (D-Mont.), is a compromise. The Administration had opposed a Congressional proposal for a new Government agency to deal with raw-material shortages. The commission is to review the state of supplies in the American economy and suggest long-term approaches to the President and Congress by Dec. 31. All raw materials, including energy sources and metal used by the electronics industry, will be investigated, Congressional sources indicated.

## **Navy studying laser communications on ships**

The Navy is investigating the possibilities of using laser communications to eliminate a good deal of the electrical cabling that connects devices on ships. Complex electronic devices could easily be coupled by laser beams, according to Dr. Sam Kotzloff, director of the Navy's Technology Base Project. Laser devices for ship-to-ship and ship-to-shore communications also look very promising, Kotzloff says. Tests indicate transmission reliability is surprisingly good even in heavy fog over water.

## **A broad range of ATS satellite experiments due**

The Applications Technology Satellite launched by NASA last month carries experiments with great ramifications for further electronic projects. The ATS will conduct educational TV and two-way medical conference demonstrations, beaming transmissions in the 2500-MHz range to 114 glass-fiber dish antennas at community and hospital facilities in remote



regions of the U.S. The satellite also will be used as a relay in L-band tests to evaluate communication and position-locating techniques between ground terminals and aircraft and ships.

The spacecraft also will be used to evaluate the effects of the earth's atmosphere on space-to-earth communications at millimeter frequencies (20-30 GHz), primarily during heavy rain, hail or wet snow. About one year from now, the satellite will be moved to a stationary orbit where it will be visible to India, which will use it for educational TV experiments.

## **Senate committee approves DOD bid to upgrade ICBMs**

The Senate and Armed Services Committee has endorsed Defense Secretary James Schlesinger's program to improve the yield and accuracy of strategic missiles, overturning a recommendation by its R&D subcommittee that would have cut the \$77-million requested by the Pentagon for new guidance and Maneuverable Re-entry Vehicle (MARV) programs. In other actions, the Senate committee deleted \$16-million requested for a new nuclear missile-firing submarine, and it cut \$44-million from the \$499-million requested for development of the B-1 bomber, limiting the program to three prototype aircraft to permit flight testing before Congress decides on further action.

The total in the Senate committee bill for procurement and R&D is \$21.8-billion, compared with House passed versions that would provide \$22.6-billion. The Administration requested \$23.1-billion.

**Capital Capsules:** The House Science and Astronautics Subcommittee has started hearings to determine whether or not Congressionally sponsored research could reduce the cost by a factor of 100 or more the process for photovoltaic conversion of solar energy. . . . The Air Force's Space and Missile Systems Organization plans to ask industry to bid around July 8 on a contract to design and deliver two passive microwave temperature sounders to be used in the Defense Meteorological Satellite program. . . . Dr. Joseph L. Byerson, senior scientist at the Air Force's Rome (N.Y.) Air Development Center has been appointed chairman of the Defense Dept. Metrication Panel. A 1971 study estimated that it will cost \$18-billion to convert the military to the metric system. . . . Sperry Rand has signed a cooperative agreement with the Soviet Union for computer technology, marine navigation, guidance and control and other company business interests. Specific projects developed under the agreement will be subject to the approval of the U.S. Export Control Office. . . . The Air Force is conducting field tests of a system that simulates electromagnetic pulse effects on the Minuteman weapon system. The EMP simulator, which will be placed above a missile silo for the tests, will emit pulses similar to that which might occur during a nuclear explosion. . . . The Pentagon is considering asking industry to furnish three to five-year warranties on military electronic systems, in the same way warranties are furnished for commercial systems. . . . Rep. Bertram Podell (D-N.Y.) has introduced legislation in the House of Representatives that would require the FCC to establish standards for telephone interconnect equipment and prohibit telephone companies from stopping its use. . . . Hughes Aircraft has won a subcontract from Boeing to develop a secure data link switching system for the Airborne Warning and Control System. The switch will hook into command and intelligence data bases to get information on attacking forces in event of an emergency. . . . The Air Force will launch 50 rockets into space for atmospheric tests during a 24-hour period around June 17. The project, called Aladdin, for Atmospheric Layering and Density Distribution of Ions and Neutrals, is aimed at developing mathematical models of the upper atmosphere and ionosphere for use in predicting communications problems and satellite orbits.



# It takes more

than a neon lamp to solve circuit problems like these...

## VOLTAGE REGULATOR: 1% ACCURACY

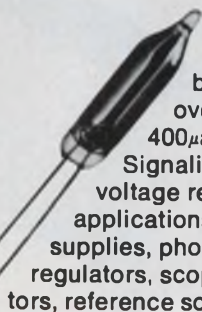

Copy machine voltage can be regulated within  $\pm 1V$  over a current range of  $400\mu A$  to  $15mA$  using a Signalite Subminiature voltage regulator. Other applications inc: reg. power supplies, photomultiplier regulators, scopes, calibrators, reference sources.

## SEQUENTIAL SWITCH FOR TV TUNER

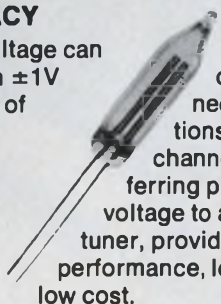

Varactor tuning systems for color TV sets use Signalite neons to perform two functions — illuminating the channel selector and transferring precise, regulated voltage to a Solid State tuner, providing reliable performance, long life and low cost.

## TV VOLTAGE MONITOR/PROTECTOR

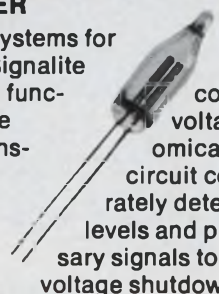

Federal x-ray emission safety regulations require control of TV picture tube voltage. Signalite's economical multi-function neon circuit components accurately detect precise voltage levels and provide the necessary signals to activate high-voltage shutdown circuitry.

It takes application help from a group of circuit specialists...  
...yours for the asking.



**SIGNALITE APPLICATION NEWS** — is used to communicate new and proven techniques and applications of Signalite's neon lamps and gas discharge tubes. Signalite Application News provides a forum for an exchange of ideas to keep the design engineer aware of the versatility of neon lamps and their many applications. Copies are available from your Signalite representative or contact Signalite, 1933 Heck Ave., Neptune, N. J. 07753, (201) 775-2490.

**SIGNALITE DIVISION  
GENERAL INSTRUMENT CORP.**









# HP's Family Planning Means A DVM To Match Your Budget And Your Needs.



An HP DVM Built For Your Needs . . . all the way from troubleshooting in the field to complex systems in the plant. Whether you need a general-purpose instrument or one dedicated to a specific task such as measuring true RMS, we can supply it. With our modular and plug-in approach we can even combine general-purpose and specialized functions. HP's innovation and advanced technology are on your side to help solve your measurement problems. Look at the capability you can obtain in just five instruments from our broad product line.

**Low-cost 970A Probe Multimeter** packs a lot of performance in a seven-ounce package. Probably the easiest-to-operate probe multimeter ever made,

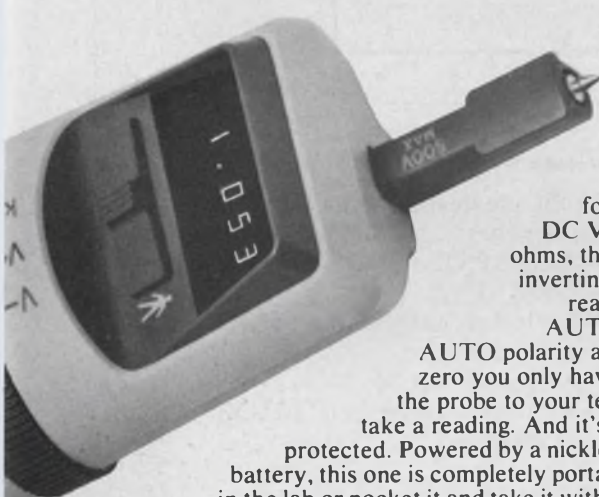

this 3½-digit instrument has only two selectors; one for choosing DC V, AC V or ohms, the other for inverting the LED readout. With AUTO ranging, AUTO polarity and AUTO zero you only have to touch the probe to your test point to take a reading. And it's overload-protected. Powered by a nickel-cadmium battery, this one is completely portable. Use it in the lab or pocket it and take it with you in the field. It's designed to simplify your measurement tasks from start to finish. You can operate it single-handed, right side up or upside down. The inverting switch lets you read the display either way. And you read it right at the test point. At just \$310\* the 970A probe multimeter is a real bargain.

**Self-Test 3490A** makes double use of its internal ICs to bring you HP's "Self-Test" capability without extra cost. The basic 5-digit 3490, ready to measure AC, DC and ohms, sells for only \$1,785\*. At low added cost you can have isolated BCD output and remote control or the versatile General Purpose Interface Bus for systems applications. Compare the 3490A with any other multimeter in its class and you'll find an unusual blend of features and performance for the money.

**Snap-On 3470 Series** lets you custom-build your own measurement system. Starting with a 4½- or 5½-digit LED display unit, you add only those modules you need. Get 4½-digit DC only for \$530\*, or 5½-digit DCV/DCA/Ohms for

\$1,200\*. Add a battery pack for \$220\*, BCD output for \$189\* or an HP "Self-Test" accessory for only \$50\*. With this series you don't have to worry about obsolescence.

**Multi-Mode 3450B** lets you add up to 12 modes of high-accuracy measurement capability to your automated system. You can have true RMS, 4-terminal ohms and the unique limit test in addition to the usual functions. The 3450 is both fast and accurate. You get 15 readings/sec. and DC accuracy to ±(0.008% of reading + 0.002% of range). Prices start at \$3,785\* for the 5-digit DC volts and Ratio model, go to \$6,616\* for total 12-mode capability.

**Speed Star 3480C/D** is systems oriented, but fine for the bench as well. This 4-digit, ±0.01% unit in DC delivers a fast 1,000 reading/sec. Get the exact capability you need by selecting plug-ins. For example, you can have DC, ohms and true RMS AC for \$3,370\* (isolated BCD output and remote control are low-cost options). Sample and hold option lets you take peak readings or do transient analysis.

HP's family of DVM's also includes high-performance AC V, DC A and ohms (Model 3469B at \$760\*), resolution of 1 PPM (Model 3462A at \$5,835\*), true RMS to 100 MHz (Model 3403C from \$1,895\*) and for systems use, the 2402A with outstanding noise rejection at high measurement speeds from \$8,000\*. No matter what your measurement needs, check HP for a solution to your problem. For more information on how HP's DVM family can help you, contact your local HP field engineer or fill out the coupon below and mail it in.

For helpful information on DVM measurement techniques, send for our 72-page application note AN-158 entitled "Selecting the Right DVM."

\*Domestic U. S. A. prices.



Sales and service from 172 offices in 65 countries.  
1501 Page Mill Road, Palo Alto, California 94306

08A-40A

I'm interested in your DVM line. Please send me:

- More information on the 970A Probe Multimeter.
- More information on the DVM family.
- Application Note 158 "Selecting the Right DVM."

Name \_\_\_\_\_ Dept. \_\_\_\_\_  
 Company \_\_\_\_\_  
 Street \_\_\_\_\_  
 City \_\_\_\_\_ State \_\_\_\_\_ Zip \_\_\_\_\_

Mail coupon to:  
 Hewlett-Packard, 1501 Page Mill Road, Palo Alto, California 94306



FROM STOCK

## The Deluxe MUX

# DG506

## 16-Channel CMOS Analog Multiplexer

No other device available has more switches per package or a greater dynamic analog signal range. The DG506 also includes a 4-line binary decode network which directly interfaces TTL, CMOS and DTL.

- $\pm 15V$  Supplies—same as your op amps.
- $\pm 15V$  Analog Signal Range—more than your op amps.
- 4-Line Binary Decode—selects one of 16 switches ON.

- Enable Control—disables all 16 switches, reduces standby power, lets you add more channels.
- Control Inputs Directly Interface TTL, CMOS, DTL.
- Break-Before-Make Switching—prevents dangerous channel shorting.
- Switching Time Less than  $1\mu s$ .
- Monolithic CMOS.

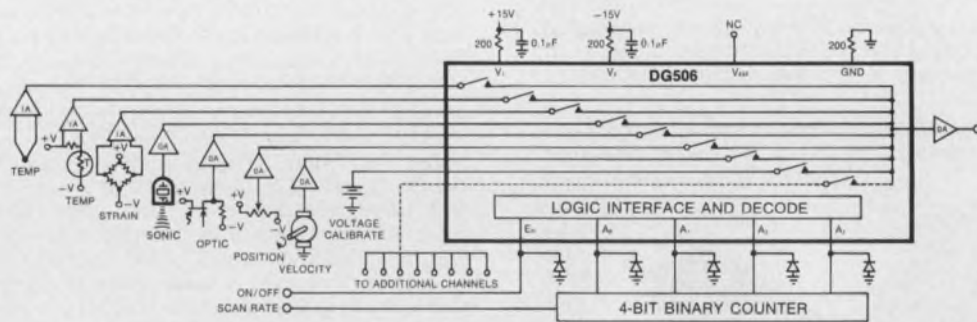

Typical Application: Sequential 16-Transducer Scanner (8 channels illustrated)

### Applications

- Process Control Systems
- Data Acquisition and Routing
- Telemetry Systems
- Analog Commutating Systems

Don't need 16 channels? The creators of the DG506 have extended this unique

family to offer the greatest selection of CMOS analog switches:

- DG200—Dual SPST
- DG201—Quad SPST
- DG507—8-Channel Differential MUX (16 switches)
- DG508—8-Channel MUX
- DG509—4-Channel Differential MUX (8 switches)

For further information

## write for data

IC Applications: (408) 246-8000, Ext. 120



### Siliconix incorporated

2201 Laurelwood Road, Santa Clara, California 95054

INFORMATION RETRIEVAL NUMBER 44



## Prosperity, the strangler

For the past few years our industry has enjoyed unprecedented prosperity. Business has been so good that many of us have been almost embarrassed to talk about it. Order rates have been at an all-time high. And yet many companies are being squeezed to the wall and some are being strangled.

The wonderful boom, coming immediately after the dreadful recession, created a new set of problems while people were still trying to cope with an old set. Just a few years ago companies worried about where to find the next order, how to cut back expenses, which engineers and which production workers could be discharged least painfully. Since prices of components kept tumbling, they worried, too, about how to squeeze the last cent out of competing suppliers and how long to delay purchase orders.

Then, without warning, the world turned upside down. Orders were plentiful; components were scarce. The suppliers who had been squeezed a few years ago had cut back their plant capacity and laid off workers. They couldn't cope with the sudden surge in demand. And they were nervous about adding plant capacity in response to what might be a temporary spurt in a basically declining market. Further they had earlier gone through a period of plant expansion just before the bottom fell out of the market. They didn't want to fall into that trap again.

The customer who, three years ago, was squeezing his vendors, suddenly found himself pleading with them to supply parts—at almost any price. The customer sometimes had to accept delivery of a 5-year supply of a component, though changing technology might make that component obsolete or undesirable in a few years. That customer had to pay immediately for his shipment. Like others, he remained silent about high reject rates.

Of course, it would be idyllic if all of us could predict the turns—if we could know when to become aggressive sellers and when to become aggressive buyers. But that's not likely. It might be nice, too, if our industry didn't go through such wild feast-or-famine gyrations. Meanwhile, though, our chances of survival and of progress can be improved if we recognize a basic truth. Companies, however incorporeal they may seem, are, in fact, run by human beings. The guy we try to crush this year may be the one who comes back to strangle us next year.



A handwritten signature in dark ink, which appears to read "George Rostky". The signature is fluid and cursive.

GEORGE ROSTKY  
Editor-in-Chief



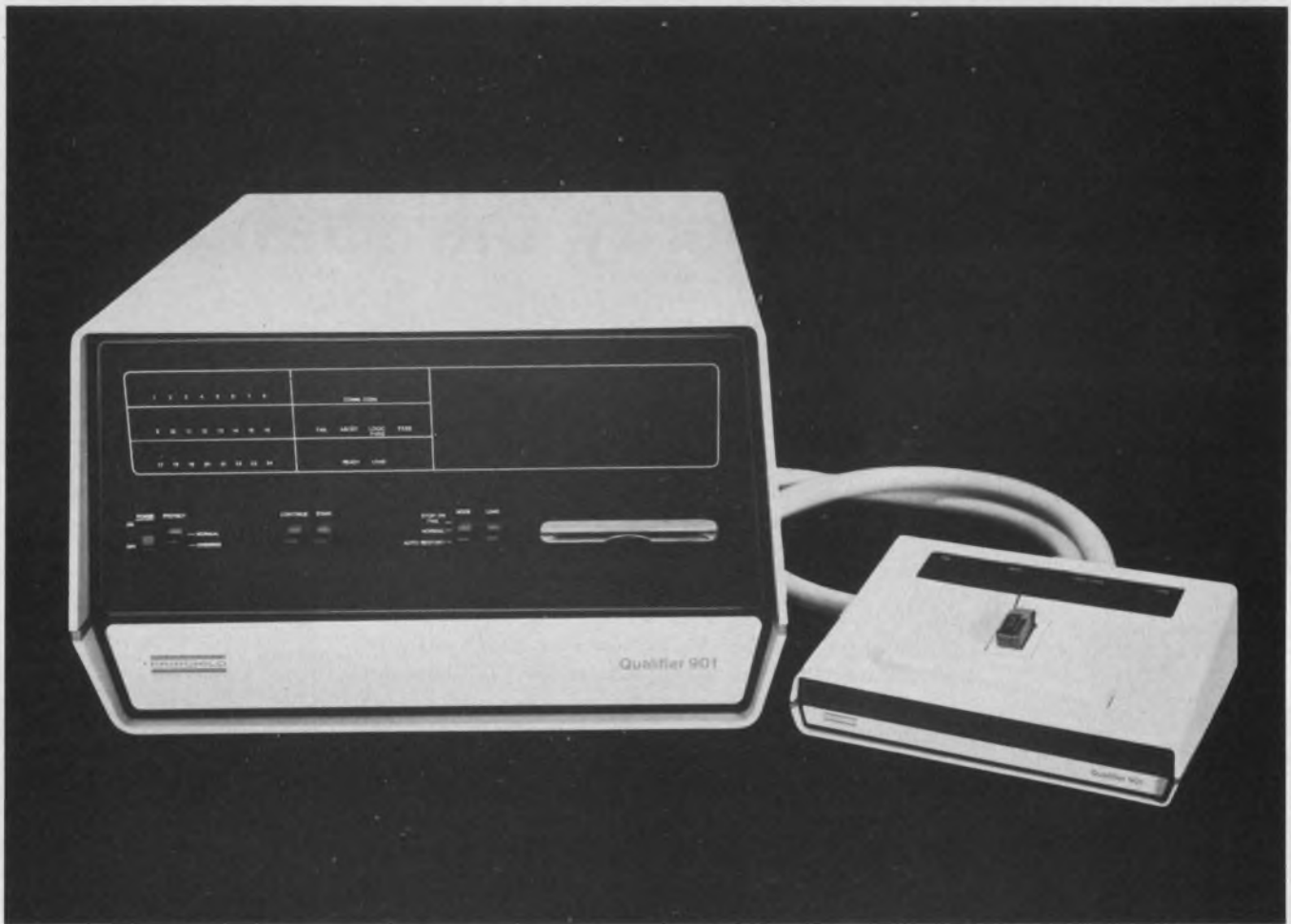

## Our new logic IC tester.

Here's how you get your money back. Take one of the durable plastic Qual Cards\* that is specifically coded to program your new Fairchild Qualifier\* 901 for incoming inspection of C-MOS, DTL and TTL logic IC's. Slide the Qual Card into the reader. Notice how flexible and unbreakable it is. Observe that there are no operators to be trained or dials to be set. Everything is in the Card. It absolutely dictates what is to be measured, to what levels and to what accuracy. In 60 to 200 milliseconds your 16- or 24-pin IC has been tested. Functionally and parametrically.



Everytime the photo-optically programmed Qual Card enters your Qualifier, money you spent on the machine is coming back. In lower costs for device programs. In convenience of program availability and storage. And in error-free, failure-analyzed IC testing. That's why our Qual Cards are your money back guarantee.

### **The Qualifier is sophisticated and flexible.**

Without being big and expensive. Besides the savings you'll get with the Qual Cards, the 901 is cost competitive on purchase price. And it's a high performance logic tester for incoming inspection that is architecturally innovative. Cross-bar switching has been eliminated. You can shift from one family of IC's to another. Instantly. The essence of the Qualifier 901 is speed. You can test common TTL parts in 60 milliseconds. A 2% failure rate of IC's at the top of the line can mean a 50% failure rate at the end of the line. The Qualifier 901 is the surest, least expensive way to avoid faulty IC's in your finished product.

For under \$8,000 you start with the Qualifier 901, a 16-pin basic test unit. For another \$2,400 you can expand that capability to a 24-pin field. That's one machine to test the two common usage IC packages. Or two machines for the price of one and a quarter.

### **Before the Qualifier tests your IC's, it tests itself.**

When the system is turned on, a comprehensive self-test analysis is performed. Everytime a program is



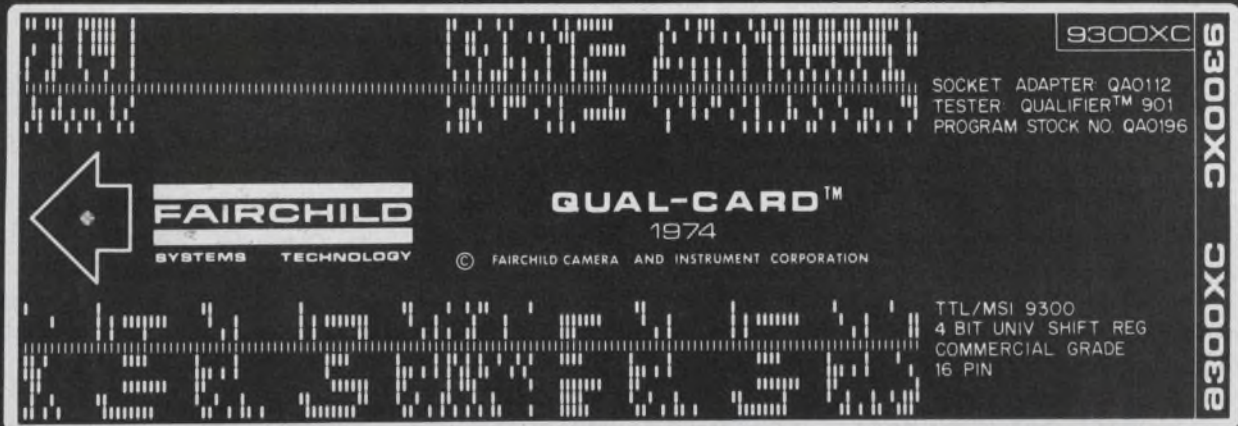

# Our money back guarantee card.

loaded, the microprocessor checks all data paths, registers, memories and the Qual Card reader. After everything checks out, the 'ready light' goes on. The Qualifier also comes with a packet of diagnostic program cards which can verify the accuracy of the drive and measurement circuits. If the machine checks out and the program's right, there's only one thing that might be faulty: the IC you're testing. And that's exactly the condition you're looking for.

## The proof is in the programming.

The Qual Card is the first virtually indestructible program medium. It leaves nothing to chance. Your Qual Card is written for you and verified by us. When it comes back by return mail, all you do is put it in the machine.

## Your operator can't miss.

There's only two things to remember.

Insert the Qual Card and IC—and read the results. There's no time lost training technicians to read time

consuming data sheets. The flexible Qual Card eliminates messy paper tapes, and takes up less room than the hard wired program boards. As for cost, the Qual Card comes in at from \$20 to \$60 each. That's more than just in the ball park price-wise when you consider the expendability of a hard wired program card that can cost up to \$300.

The Qualifier has much more than just a card-up on other IC logic testers. It's the first in a series of architecturally sophisticated testers that will be dedicated to a major family of devices. If you'd like more information on the Qualifier 901, we'll send you a brochure, a list of representatives and a growing library inventory of 200 Qual Cards now available. Call collect or write today. Start getting your money back tomorrow.

Fairchild Systems, 3500 Deer Creek Road, Palo Alto, California 94302 (415) 493-5011 TWX: 910-373-1204

**FAIRCHILD**  
SYSTEMS TECHNOLOGY  
A DIVISION OF FAIRCHILD CAMERA AND INSTRUMENT CORPORATION

\*Trade mark of Fairchild Camera and Instrument Corporation



# Get high voltage with low-cost multipliers.

If it's a low-current application, simple diode-capacitor networks can be cascaded to deliver any voltage you need.

If you need a power supply for a high-voltage, low-current application, your best bet is probably the voltage multiplier circuit. It's inexpensive. It's simple. And you can get any voltage you want by cascading multiplier stages. The voltage is limited only by the ratings of the components you use.

A voltage-multiplier circuit contains diodes and capacitors, with the devices connected to develop a dc output that is a multiple of the peak or peak-to-peak input voltage. There are two major variations of the circuit: multipliers that use an even number of diodes and those that use an odd number of diodes.

The basic rectifier circuits in Fig. 1 (equations assume perfect diodes and capacitors, loads are considered light) can be combined to

form a complete family of half-wave multipliers. A full-wave multiplier can be made by combining two half-wave multiplier sections, one positive and one negative (Fig. 2). The major disadvantage of a full-wave multiplier is that the secondary side of the transformer nearest the core requires heavy insulation to withstand one-half the output voltage. Therefore inductive coupling is worse and efficiency lower than for a transformer used with the equivalent half-wave type. Thus half-wave multipliers are better for most high-voltage power supplies.

Fig. 3 shows the two variations of half-wave multipliers. Each of these circuits consists of identical sections cascaded, except for the first stage in Fig. 3a. The first section of a multiplier with an odd number of diodes is a simple half-wave rectifier. This first section of a multiplier with an even number of diodes is a half-

Walter Wills, Product Engineer, Varo Semiconductor, P.O. Box 676, 1000 North Shiloh, Garland, Tex. 75040.

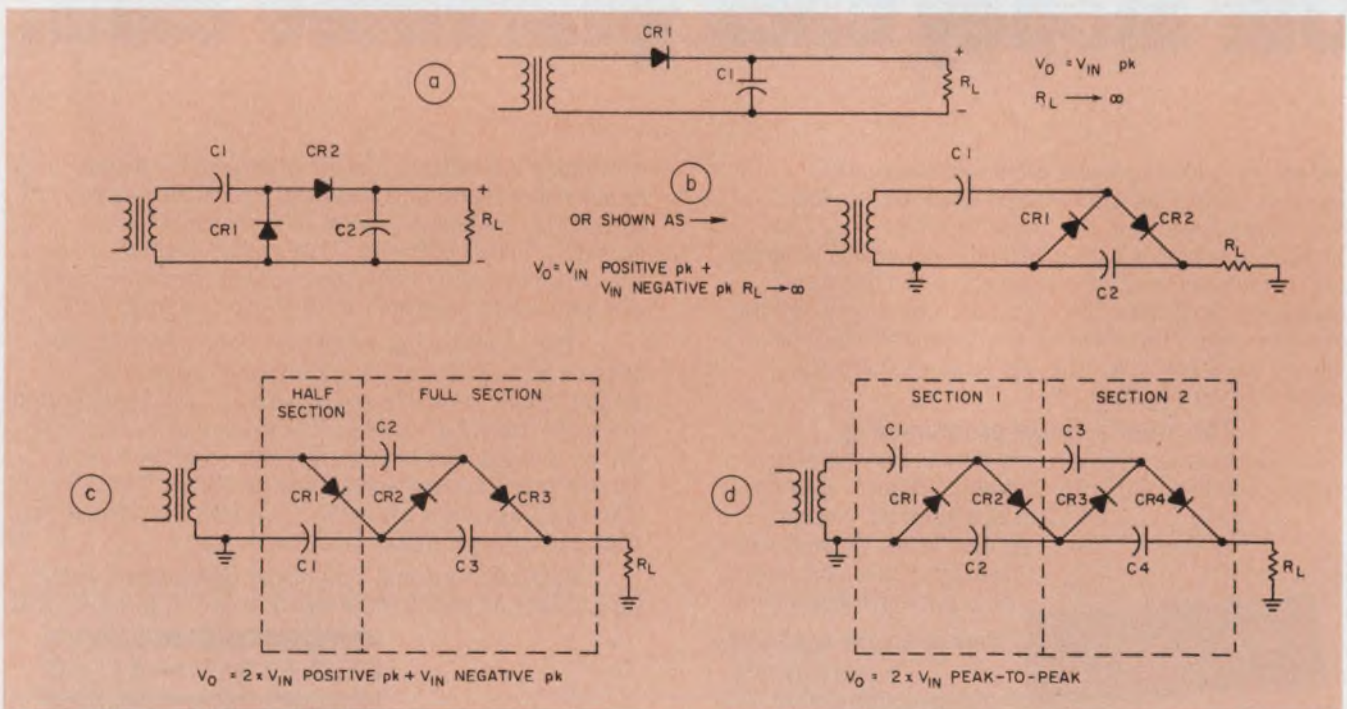

1. The basic half-wave rectifier circuit (a) can be modified to get a voltage doubler (b). If you add extra

voltage multiplier sections, various output voltages can be obtained (c and d).



wave doubler. A basic rule of thumb for multiplier designs is: For waveforms that are symmetrical about ground, use an even number of diodes; for asymmetrical waveforms, use an odd number.

### How the multipliers work

The multiplier circuit can handle any waveform, but the three most common for multiplication are sine, pulse (or square) and trapezoidal wave. The only waveform restrictions are that

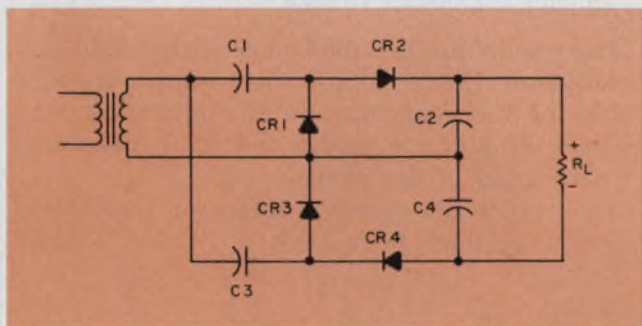

2. The full-wave voltage quadrupler circuit requires a transformer with heavy secondary insulation.

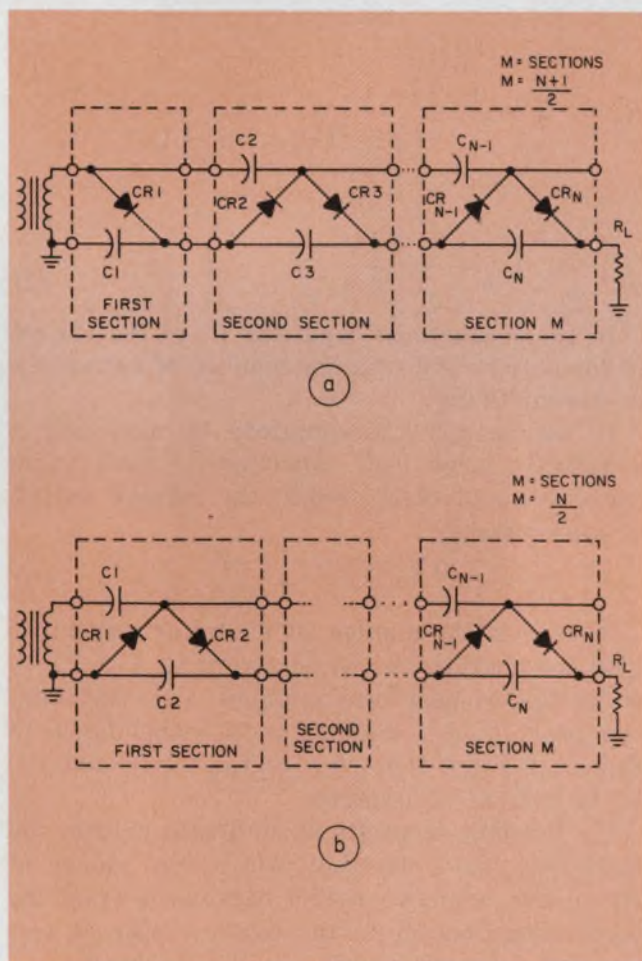

3. The multiplier with an odd number of diodes works best for asymmetrical waveforms (a), while that with an even number of diodes works for symmetrical waveforms (b).

the rise and fall times of the input signal be slower than the diode switching time.

In the signal in Fig. 4,  $V_{in}$  is a recurring waveform composed of the positive peak  $V_1$ , the negative peak  $V_2$  and an ac axis that can be displaced from dc ground by voltage  $V_{dc}$ .

Fig. 5 shows the voltages at each point of a 1.5-section multiplier. The half-wave, 1.5-section multiplier (three diode) operates as follows: During the positive peak of  $V_{in}$ , diode  $CR_1$  conducts to charge  $C_1$  to a voltage equal to  $V_1 + V_{dc}$ . Capacitor  $C_2$  acts as a coupling capacitor to couple  $V_{in}$  to point C. Diode  $CR_2$  conducts on the negative voltage peak at point C when the voltage tries to become more negative than the anode of  $CR_2$  (the anode voltage of  $CR_2$  is  $V_1 + V_{dc}$ ). Diode  $CR_3$  conducts on the positive peak at point C and charges  $C_3$  to  $V_1 + V_2$ . The output,  $V_{out}$ , is the sum of the voltages on  $C_1$  and  $C_3$ :

$$V_{out} = V_1 + V_{dc} + V_1 + V_2 = 2V_1 + V_2 + V_{dc}.$$

Only dc voltages are applied to  $C_1$  and  $C_3$ ; these capacitors are therefore dubbed "dc capacitors." An ac voltage is applied to  $C_2$ , which is called an "ac capacitor." If the input voltage is symmetrical about the zero axis, the multiplier output will be three times either peak voltage,  $V_{out} = 3V_1$ . This circuit is called a tripler. If, however, the waveform is such that  $V_1$  is much greater than  $V_2$ , the output voltage is approximately twice  $V_1$ ; the circuit could be called a doubler. For clarity, we can use the diode count to define multiplier capability.

### Diode count determines operation

The operation of the four-diode multiplier—a two-section, half-wave unit—is similar to that of the three-diode multiplier (Fig. 6). Capacitor  $C_1$  blocks the dc bias from the remainder of the multiplier and acts as a coupling capacitor to couple  $V_{in}$  to point C. Diode  $CR_1$  conducts when the negative voltage at point C becomes more negative than the anode of  $CR_1$  (the anode of  $CR_1$  is at 0 V). This causes  $C_1$  to charge to a voltage equal to  $V_2 - V_{dc}$  and simultaneously causes the positive peak at point C to reach  $V_1 + V_2$ .

The positive voltage at point C turns on  $CR_2$  and charges  $C_2$  to  $V_1 + V_2$ . Capacitor  $C_3$  acts as a coupling capacitor to couple the input waveform at point C to point E. Diode  $CR_3$  conducts when the cathode voltage becomes more negative than the anode voltage (the voltage at point D). The positive peak will be at a voltage equal to the charge on  $C_3$  plus the peak voltage at point C. This positive voltage will cause  $CR_4$  to conduct and charge capacitor  $C_4$  to  $V_1 + V_2$ . The output,  $V_{out}$ , is the sum of the voltage on  $C_2$  and  $C_4$ :

$$V_{out} = (V_1 + V_2) + (V_1 + V_2) = 2V_1 + 2V_2.$$

Both  $C_2$  and  $C_4$  are dc capacitors. Points D and



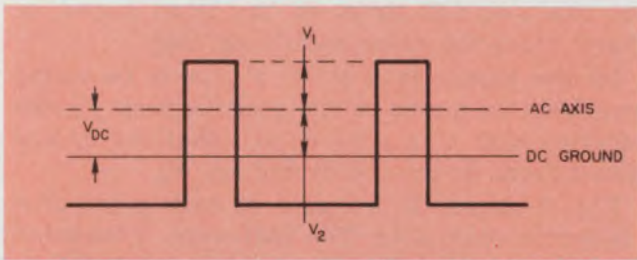

4. A recurring waveform with a positive peak  $V_1$  and negative peak  $V_2$  is used as an input for the voltage multiplier circuit described in Fig. 5.

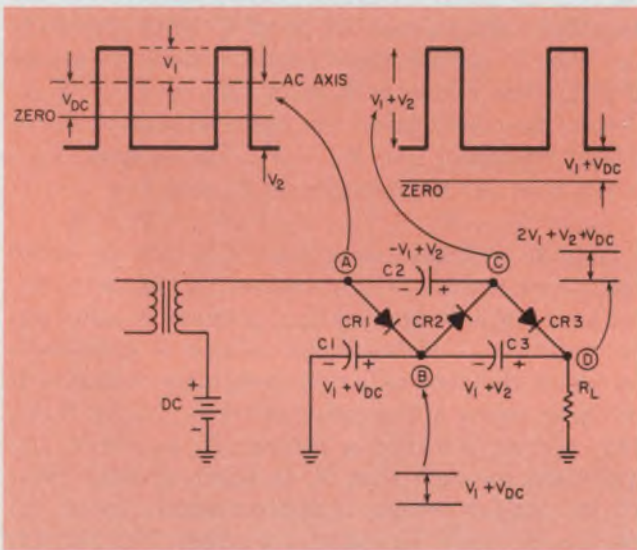

5. The voltage waveforms at different points within the multiplier circuit with an odd number of diodes show the transformation of the pulse waveform described in Fig. 4 into a much higher dc voltage.

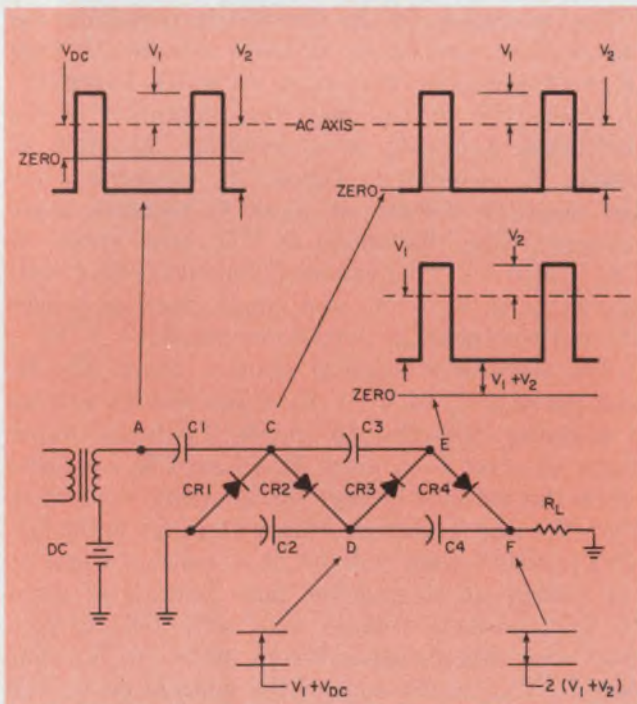

6. The multiplier circuit with an even number of diodes and the same input as described in Fig. 4 produces an even larger dc output voltage than the circuit of Fig. 5.

F are "dc points," and  $C_1$  and  $C_3$  are ac capacitors. In both the odd-diode and even-diode circuits, the diode peak-inverse voltage (PIV) ratings should be at least  $V_1 + V_2$ . In the even-diode multiplier,  $C_1$  should have a voltage rating of at least  $V_2$ . In the odd-diode multiplier,  $C_1$  should have a voltage rating of at least  $V_1 + V_{dc}$ . All the other capacitors should have a voltage rating of at least  $V_1 + V_2$ . Negative output voltages can be obtained if the diode polarities are reversed.

### Calculating the output voltage

The regulation of a multiplier with a load is a function of the input's source impedance, the values of the capacitors in the multiplier, the forward drop of the diodes and the turn-on and turn-off times of the diodes.

To compute the output voltage (or the capacitances), use these formulas<sup>1</sup>:

$$V_{o(n \text{ even})} = nV_{in} - \left[ \frac{\left(\frac{n}{2}\right)^2}{C_{n-1}} + \frac{\left(\frac{n}{2}-1\right)^2}{C_{n-2}} + \frac{\left(\frac{n}{2}-1\right)^2}{C_{n-3}} + \frac{\left(\frac{n}{2}-2\right)^2}{C_{n-4}} + \frac{\left(\frac{n}{2}-2\right)^2}{C_{n-5}} + \dots + \frac{1}{C_2} + \frac{1}{C_1} \right] \frac{I_o}{f} \quad (1)$$

$$V_{o(n \text{ odd})} = nV_{in} - \left[ \frac{\left(\frac{n-1}{2}\right)^2}{C_{n-1}} + \frac{\left(\frac{n-1}{2}\right)^2}{C_{n-2}} + \frac{\left(\frac{n-3}{2}\right)^2}{C_{n-3}} + \frac{\left(\frac{n-3}{2}\right)^2}{C_{n-4}} + \frac{1}{C_2} + \frac{1}{C_1} \right] \frac{I_o}{f} \quad (2)$$

In these equations capacitor  $C_1$  is the closest to the output, and  $n$  is the number of capacitors in the multiplier.

If we simplify the equations by assuming a sufficiently large load capacitance, equal value capacitors and ideal diodes, the voltage output is approximately

$$V_{out} = N \frac{(V_1 + V_2)}{2} - \frac{N^3}{12cf} I_{out} \quad (3)$$

Here  $N$  is the number of diodes or capacitors used for circuits like those shown in Fig. 3;  $V_1$  is the positive peak input voltage;  $V_2$  is the negative peak input voltage;  $c$  is the capacitance in farads;  $f$  is the frequency of the input, and  $I_{out}$  is the current in amperes.

To distribute capacitance optimally within the multiplier chain, use the ratio of the square of the section number counted backwards from the high-voltage output to the total number of sections. For example, a two section multiplier requires a  $2^2/2:1$  ratio for the first capacitor as compared with the last.

The optimized arrangement reduces the ef-



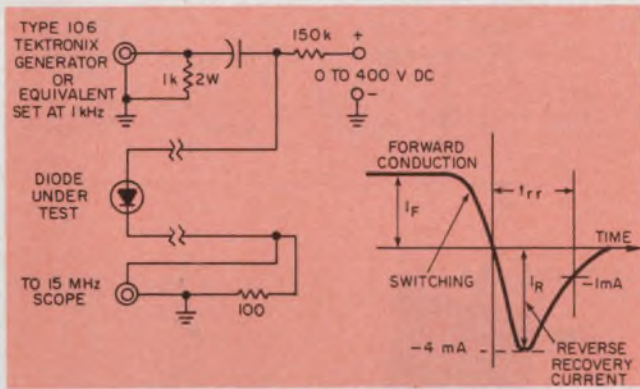

7. A simple test circuit to check diode reverse-recovery time will tell if the diodes are usable.

fective series impedance by about 25%. In production, capacitors of equal value offer savings in price and labor. And if there's no constraint on the maximum value, it is usually less expensive to standardize on a single, large, capacitance value throughout.

The over-all reactive impedance must be taken into account to determine how large the capacitor values should be.

#### Watch diode switching characteristics

The turn-on and turn-off times of the diodes are important. Junction thickness controls the turn-on time, while the amount of gold doping controls the turn-off. Both turn-on and turn-off must be kept fast, if regulation and efficiency are to be maintained. A simple test jig to determine diode recovery time is shown in Fig. 7.

The forward drop of the diodes is usually not a significant factor. For example, a typical multiplier, rated for 25 kV at 2 mA, has six diodes—each with a forward voltage drop of approximately 15 V at 10 mA. Thus this multiplier has less than a 100-V drop when operating.

The output regulation of voltage multipliers ranges from 100 V to 5 kV per milliamp of current. Some applications use regulation schemes to control power-supply output. Some common methods are shunt dc load, rectified pulse feedback and a saturable reactor in series with the high-voltage transformer. In other applications, it is desirable to have the output voltage sag with load—with very poor regulation built into the multiplier through selection of the capacitor's value.

The output voltage of a multiplier will always have some ripple in the output. Ripple is a function of load capacitance, input frequency, multiplier impedance and input-to-output coupling.

The load capacitance acts as a filter, and the effective series impedance of the multiplier limits voltage ripple. If regulation is not a consideration or if load current is almost constant, a series

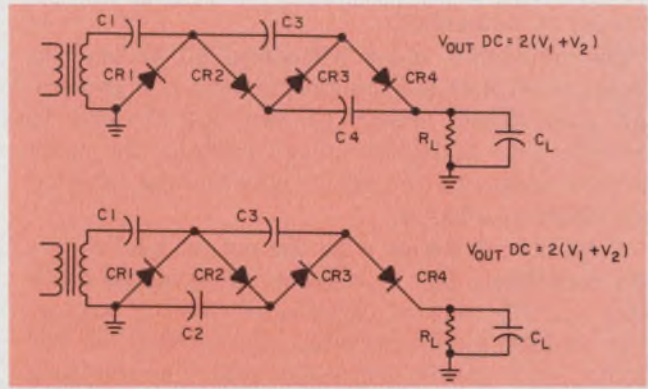

8. To reduce component cost and count if the load is capacitive, remove one of the doubling capacitors.

resistor can be added to the multiplier output. The series resistor will act with the load capacitance as an RC filter.

The high-frequency components of the input voltage are the most easily coupled into the output. But the higher frequencies are also easier to filter at the multiplier output when necessary. The most unpredictable ripple component, though, is generated by stray capacitive coupling of the input to the output terminal. This coupling is difficult to control. The mechanical layout of the multiplier can reduce it, and if more ripple reduction is required, an electrostatic shield can be used to isolate the output area further from the input. Also the encapsulating compound should have a low dielectric constant.

#### Variations for special applications

For applications with a very high load capacitance, any one of the dc capacitors can be omitted in the multiplier and it will still function (Fig. 8). While this appears to be a good way to reduce component costs and package size, consider what happens when the output terminal is arced to ground: The distribution of voltages on the diodes becomes unequal, which causes more stress on some diodes than others. The uneven distribution can cause a diode's peak inverse rating to be exceeded and a malfunction to occur. For better transient protection, leave all the capacitors in the circuit.

Many applications require a second voltage that is proportional to the output voltage. A tap at any dc point of the multiplier can be used. The ratio of the voltages can be determined if you examine the circuit up to the tap as a complete unit and the total multiplier as another.

Consider carefully the maximum average current. The multiplier current ratings are intended to keep the components cool enough to perform reliably. It will help, of course, if the high-voltage drive source has some maximum-load protection that reduces the input voltage if too much



current is demanded.

The multiplier must withstand all arcing, including that between the output lead and ground, and also direct shorts of the output lead to ground. The multiplier must sustain the peak current drawn by the arc or short as the internal capacitors discharge.

A resistor in series with the output lead serves two functions: (1) It reduces the Q of the oscillator circuit that is established during arcing, thus reducing considerably the stress on the diodes, and (2) It limits the peak current to a value that the diodes can handle safely. The value of this resistance must be high enough to do the limiting job but not so high as to promote arcing around or through the resistor body or overheating at maximum current drain when the output arcs to ground.

### Consider the mechanical layout

The mechanical design, mounting method and location of the multiplier can all affect current capability. The thermal conductivity of the encapsulating medium is the top consideration. The diodes, and to some extent the capacitors, dissipate heat because of forward-drop, switching and leakage losses, and this heat must be removed to prevent the diodes from going into thermal runaway. In addition the dielectric strength of the encapsulating medium must be great enough to prevent inter-component or inner-component-to-environment arcing or corona. High dielectric strength also permits denser packaging.

The dielectric constant of the encapsulating medium should be low to minimize the capacitance from components to the environment—usually ground. The input terminal-to-ground capacitance, in particular, should be a minimum to reduce unwanted ringing at the input terminal. The low dielectric constant also minimizes the chance of a corona from the multiplier case generating heat and causing rf radiation.

The terminal location and its shape should not cause arcing or corona regardless of temperature, humidity or altitude. When the terminal consists of an insulated wire emerging from the encapsulation medium, it must be protected at the point of exit against insulation fractures when the wire is flexed.

The encapsulating medium must withstand predetermined thermal-shock cycles with no damage to the inner components or loss of performance.

### Some design examples

What information is needed to design a voltage multiplier? Input voltage, input frequency,

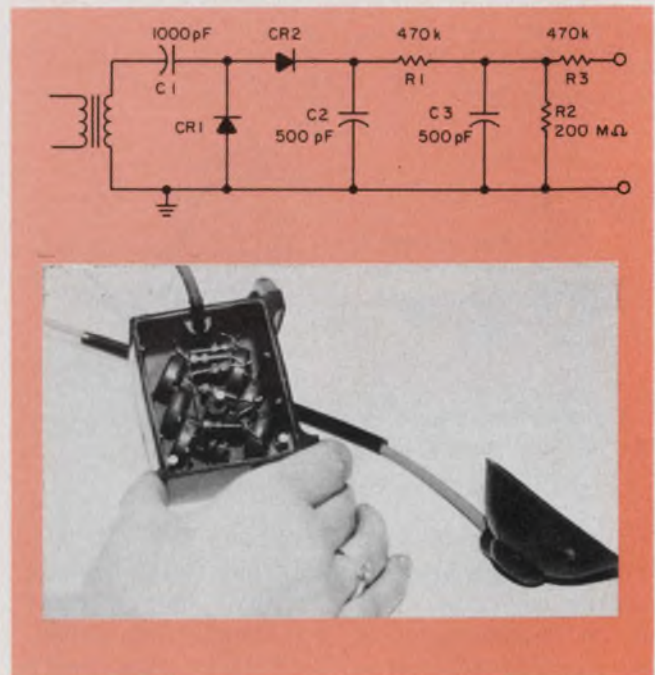

9. A voltage doubler and filter can be combined to give very-low-ripple outputs.

input waveshape, output voltage, output current, ripple limits and regulation.

Let's assume a 30-kHz, 10-kV pk-pk, zero-centered sine wave is the input for a circuit that will deliver 10 kV at 50  $\mu$ A out with a ripple of less than 4 V pk-pk and regulation of  $\pm 150$  V. Since there is voltage symmetry, a multiplier with an even number of diodes can be used. The 10-kV output means that only one doubling stage is needed, since  $5 \text{ kV} \times 2\sqrt{2} = 14.14 \text{ kV}$ —more than enough for the output.

The basic circuit of Fig. 1b can be modified to produce the circuit of Fig. 9. The capacitor values can be calculated from Eq. 1, although for more complex multiplier circuits, Eq. 3 can be used for rough approximations. Capacitors  $C_2$  and  $C_3$  and resistors  $R_1$ ,  $R_2$  and  $R_3$  form a pi-filter and bleeder network, with time constants adjusted for the 30 kHz input ripple.

As another example, consider an input signal with a pulse repetition rate of 14,734 pps and a pulse width of 12  $\mu$ s. The input voltage is 9-kV pk, and the desired output voltage is 25 kV at 2 mA. To design this unit, start with a multiplier that has an odd number of diodes. Compute the number of stages needed—in this case,  $9 \text{ kV} \times 3 = 27 \text{ kV}$ . A voltage tripler is needed, such as the one shown in Fig. 3a. The capacitor values can be derived from Eqs. 1 or 2, or a simplified version of these equations, once some approximations are made. ■■

### Reference

1. Brugler, J. S., "Theoretical Performance of Voltage Multiplier Circuits," *IEEE Journal of Solid State Circuits*, June, 1971, pp. 132-135.





## Power, Peripherals, Price/Performance ...All At Your Fingertips.

Problem solving was never so cost effective, never so convenient. Because Hewlett-Packard's 9830 Calculator System now puts the computational power you need, where you need it most—right on your desk. It's always at your fingertips to give you immediate solutions to your most complex problems... and you don't have to be a computer expert to use it. Enter your data in any format you please—through the calculator keyboard or through a card reader, paper tape reader or digitizer. And get fast, precise answers any way you want them, from fully formatted text to graphs, pie charts, and histograms. Best of all, you communicate with the HP 9830 on your terms. HP BASIC Plus, coupled with the alphanumeric display and typewriter-like keyboard, lets you operate and program the system in a relaxed, almost conversational manner.

But along with the calculator simplicity and a calculator price—as low as \$300\* per month—you get big-machine power: 2k words of user memory, a high-performance cassette, and a 7.5k

word, built-in operating system ROM. Add plug-in ROM's and user memory modules and you triple that power. Add one or more cassettes—or Mass Memories with up to 4.8M words—and your problem-solving capability becomes almost dimensionless. Just as important, this power is so easy to use. With the 9830's unique, programmable cassette, you can program keys to do what you want them to do. Or you can add programs from HP's extensive software library to automatically execute the functions you need. Either way, a single keystroke then commands the 9830 to perform a complete series of steps.

For a closer look at the HP 9830, just return the coupon. We'll send complete details—or arrange a hands-on demonstration at your convenience.

\*Domestic U.S.A. price only. Leases, where available, include service contracts.



Sales and service from 172 offices in 65 countries  
P.O. Box 301 Loveland, Colorado 80537

Please tell me more about your HP 9830 Programmable Calculator System.

Information only.  Hands-on demonstration.

Name \_\_\_\_\_

Title \_\_\_\_\_

Company \_\_\_\_\_

Address \_\_\_\_\_

City \_\_\_\_\_ State \_\_\_\_\_

Zip \_\_\_\_\_ Phone \_\_\_\_\_

Hewlett-Packard Co.

Calculator Products Division; P.O. Box 301; Loveland, CO 80537

820A



# Now. Sylvania sharpens your designer's edge.

...with the only miniature lamp handbook written specifically for the practicing engineer and designer

Tired of those four-page brush-offs that pass for application engineering data — that pat you on the head with the same old candlepower-lumen-Watt-Lambert equation, and then leave you flat?

**Sylvania engineers think you deserve more.** More information. On more subjects. On a more practical level. And, more *respect* — both for the complexity of the design problems you must solve, and the expertise you bring to solving them. That's why the new Design Data Handbook skips the spoonfeeding, and devotes about half its 56 pages to the theory and *practice* of designing with miniature lamps.

To illustrate what we mean by a practical approach, take the problem of making one indicator light on a panel more important than others. Should you opt for optics? Boost voltage for shorter wavelengths and higher-visibility blues?

For that matter, did you know that you can actually do more harm than good by isolating the indicator from the rest of the group? When you're dealing with questions of color, brightness and placement, you've got to treat them as crucial factors.

That may involve anything from the effects of filament orientation to overcoming early failures caused by bulb base heating. But one thing is certain: if you need it, it's here in the most useful, interesting, *grown-up* reference you've ever seen.

But don't take our word for it. Take the Design Data Handbook, with our compliments. A fresh light on the subject of miniature lamps may be all you need to sharpen your competitive edge in automotive, aircraft or instrument panel design.

Send for your copy and see what we mean.

Sylvania Miniature Lighting Products Inc., 526 Elm St., Kearny, N. J. 07032; (201) 997-1850

**GTE SYLVANIA**  
...where the designer's edge originates

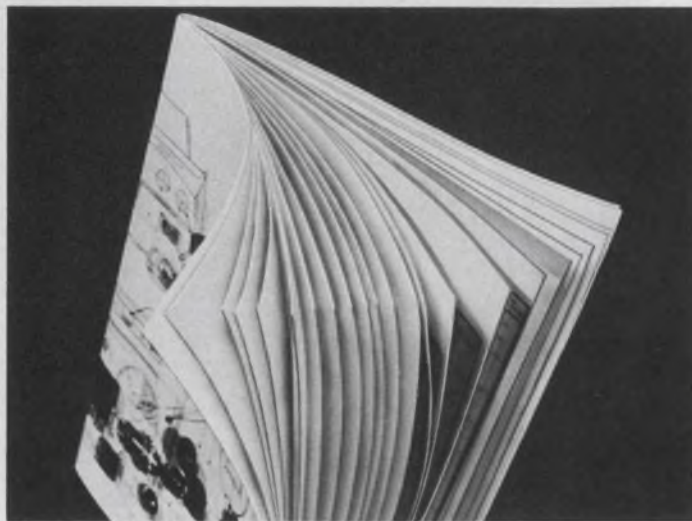

To whet your appetite, here's a brief summary of the design data section

#### THEORY

- Electromagnetic radiation
- The optical spectrum
- The laws of thermal radiation
- The visible spectrum
- The human eye
- Color vision
- Photopic and scotopic vision
- Aging effects
- Visual acuity
- Background luminance effects

#### PRACTICE

- Filament orientation
- Inrush current
- Shock and vibration
- AC vs DC operation
- Bulb and base heating
- Calculating temperature rise
- Flashing
- Indicator voltage variations
- Reinforcement
- Contrast
- Legibility
- Pilot-signal service
- Multi-level signals
- Illumination service
- Battery operation
- High-intensity lamps
- Lamps that use optics
- Edge lighted panels







Chances are you own a continuously tunable electronic filter. So by now you probably realize that continuously tunable filters are low performance instruments with, at best, 5<sup>0</sup>/<sub>100</sub> accuracy. And with poor reproducibility of settings, poor frequency accuracy and poor phase drift characteristics. And although continuously tunable filters provide infinite resolution, most users find infinite resolution neither important nor desirable unless there's corresponding accuracy.

But all this isn't why we say "junk it."

WHAT YOU SET, ISN'T WHAT YOU GET.

Take a look at the graph. As you can see, the front panel filter settings don't tell you the -3dB cutoff frequencies, the bandwidth, the noise bandwidth, and the center frequency. Or the insertion loss. You have to measure them — a time consuming, costly procedure.

THERE'S A BETTER WAY.

Ithaco offers two types of filters with switch selectable frequency settings. One type has 3 decimal digit frequency resolution for the user who not only needs resolution but also wants to know where he is without measuring.

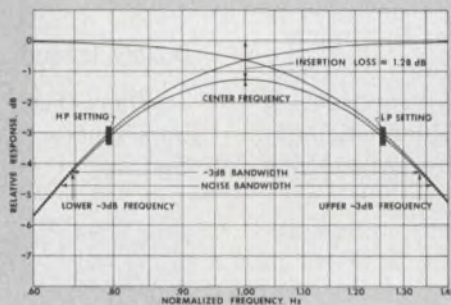

Normalized gain, attenuation, phase, and pulse response curves are printed on top of the filter. The other type uses the internationally accepted 1/10 decade [1/3 octave] frequency step — so you can operate with octave, decade and other convenient band pass settings, and still have sufficient frequency resolution for general lab and data acquisition applications. These filters have all the information shown on the graph printed on top — for all filter settings. And that's why we say "take your laboratory filter and junk it."

MORE NAILS IN YOUR FILTER'S COFFIN . . .

Standard accuracy of all Ithaco filters is  $\pm 1^0$ /<sub>100</sub> in frequency,  $\pm 2^\circ$  in phase, and  $\pm .1$ dB insertion loss — all at least twice as good as the best the competition can offer. Plus, output drift is an order of magnitude lower than the competition. And self-noise is minimal. Best of all, Ithaco filters are competitively priced.

NOW THAT YOU NEED A NEW FILTER . . .

Write to Ithaco Inc., 735 W. Clinton Street, Ithaca, N. Y. 14850. Or, if you can't wait [we understand] call 607-272-7640, TWX 510-255-9307.

# Take your laboratory filter and junk it.

**ITHACO**



# Resolve gain/efficiency conflicts by proper analysis of interstage network components. You'll get higher power outputs with minimum VSWR.

If you've ever breadboarded a wideband uhf transistor power amplifier and attempted to tune for optimum output and VSWR, you know the following experience is not new: Tune for highest gain, and input VSWR rises; adjust for lower VSWR, and gain drops. It's as though there is an unresolvable conflict between maximum power output and lowest reflected power at the input.

The usual reaction after numerous trial-and-error adjustments is to accept a disappointing compromise and to settle for amplifier efficiency that is lower than that predicted by painstaking circuit analysis.

Don't blame the design frustrations on marginal transistors. More often the cause is losses in the common impedance network components. Two separate, but interdependent, factors contribute design errors:

- Wrong choice of efficiency equations.
- Improper attention to component Q.

The latter factor prevents minimum VSWR and maximum power output from occurring simultaneously. Higher interstage component Q brings the two points together and greatly improves circuit stability.

## Singly loaded, or high-impedance cases

Much of the confusion on equations can be traced to vacuum-tube days. When vacuum tubes were the only active devices for circuits, the equivalent parallel output resistances were so high that attention was focused largely on the ratio of the tank-circuit  $R_o$  (equivalent series resistance; see Table 1) to the low impedance load, with the power transfer basically a function of these two resistances.

To generalize the efficiency equation to include the effects of both center frequency and bandwidth, the mathematical expression for the power-transfer efficiency of a single LC network in vacuum-tube circuits is:

$$\eta = \frac{P_{out}}{P_{in}} = \sqrt{1 - \left(\frac{Q_L}{Q_U}\right)^2}$$

With today's low-impedance technology there is confusion because many engineers are applying high-impedance (singly loaded) equations to both tube and transistor circuits. Let's consider the alternative equations and how they relate to specific circuit conditions.

## Doubly loaded, or low-impedance, circuits

Where both the source and the load are low impedances, there is an additional shunt path for the rf current through the parallel-source

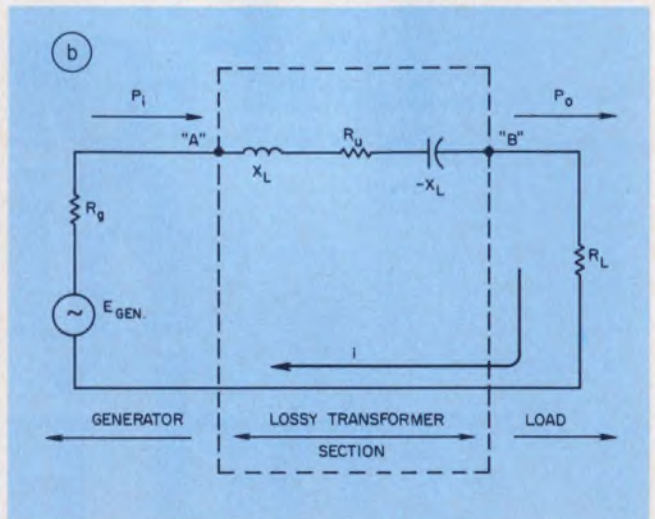
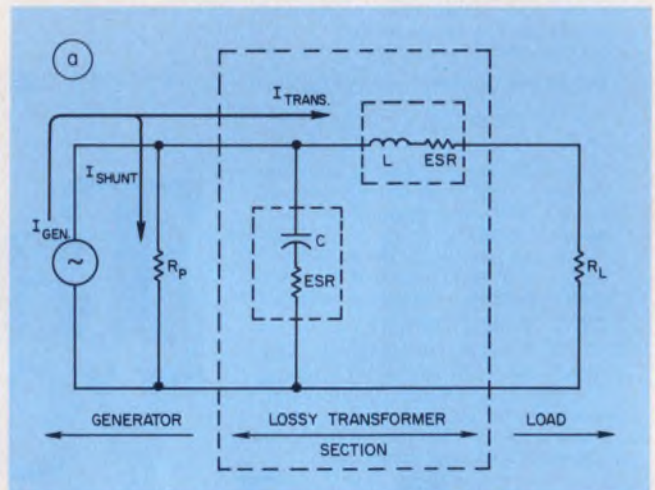

1. Network efficiency is reduced by the parallel-source resistance  $R_p$  of the current generator (a). The equivalent series circuit at resonance is shown in "b."

Vincent F. Perna Jr., Consultant, American Technical Ceramics, Huntington Station, N.Y.



resistance,  $R_u$ , of the generator that cannot be ignored in determining network efficiency. Fig. 1a illustrates this loss path and also the dissipative sources (ESR) in the network components that result in a lossy transformer.

Various equations permit conversion of this combinations of paths at resonance to a series circuit (Fig. 1b). From this, we can derive the efficiency equations of the network. More than

**Table 1. Definition of terms**

$P_i$	= power in $R_u$ + power in $R_L$
$P_o$	= power in $R_L$
	= $\frac{P_o}{P_i}$ = rf power-transfer-efficiency of network between points "A" and "B" in Fig. 1(b).
$Q_u$	= unloaded Q of a network = $\frac{X_L}{R_u} = \frac{X_c}{R_u}$ at resonance.
$Q_L$	= loaded Q of a network. Often unspecified (and therefore ambiguous) as to whether doubly or singly loaded. Can imply the combined influence of both generator and load. A better notation would be: $Q_s$ (see below).
$Q_d$	= doubly-loaded Q of a network = $\frac{X_L}{R_u + R_g + R_L}$ , see Fig. 1(b).
Doubly-loaded	= both the generator and the load are simultaneously connected to the network.
$Q_s$	= singly-loaded Q. Means the series-equivalent of $R_g$ equals zero (or $R_p$ , the shunt equivalent, equals infinity) when an $R_L$ is attached. Often approximated by vacuum tubes as generators, when $R_L$ is relatively low.
$E_g$	= generator voltage
$i$	= loop current in series-equivalent network.
$R_g$	= series-source resistance of voltage generator.
$R_u$	= effective equivalent series resistance of shunt and series elements of a given impedance-matching section.
$R_s$	= ESR
$R_L$	= load resistance
ESR	= equivalent series resistance = the effective rf loss-generating element of a component of a circuit.
$Q_L$	= $\left(\frac{f_o}{BW}\right) = \left(\frac{\text{network center frequency in MHz}}{\text{network } -3 \text{ dB bandwidth in MHz}}\right) = \left(\frac{f_o}{2\Delta f}\right)$
BW	= $\left(\frac{BW}{f_o}\right) \times 100\%$ = percentage bandwidth with $f_o$ at the center.
$R_p$	= parallel-source resistance of current generator.

one possible equation can be developed. Let's see why.

Equivalent resistance  $R_u$  represents the lossy transformer, and it becomes apparent that  $P_o$  at Point B cannot be the same as  $P_i$  at Point A because of the power division between  $R_u$  and  $R_L$ . If the circuit is carefully tuned for maximum gain, the lowest input VSWR will not simultaneously occur. During the tuning for an optimum solution both VSWR and  $P_o$  will undergo large changes as variations in tuning reactances shift the nonlinear resistance of the semiconductor. Ultimately, depending upon the needs of the associated stages, one of several alignment conditions will be acceptable:

Case S: No specification of VSWR conditions, since the circuit is only singly loaded.

Case I: Generator conjugately matched to the network-and-load ( $S_{11} = 0$ ). This offers the lowest input VSWR, but not necessarily highest power output or over-all gain.

Case II: Neither the generator nor the load conjugately matched to the other and the network ( $S_{11} \neq 0$ ;  $S_{22} \neq 0$ ). This case represents a compromise between best VSWR and best gain, but not the optimum of either. This compromise situation is the one most commonly faced when tuning transistorized rf amplifiers.

Case III: Load conjugately matched to the network and generator ( $S_{22} = 0$ ). This provides the highest output power or over-all gain, but not necessarily lowest input VSWR.

The power-transistor efficiency equations that apply, respectively, to each of these cases are:

$$\text{Case S: } \eta = \left(\frac{P_o}{P_i}\right) = \left[1 - \left(\frac{Q_u}{Q_i}\right)\right] \quad (1)$$

$$\text{Case I: } \eta = \left(\frac{P_o}{P_i}\right) = \left[1 - \left(\frac{2Q_d}{Q_u}\right)\right] \quad (2)$$

$$\begin{aligned} \text{Case II: } \eta &= \left(\frac{P_o}{P_i}\right) = \left[1 - \left(\frac{Q_d}{Q_u}\right)\right]^2 \\ &= 1 - \left(\frac{2Q_d}{Q_u}\right) + \left(\frac{Q_d}{Q_u}\right)^2 \quad (3) \end{aligned}$$

$$\text{Case III: } \eta = \left(\frac{P_o}{P_i}\right) = \left[\frac{1}{1 + \left(\frac{2Q_d}{Q_u}\right)}\right] \quad (4)$$

Comparing the three formulas for the doubly loaded case (typical of semiconductor circuits) with Eq. 1 for the typical singly loaded case (vacuum tube circuits), we see that the attainable efficiency is reduced by a factor of two. This is the basic mathematical origin of much of the confusion encountered when trying to predict circuit efficiency in low-impedance applications. These uncertainties have persisted over a long period because so many other additional causes of confusion have simply obscured what was happening.

If Eqs. 1 through 4 are plotted, we obtain Fig. 2, and when these data are converted to



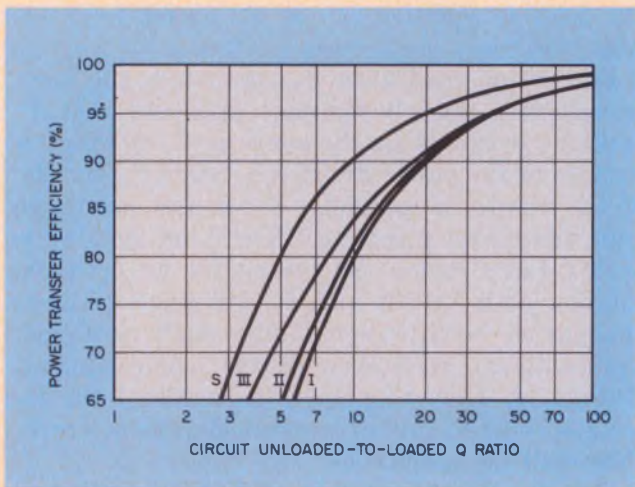

2. Ratio of circuit unloaded-to-loaded  $Q$  vs power transfer efficiency would seem to indicate that the 90% efficiency level is roughly the point of diminishing returns. Not so. See Fig. 3.

loss in dB, we obtain Fig. 3. These two graphs offer the designer a rapid visual means of analyzing circuit performance and the effect of component selection on efficiency and power output. The curves also show the magnitude of the errors possible (per LC section) from a wrong choice of equation.

### Blame component $Q$ , not 'marginal' transistors

While varying  $X_C$  and  $X_L$  to maximize power at Point B in Fig. 1b, we are, in effect, calling  $R_g + R_u$  "the generator," and thus lose control of VSWR at Point A. A converse problem arises

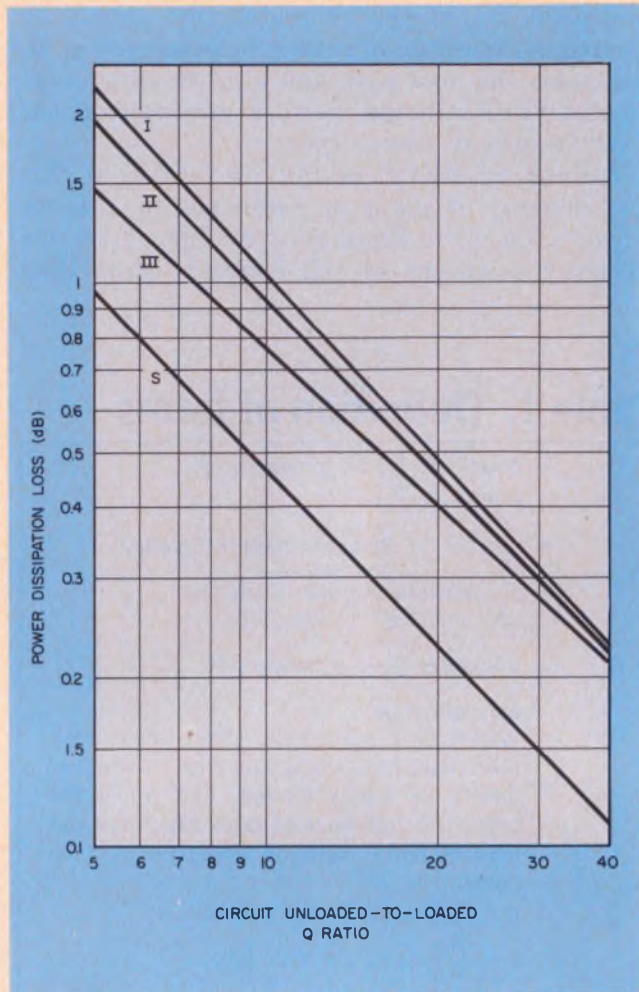

3. Circuit unloaded-to-loaded  $Q$  vs power dissipation loss in dB shows that the 90% point of Fig. 2 is equivalent to a loss close to 0.5 dB—unsatisfactory for rf circuits that provide gains of only 3 to 8 dB.

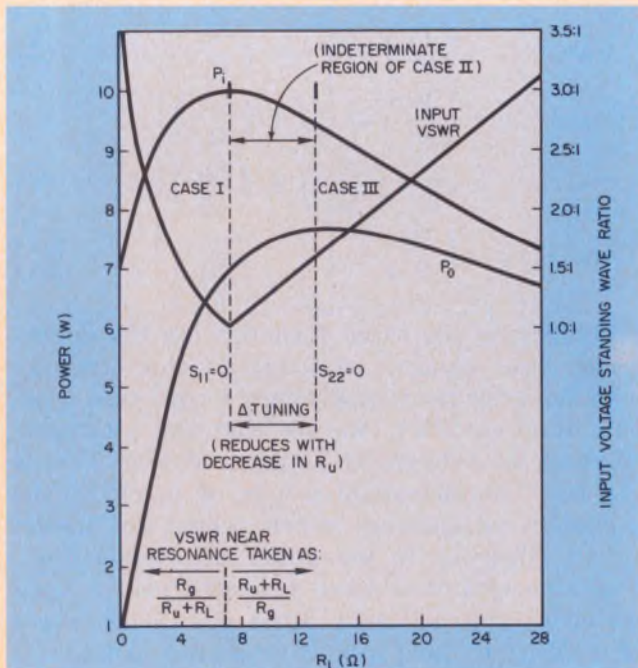

4. If component  $Q$  is increased,  $R_u$  decreases and the  $P_o$  curve would move towards  $P_i$  until minimum input VSWR and maximum power output occur simultaneously.

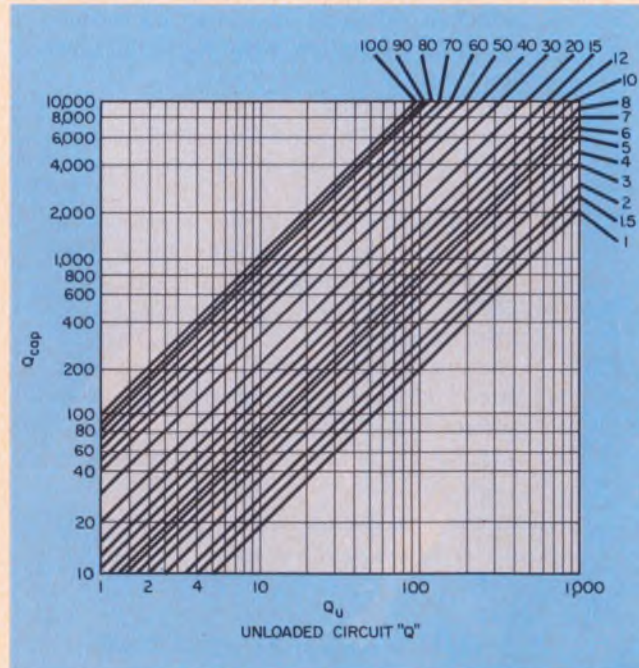

5. The required capacitor unloaded  $Q$  can be found quickly once the  $Q_{cap}/Q_{ind}$  ratio is established. Careful capacitor selection is needed to get high values.



## Table 2. Interstage network data

Component Q	Section A	Section B	Section C	Section D	Section E
Capacitors:	$Q_{C_A} = 600.$	$Q_{C_B} = 180.$	$Q_{C_C} = 120.(each)$	$Q_{C_D} = 250.$	$Q_{C_E} = 2300.$
Inductors:	$Q_{L_A} = 25.$	$Q_{L_B} = 16.$	$Q_{L_C} = 12.$	$Q_{L_D} = 30.$	$Q_{L_E} = 45.$
Bandwidth data					
Loaded Network Q:	$Q_{L_A} = 1.36$	$Q_{L_B} = 1.34$	$Q_{L_C} = 1.22$	$Q_{L_D} = 1.53$	$Q_{L_E} = 1.53$
$Q_L = \sqrt{\frac{R_o}{R_{in}} - 1}$					

when the input VSWR is minimized without regard to output power. The two cases are illustrated in Fig. 4, where the arbitrarily chosen conditions for the elements of Fig. 1b are

$$E_k = 20 \text{ V}, R_k = 10 \Omega, R_u = 3 \Omega.$$

$R_L$  is the independent variable and  $X_c = X_L$ . This value of  $R_u$  is large enough to emphasize the spread between the  $P_{in}$  and  $P_{out}$  curves, which results from using matching network components with insufficient Q and not from "marginal" transistors.

If component Q were increased,  $R_u$  would decrease, and the transformer would become less lossy. The greater this improvement, the more the  $P_o$  curve of Fig. 4 will move toward that of  $P_i$ , until the conditions of minimum input VSWR and maximum output power occur simultaneously.

The increased efficiency saves valuable rf from being wasted in overheating the components of the impedance transformer. Higher component Q also provides the option of a switch

to a less-expensive, lower-level device, since the rf formerly reflected by the next stage no longer upsets the driver's stability<sup>2</sup> nor is it dissipated as unwanted heat in its collector. This condition of more constant gain and bandwidth in both driver and power amplifier reduces the need for saturation, and thus decreases the demand on the dc supply. Not only is there an immediate saving from fewer unnecessarily blown transistors, but also a decrease in engineering and production time to find an acceptable compromise between VSWR, power output and stage efficiency.

To attain this goal, of course, requires a very high  $Q_u/Q_L$  ratio for each resonant section. Experience in this regard so far seems to indicate that careful capacitor selection offers the greatest potential for improvement. An approximation to the lowest loss practically attainable would result from choice of a capacitor with a Q of 100 times that of the inductor. This would reduce its contribution to  $R_u$  to a relatively negligible amount.

If such a capacitor is not available, choose the

## Table 3. Dissipation losses for interstage matching sections

Step	Circuit parameters	Section A	Section B	Section C	Section D	Section E
1	$\left(\frac{Q_c}{Q_l}\right)$	$\left(\frac{600.}{25.}\right) = 24.$	$\left(\frac{180.}{16.}\right) = 11.3$	$\left(\frac{120.}{12.}\right) = 10.$	$\left(\frac{250.}{30.}\right) = 8.3$	$\left(\frac{2300.}{45.}\right) = 51.1$
2	Circuit section unloaded Q (= $Q_u$ ) from Fig. 5	24.	14.7	10.9	26.9	43.
3	$\left(\frac{Q_u}{Q_L}\right)$	$\left(\frac{24.}{1.36}\right) = 17.6$	$\left(\frac{14.7}{1.34}\right) = 11.0$	$\left(\frac{10.9}{1.22}\right) = 8.9$	$\left(\frac{26.8}{1.53}\right) = 17.5$	$\left(\frac{44.1}{1.53}\right) = 28.9$
4	Case "S" dissipation loss (in dB) from Fig. 3	0.253	0.415	0.515	0.255	0.153
5	Case "II" dissipation loss (in dB) from Fig. 3	0.507	0.831	1.03	0.511	0.306
6	Case "S" efficiency (%) from Fig. 2	94.3	90.9	88.8	94.3	96.5
7	Case "II" efficiency (%) from Fig. 2	89.0	82.6	78.9	88.9	93.2



# Table 4. Comparison of assumed values of network loss

Data source	$M_1$ (Input matching network)				$M_2$ (Output matching network)		
	Section A	Section B	Section C	Total	Section D	Section E	Total
Initial guess (in dB)	—	—	—	1.0	—	—	0.5
Case "S" Wrong choice of equation	0.253	0.415	0.515	1.183	0.255	0.153	0.408
Case "II" Real life	0.507	0.831	1.03	2.368	0.511	0.306	0.817

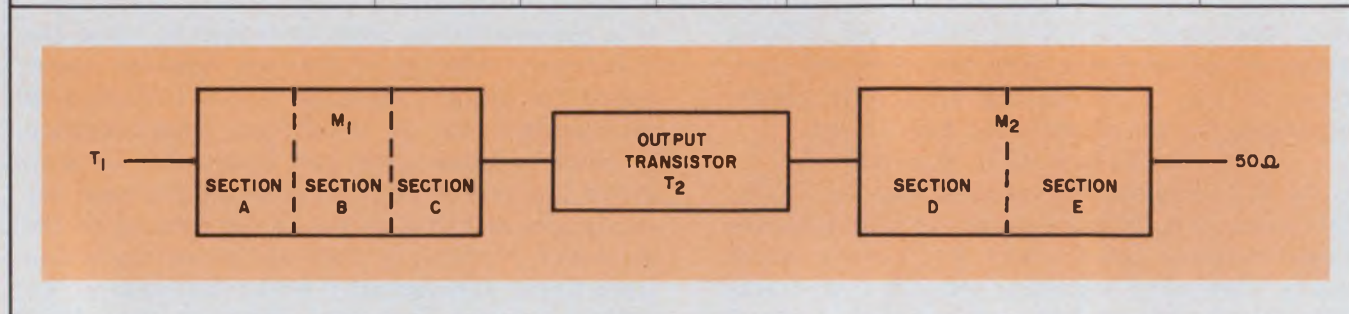

highest Q inductor and capacitor, and from Fig. 5, determine the best attainable resonant section unloaded Q. This, plus the bandwidth information in the loaded Q ( $= Q_L$ ), when used in Fig. 3, will give the expected loss in dB per LC section of the interstage transformer.

Raising capacitor Q also results in improved circuit performance during high ambient temperatures, since the rate of temperature rise in

capacitors from internal losses exceeds that of inductors. This slow heat removal lowers Q as internal temperature rises, raising the ESR, which then generates more heat and can lead to thermal runaway. If no margin of safety is built into the selected value for capacitor Q, a visible falloff will be observed<sup>3</sup> in passive network output, with increased input power, increased ambient temperature or increased frequency—any

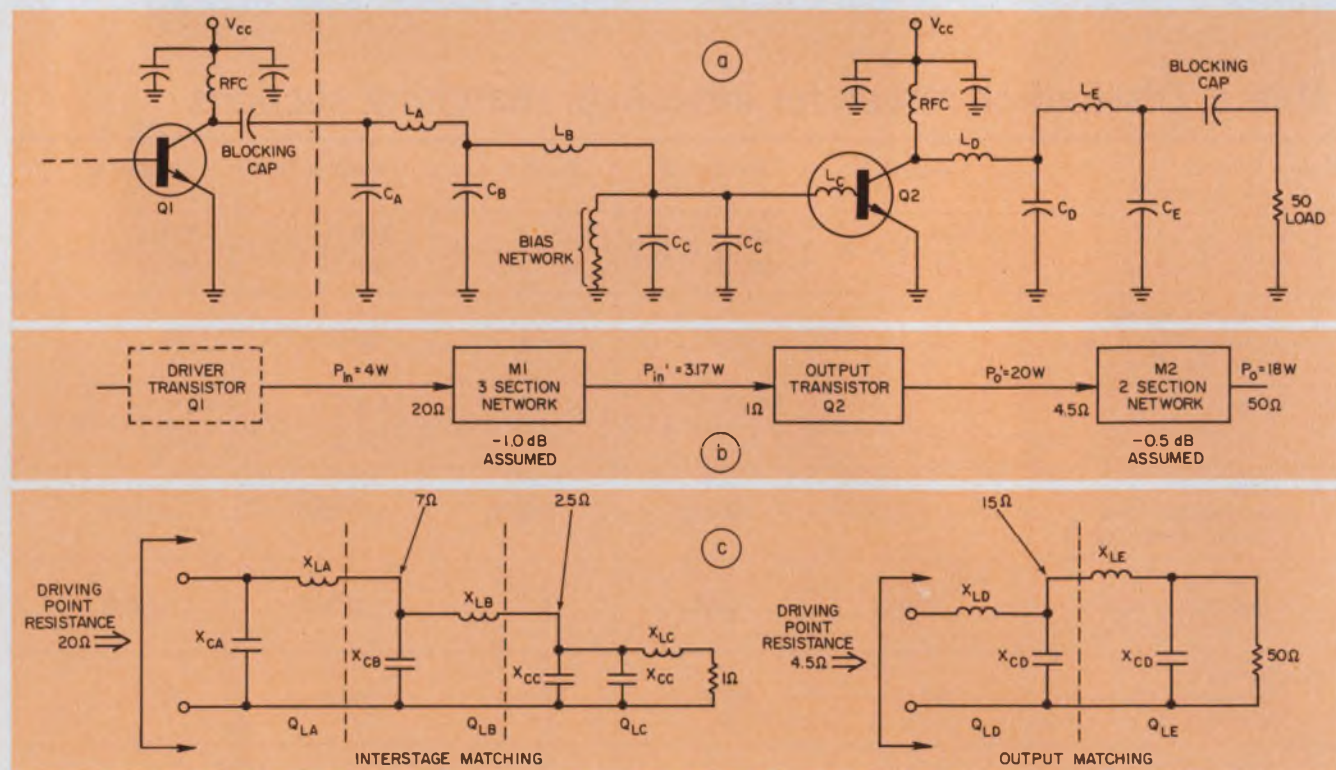

6. An 18-W, 400-MHz final stage of a wideband amplifier chain. Shown are the circuit (a), block diagram (b)

and matching networks (c). Circuit performance is optimized as shown in the design example.



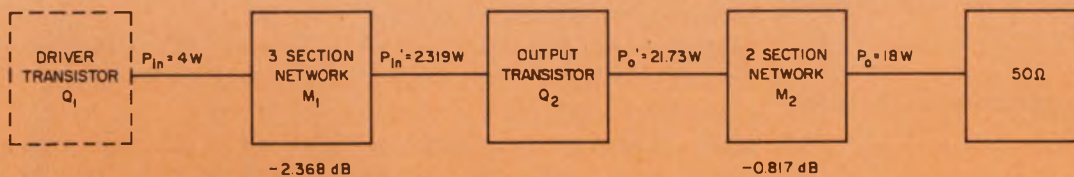

7. Higher actual interstage network losses than predicted dictate the need for a more exotic transistor at

higher cost or selection of components with improved  $Q_c$ . Otherwise, performance must be traded off.

one of which is an early symptom of runaway.

The design of the final stage of the wideband amplifier is in six steps. The steps are, along with a design example, as follows:

Step 1. List basic system requirements. For example:

- $V_{cc} = 15.5$  V dc,
- $f_o = 400$  MHz,
- $P_o = 18$  W,
- Final-stage gain = 6.5 dB,
- Final-stage dc-to-rf conversion efficiency,  $\eta_o = 60\%$ ,
- Load resistance = 50  $\Omega$ .

Step 2. Make initial assumptions:

- Output network ( $M_2$ ) loss = 0.5 dB,
- Interstage (input) network ( $M_1$ ) loss = 1.0 dB.

Step 3. Begin with rough calculations:

(A) Collector  $R_o$  is based on assumed loss in  $M_2$  and required  $P_o$  (18 W).

- (1) Assume  $V_{sat} = 2$  V.
- (2) To yield a  $P_o$  of 18 W, an output power from the transistor ( $P_o'$ ) of 20 W is required to overcome the loss in  $M_2$ . Since,

$$R_o = \frac{(V_{cc} - V_{sat})^2}{2P_o'}$$

$$R_o = 4.5 \Omega$$

(B) Calculate required transistor collector efficiency. (Assume that the drive-power contribution to output power is negligible). Since the design requirements are:

$$P_o = 18 \text{ W},$$

$$\text{and, } \eta_o = 60\% = \frac{P_o}{P_{dc}}$$

$$\text{then } P_{dc} = \frac{18}{0.6} = 30 \text{ W}.$$

Thus the required collector efficiency is

$$\eta_o' = \frac{P_o'}{P_{dc}} = \frac{20 \text{ W}}{30 \text{ W}} = 66.7\%.$$

(C) Find required transistor gain. Since the final-stage gain required is 6.5 dB and the final-stage

$$\text{gain} = \text{transistor gain} - \text{loss}_{M_1} - \text{loss}_{M_2}, \text{ transistor gain} = 6.5 + 1.0 \text{ dB} + 0.5 \text{ dB} = 8.0 \text{ dB}.$$

(D) Calculate required base driver power. Since gain = 8 dB and  $P_o' = 20$  W,  $P_{in} = 3.17$  W.

(E) Determine required drive to final stage:

$$\text{Loss}_{M_1} = 1.0 \text{ dB}, \eta_{M_1} = 79.4\%$$

$$P_{in} = \frac{P_{in}}{\eta_{M_1}} = \frac{3.17}{0.794} = 4 \text{ W}.$$

Step 4. Find a suitable transistor, based upon  $P_o = 20$  W,  $f_o = 400$  MHz,  $G_p = 8$  dB, and  $\eta_o' = 66.7\%$ .

Step 5. Design interstage network and select components. The calculations are in Table 2.

Step 6. Calculate actual losses (see Tables 3 and 4) and compare with assumptions.

When a circuit performs poorly, a common error is to keep the original design but substitute a more expensive transistor. The problem, however, is more often the lossy matching network components and not the semiconductor. ■■

#### References

1. Perna, V., "Evaluate Transistor Bandwidth the Easy Way," *Electronic Design*, Dec. 20, 1970, pp. 40-42.
2. Gledhill, C. S., and Abulela, M. F., "Scattering Parameter Approach to the Design of Narrow Band Amplifiers Employing Conditionally Stable Active Elements," *IEEE Trans. on MTT*, January, 1974, pp. 43-48.
3. RF Capacitor Handbook, "Have You Wondered Why Your Competition Matches Your Performance With Fewer Stages" American Technical Ceramics, Section 2-7.
4. "Reference Data for Radio Engineers," Fourth Edition. Howard W. Sams & Co. Inc., pp. 575-582.
5. "The Radio Handbook," Fifteenth Edition, Editors and Engineers, Ltd., p. 58.
6. Terman, F. E., "Radio Engineer's Handbook," McGraw-Hill, 1943, p. 450.

#### Acknowledgement

The author is indebted to Ron R. Rippey of NASA at the Goddard Space Flight Center for providing mathematical derivations. Also he thanks Samuel J. Klein of ATC for many valuable contributions.

Readers desiring a free reprint of this article with the full mathematical derivation of the efficiency equations plus an extensive bibliography, circle Reader Service No. 318.



- Independent control of pulse high and low levels
- Pulse amplitude to 5 volts
- Output window +5 V to -5 V
- Less than 1 ns risetime
- 250 MHz rep rate

The Tektronix PG 502 Pulse Generator is a high performance instrument ideal for designing, testing, or maintaining the logic circuitry in high-speed digital computers, and similar applications. It is a general purpose signal source with rise and fall times less than 1 ns. Both the pulse duration and period of the PG 502 output can be controlled and independent control of the pulse high and low levels is offered. The trigger circuit includes external trigger input, manual triggers, and pre-trigger output.

Tektronix offers a range of signal sources in addition to the PG 502.

FG 501 Function generator; 0.001 Hz to 1 MHz, five waveforms . . . . . \$ 350

FG 502 Function generator; 0.1 Hz to 11 MHz, 25 ns rise and fall, five waveforms . . . . \$ 490

PG 501 Pulse generator; 5 Hz to 50 MHz, 3.5 ns rise and fall . . . . . \$ 325

PG 502 Pulse generator; 250 MHz, 1 ns rise and fall, independently controllable logic 1 and 0 levels . . . . . \$1,150

PG 505 Pulse generator; 100 kHz, 80 V floating output, independently variable rise and fall times . . . . . \$ 295

RG 501 Ramp generator; 10 $\mu$ s to 10s ramp, with four scope type trigger controls . \$ 175

# Signal Sources: Another way to think of Tektronix



SG 502 RC oscillator; 5 Hz to 500 kHz, sine and square-waves, 0.035% distortion . . . \$ 325

SG 503 Sinewave oscillator; regulated, constant-amplitude variable from 250 kHz to 250 MHz . . . . . \$ 690

TG 501 Time-mark generator; 1 ns to 5s markers, measures timing errors with resolution within 0.1% over timing-error range of 7.5% . . . . . \$ 745

Signal sources are just one category of instruments in the Tektronix TM 500 Series. Presently, 24 general purpose modular test and measurement instruments are available including digital counters, digital multimeters, power supplies, signal processors, and CRT monitors. These inter-

changeable instruments plug into power units with single (\$115) or triple (\$150) compartments. In the triple compartment power unit, the modules can be interconnected via a common interface board and optional rear panel connectors. This results in increased intermodule capabilities and can actually produce a synergistic effect. The modularity feature also saves bench space. The TM 500 Series is based on the latest technology and proven principles developed in building oscilloscopes.

Send for a free brochure and spec sheets on signal sources, and Tektronix other TM 500 test and measurement instruments. They're all new ways to think of Tektronix!

Write: Tektronix, Inc.  
P.O. Box 500  
Beaverton, Oregon 97005  
In Europe write:  
Tektronix Ltd.  
P.O. Box 36  
St. Peter Port, Guernsey, C. I., U.K.

U.S. Sales Prices FOB Beaverton, Oregon



INFORMATION RETRIEVAL NUMBER 48  
FOR DEMONSTRATION, CIRCLE 245

Digital Multimeter  
Price, \$395 to \$505

Pulse Generator  
Price, \$1,150

Counter  
Price, \$1,295

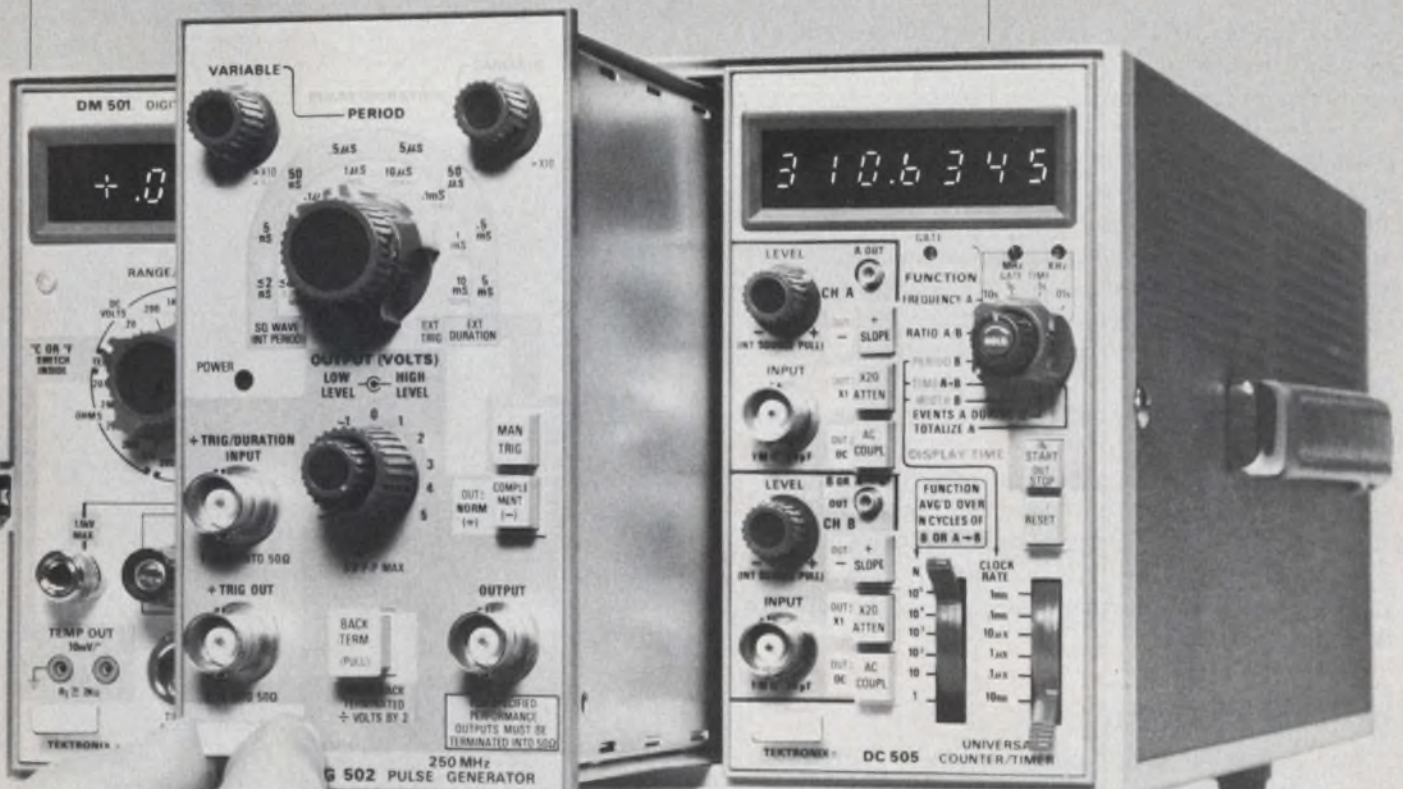



# Clean up your logic schematics

so anyone can understand them. It's easy when you put together a consistent set of symbols and names.

Time, money and tempers can be saved when a logic drawing clearly conveys a designer's intent. But to get a good logic schematic, you need a good set of rules—one that assigns logic-signal names, uses appropriate dual symbols for the various gates, and ties it all together with the proper application of clock-trigger symbols.

A typical set of such rules has four main premises:

1. The presence—or lack—of a bubble at the output of a gate or symbol determines whether a HIGH or LOW output voltage asserts the indicated function.

2. A bubble at the input of a gate or symbol cancels the output bubble of a preceding gate or symbol.

3. A bubble at the input of a gate or symbol cancels the bar of a signal or adds a bar to an unbarred signal name at the input.

4. The logic name of a signal should agree with the output of the gate or symbol that generates the signal—that is, an unbubbled output should be assigned an unbarred signal name, and a bubbled output should be assigned a barred signal name. However, there are exceptions; so this may not be universally possible.

Let's see how these rules are developed. Nowadays positive logic is so universal that some engineers confuse barred, or false, positive logic with negative logic.

In positive logic, a signal is considered TRUE—whether barred or unbarred—if the signal assumes the higher of two possible voltage states. It is only when the TRUE state is associated with a signal's name that the state of the signal becomes specified.

## What's the TRUE state?

For example, if the signal called  $\bar{A}$  is HIGH,  $\bar{A}$  is TRUE so that the quantity A is FALSE. Likewise in negative logic a signal is considered TRUE when it assumes the lower of two pos-

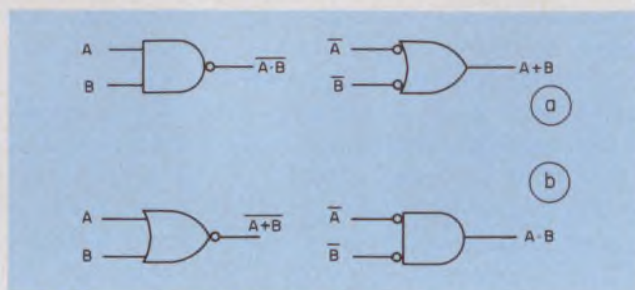

1. Because one circuit can provide two functions in either of two types of logic, confusion often results. Thus, in positive logic, dual symbols are used to indicate the AND or the OR (a). With negative logic, the same functions can be represented by duals with bubbles at either the input or output (b). Adding to the confusion is the fact that barred signals are used with both logic types. Fortunately, negative logic is rarely used.

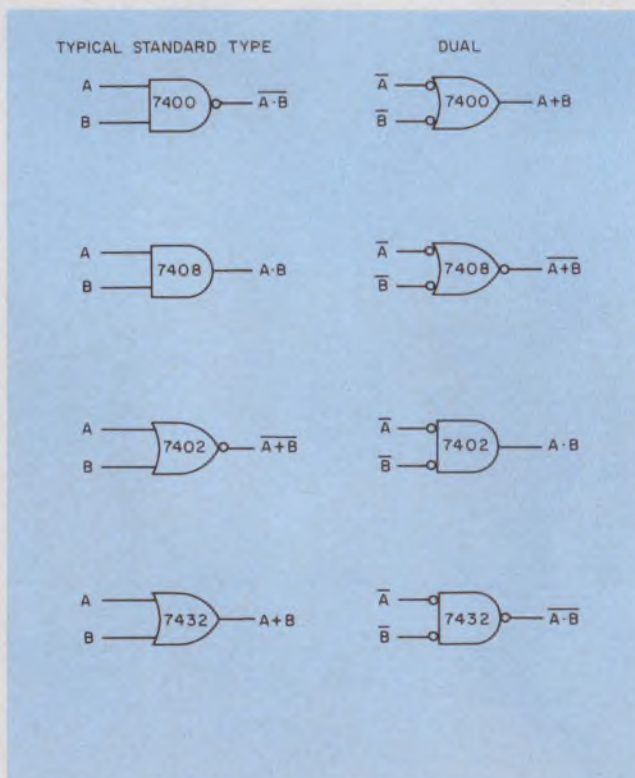

2. Summary of duals for four common positive-logic gates: Bubbles determine whether a HIGH or LOW output provides the function.

**Stanley H. Dinsmore**, Senior Electronics Engineer, Precision Instrument Co., 2323 Owen St., Santa Clara, Calif. 95051.



sible voltage states. Again—for negative logic—if the signal called  $\bar{A}$  is LOW, then the quantity A is FALSE.

The omnipresent NAND gate is the physical implementation of the logic circuit that gives a LOW output if and only if all of its inputs are HIGH. Conversely the same physical circuit—the NAND—will give a HIGH output if any input is LOW.

Thus in positive logic, a circuit can provide the barred AND of the unbarred inputs or the unbarred OR of the barred inputs. This can be represented symbolically by duals (Fig. 1a).

In negative logic, the identical physical circuit provides the barred OR of the unbarred inputs or the unbarred AND of the barred inputs (Fig. 1b). But since positive logic is so universally used in most current IC hardware, it doesn't really pay to spend much time on negative logic.

A summary of the duals of the four standard logic functions is shown in Fig. 2. Dual symbols give the logic designer a chance to clarify his intent; that is, he can emphasize that a function is to be an ANDing or an ORing of the input signals.

### Understanding the diagrams

To understand logic diagrams better, let's look at two examples (Fig. 3). Which makes it easier to see what the output is? For the upper circuit, did you mentally start to say, "If A or B is LOW, then the output is HIGH," and then continue in this manner? If you did, look at the lower circuit. Here, it's almost trivial to say, "The output is C AND (A OR B) OR D AND (E OR F)." Why is this so much easier to understand? Each of the four critical relationships has been observed; that is

1. H, the output signal, is asserted when HIGH, and is the result of an OR function.
2. The input bubbles of the OR gate cancel the output bubbles of the driving NAND gates.
3. The input bubbles of the input OR gates cancel any bars over the input signals.
4. The output signal, H, is unbarred, which agrees with the un bubbled output gate. Also, each logic symbol describes the function it performs.

Suppose, however, that the identical physical circuit were used to emphasize the AND function of the output gate. In this case, a designer would use the circuit in Fig. 3c.

In Fig. 3c, the output is now asserted when  $(C \text{ OR } (A \text{ AND } B)) \text{ AND } (D \text{ OR } (E \text{ AND } F))$  is TRUE—a totally different function. Notice that the four relationships still hold.

Flip-flops and latches come in many varieties. But the characteristics essential to all kinds is

the time at which the output changes state, or is considered valid with respect to the clock or other input signals. Clocked flip-flops can be further classified depending on whether they are edge or level-triggered.

### How to handle flip-flops

Flip-flop characteristics can be represented by a judicious choice of symbols. For instance, the presence or absence of a bubble at the clock input indicates the polarity of the clock edge for which the output can be considered valid.

The recently introduced symbol,  $\triangleright$ , indicates edge triggering so two symbols—the bubble and  $\triangleright$ —can indicate all but one type of clocking: the edge-triggered master portion of a master/slave flip-flop—the so called data-lockout flip-flop. Though it's not universally accepted, the symbol,  $\triangleright\triangleright$ , can indicate this type of triggering. Various types of clock inputs are listed in Fig. 4.

To make a signal's name agree in logical polarity with its source presents some special problems, which can be solved as follows:

First, the internal designations of the individual leads of the flip-flop should always remain fixed as published. For example, the Q lead is always labeled Q.

Second, if complementary signal names are used, a bubble is placed at whatever output, Q

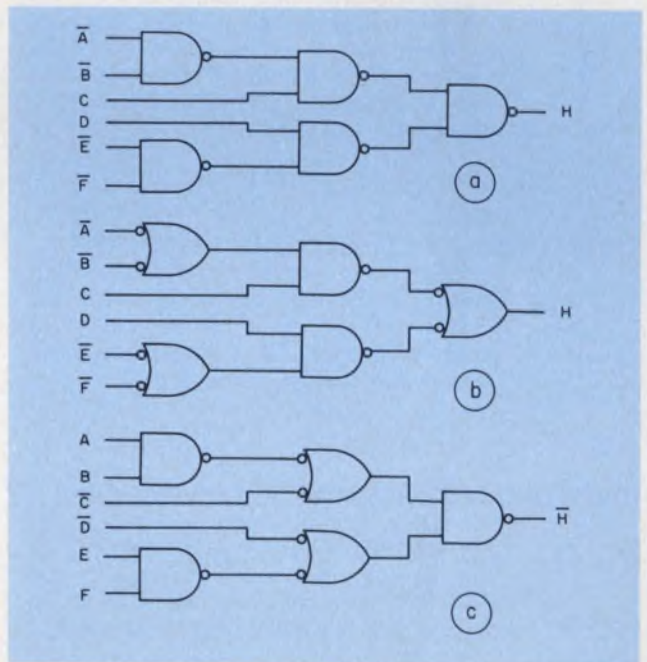

3. The proper choice of symbols can make it easier to see what's happening. Both schematics "a" and "b" have the same inputs and yield the same output. But the logic equation that relates output to input can be put down almost immediately with schematic "b." If, however, emphasis is to be put on the output AND function, a third schematic can be drawn (c).



### HI LEVEL

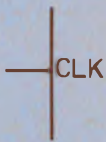

With unidirectional data inputs, such as a clock-gated latch, the output responds to the input conditions and is considered valid when the clock goes HIGH. With a bidirectional data input, as in a D-type latch, the output follows the input data while the clock is LOW, and is valid when the clock goes HIGH.

### LO LEVEL

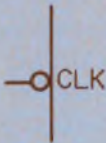

With unidirectional data inputs, the output responds to the input conditions and is considered valid when the clock goes LOW. With a bidirectional data input, the output follows the input data while the clock is HIGH, and is valid when the clock goes LOW. The 7475 D Latch is typical.

### POSITIVE EDGE TRIGGERED



The output responds to the input conditions and becomes valid only at the time of a positive going clock edge. If the flip-flop is a master/slave type, the master accepts the input data while the clock is LOW. A 7474 typifies the former and a 74105, the latter.

### NEGATIVE EDGE TRIGGERED

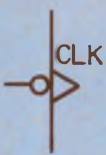

The output responds to the input conditions and becomes valid only at the time of a negative going clock edge. If the flip-flop is a master/slave type, the master accepts the input data while the clock is HIGH. A 74H101 and a 74107, respectively, are typical.

### DATA-LOCKOUT, POSITIVE EDGE TRIGGERED



These are always master/slave flip-flops in which data are accepted by the master only at the time of a negative going clock edge. The output becomes valid at the positive going edge.

### DATA-LOCKOUT, NEGATIVE EDGE TRIGGERED

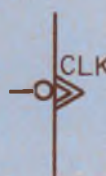

Master/slave flip-flops, where the data are accepted by the master only at the time of the positive going edge of the clock and the output becomes valid at the negative going edge. A 74111 is typical.

4. Depending on the type, a flip-flop can be triggered at its clock input by an edge or a level. An appropriate symbol tells which and gives trigger polarity. Of prime importance is the time the output becomes valid.

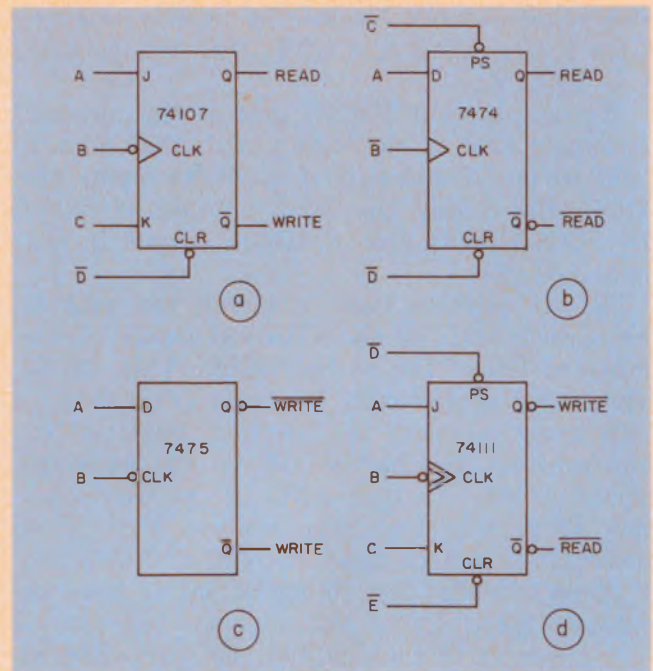

5. A variety of signal names and clock timings are available: unique, unbarred output names that respond to negative-going edges (a); complements with positive-going edge triggers (b); level clocking (c), and edge-triggered data lockout, in which bubbles at the output "tell" that output data are LOW when the output is asserted.

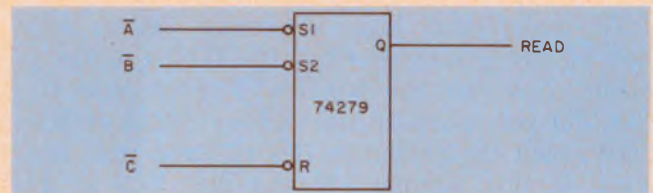

6. Quadruple latches can be symbolized one section at a time unless they are cross-coupled gates.

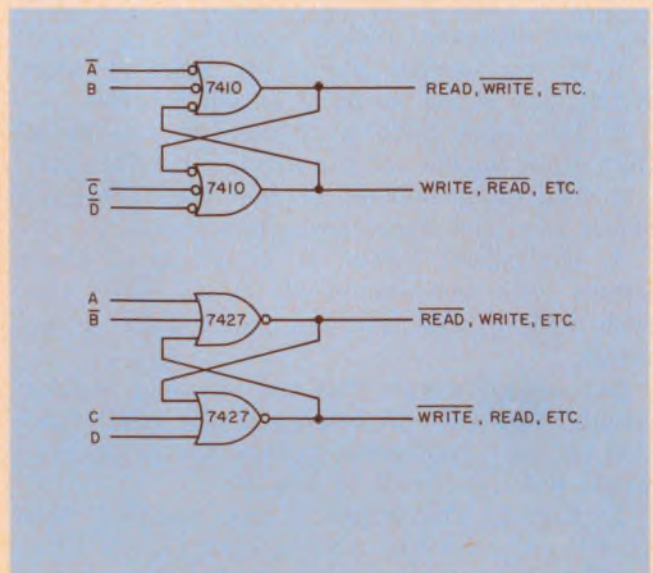

7. Cross-coupled NAND or NOR gates form an exception to the basic logic rules: The output symbol doesn't agree in sense with the signal name. Other exceptions include multiplexers and shift registers.



or  $\bar{Q}$ , is to generate the barred signal name. If unique names are needed, no bubble is used if both signal names are unbarred. If barred signal names are used, then a bubble is placed at both outputs.

Finally the relationships of an output response to the clock are seen as follows:

1. An output is valid at the leading edge of an unbarred clock signal when the clock is applied to an unbarred input. An output is valid at the trailing edge when applied to a bubbled input.

2. An output is valid at the trailing edge of a barred clock signal when the clock is applied to an unbarred input. Validity occurs at the leading edge when applied to a bubbled input.

### Correlate names with timing

There are as many ways to name outputs as there are to trigger flip-flops (Fig. 5). Figure 5a shows unbarred, unique signal names. These, of course, also have complementary meanings. A master/slave J-K flip-flop with negative-edge triggering (such as a 74107) or a direct J-K flip-flop (such as a 74H101) can illustrate clock timing.

As shown in Fig. 5a, no bubbles are used at the outputs. Since the clock signal name is unbarred, the output responds at the negative going, or trailing edge, of the clock. During the interval the clock is HIGH, either the master or the input setup time of a direct flip-flop is enabled.

The use of complementary signal names is common (Fig. 5b). A positive, edge-triggered flip-flop, such as a 7474, illustrates clock timing. Note that a bubble is now at the source of the barred output-signal name. Simultaneous use of the barred clock signal and the edge-triggering symbol indicates that the output responds at the trailing edge of the clock.

In Fig. 5c, a bubble is placed at the Q output, the source of the barred-output signal name. Here a 7475 latch illustrates the use of level clocking: The output is valid after the trailing edge of the clock.

Barred unique names or the data lockout (or edge-triggered master input of a master/slave) are set up as in Fig. 5d for the data-lockout 74111. Note that both outputs have bubbles as the source of barred signal names. In this case, outputs are valid after the trailing edge of the clock, and the input data can change after the leading edge of the clock.

Unclocked set/reset latches represented by a flip-flop symbol (as in Fig. 5d) present no problem. One section of a 74279 latch can be represented as in Fig. 6, but a problem occurs when the latch is represented by cross-coupled indi-

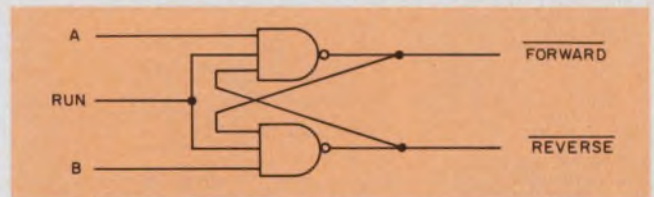

8. In its AND form, the cross-coupled NAND is suitable for circuits such as the "fall-away" latch.

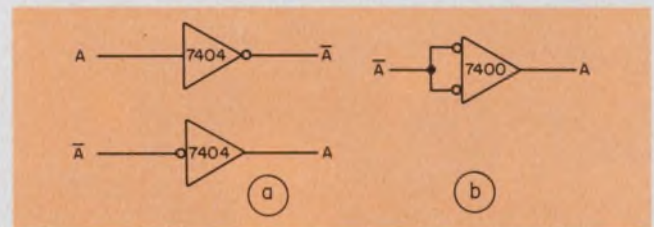

9. Inverter bubbles are placed to comply with the signal name/output rule (a). With multiple-input gates, it's best to tie the inputs together (b).

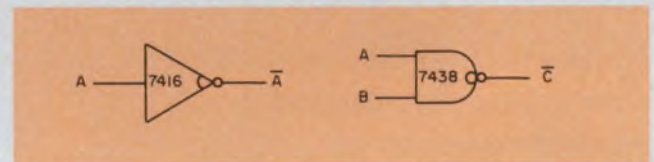

10. Open-collector logic poses a problem if it isn't identified as such. An arc at the output can do the job.

vidual NAND or NOR gates.

Usually you can convey maximum information with the OR form of either the NAND or NOR gate. This form clearly shows how the output relates to the inputs, but creates an exception to the rule that the output symbol must agree in sense with the signal's name. Two examples—for the 7410 NAND and 7427 NOR—are given in Fig. 7.

However, the AND form of the cross-coupled NAND gate can be used to advantage in a "fall away latch," in which both outputs are held HIGH until a common enable signal occurs. The latch then "falls away" to the state governed by the other inputs. This arrangement guarantees that only one of two competing functions will be TRUE (Fig. 8).

To maintain the symbol-vs-name rule, an inverter should have its bubble placed at either the output or input, so that the output signal name agrees in sense with the output of the inverter. Also when a multiple-input gate forms the inverter, it may be preferable to draw the inverter symbol with the multiple inputs of the gate tied together (Fig. 9).

There is another exception to the symbol-vs-name rule. This occurs in logic units such as multiplexers, demultiplexers, shift registers, etc.



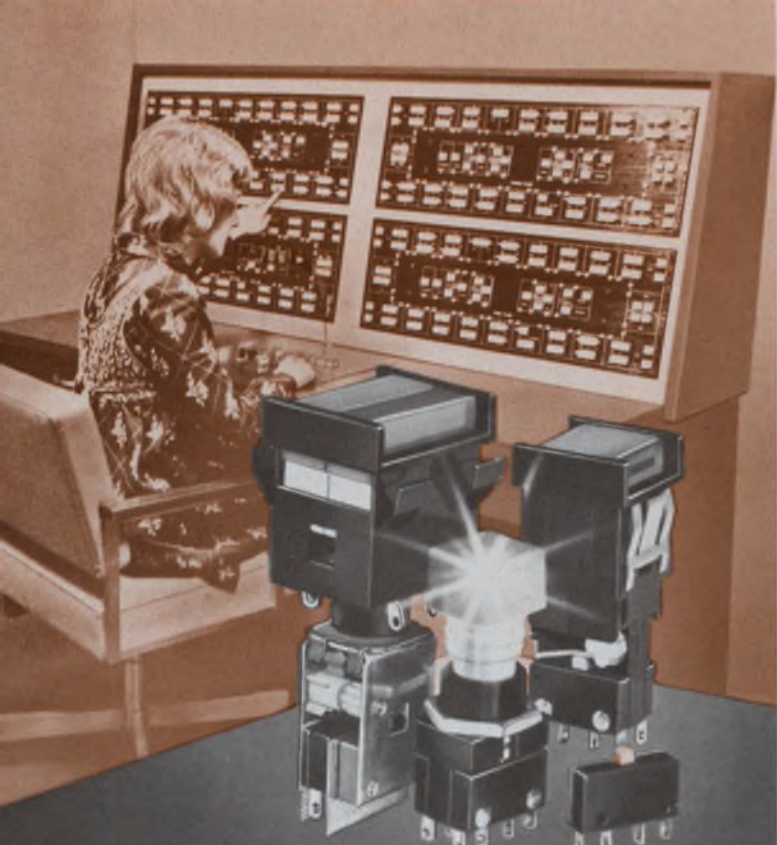

## In medical electronics, Licon® switches go where the action is.

Medical electronic equipment demands precision reliability. Licon provides it. With proven double-break, double-reliable Butterfly® switches. They work 'round the clock in X-ray machines, communications systems, automated examining tables, sample oxidizers/synthesizers and more.

Licon saves design time, too: as a single source for a broad selection of lighted and non-lighted pushbuttons, basic miniature and sub-miniature snap-action and limit switches.

Want to individualize? Replace several switches with one? Or meet a multi-functional requirement in a standard way? You can, with "added value" from Licon.

Licon switches: where the action is in medical electronics, computer systems, business machines, industrial controls. Check your Licon rep or distributor for full details. Or write for literature.



**LICON®**

Division Illinois Tool Works Inc.  
6615 W. Irving Park Rd., Chicago, Ill. 60634  
Phone (312) 282-4040 TWX 910-221-0275



# LICON

puts ideas to work  
in electronics

The Innovative Electronic Group of ITW...  
LICON • EMCON • PAKTRON

© ILLINOIS TOOL WORKS INC. 1974

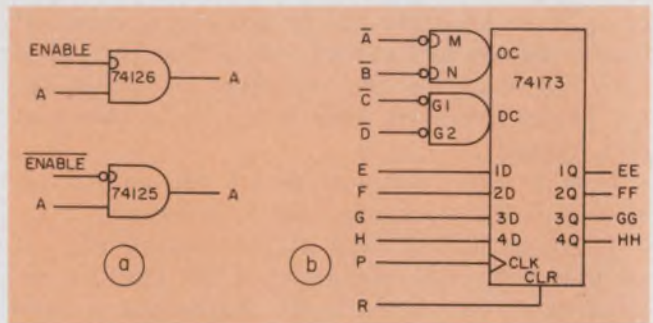

11. Three-state logic can also confuse if it isn't indicated on a schematic. An arc around the input-enable pins can identify the logic, for example, the buffers in "a" and the three-state-output quad register in "b."

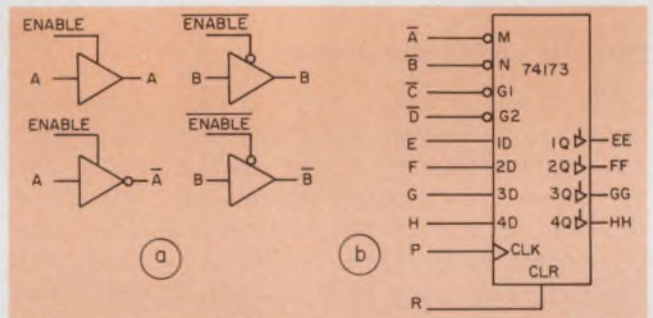

12. Perhaps a better way to identify three-state logic: buffers with enable leads at the top (a), and the quad register marked as shown in "b."

—where input signals are merely being gated to outputs or shifted.

With devices that don't change the logical sense of their input signals, judicious use of bubbles at the inputs and outputs can make the logic schematic easier to understand—for example, when barred inputs are multiplexed.

Where the device does change the logical sense—such as the AND-OR-INVERT gate (a 7451)—there is little choice: The bubbled output will produce the unbarred multiplex of barred inputs. Here the dual symbol only adds confusion.

Often it isn't clear from a drawing that a logic symbol has an open-collector output. This may not be a problem if you are familiar with the ICs or if the presence of external pull-up resistors gives the open collector away.

But to play safe, it's best to indicate an open-collector output—perhaps with an arc around the output pin on the inside of the logic symbol (Fig. 10).

Similarly, logic symbols with three-state outputs may not be easy to understand—particularly when a flip-flop's output is so enabled. This can be rectified with an arc around the input enable pin, or pins, to show the multiple-state condition (Fig. 11). Alternately, three-state can be identified as shown in Fig. 12. ■■



# Hold it.

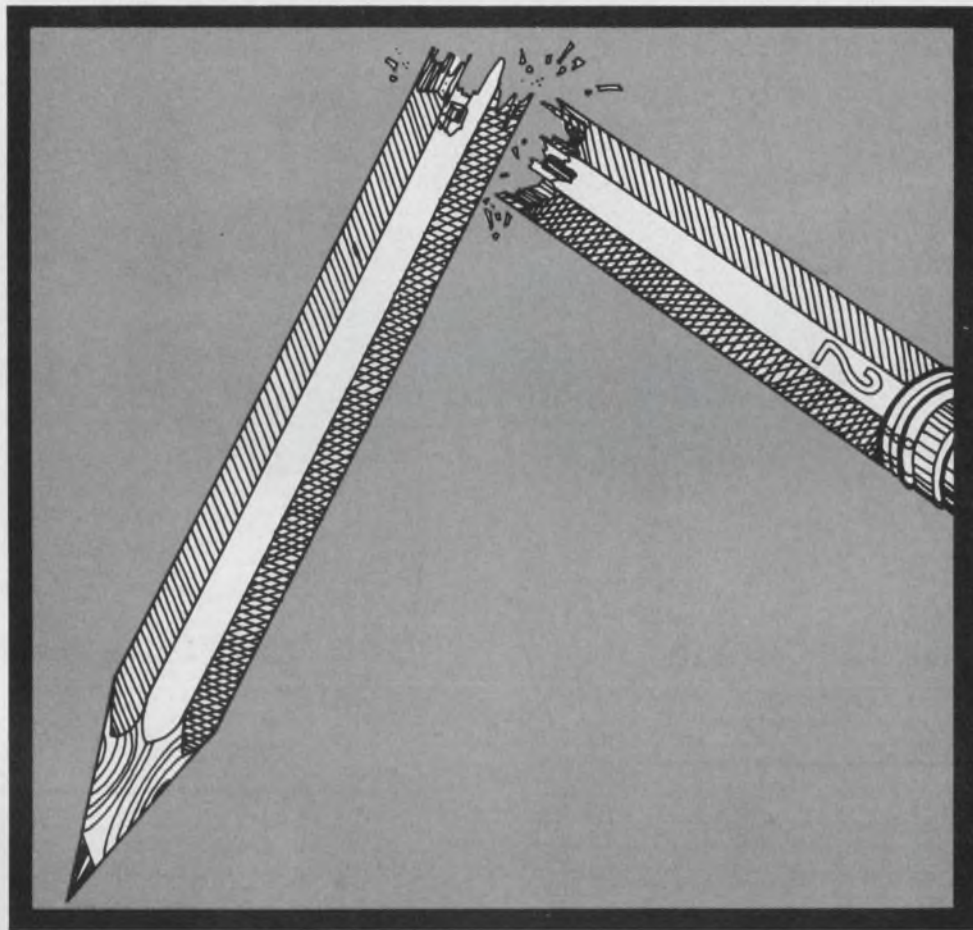

## Before you design in High Frequency Inverter Transformers, call in TRW/UTC.

High Frequency Inverter Transformers are everything you've always wanted. But you can't just drop them in. There are too many variables involved.

Have you decided on ferrite, toroidal or laminated steel cores? Are you after minimum size, weight, cost? What about efficiency? Heat can be a real problem.

At TRW/UTC we know magnetics, we know inverter transformer technology—both low voltage *and* high voltage. Show

us your circuit. We'll develop the exact transformer you need.

Don't design in problems, make TRW/UTC part of your High Frequency Inverter Transformer design. With our new plants in North Carolina and Illinois, we'll have the capacity to produce almost any transformer you need, in any quantity, at very competitive prices. Call or write TRW/UTC Transformers, an Electronic Components Division of TRW, Inc., 150 Varick Street, New York, N.Y. 10013. Telephone: (212) 255-3500.

# **TRW**® **UTC TRANSFORMERS**

INFORMATION RETRIEVAL NUMBER 50



Do you face  
a make or buy  
decision on  
power supplies?

# BUY LAMBDA'S LZ SERIES MOUNTABLE POWER SUPPLY.

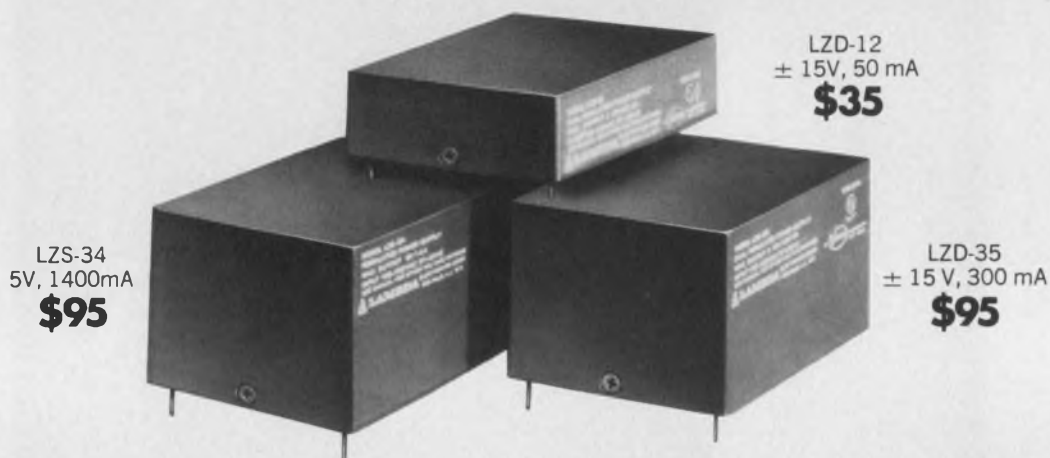

## LZ-10 SERIES SINGLE OUTPUT

MODEL	2½" x 3½" x 7/8"		PRICE <sup>(2)</sup>
	VOLTAGE <sup>(1)</sup> VDC	CURRENT mA	
LZS-10	3	317	\$35
LZS-10	4	384	35
LZS-10	5	450	35
LZS-11	10	225	35
LZS-11	12	195	35
LZS-11	15	150	35

## LZ-10 SERIES DUAL TRACKING OUTPUT

MODEL	2½" x 3½" x 7/8"		PRICE <sup>(2)</sup>
	VOLTAGE <sup>(1)</sup> VDC	CURRENT mA	
LZD-12	±15V	50	\$35

## LZ-20 SERIES SINGLE OUTPUT

MODEL	2½" x 3½" x 1¼"		PRICE <sup>(2)</sup>
	VOLTAGE <sup>(1)</sup> VDC	CURRENT mA	
LZS-20	10	247	\$55
LZS-20	12	268	55
LZS-20	15	300	55
*LZD-22	24	73	40
*LZD-23	24	129	55
*LZD-22	28	84	40
*LZD-23	28	143	55

\*Single output ratings for dual output models connected in series

## LZ-20 SERIES DUAL TRACKING OUTPUT

MODEL	2½" x 3½" x 1¼"		PRICE <sup>(2)</sup>
	VOLTAGE <sup>(1)</sup> VDC	CURRENT mA	
LZD-21	± 3	217	\$55
LZD-21	± 4	258	55
LZD-21	± 5	300	55
LZD-22	±10	61	40
LZD-23	±10	114	55
LZD-22	±12	73	40
LZD-23	±12	129	55
LZD-22	±15	90	40
LZD-23	±15	150	55

## LZ-30 SERIES SINGLE OUTPUT

MODEL	2½" x 3½" x 17/8"		PRICE <sup>(2)</sup>
	VOLTAGE <sup>(1)</sup> VDC	CURRENT mA	
LZS-30	3	633	\$65
LZS-30	4	767	65
LZS-30	5	900	65
LZS-33	10	293	65
LZS-33	12	336	65
LZS-33	15	400	65
LZS-34	3	950	95
LZS-34	4	1180	95
LZS-34	5	1400	95
*LZD-32	24	186	65
*LZD-32	28	208	65
*LZD-35	24	240	95
*LZD-35	28	280	95

\*Single output ratings for dual output models connected in series



# ...PRINTED-CIRCUIT BOARD

## LZ-30 SERIES DUAL TRACKING OUTPUT

MODEL	2½" x 3½" x 1⅞"		
	VOLTAGE <sup>(1)</sup> VDC	CURRENT mA	PRICE <sup>(2)</sup>
LZD-31	± 3	333	\$65
LZD-31	± 4	417	65
LZD-31	± 5	500	65
LZD-32	±10	163	65
LZD-32	±12	186	65
LZD-32	±15	220	65
LZD-35	±10	200	95
LZD-35	±12	240	95
LZD-35	±15	300	95

## LZ-30 SERIES TRIPLE OUTPUT

MODEL	2½" x 3½" x 1⅞"		
	VOLTAGE <sup>(1)</sup> VDC	CURRENT mA	PRICE <sup>(2)</sup>
LZT-36	5	500	\$70
	±15	50	

NOTES: (1) LZ models are adjustable between the following limits: LZS-10 2.5 to 6V LZS-11 8 to 15V LZS-20 8 to 15V LZS-30 2.5 to 6V LZS-33 8 to 15V LZS-34 2.5 to 6V LZD-12 ± 14.5 to ± 15.5V LZD-21 ± 2.5 to ± 6V LZD-22 ± 8 to ± 15V LZD-23 ± 8 to ± 15V LZD-31 ± 2.5 to ± 6V LZD-32 ± 8 to ± 15V LZD-35 ± 8 to ± 15V LZT-36 2.5V-6V for + 5V output only, ± 14.5 to ± 15.5 for ± 15V output only. Contact factory for current ratings at voltage settings not indicated in the tables. (2) All prices and specifications are subject to change without notice.

## SPECIFICATIONS FOR LZ SERIES

### Regulation

0.15%—line or load; models LZS-10, LZS-30, LZS-34, LZD-21 and LZD-31 have load regulation of 0.15% + 5mV; model LZD-12 has line or load regulation of 0.25%; LZT-36 line regulation 0.15% (+5V) 0.25% (±15V); load regulation 0.15% + 10mV (+5V), 0.25% (±15V).

### Ripple and noise

1.5mV RMS, 5mV, pk-pk

### Temperature coefficient

0.03%/°C

### Overshoot

no overshoot on turn-on, turn-off, or power failure

### Tracking accuracy

2% absolute voltage difference for dual output models only and only for the ±15V output in LZT-36; 0.2% change for all conditions of line, load and temperature

### Ambient operating temperature range

continuous duty from 0°C to + 50°C

### Wide AC input voltage range

105 to 132 Vac, 57-63 Hz

### Storage temperature range

-25°C to +85°C

### Overload protection

fixed automatic electronic current limiting circuit

### Input & output connections

printed circuit solder pins on lower surface of unit. For model LZT-36 the ± 15V outputs are independent from the 5V output.

### Controls

screwdriver voltage adjustment over entire voltage range.

### Mounting

tapped holes on lower surface

### Physical data

Size

see tables

Weight

LZ-10 series 10 oz. net 18 oz. ship.

LZ-20 series 17 oz. net 25 oz. ship.

LZ-30 series 24 oz. net 32 oz. ship.

### 60-day guarantee

60-day guarantee includes labor as well as parts

## LZ SERIES NOW AVAILABLE IN NEW TRIPLE OUTPUT MODEL



MODEL	VOLTAGE <sup>(1)</sup> VDC	CURRENT mA	PRICE <sup>(2)</sup>
LZT-36	5V	500	\$70
	±15V	50	

**1 DAY DELIVERY  
60 DAY GUARANTEE**



**LAMBDA  
ELECTRONICS CORP.**

A Veeco Company

MELVILLE, NEW YORK 11746 515 Broad Hollow Road Tel. 516-694-4200 ARLINGTON HEIGHTS, ILL. 60005 2420 East Oakton St., Unit G Tel. 312-593-2550 NORTH HOLLYWOOD, CALIF. 91605 7316 Varna Ave. Tel. 213-875-2744 MONTREAL, QUEBEC 100C Hymus Blvd., Pointe Claire, Quebec 730 Tel. 514-697-6520 HIGH WYCOMBE, BUCKS, ENG. Abbey Barn Road, Wycombe Marsh Tel. High Wycombe 36386/7/8 ORSAY, FRANCE 91 Gometz le Chatel. ACHERN-FAUTENBACH, W. GERMANY Im. Holzbosch 14 Tel. 078-41-5527



# 'Flints' that don't wear out: Piezo-crystals.

The 20,000-V sparks from ceramic piezoelectric crystals can replace gas pilot lights in home appliances.

Piezoelectric crystals for low-level phonograph pickups, microphones and accelerometers, yes. But piezoelectric crystals as a 20,000-V source? Certainly. Up to 20,000 V can be obtained from mechanical inputs to 8000 psi. Feasibility has been well demonstrated. In Europe, piezoelectric igniters have been used in space heaters and home cooking ranges for several years. The extension to starters for automatically controlled appliances such as water heaters and clothes dryers should prove just as attractive.

In this country, however, piezoelectric applications have been limited to minor appliances, such as outdoor gas grills, camp stoves and cigarette lighters.

The energy squeeze can be eased by the application of piezoelectric devices to gas appliances. It has been estimated that gas pilot lights in the U.S. consume approximately 400 billion cubic feet of gas yearly. Why not replace the pilot with a piezoelectrically actuated igniter and thereby eliminate the continuous energy-consuming flame?

## Piezo-ceramics can do the job

Voltages in the 20,000-V range are capable of producing a spark across an air gap up to 3/8-in. long. Though the accompanying average current is small, piezo-ceramics can develop sufficient energy to ignite most air/gas mixtures.

Fig. 1 sketches the dimensions of a typical piezo-ceramic body for igniter applications. Conducting electrodes cover the flat faces on each end, and the open-circuit voltage is given by

$$V = gtT, \quad (1)$$

where  $V$  = developed voltage,

$g$  = piezoelectric coefficient, (open-circuit field per applied mechanical stress),

$$= 4 \text{ V/in./psi} = 4 \text{ V-in/lb (for Vernitron PZT-4 material),}$$

$T$  = applied average stress in psi,

$t$  = thickness of the ceramic.

Polarized ceramics are not isotropic—their properties are not the same in all directions. Thus each property has a different coefficient for each direction. However, in igniter applications, it is necessary to consider only one axis.

If a stress level of 8000 psi is applied to a cylindrical structure of Vernitron PZT-4 that is 5/8-in. long, we have, according to Eq. 1

$$\begin{aligned} V &= 4.0 \times 5/8 \times 8 \times 10^3 \\ &= 20,000 \text{ V.} \end{aligned}$$

The capacitance of such an element is given by

$$C = K \frac{A}{t} = K\pi d^2/4t,$$

where  $C$  = capacitance,

$A$  = area

$d$  = diameter

and  $K$  = dielectric coefficient

$$\cong 300 \text{ pF/in. (for PTZ-4).}$$

For a diameter of 1/4 in.,

$$\begin{aligned} C &= 230 \text{ d}^2/t \\ &= 23 \text{ pF.} \end{aligned}$$

The energy developed is then:

$$\begin{aligned} \text{Energy} &= 1/2 CV^2 \\ &= 1/2 \times 23 \times 10^{-12} \times (2 \times 10^4)^2 \\ &= 4.6 \text{ mJ (millijoules).} \end{aligned}$$

Combustion experts will recognize that this is more than adequate energy to ignite common gaseous fuels (see chart). In the rare case where more energy is required, two piezo-ceramics, ar-

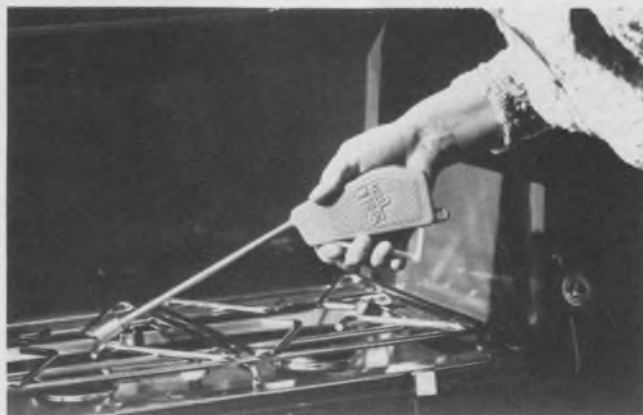

Piezoelectric igniters can be used to replace pilot lights and to ignite gas appliances.

Carmen P. Germano, Section Head, Transducers, Vernitron Piezoelectric Div., Bedford, Ohio 44014.



ranged mechanically in series and electrically in parallel, will provide twice as much energy. Obviously more energy can also be obtained from a single element of a larger size.

The strain induced in the piezo-ceramic is

$$S = \frac{T}{Y}, \quad (4)$$

where  $Y$  = Young's modulus,

$Y \cong 18.0 \times 10^{11}$  psi (for PZT-4),

$$S = \frac{8 \times 10^3}{18 \times 10^{11}}$$

$$= 0.44 \times 10^{-3} \text{ in/in.}$$

Though this strain is substantial, it is less than the maximum allowable for the material (typically  $1 \times 10^{-3}$  in/in). In fact, this level of strain should allow continuous use without fatigue problems.

### Squeezing the crystal

Two basic techniques have been used for the mechanical excitation of an igniter crystal. The

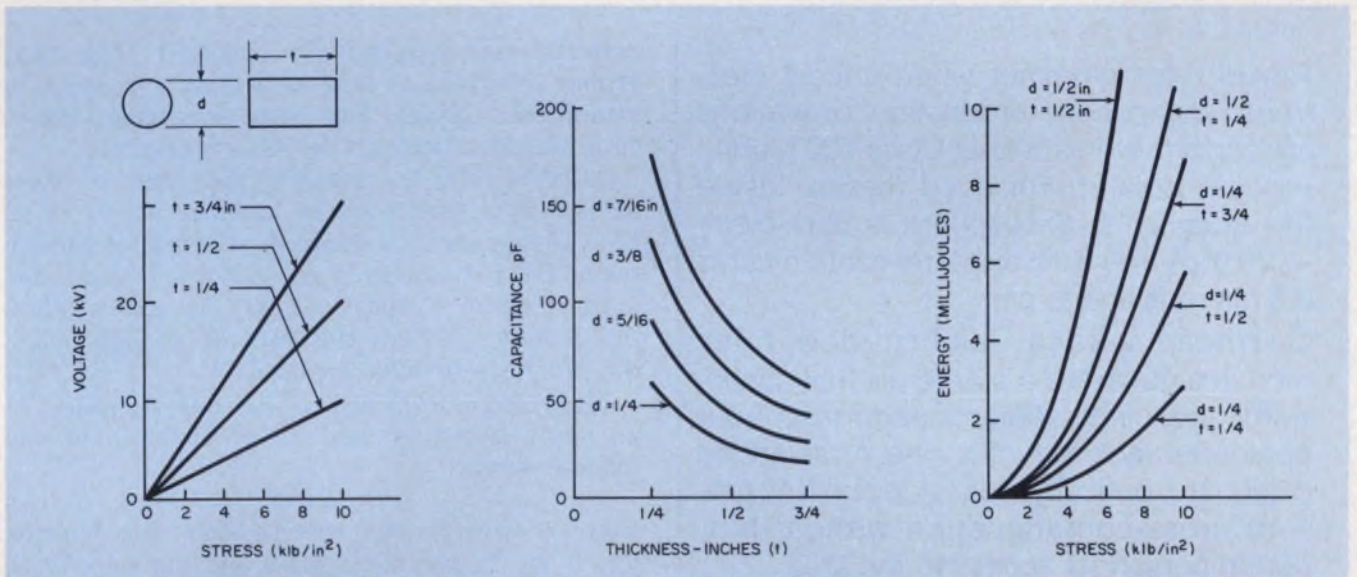

1. Plots of the properties of a typical modern piezo-electric-ceramic material show a kilovolt range of volt-

age and a high-energy capability that can generate sparks "hot" enough to ignite most combustible gases.

## Fuel-air ignition energy

Fuel	Minimum ignition energy* (mJ)	Fuel	Minimum ignition energy* (mJ)
Acetone	1.15	Heptane	1.15
Acetylene	0.03	Hexane	0.95
Benzene	0.55	Hydrogen	0.02
Butane	0.76	Hydrogen Sulfide	0.08
Carbon Disulphide	0.02	Isopropyl Alcohol	0.65
Cyclohexane	1.38	Methane	0.33
Cyclopropane	0.24	Methyl Alcohol	0.22
Gasoline	0.30	Pentane	0.82
Natural Gas	2.00	Propane	0.31

\* Based on optimum fuel/air mixtures.

From U.S. Government NASA Report #1300, "Basic Considerations in the Combustion of Hydrocarbon Fuels in Air."



# REDUCE REJECTS!

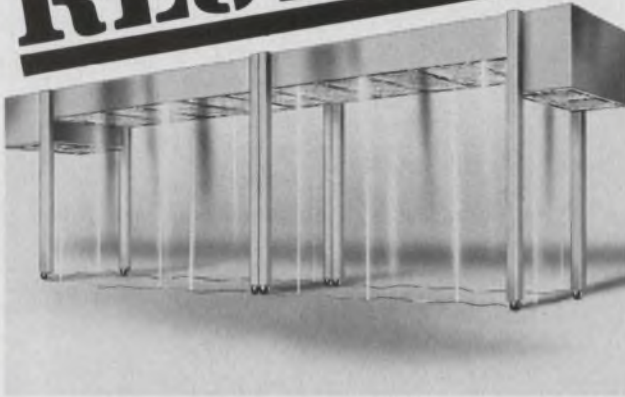

Reject rates plummet when critical electronic component production operations are performed in a Weber Class 100 Mobile Process Isolator. For good reason. Inside the Isolator the atmosphere is ultra-clean — 99.99%-free from airborne contaminants 0.3 microns and larger.

Overhead vertical laminar flow filter modules generate a sterile air flow downward, "washing" contamination from your personnel and production line. As an added safeguard, optically clear side curtains prevent cross-contamination without hindering personnel access to the area.

You can install the Weber Isolator over a critical production point. Or protect an entire line. And as your needs change, the modular design of all Weber components permits easy, economical system relocation or expansion.

In addition to the Mobile Process Isolator, Weber offers total clean rooms and portable equipment designed to meet the specific needs of the electronics industry. Write today for illustrated literature.



**WEBER TECHNICAL PRODUCTS**

1340 MONROE AVE. N.W., GRAND RAPIDS, MICH. 49505 • A DIVISION OF THE JADE CORP., SUBSIDIARY OF WALTER KIDDE & CO., INC. PHONE (616) 363-7735

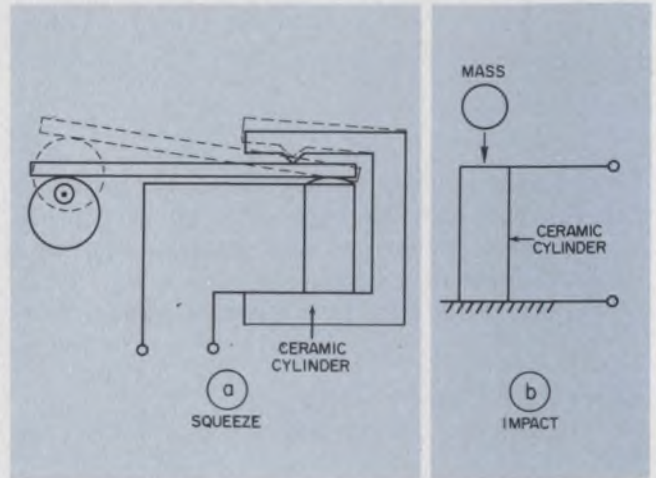

2. Either a squeeze or an impact mechanism can be used to excite the piezoelectric material to generate a high-voltage spark.

material may be gradually squeezed (Fig. 2a). It may then take as long as a minute or more to attain full voltage. For slow squeezing, therefore, electrical leakage must be minimized.

Alternatively, the ceramic body can be compressed by a spring-driven hammer action (Fig. 2b). This produces a damped, alternating voltage train; the piezo-ceramic resonates and generates a short burst of sparks. Sparking ceases when the damping reduces the level of voltage below the air gap's breakdown level.

The voltage developed in the squeeze igniter is an easily calculated and direct function of the induced strain:

$$V = gtSY \quad (5)$$

However, with impact, though the strain depends mostly on the hammer's mass and the velocity of impact, calculation is difficult and depends also on the crystal's resonant and damping factors.

In addition to not consuming standby energy, the piezoelectric effect for all practical purposes does not diminish with time. Certain limits in temperature and stress are required to avoid damaging the crystal, but these are well out of range of most practical applications. Consequently piezo-ceramics rarely need replacement. ■■

#### Bibliography

1. Cady, W. G., "Piezoelectricity," McGraw-Hill Book Co., New York, N.Y., 1946.
2. Mason, W. P., "Piezoelectric Crystals & Their Application to Ultrasonics," D. Van Nostrand & Co., Inc., New York, N.Y., 1950.
3. "Piezoelectric Technology Data For Designers," *Vernitron Handbook*.
4. Jaffe, B., "A Primer Of Ferroelectricity & Piezoelectric Ceramics," *Vernitron Publication, TP217*.
5. Germano, C. P., "On The Meaning of 'g' & 'd' Constant as Applied to Simple Piezoelectric Modes of Vibration," *Vernitron Publication, TP222*.
6. Arndt, J. P., "Piezoelectric High Voltage Generators," *Vernitron Publication, TP219*.
7. Percy, C., "High Voltage Generation From Piezoelectric Ceramics," *Electronic Engineering*, October, 1965.



# SIEMENS

## Cost Effective Solutions to Semiconductor Test Problems



### GENERAL PURPOSE IC TESTER COMPUTEST 716A

Low-cost parametric and functional tester for digital and linear circuits

### DIGITAL CIRCUIT TESTERS COMPUTEST 720 SERIES

Provides complete DC parametric and functional verification of digital IC's

### LINEAR CIRCUIT TESTER COMPUTEST 735

Tests operational amplifiers, regulators, comparators, sense amplifiers and custom linear circuits

### BENCH-TOP MEMORY TESTERS COMPUTEST 901 SERIES

Provides real-time verification of semiconductor memory performance from the device to the complete memory systems level

**FREE!**

Send for the Computest catalog of Semiconductor Test Equipment and our Semiconductor Program Library



NAME \_\_\_\_\_

COMPANY \_\_\_\_\_

ADDRESS \_\_\_\_\_

CITY \_\_\_\_\_

STATE \_\_\_\_\_ ZIP \_\_\_\_\_

Siemens Corporation  
Electronic Systems Division  
Computest Products

3 Computer Drive, Cherry Hill, N.J. 08002 (609) 424-2400

**FOR APPLICATIONS ASSISTANCE . . .  
CALL US!**



# The Sinclair Scientific. Logs, trig and arithmetic. \$99.95

(Now you can afford  
to get a little scientific.)

**Display:**  
5-digit mantissa  
2-digit exponent  
(both signable)

**Exponent:**  
200-decade range,  
from  $10^{-99}$  to  $10^{+99}$

**Functions:**  
4 arithmetic  
2 logarithmic  
6 trigonometric

**Logic:**  
Reverse Polish, with  
post-fixed operators  
for full flow chain  
calculations.

**Keyboard:**  
18 key format with  
4 "triple-action"  
function keys using  
standard, upper and  
lower case operation.

**Size:**  
4-3/8" high; 2" wide;  
11/16" thick.

**Weight:**  
3-3/4 oz.

**Warranty:**  
1 year.

**Power Source:**  
Battery operated  
with 4 inexpensive  
AAA penlight  
batteries, providing  
over 25 hours of use.

actual size

1 rad	57.2958°
ln 10	2.30259
e	2.71828
π	3.14159



Scientific calculators are fast.  
And convenient.

And, until recently, very expensive.

(A good one could cost as much as \$300.)

But now there's the Sinclair Scientific.

For an incredible \$99.95, this small scientific miracle not only performs logarithmic and trigonometric functions at the push of a button. It displays all calculations with scientific notation.

What's more, the Sinclair Scientific isn't just portable. It's pocketable.

Less than 3/4-inch thin. And 3 3/4-ounces light. It's the world's thinnest, lightest scientific calculator.

Just look at some of its essential functions, and you may never use your slide rule or log tables again:

**log and anti-log (base 10)**  
**sin and arcsin**  
**cos and arccos**  
**tan and arctan**  
**automatic squaring**  
**automatic doubling**  
**x<sup>y</sup>, including square and other roots**  
**plus the four basic arithmetic functions**

Besides performing virtually all scientific, mathematical and financial operations, it can also carry out chain calculations of unlimited length.

### What makes a scientific calculator scientific?

There are a number of calculators that call themselves "scientific."

But most, quite frankly, don't measure up.

To be a really valuable tool for engineers, scientists, technicians and students, a calculator must provide *all* of the following:

Log functions.

Plus trig functions.

Plus scientific notation (10<sup>-99</sup> to 10<sup>+99</sup>).

Clearly, a scientific calculator without scientific notation severely limits the size of numbers with which you can work easily.

And scientific notation without transcendental functions is little more than window dressing on an arithmetic calculator.

Granted, there are two companies, other than Sinclair,

offering excellent units with all the essential ingredients.

But Hewlett-Packard's models start at well over \$200.

And Texas Instruments' SR-50, at about \$170, uses a mix of logics. Which we believe is less convenient than the reverse Polish logic with post-fixed operators used by Sinclair and Hewlett-Packard.

What it all adds up to is this:

Only Sinclair provides truly scientific capacity at a truly affordable price.

### What makes the Sinclair Scientific so inexpensive?

Two important technological breakthroughs.

First, the British-built Sinclair Scientific has a *single* integrated circuit. Engineered by Sinclair. And exclusive to Sinclair.

(Competitive units require more than one chip. Their chips are larger. And also more expensive.)

Second, Sinclair's exclusive keyboard has only four function keys. All of which provide "triple-action" by changing from standard to upper or lower case mode.

Competitive products have more than twice as many keys. Most of them are infrequently used. And non-essential.

For example:

The Sinclair Scientific hasn't a square root key. But squares — and other roots — are obtainable simply by using logarithms.

Finally, extra keys mean extra cost. (Not to mention size and weight.) And fewer keys mean a simpler format to memorize — for increased speed and fewer entry errors.

### Old hands at small miracles.

Sinclair has been an innovator

in calculator miniaturization right from the start. And it's now Europe's largest manufacturer of pocket calculators.

In the last two years Sinclair brought to America the world's thinnest, lightest calculators — the Sinclair Executive and Executive Memory — as well as the Cambridge, a moderately priced 4-function unit.

Naturally, Sinclair maintains a service-by-return mail operation in the U.S. (and everywhere else in the world) to handle any product problems, should they develop.

And, the Sinclair Scientific is backed by an unconditional one-year replacement warranty.

### How to get your Sinclair Scientific.

Whether it's for yourself, your company, or as a welcome gift for any science or engineering student, the Sinclair Scientific may be ordered immediately — by mail or phone.

And, of course, you may charge it on *mail or phone* orders to your American Express, Diners Club, Master Charge or BankAmericard account.

If you're not completely satisfied, you may return the unit within 2 weeks of receipt for prompt refund.

Just use the coupon below, or call (800) 223-5764, toll free.

The Sinclair Scientific.

It's the logical choice for people who want the answers in their pockets. At a price that's easy on their wallets.

**sinclair<sup>TM</sup>**  
**SCIENTIFIC**  
**The logical choice.**

### ORDER FORM

For credit card phone orders call (800) 223-5764, toll free.  
(New York residents call (212) 688-6623.)

To: Sinclair Radionics, Inc. 375 Park Avenue, New York, New York 10022 (6-A)

Please send me \_\_\_\_\_ Sinclair Scientific(s) at \$99.95 (plus \$3.50 per unit, shipping and handling) including batteries, carrying case, instruction booklet and warranty. (New York residents add sales tax.)

Enclosed is my check for \_\_\_\_\_.

Please charge my credit card account.

Credit Card \_\_\_\_\_

Account No. \_\_\_\_\_

Expires \_\_\_\_\_

Master Charge Code # (4 digits) \_\_\_\_\_

Signature \_\_\_\_\_

Name \_\_\_\_\_

Company \_\_\_\_\_

Address \_\_\_\_\_

City \_\_\_\_\_

State \_\_\_\_\_ Zip Code \_\_\_\_\_

All Sinclair pocket calculators, including the Executive (\$79.95), Executive Memory (\$99.95) and Cambridge (\$44.95), are available at better stores everywhere.



# Get gain control of 80 to 100 dB

by using a two-quadrant multiplier. You can make one from a four-quadrant monolithic multiplier.

It's common to use a monolithic four-quadrant multiplier as a gain control: Simply use one input for the signal and the other for the control. But if the application calls for use of a unipolar control signal, better performance can be obtained with a true two-quadrant multiplier—one that has a bipolar and a unipolar input, as opposed to a four-quadrant unit, which is designed for two bipolar inputs. With reasonable care with the two-quadrant multiplier, you can achieve a control range of 80 to 100 dB with less than 0.5% total harmonic distortion.

A standard four-quadrant IC multiplier can be made to operate as a two-quadrant unit—a little appreciated, but inherent, capability of these transconductance multipliers. Operational transconductance amplifiers also make good controlled gain amplifiers, because of their structural similarity to two-quadrant multipliers of the transconductance type.

## Transconductance multipliers: How they work

Virtually all popular monolithic multipliers operate on the principle of variable transconductance. A simple circuit that performs two-quadrant transconductance multiplication (Fig. 1) varies the emitter current of a matched pair of bipolar transistors. If the voltage  $E_x$ , which is applied differentially to  $Q_1$ - $Q_2$  is zero, the differential output current is zero. As  $E_x$  varies, the output signal  $Q_1$ - $Q_2$  will be

$$I_o = \frac{q}{2KT} I_e E_x.$$

This differential output,  $I_o$ , is applied to  $A_1$ , a differential current-to-voltage converter. The output voltage from  $A_1$  will be

$$E_o = I_o R_{10} \\ = \frac{q}{2KT} I_e E_x (R_{10})$$

Finally, if we vary the emitter current of  $Q_1$  and  $Q_2$  with a second input,  $E_y$ , the emitter current  $I_e$  will be approximately

$$I_e = \frac{E_y}{R_3}$$

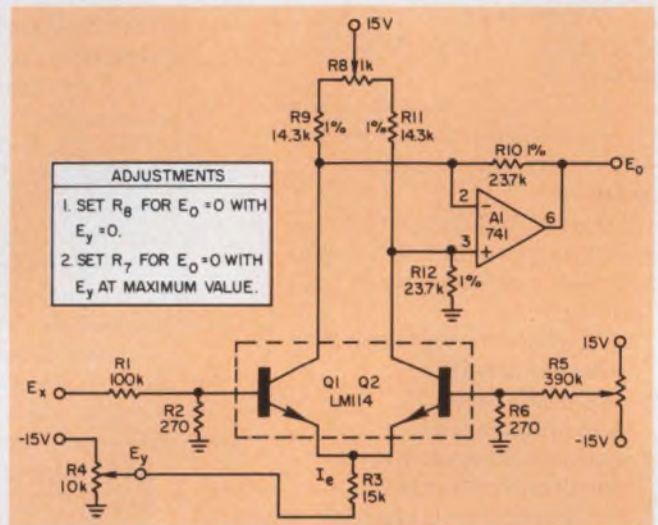

1. The two-quadrant transconductance multiplier operates through variation of emitter current in a differential pair. The circuit handles inputs of up to 2.5 V rms, but it has limited dynamic range as a gain control because of nonlinearities in the differential pair.

With some rearrangement, the value for  $I_e$  can be substituted into the equation for  $E_o$ , which then becomes

$$E_o = (E_x E_y) \frac{(q)}{2KT} \left( \frac{R_{10}}{R_1} \right).$$

This equation shows that the circuit accomplishes multiplication of  $E_x$  and  $E_y$ , provided the other terms of the equation are constant.

An examination of the figure will show that this circuit responds only to single polarities of  $E_y$  (negative in this example), but to bipolar signals at  $E_x$ . This is, by definition, two-quadrant multiplication. As  $E_y$  is varied to change  $I_e$ , the collectors of both  $Q_1$  and  $Q_2$  will rise and fall with the change in common-mode signal that this represents.  $A_1$  and the differential bridge resistors,  $R_9$  to  $R_{12}$ , reject this common-mode signal while also amplifying the desired differential signal,  $I_o$  from  $E_x$ . Bridge balance is critical to obtain good rejection of the  $E_y$  signal at the output. Therefore the bridge should be made of close-tolerance (0.1%) components or be nulled, as shown, with  $R_{10}$ . Resistor  $R_7$  zeroes the offset voltage of  $Q_1$  and  $Q_2$ . The circuit of Fig. 1 is linear only for relatively small signal amplitudes

Walter G. Jung, 1946 Pleasantville Rd., Forest Hill, Maryland 21050.



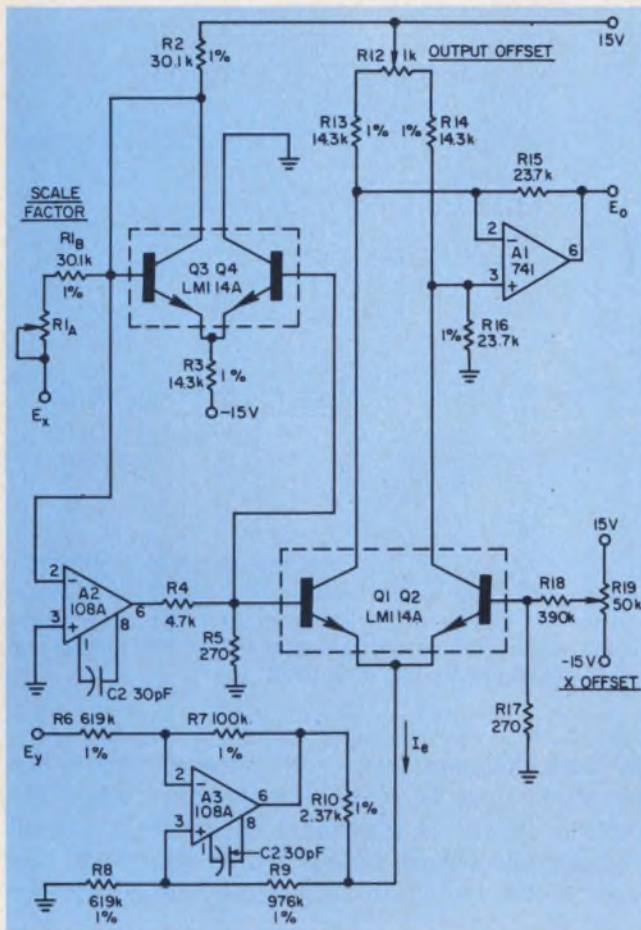

2. Improved multiplier achieves attenuation control of 80 to 100 dB. The differential pair  $Q_3$ - $Q_4$  in the loop around  $A_2$  helps to generate the proper predistorted drive to offset the nonlinearity in multiplier pair  $Q_1$ - $Q_2$ . A controlled-current source,  $A_3$ , also improves linearity.

of  $E_x$  (approximately  $\pm 10$  mV at the base of  $Q_1$ ). Therefore an attenuator network (such as the pair  $R_1$ - $R_2$ ) is needed to scale the small input range to the desired input range. The components shown allow a 2.5 V rms input.

To compensate for the  $KT/q$  component of the gain equation and provide a net gain that is temperature-compensated, let  $R_2$  have a tempco of 0.3%/C. For example, you can make up  $R_2$  from two series resistors—120  $\Omega$ , 0.7%/C and 150  $\Omega$ , 0.0%/C.

Practically any reasonably matched monolithic pair will do for  $Q_1$  and  $Q_2$ , but well-matched types yield better performance. They should be nulled, since the total signal input is not large compared with even a 1-mV offset. Nulling will also reduce distortion.

### Improving the basic 2-quadrant multiplier

The circuit of Fig. 2 improves upon the first one in two major areas. First, the nonlinearity of the pair  $Q_1$ - $Q_2$  at the  $E_x$  input is compensated by the derivation of a predistorted voltage drive with the feedback loop around  $A_2$  and  $Q_3$ - $Q_4$ .

Differential pair  $Q_3$ - $Q_4$  is identical to  $Q_1$ - $Q_2$  and operates with a fixed emitter current. The pair  $Q_3$ - $Q_4$  is connected in the loop so that the current swing in  $Q_3$  equals the current swing in  $R_1$ , which is also the input current. Op amp  $A_2$  will force the current output from  $Q_3$  and  $Q_4$  to be linear, although the voltage drive developed at the input to  $Q_1$  (and  $Q_2$ ) will be quite nonlinear. Therefore  $Q_1$ - $Q_2$  may also be driven in parallel from this voltage with the expectation of a linear output. To scale the  $E_x$  input voltage,  $R_1$  is trimmed for the desired full-scale input current—in this case,  $\pm 250$   $\mu$ A for  $\pm 10$  V. To minimize errors due to cumulative offsets,  $Q_1$ - $Q_2$ ,  $Q_3$ ,  $Q_4$ , and  $A_2$  are low-offset types.

The other departure from this basic scheme is in the method of current drive for the controlled pair  $Q_1$ - $Q_2$ . The simple resistive current drive used in Fig. 1,  $R_3$ , does not ensure linear variations in  $I_e$  as  $E_y$  approaches zero. A feedback configuration is needed to linearize  $I_e$ . This is accomplished by a bilateral voltage-controlled current source,  $A_3$ , and its associated components. This circuit supplies an output current that is in linear for any level of  $E_y$  and extends the linear control range to small levels of  $E_y$ . Amplifier  $A_3$  has a low offset voltage to minimize any nonlinearity of  $E_y$  due to  $V_{io}$  at low values of  $E_y$ , and therefore it requires no trim. The other trim adjustments perform functions similar to those of Fig. 1.

The improved circuit removes limitations on the drive to  $Q_1$ - $Q_2$ . Nearly the full dynamic range of current output swing can be used by virtue of the predistorted voltage from  $Q_3$ - $Q_4$ . Also, variations in drive for temperature compensation are automatically provided by the  $Q_3$ - $Q_4$  pair as they generate the required transfer curve for  $Q_1$ - $Q_2$ .

The dynamic range of emitter current control of bipolar transistors used as transconductance gain controls is extremely high, and attenuations of 80 to 100 dB for control are not overly difficult to achieve. Of course, when the designer strives for such performance, noise and errors sources can easily creep in from many points. The circuit layout should be clean, supplies well bypassed, good grounding practices observed and attention given to stray coupling effects. With the components shown, the circuit allows a  $\pm 10$ -V swing for  $E_x$ , a control range of  $10 > E_y > 0$ , and it provides an output

$$E_o = \frac{E_x E_y}{10}$$

### Changing 4-quadrant to 2-quadrant

The 1595/1495, a well-known monolithic transconductance multiplier, uses a circuit structure similar to that in Fig. 3a. The circuit consists of a pair of cross-connected differential pairs ( $Q_1$ - $Q_2$  and  $Q_3$ - $Q_4$ ) fed by controlled emitter currents



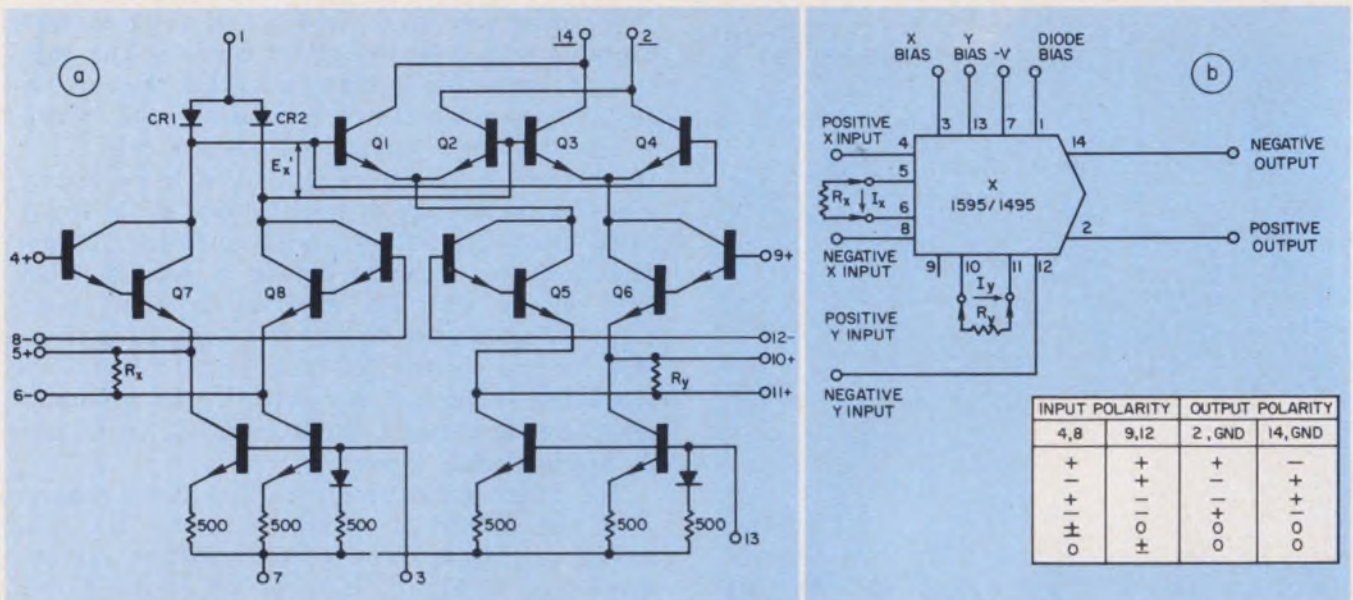

3. The 1595/1495 monolithic multiplier circuit (a) uses two cross-connected differential pairs. These units provide limited gain-control range because of distortion

caused by a lack of balance between opposing pairs. The symbolic representation emphasizes the chip's use as a voltage-controlled attenuator (b).

( $Q_7$ - $Q_8$ ), and it has a common differential base drive ( $E_x'$ ). If the circuit is sectioned between  $Q_2$ - $Q_3$  and  $Q_7$ - $Q_8$ , each half may be recognized as a single controlled-emitter-current differential pair similar to  $Q_1$ - $Q_2$  of Fig. 1. In fact, the circuit is a pair of two-quadrant multipliers that are connected to form a composite four-quadrant multiplier.

The actual multiplying transistors are  $Q_1$ - $Q_4$ . They receive the processed  $E_x$  signal ( $E_x'$ ) after it has been nonlinearly processed by corrective diodes CR<sub>1</sub> and CR<sub>2</sub>. The multiplier section gives the product of the currents from  $Q_7$ - $Q_8$  and  $Q_5$ - $Q_6$ . These currents are, in turn, linearly scaled from  $E_x$  and  $E_y$ , respectively, by external resistances  $R_x$  and  $R_y$ , which are differentially connected at the emitters of  $Q_7$ - $Q_8$  and  $Q_5$ - $Q_6$ . Fig. 3b shows the unit in symbolic form, and it depicts the input-output nodes along with the cell's multiplicative action. As should be apparent, the 1595 is a cell that multiplies currents and furnishes a differential output current. The inputs are the differential voltages  $E_x$  and  $E_y$ , and these are scaled by resistors  $R_x$  and  $R_y$  to yield currents  $I_x$  and  $I_y$ . These currents, given by the equations

$$I_x = \frac{E_x}{R_x} \text{ and } I_y = \frac{E_y}{R_y},$$

are multiplied by the cell.

### Gain control with 1595-type multipliers

To use a four-quadrant multiplier as a gain-controlled block, all that need be done is to apply a signal to one input ( $E_x$  or  $E_y$ ) and a variable control voltage to the opposite side. As a voltage-controlled attenuator—the function represented

in block diagram form—this type of circuit has an attenuation of 0 dB (unity gain) when the control voltage is maximum. Below this control voltage, the output is attenuated by 20 dB for each 20-dB reduction in control voltage (linear multiplication).

However, the drawback is that this relation is only valid over a dynamic range of about 60 dB. And the distortion increases rapidly as the gain is reduced, with typical THD figures of 1 to 2%. Neither of these characteristics is satisfactory for a high-quality signal-processing device. The limits are imposed by the basic four-quadrant structure, which relies on the balance between two opposing two-quadrant multipliers and their cancellation to achieve zero output. In regard to pure attenuation capability, this system is inherently weak and should not be considered for attenuations beyond 40 dB. This limits the four-quadrant multipliers to relatively unsophisticated gain-control applications.

However, the 1595, which is a four-quadrant device, can just as easily be used as a two-quadrant device, with the higher performance that this mode offers. To convert the 1595 to two-quadrant operation, you need only disable one of the two-quadrant multipliers shown in Fig. 3a.

In this version (Fig. 4),  $Q_5$  is disabled when both its base and emitter (pins 11 and 12) are grounded and no bias is supplied to its current source. This removes  $Q_1$  and  $Q_2$  from the circuit, so the output can only come from  $Q_3$  and  $Q_4$ . These transistors are then used as a two-quadrant multiplier section, with  $Q_4$  as a precision-controlled current source.  $Q_3$  is biased externally by op amp A<sub>2</sub>, which acts as a positive input voltage-controlled current source.



As shown, the circuit resembles the improved two-quadrant multiplier of Fig. 2 and has a comparable dynamic range. In addition the only significant source of distortion is the linearization diodes that process the  $E_x$  signal internally. This distortion consists mostly of second harmonics and can be controlled if the  $I_x$  current is limited by appropriate scaling with  $R_3$  ( $R_x$ ). For example, in the circuit shown, the THD is below 0.5% at a full-scale  $E_x$  input of  $\pm 10$  V, and it reduces to negligible levels with lower input levels typical for operation in an audio chain. The output scale factor and the control range of  $E_y$  are the same as in the circuit in Fig. 2.

The two-quadrant multiplier is also quieter than the four-quadrant. It reduces the output noise level along with the signal, whereas a four-quadrant type does not. This factor is important where good S/N and dynamic range are important.

One difference between this circuit and the previous ones is the use of the voltage-controlled current source,  $A_2$ . The accuracy of this determines the over-all dynamic range of attenuation. The residual offset voltage of  $A_2$  limits the current source accuracy and therefore the dynamic range of the circuit for small values of the control signal. This offset voltage should be nulled for best results—the full-scale voltage at the input of  $A_2$  is only 0.5 V.

Other variations of voltage-controlled current-source circuits may be used if they are compatible with the bias requirements of the 1595. As shown, the current in  $R_3$  is 2 mA for unity gain, and the bias voltage level at pin 10 of the 1595 should be 0.5 V or less. Diode CR<sub>1</sub> prevents  $V_{EB}$  breakdown of  $Q_{11}$  if a negative input is inadvertently applied to  $A_2$ . The circuit of Fig. 4 uses a dual 741 for  $A_1$ - $A_2$  to achieve minimum component count. Different types of amplifiers should be considered if other design goals are more important.

### Transconductance op amps as gain controls

With the circuit of Fig. 4, a fair amount of level shifting and scaling must be done for the interface to the gain control. However, some of this circuitry can be eliminated by use of a device that has the level-shift and gain-control interfacing built in. Such a circuit is the OTA, or operational transconductance amplifier.

An OTA (Fig. 5a) can be regarded as a differential amplifier with a single-ended output. Its gain,  $A_{vo}$ , is given by the equation

$$A_{vo} = g_m R_L,$$

where  $g_m$  is the OTA transconductance and  $R_L$  is the load resistance. Its output current is zero when the differential input voltage is zero. By comparison with the familiar voltage-output op

amp, an OTA can be said to have some of the same ideal characteristics, but its output terminal is an ideal current source. An OTA also has a third signal input terminal that is used to change  $g_m$  and thus vary gain. A schematic diagram for the 3080, a commercial OTA, is shown in Fig. 5b.

An OTA is an ideal two-quadrant transconductance multiplier. But it is usually simpler to use an OTA for a multiplying function, since it contains much—all, in some applications—of the needed hardware.

The simplest circuit that uses the variable-gain property of an OTA is the voltage-controlled amplifier (Fig. 6a). In this a variable voltage at the  $E_y$  input varies the current in  $R_{ABC}$  ( $I_{ABC}$ ) and the  $g_m$  of the 3080.  $I_{ABC}$  is at its maximum of 500  $\mu$ A when  $E_y = 0$ , and is reduced as  $E_y$  approaches the  $V^-$  potential ( $-15$  V).

The output current of the 3080 develops a voltage across  $R_L$  ( $R_o$ ), which constitutes the output voltage. As the gain of an OTA is  $g_m \times R_L$ , the full-scale  $g_m$  of approximately 10 mmho

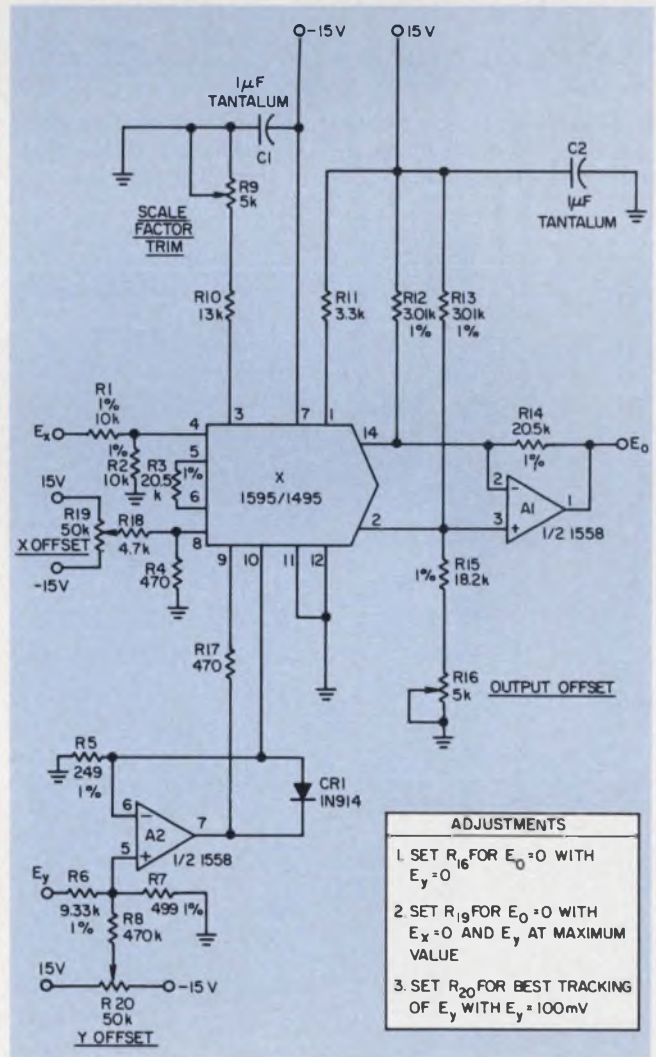

4. Two-quadrant operation of 1595/1495 IC increases the dynamic range to 80 dB. The connections shown disable one of the two-quadrant multipliers. Op amp  $A_2$  provides a controlled current source, as in Fig. 2.



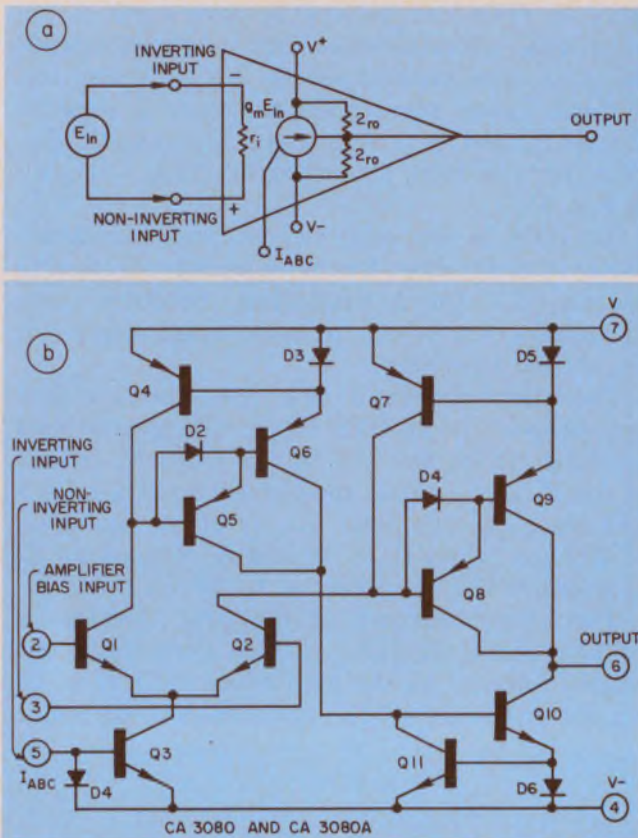

5. Transconductance amplifiers (a) can function as gain controls, since they contain the necessary differential transconductance pair— $Q_1$ - $Q_2$  in this case (b).

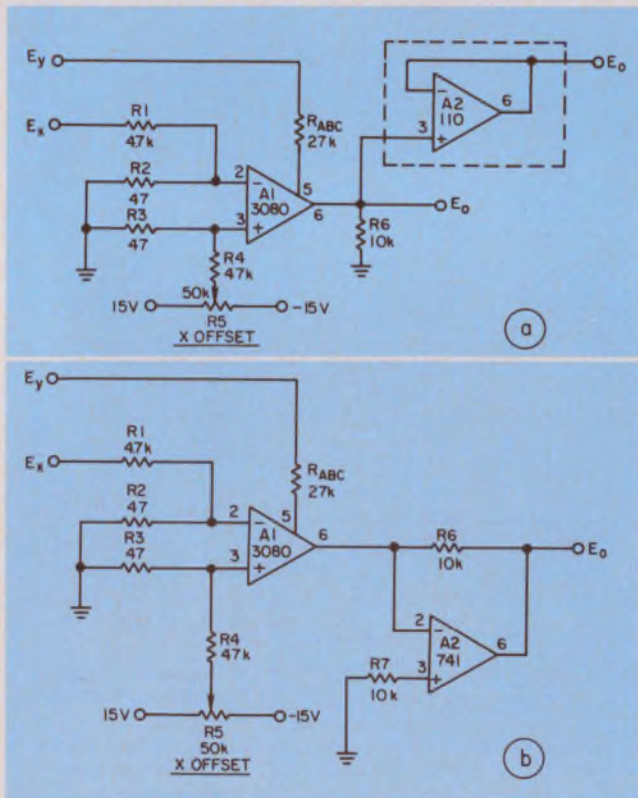

6. Let  $E_c$  control the differential current, and the operational transconductance amplifier provides variable gain. The first version (a) isolates the output ( $Z_o \approx 10$  k) with a voltage follower. Alternatively a current-to-voltage converter (b) can be used with the same results.

$\times 10$  k $\Omega$  yields an OTA input/output voltage gain of  $10^{-2} \times 10^4 = 100$ . This, of course, assumes that any external parallel loading across  $R_o$  will be negligible.

The input voltage applied to  $A_1$  is reduced by the voltage divider.  $R_1$  and  $R_2$  form a 100/1 divider that scales a nominal  $\pm 1$  V signal to  $\pm 10$  mV at  $A_1$ . Larger input amplitudes may be used, if greater output nonlinearity is tolerable, up to a point where the output voltage is limited to  $\pm I_{ABC} \times R_o$  V, or  $\pm 5$  V. The control voltage range is  $-15$  to  $0$  V.

The gain of the OTA is a direct function of  $g_m$ ;  $g_m$  variations with temperature give it a  $-0.3\%/^{\circ}\text{C}$  gain coefficient. This may be compensated for by making the  $R_1$ - $R_2$  divider-ratio temperature dependent by an equal and opposite amount, as discussed with Fig. 1. The  $g_m$  tempco should be considered in any OTA open-loop gain stage if you want good stability.

Since input signals of  $\pm 10$  mV are not significantly greater than the possible input offset voltage of an OTA, offset voltage adjustment will normally be required;  $R_5$  is adjusted for a zero dc output voltage at maximum gain.

A disadvantage of this basic OTA gain control for some applications is its high output impedance, which is, in fact, the value used for  $R_o$ . Gain can be made independent of loading by following  $R_o$  with a unity gain, zero-offset buffer such as a 110 voltage follower. Much higher gains can be realized;  $R_o$  can now assume values up to  $1$  M $\Omega$  before the offset across it (due to  $A_2$ 's bias current) becomes appreciable.

A second version of the basic circuit uses a current-to-voltage converter (Fig. 6b).  $A_2$  converts the OTA current output into a voltage across  $R_o$ . For equivalent values of  $R_o$ , the output voltage in this case is identical to that of Fig. 6a, with an additional sign inversion caused by  $A_2$ . Amplifier  $A_2$  is shown as a general-purpose op amp, but it can be any op amp compensated for unity gain that is consistent with other circuit requirements.  $R_o$  (and  $R_7$  also) can be raised for greater gains, as before, but if values beyond  $100$  k $\Omega$  are desired, a low-input amplifier should be considered for  $A_2$ .

When OTAs are used in gain-controlled stages, there are several points to consider to obtain best performance. Besides the temperature dependence of transconductance and the limitation on linearity and dynamic range, the  $I_{ABC}$  interface must be considered, if extended range of linearity is to be achieved or functions other than linear control are to be realized.

The circuit of Fig. 7, a form of two-quadrant multiplier, incorporates a number of features that increase precision. The circuit uses diodes for compensation of the input signal to achieve linear operation, and to compensate for the



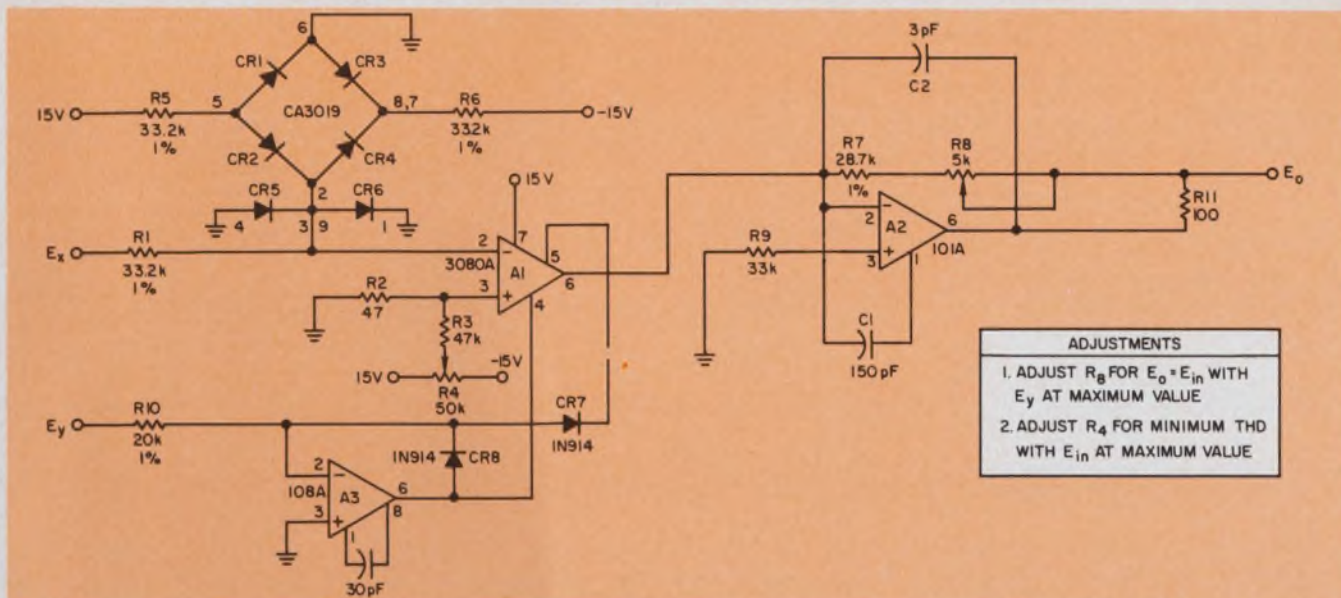

7. A more sophisticated version of the variable-gain amplifier uses a diode bridge to compensate for trans-temco of the transconductance amplifier. And both features are accomplished without active circuitry.

The diode bridge consisting of matched diodes CR<sub>1</sub> to CR<sub>4</sub> is biased by a current value nominally equal to  $I_{ABC(max)}$ . With one side of the bridge grounded (pin 6), the impedance looking into the opposite side (pin 2) is very low—essentially the diode dynamic impedance. If a linear current is fed into the bridge at this junction, the voltage developed will be the current/voltage characteristic of the bridge, and it will be identical to the differential-amplifier input voltage for a linear output current. A current source to drive the bridge is approximated by R<sub>1</sub>, which converts the input voltage to a current that is absorbed in the bridge. The resultant voltage—applied to A<sub>1</sub> as an input voltage—linearizes its characteristics for higher input levels and automatically adjusts the drive for temperature variations.

With this technique, the drive to A<sub>1</sub> can be increased to nearly 100 mV p-p, which, with respect to the previous 20 mV, is an increase of 15 dB. With the values shown, the circuit handles input and output signal levels of ±10 V and accepts control voltages between 0 and 10 V. Even at these high levels, the distortion remains well below 1%, and at lower levels it falls to below 0.1% or better. R<sub>8</sub> is a trim for unity gain at  $I_{ABD(max)}$ .

The currents in R<sub>5</sub> and R<sub>6</sub> must be balanced for minimum bridge voltage offset; if this is not done, additional distortion will be caused by the unbalanced transfer characteristic. Thus R<sub>5</sub>-R<sub>6</sub> should be of close tolerance, and V<sup>+</sup> and V<sup>-</sup> should track.

The control current for A<sub>1</sub> is generated by A<sub>3</sub>, a precision voltage-controlled current source that forces  $I_{ABC}$  to be linearly proportional to E<sub>y</sub>. For

conductance tempco and to preprocess the input signal E<sub>x</sub> for greater linearity.

best linearity, A<sub>3</sub> should be a low offset voltage type, or it should be trimmed. Four-decade (80 dB) or greater operation is possible with a 3080A for A<sub>1</sub>. However, A<sub>3</sub> should be a 108 or a FET-input type—such as an 8007—for  $I_{ABC}$  levels below 100 nA for best low-level tracking.

The means of obtaining the  $I_{ABC}$  drive from A<sub>3</sub> in this circuit is unusual, in that A<sub>3</sub> drives the OTA's V<sup>-</sup> terminal to force the current in the  $I_{ABC}$  mirror diode to be equal to the current in R<sub>10</sub>. This method works well, but it is limited to configurations where the OTA output sees no voltage swing, as with the current-to-voltage converter shown. CR<sub>7</sub> provides proper voltage biasing for the  $I_{ABC}$  terminal, which must be a diode drop (or more) below the voltage at the differential inputs. The advantage is that this A<sub>3</sub> stage provides a precise form of  $I_{ABC}$  control without a level-shift transistor, while E<sub>y</sub> is still referred to ground.

Another desirable form of  $I_{ABC}$  control is one exponentially related to the input control voltage E<sub>y</sub>. An antilog generator can be modified for this purpose to generate an output current ( $I_{ABC}$ ) that is exponentially related to an input voltage. This combination will yield an attenuation that changes by a factor of 10 for each 1-V change of E<sub>y</sub>, or 20 dB/V. This is a distinct advantage in audio mixing consoles, for example, where straight-line attenuators are calibrated in decibels.

These examples are but a few of those possible with the OTA. Others are linear or digitally programmed integrators, filters and amplifiers. ■■

#### Acknowledgement

This article was adapted from sections of the author's book "The IC Op Amp Cookbook," published by Howard W. Sams & Co., Inc., Indianapolis, Ind.



This chip  
is the world's first  
SOS processor.



It makes all the  
stuff on the next page  
possible.



Silicon-on-sapphire isn't new. The aerospace industry and the military have recognized its high-speed, high-density and high-reliability characteristics for years.

But no one was ever able to use it in a computer processor.

Until now.

Now General Automation designers have built the world's first commercial processor using SOS technology.

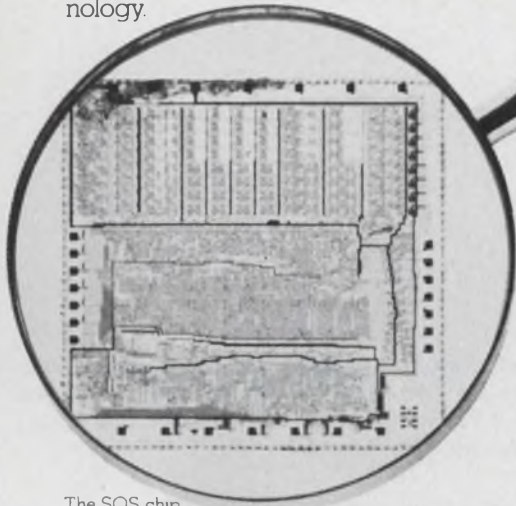

The SOS chip magnified 16 times

They've placed 2000 gates or the equivalent of 4000 to 5000 transistors on a single semiconductor chip.

An 800 times size reduction from its predecessor product, the SPC-12.

### The world's first microcomputer.

That tiny SOS chip has made it possible to bring you the LSI-12/16. A complete digital automation microcomputer with from 1K to 32K bytes of semiconductor memory.

We call it the world's first microcomputer because it's the only

always meant you had to make major concessions in performance.

With SOS you make none.

The LSI-12/16 has an instruction execution cycle time of 2.64 microseconds.

It's faster than any microprocessor on the market.

It's more powerful. And lower in cost. In board-only configuration with 1K memory, it costs only \$495 in minimum OEM quantities of 1000 per year. In short, we offer all the performance of a minicomputer at microprocessor prices.

### Breakthroughs across the board.

The LSI-12/16 is the first microproduct to successfully put all of the following on a single board:

A processor, power fail/auto

unique built-in ROM patch that lets the user retrofit new instructions to any ROM.

### Custom tailoring.

There's one more advantage the LSI-12/16 has that no other microproduct can offer. It's the systems backup and application expertise that General Automation gives you. Helping solve customer problems has always been our long suit. It still is.

We can customize I/O boards and match the LSI-12/16 exactly to your requirement.

Our microcomputer is available in one of two different configurations: As a board-only system, packaged with memory, control console and processor on a single 7-3/4 by 10 inch printed circuit board.

Or the same board packaged in an enclosure with power supply, battery backup for semiconductor memory and card slots for additional I/O boards.

For more information, write

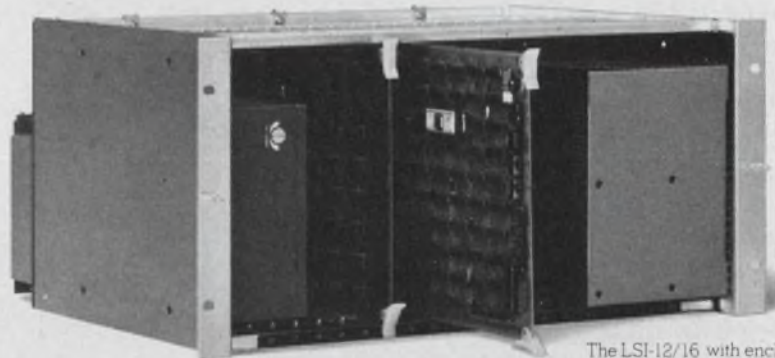

The LSI-12/16 with enclosure.

restart, remote cold start, 16 bit parallel I/O interface and up to 2K bytes of semiconductor memory.

But we didn't stop there.

GA engineering has also overcome the problems associated with semiconductor memory. Like loss of data in the event of power failure.

We handled that by developing an auxiliary battery backup system that will activate immediately upon loss of power and will retain the contents of memory for up to 15 hours.

In case you're interested in more memory, we've designed a piggyback board that will give you an additional 2K of RAM or 8K of ROM.

And if there's ever an error in ROM programming, it can be corrected. The LSI-12/16 has a

General Automation, 1055 South East Street, Anaheim, California 92805. Or call us at (714) 778-4800.

Our European headquarters is at Centre Silic, Cidex L242, 94533 Rungis, Paris, France. Call 686-7431.

# GENERAL AUTOMATION

A new generation of computer processors is beginning. All because of this.



The board-only system.

microproduct available that gives you the performance, the systems features, the reliability and the applications support you would normally expect from a minicomputer.

### More work, less money.

In the past this kind of size reduction

INFORMATION RETRIEVAL NUMBER 55



# Sharpen active null networks by use of pole-shift circuit techniques. You'll get networks that yield increased Qs and nulls in excess of -60 dB.

A common problem of null networks—important parts of communication and instrumentation equipment—is that the nulls just aren't sharp enough. Higher Qs are needed, and these can be obtained by use of a pole-shifting network (Fig. 1). Variations of the circuit can yield nulls in excess of -60 dB.

The basic parallel-T RC null network (Fig. 2) yields a Q of 1/4. The network has the following normalized transfer function:

$$F(s) = \frac{s^2 + 1}{s^2 + 4s + 1} \quad (1)$$

The frequency-response curve (Fig. 2b) might seem to possess a sharp enough null. A measurement at the -60-dB points results in a relative bandwidth (BW) of 0.4% of the null frequency ( $F_0$ ). If a Q calculation is made, an apparent Q of  $F_0/0.004 F_0$ , or 250, is obtained. Compare this high value with the known maximum Q of 1/2 for passive RC circuits.

The difference, of course, results from the fact that bandwidth is not measured at the -3-dB points. When it is, we see in Fig. 2a that  $Q = F_0/BW_{3dB} = 1/(4.236 - .236) = 1/4$ , which is low-Q indeed. These values can also be obtained from the quadratic denominator in Eq. 1. If we assume a quadratic form of  $s^2 + As + B$ , then resonant frequency  $\omega_0 = \sqrt{B}$  rad/sec,  $BW_{3dB} = A$  rad/sec and  $Q = \sqrt{B}/A$ . For the transfer function of Eq. 1, Q becomes 1/4. To obtain a higher Q null network, the coefficient of the s term in the denominator must be made smaller.

## Improved circuit increases Q

The generalized circuit of Fig. 1 achieves increased Qs when the output voltage is fed back to the original three-terminal network, identified by its gain  $\beta$ . Theoretically the voltage amplifier can have a gain between 1 and  $-\infty$ , but typically it is  $0 < K < 1$ . Since  $E_{32} = \beta E_{12}$  (by definition),  $(E_0 - K E_0) = \beta (E_1 - K E_0)$ .

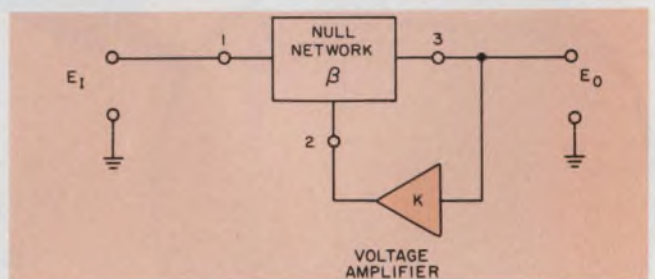

1. Sharp nulls can be obtained with a feedback loop that returns a voltage, in-phase with the output, to the null network. Circuits based on this simple scheme can yield nulls of -60 dB or more.

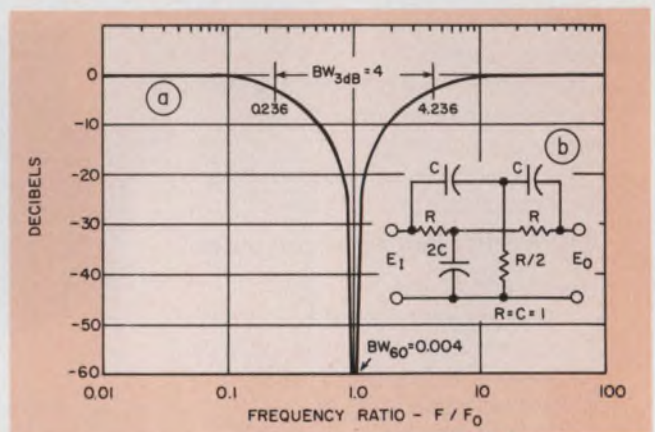

2. The basic parallel-T RC null network has a normalized transfer characteristic (a) that exhibits a -3-dB bandwidth of  $4F_0$ , corresponding to a Q of 1/4.

The total network transfer function,  $G(s) = E_0/E_1$ , becomes  $\beta/(1 - K + K\beta)$ . Use of the network in Fig. 2 allows the substitution of  $F(s)$  in Eq. 1 for  $\beta$ . We then obtain the following result:

$$G(s) = \frac{s^2 + 1}{s^2 + 4(1 - K)s + 1} \quad (2)$$

From the form of the transfer function, note these features:

- The null frequency remains the same.
- The frequency response remains symmetrical about  $\omega_0$ .
- Bandwidth becomes  $4(1 - K)$  instead of 4.
- Q increases as K approaches unity.
- The circuit oscillates when  $K \geq 1$ .

Allan Lloyd, Engineering Specialist, Philips Broadcast Equipment Corp., Montvale, N.J. 07645.



■ Q decreases for  $K < 0$ .

The Q of any null network can be increased by use of in-phase feedback. If the original null network does not have unity gain at zero frequency, the gain of the Q-network varies as a function of Q.

### Example: Wien-bridge circuits

Let's now apply the technique to two of the three Wien-bridge active null networks shown in

A Q-multiplied version of Fig. 3a appears in Fig. 4. In place of the K amplifier of Fig. 1, resistor  $R_5$  feeds back some of the output voltage to the junction of  $R_3$  and  $R_4$ . Resistors  $R_3$  and  $R_4$  are adjusted to obtain the null. The network transfer function can be written as follows:

$$G(s) = K_1 (s^2 + \omega_0^2) / [s^2 + (\alpha_1 + \alpha_2 - K_1 \alpha_3 / K_3) s + \omega_0^2], \quad (3)$$

where  $\alpha_1 = 1/R_1 C_1$ ,  $\alpha_2 = 1/R_2 C_2$ ,  $\alpha_3 = 1/R_1 C_2$ ,  $\omega_0^2 = 1/\alpha_1 \alpha_2$ ,  $F_0 = 1/2\pi (R_1 R_2 C_1 C_2)^{1/2}$  Hz  
 $K_1 = R_4 / (R_3 + R_4) = G(0) < 1$

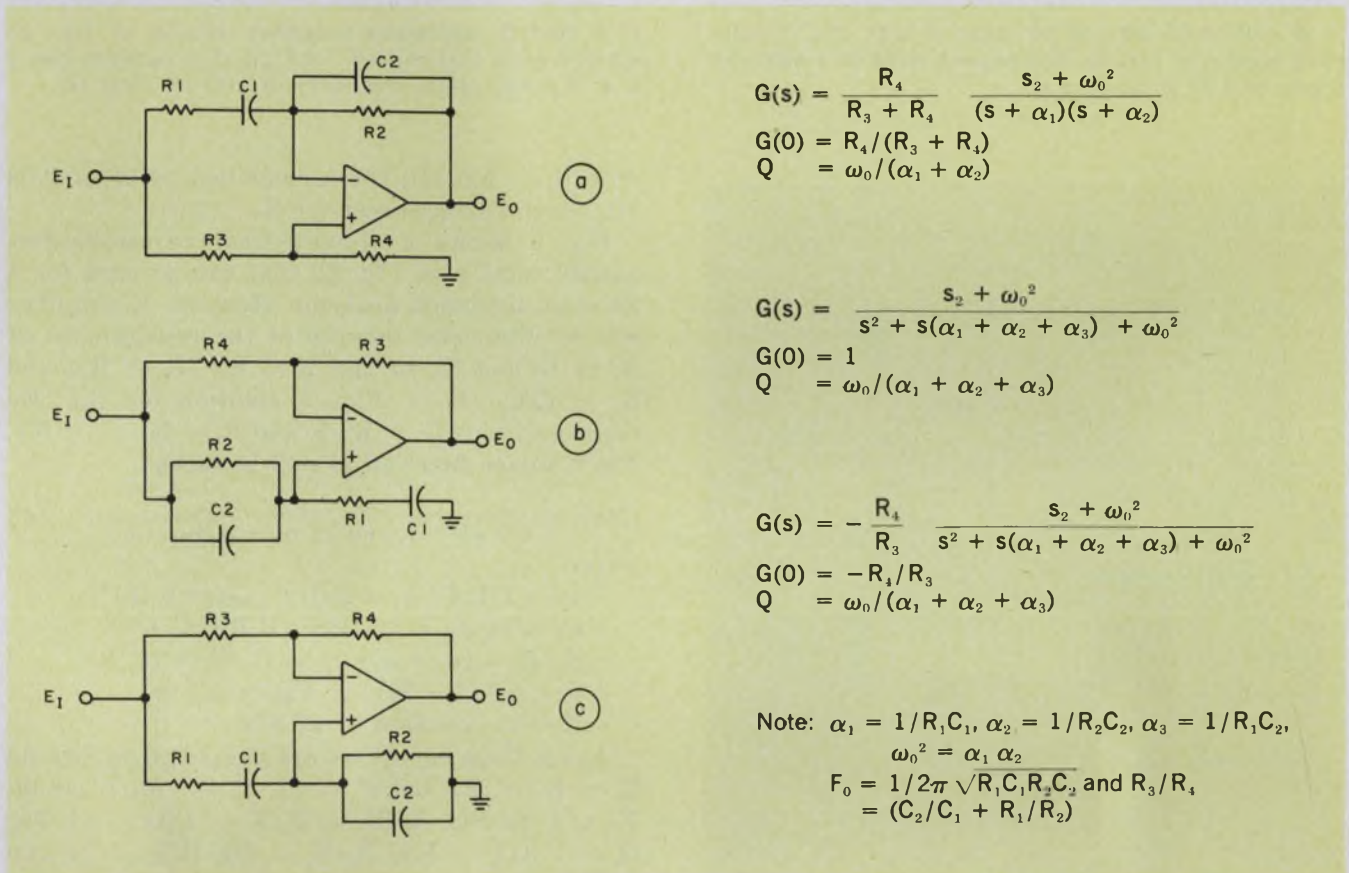

3. Active Wien-bridge null networks with unmultiplied Q. All circuits can exhibit a Q higher than that of Fig. 2. Q increases to a high of 1/2 but without unity gain (a).

Fig. 3. Note that the circuit of Fig. 3a can never have unity gain because of the  $R_3$ - $R_4$  divider. The circuit in Fig. 3b always exhibits unity gain for all values of R and C; with  $C_1$  open or  $C_2$  shorted, the circuit acts like a unity-gain follower. The circuit of Fig. 3c provides negative unity gain only if  $R_3 = R_4$ —a condition that sets the impedance ratio of  $Z_1/Z_2$ .

All three circuits can be nulled for any non-singular combination of  $R_1 C_1 R_2 C_2$  values; the maximum Q occurs when  $R_1 C_1 = R_2 C_2$ . The circuit of Fig. 3a yields the highest Q, 1/2, or twice that of the network in Fig. 2b. The two other circuits of Fig. 3 can also provide higher Qs than that in Fig. 2b.

The limitation is overcome by the unity-gain circuit (b) but with some sacrifice in Q. A circuit with negative unity gain can also be obtained (c).

$$K_2 = R_4/R_3 = Q(\alpha_1 + \alpha_2 + \alpha_3)/\omega_0$$

$$K_3 = R_5/R_3 = 1/[(\alpha_1 + \alpha_2)/\alpha_3 - 1/K_2]$$

Also,  $G(0)$  approaches unity as Q increases toward an infinite value.

The equations can be simplified if we let  $R = R_1 = R_2$  and  $C = C_1 = C_2$ . As a result,  $F_0 = 1/2\pi RC$ ,  $K_1 = (1 - 1/3Q)$ ,  $R_4/R_3 = (3Q - 1)$  and  $R_5/R_3 = (3Q - 1)/3(2Q - 1)$ . For a fixed-Q, fixed-frequency application, simply select a convenient RC to give the right null frequency. Specify  $R_3$ , and calculate  $R_4$  and  $R_5$  from  $R_3$  and the desired Q.

A deluxe Q-multiplied version of Fig. 4 features both adjustable frequency and adjustable Q without interactions of Q, frequency and null



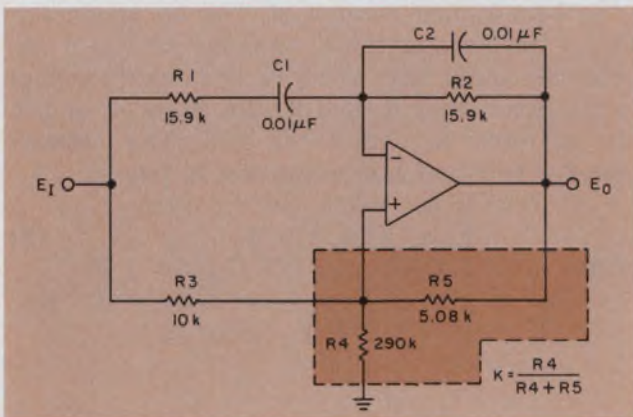

4. A null of 65 dB can be obtained with this Q-multiplied version of Fig. 3a. The network nulls at 1 kHz with a gain of 0.97 and a Q of 10.

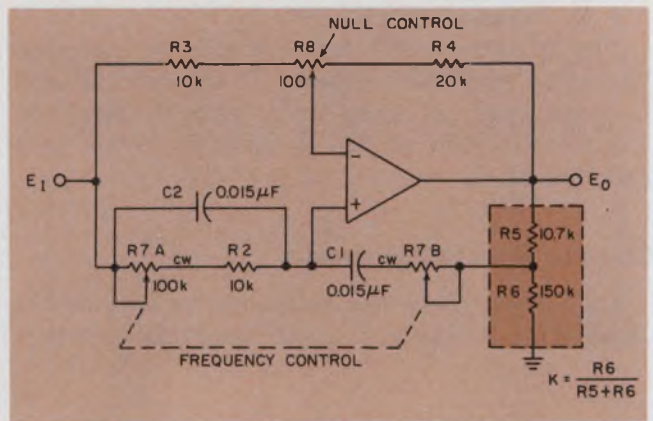

6. A fixed-Q, adjustable-frequency version of Fig. 3b exhibits nulls that exceed -65 dB. The network has a Q of 5.1 and center frequency of 100 to 1000 Hz.

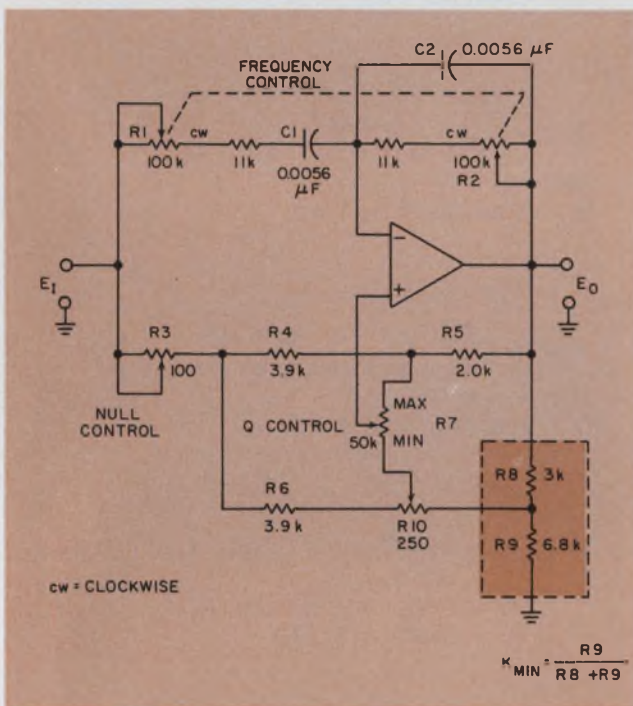

5. Q can be adjusted from 0.85 to 10 without affecting the -60 dB null or its frequency in this "deluxe" version. Independent frequency control allows 250-to-2500-Hz variations. To align  $R_{10}$ , set  $R_7$  to  $Q_{max}$  and obtain the null with  $R_3$ . Then set  $R_7$  to  $Q_{min}$ , and again obtain the null with  $R_{10}$ . Repeat if necessary.

controls (Fig. 5). But the network does not have constant gain. It can vary over a 4-dB range as Q varies.

The network Q can be changed because variable amounts of the output  $E_o$  are fed back to the noninverting input of the amplifier without change in the amount of  $E_i$  fed in. This is achieved by connection of Q-controlling resistor  $R_7$  across a bridge circuit that has the same amount of  $E_i$  at both sides of the bridge but different amounts of  $E_o$ . The bridge circuit consists of  $R_4$  and  $R_6$ , and  $R_9 = 6.8$  k $\Omega$  in parallel

with  $R_x = 3.0$  k $\Omega$ , for a combined value of 2.08 k $\Omega$ , which balances resistor  $R_5 = 2$  k $\Omega$ .

Fig. 6 shows a Q-multiplied, adjustable-frequency version of Fig. 3b that can be used for a low-cost distortion analyzer. Here the K amplifier can be eliminated because of the replacement of  $R_1$  by  $R_5$  and  $R_6$ , so that  $K = R_6 / (R_5 + R_6)$  and  $R_1 = R_5 R_6 / (R_5 + R_6)$ . A solution for the two resistors yields  $R_5 = R_1 / K$  and  $R_6 = R_1 / (1 - K)$ . The transfer function at null becomes

$$G(s) = \frac{s^2 + \omega_0^2}{s^2 + (1 - K)(\alpha_1 + \alpha_2 + \alpha_3)s + \omega_0^2}, \quad (4)$$

where

$$\alpha_1 = 1/R_1 C_1, \alpha_2 = 1/R_2 C_2, \alpha_3 = 1/R_1 C_1$$

$$\omega_0^2 = \alpha_1 \alpha_2, F_0 = 1/2\pi (R_1 R_2 C_1 C_2)^{1/2}$$

$$R_4/R_3 = (\alpha_1 + \alpha_2)/\alpha_3 = C_2/C_1 + R_1/R_2$$

$$Q = \omega_0 / (1 - K)(\alpha_1 + \alpha_2 + \alpha_3) \text{ or}$$

$$K = 1 - \omega_0 / Q(\alpha_1 + \alpha_2 + \alpha_3).$$

Again these equations are simplified by letting  $R = R_1 = R_2$  and  $C = C_1 = C_2$ . As a result,  $F_0 = 1/2\pi RC$ ,  $R_4/R_3 = 2$ ,  $K = (3Q - 1)/3Q$ ,  $Q = 1/3(1 - K)$ ,  $R_5/R = 3Q/(3Q - 1)$  and  $R_6/R = 3Q$ .

To complete the design, select R and C for the highest null frequency. Specify  $R_3$  and Q, and calculate K,  $R_1$ ,  $R_5$  and  $R_6$ . Add dual potentiometers  $R_{7A}$  and  $R_{7B}$  to obtain frequency variability. The lowest frequency,  $F_L$ , can be calculated from the equation

$$F_L = F_0 R / (R + R_7).$$

Resistor  $R_4$  provides a null balance to accommodate tracking errors due to  $R_7$ .

A Q-multiplied version of Fig. 3c would require a parallel RC network (equal to  $nZ_3$ , where n is a function of Q) as the positive feedback element. The disadvantages of the additional capacitance include possible op-amp oscillation. Another possible null network is Fig. 3a with  $Z_1$  and  $Z_2$  interchanged. Although it possesses a real frequency null, its transfer function,  $G(s) = K(s^2 + \omega_0^2)/s$ , has poles at  $F = 0$  and  $F = \infty$ . Hence it is unsuited to our application. ■■



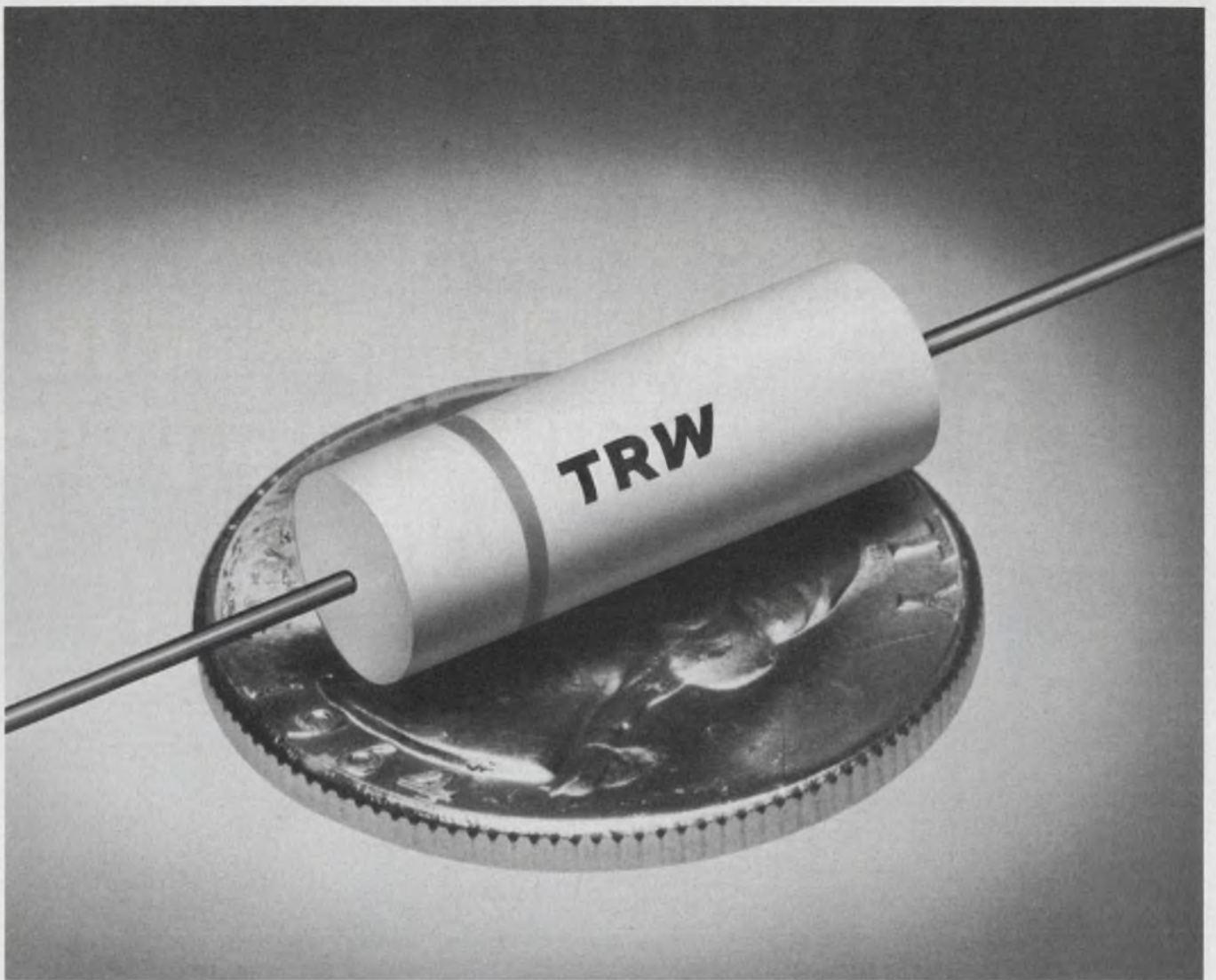

## Pay a little more for our products. Get more for yours.

In wound film and solid tantalum capacitors, TRW offers you a capability second to none. For one simple reason.

We figure you can't make quality capacitors and me-too capacitors under the same roof. Because sooner or later, one operation will foul the other one up. So we take the quality route. Count on it.

Count, too, on some shirt-sleeve-minded guys who can understand what *you're* talking about when you have a capacitance problem. R&D, design, QC, application engineering, packaging . . . they've *been there*. No blue sky.

All this will cost you a little more per capacitor. In return, it can help *your* product earn a reputation for "no headaches, no surprises." What better edge in today's marketplace?

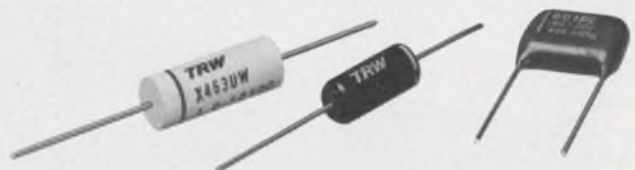

TRW Capacitors, an Electronic Components Division of TRW, Inc., Box 1000, Ogallala, Nebraska 69153.

# TRW<sup>®</sup> CAPACITORS

INFORMATION RETRIEVAL NUMBER 56



**Before we wrote the only  
Computer User Plan, we built  
today's best planned computer.**

**The Prime 300.**

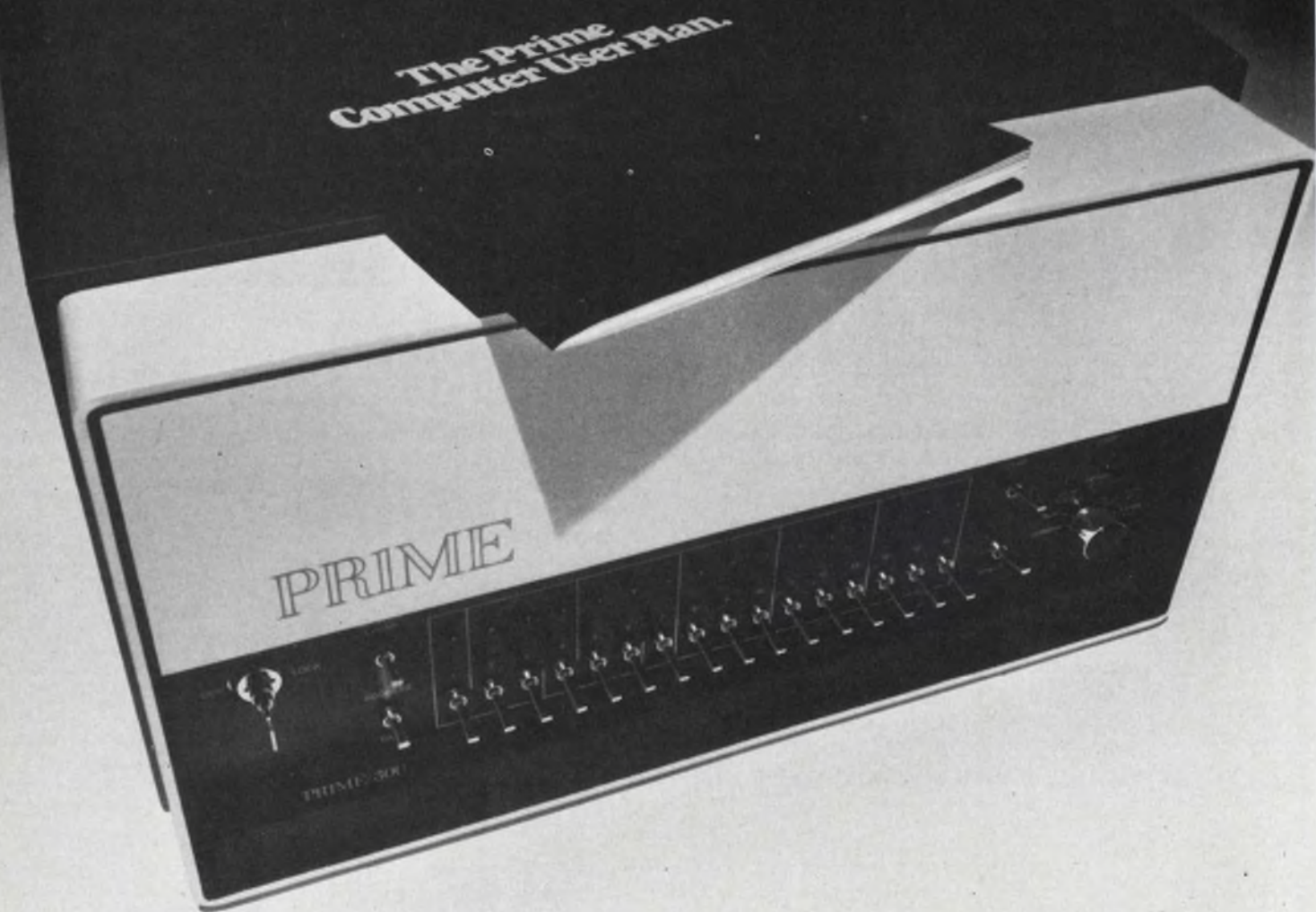



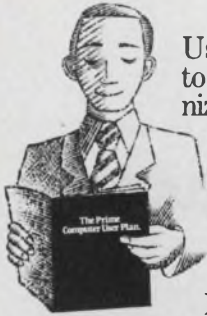

The Prime Computer User Plan brings common sense to buying a computer. It recognizes the simple fact that your needs might change someday.

The Plan introduces the first two-year guaranteed trade-in policy. It details the upward and downward compatibility features only Prime offers. In short, it gives

every assurance you can always put a Prime system to use.

We consider The Plan a new way to buy, use and upgrade computer systems. We also give you the systems to consider: The Prime 100, 200 or 300. The chart below is a preview of what to expect in each.

Standard Processor Features	
Prime 300 Central Processor (1 board)	<ul style="list-style-type: none"> <li>Virtual Memory – automatic paging, mapped address translation to 256K words, restricted execution mode, and memory protect.</li> </ul>
Prime 200 Central Processor (1 board)	<ul style="list-style-type: none"> <li>Stack Procedure Instructions</li> <li>Micro Verification Routines**</li> <li>Hardware Multiply/Divide and Double Precision Arith.*</li> <li>DMC/DMT Capability*</li> <li>Automatic Program Load From Input Devices (PTR, TTY, CR, MT, Disk)*</li> </ul>
Prime 100 Central Processor (1 board)	<ul style="list-style-type: none"> <li>Memory Byte Parity</li> <li>Processor Byte Parity</li> <li>Full Addressing Modes – direct, indirect, and indexed in both sectored and relative modes</li> <li>Virtual Instruction Package (VIP) – automatic trapping of unimplemented instructions and substitution of functionally equivalent software subroutines.</li> </ul>
	<ul style="list-style-type: none"> <li>8-Channel Programmable DMA</li> <li>4 Channel Full Duplex Asynchronous Serial Interface</li> <li>Multi-level Vectored Priority Interrupt System</li> </ul>
	<p>* Optionally available on Prime 100 and 200</p> <p>**Optionally available on Prime 200</p>

The chart suggests there's a little 300 in every Prime computer. Naturally, we planned it that way. Our 300 is just the reverse of the big box with a little computer inside.

Other 300 features will tell you just how big it is. For instance, there's high-speed MOS memory with 32K words per board. Up to 256K words per system. There's floating point arithmetic and writable control store, too. In short, there's everything you'll need in the computer you can plan with. Work out a multi-function system or plan a multi-user arrangement. The diagram that follows is just one way to go.

The Prime 300 supports a multi-user, virtual memory Disk Operating System (DOS VM) and a foreground/background Real Time Operating System (RTOS VM).

A Prime 300 with virtual memory easily accommodates over a dozen users. What's more, each is guaranteed 64K words of virtual memory available to program in FORTRAN, BASIC, Macro Assembler and Micro Assembler.

The system files and paging space are all provided by cartridge disk. Our new diskettes offer low cost storage for personal user files.

A Prime 300 is good. How good can best be seen in The Plan. It shows how to upgrade from the 100 right on to the 300. In the process, you don't change software. The time and expense of reprogramming are gone. You can also use the 300 as a software development system. The software will run on 100's or 200's without modification. The Plan guarantees this kind of system compatibility.

The Plan also goes into system integrity features. Memory Byte Parity and Processor Byte Parity are standard in the Prime 300. Micro-verification routines (also standard) and controller loop-back allow you to isolate faults to a single board.

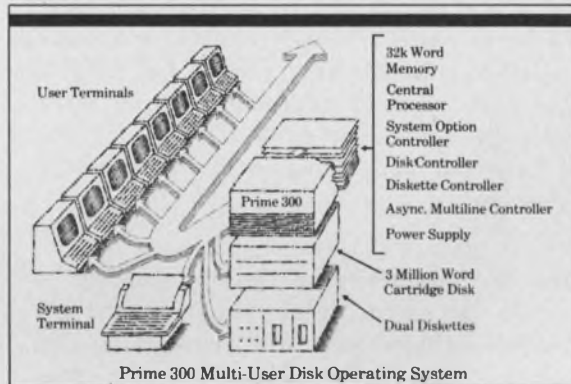

The Plan then spells out our total service options. They run from comprehensive on-call service contracts to Prime's unique Air Spare System. With Air Spare, we'll air express, for a minimal charge, any backup boards you may need from our nearest service center. We'll make repairs on faulty boards and have them back in no time. Meanwhile, you'll be operating full-time thanks to Prime.

There's more to The Plan. The best way to discover how much is to have your own. Send for it. The coupon below, like the Prime 300, will make it all possible.

To: Prime Computer, Inc.  
23 Strathmore Rd.  
Natick, Ma. 01760

- Send The Plan  
 Send the Planner  
(He'll call for an appointment.)

Name \_\_\_\_\_  
Title \_\_\_\_\_  
Company \_\_\_\_\_  
Address \_\_\_\_\_  
City \_\_\_\_\_ State \_\_\_\_\_ Zip \_\_\_\_\_

**PRIME**



## Every new engineer needs a design guide.

This engineering chief offers a primer checklist that he says will lead to better competitive products quicker.

*If you don't want something strongly enough to make a full effort to get it, making a partial effort can be a waste of time. Designing a competitive product calls for just such a full effort. One of the best ways to approach the job is to follow a step-by-step design guide. Here is a guide that will help the new designer build a better product quicker.*

**Compare the competition:** Before starting a design, study in great detail the competitor's product; it will prevent you from reinventing the wheel. You may also find weaknesses in the competitor's design that you can improve on in your own.

**Use published circuits:** All engineers have pride and are reluctant to use known or published circuits. If you can reduce product cost or improve performance, use original design. But using published circuits, which are usually pretested and stable, often minimizes exhaustive reliability tests. And published circuits can be modified to suit most design needs.

**Don't let problems delay the project unnecessarily:** If problems arise in the design of circuits, don't hesitate to ask for help. The important thing is not to let the problem linger long enough to cause a delay. Another approach is to forget the problem for the time being and go on to some other part of the circuit. While you're working, perhaps the answer to the problem will come to you. At least doing it this way will not delay the project.

**Be flexible:** If you have difficulty getting a circuit to perform its intended function, don't waste too much time on it. Try another approach. Even if you finally get the difficult circuit to work, its performance will probably be

marginal anyway. Using the right circuit will give you performance with plenty of reserve.

**Test each stage of your design:** Don't waste time breadboarding a circuit until you're sure it will work on paper. Breadboard one stage at a time. Make sure that each stage is working well before going on to the next. Temperature-test each stage with the heat gun and the cold spray. If each stage is temperature stable, the entire unit will be stable. This will also minimize final temperature tests when the unit is completed. It's much simpler to temperature stabilize one stage at a time than it is a completed unit.

**Keep the design simple:** Simple circuits are less costly and relatively stable. Don't get involved in complex compensation circuits because they will cause problems in production. Good circuits don't need compensation.

**Learn when to stop designing:** An engineer can work on a design for many months or even years and strive for perfection. And yet someone may come along the day it's completed and improve it or find fault with it. Meanwhile the market for it is gone, because the product is obsolete and the development time and cost go down the drain. Finish your designs as quickly as possible by asking yourself two questions: "Will it do the job it's supposed to do?" and "Is it as good or better than our competition?" If the answers are yes, let it go.

**Involve production during the design stage:** When the engineering prototype model is complete, many companies normally call in production people to decide if it's producible. If changes are recommended, the project engineer may be reluctant to make them, since the unit is already designed and one design change may lead to another. Involve production specialists at the top of the project. Ask them for their ideas on layout. You'll be surprised at their cooperation. When you hold your prototype meetings, you'll

---

Walter J. Cerveny, Manager of Electronic Engineering, Triplett Corp., Bluffton, Ohio 45817.



## Walter J. Cerveny and Triplett Corporation



Walter J. Cerveny realized the value of management experience early in his engineering career. Fifteen years ago he started setting goals and standards of performance, and schedules for engineering projects and later he learned to set up engineering budgets and to participate in product planning. He was probably one of the first engineers in the country to be a member of both IEEE and the American Management Association.

After he had become an aircraft mechanic at General Airmotive in Cleveland in 1941, his engineering career was postponed by World War II. He attended USAF Radio School. When he left the service, he enrolled at the American Institute of Engineering and Technology where he earned a B.S.E.E. Subsequent courses in NTSC Standards and in Electronic Circuits at Penn State helped him to further prepare for a career in electronics.

He designed and/or directed the design of over 70 products in the instrumentation and communication fields for three companies, including The Hickok Electrical Instrument Company; Amphenol Corporation; and Triplett

Corporation. The majority of the new products were proprietary designs on which the combined sales amounted to approximately 36 million dollars.

Some of Cerveny's other accomplishments include: Chairman of a National Subcommittee on Digital Panel Instruments for the National Electrical Manufacturers Association; a semiconductor preconditioning and test program to screen potential device failures, thereby improving product reliability; seven instrument circuit patents; many articles on instrumentation and design for various trade publications. He also wrote a book entitled "Facts on Transistors."

His present employer, Triplett, makes meters, VOMs and electronic test equipment. Founded in 1904 by R. L. Triplett, the company developed one of the first tube testers in the mid-20s, multimeters in the early 30s, and a complete line of test instruments after World War II.

Cerveny has pioneered instrumentation for color TV, developing both the first NTSC color bar generator for the service field, and a complete line of color TV instrumentation. He also has pioneered a line of FET VOMs.



## Outline for a project work plan

The following ingredients are integral parts in the organization of a design project:

- Start and completion dates—plus all key dates, when sales sample will be ready, tooling start, etc.

- Complete description of product proposed. Target specifications and selling price.

- Total cost of project—estimate to include manpower, tooling, special equipment, books, etc.

- Proposed packaging concept.

- Tooling and special equipment needed.

- Manufacturing methods and process.

Detailed scheduling of the project calls for the following 20 steps:

1. Theoretical phase.

2. Breadboard phase.

3. Tests for performance and specifications.

4. Engineering model.

5. Packaging designs.

6. Drawings.

7. Environmental tests.

8. Release of drawings and parts list for purchase of components for production run.

9. Manual draft.

10. Illustrations for manual.

11. Release of manual to printer.

12. Calibration and inspection procedures.

13. Design of fixtures—test equipment and tooling for production.

14. Building of production sample.

15. Pilot run of 5 to 25 units (build).

16. Pilot run debugging and tests.

17. Field tests.

18. Training of production personnel.

19. Final changes.

20. Release to production.

get their blessings. You'll save labor costs, because you won't have to make so many changes after the prototype is finished.

**Keep tooling costs down:** New tooling is expensive and isn't worthwhile unless you're producing 10,000 or more pieces. There are a few exceptions to this, but, generally speaking, try to use miscellaneous tooling that is available in your plant.

**Keep the cost of material and labor low:** These savings are best achieved in the design stage. Consider the number of parts you use. In designing circuits it's easy to reach your goal with a classical approach. This may save design time, but the circuit will contain many more parts than are needed.

You can save on parts by doing the following:

- Match the impedance of one stage to another. This will result in more efficient power transfer and therefore fewer stages or parts.

- Use higher-gain transistors and fewer stages.

- Combine multiple functions in one.

- Look for new devices as they are introduced. They may allow you to do more with less.

- Use published circuits and simple circuits.

- After you complete a circuit, examine it again for further simplification.

- Don't specify parts that are available from only one vendor.

Following are some labor-saving suggestions:

- Minimize the number of wire interconnec-

tions. Include most wiring on the PC board.

- Make a good switch layout that minimizes the number of connections around the switch.

- Lay out the unit in sections, so it can be put together with subassemblies.

- Eliminate machining operations, such as tapped holes, milling and turning.

- Eliminate or minimize painting and plating; use pre-plated stock and plastic parts.

- Consider the production worker; try to visualize how he would put it together.

- Use speed nuts and rivets wherever possible.

**Simplify mechanical design and drafting.** This is where 60% to 70% of project time is spent, mainly because each product requires many drawings. There are three ways you can save here: (1) Simplify drawings as much as possible; don't include unnecessary detail. (2) Use word drawings wherever possible, and never make final drawings when the product is in the early design stages. (3) Make only rough sketches to get a model or two built. After the models are debugged and modifications are made, then start final drawings.

Also, before you start to design any mechanical parts, such as brackets, chassis and screw-machine parts, make a brief search of available products. Perhaps an existing part can be used. This will save time, increase the quantity of the part and reduce its cost.

A final word: Work tends to expand to fit the time allowed. A good habit to form is to commit yourself to a deadline and then set out to prove the job can be done. ■■



# BOURNS® SPACE SAVER CERMET CONTROLS



ARE—

**INTERCHANGEABLE WITH CTS 550 and 600** — Series 3852 is an exact CTS 550 replacement with less space required; Series 3859, ordered with a plastic bushing, also is interchangeable and costs even less. Series 3862 is interchangeable with the CTS 600 and is a better 1/2 inch diameter control.

**THIN** — Cut the bulk out of your new design... try the controls with the thinnest back-panel profiles in the industry — 1/4".

**QUIET** — CRV is conservatively specified at 3% of total resistance. Actually it's substantially less on most units.

**CERMET** — This provides the designer with BETTER STABILITY, HIGHER POWER-RATING, AND A  $\pm 150$  ppm/°C TEMPCO.

## COMPETITIVELY PRICED

SERIES	100 piece quantity*	2000 piece quantity*
3852	\$1.56	\$ .81
3859	1.27	.66
3862	2.20	1.18

**AVAILABLE** — All three Series, including their various shaft, bushing, and shaft-end styles, are stocked in-depth at each of 73 Bourns distributor locations. Delivery on standards is 24 hours.

## LOOK AT THE SIGNIFICANT SPECS —

	MODEL 3852/3859	MODEL 3862
Power Rating	2 watts at 70°C	1 watt at 125°C
Temperature Coefficient	$\pm 150$ ppm/°C	$\pm 150$ ppm/°C
Diameter	3/4"	1/2"
Depth Behind Panel	1/4"	1/2"
Resistance Range	50 $\Omega$ to 5 megohms	100 $\Omega$ to 5 megohms
Resistance Tolerance	$\pm 10\%$	$\pm 10\%$
Bushing	metal and plastic, locking and non-locking, plus snap-in	metal; locking and non-locking

\* Prices are U.S. Dollars, F.O.B., U.S.A.

**FOR A COPY OF OUR COMPREHENSIVE 22-PAGE BROCHURE, OR TO ENTER YOUR ORDER, CONTACT YOUR LOCAL BOURNS SALES OFFICE, DISTRIBUTOR, OR THE FACTORY-DIRECT.**



TRIMPOT PRODUCTS DIVISION • 1200 COLUMBIA AVE., RIVERSIDE, CALIF. 92507

INFORMATION RETRIEVAL NUMBER 58





GENERAL  ELECTRIC



# All Time Meters are not created equal.



Only General Electric gives you reliability like this . . .

Our new Type 240 elapsed-time meters are recognized under the Component Program of Underwriters' Laboratories, Inc. Inside is a GE Telechron synchronous motor with proven dependability, and the all-new time-keeping mechanism never requires maintenance. Even the outside case is made of tough GE Noryl® for impact resistance. When you specify GE time meters, you can stop worrying about reliability.

Resetting is easy . . . just push the button.

Reset your hours or minutes indicator to zero simply by pushing the button. No knobs. No wasted motion. Just fast and accurate resetting every time. Push-button reset is available on Type 240 in behind-panel or BIG LOOK® style in 2½" and 3½".

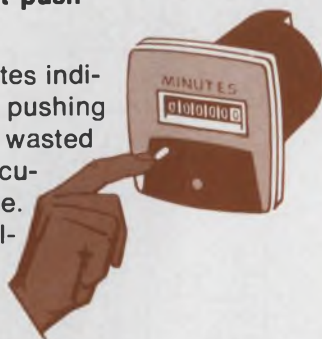

GE time meters go where you want.



Slip the new Type 240 into *existing* mounting holes . . . just order from a variety of optional mounting-stud positions. And no new punching or dimensional drawing changes are needed to replace older GE Type 235 or 236 time meters. You can replace whatever you're using with new Type 240's. And get crisp, readable style to improve your panel or equipment.

The time meter you need is ready.

There's the all-new, behind-panel model (with glass window) for a neat, trim look. Or the wide-eyed BIG LOOK style that matches your other GE panel meters. Or choose the weather-proof conduit case, the round case, the square case, or the portable-stand case. In 120, 208, or 240-volts a-c and 50 or 60 Hertz. No one can match your design requirements like General Electric.



For a catalog of GE's full line of panel meters, contact your nearby authorized GE Distributor, Modification Center, or GE Sales Office. Or write to General Electric Company, Section 592-46, One River Road, Schenectady, N.Y. 12345.

**Specify  
General Electric...  
just for good measure.**



## Timer/counter chip synthesizes frequencies, and it needs only a few extra parts

The XR-2240 monolithic timer/counter, manufactured by Exar, can be used as a frequency synthesizer because it can both multiply and divide an input reference frequency.

It can multiply simultaneously the input frequency by a factor  $M$  and divide it by a factor  $N + 1$ , where both  $M$  and  $N$  are selectable integer values. Therefore the circuit can produce an output frequency:

$$f_o = f_R [M / (1 + N)],$$

where  $f_R$  is the input reference frequency. And  $M$  and  $N$  can have any integral value:

$$1 \leq M \leq 10 \text{ and } 1 \leq N \leq 255.$$

The multiplication factor,  $M$ , is derived when the 2240's internal time-base oscillator locks onto harmonics of the input frequency. The division factor,  $N$ , is determined by a preprogrammed count of the unit's binary counter section.

When there is no external reference input, the circuit's oscillator runs free at  $f_s = 1/RC$ .  $R$  and  $C$  are external components connected to pin 13. The unit's internal 8-bit binary counter can be programmed to divide this frequency so that

$$f_o = f_s [1 / (1 + N)].$$

The time-base oscillator should run free at a frequency near  $M$  times the input frequency. Then the oscillator can synchronize with the  $M^{\text{th}}$  harmonic of  $f_R$ . The typical capture range of the circuit is better than  $\pm 3\%$  for values of  $1 \leq M \leq 10$ . The time-base can hold accurately to within  $\pm 0.5\%$  of the setting, so a given harmonic doesn't have a problem of remaining in synchronism. The recommended waveform for  $f_R$  is a 3-V-pk-pk pulse train with a duty factor of 30 to 80%.

The divider modulus,  $N$ , is chosen by the connection of selected counter outputs to a 3 k $\Omega$  common pull-up resistor. The output waveform is a pulse train with a fixed pulse width,  $T = RC$ , and a period  $T_o = (N + 1) RC$ . An external 3-stage delay network, between the output and the trigger and reset terminals of the XR-2240, resets and retriggers the circuit to maintain a

periodic output waveform. For the network component values shown in the figure, the circuit can operate with the timing components in the range of

$$0.005 \mu\text{F} \leq C \leq 0.1 \mu\text{F}; 1 \text{ k}\Omega \leq R \leq 1 \text{ M}\Omega.$$

The XR-2240 is a low-frequency device whose maximum output frequency is limited to  $\approx 200$  kHz.

In a particularly useful application, the circuit generates stable clock frequencies that are synchronized to the 60-Hz line. For example, you can generate a 100-Hz reference by setting  $M = 5$  and  $N = 2$ , so that

$$f_o = (60) 5 / (1 + 2) = 100 \text{ Hz.}$$

Dale T. Pohlman, Exar Integrated Systems, Inc., Sunnyvale, Calif. 94086. CIRCLE NO. 311

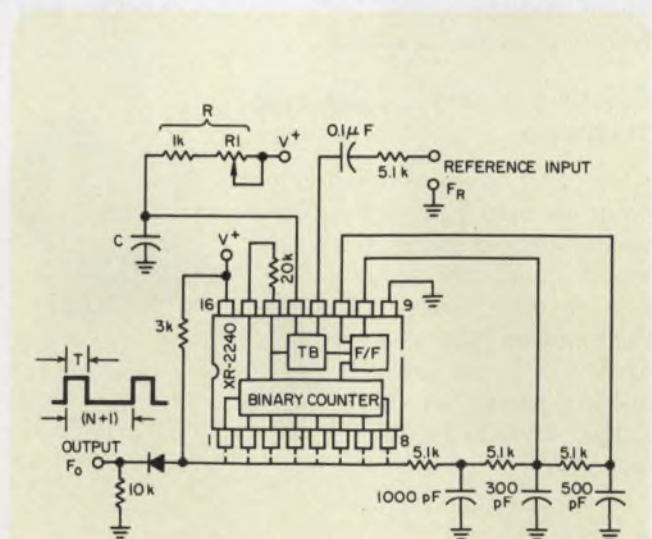

Variable resistor  $R$ , adjusts the RC time constant to lock the timer/counter's internal oscillator to the  $M^{\text{th}}$  harmonic of the reference frequency  $f_R$ . The dividing factor,  $N$ , is determined by the unit's binary counter.





## Just arrived! Our 12-bit CMOS DAC.

Our new baby's a beauty. With 12-bit resolution and *guaranteed* linearity of  $\pm\frac{1}{2}$  LSB in 10 bits over  $-55^{\circ}$  to  $+125^{\circ}\text{C}$ .

We've christened it Model 872, and it's a *complete* DAC. CMOS input logic, R-2R ladder, micropower output amp, internal reference—even preset zero offset and gain—are all inside.

And all of this comes in one neat package just 1" by 1.5". Price is \$49.50 to \$66 in 200-piece quantity, depending on linearity and internal reference specs.

You might have expected it, considering that we're one of the country's major suppliers of DACs...and among the leading hybrid manufacturers, too. We make a lot of standard hybrids, but we're also great problem-solvers in custom situations.

If you need immediate technical literature or the telephone number of your local Beckman/Helipot representative, call toll-free (800) 437-4677.

**Beckman**<sup>®</sup>  
HELIPOT DIVISION



# Fine control of high-power voltage with a low-current variable transformer

Two filament transformers and a low-current variable transformer can provide linear adjustment of high-power line voltage between selected limits.

The need for a limited range of line-voltage control—between, say, 105 and 130 V—arises very frequently in the design, testing and servicing of electronic equipment. The voltage can be controlled with a conventional variable transformer, but this has many shortcomings—such as the high cost of high-current units and the use of only a fraction of the total range, resulting in poor control definition. Each step between turns of the variable transformer's winding represents a high percentage of the limited voltage range you are seeking, which makes it difficult to set to a specific voltage.

With the circuit shown, the full dial of the variable transformer covers the entire limited control range. The circuit does this with two low-cost filament transformers. The filament transformer secondaries should have current ratings that are equal to or greater than the load current, and their combined voltages should equal the difference between the desired low and high limits.

For a 105-to-130-V range, if the nominal line voltage is 117.5 V, each secondary should be 12.5

V. Thus you get an output of  $117.5 \pm 12.5$  V. In the circuit shown, the nominal line voltage is 124 V, so the aiding secondary must be 6 V and the bucking secondary 19 V.

The variable transformer's current rating needs to be high enough to carry only the larger of the two transformer primary-winding currents. This is roughly equal to the load current divided by the filament transformer's voltage ratio.

*John T. Bailey, 86 Great Hills Rd., Short Hills, N.J. 07078.*

CIRCLE NO. 312

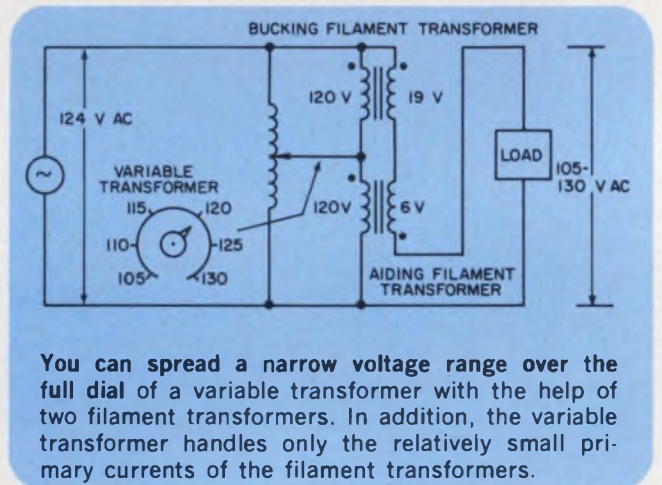

# Single EXCLUSIVE-OR quad produces complementary spikes from clock pulses

A single SN7486 or CD4030 can be used to produce both positive and negative-going spike pulses that correspond to the leading and trailing edges of rectangular clock pulses. The circuit shown is more reliable and economical than the one-shot or differentiator circuits that are often employed. The sharp spike pulses find many synchronizing and timing uses in digital systems.

The gate package contains four EXCLUSIVE-OR gates.  $G_1$  inverts the input signal and delays it by roughly 10 to 30 ns. The input signal and the delayed signal are combined in  $G_2$ . The inputs to  $G_2$  are different, except for the small amount of time when the clock signal changes its state. Thus  $G_2$ 's output is always HIGH except at these transition times.

$G_2$  inverts the output of  $G_1$ , and its output is a delayed replica of the input. Since the two inputs to  $G_3$  are always the same, except during

clock transitions, the output consists of positive pulses from a LOW base line.

*Larry R. Martin, Hewlett-Packard Co., 3273 Airway Dr., Santa Rosa, Calif. 95402.*

CIRCLE NO. 313

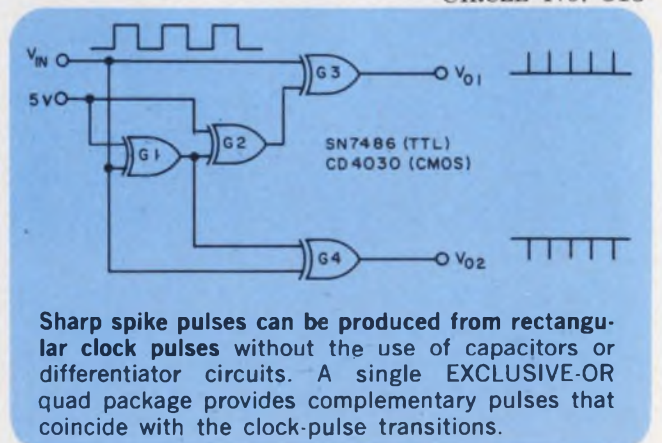



# Proven Ideal for Instrumentation Manufacturers!

## High Frequency Counters from PLESSEY.

Most leading manufacturers of 512 MHz counters have one great thing in common: Plessey high-speed divider circuits in the front end of their instruments. The reason for their unanimous choice? Plessey makes the best possible device for their application. Yours, too.

In fact, Plessey Semiconductors offers a comprehensive line of high-frequency dividers up to 1 GHz... all state-of-the-art... all ideal for virtually every counter application.

### Divide by 2, 4, 5 or 10

You can specify Plessey counter IC's to divide by 2, 4, 5 or 10. With some decade devices, you get BCD outputs, too. And you get guaranteed frequency of operation over the entire temperature range of 0°C to +70°C on commercial grades, -55°C to +125°C on MIL Grades.

### Higher Frequency, Lower Power Consumption

You've probably heard this statement from Plessey before. As usual, nobody even comes close to our input frequencies of up to 1,000 MHz. With an incredibly low power drain, as you can see from the tables.

### Plessey offers Custom Counters, too

Send for our data sheet with all the facts. Whatever your counter application, we bet you'll find Plessey has the best approach. And, in the rare case where we don't have a standard counter for your exact requirements, let us quote on a custom. For more information, write or call today. **You'll find it pays to specify Plessey.**

### YOUR CHOICE OF HIGH FREQUENCY COUNTERS

Type*	Modulus	Speed (MHz)**	Power Drain (mA typ)
SP600A & B	+4	250	16
SP601A & B	+4	150	16
SP602A & B	+2	500	12
SP603A & B	+2	400	12
SP604A & B	+2	300	12
SP607B	+2	600	12
SP613B	+4	700	60
SP614B	+4	800	60
SP615B	+4	900	60
SP616B	+4	1,000	60
SP620B	+5	400	55
SP621B	+5	300	55
SP622B	+5	200	55
SP630B	+10	600	70
SP631B	+10	500	70
SP632B	+10	400	70
SP634B	+10 w/BCD outputs	700	80
SP635B		600	80
SP636B		500	80
SP637B		400	80

\* Guaranteed operating temperature for "A" types -55°C to +125°C, "B" types 0°C to +70°C.

\*\* Guaranteed input frequency range (sine wave).

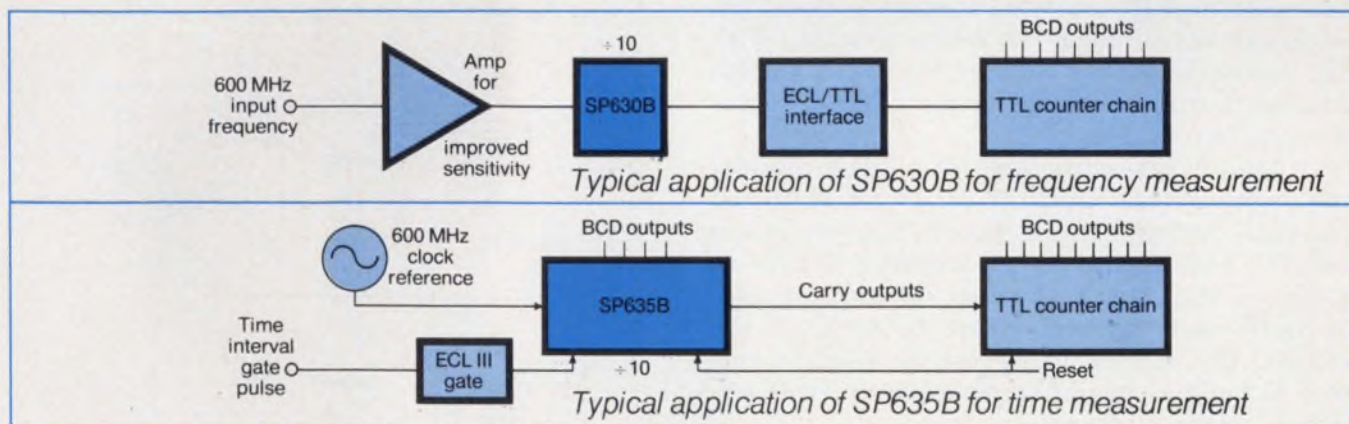

**PLESSEY SEMICONDUCTORS**

1674 McGaw Avenue, Santa Ana, California 92705, (714) 540-9945

INFORMATION RETRIEVAL NUMBER 61



# Op amps multiplex analog signals without need for FET switches

The accessibility of key internal circuit nodes allows the use of 101-type op amps for applications not often associated with op amps. For example, you can build an operational analog multiplexer that switches  $\pm 10\text{-V}$  input signals, provides over 80-dB isolation between the on and off condition and uses no FET switches.

In the simplified sketch of the internal circuitry for the LM101A (Fig. 1), the second-stage amplifier,  $Q_{10}$ , develops the full output swing at pin 8, which is then buffered by the output stage and appears with low impedance at pin 6.

A  $100\text{-}\mu\text{A}$  current source loads  $Q_{10}$ , but the circuit has the ability to sink substantially greater current—approximately  $600\ \mu\text{A}$  at room temperature. This fact raises interesting possibilities. If  $N$  (two or more) 101As are bussed together at pin 8 and all but one are disabled by holding  $Q_{10}$  off, the  $Q_{10}$  stage of the enabled op amp can sink the excess source current—which will be  $N$  times  $100\ \mu\text{A}$ —but still operate normally. The other amplifiers will not respond to their respective inputs.

To override the balanced differential input stage, a current that is much greater than the nominal stage current is forced into pin 5, and causes  $Q_6$  to saturate. This clamps  $Q_{10}$  off. This action occurs regardless of the differential input-voltage state. When the current is removed,  $Q_{10}$  again conducts and normal op-amp operation is restored.

Fig. 2 is an example of a precision multiplexer that uses no FET switches and has a closed operational loop around the active channel. With the feedback, the on channel acts as a voltage follower buffer connected to the selected source by a perfect switch.

A  $150\text{-}\mu\text{A}$  current source ( $Q_1$  or  $Q_2$ ) disables the inactive stage via  $Q_{10}$ . With all pin 8s bussed together, feedback can be taken from one of the outputs and applied to all negative inputs in common. The stage that is not disabled operates normally and transmits either  $E_1$  or  $E_2$  to the output. Up to four 101As can be used in this way to build a one-of-four multiplexer (with additional logic, of course).

Performance is limited only by the 101A parameters. The configuration is self-buffering, has a very high input impedance, can be offset-nulled in each channel and is easily programmed with standard logic elements. Isolation between off and on is over 80 dB. And once addressed, a

selected channel can be acquired at  $0.5\ \text{V}/\mu\text{s}$ , the 101A slew rate.

Walter G. Jung, 1946 Pleasantville Rd., Forest Hill, Md. 21050. CIRCLE NO. 314

## References

1. Jung, Walter G., "Transistor and Two Resistors Reduce Noise and Widen Bandwidth of 101/748 Op Amps," *ED* No. 14, July 5, 1973, p. 78.
2. Jung, Walter G., "Op Amp in Current-Differencing Mode Becomes a Noninverting Audio Mixer," *ED* No. 10, May 10, 1974, p. 130.

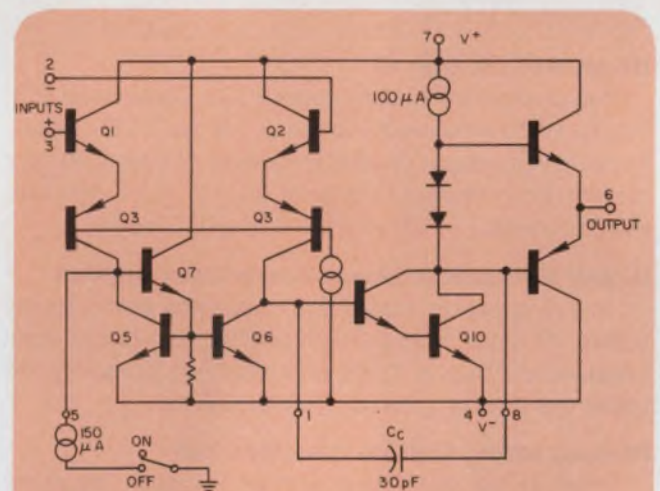

1. A 101A op amp can be enabled or disabled by a current source applied to pin 5. Application of the current saturates  $Q_6$ , which, in turn, clamps off voltage amplifier  $Q_{10}$ .

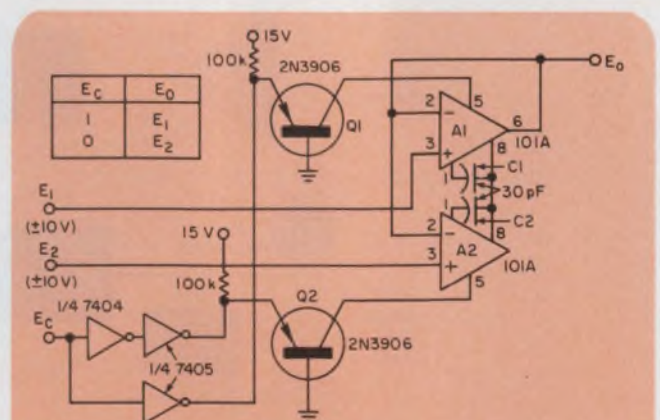

2. Precision multiplexer uses gated op-amp followers. Feedback is taken from one of the outputs, since all voltage amplifiers (pin 8s) are connected together. Transistors  $Q_1$  and  $Q_2$  provide the gating currents.



# Which of these spring contacts can you get from Instrument Specialties?

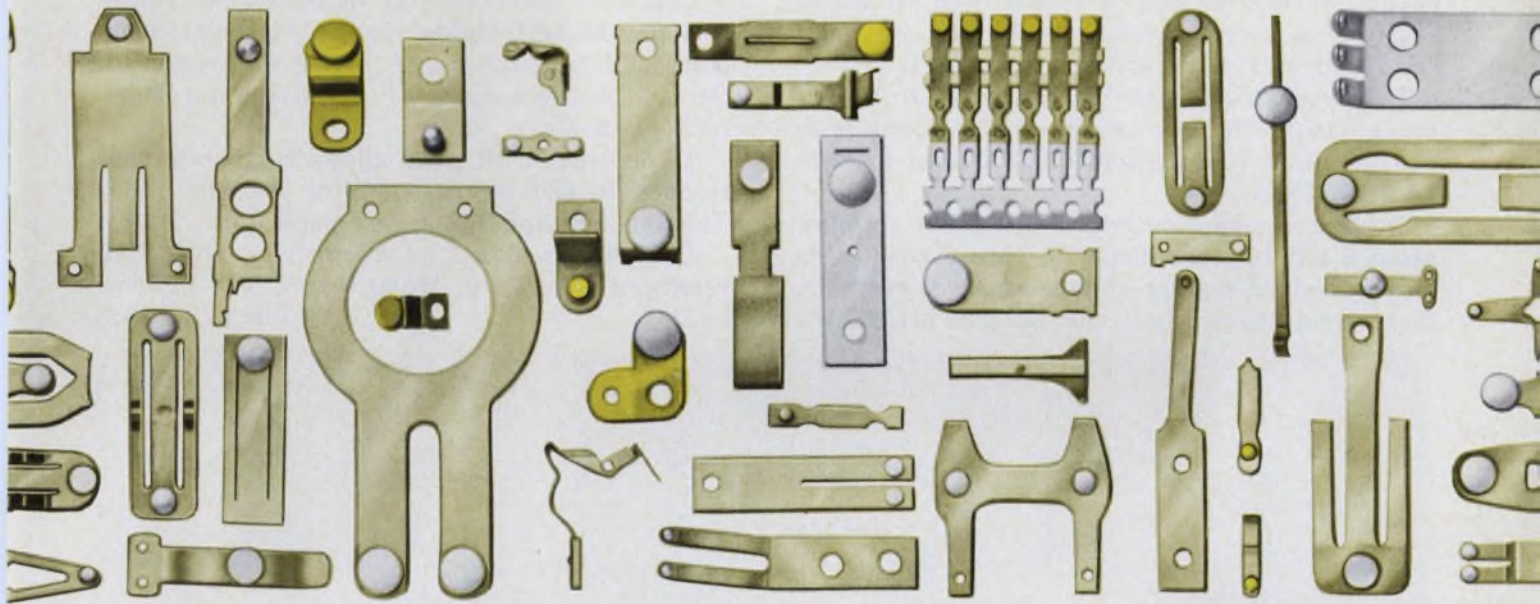

## All of 'em!

The number of different designs and combinations of springs and contacts is as boundless as your imagination. Yet, no matter what your requirements, chances are i/s can meet them. Specialists in the design and manufacture of beryllium copper springs, we can furnish these springs with your choice of many types of gold, silver or other precious metal contacts.

Perhaps you require large welded contacts in which precious metal is bonded to a layer of inexpensive material. Or, small welded contacts in which precious metal is welded directly to the spring. Or, riveted contacts offering close tolerances with either single or double headed contacts. Instrument Specialties has all of them!

One other thought: Sometimes, you may *think* you need welded or riveted contacts. However, our engineers may find that our CONTIP® bonding technique, or our gold selective plating process, can meet your needs at considerably less cost. If so, we'll tell you that, too.

Our latest catalog contains complete information on all types of i/s spring contacts. For your free copy, circle the Reader Service Card or write us at Dept. ED-51.



INSTRUMENT SPECIALTIES CO., INC.  
Little Falls, New Jersey  
Phone 201-256-3500



# Simple circuit tests coaxial cables for opens, shorts and intermittents

A simple tester can quickly detect open, shorted or intermittent coaxial cables. The circuit is sensitive to submicrosecond faults and will hold the result until the operator resets the tester.

Both ends of the cable are connected to the circuit's input BNC, or other coaxial connectors, and the Start-Test pushbutton is pressed to reset both flip-flops.

$Q_1$  is a constant-current source that supplies about 5 mA to zener diode  $D_1$  when a good cable is attached.  $D_1$ 's zener voltage of 3.3 V keeps  $D_1$  from conducting, since the latter's breakdown

voltage is a higher 6.8 V.

Thus both flip-flops stay in their reset states. And the OK-LED lights via the AND gate composed of  $D_3$ ,  $D_4$ , and  $Q_3$ . If pulling or twisting of the cable causes a short,  $FF_2$  is set and the Short-LED lights.

An open-circuited cable allows current to flow through  $D_2$  and the base-emitter junction of  $Q_2$ . This sets  $FF_1$ , and lights the Open-LED.

*J. A. Stanko, Supvr. of Electronics, State University of New York, Stony Brook, N.Y. 11790.*

CIRCLE No. 315

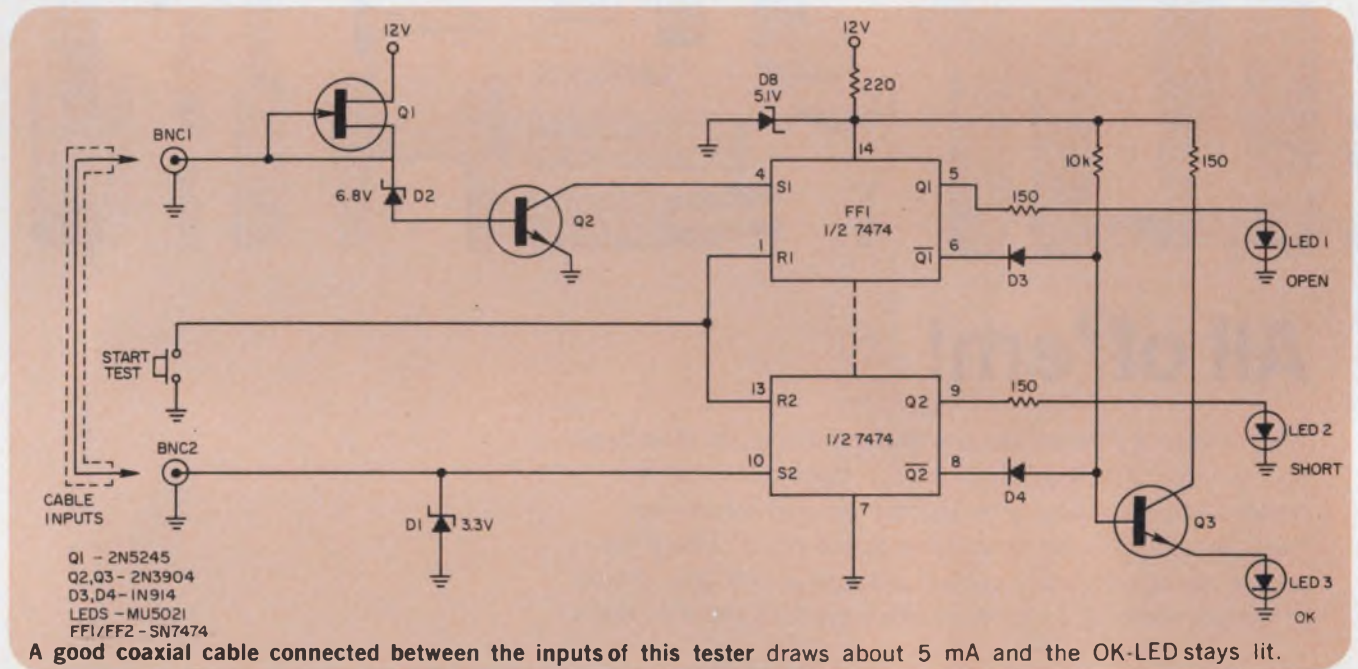

## IFD Winner of February 15, 1974

Gary Steinbaugh, Engineer, Westinghouse Research Laboratory, Pittsburgh, Pa. 15235. His idea "Character-Generation Circuit Uses Single Y-axis Scope Input to Display Alphanumerics" has been voted the Most Valuable of Issue Award.

Vote for the Best Idea in this issue by circling the number for your selection on the Information Retrieval Card at the back of this issue.

**SEND US YOUR IDEAS FOR DESIGN.** You may win a grand total of \$1050 (cash)! Here's how. Submit your IFD describing a new or important circuit or design technique, the clever use of a new component or test equipment, packaging tips, cost-saving ideas to our Ideas for Design editor. Ideas can only be considered for publication if they are submitted exclusively to ELECTRONIC DESIGN. You will receive \$20 for each published idea, \$30 more if it is voted best of issue by our readers. The best-of-issue winners become eligible for the Idea of the Year award of \$1000.

ELECTRONIC DESIGN cannot assume responsibility for circuits shown nor represent freedom from patent infringement.



# MORE SWITCH FOR THE MONEY.

## NOW YOU CAN SPECIFY PRACTICALLY ANY CUSTOM PUSHBUTTONS ON SWITCHCRAFT'S DW "Multi-Switch®"

There's almost no limit to the variety of pushbuttons you can use on this space-saving, multiple-station pushbutton switch. It has a newly designed "Cross-Rib" actuator located on each module

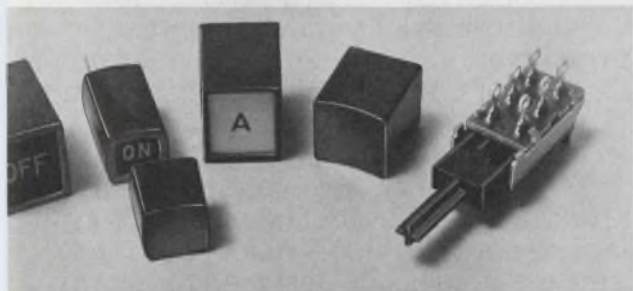

that makes the switch more versatile than ever.

The "Cross-Rib" actuators conform to industry standards and are furnished  $\frac{3}{4}$ " and  $\frac{1}{8}$ " long to accommodate different size pushbuttons. They solve many operator-machine interface problems

when used with Switchcraft non-illuminated "Dual," "Showcase," concave or convex face, rectangular, round or square pushbuttons, or the unique "Glo-Button" that achieves simulated illumination.

## MORE QUALITY FOR THE MONEY.

In a nutshell, the Series 70000, 71000 DW "Multi-Switch®" is an economical 1 to 18 station switch, that offers up to 4 PDT switching per station; Interlock, All-Lock, Non-lock or Push-lock/ Push-release functions, plus an almost unlimited variety of electromechanical and electrical accessory options. These switches are adaptations of the Switchcraft Series 65000 DW "Multi-Switch®" switches that

are noted for their simplicity, economy and reliability.

## DW POWER MODULES FOR HEAVY CURRENT SWITCHING

For "on-off" power switching, motor control and a variety of other high-current

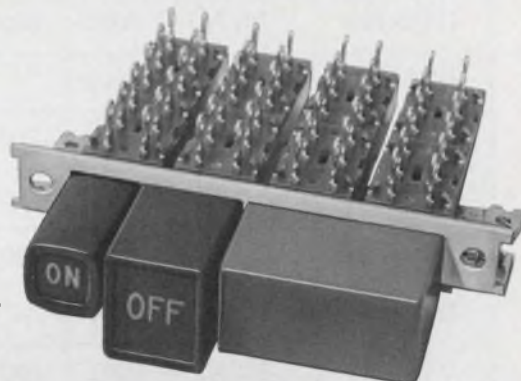

applications, specify a DW Power Module—one per station maximum. Turret terminals are brass with tin-lead coating. The snap-action switch is Form 1-C rated at 11 amps, and is U.L. and C.S.A. listed. The mounting brackets and insulating shields are designed to meet those same requirements.

## YOUR FREE DICTIONARY

We publish a handy dictionary of switching and connecting terminology. Write us for your free copy and we'll also put you on the list for TECH-TOPICS. Over 12,000 engineers find the application stories in this technical review extremely helpful. SWITCHCRAFT, INC., 5529 N. Elston Avenue, Chicago, Illinois 60630



**SWITCHCRAFT**  
INC.

INFORMATION RETRIEVAL NUMBER 63

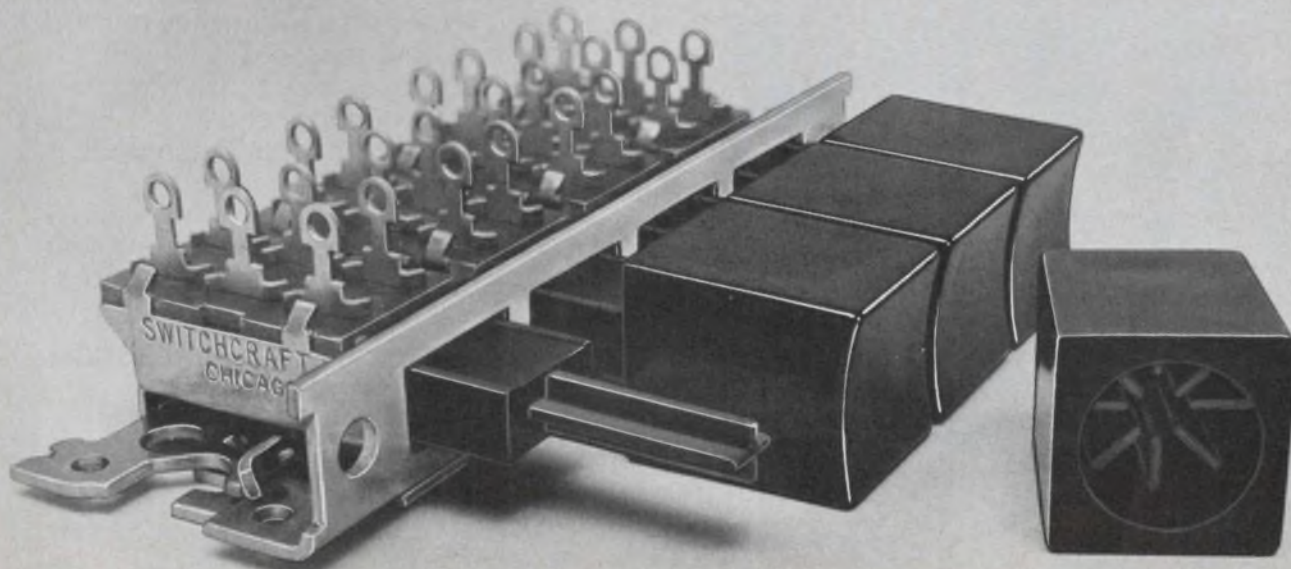



# NEW VALUES HIGH ENERGY

TYPE	$I_C(\text{max.})$	$V_{CE0}$	$V_{CEV}$	$V_{CE0(\text{BUR.})}$	$V_{CE(\text{sat.})}$ @ $I_C, I_B$	Power Dissipation (max.)	$h_{FE}$ min./max. @ $I_C, V_{CE}$
DTS-701	1.0 A	800V	—	600V	—	50W	20/— @ 150mA, 5V
DTS-708	3.0 A	900V	900V	600V	2.0V max. @ 1.0A, 250mA	50W	—
DTS-709	3.0 A	900V	900V	600V	1.0V max. @ 2.0A, 800mA	50W	—
DTS-710	3.0 A	900V	—	600V	—	50W	10/50 @ 150mA, 5V
DTS-712	3.0 A	900V	1200V	700V	—	50W	2.5/— @ 2.0A, 5V
DTS-714	3.0 A	900V	1400V	700V	—	50W	2.5/— @ 2.0A, 5V
DTS-723	3.0 A	1000V	1200V	750V	0.8V max. @ 1.0A, 250mA	50W	10/— @ 500mA, 5V
DTS-801	2.0 A	800V	—	700V	—	100W	20/— @ 200mA, 5V
DTS-812	5.0 A	900V	1200V	700V	—	100W	2.2/— @ 3.5A, 5V
DTS-814	5.0 A	900V	1400V	700V	—	100W	2.2/— @ 3.5A, 5V

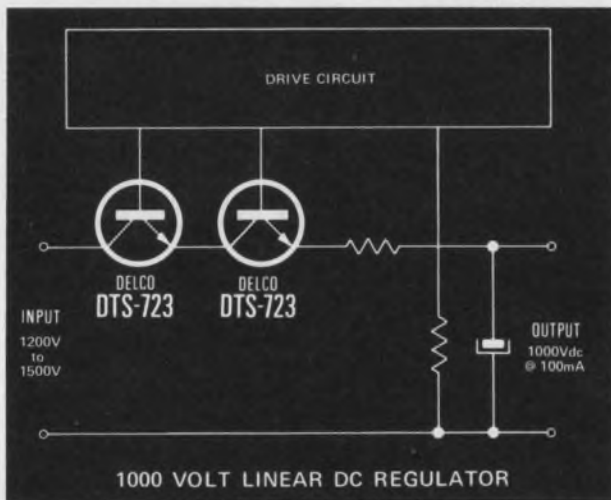

APPLICATION NOTE 45

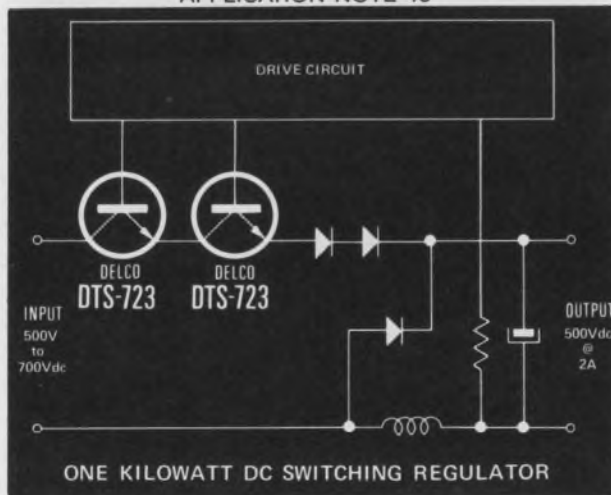

APPLICATION NOTE 46

Delco Electronics has made it possible for your Delco distributor to offer you better values than ever on these ten silicon high-power transistors. What's more, he has them in stock now and there's a healthy factory inventory to back him up.

These high quality, high voltage devices are all NPN, triple diffused, and packaged in Delco's solid-copper TO-204MA (TO-3) case.

Some are specifically designed for use in high voltage switching circuits where inductive loads or fault conditions pose problems. Some are ideal for linear regulators and power amplifiers.

In fact, all the devices share Delco's reputation for being ideal where circuit conditions and high energy requirements are a concern. And because they're 100 percent pulse energy tested, you know they're rugged.

The circuit diagrams in this ad will give you a quick reading of how these ten transistors can meet your needs.

Applications literature and complete device data are available from your Delco distributor.

Give him a call for the information you need and the delivery promises and prices you'll like.

**NOW AVAILABLE FROM THESE DISTRIBUTORS  
IN PRODUCTION QUANTITIES.**

**ALABAMA, Birmingham**  
Forbes Distributing Co., Inc.  
(205) 251-4104

**ALABAMA, Huntsville**  
Powell Electronics  
(205) 539-2731



# ON DELCO'S TRANSISTORS.

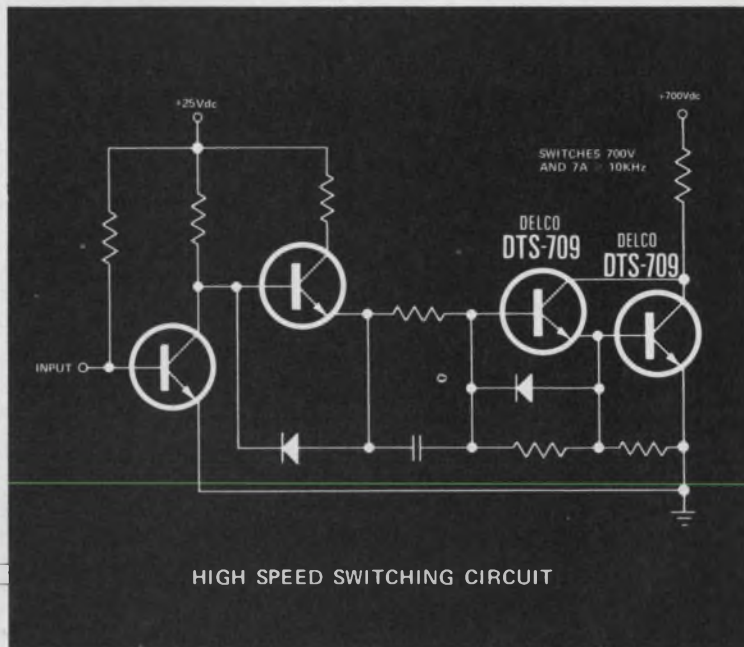
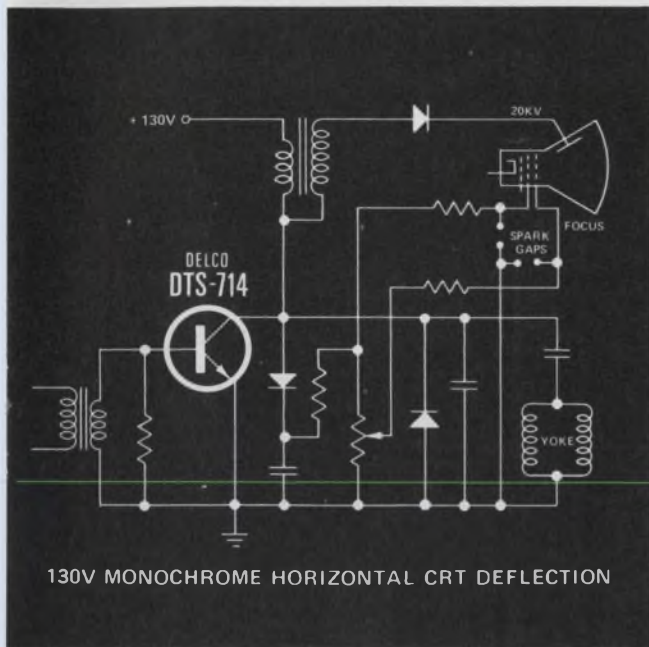

APPLICATION NOTE 54

**ARIZONA, Phoenix**  
Sterling Electronics, Inc.  
(602) 258-4531

**CALIFORNIA, Goleta**  
R.P.S. Electronics, Inc.  
(805) 964-6823

**CALIFORNIA, Los Angeles**  
Kierulff Electronics, Inc.  
(213) 685-5511

**CALIFORNIA, Los Angeles**  
R.P.S. Electronics, Inc.  
(213) 748-1271

**CALIFORNIA, Palo Alto**  
Kierulff Electronics, Inc.  
(415) 968-6292

**CALIFORNIA, San Diego**  
Kierulff Electronics, Inc.  
(714) 278-2112

**CALIFORNIA, San Diego**  
R.P.S. Electronics, Inc.  
(714) 292-5611

**COLORADO, Denver**  
Kierulff Electronics, Inc.  
(303) 371-6500

**CONNECTICUT, Norwalk**  
Harvey Electronics  
(203) 853-1515

**FLORIDA, Miami Springs**  
Powell Electronics/Florida  
(305) 592-3260

**FLORIDA, Orlando**  
Powell Electronics/Florida  
(305) 859-1450

**ILLINOIS, Rosemont**  
Kierulff Electronics, Inc.  
(312) 678-8560

**ILLINOIS, Skokie**  
Bell Industries  
Electronics Distributors Div.  
(312) 282-5400

**INDIANA, Indianapolis**  
Graham Electronics Supply, Inc.  
(317) 634-8202

**INDIANA, Indianapolis**  
Harvey-Indiana  
(317) 297-4910

**MARYLAND, Baltimore**  
Radio Electric Service Co.  
(301) 823-0070

**MASSACHUSETTS, Needham Heights**  
Kierulff Electronics, Inc.  
(617) 449-3600

**MASSACHUSETTS, Newton**  
The Greene-Shaw Co., Inc.  
(617) 969-8900

**MICHIGAN, Farmington**  
Harvey-Michigan  
(313) 477-1650

**MINNESOTA, Minneapolis**  
Stark Electronics Supply Co.  
(612) 332-1325

**MISSOURI, Kansas City**  
Walters Radio Supply, Inc.  
(816) 531-7015

**MISSOURI, St. Louis**  
LCOMP-St. Louis  
(314) 647-5505

**NEW JERSEY, Clifton**  
Wilshire Electronics/New Jersey  
(201) 365-2600 (212) 244-8930

**NEW YORK, Binghamton**  
Harvey Electronics  
(607) 748-8211

**NEW YORK, Buffalo**  
Summit Distributors, Inc.  
(716) 884-3450

**NEW YORK, Farmingdale**  
Wilshire Electronics/Long Island  
(516) 293-5775

**NEW YORK, Woodbury**  
Harvey Electronics  
(516) 921-8700 (212) 895-9260

**OHIO, Cincinnati**  
United Radio, Inc.  
(513) 761-4030

**OHIO, Cleveland**  
Pattison Supply Co.  
Industrial Electronics Division  
(216) 441-3000

**PENNSYLVANIA, Philadelphia**  
Almo Electronics  
(215) 676-6000

**PENNSYLVANIA, Pittsburgh**  
RPC Electronics  
(412) 782-3770

**SOUTH CAROLINA, Columbia**  
Dixie Radio Supply Co., Inc.  
(803) 253-5333

**TEXAS, Dallas**  
Adleta Electronics Company  
(214) 741-3151

**TEXAS, Fort Worth**  
Adleta Electronics Company  
(817) 336-7446

**TEXAS, Garland**  
Kierulff Electronics, Inc.  
(214) 271-2471

**TEXAS, Houston**  
Harrison Equipment Co., Inc.  
(713) 224-9131

**WASHINGTON, Seattle**  
Kierulff Electronics, Inc.  
(206) 763-1550

**IN CANADA**  
**ONTARIO, Scarborough**  
Lake Engineering Co., Ltd.  
(416) 751-5980

**ALL OVERSEAS INQUIRIES:**  
General Motors Overseas Operations  
Power and Industrial Products Dept.,  
767 Fifth Avenue, New York, N.Y.  
10022. Phone: (212)-486-3723.

**Delco Electronics**  
**Regional Sales Offices**

Union, New Jersey 07083  
Box 1018 Chestnut Station  
(201) 687-3770

Van Nuys, California 91404  
Box 2968  
(213) 988-7550

General Sales Office  
700 E. Firmin, Kokomo, Ind. 46901  
(317) 459-2175  
Operator (317) 457-8461



Delco Electronics, Division of General Motors.



## System reads OCR-B font at 400 characters/s

An optical character-recognition (OCR) system—the UCLM-3—can read an OCR-B font at 400 characters/s.

Designed by researchers at University College in London, the UCLM-3 operates with parallel inputs and parallel computation at any paper velocity. Thus the circuitry is simplified and its cost reduced. Clock pulses, shift registers and synchronization circuits associated with regular scanning systems are completely eliminated.

One standard low-cost IC is widely used throughout the prototype UCLM-3 model, along with a specially developed programmable read-only memory that is easily adaptable to LSI technology.

The Y input consists of a bundle

of 0.01-in.-diameter optical fibers, and the output is a computer-compatible, pulse-coded representation of the character.

The device has been successfully used to read hand-printed characters that were written to resemble the printed characters. In addition to regular EDP applications, the UCLM-3 may be adapted as a hand-held audio reader for the blind.

The researchers hope to cut the desk-top size of the device to pocket-calculator size, through future use of LSI circuitry.

The designers are also at work on a version of the system that will operate at up to 40,000 characters/s, and will have a camera lens instead of the fiber optics.

Operation over nonloaded sections of cable is possible, with system lengths up to about 18,000 feet of 24-gauge cable (equivalent to a line loss of 43 dB at 76 kHz).

The system may, however, be operated over the same cables as any other compatible central-station/subscriber installations, GTE International says.

---

## Tiny ferrite circulators offer big performance

Miniature ferrite circulators that have the same broadband and low-loss characteristics of much larger, earlier types have been announced by Mullard in England. The devices have power ratings of up to 300 W at uhf and 50 W at microwave frequencies.

The uhf circulators are primarily intended for television systems, but they can also be used in local-oscillator chains and injection-locked sources. The microwave circulators are designed for use in the S, C and X bands. They are reported to be particularly suitable for microwave subsystems, such as solid-state reflection amplifiers, and in airborne radar equipment.

CIRCLE NO. 319

---

## Analog-digital control of traffic is studied

The feasibility of a system that would provide analog and digital information on road conditions through TV signal analysis is under study by French engineers.

TV cameras would be placed strategically on roads and would send brief reports to a central control station. Scans would be stored and digitized at the control center for extraction of information on traffic flow, speed, density and average car occupancy.

The system operator could choose a picture, data or a combination of both for his console readouts. With this information, he could vary the traffic pattern by remote operation of traffic lights, indicator panels and other aids.

## Private wires added to existing phone cables

A low-cost, single-channel station carrier system that can provide a private-line telephone circuit in addition to existing single or multi-party service on a cable pair has been announced by GTE International of Milan, Italy. The equipment is designed for applications where second lines must be added to existing services or when seasonal or emergency installations are required.

The system uses double-sideband amplitude modulation of the 76-kHz carrier from the central office to the subscriber, and of the 28-kHz carrier signal from the subscriber to the central office. Automatic carrier-level regulation minimizes intersystem interference.

---

## PLZT light-gate array used for page composer

A prototype array of PLZT, opto-electronic, ceramic light gates that may pave the way for a new holographic page composer is under development at Plessey's Allen Clark Research Center in Towcester, England. The array has a set of electrodes deposited on each side of a 200- $\mu$ m thick, normally transparent PLZT plate.

The plate is sandwiched between crossed polarizers. Application of a voltage modifies the birefringence of the ceramic, rotates the polarized light from a 5-mW helium-neon laser, and increases light transmission through the device up to 100 times. When the voltage is removed, the sandwich becomes opaque as birefringence drops to zero.

PLZT was originally developed at the AEC's Sandia Laboratories in Albuquerque, N.M.



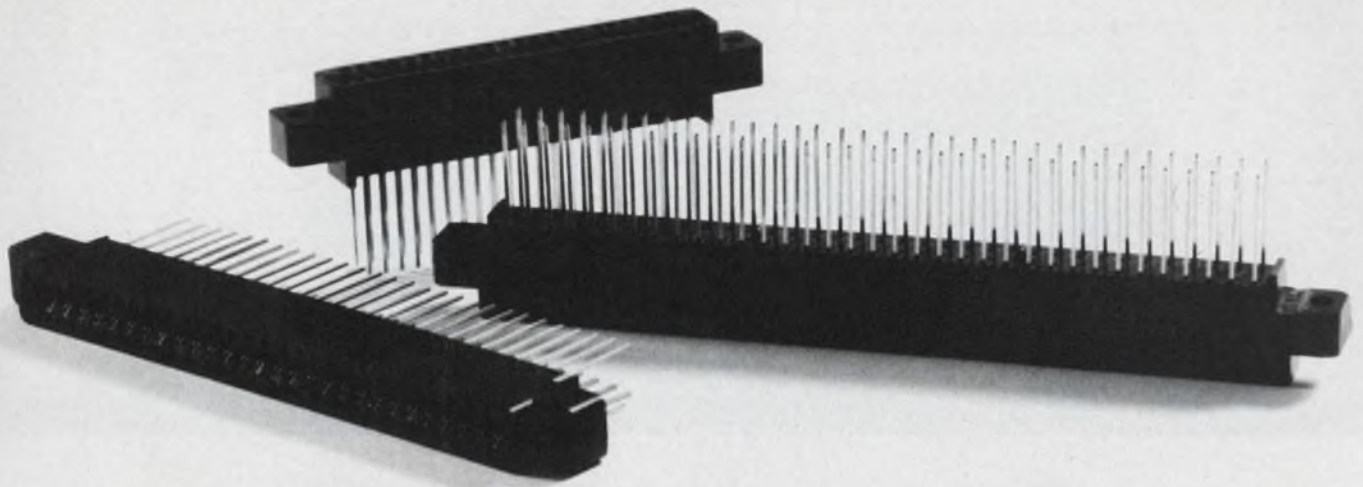

# Presenting our better-mouse-trap line. No frills at all.

When you cut price without cutting quality, soon no one thinks of it as a cut price. That's where our Norsman line of wire wrap P/C connectors is headed. Here's why:

The insulator — it's tough, resilient, non-conductive — everything you need in a wire wrap body. And it's made out of low cost phenolic, not the higher cost diallyl phthalate (if you need to meet mil specs, we have that in one of our other lines).

Contacts are semi-bellows and gold-plated — but

plated with our unique AuTac (TM) process. You get .000050" gold plate all along the mating surfaces for a sure, gouge-proof, pop-off-proof contact — but that's it. No wasted gold.

And you can find the size you need — Norsman is a full line from 15/30 to 50/100 contacts, in either .100 or .125 contact centers.

The whole Norsman idea is as simple as it is old: keep performance up and cost down. It works.

Send for details. We haven't told you everything.

**Tell me everything.**  Send me detailed literature.

Name \_\_\_\_\_

Title \_\_\_\_\_

Company \_\_\_\_\_

Telephone \_\_\_\_\_

Address \_\_\_\_\_

City \_\_\_\_\_

State \_\_\_\_\_

Zip \_\_\_\_\_

 **Viking**  
**CONNECTORS**

Viking Industries, Inc /21001 Nordhoff St /Chatsworth, Calif 91311/(213) 341-4330

"See us at Negcon Show, Booth 4910"  
INFORMATION RETRIEVAL NUMBER 65



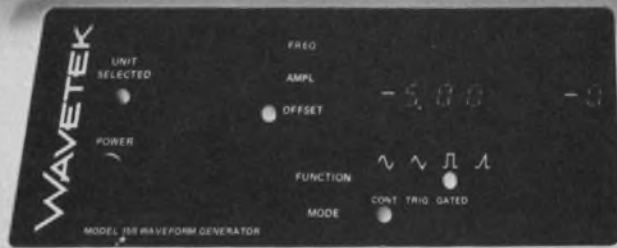

# Program waveforms with or without lifting a finger.

**With.** Your finger, and Model 159's keyboard, can generate sines, squares, triangles, and ramps. Control frequency, amplitude, and offset to three digits. Reverse phase, polarity, activate triggered and gated modes at the touch of a button. A bright L.E.D. display shows



each command as you enter it on the keyboard.

**Without.** Model 159 and its remote-control-only version, Model 158, can be programmed by all types of remote ASCII sources, including computers, TTYs, even other Model 159



keyboards. Model 158/159 ranges: frequency—1 Hz to 3 MHz; amplitude—20 mV to 10 V; DC offset—up to  $\pm 5$  V. Model 158, \$1,245; Model 159, \$1,495.

For more information, circle our reader service number or contact Wavetek direct.

**WAVETEK®**

P.O. Box 651 San Diego, CA 92112  
Tel. (714) 279-2200 TWX 910-335-2007



## new products

# Digital phase meter gives highest accuracy, at less than \$2000

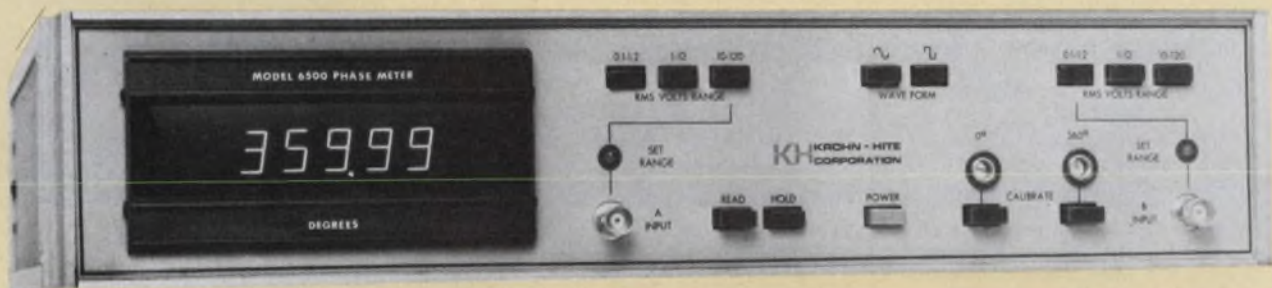

Krohn-Hite, 580 Massachusetts Ave., Cambridge, Mass. 02139. (617) 491-3211. \$1995; 8 weeks.

Not only is Krohn-Hite's 6500 twice as accurate as any other digital phasemeter, the unit also eliminates or ameliorates some of the annoying problems that commonly plague the phasemeter.

For instance, the  $\pm 0.05^\circ$  phase accuracy of the five-digit 6500 is unaffected by unequal input signal levels, which can range from 0.1 to 120 V rms. Nor does the accuracy spec of the Krohn-Hite have to be de-rated with input level, as do other meters.

Another problem that's been overcome is that of ambiguity at angles close to  $0^\circ$ ,  $180^\circ$  or  $360^\circ$ . With most meters, you've got to switch ranges to avoid erratic readings or discontinuities. But the 6500 reads directly from  $000.00^\circ$  to  $360.00^\circ$ , so that you can measure a phase difference as small as  $0.01^\circ$  without meter fluctuations.

However, since the 650 displays only positive polarities, you must remember that the meter reading always indicates the angle by which channel A leads channel B.

Thus if the instrument reads,

say,  $90^\circ$  and the two input signals are interchanged, the new reading will be  $270^\circ$ —not  $-90^\circ$ .

Still another error is mitigated by the 6500: that caused by signal crossover distortion and noise. Consequently even-harmonic distortion in the channel-A signal causes an error of less than  $0.06^\circ/\%$ , and odd harmonics less than  $0.6^\circ/\%$  ( $\% =$  percent distortion).

On the second channel, distortion error depends on the harmonic number and, for even harmonics, ranges from less than  $0.06^\circ/\%$  for the second harmonic to a maximum of  $0.3^\circ/\%$  for the sixth. Odd harmonics cause errors of less than  $0.6^\circ/\%$ .

The noise-caused error of the Krohn-Hite unit is specified as less than  $0.4^\circ$  for sinusoidal inputs with a Gaussian noise distribution flat to 5 MHz and 20 dB below the input.

Note that the listed accuracy of the 6500 is guaranteed for sine-wave inputs from 20 Hz to 50 kHz. From 10 to 20 Hz, and from 50 to 100 kHz, de-rate accuracy to  $\pm 0.1^\circ$ . Beyond 100 kHz, accuracy drops at a rate of  $\pm 0.7^\circ$  per 100 kHz out to 5 MHz—the maximum

usable frequency.

Other waveforms—triangles, square waves and positive pulses—are handled by the 6500. For square waves, accuracy is  $\pm 0.05^\circ$  from 10 Hz to 5 kHz.

The final accuracy of any measurement also depends on how much time has passed since the previous calibration, and on temperature variations as well. With sinusoidal inputs from 20 Hz to 50 kHz, you can expect the 6500 to show a 30-day drift of not more than  $\pm 0.0025^\circ$ .

But you won't get this low figure unless you remember to use the instrument's front-panel screws to calibrate periodically the unit's  $0^\circ$  and  $360^\circ$  (full-scale) settings.

Without adjustments, add  $\pm 0.05^\circ$  per eight hours, or  $\pm 0.2^\circ$  over 30 days to the drift spec. Temperature variations result in a further drift of  $\pm 0.01^\circ/^\circ\text{C}$  from 10 Hz to 100 kHz,  $\pm 0.05^\circ/^\circ\text{C}$  to 1 MHz, and  $\pm 0.05^\circ/^\circ\text{C}$  per MHz out to 5 MHz. Ambient range is 0 to 45 C.

Other features of the Krohn-Hite 6500 include storage of the reading and an analog output of  $-10$  mV/per phase degree.

CIRCLE NO. 250



# NEW! Systems Integration through Switching!

How do you reconfigure four data acquisition channels and 500-600 transducer leads from each of eight test stations — frequently, reliably, quickly, without distorting low level analog signals? Easy. Integrate your system with a matrix switch using 60-circuit T-Bar "Pluggables" that mate directly with wrappable connectors.

T-Bar makes high density multi-pole switches and relays — designs and fabricates special switching systems — reliably and economically. That's all we do. And we've been doing it for 15 years. If you switch a lot of lines — all at once or a few at a time — write or phone today for T-Bar's new Series 6900 Pluggable Switching Catalog.

**T-Bar** INCORPORATED  
SWITCHING COMPONENTS DIV.  
141 Danbury Road, Wilton, CT 06897  
Telephone: 203/762-8351

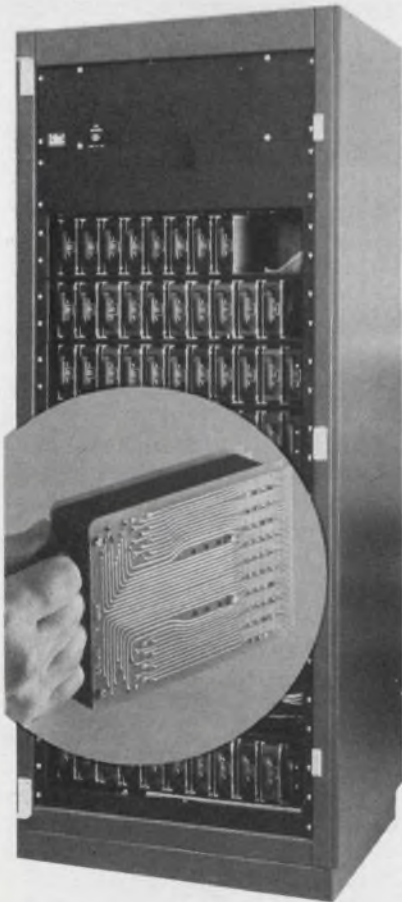

INFORMATION RETRIEVAL NUMBER 67

## INSTRUMENTATION

### Compact synthesizer tunes to 180 MHz



*Telline Radio, 6630 Electronic Dr., Springfield, Va. 22151. (703) 354-6000. \$2200 ea; 60 days.*

Model SM-123 synthesizer provides output logic to translate front-panel readout to actual receive or transmit frequency in lieu of synthesizer output frequency. Salient features of the synthesizer include: Tunes any 10-MHz band from 10 to 180 MHz; 1-kHz standard channel spacing; output level 6 dBm; phase noise 55-dB below carrier.

CIRCLE NO. 257

### Rf millivoltmeters handle low FM levels



*Motorola, Communications Div., 1301 Algonquin Rd., Schaumburg, Ill. 60172. (312) 358-7900. Under \$300; 4 wks.*

Models S-1339A analog and S-1340A digital rf millivoltmeters measure very low rf levels (1 mV fs) of FM two-way radio communications frequencies. A mirrored-scale panel meter on the S-1339A analog unit has linear 0 to 3 and 0 to 10 voltage scales. A dBm scale, referred to 1 mW in 50  $\Omega$ , is standard. The S-1340A digital model has a 4-digit display blanked for 5% overrange and below 20% full scale, with full scale counts of 3000 and 1000. BCD outputs and commands are included.

CIRCLE NO. 258

### Tester handles variety of digital modules

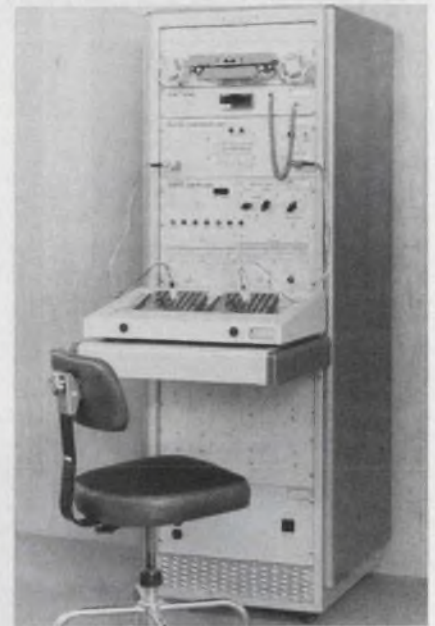

*Edmac Associates, 333 W. Commercial St., Rochester, N.Y. 14445. (716) 385-1440. \$25,000; 120 days.*

Model 3100 digital-circuit tester is a general-purpose set that can handle a multiplicity of circuit modules. The unit consists of a tape reader, digital voltmeter, digital-comparison unit, central controller, adapter assembly and power supplies. At each step of the test, the central controller examines, on a bit-for-bit basis, the output of the test unit and compares it with the correct output supplied by the tape reader. A typical logic PC board can be tested in less than 5 s.

CIRCLE NO. 259

### Function generator spans 10 decades

*Philips, P.O. Box 523, Eindhoven, the Netherlands.*

PM 5167 function generator covers the frequency range of 1 mHz to 10 MHz (10 decades) and gives an output voltage of 40-V pk-pk open-circuit or 20-V pk-pk into 50  $\Omega$ . The unit generates sine, square and triangular waveforms, as well as sawtooths and pulses with ratio of 1:9 and 9:1. A linear frequency-indication scale gives a setting accuracy of 2%  $\pm$  0.2% (0.1 Hz to 10 kHz) of maximum range value, and small variations ( $\pm$  5%) can be made in frequency with a fine-tuning control.

CIRCLE NO. 260



# Pick The General-Purpose Scope Chosen By Thousands of Specialists . . . HP's 180 System.

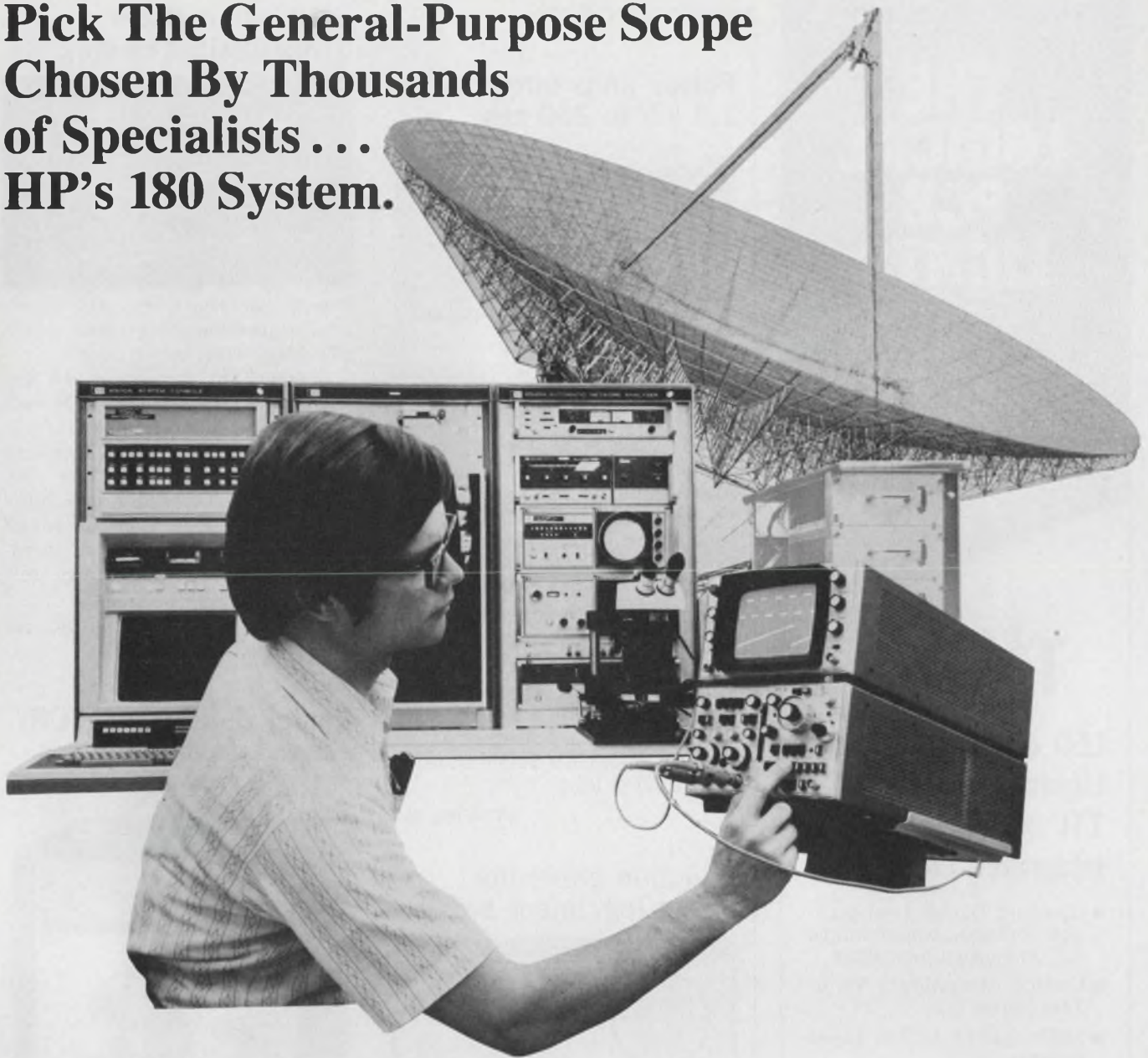

Specialists choose the 180 System for its flexibility, performance, and price. Its variety of mainframes and plug-ins lets them select the optimum system for their specific application. Consider these examples.

Specialists working in the very demanding low-frequency areas, such as biomedical and control circuits design, use the large-screen, dual-channel system. They do this because it offers maximum visibility of their waveforms, highly repeatable measurements, excellent dependability, and it costs less than \$2,000\*.

Digital designers working with RTL to ECL logic make their measurements on a 100 MHz, dual-channel system that gives them delayed sweep, DC offset and selectable trigger source...all for only \$3,100\*.

Specialists in communications and high-speed digital applications frequently use the dual-channel 250 MHz real-

time 180 systems with prices starting at \$3,900\*.

Plug-ins extend the system's capabilities to include Spectrum Analysis, TDR and Sampling to 18 GHz. Variable persistence mainframes are available too. With this breadth of measurement capability, there's a 180 System to meet your needs. For more information, contact your local HP field engineer. Or, write Hewlett-Packard, 1501 Page Mill Road, Palo Alto, California 94304.

\*Domestic USA prices only

**HEWLETT  PACKARD**

Sales and service from 172 offices in 65 countries.  
1501 Page Mill Road, Palo Alto, California 94306



INFORMATION RETRIEVAL NUMBER 68



# THE LOGICAL PCB LIGHTS

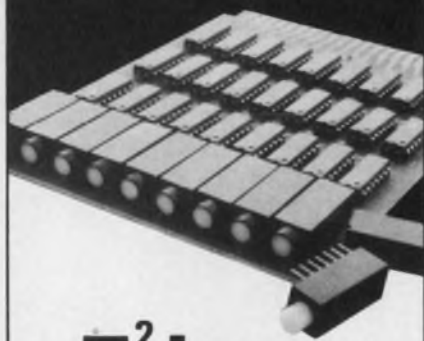

## T<sup>2</sup> Lite

### LED & Incandescent Lights with Built-in TTL or ECL Integrated Circuits

- Standard Dual-In-Line package contains complete logic I.C. plus visual indication
- Choice of standard 74 or 74H Series I.C.
- LED's feature built-in series resistor
- Long life incandescent lamps include built-in keep alive bias

Convenient combination package reduces cost, saves space and speeds up assembly. Units are available for immediate delivery with a wide choice of lens colors.

Call or write for more information today!

the little light people

## DATA DISPLAY PRODUCTS

5428 W. 104th St., Los Angeles, Ca. 90045  
(213) 641-1232

## INSTRUMENTATION

### Power amp outputs 1.4 kW to 250 kHz



*Electronic Navigation Industries, 3000 Winton Rd. S., Rochester, N. Y. 14623. (716) 473-6900. \$1995; stock to 60 days.*

Model 1140L is an all solid-state power amplifier that operates over the range of 9 to 250 kHz with a gain of 50 dB. Somewhat reduced gain and power output is available at frequencies up to 450 kHz. Input is 50  $\Omega$ . Output power from 0 to more than 1.4 kW is continuously adjustable. Any load impedance from an open to a short may be connected to the output of the 1140L without damage or oscillation. Maximum power transfer is to a 50  $\Omega$  load.

CIRCLE NO. 261

### Function generator offers log/linear sweep



*Interstate Electronics, 707 E. Vermont Ave., P. O. Box 3117, Anaheim, Calif. 92803. (714) 772-2811. \$695; 30 days.*

Model F37 is a logarithmic/linear sweep function generator with a frequency range of 0.03 Hz to 3 MHz and a maximum sweep width of 1000:1. X-Y format response plots and other displays may be driven with either of the generator's two plotter drive outputs—a front-panel frequency analog signal for linear sweep, and a sweep monitor on the rear panel for wideband logarithmic sweep. The unit's internal sweep generator will repetitively trigger up to 90 K bursts each second.

CIRCLE NO. 262

### 3-1/2-digit DMM gives decibel ranges



*United Systems Corp., 918 Woodley Rd., Dayton, Ohio 45403. (513) 254-6251. \$395; stock.*

Model 2180 is said to be the first 3-1/2-digit bipolar DMM with all five standard multimeter functions, plus five decibel measurement ranges extending from -60 to +56 dB. Offered are a basic accuracy of 0.1%, resolution of 100  $\mu$ V, and battery or ac operation. Weight of the 31-range unit is just 2 lb.

CIRCLE NO. 263

### Tester determines SCR, zener and diode specs

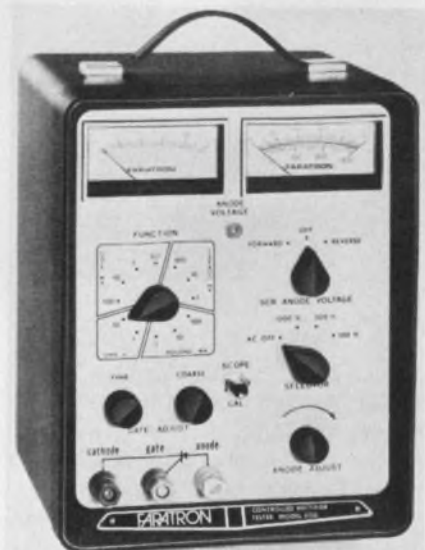

*Faratron Corp., 280 Green St., South Hackensack, N.J. 07606. (201) 488-1440. \$595.*

Model S-120 portable SCR tester can also test both zener and standard diodes. Zener diode volt-ampere characteristics can be displayed on a scope and forward-blocking voltage, full-cycle leakage and forward drop can also be checked on standard silicon diodes. The unit determines the following SCR characteristics:  $V_{GF}$ ,  $I_{GF}$ ,  $V_{BO}$ ,  $I_S$ , PRV,  $I_R$  and  $I_H$ .

CIRCLE NO. 264



**Inselek can now provide total custom LSI design and fabrication, at a price competitive with bulk CMOS, and do it in less time than our competition.**

**The Classical Design Story —**

A typical approach to custom LSI circuits employs either MOS or bipolar technologies. MOS offers low cost and low power, but lacks a high switching speed. Bipolar has the speed, but it's expensive to make and power dissipation is high. This leaves you with a formidable design decision. Will it be MOS or bipolar? Either way it's a compromise.

**The No Compromise Way —**

Inselek now offers you a custom SOS/CMOS approach where you never have to compromise. Using our proven technology you'll receive all the inherent benefits of both MOS and bipolar, and obtain comparable development costs as well. Here's what we'll do for you. Inselek will either design and fabricate a custom SOS/CMOS IC for you, or produce integrated circuits from your own design (in either ceramic or plastic packages), or, if you prefer, we'll provide you with only the wafers. Any way you choose you come out a winner.

**Getting Started —**

Before you commit to any process, get all the facts first. Compare costs, reliability and technologies. For details on the Inselek "No Compromise Way" circle the reader service number or write:

**Inselek, Inc.**, 743 Alexander Road, Princeton, N.J. 08540.  
Telephone: (609) 452-2222.

You'll find we may not be very modest, but we're easy to do business with.

# Inselek customizes the SOS/CMOS IC.



**INSELEK™**

SALES OFFICES IN  
CONCORD, MASS (617) 369-5298 AND  
LOS ANGELES, CALIF. (213) 889-2788

DISTRIBUTORS  
WEST COAST— WESTATES (213) 341-4411 NEW ENGLAND— GREEN SHAW (617) 969-8900 MID-ATLANTIC— WILSHIRE ELECTRONICS (609) 786-8990

INFORMATION RETRIEVAL NUMBER 70



# Incremental voltage divider.

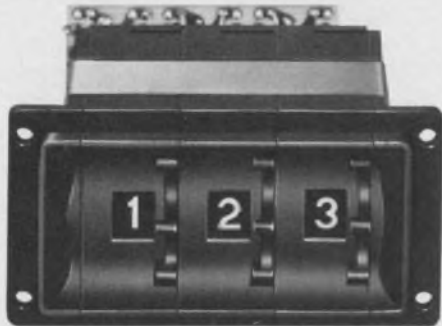

We call it Thumbpot™. And it'll do anything a 10-turn pot will do, but better. Obviously it's easy to read and easy to set. When you return to a setting it's **exactly** what you had before. Other advantages are a choice of sizes, incredible reliability, housings sealed against dust, low price, and such options as lighting, position stops, and shielding. It's available in stock from G.S. Marshall, Hall-Mark, and Schweber.

And us.

## EECO

1441 East Chestnut Avenue/Santa Ana, California 92701/Phone 714/835-6000

INFORMATION RETRIEVAL NUMBER 71

# cut costs 40% on parts like this

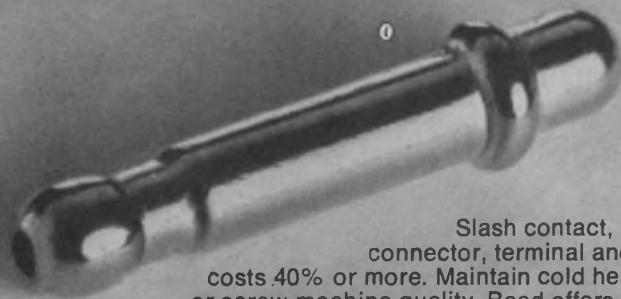

Slash contact, lead, connector, terminal and pin costs 40% or more. Maintain cold headed or screw machine quality. Bead offers a full line of standard products. Formed by our fast, accurate virtually waste free multi-swaging process to give you fast delivery, low prices. We provide custom engineering to meet your special requirements. Write or call for our new catalog.



## bead electronics

A Division of Bead Chain Mfg. Co.  
58 Mountain Grove St., Bridgeport, Conn. 06605  
Phone: (203) 334-4124

INFORMATION RETRIEVAL NUMBER 72

## INSTRUMENTATION

### DPI allows room for your own circuits

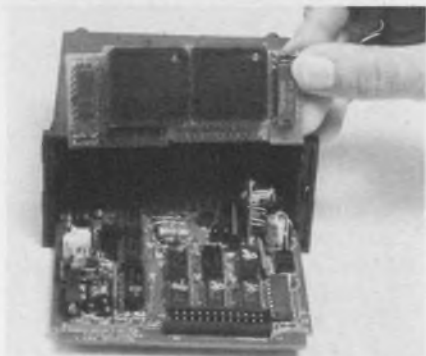

Analogic, Audubon Rd., Wakefield, Mass. 01880. (617) 246-0300. \$92 (100); 30 days.

The AN2536 5-V-powered, 3-1/2-digit panel instrument features automatic zeroing, floating true-differential inputs and a true integrating a/d converter. The DPI provides space and power for an optional PC board on which to include customer or company-designated circuitry. In addition, the display assembly can be removed and used as a remote display. The unit is housed in a 96 × 48 × 95.4-mm DIN-standard (international standard) case.

CIRCLE NO. 265

### Pushbutton attenuators offered for audio use

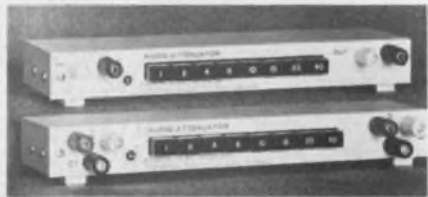

Edison Electronics Div., Grenier Field Municipal Airport, Manchester, N.H. 03103. (603) 669-0940. \$75 to \$100; 12 weeks.

Series 1690 and 1963 attenuation networks are pushbutton operated and specifically designed for audio and low-frequency applications. Both types employ noninterlocked switches to provide a selection range of 1 to 100 increments of attenuation in 1-dB steps. The units are available in unbalanced "T" or centertapped balanced "H" circuits, and both are offered in standard impedances of 150, 500 or 600 Ω. In all cases, input and output impedances are equal.

CIRCLE NO. 266



## Unit measures noise figure of transistors

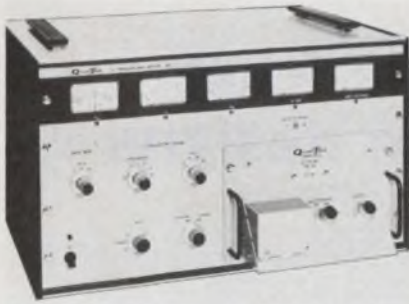

Quan-Tech, Randolph Park West, Route #10, Randolph Township, N.J. 07801. (201) 361-3100. 340B: \$2500; 1340: \$2300.

Model 340B rf-transistor noise analyzer directly measures self-generated transistor noise from 0 to 40 dB. The instrument provides meter readout of noise figures for both bipolar and FETs at frequencies between 1 and 60 MHz. It requires use of the Model 1340 front panel, frequency plug-in head, which is selected for one of the five test frequencies available.

CIRCLE NO. 267

## Laser trimmer can be programmed

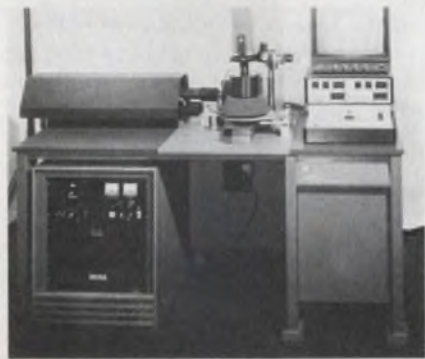

Teradyne Inc., 183 Essex St., Boston, Mass. 02111. (617) 482-2700. \$39,800.

The W233 Unitrimer is an automatic laser trimming system designed for hybrid circuits with only a few resistors each, for development work, or for multiple trims in low-volume applications. Either one or two trims can be programmed by means of front-panel digit switches. The Unitrimer can also be electrically programmed to interface with other systems. Length and direction of cut, desired resistance or voltage, Q-switch rate, bite size, and trim speed are all programmable.

CIRCLE NO. 268



# The 12 BIT IC DAC... from Hybrid Systems, naturally.

### Why Naturally?

We offer the alternative to the cookie-cutter approach to converter fabrication. We laser-trim our own thin-film nichrome R-2R networks and combine them with matched monolithic quad switches... for complete control over accuracy.

**IC SIZE:** 16 pin DIP compatible. **12 BITS ACCURACY:** A true 12 bits.

**LOW DRIFT:** 1PPM/°C linearity **CODE:** Inverted offset binary.

**READY-TO-USE:** Built-in reference, ladder, switches; pretrimmed output amplifier in the DAC346V-12-BP. **RELIABLE:** MIL-STD-883 hybrid  $\mu$ circuit processing.

**TEMPERATURE RANGE:** 0°C to +70°C (Commercial).

**HOW TO ORDER:** DAC345I-12-BP, Current Out, 16 pin DIP... \$79. DAC346V-12-BP, Voltage Out, 18 pin DIP... \$89. (Wide temperature range, hermetic, MIL versions available).

For Fast Action, Call:

In USA: (617) 272-1522 (or TWX 710-332-7584).

In Europe: Hybrid Systems GmbH, 61 Darmstadt, Luisenplatz 4, Germany Tel. 6151-291595.

Hybrid Systems Corporation  
Burlington, Massachusetts 01803

**Hybrid Systems**  
CORPORATION



# TO-5's WE CAN Cool 'em



**5.0¢\***

1134-U Press on  
Typical  $R_{\theta}$ , 59°C/W



**5.1¢\***

2226-U Press-on  
Clears adjacent compo-  
nents  
Typical  $R_{\theta}$ , 59°C/W



**8.2¢\***

2230-B5, 3/4" Press-on  
gear type, screw mount  
Typical  $R_{\theta}$ , 51°C/W



**8.5¢\***

2257-R 1/2" Press-on  
gear type  
Typical  $R_{\theta}$ , 68°C/W

Popular, easy-to-use economy coolers for PC board components. Thermalloy offers the most complete line of heat sinks in the industry: over 100 designs for cooling all types of packages including DIP's, plastics, TO-3's, TO-66's, and power transistors.

\*Prices for 5000 quantity  
 $R_{\theta}$  values for natural convection @ 1 W

Free Samples  
and Catalog  
Write Today



**Thermalloy Inc.**

NUMBER ONE IN SEMICONDUCTOR ACCESSORIES  
P.O. BOX 34829  
2021 W. VALLEY VIEW LANE, DALLAS, TEXAS 75234  
PHONE 214-243-4321/TWX 910-860-5542

## INTEGRATED CIRCUITS

# 256 X 4-bit static RAM simplifies system designs

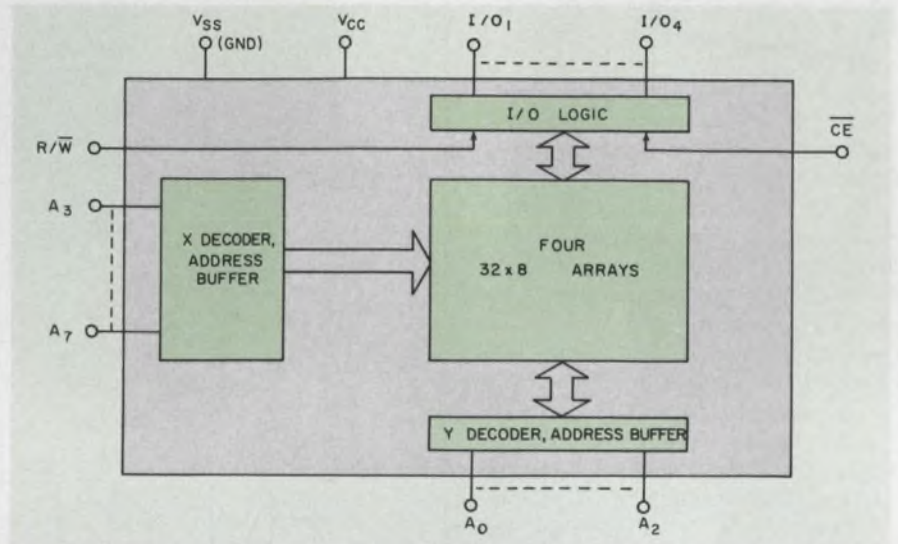

Signetics, 811 E. Arques Ave., Sunnyvale, Calif. 94084. (408) 739-7700. P&A: See text.

The latest in 1-k, NMOS static random-access memories (RAMs) eliminates excess storage space. The Signetics Model 2606 RAM uses a 256- $\times$ -4-bit organization to reduce the number of packages needed for memories under 1 k word.

The 2606 also uses a shared three-state input/output structure that reduces the circuitry needed for multiplexed data-bus operation. In addition it is housed in the same 16-pin, dual in-line package used by all other 1-k RAMs. Most other RAMs, though, use a 1024- $\times$ -1-bit structure, which means that the smallest memory made is 1024 words deep.

Other features of the 2606 static RAM include access and cycle times of 750 ns, power dissipation of 200 mW typical and operation from a single 5-V supply.

Compared to equivalent dynamic RAMs, these speeds appear slow. However, the 2606 doesn't require the clock, refresh and other circuitry usually associated with dynamic memories. This additional circuitry could actually reduce the

dynamic memory speed to that of static.

Only two 2606 RAMs are needed to accommodate a byte (8-bit word). This contrasts with the eight which would normally be required if standard 1-k- $\times$ -1-bit memories were used.

Since most computer or micro-processor systems use bidirectional data busses, use of the 2606 can reduce the decoding circuitry needed for the input/output lines.

The internal organization of the 2606 is simple. It contains four arrays, each with 32 rows and eight columns (see diagram). One of the 32 decoders, controlled by inputs  $A_3$  and  $A_7$ , selects individual rows. Similarly, individual columns are selected by eight column decoders controlled by inputs  $A_0$ ,  $A_1$  and  $A_2$ . Data are written into or read from the four input arrays through the four input/output terminals in parallel.

In plastic DIPs (suffix B), the 2606 costs \$10.40 in quantities of 100 or more. The higher-speed 2606-1 RAM costs \$11.65 for the same quantities and package style. Delivery is 8 weeks, and samples are available from distributors.

CIRCLE NO. 256



# ULTRA-MATCHED INSTRUMENTATION OP AMPS... *made easy!*

$\Delta V_{os} - 70 \mu V$

$TC \Delta V_{os} - 0.3 \mu V / ^\circ C$

$I_B - InA$

$\Delta CMRR - 123dB$

14 Pin DIP Package

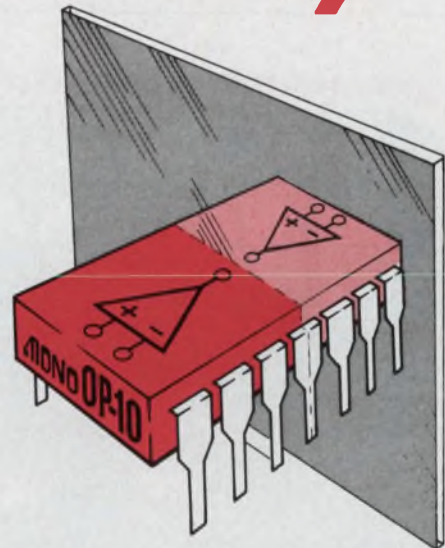

## AT LAST—MATCHED DUAL OPERATIONAL AMPLIFIERS!

New monoOP-10 makes matched amplifier designs easy — two low noise, low drift, low bias current monoOP-05 Instrumentation OP Amps in a 14 pin DIP! Of course, they're fully compensated and completely protected so there's nothing to add but your ingenuity. And the tight matching makes possible a new generation of applications including high input

impedance instrumentation amplifiers with no chop- per noise, low drift multistage active filters, matched channel amplifiers, tracking dual voltage references and . . . No more costly hand selection of individual op amps — monoOP-10 saves time, space and cost while boosting performance! Try one — they're off-the-shelf at your PMI distributor now!

### GUARANTEED MIN/MAX SPECIFICATIONS

	monoOP-10AY	monoOP-10Y	monoOP-10EY	monoOP-10CY	
Operating Temp. Range	-55/+125	-55/+125	0/+70	0/+70	$^\circ C$
$\Delta V_{os}$ ( $V_{os1}-V_{os2}$ )	180	500	500	—	$\mu V$
$TC \Delta V_{os}$	0.8	1.2	0.9	—	$\mu V / ^\circ C$
$\Delta CMRR$	114	106	106	—	dB
Input Bias Current	3.0	3.0	4.0	7.0	nA
Noise (0.1 Hz to 10 Hz)	0.6	0.6	0.6	0.65	$\mu V$ , pk-to-pk
Long Term Drift*	0.2	0.2	0.2	0.3	$\mu V / Month$
Price @ 100 pcs.	\$60.00	\$40.00	\$25.00	\$16.00	

\* Typical long term drift trend, averaged over a 12 month period (per amplifier)



**PRECISION  
MONOLITHICS  
INCORPORATED**

1500 SPACE PARK DRIVE, SANTA CLARA, CALIFORNIA 95050  
TEL. (408) 246-9225 • TWX 910-338-0528 • CABLE MONO

#### AUTHORIZED DISTRIBUTORS

NEW YORK METROPOLITAN AREA Harvey Radio, Woodbury, N.Y.: (516) 921-8700 • NEW ENGLAND AREA Gerber Electronics, Dedham, Mass.: (617) 329-2400 • UPSTATE NEW YORK Harvey Federal Electronics, Binghamton, N.Y.: (607) 748-8211 • NORTHEAST Newark Electronics, Woburn, Mass.: (617) 935-8350 • BALTIMORE-WASHINGTON Whitney Distributors, Baltimore, Md.: (301) 944-8080 • PHILADELPHIA Hallmark Electronics, Huntingdon Valley, Pa.: (215) 355-7300 • MICHIGAN RS Electronics, Detroit, Mich.: (313) 491-1000 • SOUTHEAST Kirkman Electronics, Winston-Salem, N.C.: (919) 724-0541 • EAST CENTRAL Pioneer/Cleveland, Cleveland, Ohio: (216) 587-3600 • Pioneer/Dayton, Dayton, Ohio: (513) 236-9900 • CENTRAL Hallmark Electronics, Elk Grove Village, Ill.: (312) 437-8800 • Minneapolis, Minn.: (612) 925-2944 • St. Louis, Mo.: (314) 521-3800 • TEXAS-OKLAHOMA Sterling Electronics, Houston, Texas: (713) 623-6600 • Dallas, Texas: (214) 357-9131 • SOUTHWEST Sterling Electronics, Albuquerque, N.M.: (505) 345-6601 • Phoenix, Ariz.: (602) 258-4531 • WEST Westates Electronics Corp., Chatsworth, Calif.: (213) 341-4411 • Sterling Electronics, San Carlos, Calif.: (415) 592-2353 • Intermark Electronics, Sunnyvale, Calif.: (408) 738-1111 • Denver, Colo.: (303) 936-8284 • Salt Lake City, Utah: (801) 359-0531 • San Diego, Calif.: (714) 279-5200 • Santa Ana, Calif.: (714) 540-1322 • Almac-Stroom, Seattle, Wash.: (206) 763-2300 • Portland, Ore.: (503) 292-3534

INFORMATION RETRIEVAL NUMBER 75



## 8-digit calculator IC performs 5 functions

*Antex Industries, Inc., 455 E. Middlefield Rd., Mountain View, Calif. 94043. (415) 961-1111. \$9 (1000); 30 days.*

A five-function, 8-digit calculator circuit, called the 3003, features percentage calculations with

mark-up and mark-down, repeat add and subtract, constant operation for multiplication and division, a floating decimal point and arithmetic calculations. Other features include direct segment drive for LED displays, internal clock, single 12-V power supply, 87-mW typical power dissipation and zero suppression of all nonsignificant zeros. The circuit comes in a 28-pin DIP.

CIRCLE NO. 269

## Frequency triggers MOS switches

*Consumer Microcircuits of America, 10727 Indian Head Industrial Blvd., St. Louis, Mo. 63132. (314) 423-4900.*

The FX-501 (R) series of MOS/LSI frequency-sensitive switches can be triggered on and off by tone bursts adjustable to any value from 10 Hz to 20 kHz. Input signals may be as low as 35 mV. The FX-501 has a fixed 7% tone-channel bandwidth, while the FX-501-R bandwidth is externally adjustable from 2 to 10%. The circuits come in 8-pin and 10-pin TO-5 cases and they operate from supply voltages of 8 to 15 V.

CIRCLE NO. 270

## Linear FET switches have low feedthrough

*Crystal Industries, Inc., 1014 N. Vine St., Hollywood, Calif. 90038. (213) 466-6452.*

Originally intended for the switching of large dynamic-range audio signals, the company's new TTL-programmable FET switches can handle an input voltage range of  $\pm 15$  V over the dc-to-100-kHz frequency range. The SPDT switches have a feedthrough of  $-95$  dBm (referred to output) at 1-kHz toggle rates and a linearity in the ON state of better than 0.01%. Switching time is about 2  $\mu$ s and power consumption is typically 600 mW for each SPDT switch. ON and OFF resistances are 50 and 10<sup>9</sup>  $\Omega$ , respectively.

CIRCLE NO. 271

## 1.1 V runs 21-stage COS/MOS counter

*RCA Solid State Div., Route 202, Somerville, N.J. 08876. (201) 722-3200. \$9 (1000).*

A low-voltage COS/MOS 21-stage counter, called the TA6152, can be operated from supplies in the 1.1-to-6-V range. The TA6152 consists of 21 negative-edge counter stages, two output-shaping flip-flops for a 3.125% duty cycle, two inverter output drivers, and input inverters for use in a crystal oscillator. The TA6152 is similar to the CD4045A, but operates at lower voltages. The new IC comes in a 16-pin DIP.

CIRCLE NO. 272

## 8 CASES FOR SWITCHING TO NATIONAL<sup>®</sup> SCRs

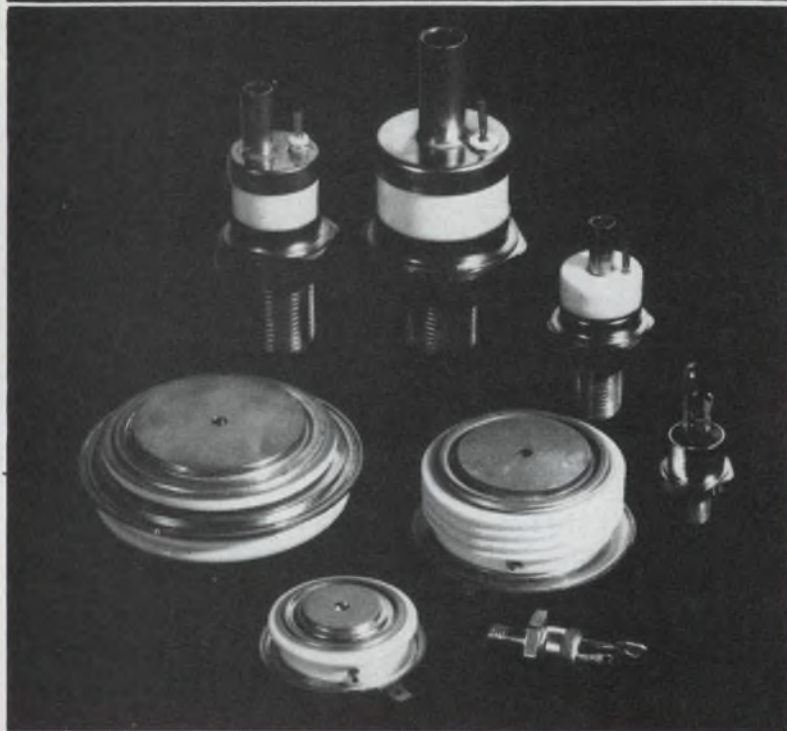

16-1600 Amperes rms  
25-1700 Volts  
Power and Inverter SCRs  
Patented Regenerative Gate

*Call or write for full details*



**NATIONAL ELECTRONICS**

a varian division

geneva, illinois (312) 232-4300



# We make the linear you need.

## **Only Intersil delivers them all.**

Come to us for the device you need most. We specialize in complex linears for the system design engineer, and we also make and deliver the hard-to-find alternate source devices you've been looking for.

## **Advanced proprietary devices.**

We manufacture a complete line of FET-input op amps such as the Intersil 8007, with 1 pA input current; its trimmed version (the 8007-1) with 2 mV  $V_{os}$  and 5  $\mu V/^\circ C$  drift; or our 8043, the industry's first monolithic dual FET input op amp. We make low noise op amps, high speed amps, low power amps in single, dual and triple monolithic versions.

And more! Our 8038 VCO generates sine, square, triangular, sawtooth and pulse waveforms. The 8048 and 8049 are the first monolithic log and antilog amplifiers. We make low power voltage comparators, analog multipliers, voltage regulators and other advanced linear functions.

## **Popular alternate-source devices.**

We offer a full selection of standard types such as the LM100 and LM105 voltage regulators, LM102 and LM110 voltage followers, LM101A, LM108A and UC4250 op amps, the LM111 comparator and the NE555 timer.

## **And i38510 linears.**

Data sheet linears, processed to MIL-M-38510 requirements, are immediately available through the i38510 program.

Ask for our 1974 Products Catalog, with data sheets, designer's guides, industry cross references and a complete listing of application notes. From Intersil, 10900 North Tantau Ave., Cupertino, CA 95014

## **Get 'em here.**

### **Intersil stocking distributors.**

Elmar/Liberty Electronics.  
Schweber Electronics.  
Semiconductor Specialists.  
Weatherford.

### **Intersil area sales offices.**

Boston (617) 273-2055.  
Chicago (312) 371-1440.  
Los Angeles (213) 532-3544.  
Minneapolis (612) 925-1844.  
New York (201) 567-5585.  
San Diego (714) 278-6053.  
San Francisco Bay Area  
(home office) (408) 257-5450.  
Upstate New York  
(315) 463-3368.

### **Representatives in all major cities.**





# There's only 1 low priced 12 bit D/A...

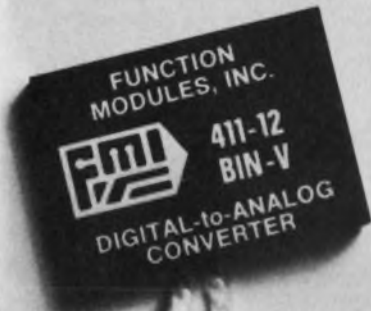

that remains  
monotonic over  
it's temperature  
range.

It takes precision matched ladder resistors that track to 2ppm/°C to achieve 12 bit monotonicity. And all the other low cost D/A's fail to provide sufficient linearity drift to pass the monotonicity test with temperature. In fact most don't even specify linearity drift which is the key D/A performance parameter. At \$59 (1 to 9 pieces) the 411-12 is the lowest cost for the performance.

**And they're in stock!**

Other 411 Models with corresponding price/performance are available...

Call or write today

**FUNCTION MODULES, INC.**  
711B W. Seventeenth St.  
Costa Mesa, CA 92627  
Phone: (714) 645-6001

## INTEGRATED CIRCUITS

### Calculator chip set eases key sequences

*Philips, P.O. Box 523, Eindhoven, the Netherlands.*

The DCS-139 two-chip MOS calculator set contains the complete electronics for 12-digit, four-function calculators, including drive circuitry for gas-discharge displays. The clock oscillator and power-on clear circuitry are contained on the chips. With the new chip set, add-ons and discounts can be computed without the use of the exchange key. Other improvements over the company's earlier models include continued computations (following overflow) through a depression of the CE key.

CIRCLE NO. 273

### ECL-10k line adds high-speed RAMs

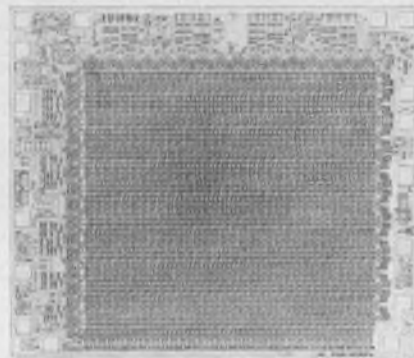

*Fairchild, 464 Ellis St., Mountain View, Calif. 94042. (415) 962-3816. F10415: \$70; F10410. \$21 (100-999); stock.*

A 1024-bit RAM, the F10415, and a 256-bit RAM, the F10410, extend the company's ECL-10,000 line. The F10410 memory features typical address access times of less than 20 ns. Maximum address-access, read-cycle and write-cycle times are 35 ns over the 0-to-75°C temperature range and ±5% variation in supply voltage. Chip select access time is 12 ns maximum over the same ranges. The 1024-bit memory has typical address access times of less than 45 ns. Maximum address, read-cycle and write-cycle times are 65 ns over the same ranges, and maximum chip-select access time is 30 ns.

CIRCLE NO. 274

### Current booster delivers 600 mA

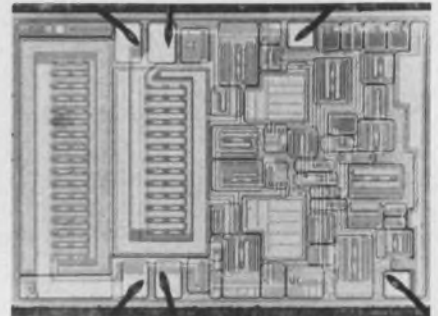

*Harris Semiconductor, P.O. Box 883, Melbourne, Fla. 32901. (305) 727-5407. \$6.50 to \$14.00 (100); stock.*

An IC current booster—the HA-2630—can output ±600 mA, or about 50% more than competing devices according to the company. Current to the load can be limited by connection of two external resistors. The unity voltage-gain amplifier also features a slew rate of 500 V/μs, small-signal bandwidth of 8 MHz and an output resistance of 2 Ω. The new amplifier comes in a TO-8-type can for mounting with or without heat sink.

CIRCLE NO. 275

### 16-bit register file reads while it writes

*Motorola, P.O. Box 20924, Phoenix, Ariz. 85036. (602) 244-3467. \$16.13 up (100-999); stock.*

The CMOS 4 × 4-bit multiport register file permits independent reading of any two words while writing into any one of four words. The new memory dissipates only 0.02 mW at 10 V. Speed is typically 500 ns at 10 V to access any word, and write times can range up to a microsecond. Address changing and data entry occur on the rising edge of the clock. When the write-enable input goes low, the contents of any word accessed doesn't alter. Available in a 24-pin DIP, the new IC uses a single-phase clock with no restrictions on rise or fall times, has a logic swing that is independent of fanout, and it features three-state outputs.

CIRCLE NO. 276



# PROGRAMMABLE UNIUNCTIONS

## VERSATILITY

General Electric's 2N6027, 28 series programmable unijunction transistors (PUTs) continue to fascinate designers.

With just two resistors, you can vary key parameters ( $\eta$ ,  $R_{BB}$ ,  $I_P$ ,  $I_V$ ) of the PUT. It's like being able to design the ideal component for your circuit. Low leakage current and low peak point current permit use in long interval timer circuits....and they're excellent SCR trigger devices thanks to their fast, sure high-output pulse. GE PUTs, in plastic TO-98 packages, invite new applications.... especially where performance and cost are important.

## GE EXPERIENCE

GE invented the unijunction....has manufactured and sold more unijunctions than anyone else....published most of the application notes on unijunctions....and offers users over 56 different unijunction types.

PRACTICE MAKES PERFECT.

## FREE DESIGN KIT

Available from any authorized GE distributor or by writing to General Electric Semiconductor, Electronics Park, 7-49, Syracuse, NY 13201,....includes PUT samples, specification sheets and useful application notes.

REMEMBER...for UNIUNCTIONS

**it's still GE**

GENERAL  ELECTRIC



# Why buy semiconductor protective fuses from a semiconductor company?

Because they make your equipment work better.

Here's why. First, you can make a better match between the semiconductor and fuse, because we tell you more about their behavior than anyone else. We give you curves and graphs on every single rating, including worst case conditions. That's more than anyone else can say.

Second, IR's AMPKLIP fuses are more reliable. We use welded construction, not soldered, to prevent thermal fatigue from changing the parameters.



And we use a ceramic body instead of phenolic, so the fuse won't char.

Third, speed is the whole point in protecting semiconductors, and AMPKLIP fuses are generally faster than any others in head-to-head competition.

Get the full story on 130 to 700-Volt AMPKLIP fuses. Call your local IR sales office or distributor, or write on company letterhead for our 100-page Semiconductor Fuse Application Handbook, to: International Rectifier, 233 Kansas Street, El Segundo, California 90245.

... the innovative power people

INTERNATIONAL RECTIFIER



INFORMATION RETRIEVAL NUMBER 80

## new SWITCHING VOLTAGE REGULATORS



### HIGH PERFORMANCE

High Efficiency . . . to 90%  
MTBF > 100,000 hrs  
Low Case Temperature Rise . . .  
< 10°C above ambient  
Load Regulation . . . 0.1%

### SMALL SIZE

2" x 2" x 7/8" Encapsulated Module

LOW COST From \$30<sup>95</sup> (1.9)

### FOR USE IN

Point of Load Regulation  
High Efficiency Power Supply  
Designs  
Battery Powered Applications

1 or 2 Amp Models from 5 to 28 Vdc

Also Available: High Efficiency Power Supplies and Power Supply Kits

Our NEW 32 page catalog describes our full line of component module, PC card, open-frame, cased, and laboratory power supplies, DC/DC converters, DC/AC inverters, DC/DC isolators, switching regulators, and power kits.



SEMICONDUCTOR CIRCUITS, INC.

306 RIVER STREET ■ HAVERHILL, MASSACHUSETTS 01830  
(617) 373-9104

INFORMATION RETRIEVAL NUMBER 81

## INTEGRATED CIRCUITS

### Low-power Schottky ICs have 8-ns delay

Signetics, 811 E. Arques Ave., Sunnyvale, Calif. 94086. (408) 739-7700.

Typical circuits in the low-power Schottky line—the 54/74LS family—feature a dissipation of 2 mW per gate and propagation delay of 8 ns, when the circuits operate at a 35-MHz toggle rate. The 54/74LS speed-power product is 15 picjoules, or five times better than standard 54/74 ICs. The initial offering in the line consists of two hex inverters—the 54/74LS04 and 54/74LS05. About 20 devices, including a 4-bit arithmetic unit, are planned for introduction this year.

INQUIRE DIRECT

### IC contains successive approximation register

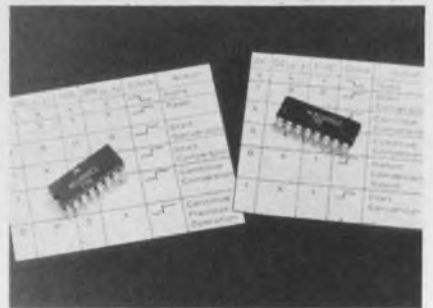

Motorola Semiconductor Products, Inc., Box 20924, Phoenix, Ariz. 85036. (602) 244-3466. \$8.06 up (100 up); stock.

The MC14549 and MC14559 ICs are 8-bit CMOS successive-approximation registers that provide the digital control and storage necessary for successive-approximation a/d converters. The master reset on the MC14549 can be used for a cascaded mode when greater than 8 bits are required. The feed-forward of the MC14559 can be used for register shortening when end-of-conversion is required after less than eight cycles. In the successive-approximation technique, the digital output is determined one bit at a time, starting with the most significant bit. Previously use of this technique generally required many combinations of MSI/SSI packages.

CIRCLE NO. 277



## CMOS dividers use 50 or 60-Hz input

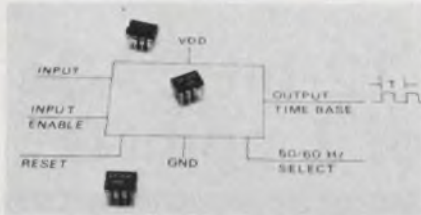

LSI Computer Systems, Inc., 22 Cain Dr., Plainview, N.Y. 11803. (516) 293-3850. \$5.90 (100); stock to 6 wks.

Three RED Series of CMOS static dividers generates a time base from either 50 or 60-Hz power lines. Depending on type used, repetition rates can be generated with these values: 10 pulses per second, 1 pulse per second or 1 pulse per minute. Selection of division for 50/60-Hz operation is determined by external connection of the mode-select terminal to either  $V_{DD}$  or ground. The dividers operate from a single 5-to-15-V-dc supply, and they come in 8-pin DIPs.

CIRCLE NO. 278

## IC contains disc demodulator

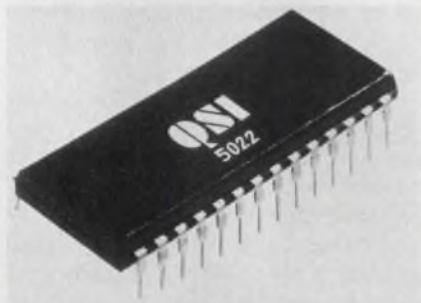

Quadracast Systems, Inc., 107 N. Bayshore Blvd., San Mateo, Calif. 94401. (415) 348-8400.

The QSI 5022 integrated circuit performs all the functions needed for a CD-4 discrete-disc demodulator and a low-noise phono pre-amplifier. Two of these ICs and several discrete components form a complete CD-4 system. The new IC features a typical distortion of 0.5%, typical system separation (including cartridges and records) of 25 dB and minimum frequency response of 30 Hz to 15 kHz. The QSI 5022 also specs a typical dynamic range of 90 dB. It operates from a 12-to-15-V dc supply and comes in a 28-pin DIP.

CIRCLE NO. 279

# Cover 2-18 GHz with only 2 swr bridges

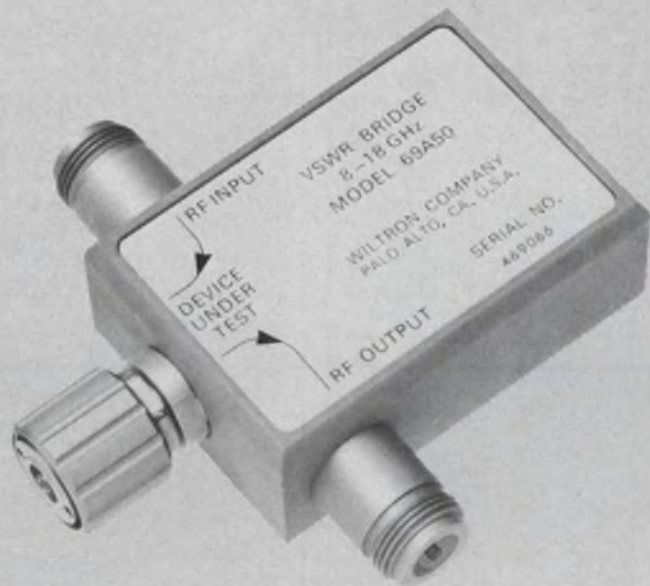

You can now measure swr and return loss over the entire 2 to 18 GHz range with only two WILTRON swr bridges.

Besides wide frequency coverage these new bridges also give you high directivity — at least 35 dB. That's very important to you when you need to measure low swr.

WILTRON swr bridges are the simple, fast and economical way to measure swr and return loss. The new 69A50 (8-18 GHz) is only \$725; the 64A50-2 (2-8 GHz) only \$670. They replace a lot of reflectometer hassle.

Call Walt Baxter at WILTRON today for more information about these bridges. Or about other WILTRON bridges down to 50 kHz.



Read the technical details  
in our 8-page  
"WILTRON Technical Review."  
Ask for Vol. 1, No. 1.



930 E. Meadow Drive • Palo Alto, Ca. 94303 • (415) 321-7428



What  
you see  
is what  
you get



Better yet, what you set is what you get! When you set a DIGIVIDER voltage divider or DIGIDECADE resistance decade at a value, you get only that—value (within 1/10 of 1% accuracy). We make them with more liberal tolerances, too. But, regardless of your accuracy requirements, (1.0%, 0.5%, 0.25% or 0.1%) you get...

- In-line readout • Positive detent action
- Absolute repeatability (no hysteresis)
- ...in less space and for less money per digit than a 10 turn precision potentiometer.

We make DIGIVIDERS or DIGIDECADE assemblies in any of our modular switch lines.

Send for our DIGIVIDER, DIGIDECADE Catalog today and see what you get.

There is a Digitran authorized distributor and a sales engineering group in your area.

See pages 1148 and 1149, Vol. 2 in the 1973-74 EEM Directory for more Digitran products.

**DIGIVIDER  
DIGIDECADE**  
MORE SWITCHES FROM THE  
**DIGITRAN**  
COMPANY

Division of Becton, Dickinson and Company   
855 South Arroyo Parkway / Pasadena, Ca. 91105  
Telephone: (213) 449-3110 / TWX 910-588-3794

INFORMATION RETRIEVAL NUMBER 83

## Laser trimmed, 12-bit DACs offer tempcos of 1 ppm/°C

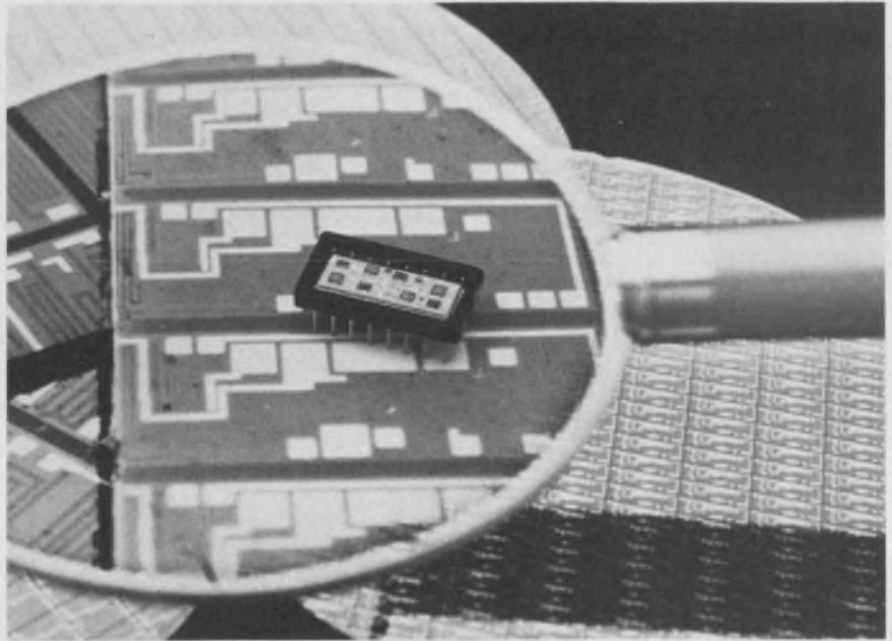

Hybrid Systems, 87 Second Ave., Burlington, Mass. 01803. (617) 272-1522. P & A: See text.

Complete 12-bit digital-to-analog converters have linearity temperature coefficients of 1 ppm/°C typical and 3 ppm/°C maximum. The Hybrid Systems' units, DAC-345I and DAC-346V, are laser-trimmed, thin-film hybrid circuits housed in 16 and 18-pin dual in-line hermetic packages, respectively. The 345I provides a bipolar current output and the 346V a bipolar voltage output.

The 345I has a large-signal (major transition) settling time of 1  $\mu$ s maximum to 0.01%. The linearity is typically  $\pm 1/2$  LSB. Since the current-output mode is not internally trimmed, scale-factor accuracy is  $\pm 5\%$ . The temperature coefficient of the scale factor, however, is 25 ppm/°C.

The current output of the DAC spans  $-1$  to  $+1$  mA, but it has a voltage compliance of  $\pm 0.25$  V maximum. The output impedance of the 345I is the impedance of the ladder network—about 4.25 k $\Omega$ .

The voltage-output version of the DAC has a somewhat higher settling time of 15  $\mu$ s maximum, an output current compliance of

5 mA, an output voltage span of  $-5$  to  $+5$  V, a scale-factor accuracy of 0.1%, a scale-factor tempco of 15 ppm, a linearity tempco of 1 ppm/°C and an output impedance of 0.1  $\Omega$  or less.

Both the 345I and the 346V use inverted offset binary input coding and require only  $\pm 15$ -V power supplies. Their power supply rejection ratios are a good 0.05%/V maximum, and standard models operate over a 0-to-70°C temperature range. The case size is typically 1  $\times$  0.5  $\times$  0.2 in.

Two of the closest competing units include the MN312 from Micro Networks (5 Barbara Lane, Worcester, Mass. 01604) and the DAC85C from Burr-Brown (International Airport Industrial Park, Tucson, Ariz. 85706).

The MN312 without an output amplifier costs \$79, settles in 0.5  $\mu$ s, requires an external reference voltage, is also housed in a 16-pin DIP and, for the most part, matches specs with the Hybrid Systems' DAC-345I.

The DAC85C which also costs \$79, settles in 0.3  $\mu$ s, has higher tempcos, requires a third power supply and is housed in a 1.4  $\times$

(continued on p. 144)



# Versatec does it again!

## Announcing 200-points-per-inch resolution

Versatec is making points like crazy.

While the rest of the electrostatic printer industry is plugging along at 80 points per inch . . . or 100 . . . we now introduce our tour de force . . .

The Matrix 1200A Printer/Plotter. Clearly the most impressive performer **ever** in electrostatic printers and plotters.

Consider. We can plot 3,600,000 points on a standard 8½ x 11 inch page!

In nine seconds.

Produced by 2,112 writing nibs in a dual-array configuration.

This staggering capability delivers overlapping dots and the kind of fine line resolution you expect from the best pen plotter . . . but 100 times faster.

And as for the printed page, the 1200A will print 132 16 x 16 dot matrix characters across the page at 500 LPM . . . in a typeface that is more handsome than that of any impact printer. You're looking at a sample of it right here.

You're probably thinking — "How come it's Versatec, Versatec, Versatec all the time who's making the breakthroughs?"

We are the only one with MEWT™, a true electrostatic writing technique. Years ago, we broke the price barriers with the least expensive electrostatic printers and plotters. And now we offer twice the resolution of anyone else.

With over 1,500 Matrix units in 20 countries

around the world, we're designing better products than anyone else.

But back to our Matrix 1200A. Write us today for more information, including a 200 points per inch print and plot sample that will knock your eyes out.

You have to see it to believe it.

Versatec, Inc.,  
10100 Bubb Road,  
Cupertino, California 95014.  
(408) 257-9900.



 **VERSATEC**

**Specialists  
in hard copy  
information  
display**



# Art Wire introduces the better keyboard key contact.



The Art Wire Calculator Keyboard key contact is better because it's designed for the job. It is a cold-formed key insert, used as the circuit board contact. The head acts as a stop for precisely locating the contact inside the key, the crimps increase the strength of the assembly, and reduce the tendency to twist. The chamfered or radiused end makes insertion easier, and a more positive contact. We supply the key contact in a variety of configurations to fit your need. Which ever one you choose, it is more economical because it is cold formed on automatic equipment.

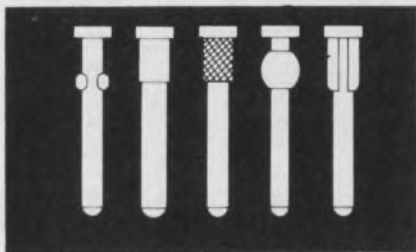

Write for full information, or send a print or part for quotation.



**ART WIRE & STAMPING COMPANY**  
116 Wing Drive, Cedar Knolls, New Jersey 07927

INFORMATION RETRIEVAL NUMBER 86

## MODULES & SUBASSEMBLIES (continued from p. 142)

0.8 × 0.25 in. package that is almost double the size of the Hybrid Systems' units.

The Hybrid Systems' DACs are available for a commercial temperature range (0 to 70 C) at \$79 for the 3451 and \$89 for the 346V in single quantities. Military-temperature versions, rated for MIL-STD-883, class C, are available for an additional \$20 per unit. All units are available from stock.

Hybrid Systems **CIRCLE NO. 253**

Burr-Brown **CIRCLE NO. 254**

Micro Networks **CIRCLE NO. 255**

## Power transducer has an accuracy of 0.1%

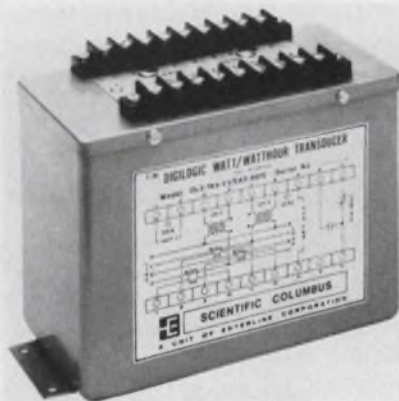

*Scientific Columbus, 1035 W. Third Ave., Columbus, Ohio. 43212. (614) 294-5671.*

The Digilogic watt transducer provides an accuracy of ±0.1% of reading by using an integrating analog voltage-to-frequency converter. Both watts and watthours are measured simultaneously. The inputs to the transducer can be from tie line interchanges, distribution transformers or other points in a power system. Both forward and reverse directions of power flow or energy are measured accurately. The instantaneous watt output is the conventional 0 to ±1 mA dc current. The watthour outputs are contact transfers or pulses proportional in number to watthours. Long term stability is maintained by use of a quartz crystal reference. Size of the unit is 8 × 3.5 × 7 in.

**CIRCLE NO. 280**

## Transistor power module handles 400 A at 350 V



*Solitron Devices, 1177 Blue Heron Blvd., Riviera Beach, Fla. 33404. (305) 848-4311.*

The CAXX01 power module can handle input input voltages of 350 V max and peak currents of 500 A. This unit is designed as a common-emitter configuration with one driver transistor driving 10 paralleled output transistors. Typical specifications for the power module are: Collector-base voltage, 375 V; collector-emitter voltage, 350 V; emitter-base voltage, 10 V; peak collector current (with a pulse width ≤ 3 ms and a duty cycle ≤ 2%), 500 A, continuous collector current, 400 A and power dissipation at  $T_c = 25 C$ , 2800 W. Dimensions of the housing are 6.5 × 6.5 × 2 in. and the unit weighs 5 lb.

**CIRCLE NO. 281**

## Convert-upon-command and prevent data skew

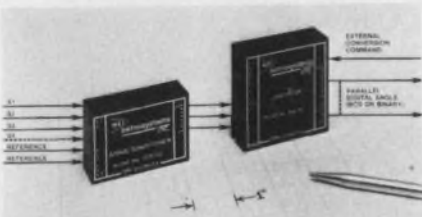

*Astrosystems, 6 Nevada Dr., Lake Success, N.Y. 11040. (516) 328-1600.*

A convert-upon-command feature of single-channel and multiplexed converters provides accurate synchronism with the computer. This results in the elimination of data skew and staleness at speeds up to 2000 °/s. Modular synchro and resolver-to-digital converters, available in 10 to 14-bit binary and 1° to 0.1° BCD models, have this conversion-control capability.

**CIRCLE NO. 282**



# Everything you need in ferrites

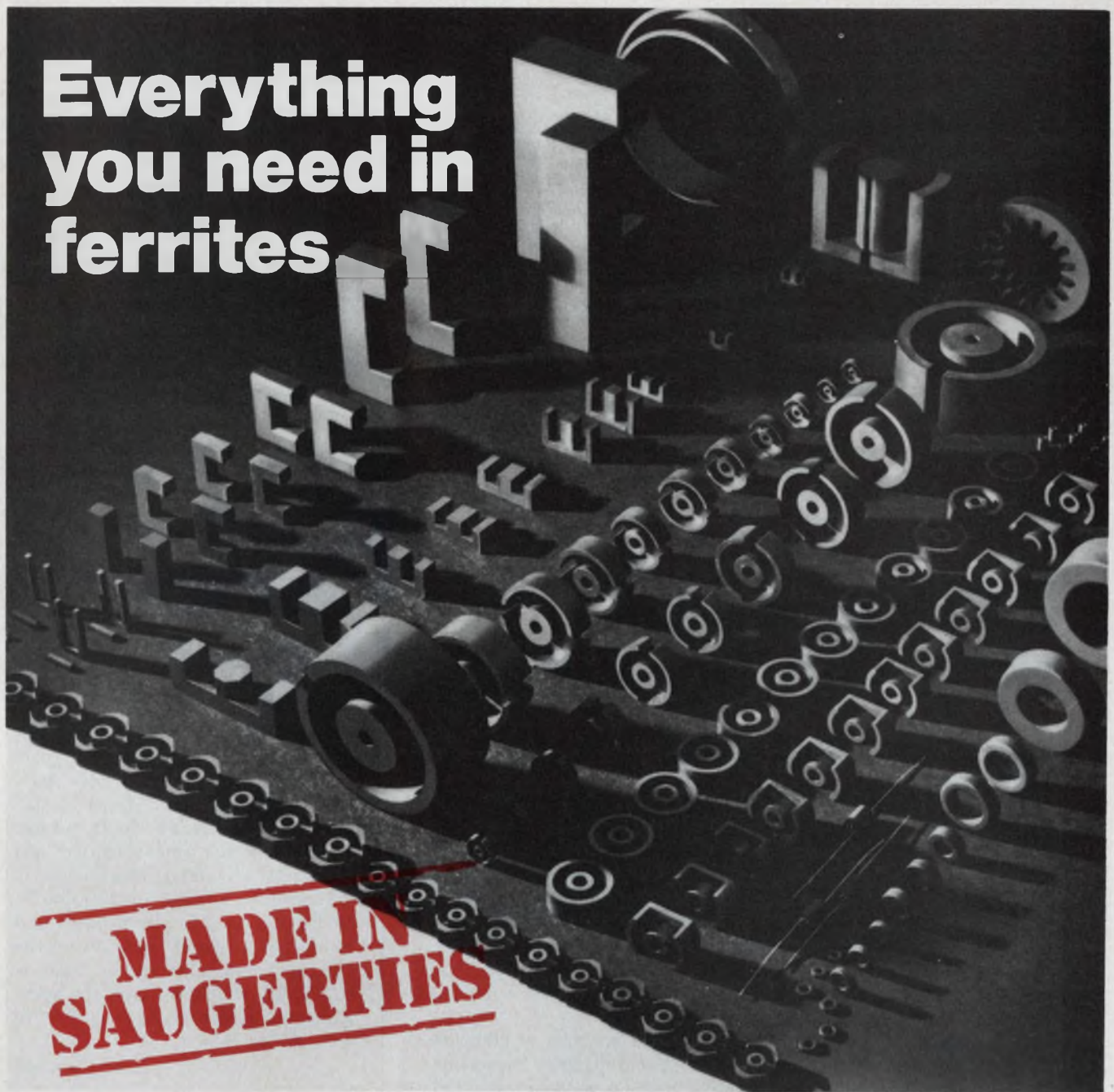

**Broad Product Line:** Ferroxcube offers a complete array of sizes and shapes of ferrite cores. They're made in Saugerties, N.Y. and stocked throughout the U.S.A. Toroids for pulse transformers, pot cores or square cores for precision filters, transformer cores in all sizes and shapes— E, U, I, specials and read-only memory cores—you can trust Ferroxcube to provide the optimum core for your inductors.

**Unsurpassed Materials Technology:** Ferroxcube, the acknowledged U.S. leader in ferrite technology, offers a wide range of standard materials for your cores. Chances are that one of them has exactly the *right combination of characteristics* for your application. And, you can depend on Ferroxcube to deliver the same uniform,

product characteristics year after year for consistent, optimum circuit performance in your designs.

**24-hour Availability:** Standard components are available for 24-hour delivery from any of seven warehouses conveniently located in Boston, New York, Saugerties, Philadelphia, Chicago, Santa Clara and San Diego.

If you're up on the advantages of ferrites, discover the added values of dealing with Ferroxcube. Ask for the new 1973 catalog. If you're new to ferrites and the design possibilities they open up, talk to one of our applications engineers. Call 914•246-2811, TWX 510-247-5410 or write Ferroxcube, Saugerties, N.Y. 12477.

Ferroxcube linear ferrites—made in Saugerties, N.Y. and stocked in seven U.S. locations.



**FERROXCUBE** CORPORATION, SAUGERTIES, N.Y. 12477 • 914•246-2811  
A NORTH AMERICAN PHILIPS COMPANY

Distributed through North American Philips Electronic Components Corporation with warehouses in Boston 617 • 899-7100, New York 516•538-2300, Saugerties 914•246-5861, Philadelphia 215•836-1616, Chicago 312•593-8220, San Diego 714 • 453-5440

16404

INFORMATION RETRIEVAL NUMBER 87



## F/v converter covers 5 Hz to 300 kHz

Solid State Electronics, 15321 Rayen St., Sepulveda, Calif. 91343. (213) 894-2271.

The Series 486E expanded scale Freqmeters provide a dc output linearly proportional to the input frequency. The input center fre-

quency can be specified anywhere from 10 Hz to 200 kHz. The frequency deviation from  $\pm 1\%$  to  $\pm 50\%$  of the center frequency gives a total range of 5 Hz to 300 kHz. Any of the standard IRIG proportional and constant bandwidth channels are also available. The unit will function correctly when driven with square, sine, triangular, pulse or any other zero-crossing signals.

CIRCLE NO. 283

# OUR ANGLE: The FIRST Digital Phase Angle Voltmeter



...This NEW DPAV provides complete analysis of complex AC waveforms at discrete frequencies and displays the results on a high readability  $4\frac{1}{2}$  digit display. Parameters measured are Total, Fundamental, In-Phase, and Quadrature voltage plus Phase Angle. Phase angle is displayed directly in degrees from  $0^\circ$  to  $360^\circ$  with a resolution of  $0.1^\circ$ .

The Model 220 operates phase-sensitively at a single factory-set frequency from 30 Hz to 32 KHz. The Model 225 has the capability of operating with two to four pre-specified frequencies. Both models have a total voltage measuring capability from 30 Hz to 100 KHz.

The DPAV can be used on the bench or in Automatic Test (ATE) applications. Remote programming,  $10M\Omega$  input isolation auto ranging, and BCD output options allow for complete hands-off operation necessary in automated test consoles. Priced from \$2950.00.

Let our sales engineering representative demonstrate our NEW angle to you. Call toll-free (800) 645-9200 for his name and address.



**NORTH ATLANTIC industries, inc.**

200 Terminal Drive, Plainview, New York 11803 • Phone (516) 681-8600  
California District Office: 13418 Wyandotte Street, N. Hollywood, CA 91605 • Phone (213) 982-0442

INFORMATION RETRIEVAL NUMBER 88

## Signal transmitter has rate limited output

Rochester Instrument Systems, 275 N. Union St., Rochester, N.Y. 14605. (716) 325-5120.

The Model SC-1396 rate limited signal transmitter has a rate of output signal limit that is continuously adjustable over a 10:1 range. Precise rate limiting to 60 min. is provided. Both true and live zero control signals can be generated by the SC-1396. A reed relay contact output is provided. All standard inputs (1 to 5, 4 to 20, 10 to 50 mA dc or 1 to 5 V dc) are accepted by the unit. Accuracy is  $\pm 0.25\%$  and repeatability is  $\pm 0.1\%$  of span.

CIRCLE NO. 284

## S/d converters deliver 13-bit binary data

C & A Products, 37-12 58 St., Woodside, N.Y. 11377. (212) 779-4303. \$480 (unit qty.); 4 wk.

The SD300 Series units are continuous phase-locking synchro-to-digital converters. They transform either a three-wire synchro or four-wire resolver input to a 13-bit binary or 4.5 decade BCD output. Input is transformer isolated and transient protected. Resolution is 2.6 minutes binary or 3 minutes BCD. Accuracy is six minutes and is specified worst case over the full environmental range. Size is  $4.7 \times 3.5 \times 0.85$  in. and the operating temperature range is 0 to 70 or  $-55$  to  $+85$  C.

CIRCLE NO. 285

## Electronic speed control saves ac power

Marathon Electric, P.O. Box 1407, Wausau, Wis. 54401. (715) 675-3311.

The Wattmiser, an adjustable speed control system, is designed for use with systems that use 25 horsepower motors and larger. The Wattmiser secondary ac motor control captures and regenerates 97% of the electric power conventional control systems waste. This results in an over-all savings of 10 to 40%. The unit is an electronic method of controlling the speed of ac wound-rotor motors while recovering and regenerating static power.

CIRCLE NO. 286



# Micaply<sup>®</sup> Substrates and Circuits

## For Thick/Thin Film Applications

### Thick/thin film resistor-conductor circuits utilizing Micaply Ohmega<sup>™</sup> Resistor-Conductor Laminates

### Hybrid microcircuits utilizing Micro-Thin Copper Clad Laminates (a low cost ceramic substrate alternative)

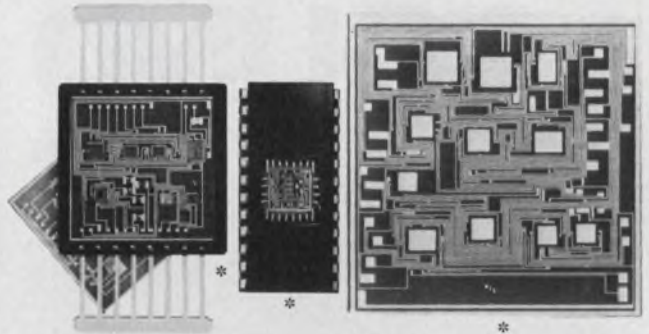
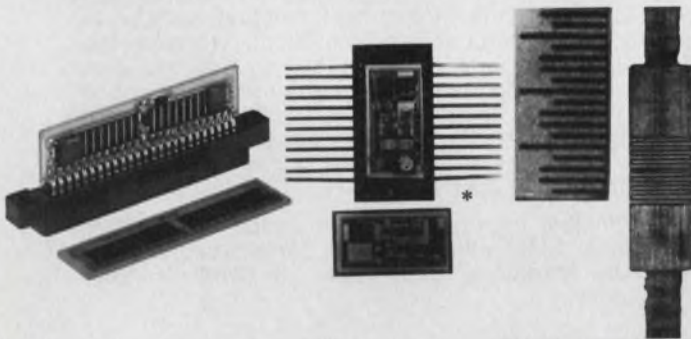

Circuits of Micaply Ohmega<sup>™</sup> offer designers a proven epoxy glass substrate with both the resistor and conductor layers completely covering the substrate on one or both sides. **Selective etching produces conductors complete with integral thin film type resistors as shown at the right.** The circuits shown above are examples of its use to replace more expensive thick/thin film resistor circuits and discrete resistor circuits.

Complete design assistance and circuit production are available. Contact us for an evaluation of your requirement and comprehensive technical literature. Find out how Micaply Ohmega<sup>™</sup> can reduce your circuitry cost.

- Much lower cost than conventional materials and processing.
- 25 or 100 ohms-per-square sheet resistivity.
- Line widths consistent with thin film microelectronic techniques.
- Subtractive etching process — no screening, firing, or vacuum equipment required.
- 10" x 36" sheets for processing economy.
- Can be easily drilled and cut.
- Can be multilayered for higher density.
- Resistors can be laser trimmed.

\* Circuits courtesy Micro Telemetry Systems

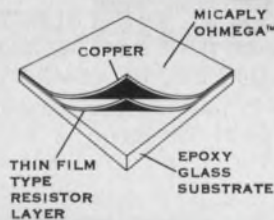

Before Etching

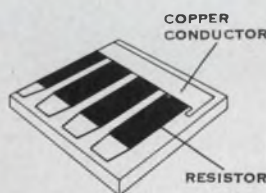

After Etching

Micaply<sup>®</sup> Micro-Thin Copper Clad Laminates make possible lower cost hybrid microcircuits. Epoxy glass microcircuits like the ones shown above eliminate the cost and costly processing of ceramic in many applications. Micro-Thin is an epoxy glass laminate completely clad on one or both sides with 100 microinches of copper. Using conventional etching techniques conductors with line widths as fine as two mils can be produced.

Complete design assistance and prototype service is available. Contact us for an evaluation of your requirement and for comprehensive technical literature. Find out how Micaply<sup>®</sup> Micro-Thin can reduce your microcircuit costs.

- Much lower cost than metal coated ceramic substrates.
- 100 microinch copper clad epoxy glass.
- Can be easily drilled and cut.
- 10" x 12" sheets for processing economy.
- Etched line widths as fine as two mils.
- Can be multilayered for higher density.
- Active and passive chips are easily bonded.
- No screening, firing, or vacuum equipment required.



**Request complete literature on Micaply Ohmega<sup>™</sup> and Micro-thin Copper Clad Laminate materials and production services.**

The **Mica** Corporation

10900 Washington Boulevard, Culver City, California 90230, (213) 839-5282, TWX: 910-340-6365, Telex: 674999

**Micaply International, Ltd.** Silloth, Cumberland, England, Silloth 571, Telex: 64120, Cable: Micaply Silloth

INFORMATION RETRIEVAL NUMBER 89



**WANT A 16K BY 20  
650 NSEC. MEMORY  
ON A SINGLE CARD?**

**YOU  
JUST  
FOUND  
IT**

Not only do we have just the memory you're looking for, we have it in a thoroughly field-proven design. A design that has been accepted — even by our competitors — as the industry standard. Basically it is the same reliable 3 Wire, 3D design as our MICROMEMORY 3000. We doubled the capacity, but kept everything else the same.

It is the MICROMEMORY 3000DD. Consider its credentials. Cycle and access times of 650 nsec. and 300 nsec., respectively. Power requirements of  $\pm 15\text{VDC}$  and  $+5\text{VDC}$ . The complete system, including all necessary logic, drive and sense circuitry complete on one convenient plug-in circuit board. Standard configuration of 16K by 16, 18, or 20 bits, alterable to 32K by 8, 9, or 10. And it is interchangeable with the original MICROMEMORY 3000.

The MICROMEMORY 3000DD is also available as a pre-packaged, multi-card system, complete with power supply, self-test and interface cards, and various other features and options. And standard chassis are available to hold from one to 16 memory cards. Since both the original 8K MICROMEMORY 3000 and the new 16K MICROMEMORY 3000DD cards can be inter-mixed, this gives you new and greater growth flexibility from 8K to 256K.

Get complete information and technical details from your local EMM office, or call Commercial Memory Products Marketing Department at (213) 644-9881. Do it today.

**EMM ELECTRONIC  
MEMORIES  
COMMERCIAL MEMORY PRODUCTS**

A Division of Electronic Memories & Magnetics Corporation  
12621 Chadron Ave., Hawthorne, Calif. 90250

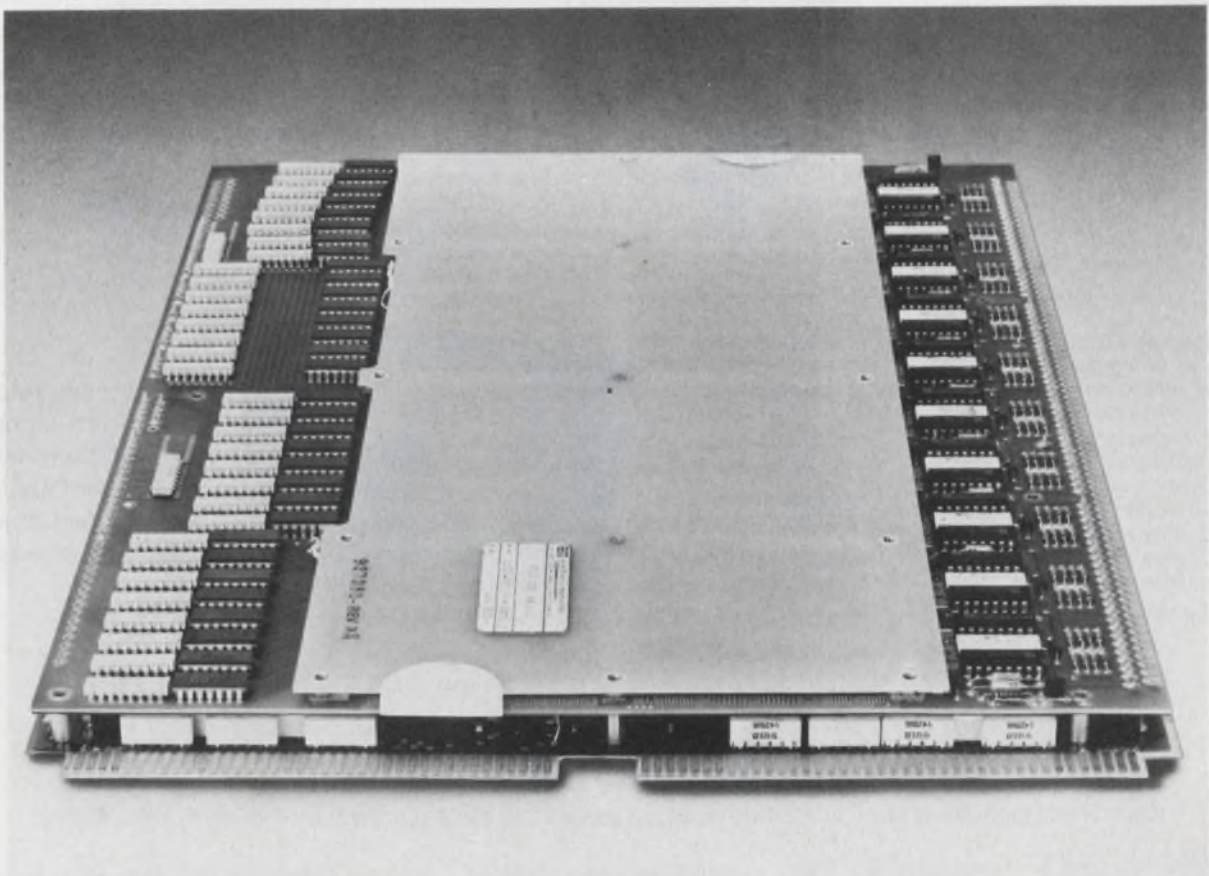



**Audio equalizer has three overlapping ranges**

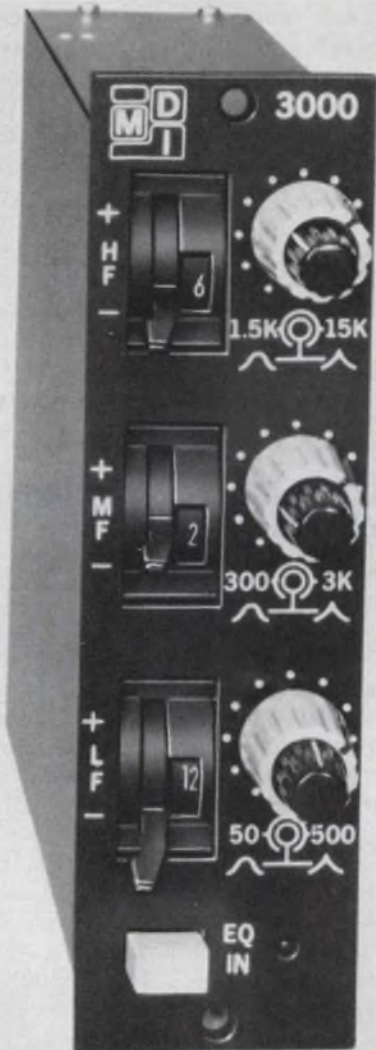

Modular Devices, 1385 Lakeland Ave., Airport International Plaza, Bohemia, N.Y. 11716. (516) 567-9620. \$325; stock to 90 day.

The Model 3000 equalizer has three independent overlapping frequency ranges: 50 to 500 Hz, 300 Hz to 3 kHz, and 1.5 to 15 kHz. Each range has its own continuously variable center frequency and bandwidth controls. The degree of equalization of the bell shaped response is individually selectable in 12 discrete steps from -12 dB of dip to +15 dB of boost. This unit also has a voltage controlled equalization in-out switch and a LED indicator for use with automated programmers. The Model 3000 measures 1.5 x 5.25 x 6 in. and has transformer coupled outputs.

CIRCLE NO. 287

**Quartz digital clock circuit fits in a TO-5**

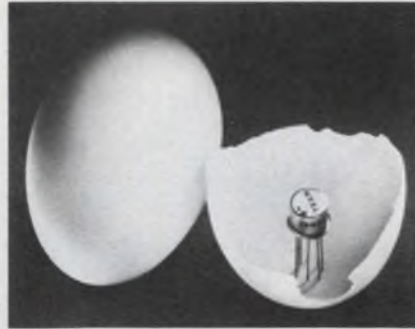

Q-Tech, 11529 W. Pico Blvd., Los Angeles, Calif. 90064. (213) 473-1105. Under \$20 (1000-up); stock to 3 wk.

Two hybrid thin-film crystal-controlled oscillators with frequencies of 65.536 kHz are available in a TO-5 package. The oscillators are available in both CMOS and TTL versions. The AT cut quartz crystal temperature characteristics of the oscillators keep them stable to within 50 ppm over an operating temperature range of 0 to +50 C. The CMOS version (designated QT1C2-65536) operates on 12 V while the TTL version (QT1T2-65536) operates on 5 V. Both versions are also available in other frequencies. At additional cost, the 50 ppm stability is available over an operating temperature range of -55 to +125 C.

CIRCLE NO. 288

**DIP compatible crystal oscillators drive TTL**

Vectron Laboratories, 121 Water St., Norwalk, Conn. 06854. (203) 853-4433. 2 to 8 wk.

The CO-239 DIP compatible crystal clock oscillator drives 10 TTL loads at any frequency in the 4-to-100-MHz range. It operates from 5 V dc and provides stability better than  $\pm 0.0025\%$  over 0 to 70 C. The low profile module plugs directly into a 14-pin dual in-line socket and measures only 0.8 x 1.4 x 0.23 in. Options include the CO-239-2 which provides stability better than  $\pm 0.005\%$  over -55 to +125 C and the CO-239-3 which provides stability better than  $\pm 0.0003\%$  over 0 to 50 C. The CO-231, a larger package, offers identical characteristics at frequencies as low as 1 Hz.

CIRCLE NO. 289

**There's an EMM office near you.**

**WESTERN REGION**

Regional Office

**SAN FRANCISCO**  
(408) 247-9711

**LOS ANGELES AREA**  
(213) 644-9881

**ORANGE COUNTY AREA**  
(714) 639-5811

**MINNEAPOLIS AREA**  
(612) 941-2404

**PHOENIX AREA**  
(602) 968-2492

**DALLAS AREA**  
(214) 231-7207

**EASTERN REGION**

Regional Office

**BOSTON**

(617) 861-9650

**CHICAGO AREA**  
(312) 297-7090

**WASHINGTON, D.C. AREA**  
(703) 941-2100

**NEW YORK AREA**  
(516) 423-5800

**CLEVELAND AREA**  
(216) 842-8920

**International OFFICES**

**European Headquarters**

**BELGIUM**

(03) 76.69.75

**UNITED KINGDOM**

(01) 751-1213

**WEST GERMANY**

(0811) 74.30.40

**Far East Headquarters**

**JAPAN**

(03) 404-8520

**EMM** ELECTRONIC MEMORIES & MAGNETICS CORPORATION.

12621 Chadron Avenue  
Hawthorne, Calif. 90250  
(213) 644-9881



## Data-acquisition system handles $\pm 300$ V CMV

Datel Systems, 1020 Turnpike St., Canton, Mass. 02021. (617) 828-8000. From \$4121.

The Model DAS-300CMV, flying-capacitor, 64-channel data acquisition system offers  $\pm 300$  V of common-mode operation. The 64 differential channel system accepts analog differential voltage inputs of 0 to +5, 0 to +10 (unipolar) or  $\pm 5$ ,  $\pm 10$  V (bipolar) and converts these inputs to 8, 10, 12, or 14-bit binary words. The system operates in either a single or multiscan mode. In the single scan mode the system converts 200 samples per second. In the multiscan mode, all 64 channels can be cycled every 5.5 ms. The digital output coding can be offset binary or two's complement for bipolar inputs or straight binary for unipolar inputs. In the single scan mode inputs can be sequentially or random addressed under external computer control. System specifications include a 100 dB CMRR from dc to 1 kHz with a 1 k $\Omega$  source imbalance. Linearity is within  $\pm 0.01\%$  of full scale range. Temperature coefficient of zero (offset) is  $\pm 15$  ppm/ $^{\circ}$ C of fs and range (gain) tempco is  $\pm 13$  ppm/ $^{\circ}$ C. Over-all system accuracy is  $\pm 2.5$  mV,  $\pm 1/2$  LSB, including all internal error sources. Nominal input impedance is  $10^{10}$   $\Omega$ . An optional front panel LED display indicates up to 14 bits of binary data and the 6-bit channel address. All necessary  $\pm 15$  and +5 V regulated supplies, which are powered by the conventional 115 V, 60 Hz ac line are included.

CIRCLE NO. 290

## Telephone call dialer handles 11-digit calls

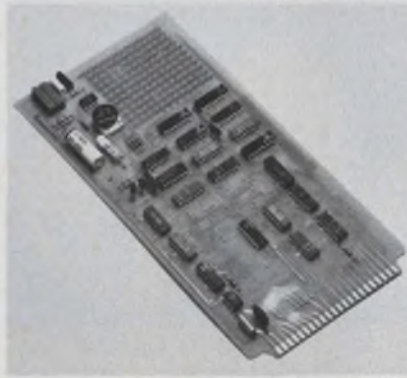

Advanced Terminal Systems, P.O. Box 90121, Los Angeles, Calif. 90009. (213) 644-5321.

The AD-1201 solid state telephone dialer fits on a single EIA standard  $4.5 \times 9.25$  in. PC card. Both pulse and tone dialer modules are available. You can field program a single telephone number up to 11 digits long. Options for larger numbers are available. End of number programming is also provided to permit automatic switchover to either the voice or data mode on completion of the dialing sequence. Dialing is initiated by either a DTL/TTL signal or contact closure. Separate controls are included for line hold and redial initiation. An initial dial tone timeout is always provided prior to the first dialed digit. Additional programmed dial tone timeouts are available prior to the 2nd, 3rd, 4th and 5th digit. On-board controls are provided for pulse rate, inter-digit duration, percent break (pulse dialer), tone inter-digit duration and tone amplitude (tone dialer). Compatible interface signals are provided for Bell System voice or data couplers.

CIRCLE NO. 291

## A/d converter delivers 12-bits in 40 $\mu$ s

Zeltex, 940 Detroit Ave., Concord, Calif. 94518. (415) 686-6660.

The Model ZAD-12QZ analog-to-digital converter provides 12-bit resolution and has conversion speed of 40  $\mu$ s. As well as offering "spec for spec" equivalence to the ADC 120Z from Analog Devices the ZAD-12QZ has low noise and good temperature stability. The ZAD-12QZ is also pin-interchangeable with the company's ZAD-1000 series, thus offering the user an easy means to upgrade performance or increase speed up to 10  $\mu$ s at 12 bits.

CIRCLE NO. 292

## Linear power amplifier delivers 1500 W

Amplifier Research, 160 School House Rd., Souderton, Pa. 18964. (215) 723-8181. \$18,500; 150 day.

Model 1500LA, a self-contained high-power broadband amplifier, is designed for laboratory applications. It provides 1500 W of cw swept power or over 4000 W of pulse power from 1 to 150 MHz. This linear amplifier reproduces all types of modulation—AM, FM or pulse. The pulse mode lets the user produce rf pulses or rf bursts of over 4000 W peak power at a duty cycle up to 25%. Model 1500LA also features a second power output level of 100 W. This can be used for initial test and adjustment and thus eliminate possible damage. Another feature is a continuously variable attenuator—the operator can adjust the amplifier gain over a 20-dB range.

CIRCLE NO. 293

**ANA & LOG**

OH, LOG, WHAT ARE YOU GOING TO DO? HIT OR MISS-HARRY WANTS TO GUN YOU DOWN TO SETTLE THAT 16 BIT SCORE.

NEVER FEAR, MY DEAR, WITH MY TRUSTY A-856 I'LL FINISH HIM OFF IN 8 $\mu$ S.

MY GOODNESS, YOU'RE FAST!

AND ACCURATE; THE A-856 DOES IT ALL.

**ANALOGY**

BEAT THE BAD GUYS WITH THE A-856 A/D HIGH SPEED CONVERTER. RESOLVES 1:65 536 WITH CONVERSION SPEED OF 8 $\mu$ S, THAT'S 125,000 SAMPLES PER SECOND! TEMPERATURE STABILITY OF  $\pm 5$  PPM/ $^{\circ}$ C, LINEARITY  $\pm 10$  PPM.

**intech** INCORPORATED  
(408) 244-0500  
1720 COLEMAN, SANTA CLARA CA 95050



# For \$495.<sup>00</sup>

## Screen out your bad IC's before they hide out.



Plug In device.

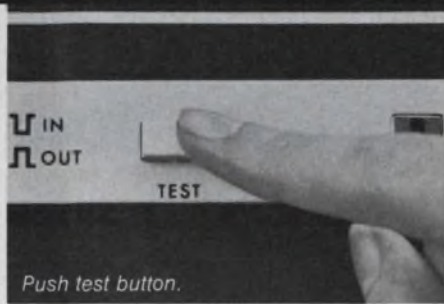

Push test button.

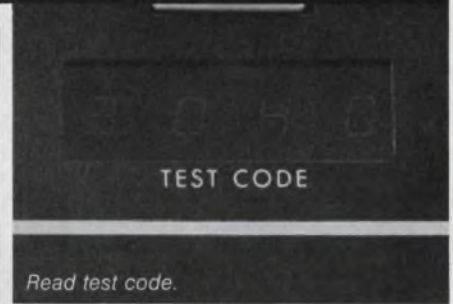

Read test code.

### Easy as one...two...three

The Model 1248 IC Functional Tester will start paying for itself on the first day of use, even low volume use. Incoming digital ICs—TTL, DTL, and CMOS—can be tested for functional failure at the rate of 10 per minute or better by a non-technical person. Plug in, push the button, and eliminate *all* your DOAs before they go into your circuit and require expensive trouble-shooting to track down.

Operation is simplicity itself.

After the switches are set to apply the proper function to each pin of the 14 or 16 pin DIP, testing is a matter of seconds—one second for TTL/DTL and five seconds for CMOS. The test result, displayed as a



highly visible four-digit test code, is absolute. No comparison with a "good" IC is necessary. Switch settings and test codes for most devices on the market come with the instrument, along with complete instructions including how to test unlisted devices.

Self-contained, rugged, and compact, this tester goes anywhere. You are invited to try it—free. No obligation if returned within 10 days. Call or write the factory for our full-color booklet on this unique IC functional tester.

Electro Scientific Industries,  
13900 N. W. Science Park Dr.  
Portland, Oregon 97229.  
Telephone 503/646-4141.  
Telex 36-0273.

**esi**

### CHANGEVER TO TEST ANOTHER IC IS FAST.



insert different device socket if necessary.



push proper mode button.



set switches to new positions.

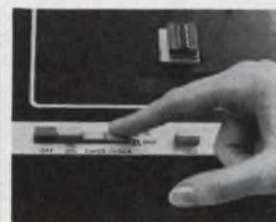

check clock button for polarity. Now test as above, one, two, three!

INFORMATION RETRIEVAL NUMBER 93





## THE SMALLEST LED SWITCH/INDICATOR ON THE MARKET



ACTUAL SIZE

NOW AVAILABLE IN RED, GREEN, YELLOW AND REDUCED 15%!

Low As **\$3.50** Each in 100 Qty's.

Subminiature SSBL Series combines long life LED and SPST-NO-DB switch in a low cost, highly reliable unit that fills a variety of display and control functions — especially where space is limited. Projects only  $\frac{5}{8}$ " behind panel with turret lug terminals (as shown) or 1" with .025" square Wire-Wrap terminals. Mounts in  $\frac{1}{4}$ " hole on  $\frac{3}{8}$ " centers.

Bright indication, low power consumption and resistance to shock, vibration and extreme temperature changes make this LED the perfect replacement for incandescent or neon lamps in low current, solid state applications. Lens has Fresnel rings that distribute light for maximum visibility.

Momentary contact pushbutton switch has rating of 100 mA @ 115 VAC and life exceeding 1 million operations at rated current. The SSBL operates from a 5 VDC supply; however, can accommodate up to 28 VDC by adding an external series resistor.

**MATCHING LED INDICATOR CUT 22%!**



Low As **\$2.10** Each in 100 Qty's.

The SSIL Series has all the outstanding features of the SSBL, but is an indicator only. Built-in resistor adapts unit for 5 to 28 VDC operation.

TEC also has a matching switch only — the SBS — plus subminiature indicators and switch/indicators with neon and incandescent lamps.

NOTE: Green and yellow LED's are available only with 5V rating.

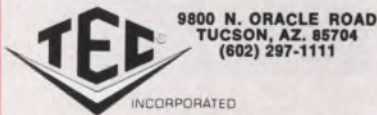

9800 N. ORACLE ROAD  
TUCSON, AZ. 85704  
(602) 297-1111

## DATA PROCESSING

### Double-capacity memory board available in MOS

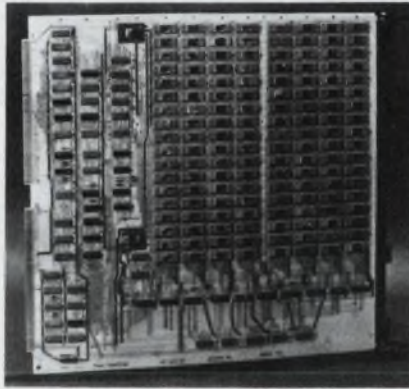

Prime Computer, 17 Strathmore Rd., Natick, Mass. 01760. (617) 655-6999. See text.

A 16-by-18-in. board contains 32-k words of MOS memory, twice that of core boards. The memories are available in speeds of 1000, 750 and 600 ns and use the new 4-k memory chips. The boards are designed for use with the company's computers and provide storage for 16-bit words and two parity bits. This by no means the smallest solid-state board. General Automation of Anaheim, Calif., offers its Micromemory unit, a 7.75-by-11-in. board that holds 32-k words and has a 500 ns cycle time. The board from Prime Computer sells for \$11,000; a Model 100 CPU together with the board sells for \$15,000.

CIRCLE NO. 294

### Fixed-head drives for PDP-11 memories

Digital Equipment Corp., 146 Main St., Maynard, Mass. 01754. (617) 897-5111. See text; 60-90 days.

Two fixed head discs, designated the RJS $\phi$ 3 and RJS $\phi$ 4 systems, have average access times of 8.5 ms and transfer 16-bit words at 250 kHz rates. Priced at \$14,000 the RJS $\phi$ 3 includes a controller and a rack-mounted RS $\phi$ 3 fixed-head disc drive with a storage capacity of 256-k, 16-bit words. For \$18,000 the RJS $\phi$ 4 includes a controller and a rack-mounted RS $\phi$ 4 fixed-head disc drive with a storage capacity of 512-k, 16-bit words. Both systems are expandable to a total of eight drives per controller.

CIRCLE NO. 295

### Processor helps PDP-11 rush array calculations



CSP Inc., 209 Middlesex Turnpike, Burlington, Mass. 01803. (617) 272-6020. See text.

The CSPI-4011 processor offers high-speed signal processing speeds to PDP-11 users. The peripheral performs a wide variety of array manipulations that include FFT, inverse FFT, cartesian-to-polar conversion, convolution and correlation. A complex FFT with 1024 points takes less than 5 ms; a 1024  $\times$  1024 complex multiply is done in 2.5 ms. The 4011 handles array sizes to 8192 complex values and uses 16-bit words for the real and imaginary components. Less than 2  $\mu$ s are needed for the host to initiate computation. Prices start at \$25,000 and range up to \$40,000, depending on the options selected.

CIRCLE NO. 296

### Cross-bar switches address in 100 ns

Opto-Logic, 3450 E. Spring St., Long Beach, Calif. 90806. See text; 120 days.

These optically decoupled cross-point switches connect any input to a single output with an address time of 100 ns. The switches handle analog or digital lines with bit rates in the range of 10 to 28 MHz. There are two models: a unidirectional unit and a bidirectional unit, with all input, output and address electronics. The cost per crosspoint is under \$3.

CIRCLE NO. 297



# A dual-trace "mini" that's quite a scope!

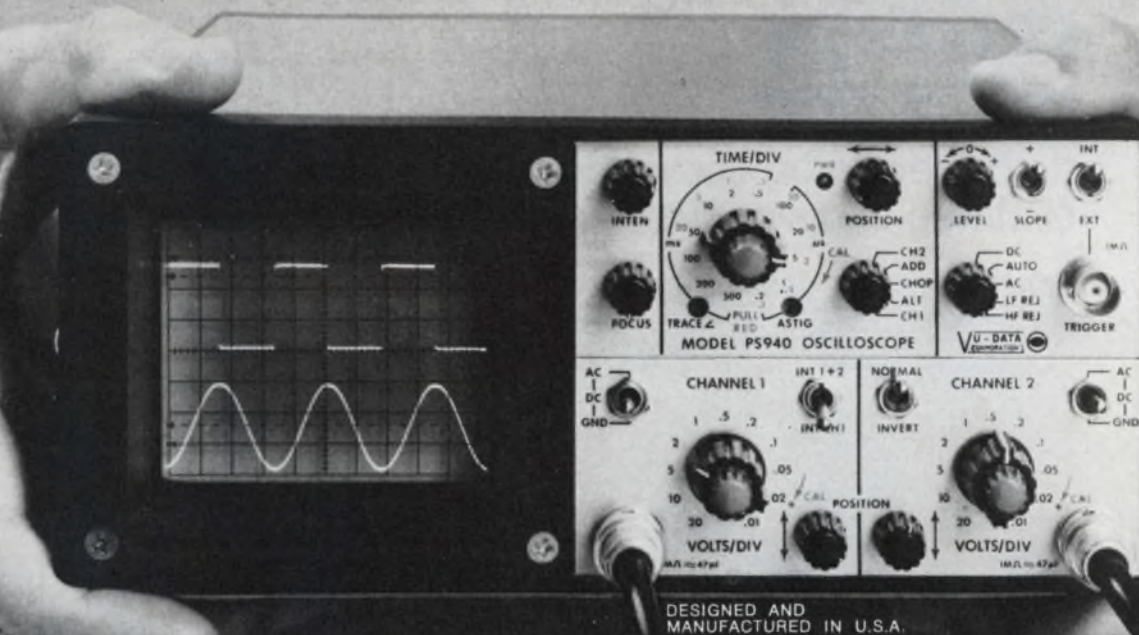

DC - 20 MHz bandwidth  
18 nsec risetime

21 sweep ranges to 100 nsec/div  
10 mV/div sensitivity

Delay line included  
8 x 10 div display area

Weighs only 9.5 lbs  
Fits in a tool kit or brief case

Battery, AC or DC powered  
Battery charge indicator

If you need a high-performance portable scope, but don't feel like lugging the weight around—or lack the space, then consider Model PS940A. This dual-trace mini-portable oscilloscope provides all the basic features and quality of a sophisticated laboratory oscilloscope, yet it adds a new dimension to portable scope applications. Its weight and size (9.5 lbs and fits in a tool kit or brief case) make it easy to carry to every job, in the plant or in the field. It may not be

a lab scope, but it triggers like one—and in most applications it has the features to serve you well. With 20 MHz bandwidth, 18 nsec risetime, 100 nsec/div sweep rate and 10 mV/div sensitivity, Model PS940A is the dual-trace "mini-scope" to beat! Available now for only \$1,095.

Interested? Call Hal Wardein at (714) 279-6572, or write to us at 7170 Convoy Ct., San Diego, CA 92111.

INFORMATION RETRIEVAL NUMBER 95

From a Leader in Mini-Portable Oscilloscopes

**VU-DATA**  
CORPORATION 



## Cassette program loader weighs 14 lb

*Electronic Processors, Inc., 1265 W. Dartmouth Ave., Englewood, Colo. 80110. (303) 798-9305. \$995 (quan).*

A program loader that combines accuracy with briefcase portability has been introduced. Called STR-

LINK, the unit features speed tolerant recording on cassettes and is specifically designed for on-site loading of programmable controllers, remote computers and terminals. STR-LINK can be used with either a 20-mA current loop or RS 232 interface. The program loader has a read/write capability of 110, 150, 300, 600 or 1200 baud. The unit measures 18 × 13 × 5 in. and weighs 14 pounds.

CIRCLE NO. 298

## tecnetics economy watts line

dc-dc regulated converters.  
six, three and one watt.



Designed primarily for the commercial market, tecnetics 1000 Series 6, 3 and 1 watt DC-DC regulated converters are low in price and profile. Wide selection of inputs, outputs and power levels.

Input voltage models range from 5VDC to 48VDC.

Output voltages (VDC):

Single: 5V to 48V

Dual: 10V to 24V

Triple: 5V and ± 15V; 5V and ± 12V

Regulation: Line (low to high) 0.1% max.  
Load (NL to FL) 0.3% max.

Overload and short circuit protection standard on all models.

Availability: stock to four weeks.

Prices range from \$44 to \$99

Write or call for more details on specifications, applications and the new 1974 catalog from tecnetics.

**tecnetics**® The Power Conversion Specialists

P. O. Box 910 1625 Range Street, Boulder, Colorado 80302  
(303) 442-3837 TWX 910-940-3246

## Floppy-disc storage available for most minis

*Standard Logic Systems, 3481 S. Main St., Santa Ana, Calif. 92707. (714) 556-1400. 30 days.*

A floppy disc storage system, named the FD-8200, is available with interfaces for most popular minicomputers. The unit provides 77 data tracks, each with a storage capacity of 8 sectors × 256 words. The transfer rate is 31 k byte/s. Track-to-track movement and head settling time (last track) are both 10 ms.

CIRCLE NO. 299

## Keyboard family has bounceless outputs

*Mechanical Enterprises, 5249 Duke St., Alexandria, Va. 22304. (703) 751-3030. See text.*

A family of 15 keyboards, encoded with the Harris HD-1065, features four-bit parallel output and two-key rollover. All outputs are bounce-free and TTL-compatible. The boards contain 10, 12 or 16 keys and are available with three switch styles: low-profile for hand-held keyboards, full-stroke mechanical spring and full-stroke mercury tube. Prices range from \$34 for a single 10-key unit to \$45 for the most expensive 16-key board.

CIRCLE NO. 300

## Display system handles graphics and characters

*Ramtek Corp., 292 Commercial St., Sunnyvale, Calif. 94086. (415) 941-8860. From \$8000; 90 days.*

A graphic display system designated the Model FS-2000 can address a character to any location on a 256 × 256 grid. Images are stored in display lists which can be read back in whole or in part into the CPU through bi-directional interfaces. The unit can display bar charts, histograms, flow diagrams, and other important data. Features include automatic overwrite of a character on a graphic entity, nondestructive overlay of characters, capacity to display as many as 2000 entities, (or paint the screen white with four bytes) and two-byte relocation of any display block. Interfaces are available for most minicomputers.

CIRCLE NO. 301



# Open a Savings Account with our new megapower SCRs



When you invest in IR's new Megapower SCR Family Savings Plan you start earning dividends three important ways.

First, you can eliminate over 70% of the devices and parts normally needed (see the 3-phase converter "savings account" below for full details). That gives you a lower total system cost, plus more reliability.

Second, having fewer parts cuts assembly time sharply, increases reliability and makes your field servicing that much easier, too.

Third, Megapower SCRs give you more production power with only a minimum change in your equipment size.

If you want to parallel Megapower SCRs, there's a special bonus. Our epitaxial process

yields SCRs of virtually identical switching characteristics, so you eliminate expensive current balancing equipment. It also produces the high voltage SCRs you need. Specifically: 700A(av), 500 to 2100V; 850A(av), 500 to 2000V; 1000A(av), 500 to 1500V, and 1600A(av), 500 to 1200V.

There is also an extra dividend in overall productivity because Megapower SCRs will keep your equipment on line longer. Their surge capability is so high, they can ride through massive overloads without resorting to protective fuses.

Open a savings account today. Call your IR branch office, or bank headquarters (213) 678-6281; Telex: 67-4666. International Rectifier, 233 Kansas Street, El Segundo, CA.

## IR'S 4800 Amp, 3-PHASE CONVERTER SAVINGS ACCOUNT

Parts Per Assembly	4800A Assy. Using 3-550A SCRs Per Leg	4800A Assy. Using 1-1600A SCR Per Leg	Parts Saved Per Assy.
1. SCRs	18	6	12
2. Heat Sinks	21	9	12
3. Clamps	18	6	12
4. Fuses	18	6	12
5. Balancing Reactors	18	0	18
6. Trigger Pulse Pwr. Amplifiers	6	0	6
7. Isolated Gate Drive Windings	18	6	12
<b>Totals</b>	<b>117</b>	<b>33</b>	<b>84</b>

# International Rectifier

International Rectifier, 233 Kansas Street, El Segundo, CA 90245. . . *the innovative power people*



INFORMATION RETRIEVAL NUMBER 97



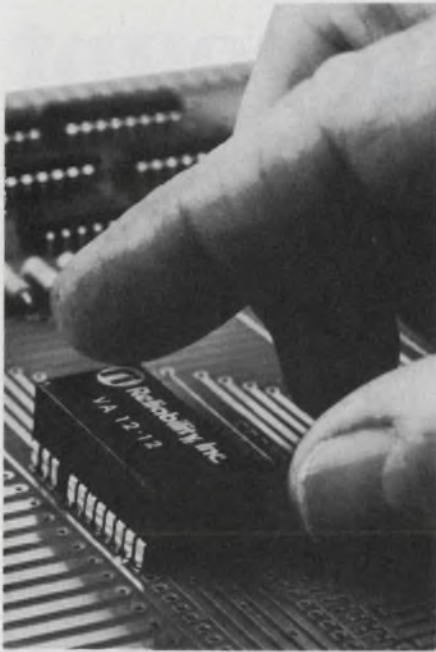

## DATA PROCESSING

### Tape reader loads Intel microcomputer faster

*iCOM, Inc., 21243 Ventura Blvd., Woodland Hills, Calif. 91364. (213) 340-0611. \$995; 30-60 days.*

The Model R808 paper tape reader allows Intel users to load programs nearly 12 times faster than with a Teletype. For example, the Intel paper-tape assembler program can be loaded in three minutes, instead of 35 minutes for the other method. In addition to the speed advantage, the iCOM unit uses a photoelectric character detector, considered to be more reliable than the mechanical type used in a Teletype. The R808 interfaces through two ribbon cables (which are included) that attach directly to the standard Intel I/O board. Additional microperipherals can be added by daisy-chaining ribbon cables.

CIRCLE NO. 302

### CRT controller handles graphic displays

*Tano Corp., 4521 W. Napoleon Ave., Metairie, La. 70001. (504) 888-4884. \$3295 (with graphics); 60-90 days.*

The Model 5300 CRT display controller allows display of up to 3200 upper case ASCII alphanumeric symbols on any standard high quality NTSC-compatible video monitor. Standard format is 40 lines of 80 characters each. Characters are formed as a 7 x 5 dot matrix in a 10 x 6 dot field. An optional 32-character special symbol set uses the full 10 x 6 dot-matrix area, for drawing graphic symbols that include horizontal and vertical strokes. The display controller features an internal 2-k x 16-bit MOS RAM which is accessible by both the PDP-11 UNIBUS and the display refresh logic. Since the memory is a true two-port structure, no CPU or bus overhead results from the continuous display refresh. The buffer behaves exactly like the PDP-11 main memory; all PDP-11 instructions can operate on the displayed characters.

CIRCLE NO. 303

### Compact LSI modems offered to OEMs

*International Communications Corp., 7620 N.W. 36 Ave., Miami, Fla. 33147. (305) 691-1220.*

The Blue Chip Series of modems is engineered for use by OEMs. They use LSI technology and provide built-in diagnostics. The first modem in the series, Model CM-244A, provides 2400 bit/s synchronous operation over four-wire private lines.

CIRCLE NO. 304

### Tape system can handle up to eight drives

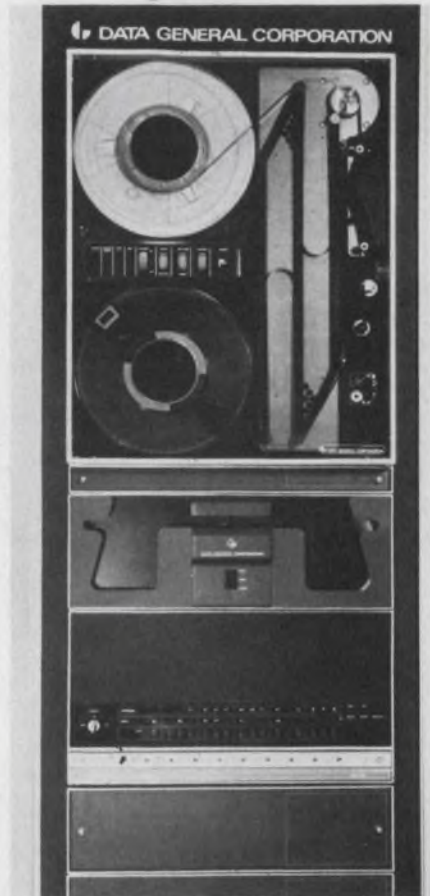

*Data General, Southboro, Mass. 01772. (617) 485-9100. See text; stock.*

A magnetic tape subsystem, which can include up to eight magnetic tape transports, is available in 7 and 9-track models. The transports read and write tape at 75 in/s and have a data density of 556 and 800 bit/in on the 7-track model, and 800 bits per inch on the 9-track model. The data transfer rate is 60,000 char/s. The first unit in a system is priced at \$9900. Additional units each cost \$6700.

CIRCLE NO. 305

# POWER

FOR YOUR

• OP AMPS

• LINE RECEIVERS

• COMPARATORS

Convenient, money saving, practical — V-PAC® power sources give you needed voltages for linear ICs from standard +5v source. Operate as many as 25 linear devices from a single V-PAC power source!

Standard DIP pin configuration, and less than a third cubic inch volume, lets you use V-PAC sources right on the PC card, with minimum length interconnections.

TYPE:	VA 12-12	VA 15-15	VA 12-6
VOLTAGES:	+12 -12	+15 -15	+12 -6

Write or call for full specifications.

WEST:

213-843-5200  
214-231-6181  
505-265-6794  
312-654-8645  
415-593-2189  
206-747-9424

EAST:

513-761-5432  
201-992-2505  
803-288-4450  
416-743-9130  
617-272-7655  
305-941-5544



**Reliability, Inc.**

5325 Glenmont, Houston, Texas  
77036 • 713-666-3261

Europe and the Far East: TISCO (TI Supply Co.)

TWX: 910-881-1739 \*TM, Reliability, Inc.

INFORMATION RETRIEVAL NUMBER 98



now  
available  
from your Bodine distributor

He'll give you off-the-shelf service on our new 42R A-C motors and gearmotors.

From 1/12 through 1/4 hp ■ High output-to-size and weight ■ Totally enclosed, fan cooled (TEFC) ■ NEMA 42 frame configuration ■ Ball bearings standard ■ Available in split-phase, permanent split capacitor and three-phase designs ■ Gearmotor torques to 342 lb.-in. ■ High overhung load capacity.

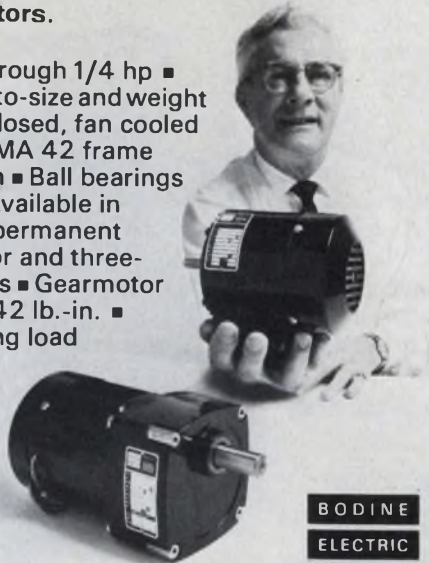

BODINE  
ELECTRIC  
COMPANY

Call your nearby Bodine distributor.

Bodine Electric Co., 2528 West Bradley Pl., Chicago, Ill. 60618

INFORMATION RETRIEVAL NUMBER 99

i'm  
free



I'M A  
MAIL-LITE®  
SHIPPER

1 CASE of Mail-Lite FREE when you buy my \$50 table model heat sealer.

2 CASES of Mail-Lite FREE when you buy my \$100 floor model heat sealer.



Labor Savings: Can be heat sealed closed in 2 seconds  
Postal Savings • Waterproof • Pufferproof • Lightweight • Clean



WRITE TODAY FOR INFORMATION ON OUR MAIL-LITE SHIPPERS AND THE SPECIAL HEAT SEALER OFFER.

**Sealed Air Corporation**

19-01 State Highway 208, Fair Lawn, New Jersey 07410

INFORMATION RETRIEVAL NUMBER 100

ELECTRONIC DESIGN 13, June 21, 1974



\* ACTUAL SIZE

# BRAXTON

— The name to remember for . . .

## PRECISION, SUB-MINIATURE CONNECTOR COMPONENTS

- DEEP DRAWN SEAMLESS
- .0001 TOLERANCES DOWN TO .019" O.D. (outside diameter)
- IN WIDE CHOICE OF METALS INCLUDING THE NOBLE METALS

**AT COST SAVINGS  
OVER OTHER METHODS  
OF MANUFACTURE**

- COAXIAL STANDARD
  - COAXIAL MINIATURE
- CYLINDRICAL STANDARD
  - CYLINDRICAL MINIATURE
- CYLINDRICAL SUB-MINIATURE
- PRINTED CIRCUITS • FLAT CABLE



1733 MONROVIA AVE.  
COSTA MESA, CA. 92627  
(714) 645-7363

ECHO LAKE ROAD  
WATERTOWN, CT. 06795  
(203) 274-6781

**BRAXTON  
MANUFACTURING CO., INC.**

INFORMATION RETRIEVAL NUMBER 101



## Compact disc drives store 10 M bytes



Microdata, 1781 Red Hill Ave., Irvine, Calif. 92705. (714) 540-6730. See text; 90 days.

The Series 9000 cartridge disc drives feature 100 and 200-track/in. recording density in single and dual disc configurations. They can provide up to 10 million bytes of on-line storage in an 8.75-in. space. The single-disc versions use an IBM 5440 type removable disc cartridge for large on-line capacity and unlimited off-line storage on additional cartridges. The dual-disc drives employ the removable cartridge, plus a permanent rotating disc. The series features high positioning accuracy to allow interchangeability of cartridges between drives and 1500 or 2400 rpm disc rotation. The prices are \$3900 for 5-M byte and \$4500 for 10-M byte capacity.

CIRCLE NO. 306

## Versatile controller handles local data

Advanced Terminal Systems, Inc., P.O. Box 90121, Los Angeles, Calif. 90009. (213) 644-5321.

The MC-1600, a communications-oriented programmable controller, provides for internal as well as external data communications when used with appropriate interface modules. The unit is capable of data storage and forwarding, formatting, code conversion, error detection and correction, multiplexing, port contention and certain arithmetic computations. The unit can operate as a stand-alone controller or as a front-end processor for a standard minicomputer or larger computer. The microinstruction cycle time of the MC-1600 is under 200 ns; typical program instructions can be handled at the rate of 1 MHz.

CIRCLE NO. 307

## CPU module boasts mini-level performance

Fabri-Tek, Inc., 5901 S. County Rd. 18, Minneapolis, Minn. 55436. (612) 935-8811. \$990 (100 quan); 30-60 days.

The MP12 is a complete 12-bit CPU with 4-k of core memory that plugs into a standard 19-in. rack. The module, built with TTL circuits, has all the minicomputer features: single word, double word and floating point data formats; programmable or direct memory access I/O; interrupt system and a full range of software. The memory cycle time is 1.5  $\mu$ s and the unit interfaces up to 64 peripheral devices. The instruction set is compatible with the PDP-8 mini. An external 5-V, 40-W will power the MP12.

CIRCLE NO. 308

## Mini series boasts 4-k RAM and DMA

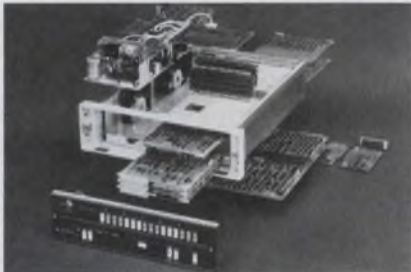

Hewlett Packard, 1501 Page Mill Rd., Palo Alto, Calif. 94304. (415) 493-1501. See text.

The 21MX series 16-bit mini-computers use 4-k RAMs for main memory. Two processors are available in this series—the 2015A and the 2108A. The smaller unit (2015A) can hold 32-k words in the mainframe and has four I/O channels. The larger machine has nine I/O channels and space for 32 k—expandable later this year to 64 k. The machines feature 24-bit microprogrammable control store (up to 4096 words), 2100 compatibility and a dual channel selector. The selector is dynamically assignable to any two device channels and contains all logic, memory address and word count registers needed for direct memory access (DMA) operations. The smaller processor with 16-k of memory will sell for \$7400; the larger machine will cost about \$920 more.

CIRCLE NO. 309

# cost/ quality

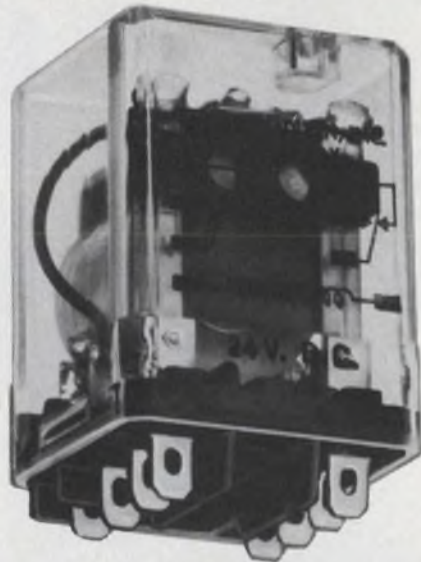

Optimum Q/C relationship is only one reason for choosing the 283 Frame family over other 10-amp control relays. Few GP relays have such excellent packaging density capabilities, or are so readily available in so many enclosed and open styles, with ac & dc coils, 1-3 pole contact arrangements, 3-way terminals for solder, quick-connect, or plug-in, to matching sockets, and so on. Popular styles are stocked by S-D distributors. All are quickly available from the factory.

To learn more, ask for a copy of our latest Relay Catalog.



**STRUTHERS-DUNN, INC.**  
Pitman, New Jersey 08071  
Canada: Struthers-Dunn Relay Div.,  
Renfrew Electric Co. Ltd.



# relays renewed

## TEMPERATURE-CONTROLLED SAFETY INTERLOCK

The interlock circuit of Figure 1, submitted by JWS of McKeesport, Pennsylvania, protects electric furnace operators by cutting off high frequency power following the heating cycle. The heating cycle is under control of a cam programmer operated by motor M.

R1 is a two-coil latch relay, such as S-D type MRRNL2A reed relay or electromechanical type A255XBXP, depending upon load contact requirements. R2 may be any DPST reed or electromechanical relay, such as S-D type MRRN2A or 219XBXP.

SW1 and SW2 are temperature-controlled switches, shown in the low-temperature start-up position. Pushbutton PB1 energizes latch relay R1, completing the circuit through external limit switches to allow furnace operation and powering the program drive motor.

During the heating cycle, as the temperature approaches the high end of the program, SW1 opens so that the R1 release coil can not be energized. Approximately 10 degrees higher, SW2 closes to energize relay R2.

When the temperature peaks out and starts down, switch SW2 opens, but relay R2 remains energized through its own holding contacts. Approximately 10 degrees lower, switch SW1 re-closes and energizes the R1 release coil. This drops out both relays and the program stops until manually restarted by pressing pushbutton PB1. The program can be stopped at any time by pushbutton PB2.

Two more of the over 800 relay applications submitted last year to Struthers-Dunn's 50th Anniversary Relay Contest. These thought starters are a small sample of the endless possibilities for relay-operated systems. This month's circuits use three different members of S-D's growing family of 12-pin plug-in industrial relays.

FIG. 1

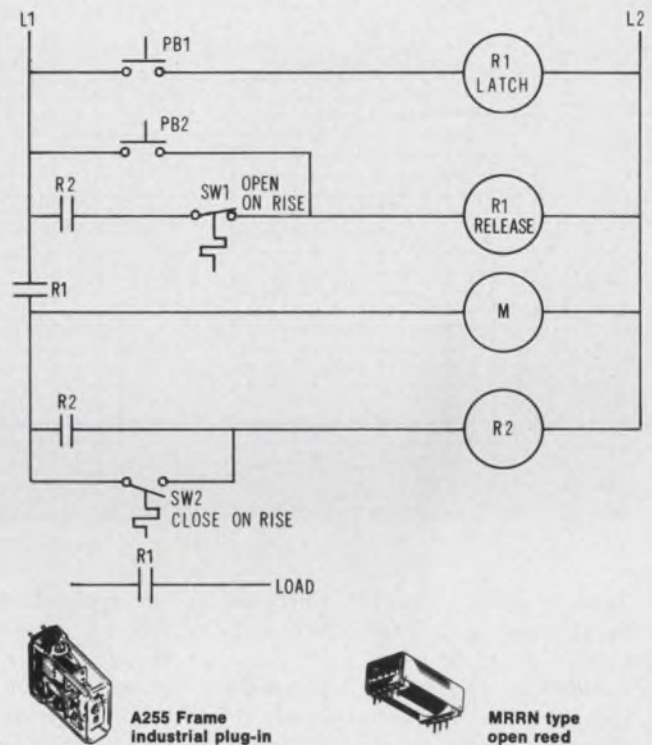

A255 Frame industrial plug-in



MRRN type open reed

## SIMPLE PUMP ALTERNATOR WITH A PLUS

A Struthers-Dunn Frame 211 sequence relay offers an economical way of equalizing the usage of two pumps, according to ZAP of Sulphur, La. In his automatic level control, Figure 2, float switch A operates one of two pumps to maintain the desired level. When one pump can't keep up with demand, float switch B cuts-in the second pump. The stepping action of sequence relay RA1 helps increase motor life by alternating operation between pumps A and B to provide approximately the same amount of operating time for each pump. Relay R1 carries the load to increase the operating life of float switch A.

RA1 should be our Type 211XBXP which transfers contacts when de-energized. It's a close relative of the Type 219XBXP recommended for R1. Both use our rugged, 12-pin industrial socket.

FIG. 2

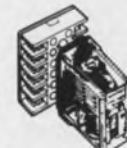
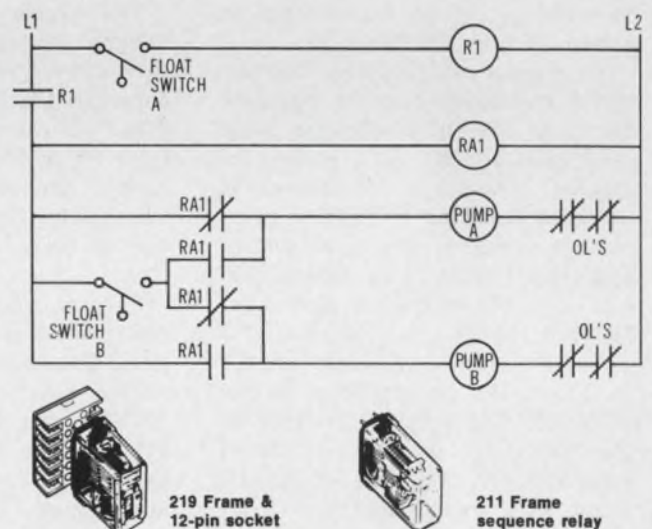

219 Frame & 12-pin socket



211 Frame sequence relay

Struthers-Dunn Relays Are Stocked by Over 125 Distributors



**STRUTHERS-DUNN, INC.**

PITMAN, NEW JERSEY 08071

Canada: Struthers-Dunn Relay Div., Renrew Electric Co., Ltd.

1974 Catalog specs over 100 basic relays —EM, Reed, Hybrid, Solid State— plus solid state Programmable Controllers. Circle reader service card with number below for your copy.





# Flexible material changes resistance in one direction

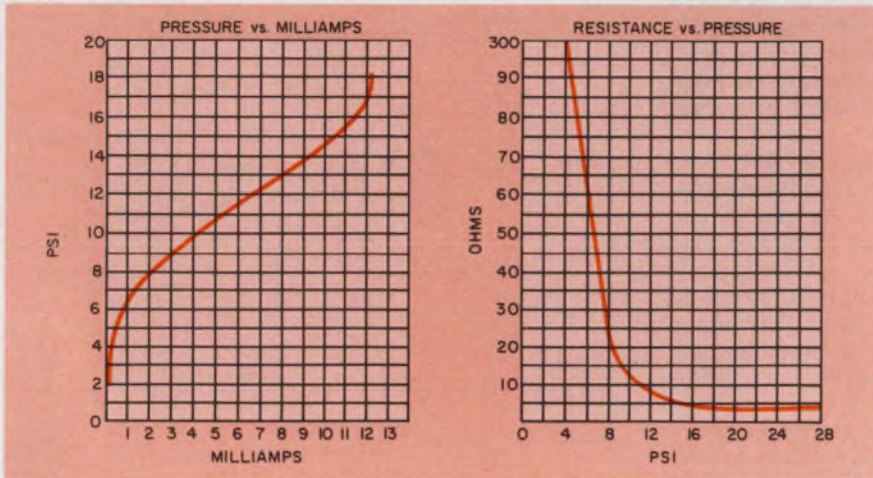

Dynacon Industries, 117 Fort Lee Rd., Leonia, N.J. 07605. (201) 947-0106. P & A: See text.

Flexible, rubber-like substances now provide one-dimensional resistance changes of over a million to one. The Dynacon Industries' materials, called Dynacon, normally come in sheets that are 0.02-to-0.03-in. thick. They are available in areas of 100 sq. in. or more at a cost of only \$0.15/sq. in.

At normal air pressure, the material resistance between opposite points on the top and bottom sides is at least 10 M $\Omega$ . As pressure increases, resistance decreases. It drops to less than 10  $\Omega$  for a pressure increase of only 9 psi, and to less than 1  $\Omega$  at 25 psi above normal—all with negligible lateral resistance change.

Switch points, as close as 0.1 in. apart, can be connected to the material. The cycling lifetime of the material is guaranteed for at least 250,000 switching operations when used with loads of 5 V at about 100 mA. The operating temperature range spans from -60 to +450 F.

The material handles up to 5 A/sq. in. on an intermittent basis and 500 mA continuous. The compound can handle voltages of up to 500 V, although the recommended operating range covers low-volt-

age applications (6-to-13-V). If the voltage exceeds material ratings, though, the material is fail-safe—it becomes an open circuit.

The Dynacon material can be cast or molded; it can also be die-cut for various shapes. There are five basic resins that the material can be based upon, depending upon the application.

The elastic material conforms linearly to applied pressure. Its resistance, however, follows an exponential tracking curve, to within 2%. Calibration accuracy is 0.5%. Over 80 to 85% of the resistance range, the material will follow Ohm's law. Thus heating is a function of the current, resistance and time.

Several other companies offer materials that have similar properties. One company with a very similar product is Chomerics, Inc. (77 Dragon Ct., Woburn, Mass. 01801). The Chomerics' material, though not intended for the same applications, also has the vertical resistance property.

The Chomerics' material is useful as a flexible connector in MOS circuitry. For contacts spaced 0.02 in. apart, the leakage through the material is almost negligible, since the resistance is greater than 10<sup>9</sup>  $\Omega$ . When compressed, the material has a maximum contact re-

sistance of 0.5  $\Omega$ .

Since the material made by Chomerics is intended for connectors, it's designed to form a tight seal that is unaffected by different parts tolerances. The material costs about \$0.50/sq. in. in sample lots of 1-ft.<sup>2</sup> pieces. The projected cost drops to under \$0.20 for production quantities. Chomerics claims that contact densities of 600 points/sq. in. are possible.

The Dynacon material is presently available in sample kits that contain at least 50 sq. in. of the pressure sensitive material. The kit costs \$10 if payment accompanies the order, and \$12 if it has to be invoiced.

Dynacon Industries CIRCLE NO. 251  
Chomerics CIRCLE NO. 252

## Dielectric paste keeps color after firing

Thick Film Systems Inc., 324 Palm Ave., Santa Barbara, Calif. 93101. (805) 963-7007. \$15 per oz (25 oz and up); 10 days.

Six screen printable dielectric pastes retain their color in multilayer application, even after firing. These new Iso-Ohm formulas, designated Series 1017RC, provide colored insulating layers between two or more conductors. Colors available are blue, aqua, green, tan and yellow, as well as black and a standard uncolored formula. Thus, specific crossovers or different layers in the same multilayer circuit can be easily identified. In fired films 1.4 to 1.7-mils thick, the formulas have a dielectric constant of 6-8, a breakdown voltage greater than 550 V and insulation resistance above 10<sup>12</sup>  $\Omega$ . The printed films are processed at a firing temperature of 850 to 950 C.

CIRCLE NO. 310



# SET POINT CONTROL with DECITRAK<sup>®</sup> OPTICAL ENCODERS

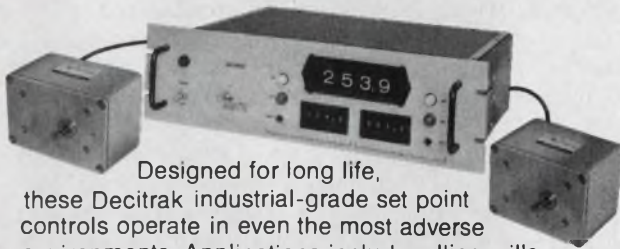

Designed for long life, these Decitrak industrial-grade set point controls operate in even the most adverse environments. Applications include rolling mills, machine tools, nuclear reactor controls, and materials handling. Features include:

- Closed-loop set point control
- Absolute or incremental control
- Metric and English units
- Plug-in modular design
- Drives AC, DC, and stepper motors

Call or write today for more details and your copy of our applications brochure.

*Theta* **INSTRUMENT CORP.**

Specialists in Digital Automation  
Fairfield, New Jersey 07006  
Phone: 201 - 227-1700

INFORMATION RETRIEVAL NUMBER 105

## STRIP BUS by Rogers

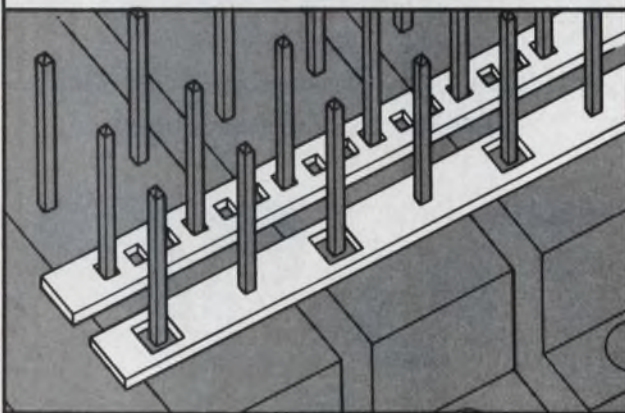

**Low Cost Bussing Systems**  
**Easy Installation**  
**Reliable Solder Joints**  
**Greater Pin Exposure**

*Write or call for details*

 **Rogers Corporation / Chandler, Arizona 85224**  
West: (602) 963-4584 East: (203) 774-9605

INFORMATION RETRIEVAL NUMBER 106

ELECTRONIC DESIGN 13, June 21, 1974

## You say you want a

low-profile snap-in-mounting push button switch or matching indicator that is interchangeable with most 4-lamp displays... available in a full range of cap colors... with a choice of bezels with or without barriers in black, gray, dark gray or white.



## and a

legend presentation that's positive (like this one) or negative (like the one below) or just plain (like the one above)... one that's white when "off" and red, green, yellow (amber), blue or light yellow when "on"... or colored both "on" and "off."



## and a

highly reliable switch proven in thousands of installations... available in momentary or alternate action... N.O., N.C. or two circuit (one N.O., one N.C.)... that accommodates a T-1 3/4 bulb with midjet flanged base, incandescent, in a range of voltages from 6-28V.



*etc.*  
*etc.*  
*etc.*

*Now, for the first time Dialight gives you custom panel designing with a standard line of push-button switches and matching indicators*

Dialight offers a broader range of switch and indicator possibilities than you'll find anywhere in a standard single-lamp line. Sizes: 3/4" x 1", 5/8" and 3/4" square and round. Send today for our new full-color catalog.

**DIALIGHT**

A North American Philips Company  
Dialight Corporation, 203 Harrison Place, Brooklyn, N. Y. 11237

INFORMATION RETRIEVAL NUMBER 107



## Heat sinks solder or clip to PC board

*International Electronic Research Corp., 135 W. Magnolia Blvd., Burbank, Calif. 91502. (213) 849-2481. \$23 per 1000.*

Electronic circuits with TO-5 and TO-18 metal-case devices can have both shock and vibration retention and increased power dissipation with two new heat sinks. One dissipator solders to the circuit board and the other is attached by screw or rivet methods. In heat-dissipation tests, the solder-type, designated the Space series, permitted a TO-5 transistor to be operated at 850 mW with a case rise above ambient of 55 C. The other dissipator, called the Clip series, held the TO-5 case to the same temperature rise with a power dissipation of 600 mW. The transistor operated bare could dissipate only 380 mW for a 55 C rise.

CIRCLE NO. 320

## Jumper-strip flat wire reduces stress at joint

*Ansley Electronics Corp., 3208 Humboldt St., Los Angeles, Calif. 90031. (213) 223-2331. From \$0.05 per conductor; stock to 4 to 6 wks.*

Flex-Strip jumpers in four insulating materials—Nomex, Mylar, Teflon and Kapton—cover the full range of most applications. Jumpers have flat and round conductor sections that are laminated between the insulating material. Flat sections of conductor provide flexibility and reduce stress at soldered contacts. Round sections serve as contacts to fit circuit-board patterns or sockets. The round portions are preplated, ready to solder. There are five choices of conductor center-to-center distances—0.050, 0.100, 0.125, 0.150 and 0.200 in. And four contact configurations—straight, straight staggered, bent 90 degrees and 90-degree staggered—are offered to meet most needs. Standard sizes are 1, 2 and 3-in. lengths with 2 to 60 conductors.

CIRCLE NO. 321

## Connectors withstand nuclear radiation, 1500 F

*Gulton Industries, Inc., 6400 Roland Ave., Buena Park, Calif. 90621. (714) 523-3480.*

A new family of hermetically sealed connectors with Durock insulation is constructed with ceramic material. The receptacles and plugs can operate continuously at  $1 \times 10^{15}$  RADS—a major part of the present 40-year nuclear-reactor life requirement—and at temperatures as high as 1500 F. The TI Series connectors are designed with a double-lead acme thread for fast, positive coupling; the BL Series provides complete interchangeability with MIL-C-26842 types, and features a bayonet-type locking nut. And the HP Series is interchangeable with MIL-C-5015 types. Most models of the Durock connectors can be provided with a wide variety of thermocouple materials in any of the contacts. Both the contacts and the connector bodies can be plated.

CIRCLE NO. 322

# the world's most accurate 4 1/2 Digit Multimeter



**\$675**

No other 4 1/2 digit DMM offers as many standard features, as much proven reliability and overall performance as the Model 2440.

100µ V to 1000 VDC (accuracy ±0.007% of reading ±1 i.s.d. for six months.) The most accurate 4 1/2 digit meter available.

100µ V to 500 VAC

2-wire and 4-wire resistance, 100 milliohms to 12 megohms.

DC/DC ratio, AC/DC ratio

Standard features include:

- Auto-Ranging
- Remote-Ranging
- Auto-Zeroing
- Remote-Trigging
- Isolated BCD output

Documented by full test data and Certificate of Conformance.

**DATA PRECISION**  
..years ahead

Data Precision Corporation  
Audubon Road, Wakefield, Mass. 01880 (617) 246-1600

### CALL YOUR LOCAL OFFICE FOR A DEMONSTRATION

AL	(205) 533-8888
AZ	(602) 994 0519
CA (N)	(408) 732 9000
CA (S)	(714) 540 3180
CO	(303) 448 5284
CT	(203) 525 7847
FL	(813) 294 5816
GA	(404) 487 7117
HI	(808) 762-4286
IL	(312) 683 0282
IN	(317) 293 0827
MA	(617) 273-0188
MD	(301) 552 2200
MI	(313) 482 1229
MN	(612) 781 1811
MO (W)	(816) 737-0086
MO (E)	(314) 731 2331
NC	(818) 387-5818
NJ (S)	(215) 826-8711
NJ (N)	(201) 883 8680
NM	(505) 266 6471
NV (N)	(318) 446 0220
NV (S)	(518) 482 3600
OH (N)	(216) 725 6580
OH (S)	(613) 298 3033
OR	(503) 238 0001
TX (N)	(214) 234-4137
TX (S)	(713) 461 4487
UT	(801) 248 3181
WA	(206) 783 2210
CAN (W)	(416) 787 1208
CAN (E)	(613) 722 6874
CAN (E)	(514) 731 8228

Vernitron long life motors should be used for any positioning requirement where continuous rotation is not essential. Infinite resolution and high linearity allow these motors to provide high accuracy in positioning, actuating, tensioning, measuring, and indicating applications. These motors provide smooth operation with no slot effect. They also offer high torque with low input power and high acceleration rates as well as no gears, no mechanical or electrical noise, no explosion hazard, no friction, and no ripple torque. Vernitron brushless DC torque motors are available in two and four-pole designs, in a variety of sizes and outputs. Peak torque ratings range from 5 to 600 oz-in. Frameless or housed versions are available. Special designs to your requirements also supplied. Vernitron Control Components, A Division of Vernitron Corp., 2440 West Carson Street, Torrance, California 90501, Telephone (213) 328-2504.

## Vernitron Limited Rotation Wide Angle Brushless DC Torque Motors

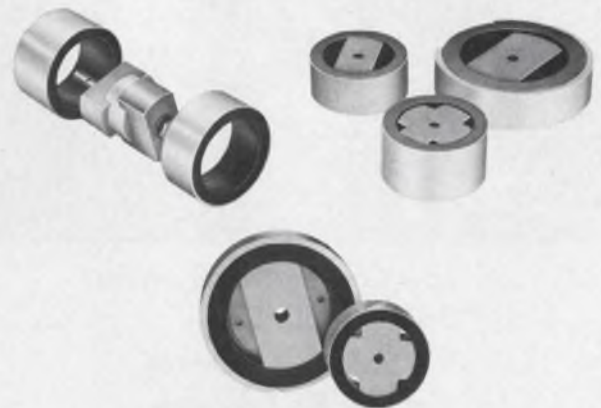

**vernitron**<sup>®</sup>



# The best ultra-precision resistor value

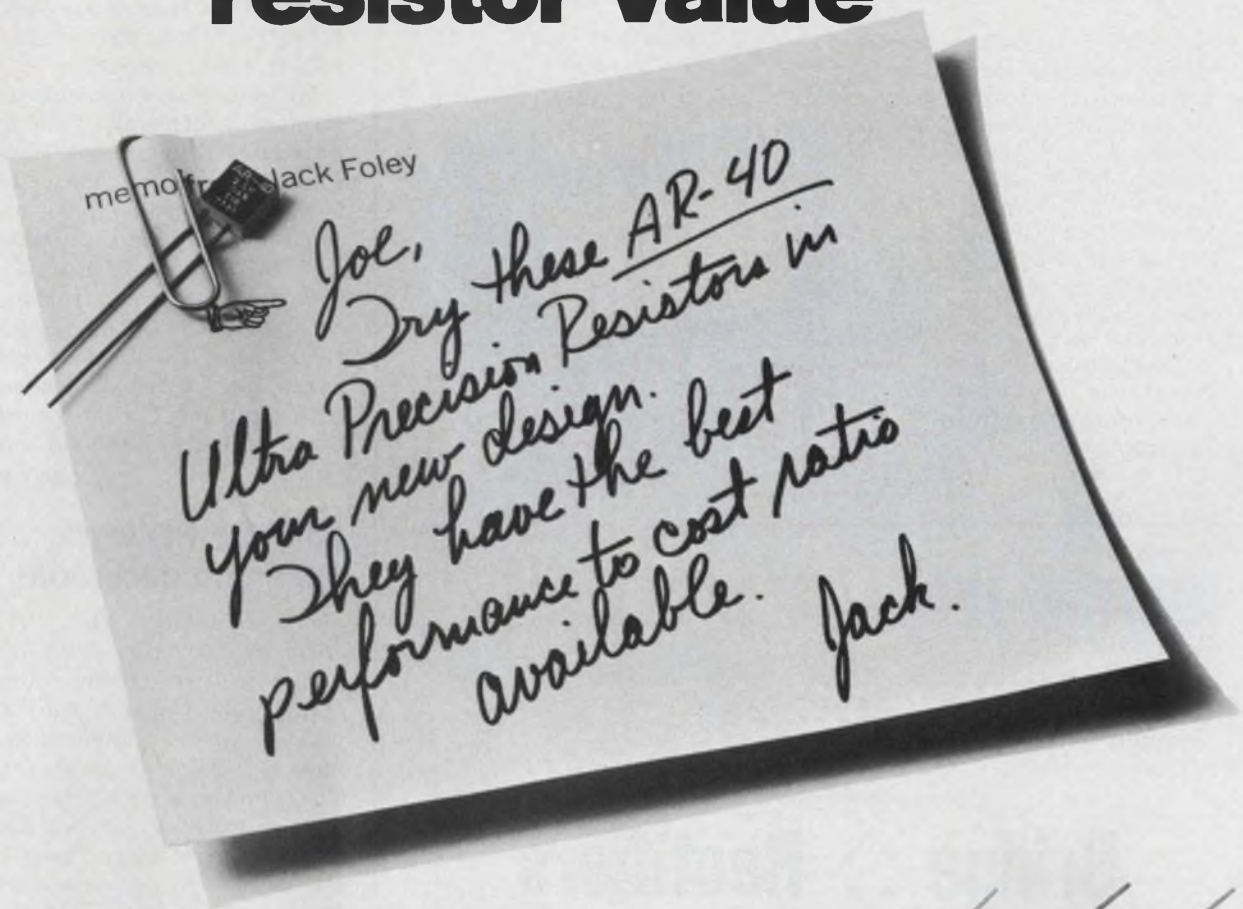

Hung up on resistor performance vs cost? Then check the AR40 metal film resistor—sophisticated, ultra-precision resistors from TRW's precision resistor technology.

With the AR40, you get ultra-precision, exceptional stability, and documented reliability. Temperature coefficient to  $\pm 2$  PPM/ $^{\circ}$ C and tolerances to .01% are standard. High frequency characteristics are outstanding and noise levels are not even measurable on commercially available equipment.

Additional value is provided by the AR40's rugged construction which withstands normal production handling. The AR40 is available now to solve your ultra-precision resistor problems at a cost you can afford.

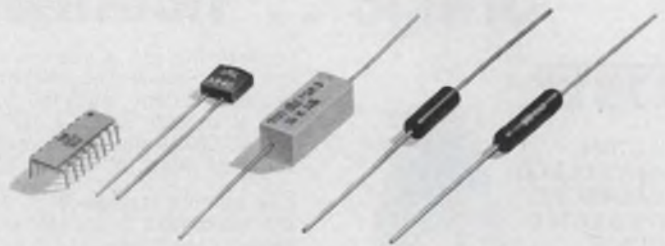

*Complete resistor choice.* TRW offers you a total resistor capability—carbon comp., thin-film, Metal Glaze™, wirewound, networks. For specs and application data on the AR40, contact your local TRW sales representative. Or write TRW/IRC Resistors, an Electronic Components Division of TRW, Inc., 2850 Mt. Pleasant St., Burlington, Iowa 52601. (319) 754-8491.

## Performance and dimensions

TCR CLASS	STANDARD TEMP. COEFF. ( $^{\circ}$ C)	RESISTANCE RANGE* (Ohms)	STANDARD TOLERANCE RANGE ( $\pm$ %)	WATTAGE 85 $^{\circ}$ C	DIMENSIONS IN INCHES
T-18	2 ppm 0 to 60 $^{\circ}$ C 5 ppm -55 to 125 $^{\circ}$ C	20 to 100K	.01 to 1.00	.3 watts	Height .320 $\pm$ .020
T-16	5 ppm 0 to 60 $^{\circ}$ C 10 ppm -55 to 125 $^{\circ}$ C				Length .295 $\pm$ .010
					Width .100 $\pm$ .010
					Lead spacing .150 $\pm$ .010
					Lead gage # 22 .0253**

\*Wider ranges available, contact factory. \*\*Lead length 1.00 minimum

## TRW<sup>®</sup> IRC RESISTORS

INFORMATION RETRIEVAL NUMBER 110



# Control Meter Relay Systems

Servo-Tek's NEW Control Meter Relay Speed Indicating System is designed for accurate speed monitoring and speed limit control in process and control machinery. Adjustable single and double set point systems, accuracy  $\pm 2\%$  full scale, repeatability 0.5%, speed ranges from 0-10 rpm to 0-12,000 rpm. Double set points adjust to  $0^\circ$  of each other. The system's permanent magnet dc generator can also provide a signal to auxiliary equipment.



FREE CATALOG of rotating components available.  
Be Selective. Turn To...

**SERVO-TEK**  
PRODUCTS COMPANY

1086 Goffle Road, Hawthorne, NJ 07506 • 201-427-3100

Servo-Tek of California, Inc.  
8155 Van Nuys Blvd., Van Nuys, CA 91402 • 213-786-0690

INFORMATION RETRIEVAL NUMBER 111

## Bridge Rectifiers



**IBR**

SILICON  
CONTROLLED  
AVALANCHE  
INTEGRATED  
BRIDGE  
RECTIFIERS



For designers  
who need

**Small size**  
**Maximum efficiency**  
**Greater versatility**

Look to the IBR if you have a design problem that requires an efficient 10 A or 25 A full-wave bridge with 100 V, 200 V, 400 V, 600 V or 800 V ( $V_{RRM}$ ) ratings, and 250 V, 450 V, 650 V and 850 V minimum avalanche voltages. Also in 15A or 36A three phase.

Low thermal resistance,  $\leq 1^\circ \text{C/W}$  ( $R_{\theta jc}$ ) for full rated load operation at  $100^\circ \text{C}$ ,  $T_c$ . IBR cases are hermetically sealed and electrically isolated.

When you design-in an IBR, the controlled avalanche characteristics permit you to use lower PRV safety factors, and if you need it, the IBR series offers you fast recovery versions (200 nanosec,  $t_r$ ). The IBR is available in press-fit, TO-3 outline mounting flange and stud mount.

Only **\$2.50** ea (10 A, 200 V,  
TO-3 mounting  
1000 qty.).



Design us in — We'll stay there

**VARO**

**VARO SEMICONDUCTOR, INC.**

P.O. BOX 676, 1000 N. SHILOH, GARLAND, TEX. 75040, 214/272-4551, TWX 910-860-5178

Distributed by:

ALLIED ELECTRONICS, Chicago, Ill. 312/421-2400. THE ALTAIR CO., Houston, Tex. 731/781-5300; Richardson, Tex. 214/231-5166. BELL INDUSTRIES, Menlo Park, Cal. 415/323-9431; Skokie, Ill. 312/965-7500; Bellevue, Wash. 206/747-1515. CRAMER ELECTRONICS, Nationwide, Newton, Mass. 617/969-7700; MILGRAY ELECTRONICS, Freeport, N. Y. 516/546-6000; Hyattsville, Md. 301/864-1111; Cherry Hill, N. J. 609/424-1300. WESTATES ELECTRONICS, Chatsworth, Calif. 213/341-4411.

In Canada:

ELECTRO SONIC, Toronto, Ont. 416/924-9301. R.A.E. ELECTRONICS, Vancouver, B. C. 604/687-2621.

INFORMATION RETRIEVAL NUMBER 112

## PACKAGING & MATERIALS

### Heater element has high flexibility

*Electro-Flex Heat, Inc., Northwood Industrial Park, Bloomfield, Conn. 06002. (203) 242-6287.*

Hi-Flex heater elements are constructed to offer all of the thermal properties of standard fiberglass-reinforced silicone-rubber heaters, but with considerably increased flexibility. This is accomplished by the use of less fiberglass fabric and more silicone rubber. The heaters are a nominal 0.080-in. thick. Also, the heating elements have high thermal conductivity, withstand 450 F continuously and can conform to irregular surfaces.

CIRCLE NO. 323

### Film for PC work needs no darkroom

*Scott Graphics, Inc., Holyoke, Mass. 01040. (413) 536-7800.*

SG Positive II film eliminates many production problems and reduces costs associated with silver films, according to Scott Graphics. The film is a molecular-imaging, positive-working, contact film that makes positive copies from a positive master. SG retains enough color for proper registration in yellow-lit rooms. Also, the silver-film bleaching step, which weakens the silver image, is unnecessary when SG Positive II film is used. Its fast exposure makes it less susceptible to the effects of image expansion prevalent with silver masters. And since it is dry processed, the Scott film is not susceptible to the pinholing found in silver film images. This eliminates the opaquing steps needed with many silver masters. Because it is a molecular-imaging film, darkroom facilities for development are not required. Duplicates can be made in normal room light and its dry processing characteristic eliminates the need for chemical solutions and drying time. Overdevelopment is impossible. The SG film is available on a 7-mil polyester film base, and it can be exposed in conventional graphic arts contact printing equipment with high ultra-violet light sources. The resolution potential of the film is in excess of 500 lines per millimeter.

CIRCLE NO. 324



## Mag-shield encloses video recording heads



Ad-Vance Magnetics, Inc., 226 E. Seventh St., Rochester, Ind. 46975. (219) 223-3158. Under \$100 (100 up); 2 to 3 months.

AD-MU Model RH enclosures shield video recorder-head assemblies from a wide range of magnetic-field interferences. The shielding is effective throughout the entire audio spectrum. Multiple-layer construction and shield grounding also provides electric-field shielding. The three-layer, three-piece shield consists of a cover and a five-sided, two-section enclosure with a butt-mating, overlap-joint design. Magnetic-field penetration is minimized by machined mating surfaces that assure good contact. The inner layer of all three pieces is AD-MU-78, high-permeability alloy, 0.04-in. thick; the middle layer is non-magnetic stainless steel, 0.03-in. thick; and the outer layer is AD-MU-48 medium-mu, a high-saturation alloy, 0.054-in. thick. Both AD-MU layers are spot welded to the stainless-steel layer.

CIRCLE NO. 325

## Epoxy adhesive is thermally conductive

Aham, 968 W. Foothill Blvd., P.O. Box 909, Azusa, Calif. 91702. (213) 334-5135.

Aham 985 adhesive offers the combination of high thermal conductivity and high dielectric strength for electronic components in heat-sink application. The adhesive is a smooth, orange, epoxy paste packaged in a two-compartment plastic pouch that is separated by a special removable leak-proof clamp. The paste is available in two sizes—40 and 100-g packages. The operating temperature for Aham 985 is 70 to 125 C and it will cure at room temperature. For higher temperature to 205 C, Aham 985-HT is suggested.

CIRCLE NO. 326

NEW  
FROM  
AIRPAX

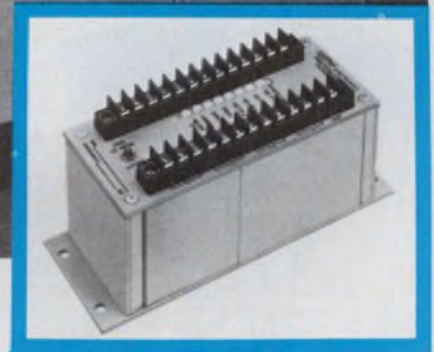
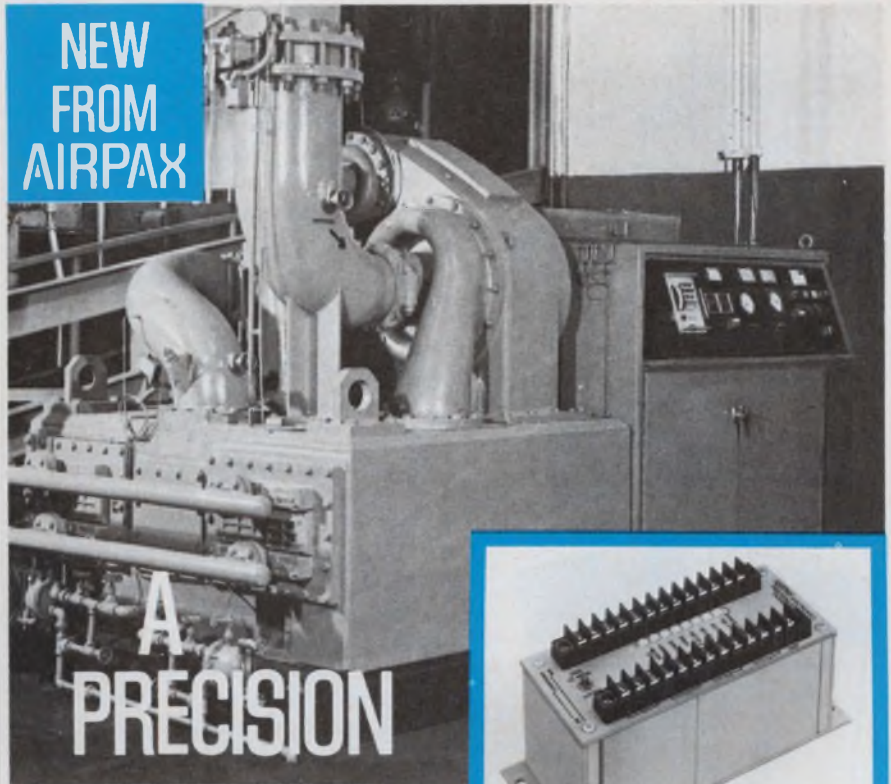

# CONTROL TACHOMETER THE SERIES 300

Compact, solid state, flexible and all new... designed to meet industrial control requirements... can monitor shaft RPM... provide start-up, over/underspeed protection, turbine overspeed alarm and control; sequential switching; conveyor protection and machine control. The 300 Tachometer will accept signals from any type sensor. It will operate from signals produced by magnetic or zero-velocity type pickups mounted in proximity to a rotating gear as well as many other signal sources. Set points are adjustable from 0-100% of full scale range. Other set point options available for special application requirements. Analog control outputs, verify features, selectable relay logic and other standardized options are available.

Write for bulletin 8511.

AIRPAX Controls Division P.O. Box 8488  
Fort Lauderdale, Florida 33310 Phone: 305/587-1100

# AIRPAX™

INFORMATION RETRIEVAL NUMBER 113



# GENERAL ELECTRIC'S TYPE 75F BLACK HAWK CAPACITOR

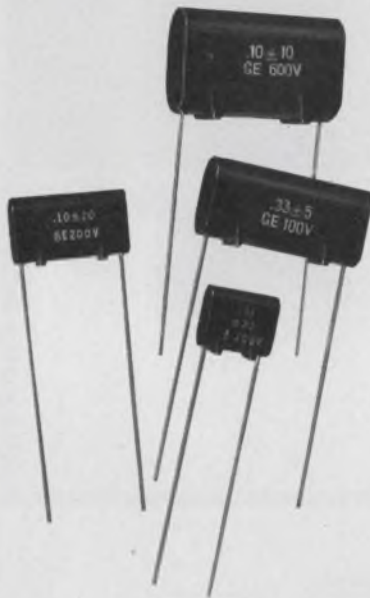

Black Hawk polyester film capacitors offer you these most sought after features:

- Molded epoxy encapsulation, precise dimensions, mounting feet and welded leads for "damage resistance" to vibration and shock.
- Top utilization of circuit board space with precise dimensions in case and lead location.
- Elevated mounting feet for greater stability and protection during dipping.
- Low dissipation factor with an exceptionally strong welded lead connection.

For more information on these, or any of General Electric's wide range of capacitors, call your nearest GE sales office today, or write Section 430-55, Schenectady, N. Y. 12345

## MAKE SOMETHING OUT OF IT!

GENERAL  ELECTRIC

INFORMATION RETRIEVAL NUMBER 114

## COMPONENTS

### Divider network ratios guaranteed to 0.1%

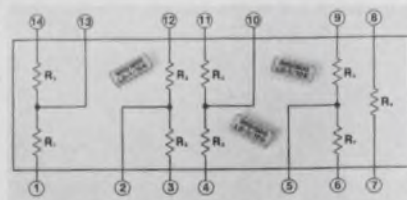

STANDARD PRECISION RPD1800 THIN-FILM ATTENUATORS/DIVIDERS FROM ANALOG DEVICES, INC.

Analog Devices, Route 1 Industrial Park, P.O. Box 280, Norwood, Mass. 02062. (617) 329-4700. 0.1%-10 k $\Omega$ : \$5 (100 up); 10 wks. (100/mo.).

Standard thin-film divider networks for quad amps, the RPD-1800 series, offer precise unity gain functions with resistance values from 2 k $\Omega$  to 100 k $\Omega$ . Each network comes in a 14-pin DIP package. Ratio accuracies of  $\pm 1\%$ ,  $\pm 0.1\%$ , and  $\pm 0.01\%$  are guaranteed. Thin-film processing provides a long-term ratio stability of 0.01%/year at 25 C, a ratio that tracks with temperature to 1 ppm/ $^{\circ}$ C and a noise level of less than -40 dB. High speed applications are suggested by the network's 10-ns settling time and its ultra-low 1-pF interlead capacitance.

CIRCLE NO. 327

### Hybrid xformer varies less than 0.3 dB

OPT Industries, Inc., 300 Red School Lane, Phillipsburg, N.J. 08865. (201) 454-2600.

Hybrid transformer, Series 6000, for 4-wire to 2-wire terminating equipment and for 2-wire repeaters has less than 0.3-dB variation in response over the 300-to-3600-Hz range. Insertion loss is 4.3-dB max when measured at 1000 Hz. Distortion is less than 0.3%. Impedances are 600  $\Omega$  for the 4-wire and 2-wire side with a 900- $\Omega$  tap available on the 2-wire side. The transformer measures 6  $\times$  2-5/8  $\times$  1-1/2 in., and it is cast in a plastic case. Standoff studs and 0.2-in.-centered pin mounting are standard for PC-board plug-in applications. Dual-repeat coils are available with impedances of 300, 600, 450, 900, 1200 or 1800  $\Omega$ , all with center taps. The 600- $\Omega$  coils are standard.

CIRCLE NO. 328

### Circuit breaker gives alarm only on overload

Heinemann Electric Co., Magnetic Dr., Trenton, N.J. 08602. (609) 882-4800.

A new type of internal circuit in Series CF circuit breakers distinguishes between electrical tripping and manual switching. Available in back-connected single and multipole versions, these hydraulic-magnetic breakers are rated to 100 A at 240 V and 60 Hz. The Trip-Alarm feature consists of miniature SPDT or DPDT contacts that actuate when the breaker trips electrically, but not when the breaker is manually switched. Thus there is no ambiguity that an actual fault has occurred.

CIRCLE NO. 329

### Composition pots come in 1/2-in. versions



Allen-Bradley, 1201 S. Second St., Milwaukee, Wis. 53204. (414) 671-2000.

Type WR, hot-molded, composition variable resistors with axial or radial leads are offered in several versions. Types WRS or WRH have radial leads and a rear mounted switch. They're offered in both splash-dust resistant and immersion-sealed versions. Ranges and tolerances are: 100  $\Omega$  to 5 M $\Omega$   $\pm 10\%$  and  $\pm 20\%$ , power, 0.5 W at 70 C; voltage (rms or dc), 350 V; operating temperature range, -55 to 120 C; case dimension, 27/64-in. deep  $\times$  1/2-in. dia. Their hot-molded resistance tracks have a large cross-section, and thus, low current densities for short-term overload protection and long operating life. Control is smooth and resolution virtually infinite. Essentially noninductive, the resistors can be used at high frequencies where wirewound units are impractical. Five standard tapers are available: linear, modified linear, cw modified logarithmic, ccw modified logarithmic and cw exact logarithmic.

CIRCLE NO. 330



# Hughes heat pipes. Order 'em hot off the shelf.

Now you can order heat pipes just like you order nuts and bolts. Because now Hughes stocks heat pipes in a variety of standard, off-the-shelf sizes and thermal capacities. (If you have a heat transfer problem that calls for a custom solution, we solve those, too.)

## 1333H STAINLESS STEEL AND AMMONIA

Thermal transport capacity: 50 watts with evaporator 90° below condenser, 15 watts horizontal operation, 7 watts with evaporator 90° above condenser. Recommended operating range: -80° to +90°C. Weight: 8 grams. Active Length: 5.69 inches. Diameter: 3/16". \$37.00.

## 1370H COPPER AND WATER

Available in diameters of 1/4", 1/2", and 1" at \$37.00, \$40.00 and \$50.00, respectively, with thermal transport capacities of 345, 750, and 6000 watts with the evaporator 90° below condenser; 115, 250 and 2000 watts horizontal operation; 38, 60, and 500 watts with evaporator 90° above condenser. Recommended operating range: +50° to +150°C. Weight: 21, 70, 550 grams. Standard Active Length: 6, 6, 12 inches.

## 1350H STAINLESS STEEL AND METHANOL

Available in diameters of 3/16" and 1/4" at \$37.00 each and 1/2" at \$40.00. Thermal transport capacities are 55, 75, and 180 watts with evaporator 90° below condenser, 17, 25, and 60 watts horizontal operation, and 6, 10, and 20 watts with evaporator 90° above condenser. Recommended operating range: -40° to +120°C. Weight: 8, 11, and 38 grams. Standard Active Length: 6 inches.

## 1361H FLEXIBLE STAINLESS STEEL AND METHANOL

Available in active lengths of 7" and 8" at \$75.00 each, with thermal transport capacities of 20 watts with the evaporator 90° below condenser, 7.5 watts horizontal operation, 2.5 watts with evaporator 90° above condenser. Recommended operating range: -40° to +120°C. Weight: 20 grams. Diameter: 1/4".



**HUGHES**  
HUGHES AIRCRAFT COMPANY  
ELECTRON DYNAMICS DIVISION

For detailed information, or if you have a hot requirement and want one now, just fill out and send in the coupon. Hughes Electron Dynamics Division, 3100 W. Lomita Blvd., Mail Station 2124, Torrance, California. (213) 534-2121.

PLEASE PRINT

SEND INFORMATION.

SEND QUICK ORDER FORM.

NAME \_\_\_\_\_ COMPANY \_\_\_\_\_

ADDRESS \_\_\_\_\_ CITY \_\_\_\_\_

STATE \_\_\_\_\_ ZIP \_\_\_\_\_ TELEPHONE \_\_\_\_\_

All prices shown are effective in U.S.A. and Canada

ED-6

INFORMATION RETRIEVAL NUMBER 115



COMPONENTS

**Nonpolarized capacitor handles reverse volts**

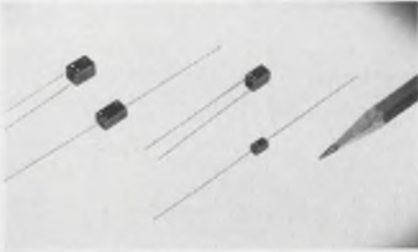

Sprague Electric Co., 347 Marshall St., North Adams, Mass. 01247. (413) 664-4411.

Type 184D plastic-film nonpolarized solid-electrolyte Tantalex capacitors can be used with voltage reversals that would damage polarized capacitors. They are also available in by-pass applications where high ripple voltages are encountered. The capacitors are enclosed in a polyester-film sleeving and end-sealed with an epoxy resin for moisture resistance. They are available in nine case sizes with axial or radial leads.

CIRCLE NO. 331

**Cermet trimmer claimed to have no springback**

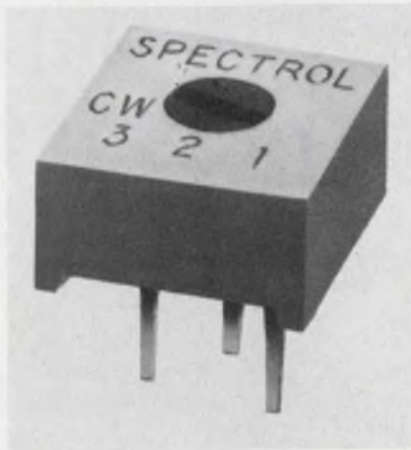

Spectrol Electronics Corp., 17070 E. Gale Ave., City of Industry, Calif. 91745. (213) 964-6565. \$0.60 (100 up); stock.

Spectrol claims that its new single-turn 3/8-in-square cermet trimmer, Model 63, virtually eliminates springback problems. Both top-adjust and side-adjust configurations plug into competitive Models 362, 3389 and 72 sockets.

CIRCLE NO. 332

**Magnetic speed sensor intrinsically safe**



Electro Corp., 1845 57th St., Sarasota, Fla. 33580. (813) 355-8411. \$50 list; stock to 4 wks.

The Model 3042 magnetic speed sensor has all the features of conventional noncontact sensors plus intrinsic safety in hazardous environments as defined by ISA Bulletin RP 12.2 for Intrinsic Safety. Also, the unit's voltage-limiting method reduces noise pickup. Its characteristics include: 16-V-pk-pk output at 1000 in/s with an eight-pitch, 12-tooth gear and 0.005-in. clearance; maximum short-circuit current of 10 to 40 mA at 1000 in/s; coil resistance of 200 Ω max and inductance of 15 mH max.

CIRCLE NO. 333

**Keithley's new DMM really does have a difference!**

That's the best way to describe the auto-ranging Model 168 Digital Multimeter. It's got the sensitivity (100 microvolts) and full function capability (ac/dc volts, amps, ohms) needed for bench work, plus the carrying ease and optional battery operation needed for portability. And more. Only \$299. Send for data now.



**KEITHLEY INSTRUMENTS**  
U.S.A.: 28775 AURORA ROAD, CLEVELAND, OHIO 44139  
EUROPE: 14, AVENUE VILLARDIN, 1009 PULLY, SUISSE

INFORMATION RETRIEVAL NUMBER 116

**IT'S YOUR MOVE TO BETTER MATRIX BOARDS**

RELIABILITY • ECONOMY AND STANDARDIZATION

UP TO 8 DECK SWITCHING

.125 CENTERS

.250 CENTERS

.100 CENTERS

BUSSED CONTACT

ISOLATED CONTACT

DUAL CONTACT STRIPS

CLOSED ENTRY DESIGN

MIXED CONTACTS

SHORTING PINS

TERMINAL OPTIONS

MOUNTING OPTIONS

CODED PANELS

WRITE FOR CATALOG

DIODE PINS

LIGHTED PINS

COLORLED PANELS

SPECIAL TENTH INCH MATRICES AT \$.08 PER POINT

**CO-ORD SWITCH**  
A DIVISION OF LVC INDUSTRIES INC.  
135-25 37th AVE. FLUSHING, N.Y. 11354 • 212-939-9777

INFORMATION RETRIEVAL NUMBER 117

ELECTRONIC DESIGN 13, June 21, 1974



# Watch Out.

## The volts are out to ruin your computer, maybe your entire system!

Nobody needs to remind you that the erratic demand on electric power these days has created a potential "brownout" condition in just about every major industrial area. Protecting your computer or system from the crazy dips and surges in voltage is critical. A slight dip can cause a computer to drop a few digits, lose parity, distort information, or lose its memory entirely. A surge damages delicate components and ruins printed circuits.

Sola Electric's "brownout insurance" comes in the form of highly reliable constant voltage transformers and Solatron® Voltage Regulators

—in a wide range of specifications. Most are standard units and immediately available for off-the-shelf shipment. And our applications engineering people are ready to help right now —whether you're designing voltage regulation into your equipment or adding protection to an existing system.

Protect yourself. Contact your local Industrial Distributor or the AC Products Group at Sola Electric. Call (312) 439-2800 or write Sola Electric, 1717 Busse Rd., Elk Grove Village, Illinois 60007.



### Get brownout "insurance" from SOLA

SOLA BASIC 

**SOLA**

SOLA BASIC DIVISIONS ANCHOR ELECTRIC · BISHOP ELECTRIC · DIELECTRIC COMMUNICATIONS · DOWZER ELECTRIC · GUTH LIGHTING  
HEVI-DUTY ELECTRIC · LINDBERG · NELSON ELECTRIC · SIERRA ELECTRIC · SOLA ELECTRIC · TEMPRESS  
WARREN G-V COMMUNICATIONS

INFORMATION RETRIEVAL NUMBER 118



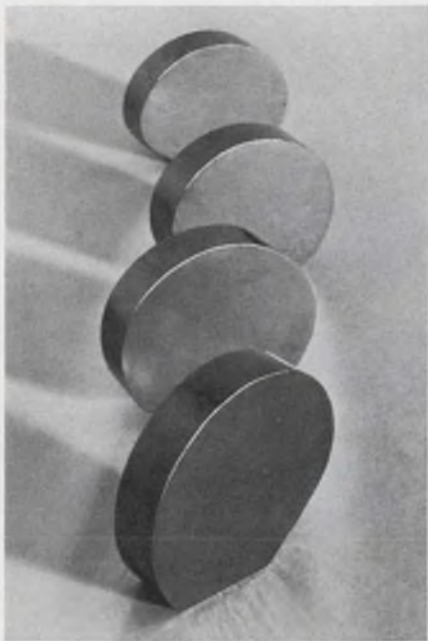

## Our compounds are your right answer for...

### DIODE DISPLAYS, INFRARED DEVICES, ELECTRONIC COMPONENTS

Asarco Intermetallics Corporation offers a wide range of III-V compounds used in the production of light emitting diodes (LED) and photoluminescent displays.

We provide gallium arsenide, gallium phosphide and indium phosphide in both polycrystalline and single crystal form. All polycrystalline materials are available as ingots. Gallium phosphide and indium phosphide are also available in granular form.

Gallium arsenide single crystals are boat grown with typical cross-sections of 19mm x 47mm for a (111) orientation and 33mm x 47mm for a (100) orientation.

You can order single crystals of our III-V compounds as ingots or slices, as cut or polished.

All materials are furnished in small quantities for evaluation or in large volume for production use. For more information contact us at 120 Broadway, New York, N.Y. 10005. Or call 212-732-9500.

# ASARCO INTERMETALLICS CORPORATION

INFORMATION RETRIEVAL NUMBER 119

## COMPONENTS

### Numerical display readable in sunlight



*Symbolic Displays, Inc., 1762 McGraw Ave., Irvine, Calif. 92705. (714) 546-0601. To \$12 (1000 up).*

Modular Mini-Bit readout displays are miniature, seven-segment, incandescent units less than 3/8-in. high. An average output intensity of 10,000 fL at 5 V provides a 3 to 1 contrast ratio in bright sunlight. The unit's incandescent lights assure that segments have optimum stroke-widths, and that the units provide a viewing angle to 160 degrees. Plug-in capability makes throw-away replacement easy and economical. The units have a 10,000-h mean life. They are available in many colors.

CIRCLE NO. 334

### Latching reed relays use orthogonal fields



*Information Transfer, Inc., P.O. Box 357, Holcomb, N.Y. 14469. (315) 657-7074.*

Multipole, magnetic-latching reed relays latch without the usual prebiasing magnets. Instead, a saturable core is used to maintain the contact closure. An orthogonal arrangement of magnetic fields eliminates false closures, a common fault found in latching reed relays. The relay is available with as many as 6-Form-A or 4-Form-C contacts, or a combination of Forms A and C. Thermal emf specs of less than 1  $\mu$ V can be achieved. The relay can be made to latch in 300  $\mu$ s. Reeds are available for high-voltage, low-thermal, rf or general-switching requirements.

CIRCLE NO. 335

### Solenoid valves mount onto PC boards

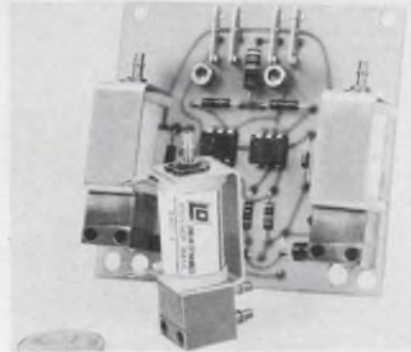

*Linear Dynamics, 204 Andover St., Andover, Mass. 01810. (617) 475-7165. \$15 (1-9); stock.*

Series 11, 2-way, 3-way and directional-control miniature solenoid valves are equipped with spade lugs, which may be rotated for mounting directly on a PC board. Thus air controls can be brought directly to the electronic circuitry. The valves are equipped with 12-V-dc coils and they have brass bodies. Many design variations are available. Pressures in excess of 100 psi can be provided, mechanical parts and body materials can be altered and seats, seals, and a choice of voltage ranges can be selected.

CIRCLE NO. 336

### Low-cost cermet trimmer rated at 0.5 W



*TRW/IRC Potentiometers, 2801 72nd St. N., St. Petersburg, Fla. 33733. (813) 347-2181. \$0.60 (100 up); stock.*

A new series of single-turn 3/8-in.-square cermet trimmers for commercial-industrial applications, designated Type 76, is available in 14 standard resistance values from 100  $\Omega$  to 2 M $\Omega$ . Each of six mounting configurations has plated 0.016-in. round pins for wave soldering on PC boards. Standard resistance tolerance is  $\pm 20\%$  ( $\pm 10\%$  also available) with a 0.5-W power rating at 70 C. The rated operating temperature range is  $-55$  to 125 C with a standard temperature coefficient of  $\pm 150$  ppm/ $^{\circ}$ C. Units with a  $\pm 100$  ppm/ $^{\circ}$ C are also available.

CIRCLE NO. 337



**Quick delivery**

# Fujitsu Quality on Sale in

# **ALOXCON**

## Aluminum Solid Electrolytic Capacitor

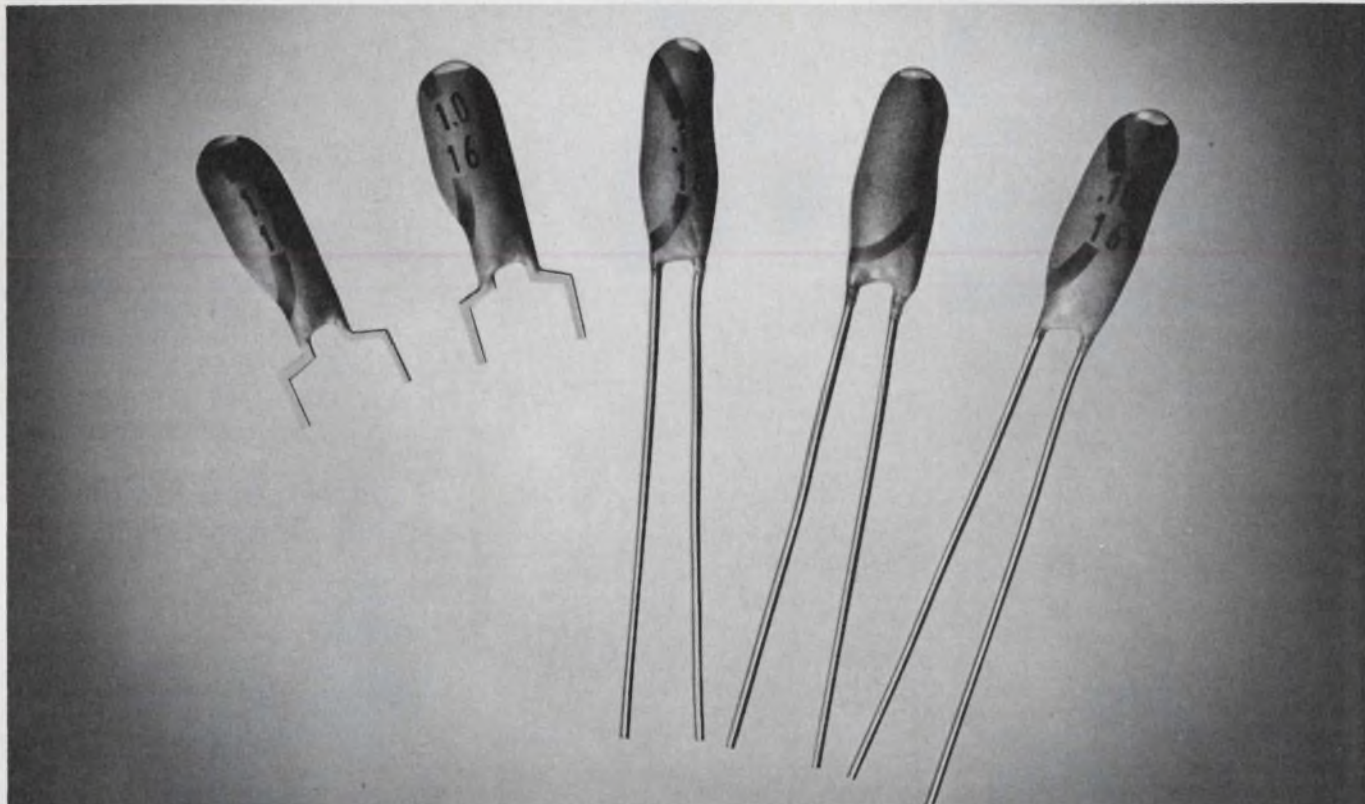

The ALOXCON, developed with Fujitsu's special product techniques, is designed for use in general electronic equipment.

Features include:

1. High backward breakdown voltage (small backward leakage current)
2. Excellent temperature & frequency characteristics (Resonant frequency: 1 ~ 10 MHz)
3. Special safety structure, which eliminates possibility of explosion or burning down.
4. Space-saving flexible mounting



Item	Specifications				
Operating temperature range	-55 ~ 85°C				
Leakage current	Below the larger value of either 0.06 CV or 3 μA				
Capacitance	0.1 μF ~ 10 μF Tolerance: +40% (:20%*) *negotiable				
Loss tan δ	10% max				
Working voltage (WV) and surge voltage (SV)	Working voltage (V)	6.3	10	16	25
	Surge voltage (V)	8	13	20	32

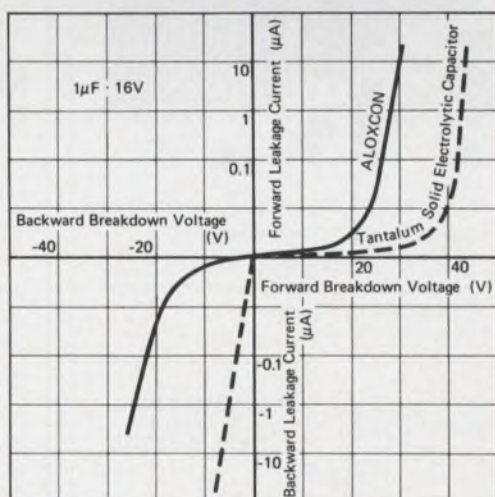

E-I Characteristics

**FUJITSU LIMITED**  
*Communications and Electronics*  
 Marunouchi, Tokyo, Japan

For further information, please contact:  
 Head Office: 6-1, Marunouchi 2-chome, Chiyoda-ku, Tokyo 100, Japan Telex: J22833  
 New York Office: 680 Fifth Avenue, New York, N.Y. 10019, U.S.A. Phone: (212) 265-5360  
 Fujitsu California Inc.: 1135 East Janis Street, Carson, California 90746, U.S.A. Phone: (213) 636-0858, (213) 537-8930

**MAIN PRODUCTS**  Telephone Exchange Equipment  Carrier Transmission Equipment  Radio Communication Equipment  Space Electronics Systems  Electronic Computers & Peripheral Equipment (FACOM)  Telegraph & Data Communication Equipment  Remote Control & Telemetry Equipment  Electronic Components

INFORMATION RETRIEVAL NUMBER 120



**FROM  
BREADBOARD  
TO FINAL  
PACKAGING  
HARDWARE...**

**ALL AVAILABLE  
FROM ONE SOURCE**



★ **ADHESIVE BACKED  
CIRCUIT SUB-ELEMENTS**  
(Over 200 Pre-Drilled component mounting  
patterns available "off-the-shelf.")

★ **EPOXY GLASS BOARD  
MATERIALS**

- 76 Standard "Off-the-Shelf" Boards.
- Including Unclad, Copper Clad, Cut & Peel  
Copper Clad, Pre-etched "X-Y" Pattern and  
Plated thru Hole Copper Clad.
- .100" Grid Hole Pattern or Undrilled

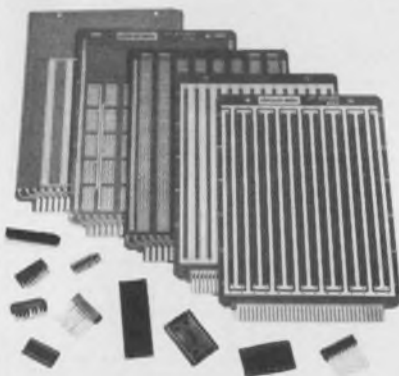

★ **GP CIRCUIT BOARDS and ACCESSORIES**

- Highest Quality — Choose from 74  
"Off-the-Shelf" Boards.
- Sockets — Low & Standard Profile, P.C. and  
Wire Wrap • Highest Quality Gold Contacts.
- Adapter plugs • Connectors
- Card Pull Handles



**CIRCUIT-STIK'S  
NEW CUT &  
PEEL BOARDS**

SEND FOR OUR NEW CATALOGS #502 & #801

**circuit-stik**

P.O. BOX 3396 • Torrance, California 90510  
Phone (213) 530-5530

## COMPONENTS

### Voltage-sensitive relay covers 100 mV to 300 V



*Extron Co., 5735 Lindsay St., Min-  
neapolis, Minn. 55422. (612) 544-  
4197. \$140 (unit qty); stock.*

Extron's Model EP7333 voltage-sensitive relay is adjustable over a wide range of ac and dc voltages. The relay features modularity in construction, an adjustable differential between pull-in and drop-out and stable set points. A LED gives a visual indication of the trip point to make trip-point adjustment easier. Sensitivity ranges from 100 mV to 300 V. Thus the relay can sense small voltages across meter shunts or monitor 120-to-230-V-ac lines for over-or-undervoltage detection.

CIRCLE NO. 338

### Motor has linear 1-in. travel, 32-lb force

*Information Magnetics Corp., 5743  
Thornwood Dr., Goleta, Calif.  
93017. (805) 964-6828.*

Model 40 linear-motion motor provides precise positioning movements over a distance of one inch. The linear motor produces a maximum pulse force of 32 lbs. It has a coil mass of 0.3 lb. The motor is available with a choice of an electromechanical or optical 100-line/in. position transducer or with an optical 200-line/in. position transducer. The motor operates either horizontally or vertically. Stray flux leakage 6 in. from the motor face is held to 5 gauss maximum.

CIRCLE NO. 339

### Thin-film resistors track to 1 ppm

*LRC, Inc., Digital Dr., Hudson,  
N.H. 03051. (603) 883-8001.*

A series of thin-film resistor ladder networks, compatible with quad current switches, is packaged in a 24-pin ceramic DIP or supplied as a chip network. For d/a converters, three devices—12-bit, 10-bit and 8-bit networks—provide ratio accuracies that range from 0.012% of full scale for a 12-bit network to 0.192% for an eight-bit network. Resistor values are specified by the customer. Laser trimming allows rapid delivery of both standard and custom networks in volume. Single-chip substrate design of the ladder networks minimizes parasitic capacitance and results in rapid settling speed. Operating temperature range is from -55 to 125 C. Temperature tracking is typically better than 1 ppm.

CIRCLE NO. 340

### Capacitor line features solder-dipped terminals



*International Importers Inc., 2242  
S. Western Ave., Chicago, Ill.  
60608. (312) 847-6363.*

A new line of can-type Rubycon electrolytic capacitors uses solder-dipped terminals to eliminate the need for clamps for mounting. They are available in single-section, type LA, or multisection, type LAB, construction. They meet all performance requirements of JIS, C5141 and either meet or exceed all EIA electrical specifications. Capacitance in single-section types is available in values 33 to 470  $\mu$ F; the double-section capacitors, 10/10 to 220/220  $\mu$ F; and multisection units, 10/10/10, to 47/47/47  $\mu$ F. Combinations are also available. Voltage ratings range from 160 to 500 WV dc.

CIRCLE NO. 341



**Chips contain isolators, circulators**



Western Microwave Lab. Inc., 1260 Birchwood Dr., Sunnyvale, Calif. 94086. (408) 734-1631. \$175 (small quantity); 30 days.

A series of microstrip-chip isolators and circulators operates from 2.4 to 18 GHz with bandwidths of 15% and more. Typical specs are 20-dB isolation, 0.5-dB insertion loss and a 1.25:1 VSWR. Units are mounted on a 0.035 or 0.025-mil ferrite chip.

CIRCLE NO. 342

**50-Ω load handles 20 W**

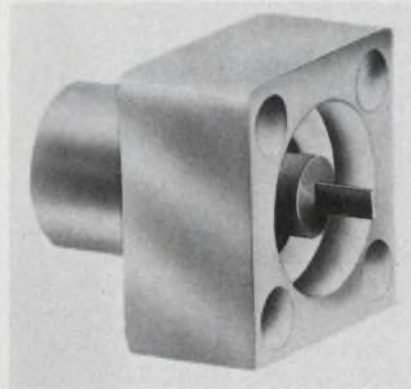

EMC Technology Inc., 1971 Old Cuthbert Rd., Cherry Hill, N.J. 08034. (609) 429-7800. \$8.70 (1000); stock to 4 wks.

The Model 8070 50-Ω load specs a 20-W rating. The unit exhibits VSWRs of 1.10 at 1 GHz, increasing to 1.50 maximum at 12 GHz. It is designed for 3-mm coaxial connection, and the unit comes in a flanged body for external mounting.

CIRCLE NO. 343

**Fast radar distribution amp has small size**

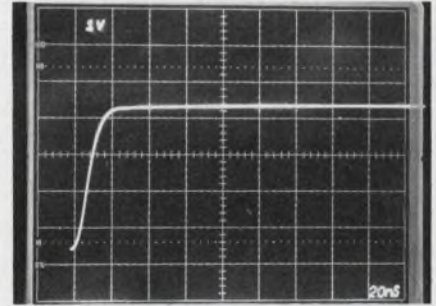

M. S. Kennedy Corp., Pickard Dr., Syracuse, N.Y. 13211. (415) 455-7077. \$500 per channel.

The Series 1000 radar-distribution amplifier system, reportedly five times faster than any presently available unit, has a settling time of less than 20 ns to 1% under any gain condition. The new unit features a 4 or 6-channel non-inverting amplifier and it has an adjustable gain range of 1 to 10. Output voltage swing is ±5 V maximum. The compact unit measures 7 × 7 × 2 in.

CIRCLE NO. 344

**These products will cut your cleaning costs!**

Aerosol MS-180, pure, efficient and inexpensive. It saves time and it saves money. Cleans electronic assemblies, PC boards, components, contacts quickly. Fast, safe, portable MS-180 is indispensable!

Also available in quarts, gallons and 5 gallons.

"Two-Product Trial Unit" includes:

- MS-180 Freon TF® Degreaser
- MS-226 "Cobra" Extension & Brush

Meets Fed. Spec. BB-F-671-A/Fed. Spec. BB-C-00310A/Mil-C-81302B Type II and KS-20406/Fed. Stock No. 6850-105-3084/Propellant BB-F-1421.

©E. I. DuPont & Co.

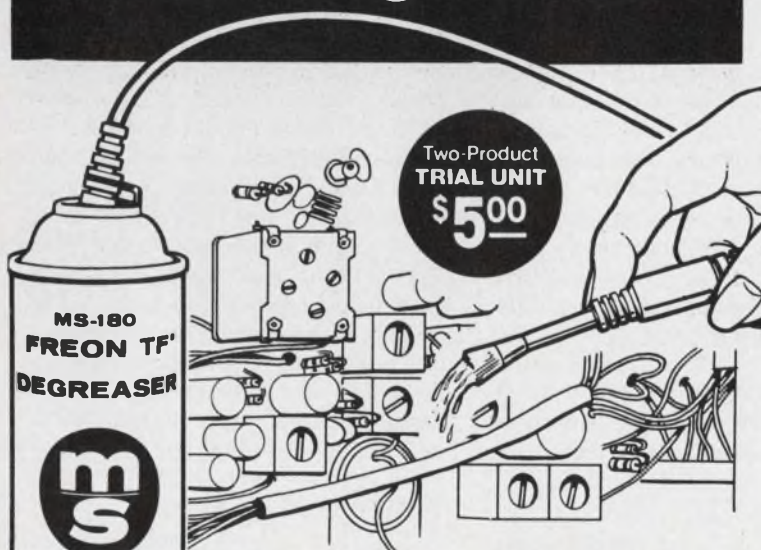

Two-Product TRIAL UNIT \$5.00

**ms miller-stephenson chemical co., inc.**  
Danbury, Connecticut 06810 (203) 743-4447

- ED
- Enclosed is \$5.00, please send my "Two-Product Trial Unit" (MS-180 & MS-226)
  - Please send FREE literature and prices.

NAME \_\_\_\_\_ TITLE \_\_\_\_\_

DEPT. \_\_\_\_\_

COMPANY \_\_\_\_\_

ADDRESS \_\_\_\_\_

CITY \_\_\_\_\_ STATE \_\_\_\_\_ ZIP \_\_\_\_\_

CHICAGO • LOS ANGELES • TORONTO  Dist. in ITALY • GERMANY • FRANCE • ENGLAND • SCOTLAND • SPAIN • NETHERLANDS • LEBANON

INFORMATION RETRIEVAL NUMBER 122



## 12-GHz TV klystron outputs 1 kW

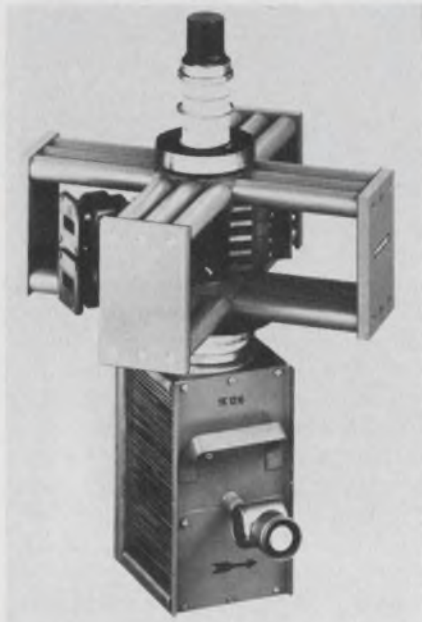

*Amperex Electronic Corp., Hicksville, N.Y. 11802. (516) 931-6200.*

A 12-GHz TV klystron, called the YK1210, can generate 1 kW. The unit has greater than 48-dB gain and it requires less than 20 mW of drive. Other features include permanent magnet focusing, which eliminates bulky components usually required. The klystron uses air cooling, has a built-in ion pump and may be operated with or without depressed collector.

CIRCLE NO. 345

## Synthesizers feature frequency agility

*Spectra Electronics, Inc., 1000 Ames Ave., Milpitas, Calif. 95035. (408) 263-4550. 150 days.*

The Model SE-1400 family of low-noise, frequency-agile frequency synthesizers has an rf frequency range of 1 to 18 GHz (in selected bands) and an rf output up to 1 W (into a 50-Ω load). Signal-to-phase-noise ratio exceeds 40 dB (in a 30-kHz band centered on the signal, excluding ±0.5 Hz centered on signal). Signal-to-spurious-content ratio exceeds 80 dB. The family has a standard frequency stability of 1 part in 10<sup>6</sup> per 24 hours. Switching time, including settling, is as low as 50 μs.

CIRCLE NO. 346

## Vhf-uhf filters employ combline construction

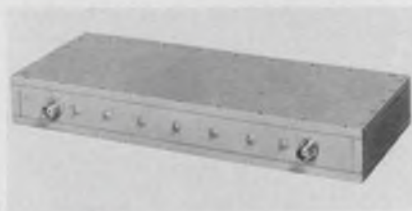

*Microwave Filter Co., 6743 Kinne St., East Syracuse, N.Y. 13057. (315) 437-4529. \$260; 3 wks.*

The series 3070 bandpass filters feature low-loss combline construction, and they are available with customer-specified center frequency from 130 to 515 MHz. Bandwidths range from 4 to 15%. These seven-pole filters have 3/30 dB shape factor of 1/1.35.

CIRCLE NO. 347

## Tandem attenuator conserves space



*Telonic Altair, 21282 Laguna Canyon Rd., Laguna Beach, Calif. 92652. (714) 494-9401. \$190 up; 30 to 60 days.*

A miniature rotary attenuator, in a tandem configuration, can provide an attenuation range of 0 to 109 dB in 1-dB steps. The compact —1.31 × 4.65 in—solid-state device eliminates the need to cascade several attenuators for large attenuations, and it features direct digital readout on a single dial. Two models are available, both capable of operating over a standard frequency range of dc to 2 GHz at a 3-W power level. The Model 8142 has a 0-to-69-dB attenuation range, and the Model 8140 covers a full 0 to 109 dB. Other specifications include a ±2-dB accuracy, insertion loss of 0.4 dB and impedance of 50 Ω.

CIRCLE NO. 348

## C-band transponder checks pulse coherency



*Vega Precision Lab. Inc., 239 Maple Ave., West Vienna, Va. 22180. (703) 938-6300.*

The Model 355C, C-Band pulse-coherent transponder can be used with tracking radars to extract doppler information from the return pulse. The solid-state receiver can be left ON in a low-power standby mode that consumes less than 1.5 W. The unit automatically switches into operation after about 10 valid interrogations are decoded. The transponder begins to transmit after only 40 seconds of warmup time. Operating power drain is held to less than 14 W under all conditions.

CIRCLE NO. 349

## X-band nanosecond pulse gen priced at \$235



*Bear & Hasty Enterprise, P.O. Box 22053, University City, San Diego, Calif. 92122. (714) 278-4559. P: See below; 4 to 6 wks.*

The MNPG-X1 Series of low-cost X-band nanosecond pulse generators uses a low impedance, video drive signal of 0.5 to 1 V peak with a 1-to-10 ns rise time. They may be driven at repetition rates up to 50 kHz to produce rf output pulses of about 1 ns in width at a power level of about 4 W pk. The generators operate from a 400-to-600-V-dc supply, drawing 10 mA maximum. The generators are priced at \$235 in 1-to-5 quantities.

CIRCLE NO. 350



# The world's biggest little black box is on the road



It's a unique display of TRW Electronic Components' newest products, circuit applications and ideas—coming right to you.

Picture a typical electronics chassis, grown to mammoth proportions. In fact, to the size of a 40-foot tractor-trailer; far and away the world's *biggest* "little black box." Inside, you'll find components which look like nothing you've ever seen before—because the scale is *giant*. Five feet high for some.

Our technical experts will be on hand to answer your questions on more than 1000 different products from the 14 separate divisions that form TRW Electronic Components.

And the show is on the road right now. We're zig-zagging our way across country, stopping at 155 plants in 27 states. Watch for announcements when we'll be in your area. TRW's little black box is where electronics is, and we're bringing it where you are. Because we *are* TRW.

**TRW<sup>®</sup> ELECTRONIC COMPONENTS**

Connectors • Resistors • Semiconductors • Capacitors • Motors • PC Boards • Potentiometers • Transformers • Coils and Inductors • Wire and Cable



### Compact chassis units offer outputs to 75 V



Acopian Corp., Easton, Pa. 18042. (215) 258-5441. \$55 to \$135; 3 days.

EB Series of miniaturized power supplies now includes models that provide regulated outputs up to 75 V. Output-current ratings range from 30 mA to 2.5 A. Dual-output models provide either  $\pm 12$  or  $\pm 15$  V, with ratings from 100 to 500 mA. Most models have a line and load regulation of  $\pm 0.05\%$ , and a ripple of 1 mV rms.

CIRCLE NO. 351

### Lab supply holds noise and ripple to 1.5 mV



L & F Electronics, P.O. Box 2186, Riverview, Mich. 48192. \$39.95 plus \$2 for shipping.

Model 7711 variable dc supply provides up to 1 A at voltages from 2 to 18 V with less than 1.5 mV rms ripple and noise. The unit is housed in a 2-1/2 x 4 x 6-1/2-in. grey-toned metal cabinet. The regulator is current limited at 1 A, so the output can be short-circuited for several hours without harm. Maximum variation in output voltage, from no load to full load, is 40 mV. For a 10% change in line voltage, there is less than a 50-mV change in output voltage.

CIRCLE NO. 352

### Low-voltage supplies deliver 1.2 to 4.75 V

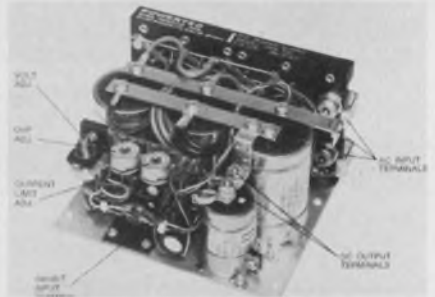

Powertec Inc., 9168 DeSoto Ave., Chatsworth, Calif. 91311 (213) 882-0004. \$10 to \$175.

SM Series power-supply line now offers 10 new low-voltage models. The models, designated -050, cover the range of 1.20 to 4.75 V at 0.16 to 75 A and have the same physical and electrical configurations as existing SM models -100 through -500. They also provide the same features of the established line, including voltage, over-voltage, and current-limit adjustments without the additional external components.

CIRCLE NO. 353

## YOU DESIGN IT... WE'LL SUPPLY IT... WITHOUT COSTLY TOOLING

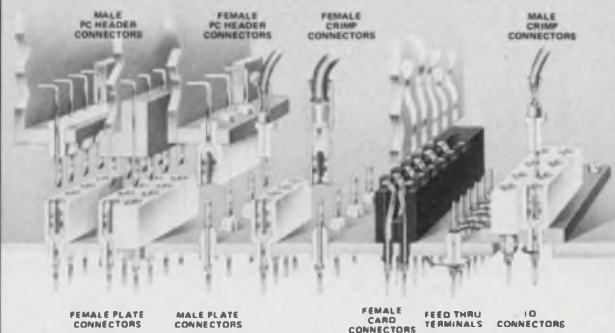

This is National Connector's Modular Plate Inter-Connection System — offering versatility plus for you, the circuit designer. Your own custom design... little or no tooling required.

Almost unlimited flexibility, size and shape — .100, .125, .150 or .200 spacing. Density — up to 100 contacts per square inch, all in a sturdy aluminum plate.

FREE DESIGN GUIDE describes our entire line of connector configurations — contacts, insulators, ground bushings, plate and molded connectors, PC headers and PC connectors.

Ask for it!

## NATIONAL CONNECTOR

9210 Science Center Drive ■ Minneapolis, Minnesota 55428 ■ (612) 533-3533

DIVISION OF **FABRI-TEK** INC.

## P.C. CARD CAGES

Ready to Assemble — All parts in stock.



**\$15.00**  
(not including UNITRACK card guides)

Another feature of Versa-Cage: P.C. cards are held in vibration and shock absorbing UNITRACK card guides with snap-in bushings for quick, easy assembly.

VERSA-CAGE™ standard 19" card cages are rigid, sturdy, low cost and assemble in less than 5 minutes. Hold 30 p.c. cards on 1/2" centers. Standard End Plates adjust for cards up to 1 1/4" x 6 1/2". Pre-punched card guide holder bars and connector bars available on 1/2", 3/4" and .200" centers.

(All parts are available for special cabinets you may wish to make. Catalog lists prices.)

## UNITRACK™

UNITRACK Division, Calabro Plastics, Inc.  
8738 West Chester Pike Upper Darby, Pa. 19082  
Telephone (215) 789-3820



# We bridged the forward surge gap. For extra protection.

Our bridge rectifier ratings for DC output and forward surge capacities are substantially greater than those of competitive devices. Even though our physical dimensions are the same.

So, our single phase and three phase bridge rectifiers provide important added safety at normal operating levels.

You no longer have to take the chance of using a marginally rated bridge rectifier and running the chance of expensive down time and replacement costs.

Wagner single and three phase bridge rectifiers as well as center tap rectifiers come in standard size packages. Only our current ratings and forward surge ratings are higher.

**B-10 Series.** DC rating-30A@75°C Case. Forward Surge rating-400A@ rated load. B-10 Series replaces look-

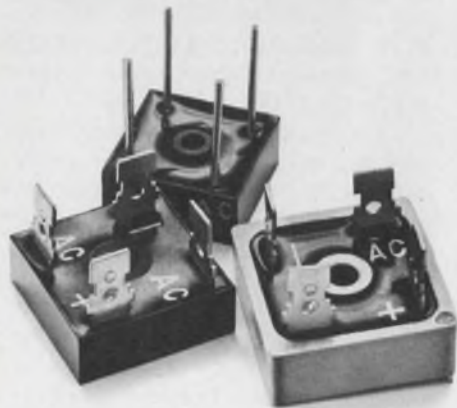

alike bridges rated up to 25A and from 50 to 1,000 PRV per leg.

**B-40 Series.** DC rating-15A@75°C Case. Forward surge rating-300A@ rated load.

**B-50 Series.** DC rating-10A@75°C Case. Forward surge rating-300A@ rated load.

For additional information on Tung-Sol® bridge rectifiers, write to: Tung-Sol Division, Wagner Electric

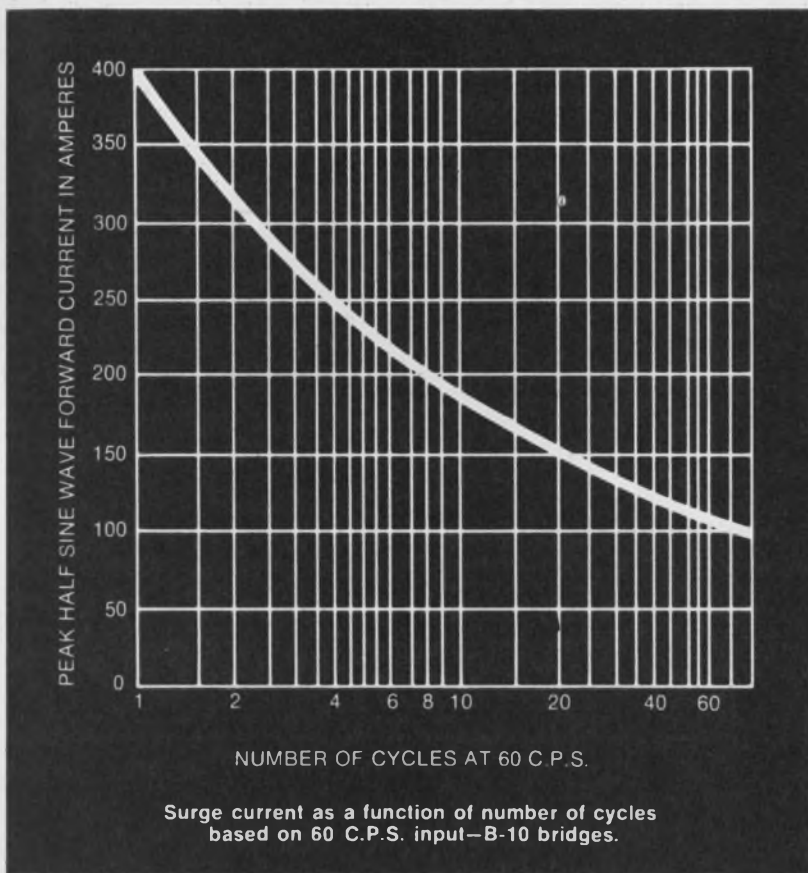

Corporation, 630 West Mt. Pleasant Avenue, Livingston, New Jersey 07039.

*Wagner makes other quality products in volume for the electronics industry, including vacuum fluorescent readouts, power supplies and subsystems, silicon rectifiers, resistors, miniature lamps and status indicators. And Wagner offers contract manufacturing.*

## WAGNER®

**We've got a lot more riding for you.**



MONOLITHIC CRYSTAL FILTERS

the  
State  
of the  
Art

#### SAVING ENERGY

It's an important topic these days. Especially to the communications industry. In almost every field, better communications means energy saved. As the cost of energy increases, so does the challenge to provide more and better communications equipment and systems.

Our company is involved in only a small area of communications—monolithic and tandem monolithic crystal filters. But, we see our responsibility in the total order of things. Whether it's reliable delivery of parts or production prototypes for your next generation of equipment, we're ready to help you save energy for everyone.

#### SPEAKING TO THE DEAF

Our monolithics find their way into some fascinating and unusual applications. For instance—a narrow-band FM system which allows children with severely impaired hearing to participate in normal classroom activities. One of the requirements of the system was that both the students' receivers and the teacher's transmitter allow unhindered movement by the wearer. Another was freedom from interference, including interference from other systems in nearby classrooms. Cost was also an important factor. One of our standard 10.7 MHz tandem monolithic crystal filters in each receiver takes care of the interference. Its size is consistent with the needs of the wearer. Its cost is consistent with educational budgets.

What's your production application? Talk with us about it. We may be able to help. And if your interests include teaching the deaf, we'd be happy to put you in touch with the manufacturer of this equipment.

**Pti**

**Piezo Technology Inc.**

2400 Diversified Way Orlando, Florida 32804  
305-425-1574

The Standard in monolithic crystal filters.

#### POWER SOURCES

### Chassis mount modular units offered

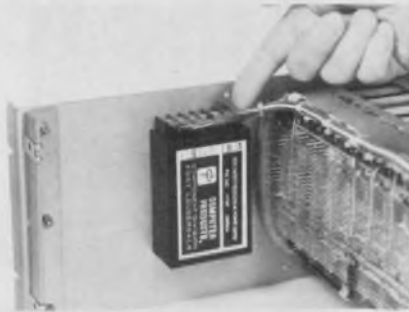

Computer Products, Inc., Fort Lauderdale, Fla. 33307. (305) 974-5500. \$39 to \$74.

PM 300 Series is a chassis mount version of the company's encapsulated, regulated dc power supplies. Threaded-insert mounting and barrier-type terminal-strip connections allow easy prototyping and efficient one-shot design work. Single-output models are available from 5 to 24 V at current ratings to 1.0 A. Dual-output models offer  $\pm 12$  V or  $\pm 15$  V at 65 to 240 mA. Regulation is typically  $\pm 0.05\%$  with ripple and noise of 1 mV rms (2 mV rms for 5-V models). Input is  $115 \pm 10$  V ac (50 to 400 Hz). Tempco is  $\pm 0.02\%/^{\circ}\text{C}$ . Size is  $2.7 \times 4 \times 1.44$  in.

CIRCLE NO. 354

### Dual-output modules need no derating



Energy Electronic Products, 6060 Manchester Ave., Los Angeles, Calif. 90045. (213) 670-7880. \$45 (OEM price); stock.

PM200 and PM201 are dual  $\pm 15$  V power-supply building blocks. Featured are outputs of  $\pm 100$  mA; regulation of 0.2%, line and load; ripple and noise of 1 mV rms; tempco of  $0.02\%/^{\circ}\text{C}$ , typical; and no derating over  $-25$  to  $+71^{\circ}\text{C}$ . Short-circuit protection is built-in.

CIRCLE NO. 355

### 'No break' sine power given by inverter line

Electro-pac Div. of Instrumentation & Control Systems, Inc., 129 Laura Dr., Addison, Ill. 60101. (312) 543-6200. From \$600 to \$15,000; stock to 30 days.

Series "E" inverters maintain power level in spite of ac-power-line outages. Designed for continuous duty operation, these solid-state units provide  $\pm 2\%$  regulated sine-wave power from input voltages of 48, 120 or 240 V dc. Outputs range from 0.5 to 15 kVA, with frequencies of 120, 240, 60 or 50 Hz.

CIRCLE NO. 356

### Dc/dc converter gives up to 30-W output



B. H. Industries, 2218 Cotner Ave., Los Angeles, Calif. 90064. (213) 479-8278. \$119 (1-9); 3 wks.

This regulated dc/dc converter module, with dual 15-V tracking outputs, delivers 30 W maximum output. The Series 2030 supplies 1 A continuously with a current limit of 1.3 A. Output-voltage accuracy is 150 mV. Regulation is 10 mV typical for a 30% line change and 10 mV typical for a full-load change. Temperature regulation is  $0.015\%/^{\circ}\text{C}$  maximum. The series includes three models with input voltages of 12, 24 and 28 V.

CIRCLE NO. 357



# NCR / A GOOD JOB / THE GOOD LIFE

NCR's new Accounting Computer Division offers exciting assignments developing general purpose computer systems. We want talented individuals who want professional recognition, personal growth, technical development and advancement opportunity. You'll work in the environment of a new facility ... and live in friendly, uncrowded Wichita where you can spend off-work hours enjoying the Good Life of Clean Air Kansas.

## ENGINEERS:

- Minicomputers • Business Systems • Circuit Design • Communications • Logic Design • Systems Formulation • Systems Architecture • Design Automation • Analog Circuit Design

## SYSTEMS SOFTWARE PROGRAMMERS:

- Minicomputer Operating Systems • Communications • File Management • Assemblers • Compilers

## MICROPROGRAMMERS:

- S-Languages • Emulators • Virtual Memory • Minicomputer Architecture

Get the full story today. Send your resume including salary history and requirements to Ron Clarke, Professional Placement, P.O. Box 1297CR, Wichita, Kansas 67201. An Equal Opportunity Employer M/F

# NCR

INFORMATION RETRIEVAL NUMBER 902



## CUT PRODUCTION TIME WITH THESE LOW COST COMPONENT LEAD BENDERS

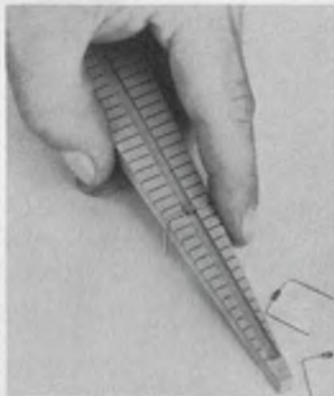

Up to 1200 component leads per hour may be formed with these simple, precise units. They cut production time and eliminate damage to components and leads. Designed primarily for resistors and diodes, MARK Series Component Lead Benders produce perfect bends. Tantalum capacitors, axial lead components, jumper wires, and other similar parts may also be formed easily and efficiently. Ideal for both prototype and production situations.

Bends are made rapidly with gentle finger pressure and meet N.A.S.A. Specification MSFC-PROC-256. No other tools are required. The aggravation and component damage associated with the long-nose plier "free bending" technique is completely eliminated. Industry proven since 1959, the MARK Series offers 5 models for forming 1/8 watt, 1/4 watt, 1/2 watt, 1 watt, and 2 watt size component leads. Priced under \$5.00, these quality tools are available for off-the-shelf delivery. For complete information write or call:

**RG ENTERPRISES, INC.**  
P.O. BOX 667  
SCOTTSDALE, ARIZONA 85252  
TELEPHONE (602) 948-9888

INFORMATION RETRIEVAL NUMBER 127

ELECTRONIC DESIGN 13, June 21, 1974

## Is the STATE-OF-THE-ART CREEPING UP on YOU?



The Center offers several informal programs for Engineers and Technicians who want to advance or keep abreast of the State-of-the-Art!

We have courses for you, or others in your organization; that will help bridge the gap from relays (or wherever you're at) to today's latest devices.

We have LOW COST "hands-on" learning programs which include: TTL, ECL and MOS, Digital I.C.'s, Transistors, Zeners, UJT's MOS/FET's & J/FET's ... plus more.

## SEND FOR FREE CATALOG

or Call Gene Presta at 513/296-1020

Yes, I'm interested in learning about your programs!

Name \_\_\_\_\_

Street \_\_\_\_\_

City \_\_\_\_\_ State \_\_\_\_\_ Zip \_\_\_\_\_



Phone: 513/296-1020  
2876 CULVER AVENUE  
DAYTON, OHIO 45429  
ED 674

INFORMATION RETRIEVAL NUMBER 128

179



MF ELECTRONICS gives you

## More specs for your money

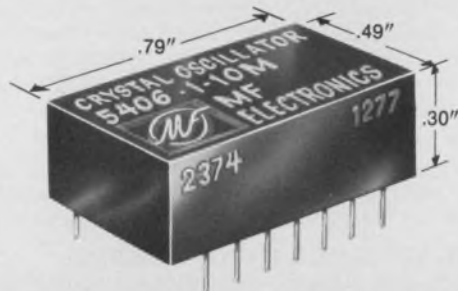

### **CRYSTAL OSCILLATORS** MF 5406 SERIES • LOW PROFILE, PLUG-IN DESIGN FOR DIP USE

- 1 Wider Frequency Range  
4-50 MHz
- 2 Wider Temperature Range  
0° to 65°C standard, -55° to +125°C available
- 3 Greater Stability  
.005% or .0025% available

FOR DETAILS ON THESE AND OTHER MF CRYSTAL OSCILLATORS, CONTACT

 **MF ELECTRONICS CORP.**  
118 EAST 25th STREET, NEW YORK, N.Y. 10010 • (212) 674-5360 • TWX: 710-581-4109

INFORMATION RETRIEVAL NUMBER 129

## CHIP CAPACITORS For Delay Lines

RMC Chip Capacitors are particularly useful for delay lines such as this one developed and manufactured by **EL-RAD MANUFACTURING CO.** EL-RAD, a leading producer of delay lines for computers, specifies RMC Chip Capacitors to insure the reliability of their delay lines.



Voltage ratings:	25, 50, and 100 V DC.
SIZES:	.050 x .100 .125 x .175* .250 x .225*
DIELECTRICS:	NPO, K2000(Y5P), K6500(Z5U),
Temp. Compensating:	P100 thru N750

\*Leaded units available.

*Radio Materials Company*

Div. of P. R. Mallory & Co. Inc.

4242 West Bryn Mawr Avenue Chicago, Illinois 60646

**(312) 478-3600**

INFORMATION RETRIEVAL NUMBER 130

POWER SOURCES

## Dual-output trackers offered for op amps

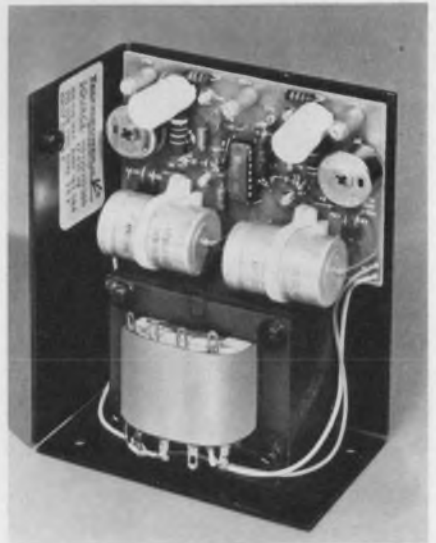

*Technipower Inc., Benrus Center, Ridgefield, Conn. 06877. (203) 438-0333. \$49.30; stock.*

NLPD dual-output series is specifically designed for commercial and industrial op-amp applications. These tracking supplies feature field-repairable IC control circuitry, full output ratings to 40 C, with derating to 71 C, and the company's standard five-year warranty. Models are available for 12 and 15-V op amps, with power outputs up to 21 W.

CIRCLE NO. 358

## 16 models added to open-frame line

*Deltron Inc., Wissahickon Ave., North Wales, Pa. 19454. (215) 699-9261. Start at \$39.*

OMNI Series open-frame power supplies now include sixteen new models. These single-output units can deliver up to 302-W per output and can be used in a virtually unlimited number of multiple-output configurations. Ratings range from 5 V, 31.5 A to 28 V, 10.8 A. The new higher-current models have been designated the T Series. Any unit in this series can be intermixed with the original M Series to form multiple-output models. Specs of the new series remain the same as the original OMNI, with line and load regulation and ripple at 0.01%.

CIRCLE NO. 359



## Shielded converters exhibit low noise



Hybrid Systems, 87 Second Ave., Burlington, Mass. 01803. (617) 272-1522. \$69; stock to 2 wks.

D15 Series dc/dc converters provide dual outputs of  $\pm 15$  V dc at  $\pm 100$  mA, regulated to 0.01%, with 11-mV noise content. The standard input, a single dc voltage, is 5 V dc for Model D15-100/5 and 12 V dc for Model D15-100/12. Efficiency is 65%. All six sides of the  $2 \times 2 \times 0.375$ -in. module are tightly shielded by a continuous, conductively coated copper layer, while transfer isolation is 80 pF and  $10^9 \Omega$ . No derating is required over the operating range of  $-25$  to  $+70$  C. Modules are burned in for 72 h.

CIRCLE NO. 360

## Supply powers dc/dc transducers



Pickering & Co., 101 Sunnyside Blvd., Plainview, L.I., N.Y. 11803. (201) 391-4400. \$69.00 (unit price); 3-4 weeks.

Model 9700 power supply is intended for all types of dc/dc LVDTs and RVDTs which operate on 6 V dc. Specs include a maximum change in dc voltage output level of  $\pm 0.05\%$  with input of 105 V, 60 Hz to 125 V, 60 Hz; no load to LVDT load less than 0.02% change in output voltage; power output of 5 W max (6 V dc, 800 mA); and short-circuit protection of 750 mA maximum.

CIRCLE NO. 361

# So you're looking for bandpass filters...

## better check Vernitron... (the ceramic filters people)

Miniature, lightweight, stable, fixed-tuned—that's ceramic filters for you. And Vernitron, innovator in piezoelectric technology, has varieties for almost any kind of communications equipment—consumer, commercial, military. If you're looking for size-reduction, cost-reduction—and high performance where it counts—it will pay you to check with Vernitron. A few examples:



### FM-4

10.7 MHz monolithic miniature for quality FM's. Only 0.016 cu. in.—replaces four tuned circuits 20 times its size. Bandwidth: 235 kHz @ 3 dB; 825 kHz @ 40 dB. Less than  $\frac{1}{2}\%$  distortion. The filter for the best in home entertainment, auto, or commercial FM's. Data sheet 94033.

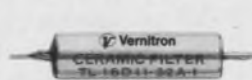

### 11-DISC LADDER FILTER

Rugged little 455 kHz lump-filter for MIL or commercial. Rejection above 60 dB in less than 0.1 cu. in. Six standard models, 6 to 40 kHz @ 6 dB. Great for handhelds, mobile or airborne. Data sheet 94029.

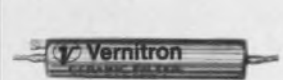

### 17-DISC LADDER FILTER

455 kHz. Ultimate in selectivity, stability and ruggedness for MIL-quality AM's or FM's. Ten standard models, shape factors 2.5:1 to 1.4:1. Rejection to above 80 dB. Highest shock and vibration resistance. Data Sheet 94017.



### TCF SERIES

Low-cost 455 kHz filter with fixed-tuned LC input, for 2-way, landmobile, aircraft, navigation or CB. Choice of standard bandwidths—6, 12, 18, 30 and 35 kHz. Highest selectivity at lowest cost. Data sheet 94026.



### LOW FREQUENCY (LF) SERIES

9 to 50 kHz. High-performance miniature for LF communications or Omega systems, selective calling, U/W sound, command-destruct. Rejection to 40 dB. Can be cascaded for higher rejections. Cascaded assemblies available; also shock/vibration units to MIL specs. Data Sheet 94030.



TO TF

### TRANSFILTERS®

Low-cost replacements for inductive or capacitive elements in IF stages or discriminators. TF's contain single resonator, 2 terminals; TO's are complete filters with 3 terminals. Excellent interstage couplers for transistor circuitry. Data Sheets 94018-20.

**NEED DESIGN HELP?** Computer-design facilities give us an edge in designing specials for special needs. If it's bandpass filters you're looking for, get in touch.



## Vernitron Piezoelectric Division

232 Forbes Road / Bedford, Ohio 44146 / (216) 232-8600

INFORMATION RETRIEVAL NUMBER 131



## Yellow and green LEDs replace filament lamps



Dialight, 203 Harrison Pl., Brooklyn, N.Y. 11237. (212) 371-8800. \$1.18 (1000 up); 2 to 3 wk.

The Datalamp cartridge lamps (507 series) include green and yellow LEDs as a light source. Datalamp cartridges may be used as direct replacements for existing cartridges that now use an incandescent lamp operating from a dc power source. An incandescent series of Datalites is also available in voltages from 3.6 to 28 V dc at a maximum current of 20 mA. The Datalamp cartridge is supplied in a black anodized finish that produces a high contrast ratio. Polarity is marked on the cartridge housing and the terminal base is keyed to ensure proper installation.

CIRCLE NO. 362

## Microwave transistor has 3.5-dB noise figure

Avantek, 3175 Bowers Ave., Santa Clara, Calif. 95051. (408) 249-0700. \$100 (1 to 5); stock.

The AT-2641 microwave transistor offers a guaranteed noise figure at 4 GHz of 3.5-dB maximum. The arsenic emitter transistor is packaged in a rugged hermetic 70-mil all ceramic stripline case and also offers a power gain, usable to 8 GHz. Typical gain performance is 15.5 dB at 2 GHz, 9.5 dB at 4 GHz and 3.5 dB at 8 GHz. Typical noise figure performance is 1.5 dB at 1 GHz, 2.3 dB at 2 GHz and 3.1 dB at 4 GHz. In addition, the transistor has relatively flat gain and noise figure performance with collector current to 15 mA.

CIRCLE NO. 363

## High power thyristor handles 850 A rms

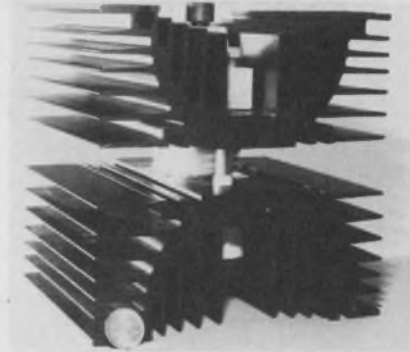

Alsthom-DRE, 9, rue Ampere, 91301 Massy, France.

The TTRI series units are long perimeter auxiliary cathode controlled thyristors. The TTRI 85-GA has an  $I_T$  rms of 850 A at a 75-C case temperature. Since the control perimeter is long, switching losses are low and the di/dt is 1000 A/s. Some other characteristics of the 85-GA include voltage rating,  $V_{DWM} = V_{RWM} = 1000$  V; critical rate of rise of off-state voltage is greater than 200 V/ $\mu$ s; an on-state voltage of less than 4.2 V; a conventional turn-off time of 18  $\mu$ s or less and a gate controlled turn-on time of less than 3  $\mu$ s.

CIRCLE NO. 364

## Replacement transistors work up to 520 MHz



Solid State Scientific, Montgomeryville, Pa. 18936. (215) 855-8400. 5944: \$7.50; 5945: \$10.75, 5946: \$16 (1 to 99); stock.

Three in-socket replacement npn silicon transistors are the 2N5944, 2N5945 and 2N5946. They have power outputs of 2, 4 and 10 W, respectively. These transistors are designed for 12.5-V uhf large signal amplifier applications and can operate up to 520 MHz. They are available in an MT-90 package and fit existing sockets for similar EIA registered transistors. All transistors are 100% tested for VSWR and other rf parameters.

CIRCLE NO. 365

## Red diffused LED has brightness of 70 ft-lam



Shigoto Industries, Empire State Bldg., 350 Fifth Ave., N.Y., N.Y. 10001. (212) 695-0200.

The GL-31AR GaAsP red LED is mounted on a ceramic header with epoxy lens. It emits a spectrally narrow band of red light peaking at 6550 Å, with typical brightness of 70 ft-lamberts at  $I_F = 30$  mA. The header and lens over-all dimensions are 0.117 in. diameter and 0.138 in. high. The LED has a maximum power dissipation of 100 mW and a continuous forward current of 50 mA. The LED also has an operating temperature range of -25 to +85 C.

CIRCLE NO. 366

## Power rectifier diodes span 50 to 400 V

RCA, Route 202, Somerville, N.J. 08876. (201) 722-3200. From \$1.25 (1000-up); stock.

Four series of 50-to-400-V fast-recovery silicon rectifiers handles currents of up to 30 A. These four series include 40 rectifiers (6, 12, 20 and 30-A types) that have a maximum reverse-recovery time of 200 ns. The 6-A (1N3879-1N3883 and 1N3879R-1N3883R) and the 12-A (1N3889-1N3893 and 1N3889R-1N3893-R units) are supplied in hermetic DO-4 packages. The 20 and 30-A types (1N3899-1N3903, 1N3899R-1N3903R, 1N3909-1N3913 and 1N3909R-1N3913R) are supplied in hermetic DO-5 packages. Each series includes both forward-polarity (cathode connected to the stud) and reverse polarity (anode connected to the stud) types that have peak-reverse-voltage ratings of 50, 100, 200, 300, and 400 V. The reverse-polarity types, indicated by the R suffix in type-number designations, are suited for applications that require operation of the anode at ground potential.

CIRCLE NO. 367



## Use Deltrol Series C Solenoids where LOW COST is essential

Deltrol Series C solenoids are used extensively in automotive, appliance and vending machine volume applications where cost must be kept at a minimum. These low and medium power linear-type units are available in seven basic sizes with variations available to match a wide range of applications. Intended primarily for AC operation at Class A coil temperatures, Deltrol "C" - frame solenoids exhibit a high starting force and fast plunger operation. An optional buzz trimmer eliminates AC hum while providing improved magnetic characteristics for cooler, more efficient operation. Units feature smooth plastic plunger guides for long life with an optional special phenolic guide available for higher than average temperature applications. Most standard units feature nylon encapsulated coils for improved heat dissipation and greater resistance to moisture, shock and rough handling. Standard rating covers a six to 240 VAC coil voltage range. These inexpensive "C" - frame solenoids are interchangeable with many competitive "D" or box-frame units. Options include push-mode units, spring returns, custom mounting frames and special coil treatment.

1712

INFORMATION RETRIEVAL NUMBER 132

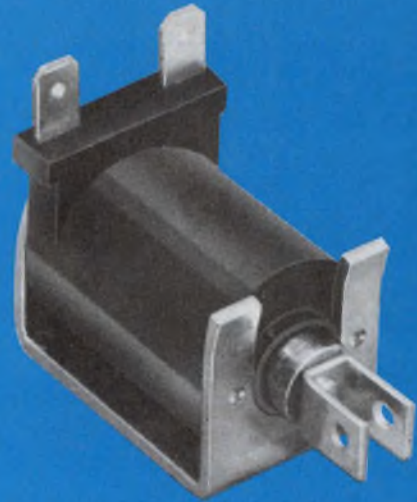

### DELTROL *controls*

Division Of Deltrol Corp.

2745 South 19th Street, Milwaukee, Wisconsin  
53215, Phone (414) 671-6800, Telex 2-6871

## KNOB KNOW-HOW

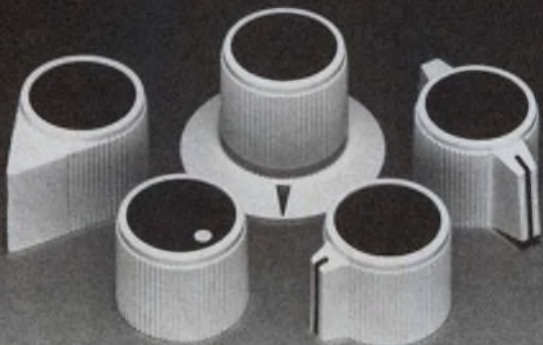

We know how to build quality and attractive styling into our knobs & dials. We've been doing it for more than 30 years.

**ROGAN  
CORPORATION**

Telephone (312) 498-2300  
3455 Woodhead Drive, Northbrook, Illinois 60062

INFORMATION RETRIEVAL NUMBER 133

ELECTRONIC DESIGN 13, June 21, 1974

## THE COMPATIBLES

Spectrum Technology is your one source for frequency control devices that are compatible with the high technology logic of the Seventies. Standard, modified or custom designs include subminiature hybrid circuit crystal oscillators, dual in-line low profile hybrid circuit logic clocks, low cost crystal oscillator IC logic clocks, and TCXO's. Write or call for details.

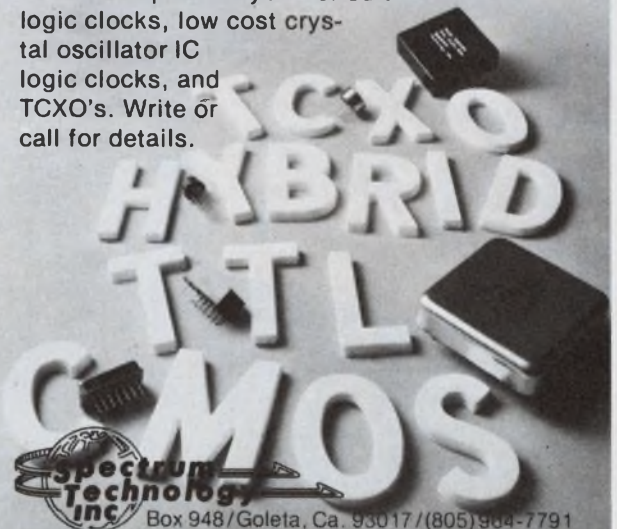

Box 948/Goleta, Ca. 93017/(805)964-7791

Frequency Control & Timing Systems Products  
Crystal Oscillators • Logic Clocks • TCXO's.

INFORMATION RETRIEVAL NUMBER 134

183



# WIRE WRAPPING PANELS

We didn't invent wire wrapping, but we might as well have. Standard Logic offers the finest and most complete line of wire wrapping logic panels available. Anywhere. We're also the world's leading supplier of semi-automatic wiring machines. And we have one of the nation's largest contract wiring service facilities.

Call, write, or wire:  
Standard Logic,  
2215 South  
Standard Ave.,  
Santa Ana, California 92707 Telephone: (714) 979-4770



**STANDARD LOGIC, INC.**



SEND for the latest word on wire wrappable logic panels and wiring machines.

INFORMATION RETRIEVAL NUMBER 135

## Fight Brownouts with TOPAZ LINE REGULATORS

- No Distortion • Most Efficient
- Lowest Cost • Smallest Size



500 VA to 24 kVA

Priced from \$290.

**TOPAZ**  
ELECTRONICS

SOLUTIONS TO  
POWER PROBLEMS

3855 Ruffin Road, San Diego, CA 92123 Phone (714) 279-0831 TWX (910) 335-1526

INFORMATION RETRIEVAL NUMBER 136

## DISCRETE SEMICONDUCTORS

### Green LEDs dissipate 112 mW at 25 C

Dialight, 203 Harrison Pl., Brooklyn, N.Y. 11237. (212) 497-7600. \$0.55 (100-up); stock.

The 521-9206 series of miniature gallium phosphide LEDs provides a bright green light. Maximum ratings for the lamp include: Power dissipation of 112 mW, derated linearly from 25 C at 1.49 mW/°C; storage and operating temperature is -20 to 100 C; continuous forward current is 40 mA; peak pulse current 1 A at 1  $\mu$ s pulse, 1% duty cycle; and a peak reverse voltage of 5 V.

CIRCLE NO. 368

### Reverse conducting thyristor handles 600 A

#### THYRISTOR A CONDUCTION INVERSE (T.C.I.)

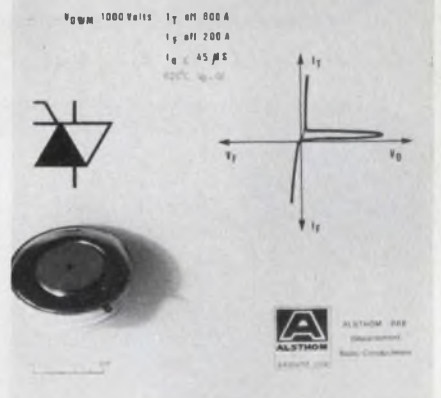

Alsthom-DRE, 9, rue Ampere, 91301 Massy, France.

The TCI is a power semiconductor which combines an auxiliary cathode controlled thyristor and a parallel connected reverse polarity fast recovery diode. The 60/20 TCI handles 600 A rms dc through the thyristor and 200 A rms through the diode. The TCI's main characteristics include: A voltage rating of  $V_{DWM} = 1000$  V; a junction temperature rating of -40 to 125 C; a di/dt of 800 A/ $\mu$ s; a dV/dt of 200 V/ $\mu$ s; and an on-state voltage (at 25 C and 500 A) of 1.5 V for the thyristor and 1.6 V for the diode. Case dimensions are: diameter of 83 mm and thickness of 34.5 mm.

CIRCLE NO. 369



## Seven-segment LED digits are 0.5 in. high

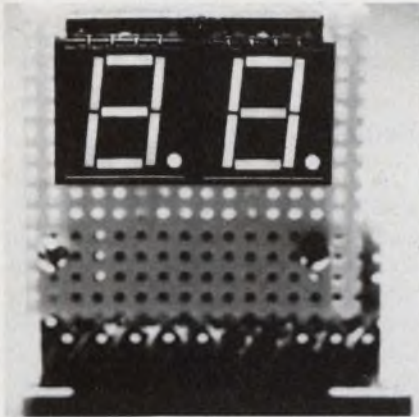

Fairchild Camera & Inst., Optoelectronics Div., 464 Ellis St., Mountain View, Calif. 94042. (415) 962-3816. \$2.65 (1000-up); stock.

A 0.5-in. high LED numeric display is available in either common-anode (FND-500) or common-cathode (FND-507) format. Both types are compatible with the company's monolithic driver circuits, the 9368 and the 9370, respectively. The displays also interface directly with MOS logic. The seven-segment display digits use GaAsP technology, need a 5-mA average drive current per segment and a 3-V power supply. For desktop calculator applications only a 2-mA average drive current is needed.

CIRCLE NO. 370

## Npn power transistors come in three packages

Solitron Devices, 1177 Blue Heron Blvd., Riviera Beach, Fla. 33404. (305) 848-4311. From under \$3 (large qty.); 3 to 4 wk.

Fast switching industrial npn silicon power transistors have a peak current capability of 10 A. This series is available in three packages, the standard TO-3 (SDT 85301-SDT 85310), the TO-39 (SDT 85501-SDT 85510) and the TO-66 (SDT-85601-SDT 85610). Gain of the transistors is flat from below 10 mA to above 5 A. Typical features include  $BV_{CE0(sus)}$  from 40 to 150 V,  $BV_{CE0}$  from 60 to 170 V and  $I_C = 10$  A. The thermal resistance is from 1.5 C/W and  $f_t$  of 40 MHz is typical.  $V_{CE(sat)}$  is 0.6 V maximum and  $V_{BE(sat)}$  is 1.5 V maximum.

CIRCLE NO. 371



## THE RIGHT PARTS AT THE RIGHT TIME

At Syntronic Instruments we make every effort to keep ahead of the times. That means anticipating materials shortages and planning our production to suit your schedules.

Planning starts with our design engineers who help you select and specify the right precision yoke for your CRT display.

For prototypes and production runs we do our own precision machining, our own tooling, our own molding of intricate parts, and of course, our own coil winding and assembly.

Our own computer installation is used for material requirements planning, production scheduling, bill of materials files and explosions and cost accounting functions which support our purchasing and production activities.

As the largest manufacturer of precision yokes and coils we have a highly specialized organization... devoted to getting you the right parts at the right time.



SYNTRONIC INSTRUMENTS, INC.  
100 Industrial Road, Addison, IL 60101  
Phone (312) 543-6444



# Keystone THERMISTOR TASK MINDERS

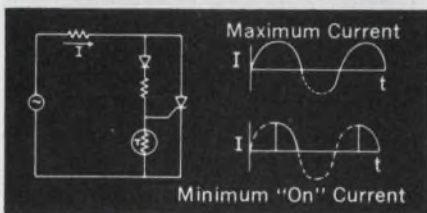
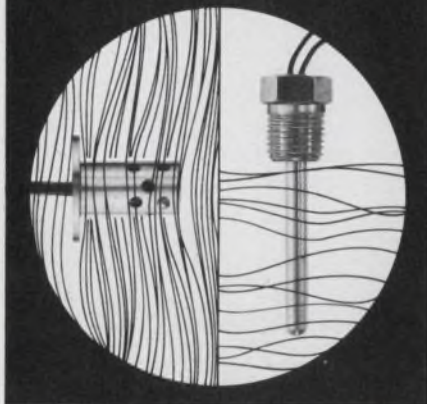

## LOW-COST TEMPERATURE CONTROL

As the resistance of the thermistor decreases, a larger voltage is required to fire the SCR. In this circuit, conduction angles from 90° to 180° can be achieved. Thus, the minimum "on" current will be 50% of the maximum "on" current.

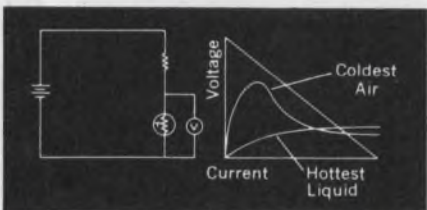

## LIQUID LEVEL DETECTION

Taking advantage of the difference in dissipation constant between a liquid and a gas enables thermistors to serve as liquid level sensors over a wide range of temperatures.

Send for 12-page thermistor probe catalog detailing 23 styles and 6 applications.



# Keystone

CARBON COMPANY  
Thermistor Division  
St. Marys, PA 15857  
814/781-1591 • Telex 91-4517

INFORMATION RETRIEVAL NUMBER T38

## application notes

### Magnetic shield

How to effectively shield complex high resolution video recorder head assemblies from a wide range of magnetic field interferences that prevent optimum operation is shown in a two-page data sheet. Ad-Vance Magnetics, Rochester, Ind.

CIRCLE NO. 372

### Optically coupled isolators

Application Note AN 948 describes the performance to be expected from the HP 5082-4350/51/60 isolators as line receivers in a TTL-TTL compatible NRZ data transmission line. Hewlett-Packard, Palo Alto, Calif.

CIRCLE NO. 373

### Solder problems, solutions

Over 20 soldering problems and solutions are given in a first-aid soldering bulletin. Pure Alloys, Westbury, N.Y.

CIRCLE NO. 374

### Fused quartz

Obtaining long operating life from fused quartz used in high-temperature applications is the subject of an eight-page bulletin. General Electric, Lamp Parts & Equipment Sales, Cleveland, Ohio.

CIRCLE NO. 375

### Rotating machines

How to detect and analyze vibration in rotating machines, such as motors, reactors, engines, turbines and generators, is discussed in a two-page bulletin. Signal Analysis Operation, Honeywell, Hauppauge, N.Y.

CIRCLE NO. 376

### Phase-loss protection

An application guide aids in the installation of phase-loss, low-voltage and phase-reversal protection in three-phase power systems. The easy-to-read 12-page booklet contains schematics and charts. Time Mark, Tulsa, Okla.

CIRCLE NO. 377

## design aids

### Sensitivity selector

A handy design aid for the selection and proper use of the company's sensors in synchronous timing and speed monitoring applications. It provides specifications including output pulse levels achievable with combinations of various pitch gears, air-gap settings and pole-piece sizes, all at prescribed speeds. Electro Corp.

CIRCLE NO. 378

### Calculator

A weight/thickness calculator for wire, foil and coatings presents a graphical method for obtaining the weight per unit area for foils and coatings and weight per unit length of wires. Cotronics.

CIRCLE NO. 379

### Heating materials

Electrical, thermal and mechanical properties of electric resistance heating materials are listed in a brochure. The Kanthal Corp.

CIRCLE NO. 380

### High-voltage capacitors

A quick guide to MIL-style CQ72 high-voltage, hermetically sealed capacitors abstracts all important data from MIL-C-19978 in an easy-to-use format. Sprague.

CIRCLE NO. 381

### Crimp tool chart

An MS crimp tool wall chart lists all government designations, company numbers, FSN and contracts accommodated. Buchanan Crimp Tool Products.

CIRCLE NO. 382

### Spacer selector

A handy double-sided selector helps find clearance I.D. and threaded I.D. for brass (cadmium plated), fiber and phenolic spacers on one side. The other side gives data for aluminum and nylon spacers. Herman H. Smith, Inc.

CIRCLE NO. 383



**NOW! MORE APPLICATIONS!**

Teflon-FEP  
**SHRINK-FIT**  
Tubing



**PENNTUBE<sup>†</sup> II-SST**  
(Super Shrinkable Teflon\*)

**1<sup>2</sup>/<sub>3</sub>:1 SHRINKDOWN**

Now, more applications including encapsulating many heat sensitive materials. Insulates, strain relieves, moisture proofs, protects. Fewer sizes need be stocked.

Chemically inert with excellent electrical and mechanical properties. Will not burn or support flame. Excellent for: chafe guards—electrical terminal and splice insulation—covering over plastic, metal and wood—jacketing for cable harness assemblies, etc.

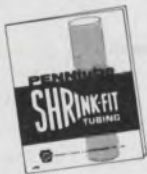

**FREE! SEND FOR FOLDER.**

**PENNTube Plastics Co., Inc.** /  **SUBSIDIARY OF DIXON INDUSTRIES**

Madison Ave. & Holley St., Clifton Heights, Pa. 19018 • (215) 622-2300



Export Div. • 5710 Empire State Bldg., N.Y. 10001  
\*Du Pont Reg. T.M. †PennTube Plastics Co. Reg. T.M.

INFORMATION RETRIEVAL NUMBER 139

Your load impedances can't upset  
our 1 kW broadband amplifier

**Model 1000L will drive  
any load impedance**

**10 KHZ - 220 MHZ**

Versatile and reliable -- that's the best way to describe Amplifier Research's Model 1000L. This powerful 1000-watt unit features unique protective circuitry to permit operation into any load impedance without shutdown or damage. And it's simple to operate -- all you need is a standard sweep or signal generator. Convenient front panel controls permit you to select the desired operating mode -- 100 or 1000-watt CW output or 4-kilowatt pulse output. Model 1000L is ideally suited for antenna and component testing, equipment calibration, EMI susceptibility testing, biological research, and a variety of other applications. For complete information, write or call Amplifier Research, 160 School House Road, Souderton, Pa. 18964 Phone 215-723-8181



 **AMPLIFIER RESEARCH**

INFORMATION RETRIEVAL NUMBER 140

**Recruitment Advertising gets READ  
... in Electronic Design**

**RATES**

1 page .....	\$2,140.
3/4 page (3 cols.) .....	1,620.
1/2 page (2 cols.) .....	1,080.
1/4 page (1 col.) .....	540.
1/8 page (1/2 col.) .....	270.
1/16 page (1/4 col.) .....	135.
One column inch .....	54.

**DATA**

Four column make-up. Column width: 1-3/4". Each issue mails two weeks prior to the issue date. Closing dates for camera-ready mechanicals or film is one week before mailing date. If desired, Electronic Design will set type at no charge (closing date is 2 weeks prior to mailing date).

**84,000 DESIGN ENGINEERS AND ENGINEERING MANAGERS**

Call the Recruitment Hotline: (201) 843-0550 X203 or clip & mail this coupon to: Recruitment Manager, Electronic Design, 50 Essex St., Rochelle Park, N.J. 07662.

I'm interested in placing recruitment  
advertising in electronic design.

Issue \_\_\_\_\_ Size of ad \_\_\_\_\_  
 My copy is enclosed  I need more information  
 Name \_\_\_\_\_ Title \_\_\_\_\_  
 Company \_\_\_\_\_ Telephone \_\_\_\_\_  
 Address \_\_\_\_\_  
 City \_\_\_\_\_ State \_\_\_\_\_ Zip \_\_\_\_\_

Small, but mighty!

**DORMEYER**  
**SUPER-C**  
**SOLENOID**

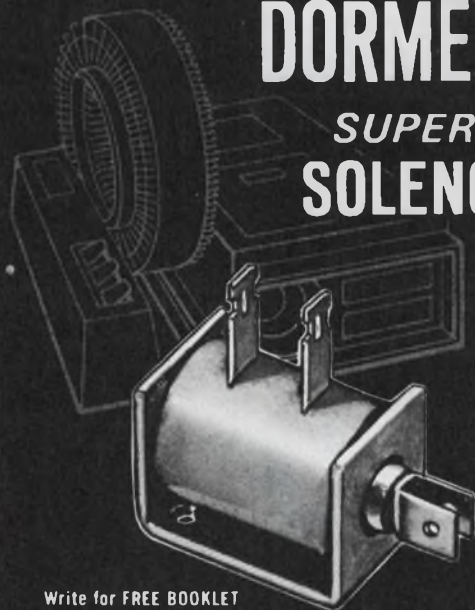

Used on  
Remote  
Control  
Automatic  
Slide  
Projectors

Write for FREE BOOKLET

"SOLENOIDS, What they are—How to use them!"

**DORMEYER INDUSTRIES, Inc.**

3414 No. Milwaukee Ave., Chicago, Illinois 60641

▲ WORLD'S LARGEST MANUFACTURER OF SOLENOIDS—COILS—TRANSFORMERS



**DORMEYER**  
Dependability

INFORMATION RETRIEVAL NUMBER 141





Your source  
for Electronic  
Discharge  
Printers

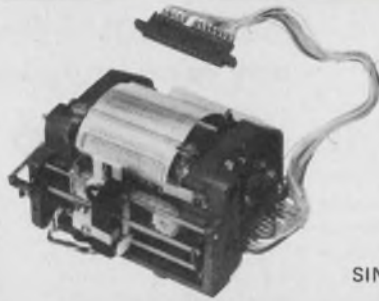

**\$130**  
1606A  
16 COLUMN

**\$150**  
2106A  
21 COLUMN

SINGLE QUANTITY PRICE  
VOLUME DISCOUNTS

**FAST** 6 LINES PER SEC.

**QUIET** NON IMPACT PRINTER

**SMALL** 3.3" X 4.5" X 4.5"

**LIGHT** ONLY 1.5 POUNDS

**LONG LIFE** MTBF 5.5 MILLION LINES

HOOK UP WITH HYCOM. These quick, quiet and compact alphanumeric printers need no ribbons and have fewer moving parts . . . adding up to economy and reliability. Get them from the source . . .

## HYCOM

16841 Armstrong Avenue, Irvine, California 92705, Telephone (714) 557-5252

Your source for Microelectronic Systems  
Custom MOS/LSI • Communication Systems • Dedicated Calculators

INFORMATION RETRIEVAL NUMBER 143

Try it first. Send for a free sample.

# Tempilabel<sup>o</sup>



### Temperature Indicating Labels

The center spot on a Tempilabel<sup>o</sup> turns black when the surface to which it is affixed reaches the specified temperature (from 100° to 600°F).

Tempilabels<sup>o</sup> are available with single spots, or with multiple spots for monitoring safe operating temperatures. They provide permanent temperature records, and are thus useful in designing components and selecting materials.

If you are not now using Tempilabels<sup>o</sup>, fill in the coupon. We'll be glad to send you a sample that you can try in your own plant or laboratory.

### Tempilabel<sup>o</sup>

Division, Big Three Industries, Inc.  
Hamilton Blvd., South Plainfield, N.J. 07080  
Phone: 201 • 757-8300 • Telex: 138662

Send sample of Tempilabel<sup>o</sup>.  
For use at      °      temperature.

Name \_\_\_\_\_

Title \_\_\_\_\_

Company \_\_\_\_\_

Street \_\_\_\_\_ City \_\_\_\_\_

State \_\_\_\_\_ Zip \_\_\_\_\_

# Can you spot your limitations?

INFORMATION RETRIEVAL NUMBER 144

## evaluation samples

### Universal wiring panel

A universal wiring panel follows a set pattern of straight parallel copper strips bonded to a piece of phenolic/or glass laminate. A set pattern of holes makes up a matrix with a pitch of 0.1 × 0.1 in. between adjacent centers. The copper strips are 0.025-in. W, 0.0015-in. T and spaced 0.025-in. apart. Vero Electronics.

CIRCLE NO. 384

### Sleeves and tubing

A six-page folder contains sample lengths of insulating sleeveings and tubings arranged by temperature classification. Physical and electrical parameters are in tabular form to facilitate selection. There are tables of standard ASTM and NEMA sizes and dimensions. Letterhead requests only. L. Frank Markel & Sons, Norristown, Pa. 19404.

INQUIRE DIRECT

### Multipurpose lubricant

Motor mica lubricating compound, a white dry powder, can be used either as an additive to present lubricants or in dry form. The lubricant exhibits a natural affinity to metal inertness with good heat conductivity. It boasts a low coefficient of friction, is electrically nonconductive, non-toxic and contains no silicones. Scientific Lubricants.

CIRCLE NO. 385

### PCB switches

Subminiature PCB two-circuit switches can be used for subchassis checkout and interlock circuits, as well as for front-panel application. Horizontal and vertical mount versions are available as two or three-position toggles, or as momentary, or latchdown, pushbuttons. Letterhead requests only. Control Switch, 1420 Delmar Dr., Folcroft, Pa. 19032.

INQUIRE DIRECT



## vendors report

Annual and interim reports can provide much more than financial-position information. They often include the first public disclosure of new products, new techniques and new directions of our vendors and customers. Further, they often contain superb analyses of segments of industry that a company serves.

Selected companies with recent reports are listed here with their main electronic products or services. For a copy, circle the indicated number.

**Basic.** Power and interface devices for telephone systems, power sources, magnetic components, PC cards, assemblies and ceramics.

CIRCLE NO. 386

**Sprague.** Capacitors, semiconductors and integrated circuits, assemblies, filters, special components, component assembly and test equipment, instruments and standards and resistors.

CIRCLE NO. 387

**Hazeltine.** Computer peripheral equipment, automatic editing equipment, color-film analyzers, military electronics, air-traffic control products and digital video display systems.

CIRCLE NO. 388

**Howell Instruments.** Precision measuring and recording equipment, PC boards and electronic wiring devices.

CIRCLE NO. 389

**NCR.** Point-of-sale equipment, financial systems, commercial industrial systems and medical systems.

CIRCLE NO. 390

**The Richardson Co.** Specialty chemicals, engineered industrial materials and parts.

CIRCLE NO. 391

**ITT.** Telecommunication products and operations, industrial products, automotive products, consumer products and services, defense-space programs, business and financial services and natural resources.

CIRCLE NO. 392

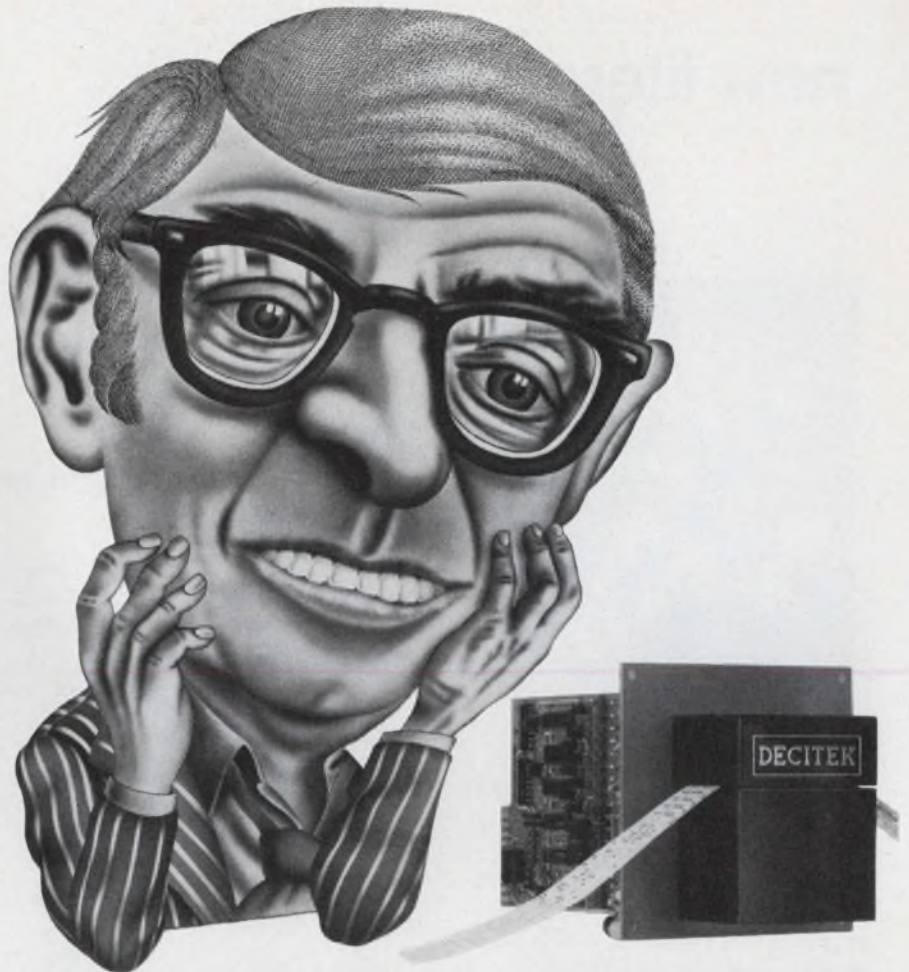

# PLAY IT AGAIN, SAM.

Sam is the name of Decitek's new low-cost 100 cps photoelectric tape reader. Sam? We could tell you that it's short for something like Superior Alignment Motion, which is precisely what our patented dual sprocket drive provides. But it isn't. We simply felt that Sam has a nice friendly ring to it and is easy to remember.

Sam offers good credentials.

This new reader incorporates the same unflappable tape transport that is the heart of Decitek's eye-blinking 600 cps reader. This drive doesn't need edge guides or keepers, there's no tape skew. Positive registration is assured — repeatedly through thousands of reruns with no measurable tape wear.

Fiber optic lighting from a single light source plus photo-transistor sensing are features that deliver dependable high-quality performance.

All this at a cost that compares favorably with mechanical readers!

For all the details on this new low-cost, highly reliable reader, just drop us a note or card with the words "Play it again, Sam."

*When reading matters*

## DECITEK

A DIVISION OF JAMESBURY CORPORATION  
250 CHANDLER STREET, WORCESTER, MASSACHUSETTS 01602, (617) 798-8731

INFORMATION RETRIEVAL NUMBER 145



# new literature



## Switches

Subminiature toggle, rocker, illuminated rocker and paddle handle switches are featured in a 12-page catalog. General specifications, outline drawings and mounting data are included. C&K Components, Watertown, Mass.

CIRCLE NO. 393

## Dc power supplies

Miniaturized epoxy encapsulated modular dc power supplies are described in a brochure. Tear-off terminal templates help prepare PC-board artwork or serve as drilling templates. They indicate the precise locations of mounting holes, output and input terminals and output trim controls. Specifications, dimensional line drawings and prices are provided. Amphenol, Broadview, Ill.

CIRCLE NO. 394

## Polyester PTFE blends

Temperature and wear resistant composite material resulting from blends of Ekonol polyester and polytetrafluoroethylene (PTFE) is described in a bulletin. The Carborundum Co., Niagara Falls, N.Y.

CIRCLE NO. 395

## Environmental instruments

A 48-page catalog describes instruments and test kits for water quality and pollution control. Ecologic Instrument, Bohemia, N.Y.

CIRCLE NO. 396

## Tape recorder/reproducer

Performance characteristics and specifications of the company's 10-286 instrumentation tape recorder/reproducer for airborne portable applications are described in a four-page illustrated brochure. Genisco Technology, Compton, Calif.

CIRCLE NO. 397

## Dc op amps

Data on dc operational amplifiers of widely differing characteristics are described in a catalog. Modular Devices, Bohemia, N.Y.

CIRCLE NO. 398

## Impulse counter

Electromechanical impulse counters are described in a six-page illustrated guide. The guide contains specifications, dimensions, photos and prices. B & B Motor & Control, New York, N.Y.

CIRCLE NO. 399

## Pulse generators

An unusual circular slide chart application selector is the main feature of an eight-page catalog describing pulse and function generators. Interstate Electronics, Anaheim, Calif.

CIRCLE NO. 400

## Solid-state sweeper

The Model 430A 0.01-to-18-GHz solid-state sweeper is described in a 12-page brochure. Specifications and features—including rf output power levels are included. Weinschel Engineering, Gaithersburg, Md.

CIRCLE NO. 401

## Data conversion handbook

The topics covered in this 150-page handbook include codes, d/a converters, a/d converters, sample/holds and analog multiplexers. An appendix contains a 2" and resolution table, exponential settling table, temperature conversion chart and a reactance chart. The cost of this handbook is \$1.50. Hybrid Systems, 87 Second Ave., Burlington, Mass. 01803.

INQUIRE DIRECT

## Lasers and accessories

Performance characteristics of the company's carbon dioxide (CO<sub>2</sub>) sealed-tube lasers are described in a 16-page catalog. It contains applications, hardware, specifications of the lasers and accessories, and a CO<sub>2</sub> laser theory section with bibliography. GTE Sylvania, Mountain View, Calif.

CIRCLE NO. 402

## Active filters and op amps

A 308-page active-filter and operational-amplifier handbook is loaded with schematics and technical data. The only catch—it's all in French. Thomson-CSF, Sescosem, Paris, France.

CIRCLE NO. 403

## Ac motor speed control

The "Ramsey Primer" is an easy-to-read discussion of the "what and how" of an adjustable frequency ac motor speed control. The handbook carries the reader through the reasons for the use of an adjustable frequency drive, how it works and where these drives are best employed. The book is free upon request received on a company letterhead. Ramsey Controls, 351 Rte. 17, Mahwah, N.J. 07430.

INQUIRE DIRECT

## CRT terminal

A CRT display and data entry terminal, the Keyview, is featured in a four-page bulletin. Key specs and options are included. Information Design, Bedford, Mass.

CIRCLE NO. 404

## DPMs

Updated data sheets for 11 series of DPMs include the latest specs, available models and options and prices. Electronic Research Co., Shawnee Mission, Kan.

CIRCLE NO. 405

## Inductors and components

More than 3500 rf coils, rf chokes and related components are described in a 92-page catalog. Schematic diagrams showing adjustment accessibility for all shielded and unshielded coils are given. Bell Industries, Compton, Calif.

CIRCLE NO. 406



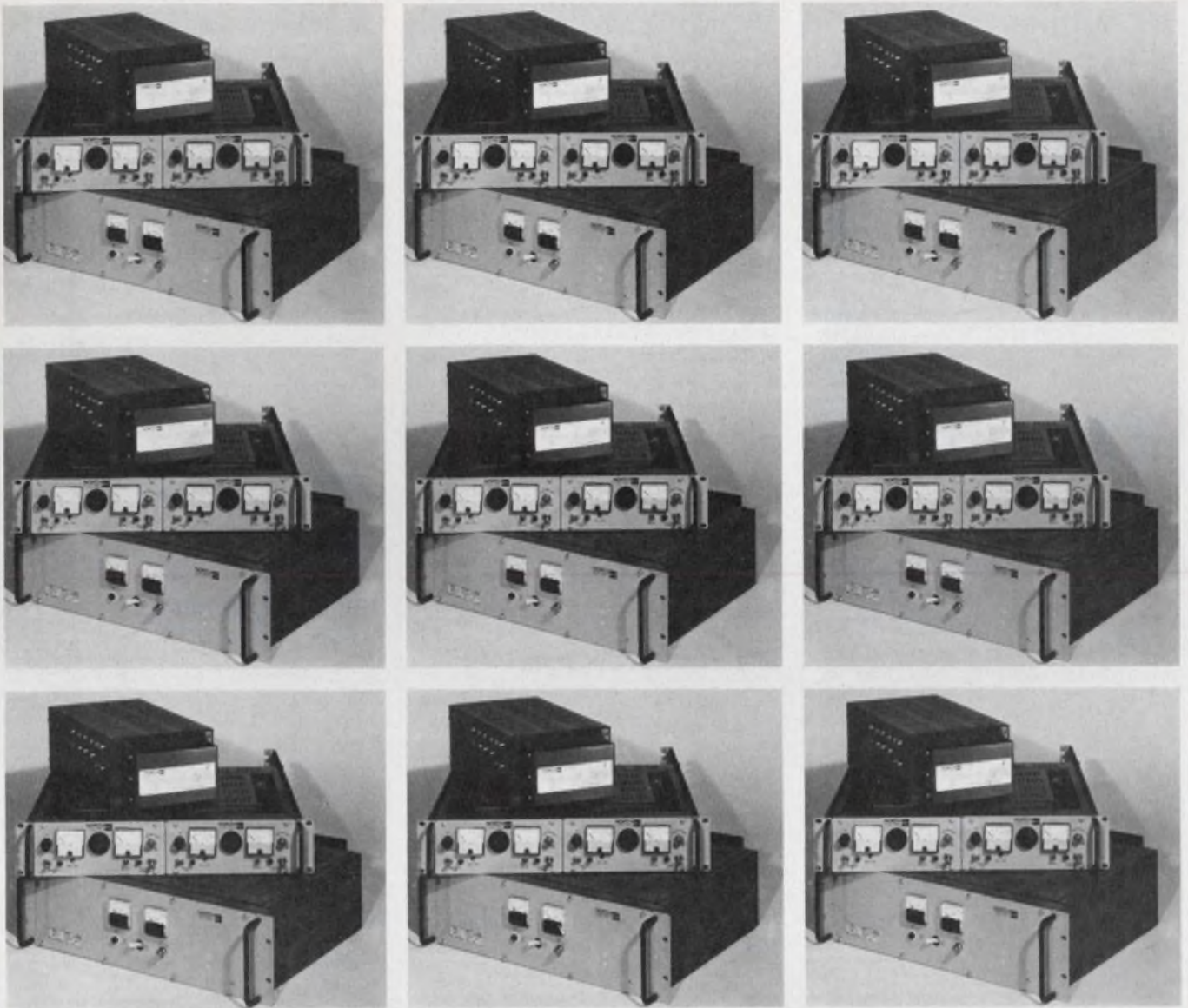

## Whether you buy one's, two's or multitudes North delivers power reliability!

The performance of your business machine products should never depend on anything less than reliable power supplies. It just doesn't make sense to risk the valuable reputation of a major piece of equipment over a minor component—especially, when the cost difference is so little.

Many O.E.M.'s are beginning to agree with this point of view, and if you're one of them, we'd like to quote your next power supply order. Whether you need one unit—or one hundred, North Electric has both the product selection and the production capacity to deliver more "reliability" for your power supply dollar.

And, to back it up, we offer the industry's finest technical specialists and more than 40 years experience as the leader in custom power supplies.

SP-15

Send for a product catalog today, or for service information call your North Standard Product Manager at 419/468-8874.

MODEL	10000
VDC	AMPS
0-7.5	2.10
0-16	1.25
0-25	0.85
0-33	0.68

DUAL OUTPUT SUPPLIES	
MODEL	N60052
VDC	AMPS
±15 12	400MA
MODEL	N60052
VDC	AMPS
±15 12	1.0A

Listed here are the more popular models—many other voltages are available.

MODEL	11000	12000	13000	14000	15000	16000	17000	18000
VDC	AMPERES							
5.0	3.9	5.3	11.3	13.0	20.0	32.5	49.0	82.0
12.0	2.8	4.2	8.0	10.5	15.0	23.0	36.0	58.0
15.0	2.4	3.7	7.5	9.5	14.0	20.5	27.0	47.0
18.0	2.1	3.3	6.0	8.0	13.0	18.0	26.0	40.0
24.0	1.5	2.8	4.2	7.0	11.0	15.0	21.0	33.0
28.0	1.4	2.4	4.0	6.3	9.0	14.0	20.0	29.0
36.0	1.2	2.2	3.1	5.6	8.0	11.0	14.0	23.0
48.0	.95	1.8	2.6	4.2	6.0	8.0	10.0	18.0

**NORTH**   
ELECTRIC COMPANY

North Electric Company / Galion, Ohio 44833 / A United Telecom Co.

INFORMATION RETRIEVAL NUMBER 146





### Dc power supplies

A 52-page catalog provides specifications on over 200 precision dc power supplies and power modules. The catalog is sectionalized starting with a glossary of power-supply terms and application notes defining the purpose and use of dc power supplies. Systron-Donner, Westbury, N.Y.

CIRCLE NO. 407

### Green LEDs

A two-page bulletin details the 521-9202 and 521-9203 green LED lamps. Dialight, Brooklyn, N.Y.

CIRCLE NO. 408

### Microwave products

Beam-lead microwave semiconductors including p-i-n switching diodes, Schottky barrier mixer diodes, step-recovery diodes and capacitors with JEDEC values from 0.33 to 150 pF are covered in a booklet. Texas Instruments, Dallas, Tex.

CIRCLE NO. 409

### Passive filters

A minicatalog shows bandpass, low-pass and high-pass filters. CirQTel, Kensington, Md.

CIRCLE NO. 410

### Clutches and brakes

Features, functions, standard unit types and mounting styles of clutches and brakes are given in a 10-page catalog. Moment of inertia measuring instruments are also included. Inertia Dynamics, Collinsville, Conn.

CIRCLE NO. 411

### Low-speed modems

A series of low-speed modems that provide full duplex operation over private lines or over DDD networks is described in a bulletin. Tele-Dynamics, Fort Washington, Pa.

CIRCLE NO. 412

### Centrifuge rotors

"Semiconductor Rotors for Acceleration Testing" presents information on the 50,000-rpm Model L3-CT ultra-centrifuge, three basic semiconductor rotors and special rotors and carriers. Photographs and diagrams illustrate techniques for accommodating diodes, DIPs, transistors and flatpacks in X, Y and Z orientations. Beckman Instruments, Spinco Div., Palo Alto, Calif.

CIRCLE NO. 413

### Material test systems

Materials test system brochure describes the Series 810 features and capabilities. MTS Systems, Minneapolis, Minn.

CIRCLE NO. 414

### Security monitor

A data sheet describes the building security monitoring applications of the System 630. Plantronics, Santa Clara, Calif.

CIRCLE NO. 415

### PC card guides

A 24-page catalog provides information on PC card guides, card ejectors and component mounting spacers. Applications information, specifications and prices are included. Bivar, Santa Ana, Calif.

CIRCLE NO. 416

### Laser cutting

A series of *Technotes* describes CO<sub>2</sub> laser cutting applications. The first issues contained background information on laser cutting, typical cutting rates and case histories of industrial applications. Future issues will discuss operating costs, cost reduction benefits and technical advantages of lasers in relation to conventional cutting methods. Ferranti Electric, Laser Dept., Sturbridge, Mass.

CIRCLE NO. 417

### Digital signal processor

An eight-page data sheet describes and illustrates the DSP, a hardwired, stand-alone FFT processor that operates as an instrument rather than a computer. The data sheets present the mathematical equations underlying each function and illustrate many of the X-Y display modes the DSP makes possible. Spectral Dynamics, San Diego, Calif.

CIRCLE NO. 418

### Furnace tubes

Furnace tubes that do not crack when an unexpected power interruption occurs are described in an information packet. Dow Corning, Midland, Mich.

CIRCLE NO. 419

### Computer products

"Tektronix Computer Products," a 48-page catalog, includes details on computer display terminals, hard-copy units, display units, interfaces, software and other accessories. Included are brief histories on the development and use of the computer. Tektronix, Beaverton, Ore.

CIRCLE NO. 420

### Eastman Kodak index

An index lists more than 800 books, guides and pamphlets which the company publishes relative to its photographic products and techniques. Eastman Kodak, Rochester, N.Y.

CIRCLE NO. 421

### Ribbon cable

"Great Connections with Flat Ribbon Cable," a 12-page brochure, pictures and describes some of the more interesting applications of multiconductor ribbon cable. Included in the brochure is a comparative evaluation of insulation materials. Spectra-Strip, Garden Grove, Calif.

CIRCLE NO. 422

### Video editing equipment

A four-page brochure describes the operating controls of each of the company's video tape editing products and their key operating features. Datatron, Santa Ana, Calif.

CIRCLE NO. 423



# Magnetic Reed BURGLAR ALARM

## Door and Window Switches for Concealed Installation

- No installation screws, nails or glue required
- No magnet loss in hollow doors
- Will operate through a big 1/2" gap
- Six types: SPST-NO, SPST-NC, SPDT.  
Each available with supervisory loop
- Guaranteed for 2 years or 10 million cycles
- Lowest price



Also available for steel doors.  
Ask for free sample of SPST-NO on your letterhead  
or call 308-235-4645.



**GEORGE RISK  
INDUSTRIES, INC.**

802 South Elm, Kimball, Nebraska 69145  
Phone: 308-235-4645 TWX: 910-620-9040

INFORMATION RETRIEVAL NUMBER 147

**the  
light  
heavyweights**

When you insist on excellence, go with the winner. Shigoto. Makers of the most complete line of miniature, sub-miniature, micro-miniature, neon, and axial lead lamps. Every Shigoto lamp is designed to optimize efficiency at lower costs. Engineered to perform exactly or higher than rated. To do what it promises to do. Dependably. With delivery that makes sure your ideas can see the light fast. Get our Catalog. You'll find just what you're looking for. Or we'll make it up for you... no matter how exacting your specifications. Our other outstanding O. E. M. components will help you see a bright light too.

**shigoto**

WE CAN MEET YOUR CHALLENGE

Write or phone for our catalog and more information.

**Shigoto Industries Ltd.**

350 Fifth Ave., N.Y. 10001 • (212) 695-0200 / Telex 224219  
One of the World's Largest Manufacturing Importers

INFORMATION RETRIEVAL NUMBER 148

INFORMATION RETRIEVAL NUMBER 149 ►

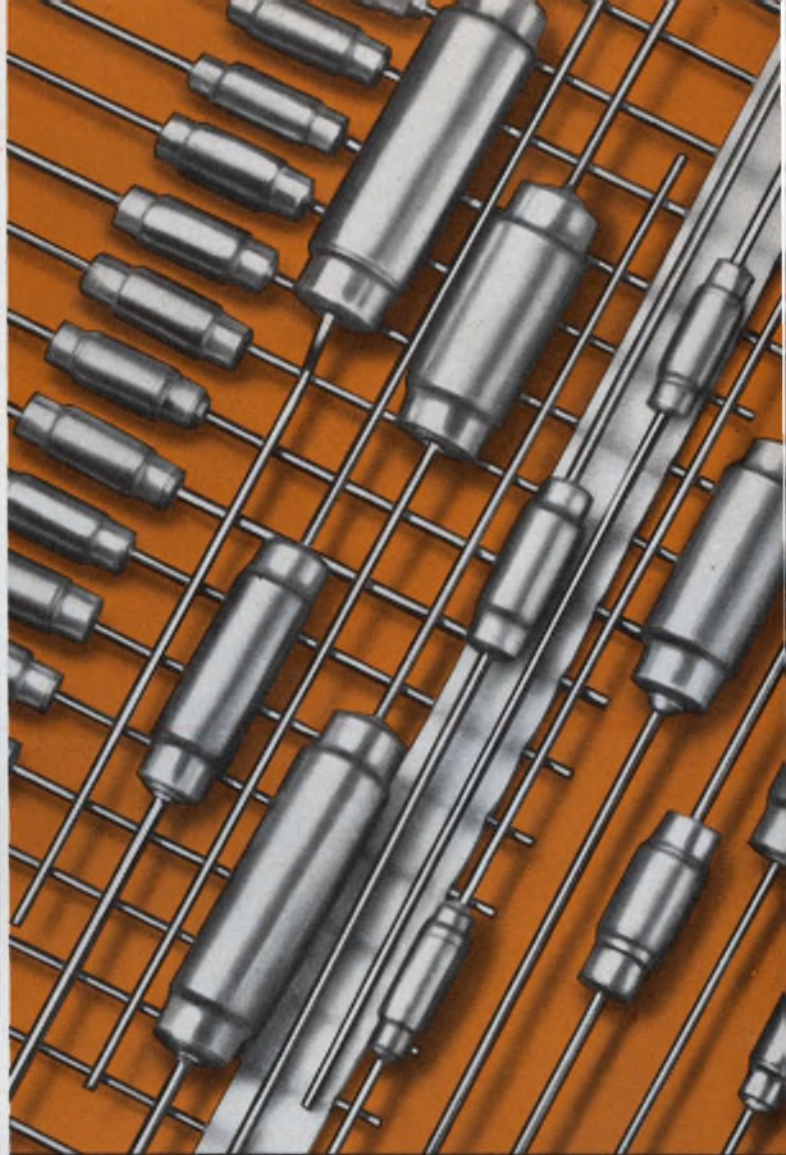

Last year these  
Paktron® film capacitors  
were revolutionary.

Now they are the standard.

And for good reasons. The Micromatic® capacitor, revolutionary for being wound on its own leads—and for its self-encased construction. Both polyester and polypropylene versions are widely accepted in industrial applications. Tape reeled for automatic insertion. Send for test samples and data.

PAKTRON, Division Illinois Tool Works Inc.,  
900 Follin Lane, S. E., Vienna, Virginia 22180.  
Phone (703) 281-2810. TWX 710-833-0682.



**ITW PAKTRON®**  
innovators in film capacitors

The Innovative Electronic Group of ITW...  
PAKTRON • LICON • EMCON

© ILLINOIS TOOL WORKS INC. 1974



# Electronic Design's

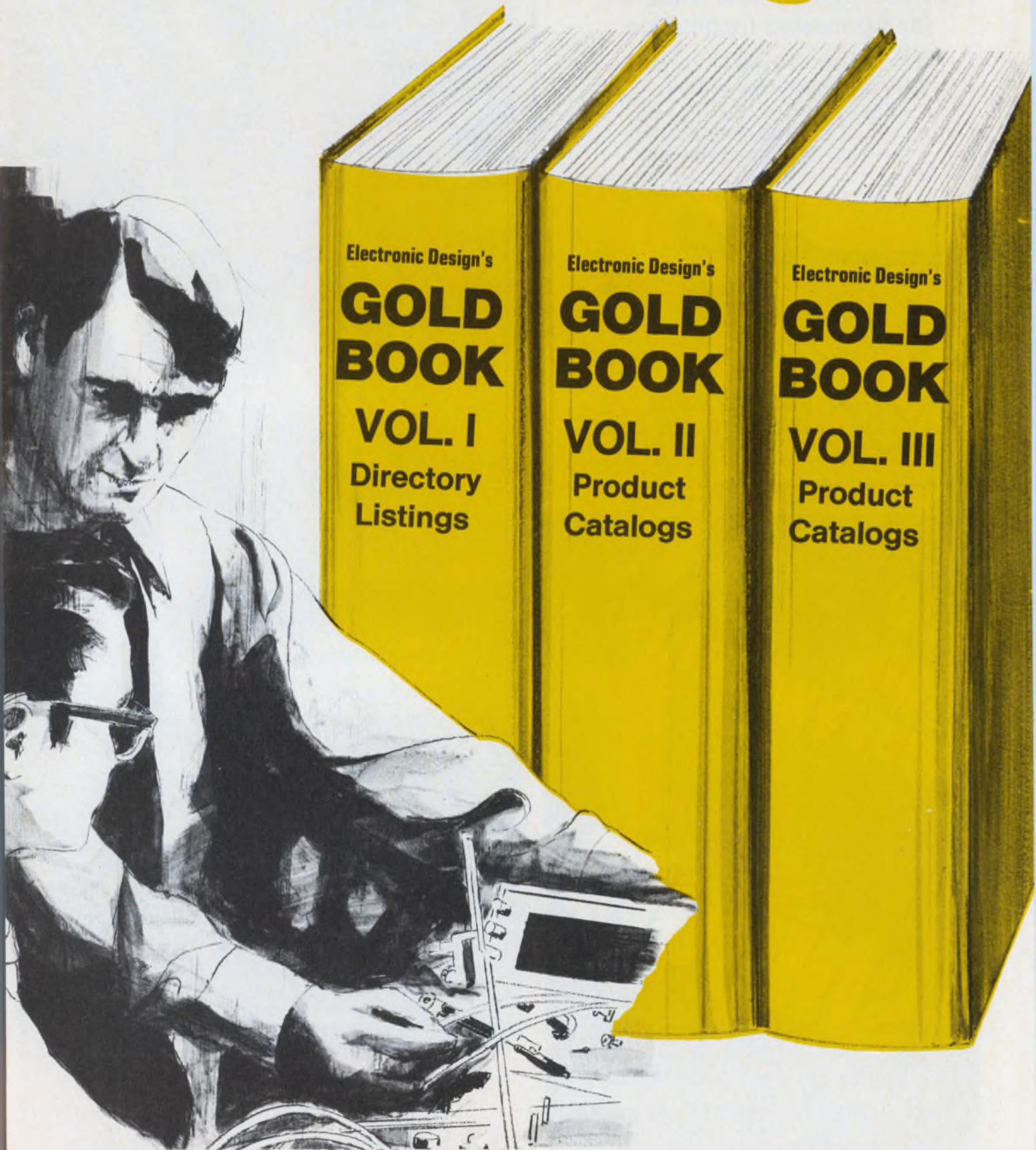

Electronic Design's  
**GOLD BOOK**  
VOL. I  
Directory Listings

Electronic Design's  
**GOLD BOOK**  
VOL. II  
Product Catalogs

Electronic Design's  
**GOLD BOOK**  
VOL. III  
Product Catalogs



# GOLD BOOK

**IS TAKING SHAPE**

**INDUSTRY RESPONSE HAS  
PUSHED THE SIZE UP TO  
3 VOLUMES!**

We promised that *Electronic Design's* GOLD BOOK would make all other directories seem obsolete. Response from electronics manufacturers has been so enthusiastic that three volumes are required for the first edition!

Volume I contains directory listings — who makes what and where to find it. Volume II and III contain product information — catalog-type material, application data, product specs, technical details. When you see and use *Electronic Design's* GOLD BOOK you'll wonder how you ever got along without it. It's the one-step reference and purchasing tool that will save you many hours as you search for the exact products to meet your needs.

**COMING YOUR WAY**

**JULY 1974**

**ANOTHER SERVICE FOR READERS FROM**

**Electronic Design**





**Thin-Trim variable capacitors** provide a reliable means of adjusting capacitance without abrasive trimming or interchange of fixed capacitors. Series 9401 has high Q's and a range of capacitance values from 0.2-0.6 pf to 3.0-12.0 pf and 250 WVDC working voltage. Johanson Manufacturing Corporation, Boonton, New Jersey (201) 334-2676.

INFORMATION RETRIEVAL NUMBER 181

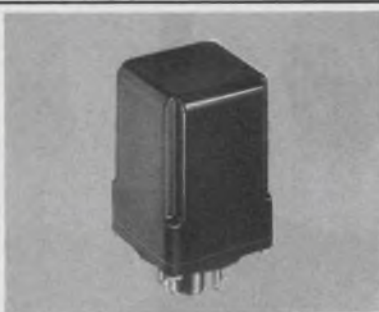

**Solid state octal plug-in flasher**—Type FS223 handles 1 amp resistive, incandescent, inductive loads at 24VDC, 90 flashes/min. Reverse polarity protected. Low cost. We make the broadest line of solid state flashers. SSAC PRECISION PRODUCTS, INC. P.O. Box 395, Liverpool, N.Y. 13088. (315) 699-2551.

INFORMATION RETRIEVAL NUMBER 184

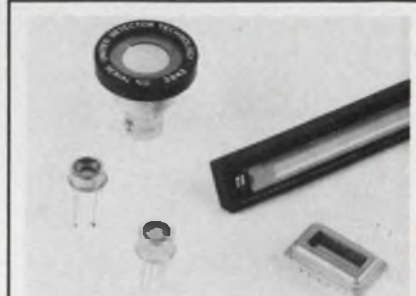

**UDT offers a complete line of silicon photodiodes.** Schottky for large area and enhanced UV responsivity, planar diffused for low noise and extended responsivity, photops (detector/amplifier combinations), special arrays and detectors to customer specifications. United Detector Technology, 1732 21st St., Santa Monica Ca 90404. (213) 829-3357.

INFORMATION RETRIEVAL NUMBER 187



**A FREE EDUCATION IN MAGNETIC MATERIALS AND COMPONENTS**, from Magnetics Technology Center. MTC keeps career design people continuously informed, by mail, on the state of the art. Our expertise and products helped put men on the moon. We can aid your career, too. Send for details on how to enroll. Magnetics, Butler Pa. 16001.

INFORMATION RETRIEVAL NUMBER 182



**Buckbee-Mears Flexible Circuitry** can speed production, save space and weight, and reduce assembly costs over conventional discrete interconnection. Buckbee-Mears provides engineering service, from preliminary drawings through testing to finished product. Buckbee-Mears Co., 345 E. 6th, St. Paul, Minn. 55101. (612) 228-6371.

INFORMATION RETRIEVAL NUMBER 185

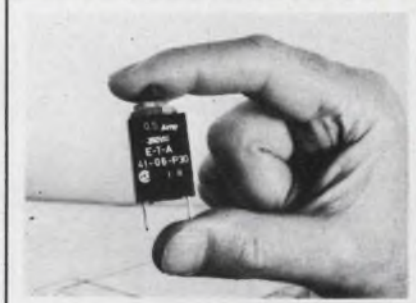

**Overcurrent Protector**, manual reset eliminates fuse replacement. Convenient panel mounting. 15 fractional ratings from 0.1 to 3 amp. Other models up to 400 amp. Trip-free and fool-proof, UL and CSA approved. High quality, low cost—\$1.12 ea. in 1000 lots. E-T-A Products Co. of America, 6284 N. Cicero Ave., Chicago, Ill. 60646. Tel. (312) 545-1553.

INFORMATION RETRIEVAL NUMBER 188



**PED-A-VAC Desoldering System**—Places all power desoldering/soldering elements in one location. Foot-controlled vacuum generator uses standard shop air. Adjustable tip temperature control. Mechanical switching won't damage circuit components. PACE, INC. 9329 Fraser St., Silver Spg., Md. 20910

INFORMATION RETRIEVAL NUMBER 183

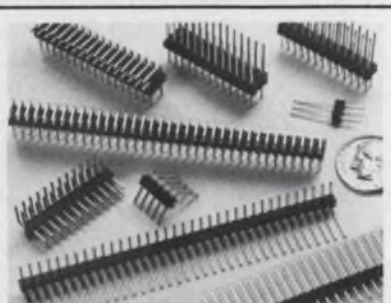

**Straight & Right-Angle Headers** provide an economical method of attaching complete matrices of .025" square posts to PC boards to serve as male contacts for interconnection systems. Available with up to 36 pins per row in several popular pin lengths. A P Products Inc., Box 110, Painesville, Ohio 44077.

INFORMATION RETRIEVAL NUMBER 186



**Extra high voltage power transistor**,  $V_{CB} & V_{CE} = 1500V$ ,  $I_C = 5A$ ,  $P_d = 12.5W$ ,  $I_B = 4A$ . Field-tested reliability, rugged TO-3, quality product from Telefunken. Cost: 1-24: \$7.70, 25 up: \$6.93, 100 up: \$5.40. Also 5 other types to 1700V available from stock. Energy Electronic Products, 6060 Manchester Avenue, Los Angeles, CA 90045 (213) 670-7880.

INFORMATION RETRIEVAL NUMBER 189



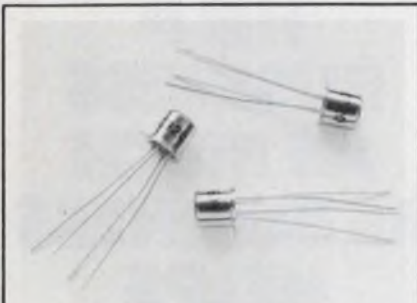

Low noise IF transistors. Type NC-921 and NC 920 have maximum 70 MHz noise figures of 1.2 dB and 1.5 dB respectively when measured in an untuned, broadband amplifier. The NC921 noise figure is typically 1 dB in a tuned amplifier. TO-72 package. California Eastern Laboratories, Inc. One Edwards Court, Burlingame, California. (415) 342-7744.

INFORMATION RETRIEVAL NUMBER 190



Free catalog of 34,500 power supplies from the worlds largest manufacturer of quality Power Supplies. New '74 catalog covers over 34,500 D.C. Power Supplies for every application. All units are UL approved, and meet most military and commercial specs for industrial and computer uses. Power Mate Corp. (201) 343-6294.

INFORMATION RETRIEVAL NUMBER 193

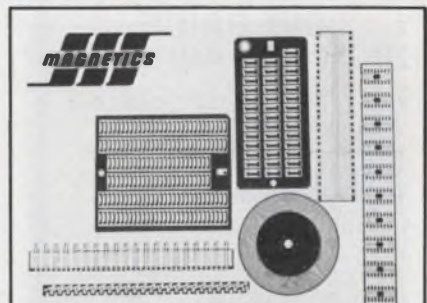

**THIN METAL PARTS BY MAGNETICS' PHOTOETCH PROCESS** cuts costs and lead time substantially. Photoetching eliminates die costs, assures precise tolerance and uniformity. Ideal for recording head laminations, lead frames, etc. We stock popular alloys, .000125" up. Full plating, selective plating offered. Magnetics, Butler Pa. 16001.

INFORMATION RETRIEVAL NUMBER 196



Low-Profile gas discharge readout assemblies packaged on horizontal p.c. boards for applications with limited top/bottom mounting space. Includes decoder/driver and optional power supply for 5 VDC input. Master Specialties, 1640 Monrovia, Costa Mesa, Calif. 92627. (714) 642-2427.

INFORMATION RETRIEVAL NUMBER 191



Miniature wideband current probe. Low impedance Model 711 probe allows insertion in current path of high-speed circuits without affecting circuit operation. 8KHz-100MHz BW gives 3.5ns risetime and sensitivity of 1V/A  $\pm 1\%$ . Use in all high speed current circuits. \$33.00. American Laser Systems, Inc. 106 James Fowler, Goleta, CA 93017

INFORMATION RETRIEVAL NUMBER 194

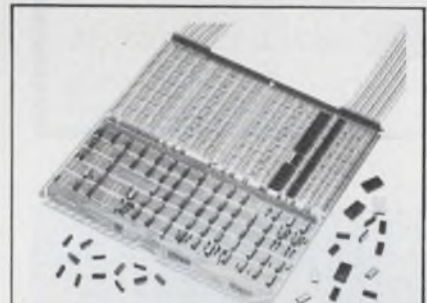

NOVA/DCC-116 general purpose interface board provides: multiple device selection, 4 I/O registers, DMA zero word count detect, 105 socket positions for 14, 16, 24 & 40 PIN IC's. Basic board (all features of data general 4040 plus multiple device select) \$350. MDB Systems, Inc., 981 N. Main St., Orange, CA. (714) 639-7238.

INFORMATION RETRIEVAL NUMBER 197



A collector's item . . . 20th anniversary issue of Electronic Design (11/23/72) salutes 25th anniversary of the transistor, features milestones in design over past quarter century. Rare nostalgic view of industry. Fascinating reading. \$2 per copy pre-paid. Checks, money orders: Electronic Design, Promotion Mgr., 50 Essex St., Rochelle Park, N.J. 07662.

INFORMATION RETRIEVAL NUMBER 192

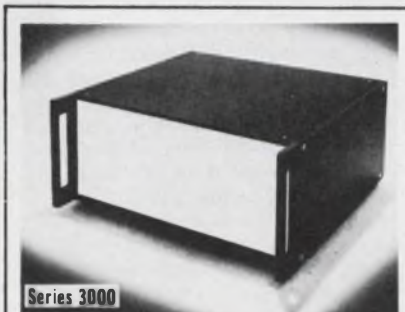

Versapac aluminum enclosures provide maximum strength with minimum weight. Top and bottom covers are easily removed for instant access. Height, width, & depth are interchangeable. Brushed panels easily removed for punching and painting. Janise Electronic Specialties, Inc., 3033 Jefferson St. San Diego CA 92110. (714) 295-6273.

INFORMATION RETRIEVAL NUMBER 195

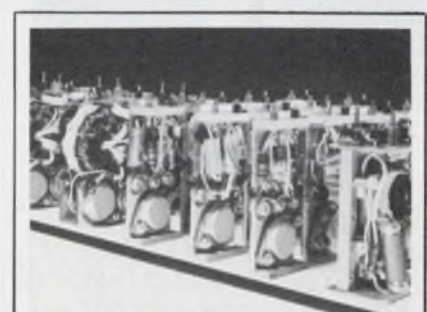

Custom Power Supplies from off-the-shelf sub-modules. Over 1200 configurations. No engineering charges! AC (115VAC, 50-500Hz) and DC (12, 28, 48 & 115VDC) inputs. Multiple isolated and regulated (to .1%) DC outputs. 1-500 Watts. Miniaturized. Efficiencies to 85%. Arnold Magnetics, Culver City, Ca. (213) 870-7014.

INFORMATION RETRIEVAL NUMBER 198



# PIEZOELECTRIC TUNING FORK

**LOW PRICE  
HIGH RELIABILITY**

TYPE : TFQ 697.5Hz~1492.5Hz



20<sup>L</sup>×8.0<sup>H</sup>×6.5<sup>W</sup>mm

TYPE : TFA 712.5Hz~1500Hz



33<sup>L</sup>×10<sup>H</sup>×9<sup>W</sup>mm

 IWATA ELECTRIC CO., LTD.

Mansei Bldg. Rm. 36 1-16, 1-Chome  
Soto-Kanda, Chiyoda-ku, Tokyo 101, Japan

INFORMATION RETRIEVAL NUMBER 155

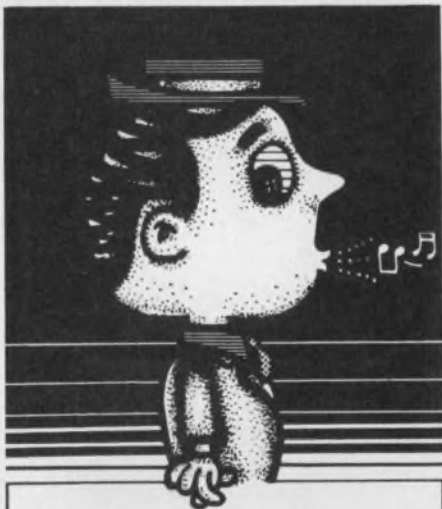

**you're whistling  
in the dark.**

... if you haven't had your blood pressure checked lately. You could have high blood pressure and not know it. It can lead to stroke, heart and kidney failure. See your doctor—only he can tell.

For information  
Ask your Heart  
Association



## Electronic Design

ELECTRONIC DESIGN's function is:

- To aid progress in the electronics manufacturing industry by promoting good design.
- To give the electronic design engineer concepts and ideas that make his job easier and more productive.
- To provide a central source of timely electronics information.
- To promote communication among members of the electronics engineering community.

Want a subscription? ELECTRONIC DESIGN is sent free to qualified engineers and engineering managers doing design work, supervising design or setting standards in the United States and Western Europe. For a free subscription, use the application form bound in the magazine. If none is included, write to us direct for an application form.

If you do not qualify, you may take out a paid subscription for \$30 a year in the U.S.A., \$40 a year elsewhere. Single copies are \$1.50 each.

If you change your address, send us an old mailing label and your new address; there is generally a postcard for this bound in the magazine. You will have to requalify to continue receiving ELECTRONIC DESIGN free.

The accuracy policy of ELECTRONIC DESIGN is:

- To make diligent efforts to ensure the accuracy of editorial matter.
- To publish prompt corrections whenever inaccuracies are brought to our attention. Corrections appear in "Across the Desk."
- To encourage our readers as responsible members of our business community to report to us misleading or fraudulent advertising.
- To refuse any advertisement deemed to be misleading or fraudulent.

Microfilm copies are available of complete volumes of ELECTRONIC DESIGN at \$19 per volume, beginning with Volume 1, 1961 through Volume 20. Reprints of individual articles may be obtained for \$2.00 each, prepaid (\$.50 for each additional copy of the same article) no matter how long the article. For further details and to place orders, contact the Customer Services Department, University Microfilms, 300 North Zeeb Road, Ann Arbor, Michigan 48106 telephone (313) 761-4700.

Want to contact us? If you have any comments or wish to submit a manuscript or article outline, address your correspondence to:

Editor  
ELECTRONIC DESIGN  
50 Essex Street  
Rochelle Park, N.J. 07662

## DO COLLEGES HELP BUSINESS AS MUCH AS BUSINESS HELPS COLLEGES?

Yes, they do. But not in the same proportion.

Business contributes about 15% of the total voluntary support received by colleges.

But today, business gets half the college-trained people who are employed. Tomorrow, it will need even more.

As a result, businessmen should think seriously about increasing the level of corporate giving to education. Can you, as a businessman, think of a better investment?

For the latest national figures on corporate giving to higher education, write on your letterhead for "CFAE Survey of Corporation Support of Higher Education," and enclose \$2.00 to help cover costs. Mail to: Council for Financial Aid to Education, 6 East 45th Street, New York, N.Y. 10017.

Give to the college of your choice. Now.



Advertising contributed for the public good.



# Electronic Design

## Advertising Sales Staff

Tom W. Carr  
Vice President &  
Sales Manager

## Rochelle Park, N.J. 07662

Robert W. Gascoigne  
Daniel J. Rowland

(Recruitment, Quick Ads, Classified)

50 Essex Street  
(201) 843-0550  
TWX: 710-990-5071

## Philadelphia

Thomas P. Barth  
50 Essex Street  
Rochelle Park, N.J. 07662  
(201) 843-0550

## Boston 02178

Gene Pritchard  
P.O. Box 379  
Belmont, Mass. 02178  
(617) 489-2340

## Chicago 60611

Thomas P. Kavooras  
Berry Conner, Jr.  
200 East Ontario  
(312) 337-0588

## Cleveland

Thomas P. Kavooras  
(Chicago)  
(312) 337-0588  
(call collect)

## Los Angeles 90303

Stanley I. Ehrenclou  
Burt Underwood  
2930 Imperial Highway  
Inglewood, Calif.  
(213) 757-0183

## San Francisco 94022

Jerry D. Latta  
P.O. Box 1248  
Los Altos, Calif.  
(415) 965-2636

## London

For United Kingdom and Europe

John Ashcraft  
John Ashcraft & Co.  
12, Bear St.  
Leicester Square  
London WC2H 7AS England  
Phone: 01-930-0525

W. J. M. Sanders  
John Ashcraft & Co.  
Herengracht 365  
Amsterdam C., Holland  
Phone: 020-24-09-08

## Tokyo

Haruki Hirayama  
Electronic Media Service  
5th Floor, Lila Bldg..  
4-9-8 Roppong  
Minato-ku  
Phone: 402-4556  
Cable: Electronicmedia, Tokyo



# Design Data from Manufacturers

Advertisements of booklets, brochures, catalogs and data sheets. To order use Reader-Service Card (Advertisement)

## The First Spectrum Analyzer-Calculator Simplifies Noise & Vibration Analysis in Real Time

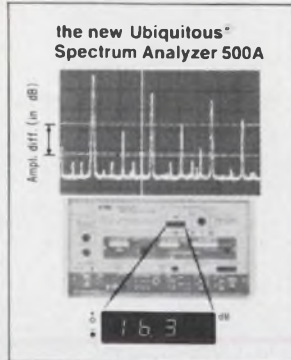

**New Ubiquitous® UA-500A** is world's first combination 500-line spectrum analyzer-averager that automatically **calculates** (computes): absolute frequency & amplitude in dB or % of full scale; relative amplitude above and below your calibration signal; frequency deviation from your chosen reference frequency; frequency in Hz and CPM (cycles/min.) for ease in reading RPM; which peaks are harmonically related by isolating them from others with harmonic markers or eliminating all else from the CRT display. Applications simplified include: machine diagnosis, rotating machine analysis, noise source identification, mechanical signatures, underwater acoustics, and noise reduction. Built-in dual memory averager allows comparison of past & present data. Small, portable, only 8¾" high. Highest speed: real-time 100% analysis to 10kHz. Thirteen ranges from 0-10Hz to 0-100kHz providing analysis bandwidths of .02Hz to 200Hz (also 0-5mHz direct input). Simplest to use.

CIRCLE NO. 171

**Federal Scientific Corporation** An Affiliate of Nicolet Instrument

615 West 131st St., New York, N.Y. 10027 (212) 286-4400 TWX: 710 581 4059

## "USING OPERATIONAL POWER SUPPLIES"



A new 32-page handbook is offered by Kepco, Inc., to engineers and designers on ways to get the most from programmable power supplies.

The Kepco text approaches a power supply from the point of view of its signal processing capability, and develops equations to define gain, linearity, offset, speed, bandwidth, accuracy, etc.

**Using Operational Power Supplies** also devotes considerable space to the problems of digital interface, reviewing the hardware by which Kepco Bipolar and Unipolar Operational Power Supplies can be controlled by digital logic. Send for your free copy.

**Kepco, Inc.**

131-38 Sanford Avenue, Flushing, New York 11352

Phone: 212-461-7000, Ext. 742

CIRCLE NO. 172

## FAST FOURIER TRANSFORM PROCESSOR FOR \$6,000

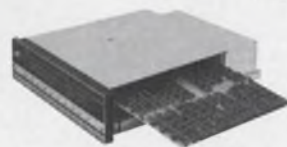

The 306/MFFT Fast Fourier Transform Processor is delivered with all control programs and plugs directly into any Data General Nova computer. It offers a complete Fourier Transform capability including Forward and Inverse FFT, Spectral magnitude, Hanning Weighting, and Complex Multiplication. Arrays from 16 to 16,384 real samples can be processed. An array of 1024 real samples is transformed in only 139 ms.

Time domain signal processing functions, such as correlation and convolution, can be calculated utilizing the high speed array operations  $X$ ,  $\div$ ,  $+$ ,  $-$ ,  $\sqrt$  and  $\Sigma$ .

Call or write today for brochures on 306/MFFT or Elsytec's complete line of Fourier Spectrum Analyzers and Higher Speed Hardware Fast Fourier Transform Processors.

CIRCLE NO. 173

**ELSYTEC INC.**

212 Michael Drive, Syosset, New York 11791 (516) 364-0560



# recruitment and classified ads

**SAME DAY SHIPMENT**  
Minis & Peripherals  
**PDP SPECIALISTS**  
8, 8I, 8L & 11

**NEW 300 LPM**  
**PRINTERS**

**PDI CARD READERS**

**BRPE PUNCHES**

**\$750 Minis**

**TELETYPE 35 & 37**  
**DEC & HONEYWELL Modules**  
617/261-1100

Send for Free Report "Maintenance  
of Computers"

**AMERICAN USED COMPUTER CORP.**  
P.O. Box 68, Kenmore Sta.  
Boston, MA 02215  
Members Computer Dealers Association

CIRCLE NO. 239

## FREE ALARM CATALOG

Full line of professional burglar and  
fire alarm systems and supplies 96  
pages, 450 items. Off the shelf delivery,  
quantity prices.



mountain west alarm  
4215 n. 16th st., phoenix, az. 85016

CIRCLE NO. 240

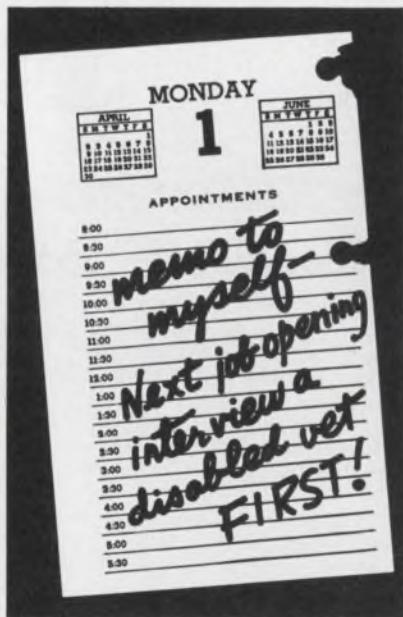

The President's Committee  
on Employment of the Handicapped  
Washington, D.C. 20210

# advertiser's index

Advertiser	Page
AMP Incorporated	25, 26, 27, 28
A P Products, Inc.	196
Abbott Transistor Laboratories, Inc.	6
Acopian Corp.	41
Airpax Controls Division	165
Allen Bradley Co.	45
Amerace Corporation, Control Products Division	37
American Laser Systems	197
Amphenol Connector Division, Bunker-Ramo Corp.	44, 44A—J
Amphenol Industrial Division, Bunker-Ramo Corp.	14, 15
Amplifier Research Corporation	187
Arnold Magnetics Corp.	197
Art Wire & Stamping Co.	144
Asarco Intermetallics Corporation	170

Bead Electronics	132
Beckman Instruments, Inc. Helipot Division	115
Bodine Electric Company	157
Bourns, Inc., Trimpot Products Division	111
Braxton Manufacturing Co., Inc.	157
Buckbee-Mears Company	196
Burroughs Corporation	30

California Eastern Laboratories, Inc.	197
Centralab, The Electronics Division of Globe-Union, Inc.	52, 52A
Center for Technical Development, Inc., The	179
Circuit Stik, Inc.	172
Comstron Corporation	39
Corning Glass Works, Electronic Products Division	52B, 52C

Dale Electronics, Inc.	Cover II
Data Display Products	130
Data Precision Corporation	162
Datel Systems, Inc.	Cover III
Decitek, A Division of Jamesbury Corp.	189
Delco Electronics, Division of General Motors Corporation	122, 123
Deltrol Controls	183
Dialight Corporation	161
Digital Equipment Corporation	29
Digitran Company, The	142
Dormeyer Industries, Inc.	187
Dow Corning Corporation	10, 11, 13

EECO	132
E-T-A Products Co. of America	196
Electro Scientific Industries	151
*Electronic Design	52D
Electronic Design	187, 197
Electronic Memories & Magnetics Corp.	148, 149

Advertiser	Page
Elsytec, Inc.	199
Energy Electronic Products	196

Fairchild Systems Technology, A Division of Fairchild Camera and Instrument Corporation	62, 63
Federal Scientific Corporation	199
Ferroxcube Corporation	145
Fuji Electrochemical Co., Ltd.	53
Fujitsu Limited	171
Function Modules, Inc.	138

GTE Sylvania Incorporated	52D
GTE Sylvania, Parts Division	47
General Automation, Inc.	100, 101
General Electric Company	166
General Electric Company, Display Devices	112, 113
General Electric Company, Semi- conductor Products Department	139
Gold Book, The	194, 195

Hamlin, Inc.	8
*Hayden Book Company, Inc.	52B
Hewlett-Packard	1, 58, 59, 69, 129
Hughes Aircraft Company, Electron Dynamics Division	167
Hybrid Systems Corp.	133
Hycom	188

Indiana General	43
Information Retrieval Card	204A-B
Inselek, Inc.	131
Instrument Specialities Company, Inc.	119
Intech, Incorporated	150
Intel Corporation	4, 5
International Rectifier	140, 155
Intersil	137
Ithaco, Inc.	71
Iwata Electric Co., Ltd.	198

Janise Electronic Specialties, Inc.	197
Johanson Manufacturing Corp.	196
Johnson Company, E. F.	24

Keithley Instruments, Inc.	168
Kepeco, Inc.	199
Keystone Carbon Company	186
Krohn-Hite Company	12

LVC Industries, Inc., Co-ord Switch	168
Lambda Electronics Corp.	86, 87
Licon, Division of Illinois Tool Works, Inc.	54



Advertiser	Page
3 M Company	20
MDB Systems	197
MF Electronics Corporation	180
Magnetics, Inc.	196, 197
Master Specialties	197
Mepeco/Electra, Inc.	35
Mica Corporation, The	147
Microswitch, A Division of Honeywell	22, 23
Miller Stephenson Chemical Co., Inc.	173
Mini-Circuits Laboratory	203
NCR	179
National Connector Corporation	176
National Electronics, A Varian Division	136
Neuses, Inc., P. K.	201
North Atlantic Industries, Inc.	146
North Electric Company	191
Optron, Inc.	7
Pace, Inc.	196
Paktron, Division Illinois Tool Works, Inc.	193
Penntube Plastics Co., Inc.	187
*Philips Industries Electronic Components and Materials Division	52A, 52C, 117
*Philips Industries, Test and Measuring Instruments Dept.	115
Piezo Technology, Inc.	178
Plessey Semiconductors	117
Power/Mate Corp.	197
Precision Monolithics, Incorporated	135
Prime Computer, Inc.	106, 107
R G Enterprises, Inc.	179
RCA Solid State	Cover IV
Radio Materials Company	180
Reliability, Inc.	156
Risk Industries, Inc., Geo.	193
Rogan	183
Rogers Corporation	161
SSAC Precision Products, Inc.	196
Sealed Air Corporation	157
Semiconductor Circuits, Inc.	140
Servo-Tek Products Company	164
Shigoto Industries, Inc.	193
Siemens Corporation, Components Division	18, 19
Siemens Corporation, Electronic Systems Division	91
Signalite, Division of General Instrument Corporation	57
Signetics Corporation	16, 17
Siliconix, Incorporated	60
Sinclair Radionics, Inc.	92, 93

Advertiser	Page
Sola Electric, Division of Sola Basic Industries	169
Spectrum Technology, Inc.	183
Sprague Electric Company	9
Standard Logic, Inc.	184
Struthers-Dunn, Inc.	158, 159
Switchcraft, Inc.	121
Sylvania Miniature Lighting Products, Inc.	70
Syntronic Instruments, Inc.	185
Systron-Donner	54
T-Bar Incorporated	128
TEC, Incorporated	152
TRW Capacitors, an Electronic Components Division of TRW, Inc.	105
TRW, Electronic Components	175
TRW/Globe Motors, an Electronic Components Division of TRW, Inc.	204
TRW/IRC Resistors, an Electronic Components Division of TRW, Inc.	163
TRW/UTC Transformer, an Electronic Components Division of TRW, Inc.	85
Tectetics, Inc.	154
Tektronix, Inc.	78, 79
Teledyne Relays, A Teledyne Company	2
Teledyne Semiconductor	33
Tempil Division, Big Three Industries, Inc.	188
Texas Instruments Incorporated	21
Thermalloy Company	134
Theta Instrument Corp.	161
Thomas & Betts Company, The	49
Topaz Electronics	184
U. S. Components, Inc.	201
Unimax Switch Corporation	51
Unitrack Division, Calabro Plastics, Inc.	176
United Detector Technology, Inc.	196
Varo Semiconductor, Inc.	164
Vernitron Control Components	162
Vernitron Piezoelectric Division	181
Versatec, Inc.	143
Viking Industries, Inc.	125
Vu-Data Corporation	153
Wagner Electric Corporation	177
Wavetek	126
Weber Technical Products	90
Wiltron Company	141

\*Advertisers in non-U.S. edition

# USC UPCC/REPC CONNECTORS

Draw-Pull and Screwlocking. Built to MIL-C-55302 & Commercial Specifications. Printed Circuit & Related Applications. REPC Connectors are Removable. Re-Entrancy. Crimp Contact Types

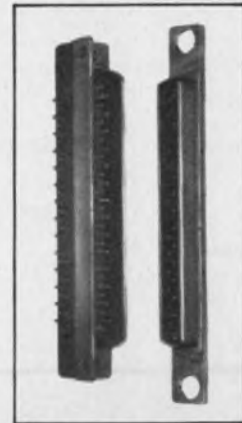

1 of over 20,000 Connector Types Manufactured. Send today for UPCC-REPC-A Series 32-page Catalog

## U.S. COMPONENTS, INC.

Leader in advanced engineering design  
1320 Zerega Avenue  
Bronx, N.Y. 10462  
(212) 824-1600 TWX: 710-593-2141  
Cable: COMPONENTS, NYK

INFORMATION RETRIEVAL NUMBER 156

# NEUSES

## COMPLETE RELAY SERVICE TOOL-KIT

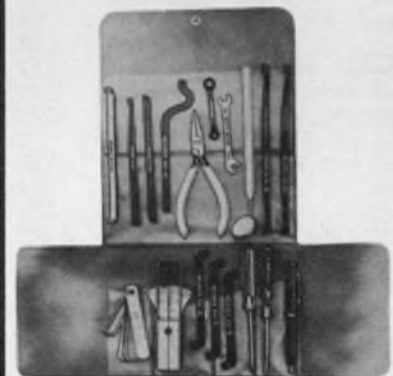

18-piece tool set includes everything needed to service, align, check and maintain relays. Includes: Contact Burnisher with extra blades, Spring Tension Gauge, Wrenches, Thickness Gauge Set, Inspection Mirror, etc. All in handy Vinyl Case; with Instruction booklet.  
No. TK-18 Kit . . . . . \$38.60

P. K. NEUSES, INC.  
Box 100 - Arlington Heights, Ill. 60006

PRECISION TELECOMMUNICATION TOOLS  
INFORMATION RETRIEVAL NUMBER 157



# product index

**Information Retrieval Service.** New Products, Evaluation Samples (ES), Design Aids (DA), Application Notes (AN), and New Literature (NL) in this issue are listed here with page and Information Retrieval numbers. Reader requests will be promptly processed by computer and mailed to the manufacturer within three days.

Category	Page	IRN	Category	Page	IRN	Category	Page	IRN
<b>Components</b>			<b>Data Processing</b>			<b>Integrated Circuits</b>		
capacitor, electrolytic	171	120	CRT terminal (NL)	190	404	instruments, program-		
capacitor, solid-electro-			calculator, pocket	93	54	mable	54	41
lyte	168	331	calculator system	69	246	keyboard, program-		
capacitors	24	20	computers	107	57	mable	126	66
capacitors	35	24	controller, CRT	156	303	laser trimmer	133	268
capacitors	105	56	controller, data	158	307	multimeter, 4-1/2-digit	162	108
capacitors	166	114	display, graphic	154	301	noise analyzer	133	267
capacitors	172	341	keyboard	154	300	oscilloscope, mini	153	95
capacitors, chip	180	130	loader, program	154	298	phasemeter	12	10
capacitors, film	193	149	memory board, MOS	152	294	phasemeter	127	250
circuit breaker	166	329	memory cards	148	90	power amplifier	130	261
components	19	16	memory, disc	152	295	rf millivoltmeter	128	258
connectors	176	123	memory, disc	158	306	SCR tester	130	264
connectors	201	156	memory, mag tap	156	305	scope, general-purpose	129	69
controls	111	58	microcomputer	158	308	signal sources	79	48
controls, pushbutton	51	32	minicomputer	158	309	synthesizer	128	257
display, numerical	170	334	modem, data	156	304	tachometer, control	165	113
displays	30	22	processor, array	152	296	tester, IC	63	45
displays, liquid crystal	16	14	reader, paper tape	156	302	voltage divider	142	83
encoders, optical	161	105	storage, floppy-disc	154	299	voltmeter, phase-angle	146	88
ferrite cores	53	40	switches, crosspoint	152	297			
ferrites	43	28	tape reader	189	145	<b>Integrated Circuits</b>		
fuse, semiconductor	140	80				booster current	138	275
lamps, lead	193	148	<b>Discrete Semiconductors</b>			chip, calculator	138	273
lamps, neon	57	42	diodes, power	182	367	counter, 21-stage	136	272
meter, relays	164	111	display, LED 7-seg	185	370	demodulator, 4 channel	141	279
motor, linear	172	339	display products	113	59	dividers, CMOS	141	278
motors	204	159	LED, red diffused	182	366	IC, calculator	136	269
motors, ac	157	99	LEDs	130	69	IC, SOS/CMOS	131	70
motors, dc torque	162	109	LEDs, green	184	368	ICs, linear	17	14
networks, resistor	166	327	lamps, LED panel	182	362	ICs, linear	IV	243
potentiometers, comp.	166	330	opto-electronics	7	6	processor, SOS	101	55
reed relay, latching	170	335	rectifier bridges	177	125	RAM, ECL	138	274
relay, solid-state	2	2	rectifiers, bridge	164	112	RAM, 2-5-6-bit	134	256
relay, volt sensitive	172	338	SCRs	136	76	register, a/d	140	277
relays	158	102	SCRs	155	97	register, 16-bit	138	276
relays	159	183	switch/indicator, LED	152	94	switches, FET	136	271
resistor network	45	29	thyristor, high power	182	364	switches, MOS	136	270
resistor, trimmer	170	337	thyristor, power	184	369	thermistors	186	138
resistors	II	241	transistor, high-energy	123	64			
resistors	163	110	transistors, power	185	371	<b>Microwaves &amp; Lasers</b>		
resistors, thin film	172	340	transistors, uhf	182	365	amp, radar distribution	173	344
solenoids	183	132	transistors, $\mu$ W	182	363	attenuator	174	348
solenoids	187	141	unijunctions	139	79	filters	174	347
switch, pluggable	128	67				generator, pulse	174	350
switches	23	19	<b>Instrumentation</b>			isolator, circulator chips	173	342
switches	84	49	alphanumeric printer	188	143	klystron	174	345
switches	121	63	attenuators	132	266	load	173	343
switches	193	147	bridges	141	82	mixers, double-balanced	203	158
switches (NL)	190	393	counters, high frequency	117	61	synthesizers	174	346
switches, indicator	161	107	DMM	130	263	transponder	174	349
switches, pushbutton	52A	34	DMM	168	116			
transducer, speed	168	333	DPM	132	265	<b>Modules &amp; Subassemblies</b>		
transformer, hybrid	166	328	DVMs	59	43	active filters and		
transformers	85	50	digital tester	128	259	op amps (NL)	190	403
trimmer, cermet	168	332	function generator	128	260	amplifier	187	140
tuning fork	198	155	function generator	130	262	amplifier, power	150	293
valves, solenoid	170	336	IC functional tester	151	93	clock, quartz	149	288
voltage divider	132	71	IC, tester	91	53	control, speed	146	286
						converter, a/d	150	92



Category	Page	IRN
converter, a/d	150	292
converter, d/a	142	253
converter f/v	146	283
converter, s/d	146	285
converters, s/d	144	282
crystal filter	178	126
DAC, CMOS	115	60
DAC, 12-bit	138	78
DAC, 12-bit IC	133	73
dc op amps (NL)	190	393
dialer, telephone	150	291
equalizer, audio	149	287
filters	21	15
filters	71	47
filters	181	131
module, power transistor	144	281
op amps	135	75
oscillators, crystal	149	289
oscillators, crystal	180	129
system, data-acquisition	150	290
transducer, power	144	280
transmitter, signal	146	284
<b>Packaging &amp; Materials</b>		
boards, general purpose	172	121
boards, matrix	168	117
bus	161	106
cable ties	49	31
cards, pc	176	123
cleaner, aerosol	173	122
components, connector	157	101
connector, multipin	162	322
connector pin	132	72
connectors, pc	37	25
connectors, pc	125	65
contacts	144	86
enclosure, mag-shield	165	325
epoxy adhesive	165	326
film, pc	164	324
flat cable connector	20	17
gold on lead frame	47	30
heat pipes	167	115
heat sinks	134	74
heat sinks	162	320
heater elements	164	323
interconnections	15	13
isolator, mobile process	90	52
jumper strips	162	321
knobs & dials	183	133
labels	188	144
lead bender	179	127
material, resistive	160	251
panels	184	135
paste, dielectric	160	310
semi packaging materials	11	9
springs and contacts	119	62
substrates and circuits	147	89
systems, thick-film	52	33
tool kit	201	157
tubing, shrinkable	187	139
yokes and coils	185	137
<b>Power Sources</b>		
compact supplies	176	351
dc/dc converter	178	357
dc/dc converters	181	360
dual-output units	180	358
inverter	178	356
lab supply	176	352
low-voltage supply	176	353
modular supply	178	354
open frame supply	180	359
power sources	156	98
power supplies	6	5
power supplies	41	27
power supplies	87	51
power supplies	191	146
power supply module	178	355
regulator, switching	140	81

Category	Page	IRN
regulators	184	136
transducer supply	181	361
voltage regulators	169	118
<b>new literature</b>		
active filters and op amps	190	403
bandpass filters	192	410
CRT terminal	190	404
centrifuge rotors	192	413
clutches and brakes	192	411
computer products	192	420
dc op amps	190	398
dc power supplies	190	394
dc power supplies	192	407
DPMs	190	405
digital signal processor	192	418
Eastman-Kodak index	192	421
environmental instruments	190	396
furnace tubes	192	419
green LEDs	192	408
handbook, a/d and d/a converters	III	242
handbook, lamp	70	46
impulse counter	190	399
inductors and components	190	406
laser cutting	192	417
lasers and accessories	190	402
low speed modems	192	412
material test system	192	414
microwave products	192	409
pc card guides	192	416
polyester PTFE blends	190	395
pulse generators	190	400
ribbon cable	192	422
security monitor	192	415
seminars	179	128
solid-state sweeper	190	401
switches	190	393
tape recorder/reproducer	190	397
video editing equipment	192	423
<b>design aids</b>		
fused quartz	186	375
magnetic shield	186	372
optically coupled isolators	186	373
phase-loss protection	186	377
rotating machines	186	376
soldering solutions	186	374
<b>application notes</b>		
calculator	186	379
crimp tool chart	186	382
heating materials	186	379
high-voltage capacitors	186	381
spacer selector	186	383
v/s sensitivity selector	186	372
<b>evaluation samples</b>		
multipurpose lubricant	188	385
universal wiring panel	188	384

# DOUBLE-BALANCED MIXERS

Great Value at

**\$7.95**  
500 piece quantities.

\$9.95 in quantities of 1 to 49 pieces

DC-500MHz  
6dB conversion loss  
40dB isolation  
EMI shielded case



A breakthrough in technology and high production volume enables Mini-Circuits Laboratory to offer these new products at an unprecedented low price.

In today's tough competitive market can you afford not to use these remarkably low priced and high performance units?

Ruggedness and durability are built in the SRA-1. These new units are packaged within an EMI shielded metal enclosure and hermetically sealed header. They use well matched hot-carrier diodes and uniquely designed transmission line transformers.

We invite you to convince yourself. Place your order now and check our delivery, product performance and reliability.

## Mini-Circuits Laboratory

2913 Quentin Rd., Brooklyn, N.Y. 11229  
(212) 252-5252, Int'l Telex 620156  
A Division Scientific Components Corp.

\*FRANCE S.C.I.E., \*31, rue George-Sand, Palaiseau 91, France \*GERMANY, AUSTRIA, SWITZERLAND: Industrial Electronics GMBH, \*Klüberstrasse 14, 6000 Frankfurt/Main, Germany \*UNITS IN STOCK

ENGLAND; Dale Electronics; Dale House, Wharf Road, Frimley Green, Camberley, Surrey. JAPAN; Denisho Kaisha, Ltd.; Eguchi Building, 8-1, 1-Chrome, Hamamatsucho, Minato-Ku, Tokyo.

\*UNIT IN STOCK.

INFORMATION RETRIEVAL NUMBER 158



# Your design was beautiful, but you got a hot mini motor and no space for cooling. Now what do you do?

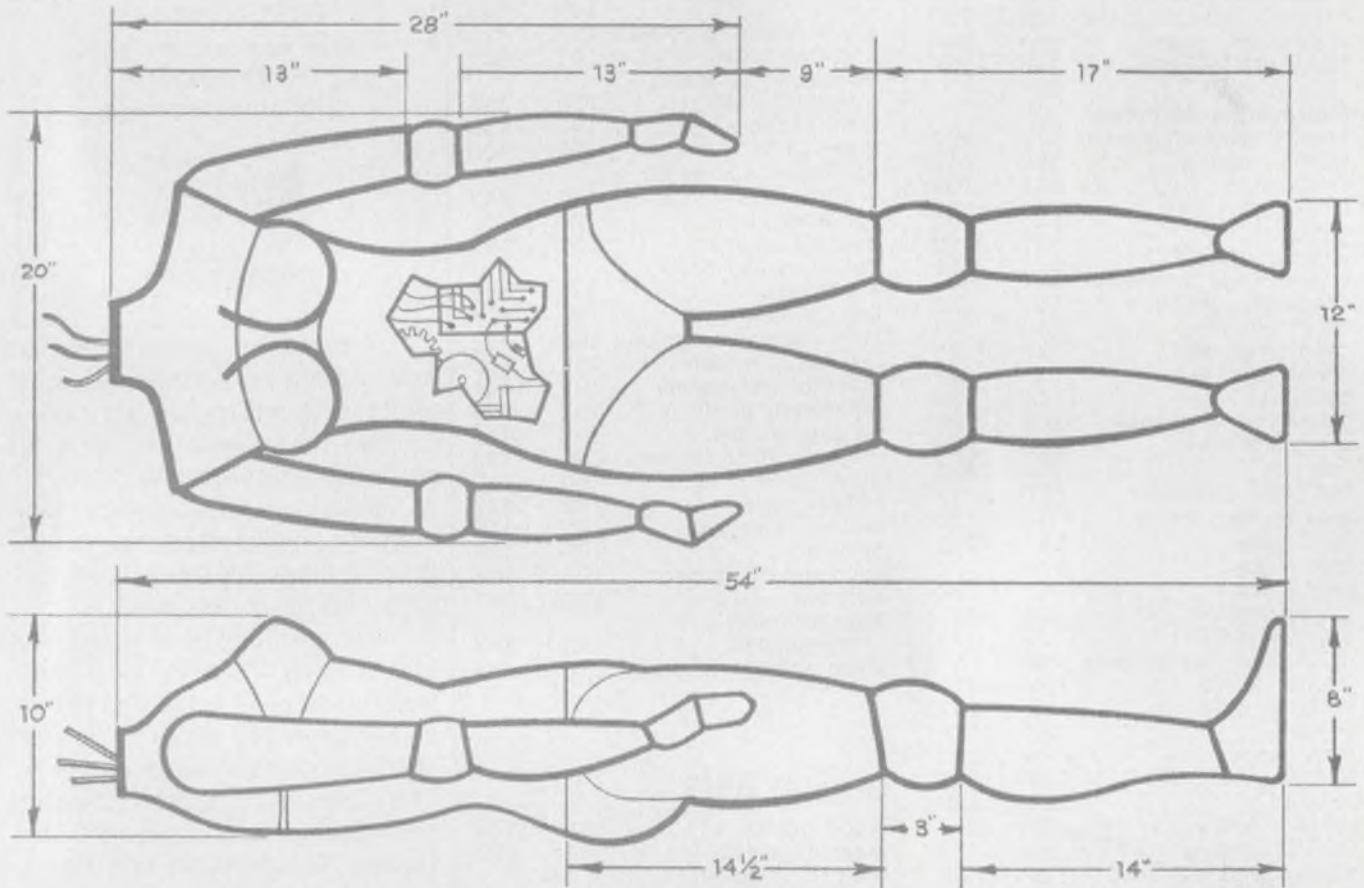

**Good time to call TRW/Globe.** Chances are good we can rescue your dream design from the potential wastebasket.

One of our precision miniature motors and blowers can probably fit the same shape with equal or better performance.

Designers constantly come to us with their occupational hazard: changing parameters. "Got to get more torque in the same space." "Now we need a

limit switch and a brake." "Our service people want a motor they can forget." "Some dingaling forgot about this motor, so now it has to fit way back in there."

The ways we can help you cope with changing parameters are described in our **free booklet: "Quick-change Artists."** TRW/Globe Motors, an Electronic Components Division of TRW Inc., Dayton, Ohio 45404 (513-228-3171).



## TRW GLOBE MOTORS

INFORMATION RETRIEVAL NUMBER 159



# ENGINEERING PRODUCT HANDBOOK

## A/D and D/A Converters

- ANALOG MULTIPLEXERS
- SAMPLE AND HOLDS
- DC AMPLIFIERS
- MODULAR DATA ACQUISITION SYSTEMS
- V/F & F/V CONVERTERS
- ACTIVE FILTERS
- POWER SUPPLIES
- DIGITAL PANEL METERS

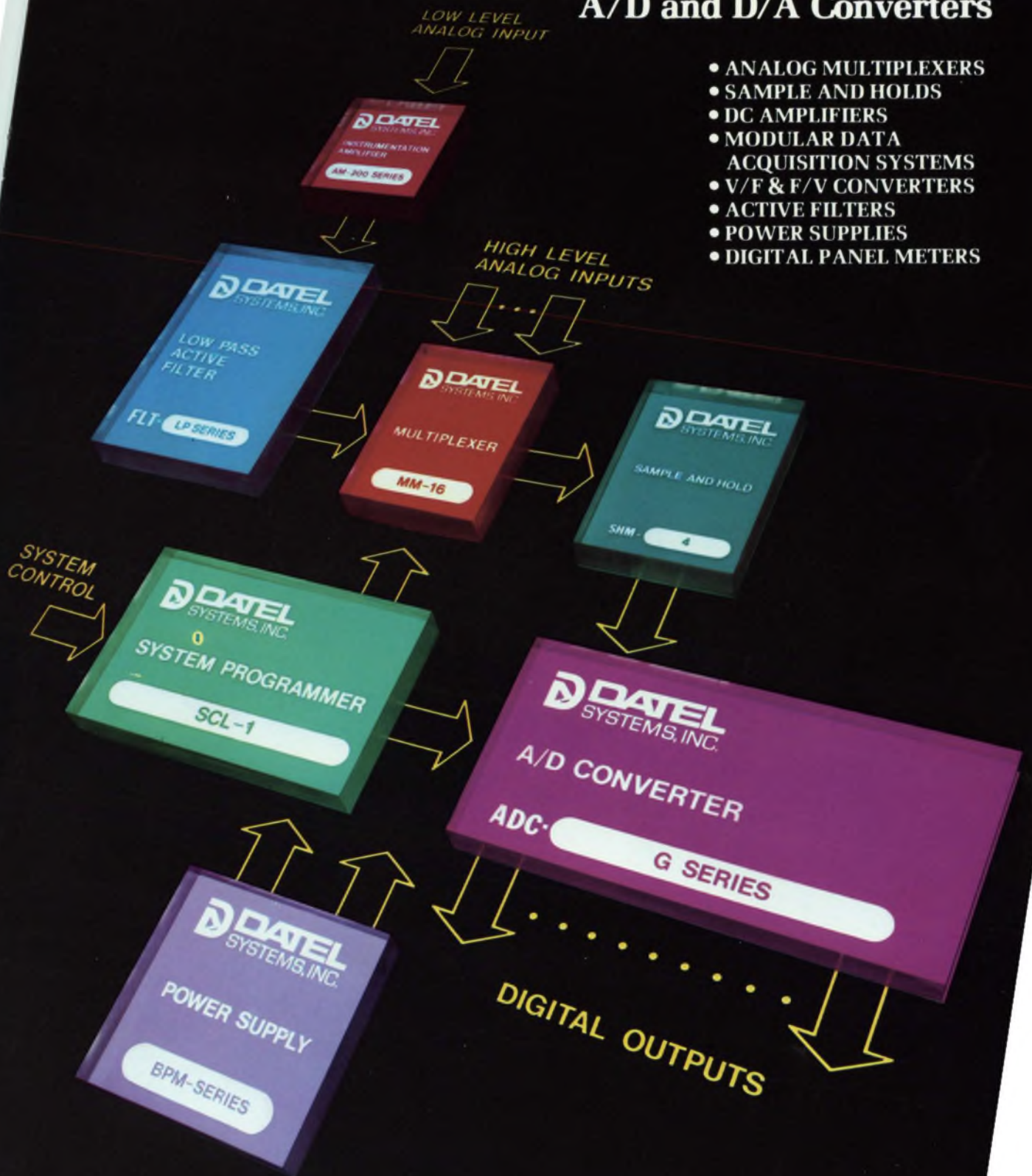

FOREIGN SUBSIDIARIES:  
 WEST GERMANY/DATELEK SYSTEMS GmbH-8 MÜNCHEN 71 • TEL 089/78 40 45 • TELEX 5212855  
 FRANCE/DATEL SYSTEMS SARL, 750 16 PARIS, FRANCE • TELE 603-06-74/603-05-31  
 UNITED KINGDOM - BASINGSTOKE, HAMPSHIRE, RG-24 9NT • TELE BASINGSTOKE

**DATEL**  
 SYSTEMS, INC.  
 1020 TURNPIKE STREET, CANTON, MASS. 02021  
 • TEL. (617) 828-8000  
 • TELEX 021222





## **The solid-state janitor. If you want to design one tomorrow, we're ready with your linear IC's today.**

Whatever you conjure up, we can help make a reality.

Maybe you're looking ahead to remote control using Digital to Analog Converters, to advanced mobile communications equipment, even to a completely automated factory. However advanced your design, we have a full house capability to help you get from the drawing board to the real world. We can supply the popular standard types, meet your

custom requirements and offer proprietary types.

We can help you with other products, too. We're a commodity supplier of power transistors; a recognized leader in CMOS; developers of liquid crystal displays; technology innovators of RF components; and a major supplier of thyristors.

In addition to comprehensive technical product data, RCA also gives you professional and expe-

rienced field engineering and applications support. As well as a commitment to excellence in everything from research to manufacturing.

So whatever you're into, and whatever you need, check with us first. Chances are one or more of our products anticipate your needs. A good place to start is to check our handy product-line guide. Write RCA Solid State, Section 57F21, Box 3200, Somerville, N.J. 08876.

**RCA** Solid State