

Electronic Design 12

VOL. 22 NO.

FOR ENGINEERS AND ENGINEERING MANAGERS

JUNE 7, 1974

The data-acquisition maze: With a complex array of analog and digital circuits, systems are hard to specify. Each functional block has problems, and each must be

compatible with all its neighbors. Specs and performance can vary from company to company. For a look at what's available and what to look out for, see pg. 70.

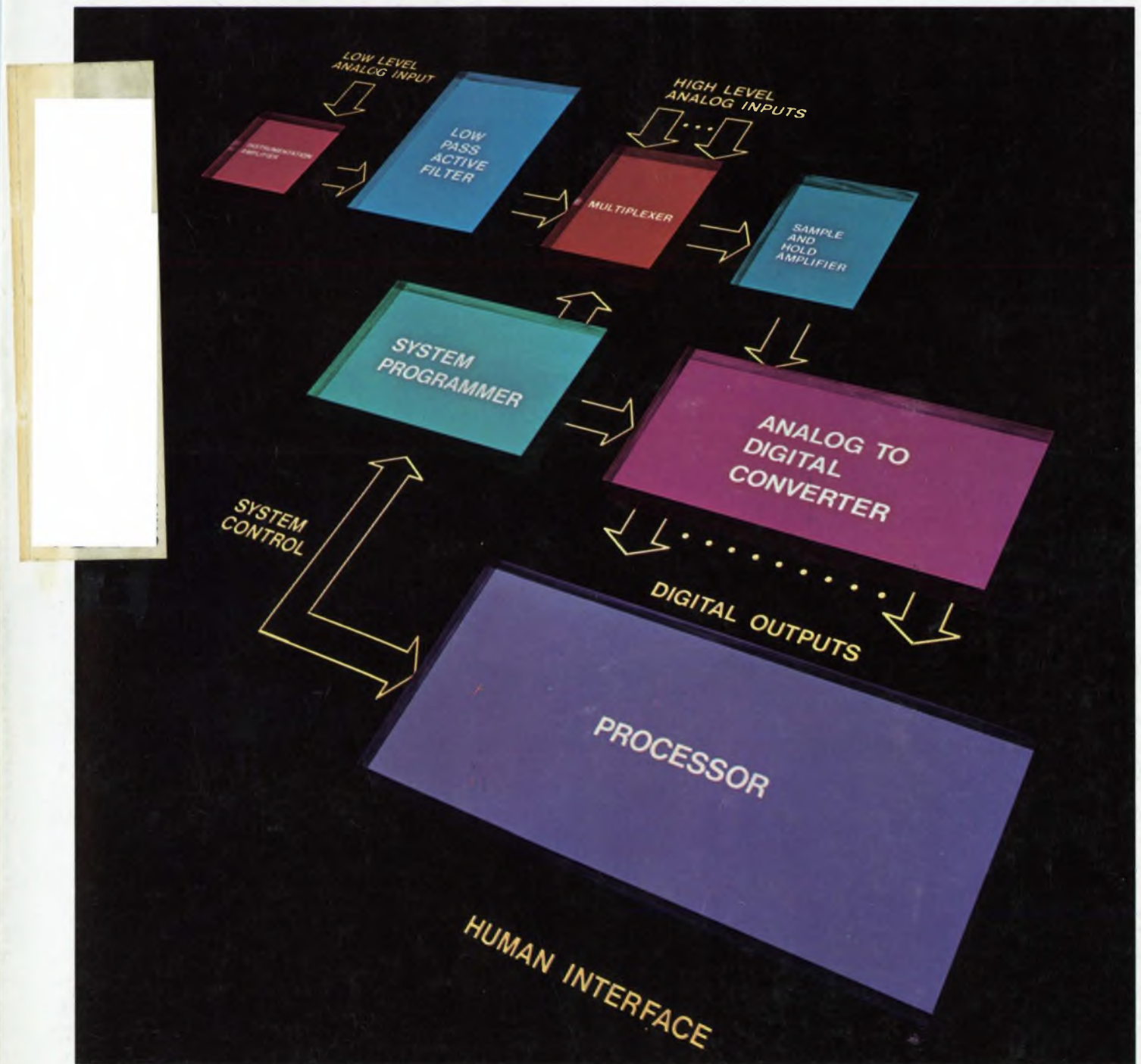



Ultra reliability in
ultra-miniature
transformers...

...and they're off the shelf!

PICO Electronics' patented construction combines mass production with the utmost in reliability to produce the smallest possible transformer.

These little giants handle up to 600 milliwatts at 1 KHz and 1.5 watts at 10KHz. They cover the frequency range of 300Hz to 250KHz. Primary or Secondary impedances of 3.2 ohms to 250K ohms. Pulse applications .05 μ s to

100 μ s. Construction can be TO-5 plug-in, insulated flexible leads or flat pack ribbon style.

Size variations from $\frac{1}{4}$ " dia. x $\frac{1}{4}$ " ht. to $1\frac{1}{32}$ " dia. x $\frac{1}{2}$ " ht. Special designs with $\frac{1}{4}$ " dia. and .180" ht.

Pico Electronics is a Q.P.L. source. All transformers are hermetically sealed in a metal case and in strict compliance with MILT-27 specifications. Every Pico device has the added reliability feature of being

guaranteed for 25 cycles of thermal shock (MIL-STD-202D, method 107C).

Industrial and Commercial designs are also available for maximum economy.

Over 600 standard transformers to choose from... Delivery—stock to one week... specials take a little longer—9 days.

Send for free 36 page catalog.

PICO Electronics, Inc.

50 South MacQuesten Pkwy., Mt. Vernon, New York 10551 • Telephone 914-699-5514

YOU HUM THE TUNE, EXAR PLL WILL SING IT

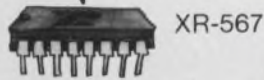
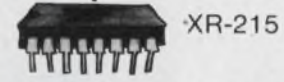

We have the broadest chorus line of Phase Lock Loop circuits available today. Take a brief look at our ever-expanding PLL line:

The XR-210 is designed for FSK Modulation and Demodulation and features a self-contained output logic driver, compatible with RS-232C requirements.

Use the XR-215 for FM or FSK demodulation, frequency synthesis and filter tracking. It has a 5V to 26V supply range and 0.5 Hz to 35 MHz frequency bandwidth. What's more, it's bipolar logic compatible.

The XR-S200 is a do-it-yourself building block. With this you design your own PLL circuits by selecting external connections and components. You get instant pro-

totypes with minimum fuss and costs.

Moving right along... the XR-567 PLL is designed for tone and frequency decoding. It has a bandwidth adjustable from 0 to 14%, sinks up to 100 mA of load current and has a logic compatible output. Our dual version, the XR-2567, is a real hummer with even better temperature tracking and matching characteristics. Power supply rejection is improved by an order of magnitude over the single version. The dual outputs can switch up to 100 mA at 26 volts.

All together now. We would like to send you the complete musical score on our PLL products. Our data sheets are good and they're filled with applications data. Write now, write.

EXAR SPEAKS YOUR LANGUAGE



EXAR INTEGRATED SYSTEMS

A Subsidiary of R-ohm Corporation 16931 Milliken Ave., Irvine, CA. 92705 (714) 546-8780 TWX 910-595-1721

EXAR SALES REPRESENTATIVES Alabama, Georgia, Mississippi, North Carolina, South Carolina and Tennessee: K & E Associates, Kennesaw, Georgia (404) 974-4264
 Arkansas, Louisiana, Oklahoma and Texas: Evans-McDowell, Dallas, Texas (214) 238-7157 California: De Angelo, Rothman and Co., Culver City (213) 398-6239, Logan Sales Co., Redwood City (415) 369-6726 Connecticut, Maine, Massachusetts, New Hampshire, Rhode Island and Vermont: Com-Sale, Waltham, Massachusetts (617) 890-0011, Meriden, Conn (203) 634-0179 Indiana, Kentucky and Ohio: McFadden Sales, Columbus, Ohio (614) 221-3363 Idaho, Oregon and Washington: SD-R Products & Sales, Bellevue, Washington (206) 747-9424 Illinois and Wisconsin: Mar-Con Associates, Inc., Skokie, Illinois (312) 675-6450 Maryland, Virginia and Washington, D.C.: Rep-tron, Inc., Silver Spring, Maryland (301) 593-4844 New Jersey (South) and Pennsylvania: Harry Nash Associates, Willow Grove, Pennsylvania (215) 657-2213 New Jersey (North) and New York: MOS Associates, Floral Park, New York (516) 694-5923 Canada: Harvard Electronic Sales, Laval, Quebec (514) 681-1400
EXAR DISTRIBUTORS California: EEP Corporation, Culver City (213) 838-1912, Intermark Electronics, San Carlos (415) 592-1641, San Diego (714) 279-5200, Santa Ana (714) 540-1322 Colorado: Intermark Electronics, Denver (303) 936-8284 Indiana: Graham Electronics, Indianapolis (317) 634-8202 Massachusetts: Gerber Electronics, Dedham (617) 329-2400 Washington: Intermark Electronics, Seattle (206) 767-3160

INFORMATION RETRIEVAL NUMBER 2

There's a little tiger in every Cherry switch



...but we're pussycats to do business with

Our products are tough, but our people aren't... and that's the beauty of dealing with Cherry.

You see, we can control the quality of our switches because we fabricate most of our own parts (moldings, stampings, springs, printed circuits, etc.) And we can keep the price down because we're loaded with automatic equipment to handle high volume.

But the real difference is in the *people* you work with at Cherry... from your first contact with a technically trained sales representative... through careful analysis and recommendations by engineers

who are really concerned about *your* problem... to production scheduling and customer service men who follow-up and expedite to make sure we keep our delivery promise to you.

Of course we're proud of our modern facilities and equipment... but what we're proudest of is our reputation for customer service. Try some.



Test a free sample "tiger" from the pussycats at Cherry. Ask for our latest catalog which contains complete information on all our switches and keyboards, and we'll include a free sample switch. Just TWX 910-235-1572... or PHONE 312-689-7700... or circle the reader service number below.

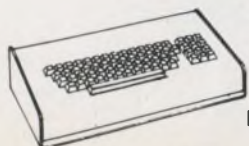

CHERRY



CHERRY ELECTRICAL PRODUCTS CORP. • 3609 Sunset Avenue, Waukegan, Illinois 60085

ELECTRONIC DATA ENTRY KEYBOARDS • ELECTRONIC DESK TOP CALCULATORS

INFORMATION RETRIEVAL NUMBER 3



NEWS

- 29 **News Scope**
- 34 **Better and cheaper integrated circuits** are on the way with two advances in processing.
- 36 **Electron-beam projection system** gives 3-way improvement in ICs.
- 38 **Domestic satellites** promise to revolutionize communications.
- 44 **Electrochromic display** offers challenge to liquid crystals.
- 48 **Low-cost, standard MIC packages** are within the designer's reach.
- 55 **Washington Report**

TECHNOLOGY

- 70 **FOCUS on data-acquisition equipment:** This special report examines the maze of error sources that can plague data-acquisition equipment. Many subtleties and tradeoffs in sub-system design and selection are also discussed.
- 92 **Opto-isolator logic units** add flexibility to digital design. They provide input-to-output isolation, low noise feedthrough and response to dc and fast pulses.
- 100 **MOS/LSI microprocessor selection:** Here are basic hardware, software and design points to consider before you start a microcomputer design.
- 116 **Get standby LSI memory power,** and you have a nonvolatile setup that competes with core. Pulsed refreshed cycles allow a small battery to preserve data.
- 124 **Curb analog data errors with PCM** recording techniques. They offer higher S/N ratios and accuracies than either AM or FM methods.
- 130 **Calculate with a v/f converter.** Only a few simple modifications are needed to allow accurate multiplication, division and square-root extraction.
- 136 **Match impedances with tapered lines** when you test microwave transistors, and you'll avoid the destruction of expensive devices.
- 142 **Start your own electronics business**—but look before you leap.
- 150 **Ideas for Design:** Current clamp blocks destructive discharges of large filter capacitors . . . A/d converter remembers signal peaks whose duration is less than 50 ns . . . Simplified biofeedback circuit detects alpha-wave activity.
- 156 **International Technology**

PRODUCTS

- 168 **Modules & Subassemblies:** High-speed s/h circuit gives gain up to 1000.
- 158 Data Processing
- 179 Integrated Circuits
- 184 Packaging & Materials
- 190 Components
- 194 Microwaves & Lasers
- 204 Instrumentation
- 212 Discrete Semiconductors
- 217 Power Sources

Departments

- 69 **Editorial:** The job that couldn't be done
- 7 Across the Desk
- 224 Application Notes
- 225 Design Aids
- 226 New Literature
- 236 Advertisers' Index
- 238 Product Index
- 240 Information Retrieval Card

Cover: Photo by Chadman Studios, Boston, courtesy of Datel Systems Inc.

From CPU 8080 Microcom

Intel's new 8080 n-channel microcomputer is here—
incredibly easy to interface, simple to program and with up
to 100 times the performance of p-channel
MOS microcomputers.

Best of all, the 8080 is real—in production
at Intel and available in volume quantities,
today. It's also available through distributors
along with a growing line of peripheral
circuits and a new version of the
Intellec 8, a program and hard-
ware development
system for the 8080,

all supported with software
packages, design documenta-
tion and manuals, and backed
by more than 100 man years
of microcomputer expertise.

The 8080 is the inevitable
successor to complex custom
MOS and many large discrete
logic subsystems. It is the
industry's first general purpose
n-channel microcomputer and
the first high performance
single-chip CPU, with extremely
simple interface requirements and
straightforward programming. It runs a
full instruction cycle in 2 microseconds.

As such, the 8080 extends the economic
benefits of Intel's p-channel microcom-
puters to a new universe of systems that need
fast, multi-port controllers and processors. These
systems include intelligent terminals, point of sale
systems, process and numeric controllers, advanced



to software, the puter is here.

calculators, word processors, self-calibrating instruments, data loggers, communications controllers, and many more.

You can use 256 input and 256 output channels, handle almost unlimited interrupt levels, directly access 64 kilobytes of memory, and put many satellite 8080 processors around a single memory.

Interfacing is minimal and design is easy with the 8080 because all controls are fully decoded on the CPU chip itself and inputs and outputs are TTL compatible. There are separate data, address and control buses.

The 8080 microcomputer has 78 basic instructions, including the 8008 set plus new ones that make possible such features as vectored multi-level interrupt, unlimited subroutine nesting and very fast decimal and binary arithmetic.

Program development for the 8080 can be done either on a large computer using the Intel software cross products (PL/M systems language compiler, macro-assembler and simulator), or on an Intellec 8 development system with a resident monitor, text editor and macro-assembler.

The new 8080 product family includes performance matched peripheral and memory circuits configured to minimize design effort and maximize system performance. Large, low cost RAMs, ROMs, PROMs and I/O devices are available now and we will soon announce other 8080 LSI support circuits.

The 8080 is easier to use and more economical than any high performance microcomputer in sight. It's here now, in volume, from the inventors of the micro-computer and the people who lead the industry in production and design support.

Intel Corporation, 3065 Bowers Avenue, Santa Clara, California 95051.
(408) 246-7501.

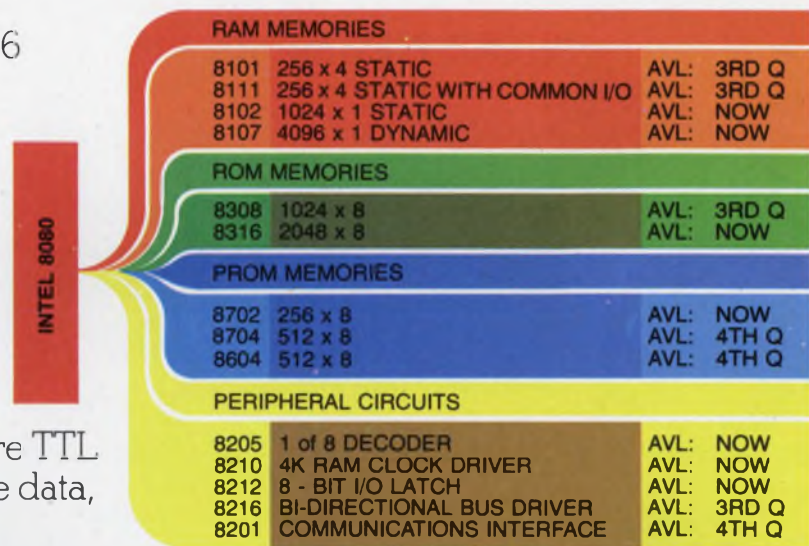

INTEL 8080 PRODUCT FAMILY

intel® Microcomputers. First from the beginning.

FLAT INTERCONNECTS YOUR COMPLETE SOURCE

Ribbon Cable / IC Interconnects / Custom Harnesses

You're sold on flat cable, now buy it at its best. Precise, compact cable packages to fit your specifications perfectly, computer-loomed for unmatched versatility by Woven Electronics.

Handling ease of independent non-bonded leads speeds production, cuts cost, while technical characteristics outrank other flat cable forms.

Make Woven your source for jumpers, continuous rolls, special harnesses, all your interconnect needs.

WOVEN ELECTRONICS

P.O. Box 189 Mauldin, South Carolina 29622
803/963-5131



Vice President, Publisher

Peter Coley

Editors

Editorial Offices

50 Essex St.

Rochelle Park, N.J. 07662

(201) 843-0550

TWX: 710-990 5071

Cable: Haydenpubs Rochellepark

Editor-in-Chief George Rostky

Managing Editors:

Ralph Dobriner

Michael Elphick

Associate Editors:

Dave Bursky

Jules H. Gilder

Morris Grossman

Seymour T. Levine

John F. Mason

Stanley Runyon

Edward A. Torrero

Richard L. Turmail

Contributing Editors:

Peter N. Budzilovich

Robert Wollins

Editorial Field Offices

East

Jim McDermott, Eastern Editor

P.O. Box 272

Easthampton, Mass. 01027

(413) 527-3632

West

David N. Kaye, Senior Western Editor

2930 West Imperial Highway

Inglewood, Calif. 90303

(213) 757-0183

Northe K. Osbrink, Western Editor

112 Coloma St.

Santa Cruz, Calif. 95060

(408) 426-3211

Washington

Heather M. David, Bureau Chief

2506 Eye St., N.W.

Washington, D.C. 20037

Editorial Production

Marjorie A. Duffy

Art

Art Director, William Kelly

Richard Luce

Anthony J. Fischetto

Production

Manager, Dollie S. Vieblg

Helen De Polo

Anne Molfetas

Christopher G. Hill

Circulation

Manager, Evan Phoutrides

Information Retrieval

Peggy Long

Promotion

Manager, Jeffrey A. Weiner

Karen Kerrigan (Reprints)

Nuclear transients can be complicated

The article "Protect Against Nuclear Transients" (ED No. 4, Feb. 15, 1974, p. 64F) is misleading. The technique, as presented, considers only the upset aspect of hardening and completely ignores neutron degradation and the latch-up phenomenon of junction-isolated integrated circuits. The latter effect is more detrimental and can occur for radiation doses similar to upset. The article presents the radiation from nuclear blasts as a single entity, whereas there are different particles and rays, each with its distinctive effects.

The author does not mention that the discharge of capacitors by ionization radiation is a limitation of the data-storage technique. The increase in the size and weight of systems in which this technique is used, and the reduction in speed make shielding a definite tradeoff in many cases.

*Henry Kay
Staff Engineer*

Intelcom Rad Tech
P.O. Box 80817
San Diego, Calif. 92138

The author replies

I do not believe the article was misleading. It was very clearly stated that my technique applied only to the transient-upset phenomenon.

As for neutron degradation, this is a long-term effect that should be clearly treated as such and included in other long-term aging effects. However, neutron degradation can be serious. Depending up-

on who supplies the data, this can result in a $\pm 40\%$ degradation in long-term component design tolerance. In addition, while semiconductor manufacturers may brag about their hardened devices, it's hard to pin them down to actual figures, such as of merit, design and neutron-dosage levels. Some companies are actively engaged in large-scale testing programs to establish reliability figures and exposure rates. But these data are not easily available to outsiders.

As for the latchup phenomenon in junction-isolated integrated circuits, I thought it was common knowledge that this device is very susceptible to scrambling at low-dosage levels when used in registers, latches and counters. This deficiency was known at least two years ago, so the junction-isolated technique was replaced by other hardening techniques.

With regard to the discharge of capacitors caused by ionizing radiation, a better choice of dielectrics—use of glass or ceramic capacitors rather than organic dielectrics—is needed.

Let me turn to the matter of tradeoffs between size, weight and speed of circuits hardened by the RC storage network vs the use of shielding. First, Mr. Kay does not appear to have been exposed to contract requirements that forbid the use of shielding unless there is no other way to protect circuits; then it may be permitted by special contractor approval. Second, almost all communications systems for very-long-range and satellite applications do not make use of very high-speed toggle or through-

(continued on pg 8)

Electronic Design welcomes the opinions of its readers on the issues raised in the magazine's editorial columns. Address letters to Managing Editor, Electronic Design, 50 Essex St. Rochelle Park, N.J. 07662. Try to keep letters under 200 words. Letters must be signed. Names will be withheld on request.

giga-trim capacitors for microcircuit designers

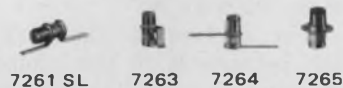
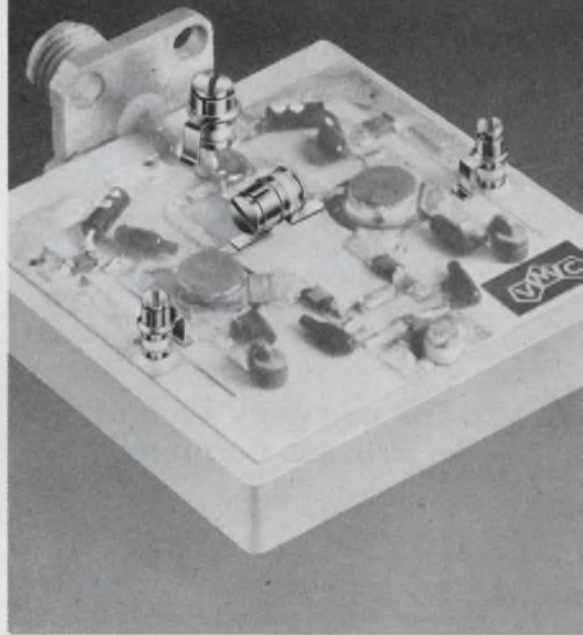

Giga-Trim[®] (gigahertz-trimmers) are tiny variable capacitors which provide a beautifully straight forward technique to fine tune RF hybrid circuits and MIC's into proper behavior. They replace time consuming cut-and-try adjustment techniques and trimming by interchange of fixed capacitors.

Applications include impedance matching of GHz transistor circuits, series or shunt "gap-trimming" of microstrips, external tweaking of cavities, and fine tuning of crystal oscillators.

Johanson

MANUFACTURING CORPORATION

BOONTON, NEW JERSEY 07005
201 / 334-2676

(continued from page 7)

put rates. The limitation here is not on internal-circuit performance but on carrier bandwidth restrictions. Third, the RC storage hardening technique has been incorporated directly in the basic chip for a number of integrated circuits. Hence the increase in weight is negligible for these special IC devices.

Finally, let me assure Mr. Kay that I am neither a salesman for semiconductor devices nor am I interested in pushing the use of shielding. To each his own.

Antonie N. Paolantonio, P.E.
17806 Elkwood St.
Reseda, Calif. 91335

The company's name is Process Computer

Discerning readers of our computer issue (ED No. 9, April 26, 1974) may have noticed that Process Computer Systems—the company whose ad appears on pages 277 and 279—was somehow given a new name in the microprocessor story on page 90.

The caption on that page, and the references to the company in the text, referred to the company as Process Control Systems, instead of Process Computer Systems. Our apologies.

Binary/BCD converter corrected by reader

Fig. 5 in "Fast BCD/Binary Conversions" (ED No. 22, Oct. 25, 1973, pp. 84-89) raises a question. The ROM that takes care of the first seven bits (numbers up to 127) provides numbers up to only 99. How do you generate the numbers between 100 and 127?

A possible implementation (see figure) uses two ROMs (256×8 bits) for the first 8 bits and three for the next 8, instead of 3 (512×8) ROMs.

Lucien I. Facchin
Dept. of Computer Science
University of Illinois
Urbana, Ill. 61801.

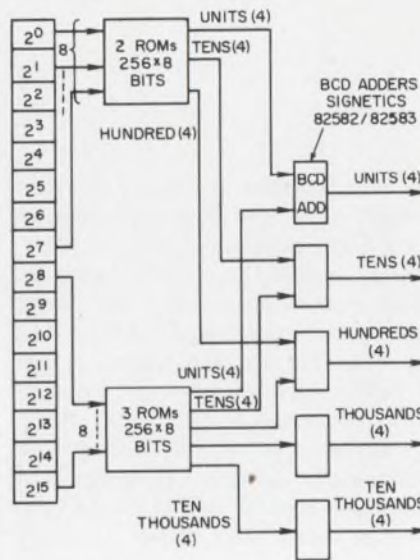

The author replies

Mr. Facchin's comment is correct.

The only thing I could suggest other than use of an additional ROM to obtain the one-bit output would be to use a hardware decoder. This could be less expensive and more efficient.

H. A. Raphael
Manager, Processor Electronics
The Singer Co.
Business Machines Div.
San Leandro, Calif. 94577.

A word of caution on CMOS and power

The article "Focus on CMOS" (ED No. 6, March 15, 1974, p. 86) mentions that a CMOS digital IC has increased power-supply drain as its input or output frequency increases. It also notes that CMOS devices have a large noise immunity, so you can, in many cases, drive them from a TTL gate. The article does not mention, however, that if you do not drive the CMOS all the way to its V_{cc} level, it will draw more power on a dc or quiescent basis.

For example, if a low-power TTL output at 3 V dc drives a CMOS input gate, the CMOS gate may draw perhaps 0.05 to 0.5 mA

of drain. This won't usually squander your power budget or melt your CMOS, but it is a price you will pay when you try to avoid the use of pull-up resistors for the TTL.

Robert A. Pease
Staff Engineer

Teledyne Philbrick
Allied Drive at Route 128
Dedham, Mass. 02026

Those 'distracting' ads improve his thinking

With all due respect to the "future woman engineer" (see "Women in Ads leave Future Engineer Cold," ED No. 5, March 1, 1974, p. 16), I must differ with her sentiments on the use of women in professional advertising.

As one who conscientiously reads the dozen or so technical magazines, journals and newspapers that cross my desk fortnightly, I find a definite need for the variety of color, style, size and approach exhibited by the advertisements that appear in ELECTRONIC DESIGN. What is more desensitizing, more boring than an advertising message devoid of impact, appeal and emotion?

What Joyce Wetenkamp apparently does not yet realize is that good engineering, like any other logical thinking process, thrives not on a lack of noise-like irrelevancies but rather on an abundance of them. A thinking process with no noisy distractions soon grinds to an unproductive conclusion. We need those jogs, those distractions to keep us "loose" and out of the ruts.

So here's a toast to the Guardian Angel, the Tektronix model, the Wavetek jitter-buggers and pretty Heather David. May they continue to smile at us, catch our attention, distract us from our complacencies and remind us what it is all about. Here's to more, not less, pretty people in your ads.

George V. Colby Jr.

7 Hawthorne Road
Lexington, Mass. 02173



MEASUREMENT COMPUTATION

innovations from Hewlett-Packard

NEWS

JUNE, 1974

in this issue

Two new low-cost
crystal-based counters

New price reductions
for the HP-35 and HP-45

Information management
keeps up with technology

New wave analyzer for precision and portability in the field

Here, the 3581A wave analyzer checks field equipment performance for the Omega navigation system, a global system that should become fully operational in 1975.

HP's new low-frequency analyzer has a built-in counter for frequency accuracy and a battery option for convenience and portability. Take the 18 lb. (8.1 kg) wave analyzer where you need it the most—out in the field—to check power or telephone lines.

Accurate single-frequency measurements are fast and easy, from 15 Hz to 50 kHz with 1 Hz resolution and 3 Hz bandwidth. The built-in counter displays tuned frequency on a 5-digit LED readout. Signal amplitude appears on a four-scale analog meter. Two scales are for log displays of 90 dB and 10 dB (expanded), and the other two are linear with 1 or 3 full scale.

(continued on page 3)



Super-counter for superb time interval measuring and easy system interface

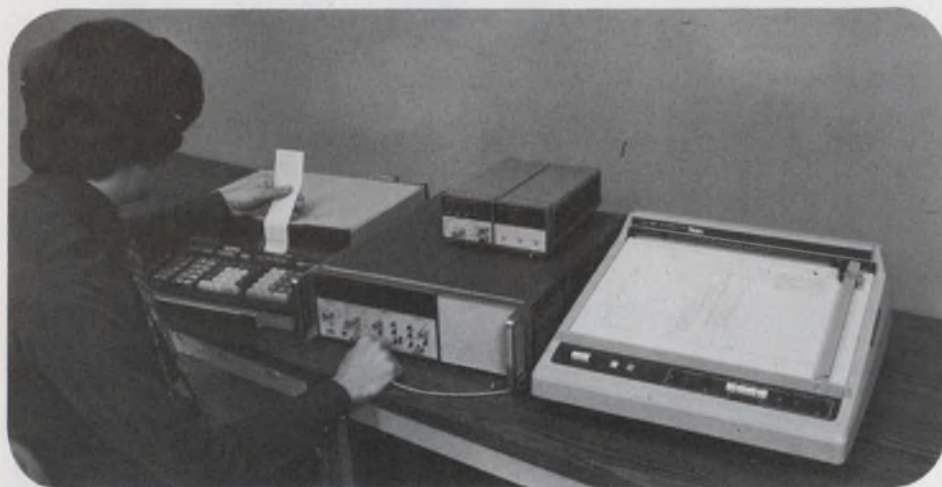

The HP 5345A counter's unmatched capabilities in time interval measurements and automatic systems operation pay off in applications such as the time interval jitter measuring system shown above.

Precision time interval measurements are central to measuring rise time, propagation delay, slew rate, and phase. These are just a few applications that can be served better than ever by the time interval capability of HP's new 5345A electronic counter.

Compatibility with the HP interface bus makes the counter a natural for systems applications. For example, the system shown above is easily assembled using an HP 9820A calculator, 9862A plotter, and the 5345A counter to analyze time interval jitter.

The 5345A offers 2 ns single-shot time interval resolution. With an improved averaging technique, resolutions to 2 ps are achieved for repetitive signals. High sensitivity of the 500 MHz input amplifiers (better than 10 mV rms) ensures accurate trigger level settings. And for very fast pulses in 50 Ω systems, you can switch to 50 Ω impedance to prevent error-causing reflections.

The 5345A also makes frequency, frequency average, period, period average, ratio, totalize, and gated measurements over the dc to 500 MHz bandwidth. Plug-ins extend the counter's capability for communications and microwave measurements.

There's more. Just check the HP Reply Card.

Calculator control and HP's new ASCII programmable modules that extend the 5345A's measurement capabilities are explained in a new series of application notes. The series includes: the characterization of voltage controlled oscillators, determining probability density distribution of a series of measurements, frequency stability measurements, and the measurement of fractional frequency deviation and FM deviation. VCO characteristics covered are: the transfer function measurement, differential and integral non-linearity and dual VCO tracking error.

Each application note describes how to connect the necessary equipment, how to operate the resulting calculator-controlled system, and certain key measurement considerations that should be noted. The notes also include a complete listing of the HP 9820/21 calculator program and a flow diagram of the software.

To learn more, check the HP Reply Card.

New quality counters at surprisingly low prices



These new counters have 25 mV sensitivity, LED displays, measure ratio as well as frequency, and weigh just 4.75 lbs. (2.2 kg).

Two new electronic counters carry extremely low price tags, yet offer high-stability crystal time bases crucial to counter accuracy and usually found only in costlier models. Either new counter is ideal for production line testing, frequency monitoring, service and calibration, training classes or—at this price—even for hobbyists and radio hams.

The 80-MHz model 5381A has a 7-digit display. Model 5382A counts to 225 MHz and displays 8 digits. Resolution is 10 Hz at 0.1 sec gate time, 1 Hz at 1 sec, and 0.1 Hz in 10 sec.

Aging (drift) rate is <3 parts in 10⁷ per month, reducing recalibration. Temperature-resistant and rugged, the two counters also protect against overload. Even in their wide-open settings, they'll take 200 Vdc without harm.

A three-position input attenuator lets you measure noisy or high voltage inputs. Unlike other low-priced counters, these will also operate on an external precision time base through a built-in rear connector.

For more information, check the HP Reply Card

Get 4-channel lab quality recording with portable tape recorder

The 3960A instrumentation tape recorder gives you portability along with performance and features found only in the most expensive laboratory machines. Portability is the ruggedness of the solid aluminum casting, the capability of operating from either ac or dc power sources, and a built-in dc calibrator.

Use the 3960A in data acquisition and data reproduction applications. Tape speeds range from 15/16 ips for long-term FM recording of slowly changing phenomena to 3¾ ips for acoustic evaluation and up to 15 ips for vibration studies. The low-speed performance is outstanding, an important asset to medical researchers and others who record slowly changing variables.

The FM signal-to-noise ratio at 15/16 ips is 44 dB. At higher speeds, the FM signal-to-noise ratio is 48 dB. Data electronics for direct recording has a frequency response up to 60 kHz and up to 5 kHz for FM.

For more information, check the HP Reply Card.



The 3960A recorder uses ¼ in. (0.6 cm) tape or standard 7 in. (17.8 cm) reels.

HP multiprogrammer system expands your I/O capability to 240 channels

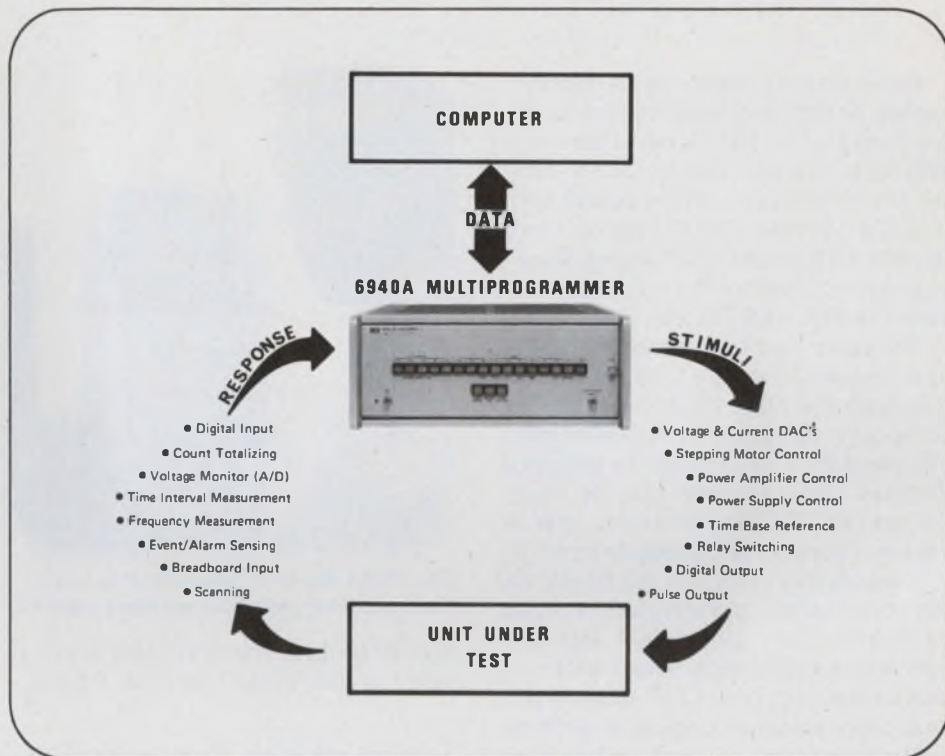

Multiprogrammer mainframes and plug-in cards let you design and build low-cost automatic test systems more efficiently.

You'll never run out of computer I/O slots when you design your automatic test system around the 6940A multiprogrammer. You need just one 16-bit duplex computer I/O channel to interface with the multiprogrammer. The 6940A holds up to 15 plug-in analog and digital I/O cards, mixed in any combination. Some plug-ins convert programmed data into analog and digital output signals to stimulate units under test; others convert analog and digital responses into digital data for input to the computer.

If you need more than 15 programmable I/O channels, simply add 6941A extender mainframes. Each extender

holds 15 plug-ins, and you can add up to 15 extenders—giving you a total of 240 plug-in cards controlled from one computer I/O slot.

Just one software driver controls any variety of multiprogrammer plug-ins. This lets you make changes and additions in the type and number of I/O cards without worrying about reconfiguring the software driver or operating system.

There's more. Just check the HP Reply Card.

(continued from page 1)

It's ideal for harmonic analysis, fm and phase noise measurements of high-frequency signals, evaluating sonar devices, and analyzing low-frequency radio transmission systems. Portability lets you check power line interference simply, accurately, on-site.

A communications version, model 3581C, analyzes telephone voice channels, both single and up to 12 multiplexed. You can also pinpoint interference on data channels, look for spu-

rious tones, and analyze levels of transmitted tones. We even provide a loudspeaker, headphone jack, and transformer so you can patch the 3581C directly onto telephone lines. Optional rechargeable batteries run the analyzer for 12 hours.

To learn more, check the HP Reply Card.

Scope plug-in aids design and troubleshooting

Accurate measurements in digital/analog design and troubleshooting are supplied by the 1835A two-channel 200 MHz vertical plug-in for HP 183 series oscilloscopes. Wide bandwidth, coupled with the 1 ns/div sweep speed of HP's 1840A and 1841A time base plug-ins, is ideal for timing measurements in ECL and TTL circuits.

You can trigger from either channel A or B, maintaining true time relationship with the other channel. With the composite mode, each channel triggers independently in alternate or chopped displays. Either channel may be inverted, and an ADD mode lets you look at the two channels differentially ($\pm A \pm B$).

Integrated circuits provide 10 mV/div deflection factor, and a thick-film planar attenuator offers selectable 1 M Ω or 50 Ω input impedance. The 1 M Ω (ac/dc) input has only 12 pF shunt capacitance for minimal loading. In probing applications, you can reduce this low capacitance even further by using 10:1

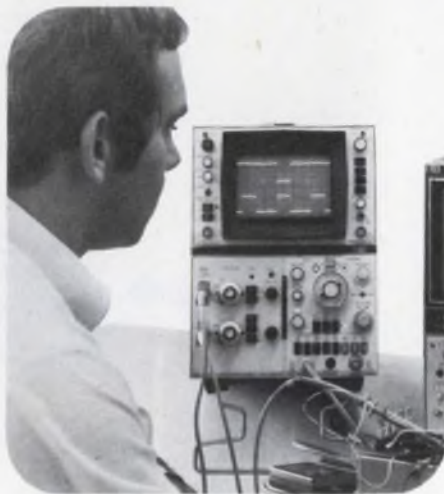

The 1835A 200-MHz bandwidth plug-in displays glitches that could cause timing problems.

divider probes. The 50 Ω input termination has low VSWR for pulse fidelity.

Send the HP Reply Card for details and specifications.

Universal card reader inputs 300 cards per minute

HP's 300 cards-per-minute optical mark reader is flexible as well as fast: the 7260A accepts all types of punched

This desktop serial card reader is quiet enough for the office, fast enough to keep up with your computer.



or marked card, even specially designed forms. With appropriate clock marks, single cards may be both punched and marked, in any number of columns from 1 to 80.

The 7260A can be used with terminals, computers or remote data systems via a modem or direct connection. Data rates are switchable from 110 baud to 2400 baud. Data is stored in buffers so that you can optimize the card feed rate for high transmission efficiency. The 7260A transmits 7-level ASCII code, but other decoding options are available.

Quantity and OEM discounts are also available.

For more information, check the HP Reply Card.

New line printer handles calculator output

Usually line printers are considered computer system peripherals; but now HP offers a reliable line printer for your 9830 calculator system.

The new HP 2607A line printer prints 200 lines per minute, has a full 132 column line width, and 8-level tape control for vertical formatting. The 64 character set is standard USASCII code; characters are styled from a 5 x 7 dot matrix. The line printer is so compact, you can use it on a movable stand or keep it on a desktop or tabletop next to your calculator.

Installation is quick and easy. Simply plug an 11287A interface card into the 9830 calculator, connect the interface cable, and configure the system to your requirements. With the powerful programming capability of the 9830, it's difficult to tell where the calculator system ends and the computer system begins.

To learn more, check the HP Reply Card.



This new line printer substantially increases the through-put of the 9800 series calculators.

New multiplexer options for HP 9600 systems

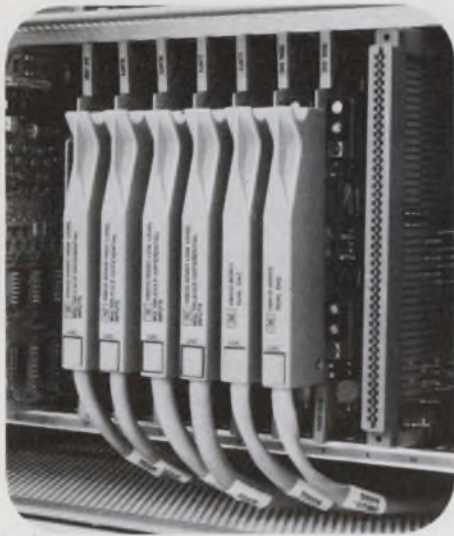

Each multiplexer input circuit provides high common mode rejection from transients and noise. Drift is eliminated by an offset sampling amplifier which further improves accuracy.

Two new multiplexer options for HP 9600 series computerized measurement and control systems let you input analog signals as low as 10 mV.

The 12760 is a relay low-level multiplexer while the 12761A is a solid-state model. Either one switches low-level analog inputs to an HP 2313B A/D interface subsystem. To install the multiplexer, simply slip a printed circuit card into the subsystem.

Both multiplexers accept 16 differential analog inputs and have programmable gains. The solid-state model provides 8 low-level ranges from $\pm 10V$ to $\pm 800V$ full scale. Sampling rate is up to 50 Hz. The relay multiplexer provides 7 low-level ranges from $\pm 10mV$ to $\pm 400V$ full scale and offers protection against high common mode voltage and rejection. Sampling rate is up to 20 Hz.

Send the HP Reply Card for details and specifications.

New low-cost microwave step-attenuators

Automated manufacturing and testing procedures enable HP to offer precision coaxial step-attenuators with outstanding performance at attractive prices. There are two attenuation ranges, 0-70 dB and 0-110 dB in 10 dB steps. The units can be specified for either dc—18 GHz or dc—4 GHz frequency coverage. The HP 8495/8496 attenuators contain thin-film (tantalum or sapphire substrate) attenuation elements that are switched in or out with extremely high repeatability (typically within 0.02 dB), even after thousands of switching cycles.

Both units have high accuracy (typically 1.6% to 4 GHz, 4% to 18 GHz) and low VSWR (1.35 at 4 GHz, 1.7 at 18 GHz). Bench models have three connector types available: type N, SMA and APC-7. Step-attenuator versions for installation within equipment are also offered.

There's more. Just check the HP Reply Card.



Compact size makes these precision attenuators ideal for bench use or installed in equipment.

Expedited entry keyboard speeds calculations



The new expedited entry keyboard for the HP-81 business calculator makes problem-solving even faster.

Thanks to a new optional expedited entry keyboard, the HP-81 business desktop calculator solves problems as fast as you can use it. The calculator stores up to 64 keystrokes while simultaneously performing your previous calculations. You can start a new problem while the calculation is solving another.

This preprogrammed business machine solves problems of investment analysis, loans, bonds, annuities, depreciation and statistics. Simply key in your figures, and the calculator prints the answer. There's no programming involved—if you can use an adding machine, you can operate the HP-81.

Besides the built-in financial functions, the HP-81 can compute mean and standard deviation, correlation coefficient, and a two-variable trend line. If you make an error, such as dividing by zero, an error message tells you why the operation cannot be performed.

All this computational power comes in a small 13.5 lb (6.12 kg) machine that fits easily on a corner of your desk.

For more information, check the HP Reply Card.

Digital triggering pinpoints analog problems

A handy new measurement technique: capture the analyzer's trigger signal on a scope display and use both to find the cause of trouble.

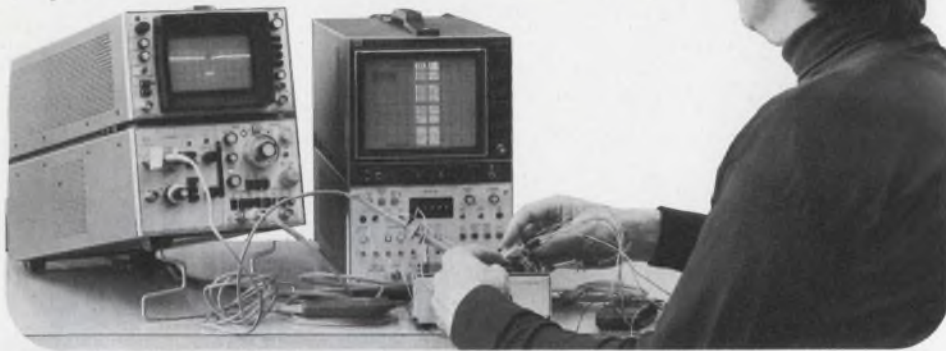

Twelve-bit parallel pattern recognition capability enables the 1601L logic state analyzer to trigger on a particular logic pattern. The unique trigger signal, available as a front panel output, is an extremely powerful tool in digital circuit analysis. By applying this trigger signal to an oscilloscope, the scope's display is positioned in the same "time window" as the digital event.

Let's look at a practical application of digital triggering. Functional checks of a two-decade BCD counter reveal that it is resetting to zero at state 89 rather

than 99. A problem on the reset line is the probable cause. However, when the oscilloscope is connected to the master reset line, several pulses that could cause the problem are displayed. The one that's causing the premature reset is not readily apparent. By connecting the analyzer trigger output to the scope's external input and setting the analyzer trigger switches to state 89, the glitch is readily apparent.

Send the HP Reply Card for details and specifications.

HP solid-state sweepers deliver high power output



High power output across all bands—a value feature of HP's 8620 solid-state plug-in sweeper.

The 8620 series solid-state sweepers cover 3 MHz to 18 GHz with high power output that makes these solid-state

sweep oscillators comparable to BWO-type sweepers. Standard units deliver at least 40 mW to 4.2 GHz and ≥ 10 mW all the way to 18 GHz.

Modular design gives you unparalleled flexibility. Start with either of two mainframes, then choose from 9 single-band plug-ins or RF module combinations to get multi-band coverage conveniently and compactly. Standard features include 1% sweep linearity, low spurious signals, high stability, fully-calibrated Start/Stop, and ΔF sweeps.

In 6 weeks or less, your 8620 sweeper will be delivered and operating.

Send the HP Reply Card for details and specifications.

New low prices for HP-45, HP-35 pocket calculators

In these days of rising inflation, powerful computation capability in the palm of your hand now costs less. Prices for the HP-45 and HP-35 have been reduced.

The HP-45 has a 4-register stack, 9 addressable memory registers, and more than 44 sophisticated functions. You can perform register arithmetic, polar/rectangular coordinate conversions, metric/U.S. conversions, logarithms, and trigonometric functions in 3 different input modes—degrees, radians and grads.

The HP-35—with 4-register stack and an addressable memory register—handles logarithms, exponents and trigonometric functions within seconds.

Each calculator comes with a carrying case, an ac adapter/recharger, and an owner's handbook.

For more information, check the HP Reply Card.



New lower prices for the HP-45 and HP-35 are really something to smile about.

HEWLETT-PACKARD COMPONENT NEWS

Introducing three new isolators

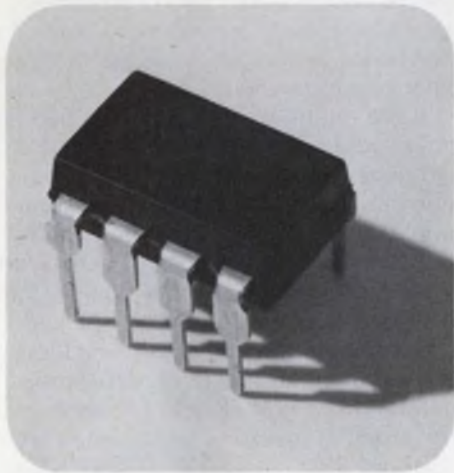

For maximum dc/ac isolation between each input and output, use HP's new 5082-4364 dual isolator.

HP now offers the 5082-4370 series isolators containing a high gain, high speed photodetector that provides a minimum current transfer ratio (CTR) of 300% at input currents of 1.6 mA for the 5082-4370 and 400% at 0.5 mA for the 5082-4371. The excellent low input current CTR lets you use these devices in applications that require low power consumption. Separate pin connections for the photodiode and output transistor permit high speed operation and TTL-compatible output.

Also available is a dual version of our popular high-speed optically-coupled isolator. The new 5082-4364 consists of a pair of optically-coupled gates in an 8-pin dual-in-line package. It's completely TTL compatible and has propagation delays of 50 ns. The high speed of this device makes it ideal for use as a line receiver in high noise environments.

There's more. Just check the HP Reply Card.

Optoelectronics at a glance

HP's new short-form *Optoelectronics Catalog* describes our complete line of lamps, displays, and isolators—in just 6 pages. This concise guide contains the three latest additions to the HP optoelectronics line: the 5082-7740 common cathode LED display, the 5082-4487 low-cost LED lamp, and the 5082-7430 low-power numeric display.

For your free copy, check the HP Reply Card.



New diode and transistor catalog now available

Which diode or transistor meets your design specs? Simply refer to HP's new *Diode and Transistor Catalog*, a comprehensive reference containing complete specifications on:

- Microwave transistors
- Schottky diodes
- PIN diodes
- Impatt diodes
- Step recovery diodes
- High reliability devices

The catalog includes packaging specifications and drawings to aid the circuit designer.

For your free copy, check the HP Reply Card.

New large-digit LED display

LEDs are growing—in size as well as popularity. Now, HP offers a seven-segment display with large .43 in. (1.1 cm) high numbers. The 5082-7750 series devices are common anode LED displays with a choice of right or left hand decimal point.

You can read these bright displays from up to 20 feet away. Distance viewing is also enhanced by the high contrast ratio and wide viewing angle. IC compatibility makes the 5082-7750 series ideal for electronic instrumentation, point of sale terminals, TVs, radios, and digital clocks.

Send the HP Reply Card for details and specifications.

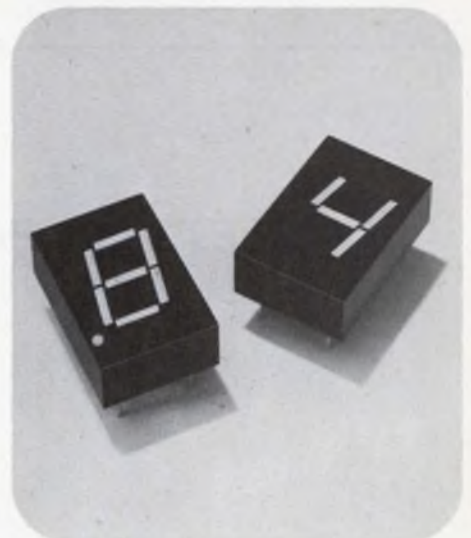

Standard 0.3 in. (0.66 cm) dual-in-line package permits easy mounting on PC boards or in standard IC sockets.

New scientific minicomputer system performs maxi-computer information management tasks

Compact, streamlined, and capable:
HP's new S/250 scientific
information management system.

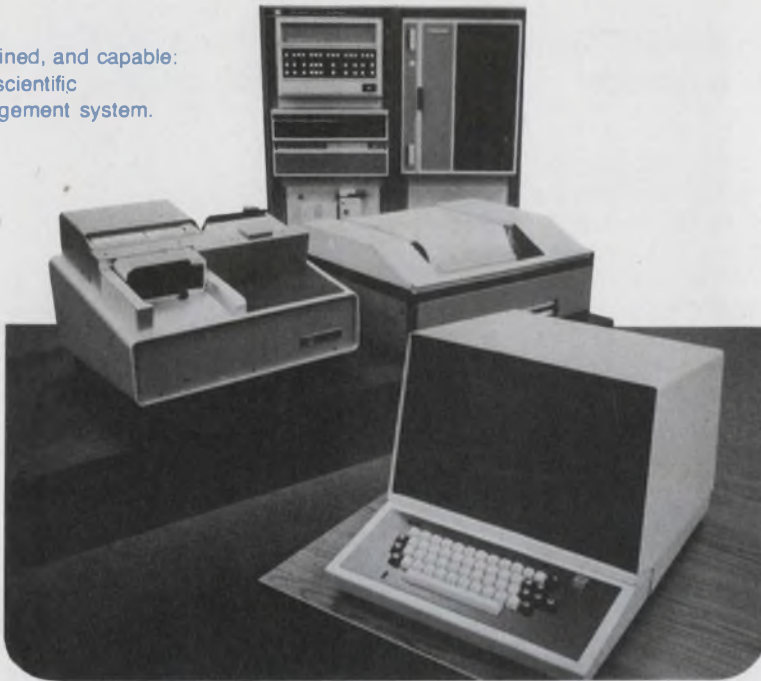

If you are in charge of an engineering laboratory or research project, your data management procedures may be inadequate for the rapid accumulation of information. You need to store growing data files yet access them quickly. Not only do your variables change, but the data sets interact dynamically. Timely reporting gets difficult. Outside services may be unreliable and costly.

Then there's the security problem—preventing unauthorized personnel from accessing sensitive data. Until now, you could find the capability that you need only in large, expensive computers.

The new HP S/250 scientific data management system solves all these problems. This compact system combines a proven minicomputer with a

versatile disc operating system and powerful data base management software. You can use it in a dedicated environment or in multiple modes. You can write application programs in FORTRAN, ALGOL and assembly language. The built-in data manipulation software (IMAGE/2000) reads, updates, deletes and modifies data. Format the output for reports according to your preference, without knowledge of computer programming.

In the multiple user mode, 32 people can concurrently enter data, retrieve it and generate reports. In the data communications mode, a special telecommunications software package enables the S/250 to communicate directly with an IBM 360 or 370. And of course, the S/250 interfaces with other HP systems.

Standard hardware features include floating point arithmetic, micro-programmed fast FORTRAN processor, 48K bytes of memory, removable cartridge disc that stores 4.8 million bytes (alternately expandable to 93 million bytes), keyboard display console, 200 lpm line printer, 1600 bpi magnetic tape drive, and microprogramming capability. Like all HP computer systems, the S/250 is supported worldwide.

To learn more, check the HP Reply Card.

HEWLETT  **PACKARD**

East-20010 Century Blvd., Germantown,
MD 20767, Ph. (301) 428-0700.

South-P.O. Box 2834, Atlanta, Ga. 30328,
Ph. (404) 436-6181.

Midwest-5500 Howard Street, Skokie, Ill. 60076,
Ph. (312) 677-0400.

West-3939 Lankershim Boulevard, North
Hollywood, Calif. 91604, Ph. (213) 877-1282.

Europe-Post Office Box 85, CH-1217 Meyrin 2,
Geneva, Switzerland, Ph. (022) 41 54 00.

Canada-6877 Goreway Drive, Mississauga,
Toronto, L4V 1L9, Ph. (416) 678-9430.

Japan-Yokogawa-Hewlett-Packard, 1-59-1,
Yoyogi, Shibuya-ku, Tokyo, 151.

now...
**RESISTOR
NETWORKS**

from
BOURNS

The Leader in resistive component technology now brings you a line of thoroughly tested and qualified DIP and SIP Resistor Networks . . . that live-up to their specifications, stand-up to your applications. BOURNS® Resistor Networks are available off-the-shelf in a selection of standard configurations to replace the most popular Allen-Bradley, Beckman, Dale, Sprague, CTS, Centralab, and Mepeco part numbers.



CONSIDER WHY BOURNS IS BETTER:

- Proven thick-film production expertise
- Proprietary resistor ink system provides $\pm 100\text{ppm}/^\circ\text{C}$ tempco through all resistances . . . from 33Ω to $220\text{K}\Omega$
- Better power handling characteristics
- Design qualified and life tested to meet or exceed tough Mil-Standards.

Inquiries for special values, schematics and specifications invited.

Your local Bourns representative has complete specs, cross-reference data and order forms at the ready. Call him today . . . or the factory direct.



BOURNS, INC., TRIMPOT PRODUCTS DIVISION
1200 COLUMBIA AVENUE
RIVERSIDE, CALIF. 92507

INFORMATION RETRIEVAL NUMBER 7

BOURNS

**TRIMPOT®
PRODUCTS**

ADJUSTMENT POTENTIOMETERS
PRECISION POTENTIOMETERS
CONTROLS/VARIABLE RESISTORS
RESISTOR NETWORKS



TRIMPOT® PRO
ADJUSTMENT
PRECISION

TRIMPOT PRODUCTS



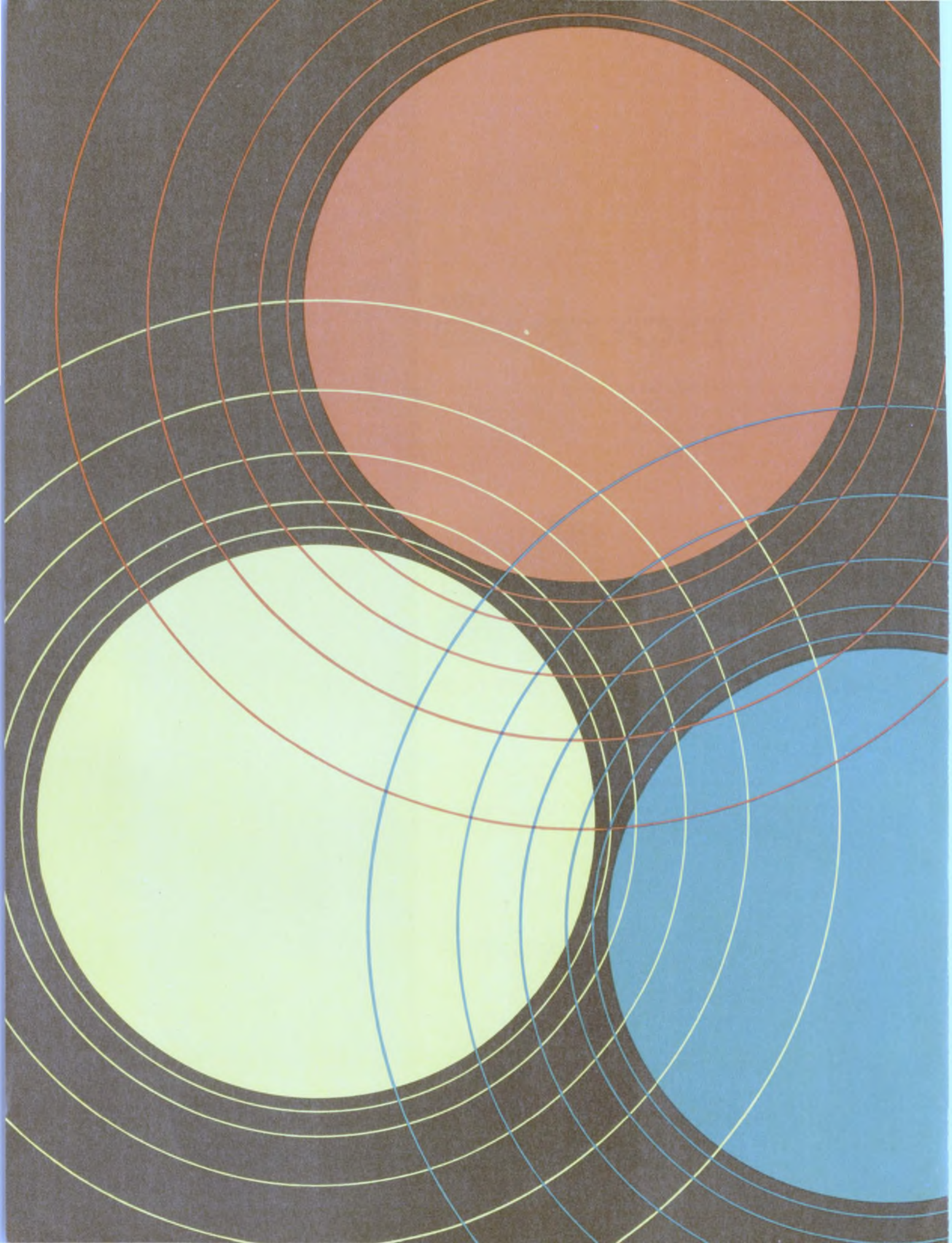

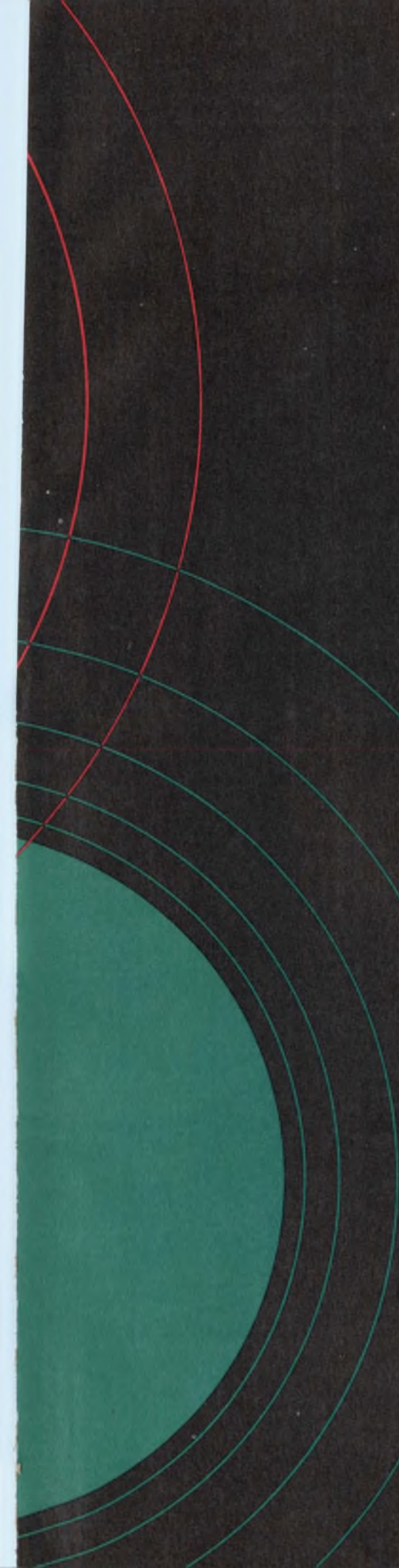

We got the sun in the morning and volumes of red, green and yellow LEDs at night.

There are bright spots during these days of shortages, crunches and allocations.

LEDs, for instance.

Motorola has volumes of red, green and yellow LEDs in over a dozen different types in 15 different packages.

Enough to keep you supplied for virtually all your panel mount, fault-indicating, high-ambient-light, low-ambient-light, backlighting, instrumentation, industrial control and appliance needs for 1974 and beyond.

We've got volumes because we've got unmatched production capability to supply volumes. People, lines, engineering know-how, piece parts, etc. . . . all the things we've been noted for in so many other semiconductor successes.

We'd like to show you more. Write for the Motorola Optoelectronic Selector/Cross-Reference Guide. Box 20912, Phoenix, AZ 85036.

Contact your franchised Motorola distributor or factory representative for all the LEDs you need for all the designs you have.

A warm experience . . .

obvious
From Motorola, the LED producer.



Interface your PDP-11 with a screwdriver.

Attention all you PDP-11 owners out there.

We've been watching you.

And a lot of you are doing the same kind of interfacing.

Hooking up standard peripherals. Converting analog signals to serial ASCII. Directly accessing storage memory. Hooking up remote instruments and custom peripherals that have BCD outputs. Doing the same thing over and over.

Hold it.

Our new DECKits can save you a lot of time and frustration.

DECKits are instant interfaces — basically just a few modules and a PDP-11 systems unit.

Just plug the modules into the systems unit, screw the unit into the PDP-11, and attach the connectors. Your equipment is interfaced.

There's no design time. No breadboarding.

No wirewrapping. The modules and design for each kit have been pretested and fully documented and are ready to solve your interface problem.

Start your interface now. Pick up your pencil and circle our number on the readers service card. We'll send you a complete description of all the DECKit interfaces now available.

We're Digital Equipment Corporation, Logic Products Group, Maynard, Massachusetts 01754. (617) 897-5111, extension 2785.

In Canada: P.O. Box 11500 Ottawa, Ontario, K2H 8K8. (613) 592-5111.

In Europe: 81 Route de l'Aire, 1211 Geneva 26. Telephone: 42 79 50.

**We think interfacing is so important,
we've devoted an entire department to it.**

digital

INTRODUCING LITTELITES FROM LITTELFUSE



SNAP-MOUNT PLASTIC LITES

For rectangular, $\frac{5}{16}$ " and $\frac{1}{2}$ " diameter mounting holes. Flex arms insure positive retention and protection against shock and vibration.



SUBMINIATURE LAMP HOLDERS

Eight series of holders for front or rear mounting into $\frac{3}{8}$ ", $1\frac{1}{32}$ ", or $1\frac{1}{32}$ " clearance holes. For use with replaceable neon or incandescent midget flanged base lamps.



CARTRIDGE LAMPS AND LAMP HOLDERS

Available with solid state, incandescent, and neon lamps. Mating holders mount into $\frac{3}{8}$ " clearance holes.



MINIATURE LAMP HOLDERS

For front mounting into $1\frac{1}{16}$ " clearance holes. Designed to accept replaceable bayonet based neon and incandescent lamps.

**The most unique indicator light
and service program ever offered
to manufacturers**

We're out to win you over to Littelfuses with top quality, fast service, and hard facts. Judge for yourself:

FACT 1. Littelfuse is the only manufacturer that offers all four types of indicator lights, saving you time, paperwork, and money.

FACT 2. Littelfuse has all new tooling and total in-house production capabilities for top quality, better control, and faster processing.

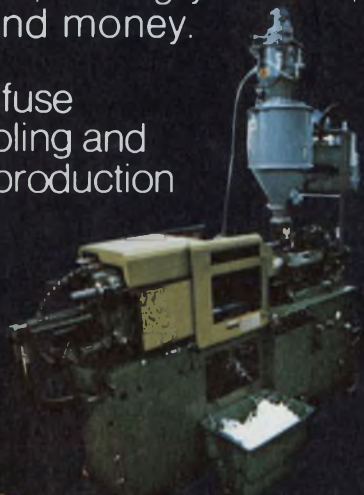

FACT 3. Littelfuse has a computerized service center that can cross reference, price, and provide availability information . . . all within seconds.

FACT 4. Littelfuse means fast, prompt delivery.

FACT 5. Littelfuse has a Littelfuses team of R & D and sales engineers to assist you.



FACT 6. Littelfuse offers the widest selection of packaging available.

FACT 7. Littelfuse offers one-stop shopping for your additional circuit protection and control device needs.

FOR MORE INFORMATION

Contact Littelfuse or your local Littelfuse representative and ask for our

Littelfuses Product Guide or individual product catalogs:



Cartridge Lamps and Lampholders	Cat. No. LL-C574
Subminiature Lampholders	Cat. No. LL-S574
Miniature Lampholders	Cat. No. LL-M574
Snap-Mount Plastic Lites	Cat. No. LL-P574

LITTELFUSE LITTELFUSES

Your indication of quality and service

800 E. Northwest Highway
Des Plaines, Illinois 60016
(312) 824-1188

Subsidiary of Tracor

The R10: our compact, multi-purpose relay.

You might say we designed it to be many things to many people.



Copiers, computer peripherals, communication equipment, business machines, precision instruments—you'll find our R10 in a multitude of applications requiring a compact, reliable, multi-pole relay. That's because it probably gives you more design options than any other single relay.

Consider these choices: Contact arrangements to 8PDT. Ratings from dry circuit to 10 amperes. Six styles of contacts, including bifurcated. Sockets with solder or printed circuit terminals, including one for mounting the relay horizontal to a printed circuit board—and all with or without grounding provisions.

R10 relays have U/L Compo-

nent Recognition. Models to 6PDT have C.S.A. Component Recognition. Life expectancy is to 100 million operations, depending on contacts and load. The R10 is available with a voltage- or current-sensitive coil. Pick-up ranges from 2.25 to 86 VDC, 5 to 86 VAC, or 0.85 to 45 milliamp, with proper power supply. Depending on the number of contacts, the R10 weighs from 22 to 40 grams.

R10 relays are in stock at your leading electronic parts distributor;

or call your P&B representative. For your copy of the 226-page catalog showing the complete P&B line write Potter & Brumfield Division of AMF Incorporated, Princeton, Indiana 47670; or phone 812 385 5251.



Solving Switching Problems
is what we're all about.



Look what 5 volts can get you.

These five DPMs use the same 5VDC supply that powers the digital logic in your system.

This simplifies your design and improves reliability. It saves space, saves money, and reduces the amount of heat that's generated. And, because there's no line-power voltage near the DPM, internally generated noise is virtually eliminated.

So you get more reliable readings. And here's what else you can get for 5 volts. BCD outputs. Overvoltage, polarity, and status indication. Automatic zero correction and programmable decimal points. Aluminum cases that install in a snap.

Each meter is given a seven-day burn-in before shipping. And we're shipping right now.

Our 5 volt DPMs are a whole new class of digital panel meters—a whole new way of thinking. Because now you can think of the DPM as a component, just like any other component in your system.

Take a look below. You'll find a meter that solves your particular problem. Then give us a call. Order a sample.

A low-cost 3½ digit DPM for OEM applications. An advance in price/performance capabilities for 3½ digit DPMs. LED display. Bipolar, single-ended input. Full scale range of 0 to ±199.9mV. 0.05% ±1 digit accuracy. Automatic zero and polarity. Normal mode rejection of 40dB at 60Hz or 50Hz. Common mode rejection of 60dB at ±200mV. Fully-latched DTL/TTL compatible outputs and control interface signals. Optional ratiometric input. Only ¾" deep. **\$89 in 100's. AD2010.**

A high-performance 4½ digit DPM for systems applications. Capable of performing precision measurements of floating differential voltages in noisy environments. LED display. Full scale range of 0 to ±1.9999V. 0.01% ±1 digit accuracy. Automatic zero and polarity. Normal mode rejection of 60dB at 60Hz or 50Hz. Common mode rejection of 120dB at ±300V. Optically-isolated analog section. Fully-latched DTL/TTL compatible BCD outputs and control interface signals. **\$199 in 100's. AD2004.**

A simple, reliable 3½ digit DPM for high-visibility display applications. Incandescent display. Bipolar, single-ended input. Full scale range of 0 to ±199.9mV. 0.05% ±1 digit accuracy. **\$89 in 100's. AD2001.**

A high-performance 3½ digit DPM for systems applications. The kind of performance you need for complex system interfacing and data processing. Incandescent display. True differential instrumentation amplifier input. Full scale range of 0 to ±199.9mV. 0.05% ±1 digit accuracy. Automatic zero and polarity. Normal mode rejection of 40dB at 60Hz or 50Hz. Common mode rejection of 80dB at ±2.5V. Fully-latched DTL/TTL compatible BCD outputs and control interface signals. **\$99 in 100's. AD2003.**

A low-cost 2½ digit replacement for analog meters. Incandescent display. Unipolar, single-ended input. Full scale range of 0 to +1.99V. 0.5% ±1 digit accuracy. Optional: variable reading rates, BCD outputs, and control signals. **\$59 in 100's. AD2002.**

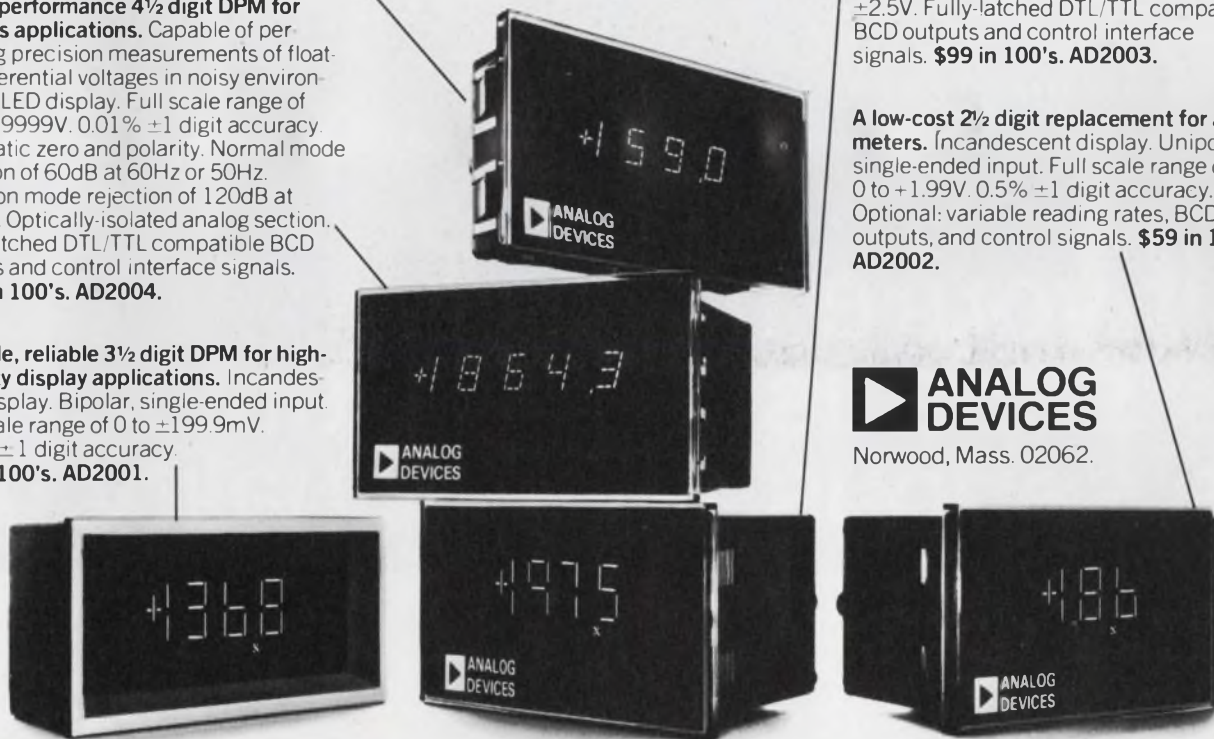

ANALOG DEVICES
Norwood, Mass. 02062.

Call 617-329-4700

for everything you need to know about 5 volt DC-powered DPMs.



New
space
saving
additions
to our
line
of 1/2" diameter
variable
resistors.

If you're really
serious about cost,
be serious about quality.

Our 1/2" diameter variable resistors help you fight panel congestion. Type WR (lug terminals on side of case) and Type WRS (WR with rear mounted SPST switch). Both types give you famous Allen-Bradley hot molded composition resistance tracks for dependable, long term perform-

ance. Power rating 0.5 watt at 70°C. Linear taper available in values from 100 ohms to 5 megs. Four other standard tapers available from 500 ohms to 2.5 megs. Tolerance $\pm 20\%$ or $\pm 10\%$. Request specifications publication 5220. Contact your Allen-Bradley Electronic Distributor or

write Allen-Bradley Electronics Division, 1201 South Second Street, Milwaukee, Wisconsin 53204. Export: Bloomfield, New Jersey 07003. Canada: Allen-Bradley Canada Limited, Cambridge, Ontario. United Kingdom: Jarrow, Co. Durham NE32 3EN.



INFORMATION RETRIEVAL NUMBER 13



ALLEN-BRADLEY
Milwaukee, Wisconsin 53204

Bubble memories advance from chip to module stage

Progress in magnetic bubble memories has advanced from the chip-fabrication stage to the development of bubble-memory modules.

At the International Magnetics Conference in Toronto, several researchers described their work. Among the developments discussed were these:

- A bubble memory from Hewlett-Packard, designed for use in calculators, computers and instruments.

- A simplified packaging method that uses flat-faced coils to produce the magnetic driving field.

- An experimental 460,544-bit mass memory that could replace fixed-head discs.

According to Richard B. Clover, an engineer at Hewlett-Packard Laboratories in Palo Alto, Calif., the HP memory module contains conventional garnet bubble chips, wire-wound coils that produce the magnetic driving field and a permanent magnet structure to produce the bias field. The unit is housed in high permeability, magnetic shielding material.

A novel feature of the HP bubble memory is the double differential detection scheme used. This technique, Clover explained, uses two pairs of chevron stretcher detectors for each serial data stream. By use of this approach, a nearly optimum signal-to-noise ratio is obtained, even in the presence of permalloy domain switching noise, flux pickup from the drive field and turn-on transients.

The differential detector, said Clover, produces a signal that is twice as large as it normally would be, and it yields a device that is independent of the bias field and temperature.

While he would not give the size of the module that was tested, Clover did indicate that the ultimate aim was to produce a memory

of several million bits that could be used with desk-top electronic calculators, instruments and mini-computers.

At the same session, Harumi Maekawa, senior engineer at Fujitsu's Solid-State Laboratory in Japan, described a new method of packaging bubbles with flat-faced drive coils. The chief advantage of the coils, he said, is that they simplify the construction of bubble-memory modules.

The basic structure, Maekawa explained, consists of two sets of flat, elliptically shaped, spiral coils. Each set of coils is composed of two orthogonal coils. Up to 16 bubble chips can be mounted on a substrate, which is then sandwiched between the two sets of coils. The rotating drive field is generated when sine and cosine currents are applied to each set of coils.

In explaining why he chose this approach, Maekawa noted that the structure simplified module fabrication and made it possible to remove chips easily if needed. With the more conventional solenoid coils now used, this is very difficult.

What is probably the largest working bubble-memory module to date was described by Paul Michaelis, a researcher at Bell Laboratories, Murray Hill, N.J. According to Michaelis, the experimental module contains 32,896 14-bit words, for a memory size of nearly half a million bits. This capacity is provided by 28 chips, each of 16,448 bits, assembled on two substrates.

The memory is driven by a 102-kHz rotating field, has an average access time of 2.7 ms and a read/write time of 5 ms.

CCDs proving worth in digital memories

When charge-coupled devices

were introduced four years ago, many designers said that they were good for imaging and linear applications but that they could never compete with standard technology in the digital memory area. Last month the advantages of CCDs in digital memories were underscored at the International Magnetics Conference in Toronto.

CCDs have distinct advantages for memory applications, particularly in the area of high density, papers at the conference indicated. In a presentation on mass-memory applications, Douglas Colton, a researcher from Bell-Northern Research, Ottawa, noted that the technology had advanced to the point where 16-kilobit chips could be fabricated on wafers about the same size as current 4-k RAMs—and at between one-quarter and one-half the price.

Elaborating, Colton pointed out that a serial device could be fabricated on a chip that is 20% smaller than current 4-k devices, while a decoded 16-k memory would require a chip about 10% larger.

In discussing costs, he noted that the serial 16-k unit would cost only one-fourth as much as 4-k RAMs, while a decoded version would be one-half the price.

As for operating characteristics, Colton said that such a 16-k chip could operate at data rates of between 5 and 10 MHz and have an access time of between 25 and 50 μ s.

Colton predicted that chips of this type would be announced by late this year or early 1975. Information from other sources indicates that the earlier date is more likely.

Peering further into the future, Colton said that with CCD technology, 32-k and 64-k memory chips would be possible. He noted, however, that electron-beam fabrication would be necessary to achieve this density.

Joe E. Brewer, an engineer from Westinghouse's Defense and Electronic Systems Center in Baltimore, another speaker at the memory session, disagreed with Colton. He said that if CCD technology was combined with MNOS, cell areas of 0.5 square mils per bit would be possible. This he continued, would allow the fabrication of 64-bit devices on a chip 245 by 245 square mils.

Westinghouse is currently working on NOV-CAM (nonvolatile charge-addressed memory) devices, Brewer reported. He stressed, however, that the company had not fabricated such large devices.

In explaining why such high density is possible with a NOV-CAM device, Brewer said that much of the overhead circuitry required by CCDs is eliminated. This, he continued, is because the information is stored in a nonvolatile mode in the MNOS portion of the device.

Electron beam produces ICs of 0.2- μ line width

With the introduction of the first commercial electron-beam micropattern generator, ICs with line widths down to 0.2 μ on 0.4-centers can be produced from stored digital patterns.

Shown at the Semicon-West '74 show in San Mateo, Calif., the generator—the EBMG 600—is built by Radiant Energy Systems in Newbury Park, Calif. It gives the semiconductor industry a capability that existed before only in the research laboratories of companies like Hughes Aircraft, IBM and Texas Instruments.

Without such equipment, line widths of less than 2 μ are impractical to produce. The width on the new system is held to $\pm 10\%$.

The EBMG 600 can be used for the production of masks or for direct pattern writing on a silicon wafer.

In the direct-writing mode, a 2-1/2-in. wafer can be written in about one hour. According to William B. Livesay, vice president of engineering at Radiant Energy Systems, the process would take about four hours if conventional photolithographic techniques, including an optical pattern generator, were used.

The system includes a computer-aided-design capability by which an operator can develop and design the device structure on an interactive graphic display. Then with the push of a button, he can write the pattern directly into a silicon wafer.

The electron beam is produced by a tungsten field-emission cathode of about 0.5- μ dia. The elec-

trons pass through an aperture, then through an electrostatic lens. After passing through the lens, the electrons are focused, through a set of deflection coils, past the secondary electron detector and then onto the substrate target. The substrate is mounted on an x-y movable table.

A Nova 800 minicomputer with 32 k of core, from Data General, Southboro, Mass., controls the system with the aid of a magnetic tape deck, a 1.2-megaword disc and an interactive graphic display.

The company expects to introduce the EPS-1200 and the EPS-1500 electron-projection and alignment systems to do this job. (see p. 36 of this issue.)

The 1978 automobile: Processing systems

“By 1978 automobiles will be testing on-board processing systems to handle such functions as electronic fuel control, ignition control with automatic spark advance, generator control and cruise control.”

The prediction is made by Robert B. Hood, manager of advanced automotive products at Fairchild Camera and Instrument, Mountain View, Calif. Hood, who will speak at the Automotive Electronics Conference and Exposition in Detroit, June 11 to 13, says the auto industry will probably have a system in which all vehicle communications are handled via digital multiplexing.

The same box for on-board processing systems, he says, could also be part of a closed-loop servo control for the throttle position, for the distribution of cylinder-to-cylinder fueling and ignition selection, for signal processing for the dashboard tachometer, for diagnostic functions and for some emissions control—perhaps direct exhaust gas feedback.

With digital multiplexing, Hood says, vehicle wiring harness will be reduced to perhaps four wires: positive power (battery), data bus, control bus and negative power (ground).

The problem, he explains, is not in the complex areas like LSI, as formerly believed, but in the sensing function and the development

of actuate functions. The actuate functions are particularly difficult, Hood says, because the load used by the automobile manufacturers for electric window motors and for electric seat controls are subject to large transients in current and voltage.

Electronics will dramatically improve safety, emissions and economy, Hood says, and “in the long run, electronics will decrease the cost of cars.”

New switch cuts cost of liquid-crystal panel

Using liquid-crystal light valves and a new type of switch, Rockwell International has developed a portable control panel that it says is 10 times cheaper to produce than the mosaic of switches and lights now used.

According to Larry Tannas, head of the Display Technology Group in the Anaheim, Calif., company's Electronic Research Div., the panel—called a keyboard entry device—is a one-piece sandwich of plastics, glass and organic films. It is completely transparent.

The panel measures 4 by 8 in. and contains 64 separate switch/display elements. Switches are composed of a layer of flexible plastic, on which are deposited indium-tin oxide contact, a liquid film of a transparent petroleum dielectric and another indium-tin oxide electrode on a glass substrate. When pressure is applied to the switch, the liquid dielectric is forced out, and the two switch contacts come together.

The glass substrate of the switch is the top half of another sandwich, this one comprising the liquid-crystal light valve.

To use the keyboard entry device, the engineer places a sheet of paper that contains the data for display under the transparent panel. By appropriate circuit design, the panel can display information in a normally visible mode or a normally blocked mode. In the blocked mode, the liquid-crystal light valves prevent the information from being viewed, notes Tannas.

The unit was originally developed for the Navy Electronics Laboratory Center in San Diego.

SerenDIP-itous reminder

A versatile family of solid state DIP relays

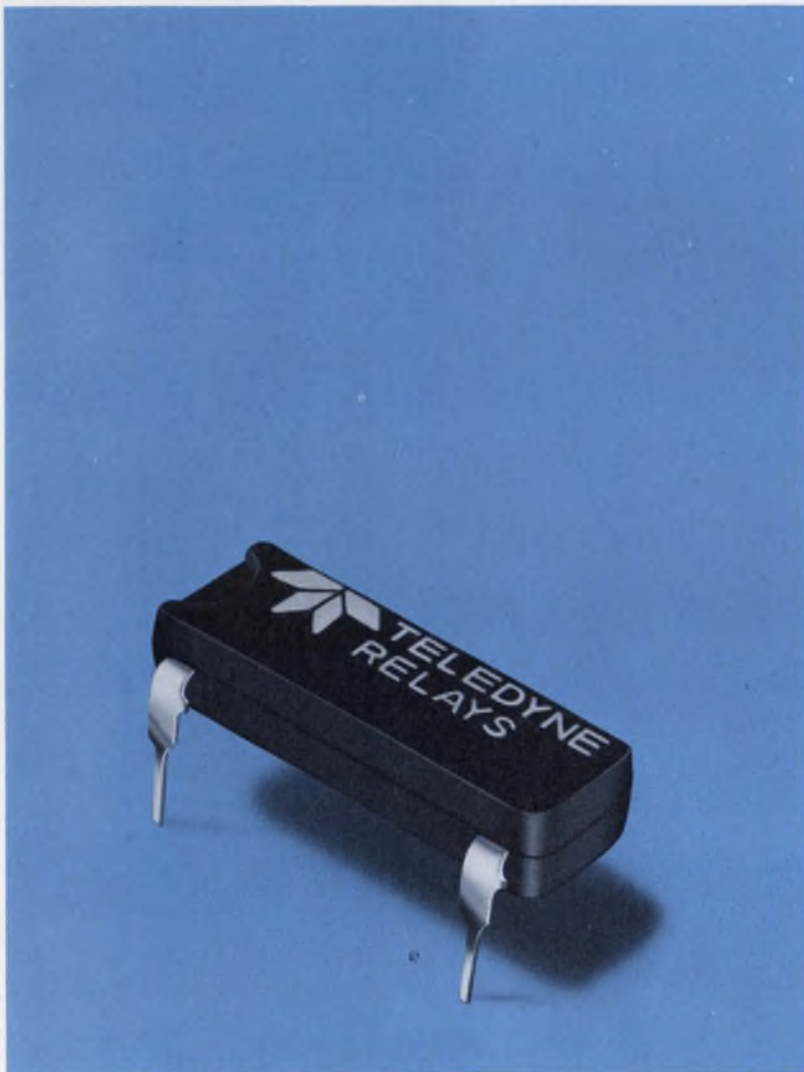

Serendipity is a gift for finding valuable or pleasant things you hadn't looked for. Teledyne, the world's largest maker of solid state relays makes serendipity for engineers — We make SERENDIP®s.

The SERENDIP® family includes four kinds of solid state DIP relays for different jobs. They up-grade, with all the advantages of solid-state — total input/output isolation, low-level logic input compatibility, fast response time, no "contact bounce" (drive IC's directly), and long life dependability. All this in low profile TO-116 DIP packs with equally low cost.

About those different jobs. The 640-1 features bi-polar output, AC or DC up to 50v/80Ma, with low ON resistance — 2 ohms typical. Use it for isolated line drivers and data couplers, A/D converters, modulators and demodulators.

The 641 is a small AC powerhouse — 1 AMP Triac output, 140 or 280 VAC with a 10 AMP surge rating. Try it for lamp or inductive load control — solenoids, motors, transformers, etc. And the 641 is now UL recognized.

The 643's are DC versions capable of switching up to 60v/400Ma or 250v/100Ma. They actually exceed current and voltage switching capabilities of opto-isolators. In communications, use them for keyer switching — or as telegraph relays.

Finally, the 644 is a low offset voltage unit that solves switching problems in instrumentation applications. Use it for low level transducer signal switching, series choppers, scanners, sample-and-hold, multiplexing, etc.

The SERENDIP® family — a pleasant reminder from Teledyne Relays. Ask your rep or distributor, or call us.

 **TELEDYNE RELAYS**

3155 West El Segundo Boulevard Hawthorne, California 90250
Telephone (213) 973-4545

MOSTEK's 16-pin 4K RAM makes memory design easy.

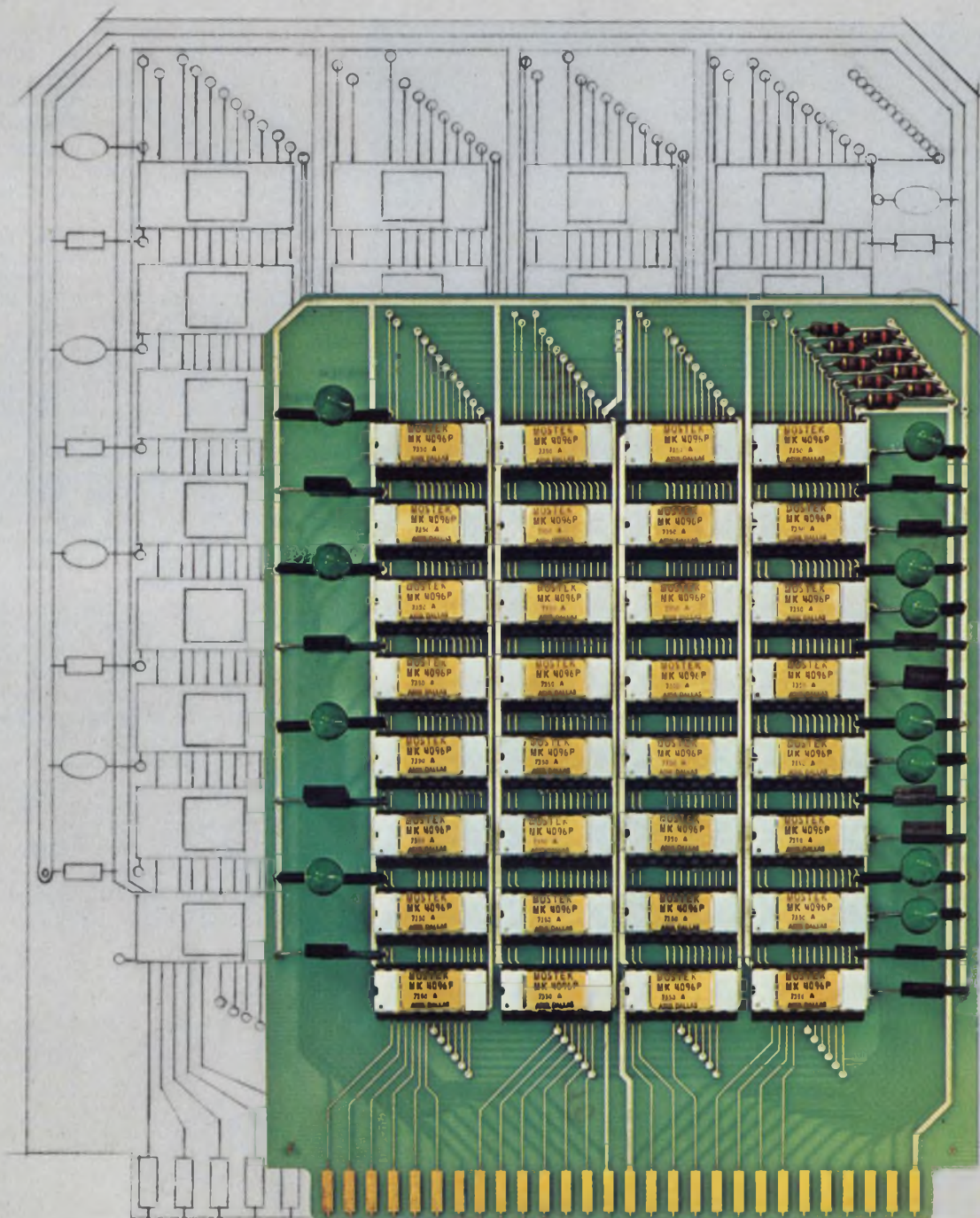

MOSTEK's MK 4096P enables you to reduce memory board size by 50%.

With MOSTEK's MK4096P you can reduce memory board size by 50% and power dissipation by 45% over 22-pin RAMs with no increase in package count. Add up the advantages for yourself.

The MK4096 incorporates TTL-compatible clocks, eliminating the need for special high-voltage clock drivers required by 22-pin competitive devices. Low clock line capacitance with the MK4096 means fewer drivers and less delay.

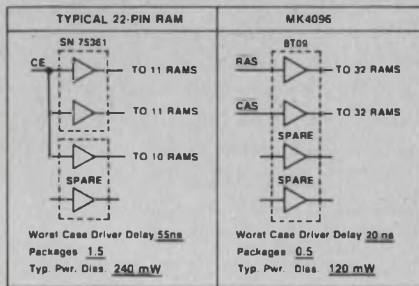

Fewer signal lines and signal drivers required. Compared with 22-pin packages, the MK4096 requires six less address lines to be driven throughout the memory matrix. In addition to making PC layout easier, this means fewer address drivers are required.

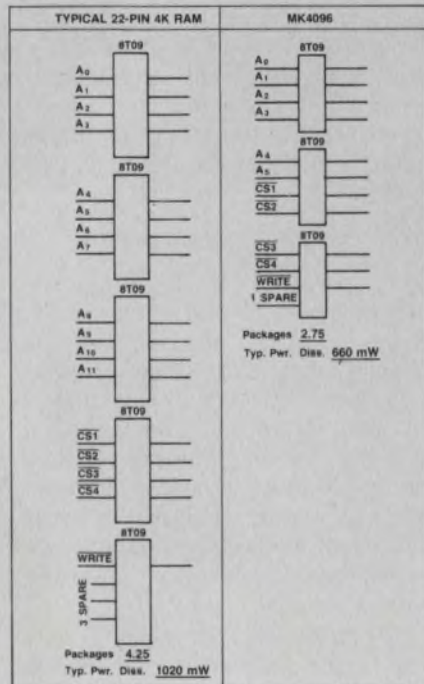

Only standard TTL required for chip select decode logic. Using MOSTEK's MK4096, two-level decode logic for

a 16K by 8 memory matrix can be implemented with standard or "L" series TTL, whereas "H" or "S" series is required by competitive 22-pin 4K RAMs. This is because the MK4096 requires decoded chip select information to be valid at the Column Address Strobe (CAS) leading edge which is 150 nsecs into the cycle. The 22-pin alternates require valid chip select information no later than 70 nsecs after the cycle begins.

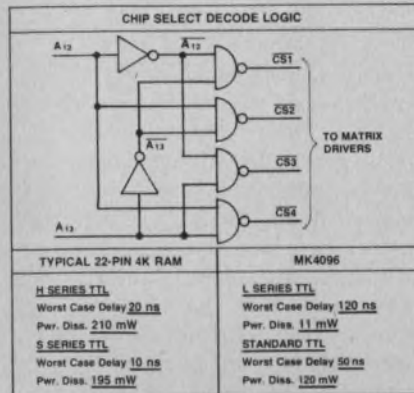

No additional packages required for second strobe or clock signal.

Timing specifications for the MK4096 allow use of the existing WRITE signal timing logic as the Column Address Strobe generator so no additional timing channel needs to be added to the memory controller. Thus there is no requirement for additional packages.

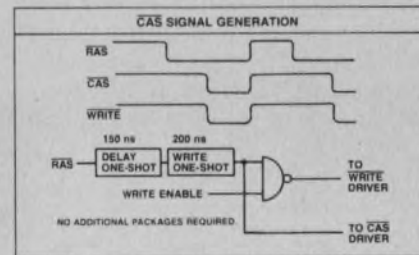

Address multiplexing is accomplished easily. Multiplexing of addresses is common to all memory systems using dynamic RAMs due to the refreshing requirement. 22-pin 4K RAMs require a 6-bit refresh address as does the MK4096. The only additional requirement with the MK4096 is that the address be multiplexed in two 6-bit bytes, accomplished with a multiplexer that is 3-wide instead of 2-wide and a multiplexer control that is 2-bits wide instead of 1-bit wide.

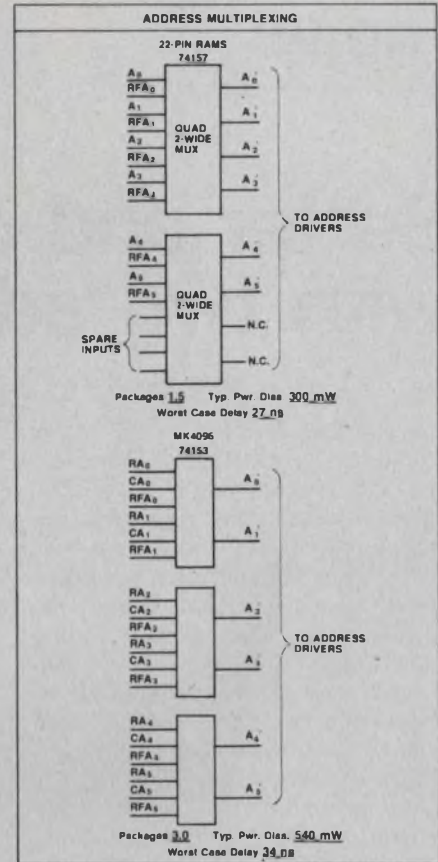
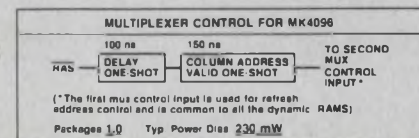

Result? The MK4096 scores highest in density, lowest in power dissipation and requires no additional packages in the memory controller.

	TYPICAL 22 PIN 4K RAM	MK4096
Total Packages	7.25	7.25
Total Typical Power Dissipation	1770 mW	1561 mW
Total Power Dissipation Including Rans	23.53 W	14.36 W

Add up the advantages of MOSTEK's 4K RAM and you'll understand why it's already becoming the industry leader in design ease, performance and volume availability. Call your nearest MOSTEK distributor or representative for more details or contact MOSTEK, 1215 West Crosby Road, Carrollton, Texas 75006, (214) 242-0444.

Now, alternate sourcing of the MK4096 by Fairchild!



Better and cheaper ICs on the way with two advances in processing

The first machines for fully automated processing of IC wafers are now commercially available, and the benefits for designers are expected to be substantial.

Dr. Sam Harrell, vice president of engineering for the Cobilt Div. of Computervision Corp., Sunnyvale, Calif., developer of the machines, sees a breakthrough in IC production speed, accuracy, uniformity and lower costs.

[In a related development, the first commercial electron-beam-projection system is expected shortly, with promise of faster, denser, more reliable ICs. p. 36.]

"There are a number of important variables in photoresist processing which are pinned down by automating the system," Harrell explains. "The automated processor assures the condition of the

wafer surface—protecting it from scratches and contamination from handling. Other parameters more closely controlled by the machine than by operators are: the uniformity of the resist coating, the time-temperature cycle in baking, and mask alignment, contact and exposure. Finally the small size of the machines permits a smaller, more controlled clean room."

Called the Autofab I and II, the two fabrication systems differ in layout but not in performance. Autofab I delivers the completed wafers at the opposite end from where they are loaded, and Autofab II uses a U-shaped process, delivering them at the same end of the system.

The systems are reported to process up to 180 1.5-to-4-in. silicon wafers an hour from raw material to the ready-to-diffuse state. The process is totally automatic, limiting the function of the operator to loading and unloading

wafer cassettes and watching fluid supplies.

In conventional IC production, a silicon wafer, containing a large number of potential chips, must go through the wafer fabrication step several times. Each time a layer is added or etched away—during oxide growth, epitaxial growth, diffusion or metallization—the wafer-fabrication process defines the limits of the area to be processed. A thin layer of photosensitive emulsion or resist is applied to the wafer. The wafer is coated with an emulsion while it spins, to produce a uniform thin layer.

Next, the coated wafer is soft-baked to drive off the solvents from the resist, put in contact with a photo mask and exposed. After exposure, the wafer is developed and unexposed areas are removed by a solvent.

Finally the wafer is hard-baked to render it ready for processing. Errors produced by faulty coating, poor mask alignment or improper development are cumulative—making wafer fabrication a major factor in determining IC yield and quality.

Up to 25 steps automatically

In operation, a standard cassette holding 15 wafers is placed on an unloading station—and the system takes over. The cassette is lowered, and a wafer is picked out by a drive belt and delivered to a photoresist spinning station. The spinning cycle has a controlled acceleration rate, and as the resist is applied, the wafer undergoes a programmed cycle of spinning at various speeds.

After spinning, the wafer is carried to the bake oven. Inside the oven, the wafer is handled by an Archimedes screw system, designed to allow the maximum number

Northe K. Osbrink
Western Editor

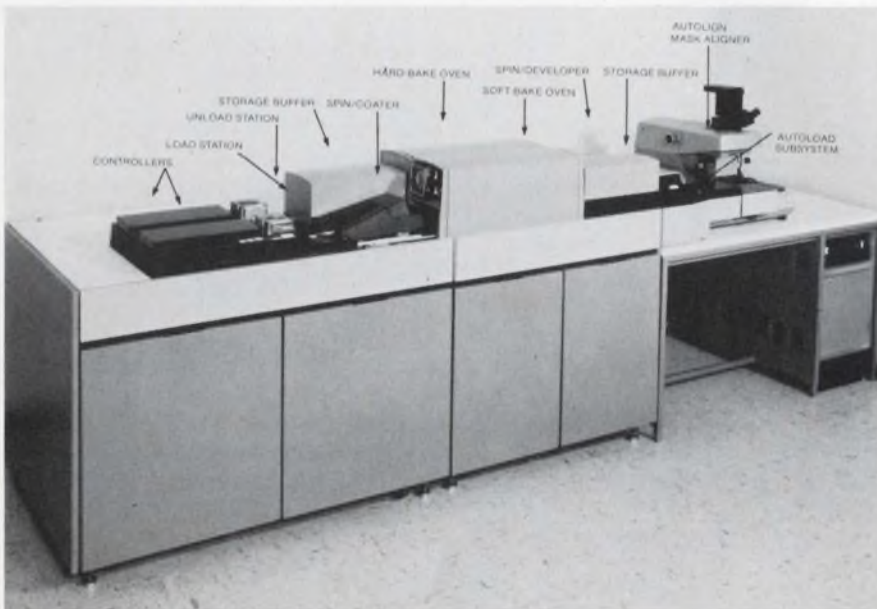

Automated wafer-fabrication system, the Cobilt Autofab II, measures 6 by 12 ft. It can process up to 180 IC wafers an hour.

Picture video copies like these as part of your system.

\$3395, single unit price.

Hard copies are the record keeper of modern display systems. They're a time-saver, too, providing output for busy people to read at their leisure. Unfortunately, however, copy quality has been inconsistent. Until now. Look at our versatile, low-cost 4632 Video Hard Copy Unit!

Our 4632 gives your systems consistent high quality, high resolution, grey scale and black and white copies on 8½" x 11" paper. In other words, copies you can read.

It interfaces quickly to alphanumeric or graphic display terminals and scan converters. All you need is access to one of these video sources:

1. Composite video; 2. Video, horizontal drive, vertical drive; 3. Video, composite sync. And it operates at any standard line rate.

The 4632 is a dry process performer using 3M® Dry-Silver paper. It's light and compact, yet built sturdily for hard use and designed for easy servicing.

We have more display ideas for your system, too. Such as scan converters and a full line of monitors and displays. OEM and end user quantity discount prices available. For the complete picture, phone your nearby Tektronix office or write: Tektronix Information Display Division, P. O. Box 500, Beaverton, Oregon 97005.



Graphics. The mind's eye, for those who think tomorrow.

of wafers to fit in a limited area. Because of the better control of heat flow in the closed oven, the equipment is said to consume about half the electrical energy of a conventional open-ended tunnel oven.

At the oven output is a "buffer storage," which can hold up to 50 wafers.

Once coated and soft-baked, the

wafers are delivered to the Auto-align machine by a series of rubber drive belts. The mask aligner uses a closed-loop position-sensing and control system to bring the wafer into alignment with the mask. The mask and wafer are brought into contact only during exposure, and a low-pressure nitrogen pillow behind the wafer allows uniform contact with a minimum of pressure.

After exposure, the wafer is delivered to a spinner for solvent development, and finally to a hard-bake oven and the output station.

Autofab I is about 3 ft wide and 22 ft long, and Autofab II is the same width and 11 ft long. Both units are in the \$100,000 price range, with deliveries scheduled to start in the third quarter of this year. ■■

Electron-beam-projection system gives 3-way improvement in ICs

Faster, denser and more reliable ICs are promised with the imminent availability of the first commercial electron-beam-projection system.

The new machine, called the EPS-1200, is being developed by Radiant Energy Systems, Inc., Newbury Park, Calif., and the company says it will be available before the end of the year. In addition to improving ICs, the machine is said to be capable of improving production by eliminating defects caused when masks wear out.

According to Evan Friedmann, the company's manager of electronic engineering, the EPS-1200 can handle 3.5-in. wafers. The throughput rate is currently 60 wafers an hour, but that should be increased soon to 180 wafers an hour, he says.

The electron-projection system, the result of four years of developmental work, uses a PDP 8/E minicomputer to provide totally automatic operation. Several companies, including IBM and Thompson CSF, have tried to produce a commercial electron-beam-projection system, Friedmann reports, but have not yet been successful.

For a commercially acceptable system, he explains, two requirements must be met: A means of making high-speed, accurate alignments must be developed, and a way of making low-distortion image projections must be found.

Friedmann says that Radiant Energy Systems achieved accurate, high-speed alignment by projecting an electron beam, detecting any error signal that results from misalignment and then feeding the error signal into the PDP 8/E mini. The mini takes the signal, calculates where the electron beam should be and produces a signal that controls the magnetic field that steers the beam. Thus the computer closes the feedback loop to correct the beam position.

Why low distortion is important

Explaining why a low-distortion image is important, Friedmann points out that multiple alignments are necessary in the manufacture of a device. If there is localized distortion in the magnetic field, positioning of the wafer in the magnetic field becomes extremely difficult. To overcome the highly restrictive mechanical requirements of such a system, it is necessary to eliminate magnetic distortion in both the focusing and steering fields of the electron beam. Radiant Energy Systems does this by maintaining, as nearly as possible, a perfect axial electric field and by choosing the proper materials and geometrical configuration.

The electron-beam-projection system can produce ICs between 0.2 and 0.5 μ wide. This is an order of magnitude better than results with conventional photolithographic techniques. The smaller line widths mean that it is possible to produce higher-density devices that are faster and more reliable.

A one-order-of-magnitude decrease in line size means that theoretically it is possible to increase the density of ICs by two orders of magnitude. But, as Friedmann points out, that is not exactly so. The more devices that are fabricated on a chip, the more interconnects required. This increase in space-eating interconnects limits density increases to less than two orders of magnitude. Still, the space saving is great.

The increased density of electron-beam-fabricated circuits can result in simpler circuits. For example, with MOS devices, it often is necessary to "go off chip." This frequently means that additional driver circuits are required. But if the functions of several chips can be performed by a single device, it is possible to minimize the interface circuitry.

Another big plus for the electron-beam system, Friedmann says, is that infinite mask life is possible; there is no mechanical contact between the mask and the substrate.

The highest resolution for an optical system is obtained when the mask comes in contact with the substrate. As soon as the mask moves away from the substrate, diffraction effects result in loss of resolution. This is because it is difficult to focus and control photons.

Electrons, however, do not suffer from these problems. They can be controlled both magnetically and electrically. As a result, it is possible to focus an image with extremely high resolution. ■■

Ludwig Lectures.

Getting a fix on fast settling.

In numerous linear-circuit applications where the nature of the signal is pulse-like or step-like it is essential to reach a new level quickly and accurately after a large signal transition. However, we find that we cannot predict this performance from the classical specifications of frequency response and slew rate. Therefore, a direct specification — settling time — was established which defines the maximum total time required from the occurrence of an abrupt input transition until change is *satisfactorily complete*.

A slight misunderstanding...

The major areas of concern are in defining the input conditions, and what it means for the output change to be satisfactorily complete.

The real settling spec ought to cover these by defining a settling time to within X% (for example .01%) of final value for a large signal change (usually 10V) on the input. But both must be stated.

Close, but no cigar.

Some vendors base "Settling Time" specs on a small step change at the input and you still don't know what will happen in the large signal case. But the issue of "satisfactorily complete" on the output is full of cute pitfalls — let me show you.

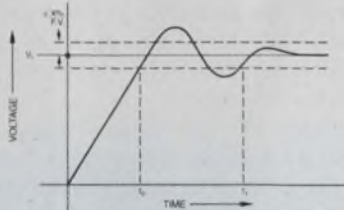

Notice in the curve that the output first occurs with $\pm X\%$ of full-scale-error-to-final-value at t_0 but doesn't stay within this error band. It thereafter bangs around due to the underdamped nature of the system. The real settling time should be stated as t_1 .

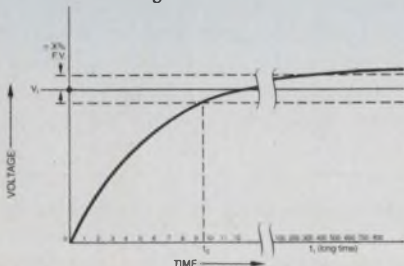

Now look at graph B. The response is critically damped and settling seems to occur at t_0 . But watch out. If we look far down scale we note that the apparent final level V_1 wasn't the final level at all.

Question, how long do you wait to define what V_1 (final level) really is? You have to figure that out.

This long settling "tail" often occurs with time constants long compared to any computable electrical time constants in the system and is usually the result of less than ideal thermal management or slight pole/zero mismatch. If you're trusting your vendor's settling time measurements, make sure that you (and your vendor) understand his definition and their use of it, otherwise you're in trouble.

Who needs it?

Anyone handling signals having discontinuities needs fast settling. For example, following a multiplexer, on a PAM Bus, at the output of a DAC, in building a precision square wave, at the input to an oscilloscope, etc.

How good can you have it?

At Philbrick we give you *guaranteed* settling time because we figure your system has to always meet its spec — not just typically and that's more than just important. We offer a host of op amps, discrete modules, hybrid IC's and monolithic IC's with state of the art settling including our T0-99 units, 1322 (300 ns to .1%), 1324 (1 μ sec. to .01%) guaranteed. The star of the show is our new DIP unit with FET inputs, the 1430, which offers 100 ns to .1% and 200 ns max to .01%. And you

don't give up dc performance to get it. The 200 ns to .01% is just what you need for a fast 12 bit system. The open loop gain of 200K, input currents of 150pA, and an offset voltage of 1mV give you the dc accuracy to go with it. The 50 mA output capability will let you drive almost anything, but you don't pay for it with high quiescent current and its attendant power consumption.

Don't settle for less.

You could have the fastest settling op amp in the world and get lousy system settling unless you're very careful. Some of the common pitfalls that catch people are things like too much load capacity, too much summing point capacity, too high a circuit impedance for the stray and input capacities, use of inductive wire-wound resistors, and not figuring on the effect of current source output capacities in current-to-voltage converter applications. You've got to handle your power supplies very carefully too, by bypassing up close to the unit with the right kind of capacitor.

In any event, to make sure you get the right story on settling time and use the information properly, telephone, (617) 329-1600. Or write us, Dedham, Mass. 02026. In Europe, Tel. 73.99.88, Telex: 25881. Or write, 1170 Brussels, Belgium.

 **TELEDYNE
PHILBRICK**

Dave Ludwig
Director of Engineering



Comes the satellite revolution in American communications

At first glance, domestic satellites are only a small part of the nation's communications network. Just one such American satellite is up—Westar—and only one other satellite—another Westar—is scheduled for launching this year.

But that's just the tip of the iceberg.

Within three years at least five other domestic communications satellites will be launched. And by then, the state of communications in the United States will have been changed unalterably. A new era of faster, cheaper, more versatile communications is opening.

Four corporate organizations are now either providing communication services via satellite or are preparing to. Some are leasing channels from Canada's Telesat Anik II satellite. One plans to lease channels from Western Union's Westar. Three are building satellites of their own. And they all have their own earth stations and will build more in response to demand.

Western Union's system, which is holding a third Westar in reserve, uses five earth stations.

American Satellite Corp. and RCA both lease channels from Canada's Telesat Anik II satellite.

American Satellite, a subsidiary of Fairchild Industries, plans to cancel its channels with Anik II and lease channels from Westar.

RCA Globcom has four earth stations working with its Anik II channels and will soon build two more to serve Alaska. By early 1976, RCA expects to have three satellites of its own in orbit, with plans to build more earth stations

as business demands.

CML, a joint venture composed of Comsat General, MCI and Lockheed, is an approved participant in the competitive satellite arena but has not formally asked for approval of a technical design. "We will do this sometime this year," a spokesman for the joint venture says. "We hope to have a system up in early 1977."

A fifth satellite system, not in competition for private business with these four—at least for the first three years of operation—will be put up by Comsat General for American Telephone & Tele-

graph and General Telephone and Electronics. This system will consist of three satellites in orbit, with a fourth held in reserve for immediate launching, if needed. AT&T and GTE will build a minimum of nine earth stations for their satellites, which they will operate themselves.

AT&T and GTE's satellite channels will provide, by satellite, more of the same data-transmission service now available with their land lines—telephone, television and telecopier. They will simply accommodate the normal, expected growth in domestic communications, and they may even bring down the prices a little.

The competing systems, on the other hand, promise new services. Voice, video and digital data transmission, which now costs industry billions of dollars a year via non-competitively operated land lines, will be much cheaper and therefore will be used to a much greater extent. Western Union says its satellite services will cut costs to industry by 50%.

Instead of buying these services from AT&T, a company will be able to lease channels from competitive carriers and set up its own internal network. A big corporation, for example, will be able to bring together its far-flung division managers for conferences via satellite and closed-circuit television.

Reports, designs and schematics can be facsimiled from one plant to another over a company's own leased network, instead of being

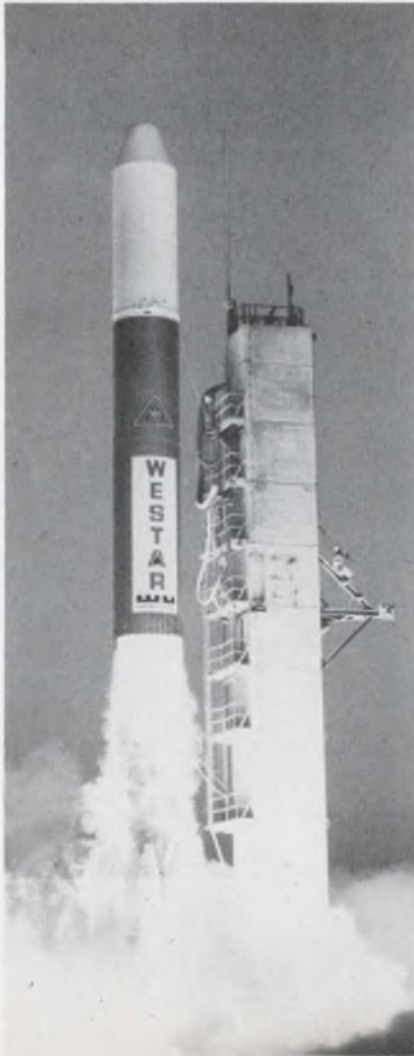

Roaring into orbit in April, Westar is the first of four planned domestic communication satellite systems. Westar, owned by Western Union, has 12 channels.

John F. Mason
Associate Editor

Due to a major industry breakthrough it is now possible to get gassed automatically.



The breakthrough: \$990 for a full-blown OEM computer in quantities of 200—the NAKED MINI®/LSI. The possibilities? Virtually endless.

With our new mini, for example, you can build the gas station of the future. Right now. Because the NAKED MINI/LSI makes it economically feasible to handle even the most mundane jobs by computer.

For instance: complete self-service gas pumping by inserting credit cards or cash. Automatic card verification. Taking “bad” cards out of circulation. Volume profiling by hour, day, month or year. Round-the-clock monitoring of activities. Alerting security centrals to vandalism, excessive gas fumes or fires.

But there's a lot more. Our computer can also run station vending machines. Help plan gas delivery schedules. Talk to motel/hotel computers so the traveler can make advance reservations by credit card.

Still, with all these added tasks, you're only using a small percentage of our available computer power. The power of our full-scale LSI processor with 168

instructions, 4K x 16 memory and fully implemented input/output for low-cost interfacing.

At \$990 per mini, you can afford to take new design routes. Develop new functions that result in better mileage and more convenience for you and your customers. It could be an innovative drive for gas stations or any other business that would profit from computer automation.

Write or call: Computer Automation, Inc., 18651 Von Karman, Irvine, California 92664. Tel. (714) 833-8830. TWX 910-595-1767.

THE NAKED MINI® COMPANY
Computer Automation, Inc.

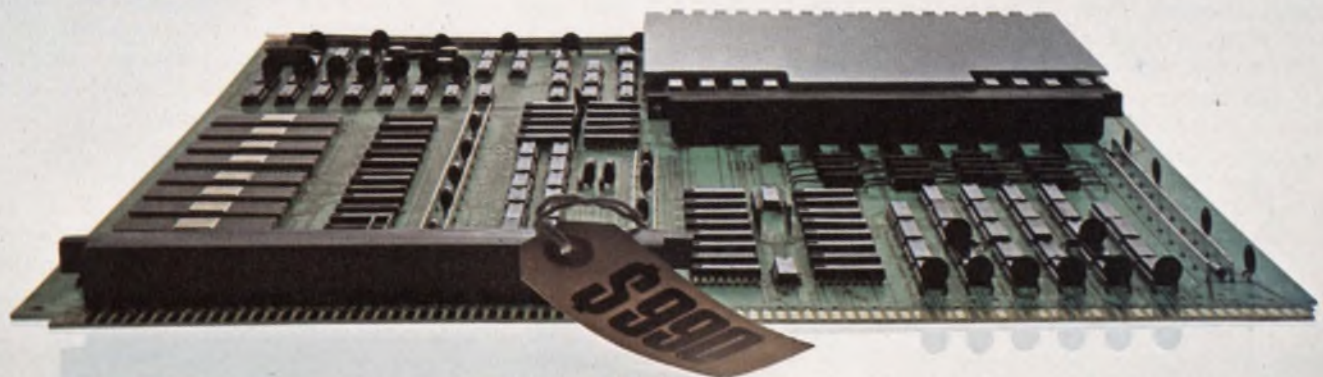

*NAKED MINI is a registered trademark of Computer Automation, Inc.

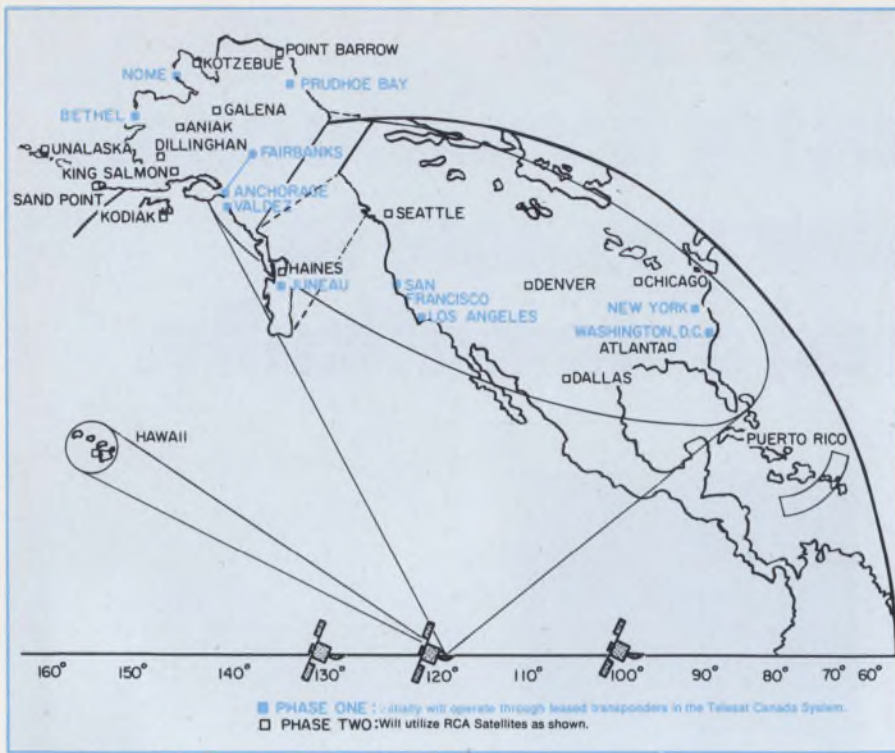

RCA Globcom now leases channels from Telesat Canada's Anik II satellite. With Phase II, Globcom will use its own 24-channel stations with a number of new earth stations, as shown.

sent by mail. And the Federal Government will get data around the country faster and cheaper than it now does.

Cable television will get a boost from these commercially owned networks, especially with the aid of single-channel-per-carrier devices—equipment that enables a ground station to receive a channel addressed specifically to it.

All this has been slow in coming because the Federal Communications Commission has moved with caution, big companies have jockeyed around with first one joint-venture partner and then another, the potential market has been hard to pin down, and powerful pressure groups have been at work. One big potential customer the carriers had counted on for a long time slipped right through their fingers—the television networks.

"TV was interested until AT&T cut the land-line rates so drastically they cooled off," one carrier representative says.

Meanwhile designers didn't know what to do. Some companies thought a 124-channel satellite would be about right.

What finally went up was Western Union's 12-channel Westar, built by Hughes Aircraft and al-

most identical to the Canadian Anik II, which also has 12 channels and also was built by Hughes.

CML's design is not final yet, but it will probably operate at 12 and 14 GHz, instead of the 4 and 6 being used by the other stations. And it will use "between four and 12 wide transponders—transponders 105 MHz wide rather than the 36 MHz width being used by the others," a spokesman says.

RCA's Globcom is going a step beyond its competitors. Its satellites, now being built by the RCA Astro-Electronics Div., Princeton, N.J., will each have 24 channels. It will weigh 2000 pounds, light enough to be lifted into orbit by the relatively inexpensive Thor-Delta 3914 rocket.

Comsat General's satellite being built for AT&T and GTE will also provide 24 channels but will weigh 3700 pounds and will be boosted into orbit by the more expensive Centaur rocket.

What today's network is like

Westar, like all domestic communications satellites in orbit or planned for orbit, is synchronous, hanging over a fixed position on the earth. Each transponder is

capable of relaying to any of its five earth stations data at 50 megabits per second, one color television signal with program audio or 1200 one-way voice channels.

The spacecraft is spin-stabilized. Electrical power is supplied by approximately 20,500 solar cells, which cover the drum-shaped spinning body. Approximately 200 W of prime power are needed for proper operation of all its communications systems, and this should still be available after seven years of operation.

The heart of the system is a communications repeater, which consists of 12 independent, fixed-gain amplifiers, each with a bandwidth of 36 MHz. Common to all transponders is a wideband receiver that establishes the system noise temperature, translates 6-GHz receiver carriers to 4 GHz for down transmission and amplifies the 4-GHz carriers to an intermediate power level prior to channeling the transmission.

Two multiplexers, each incorporating six waveguide filters, allot received signals to odd and even transponders. High-efficiency TWT amplifiers boost the signals.

The Westar satellite antenna is a lightweight, five-foot-diameter parabolic reflector skeleton with supporting ribs fabricated of an aluminum honeycomb graphite-fiber composite. A gold-plated, metallic-knit material covers the parabolic skeleton.

The antenna feed consists of four horns, common to both transmit and receive, and of separate feed-drive networks for incoming and outgoing signals. Transmit signals are polarized parallel to the satellite spin axis and receive signals perpendicular to it.

Each of the five earth stations has a single 50-foot-diameter antenna pointed at the prime traffic-carrying satellite. A second 50-foot antenna will be installed at all earth stations during the first quarter of 1975 to provide access to the second satellite.

The earth stations will be equipped with either analog or digital multiplex, as required. They initially will access five transponders, through appropriate transmitters and receivers to provide a network for voice and data traffic.

RCA's 24-transponder system,

We have a keyboard to fit every need and every budget.

At MICRO SWITCH, we have the world's most complete line of solid-state keyboards. Which means unmatched design flexibility for you.

Our application engineers will custom tailor a keyboard to your exact specifications. Whether from our time-proven SW series or our new low-profile SD series.

Choose from keys offering over 8,000 legends, 30 colors, and 60 shapes, including standard, sculptured or re-legendable keys.

Or create new keys to fit your needs. Even lighted and two-level keys are available.

MICRO SWITCH keyboards are available with features like MOS, TTL and DTL encoding, and with two-key or N-key rollover. Your choice of arrays include standard touch typing and point-of-sale.

Working with MICRO SWITCH, you draw on our extensive solid-state experience. We've been designing reliable keyboards for hundreds of

applications since 1968 and are presently producing over 1,000 units a week. Each offering a 1% AQL and two-year warranty. This means we can supply you quickly at lower unit prices.

So whatever your needs, and whatever your budget, we'd like to supply a keyboard to fit. Contact a MICRO SWITCH Branch Office for complete information.



MICRO SWITCH
FREEPORT, ILLINOIS 61032
A DIVISION OF HONEYWELL

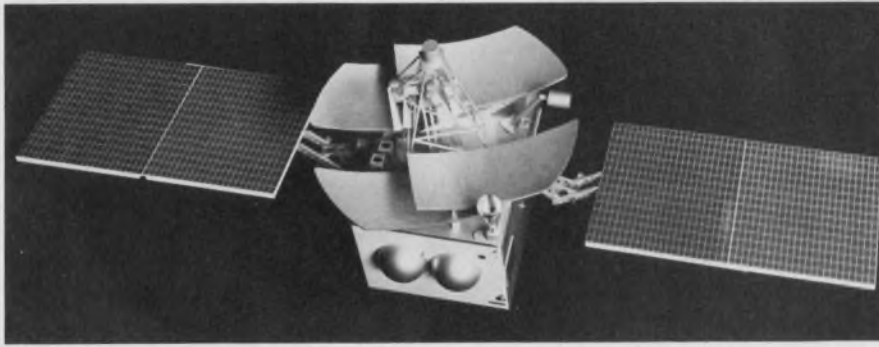

A new generation of domestic communications satellites will emerge with RCA Globcom's 24-channel satellite, scheduled to go up in early 1976.

still under development, will incorporate three features not found in the 12-channel domestic communication satellites:

1. Three-axis attitude control, which allows extra weight in the communications payload and power margins over current dual-spin satellites.

2. Cross-polarized signals to enable frequency reuse.

3. Graphite-fiber, epoxy-composite material for each of 24 input and output filters. These are considerably lighter than the invar filters normally used.

"Three-axis stability was not formally requested in Globcom's performance requirements," says C. R. Hume, manager of the RCA Satcom satellite program in Princeton. "It just turned out to be the best solution. It provides more power and enables us to operate all 24 transponders at once. You don't get the power out of a spinner that you do out of a three-axis craft, whose panels are pointed toward the sun all the time."

Cross-polarization has allowed RCA to get twice the amount of channels from the same frequency band, Hume says. "What we've done," he explains, "is arrange the antenna reflector so that one paraboloid overlaps the other."

The 500-MHz band is divided into 12 channels, spaced 40 MHz apart and polarized. A second group of 12 interstitial channels is cross-polarized with respect to the first group.

"If you feed one reflector from a horn with rf that is polarized in one direction, the wires will reflect those waves," Hume notes. "If, however, you also illuminate it with a signal that is polarized in the other direction, the wires will not

reflect that polarization; the signal passes through because the material is rf transparent. But you're getting reflection from both antennas, one from the back and one from the front."

Significant weight reduction was achieved by switching from invar to graphite-fiber, epoxy-composite filters as the basic material for waveguides. The material consists of layers of graphite fibers bonded with interleaved layers of cured epoxy resin. This factor, coupled with constraints associated with the mechanics of fiber application to the waveguide cross-section, results in a waveguide laminate design that provides a coefficient of thermal expansion similar to that of invar along the length of the waveguide and across the waveguide width. The thickness of the material used in the waveguide, however, has a significantly different expansion characteristic.

RCA considered going even further in reducing the weight of the filters, by examining an elliptical design. "But there are still electrical design problems not solved in such a configuration," Hume says. "There are more couplings between the sections than there are using the Chebyshev approach."

RCA's satellites are also designed for operation in the 4 and 6 GHz bands—4 GHz down and 6 GHz up.

Looking to the future

RCA considered going to the relatively unused 14-GHz frequency rather than the much-used 4 and 6-GHz band, which is the standard frequency for common-carrier microwave links. Using 4

and 6 GHz means building earth stations far enough outside of a city to avoid interference with the normal microwave communications. And this, in turn, means building costly communications from the earth station to the city.

"The 14-GHz band wouldn't have interfered with anything in a city and could have been brought right into town," Hume says. "But the cost of putting 14-GHz equipment in the satellite outweighed all these advantages and 4/6 GHz equipment was used.

"Eventually we'll probably go to 40 GHz, using a completely digital mode. But technologically, 40 GHz isn't quite here yet."

AT&T is going to experiment with 32 GHz in the satellite that Comsat General is building for it.

"Advanced technology is used throughout the design where it pays to do so," Hume says. "ICs and CMOS are common. There may be some LSI, but no significant amount. LSI doesn't really pay off in a package this small."

"We're using a 98-foot antenna now because we happen to have one," Hume says. "But generally speaking, for four or five circuits, you need a 15-foot antenna. When you have 50 or more circuits, a 33-foot antenna is useful. And for thousands of circuits, you need a 98-footer."

Hume adds: "With FCC approval we propose to use 10-foot antennas in places like Alaska, where they have to be taken in by helicopter."

The big innovation in ground networks is the single-channel-per-carrier technique, which is incorporated in earth stations being built by the General Electric Space Div. in Valley Forge, Pa. The stations are equipped with a Demand Assigned Multiple-Access capability, a GE spokesman explains, which permits any incoming trunk at any location to be connected to any other trunk. The transmission link consists of a pair of simplex satellite circuits allocated from the pool of circuits. The selection and allocation of these circuits is managed by a system routing center, where the satellite transponders are divided into multiple simplex channels. Thus the system is capable of communicating with multiple satellites as well as multiple transponders within a satellite. ■■

Still fighting snap, crackle and pop?

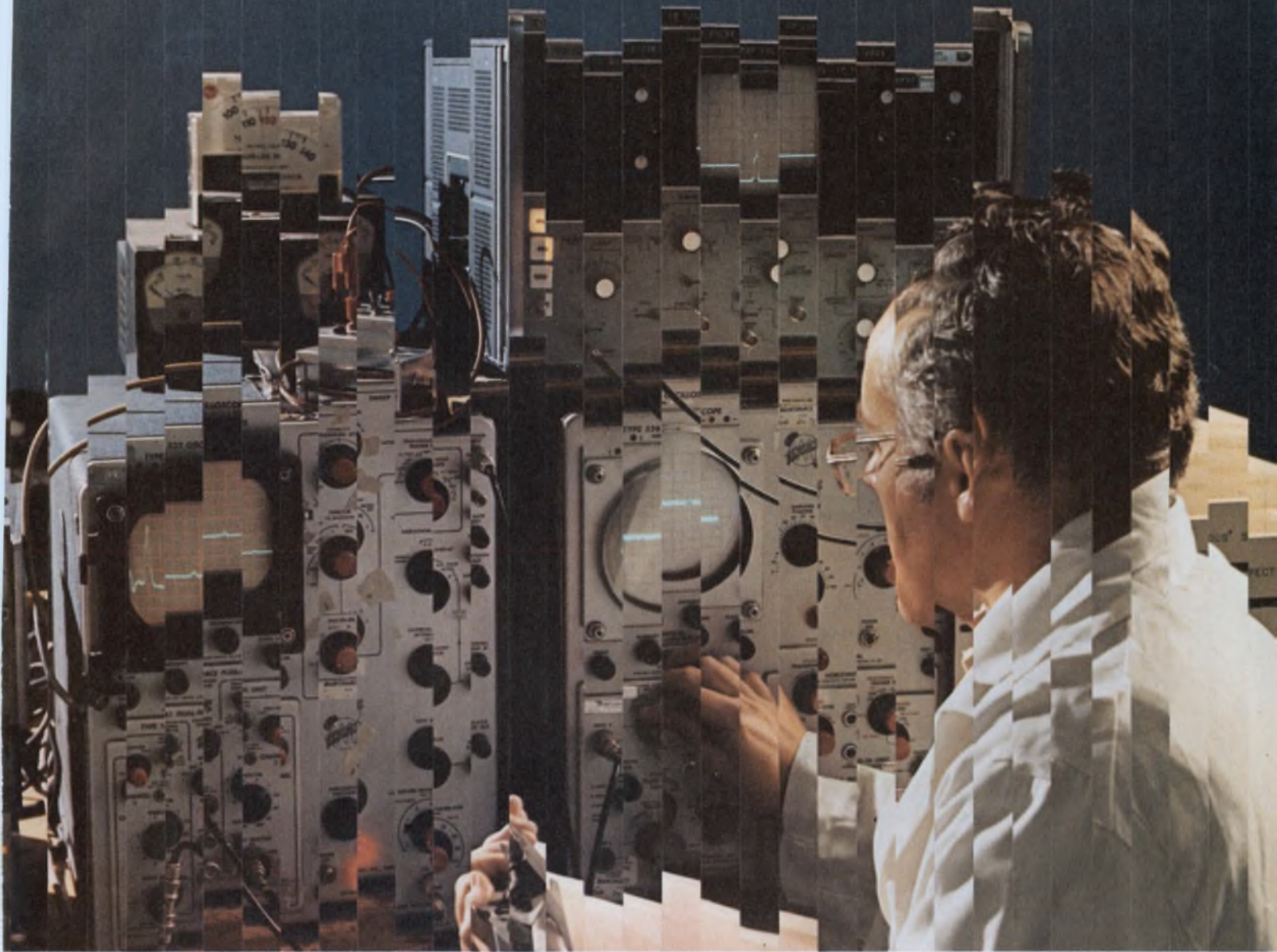

Noise has a way of showing up in circuits. Bendix has a way of preventing it. Filter connectors. Boasting some of the best attenuation curves available, Bendix filter connectors solve a wide range of low-pass filter problems. Small wonder Bendix is first choice in the fight against snap, crackle and pop.

These versatile connectors, production tooled, are available in a wide range of cylindrical and rectangular configurations designed to meet most any industrial, commercial and military application.



Configurations that can be intermateable with most MIL-Spec and popular commercial connectors and special designs for advanced state-of-the-art equipment. There's sure to be one that meets your attenuation and frequency requirements. You'll like what you hear when it comes to the price, too. And that goes for delivery as well.

Write for our new catalog. It's yours for the asking. The Bendix Corporation, Electrical Components Division, Sidney, New York 13838.

Bendix

Electrochromic display offers challenge to liquid crystals

The strong lead held by liquid crystals in low-power display applications may soon be challenged by a new device known as the electrochromic display.

In a presentation at the recent Electronic Components Conference in Washington, D.C., Satyen K. Deb, director of research for the Optel Corp., Princeton, N.J., noted that like the liquid crystal, the electrochromic display is passive—doesn't emit light—and can be used either in a transmissive or reflective mode. Although still in the laboratory, the device has several advantages that make it more attractive than liquid crystals. These include data-storage capability, wide viewing angle and a wider temperature range of operation.

In explaining what an electrochromic display is, Deb says that it is made from a material whose light-absorption properties are changed by an externally applied electric field. Ordinarily, he continues, electrochromic materials do not absorb light in the visible range of the spectrum; so they are completely transparent. But when a moderate electric field is applied, the material develops an absorption band in the visible spectrum and takes on a color, Deb reports.

This color change remains even after the electric field is removed and lasts from minutes to months; hence the memory capability of the display. The color change can be reversed and the display returned to its original state when the polarity of the applied electric field is simply reversed.

Fabrication is simple

As with liquid-crystal displays, the fabrication of electrochromic devices is relatively simple. A thin film of electrochromic material—such as tungsten trioxide—is evaporated onto a transparent, conducting glass substrate. The film,

which ranges in thickness from 0.3 to 1 μ , can be deposited either by sputtering or thermal evaporation, Deb says. A second layer of insulating material is then deposited over the oxide layer. The sandwich like structure is completed by the third layer—a transparent gold electrode.

When a dc voltage is applied to this structure so the electrode adjacent to the electrochromic layer is made negative, electron injection occurs, and the material turns deep blue. When the polarity of the voltage is reversed, no electron injection is possible. This happens because an electron-blocking layer is present near the second electrode, and the injected electrons are extracted back to the newly formed anode.

Since this display is absorptive, it does not have the disadvantage of a narrow viewing angle, like liquid crystals.

The electrochromic display also has a clearly defined threshold voltage that determines the point at which coloration will occur. The existence of this threshold makes it easy to matrix—address the display. The threshold voltage is a function of the electrochromic ma-

(continued on page 47)

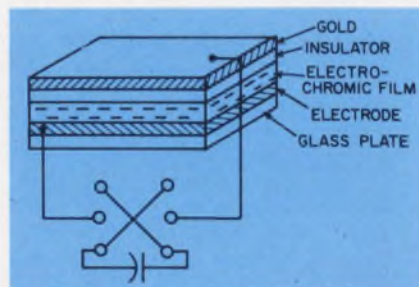

The electrochromic display is a solid-state passive display. When the lower electrode is negative, the electrochromic film turns deep blue. Reversing the polarity makes it clear again.

Your closest SIGNETICS distributor is...

ARIZONA
Phoenix: Hamilton/Avnet Electronics (802) 275-7851
Phoenix: Kierulff Electronics (602) 273-7331

CALIFORNIA
Culver City: Hamilton Electro Sales (213) 870-7171
El Segundo: Liberty Electronics (213) 322-8100
Los Angeles: Kierulff Electronics (213) 685-9525
Mountain View: Hamilton/Avnet Electronics (415) 961-7000
Palo Alto: Kierulff Electronics (415) 968-6292
San Diego: Cramer Electronics (714) 565-1881
San Diego: Hamilton/Avnet Electronics (714) 279-2421
San Diego: Kierulff Electronics (714) 278-2112
Sunnyvale: Cramer Electronics (408) 739-3011

CANADA
Downsview: Cesco Electronics (416) 661-0220
Downsview: Cramer Electronics (416) 661-9222
Montreal: Cesco Electronics (514) 735-5511
Montreal: Hamilton/Avnet Electronics (514) 735-6393
Ottawa: Cesco Electronics (613) 729-5118
Ottawa: Hamilton/Avnet Electronics (613) 725-3071
Quebec: Cesco Electronics (418) 524-3518
Vancouver: Bowtek Electric Co. Ltd. (604) 736-7677

COLORADO
Denver: Cramer Electronics (303) 758-2100
Denver: Hamilton/Avnet Electronics (303) 534-1212

CONNECTICUT
Hamden: Arrow Electronics (203) 248-3801
Georgetown: Hamilton/Avnet Electronics (203) 762-0361
North Haven: Cramer Electronics (203) 239-5641

FLORIDA
Hollywood: Hamilton/Avnet Electronics (305) 925-5401
Hollywood: Schwaber Electronics (305) 927-0511
Orlando: Hammond Electronics (305) 241-6601

GEORGIA
Atlanta: Schwaber Electronics (404) 449-9170
Norcross: Hamilton/Avnet Electronics (404) 448-0800

ILLINOIS
Elk Grove: Schwaber Electronics (312) 593-2740
Elmhurst: Semiconductor Specialists (312) 279-1000
Schiller Park: Hamilton/Avnet Electronics (312) 678-6310

INDIANA
Indianapolis: Semiconductor Specialists (317) 243-8271

KANSAS
Lenexa: Hamilton/Avnet Electronics (913) 888-8900

MARYLAND
Hanover: Hamilton/Avnet Electronics (301) 796-5000
Rockville: Pioneer Washington Electronics (301) 424-3300
Rockville: Schwaber Electronics (301) 881-2970

MASSACHUSETTS
Burlington: Hamilton/Avnet Electronics (617) 273-2120
Newton: Cramer Electronics (617) 959-7700
Waltham: Schwaber Electronics (617) 890-8484

MICHIGAN
Detroit: Semiconductor Specialists, Inc. (313) 255-0300
Livonia: Hamilton/Avnet Electronics (313) 522-4700
Troy: Schwaber Electronics (313) 583-9242

MINNESOTA
Edina: Hamilton/Avnet Electronics (612) 941-3801
Minneapolis: Semiconductor Specialists (612) 854-8844

MISSOURI
Hazelwood: Hamilton/Avnet Electronics (314) 731-1144

NEW MEXICO
Albuquerque: Hamilton/Avnet Electronics (505) 765-1500

NEW YORK
Buffalo: Summit Distributors (716) 884-3450
Farmingdale, L.I.: Arrow Electronics (516) 694-6800
Rochester: Schwaber Electronics (716) 328-4180
Syracuse: Hamilton/Avnet Electronics (315) 437-2642
Westbury: Hamilton/Avnet Electronics (516) 333-5800
Westbury: Schwaber Electronics (516) 334-7474

NORTHERN NEW JERSEY
Cedar Grove: Hamilton/Avnet Electronics (201) 239-0800
Saddlebrook: Arrow Electronics (201) 797-5800

SOUTHERN NEW JERSEY AND PENNSYLVANIA
Cherry Hill, N.J.: Milgray-Delaware Valley (609) 424-1300
Moorestown: Arrow/Angus Electronics (609) 235-1900
Mt. Laurel, N.J.: Hamilton/Avnet Electronics (609) 234-2133

CENTRAL NEW JERSEY AND PENNSYLVANIA
Somerset, N.J.: Schwaber Electronics (201) 469-6008

NORTH CAROLINA
Greensboro: Hammond Electronics (919) 275-6391

OHIO
Beachwood: Schwaber Electronics (216) 464-2970
Dayton: Hamilton/Avnet Electronics (513) 433-0610
Cleveland: Arrow Electronics (216) 464-2000
Cleveland: Pioneer Standard Electronics (216) 587-3600
Kettering: Arrow Electronics (513) 253-9176

TEXAS
Dallas: Cramer Electronics (214) 350-1355
Dallas: Hamilton/Avnet Electronics (214) 661-8661
Houston: Component Specialists (713) 771-7237
Houston: Hamilton/Avnet Electronics (713) 526-4661

UTAH
Salt Lake City: Alta Electronics (801) 486-7227
Salt Lake City: Hamilton/Avnet Electronics (801) 262-8451

WASHINGTON
Bellevue: Hamilton/Avnet Electronics (206) 746-8750
Seattle: Cramer Electronics (206) 762-5722

Now, a 576-bit RAM for men of few words.

Target-designed 64 x 9 for 45ns buffers and scratch pads.

Making small talk just got easier. With still another world's first from Signetics. Our 82S09 RAM of 576 bits: the largest bit count ever put into a bipolar RAM with more than one bit per word. This 64 x 9 is available now in volume, and multiple-sourced.

What's in it for you? Say you've got a scratch pad or buffer that only calls for 16 to 128 words. Till now your choices were all bad news. Either you wasted memory capacity with oversized organization and gadgety multiplexing schemes, or you strung together a lot of little RAMs. Either way, you lost. In terms of high tabs for extra circuitry, bigger boards, and the power to keep them going. Not to mention penalties in memory speed.

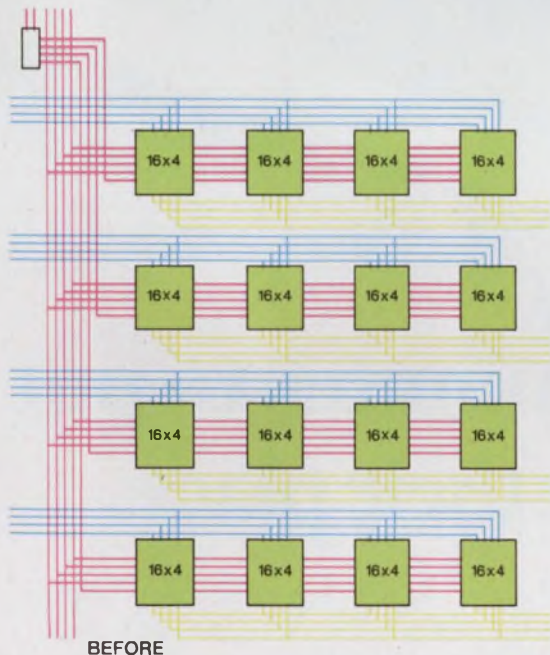

For small, dense memory applications, the unique 82S09 RAM—with new cell design and enhanced 64 x 9 organization—shrinks board space requirements, lowers component count and power cost, but slams out all the speed you can handle. (Schottky technology delivers 45ns, worst case.) With all the traditional bipolar RAM features in the bargain. Full decoding. Chip enable. Open collector. And a vital bonus, the ninth bit for parity.

If the picture still needs a little focussing, take a minute to scan our Comparison Chart, based on production of 200 systems.

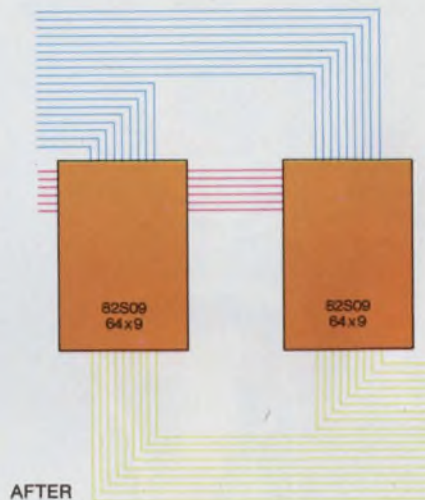

		"Before"	"After"
Parts Cost*	Decoder	\$ 2.80	\$ 0.00
	8225/7489	96.00	85.20
		98.80	85.20
Board Space		1.5	1.0
Access Time ⁽¹⁾	Decoder	20ns	0
	8225/7489	50ns	45ns
		70ns	45ns
Power Dissipation	Decoder	0.1 Watt	0
	8225/7489	6.4 Watts	1.7 Watts
		6.5 Watts	1.7 Watts
Solder Connections	Decoder	16	0
	8225/7489	256	56
		272	56

(1) Even with 3101A (35ns), the total 64 x 16 array access time is 55ns.
*Signetics 100-up published price.

Okay, talk may be cheap. So make us lay it on the line. Today, from your local distributor.

CLIP THIS COUPON AND ATTACH TO LETTERHEAD FOR FAST ACTION.

Signetics—RAMs
P. O. Box 3004-12
Menlo Park, California 94025

Spec sheets first, please, on the 82S09, the new bipolar 45ns Schottky RAM you've raved about and said is available now.

Name _____

Title _____ Mail Stop _____

Signetics Corporation, a subsidiary of Corning Glass Works

signetics

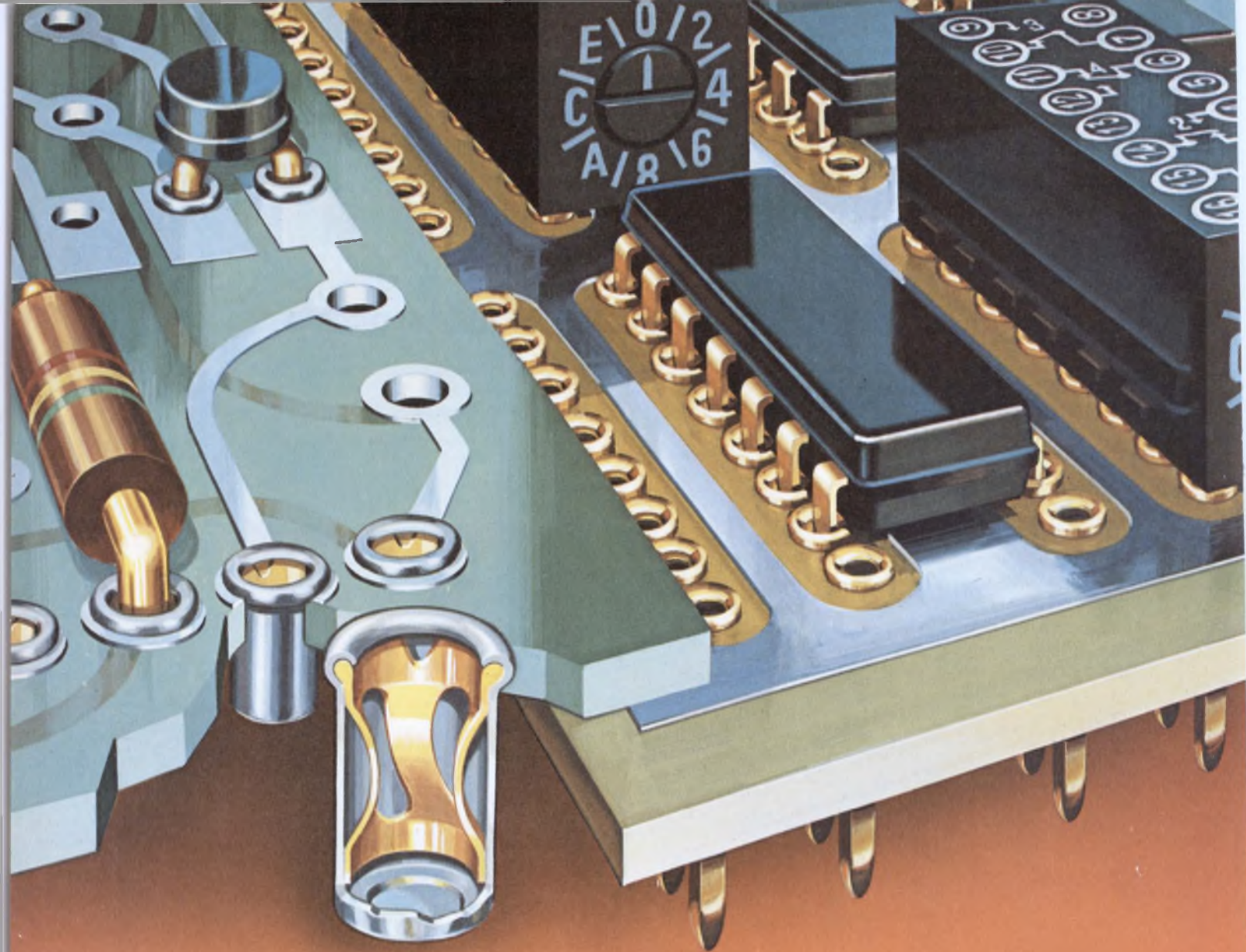

AMP gives you 60 minutes to put 3,000 sockets in their place.

Because that's all the time you need
with our high-speed socket applicator.
The sockets themselves give you easy pluggability.

And easy mounting
of leaded devices
such as transistors,
crystals, plug-in
relays and integrated
circuit packages.



AMP sockets have closed or knockout bottoms,
plus posted versions. They can take round or
rectangular leads. And their low profile offers high
packaging density. Gold- and tin-plated sockets are
available, and all have excellent solderability.

So if you want quick, reliable loading of miniature
spring sockets into dielectric panels, at low applied
cost, call (717) 564-0100. Or write AMP Incorporated,
Harrisburg, Pa. 17105.

AMP is a trademark of AMP Incorporated.

AMP

INCORPORATED

INFORMATION RETRIEVAL NUMBER 22

(continued from page 44)

EUROPE

Austria—AMP Austria. Branch of AMP Deutschland G.m.b.H., Markgraf-Ruediger Str. 6-8, 1150 Vienna. Phone: 924191/92

Belgium—AMP Belgium. Branch of AMP-Holland N.V., Rue de Brabant 62-66, Brussels. Phone: 19.36.07

France—AMP de France, 29, Chaussee Jules-Cesar, Boite Postale No. 39, 95301-Pontoise (Val d' Oise), France. Phone: 464-92-20, 464-92-30

Germany—AMP Deutschland G.m.b.H., Amperstrasse 7-11, 607 Langen, B. FFM., West Germany. Phone: (06103) 7091

Great Britain—AMP of Great Britain Limited, Terminal House, Stanmore, Middlesex, England. Phone: 01-954-2356

Holland—AMP Holland N.V., Papierstraat 2, s-Hertogenbosch, Holland. Phone: (04100) 25221

Italy—AMP Italia S.p.A., Via Fratelli Cervi 15, 10093 Collegno (Torino), Italy. Phone: 785-656

Spain—AMP Espanola, S.A., Apartado 5294, Pedro IV, 491, 495, Barcelona 5, Spain. Phone: 307-75-50

Sweden—AMP Scandinavia AB, Datavagen 5, 175 00 Jakobsberg, Sweden. Mailing Address: Fack S-175 20 JARFALLA 1, Sweden. Phone: 0758/104 00

Switzerland—AMP A.G., Haldenstrasse 11, 6006 Luzern, Switzerland. Phone: (041) 235421, 235422, 235423

NORTH AMERICA

Canada—AMPOF CANADA LTD., 20 Esna Park Drive, Markham, Ontario. Phone: 416-499-1251

Mexico—AMP de Mexico, S.A., Apartado Postal 179, Naucalpan de Juarez, Edo. de Mexico. Phone: Mexico City 576-41-55

Puerto Rico—AMPOF CANADA LTD., 677 Calè de Diego, Rio Piedras, Puerto Rico 00924. Phone: (809) 766-2346

United States—AMP Incorporated, Harrisburg, Pa. 17105. Phone: 717-564-0100

SOUTH AMERICA

Argentina—AMP S. A. Argentina 4 de Febrero, 76 Villa Zagla—SAN MARTIN, Buenos Aires, Argentina. Phone: 752-4612

Brasil—AMP do Brasil Ltda., Rua 7 de Abril 355, Sao Paulo, Brasil. Phone: 335204

PACIFIC

Australia—Australian AMP Pty. Limited, 155 Briens Road, Northmead, N.S.W. 2152 Australia. Mailing Address: P.O. Box 194, Baulkham Hills, N.S.W. 2153 Australia. Phone: 630-7377

Japan—AMP (Japan), Ltd., No. 15-14, 7-Chome, Roppongi Minato-Ku, Tokyo, Japan. Phone: 404-7171

For AMP products and services in most other countries, there's a network of official distributors. To get more information about them, please write: AMP International Division, Harrisburg, Pa. 17105, USA.



material used, the thickness of the electrochromic layer, the thickness of the insulating layer and the materials from which the electrodes are constructed.

The response time of the display varies over a wide range depending on the fabrication, the materials and the mode of operation. Because of the relatively high charge density required for a high-contrast display, the writing speed is relatively low (200 ms).

They consume less power

Electrochromic displays look so good that, in an informal evening panel session, even Robert Young, a senior scientist with American Microsystems in Sunnyvale, Calif. (and a proponent of liquid-crystal technology) admitted that the new display could outshine liquid crystals in some ways. Specifically, Young noted that because of its memory capability, the electrochromic display could consume less power than a liquid crystal one. Explaining further, he noted that while higher peak power is needed to operate the device, this power is only needed to change information. No power is required to retain the information in memory. Thus the average power consumed could be lower. Another advantage,

Young admits, is that the electrochromic device described by Deb is a solid-state unit, and has a broader range of operating temperatures than liquid crystals.

Electrochromic displays do have some problems, however. They are not as fast as liquid crystals, says Young. And because they require an erase signal, circuits will have to be redesigned to use them.

James H. Becker, principal scientist for Xerox Information Systems, Dallas, Texas, also sees some problems with electrochromic displays. The main one is that the displays operate in a current instead of a field mode. The current-mode operation can result in unwanted and uncontrollable space charge in the device. The space charge could move around and disrupt the operation of the display. Another possible problem, notes Becker, is that since evaporation is used to fabricate the device, its size is limited to that of a CRT.

Despite the disadvantages, the consensus of the engineers present was that electrochromic displays could become very important. Whether they do or not, however, depends on how many companies get involved. According to Becker, only a few companies have publicly acknowledged that they are working on these displays. If they are to become commercially successful, a much more concerted effort is needed, he says. ■■

COMPARISON OF SEVERAL TYPES OF DISPLAYS

Display	Plasma Discharge	LED	Liquid Crystals		Electrochromics	
	Active	Active	DS	FE	Inorganic	Organic
State	Gas	Solid	Passive	Passive	Passive	Passive
Voltage (Volts)	200-300	1.5-5	Liquid	Liquid	Sol/Liq	Liquid
Current/cm ² or Charge	0.1 mA	10-100 mA	15-20	3-8	0.25-20	.2-1.5
Response Time	10 μSec	0.1 μSec.	10 mA	1.5 mA	2-20 mC	~2 mC
Threshold	10 μSec	0.1 μSec.	10-100 mSec	200 mSec	200 mSec	20 mSec
Storage	Yes	Yes	No	Yes	Yes	Yes
High Ambient Light	No	No	No	No	Yes	Yes
Directionality	Poor	Poor	Good	Good	Good	Good
	None	None	Yes	Yes	None	None

Domestic or Professional YOUR potentiometer is here

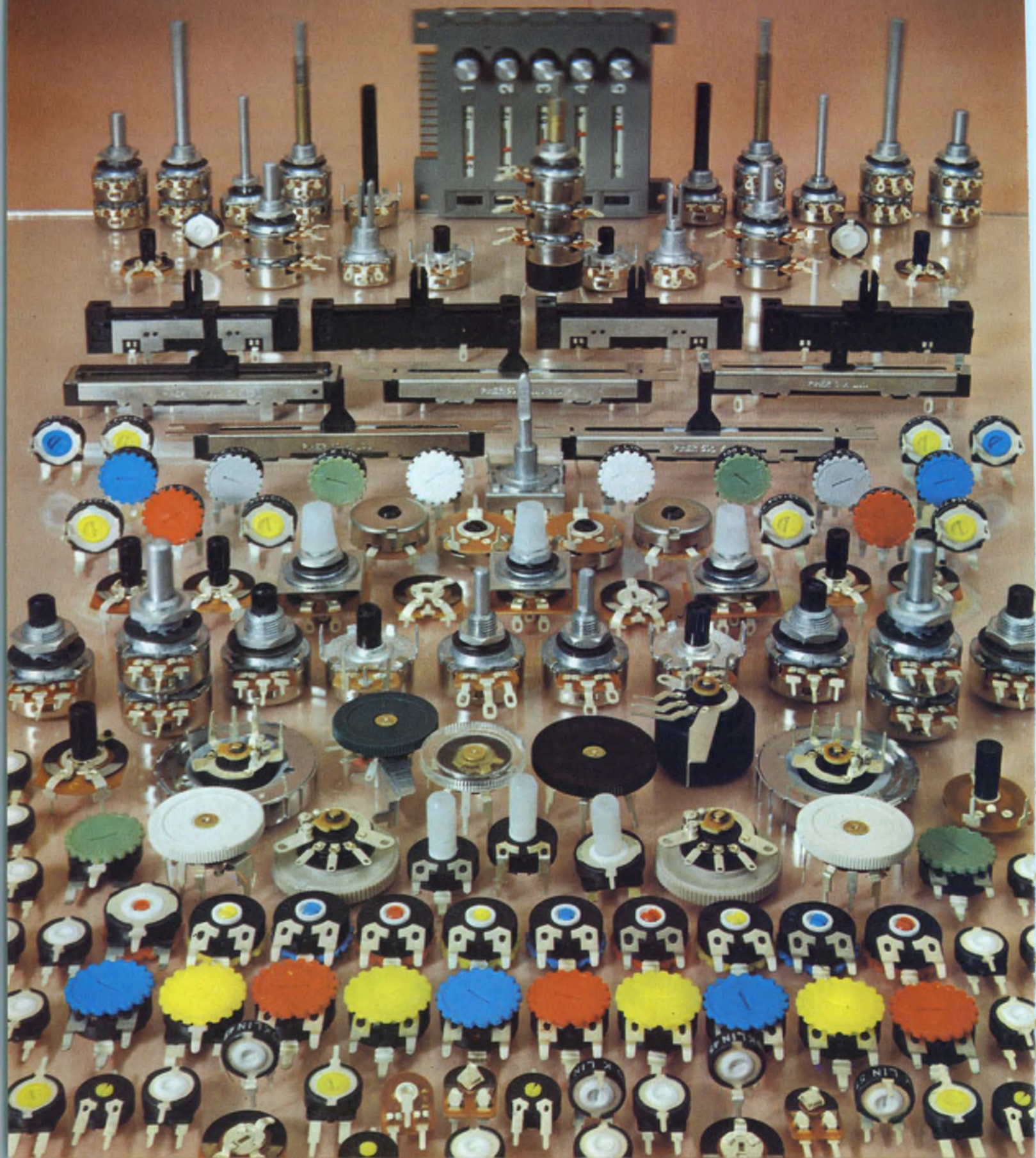

With our range of preset, rotary spindle, slider and rectilinear potentiometers – all designed round the prime requirements of noise-free operation and long life – we have brought new standards of quality and reliability to the potentiometer market for domestic or professional use.

In a technology not normally associated with dramatic breakthroughs we have introduced new ideas to component design and manufacture.

Like our Series PT preset pots which are fully enclosed in flame retardant plastic for protection from environmental factors. And the new PL40 slider pot, with its enclosed track and specially designed wiper movement that eliminates jitter, giving ultra-smooth operation.

Of course we also provide the usual options, like matched pairs for stereo applications, various terminal arrangements, earth screening and mains switches.

There's also the new PL25, a 20-turn rectilinear preset control for radio and tv varicap tuning applications.

In short, in any situation calling for high quality potentiometers, the discerning engineer should turn to PIHER.

Write or ring for full details.

U.K. – PIHER International LTD,
Romar House, The Causeway,
Staines, Middlesex, England.
Tel: Staines 56157. Telex 934167.

U.S.A. – PIHER International Corp.,
1239 Rand Road, Des Plaines,
Illinois 60016, U.S.A.
Tel: 312 297 1560. Telex 282154.

Germany – PIHER International GmbH,
85 Nurnberg, Tuchergartenstrasse 4,
W.Germany.
Tel: 0911 533 051. Telex 623354.

France – PIHER International SARL,
83, Rue Etienne Dolet, 94230,
Cachan, France.
Tel: 656 26 07. Telex 27107.

Italy – PIHER International S.P.A.,
Via Censio 34, 20154 Milan, Italy.
Tel: 314532/316213.

Head Office – Riera Cañado,
s/n Apartado de Correos 53,
Badalona (Barcelona), Spain.
Tel: 389 03 00. Telex 59521.

 **PIHER**

NEWS

Low-cost, standard MIC units are within designer's reach

Two approaches to the solution of a pressing problem in the microwave industry—the lack of a low-cost standard microstrip integrated-circuit (MIC) package—will be discussed at this month's International Microwave Symposium at the Georgia Institute of Technology in Atlanta. Both of the new packages are reported ready for production.

Present custom versions of MIC packages are expensive, and this is limiting their use.

Bendix offers a package

One new approach to a standard MIC package will be described by Dean Nelson, an engineer with the Bendix Electrical Components Div., Sidney, N.Y., in a paper on "Microwave Planar Packages." The principal advantage of the Bendix approach, called a Controlled Impedance Package, are reductions in space, weight and cost, according to Nelson.

The package, he points out, is

square (See figure). It has a flat, glass base, with the leads fabricated on the base. The sides of the package are of glass, and a metal cover is hermetically sealed on top of the sides.

The MIC substrate carrying the microwave circuitry is set inside the glass housing, and the substrate's microstrip leads are connected to those of the package.

The Bendix package costs less, he says, than buying a custom-machined box and putting a number of coaxial connectors on it. In quantities of 1000, the package costs about \$11. This includes the tooling costs, Nelson says, pointing out that for higher production runs, the cost drops considerably.

"Our package uses no coaxial connectors or coaxial feed lines, which means that the total package can be made much smaller and lighter," the Bendix engineer says. "Instead, based upon microwave stripline theory, we have developed a package in which leads coming

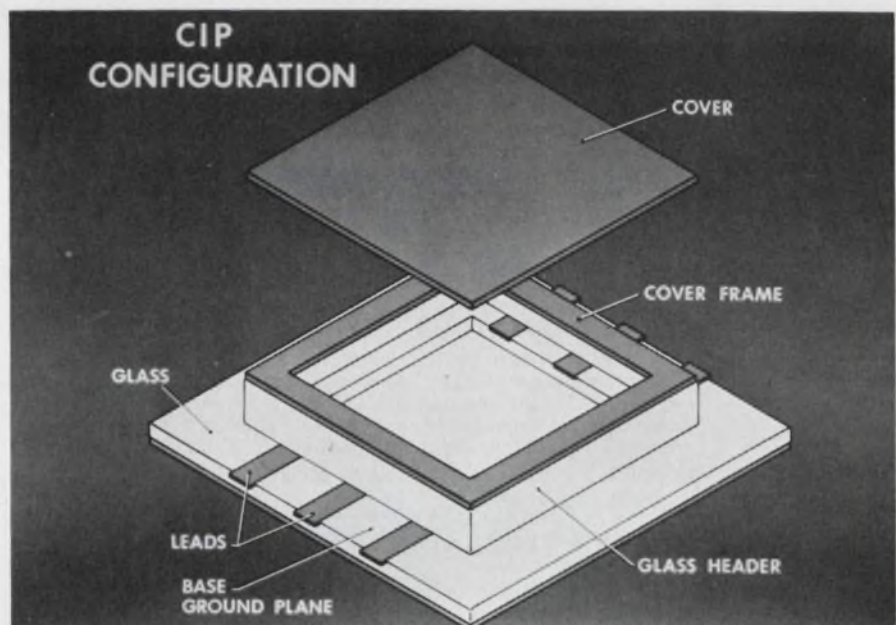

Circuit connections to the Bendix microwave IC packages are made by means of striplines. No coax connectors are used. The Controlled Impedance Package is mounted on a special mother board prepared for this system.

◀ INFORMATION RETRIEVAL NUMBER 24

Solid Tantalums for Solid Performance

MOLDED, PLASTIC-ENCASED ECONOLINE™ TANTALEX® CAPACITORS

Type 198D Economically priced. Flame-retardant case has flatted section and polarity indicator for easy-to-read marking and error-free insertion. High volume production-oriented design for efficient assembly. Molded straight-wall case eliminates cracking as well as soldering problems associated with epoxy rundown.



ASK FOR BULLETIN 3546

INFORMATION RETRIEVAL NUMBER 174

EPOXY-DIPPED TANTALEX® CAPACITORS

Type 196D Low-cost capacitors that utilize high-quality tantalum pellet construction. Dipped coating is hard insulating resin highly resistant to moisture and mechanical damage. Designed for printed circuit board applications. Wide range of capacitance values with voltage ratings from 4 to 50 VDC.



ASK FOR BULLETIN 3545B

INFORMATION RETRIEVAL NUMBER 175

HERMETICALLY-SEALED METAL-ENCASED TANTALEX® TUBULAR CAPACITORS

Type 150D Polarized units offer high capacitance, long life, low leakage current, low dissipation factor, and high stability. Also available to Spec. MIL-C-39003 as CSR09, CSR13, and CSR23.

Type 151D Non-polarized capacitors with the same outstanding characteristics as Type 150D units. Also available to Spec. MIL-C-39003 as CSR91.



ASK FOR BULLETINS 3520G, 3520.2A, 3521B, 3521.7

INFORMATION RETRIEVAL NUMBER 176

MOLDED DOMINO® TANTALEX® CAPACITORS

Type 193D For hybrid circuit and low-profile printed circuit board applications. Offer superior mechanical protection as well as excellent stability in severe operating and storage environments. Can be attached to substrates or circuit boards by conventional methods.



ASK FOR BULLETIN 3532A

INFORMATION RETRIEVAL NUMBER 177

ULTRA-MINIATURE TANTALEX® CAPACITORS FOR MINIATURE CIRCUITS

Types 182D and 183D Cylindrical-shaped Type 182D and rectangular-shaped Type 183D capacitors, ideal for subminiature assemblies requiring the ultimate in component density, offer high volumetric efficiency. Housed in polyester-film sleeving with epoxy resin end seals, ensuring excellent moisture resistance.



ASK FOR BULLETIN 3517

INFORMATION RETRIEVAL NUMBER 178

MINIATURE RED TOP® TANTALEX® TUBULAR CAPACITORS

Type 162D Capacitors in resin-sealed cases offer excellent stability. For use on printed wiring boards, in packaged circuit modules, and in applications where space is at a premium. Priced competitively with axial lead molded case units. Available on reels, with taped leads, for automatic machine insertion on PC boards.



ASK FOR BULLETIN 3536B

INFORMATION RETRIEVAL NUMBER 179

For complete technical data on any of these Sprague solid tantalum capacitor types, write for the applicable Engineering Bulletin(s) to Technical Literature Service, Sprague Electric Company, 347 Marshall Street, North Adams, Mass. 01247.

SPRAGUE
THE MARK OF RELIABILITY

NEWS

out of the package are of very tightly controlled dimensions and spacing. And the dielectric material we use between the leads further aids in controlling the feed-line impedance.

"Because of this particular design, you can couple directly from the feed line to the circuitry inside the package without the need for coaxial connectors.

Nelson points out that the excellent impedance matching provided by the package minimizes distortion of microwave pulses.

The package is supplied as a basic unit without internal circuitry. The MIC circuitry is provided by the purchaser.

"Our package is developed around MIL-Standard 883," Nelson says, "and is hermetically sealed. It meets the maximum leakage requirements of 1×10^{-8} cm³/s."

Packages stamped out

A second approach to a standard MIC package—a hermetically sealed MIC formed by impact extrusion—is a high-production, low-cost process, according to two representatives of Microwave Associates, Burlington, Mass.

The two—John Miley, engineering group leader, and Kachas Derdarian, manager of mechanical engineering—will tell the symposium of the company's approach in a session on "The Real World of MIC Packaging."

"The government is looking for some way to mass-produce a standard, low-cost MIC box that will meet environmental specs and provide a hermetic or vacuum seal—similar to MIL-Standard 883, which is the monolithic-chip military standard," Miley notes.

"Our package, developed under a production-engineering-measures contract for the Army Electronics Command in Ft. Monmouth, N.J., can be punched out in large quantities. We compared housings for a 1-by-2-in. ceramic MIC substrate, and in quantities of about 1000—which includes tooling costs. Our package runs about \$11.50, while the custom-machined version is about \$29.

New!

Rugged...versatile

"The Persuader"

The S190 switchlight outguns everything its size... costs only \$1.62*

In every era, new products come along to keep the competition honest, with all the cards on the table. So we invite you to compare our S190 series with other switchlights. Check our variety of lens colors and easy mount panel adaptors... our wide terminal spacing for easy and fast wiring: solder, quick connect, PCB... our no-tool lamp replacement, long life wiping contacts, rugged molded case. Consider the low cost when you realize that the S190, with its 2 Form C action, has greater circuit flexibility than most switchlights on the market. And it's easily available at your local distributor! Call our sales office in your area for applications assistance... we're located in major cities, world wide. Clare-Pendar Co., Box 785, Post Falls, Idaho 83854, (208) 773-4541.

*In quantities of 1000



CLARE-PENDAR
Switchlights & Keyboards



"For production in the many thousands, we see the cost, depending on package size, going as low as \$1.50 to \$3.

Miley says the production process is cold-flow. A slug of aluminum with the same surface area as the final package is used. The thickness of the slug depends upon the required side-wall thickness. Under very high pressure, the aluminum cold-flows to final dimensions.

Some machining has to be done, Miley notes. The piece comes out of the press with a mounting flange on all four sides. The inside mounting area must be machined, because the MIC ceramic circuit

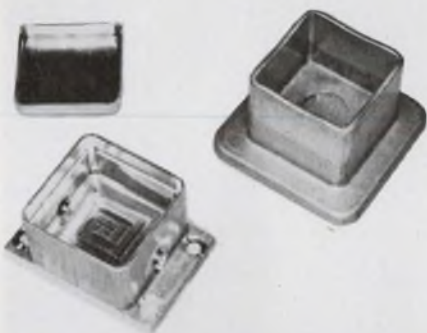

The impact-extruded case and lid provide a hermetically sealed micro-strip integrated circuit package.

requires a very flat surface. Also, holes for mounting and for coaxial connectors must be drilled. Special 3-mm coaxial connectors were developed, the engineering leader points out, to ease repair of the MIC.

The lid of the package is coined and drawn, Miley says. After the ceramic MIC and connectors have been assembled, the cover is welded onto the package. The cover is designed with a lip, so it can be opened and resealed at least once for repair, and possibly twice.

While the MIC can be mounted directly to the base of the housing, provisions are also made for use of a carrier—a metal substrate on which the MIC is placed. The carrier can be removed easily to gain access for repairs. ■■

TEKTRONIX HAS A NEW LINE TO TEST YOUR MEMORY

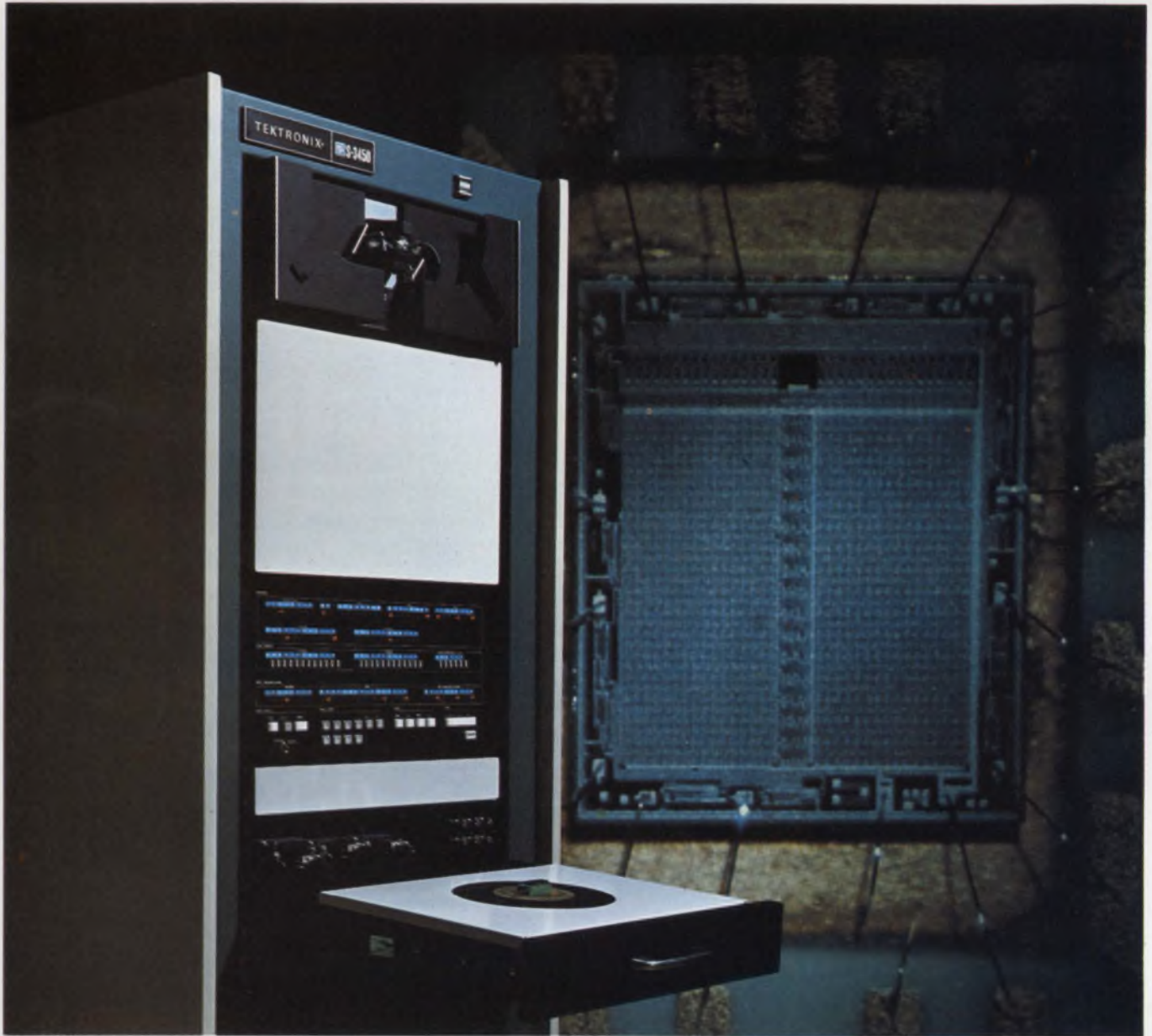

Meet the latest additions to the growing lines of TEKTRONIX Automated Test Equipment, the S-3400 Series of Semiconductor Memory Test Systems. These S-3400 systems are modularly constructed, fully programmable, stand alone semiconductor memory testers; capable of performing dc parametric, and functional tests on semiconductor memory devices.

The S-3400 systems have been designed and built to give you a system that can completely and effectively test all semiconductor memories. With interfaces available for wafer probers and automatic device handlers, a total package may be configured to supply you with a complete solution for your semiconductor memory testing requirements.

The S-3400 series joins with our S-3100 series and S-3260 Automated Test Systems to bring to you a wide range of test and measurement solutions. For more information contact the Systems Applications Engineer nearest you listed on the opposite page, circle the reader service card or write Box 500 A, Beaverton, OR 97005



Cadmium-telluride detector has highest sensitivity yet

A cadmium-telluride photoconductive sensor has been developed that exhibits substantial sensitivity at the highest continuous operating temperature yet recorded for an IR semiconductor.

The new detector, developed by Tyco Research Laboratories, Waltham, Mass., is reported to operate continuously in a 750-F ambient and to be able to detect a six-inch-diameter flame 10 feet away against a background of 1000 F.

"Cadmium telluride is one of the few new semiconductors developed for practical uses in the last few years," says Dr. Gerald Entine, senior scientist at Tyco. He points out that the material was developed under Air Force sponsorship for a jet-engine fire detector.

"The electronic properties of cadmium telluride make it useful in devices such as infrared, nuclear-radiation and gamma-ray detectors and solar cells," Entine points out. He notes that cadmium telluride has a crystal structure similar to that of silicon and gal-

lium arsenide, and can be produced in both P and N-type material.

But most important, Entine says, cadmium telluride has two characteristics needed for the high-temperature applications like the fire detector.

High temperature sensitivity

First, it has a wide energy band gap. The wider the gap, the higher the temperature at which the material retains useful sensitivity. For example, cadmium telluride has a band gap of 1.44 electron volts. A telluride sensor properly doped for this application has a room-temperature resistance of about 50 M Ω . The resistance decreases exponentially with temperature increase, typically to 500 Ω at 750 F. But the cell is still sensitive enough to detect a 50- μ W/cm² infrared signal with a signal-to-noise ratio of better than 20 to 1.

By contrast, silicon, which has a band gap of 1.1 electron volts, has an upper useful operating temperature of about 450 F. At 750 F its sensitivity is destroyed.

Secondly, instead of having a broad response in the near-infrared, cadmium telluride has a narrow spectral peak response at 0.975 μ m. This permits it to discriminate between the temperature of a burning jet-fuel flame and the broad infrared radiation of a 1000-F background.

Chlorine-doped cadmium telluride, which was developed originally for gamma-ray detectors, proved to be particularly effective for the infrared fire detector.

Each fire-detector unit contains two separate cadmium cells for redundancy. The finished assembly is comprised of two hermetically sealed sensors—in TO-5 headers with windows—secured in a hermetically sealed housing. The latter seal was included for maximum reliability. ■■

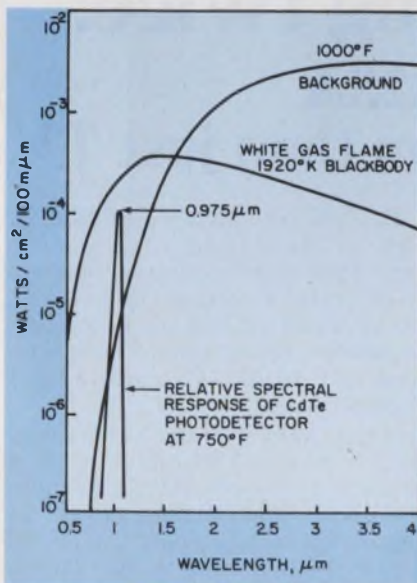

The narrow spectral response of cadmium telluride at 0.975 μ m makes it suitable for detecting flames against a hot, broad-band infrared background radiation.

Call the
Tektronix
Systems
Application
Engineer
nearest you.

CALIFORNIA Palo Alto 94303

3750 Fabian Way
Phone (415) 326-8500
(Info. Disp. Prod. 415-321-7728)

Van Nuys 91406

16930 Sherman Way
Phone (213) 987-2600
From L.A. call: 873-6868

GEORGIA Atlanta 30341

2251 Perimeter Park
Phone (404) 451-7241

MARYLAND Baltimore

1526 York Road
Lutherville 21093
Phone (301) 825-9000
From Harrisburg, Lancaster and
York Area call: ENterprise 1-0631

MASSACHUSETTS Boston

244 Second Avenue
Waltham 02154
Phone (617) 890-4550

NEW MEXICO Albuquerque 87108

1258 Ortiz Drive, S.E.
Phone (505) 268-3373
Southern N.M. Area: ENterprise 678

NEW YORK Endicott

3214 Watson Blvd.
Endwell 13760
Phone (607) 748-8291

TEXAS Dallas 75240

4315 Alpha Road
Phone (214) 233-7791

HOME OFFICE Tektronix Industrial Park

Box 500
Beaverton, Oregon 97005
Phone (503) 644-0161



TEKTRONIX®
committed to
technical excellence

CROSS MODULATION VS GAIN REDUCTION

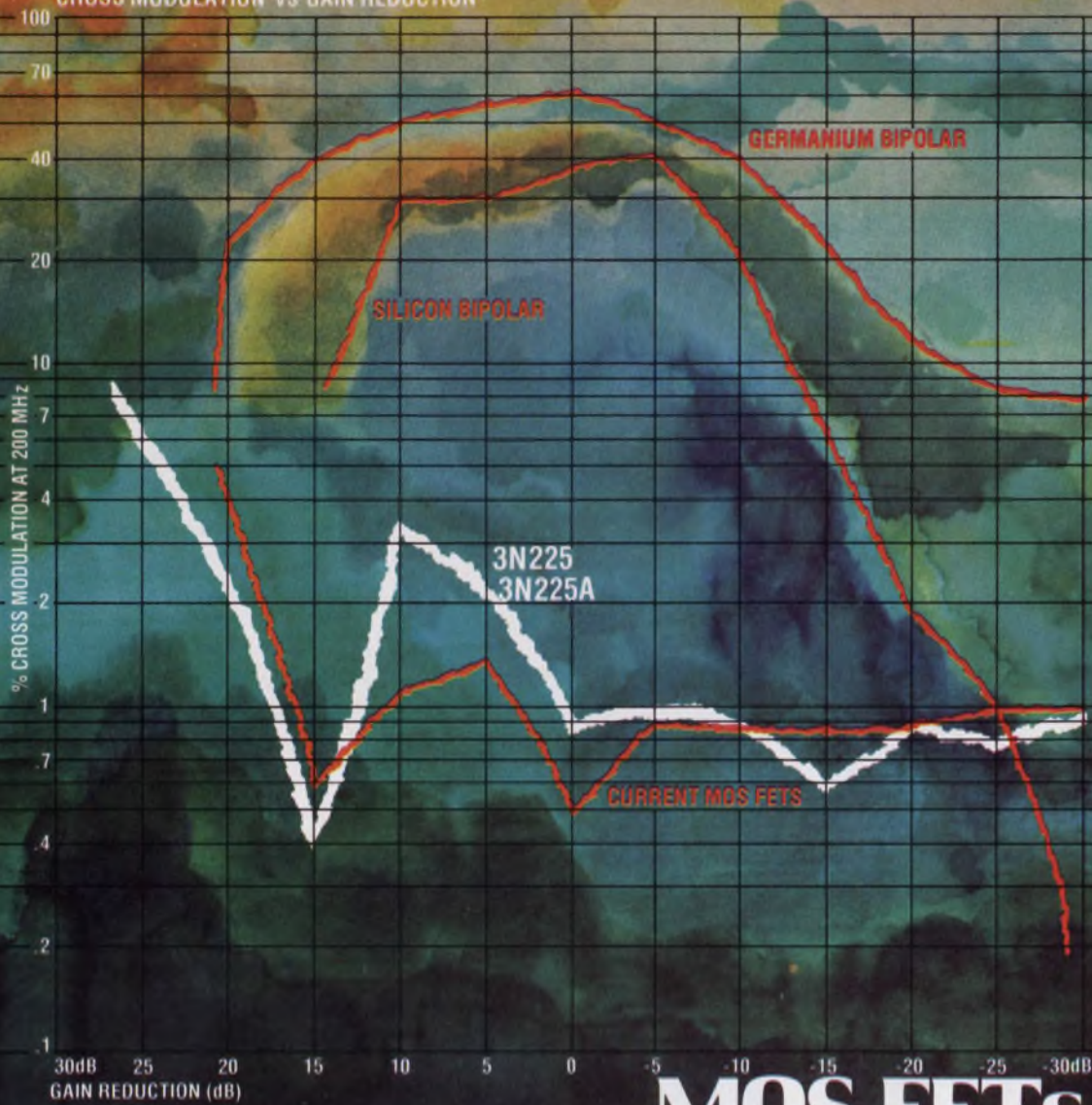

MOS FETS

It's like lightning striking twice.

TI's new 3N225 and 3N225A

...and there's lots more uses for them than just TV.

900 MHz noise figure - 4.5 dB typical. 900 MHz gain - 15 dB typical. That's what the 3N225 and 3N225A deliver - consistently and reliably. Virtually nothing in the industry comes close to this capability.

The 3N225 and 3N225A need no special handling procedures either. Integrated back-to-back diodes between gates and source protect against excessive voltage.

And designers also get high stage gain and excellent stability without neutralization - because feedback capacity is so extremely low.

Right now, leading TV manufacturers are designing with 3N225

and 3N225A in a big way. Especially in tuners, IF strips and UHF pre-amplifiers where linear, low noise is really an important requirement. A requirement that includes more applications than just TV, however.

	45-MHz		200-MHz		450-MHz		900-MHz	
	Gain	Noise Figure	Gain	Noise Figure	Gain	Noise Figure	Gain	Noise Figure
3N201 series	25	1.8	24	2.7	-	-	-	-
3N204 series	30	1.8	24	2	18	3.2	-	-
3N211 series	33	1.8	28	2.2	21	5	-	-
3N225 series	32	1.8	28	2	21	3	15	4.5

For instance 3N225 and 3N225A can be designed into CATV. Detection alarm systems. Medical electronic devices. Measuring instrumentation. Plate-wire memories. Video signal processors. And all types of mobile and fixed receivers.

Many applications that could only be realized by using vacuum tubes can now use MOS FETs like the 3N225 and 3N225A - often at significant cost savings.

For data sheet, write Texas Instruments Incorporated, P.O. Box 5012, M/S 308, Dallas, Texas 75222.



TEXAS INSTRUMENTS
INCORPORATED

washington report



Heather M. David
Washington Bureau

NASA seeks communications advances

The national space agency is trying to transmit more data in the same bandwidth by developing a 16-level modulation communication system that combines four levels of amplitude with four levels of phase modulation. The combination was chosen after a series of tests at Jet Propulsion Laboratory with many combinations of amplitude, frequency and phase modulation.

NASA also reports gains in antenna design. Aided by an advanced computer program, antennas have been designed to generate beam contours that can conform to prescribed, irregular boundaries of time zones or states. This will permit neighboring satellites to work well without interfering with each other.

Both efforts are part of NASA's advanced communications research program, which will continue despite the fact that the agency has retired from the business of actually producing and launching communications satellites.

A new U.S. earth-resources agency proposed

A bill to establish an Earth Resources Observation Administration has been introduced in the Senate and is being considered by the Senate Aeronautical and Space Sciences Committee. According to its principal sponsor, Sen. James Abouresk (D-S.D.), the new administration would be part of the Interior Dept. and would have primary responsibility in the Government for "turning remote sensing technology into an operational reality." The administration would be empowered to contract with NASA for the design, development and launching of future earth-resources satellites. While the present Earth Resources Satellite System (ERTS) has produced some spectacular results, Senator Abouresk says, data flows are running two months late and potential users are being discouraged from using the satellite system operationally because of the danger of termination or interruption of data.

AWACS countermeasures key to its future

The fate of the Airborne Warning and Control System (AWACS), with its huge lookdown radar designed to pick out enemy aircraft from ground clutter, will hinge on whether the Air Force can convince Congress that the radar cannot be jammed effectively. Sen. Thomas Eagleton (D-Mo.) says that a classified report by the General Accounting Office shows that the AWACS radar could be completely blacked out by inexpensive ground-based jammers. The Air Force admits that radar could be jammed, but it says this would take large numbers of jammers. The House Armed Services Committee slashed the AWACS fund request and

says it won't give full authority until the R&D program is further along and the additional electronics, recently ordered when the Pentagon decided to put AWACS in a tactical role, have been fully tested. The results of the tests, including new counter-countermeasures gear, should be available by December.

An 'agile' airborne radar to be developed

Westinghouse Electric has been selected to develop what promises to be the Defense Dept.'s most advanced airborne radar, officially named the Electronically Agile Radar. The company was one of four—which included Goodyear Aerospace, Hughes, and Raytheon—that performed advance studies to see whether a multimode, phased-array radar could be developed to combine all the various airborne radar tasks, including both air-to-air and air-to-ground functions. Westinghouse, under a \$2.8-million contract, will deliver two systems by 1978 for ground and flight tests. The U.S. is not presently planning any new aircraft capable of carrying the multimode radar, although the radar could go on later models of the B-1 bomber.

U.S. to study train automation

The Office of Technology Assessment, the agency set up by Congress to provide expert advice on technical subjects, plans to examine the state of technology of automatic train controls. Its interest reportedly is being spurred by problems with the California Bay Area Rapid Transit system and other smaller systems. The office will issue a contract for a comprehensive analysis of all the basic hardware systems installed or planned for major transit systems in the U.S. But it has not yet decided who will do the study.

Capital Capsules: The Air Force is planning advanced computer research with an eye toward development of a radiation-hardened computer for an advanced ICBM that could one day replace the Minuteman III. The program includes definition of an advanced computer and the development and testing of CMOS and MNOS devices. . . . The National Science Foundation is sponsoring a study of computer science research aimed at defining what computer science is, what major research problems are under investigation and the relationship between research and application of computers to national needs. The principal investigator, Dr. Bruce W. Arden, Chairman of Princeton University's Electrical Engineering Dept., is seeking suggestions and ideas. . . . NASA has completed agreements with seven colleges and universities to award 20 aerospace fellowships to encourage women and members of minority groups to seek careers in engineering and certain scientific fields. . . . The Defense Dept.'s air-to-air radar homing missile, the Hughes Brazo, has passed its first flight test. The missile designed to lock onto an aircraft fire-control radar, is a joint Navy-Air Force developmental effort. . . . The Environmental Protection Agency is looking for a contractor with capability in remote-monitoring instruments and techniques to determine how monitoring instrumentation can be used to enforce clean-air programs. . . . The Navy Regional Procurement Office, Long Beach, Calif., plans to invite industry bids for a contract to develop an improved LED. Use of a higher modulation bandwidth in the near-infrared spectrum allows the new diode to have increased radiance and longer life than present LEDs. . . . Aerospace Corp., acting as a prime contractor to the Law Enforcement Assistance Administration, will subcontract for the design and fabrication of a low cost, prototype electric field-sensor system, for use with low-cost residential and small-business security systems.

Fingertip signal averaging...

...and a lot more

Any signal that can be displayed can be digitized, stored, and processed by the TEKTRONIX Digital Processing Oscilloscope.

A noisy signal . . .

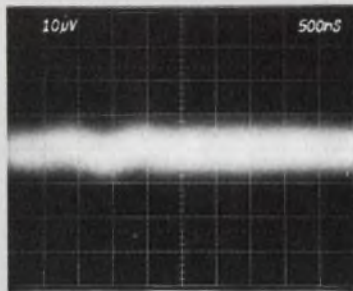

. . . is made useful by signal averaging with the DPO.

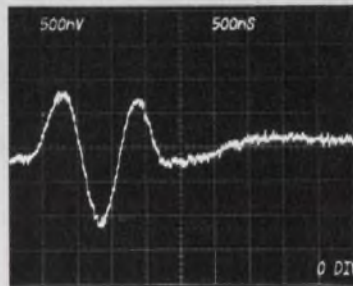

Over 30 TEKTRONIX 7000-Series oscilloscope plug-ins give the DPO unmatched acquisition flexibility. Signals from microvolts to kilovolts in amplitude, from picoseconds to seconds in duration, and from dc to 14 GHz are now available for computer analysis.

The range of possible measurements is almost unlimited. Program call buttons on the DPO give you fingertip access to waveform processing from simple multiplication, addition, and subtraction to integration, differentiation, Fourier transforms, and correlation.

Get all the details from your local Tektronix Digital Applications Engineer. For your copy of the "Digital Processing Oscilloscope" brochure, contact: Tektronix, Inc., P.O. Box 500A, Beaverton, OR 97005. Phone: (503) 644-0161. In Europe: Tektronix Ltd., Guernsey, C.I., U.K.

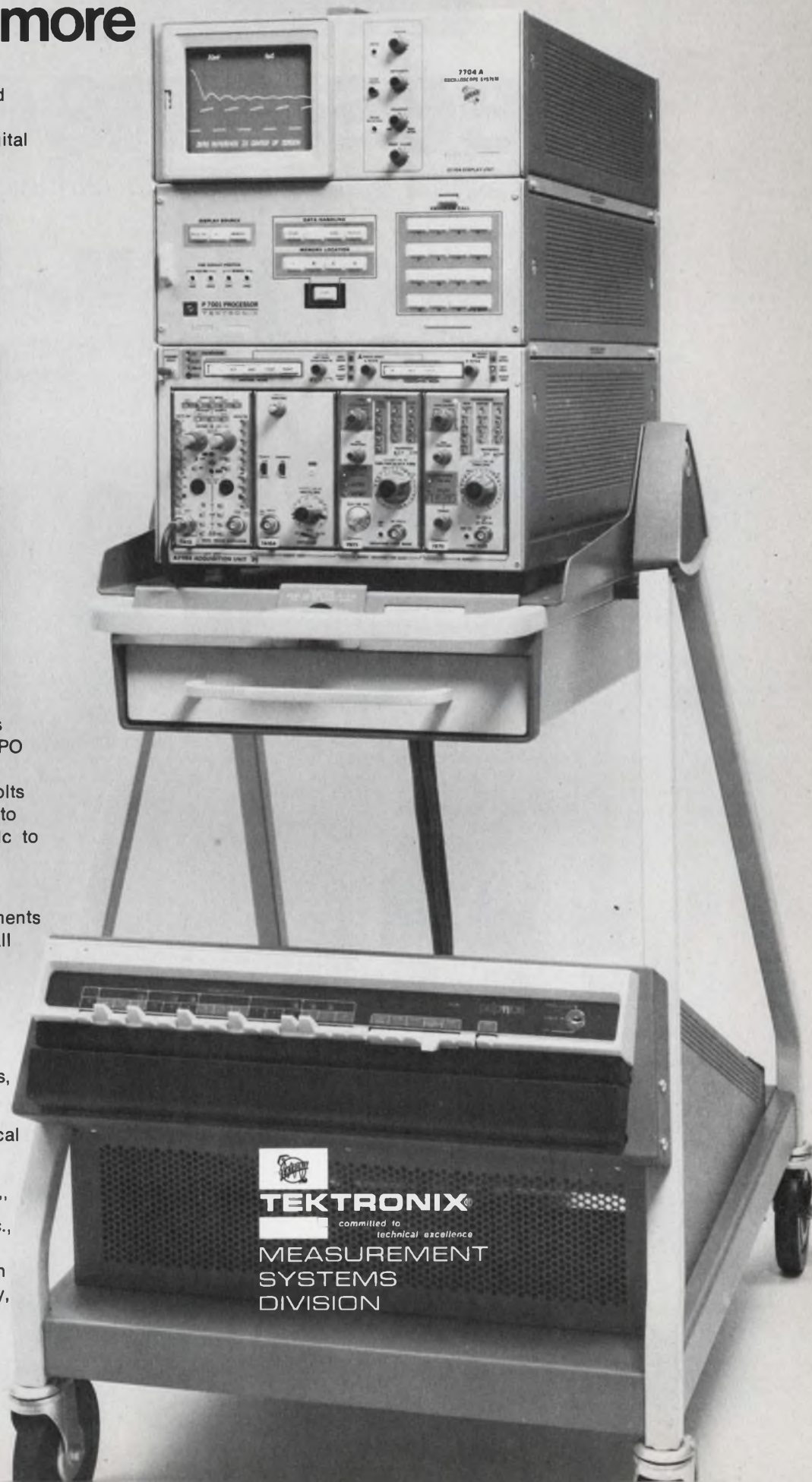

TEKTRONIX

committed to
technical excellence

MEASUREMENT
SYSTEMS
DIVISION

INFORMATION RETRIEVAL NUMBER 30
FOR DEMONSTRATION, CIRCLE 208

Dialight sees a need:

(Need: Single source supply for all indicator lights.)

See Dialight.



INCANDESCENT OR NEON MINIATURE AND LARGE INDICATORS

Designed to accommodate either incandescent (2-250V) or neon (105-250V) lamps for panel mounting in 11/16" or 1" clearance holes. Units meet or exceed MIL-L-3661 requirements; all are listed in Underwriter's Recognized Components Index. Wide selection of lens shapes, colors,

finishes and terminations. Many lenses may be hot stamped, engraved or offered with film legend discs. Oil-tight units with unique "O" ring construction make them oil, water and dust tight on the face of the panel. Available off the shelf for prompt delivery.



LED, INCANDESCENT OR NEON ULTRA-MINIATURE DATALITES®

Meet or exceed MIL-L-3661. Replaceable plug-in cartridges for 1.35-125V operation. Indicators mount as close as 1/2" centers; available with red, green, amber, blue, white translucent, light yellow or colorless lenses in wide range of lens shapes, legends and finishes. Off-the-shelf.



INCANDESCENT OR NEON SUB-MINIATURE INDICATORS

Meet or exceed MIL-L-3661. Mounts in 15/32", 1/2" or 17/32" clearance holes. Incandescent for 1.35-28V; neon has patented built-in current limiting resistor. Choice of cylindrical, faceted, convex, flat, square and round lens shapes, colors, finishes, legends. Off-the-shelf.

DIALIGHT

Dialight, A North American Philips Company
203 Harrison Place, Brooklyn, N. Y. 11237 (212) 497-7600

SEND ME FREE INDICATOR LIGHT PRODUCT SELECTOR GUIDE.



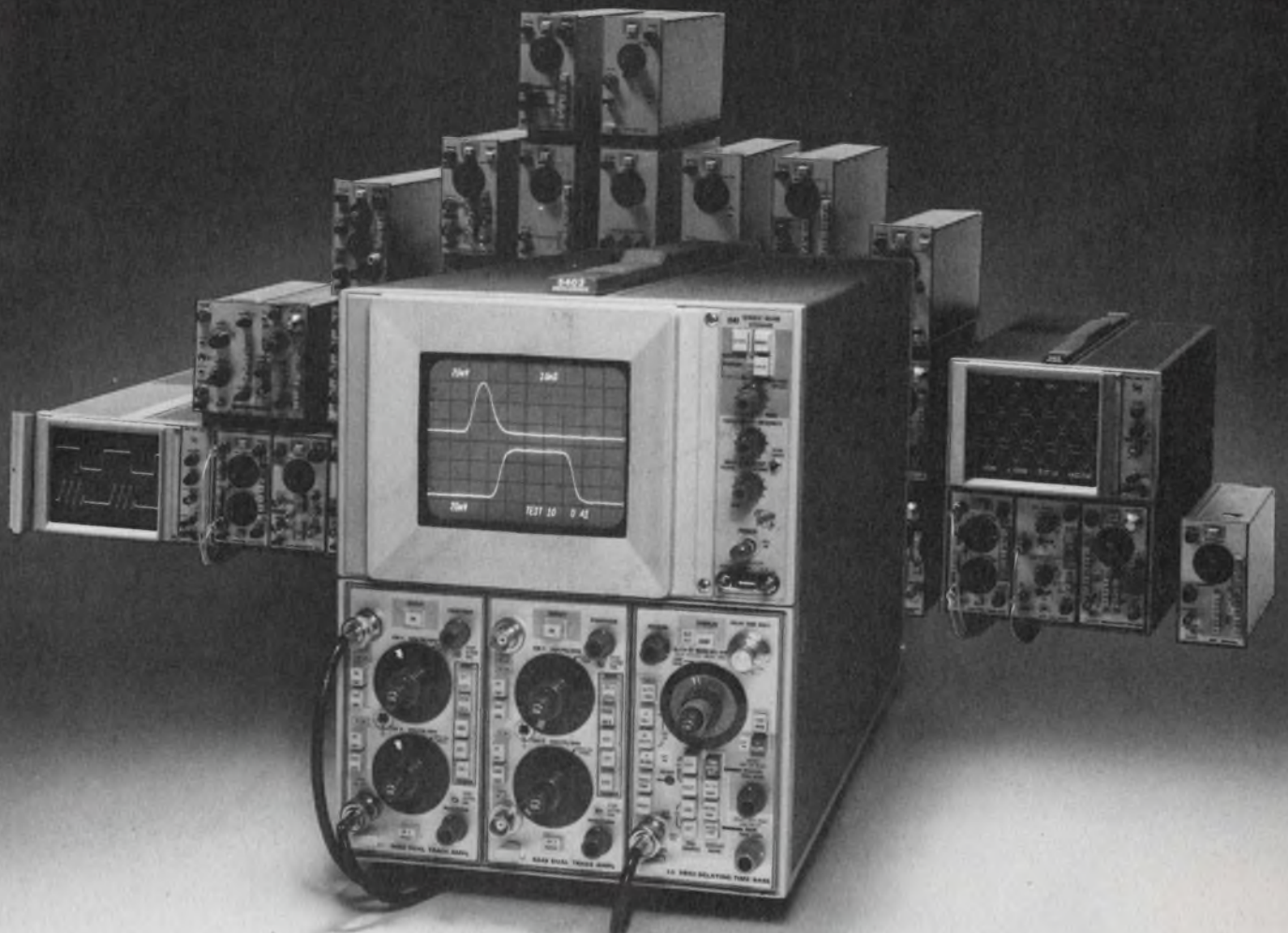

Capture Those Hard to View Signals at Low Cost

Single shot events; high speed, low repetition rate signals; changes in successive sweeps, very slow signals; repetitive signals obscured by random noise—all of those hard to display waveforms are easy to view using the new 5403/D41 Variable Persistence Storage Oscilloscope from Tektronix.

You vary waveform storage time for the 5403/D41 simply by turning a dial. Normal intensity viewing time ranges from milliseconds up to 5 minutes and a waveform can be saved for up to an hour by simply pushing a button.

With a writing speed of 5 div/ μ s, 60 MHz bandwidth and the added convenience of a 3 plug-in mainframe, the 5403/D41 saves you hundreds of dollars over the price of other variable persistence storage oscilloscopes. Complete with 60 MHz vertical amplifier and 10 ns/div time base, the 5403/D41 is priced from only \$2450. What's more; with the flexible, easy-to-use 5403/D41 you can add unique

convenience features: CRT readout of deflection factors, and user programmable CRT readout of test identification data.

Versatile, Modular Family. The 5403/D41 Variable Persistence Storage Oscilloscope is the latest addition to the versatile, modular 5000 Series. With this flexible family you can tailor the oscilloscope best suited to your measurement needs by choosing from 2 mainframes (60 MHz or 2 MHz bandwidth), 7 display modules, and 21 diverse plug-ins. 5000 Series measurement flexibility includes a 60 MHz dual trace amplifier, a 10 ns/div sweep rate delayed time base, an easy-to-use dc to 1 GHz sampler, a dc to 100 kHz spectrum analyzer, a 10 μ V/div differential amplifier, a differential comparator accurate to 0.20%, a four trace amplifier (8 traces with two amplifiers), and a semiconductor curve tracer.

The flexible 5000 Series is designed to handle your present measurements and is expanding to meet your future needs.

To learn more about the new 5403/D41 Variable Persistence Storage Oscilloscope and how this low cost instrument can make difficult signals easy to measure, contact your local Tektronix Field Engineer or write Tektronix, Inc., P.O. Box 500, Beaverton, Oregon 97005. In Europe write Tektronix, Ltd., P.O. Box 36, St. Peters Port, Guernsey, C.I., United Kingdom.

INFORMATION RETRIEVAL NUMBER 32

FOR DEMONSTRATION, CIRCLE 206



TEKTRONIX®
committed to
technical excellence

surround it
with something special





Safety. Reliability. Long-haul performance. Cost. They all have an effect on your product's design parameters and capabilities.

Belden has a custom design capability in wire, cable, and cord that can help you meet the most demanding performance for your products. We've helped solve some extraordinary problems. Can provide definitive data and answers on flex life, oil resistance, electrical characteristics, aging that can cope with practically any environment your specific job criteria calls for.

Talk to your Belden specialist about it. He understands design requirements. Can give you straight answers on cable or cord design feasibility. What modifications are possible. What the trade-offs are. The costs involved. We haven't perfected that "fancy" jacketing yet, but can improve the wire, cable, or cord package you need to meet the most challenging electrical, physical and thermal applications you might be faced with.

If you need answers right now, phone:
(312) 887-1800, Transportation Division
(312) 681-8920, Electrical Division
(317) 966-6681, Electronic Division
Or write Belden Corporation, P. O. Box 386, Geneva, Illinois 60134.

H-2-3

BELDEN 

INFORMATION RETRIEVAL NUMBER 234



The new Keithley Model 168 autoranging DMM... ...vive la différence!

There really is a difference in Digital Multimeters, and once you've experienced Keithley's 168 you'll know why we say *vive*! If you're tired of "general-purpose" promises that turn into run-of-the-mill

performances; if you want that bit extra that'll make your job easier, then *vive la différence*... here's the DMM for you! Send for our DMM Selector Guide or call us for demo now. **Phone (216) 248-0400.**

AC
DC
VOLTS
AMPS
OHMS

5 functions

100 μ V to 1000 V dc
100 μ V to 500 V ac
0.1 μ A to 1 A dc
0.1 μ A to 1 A ac
100 m Ω to 20 M Ω

two-terminal input

Simple to connect. You can't get it wrong. Eliminates the word "whoops" from your vocabulary. Saves temper, too.



options & accessories

Rechargeable batteries that you can install anytime. An RF probe for high frequencies. Test leads. A 50-amp current shunt too.

hi-lo ohms

Select either of two voltage levels, 1 V or 100 mV, for ohms measurements. You can have your PN junctions either way you want 'em... on or off.

price

Enough said? Order one... or two... or three now!

\$299⁰⁰



automatic ranging

You just connect the signal and push the function. The decimal point pops into position automatically and the display is direct reading. That does save time!

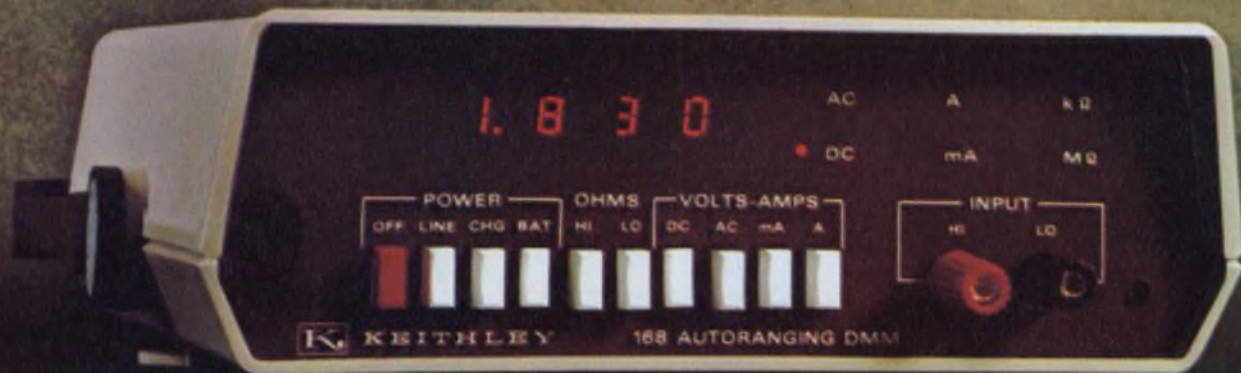

K KEITHLEY INSTRUMENTS
U.S.A.: 28775 AURORA ROAD, CLEVELAND, OHIO 44139
EUROPE: 14, AVENUE VILLARDIN, 1009 PULLY, SUISSE

FOR PEOPLE WHO WANT TO READ ALL ABOUT IT!



We have nothing less than a fully illustrated, systematic, easy-to-use survey of the entire field of data management as it exists today. It covers it all, from A to Z, so it's for everybody. The programmer tightening up his files. The analyst working out a workable timesharing program. Top management needing industry-wide perspective on competitive system designs.

It's a rare publication that takes a unique "blueprint approach" to current know-how. Beginning with the single data item as the first building block in total system design. And progressing through specific techniques for data structures, streams, files . . . total hardware and operating system control . . . the latest advances in timesharing and multiprogramming . . . system modeling and simulation . . . complete

designs for various types of commercial accounting and document-oriented storage and retrieval systems. It all adds up to a vast and impressive "top to bottom" view.

And it does it all in fresh, jargon-free language, with scores of illustrations and diagrams for a rapid, visual grasp.

Whether you use it as an on-the-job manual, as a desk-top reference, or as a conference room companion with all the answers, it's an indispensable tool guaranteed to broaden your perspective and practical skill in a field that knows no limits to growth and progress. And generally give you the professional confidence that comes from knowing just about everything that's going on.

#5100-X, 6 x 9, 300 pages, cloth \$14.95

To Order:

Circle the **Information Retrieval Number** to order your 15-day free examination copy of **Data Management for On-Line Systems** by David Lefkowitz. At the end of that time please remit payment or return the book with no further obligation.



Hayden Book Company, Inc., 50 Essex Street, Rochelle Park, N. J. 07662

SIEMENS

The unvarying ingredient in every Siemens component: batch-to-batch quality.

Even though Siemens makes 50,000 different shapes and sizes of components, to meet virtually any need *and* the reality of your economics, we're best known for the efforts we devote to quality. Year after year, batch after batch. (We've made 500 million pot cores in the last 5 years alone.)

One of the reasons for our high level of quality and reliability is the two million dollars we invest every working day in research and development. Our R&D program has paid off well—90% of the components we offer today were not available 10 years ago.

R&D has also enabled Siemens to pioneer metallized polyester-film (MYLAR*) capacitors, tuning-diodes, gas-filled SVP's® and cradle relays. And there are more innovations on the way.

If you depend on electronic components, you can depend on Siemens. Batch after batch, the quality never varies.

*DuPont registered trademark.

For details, get in touch with your local Siemens specialist, or fill in the coupon below.

Please indicate your specific area of interest and mail to:
Siemens Corporation, Components Division
186 Wood Avenue South, Iselin, N.J. 08830

- | | | |
|---|---|---|
| <input type="checkbox"/> BWO's | <input type="checkbox"/> LCD's | <input type="checkbox"/> Semiconductors |
| <input type="checkbox"/> Capacitors | <input type="checkbox"/> LED's | <input type="checkbox"/> Opto-Electronics |
| <input type="checkbox"/> Ferrites | <input type="checkbox"/> Planar Triodes | |
| <input type="checkbox"/> Gas - Filled Surge Voltage Protectors (SVP®) | <input type="checkbox"/> Relays | |

Name _____ Title _____

Company _____ Tel. _____

Address _____

City _____ State _____ Zip _____

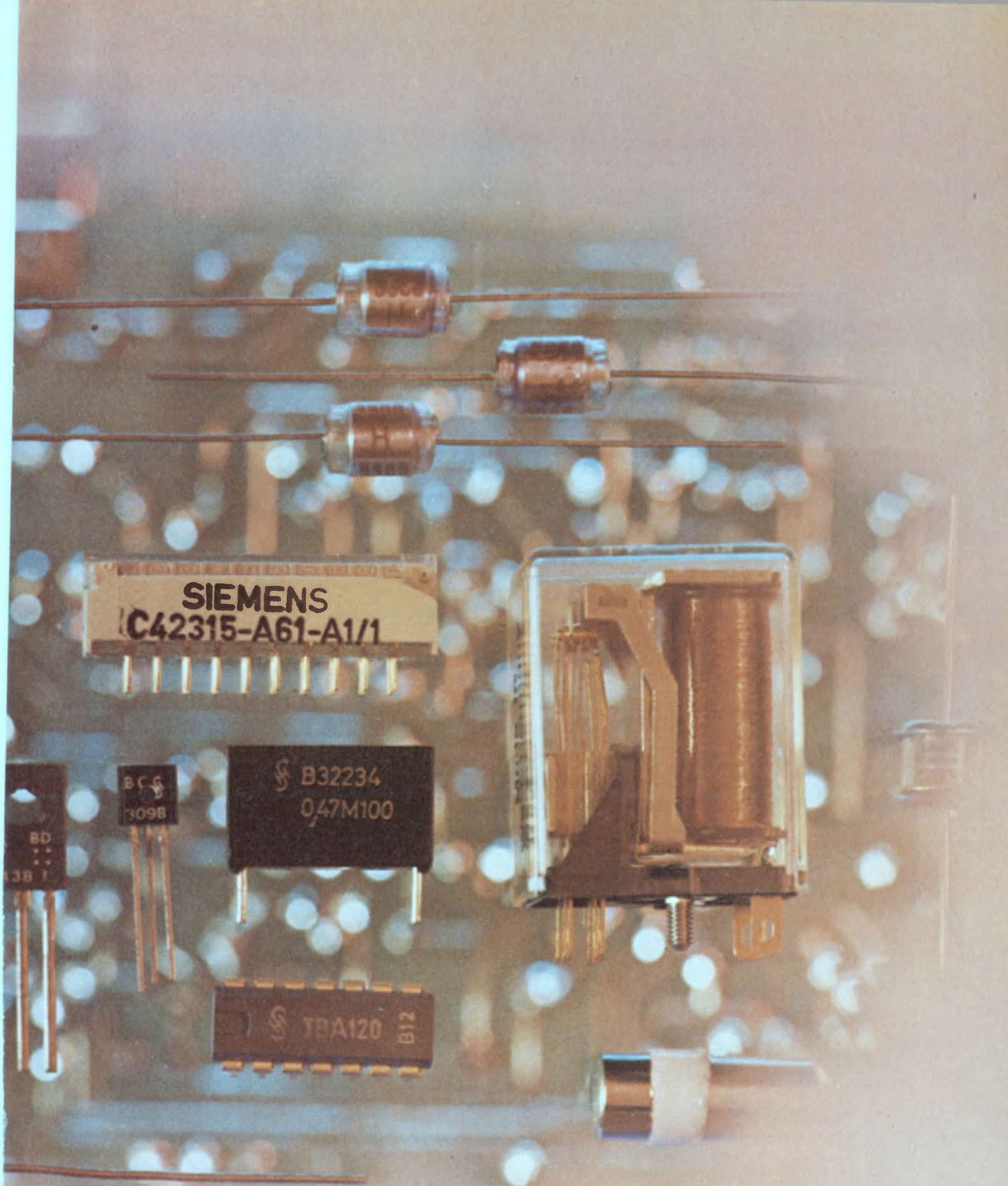

Siemens Corporation
Components Division

186 Wood Avenue South, Iselin, N.J. 08830 (201) 494-1000

INFORMATION RETRIEVAL NUMBER 35

DigiTec introduces
another product in the

HT SERIES *(a breakthrough in
High Technology)*

4½ digit, precision Digital Multimeter.

DigiTec's new Model 2210, Digital Multimeter is a full 4½ digit, bi-polar instrument, combining pushbutton convenience with laboratory accuracy and performance. Consistent with the design standards of the HT Series, the Model 2210 delivers the highest level of reliability and serviceability. DigiTec's new, revolutionary "HT Converter," A to D conversion technique, coupled with the use of proprietary LSI, has significantly reduced

component count providing the basis for high reliability. All circuitry and components are state-of-the-art, with plug-in ICs, LEDs and circuit board for easy maintenance. As with all DigiTec HT Series instruments, the Model 2210 is housed and protected by a contemporary, designer-styled, aluminum enclosure that provides an outward appearance as advanced as the technological innovations it contains.



Model 2210
Digital Multimeter **\$525.**

Features: Revolutionary "HT Converter" / DC ranges to 1000 volts with autopolarity, sensitivity 100 μ V / AC ranges to 1000 volts, sensitivity 100 μ V / Basic accuracy .02% / Resistance ranges to 20 megohms, sensitivity 0.1 Ω / 4½ digit, large easy-to-read Monsanto LED display / 13 measuring ranges, pushbutton selected / Rack mountable, diecast and extruded aluminum enclosure / Compact half-rack size / Optional, optically isolated parallel BCD output / Available from stock / Generous OEM quantity discounts on request.

UNITED SYSTEMS CORPORATION
918 Woodley Road, Dayton, Ohio 45403
Ph (513) 254-6251 Twx (810) 459-1728
a subsidiary of

Monsanto

INFORMATION RETRIEVAL NUMBER 235

DigiTec

FOR DEMONSTRATION CIRCLE 236

You can't get this from Augat.



The blank card you see above has 120 connector contacts and 22 built-in test points. It will accept a fantastic variety of sockets, microboards, and discrete components.

It is our 3-D Dual-in-Line Socket Card. You can buy it blank and install only the sockets you need. Or you can buy it with sockets

already installed in a variety of standard configurations.

You get what you need, and you pay for no more. And it will liberate your design ideas as no Augat board can.

Try us. We'll see you through.

EECO

1441 East Chestnut Avenue
Santa Ana, California 92701
Phone 714/835-6000
Also from G. S. Marshall Company nationwide.

FREE SOCKET BOARD AND PACKAGING
HARDWARE CATALOG!

We'll send it to you if you'll send us the
information below.

Name _____

Position _____

Company _____

Address _____

FET CHIPS For Hybrids

from the industry leader in high-quality FET products

When your hybrid design calls for FET chips to a JEDEC specification, your first choice should be Siliconix JEDEC-equivalent dice. You can select from more than 500 different JEDEC-type FET chips, all manufactured with the same meticulous attention to product quality which has made Siliconix a byword in the industry.



FET Input Op Amp

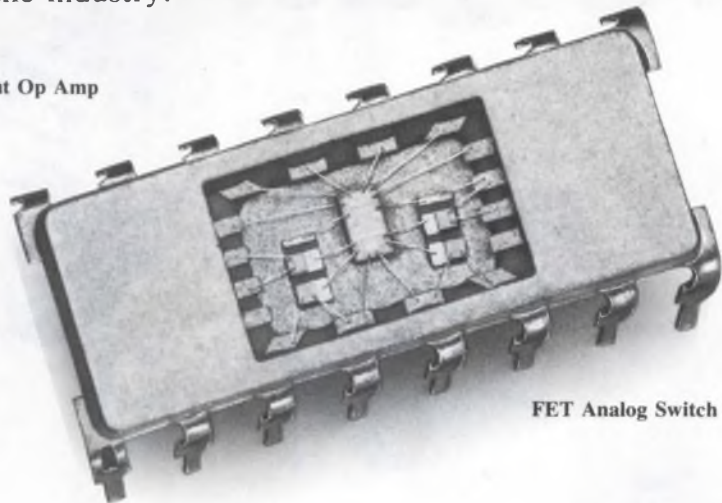

FET Analog Switch

All standard Siliconix FET chips are equivalent to their JEDEC or house-numbered parents on *all testable parameters*. We have hundreds of JEDEC and house-numbered parts in our product line. To specify a JEDEC-equivalent chip simply add the suffix "CHP," as in 2N4416 (JEDEC registration) = 2N4416CHP (chip form). When

your design calls for a special device, remember that we've produced over 4000 different FETs sorted to custom electrical specifications—We'll be happy to select to your individual requirements.

For additional information on chips recommended for new equipment design or replacement service, plus a list of tested parameters and test conditions

write for data

FET Applications Engineering (408) 246-8000, Ext. 120



Siliconix incorporated

2201 Laurelwood Road, Santa Clara, California 95054

INFORMATION RETRIEVAL NUMBER 37

The job that couldn't be done

I don't know who wrote it, nor where. But ages ago I read a little ditty that went something like this: *The experts said it couldn't be done./ And to look at the job, who wouldn't?/ But I tried the job that couldn't be done./ And what do you know?/ It couldn't.* That seems to prove once again, that the experts are right. But they aren't always. There's a wonderful repudiation of experts in Thor Heyerdahl's *The Ra Expeditions*, published by Doubleday & Co., Garden City, N.Y., 1971. Heyerdahl wanted to prove that the ancient Egyptians could have brought their culture to South America in boats made of papyrus—yes, the stuff they made paper from. Well the experts assured him that it couldn't be done. The president of the Egyptian Papyrus Institute insisted that papyrus sinks after two weeks, even on a river. And archaeologists said that papyrus dissolves in sea water and breaks up in the waves. The experts placed papyrus reeds in a bathtub and, by golly, they sunk—proving that a papyrus boat couldn't cross the Atlantic.



But Heyerdahl wasn't smart enough to listen to the experts. With a crew of seven men in 1969 and eight men in 1970, he made two trips in papyrus boats from the Moroccan city of Safi. With the first, he almost reached, and with the second, he succeeded in reaching Barbados, off the coast of Venezuela. Each voyage covered almost 3300 miles in eight weeks.

The experts had learned that an individual papyrus reed is soft and sappy, so it will absorb water and sink. But when many reeds are roped tightly together, water won't penetrate their ends, so they'll float. Such experts, in an earlier era, might have proven that a steel ship can't float because a slab of steel sinks. As they often do, the experts performed the wrong experiment. They drew conclusions from partial evidence and incomplete experience.

Are most of us any better? How often do we reject design approaches because experts proved they can't work. How often do we assume that unexplored avenues must lead to dead ends? How many of us have the guts to say: "I know this can't work, but I'm going to try it?" The "impossible" design can be the most brilliant.

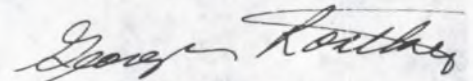

GEORGE ROSTKY
Editor-in-Chief

FOCUS

on
Data-acquisition
equipment

Plants halted. Products ruined. Thousands of dollars lost—just because something went wrong with a data-acquisition system. It may sound incredible but it often happens. With many data-acquisition systems, a slight inaccuracy can blossom into a system shut-down.

System accuracy can never be better than the sum of its parts—and it's usually worse. Inaccuracies don't just add up. Often they are multiplied by factors like amplifier gain. Whether you build or buy a system, you need more than casual care.

Basically you have two options. And no matter which you choose, problems are certain. You can buy a complete system, where all you have to do is turn a key; or you can piece together a system from parts, and worry about matching component specs and doing the programming.

Usually a data-acquisition system will contain the following:

- Specialized amplifiers or other circuits to

condition sensor outputs so that they can be either transmitted or converted.

- Multiplexers to combine many data signals onto one line.
- Sample-and-hold (s/h) circuits to hold analog voltages steady long enough for conversion.
- Analog-to-digital (a/d) or voltage-to-frequency (v/f) converters to convert the analog into digital form for either transmission or analysis.

Problems? Vendors have been known to exaggerate or overestimate the performance of their equipment, and this can be especially troublesome if you piece one circuit from Company A to another from Company B.

Here are some areas of potential confusion:

- System accuracy. Should individual errors be worst-case summed? Averaged? Rms'd?
- Over-all system throughput. Measurement speed depends on various settling times, conversion times and multiplexing delays.

Dave Bursky
Associate Editor

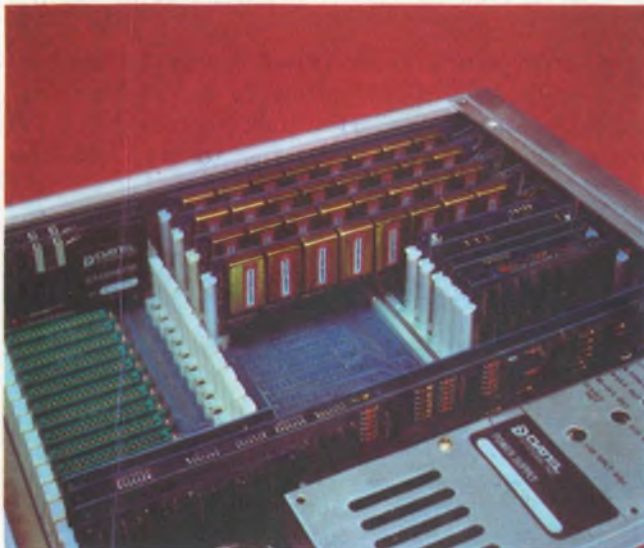

Plug-in circuit cards (left) are used in the Datel-256 data-acquisition system to perform all signal-conversion and sampling functions. This system can be expanded up to 256 channels due to its structure. Some of the front-panel options are shown above, including channel-select and manual controls.

- Noise immunity. Spikes and common-mode signals may be present on one or more of the input channels.

- Temperature stability. Voltage offsets and other errors of the individual circuits drift with temperature.

- Computer programming. Does the computer have enough memory, is it fast enough, are there enough input/output lines?

- Real system cost. This includes installation, setup, programming and maintenance.

System accuracy disappears in many ways

A data-acquisition system's accuracy depends upon many factors: signal losses during transmission, multiplexing inaccuracies, amplifier errors, s/h circuit errors, a/d converter errors and computational round-off errors. The over-all system spec should be a combination of all the possible error sources.

Errors due to transmission signal losses are easily overlooked because they occur outside the equipment. If long leads are required in a plant or lab, losses will, of course, result from line resistance, inductance, and shunt capacitance. Furthermore signals can become garbled by noise picked up from power lines, machinery or electrical equipment.

No matter what the equipment, the site at which it operates has a great deal to do with its performance. The electrical conditions of the plant or lab, power-line conditions, temperature, corrosive gases and moisture can all deteriorate system performance.

Wires scattered about in a plant or lab are apt to pick up stray noise or induced voltages if they are near power lines or heavy equipment. Even data-acquisition systems that are mounted on circuit cards in a computer mainframe have to be shielded against the heavy digital switching

noise from the memory circuits and the logic.

Induced voltages in the signal lines can be filtered out if their signal spectrum differs widely from the signal to be measured. You can minimize the unwanted noise with either a low-pass, bandpass, high-pass or notch type filter. Noise generated by equipment operating from the same power line can also find its way into the system if special line filters are not used or if the unit is operated in an environment for which it wasn't designed.

Noise and voltage spikes on the signal lines pose a threat to any computer system. If the spikes are large, there's a good chance they can reach all the way into the processor and burn out logic circuits. To avoid this, various isolation techniques have been developed—optical couplers are becoming increasingly popular. System operation can also be maintained by use of floating, fully differential instrumentation amplifiers, with high common-mode rejection and filtering.

The plant layout may affect operation in strange ways. With the centralization of control rooms, the sensors, in many cases, must be placed far from the mainframe equipment. Long cable runs are then required, and increased resistance and capacitance result. In some systems this increase can slow the over-all loop response or cause reading errors. Imbalances in thermocouple wire and changes in lead lengths are not always compensated for, and this can lead to calibration and accuracy problems.



Any or all of four input channels can be displayed by the Macrodyne ERDAC III data-acquisition system. The instrument digitizes and stores incoming analog signals.

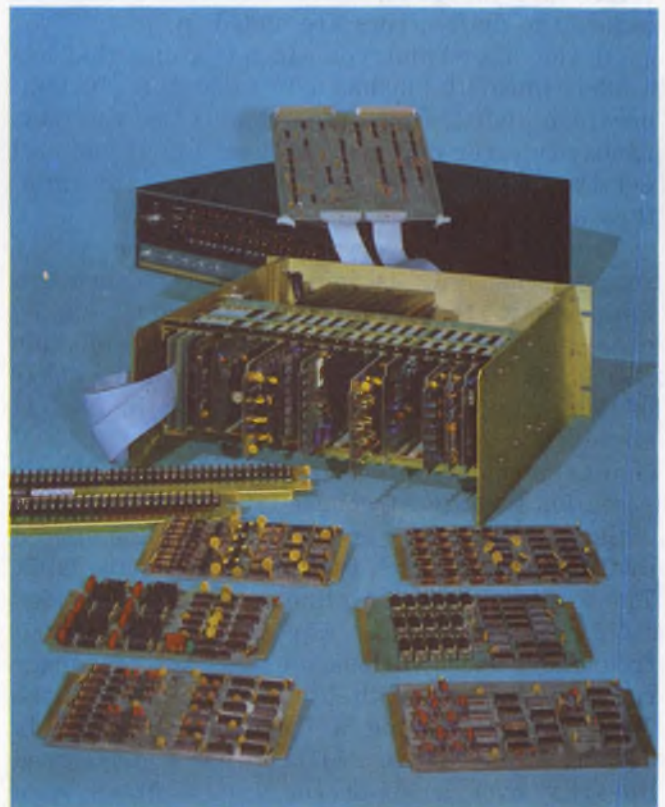

The RTP series of circuit cards and card cages, from Computer Products, covers almost any data-acquisition problem you might encounter.

If you do the signal conversion at the sensor instead of at the computer, you can save on signal conditioning circuitry—by using more converters—and reap the benefit of digital data transmission. The choice is yours—you can use an a/d or a v/f converter to transmit the signal digitally.

For slowly varying signals either an a/d or v/f converter can produce accurate results. But, as signal frequencies increase, a/d converters can't follow the signal, and converter digital outputs may have substantial errors. (For more about converters see "Focus on A/D and D/A Converters," ED No. 1, Jan. 4, 1973, p. 56.)

V/f converters usually respond faster than a/d's, but they introduce their own problems—linearity errors and temperature drifts. The linearity spec defines the accuracy with which the converter will change a voltage into a corresponding frequency. And the temperature coefficients tell you how much the circuit drifts with temperature.

Most manufacturers sell units that are a compromise between good linearity and temperature drift. For example, you can buy a converter that has a linearity error of 0.05% maximum, but has a temperature drift of, say, 100 to 200 parts-per-million (ppm) for every degree change in temperature. Thus, for a 10-C change the frequency might drift by as much as 2 kHz if you use a 1 MHz converter. The linearity of this converter also causes an inaccuracy of 500 Hz even before the drift errors are added in.

On the other hand, you can buy a unit that has a 0.5% linearity but has a 10 to 50 ppm/°C temperature drift. Here repeatability is the key. Linearity error may not be important if you still get the same output frequency five or ten minutes later.

Tradeoffs are everywhere—even the power supply sensitivity is important. You must examine how the units react to power-supply changes. Simple op amps have high rejection ratios, but more complex circuits can have drifts of 500 ppm/1% change in V_{cc} , or higher. If standard ± 15 V supplies are used, a 0.15 V change in their output could produce a 500-Hz variation in output frequency for a v/f converter.

Several units have evolved—with a line offered by Teledyne-Philbrick typical of what's available. The Philbrick units are linear, voltage-controlled oscillators that can rapidly change output frequency over various voltage or frequency ranges. The unit with the widest range is the Model 4705, covering a frequency span of six decades from 1 Hz to 1 MHz. It has a guaranteed linearity over a six-decade input-voltage span of 0.001%. Resolution of this unit is equivalent to a 14-bit a/d converter, a stability of 44 ppm/°C and hook-up that permits unipolar or bi-

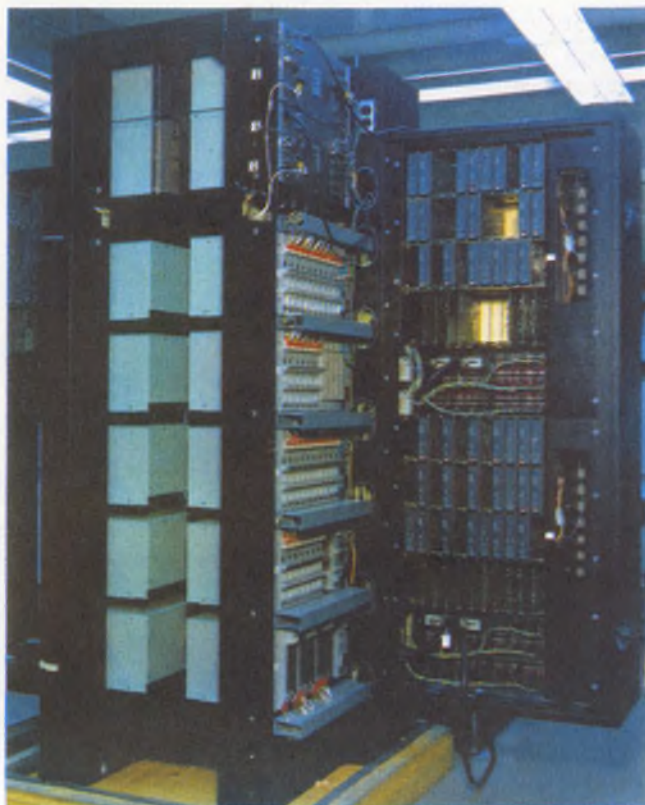

Large rack-mounted systems, such as these from Foxboro Corp., provide data-acquisition and control functions for large plants where safe equipment is needed.



The flow of data at either a laboratory or plant site can be controlled by the Digital Equipment PDM-70 programmable data mover. It uses simple programming.

polar, voltage or current, inputs. Cost for the 4705 module is \$125 in singles.

Other modular circuits are not only making inroads, but in some cases are taking over areas such as voltage-to-frequency and frequency-to-voltage conversion. One of the newest products that can encode analog signals into digital form is the Deltaverta encoder from Hybrid Systems.

This encoder uses a form of delta-sigma modulation to produce a pulse train output that is both proportional to the input voltage and synchronous with an externally applied clock frequency. The DV-610 and DV-611 encoder and decoder modules can form a two-way data-acquisition and control system by use of time-division multiplexing. The encoding scheme is a low-cost way of acquiring analog data, with 0.01% linear-

ity and minimal signal conditioning (see "The Low-Cost Way to Send Digital Data," ED No. 2, Jan. 18, 1974, p. 68.)

At present the Deltaverta modules can accept only 0 to -10 V and deliver a TTL-compatible output. Speed is also on the low side with the optimum clock frequency for conversion about 10 kHz. If high resolution isn't necessary, these units, at \$39 apiece, should prove quite useful.

Advances in a/d conversion circuitry are also taking place. Low-power circuits like CMOS are used for digital control functions within the converter. Hybrid Systems, for example, has the Model 575-12, a 12-bit, low-speed a/d converter that draws only a few milliwatts. This converter circuit has good linearity (± 0.5 LSB) and is priced under \$200.

Other advances are shrinking converters. Twelve-bit successive approximation converters can now fit in small, dual-inline packages. Micro Networks' MN series of DIP packaged converters are complete circuits with reference elements and amplifiers. Available in a wide variety of formats and input ranges, they are trimmed to minimize offsets and drifts.

As we've already seen, most conversion schemes work well with slowly changing inputs, but the converter outputs can't easily follow rapid voltage fluctuations.

Freeze the converter input

To freeze rapidly changing inputs, s/h circuits are often used in front of the a/d converter. But this doesn't completely solve the accuracy problem. The sample-and-hold circuits introduce other errors. And some of these errors aren't always mentioned on manufacturers' data sheets. A pedestal error occurs in s/h circuits each time the circuit switches from the track to the hold state. This stems from the capacitive transfer of residual charge across the turned-off switch onto the holding capacitor. The same switch signal that controls the s/h circuit causes a small voltage spike when the circuit switches to the track mode.

How long can the s/h circuit hold the captured voltage? This depends, among other things, on the dielectric absorption effects of the holding capacitor. The capacitor must be of high quality to retain a sampled voltage accurately. This is especially important in multichannel simultaneous-sampling systems, where the individual s/h circuits may not be immediately polled for data—there may be a delay of a millisecond or so. Another thing: Voltage droop, caused by input leakage currents in the sampling circuit, can also affect systems accuracy.

Does the device driven by the s/h circuit have any pump-out current? Pump-out current feeds



This Bell & Howell data-acquisition system makes possible a variety of applications. The multichannel inputs can be plotted on the X-Y recorders housed in the rack.



When connected to a 7000 series scope and a PDP-8 computer, the Tektronix digital-processing plug-in, Model 7001, does a multitude of data-acquisition tasks when hooked up to the desired scope plug-ins.

back into the s/h circuit and produces an error voltage, or it causes errors within the signal source—ringing, noise or distortion.

As an example of how pump-out current can affect precision amplifiers, consider the following: Assume a signal source has an output resistance of 1 k Ω , a full-scale input signal amplitude of 10 mV and an operating temperature of 40 C. These conditions could produce a pump-out current of "only" 4 nA from the load device. But this would cause a 4- μ V error voltage across the 1 k Ω input source impedance—a 0.04% error based on the 10-mV full-scale. To avoid results like these you must be careful when interfacing different system components to avoid accuracy losses. An amplifier that's accurate to 0.01% won't necessarily give you that system accuracy.

What about overload of the s/h or amplifier circuits? How fast do the circuits recover from voltage overloads? When amplifiers or s/h units are switched from channel to channel, are they going to face wide signal level variations? Look for all this information on the data sheets, but you'll rarely find any of it. Component heating can affect the accuracy of low-level signals and amplifier response: so ask the manufacturer about it if you have any doubts.

Modular s/h circuits are available from many companies. Most of the larger manufacturers of a/d converter modules, such as Teledyne-Philbrick, Analog Devices, Hybrid Systems, Burr-Brown and Intech, also have modular s/h circuits that include the holding capacitor. And some companies offer s/h modules with pinouts for an external holding capacitor.

Burr-Brown, for example, has a hybrid IC s/h circuit that requires only a holding capacitor



SERDEX data-manipulation modules from Analog Devices can transform parallel binary or BCD data into serial ASCII-coded binary for simple data transmission.

to function. The voltage droop of this amplifier is a low 0.1 mV/ms, and the capacitor determines the rest of the hold characteristics. This unit, Model SHC-23, costs \$45 in singles and is housed in a TO-8 metal can.

Several companies have fabricated pairs of amplifiers with the necessary FET switches as single-chip circuits which they sell as general-purpose s/h amplifiers.

Multiplexer and scanner problems

To collect many channels of data and combine them onto a single line, you will need either a multiplexer or relay scanner. Of recent advances in multiplexers, the single-chip, 16-channel analog IC dominates; older modular circuits are slowly giving way to this new unit. Relay scanning circuits are advancing too, with better thermal design, isolation and shielding methods, but scan-

ners may be fighting a losing battle in the long run as solid-state multiplexers move in to replace them in all systems except those that involve extremely low level signals (below, say, 10 mV).

When trying to decide which multiplexer or scanner to select, make sure you check these operating requirements:

- Can you randomly access each channel or must you sequentially scan all inputs?
- Are you mixing low-level signals?
- How much noise do the solid-state or relay switches create?
- How does voltage overload affect the unit?
- Does thermal heating from overloads affect operation?
- How much control circuitry do you need to support the multiplexer or scanner?
- Can the multiplexer be expanded? Can you daisy-chain several units for easy system expansion?

Problems faced when analyzing multiplexer specs include thermal and voltage offsets, contact resistance, switch resistance, contact bounce, switching time and level matching.

To preserve signals buried in noise—especially low-level signals—avoid solid-state switches. Noise in semiconductor materials often overrides low-level analog signals. Mercury-wetted reed relays with switched ground shields offer the best solution. Since low-level analog signals are usually of very low frequency, the slowness (100 operations/s) of mercury-wetted relays shouldn't pose any serious problems.

For low-level transducer signals, signal conditioning at the sensor location usually allows the most accurate data acquisition. If many low-level points are grouped near each other, a low-level signal scanner or multiplexer can minimize the number of amplifiers needed. You can first multiplex the signals, then feed them through a single amplifier.

In this single-amplifier approach, crosstalk within the multiplexer, bandwidth limiting of the amplifier, settling time of both the amplifier and multiplexer and other factors can destroy the signals. Other problems, like the need to run a line to the sensor to supply power for the conditioning equipment, must also be considered.

The signal conditioning boxes go by different names, but they all include amplifiers, gain controls and, sometimes, reference elements—such as thermocouple reference junctions or a voltage reference.

Most data sheets claim dazzling system throughputs. Make sure that the speed given is for the entire system and not just for the system's heart—the a/d converter. Not only should the spec include the a/d conversion time but also the acquisition time of the s/h circuit, the com-

puter delays, the processing time and the settling times.

System speed: How fast can you move data?

In a computer-based system, you can't always enter data as fast as the information arrives. Make sure the computer can handle the data while it still controls the system. If your data rate is too high, software delays can cause the system to bog down, even though you haven't exceeded the converter or front end throughput rate.

If raw input data must be processed on a real-time basis, the number of sensors to be handled should not exceed 1000. Thus if you want to sample all the points in one second and do some processing of the data, 1 ms per point would probably allow between 10 and 60 operations to be completed under computer control. Of course, the exact number of operations and points depends upon the speed of the processor.

For more than 1000 points, you'll be better off using direct memory access (DMA). This computer feature permits the raw digital data to be stored sequentially, directly into the memory. With this option, your system speed depends more upon converter and s/h circuit delays than on software limitations.

Can you talk to the system?

Putting together a system isn't the only problem. How do you control it once it's wired? Should you use a hard-wired controller with switch-selectable speeds? Or should you use program control to tell the system what, and when, to sample?

Software control is, of course, the most flexible: All you do is tell the computer which lines to switch and where to store the data. But you still have problems. In what language must the control sequence be written? How many control lines are available? Can you skip several channels or are you stuck with "dead time" (the time it takes to cycle through unused channels)? Does the system include a time clock? If it does, can the clock be computer controlled or is it under manual control? Does it have a battery back-up?

Many of the new systems use programmable read-only memories to hold control instructions. Can the memories be altered at the site? Are they inexpensive enough to be "throw away" units?

Are all your incoming data in the right form for the computer? Data may be transmitted as straight binary, binary-coded decimal, ASCII coded binary or some other form. Of course, the computer should have the processing and storage



The modularized construction of the Monitor Labs Model 9400 data-acquisition system can be seen in this front view. CMOS circuitry keeps the power dissipation low.



Time, channel number and parameter value are displayed on the front panel of the Digitec Model 1266 data logger. It has a built-in system clock and manual switches to control the scan rate and the scan mode.

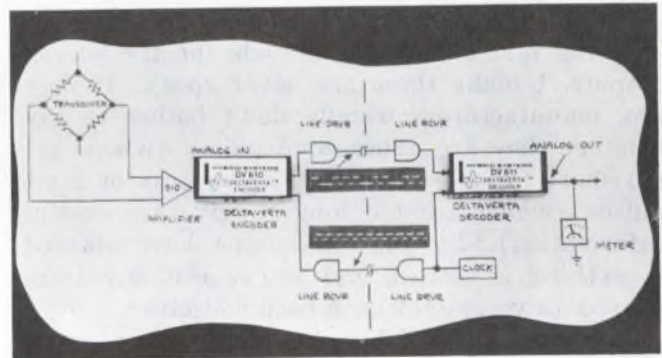

Low-cost alternatives to a/d and v/f converters for serial data transmission are available with Deltaverta encoder and decoder modules from Hybrid Systems.

capability for the data.

Other desirable features in a data-acquisition system include some storage registers so the computer doesn't have to hold a request until the data are available. Adjustable time delays in the system can help the computer match the speed of the various subsystems. Suitable propagation delays also help guarantee that the data on the input lines have settled before they are sent to the computer for processing.

In any data acquisition setup—especially if

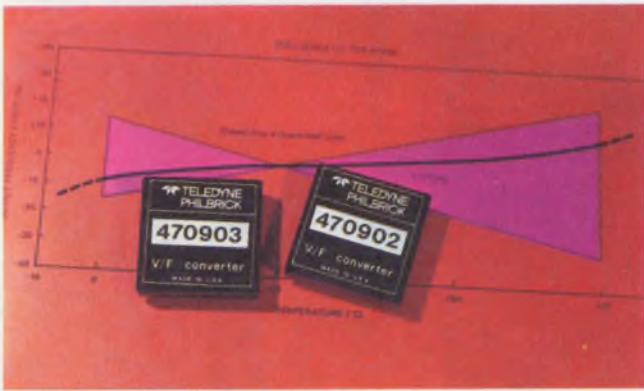

Frequency spans from dc to 1 MHz and voltage or current spans are handled with very low drift by Teledyne-Philbrick's line of v/f and f/v converters.

you assemble it yourself—many different specs must be matched.

The pieces must work together

As a start check the input circuits. There are many types of input amplifiers. You can have a flying-capacitor differential input, a true instrumentation-amplifier, or a three-wire system with or without a switched ground line. You can also have a chopper-stabilized, transformer-coupled input.

If the system has an analog output, it's wise to have a differential common-mode return for the d/a converter output—most don't. Most use a system ground that tends to be very noisy.

In the system controller, you should have blanking and unblanking signals for the analog outputs. Usually these are never spec'd. If they are, manufacturers usually don't bother to say whether they are nanosecond pulses (which are too short for most modular converters) or 5-ms pulses (which are too long to give any useful information). By the time 5-ms have elapsed everything is settled, and you've lost any transient data you might have been collecting.

Asynchronous serial lines can also present problems. What types of line drivers and receivers are used? If the data sheet lists a 20-mA current loop, this can mean any of myriad drivers and receivers—some compatible with long lines, some with short, some with coax, etc. Some lines are optically coupled and are touted for their isolation. But when manufacturers tell you they're optically coupled, they don't say you can run only 300 baud because optical coupling reduces the speed.

Signal conditioning amplifiers, whether in modular or rack-mounting form offer you many forms and quality levels to choose from. Regardless of which form you use, in data acquisition, certain specs predominate as the most critical.

For good accuracy and stability, common-mode

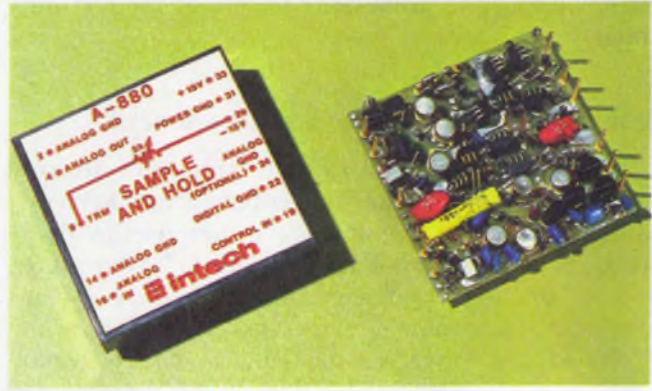

The A-880 sample-and-hold circuit, by Intech, provides a sample acquisition time of $1.4\text{-}\mu\text{s}$ and a voltage droop of only 1 mV/ms .

rejection should be high and stability drift low. Rack mounted units are capable of 126 dB or better of CMRR and 0.001% gain stability. Modular units are rapidly approaching these performance levels, but still have a little way to go.

So called "instrumentation amplifiers," known for their high precision, have a major advantage over high quality op amps—ease of gain setting without deterioration of the CMRR or input impedance. All you have to change on an instrumentation amp is a single resistor—on a typical op amp you would have to tweak anywhere from two to five resistors to do the same job.

All forms of signal conditioning amplifiers are notorious for their drift, noise and other error sources (see "Focus on Analog Function Modules," ED No. 21, Oct. 11, 1973, p. 64).

High quality rack-type amplifiers usually offer the best performance—but at a price. Their voltage drifts range from one or two microvolts per degree of temperature change to less than $0.1\text{ }\mu\text{V}/^\circ\text{C}$. Modular devices typically have drifts that range from tens of microvolts down to about $1\text{ }\mu\text{V}$. Some of the companies that make the precision rack signal conditioners include Ectron, Computer Products, Newport Labs, Preston Scientific, Dynamics Electronic Products, Hawkeye Instruments and Scientific Columbus.

Module houses like Analog Devices, Teledyne-Philbrick, Datel and Analogic offer modular instrumentation amplifiers that also qualify as "precision" units. Today there are even a few monolithic instrumentation amplifiers, including chopper-stabilized versions.

Watch out for high precision specs, though. An amplifier's common-mode rejection might be listed as 120 dB (a million-to-one ratio). But if we look at a 10-mV input signal and assume that a 100-V common-mode voltage exists—a likely possibility at industrial sites—a false signal of $100\text{ }\mu\text{V}$ will also appear on the input. This

additional signal actually amounts to a 1% error, thus "wasting" the 0.1% or better accuracy of the amplifier.

Not only must the common-mode rejection ratio be greater than 120 dB, it must also hold up for large line unbalance and different frequency ranges. Unfortunately the CMRR drops off rather sharply as the frequency increases above about 10 Hz.

The temperature stability is also critical. Over varying temperatures, the set gain of the amplifier can change. Usually the better the amplifier, the less the change. Temperature coefficients of commercial units are now down to numbers like 0.001 or 0.003%/°C. Nevertheless, a temperature variation of, say, 40 C would change the gain by 0.12%—a large variation if we're talking about 0.001% accuracy.

Many temperature errors are referred to the input (RTI) while others look better if they are referred to the output (RTO). To compare "apples with apples," RTI errors can be multiplied by the amplifier gain to obtain the equivalent RTO errors.

To counter losses in precision due to temperature drift, the easiest solution would be to build better units. One example of what's available in rack-mounting precision amplifiers, is the 700 series of units from Ectron. These amplifiers are wideband, dc differential circuits that are available in over 500 configurations.

Basic amplifiers have common-mode voltages of 300 V, rejection ratios of 126 dB, 0.005% linearities, 0.01% gain accuracies, 0.003%/°C gain stabilities, 1 $\mu\text{V}/^\circ\text{C}$ zero stabilities and bandwidths of greater than 100 kHz.

Some options include manual or computer-controlled gain, selectable three-pole active fil-



Radial arrangement of components in the Computer Labs Model 7110 a/d converter keeps propagation delays constant between all the converter signal paths. This unit converts 10 bits at 10 MHz.

ters, six gain ranges, a gain-range display, four or 10-line control and manual overrides. Prices for the manually controlled models start at \$330, while the computer-controlled versions start at \$640.

Another interesting unit is the triple-mode charge amplifier Model 7350 from Dynamics Electronic Products. This instrument can be used as an ac line amplifier or a strain gauge or thermocouple instrument. It has a gain of 1 to 1000, a gain charge of 0.1 to 1000 mV/pC. The 7350 has a 120-dB common-mode rejection, a 100-kHz frequency response and 5 μV of noise (referred to the input).

A differential charge amplifier permits the use of grounded transducers. This allows the transducer mass to be minimized and can also eliminate problems caused by mounting insulation. Differential action allows common-mode signals to be rejected by use of conventional guard techniques.

Other features like filters, calibrators, gain-control options are all available. The Tri-mode amplifier has a base price of \$665, plus options that can range from \$20 to \$110. All circuits are protected against excessive input signals and output short circuits. This type of instrument is best suited for multiple applications where you cannot justify dedicated instruments for each measurement function you must perform.

Standardization does exist somewhere

About 60 companies have started to standardize their product lines to Computer Automated Measurement and Control (CAMAC) guidelines. These guidelines include standards for module sizes, card cages, specifications, ground planes, connector pinouts and methods of data communication between modules.

CAMAC equipment can mate with just about anybody's computer. This lets industry fix the design of front ends without freezing the processor design.

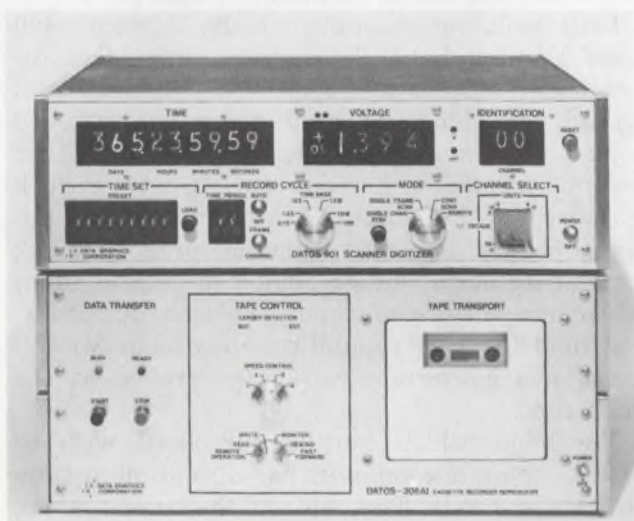

A multichannel data-acquisition system is formed when the Datas 306 cassette recorder-player and Datas 901 scanner-digitizer are combined. The equipment is from Data Graphics Corp.



An automatic weighing system from Martin-Decker uses pressure transducers to acquire data through a central digitizing controller.

If you're not sure which CAMAC specs to call out, you can get a copy by writing to the Government Printing Office, Washington, D.C. 20402. Ask for documents TID-25875, 25876, 25877 and 26488.

Each modular instrument designed for CAMAC use is housed in a rack-mountable case that is 12 in. long \times 8.75 in. high. The widths come in multiples of 0.7 in. Included within each module are control circuits that can decode the function requested, recognize the address being requested, generate interrupts and detect errors. This circuitry is included in the module in addition to the circuitry for the unit's specific function—a/d converter, d/a converter, multiplexer, shift register, etc.

Each module has a front panel with room for indicators, control switches and monitor points. Up to 32 different functions, in different modules, can be selected with a five-bit function code. Functions are defined for such actions as write, read, selective set, selective clear, clear, test status, enable, disable and execute.

Kinetic Systems, one of the many companies that offer CAMAC-compatible units, has over 50 different types. The CAMAC card cage, commonly called a "crate," can hold up to 23 unit widths (0.7 in.); costs range from about \$3000 to over \$10,000. The price includes cabling, power supplies and computer interface. The company's higher priced systems also include a microprogrammable branch driver, complete with its own power supplies. The individual CAMAC modules cost anywhere from \$250 to \$1500, depending upon the function desired.

As an example of the available modules, let's look at Kinetic Systems' 3500 series. In it are four a/d converter cards—two with 10-bit resolution and two with 12-bit. Each pair of modules offers either a single converter or a dual converter on a single card. Prices range from \$850



Several switch-selectable scan speeds are available with the Kaye Instruments Digistrip transmitter. The unit handles 15 data channels and outputs them in ASCII.

for the single 10-bit unit to \$1260 for the dual 12-bit unit. The conversion time for any of the units is less than 25 μ s, and the resolution accuracy is better than ± 0.5 LSB. The input impedance is greater than 100 M Ω , and input ranges of either 0 to 10 V or ± 5 or ± 10 V are jumper-selectable. Outputs are coded in 2's complement, when the converters are used in the bipolar mode.

Other types of CAMAC modules available include digital output registers, d/a converters, input registers, relay multiplexers, digital frequency scalars, counters, timers and controllers.

The full system: Endless varieties

When you buy a full system from one manufacturer, you eliminate the need to match many different specs. Many companies make data-acquisition systems that have tremendous flexibility through use of computer controls.

Let's look, for example, at the System 9400 from Monitor Labs. The system interfaces directly with a Nova minicomputer. Software programs are included so the unit can be controlled in assembly language, Basic or Fortran. Other features include: a low-power CMOS time clock with battery backup that lasts for days; individual channel skipping; function programming; monitoring mode; either analog or digital input acceptance; choice of input function digitizers; and multifunction capability, in which two internal a/d converters can be controlled at the same time.

The 9400, which can be purchased with or without the minicomputer, has an optimum sample rate of 1 kHz. The price of the basic system, \$5650, includes software, the digital interface, a column printer, a controller board, the digital time clock and 10 input channels. Starting with this basic package, expander-controller boards

and analog input boards can be added to increase the number of channels to 1000.

Monitor offers four types of input boards that can accommodate signals from microvolts to tens of volts. These analog-signal boards are made for 10 three-wire or 10 four-wire sensor inputs. Special signal-conditioning circuits can also be connected to shape or attenuate signal levels under computer control. The digitizing circuits within the 9400 resolve analog signals to one part in 40,000, using either dual-slope or successive-approximation conversion techniques.

Expandability and flexibility are necessities for data-acquisition systems. Aside from expansion capabilities of up to 1000 points, programmable read-only memories are used for system control in Monitor's 9400 and similar systems. Thus if the control sequence has to be altered, you just plug in another set of ROMs, and your system is back on line. Skip and control-function programming are done on special cards that contain banks of switches. This means that channels can be added or taken off-line in the field—with no wiring changes.

PCM for data acquisition

Pulse-code modulation (PCM) is gaining favor for systems that involve serial-data telemetry. The Data Manager II, made by Tetrahedron, offers a PCM encoding scheme to give high signal-to-noise ratios and automatic ranging for a very wide dynamic range. It also has a parity check for error suppression and an incremental motor that offers flexible recording rates for low sampling times and long recording times. The system has 14 channels for analog inputs, a time channel, a maximum input range of ± 10 V, a scanning rate that can vary from 0.01 to 20 scans/s and recording times from 800 to 4 million seconds per tape.

Options for the Data Manager system include computer interfaces for either EBCDIC or ASCII codes; or a true digital integrator to record the difference between the digital values on any two channels and accumulate the sum of the difference.

The basic system with 14 channels sells for \$9300. The maximum frequency that the equipment can handle though is quite low—only about 5 to 7 Hz.

One of the most unusual systems for data acquisition and display is the M/S 20D, made by Metra Instruments. This instrument accepts transducer signals in the 5-mV-to-5-V range and provides bar-graph CRT displays and digital readout in engineering units. It also has both BCD and serial outputs for other interfaces.

The M/S 20D can handle 20 to 80 points, and it provides a permanent record on either a tape

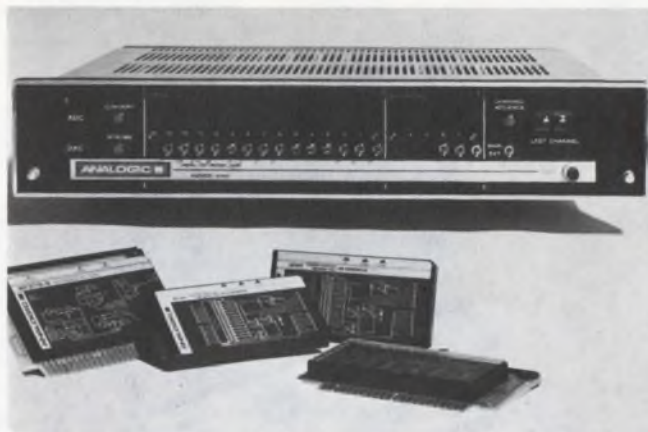

The Analogic 5800 data-conversion system can combine both a/d and d/a converters, sample-and-hold circuits and multiplexers to handle up to 64 channels of data.

console or a printer. The display tube is a 20-in.-diagonal CRT that provides an accuracy of 1% of full scale. Standard systems come with 50-channel capability, with automatic brightening of every fifth channel for easy identification.

Signal conditioners are also available in the M/S 20D for thermocouple inputs. The unit is pretty large—the display measures $19 \times 17.5 \times 13$ in., and the control section is made for 19-in. rack-mounting. The cost of the basic system is \$4000, and conditioning options add several hundred to thousands of dollars to the price.

Versatility in compact units

The Gould 6000 data-acquisition system has a fully floating front end that provides 120-to-140-dB common-mode rejection. The system can be operated up to 200 V off ground, and it has up to a 200-V input protection circuit to prevent overload damage. It also has an amplifier with high input impedance and programmable gain. Input impedance is greater than 100 M Ω , and each analog input has four gain ranges.

The 6000 system accepts both analog and digital input signals—analogue signals from ± 10 V, full scale, down to 5 μ V can be mixed with 3-digit hexadecimal, BCD or octal digital inputs. There is a choice of real-time monitoring for a single channel or all channels. You can also select a local display for a single channel of all the channels you are monitoring, or you can monitor the channels on a video or teleprinter display.

The built-in tape deck for a 3M cartridge can store 500,000 readings of 16 bits each. The System 6000 operates from 0 to 50 C, has 0.05% resolution and weighs less than 40 lb. It can handle from 8 to 128 channels.

System-6000 options include interfaces for a tape deck, a PDP-8 computer parallel input, and



For field data-logging applications, the Model 4434 data-acquisition system from Incredata has all the necessary equipment in a sturdy case.

a general-purpose serial-data input to hook up an ASCII port. You can slave extra scanners to the master unit for additional channel data acquisition. Data are recorded on the unit with a four-track, 800-bit range-encoding signal. Recording time can range from 43 minutes for a 200 point/s scan to 225 days for one scan every 10 minutes. Prices for the basic unit and some of the option cards are as follows: The 6000 mainframe costs \$3400, the analog input analog cards \$450, and the output interface cards for the minicomputer or general-purpose computer about \$1100, respectively.

Sometimes the collection of image data is a necessity. The IDAS image data-acquisition system from Kantronics collects video data in digital form. IDAS uses a camera and a video quantizer to interface with a computer. Typical uses for the system include measurement of the contents of assembly-line products, alignment of visual video signals, enlargement of microscopic images and tracking and monitoring of laboratory-stimulated animals. The basic cost of IDAS is \$3325. This includes a camera, quantizer, TV monitor, computer interface and a sync generator.

The ERDAC III system from Macrodyne is a self-contained transient recording data acquisition system. It can capture, digitize, record, display, measure and recall data. All collected data can be stored on a 3M tape cartridge.

Data that the ERDAC stores are first held in

a 4-kword-by-10-bit memory and can be transferred to the tape at any time. Four analog input channels provide the display with 100-kHz maximum signals and still give a 1-MHz time resolution. To ease data transfer, ERDAC has both serial and parallel data outputs.

For data display, a built-in 4 × 5 in. CRT can be controlled to show either one or all four data channels. A moveable cursor for the display can be shifted along the X-axis (time) to set the desired triggering point. The cursor appears as a bright spot on the display. Its position is also displayed on a LED numeric readout for both time and amplitude.

But the ERDAC III doesn't come cheap—the digital scope and amplifier channels cost \$12,500. The package is fairly large—10 × 16 × 22 in. and weighs about 40 lb.

Some other medium-priced systems include: Datagraphics' Models 701 and 305, Digitec's Models 1200 and 1500, Doric's Digitrend 200 and 210, Data Technology's Milliverter and DL1000, Electronic Modules' Minimux, Esterline's Model D2020 and Neff's Model 620. Most medium-priced units (\$2000 to \$7000) offer input ranges from 10 mV to 10 V, 3-1/2 or 4-1/2-digit resolution, 100 to 200% overranging, 0.1% or better accuracy, differential voltage between channels of from 12 to 300 V, and varying degrees of expansion capability and control options.

The more you pay, the more you get

Many computer manufacturers also offer data acquisition front ends for the units. Companies like Digital Equipment (DEC), IBM, General Automation, Data General, Texas Instruments, Modular Computer, Interdata and Hewlett-Packard sell full-sized data-acquisition systems that are used to monitor large industrial processes or to collect huge amounts of data for analysis.

Texas Instruments' TIMAP, CFS I and DFS IV are some of the largest systems. They're made for field use—on the back of a trailer-truck. These systems cost upward of \$100,000 and are used mainly for geophysical data collection and analysis. IBM's System 7 also can collect, control and analyze data, but at a price of \$70,000.

DEC offers many different systems based on either its PDP-8 or 11 minicomputers. For the most part, these are plant-based systems intended for collecting data from processes for subsequent control and analysis. Typical of DEC control systems is the IDACS 8/C. This PDP-8 based system offers complete control of any process by programming of input and output conditions with an industrial form of the BASIC language. A typical system consists of a PDP-8F computer, a dual tape drive, a terminal and

input/output boards.

Modular Computer's data-acquisition front end for its Modcomp minicomputers includes analog input options that allow inputs from potentiometers, amplifiers, accelerometers, flow meters, thermocouples, strain gauges, RTDs, pressure transducers, analyzers, chromatographs, spectrometers and more. Accuracy for the front-end equipment is specified at $0.05\% \pm 0.5$ LSB.

Each subsystem board for the analog inputs includes its own a/d converter and optical isolation between the controller interface and the subsystem to prevent transients from damaging the computer system or the controller. The controller can handle eight to 128 high-level analog inputs, eight to 512 wide-range medium-level signals and eight to 512 other wide-range analog inputs (mainly for low-level signals). Other optional features of these analog boards are automatic gain ranging under computer control, 15-bit resolution and ± 200 -V signal-handling capability.

If such large system capability isn't needed, Modular Computer also offers the MODAC subsystem. This provides 16 or 32 input channels and two, four or eight analog outputs. A serial data link allows for placement of the subsystem up to one mile from the computer.

What about plant control?

Looking for large plant control and acquisition systems? Check into equipment made by companies like Foxboro Corp. Foxboro's Spec-200 system uses a building-block approach and a bus-oriented structure to facilitate assembly of a system. Rack units accept plug-in amplifiers, conditioners, converters, multiplexers, controllers, etc.—all designed to work together with almost any computer system.

Spec-200 hardware, since it is made for industrial environments, is designed to be intrinsically safe. All units comply with Underwriters Labs (U.S.), PTB (German), CSA (Canadian) and BASEEFA (English) and other safety and electrical standards around the world.

If you already own a computer system, there are peripherals that can be added to provide data acquisition and control functions. For instance, Hewlett-Packard has just introduced a front-end—the HP 30300A—for the HP-3000 minicomputer-based time-sharing system. This unit is a programmable controller with an input/output structure designed for on-line instrument connection.

The 30300A uses the HP 2100 minicomputer as its controller. The basic system comes with 8 kwords of memory, a dual-port controller, a programmable time-base generator, a self-contained power supply, a paper-tape reader and an inter-

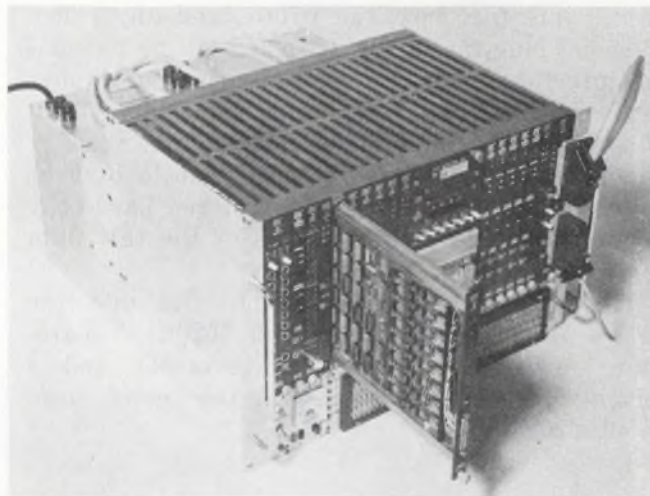

This CAMAC system crate, manufactured by Kinetic Systems, uses standardized plug-in modules. The modules are typically 0.7 in. wide and have uniform terminations for hook-up.

face kit. It also has 11 input/output channels available for data inputs. This system has a cost of about \$18,000.

One of the options available for the 30300A is a 16-channel analog input card made for high-level signal acquisition. It contains a 12-bit a/d converter, has a 20-kHz conversion rate and costs \$2000. The HP-3000 computer system, which includes a central processor with 96 kbytes of memory, a card reader, a line printer, a tape drive and 9.4 Mbytes of disc storage costs \$165,000. The 3000 can be programmed in high-level COBOL, FORTRAN, BASIC and a systems program language.

Vidar Corp. offers both complete systems and individual components for data-logging or control systems. These systems range in complexity from a close-to-\$1-million FM-multiplex recording system for rocket-engine measurements to a \$5000 system for logging data from production lines.

One of the systems made by Vidar is the 5400 programmable data logger. It uses a minicomputer to control and supervise the monitoring of 1000 channels of low or high-level signals.

Another Vidar system, the 600/6403, designed for low-level data acquisition, can handle 20,000 channels a second and deliver 12-bit data words. It also has 10 programmable gain ranges, with autoranging capability to 12,000 samples/s.

Tektronix offers a digital-processing oscilloscope. This unit, designed for laboratory data acquisition and analysis, uses a DEC minicomputer to process digitized signals from the scope. The data are handled with any mathematical algorithm you write and are displayed on the oscilloscope.

A precision data-acquisition system can be built with an ordinary Tektronix 7000 scope, a

digital interface box, the P7001, and any range of scope plug-ins, along with a mini or calculator interface. You can add a variety of input/output devices and peripherals for system flexibility. Cassette or high-speed paper-tape reader/punch units can be used for program loading or data logging. A graphics terminal and hard-copy printer can give printed copies of the raw data or plotted results.

The basic processor box that fits into the Series 7000 scope costs about \$5200. A bare-bones system, including the processor and a terminal to communicate with the scope, costs about \$20,000.

You've got to move the data

In industrial or laboratory situations it isn't enough to acquire the data; you must also send it to the processor. To do this, Analog Devices has developed the Serdex line of industrial data-acquisition and control modules. The Serdex transmitter, Model STX-1003, converts the 4-digit parallel BCD code that a/d converters can output into two-wire, compatible, serial ASCII code. This coded output is compatible with either a computer serial link or a data terminal serial link. The receiver module, Model SRX-1005, does the reverse; it converts serial ASCII to 4-digit parallel BCD for possible d/a conversion into a control signal.

The other modules in the Serdex series include a multiplexer pair, SMX-1004 and SMC-1007, which can combine up to 16 process lines onto a two-wire cable, and a clock module, SCL-1006, which can supply all the timing and control signals for all the other units. The clock module also supplies the operating voltages needed by the other units. The transmitter or receiver costs \$179, the multiplexer pair \$214 and the clock module \$65.

Another recently developed system for serial data exchange is DEC's PDM-70—a programmable data mover with input/output slots that accept up to seven boards. The boards accept either digital or analog data. The PDM-70 takes these data and converts them into serial ASCII for two-wire transmission.

Each of the option boards contains a universal asynchronous receiver-transmitter that does the actual code conversion. The options available include a BCD or binary input board that will accept up to a 32-bit parallel word and reformat it into serial ASCII. The BCD/binary output board does just the reverse. The analog input board can handle up to four differential channels and can convert the analog signals into serial ASCII. The converter boards have programmable gains and full-scale voltage ranges of ± 1.999 V, ± 199.9 mV, and ± 19.99 mV.

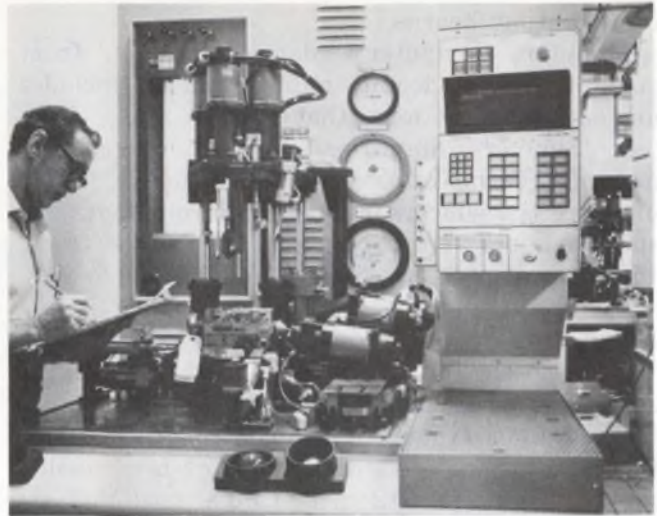

A carburetor test stand, made by General Automation, controlled by a computer-based data-acquisition system, not only tests the units but also keeps track of all the test data.

This board also has a mirror image board—the analog output option.

The control circuits within the PDM-70 let you change the control, scan sequence or routing of the signals at a moment's notice. This eliminates a lot of the down time when changes must be made in a controller. The basic main chassis, with the built-in control keyboard and alphanumeric display, costs \$2050. The optional analog-signal input boards are priced at \$650, and their matching analog output boards \$450.

There is still another connecting link between the sensor and the computer—the card and rack system. One, manufactured by Computer Products, has real-time peripheral cards and racks that can be assembled into any type of data-acquisition or control system.

The RTP 7400 series of subsystem cards includes such functions as a/d conversion, sample/hold and low-level multiplexing control cards. Computer input/output interface cards for almost any manufacturer's computer are available from Computer Products.

In the 7400 series each functional circuit card comes completely documented, so all controls and specs can be defined. This subsystem building-block approach is a step toward standardization. At least you know which pins represent control data, power-supply and other lines. This allows rapid system changes.

The input/output expander card, which differs for each computer, controls all the cards plugged into the system chassis. Each expander board can handle up to eight peripheral subchassis, which can hold up to 16 circuit boards to perform any desired function.

One of the analog front ends is the 7480—a wide-range analog input system. This card cage

system uses either dry or mercury-wetted, three-pole reed relays, with eight relay input channels to a circuit card. Operating speed of the relay switches is 200 samples/s for the dry relays and 100 for the mercury-wetted ones.

Each sampled signal then gets amplified by a programmable gain amplifier and digitized by an integrating 13 or 15-bit a/d converter, depending upon sampling speed. The system can be expanded to handle a maximum of 512 multiplexed input channels.

The 7470 system, designed for low-level signal acquisition, uses field-effect transistor switches and transformer coupling. Common-mode rejection at 60 Hz is a comfortable 120 dB, with a 1-k Ω input unbalance. Each channel input is on a separate circuit card, but this gives a very high degree of isolation and a 300-V common-mode range.

The 7470 system includes the low-level amplifiers, multiplexer, a/d converter and computer interface/controller. This front-end system offers an over-all accuracy of $\pm 0.05\%$ of full scale, referred to the output; linearity of 0.03% of full scale, from best straight line; differential feedback current (pump-out) of 5 nA for any channel that is sampled 100 times a second or less, and a channel sampling rate of 8000, 4000, 2000, or 1000 channels/s. The channel sampling speed includes a/d conversion and data-transfer times.

Prices for Computer Products' RTP-series equipment start at about \$900 for the input/output control boards, and \$120 and up for cabling, depending upon length. The analog input subsystems, made for wide-range input signals, use expansion chassis that can hold 16 eight-channel cards and the empty chassis costs about \$800.

Prices for the eight-channel input cards range from \$240 a card to over \$400, depending upon filtering options. The main chassis, which includes the multiplexer, a/d converter and the control circuitry, costs about \$2500 and can control up to 128 channels. Prices for the low-level system mainframe are in the area of \$2700 for the 64 input-channel version, with the channel cards about \$100 each.

Options for the equipment line include higher-resolution converters, single or double-pole filters, automatic gain ranging, manual controllers and voltage calibrators.

Systems, but not quite systems

Many data-acquisition systems are sold without the computer, though they're designed for a direct computer interface. These usually are a "mix and match" network of specially designed circuit functions that are meant to work together to acquire data.

For instance, the Datel 256 and the Analogic

5800 are rack-mounted units that can contain a/d and d/a converters, sample-and-hold circuits, storage registers, multiplexers and the control circuitry needed to sequence all these blocks. System prices range from \$1500 to \$7000.

Datel's System 256 offers several options on the front panel and many internal converter arrangements. Since these rack units are arranged on a bus-oriented structure, system expandability and modifications are as simple as pulling out one card and plugging another in.

Depending upon your application, the system mainframe for the Analogic 5800 can handle up to 64 channels, while the Datel 256 system can handle up to 256. Either system can be expanded with additional chassis to handle another 256 channels for the Datel 256 system or to over 4000 channels for the Analogic 5800. Both systems also have simultaneous s/h capability.

Smaller than a rack

- There are several smaller data-acquisition units that are not quite as flexible as the systems we've just looked at but which are much lower priced. These are the single-card data-acquisition systems such as the Analogic MP6912, the Data Translation DT1610 and the Datel DAS-16-LP.

Both the Analogic and Data Translation units are basically 16-channel data-acquisition systems on 3 \times 5 in. circuit cards each 0.375 in. high. These systems cost about \$700 for a throughput rate of 100 kHz (12-bit words). Each unit, though, contains a 16-channel solid-state high level multiplexer, instrumentation amplifier, sample/hold circuit and 12-bit a/d converter.

The Datel DAS-16-LP is slightly different. It also is a 16-channel system, but it draws very little power and is much slower than the other units—with a 2.2 kHz throughput. It uses CMOS circuitry to keep power requirements down to the microwatt level (120 μ W standby). The DAS-16-LP is also a bit larger than the other two units; it measures 4.5 \times 6 \times 1 in., but includes all control circuitry for the a/d converter, s/h circuit and multiplexer. The unit costs about \$750.

Present systems and circuit trends for data acquisition favor greater versatility and smaller packages. Many circuits—amplifiers, a/d converters, v/f converters, multiplexers and sample-and-holds—are appearing as monolithic or hybrid ICs. System throughput speeds are on the increase, allowing more points to be sampled in less time. The use of CMOS circuits has reduced power consumption and size a hundredfold, and in the next few years further advances appear assured. ■■

(continued on next page)

Need more information?

We wish to thank the many companies that provided information used for this report. The products cited in the report were selected for their illustrative, or in some cases, unique qualities. However, manufacturers not mentioned in the report may offer similar products. Readers may wish to consult manufacturers listed here for further details. Coding: (D)—full computer based system available with or without the computer, (M)—modular PC mounting subsystems, (R)—rack type card subsystems and (S)—stand-alone, noncomputer-controlled systems.

A. D. Data Systems, Inc., 830 Linden Ave., Rochester, N.Y. 14625. (716) 381-2370. (R, Van Gelder). (M) **Circle No. 338**

Acromag, Inc., 30765 Wixom Rd., Wixom, Mich. 48096. (313) 624-1541. (R, Hennings). (M) **Circle No. 339**

Active Control Instrumentation, Box 194, East Northport, N.Y. 11731. (516) 864-2111. (M) **Circle No. 340**

Acurex Corp., 485 Clyde Ave., Mountain View, Calif. 94040. (415) 964-3200. (J. Dennis). (M,R,S) **Circle No. 341**

Allis-Chalmers, Box 512, Milwaukee, Wis. 53201. (414) 475-2000. (D. Gibson). (D,R,S) **Circle No. 342**

American Astrionics, Div. of Technicolor, 291 Kalmus Dr., Costa Mesa, Calif. 92626. (714) 557-8480. (N. Vogel). (M,R) **Circle No. 343**

American Electronic Labs., Inc., Box 552, Lansdale, Pa. 19446. (215) 822-2929. (K. Farber). (R,S) **Circle No. 344**

American Instrument Co., Div. Travenol Labs., Inc., 8030 Georgia Ave., D16-2, Silver Spring, Md. 20910. (301) 589-1727. (R. Reich). (D,S) **Circle No. 345**

Analog Devices, Inc., Box 280, Route 1 Industrial Park, Norwood, Mass. 02062. (617) 329-4700. (M. Klapfish, Serdex; F. Pouliot, Modules). (M) **Circle No. 346**

Analogic, Audubon Rd., Wakefield, Mass. 01880. (617) 246-0300. (P. Pollins). (M,R,S) **Circle No. 347**

Bailey Meter Co., Sub. Babcock & Wilcox, 29801 Euclid Ave. Wickliffe, Ohio 44092. (216) 943-5500. (E. Gabrosek). (D,R,S) **Circle No. 348**

Beckman Instruments, Helipot Div., 2500 Harbor Blvd., Fullerton, Calif. 92634. (714) 871-4844. (H. Frazier). (M,S) **Circle No. 349**

Bell & Howell Co., Electronic & Instr. Group, 360 Sierra Madre Villa, Pasadena, Calif. 91109. (213) 796-9381. (R. Batiste). (D,R,S) **Circle No. 350**

Betatronics Inc., 9440 Lincolnwood, Evanston, Ill. 60230. (312) 676-1747. (H. Allen). (M) **Circle No. 351**

Biocom, Inc., 9522 W. Jefferson Blvd., Culver City, Calif. 90230. (213) 836-7263. (B. Dickey). (M) **Circle No. 352**

Biomation Corp., 10411 Bubbs Rd., Cupertino, Calif. 95014. (408) 255-9500. (D. Blecki). (S) **Circle No. 353**

Burr-Brown Research Corp., International Airport Ind'l Park, Tucson, Ariz. 85706. (602) 274-1431. (R. Gadway). (M,R) **Circle No. 354**

Burrhoughs Corp., 1649 Wilshire Blvd., Los Angeles, Calif. 90017. (213) 488-4520. (P. Meninger). (D) **Circle No. 355**

Calex, Box 555, Alamo, Calif. 94507. (415) 932-3911. (S. Cuff). (M,R) **Circle No. 356**

Chrono-Log Corp., 2583 W. Chester Pike, Broomall, Pa. 19008. (215) 356-6771. (D. Viberman). (R) **Circle No. 357**

Columbia Research Labs., MacDade Blvd. & Bullens La., Woodlyn, Pa. 19094. (215) 532-9464. (J. Sarty). (M,R) **Circle No. 358**

Computer Automation, Inc., 18651 Von Karman, Irvine, Calif. 92664. (714) 833-8830. (R. Drew). (D) **Circle No. 359**

Computer Conversions Corp., 6 Dunton Ct., East Northport, N.Y. 11731. (516) 261-3300. (S. Renard). (M) **Circle No. 360**

Computer Labs., 1109 S. Chapman St., Greensboro, N.C. 27403. (919) 292-6427. (D. Brockman). (M,R) **Circle No. 361**

Computer Products, Box 23849, Ft. Lauderdale, Fla. 33307. (305) 974-5500. (L. Buck). (D,R) **Circle No. 362**

Computer Signal Processors, 209 Middlesex Turnpike, Burlington, Mass. 01803. (617) 272-6020. (L. Grady). (D,S) **Circle No. 363**

Conrac Corp., Sherwood Lane, Fairfield, N.J. 07006. (201) 575-8000. (P. Daro). (D,S) **Circle No. 364**

Consolidated Controls Corp., 12 Durant Ave., Bethel, Conn. 06801. (203) 743-6721. (H. Drucker). (D,S) **Circle No. 365**

Control Data Corp., P.O. Box O, Minneapolis, Minn. 55440. (612) 853-5508. (K. Nichols). (D,S) **Circle No. 366**

Control Equipment Corp., 171 Lincoln St., Lowell, Mass. 01851. (617) 459-0573. (G. Stephens). (D,S) **Circle No. 367**

Control Logic Corp., 9 Tech Circle, Natick, Mass. 01760. (617) 655-1170. (A. Ross). (D,R) **Circle No. 368**

Cunningham, Sub. Gleason Works, 10 Carriage St., Honeoye Falls, N.Y. 14472. (716) 624-2000. (G. Appleton). (R) **Circle No. 369**

Custer Research Inc., P.O. Box 305, Fleetwood, Pa. 19522. (215) 376-2842. (L. Lewis). (R) **Circle No. 389**

Cycon Inc., 1080 E. Duane Ave., Sunnyvale, Calif. 94086. (408) 732-8311. (W. Peacock). (M) **Circle No. 370**

Data Control Systems, Commerce Dr., Box 584, Danbury, Conn. 06810. (203) 743-9241. (J. Lombardo). (D,M,R,S) **Circle No. 371**

Data General Corp., Rte. 9, Southboro, Mass. 01772. (617) 485-9100. (A. Ashton). (D) **Circle No. 372**

Data Graphics, 8402 Speedway Dr., San Antonio, Tex. 78230. (512) 342-9486. (J. Peddie). (D,S) **Circle No. 373**

Data Systems Engineering, 1620 E. Ball Rd., Anaheim, Calif. 92805. (714) 535-2894. (S. Reese). (D,S) **Circle No. 374**

Data Technology, 2700 S. Fairview, Santa Ana, Calif. 92706. (714) 546-7160. (D. Cappelletti). (D,M,S) **Circle No. 375**

Data Translation, 109 Concord St., Framingham, Mass. 01701. (617) 879-3595. (F. Molinari). (M,R) **Circle No. 376**

Datacom, Inc., Box 278, Fort Walton Beach, Fla. 32548. (904) 242-3113. (T. Jaye). (D,R,S) **Circle No. 377**

Datametrics Inc., 340 Fordham Rd., Wilmington, Mass. 01887. (617) 658-5410. (H. Grey). (D,R,S) **Circle No. 378**

Datascan, Electronic Prod., Box 785, Clifton, N.J. 07013. (201) 478-2800. (G. Moore). (M) **Circle No. 379**

Datel Systems Inc., 1020 Turnpike St. Canton, Mass. 02021. (617) 828-8000. (L. Copeland). (D,M,R,S) **Circle No. 380**

Datum Inc., 170 E. Liberty Ave., Anaheim, Calif. (714) 533-6333. (B. DeVito). (D,S) **Circle No. 381**

Delco Electronics Div., General Motors Corp., 700 E. Firmin St., Kokomo, Ind. 46901. (317) 459-2175. (J. Polhamus). (S) **Circle No. 382**

Design Automation, Inc., 809 Massachusetts Ave., Lexington, Mass. 02173. (617) 862-8998. (N. Sokal). (D) **Circle No. 383**

Digital Equipment Corp., Main St., Maynard, Mass. 01754. (617) 897-5111. (P. Connell). (D) **Circle No. 384**

Doric Sci. Corp., 3883 Ruffin Rd., San Diego, Calif. 92123. (714) 277-8421. (G. Shockey). (D,S) **Circle No. 385**

Dynalab Corp., 7808 Gloria Ave., Van Nuys, Calif. 91406. (213) 781-3151. (D. Espy). (M) **Circle No. 386**

Dynamic Measurements Corp., 6 Lowell Ave., Winchester, Mass. 01890. (617) 729-7870. (M) **Circle No. 387**

Dynamics Electronic Products, Inc., 12117 E. Slauson Ave., Santa Fe Springs, Calif. 90670. (213) 945-2493. (D. Cantrell). (R,S) **Circle No. 388**

EMR Telemetry, Box 3041, Sarasota, Fla. 33578. (813) 958-0811. (S. Bass). (D,S) **Circle No. 390**

Ectron Corp., 8133 Engineer Rd., San Diego, Calif. 92111. (714) 278-0600. (J. JaQuay). (D,R) **Circle No. 391**

Edmac Assoc., Inc., 333 W. Commercial St., East Rochester, N.Y. 14445. (716) 381-5472. (R. Boisvert). (D,S) **Circle No. 392**

Electronic Modules Corp., Box 141, Timonium, Md. 21093. (301) 666-3300. (A. Rutledge). (M,R,S) **Circle No. 393**

Esterline Angus Div., Esterline Corp., Box 24000, Indianapolis, Ind. 46224. (317) 244-7611. (R. Moore). (D,S) **Circle No. 394**

Fluidyne Instrumentation, 470 27th St., Oakland, Calif. 94612. (415) 444-2376. (R. Jennings). (D,S) **Circle No. 395**

Fogg Systems Co., 1380 S. Dahlia St., Denver, Colo. 80222. (303) 758-2979. (H. Fogg). (M,S) **Circle No. 396**

Foxboro Co., 38 Neponset Ave., Foxboro, Mass. 02035. (617) 543-8750. (D. Aiken). (D,S) **Circle No. 397**

Function Modules, Inc., 2441 Campus Dr., Irvine, Calif. 92664. (714) 833-8314. (S. Osgood). (M) **Circle No. 398**

G B Instruments, 2030 Coolidge, Hollywood, Fla. 33020. (305) 944-7144. (B. Richard). (D) **Circle No. 399**

General Automation, Inc., 1055 East St., Anaheim, Calif. 92805. (714) 778-4800. (D) **Circle No. 400**

General Devices, Inc., P.O. Box 253, Princeton, N.J. 08540. (609) 924-2500. (M. Medvin). (M) **Circle No. 401**

Geo Space Systems, Div. of Trak Microwave, 4722 Eisenhower Blvd., Tampa, Fla. 33614. (813) 884-0492. (J. McNabb). (D,R,S) **Circle No. 402**

Gould Inc., Instrument Systems Div., 3631 Perkins Ave., Cleveland, Ohio 44114. (216) 361-3315. (Mr. Swyt). (D,S) **Circle No. 403**

Gulton Ind., Inc., Controls & Instrument Group, 1644 Whittier Ave., Costa Mesa, Calif. 92627. (714) 642-2400. (J. Hayer). (D,S) **Circle No. 404**

Gulton Inds., Data Systems Div., 15000 Central, East Albuquerque, N.M. 87112. (505) 299-7601. (D. Thomas). (D,S) **Circle No. 405**

Hawkeye Instruments, Inc., 3545 Third Ave., Marion, Iowa. 52302. (319) 377-8241. (D. Meuler). (D,R,S) **Circle No. 406**

Hewlett-Packard, 1501 Page Mill Rd., Palo Alto, Calif. 94304. (415) 493-1501. (M. Fourneli). (D,R,S) **Circle No. 407**

Holt Instrument Labs., Box 230, Oconto, Wis. 54153. (414) 834-2222. (C. Howells). (S) **Circle No. 408**

Honeywell, Indl. Div., 1100 Virginia Dr., Fort Washington, Pa. 19034. (215) 643-1300. (J. Turner). (M) **Circle No. 409**

Honeywell, Process Controls Div., 2255 W. Desert Cove Rd., Phoenix, Ariz. 85029. (602) 943-2341. (J. Hoag). (D,S) **Circle No. 410**

Honeywell Inc., Test Instr. Div., Box 5227, Denver, Colo. 80217. (303) 771-4700. (A. Tucker). (D,R) **Circle No. 411**

Hughes Industrial Prod. Div., 2020 Oceanside Blvd., Oceanside, Calif. 92054. (714) 757-1200. (B. Curry). (D,R,S) **Circle No. 412**

Hybrid Systems Corp., 87 Second Ave., Burlington, Mass. 01803. (617) 272-1522. (C. Kramer). (M) **Circle No. 413**

Hycorp, Inc., Box 250, Maynard, Mass. 01754. (617) 877-4578. (N. Palazzini). (M) **Circle No. 414**

IBM Systems Product Div., 1000 Westchester Ave., White Plains, N.Y. 10604. (914) 696-1900. (B. Connelly). (S) **Circle No. 415**

Incre-Data Corp., 6405 Acoma Rd., S.E., Albuquerque, N.M. (505) 265-9575. (S) **Circle No. 416**

Industrial Measurements & Controls Div., Int'l Rectifier, 250 N. Thomas St., Pomona, Calif. 91766. (714) 623-4371. (J. Jones). (M,R) **Circle No. 417**

Information Transfer, Inc., Box 357, Holcomb, N.Y. 14469. (315) 657-7074. (M. Tubinis). (D,S,R) **Circle No. 418**

Intech, 1220 Coleman Ave., Santa Clara, Calif. 95050 (408) 244-0500. (B. Jumper). (M) **Circle No. 419**

Integrated Systems, Inc., 6528 Interstate 85, Norcross, Ga. 30071. (404) 448-8302. (D. Bergert). (D,R,S) **Circle No. 420**

Inter-Computer Electronics, Sub. AEL, Box 507, Lansdale, Pa. 19446. (215) 855-0922. (H. Anderson). (M,R) **Circle No. 421**

Interdata, 2 Crescent Pl., Oceanport, N.J. 07757. (201) 229-4040. (C. Hoppin). (D) **Circle No. 510**

Interface Engineering Inc., 386 Lindelof Ave., Stoughton, Mass. 02072. (617) 344-7383. (T. Scanlon). (M) **Circle No. 422**

Ithaco, Inc., 735 W. Clinton St., Ithaca, N.Y. 14850 (607) 272-7640. (D. Chandler). (D,R) **Circle No. 423**

John Fluke Mfg. Co., Inc., Box 7428, Seattle, Wash. 98133. (206) 774-2211. (J. Froland). (D,R,S) **Circle No. 424**

Julie Research Labs, Inc., 21 W. 61st St., New York, N.Y. 10023. (212) 245-2727. (O. McBride). (D,R,S) **Circle No. 425**

Kantronics Co., 1202 E. 23rd St., Lawrence, Kan. 66044. (913) 842-7745. (P. Anderson). (D,S) **Circle No. 426**

Kaye Instruments, Inc., 737 Concord Ave., Cambridge, Mass. 02138. (617) 868-7080. (P. Thomas). (D,S) **Circle No. 427**

Keithley Instruments, Inc., 28775 Aurora Rd., Cleveland, Ohio. 44139. (216) 248-0400. (A. Oiverio). (D,R,S) **Circle No. 428**

M. S. Kennedy Corp., Pickard Dr., Syracuse, N.Y. 13211. (315) 455-7077. (B. Lesjack). (M) **Circle No. 506**

Kinetic Systems, Maryknoll Dr., Lockport, Ill. 60441. (815) 838-0005. (L. Klaisner). (D,R,S) **Circle No. 429**

Lancer Electronics Corp., 1416 W. Main St., Norristown, Pa. 19401. (215) 539-4410. (C. Spilman). (D,M,R,S) **Circle No. 430**

Lear Siegler, Instr. Div., 4141 Eastern Ave., S.E., Grand Rapids, Mich. 49508. (616) 241-7000. (C. Voice). (M) **Circle No. 431**

Lecroy Research Systems Corp., 126 N. Rte. 303, West Nyack, N.Y. 10994. (914) 358-7900. (A. Michawoski). (D,M,R,S) **Circle No. 432**

Leeds & Northrup Corp., Sumneytown Pike, No. Wales, Pa. 19454. (215) 643-2000. (R. Dorris). (D,R,S) **Circle No. 433**

Macrodyne, 1900 Maxon Rd., Box 1079, Schenectady, N.Y. 12301. (518) 372-5619. (D. Antos). (D,S) **Circle No. 434**

Martin-Decker Co., 1928 S. Grand Ave., Santa Ana, Calif. 92705. (714) 540-9220. (D. Moore). (D,S) **Circle No. 435**

Mecca Electronics, 270 N. 4 West, Hyrum, Utah 84319. (801) 245-6911. (F. Brown). (M) **Circle No. 507**

Metra Instr. Inc., 1240 Space Park Way, Mountain View, Calif. 94040. (415) 961-7249. (M. Fitting). (S) **Circle No. 436**

Metric Systems, 736 N. Beal St., Fort Walton Beach, Fla. 32548. (904) 242-2111. (D. Gardner). (D,R,S) **Circle No. 437**

Metrix Inst. Co., Box 36501, Houston, Tex. 77036. (713) 668-2386. (B. Lacy). (D,R) **Circle No. 438**

Micro Networks, 5 Barbara Lane, Worcester, Mass. 01604. (617) 756-4635. (B. Smith). (M) **Circle No. 439**

Mini-Systems, Inc., 20 David Rd., North Attleboro, Mass. 02761. (617) 695-0206. (D. Allen). (M) **Circle No. 440**

Modular Computer Systems, 1660 W. McNab Rd., Fort Lauderdale, Fla. 33309. (305) 974-1380. (P. Haller). (D,R,S) **Circle No. 441**

Monitor Labs, Inc., 4202 Sorrento Valley Blvd., San Diego, Calif. 92121. (714) 453-6260. (F. Mazanec). (D,S) **Circle No. 442**

Montedoro-Whitney Corp., 2740 McMillan Rd., San Luis Obispo, Calif. 93401. (805) 543-1233. (J. Palmer). (D,R,S) **Circle No. 443**

Natel Engineering Co., Inc., 8944 Mason Ave., Canoga Park, Calif. 91306. (213) 882-9620. (J. Naster). (R,S) **Circle No. 444**

Nationwide Electronic Systems, Inc., 7N662 Route 53, Itasca, Ill. 60143. (312) 289-8820. (R. Einsiedel). (D,R,S) **Circle No. 445**

Neff Instruments Corp., 1088 E. Hamilton Rd., Duarte, Calif. 91010. (213) 357-2281. (J. Hueckel). (D,S) **Circle No. 446**

Newport Labs, Inc., 630 E. Young St., Santa Ana, Calif. 92705. (714) 540-4914. (L. Kinney). (D,R,S) **Circle No. 447**

Nicolet Instrument Corp., 5225 Verona Rd., Madison, Wis. 53711. (608) 271-3333. (R. Penrod). (S) **Circle No. 448**

Non-Linear Systems Inc., Box N, Del Mar, Calif. 92014. (714) 755-1134. (B. Fisher). (D,R,S) **Circle No. 449**

North Atlantic Inds., 200 Terminal Dr., Plainview, N.Y. 11803. (516) 681-8600. (P. Wittenberg). (M,R) **Circle No. 450**

North Hills Electronics, Inc., Alexander Pl., Glen Cove, N.Y. 11542. (516) 671-5700. (V. Macri). (M,R) **Circle No. 451**

Omega Engineering Inc., Box 4047, Stamford, Conn. 06907. (203) 359-1660. (B. Hollander). (M,R) **Circle No. 452**

OpAmp Labs., Inc., 172 S. Alta Vista Blvd., Los Angeles, Calif. 90036. (213) 934-3566. (B. Losmandy). (M) **Circle No. 453**

Optical Electronics Inc., Box 11140, Tucson, Ariz. 85706. (602) 624-8358. (S. Day). (M) **Circle No. 454**

PCB Piezotronics Inc., P.O. Box 33, Buffalo, N.Y. 14225. (716) 684-0001. (J. Lally). (M,R) **Circle No. 508**

PPM Inc., 32 W. Monroe St., Bedford, Ohio 44146. (216) 232-1880. (A. Bletcher). (R,S) **Circle No. 455**

PRD Electronics, Inc., Systems Div., 6801 Jericho Tpk., Syosset, N.Y. 11791. (516) 364-0400. (A. McArthur). (S) **Circle No. 456**

Perkin-Elmer Corp., Main Ave., Norwalk, Conn. 06856. (203) 762-4786. (L. Kovarovic). (M,S) **Circle No. 457**

Phoenix Data Inc., 3384 W. Osborne Rd., Phoenix, Ariz. 85017. (602) 278-8528. (B. Nelson). (M,R) **Circle No. 458**

Plessey Semiconductors, 170 Finn Ct., Farmingdale, N.Y. 11735. (516) 694-7377. (B. Erde). (M) **Circle No. 459**

Preston Scientific, 805 E. Cerritos Ave., Anaheim, Calif. 92805. (714) 776-6400. (B. Spear). (R) **Circle No. 460**

Prime Computer Inc., 23 Strassmore Rd., Natick, Mass. 01760. (617) 655-6988. (G. Dannunzio). (D) **Circle No. 461**

Princeton Applied Research Corp., Box 2565, Princeton, N.J. 08540. (609) 452-2111. (R. Reggeu). (D,R,S) **Circle No. 462**

Quantalog, Box 1523, Ann Arbor, Mich. 48106. (313) 769-4936. (E. Therkelsen). (D,R,S) **Circle No. 463**

Quan-Tech, Randolph Park West, Route 10, Randolph Township, N.J. 07801. (201) 361-3100. (L. Kniepl). (M,R) **Circle No. 509**

Radiometric Technology, Inc., 28 Vernon St., Wakefield, Mass. (617) 245-8070. (R. Porter). (D,S) **Circle No. 464**

Raytheon Data Systems, 1415 Boston-Providence Turnpike, Norwood, Mass. 02062. (617) 862-6600. (C. Donahue). (D) **Circle No. 465**

Recorder Systems Div., Gulton, Ind., Inc., Gulton, Ind. Park, East Greenwich, R.I. 02818. (401) 884-6800. (J. Charney). (R,S) **Circle No. 466**

Richard Lee Co., Box 724, New Providence, N.J. 07974. (201) 665-1333. (H. Kundrat). (M,R) **Circle No. 467**

Rochester Instrument Systems, Inc., 275 N. Union St., Rochester, N.Y. 14605 (716) 325-5120. (R. Mercier). (M) **Circle No. 468**

Rohde & Schwarz Sales, 111-A Lexington Ave., Passaic, N.J. 07055. (201) 773-8010. (C. Barlow). (R) **Circle No. 469**

Roim Corp., 18922 Forge, Cupertino, Calif. 95014. (408) 257-6440. (T. Blackley). (D,M,S) **Circle No. 470**

SCI Systems Inc., 8330 Broadway, Houston, Tex. 77017. (713) 641-0211. (D. Beck). (D,M,R,S) **Circle No. 471**

SCR Div., Moxon, Inc., 2222 Michelson Dr., Irvine, Calif. 92664. (714) 833-2000. (J. Heyer). (D,M,R,S) **Circle No. 472**

Scientific Columbus, Div. Esterline Corp., 1035 W. 3rd Ave., Columbus, Ohio 43212. (614) 294-5671. (W. Traetow). (M,R) **Circle No. 473**

Sensotec, Inc., 1400 Holly Ave., Columbus, Ohio 43212. (614) 294-5436. (C. Easton). (M,R) **Circle No. 474**

Singer Co., Kearfott Div., 1150 McBride Ave., Little Falls, N.J. 07424. (201) 256-4000. (G. Tiker). (M) **Circle No. 475**

Solid State Electronics Corp., 15321 Rayen St., Sepulveda, Calif. 91343. (213) 894-2271. (E. Politi). (M) **Circle No. 476**

Spacetac, Inc., Sub. Corning Glass Works, Burlington Rd., Bedford, Mass 01730. (617) 275-1710. (R. Reed). (D,M,S) **Circle No. 477**

Spatial Data Systems, Inc., 132 Aero Camino, Goleta, Calif. 93017. (805) 967-2383. (F. Clarke). (D) **Circle No. 478**

Sprague Electric Co., 481 Marshall St., No. Adams, Mass. 01247. (413) 664-4411. (S. Chertok). (M) **Circle No. 479**

Struthers-Dunn, 411-14th St., Bettendorf, Iowa 52722. (319) 359-0318. (R. Alessandrini). (M,S) **Circle No. 480**

Systron Donner Computer Systems Div., 10 Systron Dr., Concord, Calif. 94518. (415) 682-6161. (J. Cunningham). (D,R,S) **Circle No. 481**

TRW Industrial Applications, 9841 Airport Blvd., Los Angeles, Calif. 90045. (213) 535-2212. **Circle No. 483**

TRW System Engineering and Integration, 1 Space Park, Redondo Beach, Calif. 90278. (213) 535-0374. (B. Gordon). (D,S) **Circle No. 482**

Taylor Inst. Process Control Div., Sybron Corp., 95 Ames St., Rochester, N.Y. 14601. (716) 235-5000. (D. Osborne). (D,M,R,S) **Circle No. 484**

Tech-S, Inc., 37720 Plymouth Rd., Livonia, Mich. 48150. (313) 425-9800. (B. Emerson). (D,S) **Circle No. 485**

Tektronix, Inc., Box 500, Beaverton, Ore. 97005. (503) 644-0161. (D. Butts). (D,S) **Circle No. 486**

Teledyne Geotech, Box 28277, Dallas, Tex. 75228. (214) 271-2561. (B. Rhoads). (D) **Circle No. 487**

Teledyne Philbrick, Allied Dr. at Rte 128, Dedham, Mass. 02026. (617) 329-1600. (F. Goodenough). (M) **Circle No. 488**

Telstar Electronics Corp., 700 Hummel Ave., Dept. EB, Southold, N.Y. 11971. (516) 765-9292. (R. Marston). (S) **Circle No. 489**

Tempo Instrument Inc., 51 E. Bethpage Rd., Plainview, N.Y. 11803. (516) 694-4400. (H. White). (M) **Circle No. 490**

Tetrahedron Assoc., 7605 Convoy Court, San Diego, Calif. 92111. (714) 277-2820. (S. Yalof). (D,S) **Circle No. 491**

Texas Instruments, P.O. Box 1444, Houston, Tex. 77001. 713 777-1301. (H. Labban). (D,S) **Circle No. 492**

Unholtz-Dickie Corp., 3000 Whitney Ave., Hamden, Conn. 06518. (203) 288-3358. (L. Shaw). (M,R) **Circle No. 493**

United Systems Corp., 918 Woodley Rd., Dayton, Ohio 45403. (513) 254-6251. (B. Slemmer). (M,R,S) **Circle No. 494**

Validyne Engineering Corp., 19414 Londeluis St., Northridge, Calif. 91324. (213) 886-8488. (M. Kopp). (M,R) **Circle No. 495**

Varian Data Machines, 2722 Michelson Dr., Irvine, Calif. 92664. (714) 833-2400. (H. Stover). (D) **Circle No. 496**

Vega Servo-Control, Inc., 2611 Elliott Ave., Troy, Mich 48084. (313) 585-3600. (H. Moulds). (S) **Circle No. 497**

Vernitech, Div. of Vernitron Corp., 300 Marcus Blvd., Deer Park, N.Y. 11729. (516) 586-5100. (D. O'Neal). (M) **Circle No. 498**

Vibration Instr. Co., 1614 Orangethorp Way, Anaheim, Calif. 92801. (714) 879-6085. (M. Marsh). (M,R) **Circle No. 499**

Vidar Corp., 265 N. Whisman Rd., Mountain View, Calif. 94040. (415) 965-3050. (E. Scott). (D,S,R) **Circle No. 500**

West Coast Research Corp., Box 25061, Los Angeles, Calif. 90025. (213) 478-8833. (H. Spivack). (R,S) **Circle No. 501**

Westinghouse Electric Corp., Industry Systems Div., 200 Bader Dr., Pittsburgh, Pa. 15238. (412) 782-1730. (R. Masterson). (D,M,R) **Circle No. 502**

Weston Instruments, Inc., 614 Frelinghuysen Ave., Newark, N.J. 07114. (201) 243-4700. (R. Bilby). (D,R) **Circle No. 503**

Xerox Data Systems, Systems Prod. Dept., 701 S. Aviation Blvd., El Segundo, Calif. 90245. (213) 679-4511. (M. Lazdins). (D) **Circle No. 504**

Zeltex, Inc., 1000 Chalomar Rd., Concord, Calif. 94520. (415) 686-6660. (D. Terry). (M,R) **Circle No. 505**



John Donohue's "blue line" turns out keyboard switches faster than you can say Oak.

John Donohue, Director of Manufacturing here at Oak, is mighty proud of his "blue line." He ought to be. It's the most sophisticated fully-automated keyboard switch assembly facility in the industry. It was designed with the customer in mind. We wanted to make sure we'd be able to meet his demands for huge quantities of our popular keyboard switches.

And popular they are. We build keyboard switches for everything from miniature calculators to data entry systems to point-of-sale terminals. You can buy them individually or in completely assembled custom keyboards.

If you need low-profile keyboard switches—we have 'em. Our Series 415 switches have a profile of less than $\frac{1}{2}$ inch. And they're available in either single or double "human engineered" keycaps that dress up any product design.

Series 400 and 475 keyboard switches are built with self-cleaning gold cross-bar wiping contacts. You're assured of trouble-free operation through millions of cycles. And our variety of contact arrangements gives you true design versatility.

We also offer a full selection of lighted and unlighted pushbutton switches plus almost any other type of switch you can put your finger on. Let us know your needs.

Write Lou Roels at Oak for product literature, helpful keyboard design tips and free samples of our keyboard switches.

DAK Industries Inc.

SWITCH DIVISION / CRYSTAL LAKE, ILLINOIS 60014
TELEPHONE: 815-459-5000 ■ TWX: 910-634-3353 ■ TELEX: 72-2447

INFORMATION RETRIEVAL NUMBER 38

"Keep 'em coming, John"

MINI MAGIC

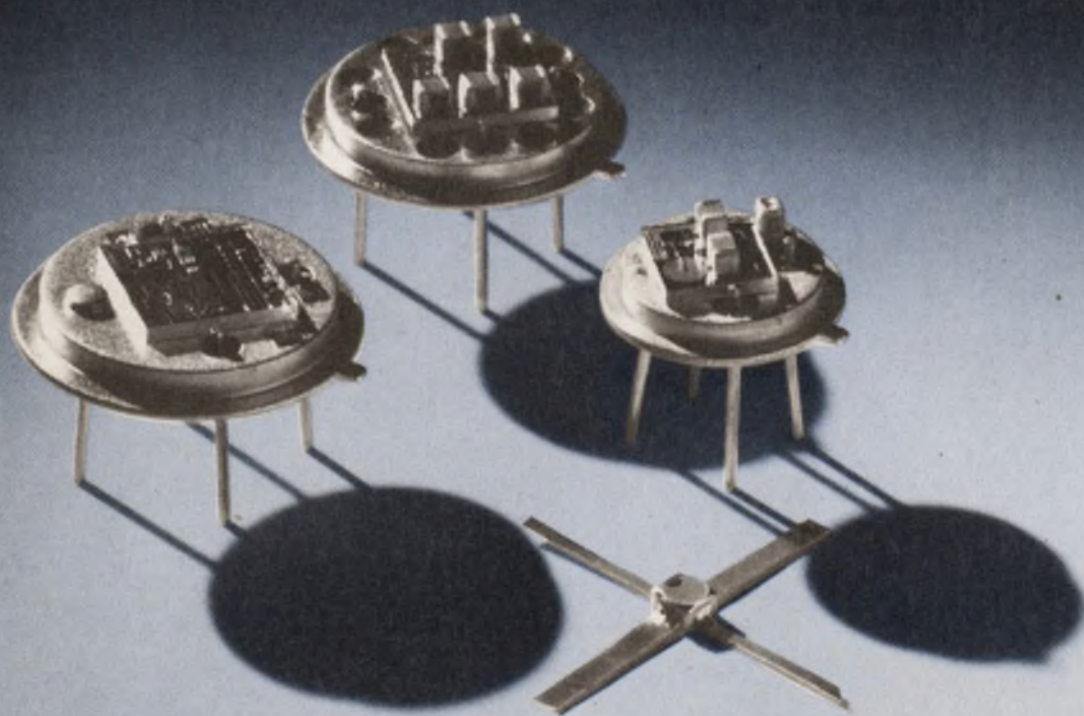



Low-noise, Microwave Transistors

It's been said a manufacturer needs "magic" to make microwave transistors. It would appear, however, it takes even more than magic to make dependable deliveries.

AVANTEK IS DELIVERING. You'll find unbelievable inventories, along with some very impressive specifications. Take our AT-4641 for example. It offers a guaranteed noise figure of 3.5 dB maximum at 4 GHz—and it's available from stock! Just phone or return our coupon. We'll send complete data on the AT-4641 and other low-noise transistors in the 60 to 8000 MHz range. For a good measure, we'll also throw in our TRANSISTOR PRIMER, Parts I and II.

Mini Magic Marriage. Combine the fantastic low-noise capability of Avantek transistors with thin film technology—and you've got a real mini magic marriage. Avantek miniature microwave amplifiers and oscillators offer the designer a new level of versatility, with NO compromises in performance.

UTO



Looking for low-noise and high dynamic range from 5 to 2300 MHz? You'll find it in Avantek TO-8 packaged UTO amplifiers. All models are available in Hi Rel UTO "R" counterparts. Check our UTO "R" Series Brochure. It describes

the manufacturing processes and screening procedures for standard and "R" version UTO's. Data sheets also available for the asking.

VTO



Avantek VTO's offer you the latest in microwave technology at remarkably low-cost: eight tunable, overlapping bands from 600 to 6600 MHz. They're the SMALLEST varactor-tuned units around, delivering power at +10 to +13

dBm. You'll find all the facts in our VTO Applications Brochure and Data Sheets.

GPD



This "tame transistor" brings more than SIX OCTAVES of flat RF bandwidth to your circuit designs. You get the same UTO and VTO thin film construction—but in a tiny TO-12 can. A GPD-401 can give you 13 dB gain and 4.5 dB

noise figure at 5 to 400 MHz. The Avantek GPD, priced at \$30 or less in quantities of one to nine, clearly represents the best miniature amplifier buy today. Ask for Data Sheets and our 18-page booklet, DESIGNING WITH GPD AMPLIFIERS.

Avantek ... years ahead today.

3175 BOWERS AVENUE
SANTA CLARA, CALIFORNIA 95051
(408) 249-0700
TWX 910-339-9274

DOMESTIC REPRESENTATIVES

ALABAMA (205) 534-9771
Gentry Associates, Inc.
2109 W. Clinton Ave., Room 422
Huntsville, AL 35805

ARIZONA (602) 956-5300
The Thorson Company
2505 E. Thomas Road
Phoenix, AZ 85016

CALIFORNIA (213) 476-2251
Cain Technology
522 S. Sepulveda Blvd.
Suite 107
Los Angeles, CA 90049
(415) 948-6533
Cain-White & Company
175 S. San Antonio Road
Los Altos, CA 94022

COLORADO (303) 355-3521
The Thorson Company
5040 E. 41st Avenue
Denver, CO 80216

D.C. and VIRGINIA
(202) 783-7319
Applied Engineering Consultants
Washington, DC

FLORIDA (305) 894-4401
Gentry Associates, Inc.
550 North Bumby Avenue
Orlando, FL 32803

ILLINOIS
(312) 298-3600 thru 3603
Cozzens/Cudahy, Inc.
1301 North Rand Road
Des Plaines, IL 60016

INDIANA (317) 244-2456/1879
Cozzens/Cudahy, Inc.
21 Beachway Drive
Indianapolis, IN 46224

KANSAS (913) 362-0919
E.I.R. Company
6405 Metcalf, Suite 205
Shawnee Mission, KS 66202

MARYLAND (301) 465-1272
Applied Engineering Consultants
9051 Baltimore National Pike
Building 3, Office A
Ellicott City, MD 21043

MASSACHUSETTS
(617) 272-4550
Tritek, Inc.
165A Bedford Street
Burlington, MA 01830

MICHIGAN (313) 482-1229
Micro Sales Corporation
7522 Emily
Detroit, MI 48234

MINNESOTA
(612) 884-4336/4337
Cozzens/Cudahy, Inc.
10800 Lyndale Avenue South
Minneapolis, MN 55420

MISSOURI (314) 837-0597
E.I.R. Company
47 Village Square Shopping Center
Hazelwood, MO 63042
(314) 423-1234

Cozzens/Cudahy, Inc.
10534 Natural Bridges Rd.
St. Louis, MO 63134

NEW JERSEY (L.I. & N.Y.C.)
(201) 224-6911
Technical Marketing Associates
2460 Lemoine Avenue
Fort Lee, NJ 07024

NEW MEXICO (505) 265-5655
The Thorson Company
5921 Lomas Blvd., N.E.
Albuquerque, NM 87110

NEW YORK (315) 685-5731
Robtron
2-4 Fennell Street
Suite 209
Skaneateles, NY 13152

NORTH CAROLINA
(919) 227-3639
Gentry Associates, Inc.
420 Almance Road
Burlington, NC 27215

OHIO (513) 298-3033
Micro Sales Corporation
1250 West Dorothy Lane
Dayton, OH 45409

(216) 243-7430
Micro Sales Corporation
2085 Riverside Drive
Cleveland, OH 44107

PENNSYLVANIA
(215) 927-7777
Eastern Instrumentation of
Philadelphia
613 W. Cheltenham Avenue
Philadelphia, PA 19126

TEXAS (214) 233-5744 thru 46
The Thorson Company
4400 Sigma Road
Dallas, TX 75240

(713) 771-3504
The Thorson Company
6655 Hillcroft, Suite 224
Houston, TX 77036

WASHINGTON (206) 632-0710
The Thorson Company
909 Northeast 43rd Street
Suite 206
Seattle, WA 98105

LITERATURE COUPON

SEND DATA SHEETS AND BROCHURES

- TRANSISTORS UTO VTO
 GPD HAVE REPRESENTATIVE CALL

NAME _____ TITLE _____
COMPANY NAME _____
ADDRESS _____
MAIL STOP _____
PHONE _____ EXT. _____

Start with our new Blue Streak™ cable

... it's loaded with features designed to lower your installed costs. For instance, every fifth conductor is color coded for quick identification and the Blue Streak immediately identifies polarity. The unique cable construction permits clean conductor separation for breakouts and easy insertion into connector assemblies. Available in 50 conductors or less — solid or stranded wire — this U/L listed self-extinguishing cable is the perfect companion for the new one-piece connectors.

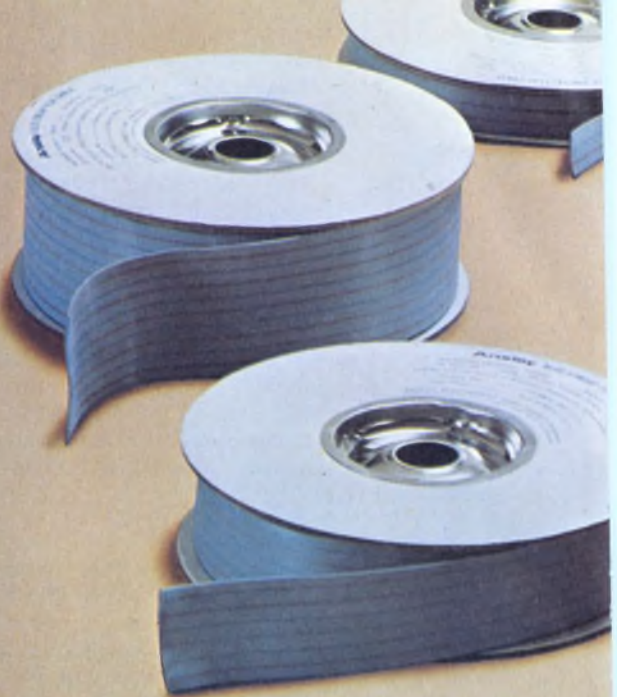

New cable connector system...It's designed to lower your installed costs.

Our new insulation displacing flat cable connectors install in 1/3 the time

... simply because they come to you in *one* piece. Two benefits result; assembly of the connector itself is eliminated and the time consuming job of lining up the cable on the connector is no longer necessary.

To install — simply insert the cable end into the connector and crimp. It's that easy — fast — and reliable! Speaking of reliable — our new connectors feature an exclusive "tulip" contact design which provides 4 contact points per conductor. In addition, the front of the "tulip" contact is designed to act as a strain relief on the wire.

We'll be more than happy to send you a test report on contact reliability.

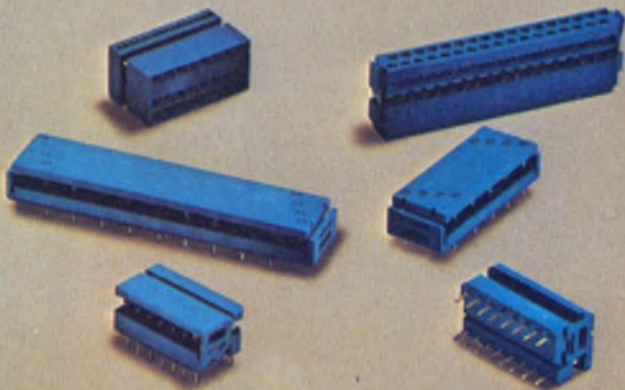

A perfect crimp every time

... because our Blue Streak hand tools feature the Shure-Stake® principle which makes the tool responsible (not the installer) for the compression connection. Your installer must complete the set compression stroke before the connector can be removed. It's as fool proof and reliable as a compression connector tool can be. A full line of bench mounted tools with interchangeable dies are also available.

The Ansley Team — One Piece Connectors — Shure Stake® Hand Tools and Blue Streak™ Cable — all combine to offer you the most reliable connection package at the lowest installed cost.

Ansley

ANSLEY ELECTRONICS CORP.
Subsidiary of Thomas & Betts Corporation 

3208 Humboldt St., Los Angeles, Ca. 90031
Tel. (213) 223-2331, TWX 910-321-3938



SOLD COAST TO COAST THROUGH AUTHORIZED ANSLEY DISTRIBUTORS.

INFORMATION RETRIEVAL NUMBER 41

Here are two of the world's best oscilloscopes.

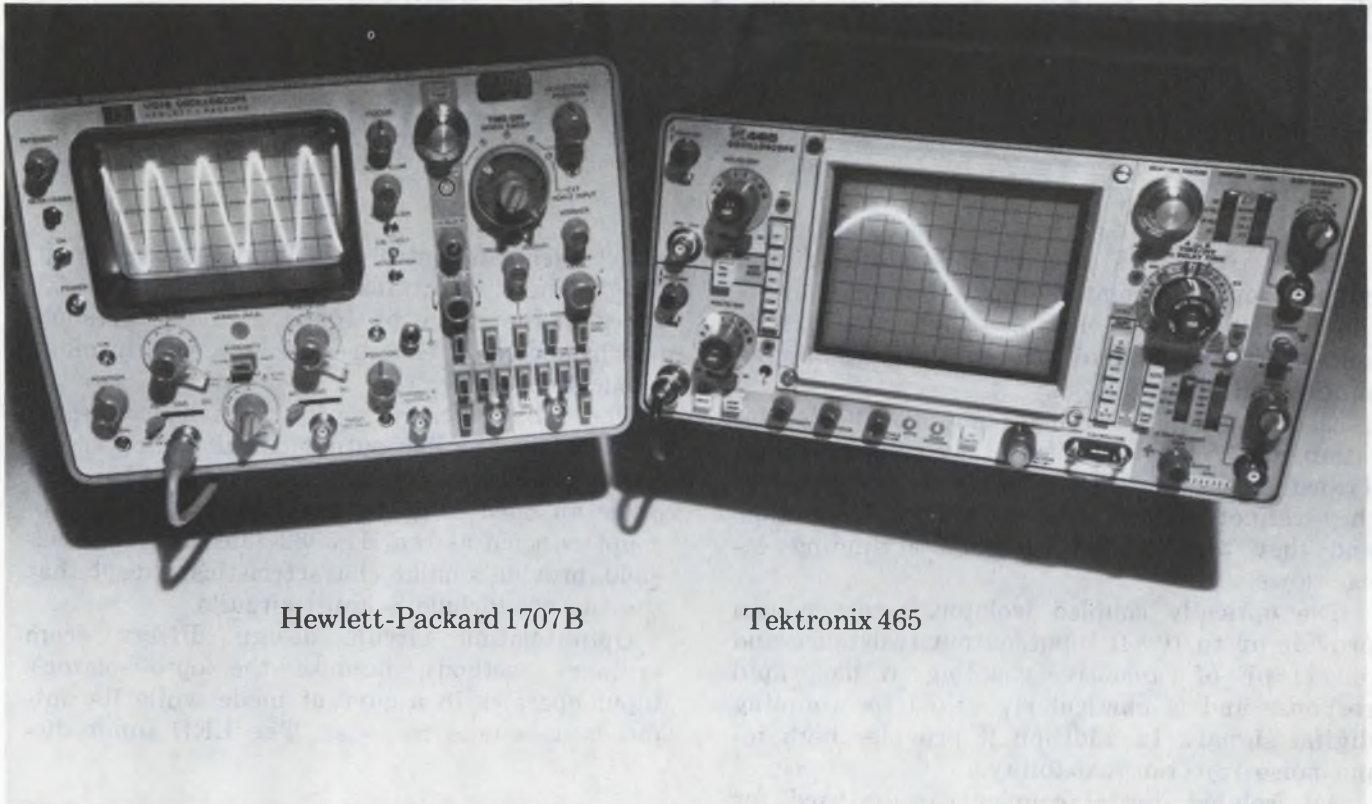

Hewlett-Packard 1707B

Tektronix 465

Here's why you shouldn't own either one.

You can lease one for as little as \$45 per month.

We can give you immediate delivery on either the Hewlett-Packard 1707B or the Tektronix 465, in quantity.

The Hewlett-Packard scope lease is \$45 per month for 36 months. The Tektronix 465 is \$50 per month for 36 months.

Anyway you choose, leasing is the best thing that ever happened to a tight capital equipment budget. You pay for your scope as you use it ... and you pay for it out of the profits it generates.

Call your closest Instant Inventory Center and ask us about short term rentals, delivery, and other lease terms for scopes or any other electronic equipment you need, up to and including minicomputers.



Anaheim, California (714) 879-0561
Dallas, Texas (214) 661-8082
Fort Lauderdale, Florida (305) 771-3500
Gaithersburg, Maryland (301) 948-0620
Burlington, Massachusetts (617) 273-2770
Mountain View, California (415) 968-8845
Oakland, New Jersey (201) 337-3757
Rexdale (Toronto) Ont., Canada (416) 677-7513
Des Plaines, Illinois (312) 827-6670

Rental Electronics, Inc.

A **PEPSICO** leasing company.

Opto-isolator logic units

add flexibility to digital design. They provide input-to-output isolation, low noise feedthrough and response to dc and fast pulses.

There are several ways to isolate a digital circuit's output from its input, but only one—the optically coupled isolator—gives you high dc voltage isolation and low capacitive coupling simply and directly.

Electromechanical relays can provide dc isolation, but relays are limited by slow response. Transformers can do the isolation job, too, but they cannot properly reproduce digital signals, and they tend to have high interwinding capacitance.

The optically coupled isolator, however, can provide up to $10^{12}\text{-}\Omega$ input/output resistance and only 1 pF of capacitive coupling. It has rapid response and is particularly suited for coupling digital signals. In addition it provides high input-noise rejection capability.

An isolated digital coupler can be used for applications such as these:

- Coupling data to and from data-transmission lines.
- Controlling signaling attachments to telephone lines.
- Controlling switching in high-voltage and high-power circuits.
- Acting as a feedback element in regulated dc power supplies.
- Replacing polar relays in teletypewriter communications systems.
- Converting sine waves to square waves, and coupling logic circuits to power lines or other sine-wave systems for synchronization.

These digital circuits require dc isolation, which the ordinary solid-state circuit, with its common dc path between input and output, can't provide.

Light makes the connection

The basic opto-isolator combines a fast LED with an equally fast photodiode. Often the photodiode is coupled to a differential-input amplifier,

which then can control a Schmitt-trigger circuit. The Schmitt circuit can provide rise and fall times in the range of 10 ns, and its threshold and hysteresis effects are advantageous in many applications (Fig. 1).

The Schmitt-trigger output can be connected to a TTL-compatible output circuit. One version has a totem-pole output circuit (MCL610), another an open collector (MCL611). Other opto-couplers, such as the HP5982-4352 and HP5082-4360, provide similar characteristics, except that they do not include Schmitt circuits.

Opto-isolation circuit design differs from ordinary methods, because the opto-isolator's input operates in a current mode while its output is a voltage response. The LED input di-

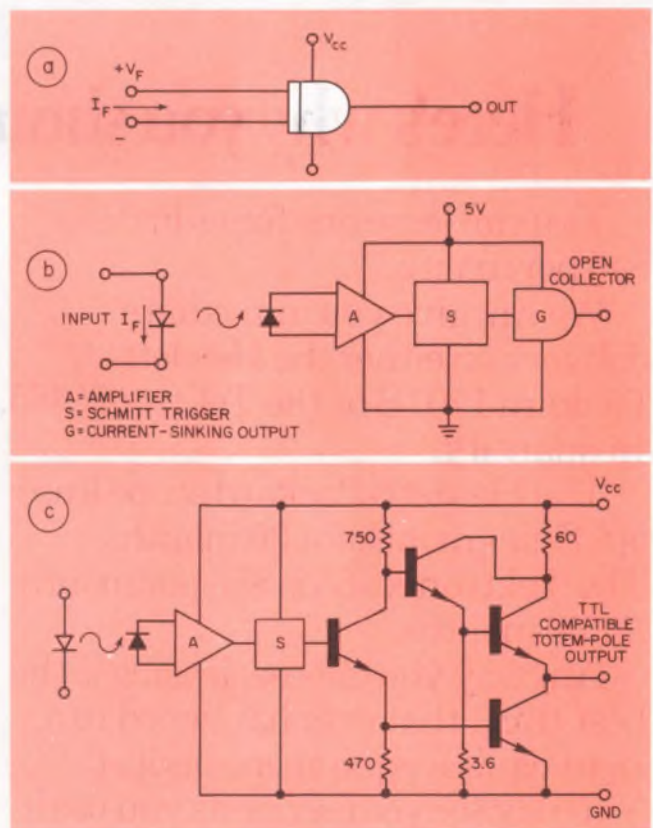

1. Opto-isolator logic couplers (a) can have an open-collector, current-sinking output (b) or a TTL-compatible, totem-pole output (c).

Grant C. Riddle, Applications Engineering Manager, Monsanto Commercial Products Corp., Palo Alto, Calif. 94304

tates the use of the current input.

This is an important advantage, because common-mode noise voltages, which usually have little current capability, are easily rejected. Common-mode variations of hundreds of volts and even fast-rising noise spikes are easily handled.

Therefore for direct-logic drive, the optoisolator input isn't specified as HIGH or LOW, as in normal gate inputs. Instead the LED input is ON or OFF as determined by the current flow through the LED. The input LED is a forward-biased diode. It has a threshold voltage, V_{FT} , of about 1.1 V. At the operating point, $V_F = 1.2$ to 1.3 V, the typical current for an MCL-600 series unit is $I_F = 10$ mA. The diode's

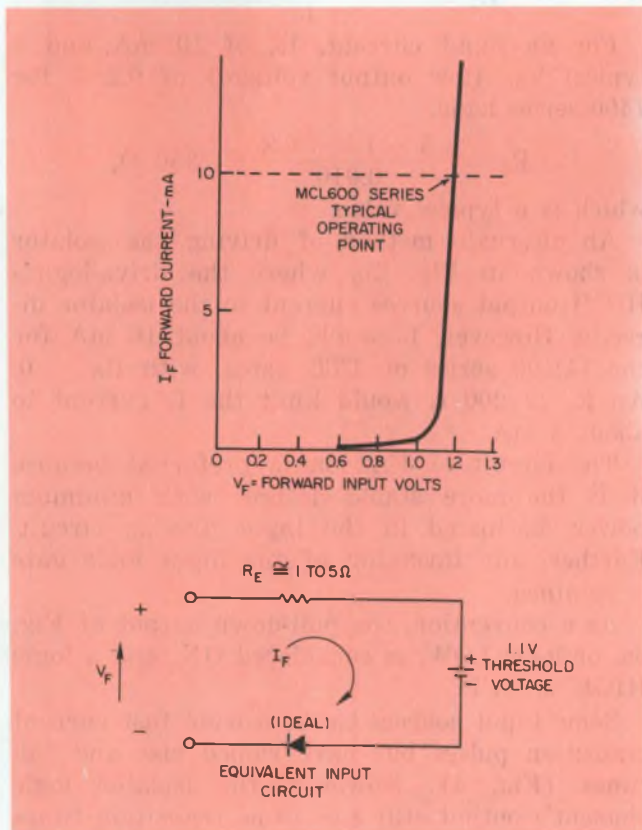

2. The LED input of an optoisolator behaves as a diode with a threshold voltage of about 1.1 V and a dynamic resistance of between 1 and 5 Ω .

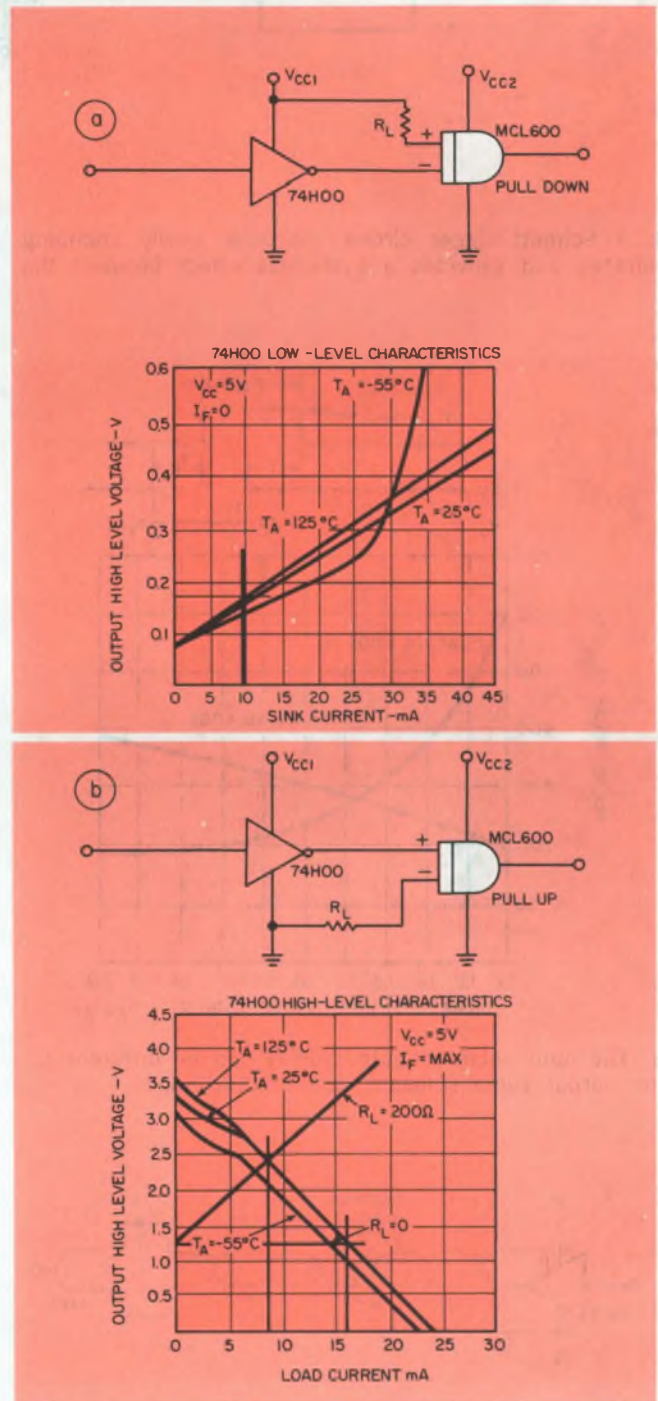

3. The input current to the optoisolator can be derived from a TTL element and controlled by a resistor, R_L , in either a pull-down or pull-up configuration.

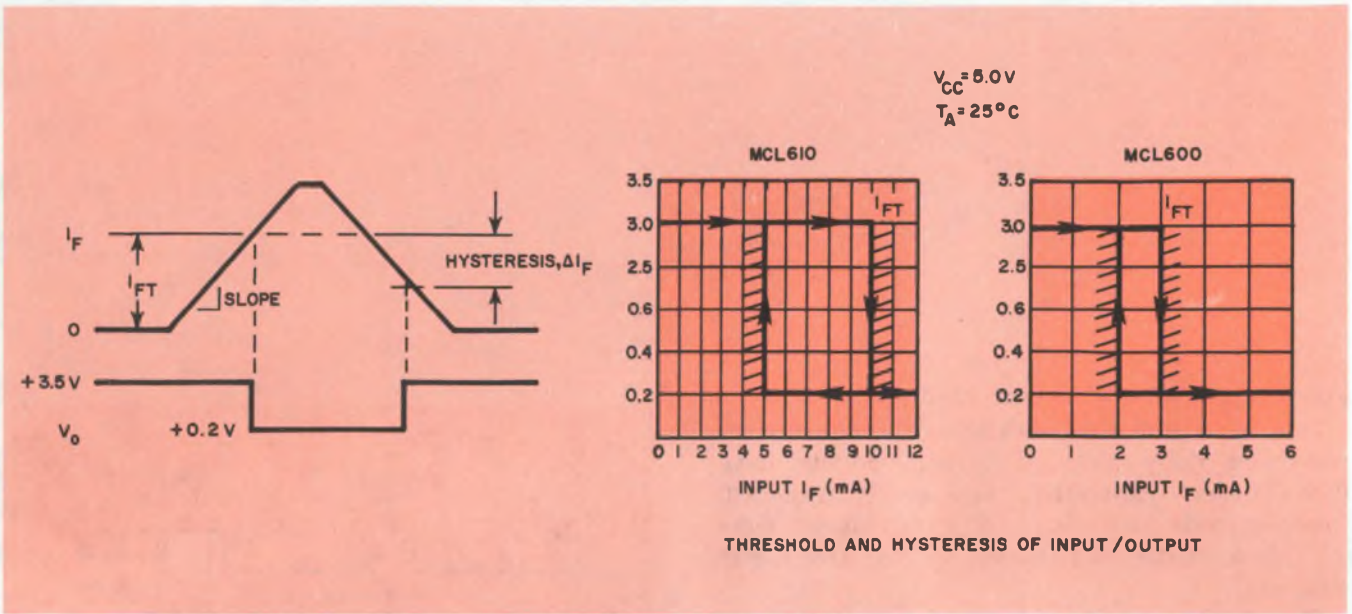

4. A Schmitt-trigger circuit sharpens slowly changing voltages and provides a hysteresis effect between the

rise and fall of the signal edges. This squaring effect is useful in analog/digital interfacing.

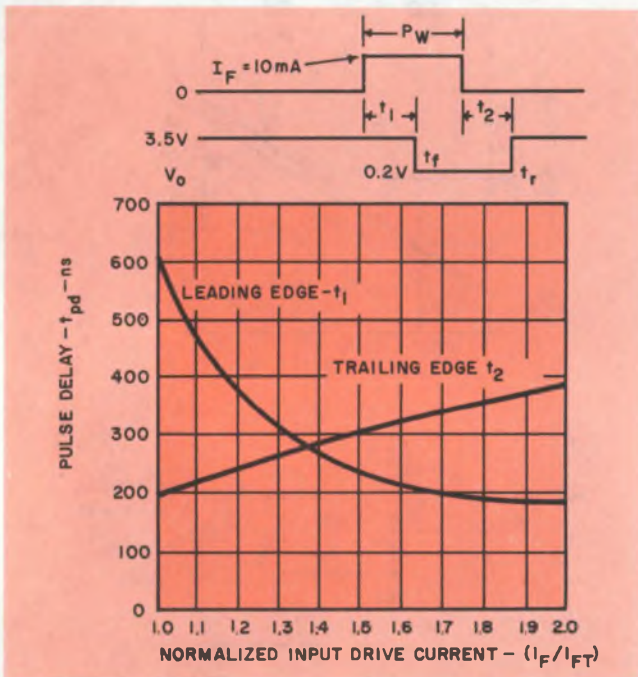

5. The opto-isolator's output delay can be different for the output signal's leading and trailing edges.

equivalent dynamic resistance, R_E , is 1 to 5 Ω (Fig. 2).

When the input to the isolator is driven from a normal TTL output circuit, the drive circuit's logic LOW output (current-sinking state) is controlled by the value of R_L (Fig. 3a).

$$R_L = \frac{V_{CC} - V_F - V_{OL}}{I_F}$$

For an input current, I_F , of 10 mA and a typical V_{OL} (low output voltage) of 0.2 V for 7400 series logic,

$$R_L = \frac{5 - 1.3 - 0.2}{0.010} = 350 \Omega,$$

which is a typical value.

An alternate method of driving the isolator is shown in Fig. 3b, where the drive-logic's HIGH output sources current to the isolator directly. However, I_F would be about 16 mA for the 74H00 series of TTL gates, with $R_L = 0$. An $R_L = 200 \Omega$ would limit the I_F current to about 8 mA.

The circuit of Fig. 3a is preferred because it is the more stable design, with minimum power dissipated in the input driving circuit. Further, any inversion of the input logic gate is retained.

As a convention, the pull-down output of Fig. 3a, or logic LOW, is considered ON, and a logic HIGH is OFF.

Some input sources can't provide fast current transition pulses but have sloped rise and fall times (Fig. 4). However, the isolator logic element's output still has 10-ns transition times because of the unit's internal Schmitt-trigger circuit. Note that the two trigger levels differ because of the circuit's hysteresis. Thus this

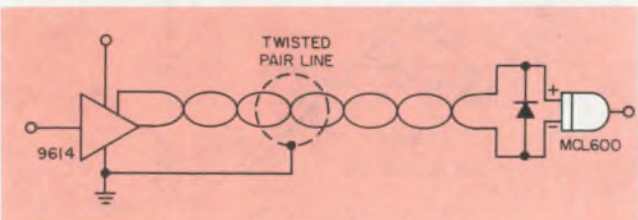

6. Data line coupling is an important application that takes full advantage of an opto-isolator's input/output isolation and its pulse-sharpening and noise-rejection capabilities to couple lines to digital circuits.

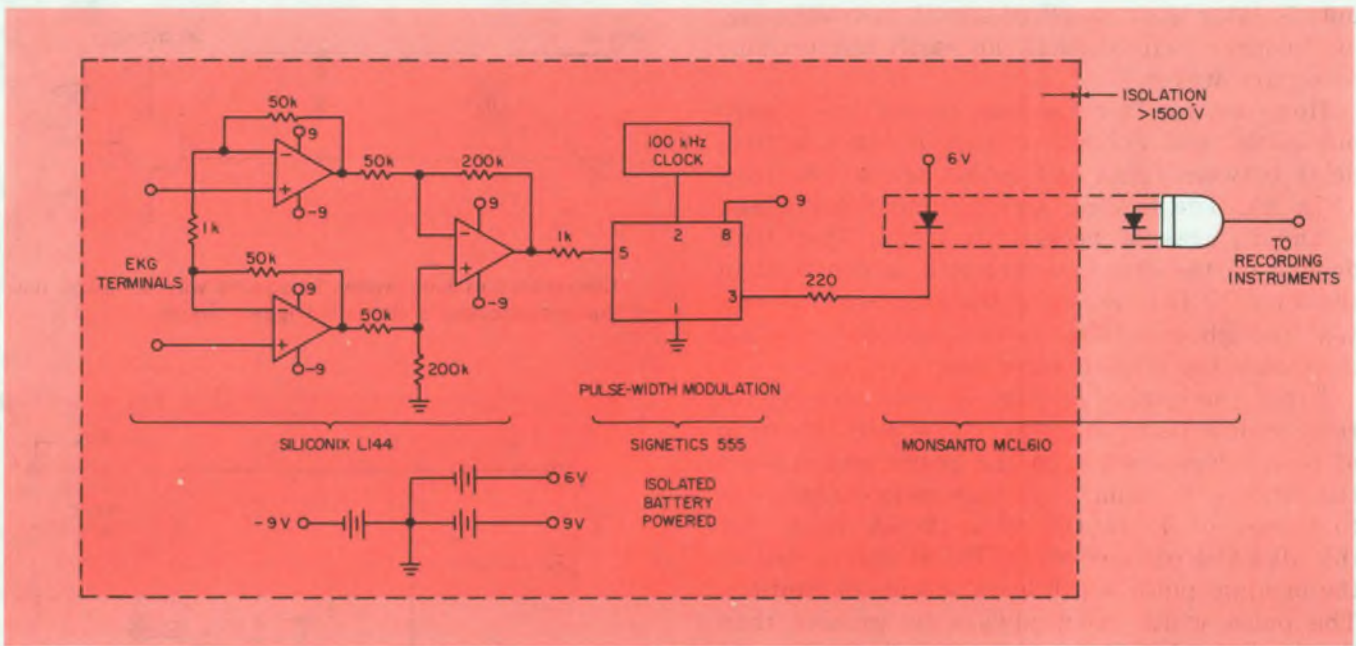

9. Medical electronic instruments when linked to patients need the high-isolation qualities of opto-isolators.

provides frequency doubling and consequently its output is a more audible 40 Hz.

This output signal can be used to trigger other devices or circuits, such as a large bell and a flashing light in extra-noisy surroundings. A similar sensor circuit can be used in a modem terminal to answer incoming calls automatically.

Another possible use of an opto-isolator on a telephone line is shown in Fig. 8c. Such a circuit can keep an accurate record of the cumulative time spent on the phone.

On-line phone current causes an opto-isolator, such as the MCL600, to enable an AND gate to pass 10-ppm clock pulses. The clock pulses are derived from the power line by counting down the 60 Hz after squaring with a second MCL-600. The gated signal is then counted by a decade counter in tenths of minutes, minutes and hours in a clock counter circuit, and displayed on seven-segment numeric devices. A duplicate counter with an automatic reset from the gating control can display the duration of

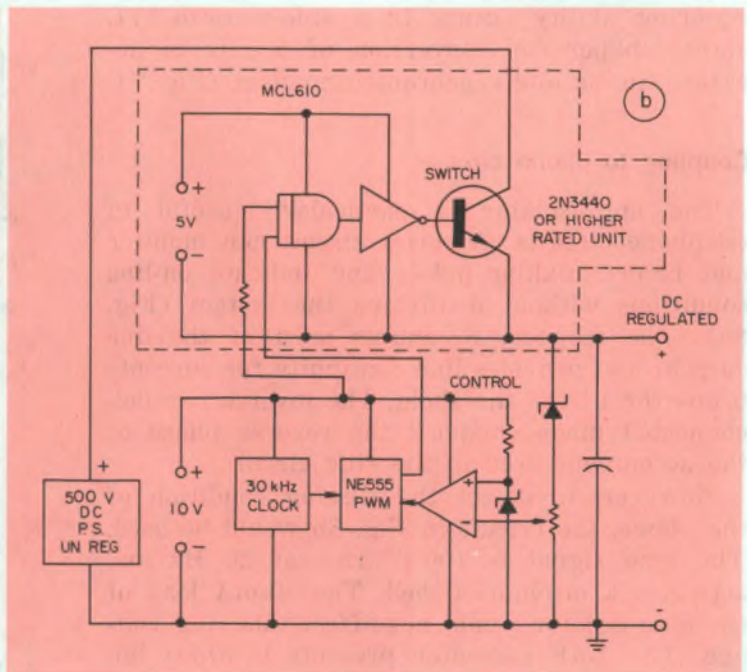
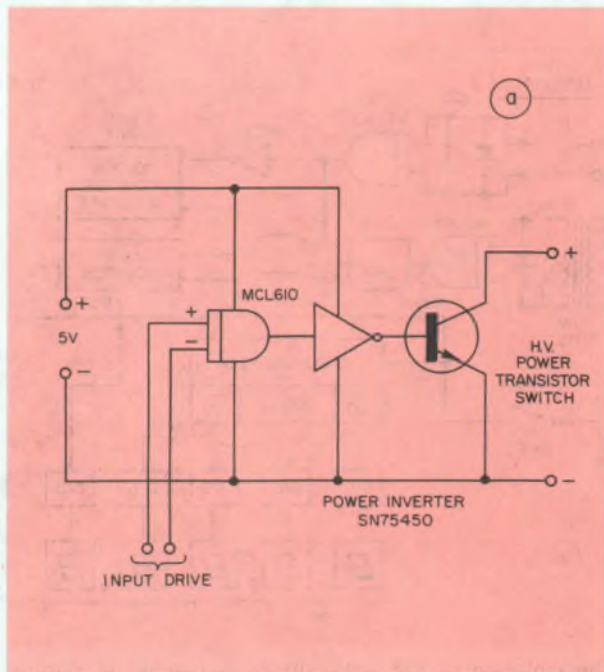

10. Sensing and controlling regulated high-voltage, high-power supplies require the isolation properties that the

opto-isolator can provide. The isolator can couple a high-voltage level to a low-level control circuit.

any individual call.

One application where high isolation is absolutely essential is the monitoring of electrocardiograms. During EKG measurements without isolation, improperly grounded line-powered equipment can kill the patient.

In Fig. 9, the EKG voltage is converted to pulse-width modulation, which then powers the LED. The patient-connected system is powered by a battery pack, and the optocoupler provides $10^{12} \Omega$ isolation that can withstand 1500-V-dc stress between the patient and the recording equipment.

Isolated power switch of many uses

The opto-isolator's frequency response extends down to dc, so it can be used wherever long-term signal levels must be maintained. In Fig. 10a the logic isolator drives an SN75450 power inverter, which, in turn, drives a power-transistor switch. The power transistor can be a high-voltage unit. Since the 75450 can supply 500 mA into the power-transistor's base, the transistor can easily handle to 5 A in the saturation mode. In the turn-off condition, the inverter clamps the power-transistor's base to help reduce the transistor's recovery time.

This basic circuit has many applications. For example, in a switching-regulator power supply (Fig. 10b), the isolator circuit of Fig. 10a is used to couple pulse-width-modulated pulses from the low-level error-feedback circuits to the high-voltage, high-power switching device that controls the output. The isolator's low coupling input/output capacitance, typically 1 pF, prevents high-voltage spikes from feeding back and interfering with the modulator's operation.

Also, two power-switch circuits can be combined to make a dc teletypewriter polar-transmitter "relay" (Fig. 11a). In this circuit the input LEDs are connected in parallel but with opposite reversed polarity to sense the polarity of the input voltage.

Since MCL600 units provide a logic HIGH with no input current, both switching transistors (Q_2 and Q_4) are OFF for a no-input condition. Q_2 or Q_4 is turned ON only when its respective LED is ON, and only one LED can be on at a time. The input RC filter provides a time delay when the polarity changes to allow the conducting transistor to recover before the cut-off transistor starts to conduct. And the associated power sources are current-limited to 60 mA and adjusted for the particular line-load conditions.

A matching polar receiving "relay" is arranged with two LEDs connected in inverse-series. Opposing silicon diodes provide a current path until the threshold current of the LED

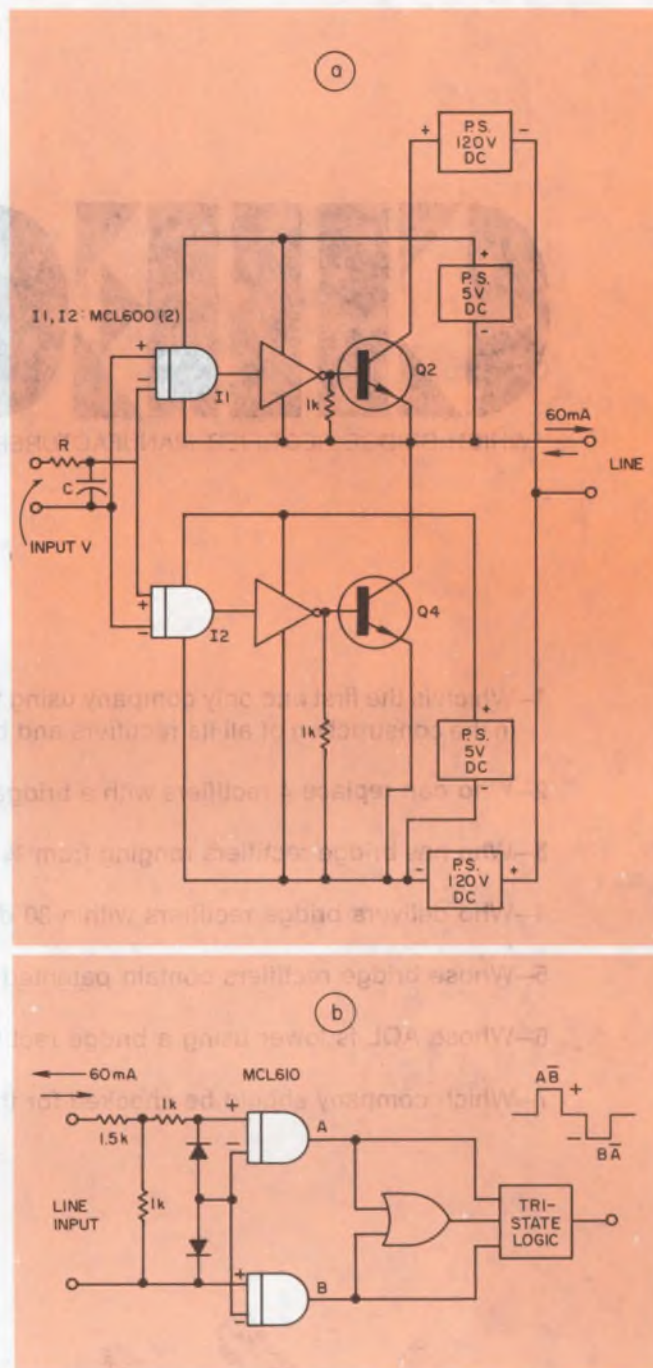

11. Opto-isolator circuits can function as polar transmitter relays (a) and polar receiver relays (b).

begins (Fig. 11b). The EXCLUSIVE-OR circuit provides an indication of an open-line condition when both opto-isolator units have logic HIGH outputs. Thus a three-state logic output can be obtained or the EXCLUSIVE-OR output can be used as an alarm signal for open-line conditions. ■■

Bibliography

1. McDermott, J., "Standardization of Opto-isolators Is Beginning," *Electronic Design*, Feb. 1, 1974, pp. 26-34.
2. Cushman, R.H., "Designer's Guide to Optical Couplers," *EDN*, July 20, 1973, pp. 50-57.
3. Monsanto E.S.P., *Application Notes Series 500 through 520*.

CHECK IT

WHICH BRIDGE RECTIFIER MANUFACTURER GIVES YOU THE MOST FOR YOUR MONEY?

- 1—Which is the first and only company using flame-retarding materials (classified 94V-0) in the construction of all its rectifiers and bridge rectifiers?
- 2—Who can replace 4 rectifiers with a bridge rectifier at no additional cost?
- 3—Who has bridge rectifiers ranging from ¾A to 25A?
- 4—Who delivers bridge rectifiers within 30 days A.R.O.?
- 5—Whose bridge rectifiers contain patented glass passivated rectifiers?
- 6—Whose AQL is lower using a bridge rectifier instead of 4 rectifiers?
- 7—Which company should be checked for the lowest priced bridges, anywhere?

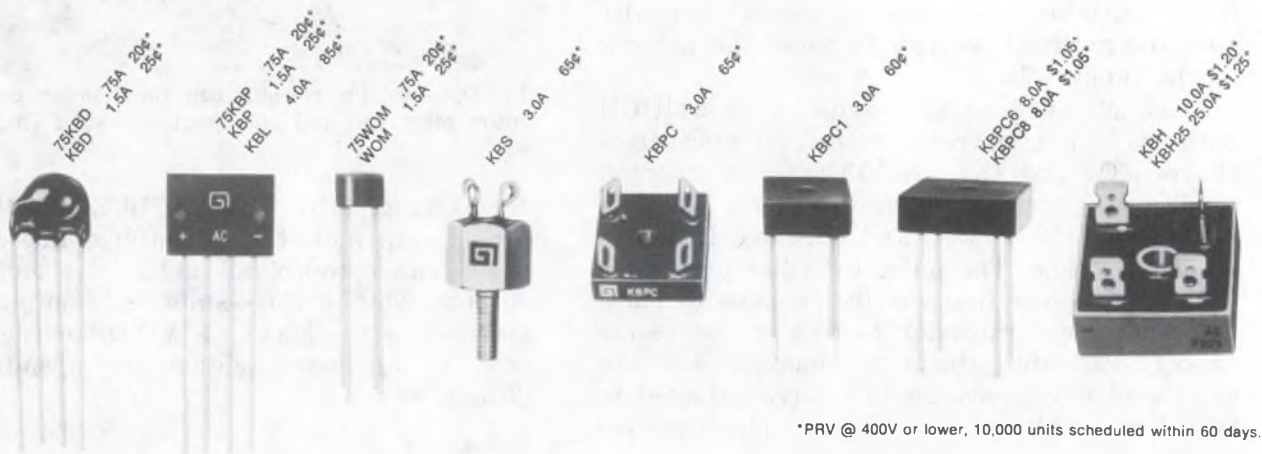



**GENERAL
INSTRUMENT**

MOTOROLA

VARO

UNITRODE

SEMTECH

DIODES INC.

.....	<input checked="" type="checkbox"/>	<input type="checkbox"/>	<input type="checkbox"/>	<input type="checkbox"/>	<input type="checkbox"/>	<input type="checkbox"/>
.....	<input checked="" type="checkbox"/>	<input type="checkbox"/>	<input checked="" type="checkbox"/>	<input type="checkbox"/>	<input type="checkbox"/>	<input type="checkbox"/>
.....	<input checked="" type="checkbox"/>	<input checked="" type="checkbox"/>	<input checked="" type="checkbox"/>	<input type="checkbox"/>	<input type="checkbox"/>	<input type="checkbox"/>
.....	<input checked="" type="checkbox"/>	<input type="checkbox"/>	<input type="checkbox"/>	<input type="checkbox"/>	<input type="checkbox"/>	<input type="checkbox"/>
.....	<input checked="" type="checkbox"/>	<input type="checkbox"/>	<input type="checkbox"/>	<input type="checkbox"/>	<input type="checkbox"/>	<input type="checkbox"/>
.....	<input checked="" type="checkbox"/>	<input checked="" type="checkbox"/>	<input checked="" type="checkbox"/>	<input checked="" type="checkbox"/>	<input checked="" type="checkbox"/>	<input checked="" type="checkbox"/>
.....	<input checked="" type="checkbox"/>	<input type="checkbox"/>	<input type="checkbox"/>	<input type="checkbox"/>	<input type="checkbox"/>	<input type="checkbox"/>

GI'S GOT IT!

Fill out coupon and mail. Or call toll-free 800-645-1247 (In New York State call 516-733-3235)

General Instrument Corporation
Semiconductor Components Division
600 W. John St., Hicksville, N.Y. 11802

- | | | | |
|-------------------------------------|-------------------------------------|-------------------------------------|---|
| <input type="checkbox"/> 75KBD .75A | <input type="checkbox"/> 75WOM .75A | <input type="checkbox"/> KBPC1 3.0A | <input type="checkbox"/> KBH 10.0A |
| <input type="checkbox"/> KBD 1.5A | <input type="checkbox"/> WOM 1.5A | <input type="checkbox"/> KBL 4.0A | <input type="checkbox"/> KBH25 25.0A |
| <input type="checkbox"/> 75KBP .75A | <input type="checkbox"/> KBS 3.0A | <input type="checkbox"/> KBPC6 8.0A | <input type="checkbox"/> Bridge Reference Guide |
| <input type="checkbox"/> KBP 1.5A | <input type="checkbox"/> KBPC 3.0A | <input type="checkbox"/> KBPC8 8.0A | |



Check! I want the most for my money.
Please send me complete information on
General Instrument's bridge rectifiers (those
I've checked):

NAME _____ TITLE _____

COMPANY _____ ADDRESS _____

CITY _____ STATE _____ ZIP _____

**GENERAL INSTRUMENT CORPORATION
SEMICONDUCTOR COMPONENTS**



INFORMATION RETRIEVAL NUMBER 43

MOS/LSI microprocessor selection:

Here are basic hardware, software and design points to consider before you start a microcomputer design.

With the suddenly popular MOS/LSI microprocessor turning up in many new and intriguing applications, some down-to-earth questions are confronting designers: Is a microprocessor right for my application? If it is, which one should I choose?

Microprocessors are used primarily to replace or upgrade random-logic designs.¹ Selection problems can be simplified by careful analysis of hardware requirements, software capabilities and the design aids offered by manufacturers.

A microprocessor is more efficient than a random-logic design when the following conditions are present:

- About 50 or more ICs are used in sequential or combinational designs to perform many functions.
- Functional flexibility or expansion capability is desired.
- Random collection and routing of data are required.

Alan J. Weissberger, Microprocessor Applications Engineer, National Semiconductor, 2900 Semiconductor Dr., Santa Clara, Calif. 95051.

- Complex, logic decisions must be made. (Array logic—in the form of ROMs, pROMs and PLAs, or programmable logic arrays—is another alternative for this condition.)

- Arithmetic computations are needed. (Bipolar 4-bit arithmetic logic units and some of the newer logic devices can also fulfill this need.)

- Speed requirements are not excessive. Although microprocessor speeds are not high, the use of wide-word, or multiple microprocessors, can increase throughput.

Microprocessors can be used in any quantity. For high-volume—more than 25,000 units—a small number of microprocessors can be used for prototyping or pre-production runs before you go to a custom LSI design.

A listing of some microprocessors and vendors appears in Table 1.

What are the key features?

The importance of individual microprocessor characteristics depends heavily on the application. Here is a checklist of key features to consider before making a selection.

Table 1. Some microprocessors announced and expected

4 bit Structured chips, cards, systems	4 bit Building block chips	8 bit Chips, cards, systems	12 bit Chips	16 bit Cards	Custom Chips
<p>*Rockwell PPS-4, 20102D02</p> <p>*Applied Computing Technology PPS-4MP, CBC-4, prototyping systems (for PPS-4 and MCS-4)</p> <p>*Intel 4004, MCS-4, Intellec 4</p> <p>*Fairchild PPS-25</p> <p>National Semiconductor IMP-4, FILU</p>	<p>*National Semiconductor RALU, CROM</p> <p>Monolithic Memories bipolar LSI controller 6701</p>	<p>*Intel 8008, MCS-8, Intellec 8, 8080</p> <p>*National Semiconductor IMP-8C, IMP-8P</p> <p>Signetics PIP</p> <p>Motorola M6800</p> <p>RCA COSMAC</p> <p>DEC MPS, PDP-8A</p> <p>Pro-Log MPS-803, MPS-805</p> <p>Rockwell PPS-8</p> <p>General Automation (Rockwell circuits) LSI 12/16</p>	<p>Toshiba LCS-12</p> <p>Intersil CMOS LSI PDP 8-A</p>	<p>*National Semiconductor IMP-16C, IMP-16L, IMP-16P</p> <p>Computer Automation Naked Mini LSI 1</p> <p>Raytheon RP16 (bipolar LSI)</p>	<p>American Microsystems (used by Frigidaire)</p> <p>Western Digital (used by DEC)</p> <p>Mostek</p> <p>Rockwell (used by General Automation)</p>

* Introduced commercially

Word Length	Applications	Characteristics
4-bit	Control logic, simple digital systems	Low cost, simple design
8-bit	General purpose microprocessors, data processing	Wide range of applications, moderate cost
12-bit	High speed digital systems, data processing	High performance, moderate cost
16-bit	High speed digital systems, data processing, scientific applications	High performance, high cost

- Word length.
- Architecture.
- Speed.
- Programming flexibility.
- Completeness. (How many additional circuits are needed to make it work?)
 - Available design aids (both hardware and software).

Word length should be the first feature to consider (Table 2). The determining requirements are analog resolution, computational accuracy, character length and width of parallel digital inputs or outputs. Microprocessors are structured for fixed word lengths or for modular expansion by a parallel combination of building-block chips. In the latter category, National Semiconductor and Monolithic Memories have 4-bit "slices" of a CPU, or central processing unit. In some microprocessors the word lengths for addresses exceed those for instructions—for example, General Automation's LSI 12/26, Intersil's LSI PDP 8-A and Rockwell's PPS-4. A large address word eliminates the need to manipulate smaller—4 and 8-bit—data registers to obtain 12-to-16-bit addresses. Higher-speed parallel, rather than time-multiplexed serial, addressing is a resulting benefit. In general, longer word lengths for either addresses or instructions provide higher system throughput and more powerful memory addressing, while shorter word lengths require somewhat less hardware and smaller memories.²

Architectural features include general-purpose registers, stacks, interrupts, interface structure and choice of memories. General-purpose registers are used for addressing, indexing, status and as multiple accumulators. They simplify programming and conserve main memory by eliminating memory buffering of data. Multiple accumulators are especially important for ROM programs that have no writable memory.

Stacks can be used for nesting subroutines and interrupts and for temporary storage of data when programs reside in ROMs. Stacks consist of read/write (RAM) memory locations maintained by software—called a pointer stack—or by registers built into the processor chip—called

Microprocessors: Some ABC's

All microprocessors use large-scale integrated-circuit technology. Silicon-gate, p-channel MOS is the most commonly used process. But manufacturers also employ n-channel MOS, silicon-on-sapphire MOS and bipolar processes for increased speed. And they use complementary MOS for lowered power dissipation.

Programmability—that flexible feature not found in random-logic designs—can be obtained on one of two levels. A very detailed level of control is provided at the *micro*-instruction level. These micro-instructions may be used to obtain a *macro*, or machine-language, instruction set, which is then used to write control programs for the microprocessor. New machine-language instructions may be defined by coding new micro-routines. In this way an instruction set can be tailored to an application.

Control programs can also be written in micro-code. This provides increased execution speed and more detailed control at the expense of more difficult programming. Microprocessors that are not microprogrammable contain fixed, general-purpose instruction sets, which are often adequate for most applications.

a hardware stack. The pointer stack—found in the Intel 8080—offers size restricted only by the external RAM, but it must be maintained by software. The hardware stack—found in National Semiconductor's IMP, Rockwell's PPS-4, and Signetics' PIP—is faster, but its size is limited. An additional advantage of the hardware stack is that RAM is not required.

For applications where asynchronous or unpredictable events occur, an interrupt capability is valuable. Throughput increases, since the processor can perform useful work concurrent with I/O (input/output) operations. The major characteristics of this capability include interrupt latency (time to recognize the interrupt and branch to the service routine), response (time to identify the interrupted device and be-

Table 2. Applications and characteristics depend on word length

	4-bit Arithmetic or simple control functions	8-bit Controller	16-bit General Purpose	20, 24, 32-bit Special purpose
Typical applications	BCD display control or calculation Electronic cash registers Business and accounting systems Credit card verification Intelligent instruments Appliances Game machines	Intelligent terminals and instruments Data concentrators or front-ends (communications pre-processor) On-board computer (automobile) Process, numeric and machine control Text editing typewriters Traffic control Education—computer science courses or computer design projects Medical electronics Measurement systems	Data acquisition systems—a/d, d/a processing Process monitoring and alarm Supervisory control—gas, power, water distribution Navigational systems Automatic test systems (particularly in-house LSI testing by semiconductor manufacturers) Word processing systems Peripheral control	Digital signal processing—FFT, auto correlation Digital filtering Interfaces to larger computers (wider word length)
Key characteristics	Controller or arithmetic processor Simplified I/O BCD arithmetic instructions Address formation capability Small parts count for minimum systems Low cost and easy to use	Flexible I/O Hardware to reduce software overhead and simplify I/O Multiple addressing modes Interrupt feature Speed		Higher throughput and/or speed requirements Modular LSI building blocks Multiprocessor configurations Special math instructions or routines

gin execution of the device service code) and software overhead (to get to the service routine and return to the main program). Single line, multilevel and vectored interrupts offer various speed-hardware tradeoffs. Cascaded interrupt capability (interrupting an interrupt) is essential if slow and fast devices are to be mixed in a system. Interrupt enable flags are used to mask or unmask individual levels.

In a single-line interrupt system, all device-interrupt requests are ORed together to form one request line. The program must identify the device interrupting and resolve priority. This may be done by issuance of a device-select status order, in which all devices report their interrupt status on an assigned bit of the I/O bus. Multiple sense (multilevel) lines are sometimes provided for this function. These lines are interrogated by individual device-select status orders. A vectored interrupt offers very fast response by directly branching to a memory location that corresponds to a specific interrupt. Request/acknowledge and interrupt identification use external hardware, thus alleviating software overhead and increasing speed.

Consider the latency and response times of National Semiconductor's IMP-16C single-line and

vectored interrupts (Table 3). The total time to get to the service routine for the device can be as high as 34.85 μ s for single-line interrupts, but only 4.55 μ s for vectored interrupts.

The choice of memories is important because the memory section often represents a major portion of hardware cost. Read/write memories are commonly used for variable data storage and for program storage during software development. Field-programmable ROMs have become quite popular for program storage in small and intermediate-volume systems and for high-volume prototype systems. MOS pROMs may be erased by ultraviolet light and then reprogrammed. For ease of design, memory modular blocks should be used; the memory-address bus width determines the upper limit of expansion (maximum number of addressable locations). Available microprocessor cards include ROM, pROM and RAM memories and eliminate the need to design or specify a memory system for limited storage requirements.

The interface structure should be easy to use for simple, low-cost applications (parallel or serial). Separate busses for data, addresses, memory and peripheral input and output are most appropriate in this case.

While the type of control depends on the processor, higher throughput results from the use of a direct-memory-access (DMA) bus. In this arrangement, a peripheral device communicates directly with memory without disturbing the CPU. Interfacing is more complex because request and acknowledge signals must be exchanged between the device and an autonomous bus controller. When a single bus is used, data and addresses must be time-multiplexed, and latches must be provided to hold the address stable while memory or a peripheral are accessed.

Provision for handshake I/O control allows convenient interfacing with peripherals of varying response time. Control flags and jump condition inputs are useful to reduce hardware decoding and software overhead. If multiple devices are to be connected over the same I/O lines, three-state or open-collector TTL logic is required to drive the bus. The microprocessor I/O circuitry should directly interface with these signals.

How do you measure speed?

Cycle time, state time, minimum instruction time, time to add two numbers, and interrupt response time have been given to measure speed. These numbers are rather meaningless, for they do not measure the power of the instruction set. Benchmark programs for a specific task should be coded and the execution times compared to determine which microprocessor meets the speed requirements.

The degree of programming flexibility can be determined from an examination of the instruction set.³ Multiple addressing modes conserve main memory, simplify programming and increase speed through single-word memory-reference instructions. For programs stored in ROM or pROM, indexing or pointer addressing are the only means to access data tables in program loops. Other useful capabilities include bit and byte manipulation, multiply and divide, double-precision arithmetic, normalize and I/O control instructions.

Custom instructions through microprogramming can upgrade performance by optimizing the microprocessor architecture. In some cases other processors, including minicomputers, may be emulated with the microprogram control technique, thereby enabling software built for a larger machine to run on a microprogrammed microprocessor.

The number of additional IC packages required provides an indication of the completeness of the microprocessor set. For example, the Intel 8080, a one-chip microprocessor, requires six logic circuits, nine memory packages and two clocks for a minimum system. To drive more than one TTL

Table 3. Latency and response times: Keys to speed

	*Latency time— μ s	Response time— μ s	Total interrupt overhead time— μ s
Single-line interrupt	5.95	0-28.9 (1 to 16 devices)	5.95-34.85
Vectored interrupt	4.55	0 (independent of number of devices)	4.55

* Plus time to complete current instruction

load, address and data buffering must be supplied.' In many cases a more powerful multichip processor may be used with no increase in total component count.

Functions generally requiring additional components include clock generation and timing, memory and I/O control, data and address buffering, multiplexer inputs, interrupt control, and sometimes memory refresh control (for dynamic MOS RAMs) and additional power-supply voltages.

What support do you need?

In addition to the microprocessor itself, support should be provided by the manufacturer to simplify the application of the processor and the development and prototyping of the end product. This category includes documented manuals, application literature, area field specialists, prototyping systems—such as National Semiconductor's IMP 8P and 16P, Intel's Intellec 4 and 8 and Applied Computing Technology's PPS-4MP (for Rockwell PPS-4). Also generally useful are program-development software and the ability to fashion the microprocessor into different configurations.

Prototyping systems are essential to develop and debug hardware, firmware and software for the end product. The ingredients of such a prototyping system include expanded memory capability, a teletypewriter or card-reader interface, power supply, chassis, control panel and support software (assemblers, compilers, loaders, debug and edit packages). A pROM programmer provides very fast turnaround time when control programs are modified.

With a processor card, you get an assembled and tested microprocessor system, complete with memory. Cards are often more economical than chips for low-volume applications. They may be used for development of early production models for high-volume applications, before they are replaced by an in-house design.

SCR CONTROLLED BRIDGE RECTIFIERS & POWER SWITCHES

NEW

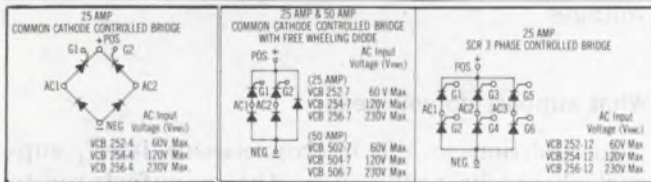

TYPICAL CIRCUITS

COMPLETE STANDARD LINE INCLUDES:

IN PRESS-FIT PACKAGES: 25A AC POWER SWITCH; 25A HALF-WAVE POWER SWITCH; 25A CENTER TAP CONTROLLED BRIDGE AND 25 AMP COMMON CATHODE CONTROLLED BRIDGE. IN ELECTRICALLY ISOLATED EPOXY BARRIER PACKAGES WITH INTEGRAL MOUNTING PAD: 25A & 50A COMMON CATHODE CONTROLLED BRIDGE WITH FREE WHEELING DIODE, SINGLE AND THREE PHASE; 50A COMMON CATHODE CONTROLLED BRIDGE, SINGLE AND THREE PHASE; 25A SCR CONTROLLED BRIDGE, SINGLE AND THREE PHASE. CUSTOM DESIGN AVAILABLE.

The VCB series of 25A and 50A controlled bridges and power switches are available in a 3/4" press-fit package, with three mounting options and in epoxy packages. All units are hermetically sealed.

The epoxy packages are explosion proof and electrically isolated with double isolation available. SCR's are glass passivated. All chips are soldered to an integral copper mounting pad for improved thermal characteristics, typically $< 1^{\circ}\text{C}/\text{W}(\text{R}\theta_{\text{JC}})$. Epoxy barriers have been placed between standard .250" Faston and/or #10-32 terminals. Spacing exceeds NEMA standards.

Typical applications include DC motor speed controls, temperature controllers, battery chargers, inverters, frequency changers, D.C. power supplies, and servo systems.

All units are available in 60V, 120V or 230V, (V_{RMS}), with 200V, 400V and 600V DC Blocking Voltages.

Typical economical pricing:

VCB252-7 (200V, 25A) \$9.00 ea.,
100 qty.



Design us in . . . we'll stay there

VARO

VARO SEMICONDUCTOR, INC.

P.O. BOX 676, 1000 N. SHILOH, GARLAND, TEX. 75040
(214) 272-4551 TWX 910-860-5178

INFORMATION RETRIEVAL NUMBER 44

Of course, chips represent the ultimate in low cost and small size, but the designer must interface them with additional components and perform the necessary tests. The components selected must meet exact speed, power and functional specifications.

Manufacturers often point to such features as the number of instructions and registers, memory bandwidth and speed to measure computing power. These criteria are often misleading because they are defined differently by various manufacturers. The only real way to determine the effectiveness of a microprocessor is to code benchmark programs or experiment with representative logic designs. ■■

References

- Lewis, D.R. and Siena, W.R., "Microprocessors or Random Logic" (three-part series), *Electronic Design*, Sept. 1, 1973, p. 106.
- Reyling, G., "Microprocessors—Next Generation in Digital Design," *EE Systems Engineering Today*, November, 1973, pp. 86-90.
- Weiss, D., "Software for MOS/LSI Microprocessors" (three-part series), *Electronic Design*, April 1, 1974, p. 50.
- Mazor, S., "A New Single Chip CPU," *COMPCON 1974 Proceedings*, pp. 177-180.

Need more information?

Readers may obtain more information on manufacturers' microprocessor products by circling the appropriate information retrieval number.

- *American Microsystems, Inc., 3800 Homestead Rd., Santa Clara, Calif. 95051. (408) 246-0330. **Circle No. 320**
- **Applied Computing Technology, 17961 Sky Park Circle, Irvine, Calif. 92707. (714) 557-9972. **Circle No. 321**
- Computer Automation, Inc., 895 W. 16th St., Newport Beach, Calif. 92660 (714) 642-9630. **Circle No. 322**
- Digital Equipment Corp., 146 Main St., Maynard Mass. 01754. (617) 897-5111. **Circle No. 323**
- Fairchild Semiconductor, 464 Ellis St., Mountain View, Calif. 94040. (415) 962-5011. **Circle No. 324**
- General Automation, 1055 S. East St., Anaheim, Calif. 92805. (714) 778-4800. **Circle No. 325**
- Intel, 3065 Bowers Ave., Santa Clara, Calif. 95051. (408) 246-7501. **Circle No. 326**
- Intersil, 10900 N. Tantau Ave., Cupertino, Calif. 95014. (408) 257-5450. **Circle No. 327**
- Microsystems International Ltd., P.O. Box 3529, Station C, Ottawa, Canada K1J 4J1. **Circle No. 328**
- Monolithic Memories, 1165 E. Arques Ave., Sunnyvale, Calif. 94086. (408) 739-3535. **Circle No. 329**
- *Mostek Corp., 1215 W. Crosby Rd., Carrollton, Tex. 75006. (214) 242-0444. **Circle No. 330**
- Motorola Semiconductor Products, P.O. Box 20912, 5005 E. McDowell Rd., Phoenix, Ariz. 85036. (602) 244-3465. **Circle No. 331**
- National Semiconductor Corp., 2900 Semiconductor Dr., Santa Clara, Calif. 95051. (408) 732-5000. **INQUIRE DIRECT**
- **Pro-Log Corp., 852 Airport Rd., Monterey, Calif. 93940. (408) 372-4593. **Circle No. 332**
- RCA Solid State Div., Route 202, Somerville, N.J. 08876. (201) 722-3200. **Circle No. 333**
- Raytheon Semiconductor, 350 Ellis St., Mountain View, Calif. 94040. (415) 968-9211. **Circle No. 334**
- Rockwell Microelectronics Div., P.O. Box 3669, 3430 Miraloma Ave., Anaheim, Calif. 92803. (714) 632-2321. **Circle No. 335**
- Signetics, 811 E. Arques Ave., Sunnyvale, Calif. 94086. (408) 739-7700. **INQUIRE DIRECT**
- Toshiba Transistor Works, 1-Komukai, Toshiba-Cho, Kawasaki-Chi, Japan. **Circle No. 336**
- *Western Digital, Box 2180, 19242 Red Hill Ave., Newport Beach, Calif. 92663. (714) 557-3550. **Circle No. 337**
- *Primarily engaged in custom chips.
- **Primarily engaged in prototype development systems.

Control Logic Programming

turn to CTS

for DIP set-up switches

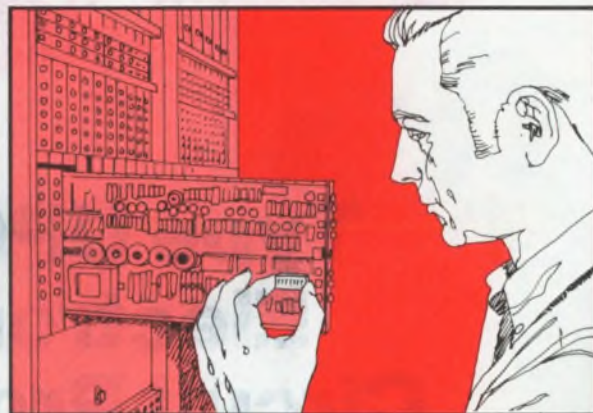
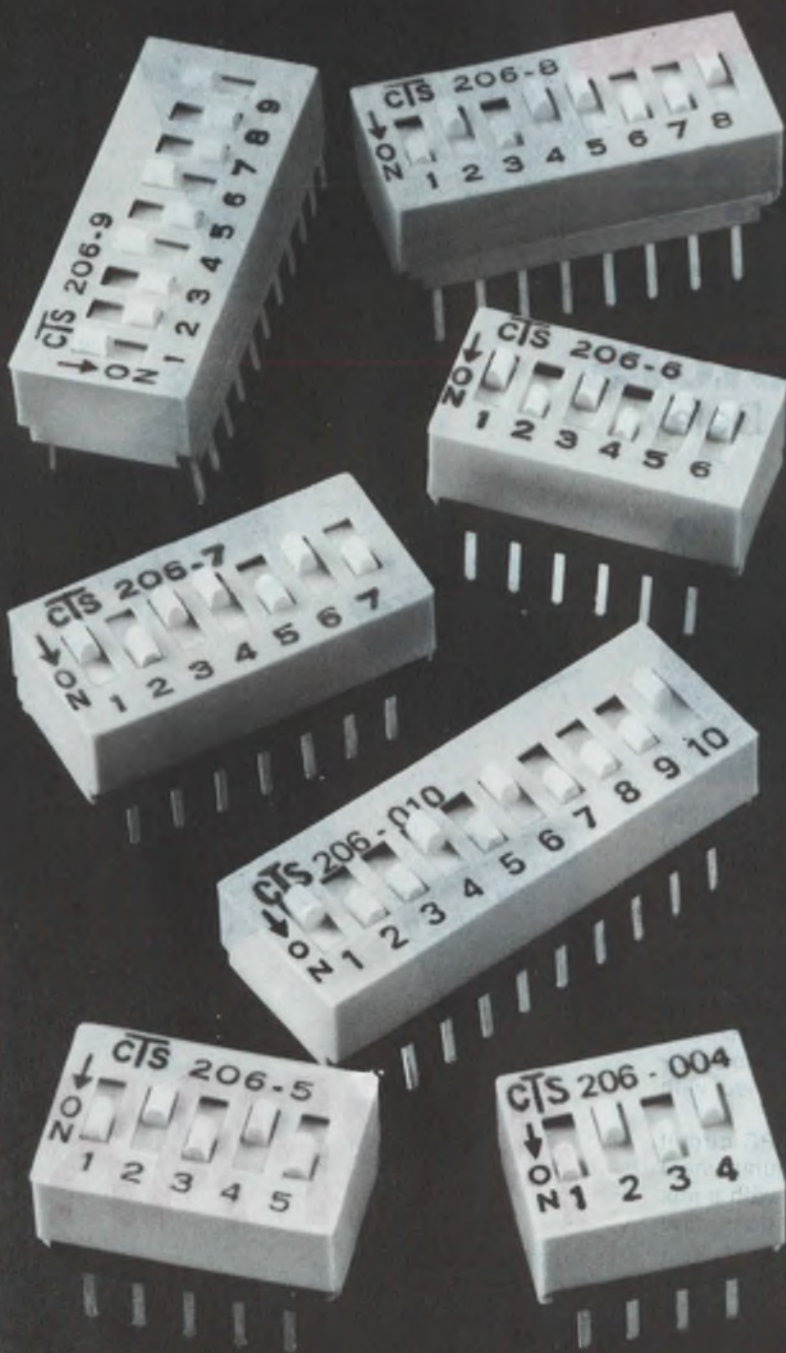

New CTS 206 Series switches will streamline your logic programming. These dual-in-line packages mount on the same PC board as other circuit components, eliminating the need for special mounting hardware/interconnection wiring. Program up to 10 different functions and/or signal levels with one compact switch.

CTS offers 7 different packages with 4 through 10 individual SPST slide switches per package. Automatic insertion saves you time and money. Units have .100" x .300" centers for inserting into either PC boards or standard IC sockets. Gold plated contacts that wipe on make and break assure low contact resistance over long life.

Designed for computer, computer peripheral, communication, test equipment and numerous other programming applications. Use good logic, turn to CTS. Find out more about our new, economical 206 series switch today. CTS Keene, Inc., 3230 Riverside Avenue, Paso Robles, California 93446. Phone: (805) 238-0350.

CTS CORPORATION
ELKHART, INDIANA



Stop Nuisance Tripping!

Type UPG/APG Electromagnetic Circuit Protectors with patented Inertial Delay.

Typical XFMR Transients
(Peak currents to 20X
nominal) results in
NUISANCE TRIPS. Solution:
Use Airpax Inertial Delay.

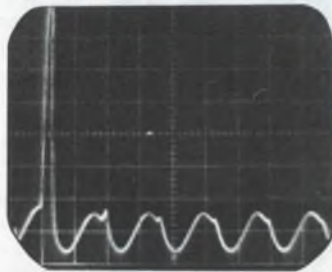

Airpax Type UPG/APG circuit protectors assure positive protection without nuisance tripping. This is accomplished by an exclusive Airpax inertial delay that provides tolerance of short duration inrush currents without decreasing steady state protection.

The UPG/APG line of low cost, compact circuit protectors offers series, shunt, and relay configurations with a choice of delays and ratings. Ratings are from 20 milliamperes to 30 amperes, 250 volts maximum at 60Hz, 250 volts at 400Hz, and 65 volts dc maximum. A SPDT auxiliary switch, for remote signalling or alarm, rated at 5 amperes, can be supplied with series trip types.

Available in 1, 2, and 3 pole versions, UPG/APG circuit protectors offer a choice of toggle, rocker arm, or thumbwheel actuators. All multipole assemblies can be furnished with a mix of current ratings, delays, internal circuit configurations, and terminal styles.

To get the full story on Airpax Type UPG/APG electromagnetic circuit protectors, write for Bulletin 2003.



AIRPAX™

Airpax Electronics
CAMBRIDGE DIVISION
Cambridge, Maryland 21613
Phone (301) 228-4600

THE TRIMLINE SERIES

DISTINCTIVE ELECTRONIC ENCLOSURES



PREMIER METAL PRODUCTS COMPANY

A DIVISION OF SUNSHINE MINING COMPANY

337 MANIDA STREET, BRONX, N. Y. 10474 (212) 991-6600



ACDC ANNOUNCES THE GRAND OPENING OF OUR NEW HIGH EFFICIENCY POWER SUPPLY.

We've opened it up to give you an inside look at things like the modular construction that adds to reliability and simplifies circuit check out...the low voltage drop, high speed rectifiers that combine the best elements of reliability, speed and low forward voltage drop...the low impedance output capacitors that reduce high frequency ripple to about 5mV peak-to-peak...and the sealed input EMI filter that minimizes conducted RFI.

These 20KHz inaudible switchers operate from 115/230VAC, 47-63Hz or from 150VDC with 70% efficiency and 0.1% regulation. (100VAC also available).

Overvoltage and overload protection is standard and EMI is minimized by shielding and filtering. (We even offer an optional built-in filter for compliance with Mil-Std 461, CE03). You get low inrush on turn on for soft start and can parallel up to six switchers in master-slave configuration.

There are 10 models in this new series. Five 300 watt models range from 5V at 60A to 24V at 14A. Five 500 watt models range from 5V at 100A to 24V at 23A. They're all in our new brochure. Just circle the reader service number and we'll get a copy to you right away. However, if you would like a copy of our 64-page catalog containing technical data on our complete line, fill out the coupon company letter-head.



Name _____

Company Name _____

Address _____

City _____

State _____

Zip Code _____

acdc electronics inc

Oceanside Industrial Center Oceanside, CA 92054 (714) 757-1880

vactec phototransistors

VACTEC, INC.

2423 Northline Industrial Blvd.

Maryland Heights, Mo. 63043

Phone (314) 872-8300

Vactec npn epitaxial large chip, high sensitivity phototransistor. An enlarged section of the wafer forms the colorful background.

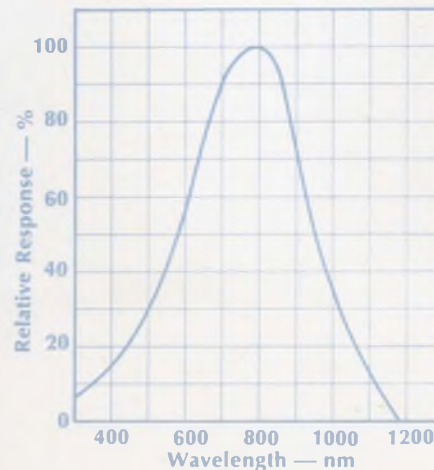
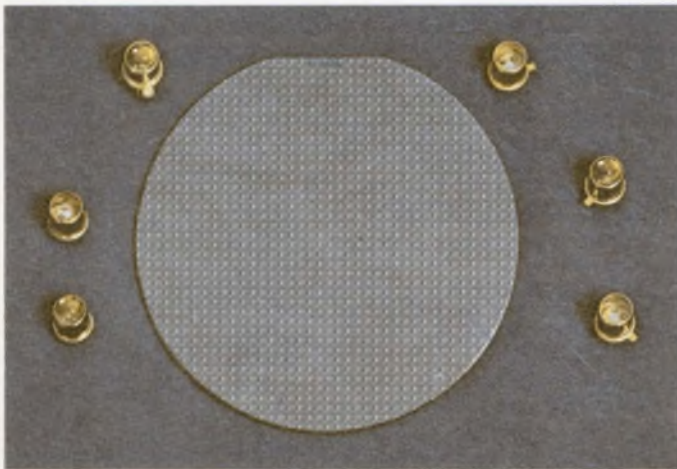

Standard Vactec phototransistors provide very high sensitivity and good blue response. Liberal design flexibility is also offered with trade-off for some characteristics, including: light current; response time; spectral sensitivity; and breakdown voltage. Selection of packages are TO-18, co-axial, pill, non-hermetic TO-18 size and special arrays on 50-mil or 25-mil centers.

Custom design is practical for quantities as low as 10M per year. Masking charges are nominal. Our automatic test capability includes 100% sort (with light applied) for I_{CEO} , breakdown voltage and dark current. Vactec can also second-source practically anyone's phototransistors. Write for Bulletin VTТА-1 today.

A flexcircuit to fit new camera technology.

We did it for Polaroid.

Polaroid's SX-70 Land camera. More revolutionary than the first camera marketed by Polaroid. And more demanding in terms of technology.

Just distributing battery power to electronics, switches, film roller motor and shutter solenoid requires connecting 30 points. And in a camera housing measuring 4½ x 7 x 1⅞ inches you can bet that space is at a premium.

Polaroid engineers needed a wiring harness that almost didn't have a third dimension. And they got it in a Schjeldahl flexcircuit only eight mils thick. Fully insulated both sides with Kapton® polyimide film. Fused solder on all pads for clean reflow soldering. Flexes into 5 planes. Fits the space available. Designed for volume production. That's using flex-circuitry as it should be used.

Schjeldahl did it for Polaroid.



Schjeldahl Company

Electrical Products Division
Northfield, Minnesota 55057
Phone: (507) 645-5633

The state of the art people in volume flexible circuits

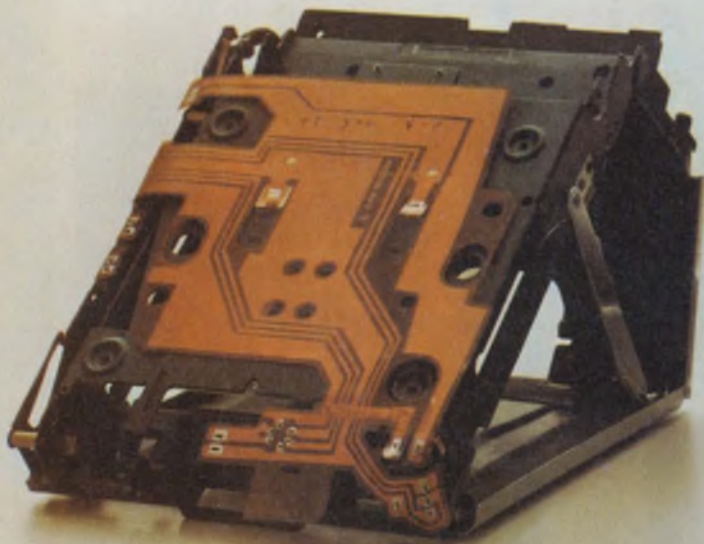

And we can do it for you.

NEW

PANDUIT® Fully Automatic Cable Tie Installation Tool

Automatically feeds cable tie around the bundle, tensions the tie, and cuts it off flush — all in less than 1 second!

Panduit introduces the first lightweight fully automatic cable tie installation tool to be conveniently hand held. Now you can gain high-volume production with minimum fatigue.

Lightest, Most Compact. The PAT1M tool weighs just 1¼ lbs. — a fraction of competitive tools — and is sized to fit the operator's hand. Separate dispenser unit can be conveniently placed out of the way.



Dispenser Unit

Fast Operation. Simply place jaws around the bundle and touch the start button. The tool automatically installs a one-piece PAN-TY® cable tie around the bundle, tensions the tie and cuts it off flush — all in less than 1 second. The all-nylon tie meets MIL. STD. MS3367-4. The dispenser magazine holds 100 ties, twice the capacity of competitive units, reducing reload time by 50%.

Versatile. The unique design of the PAT1M allows cable tie installation closer to harness board accessories. The tool and dispenser operate in any angle or position. This tool can be used on bundle diameters from 1/16" to 3/4".

The PAT1M automatic tool is part of a complete line of cable tie installation tools including PPTS pneumatic, GS2B and GS4H hand operated. The PAT1M tool is available for lease from Panduit Corp. Panduit's full line of wiring components, including PAN-TY® and STA-STRAP® cable ties, PANDUCT® plastic wiring duct and PAN-TERM® terminals, is sold through authorized Panduit Stocking Distributors.

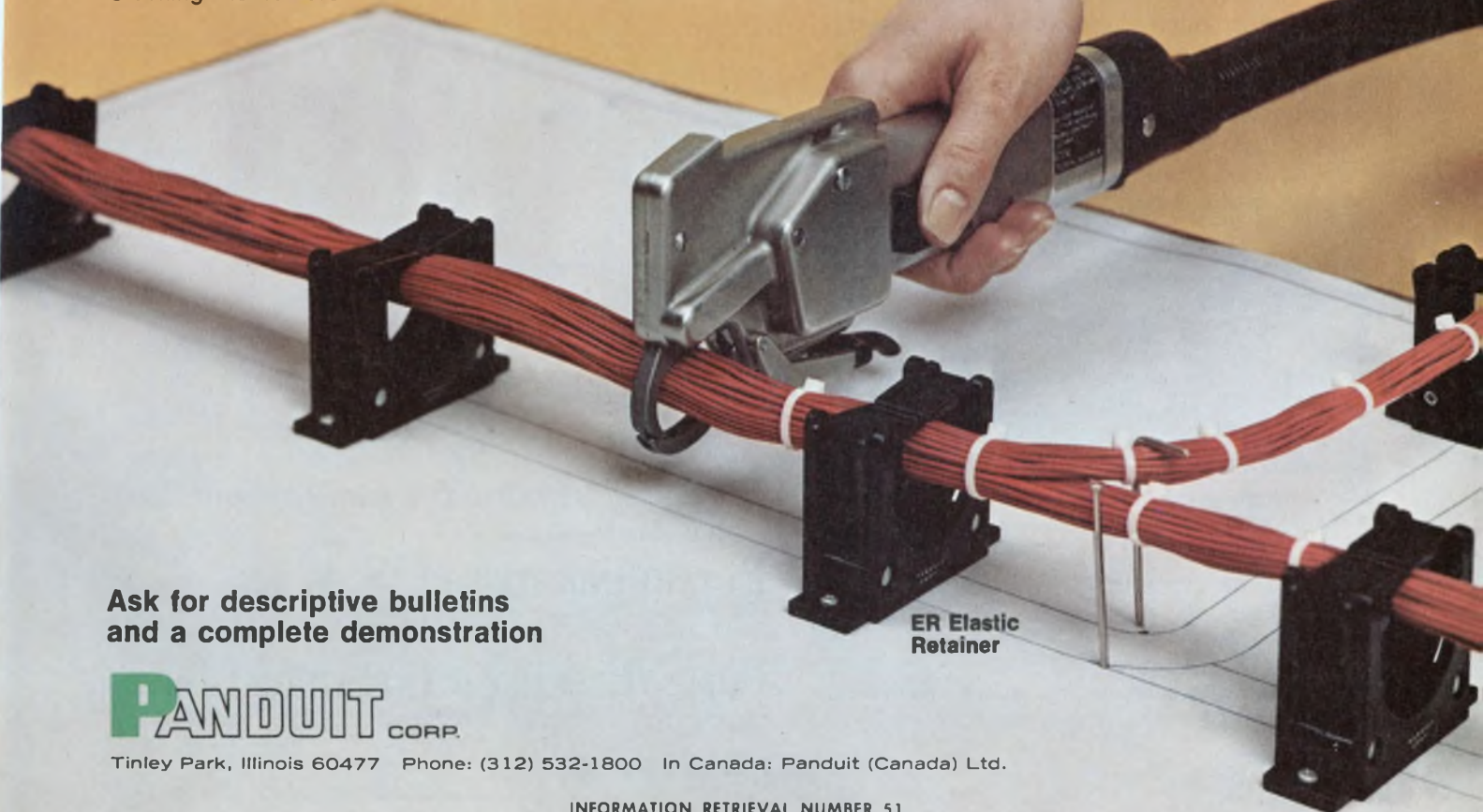

Ask for descriptive bulletins and a complete demonstration

ER Elastic Retainer

PANDUIT CORP.

Tinley Park, Illinois 60477 Phone: (312) 532-1800 In Canada: Panduit (Canada) Ltd.



...when one has a sure thing it is hard to resist showing off a little. Just as the royal flush is a guaranteed winner in poker, Futaba parts mean the same certainty for most major Japanese manufacturers. Precision manufacturing and reliability of performance are two reasons. Another great reason is constancy of supply. No matter how good parts are, this means nothing if they are not available when needed. With modern, high-capacity manufacturing facilities, this is where Futaba holds a real winning hand. Futaba parts—just ask for them.



Standard keyboard switches and key tops available from FUTABA stock for instant keyboard layout on your mounting plate.

OTHER FUTABA PRODUCTS:

- Press die sets.
- Mold bases for plastics.
- Material feeders for press work.
- Automatic stopping devices for automatic machinery.
- Radio control for hobby aircraft, race cars, etc.

***WE DON'T MEAN
TO SHOW OUR HAND, BUT...***



"FUTABA—THE BRIGHT PRODUCER"

● For additional information, please contact:

FUTABA INDUSTRIES U.S.A.
630 West Carob Street, Compton, California 90220, U.S.A.
Phone: (213) 537-9610 Telex: 69-1227

FUTABA ELECTRONIC INDUSTRIES LIMITED
Super Bldg., 1-11-5, Sotokanda, Chiyoda-ku, Tokyo, Japan. Phone: 255-5881
Telex: J26532

Monsanto introduces its *HT* SERIES *(a breakthrough in High Technology)* with four Universal Counter/Timers

Monsanto's new HT Series (High Technology) of frequency and time instruments designed to meet the rigid requirements of laboratory and field use, is the 8500 family of Universal Counter/Timers. They constitute another major achievement in our continuing R & D program to produce digital instrumentation of ultimate reliability and performance. These demanding standards have been realized by using field proven technology, unique designs

and state-of-the-art components and circuitry. The application of human engineering principles enables simple and self-evident use of the instrument. Our proudest achievements, these HT Series instruments are housed in attractive, designer-styled, diecast aluminum enclosures that provide an outward appearance as advanced as the technological innovations they contain.



8500 Series
 prices range from
\$650.

The 8500 Series of Universal Counter/Timers consists of four separate models with ranges of 50 MHz, 150 MHz, 550 MHz and 1 GHz.

All models feature: Complete Counter-Timer functions of Frequency, Period, Period Average, Time Interval, Time Interval A to B, Ratio and Totalize/Full 9 digit, Monsanto, easy-to-read amber LED display/Opti-ranging for optimum display resolution/10 mV rms sensitivity with AGC for VHF & UHF measurements/High stability, oven controlled, crystal oscillator/Optional parallel BCD output/Optional higher stability TCXO oscillator/Available from stock/Generous OEM quantity discounts.

UNITED SYSTEMS CORPORATION
 918 Woodley Road, Dayton, Ohio 45403
 Ph. (513) 254-6251 Twx. (810) 459-1728
 a subsidiary of

Monsanto



YOU'RE LOOKING at the PERFECT SOURCE for CRYSTALS, OSCILLATORS and CRYSTAL FILTERS

ERIE is bursting with a full line of QUARTZ CRYSTALS . . . with deliveries to meet your production schedules. 1 kHz to 200 MHz . . . AT, JT, DT, NT, SL, 5°X, GT.

We have exotic crystals and very simple crystals, low frequency and high frequency crystals. And we manufacture and test to meet or exceed Mil-C-3098 standards. ERIE provides a better crystal because we control our total manufacturing process in-house.

Our broad line of CRYSTAL OSCILLATORS range from low cost TTL dip package types to complex high stability, high reliability oscillators . . . both military and industrial types.

When it comes to CRYSTAL FILTERS, ERIE can design and manufacture the filter best suited to your application. There is virtually no limit to the variety we produce . . . including Monolithic Crystal Filters.

So come to ERIE for a fast, accurate and down-to-earth answer to your frequency control problem. One factor remains constant . . . you'll get a fair, cost-conscious answer. We have the technology and the products to implement effective crystal performance.

WRITE FOR OUR CATALOG
OR CALL 717/249-2232
FOR ENGINEERING AND
PRICING HELP.

ERIE FREQUENCY CONTROL

453 LINCOLN ST., CARLISLE, PENNSYLVANIA 17013
DIVISION OF ERIE TECHNOLOGICAL PRODUCTS, INC.



The widest selection of analog CMOS switches and multiplexers.

Available now.



Get them all from one source. And get them fast. 4-, 8- and 16-channel multiplexers. Quad and dual SPDT switches.

Some of our designs you've never seen before. They'll give you specs, functions, and package options you can't order anywhere else.

And we've got other designs you'll recognize right away. You probably ordered them from someone else a while ago — and you're still waiting for delivery.

Check them out. They'll give you the design benefits of CMOS — and the lowest power dissipation you can get.

The multiplexers:

AD7501 8-channel
AD7502 differential 4-channel.
AD7503 8-channel.

AD7506 16-channel.
AD7507 differential 8-channel.

The switches:

AD7510/AD7511/AD7519 quads.
AD7512 dual SPDT.

AD7513 dual.

AD7516 quad.

Get it only from us. Again, only from us.

A replacement for HI1818.

Replaces DG506.
Replaces DG507.

You can't get them anywhere else. Another that's ours alone.

Use it instead of DG200.

Instead of CD4016A.

The price is right.

So give us a call — to order or to ask for our new catalog. It'll tell you everything you need to know about our entire line of analog CMOS switches and multiplexers.

East Coast: (617) 329-4700.

Midwest: (312) 297-8710.

West Coast: (213) 595-1783.

Our analog CMOS switches and multiplexers, like our AD7520 CMOS DAC, are more innovative uses of advanced technology — to keep you (and us) a step ahead of everyone else.

Analog Devices, Inc., Norwood, Mass. 02062.



Get standby LSI memory power, and you have a nonvolatile setup that can compete with core. Pulsed refresh cycles allow a small battery to preserve data for over a month.

A small, low-cost battery system can keep a large-scale-integrated memory nonvolatile if the power goes out or is reduced critically. The standby system will provide timed bursts of refresh cycles to keep the data intact for more than a month, while consuming a minimum of power from the battery.

With the battery setup, LSI memories can compete fully with core on the basis of price and reliability—especially in view of the volume production promised by the recent introduction of 4-k RAMs.

The nonvolatile LSI memory system has two modes of operation. In the normal mode the memory operates on dc power derived from an ac power line. During this time the memory serves the central processing unit or another memory user. Manufacturers' spec sheets and applications notes adequately describe the device's operation in this mode.

In the standby mode, the memory system operates on a battery, and it performs only the refresh cycles required to maintain data integrity. Such a system has the following requirements:

- LSI memory arrays capable of operation at low power in a standby mode.
- A battery capable of supplying current for the duration of the nonvolatile period (see box).
- A voltage regulator to supply logic and MOS power from the battery.
- A power supply to charge the battery during the normal operating mode.
- Power-switching circuits to provide pulsed logic power.
- Control logic to perform the required memory refresh sequence.
- MOS driver circuits that can be operated on pulsed power.
- A refresh timing circuit that can operate at low power levels.

Unlike the operating mode, the standby mode is usually overlooked in the data provided by

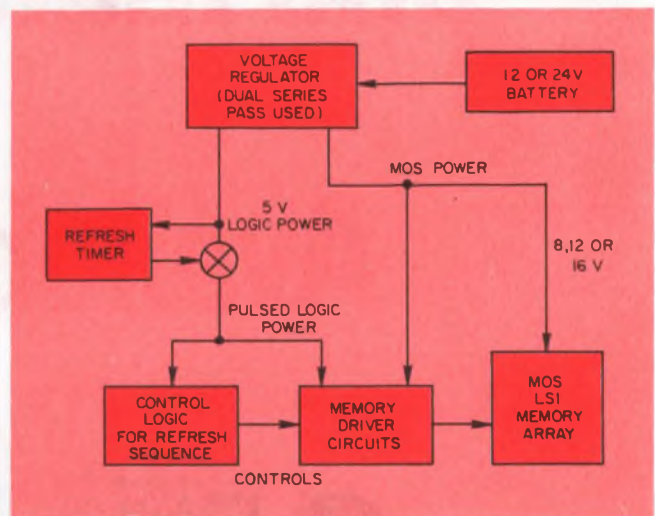

1. Battery-regulator combination furnishes logic power (5 V) and MOS power. The memory is refreshed in pulsed cycles by the timer to conserve the battery. Relatively simple circuits suffice.

semiconductor houses. Consider the standby system in Fig. 1. Two power voltages are provided by the battery-regulator combination—logic power and MOS power. Logic power, typically +5 V, runs the standby refresh timer and, through a switch, the control logic and the interface drivers for the MOS arrays. MOS power, typically +12 or +16 V, runs the MOS LSI memory arrays and the interface drivers between the control logic and the memory arrays. Some MOS LSI memories require a third or fourth voltage for operation. These extra voltages are normally used only by the memory arrays.

Logic power for the refresh logic and for the driver circuits, in most cases, is pulsed on for a low duty cycle to minimize power consumption. The switch that applies the pulsed power is controlled by a timer. The pulse rate is such that the particular memory array type used maintains data integrity. When logic power is pulsed on, the control logic for the refresh sequence steps through a series of operations to refresh the data in the memory arrays. The refresh timer then turns off the pulsed logic power until it is time for the next refresh sequence.

Daren Appelt, Member of the Technical Staff, Texas Instruments, Inc., Digital Systems Div., P.O. Box 2909, Austin, Tex. 78767.

Most 1024-bit memory arrays require 32 memory cycles to complete memory refresh—that is, to address all 32 rows; 4096-bit arrays require 64 cycles. During the normal operating mode the refresh cycles are spaced evenly in time to create the least interference with the CPU. In the standby mode these cycles are performed in a burst, during the time when the standby pulsed logic power is on.

Transition between the two modes, operating and standby, is another aspect to consider. Fig. 2

There are eight subsystems that must be considered for a viable memory unit. The subsystem requirements include:

Memory array requirements—To be useful in a nonvolatile memory system, an LSI memory array must satisfy the cost/performance and reliability required of it in the normal operating mode in addition to providing low-power standby operation. The details of the standby mode are often hidden in the vendor's specification sheet. First, there must be a zero Q-current state (low

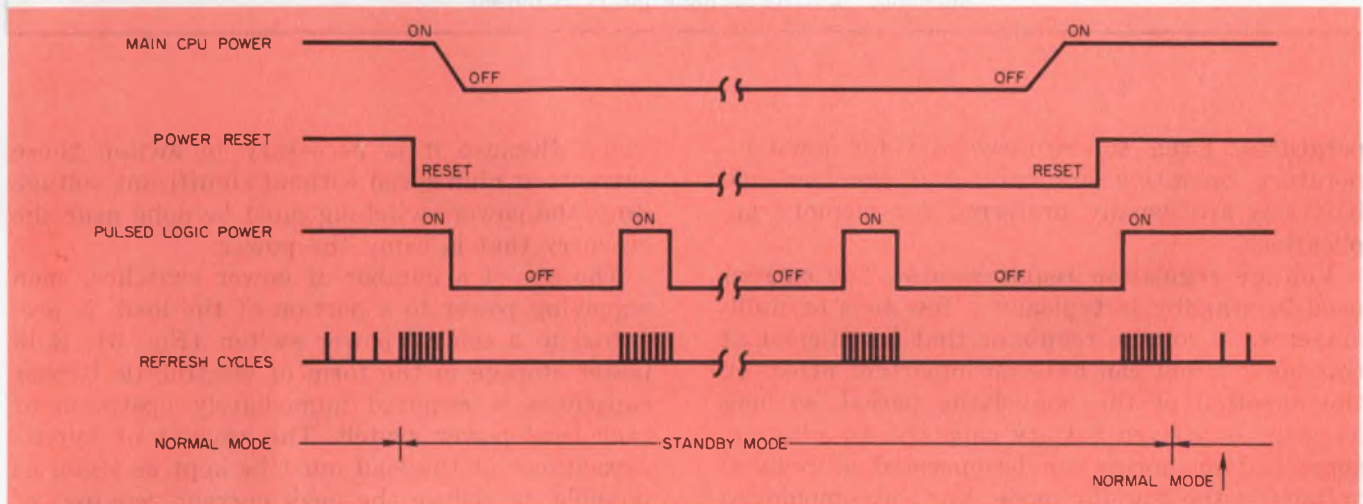

2. Control of the transition between the memory's standby and normal operating modes is via a power-reset signal furnished by the main system supply. During the standby mode, refresh cycles are performed in bursts;

shows the transitions from normal to standby and back to normal again. Control of the transitions is accomplished by a power-reset signal generated by the main system power supply to indicate when main power is unstable. When the reset signal is applied, the memory system immediately enters the standby mode, does a burst of refresh cycles and then switches off the pulsed logic power. The refresh bursts repeat, as determined by the standby refresh timer, until main power is restored. When main system power is restored and stable, the main system power supply clears the power reset signal. Upon completion of the next refresh burst, the pulsed logic power will stay on, and the memory system will re-enter its normal mode.

Design elements of standby mode

Each of the elements in the standby system has special design requirements for effective standby-mode performance (Table 1). The major design objective is to reduce the standby power consumption so that a small, low-cost battery will provide a long nonvolatile period.

in the normal mode they are spaced out to avoid interference with the CPU. The bursts continue until main power is restored which clears the power-reset signal. Normal operation begins after one last refresh burst.

quiescent current state) for the device, in which the current drawn from the power lead or leads is near zero. (Some 1103-type devices require one of the address leads to be pulsed to reach this state.) Second, the device should have reasonably low input capacitance, particularly if the inputs require large voltage swings. The power burned just driving the input capacitance can be a significant factor— CV^2 multiplied by the repetition rate, for resistive driver circuits.

Battery requirements—Batteries for application in nonvolatile LSI memory systems should be sealed, rechargeable cells that offer long service life. Five-year service without maintenance is a good goal. Standby memory power use is characterized by repeated periods of light discharge and long periods of slight overcharge. Under these conditions, most NiCd batteries cannot deliver their rated capacity on the first full-depth discharge. If the memory is being designed for more than a month of nonvolatility, the self-discharge characteristics of the NiCd system may also become significant. Some of the newer, sealed lead-acid batteries do not have these drawbacks. Their capacity, however, is greatly reduced at low tem-

Table 1. System design elements

Condensed design characteristics	
Memory component	Special requirements in nonvolatile system
LSI Memory array	Low power standby operation
Battery	3-5 Year service life, sealed, low self-discharge
Voltage regulation	Efficient at low supply currents
Main system power supply	Maintains battery charge, generates a power failure reset signal
Power switching	Provides pulsed logic power, has local energy storage distributed near loads
Refresh control logic	Low power, operates on pulsed power
MOS driver circuits	Zero quiescent-current operation with logic power off, must not "glitch" as logic power is pulsed

peratures. Even so, requirements for low-temperature operation are rare, and the lead-acid batteries are usually preferred for memory applications.

Voltage regulation requirements—The current used in standby is typically a few tens of milliamperes. A voltage regulator that is efficient at this low current can have an important effect on the duration of the nonvolatile period, so long as there is a fixed battery capacity. In addition, some LSI memories can be operated at reduced voltage in the standby mode. For these memories the standby voltage regulator can be designed to operate with a lower voltage battery in order to conserve power.

Main system power-supply requirements—The main power supply must provide power to charge the battery when ac power is on. This source can take the form of a simple trickle-charge circuit, unless ac power is expected to be off for most of the time. The main power supply must also generate a power failure reset signal, which is activated as soon as ac power failure is detected and then deactivated when power is restored and all derived dc power voltages are stable. This is the signal that causes the memory system to enter the standby mode. The importance of the correct sequencing of the power reset signal cannot be overstated.

Power-switching requirements—The power-switching circuitry applies the logic power from the standby regulator to the refresh control logic in pulses, as demanded by the standby refresh timer. This ability to switch off the power to the control logic and driver circuits reduces the power they require by a factor of 1000 in some cases.

But power switching is complicated by the fact that control logic (especially TTL) and driver circuits require bypass capacitors from power to ground. High peak currents result when power is switched on to capacitors from power to ground. In addition the MOS drivers draw high peak currents as they charge MOS circuit input capaci-

tance. Because it is necessary to switch these currents at high speed without significant voltage drop, the power switching must be done near the circuitry that is using the power.

The use of a number of power switches, each supplying power to a portion of the load, is preferred to a central power switch (Fig. 3). Bulk power storage in the form of electrolytic bypass capacitors is required immediately upstream of each local power switch. The amount of bypass capacitance at the load must be kept as small as possible, to reduce the peak current required of the power switch and to reduce the power used in charging the bypass capacitance for each refresh event. Multilayer printed-circuit boards with ground and power planes provide an efficient power-switching system for this application.

Refresh control-logic requirements—The refresh-control logic performs a series of memory cycles to particular memory addresses. The sequence allows the dynamic cells of the MOS memory to be recharged. Power needed for this pur-

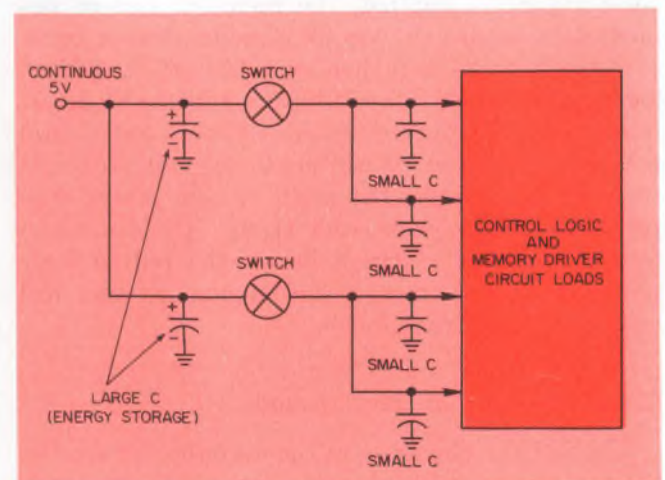

3. The switched power is subdivided near the loads to avoid voltage drops from the high peak currents drawn by bypass capacitors (with TTL logic) and MOS input capacitance. Simple transistor switches suffice for control of the dc power.

Table 2. Power budget for an 8-k memory

8k × 17 bit, 1103 memories used				
Function	Refresh rate dependent	Power at room temp	System percent	Percent of MOS
Control logic	Yes	3.8 mW	3.4%	9.5%
Driver circuits	Yes	5.7 mW	5.0%	14.2%
Clock capacitance	Yes	1.8 mW	1.6%	4.5%
Address capacitance	Yes	2.2 μW	—	—
MOS arrays	Yes	40.2 mW	35.5%	100.0%
Power switching	Yes	0.13 mW	0.1%	0.3%
MOS leakage	No	10.0 μW	—	—
Refresh timer	Yes	25.0 μW	—	—
Voltage regulator	Yes	61.7 mW	54.4%	153.5%
Battery power (total)	Yes	113.33 mW	100.0%	281.9%

pose may be reduced in several ways. Intelligent logic design can reduce the number of logic elements required. The technique used to generate memory timing signals is another factor. Delay-line or precision-RC timing are favored over digitally generated memory timing to reduce power consumption. Low-power logic elements, MSI counters, and even discrete components can often be used to advantage.

MOS driver circuit considerations—The memory driver circuits must have a zero Q-current state so they will not draw power between refresh cycles. In the zero Q-current state, the driver's output should be biased to maintain a ZERO signal to the memory arrays. Drivers must also be insensitive to their logic inputs when the control logic that feeds them is powered down. The insensitivity can usually be achieved by switching one or more of the driver supply voltages off dur-

ing the interval between refresh events. When the supply voltages are switched, the drivers must not generate "glitches" on their outputs, since these will most probably affect the viability of memory data.

Refresh timer considerations—The refresh timer is a key element of the standby system. It is the only circuit that operates continuously. It cannot use low duty-cycle switched power and therefore must be a very low-power design. The refresh timer should also sense the temperature of the memory, so that the refresh rate can be reduced at low temperatures. Fig. 4 shows the refresh rate requirement as a function of temperature for a typical MOS LSI dynamic memory. Most device manufacturers specify the refresh rate at 70 C.

Because of the cost of testing at high temperatures, the devices are tested in production at room temperature at a low refresh rate. A refresh timer designed to sense temperature can reduce the refresh rate by a large factor. This can extend the nonvolatile period by a factor of 20 in some systems—a technique patented by Texas Instruments. In practice, the memory system designer must characterize the memory devices and apply a large measure of conservatism, because the LSI memory manufacturers do not currently specify or guarantee the entire temperature curve.

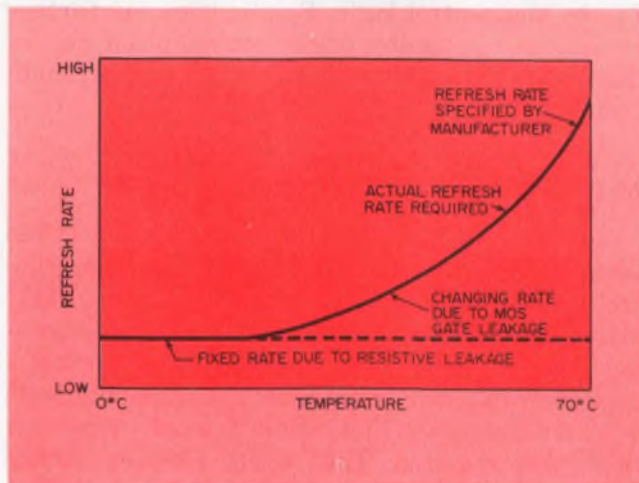

4. To further decrease battery drain, the refresh cycles are spaced in accordance with the memory temperature. Charge leakage decreases with temperature, but most manufacturers only guarantee the value at 70 C; so be sure to choose a conservative model.

Standby power in the 960A mini

An example of how standby power can make an LSI memory nonvolatile is TI's 960A minicomputer. Table 2 shows the sample power budget in the standby mode of an 8 k × 17, Model 960A, minicomputer memory. A 4.5 A-h, 24-V battery is used. At room temperature the nonvolatile period is a little over a month. The memory is built

missing links

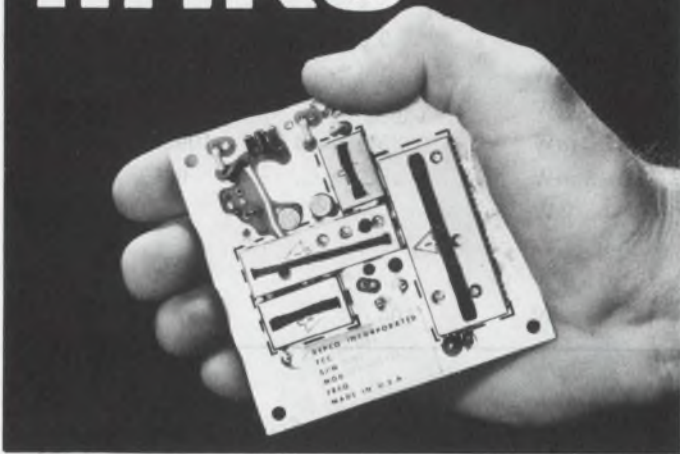

Radio Links...!! We Got 'Em

If you're designing telemetry or data acquisition systems requiring tone, voice, or low-speed digital data transmission... or combinations... and don't have Repco's modular radio links in the design, you're missing a lot. Low cost, small size, reliability, easy installation, low battery drain, and virtually unlimited design freedom.

These stable, FCC type accepted radio links are made up of plug-in modules, each a complete state-of-the-art circuit. Servicing is as uncomplicated as unplugging a module and re-plugging another.

Take a look at the specs to see what isn't missing:

Transmitters (Typical)

2 millisecond turn on time, .5 up to 25 watt RF output available. Current drain as low as 180 ma.; 12v and 15v models available, size 3.32" x 3.32" x 1".

Receivers (Typical)

12v and 15v models, current drain as low as 4.6 ma. (standby). Frequency stability VHF $\pm .001\%$ - UHF $\pm .00005\%$ (-30 to $+60^{\circ}\text{C}$) Size 3.32" x 3.32" x 1".

For use under FCC parts 21, 81, 89, 91, 93, 95(A), and U.S. Government Services (non-tactical).

Write today

for complete information on low (25-50MHz), mid (66-88MHz), high band (132-174MHz), and UHF (450-470MHz) transmitters and receivers. All at prices which will surprise you.

REPCO Incorporated

Special Products Department
P.O. Box 7065
Orlando, Florida 32804
Telephone (305) 843-8484

Repco

How long are data kept?

Just how long should a memory system be designed to operate without normal power? For some applications five minutes is sufficient. For others, a month or more of power outage must be tolerated. The plot shows the results of an informal survey of minicomputer applications. The number of computers in the field is plotted against the required nonvolatile memory time. Most minicomputer memory requirements are for between a day and a week of nonvolatility. Typical of these are data communication, process control, and automation applications.

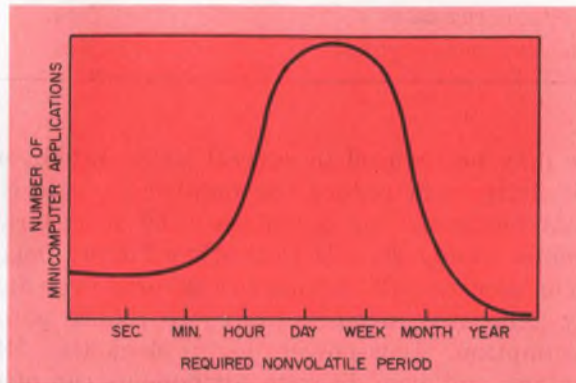

of 1103-type devices.

Consider the power budget of the 960A standby system with a view toward reducing power consumption even further. The voltage regulation requires 54% of the power from the battery; a highly efficient regulator would double the nonvolatile period. Of the power not wasted by the regulation, 82% is used by the memory devices themselves, 11% by the MOS drivers and a mere 7% by the control logic. Possibilities for further reductions in standby power consumption lie, for the most part, with the LSI memory device manufacturers.

What's ahead for LSI memory

As advances are made in the memory devices themselves, the requirements for a complex control sequence for each refresh event will likely disappear. Refresh will involve no more than pulsing a single clock input to the memory device.

Conceivably memory devices could be built with extra storage cells that would indicate when refresh was required. Then every memory device in the system could be refreshed at the rate that its leakage required, thereby reducing refresh rates by a factor of perhaps 100. At such a low refresh rate, it would be easy to achieve many months of nonvolatility at very low cost. ■■

11 audios 6 packages countless applications

Visit our hospitality suite
Chicago Spring Conference,
June 10th and 11th, 1974.



TBA 820
2W - 12V - 8Ω
0.75W - 6V 4Ω

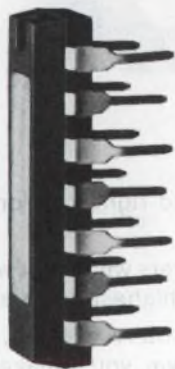

TAA 621 A12
2.2W - 18V - 16Ω
TAA 611 B12
1.15W - 9V - 8Ω

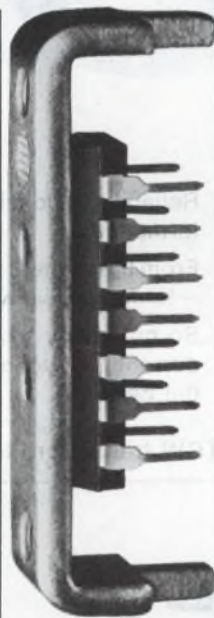

TBA 641 B11
4.5W - 14V - 4Ω
TAA 621 A11
4W - 24V - 16Ω

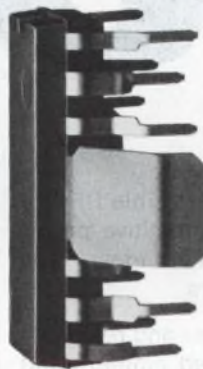

TBA 810S
6W - 14.4V - 4Ω
Thermal shut-down
TBA 800
5W - 24V - 16Ω
4.7W - 18V - 8Ω
TCA 830
3.4W - 12V - 4Ω
2W - 9V - 4Ω
Thermal shut-down



TCA 940
10W - 20V - 4Ω
6.5W - 20V - 8Ω
Fully protected
TBA 810AS
6W - 14.4V - 4Ω
Thermal shut-down



TDA 2020
15W - ±15V - 4Ω
(THD = 1%)
10W - ±15V - 8Ω
(THD = 1%)
Fully protected

Intercom systems. Two-way radios. Paging systems. Walkie-talkies. Alarm systems. Loudspeaking telephones. Telephone answering systems... And, of course, battery or line operated TVs, record players, car radios, tape recorders, home radios, stereo equipment... You name the audio application - we have the monolithic audio

amplifier to meet your particular requirements for cost and performance.

SGS-ATES is the world's largest supplier of monolithic audio power amplifiers. Our range covers more devices than can be offered by any other manufacturer, and includes circuits featuring thermal shut-down, complete short-circuit

protection and output power up to 20W.



SGS-ATES Semiconductor Corporation
435 Newtonville Avenue
Newtonville, Mass. 02160
Phone: 617-9691610

We've lined up some great ways for you to go

You've got a direct line to the best possible RF and microwave power amplifiers. At competitive prices. Because TRW makes the best—and broadest—line of competitively priced RF transistors.

That means performance, ruggedness and reliability. It means gold metallization, ballasted emitters and the best thermal dissipation characteristics.

Reliability is designed right in. Along with top performance.

From the highest powers with the lowest IMD's at HF — to microwave with highest powers and lowest θ_j-c .

So no matter what you're making, new design or current production item, you'll make it better...with the best.

If you make RF and microwave amplifiers, use these TRW transistors to make them better

OSCILLATORS 1.5-3.0 GHz



PT5784
1.5-2.0 GHz



2N5482
1.8-2.3 GHz



PT5798
2.3-3.0 GHz

For complete set of data sheets, circle Reader Service Card number 210

Features:

300mW — 1W output.
Low noise figure.
Gold metallized for reliability.

SINGLE SIDEBAND RADIO — 12V. Marine, mobile, amateur 1.5-30 MHz

10mW →



PT5701



2N6458



using two
2N6460

→ 120 WATTS MIN.
—32 Db IMD
1.5-30 MHz

For data sheets and 100W application note CT-129, circle Reader Service Card number 211

Features:

Up to 75W per device—PEP or CW.
Infinite VSWR. Better than —32Db IMD.
High gain, broadband design.

SINGLE SIDEBAND RADIO — 28V. High power base stations, marine radio 1.5-30 MHz

25mW →



PT8551



2N5707



using two
PT6665A

→ 180 WATTS MIN.
—32 Db IMD
1.5-30 MHz

For data sheets, 320W and 1KW application note CT-129, circle Reader Service Card number 212

Features:

Full 1KW broadband amplifier easily made from combination of four 320W modules.
Up to 100W per device—PEP or CW.
Infinite VSWR. Better than —32Db IMD.
High gain, broadband design.

VHF/UHF AMPLIFIERS—VHF/UHF communications, tactical radio, instrumentation.

VHF, 30-200 MHz:

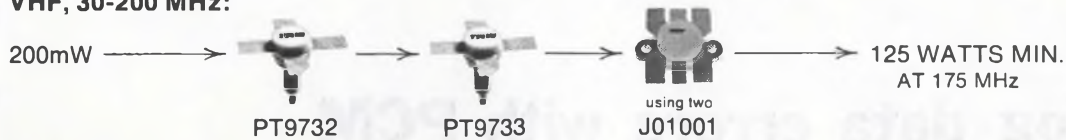

UHF, 200-600 MHz:

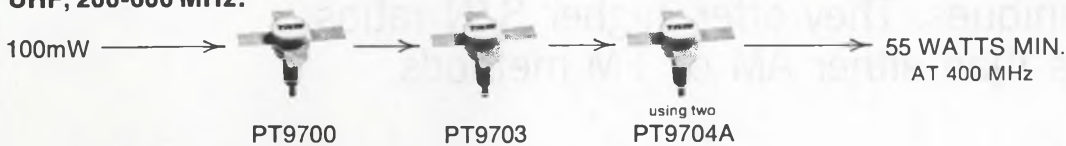

For complete data sheets, circle Reader Service Card number 213

Features:

High gain. High power. Ballasted for ruggedness. Get required output with fewer devices.

UHF TACTICAL RADIO—225-400 MHz broadband operation

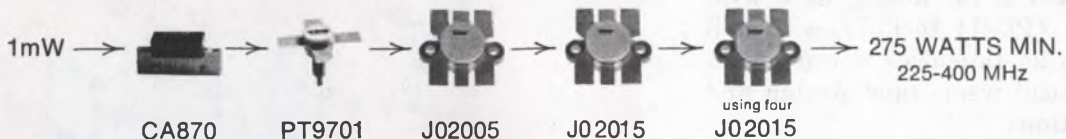

For data sheets and broadband 120W/60W amplifier application note CT130, circle Reader Service Card number 214

Features:

Designed for high power broadband operation. Drivers and finals input matched.* TRW gold system for reliability.

MOBILE BASE STATION—RADIO RELAY—ECM—600-1000 MHz (28V)

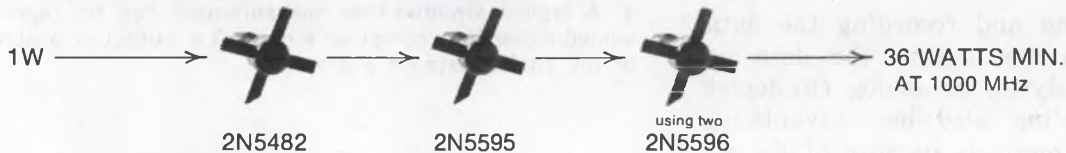

For complete set of data sheets, circle Reader Service Card number 215

Features:

High gain. Ballasted for ruggedness. Gold metallized for long life. True hermetic package.

ECM—TELEMETRY—RADIO RELAY—INSTRUMENTATION—400-1000 MHz

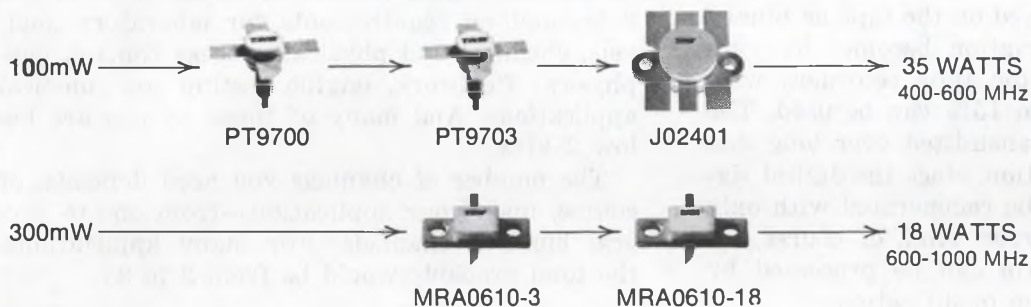

For complete set of data sheets, circle Reader Service Card number 216

Features:

Broadband high power. Gold metallized. Ballasted for ruggedness. Internally matched final devices.*

RADIO RELAY—TELEMETRY—ECM—INSTRUMENTATION—1-2.3 GHz

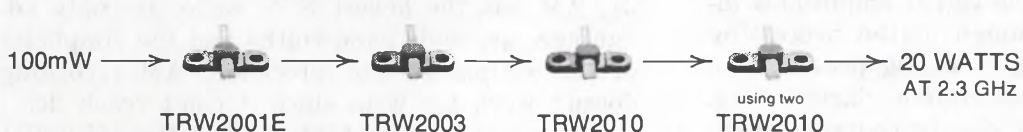

For complete set of data sheets, circle Reader Service Card number 217

Features:

Will withstand infinite VSWR. Highest gain. Gold metallized for long life.

*TRW Patent 3,317,006

Your TRW Distributor has data sheets and application notes on the full line of TRW RF power transistors. For additional information, write TRW Semiconductors, an Electronic Components Division of TRW, Inc., 14520 Aviation Blvd., Lawndale, California 90260. Or call Don Comm at (213) 679-4561.

TRW SEMICONDUCTORS

These products are available through the following authorized distributors:

Almo Electronics
Bell Industries
Cramer Electronics Inc.

Electronics Marketing Corp.
Elmar Electronics Inc.
Hall-Mark Electronics Corp.

Pyttronic Industries Inc.
Rochester Radio
Semiconductor Concepts Inc.

R. V. Weatherford Co.
Westates Electronics Corp.
Wiltshire Electronics

Curb analog data errors with PCM

recording techniques. They offer higher S/N ratios and accuracies than either AM or FM methods.

Tired of errors in recording or replaying analog data? Try encoding the analog data with pulse-code-modulation (PCM) techniques. You'll bypass such problems as tape-deck speed variations, magnetic tape-head wear, tape stretch and head-alignment variations.

Alternatively, you can use the newer direct-recording AM units or the more complex FM units, but they'll only reduce, not eliminate, the problems.

By directly encoding and recording the data in digital form, you can output the data as either digital (for analysis) or analog (to depict trends). PCM recording also has advantages over the FM or AM methods because of its accuracy, signal-to-noise (S/N) ratio, portability, reproducibility, ease of operation and competitive pricing.

Since the data are placed on the tape as binary bits, recorder speed variation becomes less important; inexpensive audio tape recorders with speed variations of up to 15% can be used. The digitized data can be transmitted over long distances without deterioration, since the digital signals, unlike analog, can be regenerated with only a small probability of error. And, of course, information in digital form can be processed by computers with almost no modifications.

With PCM, you get the best of two worlds—digital and analog. The technique requires analog signal sampling at regular discrete intervals and subsequent encoding of the signal amplitudes into a digital format. Although digital processing offers far greater accuracy, analog presentation has the advantage of descriptive clarity (Fig. 1). A glance at a graph clearly conveys meaningful trends.

What range of data?

Analog data often cover wide frequency and voltage spans. For ease of comparison, let's first consider the collection of a restricted range of

Stan Yalof, President, and Louis Shrinkle, Design Engineer, Tetrahedron Associates, 7605 Convoy Ct., San Diego, Calif. 92111.

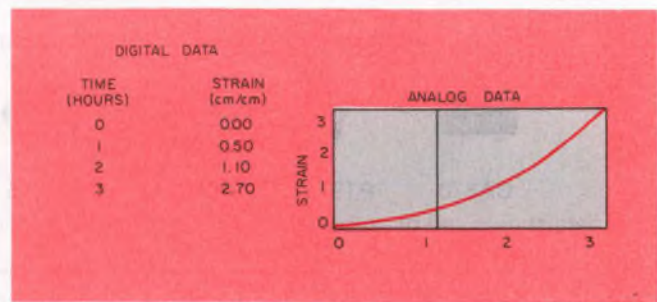

1. A typical strain-vs-time measurement can be represented either by a computer's numerical output or a plot of the analog data on a graph.

data from sensors, especially those that have frequency outputs below about 5 kHz. This restricts the region covered to about 90% of the data-handling requirements for laboratory analysis, chemical and physical process control, geophysical fieldwork, engine testing and medical applications. And many of these signals are below 2 kHz.

The number of channels you need depends, of course, upon your application—from one to several hundred channels. For many applications, the total probably would be from 3 to 30.

The pros and cons

Of the three major recording methods (Fig. 2), AM has the lowest S/N ratio. Its only advantages are wide bandwidths and the simplicity of the equipment. For precision, AM recording doesn't work too well, since it can't reach dc.

FM systems offer high S/N ratios (50 dB) where voltage-to-frequency and frequency-to-voltage converters are used. These circuits fill the tape's dynamic range with the FM signal thus eliminating biasing problems, and providing a frequency response down to dc. But the limitation imposed on the S/N ratio by flutter or fluctuating speed can give the frequency-to-voltage converter false information (similar to Doppler shifting).

Most data-acquisition requirements for a good S/N ratio from dc to 5 kHz and for multichannel

performance virtually rule out AM recording and leave only FM and PCM as possible techniques to work with.

For many circumstances, the choice is clear: If S/N ratio requirements are above 50 dB and high accuracies are required at any frequency, PCM recorders must be used.

The S/N ratios of PCM systems are about 74 dB, compared with FM ratios of about 50 dB (see table). With auto-ranging, the PCM dynamic range can be extended to more than 100 dB. However, if you can take a lot of noise and

Comparison of the basic recording methods

	Bandwidth	Dynamic Range	Signal To Noise Ratio	Accuracy
PCM	DC → 2 kHz	72 dB	72 dB	±.025% of F.S.
FM	DC → 500 kHz	Depends upon S/N tolerance ratio	34-51 dB	±1% of F.S.
Direct	200 Hz → 2 MHz	Depends upon S/N tolerance ratio	23-38 dB	±3% of F.S.

need many channels of data on tape at the high end of the frequency range, FM recording has a definite cost advantage; high-speed analog-to-digital converters for the PCM recording method are expensive.

You can get higher speed

To achieve higher input frequencies, you can increase the speed of the tape, but at the sacrifice of storage space. To do this, though, you must switch from incremental to continuous recorder drive.

The advantages of PCM over FM (Fig. 3) in bandwidths up to 5 kHz can be illustrated as follows: When you record two channels of data at a 1-kHz bandwidth, a serial PCM code can give a bit-packing density of 5 kbit/in. If each channel has 18 bits per word and the required sampling rate is 3000 ($3 \times f_{max}$), the minimum tape speed needed becomes

$$S = \frac{(2 \text{ words}) (18 \text{ bits/word}) (3000 \text{ words/s})}{(5 \text{ kbit/in.})}$$

$$= 21 \text{ in./s.}$$

A tape transport that has the industry standard speed of 30 in./s can easily handle this and still provide a 1-kHz bandwidth at a 74-dB S/N ratio. And if the word length is increased by three bits, the dynamic range of the system can be raised by more than 30 dB. This can easily be done with digitally controlled amplifier gains. On the other hand, if you use FM techniques at the same speed and bandwidth, you would get a 50-dB S/N ratio.

For high-performance PCM, let's consider a single system, assembled to Inter-Range Instrumentation Group (IRIG) standards.^{1, 2} This system uses commercially available a/d converters and recorder mechanisms. It could use a 120 in./s, 12-track head and recorder with a 30-to-40 kbit/in. packing density (readily available with special coding). Performance can now be calculated as:

$$\frac{(120 \text{ in./s}) (30 \text{ kbit/in.}) (12 \text{ tracks})}{(16 \text{ bits/word})}$$

$$= 2.75 \times 10^6 \text{ conversions/s.}$$

With throughput this high, the a/d converter

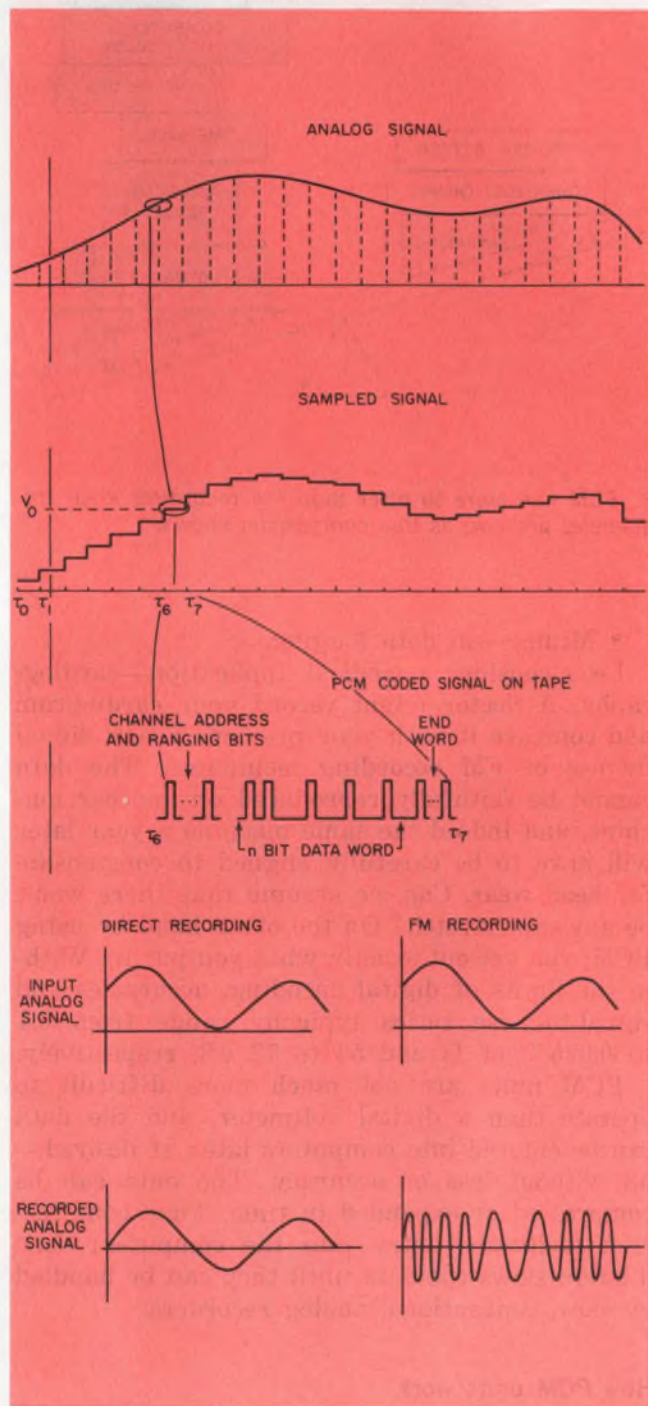

2. The three methods of data recording differ in performance when they are all plotted on a signal-voltage-vs-time display and compared.

must have a 0.3- μ s conversion time and a bandwidth of

$$\frac{2.75 \times 10^6 \text{ conv/s}}{3 \text{ conv/cycle}} = 900 \text{ kHz.}$$

Depending upon the formatting, the S/N ratio can still be up around 74 dB³. If the number of channels is increased to 12, you have an approximate bandwidth per channel of 80 kHz with a 74-dB S/N ratio.

By comparison, a high-performance FM system that uses the same speed of tape equipment can provide dc-to-80 kHz performance with a 51-dB S/N ratio, or dc-to-500-kHz performance at a 35-dB S/N ratio.

Either system costs a lot if PCM techniques are used. For bandwidths above 80 kHz, FM is the best choice. And at or below 80 kHz, PCM has performance advantages, which, if required, would make it the better choice. Below about 5 kHz, PCM tends to have all the advantages.

A need for data scaling

To store analog data correctly (Fig. 4), especially with AM or FM recorders, you must know beforehand approximately what the data will look like. This is essential for proper scaling to prevent distortion (such as that caused by clipping). Lacking knowledge of the data's characteristics, you must repeat test runs until the data are scaled correctly.

If after examining recorded data, you wish to compare the results with some other variable—time, temperature, frequency or stress—you usually have to set up or repeat a test. This is wasteful and not always possible.

For many mechanical, medical and geophysical tests, which usually have frequencies below 2 kHz, PCM recording techniques offer the most advantages. With PCM, you pay for bandwidth with data bits, although it is practical to push performance way up into the megahertz region.

For example, the French exhibited PCM television at Expo '67 in Montreal, NASA uses high-frequency PCM for telemetry, and Bell Telephone uses it as a carrier system. It also is employed in these applications:

- Automotive—for engine-combustion, shock and vibration monitoring.
- Aviation—in flight and wind-tunnel crash recording.
- Biological—for neurological signals.
- Chemical—for laboratory-instrument process monitoring.
- Structural engineering—for recording mechanical properties, shock and vibration.
- Geophysics—in seismic monitoring and data logging.
- Medical—in cardio-neurological and metabolic monitoring for patient care.

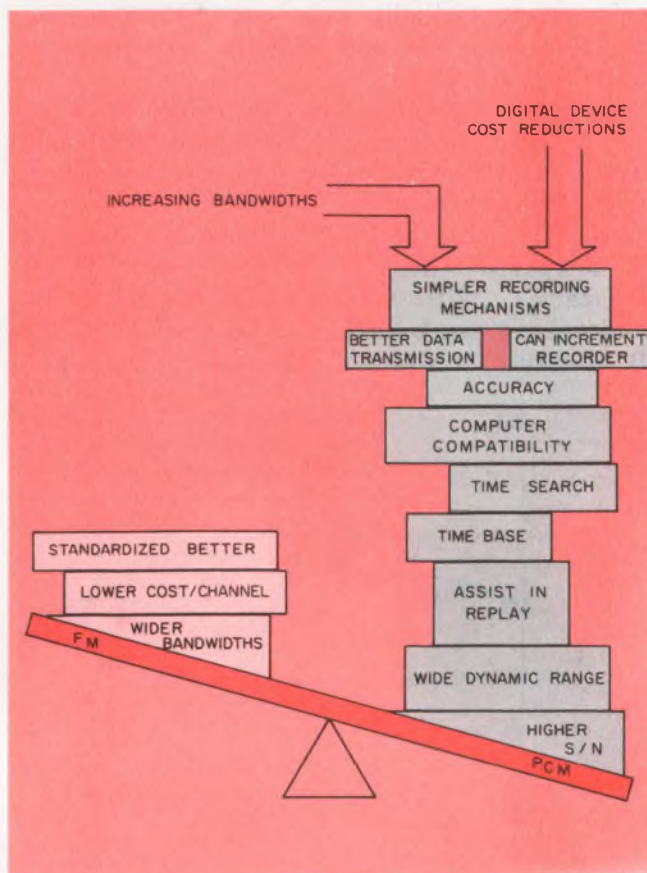

3. PCM has more to offer than FM recording when frequencies are low, as this comparison shows.

■ Mining—in data logging.

Let's consider a medical application—cardiography. A doctor might record your cardiogram and compare it with your previous year's signal by use of FM recording techniques. The data cannot be faithfully reproduced on another machine, and indeed the same machine a year later will have to be carefully aligned to compensate for head wear. Can we assume that there won't be any tape stretch? On the other hand by using PCM, you get out exactly what you put in. Within the limits of digital encoding, accuracies and signal-to-noise ratios typically range from 0.1 to 0.025% of fs and 54 to 72 dB, respectively.

PCM units are not much more difficult to operate than a digital voltmeter, and the data can be entered into computers later, if desired—all without loss of accuracy. The data can be compressed or expanded in time. Time compression facilitates entry into the computer; time dilation slows the data until they can be handled by slow, conventional analog recorders.

How PCM units work

Several types of instruments are available for data collection and replay. Most take in multiple channels of analog data directly from other

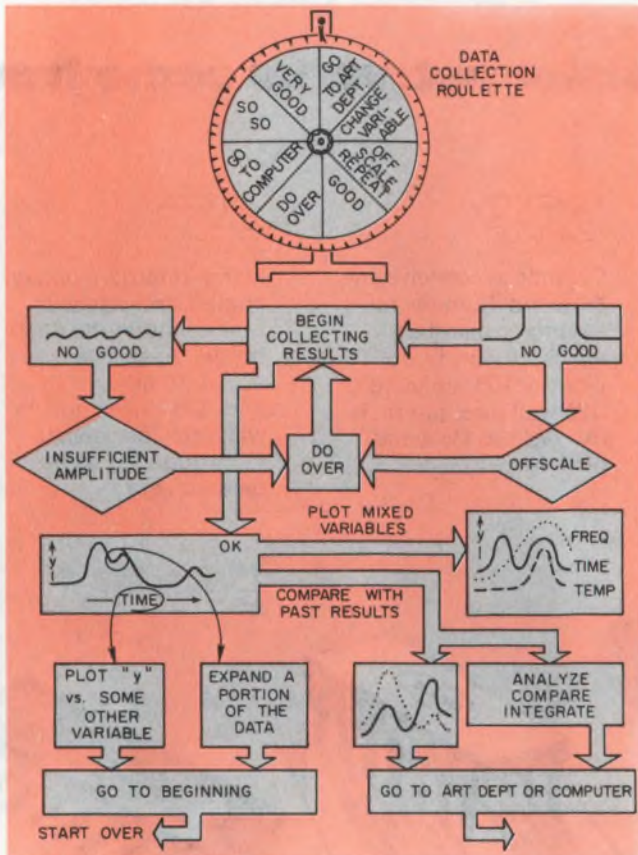

4. The game of data collection is one of chance—unless you use the right system for your needs.

instruments, some can automatically switch gain range and all store the data digitally on magnetic tape. Then data can be delivered in either analog or digital form.

The sequence of operations and the controls for a typical system are shown in Fig. 5. The unit here uses a block-data sequence, while a much more simple PCM unit would trade the versatility of front-panel controls and auto-ranging for a larger operating bandwidth.

The various controls on the front panel direct digital and analog circuitry to perform recording, replay, time search and tape direction control. The circuitry consists of two networks: one for power and control, the other for conveying data signals. Since there is considerable interplay between many of these functions, it is difficult to segregate these into particular blocks.

The cycle-select logic synchronizes the activities of the various blocks, with sequencing assistance from the time comparator. The recording sequence begins with inputs from up to N channels of analog data through the input-scaling block. The inputs are scanned at selectable rates and translated into a digital word by an a/d converter. The converter assigns most of the bits to the value and sign of the analog input. The other bits are assigned for autoranging, for

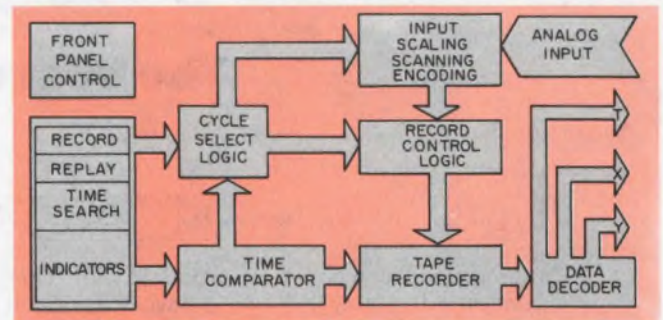

5. Control and operating sections of a recorder work together to acquire and scale data for analysis.

the channel address, and for parity to aid in error detection in the data words.

The digital words are passed through the signal network into the tape recorder. In this way up to a million coded words can be stored in block or on a tape cassette. On replay, the procedure is reversed, and the recorder can output (through the decoder) several channels of data and time in either analog or digital format. With this approach, data are inputted, stored and automatically outputted with no loss of accuracy.

Onward to the limit

Commercially available a/d converters have typical sample word rates from 20 kHz, with resolution up to 15 bits, to 100 MHz at four bits of resolution. Some researchers^{4, 5, 6, 7} even claim to have attained 20-bit resolution at 100 MHz by use of an 84-track, 180-in./s recorder.^{8, 9} The recorder has a bit-packing density of 40 kbits/in./track with a reported bit error rate of 5×10^6 . The bandwidth and S/N ratio of a single channel work out to

$$\frac{(40 \text{ kbits/in.}) (84 \text{ tracks}) (180 \text{ in./s})}{(20 \text{ bits/word}) (3 \text{ conv./cycle})} = 10 \times 10^6 \text{ Hz.}$$

This bandwidth even exceeds that of FM and results in an S/N ratio greater than 100 dB. ■■

References

1. "Test Methods for Telemetry Systems and Sub Systems," Inter-Range Instrumentation Group (IRIG), Document #118-73.
2. Telemetry Standards," IRIG Document #106-73.
3. Bessette, O. E., "A High-Capacity, High-Rate Instrumentation Tape-Recorder System," International Telemetry Conference, 1973, pp. 74-79.
4. Wells, Jon V., "High Density PCM Magnetic Tape Recording," International Telemetry Conference, 1973, pp. 66-73.
5. "Magnetic Tape Recording Handbook," Hewlett-Packard Application Note 89.
6. Gili, Paul, "Getting the Drift of VCO Instability," *Microwaves*, Mar., 1974, pp. 42-45.
7. Review of specifications contained in data sheets supplied by: Ampex, Bell & Howell, Hewlett-Packard, Philips, Sangamo, Tandburg and Tetrahedron Associates.
8. Staff, "Analog-to-Digital Converter Survey," *Instrument & Control Systems*, Sept. 1969, pp. 115-138.
9. Spitzer, Charles F., "Digital Magnetic Recording of Wide-Band Analog Signals," *Computer Design*, Oct., 1973, pp. 83-90.

The best resistor networks come from

LDP

Ceramic sandwich construction with epoxy coating. Suitable for automatic insertion. Available with 14, 16, 18 pins on .100" spacings. .125 watt max. per resistor. 1, 1½, 1¼ watts per network.

TKR-36

Double width DIP network designed for precision D/A conversion. Resistance: 1K, 5K, 10K, 20K. Accuracy: $\pm\frac{1}{2}$, 1, 2 LSB. Tolerance: $\pm 5\%$ typical.

SDP

Ceramic sandwich construction. Suitable for automatic insertion. Available with 14, 16, 18 pins on .100" spacings. .125 watt max. per resistor. 1½, 1¼, 1½ watts per network.

CSP

Flame retardant epoxy coated package with built-in standoffs (lead frame). Available with 4, 6, 8, 10 pins on .100" and .125" spacings. ⅛ watt max. per resistor. ½ through 1¼ watts per package.

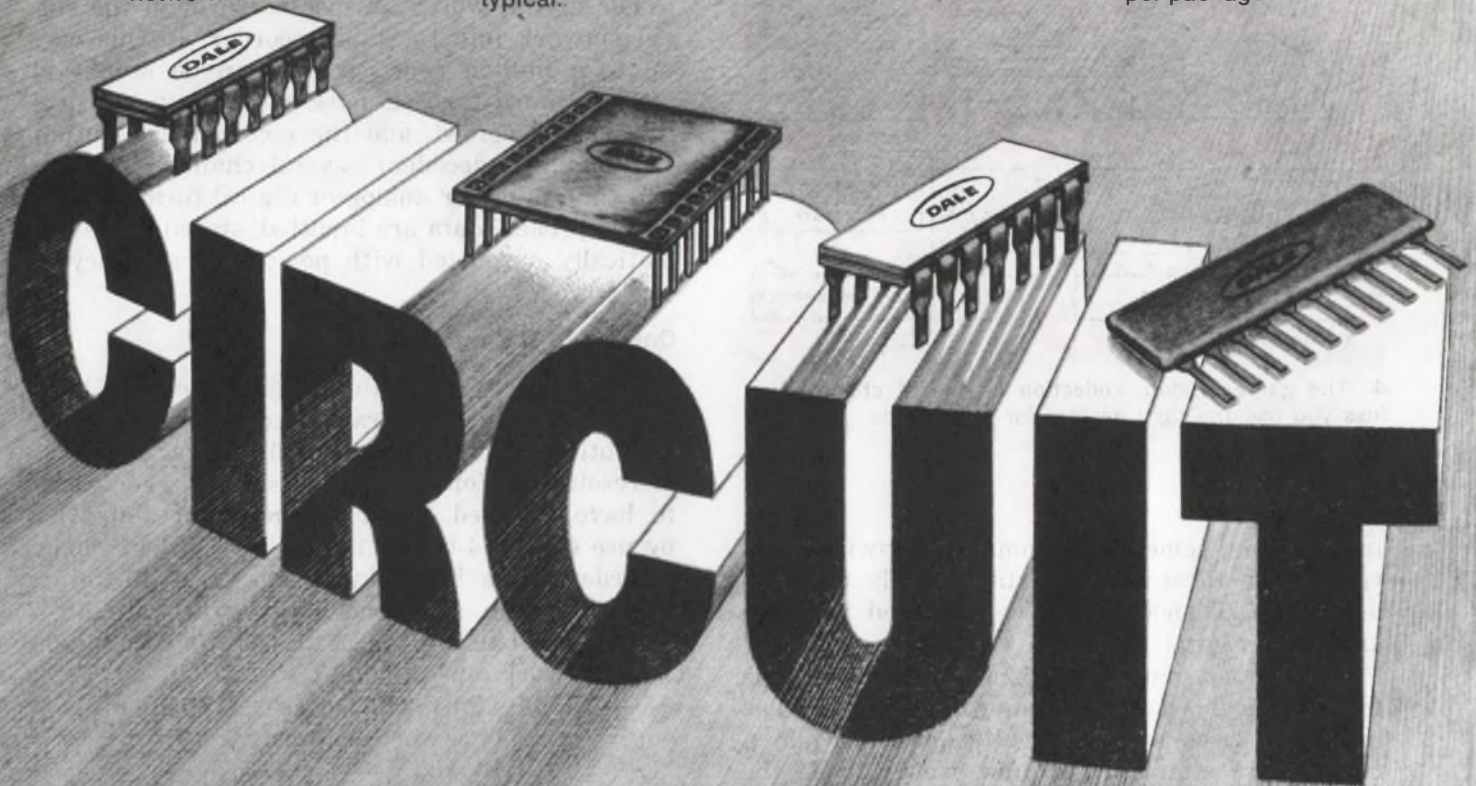

If you're going to depend on thick film networks to save space and money—depend on Dale. For the past five years, we have been quietly using our unmatched resistor know-how to build a strong, deep line of standard dual and single in-line packages. Our ability to produce quality can be measured by the fact that we were the first to be qualified to MIL-R-83401...and a look at our expanded laser trimming facilities will convince you that we're geared for volume. We can match your needs with one of the labor-saving packages above. Call today...402-371-0080.

the people who really know resistors.

DFP

Ceramic flatpack.
Resistance range:
20 ohms to 1 Meg.
Power: .2 watt or .1
watt per resistor,
depending on con-
figuration. .65 watt
max. per network at
25°C.

SIP

Solid block ceramic sin-
gle in-line package with
built in ceramic standoffs.
Available with 4, 6, 8, 10
pins on .100", .125" and
.150" spacings. .125 watt
max. per resistor. ¾
through 2 watts per
network.

SDM

Meets requirements of
MIL-R-83401. Ceramic
sandwich construc-
tion. Suitable for auto-
matic insertion. Avail-
able with 14, 16, 18
pins on .100" spacings.
.10 watt max. per re-
sistor. 1¼ watts max.
per network.

CDM

Ceramic sandwich con-
struction with epoxy coat-
ing. Suitable for automatic
insertion. Available with 14, 16,
18 pins on .100" spacings.
.10 watt max. per resistor. 1¼
watts max. per network.
Designed to meet MIL-R-
83401.



BASIC NETWORK SPECIFICATIONS

Resistance Range: 10 ohms to 1 Meg.,
depending on tolerance.

Tolerance: ±1%, 2%, 5%, 10%, 20%

T.C.: ±300 PPM/° C (lower available)

THICK FILM CHIP RESISTORS

75, 100, 150, 300 mw sizes available
in 100 ohms to 500K ohms range.

Tolerance as above. T.C.: ±200 PPM.



DALE ELECTRONICS, INC. A subsidiary of The Lionel Corporation

P.O. Box 74, Norfolk, Nebraska 68701. In Canada: Dale Electronics Canada Ltd.

In Germany: Dale Electronics GMBH, 8 Munchen 60, Falkweg 51

For the name of your nearest Dale representative, phone 800-645-9200

Calculate with a v/f converter. Only a few simple modifications are needed to allow accurate multiplication, division and square-root extraction.

With a few simple modifications, a wide-range voltage-to-frequency converter can be used to form accurate ratios or products or to take the square root of a voltage.

Several companies offer suitable v/f converter modules. Or you can build your own.¹ The modifications that allow you to perform calculations stem from the basic operation of the converter (Fig. 1).

A voltage, V , at the input causes a current, I , to charge capacitor, C , and thereby vary the output voltage, V_o , of the integrator. When V_o passes a reference level, V_{ref} , a comparator triggers and, in turn, initiates a timing circuit.

The timing circuit controls a current generator whose output is a current pulse of length, T_d , and amplitude, I_d . Consequently during the cycling time, T , the capacitor discharges by an amount, $I_d \times T_d$, and collects a charge of $I \times T$.

Since the input charge equals that put out (for full discharge), we get

$$I \times T - I_d \times T_d = 0.$$

Consequently the frequency of the output voltage is given by

$$f = \frac{1}{T} = \frac{I}{I_d \times T_d},$$

and the output frequency is proportional to the ratio of the two currents I and I_d .

Modifications yield arithmetic operations

If the converter is fitted with input circuits, so that currents I and I_d are proportional to two input signals, V_1 and V_2 (Fig. 2), then $I = V_1/R_1$ and $I_d = V_2/R_2$, and

$$f = \frac{R_2}{R_1 \times T_d} \times \frac{V_1}{V_2}. \quad (1)$$

The ratio of two voltages is thus obtained. With a T_d of 100 μs (Fig. 3) and the component values shown in Fig. 2, ratios can be formed with less than 0.15% deviation (least mean square) over a one-decade range (Table 1). Since T_d is

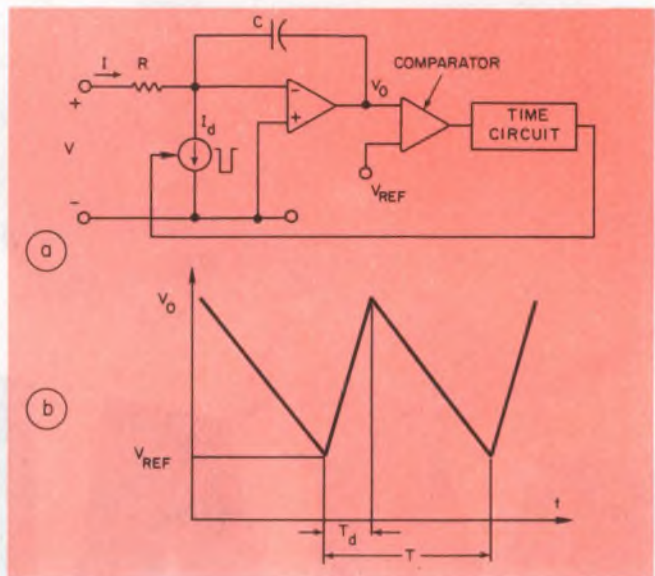

1. A linear, wide-range voltage-to-frequency converter can be built by use of a constant-current generator, (I_d), to control the discharge of an integrating capacitor (a). The output voltage shows the capacitor charge/discharge cycle (b). Frequency depends on T_d .

less than T , current I_d must be greater than I . This inequality sets the lower limit of V_2 .

The v/f converter is also useful as an active component to obtain square roots and products. If the voltage at input 2 (V_2) is made proportional to the output frequency, f , then from Eq. 1,

$$\begin{aligned} f &= K_1 \frac{V_1}{V_2} \\ &= K_1 \frac{V_1}{K_2 f} \\ \therefore f &\propto \sqrt{V_1}. \end{aligned} \quad (2)$$

To realize this relationship with hardware, first convert the output pulse train to a dc level, V . This is necessary because the v/f accepts only dc or a slowly varying voltage at input 2. A simple RC filter will perform the conversion adequately, provided that the amplitude of the pulse train is constant and that the change in output impedance of the timing flip-flop (CD 4013) is small compared with R_5 (Fig. 4).

The output voltage of the RC filter is then fed

Bengt Alvsten, University of Lund, Solvegatan 14, S-223 62, Lund, Sweden.

directly into input 2. With the values given in Fig. 4 for R and C, the output frequency is proportional to the square root of the input level over about a 10-to-1 span of input. Deviation from an ideal straight line is less than 0.07% over this span (Table 2).

Multiplication is also possible

It is well known that the inverse characteristic of an active circuit can be produced if the circuit

is placed in the feedback loop of an amplifier. Thus if the v/f and low-pass filter combination connects the output of an op amp with its input (Fig. 5), we get

$$\frac{V_{in}}{R_6} = \frac{V}{R_6}$$

But

$$V \propto \frac{V_1}{V_2} \propto \frac{V_{out}}{V_2},$$

so

$$V_{out} \propto V_{in} \times V_2. \quad (3)$$

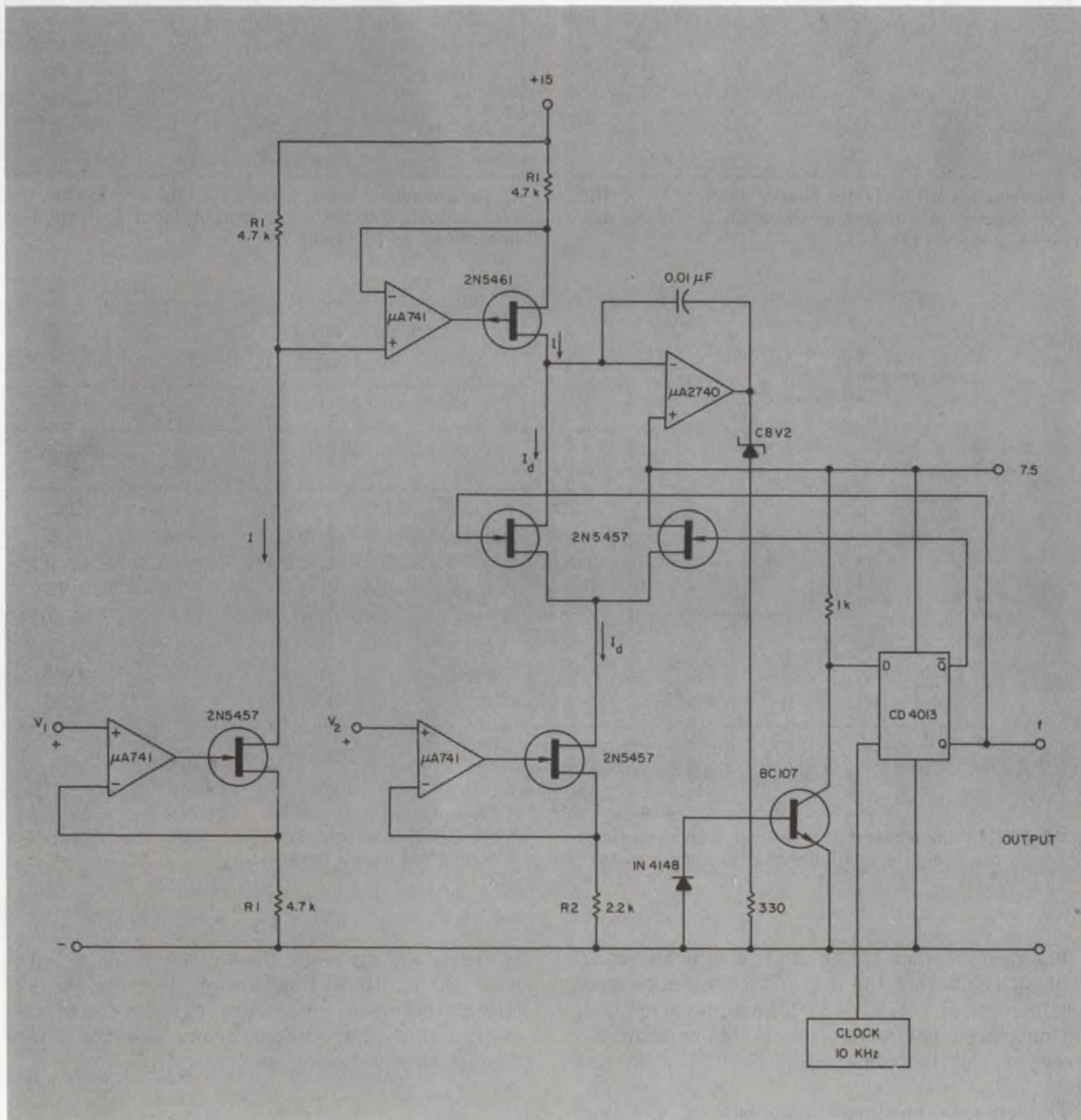

2. Modified v/f converter accepts two input levels, V_1 and V_2 , and outputs a frequency proportional to the

ratio of the two inputs. The discharge period of the integrating capacitor is fixed by the clock.

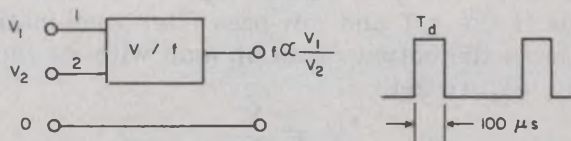

Table 1

V_2^{-1} (volt) ⁻¹	f_{measured} Hz	Deviation %
5.000	2394	0.02
2.500	1196	-0.06
1.667	796.8	-0.08
1.250	597.4	-0.05
1.000	477.9	-0.02
0.8333	398.2	0.01
0.7143	341.4	0.07
0.6250	298.7	0.10
0.5556	265.5	0.12
0.5000	238.9	0.15

3. Performance of the ratio circuit: With a T_d of 100 μs , the data show a maximum deviation of 0.15% over a one-decade span (Table 1).

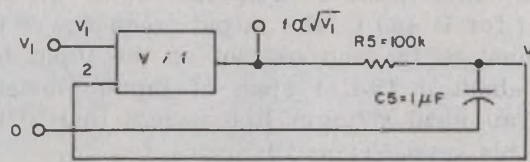

Table 2

$\sqrt{V_1}$ (volt) ^{1/2}	f_{measured} Hz	Deviation %
0.4472	1526	-0.20
0.6325	2153	-0.00
0.7746	2633	0.05
0.8944	3037	0.06
1.0000	3393	0.07
1.0954	3714	0.05
1.1832	4007	-0.02
1.2649	4282	-0.02
1.3416	4540	-0.03
1.4142	4784	-0.03

4. To take square roots, a low-pass filter is added at the v/f's output. Results of an output/input test show a linearity of 0.2% (Table 2).

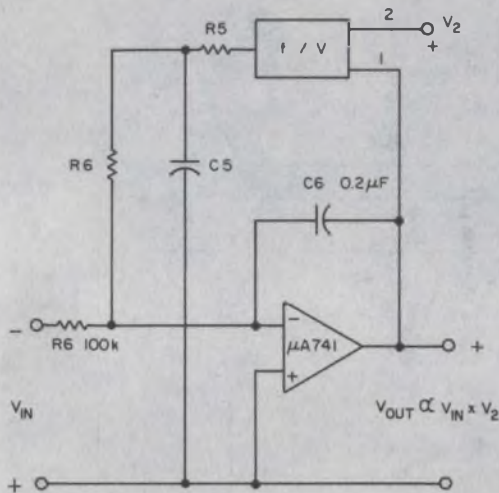

Table 3

$V_1 = 0.250 \text{ V}$			$V_1 = 2.000 \text{ V}$		
V_2 volts	V_{out} (volts) ²	Deviation %	V_2 volts	V_{out} (volts) ²	Deviation %
0.250	0.0355	0.14	0.250	0.2825	-0.3
0.500	0.0706	-0.02	0.500	0.5650	0.02
0.750	0.1057	-0.07	0.750	0.8471	0.05
1.000	0.1409	-0.03	1.000	1.128	0.07
1.250	0.1761	0.00	1.250	1.410	0.00
1.500	0.2114	0.06	1.500	1.692	0.03
1.750	0.2465	0.03	1.750	1.974	0.00
2.000	0.2815	-0.04	2.000	2.255	-0.03

5. By placing the converter in an op amp's feedback loop, you can design a multiplier that exhibits less than

0.3% deviation (Table 3). In this case, the output is a voltage rather than a frequency.

The performance of the multiplier is shown in Table 3. (Note that the $R_5 - C_5$ combination may not be needed.) With the least-square method, the measured values deviate not more than the error of the instruments used—0.3%, or one digit.

The circuits outlined presuppose a v/f that has two inputs—one to control the charge and the other the discharge process. Since such a con-

verter is usually very linear, the ratio, square-root and multiplication circuits can also be extremely accurate. Of course, the associated circuitry—the voltage-to-converters and the filters—must also be linear. ■■

Reference

1. "Linearize Your V/F Converter, *Electronic Design*, No. 23, Nov. 8, 1973, p. 112.

Why Remex is the bee's knees in digital cassette systems

- Get speed, reliability, to keep your system humming
- Low cost takes the sting out of upgrading your great punched tape system
- And what you miss without Remex is really a-pollen.

Remex offers you the world's most advanced, innovative digital cassette mechanism and systems including complete, compatible interface packages tailored to popular minicomputers.

REMEX DIGITAL CASSETTE TAPE DRIVES pack highly advanced features into a small, economical package, offering unexcelled reliability in data handling.

REMEX DIGITAL CASSETTE TRANSPORTS combine precision tape drives with necessary read/write and control electronics. An excellent module for building high reliability/high performance systems, at a low O.E.M. price.

THE COMPLETE DIGITAL CASSETTE SYSTEM with one, two or three drives to give you full parallel data storage with phase encoding, error detection and correction. DTL/TTL compatibility and with complete interface packages. Very competitively economical.

THE EXCLUSIVE REMEX Punched Tape Emulator that simply plugs into your punched tape system to increase its read/write speed up to four times, and its storage capacity up to 10 times. And you use both your existing hardware and software!

AND NOW, advanced floppy disk drives and floppy disk systems. They're real honeys.

For full information on all or any part of the complete Remex line, write Remex, 1733 Alton St., Santa Ana, California 92705. (714) 557-6860. In Europe and the U.K., contact S.p.A., Microtecnica, Torino, Italy.

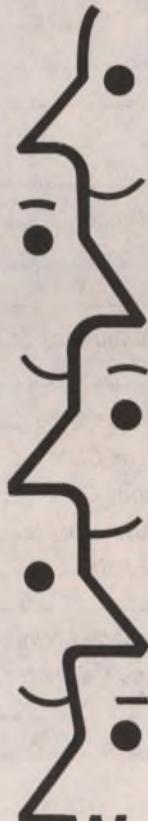

Digital cassette tape system with complete interface package.



Plug-compatible Punched Tape Emulator



Digital cassette tape drives

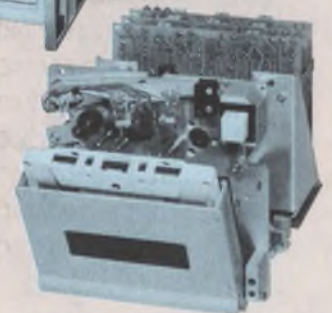

Digital cassette transports

We work with you!

REMEX



Ex-Cell-O Corporation

Not just a second source. But a Introducing Harris'

Here they are—22 device types offering true alternate-source availability for 54C/74C CMOS. Combined with our existing 4000 series and custom LSI capability, addition of these new units makes Harris one of the few suppliers with total CMOS capability. So, choose from our 54C/74C series—44 devices with more on the way.

Our 54C/74C series, designed to reduce system costs, is pin-for-pin and function-for-function equivalent to T²L 7400 devices. Among their cost-saving features are low power supply requirements, less power supply regulation, fewer bypass capacitors, simpler design, and simplified power

distribution. The units also offer high noise immunity—typically 45% of supply voltage, and they have a guaranteed 1V noise margin. This means that 1V of noise at the input will not cause the output to rise beyond T²L levels. As a result, logic errors are less likely.

Applications are easy, too, with industry standardized input and output characteristics. Experience acquired with the 7400 series can also be applied directly to use of the 54C/74C's. For details, see your Harris distributor or representative.

	100-999 UNITS	
	-55°C to +125°C	0°C to +70°C
HD-54C00/74C00 Quad 2 NAND Gate _____	2.98	.69
HD-54C02/74C02 Quad 2 NOR Gate _____	2.98	.69
HD-54C04/74C04 Hex Inverter _____	3.30	1.04
HD-54C10/74C10 Triple 3 NAND Gate _____	2.98	.69
HD-54C20/74C20 Dual 4 NAND Gate _____	2.98	.69
HD-54C42/74C42 BCD to Decimal Decoder _____	7.15	3.30
HD-54C73/74C73 Dual J-K Flip Flop with Clear _____	4.75	2.26
HD-54C74/74C74 Dual D Flip Flop _____	4.20	1.45
HD-54C76/74C76 Dual J-K Flip Flop with Clear and Preset _____	4.75	2.26
HD-54C107/74C107 Dual J-K Flip Flop with Clear _____	4.75	2.26
HD-54C151/74C151 8 Channel Digital Multiplexer _____	6.40	3.95
HD-54C154/74C154 4-Line to 16-Line Decoder/Demultiplexer _____	16.20	5.40
HD-54C157/74C157 Quad 2 Multiplexer _____	5.10	2.88
HD-54C160/74C160 Decade Counter with Asynchronous Clear _____	10.40	5.70
HD-54C161/74C161 Binary Counter with Asynchronous Clear _____	10.40	5.70
HD-54C162/74C162 Decade Counter with Synchronous Clear _____	10.40	5.70
HD-54C163/74C163 Binary Counter with Synchronous Clear _____	10.40	5.70
HD-54C164/74C164 8-Bit Parallel Out Serial Shift Register _____	11.00	4.35
HD-54C173/74C173 Three State Quad/D Flip Flop _____	9.15	3.80
HD-54C192/74C192 Synchronous 4-Bit Up/Down Decade Counter _____	10.30	5.65
HD-54C193/74C193 Synchronous 4-Bit Up/Down Binary Counter _____	10.30	5.65
HD-54C195/74C195 4-Bit Register _____	5.70	3.75

WHERE TO BUY THEM: ARIZONA: Phoenix—Hamilton Liberty Weatherford Scottsdale—HAR (602) 946-3556 CALIFORNIA: Anaheim—Weatherford El Segundo—Liberty Glendale—Weatherford Long Beach—HAR (213) 426-7687 Mountain View—Elmar Palo Alto—Weatherford HAR (415) 964-6443 Pomona—Weatherford San Diego—Liberty Weatherford COLORADO: Commerce City—Elmar Denver—Hamilton Englewood—Weatherford CONNECTICUT: Danbury—Schweber Norwalk—Harvey FLORIDA: Hollywood—Hamilton Schweber Melbourne—HAR (305) 727-5430 GEORGIA: Atlanta—Schweber Norcross—Hamilton ILLINOIS: Elk Grove Village—Schweber Schaumburg—HAR (312) 894-8824 Schiller Park—Hamilton INDIANA: Indianapolis—Pioneer KANSAS: Lenexa—Hamilton MARYLAND: Baltimore—Hamilton Rockville—Schweber MASSACHUSETTS: Burlington—Hamilton Lexington—Harvey Wellesley—HAR (617) 237-5430 MICHIGAN: Livonia—Hamilton Troy—Schweber MINNESOTA: Edina—Hamilton Schweber Minneapolis—HAR (612) 432-6111 MISSOURI: Hazelwood—Hamilton NEW JERSEY: Cedar Grove—Hamilton Mt Laurel—Hamilton Somerset—Schweber NEW MEXICO: Albuquerque—Hamilton Weatherford NEW YORK: East Syracuse—Hamilton Melville—HAR (516) 249-4500 Syracuse—HAR (315) 463-3373 Rochester—Schweber Westbury—Schweber Woodbury—Harvey NORTH CAROLINA: Raleigh—Schweber OHIO: Beachwood—Schweber Cleveland—Pioneer Dayton—Pioneer HAR (513) 226-0336 PENNSYLVANIA: Wayne—HAR (215) 687-6680 TEXAS: Dallas—Hamilton Weatherford HAR (214) 231-9031 Houston—Hamilton Weatherford UTAH: Salt Lake City—Hamilton WASHINGTON: Seattle—Liberty Weatherford WASHINGTON, D.C.: HAR (202) 337-3170 CANADA: Mississauga Ontario—Hamilton Montreal Quebec—Hamilton Ottawa Ontario—Hamilton

LEGEND FOR HARRIS SALES OFFICES & DISTRIBUTORS: Elmar Electronics (Elmar), Hamilton Avnet Electronics (Hamilton), Harris Semiconductor (HAR), Harvey Electronics (Harvey), Liberty Electronics (Liberty), Pioneer Standard Electronics (Pioneer), Schweber Electronics (Schweber), R. V. Weatherford Co. (Weatherford)

source with total CMOS capability.

New 54C/74C Series

Our 4000 (S) series offers you the fastest, low-power logic devices available today. With 10-volt power supplies, speeds are typically twice that of comparable IC's. Power supply range is 3 to 15VDC, while noise immunity is typically 45% of supply voltage. Other advantages are low power dissipation and elimination of SCR latch-up problems. All units are pin-for-pin compatible with the CD-4000A series. And you have a choice of high-speed or direct CD-4000A replacement characteristics. To order a high-speed unit just add the suffix "S" to the HD-4000 part number (HD-4000S). For a direct CD-4000A replacement add an "A" to the number (HD-4000A).

In addition to the HD-4000 series, we offer the HD-4800 group of Harris proprietary devices. Among these devices are six units which together comprise the first family of three-state CMOS interface circuits available. By providing the ability to regulate the state of hard wired outputs, these interface circuits permit an extremely high level of flexibility in buss oriented systems design. These units also have buffered outputs for driving high capacitive lines and T²L directly. When four circuits are utilized, they permit the user to perform logic translation (i.e. MOS to T²L) directly at the buss line. For complete details on our 4000 and 4800 series, see your Harris distributor or representative.

	100-999 UNITS			
	-40°C to +85°C		-55°C to +125°C	
	A	S	A	S
HD-4000 Dual 3 NOR Gate plus Inverter, 14 pin DIP	.78	1.86	1.17	3.10
HD-4001 Quad 2 NOR Gate, 14 pin DIP	.78	1.98	1.17	3.30
HD-4002 Dual 4 NOR Gate, 14 pin DIP	.78	2.04	1.17	3.40
HD-4007 Dual Complementary Pair plus Inverter, 14 pin DIP	.78	1.59	1.17	2.65
HD-4009 Hex Inverter/Buffer, 16 pin DIP	1.69	3.15	2.54	5.25
HD-4010 Hex Buffer, 16 pin DIP	1.69	3.15	2.54	5.25
HD-4011 Quad 2 NAND Gate, 14 pin DIP	.78	1.98	1.17	3.30
HD-4012 Dual 4 NAND Gate, 14 pin DIP	.78	2.07	1.17	3.45
HD-4013 Dual D Flip Flop, 14 pin DIP	1.62	2.85	2.43	4.75
HD-4019 Quad AND/OR Select Gate, 14 pin DIP	1.91	3.03	2.87	5.05
HD-4023 Triple 3 NAND Gate, 14 pin DIP	.78	2.06	1.17	3.44
HD-4025 Triple 3 NOR Gate, 14 pin DIP	.78	2.06	1.17	3.44
HD-4030 Quad Exclusive OR Gate, 14 pin DIP	1.63	2.27	2.45	3.79
HD-4804 Three State Hex Buffer with Level Translator, 16 pin DIP	-	6.15	-	7.67
HD-4805 Three State Hex Buffer Inverter with Level Translator, 16 pin DIP	-	6.15	-	7.67
HD-4806 Three State Triple True/Complement Buffer with Disable, Independent Level Translator, 16 pin DIP	-	6.15	-	7.67
HD-4807 Hex Buffer with Disable, 16 pin DIP	-	6.15	-	7.67
HD-4808 Three State Hex Buffer with Disable, 16 pin DIP	-	6.15	-	7.67
HD-4809 Triple True/Complement Buffer, 16 pin DIP	1.69	3.15	2.54	5.25
HD-4810 Three State Triple True/Complement Buffer with Disable, Common Level Translator, 14 pin DIP	-	6.15	-	7.67
HD-4811 Quad Exclusive NOR Gate, 16 pin DIP	1.63	2.27	2.45	3.79
HD-4814 Hex Inverter, 16 pin DIP	.97	2.27	1.45	3.80

HARRIS
SEMICONDUCTOR
A DIVISION OF HARRIS-INTERTYPE CORPORATION
P.O. Box 883, Melbourne, Florida 32901
(305) 727-5430

Match impedances with tapered lines

when you test microwave transistors, and you'll avoid the destruction of expensive devices.

If you're searching for a high-power microwave transistor, you'll find a growing number to meet your system needs. But mismatch the 50- Ω test equipment to the ohm-or-less input impedance of these new devices, and burnout may cost you hundreds of dollars. Microstrip exponentially tapered lines offer insurance against such losses by providing a near-perfect match over a wide frequency range.

The tapered lines have advantages over the conventional stub tuner and uniform microstrip transmission line. But they have a major drawback: They're bulky. This and other factors usually limit their use to transistor characterization rather than practical amplifier designs.

Let's compare stub tuners, uniform transmission lines and tapered lines and then examine how the tapered lines can be most useful in testing and in prototype designs.

The ideal impedance-transforming network

Here are the requirements for an ideal impedance-transforming network:

- Wide bandwidth.
- Independent control of the real and imaginary parts of the impedances to be presented to the transistor under test.
- Limited range for real and imaginary components of impedance (to avoid the possibility of severe mismatch, which could destroy the transistor under test).
- Low loss.

Stub tuners are very popular and meet the wide bandwidth demand. However, both the real and imaginary components change simultaneously, and impedances can vary over a wide range with only a slight change in stub positioning. It is difficult to determine what impedances are presented to the transistor by observation of the

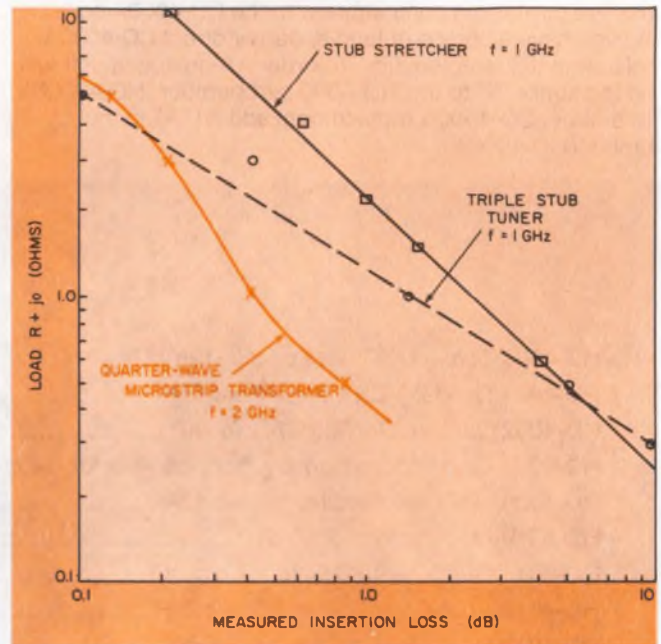

1. A quarter-wave microstrip transformer offers less insertion loss than other approaches when an impedance of 3 Ω or less is matched to 50 Ω .

physical settings alone. Finally, stub tuners become lossy at high transformation ratios. Fig. 1 shows the measured insertion loss in decibels in matching $R + j0$ to 50 Ω . Below 3 Ω the insertion losses for the triple-stub tuner and the stub stretcher far exceed the insertion loss of microstrip quarter-wave transformers.

Uniform microstrip transmission lines, combined with variable lumped element capacitors, offer less loss than stub tuners, but they are limited to a narrow bandwidth, often requiring more than one circuit to characterize a transistor over a wide frequency range.

Designing the tapered line

The exponentially tapered microstrip transmission line can supply a broadband match between two real impedances, if certain conditions are met.¹ The imaginary component of the device impedance can be tuned out by a series-tunable

Robert P. Arnold and William L. Bailey, Motorola, Inc., Semiconductor Research and Development Laboratory, Phoenix, Ariz. 85008.

element—a series capacitor if that is required—or a variable capacitor in series with a small inductance, if a variable inductive reactance is required. A real impedance presented to the low-impedance end of the microstrip exponentially tapered line will then be transformed to 50 Ω.

The requirements for the tapered line are:²

- It must be operated above its cutoff frequency.
- Its characteristic impedance at the source end must be 50 Ω.
- Its characteristic impedance at the low-impedance end must equal the real impedance that it is required to transform.

The last requirement appears to rule out the tapered line. In practice, however, a variable shunt capacitor at the device input suffices to achieve the small transformation to match the real component of the input impedance of the transistor under test to the characteristic impedance of the tapered line at the low-impedance end.

The basic equations used to design the exponentially tapered line are

$$\frac{Z_o(X)}{Z_o(0)} = e^{\delta X} \quad (\text{Physical}) \quad (1)$$

$$= e^{F\phi} \quad (\text{Electrical}),$$

where X is the distance from the low-impedance (wide) end, $Z_o(X)$ is the characteristic impedance at X , $Z_o(0)$ is the characteristic impedance at the low-impedance end, δ is the physical taper rate, and F is the electrical taper rate (Fig. 2). For $W \gg H$ (line width \gg dielectric thickness), the two expressions in Eq. 1 are very similar. Then we can define the transformation ratio, T , by

$$T = \frac{Z_{o2}}{Z_{o1}} = e^{\delta \ell} = e^{F\phi}, \quad (2)$$

where Z_{o1} = line impedance at low- Z (wide) end,
 Z_{o2} = line impedance at high- Z
 (narrow) end (usually 50 Ω),

ℓ = total physical line length,

ϕ = total electrical line length.

Knowing the desired end impedances (hence T), we may calculate $\delta \ell$ or $F\phi$ from Eq. 2. Specification of the desired cutoff frequency and the

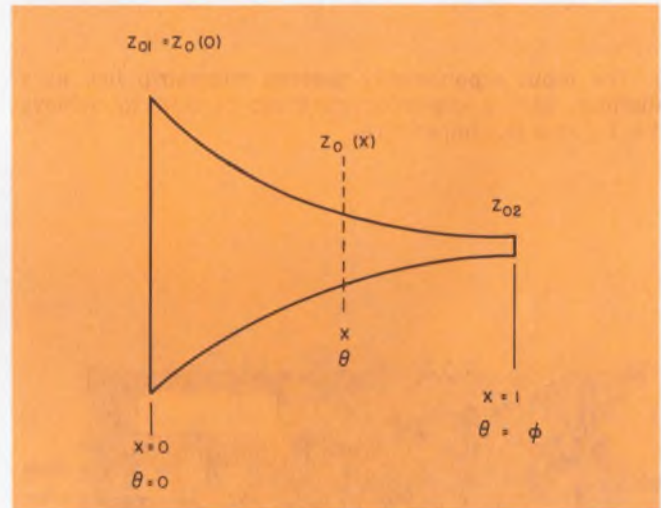

2. In the exponentially tapered line $Z_o(0)$ is the characteristic impedance at the low-impedance end.

material dielectric constant determines the taper rate δ by:

$$f_{\text{cutoff}} = \frac{\delta c}{4\pi \sqrt{\epsilon_r}}$$

or

$$\delta = \frac{4\pi \sqrt{\epsilon_r}}{c f_{\text{cutoff}}}, \quad (3)$$

where c is the velocity of light. The cutoff frequency is chosen to be three or four times lower in frequency than the frequency of circuit operation. This ensures broad bandwidth and negligible loss. Combining Eqs. 2 and 3 yields the physical and electrical lengths

$$\ell = \frac{\ln T}{\delta}$$

$$\text{and } \phi = \frac{\ln T}{F} = \frac{\beta \ln T}{\delta},$$

$$\text{where } \beta = \frac{2\pi f \sqrt{\epsilon_r}}{c} \text{ and } F = \frac{\delta}{\beta} \quad (4)$$

The line widths are obtained from the well-known relationship

$$Z_o = \frac{377 H}{\sqrt{\epsilon_r} W},$$

where H is the dielectric thickness.

An example of the practical application of this

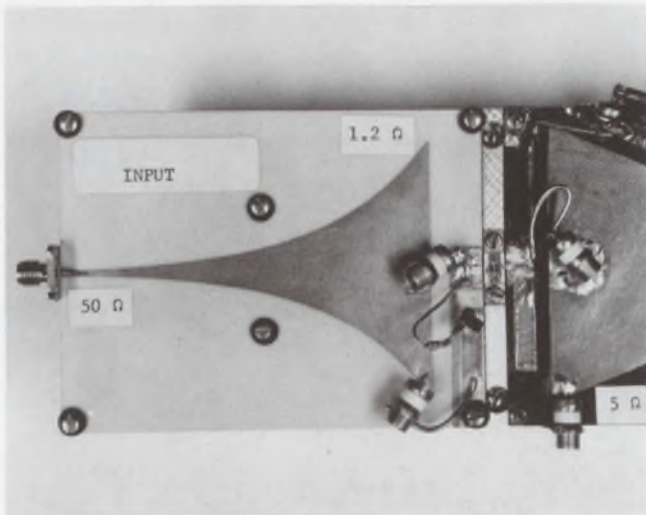

3. The input exponentially tapered microstrip line uses alumina, with a dielectric constant of 9.9, to achieve the 1.2- Ω input impedance.

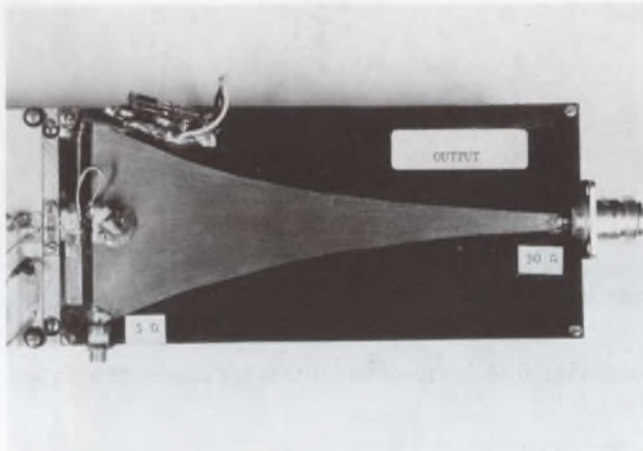

4. The output tapered line is constructed on Teflon-Fiberglas, with a dielectric constant of 2.55, to match the transistor output to the 50- Ω load.

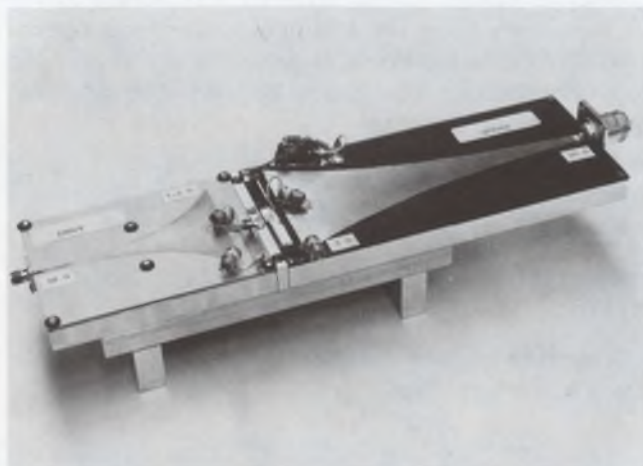

5. The completed test setup is large, but it reduces device burnout stemming from impedance mismatch.

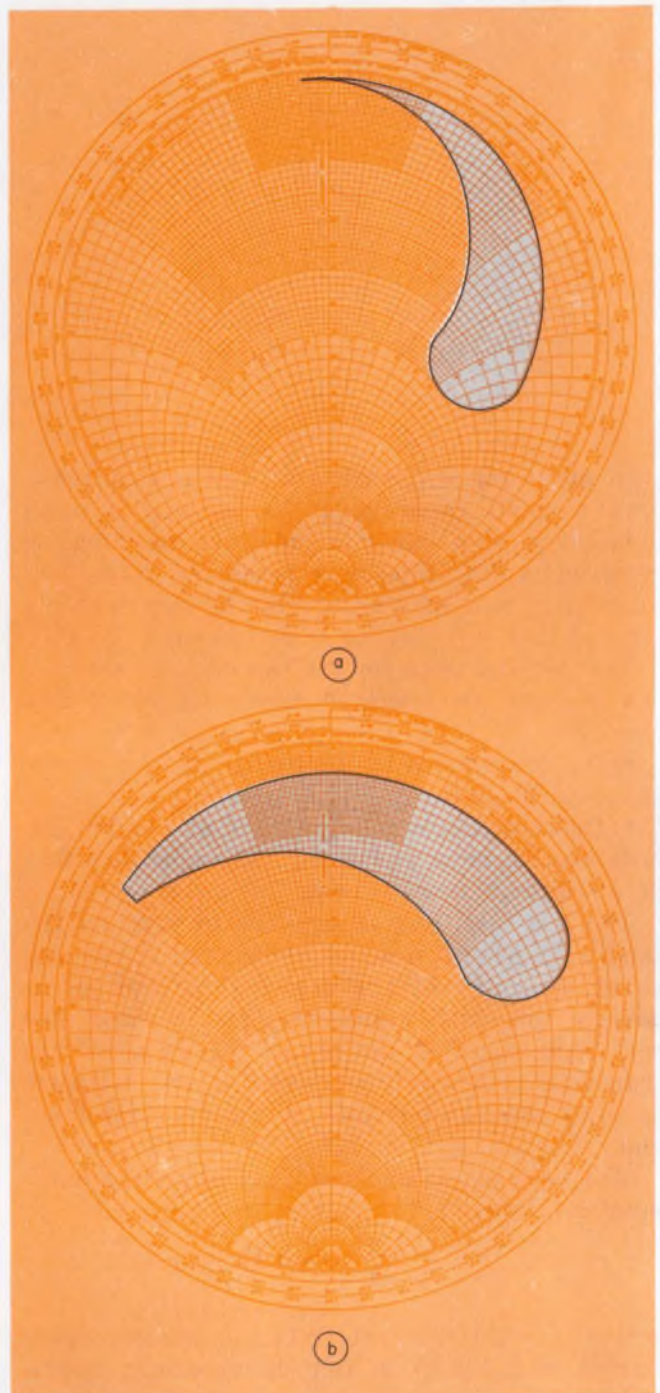

6. The tuning range of the input stage (a) and the tuning range of the output circuit (b).

approach is shown in Fig. 3. The exponentially tapered microstrip line for the input matching circuit is constructed on 25-mil-thick alumina ($\epsilon_r = 9.9$) and transforms from $1.2 + j0$ ohms to $50 + j0$ ohms over a range of 700 to 1400 MHz. Alumina is used to restrict the width at the low-impedance end, to minimize spurious modes at the discontinuity. Specifically $W_1 = 2.4$ in., $W_2 = 24$ mils, $l = 3.5$ in., $\phi = 316^\circ$ at $f = 1$ GHz, and $f_c = 318$ MHz.

The variable-shunt capacitor, shown connected to the tapered line at the low-impedance end, transforms the real component of the device in-

put impedance from 0.5 to 1.2 Ω . The series-variable capacitor reduces the imaginary component to zero. Fig. 4 shows a similar circuit (constructed on Teflon-Fiberglass $\epsilon_r = 2.55$) that is used to transform the 50- Ω load impedance to the value required by the output of the transistor for optimum performance. The circuit has $W_1 = 2.7$ in., $W_2 = 0.17$ in., $l = 6.2$ in., $\phi = 290^\circ$ at $f = 1$ GHz, and $f_c = 219$ MHz. Although the advantages of the approach described here are of value particularly for input matching, it can be used in the output circuit also.³ The over-all configuration is shown in Fig. 5.

Results prove the technique

This approach has proved valuable in the initial characterization of a number of microwave power transistors, and its advantages are as follows:

- The range of impedances that it presents to the transistor, particularly at the input, are limited to close to what is required, with little possibility of unintentionally high VSWR conditions being obtained (see Fig. 6a and b):
- The tapered line is continuously tunable over an octave bandwidth.
- The impedances can be varied in a controlled manner.
- For the high transformation ratios considered here, the losses are lower than those of typical stub tuners.
- In practice, the destruction of new devices was significantly reduced. (It is possible that this was due in part to the cutoff⁴ characteristics of the tapers, which reduced the tendency toward low frequency oscillation.)

This method is not recommended as a replacement for conventional matching circuits when characterized devices are used. This is because 10% greater Class-C performance can be achieved by use of narrowband circuits. However, it has considerable advantage in the initial characterization of newly designed devices, where the impedances of the transistors are not yet known and the destruction of expensive experimental devices is rather serious. Also, one circuit can be applied over a large bandwidth. ■■

References

1. Ramachandran, V., "Design Charts of an Exponential Transmission Line for Impedance Matching," *IEEE Trans. on Circuit Theory*, December, 1963, pp. 516-520.
2. *Ibid.*
3. Kamnitsis, C., "Broadband Matching of UHF Micro-Strip Amplifiers," *Microwaves*, April, 1969, pp. 54-56.
4. Burrows, C. R., "The Exponential Transmission Line," *Bell System Technical Journal*, October, 1938, pp. 555-573.

Acknowledgements

A portion of this work was performed under contract F33615-70-C-1553 for Wright-Patterson AFB, Ohio. The authors wish to thank Jack Kalmar and Wen Ou for contributing the loss-measurement data.



In industrial controls, Licon® switches go where the action is.

Dependability rates top priority in industrial controls. That's why you'll find Licon's proven double-break, double-reliable Butterfly® switches controlling the action in automated handling systems, numerically controlled machine tools and other critical control applications.

Licon's single-source, broad line selection saves design time, too. It includes lighted and non-lighted pushbuttons, heavy-duty miniature and sub-miniature snap-action and limit switches.

Want to individualize? Replace several switches with one? Or meet a multi-functional requirement in a standard way? You can, with "added value" from Licon.

Licon switches: where the action is in industrial controls, business machines, medical electronics, computer systems. Check your Licon rep or distributor for full details. Or write for literature.



Division Illinois Tool Works Inc.
6615 W. Irving Park Rd., Chicago, Ill. 60634
Phone (312) 282-4040 TWX 910-221-0275



LICON

puts ideas to work
in electronics

The Innovative Electronic Group of ITW
LICON • EMCON • PAKTRON

ILLINOIS TOOL WORKS INC. 1974

ELEC-TROL ON SCHEDULE



MAKING THE BEST DARN RELAYS IN THE COUNTRY

That's no idle boast. Elec-trol didn't grow to be one of the largest dry reed relay manufacturers by accident. Product quality did it. Product quality and product performance in demanding applications. Applications like yours, for instance.

We started with engineering. Everyone does, but with us it was an obsession. We took on problems that no one else could solve, and solved them. Not once, but time and time again. We earned our reputation that way, and we've made it a habit ever since — not only engineering the finest possible product, but the most effective and cost effective solutions to your specific application problems.

But engineering doesn't really solve your problems; products do. Products you can count on; most of them off the shelf. Delivery you can count on to meet your own production schedules. Service you can

count on from select local distributors. It wasn't easy, but we solved those problems, too.

Today we can provide you with reed relays to meet almost any application. We can provide them when you need them at the right price.

Take our Open Line, for instance. They are designed to provide you with high quality at a budget cost, when environment is not a critical consideration.

Our Econo-Line is one step up in environmental protection — but not in performance. There is no step up in performance. They are designed to meet more stringent environmental conditions; the enclosed type for severe industrial and similar environments, and the sealed type to meet military applications.

Then, of course, our DIP line gives you all the good things that come with DIP configurations: parts

density, automatic insertion, board spacing, plug-in capability.

Whatever the application you're designing for — communications, computers, industrial control systems, instrumentation and test equipment, military, automotive, what have you — chances are one of our standard products will meet your need. If not, we have many special products and our engineers are always on the job to solve your problems.

If you'd like specific technical information on any of our products call or write us at the address below, and let us know your requirements.

ELEC-TROL INC.

26477 North Golden Valley Road
Saugus, California 91350
Telephone (805) 252-8330,
(213) 788-7292 TWX 910-336-1556.

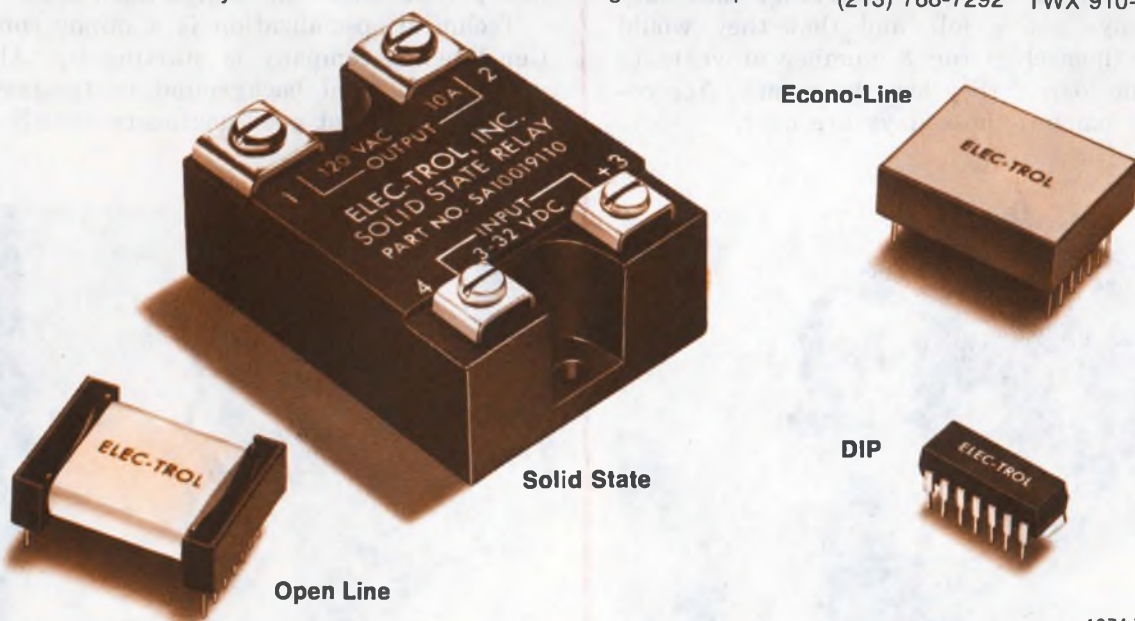

1974-75
eem
VOL. TWO

1974-75
**GOLD
BOOK**

INFORMATION RETRIEVAL NUMBER 64

Start your own electronics business —but look before you leap

Many engineers have thought about starting an electronics company. It's an exciting thought, because although many have failed in the attempt, others have prospered. Starting a company means understanding and applying some basic ground rules and then girding yourself for some very nasty surprises along with the welcome ones.

Seven years ago Donald Bruck founded Hybrid Systems Corp. in Cambridge, Mass., which now produces a range of products, from thick and thin film microelectronics to discrete component modules. Samuel Wilensky joined Bruck full time two years after the startup of the company and became a principal. Following are some ABC's for prospective electronics-company founders, based on the experiences of Bruck, now president of Hybrid Systems, Burlington, Mass., and Wilensky, vice president of modules. Here is their story:

By DONALD B. BRUCK

Seven years ago an engineer could go into a bank and, without any trouble at all, borrow \$10,000, \$20,000, and even \$30,000 to start a company. Bankers thought that engineers were extremely ethical and hard-working, that they could always get a job, and that they would discipline themselves for X number of years to pay off the loan if they lost the money. According to my banker, those days are over.



By DR. SAMUEL WILENSKY

Starting a company isn't the result of spontaneous combustion; you have to set yourself on fire. Start a company because you want to run one and make money, not because you have a new product that will change the world.

Technical specialization is a minor consideration when a company is starting up. Although you need a good background in fundamentals, the feeling is that good engineers usually can be



Donald B. Bruck, (continued)

One of the reasons starting a company is different today is that investors no longer feel that electronics companies never go bankrupt. Seven years ago suppliers didn't bother to tell our company, for example, that we were four, five or even six months late in payment. We really had the use of their working capital to get started. They felt that if we got into a bind, we could always go public, give up some small fraction of our company and raise a considerable sum of money. The market for electronic company stock is not quite as favorable today, and you can no longer expect to obtain working capital from your suppliers.

Also, the electronics industry is so sophisticated now that it is far less tolerant of an amateurish startup. Seven years ago a group of amateurs could form a company and, through on-the-job-training, fumble their way to ultimate success.

Dr. Samuel Wilensky, (continued)

found. When we started, for example, I didn't know what an a-to-d converter was, and that's our main business; so I don't think technical experience is of vital importance. Being versatile and a fast learner is more important. Most important for the startup is finding a solid business to go into—one that has a market and needs a good, aggressive company.

Prove your commitment

After you've started a company, be prepared to sacrifice. Donald Bruck and I worked without salary for two years to finance our startup. But sacrifice means more than involvement; it means commitment.

If you have to ask investors for money to start a company, show them that you're committed to the task, by proving that you've got all of your

Do's and don'ts for prospective entrepreneurs

Here are some do's and don'ts that Samuel Wilensky recommends for engineers who want to start a company:

- **Don't ever think that you're smarter than the next guy.** Someone always knows something you don't. Be careful of the "not invented here" attitude. It's an easy bind to get into if you're from an academic or research background. If you see a good idea, use it. Even though you're convinced that a particular module construction is the way to go, be quick to change your mind if all the customers are buying another type.

- **Don't start a company alone.** In general, if two persons are involved, when one is down, the other is up. It depends on the personalities, of course, but if you're alone, you've got to be a very special person to pick yourself up and keep going when things look bleak.

- **Do keep the component count down.** When you're designing a one-of-a-kind item in a research lab, you can make it as complex as you want; the component count is not a factor. But when you're designing something for the production line, you've got to keep the parts count to a minimum, because it's less expensive, easier to assemble and usually more reliable. At first, Hybrid Systems found it difficult not to over-design many of its circuits. Now there's a standing joke at the company: "When a new bread-board works, we cut out components until it stops working," Wilensky says. "Then we solder

that one back and start cutting out some more. It's very easy to throw in a filter capacitor here and an unnecessary resistor there when you don't really need them."

- **Don't panic.** Hybrid Systems' first big job was a unit it built for Westinghouse. The company had invested a lot of time and money in the product. After about 40 units were shipped Westinghouse said it didn't like the way the equipment was being built. There was near panic at Hybrid Systems' headquarters, because the company had risked everything on one item, and if that was going to be rejected, the business could go under. Solution: We made suggested changes after talks with Westinghouse.

- **Do be open to suggestions, and look into alternatives.** For example, when you set up a production facility, you've got to convince yourself that it doesn't take a Ph.D to trim a module. At Hybrid Systems, the founders had thought it would take a highly trained person; it doesn't. It takes a trained person to write a test procedure. But there's not much that Hybrid Systems assembles that can't be done by the average person. If the person off the street can't do it, then it's too complicated and shouldn't be built that way.

- **Do remember that the customer is still the customer.** When he tells you that your product isn't performing, you can't just tell him that he isn't using it right. You've got to figure out how to build the circuit so he can use it.

Some advice on the business side

Engineers intent on starting their own companies are advised by Donald Bruck to consider these business tips:

■ **Gain a competitive advantage:** In the electronics industry people often put together a team composed of extremely talented individuals who are qualified to compete against other talented and equally ambitious people. Then they all go to the market arena and fight over nano-seconds in performance.

In some cases, it might be a good idea to take your bright team to some industry other than electronics, where the team has an advantage over the competition and not just the qualifications for competing.

■ **Increase your probability of success.** If your immediate goal is to achieve a \$10-million company, there are two alternatives—10 \$1-million projects or one \$10-million project. If you do 10 \$1-million projects, each project, by itself, is not large enough to attract the bigger companies with greater resources than your own company's. Therefore your competition is easier, and the cash required is smaller.

If you do the one \$10-million dollar project, you'll have to bring in investors, leaving you with a smaller percentage, and your probability of success diminishes because of an increase in competition from larger established companies.

■ **Avoid becoming a captive.** One of the most significant causes of the lack of growth with startup companies is that they take on custom, one-shot projects. There are always potential customers lurking around to lure you with these offers that the most successful companies won't

accept. The one-shotters wave large purchase orders at you, but they won't buy in production quantities for years. Once the startup company takes on this carrot, it becomes a captive supplier of this manufacturer. The profitability for the product is never as good as you thought it would be, because your customer finds out what parts cost, and since he is essentially your only customer, he forces you to lower your prices at the threat of taking his business elsewhere.

When you finish shipping this marginally profitable job, you suddenly wonder what you're going to do next. That sends you after an even bigger carrot. You hop from carrot to carrot, never getting your original product ideas rolling, because you're putting your engineering efforts into these customized carrots rather than into products for the future. There are a lot of small companies that claim to have a large product line when, in reality, they are custom houses for a few large customers.

■ **Pace the company's growth properly.** A design engineer who has never been in business before often comes to the rude awakening that successful companies do not always survive. From a cash-flow point of view, if the company grows too fast, it can just as easily become insolvent as it can by growing too slowly. In both cases you can assume a profitable operation. The cash demands—such as the increase in inventory, increase in receivables and the working capital requirements, in general outstrip your resources, even though, you're profitable. You can't depend on always having the minimum cash-flow requirement rate of growth.

Donald B. Bruck, *(continued)*

Now the competition is far keener; there is less room for mistakes.

The competition is tight

When our company started, the industry was expanding into many new product areas. Companies had their sights set on various markets that didn't significantly overlap. Today companies attack most new product areas systematically; your company won't be as immune from competition for as long as it might have been seven years ago.

If I were to start a company today, I'd pick a product area, talk to the leaders in that industry to find out who their best people were and see if I could lure those people together into a new company. The best way is to determine what products the market is buying and, if that market

Dr. Samuel Wilensky, *(continued)*

own money in it. If a company goes under, investors don't want to see any fat cats walking away from the ruins, particularly if they have their own \$500,000 still invested in it.

Prospective backers also want to know if there's a large enough market to support the product. What they don't like is a new idea and the notion that you're going to *create* the market for it. They know that you never will; by the time you've created the market, the business will have gone under, and someone else who has learned from your mistakes will take advantage of the market you've established.

Prospective backers want to know if the company principals are competent in what they're doing. Consequently they want to back people who have good credentials—MIT, Harvard Business School, a Ph.D., a master's degree, experience in a variety of things, anything that will

Donald B. Bruck, *(continued)*

is big enough for your purposes, offer a better, cheaper line, or work harder than the competition.

There is an aspect of the present situation that actually works in favor of individuals attempting to start up a company at this time. There has been attrition of companies and of people with marginal capabilities and strategies. Hence the competition is much more realistic now in pricing. The previous situation—in which prices were lowered by some companies to whatever it took to secure and maintain ever-expanding sales, without due regard to costs and losses—has greatly diminished.

In short, the newly rediscovered importance of bottom-line profits has had the effect of weeding out the lunatics and perhaps of giving newly founded companies that employ sound business strategies a better chance of survival.

Organize your thoughts with a plan

But before you start a company, you should draw up a business plan.

A business plan tells the prospective investor where you intend to go and how you intend to do it. You have to describe the market you're going into and define the products, and then very carefully discuss the competition. Don't ignore a strong competitor, because you'll damage yourself more when the investor unearths that characteristic of the market. Face up to competition and explain why you think you can either compete with it or go around it.

If you can't cope with the competitor, perhaps you've chosen the wrong market. One of the best reasons for putting together a business plan is to organize your thoughts. When you put your plan on paper and you're faced with having to cope with the competition, finances, distribution systems and their bearing on sales, purchases and collection, you find those areas have meaning only with regard to each other in a time frame. You can see the impact of each on the others, and you start to get a better feel for what is necessary and what is practical to accomplish.

The biggest shock that engineers get from formulating profit-and-loss sales projections and cash-flow projections is learning that those two projections are different.

I've helped a couple of engineers get a business started, and I couldn't help but detect their disdain for accounting and finance. They seemed to think that if you have a company that's profitable, everything else falls into place. They soon learned that the presentation of numbers is not a casual exercise.

Business plans don't differ too much. If you know roughly what the gross margins are in a

Dr. Samuel Wilensky, *(continued)*

show them that you have a considerable technical and business experience. They like to see a business plan; they want to know that you're not just a part-time professor with a product. No matter how much money you think you're going to need, you're going to need more. If you're well financed and hire good people, you can usually survive long enough to get into some area where you can make money.

People-dealing a challenge

Being an engineer in a small company means that you've got to be a technician and also a salesman, because you're going to be out in the field talking to the customer and on the phone when he calls you for technical information. You've got to be an administrator, too, to pull all of these things together and make them work as an entity. You're the one who changes the toilet paper in the bathroom, because you're the only one who'll do that sort of task.

There are benefits—you are your own boss. But that presents its own special challenges. The two most difficult challenges for me as an engineer when we started the company were dealing with people and handling production and engineering simultaneously.

For me, dealing with people is the biggest headache of all. In starting a company, you meet more people than you do as an engineer. When I doubled as the purchasing agent, I had to learn to talk with salesmen, something I never did as an engineer. I have an academic background, and I worked with 10 to 20 people in a research lab, most of them on a peer level.

In a business it's a different story. There are personnel problems that never come up in the lab. A secretary comes to you in tears because one of the other girls looked at her wrongly. Or a guy says he has to have a raise or he's walking out the next day.

Hiring people is difficult, too. We try to hire a person who's working in the field now and who has experience and a good reputation. You've got to convince him that he can grow with a small company. If you give him an equity position in the company, you've got to be sure that he's as serious about the company as you are.

Whether I'm directing people, or hiring them, or buying from them or selling to them, for me honesty with people is probably the best policy. Whenever I tried to push the truth slightly, I never told a very good story.

Mixing production and engineering

Another difficulty for an engineer who starts a company is that there is always pressure to get

Donald B. Bruck, (continued)

particular field, there are certain inherent characteristics that force remaining numbers to come out somewhat similar. But the formulation of a plan is tremendously enlightening to the individual who does it. ■■



Donald B. Bruck and Dr. Samuel Wilensky study the assembly process in their Burlington, Mass., plant.

Dr. Samuel Wilensky, (continued)

the product out of the door. In a sense, you sometimes have to compromise your ideals of quality to push things out on time. It's very difficult doing both production and engineering. On the one hand you want to push products out the door and, on the other hand, you don't want to ship a defective item. Since you have to balance these two things, you've got to learn when the unit is good enough to ship. If my engineers finish 99% of the product and are still working hard on it, I tell them to stop. To get that extra 1% may take them the same amount of time it took to get the first 99%, and it's just not worth the investment in time and effort.

When you start a new product, find someone who has made it before; at least you won't repeat the same mistakes he made. It's worthwhile talking to someone or hiring an engineering consultant to show you the problems that you're going to run into. In a sense, you've got to divorce yourself from engineering and realize that you're in a business. ■■

Donald B. Bruck, Dr. Samuel Wilensky and Hybrid Systems Corp.

For a time one might have thought that Donald Bruck was going to become a professional student; he earned a B.E.E. at Rensselaer Polytechnic Institute; a Master of Science (electrical engineering) at MIT, a Master of Science (physics) at Northwestern University; and an MBA at Harvard.

But his education coupled with the business and technical experiences he picked up along the way helped him to found Hybrid Systems Corp., in 1967. His experiences included stints as sales director with Burr-Brown Research Corp.; Sales engineer at GPS Instrument Co.; computer programmer at Wolf Research & Development Corp.; and manager of systems development contracts and programs with the U.S. Air Force.

He incorporated Hybrid Systems in 1965 with a capital base of only \$500.00. The mailing address was a post office box, the phone terminated only at an answering service, and the products were manufactured in the home.

From May 1967 sales doubled every year and the company has been profitable every year since 1970. In September, 1973, Hybrid Systems Corp. acquired the hybrid thin/thick film operation of Sprague Electric Company in Worcester, Mass. At the present time, Hybrid Systems Corp. employs over 200 persons and has a sales rate in

excess of \$7,000,000 per year. The company is privately held.

Dr. Samuel Wilensky had spent some of his engineering career teaching and some of it researching before becoming a principal of Hybrid Systems Corp. After he had earned his B.S. (electrical engineering) and his Ph.D at MIT, he taught nuclear physics courses at his alma mater, and, two years later taught a course in nuclear reactor engineering.

Sandwiched between Wilensky's teaching assignments were two research positions, one at MIT Rockefeller Accelerator, where he designed instrumentation for Van De Graaff Accelerators, the other at Massachusetts General Hospital and Harvard Medical School, where he was responsible for the instrumentation designs, and computer operation of Cyclotron.

He has published numerous articles and papers, including "SIGNMA: A Code to Change the Gain of a Multichannel Analyzer Output," Computation Center Final Report M2351, M.I.T., Cambridge, Mass.; "Hybrid Scintigram Display System," presented at the 16th Annual Meeting of Society of Nuclear Medicine, New Orleans, June, 1969; and "Computer Processing and Display of Positron Scintigrams and Dynamic Function Curves," *Medical Radioisotope Scintigraphy*, Vol. 1, (815-827) IAEA Vienna, 1969.

OUR 5V POWER MINI'S STACK UP LIKE THIS



OUTPUT VOLTAGE	OUTPUT CURRENT AMPS.	REGULATION LOAD $\pm\%$	REGULATION LINE $\pm\%$	RIPPLE MV RMS	PRICE	MODEL	SIZE INCHES
5	.250	.05	.05	0.5	\$39.00	5E25	2.3 x 1.8 x 1.00
5	.500	.1	.05	1	49.00	5E50A	3.5 x 2.5 x 1.00
5	1.0	.2	.05	1	69.00	5E100	3.5 x 2.5 x 1.25
5	1.5	.3	.1	1	98.00	5E150	3.5 x 2.5 x 1.25
5	2.0	.15	.05	1	110.00	5E200	3.5 x 2.5 x 2.00
5	2.5	.15	.05	1	125.00	5E250	3.5 x 2.5 x 2.00

... and the model you choose will be shipped 3 days after Acopian receives your order. With a 105-125 VAC input, use it at full rated load to 71° C. Short circuits won't damage it. These mini-modules can be mounted on a printed circuit

board in a space of only a few square inches. Generous quantity discounts are available. Or, if you're working with other voltages, choose from hundreds of other models. Single outputs from 1 to 75 volts.

Duals for op-amps with output currents from 25 to 500 ma. Even triple outputs. Complete details on these plus a comprehensive line of other power supplies and systems are included in the Acopian 73-74 catalog. Request a copy.



Corp., Easton, Pa. 18042. Telephone: (215) 258-5441.

INFORMATION RETRIEVAL NUMBER 65

MONO-GLASS... A JEWEL OF A CAPACITOR

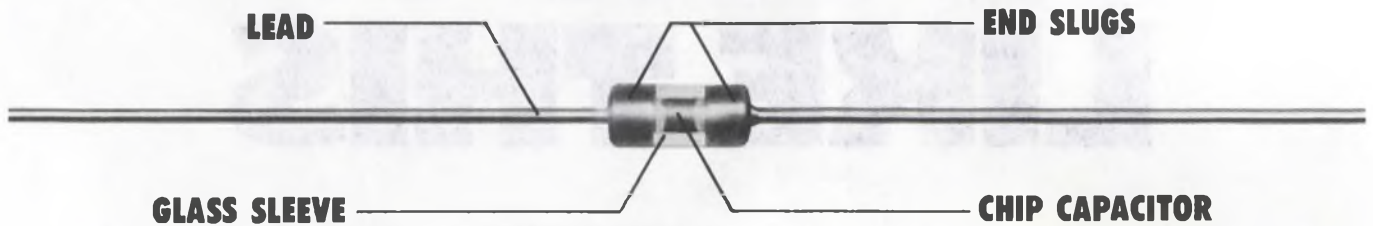

U.S. Capacitor Corp. has done something elegant for high volume capacitor users . . . MONO-GLASS.

This glass encapsulated monolithic ceramic capacitor offers something special: for the Design Engineer looking for cost reduction and dependability; for the purchasing agent looking for low price with fast delivery; for the incoming Q.C. inspector who is looking for reliability.

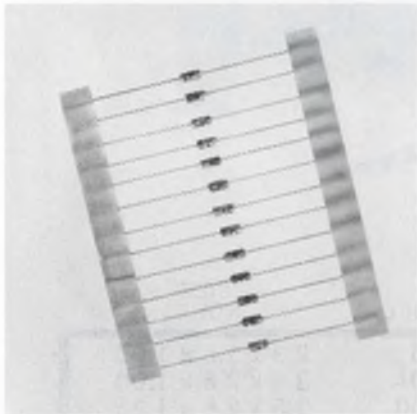

AUTOMATIC INSERTION:

If you use it, you know the substantial savings in time and cost. MONO-GLASS is designed for automatic insertion with the same equipment used for diodes and resistors. Reel packed and ready for your machines.

DURABILITY:

Our hermetically sealed, glass-to-metal construction offers these advantages: solderless internal contacts that won't reflow in your wave-soldering process; no glass fracturing during lead forming—stress is transferred to the end slugs rather than the glass sleeve.



HIGH VOLUME; LOW PRICE

USCC's production capability for chip capacitors is second to none. MONO-GLASS is produced by a simple assembly technique. Combine these two and you get the best possible delivery for high quantity requirements, at a budget price.

WIDE SELECTION:

Four case sizes are available200 x .100; .250 x .100; .300 x .150 and .400 x .150. The 50 and 100 WVDC units offer up to .01 mfd in COG dielectric, to .18 in X7R and up to 1.0 mfd in the Y5V dielectric.

RELIABILITY:

USCC is the proven leader in state-of-the-art, demonstrated on N.A.S.A. life support and guidance systems. Commercial as well as military aerospace applications benefit from the high reliability features of our products—the best available.

MONO-GLASS is our lowest priced ceramic axial lead capacitor, offering a new quality capability for communications, navigation and guidance, computer business machines or anywhere that high volume, low price is required.

Write or call for an evaluation sample, more technical data or applications help for your special requirements. Remember, USCC-Centralab.



USCC/Centralab

Electronics Division • Globe-Union, Inc.

2151 North Lincoln Street • Burbank, California 91504
(213) 843-4222 • TWX: 910-498-2222



INFORMATION RETRIEVAL NUMBER 66

Open a Savings Account with our new megapower SCRs



When you invest in IR's new Megapower SCR Family Savings Plan you start earning dividends three important ways.

First, you can eliminate over 70% of the devices and parts normally needed (see the 3-phase converter "savings account" below for full details). That gives you a lower total system cost, plus more reliability.

Second, having fewer parts cuts assembly time sharply, increases reliability and makes your field servicing that much easier, too.

Third, Megapower SCRs give you more production power with only a minimum change in your equipment size.

If you want to parallel Megapower SCRs, there's a special bonus. Our epitaxial process

yields SCRs of virtually identical switching characteristics, so you eliminate expensive current balancing equipment. It also produces the high voltage SCRs you need. Specifically: 700A(av), 500 to 2100V; 850A(av), 500 to 2000V; 1000A(av), 500 to 1500V, and 1600A(av), 500 to 1200V.

There is also an extra dividend in overall productivity because Megapower SCRs will keep your equipment on line longer. Their surge capability is so high, they can ride through massive overloads without resorting to protective fuses.

Open a savings account today. Call your IR branch office, or bank headquarters (213) 678-6281; Telex: 67-4666. International Rectifier, 233 Kansas Street, El Segundo, CA

IR'S 4800 Amp, 3-PHASE CONVERTER SAVINGS ACCOUNT

Parts Per Assembly	4800A Assy. Using 3-550A SCRs Per Leg	4800A Assy. Using 1-1600A SCR Per Leg	Parts Saved Per Assy.
1. SCRs	18	6	12
2. Heat Sinks	21	9	12
3. Clamps	18	6	12
4. Fuses	18	6	12
5. Balancing Reactors	18	0	18
6. Trigger Pulse Pwr. Amplifiers	6	0	6
7. Isolated Gate Drive Windings	18	6	12
Totals	117	33	84

International Rectifier

International Rectifier, 233 Kansas Street, El Segundo, CA 90245. . . . the innovative power people



INFORMATION RETRIEVAL NUMBER 67

Current clamp blocks destructive discharges of large filter capacitors

A current-clamp circuit prevents damage from accidental fast discharge of large power capacitors.

As long as the power supply can furnish the necessary load current and voltage, CR₁ conducts and C₁ provides the requisite filtering. The auxiliary circuit supplies a portion of C₁'s charging current, 1.2 A at 0.9 V.

When a short circuit occurs, point A is more positive than point B, and CR₁ blocks most of the discharge through the external circuit. Part of the energy is diverted through CR₁, which can handle large surge currents. Meanwhile the main breaker in the supply operates, and power is shut down. The circuit limits the capacitor dump current to 1.6 A at any load.

The components shown are for an HP 6274 A supply rated at 70 V/18 A. They also apply to Trygon MC 7C-150-20 supply rated at 160 V/16 A. With the Trygon supply operated at 70 V, 18 A, the peak current was 4 A and had a triangle-shaped decay curve that lasted 1 ms.

The ripple with both supplies used in conjunction with the circuit is

HP at 30 V and 10 A: 1 mV (rms),

Trygon at 70 V and 18 A: 20 mV (rms).

On the other hand, the supply specs were

HP at 60 V and 16 A: 500 μ V,

Trygon at 100 V and 16 A: 14 mV.

The circuit introduces little additional ripple.

John B. Ayer, Engineer, 2013 Deerhurst, Ottawa-K1J8H2, Ontario, Canada.

CIRCLE NO. 311

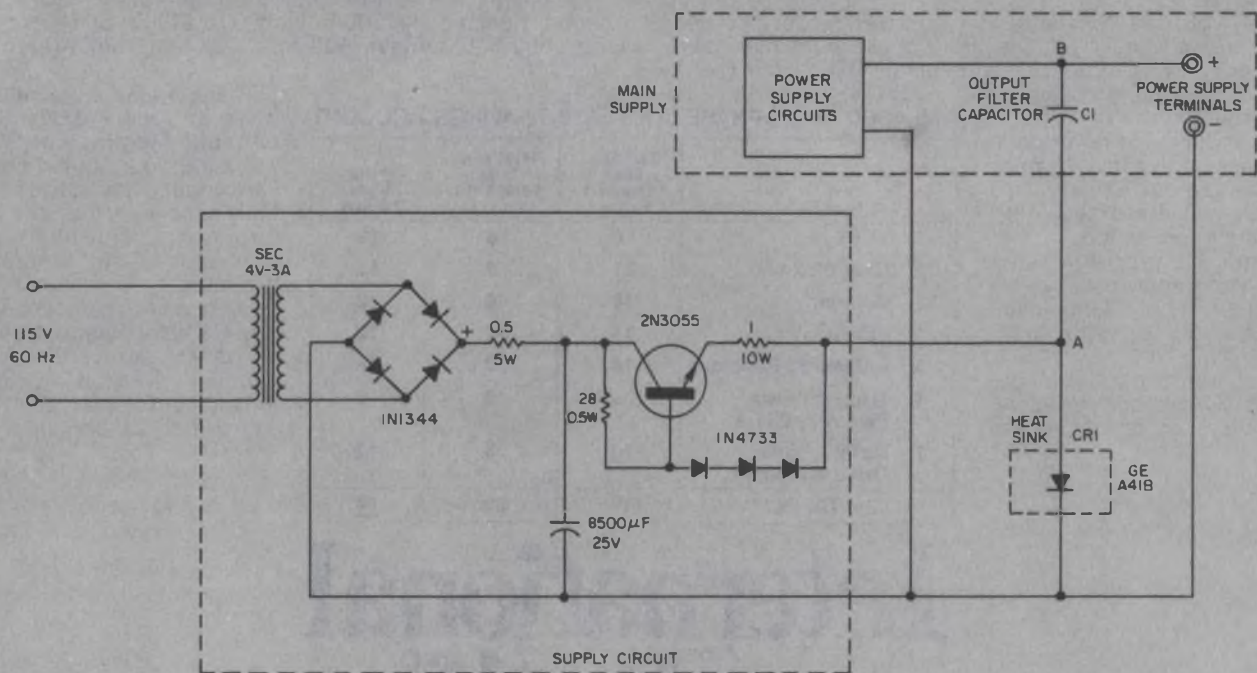

External circuitry limits current surges caused by a short circuit of an output filter capacitor.

The reader that can stay on, and on, and on. The 603.

The price of the Model 603 V-O-M is only \$173.

The one V-O-M you can forget about forgetting to turn off. The incredible Model 603 FET V-O-M with exclusive Triplet Micro-Power™ draws only 10 μ A, can stay on indefinitely without impairing performance. Ideal wherever frequent test changes, interruptions, distractions—or gremlins—keep your V-O-M working when you're not.

Truly outstanding features:

1. Exclusive Triplet Micro-Power (TMP™) provides battery life in excess of a year for carbon batteries with unit left on continuously 24-hours a day.
2. Low-Power Ohms (LP Ω ™)—6 ranges with 70 mV power source for in-circuit measurements without damage to components.
3. FET V-O-M with Patented Auto-Polarity—convenient and time-saving, always reads up scale.

Accurately measures electric and electronic circuits on production lines, in quality testing, during maintenance, in service shops and on calls, in the laboratory or classroom, in the field.

One range selector switch operates the unit. One probe handles all functions—AC, DC, MA, Ohms—and a simplified scale utilizes only 4 arcs for all 44 ranges. The Low Power Ohm circuit permits fast circuit measurements without biasing semiconductor device junctions. The

Model 603 also has a unique, Patented Auto-Polarity circuit: push a button, measure either plus or minus voltages without switching leads. Make very fast voltage checks where polarity is known or doesn't matter.

For more information or a free demonstration, call your Triplet distributor or sales representative.

For the name of the representative nearest you, dial toll free (800) 645-9200. New York State, call collect (516) 294-0990. Triplet Corporation, Bluffton, Ohio 45817.

TRIPLET
ALL YOU'LL EVER NEED IN V-O-M's.



Triplet. The easy readers.

INFORMATION RETRIEVAL NUMBER 68

A/d converter remembers signal peaks whose duration is less than 50 ns

A parallel a/d converter plus some digital logic forms a circuit that can retain signal peaks of very short duration. The circuit includes externally controlled digital logic that either tracks the input signal or latches onto the high state.

The \bar{A} output of each comparator is connected to an R-S flip-flop comprised of three, two-input NAND gates (Fig. 1). The \bar{A} output remains high until the input to the comparator exceeds the reference level, V_{REF} . When this happens, the \bar{A} output falls and the values of the A' and \bar{A}' outputs toggle—that is, A' goes from low to high and \bar{A}' goes from high to low.

With the control signal at 5 V, the outputs A' and \bar{A}' toggle between states as the input goes above and below the reference level. If the control line is set to 0 V, the outputs latch when the input exceeds the reference voltage, and A' remains high. However, the comparator output can still toggle between the high and low states.

A four-bit converter (Fig. 2) has 15 comparators and can output 16 states, zero included. Schottky-clamped TTL logic decodes the comparators. The reference voltage for each comparator is 100 mV more positive than the one below; the bottom comparator is referenced to 100 mV.

Some of the logic gates serve no purpose in decoding the comparator states. Their inclusion helps equalize the propagation delay to the decoded outputs. With the components shown, the circuit has retained peaks with less than 50-ns duration.

Gerald C. Stoker, Senior Engineer, Sandia Laboratories, NDT Div. 9352, Albuquerque, N.M. 87115.
CIRCLE No. 312

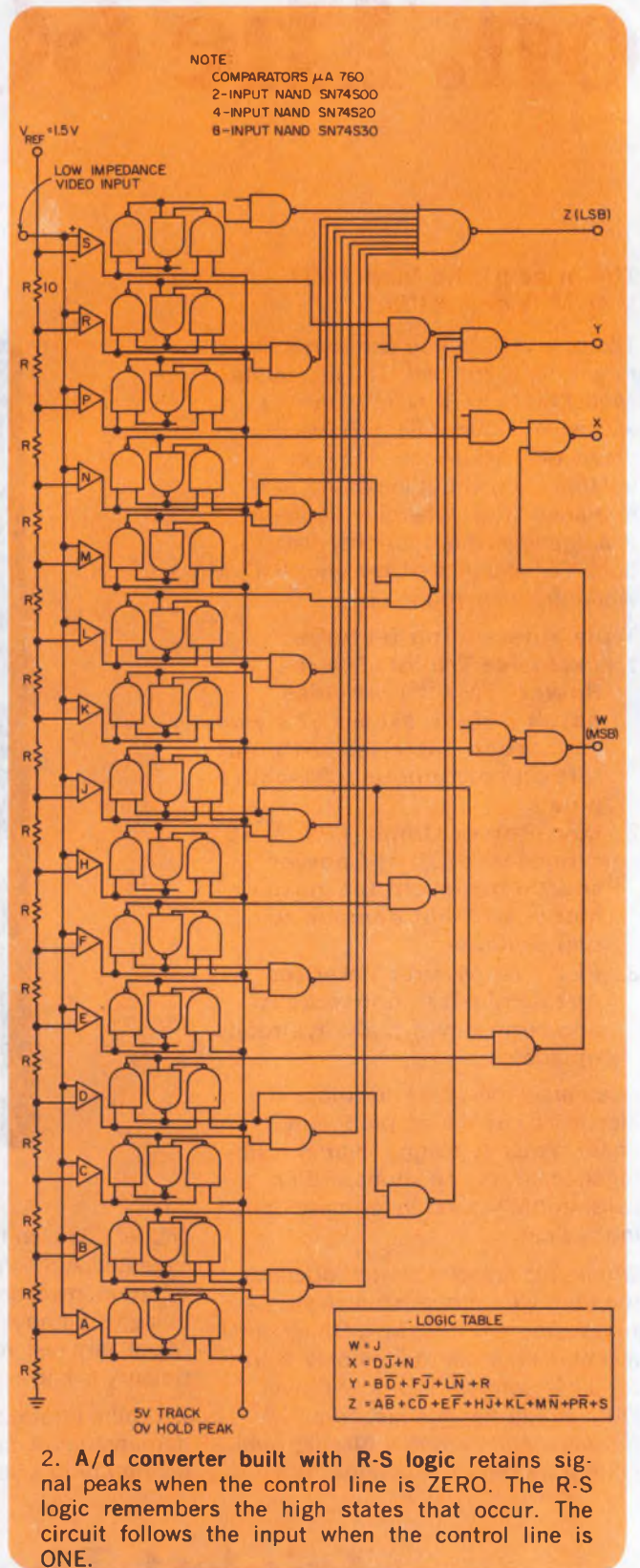
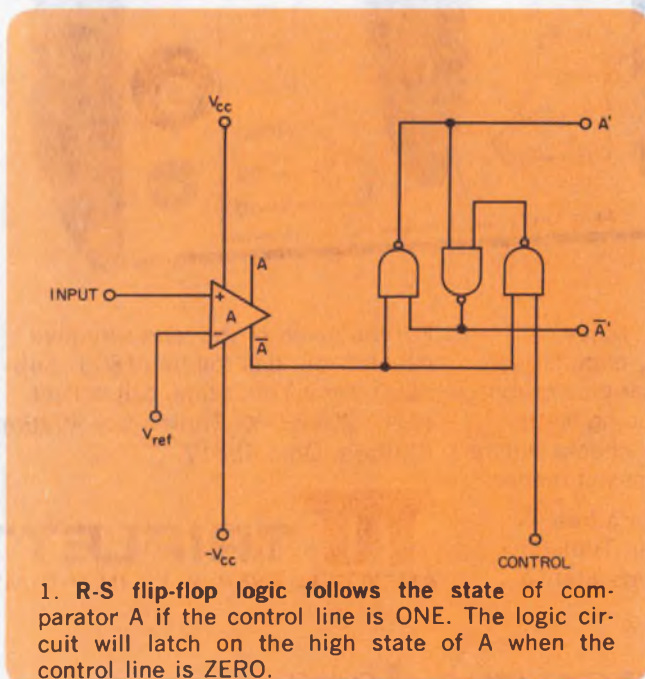

if it's a meter or meter relay,

Stock or Special...

Simpson makes it.



Stock:

Simpson distributors nationwide stock over 1,500 types, ranges, styles and sizes of panel meters, relays and controllers. They're all listed in Catalog 4200. Write for your free copy.

Special:

Need a special or unusual meter? Let Simpson help you custom design it. Send us your specs and we'll send you a quote. But check our catalog first — that "special" may be a standard Simpson stock item.

Get off-the-shelf delivery from your local electronics distributor.



SIMPSON ELECTRIC COMPANY

853 Dundee Avenue, Elgin, Illinois 60120
(312) 695-1121 • Cable: SIMELCO • Telex: 72-2416

IN CANADA: Bach-Simpson, Ltd., London, Ontario

IN ENGLAND: Bach-Simpson (U.K.) Limited, Wadebridge, Cornwall

IN INDIA: Ruttonsha-Simpson Private, Ltd., Vikhroli, Bombay

KATY INDUSTRIES



ELECTRICAL EQUIPMENT GROUP

Simplified biofeedback circuit detects alpha-wave activity

A simple circuit can detect alpha waves and provide feedback of alpha activity to the user.

The circuit provides high input impedance, high gain, selective alpha-wave filtering from 8 to 13 Hz and a time-averaged indication of activity. The tone produced by the speaker rises in pitch as alpha waves appear and falls off as the activity decreases.

The circuit is divided into three parts. The first stage, a high input-impedance differential amplifier, raises the level of the minute brainwave voltage about 2000 times. The second stage, an active filter for alpha-wave frequencies, rejects other classes of brainwave activity. The filter allows over-all gain control by means of a 10-k potentiometer.

The final stage, a voltage-controlled oscillator and speaker driver, examines the average level of

alpha activity. The frequency of the tone at the speaker follows the averaged voltage at the output of C_5 . Batteries are used because they are safer than line supplies, and provide less interference to the faint brainwave signal (5 to 50 μV).

Electrode preparation and placement is covered in the reference, but note that a third or common electrode is also needed. The requirement is met if you mount the circuit in a metal box and hold it during use. The gain potentiometer R_{12} is adjusted to match the sensitivity of the circuit to the subject's specific alpha levels.

Paul Lutus, Design Engineer, Philips Broadcast Equipment Corp., Government Systems Div., One Philips Parkway, Montvale, N.J. 07645

Reference

Stoyva Johann (Ed.), "Biofeedback & Self-Control," Albine Publishing Co., New York, N.Y., 1971.

CIRCLE No. 313

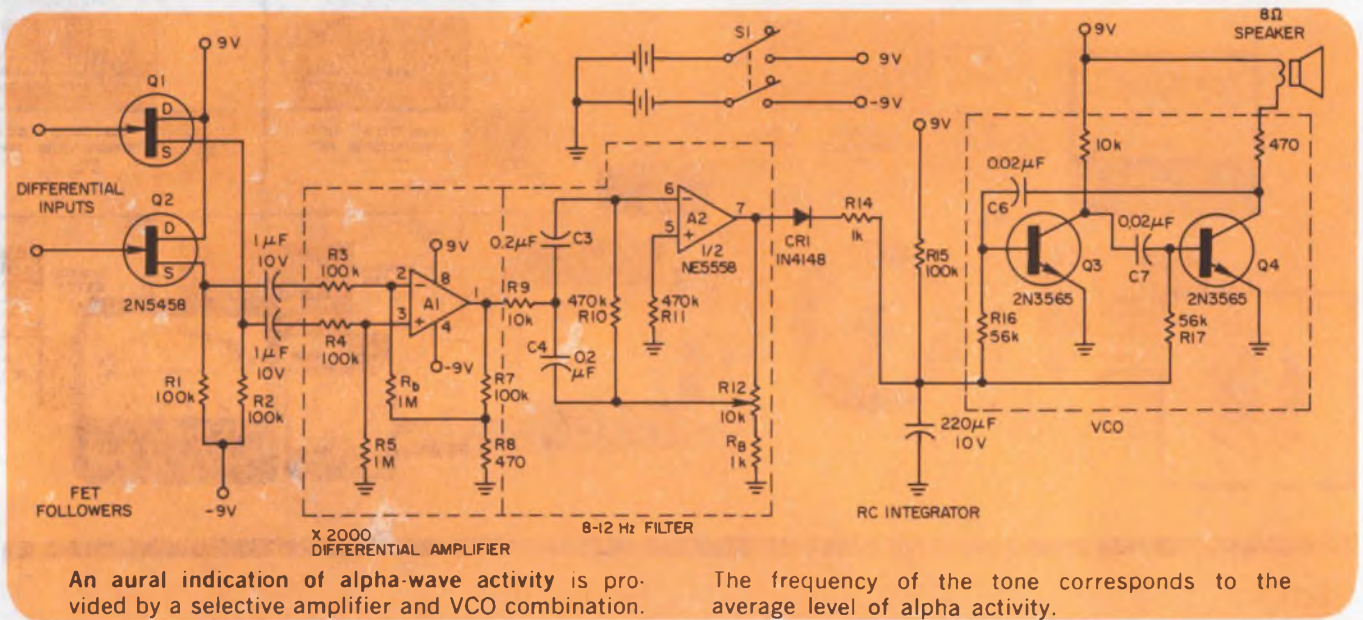

IFD Winner of February 1, 1974

P.R.K. Chetty, Indian Space Research Organization, A 3-6, Peenya Industrial Estate, Bangalore, India 560022. His idea "EXCLUSIVE-OR Circuit Handles Wide Range of Input Levels Without Power Supply" has been voted the Most Valuable of Issue Award.

Vote for the Best Idea in this issue by circling the number for your selection on the Information Retrieval Card at the back of this issue.

SEND US YOUR IDEAS FOR DESIGN. You may win a grand total of \$1050 (cash)! Here's how. Submit your IFD describing a new or important circuit or design technique, the clever use of a new component or test equipment, packaging tips, cost-saving ideas to our Ideas for Design editor. Ideas can only be considered for publication if they are submitted exclusively to ELECTRONIC DESIGN. You will receive \$20 for each published idea, \$30 more if it is voted best of issue by our readers. The best-of-issue winners become eligible for the Idea of the Year award of \$1000.

ELECTRONIC DESIGN cannot assume responsibility for circuits shown nor represent freedom from patent infringement.

Watts New



Sorensen introduces the new, higher power density DCR-B series lab/system dc power supplies. Designed specifically as an extension of the popular single-phase DCR-A series. Minimum panel height is 3½". Power output is up to 2700 watts. Noise and ripple are 50% lower than in previous models.

Other DCR-B advantages: low cost-per-watt; fast response time; choice of 32 new versatile models to cover a broad range of applications; exceptional efficiency and dependability; and new, less expensive overvoltage protection option that can be installed at the factory or in the field. For complete data, contact the Marketing Manager at Sorensen Company, a unit of Raytheon Company, Manchester, N.H. 03103. (603) 668-4500.

Representative Specifications – DCR-B

Voltage Ranges: 0-10, 20, 40, 60, 80, 150, 300, 600 volts DC			
Efficiency: Up to 86% typical			
Panel Height	Cooling	Nominal Output Power (watts)	Price Range
3½"	convection	500	\$400-475
5¼"	convection	1000	575-690
7"	convection	1800	775-975
7"	fan	2700	1075-1125

Sorensen
POWER SUPPLIES

Subnanosecond transients detected with ECL logic

A tunnel diode, coupled directly to a gate of the emitter-coupled logic family detects subnanosecond transients with an output signal that is ECL-compatible.

Developed at Hull University in England, the circuit has a tunnel diode that is dc-biased at 8 mA through a 200- Ω resistor to ground. With the diode in its low state, the transient input voltage develops a current through the 100- Ω resistor. Provided that this current is large enough, the tunnel diode switches to its high state.

During the switching the tunnel diode has an effective load of 100 Ω in parallel with 200 Ω , or 6 Ω . The switching time is directly proportional to the total capacitance across the tunnel diode, which is the sum of the junction capacitance, the logic-gate input capacitance and any stray capacitance. A typical junction capacitance is 1.5 pF and, for a logic-gate value of 3 pF, the total capacitance

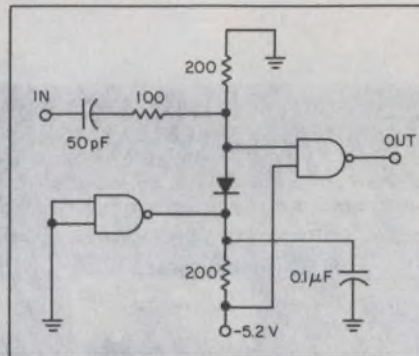

across the diode is about 6 pF. With a bias current of 8 mA, the predicted diode switching time is 0.35 ns. With a 0.5-ns-duration pulse, the circuit operates satisfactorily down to 0.5 V, at which point the switching becomes erratic. The addition of inductance between the diode and the gate input can improve the switching speed by removal of the shunt-capacitance effect of the logic gate.

Phase shifter holds amplitude within $\pm 0.4\%$

A German phase shifter for the 0-to-5000-Hz range has been designed to maintain amplitude deviations within $\pm 0.4\%$. The phase angle can be varied between 0 and 180° with infinite resolution.

Developed at the Institut Für Nachrichtentechnik in Braunschweig, West Germany, the shifter is being used to set up the calibration equipment for a magnetometer.

Three operational amplifiers are used in the shifter—one as the main phase shifter and two as input and output buffers. For stability, metal-film resistors and low-loss, low-inductance capacitors are

used in the feedback loops.

The variable, phase-angle potentiometer control presented problems because parasitic inductances and capacitances greatly influence amplitude stability. The combination finally chosen—a 24-pole ceramic switch with a series of 2-k Ω metal-film range resistors, switched in series with a 2.7-k Ω single-turn Cermet potentiometer—is described as superior to a wire-wound potentiometer and a conductive-plastics type. The phase-shifting capacitance is switched in steps, to linearize the phase control over three decades.

Anisotropic conductors herald new devices

A new class of anisotropic conductors, which conduct electricity in one plane only, is under development at Brown Boveri in Switzerland. The substances are said to be perfect insulators for voltages perpendicular to the conducting plane.

The anisotropic properties are induced by long chains of platinum atoms in substances such as potassium-platinum-cyanide. Such properties are expected to be useful in microwave-cavity technology and optics. For example, since the electrical vector of visible light is also short-circuited along the conducting plane, transparent layers of anisotropic conductors are suitable for polarized filters.

A flight simulator for the Concorde due

A supersonic flight simulator for the Concorde SST will be built by Redifon Flight Simulation, in Crawley, England, in collaboration with the British branch of Link-Miles (Singer Co.). A contract, awarded by the British Aircraft Corp. calls for use of a Link six-axis motion system, a Redifon Duoview color closed-circuit TV display, and Redifon R200A computers and interface equipment.

4-k-bit core memory to go into solar probe

A 4-k-bit ferrite core memory, to be incorporated in the Helios solar-probe spacecraft, has been designed through the cooperative efforts of Siemens, in West Germany, and the Braunschweig Technical University.

Total mass of the unit is 42 grams. Mechanical stability is 38 g for vibrations between 50-to-200 Hz, and 6 g in the 200-to-2000-Hz range. The temperature range is between -55 and +110 C.

THE FIRST PRACTICAL DATA-ACQUISITION MODULE:



**Complete 12-bit,
16-channel
system fits 0.5"
card spacing--
anywhere.**

**Better
performance,
at lower cost,
than individual
module
combinations.**



0.375"
THIN

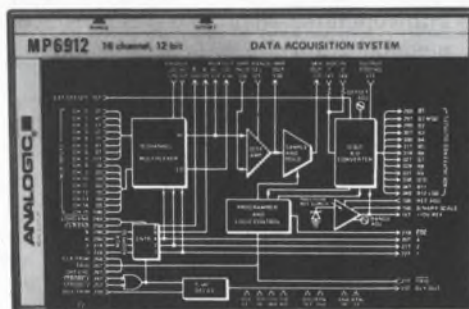

On a minicomputer motherboard, medical instrument or process control system . . . mounted on a single small card . . . plugged directly into a card-cage connector—there's always room for the 0.375"H x 4.6"W x 3.0"L Model MP6912: With space at a premium, this remarkable plug in, easily serviceable high-performance / low-cost system is your first really practical alternative to either in-house design or larger more costly systems. Particularly since you'd actually pay *more* to get comparable performance from individual modules that need 3-5 times the "real estate".

You get a 16-channel multiplexer (expandable to 256 channels), fast sample and hold, and a 12-bit A/D converter (accuracy $\pm 0.025\%$ at a 100kHz thrupt rate), integrated with complete programming, control, and timing logic. (That's what we call the first *practical* data acquisition module.)

What you don't get is equally important: error accumulation; module inter-connection costs and headache; redesign challenges

every time the application changes; and testing, documenting, and quality-controlling at the module level.

The MP6912 is an optimized design: 100% shielding on all six sides to minimize interference; minimum parts count for inherently high reliability; an exceptional 100kHz basic throughput rate that can be "short cycled" up to 450kHz; buffered outputs for trouble-free digital inter-connection.

A companion D.C. to D.C. converter, the MP3020, which is powered by the +5V logic supply is also available to provide all the power needed for the MP6912 in a compatible 0.375" thin package.

Write for our 16-page designer's guide to the MP6912—applications and timing diagrams, set-up and calibration procedures, etc. and see why the Analogic alternative makes sense. Analogic, Audubon Rd., Wakefield, Mass. 01880; phone (617) 246-0300.

Northeast, 617-235-2330, 203-966-2580,
315-466-0220, 201-652-7055,
212-947-0379

Mid Atlantic, 215-272-1444,
215-687-3535, 703-790-5666,
301-252-8494

Midwest, 314-895-4100, 913-362-0919,
216-267-0445, 513-434-7500,
313-892-2500, 412-892-2953,
312-283-0713, 414-476-1500,
317-844-0114

South, 713-785-0581, 214-620-1551,
305-894-4401, 919-227-3639,
205-534-9771, 305-773-3411,
813-867-7820

West, 303-744-3301, 505-523-0601,
602-946-4215, 505-292-1212,
714-540-7160, 415-398-2211,
206-762-7664, 503-643-5754,

Canada, 613-836-4411, 604-688-2619,
416-499-5544, 514-636-0525,
902-434-3402

ANALOGIC
... The Digitizers

new products

Desk-top terminals have advanced features



Car-Mel Electronics, 2218 Cotner Ave., Los Angeles, Calif. 90064. (213) 477-4216. \$1110 (100 quan); stock.

The compact D-302 CRT terminal can be used to enter information on a screen and transmit the data at high speed (up to 9600 baud) to a polling computer. The terminals also include the protected field feature. Up to 128 terminals may be connected to a single computer port—directly or by use of a modem—since each terminal may be daisy-chained to the next one in the line and has its own specific address.

CIRCLE NO. 253

Interface card links HP 2100s at 25 Mbit/s

Hewlett-Packard, 1501 Page Mill Rd., Palo Alto, Calif. 94304. (415) 493-1501. Stock.

A high-speed series interface links HP 2100 computers. The hardwired interface card, designated the HP 12889A, enables asynchronous data transfer at 2.5 Mbits/s at distances up to 1000 feet and up to 1.25 Mbit/s at distances up to 2000 feet. The device plugs directly into the I/O structure of each 2100 to be linked. Also supplied is a software driver that is compatible with HP's disc-operating system, DOS-III.

CIRCLE NO. 254

Two LSI processors aim for low end of market

Digital Equipment Corp., 146 Main St., Maynard, Mass. 01754. (617) 897-5111. See text.

Two processors—an 8-bit LSI Microprocessor Series (MPS), and a 12-bit MSI version of the PDP-8—are designed for the low end of the computer market. The MPS with a basic configuration of CPU plus 1 K of RAM sells for \$745 in single quantities and \$445 for 1000 units. The PDP-8/A will sell for \$895 in single units and \$537 for 1000 unit quantities. The Microprocessor Series consists of five modules that include CPU, RAM and PROM. The CPU module communicates over an 8-bit data and memory bus, and contains an 8-bit parallel arithmetic unit. All program preparation is performed on a 4-k, PDP-8. The 12-bit PDP-8/A miniprocessor is a two module configuration. The CPU can address up to 32-k words. The unit allows for efficient use of memory and has a cycle time of 1.5 μ s. The PDP-8/A is fully compatible with existing PDP-8s in hardware and software and can execute all existing PDP-8 programs.

CIRCLE NO. 255

Modular CRT terminal offers 64-color graphics

Cybernex Corp., 922 Industrial Ave., Palo Alto, Calif. 94303. (415) 328-8470. From. \$5120.

The AS103 is a vector programmed CRT terminal that provides high speed graphics in up to 64 colors. Plug in function generators are available for vectors, characters and circles. The unit can be interfaced directly to a minicomputer and uses the host's memory for refresh or can be supplied with a list processor that provides a local refresh buffer and data formatting capabilities. The AS103 has a 10 \times 8-in. viewing area with 1024 \times 1024 addressable points. Interfaces and software are available for popular minis.

CIRCLE NO. 256

Graphics tablet mated with calculators



Summagraphics Corp., 398 Kings Highway, Fairfield, Conn. 06430. (203) 384-1344. See text.

An interface is available to connect the manufacturer's Data-Tablet/Digitizer with the HP-9800 Series of calculators. The Data Tablet digitizes graphical source data, thus enabling the calculator to compute distances, perimeters, areas, regressions, and other factors from source material. Prices for digitizer and interface range from \$1750 to \$4400, depending on the useful working area and quantity ordered.

CIRCLE NO. 257

Tablets add free-hand graphics input

Tektronix, P.O. Box 500, Beaverton, Ore. 97005. (503) 644-0161. August.

The graphics tablet line includes two standard sizes. The 4953 is 11-by-11 in., has a 10-bit format, and is intended primarily for use with the 4010, 4012 and 4013 terminals. The 4954 tablet is 40-by-30 in., has a 12-bit format, and is intended for use with the larger Tektronix 4014 and 4015 terminals. Each of the tablets, however, will work with any of the terminals. The tablet converts the position of a pen on a writing surface into the digital information required to position the writing beam on the screen of a terminal. Graphic data can be simultaneously transmitted to the computer and the terminal to provide a local display, or it can bypass the terminal if no local display is wanted. The smaller tablet has a 1024 \times 1024 point grid with 0.01-in. spacing. The larger tablet uses a 4096 \times 4096 point matrix with 0.01-in. spacing.

CIRCLE NO. 258

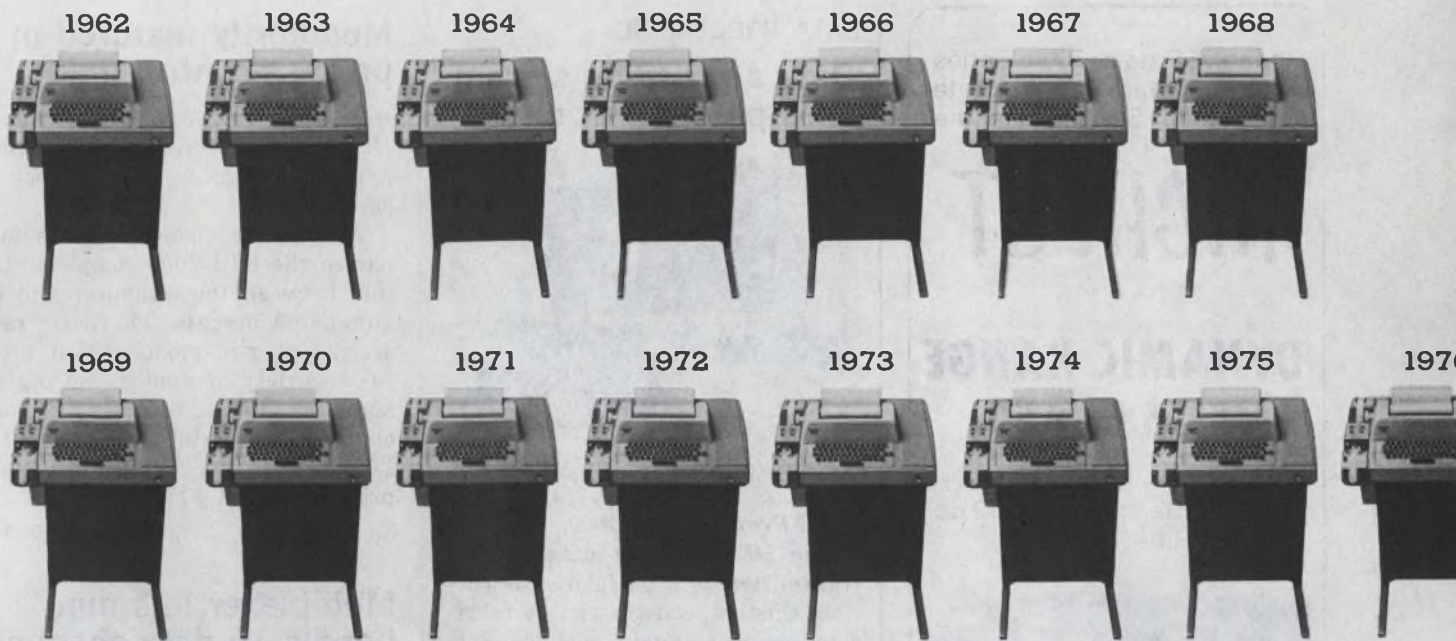

Just how much longer will the model 33 be around?

The moment economy, reliability and versatility in data communications go out of date, the model 33 will become obsolete. But the more we look at today's business and economic environment, the more it seems the model 33 will live forever.

Because where else can you get so much for so little?

When the model 33 was first introduced, it was a bargain. Today, it's still a bargain. But it's hardly the same machine.

We've got a team of engineers assigned to the model 33 and their job is to keep making it better. Every year, they come up with a number of new features and improvements. Some improvements make the 33 more

dependable and versatile. Others make it easier and more economical to manufacture.

Because of these changes, the model 33s we're building today are standard-duty terminals instead of light-duty units. And our manufacturing changes have enabled us to stay ahead of rising costs.

Since we feel the model 33 is going to be around for a long, long time to come, our parts support, quality service and continued product improvement programs are as strong as ever.

It takes more than manufacturing facilities to build the terminals Teletype[®] Corporation offers. It also takes commitment. From people who think service is as important as sales. In terminals for computers and point-to-point communications.



The computercations people.

For more information about any Teletype product, write or call: TERMINAL CENTRAL Teletype Corporation, Dept. 89U, 5555 Touhy Avenue, Skokie, Illinois 60076. Phone 312/982-2500. Teletype is a trademark registered in the United States Patent Office.

Phoenix Data's 7000 Series Automatic Gain Ranging Data Acquisition System has the

HIGHEST

DYNAMIC RANGE IN ITS CLASS

Dynamic Range input: 112 db
Thruput Rate: 50 KHz

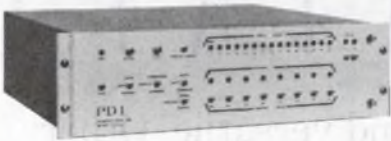

Phoenix Data's 7000 Series

The 7000 Series of High-Speed, Automatic/Programmable, Gain-Ranging Data Acquisition Systems offer *maximum flexibility* in Input Levels, Scanning Rates, and Resolution at *minimum cost per channel*.

FEATURES:

- Dynamic Range input of 112db
- Five Customer-Selectable gains from 1 to 100.
- ADC resolution thru 15 Binary Bits.
- Full Scale Input Ranges from ± 10 millivolts to ± 10.24 volts.
- Automatic or programmed Gain Ranging thruput rate to 50 KHz.
- Thruput rate to 100 KHz at Unity Gain.
- CMRR of 94db.
- Thruput accuracy to 0.01%.
- Up to 128 differential input channels with expansion capability.

If it's stability, accuracy, speed, or all-around quality performance you need in Data Conversion, contact Phoenix Data *now!*



PHOENIX DATA, INC.

3384 West Osborn Road
Phoenix, Arizona 85017

Ph. (602) 278-8528. TWX 910-951-1364

INFORMATION RETRIEVAL NUMBER 37

DATA PROCESSING

Data acquisition system uses plug-in modules



Metrodata Systems, P.O. Box 1307, Norman, Okla. 73069. (405) 329-7007. From under \$4000.

The DL640 series data logger/transmitter uses modular construction. Custom systems can be fabricated using standard modules. Servicing is easy and requires no special tools. The standard DL640 accepts one to 24 analog inputs, expandable up to 72. In addition, 12 digital BCD inputs can be provided. Data are recorded on 0.5-in. computer compatible magnetic tape or on the company's TD-60 tape deck using a 0.25 in. \times 1200 ft. endless loop tape cartridge. Time data are automatically entered in each data scan in days, hours, minutes, and seconds and are set by front panel switches. The unit also has selectable scan rates, scan lengths, and 17 scan intervals. Data in any channel may be selected and displayed on the front panel. The system uses either 12 V dc or 115 V ac with stand-by dc capability in case of line failure.

CIRCLE NO. 259

Floppy disc is also IBM compatible

Control Data Corp., Box 0, Minneapolis, Minn. 55440. (612) 853-4094.

The CDC 878 flexible disc is interchangeable with the IBM 3540/3740 product family, as well as the manufacturer's 9400 and equivalent drives. Preformatting makes the CDC 878 compatible with the IBM Diskette. The format includes 77 tracks with 26 sectors per track and a maximum of 128 bytes per sector. The disc is shipped error-free, but the format allows for two spare tracks should noncorrectable errors occur during usage.

CIRCLE NO. 260

Modularity featured in process-control link

Process Computer Systems, 5467 Hill 23 Dr., Flint, Mich. 48507. (313) 744-0225. See text; stock to 90 days.

A process control interface named the GPI 2000 completes the link between the computer and an automated process. The basic rack accepts plug-in modules that process a variety of analog and digital signals. Other modules provide channel addressing and computer I/O interfacing. Typical interface prices begin at \$1790.

CIRCLE NO. 261

Multiplexer lets mini handle 16 data channels



Hewlett-Packard, 1501 Page Mill Rd., Palo Alto, Calif. 94304. (415) 493-1501. \$2200; stock.

The 12920A, a high-performance multiplexer, enables signals from up to 16 communication lines to be channeled through the HP-2100 computer's I/O system. The asynchronous 16-channel unit operates at programmable data rates from 57 to 2400 baud per channel and can interface with asynchronous devices that are hardwired locally or connected remotely through a 103-type data set. The basic 12920A kit consists of three interface cards, a connector panel and cables and is installed into existing I/O slots of the 2100 central processing unit. The system offers several programmable features such as character length (from 5 to 12 bit); full-duplex, half-duplex, or echoplex-mode transmission; speed and break detection, parity generation and checking; and variable-length stop code. An automatic answering feature is also included. An optional control interface, priced at \$800, allows the connection of up to 16, 202-type data sets.

CIRCLE NO. 262

1000 dB/ DECADE SLOPE ACTIVE FILTERS

FOR MAXIMUM ADJACENT FREQUENCY REJECTION

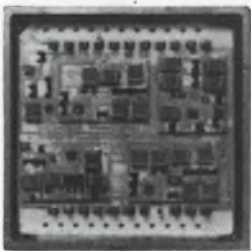
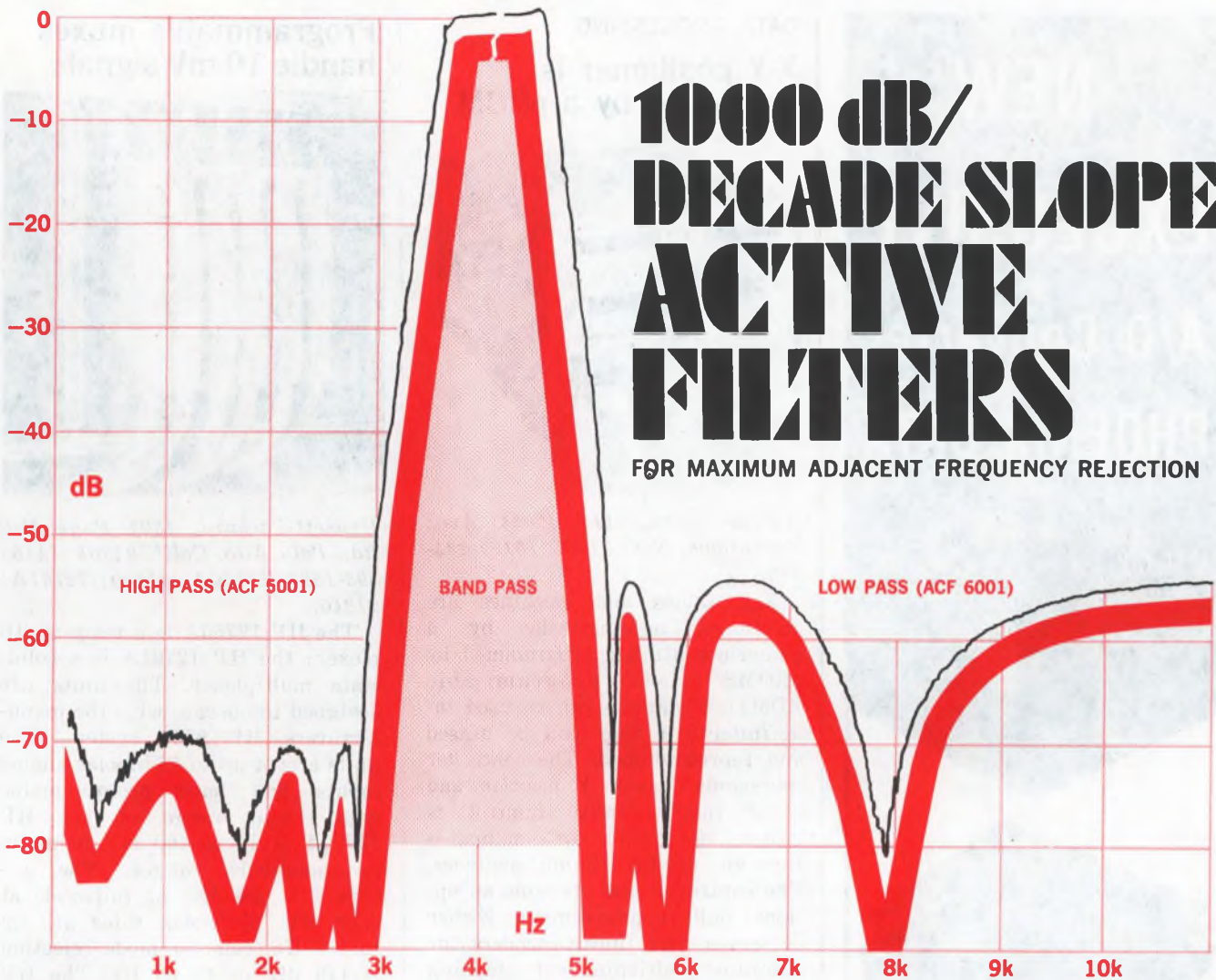

General Instrument's new state-of-the-art active filters are designed for use in telecommunications systems, data and signal processing, biomedical, navigational, seismographic and other applications . . . wherever critical frequency rejection is a must.

Available in both high pass (ACF 5001) and low pass (ACF 6001) versions, these filters can be used together as a band pass filter. Each is packaged in a 1.6" x 1.6" x .25" hermetically sealed metal plug-in case.

Both filters are 8th order Cauer Elliptical in design with characteristics in the 3 to 6 kHz range.

For complete information on these, or any other General Instrument hybrid active filter, fill in and mail the adjacent coupon, or call (516) 733-3243.

GI'S GOT IT!

General Instrument Corporation,
Hybrid Division,
600 W. John St., Hicksville, N.Y. 11802

Please send me complete information on the following
General Instrument Hybrid Active Filters:
(check boxes indicating your interest)

- | | |
|---|--|
| <input type="checkbox"/> 1000 dB Elliptical | <input type="checkbox"/> Linear Phase |
| <input type="checkbox"/> Low Pass | <input type="checkbox"/> Cauer |
| <input type="checkbox"/> High Pass | <input type="checkbox"/> Universal |
| <input type="checkbox"/> Band Pass | <input type="checkbox"/> C-Message |
| <input type="checkbox"/> Band Rejection | <input type="checkbox"/> 1000 Hz Notch |
| <input type="checkbox"/> Butterworth | <input type="checkbox"/> 50 or 60 Hz Rejection |
| <input type="checkbox"/> Chebyshev | <input type="checkbox"/> Comb |
| <input type="checkbox"/> Bessel | <input type="checkbox"/> Leap-Frog |
| <input type="checkbox"/> Bi-Quad | <input type="checkbox"/> Custom |

NAME _____ TITLE _____

COMPANY _____

ADDRESS _____

CITY _____ STATE _____ ZIP _____

**GENERAL INSTRUMENT CORPORATION
HYBRID DIVISION**



NEW
and
EXCLUSIVE
an
A/D Converter
from
PHOENIX DATA
with

High Speed: 4 usec.
(250,000 conversions per sec.)
High resolution: 15 bits
High accuracy: 0.0065% of FSR



New Model ADC1215F converter from Phoenix Data is available in two basic models: Single-ended and differential.

Phoenix Data's new Model ADC1215F A/D converter has a resolution of 15 binary bits and a total conversion time of 4 microseconds (250,000 conversions per sec). Accuracy of 0.0065% of FSR is guaranteed in addition to complete monotonicity. Analog dynamic range is in excess of 86 db.

If it's stability, accuracy, speed, or all-around quality you need in Data Conversion, contact Phoenix Data now!



PHOENIX DATA, INC.

3384 W. Osborn Rd. Phoenix, AZ 85017
Ph. (602) 278-8528, TWX 910-951-1364

INFORMATION RETRIEVAL NUMBER 75

DATA PROCESSING
**X-Y positioner is
controlled by a pROM**



Anorad Corp., 115 Plant Ave.,
Smithtown, N.Y. 11787. (516) 234-
1824.

X-Y tables and machines are positioned automatically by a numeric controller programmed by pROMS (field programmable ROMs). Programs can be used indefinitely, or they can be erased and reprogrammed. The controller commands X and Y position and speed independently. Control is either automatic or manual—through digital thumb switches. The controller also contains an optional built-in programmer. Either dc servos with linear encoders for accurate positioning, or stepping motor drivers for less stringent requirements can be used.

CIRCLE NO. 263

**Remote data logged
and formatted to tape**



Memodyne Corp., 369 Elliot St.,
Newton Upper Falls, Mass. 02164.
(617) 527-6600. See text; 2-4 wks.

The 4000 data logging system gathers remote data for processing at a central facility. The heart of the system is a standard Philips tape cassette. Data are recorded incrementally, bit-by-bit on a low-power cassette transport. The tapes are later converted to IBM tape format or serial ASCII. Prices range from \$325 for a transport to \$7459 for a complete IBM-compatible tape converter.

CIRCLE NO. 264

**Programmable muxes
handle 10 mV signals**

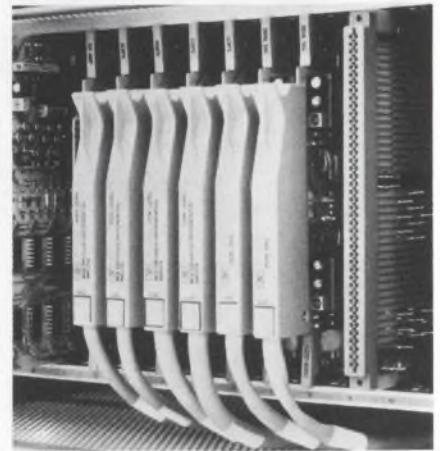

Hewlett-Packard, 1501 Page Mill
Rd., Palo Alto, Calif. 94304. (415)
493-1501. 12760A: \$1600; 12761A:
\$1240.

The HP 12760A is a relay multiplexer; the HP 12761A is a solid-state multiplexer. The units are designed to operate with the manufacturers HP 9600 system. The units accept up to 16 bipolar analog inputs and have programmable gain. Input range of the HP 12760A is 10 to 400 mV in seven programmable ranges. The accuracy is $\pm 0.29\%$ of full scale at ± 10 mV. Multiplex rates are up to 150 Hz; common-mode rejection is 115 dB, dc to 60 Hz. The HP 12761A offers eight programmable ranges. Its accuracy is $\pm 0.33\%$ of full scale with ± 10 mV input at 20 Hz sample rate. Common mode rejection exceeds 100 dB, dc to 60 Hz.

CIRCLE NO. 265

**External memory board
helps debug programs**

Douglas Electronics, 718 Main
Blvd., San Leandro, Calif. 94577.
(415) 483-8770. \$175; stock.

A Memo and Register board named the 101-DE-8 is compatible with PDP-8/e computer system. The board provides four MQ-like registers for temporary storage of repetitive data values and eight memo flip flops to control program flow. The registers permit an accumulator value to be stored and retrieved without first clearing the accumulator. The memos permit the programmer to set up program branches in advance and provide ready access to decision points.

CIRCLE NO. 266

When your design calls for the brightest readout...

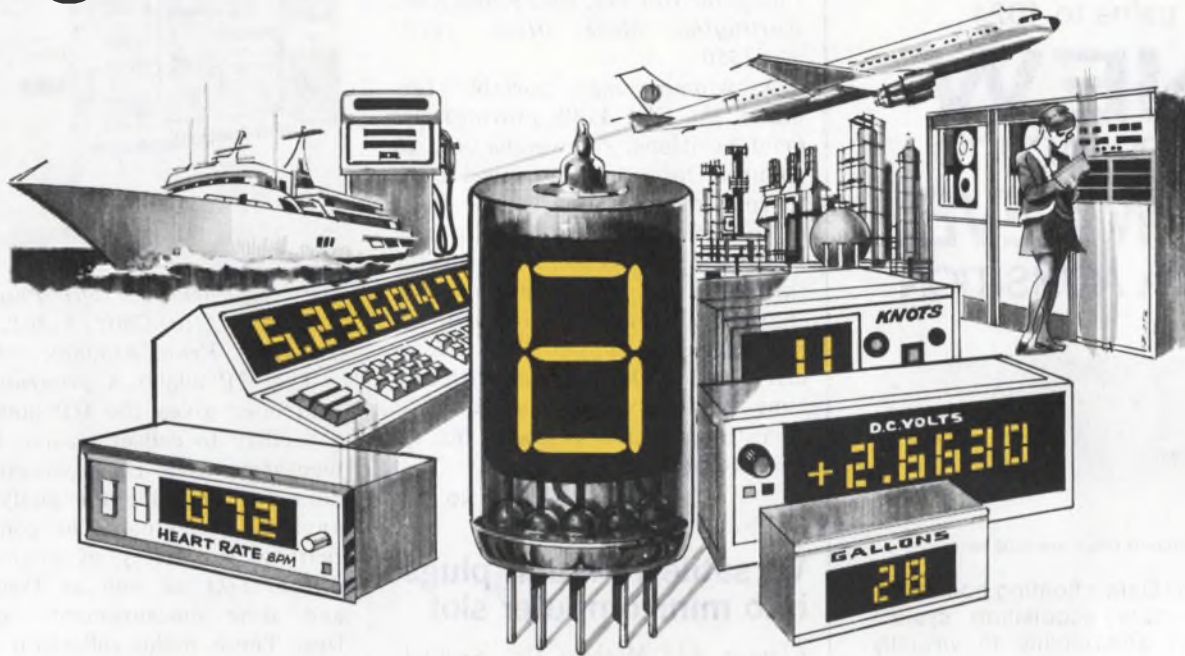

consider all the advantages of RCA NUMITRON Display Devices.

In applications where brightness is critical RCA NUMITRON devices meet your most exacting requirements. They don't wash out, even in direct sunlight!

But brightness is just one important feature to think about when selecting display devices. Consider all the features that RCA NUMITRON devices have to offer:

- Unlimited color filter selection because of wide-spectrum light emission.
- Brightness is completely controllable — the device maintains uniform brightness, from segment-to-segment, even when operated at reduced voltages.
- High reliability and rugged construction. Life expectancy is more than 100,000 hours.
- Low-voltage operation (4.5 volts or 2.5 volts nominal).
- Compatible with IC decoder/drivers such as the RCA CD2500E family.
- Freedom from induced or radiated interference.
- Planar construction offers uncluttered,

wide-angle viewing.

- Operating temperature range from -50°C to $+125^{\circ}\text{C}$.

RCA NUMITRON devices are rugged! The DR2200 Series can withstand shock of 200g and vibration of 20g max. over a 60 to 500 Hz frequency range. NUMITRON displays are flexible, too. Solderable base pins permit direct PC board mounting. The DR2000 series of devices fit low-cost 9-contact miniature sockets. DR2100 and DR2200 Series fit TO-5 10-contact sockets.

Bright, sharp, dependable — RCA NUMITRON devices offer many important performance advantages to designers of readout equipment for industrial, commercial, or military applications.

Ask for RCA's NUMITRON Display Devices Designer's brochure (NUM-421A). You'll get the latest application information and data. Contact your RCA representative or RCA NUMITRON Device Distributor, or write, RCA Commercial Engineering, Sec. 57F7 415 S. 5th St., Harrison, N.J. 07029.

RCA NUMITRON
Display Devices

INTERNATIONAL SALES OFFICES: ARGENTINA—Casilla de Correo 4400 Buenos Aires/BRAZIL—Caixa Postal 8460 Sao Paulo/CANADA—21001 No. Service Rd. Ste. Anne de Bellevue 810 Quebec/ENGLAND—Sunbury-on-Thames, Middlesex/HONG KONG—P.O. Box 112/MEXICO—Apartado 17-570 Mexico 17, D.F./SWITZERLAND—118 rue du Rhone CH1204 Geneva.

INFORMATION RETRIEVAL NUMBER 76

Overall analog
dynamic range: 132 db

Automatic/
programmable
gains to 1024

NEW APPROACH TO LOW LEVEL DATA ACQUISITION

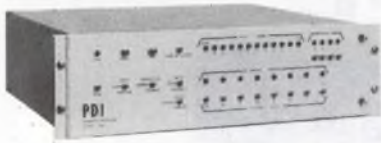

Phoenix Data's new 8000 Series

Phoenix Data's floating point 8000 Series data acquisition system features adaptability to virtually any analog input signal currently in use—offering automatic or programmed gain selection with 11 binary ranges from ± 10 millivolts to ± 10.24 volts full scale. The data word (12 binary bits) is combined with the range data (4 binary bits) for a 16 bit output word in the automatic ranging mode. The system will resolve input changes of 5 microvolts on the ± 10 millivolt range for an overall analog dynamic range of 132 db.

FEATURES:

- ADC resolution of 12 binary bits.
- 11 binary gain ranges.
- ± 10 mv to ± 10.24 V input ranges.
- Solid state MOSFET multiplexing.
- Thruput rates from 1 to 20 KHz.
- Auto or programmable gains.
- Up to 128 channels per chassis.
- System accuracy of .05% of reading.
- System T.C.: $0.001\% \text{FSR} \pm 1 \mu \text{ volt RTI}/^\circ\text{C}$.

If it's stability, accuracy, speed, or all-around quality you need in Data Conversion, contact Phoenix Data now!



PHOENIX DATA, INC.

3384 West Osborn Road
Phoenix, Arizona 85017

Ph. (602) 278-8528. TWX 910-951-1364

DATA PROCESSING

Portable terminal now has 132 print positions

Computer Devices, Inc., 9 Ray Ave., Burlington, Mass. 01803. (617) 273-1550.

A wide-carriage portable terminal, the CDI 1132, provides 132 print positions, yet weighs only 25 pounds. Output is furnished by a thermal printer at selectable rates of 10, 15 and 30 char/s in both upper and lower case. The operator can select line widths of 80 or 132 characters from the keyboard. An integral acoustic coupler allows direct use of the terminal with any time-sharing system. The CDI 1132 operates with ASCII codes, but an APL version is available.

CIRCLE NO. 267

Versatile FFT unit plugs into minicomputer slot

Elsytec, 212 Michael Dr., Syosset, N.Y. 11791. (516) 364-0560. \$6000; 60 days.

The 306/MFFT consists of one card, which plugs directly into any Data General Nova computer. The unit performs Fourier transform related operations that include forward and inverse FFT, spectral magnitude, Hanning weighting and complex multiplication. When used with a NOVA 800, a 1024 real-sample time series can be Fourier transformed and the magnitude of the spectrum formed in 139 milliseconds. Time domain signal processing functions such as correlation and convolution can be rapidly calculated at a rate of $2.8 \mu\text{s}$ per multiply-accumulate. The 306/MFFT is also capable of performing hardware single precision and some double precision arithmetic operations. The unit automatically carries out an arithmetic operation on a complete array with hardware that advances the addresses, counts and number of points processed and checks for the end of the array. In a Nova 800, the 306/MFFT performs single precision adds, subtracts, multiplies, divides and square roots of arrays in $2.8 \mu\text{s}$ per array element. This is equivalent to reducing the cycle time of the Nova 800 from 800 ns to 150 ns.

CIRCLE NO. 268

Controller lets user put instrumentation on-line

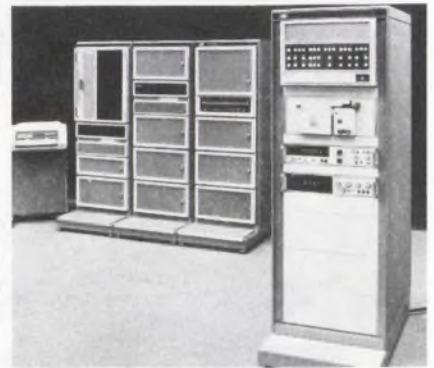

Hewlett Packard, 1501 Page Mill Rd., Palo Alto, Calif. 94304. (415) 493-1501. From \$18,000; 90 days.

The HP 30300 A programmable controller gives the HP 3000 user a facility to collect on-line instrumentation data. Once collected, the data are available for analysis on any 3000 terminal. The controller features a variety of analog and digital I/O as well as frequency and time measurement capabilities. These make collection of instrumentation data an easy task. The controller based on the HP 2100 mini, is a CPU with 8-k words of core and has a dual port controller.

CIRCLE NO. 269

Lab instrument counts and logs random events



Columbus Instruments, P.O. Box 5244, Columbus, Ohio 43212. (614) 488-6176. \$4700.

Model TMC-6 helps automate long duration laboratory experiments in which event counting is used. Six individual counters (five digits) log the events. At the end of a timing cycle, a multiplexer circuit scans the counters and prints the information on a TTY. At the same time, the TTY furnishes a punched tape. The cycle is adjustable from 1 s to 99 min by front panel controls. An optional a/d converter allows the user to record analog signals. The counters furnished operate at a maximum rate of 1 MHz. Slower units can be furnished at the customer's request.

CIRCLE NO. 270

Ferrite power supplies are more efficient and cost less.

Inverter-Rated ferrites™ end the guesswork.

Replace metal laminations with ferrite components and get a lot of trade-offs going in your direction. Less weight. Higher efficiency. Smaller size. Better regulation. And lower system cost.

New applications

High frequency, low loss ferrites from Indiana General have improved the efficiency of inverters and power supplies in everything from computers to portable test equipment.

Whenever you need high efficiency power transfer, our Inverter-Rated components will also give you better regulation and vastly simplify your filter requirements.

Today's answer

Improved ferrite technology has made it economically feasible to operate inverter systems at 2KHz and beyond.

Inverter-Rated® ferrite components from Indiana General are designed and tested specifically for high frequency operation and feature low power loss to 150°C.

With our full line of components you can select the circuit characteristics you need in meeting your specific application requirements.

Ferrites for inverters

We specify and guarantee inductance and core loss under maximum and recommended conditions to end guesswork. By giving you circuit performance data instead of routine magnetic parameters, we make your design task easier and more precise.

Inverter-Rated components are tested under square wave drive so the performance you design in —stays in.

Free design guide

Our new design guide has all the

facts you need; component specifications, temperature characteristics and application data. The design procedure we outline in this guide and an afternoon of your time will tell you if higher frequency operation is the solution to your specific power supply requirements.

Circle the Bingo card for your copy or call (201) 826-5100 and ask us for specific answers to your requirements. Either way, if you're talking high efficiency power supplies, talk to the ferrite experts.

That's us.

Indiana General
Keasbey, N.J. 08832

National distribution through Permag locations in Atlanta, Boston, Chicago, Dallas, Detroit-Toledo, Los Angeles, New York and San Francisco.

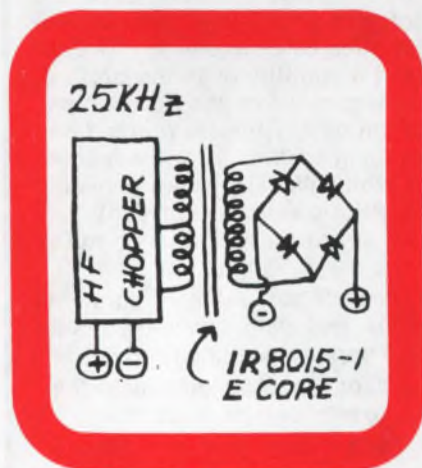

 **indiana general**

a division of Electronic Memories & Magnetics Corporation

INFORMATION RETRIEVAL NUMBER 78

Honeywell computer family announced

Honeywell, c/o Carl Byoir & Associates, 40 Walnut St., Wellesley, Mass. 02181. (617) 237-4100.

A new family of computers, the Series 60, comes in seven models that ranges from small systems, that rent from under \$5000 a month, to large ones for \$100,000 a month. The machines are byte oriented. The smallest machine, Model 66/20 handles up to 131 kbytes of MOS memory with 1.4 μ s cycle time. The top-of-the-line unit handles 8 Mbytes of MOS memory and can address 6-billion bytes of virtual memory. Memory access is on a word basis—the smallest machine accesses two bytes at a time the largest eight bytes. An interesting feature is the use of an electrostatic printer that can produce the equivalent of 18,000 lines/min.

CIRCLE NO. 271

Computer breadboards hf circuit designs

Hewlett Packard, 1501 Page Mill Rd., Palo Alto, Calif. 94304. (415) 493-1501. \$3000.

BAMP (Basic Analysis and Mapping Program) is a computer-aided design procedure to model high-frequency circuit designs that run on the HP-2000 Series time-share systems. The system can be used simultaneously by as many as 32 design engineers, each as if he had the system to himself. The system exploits the S-parameter characterization of active circuitry. The software includes a library of S-parameter data on commercially available active high-frequency components. One can ask the system to optimize for gain, power, bandwidth, for example, and quickly see the available tradeoffs. One can also call up plots of time delay as a function of frequency, for full information on FM or PM circuit distortion before any hardware is ever assembled.

CIRCLE NO. 272

Graphics system works with IBM 360/370

Gould Data Systems, 20 Ossipee Rd., Newton Upper Falls, Mass. 02164. (617) 969-6510. \$20,400-\$39,700; 60 days.

According to the manufacturer, the Plotmaster system breaks the bottleneck in existing computer-generated graphics and allows IBM 360/370 computers to plot data up to 400 times faster than with pen plotters. A specially designed controller transfers data from the computer to Gould's 4820, 5000 or 5100 series electrostatic printer/plotters. In the on-line mode, the controller operates on the computer's selector, byte-multiplexer or block-multiplexer channels. In the off-line mode, a nine-track, 800 or 1600 bit/in read-only tape drive is used for data input to the printer/plotter unit. All software is written in assembler language to conserve internal storage and make efficient use of the main computer. Each subroutine package, however, is callable from Fortran programs.

CIRCLE NO. 273

THINK SINGER

OEM Printer Mechanisms for your Mini-Computer I/O Consoles



Singer's Model 30 OEM Printer Mechanism has been designed with you in mind. It has the performance characteristics and high reliability you need to enhance your Mini-Computer system. Plus, our low mechanism price will make your I/O Console both more competitive and a contributor to the profit of your system sale. Your customers will like the 30 char/sec print speed, low noise level, high quality impact printing and the flexibility of the paper handling system. And, the mechanism's design simplicity and high reliability make servicing extremely simple—we have eliminated all conventional clutches, brakes, stepper or servo motors and complex mechanical mechanisms.

We offer Model 30 in both 80 and 132 column configurations with a broad range of options including forms-feed, tab, vernier platen, and an integrated paper-tape punch and reader.

Send for our new catalog and/or request a demonstration; call, write or circle the reader service number.

Singer-International Teleprinter Corp., 286 Eldridge Road, Fairfield, New Jersey 07006, (201) 785-4450, TWX 710-988-3658.

SINGER

INTERNATIONAL TELEPRINTER CORP.

Undistorted truth

from the new Weston 4445 DMM with true RMS capability.

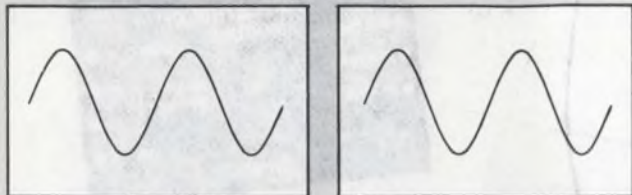

Can your present average-reading DMM tell the difference between these two computer-generated sine waves? Probably not.

But the Weston new model 4445, a low-cost, 3½-digit RMS-responding DMM can. It can seek out and detect the 1% distortion in the third harmonic of the wave on the right. And it could do the same even if the wave were square, triangular or odd-shaped.

So don't depend on just any DMM for those critical AC voltage readings. Stop guessing at those last one or two digits. Get a Weston model 4445 with RMS capability and read every wave to a guaranteed $\pm 0.5\%$ accuracy \pm one digit across ranges from a low 200mV to a full 1000V with 100uV resolution.

For only \$450 you get all this, plus 5 DC voltage ranges, 200mV to 1000V; 6 resistance ranges, 200 ohms to 20 megohms; 2 DC current ranges, 200uA to 2mA; plus 2 AC RMS current ranges, 2uA to 2mA—all fully over-load protected.

And you get it all inside a fully portable, shock-resistant case measuring only

2.25" x 5.45" x 7". Weighs only 2.5 lbs. Comes complete with four nickel cadmium batteries for up to 10 hours continuous operation, and AC line converter for bench-work. Fuses, probes, and carrying case are included, of course.

9744 Transducer adds RMS to any one-volt digital instrument.

If you already use a digital voltmeter with 1-volt DC range, you can add RMS with the new Weston 9744 Transducer.

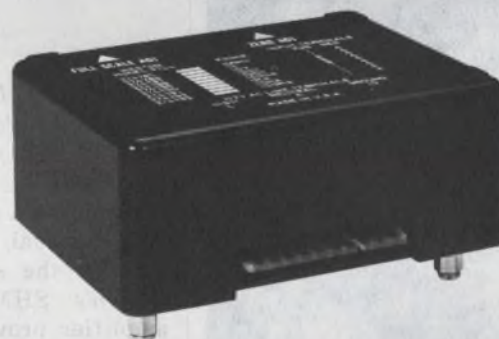

Model 9744 can be ranged to accept AC input from 100mV through 700V. It converts the input to a 1-volt DC output signal for the full-scale RMS value of the AC signal. Will also scale AC current input from 1uA to 1mA. Operates on either 115V or 230V, 50-60 Hz line.

List price only \$150 with case.

See both these exciting new examples of WESTON leadership in test equipment at your nearby distributor today. Or, write direct to Weston Instruments, Inc., 614 Frelinghuysen Ave., Newark, N.J. 07114.

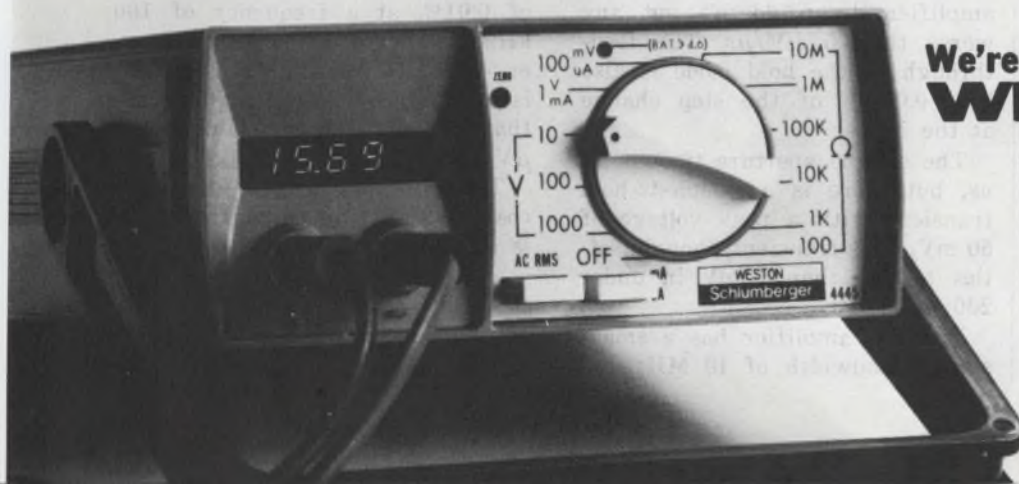

We're either first or best. Or both.
WESTON® WESTON Schumberger

INFORMATION RETRIEVAL NUMBER 80

The new 420L offers everything but the pedestal you'll want to put it on.

The pedestal's optional, but the broad frequency coverage of 100 kHz to 280 MHz and a power output up to 20 watts are standard in this state-of-the-art RF power amplifier.

Linear Class A circuitry will faithfully reproduce input modulations including AM, FM, SSB, TV and pulse with minimum distortion. Completely solid-state, the 420L will supply full power output into any load impedance (from an open to a short circuit).

Driven by any signal generator, frequency synthesizer or sweeper, the 420L is a flexible and versatile source of RF power for general laboratory work, RFI/EMI testing, signal distribution, RF transmission, laser modulation and ultrasonics.

The new 420L offering everything but the pedestal you'll want to put it on, at \$2950.

For further information or a demonstration contact ENI, 3000 Winton Road South, Rochester, New York 14623 (716) 473-6900 or TELEX 97-8283

ENI

The world's leader in solid state power amplifiers



INFORMATION RETRIEVAL NUMBER 81

High-speed s/h circuit gives gain up to 1000

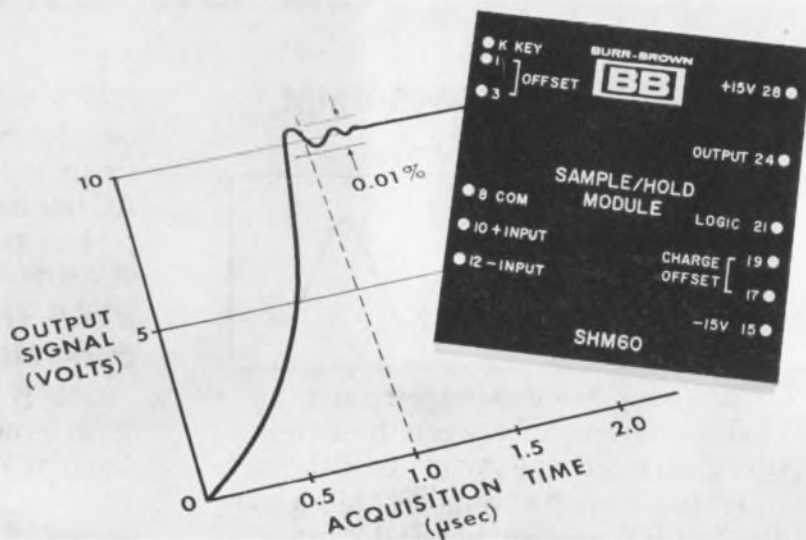

Burr-Brown, International Airport Industrial Park, Tucson, Ariz. 85706. (602) 294-1431. P & A: See text.

Sampling a signal at high speeds isn't unusual, but getting a high gain at the same time is. Burr-Brown's SHM60 sample-and-hold amplifier provides gains from ± 1 to ± 1000 —set by external resistors. Also, it works at system throughput rates from 50 kHz to 1 MHz.

The amplifier has a full-scale voltage range of -10 to $+10$ V. Its acquisition time for a 10-V step is $1 \mu\text{s}$, while for a 20-V step it increases to only $1.5 \mu\text{s}$. The s/h circuit gain error, guaranteed for either step input, is a low 0.01%. Errors in gain caused by changes in temperature are kept to below $\pm 2 \text{ ppm}/^\circ\text{C}$.

When put into the hold state, amplifier droop doesn't get any worse than $5 \mu\text{V}/\mu\text{s}$. The feedthrough in the hold mode is also low—0.005% of the step change at the input.

The sample aperture time is 12 ns, but there is a sample-to-hold transient with a peak voltage of 50 mV. This transient, though, settles to less than 1 mV in under 200 ns.

The s/h amplifier has a small-signal bandwidth of 10 MHz and

a slew rate of $25 \text{ V}/\mu\text{s}$ maximum. The input impedance of $10^{11} \Omega$ keeps the input bias currents to about 50 pA typically.

The SHM60 competes with many other s/h circuits. Two of the closest competitors are the SHM-2 from Dattel (1020 Turnpike St., Canton, Mass. 02021) and the SH730 from Hybrid Systems (87 Second Ave., Northwest Park, Burlington, Mass. 01803).

Both of these units cost \$89 in single quantities, but they have quite different characteristics. The Dattel circuit has no input buffer amplifier, and its small-signal bandwidth is only 500 kHz. It also has a fixed gain of $+1$ and a rather high droop rate of $50 \mu\text{V}/\mu\text{s}$.

The Hybrid Systems unit offers variable gains from ± 1 to ± 100 and a 5-MHz small-signal bandwidth. But it has a feedthrough of 0.01% at a frequency of 100 kHz. Its aperture time is also longer—about 50 ns. And its gain drift is more than 10 times higher than that of the SHM60—almost $25 \mu\text{V}/^\circ\text{C}$.

The Burr-Brown s/h circuit costs \$99 in single quantities and is available from stock.

Burr-Brown	CIRCLE NO. 250
Dattel	CIRCLE NO. 251
Hybrid Systems	CIRCLE NO. 252

Who's tuned in on consumer electronics?

Rate ITT by its accomplishments. Take a look at our 3701 — it's a complete monolithic 2-watt FM sound system for TV, radio and other FM sound communications. It is packaged in a 14-pin power DIP. It eliminates shielded volume control cables and is impervious to output short circuits. It drastically reduces your total component requirement while providing limiting with less than 100 μ V input. It's only one in a line of ITT devices that includes the popular 1330, 1352, 3064, 3065 (plus several proprietary circuits), as well as double-plug diodes, glass rectifiers, zeners and other consumer-oriented components. Tune in to ITT now!

ITT...Logically

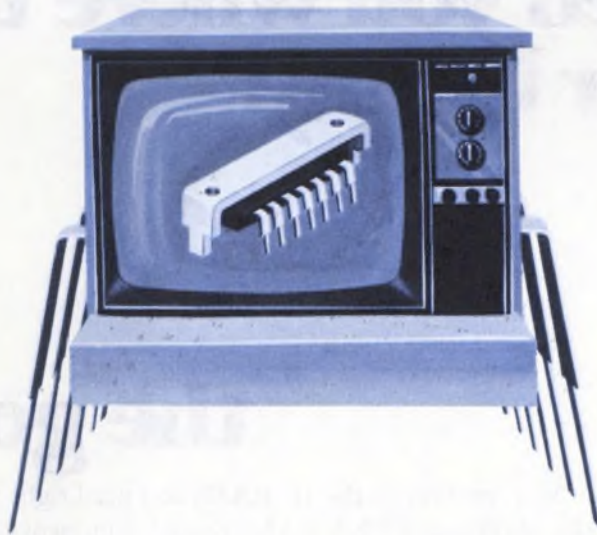

semiconductors

ITT Semiconductors is a division of International Telephone and Telegraph Corporation, 3301 Electronics Way, West Palm Beach, Florida 33407. Phone 305/842-2411. Factories in West Palm Beach, Florida • Lawrence, Massachusetts • Footscray, England • Colmar, France • Freiburg, Germany • Cascais, Portugal • Taipei, Taiwan • Sydney, Australia.

ITT



**“Okay, okay.
You tell me where we can find
twenty thousand RAMs a week
for that much less than the 2102
and I’ll tell you where to find
the Easter bunny.”**

Give him the good news:

You can find all the 1K RAMs you need right now—right here at AMI. We have 4006, 4008 and 4008-9 RAMs ready for immediate delivery. They’re pin-for-pin with Mostek’s. But you can get more of ours—faster. (Stands to reason that when you have larger production facilities you can produce more.) The price is right, too. For example, the 4008-9 is yours for just \$3.50 in quantities over 1000. You get the advantages of a 2102 system, while saving a bundle with our 4006 family. You can get an application note on how to do it, and a free sample, by writing to

Frank Rittiman, AMI, 3800 Homestead Road, Santa Clara,
CA 95051. Phone: (408) 255-3651. Or ask your distributor.

AMI
AMERICAN MICROSYSTEMS, INC.

The charge of the 1K RAMs.

No more waiting for your 4006 family.

You have a perfect combination of price/performance for your 1024 bit MOS RAM applications. Use them for buffer or scratch pad memories. Or for peripherals, terminals, displays, programmable calculators, cash registers, optical scanners, spectro-analyzers.

And we give you more than fast deliveries. We give you specs like these:

P/N	S4006	S4008	S4008-9
No. of Bits	1024x1	1024x1	1024x1
Access Time	400 ns	500 ns	800 ns
Cycle Time	650 ns	900 ns	1000 ns
Power Supply	+5V, -12V	+5V, -12V	+5V, -12V

And this is how the S4006/8/8-9 looks on paper:

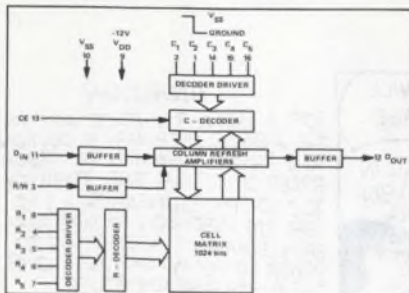

AMI

MODULES & SUBASSEMBLIES

High speed a/d operates at MIL temps

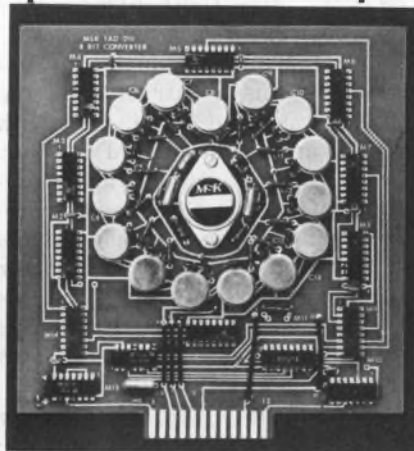

M. S. Kennedy, Pickard Dr., Syracuse, N.Y. 13211. (315) 455-7077.

The T.A.D.C. series of a/d converters can work over either the commercial (0 to 70 C) or MIL (-55 to +125 C) temperature ranges with temperature drifts of less than 1 bit over the entire range. Hybrid and modular construction allows a variety of bit and speed combinations. Model and speed combinations are as follows: 8-bits at 10 MHz, 9-bits at 2 MHz, 5-bits at 20 MHz and 4-bits at 20 MHz. All units are mounted on a 6 x 6 in. PC card.

CIRCLE NO. 274

Fast settling DACs resolve 8 or 10-bits

Analog Devices, Rte. 1 Industrial Park, P.O. Box 280, Norwood, Mass. 02062. (617) 329-4700. \$119 (8-bit), \$139 (10-bit); stock.

Model DAC1106 is a high speed, current output digital-to-analog converter with either 8 or 10-bit resolution that settles to 10-bit accuracy in 50 ns. The unit is packaged in a 2 x 2 x 0.4 in. module and has fully DTL/TTL compatible positive-true logic inputs. The settling time to $\pm 1/2$ LSB is 25 ns for the 8-bit version, 50 ns for the 10-bit. Both units have $\pm 1/2$ LSB linearity, ± 10 ppm/ $^{\circ}$ C gain temperature coefficient, and $\pm 0.002\%$ /V power supply rejection. A single ± 15 -V-dc power supply is the only power required. The unit is specified for operation over the 0-to-70-C temperature range.

CIRCLE NO. 275

12-bit d/a converter settles to 0.1% in 25 ns

Datel, 1020 Turnpike St., Canton, Mass. 02021. (617) 828-8000. \$149.

Model DAC-HI12B high resolution d/a converter will settle within 25 ns to 0.1% of full scale. This unit also has a linearity of $\pm 1/2$ LSB and a temperature coefficient of ± 20 ppm/ $^{\circ}$ C. The DAC-HI2B has output flexibility. The current-type output supplies 5 mA which can be fed directly into an external resistor to give a 1.2 V maximum output. By external pin strapping, a bipolar output of ± 1.2 V can be generated across the output load resistor. Data inputs are TTL/DTL compatible and straight binary coded for a unipolar output. Coding for bipolar outputs may be either offset binary or 2's complement. Input power requirements are +15 V dc at 40 mA and -15 V dc at 20 mA. The power-supply rejection ratio is 0.0085%/V.

CIRCLE NO. 276

Parallel pulses changed to serial by converter

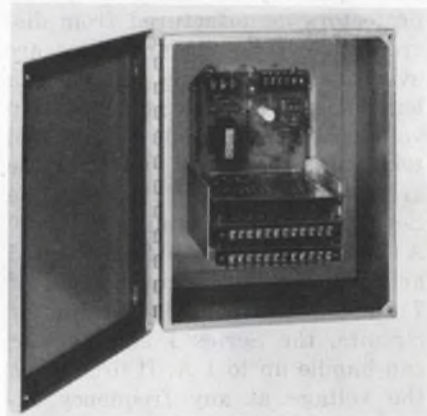

Sys-Tec, 877 Third St., S.W., New Brighton, Minn. 55112. (612) 636-6373.

The CS-181 pulse count summer converts parallel coincident input signals to serial output pulses equally spaced in time. Its four or eight inputs feature optical isolation, thus permitting the unit to operate in electrically noisy industrial locations, and at input speeds greater than mechanical contacts can provide. The output may be either relay or solid state. The unit is housed in a 12 x 10 x 6 enclosure and requires either 117 V ac, 60 Hz or 18 V dc. Output capability is 2500 counts/s.

CIRCLE NO. 277

MODULES & SUBASSEMBLIES

Over/undervoltage protectors handle 30 A

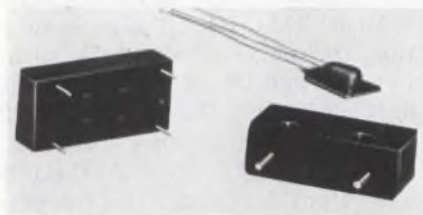

Heinemann Electric, Trenton, N.J. 08602. (609) 882-4800.

A line of overvoltage protection devices is made for use in semiconductor circuits. The smallest device is a 5-A hybrid unit. It contains a sense amplifier, control circuit and an SCR crowbar. A voltage transient or overvoltage causes the SCR to fire, shunting the line to ground within 500 ns. An external device, such as a circuit breaker, removes the load from the line about 10 ms later. Standard trip voltages for the hybrid protectors are 16.5 and 6.5 V dc. Protectors with trip voltages of 7 and 5.5 V dc are available on special order. For operating currents higher than the capability of the 5-A hybrid, protectors manufactured from discrete electronic components are available. The Series 10 dc can handle up to 10 A; standard trip voltages are 6.5 and 16.5 V dc, and trip voltages of 5.5 and 32 V dc are available on special order. The Series 30 dc can handle up to 30 A; standard trip voltages are 6.5 and 16.5 V dc, and trip voltages of 7 and 32 V are available. For ac circuits, the Series 1 ac protector can handle up to 1 A. It fires when the voltage at any frequency exceeds 143 V rms.

CIRCLE NO. 278

Opto isolators reduce delays to under 50 ns

Hewlett-Packard, 1501 Page Mill Rd., Palo Alto, Calif. 94304. (415) 493-1501. \$9.90 (100-up); stock.

Model 5082-4364 dual opto isolator contains a pair of inverting optically isolated gates, each with a LED and an integrated detector. Delay times of 50 ns can be obtained with this high-speed device. The unit requires a supply voltage of 5 V and the input current for an eight gate fan-out (13 mA) is 5 mA. Common-mode rejection is 20 V at 1 MHz. Performance specs are guaranteed over 0 to 70 C.

CIRCLE NO. 279

Single module performs v/f or f/v conversion

Datel, 1020 Turnpike St., Canton, Mass. 02021. (617) 828-8000. \$59 (10K), \$79 (100K); stock.

The VFV series of converters operates as either voltage-to-frequency or frequency-to-voltage converters. You can select the function just by external pin connection. In addition, these units have voltage inputs of 0 to +10 V or 0 to -10 V, current inputs of 0 to +1 mA or 0 to -1 mA, positive or negative going output pulses and DTL/TTL or CMOS compatibility, all by external pin connection. The 0.005% or 0.05% linearity (10 or 100 kHz unit, respectively) holds down to zero input voltage. As an f/v converter, full-scale output voltages of 0 to +10 or 0 to -10 V may be selected by external pin connection. There is also provision for an external integrating capacitor to reduce output ripple.

CIRCLE NO. 280

Optical switches come in 64 different models

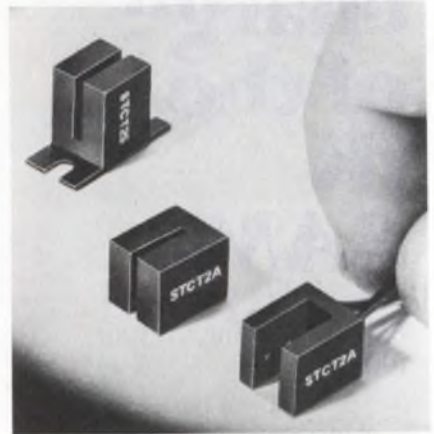

Sensor Technology, 21012 Lassen St., Chatsworth, Calif. 91311. (213) 882-4100. \$12; 30 day.

The solid-state Opto-Switch, an optoelectronic control switch, is available in 64 standard models. There are 16 models in each of four basic electrical configurations. The Opto-Switch comes in either single or dual-channel models, with a choice of sensing gaps of either 0.06 or 0.2-in. Mounting options include standard DIP pins with or without base, or wire leads with or without a base. The units measure 0.4 x 0.4 x 0.5 in. Each switch contains a GaAs infrared LED and a photodetector, packaged in a plastic case. Designs include a choice of four combinations of emitter and sensor circuitry: LED-phototransistor pair; LED-phototransistor plus amplifier; LED-photo-Darlington transistor; and LED-photo-transistor plus amplifier and Schmitt trigger. The latter units can be used directly with TTL/DTL/MOS logic-level circuits.

CIRCLE NO. 281



ANALOGY
FOR A BETTER VINTAGE A/D TRY THE A-851 12 BIT BINARY RESOLUTION AT 1 PART IN 4096 WITH CONVERSION SPEED OF 2.5 μS. TEMP. STABILITY TO +20 PPM/%; LINEARITY ± 1/2 LSB. ITS PRECISION VOLTAGE REFERENCE MAKES IT INSENSITIVE TO POWER SUPPLY AND LOAD VARIATIONS. THE A-851 IS HEADY STUFF.

intech INCORPORATED
(408) 244-0500
1720 COLEMAN, SANTA CLARA CA 95050

Our motors do the things most motors can't do

Precise positioning / Precise speed regulation / Precise tension control

Only a DC servo motor can respond in milliseconds to rapidly programmed commands. It'll stop, go, accelerate or decelerate, reverse direction at full speed, maintain constant speed under variable torque load or hold constant tension under variable speed . . . precisely as you want it to.

That's the kind of performance you can expect from all Inland Motor DC servos with temperature-stable magnets and rugged, high-duty-cycle capability. They'll give precise control of position, rate or tension in computer peripheral sub-systems like magnetic tape drives, incremental transport drives, capstan drives and high speed printout systems.

Thirty-two off-the-shelf models range from tiny "inch-cube" size to a fist full of power . . . from 7 to 300oz. in torque . . . speeds to 8,000 RPM . . . as low as 20.6 watts at peak torque . . . and less than \$25 in quantity lots.

For specifications or technical data, call your local Inland Motor Representative or contact us direct.

INLAND MAKES A DIFFERENT KIND OF MOTOR



INLAND MOTOR DIVISION Kollmorgen Corporation

501 First St., Radford, Va. 24141, Phone: (703) 639-3973, TWX: 710 875-3740

INFORMATION RETRIEVAL NUMBER 86



Mission

IMPOSSIBLE?

WANTED:

2 Watts Output
High Linearity
Ultra Wideband
No Tuning
All Solid State
Low Distortion
High Gain
Low, Low Cost

RESULT: M502C



We have removed the I.M. and made it Possible!

Our M502 produces over 2 watts of linear power output from 0.5 to 500 MHz without tuning.

Order Yours Today



R.F. POWER LABS, INC.
11013-118th Pl. N.E.
Kirkland, Wa. 98033
(206) 822-1251

OVERSEAS OFFICES:

Australia-Scientific Devices; England-Wessex; Finland-Into Oy; France-REA; Holland-Air-Parts Ith'n'l; India-Electronic Enterprises; Israel-RDT; Italy-Motordiesel; Japan-Seki; New Zealand-S.D. Mandeno; Norway-Morgenstjerne; Portugal-Rualdo; So. Africa-Baker; Sweden-Wentzel; Switzerland-Silectra.

INFORMATION RETRIEVAL NUMBER 87

MODULES & SUBASSEMBLIES

High speed DAC has 15 MHz word rates



Computer Labs, 1109 S. Chapman St., Greensboro, N.C. 27403. (919) 292-6247. From \$850; 8 to 10 wk.

The RDA series of d/a converters is made for reconstructing TV and other video signals. The 8 and 10-bit converters include a deglitching circuit to remove spike discontinuities from the analog output. Input word-rates of 15-MHz are possible, with optional output amplifiers for applications requiring greater drive. The units are mounted on 5.5 x 6 in. edge-connector PC cards.

CIRCLE NO. 282

High speed FET op amps slew at 400 V/ μ s

Analog Devices, Rte. 1 Industrial Pk., P.O. Box 280, Norwood, Mass. 02062. (617) 329-4700. \$99 (A), \$119 (B).

The Models 51A and 51B differential FET-input op amps provide ± 100 mA minimum output current over a 6 MHz minimum full-power bandwidth. The units have a 400 V/ μ s minimum slew rate and a 250 ns maximum settling time to 10-bit accuracy (0.05%, or 140 ns maximum to 8-bit accuracy or 0.1%). The Model 51 has a CMRR of 60 dB minimum for a ± 10 V common-mode voltage and an 80 MHz small-signal unity-gain frequency response. The Model 51 is a MIL-type design that uses hermetically sealed semiconductors and operates over -55 to 100 C. The Model 51A has a voltage drift of ± 50 μ V/ $^{\circ}$ C maximum and the Model 51B has ± 20 μ V/ $^{\circ}$ C. Both units are packaged in 1.82 x 1.22 x 0.61 cases.

CIRCLE NO. 283

Sine wave oscillator keeps distortion low

Frequency Devices, 25 Locust St., Haverhill, Mass. 01830. (617) 374-0761. \$25 (100-up); 2 to 4 wk.

The 450 Series of modular sine wave oscillators are low distortion (0.1%) units. They are amplitude stable to within 0.1 dB and are packaged in a low profile 1.5 x 2 x 0.4 in. case. The oscillators are available in any frequency specified by the customer in the range from 100 Hz to 10 kHz. Other features include an accuracy of $\pm 1\%$ (externally adjustable $\pm 5\%$), a stability of 0.02 %/ $^{\circ}$ C, an output amplitude of 20 V pk-pk, an output impedance of less than 10 Ω and a dc offset of under 5 mV. Power requirements of the circuit are ± 15 V at ± 8 mA.

CIRCLE NO. 284

Differential multiplexer handles ± 10 V signals

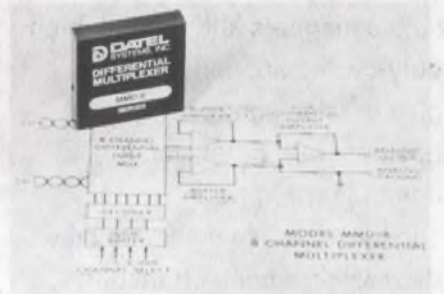

Datel, 1020 Turnpike St., Canton, Mass. 02021. (617) 828-8000. \$169 (1 to 9).

The Model MMD-8 differential multiplexer consists of eight pairs of analog switches. A channel select inhibit (all channels off) is provided so that two MMD-8's can be stacked to provide 16 channels of differential analog multiplexing. Differential input signals up to ± 10 V can be handled. Without the amplifiers, switching time is typically 500 ns, while the output settling of the amplifier is 4 μ s. The differential output amplifier will deliver ± 5 mA with a linearity of 0.01%, an offset adjustable to less than 1 mV, and a temperature coefficient of 60 μ V/ $^{\circ}$ C. The amplifier has a slew rate of 100 V/ μ s. The unit is housed in a 2 x 2 x 0.375 in. encapsulated module with dual-in-line pinning (0.1 in. grid) and requires only ± 15 V at ± 20 mA.

CIRCLE NO. 285

KEMET® CERAMICS:

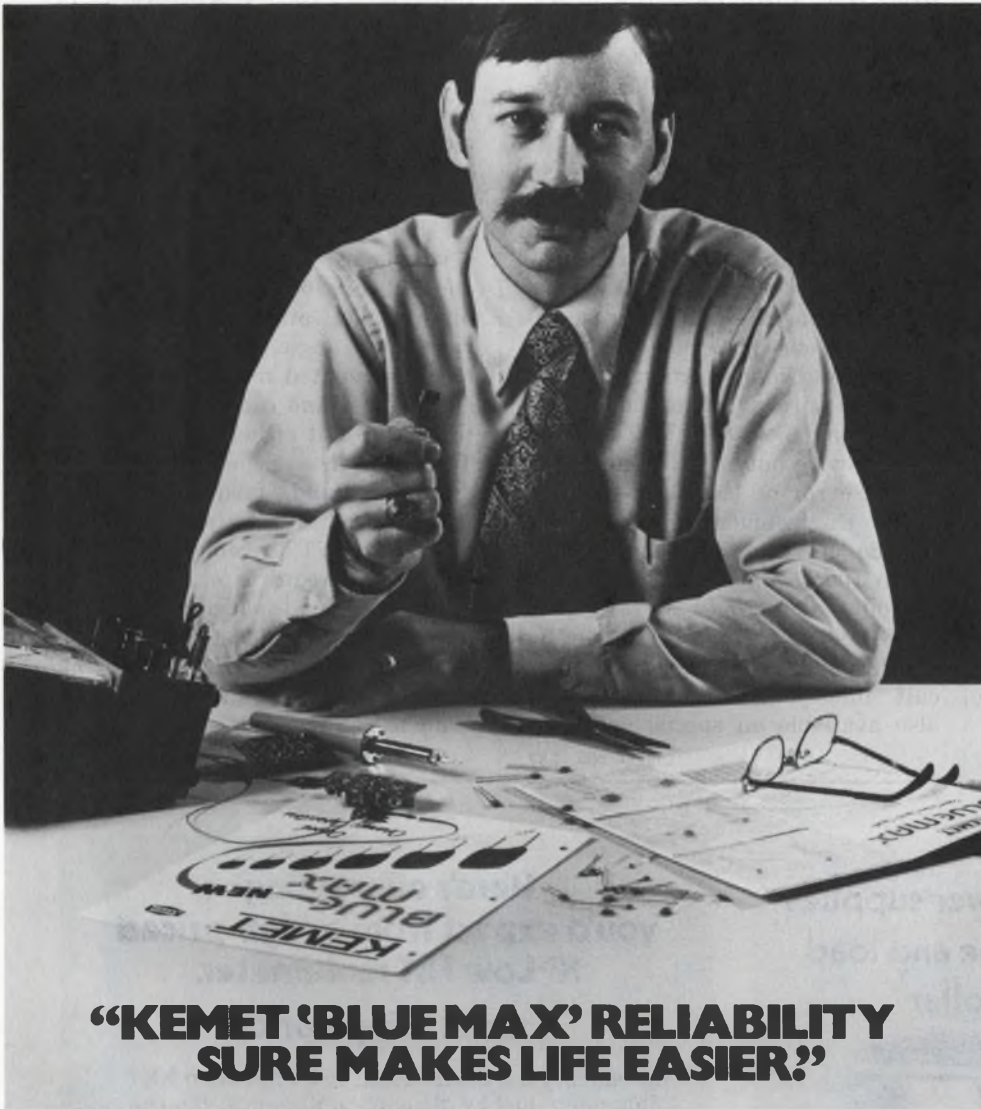

**“KEMET ‘BLUE MAX’ RELIABILITY
SURE MAKES LIFE EASIER.”**

a shield of precision-dipped epoxy that even meets the UL Standard 492 flame test.

Beginning to sound good? Then you'd better look into it. You'll be surprised how much more you can get done—and easier, too—by standardizing on “Blue Max” Capacitors.

They're available now in three dielectrics—COG Ultra-Stable, X7R Stable, and Z5U General Purpose—in six precision case sizes.

And you can pick from more than 350 CV values in a capacitance range from 2.2 pF to 4.7 uF for operation on 50, 100 and 200 VDC working voltages.

What more can I tell you?

Try 'em out yourself. Write to Union Carbide and ask for free engineering samples and a specification guide.

Be sure to get the name right. KEMET “Blue Max”—the maximum CV range, precision dipped, ceramic capacitors.

You'll be surprised how easy they can make your life!

UNION CARBIDE COMPONENTS DEPARTMENT

P. O. Box 5928, Greenville, S. C. 29606
Phone: (803) 963-7421 TWX: 810-287-2536

Mail to:

UNION CARBIDE
COMPONENTS DEPARTMENT
P. O. Box 5928, Greenville, S. C. 29606

Sure, I'd like to take it easy—and get total design flexibility, too. Send me specification information and free engineering samples of KEMET “Blue Max” Capacitors!

Name _____ Title _____

Company _____

Address _____

City _____ State _____ Zip _____



When I breadboard a new system, I use reliable components. Right from the start.

Take capacitors, for instance. KEMET “Blue Max” Capacitors give me the reliability I need. And total design flexibility, too.

That's a combination that can really make your life a lot easier.

What do you need in your capacitors? Size? Lead spacing? Choice of dielectrics? Capacitance range?

Voltage? Price and delivery?

You get all of these with “Blue Max” Capacitors—the maximum CV range, miniature, precision epoxy dipped, monolithic ceramic capacitors from KEMET.

They're built on fully automated lines. So you get uniform dielectric thickness, electrode integrity, and consistent electrode-to-termination continuity.

And talk about solid quality! “Blue Max” Capacitors are the same inside as KEMET high-volume molded Military CKs. They stay tough and dry inside

Pwr transducers handle watts, vars, pf and more



E.I.L. Instruments, 1830 York Rd., Timonium, Md. 21093. (301) 252-1260.

Custom solid-state power transducers are designed for use in alarm, indicating and recording systems. These watt, vars, frequency and power factor transducers are used along with digital and analog meters from all major manufacturers. In-house calibration facilities are available for variable frequency, variable power and variable phase angle.

CIRCLE NO. 286

Synchro amplifier has 1 MΩ input impedance

Singer, Kearfott Div., 1150 McBride Ave., Little Falls, N.J. 07424. (201) 256-4000.

The Model C70 3718 005 synchro amplifier can drive multiple synchro loads with Thevenin equivalent impedances as low as 50 Ω line-to-line. The amplifier has an input impedance greater than 1 MΩ thus minimizing loading and error factors. The synchro amplifier requires power of 115 V, 400 Hz and generates all other necessary power requirements. The input/output configuration consists of three-wire synchro inputs and amplifying them (at unity gain) to a three-wire output with an input/output error of less than six minutes. Environmental capabilities include operation in temperatures up to 100 C and relative humidity of 100% at altitudes up to 70,000 ft. Other units that accept 60 Hz synchro inputs and have short-circuit input/output protection are also available on special order.

CIRCLE NO. 287

Tracking s/d converters are accurate to ±4 min.

Computer Conversions Corp., 6 Dunton Ct., East Northport, N.Y. 11731. (516) 261-3300. Under \$400; 4 wk.

A series of small 14-bit synchro-to-digital tracking converter modules provides accuracies of ±4 min. of arc, ±0.9 LSB. These units are 2.6 × 3.1 × 0.82 in. and are made for PC board mounting. They convert synchro inputs of 11.8 or 90 V, 400 Hz, or 90 V, 60 Hz, into 14-bit parallel binary outputs that represent angle. The converters have an isolated reference and synchro inputs and can track rates up to 1800 °/s at either 60 or 400 Hz. They are also insensitive to input amplitude and frequency variations. The digital output is buffered and DTL/TTL compatible. Part No. SDC40 requires a 26 V or 115 V ac reference input and ±15 V at 50 mA, -15 V dc at 30 mA, and +5 V dc at 350 mA. Operating temperature ranges are 0 to 70 or -55 to +85 C.

CIRCLE NO. 288

overload protected power supplies with more filtering, line and load regulation per dollar

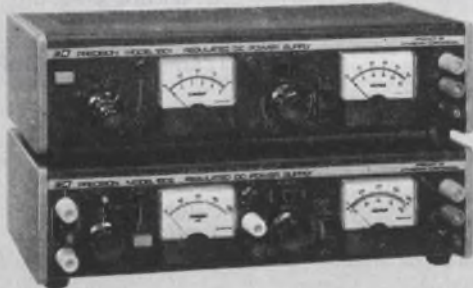

B&K Model 1601 • \$170.00
0-50 VDC @ 0-2 Amperes
Typical regulation:
line-0.02%, load-0.07%
Ripple: 5mV p-to-p

B&K Model 1602 • \$180.00
0-400 VDC @ 0-200 mA
Typical regulation: 0.1%.
Ripple: 10mV p-to-p
0-100 VDC @ 0-2mA
6.3/12.6VAC @ 3.5A

The output voltages are continuously variable over full range with a single control. Foolproof fully automatic overload shuts down when current on 2 A or 200 mA supply exceeds the adjustable preset level. Pushbutton restores operation. See your distributor or write Dynascan Corporation.



INFORMATION RETRIEVAL NUMBER 89

Here's everything you'd expect from a high-priced Hi-Low FET multimeter.

Except a high price.

Introducing the B&K Model 290 solid-state FET Multimeter. Just by glancing at its specs, you can tell that the 290 is capable of more applications than any other multimeter in its class. 75 ranges. Hi-Lo power ohms ranges (low power only 33 mV). 15 megohms input impedance. A large 7" meter. 50 mV to 1500V full-scale sensitivity on both AC and DC. 50 micro-amp current range. Rx0.1 ohm range with 1 ohm center scale lets you measure low resistance down to .01 ohm. Circuit provides automatic overload protection with fuses and spark gaps. More multimeter for your money — that's

just what you expect from B&K.

Contact your distributor, or write Dynascan Corporation. Model 290 Hi-Low FET Multimeter including Model PR-21 Probe:

\$140⁰⁰



B&K Very good equipment at a very good price.

Dynascan Corporation
1801 West Belle Plaine Avenue, Chicago, Illinois 60613

INFORMATION RETRIEVAL NUMBER 90

ELECTRONIC DESIGN 12, June 7, 1974

Ever have the feeling your biggest connector problem is trying to tell your connector suppliers what your problem is?

We may be the best listeners in the connector business.

We've listened so well over the past 23 years and come up with so many right answers that we now have one of the broadest lines of P/C connectors around.

Tell us your design needs and chances are we'll have the answer right on our shelf.



If we don't, we also have one of the best design engineering departments (not the biggest, by any means, but the best, we think). And our P/C Connector Product Manager has absolutely nothing better to do than listen to your needs.

Call him. Right now. He'll start listening -before he starts to answer.



Call (213) 341-4330.

Ask for the P/C Product Manager

 **Viking**
CONNECTORS

Viking Industries, Inc./21001 Nordhoff St./Chatsworth, Calif. 91311

INFORMATION RETRIEVAL NUMBER 91

Design refresher on Metal Glaze™ resistors

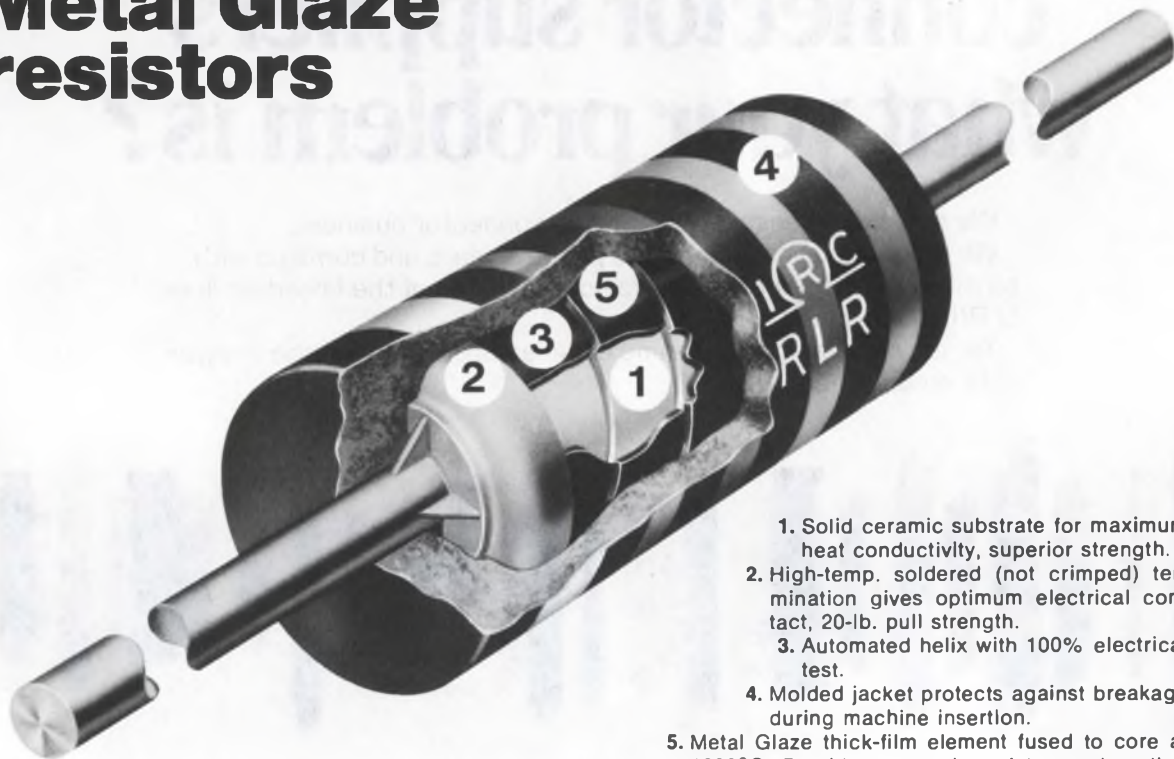

1. Solid ceramic substrate for maximum heat conductivity, superior strength.
2. High-temp. soldered (not crimped) termination gives optimum electrical contact, 20-lb. pull strength.
3. Automated helix with 100% electrical test.
4. Molded jacket protects against breakage during machine insertion.
5. Metal Glaze thick-film element fused to core at 1000°C. Provides a tough resistor system that withstands overloads, environmental extremes.

An all-purpose resistor? Not *quite*. But if you're designing any type of low-power circuitry, it usually pays to look at Metal Glaze.

Mechanically, these resistors are nut tough. Electrically, they offer excellent load life stability. And thermal characteristics are outstanding, giving you lower operating temperatures, greater reliability. In fact, you can often *double-rate* Metal Glaze resistors. So you can use smaller resistors, save board space.

The quality and cost effectiveness of Metal Glaze resistors have been proven *billions* of times over—in all types of electronic equipment, worldwide. Available in ratings ≤ 5 watts, $\geq 1\%$ tolerance, and ranges as low as 1 ohm.

Complete resistor choice. TRW offers you a total resistor capability—carbon comp., thin-film, Metal Glaze, wirewound, networks. For complete specs and application data on Metal Glaze, contact your local TRW sales representative (or TRW/IRC's Boone, N.C., plant—(704) 264-8861). Or *write* TRW/IRC Resistors, an Electronic Components Division of TRW, Inc., 401 N. Broad St., Philadelphia, Pa. 19108.

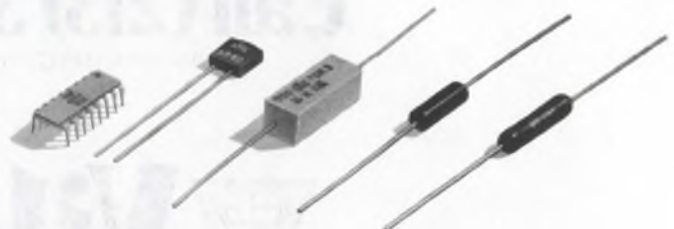

TRW® IRC RESISTORS

™Metal Glaze is TRW/IRC's trademark for its thick-film resistors.

INFORMATION RETRIEVAL NUMBER 92

TRW/IRC Resistors Metal Glaze™ Locations of Distributor Stock

Arizona

Moltronics of Arizona, Inc.
Phoenix (602) 272-7951

Northern California

Bell Industries
Menlo Park (415) 323-9431
Cramer Electronics, Inc.
Sunnyvale (408) 739-3011

Southern California

Bell Industries
Gardena (213) 321-5802
Cramer Electronics, Inc.
Irvine (213) 771-8300
Rampart Components, Inc.
Woodland Hills (213) 887-7260
R. V. Weatherford Co.
Glendale (213) 849-3451

Illinois

Allied Electronics Corp.
Chicago (312) 421-2400
Cramer Electronics, Inc.
Mt. Prospect (312) 593-2030

Massachusetts

Cramer Electronics, Inc.
Newton (617) 969-7700
DeMambo Electronics Corp.
Boston (617) 787-1200
Wilshire Electronics
Cambridge (617) 491-3300

Michigan

Gulf/Bodelle
Ann Arbor (313) 769-8650
Harvey-Michigan, Inc.
Farmington (313) 477-1650

Minnesota

Hall-Mark Electronics Corp.
Minneapolis (612) 925-2944

New Jersey

Wilshire Electronics
Clifton (201) 365-1150

New Mexico

Cramer Electronics, Inc.
Albuquerque (505) 265-5767

New York

Cramer Electronics, Inc.
Hauppauge, L.I. (516) 231-5600
Hall-Mark Electronics Corp.
Farmingdale, L.I. (516) 293-7500
Rampart Components, Inc.
Hauppauge, L.I. (516) 273-5500
Rochester Radio
Rochester (716) 454-6300

Ohio

Electronics Marketing Corp.
Columbus (614) 299-4161

Pennsylvania

Philadelphia Electronics, Inc.
Philadelphia (215) 568-7444
Pytronic Industries, Inc.
Philadelphia (215) 643-2850

Texas

Hall-Mark Electronics Corp.
Dallas (214) 231-6111

Utah

Cramer Electronics, Inc.
Salt Lake City (801) 487-4131

Washington

Robert E. Priebe Co.
Seattle (206) 682-8242

Wisconsin

Marsh Electronics, Inc.
Milwaukee (414) 545-6500

TRW/IRC RESISTORS

INTEGRATED CIRCUITS

4-k RAM comes in 16-pin DIP

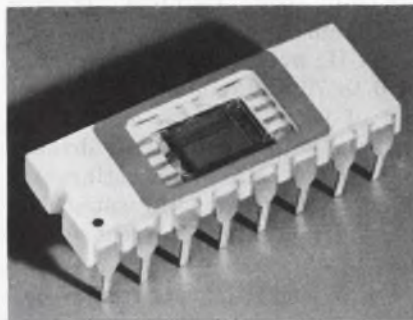

Mostek Corp., 1215 W. Crosby Rd., Carrollton, Tex. 75006. (214) 242-0444. \$45 (100); 6-8 wk.

A 4096-bit dynamic n-channel MOS RAM, called the MK 4096P, comes in a standard 16-pin ceramic package. The new RAM features 350-ns access time and single-transistor cell design. The RAM offers read and write cycles of 500 ns. All inputs and outputs including clocks are directly TTL-compatible, and voltage pins are located on package corners to simplify board layout. Power supplies required are 12, 5 and -9 V. Active power is under 100 μ W per bit, while standby power is under 2.5 μ W per bit. Refresh time for each of the 64 row addresses is 2 ns. All specs apply over a temperature range of 0 to 70 C.

CIRCLE NO. 289

ICs contain logic for clocks and timers

National Semiconductor Corp., 2900 Semiconductor Dr., Santa Clara, Calif. 95051. (408) 732-5000. \$14 (100); stock.

Two digital alarm-clock circuits, intended for use with gas-discharge displays, contain all of the logic required to build a variety of clocks and timers. The new ICs, called the MM5370 (for 60-Hz operation) and the MM5371 (for 50-Hz operation), interface with seven-segment displays to exhibit three modes—time, alarm set, and sleep time. The display format may be either 12 hours with leading zero blanking and AM/PM indication, or 24 hours. The circuits operate from voltages in the 8-to-29-V range, and they don't require a regulated power supply.

INQUIRE DIRECT

IC quad op amp uses single supply

RCA Solid State, Route 202, Somerville, N.J. 08876. (201) 722-3200. CA3401E: 75¢.

The CA3401E quad op amp operates from a single positive power supply. The monolithic circuit requires no external compensation and has a 3-pF on-chip capacitor to maintain closed-loop stability in each amplifier. The CA3401E features a supply range of 5 to 18 V, unity-gain bandwidth of 5 MHz typical, bias current of 50 nA typical and open-loop gain of 60 dB typical.

CIRCLE NO. 290

1024-bit pROMs feature 15-ns access

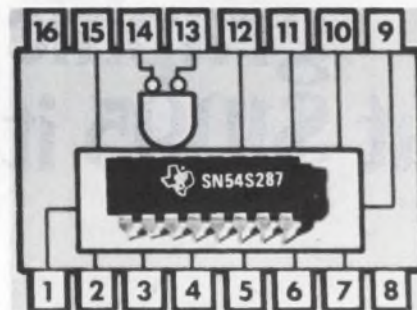

Texas Instruments, P. O. Box 5012, M/S 308, Dallas, Tex. 75222. (214) 238-2894. \$17.52 (100); stock.

Two ROMs, called the SN74S287 and SN74S387, feature a typical enable access time of 15 ns. The 'S287 memory has a three-state output; the 'S387 features an open-collector output. Operation of the pROMs is guaranteed over the 0-to-70-C temperature range. Each pROM comes in a 16-pin plastic DIP.

CIRCLE NO. 291

FET op-amp drift drops to 5 μ V/°C

Intersil, 10900 N. Tantau Ave., Cupertino, Calif. 95014. (408) 257-5450. \$9.50 to \$49.50 (100).

The 8007 series of low-drift FET-input op amps combines a bias current of 10 pA with drifts as low as 5 μ V/°C (8007-1). Offset voltage ranges from a high of 10 mV down to 2 mV. Other 8007 specs include a 6- μ V/sec slew rate, \pm 12-V input range and a 90-dB common-mode rejection. The ICs come in TO-5 cans and operate over the 0-to-70-C temperature range.

CIRCLE NO. 292

INTEGRATED CIRCUITS

Counters operate up to 1 GHz

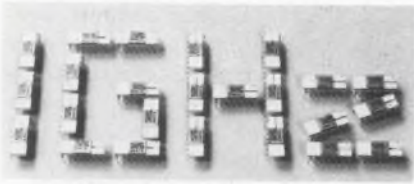

Plessey Semiconductors, 674 Mc-

Gaw Ave., Santa Ana, Calif. 92705. (714) 540-9979. \$96 to \$120 (100-999); stock.

The SP613 through 616 series divide-by-four counters provide maximum operating frequencies up to 1 GHz over a temperature range of 0 to 70 C. Counter outputs consist of complementary emitter-followers, both capable of driving 100-Ω lines. Maximum ratings include a power-supply voltage of 8.5 V and output current of 15 mA.

CIRCLE NO. 293

Op amp features 5-μV noise and 15-pA bias

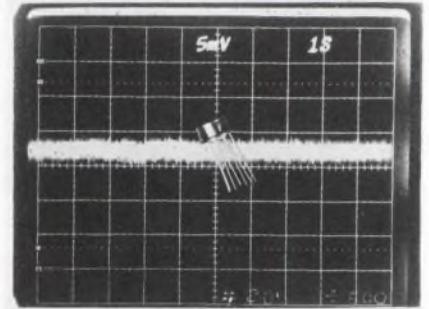

Analog Devices, Route 1 Industrial Park, P. O. Box 280, Norwood, Mass. 02062. \$5.90 up (100).

The AD514 FET-input op amp guarantees a maximum noise level of 5 μV pk-pk in a 0.1-to-10-Hz bandwidth. The IC also combines a maximum bias current of 10 pA with offset voltages below 20 mV and an open-loop gain above 50,000. The AD514 comes in a TO-99 package.

CIRCLE NO. 294

Your mini's graphic display, at \$1095 it's no steal.

No need for your display to cycle steal. Megatek's graphic interface (now available for NOVA Series) provides a built-in memory with 50Hz refresh to generate flicker-free (regardless what your CPU is doing) dynamic displays on your x-y scope.

Free 90% of your mini's time and save software expense. Interactive graphics are now available with Megatek supplied software. Ready to use.

And to preserve your scope displays use Megatek's hard copy x-y recorder adapter. Performance at the lowest cost, seeing is believing. Call us for details on NOVA, PDP-11 and NAKED MINI/ALPHA 16 — (714) 224-2721 or write Megatek, 1055 Shafter Street, San Diego, CA. 92106.

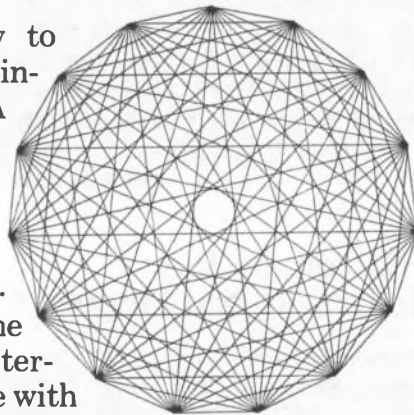

Dual counters replace single units

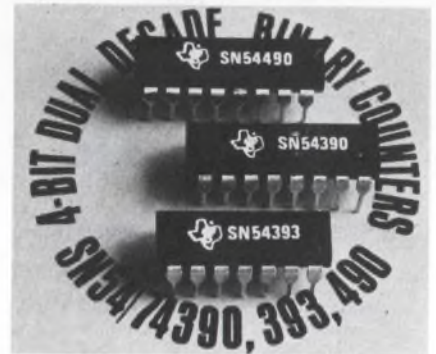

Texas Instruments, P.O. Box 5012, M/S 84, Dallas, Tex. 75222. (214) 238-3741. \$1.76 up (100); stock to 12 wk.

Three dual 4-bit TTL counters—the SN54/74390, SN54/74393, and SN54/74490—are dual versions of the popular SN54/7490A and SN54/7493A 4-bit counters. All three counters incorporate full parallel outputs from each 4-bit section. They accept count frequencies from dc to typically 35 MHz. The '390 BCD circuit has both divide-by-two and divide-by-five clock inputs as well as individual direct clear inputs. The '490 BCD counter features a divide-by-10 clock, direct clear, and a preset-to-nine input for each 4-bit stage.

CIRCLE NO. 295

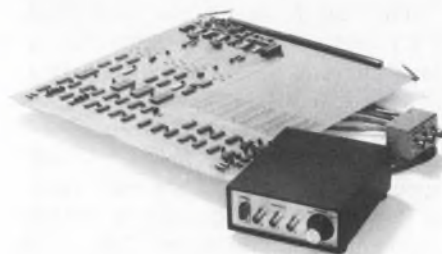

MEGATEK
BUDGET PERIPHERALS

Graphics Interface: its own refresh memory.

INFORMATION RETRIEVAL NUMBER 93

Problem solving... with Victoreen High Voltage Technology

1 UNORTHODOX CRT DRIVE

How did we meet ever-expanding requirements for increased bandwidth and lower power consumption, coupled with the availability of high-voltage zener-type diodes (Victoreen Corotrons)? With an unorthodox drive scheme for CRT's.

Basically, this scheme is a mirror-image of the conventional method. Instead of supplying the CRT anode with very high voltage, we ground the anode and supply a drive signal, riding at approximately -1800 volts, to the grid. The advantages? Being direct-coupled there are no reactive components to limit high-end frequency response or cause roll-off

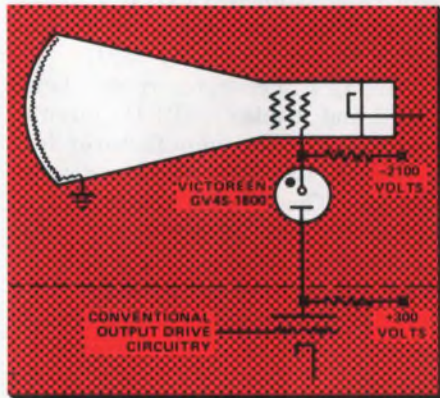

at the low end. Second, the face plate of the CRT does not build up static charges which can distort the display.

Even though the Corotron operates in the corona mode of discharge, it has no voltage jumps or jitters. Corotrons are not tied to "natural" operating voltages and are adjustable in manufacture from 350 to 30,000 volts. Corotrons also have a positive regulation curve eliminating possible relaxation oscillation.

2 FROG MUSCLES TO BRAIN WAVES

Colleges and universities, medical research laboratories and a number of R&D firms are faced daily with the need for controlled high-amplification of a wide variety of extremely low level signals. Such signals are derived from frog-muscle experiments, brain-wave measurements, cardiac research, avalanche-breakdown, currents in ionization chambers as well as from a range of constant-current sources.

The operational amplifier provides the amplification required because of theoretical infinite-gain characteristics. However, at full gain an op-amp tends to be unstable and go into oscillation; further, amplified signals are difficult to fully analyze if the gain is unknown.

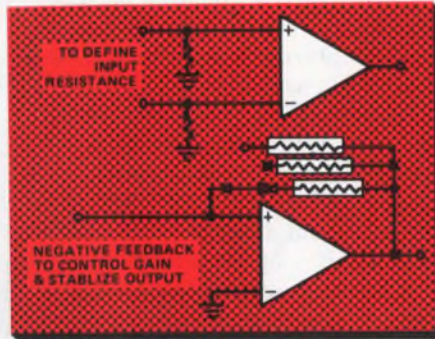

Victoreen MINI-MOX resistors are used widely to modify op-amp characteristics to: 1. Stabilize output and eliminate oscillation. 2. Define gain so measurements can be quantified. 3. Restrict bandwidth to the region of specific interest.

Smaller than a conventional resistor and compatible with a TO-3 can, MINI-MOX resistors are ideal for highly-stable, low-level, miniature electronic circuitry.

They typically have a voltage coefficient of -5 ppm/volt, full-load drift of less than 2% in 1000 hours, temperature coefficient of 100 ppm, and a Quatech noise of less than 1.5 μ V/volt at 20M ohms. They are available in values from 100K to 10,000M ohms in 1, 2, 5 and 10% tolerances.

3 A PROBE FOR HIGH POTENTIAL

Two Victoreen MAXI-MOX resistors used in series can serve as a probe in radar circuitry capable of measuring voltages up to 60,000 volts. The probe, compatible with a number of voltmeters of different manufacture, has both short- and long-term stability. Short-term stability assures negligible drift and fluctuation

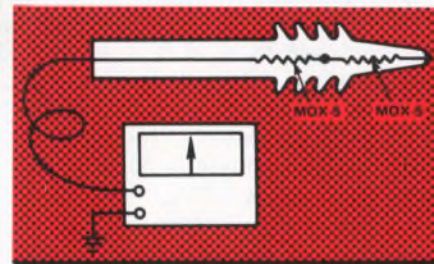

during measurement, while long-term stability maintains the original calibration accuracy of the probe.

Each MOX-5 resistor used in the probe has a maximum operating voltage of 37,500 volts with a power rating of 12½ watts. The voltage coefficient is 1 ppm/volt over the complete voltage range of the MOX-5, while the temperature coefficient is better than 300 ppm from

-55° to 125°C.

MAXI-MOX resistors have full-load drift less than 1% in 2000 hours of operation, and are available in tolerances of 1, 2, and 5% in values from 10K to 2,500M ohms. A silicone varnish conformal coating provides environmental protection while allowing a maximum hot-spot temperature of 220°C. In addition, it is compatible with commonly-used potting compounds.

4 SPARK GAPS SPARK INTEREST

Victoreen SGSP spark gaps normally protect electrical circuits from damage from transient voltage spikes; however, Optical Radiation Corporation, Azusa, Ca. uses them to ignite a Xenon lamp in a theatrical lamphouse to project motion pictures. Xenon lamps provide two

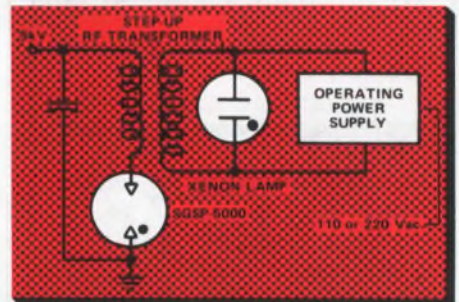

advantages; one, being very small and brilliant, light radiation is easier controlled; second, efficiency is higher, so smaller lamphouses with greater output result. The design won the company an Academy Award in technical achievement.

In operation, the capacitor is charged until the SGSP-5000 breaks down. The stored energy is released through the transformer primary, producing a very high voltage pulse in the secondary which ignites the Xenon lamp. This provides an extremely reliable method of starting the lamp. Once ignited, operation is sustained by a lower-voltage line operated power supply.

**Victoreen Instrument Division
of VLN Corp.
10101 Woodland Avenue
Cleveland, Ohio 44104**



AMPERITE

TOP QUALITY
Still at **LOW PRICE!**

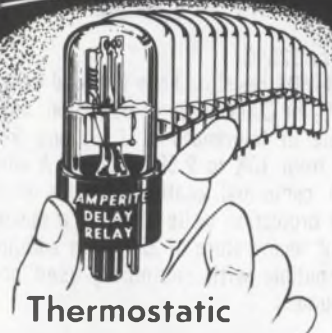

Thermostatic DELAY RELAYS

Hermetically Sealed for Maximum Stability

Delays: 2 to 180 Sec.*

Hermetically sealed — not affected by altitude, moisture, or climate changes... **SPST only** — normally open or normally closed... Compensated for ambient temperature changes from -55°C to $+80^{\circ}\text{C}$... **Rugged, explosion-proof, long-lived**... Standard radio octal and 9-pin miniatures.

Price, standard or min., under \$4.00 ea.

*Miniatures delays: 2 to 120 seconds.

PROBLEM? Send for Bulletin No. TR-81.

New! LONG DELAYS

240 & 300 Sec.

Same rugged construction, hermetic sealing and stability as the shorter Delay Relays described above... For delays beyond 300 seconds, these Relays may be used in-series.

Price, under \$6.00 ea.

Write for Bulletin No. LD-73.



DIFFERENTIAL RELAYS

For automatic overload, over-voltage or under-voltage protection... Made only to specifications for 70V, 80V, 90V and 100V.

Price, under \$6.00 ea.

AMPERITE BALLAST REGULATORS

Automatically keeps current and voltage at a definite value. For AC or DC... Hermetically sealed, rugged, vibration-resistant, compact, most inexpensive.

Price, under \$3.00 ea.

Write for 4-p. Bulletin No. AB-51.

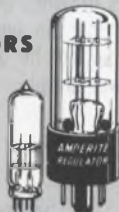

AMPERITE

600 PALISADE AVE., UNION CITY, N.J. 07087

Telephone: 201 UNION 4-9503

In Canada: Atlas Electronics, Ltd.,
50 Wingold Ave., Toronto 19

INTEGRATED CIRCUITS

Bipolar ICs modulate, demodulate

Plessey Semiconductors, 1674 McGaw Ave., Santa Ana, Calif. 92705. (714) 540-9979. \$2.50 (100-999); stock.

Two bipolar IC doubled-balanced modulators, the SL 10001A and B, contain internal bias which allows direct balanced transformer input or single-ended capacitor drive. The new modulators/demodulators feature a carrier and signal suppression of 50 dB, low noise level of -112 dBm, intermodulation suppression of -58 dB, supply current of 4 mA and unity conversion gain. The circuits have a two-stage common-collector output, and a pair of diodes are provided for optional limiting of the carrier input.

CIRCLE NO. 296

IC performs sample/hold function



Harris Semiconductor, P. O. Box 883, Melbourne, Fla. 32901. (305) 727-5407. \$14.85 (100); stock.

Monolithic sample-and-hold amplifiers make their debut with the company's introduction of the HA-2425. The new IC has a slew-rate-to-droop-rate ratio of 5×10^6 and requires an external holding capacitor. Other features include TTL/DTL-compatible control input, 2-MHz bandwidth, 50-ns aperture time and a $5\text{-V}/\mu\text{s}$ slew rate. The new circuit consists of an op amp with its output in series with an analog switch that has a 1-nA maximum leakage current. The switch is buffered by a MOSFET-input unity-gain amplifier. The HA-2425 comes in a 14-pin, hermetically sealed DIP, and it operates over the 0-to-75-C temperature range.

CIRCLE NO. 297

256-element CCD operates at 10 MHz

Fairchild Semiconductor, 464 Ellis St., Mountain View, Calif. 94042. (415) 962-3816. \$125 (100-999).

The company's latest charge-coupled device, the CCD 110, is a 128/256-element linear sensor. A two-phase device, the new sensor can be operated with standard TTL-level clocks at data rates in excess of 10 MHz. Other features include on-chip preamplifier and compensation amplifier, and a dynamic range of 200:1. The device comes in an 18-pin DIP with a glass window.

CIRCLE NO. 298

Microprocessor system gets new IC

Microelectronic Device Div., Rockwell International, P. O. Box 3669, 3430 Miraloma Ave., Anaheim, Calif. 92803. (714) 632-2321.

An LSI general-purpose keyboard and display (GPKD) circuit is offered by the manufacturer for use with its PPS microprocessor system. The GPKD permits an automatic scan of keyboards with as many as 64 keys. It also provides multiplexed outputs for displays that have up to 32 digits and optional discrete status indicators. Included in the circuit is a nine-key first-in, first-out stack that provides nine keys of buffering.

CIRCLE NO. 299

64-bit RAMs access in 10 ns

Signetics, 811 E. Arques Ave., Sunnyvale, Calif. 94086. (408) 739-7700. \$12.95 to \$13.70 (100).

Three 64-bit ECL RAMs are offered for computer applications including scratch pads and buffers. The 10140 and 10148 memories combine a typical access of 10 ns and write cycle of 18 ns with a typical power dissipation of 420 mW. The 10140 drives 90- Ω lines; the 10148 is designed for 50- Ω lines. The third memory—called the 10151 and originated by the company—has a latch circuit on the data output line. Otherwise, the characteristics of the 10151 are the same as those of the 10140 and 10148.

INQUIRE DIRECT

Thinking about Microcomputers?

After selecting the microcomputer for your job, how are you going to integrate it into your product or system?

Applied Computing Technology's series of ASSEMBULATORS (assembler-simulators) offer a complete stand-alone micro-computer development capability. Applied Computing Technology builds ASSEMBULATOR development systems for the Rockwell International and Intel series of 4 bit and 8 bit microcomputers.

The ASSEMBULATOR features real-time microcomputer simulation including ROM simulation up to full system capacity. A resident assembler transcribes machine language directly into the ROM simulator memory from mnemonic instructions inputted via the teletype.

A resident utility system allows quick display and change of simulated ROM and RAM. Input-Output channels within the ASSEMBULATOR provide for interface with external electronics.

Integral programmers allow direct memory transfer to Programmable-Read-Only-Memories.

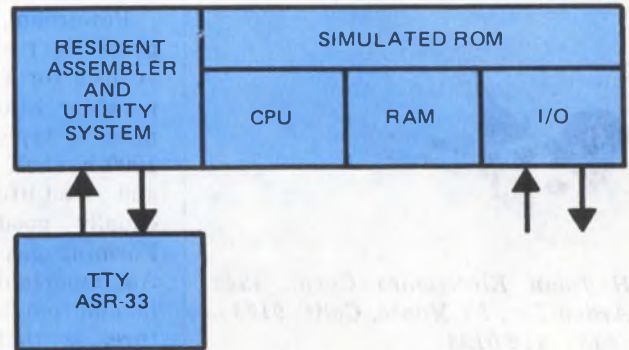

**APPLIED
COMPUTING
TECHNOLOGY
INCORPORATED**

17961 Sky Park Circle
Irvine, CA 92707

(714) 557-9972

INFORMATION RETRIEVAL NUMBER 96

SIGNAL CONDITIONING for all types of Transducers

**All solid state 3KHz
Carrier System For
Variable Reluctance,
Strain Gage or
LVDT Transducers**

MC1 Module case can house
up to 20 plug-in units...
provides carrier & DC
operating voltages.

Size: MC1-10 5 1/4" x 19" x 12" Price: \$730.
MC1-20 8 3/4" x 19" x 12" 910.



Input power: 105 to 125 V

Interchangeable plug-in units available

CD90 Very high gain carrier demodulator for use
with strain gage bridge variable reluctance
transducers, differential transformers (LVDT) and others.
Input Sensitivity: 0.1 mv/V for 10 VDC output
Output A Signal: ±10 VDC at 100ma, short-circuit
proof

Output B Signal: Standard provides ±1 VDC
Price: \$350 (from stock)

SG71 A signal conditioner and power supply for
strain gage bridge circuits. Provides buffered, short-
circuit proofed DC excitation to the bridge.

Input Sensitivity: 1 mv/V
Output A: ±10 VDC at 10ma
Output B: ±100ma maximum
Price: \$225 (from stock)



CD90

Other special purpose plug-in units available.



WRITE FOR CATALOG
19414 Londelius Street
Northridge, Calif. 91324
Phone (213) 886-8488
Telex 65-1303

INFORMATION RETRIEVAL NUMBER 97

ELECTRONIC DESIGN 12, June 7, 1974

If you think there
are no other ways to cut your
POWER SUPPLY
costs, get proven performers and
realistic delivery...
you didn't figure on

MX SERIES
Hi-performance low cost
OEM Power Supplies

from **\$84.00**



TODD PRODUCTS CORP.
123 Milbar Blvd., Farmingdale, N.Y. 11735 • (516) 293-3440

INFORMATION RETRIEVAL NUMBER 98

Cable stripper handles wide range of sizes



Hoffman Electronics Corp., 4323 Arden Dr., El Monte, Calif. 91734. (213) 442-0123.

The Hi-Peeler cable stripper features hardened, heat-treated-steel cutting blades, made of nickel-plated, drop-forged steel and comfortable plastic hand grips. The stripper handles wire sizes from 6 AWG to 400,000 cmil and it is easily pre-set with its graduated setting screw. The unit can be used to strip the ends of wire or in-line for splicing.

CIRCLE NO. 300

Thick-film resistor paste fires at 780 C

Thick Film Systems, Inc., 324 Palm Ave., Santa Barbara, Calif. 93101. \$45 per oz; 10 days.

Powerohm, 780 Series, screen-printable resistor pastes were developed for a low 780-C firing temperature. Stability after laser trimming is typically about 0.05% for 1000-h shelf, thermal, hot-column and load-life tests. Stability is equally good after exposure in Forming gas at 150 C for 10 min. An important cost saving feature, in addition to low firing temperature, is that the paste requires only a 25-min. firing cycle. Thus, energy consumption is low and over twice the number of circuits, or discrete components, can be fired in the same time that higher-priced, higher-firing temperature systems require. The 780 Series formulas are available with resistivities from 50 to 1,000,000 ohms per square and with TRCs of 0 to ± 200 ppm.

CIRCLE NO. 301

Assortment of wing nuts handy to have around

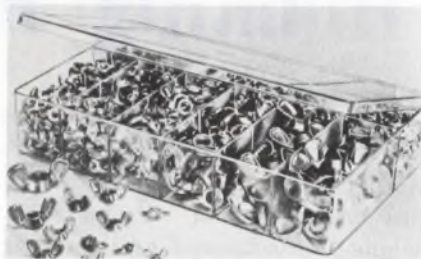

Product Components Corp., 36 Lorraine Ave., Mount Vernon, N.Y. 10553. (914) 699-8640. \$36 per box.

There are hundreds of everyday uses in the shop, factory, lab and in the field for this all-purpose, 825-piece, wing-nut assortment. Twelve most popular wing-nut sizes are packaged in a see-through box with a separate compartment for each size. The nuts are a nickel-plated, die-cast, zinc alloy that is rustproof and corrosion resistant. They will not freeze on bolts. Their accurate threads are tapped square to the face and they have washer-like bosses.

CIRCLE NO. 302

ANALYZE 1 MHz to 3 GHz



The AL-60 spectrum analyzer features a 70 dB distortion free display over the frequency range of 1 MHz to 3 GHz with an 8 x 10 cm display. This range is covered in three bands, 1 MHz to 1000 MHz, 1 GHz to 2 GHz and 2 GHz to 3 GHz. All three bands feature the same 105 dBm sensitivity and 1 GHz dispersion. Available from stock.

Texscan

A WORLD LEADER IN ELECTRONICS
"And Coming On Strong"

Texscan Corporation
2446 North Shadeland Avenue
Indianapolis, Indiana 46219
Ph: 317 357-8781
TWX: 810-341-3184 Telex: 272110

LOW COST-HIGH RELIABILITY TWO-CIRCUIT SUB-MINIATURE PUSHBUTTONS FOR PRINTED CIRCUIT BOARDS

- Ideal for Sub-chassis Checkout, Interlock Circuits, and Field Service
- No Mounting Hardware

TYPICAL SPECIFICATIONS

Mechanical Life
500,000 operations, min.
Contact Resistance 0.025 ohms, max.
Dielectric 1000 volts, rms.
Ambient Temperature Range
-20°C. to +70°C.
Weight 0.06 ounce

Available in momentary action or latch-down.

PCB Toggle Switches. Also available in 2 or 3 position momentary and/or maintained.

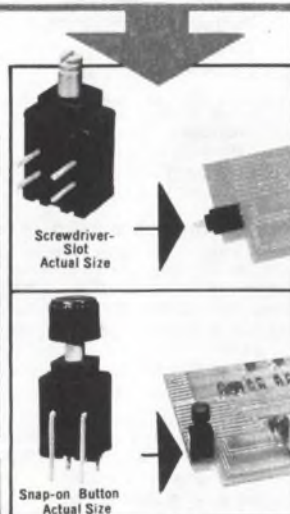

CONTROL SWITCH INC.

A SUBSIDIARY OF CUTLER-HAMMER INC.
1420 Delmar Drive • Folcroft, Pa. 19032 • (215) LU-6-7500

Representatives and Stocking Distributors Throughout the United States, Canada, and Europe

CELCO makes "Above-Average" YOKES for "Above-Average" CRT Displays

Need a deflected CRT spot as small as 0.00065"?

The CELCO HDQ High-Resolution Deflectron for Satellite Photography Read-out was the choice of one of our customers for their "Above-Average" display requirements.

You can get performance like that with a CELCO YOKE optimized on your CRT for your "Above-Average" display. (measured with a CELCO CRT Spot Analyzer.)

Or YOUR "Above-Average" display may require fast Zero-approach settling time, as required in a Fingerprint Scanning job where CELCO HDN Deflectrons are specified to recover to 0.01% in 25 μ s.

Precision Linearity on the final film plane or work surface, in Integrated Circuit Mask-Generator Displays enables producers of LSI technology to make low-cost computers for all of us. CELCO Special Deflectrons and Linearity Correctors LC123 are being used by several equipment builders for their "Above-Average" displays.

For PEPR, a system for reading Bubble Chamber photographs, developed by a few individuals at MIT and refined and expanded by others at leading universities throughout the world, CELCO was asked to provide special Low Residual Yokes for their project. CELCO produced their HD Deflectron with special 0.003% residual, and GFJ irrrotational Focus Coils to help achieve the performance of these "Above-Average" displays. CELCO DAPP2N-7 Amplifiers drive the Dynamic Focus Coil; a CELCO DAPP2N-5 Amplifier was selected by another PEPR group to drive the CELCO B1700 Di-Quadrupole which produced the rotating high-resolution scanning line!

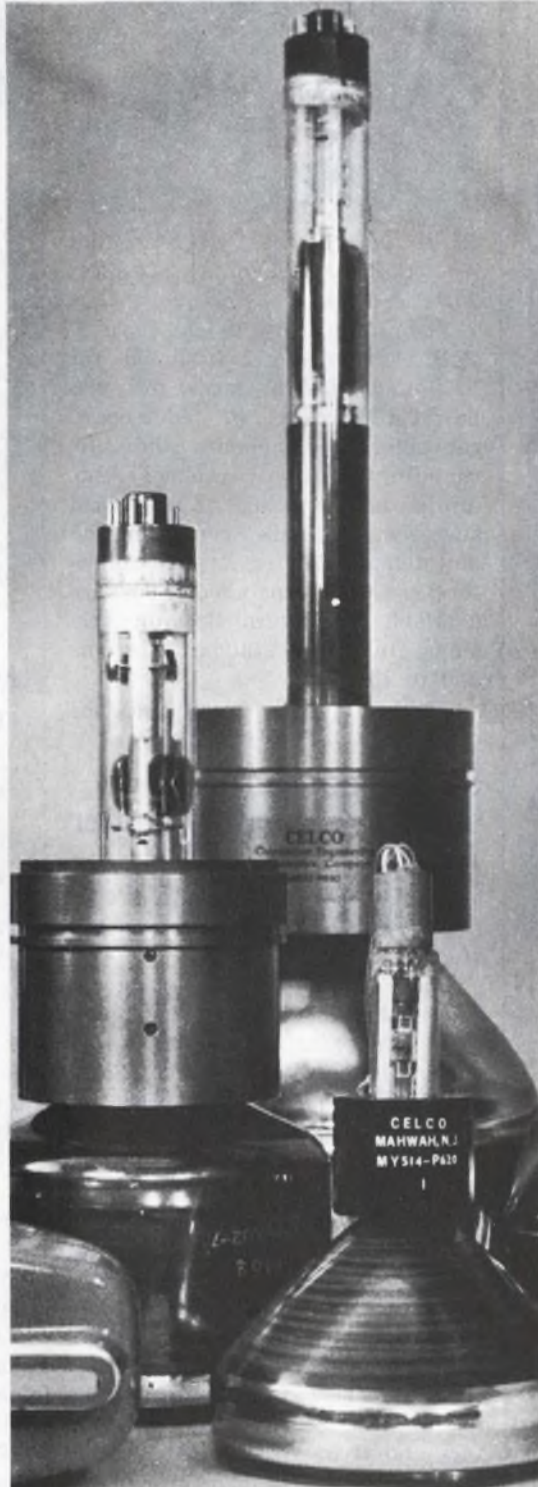

"Above-Average" Recording Storage Tube displays with 1 $\frac{1}{16}$ " neck scan converters and storage tubes need CELCO QY and QD Recording Storage Tube Yokes.

CELCO electronics and magnetics were integrated into a CELCO "DS" Special Display System for Oil Exploration and Data Reduction where "Above-Average" Linearity, Spot Growth, Zero-approach, Bandwidth, and Residual performances were required. Our customer decided to use CELCO's unique display experience to achieve his "Above-Average" display.

CELCO "Above-Average" deflection yokes, focus coils, beam-centering and aligners, astigmatic correctors, and pincushion correctors applied to your specific requirement will help you produce YOUR "Above-Average" Direct-View Display.

REMEMBER CELCO YOKES, whether you want to send a man to the moon, a probe to Jupiter or Mars, investigate chromosomes or trophoblast for cancer research, or build a large format scanner to generate typesetting masters, X-Ray enhancement, or data digitization.

- CELCO CRT Mounts, coil positioners, holders and magnetic shields will enable you to get everything together to achieve your "Above-Average" display.
- Write for CELCO YOKE BROCHURE and your FREE CELCO CRT Display Computer Slide Rule to compute the CELCO YOKE you need for your "Above-Average" CRT Display.

UPLAND CA 714-982-0215
MAHWAH NJ 201-327-1123

(average is so . . . ho-hum to us.)

"Above-Average" YOKES for "Above-Average" CRT Displays.

CONSTANTINE ENGINEERING LABORATORIES COMPANY
1150 E. Eighth Street, Upland, CA 91786

70 Constantine Drive, Mahwah, N J 07430



INFORMATION RETRIEVAL NUMBER 101

1
AMERICAN MADE

Tolerance
SCHAUER
1-Watt
ZENERS

Immediate Shipment
Low Prices

ANY voltage from 2.0 to 16.0

Quantity	Price each
1-99	\$1.07
100-499	.97
500-999	.91
1000-4999	.86
5000 up	.82



All welded and
brazed assembly

No fragile
nail heads

Gold
plated
leads

Write for complete
rating data and other
tolerance prices.

**Buy the kit—
Save
a lot**



Kit contains a 51-piece assortment of SCHAUER 1% tolerance 1-watt zeners covering the voltage range of 2.7 to 16.0. Three diodes of each voltage packaged in reusable poly bags. Stored in a handy file box. Contact your distributor or order direct.

A \$54.57 value for
ONLY \$24⁵⁰

Semiconductor Division

SCHAUER
Manufacturing Corp.

4511 Alpine Ave. Cincinnati, Ohio 45242
Telephone: 513/791-3030

PACKAGING & MATERIALS

**Card ejectors reduce
stress on connectors**



Bivar Inc., 1500 S. Lyon St., Santa Ana, Calif. 92705. (714) 547-5832. \$0.18 (1000 up); stock.

The family of nylon Card-O-Pull card ejectors, designed for 1/16 and 3/32-in. cards, prevents harmful stresses on edge-board connectors, components and surrounding support systems. Also, minimized handling of PC-board surfaces prevents contamination and damage to circuitry. The ejectors are easily installed. They are available in several locking versions, in eight standard designs and in 13 colors.

CIRCLE NO. 303

**Solder pot features
safety, removable heater**

Plato Products, Inc., 4357 N. Rowland Ave., El Monte, Calif. 91731. (213) 283-0466. \$54 (unit qty); stock.

The Plato Model 100 solder pot can make soldering areas much safer. All parts of the Model 100, except the crucible and dross tray, are safe to touch—even when the operating temperature reaches 975 F. In addition, the Model 100 has a 3-wire-grounded, UL-listed, 6-ft. cord with a NEMA 5-15 connector and receptacle. And should the sealed-disc heating element ever need replacing, it can be done easily by removing four nuts. The pot has a removable dross tray for easy cleaning, thermostat control from 500 to 975 F, adjustable leveling feet and it operates on 110 V, 60 Hz and uses 350 W. The crucible is 1-1/2-in. deep by 2-1/2-in. diameter. Over-all dimensions are 7-1/2-in. high by 6-in. diameter.

CIRCLE NO. 304

**Crimping kit is handy
around the lab or shop**



Electrical Construction Products, Hackettstown, N.J. 07840. (201) 852-1122.

A new kit of Buchanan copper and steel crimp connectors, splice cap insulators, terminal lugs and a C24 hand crimping tool enables electronics personnel to splice or terminate virtually any wiring job. Its metal box has individual partitions to separate the parts and a parts location chart allows easy identification. Parts are available to restock the kit.

CIRCLE NO. 305

**Multishielded cable
reduces noise pickup**

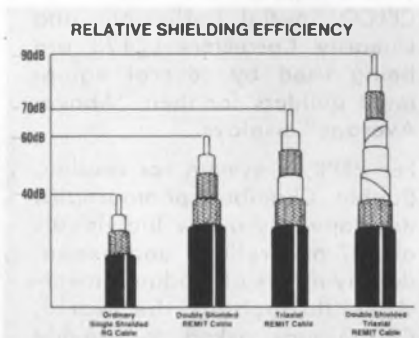

Times Wire & Cable Co., 358 Hall Ave., Wallingford, Conn. 06492. (203) 269-3381.

Called Remit, for reduced electromagnetic interference, these flexible cables were developed to give from 20 to 50-dB better isolation than standard single-shielded RG cables. Remit RDT-178, for example, is a double-shielded-triaxial cable that performs to the same electrical characteristics as RG-178B/U, but it offers 50 dB more isolation. The cables are available in double-shielded, triaxial and double-shielded-triaxial constructions.

CIRCLE NO. 306

Frame them any old way

Or any new way.

Then sit back and watch your Ise display electronics get your ideas across. Beautifully.

In an eye-easy fluorescent green glow.

At the same time, they're low on voltage and current drain.

High on stability.

Pick the readouts that offer more of everything, including variety, for a whole host of digital display ideas.

They're a difference you can see.

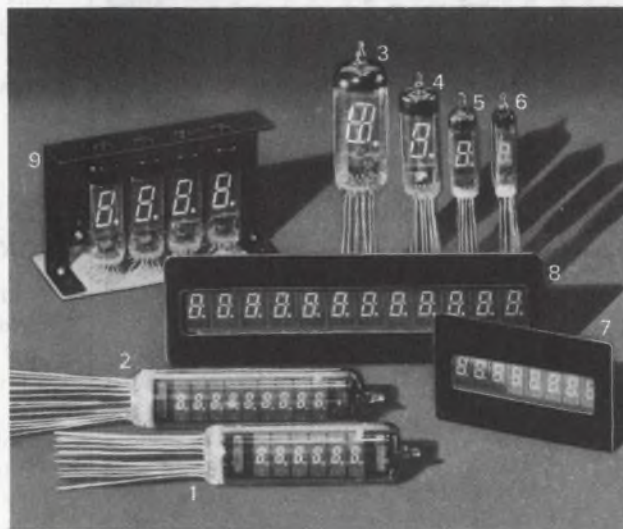

1. DP60A
 2. DP90A
 3. DG19E
 4. DG12H
 5. DG10F1
 6. DG 8F
 7. DP 89A
 8. DP127F
 9. DMCL12H (NEW)
- Display module w/counter & latch**
- Fluorescent green glow.
 - 12-pin connector
 - Three performance perfect models.
 - Custom ROM programming with other than BCD and seven-segment output.

The Brighter Side of Electronics



Creator of Fluorescent Digital Display:

ISE ELECTRONICS CORP. P.O. Box 46 Ise-city, Mie Pref., Japan
Tel: (05963) 5-2121 Telex: 4969523

International Sales Div.:

ISE INTERNATIONAL CORP. 2-7-7, Higashi-Shinbashi, Minato-ku, Tokyo, Japan
Tel: 433-6616 ~ 9 Telex: J26546 Cables: "ISEWORLDREP" TOKYO

Sales & Technical Office:

ISE CORP. OF AMERICA 1472 West 178th Street, Gardena, Calif., 90248 U.S.A.
Tel: (213) 532-0470 Telex: 230674910

Representative: Paris, Munich, Amsterdam, Stockholm, Vienna, Milan, Bombay, Hong Kong, Taipei.

INFORMATION RETRIEVAL NUMBER 103

Magnet wire operates at 1500 F, 1×10^{15} RADS

Gulton Industries, Inc., 6400 Roland Ave., Buena Park, Calif. 90621. (714) 523-3480.

Durock-insulated magnet wire will operate at temperatures to

1500 F and in nuclear-power generator applications where the radiation levels reach 1×10^{15} RADS. The insulation is a flexible silico-ceramic compound that is applied in ultra-thin layers of 0.0003 to 0.0005-in. The insulation is available on all types of wire, including nickle-clad copper, nickle-clad silver and stainless steel-clad copper wire. The wire can be bent around a mandrel only seven times the wire diameter without damage.

CIRCLE NO. 307

Headers with square posts attach to plugs



A P Products, Inc., 72 Corwin Dr., Box 110, Painesville, Ohio 44077. (216) 354-2101.

Molded, straight and right-angle pin headers with up to 36 pins and 0.025-in. square posts are especially designed for the plug-in attachment of single or dual row connectors with contacts on 0.1-in. centers. They also provide a patch-board matrix where discrete, single-position connections may be made. The single-row headers offer a special break-to-length feature and the plastic bodies are stackable for 0.100-in. row spacing. Plastic matrix spacer strips are available separately for increasing row spacing in 0.1-in. steps. Double-row headers are available in any lengths up to 36 pins per row. They are made up of single-row headers, either straight or right-angle, which have been ultrasonically welded together.

CIRCLE NO. 308

DELAY LINES

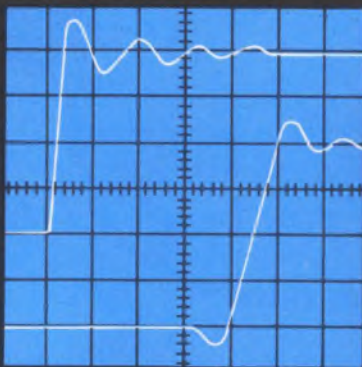

**60 OFF-THE-SHELF
DIP MODELS... TO
250 NSEC...
THOUSANDS OF
SPECIALS
SHIPPED
MONTHLY BY**

PULSE ENGINEERING!

Choose from our broad standard line or let us build to your specifications. We're geared to large volume production and delivery.

Write for complete information or send your specifications for quote-

DELAY LINES • MICROELECTRONICS MINIATURE MAGNETICS

Call your nearest regional office:

ABINGTON, PA.
(215) 887-4343

BOCA RATON, FLA.
(305) 391-3803

SANTA CLARA, CALIF.
(408) 248-6040

WALTHAM, MASS.
(617) 894-0950

CHICAGO, ILL.
(312) 992-3720

STUDIO CITY, CALIF.
(213) 872-0735

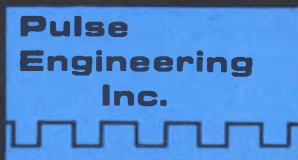

A Varian Subsidiary

Pulse Engineering

P.O. Box 12235 • San Diego, Calif. 92112
Phone 714-279-5900 • TWX 910-335-1527

Polyimide-glass resists solder temperatures

Sanders Associates Inc., Grenier Field, Manchester, N.H. 03103. (603) 885-2810.

Multilayer PC wiring boards that are made with polyimide glass enable the fabrication of up to 17 conductor layers and 3500 holes on an 8 x 7-in. board only 0.125-in. thick. Polyimides are heat-resistant materials that can withstand soldering temperatures almost indefinitely. Bond strength doesn't degrade during the heat process, soldering doesn't lift off pads and measing doesn't occur.

CIRCLE NO. 309

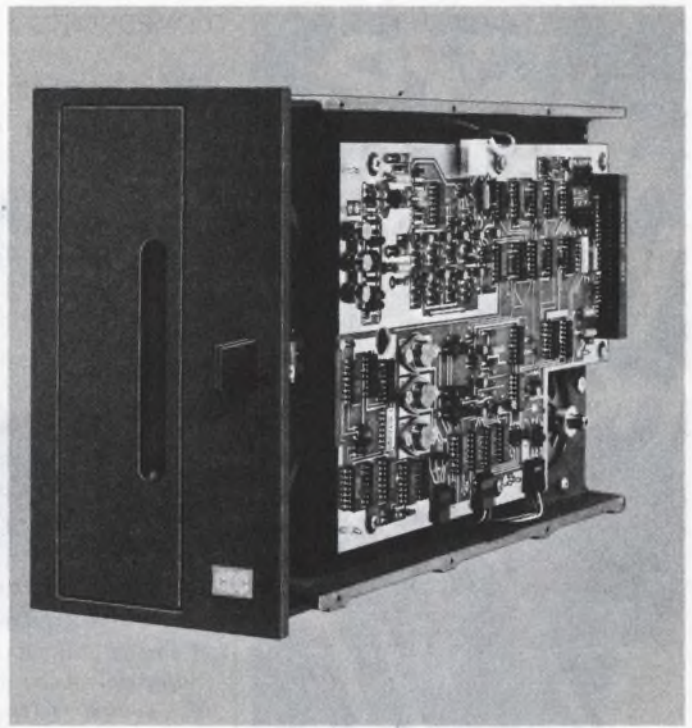
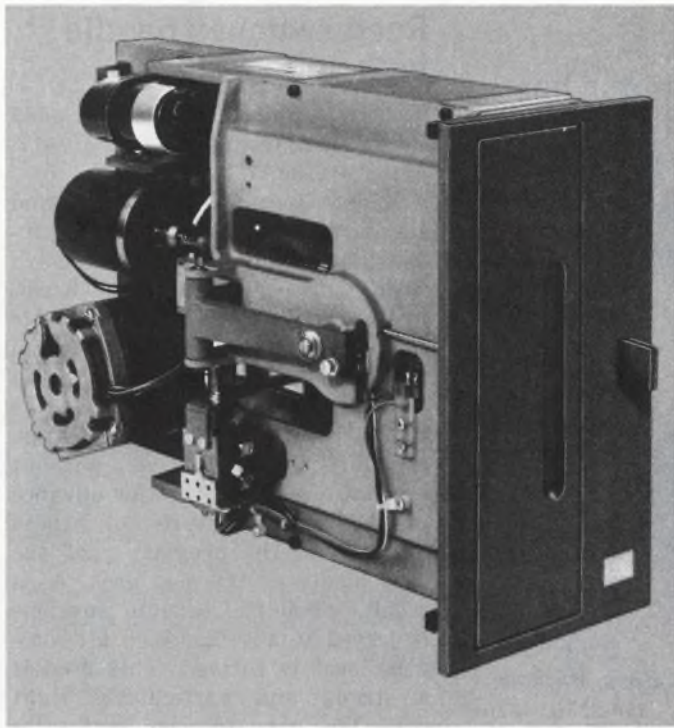

The CONTROL DATA® 9400 Flexible Disk Drive is read/ write/media compatible.

Technical sophistication and design simplicity best describe the Control Data Model 9400 Flexible Disk Drive. A low cost, 3 megabit, random access information storage device utilizing a removable, flexible, mailable 7.88-inch magnetic disk compatible with diskettes in the 3740. Weighs just 12 pounds. Can sit on a desk top or be mounted in an equipment cabinet. Data transfer rate is 249,948 BPS. All this, designed for a 5 year product lifetime. We invite you to send coupon, or contact your Control Data OEM Representative nearest you.

CONTROL DATA
CORPORATION

Control Data Corporation
Tom Farrell, OEM Marketing Manager,
Hawthorne Operations, 2815 W. El Segundo Blvd.,
Dept. ED-64, Hawthorne, CA 90250

Name _____

Title _____

Company _____

Address _____ Phone _____

City _____ State _____ Zip _____

I want to see a demonstration of the Control Data Model 9400 Flexible Disk Drive. Have my Representative call.

**We're
hard
headed**



on the surface

And because of it our LTC® lifetime ceramic heads will last 10 times longer, and survive your drives' life expectancy. Our claim means savings . . . and a lot more. Contact us for information.



NORTRONICS

Company, Inc.
8101 Tenth Ave. North Minneapolis, Minn. 55427
Telephone (612) 544-0381

COMPONENTS

PM stepper motor has 1-1/2-oz-in. detent

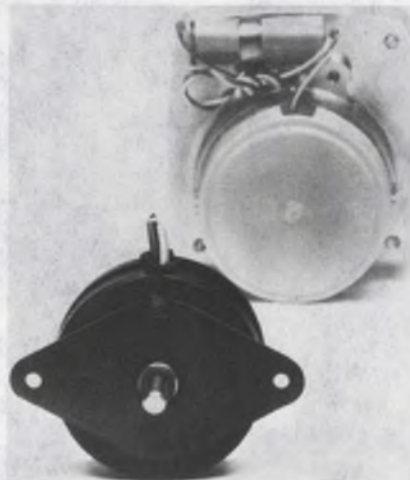

Molon Motor & Coil Corp., 3737 Industrial Ave., Rolling Meadows, Ill. 60008. (312) 259-3750. \$10 (5000 up).

Molon's new PM stepper motor, only 2-1/2 D × 7/8 L in., replaces higher-priced stepper motors in business machines, computer peripheral and communication equipment. The simplest excitation mode uses a unipolar four-phase power supply. For this mode, the motor is constructed with center-tapped windings. Standard voltages are 6, 12 and 24 V. The motor's step angle is 7-1/2 degrees; its running torque is 4 oz-in. at 100 pps; and its static torque is 10 oz-in. The maximum no-load response rate is 260 pps. In addition, the rotor exhibits a detent-torque of 1-1/2 oz-in. The motor is available with a gearbox.

CIRCLE NO. 310

Microphone operates on electret charge

Thermo Electron Corp., 101 First Ave., Waltham, Mass. 02154. (617) 890-8700.

Model 5336 TElectret condenser microphones are very small (0.280-in. square by 0.160-in. deep), and low in cost (not supplied). They offer a smooth, extended frequency response from 50 to 16,000 Hz, and they are completely sealed. An IC hybrid pre-amplifier is built into the unit. TElectret microphones are powered by a permanent electric charge built into the diaphragm.

CIRCLE NO. 511

Reed switches handle high voltages

Current Industries, Inc., 3359 Ocean Ave., Oceanside, N.Y. 11572. (516) 678-3895.

A new line of subminiature and standard reed switches have unusually high voltage breakdown ratings. The subminiature (0.098-in. dia) switches are available with ratings up to 1000 V dc and the standard (0.177-in. dia) switches are available with ratings to 3600 V dc. This high-voltage capability is achieved without evacuation stems. A major advance in the manufacture of these switches is the preglazing of the reed blades at the seal area. As a result, when the capsule envelope is joined to the blades, a glass-to-glass seal is formed. This creates a strong and particularly tight seal. The glass-to-glass seal technique also enables the envelope material to be lead-free borosilicate glass. Thus, the switches also feature excellent thermal-shock characteristics, as well as the high open-contact resistance.

CIRCLE NO. 512

Sensor measures radial or axial movement

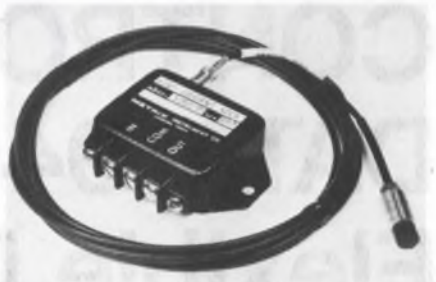

Metrix Instrument Co., P.O. Box 36501, 5760 Rice Ave., Houston, Tex. 77036. (713) 668-2386.

Model 5265 noncontact proximity sensor measures radial vibration or axial position of machinery shafts and other metallic objects. Operating on the eddy current principle, the sensor can detect either a static change of position or vibrations to 10 kHz. Motions as small as 40 μ-in. and up to 0.05 in. can be measured. The sensitivity can be adjusted to 0.1 V/mil. The unit operates on 12 V dc. The temperature range of the driver unit is -20 to 65 C and the probe -20 to 100 C.

CIRCLE NO. 513



We take your reputation seriously.

That's why we build and test our Standard Power Modules so carefully.

A basic component like the power supply can put an expensive machine out of business. And, while the shutdown may be temporary—the loss of reputation and customer confidence may be permanent.

This is why many O.E.M.'s are taking another look at their power supply "economies." When they do, North Electric looks better and better.

This is because our line of Standard Power Modules offers the highest levels of engineering and quality control in the industry—the same standards that have made North the leading custom power source for more than 40 years.

That's why, when North delivers power—you can bet your reputation on it.

Send for a catalog today, or call your North Product Manager at 419/468-8874.

MODEL	11000	12000	13000	14000	15000	16000	17000	18000
VDC	AMPERES							
5.0	3.9	5.3	11.3	13.0	20.0	32.5	49.0	82.0
12.0	2.8	4.2	8.0	10.5	15.0	23.0	36.0	58.0
15.0	2.4	3.7	7.5	9.5	14.0	20.5	27.0	47.0
18.0	2.1	3.3	6.0	8.0	13.0	18.0	26.0	40.0
24.0	1.5	2.8	4.2	7.0	11.0	15.0	21.0	33.0
28.0	1.4	2.4	4.0	6.3	9.0	14.0	20.0	29.0
36.0	1.2	2.2	3.1	5.6	8.0	11.0	14.0	23.0
48.0	.95	1.8	2.6	4.2	6.0	8.0	10.0	18.0

DUAL OUTPUT SUPPLIES	
MODEL	N60052
VDC	AMPS
±15 12	400MA
MODEL	N60053
VDC	AMPS
±15 12	1.0A

MODEL 10000	
VDC	AMPS
0-7.5	2.10
0-16	1.25
0-25	0.85
0-33	0.68

Listed here are the more popular models—many other voltages are available.

NORTH 
ELECTRIC COMPANY

North Electric Company / Galion, Ohio 44833 / A United Telecom Co.

SP-18



INFORMATION RETRIEVAL NUMBER 107

Murata's Posistors® can.....

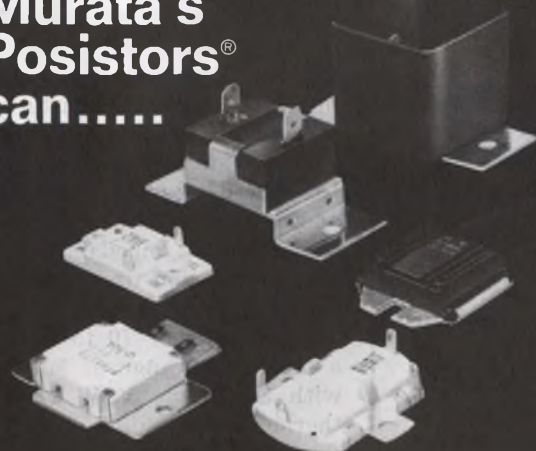

...heat, switch, start motors, control temperature, limit current, sense, aid automotive anti-pollution devices, control and on and on. They're small but powerful positive temperature coefficient devices that can handle hefty loads with a degree of reliability that mechanical switching contacts find impossible to imitate. Let us give you a few ideas as to how Posistors can fit into your scheme of things . . . just circle the reader service number below.

muRata MURATA CORPORATION OF AMERICA
2 Westchester Plaza, Elmsford, New York 10523
Telex: MURATA EMFD 137332 / Phone: 914/592-9180
A Subsidiary of Murata Mfg. Co., Ltd., Japan

INFORMATION RETRIEVAL NUMBER 108

ELECTRONIC DESIGN 12, June 7, 1974



New goodies add measure power to Fluke 8000A

Best selling 3½ digit DMM even better with new options and accessories

New ac/dc high current option lets you measure 10 A. continuously or up to 20 A. momentarily. New low 2 and 20 Ω scales give 0.001 Ω resolution. Low cost RF probe offers new capability.

Other options include rechargeable battery pack, digital printer output, deluxe test leads, 40 kV high voltage probe, 600 A. ac current probe, carrying cases, dust cover and rack mount.

Basic "best buy" \$299 DMM feature dc accuracy of 0.1%. Measure ac/dc volts from 100 μv to 1200 v, current from 100 nanoamperes to 2 A. and resistance from 100 milliohms to 20 megohms. Guaranteed 20,000 hour MTBF.



For data out today, dial our toll-free hotline, 800-426-0361

John Fluke Mfg. Co., Inc., P.O. Box 7428, Seattle, WA 98133

INFORMATION RETRIEVAL NUMBER 109

191

Sophisticated systems need sophisticated converters

Perkin-Elmer will custom design Varidac® ac D/A converters to fit your circuitry.

- Custom converters up to 15 bits of accuracy and 18 bits of resolution.
- Transformer based — highest reliability and stability.
- Designed in the system perspective.
- Off-the-shelf modules available up to 13 bits of accuracy and 12 bits of resolution: Varidac-1 mini-converters, Varidac-2 dual channel converters for D/S systems, Varidac-4 computing resolvers, and complementary transformers.

Send for data sheets, and for a free laminated Binary/Angular Conversion Card. Perkin-Elmer Corporation, Electronic Products Dept., Main Avenue, Norwalk, CT 06856. (203) 762-4786.

PERKIN-ELMER



INFORMATION RETRIEVAL NUMBER 110

System 9400 changes as quickly as your needs do.

DATA LOGGER

A new breed of data logger that easily configures to your needs now—quickly reconfigures as your requirements change. Can be stand-alone logger or part of a powerful NOVA computer based system with software drivers in BASIC, FORTRAN and ASSEMBLY languages.



Outputs to integral printer, TTY, mag tape, modem, punch tape. Don't get locked into another logger before you've seen the

System 9400 in action. Contact Monitor Labs Incorporated, 4202 Sorrento Valley Boulevard, San Diego, CA 92121. Tel: (714) 453-6260. TWX: 910-337-1278.



INFORMATION RETRIEVAL NUMBER 111

COMPONENTS

Voltage sensor has repeatability of 0.1%

Time Mark Corp., P.O. Box 15127, Tulsa, Okla. 74115. (918) 939-5811. \$23 to \$27 (100 up); stock.

Series 260 solid-state sensing relays for over or undervoltage detection are housed in standard eight-pin octal relay cases. Models cover the range of 4 to 500 V ac or dc. The ac models can operate at from 25 to 2000 Hz. Adjustment of the voltage set-point is made with a small screwdriver through a hole in the rear of the case. The output is a SPDT contact rated at 2 A. Hysteresis between pull-in and drop-out is typically 0.3% of the monitored voltage. Repeatability for fixed conditions is less than 0.1%.

CIRCLE NO. 514

PC-board relay mounts with daughter board

Executone, Inc., 29-10 Thomson Ave., Long Island City, N.Y. 11101. (212) 392-4800. 24BW2G: \$1.73 (5000 up).

A low-cost PC-board relay for use in rf or thermocouple circuitry uses a PC daughter board that becomes an integral part of the relay. The daughter board can have intricate conductor patterns that serve both as fixed contacts and also provide special characteristics for these applications. Patterns and ground planes can match the characteristic impedance of attached transmission lines in the range of 50 to 75 Ω and achieve cross-talk isolation of 70 to 50 dB over a frequency range of 50-250 MHz with acceptable VSW ratios. For thermocouple switching, the copper conductor pattern is first plated with a nickel barrier, and then, hard gold. This pattern, when mated with the gold contacts of the swinger blades of the relay, maintain the thermal emf under 2 μ V. A bead-pin header also allows you to unplug the relay. Relays are supplied with coils of 6 to 24 V dc, either magnetic latching or nonlatching and with contact configurations to 4PDT, or an 8-pole combination of 4PNO and 4PNC. Contacts are rated to 0.5 A.

CIRCLE NO. 515

Proximity switch comes in several packages

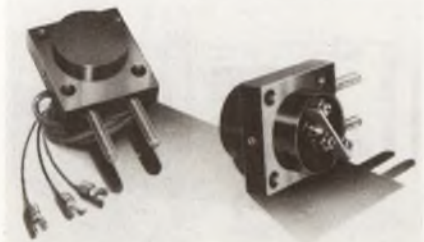

Electro Corp., 1845 57th St., Sarasota, Fla. 33580. (813) 355-8411. 55501-3: \$8; 55501-7: \$9 (unit qty); stock to 30 days.

Completely sealed and shock resistant metal sensing devices are available in two package configurations: three models (Series 55501-3) with screw terminals for external connection, featuring an operating check LED; and three models (Series 55501-7) with an integral three-wire cable. All have a universal three-axis mounting bracket. The sensing circuit is designed to provide a stable and fixed sensing distance of 0.625 in. for steel, and 0.2 in. for aluminum targets. The switching circuit has an operating range of 0 to 10,000 impulses-per-second. Output for all models is 200 mA dc with supply voltages of 5, 12 and 24 V dc.

CIRCLE NO. 516

Gas filled relays defibrillate hearts

Kilovac Corp., P.O. Box 4422, Santa Barbara, Calif. 93103. (805) 684-4560. \$125 (1-9); stock to 30 days.

Model KM-14, a DPDT gas-filled relay, designed specifically for use in heart defibrillator instruments, also has a broad range of other applications. The relay is capable of switching up to 500 W-s of pulse energy. In defibrillator applications, its DPDT contact arrangement allows the patient to be completely isolated from the voltage source. The gas filled relay provides "soft" switching to reduce transients that could have a detrimental effect on the patient and the associated circuitry. The glass envelope is encapsulated in plastic to reduce handling damage. The standard relay has a 12-V-dc coil, but other coil voltages are available on request.

CIRCLE NO. 517

NO ONE CAN MATCH OUR LINE-UP

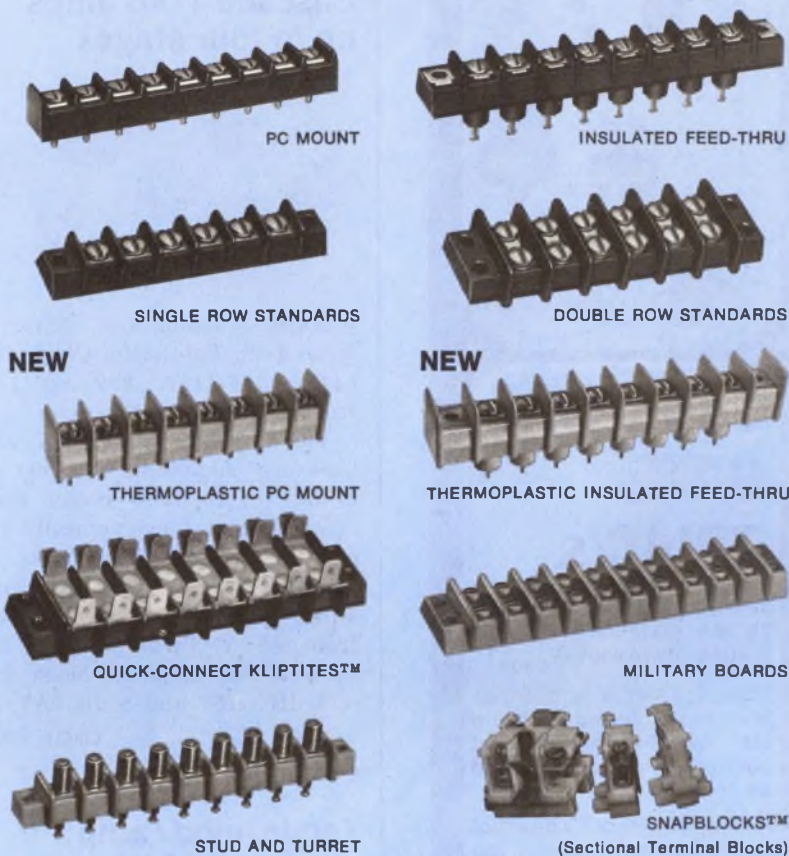

Kulka

A NORTH AMERICAN PHILIPS COMPANY

Kulka Electric Corp., 520 South Fulton Avenue, Mount Vernon, New York 10551

KULKA'S AUTHORIZED INDUSTRIAL DISTRIBUTORS

- | | | |
|-----------------------------------|-----------------------------------|------------------------------------|
| AZ—Phoenix, Parts Elex. | MD—Baltimore, Radio Elec. Service | OH—Cleveland, R.P.C. Inc. |
| CA—Los Angeles, Fisher/Brownell | MD—Hyattsville, Milgray/Wash. | OH—Cleveland, Pattison Supply |
| CA—Los Angeles, Radio Products | MA—Dedham, Gerber Elex. | OH—Columbus, Hughes-Peters |
| CA—Mountain View, Ratei Elex. | MA—Newton, Green-Shaw Co. | OH—Dayton, John A. Becker Co. |
| CA—Santa Clara, Fisher/Brownell | MI—Augusta, Great Lakes Elex. Co. | OK—Oklahoma City, Electro Enterp. |
| CO—Denver, Denver Walker Radio | MN—St. Paul, Ragon Elex. | PA—Erie, Mace Elex. |
| CT—Fairfield, "U" Tronics | MO—Kansas City, Walters Radio | PA—Harrisburg, Pyttronics Inc. |
| CT—Waterbury, Bond Radio Elex. | MO—St. Louis, L-Comp | PA—Philadelphia, Simco Elex. |
| FL—Ft. Lauderdale, Peerless Radio | NB—Lincoln, Scott Elex. Supply | PA—Pittsburgh, R.P.C. Inc. |
| FL—Miami, Electronic Equip. Co. | NJ—E. Rutherford, Kappe Elex. | PA—Pittsburgh, Cameradio |
| FL—Winter Park, Electronic Equip. | NM—Albuquerque, Industrial Elex. | PA—Reading, Geo. D. Barbey Co. |
| GA—Atlanta, Brownell Electro | NM—Albuquerque, Walker Radio Co. | SC—Columbia, Dixie Radio Supply |
| IL—Chicago, Merrill Elex. | NY—Buffalo, Summit Dist. | TX—Dallas, Adleta Elex. |
| IL—Rockford, Mid-West Assocs. | NY—Elmford, Melville Radio Corp. | TX—Dallas, Solid State Elex. |
| IL—Rosemount, Advent Elex. | NY—Farmingdale, Arrow Elex. | TX—Houston, Southwest Elex. |
| IL—Westchester, L-Comp Inc. | NY—Lynbrook, Peerless Radio Corp. | UT—Salt Lake City, W. H. Bintz Co. |
| IN—Indianapolis, Graham Elex. | NY—Mt. Vernon, QAR Indl. Elex. | VA—Charlottesville, Virginia Radio |
| IN—So. Bend, Radio Dist. Co. | NY—New York, Center Indl. Elex. | WA—Seattle, Radar Elex. Co. |
| IA—Cedar Rapids, Deeco Inc. | NY—New York, Midway Indl. Elex. | WA—Tacoma, C & G Elex. Co. |
| IA—Des Moines, Mid-State Dist. | NY—Rochester, Simcona Elex. | WV—Beckley, Halley Elex. Co. |
| KS—Wichita, Radio Supply Co. | NY—Rochester, Summit Dist. | CAN—Downsview Ont., Cescio Elex. |
| ME—Portland, Holmes Elec. Supply | NC—Winston-Salem, Kirkman Elex. | CAN—Montreal Quebec, Cescio Elex. |
| | OH—Cincinnati, Hughes-Peters | |



SENSITIVE GATE TRIAC's

3mA, 4mA, 5mA, 10mA and 25 mA (IGT) All quadrant grating 50V to 600V (V_{DROM})

Hutson TRIAC's and SCR's are ideally suited for solid state switches, motor speed controls, lighting, heating and air conditioning controls.

Patented Di-Mesa™ construction is designed to assure you of reliability and superior performance. Hutson's complete line of TRIAC's and SCR's are available as void-free, glass-passivated chips or in all standard package configurations.

Call on Hutson's state-of-the-art thyristor technology when you need reliability and economy.



Box 34235 • 2019 W. Valley View
Dallas, Tex 75234 (214) 241-3511
TWX 910-860-5537

Representatives:

New York City Area. 201/399-4350.
Seattle 206/454-0300. Los Angeles
213/240-3151. Dallas 214/231-6181.
Baltimore 301/944-8262. Denver 303/
757-7679. Ft. Lauderdale 305/772-
5100. Chicago 312/286-1500. Detroit
313/499-0188. Syracuse 315/699-
2671. Indianapolis 317/888-2260. At-
lanta 404/427-0241. Canada 416/638-
1322. Beaverton 503/643-1644. Dayton
513/433-2511. Phoenix 602/968-9037.
Minneapolis 612/866-3035. Boston
617/890-8040. Kansas City 816/765-
2998

Distributors:

Elizabeth 201/345-2420. Los Angeles
213/240-3151. Denver 303/934-5505.
Chicago 312/323-9670. Canada 416/
635-9880. Rochester 716/454-7800.
Salt Lake City 801/486-7227. Belgium
02362135. Brussels 02352135. Den-
mark (01) 295622. England (09924)
67161. Norway 472702272. Spain 234-
62-62. Sweden 08-28-5940. Switzer-
land 051-852201.

MICROWAVES & LASERS

Cascade TO-8 amps up to four stages



Watkins-Johnson Co., 3333 Hillview Ave., Palo Alto, Calif. 94304. (415) 493-4141. \$99 up (1-9); stock (small quantities).

The WJ-A5 and WJ-A7 amplifiers are cascaded 5-to-500 MHz units. Up to four stages can be cascaded to achieve typically 58-dB gain and ± 0.5 -dB flatness. The amplifiers are supplied in hermetic 4-pin TO-8 packages and operate from 15 V (WJ-A5) and 24 V (WJ-A7) dc supplies. Noise figure is 4 dB (A5) and 5 dB (A7).

CIRCLE NO. 518

Tacan mod/amp outputs 100 W peak

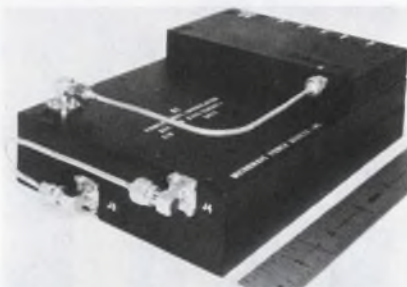

Microwave Power Devices, Adams Ct., Plainview, N.Y. 11803. (516) 433-1400. 90-120 days.

The Model PWA9612/1489, a broadband solid-state modulator/amplifier, delivers 100 W peak Gaussian-shaped pulses (MIL-STD-291B) over the 960-to-1215 MHz range. The unit weighs only 2-1/4 lbs and measures 4-1/4 \times 6-1/4 \times 1-13/16 in., and it doesn't require tuning or Gaussian-shaping adjustments over the full frequency range and over the -55 to 85 C temperature range. Other features include an rf gain of 40 dB, circulator protection against load mismatches, second harmonics under 45 dB below the carrier and an over-all average power consumption of 17.5 W.

CIRCLE NO. 519

Digital power meter handles 18-GHz signals



Systron-Donner Corp., 735 Palomar Ave., Sunnyvale, Calif. 94086. (408) 735-9660. \$1725; stock.

A digital power meter for measurement of cw and swept rf power covers the 1-to-18,000-MHz frequency range. Called the Model 4020, the new meter has a dynamic range of +10 to -40 dBm without autoranging. The four-digit display provides direct readout of power in both 50 and 75- Ω systems in dBm, with a linearity of ± 0.04 dB for any 10-dB range. Resolution is 0.01 dB over the full dynamic range. Other features include high stability—no zero drift at -40 dBm—field replaceable power sensing element and self-calibration.

CIRCLE NO. 520

100-W L-band amp has 15-ns rise, fall

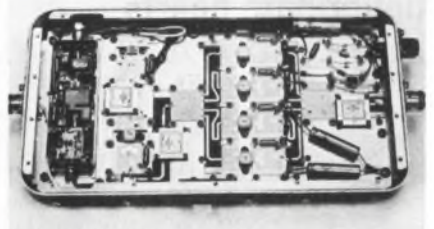

Trak Microwave Corp., 4726 Eisenhower Blvd., Tampa, Fla. 33614. (813) 884-1411. \$3800; 135 days.

Use of microstrip, thin-film hybrid and miniature ferrite technology results in a 150-W pulsed L-band solid-state amplifier with 15-ns rise and fall times. Minimum output power is 100 W, and peak input power can be 1 to 4 mW. At 1300 MHz, the amplifier has a 110-MHz bandwidth with a gain flatness of ± 0.5 dB maximum in any 30-MHz band from 1250 to 1350 MHz. The unit operates on a 0.002 duty cycle.

CIRCLE NO. 521

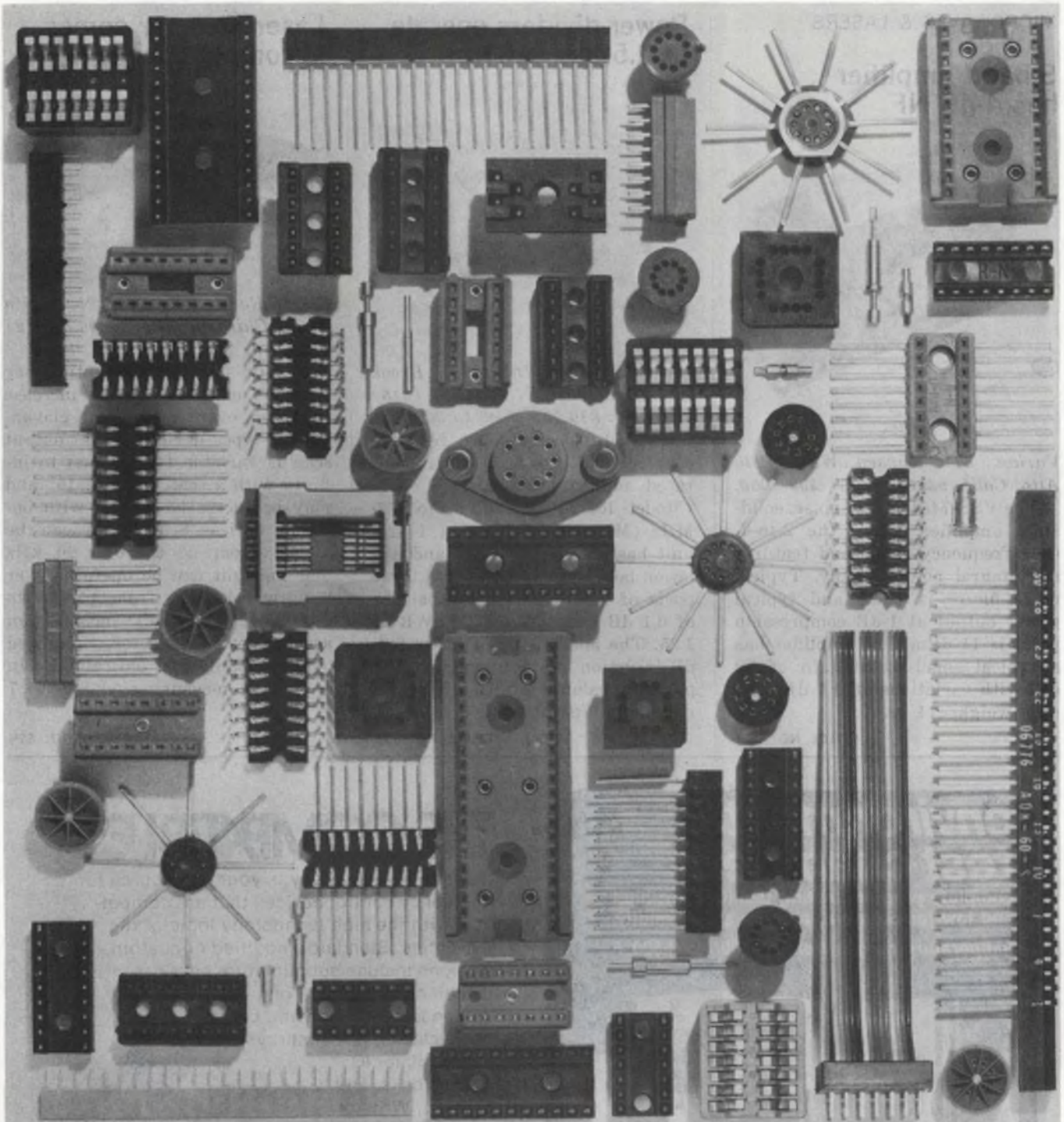

SOCKETS

The most complete competitive line in the industry.

Literally hundreds of socket products - over 800 standard items. Sockets for 8-pin mini-Dips to 64-pin LSIs. Can styles. Transistor sockets. Pin sockets. Surface mount, solder and wirewrap styles. Adaptors. Plugs. Jumpers. Even complete interconnect systems. You name it, we make it. To meet

RNs exacting standards. At a price that's right. And delivered when and where you need them. Off the shelf. From our plant or one of 20-plus stocking distributors. If you need to know about plug-ins, see ...The Socket People.



ROBINSON NUGENT INC.
800 EAST EIGHTH STREET
NEW ALBANY, INDIANA 47150
(812) 945-0211/TWX 810-540-4082

S-band amplifier has 4-dB NF

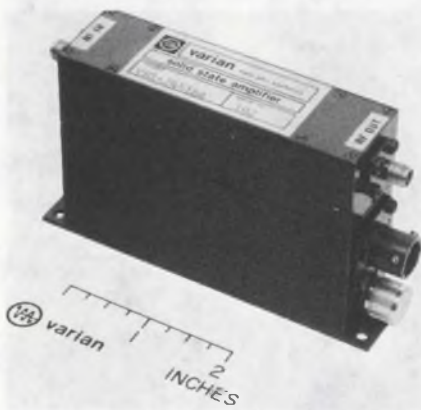

Varian, 611 Hansen Way, Palo Alto, Calif. 94303. (415) 493-4000.

The VSS-7451JP low-noise, solid-state amplifier covers the 2-to-4-GHz frequency range and features an integral power supply. Typical noise figure is 4 dB and typical power output at 1-dB compression point is 11 dBm. The amplifier has a typical small-signal gain of 30 dB, with variations of ± 1 dB. The unit weighs 11 oz.

CIRCLE NO. 522

Power dividers operate at 0.5 and 1 GHz

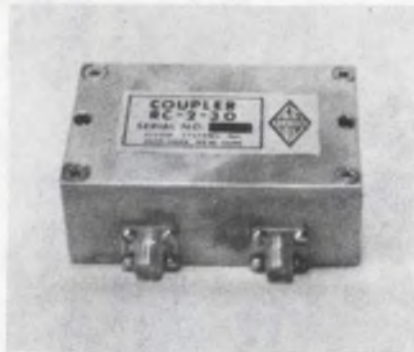

Elcom Systems, Inc., 127F Brook Ave., Deer Park, N.Y. 11729. (516) 667-5800. \$39.50; stock to 30 days.

Two 50- Ω coaxial SMA resistive coupler and power dividers are rated for at least dc to 1 GHz (Model RC-2-30) and dc to 500 MHz (Model RC-3-30). The 1-GHz unit has an insertion loss and isolation between any two of its three ports of 6.25 dB. It has a balance of 0.1 dB and maximum VSWR of 1.35. The 500-MHz unit has a 9.6-dB insertion loss between any four ports, a balance of 0.2 dB and a maximum VSWR of 1.65.

CIRCLE NO. 523

Laser scanner comes in compact package



Zenith Radio Corp., 1900 N. Austin Ave., Chicago, Ill. 60639. (312) 745-5035. \$7950.

A solid-state acousto-optic laser scanner provides a 10-20 increase in speed over commercial galvanometer-type devices. The output scan is variable from 6 mm to infinity with a scan angle of 15° and may be increased to 40° with optional optics. Scan rates can be varied from dc through 20 kHz and the unit can be operated over laser wavelengths from 4416 Å to 10,600 Å. The unit includes an acousto-optic deflector, required optics, mounts and optical rails in a package measuring 31-1/2 x 7 x 7 in.

CIRCLE NO. 524

environmental test chambers

complete program testing facilities for: high and low temperature, altitude and humidity. temperature ranges from: -150° to +500°F

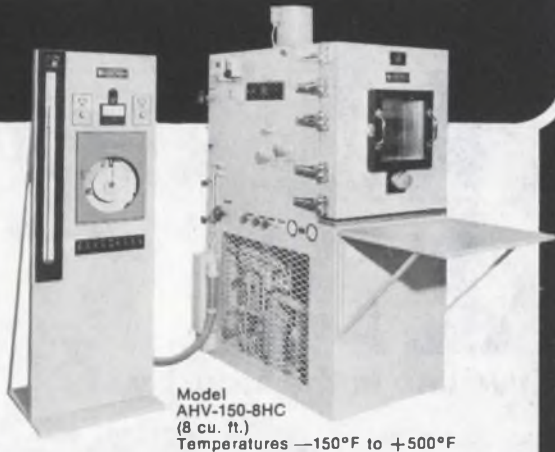

Custom units, designed and built to your specifications. For FREE, NO OBLIGATION quote, send us your temp. range, size and chamber needs.

Get the facts today. Send for our new FREE test chamber brochure.

CINCINNATI SUBZERO PRODUCTS INC.

2612 Gilbert Ave., Cincinnati, Ohio 45206
Phone: (513) 751-8810

INFORMATION RETRIEVAL NUMBER 115

THE COMPATIBLES

Spectrum Technology is your one source for frequency control devices that are compatible with the high technology logic of the Seventies. Standard, modified or custom designs include subminiature hybrid circuit crystal oscillators, dual in-line low profile hybrid circuit logic clocks, low cost crystal oscillator IC logic clocks, and TCXO's. Write or call for details.

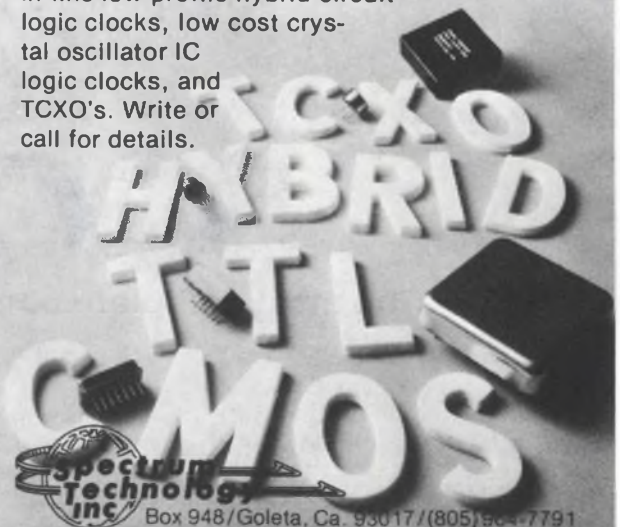

Frequency Control & Timing Systems Products
Crystal Oscillators • Logic Clocks • TCXO's.

INFORMATION RETRIEVAL NUMBER 116

ELECTRONIC DESIGN 12, June 7, 1974

A BETTER METER.

Data Precision's newest multimeter — the 1/2 digit MODEL 3500 — is a second generation instrument that combines the best of both worlds.

More features.
For less money.

MODEL 3500 incorporates all of the proven circuitry advances that made our 2500 Series the internationally accepted price/performance leader.

Tri-phasic™ auto-zero, Ratiohmic™ 2- and 4-wire resistance, and Isopolar™ high stability referencing.

With a 6 month basic DC accuracy of $\pm 0.007\%$ of reading $\pm 0.001\%$ of full scale ± 1 LSD, full autoranging from 1 microvolt to 1000V (DC or AC peak) and 1 milliohm through 12 megohms resistance, 20% overranging, DC Ratio, isolated BCD output, remote triggering and remote ranging, it represents the most sophisticated laboratory multimeter you can buy for less than \$1000.

\$995.
complete

MODEL 3500 features the industry's most reliable, field proven circuit technology packaged behind a big, bright and easy-to-read 1/2 inch planar gaseous display. And none of the bugs of an unproven design.

MODEL 3500 measures DCV, 1 microvolt to 1000 Volts; ACV, 1 microvolt to 700V RMS, 30 Hz to 100KHz; Resistance, 1 milliohm to 12 megohms; and Ratio.

AVAILABLE NOW

Contact your local Data Precision representative to arrange for a demonstration.

AL (205) 533-5896	MA (617) 273-0198	NY (S) (516) 482-3500
AZ (602) 994-9519	MD (301) 552-2200	OH (N) (216) 725-4560
CA (N) (408) 733-9000	MI (313) 482-1229	OH (S) (513) 298-3033
CA (S) (714) 540-7160	MN (612) 781-1611	OR (503) 238-0001
CO (303) 449-5294	MO (W) (816) 737-0066	TX (N) (214) 234-4137
CT (203) 525-7647	MO (E) (314) 731-2331	TX (S) (713) 461-4487
FL (813) 294-5815	NC (919) 787-5818	UT (801) 268-3181
GA (404) 457-7117	NJ (S) (215) 925-8711	WA (206) 763-2210
HI (808) 262-6286	NJ (N) (201) 863-5660	CAN (W) (416) 787-1208
IL (312) 593-0282	NM (505) 265-6471	CAN (W) (613) 772-5874
IN (317) 293-9827	NY (N) (315) 446-0220	CAN (E) (514) 731-9328

Data Precision Corporation
Audubon Road, Wakefield, MA 01880
(617) 246-1600

 **DATA PRECISION**
...years ahead

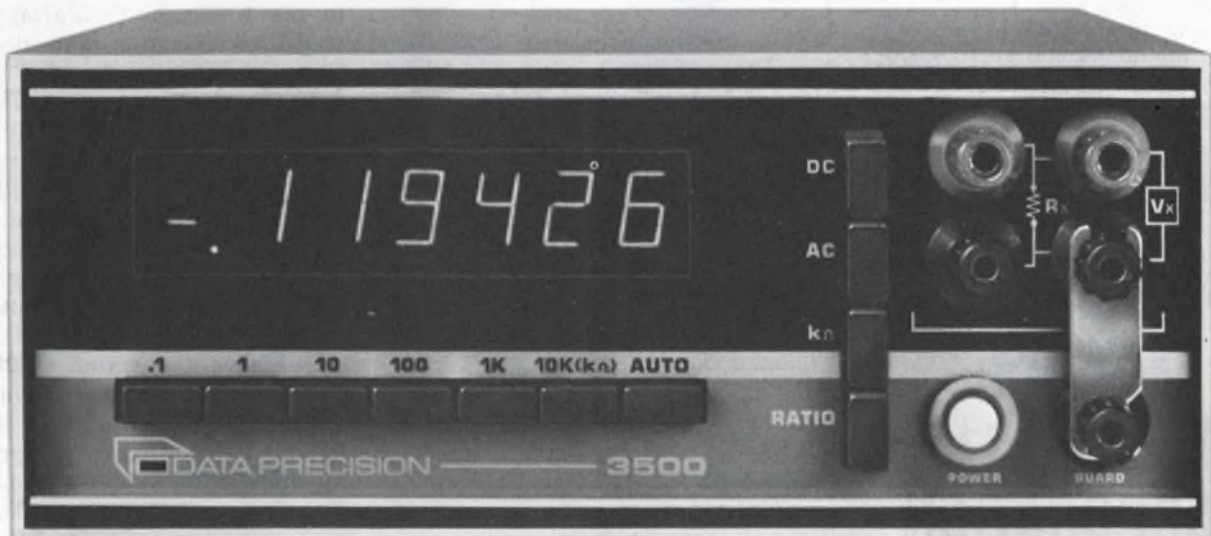

INFORMATION RETRIEVAL NUMBER 117

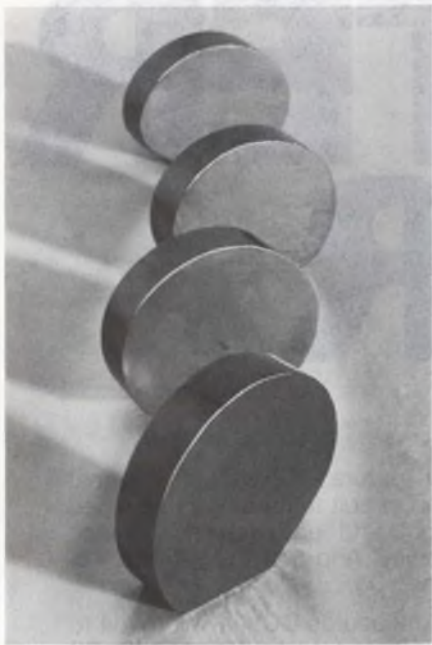

Our compounds are your right answer for...

DIODE DISPLAYS, INFRARED DEVICES, ELECTRONIC COMPONENTS

Asarco Intermetallics Corporation offers a wide range of III-V compounds used in the production of light emitting diodes (LED) and photoluminescent displays.

We provide gallium arsenide, gallium phosphide and indium phosphide in both polycrystalline and single crystal form. All polycrystalline materials are available as ingots. Gallium phosphide and indium phosphide are also available in granular form.

Gallium arsenide single crystals are boat grown with typical cross-sections of 19mm x 47mm for a (111) orientation and 33mm x 47mm for a (100) orientation.

You can order single crystals of our III-V compounds as ingots or slices, as cut or polished.

All materials are furnished in small quantities for evaluation or in large volume for production use. For more information contact us at 120 Broadway, New York, N.Y. 10005. Or call 212-732-9500.

ASARCO INTERMETALLICS CORPORATION

INFORMATION RETRIEVAL NUMBER 118

MICROWAVES & LASERS

Tunnel-diode amp forms transponder front end

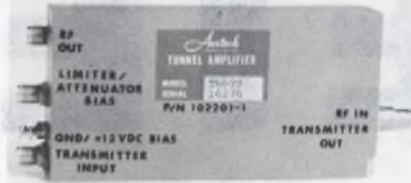

Aerotech Industries, 825 Stewart Dr., Sunnyvale, Calif. 94086. (408) 732-0880.

The T6699 tunnel-diode amplifier, a transponder front end, operates over the 5.4-to-5.9-GHz frequency range and provides an over-all rf gain of 14 dB maximum. Noise figure is 7 dB maximum and 1-dB output compression is at least -18 dBm. The T6699 can transmit 800 W peak at a 0.001 duty cycle. Maximum VSWR at rf ports is 1.35.

CIRCLE NO. 530

Test module signals at high and low levels



Trak Microwave Corp., 4726 Eisenhower Blvd., Tampa, Fla. 33614. (813) 884-1411. \$600; 60 days.

A series of thin-film hybrid test modules, the Model 5040-1004, contains internal gating in a shielded case and offers a high and low level test signal for dynamic tests. The unit operates over the 100-to-150-MHz frequency range and it features rise and fall times of 0.2 μ s. The module measures 1.33 x 1.33 x 0.49 in, and the circuit operates from a 12-V-dc supply, drawing 80 mA maximum.

CIRCLE NO. 531

Gunn-diode line lists 400-mW output

Alpha Industries, Inc., 20 Sylvan Rd., Woburn, Mass. 01801. (617) 935-5150. \$8.90 to \$300; stock to 4 weeks.

A line of Gunn-effect diodes, called the DGB-6800 series, offers a range of cw output power from 25 to 400 mW at discrete frequencies between 4 to 18 GHz, and 25 to 250 mW between 26.5 to 40.0 GHz. The diodes are available with a choice of four standard ceramic/metal case styles. The diodes operate from supplies in the 5-to-15-V range.

CIRCLE NO. 532

Laser scriber handles 100 wafers per hour

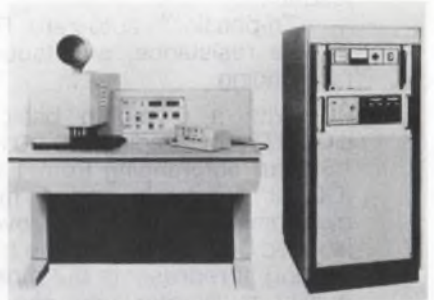

Electroglas, 2901 Coronado Dr., Santa Clara, Calif. 95051. (408) 246-6500. \$63,500.

A laser wafer scriber for semiconductor and IC production provides throughputs of up to 100 wafers per hour. The throughput rate, reportedly the highest available, is achieved through use of a proprietary X-Y motion system. Called the Model 1400AX, the new scriber uses a vacuum wafer chuck in the forcer unit. Digitally controlled acceleration and deceleration achieve accuracies of 0.0005-in. over the total area of travel. The area of the wafer to be cut is exposed to a finely focused beam of Q-switched YAG laser radiation with a wavelength of 1.06 μ . Pulsing action is created by an acousto-optic Q switch, providing high peak power pulses at selectable intervals ranging from 5 to 50 kHz. The pulses have a duration of 250 ns. The new scriber has a variable scribing speed of 0.5 to 10 in. per second. Scribe depth is typically 2.0 mils at 10 in. per second, and it is deeper at slower speeds.

CIRCLE NO. 533



If you're into control applications, We'll give you one-million good reasons to spend 19¢.

Here they are. MA47110s, MA47111s and MA47120s. Hermetically sealed glass packaged PIN diodes from Microwave Associates. 19¢ apiece in quantities of 1,000,000.

These rugged, application-oriented diodes are designed for use as switches and current controlled attenuators in constant impedance AGC circuits, such as those found in CATV and other communications systems. But the MA47111 gives you even lower intermodulation products than the MA47110.

The MA47120 is what you're looking for if you work with modulating circuits and matrix switching at frequencies as low as 1 MHz.

And all three of them give you uniformity and

repeatable performance. Even under extreme environmental conditions.

That means they're ideally suited for control applications. Like RF switching, limiting, duplexing, phase shifting, variable attenuation, modulation and pulse forming.

If you have a prototype to test, we'll be glad to send you some free samples. Because we're sure you'll be more than satisfied with what you can get for 19¢.

Microwave Associates, Inc., Northwest Industrial Park, Burlington, Mass. 01803, 617-272-3000; Dunstable Woodside Estate, Dunstable, Beds., United Kingdom, Tel: Dunstable 601441.

11-GHz varactor Gunn osc delivers 13 dBm

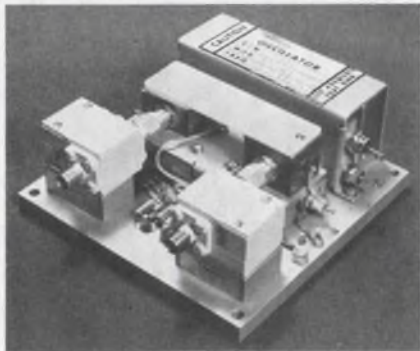

Omni Spectra, Inc., 1040 W. Alameda Dr., Tempe, Ariz. 85282. (602) 966-1471. \$2750; 3 weeks.

The Model A30463 dual-channel varactor-tuned Gunn oscillator spans the 10.8-to-11.35-GHz range, delivering +13 dBm. The oscillator also has a high modulation capability of 50 MHz in 3 ns. The unit includes an output isolator and a 115-V heater.

CIRCLE NO. 525

2-GHz transistor outputs 1 W

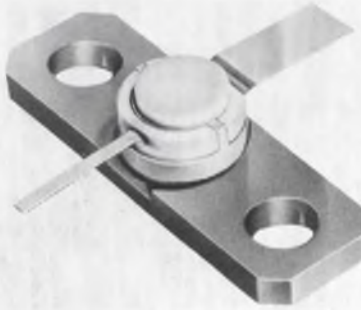

RCA, Route 202, Somerville, N.J. 08876. (201) 722-3200. \$52 (25-99); stock.

The RCA2001 transistor, for the 500-MHz to 2-GHz range, yields 1 W with 7 dB gain at 2 GHz when used with a 28-V supply. The new transistor is designed for various applications involving stripline, microstripline or lumped-constant circuits. The transistor comes in the company's HF-46 flanged ceramic-metal package, which features low inductance and low parasitic capacitance.

CIRCLE NO. 526

42-to-50-GHz Gunn osc supplies up to 150 mW



Varian, 611 Hansen Way, Palo Alto, Calif. 94303. (415) 493-4000. \$900; 30-60 days.

The VSQ-9021 series of Gunn-effect oscillators delivers 5 to 150 mW in the 42-to-50-GHz frequency range. The oscillators are factory adjusted to operate at a specified frequency and output power, with standard models tunable ± 100 MHz. Units weigh 4 oz and they use conduction cooling. Heat-sink temperature range is 0 to 50 C.

CIRCLE NO. 527

BLILEY ULTRASONIC DELAY LINES

- Application: RF systems & Digital storage
- Major Types: Analog (echo & polygonal) and Digital (low TC glass)
- Delay Time Range: 1 to 3000 μ sec
- Frequency Range: 2 to 100 MHz

Custom Design and Data Information Available On Request

Bliley if you buy quality

BLILEY ELECTRIC COMPANY
2545 West Grandview Boulevard
Erie, Pennsylvania 16512



INFORMATION RETRIEVAL NUMBER 120

Now Mil Spec Capacitors

Radial/Axial Leads • All Values

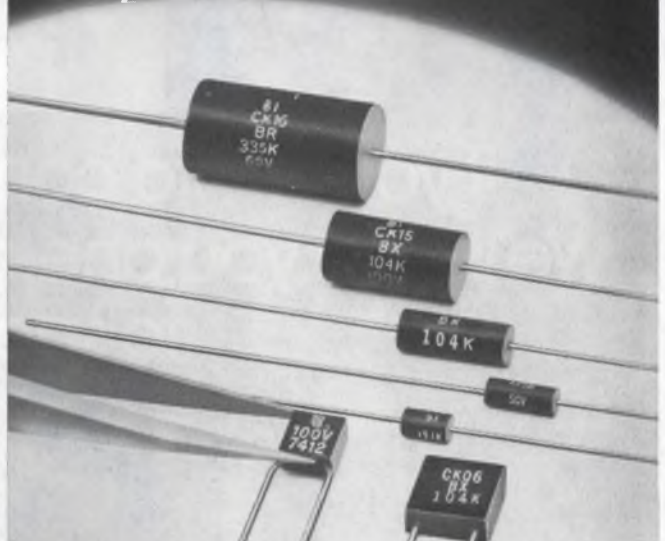

Many values off the shelf, other deliveries 6-8 weeks. CK05, CK06, CK12, CK13, CK14, CK15, CK16. Commercial versions available.

Write for full line ceramic capacitor catalog.



BELL INDUSTRIES / Electronic Components Division
150 WEST CYPRESS AVE. • BURBANK, CALIFORNIA 91505
(213) 846-9302 • TWX 910-498-2207

INFORMATION RETRIEVAL NUMBER 121

ELECTRONIC DESIGN 12, June 7, 1974

Power sweepers compete with BWOs



Weinschel Engineering, P. O. Box 577, Gaithersburg, Md. 20760. (301) 948-3434. \$2745 up; stock to 60 days.

The series 430AP solid-state power sweeper, for the 1-to-18-GHz frequency range, reportedly provides performance characteristics previously available only from BWO sweepers. The sweepers have a leveled power of 30 mW in C band, 25 mW in X band and 20 mW in Ku band. Sweep speeds reach 10 ms per sweep for a flicker-free display without the use of long persistence scopes. Also available are digital frequency programming and pulse-modulation options with rise times under 50 ms.

CIRCLE NO. 528

1-to-18-GHz detector senses -50 dBm



Microphase Corp., Box 1166, Greenwich, Conn. 06830. (203) 661-6200.

The Model CSM-3118 detector covers the 1-to-18-GHz frequency range with a tangential sensitivity that is better than -50 dBm (2-dB video noise figure and 2-MHz bandwidth). The detector has a 0.807-in. "insertion length" and features a response that is flat with ± 1.2 dB (± 1.5 dB maximum). It uses a silicon Schottky chip.

CIRCLE NO. 529

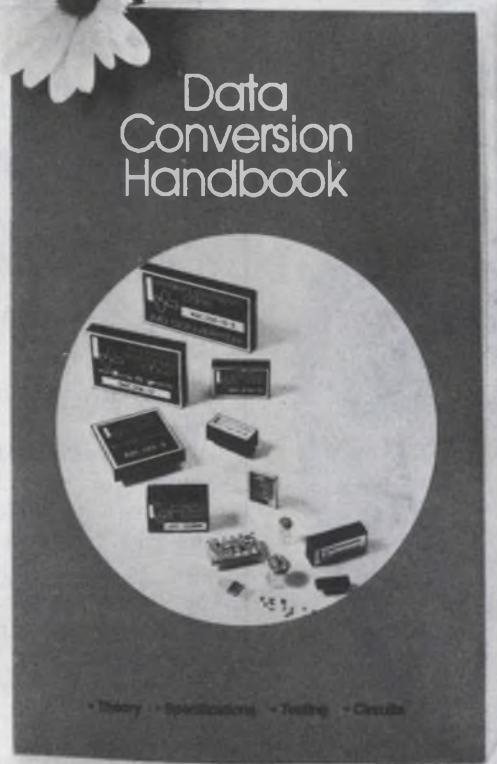

The Book... From Hybrid Systems, Naturally.

This 176-page handbook is offered as a guide to design engineers and others who specify and/or buy electronics... and who are tired of groping their way through the muddle and mystique of data conversion.

It's readable... because it was written by practitioners rather than theoreticians, not to amaze but to inform. It defines the qualities, specifications and techniques that combine to give D/A and A/D converters their special character. It relates those considerations to specific areas of application.

Chapters include: DIGITAL-TO-ANALOG CONVERTERS
• ANALOG-TO-DIGITAL CONVERTERS • SAMPLE/HOLDS
• ANALOG MULTIPLEXERS • CODES.

Mail \$1.50 (for postage and handling) to:

87 Second Avenue, Burlington, Massachusetts 01803

Hybrid Systems
CORPORATION



hot stuff

or cold, CHR's family of TEMP-R-TAPE of Kapton provides outstanding endurance. They retain their excellent mechanical and electrical properties over a wide temperature range, -100 to +500F.

Available in thicknesses from .001" to .0045" with a choice of several adhesive systems including adhesive two sides.

Find your CHR distributor in the Yellow Pages under "Tapes, Industrial" or in industrial directories. Or write for complete specification kit and sample. The Connecticut Hard Rubber Company, New Haven, Conn. 06509.



an ARMCO company
INFORMATION RETRIEVAL NUMBER 123

MICROWAVES & LASERS

Fast pulse-laser xmtr yields 6 W at IR



EPI Corp., 1241 Birchwood Dr., Sunnyvale, Calif. 94086. (408) 734-8235. Under \$1000 (complete system).

A self-contained injection-laser system, for optical receiver tests, produces 5-ns pulses with less than 1-ns rise times and 6 W peak at rates to 20-k pulses per second. The light is infrared at 905 nm and divergence angle is only 10 milliradians. The hand-held laser can operate from self-contained batteries.

CIRCLE NO. 534

Module forms doppler sensor



General Electric, 316 E. 9th St., Owensboro, Ky. 42301. (502) 683-2401.

With an antenna, a microwave-circuit module—called the C-2126A MCM—forms a complete doppler-motion detector sensor. The unit limits spurious and harmonic-related outputs to meet Part 15 FCC regulations. The sensor operates at 10.525 GHz and from bias supplies of 8 V dc and 120 mA. The unit has a -30 to 70 C temperature range, and it specs an harmonic output of 2500 μ V/m at 100 feet. The module measures 2.5 x 1.62 inches.

CIRCLE NO. 535

Ku-band switches offer 100-dB isolation

Hyletronics Corp., Newton Rd., Littleton, Mass. 01460. (617) 486-8911. 60 days.

The Model SK-606N Ku-band (12 to 18 GHz) switch provides a minimum isolation of 100 dB and specs insertion loss at 3.5 dB. The switch can handle up to 3 W of cw power, and it has a switching time of about 100 ns. Units are designed to meet environmental MIL specs.

CIRCLE NO. 536

2 to 12.4-GHz spiral antenna costs \$60



Sanders Associates, Microwave Div., Grenier Field, Manchester, N.H. 03102. (603) 669-4615. \$60.

A spiral antenna that sells for only \$60 operates over the 2-to-12.4-GHz and has a beamwidth of 70°. Called the AS-212, the new antenna includes an SMA connector, weighs only 3 oz and has circular polarization with a typical axial ratio of 1.5 dB. VSWR is 2.5:1 and gain is 0 dBI.

CIRCLE NO. 537

Laser trimmer costs 10¢/hour to operate

GTE Sylvania, 1 Stamford Forum, Stamford, Conn. 06904. (415) 966-2452.

A low-cost thin-film resistor laser trimmer, called the Model 607, produces 1-1/4 W output power in a single-transverse mode. The Q-switch Neodymium:YAG device uses air-cooled tungsten-halogen lamps that cost 10¢ per hour to operate. No additional power is needed because the 607 operates from any 115-V receptacle.

CIRCLE NO. 538

If you're using Pertec or Wangco tape transports today, you can be saving money tomorrow.



You have a right to be skeptical. You've heard the claim before. But Microdata backs it up.

Microdata tape transports are priced lower than any other major manufacturer. Because we're plug-compatible with your OEM product, it's also extremely easy for you to take advantage of the savings we offer.

When you put Microdata 8.5" or 10.5" tape transports into your systems, you get all the performance and reliability you demand. At the same time, you pick up some very attractive sales features to build a strong competitive edge into your product. These include such welcome additions as dynamic braking. Full 200 inches per second fast forward and rewind. Trouble-free direct drive. The security of file protection. The accuracy of a forward and reverse electronic de-skewer. With the added convenience and economies of a Microdata formatter readily available.

If you want to start saving tomorrow, talk to us about price and delivery today. Or if you'd like more information first, send for literature and we'll include data on our new disc drives. With the same kind of impressive features, the same spectacular pricing as our tape transports. Microdata Corporation, 17481 Red Hill Avenue, Irvine, California 92705. Telephone 714/540-6730.



Microdata

Bring us your problems.

MICRODATA SALES OFFICES: New York 516/724-4807; Philadelphia 215/337-1839; Boston 617/543-6306; Detroit 313/477-8686; Chicago 312/948-9440; Washington, D.C. 301/881-6282; Dallas 214/239-8186; Los Angeles 714/540-6730; San Francisco 408/225-3235; Canada 416/678-1500

INFORMATION RETRIEVAL NUMBER 124

Option converts DMM to true-rms reader



California Instruments, 5150 Convooy St., San Diego, Calif. 92111. (714) 279-8620. \$575; 30-45 days.

This true-rms converter is optional with the DMM 50 and extends the capability of the 5-1/2-digit multimeter. The option—which provides both ac and ohms functions—offers rms ranges of 1, 10, 100 and 1000 V fs with 20% overrange on all but the 1000-V range, which has 10%. Frequency response is from 10 Hz to 100 kHz, with accuracies from ±0.15% to +1.0% of reading, depending on input frequency, and crest factor is 7:1.

CIRCLE NO. 539

Unit prescales by 100 or 1000

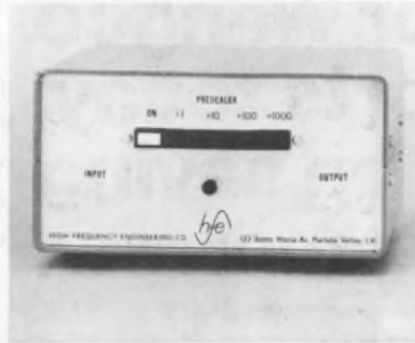

High Frequency Engineering Co., 123 Santa Maria Ave., Portola Valley, Calif. 94025. (415) 851-8108. \$455; stock.

Model PS-1000 frequency-counter prescaler divides an incoming 20-to-1000-MHz frequency by selectable factors of 100 to 1000 and delivers the processed output as 2-V pk-pk square waves. Specs include: Input sensitivity from 100 to 1000 MHz of 100 mV typical; maximum input signal of 3 V rms, 50 V dc; input and output impedance of 50 Ω; and output rise time of 20 ns.

CIRCLE NO. 540

Pulsar outputs 10 MHz, costs just \$470



Interstate Electronics, 707 E. Vermont Ave., P. O. Box 3117, Anaheim, Calif. 92803. (714) 722-2811. \$470.

P12 pulse generator outputs pulses from 10 MHz down to 0.01 Hz and features calibration-free circuitry. The unit offers simultaneous positive and negative pulses at less than 5-ns rise/fall times, square waves, single and double modes, and a special normal/complement selector. Each channel has individually adjustable amplitude from 1 to 10 V. One-decade pulse width, delay, and rate adjustments are further refined with continuously adjustable 10:1 verniers.

CIRCLE NO. 541

ABSOLUTELY

the world's most accurate rulings using vacuum deposit chrome, etch and fill or emulsion processes. They're produced on the world's largest 1 micro inch numerically controlled ruling engine with interferometric feedback controls. Need precision scales, grids, slits, reticles, Ronchis numbers, letters, circles, dots, or nickel mesh? We stock many items for immediate delivery. Send for brochure No. 38-36.

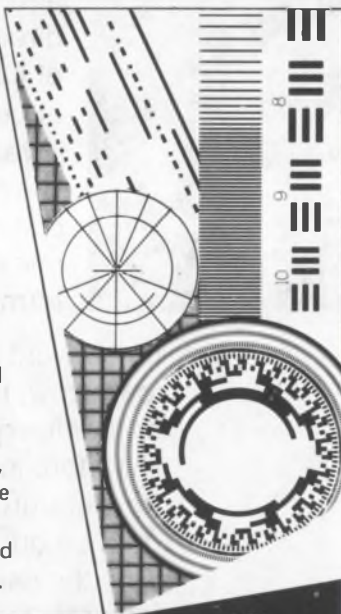

SCALES RULINGS RETICLES & GRIDS FROM THE WORLDS LEADING SCALE MAKERS.

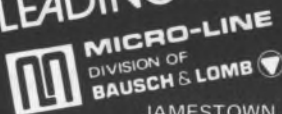

JAMESTOWN, NY 14701 716/488-1958

THE 25 YEAR METERS...



10/20/50/100 A AC: \$99.00

YEW's Precision Portables!

95% of all YEW precision portables that are returned for calibration certification are within original specifications, even after 25 years of use. We have even had instruments dating back 50 years within original specifications. That is long term reliability and that is why YEW is the world's largest manufacturer of precision portables.

Add taut band 0.5% accuracy, high quality and low cost, fast service, a vast selection of models and 25 years from now, you'll be glad that you tried a YEW portable. Prices start at \$95.

1% Portables also available. Prices start at \$37.



Yewtec Corporation
1995 Palmer Ave., Larchmont, N. Y. 10538
Telephone: 914 834-3550

60 Years of Measuring and Recording Instrumentation

Digivue® - a better way to look at it.

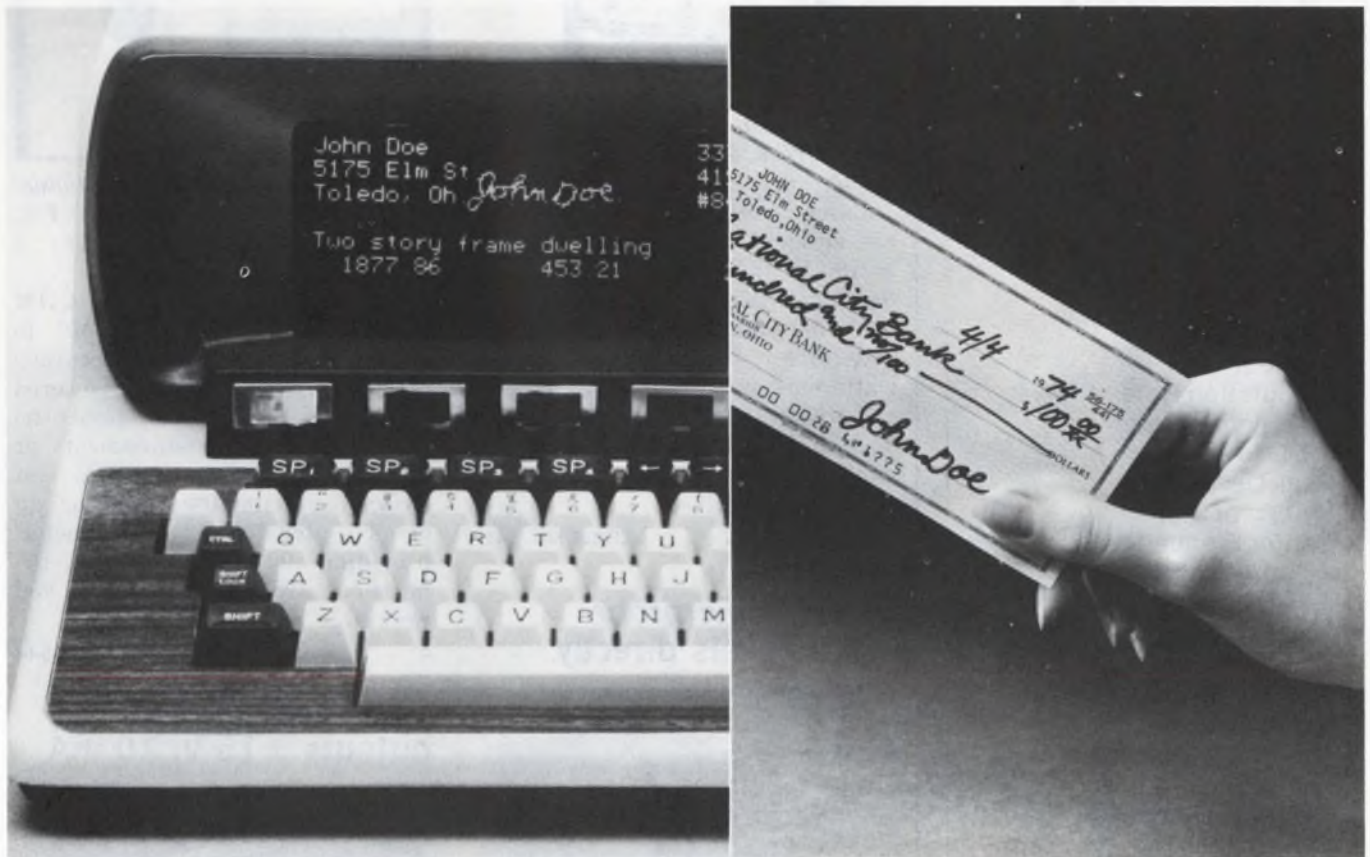

Digivue 80-33 in demonstration unit, showing high-contrast display for use in signature verification

Because computer time is valuable to your customers, Digivue display/memory units offer an unforgettable advantage.

The advantage is inherent memory and it's an inherent part of every Digivue unit. This makes Digivue units especially useful for graphic presentations like signature verification since refresh is not required.

And Digivue units offer a high-contrast, flicker free display for precise readings with less chance of eye fatigue for people who spend long periods referring to data displays and computer terminals.

There's a lot more to Digivue, too. Our 512-60 models have hard copy and rear projection capabilities. And Digivue panels are flat and thin, allowing precise display and broad equipment design parameters.

As you may have guessed, Digivue display/memory units currently cost more than CRT's. But then, they offer a lot more. For a booklet that explains Digivue more fully, call (419) 242-6543, Ext. 66-415. Or write Electro/Optical Display Business Operations, Owens-Illinois, Inc., P.O. Box 1035, Toledo Ohio 43666

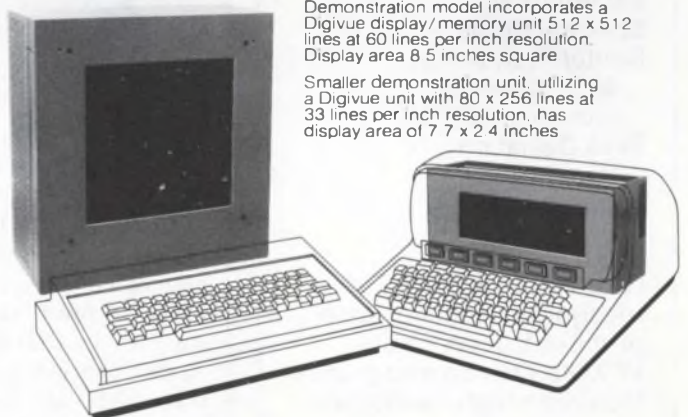

Demonstration model incorporates a Digivue display/memory unit 512 x 512 lines at 60 lines per inch resolution. Display area 8.5 inches square

Smaller demonstration unit, utilizing a Digivue unit with 80 x 256 lines at 33 lines per inch resolution, has display area of 7.7 x 2.4 inches

OI
OWENS-ILLINOIS

Toledo, Ohio

INFORMATION RETRIEVAL NUMBER 127

VCXO's: Unmatched Versatility.

Damon continues to be recognized as the leader in the design and production of low noise VCXO's. Backed by the technical expertise of our engineering team, Damon offers VCXO's with unique performance characteristics:

Highest Modulation Rate

Modulation Rate:

DC to 200 KHz

Peak Deviation:

.03% of C.F.

Center Frequency:

1 to 140 MHz

F.M. Distortion:

Less than 5%

Widest

Deviation Bandwidth

Peak Deviation:

0.5 to 300 KHz

Linearity: $\pm 3\%$

Center Frequency:

0.1 to 60 MHz.

Frequency Stability:

Less than 100 PPM,

0° to 50°C

Exceptional Spectral Purity

Center Frequency:

40 to 120 MHz

(overtone VCXO)

Peak Deviation:

10 to 30 KHz

Linearity: $\pm 1\%$

Damon Electronics: The recognized leader in state-of-the-art, dependable VCXO's. Damon also manufactures a high-quality line of crystal filters.

For further information, write or call Ed Doherty, ext. 666.



DAMON
ELECTRONICS DIVISION

80 WILSON WAY WESTWOOD, MASS. 02090 TEL. (617) 449-0800

INSTRUMENTATION

Meter measures laser power to 250 W



International Light, Dexter Industrial Green, Newburyport, Mass. 01950. (617) 465-5923. \$772.

Laser power meter, Model IL500, can measure power levels from 2.0×10^{-7} W up to 250 W with neutral-density attachment. Features include illuminated dial for darkroom use, direct readout in watts or watts/cm² and three chart-recorder outputs of 10, 100 and 1000 mV. The unit can also be used as a nanoammeter. Spectral range is 200 to 800 nm.

CIRCLE NO. 542

CMOS logic probe reads levels directly



Kurz-Kasch, David K. Burdap Bldg., Dayton, Ohio 45439. (513) 298-9971. \$89.00; stock.

Model LP-575 CMOS logic probe offers a direct-reading LED display of logic-level information. The probe is for 5 through 15-V logic supplies in CMOS digital circuits. A new concept maintains the logic thresholds at nominally 70% of the supply for a logic ONE, and 30% of the supply for a logic ZERO. Deadband is approximately equal to 30% to 70% of V_{dd} and is indicated by no display. Pulse trains or single-cycle pulses (negative or positive) of 100-ns duration or greater are indicated by a red LED display.

CIRCLE NO. 543

Portable unit measures to 10-million M Ω



Eltec Instruments, Central Industrial Park, Daytona Beach, Fla. 32014. (904) 252-0411. \$225; 2 weeks.

Model 600 HIGH MEGOHM meter measures from 0.1 M Ω to 10-million M Ω , with an accuracy of $\pm 5\%$. The battery-powered solid-state FET circuit needs no warm-up time. No adjustments or calibration are required. A test switch acts simultaneously as an on-off switch for the entire meter, providing 400 hrs battery life. Dimensions are $8 \times 5 \times 6$ in. and weight is 5 lb.

CIRCLE NO. 544

5-V-powered DPM outputs ± 15 V, 10 mA



Analog Devices, Route 1 Industrial Park, P. O. Box 280, Norwood, Mass. 02062. (617) 329-4700. \$122 (100); stock.

The AD2006/D is a 5-V-powered version of the recently introduced line-powered AD2006, a 3-1/2-digit DPM featuring Sperry displays. By offering a ± 15 -V at 10-mA output, the AD2006/D provides sufficient output power to drive many of the circuits that it measures. Like its line powered counterpart, the AD2006/D offers a differential input and ratiometric operation as standard features. With a full scale of ± 1.999 V, the unit has a maximum error of 0.05% reading ± 1 digit. Tempco is less than 50 ppm/ $^{\circ}$ C.

CIRCLE NO. 545

**RF Microwattmeters—
Analog and Digital—
FS Sensitivities from
10 nW to 10 mW**



MODEL
42B/42BD

Boonton rf microwattmeters offer unrivalled sensitivity: 10 nW fs to 10 mW fs; from 200 kHz to 18 GHz, at highest stability ever attained at these sensitivities. Analog (42 B) or digital (42 BD) versions, both with linear DC outputs and logic-level programmability. BCD outputs are standard on digital version, auto-ranging and dB display (0.01 dB resolution) optional. Boonton Electronics, Parsippany, N.J. 07054

INFORMATION RETRIEVAL NUMBER 221

**Wide-Range
Programmable
Capacitance Meters**



MODEL
72B/72BD

Boonton analog (72B) and digital (72BD) provide rapid, accurate, 3-terminal and differential measurements, at 1 MHz, from 1 pF fs. Measures semiconductor-junction capacitance at low (15 mV) test level, with provision for external DC bias. Phase-sensitive detector measures accurately even at $Q=1$. Logic-level range programmability and fast-tracking DC output are ideal for ATE. Model 72BD has standard BCD output and autoranging. Boonton Electronics, Parsippany, N.J. 07054

INFORMATION RETRIEVAL NUMBER 222

**Direct Capacitance Bridge
0.00005 to 1000 pF
and 0.01 to 1000 mho**



MODEL
75D

Boonton Model 75D Direct Capacitance Bridge is designed for 1 MHz capacitance and loss measurement. Capacitance range, 0.00005 pF to 1000 pF; basic accuracy, 0.25%. Conductance range: 0.01 mho to 1,000 mho, basic accuracy, $\pm 5\%$. Internal bias from -6 V to +150 V. Adjustable test level, 1 mV to 250 mV, at 1 MHz. Two modes of operation allow either conventional capacitance and loss measurements or one-control balance for capacitance only. 3-terminal input configuration. Boonton Electronics, Parsippany, N.J. 07054

INFORMATION RETRIEVAL NUMBER 223

INFORMATION RETRIEVAL NUMBER 224 ►

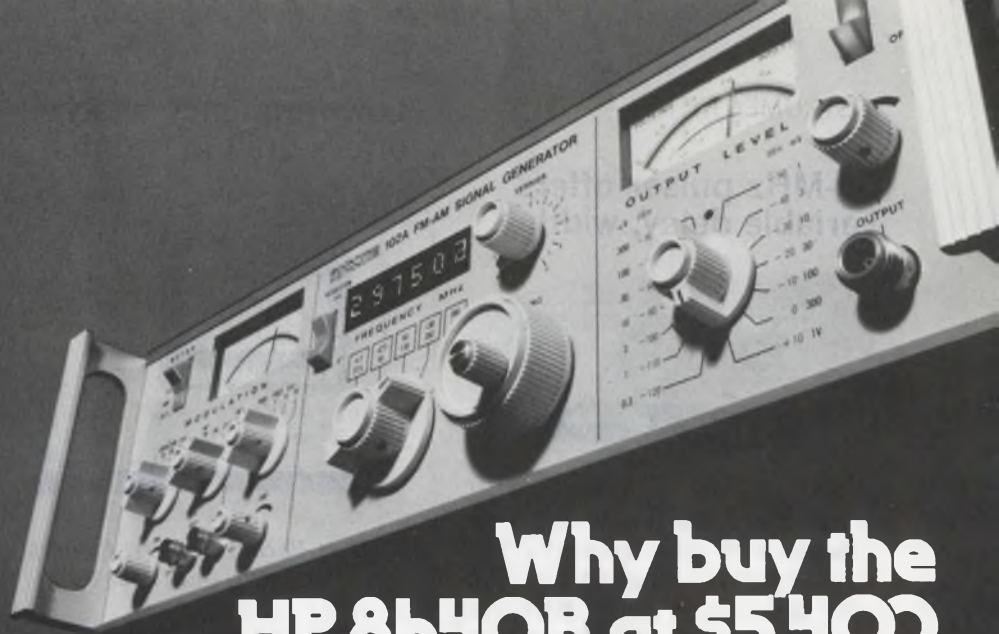

**Why buy the
HP 8640B at \$5,400
when \$2,205 less
will get you Boonton's
competitive 102A
signal generator?**

Our Model 102A, at \$3,195, has everything you need for just about any AM/FM application — plus seven performance and convenience features you won't get in the HP \$5,400 design.

What did we leave out?

Phase-lock synchronization, for one (but our dc-coupled FM channel can be externally locked if you need better stability than our typical 4 ppm); and narrow-pulse modulation (belongs in a different class of generators).

What did we add?

Four different signal-generation techniques — for optimum performance in each band, from 4.3 to 520 MHz, without the usual compromises in noise, stability, or residual-distortion characteristics.

The most logical panel layout and convenient control setup you've ever seen. And a unique adjustable "feel" main drive mechanism for narrow-band receiver setting with ease — even without our electrical vernier.

Separate meters for modulation and output — no annoying auto-ranging or out-of-range annunciators . . . we don't need them.

15 minute warmup to typically

meet 10 ppm/10 minute stability — made possible by low internal dissipation (only 30 watts; no fan!)

Wider FM deviation at low carrier frequencies than any other design in this class (how does 2 MHz peak-to-peak grab you?)

A detected-AM-output option, to verify our negligible phase-shift for VHF-omni testing.

Versatile modulation features — like five internal frequencies, 30% and 100% AM scales, and true-peak-responding AM and FM metering.

All these performance pluses are coupled with low spurious and close-in noise, excellent low-frequency phase integrity, really effective leveling, a low and flat VSWR curve, accurate wide-range attenuation, high output power . . . all of it buttoned up tight for low leakage in a lightweight 30 pound package.

. . . and it's all yours for \$3,195. Get the full specs today — before you spend 70% more . . .

For complete data or a demonstration write or call Boonton Electronics Corp., Rt. 287 at Smith Road, Parsippany, N.J. 07054, (201) 887-5110.

BOONTON

50-MHz pulser offers variable delay, width



Alpha Systems, Neumuller GMBH, 8 Muchen, 2 Karlstrasse 55.

Model 120 pulse generator features repetition rates of less than 1 Hz to greater than 50 MHz, rise and fall times of less than 3.5 ns, and simultaneous positive and negative outputs. Pulse amplitude is variable from less than 200 mV to greater than 10 V into 50 Ω. Rep rate, delay and width jitter are less than 0.1% of setting or 50 ps, whichever is greater, and waveform aberrations (undershoot, overshoot and top slope) are less than 5% of amplitude.

CIRCLE NO. 546

Low-frequency analyzer offers built-in counter



Hewlett-Packard, 1501 Page Mill Rd., Palo Alto, Calif. 94304. (415) 493-1501. \$2600; stock.

Model 3581A 15-Hz-to-50-kHz Wave Analyzer has a built-in counter that displays the tuned frequency with 1-Hz resolution on a LED digital readout. Accuracy is 3 Hz. Signal amplitude is read on a four-scale analog meter. Sensitivity is 100-nV full scale, dynamic range is 85 dB and max input is 30 V. Bandwidths are selectable from 3 to 300 Hz.

CIRCLE NO. 547

Build your own sweep generator



MITS Inc., 6328 Linn, N.E., P.O. Box 8636, Albuquerque, N.M. 87108. (505) 265-7553. Kit: \$119.95; Assembled: \$149.95.

Model SG 1900 Audio Sweep Generator can be used as both a fixed-frequency (cw) and a sweep generator, and has adjustable logarithmic and linear sweep modes from 10 ms to 100 s. Three waveforms are outputted: sine, square and triangle. Specs include a range of 1 to 100 kHz; response of ±0.1% to 20 kHz and ±0.15% to 100 kHz, with average distortion for the sine wave of 1.5% over 10 Hz to 20 kHz.

CIRCLE NO. 548

Mini Bus[®] by Rogers

For noise and cost reduction

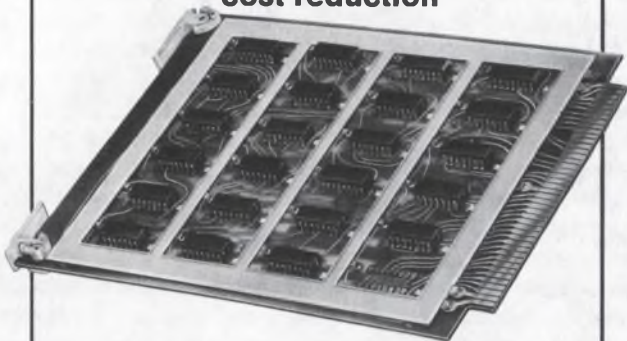

A small, voltage-distributing busbar for PC card application, each Mini/Bus gives you built-in capacitance . . . noise-cutting capacitance that means more reliable, compact circuit packaging at a fraction of multilayer prices. Write for data.



Rogers Corporation / Rogers, Conn. 06263

INFORMATION RETRIEVAL NUMBER 130

STANDOFFS AND SPACERS



Over 200 assorted sizes and styles cataloged for you to choose from. Available in Aluminum, Brass and Phenolic, tapped or thru-hole. Immediate delivery from stock. Free engineering service for your special requirements.

NEW FREE CATALOG ON REQUEST

Manufacturers of Standardized Hardware for Electronics



KEYSTONE ELECTRONICS CORP.

49 Bleecker Street • New York, N.Y. 10012

INFORMATION RETRIEVAL NUMBER 131

ELECTRONIC DESIGN 12, June 7, 1974

Sometimes a digital computer gets so trapped in detail, it takes an analog to get things moving

Choosing the right iron is an exercise in logic—work for a digital computer. Plotting the optimum path for the ball is done by processing all the variables in parallel fashion—as an

analog computer does. But we can't carry two computers to the links. Or can we?

Current theory says the human brain is like a hybrid computer. One half does sequential calculation; the other, parallel processing. The interaction of the two produces some pretty flashy results.

So do EAI PACER™ systems. Because they're hybrids, too. They blend analog and digital computing techniques to solve enormous problems with speed and efficiency that are not possible otherwise.

They will, for instance, complete large-scale simulations

in one-hundredth the time that it would take even the largest digital—and at a small fraction of the cost.

That's why EAI PACER systems can be found at work in scientific and engineering organizations wherever speed and price/performance ratios are considerations. For more facts from the world's largest manufacturer of hybrid computers, write Electronic Associates, Inc., West Long Branch, N.J. 07764. Or call (201) 229-1100.



Electronic Associates, Inc.

...in test systems where integrity is essential, specify cunningham



Crossbar switches

FROM TEN TO THREE HUNDRED 6 WIRE CROSSPOINTS. EXTREMELY LOW PATH RESISTANCE, LOW NOISE AND MINIMAL THERMAL EMF. MINIMUM OF 20 MILLION OPERATIONS/CROSSPOINT LIFE EXPECTANCY. HANDLES LOW LEVEL AND BROADBAND SIGNALS.



reed matrix

STANDARD 5X10 (50 CROSSPOINT) MATRIX FOR GROUP TO GROUP SWITCHING. INTERMEDIATE FREQUENCY (IF) HANDLES DC TO 4 MHz SIGNALS. HIGH FREQUENCY (HF) CAPABILITY OF 60 MHz WITH SHIELDED SIGNAL PATHS.



matrix controller

INTERFACES A SWITCH MATRIX TO ANY 16 BIT ADDRESS DEVICE. FACILITATES A WIDE VARIETY OF SWITCH MATRIX APPLICATIONS BY PROGRAMMABLE REMOTE AND MANUAL CONTROL. ESPECIALLY USEFUL IN AUTOMATIC TESTING OR TELEMETRY SWITCHING.



scanners

FOR SEQUENTIAL OR RANDOM CONNECTION OF INSTRUMENT LEVEL SIGNALS. REED SCANNERS OFFER HIGH SPEED SWITCHING FOR DATA LEVELS. CROSSBAR SCANNERS BEST FOR LOW THERMAL OR LOW NOISE DATA ACQUISITION SYSTEMS. BOTH FEATURE LOCAL AND REMOTE CONTROL.

applications assistance

FOR ADDITIONAL DATA OR APPLICATIONS ASSISTANCE, CALL THE CUNNINGHAM CORPORATION, HONEYEYE FALLS, NEW YORK: (716) 624-2000.

Cunningham Corporation
SUBSIDIARY OF GLEASON WORKS

INSTRUMENTATION

Microwave counter handles pulsed signals



Hewlett-Packard, 1501 Page Mill Rd., Palo Alto, Calif. 94304. (415) 493-1501. \$3450.

This plug-in counter, Model 5345A, needs just 1 s to measure any frequency from 1 Hz to 500 MHz with 9-digit resolution. The unit resolves one-shot time intervals to 2 ns, measures the frequency of rf pulses as brief as 50 ns and can resolve repetitive time interval measurements to 1 ps. The counter is available with full digital output, input programming capability, calculator interface and accessories to 18 GHz.

CIRCLE NO. 549

On-line unit measures FET specs



Lorlin Industries, Inc., Precision Rd., Danbury, Conn. 06810. \$56,300; 90 days.

The PICOFET-100 system provides total on-line control in the testing of FETs; n or p-channel devices in enhancement or depletion modes, single gate, dual gate or dual FETs in array or discrete package form and vacuum tube replacements. In addition to measuring leakage currents in the low picoamp range, the standard PICOFET-100 can run a gamut of tests which include breakdowns up to 500 V, output admittance and resistance, plus forward currents up to 2 A. The standard unit also measures ac parameters.

CIRCLE NO. 550

Impedance bridge works from batteries



Tucker Electronics, P.O. Box 1050B, 1717 S. Jupiter Rd., Garland, Tex. 75040. (214) 348-8800. \$525; stock.

The 610A is a 5-digit nulling-type impedance bridge that measures resistance (0 to 12 MΩ in seven ranges), capacitance (0 to 1200 μF in seven ranges), inductance (0 to 1200 H in seven ranges), conductance (0 to 1.2 mhos in seven ranges), storage factor (0.1 to 1000 at 1 kHz in two ranges), and dissipation factor (0 to 1.05 at 1 kHz in two ranges). Accuracies are: 0.25% of reading on all R&G ranges, 1.0% of reading on all C&L ranges and ±5.0% on all Q&D ranges. Resolution is ±0.001% of range.

CIRCLE NO. 551

4-digit DMM operates from line or batteries



Data Technology, 2700 S. Fairview St., Santa Ana, Calif. 92704. (714) 546-7160. \$399; stock.

Called the Model 45, this 10,000-count (4-digit) DMM operates from either line or battery power. The unit has five ac and five dc voltage ranges with 10-μV resolution, six resistance ranges with 10-mΩ resolution and five ac and five dc current ranges with 10-nA resolution. Battery charge life is 10 to 12 hours, power consumption is 3 W and size is 2.5 × 6.25 × 9 in. Weight is 2.3 lb.

CIRCLE NO. 552

We have the

X-Y OEM RECORDER

for YOU

Thousands in use
world wide

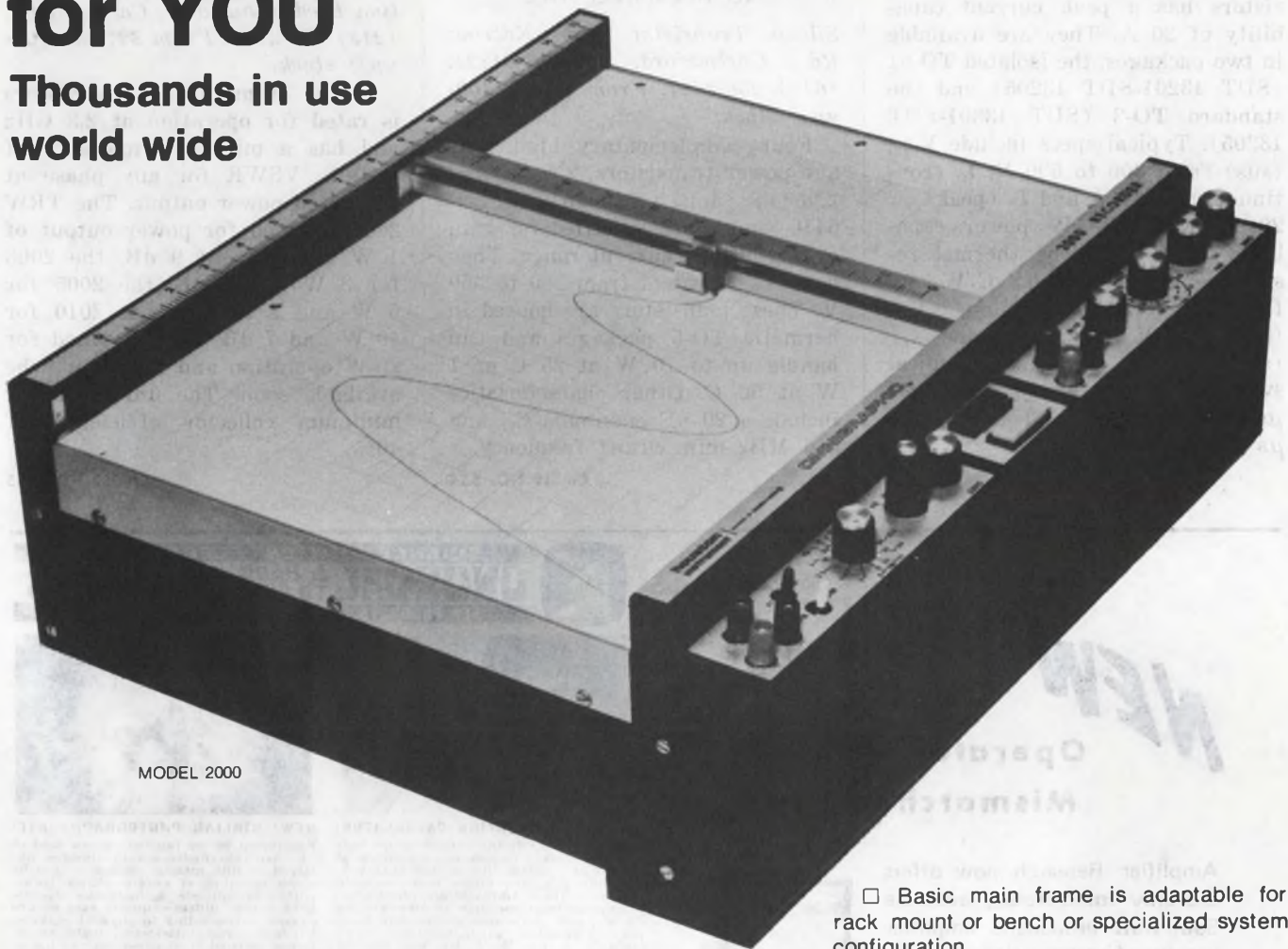

MODEL 2000

Ask for OEM Discount

- Basic main frame is adaptable for rack mount or bench or specialized system configuration.
- All controls and functions are in modular form that plug in and plug out for maximum flexibility. 27 modules now available.
- 30 in./sec. speed standard with 40 in./sec. available.
- \pm 0.2% accuracy; pen lift-local or remote control standard.

Write today for complete brochure and special OEM price discounts.

**THE
RECORDER
COMPANY**

**houston
instrument**

ONE HOUSTON SQUARE (at 8500 Cameron Road) AUSTIN, TEXAS 78753

(512) 837-2820

TWX 910-874-2022

cable HOINCO

European Office Rochesterlaan 6 8240 Gistel Belgium Telephone 059-27445 Telex BAUSCH 19399

INFORMATION RETRIEVAL NUMBER 134

Power transistors handle peak currents of 20 A

Solitron Devices, 1177 Blue Heron Blvd., Riviera Beach, Fla. 33404. (305) 848-4311. 301: \$10, 201: \$30 (large quantity); 3 to 4 wk.

A series of high current, fast switching npn silicon power transistors has a peak current capability of 20 A. They are available in two packages, the isolated TO-61 (SDT 13201-SDT 13205) and the standard TO-3 (SDT 13301-SDT 13305). Typical specs include V_{CE0} (sus) from 300 to 500 V, I_C (continuous) = 10 A and I_C (peak) = 20 A, with 125 W power capability at 100 C. The thermal resistance is typically 0.8 C/W and $f_t = 15$ MHz (minimum). V_{CE} (sat) = 1 V (maximum) and V_{BE} (sat) = 1.4 V (max). Typical switching times are $t_{on} = 0.25 \mu s$, $t_r = 1.6 \mu s$ and $t_f = 0.35 \mu s$ (typical).

CIRCLE NO. 553

High V power transistors handle up to 350 V

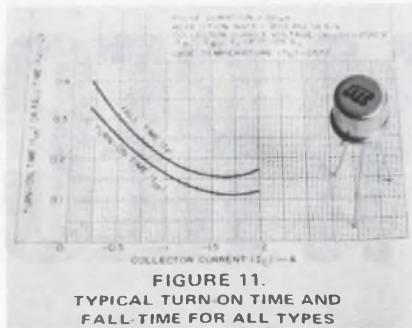

FIGURE 11. TYPICAL TURN ON TIME AND FALL TIME FOR ALL TYPES

Silicon Transistor Corp., Katrina Rd., Chelmsford, Mass. 01824. (617) 256-3321. From \$0.87 (100-up); stock.

Four complementary high voltage power transistors, 2N3439 and 2N3440 (nnp), 2N5415 and 2N5416 (pnp), are specified for gain over a 50 mA current range. They have V_{CE0} ratings from 200 to 350 V. These transistors are housed in hermetic TO-5 packages and can handle up to 10 W at 25 C or 1 W at 50 C. Other characteristics include a 20 pF maximum C_{ob} and a 5 MHz min. cutoff frequency.

CIRCLE NO. 554

Microwave transistors operate at 2.3 GHz



TRW Semiconductors, 14520 Aviation Blvd., Lawndale, Calif. 90260. (213) 679-4561. From \$27.55 (100-up); stock.

A line of microwave transistors is rated for operation at 2.3 GHz and has a mismatch tolerance of infinite VSWR for any phase at full rated power output. The TRW 2001 is rated for power output of 1 W and gain of 9 dB, the 2003 for 3 W and 8 dB, the 2005 for 5 W and 8 dB and the 2010 for 10 W and 7 dB. Devices rated for 20-W operation and higher will be available soon. The units offer a minimum collector efficiency of 40%.

CIRCLE NO. 555

NEW

5000-Watt Amplifier

Operates with any Mismatched Load

Amplifier Research now offers the only commercially available 5000-watt broadband amplifier capable of operating into any mismatched load without damage or shutdown. Model 5000LA, with its unique protective circuitry for maximum reliability, provides 5000 watts of swept power output from 1-100 MHz. This powerful unit is ideal for antenna and component testing, equipment calibration, EMI susceptibility testing, biological research, and a variety of other lab applications. For complete information, write or call Amplifier Research, 160 School House Road, Souderton, PA 18964. Phone: 215-723-8181.



AR AMPLIFIER RESEARCH

INFORMATION RETRIEVAL NUMBER 135

SCIENCE · OPTICS · ELECTRONICS

EDMUND & HARD TO FIND BARGAINS

NEW PRODUCTS · NEW MATERIALS · NEW METHODS



METRIC CONVERTING CALCULATOR!
Amazing 5-oz. electronic machine not only has 38 instant conversion capabilities at touch of 1 button, it's a high quality 5-function calculator with a memory—worth the price alone. Add, subtract, directly figure percentages, multiply, divide—carry on U.S. metric conversions during any function! Conversions: gal./l, miles/km, qts./l, yds./m, in./cm, °F/°C, etc. Spcl keys for sq. & cubic measurement. Rechargeable nickel battery. **Stock No. 71.982DA (4 3/4 x 2 1/2 x 1 1/2") \$109.95 Ppd.**



NEW! KIRLIAN PHOTOGRAPHY KIT!
Experiment in the fascinating new field of "Kirlian" electrophotography—images obtained on film without camera or lens by direct recording of electric charge transmitted by animate & inanimate objects. Each "aura" differs—animate aura said to change corresponding to physical changes. Kit incl's portable darkroom, double transformer isolated from power source; instrs. **Stock No. 71.938DA \$49.95 Ppd.**
"High Voltage Photography" by H. S. Dakin **No. 9129DA (60-PG. PPBK.) \$5.00 Ppd.**



HOW TO BEAT THE ENERGY CRISIS
Shop Solar Headquarters USA—that's us! Our "Solar Home Plans" book gives det. on bldg 5 homes; hi-output Silicon Solar Cell can power a boat, toy car; Conversion Kit shows how sun's energy becomes electricity to run small motors, etc. Solar Cooker cooks great; Furnace Kit goes to 2000°!
(Solar Home Plans)
No. 9440DA \$10.00 Ppd.
No. 30.538DA (Silicon Cell) \$11.95 Ppd.
No. 60.505DA (Conversion Kit) \$18.00 Ppd.
No. 71.653DA (Port Cooker) \$10.75 Ppd.
No. 70.533DA (Furnace Kit) \$4.00 Ppd.



GIANT FREE CATALOG
Brand new 1974 edition — 180 pages. Hundreds of unique new items! Hard-to-get surplus bargains. Ingenious scientific tools. 1000's of components: lenses, prisms, wedges, mirrors, mounts, all types of accessories. 100's of instruments, lasers, comparators, magnifiers, telescopes, projectors, microscopes, binoculars, phot attachments, black-light equipment and the world's largest selection of unique lighting equipment. Fully illustrated. Great buys! Write for Catalog "DA".

EDMUND SCIENTIFIC CO. PLEASE ORDER BY STOCK NO. - MONEY BACK GUARANTEE
300 EDSCORP BLDG. BARRINGTON, NEW JERSEY 08007
\$10.00 MIN. OPEN ACCOUNT TO WELL RATED FIRMS - PLEASE ADD \$5.00 HANDLING - TELEPHONE 609 567 3688

INFORMATION RETRIEVAL NUMBER 136

3,500 VOLT ISOLATION 100% CURRENT TRANSFER OPTO COUPLER

HOW GENERAL ELECTRIC DOES IT

General Electric's unique glass isolation produces precise alignment and controlled spacing between the LED and the silicon detector thus optimizing photon coupling...minimizing the effect of the inverse relationship of isolation voltage and current transfer ratio...and yielding optoelectronic couplers with BOTH high isolation voltage and high current transfer ratios.

3 new models 4N35, 36, 37 are characterized for high isolation voltage and high current transfer ratios. 4N35 offers 3,500 volts (peak) and 100% transfer ratio for \$1.85 each in 1,000 lot quantities.

Available now from any authorized GE Semiconductor distributor or GE Electronic Components Sales Office.

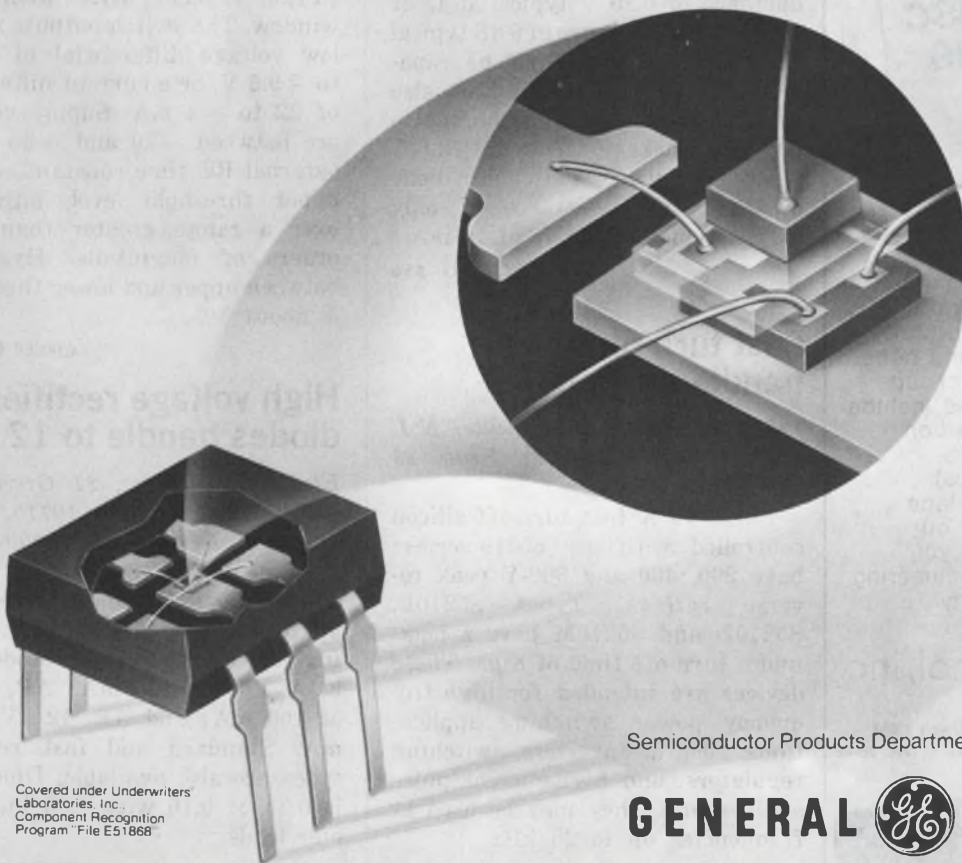

Covered under Underwriters
Laboratories, Inc.
Component Recognition
Program File E51868

Semiconductor Products Department, Syracuse, New York.

GENERAL  **ELECTRIC**

YOUR SAKATA REPRESENTATIVE CAN DELIVER CAPACITORS

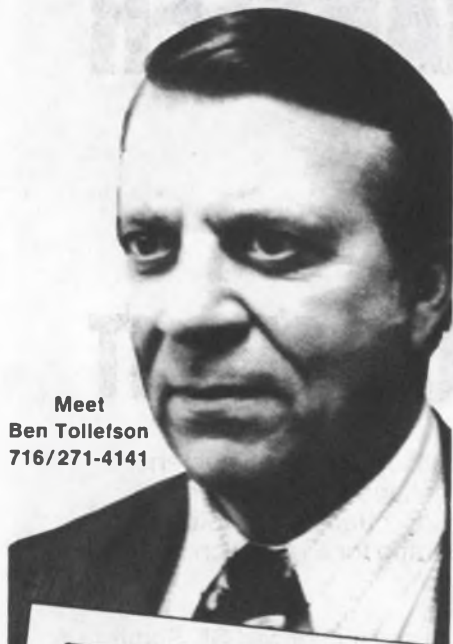

Meet
Ben Tollefson
716/271-4141

**CERAMIC DISC
CAPACITORS**
in 14-15 weeks,
at 10-15% less

Ben Tollefson (pictured above) is the Sakata representative for the upper New York area. Like all Sakata representatives, he can give you faster delivery and better prices on a wide variety of top quality components. These include resistors (composition, carbon and metal film), capacitors, (ceramic disc, electrolytics), panel meters, lamps and tape heads. Wire or phone for our price and delivery before you buy. Free catalog and engineering available. Delivery of many items from stock.

sakata international, inc.

312/593-3211

651 Bonnie Lane, Elk Grove Village, Illinois 60007
resistors • capacitors • lamps • meters • tape heads

Save time, money
with SAKATA

DISCRETE SEMICONDUCTORS

Tuning diodes have a 6:1 capacitance change



Motorola, P.O. Box 20912, Phoenix, Ariz. 85036. (602) 244-3466. From \$10 (100 up); stock.

The MV205 hyper-abrupt tuning diode offers a guaranteed minimum tuning ratio of 4.5 C₃/C₂₅ at 1 MHz, and a minimum Q of 225 at 9 pF at 100 MHz. Typical capacitance variation from 2 to 25 V is 12 to 2 pF. The MV206 is similar but with relaxed specifications for less critical applications. Guaranteed tuning ratio C₃/C₂₅ is 4, while minimum Q is 150 at 100 MHz. The MBD103 silicon hot-carrier mixer (Schottky) diode has a high forward conductance of 0.35 V typical at I_F of 100 μA, a noise figure of 6 dB typical at 1 GHz and less than 1 pF capacitance at 0 V. The MBD103 also has a low series inductance due to its pill package. The MPN3601 p-i-n microwave switching diode has a series resistance of only 0.34 Ω typical at an I_F of 10 mA.

CIRCLE NO. 556

Fast turn-off SCRs handle up to 600 V

RCA, Box 3200, Somerville, N.J. 08876. (201) 722-3200. From \$3 (1000-up); stock.

Three 10 A fast turn-off silicon controlled rectifiers (S5210 series) have 200, 400 and 600-V peak reverse ratings. Types S5210B, S5210D and S5210M have a maximum turn-off time of 8 μs. These devices are intended for high-frequency power switching applications, such as inverters, switching regulators, and high-current pulse applications. They may be used at frequencies up to 25 kHz.

CIRCLE NO. 557

Abrupt junction tuning diodes guarantee specs

KSW Electronics, S. Bedford St., Burlington, Mass. 01803. (617) 273-1730. From \$0.90 (100-up).

Abrupt junction tuning diodes in the KV620-666 series offer guaranteed tuning ratios and temperature coefficients. Tuning voltages should not exceed 15 to 20 V. The series has 4-V capacitance values of 6.8 to 300 pF. The KV-620-666 series diodes are directly interchangeable for many 1N, MV, PC and V prefix diodes sold by other manufacturers.

CIRCLE NO. 558

Light activates MOS switches



Integrated Photomatrix Inc., 1101 Bristol Rd., Mountainside, N.J. 07092. (201) 233-6010.

The IPI-15/17 series of light-activated switches combines a photodiode, buffer and Schmitt trigger on a single MOS chip. Packaging consists of 4-lead TO-18 (Type IPI-15) and 6-lead TO-71 (Type IPI-17) style with glass window. The switch outputs a high-low voltage differential of -0.25 to -9.5 V, or a current differential of 22 to -4 mA. Supply voltages are between -20 and -30 V. An external RC time constant sets the upper threshold level, adjustable over a range greater than three orders of magnitude. Hysteresis between upper and lower thresholds is about 3%.

CIRCLE NO. 559

High voltage rectifier diodes handle to 12 kV

Electrical Devices, 21 Gray Oaks Ave., Yonkers, N.Y. 10710. (914) 965-4400. From \$1.70 (1000-up).

A line of 8-to-12-kV miniaturized, silicon diodes handles currents of up to 125 mA. The electrical ratings of the diodes are: Model AM, 8 kV PIV at 125 mA; AP, 10 kV at 100 mA; and AR, 12 kV at 80 mA. Standard and fast recovery types are also available. Diode size is 0.38 × 0.16 with 0.03 in. diameter leads.

CIRCLE NO. 560

Send for our brushup course on Brushless Synchros and Resolvers.

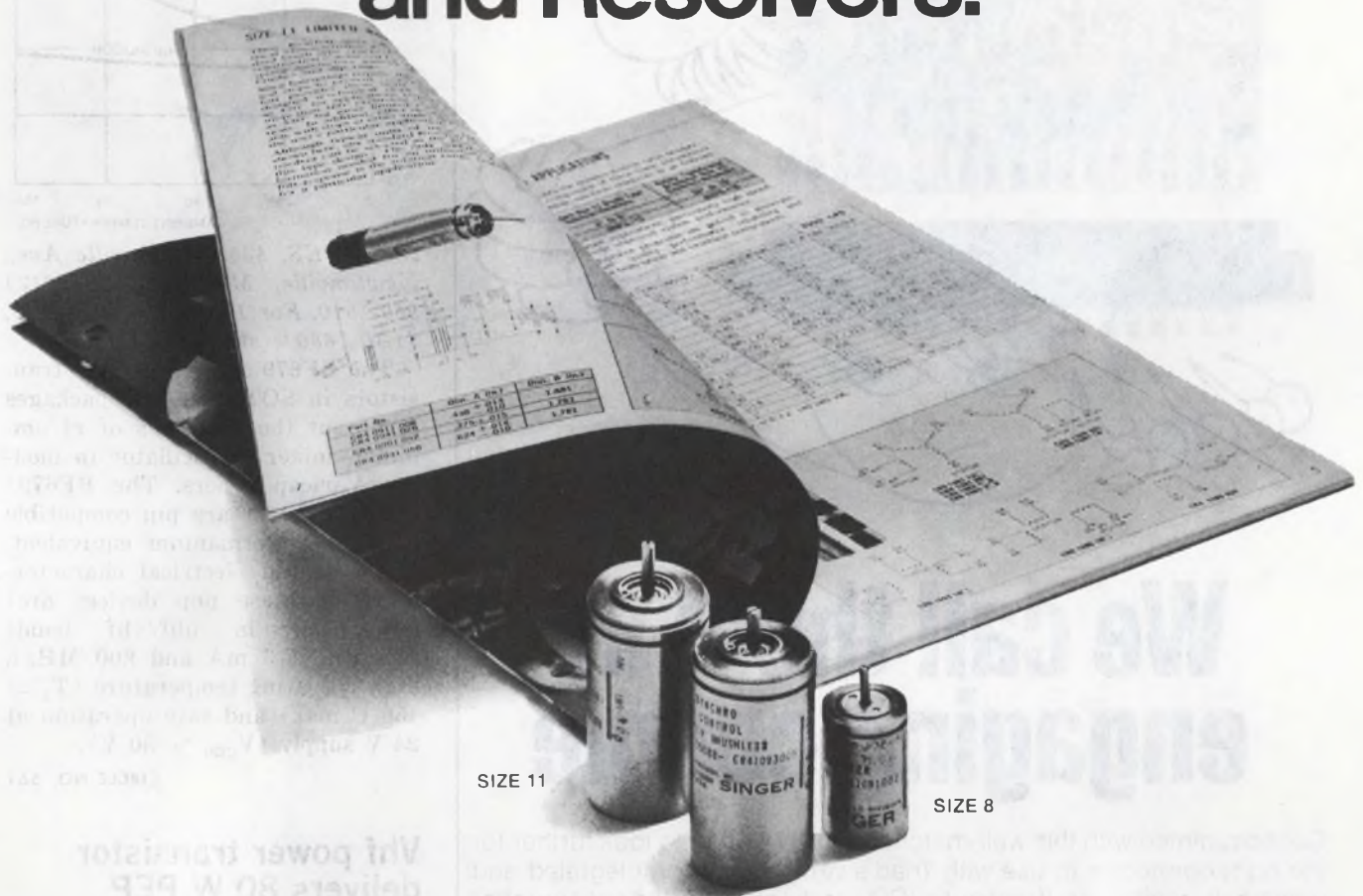

Faced with applications where synchros and resolvers have to be driven at extremely high speeds? Or where brush wiping contact can't be permitted?

Kearfott Brushless Components provide system performance advantages. (Instead of standard brushes and slip rings, rotary transformers couple power into the synchro motor.) And extra-wide bearings give you increased reliability and load-carrying capacity.

Our Brushless Synchros offer you a number of other benefits, too. Longer life, since there's nothing to wear but the bearings. No spurious signals from high-speed brush bounce which Digital Computers can interpret as a command input. Elimination of brush friction for Indicators that require the ultimate in minimum loading. And an end to RFI noise.

Kearfott Brushless Synchros and Resolvers also serve as excellent low cost Brushless Encoders when used in combination with Kearfott TRIGAC I S/D converter cards.

Like to know more? Write for our 36-page brochure on Synchros and Resolvers. It's packed with facts and figures on Brushless Synchros for

limited and continuous rotation applications—plus our full line of Synchros and Resolvers. The Singer Company, Kearfott Division, 1150 McBride Avenue, Little Falls, New Jersey 07424.

SINGER

AEROSPACE & MARINE SYSTEMS

The Singer Company, Kearfott Division
1150 McBride Avenue
Little Falls, New Jersey 07424

Gentlemen:

- I want to know more about Brushless Synchros. Rush me your 36-page booklet on Synchros and Resolvers.
- I have an application for Brushless Synchros. Have a company representative call.

Name _____

Title _____

Company _____

Address _____

City _____ State _____ Zip _____

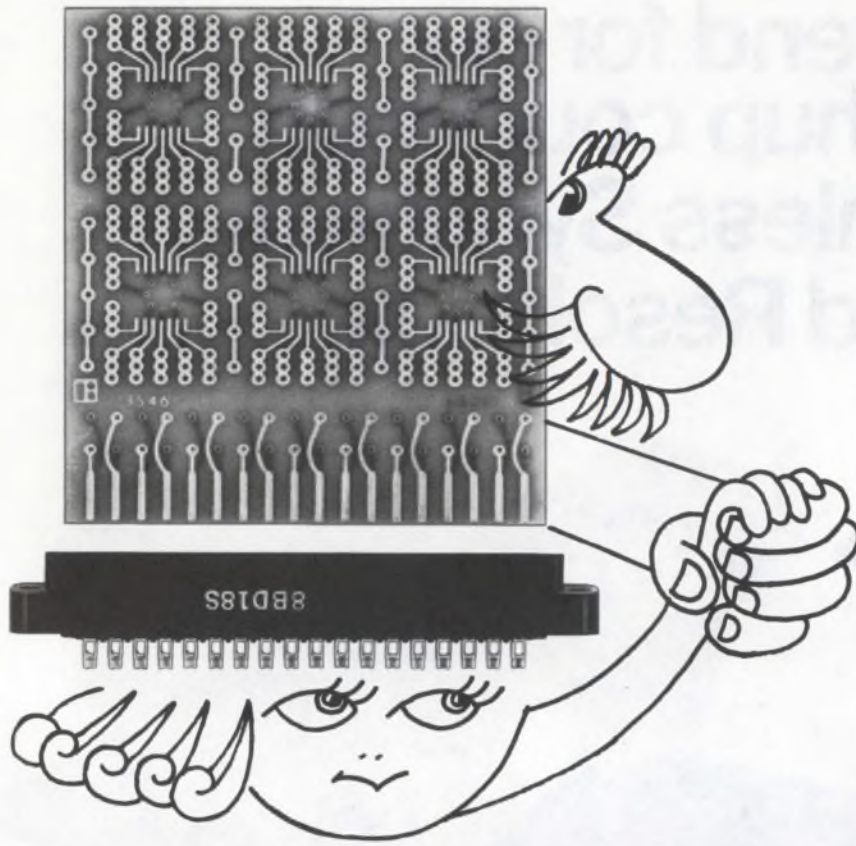

We call them an engaging couple

Get acquainted with this well-matched pair. No need to look further for the right connector to use with Triad's versatile line of integrated and universal circuit cards. If you put a "CO" prefix ahead of the card number, you'll get the applicable Winchester connector in the same package with the card — ready for you to put together.

Triad has many low-cost, fast-delivery cards for breadboarding and testing use: cards for flat packs, TO-5's and dual in-line packages — with or without connectors; plug-in terminal cards, extender cards, solder training cards.

So, if you want to meet an engaging couple, call your nearest Triad distributor. He can also help on your transformer, inductor and filter requirements — we're big in these components, too. Triad-Utrad Distributor Services, 305 North Briant Street, Huntington, Indiana 46750.

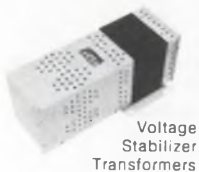

Voltage Stabilizer Transformers



Commercial Grade Powers and Audios



Transistor Power Supply Transformers



Integrated Circuit Cards



TRIAD-UTRAD
Litton Distributor Services

INFORMATION RETRIEVAL NUMBER 140

DISCRETE SEMICONDUCTORS

Pnp rf transistors have 3 dB noise at 800 MHz

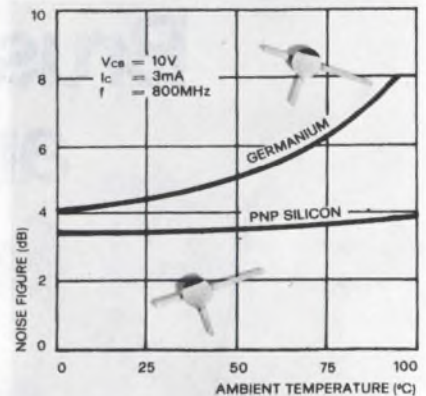

SGS-ATES, 435 Newtonville Ave., Newtonville, Mass. 02160. (617) 969-1610. For 100 up: \$1.20 (679), \$1.10 (680); stock.

The BF679 and BF680 pnp transistors in SOT-37 plastic packages carry out the functions of rf amplifier, mixer or oscillator in modern Varicap tuners. The BF679/680 transistors are pin compatible with their germanium equivalent. The essential electrical characteristics of these pnp devices are: low noise in uhf/vhf bands (3.5 dB at 3 mA and 800 MHz), high operating temperature ($T_j = 150$ C max) and safe operation at 24 V supply ($V_{CE0} > 30$ V).

CIRCLE NO. 561

Vhf power transistor delivers 80 W PEP

RCA, Box 3200, Route 202, Somerville, N.J. 08876. (201) 722-3200. \$36 (100-up); stock.

Type 41042 vhf power transistor can deliver 80 W of peak envelope power at 136 MHz. It is intended for use in amplitude-modulated amplifiers operating in the frequency range from 118 to 136 MHz. At 136 MHz, it provides 20 W of cw power with a 13-V supply, and 80 W PEP with a 26-V supply. It can withstand an infinite load mismatch at the 80-W PEP level. The device is an epitaxial silicon npn planar transistor with overlay emitter-electrode construction. Integral silicon emitter-ballasting resistors are used for ruggedness and overdrive capability. It is supplied in a HF-44 package.

CIRCLE NO. 562

Line-voltage regulators protect against brownout

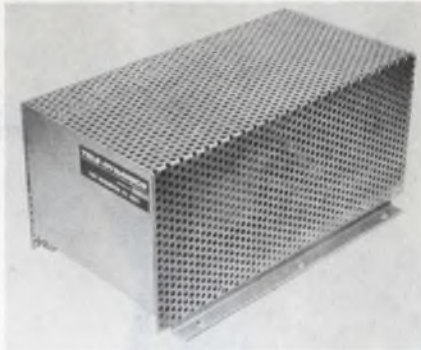

Tel-Dynamics/Wanlass, 525 Virginia Dr., Fort Washington, Pa. 19034. (215) 643-6161. \$150 to \$190; 6 wk.

This patented series of line-voltage regulators is used to protect motors, controls and other instrumentation sensitive to under or overvoltage line conditions—such as summer “brownouts.” Called Varax Line Voltage Regulators, the new devices are for use in 115 or 230-V applications. Five series are rated 500, 1500, 3000, 5000 and 10,000 VA. Output is constant for input variations from 90 to 125 V on 115-V nominal lines, or 180 to 250 V on 230-V nominal lines.

CIRCLE NO. 563

Seven computer supplies offered



Lambda Electronics, 515 Broad Hollow Rd., Melville, N.Y. 11746. (212) 371-8800. \$535; stock.

Called the series LX-7, this 4-15/16 × 10-1/8 × 16-1/2-in. power supply is built with adjustable overvoltage protection, is convection cooled, and requires no blowers. Seven, single-voltage output models are available: 5, 6, 12, 15, 20, 24, and 28 V, all ±5%. Currents at 40 C for these voltages, respectively, are 65, 59, 40, 36, 28, 25 and 22 A.

CIRCLE NO. 564

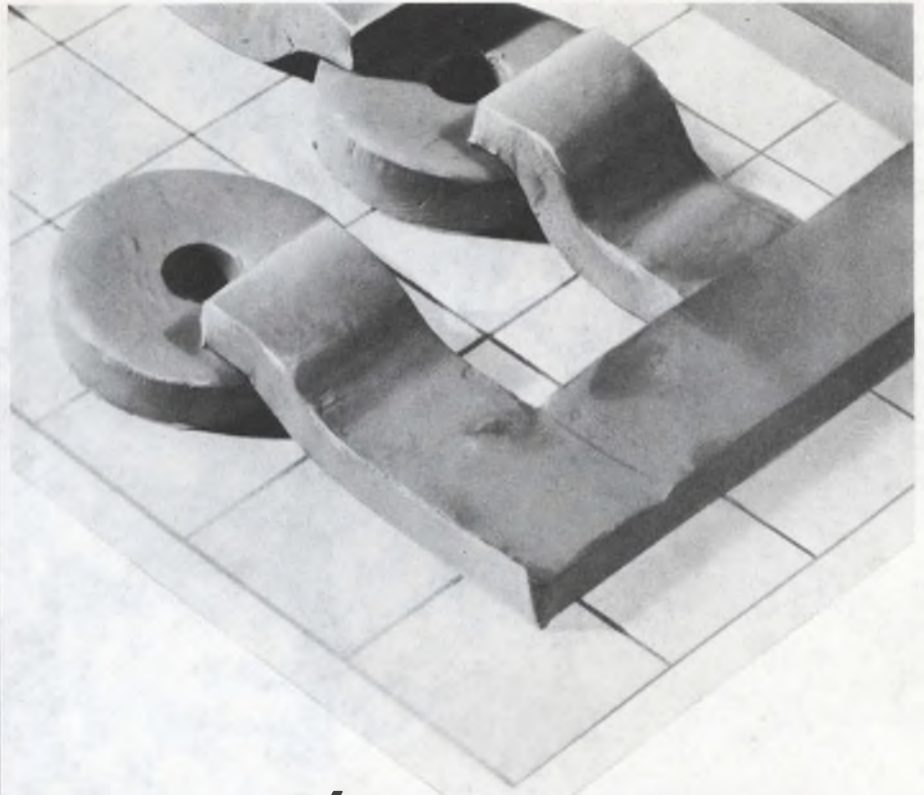

Having P/C repro problems? Maybe your artwork is too fat.

What you see here is a clay model representing art made with die-cut symbols. To your eye your artwork doesn't look like that. But the lens of the repro camera picks up the buildup of those die-cut symbols and tape.

Mecanorma symbols, on the other hand, are printed on an ultra-thin transparent carrier film just 20 microns thick! The tape lies flat. There is no buildup, hence there is no distortion, no parallax.

You can apply Mecanorma symbols with pinpoint accuracy, too. Unlike die-cut symbols, Mecanorma comes in handy transparent strips which give you rapid and precise positioning. No sticky situations, either. The symbols and the carrier sheet can actually come in contact with your work surface without the symbol sticking before you want it to.

And if you change your mind, you can quickly correct it with tape or rubber cement pick-up (it's 40% or 50% quicker than other methods). Mecanorma symbols come in a flat box so they're easy to store (they have a 7-year shelf life). And if you think variety is the spice of life, we have over 800 different symbols to keep you happy.

To prove Mecanorma symbols are all we say, we'll send you some samples and one of our catalogues. Free. Just write Keuffel & Esser Co., 20 Whippany Road, Morristown, N.J. 07960.

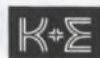

KEUFFEL & ESSER CO.

INFORMATION RETRIEVAL NUMBER 141

CUT



Electronic Design's

DOWN YOUR DETECTIVE WORK

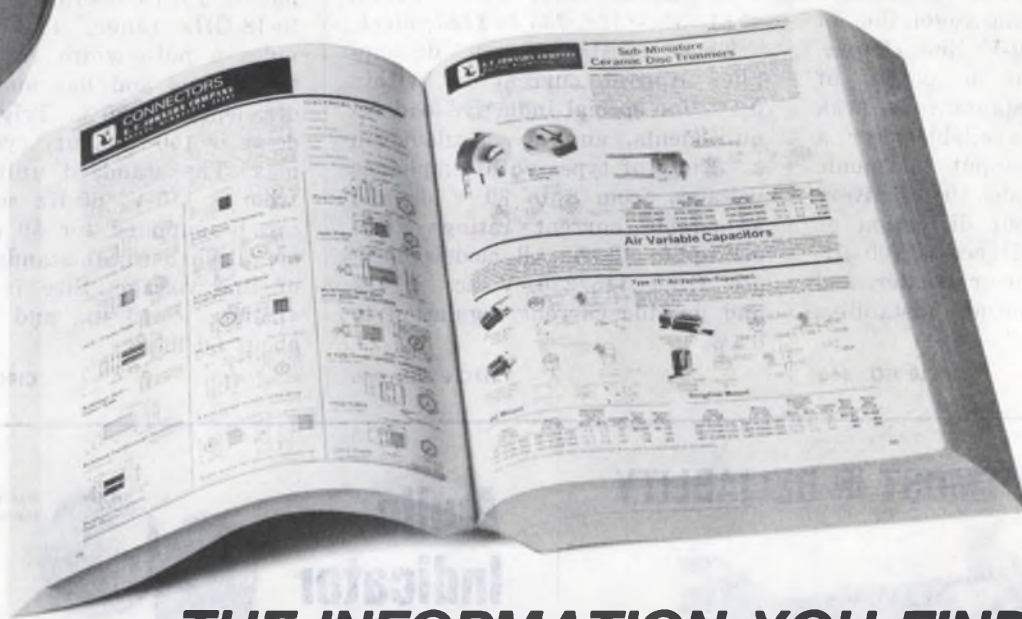

**THE INFORMATION YOU FIND HERE
WILL SAVE YOU TIME AND MONEY**

When you see *Electronic Design's* GOLD BOOK you'll wonder how you ever got along without it. You don't have to be a super-sleuth to find out who makes what or where to find it.

For example, there are almost 300 catalog pages on Monolithic ICs alone; almost 300 pages on Power Supplies; over 250 catalog pages on Instruments; almost 200 pages on Semiconductors — approx. 4,000 pages of directory data and technical material in all.

And the Directories — they're the most complete and comprehensive, the most thorough and useful reference sources ever compiled. Almost 7,500 manufacturers are listed with *complete* address, zip and phone. In most cases (where applicable) you also get 800 (toll-free) numbers, Telex, TWX, cable address, facsimile equipment with make and number, plus QPL and FSC designations, financial data and names of key officers.

5,000 distributors are listed — with both alphabetic and geographic access — in the *Distributors Directory*.

See how often *Electronic Design's* GOLD BOOK will answer your questions before you even pick up the phone. Keep the manufacturer's tech pages in front of you when you call — it can speed the discussion and help you communicate your needs quickly and easily.

GOLD BOOK

COMING JULY, 1974

Line corrector regulates to 0.025%

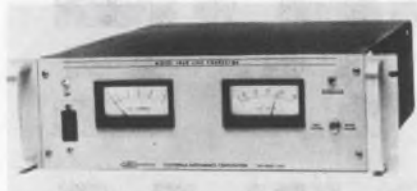

California Instruments, 5150 Convoy St., San Diego, Calif. 92111. (714) 279-8620. \$1495; 30 days.

Model 1060 line corrector delivers an output of 115 V rms at 0 to 10 A with a line regulation of 0.025% for a 10-V line change. Though rated for an output of 1000 VA, an instantaneous peak of 5000 VA is available. For a maximum 10% input harmonic distortion, the Model 1060 delivers a maximum output distortion of 0.2%. Load capacitance is 100 μ F at 0.1 power factor or greater, and peak output amplitude instability is $\pm 0.01\%$ cycle-to-cycle.

CIRCLE NO. 565

Constant-current units output to 12 A



Standard Power, 1400 S. Village Way, Santa Ana, Calif. 92705. (714) 558-8512. \$55 to \$125; stock.

These constant-current dc supplies control current to within 0.1% for special inductive-load requirements, and are available in a variety of types with compliance voltages from 8 to 30 V dc and adjustable current ratings from 0.1 up to 12 A. All models operate from 115/230 V ac, $\pm 10\%$ and provide current regulation to 0.1%.

CIRCLE NO. 566

Lab supply pulses TWTs to 18 GHz



Litton Industries, Electronic Tube Div., 960 Industrial Rd., San Carlos, Calif. 94070. (415) 591-8411.

This power supply, the Model 624, is designed for use with the company's family of kilowatt, pulsed TWTs operating in the 2-to-18-GHz range. The unit provides a pulse-width range of 0.1 to 15.0 μ s and has an operating efficiency of 80%. Trigger to rf delay is 150 ns; duty cycle is 2%, max. The standard unit operates from a 115-V, 60-Hz source, but can be supplied for 50 or 400-Hz operation at most standard values of line voltage. Size is 7 \times 19 (panel) \times 18 in., and weight is about 60 lb.

CIRCLE NO. 567

FOR THE UTMOST IN RELIABILITY



TIME DELAY TIMER Series CSF

It is one of industry's most versatile compact delay timers, offering dial adjustability, automatic reset, external clutching and 10 amp. SPDT snap action load contacts. Repeat accuracy is $1\frac{1}{2}\%$. Resets in $\frac{1}{2}$ second at maximum settings. Voltages: 120, 240/50-60 hertz. All of our timers are made to give you service far beyond what you'd reasonably expect. Our line consists of 17 basic types, each available in various mountings, voltages, cy-

cles, circuits and load ratings... and with whatever special wrinkles you may need. Bulletin 305 tells all about our reliable Delay Timers. Write for it or a catalogue of the entire line. If you have an immediate timer requirement, send us your specifications. Or for fast-service call (201) 887-2200.



Industrial Timer Corporation, U.S. Highway 287, Parsippany, N. J. 07054

INFORMATION RETRIEVAL NUMBER 142

Audio Indicator "Systems"



Speed Up Installation...

add versatility, too!

Take your choice. Components... or systems.

AI-100 series Audio Indicators

AI-100 Series Audio Indicators: Rugged, reliable, steel encased. Rated at a very noticeable 76 dB at 400 Hz. Four models: AI-101 (3 VDC); AI-103w (3 VDC with third wire collector); AI-105 (5 VDC); AI-112 (12 VDC). Use panel mounts for added versatility. **PM-100:** fits $1\frac{1}{8}$ " opening in $\frac{1}{8}$ " panel. Terminals accept .250" female disconnects, screws, or solder. **PM-101:** for $\frac{1}{2}$ " openings in $\frac{1}{8}$ " panels. Bezel, self tap screws, or adhesive mounting. Special mounts made for OEM. What are your needs?



3680 Wyse Road
Dayton, Ohio 45414
Tel. 513-890-1918
TWX 810-450-2523

IN EUROPE
projects unlimited/
Europe B.P. 15:
6100 Mont Sur
Marchienne
Belgium. Telex 51-390
Tel (07) 36 84 86

D.I.A.L. 800-645-9200 for the name of your nearest representative.

INFORMATION RETRIEVAL NUMBER 143

ELECTRONIC DESIGN 12, June 7, 1974

Op amp supplies
output to 2000 V



*Kepco, Inc., 131-38 Sanford Ave.,
Flushing, N.Y. 11352. (212) 461-
7000. \$483; 90 days.*

OPS-IXB group of high-voltage operational amplifiers is rated for 20 W, with 500, 1000 and 2000-V output. The new models feature a low drift, integrated front end for stability, and have a built-in "free amplifier" for low-level programming by passive devices. A simple 0-to-5-k Ω rheostat, supporting just 0 to 5 V, will program the Model OPS 1000B over its entire 0-to-1000-V, 0-to-20-mA range. OPS-IXB models feature a 12-terminal front-panel patch board for dc output, with signal input and feedback connections superimposed over a schematic representation of the circuit.

CIRCLE NO. 568

High-voltage units hook up to CRTs, PMTs

*Spellman High Voltage Electronics
Corp., 1930 Adee Ave., Bronx, N.Y.
10469. (212) 671-0300. Begin at
\$85; 3-4 wks.*

This line of high-voltage units is divided into two categories: FWRM and WRM. FWRM consists of slot supplies with output voltage variable over a narrow range. The WRM models are fully adjustable from near 0 to maximum rated output voltage. Both FWRM and WRM units are available with output ratings up to 30 kV and 30 W. Featuring both remote voltage and remote resistance programming, all models are available with either positive or negative output polarity with respect to ground. Line regulation for all modules is $\pm 0.01\%$, load regulation is 0.05% for full-load change. Ripple is 0.01%/W pk-pk.

CIRCLE NO. 569

We chose to call our new Real-Time Spectrum Analyzer Omniscient* and we'll continue to!

With a name like that you have to measure up, and the EMR Model 1510 does. It goes anywhere, does any job ... It's a Fourier Analyzer, a Spectrum Averager and a Display in one convenient, portable package. And most important, it performs its tasks digitally ... no interactive controls to fumble with ... no complicated computer interface problems.

But to be Omniscient there must be more ... and there is!

- Switch it on, it's ready to operate without calibration
- Analyze a signal repeatedly and get repeatable answers ... over and over again
- 60 dB dynamic range at the input and no gimmickry
- Foolproof LED display of signal amplitude, frequency and averaging time
- Control setting status appears on graticule of CRT for permanent photographic record
- Availability of many options ... Peak Hold, 3-D Display, Computer Interface, Low Frequency Sync, Any Window, etc.

*Possessed of universal or complete knowledge —



Well ... What else could we call it?

Write today for a comprehensive technical brochure or call for a demonstration.

EMR EMR
Schlumberger

EMR Telemetry
Weston Instruments, Inc.
Box 3041, Sarasota, Florida 33578
813-958-0811

THE LINE PRINTER FOR THE LONG RUN



OEMs select it because users prefer it.

This line printer is designed for the long runs—applications where printing is measured in hours instead of minutes. It's a line printer. Full 132 columns, 200 lines per minute. That means 200 lpm regardless of line length!

It's reliable. Quiet. Quality print. No duty cycle limitations. A one year warranty to back it up.

Drive it as hard as you want. Over a thousand Tally Line Printers in the field and not a single mechanical failure! As an OEM, that means Tally printers won't eat you alive in service calls.

Tally has the data processing printer. A printer with all the data processing features your user expects. Eight channel VFU. 64 character set. 96 character upper and lower case option. Various fonts. Foreign languages.

Enhance your computer system with this super reliable, long run line printer. Find out all the features. Write or call Tally Corporation, 8301 So. 180th Street, Kent, Washington 98031. (206) 251-5647.

TALLY®

INFORMATION RETRIEVAL NUMBER 145

POWER SOURCES

Line-voltage regulators keep output to $\pm 1\%$

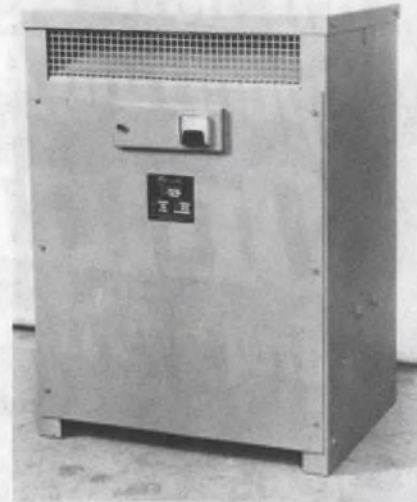

Electro Engineering, 401 Preda St., San Leandro, Calif. 94577. (415) 653-5990. \$970 to \$31,500; 8 to 14 wks.

LVR Series is a line of single and three-phase automatic LVRs in the power range of 3 to 2500 kVA. The electromechanical units combine a variable auto-transformer with an all-solid-state control device to reduce line-voltage fluctuations of $\pm 10\%$ to within a $\pm 1.0\%$ bandwidth, with no waveform distortion.

CIRCLE NO. 570

Switching modules give efficiencies to 80%

Abbott Transistor Laboratories, 5200 W. Jefferson Blvd., Los Angeles, Calif. 90016. (213) 936-8185. \$245 (1-4); stock.

Hi-efficiency series of power modules converts 47 to 440-Hz lines to 50 W of regulated power. Model "VN50" series uses a new approach in switching technology to provide a line of 21 high-efficiency (up to 80%) power modules. Any output voltage between 4.7 and 50 V dc is available in a package that measures only $3\text{-}7/8 \times 6\text{-}1/4 \times 2\text{-}3/4$ in. Line and load regulation are held to 0.4% and ripple to 30-mV rms maximum. Baseplate temperature range is 0 to 71°C and maximum tempco is 0.03%/°C.

CIRCLE NO. 571

PC-mount unit gives triple output



Lambda Electronics, 515 Broad Hollow Rd., Melville, N. Y. 11746. (516) 694-4200. \$70; stock.

The company has added a new triple-output model to the LZ series. The new model is the LZT-36, a 5-V dc, 500-mA; $\pm 15\text{-V}$ dc, 50-mA unit. This addition makes a total of 26 single, 19 dual and one triple-output models in the series. The models in this PC-mount series have continuously adjustable voltages, are field repairable and foldback-current limited. They have a wide input voltage range (105 to 132 V ac), are short-circuit proof, have a vacuum-impregnated transformer and are designed for series operation.

CIRCLE NO. 572

Dc inverters operate from 350 to 600 V



Nova Electric, 263 Hillside Ave., Nutley, N.J. 07110. (201) 661-3434. Approx. \$600 to \$4500; 60 days.

These high-dc-input voltage inverters—the SD, SSD, SSDD series—include 18 models that operate from voltage levels of 350, 450 and 600 V dc. The fully transistorized, modular units provide 115 V, 60 Hz at power levels from 125 VA to 3 kVA. Specs include sine wave output, short-circuit and overload protection and voltage regulation of 1%. Input transient protection is optional up to 4 kV for 10 ms. 50 and 400-Hz outputs are available on special order. Typically, the 250-VA unit measures $16\text{-}3/4 \times 9 \times 6\text{-}3/4$ in.

CIRCLE NO. 573

RCA introduces the "easy way" to buy test equipment.

RCA's new Easy Payment Plan makes it possible for you to own . . . *immediately*, any of the electronic instruments shown in the table below for just a small down payment and only four additional easy payments.

No interest . . . no special charges to worry about. Just meet your local participating Distributor's credit criteria.

So check off the instruments you need and visit your nearest participating RCA Electronic Instruments Distributor. Or write to RCA Electronic Instruments, 415 S. Fifth St., Harrison, N.J. 07029. A distributor will contact you. He'll show you the quick and easy way to own the best in RCA test equipment.

But hurry. This great offer ends on July 31, 1974.

Model WO-33B

New "super" portable 3" Oscilloscope
\$229.00 **\$71.00 Down**



Model WO-535A

Triggered sweep DC to 10 MHz
5" Oscilloscope
\$349.00 **\$104.00 Down**

Model WO-505A

DC to 10 MHz 5" Oscilloscope
\$329.00 **\$101.00 Down**



Model WV-510A

Master VoltOhmyst®
\$135.00 **\$40.00 Down**

Model WV-98C

Senior VoltOhmyst®
\$99.95 **\$30.00 Down**



Model WV-500B

Portable Solid-State VoltOhmyst®
\$99.95 **\$30.00 Down**

Model WV-532A

Relay-protected VOM
\$99.95 **\$30.00 Down**



Model WA-504B/44D

Audio Sine/Square-wave Generator
\$109.50 **\$36.00 Down**

Model WR-514A

TV Sweep Chanalyst
\$380.00 **\$114.00 Down**



Model WR-515A

Master Chro-Bar Generator
\$189.00 **\$56.00 Down**

Model WR-538A

Super Chro-Bar Generator
\$129.95 **\$39.00 Down**



Model WT-333A

Picture Tube Tester/Rejuvenator
with "SIMUL-TEST"
\$189.00 **\$56.00 Down**

Model WT-524A

Dynamic Transistor/FET Tester
\$159.00 **\$47.00 Down**



Model WP-702A

Dual Output DC Power Supply
\$99.00 **\$30.00 Down**

ALL PRICES SHOWN ARE OPTIONAL WITH DISTRIBUTOR

TRADEMARK(S)® REGISTERED
MARCA(S) REGISTRADA(S)

Specialists demand the best tools of their trade.

RCA Electronic Instruments

INFORMATION RETRIEVAL NUMBER 146

application notes

Analog networks

"Circuit Design and Network Analysis" describes Electronic Engineering Pac Volume 1. This software package is used with the HP 9820 or 9821 calculators and contains programs in five categories: network analysis, filter design, transfer function analysis, component design and digital logic minimization. Hewlett-Packard, Palo Alto, Calif.

CIRCLE NO. 646

Permanent magnets

Magnet fundamentals and specific design considerations are outlined in a 16-page summary of design techniques for magnet systems. Indiana General, Valparaiso, Ind.

CIRCLE NO. 647

Filter measurements

Data on how to use tunable notch and peak filters to facilitate telephone line measurements and tests for data transmission are given in a four-page brochure. All measurements are referenced to Bell technical reference guidelines, PUB 41009. SEG Electronics, Jamaica, N.Y.

CIRCLE NO. 648

Waveform recorder

An application note describes how waveform (transient) recorders have been powerful new tools for studying fast chemical reactions. Biomat, Cupertino, Calif.

CIRCLE NO. 649

Dry photoresist stripping

Use of plasma instrumentation for removal of photoresist from aluminum substrates is described in an application note. The note describes the advantages of using the dry plasma technique as compared with organic stripping. Teagal, Richmond, Calif.

CIRCLE NO. 574

Spectrum analyzer

How to use on-line real-time spectrum analysis to test and service high-quality tape recorders is described in a four-page technical paper. Federal Scientific, New York, N.Y.

CIRCLE NO. 575

Variable angle techniques

Variable angle attenuated-total-reflectance (ATR) techniques to simplify surface studies are illustrated in a 16-page booklet. These techniques can be used in analyzing plastics, rubber, paper, resins, ink, fiber, wax, blood, multilayered films and coatings of almost any type. Barnes Engineering, Stamford, Conn.

CIRCLE NO. 576

Magnetic sensors

A report covers design criteria and application requirements for obtaining precision synchronous timing with the use of analog (passive) and digital (active) magnetic sensors. Electro Corp., Sarasota, Fla.

CIRCLE NO. 577

ALCOSWITCH

We've used the inner mechanism of our best quality toggle switch to create one of the world's greatest SLIDE SWITCHES. You have available a high current capability built into a compact, low profile, PC mounted switch.



Call (617) 685-4371 for details, applications, samples and quotations.

ALCOSWITCH

ALCO ELECTRONIC PRODUCTS, INC.
1551 Osgood St., No. Andover, Mass. 01845

INFORMATION RETRIEVAL NUMBER 147

ALCOSWITCH

The World's smallest BI-DIRECTIONAL, CODE PUSHBUTTON switch with large easy-to-read numerals. Available in a variety of coded outputs (includes decimal) and lots of mounting and mating accessories.

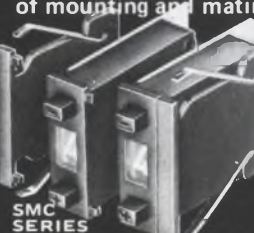

Call (617) 685-4371 today for detailed information and ask us for a "dummy" switch to study and compare on your own panel design.

ALCOSWITCH

ALCO ELECTRONIC PRODUCTS, INC.
1551 Osgood St., No. Andover, Mass. 01845

INFORMATION RETRIEVAL NUMBER 148

Heath 15 MHz scope with triggered sweep...

just \$329.95*
in Kit form...

only \$475*
Factory Assembled & Calibrated



An excellent bench or design scope at low cost. DC-15 MHz vertical bandwidth with 24 ns risetime ...10 mV input sensitivity ...12 calibrated vertical attenuator positions up to 50 V/cm...1 megohm/40 pf input Z protected up to 600 VDC...22 calibrated time bases from 2 s/cm to 0.2 μs/cm... x5 magnifier...normal or auto triggering...AC/DC coupling...ext. trigger input...built-in calibrator...6 x 10 cm screen...120/240 VAC operation. Send for FREE catalog for complete details & specs.

Kit IO-104, 44 lbs. \$329.95*
Factory assembled & calibrated SO-106A, 40 lbs. \$475.00*

HEATH
Schlumberger

Send for FREE catalog NOW!

Heath Company, Dept. 66-6
Benton Harbor MI 49022

Please send latest Heathkit catalog.

Name _____

Address _____

City _____

State _____ Zip _____

*Mail order prices; FOB factory TE-304

INFORMATION RETRIEVAL NUMBER 149

ELECTRONIC DESIGN 12, June 7, 1974

design aids

Flame-retardancy charts

An easy-to-follow product performance chart identifies at a glance which flame retardant and/or UL tests have been passed by Scotch-brand electrical tapes, ScotchTite tubings, 3M tubings and Scotchcast resins. A second chart, a UL recognition guide, includes file numbers and guide numbers for tapes, resins, tubings, thermal cutoffs and Scotch-brand film. 3M.

CIRCLE NO. 578

Thumbwheel switches

"Our Codes Are No Secret" is the theme of a 22 x 34 in. thumbwheel switch wall chart. Included with the 79 switch code charts are photographs, dimensions and descriptions, plus features and options covering all series. The Digi-tran Co.

CIRCLE NO. 579

Zener voltage regulators

A product locator for zener voltage regulators lists power ratings, voltage ratings, tolerance range, case style and data sheet number. The literature shows 12 photographs of various devices with their dimensions. International Rectifier, Semiconductor Div.

CIRCLE NO. 580

Metric conversion aids

A catalog offers a variety of metric educational aids, such as a wall chart, three-dimensional mechanical devices, slide-rule type converters and color and sound films. Millimeter Industrial Supply.

CIRCLE NO. 581

4-color LED kit

Designer kits contain 15 different light-emitting diode lamps in four colors—red, green, yellow and orange. All are in 0.125, 0.160 and 0.200-in. diameter package sizes. They may be purchased at an introductory price of \$7.95 each. Cramer Electronics, 85 Wells Ave., Newton, Mass. 02159.

INQUIRE DIRECT

super 8 channel recorder

O.E.M. CONFIGURATION — No toll-free fancy case, a complete eight channel recorder at a low O.E.M. price. COMPACT — LIGHT — PORTABLE — 23" wide, 17" high and 10" deep. Weighs just 59 lbs. FULL 1/2" CHANNEL WIDTH — Permits greater resolution and ease of reading. AUTOMATIC CHART FEEDING — Five second chart loading. CONTINUOUS VARIABLE CHART SPEED — ASTRO DRIVE provides variable speed recording with Tachometer read-out. ROTARY TIP STYLUS — Rugged, long-life tubular construction.

AND LOTS MORE!
PHONE OR WRITE FOR BROCHURE

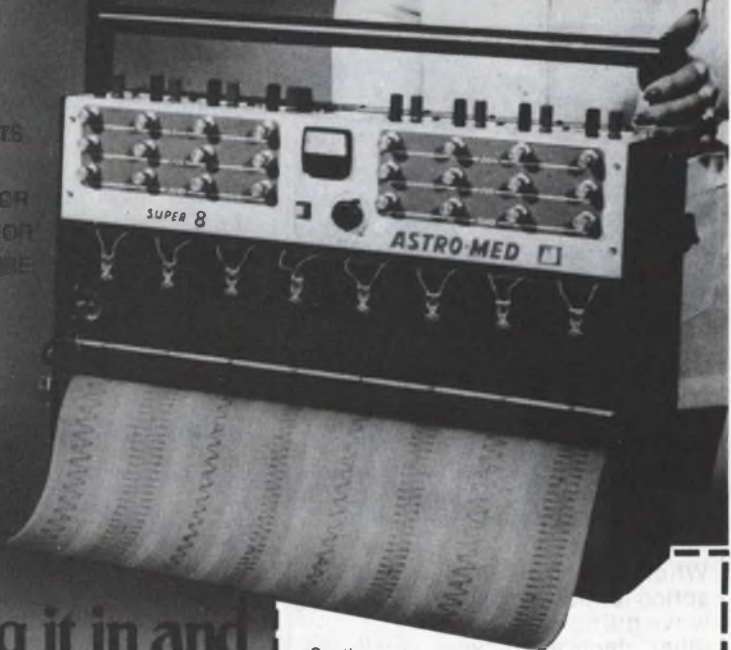

Plug it in and put it to work for only \$3388

Gentlemen:
Please send complete literature.

Our application is _____

Telephone _____

Name _____

Title _____

Organization _____

Street _____

City _____

State _____ Zip _____

ASTRO-MED **AI** **ATLAN-TOL INDUSTRIES INC.**

A DIVISION OF ATLAN-TOL INDUSTRIES, INC.
ATLAN-TOL INDUSTRIAL PARK
WEST WARWICK, RHODE ISLAND 02893
(401) 828-7010

INFORMATION RETRIEVAL NUMBER 150

**How to achieve
good electrical
connection with low
compressive loads:
SERVOMETER
bellows
contact springs.**



SERVOMETER gold-plated bellows contact springs are designed to insure adequate electrical continuity on circuit parts where tolerance buildup could become a problem. They provide:

- . a minimum of self inductance
- . extremely low DC resistance
- . a minimum of insertion loss
- . lifetime spring repeatability
- . and they require only moderate forces to insure good electrical contact between the mating parts.

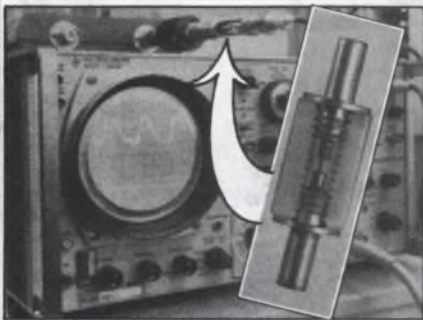

A typical application involves microwave device research. A gallium arsenide sample is firmly supported by the **SERVOMETER** bellows spring contact without undue compressive loads which would shatter this delicate material.

Whenever you need a contact spring for use in a diode, delay line, waveguide component, or any other electronic device, you'll find a **SERVOMETER** bellows contact to do the job. A variety of configurations are available from stock. Or we'll design a contact to fit your specific applications.



Send today for
**CATALOG and
FREE
SAMPLE**

MINIATURE METAL BELLOWS
SERVOMETER
82 INDUSTRIAL EAST, CLIFTON
NEW JERSEY 07012 (201) 773-0474

new literature



Power supplies

A 196-page power supply catalog and application handbook is subdivided into these sections: power components, power kits, standard power supplies, custom power supplies and power instruments. Data include available models, sizes, electrical specifications and prices. Dimensional mounting drawings, photos of the packages and connection diagrams are supplied. Lambda Electronics, Melville, N.Y.

CIRCLE NO. 582

Sliding potentiometers

General construction details and a model selection chart for the PL40 series sliding potentiometers are shown in a four-page catalog. Mounting styles, housing dimensions and shaft configuration details are given for the PL60 series as well as a selection chart and mounting hole pattern. Piher, Des Plaines, Ill.

CIRCLE NO. 583

Magnetic tape I/O system

A 12-page catalog describes magnetic tape I/O systems for mini-computers, cassette transports and systems and precision timing instrumentation. Also included are sections on the optical mark reader, complete computer systems and graphic arts tape systems. Datum, Anaheim, Calif.

CIRCLE NO. 584

Automatic test processor

A six-page pocket guide describes the Datatester 400 automatic test equipment processor. The guide includes an operational diagram of the system as well as a complete instruction set. Data Test, Concord, Calif.

CIRCLE NO. 585

Laser system

An eight-page brochure features a design-it-yourself "building block" concept incorporated in the company's K1 series solid-state laser system. Korad, div. of Hadron, Santa Monica, Calif.

CIRCLE NO. 586

Programmer

A stepping drum programmer for controlling sequential operations is described in a four-page bulletin. Tenor, New Berlin, Wis.

CIRCLE NO. 587

Heat dissipators

Heat sinks, heat dissipators, dissipator/retainers and other thermal management devices for electronic circuits and components are described in a 68-page catalog. IERC, Burbank, Calif.

CIRCLE NO. 588

Schottky diodes

A power Schottky diode, believed to be the first such device rated for a junction temperature of 125 C, is described in a data sheet. Device ratings, characteristics and curves are included. TRW Semiconductor, Lawndale, Calif.

CIRCLE NO. 589

IC sockets

A four-page brochure shows 14, 16 and 24-pin IC sockets including one, two and three-level wrapped wire styles with gold or tin-plated leads. Solder tail models are shown for providing IC plugability on soldered boards. Features and specifications including dimensions and material characteristics are pointed out. Scanbe, El Monte, Calif.

CIRCLE NO. 590

SIGNAL CONDITIONING

for all types of Thermocouples
in Data
Acquisition
Systems



Validyne TR41 Thermocouple Reference Junction offers low cost heated reference with complete isolation for up to 100 channels. Low induced noise & stability maintained through the use of a proportional heating circuit whose temperature accuracy exceeds that of the common ice bath.

TR41 designed for single circuit thermocouple input with choice of terminals or thermocouple jacks. Additional circuit available for terminating or carry-thru of shield wire. Temperature stability: $\pm 1/10^\circ\text{F}$ long term unattended operation.

Junction Temp: 150°F standard. Optional temperature from 10°F above ambient to 250°F .

Power Requirements: 105-125 volts, 50 to 400 Hz, Standard 28VDC optional.

TR42 provides for the alternate use of different thermocouple materials with the output pair for each channel.

TR43 offers 5 or more input terminals for use with 3 or more types of Thermocouple pairs for each output circuit.

Units available with special panel configurations and optional features.

Price & Delivery \$250 Base all models 4 weeks
Plus \$10/channel TR41 \$15/channel TR42 \$18/channel TR43



Validyne
ENGINEERING CORPORATION

WRITE FOR CATALOG
19414 Londelius Street
Northridge, Calif. 91324
Phone (213) 886-8488
Telex 65-1303

INFORMATION RETRIEVAL NUMBER 152

OTTO® Sub-subminiature Switches

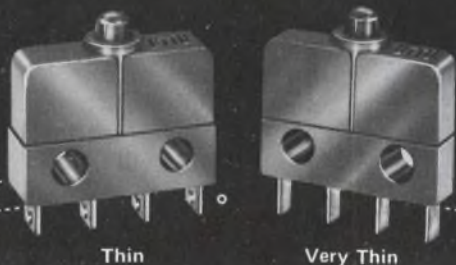

snap-action • precision • 8 A. to dry circuit!

Less than 10 milliohms contact resistance in a ten million cycle switch! That's the OTTO B3 series with patented* design featuring high contact force and minimal contact bounce. Commercial or military, your options include "thin" and "very thin" sizes, contact arrangements to form Z, terminals, and contact materials. Load ratings to 8 A. resistive. Actuators available, too.

For full details including prices and local distributors, write for Bulletin B3.

*U.S. Pat. No. 3,612,793

OTTO CONTROLS Division, OTTO engineering, Inc.
36 Main Street, Carpentersville, Illinois 60110 • Phone: 312/428-7171
© OTTO engineering inc.

INFORMATION RETRIEVAL NUMBER 153

ELECTRONIC DESIGN 12, June 7, 1974

DI-MAG

... SUPER
SENSORS

THE SENSIBLE CHOICE...

- **DIGITAL OUTPUT** — Constant amplitude pulses independent of surface speed or air gap.
- **COMPATIBILITY** — Direct interface with TTL, DTL or HTL logic.
- **NOISE IMMUNITY** — High signal-to-noise ratio not achievable in analog sensors.

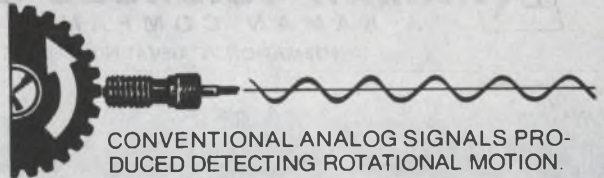

CONVENTIONAL ANALOG SIGNALS PRODUCED DETECTING ROTATIONAL MOTION.

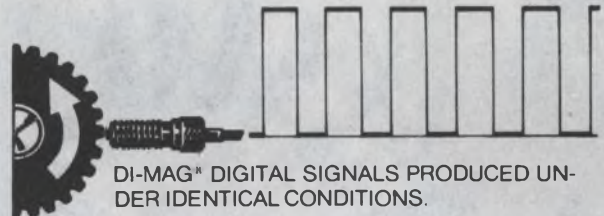

DI-MAG® DIGITAL SIGNALS PRODUCED UNDER IDENTICAL CONDITIONS.

DI-MAGS® work particularly well in these computer peripheral functions and applications:

- FEED RATE CONTROL
- PRINT HAMMER SYNCHRONIZATION
- DISK POSITION INDICATION
- DISK AND TAPE DRIVE RPM MEASUREMENT
- INDEXING CONTROL
- CONTROL SIGNAL FOR CLOSED-LOOP SERVO SYSTEMS.



THAT'S WHY I'M CALLED THE SUPER SENSOR!

Send for your free copy of our Di-Mag® "AIR GAP/V/S SENSITIVITY" selector.



ELECTRO
CORPORATION

1845 57TH STREET, SARASOTA, FLORIDA 33580
AREA CODE (813) 355-8411 • TELEX 5-2683

INFORMATION RETRIEVAL NUMBER 154

**You're Looking At The World's
Smallest Displacement Transducer.
Think of the Possibilities!**

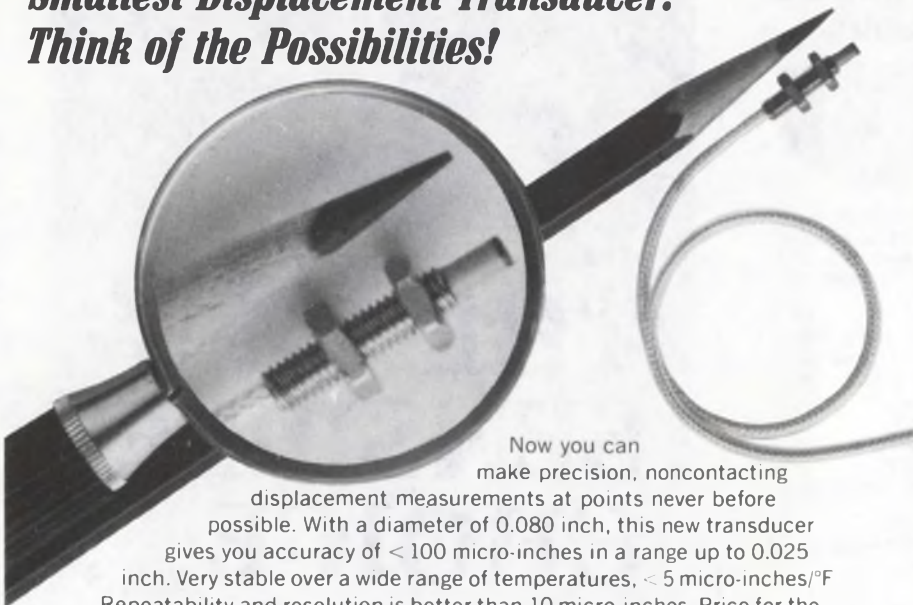

Now you can make precision, noncontacting displacement measurements at points never before possible. With a diameter of 0.080 inch, this new transducer gives you accuracy of < 100 micro-inches in a range up to 0.025 inch. Very stable over a wide range of temperatures, < 5 micro-inches/°F. Repeatability and resolution is better than 10 micro-inches. Price for the KD-2300 - .5 SU is \$445, including associated electronics. (For optional power supply and digital readout, add \$395). Other noncontacting systems with ranges to 3 inches. For facts, contact: Kaman Sciences Corporation, P.O. Box 7463, Colorado Springs, CO 80933. (303) 598-5880.

KAMAN SCIENCES CORP.
A KAMAN COMPANY
INFORMATION RETRIEVAL NUMBER 155

18 sizes...
10-14-20-24-26-30-36-40-44-50-54-56-60-66-70-90-100-120

We have expanded our series WTB right angle PC Connectors to include sizes up to 120 contacts and a choice of solder cup, dip pin, or Wire-Wrap* terminals. Crimp terminals available on all sizes up to 90. This very versatile subminiature connector features 100" spacing, 2 rows offset for .050"

For details, call 214/233-2000 or write our Dallas plant at 4321 AirBorn Drive, Addison, Texas 75001

AirBorn, Inc.

INFORMATION RETRIEVAL NUMBER 156

NEW LITERATURE



Digital oscilloscopes

"The general purpose, high precision, digital oscilloscope," a 12-page brochure, discusses the design philosophy, operation, mid-signal trigger, display capabilities, accuracy, resolution and interfaceability when digital techniques are used in an oscilloscope. Nicolet Instrument, Madison, Wis.

CIRCLE NO. 591

Rf tuning diodes

Specifications and application data for variable capacitance tuning, band switching and afc diodes are given in a six-page brochure. Charts of diode capacitance vs reverse voltage, outline drawings of the five different package configurations, and a sample schematic diagram of the front end of an FM auto radio are included. Amperex, Slatersville, R.I.

CIRCLE NO. 592

Aluminum heat sinks

A bulletin profiles extruded heat sinks. Printed on one side, this 8-1/2 x 11 in. bulletin opens out to a 48-1/2 in. wall chart. Featured are 101 aluminum extrusion shapes, scaled 1/4 to 1 in. Wakefield Engineering, Wakefield, Mass.

CIRCLE NO. 593

Monolithic circuits

An eight-page brochure describes standardized custom monolithic circuits. Interdesign, Sunnyvale, Calif.

CIRCLE NO. 594

Buy the Ballantine 3/24 DMM

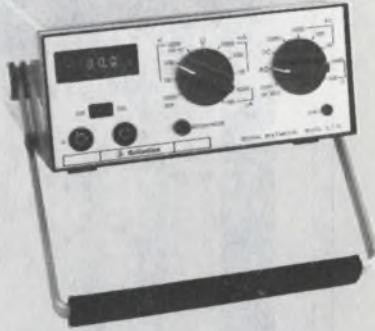

24 Ranges — 3 Full Digits

- AC Volts, AC Current, Ohms, DC Volts, DC Current
- Fully Overload Protected
- 300 Hour Dependable Battery Life
- Pocket Size — Weighs Under 2 Pounds
- 0.2% DC Accuracy — AC to 20 kHz

Available from Stock
Factory/Distributor

\$195
complete



Ballantine Laboratories, Inc.

P.O. Box 97, Boonton, New Jersey 07005
201-335-0900, TWX 710-987-8380

INFORMATION RETRIEVAL NUMBER 157

Power Modules 400 Series

Overvoltage
Protection
Standard

4 x 4½ x 1¾

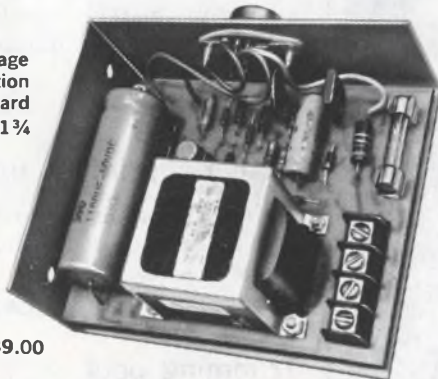

\$39.00

MOD	VOLT	AMPS
86-401	5	1.5
86-402	6	1.3
86-403	10	1.0
86-404	12	0.8
86-405	15	0.75
86-406	24	0.4

Small, open frame, power modules, economical but without any compromise with quality. Connections are by screw type barrier terminals. Foldback current limiting and overvoltage protection are standard protective features.

REQUEST BULLETIN PS-401

115 Marine St., Farmingdale, N.Y. 11735 • (516) CH 9-2336

VOLTEX

INFORMATION RETRIEVAL NUMBER 158

ELECTRONIC DESIGN 12, June 7, 1974

DO-IT-YOURSELF grabber



NEW

- Simplified Assembly
- Versatile
- Comfortable Finger Grip Action
- Completely Field Serviceable
- Molded of Tough Lexan*

**Model 3925
Mini Test Clip**
Shown Actual Size

This test clip with gold plated hook is excellent for rapid testing of components and Wire Wrap† pins. Clip is completely insulated to point of connection. Build any combination of test leads with wire up to .090 dia. Easy and comfortable to operate. Molded of rugged Lexan to resist melting when soldering. Write for literature and prices.

SIMPLIFIED ASSEMBLY

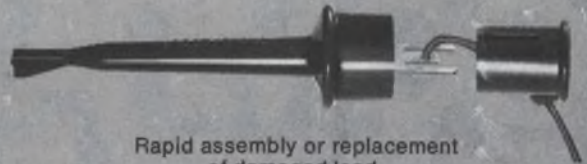

Rapid assembly or replacement
of damaged lead.

MODEL 3925

hooks onto components or slips over square Wire-Wrap pins

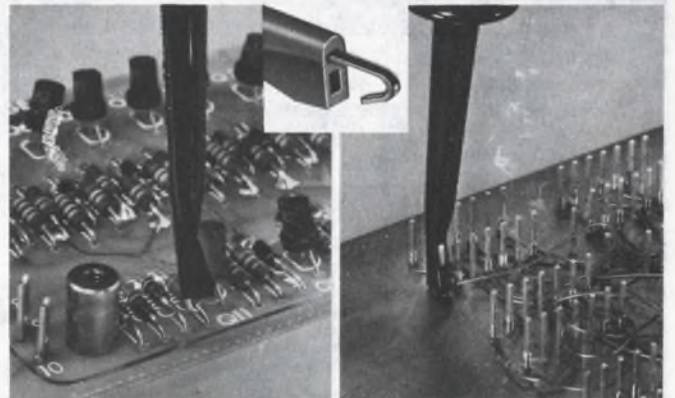

*Lexan is a General Electric trade-mark. †Registered trade-mark of Gardner-Denver Co.



POMONA ELECTRONICS

A Division of ITT

1500 East Ninth St., Pomona, Calif. 91766
Telephone (714) 623-3463

INFORMATION RETRIEVAL NUMBER 159

Now — Build your own High-Speed Digital Test Equipment

From DC to 100 MHz. Choose From Over 20 Plug-In Modules: • Signal Sources . . . Oscillators Used to Drive Other Modules • Data/Word Generators . . . Serial/Parallel/Pseudo Random Outputs

- Digital Width and Delay . . . Wide Range with 1 Nanosecond Resolution
- Signal Conditioning . . . Amplifiers to Vary Width, Delay, Amplitude, Offset
- PCM BERT . . . Transmitter/ Receiver with Auto Sync and Counter.

Buy only what you need to synthesize the exact complex waveform you want. You can add on, later . . . even specialized modules.

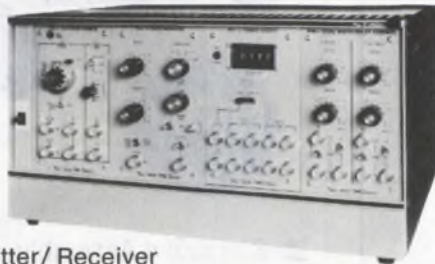

tau-tron
inc

11 Esquire Road, North Billerica, Mass. 01862 Tel: (617) 667-3874

INFORMATION RETRIEVAL NUMBER 160

NEW LITERATURE



Reed switches

An illustrated catalog aids in the selection and application of reed switches. The catalog covers various forms of actuation, including proximity switching with permanent magnets, bias switching, shielding and electromagnetic actuation. Hamlin, Lake Mills, Wis.

CIRCLE NO. 595

Before you buy

COMPARE MODULATION METERS

We invite you to use Radiometer's Type AFM2 or AFM3 in your laboratory on a 10 day trial. Check features, specifications and especially performance in your own precise measurements of FM deviation and AM modulation on carriers from 5 MHz to over 1 GHz. Determine distortion levels of signal generators or transmitters and make sensitive measurements of incidental AM or incremental FM on carriers.

You can check all these and more.

For details contact us at
811 Sharon Drive,
Cleveland, Ohio 44145
Phone 216/871-8900

 **THE LONDON COMPANY**

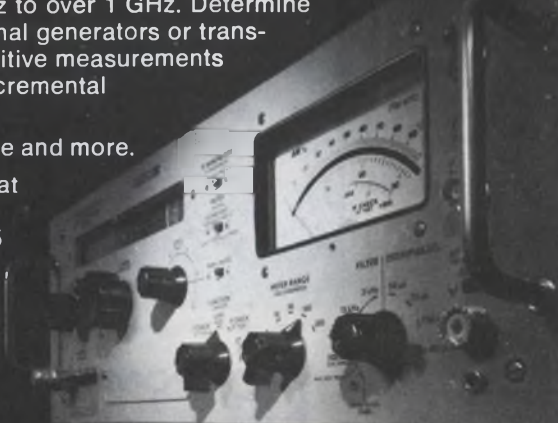

A quality product of **RADIOMETER COPENHAGEN**

INFORMATION RETRIEVAL NUMBER 161

Infrared thermometers

An energy-saver booklet gives examples showing how infrared thermometers have saved energy and scarce materials while increasing product yield. Raytek, Mountain View, Calif.

CIRCLE NO. 596

Numeric printing unit

The 4508 numeric printing unit is illustrated in a brochure. Facit-Addo, Secaucus, N.J.

CIRCLE NO. 597

Trimming pots

A 12-page bulletin, "Cermet Trimming Potentiometers," includes six key parameter tables which allow comparison of specifications such as power, size, turns and maximum operating temperature. Specification tables for military and industrial models present available sizes, pin spacings and performance characteristics for all standard trimmers. Beckman Instruments, Helipot Div., Fullerton, Calif.

CIRCLE NO. 598



EMI SHIELDING

- Knitted wire shielding strip gaskets and special shapes.
- Wire mesh and elastomer seal/shield gaskets.
- Thin elastomer filled meshes for shielding/sealing.
- Honeycomb, screen and mesh shielded vent panels.
- Shielded optical viewing windows.
- Metal or carbon filled conductive elastomers.
- Conductive paint, adhesives, epoxies and caulking compounds.

These and more in TECKNIT's Design Guide.

TECKNIT® | Technical Wire Products, Inc.

Eastern Division • 129 Dermody St., Cranford, NJ 07016 (201) 272-5500
 Western Division • 427 Olive St., Santa Barbara, CA 93101 (805) 963-1867

INFORMATION RETRIEVAL NUMBER 162

HECON predetermining counters do more than count for you!



- | | |
|------------|------------|
| • Control | • Regulate |
| • Batch | • Position |
| • Automate | • Guide |
| • Direct | • Program |
| • Measure | • Inspect |
| • Mix | • Analyse |
| • Record | • Turn |
| • Package | • Shift |
| • Switch | • Advance |
| • Actuate | • Select |

Make them count for you today.
 Call or write for free 36 page
 catalog - includes comprehensive
application section.

HECON CORPORATION

Hecon Corporation, PO Box 247,
 Eatontown, N.J. 07724/(201) 542-9200
 Hecon of Canada, Ltd., 80 Galaxy Blvd.,
 Rexdale, Ontario M9W-4Y8/(416) 678-2441.

27

INFORMATION RETRIEVAL NUMBER 163

ELECTRONIC DESIGN 12, June 7, 1974



Check in one direct move with Brandenburg's new HV meter

We thought it was about time somebody supplied *direct reading* meters for high voltage, so we've produced three—one for up to 5kV, one for 15kV and one for 30kV to complement our range of HV power supplies.

The meters are operated by two 9V internal batteries (800 hours life) linked with a built-in checking facility. Positive or negative ground is available, selected by a front panel switch. And, as with all Brandenburg products, there is a 12 months unconditional guarantee.

- Accuracy of 1% fsd over voltage range of 0.30kV d.c.
- Less than 1 μ A drawn at 30kV d.c.
- 4.5in (114 mm) scale mirror-backed meter.
- Temperature range 5-35°C.
- Dimensions only 7 x 8 x 5½in high (200 x 145 x 178mm).
- Recorder output.

Yet another Brandenburg piece in the high voltage game

brandenburg
 STABILISED HIGH VOLTAGE

Brandenburg Limited, 939 London Road, Thornton Heath, Surrey,
 CR4 6JE, England. Tel: 01-689 0441 Telex: 946149

Agents or distributors in most principal countries.

P6437

INFORMATION RETRIEVAL NUMBER 164

231

Log video amps

Four models of standard direct coupled log video amplifiers designed to provide wide dynamic range logging with low-frequency response (dc to 5 MHz) and a capability to process pulsed data at duty factors up to 25% are described in a brochure. American Astrionics, Costa Mesa, Calif.

CIRCLE NO. 599

Compact relay

The compact industrial RY relay is illustrated in a six-page brochure. The booklet shows ease of contact conversion (18 s without rewiring) and the simplified coil-changing procedure, again without wiring changes. Variations of the relay for a number of applications are described, and four accessories are illustrated. Micro Switch, Freeport, Ill.

CIRCLE NO. 600

Microwave diode chips

Microwave semiconductors available in chip and beam-lead form for microstrip and stripline applications are specified in a 14-page catalog. A special section details the methods for handling and bonding both beam-lead devices and semiconductor chips. It gives recommendations on use of equipment, substrates, wire or ribbon attachment, metalization and materials. Alpha Industries, Woburn, Mass.

CIRCLE NO. 601

Semiconductors

A 56-page book, printed in two colors, provides a quick reference guide to discrete power devices, hybrid power regulators and Schottky diodes. Package illustrations and dimensional drawings are provided. Solitron Devices, Riviera Beach, Fla.

CIRCLE NO. 602

Dc power converter

A two-page bulletin covers the MP3020 dc/dc power converter. Analogic, Wakefield, Mass.

CIRCLE NO. 603

Microwave p-i-n diodes

A six-page catalog contains specifications and mechanical outlines of microwave p-i-n diodes. Outline drawings of 26 standard packages are included plus typical examples of the company's custom package capability. Unitrode, Watertown, Mass.

CIRCLE NO. 604

Liquid-crystal displays

A 12-page brochure describes liquid-crystal displays. The brochure includes a description of nematic-liquid crystals, applications information, turn-on, turn-off curves, drawings and circuit diagrams. Siemens, Iselin, N.J.

CIRCLE NO. 605

Noise analysis equipment

A 16-page short-form catalog describes and illustrates instruments and systems for spectrum analysis and processing. Products range from tracking filters to real-time spectrum analyzers and digital signal processors and systems. Spectral Dynamics, San Diego, Calif.

CIRCLE NO. 606

PLUG UGLY.™

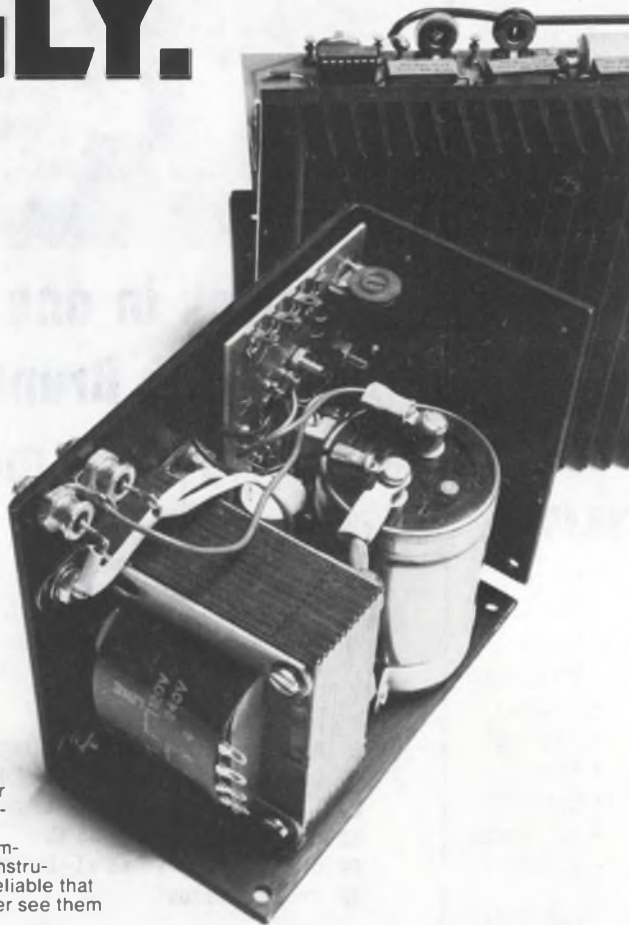

**\$44 (1-9)
5V, 6A**

They're not much to look at

Because instead of fancy front panels, we designed our standard open-frame dc power supplies to cover 90% of your OEM applications. And once you plug them into your computers, peripherals or instrumentation, they're so reliable that chances are you'll never see them again.

They're designed and built conservatively, so you get full rated power all the way up to +55°C. Regulation, ripple and noise are specified by the book. And with no expensive options, you can now get your dc power for as little as 68¢/W (1-9 qty).

If you've looked at the competition, we know that has to be a sight for sore eyes.

For more info, use the bingo card or call 714/979-4440. Or call your local Cramer or Newark distributor and get Ugly today.

OPEN-FRAME OLV SERIES: 4-28 Vdc, 15-250 W
STANDARD FEATURES: Choice of 16 voltages, adjustable ±5%, Currents to 50A, no derating to +55°C ±0.1% IC regulation, ±0.1% ripple and noise. Remote sensing/programming. Spike suppression. Foldback current limiting. 120/240 Vac 50/60 Hz inputs.
OPTIONS: OVP crowbar. PRICES: \$24.95 to \$179 (1-9)

Elexon Power Systems 
©Copyright 1974 Eipac, Inc. ELPAC

INFORMATION RETRIEVAL NUMBER 165

Lasers

Helium-neon lasers, education packages, holography systems and optical benches and accessories are described in a 16-page catalog. Metrologic Instruments, Bellmawr, N.J.

CIRCLE NO. 607

ISA publications

The 1974 ISA catalog lists 235 current publications and educational aids on instrumentation, measurement and automatic control. The catalog contains descriptions, prices and ordering information for reference books and proceedings of ISA sponsored or co-sponsored conferences and symposia, videotape training program, audio cassettes, films, study guides, standards and recommended practices and periodicals. Instrument Society of America, Pittsburgh, Pa.

CIRCLE NO. 608

Semi replacement guide

A comprehensive revision of Sprague's 64-page Semiconductor Manual and Replacement Guide lists over 38,000 domestic and foreign OEM semiconductor parts numbers and their recommended replacement. All listings are alpha-numerical to make the manual easy to use. Sprague, North Adams, Mass.

CIRCLE NO. 609

Industrial thermocouples

A 16-page catalog covers thermocouple elements, protecting tubes, assemblies, accessories and insulators. Selection and use data and temperature recommendations are presented in an easy-to-read style. Marlin Manufacturing, Cleveland, Ohio.

CIRCLE NO. 610

Process-control systems

A brochure describes the building blocks—computers, operating systems, high-level programming languages and specific hardware—that make up process-control systems built around small computers. A typical process-control system using a back-up computer is diagrammed and explained. Data General, Southboro, Mass.

CIRCLE NO. 611

Acoustic couplers

An acoustic coupler for message communications and time-sharing applications on an international level is described in a brochure. The literature shows how a unit manufactured to CCITT standards can be used for domestic to overseas communication as well as applications to international telephone systems where permitted. Omnitec, Phoenix, Ariz.

CIRCLE NO. 612

Multiplying DAC

Model 869 four-quadrant multiplying digital-to-analog converter is covered in a six-page catalog. Block and functional diagrams, an illustration of the four-quadrant multiplier mode, plus tabulations of performance specifications and environmental characteristics clarify product capabilities and applications. Beckman Instruments, Helipot Div., Fullerton, Calif.

CIRCLE NO. 613

MEAN AND UGLY.™

\$79 (1-9)
3 outputs

Our OEM dc supplies have always been stark, but now they're twice as ugly (also 3x).

Because instead of working up a new color scheme, we've combined two and three of them on a single chassis to make them an even better buy for your computers, peripherals and instruments.

We've taken out redundancies, but they still offer the widest range of voltages you can get in a modular dc supply. Still deliver all the power we promise across the full temperature range (even with 50 Hz inputs). And still include all the features you need as standards, not expensive options.

So that now if you check us out against the competition, they're liable to tell you that we're not just ugly.

We're downright mean.

For more info, use the bingo card or call 714/979-4440. Or call your local Cramer or Newark distributor and get Ugly today.

MULTIPLE OUTPUT DLV/TLV SERIES: 1st output 5 V at 3-15 A. OVP standard. 2nd and/or 3rd outputs, each 4-28 V @ 1.5 W. OVP optional. All outputs isolated, may be used as positive or negative supplies.

STANDARD FEATURES: Choice of 16 voltages, adjustable $\pm 5\%$. Currents to 15 A, no derating to $+55^\circ\text{C}$. $\pm 0.1\%$ regulation, $\pm 0.1\%$ ripple and noise. Remote sensing/programming. Spike suppression. Foldback current limiting. 120/240 Vac, 50/60 Hz inputs.

OPTIONS: Enclosure PRICES: \$29 to \$151 (1-9)

Eletron Power Systems

©Copyright 1974 Elpac, Inc. ELPAC

INFORMATION RETRIEVAL NUMBER 166

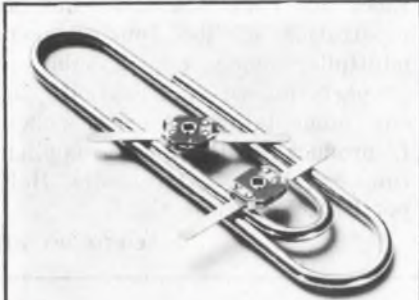

Thin-Trim variable capacitors provide a reliable means of adjusting capacitance without abrasive trimming or interchange of fixed capacitors. Series 9401 has high Q's and a range of capacitance values from 0.2-0.6 pf to 3.0-12.0 pf and 250 WVDC working voltage. Johanson Manufacturing Corporation, Boonton, New Jersey (201) 334-2676.

INFORMATION RETRIEVAL NUMBER 181



3 things make a great tape core: The proper materials . . . correct engineering . . . Magnetics. Magnetics has been a leading supplier of high permeability tape wound cores and magnetic components since 1949. Our tape cores helped put men on the moon; are used exclusively for Viking Mars Lander. Magnetics, Butler, Pa. 16001.

INFORMATION RETRIEVAL NUMBER 184



AMP Capatron data entry products. High performance. Outstanding reliability. Includes card reader/scanner and matrix badge reader. Plus tab, credit, and magnetic card readers. All are available as individual components, with choice of interface on reader/scanner. AMP Incorporated, Capatron Division, Elizabethtown Pa. 17022. (717) 367-1105.

INFORMATION RETRIEVAL NUMBER 187



Complete minicomputer mag tape systems for the PDP-8, PDP-11, and NOVA feature IBM compatibility with low price. Three reel sizes to choose from, and all standard densities, including 1600 bpi phase encoded. These systems incorporate the best-designed transports built today. Digi-Data, 8580 Dorsey Run Rd., Jessup, MD 20794, (301) 498-0200.

INFORMATION RETRIEVAL NUMBER 182



Free catalog of 34,500 power supplies from the worlds largest manufacturer of quality Power Supplies. New '74 catalog covers over 34,500 D.C. Power Supplies for every application. All units are UL approved, and meet most military and commercial specs for industrial and computer uses. Power Mate Corp. (201) 343-6294.

INFORMATION RETRIEVAL NUMBER 185



A collector's item . . . 20th anniversary issue of Electronic Design (11/23/72) salutes 25th anniversary of the transistor, features milestones in design over past quarter century. Rare nostalgic view of industry. Fascinating reading. \$2 per copy prepaid. Checks, money orders: Electronic Design, Promotion Mgr., 50 Essex St., Rochelle Park, N.J. 07662.

INFORMATION RETRIEVAL NUMBER 188

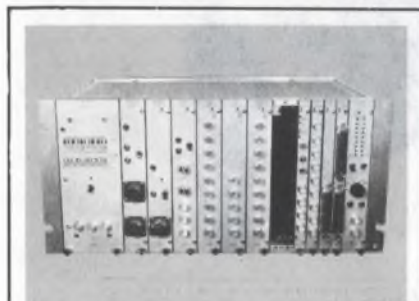

MIDAS is a universal system for controlling and monitoring scientific experiments. It operates with a teletype or interfaces with a computer to command instruments or test stands and print their responses. MIDAS is keyboard programmed by the experimenter. Starts at \$2325. TRI-COM, Inc., 12216 Parklawn Drive, Rockville, MD., 301-770-5585.

INFORMATION RETRIEVAL NUMBER 183



Thick Film Technology—Fundamentals and Applications in Microelectronics, by Jeremy Agnew. From design to finished product, this book details each processing phase, describing what to do and what pitfalls to avoid. 176 pp., 6 x 9, illus., cloth, \$8.50. Circle number for 15-day examination copy. Hayden Book Company, Rochelle Park, N.J. 07662.

INFORMATION RETRIEVAL NUMBER 186

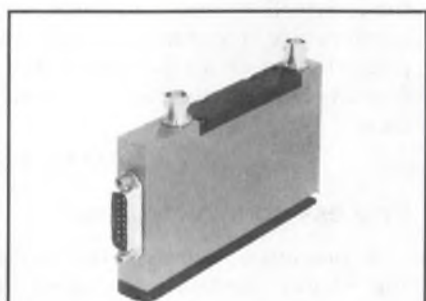

Programmable Coaxial Attenuator
0 - 63.5 db Attenuation Range . . .
.5 db Steps . . . DC thru 200 MHz
. . . Seven Bit Binary Control . . .
±2% Accuracy . . . Machined Aluminum Housing . . . MATRIX SYSTEMS CORPORATION . . . (213) 882-2008

INFORMATION RETRIEVAL NUMBER 189



The Pulsecom Model 461-6 Automatic Message Numbering Device electronically inserts station identification and message numbers. This device saves operator time, and prevents mistakes. The 461-6 operates at 45-1200 Baud with most terminals. Pulsecom Div of Harvey Hubbell Inc., 5714 Columbia Pike, Falls Church, Va. 22014. 703-820-0652.

INFORMATION RETRIEVAL NUMBER 190

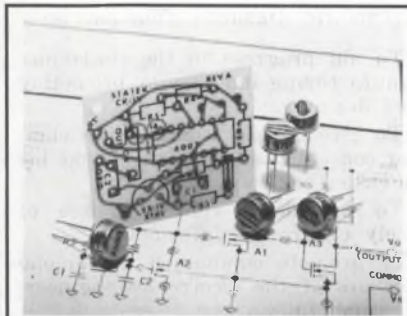

Quartz Crystal Oscillator Kits for \$27. Make bipolar series or CMOS parallel resonant oscillators. Kits include 5 or 6 SX-1 crystals (10 kHz to 240 kHz), in low profile TO-5 cans, a PC board (1.3" x 1.6") and design note. Statek Corp., 1233 Alvarez Ave., Orange, Calif. 92668. (714) 639-7810.

INFORMATION RETRIEVAL NUMBER 193

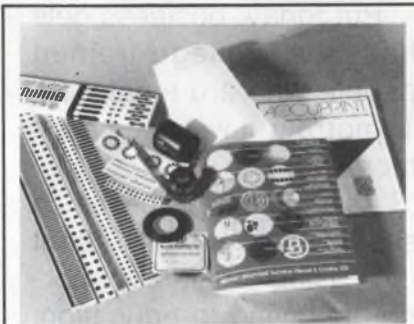

Free 84-page Printed Circuit Drafting Aids Technical Manual & Catalog contains hundreds of time & money-saving tips, plus details on over 15,000 component symbols & tapes, film, vellum, grids. Bishop Graphics, Inc., 7300 Radford Ave., North Hollywood, CA 91605, (213) 982-2000.

INFORMATION RETRIEVAL NUMBER 191

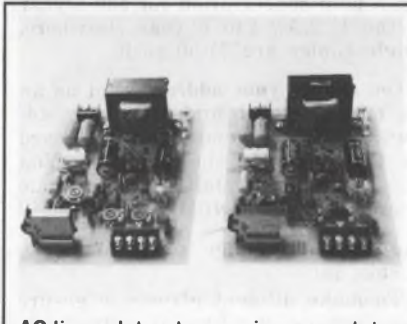

AC-line data transceiver modules wire directly to 120V AC, transmit & receive FM data via carrier-current signals on power line. Can be used with 45Ω speaker for high-quality voice communication or in telemetry applications. Stock to 4 wks., \$109/pr (1-100). Electronics Research Group, Arlington, Mass. (617) 646-9760.

INFORMATION RETRIEVAL NUMBER 194

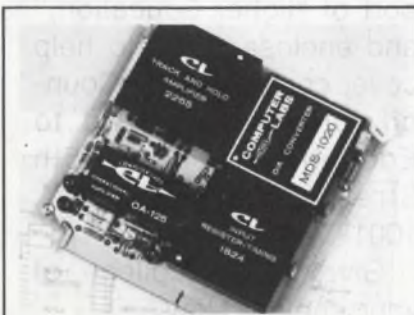

The new Computer Labs RDA Series D/A's eliminate harmonic distortion and produce clean "glitchless" pictures for reconstructed TV or other video signals. Input word rate for all models is 15 MHz with accuracies to ±0.05%. Min. settling time to either 8-bit or 10-bit accuracies. Computer Labs, 1109 S. Chapman St., Greensboro, N.C. 27403.

INFORMATION RETRIEVAL NUMBER 192



Materials for Semiconductor Functions, by E. G. Bylander. Practical handbook for selecting materials for diodes and transistors for applications in amplifiers, generators, and multi-junction devices. 220 pp., 6 x 9, illus., cloth, \$13.50. Circle number below for 15-day examination copy. Hayden Book Company, Rochelle Park, N.J. 07662.

INFORMATION RETRIEVAL NUMBER 195

Advertisers wishing to reserve Quick Ad units should note the following mechanical requirements: Specs—Supply glossy photo of product and approximately 40 words which will set no more than 10 lines of 34 characters each. AFTER SUBMISSION NO COPY CHANGES CAN BE ACCEPTED. Quick Ads cost only \$300 per insertion, less for frequency advertisers.

RATES:

1x
\$300

7x
\$280

13x
\$255

19x
\$250

26x
\$245

39x
\$240

52x
\$235

104x
\$230

SWEEP CLEAN

(out to
20 MHz)



Exact's Model 7260 VCF/Sweep Generator is an extremely versatile, high performance source for signals from 0.0001 Hz to 20 MHz that reaches into some new areas of test applications. Features include VCF input, 1000:1 sweep range, start-stop frequency control, a full range of waveforms including pulse, sine² and ramp, search mode, DC offset, step attenuation, V:f output, floating output and sync input. And it's a pulse generator, with individual width and repetition rate controls, all for just...

\$895

f.o.b. Hillsboro, Oregon



(A Subsidiary of Danalab, Inc.)
BOX 160, HILLSBORO, OREGON 97123
(503) 648-6661 TWX 910-460-8811

INFORMATION RETRIEVAL NUMBER 180



**you're whistling
in the dark.**

... if you haven't had your blood pressure checked lately. You could have high blood pressure and not know it. It can lead to stroke, heart and kidney failure. See your doctor—only he can tell.

For information
Ask your Heart
Association



Electronic Design

ELECTRONIC DESIGN's function is:

- To aid progress in the electronics manufacturing industry by promoting good design.
- To give the electronic design engineer concepts and ideas that make his job easier and more productive.
- To provide a central source of timely electronics information.
- To promote communication among members of the electronics engineering community.

Want a subscription? ELECTRONIC DESIGN is sent free to qualified engineers and engineering managers doing design work, supervising design or setting standards in the United States and Western Europe. For a free subscription, use the application form bound in the magazine. If none is included, write to us direct for an application form.

If you do not qualify, you may take out a paid subscription for \$30 a year in the U.S.A., \$40 a year elsewhere. Single copies are \$1.50 each.

If you change your address, send us an old mailing label and your new address; there is generally a postcard for this bound in the magazine. You will have to requalify to continue receiving ELECTRONIC DESIGN free.

The accuracy policy of ELECTRONIC DESIGN is:

- To make diligent efforts to ensure the accuracy of editorial matter.
- To publish prompt corrections whenever inaccuracies are brought to our attention. Corrections appear in "Across the Desk."
- To encourage our readers as responsible members of our business community to report to us misleading or fraudulent advertising.
- To refuse any advertisement deemed to be misleading or fraudulent.

Microfilm copies are available of complete volumes of ELECTRONIC DESIGN at \$19 per volume, beginning with Volume 1, 1961 through Volume 20. Reprints of individual articles may be obtained for \$2.00 each, prepaid (\$.50 for each additional copy of the same article) no matter how long the article. For further details and to place orders, contact the Customer Services Department, University Microfilms, 300 North Zeeb Road, Ann Arbor, Michigan 48106 telephone (313) 761-4700.

Want to contact us? If you have any comments or wish to submit a manuscript or article outline, address your correspondence to:

Editor
ELECTRONIC DESIGN
50 Essex Street
Rochelle Park, N.J. 07662

DO COLLEGES HELP BUSINESS AS MUCH AS BUSINESS HELPS COLLEGES?

Yes, they do. But not in the same proportion.

Business contributes about 15% of the total voluntary support received by colleges.

But today, business gets half the college-trained people who are employed. Tomorrow, it will need even more.

As a result, businessmen should think seriously about increasing the level of corporate giving to education. Can you, as a businessman, think of a better investment?

For the latest national figures on corporate giving to higher education, write on your letterhead for "CFAE Survey of Corporation Support of Higher Education," and enclose \$2.00 to help cover costs. Mail to: Council for Financial Aid to Education, 6 East 45th Street, New York, N.Y. 10017.

Give to the college of your choice. Now.



Advertising contributed for the public good.

Electronic Design

Advertising Sales Staff

Tom W. Carr
Vice President &
Sales Manager

Rochelle Park, N.J. 07662

Robert W. Gascoigne
Daniel J. Rowland

(Recruitment, Quick Ads, Classified)

50 Essex Street
(201) 843-0550
TWX: 710-990-5071

Philadelphia

Thomas P. Barth
50 Essex Street
Rochelle Park, N.J. 07662
(201) 843-0550

Boston 02178

Gene Pritchard
P.O. Box 379
Belmont, Mass. 02178
(617) 489-2340

Chicago 60611

Thomas P. Kavooras
Berry Conner, Jr.
200 East Ontario
(312) 337-0588

Cleveland

Thomas P. Kavooras
(Chicago)
(312) 337-0588
(call collect)

Los Angeles 90303

Stanley I. Ehrenclou
Burt Underwood
2930 Imperial Highway
Inglewood, Calif.
(213) 757-0183

San Francisco 94022

Jerry D. Latta
P.O. Box 1248
Los Altos, Calif.
(415) 965-2636

London

For United Kingdom and Europe

John Ashcraft
John Ashcraft & Co.
12, Bear St.
Leicester Square
London WC2H 7AS England
Phone: 01-930-0525

W. J. M. Sanders
John Ashcraft & Co.
Herengracht 365
Amsterdam C., Holland
Phone: 020-24-09-08

Tokyo

Haruki Hirayama
Electronic Media Service
5th Floor, Lila Bldg..
4-9-8 Roppong
Minato-ku
Phone: 402-4556
Cable: Electronicmedia, Tokyo



Design Data from Manufacturers

Advertisements of booklets, brochures, catalogs and data sheets. To order use Reader-Service Card (Advertisement)

Dual Hi-Speed FFT Processor Easy to Operate



Conceived from the point of view of the operating engineer rather than the computer programmer, the new Omniferous™ FFT Analyzer operates like an instrument, calculates like a computer. This Series OF-400 Analyzer is a universal digital signal analysis system for real-time viewing of changing functions, a complete instrument with all signal conditioning and display calibration built-in. For the first time an operator can observe transfer function, cross-spectra or coherence as the signal is changing without waiting for the analyzer to perform successive laborious calculations.

Features include high speed of 60,000 samples/sec throughput, and high resolution with a 2048 transform size and extra-sharp input anti-aliasing filtering. Calculates FFT, IFFT, power spectra, auto-correlation, cross correlation, and signal enhancement (time averaging), as well as the averaging of any calculated function in sum, peak or exponential mode.

The system excels in high dynamic range, ease of use, display flexibility with two simultaneous display outputs, frequency coverage to 100 kHz, and reasonable cost. Designed by the originators of the famous Ubiquitous® family of real-time spectrum analyzers.

Federal Scientific Corp.

An affil. of Nicolet Instrument

615 West 131st St., New York, N.Y. 10027 (212) 286-4400

CIRCLE NO. 171



70 page A/D-D/A Engineering Product Handbook

A new 70 page product handbook contains detailed electrical and mechanical information on A/D—D/A Converters, Sample/Hold Amplifiers, Wide Band DC Amplifiers, Instrumentation Amplifiers, Analog Multiplexers, DC-DC Converters and Data Acquisition Systems. Also included are typical applications for Data Conversion Devices.



CIRCLE NO. 172

1020 Turnpike St., Canton, Mass. 02021/(617) 828-8000

FAST FOURIER TRANSFORM PROCESSOR FOR \$6,000

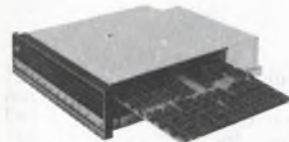

The 306/MFFT Fast Fourier Transform Processor is delivered with all control programs and plugs directly into any Data General Nova computer. It offers a complete Fourier Transform capability including Forward and Inverse FFT, Spectral magnitude, Hanning Weighting, and Complex Multiplication. Arrays from 16 to 16,384 real samples can be processed. An array of 1024 real samples is transformed in only 139 ms.

Time domain signal processing functions, such as correlation and convolution, can be calculated utilizing the high speed array operations X, ÷, +, -, √ and Σ.

Call or write today for brochures on 306/MFFT or Elsytec's complete line of Fourier Spectrum Analyzers and Higher Speed Hardware Fast Fourier Transform Processors.

CIRCLE NO. 173

ELSYTEC INC.

212 Michael Drive, Syosset, New York 11791 (516) 364-0560

recruitment
and
classified ads

SAME DAY SHIPMENT
Minis & Peripherals
PDP SPECIALISTS
8, 8I, 8L & 11

NEW 300 LPM
PRINTERS

PDI CARD READERS
BRPE PUNCHES

\$750 Minis

TELETYPE 35 & 37
DEC & HONEYWELL Modules
617/261-1100

Send for Free Report "Maintenance
of Computers"

AMERICAN USED COMPUTER CORP.
P.O. Box 68, Kenmore Sta.
Boston, MA 02215
Members Computer Dealers Association

CIRCLE NO. 170

SCOPES UNLIMITED
IS NOT
LIMITED TO SCOPES
Complete line of new and used
electronic test equipment.
SCOPES UNLIMITED, INC.
1938 S. Anaheim Blvd.
Anaheim, Ca. 92805
(714) 772-0330
East Coast Office (617) 894-5670



The President's Committee
on Employment of the Handicapped
Washington, D.C. 20210

advertiser's
index

Advertiser	Page
ACDC Electronics, Inc.	108
AMP, Incorporated	46, 47
AMP, Incorporated, Capitron Division	234
Acopian Corp.	147
AirBorn, Inc.	228
Airpax Electronics, Cambridge Division	106
Alco Electronic Products, Inc.	224
Allen Bradley Co.	28
American Microsystems, Inc.	170, 171
American Smelting & Refining Co.	198
Amperite Co., Inc.	182
Amplifier Research Corporation.	212
Analog Devices, Inc.	27, 115
Analogic Corporation	157
Ansley Electronics Corp.	90
Applied Computing Technology Incorporated	183
Astro-Med, A Division of Atlan-Tol Industries, Inc.	225
Avantek, Inc.	88, 89
Ballantine Laboratories, Inc.	229
Belden Corporation	60, 61
Bell Industries, J. W. Miller Company	200
Bendix Corporation, The, Electrical Components Division	43
Bishop Graphics, Inc.	235
Bliley Electric Co.	200
Boonton Electronics Corporation.	207
Bourns, Inc., Trimpot Products Division	19
Brandenburg Limited	231
CTS Corporation	105
CELCO (Constantine Engineering Laboratories, Inc.)	185
Cherry Electrical Products Corp.	2
Cincinnati Sub-Zero Products, Inc.	196
Clare-Pendar	51
Computer Automation, Inc.	39
Computer Labs	235
Connecticut Hard Rubber Co., The. 202 Constantine Engineering Laboratories, Inc. (CELCO)	185
Control Data Corporation.	189
Control Switch, Inc.	184
Cunningham Corporation	210
Dale Electronics, Inc.	122, 123
Damon Electronics Division.	206
Data Precision Corporation.	197
Datel Systems, Inc.	237
Dialight Corporation	58
Digi-Data Corporation	234
Digital Equipment Corporation.	22, 23
Dynascan Corporation	176
EECO	67
EMR Telemetry, Weston Instruments, Inc.	221

Advertiser	Page
Edmund Scientific Company.	212
Elec-Trol, Inc.	140, 144
Electro Corporation	227
Electronic Associates, Inc.	209
Electronic Design	234
Electronic Navigation Industries.	168
Electronic Research Corporation.	235
Elxon Power Systems.	232, 233
Elsytec, Inc.	237
Erie Technological Products, Inc.	114
Exact Electronics, Inc.	236
Exar Integrated Systems	1
Federal Scientific Corporation.	237
Fluke Mfg. Co. Inc., John	191
Futaba Industries	112
General Electric Company.	213
General Instrument Corporation, Hybrid Division	161
General Instrument Corporation, Semiconductor Components	98, 99
Gold Book, The	218, 219
Harris Semiconductor, A Division of Harris Intertype Corporation	134, 135
Hayden Book Company, Inc.	63, 234
Heath Company	224
Hecon Corporation	231
Hewlett-Packard	9 thru 18
Houston Instruments, A Division of Bausch & Lomb.	211
Hutson Industries	194
Hybrid Systems Corp.	201
ITT Semiconductor, A Division of International Telephone and Telegraph Corporation.	169
Indiana General	165
Industrial Timer, A Unit of Esterline Corporation	220
Inland Motor Division, Kollmorgen Corporation	173
Intech, Incorporated	172
Intel Corporation	4, 5
International Rectifier	149
International Teleprinter Corporation, The Singer Company	166
Ise International Corporation.	187
Johanson Manufacturing Corp.	7, 234
Kaman Sciences Corp.	228
Keithley Instruments, Inc.	62, 62A-B
Keuffel & Esser	217
Keystone Electronics Corp.	208
Kulka Electric Company.	193

Detectors Are Our Middle Name

United Detector Technology offers the widest variety of silicon photodetectors for the greatest number of applications.

SCHOTTKY BARRIER devices for applications requiring the highest UV sensitivity, largest active areas on fast response.

PLANAR DIFFUSED devices for low noise fast response applications.

MESA DEVICES for high volume low cost ruggedized large area devices.

At UDT our middle name is truly DETECTORS. Write for FREE wall chart, "Spectral Response of Silicon Photodiodes."

Write or call today. United Detector Technology, 1732 21st St., Santa Monica, Calif. 90404. telephone number: (213) 829-3357.



UNITED DETECTOR TECHNOLOGY, INC.

Advertiser	Page
Licon, Division of Illinois Tool Works, Inc.	139
Littelfuse, Subsidiary of Tracor	24, 25
Litton Industries, Inc., Triad Distributor Division	216
London Company, The	230
Magnecraft Electric Company	Cover III
Magnetics, Inc.	234
Matrix Systems	234
Megatek	180
Micro Line, Division of Bausch & Lomb	204
Microdata Corporation	203
Microswitch, A Division of Honeywell	41
Microwave Associates	199
Mini-Circuits Laboratory	241
Monitor Labs Inc.	192
Mostek Corporation	32, 33
Motorola Semiconductor Products, Inc.	20, 21
MuRata Corporation of America	191
North Electric Company	191
Nortronics Company, Inc.	190
Oak Industries, Inc.	86, 87
Otto Controls Division, Otto Engineering, Inc.	227
Owens-Illinois, Inc.	205
Panduit Corporation	111
Perkin-Elmer Corporation	192
Phoenix Data, Inc.	160, 162, 164
*Philips Industries, Test and Measuring Instruments	121
Pico Electronics, Inc.	Cover II
Piher International Corp.	48, 49
Pomona Electronics Co., Inc.	229
Potter & Brumfield, Division of AMF, Incorporated	26
Power/Mate Corp.	234
Premier Metal Products Company	107
Projects Unlimited	220
Pulse Engineering, Inc.	188
Pulsecom Div. of Harvey Hubbell, Inc.	235
RCA Electronic Instruments	223
RCA Numitron Display Devices	163
RCA Solid State	Cover IV
R. F. Power Labs, Inc.	174
Remex, Ex-Cello Corporation	133
Rental Electronics, Inc.	91
Repco, Inc.	120
Robinson Nugent, Incorporated	155
Rogers Corporation	208

Advertiser	Page
SGS-Ates Semiconductor Corporation	121
Sakata International Inc.	214
Schjeldahl Company, G. Scott Electronics Corporation	110
Schauer Manufacturing Corp.	186
Servometer	226
Siemens Corporation	62, 63
Signetics Corporation	44, 45
Siliconix, Incorporated	68
Simpson Electric Company	153
Singer Company, Inc., Kearfott Division	215
Sorensen Company, A Unit of Raytheon Company	155
Spectrum Technology	196
Sprague Electric Company	50
Statek Corp.	235
TRW/Irc Fixed Resistors, An Operation of TRW Electronic Components	178, 179
TRW Semiconductors, An Operation of TRW Electronic Components	122, 123
Tally Corporation	222
Tau-Tron, Inc.	230
Technical Wire Products, Inc.	231
Textronix, Inc.	35, 52, 53, 57, 59
Teledyne Philbrick	37
Teledyne Relays, A Teledyne Company	31
Teletype Corporation	159
Texas Instruments, Incorporated	54
Texscan Corporation	184
Todd Products Co.	183
Tri-Com, Inc.	234
Triplett Corporation	151
USCC/Centralab Electronics Division, Globe-Union, Inc.	148
Union Carbide, Components Dept.	175
United Detector Technology, Inc.	239
United Systems Corporation	66, 113
Vactec, Inc.	109
Validyne Engineering Corporation	183, 227
Varo Semiconductor, Inc.	104
Victoreen Instruments, Div. of VLN Corp.	181
Viking Industries, Inc.	177
Voltex	229
Vu Data Corporation	242
Weston Instruments, Inc.	167
Woven Electronics	6
Yewtec Corporation	204

INFORMATION RETRIEVAL NUMBER 167 ▶

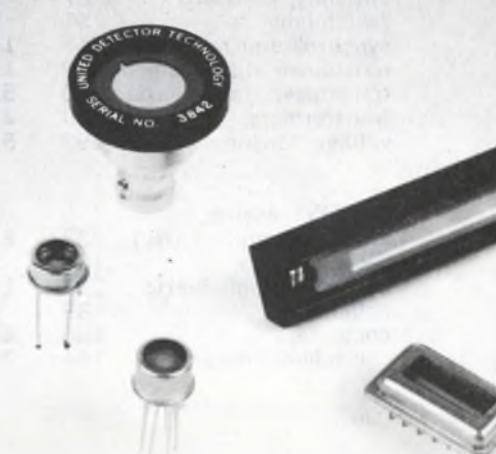

product index

Information Retrieval Service. New Products, Evaluation Samples (ES), Design Aids (DA), Application Notes (AN), and New Literature (NL) in this issue are listed here with page and Information Retrieval numbers. Reader requests will be promptly processed by computer and mailed to the manufacturer within three days.

Category	Page	IRN	Category	Page	IRN	Category	Page	IRN
Components			counter, event	164	270	DMM	66	235
capacitor	175	88	data-acquisition module	157	71	DMM	62	35
capacitors	7	6	data-acquisition system	160	73	DMM	210	552
capacitors	50	25	data-acquisition system	160	259	DMM	229	157
capacitors	148	66	data-acquisition system	164	77	DMM	167	80
capacitors	200	121	data logger	162	264	DMM, 3-1/2 digit	191	109
capacitors	214	138	debugging aid	162	266	DPM	206	545
catalog (NL)	212	136	digital cassette systems	133	60	FET tester	210	550
circuit protectors	106	46	disc, flexible	16	260	impedance bridge	210	551
compact relay (NL)	232	600	display/memory units	205	127	lightmeter	206	542
components	65	35	flexible disc	189	105	logic probe	206	543
delay lines	188	104	hybrid computers	209	132	megohmmeter	206	544
delay lines	200	120	interface, mini	159	254	memory test system	53	28
display devices	163	76	interface, mini	160	261	meters	153	69
displays	58	31	interfaces	23	9	meters	204	126
displays	187	103	microcomputer	5	4	multimeter, FET	176	90
ferrites	165	78	minicomputer	159	255	oscilloscope	57	30
indicator lights	25	10	multiplexer	160	262	oscilloscope	59	32
indicator lights	108	48	multiplexer	162	265	prescaler	204	540
microphone, capacitor	190	511	OEM printer mechanisms	166	79	pulse generator	1	2
motors	173	86	peripheral, FFT	164	268	pulse generator	204	541
photoresistors	109	49	plotter, graphics	166	273	pulse generator	208	548
potentiometers	49	24	positioner, X-Y	162	263	rms converter	204	539
proximity switch	193	516	program, CAD	166	272	recorder	225	150
pushbutton switch	224	147	radio links	120	56	recorder, X-Y	211	134
pushbuttons	184	100	tablet, digitizer	159	258	rental equipment	91	42
rf and microwave			tablet, graphics	159	257	spectrum analyzer	184	99
amplifiers	123	211	tape transports	203	124	sweep generator	208	548
reed switches	190	512	terminal	164	267	test clip	229	159
relay, PC board	192	515	terminal, CRT	159	253	test equipment	223	146
relay, gas filled	193	517	terminal, CRT	159	256	test instrumentation	207	129
relays	III	244	terminals	159	72	VOM, solid state	151	68
relays	111	51				wave analyzer	208	547
relays	141	64	Discrete Semiconductors					
relays, DIP	31	15	diodes, high-voltage	214	560	Integrated Circuits		
relays, delay	182	95	diodes, p-i-n	199	119	audio amplifier	121	57
resistor	19	7	diodes, tuning	214	556	CMOS	135	61
resistors	178	92	diodes, tuning	214	558	counters, dual	180	295
resistors, variable	28	13	diodes, zener	186	102	device, charge-coupled	182	298
slide switches	224	148	FET chips	68	37	divider, frequency	180	293
stepper motor, PM	190	310	LEDs	21	8	FM sound system	169	82
switches	2	3	posistors	191	108	ICs, linear	45	21
switches	41	19	rectifiers	99	43	memory, programmable	179	291
switches	105	45	rectifiers, SCR bridge	104	44	microprocessor	182	299
switches	139	63	SCRs	149	67	modulator-demodulator	182	296
switches	210	133	SCRs, switching	214	557	op amp, IC quad	179	290
switches, keyboard	87	38	switches, MOS	214	559	op amp, low noise	180	294
switchlight	51	26	transistor, vhf	216	562	op amps, FET-input	179	292
synchros and resolvers	215	139	transistors, pnp	216	561	RAM, 4-k	179	289
transducer, displacement	228	155	transistors, μ W	212	555	RAMs	171	84
transducer, radial, axial	190	513	transistors, high V	212	554	sample-and-hold	182	297
transformers	II	243	transistors, power	212	553			
voltage sensor	192	514	triac	194	113	Microwaves & Lasers		
						amp, L-band	194	521
Data Processing			Instrumentation			amp, tunnel-diode	198	530
acoustic couplers (NL)	233	612	assembler-simulators	183	96	amplifier	196	522
CRT displays	185	94	automatic test processor			amps	194	518
carrier system, 3-kHz	227	152	(NL)	226	585	antenna, spiral	202	537
computers	39	18	audio indicator system	220	143	detector	201	529
computers	166	271	counter	210	549	diode, Gunn	198	532
controller, instrument	164	269	counter/timer	113	168	dividers	196	523
			counters	231	163	laser, pulse	202	534

Category	Page	IRN
laser scanner	196	524
laser scribe	198	533
laser trimmer	202	538
meter, power	194	520
modulator/amplifier	194	519
module, test	198	531
oscillator, Gunn	200	525
oscillator, Gunn	200	527
sensor, doppler	202	535
sweepers	201	528
switches, Ku-band	202	536
transistor	200	526

Modules & Subassemblies

amplifier, rf	174	87
amplifier, s/h	168	250
amplifier, synchro	176	287
amplifier, 500-W	212	135
amplifiers, high speed	174	283
CMOS DACs	115	55
converter, a/d	162	75
converter, a/d	171	274
converter, a/d	192	110
converter, d/a	171	276
converter, v/f & f/v	172	280
converters, d/a	171	275
converters, d/a	174	282
converters, s/d	176	288
DACs	37	17
filters, active	161	74
isolator, optical	172	279
MUX, differential	174	285
oscillator, sine wave	174	284
power amplifier	168	81
protectors, circuit	172	278
sensor, opto	172	281
signal conditioners	183	97
totalizer, count	171	277
transducers, power	176	286

Packaging & Materials

aluminum heat sinks (NL)	228	593
cable	6	5
cable connector	90	41
cable, shielded	186	306
cable stripper	184	300
ceramic heads	190	106
compounds	198	118
connector	177	91
connectors	67	36
connectors, PC	228	156
connectors, filter	43	20
contact springs	228	151
crimping kit	186	305
ejector, card	186	303
enclosures	107	47
flexicircuits	110	50
header, terminals	188	308
installation tool	26	11
mini bus	208	130
paste, resistor	184	301
polyimide-glass boards	188	309
pot, solder	186	304
sockets	47	22
sockets	195	114
spacers	208	131
symbols	217	141
wing nut assortment	184	302
wire and cable	61	234
wire, magnet	188	307

Power Sources

constant-current supply	220	566
high-voltage units	221	569
inverters	222	573
line corrector	220	565
line regulators	217	563

Category	Page	IRN
line regulators	222	570
power module	222	571
power modules	229	158
power source	217	564
power supplies	112	52
power supplies	147	65
power supplies	176	89
power supplies	183	98
power supplies	191	107
power supplies	221	569
power supplies, dc	155	70
TWT supply	220	567
triple output module	222	572

acoustic couplers	233	612
aluminum heat sinks	228	593
automatic test processor	226	585
catalog	212	136
compact relay	232	600
dc power converter	232	603
data conversion handbook	201	122
digital oscilloscopes	228	591
heat dissipators	226	588
IC sockets	226	590
ISA publication	233	608
industrial thermocouples	233	610
infrared thermometers	230	596
laser system	226	586
lasers	233	607
liquid-crystal displays	232	605
log video amps	232	599
magnetic tape I/O systems	226	584
microwave p-i-n diodes	232	604
microwave diode chips	232	601
monolithic circuits	228	594
multiplying DAC	233	613
noise analysis equipment	232	606
numeric printing unit	230	597
power supplies	226	582
process control systems	233	611
programmer	226	588
rf tuning diodes	228	592
reed switches	230	595
Schottky diodes	226	589
semi replacement guide	233	609
semiconductors	232	602
sliding potentiometers	226	583
trimming pots	230	598

analog networks	224	646
dry photoresist stripping	224	574
filter measurements	224	648
magnetic sensors	224	577
permanent magnets	224	647
spectrum analyzer	224	575
variable angle technique	224	576
waveform recorder	224	649

flame-retardancy charts	225	578
metric conversion aids	225	581
thumbwheel switches	225	579
regulators, voltage	225	580

WIDE BAND RF TRANSFORMERS

Great Value at

\$2.95
10 piece quantities

Some Models \$3.45

0.1 - 500 MHz
50 Ohm impedance
1:1 to 16:1
impedance ratio
micro-miniature case



A breakthrough in technology and high production volume enables Mini-Circuits Laboratory to offer these new products at an unprecedented low price.

Ruggedness and durability are built in the T-series transformers. These new units are packaged within a 1/3 D.I.P. package. They use uniquely designed transmission line transformers for extra wide bandwidth.

Impedance ratios of standard models are 1:1, 2:1, 4:1, 9:1 and 16:1. MCL kit TK-1 includes 2 units of each type and sells for \$32.

We invite you to convince yourself. Place your order now and check our delivery, product performance and reliability.

Mini-Circuits Laboratory

2913 Quentin Rd., Brooklyn, N.Y. 11229
(212) 252-5252, Int'l Telex 620156
A Division Scientific Components Corp.

*FRANCE: S.C.I.E., *31, rue, George-Sand, Palaiseau 91, France. *GERMANY, AUSTRIA, SWITZERLAND: Industrial Electronics GMBH, *Klüberstrasse 14, 6000 Frankfurt/Main, Germany. ENGLAND: Dale Electronics, Dale House, Wharf Road, Frimley Green, Camberley, Surrey. JAPAN: Denzho Kaisha Ltd, Eguchi Building, 8-1 1-Chrome, Hamamatsucho, Minato-Ku, Tokyo.

*UNIT IN STOCK

INFORMATION RETRIEVAL NUMBER 200

Over 9½ million Americans are on the Payroll Savings Plan. Maybe they know something you don't.



Maybe they know it's easier to save money you never see. So they sign up for the Payroll Savings Plan. And specify an amount to be set aside from each paycheck to buy U.S. Savings Bonds.

And maybe they know Bonds are one of the best ways to feel secure about your savings. Because you always get back what you paid. Plus interest.

So maybe you'd better talk to your payroll people. And join the 9½ million already on the Payroll Savings Plan. Soon.



Take stock in America.

Join the Payroll Savings Plan.



The U. S. Government does not pay for this advertisement. It is presented as a public service in cooperation with The Department of the Treasury and The Advertising Council.

AMP CHAMPS

THE RELAYS WITH MAXIMUM POWER SWITCHING CAPABILITIES



When it comes to switching real power we call our team the Amp Champs. Contacts are rated from 15 – 100 amps at 28VDC or 115/220VAC with a wide variety of contact combinations and packaging techniques. Each relay is designed to function with absolute reliability for long life at lowest cost. Versions offered include the space saver, UL-listed, auxiliary contact, magnetic blowout for DC switching, enclosed plug-in or stud mounting, hermetically sealed, and mercury displacement power relays. Over 230 different types of power relays are in stock for immediate delivery thru our chain of nationwide distributors and Magnecraft's main plant. If you don't find what you need here, we will make it for you!



1) 15 amp Class 94 2) 35 amp Mercury Displacement Class BSX
 3) UL 25 amp Class 99 4) 20 amp Class 99DB with blowout magnet
 5) 20 amp Class 89CQ 6) 25 amp Class 97 7) 20 amp Class 93
 8) 15 or 30 amp Class 96 9) 15 amp Class 88R 10) 50 amp Class 88KD 11) 50 amp Class 99SD



Free!
STOCK CATALOG

To help specify all your relay needs, ask for Magnecraft's new 1974 Stock Catalog with the most diversified line of over 1060 relays. A Power Relay Catalog with specific data drawings, and photos on all the various relays will accompany the Stock Catalog.

Find Magnecraft Relays in EEM sec. 4500.

Magnecraft ELECTRIC COMPANY

5575 NORTH LYNCH AVENUE • CHICAGO, ILLINOIS 60630 • 312 • 282-5500 TWX 910 221 5221



The octophonic amplifier. If you want to create one tomorrow, we're ready with your power transistors today.

No matter what product you want to design — from stereo amps to ignition systems to electronic ranges — there's one thing you want to remember. Nobody's design is any better than the devices that go into it.

And at RCA, we've got the devices that make the difference. Ready now to help your product perform the way you designed it. In numbers all the way from

one to one million and beyond.

We're a commodity supplier of power transistors; a recognized leader in CMOS building blocks; developers of liquid crystal displays; a leading producer of linear IC's; technology innovators of RF power components; and a major supplier of thyristors.

In addition to comprehensive technical product data, RCA also gives you professional and experi-

enced field engineering and applications support. As well as a commitment to excellence in everything from research to manufacturing.

So whatever you're into, and whatever you need, check with us first. Chances are one or more of our products anticipate your needs. A good place to start is to check our handy product line guide. Write: RCA Solid State, Section 57F7 Box 3200, Somerville, N.J. 08876.

RCA Solid State