

# Electronic Design

VOL. 22 NO.

# 8

FOR ENGINEERS AND ENGINEERING MANAGERS

APRIL 12, 1974

**Watch spectra as never before.** Set center frequency, sensitivity, sweep width and resolution, and a program automatically selects filter bandwidth, rf/i-f gain ratio

and sweep speed. Digital storage gives infinite persistence on a vertically scanned TV display with projected reticle. A counter reads the frequencies. Page 137.

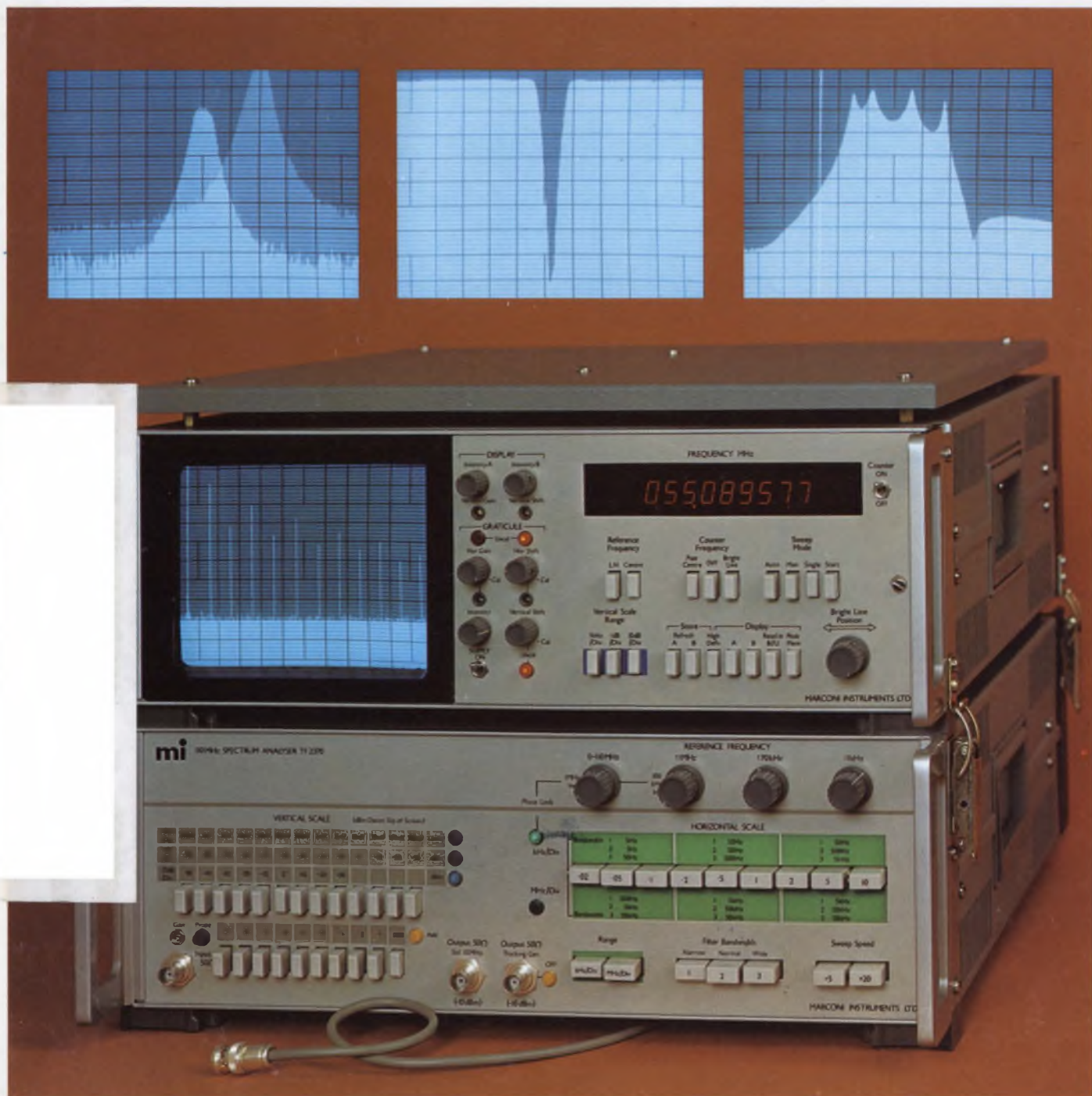

# CUTLER-HAMMER'S BIG LINE OF COMMERCIAL MINIATURES.

Toggles. Pushbuttons. Rockers. Rotaries. Available in a vast array of operator styles, colors, and shapes. Including illuminated pushbuttons and rockers. Many featuring snap-in mounting. And all in stock for fast delivery!

Now the same great quality, service and availability you've come to expect from Cutler-Hammer is available in miniature size—at a competitive price!

Make your selection. Standard or watertight. Single or multiple pole. A wide range of decorator caps, buttons, bezels that extend application flexibility. And for their size, hefty electrical/mechanical ratings.

Before you place that next order, check with your source for commercial miniature switches—your nearest Cutler-Hammer Sales Office or Authorized Stocking Distributor.



**CUTLER-HAMMER**

SPECIALTY PRODUCTS DIVISION, Milwaukee, Wis. 53201



Switch  
to No. 1

More than just switches;  
prompt availability,  
field help, innovation,  
quality assurance, too.

INFORMATION RETRIEVAL NUMBER 241

**THE NEW XR-2207 IS A PRECISION VOLTAGE CONTROLLED OSCILLATOR WITH SIMULTANEOUS SQUARE AND TRIANGULAR WAVE OUTPUTS, EXCELLENT FREQUENCY STABILITY, SUPER-WIDE SWEEP RANGE, MINIMAL FREQUENCY DRIFT, AND ULTRA-LINEAR SWEEP DRIVE.**

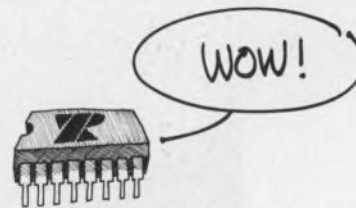

By providing 30 ppm/°C frequency stability, 3000:1 sweep range, and 0.15% /V frequency drift in the XR-2207, Exar produced a precision VCO that can easily do those tough FSK, FM generation jobs. With a minimum of external circuitry, you can use the XR-2207 in applications such as two-channel FSK generation for modems, as the VCO portion of phase-locked loop systems, and voltage to frequency conversion that formerly required crystal controlled oscillators.

With only one capacitor and four resistors, four discrete precision frequencies are generated; two TTL keying inputs enable selection between frequencies. You can also sweep your frequency over a wide 3000:1 range with the use of one extra resistor and a little voltage.

So, if you've been putting together lots of parts

for tough waveform generation, the XR-2207 can save you time and money. It's the easy way to generate variable-frequency square and triangular waves (pulse and sawtooth too!) for every application.

The XR-2207 operates with either single or dual supplies from  $\pm 4V$  to  $\pm 13V$  over a 0.1 to 1 MHz frequency range. Seven device types are available in 14 pin ceramic and plastic packages for both commercial and military applications. Call or write for the XR-2207 data sheet and application notes.

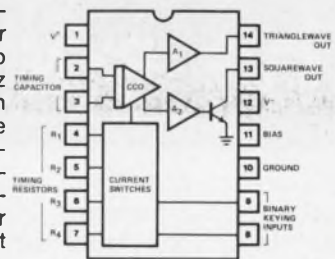

**EXAR SPEAKS YOUR LANGUAGE**

EXAR INTEGRATED CIRCUITS Products of R. ohm Corp. 16931 Milliken Ave., Irvine, CA 92705 (714) 546-8780 TWX 910-595-1721

EXAR REPRESENTATIVES: Arizona/Colorado/New Mexico BARNHILL FIVE (602) 947-7841 California - North LOGAN SALES (415) 369-6726 California - South DE ANGELO & ROTHMAN CO. (213) 398-6239 Washington/Oregon SDR SQUARED (206) 747-9424 Illinois/Wisconsin M & S SALES (312) 992-1053 Ohio/Indiana/Kentucky MC FADDEN SALES (614) 221-3363 New York City M. O. S. ASSOCIATES (516) 694-5923 Pennsylvania/Southern New Jersey HARRY NASH ASSOCIATES (215) 657-2213 Oklahoma/Texas/Louisiana/Arkansas EVANS & MC DOWELL (214) 238-7157 Michigan D E M ASSOCIATES (313) 755-6660 North Carolina/South Carolina/Virginia/Maryland COMPONENT SALES (301) 484-3647 Maine/New Hampshire/Vermont/Massachusetts/Connecticut COMPONENT SPECIALISTS (617) 667-4181 Minnesota ELECTRONICS INNOVATORS (612) 884-7471

INFORMATION RETRIEVAL NUMBER 2

You don't have  
to give up  
carbon composition  
performance to  
save space.

If you're really  
serious about cost,  
be serious about quality.

Are you cramped for board space but not in power handling capabilities? Is reliable performance vital? Then use Allen-Bradley 1/8 watt carbon composition resistors. Get the pulse handling and overload capabilities that are superior to resistors manufactured by other technologies. Exclusive hot molded construction for a

dense resistance element which reduces noise, and results in a consistent performance. Most importantly, our 1/8 watt resistors have all of the quality and reliability common to our larger sizes. Quality that really can cut your fixed resistor costs. If you think resistors are identical, write for "7 Ways to Tell the Difference in

Fixed Resistors." Available from your Allen-Bradley Electronic Distributor, or: Allen-Bradley Electronics Division, 1201 South Second Street, Milwaukee, Wisconsin 53204. Export: Bloomfield, N.J. 07003. Canada: Allen-Bradley Canada Limited, Cambridge, Ontario. United Kingdom: Jarrow, Co. Durham NE32 3EN.

Actual size



INFORMATION RETRIEVAL NUMBER 3



**Allen-Bradley**

Milwaukee, Wisconsin 53204

---

**NEWS**

- 27 **News Scope**
  - 30 **A special report on breadboards:** From \$2.50 to \$1500, good systems can save you time in circuit design.
  - 42 **IC specs available in 'seconds'** with automatic microfilm system.
  - 47 **Washington Report**
- 

**TECHNOLOGY**

- 60 **Engineers disagree on cause of shortages,** spot check shows, but agree on how to work around missing parts and the more recent squeeze on energy and raw materials.
  - 66 **MOS/LSI microcomputer coding:** It involves loaders, assemblers and even compilers. Use these and other tools to store algorithms in the system's memory.
  - 74 **The case for using ceramics:** High thermal conductivity and insulation resistance plus superior strength make these materials hard to beat for microelectronic packaging.
  - 80 **Don't lean on a/d specs** when you work with encode rates. Specs that characterize low-speed encoders may fall short when you go above 1 MHz.
  - 90 **There's more to thermal drift** than just tempco. Three measurements help pin down the effects of some often-forgotten op-amp thermal gradients.
  - 96 **Boost audio-amplifier efficiencies** in portable communications or audio equipment. To slash the power consumption try the class-D approach.
  - 102 **The four-function 'scientific' calculator.** Simplify equations and push the keys a few extra times to turn an inexpensive machine into a scientific tool.
  - 110 **Ideas for Design:** Modified data-transmission module can handle ASCII and BCD . . . Pocket-sized Geiger counter built with three micropower ICs . . . Wide-range pulse-shaping circuit gives square waves with 50% duty cycle.
  - 118 **International Technology**
  - 121 **'Top Ten'** prize-winning advertisements.
- 

**PRODUCTS**

- 137 **Instrumentation:** Spectrum analyzer outperforms rivals in 7 areas—at a price.
  - 140 **Instrumentation:** Memory-system tester handles 16-million addresses at 10 MHz.
  - 144 **ICs & Semiconductors:** NMOS microprocessor boosts speed, instruction-set power.
  - 148 **ICs & Semiconductors:** 4-k NMOS RAM combines high speed and low power.
  - 158 **Data Processing:** Floppy-disc drive scores low in size and price.
  - 150 **Modules & Subassemblies** 176 **Power Sources**
  - 166 **Discrete Semiconductors** 182 **Components**
  - 172 **Microwaves & Lasers** 186 **Packaging & Materials**
- 

**Departments**

- 57 **Editorial:** We've changed . . . haven't we?
- 7 **Across the Desk** 198 **Advertisers' Index**
- 188 **Application Notes** 200 **Product Index**
- 189 **New Literature** 200 **Information Retrieval Card**

**Cover:** Photo by Walt Sayre, courtesy of Marconi Instruments Ltd.

# The 2102 to get as it is to

The Intel 2102 n-channel RAM is the most popular 1024 bit static memory available today. It is *the* general purpose RAM with more second sources than any other semiconductor memory component.

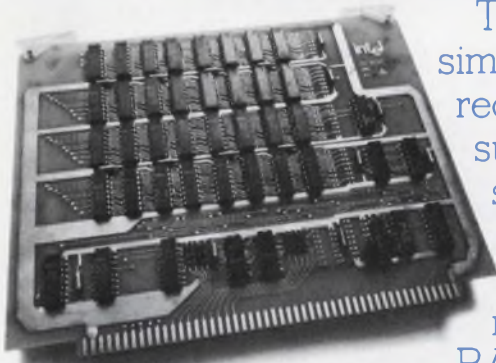

INTEL IN-26 MEMORY SYSTEM

The 2102 is extremely simple to use because it requires no peripheral supporting circuits, no special supplies, nor does it require the extra design effort needed by most RAMs to interface with TTL.

By using the 2102, you can achieve greater system economy because it does not require level shifters, MOS drivers, interface circuits, clocks, refresh and decode circuits, nor even pull-up resistors.

Every pin is TTL compatible, including the +5 volt  $V_{CC}$  supply and the three-state, OR-tie data output that simplifies memory expansion. To connect the 2102 to TTL, just add solder dots. In fact, the 2102 RAM performs exactly as if it were a TTL circuit.

The 2102 speed specs are efficient also. Guaranteed maximum access time is 1 microsecond, typical access time is 500 nanoseconds. Minimum read and write cycle time is also 1 microsecond.

The 2102 costs less per bit in quantity than penny candy. And when you

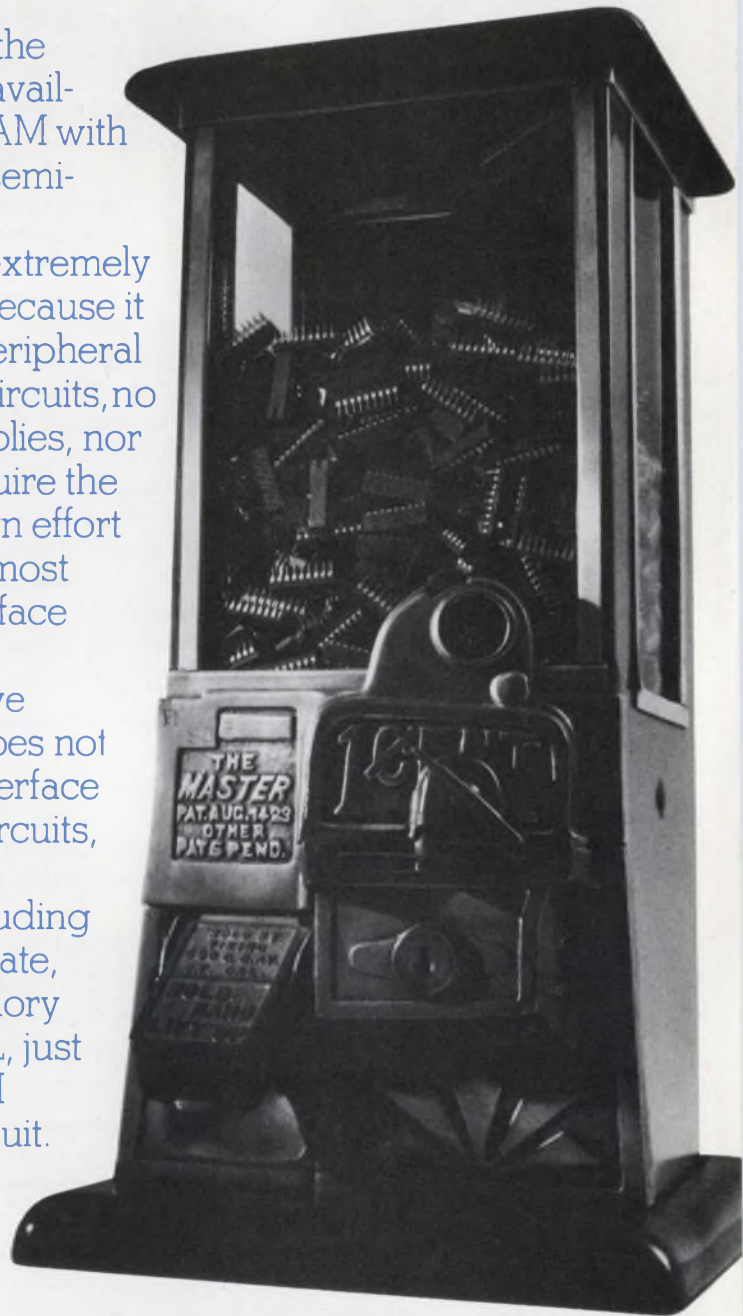

# RAM is as easy use.

## N-CHANNEL

subtract what you don't spend on design time, other parts, special supplies, boards and labor, the 2102 is easily the most economical static RAM for a wide range of applications.

What's more, the Intel 2102 is easy to get. We have been producing it in volume since early 1972 with the industry's most mature n-channel silicon gate technology. Today, we ship more 2102's than the combined outputs of the dozen or so announced second sources.

The Tektronix 31 Programmable Calculator uses the 2102 and millions of our 2102's are now being used in peripheral equipment, instrumentation and microcomputer

systems. It's a favorite with designers who want to

simulate buffer, refresh and variable

length registers with something more convenient and less costly than custom MOS registers.

The 2102 is only one of Intel's popular MOS

RAMs available in volume and from distributor stock. Send for a full catalog of our products including RAMs, ROMs, PROMs, interface circuits and Microcomputers.

Write to: Intel Corporation, 3065 Bowers Avenue, Santa Clara, California 95051. (408) 246-7501.

# intel® delivers.

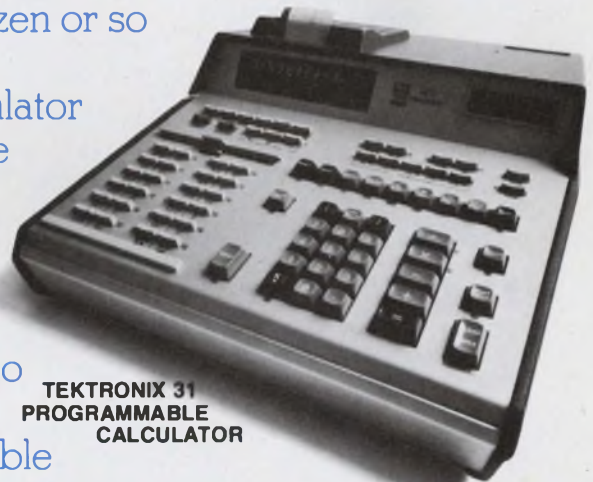

TEKTRONIX 31  
PROGRAMMABLE  
CALCULATOR

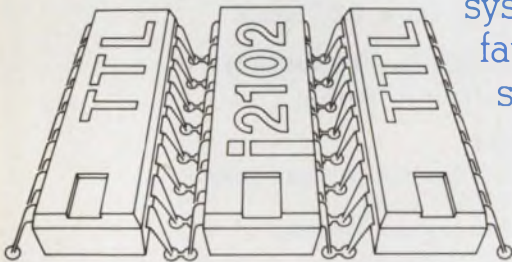

EVERY PIN IS TTL COMPATIBLE

# FLAT INTERCONNECTS YOUR COMPLETE SOURCE

Ribbon Cable / IC Interconnects / Custom Harnesses

You're sold on flat cable, now buy it at its best. Precise, compact cable packages to fit your specifications perfectly, computer-loomed for unmatched versatility by Woven Electronics.

Handling ease of independent non-bonded leads speeds production, cuts cost, while technical characteristics outrank other flat cable forms.

Make Woven your source for jumpers, continuous rolls, special harnesses, all your interconnect needs.

## WOVEN ELECTRONICS

P.O. Box 189 Mauldin, South Carolina 29662



### Vice President, Publisher

Peter Coley

### Editors

Editorial Offices

50 Essex St.

Rochelle Park, N.J. 07662

(201) 843-0550

TWX: 710-990 5071

Cable: Haydenpubs Rochellepark

Editor-in-Chief George Rostky

### Managing Editors:

Ralph Dobriner

Michael Elphick

### Associate Editors:

Dave Bursky

Jules H. Gilder

Morris Grossman

Seymour T. Levine

John F. Mason

Stanley Runyon

Edward A. Torrero

Richard L. Turmail

### Contributing Editors:

Peter N. Budzilovich

Robert Wollins

### Editorial Field Offices

#### East

Jim McDermott, Eastern Editor

P.O. Box 272

Easthampton, Mass. 01027

(413) 527-3632

#### West

David N. Kaye, Senior Western Editor

2930 West Imperial Highway

Inglewood, Calif. 90303

(213) 757-0183

Northe K. Osbrink, Western Editor

112 Coloma St.

Santa Cruz, Calif. 95060

(408) 426-3211

#### Washington

Heather M. David, Bureau Chief

2506 Eye St., N.W.

Washington, D.C. 20037

### Editorial Production

Marjorie A. Duffy

### Art

Art Director, William Kelly

Richard Luce

Anthony J. Fischetto

### Production

Manager, Dollie S. Viebig

Helen De Polo

Anne Molfetas

Christopher G. Hill

### Circulation

Manager, Nancy L. Merritt

### Information Retrieval

Peggy Long

### Promotion

Manager, Jeffrey A. Weiner

Karen Kerrigan



## across the desk

### Wrong spec given for 'Idea' circuit

The Idea for Design "Digitally Programmable Oscillator Selects Frequency in Integer Units from One to 15" (ED No. 25, Dec. 6, 1973, p. 140) contains a fundamental error. This scheme is commonly known as "rate multiplication." The circuit shown is a very inefficient rate multiplier and could be implemented by three TTL circuits. The basic mistake, however, lies in the statement that "the circuit output will have equal spacing at any selected frequency."

The output will not have equal spacing between pulses unless the input frequency is increased to 360,360 times the lowest output frequency; for this is the smallest number that can be divided by all integers from one through 15. This method can therefore generate pure output frequencies up to only  $\sim 100$  Hz. Higher-output frequencies require a phase-locked loop.

*Peter Alfke*

*Manager, Digital Applications  
Fairchild Semiconductor  
464 Ellis St.  
Mountain View, Calif. 94040*

In "Digitally Programmable Oscillator Selects Frequency in Integer Units From One to 15," the fact that 256 is not evenly divisible by all integers from one to 15 implies that no simple generator yielding equal pulse spacing for all frequencies can be built.

The only simple way to remedy the situation is to increase the input-oscillator frequency by all prime factors up to the highest desired multiple (of the unit frequency) and to redesign the generator.

The Shakib design is, of course,

quite a simple generator, with usefulness in, for example, the testing of digital circuits at various input rates. But the irregular spacing of the pulses destroys its usefulness in many audio-oscillator applications.

*J. James Belonis 2d*

*3514 SW 110th St.  
Seattle, Wash. 98146*

### The author replies

My apologies for the oversight.

However, the signal out of this circuit is a periodic signal, and its period is equal to the time it takes the basic oscillator to generate 256 pulses. This time translates into a maximum of 15 cycles at the output of the circuit. The average frequency will be equal to the selected frequency.

As Mr. Belonis mentions, this oscillator is not desirable for many audio applications. However, it is quite useful for digital applications.

A rate multiplier is similar to the circuit I proposed, but it might be quite an oversight on Mr. Alfke's part to say it takes three TTL circuits to select one to 15 units of frequency.

*John Shakib*

*IBM  
P.O. Box 1328  
Boca Raton, Fla. 33432*

### Rms or average power? It's just semantics

Many engineers talk about "rms power" when they really mean "average power." The problem is one of semantics.

When power calculations are made, voltage and current are measured in rms and the power

*(continued on page 8)*

## low cost ceramic trimmer capacitors

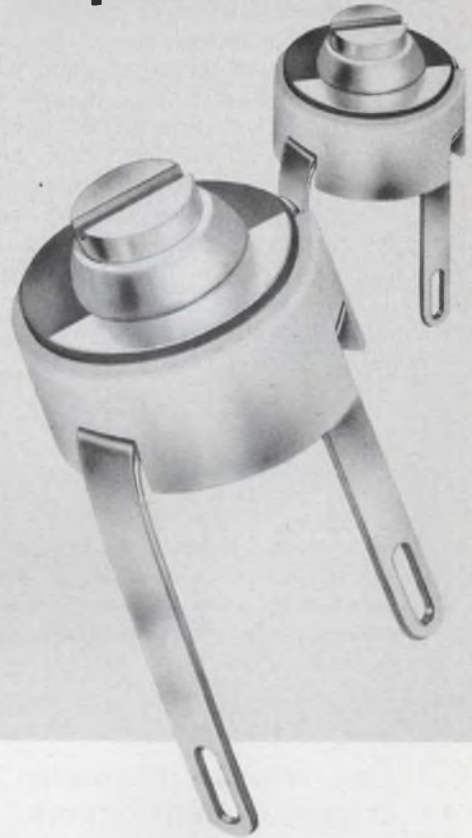

These ceramic trimmer capacitors are designed for broadband application, from audio to 500 MHz and afford an ideal *low cost* means of "trimming" circuitry such as crystal oscillators, CATV amplifiers and all varieties of communication and test equipment.

### FEATURES

- Capacitance values from 1 - 3 to 5 - 25 pf
- Low profile - .208 above board height
- Low cost - 75c in 1000 quantities
- Delivery from stock

*Johanson*

MANUFACTURING CORPORATION

BOONTON, NEW JERSEY 07005  
201 / 334-2676  
TWX 710-987-8367

INFORMATION RETRIEVAL NUMBER 6

Electronic Design welcomes the opinions of its readers on the issues raised in the magazine's editorial columns. Address letters to Managing Editor, Electronic Design, 50 Essex St. Rochelle Park, N.J. 07662. Try to keep letters under 200 words. Letters must be signed. Names will be withheld on request.

## ACROSS THE DESK

(continued from page 7)

calculated from  $I_{rms}E_{rms}$ ,  $E_{rms}^2/R$ , or  $I_{rms}^2R$ . Because rms values of voltage and current are used, it appears reasonable to call the resulting power calculation rms power.

However, derivation of both rms and average power reveals that average power =  $I_{peak}E_{peak}/2 = E_{rms}I_{rms}$ ; and rms power equals  $I_{peak}E_{peak} \sqrt{3/8}$ . Thus the two aren't equivalent. With sinusoids, it's the average power that's really of interest.

R. Tolmei

Johns Hopkins University  
Applied Physics Laboratory  
Silver Spring, Md. 20910

## Correction

The announcement of a new log amp from American Astrionics (ED No. 1 Jan. 4, 1974, p. 204) erroneously gives a lower dynamic range than that specified. The correct figure is 80 dB.

## One resistor improves trigger-system circuit

The circuit in the Idea for Design "SCR Turn-off Problem Eliminated in Rapid-Fire Stroboscope Trigger" (ED No. 22, Oct. 25, 1973, p. 116) has two minor deficiencies. The rate of charge is proportional to  $H_{fe}$  and shows considerable variation. This affects the peak current drawn from the dc supply. Secondly, the power dissipation of the series-pass transistor is  $1/2 CE^2 f$ . With the values shown, at 1 kHz, the transistor dissipates 9 W. This is considerable dissipation for a small power transistor and necessitates an adequate heat sink.

By adding a single resistor in the collector circuit, we solve both problems. The resistor is chosen to be  $H_{fe(min)}$  times smaller than the base resistor, so the transistor is allowed to saturate during the charging interval. Thus it dissipates virtually no power and does not require a heat sink. Instead the power is dissipated in the collector resistor. Since resistors can operate at much higher surface temperatures than transistors, the

thermal design is simplified. In addition the capacitor's charging rate is now primarily determined by the collector resistor RC time constant.

S.E. Summer

2 Lark Place  
Hauppauge, N.Y. 11787.

## The author replies

Mr. Summer is absolutely correct. His addition makes this circuit even more usable. The only precaution I would recommend would be to keep the resistor away from sensitive components and to provide a sink for the resistor's heat.

Dave Zinder  
Senior Engineer

Motorola Semiconductor Products,  
Inc.  
5005 E. McDowell Rd.  
Phoenix, Ariz. 85008

## Missing program line filled in by author

Please publish the following correction in the article "Multiple-Output NAND Networks," which appeared in the Nov. 8, 1973, issue of ELECTRONIC DESIGN:

On p. 104, left column, line 457 of the program should read

$$IUP = 1 + (NV-1)/IBIT.$$

This statement was missing due to a "system error."

Stephen Y. H. Su  
Associate Professor

The City College  
School of Engineering  
Dept. of Electrical Engineering  
New York, N.Y. 10031

## A lusty cheer for the Wang 2200

For shame! In your Jan. 18 issue, you list all the minicomputers and such. But you left out my favorite: the Wang 2200 system.

I admit that the definition of a "minicomputer" is sometimes vague, and that Wang itself calls its 2200 a "programmable calculator." But I believe a serious look at the specs and features would let it be added to your listings.

I really enjoy your magazine

and find it a great help in getting up-to-date data on changes in the industry.

A. K. Rosenhan, P.E.

Box 321  
Racine, Wis. 53401

## Reader agrees solvents can be a real peril

Jeremy Agnew's article "Choose Cleaning Solvents Carefully" (ED No. 5, March 1, 1974, p. 54) is both useful and necessary. My work has required the use of the photoresist process—making circuit boards and etched panels. I was casual with the materials until an amateur chemist informed me of a few of the hazards.

When I tried to learn about the safe handling of solvents, however, I found manufacturers' representatives unaware, uninformed or just plain shut-mouthed. Even the California Dept. of Public Health, while obliging, was short of information.

The best source I've yet discovered is Ethel Browning's "Toxic Solvents" (Edward Arnold Co., 1953). Her source is direct observation of industrial casualties in England. Since then, a few more solvents, including trichloroethylene, have been recognized as more than moderately hazardous. Another reference is Condensed Chemical Dictionary (Van Nostrand Reinhold).

The difficulty with solvent poisoning is its chronic nature. Twenty years might elapse before the physical damage is evident. A problem is human resistance to discovering and facing the facts, whether from an economic motive or because it's a dreary business all in all.

I think Mr. Agnew should have recommended the use of respirators and told us what gloves to use. Xylene dissolves rubber; polyethylene gloves are too thin—they tear easily.

It's not a safe world, but what excuses ignorance?

Peter Mundy

Alembia  
60 Brady St.  
San Francisco, Calif. 94103

(continued on page 19)



# MEASUREMENT COMPUTATION

innovations from Hewlett-Packard

# NEWS

APRIL, 1974

## in this issue

Lower prices for  
isolators and displays

Now, HP's dmm probe  
measures current

The most innovative  
counter of the year



### Another small miracle for engineers and scientists: the HP-65

The HP-65: a new programmable pocket-sized computer-calculator. It accepts pre-programmed magnetic cards or you can write your own programs on blank cards.

Two years ago, the HP-35 provided scientists and engineers with a revolutionary mathematical tool. Now, for the first time, Hewlett-Packard offers full programming capability in a pocket calculator. No other machine of its size and price lets you prepare and edit your own programs, then store them on magnetic cards for later use. The unique HP-65 lets you perform branching, logic comparisons, and conditional skips—sophisticated, efficient programming—over lunch, in the field, or in your home study.

The calculator has five master keys (A-E) for storing and recalling user pro-

*(continued on page 3)*

## Now, HP guarantees system specs at interface to unit-under-test

## Sampling modules extend HP 180 scopes to 18 GHz

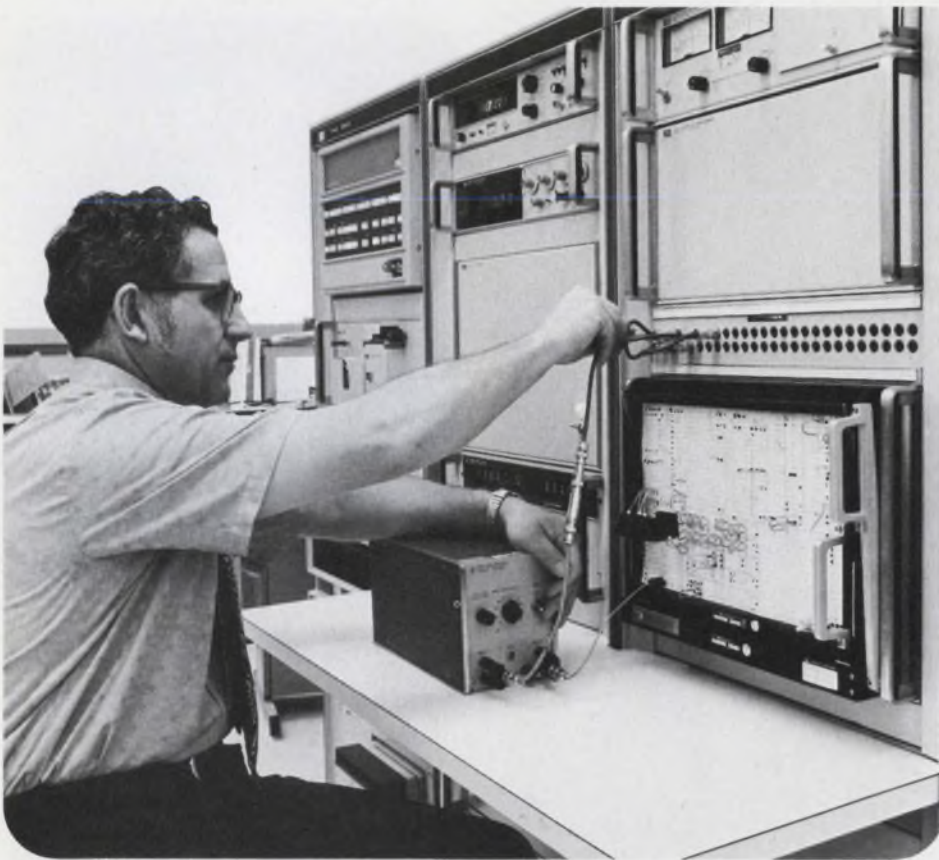

The 9510D automatic test system performs up to 400 complex tests in 4 or 5 minutes.

HP's new 9510D automatic test system is the first commercial test system *guaranteed* to meet specifications at the interface to the unit-under-test. Now you can match your requirements and pre-plan your testing facility with complete confidence; the 9510D performs each test with consistent repeatability to specified accuracy.

It's the only system with calibration initially traceable to the National Bureau of Standards. Standardization not only means reliability, but faster delivery and lower prices than custom-engineered systems.

The 9510D provides stimulus and measurement for voltage, resistance, frequency, distortion, phase, pulse digital and waveform analysis—plus RF stimulus and measurement of CW, AM and FM signals up to 500 MHz. It's designed to test electronic circuits and circuit functions, as well as sophisticated aircraft avionics, missile guidance and control, transceivers, TV receivers, satellites, navigation and communications equipment.

For specifications, check N on the HP Reply Card.

Dual-channel sampling modules for HP's 180 oscilloscopes offer qualitative and quantitative measurements of repetitive signals from dc to 18 GHz. The 1810A plug-in measures up to 1 GHz, while the 1811A module offers a choice of two sampling heads, 4 or 18 GHz. The remote sampling heads have feed-through design that allows measurements to be made using the system as a load, rather than an artificial termination in the system.

High-frequency applications include RF modulation testing, distortion and phase shift measurements up to 18 GHz. A sampling scope also displays the input vs. output of IF amplifiers to obtain gain and phase information. Fast sweep times are especially useful in nuclear laboratories for coincidence testing.

HP design improvements eliminate the need to trigger the sampling scope for modulation trapezoids. Now, you can make modulation trapezoid measurements on live transmission systems when triggering is impossible.

For details, check C on the HP Reply Card.

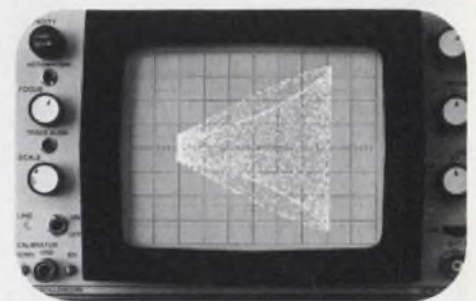

A non-triggered modulation trapezoid display of a 1 GHz carrier modulated with a 12 MHz sine wave.

## New measurement/control system can improve productivity

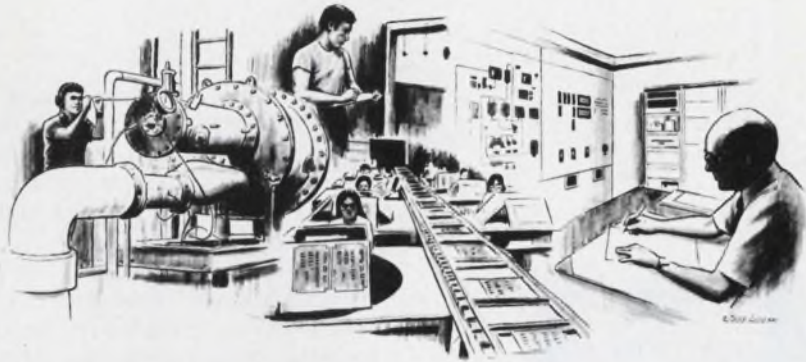

Applications for the 9610 system include: material handling, process control, information networks, and quality control.

HP's new 9610 industrial measurement and control system helps manufacturers in three important ways: it will ensure your materials are on hand, when needed, in the right quantity; it can control the manufacturing process itself; and when the job's done, the 9610 can check the quality of the finished products automatically. The system also integrates easily into a plantwide information network for management reports and data processing.

Start with a small system (12 digital I/O channels and 16 analog inputs) and expand up to 540 I/O channels and 336 analog inputs. This can be done on loca-

tion, with minimum down time. The high-speed analog subsystem has a 12-bit 45-kHz A/D converter with choice of high level and low level analog multiplexers.

Programming is done in simple HP BASIC or FORTRAN. Operating systems range from a low-cost interrupt-driven control system to a sophisticated disc-based real-time executive programmable in ALGOL and assembly language as well.

For more information, check O on the HP Reply Card.

(continued from page 1)

grams of up to 100 steps. The HP-65 can be programmed either from the keyboard or by inserting a tiny, prerecorded magnetic program card. Programs entered from the keyboard can be recorded on blank cards for future use. When you no longer need the program, erase the card and use it over again.

For your convenience, prerecorded programs are available from HP for statistical, mathematical, engineering, medical and surveying applications. Additional application pacs will be offered as they are developed. All HP-65 owners also receive a free one-year subscription to the HP-65 User's Library.

By itself, the HP-65 has 51 built-in functions: standard arithmetic operations plus logarithms, square and square root, exponential, factorial, reciprocal, and trigonometric functions. You can add and subtract in degrees, minutes and seconds format. You can choose

any of three trigonometric modes—degrees, radians and grads—and convert octal-based numbers to decimal-based integers or vice versa.

There are 9 addressable memory registers that can be used for data storage or register arithmetic. The 4-register operational stack stores intermediate answers and automatically retrieves them when needed in a calculation. Answers appear on the 10-digit LED display.

Rechargeable batteries operate the 11 oz. (3 hg) calculator for approximately 3 hours. Included with the HP-65 are hard and soft carrying cases, a recharger-adaptor, user's guides, and a standard application pac.

An impressive capability at a modest price.

For more information, check A on the HP Reply Card.

## Spectrum analysis plug-in adds to 180 scopes

HP's economical 1500-MHz spectrum analyzer, the 8558B plug-in for 180 series oscilloscopes, has performance and operating features ideal for lab, production and field applications.

● **Three-knob operation**—For most measurements, just tune the frequency (shown on LED digital readout), select frequency span width, and set the calibrated amplitude level control. The analyzer itself takes care of sweep time and resolution (1 kHz to 3 MHz).

● **Accuracy**—The 8558B offers  $\pm 1$  dB frequency response and  $\pm 5$  MHz frequency accuracy plus  $> 70$  dB distortion-free dynamic range. This is comparable to what you'd find in analyzers costing up to twice the 8558's price.

● **Versatility**—Because the 8558B is part of the HP 180 scope family, you can combine its frequency-domain capabilities with the many time-domain plug-ins available.

For more information, check M on the HP Reply Card.



Accurate measurements are made easily with the economical 8558B spectrum analyzer (shown here in a 182C oscilloscope).

## New digital power sources for test systems

Designing a minicomputer or calculator-based test system? Then you'll need a programmable power source to generate stimulus, vary  $V_{cc}$ , or adjust bias potential—namely, HP's extensive line of digital voltage and current sources. More than simple D/A converters with extra power capability, the DVSSs and DCSs satisfy all requirements for system use:

- Isolated digital inputs and outputs to eliminate ground loops.
- Flexible interface circuitry compatible with many programming sources.
- Internal storage of all digital input data to eliminate the need to refresh the supply.
- Programmable current or voltage limiting that protects supply and load.
- Feedback signals.
- External analog input to modulate the programmed output.

There are 5 digital voltage sources, programmable in 16-bit binary or 8421 BCD, covering an output range from  $\pm 10V$  to  $\pm 100V$  at currents up to 12.5A. Programming speed is 350  $\mu s$ . Two digital current sources are available: model 6140A, programmable in 16-bit binary or BCD; and 6145A, programmable in BCD only.

*For digital power source specifications, check J on the HP Reply Card.*



The 6145A digital current source has 200  $\mu s$  programming speed and 1  $\mu A$  (X1 range) or 10  $\mu A$  (X10 range) output accuracy.

## Microwave power meter has new accuracy



The 435A power meter's internal RF power reference provides added confidence in overall measurement accuracy.

HP's thermocouple power meter (435A meter/8481A sensor) covers wide ranges—10 MHz to 18 GHz in frequency and 0.3  $\mu W$  to 100 mW in power. It combines overall measurement accuracy with convenient operating features.

High accuracy results from the virtual elimination of mismatch uncertainties; the unique silicon-integrated thermocouple sensor has extremely low SWR ( $< 1.2$  at 30 MHz to 12.4 GHz,  $< 1.3$  from 12.4 GHz to 18 GHz). Overall system calibration can be verified anytime, anywhere, using the precise RF power reference that's built into the 435A meter.

Attractive optional features include an internal rechargeable battery pack and provision to operate the sensor up to 200 feet from the meter. The 435A/8481A accuracy can also work for you in field tests.

*For more information, check F on the HP Reply Card.*

## Now, prices reduced on IC troubleshooters

Now many IC troubleshooting instruments cost less, and the HP 10529A logic comparator has a new "no-cost" accessory. Price reductions affect the 10525E logic probe, 10528A logic clip, and the 5011T and 5015T kits.

The 10525E is the only logic probe with fast enough response for ECL logic. Even a 5 ns pulse causes the lamp in the probe tip to blink for 0.1 sec. The probe tip light indicates logic high, lows, open, and pulse trains.

The 10528A clips over 14 or 16-pin dual in-line DTL or TTL integrated circuits. The 16 LEDs on the clip indicate the instantaneous logic states of all the pins.

Always a low-cost way to buy IC troubleshooters, two HP kits are now even a better buy. The 5015T "mini" kit contains a logic probe, clip and pulser to stimulate your ICs in-circuit. The 5011T "maxi" kit contains the same three plus a logic comparator.

Along with each 10529A comparator, you now get a new plug-in reference board that has an IC socket and miniature switches rather than hard wiring the reference IC. You still get 10 of the old reference boards, too, for testing a specific type of IC frequently.

The new board can be ordered as a spare part (10529-60014).

*For more on these lower prices, check Q on the HP Reply Card.*



New plug-in reference board sets up quickly and economically for infrequently used ICs.

## Calculator-aided transformer design saves time and slashes costs

## New OEM disc system is fastest in its price range



Simply input your specs (say, temperature rise, voltage and current requirements). The 9830 calculator automatically selects the fabrication parameters you need.

Designing power transformers involves using several charts, graphs and tables, plus your own intuitive feeling for each problem; selecting core material; calculating losses; determining temperature rise; and planning for the required regulation. Repeated guesstimates take time because they must be done carefully and accurately.

Now, there's a better way: add an HP 9830 programmable calculator and transformer design software to your staff. The 9830 is a powerful, computer-like calculator that is fast and easy to program in BASIC. At HP's Loveland facility, it's used for all new transformer design problems.

With the 9830 calculator and the HP-developed software, accurate trans-

former designing, quoting and specifying is performed with important reductions in time and cost. The software is user-tested: HP spent 5 years developing, using, then refining the programs.

The results? Designs that once took 4 hours (using manual techniques) now take only 15 minutes with calculator-aided design. Equally significant, only a third as many HP engineers are needed to do complex transformer designs. And turn-around time, from specification to prototype shipment, has decreased from an average 10 days to 3 days.

For more on calculator-aided design, check S on the HP Reply Card.

Add a disc subsystem to the HP 2100A computer via a dual-channel DMA board, and you've got the HP 2123A, the fastest disc-based minicomputer system an OEM can buy.

The 2100A CPU provides 16K words of memory, memory parity, memory protect, hardware multiply/divide, and power fail/restart. The 5-megabyte disc has 30-ms access time, making the HP 2123A the fastest system available in its price range.

There's another HP exclusive: add a printed circuit board, Writable Control Store, to the 2123A system; and you have the only OEM disc system that is user-microprogrammable.

For more information, check D on the HP Reply Card.



The 2123A OEM disc-based system has a data transfer rate of over a million 16-bit words per second.

## New pulse generator works well with several logic families



Now, test several different circuits over a full range with one easy-to-use pulse generator.

Our new 20-MHz pulse generator has simultaneous +10V and -10V outputs, ample for HTL, DTL, RTL, discrete and analog circuits. The new 8005B also has a separate TTL-compatible output for testing TTL circuitry. Compared to its predecessor, the 8005A, the new generator has twice the pulse rate, twice the output, and three simultaneous outlets—all for the same price.

The normal/complement switch lets you change conveniently from posi-

tive to negative logic without readjusting offset. The 8005B has selectable output source impedance (50 $\Omega$  or current-source) and linear transition times from 10 ns to 2 sec. With a range from 0.3 Hz to 20 MHz, the pulse generator also features square-wave operation from 0.15 Hz to 10 MHz and a double-pulse mode to 10 MHz.

For the full story, check L on the HP Reply Card.

## Now, the dmm probe becomes a five-function bench instrument

Four months ago, HP introduced the 970A digital multimeter—a handheld probe that measures ac and dc voltages from .001V to 500V with automatic

polarity, and resistance from .001 k $\Omega$  to 10,000 k $\Omega$ .

Now, you can convert the portable 970A into a five-function bench instrument. A new optional current shunt/bench cradle adds five ranges of ac/dc current measurement capability. Simply select a current range of 0.1 mA, 1 mA, 10 mA, 0.1 A, and 1 A. The cradle binding posts add terminal versatility: it accepts wrap-around, screw-down, clip-on or banana plug terminations. All readouts still appear on the dmm's 3½ digit display.



Equally handy in the field or in the lab, the 970A takes the trouble out of troubleshooting.

For more on the probe and the new option, check P on the HP Reply Card.

## New measurement techniques with storage and variable persistence

High-speed signals, single-shot events, or low frequency signals are difficult, sometimes impossible, to see on a conventional oscilloscope. However, the HP 1703A portable 35-MHz storage scope captures these elusive signals with ease. Storage and variable persistence can solve many varied measurement problems.

At Four Phase Systems, a California computer company, a 1703A scope is used to detect a single-shot 100-ns command signal. The stored trace verifies that the pulse occurred at the proper time.

When IBM's instrumentation classes analyze the contact bounce of switches, they view these nonrepetitive signals with a storage scope. Capturing real-time waveforms lets the computer trainees examine this prevalent source of trouble. Thanks to fast writing speed, the 1703A displays these high-speed, single-shot signals clearly.

At the Utah Power and Light Company, the 1703A interrogates 40 remote stations sequentially. The signal from any one remote station is equivalent to measuring a low rep rate signal. Using a 1703A scope with delayed sweep, a technician isolates the desired signal, then adjusts the variable persistence to display both the master signal and the remote response. By comparing the two traces, he can determine the validity of the returned data.

For details and more information on storage applications, check B on the HP Reply Card.



The portable 1703A scope on-site at Utah Power and Light Company.



## Now, use source cards for data entry

Save data preparation time with HP's new 7261A parallel card reader. Designed for use directly with a computer or smart terminal, this optical mark card reader accepts source documents for data entry. Thus, your initial functional set of cards—the ones you mark with ordinary pencil—can be input directly. The intermediate step of keypunching is eliminated, as well as the possibility and probability of keypunch errors.

No special marking pencils are

necessary; and yes, you can erase mistakes. You can even make notes; the card reader ignores areas used for handwritten messages. Yet, it will read marks, punched holes, and pre-printed data. Maximum feed rate is 300 cards per minute. An optional 500-card select hopper is available for operation under computer control.

For details, check K on the HP Reply Card.

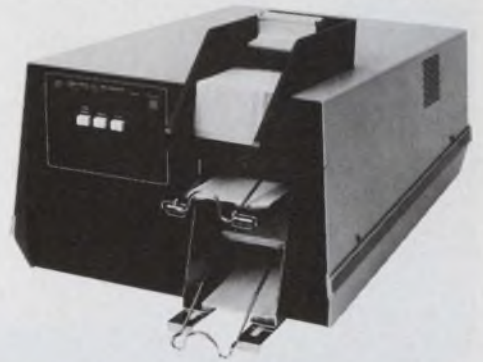

# HEWLETT-PACKARD COMPONENT NEWS

## New high-efficiency high-power IMPATTs

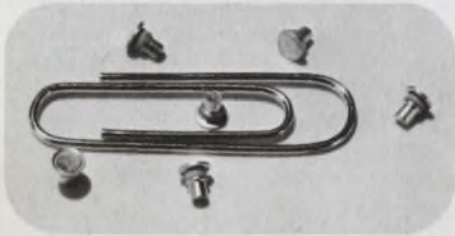

These developmental diodes have operating voltages from 100 to 143V, with operating current from 50 to 900 mA, depending upon frequency and power output.

Two new developmental silicon IMPATT diodes are now available for microwave radar and communications applications. The two pulsed units deliver peak powers of 12W at 10 GHz and 10W at 16.5 GHz. Designed for X-band and Ku-band, these double-drift diodes offer higher power and efficiency, lower junction capacitance, and lower FM noise than single-drift IMPATTs.

Two developmental CW IMPATTs, capable of 1.3 and 2.3W at 11.2 GHz, are also available for X-band oscillators and amplifiers in telecommunications applications.

For details, check R on the HP Reply Card.

## HP reduces prices of high-speed isolators

Now, you can save 22% to 40% on high-speed optically-coupled isolators. These devices combine an LED input optically-coupled with a P-N photo-diode driving a transistor. Isolation voltage is 2500V. Propagation time is only 225 ns, and bandwidth is 5 MHz. They can be direct-coupled to TTL loads at TTL speeds without additional buffers or triggers.

There are three isolators, designed for different applications. For general-purpose isolation, use the 5082-4350 with a typical dc current transfer ratio (CRT) of 11%. The 5082-4351 is a high gain device with CRT of 22% while the 5082-4352, with a CRT between 15% and 22%, is designed for critical gain control applications.

For prices and specs, check G on the HP Reply Card.

Maximum forward dc current is 20 mA; maximum forward peak current is 40 mA.

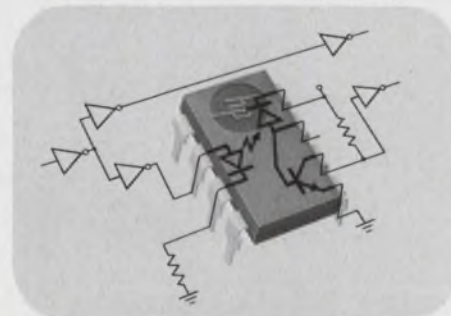

## New lower prices for hexadecimal display

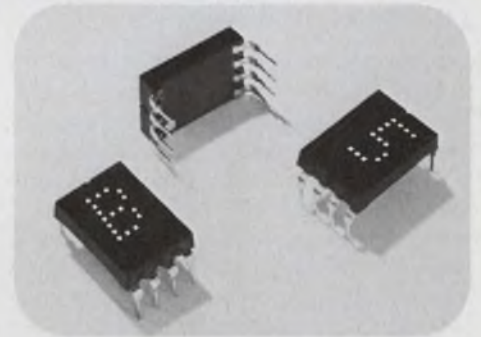

Display digits or letters with HP's low-cost hexadecimal indicators.

Now, you pay approximately 30% less for an LED display that converts binary logic to a base 16 numbering system and displays letter A-F, as well as digits 0-9. Used in computers and test instruments, this solid-state display is suitable wherever you need to show more than 10 states.

The 5082-7340 hexadecimal indicator has built-in decoder/driver and memory. The unique blanking control lets you turn off the display, and retain or change the data stored in the on-board memory. It's completely DTL and TTL compatible.

To learn more, check H on the HP Reply Card.

## New "super-counter" provides higher speed, greater resolution, and unique frequency averaging

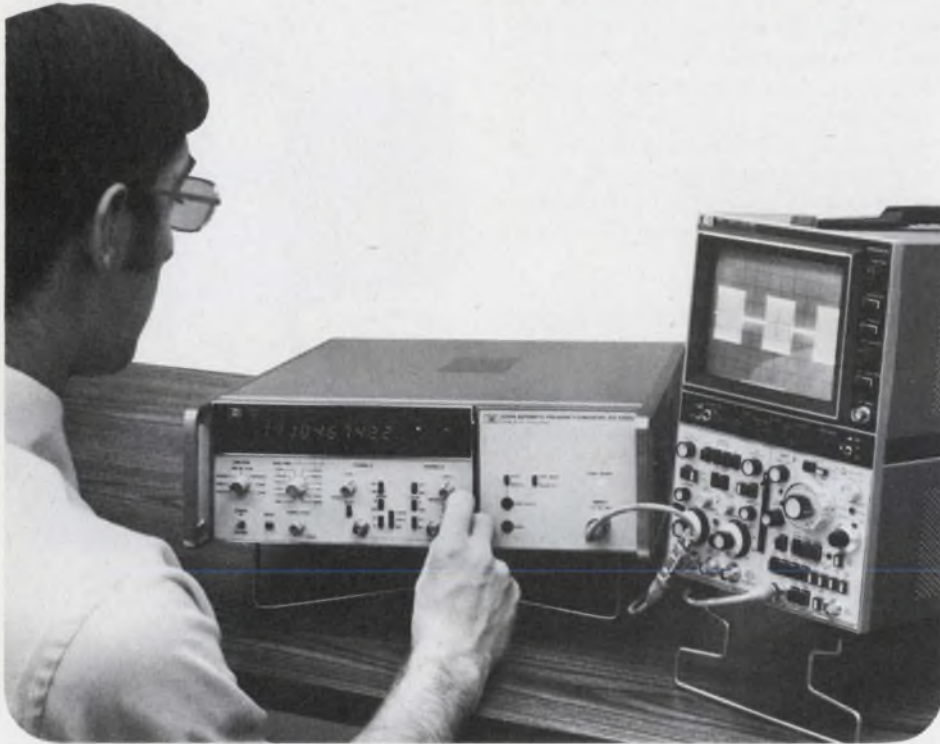

Pulsed RF and CW up to 4 GHz are measured automatically with a heterodyne converter plugged into the new counter.

Our new 5345A "super-counter" brings a quantum jump in measurement capabilities to general-purpose counters and opens new application areas.

This unique counter uses the period-measuring reciprocal-calculating technique for greater resolution in less time than conventional counters. For example, any frequency between 1 Hz and 500 MHz is displayed to 9 digits in just 1 second. Thus, for a desired resolution,

you can make hundreds more measurements in the same amount of time.

Unique input amplifiers not only give 10 mV sensitivity with switchable impedances but are also direct-coupled. Thus, the counter isn't limited to CW signals but handles non-symmetrical waveforms, random events, pulses, pulsed carriers, and time intervals.

New HP-developed sub-nanosecond digital logic ensures the counter's ac-

curacy to  $\pm 1$  clock pulse of the internal 500 MHz clock and allows gate times down to 50 ns.

Pulsed carriers can now be measured automatically, even for very narrow single-shot pulses. High-speed gating, the reciprocal technique, and a new technique known as "frequency averaging" maintain accuracy and resolution on pulses narrower than 100 ns. And plug-in modules extend automatic measurements to 4 and 18 GHz. (If you already have an HP 5245L counter, you can use the same plug-ins in the 5345A.)

Outstanding time interval capability gives resolution to 2 ns single-shot; improved time interval averaging extends into the picosecond region. External gating allows jitter to be easily characterized between any two pulses in a bit stream. Ratio measurement is more versatile than ever because you can ratio any two signals from dc to 500 MHz with full sensitivity.

System designers benefit, too, because the new counter interfaces easily with HP calculators and 2100 series computers.

*There's more. Check 1 on the HP Reply Card.*

HEWLETT  PACKARD

East-W 120 Century Road, Paramus, N.J. 07652,  
Ph. (201) 265-5000.

South-P.O. Box 2834, Atlanta, Ga. 30328,  
Ph. (404) 436-6181.

Midwest-5500 Howard Street, Skokie, Ill. 60076,  
Ph. (312) 677-0400.

West-3939 Lankershim Boulevard, North  
Hollywood, Calif. 91604, Ph. (213) 877-1282.

Europe-Post Office Box 85, CH-1217 Meyrin 2,  
Geneva, Switzerland, Ph. (022) 41 54 00.

Canada-6877 Gorway Drive, Mississauga,  
Ph. (416) 677-9478.

Japan-Yokogawa-Hewlett-Packard, 1-59-1,  
Yoyogi, Shibuya-ku, Tokyo, 151.

## ACROSS THE DESK

(continued from page 8)

### Help! He needs a clamp source

I need some clamps that must support a total of 12 oz. when fastened to the lead of an integrated circuit. The clamp should measure no more than 0.050 in. wide in reference to clamping surfaces, and 0.400 in. long, and it should not weigh more than 1/2 oz. The material is unimportant.

Can you help me locate a source?

*Gary G. Lagier*

*Quality Assurance Manager*

Viking Laboratories, Inc.  
150 Wolfe Rd.  
Sunnyvale, Calif. 94086

### Air-cooling guide gets high rating

May we congratulate ELECTRONIC DESIGN and Dave Nevala of Digital Equipment Corp. for the fine article "A Guide to Good Air Cooling" (ED No. 4, Feb. 15, 1974, p. 76).

Rotron, Inc., a manufacturer of air-moving products, has worked in close association with Digital Equipment Corp. for the past several years. Mr. Nevala's knowledge of forced-air convection cooling has enabled DEC to achieve the desired packaging densities and system reliability typical of their products.

It is gratifying to hear the virtues of forced-air cooling being expounded by someone outside of our industry.

*Gordon M. Taylor*

*Manager, Marketing Engineering*  
Rotron, Inc.  
Woodstock, N.Y. 12498

### Good-news cable

Though we've seen one of two messages from advertising agencies, advising us that their clients are doing nice things, we were rather charmed by a cable from Evenett & Desoutter in London,

(continued on page 23)

## **NEW from Sprague!**



# ECCOL<sup>®</sup> A-C CAPACITORS

for  
today's  
ecology-conscious  
world

Equipment manufacturers using capacitors with polychlorinated biphenyl impregnant are finding that some nations have prohibited the import of products containing PCB because of its toxicity and non-degradability.

To meet industry needs for capacitors without pollutants, Sprague has designed a new series of capacitors utilizing a new non-toxic, bio-degradable impregnant that exhibits essentially identical electrical performance characteristics to those of PCB. Operating life and reliability are also equivalent. Even the size of ECCOL<sup>®</sup> Capacitors is similar to previous designs, except for a slight increase in case height.

Drawn-case ECCOL<sup>®</sup> Capacitors are available in a wide range of capacitance values from 1 to 55 $\mu$ F, with four voltage ratings from 330 to 660 VAC.

**For complete technical data, write for Engineering Bulletin 4550 to Technical Literature Service, Sprague Electric Co., 347 Marshall St., North Adams, Mass. 01247.**

45P-4107

# SPRAGUE

THE MARK OF RELIABILITY

THE BROAD-LINE PRODUCER OF ELECTRONIC PARTS

INFORMATION RETRIEVAL NUMBER 7

**WANT A 16K BY 20  
650 NSEC. MEMORY  
ON A SINGLE CARD?**

**YOU  
JUST  
FOUND  
IT**

Not only do we have just the memory you're looking for, we have it in a thoroughly field-proven design. A design that has been accepted — even by our competitors — as the industry standard. Basically it is the same reliable 3 Wire, 3D design as our MICROMEMORY 3000. We doubled the capacity, but kept everything else the same.

It is the MICROMEMORY 3000DD. Consider its credentials. Cycle and access times of 650 nsec. and 300 nsec., respectively. Power requirements of  $\pm 15\text{VDC}$  and  $+5\text{VDC}$ . The complete system, including all necessary logic, drive and sense circuitry complete on one convenient plug-in circuit board. Standard configuration of 16K by 16, 18, or 20 bits, alterable to 32K by 8, 9, or 10. And it is interchangeable with the original MICROMEMORY 3000.

The MICROMEMORY 3000DD is also available as a pre-packaged, multi-card system, complete with power supply, self-test and interface cards, and various other features and options. And standard chassis are available to hold from one to 16 memory cards. Since both the original 8K MICROMEMORY 3000 and the new 16K MICROMEMORY 3000DD cards can be inter-mixed, this gives you new and greater growth flexibility from 8K to 256K.

Get complete information and technical details from your local EMM office, or call Commercial Memory Products Marketing Department at (213) 644-9881. Do it today.

**EMM** ELECTRONIC  
MEMORIES  
COMMERCIAL MEMORY PRODUCTS

A Division of Electronic Memories & Magnetics Corporation  
12621 Chadron Ave., Hawthorne, Calif. 90250

Belgium 03/76.69.75; United Kingdom 01/751-1213; W. Germany 0811/74.30.40

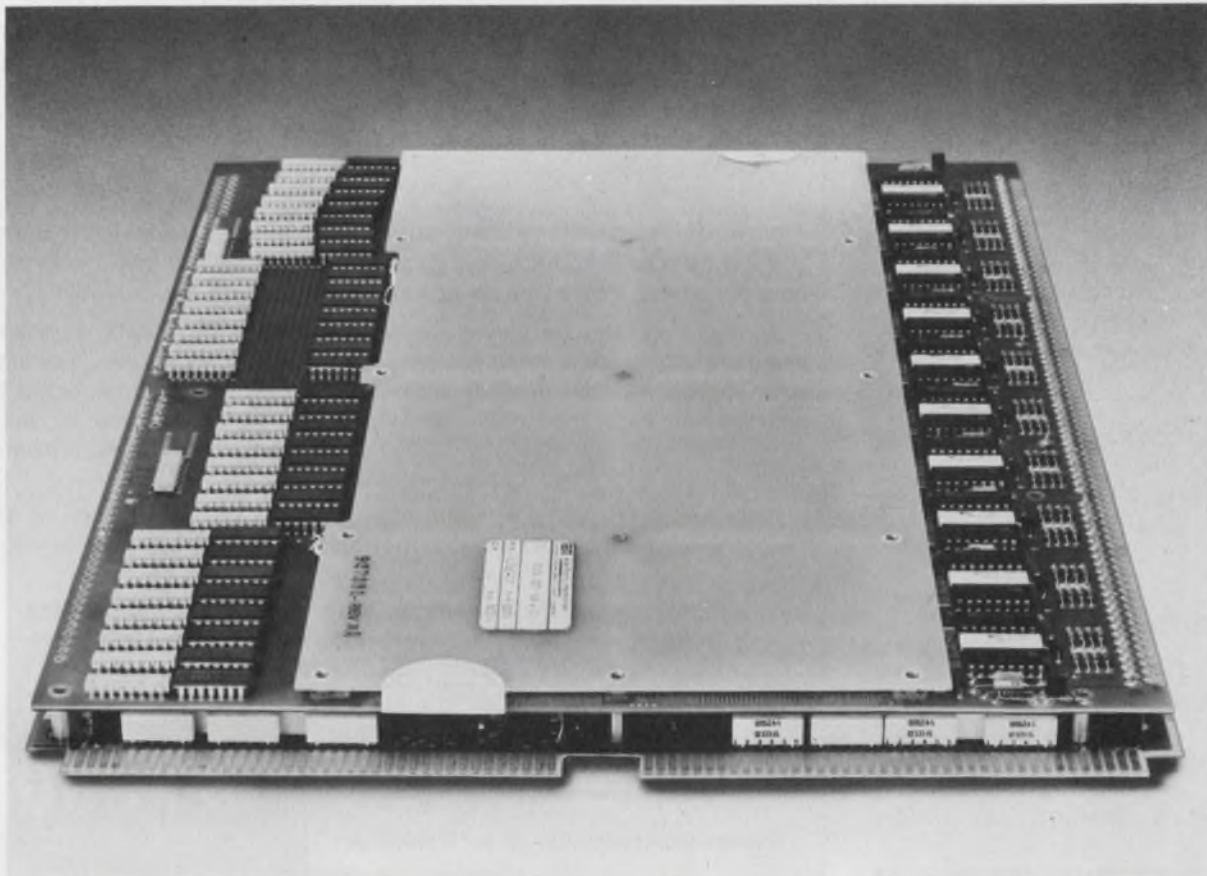

**"See us at the NCC show in Chicago, Booth 671"**  
INFORMATION RETRIEVAL NUMBER 8

ELECTRONIC DESIGN 8, April 12, 1974

**A  
LOT  
MORE  
FOR A  
LITTLE  
LESS**

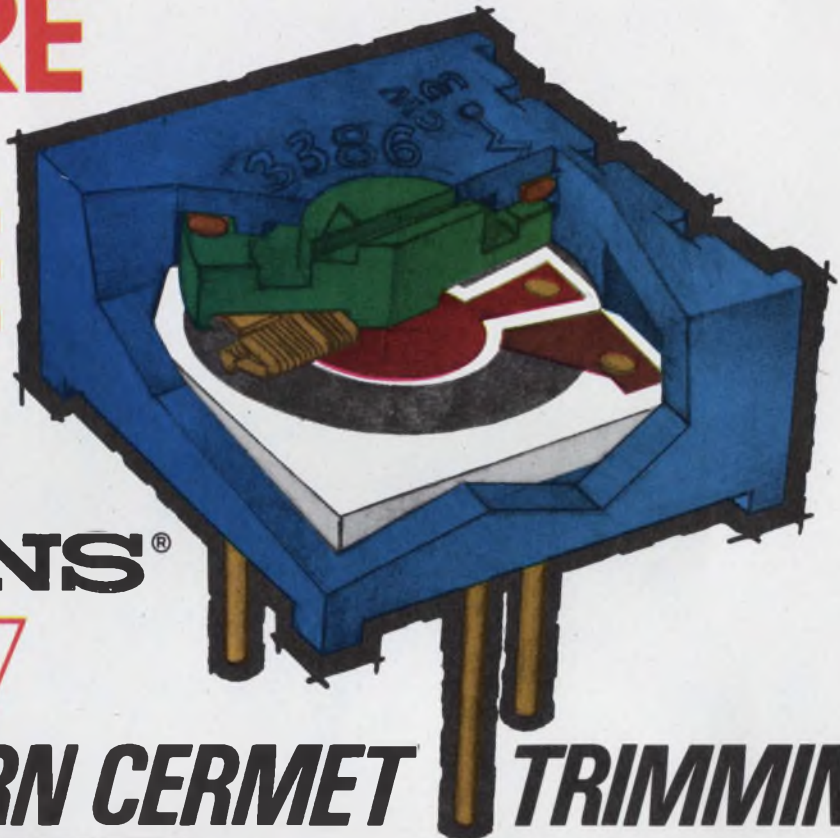

**BOURNS®**

**NEW**

**SINGLE-TURN CERMET TRIMMING POTENTIOMETER**

- VASTLY IMPROVED ADJUSTABILITY
- TWELVE TERMINAL STYLES
- SEALED FOR WAVE SOLDERING

**45¢**  
In production quantities

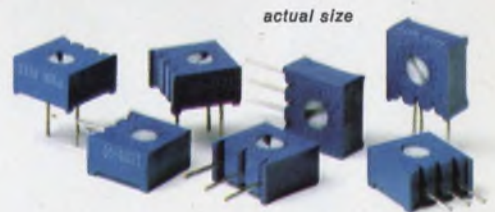

Meet Bourns new Model 3386, a product that both buyer and engineer can love . . . with super adjustability that makes for easy, accurate trimming, AND at a budget balancing price. Most importantly, it's a BOURNS product . . . and that means QUALITY and PERFORMANCE you can believe-in, and SERVICE you can depend-on.

**SIGNIFICANT SPECIFICATIONS**

- typical CRV less than 1% • infinite resolution • TC of  $\pm 100$ PPM/ $^{\circ}$ C to 200K ohms • power of .5 watt at 85 $^{\circ}$ C • thin  $\frac{3}{8}$ " square size



*For complete details, contact your local Bourns representative or distributor, or the factory direct.*



TRIMPOT PRODUCTS DIVISION • 1200 COLUMBIA AVE., RIVERSIDE, CALIF. 92507

INFORMATION RETRIEVAL NUMBER 9

**Dow Corning silicones  
protect this Time Computer<sup>®</sup>  
against a 2,500-g impact.**

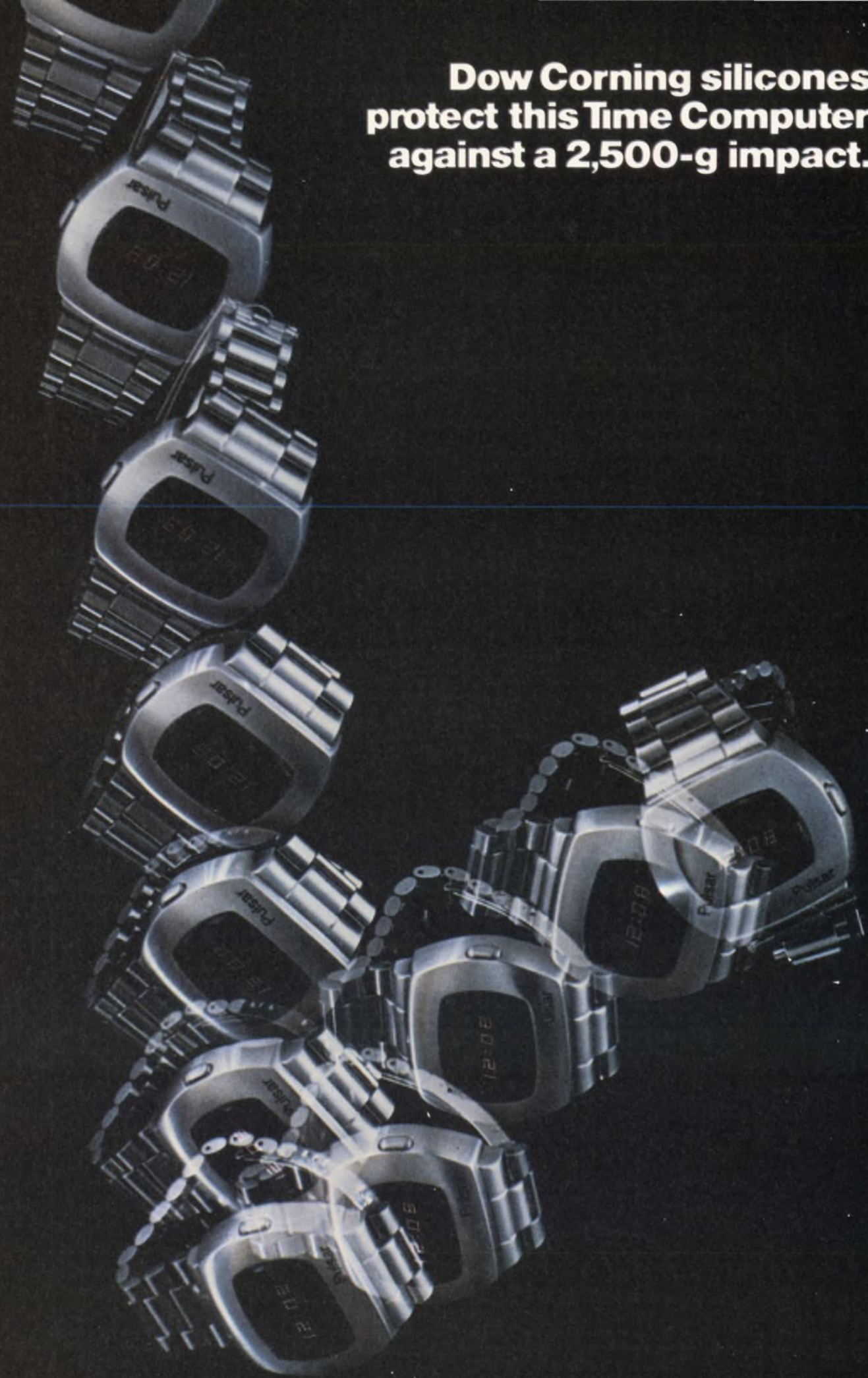

# They also protect against heat, moisture and thermal shock.

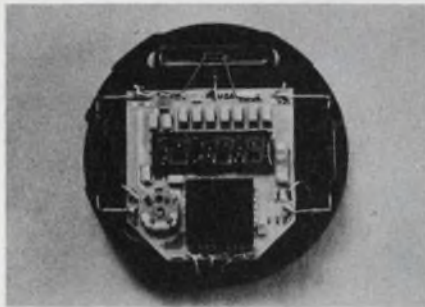

This Pulsar computer circuit uses Dow Corning silicones for shock protection, for positioning individual components, and as a moisture barrier. They all help Pulsar maintain an accuracy of  $\pm 5$  seconds per month. A major production advantage with silicones: only one hour primary cure is required before further assembly work. Yet if a circuit element is improperly placed or doesn't test out, the clear sealant can easily be cut away and the individual component replaced without complete rework. Circle No. 121.



ICs, MOS, CMOS, and other devices made with flame resistant silicone molding compounds provide in many applications the reliability of hermetics at about  $\frac{1}{3}$  the cost. These compounds are superior in moisture resistance, thermal life and electronic stability over other plastics. Their heat resistant and shock protective qualities make them especially valuable in the unusually harsh environments of automotive applications. And molding cycle times are as short as 30 seconds. Circle No. 122.

*Pulsar units withstand 2,500 g's, symbolized by this strobe illuminated scene. Courtesy Time Computer, Inc., subsidiary HMW Industries, Inc.*

\*Trademark of HMW Industries, Inc.

For cooling high-density, high-performance modules, silicone fluids thin out very little, and silicone heat-sink compounds won't melt. This results in more effective heat dissipation, required in high-voltage power supplies operating over a wide temperature range. Circle 123.

Silicone rubber insulated wire and cable, used in nuclear power-plant instrumentation and controls, provide reliable service in applications to 260 C without gumming or



melting. And they continue to function even after a fire because of their nonconducting ash. Circle No. 124.

These electronic-quality silicone products are representative of a complete line of silicones that have inherent properties making them ideal protectors for almost every circuit/system.

Send today for "Silicones for Electronic Design," a 24-page brochure full of special applications for improving electronic circuits. Dow Corning Corporation, Department A-3202, Midland, Michigan 48640. Or call your nearest Dow Corning distributor.

**Silicones; simply the best way to protect electronic circuits.**

## **DOW CORNING**



## ACROSS THE DESK

(continued from page 19)

the agency for Jermyn, Sevenoaks Kent (with U.S. headquarters in San Francisco). The cable read as follows:

"Don't believe all you read in papers. Britain not fallen in pit. Not all workers revolting. Not everyone on short time. Example: Jermyn has own generator working five-day week as usual. Satisfying worldwide demand as usual. Sun is shining. Spring is early."—John Evenett

## A little 'bureaucracy' in us all, says V. P.

Your editorial "The Bureaucracy" (ED No. 3, Feb. 1, 1974, p. 51) certainly rings true. A little of this attitude fits all of us.

Certainly we can all relate to the man or woman who fits the bill. Not only did we have a name for such people in the Army, but the name also applies to some people in our profession. In short, if the shoe fits, wear it.

I enjoyed the editorial, and look forward to more of your clever wit.

*Robert Shevlot*

*Vice President, Marketing*

Texscan Corp.

2446 N. Shadeland Ave.

Indianapolis, Ind. 46219

## Add the inflation factor

I feel that R. W. Wiegel overlooked a very important parameter in his plot of semiconductor storage-element price trends (see "The Memory Price Plot," ED No. 25, Dec. 6, 1973, p. 8). If an inflation factor were added, his plot would surely resemble more the amplitude-frequency response of a crystal filter—or any other bandpass filter viewed through a crystal ball.

*C. Humphrey*

*Engineer*

Raytheon Canada Ltd.

400 Phillip St.

Waterloo, Ontario,

Canada N2L 3X3

**This is  
not an  
Augat  
board.**



**It's  
better.**

The more creative your mind, the better you'll like our dual-in-line socket boards and cards. Because they give you more design freedom than Augat's.

For example, we put both 14- and 16-pin sockets on the same board. We build in a unique "wire wrappable" section for discrete

components. Also a "universal" section to take unusual components. And power decoupling. And "wire wrappable" test points. And so on, and so on.

Everything to serve you better.

**We're EECO. We'll see you through.**

**EECO**

1441 East Chestnut Avenue  
Santa Ana, California 92701  
Phone 714/835-6000  
Also from G. S. Marshall Company nationwide.

**FREE SOCKET BOARD AND PACKAGING  
HARDWARE CATALOG!**

We'll send it to you if you'll send us the information below.

Name \_\_\_\_\_

Position \_\_\_\_\_

Company \_\_\_\_\_

Address \_\_\_\_\_

INFORMATION RETRIEVAL NUMBER 11



# At last. A monolithic multiplier you don't have to trim.

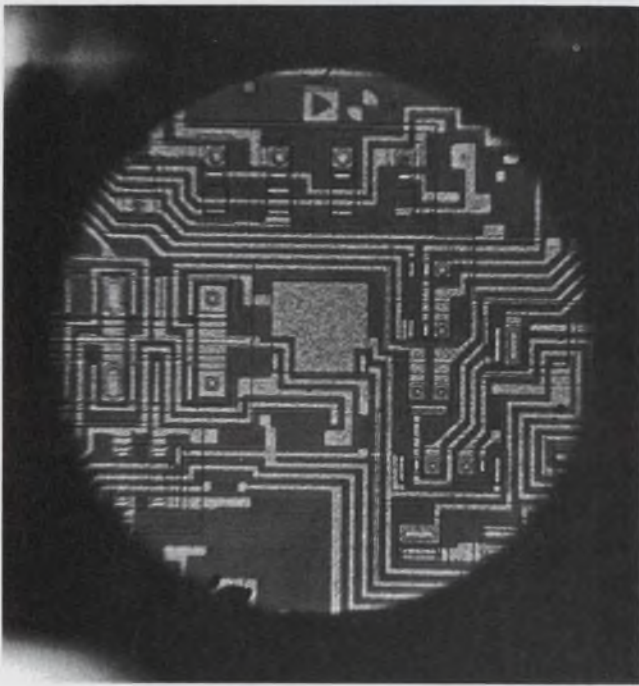

## AD532. Internally laser-trimmed by us. No problems for you. \$16 in 100's.

The AD532 is the first totally self-contained monolithic multiplier/divider. Thin-film resistors are deposited directly on the chip and trimmed during production with a computer-monitored laser.

The results?

First of all, you don't have to mess around with the trimming yourself, which saves you time and money.

Plus, you can take advantage of the inherently greater reliability of a monolithic IC. We've eliminated off-the-chip trim adjustments, so there are fewer connections and less possibility that something will go wrong.

The PSRR is improved, too, because variations in the power supply have a minimal effect on trim.

In addition, you get differential X and Y inputs, because the -X and -Y inputs are no longer needed for off-the-chip trimming. This gives you two instrumentation amplifier-like inputs with 70dB of CMR.

The AD532 is a plug-in replacement for our AD530, which has been, until now, the industry standard for small size, low cost, high performance multipliers.

Other features include a maximum error of less than 1.0% and an output swing of  $\pm 10V$ . An output null terminal permits independent setting of the output offset. The AD532 multiplies in four quadrants with a transfer function of  $(X_1 - X_2)(Y_1 - Y_2)/10$ , divides in two quadrants with a  $10Z/(X_1 - X_2)$  transfer function, and square roots in one quadrant with a transfer function of  $\pm \sqrt{10Z}$ .

All that for only \$16 in 100's.

We still make our high-accuracy AD530 multiplier and our AD531, the first programmable IC XY/Z multiplier.

IC multipliers. Just one more way to keep you — and us — a step ahead of everyone else.

For complete specs, write or call the high performance linear IC people at Analog Devices Semiconductor, Norwood, Massachusetts 02062. (617) 329-4700.



 **ANALOG  
DEVICES**

# Now you have an alternate source for 2GHz & 3GHz microwave transistors



TRW's new 2GHz & 3GHz microwave amplifier parts are available right now, off-the-shelf, from any authorized TRW distributor. So, soon as you qualify these parts, you are no longer at the mercy of a single-source manufacturer!

And here's some more news: our transistors are **not** simply "just as good" as the originals; they're better! Gold metalized to last longer. Metal migration failure is virtually non-existent. The 2GHz parts can also withstand infinite VSWR and overdrive. Yet TRW's gold metalized parts cost the same as ordinary aluminum ones (maybe less!).

These are practically drop-in parts. You can use them right now, in your present amplifiers—and, of course, in future designs. That means instant

improvement in the reliability of your amplifiers. Part for part:

	2GHz		3GHz	
	Aluminum	Gold	Aluminum	Gold
1W	MSC2001	TRW2001	MSC3001	TRW3001
3W	MSC2003	TRW2003	MSC3003	TRW3003
5W	MSC2005	TRW2005	MSC3005	TRW3005
10W	MSC2010	TRW2010	—	—

For details, call Don Comm, (213) 679-4561.

Or write TRW Semiconductors, an Electronic Components Division of TRW Inc. 14520 Aviation Blvd., Lawndale, California 90260.

## **TRW**® SEMICONDUCTORS

These products are available through the following authorized distributors:

Almo Electronics  
Bell Industries  
Cramer Electronics Inc.

Electronics Marketing Corp.  
Elmar Electronics Inc.  
Hall-Mark Electronics Corp.

Pyttronic Industries Inc.  
Rochester Radio  
Semiconductor Concepts Inc.

R. V. Weatherford Co.  
Westates Electronics Corp.  
Wilshire Electronics

INFORMATION RETRIEVAL NUMBER 13

## LSI finding a place in homes in multi-purpose alarms

Large-scale integrated circuits are starting to turn up in sophisticated security alarms for the home.

An LSI system introduced by Westinghouse Electric Corp., Pittsburgh, for use in high-rise apartment buildings has, in one system for the first time, all of these features:

- Alarm tones that distinguish fire and smoke conditions from intrusion and emergency conditions.
- Separate tones that distinguish line trouble from an actual alarm.
- A private code number for each apartment.
- Two-way voice communications between the central monitoring console and apartment units.
- An acknowledgement light that tells the resident that monitoring personnel have received the alarm.
- Adjustable arming and disarming time periods.

The all-in-one security system is based on a single, 40-pin LSI PMOS circuit. According to Douglas Drumheller, engineer in charge of the project, the original design was done with about 50 CMOS ICs. The switch to PMOS was made, he explains, when it was realized that power saved with CMOS was negligible compared with the high power required to drive the alarm speakers.

The chip is a random-logic, ion-depletion-mode device and is manufactured to MIL Spec 883 Level B, except for the burn-in requirement. The MIL spec was chosen to get very high reliability.

Smoke, heat and intrusion sensors are wired to a small master control panel in each apartment. This panel contains all of the alarm circuitry and is connected by a single cable to a central monitoring console, usually placed

in the lobby of the building.

There are two distinct alarm sounds: an electronic gong for fire and smoke, and a siren for intruders and other emergencies. These signals are digitally generated on the chip. Other functions performed on the chip include fault and level detection, system testing and supervisory control.

In addition to the MOS chip, the system contains a 256-bit bipolar pROM that holds 3-to-6-digit user code, a communication board that contains a discrete-component power amplifier for the intercom, and a local power supply.

Drumheller points out that the communication board is a plug-in that can be changed for interfacing to a CATV network.

### 4-signal RCA system joins quadrasonic race

A quadrasonic FM stereo system that broadcasts four discrete audio signals was demonstrated by RCA at the National Association of Broadcasters Conference in Houston, Tex.

The system is competing with at least seven others for ultimate adoption by the Federal Communications Commission.

Gene Bidun, broadcast professional equipment product manager for RCA Government and Commercial Systems, Moorestown, N.J., says the new system is compatible with existing stereo and monophonic FM receivers. A key feature is two modes of operation.

In one mode four separate signals are broadcast, but the subcarrier frequency that is used for FM background music cannot be used. Since background music produces considerable revenue for FM stations, it can be retained in the second mode of operation, with

only about 10 dB loss of channel separation, according to Bidun.

The RCA system will be evaluated by the Electronic Industry Association's National Quadrasonic Radio Committee this spring or summer. Not all of the systems under consideration by the EIA transmit four discrete channels. Some are matrix systems that use the existing two stereo channels and rely on phase-shifted audio components to produce a simulated four-channel effect.

With RCA's system, Bidun points out, four signals—M, X, Y and U—are combined for transmission in the same way as mono and stereo. The M channel contains all of the four-channel information, so it is compatible with existing receivers.

The standard 38-kHz stereo subcarrier is modulated by a double-sideband AM suppressed carrier to form the second, or X, channel. The third, or Y, channel is provided by a second 38-kHz subcarrier that is in quadrature with the first and similarly modulated. The fourth channel, which uses a 76-kHz subcarrier, is provided by the U signal, modulated like the X and Y channels.

All four audio signals can have a bandwidth of up to 15 kHz, and all of the information for four-channel sound is multiplexed onto the main FM carrier within a total bandwidth of 91 kHz.

Because the most significant information for four-channel sound is impressed on the three highest quality channels—M, X and Y—the fourth channel, U, may be dropped to use the FM signal channels in the 53-to-75-kHz band.

### PC-board holes made with simpler technique

A photochemical process for making "through-holes" in printed-circuits boards is reported to be cheaper and simpler than the conventional mechanical technique.

According to the developer, Sandia Laboratories, Albuquerque, N.M., the technique cuts costs by eliminating a lot of machinery: numerically controlled or optical drilling machines, as well as the jigs and fixtures normally needed for reference holes and the regis-

try of circuit art work. The processing time for finished boards is also reduced, and the technique allows complete automation of PC board manufacturing by reducing it to a batch process.

The key to the new process is a dielectric substrate containing preformed holes spaced on a 0.1-inch matrix. These 0.03-inch diameter holes conform to accepted drafting practices and match the lead patterns on such components as transistors and ICs, permitting components on both sides of the board to be connected.

The holes are punched, drilled or molded into the substrate during original manufacture, then covered on both surfaces of the board by standard copper cladding. A row of holes is left uncovered along one edge of the board for registration.

To open the proper holes in the substrate, the board is covered with a standard negative photoresist coating and exposed through a photo positive containing the hole diameters and locations for a circuit. Standard developing and etching open the holes on each side of the board.

The resulting hole pattern is then cleaned and plated through with existing techniques. Remaining steps follow the standard "panel plate" process. Larger holes for mounting, plotting and other purposes can be made with the technique, then drilled through with an inexpensive shop drill.

## Satellites to give WU 30 times more capacity

With the launching this month of the first of three domestic communications satellites, Western Union is moving to increase by thirtyfold the capacity of its transcontinental microwave transmission system.

The two other satellites are to go up in June and October.

The satellites, called Westar, are almost identical to Telesat Canada's Anik. Both the American and Canadian systems were built by Hughes Aircraft.

The three Western Union relay stations will operate with five fixed earth stations and associated microwave relay links. There will also

be a ground station for tracking, telemetry and the forwarding of commands to the satellites.

At the heart of each satellite is a communications repeater that consists essentially of 12 independent fixed-gain amplifiers, each with a bandwidth of 36 MHz. Common to all transponders is a wideband receiver that establishes the system noise temperature, translates 6-GHz receive carriers to 4 GHz for down transmission and amplifies the 4-GHz carriers to an intermediate power level prior to channelization.

A significant advance in technology over that incorporated in previous communications satellites is Westar's antenna de-spin system. De-spinning is necessary to keep an antenna oriented toward the earth while the body of the supporting satellite spins in orbit for stability.

Canada's Anik has a de-spin and antenna-pointing mechanism that uses an earth-generated control signal. This, however, "creates the possibility that signal—or power—failure at the control station could result in antenna misorientation and complete loss of communication, Western Union says.

To guard against this, Westar was provided two precautions: Highly accurate antenna spin control is provided by a pilot signal from the earth. And this is backed by a simple on-board de-spin system that takes over instantly and automatically if the pilot signal is interrupted.

Another difference is in the feed system. Anik's antenna pattern is generated by a three-horn, phased-feed system that creates an elliptical pattern over Canada. Westar uses a four-horn, phased-feed system that creates an elliptical pattern over the United States, a spot beam over Hawaii and provides a "back-porch" pattern covering Alaska and Puerto Rico.

## A-power project to try new laser optic setup

A key element in a system that may ultimately produce unlimited electrical energy from isotopes of hydrogen in sea water is a new reflecting optical system for directing and focusing high-energy laser

outputs.

Developed by the Raytheon Missile Systems Div., Bedford, Mass., for the University of California's Los Alamos Scientific Laboratory in New Mexico, the optical system is being used to determine the feasibility of using lasers to initiate controlled thermonuclear fusion. The program is part of the Atomic Energy Commission's effort to produce practical electric power with thermonuclear sources before the year 2000.

The Raytheon approach handles the laser beams at visible or infrared frequencies. Donald Banks, chief scientist at Raytheon, says the system has a much higher surface-to-aperture ratio than conventional systems do, thus reducing the power per unit area.

A proprietary material with very high dimensional stability is used. Problems with earlier systems have centered on the fact that many lens materials deteriorate because of the heat generated by the laser beam.

The new system uses highly polished geometric solids for the reflecting surfaces. A key element on which the laser energy is directed is a mirror-surfaced hyperbolic-shaped solid that resembles the nose cone of a missile. The energy is reflected from this surface to other surfaces in the focusing structure, and eventually to a target point, where the focused energy produces intense temperature and pressure.

Because the lasers can deliver large amounts of energy in short times and the beams can be focused on extremely small areas, they are potentially capable of providing compression and the intense heat of millions of degrees believed necessary to induce fusion in such materials as heavy isotopes of hydrogen. Once the nuclear reaction is initiated, the energy released—many times that put into the system—would be absorbed by liquid lithium and thermodynamically converted to electricity.

The Raytheon system will be used at the Los Alamos Laboratory to handle and focus high energy from carbon-dioxide laser chains.

The optical system was developed by Raytheon in a three-year program headed by Dr. Werner Rambauske.

# The new Keithley Model 168 autoranging DMM... ...vive la différence!

There really is a difference in Digital Multimeters, and once you've experienced Keithley's 168 you'll know why we say *vive!* If you're tired of "general-purpose" promises that turn into run-of-the-mill

performances; if you want that bit extra that'll make your job easier, then *vive la différence*... here's the DMM for you! Send for our DMM Selector Guide or call us for demo now. Phone (216) 248-0400.

**AC VOLTS**  
**DC AMPS**  
**OHMS**

**5 functions**  
100  $\mu$ V to 1000 V dc  
100  $\mu$ V to 500 V ac  
0.1  $\mu$ A to 1 A dc  
0.1  $\mu$ A to 1 A ac  
100 m $\Omega$  to 20 M $\Omega$

**price**  
Enough said? Order one... or two... or three now!

**\$299<sup>00</sup>**

### two-terminal input

Simple to connect. You can't get it wrong. Eliminates the word "whoops" from your vocabulary. Saves temper, too.



### options & accessories

Rechargeable batteries that you can install anytime. An RF probe for high frequencies. Test leads. A 50-amp current shunt too.



### hi-lo ohms

Select either of two voltage levels, 1 V or 100 mV, for ohms measurements. You can have your PN junctions either way you want 'em... on or off.



### automatic ranging

You just connect the signal and push the function. The decimal point pops into position automatically and the display is direct reading. That does save time!



**KEITHLEY INSTRUMENTS**  
U.S.A.: 28775 AURORA ROAD, CLEVELAND, OHIO 44139  
EUROPE: 14, AVENUE VILLARDIN, 1009 PULLY, SUISSE

## REPORT ON BREADBOARDS

# From \$2.50 to \$1500, good systems can save you time in circuit design

"With the right breadboarding system, I can turn out a fairly complex circuit design in a matter of hours. With the wrong kind, it may take all day, and even then, translating it to a prototype for production can be a pain in the neck."

This observation, made by an instrument designer, is echoed by engineers around the world. A good breadboarding kit is important. But what is good? And for whom?

There are all kinds to choose from. They cost anywhere from \$2.50 to \$1500, and there are advantages to all. They include these:

- *A plain board with punched holes*—the simplest form. Sometimes special pins for wired interconnections are provided. Components are mounted and connected to the pins.

- *Plug-in kits with interval bus bars*. These are slightly fancier. They require no soldering; circuits are formed by "push-in" wire connectors.

- *More complex plug-in kits*—

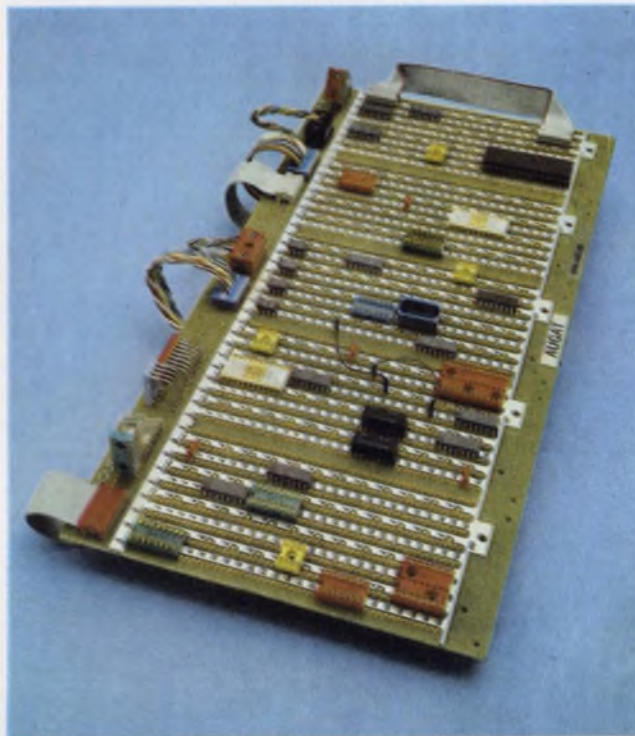

**Breadboard hardware**, by Augat, is designed to accept either ICs or sockets into which ICs can be plugged. Interconnections are made with wrapped wire.

with built-in power supply, system checks, switches and lamps. They can cost \$1500.

- *Soldered-wire systems*—a building-block approach. Special component-mounting pads are interconnected with soldered wires.

- *Self-adhesive kits*. Similar to decals, the metalized wire layouts are mounted with self-adhesive backing. To lay out a circuit, you simply peel off the backing and

press the pattern onto a circuit board.

- *Wrapped-wire panels*. They consist of rows of sockets that can be tied together by wrapped-wire solderless interconnects. Here, components are plugged in on one side of the board and interconnected from the other side with a simple wrapping tool.

### What do you need?

Which advantage is important for you? You can't have them all in any one board. These are prime considerations:

- *Simplicity or deluxe "laboratories"*? What's the case for a plain board with punched holes vs the expensive systems that come equipped with their own power supplies, pulse

generators and switches? The extras, called by some vendors "complete laboratories," run into money but can be worth it if they are used continuously by a large group of engineers whose designs are copied by technicians.

- *Reusable socket boards*. Reusability is important for schools and for engineering applications when the cost of components is a factor. You don't want to solder

John F. Mason  
Associate Editor

# P&B... get the message?

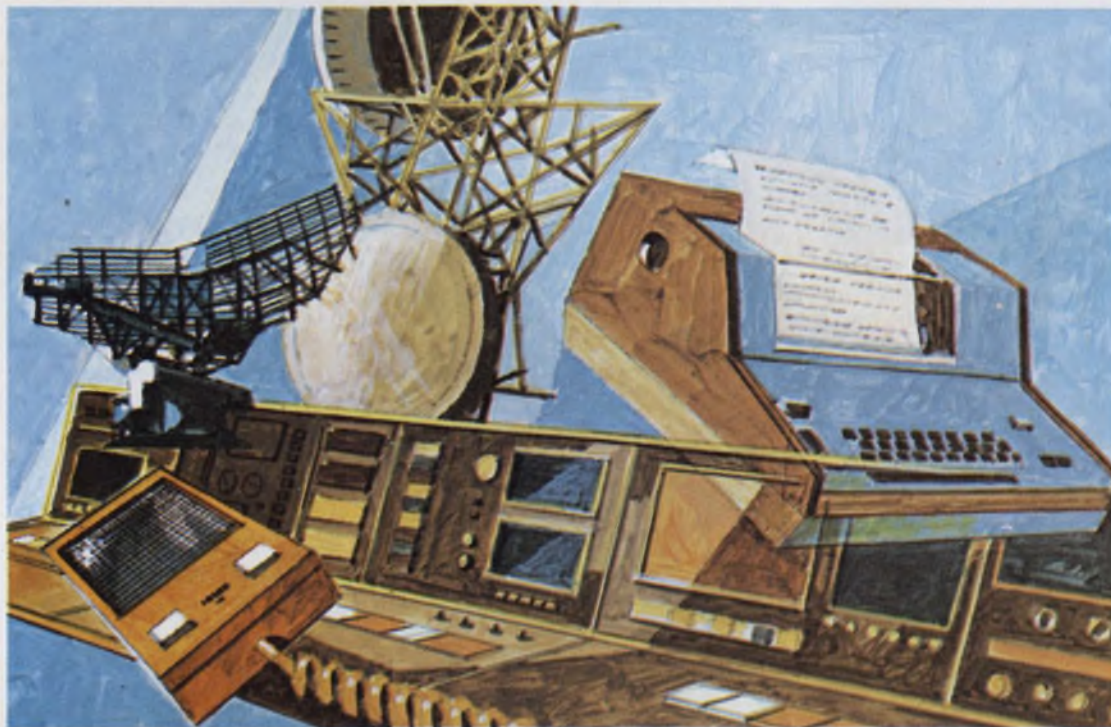

Thousands of communications equipment designers do. They specify P&B relays in their products because reliability in communications is a must, and P&B relays have a reputation for long life.

Specifying P&B is easy. After all, P&B makes more different types of relays than anyone else. Electromechanical... reed... solid state/hybrid... solid state... time delay. As well as relays created specifically for a particular application. And even relay-oriented sub-assemblies custom produced to your requirements.

And, when relays do need to be replaced, identical-to-original relays can be obtained from the

broadest network of relay distributors in the country. Ours.

Our message is clear.

Whenever you need relays or design assistance concerning relays and assemblies employing relays, contact your P&B representative. He can also give you our free

226-page catalog. Or, write Potter & Brumfield Division of AMF Incorporated, Princeton, Indiana 47670. Telephone 812 385 5251.



## Solving switching problems is what we're all about.



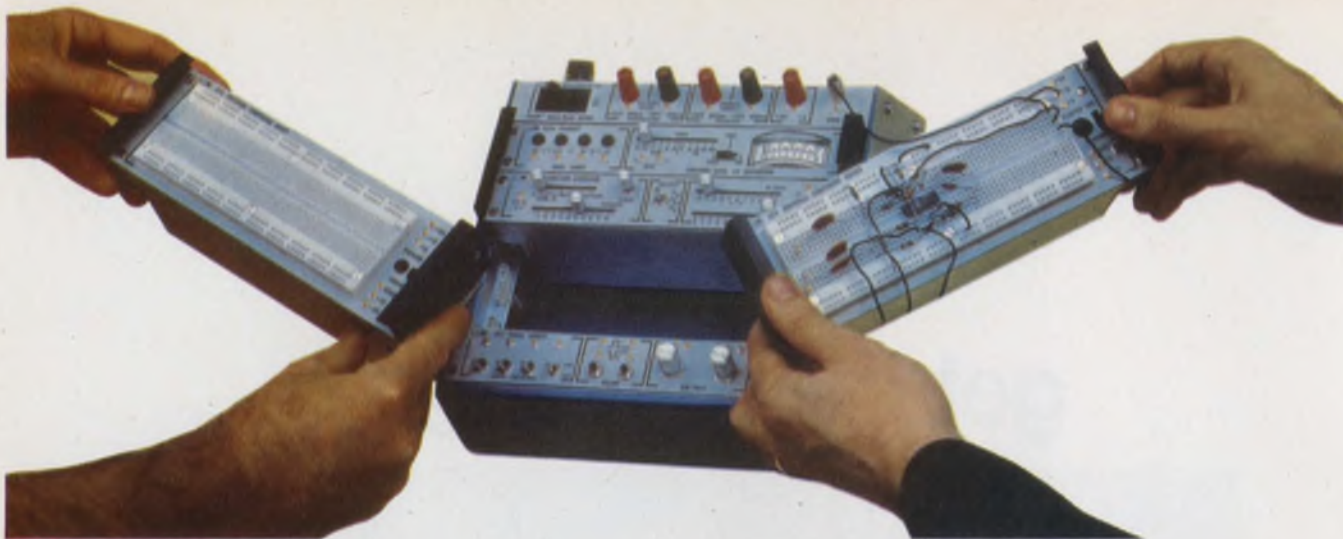

Removable sockets are provided by Adam I, by E&L Instruments, so one engineer can use the system's power

supply, pulse generator and other accessories, then remove his socket and let another engineer move in.

an expensive IC and later risk destroying it when you try to take it out. If the breadboard is going to become the prototype, of course, it's a one-shot deal anyway.

- **Ease of use and time saving.** The time it takes to design a circuit is not necessarily proportional to the quality of the finished product. You can work all day and turn out a mess if you're using the wrong hardware. The important thing is to have a system that calls for a minimum of mechanical manipulation and lets you spend your time on the creative aspect of design.

- **Standardization.** There's a strong trend toward building systems that will accommodate all kinds of components without need for adapters. It's important to be able to use what you've got on hand rather than having to go back to the factory.

- **Availability.** It's important to buy from a company with an adequate continuing line of products.

- **Versatility.** The breadboarding equipment should be able to handle simple components and advanced ICs. It should also be ready to accept new technology as it emerges. You may find that a board designed for 14 or 16-pin DIP ICs with rows on 300-mil centers may not be able to handle DIPs with 24 or 40 pins or DIPs with pins on 600-mil centers. It's also important to be able to add tie points and test points as a design progresses.

- **Reliability.** The designer can



**Tuned circuit** can be mounted in less than four minutes on a GP-7 Mini-Mount, Christiansen Radio says. It's one of 14 patterns used in the company's no-hole, no-drilling, dc-to-GHz breadboard systems.

lose time and his patience trying to figure out why an oscillator doesn't oscillate when all the time an internal bus bar is intermittent.

- **Convertibility.** Easy transition from breadboard to prototype to production model is important.

- **Cost.** It's wise not to overbuy or underbuy. For small projects, it's extravagant to use boards with elaborate jumper-terminal systems, installed sockets and power supplies. On the other hand, a lot of expensive time can be lost on a big job if special tools and connectors have to be fabricated.

#### Simple or deluxe?

When is a \$3 board better than a \$1500 system? This is not a set-

up for a joke; it's an important question with important answers.

"A simple breadboard is good if the only goal is to get a simple circuit operating to demonstrate a counting frequency or to make product variance tests, or evaluate second-source devices," says Floyd L. Hill, vice president of marketing of Vector Electronic Co., Sylmar, Calif.

"A simple flip-flop circuit can be handled by a pair of Vector's new Klip-Bloks [miniature patchboards with 0.1-inch spaced multiple contacts] mounted on a piece of perforated board with a few adjacent terminals," Hill says. "A high-speed logic breadboard may require elaborate shielding, ground-plane construction, convenient, accessible three-level power buses and a wiring technique that keeps signal interconnections as short as possible."

Vector offers its Universal Logic Cards and specific accessories for these situations.

Another plug for simplicity: "The kind of board depends a lot on where in the production development cycle it's going to be used," says Richard David, vice president of Keystone Electronic Corp. in New York. "A cheap board is good for simple designs that can be used as the prototype itself. Also, if a breadboard must be kept throughout the product life as a means of updating or checking the design, a simple board can be used; it would be ex-

*(continued on pg. 34)*



# Tic-Push-Toc-It's balanced!

New Honeywell signal conditioner  
with automatic 2 second bridge balance -  
saves time - saves money.

Strain gage excitation, automatic balance, amplification and complete signal control in this size plug-in module.

- Continuously adjustable sensitivity, readable from front panel.
- Calibrated input suppression.
- Galvanometer sensitivity and position controls.
- Tape playback mode switch.
- Local or remote sensing.
- Three non-interacting output amplifiers.
- Bipolar double shunt calibration.
- Wide sensitivity from one to 1100 mV.
- Frequency range from dc to 50 kHz.

Honeywell's new Accudata 218 is the time and money-saving strain-gage amplifier unit that electronically and automatically balances the bridge in *less than two seconds*. (Many times faster than most manual balancing units.)

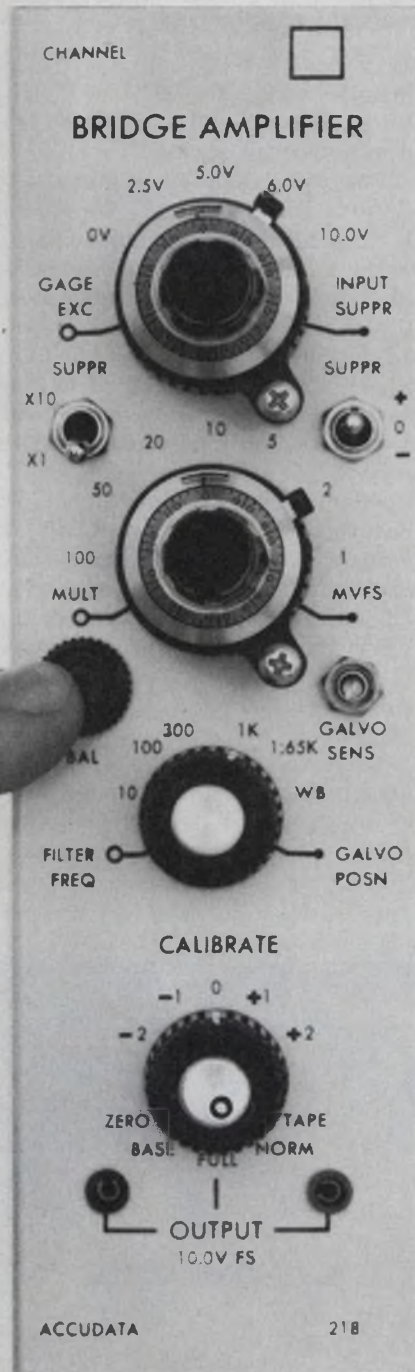

Accudata 218 - Actual Size

Other time-saving features: direct reading sensitivity for rapid calibration—reduced set up time. Tape playback selector switch eliminates need to change signal input and recalibrate system sensitivity when switching from record to playback.

AND... full scale output switch mode that eliminates external recorder calibration techniques. Internal, calibrated input suppression that eliminates the need for external power supply and hook-up.

PLUS... three non-interacting outputs that provide insurance against loss of data in the event of shorts or overloads.

Below: Two more of Honeywell's fine family of Accudata signal conditioning units: The Accudata 122/123—solid state, wide band, wide gain range differential input dc amplifiers. And the Accudata 117—a direct coupled, single ended floating wide band amplifier of moderate gain for use as a general purpose signal conditioning instrument.



For a FREE short form catalog and specifications on the Accudata 218, write or call: Lloyd Moyer, Honeywell Test Instruments Division, P.O. Box 5227, Denver, Colorado 80217 (303) 771-4700.

**Honeywell**  
The Automation Company



For breadboarding small quantities of ICs, this panel from Augat is handy, because interconnections are made with standard wire jumpers.

pensive to use a high-priced unit."

"One factor here," says Murray Gallant, president of E&L Instruments, Derby, Conn., "is whether you're working in a place that's already got the power supplies and pulse generators and other peripherals that you need for designing. A student, for example, doesn't need anything more than our SK-10, costing \$17.25, because he has access to the university equipment."

He can design as many circuits as he wants, making solderless connections to and from circuits within the SK-10 simply by inserting stripped ends of common #22 solid wire into small holes in the top of the socket. He doesn't need built-in auxiliary equipment.

"But a \$1500 deluxe model does pay off," Gallant continues, "when you are setting up a new operation where there are no power supplies, pulse generators or any of the other things you need for

breadboarding. Under these conditions it may well be cheaper to buy the entire package."

For this, E&L Instruments offers its Elite series and its Adam I. The Elite 2, for example, provides a built-in function generator, dual-output pulse generator, three independent power supplies, 12 buffered monitor lamps, four SK-10 component sockets, isolated switch and pushbutton arrays and a variety of I/O connectors. It costs \$1395.

Adam I goes a step further. It has the basic instrumentation of Elite 2 plus a socket board that can be removed, leaving space for an extra one to be slipped in. "Five or six engineers, each with his own socket, can use the same Adam mainframe," Gallant explains.

Later this year Adam II will be announced, offering a heavier power supply. Adam I costs \$450, and Adam II, which will probably

phase out Elite 2, will cost approximately \$1500.

Hewlett-Packard is now offering a digital laboratory in a compact package that was developed originally as an educational tool. The unit, Model 5035T, sells for \$650.

### Consider the components

Another factor in choosing a board is the kind of components you plan to use, says Vector's Hill: "Industrial applications often call for large components with non-standard lead and mounting dimensions." For these applications perforated boards with 0.093-inch holes on 0.265-inch centers are often used.

With large or heavy components, of course, the board, whether simple or deluxe, should be thick enough to support them. If a board bends it could cause connections to open.

When trying out new ideas, a relatively simple pre-punched board and push-in terminals are more useful than a virgin board, advises Keystone's David. Various configurations can be tried without need to punch your own holes. Keystone's boards come with hole sizes ranging from 0.042 to 0.120 inch in diameter and spaced on 0.1 to 0.375-inch centers.

Virgin boards are cheap or expensive, depending on who is using them, says E&L Instruments' Gallant. "For a hobbyist whose time is free, a virgin board is a very inexpensive device. It's one thing for *him* to spend two hours boring holes and another for a highly paid engineer."

But virgin boards do have their uses, David says. They're good for limited production runs when the design is already set. When laying out a virgin board, however, the designer should give careful consideration to the various terminal types available.

"The circuit board should not become cluttered," David notes, "nor should a terminal have more wire connections than it was designed to carry. This is particularly important in military work, where specifications determine the method and number of connections to a terminal."

Keystone offers a line of terminals that include single or multiple turrets, tubular (hollow), double-

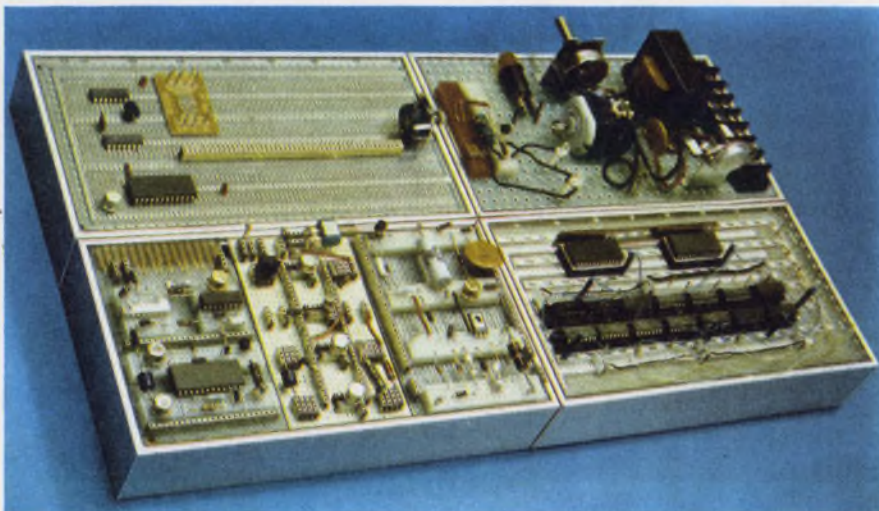

Multiconn breadboarding system, made by Vector, can accommodate almost any interconnection technique—wrapped, soldered or push-in wire.



# BROWNOUTS

and how to beat them

Even if no utility cutbacks were expected this year, you'd still have to live with brownouts caused by heavy equipment startup and excessive power demand.

And even a 10% brownout can make trouble. Solenoids actuate too slowly. Coils and transformers overheat. Inadequately protected motors run at the wrong speed or overheat. Semiconductor circuits malfunction.

Sooner or later, individual component breakdowns will precipitate broader equipment failure. When this happens, your customer isn't going to like the downtime and you're not going to like the expense (and embarrassment) of having to service an otherwise reliable product.

Heinemann comes to the rescue

with—you guessed it—a "smart" circuit breaker that takes your equipment off line before brownout can damage it. The same breaker, remarkably, also provides overcurrent protection and power switch functions. The secret is a solid-state module that senses undervoltage conditions and, after a predetermined short delay, causes the breaker to trip.

Brownout protection is a new option on any of our Series JA (up to 30A), AM1 (up to 60A), and CF (up to 100A) breakers using the patented Du-Con™ internal circuit.

Want to beat the brownout before it beats you? Contact your nearby Heinemann representative or Heinemann Electric Company, Trenton, NJ 08602. Phone (609) 882-4800.

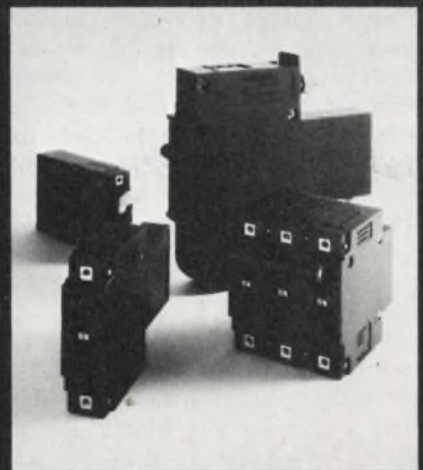

## HEINEMANN

We keep you out of trouble.

ended and split push-in types in a number of places.

### Is reusability important?

In general, it's a good idea to buy a breadboard you can reuse, says Hill of Vector. But in any given case it depends on the nature of the circuit, what you're going to do with the breadboard and how tight money is.

For schools, the whole idea is to learn and to reuse the board as long as possible. And even in some engineering applications the cost of components may be a factor—unsoldering an expensive component isn't always successful. But with cheap components, it may be cost-effective to solder parts that won't be changed anyway, Hill says.

All of Circuit-Stik's basic drill-board material, sockets and connectors can be used many times, says Donald E. Harper, the company's director of marketing in Torrance, Calif. In the case of Circuit-Stik sub-elements, the basic board is built up with standard patterns, such as three-lead transistors, and 14-lead DIP sub-elements. The active components may be removed and new components soldered in, Harper says. If you want to change a three-lead to an eight-lead TO-5 sub-element pattern, it can be done easily by replacement of the pattern, he says, adding that the remainder of the board would possibly still be reusable without any changes.

A number of companies make plug-in boards that don't require soldering and unsoldering. Boards made by Cambion in Cambridge, Mass., provide jacks or sockets for components to plug into. Some of the patch cords are of the piggy-back type, allowing many connections to be made at one point.

E&L Instruments also builds plug-in boards. According to its president, Gallant, the company has steered clear of helical spring terminals because with them "intermittent conditions inevitably result, due to the single helical spring's inability to flex, its lack of wiping action when leads are inserted and the difficulty of mounting very thin leads which simply slip out."

Since prizes are never handed out for the way you design a cir-

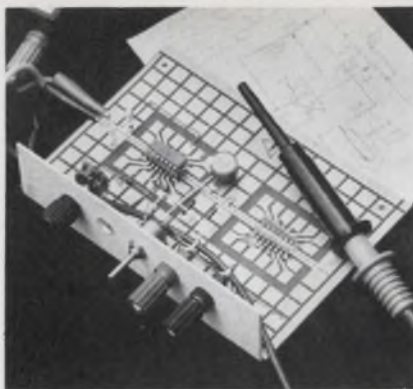

**Instant Breadboard**, by Instant Instruments, Glen Cove, N.Y., allows the engineer to assemble a circuit without inserting components. The circuit is soldered to pre-etched patterns of large, lift-resistant copper.

cuit—but only for the merit of the finished product—the faster and easier you do it, the better off you are. Some companies attack the time and ease-of-use problem by building breadboards that require no adapters and no soldering. They build plug-in boards that are designed in a logical, visual way that's easy to understand. You don't have to reverse the board to translate it to a prototype. Makers of such systems say they provide a time saving of 3 to 1 over any kind of soldering system, and 2 to 1 over any solderless system that is designed around dual-in-line packages that are built in fixed configurations. This includes wrapped wire. When you have to work with these fixed configurations and put the ICs where the breadboard manufacturer wants you to—and use his special jumpers—it takes time, according to these manufacturers.

### Quick and easy

Many manufacturers' designs are based on solderless construction with instant interchangeability, inexpensive interconnections with common jumper wire and a wide range of component sizes and shapes.

Components, both discrete and integrated, are inserted directly into the socket, with a secure spring contact to hold them in place. These springs are bifurcated, rather than helical, and are self-wiping on each insertion of components or leads. They are firmly embedded in a precision,

plastic matrix and are exceptionally uniform in contact pressure over a wide range of component lead sizes.

Some designers prefer wrapped wire for both breadboard and prototype hardware. According to R. T. Hunter, product manager of Electronic Engineering Co. of California in Santa Ana, the technique is growing rapidly.

"A technician can wrap about 40 wires per hour, which really isn't too bad," Hunter says. "And a machine can wrap, using semi-automatic equipment, in excess of 240 wires per hour."

Wrapped-wire interconnects work very well with IC socket-panel hardware, Hunter says, because when changes become necessary, they are easy to make.

"Changes of components, interconnection or circuit complexity can be made easily by hand at any time during the breadboarding or prototyping period," he says.

Other manufacturers see a disadvantage to wrapped wire—one that doesn't become apparent until you try to use it. All schematics or circuit diagrams for ICs are drawn as you look at the unit from the top, while wrapped wire is done from the reverse side of the IC. This is fine if you can get your mind to work 180 degrees out of phase, some manufacturers point out, but this takes practice.

Circuit-Stik helps the designer save time by providing pressure-sensitive circuit sub-elements as well as plug-in boards.

Holes are pre-drilled for easy insertion in the boards. And other connections, such as stripline and copper tape, are backed with adhesive. These are placed between the two points to be connected and a drop of solder is used at each end.

"The pressure sensitive adhesive holds the stripline and the tape firmly in place, but either one can be pulled free by using a sharp knife," says Harper, the company's marketing chief.

With the adhesive approach, you can easily modify sub-elements, he says, simply by slicing off one with a sharp knife and replacing it with another. A stripline can also be used to cross over other connections, because it is insulated. It can go on top of an existing de-

# vactec phototransistors

VACTEC, INC.

2423 Northline Industrial Blvd.

Maryland Heights, Mo. 63043

Phone (314) 872-8300

Vactec npn epitaxial large chip, high sensitivity phototransistor. An enlarged section of the wafer forms the colorful background.

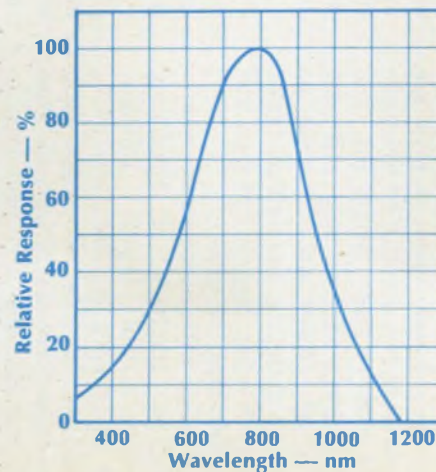
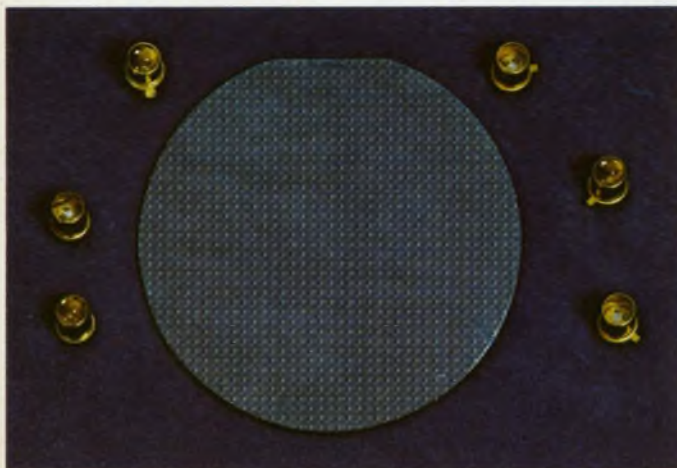

Standard Vactec phototransistors provide very high sensitivity and good blue response. Liberal design flexibility is also offered with trade-off for some characteristics, including: light current; response time; spectral sensitivity; and breakdown voltage. Selection of packages are TO-18, co-axial, pill, non-hermetic TO-18 size and special arrays on 50-mil or 25-mil centers.

Custom design is practical for quantities as low as 10M per year. Masking charges are nominal. Our automatic test capability includes 100% sort (with light applied) for  $I_{CEO}$ , breakdown voltage and dark current. Vactec can also second-source practically anyone's phototransistors. Write for Bulletin VTТА-1 today.

sign, if modification is necessary. Circuit-Stik GP boards can be used with wrapped-wire sockets, which you can modify by changing the wire.

Christiansen Radio of Laguna Beach, Calif., tries to make life easier for the designer by offering a decal-like, adhesive-backed, pre-etched circuit board, called Mini-Mount. It is designed to mount most existing electronic components on the top surface of the board.

The base material is a G-10 glass epoxy, which provides good bond strength to copper patterns. All patterns are solder-coated for easier soldering and to protect the copper from oxidation.

With Mini-Mounts, you merely decide on a tentative layout on the ground plane, remove the backing paper from the mounts and place them, with light pressure, on the ground plane. Multi-lead devices can be soldered on the mounts first, if desired. Interconnecting wires and component arrays are then soldered directly to the pads. To remove any component, you melt the solder at both ends and lift off. There are no holes or wrapped joints to contend with. Mini-Mounts can be removed and repositioned at will.

In line with photographic reproduction methods of producing printed-circuit boards. Injector-al Electronics in Glen Cove, N.Y., supplies a line of copper-clad, sensitized boards in various sizes that enable the first prototype to be made quickly, with savings in materials, time and labor when additional boards must be reproduced. The company's boards are sprayed with photoresist and baked. The board is then exposed to an ultraviolet light for a few minutes and etched. The result is described as "a quality, professional board."

The great advantage of this method, according to the company's president, Everett Wollman, is that if additional boards are needed, they can be reproduced with a few minutes exposure to light.

A word of advice is offered by Keystone's David on the use of push-in and staked terminals when pre-punched boards are used. The push-in is preferred, he says, where speed of assembly is important and terminal replacement

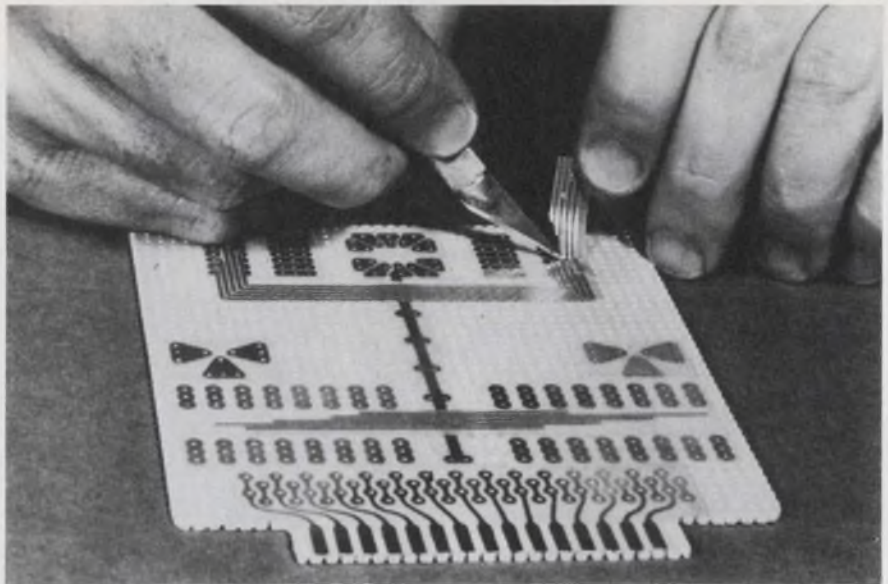

Adhesive-backed circuit sub-elements, interconnecting materials and board materials that eliminate the need for wire, are provided by Circuit-Stik.

impossible. However, push-ins tend to become loose after a number of components have been added and removed, and they can't be subjected to severe mechanical stress. They are a good choice, he concedes, in the initial stages of prototyping, where changes are frequent in the design of compact packages.

"If a large number of component changes is anticipated during the design," he says, "or some longevity is required, the turret terminal is the best."

Generally the larger the number of reliable connections that can be made at one point, the more desirable the breadboarding system, says Hill of Vector.

According to Christiansen Radio, multiple connections to ground make up the biggest node in a system and potentially the largest single source of problems. If the circuit calls for many such grounding points at the node, the breadboard should be able to furnish it conveniently.

#### How important is versatility?

To provide versatility, Christiansen Radio offers breadboards that differ in pin count, heat dissipation, physical size and shape, profile, cost, radiation sensitivity and ruggedness. The breadboard system should be able to accommodate all.

For prototyping, a wide range of component types and sizes are available that can be mixed on one

circuit board, including both discrete components and ICs. Several designs permit the mounting of any combination of DIPs, from eight leads up to 40 leads, while still permitting packaging densities as high as 49 14-lead DIPs on a card 4-1/2 by 6-1/2 inches.

Advice from several manufacturers: Ease of electrical testing is a major reason for making a breadboard. A positive feature to look for is a breadboard with a place to clip the scope probe on test points.

#### It must be reliable

Expensive engineering hours should not be spent tracing intermittent connections or other breadboard or prototype hardware problems.

Some companies offer drilled holes instead of punched holes for prototyping hardware because, as one puts it, they are "clean and accurate with no fractured edges." They are also free of contaminating glass fibers, and therefore don't have as much tendency to absorb moisture. Since the holes are cylindrical rather than partly crushed by a punching die, the cylindrical hole provides a rigid support for sockets, terminals and wrapped-wire pins.

"As a result of our quality drilling, our material offers a 65% increase in board strength over ordinary punched boards," one company official maintains.

# Here's a display breakthrough

## New plug-in display modules from Beckman ... buy the numbers



3 digit module

Easy to use

Ready for operation

— horizontally stackable to any length



2 digit module

In readability . . . size . . . and reliability — Beckman Displays lead the way. Now, Beckman pioneers with a brilliant new line of "plug-in" display modules designed for both high and low volume applications. And, top convenience.

Circuitry is built in. All you do is apply BCD and voltage inputs: the modules are ready to use. They feature the big ½" Beckman Displays that have an even centerline spacing of 0.531". The solid characters are visible at angles up to 130° in bright sunlight . . . easily readable up to 40 feet. Color? The same distinctive orange featured in all Beckman Displays (Red is available with filters).

The basic Beckman SM-850 Series modules include the display, a monolithic decoder/driver and a latch. A companion series even includes a counter. All you really

need to do is apply voltage and BCD input. And you can get the complete 2 digit unit, without counter, for only \$19.50 per digit in single unit quantity. If you order 100 the price is only \$14.25 per digit.

Beckman designed these modules to save you circuit design headaches and assembly time. Whether you use just a few displays or a million, you owe it to yourself to find out more about these neat little black boxes. Get the whole story today. Contact your local Beckman representative or stocking distributor.

**Beckman** INSTRUMENTS, INC.

INFORMATION DISPLAYS OPERATIONS

P. O. Box 3579, Scottsdale, Arizona 85257 Telephone (602) 947-8371.

## There's more eye appeal in Beckman Displays!

FOR THE NAME OF YOUR BECKMAN DISPLAYS DISTRIBUTOR OR REPRESENTATIVE

# CALL TOLL-FREE 800-645-9200

(IN N.Y. STATE, CALL COLLECT, 516-294-0990)

INFORMATION RETRIEVAL NUMBER 19

Circuit-Stik builds its boards to last beyond the original functional workbench tests. Its prototype boards are similar to production boards made from high-quality FR4 epoxy glass material. They have heavy gold and nickel plating on connectors, and where adhesive sub-elements are used, they offer a stronger bond strength than is normally used in the manufacture of copper laminate materials.

As a result, the Circuit-Stik breadboard or prototype can be wave or flow-soldered and cleaned in ultrasonic cleaning tanks with Freon and trichlorethylene. The company says its prototype boards have been subjected to high altitude and vibration and have been tested for nuclear radiation hardness, high and low temperatures and a vacuum environment with no loss in performance.

### Making the next step easy

Conversion from breadboard to prototype to production model should be as painless and inexpensive as possible.

Many breadboards can be used as prototypes, but for those that will be subjected to harsh environmental conditions that they can't survive—such as heat—some companies build PC boards that are identical to the breadboards that they sell. When the designer is satisfied with his breadboard, a technician can transfer the components to the PC board in about 20 minutes, and he's got his prototype.

Sometimes breadboards are chosen for the material they are made of—designers want them to be as much like the prototype as possible.

"We like glass epoxy boards rather than paper, because glass is closer to the thing we're making—flight equipment," says Hugo Ritucci, a senior engineer at Grumman Aerospace in Bethpage, N.Y. "Laying out our breadboard as close to the final package layout as possible gives us better performance as far as straight capacity and interwiring pick-up is concerned. We don't want any surprises when we make our final layout."

In the same vein, the breadboard

should not have better power-handling capabilities than the final model will have. And if heat sinks will be needed to dissipate heat in the production model, the breadboard model should use the same sinks.

"Mechanical changes in a production model to accommodate unexpected temperature problems are the most difficult and expensive to accomplish," one company says.

Augat believes that the use of wrapped wire saves the designer money. Even though its socket panels cost more than typical breadboards, the initial cost is

justified as the board is phased into production and is capable of weathering design changes, the company says.

One manufacturer says: "Wire is a very inexpensive patching material, compared to soldering or to use of banana plugs or special molded pins."

Christiansen Radio's bid for economy is in the use of its stick-on Mini-Mounts. "These mounts are so cheap they make the idea of throw-away breadboards feasible—unless, of course, the components have to be saved," Christiansen says. ■■

## Need more information?

We wish to thank the companies that provided information for this report. The products cited in the report have been selected for their illustrative, or in some cases, unique qualities. However, manufacturers not mentioned in the report may offer similar products. Readers may wish to consult manufacturers listed here for further details.

A P Inc., 72 Corwin Dr., Painesville, Ohio 44077. (216) 357-2101. **Circle 410**

Alco Electronic Products Inc., 1551 Osgood St., North Andover, Mass. 01845. (617) 685-4371. **Circle 411**

Amphenol Barnes Div., 24 N. Lansdowne, Lansdowne, Pa. 19050. (215) 622-1525. **Circle 412**

Augat Inc., 33 Perry Ave., Attleboro, Mass. 02703. (617) 222-2202. (E. Redgate) **Circle 413**

Buckeye Stamping Co., 555 Marion Rd., Columbus, Ohio 43207. (614) 443-9458. (R. E. Osborne) **Circle 414**

By-Buk Co., 4326 W. Pico Blvd., Los Angeles, Calif. 90006. (213) 937-3511. **Circle 415**

Caddell-Burns Mfg. Co., Inc., 40 E. 2nd, Mineola, N.Y. 11501. (516) 746-2310. **Circle 416**

Cambridge Thermionic Corp., 445 Concord Ave., Cambridge, Mass. 02138. (617) 491-5400. **Circle 417**

Centron Engineering, 24015 Garnier St., Torrance, Calif. 90510. (213) 530-4410. **Circle 418**

Christiansen Radio, 3034 Nestall, Laguna Beach, Calif. 92651. (714) 497-1506. (Allan Christiansen) **Circle 419**

Circon Corp., 749 Ward Dr., Santa Barbara, Calif. 93111. (805) 967-0404. **Circle 420**

Circuit-Stik, Inc., 24015 Garnier St., Torrance, Calif. 90510. (213) 530-5530. (D. Harper) **Circle 421**

Circuit Structures Lab, 3200 N. San Fernando, Burbank, Calif. 91504. (213) 849-6341. **Circle 422**

D-Cemco Inc., 3200 N. San Fernando, Burbank, Calif. 91504. (213) 849-6341. **Circle 423**

Di/An Controls, 944 Dorchester, Boston, Mass. 02125. (617) 288-7700. **Circle 424**

Dionics Inc., 65 Rushmore St., Westbury, N.Y. 11590. (516) 997-7474. **Circle 425**

Douglas Electronics, Inc., 718 Marina Blvd., San Leandro, Calif. 94577. (415) 483-8770. (Nancy Cain) **Circle 426**

E & L Instruments Inc., 61 First St., Derby, Conn. 06418. (203) 735-8774. (Richard Vuillequez) **Circle 427**

Electronic Engrg. Co., 1441 E. Chestnut Ave., Santa Ana, Calif. 92701. (714) 547-5651. (B. Fordiani) **Circle 428**

Elgin Electronics Inc., Walnut St., Waterford, Pa. 16441. (814) 796-2601. **Circle 429**

Fenwal Electronics, Inc., 63 Fountain, Framingham, Mass. 01701. (617) 872-8841. **Circle 430**

G C Electronics, 400 S. Wyman St., Rockford, Ill. 61101. (815) 968-9661. (E. Crockett) **Circle 431**

Injectoral Electronics Corp., 98-100 Glen St., Glen Cove, N.Y. 11542. (516) 671-6010. **Circle 432**

Instant Instrument Inc., 306 River St., Haverhill, Mass. 01830. (617) 373-9260. (J. DiPrimo) **Circle 433**

Jonard Industries Corp., 134 Marblehead Rd., Tuckahoe, N.Y. 10707. (914) 793-0700. **Circle 434**

Keystone Electronics Corp., 49 Bleeker St., New York, N.Y. 10012. (212) 475-4600. (R. D. David) **Circle 435**

LVC Industries Inc., 135-25 37th Ave., Flushing, N.Y. 11354. (212) 939-9777. **Circle 436**

NES, Inc., 7N662 Rte. 53, Itasca, Ill. 60143. (312) 773-0370. **Circle 437**

PIC Design Corp., Box 335, Benrus Ctr., Ridgefield, Conn. 06877. (203) 438-0345. (L. Small) **Circle 438**

Pico Inc., 1001 Vine St., Liverpool, N.Y. 13088. (315) 451-0680. (Robert Reece) **Circle 439**

Precision Mechanisms, 44 Brooklyn Ave., Westbury, N.Y. 11590. (516) ED-3-5955. **Circle 440**

Robinson-Nugent, 800 E. 8th St., New Albany, Ind. 47150. (812) 945-0211. **Circle 441**

Scanbe Mfg. Corp., 3445 Fletcher Ave., El Monte, Calif. 91731. (213) 579-2300. **Circle 442**

Semitronics Corp., 265 Canal St., New York, N.Y. 10013. (212) 226-5400. **Circle 443**

Servo Corp. of America, 111 New South Rd., Hicksville, N.Y. 11802. (506) 938-9700. **Circle 444**

Spectrum Dynamics, Inc., 1302 West McNab Rd., Fort Lauderdale, Fla. 33309. (305) 974-9500. **Circle 445**

Sterling Instruments, 55 S. Denton Ave., New Hyde Pk., N.Y. 11040. (516) 328-3300. **Circle 446**

Vector Electronic Co., Inc., 12460 Gladstone Ave., Sylmar, Calif. 91342. (213) 365-9661. (F. L. Hill) **Circle 447**

Vero Electronics, Inc., 171 Bridge Rd., Hauppauge, N.Y. 11787. (516) 234-0400. **Circle 448**

Victory Engrg. Corp., 128 Victory Rd., Springfield, N.J. 07081. (201) 379-5900. **Circle 449**



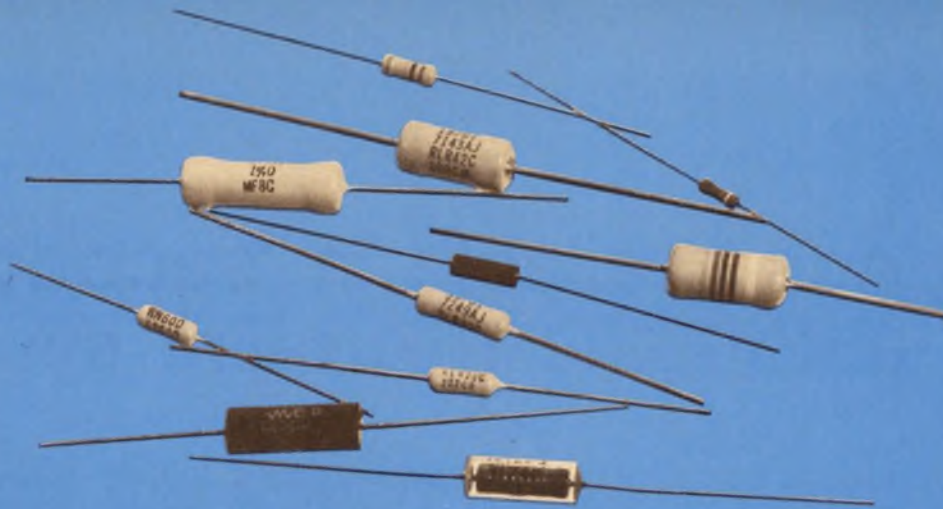

# TAKE RESISTORS!

(Take ours!)

For ultra-stable 0.1% metal films through "comp" priced carbon films, you'll find just the resistor you need from the single source for passive components ... MEPCO/ELECTRA.

Take our *metal films*. We cut across market lines with our low cost conformally coated 1% and 2% devices for consumer equipment; our high performance 0.1% industrial and commercial product; our conformally coated, molded or hermetically sealed standard military and professional parts (EDP, Communications, Instrumentation); our "top-of-the-line" ER resistors to MIL-R-39017 and 55182.

Or take our *carbon films*. We call them the "comp killers" because our price/performance ratio can't be matched. You get all the precision of film resistors, priced to knock the "comp" out

Plant Locations:  
Morristown, New Jersey; San Diego, California; Mineral Wells, Texas; Canandaigua, New York; Oakland, California.

every time. Our resistance range is 2Ω through 20 M.Ω, tolerances to 1% in all the most wanted wattage styles.

Our *thick film Cermets* are unique in the industry, offering the best resistance per unit of volume in its class. These high ohm devices are available from 100KΩ to 50 MegΩ with tolerances of 1%, 2% and 5%.

For hybrid and microwave applications, we offer our miniature, leadless *rod resistors* in thick or thin film, sized to meet the tightest hybrid module application.

Doesn't it make sense to talk to the company with the most to offer in product, experience and expertise? Talk to the Man From Mepco/Electra about all your resistor needs. Call or write Mepco/Electra Inc., Morristown, New Jersey 07960. (201) 539-2000.

Talk to the  
man from  
**MEPCO/  
ELECTRA**



Sold through  
North American Philips  
Electronic Component  
Corporation



# IC specs available in 'seconds' with automatic microfilm system

An automatic microfilm information-retrieval system to help designers find IC data is said to "do in seconds what it used to take hours, days and even weeks to do before."

The system, made by Information Handling Services, Englewood, Colo., slashes the time required to look up data in manufacturers' catalogs. With the constant introduction of new integrated circuits—and the problems that arise with last-minute design changes if the ICs aren't available—engineers need all the help they can get, says Don Van Dyken, product manager for the new Integrated Circuit Parameter Retrieval System.



IC Parameter Retrieval System reduces the time engineers need to get data sheets.

## Specs in seconds

When the system is used in conjunction with the company's Visual Search Microfilm service, Van Dyken says, the designer can move from his need for an IC circuit function—such as a flip-flop, memory or op amp—to the manufacturer's data sheet in one simple, fast operation. The complete sequence can take less than a minute, he reports.

An engineer can locate a particular IC by any one of three

methods: by functional description, such as op amp or memory; by popular industry number, such as 1103 memory or 741 op amp; or by manufacturer's number, such as NS741 or  $\mu$ A709.

Once the device is located, the designer receives basic information that includes a description

of the function performed by the IC, the technology used to produce it, the type of package it comes in, its temperature operating range, type number, original circuit number, supplier or source and where the manufacturer's data sheet can be found in the microfilm library. If a hard copy of the data sheet is required, the engineer merely pushes a button on a microfilm viewer, and the sheet is produced on the spot.

Van Dyken says that other systems give information either in tabular form, without data sheets, or classify ICs only by broad categories. The new system is timely, he continues, because with current paper shortages, some manufacturers are being forced to reduce their distribution of data sheets.

The cost of the IC information service starts at \$1440 for an 8-mm system, which can be placed on one corner of the designer's desk. The system does not include data-sheet reprint capability. For that, the 16-mm system is necessary, and it costs \$3000. Microfilms can be updated three times a year.

The system will be available for shipment in June, the company says. ■■

DESCRIPTION/ DEFINED FUNCTION	TECHNOLOGY		PACKAGING		RANGE		SOURCE CIRCUIT TYPE NUMBER/SERIES	ORIGINAL CIRCUIT NUMBER	SUPPLIER/SOURCE	FILM ICART- FRAME NUMBER
	PROC	FAMILY	CHIP	DIP	FP	HOR				
DECODER/DRVR BCD-DEC	MON	MSI TTL					N7441	7441	ICGM-SIGNETICS	-
DECODER BCD-DEC	MON	MSI TTL		A			N7442	7442	ICGM-SIGNETICS	-
DECODER EX3-DEC	MON	MSI TTL		B			N7443	7443	ICGM-SIGNETICS	-
DECODER EXCESS 3-GRAY-DEC	MON	MSI TTL		A,F			N7444	7444	ICGM-SIGNETICS	-
DEC/DRVR BCD-DEC DC HV	MON	MSI TTL		B			N7445	7445	ICGM-SIGNETICS	-
DEC/DRVR BCD-7 SEGMENT	MON	MSI TTL		A			N7446	7446	ICGM-SIGNETICS	-
DRVR BCD-7 SEGMENT	MON	MSI TTL		A			N7447	7447	ICGM-SIGNETICS	-
	MON	MSI TTL		B			N7448	7448	ICGM-SIGNETICS	-
	MON	MSI TTL								-

Sample output of the system lists ICs by circuit function. The output also indicates the technology and packaging

used, temperature range, name of the supplier and where the manufacturer's data sheet can be found.

# NOW AVAILABLE IN THE U.S.A.— FUTABA FLUORESCENT READOUTS KEYBOARDS



With over 35 years of electronics experience, FUTABA is well known for high quality, reliable fluorescent readouts and compact, attractive keyboards. Widely used by most major electronic calculator manufacturers in Japan and other countries, these items are now available for the first time in the U.S.A. in quantity. FUTABA guarantees prompt delivery!



• For additional information, please contact:

**FUTABA INDUSTRIES U.S.A.**  
630 West Carob Street, Compton, California 90220, U.S.A.  
Phone: (213) 537-9610 Telex: 69-1227

## FLUORESCENT READOUTS

※CT, CR Series for Hand Calculators  
..... Available in 6, 8 and 9 digits with or without symbol.

### FEATURES:

- Compact.
- Bright blue/green.
- Easy to read.
- Low voltage, low power.
- Direct LSI drive.

※MT, MR Series for Desk-top Calculators  
..... Available in 8, 10, 12, 14, and 16 digits.

### FEATURES:

- Plug-in type flat package.
- Easy to read blue/green readouts (0.3" high).
- Low voltage, low power.

## KEYBOARDS

M-2B: Individual mechanical switch, plug-in mounting.  
M-3: Same as M-2B, but smaller.  
FX, SD Series: Thin keyboards for hand calculators.

Standard keyboard switches and key tops available from FUTABA stock for instant keyboard layout on your mounting plate.

## OTHER FUTABA PRODUCTS:

- Press die sets.
- Mold bases for plastics.
- Material feeders for press work.
- Automatic stopping devices for automatic machinery.
- Radio control for hobby aircraft, race cars, etc.

*"FUTABA—THE BRIGHT PRODUCER"*

**FUTABA ELECTRONIC INDUSTRIES LIMITED**  
Super Bldg., 1-11-5, Sotokanda, Chiyoda-ku, Tokyo, Japan. Phone: 255-5881  
Telex: J26532

# Impulse-bonded wiring allows fast PC changes

A new method of impulse-bonded wiring is reported to reduce circuit-board fabrication costs substantially, permits rapid changes of wiring patterns during development and replaces multilayer boards—up to seven layers—with a two-sided PC board.

The bonding technique is automated. A tape-controlled machine routes the wires to the bonding points and produces accurate interconnection patterns in small areas.

Developed by the Bendix Navigation and Control Div., Teterboro, N.J., the concept was intended originally to solve circuit-board wiring problems that arose during the development of an all-weather landing system for the McDonnell Douglas DC-10 jetliner.

"During the DC-10 system development," says John Sobieski, manufacturing superintendent at Bendix, "we originally used multilayer boards. But to make developmental wiring changes required that the boards be drilled out where we didn't want circuitry between the layers. As a result, we wound up with a lot of expensive scrap and were also delayed in our development program."

To solve the problem, Bendix investigated conventional impulse-bonding wiring, because with this technique, changes can be made by rerouting wires along the surface of the board. However, that ap-

proach was not satisfactory, for a number of reasons.

One reason was cost. With the usual method of impulse-bonding, holes are drilled in the circuit board, and stainless steel studs are inserted on the rear of the board. All bonding is done to these studs. With that approach a typical board costs about \$65, Sobieski says.

"With our approach," he continues, "we've reduced the cost more than one-third by doing the bonding on the top, or component, side."

Bonding on the front side is advantageous because the board can be fabricated with standard methods of automatic component insertion and flow-soldering. The rear is left free for fault-isolation testing.

Also, with the top-side approach under numerical control, Sobieski points out, the wire can be routed between the ICs in a fairly uniform pattern on X and Y coordinates. From nine basic coordinate patterns, 80 to 90 different circuit boards can be developed, he says.

## Standard PC boards are used

"We're the only ones using a standard PC board for impulse-bonded wiring," Sobieski says. "Our system is basically a two-sided printed-circuit board with plated-through holes."

Bendix developed the bonding material—Teflon-coated nickel wire—and also modified conventional impulse-bonding equipment to obtain the performance required. An average of 50 feet of Teflon-coated nickel wiring is used to make some 500 bonds per board.

Two pressures are involved in making a bond. An initial pressure of about 9.5 pounds is applied to the nickel wiring to penetrate the Teflon coating and make the contact between the bonding electrode and the conductive PC pattern.

Wiring changes can be effected in 48 hours in contrast to several weeks for the multilayer boards, Sobieski says. ■■



**Impulse-bonding system** developed by Bendix uses Teflon-coated, nickel wire for PC board interconnections.

## Your closest SIGNETICS distributor is...

**ARIZONA**  
Phoenix: Hamilton/Avnet Electronics (602) 275-7851  
Phoenix: Kieruff Electronics (602) 273-7331

**CALIFORNIA**  
Culver City: Hamilton Electro Sales (213) 870-7171  
El Segundo: Liberty Electronics (213) 322-8100  
Los Angeles: Kieruff Electronics (213) 685-9525  
Mountain View: Hamilton/Avnet Electronics (415) 961-7000  
Palo Alto: Kieruff Electronics (415) 968-6292  
San Diego: Cramer Electronics (714) 565-1881  
San Diego: Hamilton/Avnet Electronics (714) 279-2421  
San Diego: Kieruff Electronics (714) 278-2112  
Sunnyvale: Cramer Electronics (408) 739-3011

**CANADA**  
Downsview: Cesco Electronics (416) 661-0220  
Downsview: Cramer Electronics (416) 661-9222  
Montreal: Cesco Electronics (514) 735-5511  
Montreal: Hamilton/Avnet Electronics (514) 735-6393  
Ottawa: Cesco Electronics (613) 729-5118  
Ottawa: Hamilton/Avnet Electronics (613) 725-3071  
Quebec: Cesco Electronics (418) 524-3518  
Vancouver: Bowtek Electric Co. Ltd. (604) 736-7677

**COLORADO**  
Denver: Cramer Electronics (303) 758-2100  
Denver: Hamilton/Avnet Electronics (303) 534-1212

**CONNECTICUT**  
Hamden: Arrow Electronics (203) 248-8001  
Georgetown: Hamilton/Avnet Electronics (203) 762-0361  
North Haven: Cramer Electronics (203) 238-5641

**FLORIDA**  
Hollywood: Hamilton/Avnet Electronics (305) 925-5401  
Hollywood: Schwaber Electronics (305) 927-0511  
Orlando: Hammond Electronics (305) 241-6601

**GEORGIA**  
Atlanta: Schwaber Electronics (404) 449-9170  
Norcross: Hamilton/Avnet Electronics (404) 448-0800

**ILLINOIS**  
Elk Grove: Schwaber Electronics (312) 593-2740  
Einhurst: Semiconductor Specialists (312) 279-1000  
Schiller Park: Hamilton/Avnet Electronics (312) 678-6310

**INDIANA**  
Indianapolis: Semiconductor Specialists (317) 243-8271

**KANSAS**  
Lenexa: Hamilton/Avnet Electronics (913) 888-8900

**MARYLAND**  
Hanover: Hamilton/Avnet Electronics (301) 786-5000  
Rockville: Pioneer Washington Electronics (301) 424-3300  
Rockville: Schwaber Electronics (301) 881-2970

**MASSACHUSETTS**  
Burlington: Hamilton/Avnet Electronics (617) 273-2120  
Waltham: Cramer Electronics (617) 959-7700  
Waltham: Schwaber Electronics (617) 890-8484

**MICHIGAN**  
Detroit: Semiconductor Specialists, Inc. (313) 255-0300  
Livonia: Hamilton/Avnet Electronics (313) 522-4700  
Troy: Schwaber Electronics (313) 583-9242

**MINNESOTA**  
Edina: Hamilton/Avnet Electronics (612) 941-3801  
Minneapolis: Semiconductor Specialists (612) 854-8844

**MISSOURI**  
Hazelwood: Hamilton/Avnet Electronics (314) 731-1144

**NEW MEXICO**  
Albuquerque: Hamilton/Avnet Electronics (505) 765-1500

**NEW YORK**  
Buffalo: Summit Distributors (716) 884-3450  
Farmingdale, L.I.: Arrow Electronics (516) 694-6800  
Rochester: Schwaber Electronics (716) 328-4180  
Syracuse: Hamilton/Avnet Electronics (315) 437-2642  
Westbury: Hamilton/Avnet Electronics (516) 333-5800  
Westbury: Schwaber Electronics (516) 334-7474

**NORTHERN NEW JERSEY**  
Cedar Grove: Hamilton/Avnet Electronics (201) 239-0800  
Saddlebrook: Arrow Electronics (201) 797-5800

**SOUTHERN NEW JERSEY AND PENNSYLVANIA**  
Cherry Hill, N.J.: Milgray-Delaware Valley (609) 424-1300  
Moorestown: Arrow/Angus Electronics (609) 235-1900  
Mt. Laurel, N.J.: Hamilton/Avnet Electronics (609) 234-2133

**CENTRAL NEW JERSEY AND PENNSYLVANIA**  
Somerset, N.J.: Schwaber Electronics (201) 469-8008

**NORTH CAROLINA**  
Greensboro: Hammond Electronics (919) 275-6391

**OHIO**  
Beachwood: Schwaber Electronics (216) 464-2970  
Dayton: Hamilton/Avnet Electronics (513) 433-0610  
Cleveland: Arrow Electronics (216) 464-2000  
Cleveland: Pioneer Standard Electronics (216) 587-3800  
Kettering: Arrow Electronics (513) 253-9176

**TEXAS**  
Dallas: Cramer Electronics (214) 350-1355  
Dallas: Hamilton/Avnet Electronics (214) 861-8661  
Houston: Component Specialties (713) 771-7237  
Houston: Hamilton/Avnet Electronics (713) 526-4661

**UTAH**  
Salt Lake City: Alta Electronics (801) 466-7227  
Salt Lake City: Hamilton/Avnet Electronics (801) 262-8451

**WASHINGTON**  
Bellevue: Hamilton/Avnet Electronics (206) 746-8750  
Seattle: Cramer Electronics (206) 762-5722

# JAN IC'S: NO WAIT. GREAT.

## We're organized to make life easy for JAN buyers and users.

Zing our distributors for Signetics JAN, and you'll be inundated with delivery vans—just about everything makable in 5400/54H, for instance. Demand really huge lots, and our special MILrel operation at the factory will trigger into action to amaze you with the best delivery in the industry. When your RFQ's and orders come in, they're snatched up by MILrel Marketing. RFQ's are immediately answered. Orders are immediately processed and shipped.

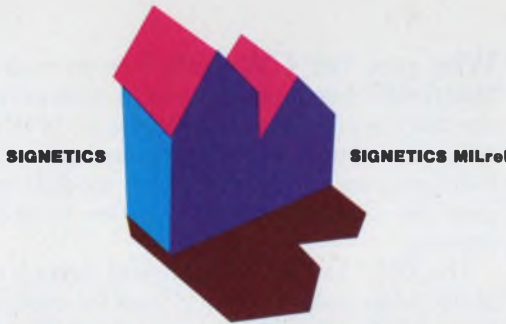

Where other suppliers jellybean JAN IC's among their commercial/industrial production, we give MILrel its own assembly and QA/QC organization within the factory. Your bonus is special attention to your order. And, when you call MILrel for a progress report, the person you talk to can finger the status right now. And keep his promises.

"Mill Run" Government source inspection lets MILrel build in quantity for stock and helps get more parts into your equipment sooner. This newest form of GSI provides in-process inspection rather than lot by lot inspection. Means we have continuous-run capability. Means you have better quality assurance, because only a dedicated production line with super-good procedures and control can be allowed Mill Run GSI. We got it, and we're the first to, in the IC business.

More firsts. First to offer the widest line in 5400/54H in the industry, so you'll have more freedom of choice. First to provide a definitive JAN IC reference (see coupon) that unscrambles the JAN/MIL/Hi-Rel mishmash of specs, certs, and terms. Get this book. It's invaluable.

Wrap it all up and it spells service in JAN IC's to you. Instant availability, wide product breadth, Mill Run GSI for faster production and deliveries, integral MILrel organization where you get the priority, first qualification on QPL slash sheets, and great product support.

Call your distributor now, for now-type needs. And send the coupon for the most definitive, helpful JAN IC handbook anywhere.

★ ★ ★ ★ ★ ★ ★ ★ ★ ★	
CLIP COUPON TO LETTERHEAD FOR FAST SERVICE	
Signetics MILrel P. O. Box 3004-12 Menlo Park, California 94025	
So JAN IC's are really big at MILrel? Okay, send me your JAN IC reference, including total product lists, and I'll see if it's as helpful as you say. My address you can get from the attached letterhead.	
Name	Title
Mail Stop	
Signetics Corporation, a subsidiary of Corning Glass Works.	

**signetics milrel**

# One 18 GHz box does it all! FM, pulsed RF, CW 5-day delivery



**Why pay for CW only?** Systron-Donner's Model 6057 frequency counter measures virtually any microwave signal from 20 Hz to 18 GHz with 1 Hz resolution. CW and AM measurements are fully automatic; FM and pulse modulated carriers use a simple 3-step operation to get direct answers.

The 6057 is priced at \$5,450, which is just about what you'd expect to pay for comparable instruments *without* FM and pulsed RF capability. However, S-D gives you a choice. If it's CW only you need to measure, then choose our Model 6016 at \$4,575, or for only \$3,695 you get a Model 6092 manual T.O. measuring system.

For details, a demo or 5-day delivery, call your Scientific Devices office (listed below). Or call collect S-D's Quick Reaction Line (415)-682-6471.

*In Europe:* Systron-Donner – Munich, W. Germany; Leamington Spa, U.K.; Paris (Le Port Marly) France.

*In Australia:* Systron-Donner – Melbourne.

SYSTRON  DONNER

Albuquerque, (505) 268-6729; Baltimore, (301) 788-6611; Boston, (617) 894-5637; Burlington, NC (919) 228-6279; Chicago, (312) 297-5240; Cleveland, (216) 261-2000; Denver, (303) 573-9466; Dayton, (513) 298-9904; Dallas, (214) 231-8106; Detroit, (313) 363-2282; Ft. Lauderdale, (305) 721-4260; Hamden CT (203) 248-9361; Huntsville, AL (205) 536-1969; Houston, (713) 623-4250; Indianapolis, (317) 783-2111; Kansas City, KS (913) 631-3818; Los Angeles, (213) 641-4800; Minneapolis, (612) 544-1616; New York City area (201) 871-3916; Norfolk, (703) 499-8133; Orlando, (305) 424-7932; Philadelphia, (215) 825-9515; Phoenix, (602) 834-1682; Rochester, NY (716) 334-2445; San Antonio, (512) 694-6251; San Diego, (714) 249-6642; San Francisco area (415) 964-4230; Seattle, (206) 454-0900; St. Louis, (314) 731-2332; Syracuse, (315) 457-7420; Washington, DC area (703) 451-6500.

INFORMATION RETRIEVAL NUMBER 23

# washington report



Heather M. David  
Washington Bureau

## **GAO scores Navy ASW sensor development**

The General Accounting Office says the Navy erred in pushing the development of three aircraft antisubmarine warfare sensor systems even though testing indicated that there were problems with the systems. In one case an integrated magnetic airborne system that detects submarines by the change in the earth's magnetic field "will not satisfy its minimum performance requirements" until a new advanced processor is installed in several years, the GAO notes.

The agency also says that Congress might want to question whether the Defense Dept. is "putting appropriate emphasis on development of needed sensor capabilities," compared with the push it is putting on the production of new antisubmarine warfare aircraft. The Navy says it, too, is concerned about sensor development and is striving to meet the problem.

## **Army developing laser guidance for common projectiles**

The Army is marrying some of its newest technology to some of its oldest, putting laser guidance on cannon-launched projectiles. The objective is to hit targets, such as tanks and armored personnel carriers, with the first round of fire before they can move to cover. At present the Army uses area-fire techniques or precision-fire methods, but is reported to get only marginal results. With the new weapon, a forward observer will illuminate the target with a narrow-beam laser when the projectile is approximately 10 seconds from the target. The projectile then homes in on the reflected laser energy. Two contractors are developing projectile models for competitive test-firing.

## **AWACS: A change in role and a new threat**

Sen. Thomas Eagleton (D-Mo.) is mounting a new drive to keep the Air Force from putting the Airborne Warning and Control System (AWACS) aircraft into production as scheduled in fiscal 1975. General Accounting Office representatives have told the Senate Armed Services Committee that they have serious reservations about the program, particularly since Defense Secretary James Schlesinger has decided to use the huge aircraft for controlling tactical air operations rather than for detection and defense against Soviet bombers, for which it was originally intended. GAO says the tactical role will require considerable upgrading of the data-processing and communication capability of the system and will increase the unit price from \$56.8-million to \$73-million.

Eagleton also cites the GAO's conclusions that the aircraft may be extremely vulnerable in a hostile air theater, being subject both to enemy air action and to electronic countermeasures that might impair or black out its look-down radar system. The agency has recommended that the system be tested against the full spectrum of state-of-the-art electronic countermeasures to determine whether known counter-countermeasures are effective. The Air Force is asking \$549.8-million for the first 12 planes plus another \$220-million for continued research and development in fiscal 1975.

## **Nadar group challenges Government patent policy**

Ralph Nader's Public Citizen, Inc., has sued in U.S. District Court for the District of Columbia in an effort to keep contractors from getting exclusive rights to any inventions they develop under Government R&D contracts. The suit is aimed at halting a new General Services Administration regulation that allows the granting of patents to such contractors. If the court rules for Public Citizen, it would affect aerospace and other military contracts. The National Aeronautics and Space Administration, however, would be unaffected; it has authority from Congress to waive rights to ownership and can grant exclusive rights to contractors.

## **FAA presses discrete-address beacon plans**

The Federal Aviation Administration has begun briefing industry on the new discrete-address beacon system it wants developed to improve aircraft control in the next decade. The system, with ground sensors and airborne transponders, will make it possible for air-traffic controllers on the ground to interrogate and get a reply from one aircraft at a time instead of all in the zone of coverage. The FAA hopes thereby to eliminate problems of "synchronous garble," caused by the overlapping responses of several aircraft flying in close proximity. The agency says it will procure three engineering models of the system and a number of aircraft transponders.

**Capital Capsules:** The Atomic Energy Commission's program to make electricity from thermonuclear fusion has been stretched out three years, making the new target date the late 1990s. The Office of Management and Budget has ordered the AEC to trim \$140-million in the fusion research budget over the next five years, which will delay the program. . . . RCA has signed an agreement with the Alaska Pipeline Service Co. for two communications systems to support the Alaska pipeline. The first will be a \$7-million interim system to be used during construction of the pipeline, the other a \$23-million system to be ready when the pipeline goes into operation in 1977. . . . The Air Force's Home Air Development Center is asking industry to submit its small-area radars for evaluation as possible sensors for protecting parked aircraft. The radar must be able to detect intruders weighing 75 pounds or more. . . . The Commerce Dept. and the State Dept. are considering negotiating an agreement with the Soviet Union that would protect U.S. patents prior to 1965. They are now unprotected. A number of U.S. technology companies, interested in trade with the Soviet, have asked for the agreement. . . . The Senate has passed a bill to establish an Office of Federal Procurement Policy. It would establish uniform Government policies and regulations. . . . The FAA plans to develop a prototype model of a new phased-array antenna to upgrade present instrument landing systems at the nation's airports.



# 1000 cm/ $\mu$ sec stored writing speed, four storage modes, and more.

## 100 MHz oscilloscope

Tektronix 7633 oscilloscope gives you 100 MHz bandwidth and 1000 cm/ $\mu$ sec stored writing speed. So you can retain and view fast rise, low repetition rate, single shot or slow moving waveforms. All with one instrument. This allows you to solve problems in computer sciences, aerospace, ballistics, communications and various other applications.

## Multi-mode storage

The 7633 offers four operating modes: Non-store, normal and fast Variable Persistence and Bistable modes are available at the touch of a button. And, an 8 x 10 div. (.45 cm/div.) mode gives the instrument's top writing speed.

## Bright, burn-resistant CRT

No special operating safeguards are necessary with the 7633's rugged, burn resistant CRT. This makes it a dependable unit for design bench, hospital laboratory, service facility or classroom. The large 8 x 10 div. CRT is easy to read in both cabinet and rackmount configurations. An alphanumeric readout, exclusive on Tektronix instruments, makes quick on-screen reference and easy interpretation of photographic records. Or, the instrument may be ordered without the readout for \$400 less.

## Part of the 7000 Series

Select from thirty different 7000 Series plug-ins. You can custom tailor your instrument to meet your immediate need. And expand its capabilities later as the need arises. A 7633 mainframe costs \$3650. A typical configuration with dual trace vertical amplifier and delaying sweep timebase sells for \$5,550. For rackmount add \$100.

## Specifications

Vertical System—Accepts all 7000 Series vertical amplifiers. Bandwidth determined by mainframe plug-in unit up to 100 MHz. Left, Alternate, Add, Chop, Right display

modes. Chopped rate approximately 1 MHz. Horizontal System—Compatible with all 7000 Series plug-ins. Fastest calibrated sweep rate is 5 ns/div. Phase shift between vertical and horizontal is 2°, DC to 35 kHz for X-Y operation. CRT and Display—Internal 8 x 10 div. (.9 cm/div) graticule with superimposed 8 x 10 div. (.45 cm/div) reduced scan area. Nonstore, variable persistence, and bistable in normal or fast and full or reduced scan storage modes push-button selected. Writing Speed and View Times—From .03 div/ $\mu$ sec until erased up to 2222 div/ $\mu$ sec at 30 sec view time. View time may be increased more than 30 times by using reduced intensity in the SAVE display mode.

## See for yourself

For a "hands-on" demonstration, contact your nearby Tektronix Field Engineer. Or write: Tektronix, Inc., P. O. Box 500, Beaverton, Oregon 97005. In Europe write: Tektronix Ltd., P. O. Box 36, St. Peter Port, Guernsey, C. I., U. K.



**TEKTRONIX®**

committed to  
technical excellence

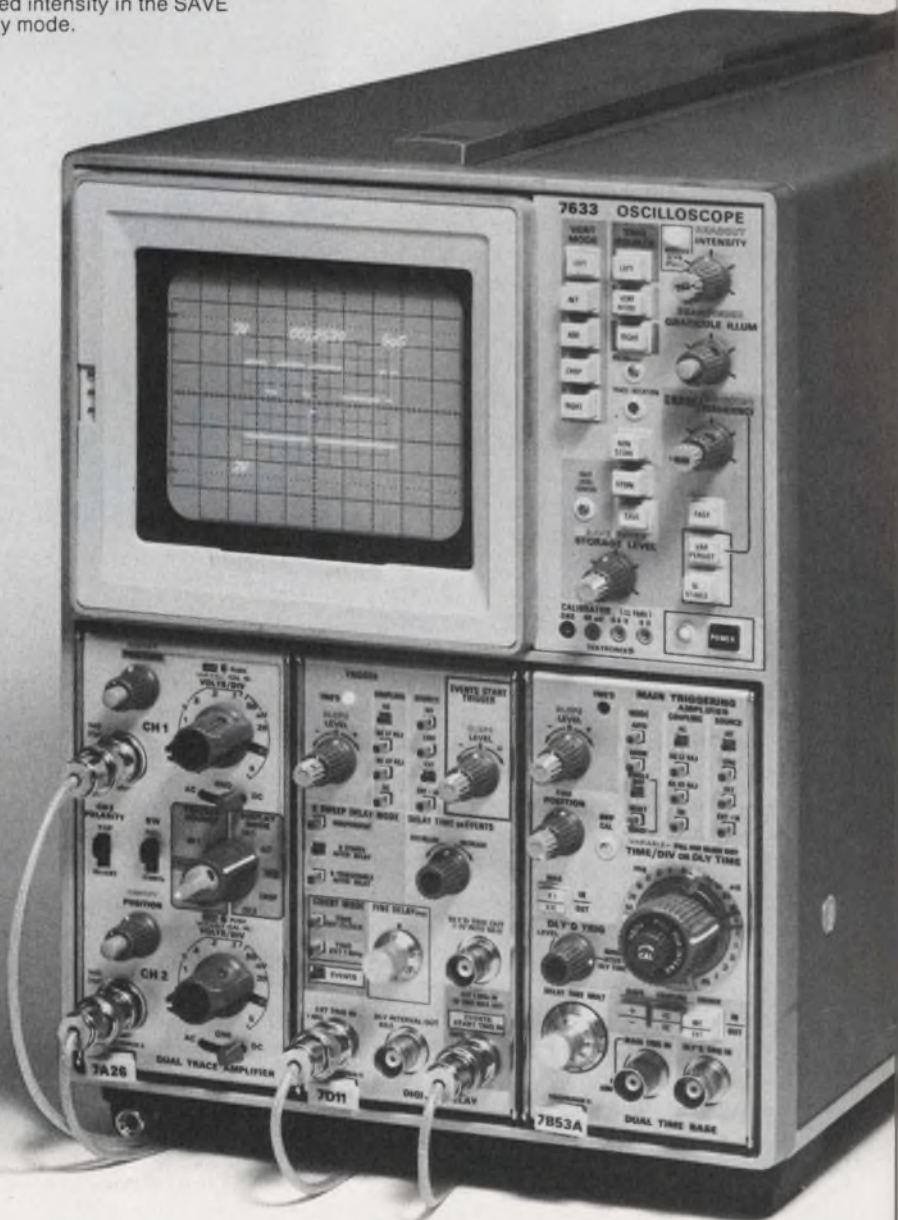

# Centralab perspectives

FOR USERS OF ELECTRONIC COMPONENTS



CENTRALAB

Electronics Division  
GLOBE-UNION INC.

5757 NORTH GREEN BAY AVENUE  
MILWAUKEE, WISCONSIN 53201

## Now users of discrete capacitors are in the chips: Here's how we made it happen.

**USCC/Centralab's evolution in productivity changed high-rel ceramic chip capacitors into economically realistic components for industry — including Detroit.**

In 1966, U.S. Capacitor Corporation was a leading producer and innovator in the field of high-rel capacitors. We were capable of 140,000 chip starts a month. They were of highest quality for use on Apollo astronauts' portable life support systems.

USCC, a division of Centralab, is now the world's *largest producer* of chip capacitors. Today our automated production machinery and improved techniques allow us to start TWENTY TWO MILLION chips per month. But perhaps of even greater importance the yield of finished ceramic chips is of such high quality that they are now price competitive in an increasing number of commercial and industrial applications.

One system which USCC/Centralab engineers developed was converting the dielectric casting process from a manual operation to a machine-fed casting process. This new equipment is so effective that production rates increased 10 fold, while virtually eliminating material defects. In short—talent in production engineering.

Our new equipment allows us to produce chips for auto radios

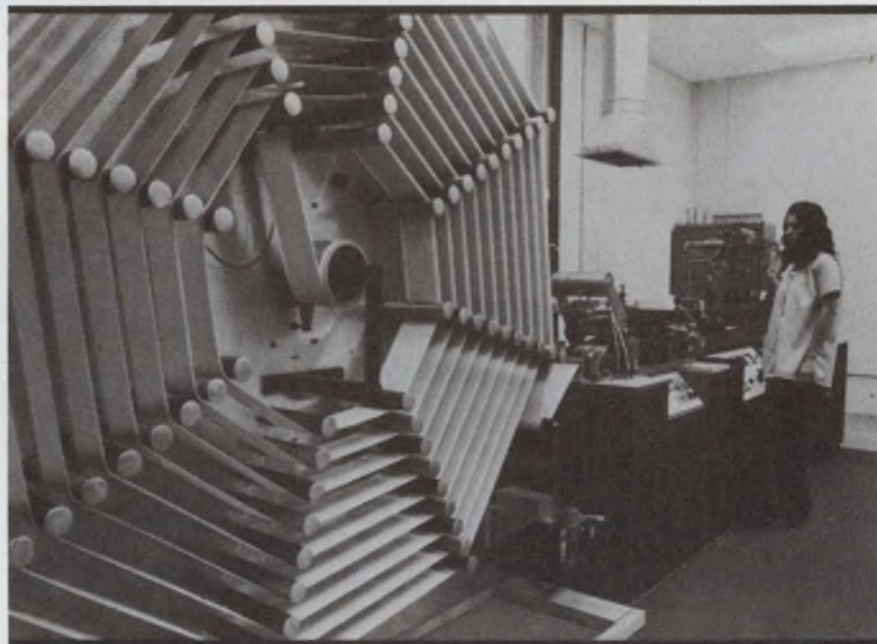

One of USCC's newest pieces of equipment which combines several operations previously done manually.

on the same production line as our high-rel units with no conflict between quality and fast delivery at reasonable prices. Our Detroit customer is now processing 25,000 auto radio circuits per day. We can keep him in the chips at the rate of 25,000 per hour.

Auto radios are only a small portion; ignition and fuel flow systems and voltage regulators are some of the new applications for an ever growing and demanding marketplace.

The same techniques that increased productivity also guaranteed utmost reliability so that

chip capacitors have evolved into a commercially practical product. If you're in the automotive business, the electronic OEM, if you make business machines or communications equipment, remember USCC/Centralab, the world's largest producer of reliable commercial ceramic chip capacitors.

Our engineering talent is available to help with your applications. Call John Vincent at USCC/Centralab (213) 843-3822.

USCC

USCC/Centralab

Electronics Division • Globe-Union, Inc.

2151 North Lincoln Street • Burbank, California 91504



## Centralab perspective:

### Pushbutton line switch.



### Mounts in any station.

With Centralab pushbutton switches you can have a line switch that's the same size as a standard six pole module and is interchangeable with other modules in an assembly. For push-ON, push-OFF operation... rated 5 amp/125 VAC (CSA).

Other pushbutton switch features include:

- 10, 12.5, 15, 17.5 and 20 mm spacing options.
- Epoxy sealed terminals.
- Interlock/lockout variations.
- 25 button styles and 18 colors.

Write Centralab for  
Bulletin 1550.

\*Isostat licensed



## Centralab perspective:

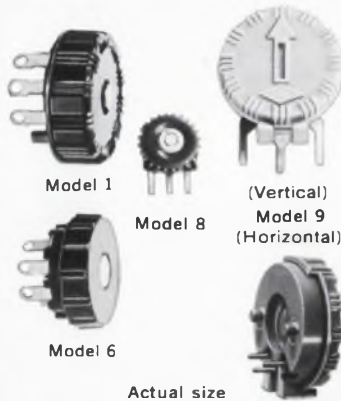

### Miniature pots at a mini-price.

Centralab gives you more to choose from in miniature potentiometers. Take the 1/5 watt, 45/64" dia. Model 9 for example. Typical pricing, in production quantities of 1000, is 34¢. That's economy because you also get:

- Rotational life in excess of 25,000 cycles.
- Choice of mountings — perpendicular or parallel plug-in.
- Resistance Range — 100 ohms to 10 megohms.
- Adjustability — Knob edge or screwdriver slot.
- Tolerance — ± 20%

For quantities under 250 contact your local Centralab Distributor.

Three other miniature potentiometers in the Centralab line of standard controls are:

- Model 1 — 5/8" dia. 1/5 watt (Available with switch)
- Model 6 — 1/2" dia. 1/10 watt (Available with switch)
- Model 8 — 9/32" dia. 1/10 watt

Get complete specifications on all four. Write Centralab for Bulletin No. EP2184.



## Centralab perspective:

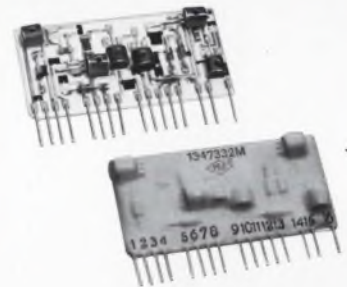

### Two thick film hybrid systems. PEC and MEC.

Centralab offers the flexibility to design and fabricate thick film modules to fit virtually any application and cost parameter.

Low-cost silver/carbon or  systems for consumer applications:

- Resistor Range.....10 ohms to 10 megohms
- Resistor Tolerance...±10% preferred minimum
- Ratio Matching.....±5% minimum
- Capacitor Types.....Ceramic and tantalum
- Active Devices.....Diodes, transistors & IC's
- Operating Temp. Range....-55° C to +85° C

Noble metal/cermet or MEC systems for commercial and industrial uses:

- Resistor Range.....3 ohms to 3 megohms
- Resistor Tolerance.....±5% minimum
- Ratio Matching.....±1% minimum
- Capacitor Types.....Ceramic and tantalum
- Active Devices.....Diodes, transistors & IC's
- Operating Temp. Range....-55° C to +150° C

For Bulletin 1429H write  
A.R. Wartchow, Manager,  
Electroceramic Marketing,  
Outside U.S.A. contact  
J.H. Meunier, Manager,  
International Sales.



**Reliability is 756 little dents  
and one big one.**





### The big squeeze.

The heelpiece and frame are the backbone of our Class H relay. The slightest squiggle or shimmy out of either and the whole relay is out of whack.

756 tiny dents on the heelpiece, plus one big one on the frame, make sure this'll never happen.

They're the result of planishing, a big squeeze. Planishing is an extra step we go through in forming the pieces to add strength and stability by relieving surface strain. It also makes the parts extra flat.

This takes the biggest press in the industry and the biggest squeeze. Both exclusively ours.

### A different kind of coil.

The heart of a relay is the coil. If ours looks different, it's because we build it around a glass-filled nylon bobbin. It costs us more, but you know how most plastic tends to chip and crack.

Also, moisture and humidity have no effect on glass-filled nylon. No effect means no malfunctions for you to worry about. No current leakage, either.

The coil is wound on the bobbin automatically. No chance of human error here.

### Springs and other things.

We don't take any chances with our contact assembly, either. Our contact springs are phosphor-bronze. Others use nickel-silver. Our lab gave this stuff a thorough check, but found nickel-silver too prone to stress-corrosion. Atmospheric conditions which cause tarnish and ultimately stress corrosion have almost no effect on phosphor-bronze.

Even things like the pileup insulators (those little black rectangles) get special attention. We precision mold them.

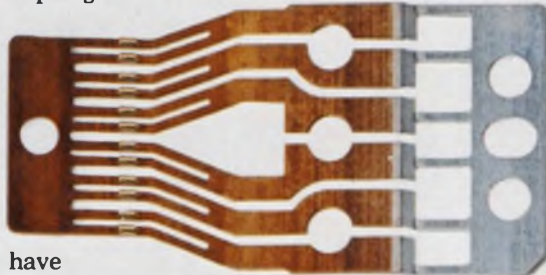

Other manufacturers just punch them out.

It makes a lot of difference. They're stronger, for one thing; and because they're molded, there's no chance of the insulators absorbing even a droplet of harmful moisture. Finally, they'll withstand the high temperatures that knock out punched insulators.

### Two are better than one.

Our next step was to make sure our contacts give a completed circuit every time. So we bifurcate both the make and break springs.

Each contact works independently to give you a completed circuit every time. Contact material is pure palladium with a gold overlay because no alloy works as well.

Edge-tinned contact springs save you the job of solder tinning them later. Also, edge-tinning enables you to safely use the same relay with sockets or mounted directly to a printed circuit board. A simple thing, but it takes a big chunk out of the inventory you have to stock.

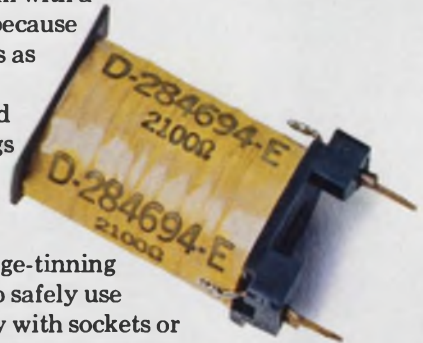

### Finally, superior protection.

Out of the dozens of plastics to choose from for our dust cover, we picked a durable polycarbonate. The same material used for plastic windshields and special vehicle bodies. It's strong, resists high temperatures, and is unaffected by most cleaning solvents.

Then, for extra safety, we put a disposable cap over the cover's open end. This seals out dirt and dust while preventing damage to the terminals during shipping and handling.

### Etc. Etc. Etc.

There's a lot more to tell about what makes our Class H relay reliable. Now we're waiting to hear from you. GTE Automatic Electric, Industrial Sales Division, Northlake, Illinois 60164.

# GTE AUTOMATIC ELECTRIC

# 5 books that should be in your personal library... order now for 15-day free examination!



## DURABILITY AND RELIABILITY IN ENGINEERING DESIGN

by Gilbert Kivenson

A unique combination of materials science, reliability, and design. Examines crucial concepts of material strength, service longevity, and reliability and describes the fundamentals of breakdown analysis. Covers new materials, design techniques and fabricating methods. 200 pp., #5851-9, cloth, \$9.95.

## PRACTICAL VALUE ANALYSIS METHODS

By John H. Fasal



An applications-oriented guide offering a working knowledge of the latest methods and techniques in value engineering and value analysis. Provides ways of evaluating and supplementing the internal cost reduction techniques that enable a company to keep pace with competition. 272 pp., #5845-4, cloth, \$11.95.

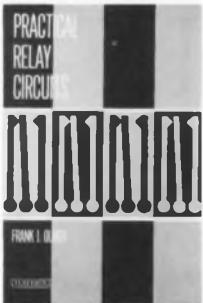

## PRACTICAL RELAY CIRCUITS

by Frank J. Oliver

Logically groups relay circuits according to the functions they perform, to help you quickly select the best circuit for your purposes. Covers the whole gamut of relay circuits and is illustrated with many circuit diagrams. 363 pp., #5802-0, cloth, \$14.95.

## ELECTRICAL/ ELECTRONIC CHECKLISTS

Written and edited by W. B. Rossnagel



Twenty-two detailed checklists on subjects including cables and connectors, communication radios, multi-coders, GSE/AGE/TSE, EMI/RFI, lasers, radar, systems, transmitters and transponders, as well as other subjects. 172 pp., #9181, cloth, \$14.00.



## PRACTICAL DESIGN FOR ELECTROMAGNETIC COMPATIBILITY

Edited by Rocco F. Ficchi

A convenient manual giving electronic designers techniques for analyzing, predicting, controlling, and reducing unwanted signals. Gives advantages and disadvantages of latest methods for reduction and control. Provides ways of selecting equipment for interference reduction. 272 pp., #5685-0, cloth, \$13.95.

### HAYDEN BOOK COMPANY, INC.

50 Essex St., Rochelle Park, N.J. 07662

Please send the book(s) checked on 15-day free examination. At the end of that time, I will remit payment plus postage, or return the book(s) with no further obligation.

5851-9    5802-0    5685-0    5845-4    9181

**\$10.00 minimum for free exam orders.**

Because of higher billing and collection costs, we must ask for payment in full with any order for less than \$10.00. Books will be shipped postpaid. Same 15-day return privilege for full refund if not satisfied.

**Save Money!** On all prepaid orders Hayden pays postage — same return privilege.

Name \_\_\_\_\_

Firm \_\_\_\_\_

Address \_\_\_\_\_

City/State \_\_\_\_\_ Zip \_\_\_\_\_

ISBN Prefix 0-8104

73-65b

Electronic Design, The Financial Times (London)  
 Electronics Weekly (London) and BOAC  
 announce the sponsoring of

# "TOMORROW IN WORLD ELECTRONICS"

a major international conference to coincide  
 with the International Instruments, Elec-  
 tronics and Automation Exhibition (IEA).

**GROSVENOR HOUSE, LONDON – MAY 14-15, 1974**

This conference, to be addressed by a panel of the electronics commu-  
 nity's most distinguished members, will consider current and future  
 technological developments in the world, and assess the challenges they  
 pose for management, marketing and financial functions in the interna-  
 tional electronics industry.

**Day One - May 14**

Chairman: Dr. C. Lester Hogan President, Fairchild Camera and Instrument Corporation	<b>Prospects for Semiconductors</b>
Mr. Earl Wantland President, Tektronix, Inc.	<b>Prospects for Electronic Instruments</b>
Mr. Edward Fennessy, CBE Managing Director Post Office Telecommunications	<b>Prospects for Telecommunications</b>
Mr. Sebastian de Ferranti Chairman and Managing Director Ferranti Ltd.	<b>Electronics in the 1980's</b>
Speaker to be announced	<b>The International Military Market for the Electronics Industry</b>
Dr. Ieuan Maddock, CB, OBE Chief Scientist Department of Trade and Industry	<b>The Commercial Exploitation of Electronics Research</b>
Mr. David Price, MP Chairman, The Parliamentary Committee for Technology	<b>Government Policies for Electronics (Luncheon Speaker)</b>
Speaker to be announced from Commission of the European Communities	<b>The Growth Potential of Electronics in the European Community</b>
Mr. Gordon Haley Manager, Systems Technology ICL Computer Development Div.	<b>Future Computer Technology</b>

**Day Two - May 15**

Chairman: M. R. J. Clayton, CBE Technical Director The General Electric Company Ltd.	<b>Vertical Integration: Components to Systems</b>
Dr. J. Fred Bucy, Jr. Executive Vice President Texas Instruments Inc.	<b>Performance and Prospects in the World's Electronics Industries</b>
Mr. J. C. Akerman Managing Director Mullard Limited	<b>The Role of an American Multi National in Europe</b>
Dr. Robert Heikes Managing Director Motorola Europe, Switzerland	<b>Japanese Electronics in World Markets</b>
Speaker to be announced	<b>New Challenges to the Instrument Industry (Luncheon Speaker)</b>
Mr. John Fluke, Sr. Chairman John Fluke Manufacturing Co., Inc.	<b>Electronics and Energy</b>
Dr. Edward David Executive Vice President Gould, Inc. Former Science Adviser to the President of the United States	<b>The Future of World Consumer Electronics</b>
Dr. William Hittinger Executive Vice President RCA Corporation	<b>International Cooperation in Electronics</b>
Monsieur Edouard Guigonis Directeur Delegue and Directeur Commercial General, Thomson CSF	

To register for the conference use the coupon below. We will be pleased to assist  
 you in securing trans-atlantic flight reservations and London hotel accommodations.  
 Registration fee for "Tomorrow in World Electronics" is \$200.

**REGISTRATION FORM**

**"TOMORROW IN WORLD ELECTRONICS"**

A major international conference sponsored by Electronic Design, The Financial Times, Electronics Weekly and BOAC.  
 Please register the following individual:

Name \_\_\_\_\_ Title \_\_\_\_\_

Additional registrations:

    Name \_\_\_\_\_ Title \_\_\_\_\_

    Name \_\_\_\_\_ Title \_\_\_\_\_

Company \_\_\_\_\_ Division \_\_\_\_\_

Address \_\_\_\_\_ Telephone \_\_\_\_\_

City \_\_\_\_\_ State \_\_\_\_\_ Zip \_\_\_\_\_

**Mail this registration form to:**  
 Ms. Gay Donneland  
 Electronic Design/Financial  
 Times Conference  
 Financial Times  
 Publications, Ltd.  
 Suite 1006  
 516 Fifth Avenue  
 New York, N.Y. 10036  
 (212) 869-3971

Registration fee: \$200 per person.  
 Make check payable to: Financial Times Ltd.  
 Payment enclosed.     Please bill me. I would like assistance in  flight  hotel reservations.

# 150 Microwatt Triple Op Amp

The L144 monolithic triple op amp draws only  $50\mu\text{A}$  of current per amplifier, from a  $\pm 1.5\text{ V}$  supply. What's more, it is

**AVAILABLE NOW FROM YOUR LOCAL DISTRIBUTOR!**

L144 features include:

- Monolithic triple op amp in DIP or Flatpac packages
- Wide power supply range— $\pm 1.5\text{ V}$  to  $\pm 15\text{ V}$
- Internal compensation
- Programmable power dissipation
- Programmable input bias current
- Single programming resistor
- 80 dB gain with  $20\text{ K}\Omega$  load
- Cost effective: \$1.63 per single op amp<sup>(1)</sup>

<sup>(1)</sup>L144CJ 100-piece price

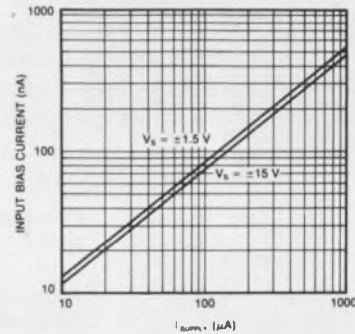

Applications examples:

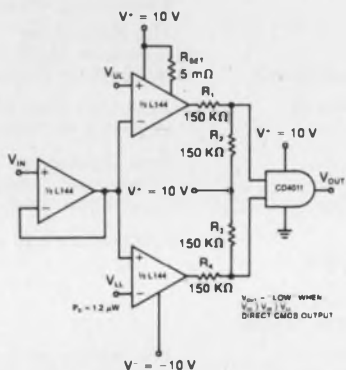

DOUBLE-ENDED LIMIT COMPARATOR

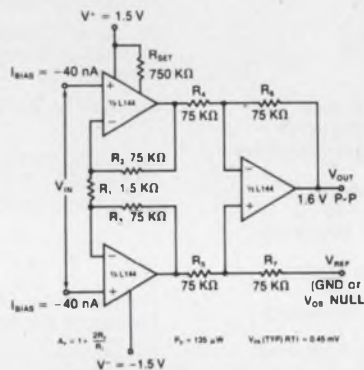

INSTRUMENTATION AMPLIFIER

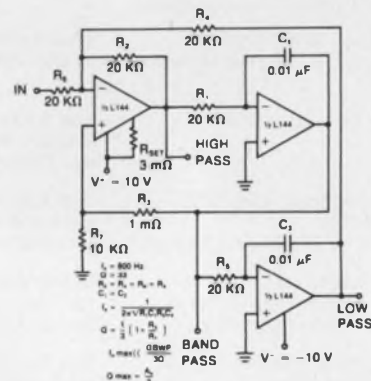

ACTIVE FILTER

The L144 is a practical industry-standard operational amplifier for use when low current drain, low voltage, low power, or very small physical size are controlling criteria. If your circuit requirements are unique—and whose aren't—our applications people are eager to help.

For complete information

**write for data**

IC Applications: (408) 246 8000, Ext. 120



**Siliconix incorporated**

2201 Laurelwood Road, Santa Clara, California 95054

INFORMATION RETRIEVAL NUMBER 30



## We've changed.... haven't we?

Not too long ago the public's image of the typical electrical engineer was of a rather studious looking, crew-cut type who wore a white shirt, conservative bow tie, dark suit and white socks. He walked around the office with a rather dazed look, dreamily pondering the solution to some complex design problem, a slip stick in his hand, a fountain pen hanging from his belt. His perception of the world around him was generally limited to a quote or two from the local paper and discussions with his peer group. His political views were on the conservative side, his temperament mild.



An unflattering image, certainly. But perhaps containing enough truth so that this stereotyped image persisted for many years. Now we begin to see a change in the popular perception of the engineer. A lot has happened to our profession in the past decade. The engineer has been as much affected by the turbulent changes in recent years as has the public in general. Sideburns and collar-length haircuts have replaced the crew-cut. His mode of dress now includes Brooks Brothers and Bill Blass. The ballpoint pen has supplanted the fountain pen; the electronic calculator, the slide rule. But far more important than these outward trappings, the engineer today has become involved.

He finds that as a professional, he needs to keep up with current events as much as technology. He reads newspapers and magazines as avidly as the technical journals. He is concerned and is increasingly involved in politics, both on a national and local level. More and more he has begun to raise questions about company ethics and the by-products and end use of his designs. He has brought about considerable change—mostly for the better—in the professional societies. In short, the engineer of today is as different from his counterpart a decade ago as the microcomputer from the mainframe.

We don't claim that his expertise is necessarily any better than his predecessor's, but we think he's become a better engineer. Being involved has not only helped him as a person but has helped his profession as well.

*Ralph Dobriner*

RALPH DOBRINER  
Managing Editor

# Trustworthy

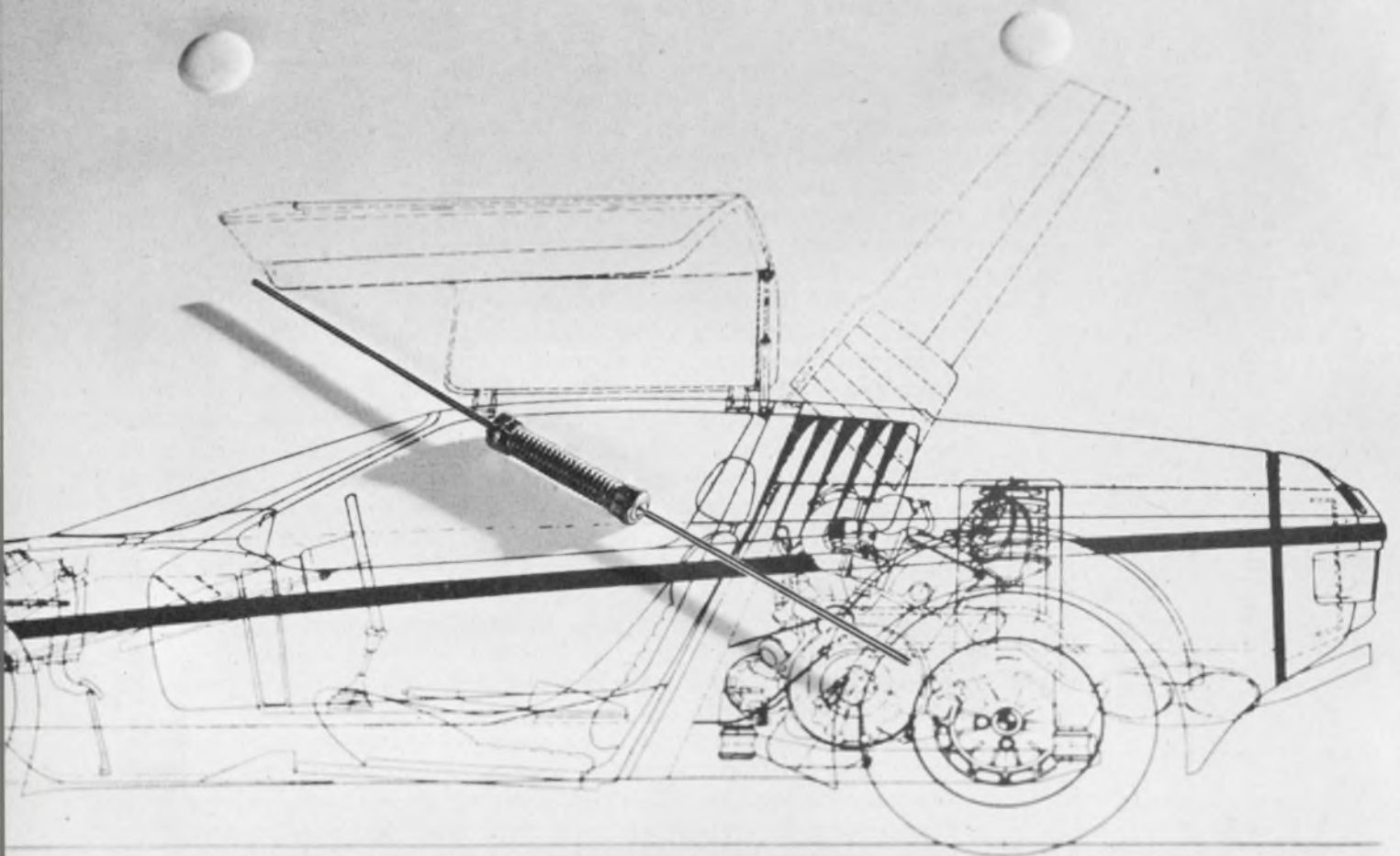

## Wirewound Resistors to help start cars.

From solid state ignition systems to appliances and entertainment devices, Dale commercial resistors are in wide demand...uncoated (CA/CR)... potted (CP)...silicone coated (CW). Pleasing price and delivery. Phone 402-564-3131.

DALE ELECTRONICS, INC., 1300 28th Ave. Columbus, NE 68601 A subsidiary of The Lionel Corporation  
In Canada: Dale Electronics Canada Ltd. In Europe: Dale Electronics GMBH, 8 Munchen 60, Falkweg 51

# resistors.

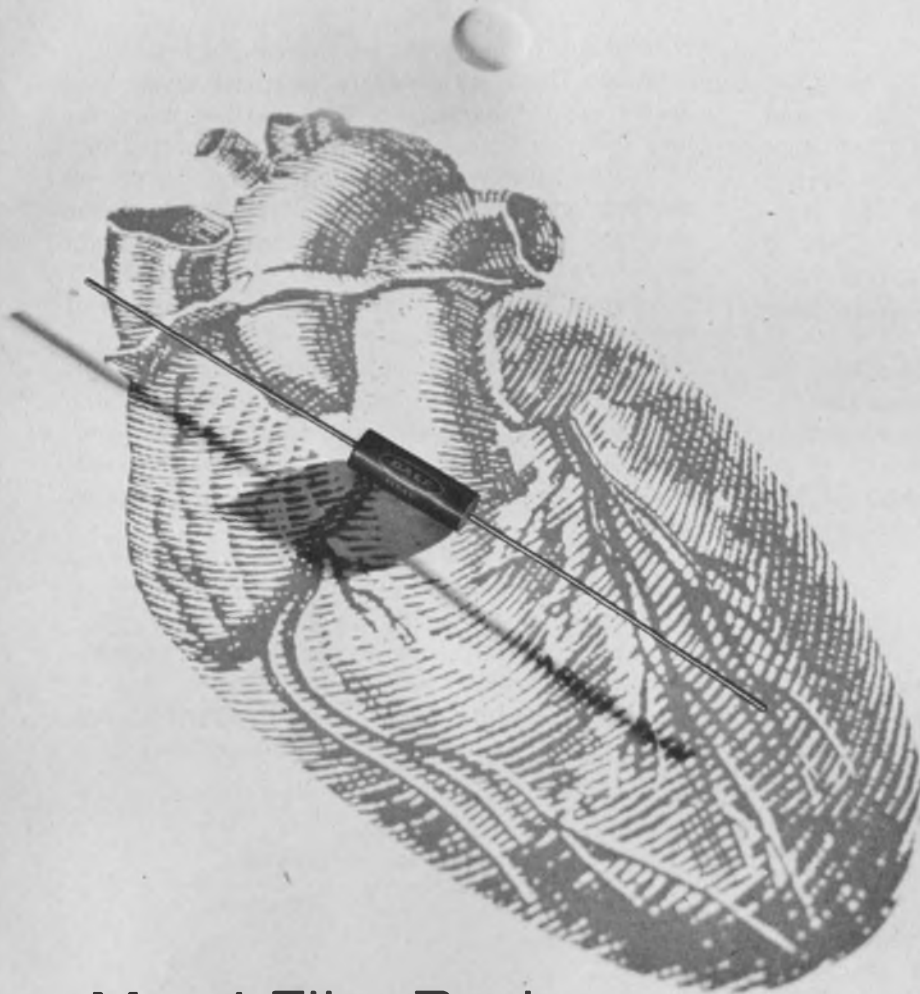

## Metal Film Resistors to help hearts beat.

Heart pacing devices and critical instrumentation applications use Dale HMF resistors. Reason: They combine the higher resistance range of carbon styles with extra precision and stability.

Deliveries? Much better.  
Phone 402-371-0080.



For the name of your nearest Dale  
Representative/Distributor Phone 800-645-9200

## Commercial Resistors Finding New Uses

Growing use in automotive, appliance and entertainment applications has prompted Dale Electronics, Inc., to expand production and shorten delivery of its entire commercial wirewound resistor line.

Dale currently manufactures low-cost uncoated wirewounds in axial and radial lead models as well as fireproof, potted versions of the same construction. Ratings up to 5 watts per inch are available in uncoated models. Potted styles are available in sizes from 2 to 10 watts and conform to EIA Standard RS 344.

For applications requiring tighter tolerances and/or environmental protection, Dale produces a complete line of industrial-grade wirewounds including solid core axial lead styles (CW) and tubular core lug and lead styles (HL). For complete information, contact Wirewound Division, Dale Electronics, Inc., Box 609, Columbus, Nebraska 68601.

CIRCLE 245

## Wall Charts Aid Resistor Selection

Two comprehensive wall charts designed to aid in resistor selection have been published by Dale Electronics, Inc.

Divided into wirewound and metal film categories, the charts show a complete range of precision, industrial and commercial styles. Basic performance and dimensional specifications are shown for all models. Both charts are 17" x 24" and are available free of charge from Dale Electronics, Inc., Dept. 860, P.O. Box 609, Columbus, Nebraska 68601.

CIRCLE 246

## High Value Metal Film Winning Design Favor; Delivery Shortened

For better resistor performance in upper value ranges formerly limited to carbon styles, many designers are specifying Dale Electronics' HMF metal film series.

These epoxy molded axial lead resistors are available with values up to 50 megohms and range in size from a subminiature 1/20 watt to 1 watt. They provide a standard tolerance of 1% plus controlled TC and excellent high frequency characteristics.

To respond to the demand for HMF styles, Dale has expanded its production facilities and is now offering shortened delivery times for popular models. Contact: Metal Film Division, Dale Electronics, Inc., Box 74, Norfolk, Nebraska 68701.

CIRCLE 247

# Engineers disagree on cause of shortages, spot check shows, but agree on how to work around missing parts and the more recent squeeze on energy and raw materials.

Dick Turmail, Associate Editor

Shortages are nothing new to producers and users of electronics. An ELECTRONIC DESIGN spot check shows that most designers and engineering managers have run into trouble getting components for well over two years now. They've been searching for substitutes, redesigning, dual-sourcing and delaying projects. As one engineer from California put it:

"Semiconductors and capacitors have been in short supply since the recession, when the industry failed to stock up against a growing consumer demand."

What is new perhaps is that now designers are trying to work around two additional shortages: energy and raw materials.

## 'Politics' attacked by some

With few exceptions, most engineers and companies are of the same mind when handling their shortage problems. They are trying familiar tactics: searching for or developing their own substitutes, establishing new product lines, improving yields, controlling manufacturing waste, cutting over-all inventories and double-ordering high volume parts, reducing lighting and heating, and driving less. But there is a great difference of opinion as to what "shortage" is.

Some respondents think that the term is a misnomer. The problem, they insist, is "politics." There will be genuine shortages, a Midwestern engineer comments, "unless we allow capitalistic free enterprise to make the infinitely complex adjustments necessary, free of all unconstitutional Government intervention."

An engineering manager from Utah says it more bluntly: "The best solution to shortages is to stop the Government from telling us how many of what kind of a thing we can make, what we can charge for it and what we can pay our employees to make it."

Another opinion from an engineer in Massachusetts is that "shortage does not require technological solutions but rather responsible Presidential and Congressional action to stop the huge

outflowings of our basic resources and products."

Others think, as does one engineer from New Jersey, that "shortage is just another word for long delivery time and higher-than-usual prices." Still others believe that shortages are a design problem or a purchasing and inventory problem, and just as many respondents admit they don't know what to believe.

Some of the other more interesting findings of the spot check are these:

- Shortages are causing destructive side effects: fewer deliveries because of scarce gasoline supplies; bigger inventories that squeeze company cash flow; destruction of business in special products sold in small quantities at a quick turn-around.
- Though two of every three companies are looking for component substitutes, only one in 10 is actually developing its own.
- Few companies are laying off employees because of shortages.
- One of 10 respondents reports that his com-

Shortages by percentage of response

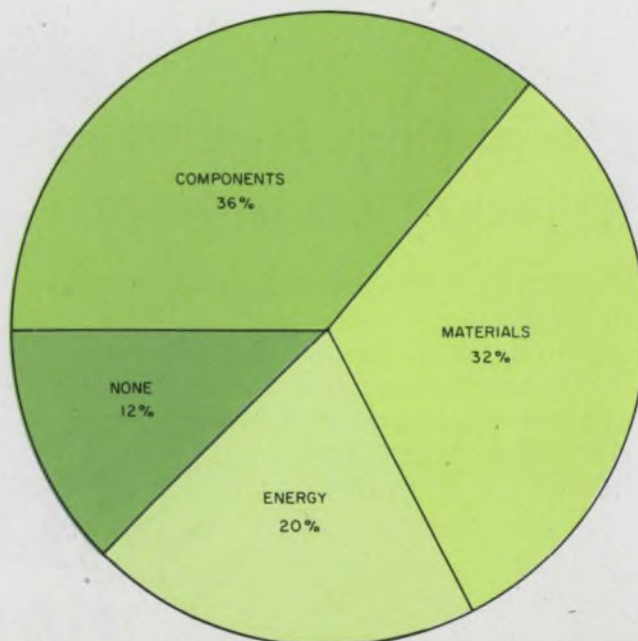

pany has no shortages at all.

■ In general, the larger the company the harder it is to maintain a normal supply of energy; the smaller the company, the harder it is to get components.

### Shortages: What—and how long a wait?

While the parts shortage is not limited to any one region of the country, the size of the company may make a difference. According to the ELECTRONIC DESIGN poll, nearly 60% of those companies grossing less than \$24-million annually are having more trouble finding components than their larger competitors. Many respondents who work for young companies grossing less than \$10-million say that because of their company's size, it's often impossible to compete with larger manufacturers on volume orders. And because the company is young, it is often low on the distributor's list of preferred clients.

However, the spot check found that larger companies were having shortage problems, too. About one-third of the companies that gross \$100-million and more are having trouble getting enough electricity, fuel oil, gasoline and natural gas, probably because they use more than smaller companies.

What components are the hardest to get and when can you get delivery?

The components in shortest supply are ICs, transistors, electrolytic and ceramic capacitors and metal-film resistors. There's also a shortage of switches, relays, zeners and gold-plated connectors.

Deliveries for most ICs are reported to take from two weeks to a year. It reportedly takes two weeks to six months to get most memories and military op amps, and deliveries for transistors—mostly small-signal (plastic), power and FETs—can take up to six months, with shorter lead times for small-signal, metal transistors.

Resistors are shipped a little sooner—usually in six to 20 weeks for fixed carbon types and fixed and variable wirewounds. But there are waiting periods of up to 45 weeks for fixed, metal film resistors.

The wait for capacitors can be from one month to a year if you want electrolytic, ceramic and tantalum types. If you prefer mica or film and paper capacitors, your wait is generally shorter—from one to five months.

### Prescriptions for shortages

What do respondents suggest as a hedge against semiconductor and component shortages? One engineer from Ohio says: "Take two days to design instead of one, and spend the second day cutting your circuit in half."

An engineer from Florida suggests that it's helpful to "get vendors to quote honest deliveries so that the designer can design around known shortages."

Another engineer from Massachusetts offers an innovative material control system, with point-of-sale terminals at the stock room and an interactive, on-line management information system in purchasing. "But purchases must be made at just the right time," he advises.

A New Yorker suggests that large-quantity deliveries of components to single companies be reduced. Instead, he would set up smaller-quantity deliveries to a greater number of companies. His reasoning is that quantity requirements do not indicate immediate use—a large delivery may sit on the shelf when some small company may need only a small quantity to support its production requirement.

Raw materials that respondents have trouble getting are paper, ceramics, solvents and many metals, including copper, brass, steel, zinc alloys and especially aluminum. There's no apparent national shortage of aluminum, but it takes great amounts of electricity to make it, and there's a shortage of electric power in some areas. The U.S. imports 81% of its aluminum supply, but a rise in the price may encourage an increase in domestic production.

Petrochemicals are also high on the respondents' list of hard-to-get raw materials, including vinyl, nylon, polystyrene, polyethylene and particularly plastics used for circuit boards and many electronic components.

Some relief is in sight. Fewer new automobiles are being built, and they require about 150 pounds

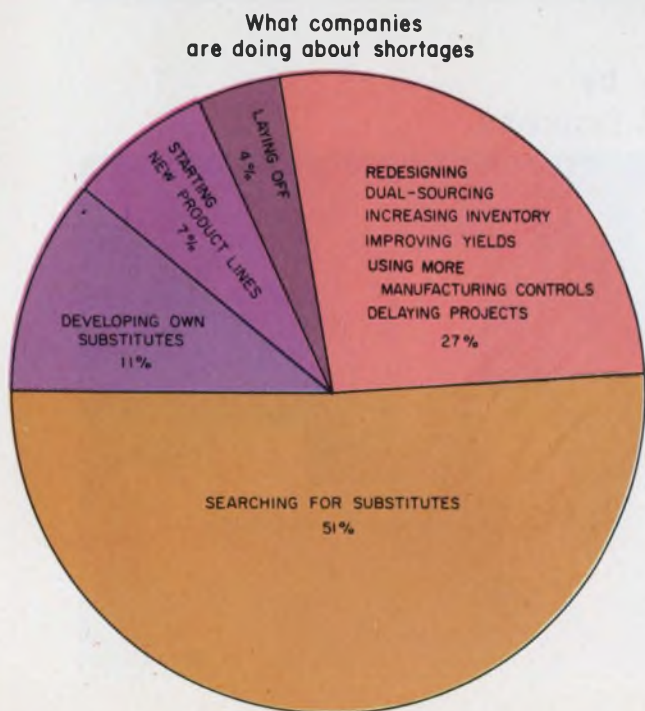

## Respondents' profile

ELECTRONIC DESIGN's spot check is based on responses to a questionnaire published on p. 42 in the Jan. 18 issue. Besides the categorizing questions of title, location, company size and industry, the questionnaire asked:

- Is your company experiencing shortages now? If yes, please specify.
- What is your company doing about its shortages?
- If your company is not currently experiencing shortages, does your management expect shortages in the future? If so, when?
- Please include technological solutions on how to deal with shortages.

Detailed replies came from 75 engineers and 25 managers in 32 states. Over half of the response was from California (14%), Massachusetts (13%), Texas and New Jersey (9% each), and New York (6%).

Two of every five respondents work for companies that gross under \$10-million annually, and one of every three for a company that grosses \$100-million or more.

Over half of the respondents work in communications, an industrial company, for the Government or in aircraft and/or aerospace. The remaining 45% are well spread in seven other electronic industry categories.

### Company size by percentage of response

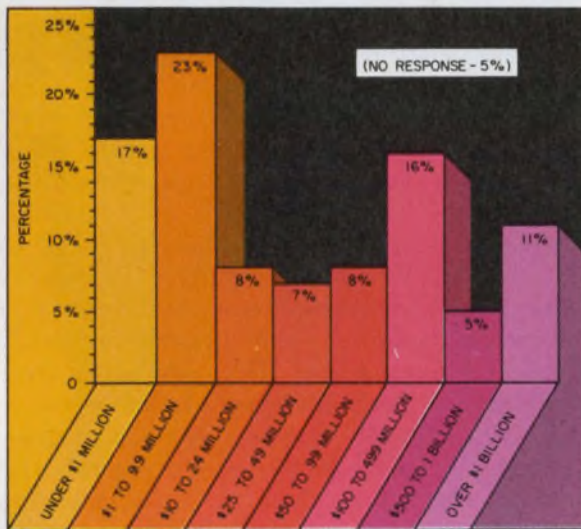

### Location by percentage of response

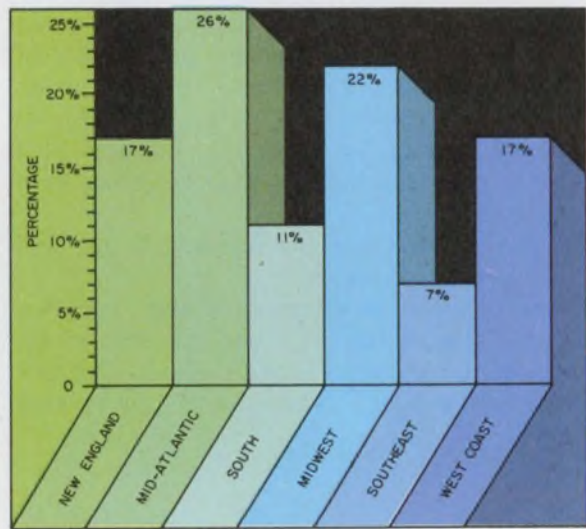

### Industry by percentage of response

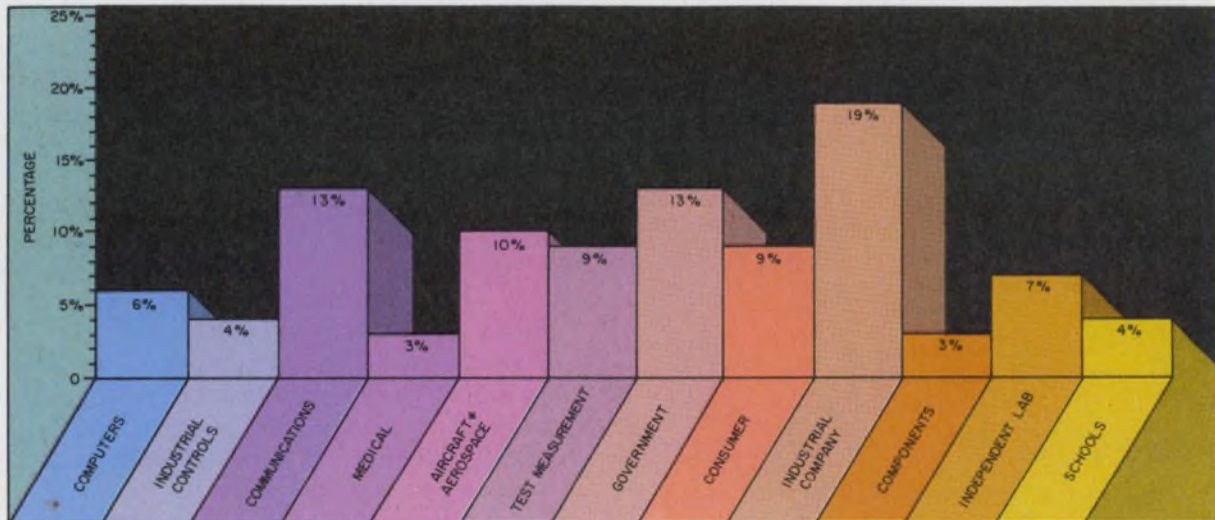

## Shortages by location

	NEW ENGLAND	MID-ATLANTIC	SOUTH	MIDWEST	SOUTHEAST	WEST COAST	SOUTHWEST
ENERGY	26 %	21%	33 %	13 %	25 %	14 %	22 %
COMPONENTS	37%	40%	27%	34 %	50%	49%	22 %
MATERIALS	30 %	33%	40 %	44 %	25%	23%	34%
NONE	7%	6%	NO RESPONSE	9%	NO RESPONSE	14%	22%

## Shortages by company size

	UNDER \$1 MIL.	\$1 TO 9.9 MIL.	\$10 TO 24 MIL.	\$25 TO 49 MIL.	\$50 TO 99 MIL.	\$100 TO 499 MIL.	\$500 TO 1 BIL.	OVER \$1 BIL.	60 V'T.
ENERGY	9 %	14%	NO RESPONSE	16 %	14 %	32 %	27 %	32 %	50 %
COMPONENTS	49 %	49%	58%	33%	28%	26%	37%	26%	17%
MATERIALS	27%	33%	42%	43%	35%	21%	27%	42%	33%
NONE	15 %	4 %	NO RESPONSE	8 %	23%	21%	9%	NO RESPONSE	NO RESPONSE

of plastic for each car; this will free some petrochemicals for use in electronic components. Also, the Federal Cost of Living Council decided in February to exempt most petrochemical feedstocks from Phase IV price regulations. There won't be any immediate turn-around, but the action should free more materials over the long range. Prices will go up initially—about 10% to 15%, it's estimated—and then follow the price of oil.

### Ideas on conservation

On energy conservation, some respondents have their own ideas. An engineer from Michigan says: "To reduce heating-oil use, we are circulating building air through the molding machine's cooling system; in summer, we'll exhaust this warm air."

Another engineer from Michigan suggests computer monitoring and control of the gas generator and furnaces for efficient operation. An Alabamian thinks that solar power and geothermal energy should be used where available—even windmills, he said, are a viable source of

electrical energy in most parts of the country. One Texan submits his theory for a thermal energy converter:

"Make a large thermopile by bonding together strips of alternate dissimilar materials (perhaps carbon and silicon carbon) like the pleats of an accordion."

Another engineer from Texas suggests using street lighting that's activated only by passing auto headlights, and time-delay switches to turn off hotel passageway and office hallway lighting after use. Also, more use of fluorescent lights instead of incandescent is suggested. An engineer from Massachusetts advises using precipitators to clean coal smoke, so coal can be used more freely.

Many respondents suggest that saving fuel is basically a measurement and control problem; that electronic controls can be used for heating, lighting and air-conditioning, and that alternative energy systems, such as solar and geothermal, will require instrumentation and controls.

But which comes first? The component, the energy, the raw materials? Or the control and instrumentation? ■■





# John Donohue's "blue line" turns out keyboard switches faster than you can say Oak.

John Donohue, Director of Manufacturing here at Oak, is mighty proud of his "blue line." He ought to be. It's the most sophisticated fully-automated keyboard switch assembly facility in the industry. It was designed with the customer in mind. We wanted to make sure we'd be able to meet his demands for huge quantities of our popular keyboard switches.

And popular they are. We build keyboard switches for everything from miniature calculators to data entry systems to point-of-sale terminals. You can buy them individually or in completely assembled custom keyboards.

If you need low-profile keyboard switches—we have 'em. Our Series 415 switches have a profile of less than  $\frac{1}{2}$  inch. And they're available in either single or double "human engineered" keycaps that dress up any product design.

Series 400 and 475 keyboard switches are built with self-cleaning gold cross-bar wiping contacts. You're assured of trouble-free operation through millions of cycles. And our variety of contact arrangements gives you true design versatility.

We also offer a full selection of lighted and unlighted pushbutton switches plus almost any other type of switch you can put your finger on. Let us know your needs.

Write Lou Roels at Oak for product literature, helpful keyboard design tips and free samples of our keyboard switches.

**DAK Industries Inc.**

**SWITCH DIVISION** / CRYSTAL LAKE, ILLINOIS 60014  
TELEPHONE: 815-459-8000 ■ TWX: 910-834-3353 ■ TELEX: 72-2447

INFORMATION RETRIEVAL NUMBER 31

"Keep 'em coming, John"

# MOS/LSI microcomputer coding: It involves loaders, assemblers and even compilers. Use these and other tools to store algorithms in the system's memory.

## Second of three articles

Engineers who incorporate MOS/LSI microcomputers in their designs face a critical need: conversion of system algorithms into instructions that can be loaded directly into the system's memory.

IC manufacturers are giving more and more attention to this phase of design, generally called coding, with improved tools and techniques to simplify the designer's task.

The basic tools available are these:

- Assemblers.
- Editors.
- Loaders.
- Compilers.
- Microprogramming.

Fig. 1 shows the primary function of the first four tools. In addition hardware or software simulators are available for program testing and error locating.

### Assembly language: the most appropriate

An assembly language, the most common for microcomputer programming, has these features: symbolic operation codes; labels that refer to memory locations—instruction or data; and symbolic names for operands, such as registers, condition flip-flops and test conditions of conditional instructions (Fig. 2).

For example, in the Fairchild PPS-25 the instruction<sup>1</sup>

$$(R_{ij}) \leftarrow (A_j) + (R_{kj})$$

replaces the contents of register  $R_i$  with the sum of the contents of the accumulator and register  $R_k$ . However, only a designated field,  $j$ , in each register is involved in the addition. The Fairchild assembly-language equivalent reads

ADD Y, X, T.

Here Y represents the name of a destination register, X the name of a source register and T a previously selected code that represents the field over which addition is to take place. The

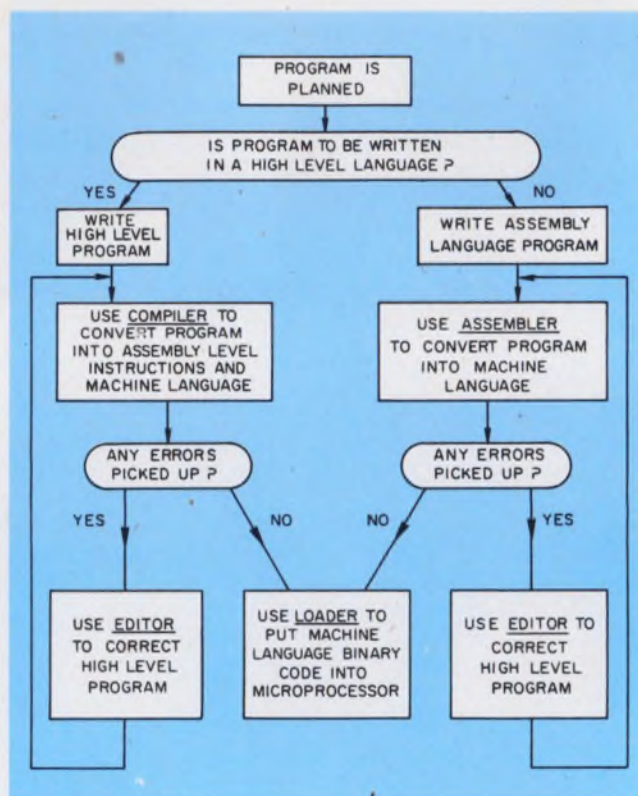

1. Preparation of the binary code to be placed in read-only memory can be simplified by use of a compiler or assembler and an editor and loader.

possible codes of T, with their meanings, include the following:

- TOTAL: Total field,
- FRAC: 19 (left-most) digit fractional or mantissa field,
- LSD: Least significant digit,
- PFIELD: Digit selected by pointer register.

In the Intel 8008, consider this conditional CALL instruction:  $PC \downarrow S$  and  $(PC) \leftarrow 14$  bit immediate field, if condition holds; otherwise do next instruction. PC refers to the program counter and S represents a last-in, first-out stack.

Such an instruction in the Intel assembly language is written

CTX PLACE.

X refers to C, Z, P or S, which mean, respective-

C. Dennis Weiss, Ph.D., Member of the Technical Staff, Bell Telephone Laboratories, Holmdel, N.J. 07733.

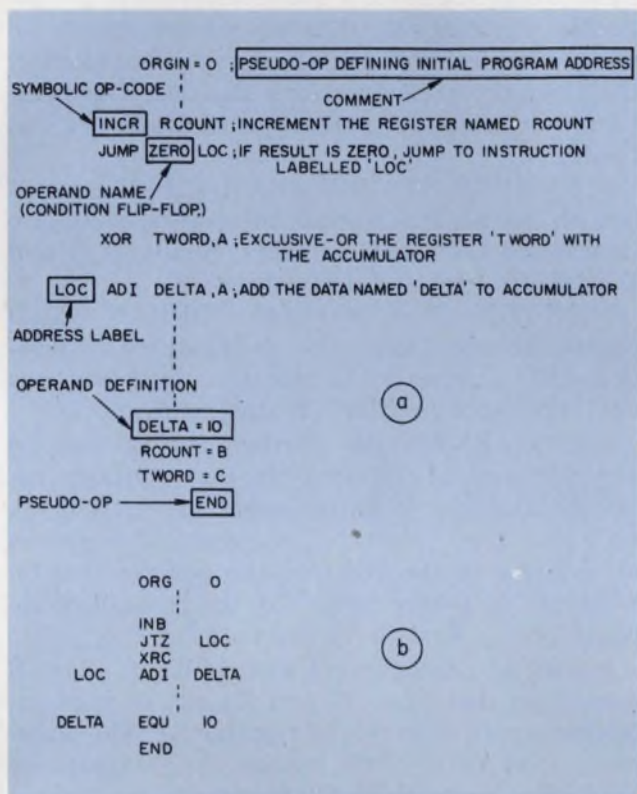

2. Part of an assembly-language program (a) illustrates the basic language features. The same program segment appears in the Intel 8008 assembly language (b).

ly, Carry = 1, Result Zero, Parity Even and Sign Bit 1. PLACE is the label associated with any other instruction in the sequence being assembled.

Hence the statement

CTP STEP1

causes the microcomputer to call STEP1 conditionally. The processor saves the program counter and replaces it by the address labeled STEP1, if the parity of the register last operated upon was even. Otherwise the instruction that follows would be executed.

The sequence

INB  
CFP STEP1  
JMP STEP2

increments register B, calls to STEP1 if the

### A line of source tape

```
LD ACφ, @. +10
```

This says LOAD register ACφ indirectly, through the address given by adding 10 (octal) to the current value of the program counter (denoted by ·)

### A line of the list tape

```
10 000 9109 LD ACφ, @. +10
```

10 = line number in assembly language program (on source tape)  
000 = location of the instruction  
9109 = hexadecimal representation of the 16-bit machine language word  
LD ACφ, @. +10 = assembly language statement written by programmer on source tape

### A line of the object tape

```
1001000100001001
```

This is a 16-bit machine language equivalent of the instruction above.

3. The assembler,—a program,—converts a source tape to a list tape and absolute object tape in this example from the National IMP-16.

parity of register B is odd or performs an unconditional JUMP to STEP2 if the parity is even.

The assembler can read a source tape or file with statements written in the symbolic assembly language (Fig. 3). Also, the assembler can construct various tables from the source file and produce an output object tape, or file, with binary numbers for the microcomputer.

For example, in the Fairchild PPS-25,

ADD B,C, FRAC

appears in the object code as

000100101010.

From left to right, 000 is the operation code for ADD; 100 is the Fairchild code for the B register; 101 is the code for the C register, and 010 represents the mask-programmed code to select the left-most 19-digit field of a register.

```

NUMBERS OCTAL
ORIGIN 0
ENTRY 1 LOAD R1, MEM 1
LOAD R2, MEM 2
*** 'LOAD' IS UNDEFINED OP-CODE ***
ENTRY 1 COMPARE R1, R2
*** DUPLICATE ADDRESS LABEL ***
JCOND PLACE
*** 'PLACE' is UNDEFINED ADDRESS
LABEL ***
*** OPERAND MISSING ***
JUMP FINISH
STORE R1, MEM; if R1 > R2, EX-
CHANGE
*** 'MEM' UNDEFINED ***
STORE R2, MEM 1
FINISH HLT
*** 'HLT' IS UNDEFINED OPERATION ***
MEM 1 = 1732
MEM 2 = 1840
*** NUMBER IS INVALID OCTAL ***
END

```

```

NUMBERS OCTAL
ORIGIN 0
ENTRY 1 LOAD R1, MEM 1
LOAD R2, MEM 2
ENTRY 2 COMPARE R1, R2
JCOND GREATER, PLACE
JUMP FINISH
PLACE STORE R1, MEM 2; if R1 > R2, EX-
CHANGE
STORE R2, MEM 1
FINISH HALT
MEM 1 = 1732
MEM 2 = 2040
END

```

4. An assembler provides error messages that start with "\*\*\*\*" in a program with errors (top). The corrected program appears at the bottom.

For the Intel 8008,

```

CTP STEP1
appears as the 3-byte instruction,
01111010
00110000
xx001110.

```

STEP1 is assumed to be an instruction stored at binary location 00111000110000. The last two bytes give, respectively, the low 8 and high 6 bits of the address. The bits marked x are "don't cares" for the 8008. The assembler could substitute any bit pattern, since the machine ignores these locations.

#### The assembler—a program

The assembler is a program that must be run on some computer. One assembler program—from Intel—can be loaded into several PROM or ROM chips and executed by a microcomputer of the type for which it is assembling. These are called "hardware assemblers," because they run on the hardware itself.

A more common situation is one in which the

assembler itself is written in Fortran. With minor modifications, the program can be run on any computer that compiles Fortran programs. Thus the designer prepares source programs, assembling them on some other computer, to obtain the object tape for the microcomputer. The Fortran-written assemblers are often made available to users through various national time-sharing, computer-service companies.

#### Assemblers contain pseudo-operations

Assemblers provide more sophisticated features. These are usually pseudo-operations, or assembler instructions, that do not assemble into microcomputer instructions directly but control the assembly of instructions that do. The more significant and common psuedo-ops are as follows:

- NUMBER SYSTEM (B,O,D). If B is written, all literals that appear in operand fields are interpreted as binary numbers. Similarly O and D establish octal and decimal modes.
- ORIGIN. The statement ORIGIN 256D causes the next instruction to be stored at location 256 (decimal). Consecutive locations are used until another ORIGIN statement appears.
- COMMENTS. It's common to intersperse English text in a source file that contains assembly language. With the selection of a symbol, such as "/" or ";" or ":", the assembler ignores all symbols to the right of the selected one on each line of source text. But the assembler reproduces the symbols in the final list file.
- EQUAL. A statement such as R1 = PLACE establishes that PLACE, and R1 can be used interchangeably as names of register R1. The statement DATA1 = 53D causes the contents of DATA1 to be taken as 53 (decimal).
- DATA GENERATING STATEMENT. A statement such as TABLE D 7, 53, 29 creates three data words stored in successive locations in memory. The first location is labeled TABLE.

#### Assemblers give error messages

The ability of assemblers to detect and point to a variety of errors in source statements is one of their most valuable features (Fig. 4). These errors are syntactic—they deal with misuse of the actual language. Assemblers normally cannot catch logic errors in the program, errors of intent or other subtle problems. A statement that contains an error is printed in the list file with a code letter—a flag—beside it. Or the entire error message may be printed.

Some common errors that can be detected include duplicate address label, undefined label and unrecognized instruction mnemonic (due perhaps to the misspelling of an operation code). Other

detectable errors include undefined operand field names, wrong number of operands and an invalid number in the number system chosen. In addition an assembler could be made to detect the error of an address referred to the same ROM page, as in a short JUMP when a long JUMP is required.

Not all errors of syntax are flagged in current microprocessor assemblers. For example, when the labeled address for a JUMP or CALL instruction is not the start of an executable instruction, the error is not generally detected.

A macro facility—a deluxe feature in assemblers—is very useful when similar sections of code are used repeatedly but variations preclude the use of conventional subroutine techniques. A macro consists of a sequence of code or a routine that is defined with such parameters as data values, addresses, labels or even instructions. An expansion of a macro involves a specific copy of this sequence in which all parameters have assigned values.

For the assembler to produce an expansion of the macro, only a single statement need be written—if you assume that the macro definition has already been given to the assembler. This statement appears at the location at which the expansion is to begin, and it contains a list of the values to be assigned. The assembler creates the complete expansion where requested.

### Editors make changes

Editors are interactive systems that allow designers to prepare a program, or text, and to make changes with simple commands. Time-sharing services, which provide remote access to microcomputer assemblers, have such editor systems. Hence designers can prepare assembly-language programs and correct them. They can add documentation and store, combine and retrieve programs. And they can output programs onto paper tape and printers with relative ease.

Once a program has been written, assembler-flagged errors corrected and a binary object tape, or file, created, the program must be loaded into the memory of the microcomputer system.

Assembled programs can be loaded into mask or field-programmable ROMs. They can also be loaded into RAMs, in which case a small bootstrap loader is required. The latter may be a minimal program loaded into several ROMs or pROMs. This bootstrap program has just enough capability to read an object tape of a complete loader program, which is placed on a tape reader under microprocessor control. More often, the bootstrap loader contains the entire loader program, and all RAM space is available to load the application program.

Application programs can be conveniently test-

### A PL/M statement

```
DECLARE (X,Y,Z) BYTE; IF X > Y THEN Z =
  X - Y + 2; ELSE Z = Y - X + 2
```

### An equivalent set of assembly language statements for the Intel 8008

```

      ORG 4000
BEGIN  LLI LOW X
      LHI HIGH X
      LAM;          accumulator contains X
      LLI LOW Y
      LHI HIGH Y
      LBM;          B-register contains Y
      SUB;          Subtract B-register from
                   accumulator
      JTS LOC2;     if result negative, jump
                   to LOC2.
LOC 1  ADI 2;       add 2 to accumulator
      LLI LOW Z
      LHI HIGH Z
      LMA;          store answer in the loca-
                   tion for Z
LOC 2  JMP FINISH
      LCI 377
      XRC;          accumulator bits
      ADI 1;        complemented
                   2's complement of X-Y in
                   accumulator
                   JMP LOC1
FINISH HLT
LOW X EQU 70;      word address of X
HIGH X EQU 10;     page address of X
LOW Y EQU 71
HIGH X EQU 10
LOW Z EQU 72
HIGH Z EQU 10
      ORG 4070
LOC X DEF 0;       X = 0 initially. Value as-
                   signed elsewhere
LOC Y DEF 0;       Y = 0 initially
LOC Z DEF 0;       Z = 0 initially
```

5. A short, readable compiler statement corresponds to many assembly-language statements.

ed in RAM before they are committed to ROMs or pROMs. However, if they are to be used in RAMs in the final system, a startup or restart procedure is needed. The procedure permits bootstrapping of the microcomputer into operation. A permanent loader is required in read-only memory.

### Advanced loader features

The most elementary binary loader simply reads successive words on the object tape and writes them into successive locations of RAM memory. The loader generally starts at a fixed origin. A relocating loader is more complex and not generally available. The reloading loader uses a special object tape and the desired origin data to automatically adjust the program addresses and load the resulting binary instructions.

With a basic binary loader, the same flexibility can be achieved by reassembly of the original source tape or file, but with a change of the ori-

- Errors in basic system design
  - difference between intended or desired operation and that achieved
- Errors in basic algorithms
  - incorrect algorithm
  - wrong strategy
  - algorithm takes too long to execute
  - arithmetic accuracy or precision unsatisfactory
- Errors in implementation
  - logic error
    - off by one count
    - conditions reversed
    - data stored in wrong order
    - microcomputer hangs up in a loop
    - data destroyed by overstore
    - wrong register used
  - coding errors
  - wrong instruction
- Errors in hardware
  - marginal operation
    - races
    - propagation delays too great
  - wiring error
  - interface signals incorrect
  - peripheral device operated improperly

6. Many potential sources of error exist in a microcomputer design.

gin using a suitable ORIGIN pseudo-operation.

Another feature of more advanced loaders is linking capability. Here program segments or routines with undefined labels or names can be loaded. The loader supplies missing cross references between the separate routines. Again, this feature can be achieved by reassembly of the entire collection of programs.

### Compilers translate languages

A compiler is a program that accepts as input data another program, written in a so-called source language. The compiler then outputs another program, written in what is called the target language. The latter can be either the assembly language or a machine language.

The source language is usually a high-level language, in which the instructions or commands are much more powerful than those of the target language. Examples of source languages are FORTRAN, COBOL, APL, ALGOL or PL/1.

Compilers make the programmer's job easier because they provide a language that requires fewer statements for an algorithm. Compilers eliminate the need to write detailed codes to control loops, to access complex data structures, or to program formulas and functions.

For example, a compiler from Intel has a subset of PL/1 instructions as its source language.

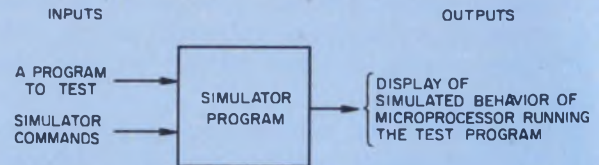

### EXAMPLE

#### INPUT TO SIMULATOR

The program itself (machine language instructions produced by an assembler)

A list of simulator commands

```
SET PC = 0, REGISTERS R1 = 1, R2 = 1,
R3 = 1
```

```
SET MEMORY LOCATIONS MEM (100)
TO MEM (150) = 0
```

```
STOP SIMULATION AFTER 20 INSTRUCTIONS
```

```
DISPLAY REGISTERS R1, R2, R3
```

```
DISPLAY MEM (100) TO M (103)
```

```
DISPLAY OCTAL
```

```
START
```

#### OUTPUT OF SIMULATOR

```
R1 = 5 R2 = 10 R3 = 73
```

```
MEM (100) = 0
```

```
MEM (101) = 377
```

```
MEM (102) = 264
```

```
MEM (103) = 113
```

7. Commands to a simulator allow designers to verify that a program is correct.

The subset language is called PL/M.<sup>2</sup> An example from PL/M illustrates the powerful nature of the source-language instructions:

```
DECLARE (X,Y,Z) BYTE;
IF X > Y THEN Z = X - Y + 2;
ELSE Z = Y - X + 2.
```

The PL/M statements are converted by the compiler into a sequence of assembly-language instructions. The instructions compute Z after they test to see if  $X > Y$ . If X is bigger, then  $Z = X - Y + 2$  is computed. If  $X \leq Y$ , then  $Z = Y - X + 2$  is computed. X, Y and Z refer to the contents of three, single-byte locations established by the DECLARE statement.

Fig. 5 shows an equivalent sequence of instructions written directly in the assembly language of the Intel 8008. Notice how much more difficult the instructions are to understand, despite the comments. And notice the increased amount of writing required, even without comments.

The use of higher-level languages has its limitations. Although errors may be reduced because of the lessened detail, new problems can be caused by failure to understand all the conventions built into the compiler. There is also invariably some loss in efficiency in compiler-generated code.

If you rely too heavily on a compiler, your mode of thinking may be too far removed from the actual microcomputer capabilities. While

programs are compact, easy to read and much easier to write, the net result may be excessive storage space and slower execution.

One solution is to write routines that are typical for an application in both the compiler's source and assembly languages. The comparison helps to determine any loss of efficiency and how significant the loss may be.

A compiler that produces assembly-language code—and not simply machine-language words—permits the use of an assembly listing for tests and verification. Also, such a compiler lets the designer eliminate redundant data movement.

### Microprogramming tailors designs

Some microcomputers—the National GPC/P,<sup>3</sup> for example—can be tailored to design requirements through use of a mask-programmed control ROM. In effect, the designer can choose, within limits, the basic machine-language instruction set if he writes the microprogram.

This flexibility simplifies use of a microcomputer as an emulator of another computer. The instruction set of the other computer is microprogrammed into the microcomputer control ROM. Execution of a program instruction corresponds to selection of the equivalent micro-routine.

Microprogramming can also be used for critical, short routines in applications where speed is of the essence. The routines can be executed faster when written in the basic control language of the microcomputer. A single machine-language instruction triggers the routine.

The microprogram instructions are more elemental than the usual machine-language instructions. Each instruction controls limited, simple operations in the microcomputer. A sequence of instructions is required for most machine-language instructions. Hence many instructions are required for an entire computational routine.

### Simulator tests programs

Many potential sources of error exist in a microcomputer program of even modest complexity (Fig. 6). A software simulator provides one of the most useful tools for testing programs.

Input data to the simulator consist of an assembled program, or object file, written for the microcomputer. In addition various commands are available to control the simulated execution of the program (Fig. 7).

The simulator output contains representations of the contents of various registers, flags and memory locations. These are shown as they would appear inside the microcomputer. The sim-

- Start simulation.
- Stop simulation after a given number of cycles of simulated instructions.
- Stop simulation when the processor reaches a specified instruction or memory location.
- Stop simulation when the contents of a specified memory location are altered.
- Display any registers, flags, program counter, stack contents, I/O ports, or memory locations specified in a command and range-list.
- Trace the simulated microprocessor by displaying elements such as registers whenever an instruction is fetched from the memory region specified in a range-list.
- Display the number of instruction states used by the microprocessor since the last simulator initialization.
- Set specified memory locations, registers and I/O ports to specific values to initialize a run.
- Interrupt the simulated microprocessor and force a CALL instruction.

8. A variety of simulator commands is available to test microcomputer programs.

- Hardware exercisers
- Test programs for RAMs
- Logic subroutines for microcomputers which do not have basic logic type instructions
- Decimal arithmetic routines
- Transcendental function routines
- Data format conversion routines
- Teletype or tape drive interface programs

9. Program libraries contain frequently used programs.

ulator commands allow designers to obtain selected outputs at simulated instants. A listing of simulator commands similar to those for the Intel 4004 and 8008<sup>1,5</sup> appears in Fig. 8.

As with all computer systems, microcomputer program libraries are beginning to form, with contributions from vendors and users. A brief listing of frequently used programs appears in Fig. 9. ■■

*The first article in the series appeared in the April 1 issue, and dealt with microprocessor instruction sets. The concluding article will discuss an application example.*

### References:

1. "PPS-25, Programmed Processor System Preliminary Users Manual," October 25, 1972, Fairchild Semiconductor, Mountain View, Calif. 94040.
2. "A Guide to PL/M Programming," July, 1973, Intel Corp., Santa Clara, Calif. 95051.
3. "General Purpose Controller/Processor (GPC/P)," Publication No. 4200005A, National Semiconductor, Santa Clara, Calif. 95051.
4. "MCS-4 Microcomputer Set, Users Manual," Revision 4, February, 1973, Intel Corp.
5. "MCS-8, 8008 Simulator Software Package," November, 1972, Intel Corp.

Free.

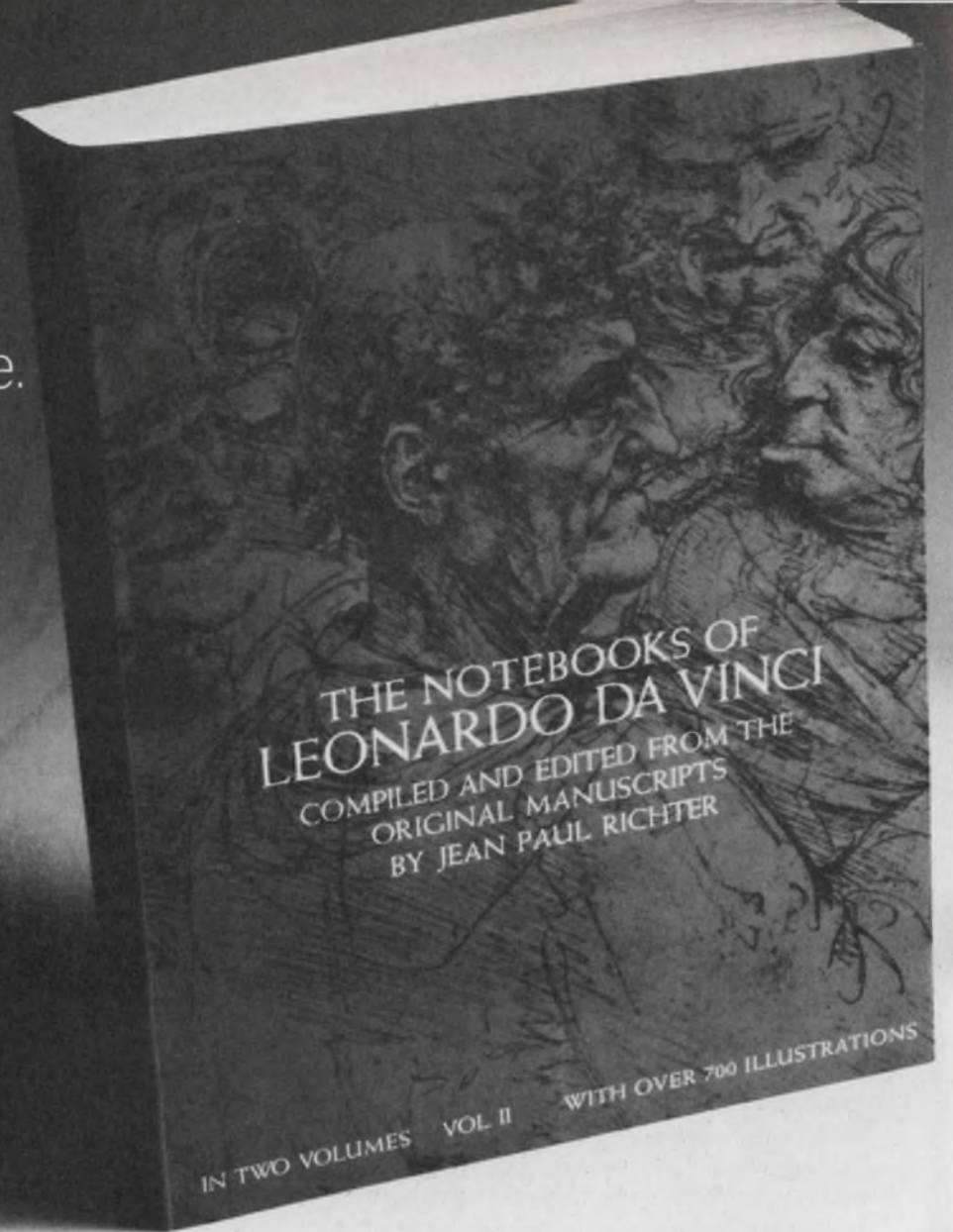

# Monroe presents 500 for 30 minutes of

## Introducing the totally new 1920.

In order to introduce a scientific and engineering electronic calculator so new and different that it defies description, we've come up with a unique kind of offer. One of the most fascinating printed works of the century. A 500 page volume of the long lost notes of Leonardo da Vinci.

Long available only to serious scholars and meticulously penned in a mysterious mirror writing, this newly translated volume contains a wealth of information. Leonardo's voluminous notes on sculpture, architecture, astronomy, anatomy, physical geography, engineering, and mechanics showing him to be centuries ahead of his time. Sold in fine bookstores for five dollars. And it's yours absolutely free.

In return for this gift, we want to show you a new electronic computing device so unique that it must be tried to be believed.

A device that allows you to work in algebraic form. And that's only the beginning. With the 1920 you work with the simplest keyboard, so comfortable that it can become second-nature.

Simpler than any you've ever tried, but with all the power you'll ever need. Plus a display you can read even from across a room.

And in 30 minutes we can show you what we mean.

And for your time, with no further obligation, we will present you with a card you return to us. As soon as we receive it, we'll send your Leonardo Volume by return mail.





# pages of DaVinci your time.

Monroe, The Calculator Company  
550 Central Avenue, Orange, New Jersey 07051

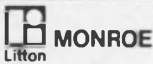

- Yes, I'd like to see the 1920. Please call for an appointment.  
 Yes, I'm interested, but send further information on your offer by return mail. ED

Name \_\_\_\_\_

Title \_\_\_\_\_

Company \_\_\_\_\_

Address \_\_\_\_\_

Phone \_\_\_\_\_

City \_\_\_\_\_ State \_\_\_\_\_ Zip \_\_\_\_\_

Our supply of the Notebooks is limited. So to be sure to get yours early, act now.

To reserve your copy, and schedule a demonstration please return the coupon or call your local Monroe office. We're sure that both our product and the Leonardo Notebook will amaze you. And provide for time well spent.

**MONROE**  
The Calculator Company.

## The case for using ceramics: High thermal conductivity and insulation resistance plus superior strength make this material hard to beat for microelectronic packaging.

With today's pressure for increased circuit density, engineers are hard-pressed to find reliable insulating materials for new designs. One material family stands out above the others: Ceramics.

Ceramics have two major advantages over plastics as a packaging or substrate material. The thermal conductivity is 25 to 100 times higher, allowing the ceramic to act as a heat sink. In addition, because ceramics can form hermetic seals, ceramic packages can protect semiconductor devices from atmospheric contamination.

Here are other reasons for using ceramics:

- The thermal expansion can be matched to that of other commonly used materials to allow for hermetic sealing with those materials.

- A wide range of dielectric constants is available, as are low dielectric losses and high dielectric strengths.

- Surface finishes with a smoothness of just a few microinches are obtained directly from the firing process. These surfaces can also be polished or glazed.

- Opaqueness is available, when needed, in light-sensitive applications.

- The materials have good mechanical properties—high strength, hardness and impact resistance. Ceramics can be molded, metalized and machined by grinding or lapping.

A ceramic is an inorganic, nonmetallic material. It may be a crystalline, polycrystalline or amorphous—for example, glass.

### Alumina: many desirable properties

Today, ceramics like beryllia, steatite, forsterite, alumina (75 to 99.7% pure  $Al_2O_3$ ), zircon, titanate and barium titanate are being used. Each has advantages and disadvantages, and the designer must consider them carefully before making a final selection. Some typical properties of the more commonly used ceramics are compared in Table 1.

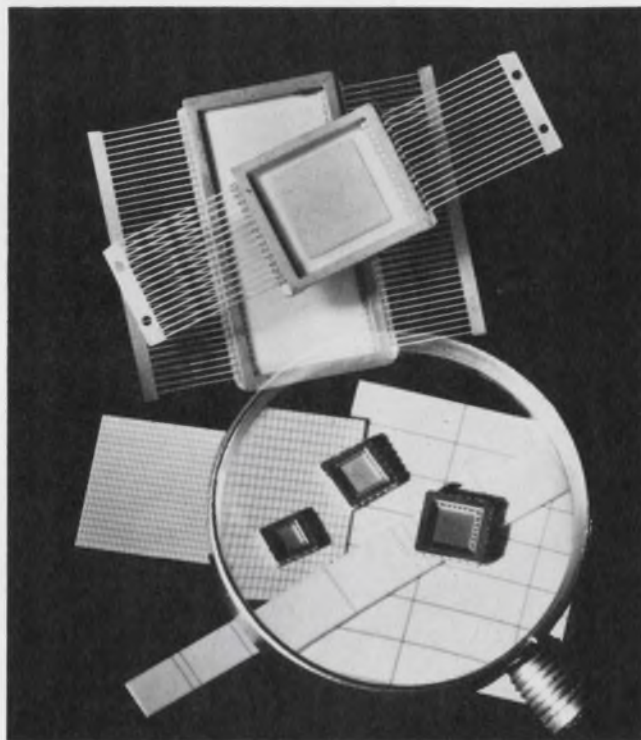

Hybrid-circuit packages (top) with 30 and 75 leads and chip carriers that seal hermetically (under magnifying glass) are made from alumina ceramic. Laser scored ceramic substrates facilitate the separation of individual circuits after processing has been completed.

The aluminas are probably the ceramic most widely used in electronics. They possess many desirable—and only a few undesirable—properties for substrate applications. Thick-film or thin-film processes can be applied to alumina, and it is the most popular, commercially available substrate for microcircuits. Its cost is moderate.

Typical thermal expansion characteristics of alumina are compared with metals and other ceramics in Fig. 1a. Alumina's compatibility with Kovar is one of its principal advantages in metal-ceramic assemblies.

Although most alumina ceramics (85 to 98%  $Al_2O_3$ ) contain entrapped porosity, it is possible to fabricate pore-free grades. They are made from high-purity oxides, and they are chemically modified to permit sintering to full density. Densification and grain growth during processing

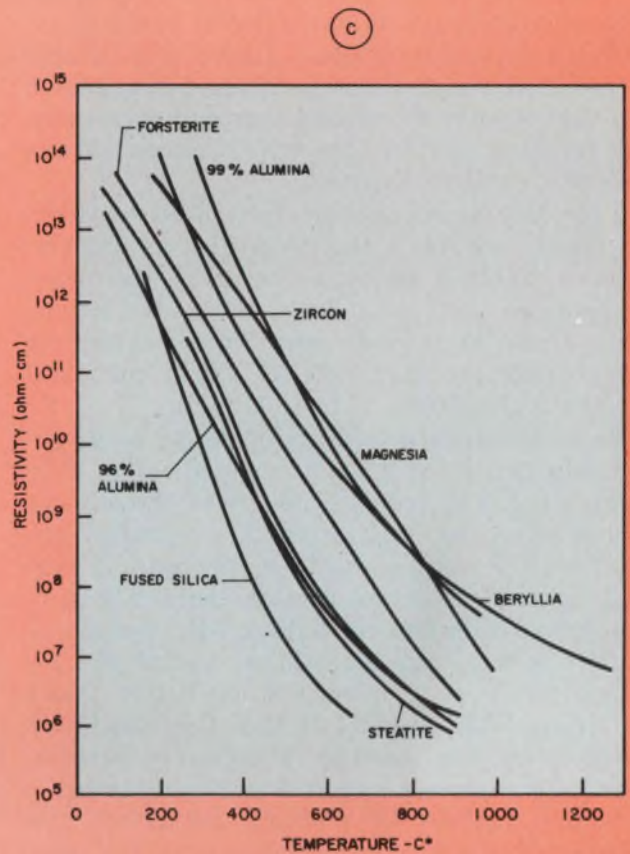
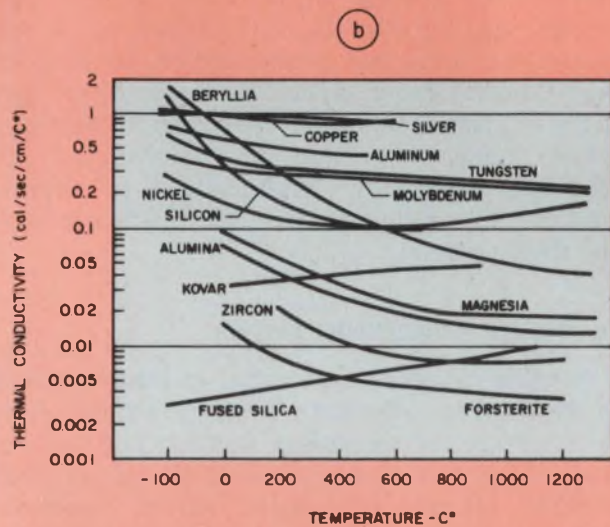
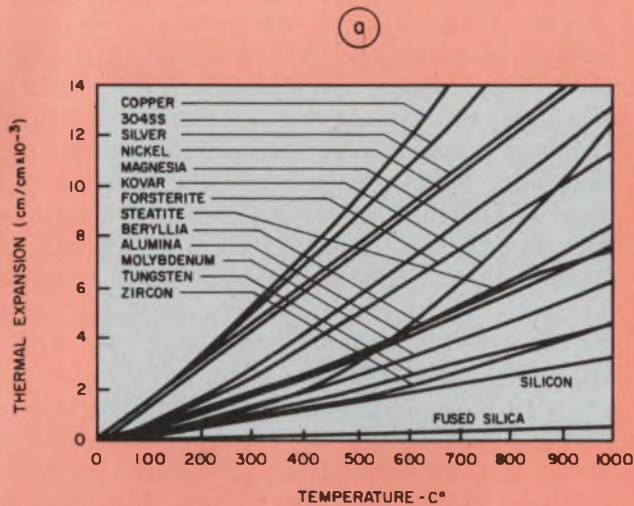

COURTESY OF NASA, WASHINGTON, D.C. "USE OF CERAMICS IN MICROELECTRONICS"  
 W. R. BRATSCHUN, A. J. MOUNTVALA, A. G. PINCUS

1. Ceramics have thermal characteristics that come close to some metals, and they also have the high resistivities needed for use as microcircuit substrates, insulators and dielectrics.

Table 1. Some representative properties of ceramic substrates

Material property	Unit	Steatite	Forsterite	Zircon	Alumina (99.5% pure)	Beryllia
Water absorption	%	Impervious	Impervious	Impervious	Impervious	Impervious
Hardness	Moh's scale	7.5	7.5	8	9	9
Thermal expansion	25 to 900 C cm/cm/°C	$8.5 \times 10^{-6}$	$11.7 \times 10^{-6}$	$4.9 \times 10^{-6}$	$7.7 \times 10^{-6}$	$8.7 \times 10^{-6}$
Dielectric strength (60 Hz ac, 1/4" test discs)	Volts/mil	220	240	220	220	230
Dielectric constant 1 MHz		5.3	6.2	8.8	9.9	6.9
Dissipation factor 1 MHz		0.0026	0.0004	0.0010	0.0001	0.0002
Loss factor 1 MHz		0.014	0.002	0.009	0.0011	0.0014

are controlled, so that gas atoms in the pores can diffuse along grain boundaries to the surface.

Alumina's disadvantages? High temperatures are required for processing. When fabricated in large plates (over 2 × 2 in.), warping may occur. And grinding can be expensive, because of the material's extreme hardness.

In the last 30 years there have been considerable improvements in the properties of alumina ceramics. Table 2 shows the progress. Hardness, for instance, has gone from 69 to 90 R45N; purity from 85 to well over 99.9% aluminum oxide; densities from 3.40 to 3.96 g/cm<sup>3</sup>; and strength from 35,000 to 100,000 lb/in<sup>2</sup>.

The surface characteristics of alumina become especially important when a conductive film is to be deposited. The required degree of smoothness depends upon the application. For thin-film applications, the surface should be smooth and free of all imperfections and contaminants. The performance of thin-film capacitors, for instance, is sensitive to substrate smoothness and requires a surface finish of 1 microinch or better. Most thin-film resistor circuits, on the other hand, can satisfactorily use as-fired alumina substrates, which have a smoothness of 5 to 8 microinches.

Surface finishes on alumina substrates are available from about 40 microinches to less than 0.5 microinch. The 92 to 96% aluminas have finishes ranging from about 15 to 40 microinches. The finish depends upon the ceramic composition, the method of forming (tape process or press) and whether or not the substrate was tumble-polished after firing. A 99.5% pure alumina substrate, when formed by the tape process, can have an as-fired finish as fine as 5 to 8 microinches.

Glazing can provide an extremely smooth surface—less than 1 microinch. But it has drawbacks: It lowers thermal conductivity and the

maximum service temperature, and has less resistance to mechanical and chemical stress.

Alumina substrates are available in sizes up to about 6-in. square in thicknesses of 0.005 to about 0.1 in. Almost any outside configuration and hole pattern is available. The standard dimensional tolerances are ±1/2% plus not less than ±0.003 in. Camber is 0.004 in./in. plus not less than 0.002 in. on as-fired substrates. At present the standard as-fired thickness tolerance is ±10%. However, there is a good indication that this will soon be reduced to ±5%. With a little extra care; a tolerance of ±7% is possible today with standard manufacturing processes.

These tolerances and properties will improve as alumina raw-material technology improves. The smaller the particle of raw material, the smaller the average crystal size of the fired ceramic and the smoother the surface of the substrate—an important consideration in thin-film applications. Purer materials reduce the incidence of stray iron, cobalt or chromium particles, which change color and alter mechanical and electrical properties. Minimization of organic contaminants reduces voids and surface pits in the fired ceramic.

#### For thermal conductivity: beryllia

Beryllia ceramics are similar in many respects to the aluminas, especially in surface smoothness, but they are not as strong. Beryllia powders are toxic; thus their cost tends to be higher than alumina because of needed safety measures. Beryllia raw-material costs are also much higher.

But beryllia has exceptionally high thermal conductivity (Fig. 1b). When used primarily as an insulator, beryllia's low dielectric constant helps to reduce crosstalk between conductors and

**Table 2. Evolution of alumina ceramics**

	1940's	1950's	1960's	1970's
Per cent Al <sub>2</sub> O <sub>3</sub>	85	96	99.5	99.95 +
Density (gm/cm <sup>3</sup> )	3.40	3.70	3.87	3.96
Hardness (R45N)	69	78	82	90
Tensile strength (psi)	20,000	25,000	30,000	60,000
Compressive strength (psi)	275,000	375,000	400,000	600,000
Flexural strength (psi)	35,000	46,000	60,000	100,000
<b>Raw Materials</b>				
Purity (% Al <sub>2</sub> O <sub>3</sub> )	95.5	99.7	99.7	99.99 +
Particle size (Microns)	44	4	1 to 2	0.3
Surface area (m <sup>2</sup> /gm)	—	1	2 to 5	10-12

### Table 3. Typical properties of various alumina substrates

Properties	Units	Per cent Al <sub>2</sub> O <sub>3</sub>		
		96	99.5	99.7
Alumina's X particle size	microns	2.9	1.5	0.6
Density	cms/cc	3.70	3.89	3.86
Thermal expansion linear coefficient cm/cm × 10 <sup>-6</sup> per °C.	25-300 C.	6.4	6.6	6.5
	25-700 C.	7.5	7.4	7.4
	25-900 C.	7.9	7.7	7.7
Flexural strength specimen 0.025" T × 0.070" W, 0.500 L	lb/in <sup>2</sup>	60,000	70,000	85,000
Dielectric constant @ 1 MHz, 25 C.		9.3	10.5	10.3
Dissipation factor @ 1 MHz, 25 C.		0.0003	0.0001	0.0002
Average crystal size	microns	4.0	3.0	1.5
Surface finish	microinches	25	8	4

to allow high signal-speed propagation.

Another ceramic family that is used primarily as an insulator is steatite porcelain. The steatites are an improvement over the traditional clay-feldspar-quartz electrical porcelains; they have lower losses in the megacycle range and are relatively easy to machine. But they also have relatively low thermal-shock resistance and low strength when compared with alumina. Steatite ceramics can, however, be made economically for use as general-purpose insulators.

Forsterite ceramics are a further improvement over steatite. They have higher resistivity, higher strength, lower losses at microwave frequencies and can be used at higher temperatures. Their higher thermal-expansion coefficient matches that of many metals, but this property can cause thermal-shock problems. Two forsterite families are finding wide use. One matches the thermal expansion of certain chrome-iron alloys; and the other, titanium.

The volume resistivities of various ceramics are shown in Fig. 1c. Note the superior high-temperature resistivity of forsterite over steatite and even 96% alumina.

Cordierite ceramics, on the other hand, are outstanding for thermal-shock resistance. Porous cordierite ceramics are widely used for heating-wire supports. They are also available as dense ceramics. Since metals have higher thermal expansion than cordierite, it's difficult to seal to.

Zircon and magnesia ceramics are not widely used in electronics. However, a special property may justify occasional application.

Magnesia is used as insulation in electrical heating elements, special thermocouples and leads for high-temperature instrumentation, because of its high electrical resistivity, relatively good thermal conductivity and ease of fabrication.

And sapphire—since it is cut from a single crystal and has no porosity or grain boundaries finds use as a substrate for the epitaxial growth of single-crystal films of materials with similar lattice dimensions. Single-crystal spinel, beryllia and quartz are also used as substrates for epitaxial films.

Even diamond crystals are sometimes used for substrates and heat sinks. Other ceramics, such as boron nitride and thoria—also find occasional use as insulators, where their unique properties fit specialized applications. But, of course, their cost is usually higher.

#### Raw-material control essential

No matter what the ceramic, tight control of the raw-material mixture is a constant necessity. Modify a mix to meet tighter tolerances on one set of characteristics and you change other important properties. For example, addition of binders causes higher shrinkage in firing, and this, in turn, makes dimensional control difficult. And careful control of temperature during the firing is mandatory. Each composition must be fired at a specified temperature to obtain certain properties. A change in firing temperature will change the properties and also the shrinkage.

Thus alumina has a considerable range of controllable properties (Table 3). A relatively new property is opaqueness. Standard white aluminas have proved ineffective for packaging LEDs and light-sensitive devices, because they transmit too much light. A new black 94% alumina has the necessary opacity, yet it retains all of the qualities of equivalent white aluminas. A piece of this new ceramic 10 mils thick will absorb 99.99% of the incident light. No incident light can penetrate a standard 20-mil-thick package. ■■

# New! Program Optimum

**Now you can design linears your way. Our new single and dual programmable op amps offer greater economy and design flexibility, let you set your own parameter specifications, and minimize power consumption at the same time.**

All it takes to tailor the characteristics of our new HA-2720/2730 is one external resistor. This provides a master bias setting which will establish the desired current-flow through the devices.

As a result, critical parameters such as bias currents, supply currents, bandwidth, slew rate, input noise, and others can be optimized to meet your particular needs. And because the devices have such a wide power supply range ( $\pm 1.2V$  to  $\pm 18V$ ) they can be used in an almost unlimited variety of linear designs.

A single programmable op amp, the HA-2720 is a direct replacement for many currently available op amps, yet it offers superior performance features over all of them. Among these are a wider range of programming, higher slew rate and bandwidth at low power levels, superior output current, and lower noise current. The HA-2730 is a dual monolithic version of the HA-2720 with identical performance features.

For the user these devices offer substantial benefits. First, they are highly reliable because

they are short-circuit protected and have internal compensation with classical frequency response. They also provide you with considerable economy because the wide range of programming possible allows you to standardize your op amp inventory and change parameters as needed. Finally, by modulating the set current terminal you can minimize systems components and obtain such applications as VCO's, Wien bridge oscillators, and waveform generators.

Among other applications are

low power instrumentation, portable battery operated instruments, active filters, and hearing aids. For details see your Harris distributor or representative.

## Features

- Wide range A.C. programming
  - Slew rate 0.06 to  $6V/\mu s$
  - Gain x
  - Bandwidth 5KHz to 10MHz
- Wide range D.C. programming
  - Power supply range  $\pm 1.2V$  to  $\pm 18V$
  - Supply current  $1\mu A$  to 1.5mA
  - Input bias current 0.4 to 50nA
  - Output current up to 15mA

Suitable for direct replacement of:

- Fairchild  $\mu A776$
- Solitron UC 4250
- National LM 4250
- Intersil ICL-8021

HA-2720  
100-999 units

- HA-2725  $0^{\circ}C$  to  $+75^{\circ}C$  \$ 3.30
- HA-2720  $-55^{\circ}C$  to  $+125^{\circ}C$  \$ 8.80
- Supplied TO-99
- HA-2735  $0^{\circ}C$  to  $+75^{\circ}C$  \$ 7.15
- HA-2730  $-55^{\circ}C$  to  $+125^{\circ}C$  \$16.50
- Supplied TO-116

## Typical Biasing Circuits

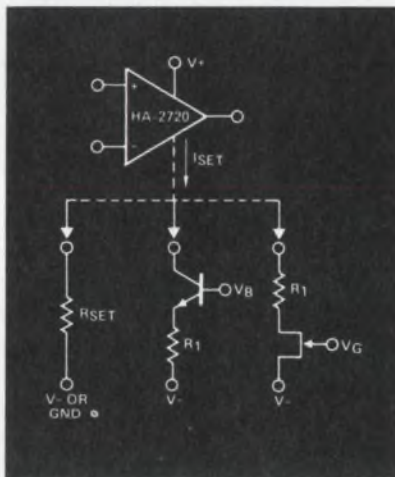

## HA-2720/30 Programming

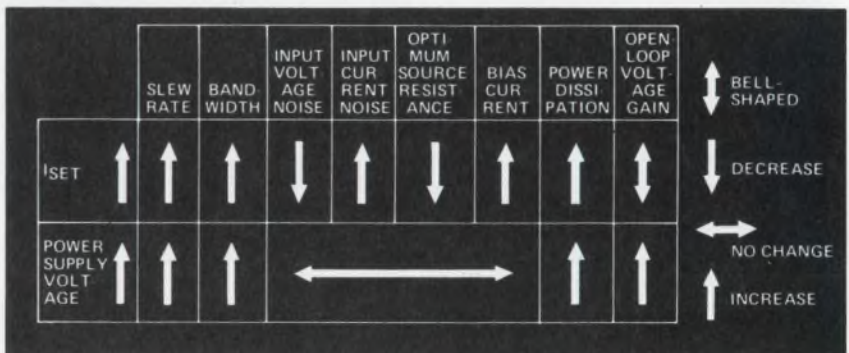

# Available Op Amps for Solutions

**HA-2720 Single Programmable Operational Amplifier**

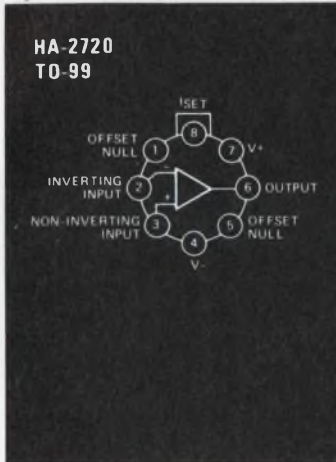

**Slew Rate vs. Supply Current**

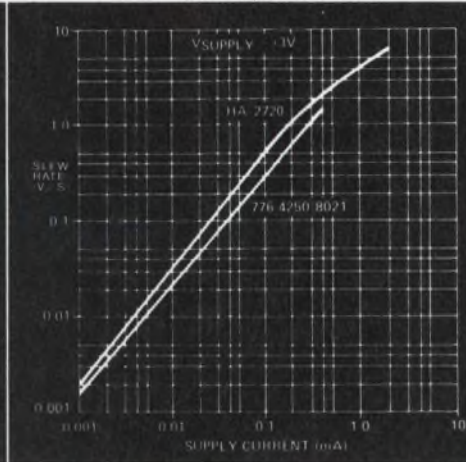

**Output Current vs. Supply Current**

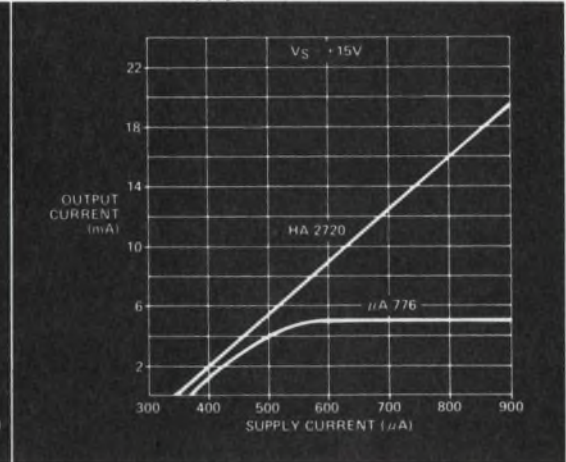

**HA-2730 Dual Programmable Operational Amplifier**

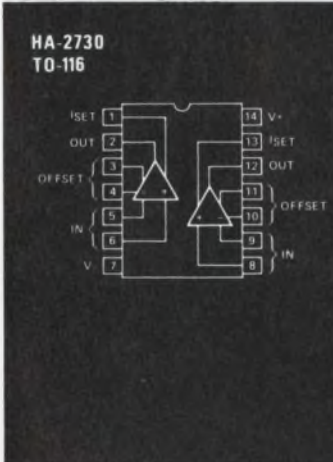

**Gain Bandwidth Product vs. Supply Current**

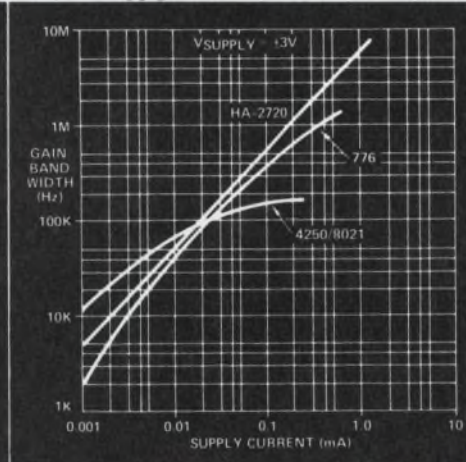

**Input Noise Current vs. Supply Current**

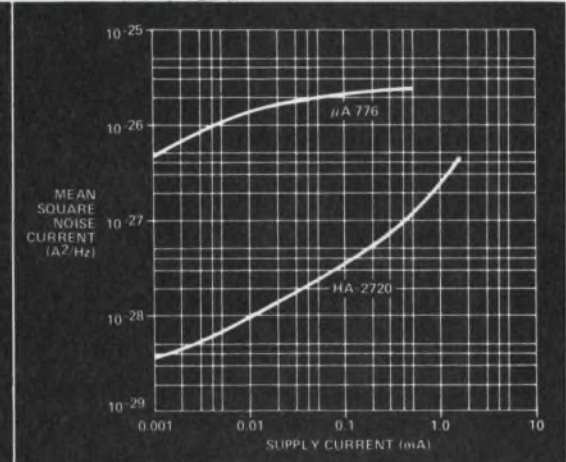

Above comparative data curves were experimentally derived or extrapolated from published data sheets where available.

# Harris



**HARRIS**  
**SEMICONDUCTOR**  
A DIVISION OF HARRIS INTERTYPE CORPORATION

P.O. Box 883, Melbourne, Florida 32901  
(305) 727-5430

**WHERE TO BUY THEM:** ARIZONA: Phoenix—Liberty, Weatherford; Scottsdale—HAR (602) 946-3556 CALIFORNIA: Anaheim—Weatherford; El Segundo—Liberty; Glendale—Weatherford; Long Beach—HAR (213) 426-7687; Mountain View—Elmar; Palo Alto—Weatherford; HAR (415) 964-6443; Pomona—Weatherford; San Diego—Liberty; COLORADO: Denver—Elmar; Weatherford; WASHINGTON, D.C.: HAR (202) 337-3170  
FLORIDA: Hollywood—Schweber; Hamilton; Melbourne—HAR (305) 727-5430; GEORGIA: Atlanta—Schweber; ILLINOIS: Chicago—Schweber; Schaumburg—HAR (312) 894-8824; Schiller Park—Hamilton; INDIANA: Indianapolis—Pioneer; KANSAS: Lenexa—Hamilton; MARYLAND: Baltimore—Hamilton; Rockville—Schweber; MASSACHUSETTS: Lexington—R&D; Wallham—Schweber; Wellesley—HAR (617) 237-5430; MICHIGAN: Livonia—Hamilton; Troy—Schweber; MINNESOTA: Edina—Hamilton; Minneapolis—Schweber; HAR (612) 432-6111; MISSOURI: Hazelwood—Hamilton; NEW JERSEY: Cedar Grove—Hamilton; MI Laurel—Hamilton; Somerset—Schweber; NEW MEXICO: Albuquerque—Weatherford; NEW YORK: Melville—HAR (516) 249-4500; East Syracuse—Hamilton; Syracuse—HAR (315) 463-3373; Rochester—Schweber; Westbury—Schweber  
NORTH CAROLINA: Raleigh—Schweber; OHIO: Beachwood—Schweber; Cleveland—Pioneer; Dayton—Pioneer; HAR (513) 226-0636; PENNSYLVANIA: Wayne—HAR (215) 687-6680; TEXAS: Dallas—Hamilton; Weatherford—HAR (214) 231-9031; Houston—Weatherford; WASHINGTON: Seattle—Liberty; Weatherford.

**LEGEND FOR HARRIS SALES OFFICES & DISTRIBUTORS:** Harris Semiconductor (HAR); Elmar Electronics (Elmar); Hamilton Avnet Electronics (Hamilton); Harvey/R&D Electronics (R&D); Liberty Electronics (Liberty); Pioneer Standard Electronics (Pioneer); Schweber Electronics (Schweber); R.V. Weatherford Co. (Weatherford)

# Don't lean on a/d specs when you work with high encode rates. Specs that characterize low-speed encoders may fall short when you go above 1 MHz.

The ancient Latin warning of *caveat emptor* may be especially applicable to high-speed analog-to-digital (a/d) converters—that is, those with word rates of 1 MHz and higher. That's because specs suitable for a/d's that operate at encode rates below 1 MHz often are not adequate for high-speed units.

Take accuracy, for example. Almost universally, a/d accuracy is spelled out as a dc spec. But dc accuracy can be interpreted in several ways, depending on how it's specified. And no matter which interpretation a potential user prefers, he'll inevitably wind up lacking valuable information.

For example, he may infer that the dc spec gives the accuracy over a wide frequency band. Unfortunately it doesn't. And, in fact, this isn't even a practical requirement.

Consider frequency response roll-off: The input circuit and track/hold circuits of an a/d don't have infinite bandwidth—any more than any circuit does. Even if the bandwidth is very wide, there inevitably will be some roll-off in the band of interest, thereby making the dc spec invalid at high signal frequencies.

On the other hand, a specifier may infer that the listed dc accuracy is an interpretation of linearity at high frequencies. It is not. He should reconsider that idea carefully also. Nonlinearities invariably become worse at high frequencies—especially at frequencies close to half the encode rate.

There's yet another interpretation of a dc accuracy spec—one that assumes a certain naiveté on the part of a potential user. The user is led to believe that a dc spec includes aperture error. This is simply not true.

## Other specs are needed

Obviously the fidelity of translation from analog to digital is the criterion for good performance. And since the analog input is often a wide-band video signal, the dc accuracy spec is only a small part of the story.

**William J. Pratt**, Senior Engineer, Computer Labs, 1109 S. Chapman St., Greensboro, N.C. 27403.

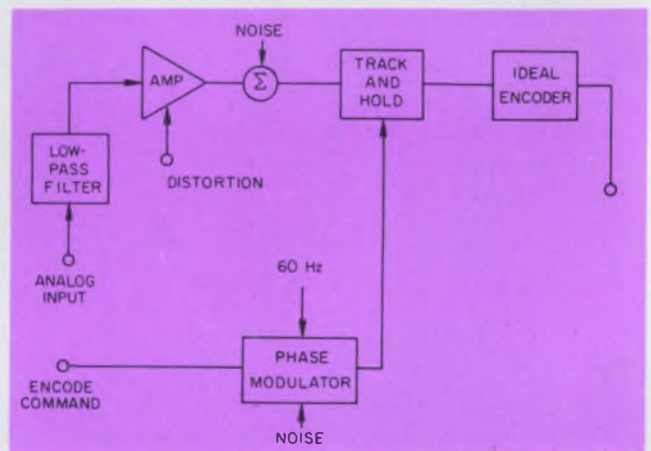

1. All a/d converters fall short of the ideal. The factors that contribute to the less than ideal performance can be accounted for if you think of the converter as ideal and treat individual error sources as additional inputs. The low-pass filter accounts for front-end roll-off.

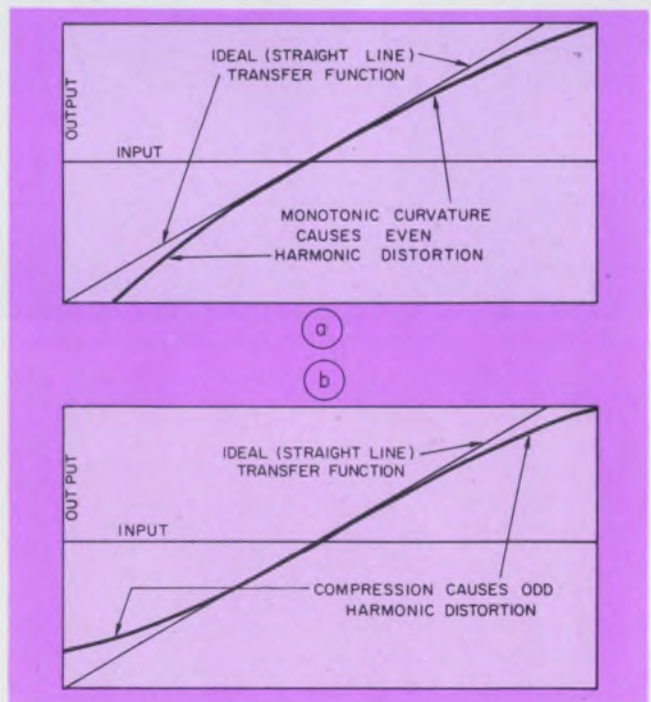

2. High-frequency rolloff of an a/d's input circuits results in departures from an ideal transfer function. Monotonic curvature of the transfer function causes even harmonic distortion (a), while compression at  $\pm$  full scale results in odd harmonics (b).



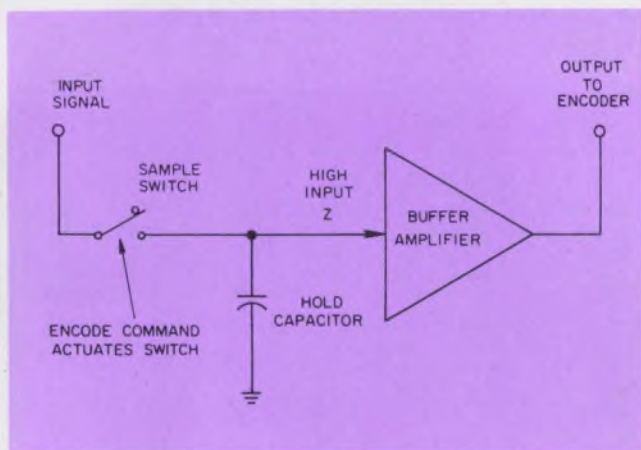

3. In the classic representation of a sample-and-hold circuit, the switch has zero resistance when closed, and opens instantly on receipt of an encode command. In practice, the sampling switch transits from a low to high resistance over some finite time interval.

The limiting input frequency of an a/d is generally that which satisfies the Nyquist sampling theorem for signal reproducibility. In some cases, however, the maximum frequency can go even higher. A converter user who recognizes this will therefore want to pin down the specs that call out the frequency-response roll-off, non-linearity, aperture time and transient response—as well as some others. Here's why:

Frequency-response roll-off should be included in an a/d spec sheet simply because an a/d's buffer amplifier and track/hold circuits have finite bandwidth. Thus you can visualize any practical a/d as an ideal converter with a low-pass filter in its front end (Fig. 1).

The filter causes some loss in sensitivity as frequency is increased, causes the rise time of input pulses to deteriorate and also contributes lag errors, which show up as an apparent time shift of the sampling point.

A conscientious a/d manufacturer will estimate and verify the flatness of the response. The estimate is usually based on the known 3-dB point of the converter front end. The manufacturer then uses the theoretical roll-off characteristics to interpolate back to the maximum ex-

pected Nyquist frequency.

If a video filter is used ahead of the a/d—a matched filter for certain pulse waveforms, for example—the filter must be designed as part of a composite filter, which consists of the actual filter network in series with the a/d equivalent-input filter.

Typically, an a/d's input roll-off characteristic is that of a single pole with a 6-dB/octave slope. The 3-dB bandwidth of the input roll-off should be at least three times the Nyquist frequency. A lower bandwidth results in excessive attenuation at Nyquist and phase nonlinearity in the pass-band, and it makes video filter design difficult.

Occasionally a spec sheet lists the higher, small-signal bandwidth simply to make the a/d look better. When small-signal bandwidth is given, a slew-rate spec must be included to know the real capabilities of the a/d.

Circuits that roll off the input bandwidth can distort high-frequency inputs, no matter how linear the circuits appear at dc. When this occurs, watch for monotonic curvature of the transfer function—which causes even harmonics—and symmetrical compression near plus and minus full scale—which results in odd harmonics (Fig. 2).

Since nonlinearity errors of this type can lead to intermodulation products within the converter, a high-frequency linearity spec is almost universally needed to evaluate system performance. Unfortunately this spec is almost universally absent from the spec sheet—and from documented test requirements as well.

Intermodulation products have particular significance when the a/d is used for digital spectrum analysis. If two or more sinusoidal signals are applied to the input of the a/d, the products can limit the dynamic range of the system.

#### Aperture time: What does it really mean?

Mention aperture time and what it is, and you have a guaranteed argument at any engineers' coffee break. The original concept of aperture time was based on the conclusion that an error occurs when that famous (or infamous, if you

prefer) a/d sampling switch opens (Fig. 3).

According to the concept, an error occurs because the input signal tends to be averaged over the finite time interval required for opening the switch.

The sampled voltage, therefore—the argument continues—does not exactly correspond to the voltage at the instant the switch starts to open. The time required to open the switch is called aperture time, and the equation that gives the error is

$$E_a = T_a \, dV/dt,$$

where  $E_a$  is the aperture error,  $T_a$  is aperture time and  $dV/dt$  is the rate at which the signal changes.

The fact is that no real error exists for such a switch. As long as the switch opens in a repeatable fashion, there is an effective sampling time—which can be regarded as the time an ideal, or zero-opening-time, switch remains closed. This sampling interval may differ from the time needed for the switch to open, but it is a constant time offset.

Effective sampling time is related to the arrival of the encode command via a fixed time interval. Neither of these fixed time delays constitutes an error. Only variable time delays can be called genuine errors.

Two types of aperture errors are commonly encountered: that of phase modulation of the hold command to the track-and-hold circuit, and systemic errors caused by the a/d's inability to encode rapidly varying inputs accurately.

In the first case, the encode signal is phase-modulated by random noise, the 60-Hz power-line frequency or some other source (Fig. 1). The magnitude of the error is proportional to  $dV/dt$  and thus qualifies as a valid aperture error.

With the systemic aperture error, the parameter of interest is the aperture time of the complete a/d system—not just the aperture time of the track-and-hold circuit.

This error generally results because the encoder portion of the system can't settle adequately to each new held value of the track-and-hold output. The higher the input slew rate, the more the encoder must gyrate to encode each new sample properly.

An encoder that uses d/a's, op amps, delay cables or other circuits that may not settle adequately will normally have larger systemic aperture errors than parallel comparator converters.

Since aperture error is a function of the analog input signal, and not the encode rate, an a/d converter can conceivably digitize both dc and low-frequency ac at an extremely high rate. But the unit may fail to digitize high frequencies—even at modest encode rates.

To know what errors to expect from a given

aperture-time spec, a specifier must know the slew rate at which the measurement was made. This is because the systemic aperture time can vary unfavorably with input slew rate.

### What's the slew rate?

If a vendor measures aperture time at a slew rate of  $1 \text{ V}/\mu\text{s}$ , for example, a potential user might incorrectly assume a certain level of performance at a slew rate of, say,  $2 \text{ V}/\mu\text{s}$ . In this case, he might expect the aperture error to be twice as great as the specification predicts. The actual performance may be far worse.

INPUT VOLTAGE	IDEAL CODE	INPUT VOLTAGE	ACTUAL CODE
+16 mV-----	10000010	+16 mV-----	10000010
+8 mV-----	10000001	+8 mV-----	10000001
0 mV-----	10000000		10000000 (ELONGATED CODE)
-8 mV-----	01111111	(20 mV)	(SKIPPED CODE)
-16 mV-----	01111110	-12 mV-----	
		(4 mV)	
		-16 mV-----	01111110 (SHORT CODE)
	01111101		01111101

4. Typical code skip near the most significant bit for an 8-bit a/d with an input range of  $\pm 1.024 \text{ mV}$ .

Thus the slew rate used for specification purposes should be at least that of a full-scale sine wave at the Nyquist frequency. In some converters the aperture error at this frequency is small—much less than 1 LSB. Consequently these converters can encode frequencies higher than Nyquist, provided signal aliasing is permitted. Or such converters can provide very accurate conversion of signals with frequencies that are less than Nyquist.

Some converters—those that are properly specified and that have very good aperture times—can operate on analog frequencies several times the encode rate. With others, if the aperture-time spec results in an error of 1 LSB at the Nyquist frequency, you can expect code skipping, loss of resolution at higher signal frequencies and reasonable performance only at frequencies below Nyquist.

If the aperture error is worse than 1 LSB at Nyquist, the usefulness of the instrument at its maximum encode rate is limited. Consider a converter with a 100-MHz maximum rate, a resolution of 8 bits and an aperture time of 2 ns.

With a 50-MHz input (the expected Nyquist for a 100-MHz encode rate), the aperture error is 30% of full scale; in effect, this makes the 8-bit machine a 2-bit a/d (no pun intended). Or,

from another point of view, the maximum input bandwidth to maintain 8-bit accuracy would be less than 1 MHz.

Still another spec that must be carefully appraised is transient response. Let's take a look at it.

### Settling time: Another evasive spec

The transient response of a converter becomes important in pulse-amplitude measurements, or when two or more channels of analog data are being time-multiplexed through the same a/d.

Under either of these conditions both the input circuits and the track-and-hold must settle fast enough to ensure that the encoded voltage is accurate to at least 1 LSB. Settling time is thus defined as the minimum elapsed time—between the application of a full-scale step at the input and the application of an encode command—that ensures accuracy within 1 LSB.

A vendor can spell out transient response by measuring the settling time of the input circuits, which are usually proprietary designs to optimize transient response and other parameters. But once the circuits are interconnected within the a/d, it's difficult to break out the performance of individual circuits.

Sometimes a vendor hangs on this difficulty as a rationale for not including a transient spec. But the spec may be deliberately left out because of poor performance. Or it may be "inadvertently" omitted because the vendor just doesn't understand its importance.

Regardless of the reason for its absence, don't be lulled into a false sense of security; transient behavior is important. Transient response is also an indirect indicator of other parameters important to front-end performance.

And response time becomes exceedingly important when the user wants to digitize pulse signals. A meaningful transient-response spec tells the user how long he must wait after the step-function input is applied to realize the converter's rated accuracy.

Other a/d specs may have to be known, depending on the application. For example, differential gain and phase specs are important to engineers who need to convert TV video signals.

### More important specs

As one might expect, the differential gain of an a/d converter is similar to that of an amplifier. It's defined as the percentage difference between the ratios of output to input amplitude (gains) for a small-signal, high-frequency sine wave at two stated levels of dc bias at the input.

Differential phase is the difference in output phase for a small-signal, high-frequency sine

wave at two stated levels of dc input bias. Distortion-free conversion of a color TV signal requires that neither the amplitude nor the phase of the chrominance signal be altered as a function of the level of the associated luminance signal. And the luminance-signal phase and gain must be unaffected by the signal level.

In an a/d converter any differential gain error causes undesirable variations in the purity of the reproduced colors as a function of luminance level. Similarly differential phase other than zero causes undesirable variations in the dominant color as a function of luminance level.

Two other common errors—code skipping and

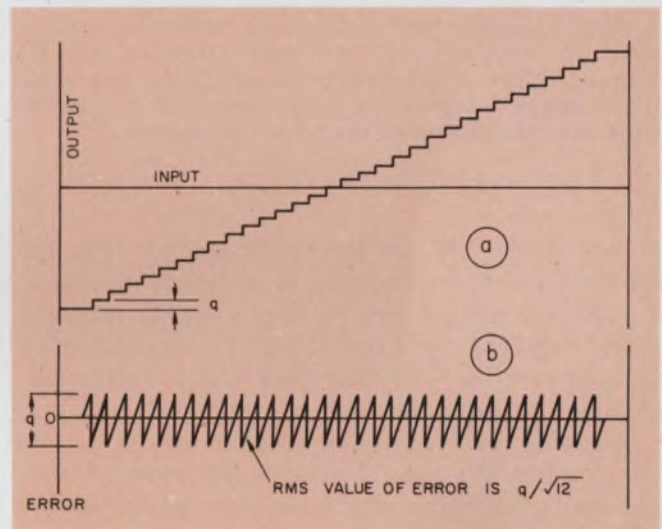

5. In an ideal, 5-bit a/d—one with no local aberrations in the transfer function (a)—the error takes the form of a sawtooth with a peak-to-peak amplitude of 1 LSB (b) and an rms value of  $q/\sqrt{12}$ .

code elongation—are special cases of nonlinearity. Code skips are generally found adjacent to elongated codes, while surrounding codes are accurate. The problem usually shows up during fast input slewing and near major-bit transitions.

Fig. 4 shows the form of a typical code skip near the most significant bit (MSB). The figure is based on an 8-bit converter with a bipolar input range of  $\pm 1.024$  V—which means each quantum level or LSB change is equal to 8 mV.

In the figure, the dotted horizontal lines opposite the voltage values represent the transition points from one level to another; the digital numbers represent the value of digital output present between those levels.

As illustrated, an elongated code is one in which the digital number represents two or more quantum levels, instead of the 1-LSB change expected in a normal code. This type of nonlinearity is often classified as a "localized aberration" in the transfer function.

In many cases, skipping and elongation errors

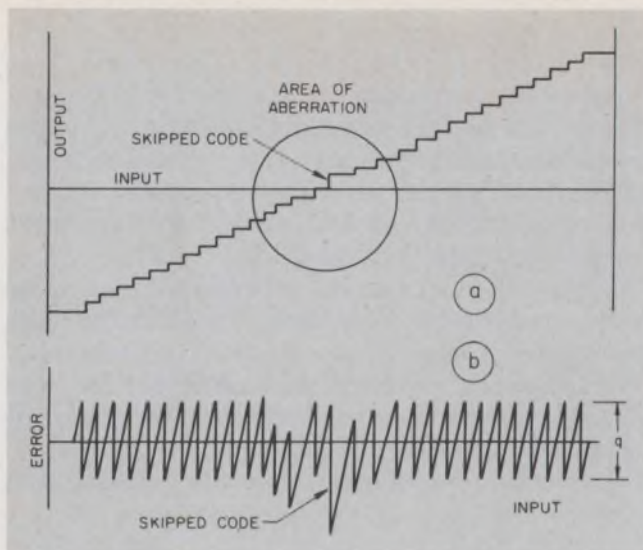

6. In a nonideal, 5-bit a/d, a local aberration appears near mid-scale (a) and the error increases (b). No formula exists to determine the additional rms noise for all possible aberrations. Each case must be handled individually to determine the noise contribution.

do not appear (or are negligibly small) when the input signal is confined to dc or low frequencies, and appear only when the input signal contains high-frequency components. Thus it's necessary to measure the transfer function at high frequencies to pinpoint such errors.

Although code skipping of this sort is an obvious error, it's really quite inoffensive in comparison with other nonlinearities, provided the number of skipped codes is small.

Code skipping does not cause much harmonic or intermodulation distortion; its worst effects are increased noise levels and a loss of resolution in the area of the code skips. Note that, in general, the s/n ratio of code-skipping a/d converters is usually much worse than the theoretical rms sine-wave-to-noise ratio of  $6n + 1.8$  dB, where  $n$  = the number of bits.

In the ideal case, with no local aberrations, the error takes the form of a sawtooth and the peak-to-peak error is 1 LSB (Fig. 5). Since the sample-to-sample error has an equal probability of assuming any value from  $-1$  LSB to  $+1$  LSB, the effect is similar to that of additive noise, with an rms value of 1 LSB (in volts) divided by the square root of 12 ( $q/\sqrt{12}$ ).

In the nonideal case, where local aberrations are present, the noise worsens (Fig. 6). Since the aberrations can take many forms, no formula can be used to determine the increase in noise level, and each case must be analyzed individually to determine the additional rms noise.

All of the comments with regard to the important a/d parameters apply equally to the converter's external drive circuits. Since it's difficult to design good transient response into, say, a video interface, the system designer should

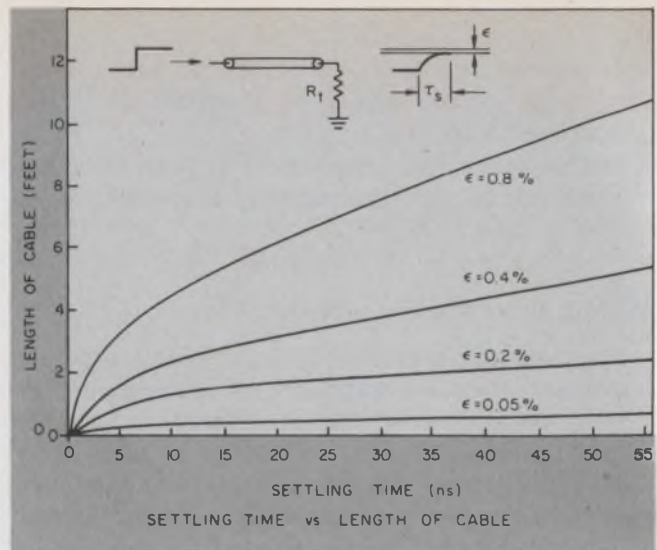

7. Settling times of RG58/U coaxial cable for a step input and for various error bands expressed as a percentage of step amplitude. Miniature cable takes longer to settle, while larger, low-loss cable takes somewhat less time than RG58/U.

avoid circuits and connections that limit transient response, rather than seeking ways to enhance the response.

Some converters require inputs of as much as 5 V into 50  $\Omega$ . Maintaining 60 dB or more of dynamic range with these units is no easy trick. Consequently the drive circuits become difficult to design and should be carefully thought out.

If a low-distortion system is required, a converter with high sensitivity or high input impedance is desirable, and a short coaxial interface is almost mandatory.

Ideally, the coaxial interface will be source-terminated. The high-impedance load allows the source driver to be fairly distortion free, and the short cable assures that reflections from the unterminated end will damp out rapidly. Ground noise and crosstalk problems are also minimized by short interface cables.

VSWR and skin effect, as well, tend to prohibit long cables (Fig. 7). Skin effect in coaxial cables prevents settling in the cables to a high degree of accuracy, even though the bandwidth and 10-to-90% rise time seem more than adequate. For example, a coaxial cable with a bandwidth in excess of 16 MHz may take microseconds to settle to 10 bits of accuracy.

High-speed analog multiplexers are particularly troublesome and should be used only when there is no alternative. If an analog multiplexer is necessary, better performance can be achieved if the multiplexer is built into the converter.

External multiplexers can normally be used in systems that need accuracies of about 1% (7 bits, or less, resolution). This accuracy is limited primarily by crosstalk introduced by an a/d input that doesn't settle fast enough. ■■

# ±15 VOLT POWER MINI'S FOR OP AMPS

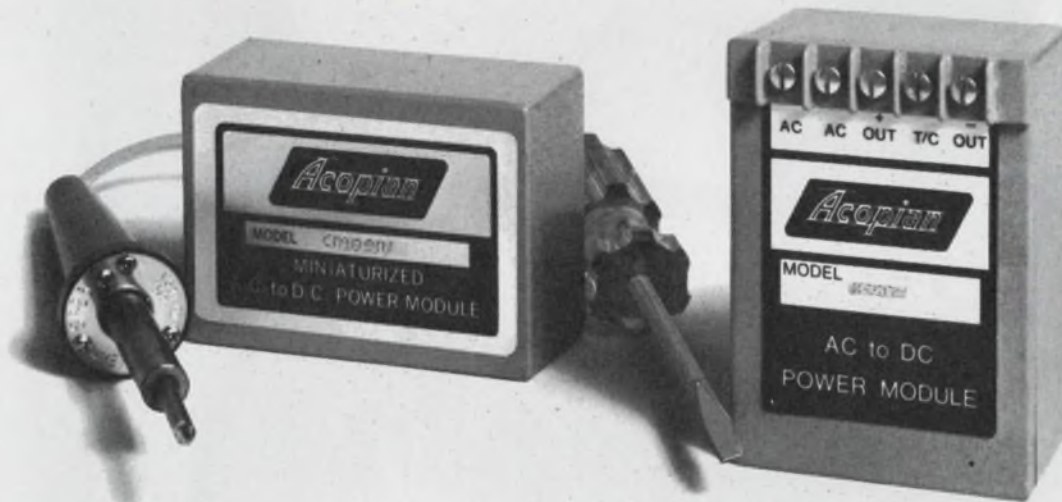

## PC-BOARD MOUNTING

OUTPUT CURRENT MA	SIZE INCHES	PRICE	MODEL
25	2.3 x 1.8 x 1.00	\$24	D15-03
50	2.3 x 1.8 x 1.00	39	D15-05
100	3.5 x 2.5 x 1.00	49	D15-10A
200	3.5 x 2.5 x 1.00	69	D15-20
300	3.5 x 2.5 x 1.25	105	D15-30
500	3.5 x 2.5 x 2.00	130	D15-50

## CHASSIS MOUNTING

OUTPUT CURRENT MA	SIZE INCHES	PRICE	MODEL
100	3.5 x 2.5 x 1.38	\$55	DB15-10
150	3.5 x 2.5 x 1.38	65	DB15-15
200	3.5 x 2.5 x 1.38	75	DB15-20
300	3.5 x 2.5 x 1.63	105	DB15-30
350	3.5 x 2.5 x 1.63	110	DB15-35
500	3.5 x 2.5 x 2.38	135	DB15-50

Line/load regulation,  $\pm 0.1\%$  or better; ripple, 1 mv; input, 105-125 VAC. Other single and multiple output models from 1 to 75 volts, to 2.5 amps. Liberal quantity discounts. Three-day shipment guaranteed.

Complete details on these plus a comprehensive line of other power supplies and systems are included in the Acopian 74-75 catalog. Request a copy.



Corp., Easton, Pa. 18042. Telephone (215) 258-5441.



## Protected ...but not from heart attack

The best protection today against heart attack is to

- Eat foods low in animal fats and cholesterol
- Stop smoking cigarettes
- Control high blood pressure
- Reduce if overweight
- Exercise regularly, moderately
- See a doctor regularly . . .

and to support your Heart Association's programs of research, education and community service.

**GIVE...** so more will live  
**HEART FUND**





# It's precision— or it's nothing.

There's no "almost right" in a multi-layer board. It's precision or it's nothing.

We emphasize this every day at ACD. It's our commitment. From art to final assembly we build the very best and we've got the talent and the plant to do this.

however...

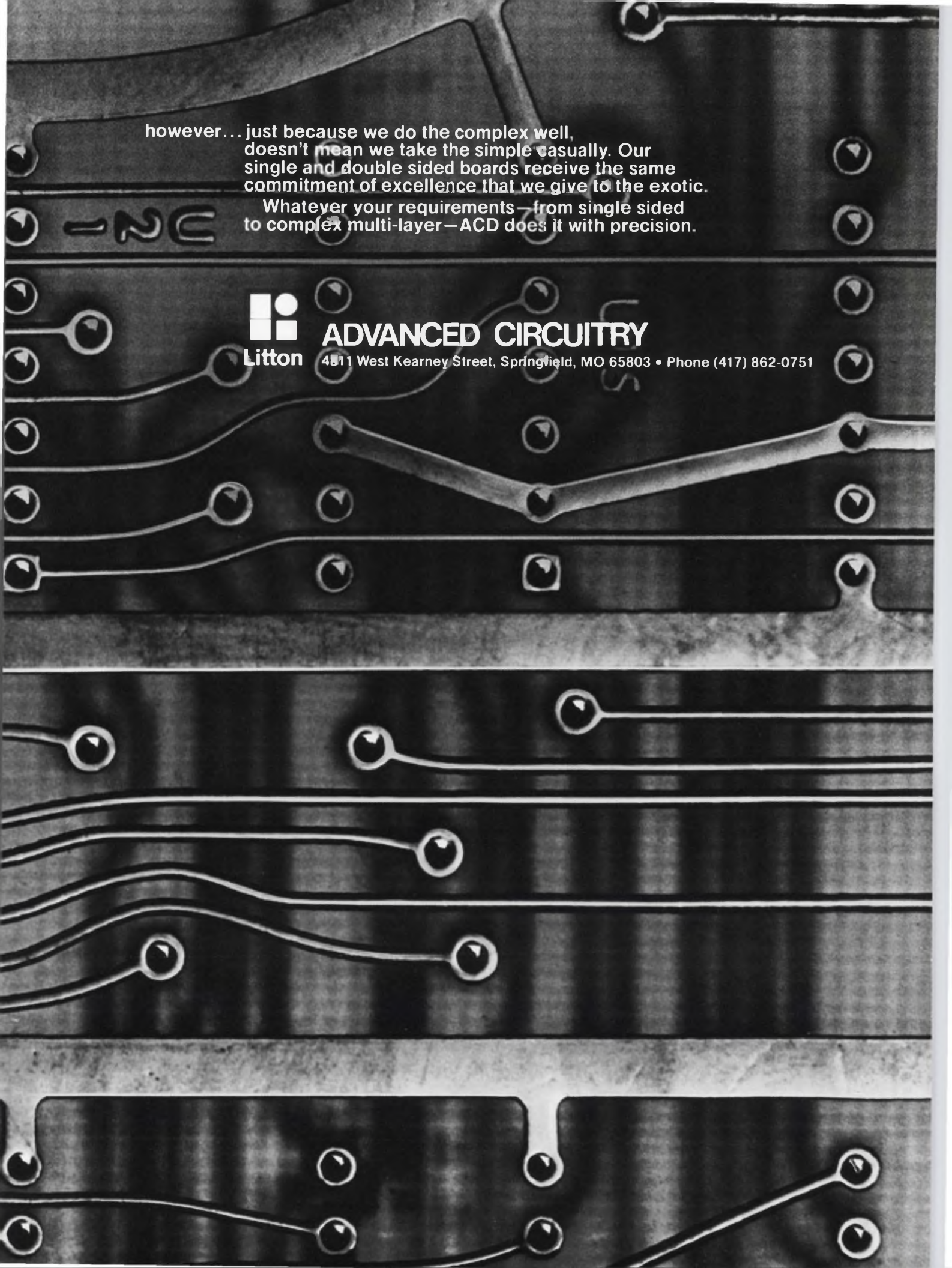

however... just because we do the complex well,  
doesn't mean we take the simple casually. Our  
single and double sided boards receive the same  
commitment of excellence that we give to the exotic.

Whatever your requirements—from single sided  
to complex multi-layer—ACD does it with precision.



Litton

## ADVANCED CIRCUITRY

4511 West Kearney Street, Springfield, MO 65803 • Phone (417) 862-0751



# Save a bundle with incoming inspection.



**Eliminate bad transistors and diodes on the finest low priced tester available.**

Catch them before they are soldered in. And knock out the heavy cost of replace, rework and requalify. Make sure your transistors and diodes are meeting spec before they're in a position to chew up your profits.

Nothing could be simpler. PATT, automatic and programmable, gives you a plain "yes" or "no," pass or fail, with high speed and accuracy. It is a highly reliable tester, designed for a large work load in the minimum of space.

The PATT 1270 is available in varying configurations; you can meet today's requirements without

buying the whole shebang and still expand as your needs expand ... without unnecessary expense, without penalty, and without delay.

The price is low! Write for additional information or call collect for demonstration. (415) 493-5011. Or TWX: 910-373-1204. Ask for PATT Marketing.

**FAIRCHILD**  
SYSTEMS TECHNOLOGY  
A DIVISION OF FAIRCHILD CAMERA AND INSTRUMENT CORPORATION

Fairchild Systems Technology  
3500 Deer Creek Road  
Palo Alto, California 94302

Please send detailed information on the PATT 1270 Transistor & Diode Tester. Our monthly test requirement is approximately \_\_\_\_\_ Transistors \_\_\_\_\_ diodes

Have a sales engineer call.

Name \_\_\_\_\_

Title \_\_\_\_\_

Company \_\_\_\_\_

Street \_\_\_\_\_

City \_\_\_\_\_ State \_\_\_\_\_

Zip \_\_\_\_\_ Phone \_\_\_\_\_

# There's more to thermal drift than just tempco. Three measurements help pin down the effects of some often-forgotten op-amp thermal gradients.

Thermal drift is probably the No. 1 enemy of high-accuracy analog circuits. In differential op amps, for instance, tempco is a must-know spec. So tempco is usually listed somewhere on the data sheet. But other thermal effects can be vital to op amp performance.

For example, signal changes can cause an op amp's internal power dissipation to change. When this happens, do thermal gradients arise that feed back into the differential input pair? If the op amp's case temperature suddenly changes, is the performance affected? And what happens to the gradients when you first turn the unit on? Any—or all—of these effects can be important.

But where do you find these on the spec sheet? In most cases, you don't. Fortunately each can be measured and subsequently used to pinpoint circuit performance more accurately. Let's see how.

## Input stage blues

In differential amplifiers thermal unbalance of the input stage—due to internal or external heat sources—is the primary offender, and gradients show up as changes in the offset voltage,  $E_{os}$ .

By monitoring offset in each of three tests—the initial drift test, the initial step-transient test and the thermal step-transient test—you can characterize the thermal-gradient effects.

The first test,  $E_{os}$  initial drift, is a dynamic measurement performed at room temperature with no input signal. Measured here are warm-up drift and time. These, in effect, tell you the amplifier's immunity to internally generated gradients and the time the amplifier needs to reach thermal equilibrium.

Initial step transient, the second test, yields the internal-power-step coefficient of offset voltage. Though it has a "stop-and-think" definition (it's the ratio of a change in a differ-

## What do the terms mean?

*Initial  $E_{os}$  mean reference level:* The thermally and electrically balanced initial  $E_{os}$  mean-reference level, referred to an amplifier's input and at some specified case temperature. This level is one of the two reference points used in the tests.

*Final  $E_{os}$  mean reference level:* The thermally stabilized, final, mean-reference level at a specified case temperature. This level may be offset from zero volts due to temperature coefficients, signal levels, etc., as required by the specific test.

*Internal power step coefficient:* This is defined by:

$$\frac{\Delta E_1 - \Delta E_2}{\Delta P_1 - P \Delta_2} = E_{os}/\text{watt (internal)}$$

where  $\Delta E_1 = E_{os}(\text{ref})_1 - \text{step level}_1$

$\Delta E_2 = E_{os}(\text{ref})_2 - \text{step level}_2$

$\Delta P_1 = P(\text{internal})_1 - P(\text{internal})_2$

$\Delta P_2 = P(\text{external})_1 - P(\text{external})_2$

where  $P(\text{external}) = \text{power delivered to load}$   
( $R_t$  and  $R_L$ )

$E_{os}(\text{ref}) = \text{mean reference level.}$

*$E_{os}$  thermal step-transient response:* The ratio of the maximum peak excursion ( $\Delta E_{os}$ ) of an amplifier (with respect to its final  $E_{os}$  mean reference level) to the step temperature change applied to the case:

$$V/^\circ\text{C} = \frac{\text{Max. peak } \Delta E_{os}}{T_{A2} - T_{A1}}$$

*$E_{os}$  thermal step-transient recovery time:* The elapsed period for an amplifier to return to within a specified percentage of the final  $E_{os}$  mean reference level, with respect to the point at which the step temperature change occurred.

ence), this coefficient actually spells out the effects of internal power-dissipation changes on  $E_{os}$  for step inputs within an op amp's linear output region.

Finally, the thermal step-transient test measures the excursion of  $E_{os}$  when an external temperature step is applied to an op amp's case. This excursion can be greater than that given by the tempco of offset. However, with some

---

Dan Sheehan, Chief Applications Engineer, Cal Tek Engineering, 29 Pemberton Rd., Wayland, Mass. 01778.

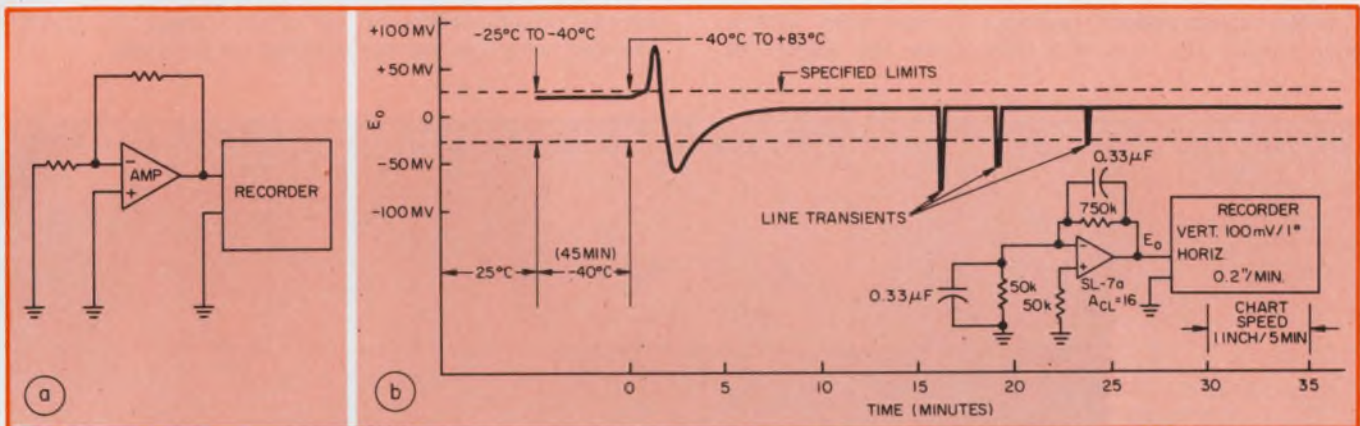

1. Simplified test setup to monitor the magnitude and settling time of the warmup drift of a differential op

amp (a). The results of actual circuit (beneath trace) are recorded (b) on a strip-chart recorder.

units the tempo of offset approaches the peak transient so closely that the transient appears relatively small. In other op amps the input sections track so well that the peak transient offset is almost nonexistent.

In each of these tests a reasonable number of units of one model should be tested under reproducible conditions. For example, the case temperature change for the thermal step-transient test is critical and must be reproduced.

In the initial step-transient test, both the loading and the step level are critical if you are to reproduce internal thermal gradients accurately. Here, the worst-case level and load should be determined by trial-and-error tests on a reasonable number of units. Note that in this test (which uses a sensitive strip-chart recorder), you can set the amplifier to any dc level within its output range, and then buck out the dc level to monitor small excursions around the higher level.

Another precaution: Rise and fall times of the equipment used in the initial step test should be at least three orders of magnitude faster than the thermal response times of the differential amplifier under test.

The feedback-resistor values used in the tests should be optimized for small  $I_{bias}$  errors and low noise current as well as for output loading. Generally feedback resistors will fall into the range of 10 to 20 k $\Omega$ .

Here are the steps for the first test,  $E_{os}$  initial drift (Fig. 1):

1. Set the sensitivity of a Houston 6520 strip-chart recorder (or equivalent) to 100 mV/inch and the chart drive rate to 0.5 inches/minute.

2. Try to arrange the total graph sensitivity so the maximum peak  $E_{os}$  is approximately half the available peak chart amplitude:

$$\text{Total graph sensitivity} = \frac{\text{Recorder Sensitivity}}{\text{Gain of amplifier under test } (A_{c1})}$$

3. Set the gain ( $A_{c1}$ ) of the amplifier with that value of feedback that minimizes the error contributed by  $I_{bias}$ :

$$I_{bias} \text{ error} = \frac{(I_{bias})(R_f)}{A_{c1}}$$

4. Short the strip-chart recorder input and adjust a midscale zero reference line for the scale sensitivity to be used. Decrease recorder sensitivity, look for amplifier output to balance to zero volts and increase sensitivity accordingly. Allow the amplifier to stabilize and then recheck the balance.

5. Look at the amplifier output with an oscilloscope to confirm output stability.

6. Record the initial reference level (zero volts) for approximately two minutes. Stop the chart drive, lift the pen and reduce sensitivity a few orders of magnitude.

7. Remove amplifier power for the period of

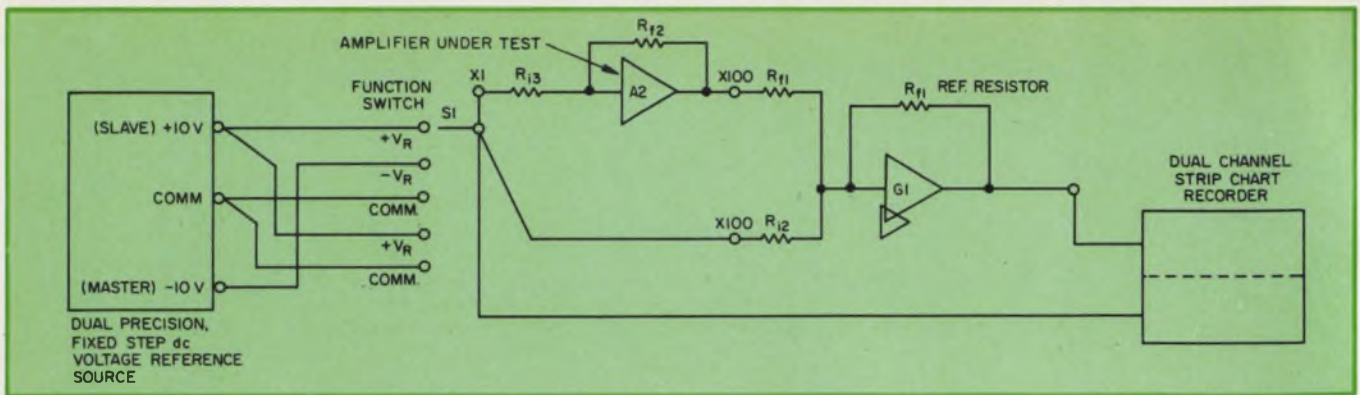

2. Initial step-transient response is measured with a fairly simple rig. The test determines the effects of

internal power changes on the offset voltage,  $E_{os}$ . Such changes occur via thermal feedback to the input.

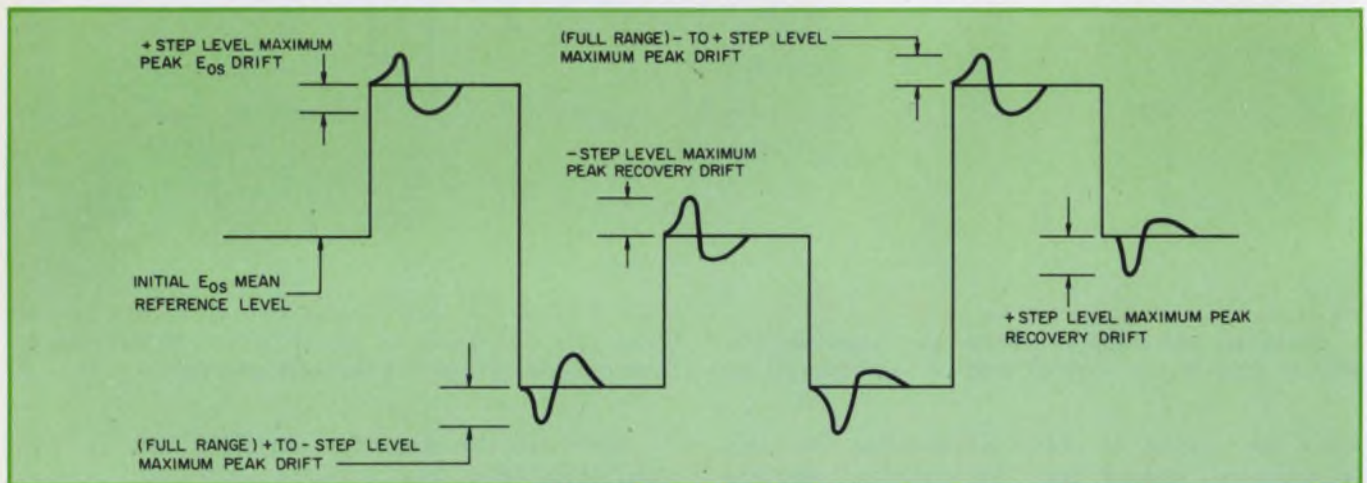

3. Various step input levels are selected by trial and error to pin down the maximum step-transient criteria.

time required for cool-off and thermally restabilize (20 minutes minimum).

8. Increase recorder sensitivity, turn amplifier power on and *immediately start the chart drive*.

The  $E_{os}$  initial drift recovery time is the total elapsed period, from the point the power-supply transient (if any) returns to the initial  $E_{os}$  reference level, until the amplifier recovers to some specified percentage of the initial  $E_{os}$  mean reference level (for example a  $\pm 10\%$  error band when  $E_o < 1$  mV).

### The step-transient test

The  $E_{os}$  initial step-transient test setup is illustrated in Fig. 2. This test generates internal thermal gradients in a reproducible manner. The input step-level signal and loading criteria should be determined (and specified) for worst-case results.

A number of errors can crop up in this test. Keep an eye out for these primary ones:

- Ratio and stability errors plus the step load regulation of the dual-reference supply.
- Accuracy, ratio and stability errors of  $A_2$ 's loop networks.

- Ratio and stability errors of  $A_1$  and those of  $A_1$ 's gain-setting resistors ( $R_{f1}/R_{i1}$ ).

- Stability of the recorder.

The test procedure follows:

1. With an accurate potentiometric nulling device, adjust the master reference ( $V_R$ ) to  $-10.00$  V and the slave to  $+10.00$  V. All amplifiers should be balanced and the corresponding precision wirewound loop-resistor networks matched. Another chopper-stabilized amplifier, such as the type used in the  $A_1$  slot, can be substituted in the  $A_2$  slot to check out the over-all test circuit for transients and instability.

2. To check out the test circuit, set the function switch to Common after the recorder has stabilized, and monitor the test-circuit output for a reasonable period of time.

3. Set the function switch to  $+V_R$  and monitor transients and drift, if any.

4. Set the function switch to  $-V_R$  and repeat, then set the function switch to Common and repeat again.

5. Remove  $A_2$  chopper amplifier and insert the differential amplifier to be tested. Allow to stabilize, then rebalance back to the recorder's previous zero-reference line.

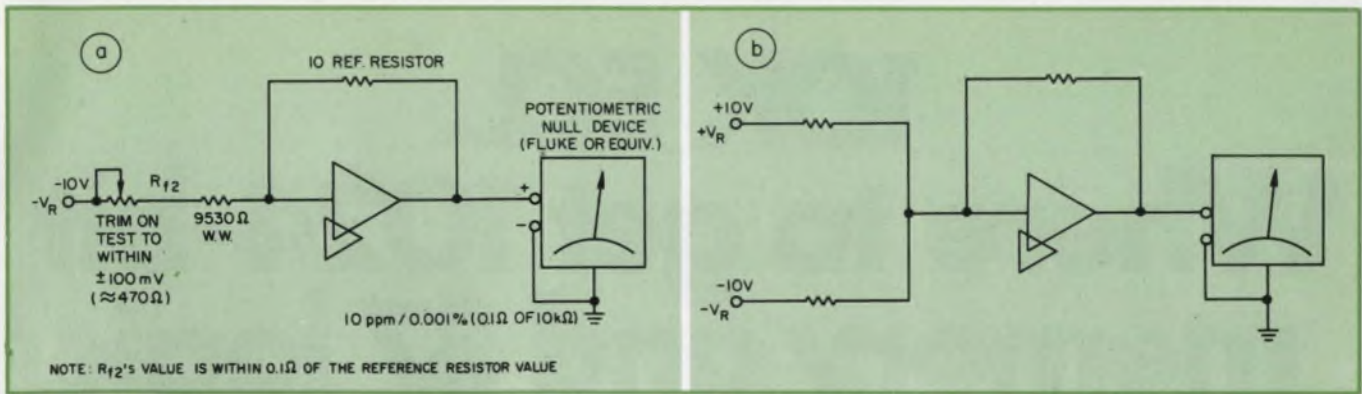

4. To match the two input resistors in the initial step-transient test, first balance the positive and negative ref-

erence voltages (a). Then use the setup in "b" to keep the gain ratio as accurate as possible.

6. After the amplifier under test has stabilized, record an initial  $E_{os}$  mean reference level for approximately 2 minutes. Then set the function switch to  $+V_R$ .

7. After the drift transient has stabilized, set the function switch to  $-V_R$ .

8. Allow stabilization, then return to Common and, again, wait until the amplifier has stabilized.

9. Set the function switch to  $+V_R$ , allow to stabilize and then set to Common.

Steps 8 and 9 give the  $E_{os}$  initial step transient and the  $E_{os}$  initial step-transient recovery time. Steps 6 and 7 provide the initial step-transient drift information—both magnitude and time.

#### Match resistors for ratio accuracy

To match the resistor ratios for the  $E_{os}$  initial step-response test, first use an accurate potentiometric nulling device and balance both the  $-10\text{-V}$  master reference supply and the  $+10\text{-V}$  slave (Fig. 4).

Although ratio accuracy—rather than absolute accuracy—is of primary importance, assume that you've got one accurate reference resistor and one accurate summing resistor for  $A_1$ . This assumption will allow you to match both the ratio and absolute accuracy of the other resistors in the circuit.

Perform the match with the previously adjusted  $-10\text{-V}$  master voltage reference as the input; with one of the chopper stabilized amplifiers; and with the accurate reference resistor as the feedback element. Use a fixed trim—less than 5% of the total input resistor value—to adjust the input resistor for unity gain at the output.

Add another resistor, similar to  $R_{f2}$  in Fig. 4, and use the positive section of the matched reference supply as the input (Fig. 4b). Adjust the fixed trim so the output is within  $\pm 100\text{ mV}$  of zero. Record the error,  $V_1$ , then swap the input

resistors and record the error,  $V_2$ . The algebraic difference between  $V_1$  and  $V_2$  should be  $< 100\text{ mV}$  (10 ppm).

The two input resistors now provide an input and feedback pair—matched to  $\pm 10\text{ ppm}$ —for  $A_2$ 's gain ratio. Repeat the matching procedure for  $R_{f1}$  and  $R_{f2}$ . The test sensitivity will now increase by  $\times 100$  (1 ppm).

Note that these steps also provide part of the information needed for the  $E_{os}$  internal power-step coefficient.

For the final test, the  $E_{os}$  thermal step transient, proceed as follows:

1. Remotely connect the external amplifier circuitry so the amplifier under test can be inserted into test chambers or oil baths without loop networks, loads, etc. These components should be kept in a stable room-temperature environment so network tempo errors won't contribute to the resulting measurement.

2. Connect the amplifier loops and recorder as described in the initial drift test procedure. Allow the amplifier to stabilize at the initial ( $T_{A1}$ ) case temperature. Record the initial  $E_{os}$  mean reference level for three minutes or more. Stop the strip-chart recorder drive.

3. Remove the amplifier from the first temperature bath and instantaneously insert the unit into a second bath at temperature  $T_{A2}$ . At the same time start the chart drive and record for the next 10 minutes or more.

4. The maximum peak  $\Delta E_{os}$  is referred to the final  $E_{os}$  mean reference level, and the thermal step-transient coefficient is:

$$\Delta E_{os} (\theta \text{ V}/^\circ\text{C}) = \frac{\Delta E_{os}}{\Delta T_A} = \frac{\text{Max. peak } \Delta E_{os}}{T_{A2} - T_{A1}}$$

The thermal transient-response recovery time is the total elapsed period from the time the case temperature-step change occurs until the final maximum peak excursion is within a specified percentage (error band) of the final  $E_{os}$  mean reference level. This information is derived from the thermal step-transient test data. ■■

# 10K ECL.

## Where to get 1024-bit memory and 37 logic devices right now.

Talk to Fairchild.

You want 10K ECL for speed. And at Fairchild we've got it for you right now.

Lots of logic. And more memory than anyone else today.

### 37 of the logic devices you want most. All off-the-shelf.

Check our list of available logic, and you'll find all the basics are there.

Including some handy items you won't find anywhere else—like our F10000 4-Bit Shift Register, our F10010 Decade Counter and our F10016 Binary Counter.

Plus 15 other helpful devices available very soon.

### Where else can you get 1024-bit 10K ECL memory in stock? Nowhere.

Or, where else can you get immediate quantities of 256-bit 10K ECL memory?

Nowhere. Except from the leader in ECL memory—Fairchild.

And, of course, we have all the 128-bit memory you need, too.

### Complete compatibility.

How does Fairchild's F10K ECL play with other ECL brands? That's easy to answer. All the way.

And for many applications, better.

### For new ECL designs, some new competitive advantages.

Of course, if you're designing a new system using 10K ECL logic and memory, you'll be decidedly ahead of your competitors by designing with *voltage-compensated* F10K ECL circuits from Fairchild.

ECL 1024-BIT MEMORIES IMPROVE SYSTEM PERFORMANCE  
Read-Modify-Write Cycle (Worst case over 0-75°C)

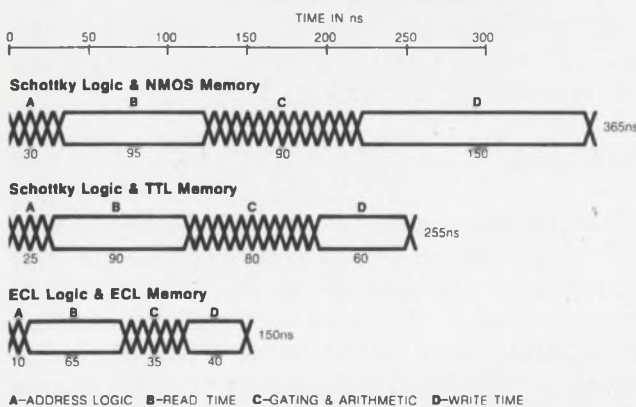

### F10K ECL Logic in Stock

Device	Description	Price 100-999
10000	4-Bit Shift Register	12.10
10010	Decade Counter	12.10
10016	Binary Counter	12.10
10101	Quad OR/NOR	1.67
10102	Quad NOR	1.67
10103	Quad OR	1.67
10105	Triple OR/NOR	1.67
10106	Triple NOR	1.67
10107	Triple Exc. OR/NOR	2.09
10109	Dual OR/NOR	1.67
10110	Dual 3/3 OR	2.09
10111	Dual 3/3 NOR	2.09
10114	Triple Line Receiver	2.09
10115	Quad Line Receiver	1.67
10116	Triple Line Receiver	1.67
10117	Dual 2 W AOI	2.09
10118	Dual 2 W OA	2.09
10119	4 W OR/AND	2.09
10121	4 W AOI	2.09
10124	TTL To ECL	4.50
10125	ECL To TTL	4.50
10130	Dual D Latch	4.46
10131	Dual D Flip-Flop	5.65
10132	Dual MUX-Latch	5.02
10133	Quad Latch	6.19
10134	Dual MUX-Latch	5.02
10160	12-Bit Parity	6.84
10161	1-8 Demux/Decode (L)	5.42
10162	1-8 Demux/Decode (H)	5.42
10164	8-1 MUX	5.42
10170	9 + 2 Bit Parity	6.84
10171	Dual 1-4 Demux (L)	5.42
10173	Quad MUX-Latch	6.19
10174	Dual 4-1 MUX	5.42
10175	Quint Latch	7.33
10179	Look Ahead	6.84
10180	Adder/Subtractor	18.00

### F10K ECL Logic Available Soon

Device	Description
2nd Quarter 1974	
10014	Active Terminator
10104	Quad AND Gate
10141	4-Bit Shift Register
10153	Neg Clock 10133
10172	Dual 1-4 Demux/Decode (H)
3rd Quarter 1974	
10135	Dual JK Flip-Flop
10136	Binary Counter
10137	Decade Counter
10176	Hex D Flip-Flop
10210	High-Speed 10110
4th Quarter 1974	
10145	16 x 4-Bit RAM
10165	Priority Encoder
10166	5-Bit Comparator
10181	4-Bit ALU
10186	Hex D Flip-Flop/Reset

### F10K ECL Memories in Stock

Device	Description	Price 100-999
10405	128 x 1-Bit RAM	\$15.00
10410	256 x 1-Bit RAM	\$21.00
10415	1024 x 1-Bit RAM	\$70.00

Our F10K is virtually immune to voltage variation, ripple and gradients. And holds noise immunity constant.

So if you want almost anything in 10K ECL today, you'll certainly want to talk to Fairchild soon.

Send for complete information on prices and delivery or contact your local Fairchild Sales Office or Distributor.

**MADE IN  
FAIRCHILD**

Semiconductor Components Group, Fairchild Camera & Instrument Corp.,  
464 Ellis St., Mountain View, CA 94040. Telephone (415) 962-5011. TWX: 910-379-6435.

# Boost audio-amplifier efficiencies

in portable communications or audio equipment. To slash the power consumption, try the class-D approach.

If you design battery-driven communication or portable audio equipment and have to squeeze more performance from a circuit powered by an already overworked energy source, consider replacing the audio-output amplifier with a more efficient design.

The typical output stage, usually biased for class AB operation, is only about 60% efficient. But in consumer electronics equipment the audio-output stage usually places the greatest demand on the battery. Only the capstan drive motor or dial-scale lamp, if used, draw more power.

The biggest problem with increasing class AB amplifier circuit efficiency, however, is that output distortion is boosted simultaneously—a dilemma caused in part by output-transistor bias-current requirements.

The solution? Use a switching-power amplifier—a design introduced about a decade ago but then rarely used. Its practical circuit efficiency is almost 90%. Besides improving the total efficiency of the system, the switching-power ampli-

fier, sometimes termed class D, has other features:

- Less need for exact output-transistor electrical characteristics or thermal matching.
- A power dissipation rating that may be only one-fourth that of a class AB design for the same output power.
- No dc bias requirements for output transistors.

The schematic diagram of a practical switching power amplifier is shown in Fig. 1. It consists of a modulator, switching power amplifier, demodulator and load. Low-frequency audio, fed into the amplifier at point A<sub>1</sub>, modulates a high-frequency square-wave carrier signal to produce pulse-width modulation. Pulse width varies as a function of the audio amplitude. Power amplification of the square wave takes place in the switching-power amplifier. The square wave varies about virtual dc ground at point B<sub>2</sub>, where it is fed to the demodulator. This stage strips the high-frequency carrier from the signal and energizes a resistive or reactive load connected across point B<sub>3</sub>.

One of the basic reasons why the class-D amplifier initially failed to gain acceptance was the problem of building a simple, yet stable modu-

**W.V. Subbarao**, Assistant Professor, North Dakota State University, College of Engineering and Architecture, Fargo, N.D. 58102.

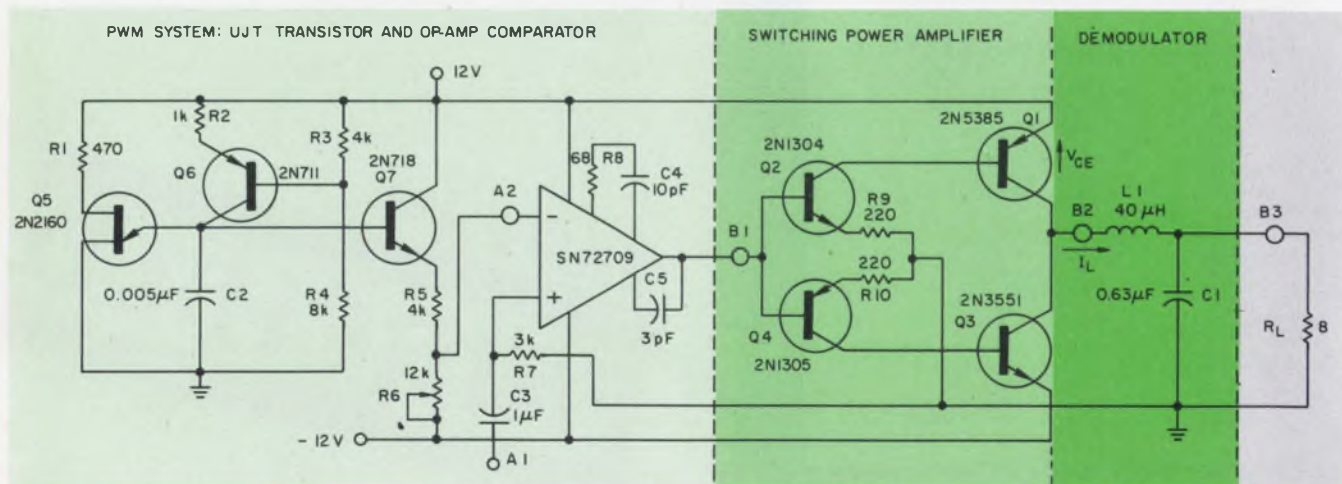

1. The circuit uses a combination of analog and digital techniques, so efficiency of the switching power amplifier approaches the theoretical 100% limit. The value of

L<sub>1</sub> is not critical, but the core material affects amplifier efficiency. Power output with an air-core coil is 8.6 W. With a magnetic core, P<sub>out</sub> drops to 8.3 W.



lator. If the modulator square-wave duty cycle varied when no modulating signal was present (an early problem), an error signal would be produced in the demodulator. In our updated design, a unijunction-transistor sawtooth generator feeds an emitter follower, which couples the carrier signal into the inverting input of a comparator. The modulating (audio) signal is fed into the comparator's noninverting terminal. The result, seen at point B<sub>1</sub>, is a pulse-width modulated current waveform.

Both germanium and silicon power transistors were used in the power-amplifier stage. In either case, equal power output was obtained. Experimental amplifier efficiency was about 85%, somewhat less than the 90% calculated. This additional efficiency loss was caused by losses in the demodulator inductor. However, as we will see, this loss can be minimized by proper inductor selection.

### A theoretical analysis

The updated switching-power amplifier was designed with the following simplified analysis:

The demodulator consists of a low-pass LC filter. At the signal frequency  $f_s$ :

$$X_L \ll R_L; X_C \gg R_L \quad (1)$$

where  $X_L$  is the inductive reactance, and  $X_C$  is the capacitive reactance. At the carrier frequency  $f_c$ :

$$X_L \gg R_L; X_C \ll R_L \quad (2)$$

If Eqs. 1 and 2 are combined,  $R_L$  is the geometric mean:

$$R_L = \sqrt{X_{L(f_s)} X_{L(f_c)}} = \sqrt{X_{C(f_s)} X_{C(f_c)}} \quad (3)$$

To find supply voltage  $V_{cc}$ , first determine output power into load  $R_L$ :

$$P_{out} = \frac{V_m^2}{2R_L} \quad (4)$$

where  $V_m$  = the peak value of  $V_o$ . At  $f_s$ :

$$V_{B2} = jI_L \cdot X_L + V_m \quad (5)$$

Output-stage power losses and efficiency are determined next. Since the square-wave driver current has a 50% duty cycle, total power dissipated can be measured in  $Q_1$  or  $Q_3$ :

$$P_{diss} = 1/2 |V_{ec(sat)}| \cdot |I_L| \quad (6)$$

Turn-on and turn-off losses are determined if

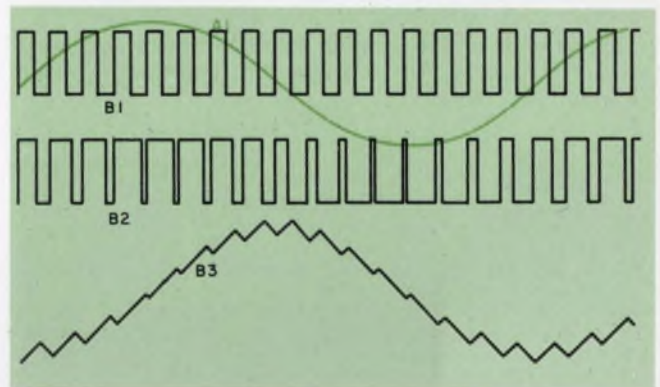

2. Waveforms at various points in Fig. 1. The sinusoidal input signal (point A<sub>1</sub>) provides a modulation frequency  $f_s$  at the comparator's noninverting terminal. Without the input signal,  $f_c$  consists of a 50% duty cycle square wave (point B<sub>2</sub>). The presence of  $f_s$  modulates  $f_c$ , and varies the duty cycle. The signal at B<sub>3</sub> consists of an amplified pulse-width-modulated carrier, integrated in a low-pass LC filter.

we assume that  $V_{ec(sat)} = 0$  V:

$$V_{ec} = V_{cc} \left[ 1 - \frac{t}{t_{on}} \right]$$

$$V_{B2} = V_{cc} \frac{t}{t_{on}} \quad (7)$$

The average power dissipated in  $Q_1$  during turn-on is

$$P_{out} = \frac{V_{cc}^2 t_{on}^2}{12 LT} \quad (8)$$

where  $T$  is the period of the carrier.

Turn-on and turn-off characteristics measured for  $Q_1$  are almost identical. The total power dissipated in  $Q_1$  during on and off periods is

$$P_{on-off} = 2 P_{on} = \frac{V_{cc}^2 \cdot t_{on}^2}{6 LT} \quad (9)$$

The total efficiency of the output stage may be measured next:

$$P_{loss} = 2 P_{diss} + 2 P_{on-off} \quad (10)$$

where efficiency =  $\frac{P_{out}}{P_{out} + P_{loss}}$  (11)

The complete switching-power amplifier of Fig. 1 is powered by a 24-V bipolar supply capable of 1.6-A output.

So much for theory. Now let's consider the practical aspects.

Solving Eq. 3, we get  $L = 40 \mu\text{H}$  and  $C_1 =$

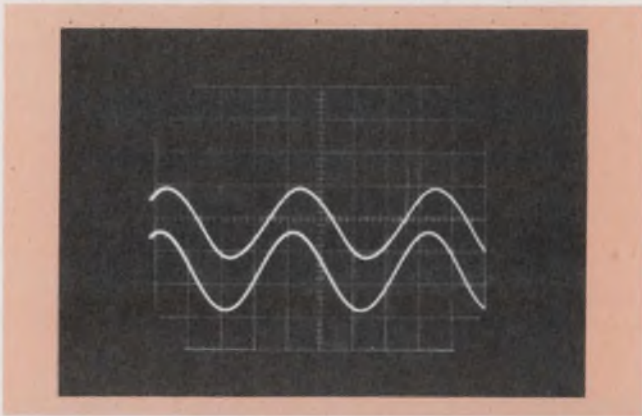

3. Phase shift of the class-D amplifier varies according to input frequency. The top sinusoid (signal at  $B_3$ ) lags the input (A) by  $19^\circ$ .

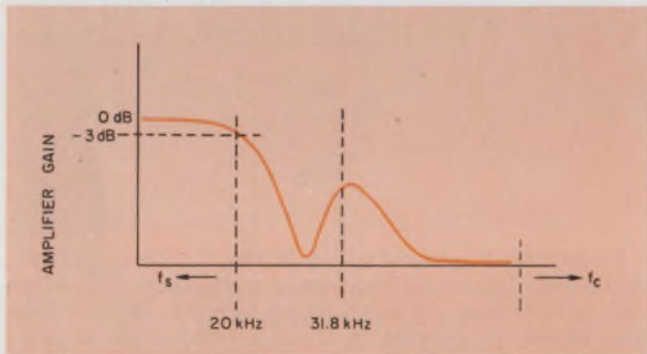

4. Frequency response of the amplifier attenuates and boosts input  $f_s$  at two points. The  $-3$  dB point shown corresponds to amplifier bandwidth. The second peak in the curve, which has a center frequency of  $31.8$  kHz, corresponds to the resonant frequency of the demodulator components.

$0.63 \mu\text{F}$ . (Frequency  $f_s$  was arbitrarily chosen to be  $10$  kHz, with  $f_c$  equaling  $100$  kHz. More about this ratio later.)

The output power (Eq. 4) was solved for  $R_L = 8 \Omega$ . Output  $P_{\text{out}}$  therefore equals  $9$  W when  $V_m = 12$  V. Allowing  $0.5 V_{cc}$  for  $Q_1$  (or  $Q_3$ ) and  $11.5$  V at point  $B_2$ , we get  $V_{cc} = 12$  V.

Output load current  $I_L$  (Eq. 5) equals  $1.6$  A.

The power dissipated in  $Q_1$  or  $Q_3$  (Eq. 6) pinpoints one of the class-D amplifier's main features:  $P_{\text{diss}} = 0.4$  W.

An increase in the carrier frequency may yield a closer approximation to the original modulating signal, but the tradeoff increases  $P_{\text{on-off}}$  losses in  $Q_1$  or  $Q_3$ . Since  $t_{\text{on}}$  is a fixed parameter of the output transistors used,  $t_{\text{on}}/T$  increases if  $T$  is reduced. Although there is no ideal ratio for  $t_{\text{on}}/T$ , best results are obtained when this ratio approaches zero. If we restrict the total power loss for both output transistors to less than  $2\%$  of output power, the  $t_{\text{on}}/T$  ratio is  $0.1$ . With the transistors used in the prototype amplifier,  $t_{\text{on}} = 1 \mu\text{s}$ ; therefore  $T = 10 \mu\text{s}$ . Solving Eq. 9, we get  $P_{\text{on-off}} = 0.06$  W.

The total power loss of the output stage (Eq.

10) yields  $0.92$  W. Efficiency (Eq. 11)  $\approx 90\%$ . Power loss in the resistive component of inductor  $L$  greatly affects over-all power loss, and therefore the efficiency of the amplifier. The prototype used a  $40\text{-}\mu\text{H}$  air-core inductor, thereby eliminating core and magnetization current losses. A typical air-core coil having a  $Q = 100$  has a dc resistance of  $0.025 \Omega$ . If space is not a primary design goal, choose an air-core coil. If space is important, a magnetic-core coil may be used; the magnetic-core coil is about  $4\%$  less efficient than the air-core version at  $Q = 100$ .

From Eq. 10, the power rating of the output transistor is  $0.46$  W. The current rating of either  $Q_1$  or  $Q_3 \geq 1.6$  A. The only other important transistor rating,  $V_{\text{CEB}}$ , equals  $2V_{cc}$ , or  $24$  V.

### Simple pulse-width modulator

While this updated version of the amplifier uses a unijunction transistor sawtooth generator and monolithic comparator, a readily available multifunction generator or monolithic timing integrated circuit could also have been used— but at greater cost.

The unijunction transistor chosen has the following characteristics when  $V_{cc} = 12$  V:  $\eta = 0.6$ ;  $V_\gamma = 0.6$  V,  $V_P = 7.8$  V;  $V_V = 1.6$  V. The combination of  $R_5$  and pot  $R_i$  is adjusted so that  $V_{A2}$  has an average value of zero volts. This parallel combination also must be an order of magnitude less than the input resistance of the inverting terminal of the comparator;  $V_{A2}$  therefore can appear to be a voltage source to the integrated circuit.

Any of the textbooks treating the UJT can be used to find component values for a particular carrier frequency. But remember that  $f_c$  helps determine final amplifier efficiency. The upper limit of  $f_c$  (and therefore the ratio between it and  $f_s$ ) is determined by the amount of distortion caused by high-frequency power. The  $10:1$  ratio set for  $f_c$  and  $f_s$  gives a final distortion of  $2\%$  at full power.

The comparator chosen has an upper frequency cutoff that is one order of magnitude greater than  $f_c$ . It is capable of  $\pm 10$  V output from a  $\pm 12$ -V supply;  $I_{\text{out}}$  is  $\pm 2$  mA. ■■

### Bibliography

- Camenzind, Hans R., "Circuit Design for Integrated Electronics," Addison-Wesley, 1968, pp. 208 to 214.
- Price, Thomas D., "FET Current Source Gives Stable, Precise Ramp," *Electronics*, Nov. 8, 1971, p. 81.
- Smeins, L. G., "Stable Unijunction VCO Needs No Critical Components," *Electronics*, Oct. 12, 1970.
- Strauss, Leonard, "Wave Generation & Shaping," McGraw-Hill, 1970, pp. 124 to 131.
- Taub, Herbert, and Schilling, Donald, "Principles of Communication Systems," McGraw-Hill, 1971, pp. 180-190.
- Wittlinger, H. A., "Application of RCA CA 3033 & CA 3033A High Performance IC Op Amps," Application Note ICAN-5641. RCA Solid State Databook, SSD-202A, 1973.

# BARGAINS GALORE on LEDs from DIALIGHT

## FEATURES:

High luminous intensity

Low cost

Low power consumption

IC compatible

Vibration/shock resistant

Solid state reliability

Life measured in years

Wide viewing angle



Dialight's high brightness 521-9200 LED is an intense large area light source that has this typical luminous intensity:

$$@ I_F = 20 \text{ mA} \quad I_0 = 2.0 \text{ mcd.}$$

## APPLICATIONS:

Panel lighting • Circuit-status indicators • Back lighting of annunciators • Alpha-numeric displays • Automobile dashboards • Appliances • Desk-top calculators • Housewares



# 9¢

Quality LEDs are 9¢ each when purchased in million piece quantities



# 21¢

LEDs from 100 to 999 are only 21¢ each.

# 17¢



If you need LEDs from 1000 to 9999, Dialight has them for 17¢ each.

# 28¢



Even if you only need LEDs from 1 to 99, Dialight has them for 28¢ each.



# 16¢

Quantities from 10,000 are a low 16¢ each and Dialight can fill your order today

# FREE!

With this coupon you can get a free LED sample. Send this coupon to your nearest Dialight distributor or give him a call.

All prices are domestic and subject to change without notice.

## DIALIGHT

Dialight Corporation, A North American Philips Company  
60 Stewart Avenue, Brooklyn, N.Y. 11237 (212) 497-7600

## AVAILABLE NOW FROM THESE STOCKING DISTRIBUTORS

**ARIZONA**  
Moltronics of Arizona, Inc.  
602-272-7951

**CALIFORNIA**  
Western Electromotive  
213-870-7621  
Bell Electronics Corp.  
415-323-9431  
Fisher/Brownell  
408-244-6182  
Richey Electronics, Inc.  
213-875-2862  
Westates Electronics Corp.  
213-341-4411

**COLORADO**  
Meter Master Instrument Corp.  
303-722-5766

**FLORIDA**  
Hammond Electronics, Inc.  
305-241-6601

**ILLINOIS**  
Newark Electronics  
312-638-4411

**INDIANA**  
Graham Electronic Supply, Inc.  
317-634-8202  
Radio Distributing Co.  
219-287-2911

**MARYLAND**  
Pioneer Washington Elect. Co.  
301-424-3300  
Radio Electric Service Co.  
301-823-0070

**MASSACHUSETTS**  
Cramer Electronics, Inc.  
617-969-7700  
DeMambro Supply Co., Inc.  
617-787-1200  
Gerber Electronics, Inc.  
617-329-2400  
Sager Electrical Supply Co.  
617-542-2281

**MICHIGAN**  
RS Electronics  
313-491-1000

**MINNESOTA**  
Gopher Electronics Co.  
612-645-0241

**MISSOURI**  
Lcomp-St. Louis, Inc.  
314-647-5505

**NEBRASKA**  
Scott Electronic Supply  
402-434-8308

**NEW JERSEY**  
Federated Electronics  
201-376-8900  
Resco Electronics  
609-662-4000  
State Electronics  
201-887-2550

**NEW YORK METROPOLITAN AREA**  
Arrow Electronics, Inc.

516-694-6800  
Harrison Radio Corp.  
516-293-7990  
Harvey Radio Co., Inc.  
516-921-8700  
Melville Radio Corp.  
914-592-7100  
Peerless Radio Corp.  
516-593-2121

**NEW YORK STATE**  
Summit Distributors, Inc.  
716-884-3450

**NORTH CAROLINA**  
Hammond Electronics of Carolina, Inc.  
919-275-6391

**OHIO**  
Hughes-Peters, Inc.  
614-294-5351  
Pioneer-Cleveland Div.  
Pioneer-Standard Electronics  
216-587-3600  
Stotts-Friedman Co.  
513-224-1111  
Sun Radio Co., Inc.  
216-434-2171

**OKLAHOMA**  
Radio, Inc.  
918-587-9124

**PENNSYLVANIA**  
Almo Electronics Corp.  
215-676-6000  
George D. Barbey Co.  
215-376-7451  
Cameradio Co.  
412-288-2600

**TEXAS**  
Harrison Equipment Co., Inc.  
713-224-9131

**UTAH**  
Standard Supply Co.  
801-355-2971

**WASHINGTON**  
Almac/Stroum Electronics  
206-763-2300

**WISCONSIN**  
Parts Mart Corp.  
414-276-4160

**CANADA**  
Saynor Electronics Ltd.  
416-445-2347  
L. A. Varah Ltd.  
604-736-9252  
Wackid Radio TV Labs, Ltd.  
613-726-1821

# FREE!



Ask for free LED Product Selector Guide. 60 pages of LEDs: discretes, indicators, displays, fault indicators, opto-isolators, etc.

# Hughes heat pipes. Order 'em hot off the shelf.

Now you can order heat pipes just like you order nuts and bolts. Because now Hughes stocks heat pipes in a variety of standard, off-the-shelf sizes and thermal capacities. (If you have a heat transfer problem that calls for a custom solution, we solve those, too.)

## 1333H STAINLESS STEEL AND AMMONIA

Thermal transport capacity: 50 watts with evaporator 90° below condenser, 15 watts horizontal operation, 7 watts with evaporator 90° above condenser. Recommended operating range: -80° to +90°C. Weight: 8 grams. Active Length: 5.69 inches. Diameter: 3/16". \$37.00.

## 1370H COPPER AND WATER

Available in diameters of 1/4", 1/2", and 1" at \$37.00, \$40.00 and \$50.00, respectively, with thermal transport capacities of 345, 750, and 6000 watts with the evaporator 90° below condenser; 115, 250 and 2000 watts horizontal operation; 38, 60, and 500 watts with evaporator 90° above condenser. Recommended operating range: +50° to +150°C. Weight: 21, 70, 550 grams. Standard Active Length: 6, 6, 12 inches.

## 1350H STAINLESS STEEL AND METHANOL

Available in diameters of 3/16" and 1/4" at \$37.00 each and 1/2" at \$40.00. Thermal transport capacities are 55, 75, and 180 watts with evaporator 90° below condenser, 17, 25, and 60 watts horizontal operation, and 6, 10, and 20 watts with evaporator 90° above condenser. Recommended operating range: -40° to +120°C. Weight: 8, 11, and 38 grams. Standard Active Length: 6 inches.

## 1361H FLEXIBLE STAINLESS STEEL AND METHANOL

Available in active lengths of 7" and 8" at \$75.00 each, with thermal transport capacities of 20 watts with the evaporator 90° below condenser, 7.5 watts horizontal operation, 2.5 watts with evaporator 90° above condenser. Recommended operating range: -40° to +120°C. Weight: 20 grams. Diameter: 1/4".



For detailed information, or if you have a hot requirement and want one now, just fill out and send in the coupon. Hughes Electron Dynamics Division, 3100 W. Lomita Blvd., Mail Station 2124, Torrance, California. (213) 534-2121.

PLEASE PRINT

SEND INFORMATION.

SEND QUICK ORDER FORM.

NAME \_\_\_\_\_ COMPANY \_\_\_\_\_

ADDRESS \_\_\_\_\_ CITY \_\_\_\_\_

STATE \_\_\_\_\_ ZIP \_\_\_\_\_ TELEPHONE \_\_\_\_\_

All prices shown are effective in U. S. A. and Canada

ED-4

# NEW: Only General Electric offers you all these benefits in green Solid State Lamps (LED's)!

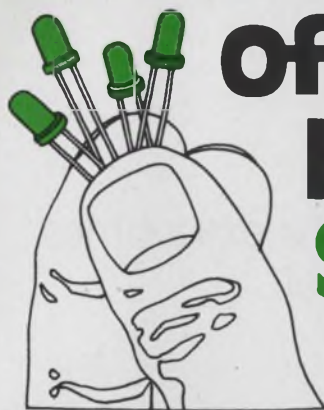

## Four new lamps — Two light outputs

You can select both the lamp size and light output you need with GE's new green bright visible SSL's. The two brightest, SSL44-2 and the 1/8" longer SSL44L-2, provide a *minimum* initial light output of 1.8 millicandela with a typical output of 2.4 mcd. Equivalent light outputs for the standard, less expensive SSL44-1 and SSL44L-1 are 0.8 minimum and 1.4 typical mcd.

## Available now

These new GE green SSL's are in stock now, ready for off-shelf delivery. Contact your GE SSL distributor or your local GE representative today to get the newest spec sheets, delivery dates and prices. (Or circle request number at bottom of ad.)

## Exclusive GE guarantees

Only GE gives you all these guarantees on every visible SSL you buy: Initial light output will be at or above the published minimum. Each lamp made is inspected at rated current for light output and forward voltage; reverse voltage at 10 $\mu$ A is 3 volts or greater. General Electric will refund the lamp purchase price to the original purchaser or provide replacements for all returned lamps not meeting these guarantees.

## FREE: Designers data kit

Write today on your company letterhead to get our free Designers Data Kit, which includes a free sample of our new green lamp as well as complete technical data. General Electric, Miniature Lamp Products Dept., Inquiry Bureau, Dept. L, Nela Park, Cleveland, Ohio 44112.



## GE electronic distributors (listed alphabetically by company name)

Almac/Stroum Electronics  
Seattle, WA

Almo Electronics  
Philadelphia, PA

Barnhill Five, Inc.  
Denver, CO

Brill Electronics  
Oakland, CA

Carlton-Bates Co.  
Little Rock, AR

Cramer Electronics  
Albuquerque, NM  
East Syracuse, NY  
Endwell, NY  
Irvine, CA

Mt. Prospect, IL  
Newton Center, MA  
North Haven, CT  
Sunnyvale, CA

Electra Distributing Co.  
Nashville, TN

Electronics Marketing Corp.  
Columbus, OH

Electronics Parts Co.  
Denver, CO

Electronic Supply  
Riverside, CA

Elmar Electronics  
Mt. View, CA

General Electric Supply Co.  
Rochester, NY

General Radio Supply Co.  
Camden, NJ

Gerber Electronics  
Dedham, MA

Graham Electronics Supply Co.  
Indianapolis, IN

G. S. Marshall Co.  
El Monte, CA

Hamilton/Avnet Electronics  
Albuquerque, NM

Bellevue, WA  
Burlington, MA  
Cedar Grove, NJ  
Culver City, CA  
Dallas, TX  
Denver, CO

Georgetown, CT  
Hanover, MD

Hazelwood, MO  
Hollywood, FL  
Houston, TX

Livonia, MI  
Lenexa, KS  
Mt. Laurel, NJ

Mt. View, CA  
Phoenix, AZ  
Salt Lake City, UT

San Diego, CA  
Schiller Park, IL  
Syracuse, NY  
Westbury, NY

Hammond Electronics  
Orlando, FL

Harpe Electronics, Inc.  
Chattanooga, TN

Hughes/Peters, Inc.  
Cincinnati, OH  
Columbus, OH

Kierulff Electronics, Inc.  
Los Angeles, CA

L Comp  
North Kansas City, MO

Lykes Electronics Corp.  
Atlanta, GA

Milgray Electronics  
Freeport, NY

Newark Electronics  
Chicago, IL  
Salt Lake City, UT

Oil Capitol Electronics Corp.  
Tulsa, OK

Olive Industrial Electronics, Inc.  
St. Louis, MO

Pioneer Standard Electronics  
Cleveland, OH  
Dayton, OH

R. S. Electronics  
Detroit, MI

Rem Electronics  
Warren, OH

Rochester Radio Supply Co., Inc.  
Rochester, NY

Rome Electronics, Inc.  
Rome, NY

Schwaber Electronics  
Atlanta, GA

Beachwood, OH  
Bridgeport, CT  
Danbury, CT

Elk Grove Village, IL  
Hollywood, FL

Rochester, NY  
Rockville, MD

Somerset, NJ  
Waltham, MA  
Westbury, NY

Semiconductor Specialists, Inc.  
Elmhurst, IL  
Indianapolis, IN  
Pittsburgh, PA

Southeastern Radio Supply Co.  
Raleigh, NC

Standard Electronics, Inc.  
Cheektowage, NY

Sterling Electronics  
Dallas, TX  
Houston, TX

Western Electromotive  
Culver City, CA

Zack Electronics  
San Francisco, CA

GENERAL  ELECTRIC

INFORMATION RETRIEVAL NUMBER 41

# The four-function 'scientific' calculator.

By simplifying equations and pushing the keys a few extra times you turn an inexpensive machine into a scientific tool.

The simple four-function calculator (Fig. 1) offers the engineer almost as much versatility as much more expensive scientific units. By altering the order in which some computations are performed, and by adding some extra steps, you can use the basic calculator to do operations like squaring, square-rooting, summing of products, summing of quotients, trig ratios and exponents.

But usually before you can do this, you must simplify the complex engineering formulas. The reduction simply eliminates some factors in the equation that would not affect the result by more than a few percent.

Once the formulas are reduced there are many areas where the four-function calculator can be used to predict the design trend quickly without lengthy analysis. Areas where this applies include power-supply filter design, signal filter design and rms signal calculations.

## Overcoming calculator limitations

The square-root operation is one of the more common math operations that is not available directly on a low-cost calculator. To perform this operation with a calculator, start with the first-order approximation for the square root:

$$\sqrt{N} = 1/2(N/A + A).$$

N is any number whose square root is to be determined, and A is the approximate square root of N. As an example let N = 86, then let A = 9, and you get:

$$\sqrt{86} = 1/2(9.5555555 + 9) = 1/2(18.555555) = 9.2777775.$$

If you need better than 5% accuracy, repeat the process with A = 9.2777775. The result is 9.273619. As a check,  $(9.273619)^2 = 86.000009$ .

This procedure for finding the square root can be expanded to find the nth root of a number N. The new formula for the nth root is:

$${}^n\sqrt{N} = \left[ \frac{N}{X^{n-1}} + (n-1)X \right] \frac{1}{n}.$$

John Ayer, Manager, Calculator Operations, Bowmar Canada Ltd., 1257 Algoma Rd., Ottawa, Ontario, Canada.

In this case, N is the number whose root is to be determined, n is the order of the root and X is the approximate value of the nth order root of N.

Let's try a problem: Find  $\sqrt[4]{28211}$ .

Let X = 13. Then  $(28211)^{1/4} =$

$$\left[ \frac{28211}{13^3} + 3(13) \right] \times (1/4) = 12.96.$$

To do mixed calculations, such as a sum of products, just follow the simple steps outlined in this example:

$$N = (35 \times 7) + (75 \times 13) + (31 \times 9).$$

Keyboard	Display
Enter 35	35
Touch ×	35
Enter 7	7
Touch =	245
Touch +	245
Enter 75	75
Touch + (13 times)	1220
Enter 31	31
Touch + (9 times)	1449

For the sum of quotients, the fractions must first be converted to a sum of products over a common denominator. For example,

$$N = 36/5 + 21/8 + 81/6$$

is converted to

$$N = \frac{36(8 \times 6) + 21(5 \times 6) + 81(5 \times 8)}{5 \times 8 \times 6}.$$

This expression can be simplified further before you use the calculator:

$$N = \frac{36 \times 48 + 210 \times 3 + 810 \times 4}{240}.$$

You can now proceed as in the sum-of-products procedure. The answer for this example is 23.325.

In cases like these, perform the multiplication or division before addition or subtraction. For numbers with decimals, convert the multiplier to a whole number before you use the sum-of-prod-

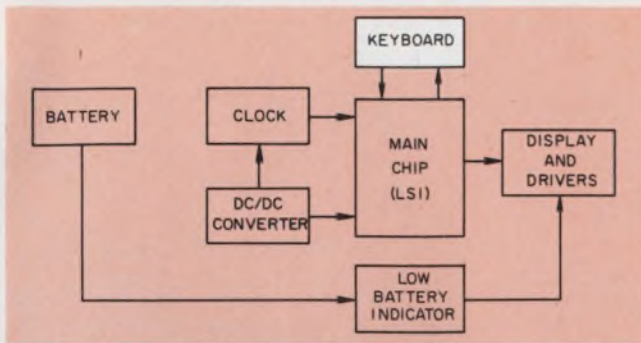

1. The basic calculator can be divided into many different functional sections that together do the computations and display the result.

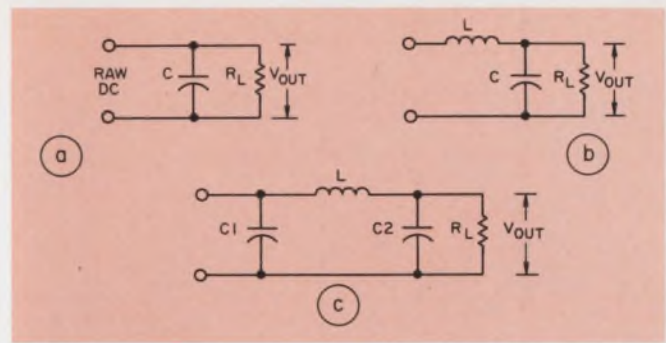

2. The simplest power supply filter (a) is a lone capacitor across the raw supply. Further filtering results if an inductor is added (b) or a  $\pi$  filter is used (c).

## The electronic calculator: Some definitions

With the large upswing in the use of portable electronic calculators, new terms have come into the engineer's vocabulary. Here are some of the more common ones:

**Automatic or manual constant:** This calculator feature simplifies reciprocal and squaring computations. Usually, a switch controls the constant, which is locked in the logic store and used when required.

**Omni constant:** The calculator can add consecutively in any steps of any predetermined size, raise the power of any number in consecutive steps.

**Significant figures:** This is the result displayed after automatic machine roundoff. For example, when an eight-digit calculator computes  $45689 \times 98745$ , it will display [45115603, although the actual result is 4511560305. The last two digits, 0 and 5, are not displayed, since the machine is limited to eight digits; only the eight most significant ones are displayed. The symbol to the left of the result indicates that the number is larger than the display can handle (i.e. overflow sign).

**Overflow indicator:** When the calculator's computing capacity is exceeded, the display will usually produce the answer with some special symbol and only the N most significant digits displayed. (This assumes that the calculator can display only N digits).

**Zero suppression:** Internal circuits prevent the zeros that precede whole numbers from being displayed—thus an uncluttered number is shown.

**Arithmetic logic:** Most calculators use this mode of operation (since the circuitry is simpler). This logic cannot directly multiply two nega-

tive numbers and give a positive answer. Also, addition and subtraction operations are not done in the same sequence as written in the original equation.

**Algebraic logic:** This calculator mode permits all calculations to be done in the order in which they are written.

**Underflow:** When the calculator's capacity is exceeded, some of the least significant digits are discarded and the resulting display is sometimes zero.

**True credit balance:** When the answer is negative, the minus sign automatically appears in the display.

**Fixed decimal point:** Location of the decimal point in the display is chosen by a selector switch. For example, if the switch is set to position six on an eight-digit machine, the numbers between 99 and 0.001 can be used. In some machines no selector is provided, and a calculation like  $123/456$  yields the answer 0.28 instead of 0.2697368.

**Floating decimal point:** In this case each entry may contain the decimal point in any position. The number and decimal point will be properly positioned automatically when displayed.

**Memory:** This gives the machine the capability to store information during chain calculations and to recall it when required. The memory eases the calculation of sums and differences of products and quotients.

Other features of many new calculators include a key that permits an eight-digit calculator to display 16 digits, an indicator that tells when the batteries are low, and a battery-saver circuit that cuts off the display after about 15 seconds to prevent excessive battery drain (the display is restored when any key is pushed).

ucts procedure discussed earlier.

Powers of  $e$  can also be calculated. To get them, though, you must approximate  $e$  as 2.7183, and the exponent must be a whole number—either positive or negative. There are two possible pro-

cedures: one for calculators that have a constant key (K), and one for those that don't (i.e. automatic). For the calculators with the automatic constant, the procedure is as follows:  
For a positive exponent—for example,  $e^1$ :

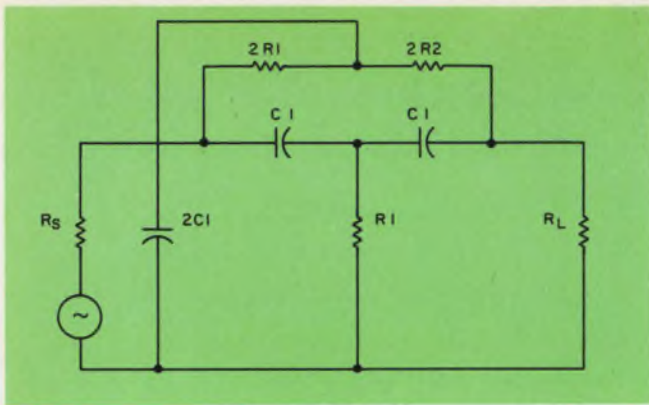

3. Design of the twin-T notch filter can be simplified if a calculator performs modified notch computations.

Keyboard	Display
Enter 2.7183	2.7183
Touch $\times$ (four times)	54.599607

For a negative exponent—for example,  $e^{-3}$ :

Keyboard	Display
Enter 2.7183	2.7183
Touch $\div$ (five times)	0.049786

Note: For negative exponents, the divide key should be pressed two times more than the absolute value of the exponent.

When the calculator has a constant switch, use the following procedure after setting the switch to K:

For a positive exponent ( $e^4$ ):

Keyboard	Display
Enter 2.7183	2.7183
Touch $\times$	2.7183
Enter 2.7183	2.7183
Touch $+=$ (three times)	54.599607

For a negative exponent ( $e^{-3}$ ):

Keyboard	Display
Enter 2.7183	2.7183
Touch $\div$	2.7183
Enter 2.7183	2.7183
Touch $+=$ (four times)	0.049786

Note: For negative exponents, add one to the absolute value of the exponent to determine the number of times the  $+=$  key should be pressed.

Even trigonometric functions and ratios can be computed on the four-function calculator. The only restriction is the maximum angle—for 5% accuracy, the angle is limited to  $30^\circ$ . To find  $\sin x$  where  $x$  is in degrees, multiply  $x$  by 0.0174. For  $\tan x$ , do the same but use 0.0175. The  $\cos x$  is simply the ratio of  $\sin x$  to  $\tan x$ .

To go the reverse route and get the angle from

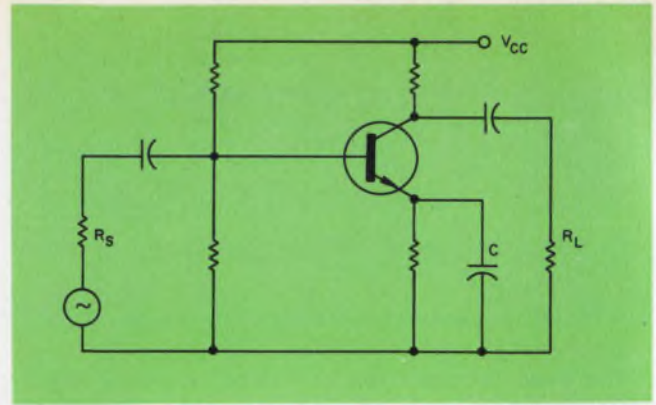

4. By simplifying the design equations for the decoupling capacitor, you can use a calculator to get the answer.

trig value, just divide the  $\sin$  or  $\tan$  value by the respective multiplying factors used before. The inverse cosine is the inverse sine of  $90^\circ - x$ .

#### Applying the solutions

These calculator shortcuts can be applied to designs. Consider a power-supply filter. For the basic C, LC or  $\pi$  filters (Fig. 2), output voltage or ripple can be calculated from some simple formulas. The circuit of Fig. 2a represents the simplest filter. Its output equation<sup>1</sup> is:

$$V_{out} = 1.4 (V_{in\ rms}) - 0.0042I_{dc}/C.$$

In this case  $V_{out}$  is dc',  $I_{dc}$  is in amps, C is in farads and  $R_L$  is in ohms. The ripple factor  $r$ , ( $R/X_c$ ) can also be computed from the equation

$$r = 0.0024CR_L.$$

If the LC filter is used (Fig. 2b), the output voltage can be calculated from

$$V_{out} = 0.9V_{in\ rms},$$

while the ripple factor becomes

$$r = 0.0000008/CL,$$

where L is in henries.

In the last case (Fig. 2c) the  $\pi$  filter has an output equation identical to the simple filter of Fig. 2a. However, the ripple factor changes to account for the extra components. The new equation is

$$r = \frac{33}{10^8(C_1C_2LR_L)}.$$

The twin-T notch filter can also be designed with the calculator. The circuit of Fig. 3 provides good selectivity and will exhibit attenuation at the notch frequency,  $f_o$ , determined by  $R_1$  and  $C_1$ . If the design requires that only  $f_o$  be rejected, then the value of either  $R_1$  or  $C_1$  is arbitrary. When gain has to be constant from dc to high frequencies, then

$$(R_1)^2 = R_0R_L/2,$$

and the notch frequency

$$f_o = 0.08/C_1R_1,$$

where C is in farads and R is in ohms.

Calculations for audio circuits are also possible. For example, if you want to convert 15 dB back to the power ratio it came from, raise 2 to



# The MACRODATA MD-107 Memory System Analyzer!

Imagine a tester that can handle plated-wire, core, or semiconductor memories... that can test complete computer memory systems, memory boards, or memory chips... that can operate at 10 MHz and compare up to 160 data bits at any of 16,000,000 addresses.

**The Macrodata MD-107 Memory System Analyzer does it all.**

- Macrodata's Cascaded Computer Control Testing Concept
- Minicomputer, Microprogrammable Processor, and CRT Display
- Key-

- board Entry of Test Programs
- Split Cycle Timing Capability
- Sophisticated Address Manipulation Capability
- Simple Software Language with Display of Directive Action for Operator Based on Test Results
- Extensive Sync Capability
- CRT Display of Device Inputs/Outputs for Test Monitoring
- CRT Message Display for Easy Program Debug
- Complete system under \$50,000.

For the full story, send for the MD-107 brochure, or call us directly.



SYSTEM BLOCK DIAGRAM

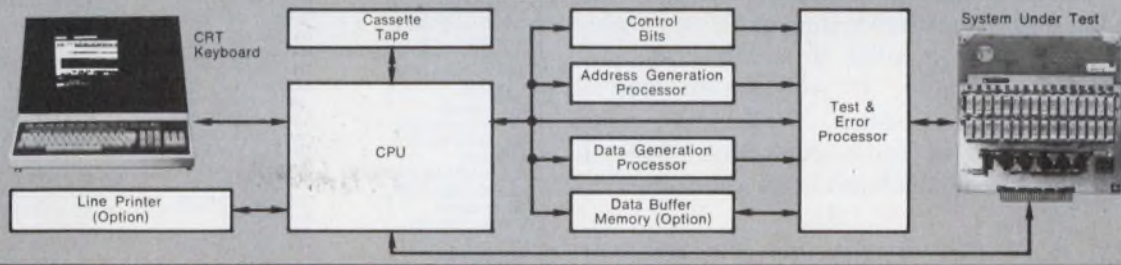

**Macrodata**



**Macrodata Corporation**, 6203 Variel Avenue, Woodland Hills, California 91364, Phone: (213) 887-5550, Telex: 65-1345  
 Sales Offices: Northern California Area Tel. (408) 735-9560 • Southwestern Area Tel. (213) 644-3611 • Scottsdale Tel. (602) 947-7841 • Minneapolis Area Tel. (612) 636-1770 • Chicago Area Tel. (312) 455-5100 • Cleveland Area Tel. (216) 461-8333 • East Coast Tel. (516) 343-8600 International: West Germany Munich Tel. (0811) 34 56 00 Telex: (841) 521-5969 • Milan, Italy Tel. 871-988/899-248 Telex: (843) 34314 • Sweden and Norway - Stockholm Tel. (08)-380-370 • Switzerland and Austria - Bern Tel. (031) 22 44 81 Telex: (845) 33172 • Tel Aviv, Israel Tel. 25 55 69 • Tokyo, Japan Tel. (03) 985-5266 Telex: (781) 272-2171 • Buckinghamshire, England Tel. High Wycombe (0494) 36 3 81 Telex: (851)837236

512 x 16  
 MEMORY

the index found by dividing the given number of dB by 3:

$$15 \text{ dB} = 2^{15/3} = 2^5 = 32 \text{ times.}$$

For a voltage or current ratio from dB, do the same thing, but then take the square root of the ratio. Example:

Convert 13 dB to its voltage ratio

$$13 = 2^{13/3} = 2^4 \cdot 1/3 = 16 + 16 \times 1/3^* = 21.$$

$$21 = \frac{1}{2} \left( \frac{21}{A} + A \right) \dots \text{see square root procedure}$$

$$= 4.48 \text{ times.}$$

The effective value (rms), arithmetic mean value (amv) and form factor (ff) of any waveform can be approximated by the following three formulas and multiplicative constants:

$$1. V_{\text{rms}} = \sqrt{\frac{1}{T} \int_0^T V^2 dt.}$$

where T is the period in seconds.

$$2. V_{\text{amv}} = \frac{1}{T} \int_0^T |V| dt.$$

$$3. \text{ff} = V_{\text{rms}} / V_{\text{amv}}.$$

These three formulas<sup>2</sup> can help tabulate the effective value, mean value and form factor for any desired waveform. The table shows a few examples that are applicable either for voltage or current.

Waveform	Rms	Mean	Form Factor
Triangular	0.578 ( $V_{\text{peak}}$ )	0.5 ( $V_{\text{pk}}$ )	1.16
Sine wave	0.707 ( $V_{\text{pk}}$ )	0.636 ( $V_{\text{pk}}$ )	1.11
Trapezoidal	0.746 ( $V_{\text{pk}}$ )	0.667 ( $V_{\text{pk}}$ )	1.12
Square	$V_{\text{pk}}$	$V_{\text{pk}}$	1.00
Rectified half-wave sine wave	0.5 ( $V_{\text{pk}}$ )	0.318 ( $V_{\text{pk}}$ )	1.57
Rectified full-wave sine wave	0.707 ( $V_{\text{pk}}$ )	0.636 ( $V_{\text{pk}}$ )	1.11

Finally, amplifier decoupling capacitor values (Fig. 3) can be computed if a few reasonable assumptions are made.<sup>3</sup> If you assume that  $R_s$  is much less than  $h_{ie}$  and  $g_m = 38I_c/10^3$ , where  $I_c$  is in amps and  $g_m$  is in amps/volt. Now, the capacitance can be calculated from the following:

$$C = 6I_c/\text{Hz},$$

where C is in microfarads and the frequency represents the lowest frequency the amplifier is expected to pass. ■■

\*Note: As in the previous example, if the fractional remainder of the exponent is 1/3 or 2/3 after division by 3, it is multiplied by the base raised to the integer part of the exponent and added to the base raised to the integer part of the exponent.

#### References

1. Filter formulas are available from several standard reference manuals.
2. Reiche, H., "Waveform Values and Factors," *Electronics and Communications*, Aug., 1967.
3. Engstrom, P., "The Decoupling Capacitor," *Wireless World*, Dec., 1971.

## ITT STOCKING DISTRIBUTORS

<b>ALABAMA</b> Birmingham ACK Radio Supply Co. Tel: 205-322-0588 Huntsville Cramer/EW Huntsville, Inc. Tel: 205-539-5722	<b>MASSACHUSETTS</b> Burlington Hamilton/Avnet Electronics Tel: 617-273-2120 Newton Cramer Electronics Tel: 617-969-7700 Cramer/International Tel: 617-969-7700 Greene-Shaw Co., Inc. Tel: 617-969-8900	Dayton Hamilton/Avnet Electronics Tel: 513-433-0610 Dayton-Cleveland Hamilton/Avnet Electronics Tel: 216-289-0550
<b>ARIZONA</b> Phoenix Cramer/Arizona Tel: 602-263-1112 Hamilton/Avnet Electronics Tel: 602-275-7851	<b>MICHIGAN</b> Detroit Semiconductor Specialists Tel: 313-255-0300 Livonia Cramer/Detroit Tel: 313-425-7000 Hamilton/Avnet Electronics Tel: 313-522-4700	<b>OREGON</b> Seattle-Portland Hamilton/Avnet Electronics Tel: 503-224-9450
<b>CALIFORNIA</b> Chatsworth Westates Electronics Corp. Tel: 213-341-4411 Culver City Avnet Electronics Tel: 213-836-7200 Tel: 714-522-8220 Hamilton Electro Sales Tel: 213-870-7171 Tel: 714-522-8200 Irvine Cramer/Los Angeles Tel: 714-979-3000 & 213-771-8300 Los Angeles Radio Products Sales, Inc. Tel: 213-748-1271 Menlo Park Bell Electronic Corp. Tel: 415-323-9431 Mountain View Capacitor Sales Tel: 415-964-8880 Hamilton/Avnet Electronics Tel: 415-961-7000 San Diego Cramer/San Diego Tel: 714-565-1881 Hamilton/Avnet Electronics Tel: 714-279-2421 Sunnyvale Cramer Electronics Tel: 408-739-3011 Woodland Hills Jaco Electronics, Inc. Tel: 714-887-6400	<b>MINNESOTA</b> Edina Cramer/Bonn Tel: 612-835-7811 Hamilton/Avnet Electronics Tel: 612-941-3801 Minneapolis Semiconductor Specialists Tel: 612-854-8841	<b>PENNSYLVANIA</b> Philadelphia-Mt. Laurel Hamilton/Avnet Electronics Tel: 215-831-1300
<b>COLORADO</b> Denver Cramer Electronics Tel: 303-758-2100 Hamilton/Avnet Electronics Tel: 303-534-1212	<b>MISSOURI</b> Hazelwood Hamilton/Avnet Electronics Tel: 314-731-1144 Kansas City Semiconductor Specialists Tel: 816-452-3900 St. Louis Olive Industrial Electronics Tel: 314-863-7800 NEW JERSEY Cedar Grove Hamilton/Avnet Electronics Tel: 201-239-0800 Cherry Hill Cramer/Pennsylvania, Inc. Tel: 609-424-5993 Clifton Wilshire Electronics/N.J. Tel: 201-365-1150 Moonachie Cramer/New Jersey Tel: 201-935-5600 Mt. Laurel Hamilton/Avnet Electronics Tel: 609-234-2133 Pennsauken Resco Electronics A Div. of Astrex, Inc. Tel: 609-662-4000	<b>TEXAS</b> Dallas Cramer/Texas Tel: 214-350-1355 Texas Watts 800-492-6940 Hamilton/Avnet Electronics Tel: 214-661-8661 Dallas-Ft. Worth Hamilton/Avnet Electronics Tel: 817-275-6561 Houston Hamilton/Avnet Electronics Tel: 713-526-4661 Richardson Altair Co., Inc. Tel: 214-231-5166
<b>CONNECTICUT</b> Georgetown Hamilton/Avnet Electronics Tel: 203-762-0361 North Haven Cramer Electronics Tel: 203-239-5641	<b>NEW MEXICO</b> Albuquerque Cramer/New Mexico Tel: 505-265-5767 Hamilton/Avnet Electronics Tel: 505-765-1500	<b>UTAH</b> Salt Lake City Cramer/Utah Tel: 801-487-4131 Hamilton/Avnet Electronics Tel: 801-262-8451
<b>FLORIDA</b> Hollywood Hamilton/Avnet Sales Tel: 305-925-5401 Orlando Cramer/EW Orlando Tel: 305-894-1511	<b>NEW YORK</b> East Syracuse Cramer Electronics Tel: 315-437-6671 Hamilton/Avnet Electronics Tel: 315-437-2642 Endwell Cramer Electronics Tel: 607-754-6661 Freeport Milgray Electronics Tel: 516-546-6000 Hauppauge, L. I. Cramer/Long Island Tel: 516-231-5600 Jaco Electronics, Inc. Tel: 516-273-5500 Rochester Cramer Electronics Tel: 716-275-0300 Westbury, L.I. Hamilton/Avnet Electronics Tel: 516-333-5800	<b>WASHINGTON, D. C.</b> Baltimore Hamilton/Avnet Electronics Tel: 301-953-7010
<b>GEORGIA</b> Atlanta Cramer Electronics Tel: 404-448-9050 Norcross Hamilton/Avnet Electronics Tel: 404-448-0800	<b>NORTH CAROLINA</b> Winston-Salem Cramer/EW Winston-Salem Tel: 919-725-8711	<b>WASHINGTON</b> Bellevue Hamilton/Avnet Electronics Tel: 206-746-8750 Seattle Cramer/Seattle Tel: 206-762-5755
<b>ILLINOIS</b> Des Plaines Edmar Electronics Co. Tel: 312-298-8580 Elmhurst Semiconductor Specialists Tel: 312-279-1000 Mt. Prospect Cramer/Chicago Tel: 312-593-8230 Schiller Park Hamilton/Avnet Electronics Tel: 312-678-6310	<b>OHIO</b> Cincinnati Cramer/Tri-States Tel: 513-771-6441 Cleveland Cramer/Cleveland Tel: 216-248-8400	<b>WISCONSIN</b> Oak Creek Cramer/Wisconsin Tel: 414-764-1700
<b>INDIANA</b> Indianapolis Semiconductor Specialists Tel: 317-243-8271	<b>MARYLAND</b> Baltimore Arrow Electronics, Inc. Tel: 301-247-5200 Gaithersburg Cramer/EW Washington Tel: 301-948-0110 Hanover Cramer/EW Baltimore Tel: 301-796-5790 Hamilton/Avnet Electronics Tel: 301-796-5000	<b>CANADA</b> Downsview, Ontario Cramer/Canada, Ltd. Tel: 416-661-9222 Halifax, Nova Scotia Consolidated Supply Co., Ltd. Tel: 902-454-8581 Mississauga, Ont. Hamilton/Avnet Electronics Tel: 416-677-7432 Montreal, Quebec Hamilton/Avnet Electronics Tel: 514-735-6393 Ottawa Hamilton/Avnet Electronics Tel: 613-725-3071 Vancouver, B. C. Cam Gard Supply, Ltd. Tel: 604-291-1441 Winnipeg, Manitoba Cam Gard Supply, Ltd. Tel: 204-786-8401
<b>KANSAS</b> Lenexa Hamilton/Avnet Electronics Tel: 913-888-8900		<b>ITALY</b> Rome Cramer/Italia Tel: 51-393-87 and 51-393-90
		<b>PUERTO RICO</b> De San German Cramer/Puerto Rico Tel: 809-892-1130 San Juan ITT Caribbean Sales & Service (P.R.) Inc. Tel: 809-767-5050 809-766-2408

**ITT**  
SEMICONDUCTORS Worldwide

# In Rectifier reliability, Nobody trumps our lead

When you need reliable rectifiers, take your lead from ITT. The latest technology makes our products both reliable and cost-competitive. For example, consider the leads on our 1-amp glass-passivated device. They're weldable, bendable, and they pass tough pull tests with ease. You can specify our 1-amp rectifiers with confidence for the cut-and-bend operations of automated insertion equipment. Our technology results in high reliability for 400 mA and 1A glass as well as 1A and 3A plastic. For a good deal, go with the reliable people who hold all the cards—including zeners, diode arrays, silicon transistors and silicon, germanium and tuner diodes. Write today for our handy cross-reference guide.

## ITT...Logically

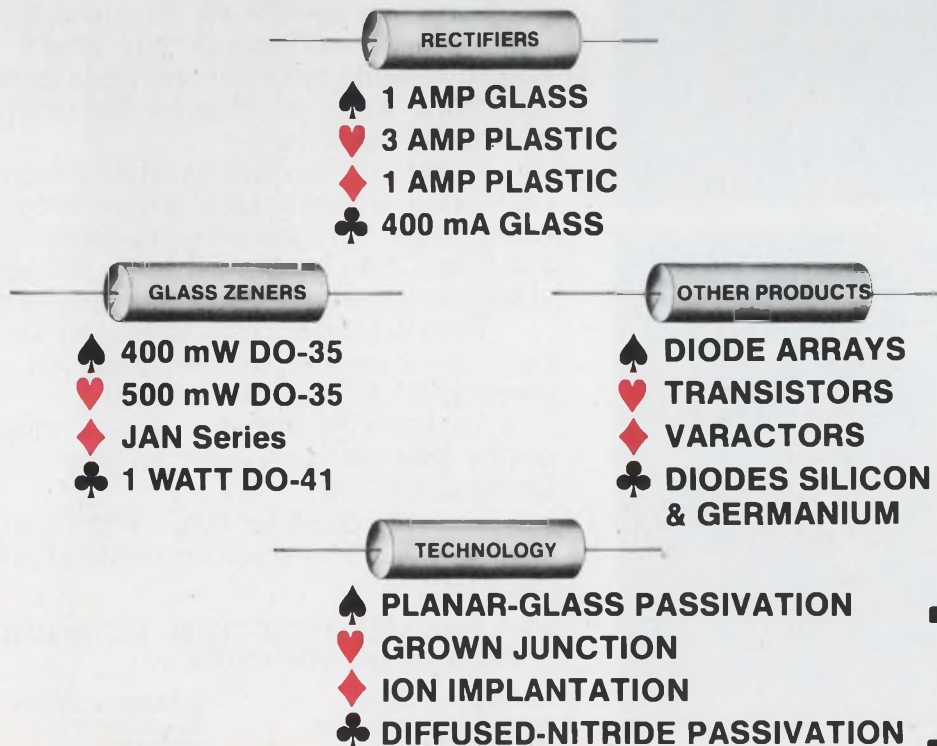

# semiconductors

ITT Semiconductors is a division of International Telephone and Telegraph Corporation, 500 Broadway, Lawrence, Mass. 08142 Phone 617-688-1881. Factories in West Palm Beach, Florida • Lawrence, Massachusetts • Footscray, England • Colmar, France • Freiburg, Germany • Cascais, Portugal • Taipei, Taiwan • Sydney, Australia

# ITT

INFORMATION RETRIEVAL NUMBER 43

# NEW VALUES HIGH ENERGY

TYPE	$I_c(\text{max.})$	$V_{CE0}$	$V_{CEV}$	$V_{CE0}(\text{sus.})$	$V_{CE}(\text{sat.})$ @ $I_{C1} I_B$	Power Dissipation (max.)	$h_{FE}$ min./max. @ $I_{C1} V_{CE}$
DTS-701	1.0 A	800V	—	600V	—	50W	20/— @ 150mA, 5V
DTS-708	3.0 A	900V	900V	600V	2.0V max. @ 1.0A, 250mA	50W	—
DTS-709	3.0 A	900V	900V	600V	1.0V max. @ 2.0A, 800mA	50W	—
DTS-710	3.0 A	900V	—	600V	—	50W	10/50 @ 150mA, 5V
DTS-712	3.0 A	900V	1200V	700V	—	50W	2.5/— @ 2.0A, 5V
DTS-714	3.0 A	900V	1400V	700V	—	50W	2.5/— @ 2.0A, 5V
DTS-723	3.0 A	1000V	1200V	750V	0.8V max. @ 1.0A, 250mA	50W	10/— @ 500mA, 5V
DTS-801	2.0 A	800V	—	700V	—	100W	20/— @ 200mA, 5V
DTS-812	5.0 A	900V	1200V	700V	—	100W	2.2/— @ 3.5A, 5V
DTS-814	5.0 A	900V	1400V	700V	—	100W	2.2/— @ 3.5A, 5V

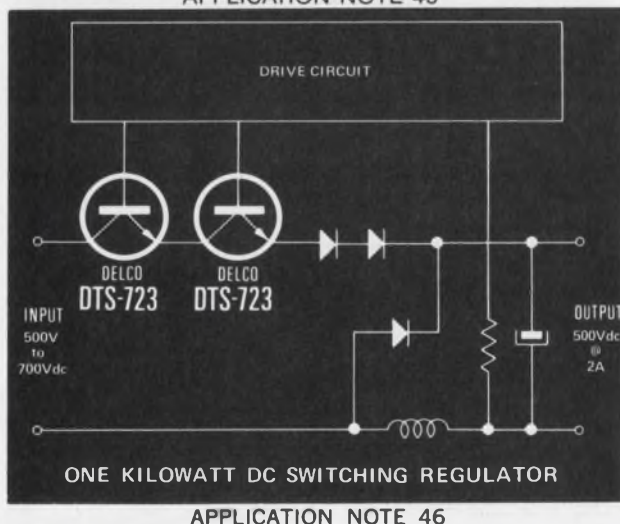
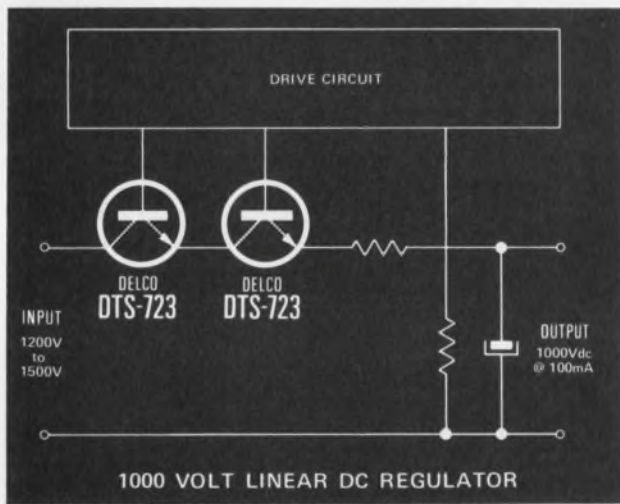

Delco Electronics has made it possible for your Delco distributor to offer you better values than ever on these ten silicon high-power transistors. What's more, he has them in stock now and there's a healthy factory inventory to back him up.

These high quality, high voltage devices are all NPN, triple diffused, and packaged in Delco's solid-copper TO-204MA (TO-3) case.

Some are specifically designed for use in high voltage switching circuits where inductive loads or fault conditions pose problems. Some are ideal for linear regulators and power amplifiers.

In fact, all the devices share Delco's reputation for being ideal where circuit conditions and high energy requirements are a concern. And because they're 100 percent pulse energy tested, you know they're rugged.

The circuit diagrams in this ad will give you a quick reading of how these ten transistors can meet your needs.

Applications literature and complete device data are available from your Delco distributor.

Give him a call for the information you need and the delivery promises and prices you'll like.

**NOW AVAILABLE FROM THESE DISTRIBUTORS  
IN PRODUCTION QUANTITIES.**

**ALABAMA, Birmingham**  
Forbes Distributing Co., Inc.  
(205) 251-4104

**ALABAMA, Huntsville**  
Powell Electronics  
(205) 539-2731

# ON DELCO'S TRANSISTORS.

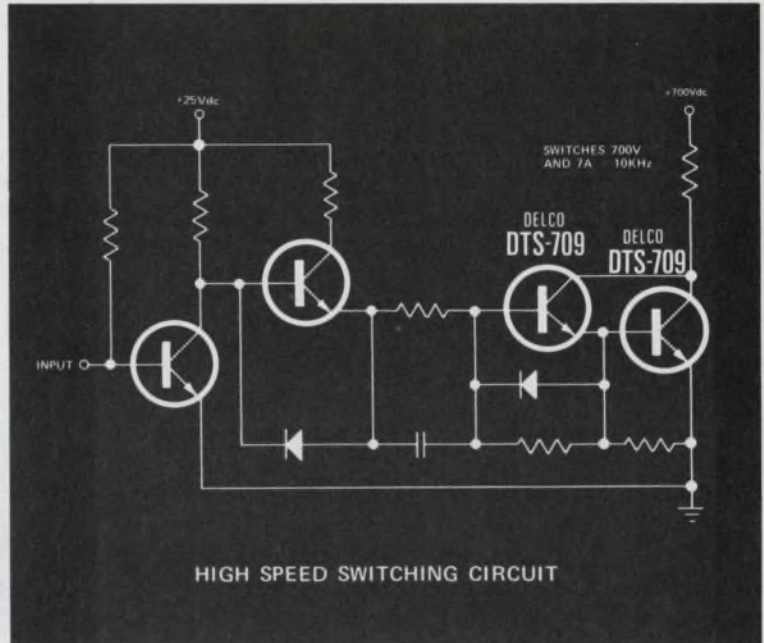
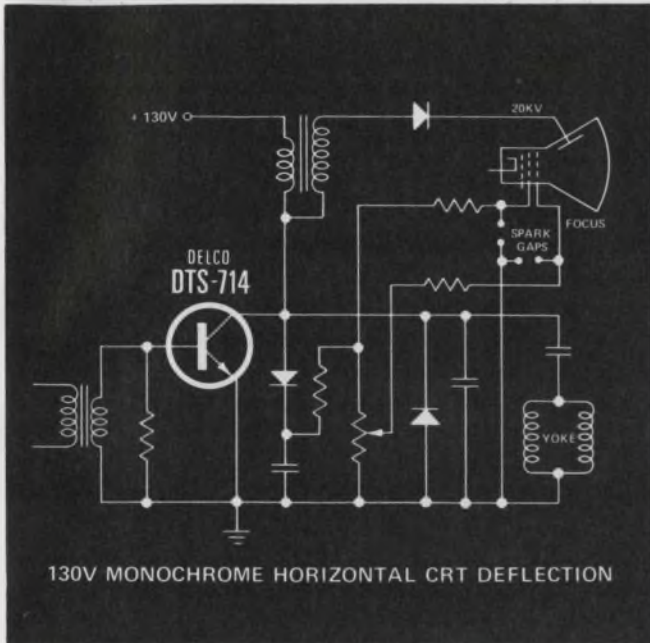

APPLICATION NOTE 54

**ARIZONA, Phoenix**  
Sterling Electronics, Inc.  
(602) 258-4531

**CALIFORNIA, Goleta**  
R.P.S. Electronics, Inc.  
(805) 964-6823

**CALIFORNIA, Los Angeles**  
Kierulff Electronics, Inc.  
(213) 685-5511

**CALIFORNIA, Los Angeles**  
R.P.S. Electronics, Inc.  
(213) 748-1271

**CALIFORNIA, Palo Alto**  
Kierulff Electronics, Inc.  
(415) 968-6292

**CALIFORNIA, San Diego**  
Kierulff Electronics, Inc.  
(714) 278-2112

**CALIFORNIA, San Diego**  
R.P.S. Electronics, Inc.  
(714) 292-5611

**COLORADO, Denver**  
Kierulff Electronics, Inc.  
(303) 371-6500

**CONNECTICUT, Norwalk**  
Harvey/Connecticut  
(203) 853-1515

**FLORIDA, Miami Springs**  
Powell Electronics/Florida  
(305) 592-3260

**FLORIDA, Orlando**  
Powell Electronics/Florida  
(305) 859-1450

**ILLINOIS, Rosemont**  
Kierulff Electronics, Inc.  
(312) 678-8560

**ILLINOIS, Skokie**  
Bell Industries  
Electronics Distributors Div.  
(312) 282-5400

**INDIANA, Indianapolis**  
Graham Electronics Supply, Inc.  
(317) 634-8202

**INDIANA, Indianapolis**  
Harvey/Indiana  
(317) 297-4910

**MARYLAND, Baltimore**  
Radio Electric Service Co.  
(301) 823-0070

**MASSACHUSETTS, Needham Heights**  
Kierulff Electronics, Inc.  
(617) 449-3600

**MASSACHUSETTS, Newton**  
The Greene-Shaw Co., Inc.  
(617) 969-8900

**MICHIGAN, Farmington**  
Harvey/Michigan  
(313) 477-1650

**MINNESOTA, Minneapolis**  
Stark Electronics Supply Co.  
(612) 332-1325

**MISSOURI, Kansas City**  
Walters Radio Supply, Inc.  
(816) 531-7015

**MISSOURI, North Kansas City**  
LCOMP-Kansas City  
(816) 221-2400

**MISSOURI, St. Louis**  
LCOMP-St. Louis  
(314) 647-5505

**NEW JERSEY, Clifton**  
Wilshire Electronics/New Jersey  
(201) 365-2600 (212) 244-8930

**NEW YORK, Binghamton**  
Harvey/Federal  
(607) 748-8211

**NEW YORK, Farmingdale**  
Wilshire Electronics/Long Island  
(516) 293-5775

**NEW YORK, Woodbury**  
Harvey/New York  
(516) 921-8700 (212) 895-9260

**OHIO, Cincinnati**  
United Radio, Inc.  
(513) 761-4030

**OHIO, Cleveland**  
Pattison Supply Co.  
Industrial Electronics Division  
(216) 441-3000

**PENNSYLVANIA, Philadelphia**  
Almo Electronics  
(215) 676-6000

**PENNSYLVANIA, Pittsburgh**  
RPC Electronics  
(412) 782-3770

**SOUTH CAROLINA, Columbia**  
Dixie Radio Supply Co., Inc.  
(803) 253-5333

**TEXAS, Dallas**  
Adleta Electronics Company  
(214) 741-3151

**TEXAS, Fort Worth**  
Adleta Electronics Company  
(817) 336-7446

**TEXAS, Garland**  
Kierulff Electronics, Inc.  
(214) 271-2471

**TEXAS, Houston**  
Harrison Equipment Co., Inc.  
(713) 224-9131

**VIRGINIA, Richmond**  
Meridian Electronics, Inc.  
(804) 353-6648

**WASHINGTON, Seattle**  
Kierulff Electronics, Inc.  
(206) 763-1550

## IN CANADA

**ONTARIO, Scarborough**  
Lake Engineering Co., Ltd.  
(416) 751-5980

## ALL OVERSEAS INQUIRIES:

General Motors Overseas Operations  
Power and Industrial Products Dept.,  
767 Fifth Avenue, New York, N.Y.  
10022. Phone: (212)-486-3723.

## Delco Electronics Regional Sales Offices

Union, New Jersey 07083  
Box 1018 Chestnut Station  
(201) 687-3770

Van Nuys, California 91404  
Box 2968  
(213) 988-7550

General Sales Office  
700 E. Firmin, Kokomo, Ind. 46901  
(317) 459-2175  
Operator (317) 457-8461



Delco Electronics, Division of General Motors.

## Modified data-transmission module can handle ASCII and BCD

By adding full 8-bit control and sequencing to the Analog Devices serial-transmission module (STX 1003), you can adapt the unit to accept both the full ASCII character set and BCD.

The module and controller can be wired to transmit a sign bit (+ or -), four BCD characters and space for nine more cycles. And on the tenth cycle, the space character is replaced by the carriage return and line feed. When used in a 20-mA current loop with a teletypewriter or some other asynchronous terminal, the system operates as an automated data logger and instrument controller for virtually any instrument that has BCD output.

The STX 1003 module converts BCD to ASCII and transmits the characters in an asynchronous mode. In the BCD-to-ASCII conversion, the four most significant bits (MSB) of the ASCII character do not change from  $1011_2$ . For transmission of characters other than numbers, these bits must be changed.

The circuit (see p. 112) controls the MSBs shown—the module inputs D16, D17, D20 and D13. Only bits 6 and 5 are controlled for the transmission of space, carriage return, line feed and the sign. In other applications, bits 7 and 8 can be controlled in the same manner.

The sequence starts when you load the module-input shift register with the BCD data and the four least-significant bits (LSB) of all other characters to be transmitted for the data point. The sequencers are at zero at this time. The BCD digits are loaded directly into shift-register positions 2 and 5. To get a plus sign (an ASCII plus is represented by  $10101011$ ), the four LSBs of the sign are loaded into the first character position; the four LSBs of the space (space =  $10100000_2$ ) are loaded into position 6 by  $G_4$ , and the transmitter stop character ( $1111_2$ ) into position by  $G_5$ . The transmitter register now contains eight parallel bits for a full ASCII character. Therefore the four MSBs must now be externally controlled.

The first character (sign),  $1010_2$  is loaded

into the four MSB positions under the control of sequencer 1. At the same time, the four LSBs ( $1011_2$ ) are loaded from the module's internal shift register.

During transmission the  $D_{21}$  output goes low, and a shift pulse is produced at  $A_3$ . This advances sequencer 1 to position 1 and internally shifts the first BCD character into position. With the subsequent transmission of the four BCD digits, sequencer 1 advances to 5. Gate  $G_3$  controls the loading of the four MSBs of the sixth character (space) into the transmitter buffer.

This cycle repeats nine times and, by the tenth cycle, sequencer 2 has advanced to 9. Now  $G_5$  loads the four LSBs of the carriage return into shift-register position 6, and the line feed bits into position 7. Gates  $G_1$  and  $G_2$  load the proper bits into the four MSB positions of the transmitter buffer (the same as for the ASCII space bits). However, the stop character is also loaded into position 8 of the shift register.

The receiver portion of the module is in the current loop. Thus any characters transmitted are received, and the available control functions can be used for control of the BCD instrument or sequencer at the other end. The circuit is set up so that when the \$ key of the connected ASCII keyboard is struck, sequencer 2 will reset (it sequences from 9 to 0 automatically).

These sequencers can enable any array of ASCII characters by proper hardware programming of the system. For instance, when more than one digital instrument sends data, an identification code, sign and decimal point can be sent by each instrument. The characters—or their sequence—are limited only by the user's ability to wire a few OR gates and diodes to the sequencer's outputs.

*David Larsen, Instructor, Chemistry Dept., Virginia Polytechnic Institute and State University, Blacksburg, Va. 24061.*

CIRCLE No. 311

(continued on pg. 112)

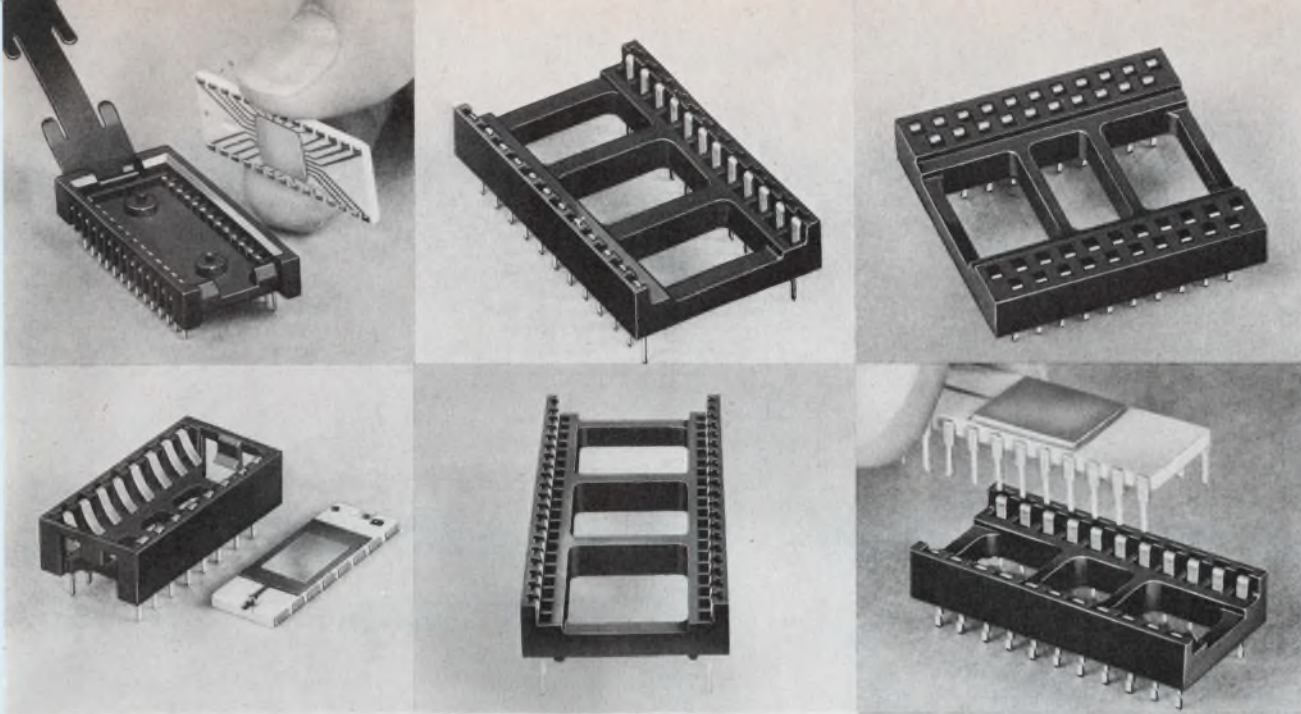

## Whether you need leaded or leadless DIP connectors, Burndy leads the way.

**We're the leaders in performance. We're the leaders in savings.**

Burndy makes pluggable DIP connectors to fit every need. Leaded or leadless. Soldered tail or solderless-wrap. Standard or hybrid. Top, bottom or side pad. All required shapes and sizes.

But they all have one thing in common. They all use tin-plated contacts that give you gas-tight, high-pressure connections as good as gold. Without the cost of gold. And *that* can lead to some very big savings.

And that's not all our pluggable DIP connectors save you. Our unique contact design prevents wicking during soldering to save rejects. Our low profile saves space. And our entire connector can be repeatedly disconnected

and reconnected to save field service time.

 **BURNDY**  
Offices in principal cities throughout the United States

Where is all this leading?

It leads to the most reliable, most economical IC connectors you can buy. No matter what your application.

For more information on our complete line of pluggable DIP connectors, write: Burndy Corporation, Norwalk, Connecticut 06856. It could lead to a very nice relationship for both of us.

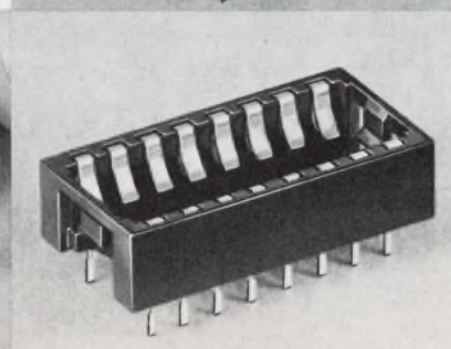
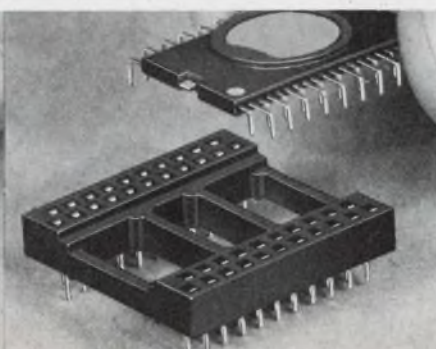
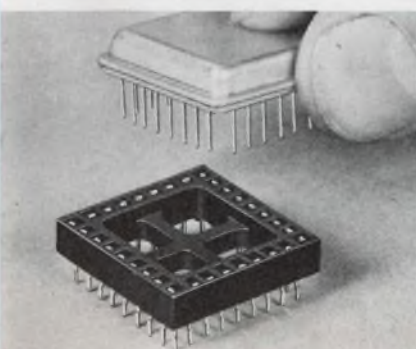
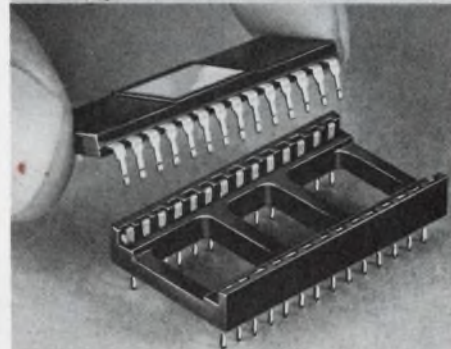
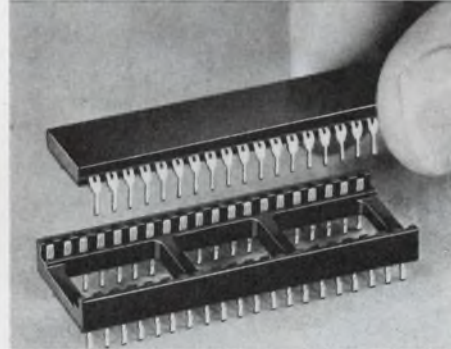
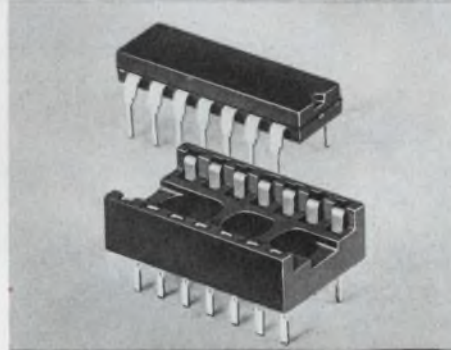
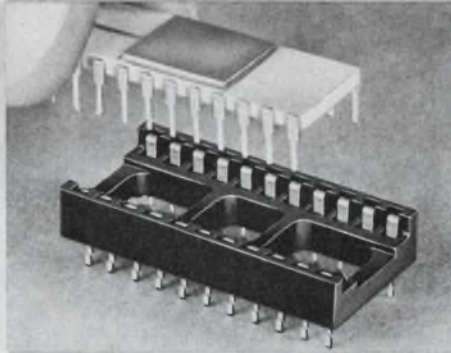

**BURNDY**  
  
 Serving industry since 1924  
**CONNECTS**

International Sales and Manufacturing: Brussels, Barcelona, Paris, Rotterdam, Stockholm, Stuttgart, Turin, Zurich, St. Helens (Eng.), Toronto, Sydney, Tokyo, Mexico City, Sao Paulo.







# NEW Simpson 360 Digital VOM



Handy and rugged enough for the field — accurate and versatile enough for the lab. And its simplicity and readability make it perfect for production line testing.

- 3-1/2" digit, non-blinking, auto-polarity 0.33" LED display
- AC line or battery operation
- 29 popular ranges including "low-power" ohms
- Analog indicator for scanning nulls and peaks
- Analog output signal permits interfacing with recorders and other instruments
- Up-down integration analog/digital conversion assures superior stability, accuracy and noise immunity

Supplied with test leads, AC line cord, operator's manual, without batteries ..... **\$275**



## SIMPSON ELECTRIC COMPANY

853 Dundee Avenue, Elgin, Illinois 60120 • (312) 695-1121  
 CABLE: SIMELCO • Telex: 72-2416  
 IN CANADA: Bach-Simpson, Ltd., London, Ontario  
 IN ENGLAND: Bach-Simpson (U.K.) Ltd., Wadebridge, Cornwall  
 IN INDIA: Ruttonsha-Simpson Private, Ltd., Vikhroli, Bombay

ORDER NOW FROM YOUR LOCAL ELECTRONICS DISTRIBUTOR OR WRITE FOR NEW CATALOG 4200

INFORMATION RETRIEVAL NUMBER 47

# Pocket-sized Geiger counter built with three micropower ICs

Three micropower ICs allow a Geiger counter the size of a cigarette pack to idle with milliwatt power consumption, yet provide the necessary peak power to the counter tube when radiation is detected. A single 6.75-V mercury battery powers the counter, which features a 1-mA count-rate meter as well as an aural output.

A regulated 900-V supply provides stable operation of the counter tube. A multivibrator, built around differential power amplifier IC<sub>2</sub>, drives the step-up transformer. Comparator IC<sub>1</sub> varies the multivibrator duty cycle to provide a constant 900 V. The entire regulated supply draws less than 2 mA.

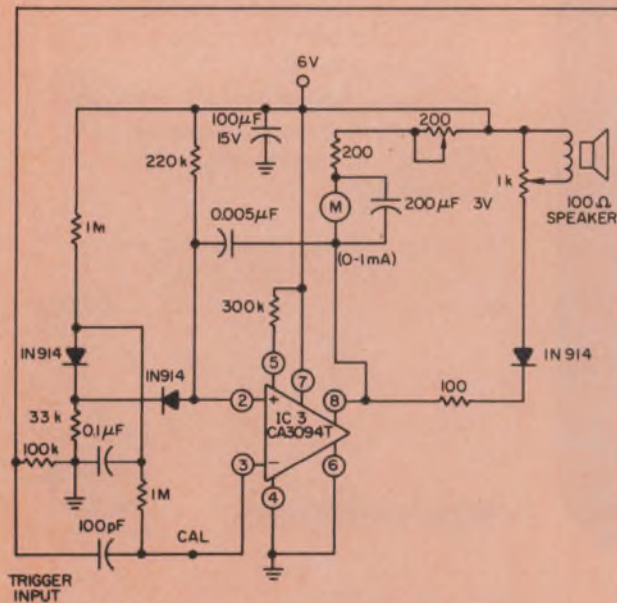
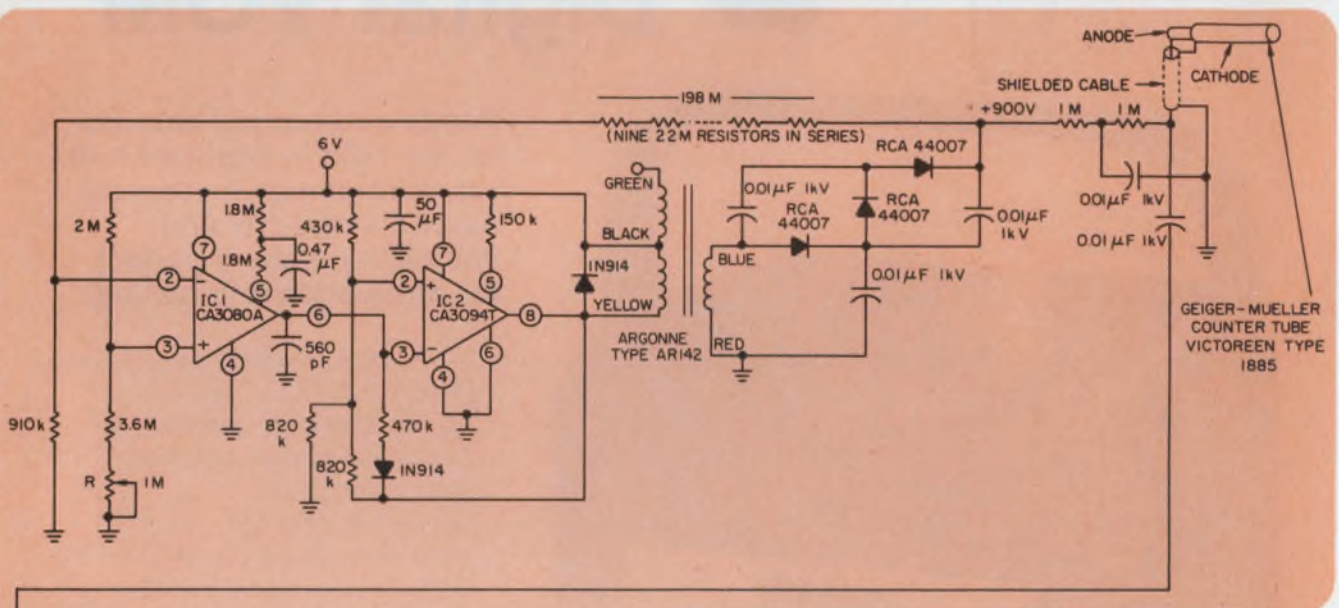

A single 6.75-V mercury battery runs this micropower Geiger counter. Full-scale meter deflection is 5000 counts/min and the entire circuit draws less than 2 mA in the absence of ionizing radiation.

A one-shot multivibrator, built with IC<sub>3</sub>, provides output pulses that have constant width and amplitude. Thus the average current through the meter is directly proportional to the pulse-rate output from the counter tube. And the constant-width pulses also drive the speaker.

Full-scale meter deflection (1 mA) represents 5000 counts/min, or 83.3 pulses/s. A convenient calibration checkpoint can be provided on the meter scale for 3600 ppm (60 pulses/s).

You can introduce the input externally if you touch a small contact on the case. The contact is wired to the CAL point shown on the schematic. The entire circuit uses 1.6 mA when no radiation is present and 3.1 mA at 83.3 pps. Sensitivity is adequate to monitor luminous clocks, watches or other potentially hazardous sources of ionizing radiation.

*John Tilicsek and Hal A. Wittlinger, RCA Solid State Div., Route 202, Somerville, N.J. 08876.*

CIRCLE NO. 312

TYPE - 256 x 1 Static SOS/CMOS Ram

NUMBER - INS4200

READ CYCLE TIME - 180 nS

WRITE CYCLE TIME - 140 nS

QUIESCENT POWER DISSIPATION - 40  $\mu$ W @ 10 V

INPUT CAPACITANCE - 6.5 pF

SUPPLY VOLTAGES - 5 to 15 volts

OUTPUT - Three-state TTL compatible, full address  
decoding and bipolar compatible pin-outs.

PACKAGE - 16 pin dual-in-line

PRICE - Mil Range (100-999) \$38.00

Comm. Range (100-999) \$21.00

**256X1  
CMOS  
RAMS**

Only Inselek makes the lowest power, highest speed 256x1 Static SOS/CMOS RAM currently available. And the price is only \$38.00 in the military range and \$21.00 for the commercial version (100-999).

Excellent prices when you consider the added benefits you're getting with our proven SOS technology . . . exceptional reliability, high speed and low power. With an Inselek INS4200

Ram, a minimum number of additional components are required due to the 3 chip select inputs, especially when employed with large memory arrays. For the applications minded engineer or manager, you'll be glad to know that they're perfect for use in point-of-sale systems, mini & micro computers, computer peripherals, calculators & portable electronic systems. One more point. The Inselek INS4200 Ram is fully compatible with other CMOS and TTL devices. Check the specs above and then contact Bob Burlingame, your applications engineering specialist at Inselek. Bob will be glad to discuss your specific requirements. Call Bob collect at (609) 452-2222, or write him at INSELEK, Inc., 743 Alexander Road, Princeton, New Jersey 08540.



SALES OFFICES IN:  
CONCORD, MASS. (617) 369-5298  
LOS ANGELES, CALIF. (213) 889-2788

**DISTRIBUTORS**

West Coast - WESTATES (213) 341-4411 • New England - GREEN SHAW (617) 969-8900 • Mid-Atlantic - WILSHIRE ELECTRONICS (609) 786-8990

# Wide-range pulse-shaping circuit gives square waves with 50% duty cycle

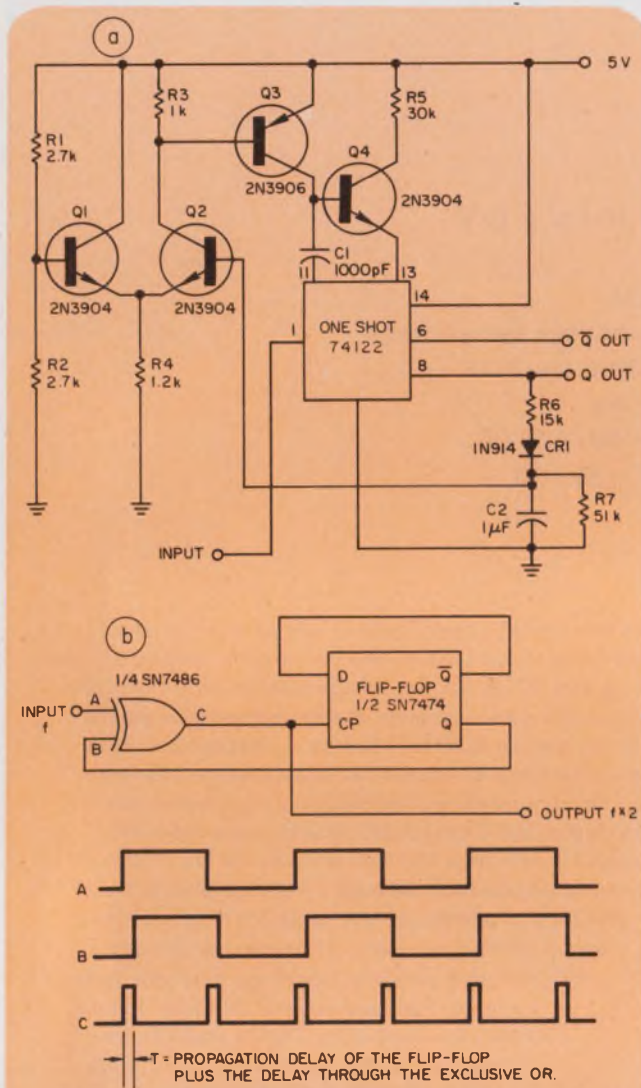

1. A 74122 retriggerable one-shot and a few components form a shaping circuit (a) that changes a repetitive pulse train into a 50% duty-cycle square wave. If you combine an exclusive-OR gate and a flip-flop (b) you can double the frequency of an input signal.

The shaping circuit of Fig. 1a automatically converts a periodic pulse train to a symmetrical square wave of the same frequency. It operates from 10 Hz to 1 MHz. The resulting square wave provides a suitable trigger source for other logic circuits such as frequency multipliers.

In the pulse-shaping circuit, transistors  $Q_1$  to  $Q_4$  form a voltage-controlled capacitance multiplier. As the voltage across  $C_2$  rises,  $Q_2$  and  $Q_3$  are forced deeper into conduction and thus charge  $C_1$  faster. This decreases the width of the output pulse from the 74122. And, in turn, it lowers the voltage at the output of the integrator formed by  $C_2$ ,  $CR_1$ ,  $R_6$ , and  $R_7$ .

If this shaping circuit is cascaded with the frequency-doubling circuit of Fig. 1b, symmetrical square waves of almost any multiple of the original clock frequency can be generated. For example, Fig. 2 combines two shaping circuits and two doubler circuits to quadruple the input frequency.

R. M. Stitt and R. L. Morrison, Burr-Brown Research Corp., International Airport Industrial Park, Tucson, Ariz. 85706. CIRCLE No. 313

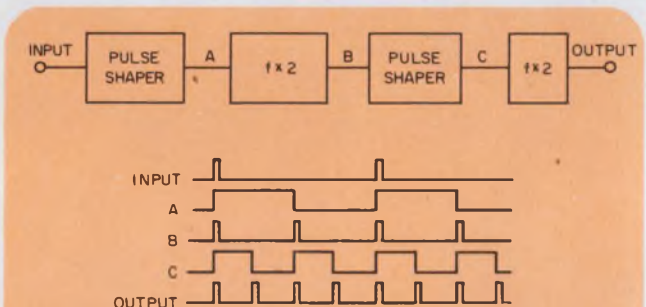

2. If the pulse shaping circuit of Fig. 1a is cascaded with the frequency-doubling network of Fig. 1b, almost any multiple of the input-signal frequency can be obtained.

## IFD Winner of Dec. 6, 1973

John Shakib, Design Engineer, IBM General Systems Div., 2000 51st St., Boca Raton, Fla. 33432. His idea "Digitally Programmable Oscillator Selects Frequency in Integer Units from One to 15" has been voted the Most Valuable of Issue Award.

Vote for the Best Idea in this issue by circling the number for your selection on the Information Retrieval Card at the back of this issue.

**SEND US YOUR IDEAS FOR DESIGN.** You may win a grand total of \$1050 (cash)! Here's how. Submit your IFD describing a new or important circuit or design technique, the clever use of a new component or test equipment, packaging tips, cost-saving ideas to our Ideas for Design editor. Ideas can only be considered for publication if they are submitted exclusively to ELECTRONIC DESIGN. You will receive \$20 for each published idea, \$30 more if it is voted best of issue by our readers. The best-of-issue winners become eligible for the Idea of the Year award of \$1000.

ELECTRONIC DESIGN cannot assume responsibility for circuits shown nor represent freedom from patent infringement.

# Reliable low-energy switching is not new at MICRO SWITCH.

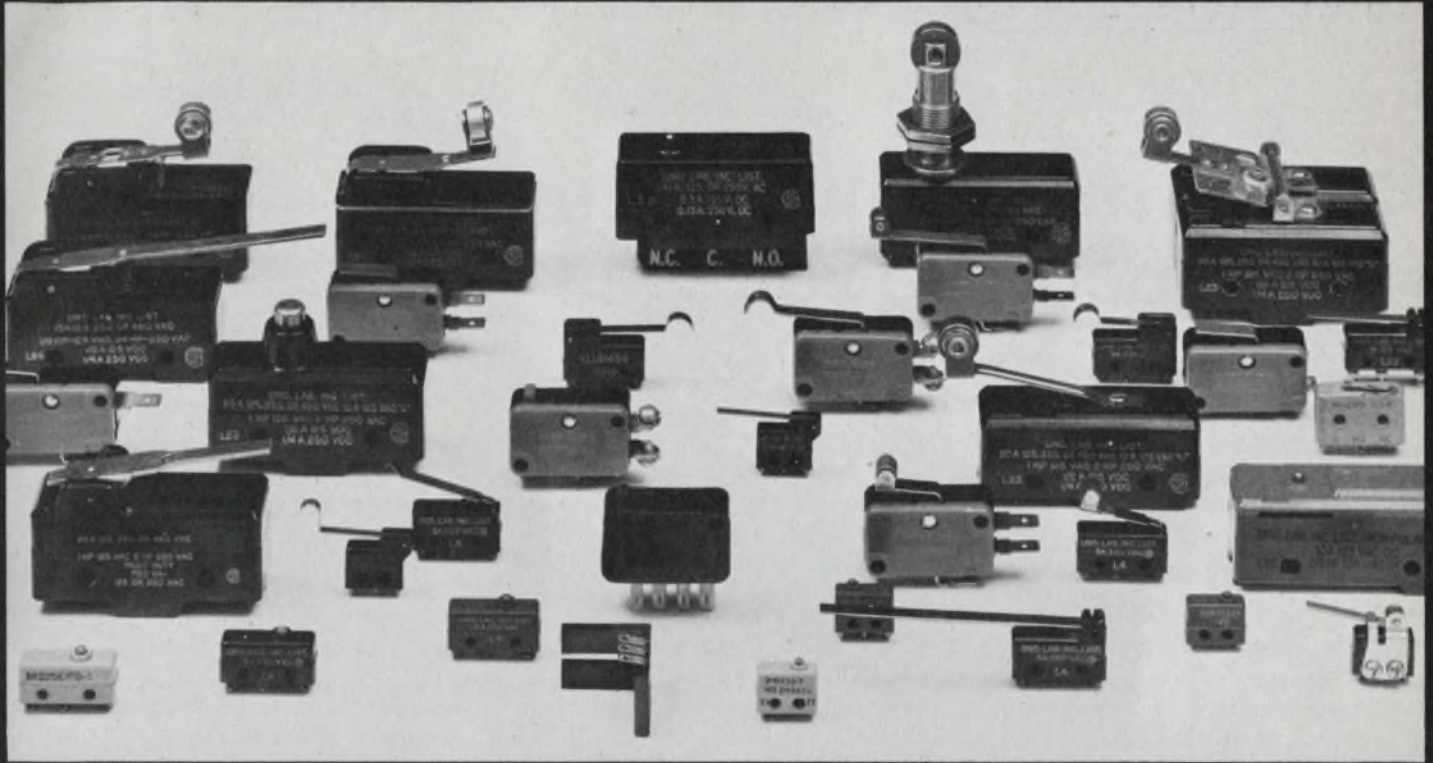

We developed our first high fidelity gold contact switch in 1953. This was only the beginning. Advances include bifurcated and cross-point contacts. Today we offer an entire low-energy basic switch line. From subminiature types less than 1/2" wide to versatile thumb-size basics.

With important features: A spring design that contributes to millions of operations. Choice of integral or auxiliary actuators. Terminal types such as solder screw, quick-connect and PC mount.

If your switching energy needs are in the milliamp range, MICRO SWITCH has a complete line of Hall-effect, magnetically operated, solid-state switches. They directly interface with logic circuits. Output options include sinking or sourcing, digital or analog.

We also offer precision switches for power functions to 25 amps. Again, choice of actuators and terminals.

Low energy, solid-state, power — for a comprehensive catalog of available switches for all energy levels, contact MICRO SWITCH.

For the address and telephone number of your nearest MICRO SWITCH Branch Office or Authorized Distributor, call toll-free 800/645-9200 (in N. Y., 516/294-0990, collect).

**MICRO SWITCH**

FREEPORT, ILLINOIS 61032

A DIVISION OF HONEYWELL

## Digital method linearizes thermocouple voltages

The inherently nonlinear output voltages of thermocouples have been linearized by use of digital techniques. The system, developed by Elektronska Industrija, in Belgrade, Yugoslavia, consists of a thermocouple, a conversion amplifier, a digital voltmeter and a linearizer.

The method is designed so that the thermocouple output and the indicated voltage are directly proportional over the range of temperature measured.

The thermocouple output is amplified and transformed in the a/d converter of the DVM to a train of pulses. In the linearizer, the pulses are counted by four count-

ing decades and a flip-flop. The counter counts pulses in groups, and from each group an inhibit gate eliminates one pulse. The lengths of the pulse groups are adjusted to compensate for the nonlinear output of the thermocouple and its permitted error.

The count of the pulses passed is displayed as the measured temperature. The pulse-group counter is a modulo-N counter, with N adjustable between 2 and 20. A decade counter similar to the SN 7490 and resettable to zero is used.

The digital linearizer can also work on the outputs of other sensors, such as those that measure pressure, flow and humidity.

---

## Microcomputer to warn of marine-engine trouble

A programmable microcomputer that costs about one-fifth that of a comparable minicomputer has been developed by Soren T. Lyngso of Copenhagen. It will be used by the Technical University of Denmark for diesel-engine monitoring and predictive maintenance.

The microcomputer will collect data from the engine and, based

on past information and present engine status, will warn of potential breakdowns. The computer program is stored in a read-only memory and cannot be inadvertently modified or erased. Hardware failures in the central processing unit will not influence the program.

CIRCLE NO. 319

---

## Charge-transfer hangup is reported overcome

Incomplete charge transfer—which limits the frequency response and the number of stages of bucket-brigade devices—is re-

ported to have been overcome by researchers at AEG-Telefunken in West Germany. One transistor and one resistor per cell are added.

The additional transistor supplies a subsidiary clock voltage to the gate of the main-cell FET. The resistor is in series with the capacitor between the gate and the drain of the FET.

The extra transistor does not conduct until the voltage from the preceding cell exceeds a certain threshold value. When the threshold voltage is reached and the controlling transistor conducts, the main-cell FET gate potential decreases rapidly. The result is a faster, more complete charge transfer through the FET than that in previous bucket-brigade devices. Lower signal losses also result.

---

## Printer reproduces details down to 0.1 mm

An electrostatic printing process that can reproduce a full range of shades of gray between black and white has been developed at the Philips Research Laboratory in Hamburg, West Germany. Details of approximately 0.1 mm can be reproduced.

In the new process, a spark discharge is generated in air, and negative ions are attracted by the positive voltage on a control electrode to the insulating surface of an image carrier. The ions pass through a cylindrical hole in an insulating plate fitted beneath the spark electrodes. This ensures that the charge on the image carrier is restricted to a small, well-defined spot.

Contactless printing makes it easy to move the image carrier to a point where the charge pattern is converted into printable copy with the aid of a toner. Wear and pollution of the charge carrier are eliminated.

The quantity of charge applied to the image carrier by the spark electrodes per current pulse—hence the density of the final print—can be varied within wide limits by adjustment of the voltage on the control electrode.

Copies can be made with a single set of spark electrodes if the image carrier underneath the electrodes is moved—but the printing rate is low. For fast printing, a row of several hundred spark electrodes, working in parallel, would be used. ■■

# Bigger and Better

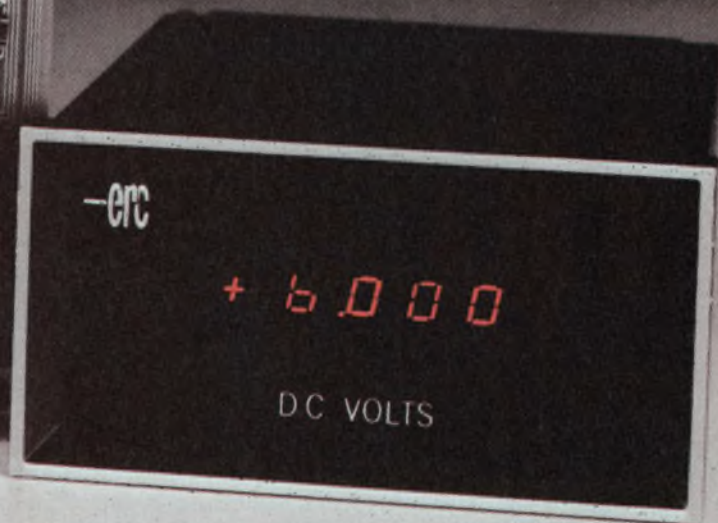
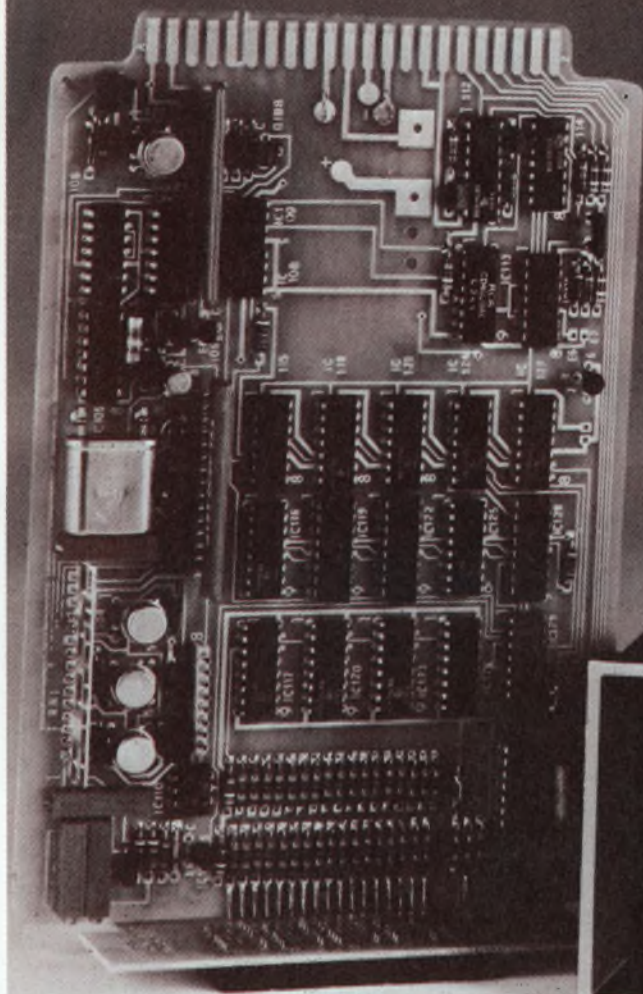

While most DPM manufacturers strive to compress their meters into a one inch cube, ERC has succeeded in making a producible and maintainable low-cost voltmeter with optically isolated parallel BCD outputs and 5999 count full-scale for reliability-conscious engineers in a package only 2.4" H x 5.06" W x 6.38" D, AND for only \$148 in quantities of 100...\$185 in single quantities. If the world's smallest DPM isn't your prime requirement but quality is, contact us for specs and delivery.

electronic research co. • a textron div

7618 Wedd  
Overland Park•Kansas 66204  
Mail to: P.O. Box 913  
Shawnee Mission•Kansas 66201  
TWX: (910) 749-6477  
Telephone: (913) 631-6700

# erc

# REI has one question for people who buy electronic test equipment.

## Why?

**When you need it fast . . . rent it.** Purchasing equipment usually involves long delivery lead times. When you rent your electronic equipment from REI it's a safe bet that you can get what you need within 36 hours of the time you call in your order, sometimes sooner. This fast service is possible because we maintain 9 Instant Inventory Centers throughout the U.S. and Canada, stocking millions of dollars worth of equipment.

**When you need it for only a short time . . . rent it.** Need equipment for a short-term project? Rent it from REI. When you don't need it any more, return it to us. It's the easy, low-cost way to use the equipment you need for just the time that you need it.

**When you care about what it costs . . . rent it.** Renting from REI can be less expensive than purchasing. There's no capital investment to adversely affect your company's cash flow. This means you'll get more mileage from your equipment budget. And, since you can treat your monthly payments as an expense in most situations, you'll also achieve tax advantages from renting.

All REI rental equipment is guaranteed to meet manufacturers' specifications and is operationally checked out prior to shipment. Routine maintenance is provided free of charge. Certification and calibration are available upon request. Our flexible arrangements include rental, rental-purchase and leasing packages to give you the use of equipment from one week to three years or more.

Get your free copy of our 1974 catalog that lists virtually every item in our rental inventory. Use reader service card, or write Rental Electronics, Inc., 99 Hartwell Ave., Lexington, MA 02173. For immediate information, call your local REI Instant Inventory Center listed below. Once you rent from REI, you may never buy electronic test equipment again.

## Rental Electronics, Inc.

A **PEPSICO** LEASING COMPANY

Burlington, MA (617) 273-2770 • Gaithersburg, MD (301) 948-0620 • Oakland, NJ (201) 337-3757 • Ft. Lauderdale, FL (305) 771-3500  
Des Plaines, IL (312) 827-6670 • Dallas, TX (214) 661-8082 • Mountain View, CA (415) 968-8845 • Anaheim, CA (714) 879-0561  
Rexdale, Ontario (PLC Leasing Ltd.) (416) 677-7513



## Think about renting. It's the smart way to go.



# **Electronic Design**

## **presents**

### **the 'top-ten' winners**

The following pages display advertisements of companies who won our "TOP TEN" contest with outstanding ads in the January 4 issue. The contest attracted thousands of readers who attempted to match their ratings of the 10 most memorable advertisements with the "recall-seen" scores from ELECTRONIC DESIGN's regular Reader-Recall survey.

Winning advertisements combine attractive colors, tasteful design and well-written copy. The result: impact. Here are the winning companies in order of highest Reader-Recall score received:

1. Dana Laboratories, Inc.
2. Guardian Electric Manufacturing Co.
3. Tektronix, Inc.
4. Computer Design Corp.
5. Hewlett-Packard
6. Hewlett-Packard
7. Corning Glass Works
8. Delta Products, Inc.
9. Hewlett-Packard
10. Signetics Corp.

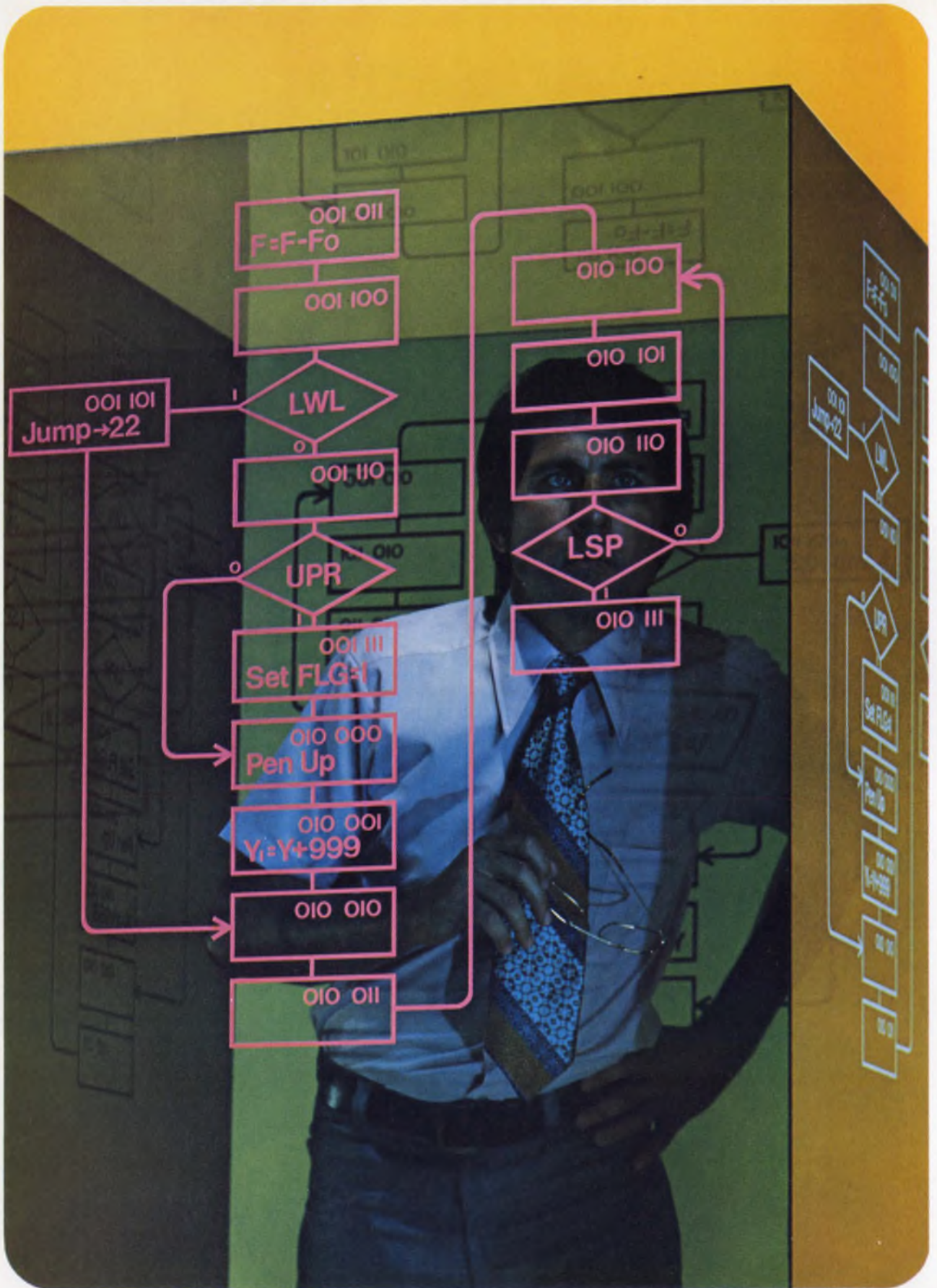

**Now – Put Yourself Inside Your Designs.  
See Your Logic Programs In Action.  
See Negative Time.**

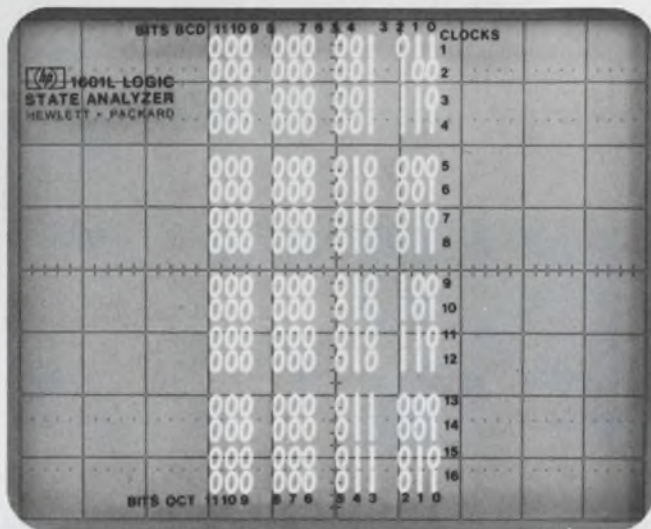

**Breakthrough ...  
The HP 1601L  
Logic Analyzer ...**

Here's a functional tester that can make a world of difference in helping you solve your digital design or test problems. With HP's 1601L you actually see each word displayed in "1's" and "0's", as shown here. Sixteen words at a time, each twelve bits wide.

**Now see what's really happening.** See each sequential step of your design, or of the equipment you're analyzing for problems. Display your digital words in "1's" and "0's," in hexadecimal, BCD or octal format. Select positive or negative logic corresponding to the type of circuitry you're working with, and adjust threshold over the  $\pm 10V$  range provided. Think of all the time you'll save in design and troubleshooting.

**See your logic in action.** "Step inside" your design and watch it pace through its sequences. If a "glitch" should occur, end your display and look back in time to see what events lead up to the problem. Diagnostics couldn't be easier.

**See dynamic data flow, negative time, much more.** The 1601L displays an action portrait. Dynamically timed by your strobe signal (up to 10 MHz), you can

delay the start of display up to  $10^5$  bits and really track your system's performance. If a problem develops, look back from the problem word (negative time) at least 15 words. Your oscilloscope will help you find the component or circuit at fault; the 1601L provides a trigger for your scope making fault isolation even easier.

**See things you've never seen before.** See those digital events you've always wanted to see. For all this capability the 1601L is priced at only \$2650\*. Or, consider the 5000A, a unit with LED display, two channels, thirty-two bits. It sells for only \$1900\*. Your local HP field engineer will be happy to arrange a "hands-on" demonstration in your office or lab.

\*Domestic U.S. prices only.



Sales, service and support in 172 centers in 65 countries.  
Palo Alto, California 94303. Offices in principal cities throughout the U.S.

06318

# The Danameter.

## \$195.



### 1 Year Battery Life.

In a digital instrument, you'd expect to fool with a battery regularly, recharging it or replacing it.

Not with The Danameter. The battery will last you at least one year. And even if you find a way to wear it out, you're only talking about 69¢.

### Liquid Crystal Readout.

The specifications on The Danameter show at a glance that this is a more accurate instrument than the one it's designed to replace.



Yet there is another type of inaccuracy The Danameter solves — in an even more dramatic way.

These are the errors that occur every day in reading an analog voltmeter. Scales are hard to separate. Increments of measurement are greatly restricted. Precise readings are difficult to make.

When you measure with The Danameter, you interpret nothing. All you are shown is a number that is precisely the information you require.

It's accurate to a degree that you never imagined possible in an instrument at this price.

Once you have selected the proper function position, The Danameter instantly interprets, selects, and converts your information. It shows in a large liquid crystal display that adjusts to all light conditions. Even direct sunlight.



### Automatic Polarity.

In measuring voltage, you're accustomed to swapping leads to get a reading.

The Danameter instantly determines polarity, and then displays it as either positive or negative. All in a fraction of a second, with no help from you.

### Almost indestructible.

You can drop it on concrete. You can kick it down the hall. When you pick it up, it'll be working perfectly.

It's the first true portable instrument of its kind. For \$195. Contact our sales department at Dana Laboratories, Inc., 2401 Campus Drive, Irvine, California 92664. Or call collect at (714) 833-1234.



**DANA**<sup>®</sup>  
Others measure by us.

1088

DMM/METER

OFF TEST

2 A

200 mA

2 mA

20  $\mu$ A

200 M $\Omega$

2 M $\Omega$

20 K $\Omega$

200 $\Omega$

2 VDC

20 VDC

200 VDC

1 KVDC

2 VAC

20 VAC

200 VAC

1 KVAC



Actual size



# We make components for guys who can't stand failures.

There's no such thing as a little failure to some guys. Either your system will perform as you designed it, or it won't. Either the right answer comes out or it doesn't. Anything less is too much to bear.

At Corning we make our components as if all your customers were just that demanding. We build an extra measure of performance into everything we make. Because, like you and the guys who use your equipment, we can't stand failures either.

## Some examples:

We make components you can depend on, like our metal film resistors—both standard and flame-proofs. Components like our glass, ceramic and glass/ceramic capacitors. Like our solid tantalum capacitors—hermetic and non-hermetic, polar and non-polar, miniature and microminiature. And like our discrete component networks—available with custom combinations of discrete microminiature resistors, capacitor chips and diodes in a dual in-line package.

## Metal films in particular:

Take our metal film resistors,

for example. They've demonstrated the extremely low failure rate of 0.00013% per 1000 hours, based on approximately one billion unit test hours. This quality is why Corning resistors have been used in high reliability programs such as Minuteman, Safeguard, Mercury, Gemini, Apollo, Mariner and Poseidon, and in virtually every other military program requiring resistors. They're qualified to the new Established Reliability specs, too.

## 100,000 hours without failure:

The following will demonstrate what we mean when we say that our metal film resistors have proven stability: In 1956, Remington Rand Univac Division of Sperry Rand Corporation began testing 1500 Corning N20, 1/2 watt, 1% resistors in a 40°C ambient under various power stressing conditions. Resistance deviations resulting from this program were minimal and unsurpassed in the industry. To confirm the stability characteristics demonstrated in the Remington Rand Univac Test, Corning remounted 600 of the original resistors in a 25°C ambient early in 1962, accu-

mulating more than 100,000 total test hours to date. Not a single unit has exceeded a 2%  $\Delta R$  from initial resistance at time zero!

## Flame proof, too:

Our metal film resistors are available in flame-proof grades, too. Their unique coating precludes flaming. And they're constructed to open under overload—rather than shorting-out as many resistors do—to protect other more expensive parts of your system.

For complete details on our metal film resistors and all of Corning's other extra reliability components, write for our new "General Design Guide" to: Corning Glass Works, Electronic Products Division, Corning, New York 14830.

And for information on availabilities, call your local authorized Corning distributor or D.I.A.L. EEM: (800) 645-9200, toll free. Or in New York state, call collect: (516) 294-0990.

**CORNING**  
ELECTRONICS





Integrated Circuits

**SIGNETICS CORPORATION**



*"Where advanced technology is just part of the service."*

Main Office and Manufacturer's Plant:  
811 E. Arques,  
Sunnyvale, Cal. 94086  
(408) 739-7700

**AUTHORIZED DISTRIBUTORS**

**ARIZONA**

Phoenix: Hamilton/Avnet Electronics  
2615 S. 21st Street . . . (602) 275-7851  
Phoenix: Kierulff Electronics  
2633 East Buckeye Road (602) 273-7331

*Put more into your lines, tie into your neighborhood distributor.*

**CALIFORNIA**

Culver City: Hamilton Electro Sales  
10912 W. Washington . . . (213) 870-7171  
El Monte: G. S. Marshall  
9674 Telstar Avenue . . . (213) 686-0141  
Los Angeles: Wesco Electronics  
5650 Jillson Street . . . (213) 685-9525  
Mountain View:  
Hamilton/Avnet Electronics  
340 E. Middlefield Road . . . (415) 961-7000  
Palo Alto: Wesco Electronics  
3973 E. Bayshore Road . . . (415) 968-3475  
San Diego: Hamilton/Avnet Electronics  
8917 Complex Dr. . . . (714) 279-2421  
San Diego: Cramer Electronics  
8975 Complex Dr. . . . (714) 565-1881  
San Diego: Kierulff Electronics  
8797 Balboa Avenue . . . (714) 278-2112  
Sunnyvale: Cramer Electronics  
720 Palomar . . . (408) 739-3011



A telephone call to your distributor is one of today's best bargains.



**CANADA**

Downsview, Ontario: Cesco Electronics  
24 Martin Ross Ave. . . . (416) 661-0220  
Downsview, Ontario: Cramer Electronics  
920 Alness Ave. Unit 9 . . . (416) 661-9222  
Montreal, Quebec: Cesco Electronics  
4050 Jean Talon West . . . (514) 735-6393  
Montreal, Quebec: Hamilton/Avnet  
935 Montee des Liesses. (514) 735-6393  
Ottawa, Ontario:  
Hamilton/Avnet Electronics  
880 Lady Ellen Place . . . (613) 725-3071  
Ottawa, Ontario: Cesco Electronics  
1300 Carling Avenue . . . (613) 729-5118

**COLORADO**

Denver: Hamilton/Avnet Electronics  
5921 N. Broadway . . . (303) 534-1212  
Denver: Cramer Electronics  
5455 E. Evans Place at Hudson . . . (303) 758-2100

Integrated Circuits — Distributors (Cont'd)

**CONNECTICUT**

Hamden: Arrow Electronics  
295 Treadwell Street . . . (203) 248-3801  
Georgetown: Hamilton/Avnet Electronics  
643 Danbury Road . . . (203) 762-0361  
North Haven: Cramer Electronics  
35 Dodge Avenue . . . (203) 239-5641

**FLORIDA**

Hollywood: Hamilton/Avnet Electronics  
4020 N. 29th Ave. . . . (305) 925-5401  
Hollywood: Schweber Electronics  
2830 N. 28th Terrace . . . (305) 927-0511  
Orlando: Hammond Electronics  
911 W. Central Blvd. . . . (305) 241-6601

Signetics takes a back seat to no one in ECL 10K. Call us on it.

**GEORGIA**

Atlanta: Schweber Electronics  
4126 Pleasantdale Road, Suite 14 . . . (404) 449-9170  
Norcross: Hamilton/Avnet Electronics  
6700 Interstate 85 Access Road, Suite 2B . . . (404) 448-0800

**SCHOTTKY ON THE DOUBLE.**  
Promote the telephone, call your distributor.

**ILLINOIS**

Elk Grove: Schweber Electronics  
1380 Jarvis Ave. . . . (312) 593-2740  
Elmhurst: Semiconductor Specialists  
195 Spangler Ave., Elmhurst Industrial Park . . . (312) 279-1000  
Schiller Park: Hamilton/Avnet Electronics  
3901 N. 25th Ave. . . . (312) 678-6310

**INDIANA**

Indianapolis: Semiconductor Specialists  
P.O. Box 41630, Weir Cook Airport . . . (317) 243-8271

*Dip into 0.15% AQL, with Signetics SUPR DIP digital circuits.*

**KANSAS**

Lenexa: Hamilton/Avnet Electronics  
37 Lenexa Industrial Center . . . (913) 888-8900

**MARYLAND**

Hanover: Hamilton/Avnet Electronics  
7255 Standard Drive . . . (301) 796-5000  
Rockville:  
Pioneer Washington Electronics  
1037 Taft Street . . . (301) 424-3300  
Rockville: Schweber Electronics  
5640 Fisher Lane . . . (301) 881-2970

Here's a direct line to the shelves of your Comparator Supermarket.



**MASSACHUSETTS**

Burlington: Hamilton/Avnet Electronics  
185 Cambridge St. . . . (617) 273-2120  
Needham Heights: Kierulff Electronics  
14 Charles Street . . . (617) 449-3600  
Newton: Cramer Electronics  
85 Wells Avenue . . . (617) 969-7700  
Waltham: Schweber Electronics  
213 Third Avenue . . . (617) 890-8484

Integrated Circuits — Distributors (Cont'd)

**MICHIGAN**

Livonia: Hamilton/Avnet Electronics  
12870 Farmington Rd. . . (313) 522-4700  
Detroit: Semiconductor Specialists  
25127 W. Six Mile Rd. . . (313) 255-0300

**MINNESOTA**

Minneapolis: Semiconductor Specialists  
8030 Cedar Ave., South . . . (612) 854-8841  
Edina: Hamilton/Avnet Electronics  
7683 Washington Avenue, South . . . (612) 941-3801

**MISSOURI**

Hazelwood: Hamilton/Avnet Electronics  
392 Brookes Lane . . . (314) 731-1144

**NEW YORK**

Buffalo: Summit Distributors  
916 Main Street . . . (716) 884-3450  
Farmingdale, L. I.: Arrow Electronics  
900 Broad Hollow Road . . . (516) 694-6800  
Rochester: Schweber Electronics  
999 Buffalo Road . . . (716) 328-4180  
Syracuse: Hamilton/Avnet Electronics  
6500 Joy Road . . . (315) 437-2642  
Westbury: Schweber Electronics  
Jericho Turnpike . . . (516) 334-7474  
Westbury: Hamilton/Avnet Electronics  
70 State Street . . . (516) 333-5800

*JAN/Hi-Rel ICs.*

*Use? Buy? Specify?*

*.....  
Your distributor qualifies.  
.....*

**NEW MEXICO**

Albuquerque: Cramer Electronics  
137 Vermont, N.E. . . . (505) 265-5767

**NORTH CAROLINA**

Greensboro: Hammond Electronics  
2923 Pacific Avenue . . . (919) 275-6391

**NORTHERN NEW JERSEY**

Cedar Grove: Hamilton/Avnet Electronics  
218 Little Falls Road . . . (201) 239-0800  
Saddlebrook: Arrow Electronics  
285 Midland Avenue . . . (201) 256-7331

No-Hitch Schottky Comparators. So easy to shop by telephone.



**SOUTHERN NEW JERSEY AND PENNSYLVANIA**

Moorestown: Arrow/Angus Electronics  
Pleasant Valley Road . . . (609) 235-1900  
Mt. Laurel, N.J.:  
Hamilton/Avnet Electronics  
113 Gaither Dr., East Gate Industrial Park . . . (609) 234-2133  
Cherry Hill, N.J.: Milgray-Delaware Valley  
1165 Marlkrass Rd. . . . (609) 424-1300

**INSTANT 883.**

Consult this page for instant 883 and JAN IC's

Integrated Circuits — Distributors (Cont'd)

**CENTRAL NEW JERSEY AND PENNSYLVANIA**

Somerset, N.J.: Schweber Electronics  
43 Belmont Drive . . . (201) 469-6008

**OHIO**

Beechwood: Schweber Electronics  
23880 Commerce Park Road . . . (216) 464-2970  
Cleveland: Arrow Electronics  
23945 Mercantile Rd. . . (216) 464-2000  
Cleveland: Pioneer Standard Electronics  
4800 E. 131st Street . . . (216) 587-3600  
Dayton: Hamilton/Avnet Electronics  
118 Park Road W. . . . (513) 433-0610  
Kettering: Arrow Electronics  
3100 Plainfield Rd. . . . (513) 253-9176



**OPTIMIZED PROMs and ROMs:**



call for optimized service.



**TEXAS**

Dallas: Hamilton/Avnet Electronics  
4445 Sigma Road . . . (214) 661-8661  
Dallas: Cramer Electronics  
2970 Blystone Ave. . . . (214) 350-1355  
Houston: Component Specialties  
7315 Ashcroft, Suite 113 . . . (713) 771-7237  
Houston: Hamilton/Avnet Electronics  
1216 West Clay Street . . . (713) 526-4661

☆☆☆ 555: ☆☆☆

The timer of 1001 uses. Promote the telephone shopping habit.

☆☆☆ 555: ☆☆☆

**UTAH**

Salt Lake City: Alta Electronics  
2280 S. Main St. . . . (801) 486-7227  
Salt Lake City:  
Hamilton/Avnet Electronics  
647 W. Billinis Rd. . . . (801) 262-8451

*One-stop shopping: call your distributor for total TTL needs.*

**WASHINGTON**

Bellevue: Hamilton/Avnet Electronics  
13407 Northrup Way . . . (206) 746-8750  
Seattle: Cramer Electronics  
5602 6th Ave., South . . . (216) 762-5722

*Your distributor brings the world to your door . . . with Bipolar ROMs and RAMs.*

Sure



# Guardian's number one in solenoids

The Guardian Angel put us in the winner's circle by offering you more types of solenoids . . . with more features . . . than anyone else in the world. Solenoids in every imaginable shape and size to meet any electromechanical requirement you can name. Solenoids with hefty 50 pound pull . . . or a fraction of an ounce. AC and DC. Intermittent or continuous duty. Pull or push or with switch attached. In more than a score of basic designs and 61 thousand variations! Plus specials to fit your specialized applications.

## ...but what have we done for you lately?

**NOW:** Virtually all Guardian Solenoids are recognized under the component program of Underwriters' Laboratories, Inc.

**NEW:** Uni-Guard Molded Coll Covers are now standard on most Guardian laminated, box-frame and U-frame solenoids.

**MORE:** The Tubular Solenoid line is expanded to include pull and push types from lifts of a fraction of an ounce to 10-pounds-plus.

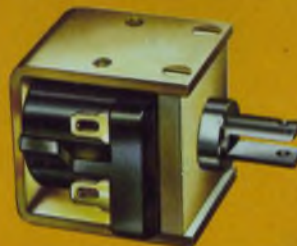

**Box-Frame Solenoids** in AC or DC for mechanical life of millions of cycles.



**Tubular Solenoids** that mount with only one mounting hole. DC only.

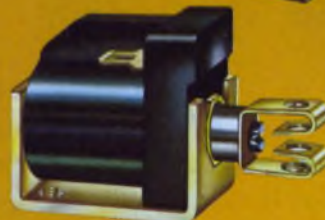

**U-Frame Solenoids** in AC or DC for minimum cost with high reliability.

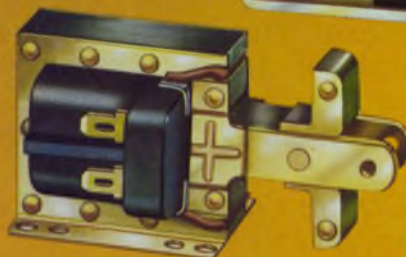

**Laminated Solenoids** in AC only for more pull over a longer stroke than DC solenoids of the same size.



# GUARDIAN®

GUARDIAN ELECTRIC MANUFACTURING CO. • 1550 West Carroll Ave., Chicago, Illinois 60607

*In a hurry? Call your Guardian Distributor.*

# Most of your design problems can be solved by an unknown.



Put down your pencil. Give the pocket calculator to your kids. Stop waiting in line at the EDP department.

If you've got problems, we've got a solution. The very first and only programmable hand-held micro computer in the world. The Compucorp Micro Scientist. The professional's machine.

It thinks the way you think. It does stress analyses. Works design problems. Breezes through drafting calculations. Solves systems headaches. Plucks the best engineering solution out of a dozen possibilities.

The Scientist allows you to have two different 80-step programs in memory at the same time. Which means repetitive calculations are a snap. And you can take it wherever you go because it's battery operable.

The Compucorp Scientist is the first hand-held machine with 13-digit accuracy and a big, bright 10-digit display. And it's the first one with an algebraic keyboard and nested parentheses.

It's also the first one with built-in polar to rectangular; rectangular to polar; trig functions;  $\log_{10}$ ;  $\log_e$ ;  $10^x$  and  $e^x$ . It also handles different forms of angle entry.

You can do register arithmetic in and out of ten storage registers. And you can set the decimal point anywhere you want it and change it whenever you want to.

Get all the facts on Compucorp Micro Computers. We may be an unknown to you, but we're already solving tough problems for thousands of design engineers around the world.

See your local Compucorp dealer. Or write Computer Design Corporation, 12401 Olympic Boulevard, Los Angeles, California 90064.



**Compucorp®**  
**The Unknown Factor in 63 countries.**

INFORMATION RETRIEVAL NUMBER 57

# SURPRISE!

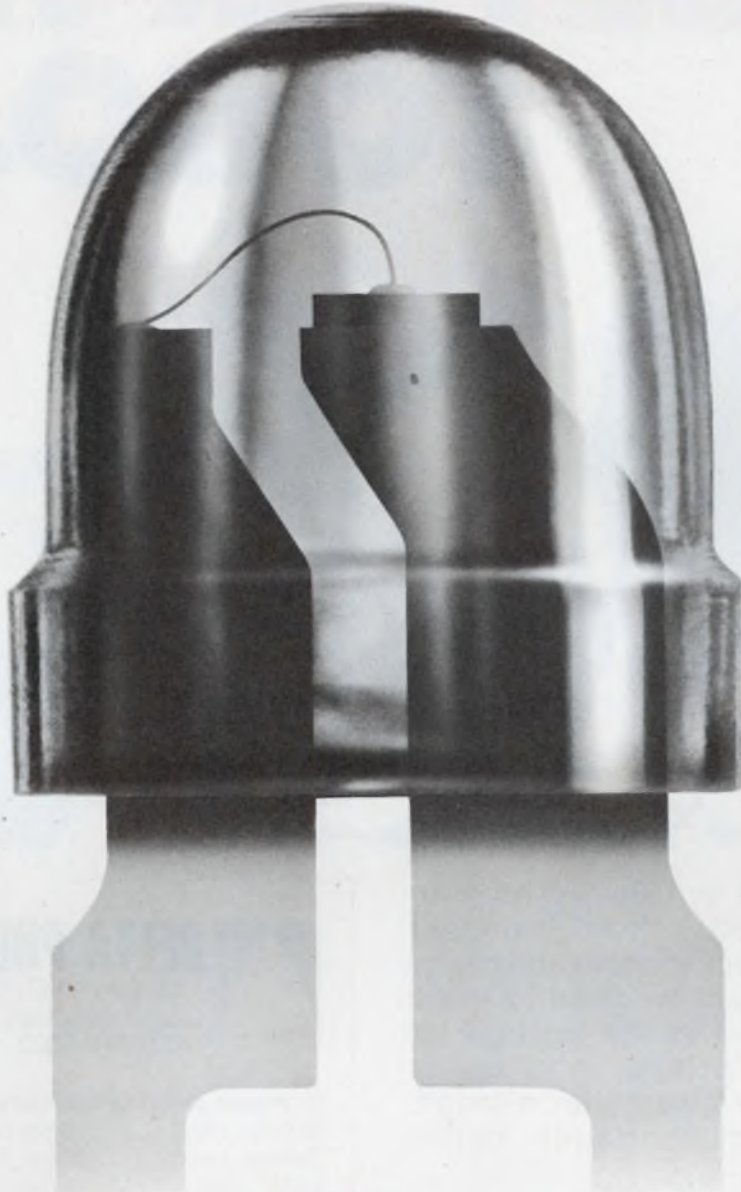

## A quality LED for just 9¢\*.

Now you can get HP quality in an LED lamp for only 9¢\*  
That's your price when you order one million. If you only need  
one thousand, the price is a low 17¢\*. And HP is ready to  
deliver that kind of volume to meet your schedule.

This T-1 size lamp features a new low profile lens for  
high density application in calculators, cameras, computers, appliances  
and automobiles. The 5082-4487 and 5082-4488 both  
have a clear lens and a 0.8 mcd at 20 mA typical light output.  
Get the full story from your nearby HP distributor  
or, write Hewlett-Packard directly.

01333

\*US Domestic only

HEWLETT  PACKARD

Sales, service and support in 172 centers in 65 countries  
Palo Alto, California 94304. Offices in principal cities throughout the U.S.

INFORMATION RETRIEVAL NUMBER 58

# THERE'S A BETTER WAY TO GO.



Energy shortages tell us we have to change our driving style. Now! It doesn't mean we have to go back to horse and buggy days. But it does mean we have to make every drop of gas give us the most go for our money. Anyone with horse sense knows that a well-tuned car gets better mileage, and in times of fuel shortages, better mileage means a lot.

The Mark Ten B Capacitive Discharge System keeps your car in better tune so it burns less gas. Using Mark Ten B is more than horse sense. It's the smart move under the hood, helping a nation survive an energy crisis and keeping you on the road. Delta Mark Ten. The best way to go.



## DELTA PRODUCTS, INC.

P.O. Box 1147, Dept. ED  
Grand Junction, Colo. 81501  
(303) 242-9000

Please send me free literature.

Enclosed is \$\_\_\_\_\_  Ship ppd.  Ship C.O.D.  
Please send: \_\_\_\_\_ Mark Ten B assembled @ \$59.95 ppd. \_\_\_\_\_ Mark Ten B Kit @ \$44.95 ppd. (12 volt negative ground only) \_\_\_\_\_ Standard Mark Ten assembled, @ \$44.95 ppd. \_\_\_\_\_ 6 Volt: Neg. Ground Only \_\_\_\_\_ 12 Volt: Specify \_\_\_\_\_ Pos. Ground \_\_\_\_\_ Neg. Ground \_\_\_\_\_ Standard Mark Ten Deltakit® @ \$29.95 ppd. (12 Volt Positive or Negative Ground Only)

Car Year \_\_\_\_\_ Make \_\_\_\_\_

Name \_\_\_\_\_

Address \_\_\_\_\_

City/State \_\_\_\_\_ Zip \_\_\_\_\_

# The first interactive graphic calculator.

## It's the 31/10 system.

A powerful calculator, graphic terminal and software combination. The first ever to place math-power, graphics and alphanumeric display at your fingertips!

The 31/10 is personal. Fast. And highly interactive. It lets you explore ideas and concepts on the spot. Plot single variable functions, specify X-Y coordinates and a lot more. Corrections and plot changes are immediate. From data entry to display, your ideas are quickly brought to light. That's responsive!

Plug in our software packages. They put the 31/10 to work. No heavy programming experience

needed. So you can deal in your concepts and not the mechanics of programming. And get graphic and alphanumeric output from natural math input.

There's more to our 31/10. Such as add-on memories for long programs. The optional silent thermal printer for listing and keeping track.

Peripherals like our hard copy unit to put in hand what's on the screen.

The costs are low, the results are priceless.

Get the facts about the 31/10 and the Tektronix reliability and worldwide service behind it. See your Tektronix sales engineer for a demonstration or write: Dwain Quandt, IDD Calculators, Tektronix, Inc., P. O. Box 500, Beaverton, Oregon 97005.

**Our programmable calculators. Natural. Powerful. Significantly less expensive.**



INFORMATION RETRIEVAL NUMBER 60



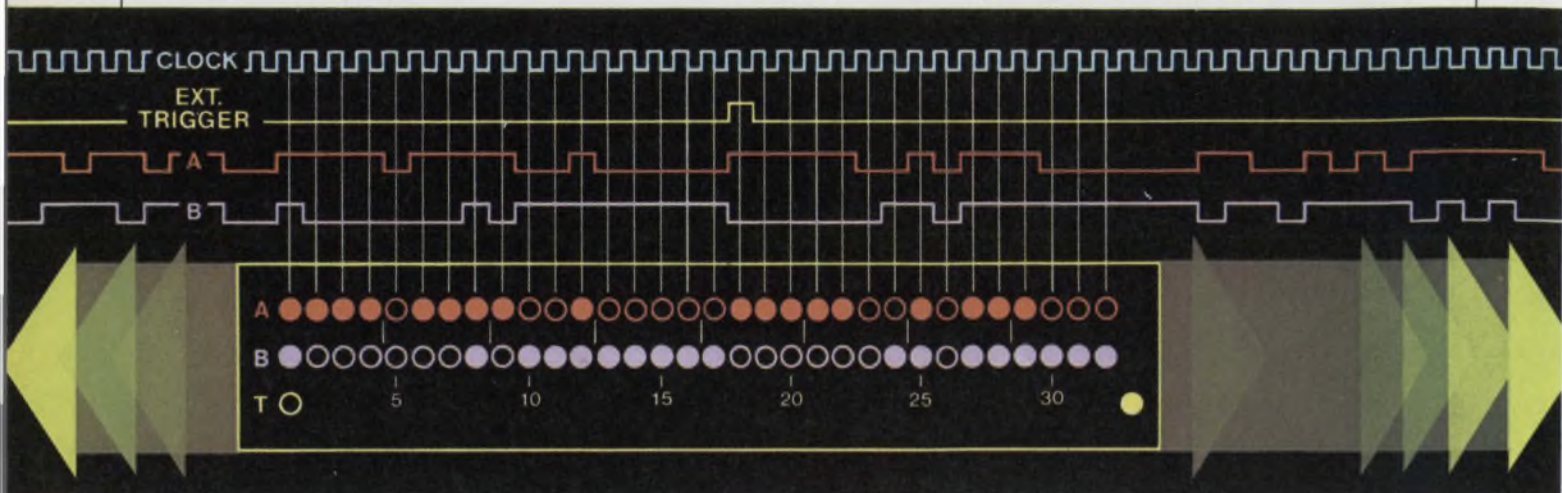

# The ordinary way of looking at digital bit streams has become obsolete.

- Diagnose Tough Digital Problems!
- See 10 ns. spikes in slow data!
- See 64 bits preceding that intermittent failure!
- See the one millionth bit after trigger!

Introducing the HP 5000A Logic Analyzer. A fast, simple, easy — and above all — accurate way to look at digital signal streams. Highs and lows are displayed by "on" and "off" states of LED's that make intuitive sense when you're working with truth-tables or timing diagrams.

Now you can look backwards as well as forwards in time from a trigger event. Plus, fast, easy-to-use waveform storage that lets you conveniently capture single-shot or transient bit streams. Add to this straightforward, almost self-explanatory controls and you have an ease of operation and display interpretation unmatched by any other method of monitoring digital bit streams.

The unique trigger circuits of the 5000A will help you extract invaluable information from your circuit. Use "CLOCKED" triggering to prevent faulty triggering in the presence

of data spikes. Use "ASYNC" triggering on that intermittent pulse from your decoder, for example, and expose its cause. Or, select a combination of any three inputs from your system for the trigger word. After triggering, the 5000A can either display the bit stream or automatically detect and display only those elusive spikes or glitches that may occur but once a day.

The HP 5000A has a capture rate of up to 10 Megabits/sec., adjustable threshold, and 1 megohm impedance. Use it with any existing logic family. Precise digital delay makes algorithm-checking and accessing of particular data in long streams incredibly

easy. Timing and display are keyed to your clock signal so absolute repeatability is assured. HP 5000A, \$1900.\*

If you need to display a series of parallel words, consider HP's 1601L Logic State Analyzer with a CRT display of 1's and 0's, \$2650.\*

To arrange for a demonstration, call your local HP field engineer today. Or write us for complete specifications.

\*Domestic USA prices only.

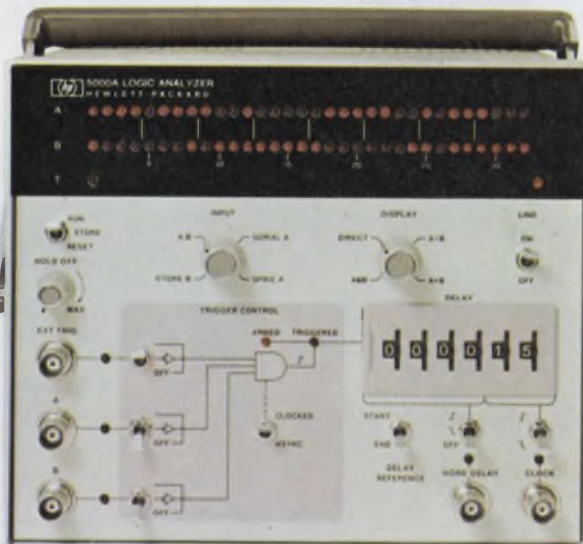

Sales and service from 172 offices in 65 countries.  
1501 Page Mill Road, Palo Alto, California 94304



## new products

# Spectrum analyzer outperforms rivals in 7 areas—at a price

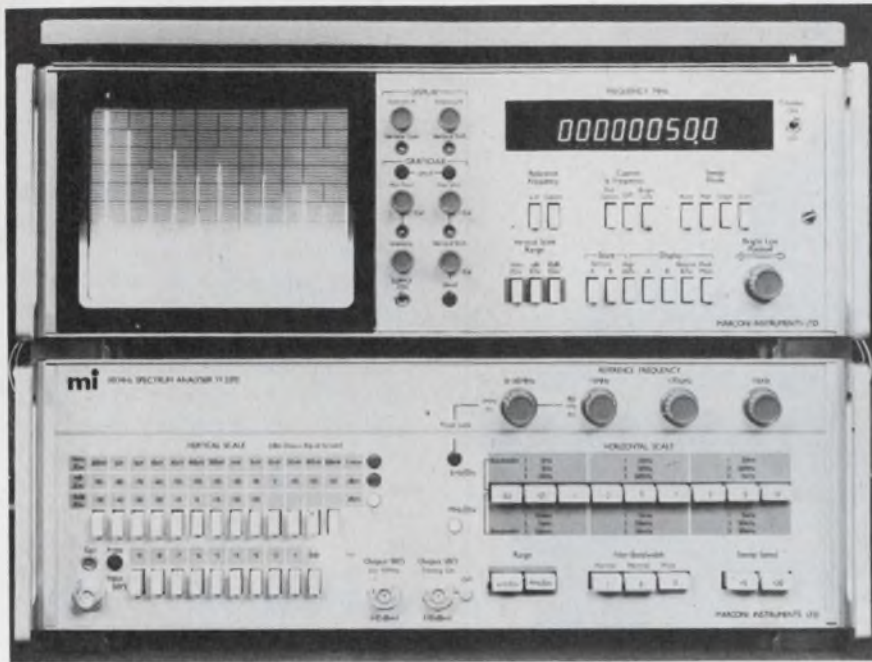

Marconi Instruments, 111 Cedar Lane, Englewood, N. J. 07631. (201) 567-0607. P&A: See text.

Marconi's 110-MHz spectrum analyzer, the TF 2370, not only brings a fresh approach to this class of instrument but also zooms ahead of all others in performance in at least seven key areas. Here's what the TF 2370 offers:

- 5-MHz minimum filter bandwidth—the narrowest available in its class by a factor of 2.
- -159-dBm minimum input (or sensitivity)—the lowest by 19 dBm.
- +25-dBm maximum input—the highest by 12 dBm.
- 100-dB displayed dynamic range—highest by 30 dB.
- 3-dB bandwidth of 30 Hz to 110-MHz—the widest of its class.
- 10 to 1, or better, i-f filter factor for all resolution settings (ratio of 60-dB to 3-dB bandwidths)—the best of its class.
- 9-digit frequency readout—highest by two digits.

And if these aren't enough to establish the TF 2370 as the leader of its frequency class, the unit

also has smaller input VSWR ( $< 1.2$ ), a larger display ( $10 \times 12$  cm) and a pack of features—like a brighter display, internal memory and automatic controls—not to be found on any competing spectrum analyzer.

Of course, such performance isn't cheap. The TF 2370—which also has a built-in tracking generator—sells for \$14,750. Delivery takes 90 days.

New features? How about this one: The user sets the center frequency, sensitivity and sweep width, and the Marconi unit automatically computes and sets the optimum sweep rate, filter bandwidth and rf/i-f gain ratio. Improper settings that can destroy valid results are automatically avoided.

Also unique is the TF 2370's use of an internal a/d converter, MOS memory and TV-type display to give an infinite-persistence, flicker-free image. The need for long-persistence CRTs or storage tubes has been eliminated, along with problems of fading, blooming and burning.

Stored data are displayed at a 76-Hz rate and vertically scanned by a 513-line interlaced raster. The brightness modulation of the lines—to a height that represents the input amplitudes—conveys the spectral information.

Superimposed on the display is a projected, electronic graticule that can be moved vertically and horizontally by  $\pm 1$  division, and a bright-line cursor that can be moved and set on any spectral line.

Thus the graticule can be shifted to fit selected spectra for parallax-free readout, and the cursor—which is coupled to a 9-digit counter—can be plunked on any line to display the line's frequency automatically on the counter.

The counter works in any of three modes: It can display the center frequency, the frequency that corresponds to the cursor position or the difference between these two frequencies. But for maximum sensitivity, the counter must be shut off to avoid leakage.

Digital storage lets the TF 2370 do several things: First, the image stays sharp, clean and bright indefinitely. Second, once contrast is set, it stays set; no continuous tweaking is needed to get the best compromise between brightness and persistence. Third, renewed data can be displayed at a higher brightness than existing data, since the brightness can be changed *after* a sweep. Finally, the memory can be split to superimpose two images for comparison tests. And not only can one image be dimmed relative to the other, either image can be kept indefinitely while the other is refreshed.

The TF 2370's closest competitor is a Hewlett-Packard analyzer. With the HP 141T display, 8553B tuning section, 8552B i-f section and optional 8443A tracking generator/7-digit counter, the complete HP analyzer comes to

(continued on page 138)

# Efficiency Experts

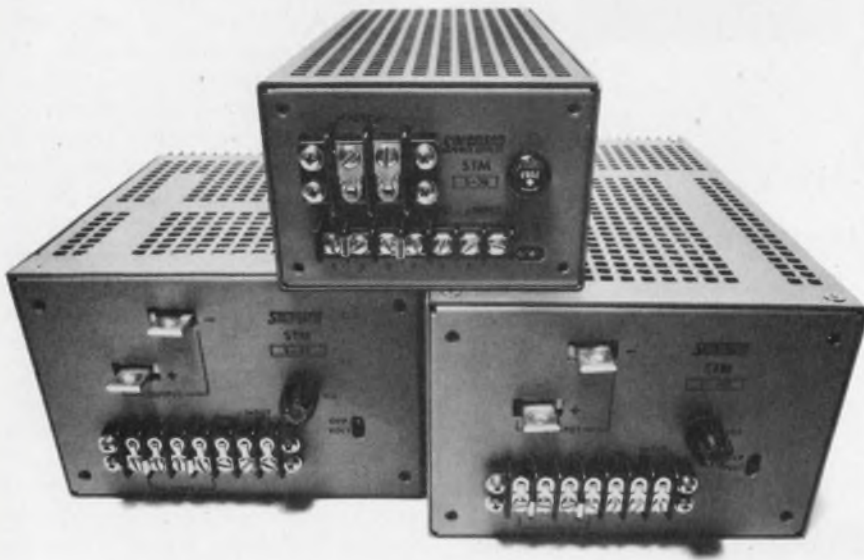

Built to save energy—modular STM switching-transistor power supplies from Sorensen. Exceptional power density and efficiency. Up to 1.5 watts per cu. in., and up to 75% efficiency in half the space of comparable competitive units. 40 models offer outputs from 72 to 780 watts (3 to 56 volts)—all with these features: cool running . . . excellent performance characteristics . . . built-in overvoltage protection . . . quiet operation . . . adjustable current limiting. For complete data, contact the Marketing Manager at Sorensen Company, a unit of Raytheon Company, Manchester, N.H. (603) 668-4500.

## Representative Specifications—STM

Regulation (comb. line & load)	0.05%		
Ripple (PARD)	rms: 3 to 10 mv p-p: 30 mv. typ.; 50 mv. worst case		
Module Sizes & Prices	Module	Size	Price
	III	5.12" x 3.31" x 9.50"	\$240-270
	IIIA	5.12" x 3.31" x 14"	\$300-330
	IVA	7.5" x 4.94" x 10.5"	\$475-495
	VI	7.5" x 4.94" x 14"	\$600-650

**Sorensen**  
POWER SUPPLIES

## INSTRUMENTATION

(continued from page 137)

\$10,625—a good \$4000 less than the Marconi unit.

But the HP analyzer doesn't have the Marconi's storage or display features, though it does have a parallax-free, internal graticule. And, of course, the TF 2370 leads in a number of important performance areas.

Strangely missing from the TF 2370's data sheet, though—and HP's catalog data—is another important spec: frequency stability.

Since it's hard to design filters with a narrow 3-dB bandwidth and a low 60-dB/3-dB ratio, it's understandable that a manufacturer will brag when he's done it. But a narrow filter doesn't guarantee outstanding frequency resolution in an analyzer. If the analyzer's residual FM causes frequency variations of greater than the 3-dB bandwidth, you can forget that hard-won filter spec.

Both analyzers, however, list a spec for frequency resolution. With the Marconi TF 2370 in the manual mode, with 5-Hz filter bandwidth and 20 Hz/div sweep, noise sidebands limit to 100 Hz the resolution of what the manufacturer calls "small" signals—that is, signals of 70 dB and down.

With the HP combo, the spec reads: "10-Hz resolution to see 60-Hz sidebands 60-dB down." To determine exactly what resolution you'll get for your particular set of inputs, ask Marconi or HP.

Two other important analyzer specs are the accuracies of the frequency and amplitude readouts.

With counter readouts, frequency accuracy is given by  $\pm 1$  count  $\pm$  time-base accuracy, and time-base accuracy depends on aging rate, tempco and line-voltage effects, if any. To get these specs, ask the vendor.

As for amplitude accuracy, HP's is listed as "to"  $\pm 0.8$  dB absolute accuracy, while Marconi's is "broken down" into quantization error, bandwidth/dispersion switching accuracy, volts/div linearity on the linear scales and log accuracies on the log scales. To get absolute accuracy, put it all together—somehow.

For Marconi **CIRCLE NO. 250**

For Hewlett-Packard **CIRCLE NO. 251**

We think of our enclosures as silent salesmen. The first ten seconds of display for an electronics unit focus simply on the package. Its color (and the other colors available), its finish and style. It won't *break* a sale—the equipment inside does that. But it sure can help *make* one. Our award winning designs and

total color range have proved it.

Does a client need a ventilating grille? A blower? What about writing surfaces, drawers, casters? We have them in production, on line and ready to go—offering the access, flexibility and mobility your clients require. We even paint our units inside and out, and assemble

them for final inspection—including most options and accessories—at the plant.

We're ready with all this, and more. Ready right now.

Write Optima Enclosures, 2166 Mountain Industrial Blvd., Tucker, Georgia 30084 or call (404) 939-6340.

**OPTIMA**

# Before you choose your next enclosure, show this ad to your salesmen.



Other Scientific-Atlanta Inc. Divisions are • Cable Communications • Instrumentation • Electro-Systems • Southern Tool and Machine • Security

INFORMATION RETRIEVAL NUMBER 63

## Memory tester handles 16 million addresses



Macrodata, 6203 Variel Ave., Woodland Hills, Calif. 91364. (213) 887-5550. See text; 6 to 8 wk.

With capabilities of testers twice its price, the Macrodata MD-107 memory-system analyzer can test, at 10 MHz, units with up to 16-million addresses.

The analyzer consists of a CPU, two cassette drives, a CRT terminal, an address-generation processor and a test-and-error processor. The basic system costs less than \$50,000, and it tests plated wire, core and semiconductor memories with word lengths from 1 to 160 bits. The analyzer's system stimulus levels can be programmed to match ECL, TTL or MOS logic families.

Cycle time, data strobe and write-command leading and trailing edge position can all be set with 1-ns resolution. Test programs are written with an in-house developed language called TECOL. The language allows for CRT display manipulation, and it has executive, interpretive and editor software.

Memory systems under test receive stimulation from the test-and-error processor. Outputs from the memory system are fed back through the error processor for

analysis. Inputs for the system under test are generated from four sections of the test set.

The data-generation processor stores one test word. This word, in turn, is controlled by the test-pattern processor. Another section, the address-generation processor, generates all possible input combinations for word lengths up to 24 bits. The last section manipulates the 11 control bits, which typically control the write, clear, strobe and data lines.

All four sections operate independently and can be changed on a cycle-by-cycle basis. Seven programmable clocks and three independently programmable cycle times are also available for the test system.

Pattern-processor software is available in microprogram form from Macrodata. The analyzer also has supportive diagnostic software routines that can test all sections of the MD-107.

The analyzer does a strictly functional test of memory systems to determine defects such as shorts, opens, incorrect components and interaction between components.

Options available with the MD-107 include a data-buffer memory and a line printer.

CIRCLE NO. 252

## 3-1/2-digit DMM costs just \$219



United Systems, 918 Woodley Rd., Dayton, Ohio 45403. (513) 254-6251. \$219; stock.

The 2110 Digital Multimeter is the latest instrument in the company's HT Series (High Technology). The unit offers 3-1/2 digits, is bipolar and portable. A built-in automatic recharger maintains the batteries at full charge as long as the instrument is connected to the power line. Fifteen ranges include dc which extends from 199.9 mV to 1000 V fs with a basic accuracy of 0.1% of reading; ac from 1.999 to 500 V fs with an accuracy of 0.5% of reading; and ohms from 199.9  $\Omega$  to 19.99 M $\Omega$  fs.

CIRCLE NO. 256

## 3 kg frequency counter covers 10 Hz to 512 MHz

Marconi Instruments, Ltd., Longacres, St. Albans, Herts, England.

The frequency counter, Model TF2424A, weighs only 6-1/2 lb (3 kg) and has a frequency range of 10 Hz to 512 MHz. Two switch selectable input channels are provided. One is a high impedance input with 30-mV sensitivity that accepts frequencies from 10 Hz to 10 MHz, and the other is a 50- $\Omega$  input with 10 mV sensitivity, covering 10 to 512 MHz. Resolution is 10 Hz up to 500 MHz. The frequency readout is displayed on a four-digit LED panel with an overflow lamp indicating when the count of 9999 is exceeded. An effective readout of eight digits is achieved by means of front-panel switches giving 10 Hz resolution with reading time of only 3.2 seconds. A 10 MHz internal crystal oscillator is operated in a constant temperature enclosure, ensuring a frequency stability of  $\pm 1 \times 10^{-7}$  over a wide temperature range. Warm-up time is four minutes from switch on to a stability of  $2 \times 10^{-7}$ . The counter may be powered by an internal NiCad battery pack or from a 110 V ac source.

CIRCLE NO. 257

# ULTRA-MATCHED INSTRUMENTATION OP AMPS... *made easy!*

$\Delta V_{os} - 70\mu V$

$TC\Delta V_{os} - 0.3\mu V/^{\circ}C$

$I_B - I_nA$

$\Delta CMRR - 123dB$

14 Pin DIP Package

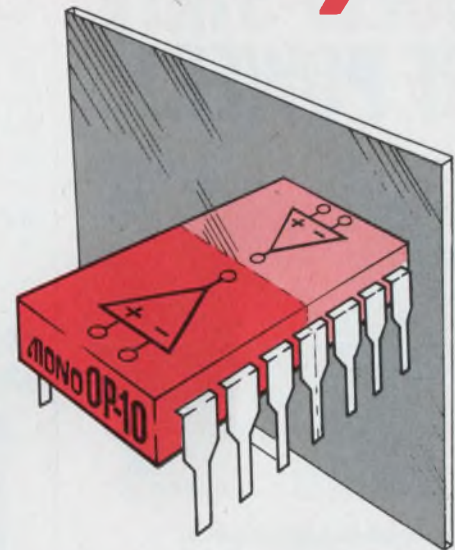

## ***AT LAST—MATCHED DUAL OPERATIONAL AMPLIFIERS!***

New monoOP-10 makes matched amplifier designs easy — two low noise, low drift, low bias current monoOP-05 Instrumentation OP Amps in a 14 pin DIP! Of course, they're fully compensated and completely protected so there's nothing to add but your ingenuity. And the tight matching makes possible a new generation of applications including high input

impedance instrumentation amplifiers with no chopper noise, low drift multistage active filters, matched channel amplifiers, tracking dual voltage references and . . . No more costly hand selection of individual op amps — monoOP-10 saves time, space and cost while boosting performance! Try one — they're off-the-shelf at your PMI distributor now!

### **GUARANTEED MIN/MAX SPECIFICATIONS**

	monoOP-10AY	monoOP-10Y	monoOP-10EY	monoOP-10CY	
Operating Temp. Range	-55/+125	-55/+125	0/+70	0/+70	$^{\circ}C$
$\Delta V_{os}$ ( $V_{os1}-V_{os2}$ )	180	500	500	—	$\mu V$
$TC \Delta V_{os}$	0.8	1.2	0.9	—	$\mu V/^{\circ}C$
$\Delta CMRR$	114	106	106	—	dB
Input Bias Current	3.0	3.0	4.0	7.0	nA
Noise (0.1 Hz to 10 Hz)	0.6	0.6	0.6	0.65	$\mu V$ , pk-to-pk
Long Term Drift*	0.2	0.2	0.2	0.3	$\mu V$ /Month
Price @ 100 pcs.	\$60.00	\$40.00	\$25.00	\$16.00	

\* Typical long term drift trend, averaged over a 12 month period (per amplifier)



1500 SPACE PARK DRIVE, SANTA CLARA, CALIFORNIA 95050  
TEL. (408) 246-9225 • TWX 910-338-0528 • CABLE MONO

#### **AUTHORIZED DISTRIBUTORS**

**NEW YORK METROPOLITAN AREA** Harvey Radio, Woodbury, N.Y.: (516) 921-8700 • **NEW ENGLAND AREA** Gerber Electronics, Dedham, Mass.: (617) 329-2400 • **UPSTATE NEW YORK** Harvey Federal Electronics, Binghamton, N.Y.: (607) 748-8211 • **NORTHEAST** Newark Electronics, Woburn, Mass.: (617) 935-8350 • **BALTIMORE-WASHINGTON** Whitney Distributors, Baltimore, Md.: (301) 944-8080 • **PHILADELPHIA** Hallmark Electronics, Huntingdon Valley, Pa.: (215) 355-7300 • **MICHIGAN** RS Electronics, Detroit, Mich.: (313) 491-1000 • **SOUTHEAST** Kirkman Electronics, Winston-Salem, N.C.: (919) 724-0541 • **EAST CENTRAL** Pioneer/Cleveland, Cleveland, Ohio: (216) 587-3600 • **Pioneer/Dayton**, Dayton, Ohio: (513) 236-9900 • **CENTRAL** Hallmark Electronics, Elk Grove Village, Ill.: (312) 437-8800 • **Minneapolis**, Minn.: (612) 925-2944 • **St. Louis**, Mo.: (314) 521-3800 • **TEXAS-OKLAHOMA** Sterling Electronics, Houston, Texas: (713) 623-6600 • **Dallas**, Texas: (214) 357-9131 • **SOUTHWEST** Sterling Electronics, Albuquerque, N.M.: (505) 345-6601 • **Phoenix**, Ariz.: (602) 258-4531 • **WEST** Westates Electronics Corp., Chatsworth, Calif.: (213) 341-4411 • **Sterling Electronics**, San Carlos, Calif.: (415) 592-2353 • **Intermark Electronics**, Sunnyvale, Calif.: (408) 738-1111 • **Denver**, Colo.: (303) 936-8284 • **Salt Lake City**, Utah: (801) 359-0531 • **San Diego**, Calif.: (714) 279-5200 • **Santa Ana**, Calif.: (714) 540-1322 • **Almac-Stroum**, Seattle, Wash.: (206) 763-2300 • **Portland**, Ore.: (503) 292-3534.

INFORMATION RETRIEVAL NUMBER 64

**Tubes?  
Forget them.**

**HERE'S 100  
WATTS OF  
SOLID-STATE  
RF POWER!**



**A state-of-the-art amplifier.**

ENI's new Model 3100L *all-solid-state* power amplifier provides more than 100 watts of linear power and up to 180 watts of pulse power from 250 kHz to 105 MHz. This state-of-the-art class A unit supplies over 50 watts at frequencies up to 120 MHz and down to 120 kHz. All this capability is packaged in a case as small as an oscilloscope, and it's just as portable.

**Extraordinary performance.**

Featuring a flat 50 dB gain, the Model 3100L is driven to full power by any signal generator, synthesizer or sweeper. AM, FM, SSB, TV and pulse modulations are faithfully reproduced by the highly linear output circuitry. Immune to damage due to load mismatch or overdrive, the 3100L delivers constant forward power to loads ranging from an open to a short circuit.

Solid-state reliability is here.

The price? \$5,690.

Write for complete information: ENI, 3000 Winton Road South, Rochester, N. Y. 14623  
Call (716)-473-6900 or TELEX 97-8283

**ELECTRONIC  
NAVIGATION  
INDUSTRIES**

**ENI . . . The world's leader  
in solid-state power amplifiers.**

**INSTRUMENTATION**

**Microvoltmeter offers  
four bandwidths**

*Rohde & Schwarz, 111 Lexington Ave., Passaic, N.J. 07055. (201) 773-8010. \$14,815.*

Type USH 1 is a Selective Microvoltmeter that operates from 10 kHz to 60 MHz. The unit uses frequency synthesizer techniques in the local oscillator to achieve a resolution of approximately 2 Hz. Special features include: measurement range of 0.3  $\mu$ V to 3 V (pk-pk and rms); linear and logarithmic (80 dB) indication; four selectable bandwidths of 200 Hz to 20 kHz; automatic tuning (sweep) to  $\pm$ 100 kHz max; and selectable input impedance of 50, 60, 75, 150  $\Omega$ , and dc coupling probe.

**CIRCLE NO. 258**

**Multipoint recorder  
shows no zero drift**

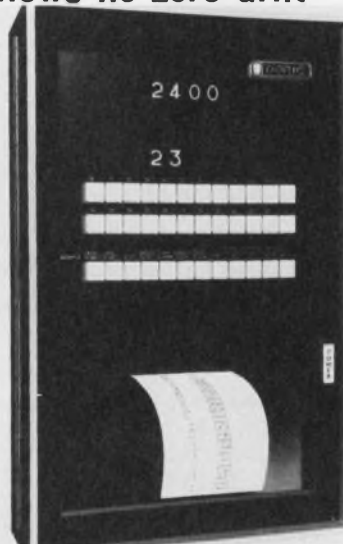

*Doric Scientific, 3883 Ruffin Rd., San Diego, Calif. 92123. (714) 565-4415. \$1575; stock to 90 days.*

Digitrend 200 is a ruggedized, digital multipoint recorder designed for industrial environments. The unit will scan, display, log and alarm outputs from thermocouples, transducers, transmitters, strain gauges, or millivolt sources. Included are: a 6-point screw terminal input panel, cold-junction compensation, choice of solid state or electromechanical scanning, a/d converter, digital display in engineering units, printout on a strip printer and a built-in electronic timer to initiate periodic logging cycles.

**CIRCLE NO. 259**

**Tester reads error rate  
at up to 75 Mb/s**

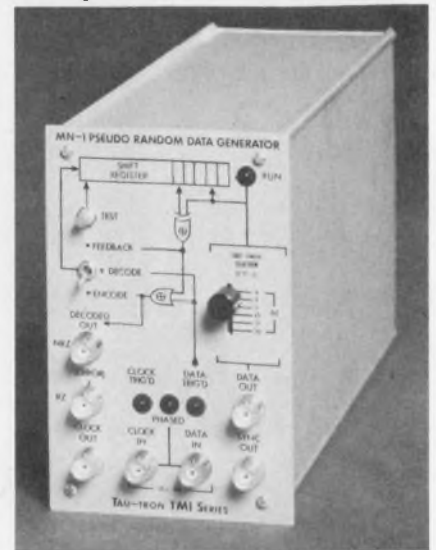

*Tau-Tron, 11 Esquire Rd., North Billerica, Mass. 01862. (617) 667-3874. MN-1: \$1000; MB-1: \$1800; 2 wk.*

This Bit Error Rate Test Set operates from 1 b/s to 75 Mb/s and provides bit error and block error measurements along with a burst error indicator. The transmitter is the MN-1 Pseudo-Random Data Generator, which creates pseudo-random codes, from 63 to over 1 million bits per period. There are six codes in all. The receiver is the MB-1, PCM BERT. It automatically synchronizes its local code generator to the received sequence independent of path propagation delay. After link-up, it provides bit error rate and block error rate measurements on a four-digit LED display.

**CIRCLE NO. 260**

**Computerized PC tester  
fits in a suitcase**

*Data Test, 2450 Whitman Rd., Concord, Calif. 94518. (415) 689-3583. Less than \$7000; 30 days.*

Weighing only 40 lb, the Data-tester 2400 is said to be the first computerized test system to fit into a suitcase. Basic features include self-contained programmable power supplies, fixed program generators, matrix pin programming, family test module and fault diagnostic probe. A built-in microprocessor executes a powerful flexible instruction set, permitting real time functional testing, simulation and exercising.

**CIRCLE NO. 261**

## Thermocouple indicator gives 0.1° linearity



Consolidated Controls Corp., 15 Durant Ave., Bethel, Conn. 06801. (203) 743-6712. \$895; 10-12 wk.

Known as the MK III, this new line of digital instrumentation is designed to measure, display, monitor and record such physical parameters as temperature, pressure, load, torque, strain, flow, rpm, volts, amperes and combinations thereof. First unit in the MK III line is the Model 50GS1 digital thermocouple indicator which includes as standard, automatic zero to overcome drift with temperature variation, internal calibration, automatic polarity indication, five-digit display, isolated BCD output, plug-in circuitry construction, and rf line filters.

CIRCLE NO. 262

## Impulse generator gives 150-ps pulse



IKOR, Inc., Second Ave., Burlington, Mass. 01803. (617) 272-4400. \$1495; 60 days.

Model R100 IMP generator is a high-voltage source said to produce 100 times more power over a wideband output than any impulse generator previously available. Specs include: spectral output of  $120 \pm 2$  dB $\mu$ V/MHz from 1 MHz to 1 GHz; a peak amplitude of 1000 V nominal; an amplitude stability of  $\pm 0.2$  dB; a rise time of less than 100 ps; -3-dB pulse width of 150 ps max.; and a rep rate of 250 Hz.

CIRCLE NO. 263

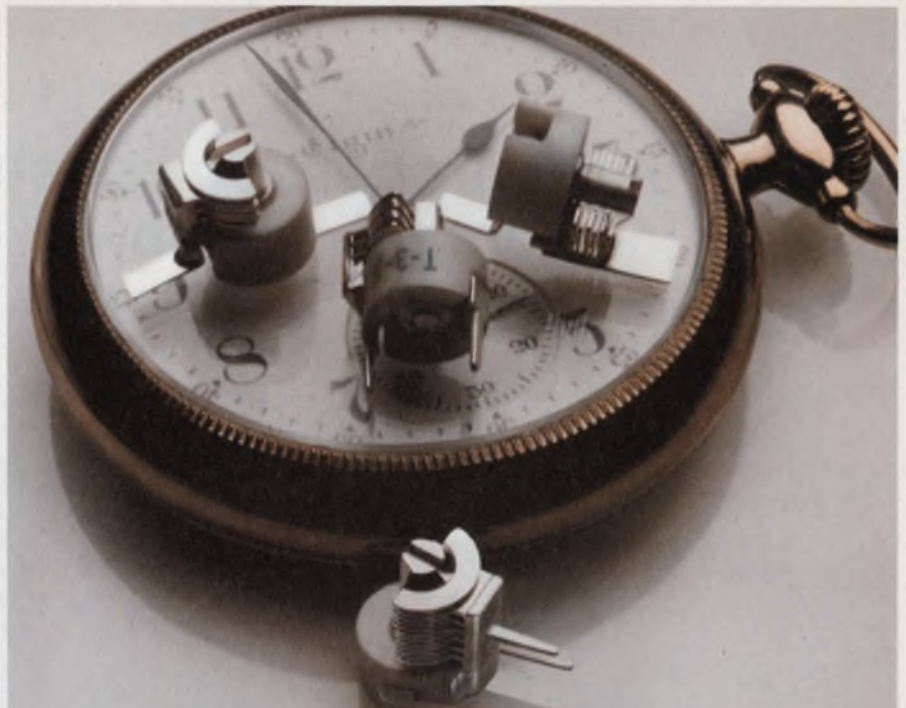

## We can deliver the world's smallest 180° air variable capacitors. On time.

And since we're nice people, we don't even charge much for them. So if you have an application that calls for a sub-miniature capacitor that you can "tweak" to a specific frequency, these Johnson trimmers are ideal.

You can choose from either PC or stripline mount, either vertical or horizontal tuning. These Type "T" capacitors are about one-third the size of the familiar type "U" capacitors, so you can save space, cut costs and insure improved performance in the most compact electronic equipment.

Rotors and stators are precision-machined from solid brass extrusions, resulting in exceptional stability and uniformity. High Q—typically 2000 at 150 MHz. Temperature coefficient is a low plus  $30 \pm 15$  ppm/°C. High torque ( $1\frac{1}{2}$  to 8 oz./inches) holds rotor securely under vibration. They're designed to meet or exceed EIA-RS 204 and MIL Standard 202C Methods 204A and 201A.

In short, these capacitors may be just what you've been looking for. It'll only cost you a stamp to get more information. And if you give us your phone number, we'll call you and send free samples after we have clarified your application.

E. F. JOHNSON COMPANY  
3005 Tenth Ave. S.W. / Waseca, MN. 56093

- Please send me technical information on the type T.  
 Also, include information on your entire line of variable capacitors.  
 I want test samples. Please call me at \_\_\_\_\_

NAME \_\_\_\_\_  
 TITLE \_\_\_\_\_  
 FIRM \_\_\_\_\_

ADDRESS \_\_\_\_\_  
 CITY \_\_\_\_\_ STATE \_\_\_\_\_ ZIP \_\_\_\_\_



**E. F. JOHNSON COMPANY**

# NMOS microprocessor boosts speed, instruction-set power

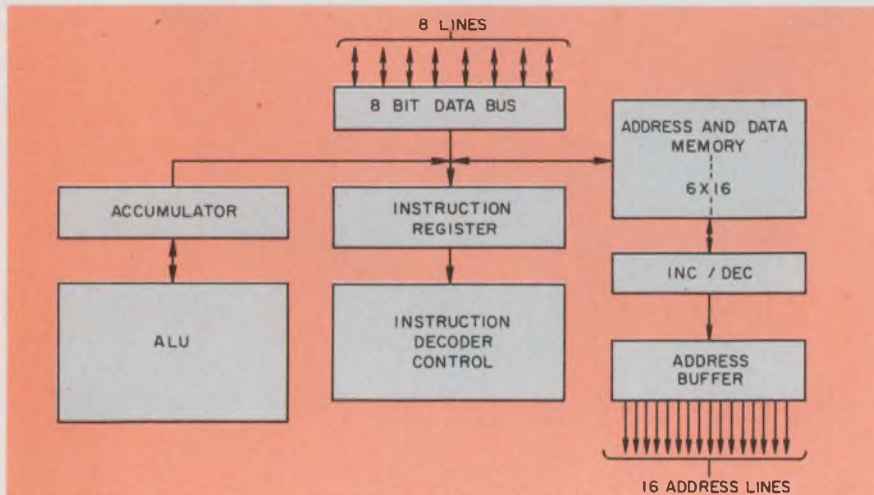

Intel, 3035 Bowers Ave., Santa Clara, Calif. 95051. (408) 246-7501. P&A: See below.

The first n-channel MOS microprocessor—Intel's long-awaited 8080—sets the pace for increased speed and improved instructions. The 8-bit NMOS silicon-gate processor has a 2- $\mu$ s instruction cycle and 74 basic instructions that include the 48 instructions of Intel's earlier 8-bit PMOS processor, the 8008.

The NMOS 8080 is an advanced design based on the PMOS 8008. The additional 30 instructions—including double-precision capability—and a 6:1 faster execution rate provide up to a 10:1 speed advantage over the 8008. Moreover the improved performance of the 8080 is obtained with a typical power dissipation of only 600 mW, the same as that of the 8008.

The 8080 can address up to 65-k bytes of memory without the need for an external address register. This compares with 16-k bytes of memory and an external register for the 8008. For a TTL I/O interface, the new processor requires six ICs, as contrasted to the 20 needed with the 8008. The NMOS 8080 comes in a 40-pin package and operates from +12 and  $\pm 5$ -V supplies.

Several architectural differences

account for the improved performance of the 8080. For example, it contains a 16-bit stack pointer and a 16-bit program counter, instead of an address storage stack with eight 14-bit locations. A portion of the external memory can be used as a last-in/first-out (LIFO) pushdown stack, addressed by the stack pointer upon the execution of a CALL, RETURN or RESTART instruction.

Most significantly, not only the program counter but also the data registers, the accumulator and the flags can be saved in the external pushdown stack. As a result, multiple interrupts can be handled more easily with the 8080.

In another difference, the NMOS 8080 doesn't use time-multiplexing of the data bus for data and addresses, as the 8008 does. The 8080 contains a separate 16-bit, three-state address line and an 8-bit bidirectional data bus, both with separate control lines. Status information is sent out at the beginning of each machine cycle. Neither control signals nor status information require decoding. Thus interface circuitry is simplified.

The address bus provides, directly, the address to memory, or, it denotes an I/O device number. The data bus provides bidirection-

al communication between memory or I/O devices for instructions and data transfers. The 8080 can handle up to 256 input ports and a similar range of outputs.

Communication on address and data lines can be interlocked by use of a Hold pin. The processor becomes suspended and address and data lines are forced into a floating state. This feature permits "OR-tying" the address and data busses with other processors for a direct-memory access (DMA) mode, or the sharing of the memory by several processors.

The 8080 can perform BCD and binary arithmetic. It also has capability for double-precision arithmetic involving two 16-bit numbers.

Intel offers an extensive line of hardware and software design aids for the 8080. The software aids include assemblers, editors and simulators, which are available on time-share systems.

Currently available through distributors, the 8080 is priced at \$360 in quantities of 1 to 24.

CIRCLE NO. 255

## COS/MOS SR contains 200 stages

RCA Solid State Div., Route 202, Somerville, N.J. 08876. (201) 722-3200. \$6 (1000).

A COS/MOS 200-stage dynamic shift register, the CD4062A, is the longest shift register available in low-power COS/MOS technology. It provides both single-phase and two-phase clocking options. The single-phase option permits operation to 1 MHz with noncritical rise and fall times. Clock input capacitance is less than 5 pF. Two-phase clock signals permit operation to 5 MHz, and further reduce clock rise and fall-time requirements at low speeds. The minimum operating speed is 1 kHz.

CIRCLE NO. 264



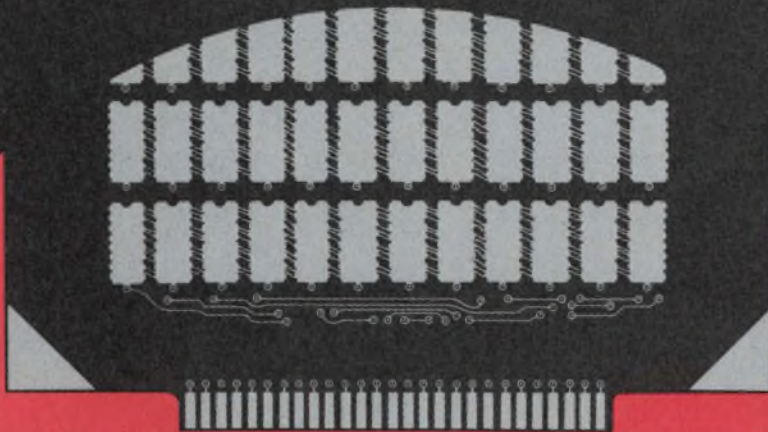

Whether your board looks like this ...

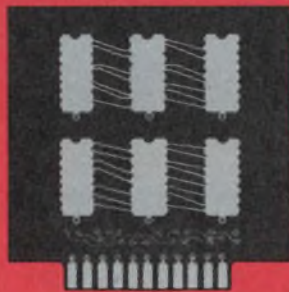

or this ...

We can build a CUSTOM C/MOS circuit for you that looks like this ...

Also remember our standard lines of 7400 TTL's and 930 DTL's.

Out-of-State Call toll free. Dial: 800-538-7906 and ask about price and delivery.

## We can optimize your design and save you money, too!

You don't have to have a big hairy system full of complex devices to get economies out of custom C/MOS.

Even if your module has as few as a half dozen standard C/MOS devices in it—we may be able to provide you with a single custom C/MOS circuit that will do it all...cost you less than you think...and could save your com-

pany thousands of dollars in production costs.

Many designers have switched to C/MOS because of its inherent low-battery drain and high noise immunity. And now many users of standard C/MOS devices are looking to custom C/MOS circuits to optimize their designs and save money, too. They see no reason to go on using 5 or 6 stand-

ard devices where 1 custom circuit will do.

For less than you think, we may be able to provide you with a prototype custom C/MOS circuit that could give your company a competitive edge. It costs nothing to send in the coupon and be brought up to date on the custom C/MOS scene. Do it now!

\_\_\_\_\_  
Name

\_\_\_\_\_  
Company

\_\_\_\_\_  
Phone

\_\_\_\_\_  
Address

\_\_\_\_\_  
City                      State                      Zip

Briefly, my application is: \_\_\_\_\_  
\_\_\_\_\_  
\_\_\_\_\_  
\_\_\_\_\_

Please call me. I want to talk about custom C/MOS.

Please send me more information.



STEWART-WARNER MICROCIRCUITS DIVISION

**STEWART-WARNER CORPORATION**

730 E. Evelyn Ave. • Sunnyvale, Ca. 94086 • (408) 245-9200

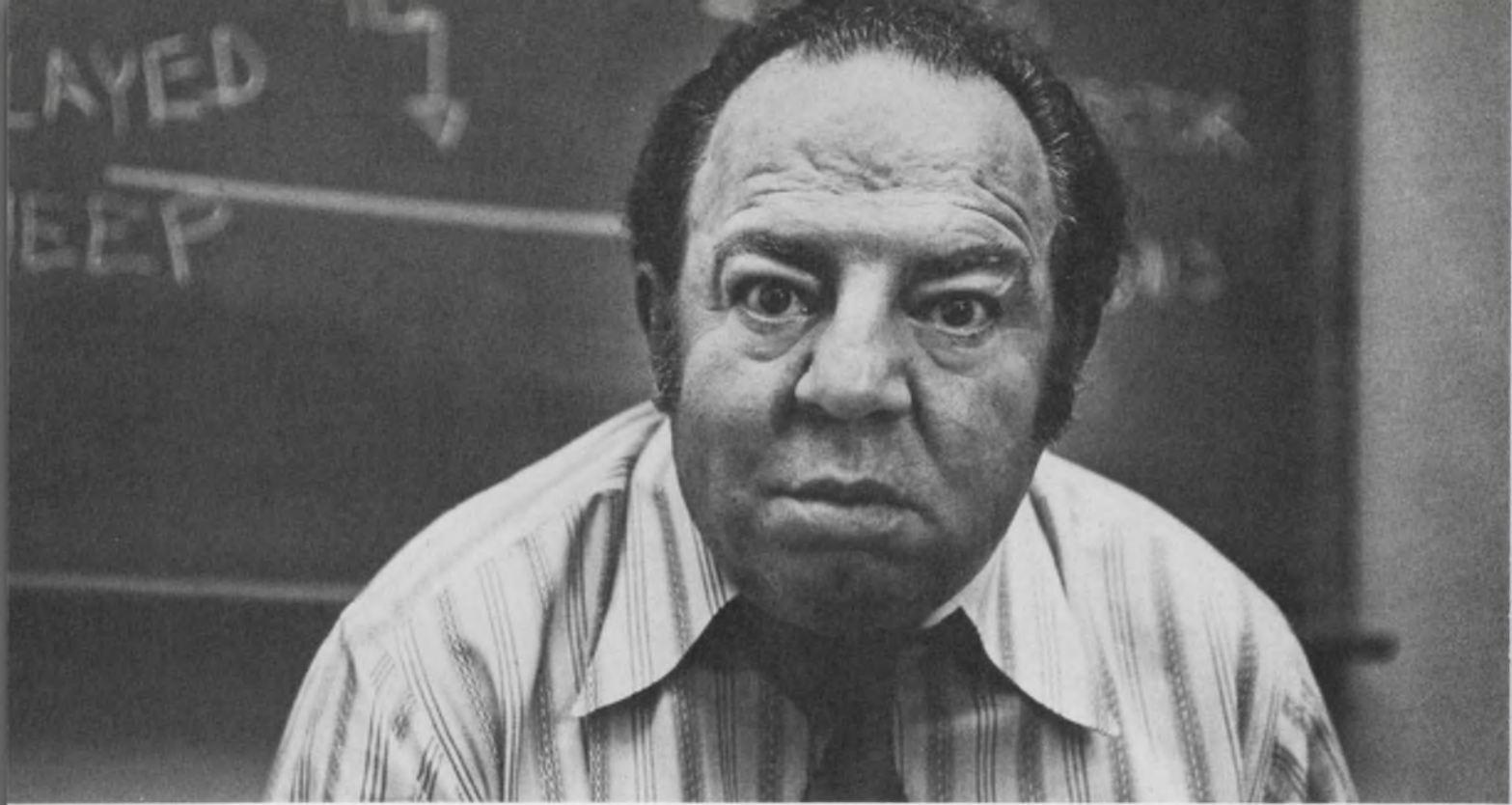

**“Sure I’m nervous.  
We’re due to start production  
in eight months and it’s taking  
three vendors to get the ROM  
organizations and patterns we need.  
“If any one of them  
falls through, we’re up the creek.”**

## **Give him the good news:**

You don't have to gamble any more. At AMI, we can design and produce all your ROM patterns—and run them in parallel. So you don't have to worry about compatibility, whether you need a 4K x 4, 512 x 10, 2K x 4, or a 64 x 9 x 7 character generator. And being the Number One MOS company, you don't have to sweat out the prototyping and production of that final ROM, because we finish them up at the same time. On time. For further information, write to AMI, 3800 Homestead Road, Santa Clara, CA 95051.

Phone (408) 246-0330.

Or ask your distributor.

**AMI**  
AMERICAN MICROSYSTEMS, INC.

# It takes a lot of ROMs to make them right.

We've been building ROMs for over four years. In that time, we've developed 1500 individual ROM patterns—more than anyone else in the business.

As the Number One MOS ROM company in terms of volume and product variety, we can handle all your ROM needs. We cover all the bases, whether your application is for code conversion, microprogramming, or character generation.

And we give you other advantages, like the best data rate in the industry (2MHz), the densest circuits (up to 16K), TTL compatibility and a choice of dynamic or static, custom or standard.

So the next time you're planning a product that needs plenty of ROMs and no production delays, remember this: if we didn't deliver, we wouldn't stay on top. And that's where we intend to stay.

## Some typical ROM specifications from an untypical MOS company.

P/N	Size	Organization	Power Supply (V)	Data Rate (MHz)	Access (ns)	Power (mW)	Directly Replaces
S8457	1536	128X12	+5, -12	1.0	1000	1000	
S8499	2240	64X5X7	+13, -13	0.5	2000	400	TMS 4100
S8564	4032	64X9X7	+5, -12	2.0	450	1000	
S8614	2560	512X5	+5, -12	2.0	450	1000	
S8771	5120	512X10	+5, -12	2.0	450	1000	
S8772	4096	512X8	+5, -12	2.0	450	1000	
S8773	2560	256X10	+5, -12	2.0	450	1000	MK 2400
S8865	8192	2048X4	+5, -12	0.5	1.3	600	SIG 2580
S8866	4032	64X7X9	+5, -12	2.0	450	1000	
S8996	16384	4096X4	+5, -12	0.6	1400	300	SIG 2580
S8996	16384	2048X8	+5, -12	0.5	1800	300	

# AMI

## ICs & SEMICONDUCTORS

### Hybrid ICs provide dual regulation

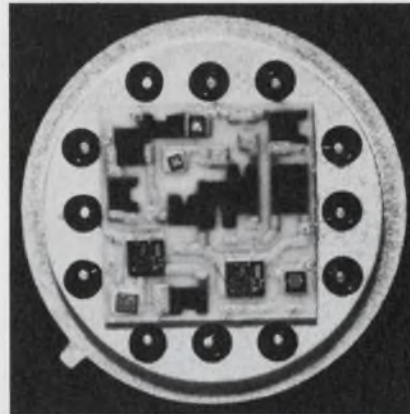

Beckman Instruments, 2500 Harbor Blvd., Fullerton, Calif. 92634. (714) 871-4848. \$20 (1-9).

The Series 843 voltage regulators are dual-tracking hybrid units with output voltages preset to  $\pm 12$  or  $\pm 15$  V ( $\pm 0.5\%$ ). The negative regulator output tracks the plus output within  $\pm 10$  ppm/ $^{\circ}$ C over the  $-55$ -C-to- $125$ -C temperature range. Line regulation is  $\pm 0.005\%/V$  and load regulation is  $\pm 0.005\%$  (no load to full load of 300 mA). The unit's TO-8 package meets MIL-STD-883 specs.

CIRCLE NO. 265

### 10-V regulator outputs 200 mA

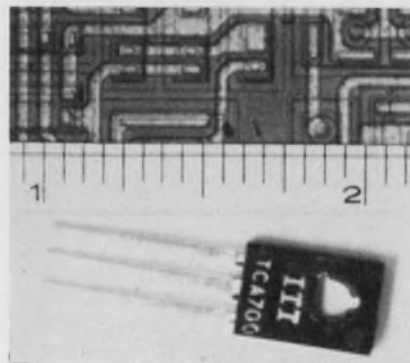

ITT Semiconductors, 3301 Electronics Way, West Palm Beach, Fla. 33407. (305) 842-2411. \$2.05 (100-999).

A compact voltage regulator, the TCA 700, features internal short-circuit and thermal-overload protection. With an input voltage of 12 to 16 V, the regulator provides a 10-V output within 1/4 V. With heat sinking, the TCA 700 can provide 200 mA at 85 C. The regulator comes on a SOT-32 package.

CIRCLE NO. 266

### Programmable op amp features low noise

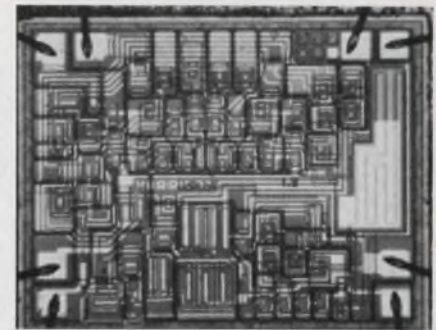

Harris Semiconductor, P.O. Box 883, Melbourne, Fla. 32901. (305) 727-5407. \$3.30 to \$8.80 (100 up).

An internally-compensated current-programmable op amp—the HA-2720—permits the tailoring of characteristics by use of a single external resistor. Slew rates can range from 0.06 to 6 V/ $\mu$ s while gain bandwidths extend from 5 kHz to 10 MHz. Dc programming offers supply voltages of  $\pm 1.2$  to  $\pm 18$  V, supply currents of 1  $\mu$ A to 1.5 mA, bias currents from 0.4 to 50 nA and output currents up to 15 mA. Typical input current noise is only  $0.7 \times 10^{-27}$  A<sup>2</sup>/Hz.

CIRCLE NO. 267

### Regulator ICs feature plastic packaging



SGS-ATES Semiconductor, 435 Newtonville Ave., Newtonville, Mass. 02160. (617) 969-1610. \$1.40 (100-999); stock.

Three-lead integrated voltage regulators—the L129, 130 and 131—are available in TO-125 plastic packages. The L129 gives an output voltage of 5 V with an input voltage of 7.5 to 20 V. The L130 gives an output of 12 V with the input ranging from 14.5 to 27 V and the L131 provides an output voltage of 15 V with the input voltage ranging from 17.5 to 27 V. The devices can supply a typical regulated current of 850, 720 and 600 mA, respectively. The circuits have a load regulation of less than 1% and a typical ripple rejection of 60 dB.

CIRCLE NO. 268

## 4-k NMOS RAM combines high speed and low power

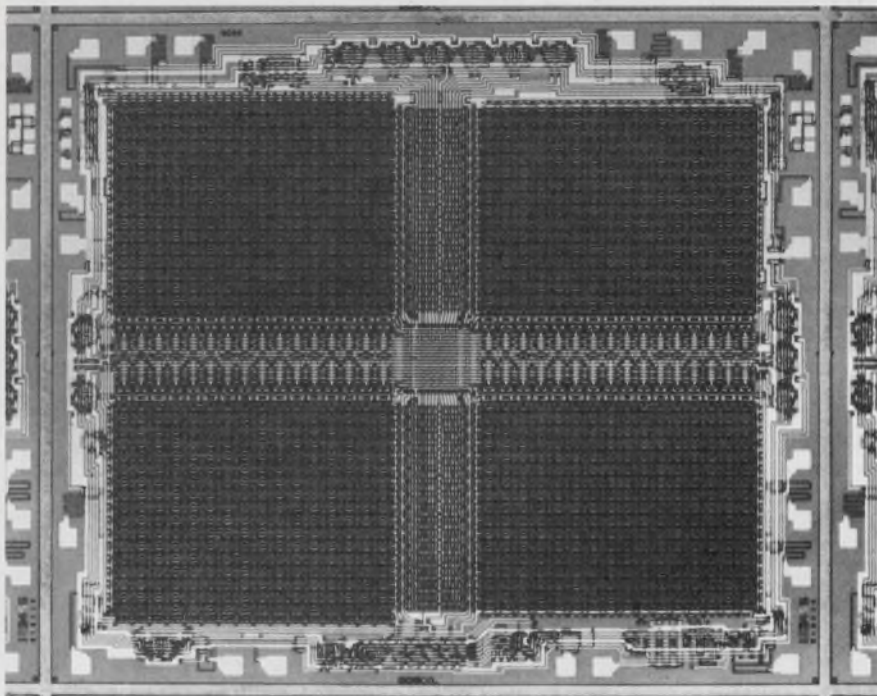

Motorola Semiconductor Products, P.O. Box 20912, Phoenix, Ariz. 85036. (602) 244-3466. 6605: \$40; 6605-1: \$33.30 (25-99); Factory stock.

The latest 4-k, n-channel RAM—Motorola's MC6605—takes the lead in both high speed and low power. The IC combines a maximum access time of 230 ns with an active power drain of 70  $\mu$ W/bit. These values represent the fastest access and lowest dissipation of any 4096-bit n-channel silicon-gate random-access memory (see "4096-Bit RAMs Making the Scene as an Alternative to Core—Finally," ED No. 3, Feb. 1, 1974, p. 40).

Furthermore the new RAM already has an alternate source in a company that co-developed the 6605 with Motorola—American Microsystems, 3800 Homestead Rd., Santa Clara, Calif. 95051.

Other pace-setting specs include the fastest read and write cycle times—350 and 450 ns minimum, respectively—and the fastest read/modify/write time—470 ns mini-

mum. The RAM requires only 32 cycles every 2 ms for refresh, compared with 64 cycles every 1 to 4 ms for other 4-k NMOS RAMs. The reduced refresh requirements result in a read/write "down" time of only 0.6%.

The 6605 RAM uses a three-transistor cell structure, which Motorola says is more reliable than the one-transistor cell used in other 4-k RAMs. The 6605 chip measures 168  $\times$  195 mils. It dissipates 5 nW per bit in a standby mode; with refresh, the dissipation becomes 0.5  $\mu$ W per bit. Total active dissipation is 400 mW.

Except for the single high-level clock, all address and control lines are TTL-compatible. Address and data lines also contain latches on the chip. And three-state outputs don't require external sense amplifiers.

Like most other 4-k RAMs, the 6605 comes in a 22-pin DIP. However, a feature of the pinout is the placement of all power connections at the corner pins. This simplifies power bus runs on large

memory-circuit boards.

A lower-priced version of the Motorola 4-k RAM—the 6605-1—relaxes the access and cycle-time specs. Access time increases to 300 ns, while read and write cycle times become 450 and 550 ns, respectively. The read/modify/write cycle time is 550 ns.

Both the 6605-1 memory and the premium model operate from +12 and  $\pm$ 5-V power supplies (at corner pins). They exhibit an input capacitance of 5 pF and a clock capacitance of 20 pF. The ICs operate over the 0-to-70-C temperature range.

For even faster applications, Motorola plans to introduce a speedier 4-k RAM. Called the MCM 6606, the IC will feature an access of 190 ns and ECL-compatible output.

CIRCLE NO. 254

## Schmitt-trigger ICs sustain battery reversal

Sprague Electric, 115 Northeast Cutoff, Worcester, Mass. 01606. (617) 853-5000.

A series of Schmitt-trigger ICs can sustain battery reversal indefinitely without damage. Four devices are offered—two single and two dual ICs in eight-pin mini-DIP plastic packages. All circuits operate over a supply voltage range of 2.2 to 6.0 V and a temperature range of  $-40$  to  $+100$  C. The ULN-3303M can switch a 75-nA resistive load with less than 50-nA input current. The ULN-3304M has a zener-diode clamped output and can control a 150-nA load with less than 50-nA input current. Two ULN-3303M devices are contained in the ULN-3305M. The ULN-3306M has zener-diode clamped output for driving inductive loads and contains one 3304M device and a second Schmitt-trigger circuit.

CIRCLE NO. 269

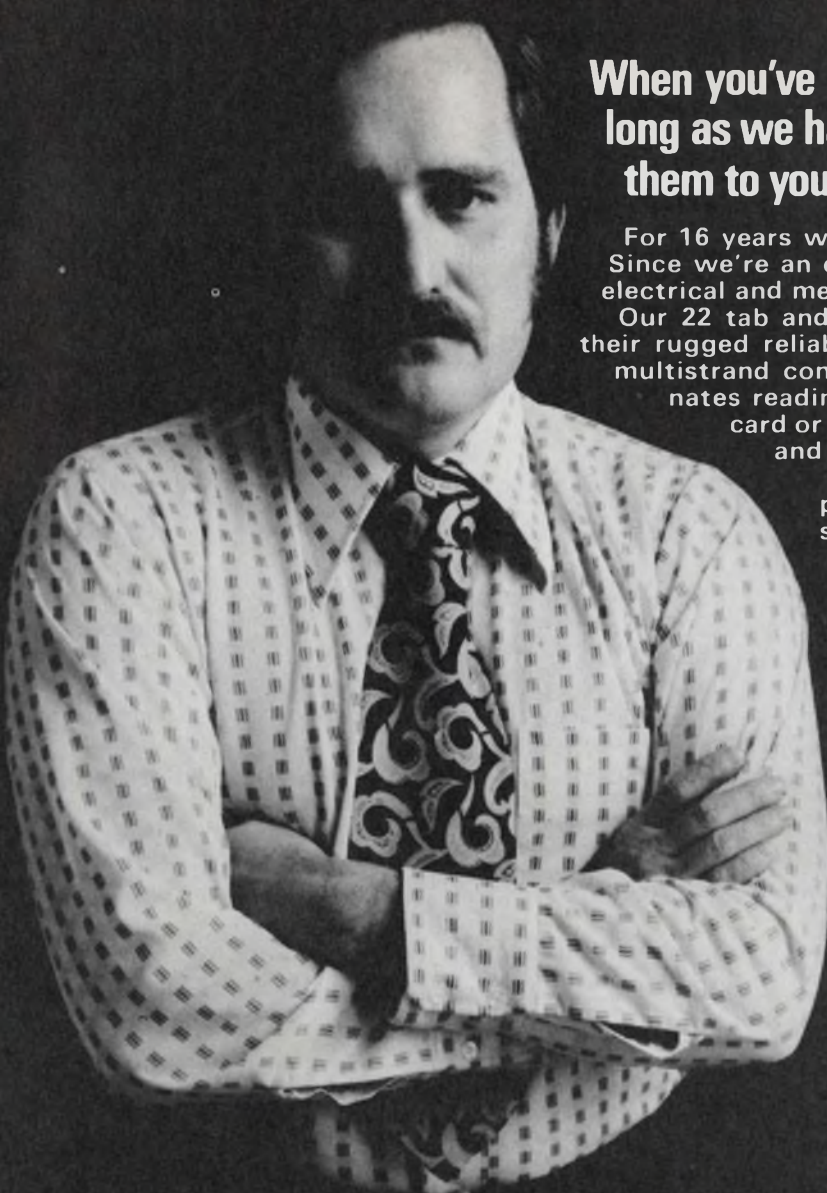

**When you've made static card readers for as long as we have, you've learned how to tailor them to your customer's specific needs.**

For 16 years we've been a static card reader specialist. Since we're an electronics company, we understand the electrical and mechanical aspects of card readers.

Our 22 tab and 80 column card readers are known for their rugged reliability and accuracy. We owe that to the multistrand continuous brush design. This design eliminates reading errors caused by contaminants on the card or misalignment. Cards are locked into place and released only when the scan is completed.

You can select from a variety of electronic packages to interface the reader to your system. There are packages like TTL-compatible scanners with two operating modes, sequential scanning and addressable by column number.

Many of our competitors do not want to be bothered with the reader modifications customers ask for. Not us. This is one of the major advantages of specifying a Hickok static card reader. In the sixty years we've been in the electronics business, we've learned how to work closely with our customers. We have years of experience in tailoring our card readers to meet our customer's specific needs.

Put our 16 years of card reader experience to work on your data input and collection problems. Find out how we can solve your card reader problems. Call our application engineers today.

# **HICKOK**

---

**the value innovator**

Instrumentation & Controls Division  
The Hickok Electrical Instrument Co.  
10514 Dupont Avenue - Cleveland, Ohio 44108  
(216) 541-8060 - TWX: 810-421-8286

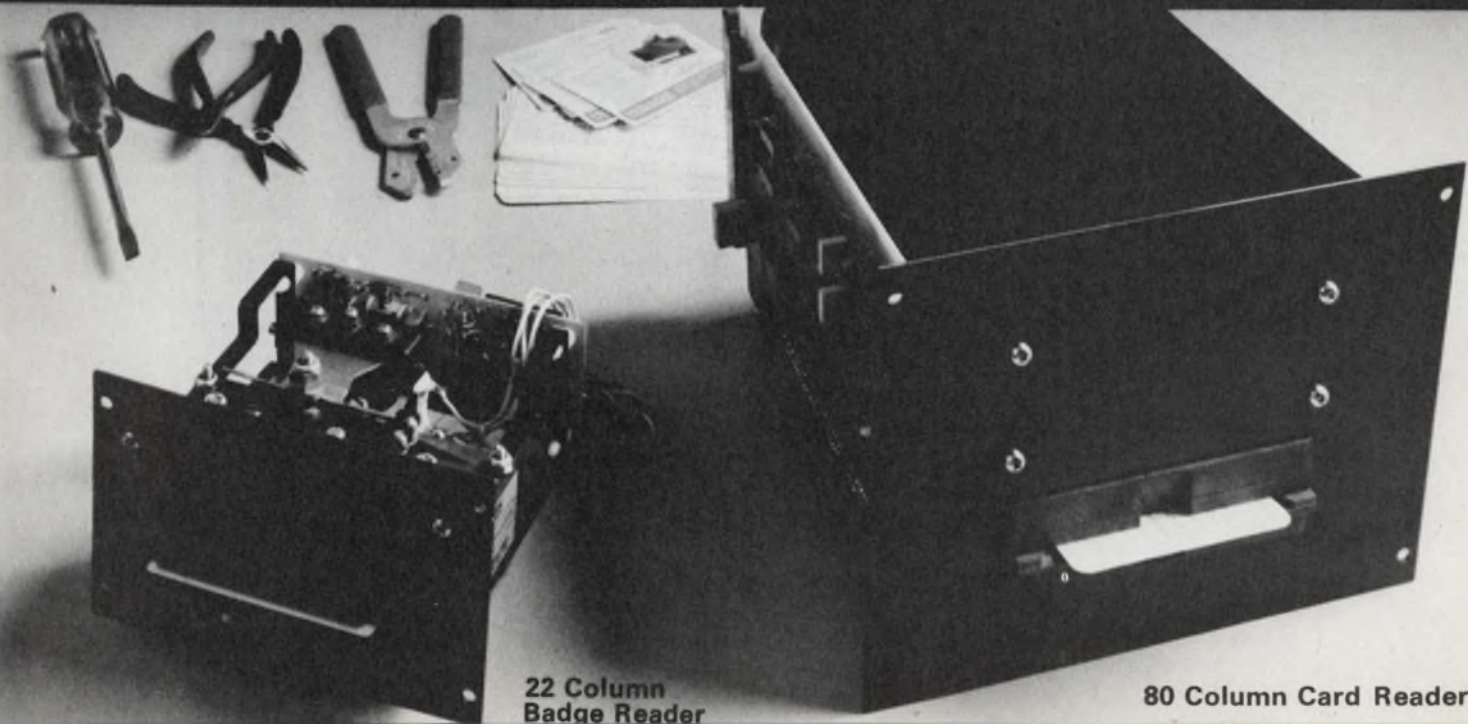

**22 Column  
Badge Reader**

**80 Column Card Reader**

### High voltage multipliers accept inputs of 1000 V

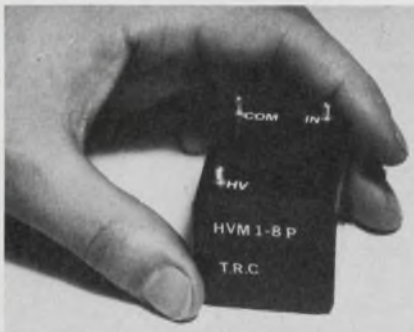

Tripp Research, 15231 Quito Rd., Saratoga, Calif. 95070. (408) 354-1916. From \$26.70; stock to 5 wk.

The HVM series of voltage multipliers will accept peak inputs up to 1000 V ac at frequencies from 10 kHz to 25 kHz. These units will multiply by 2, 4, 6, 8 or 10 times and deliver a dc output voltage. Load regulation is better than 7% and peak-to-peak ripple is 3% maximum at full load.

CIRCLE NO. 270

### V/f converters deliver outputs to 100 kHz



Teledyne Philbrick, Allied Dr. at Rte. 128, Dedham, Mass. 02026. (617) 329-1600. From \$79 (1 to 9); stock.

The 4709 series of 100 kHz v/f converters includes four active temperature-trimmed modules. The units have an extremely low drift (6 ppm/°C maximum for the 4709-03), a low nonlinearity (typically ±0.001% full scale plus ±0.004% of signal) and a wide dynamic range (typically 6 decades or 1,000,000 to 1). Full-scale temperature coefficient ranges from 6 ppm/°C for the 4709-03 to 44 ppm/°C for the 4709. The series also has a current input terminal and a package size of 2 × 2 × 0.4 in.

CIRCLE NO. 271

### FET-input op amp slews at 1000 V/μs

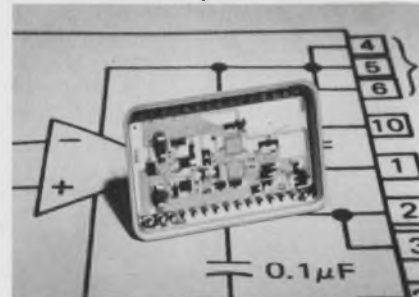

Beckman Instruments, Helipot Div., D962, Fullerton, Calif. 92634. (714) 871-4848. \$125 (1 to 9).

Model 825 FET-input op amp has a 1000 V/μs slew rate. It comes housed in a hermetically sealed, MIL performance, hybrid package. The unit has a full-power bandwidth of 10 MHz and can deliver 100 mA of load current. Other performance features include a ±3 mV offset, a 100 pA maximum bias current, a ±75 μV/°C maximum offset drift, and a 35 MHz unity gain bandwidth. Model 825 also settles to 0.01% in 300 ns.

CIRCLE NO. 272

## Two-for-One Money Saver New from Monsanto.

### 1. It's A Function Generator!!

- Frequency Range 10Hz to 1MHz
- Setability and Resolution to 0.1Hz with digital display
- Low Distortion—typically 0.1%
- Functions: Sine, Square and Offset Square Waves
- Attenuator—3,20db sections plus vernier to 4VRMS

### 2. It's A Counter!!

- Frequency Range 5Hz to 15MHz
- Six gate times for resolution to 0.1Hz
- 4 Digit LED display with memory
- Input sensitivity, 50mV RMS
- Crystal Controlled Time Base



It's A Function Generator/Counter!! Only \$445.

United Systems Corporation, 918 Woodley Road, Dayton, Ohio 45403 (513) 254-6251

A Subsidiary of

# Monsanto

DEMONSTRATION, CIRCLE 249  
ELECTRONIC DESIGN 8, April 12, 1974

## Analog multiplexers accurate to 0.025%

Transmagnetics, Inc., 210 Adams Blvd., Farmingdale, N.Y. 11735. (516) 293-3100. Model 2204: \$175; Model 2208: \$225 (1 to 9); stock to 3 wk.

Models 2204 and 2208 are compact dual 4 and dual 8-channel analog multiplexers. Up to 128 dual channels can be handled by combining these multiplexers. They have a full scale accuracy of  $\pm 0.025\%$  maximum. Settling time is typically  $3 \mu\text{s}$ . Gain of all channels is  $0.9995 \pm 0.0005$ . Drift is  $\pm 25 \mu\text{V}/^\circ\text{C}$  maximum. Frequency output is 150 kHz for full output or 5 MHz for small signal bandwidth. Both units can be supplied to operate in ambient temperatures of 0 to  $+70^\circ\text{C}$  or  $-55^\circ\text{C}$  to  $+85^\circ\text{C}$ .

CIRCLE NO. 273

## Bin level controller uses modulated LEDs



Automation Products Manufacturing, Inc., 2600 N.W. 1st Ave., Boca Raton, Fla. 33432. (305) 391-1881. From under \$100.

The 35CJ or 35CJT (time delay model) bin level controls are used in conjunction with projectors and receivers to monitor high and low level beams which are interrupted by product buildup. The 35CJT model allows a 0 to 10 s adjustable time delay on detection of either high or low level. This system functions with equal efficiency in darkness, brilliant sun, or artificial light. It also can operate in ambient temperatures to 170 F.

CIRCLE NO. 274

## NO ONE CAN MATCH OUR LINE-UP



PC MOUNT



INSULATED FEED-THRU



SINGLE ROW STANDARDS



DOUBLE ROW STANDARDS

NEW



THERMOPLASTIC PC MOUNT

NEW



THERMOPLASTIC INSULATED FEED-THRU



QUICK-CONNECT KLIPTITES™



MILITARY BOARDS



STUD AND TURRET



SNAPBLOCKS™  
(Sectional Terminal Blocks)

# Kulka

A NORTH AMERICAN PHILIPS COMPANY

Kulka Electric Corp., 520 South Fulton Avenue, Mount Vernon, New York 10551

### KULKA'S AUTHORIZED INDUSTRIAL DISTRIBUTORS

- |                                   |                                   |                                    |
|-----------------------------------|-----------------------------------|------------------------------------|
| AZ—Phoenix, Parts Elex.           | MD—Baltimore, Radio Elec. Service | OH—Cleveland, R.P.C. Inc.          |
| CA—Los Angeles, Fisher/Brownell   | MD—Hyattsville, Milgray/Wash.     | OH—Cleveland, Pattison Supply      |
| CA—Los Angeles, Radio Products    | MA—Dedham, Gerber Elex.           | OH—Columbus, Hughes-Peters         |
| CA—Mountain View, Ratel Elex.     | MA—Newton, Green-Shaw Co.         | OH—Dayton, John A. Becker Co.      |
| CA—Santa Clara, Fisher/Brownell   | MI—Augusta, Great Lakes Elex. Co. | OK—Oklahoma City, Electro Enterp.  |
| CO—Denver, Denver Walker Radio    | MN—St. Paul, Ragon Elex.          | PA—Erie, Mace Elex.                |
| CT—Fairfield, "U" Tronics         | MO—Kansas City, Walters Radio     | PA—Harrisburg, Pyttronics Inc.     |
| CT—Waterbury, Bond Radio Elex.    | MO—St. Louis, L-Comp              | PA—Philadelphia, Simco Elex.       |
| FL—Ft. Lauderdale, Peerless Radio | NB—Lincoln, Scott Elex. Supply    | PA—Pittsburgh, R.P.C. Inc.         |
| FL—Miami, Electronic Equip. Co.   | NJ—E. Rutherford, Kappe Elec.     | PA—Pittsburgh, Cameradio           |
| FL—Winter Park, Electronic Equip. | NM—Albuquerque, Industrial Elex.  | PA—Reading, Geo. D. Barbey Co.     |
| GA—Atlanta, Brownell Electro      | NM—Albuquerque, Walker Radio Co.  | SC—Columbia, Dixie Radio Supply    |
| IL—Chicago, Merrill Elex.         | NY—Buffalo, Summit Dist.          | TX—Dallas, Adleta Elex.            |
| IL—Rockford, Mid-West Assocs.     | NY—Elmsford, Melville Radio Corp. | TX—Dallas, Solid State Elex.       |
| IL—Rosemount, Advent Elex.        | NY—Farmingdale, Arrow Elex.       | TX—Houston, Southwest Elex.        |
| IL—Westchester, L-Comp Inc.       | NY—Lynbrook, Peerless Radio Corp. | UT—Salt Lake City, W. H. Bintz Co. |
| IN—Indianapolis, Graham Elex.     | NY—Mt. Vernon, QAR Indl. Elex.    | VA—Charlottesville, Virginia Radio |
| IN—So. Bend, Radio Dist. Co.      | NY—New York, Center Indl. Elex.   | WA—Seattle, Radar Elec. Co.        |
| IA—Cedar Rapids, Deeco Inc.       | NY—New York, Midway Indl. Elex.   | WA—Tacoma, C & G Elex. Co.         |
| IA—Des Moines, Mid-State Dist.    | NY—Rochester, Simcona Elex.       | WV—Beckley, Halley Elex. Co.       |
| KS—Wichita, Radio Supply Co.      | NY—Rochester, Summit Dist.        | CAN—Downsview Ont., Cesco Elex.    |
| ME—Portland, Holmes Elec. Supply  | NC—Winston-Salem, Kirkman Elex.   | CAN—Montreal Quebec, Cesco Elex.   |
|                                   | OH—Cincinnati, Hughes-Peters      |                                    |

### Fault monitoring system detects power problems

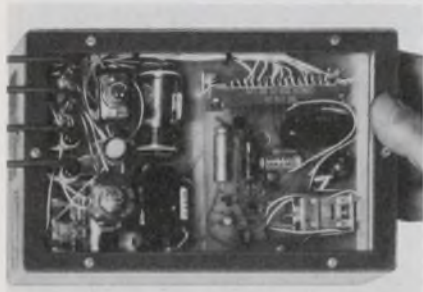

Eltron, 22 Market St., Bramwell, W. Va. 24715. (304) 248-8263.

A ground circuit monitoring system, Model GM-101, can monitor a variety of circuits, including high voltage on-pole and bore hole feeder cables, underground feeder cables, underground distribution equipment, trailing cables and more. The system consists of a transmitter which generates a low cycle signal, and impresses it on the conductors to be monitored. A companion receiver "listens" for the signal. If a fault occurs, the transmitter's control circuitry causes the supply breaker to trip and drop out. Power requirements are minimal, ranging from dc to 550 V ac, 100 W. Under normal operation, a built-in recharging system keeps small self-contained emergency power batteries at full charge. In event of a fault, the system switches to battery power and continues to monitor for approximately four hours. The system weighs less than 3 lb. and measures only 8-1/2 x 5-1/2 x 3 in.

CIRCLE NO. 275

### Voltage level detector has 20 $\mu$ V sensitivity

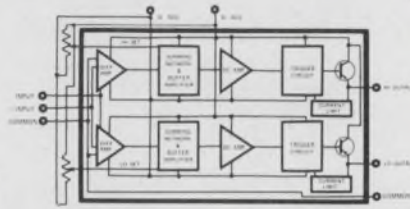

Calex, P.O. Box 555, Alamo, Calif. 94507. (415) 932-3911. \$94.

The Model 512A Voltensor, a solid-state voltage level detector, has a differential input and a sensitivity of better than 20  $\mu$ V. Two independently adjustable trip points and two separate, high level outputs are provided. The unit is available as a module or already mounted on a PC card which includes trimmer pots, pin connector and several relays.

CIRCLE NO. 276

### Eight-pole active filter covers 1 Hz to 20 kHz

Frequency Devices, 25 Locust St., Haverhill, Mass. 01830. (617) 374-0761. From \$75 (100 up).

Models 756L8B, 756L8L, 757L8B and 757L8L are eight-pole low-pass Butterworth and Bessel active filters. They are available with (-3 dB) cutoff frequencies from 1 Hz to 20 kHz. Specifications include: Passband insertion loss of 0.02 dB, 2% cutoff frequency accuracy, 1  $\Omega$  output impedance, offset voltage of less than  $\pm 2$  mV (adjustable to zero), offset drifts of  $\pm 60$   $\mu$ V/ $^{\circ}$ C and output noise of less than 75  $\mu$ V.

CIRCLE NO. 277

### Signal conditioning amp has three gain ranges

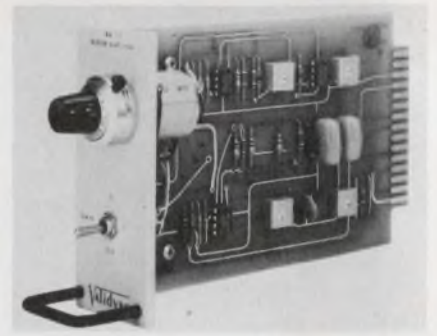

Validyne Engineering, 19414 Londerlius St. Northridge, Calif. 91324. (213) 886-8488. \$125; stock.

A signal conditioning amplifier plug-in module, BA112, provides a high impedance, differential input for ac and dc signals, and a low impedance, single-ended output. Over-all gains of 10, 1 and 0.2 are obtained by a three position toggle switch. Additionally, the gain may be varied from zero to 100% at each gain setting with a 10-turn, calibrated control. Output is high level,  $\pm 10$  V at 10 mA maximum. There is no damage if output terminals are shorted. Output impedance is less than 10  $\Omega$ . Frequency response is flat from dc to 10 kHz while the common-mode rejection is 60 dB typical, dc to 1 kHz and may be further increased by internal adjustment. The offset voltage is nominally zero although a small change is possible with gain settings. There is separate internal adjustment at each amplifier. The input bias current is 0.02  $\mu$ A typical. The temperature range is 0 to 160 F, zero shift is  $\pm 20$   $\mu$ V/ $^{\circ}$ F referred to input and span shift is 0.005%/ $^{\circ}$ F.

CIRCLE NO. 278

**ANA & LOG**

OH, LOG, WHAT ARE YOU GOING TO DO? HIT-OR-MISS-HARRY WANTS TO GUN YOU DOWN TO SETTLE THAT 16 BIT SCORE.

NEVER FEAR, MY DEAR, WITH MY TRUSTY A-856 I'LL FINISH HIM OFF IN 8U.S.

MY GOODNESS, YOU'RE FAST!

AND ACCURATE; THE A-856 DOES IT ALL.

**intech** INCORPORATED (408) 244-0500  
1220 COLEMAN, SANTA CLARA CA 95050

**ANALOGY**

BEAT THE BAD GUYS WITH THE A-856 A/D HIGH SPEED CONVERTER. RESOLVES 1:65,536 WITH CONVERSION SPEED OF 8 $\mu$ S. THAT'S 125,000 SAMPLES PER SECOND! TEMPERATURE STABILITY OF  $\pm 5$  PPM/ $^{\circ}$ C, LINEARITY  $\pm 10$  PPM.

**intech** INCORPORATED (408) 244-0500  
1220 COLEMAN, SANTA CLARA CA 95050



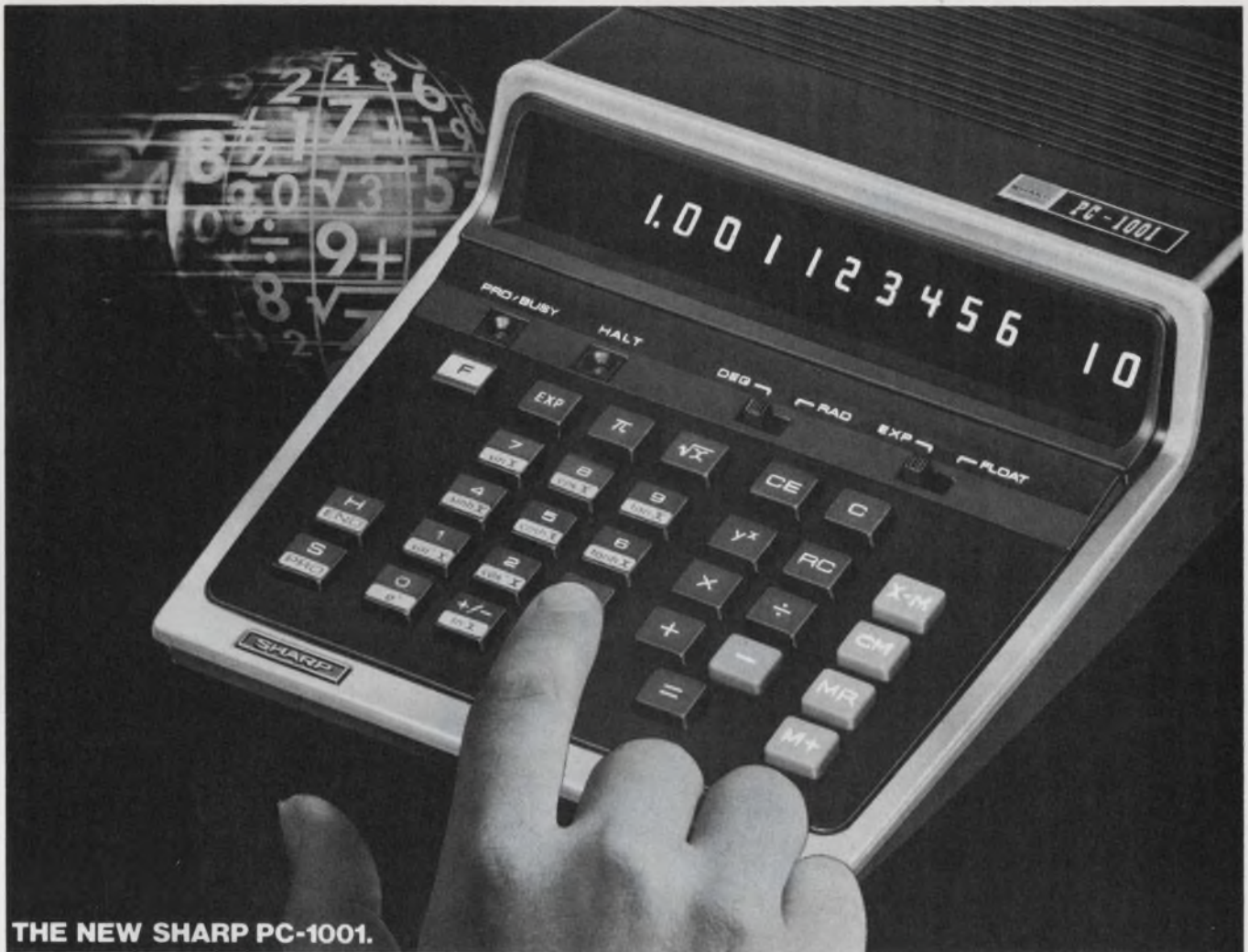

**THE NEW SHARP PC-1001.**

For fast, accurate answers to complex everyday scientific and engineering problems—count on Sharp's new PC-1001. Because not only is the PC-1001 ideal as a desktop, scratch pad, scientific, programmable calculator...it also features a 10-digit display that automatically operates in scientific notation. Results of the functions can be computed in degrees or radians at the touch of a switch.

With the PC-1001, difficult programming of functions is already incorporated. So you compute instantly with just a one-touch key operation. A total of "15" different scientific functions are hardwired in, including trigonometrical, inverse trigonometrical, hyperbolic, exponential, and logarithmic. In addition, 64 steps of programming or 8 registers are available for formula and equation evaluation. And you can use both decimal point positioning systems. Both the floating decimal point and the exponential system—with scientific notation capacity from  $10^{-99}$  to  $10^{99}-1$  and 0. The PC-1001 also features a new simplified keyboard operation.

**THE SCIENTIFIC PROGRAMMABLE BIG ENOUGH FOR YOUR DESKTOP AND SMART ENOUGH**

**TO OPERATE IN SCIENTIFIC NOTATION.**

**FROM**



**THE COMPANY THAT CREATED THE INDUSTRY™**

And here's one for the road...it's the new SHARP mini scientific calculator. Tuck this 12.3 oz. Battery Portable in your pocket and take it with you on field trips, construction sites...wherever—and for whatever you need a quick scientific answer. With 8 digits and a memory,



this ultra portable PC-1801 incorporates all the essential scientific functions including hard-wire mini programs specifically suited to the engineer. Phone toll-free (800) 447-4700 for nearest Sharp Dealer. In Illinois (800) 322-4400. Or just mail the coupon today.

Sharp Electronics Corporation, Dept. ED-4  
10 Keystone Place, Paramus, N. J. 07652  
Gentlemen: Please send me full information on Sharp's PC-1001 and PC-1801.

Name \_\_\_\_\_ Company \_\_\_\_\_  
Address \_\_\_\_\_  
City \_\_\_\_\_ State \_\_\_\_\_ Zip \_\_\_\_\_

### Active telephone-tone filters are low cost

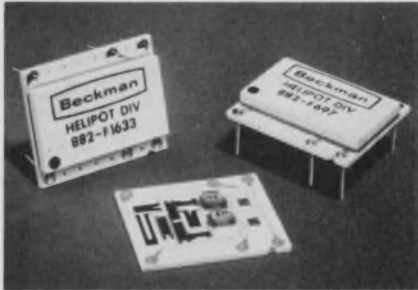

Beckman Instruments, Helipot Div., D962, Fullerton, Calif. 92634. (800) 437-4677. \$12 (1 to 9).

Series 882 telephone tone filters are pretuned bandpass active filters.  $F_0$  is preset ( $\pm 0.5\%$ ) to a standard tone frequency of 697, 770, 852, 941, 1209, 1336, 1477, or 1633 Hz, and  $Q$  is preset to  $18 \pm 10\%$ . Also, gain is preset to unity at the bandpass center frequency. Each unit has an input impedance of 30 k $\Omega$  and can supply  $\pm 2$  mA output current with less than 1  $\Omega$  output impedance. The  $F_0$  temperature coefficient is less than  $\pm 100$  ppm/ $^\circ\text{C}$  over 0 to 70 C.

CIRCLE NO. 279

### Voltage regulator cards make simple supplies

ERA Transpac Corp., 311 E. Park St., Moonachie, N.J. 07074. (201) 641-3650. \$14; stock to 30 day.

The RR series of circuit card voltage regulators is available in a choice of voltage outputs of 5, 6, 12, 15 or 24 V dc with maximum current ratings of 150 mA or 1 A. Unregulated dc input voltage can go as high as 35 V and regulator drop-out voltage is 5 V or less. Ripple reduction factor is greater than 40 dB. Input regulation is within  $\pm 0.1\%$  and load regulation within 0.3%. The response time is less than 50  $\mu\text{s}$  for a 10 to 100% load change. The regulators can operate over an ambient temperature range of  $-20$  to  $+71$  C and have a temperature coefficient of better than 2 mV/ $^\circ\text{C}$ . All components are accessible for adjustment or servicing. Size of the 150 mA design is 1-1/8  $\times$  2-3/16  $\times$  3/8 in. and it weighs 3 oz. The 1 A models are 1-5/16  $\times$  2-7/16  $\times$  1/2 in. and weigh 5 oz.

CIRCLE NO. 280

### Measure changes in tilt from 0.0003 degree

Columbia Research Labs, Woodlyn, Pa. 19094. (215) 532-9464. \$250; 2 wk.

The Series 701 inclinometers use a force balance principle. They provide an electrical output proportional to the angle of inclination from 0.0003 to 90°. Input requirements are  $\pm 15$  V dc.

CIRCLE NO. 281

### Power line protection predicts line overloads



Weston Instruments, P.O. Box 3041, Sarasota, Fla. 33578. (813) 958-0811. Typical \$7510; 4 mo.

A thermal-overload relay can protect high and medium voltage overhead lines from deterioration caused by excessive temperature rise. It can also anticipate line failures prior to their occurrence. The PSLS relay includes an analog model which reproduces the thermal condition of the line and calculates the instantaneous cable temperature from the following parameters: load current, cable thermal time-constant, line heating curve, ambient temperature and preselected solar radiation conditions. The cable temperature is displayed by a meter on the front of the device, or at a remote location. Two independent outputs are provided, one to alarm in the 40 to 80 C range, the other to trip in the 50 to 100 C range. An optional plug-in module calculates the time remaining before tripping, based on present line conditions, to permit gradual implementation of emergency procedures.

CIRCLE NO. 282

### V/f converters deliver outputs to 100 kHz

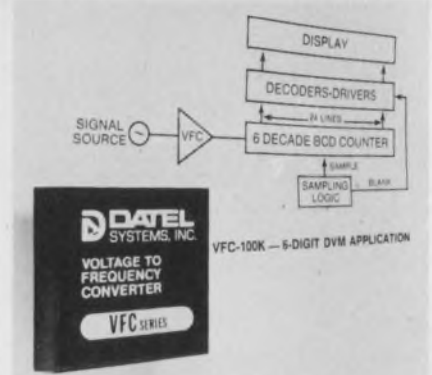

Datel Systems Inc., 1020 Turnpike St., Canton, Mass. 02021. (617) 828-6395. VFC-10K: \$89, VFC-100K: \$109; stock.

The Model VFC-100K voltage-to-frequency converter has an output frequency of 0 to 100 kHz and the Model VFC-10K has an output frequency of 0 to 10 kHz. The analog input may be either a voltage (0 to +10 V) or current input (0 to +1 mA). The output is TTL or CMOS compatible and the waveform is a fixed width negative going pulse. Voltage to frequency conversion is performed with a transfer accuracy of 0.01% and with a zero to full scale linearity of 0.005% for the VFC-10K and 0.01% for the VFC-100K. The temperature coefficient of both units is 20 ppm/ $^\circ\text{C}$ . Step response is within one output cycle of the new frequency. Both models are housed in 2  $\times$  2  $\times$  0.4 in. plastic packages with DIP compatible pinning. Power consumption is  $\pm 20$  mA at  $\pm 15$  V dc.

CIRCLE NO. 283

### Modular active filters cover 1 Hz to 20 kHz

Frequency Devices, 25 Locust St., Haverhill, Mass. 01830. (617) 372-6930. \$57 (100-up).

Models 723H6B and 724H6B six-pole high-pass Butterworth active filters are available with preset cutoff frequencies ( $-3$  dB) from 1 Hz to 20 kHz. Specifications include passband insertion loss of 0.05 dB, 2% cutoff frequency accuracy, 1  $\Omega$  output impedance, offset voltage of less than  $\pm 2$  mV (adjustable to zero), offset drifts of  $\pm 20$   $\mu\text{V}/^\circ\text{C}$  and output noise of less than 75  $\mu\text{V}$ .

CIRCLE NO. 284

If time is your business, you need Burroughs' new PANAPLEX™ clock panels\* for clear, legible display. In two character heights (0.5" and 0.7"), four or six digits per panel, with AM/PM indicator, for maximum design flexibility. Easy to see and read; wide viewing angle; low power requirements; compatible with MOS circuits; assured long life and dependability because PANAPLEX clock panels are backed by Burroughs' years of pioneering technology and manufacturing know-how . . . and they are available at competitive prices. Time will tell how much that means to you and your customers. For more information, write Electronic Components Division, P.O. Box 1226, Plainfield, N.J. 07061, or call (201) 757-3400 or (714) 835-7335.

*\*Sample quantities of panels available immediately.*



INFORMATION RETRIEVAL NUMBER 77

Burroughs



## Fast d/a converters can drive 100 mA load

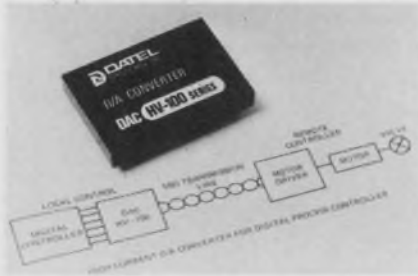

Datel Systems, 1020 Turnpike St., Canton, Mass. 02021. (617) 828-6395. From \$235 (1 to 9); stock.

The DAC-HV-100 series of d/a converters has a settling time of 50 ns while driving a 100 mA load at 5 V. The high-speed high-drive capability allows the units to directly drive 50  $\Omega$  transmission lines. The series consists of three standard versions with 6, 8 or 10-bit input resolution. Accuracy of these units is 0.1% of full scale, linearity is  $\pm 1/2$  LSB and the temperature coefficient is  $\pm 100$  ppm/ $^{\circ}$ C. Long term stability of these converters is specified at  $\pm 0.5\%$  per year. Inputs are standard TTL positive true logic levels. Power requirements are  $\pm 15$  V dc at  $\pm 70$  mA max (all bits off) with a power supply rejection ratio of 0.1%/V. The 2  $\times$  3  $\times$  0.375 in. modules operate in a temperature range of 0 to 70 C. In addition, two extended operating temperature ranges from  $-25$  to  $+85$  C and  $-55$  to  $+85$  C are offered as options.

CIRCLE NO. 285

## Logic pulse divider uses true binary control

Banner Engineering Corp., 1247 Hopkins Crossroad, Hopkins, Minn. 55343. (612) 544-3164.

The Model BIC-256P is a logic module for high-speed batch-counter operation. It receives, registers and stores sequential input pulses that are generated either by a photoelectric, proximity or other mechanical switch. This module produces one output pulse for every preset number of up to 255 input signals, with an adjustable time range from 0.02 to 1 s. It requires from 9 to 16 V, 50/60 Hz or 12 to 20 V dc, 4.5 W. Output is 15 V dc, 0.25 A maximum.

CIRCLE NO. 286

## Displays come in single or multidigit arrays

Apollo Corp., No. 465, SUWA, Takatsu-Ku, Kawasaki, Japan. From Yen 3250.

The DN series of Newtron digital displays are available in various tube sizes and arrays. The display circuits are TTL compatible and operate from 5-V-dc supplies. The typical current requirement is 105 mA at an operating frequency of 10 MHz. Operating temperature range for the single and multidigit arrays is 0 to 70 C. Options are available for the single digit arrays, starting with the basic display tube and the decoder/driver, to the tube with decoder/driver, counter and latch. The multidigit arrays also have options starting with the decoder/driver.

CIRCLE NO. 287

## Linearized bridge amp uses platinum sensors

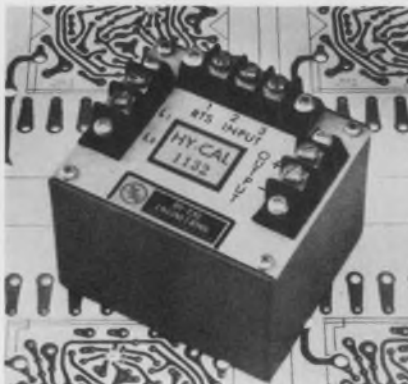

Hy Cal Engineering, 12105 Los Nietos Rd., Santa Fe Springs, Calif. 90670. (213) 698-7785.

The Model SC-2878 linearized bridge amplifier consists of a bridge network, amplifier, constant current power supply, and linearization for platinum resistance thermometers. The system provides an output voltage which is directly proportional to temperature over a specified range. It is compensated for ambient temperature changes from 0 to 120 F. Zero and span adjustments are provided, using separate potentiometers. The 1132 is designed for use with a three-wire, 100  $\Omega$  platinum resistance sensor. For short lead lengths of 10 ft. or less, a two-wire sensor may be used. Operating ranges are available from  $-165$  to 0 C to 0 to 540 C.

CIRCLE NO. 288

# TURN OFF OR ON, in due time.



Time delay is precise, compact, and cheap with this new S-D plug-in family of hybrid relays. Choose from "on" delay, "off" delay, repeat cycle, and monitor timers, all designed specifically for industrial environments. All have transient-protected solid state timing circuits that remain accurate over wide variations of voltage and temperature. Timing is adjustable from 0.1-10, 0.6-60, or 1.8-180 seconds. DPDT relay contacts handle 10 amp loads with complete input/output isolation at minimum cost.

Don't delay getting this 150 page relay catalog which tells all about timers and other relays. Check reader service card number for your copy.



**STRUTHERS-DUNN, INC.**  
Pitman, New Jersey 08071  
Canada: Struthers-Dunn Relay Div.,  
Renfrew Electric Co. Ltd.

# relays renewed

Two more of the over 800 relay applications submitted last year to Struthers-Dunn's 50th Anniversary Relay Contest. These thought starters are a small sample of the endless possibilities for relay-operated systems. This month's circuits use three different members of S-D's growing family of 12-pin plug-in industrial relays.

## TEMPERATURE-CONTROLLED SAFETY INTERLOCK

The interlock circuit of Figure 1, submitted by JWS of McKeesport, Pennsylvania, protects electric furnace operators by cutting off high frequency power following the heating cycle. The heating cycle is under control of a cam programmer operated by motor M.

R1 is a two-coil latch relay, such as S-D type MRRNL2A reed relay or electromechanical type A255XBXP, depending upon load contact requirements. R2 may be any DPST reed or electromechanical relay, such as S-D type MRRN2A or 219XBXP.

SW1 and SW2 are temperature-controlled switches, shown in the low-temperature start-up position. Pushbutton PB1 energizes latch relay R1, completing the circuit through external limit switches to allow furnace operation and powering the program drive motor.

During the heating cycle, as the temperature approaches the high end of the program, SW1 opens so that the R1 release coil can not be energized. Approximately 10 degrees higher, SW2 closes to energize relay R2.

When the temperature peaks out and starts down, switch SW2 opens, but relay R2 remains energized through its own holding contacts. Approximately 10 degrees lower, switch SW1 re-closes and energizes the R1 release coil. This drops out both relays and the program stops until manually restarted by pressing pushbutton PB1. The program can be stopped at any time by pushbutton PB2.

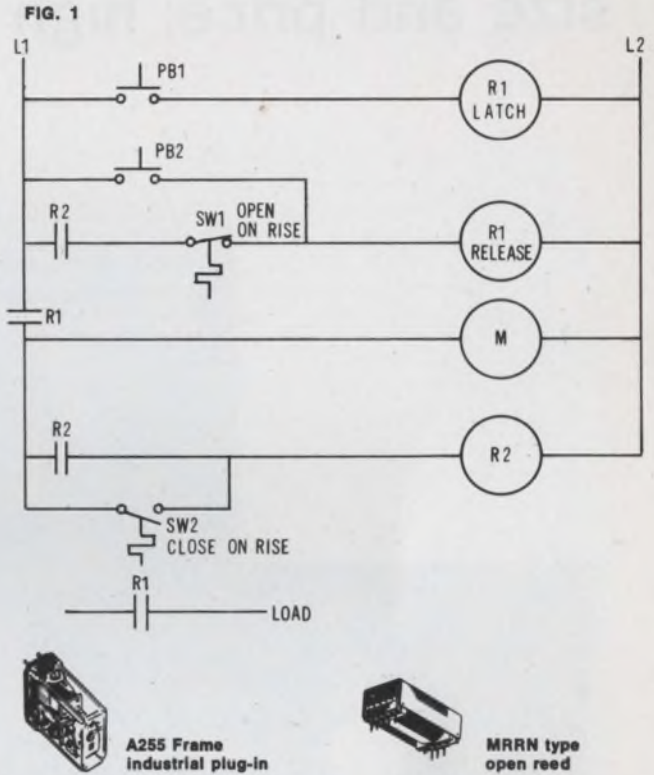

## SIMPLE PUMP ALTERNATOR WITH A PLUS

A Struthers-Dunn Frame 211 sequence relay offers an economical way of equalizing the usage of two pumps, according to ZAP of Sulphur, La. In his automatic level control, Figure 2, float switch A operates one of two pumps to maintain the desired level. When one pump can't keep up with demand, float switch B cuts-in the second pump. The stepping action of sequence relay RA1 helps increase motor life by alternating operation between pumps A and B to provide approximately the same amount of operating time for each pump. Relay R1 carries the load to increase the operating life of float switch A.

RA1 should be our Type 211XBXP which transfers contacts when de-energized. It's a close relative of the Type 219XBXP recommended for R1. Both use our rugged, 12-pin industrial socket.

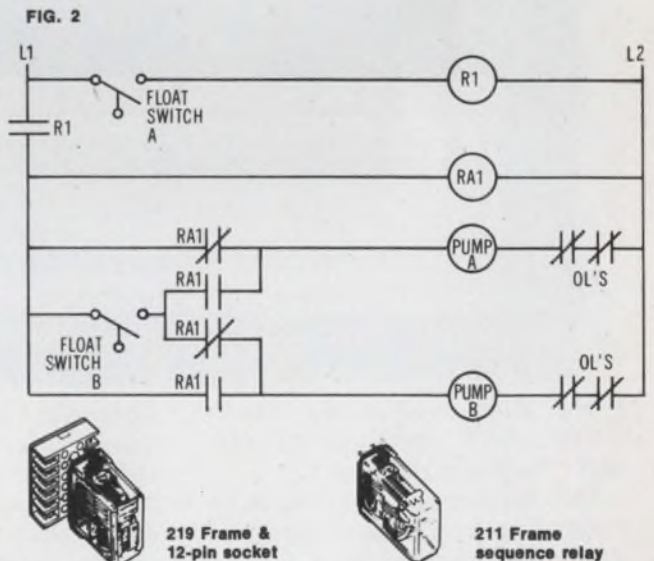

Struthers-Dunn Relays Are Stocked by Over 125 Distributors



# STRUTHERS-DUNN, INC.

PITMAN, NEW JERSEY 08071

Canada: Struthers-Dunn Relay Div., Renfrew Electric Co., Ltd.

INFORMATION RETRIEVAL NUMBER 79

1974 Catalog specs over 100 basic relays—EM, Reed, Hybrid, Solid State—plus solid state Programmable Controllers. Circle reader service card with number below for your copy.



## Floppy-disc drive scores low in size and price, high in capability

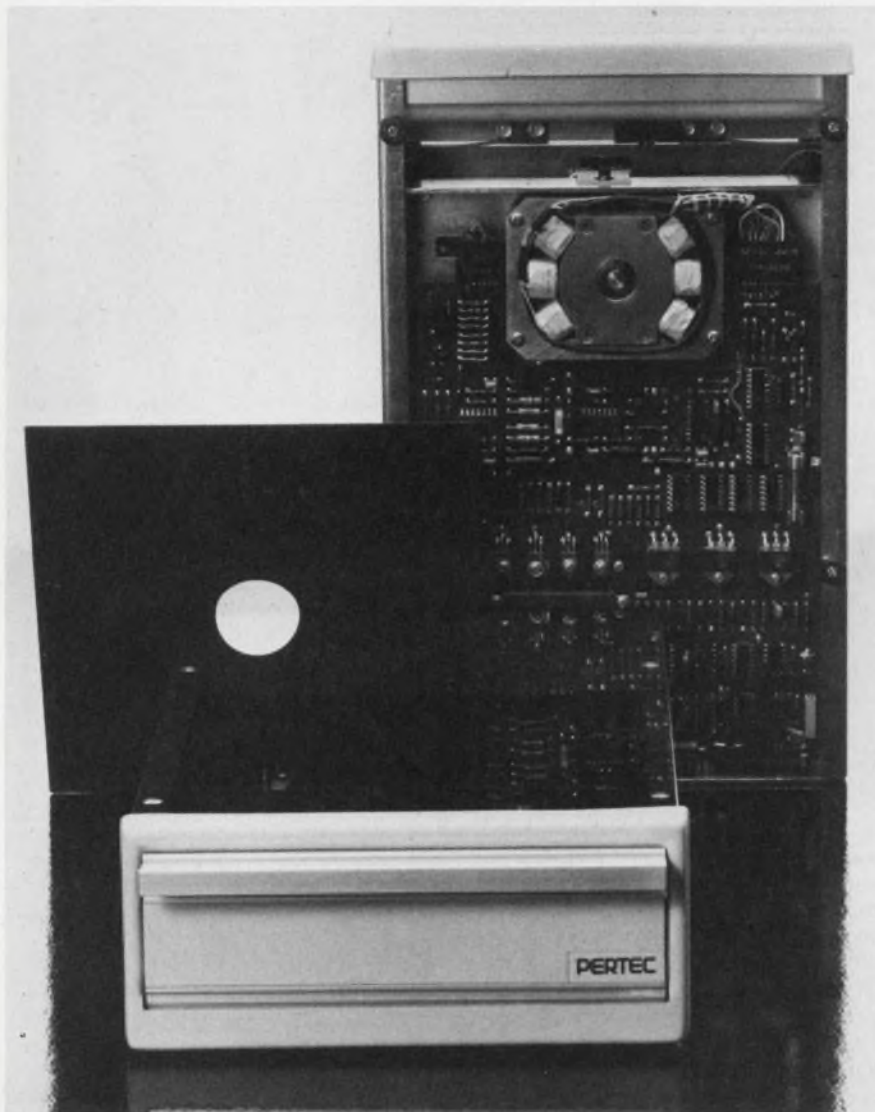

Pertec, 9600 Irondale Ave., Chatsworth, Calif. 91311. (213) 882-0030. See text; 30 day.

The smallest and least expensive floppy-disc drive is the D0330 from Pertec. It measures 3.5 × 8.75 × 14 in. and weighs 10 lb.

The flexible-disc drive costs \$650 in 1 to 99 quantities and drops to \$475 for 100 to 249. This is at least 20% cheaper than for comparable quantities of any other drive available.

Like several other drives, the

D0330 is IBM-compatible. That means that the disc is an IBM Diskette or equivalent that costs \$8 or less and that data recorded on an IBM 3740 or 3540 system can be played back on the D0330, and vice versa.

Unlike most drives the D0330 operates with only dc power supplied. A brushless dc motor rotates the disc at 360 rpm. This motor was designed inhouse by Pertec to deliver speed accuracy of ±1.5%.

Each disc contains 77 tracks on an 8-in-diameter format. There are 48 tracks/in., each track with a width of 0.012 in. With no formatting, the disc has a capacity of 3.2-million bits. With formatting to IBM standards, the capacity drops to 1.95-million.

The packing density is 6631 bits/radian and the recording code is double frequency. The data-transfer rate is 250,000 bits/s maximum.

Access times include track-to-track seek time of 10 ms; average latency of 83.3 ms; start and stop times of 3 s; head settling time of 10 ms at the last track addressed; and head loading time of 20 ms max. When the disc is inserted or unloaded the recording head moves to about 30 mils above the disc. During a stand-by condition, a command can also unload the head, for increased head life—a unique feature of this drive.

A soft error rate of 1 per 10<sup>9</sup> bits minimum and a hard error rate of no worse than 1 per 10<sup>12</sup> bits is assured. Accuracy is related to head positioning. This D0330 drive uses a head-positioning motor that is a stepping motor with three steps per track. All competing drives offer only one step per track.

Outputs from the drive are all TTL-compatible. There is no separation of clock from data pulses. No formatting and no controller are included in the basic price. An optional board, for about \$100, gives data separation, addressing and status signals. For a small additional charge, the front panel can be color-coordinated.

The drive operates over +10 to +42 C with a 20-to-80% range of relative humidity. Its dc power requirements are: +24 V ±10% at 2 A; +5 V ±5% at 1 A; and -5 V ±10% at 0.1 A.

CIRCLE NO. 253

# "CANNON'S PRESS-T-MATE CONNECTORS GOT US CONNECTIONS AT

# HALF THE COST, and we congratulations all around!"

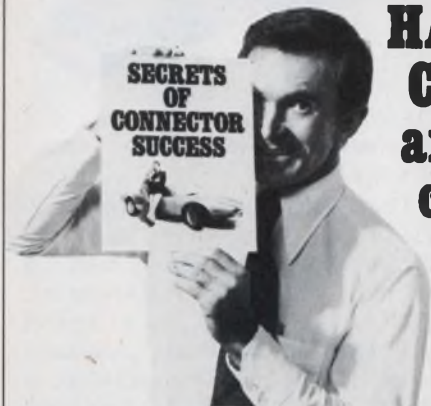

"Because PRESS-T-MATE eliminates the cost of wire wrapping and the disadvantages of soldering, it saved us a bundle. See why in 'Secrets of Connector Success'. It's a 'how to' book for 'can do' guys like us."

Contact ITT Cannon Electric, International Telephone and Telegraph Corporation, 666 East Dyer Road, Santa Ana, CA 92702. (714) 557-4700.

## CANNON ITT

INFORMATION RETRIEVAL NUMBER 81

### ABSOLUTELY

the world's most accurate rulings using vacuum deposit chrome, etch and fill or emulsion processes. They're produced on the world's largest 1 micro inch numerically controlled ruling engine with interferometric feedback controls. Need precision scales, grids, slits, reticles, Ronchis numbers, letters, circles, dots, or nickel mesh? We stock many items for immediate delivery. Send for brochure No. 38-36.

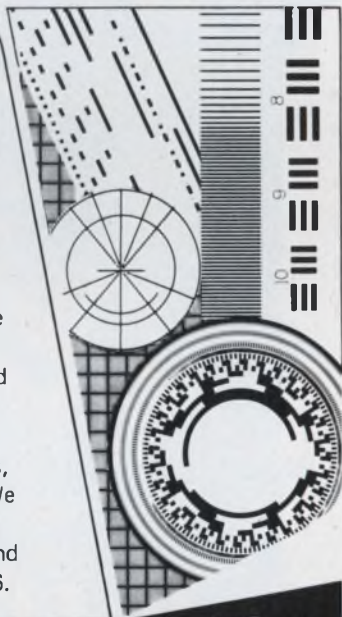

## SCALES RULINGS RETICLES & GRIDS FROM THE WORLDS LEADING SCALE MAKERS.

**MICRO-LINE**  
DIVISION OF  
**BAUSCH & LOMB**

JAMESTOWN, NY 14701 716/488-1958

INFORMATION RETRIEVAL NUMBER 82

INFORMATION RETRIEVAL NUMBER 83 ►



## Licon takes the "butterflies" out of pioneering.

By putting its double-break, double reliable Butterfly® switches to work in radar tracking stations around the world.

If you are doing some pioneering on your own, such as the initial design of equipment requiring lighted pushbutton switches, put the Licon team to work for you.

The same quality and reliability required to track the endless reaches of space are yours in every Licon® switch you specify.

Licon's lighted pushbutton switches are offered in a wide variety of switching configurations, button styles and current capabilities.

Your Licon representative or distributor has a switch solution for you.

**ITW LICON**

Division Illinois Tool Works Inc.  
6615 W. Irving Park Road  
Chicago, Illinois 60634  
Phone (312) 282-4040  
TWX 910-221-0275



# LICON

## puts ideas to work in electronics

The Innovative Electronic Group of ITW...

LICON ■ ELECTRO MATERIALS ■ PAKTRON

© ILLINOIS TOOL WORKS INC. 1974

DATA PROCESSING  
**EAROM card  
stores 1-k bytes**

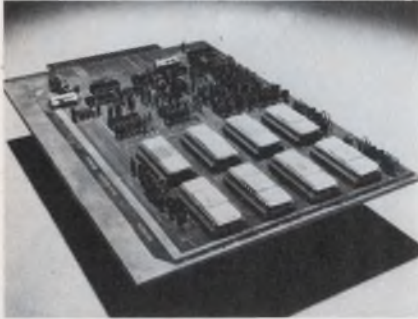

*Nitron Corp., 10420 Bubb Rd.,  
Cupertino, Calif. 95014. (408) 255-  
7550. \$995.*

The NIT-80T memory card offers 8-k of EAROM organized as 1 k × 8. Address, data I/O and control signals are compatible with TTL and CMOS levels. Read access is 20 μs; write time is 1.2 ms. The units provide indefinite storage without power (to 125 C) and require no clocks or refresh cycles. All reprogramming is done electrically through standard TTL/CMOS inputs.

CIRCLE NO. 289

**Rotational limits set  
from keyboard controller**



*Astrosystems, 6 Nevada, Dr., Lake  
Success, N.Y. 11040. (516) 328-  
1600.*

The ASI programmable limit switch replaces rotary cam-operated switches. A set of pushbuttons on the control panel allows independent user selected limits between 0 and 359.9 degrees in 0.1-degree increments. The limits can be changed even while the controller machine is in operation. The unit, which is remote from the angle transducer, provides outputs in the form of logic levels, relay contacts or solid-state switches and displays the actual shaft angle.

CIRCLE NO. 290

**Data collection system  
has card output**



*Varifab, 1700 Putnam Ave., Old  
Greenwich, Conn. 06870. (203)  
637-1434.*

The Series 600 Data Recorder-Vari-Punch is a source data collection system that can be matched to individual user requirements. The system consists of a control unit with up to three automatic input devices cable-connected to a Model 404 Vari-Punch. The control unit handles any combination of a 10-switch digital array; a 10-column badge or card reader and a time clock. Input rate is 12-columns/s. Manual information can also be entered on the Vari-Punch keyboard. Output data are punched and printed on standard 80-column tab cards or tab-card sets.

CIRCLE NO. 291

**In this corner...  
Deltrol Controls'  
Series ME Solenoid-  
The bantamweight tubular  
that packs a  
knockout punch**

Deltrol's compact tubular-type Series ME solenoids are designed to provide the highest force available where space is limited. These dependable linear type units are ideal for a virtually unlimited range of applications in the automotive, appliance, computer and machine control industries. Series ME solenoids are particularly well suited for use in airborne equipment because of their excellent performance/weight ratio. Rugged magnetic metal enclosures are highly resistant to shock, vibration, moisture and corrosion. All solenoids incorporate precision-fitted metal plunger guides for trouble-free operation of many million cycles over a wide temperature range. Five standard types are offered in diameters ranging from 7/16" to 1" with several lengths available. Standard solenoids are designed for normal operation at Class B (130° C) coil temperatures, but are also offered in Class H (200° C) ratings. Coil voltages range from six to 120 VDC. Units are available in either push or pull functions with or without spring return plungers.



**DELTROL**  
*controls*

Division Of Deltrol Corp.

2745 South 19th Street,  
Milwaukee, Wisconsin 53215,  
Phone (414) 671-6800,  
Telex 2 6871





## Closed-circuit monitor detects changing scene

Siemens, Box 3240, D-8520, Erlangen, West Germany.

The Telemat closed-circuit TV monitor unit stores the original scene and compares it with the new images for change. When a discrepancy is detected, audio and visual alarms are generated. In the associated electronics, the picture is resolved into 3200 points. When anyone of these points changes, marks appear on the screen to indicate the place where the image changed. The system is sensitive enough to detect smoke as well as intruders.

CIRCLE NO. 292

## Pocket calculator solves engineering problems

Texas Instruments, P.O. Box 5012, Dallas, Tex. 75222. (214) 238-3741. \$169.95; stock.

The highly advanced SR-50 slide rule calculator with scientific notation can process a wide range of problems from simple arithmetic to complex scientific calculations. The unit performs simple arithmetic, reciprocals, squares, square roots, nth powers, nth roots, factorials, trigonometric and hyperbolic functions (sine, cosine, and tangent), inverse trigonometric and hyperbolic functions, common and natural logarithms, and  $e^x$ . Two state-of-the-art MOS ICs built with ion-implantation technology provide the computational power required for the SR-50. One of the ICs, an arithmetic chip (233 × 240 mils), is considered to be the most complex IC ever produced. The other is one of the largest ROMs in existence (200 mils square) with 13,312 bits of memory storage. Answers are calculated to 13 significant digits and rounded 10 significant digits when displayed. The SR-50 uses all 13 significant digits for subsequent internal calculations. Answers are computed and displayed as large as  $\pm 9.99999999 \times 10^{99}$  and as small as  $\pm 1.00000000 \times 10^{-99}$ . A portable calculator, the SR-50 comes complete with vinyl carrying case and a fast-charge (3 hours) rechargeable battery pack that provides four to six hours of operation.

CIRCLE NO. 293

# What you should know about SLIMSWITCHES



### SERIES 23000 SNAP-IN SLIMSWITCH

- A List prices start at \$2.50 per switch module, (or only 25¢ per switch function, avg. ...less than most toggle, pushbutton, lever, slide or rotary switches.
- B Snap-in mounting cuts installation costs by eliminating mounting holes and hardware and lets you relax your panel cut out tolerances.
- C The molded-on bezel stops installation "headaches" by covering irregular panel cut outs, chipped paint, and scratches.
- D They're only .315" (8mm) wide, so you can put more switches into a given space. That's why we call 'em SLIMSWITCHES.
- E Our unique assembly strap lets you put switch assemblies together fast, without tools.
- F Why not stock parts and build your own switch assemblies? Or we'll assemble them for you at no extra cost.
- G Plenty of output code options, too!
- H They're good for a million detent operations. Just like more expensive switches.

They're built by DIGITRAN the originators of the DIGISWITCH the first switch of its type anywhere and that's your guarantee of high quality for the price.

There is a Digitran authorized distributor and a sales engineering group in your area. Call them, or send for details about the new SLIMSWITCH today.

More Digitran products are shown on pages 1148 and 1149, Vol. 2, of your 1973-74 EEM Directory.

ANOTHER SWITCH FROM THE  
**DIGITRAN**<sup>®</sup>  
COMPANY  
Division of Becton, Dickinson and Company [B.D.]  
855 South Arroyo Parkway / Pasadena, Ca. 91105  
Phone: (213) 440-3110 TWX 910-588-3794

## Process control system is also easy to use

*Siemens AG, D-8520 Erlangen, Postfach 3240, West Germany.*

Compatible subsystems provide open-loop control, closed-loop control and computing functions. The Teleperm-Telepneu 300 system includes electrical and pneumatic controller stations of the indicating and recording type as well as process recorders, process indicators and other switchboard instruments for process automation. The electrical and pneumatic units have the same design (dimensions and controls) making it quite easy to intermix electrical and pneumatic instrumentation. The units can be removed from their castings without interruption of operation. Ergonomic considerations are an integral part of the design. For example, only the most important indicators and control devices are on the front of the units. Uniform color schemes for the indicators and the arrangements for the controls make it easy to read or operate several neighboring units in quick succession.

CIRCLE NO. 294

## Remote scanner resolves alarms to within 1 ms

*Optron, 1201 Tappan Circle, Carrollton, Tex. 75006. (214) 242-6571.*

The Model 120 event recorder is capable of scanning 2048 points in 128  $\mu$ s with no alarms present. The interrupt time required to store a status change is 10  $\mu$ s per point. Alarms occurring less than one ms apart, but greater than 400  $\mu$ s, will be printed out sequentially with 1-ms resolution. Transitions in excess of 120 events will be stored as space becomes available. The logic cabinet of the Model 120 is situated remotely and contains terminal columns, logic systems, memory, power supplies and local control panel for maintenance use. Its printer has a full alphanumeric capability on ASR-35 or other typing devices. No alarm events are lost in the event of power failure. A core memory retains information.

CIRCLE NO. 295

## System gives 19.2-k bps over voice-grade lines



*Codex Corp., 15 Riverdale Ave., Newton, Mass. 02195. (617) 969-0600. Stock.*

The CT-6 Terminal is a packaged system comprised of the 296 Bipler and two 9600C Data Modems enclosed in a single cabinet. This system provides full-duplex data transmission at speeds up to 19,200 bit/s by combining the capacity of two independent voice-grade channels, each operating at 9600 bit/s. Significant savings can be realized by use of the CT-6 with voice grade lines instead of wideband facilities previously needed for data transmission above 9600 bit/s. In addition, the CT-6 can maintain a usable communications link despite line degradation and failures. System monitor and fault isolation features permit the user to easily check performance of each element of the communication system.

CIRCLE NO. 296

## Real-time tasks run on inexpensive systems

*Modular Computer Systems, 1650 W. McNab Rd., Fort Lauderdale, Fla. 33309. (305) 974-1380. See text.*

MAX III a real-time multiprogramming system can run on a \$19,500 computer system. The system designated the II/200 includes a 64-kbyte minicomputer, a direct memory processor and a controller for TTY and paper tape reader. The software schedules and runs real-time tasks written in Fortran in three partitions—background, middleground and foreground. The software also supports multi-user basic assembly languages. A larger system, the II/220 sells for \$32,000 and includes a 5.2 M-byte disc.

CIRCLE NO. 297

## Modem on PC board operates at 1800 baud

*RFL Industries, Powerville Rd., Boonton, N.J. 07005. (201) 334-3100. \$210; 60-90 days.*

Small in size and low in cost, the Model 6385 Data Modem operates at speeds of 1200 and 1800 baud on two and four-wire Type 3002 private lines. The modem is compatible with Bell 202D Systems and offers a variety of interfaces, including EIA, CCITT, DTL/TTL, and positive neutral. Transmit frequency, transmit level, receive sensitivity, and receive bias are all adjustable. The bias control provides adjustment to zero-bias distortion. Total peak distortion, at 1200 baud back-to-back at 25 C, is typically 4%. The modem, mounted on a PC board, measures 4.713 in. wide by 8 in. long by 0.9 in. high and uses 11-to-16-V-dc power.

CIRCLE NO. 298

## Metallized polyester capacitors wound

*The Plessey Co. Ltd., Plessey Precision, Alma Rd., Ponders End, Mddx, England. (01) 804-9511.*

High output, simplicity of construction and reliability are features of the type E11794 machines for winding metallized polyester capacitors. Up to four of these machines can be controlled by one operator and they can run for 24 hours a day, with minimum downtime for reel changing. Each machine can produce up to 18.2 elements/min when winding 50-torn capacitor elements (as an example). The machine is easily preset for the number of turns required. The unit winds capacitor elements from two or four reels of film and finishes the element with a length of pressure-sensitive tape. Completed elements are ready for end spraying and soldering of lead wires. Though designed particularly for the production of tubular polyester film elements, the machine can be used with other films such as polycarbonates having similar strength characteristics. There are facilities for offsetting one film slightly from the other. The machine is supplied with four unwind mandrels and can wind and tape two capacitor elements simultaneously.

CIRCLE NO. 299



# AMATOM

## SIGNAL LUX PANEL LIGHTS

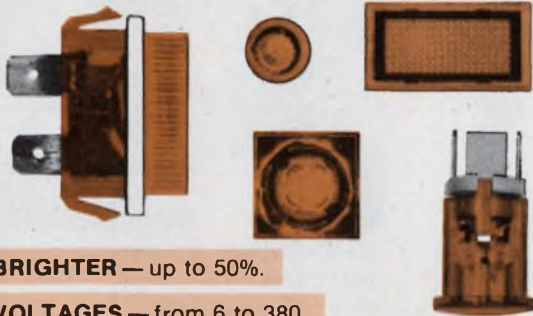

**BRIGHTER** — up to 50%.

**VOLTAGES** — from 6 to 380.

**LARGE SELECTION** of styles, sizes and colors.

**NEON, FLUORESCENT or INCANDESCENT**



**FULL LINE CATALOG AVAILABLE ON REQUEST**

**AMATOM ELECTRONIC HARDWARE CO.**  
Division of MITE Corporation      Telex: 963419  
446 Blake Street • New Haven, Conn. 06515 • (203) 397-3311

INFORMATION RETRIEVAL NUMBER 87



for design  
engineers

## new fhp motor ...and control catalog

Just published! An expanded catalog covering more than 325 stock Bodine fractional horsepower motors, gearmotors, plus controls. Helps you select and match the right motor and control for your application.

Twenty pages, 75 illustrations, tables and drawings (all drawings decimalized). Includes 14 new gearmotors, adjustable speed/torque drive systems. Optional and accessory parts for motor controls fully tabulated. Also a performance chart on K-2 motors . . . covers normal slip, high slip and synchronous motors. Ask for Catalog S-5.

**BODINE**  
fractional/horsepower  
**MOTORS**

Bodine Electric Co., 2528 West Bradley Pl., Chicago, Ill. 60618

INFORMATION RETRIEVAL NUMBER 88

ELECTRONIC DESIGN 8, April 12, 1974

# Congratulations!

## You are paying 1/3 more for your wirewrap boards...

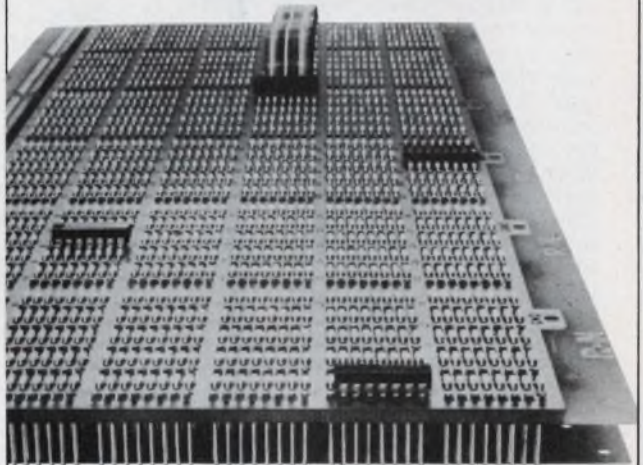

## than you should

If high cost is your measure of quality, you're paying more and getting less. Inexpensive isn't always cheap. Take RN's A-OK boards. Advanced design and engineering let us make boards more simply. And, about 1/3 less expensive than the competition. And, still offer more advantages: super-low .025" above-board profile - one-piece contact/terminal reliability - high retention of IC leads, even those just .035" long - easier (even "O") device insertion between angled lead-in arms - replaceable contact/terminals - extra heat dissipation - unobstructed visual inspection - a complete array of packaging hardware. A-OK is the most sophisticated wirewrap system available. But, all the sophistication is in the design, not the cost. RN's reputation for quality is unsurpassed. Now, we've added economy, too. It makes good sense. Think it over, then connect with...



ROBINSON NUGENT INC.  
800 EAST EIGHTH STREET  
NEW ALBANY, INDIANA 47150  
(812) 945-0211 / TWX 810-540-4082

INFORMATION RETRIEVAL NUMBER 89

MONOLITHIC CRYSTAL FILTERS

the  
State  
of the  
Art

**OF HIGHER THINGS . . .**

By international convention, the VHF frequency range extends from 30 to 300 MHz. At 30 MHz a monolithic quartz crystal filter element is about .002 in. thick and typically .25 in. in diameter. Fragile? Yes indeed. Maybe that's why only a handful of manufacturers offer crystal filters in the VHF range. Of these few, one is head and shoulders above the rest. Needless to say, that's us. (If we weren't, we wouldn't be writing this ad). Our first monolithic—way back in 1966—had a center frequency of 112 MHz. We pioneered the VHF monolithic crystal filter. And we're still pioneering. We supply production quantities of VHF monolithics at frequencies to 175 MHz. No one else can make that statement, and believe us—we're pretty high on our product.

**NOW FOR THE LOW-DOWN**

Although we're mighty proud of our VHF Monolithic Crystal Filters, much of our bread and butter is earned at lower frequencies. As low as 3 MHz in special cases. And at 10.7 and 21.4 MHz, we offer the industry's widest selection of stock model monolithic crystal filters—over 50 models in all. We can help you with all your production requirements for monolithics. More and more people are saying our low down is on the up and up.

**. . . AND WHAT TO DO WITH THEM**

Our VHF Monolithics are used as front-end filters and as up-converter filters. They're found in satellites and in commercial equipment. In the U.S. and in most other major countries of the world. In VHF two-way radios, paging receivers, and HF receivers and transmitters. And in a variety of special applications, like spectrum clean-up in frequency synthesizers.

What's your application? Whether it's one of the above or something brand-new we'll be glad to work with you. Just give us a call, or a brief note outlining your requirements. We'll take it from there.

**Pi**

Piezo Technology Inc.

2400 Diversified Way Orlando, Florida 32804  
305 425-1574

The Standard in monolithic crystal filters.

**DATA PROCESSING**

**ASCII storage terminal performs text editing**



Western Telematic Inc., 3001 Red Hill, Costa Mesa, Calif. 92626. (714) 979-0363. \$3875; 8 wks.

Designated the Data-Master I, this floppy-disc storage terminal accesses any selected line at speeds equivalent to the "carriage return" time (0.5 s) of most terminals. The unit interposes directly between existing ASCII printer/display terminals and their dataset through the RS 232 connector and in effect adds 264,000 characters to "working storage." An internal text editor simplifies corrections and updates. Organized as 2000 addressable records of up to 132 characters, each line is automatically numbered and stored with access from either the printer/display keyboard or remote processor. Edit access to the file is from a 10-key pad. Line location is constantly displayed and can be printed at the users' option. Data rates from 110 to 1200 baud are switch selectable. User selections also include Batch or Interactive modes, and a line printout width of 72, 120 or 132 characters.

CIRCLE NO. 300

**Flexible disc memory unit is IBM-compatible**

Syvor, 100 Phoenix Dr., Ann Arbor, Mich. 48104. (313) 971-0900. \$900 (100 quan); 30 days.

A flexible-disc memory that is IBM 3740-compatible, the Model 145 can store and access 250-k bytes of data (equivalent to one box of punched cards) on each side of the two discs. A stepper motor indexes the heads by one track in 2.5 ms. Average access time to a data block is 83 ms and the transfer rate is 250-k bit/s.

CIRCLE NO. 301

**Key-to-disc system has two I/O channels**



Mohawk Data Sciences Corp., Box 362, Utica, N.Y. 13503. (315) 792-2202. From \$25,000.

A shared-processor key-to-disc system designated the 1200 Key Display System includes a disc, tape drive and processor all in a single package. Each unit supports four to 12 keystations and provides a wide range of data checks and computations. A maximum of two I/O channels can be provided—one for communications and the other for a printer. Communications are half-duplex at rates up to 9600 baud. The disc provides storage for 8000, 125-character records. Tape speed is 18.75 in/s, seven or nine-track, with recording density to 1600 byte/in.

CIRCLE NO. 302

**Printing counter offers many function variations**

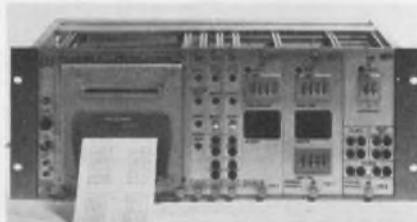

Farad Electronics AB, Nyborgsgård 1, S-126 34 Hagersten-Stockholm, Sweden.

A dual channel printing counter from AB Farad has a built-in time division multiplexer for expansion to 8 or 16 channels. The counter is controlled by either contact closures or logic level signals. The printing counter contains modules for each function: mechanical module for printing, clock and sequence unit, memory unit, timer for print intervals, start-stop controller, paper feed control and an alarm unit.

CIRCLE NO. 303

## Card reader lets program select useful fields

Digital Laboratories, 377 Putnam Ave., Cambridge, Mass. 02139. (617) 876-6220. \$3850; 30 days.

The DRC-202 card reader offers data field selection that can be changed from card-to-card under program control. This flexibility can reduce line costs and increase speed by as much as a factor of 10 for remote data transmission. The unit is plug-compatible with most minicomputers, display terminals, printers and modems. Furthermore, the control method and command code assignments allow use with virtually all current software systems from commercial time-shared and remote batch to programmable calculators. The card mechanism handles a stack of over 400 cards at 200 cards per minute. Card data are stored in a buffer so that they may be retransmitted as many times as desired.

CIRCLE NO. 304

## Program debugs Fortran source code for minis

Binary Systems, 88 Sunnyside Blvd., Plainview, N.Y. 11803. (516) 822-1585. \$200.

A program named Breakpoint allows interactive debugging of Fortran programs written for minicomputers. When operated in the interactive mode, the program allows the user to place breaks at any line of source code. The users program executes until the break is encountered. At the break, the source-code variable name and its value is examined by the user, and changes can be made if desired. The breakpoint can then be moved to another line of code and the program continued. Breakpoint contains other features such as selective printout, suppression of breaks, and other functions useful for debugging. Versions of Breakpoint are available now for IBM, DEC, Data General, Hewlett-Packard, and Mod Comp computers.

CIRCLE NO. 305

## Tester checks 30 capacitors/min

The Plessey Co. Ltd., Plessey Precision, Alma Rd., Fonders End, Mddx., England. (01) 804-9511.

The type T2730 tester subjects metallized polypropylene capacitors to a series of tests and, according to which test they have failed, separates those that are defective. The speed of testing—up to 30 capacitors per minute—makes feasible 100% testing of production batches. Capacitors are hand-loaded onto a horizontal chain conveyor which transports them past pairs of connector brushes placed along the length of the machine. Each pair of brushes connects the capacitor to one of the tests. If a capacitor fails a test, it is ejected from the conveyor by solenoid-lifted ramps. After tests that involve charging, capacitors are automatically discharged before the next test, or ejected if they failed.

CIRCLE NO. 306



## We're bringing more than 45 years of electronic experience to the world's watchmakers.

Motorola components for quartz timepieces are exceptionally reliable, because they're the result of over 45 years of experience. And that's how we're helping to solve your quartz timepiece component problems; by having products you can rely on. Inquiries about quartz componentry should be directed to Marketing Director, Motorola Timepiece Electronics, 3102 North 56th Street, Phoenix, Arizona 85018 (602) 244-4406.



**FROM  
BREADBOARD  
TO FINAL  
PACKAGING  
HARDWARE...**

**ALL AVAILABLE  
FROM ONE SOURCE**



★ **ADHESIVE BACKED  
CIRCUIT SUB-ELEMENTS**  
(Over 200 Pre-Drilled component mounting  
patterns available "off-the-shelf.")

★ **EPOXY GLASS BOARD  
MATERIALS**

- 76 Standard "Off-the-Shelf" Boards.
- Including Unclad, Copper Clad, Cut & Peel Copper Clad, Pre-etched "X-Y" Pattern and Plated thru Hole Copper Clad.
- 100" Grid Hole Pattern or Undrilled.



★ **GP CIRCUIT BOARDS and ACCESSORIES**

- Highest Quality — Choose from 74 "Off-the-Shelf" Boards.
- Sockets — Low & Standard Profile, P.C. and Wire Wrap. • Highest Quality Gold Contacts.
- Adapter plugs • Connectors
- Card Pull Handles.



SEND FOR OUR NEW CATALOGS #502 & #801

**circuit-stik**

P.O. BOX 3396 • Torrance, California 90510  
Phone (213) 530-5530

## DISCRETE SEMICONDUCTORS

### Infrared source emits over 0.4-to-5- $\mu$ m range

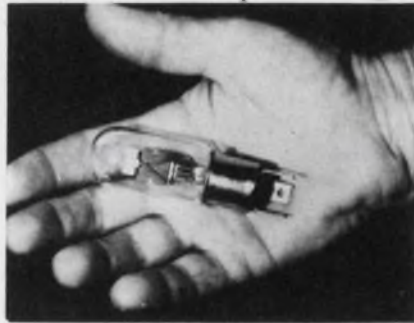

Chicago Miniature Lamp Works,  
4433 N. Ravenswood Ave., Chicago,  
Ill. 60640. (312) 784-1020.

The new lamp, Model CM8-3968, emits a 0.4 to 5- $\mu$ m spectrum, operates on a power input of 33 W at 12 V ac or dc. Its life expectancy averages in excess of 5000 h at rated voltage. Primarily for use in automotive exhaust analyzers and other pollution detecting equipment, the new lamp offers three to eight times the efficiency of standard IR sources in the 4.7  $\mu$ m wavelength necessary for carbon monoxide detection and in the 3.4  $\mu$ m wavelengths required to detect particulate matter in gases. A ceramic backplate, which is positioned next to the filament, concentrates radiation into a beam.

CIRCLE NO. 307

### FET offers 6 dB NF at 8 GHz

Plessey, Optoelectronics and Microwave Unit, Wood Burcote Way, Towcester, Northamptonshire, England.

Field-effect transistor, GAT 3, is intended for use in amplifier and oscillator applications up to X band. Performance depends upon its method of mounting. The device is available as either a chip or mounted in an LID package. Gate breakdown voltage is 10 V at  $I_g = 10 \mu$ A, while drain saturation current is 50 mA for a  $V_{ds}$  of 5 V. Cutoff voltage is 10 V and cutoff frequency is 20 GHz at  $V_{ds} = 5$  V. Common source gain is 6 dB with  $V_{ds} = 5$  V and  $V_{gs} = 0$  V. At 8 GHz, common source spot noise figure is 6 dB at  $V_{ds} = 5$  V and  $I_{ds} = 15$  mA. Total power dissipation at or below 25 C is 300 mW.

CIRCLE NO. 308

### Infrared emitting diode chip delivers 2.3 mW

RCA, Harrison, N.J. 07029. (201) 485-3900. \$0.19 (10K-up); stock.

The SG1007, a gallium arsenide infrared emitting chip, is 0.016  $\times$  0.016  $\times$  0.007 in. The SG1007 has a wavelength of peak radiant intensity of 940 nm that allows good spectral matching with silicon photodetectors. When the SG1007 is operated continuously, it provides a typical radiant flux (power output) of 2.3 mW at 100 mA.

CIRCLE NO. 309

### Green VLEDs have clear or diffused lenses

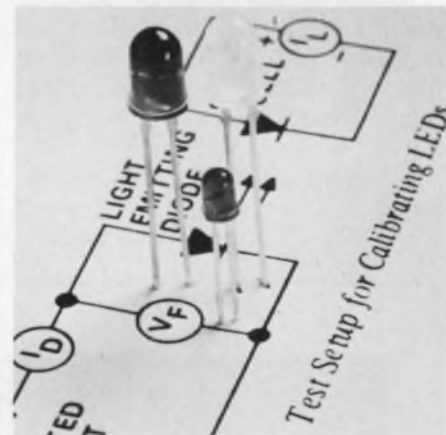

Texas Instruments Inquiry Service, P.O. Box 5012, M/S 308, Dallas, Tex. 75222. (214) 238-3741. (100-up prices); \$0.46 (211), \$0.48 (222 and 223); 4 wk.

Three gallium-phosphide green VLEDs are the TIL211, TIL222, and TIL223. The TIL211 has a 0.12-in. lens diameter. At a forward current of 25 mA the TIL211 has a minimum luminous intensity of 800 microcandelas. The filled-epoxy lens provides a diffused green source for easy viewing. Other features include 0.02 in. square leads and a lead-frame package that is adaptable to wrapped-wire installation and lead forming. The TIL222 and TIL223 have 0.25 in. diameter plastic lenses and rectangular leads. The TIL222 has a filled-epoxy lens which emits a diffused green light. The TIL223 has a clear diffused lens and a typical viewing angle of 45°. Both have a minimum luminous intensity of 1 millicandela when forward biased at 25 mA.

CIRCLE NO. 310

## High current power transistors handle 100 A



Solitron Devices, 1177 Blue Heron Blvd., Riviera Beach, Fla. 33404. (305) 848-4311. From \$35 (100 up); 3 wk.

Two series of industrial npn silicon power transistors have peak current capabilities of 70 and 100 A. Each series is available in two packages, the standard TO-3 (100 A: SDT 96401-2-3; 70 A: SDT 96304-5-6) and the TO-63 (100 A: SDT 96401-2-3; 70 A: SDT 96404-5-6). The devices are from the JAN 2N5250 family and are constructed with a single planar chip. Other features include at  $V_{CE}$  (sat) at 70 A of 1.5 V (typical), at  $h_{FE}$  at 70 A of 20 (typical) and  $BV_{CEOS}$  from 60 to 300 V.

CIRCLE NO. 320

## IC contains FM stereo decoder

N. V. Philips, P.O. Box 523, Eindhoven, the Netherlands.

The TCA290A FM stereo decoder IC features a voltage gain of 10 dB and maximum output voltage of 1 V rms. Channel separation at 1 kHz exceeds 40 dB and total distortion, with 1 V output at 1 kHz, is less than 0.2%. The chip has provision for a mono/stereo switch.

CIRCLE NO. 321

## Fast recovery 10 A bridges need only 200 ns

Varo Semiconductor, P.O. Box 676, 1000 N. Shiloh, Garland, Tex. 75040. \$1.84 (1000-up); stock.

Models VJO48X to VJ684X are fast recovery time 10-A bridge rectifiers. The units in the series have a 200-ns reverse recovery time. They are rated for a 10 A ( $I_O$ ) and 74 A ( $I_{FSM}$ ) at a  $T_C = 60$  C. The devices are available in 50, 100, 200, 400 and 600-V models.

CIRCLE NO. 322

## LED alphanumeric digits use 5 x 7 dot matrices



Precision Dynamics Corp., 3031 Thornton Ave., Burbank, Calif. 91504. (213) 845-7606.

The Nova 7 series of ASCII alphanumeric display modules uses replaceable 5 x 7 LED dot matrices. The displays are 0.35 in. high and accept a standard six-line binary code. Displays operate from a single 5-V-dc supply and have a 350 foot-Lambert brilliance. Each display module is molded in black thermoset plastic and may be stacked with up to 24 digits in a single array. A red nonglare viewing screen and brackets for mounting are provided.

CIRCLE NO. 323

# Micaply Ohmega™ A different way to design without discrete resistors.

For printed circuits and microelectronics

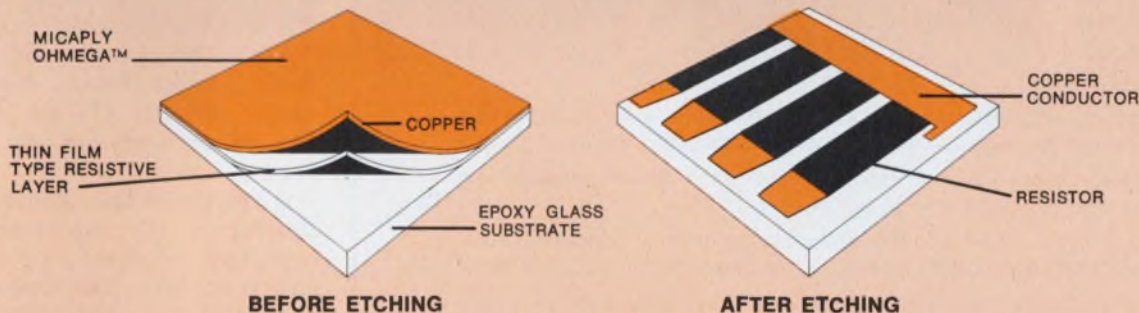

Micaply Ohmega™ can reduce costs and eliminate the need for discrete resistors. And it's available immediately.

It's a proven resistor-conductor laminate with a bi-layer cladding on one or both sides.

Etch integral resistors and conductors on the same surface. The entire process is subtractive.

No screening, firing or vacuum equipment is required.

- 25 and 100 ohms-per-square materials.
- Line widths consistent with thin film microelectronic techniques are possible.
- 10" x 36" sheets for processing economy.
- Design assistance and circuit

production available.

It's being used now for termination resistor networks, calculator circuits and microelectronics. Get the facts. Write today.

The **Mica** Corporation  
Culver City, California  
(213) 870-6861 and  
Micaply International, Silloth, England

**SCR surges to  
1.2 kV and 2.5 kA**



*International Rectifier, 233 Kansas*

*St., El Segundo, Calif. 90245. (213) 678-6281. \$805 (prototype qty.)*

Setting the pace for SCRs, the company reportedly has the highest power SCR ever manufactured in production quantities. Called the 1600PA, the SCR has a current rating of 2500 A rms (1600 A average) at up to 1200 V. Surge current reaches 35,000 A. The device is intended for such applications as rapid transit, earthmoving vehicles and metals processing.

**CIRCLE NO. 324**

**There's still  
nothing like  
vacuum tubes  
for an exceptional  
TWT  
amplifier**



Sure our amplifier uses solid state components—everywhere, in fact, except in the high voltage regulator and the TWT itself.

Why a vacuum tube regulator? Because of the greater reliability with this inherently high voltage component.

It qualifies our TWT amplifier especially for antenna pattern measurement, EMI susceptibility testing and r-f power instrument calibration.

But we utilize contemporary concepts when they add to reliable performance. Our modular construction and plug-in boards will accommodate a variety of TWTs for example.

And we can and do add VSWR protection, harmonic filtering and variable output, where required.

Octave band width 10, 20, 100 and 200 watts TWTAs from 1 GHz to 18 GHz. For detailed specifications write MCL, Inc., 10 North Beach Avenue, La Grange, Illinois 60525. Or call (312) 354-4350.



**Rectifier PIV  
reaches 40 kV**



*High Voltage Devices, 7485 Avenue 304, Visalia, Calif. 93277. (209) 733-3870.*

The VX series of Multistac Rectifiers has a range of PIVs from 15 to 40 kV. Called the VS 15, 20, 25, 30 and 40 (corresponding to the PIV rating), the new devices have an average rectified current of 25 mA at 50 C and 5 mA at 100 C. Reverse recovery time is 250 ns and forward voltage at 25 mA ranges from 24 to 48 V.

**CIRCLE NO. 325**

**10-A Darlington's come  
in improved versions**



*Solitron Devices, 1177 Blue Heron Blvd., Riviera Beach, Fla. 33404. (305) 848-4311. TO-66 versions: \$5; TO-5 versions: \$3 (1-99); stock.*

A version of the company's 10-A Darlington ICs reportedly offers improved reliability, performance and versatility. The npn versions are called the SDM 3100-3300 series, and the pnp versions are labelled the 3400 series. Typical features include a  $V_{CE0}$  from 40 to 80 V, multiple gain selections at 2.5 or 5 A, typical 5-A  $h_{FE}$  of 1000 minimum and typical 1-A  $h_{FE}$  of 10,000 minimum. They have a typical  $f_t$  of 70 MHz, and on and off time of 0.6 and 2.5  $\mu$ s, respectively.

**CIRCLE NO. 326**



## Complementary drivers provide 1-W output

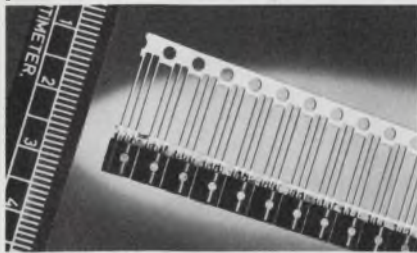

N. V. Philips, P.O. Box 523, Eindhoven, the Netherlands.

Six silicon planar epitaxial transistors, each in a TO-92-type package, have a maximum power output of 1 W at an ambient temperature of 25 C. Called the BC-635 to BC640, the new transistors have peak collector currents of 1 A, junction temperatures of 150 C and transition frequencies of typically 50 MHz. The BC635, BC637 and BC639 are npn versions having collector-emitter voltages ( $R_{BE} = 1 \text{ k}\Omega$ ) of 45, 60 and 100 V maximum, respectively. The open-base collector-emitter voltages are 45, 60 and 80 V maximum, respectively. The pnp complements are BC-636, BC638 and BC640.

CIRCLE NO. 327

## Diodes meet rigid specs

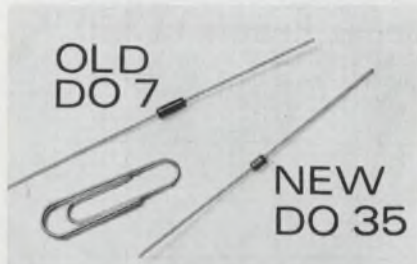

Microsemiconductor Corp., 2830 S. Fairview St., Santa Ana, Calif. 92704. (714) 979-8220. \$1.65 to \$3.15 (100); 6-8 wk.

A series of diodes meets or exceeds the requirements of MIL-S-19500/240D with interim amendments that call for metallurgically bonded devices. Called IN645-1, IN647-1 and IN649-1, the devices are electrically similar to other commercial devices but are packaged in the company's voidless-glass DO35 case. The IN645-1 conducts 500 mA forward current at 1-V  $V_f$ . PIV is 225 V. The IN647-1 conducts 500 mA at 1 V with 400-V PIV. The IN649-1 conducts 500 mA at 1 V with 600-V PIV.

CIRCLE NO. 328

## Solid-state sensor monitors gasses

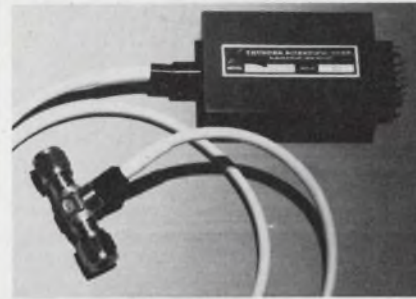

Thunder Scientific Corp., 623 Wyoming S.E., Albuquerque, N.M. 87123. (505) 265-8701.

Selective solid-state semiconductor sensors and systems monitor  $\text{CO}_2$ ,  $\text{CH}_4$  and  $\text{H}_2$  in air and cover ranges of gas concentrations from 0 to 1, 5, 25 and 100%. Humidity has negligible effects upon calibration. Sensor physical dimensions are 0.37-in. diameter by 0.16-in. height.

CIRCLE NO. 329

# 3,693 Indicator Lights in 1 LED Package

That's our new "SAVAGE" unit. A different concept in LED indication. RELAMPABLE . . . red, green, and amber LED (ours or others) . . . 2 to 28 volts . . . with or without resistors . . . snap-on flat and domed

the combination that best suits your application . . . body only . . . body and lens . . . body and lens and LED . . . body and lens and LED and resistor.

We said inexpensive. 89¢ in 2K quantities WITH red LED, 40¢ without LED. Attack your application with the "SAVAGE" approach. You can't beat our combination. TEST US. Call us, or contact your nearest Sloan Company distributor or representative.



Flat



Domed



lenses producing 180° visibility. The "SAVAGE" unit offers you an inexpensive nylon-bodied unit that provides push-in panel mounting in a 1/4" hole on 3/8" centers or PC mounting either vertical or horizontal.

Order your "SAVAGE" unit in

1974-1975  
**eem**  
Vol. TWO



**THE SLOAN CO.**

7704 San Fernando Road  
Sun Valley, California

Phone: (213) 875-1123 / TWX 910-498-2250

AMERICAN MADE

Tolerance

# SCHAUER 1-Watt ZENERS

Immediate Shipment  
Low Prices

ANY voltage from 2.0 to 16.0

Quantity	Price each
1-99	\$1.07
100-499	.97
500-999	.91
1000-4999	.86
5000 up	.82

All welded and  
brazed assembly

No fragile  
nail heads

Gold  
plated  
leads

Write for complete  
rating data and other  
tolerance prices.

Buy the kit—  
Save  
a lot



Kit contains a 51-piece assortment of SCHAUER 1% tolerance 1-watt zeners covering the voltage range of 2.7 to 16.0. Three diodes of each voltage packaged in reusable poly bags. Stored in a handy file box. Contact your distributor or order direct.

A \$54.57 value for  
ONLY \$24<sup>50</sup>

Semiconductor Division

**SCHAUER**  
Manufacturing Corp.

4511 Alpine Ave. Cincinnati, Ohio 45242  
Telephone: 513/791-3030

## DISCRETE SEMICONDUCTORS

### Fetrons replace glass vacuum tubes



Tekelec Airtronic S.A., Cité des Bruyères, rue Carle Vernet, 92 Sevres, France.

Fetrons, or solid-state tubes, can be used to replace conventional glass vacuum tubes. Fetrons use field-effect transistors that have transconductance characteristics that are similar to those of vacuum tubes. Two standard models are available. The TS6AK5—equivalent to a 6AK5 vacuum tube—operates from a 350-V plate supply, and has a plate resistance of 5 MΩ and a transconductance of 4500 micromhos. The TS12AT7—equivalent to a 12AT7 vacuum tube—also operates from a 350-V supply, and has a plate resistance of 250 kΩ and a transconductance of 3000 micromhos.

CIRCLE NO. 330

### Micropill Impatt diodes have 5% efficiency

Texas Instruments Inc., P.O. Box 5012, M/S 308, Dallas, Tex. 75222. (214) 238-3741. For 10 or more: \$140 (621), \$300 (621A); 5 wk.

The MDX621 and MDX621A are diffused silicon mesa Impatt diodes. They are packaged in durable hermetically sealed alumina micropill packages. These diodes have a built-in heat sink and are optimized for V-band applications. Other features include a conversion efficiency of up to 5% and a power output of up to 100 mW at a junction temperature of 200 C.

CIRCLE NO. 331

### Blowout-proof transistor handles 40 W at 2 A

National Semiconductor, 2900 Semiconductor Dr., Santa Clara, Calif. 95051. (408) 732-5000. 100-up prices \$17 (195), \$4.95 (395); stock.

The LM195 is a three-terminal bipolar IC that simulates a 40-W power transistor with a high switching speed. The internal protective circuitry makes the LM195 blowout-proof at output current levels of up to 2 A and at an input and output voltage level of 40 V. The current limiting and thermal shutdown circuits built into the device shut down the output stage if the output current exceeds 2 A or if the chip temperature exceeds 165 C. The only way the device can be damaged is by applying an excessive voltage, and if this happens, the LM195 fails safe—it becomes an open circuit. Electrically, the LM195 looks like a pnp transistor driving an npn Darlington with an over-all gain of over 10<sup>6</sup>. Input base current is 3 μA or less over the input voltage range of 0 to 42 V.

INQUIRE DIRECT

### Complementary power semis handle to 400 V

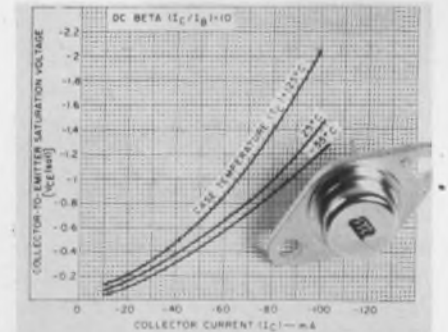

FIGURE 9.

TYPICAL V<sub>CE</sub> (SAT) VERSUS I<sub>C</sub> FOR

Silicon Transistor Corp., Katrina Rd., Chelmsford, Mass. 01824. (617) 256-3321. From \$1.08 (100-up); stock to 3 wk.

Eight different high voltage complementary power transistors can handle 35 W each and are housed in JEDEC TO-66 packages. They are rated at V<sub>ce08</sub> of 175 to 400 V. The transistors are tested at 1 A for gain, V<sub>sat</sub> and switching time. They are designated as follows: 2N3583, 84, 85, 2N4240, 2N6211, 12, 13, 14.

CIRCLE NO. 332

# Our Amps Don't Quit in a Mismatch!

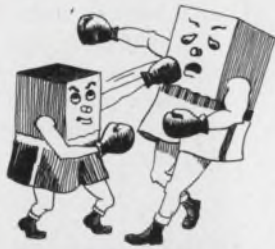

Amplifier Research has a tough line of broadband amplifiers -- all unconditionally stable and built to take on any mismatched load. These amplifiers sweep the spectrum from DC to 700 MHz and provide up to 5000 watts of RF power. Rugged design makes them perfect for antenna and component testing, equipment calibration and EMI susceptibility testing -- you'll never have to throw in the towel! Amplifier Research will also provide custom OEM packaging to meet your special requirements. Get the facts, contact:

Amplifier Research, 160 School House Road, Souderton, Pa. 18964 • Phone: 215-723-8181



INFORMATION RETRIEVAL NUMBER 97

## Solid! Murata ceramic IF filters

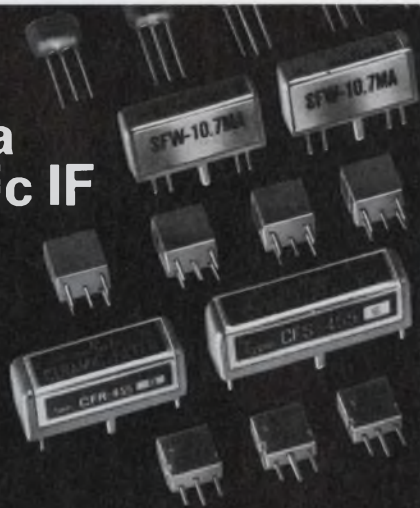

They're sharp. They're small. And, they're solid . . . for years! Murata's ceramic IF filters provide the solid-state performance in AM, FM, TV and Communications IF's that's expected by every one of our customers . . . consumer, industrial or military. Find out all there is to know about Murata's renown ceramic IF filters. Complete information is yours for the asking.

**muRata** MURATA CORPORATION OF AMERICA  
2 Westchester Plaza, Elmsford, New York 10523  
Telex: MURATA EMFD 137332 / Phone: 914/592-9180  
A Subsidiary of Murata Mfg. Co., Ltd., Japan

INFORMATION RETRIEVAL NUMBER 98

ELECTRONIC DESIGN 8, April 12, 1974



# international coil winding association

(Devoted Entirely To The Coil Winding Industry)

PRESENTS

## COIL WINDING CHICAGO '74

CONVENTION & EXHIBITION

21, 22, 23, SHERATON O'HARE HOTEL  
May, 1974 ROSEMONT, ILLINOIS, U.S.A.

Devoted exclusively to the coil winding industry this event is being held yet again to serve as a platform for presentation of specialized papers on new materials and techniques and a showcase for displaying the latest product developments.

### CONVENTION:

Papers will be presented by Internationally recognised authorities in various fields of coil winding.

### PRODUCT DISPLAY:

Covering the entire spectrum from coil winding machines to custom built coils.

### EUROPEAN AND HEAD OFFICE

Cleveland House  
344A Holdenhurst Road  
Bournemouth BH8 8BE  
Hampshire  
England  
Telephone: Bournemouth 38738  
Telex: 417123

### NORTH AMERICAN OFFICE

Suite 106  
3158 Des Plaines Avenue  
Des Plaines  
Illinois 60018  
U.S.A.  
Telephone: (312) 827-4060

Please send all details   
We are interested in a booth of ..... sq.ft. |  
NAME ..... please complete in  
BLOCK LETTERS  
POSITION .....  
COMPANY .....  
ADDRESS .....  
PRODUCTS .....

INFORMATION RETRIEVAL NUMBER 99

DESIGN ENGINEERS:

# Custom's Capacitors have what you need

Do you deal with specifications like these in your work:

- capacitance over 40 pf up
- frequencies in MHz
- voltage over 1000 VDC

Then reconstituted mica capacitors are what you need.

Do you work with energy density of .05-.25 joules/in.<sup>3</sup>, at high voltage?

Reconstituted mica capacitors will best fill your requirements.

Looking for high voltage in small packages?

You need reconstituted mica capacitors!

Another of the many advantages of reconstituted mica capacitors is excellent performance under environmental extremes.

Custom can meet your needs better, because each process in our capacitor production begins and ends with quality control to avoid failure in the field. Let us show you how we can fill your requirements.

See our page in *Electronic Buyer's Guide and EEM* and write for FREE product sheets today.

P.S. Oil exploration personnel: Custom can help you with your logging tool problems.



**CUSTOM ELECTRONICS, Inc.**  
4 Browne St., Oneonta, N.Y. 13820  
PH: (607) 432-3880 TWX: 510-241-8292

MICROWAVES & LASERS

## Attenuator series covers 1.14 to 140 GHz



Flann Microwave Instruments, Ltd., Dummere Road, Bodmin, Cornwall, PL31 2QL, England.

The direct reading precision rotary vane attenuators in the 11 series provide 0 to 60 dB attenuation to an accuracy of 0.1 dB or 1% of the reading, whichever is greater. Models are available for every waveguide size between 1.14 and 140 GHz. The VSWR is less than 1.15; insertion loss ranges from 0.5 to 1 dB depending on model size.

CIRCLE NO. 335

## X, Ku-band diodes withstand 20, 10 W



Alpha Industries, 20 Sylvan Rd., Woburn, Mass. 01801. (617) 935-5150. X-band: \$4 to \$8 (1-9); Ku-band: \$20 to \$40; stock to 30 days.

A line of point-contact mixer diodes reportedly can withstand the highest powers. X-band units—called the DMA 6497 series—handle 20 W peak for 3 ns minimum at 9.4 GHz. Ku-band units—called the DMA-6499 series—handle 10 W peak for 3 ns minimum at 16 GHz. The X-band diodes have a maximum noise figure of 7 and 7.5 dB, i-f impedance of 335 and 465  $\Omega$  and maximum VSWR of 1.3. The Ku-band units have a maximum noise figure of 7.5 to 8.8 dB, i-f impedance of 400 and 565  $\Omega$  and maximum VSWR of 1.5.

CIRCLE NO. 336

## 3-lb, 6-GHz TWT delivers 50 W

Varian, 611 Hansen Way, Palo Alto, Calif. 94303. (415) 493-4000.

A conduction-cooled TWT operates between 5.925 and 6.425 GHz and weighs only 3 lb. Called the VTC-6161H2, the tube delivers a saturation output of at least 50 W. It has a minimum 50-W gain of 45 dB and a maximum noise figure of 35 dB.

CIRCLE NO. 337

## Uhf klystron delivers 25 kW

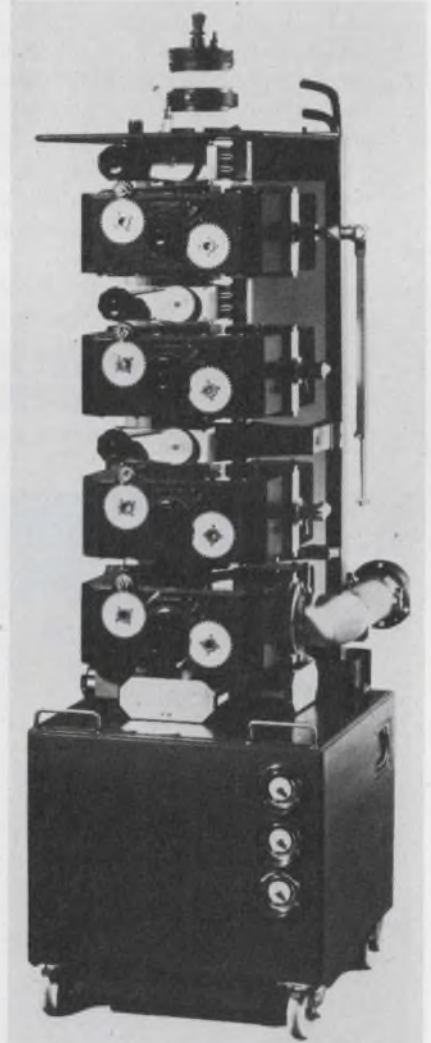

Amperex Electronic, 230 Duffy Ave., Hicksville, N.Y. 11802. (516) 931-6200.

An air-cooled uhf TV klystron, type Yk1151, outputs 25 kW, comes with permanent-magnet focussing and has a built-in ion pump. The klystron has an efficiency of about 40%, a gain in excess of 40 dB, and it requires less than 2.5 W of drive.

CIRCLE NO. 338

INFORMATION RETRIEVAL NUMBER 100

## TEDs boost power, frequency

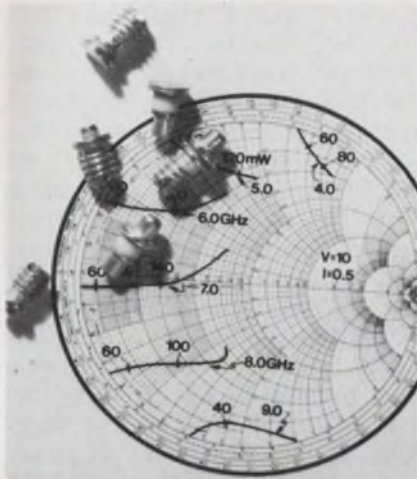

RCA Electronic Components, 415 S. Fifth St., Harrison, N.J. 07029. (201) 485-3900. \$25 up (small production qty.); stock.

A line of C and X-band transferred-electron diodes, called the S3053 through S3099, consists of 47 diodes in six basic package styles. Maximum output power reaches 500 mW. Operating frequencies range from 4 to 18 GHz in one-half and full-octave bandwidths. Life test data reportedly verify a failure rate of only  $1 \times 10^{-5}$  failures per hour.

CIRCLE NO. 339

## Phase-locked osc has $\pm 0.0002\%$ stability

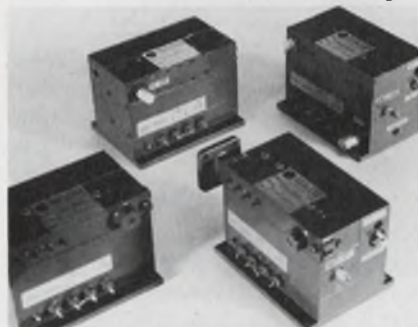

Solid State Technology, 3650 Charles St., Santa Clara, Calif. 95050. (408) 247-8620. 60 days.

The SSX series phase-locked oscillators are available with 10% bandwidths from 750 MHz to 18 GHz. A long-term stability of  $\pm 0.0002\%$  over the  $-30$  to  $+60$  C temperature range is obtained with an internal crystal oven. Output power ranges from 10 to 300 mW. And afc frequencies range from 200 kHz to 10 MHz.

CIRCLE NO. 340

# Triad throws its weight around

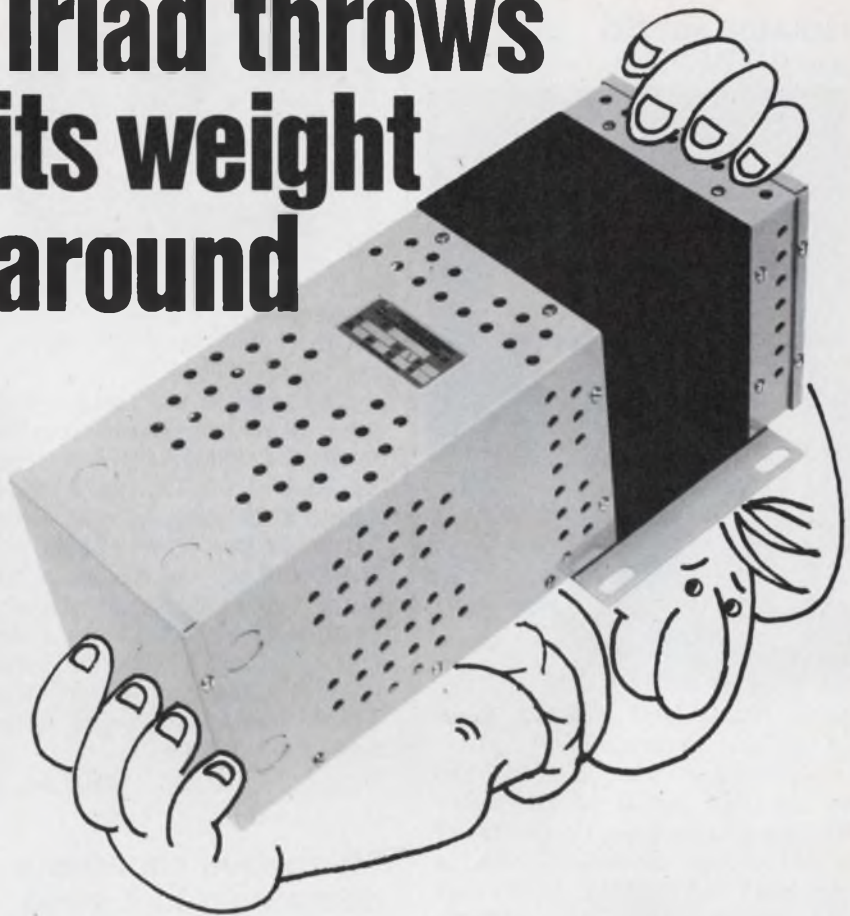

This hunk of transformer is the Triad K-106 voltage stabilizer rated at 1 KVA and weighing 60 lbs. Others in the series are rated from 50 to 750 va. They allow you to hold output voltage constant within 1% of nominal voltage when the input is varied as much as 15% from nominal. Sometimes only a "block-buster" will do the job. Triad has step-down auto-transformers rated up to 2000 va., universal rectifier powers rated up to 20 amps, and isolation transformers rated up to 1000 va. — all big, rugged and built to last.

Triad makes the miniature, too. Subminiature toroidal inductors, designed for easy printed circuit board mounting, are stocked in 28 ratings from 50 micro-henries to 400 milli-henries. Triad's Red Spec transistor audio transformers and chokes are in epoxy molded cases with base dimensions of only .310 by .410 inches. Open-type miniatures in a wide range of ratings, mounting types and sizes are in stock.



Call your nearest Triad distributor before you get in a bind on custom-designed components. He has hundreds of items in stock — many in depth for your production requirements. And — we back him up with quick service from our main plant here in Huntington, or from complete warehouse stocks in North Hollywood, California, and Dallas, Texas. Get the Triad catalog today. Triad-Utrad Distributor Services, 305 North Briant Street, Huntington, Indiana 46750.



**TRIAD-UTRAD**  
Litton Distributor Services

INFORMATION RETRIEVAL NUMBER 101

### Isolator spec'd for 6 kW

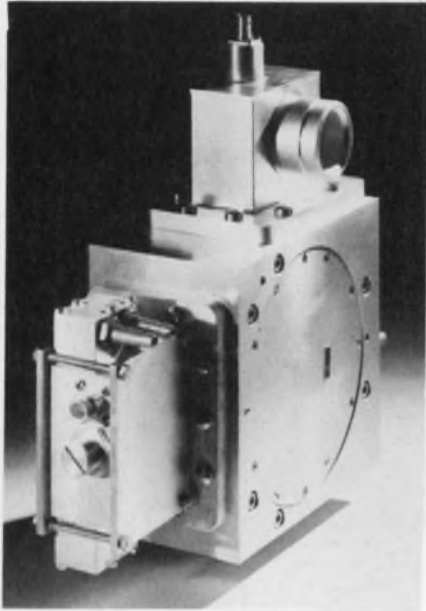

N. V. Philips, P.O. Box 523, Eindhoven, the Netherlands.

An isolator rated at 6 kW can be used for industrial microwave heating applications. It consists of a three-port circulator with a matched load on the third port and operates over the 2425-to-2475-MHz frequency range. The isolator requires 3 litres of water at 20 C per minute, with a maximum inlet temperature of 40 C. Isolation is better than 26 dB and insertion loss is less than 0.3 dB (guaranteed). In the matched condition, input VSWR is less than 1.10.

CIRCLE NO. 341

### 400-MHz transistors output up to 15 W

Motorola Semiconductor Products, P.O. Box 20924, Phoenix, Ariz. 85036. (602) 244-3466. MRF5174: \$6 (1-99); MRF5175: \$12.50 (1-99); MRF5176: \$15 (25-99); stock.

Three rf transistors—the MRF-5174, MRF5175 and MRF5176—are designed for 28-V dc transmitter applications. The MRF5174 has 2-W output and 12-dB gain at 400 MHz, while the MRF5175 yields 5-W output and 11-dB gain at the same frequency. The MRF-5176, has 15-W output at a gain of 10 dB. All outputs and gains are at 50% efficiency.

CIRCLE NO. 342

### Transistors receive JAN ratings



Ampower Semiconductor, 375 Kings Hwy., Smithtown, N.Y. 11787. (516) 582-6767. \$55.20 to \$66.50 (100-999).

The company's 2N2812 and 2N-2814 power transistors, qualified to MIL-S-19500/415 specs, have received the JAN, JAN-TX and JAN-TX (V) ratings. The 2N2812 lists a 50-MHz power of 50 W at 100 C and 60 V. Gains range from 40 to 120 at 5 A and exceed 15 at 10 A. The 2N2814 has a minimum sustaining collector voltage of 80 V. Both units come in the TO-61 configuration and operate from -65 to 200 C.

CIRCLE NO. 343

### Microwave capacitors operate up to K band

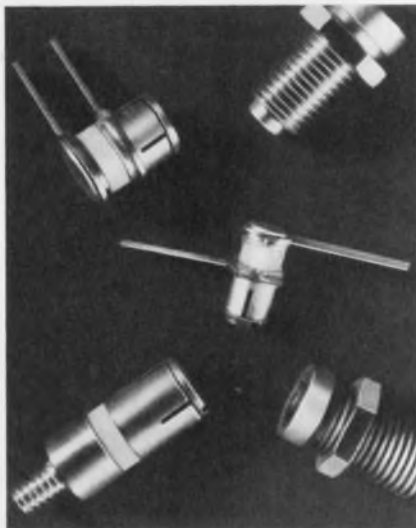

Tekelec-Airtronic S.A., Cité des Bruyères, rue Carle Vernet, 92-Sevres, France.

A family of subminiature adjustable capacitors, called the Gigatrim series, operates up to several gigahertz and has a reactive tuning capability into K band. The Q-factor is as high as 4000 at 100 MHz. The new series has a voltage rating of 500 V dc and an insulation resistance of 10<sup>4</sup> megohms at 200 V dc.

CIRCLE NO. 344

### Si Impatt diodes offer high powers

Hewlett-Packard, 1501 Page Mill Rd., Palo Alto, Calif. 94304. (415) 493-1501. 5082-X001, 5082-X002 and 5082-X003: \$175; 5082-X004: \$225 (10 up); 4 wk. (small qty.).

Peak powers of 12 W at 10 GHz and 10 W at 16.5 GHz are available with two pulsed silicon Impatt diodes. Also announced are two cw Impatts capable of 1.3 and 2.3 W at 11.2 GHz. Efficiencies of the pulsed Impatts are 11%, and 10% can be achieved with the cw diodes. The two pulsed units are called the 5082-X001 for X-Band and 5082-X002 for Ku-Band. For cw power sources at X-Band, the 5082-X003 provides 1.3 W of output power and the 5082-X004 provides 2.3 W. Operating voltages are from about 100 to 143 V, with operating current from about 50 to 900 mA.

CIRCLE NO. 345

### Components make up doppler radar system

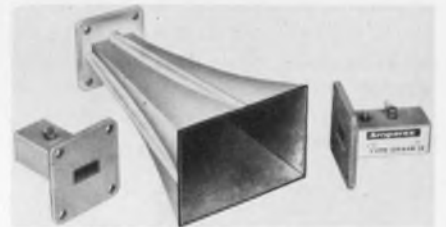

Amperex Electronic, 230 Duffy Ave., Hicksville, N.Y. 11802. (516) 931-6200. DX-446: \$37.50; ACX-01: \$6.95; DX-492: \$19.95; stock.

A horn, cavity and oscillator form a doppler radar component system. The DX-446 Gunn oscillator assembly delivers 8 mW at 10.525 GHz, while drawing only 130 mA from a 7-V source. Temperature coefficient is typically -0.25 MHz/°C, and the second harmonic is guaranteed to be below -30 dBm. The oscillator has a tangential sensitivity of -56 dBm. The ACX-01 horn provides a 16-dB gain. The horn and the DX-446 combine to produce a 1-mV pk-pk signal in response to a moving target at 10 meters. The DX-492 is a Schottky-barrier mixer diode mounted in a waveguide cavity with a WR-90 flange. This component can be combined as a receiver into a system that uses the DX-446 and the ACX-01 for 50-meter ranges.

CIRCLE NO. 346

# TOOL KITS

## FIELD ENGINEER TOOL KIT JTK-17



More than 100 fine tools used for maintenance and adjustment of electronic equipment, computers and office machines. Small tools are held securely on two removable pallets. Three roomy compartments in the bottom of the deluxe attache' case hold larger tools, optional test meter and parts boxes. A space for service manuals and schematics is provided in the cover.

Write for brochure!

## FIELD ENGINEER ATTACHE TOOL CASES



Jensen attache' cases provide a convenient way to carry a large number of tools. Three models are offered: thin-line, standard and extra deep. All cases feature solidwood frames with mahogany paneling and dovetail corners, solid brass hardware and anodized aluminum partitions. Covering is scuff-proof Marvelon. Removable small-tool pallets and partitioned compartments in bottom of the case hold tools securely in a well organized manner. Write for brochure giving dimensions and full details.

Five styles available

### Free Catalog ELECTRONIC ASSEMBLY TOOLS

Lists over 1700 hard-to-find tools used by electronic technicians, instrument mechanics, engineers and scientists. Includes a solder section and four pages of useful "Tool Tips" with valuable data on insulations, color coding, fasteners, and tool selection. Write for your free copy!



**JENSEN TOOLS and ALLOYS**

4117 N. 44th Street, Phoenix, Arizona 85018

INFORMATION RETRIEVAL NUMBER 103

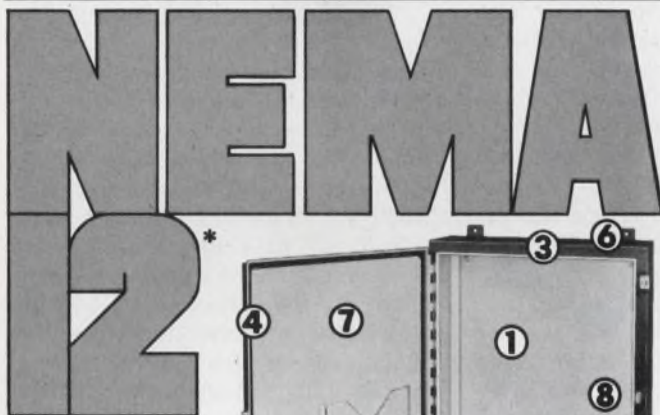

OIL TIGHT  
DUST TIGHT

1. Heavy gauge steel rigid construction. 2. All seams continuously welded. 3. Rolled lip for strength, also helps keep dirt and liquid out when door is open. 4. Neoprene door gasket with oil resistant adhesive and steel retaining strips. 5. Removable print pocket. 6. External mounting feet. 7. All sizes, full stock: wall and floor mounted, one to five door. 8. Models available in stainless steel and aluminum. For detailed specifications, write for new catalogue.

\*Also meets NEMA 13 specifications.

**Hoffman** ELECTRICAL ENCLOSURES

HOFFMAN ENGINEERING COMPANY  
Division of Federal Cartridge Corporation  
Anoka, Minnesota, Dept. ED-11

INFORMATION RETRIEVAL NUMBER 104

ELECTRONIC DESIGN 8, April 12, 1974

# DI-MAG

... SUPER SENSORS

# THE SENSIBLE CHOICE...

- **DIGITAL OUTPUT** — Constant amplitude pulses independent of surface speed or air gap.
- **COMPATIBILITY** — Direct interface with TTL, DTL or HTL logic.
- **NOISE IMMUNITY** — High signal-to-noise ratio not achievable in analog sensors.



CONVENTIONAL ANALOG SIGNALS PRODUCED DETECTING ROTATIONAL MOTION.



DI-MAG\* DIGITAL SIGNALS PRODUCED UNDER IDENTICAL CONDITIONS.

DI-MAGS® work particularly well in these computer peripheral functions and applications:

- FEED RATE CONTROL
- PRINT HAMMER SYNCHRONIZATION
- DISK POSITION INDICATION
- DISK AND TAPE DRIVE RPM MEASUREMENT
- INDEXING CONTROL
- CONTROL SIGNAL FOR CLOSED-LOOP SERVO SYSTEMS.



THAT'S WHY I'M CALLED THE SUPER SENSOR!

Send for your free copy of our Di-Mag® "AIR GAP"/S SENSITIVITY selector.



**ELECTRO CORPORATION**

1845 57TH STREET, SARASOTA, FLORIDA 33580  
AREA CODE (813) 355-8411 • TELEX 5-2683

INFORMATION RETRIEVAL NUMBER 105

## Pro-Log brings intelligence to ROM Programmings

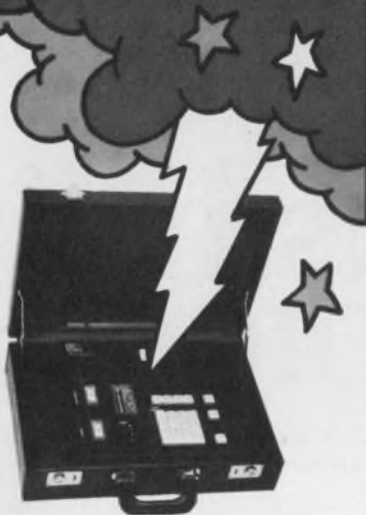

Intelligent because it's controlled by a Pro-Log microcomputer. It cuts programming time substantially, makes operation easy, and is able to interface as a conversational terminal with people, TTY, and other computers. All of this for around \$2000.

The Series 81 ROM Programmings from Pro-Log are fully portable units designed for use in engineering, quality assurance, production, or out in the field.

**Model 810: Programs 1702A ROMs**  
**Model 811: Programs 1702 ROMs**  
**Model 812: Programs National 5203 ROMs**  
**Model 813: Programs 3601 Fusible Link ROMs**

### Features:

- Programs, Lists, Duplicates, and Verifies
- Automatic erase check
- Duplicates with advance substitution
- Duplicates typical 1702A in less than 30 seconds — 1702 or 5203 in less than 5 minutes
- Hexadecimal keyboard for address and data entry
- Binary data display
- Quick load, zero insertion force ROM sockets

## ROM Programming Systems from Pro-Log



"Microcomputers, Programmings and Education"  
 852 Airport Blvd. Monterey, Calif. 93940  
 (408) 372-4593

INFORMATION RETRIEVAL NUMBER 106

## POWER SOURCES

### Dual-output supply has adjustable output

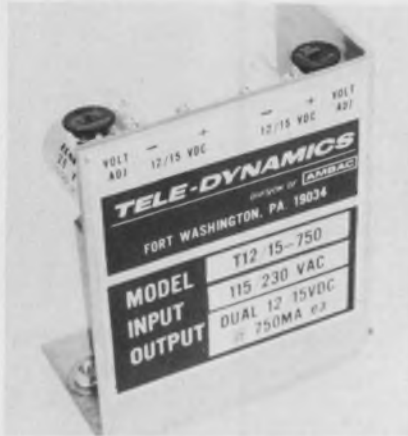

Tele-Dynamics/Wanlass, 525 Virginia Dr., Fort Washington, Pa. 19034. (215) 643-6161. \$51. (1 to 9); stock.

A dual output power supply has independently adjustable outputs from 11.7 to 15.3 V dc at 0.75 A. The T12/15 Series of supplies is designed specifically for powering op amps and logic circuits. Outputs may be paralleled for a 1.5 A output or be series connected for 23.4 to 30.6 V outputs. For powering op amps, outputs may also be connected for series tracking. The unit weighs only 2.5 lb. and operates from either 105 to 125 or 210 to 250 V, 47 to 63 Hz ac, while providing a line and load regulation of  $\pm 0.1\%$ .

CIRCLE NO. 347

### Dc/dc converters handle 125 to 48-V inputs

Wilmore Electronics, P.O. Box 2973, West Durham Station, Durham, N.C. 27705. (919) 489-3318. Start at \$580 (10); stock to 30 days.

Available in 12 rack-mount models, Series 1240 dc-to-dc converters provide voltage conversion, source-to-load isolation and protection against input transients. Models are available for the two most commonly-encountered station battery inputs of 48 and 125 V dc. Nominal dc outputs are 24, 28, 36 and 48 V and standard power output levels are 300 and 600 W. Efficiencies range to greater than 85% for some models. All models are 5-1/2 x 19 x 14-in. and weigh from 36 to 43 lb.

CIRCLE NO. 348

### Dc voltage calibrator settles in 100 $\mu$ s

Electronic Development Corp., 11 Hamlin St., Boston, Mass. 02127. (617) 268-9696. \$1350.

Model 501 programmable dc voltage calibrator features a settling time of 100  $\mu$ s max to within 0.01% of programmed value; accuracy within  $\pm 0.01\%$  of programmed value; and stability of less than  $\pm 0.001\%$  drift in 24 hours.

CIRCLE NO. 349

### Emergency ac system handles load to 1500 VA

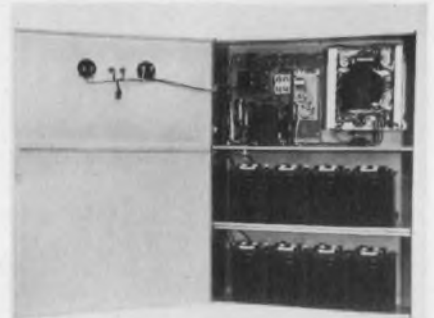

The Dual-Lite 'Co., Simm Lane, Newton, Conn. 06470. (203) 426-2585.

The Emergency AC System consists of a fully automatic, solid-state battery charger, sized XL lead or nickel-cadmium battery, dc to ac static inverter and transfer relay. The ac system is capable of powering a load from 250 VA to 1500 VA. Standard models provide 120 V, 60 Hz single phase output. The connected load is powered normally by the utility input and immediately switches over to the emergency system when normal power fails. Upon restoration of utility power, the connected load will automatically be reconnected to normal ac power. All ac system models are mounted in heavy sheet metal cabinets and are designed so that all equipment is easily accessible. Standard features of the units include a solid-state pulse type charger. The transfer circuit is unaffected by dust or dirt. Automatic dropout is also standard—a feature which disconnects the connected load from the battery after it has been discharged to a point where further use would endanger the battery itself. A pilot light indicates when the battery is being recharged.

CIRCLE NO. 350



## Switching units offer efficiencies to 88%

*Electro-Module, Inc., 2855 Metropolitan Pl., Pomona, Calif. 91767. (714) 593-3565. From \$525; stock to 30 days.*

DLR (direct line rectification) Series of modular dc switching power supplies operate at up to 88% efficiency. Five models are available in the new series: 4.2-6 V dc (100 A) 80% efficiency, 6-11 V dc (50 A) 82% efficiency, 10-17 V dc (30 A) 83% efficiency, 12-23 V dc (25 A) 85% efficiency, and 22-30 V dc (20 A) 88% efficiency. The units are packaged in aluminum cases. Key specs include output ripple and noise (max.) of 2% pk-pk, 0.5% rms; and transient response time of 0.5 ms.

CIRCLE NO. 351

## Modular high voltage supplies deliver 10 W

*Datel Systems, Inc., 1020 Turnpike St., Canton, Mass. 02021. (617) 828-6395. From \$175; stock.*

The HV Series of high voltage power supplies is available with 10 W outputs up to 20 kV while operating from a 115/230 V ac line or a  $\pm 24$  V dc source. The units are available with a choice of five different fixed voltage outputs; 10 kV at 1 mA, 12 kV at 830  $\mu$ A, 15 kV at 670  $\mu$ A, 18 kV at 560  $\mu$ A and 20 kV at 500  $\mu$ A. In addition, one of three different inputs can be selected; 100 to 125 V ac, 210 to 250 V ac or +21 to +27 V dc. Line and load regulation are typically better than 0.1% while the temperature coefficient is 0.02%/°C. Transient response is less than 2 ms, to within +5 V after a full load step change. Noise and ripple measured with a 500 pF load is 0.05% at full load. Other features offered by these HV supplies include: a voltage output monitor for connection to a meter, a means of programming the output voltage with an external resistor or, the output can be modulated with a current source such as an op amp. In addition, these supplies offer full output protection. The units are both short-circuit and overload protected by current limiting. Surge limiting provides protection for semiconductors from anode arc-over.

CIRCLE NO. 352

## High Voltage Multipliers

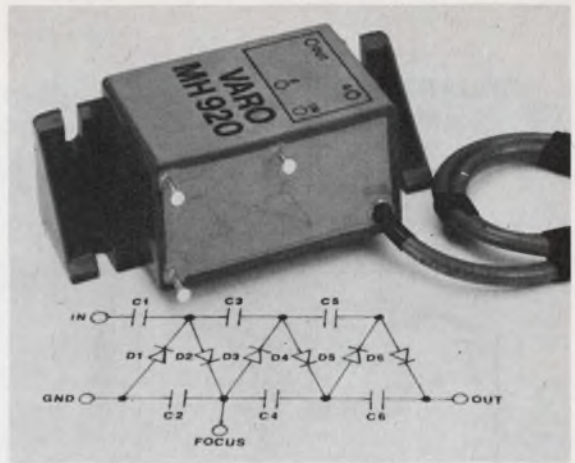

High-voltage multipliers are available for CRT display systems, electrostatic power supplies, TV receivers, and other high-voltage applications.

The series includes doublers, triplers, and quadruplers in a wide range of voltages. They are designed for reliability, maximum stability and high temperature operation. For example, the Series MH 919 Tripler (with focus tap) for color TV has a nominal output voltage of 24 kV with 8kV peak-to-peak maintained. Cases are UL SEO rated.

A wide variety of package sizes and connectors is available. Custom design service for your particular applications is also available.

**Write for free catalog.**

*Design us in —  
We'll stay there*



**VARO SEMICONDUCTOR, INC.**

P.O. BOX 676, 1000 N. SHILOH, GARLAND, TEX. 75040, 214/272-4551, TWX 910-860-5178

INFORMATION RETRIEVAL NUMBER 107

## STACOSWITCH means pushbutton displays

When you think switch, think STACOSWITCH the pushbutton display specialists. Individual or matrix mount; snap-in, dress nut, or clamping bezel mount; QPL reliability and computer-grade low cost. STACOSWITCH offers a wide range of versatile display switches...lighted and unlighted. Choice of circuitry, switch action, legend display style and type to best meet your needs.

Write today for complete catalog and prices. When you think switch... think STACOSWITCH.



Other STACO Company products: Fixed Ratio Transformers, STACO, INCORPORATED, Richmond, Indiana; Variable Transformers, STACO, INCORPORATED, Dayton, Ohio.

INFORMATION RETRIEVAL NUMBER 108

## BROADBAND POWER AMPLIFIERS

Milliwatts  
to  
KILOWATTS



"State-Of-The-Art"

NO TUNING

MODEL	POWER OUT	BANDWIDTH
M500	0.3 Watts	2-500MHz
M502	2 Watts	0.5-450MHz
M305	5 Watts	0.3-300MHz
M310	10 Watts	0.3-300MHz
30-12	12 Watts	2-32MHz
30-25	25 Watts	2-32MHz
30-50	50 Watts	2-32MHz
250-10C	10 Watts	0.2-250MHz
250-10	10 Watts	0.005-250MHz
30-12L	12 Watts	0.01-25MHz
30-25L	25 Watts	0.01-25MHz
300-145	75 Watts	0.2-300MHz
250-145	100 Watts	0.005-250MHz
220-250B	200 Watts	0.01-250MHz
220-560A	500 Watts	0.01-220MHz
220-1K60L	1000 Watts	0.01-220MHz

..... And Many Many More!



**R. F. POWER LABS, INC.**  
11013-118th Pl. N.E.  
Kirkland, Wa. 98033  
(206) 822-1251

**Foreign Representatives:** Australia-Scientific Devices; England-Wessex; Finland-Into Oy; France-REA; Holland-Air-Parts Itn'l; India-Electric Enterprises; Israel-RDT; Italy-Motordiesel; Japan-Seki; New Zealand-S. D. Mandeno; Norway-Morgenstierne; Portugal-Rualdo; So. Africa-K. Baker; Sweden-Wentzel; Switzerland-Silectra.

## POWER SOURCES

### High-voltage modules boast 10 ppm regulation

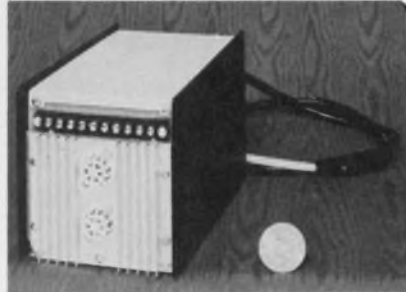

*Spellman High Voltage Electronics, 1930 Adeo Ave., Bronx, N.Y. 10469. (212) 671-0300. From \$450; 6 wk.*

SRM line of modular, high-voltage supplies boasts 10 ppm line and load regulation, as well as 0.001% rms ripple. All models operate from 28-V-dc input and are continuously adjustable over the entire range from zero to maximum-rated output voltage. Programming terminals are provided for connection to remote potentiometric or voltage-input programming sources. Size is 5-1/16 × 5-1/2 × 9-1/2 inches.

CIRCLE NO. 353

### Ac voltage regulator comes in 10 models

*Advanced Power, 1621 Sinclair St., Anaheim, Calif. 92806. (714) 997-0320.*

The AO series Controfluxer is an ac regulating filter. Rated identically for either leading or lagging load power factors these units are up-rated at all power factors below unity. Available in two input voltage ranges (117 and 234 V ac), the AO series units accept either 60 Hz or 50 Hz input power, with accessory kits available enabling full-rated output at 50 Hz. There are 10 models in the AO series, including single and dual output types. Average voltage regulation is better than ±1% for a ±10% line change at 80% of full load. Because the form factor is relatively constant, regulation of the rms output is ±2%. Load regulation is better than ±2% for a 0 to 100% load change at nominal input voltage. Input overvoltage protection maintains output down to 60 V ac, depending on load. Overload protection is provided by inherent current limiting.

CIRCLE NO. 354

### Dc converting supplies have 65% efficiency

*RO Associates, 3705 Haven Ave., Menlo Park, Calif. 94025. (415) 322-5321. About \$500; stock to 60 days.*

The Series 400 high power, 20 kHz, high efficiency converters can use input power from 12 V dc to 115 V ac. Model 450 provides 5 V dc at 50 A for logic circuitry with 115 V ac input. The over-all efficiency of these units exceeds 65% and the units have heat sinking surfaces, self-restoring crowbar overvoltage protection, logic level inputs for turn on and turn off and rapid turn off by means of the crowbar function. Output specifications based on the 5 V output are: Load regulation of 0.2% from 0 to 50 A, ±0.1% for ±10% change in input voltage; ripple and noise at 50 mV pk-to-pk dc to 20 MHz; temperature stability of 0.02%/°C and storage times greater than 10 ms in the worst case situation. These units can be operated to full output power at case temperatures of 70 C. Dual output units with outputs of 12 to 15 V dc are available at up to 10 A each side. The Series 400 size is 5.01 × 5.01 × 16.85 in. and the weight is 14 lbs.

CIRCLE NO. 355

### Sixty models form new line of switchers



*Technipower, Inc., Benrus Center, Ridgefield, Conn., 06877. (203) 438-0333.*

All models of the new CL switching power supplies are designed for 12, 24, 28, 48, 130 V dc and 115, 230-V-ac source applications. Efficiencies range to 75%, and ambient temperature ratings to 71 C. More than 60 basic and overvoltage protection models are available, with voltage outputs between 3 and 32 V dc and power levels up to 256 W.

CIRCLE NO. 356

# i'm free



**I'M A  
MAIL-LITE®  
SHIPPER**

**1 CASE of Mail-Lite FREE when you buy my  
\$50 table model heat sealer.**

**2 CASES of Mail-Lite FREE when you buy my  
\$100 floor model heat sealer.**



*Labor Savings: Can be heat sealed closed in 2 seconds  
Postal Savings • Waterproof • Pilferproof • Lightweight • Clean*



WRITE TODAY FOR INFORMATION ON OUR  
MAIL-LITE SHIPPERS AND THE SPECIAL  
HEAT SEALER OFFER.

**Sealed Air Corporation**

19-01 State Highway 208, Fair Lawn, New Jersey 07410

INFORMATION RETRIEVAL NUMBER 110

For those damp spots—

## DORMEYER

ENCAPSULATED  
**SUPER-T  
SOLENOIDS**

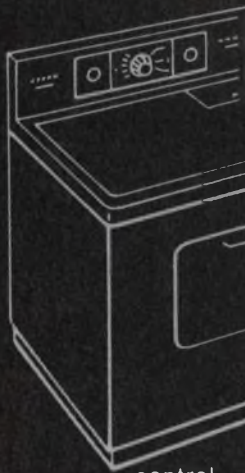

control  
operation cycles  
on automatic  
washers!

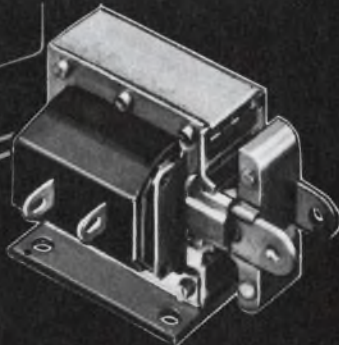

Write for **FREE BOOKLET**

"SOLENOIDS, What they are—How to use them!"

**DORMEYER INDUSTRIES, Inc.**

3414 No. Milwaukee Ave., Chicago, Illinois 60641

WORLD'S LARGEST MANUFACTURER OF SOLENOIDS—COILS—TRANSFORMERS



**DORMEYER**  
Dependability

INFORMATION RETRIEVAL NUMBER 111

ELECTRONIC DESIGN 8, April 12, 1974



## Light-Reflecting Electromagnetic Display Components

### PRE- ENCODED MODULE

is made up of 35  
light-reflecting discs  
in a 5 x 7 array — to  
display up to 11  
different characters or  
symbols.

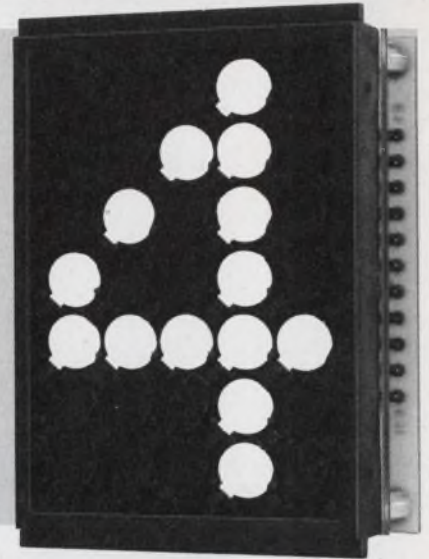

### MODULES 1 TO 18 INCHES

**MEMORY** — inherent remanent magnetism maintains the display state.

**LOW POWER** — as low as .75 joules to change data. Zero power to retain state.

**VISIBILITY** — rotating fluorescent discs provide excellent visibility over a wide range of ambient light conditions and wide viewing angles.

**RELIABILITY** — only one moving part per dot rated for over 20 million operations. No lights or mechanical linkages to wear out. Virtually maintenance free.

### FERRANTI-PACKARD DISPLAY MODULES

Ideal for

- Industrial Displays
- Scoreboards
- Traffic Control Displays
- TV Shows
- Paging Systems.

Fluorescent discs available in a range of colors.

Electromagnetic operation with remanent magnetism maintains display with zero energy input.

Inherent memory eliminates memory circuits and minimizes control and cabling costs. Modules can be driven from a common data bus.

A range of modules are available to display character sizes from 1 inch (2.54 cm) to 18 inches (45.72 cm) in pre-encoded and alphanumeric formats.

For full information and specifications, contact the Display Components Department.

## FERRANTI-PACKARD LIMITED

ELECTRONICS DIVISION,  
121 Industry Street,  
Toronto, Ontario, M6M 4M3, Canada.  
Telephone: (416) 762-3661  
Telex: 06-22007.

7305

INFORMATION RETRIEVAL NUMBER 112

179

# Electronic Design's



**WATCH FOR IT... JULY 1974**

# GOLD BOOK

MASTER CATALOG AND DIRECTORY OF SUPPLIERS TO ELECTRONICS MANUFACTURERS

## ***PUTS THE ELECTRONICS INDUSTRY AT YOUR FINGERTIPS***

- **MAKES ALL OTHER MASTER DIRECTORIES SEEM OBSOLETE**
- **A COMPLETE ONE-STEP PURCHASING TOOL**
- **MORE DIRECTORY LISTINGS AND INFORMATION THAN EVER PUBLISHED BEFORE**
- **52 PRODUCT CATEGORIES**

If you've never used a directory before, *Electronic Design's* GOLD BOOK will amaze you with its convenience and utility. Manufacturers' catalogs, spec sheets, and application data notes will be right on your desk in one convenient package. The directory listings are the most complete and detailed to date. From mid-year on you'll be referring to it daily for purchasing information and catalog data. It's the most massive compendium of product information ever compiled . . . the one-step purchasing and reference source that can save you untold hours in the search, selection and specification of the products you need.

***Another FREE Service for Readers From...***

# **Electronic Design**

# Test & Sort RCLZ

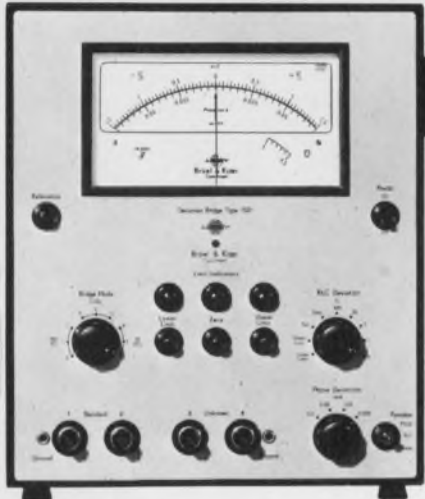

Size Shown 1:4

B & K's 1519 and 1521 Deviation Test Bridges are direct-reading instruments for fast, accurate determination of the percentage deviation of impedance and phase angle difference of capacitors, inductors, and resistors. No need for expensive standards; use your acceptable component as reference.

## APPLICATIONS

- Test or selection of precision capacitors, inductors, and resistors
- Control of automatic sorting machines
- Comparison measurements on motor windings, solenoids, and relay coils
- Locating tracking errors in ganged controls
- Testing
  - Wiring harnesses
  - Transformers
  - Passive subassemblies

## FEATURES

- Impedance comparison to 0.01% deviation, full scale
- Phase angle comparison to  $\tan \delta = 0.001$  difference
- Outside tolerance indicator lamps
- Analog output for recording and automatic control
- Relay output to sorters
- Interchangeable meter scales

**B&K Instruments, Inc.**

Bruel & Kjaer Precision Instruments  
5111 West 164th Street, Cleveland, Ohio 44142 / Telephone: (216) 287-4800  
1460 South State College Boulevard, Anaheim, Cal. 92806 / Telephone: (714) 778-2450



INFORMATION RETRIEVAL NUMBER 117

## COMPONENTS

### Electrolytic capacitors wound automatically

*The Plessey Co. Ltd., Plessey Precision, Alma Rd., Ponders End, Mddx., England. (01) 804-9511.*

Single-sectioned electrolytic capacitor elements can be wound automatically at a rate of around 4000 per eight-hour shift. The type T2400 machine winds elements from reels of pre-tabbed anode and cathode foil and from up to four reels of separator paper. The completed winding is finished with a length of pressure-sensitive tape and is ready for impregnation and assembly. The machine is designed for continuous 24-hour operation. Up to four units can be controlled by one operator. Cutouts stop the drive if the foil breaks, fails to feed, runs out, or if a tab is missing or misplaced. And the machine stops if the compressed air supply fails.

CIRCLE NO. 362

### Moving coil, iron-free rotor starts in 17 ms

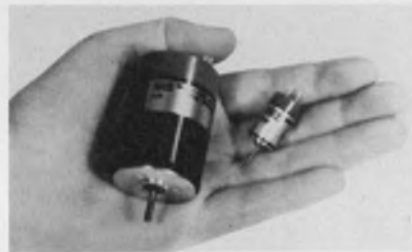

*Hico Maxon Co., 716 Willow Rd., Menlo Park, Calif. 94025. (415) 328-1111.*

A new larger, higher-torque, 26-mm (about 1-in.-D) motor, the Super 26, dwarfs Hico-Maxon's older 12-mm motor. The Super 26 is standard with a  $3 \times 13$ -mm shaft (about  $1/8 \times 1/2$  in.), but it is also available with a 2-mm diameter shaft for interchangeability with other 26-mm motors. With a long and powerful Alnico-core magnet and an iron-free, moving-coil rotor on oilite sleeve bearings, the motor has a starting time of 17 ms and a very-high torque-to-size ratio (not given). Ball bearings of several grades are available and its 6-in. leads are securely attached. A double-ended-shaft version will be available soon.

CIRCLE NO. 363

### Lighted pushbutton switch has many options

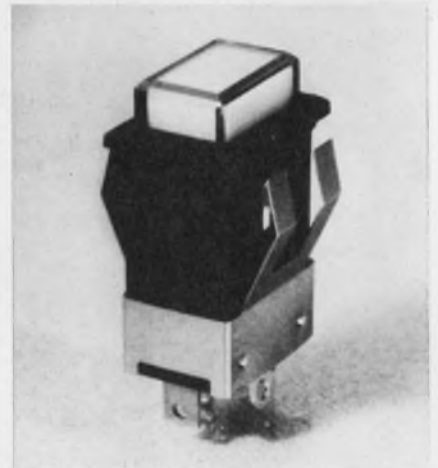

*Oshino Electric Lamp Works, Ltd., 2-5-2, Minami-shinagawa, Shinagawa-ku Tokyo, Japan. \$5 (1-10); 1-2 wks.*

Series LPS-100 lighted pushbutton switches are available with either momentary or alternate-closure actuation and in SPST or DPST contact configurations. The switches need only  $0.75 \times 0.55$  in. of panel space for mounting, and require a force of 8 oz. for operation. Lamps used are T-1-3/4 based. Contact resistance is 30 m $\Omega$  max and insulation resistance is 10 M $\Omega$ . Contact specifications are 115 V ac at 1 A and 30 V dc at 0.2 A, both for resistive loads. Switch life is a minimum of 100,000 operations over an operating temperature range of  $-10$  to 70 C.

CIRCLE NO. 364

### Reed relays are small and come in many styles

*Kempston Electrical Co. Ltd., Shirley Rd., Rushden Northants, England.*

The M30 series of reed relays has a package size just over an inch long. They have a typical operating time of 400  $\mu$ s, including bounce. The nominal coil voltage ranges from 3 to 48 V. Higher sensitivity is offered by a second series, the M31. Efficient screening is incorporated in the construction of the M30 relays and the encapsulation and other design features give a high mechanical strength at the pin-outs. Mercury-wetted contacts are also available, and internal suppression diodes may be specified.

CIRCLE NO. 365

# Internal flag, magnetic latching BITE indicator.



ACTUAL SIZE

The MI57D low power drain  
(1 watt - 25  
milliseconds)

fast response,  
high sensitivity

indicator has met the test in both military and  
industrial applications.

The flag in the MI57D is magnetically held in position and will change color only when the reset coil is pulsed. Qualified to MIL-I-83287/02.

Further information  
and complete  
specifications  
on request.



**MINELCO**

Division General Time Corp.  
A TALLEY INDUSTRIES COMPANY

135 SOUTH MAIN STREET • THOMASTON, CONN. 06787  
PHONE: 203/283-8261 • TWX: 710/475-1091

INFORMATION RETRIEVAL NUMBER 118

Unlike beer, tires,  
and Italian actresses,  
C&K's Flatted Toggle  
Switch is appealing  
because it's flat.

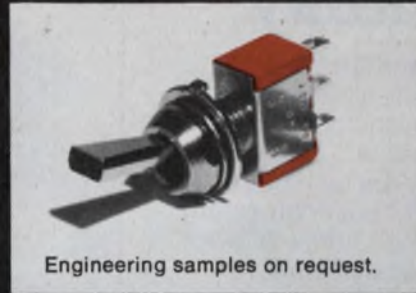

Engineering samples on request.

It's also competitively priced, made in America for rugged high-quality performance, and available in SPDT, DPDT, 3PDT and 4PDT models. A sleek, modern-looking visual design element that's as flat as Twiggy.

For more information, contact:

**C&K COMPONENTS, INC.,**  
103 Morse St., Watertown, MA 02172  
(617) 926-0800.

"See us at NEPCON Southwest"

INFORMATION RETRIEVAL NUMBER 120

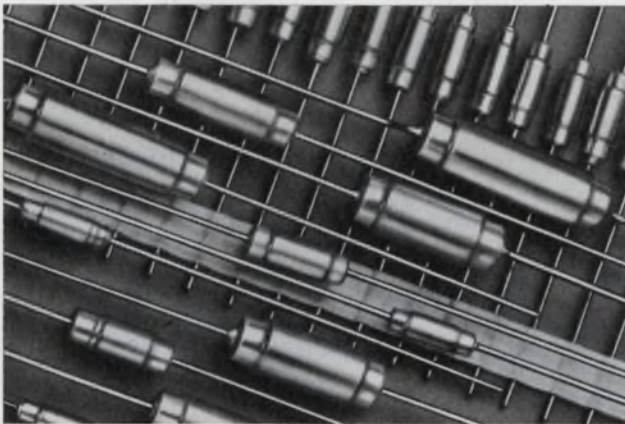

Last year these Paktron® film capacitors were revolutionary. Now they are the standard.

Because our polyester and polypropylene Micromatic® capacitors are uniquely better. Both are self-encased and wound on their own leads—no outside wrapping, no separate lead attachments. Close capacitance tolerances too. Ideal for automatic PC board insertion. For free catalog, write:

**PAKTRON**, Division Illinois Tool Works Inc.,  
900 Follin Lane, S. E., Vienna, Virginia 22180.  
Phone (703) 281-2810. TWX 710-833-0682.



**PAKTRON**  
innovators in film capacitors

The Innovative Electronic Group of ITW...

PAKTRON • LICON • EMCON © ILLINOIS TOOL WORKS INC. 1974

INFORMATION RETRIEVAL NUMBER 119

ELECTRONIC DESIGN 8, April 12, 1974

## Custom Relay Sockets for every purpose



**MODEL RB 08**  
Top Wired  
Closed Back  
Construction  
10 AMPS.—  
300 Volts



**MR SERIES**  
Miniature  
No relaying ring. Can be  
pre-wired before installing.  
Rated 5 AMPS. 4 PDT



**MODEL RB 11**  
Top Wired  
Closed Back  
Construction  
10 AMPS.—300 Volts



**MODEL QC 11**  
Top Wired  
Closed Back  
Construction  
10 AMPS.—  
300 Volts



**CM SERIES**  
Miniature  
Square base. Chassis mount.  
Solder or quick connect  
terminals. Rated 10 AMPS.  
2 PDT and 3 PDT.

**Custom  
Connector  
Corporation**

1738 EAST 30TH ST. • CLEVELAND, OHIO 44114 (216) 241-8064

INFORMATION RETRIEVAL NUMBER 116

## VCXO's: Unmatched Versatility.

Damon continues to be recognized as the leader in the design and production of low noise VCXO's. Backed by the technical expertise of our engineering team, Damon offers VCXO's with unique performance characteristics:

### Highest Modulation Rate

Modulation Rate:

DC to 200 KHz

Peak Deviation:

.03% of C.F.

Center Frequency:

1 to 140 MHz

F.M. Distortion:

Less than 5%

### Widest Deviation Bandwidth

Peak Deviation:

0.5 to 300 KHz

Linearity:  $\pm 3\%$

Center Frequency:

0.1 to 60 MHz.

Frequency Stability:

Less than 100 PPM,

0° to 50°C

### Exceptional Spectral Purity

Center Frequency:

40 to 120 MHz

(overtone VCXO)

Peak Deviation:

10 to 30 KHz

Linearity:  $\pm 1\%$

Damon Electronics: The recognized leader in state-of-the-art, dependable VCXO's. Damon also manufactures a high-quality line of crystal filters.

For further information, write or call Ed Doherty, ext. 666.



**DAMON**  
ELECTRONICS DIVISION

80 WILSON WAY, WESTWOOD, MASS. 02090 TEL (617) 449-0800

## COMPONENTS

### Rotary switch locks to control use

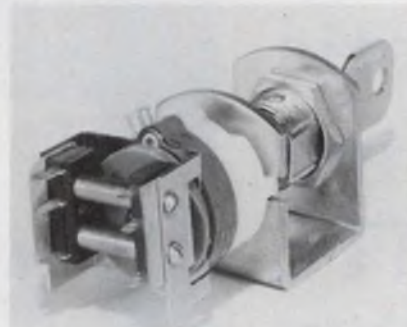

Stackpole Components Co., P.O. Box 14466, Raleigh, N.C. 27610. (919) 828-6201. \$7.29 (1000 up); 4 wks.

Stackpole's new rotary-switch assembly centers around its 1-1/8-in. D enclosed rotary switch that has 30, 45, 60 or 90-degree index angles, 1-A switching and 15-A carrying capacity. A number of standard BCD codes are available. Mounted behind the rotary switch is a single-pole or double-pole, double-throw, 10-A precision snap-action line switch for cam-operated, power, ON-OFF switching. The front of the unit is a keylock, in a flat or tubular key style, for control of equipment use.

CIRCLE NO. 366

### Solid-state relay handles 25 A at 250 V



Teledyne Relays, 3155 W. El Segundo Blvd., Hawthorne, Calif. 90250. (213) 973-4545.

Model 611 solid-state relay is rated at 140/250 V ac, 25 A and is optically isolated. It is designed to allow IC logic (3 to 32 V dc) circuits to control such tough loads as motors, solenoids and lamps. Other features include high (200 V/ $\mu$ s) output transient immunity and synchronous, zero-voltage switching for quiet rf-free operation and freedom from arcing.

CIRCLE NO. 367

### Tri-axial accelerometer claimed to be smallest



Columbia Research Laboratories Inc., MacDade Blvd. & Bullens Lane, Woodlyn, Pa. 19094. (215) 532-9464.

Miniature accelerometers, Models 612TX and 614TX, provide the simultaneous measurement of acceleration in three mutually perpendicular axes. The Model 614TX has its three low-noise cables located along one edge of the accelerometer block. Columbia Research says that these transducers are the world's smallest—50% lighter (less than 8 gr) and 70% smaller (0.082 in.<sup>3</sup>) than the smallest devices of this type previously available. Sensitivity of both models for each axis is 5 mV/g peak; charge sensitivity is 1.5 C/g; frequency response is flat within  $\pm 5\%$  from 1 Hz to 5 kHz; and amplitude linearity is  $\pm 1\%$ . The standard operating temperature range is from -100 to 350 F, with high temperature units available to 500 F.

CIRCLE NO. 368

### Miniature flasher fits DIP socket



Projects Unlimited, 3680 Wyse Rd., Dayton, Ohio 45414. (513) 890-1918.

A miniaturized, solid-state flasher, Model FL 200 DIP-Flash, in a four-pin configuration that fits a standard DIP socket, operates on any voltage from 5 to 15 V dc and handles loads to 200 mA with a current drain of less than 10 mA. It withstands temperatures from 0 to 70 C. Solid-state interruption eliminates mechanical contacts and rf noise. Typical life exceeds 6 million cycles. The nominal flash rate is 90/min.

CIRCLE NO. 369



## Small meter controller is contactless

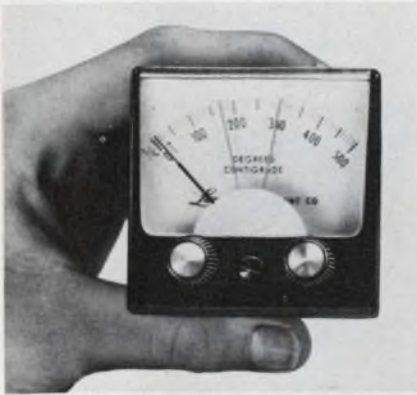

Larson Instruments Co., Greenbush Rd., Orangeburg, N.Y. 10962. (914) 359-3800. 2 wks.

Type CMC contactless meter controller, only 2-1/2-in. square and 3-in. deep, can be mounted in spaces too small for conventional units of comparable performance. The unit is completely self-contained with solid-state amplifier circuitry. Adjustable controls are accurate to within  $\pm 1/4\%$  repeatability and the unit can control a 7.5-A, 115-V-ac load. A 24-to-32-V-dc model is also available for battery-powered equipment. The meter controllers can be supplied with scales ranging from 10 mA to 1000 A or 10 mV to 1000 V, dc or ac. Pyrometer controllers have scale ranges from -200 to 3000 F, or equivalent centigrade temperatures.

CIRCLE NO. 370

## Infrared detector has element, FET and op amp

Plessey Optoelectronics, Wood Burcote Way, Towcester, Northants, England.

The PSC-222 broadband infrared detector uses a sensitive triglycine sulphate (TGS) element that operates at room temperature. The detector consists of the element, a low-noise FET preamplifier, and a standard operational amplifier output stage. Signal-to-noise ratio falls off as the square root of the frequency within the usable bandwidth. Spectral response has a lower limit of  $2 \mu\text{m}$  (set by the detector material); upper limit is set by the window transmission (maximum about  $40 \mu\text{m}$ ).

CIRCLE NO. 371

System 9400  
changes as quickly as your needs do.

# DATA LOGGER

A new breed of data logger that easily configures to your needs now—quickly reconfigures as your requirements change. Can be stand-alone logger or part of a powerful NOVA computer based system with software drivers in BASIC, FORTRAN and ASSEMBLY languages.

Outputs to integral printer, TTY, mag tape, modem, punch tape. Don't get locked into another logger before you've seen the

System 9400 in action. Contact Monitor Labs Incorporated, 4202 Sorrento Valley Boulevard, San Diego, CA 92121. Tel: (714) 453-6260. TWX: 910-337-1278.



INFORMATION RETRIEVAL NUMBER 126

# COMPLETE PACKAGING CAPABILITY

only from Vero

VEROBOARDS



D.I.P. BOARDS

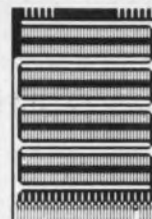

MODULE RACKS

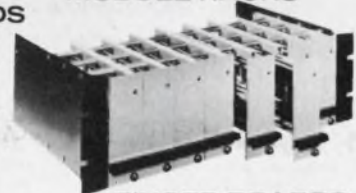

PINS



FINGER BOARDS

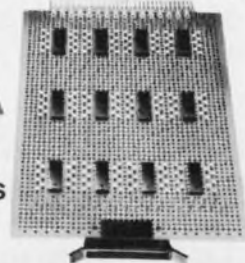

CARD HANDLES



INSTRUMENT CASES

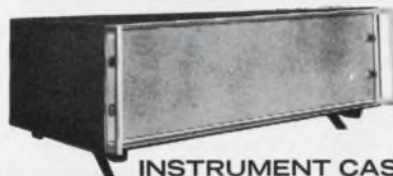

## Vero Electronics Inc.

171 Bridge Road, Hauppauge, N.Y. 11787  
Tel.: 516-234-0400 • TWX510-227-8890

INFORMATION RETRIEVAL NUMBER 127

# EVERYTHING IN PRINTED CIRCUIT BREADBOARDS

FROM

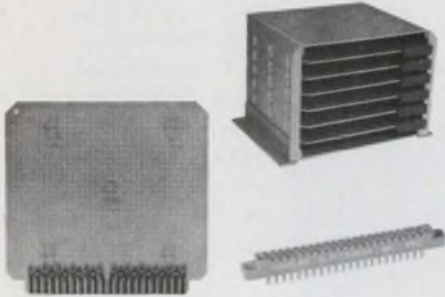

TO

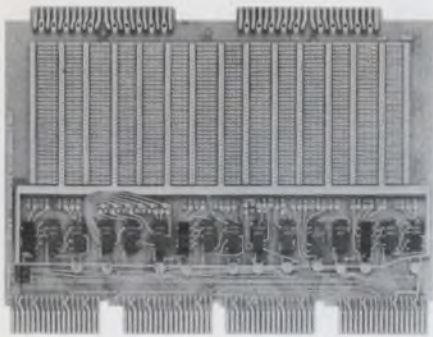

Select from over 250 standard circuit boards, card racks, connectors etc. carried in stock. Complete package systems for prototype and development work. If we don't have the right breadboard you want, we'll make it.

Many boards available for interfacing with Digital Equipment Corporation mini-computers.

## DOUGLAS ELECTRONICS, INC.

718 Marina Blvd.,  
San Leandro, California 94577  
Telephone 415/483-8770

Circle # 151 for general catalog  
Circle # 152 for DEC information.

## PACKAGING & MATERIALS

### Edge connector handles different size PC boards



*The McMurdo Instrument Co. Ltd.,  
Rodney Road, Portsmouth PO4  
8SG, England.*

The RL series of edge connectors has self-adjusting contacts that can accommodate plug-in PC boards of different thicknesses. They are optimally designed for 1.58-mm-thick boards, but adjustment of the contact spring length enables boards between 1.43-mm and 1.82-mm thick to be accommodated. The contact design also has low insertion force, typically 1.7 newtons per contact, for a 1.6-mm thick board. Contact resistance is less than 10 mΩ. RL connectors come in lengths to accommodate up to 40 contact positions with a 3.8-mm pitch, or up to 85 contact positions with a 2.5-mm pitch, in either one or two rows.

CIRCLE NO. 372

### Connector interfaces PC and power circuits

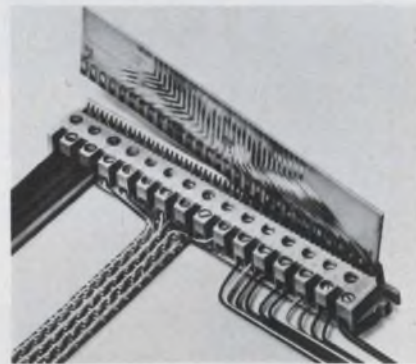

*Amerace Corp., 2330 Vauxhall Rd.,  
Union, N.J. 07083. (201) 964-4400.*

A new PC connector directly interfaces electrical and electronic circuits. Designated the Buchanan PCB block, the connector accepts the direct plug-in of 0.2-in., contact-spaced, PC boards that contain components or flat, flexible cable. And 12 through 30-AWG stranded wire can be attached to the same one-piece block. The block has 300-V insulation between circuits and each circuit can carry up to 5 A. Currently available blocks can handle 6, 12, 18, 24, 30 or 36 circuits.

CIRCLE NO. 373

### Temp-sensitive paints available in kit form



*Synthetic & Industrial Finishes  
Ltd., Imperial Works, Imperial  
Way, Watford, WD2 4JN, Herts.,  
England.*

A research and laboratory kit of Thermindex temperature-indicating paints can give an accurate picture of surface temperatures. The paints are temperature-sensitive compounds that undergo a sharp, definite change of color, when the temperature of a surface reaches or exceeds a predetermined value. Intricate surfaces or moving parts, which would otherwise require elaborate measuring equipment, can simply be coated with one or more of these paints. Isotherms can then be plotted from the resulting color changes. The kit contains a full range of paints in 1/2-oz. bottles, and a 4-oz. bottle of Solvent 'O'.

CIRCLE NO. 374

### Dispenser places shot of material accurately



*Kenics, One Southside Rd., Dan-  
vers, Mass. 01923. (617) 774-8600.*

The Kenics 500 series dispenses all flowable and thixotropic materials in small shot sizes. Its positive, no-drip, shut-off device provides accurate placement of the fluid from a 5, 75, or 200 cm<sup>3</sup> polyethylene cartridge. All components wetted by the fluid are disposable to enhance the safe handling of reactive resin formulations.

CIRCLE NO. 375

**SOLDERING +  
DESOLDERING +  
RESOLDERING =  
SOLDER ABILITY**  
ELEMENTARY TO ELITE  
WORLD'S MOST PRACTICAL SOLDER HANDLING TOOLS

*meets industries demands.....*

with a COMPLETELY PORTABLE SOLDERING/DESOLDERING/RESOLDERING SYSTEM



**EDSYN**  
15958 ARMINTA STREET  
VAN NUYS, CALIFORNIA 91406  
PHONE (213) 989-2324  
TELEX NO. 65-1469 EDSYNEX VAN

Send for our FREE 16 page  
**SOLDER ABILITY**  
manual

Ads in EEM, OTS, EBG,  
AE, TR, and EPAC Catalogs

INFORMATION RETRIEVAL NUMBER 129

**New DIP-ALARM™**  
plugs into DIP sockets

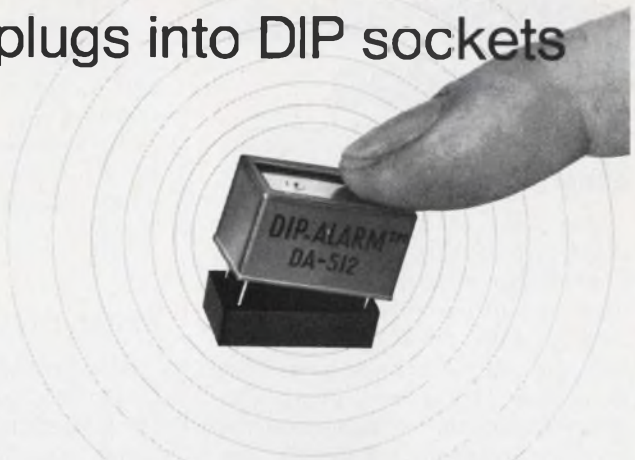

**First miniature solid state audio indicator of its kind**

**Loud news!** A loud (80 db @ 400 Hz) penetrating audio signal can be used for alarm, fault detection, warning. Can't be ignored! **Great news!** New concept in packaging — a miniature audio indicator that plugs into standard DIP sockets. Operates on standard DIP voltages (3, 5, or 12 VDC). Low cost DIP-ALARM Model DA 512 is solid state (no contacts!), low current, weighs 8 gm. Handiest new component since LED. Bulletin 1003. D.I.A.L. 800-645-9200 toll free.



3680 Wyse Road  
Dayton, Ohio 45414  
Tel. 513-890-1918  
TWX 810-450-2523

IN EUROPE  
projects unlimited/  
Europe B.P. 15;  
6100 Mont Sur  
Marchienne  
Belgium, Telex 51-390  
Tel (07) 26 84.86

D.I.A.L. 800-645-9200 for the name of your nearest representative.

INFORMATION RETRIEVAL NUMBER 131

**Design  
award  
winners**

Rogan's "Alpha Series"  
Knobs... A winner in  
INDUSTRIAL DESIGN"  
MAGAZINE'S ANNUAL  
DESIGN REVIEW. Affirming  
our opinion that front panel  
components should be  
attractive. Our brochure  
will be sent upon  
request.



**ROGAN**  
CORPORATION

3455 Woodhead Drive, Northbrook, Ill. 60062  
(312) 498-2300 • TWX 910-686-0008

INFORMATION RETRIEVAL NUMBER 130

ELECTRONIC DESIGN 8, April 12, 1974

**ATLAS** positively guarantees...



- fastest delivery
- unsurpassed accuracy
- lowest prices

on Turned and Precision-Ground  
**PHENOLIC RODS**

**EPOXY**    **BAKELITE**    Glass Supported **TEFLON**

- Stock sizes in any diameter from 3/32" to 1/2"
- Increments of .001 at no extra charge
- Most sizes available for immediate delivery
- Accuracy guaranteed to ± .001"

**Plus... the largest inventory in the world!**

SEND FOR  
COMPLETE  
PRICE LIST

**ATLAS FIBRE COMPANY**

6980 N. Central Pk. Ave. Chicago, Ill. 60645  
(3.2) 465-1234

INFORMATION RETRIEVAL NUMBER 132

# application notes

## Zener voltage regulators

The uses of high power zener voltage regulators are described in a two-page application note. The literature discusses how to use the devices with basic zener regulators, for simple voltage protection, in voltage transient suppression, in semiconductor voltage protection and for controlled inductor discharge. Each application is illustrated with a circuit diagram. International Rectifier, El Segundo, Calif.

CIRCLE NO. 376

## Magnetic foil

The use of magnetic foil, for determining the amount of shielding required for new applications, is described in a two-page application note. James Millen Manufacturing, Malden, Mass.

CIRCLE NO. 377

## Adhesives

"A Guide to Surface Preparation and Pretreatments for Adhesive Bonding" describes various techniques of surface preparations. This 45-page booklet is available for \$1 to cover postage and handling. Hardman, Belleville, N.J. 07109.

INQUIRE DIRECT

## Motor controls

The Troubleshooting Motor Control guide lists the major problems encountered in motor controls, explains the cause of these problems, and details the appropriate remedy to correct the problem. Arrow-Hart, Hartford, Conn.

CIRCLE NO. 378

## Keyboard encoding system

The use of a single MOS IC as a complete keyboard interface system is detailed in a bulletin. The theory of operation, features and design are given. National Semiconductor, 2900 Semiconductor Dr., Santa Clara, Calif. 95051

INQUIRE DIRECT

## Converters

Application notes describe a parallel-to-serial converter for dot matrix printer data input. A block diagram, truth table and logic circuits to fully illustrate the circuit are included. The text includes data on the operation of the 6-bit ASCII serial output, 20-character line input multiplexer and scanning counter. Amperex, Hicksville, N.Y.

CIRCLE NO. 379

## Multiple op amps

Features and applications of multiple micropower operational amplifiers are contained in a brochure. "Programmable Micropower Triple Op Amps" describes the device function, elements of programming and the effects of slew rate limiting. Specific applications circuits include instrumentation amplifiers, tone detectors, triple-amplifier active filters and a micropower double-ended limit detector. Siliconix, Santa Clara, Calif.

CIRCLE NO. 380

## "CANNON<sup>®</sup> BACKPLANES BROUGHT ME FAME AND FORTUNE IN ONLY SIX WEEKS."



"That's normal delivery (three weeks turnaround on prototypes). What tipped me to Cannon? Their 'Secrets of Connector Success.' It's invaluable to innovative thinkers — like you."

Contact ITT Cannon Electric, International Telephone and Telegraph Corporation, 666 East Dyer Road, Santa Ana, CA 92702. (714) 557-4700.

**CANNON ITT**

INFORMATION RETRIEVAL NUMBER 133

## Look to Ballantine for scopes

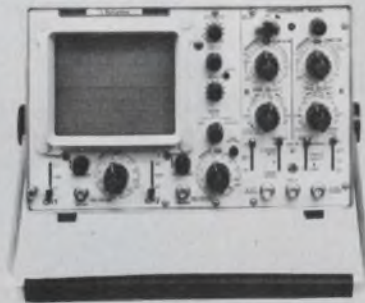

Portable • Dual Trace • X-Y

1040A	40 MHz, 5 mV Delayed Sweep Only 27 lbs.	\$1200
1066B	20 MHz, 5 mV	\$745
1010A	10 MHz, 5 mV, Only 15 lbs.	\$495
7050A	Electronic Transient Recorder	\$985



**Ballantine Laboratories, Inc.**

P.O. Box 97, Boonton, New Jersey 07005  
201-335-0900, TWX 710-987-8380

INFORMATION RETRIEVAL NUMBER 134

ELECTRONIC DESIGN 8, April 12, 1974

## new literature

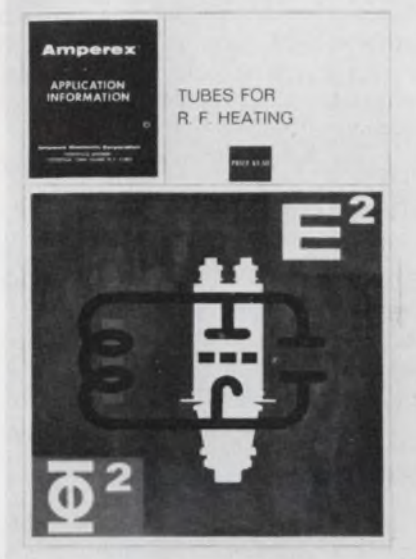

### Rf heating generators

A 180-page application textbook entitled "Tubes for Rf Heating" gives data on the practical considerations in the design of induction and dielectric rf heating generators. Amperex Electronic Corp., Hicksville, N.Y.

CIRCLE NO. 381

### Noise abatement

The environmental noise abatement brochure gives a summary of acoustical terms and community noise criteria. Also included in the 12-page brochure is a brief history and summary of current status of noise control efforts. B&K Instruments, Cleveland, Ohio.

CIRCLE NO. 382

### Digital tape deck

Features, specifications and options of the Model 6400 OEM digital tape deck are given in a two-page illustrated brochure. Gould, Instrument Systems Div., Cleveland, Ohio.

CIRCLE NO. 383

### Power supplies

Specifications, dimensions, photographs and ordering information for the PT series of rack-mounting power supplies are described in a bulletin. Models covered provide outputs from 1.5 to 50 V dc and to 60 A. Acopian, Easton, Pa.

CIRCLE NO. 384

### Ac power failures

Two brochures deal with the problems of ac power failures encountered by users of computer-controlled process equipment. Lorain Products, Lorain, Ohio.

CIRCLE NO. 385

### Stripswitch

PC board mounting stripswitch is described and illustrated in a four-page brochure, which contains specifications, photos and outline drawings. Electronic Engineering Company of California, Santa Ana, Calif.

CIRCLE NO. 386

### Monitoring-recording system

Edition 61 of "News from Rohde & Schwarz" contains features on the radiomonitoring-recording system, a TV monitoring receiver for mobile and stationary use and a mobile 20-kW antenna system for extremely rapid deployment. Rohde & Schwarz, Munich, Germany.

CIRCLE NO. 387

### Bonding systems

A 10-page illustrated brochure describes the "Jet-Melt" bonding systems that overcome disadvantages associated with conventional hot-melt systems. 3M, St. Paul, Minn.

CIRCLE NO. 388

### Wire markers

Wire, cable and safety markers are listed in sequential order, whenever possible, in an eight-page catalog. AMP Special Industries, Valley Forge, Pa.

CIRCLE NO. 389

### PM motors

A 20-page bulletin describes computer-aided design techniques for optimizing size, cost and temperature rise tradeoffs in permanent magnet motors. Motor parameters evaluated include choice of magnetic material, magnetic-to-electrical loading ratio, efficiency, and angle of magnet arc. Indiana General, Valparaiso, Ind.

CIRCLE NO. 390

# POWER SPLITTERS-COMBINERS

Great Value at

**\$7.95**  
500 piece quantities.

\$9.95 in 6-piece quantities.

0.1-400MHz  
0.5dB insertion loss  
40dB isolation  
EMI shielded case



A breakthrough in technology and high production volume enables Mini-Circuits Laboratory to offer these new products at an unprecedented low price.

In today's tough competitive market can you afford not to use these remarkably low priced and high performance units?

Ruggedness and durability are built in the PSC2-1. Packaged within an EMI shielded metal enclosure and hermetically sealed header. This new unit uses a broadband hybrid junction and uniquely designed matched transmission line transformers.

We invite you to convince yourself. Place your order now and check our delivery, product performance and reliability.

## Mini-Circuits Laboratory

2913 Quentin Rd., Brooklyn, N.Y. 11229  
(212) 252-5252, Int'l Telex 620156  
A Division Scientific Components Corp.

FRANCE: S.C.I.E., \*31, rue George-Sand, Palaiseau 91, France GERMANY: AUSTRIA, SWITZERLAND: Industrial Electronics GMBH, \*Klüberstrasse 14, 6000 Frankfurt/Main, Germany \*UNITS IN STOCK

INFORMATION RETRIEVAL NUMBER 135

New squeeze-type, needle point pen comes with choice of removable or permanent ink. Replaces adhesive dots for inspection marking of electronic components (12,000 dot ink capacity). For marking plastic or glass laboratory ware, welding and sheet metal layout, identification marking. Many other industrial uses. Five fluorescent colors—red, blue, green, orange, yellow. When ordering, specify color(s), removable or permanent ink.

**Remarkable.  
A marking pen  
and inks that  
mark on  
anything.**

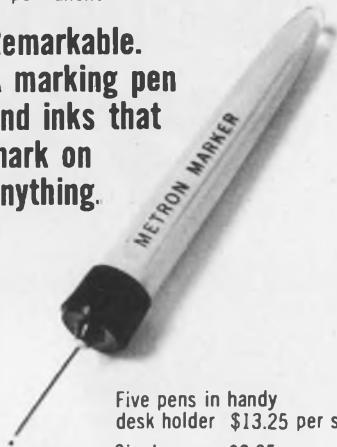

Five pens in handy  
desk holder \$13.25 per set  
Single pen \$2.95 ea.

**METRON  
MARKER**

METRON OPTICS, Box 690S  
Solana Beach, CA 92075 • 714/755-4477

INFORMATION RETRIEVAL NUMBER 136

**LABORATORY STANDARD  
SIGNAL GENERATOR**

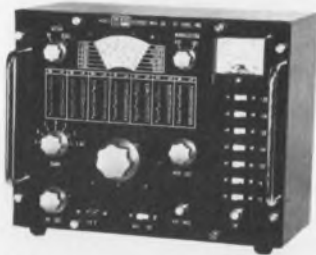

**Model SG-83C  
\$295.00**

- ✓ 50 Hz to 54 Mhz; 1 Mhz crystal; 1% accuracy
- ✓ Calibrated output 0.6 to 160,000 microvolts
- ✓ Operates from 115 volts or internal battery
- ✓ Metered internal 400 Hz or external modulation, no FM
- ✓ Low distortion silicon FET oscillator
- ✓ Send for free copy of Instruction Book with Schematic and all specifications.

**CLEMENS MANUFACTURING CO.**

630 South Berry Road  
St. Louis, Missouri 63122  
Area Code (314) WO 1-7228

INFORMATION RETRIEVAL NUMBER 137

**NEW LITERATURE**

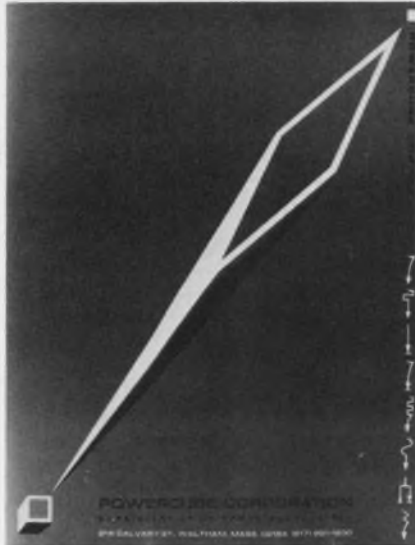

**Power circuits**

A 24-page catalog describes miniature power modules (preregulators, inverters, regulated and complementary converters, regulators and filters), complete power systems and hardware. Specs are given as well as "how-to-use" building block diagrams. Powercube, Waltham, Mass.

CIRCLE NO. 391

**Ceramic disc capacitors**

Ceramic disc capacitors, designed for coupling or uncoupling in a wide range of applications, are described in a bulletin. The bulletin contains dimensional information, test data, performance graphs and ordering specifications. Sakata International, Elk Grove Village, Ill.

CIRCLE NO. 392

**Rotary switches**

A 1-in. diameter rotary switch is described in a bulletin. The eight-page bulletin presents standard capabilities and options of the switch, designed to meet MIL-S-3786/SR-05, and contains photographs, illustrations and diagrams. OAK Industries, Crystal Lake, Ill.

CIRCLE NO. 393

**Software packages**

Four software packages for computer output microfilm (COM) systems are described in a six-page brochure. The software packages are DATACOM, CM/360 and CM/COBOL, COM T R E V E and BANCOR. Pertec, Santa Ana, Calif.

CIRCLE NO. 394

**Photoelectric products**

Retroreflective photoelectric control devices are featured in a product sheet. Applications, specifications and mounting-dimension drawings are given. A pricing and ordering guide, with full options, completes the product sheet. Micro Switch, Freeport, Ill.

CIRCLE NO. 395

**Automatic test equipment**

A 40-page brochure describes applications of computer-controlled test systems and provides configurations of specific user-oriented test systems. Instrumentation Engineering, Franklin Lakes, N.J.

CIRCLE NO. 396

**Hermetic transistors**

A 32-page catalog describes hermetic transistors, including beam lead chips, NASA and military-type devices, and the company's SURE line of wireless bonded semiconductors. Raytheon Semiconductor, Mountain View, Calif.

CIRCLE NO. 397

**High noise immunity logic**

Literature that includes a 12-page condensed catalog and a 64-page applications and specifications catalog covers nearly 40 different HiNIL devices. A description and diagram for each HiNIL device, a summary of HiNIL characteristics and basic nomenclature data are included. Teledyne Semiconductor, Mountain View, Calif.

CIRCLE NO. 398

**Air filters**

E Z Kleen air filters that come in a variety of sizes and shapes for both air filtration and EMI/RFI attenuation are described in a four-page brochure. Research Products, Madison, Wis.

CIRCLE NO. 399

**LSI/IC design system**

A six-page full-color brochure describes the MIDAS MD-180 LSI/IC design system. Complete with photos and block diagrams, the brochure explains the system in general terms and highlights its main features. Details of the hardware and software are included. Macrodata, Woodland Hills, Calif.

CIRCLE NO. 400

## VERSATILITY PLUS HIGH QUALITY

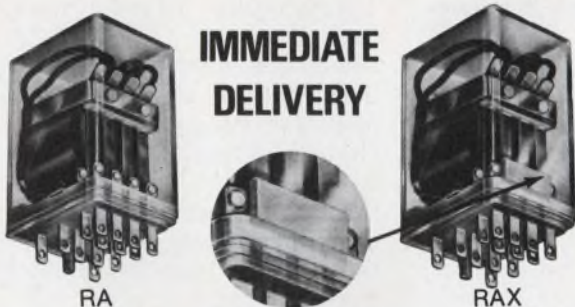

**IMMEDIATE  
DELIVERY**

The new RAX relay is an adaptation of the popular RA Type and includes plastic barriers between the movable arms, thereby enabling opposite polarity voltages to be applied to the unit without fear of arc-over.

Its rugged, compact design makes this relay ideal for commercial use, communication equipment, computers, process control applications, etc. Both the RA and RAX are miniature compact relays with 4 PDT or double make-double break action, with dust cover and pierced Faston terminals for quick connect-disconnect or soldering, or PC terminals.

The complete line of relays is U/L and CSA recognized.

Send or phone today for catalogs and complete specifications.



1140 Broadway, New York, N.Y. 10001 (212) 683-0790

INFORMATION RETRIEVAL NUMBER 138

Millions already in use

## NEW KIT LETS YOU TRY IT

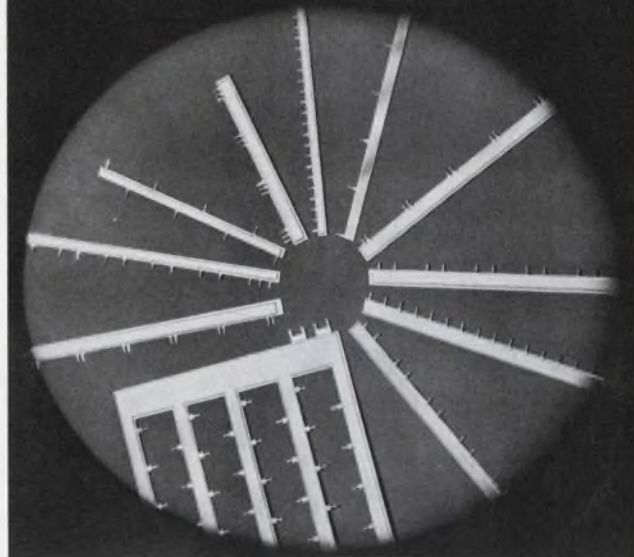

Evaluation kits @ \$25 in stock.  
Standard parts on 2 weeks delivery, or less!  
Custom parts 4 to 6 weeks delivery!

**MINI-BUS** The low-cost, noise attenuating, high packaging density, power distribution system for PC boards. Ask for data.



Rogers Corporation / Chandler, Arizona 85224  
West: (602) 963-4584 East: (203) 774-9605

INFORMATION RETRIEVAL NUMBER 139

## Recruitment Advertising gets READ ... in Electronic Design

### RATES

1 page .....	\$2,140.
3/4 page (3 cols.) .....	1,620.
1/2 page (2 cols.) .....	1,080.
1/4 page (1 col.) .....	540.
1/8 page (1/2 col.) .....	270.
1/16 page (1/4 col.) .....	135.
One column inch .....	54.

### DATA

Four column make-up. Column width: 1-3/4". Each issue mails two weeks prior to the issue date. Closing dates for camera-ready mechanicals or film is one week before mailing date. If desired, Electronic Design will set type at no charge (closing date is 2 weeks prior to mailing date).

### 84,000 DESIGN ENGINEERS AND ENGINEERING MANAGERS

Call the Recruitment Hotline: (201) 843-0550 X203 or clip & mail this coupon to: Recruitment Manager, Electronic Design, 50 Essex St., Rochelle Park, N.J. 07662.

I'm interested in placing recruitment advertising in electronic design.

Issue \_\_\_\_\_ Size of ad \_\_\_\_\_  
 My copy is enclosed  I need more information  
 Name \_\_\_\_\_ Title \_\_\_\_\_  
 Company \_\_\_\_\_ Telephone \_\_\_\_\_  
 Address \_\_\_\_\_  
 City \_\_\_\_\_ State \_\_\_\_\_ Zip \_\_\_\_\_

## OUR RESISTORS ARE ALWAYS THE SAME.



**THAT'S  
WHAT MAKES  
THEM  
DIFFERENT.**

Consistency is what Shigoto resistors are all about. And that's the important feature that makes them unique. They're rugged. Reliable. Regardless of tolerance, rating or value. We make a complete line of carbon composition or carbon and metal film fixed and variable resistors. Values from 1 ohm to 2.2 megohms. Weldable, solderable leads. Conservative ratings. Durable color coding. Temperature stability. All this, and fast delivery too. Check out our catalog. Or ask us to design to your specs. And keep us in mind for other outstanding O.E.M. components, as well.

Write or phone for our catalog and more information.

# SHIGOTO

WHEN CONSISTENCY COUNTS.

**Shigoto Industries Ltd.**

350 Fifth Ave., N.Y. 10001 • (212) 695-0200 / Telex 224219  
One of the World's Largest Manufacturing Importers

INFORMATION RETRIEVAL NUMBER 140



**Immersible connectors**

Aquacon electrical connectors are described in a 24-page catalog. The catalog layout permits ease of selection from hundreds of contact arrangements in either resilient or hard dielectrics (hermetic and nonhermetic) and solder or crimp contact terminations. The Bendix Corp., Sidney, N.Y.

CIRCLE NO. 451

**Active filters**

An article on filters for telephone message circuit noise measurement describes the history of the development of C-message and bandpass related notch filters. Specifications, based on Bell System Technical Reference 41009, are given. The article lists other filters for telephone circuit noise measurement—ERL, SRL, program weighting filters, etc. Kinetic Technology, Santa Clara, Calif.

CIRCLE NO. 452

**Nickel-cadmium batteries**

A 16-page manual covers the installation, operation and maintenance of pocket-plate nickel-cadmium storage batteries. NIFE, Copiague, N.Y.

CIRCLE NO. 453

**Communications oscillator**

Specifications for the Model 415A digital communications oscillator are given in a catalog. Bowmar Instrument Div., Acton, Mass.

CIRCLE NO. 454

**Mass flowmeters**

A six-page bulletin describes mass flowmeters. The bulletin offers details on standard specifications and options and provides costs for various model features (including nonlinear, linear, bidirection and integrating mass flows) for both single-range and dual-range flowmeters. Technology, Instruments and Controls Div., Dayton, Ohio.

CIRCLE NO. 455

**Disc memories**

The "Disc Memory Buyers' Guide" deals with modern disc design and covers the criteria for selecting the best storage device for small or medium-size computer applications. The first part of the 28-page guide deals with selecting the right medium, discusses the pros and cons of core memory, magnetic tape and disc-core units. The second part is devoted to fixed and moving-head disc drives. Engineered Data Peripherals, Santa Monica, Calif.

CIRCLE NO. 456

**"CANNON® ZERO FORCE DL CONNECTORS GAVE OUR COSTS A CUT,**

**and me a boost."**



"No wonder. The combination of a 10,000 cycle life and lower cost than other rectangular connectors made Cannon Zero-force DL's the easy choice for a tough application. It's all told here in 'Secrets of Connector Success.' Get yourself a copy, and save some wear and tear."

Contact ITT Cannon Electric, International Telephone and Telegraph Corporation, 666 East Dyer Road, Santa Ana, CA 92702. (714) 557-4700.

**CANNON ITT**

INFORMATION RETRIEVAL NUMBER 143

**PHOTO CONTROLS**

**FOR EVERY PURPOSE**

303 TYPES • 3003 VARIATIONS

- AUTOMATION
  - COUNTING
  - PACKAGING
  - CONVEYORS
  - CUT-OFF
  - DIE PROTECTION
  - PROCESSING
  - JAM-UP
  - REGISTRATION
  - MEASURING
  - SMOKE DETECTION
  - SORTING
  - FAULT DETECTION
  - LIMITING
  - ORIENTATION
  - POSITIONING
  - INSPECTION
  - TENSION
  - TRAFFIC CONTROL
  - WEIGHING
  - WINDING
- an endless variety of applications

Send for **FREE** Complete Catalog



Contains latest released information on photo-electric controls developments, application survey, 61 complete application sketches and dimensional diagrams for innumerable practical uses.

**AUTOTRON, INC.**  
3629 N. VERMILION ST.  
DANVILLE, ILL. 61832  
PHONE 217-446-0650

INFORMATION RETRIEVAL NUMBER 144

ELECTRONIC DESIGN 8, April 12, 1974



## Potentiometers and dials

Turns counting dials and related 10-turn precision potentiometers are described in a 16-page short-form catalog. Specifications, dimensional line drawings and design features of both component lines are provided. Amphenol, Broadview, Ill.

CIRCLE NO. 457

## Rectangular connectors

A 10-page catalog features Instamate DL rectangular connectors with cam-actuated contacts for mainframe computer and peripheral equipment applications. Drawings, photographs, charts, tooling plus plugs, receptacles and accessories are included. ITT Cannon Electric, Santa Ana, Calif.

CIRCLE NO. 458

## Technical papers

A listing of technical papers that deals with quantitative thin-layer chromatography describes separation techniques with a spectrum of compounds and contains many unique, original insights. Drugs, steroids, amino acids, lipids and sugars are just a few of the topics covered. Schoeffel Instrument, Westwood, N.J.

CIRCLE NO. 459

## Clad metals

A 22-page handbook for clad metals describes stripe-inlay and solder cladding. The handbook provides details on base metals, cladding metals and typical configurations. A section on metallurgy and technology is followed by design information and application photos. A glossary of terms is included. Technical Materials, Providence, R.I.

CIRCLE NO. 460

## PC connectors

A 34-page printed circuit connector catalog provides data on two basic PC-board groups, the edge-on (card receptacle) and the plug-and-receptacle types. A table of recommended PC-board dimensions, specifications, drawings and applications is given, as well as some of the latest gas-tight high-pressure (GTH) connector applications. Burndy, Norwalk, Conn.

CIRCLE NO. 461

# Mount **SEE IT YOUR WAY**

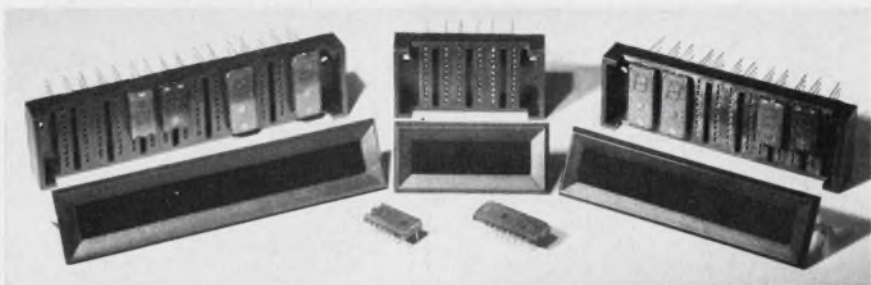

Mount ~~the~~ your in-line LED display with an IEE, unitized display mounting kit.

Now you *don't* have to buy bits and pieces of LED planar displays, individual DIP sockets, and try to align them all behind a viewing screen.

IEE has put the whole package together — molded one piece bezel (two to eight displays wide), circularly polarized viewing screen, and *universal LED socket body* that automatically aligns all DIP LED's. The universal socket is wirewrap terminated for your own interconnecting scheme, AND the socket

accepts ANYBODY'S 14-16 pin LED display with .3" row spacing. Mounting? One panel cutout; the bezel slips in and self-aligns, adjusting for panel thickness. No room for a bezel? Fine, order the universal socket and a special viewing screen for behind-the-panel mounting. Or REALLY customize with the universal socket alone. Finally, if you order IEE LED's and mounting kit as an assembly — all you have to do is slip the entire module into your panel.

Mount your LED display the IEE way; it'll make life much simpler.



OPTO-COMPONENTS/DISPLAY SYSTEMS

**Industrial Electronic Engineers, Inc.**

7740 Lemona Ave., Van Nuys, CA 91405, Tel. (213) 787-0311, TWX (910) 495-1707

Our European Office: 6707 Schifferstadt, Eichendorff-Allee 19, Germany, Tel. 06235-662.

INFORMATION RETRIEVAL NUMBER 145

## *You're Looking At The World's Smallest Displacement Transducer. Think of the Possibilities!*

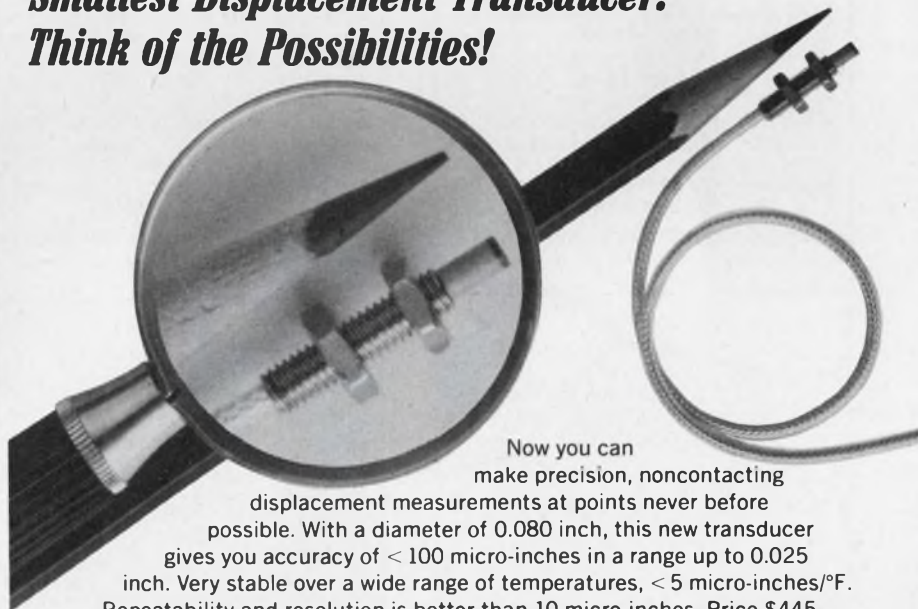

Now you can

make precision, noncontacting

displacement measurements at points never before possible. With a diameter of 0.080 inch, this new transducer gives you accuracy of < 100 micro-inches in a range up to 0.025

inch. Very stable over a wide range of temperatures, < 5 micro-inches/°F.

Repeatability and resolution is better than 10 micro-inches. Price \$445, including associated electronics. (For optional power supply and digital readout, add \$395.) Other noncontacting systems with ranges to 3 inches. For facts, contact: Kaman Sciences Corporation, P.O. Box 7463, Colorado Springs, CO 80933. (303) 598-5880.



**KAMAN SCIENCES CORP.**

A KAMAN COMPANY

INFORMATION RETRIEVAL NUMBER 146



Thin-Trim variable capacitors provide a reliable means of adjusting capacitance without abrasive trimming or interchange of fixed capacitors. Series 9401 has high Q's and a range of capacitance values from 0.2-0.6 pf to 3.0-12.0 pf and 250 WVDC working voltage. Johanson Manufacturing Corporation, Boonton, New Jersey (201) 334-2676.

INFORMATION RETRIEVAL NUMBER 181

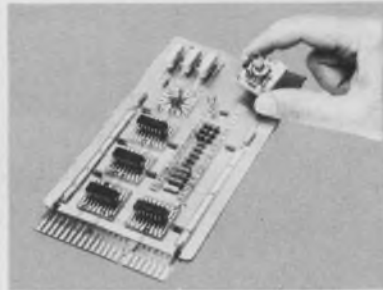

Free sample shows how you can assemble your prototype circuits in minutes even your card cage bread board. Mini-mounts, a series of etched patterns which adhere to your ground plane, mount all electronic components for prototype circuits from dc to GHz. Christiansen Radio, Inc., 1950 San Remo, Laguna Beach, Ca 92651. (714) 497-1506.

INFORMATION RETRIEVAL NUMBER 182



UDT-80X Opto-Meter offers low cost photometric/radiometric measuring capability from  $10^{-11}$  watts or  $10^{-4}$  footcandles for \$865. The 80X has  $3\frac{1}{2}$  digit readout, silicon detector, radiometric (flat 450-950 nm) photometric filters, AC and battery operation. United Detector Technology, 1732 21st St Santa Monica Ca 90404 (213) 829-3357

INFORMATION RETRIEVAL NUMBER 183

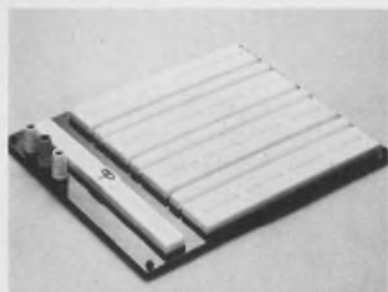

A P Breadboard II. Completely assembled; 2696 solderless plug-in tie points; no special patch cords required. Accept DIPs, TO-5's or discrete components with leads to .032". Has low impedance distribution with integral ground plane. Unparalleled high-speed circuit performance. A P Products Inc., Box 110, Painesville, Ohio 44077.

INFORMATION RETRIEVAL NUMBER 185



400 Ideas for Design, Vol. 2, Edited by Frank Egan. Ready to borrow, modify, or adapt, the top recent contributions to Electronic Design's popular "Ideas for Design" column range from amplifiers to switching circuits. 288 pp., illus., cloth, \$11.95. Circle below for 15-day examination copies. Hayden Book Co., New York, N.Y. 10011.

INFORMATION RETRIEVAL NUMBER 186



Modular DC/DC Converters. 1.5 W to 30 W. Miniature easy to use P.C.B. mtg. Hundreds of standard variations are available. All have low-noise filtered inputs and outputs. Inputs are reverse voltage protected. Regulated units have current limited outputs. (1 to 9) qty from \$37.25 B. H. INDUSTRIES, Los Angeles, Ca. (213) 479-8278.

INFORMATION RETRIEVAL NUMBER 187



NOVA/DCC-116 General purpose interface board provides multiple device selection, 4 I/O registers, DMA zero word count detect, 105 socket positions for 14, 16, 24 and 40 PIN ICS. Basic board (all features of data general 4040 plus multiple device select) \$350.00. MDB Systems, Inc., 981 N. Main, Orange, CA 92667. (714) 639-7238.

INFORMATION RETRIEVAL NUMBER 189



Free catalog of 34,500 power supplies from the worlds largest manufacturer of quality Power Supplies. New '73 catalog covers over 34,500 D.C. Power Supplies for every application. All units are UL approved, and meet most military and commercial specs for industrial and computer uses. Power Mate Corp. (201) 343-6294.

INFORMATION RETRIEVAL NUMBER 190

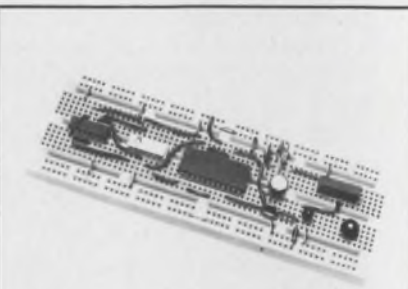

A P Super-Strip. Universal breadboarding with 840 solderless, plug-in tie points, incorporates eight distribution buses. Specifically designed for LSI packages and components with lead diameters up to .032". Accommodates up to eight 14 pin DIPs. No special patch cords required. A P Products Inc., Box 110, Painesville, Ohio 44077.

INFORMATION RETRIEVAL NUMBER 191

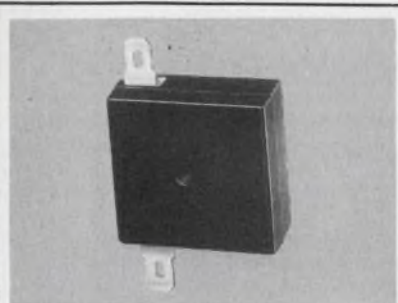

**Solid state ac flasher FS129.** Small, inch square, half inch thick package. Operates 120VAC incandescent, inductive, resistive 1 amp loads. Quickly installed with single screw, two quick-connects. We make the broadest line of solid state flashers in the industry. SSAC PRECISION PRODUCTS, INC., PO Box 395, Liverpool, NY 13088 (315) 699-2551

**INFORMATION RETRIEVAL NUMBER 184**

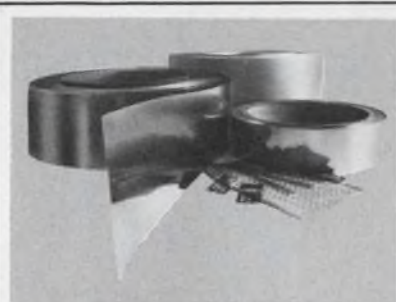

**IN ELECTRONIC ALLOYS, WE SPEAK YOUR LANGUAGE, EXACTLY.** We specialize in magnetic and controlled expansion alloys. Nickel-irons, stainless steels, beryllium, copper, down to .0005" thick. Rigid chemical and physical property control. Lots 5 lbs. - 5 tons. Photoetching also our specialty. Magnetics, Butler Pa. 16001.

**INFORMATION RETRIEVAL NUMBER 188**

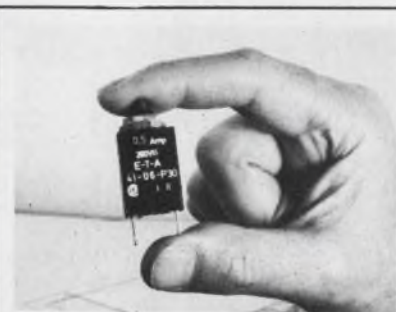

**Overcurrent Protector, manual reset eliminates fuse replacement.** Convenient panel mounting. 15 fractional ratings from 0.1 to 3 amp. Other models up to 400 amp. Trip-free and fool-proof, UL and CSA approved. High quality, low cost-\$1.12 ea. in 1000 lots. E-T-A Products Co. of America, 6284 N. Cicero Ave., Chicago, Ill. 60646. Tel. (312) 545-1553.

**INFORMATION RETRIEVAL NUMBER 192**

*Advertisers wishing to reserve Quick Ad units should note the following mechanical requirements: Specs—Supply glossy photo of product and approximately 40 words which will set no more than 10 lines of 34 characters each. AFTER SUBMISSION NO COPY CHANGES CAN BE ACCEPTED. Quick Ads cost only \$300 per insertion, less for frequency advertisers.*

**RATES:**

1x  
\$300

7x  
\$280

13x  
\$255

19x  
\$250

26x  
\$245

39x  
\$240

52x  
\$235

104x  
\$230

**NEW LITERATURE**

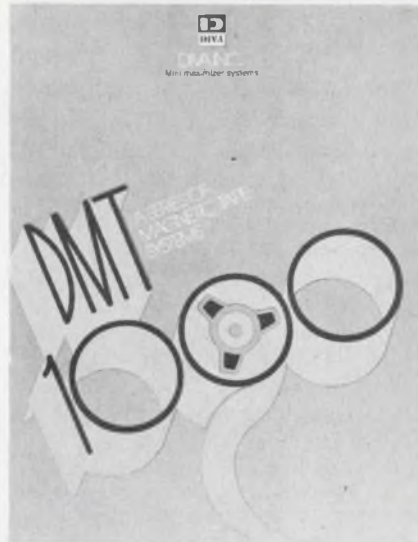

**Tape system for minis**

Specifications and descriptions of a series of magnetic tape drive systems are included in a brochure. DIVA, Eatontown, N.J.

**CIRCLE NO. 401**

**PC-board power relays**

The Model V23027 miniature PC-board power relay, for 8-A continuous and 15-A switching loads, is described and illustrated in a two-page data sheet. Siemens, Iselin, N.J.

**CIRCLE NO. 402**

**Wiring devices**

A 200-page catalog includes the latest wiring products plus product improvements. The catalog's new format is designed to facilitate product selection. All products are grouped by rating and by the same configuration or basic function. The only exceptions are those products which do not lend themselves to a centralized listing. Arrow-Hart, Hartford, Conn.

**CIRCLE NO. 403**

**Power supplies**

A 14-page component power supply reference guide includes modular encapsulated ac-to-dc, dc-to-dc and high efficiency switching regulator designs. A glossary of definitions, testing diagrams and procedures used by manufacturers in production testing of power supply units, wiring information and mechanical outlines are included. Semiconductor Circuits, Haverhill, Mass.

**CIRCLE NO. 404**

ELECTRONIC DESIGN's function is:

- To aid progress in the electronics manufacturing industry by promoting good design.
- To give the electronic design engineer concepts and ideas that make his job easier and more productive.
- To provide a central source of timely electronics information.
- To promote communication among members of the electronics engineering community.

**Want a subscription?** ELECTRONIC DESIGN is sent free to qualified engineers and engineering managers doing design work, supervising design or setting standards in the United States and Western Europe. For a free subscription, use the application form bound in the magazine. If none is included, write to us direct for an application form.

If you do not qualify, you may take out a paid subscription for \$30 a year in the U.S.A., \$40 a year elsewhere. Single copies are \$1.50 each.

If you change your address, send us an old mailing label and your new address; there is generally a postcard for this bound in the magazine. You will have to requalify to continue receiving ELECTRONIC DESIGN free.

**The accuracy policy** of ELECTRONIC DESIGN is:

- To make diligent efforts to ensure the accuracy of editorial matter.
- To publish prompt corrections whenever inaccuracies are brought to our attention. Corrections appear in "Across the Desk."
- To encourage our readers as responsible members of our business community to report to us misleading or fraudulent advertising.
- To refuse any advertisement deemed to be misleading or fraudulent.

Microfilm copies are available of complete volumes of ELECTRONIC DESIGN at \$19.00 per volume, beginning with Volume 9, 1961. Work is now in process to complete the microfilm edition of Volumes 1-8. Reprints of individual articles may be obtained for \$2.00 each, prepaid (\$.50 for each additional copy of the same article) no matter how long the article. For further details and to place orders, contact the Customer Services Department, University Microfilms, 300 North Zeeb Road, Ann Arbor, Michigan 48106 telephone (313) 761-4700.

**Want to contact us?** If you have any comments or wish to submit a manuscript or article outline, address your correspondence to:

Editor  
ELECTRONIC DESIGN  
50 Essex Street  
Rochelle Park, N.J. 07662

## King of Korrelators® Conquers Fuzziness

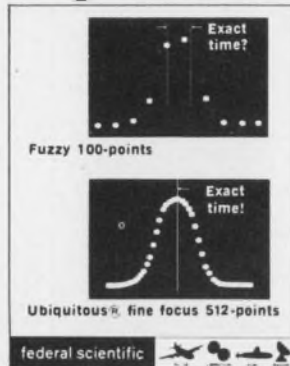

UC-201C calculates fastest, is most sensitive, and has the finest time resolution of any digital correlator. A complete time-domain measurement lab for real-time auto/cross correlation, signal enhancement, probability. For underwater acoustics, fluid dynamics, medical, noise/vibration analysis. Exact time measurements with digital dial; computes integral & differential of any stored function; pre-computational delay built-in (up to 8192 samples optional); zero time can be at center of display; sampling increments  $\frac{1}{2}$  usec to 2 sec; complete ext. (computer) control plus digital outputs; built-in test signals check all modes; small, portable, easy to use. Many options.

CIRCLE NO. 171

### Federal Scientific Corporation

615 West 131st Street, New York, N. Y. 10027

## PRECISION CORRELATOR AND SQUARE LAW DETECTOR



Princeton Applied Research Corporation announces a new, self-contained multiplier/divider, the Model 193. The Model 193 provides pushbutton selection of the functions  $A \times B$ ,  $A^2$ ,  $\sqrt{A}$ , or  $A/B$ . It can be used as a precision square law detector to measure such quantities as true average power, noise power, noise figure, noise temperature, and detectivity ( $D^*$ ). In addition to square-root and ratio modes, the Model 193 also functions as a high-quality linear modulator or voltage-controlled variable gain amplifier in its  $A \times B$  mode, and it can be used as a correlation detector for any signal for which a replica is available. For more information send for Bulletin T-337 from Princeton Applied Research Corporation.

CIRCLE NO. 172

### PRINCETON APPLIED RESEARCH CORPORATION

P.O. Box 2565  
Princeton, New Jersey 08540

## "USING OPERATIONAL POWER SUPPLIES"



A new 32-page handbook is offered by Kepco, Inc., to engineers and designers on ways to get the most from programmable power supplies.

The Kepco text approaches a power supply from the point of view of its signal processing capability, and develops equations to define gain, linearity, offset, speed, bandwidth, accuracy, etc.

**Using Operational Power Supplies** also devotes considerable space to the problems of digital interface, reviewing the hardware by which Kepco Bipolar and Unipolar Operational Power Supplies can be controlled by digital logic. Send for your free copy.

**Kepco, Inc.**  
131-38 Sanford Avenue, Flushing, New York 11352  
Phone: 212-461-7000, Ext. 742

CIRCLE NO. 173

# Manufacturers

Advertisements of booklets, brochures, catalogs and data sheets. To order use Reader-Service Card (Advertisement)

## FAST FOURIER TRANSFORM PROCESSOR FOR \$6,000

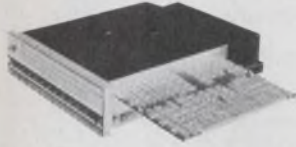

The 306/MFFT Fast Fourier Transform Processor is delivered with all control programs and plugs directly into any Data General Nova computer. It offers a complete Fourier Transform capability including Forward and Inverse FFT, Spectral magnitude, Hanning Weighting, and Complex Multiplication. Arrays from 16 to 16,384 real samples can be processed. An array of 1024 real samples is transformed in only 139 ms.

Time domain signal processing functions, such as correlation and convolution, can be calculated utilizing the high speed array operations  $X$ ,  $+$ ,  $-$ ,  $\sqrt$  and  $\Sigma$ .

Call or write today for brochures on 306/MFFT or Elytec's complete line of Fourier Spectrum Analyzers and Higher Speed Hardware Fast Fourier Transform Processors.

CIRCLE NO. 174

### ELSYTEC INC.

212 Michael Drive, Syosset, New York 11791 (516) 364-0560

# Electronic Design

## Advertising Sales Staff

Tom W. Carr  
Vice President &  
Sales Manager

Rochelle Park, N.J. 07662

Robert W. Gascoigne  
Daniel J. Rowland  
(Recruitment, Quick Ads, Classified)  
50 Essex Street  
(201) 843-0550  
TWX: 710-990-5071

## Philadelphia

Thomas P. Barth  
50 Essex Street  
Rochelle Park, N.J. 07662  
(201) 843-0550

## Boston 02178

Gene Pritchard  
P.O. Box 379  
Belmont, Mass. 02178  
(617) 489-2340

## Chicago 60611

Thomas P. Kavooras  
Berry Conner, Jr.  
200 East Ontario  
(312) 337-0588

## Cleveland

Thomas P. Kavooras  
(Chicago)  
(312) 337-0588  
(call collect)

## Los Angeles 90303

Stanley I. Ehrenclou  
Burt Underwood  
2930 Imperial Highway  
Inglewood, Calif.  
(213) 757-0183

## San Francisco 94022

Jerry D. Latta  
P.O. Box 1248  
Los Altos, Calif.  
(415) 965-2636

## London

For United Kingdom and Europe

John Ashcraft  
John Ashcraft & Co.  
12, Bear St.  
Leicester Square  
London WC2H 7AS England  
Phone: 01-930-0525

W. J. M. Sanders  
John Ashcraft & Co.  
Herengracht 365  
Amsterdam C., Holland  
Phone: 020-24-09-08

## Tokyo

Haruki Hirayama  
Electronic Media Service  
5th Floor, Lila Bldg.  
4-9-8 Roppong  
Minato-ku  
Phone: 402-4556  
Cable: Electronicmedia, Tokyo



SEMINARS ABOUT INTEL MICROPROCESSORS	PHILADELPHIA	WASHINGTON	NEW YORK	BOSTON
<b>INTRODUCTORY WORKSHOP</b> In this two-day program you'll be introduced to the Intel MCS-4, MCS-8 and 8080 with hands-on experience in writing, assembling and debugging of small programs. (2 days, Monday & Tuesday, \$325 or \$300)*	May 13-14	June 3-4	July 8-9	August 19-20
<b>PROGRAMMING LANGUAGES AND SOFTWARE</b> For experienced users, or those who've attended the workshop, this seminar provides understanding of the programmer's tools. How to exploit the assemblers and simulators, the proper use of debugging software, and programming in PLM will be covered. (1 day, Wednesday, \$150 or \$125)	May 15	June 5	July 10	Aug 21
<b>INTRODUCTION TO MICROPROCESSORS</b> For those too busy to attend the workshop, we offer this one-day condensed seminar at which the features of the MCS-4, MCS-8 and 8080 are all described. This seminar offers no hands-on experience. (1 day, Wednesday, \$150 or \$125)	May 15	June 5	July 10	Aug 21
<b>DESIGNING WITH MICROPROCESSORS</b> This seminar is aimed at the system designer who understands the overall features of the MCS-4, MCS-8 and 8080, but needs to know how to interface to TTL and CMOS, and how to make the best hardware/software trade-offs. (2 days, Thursday & Friday, \$225 or \$200)	May 16-17	June 6-7	July 11-12	Aug 22-23
SEMINARS ABOUT NATIONAL MICROPROCESSORS	WASHINGTON	NEW YORK	PHILADELPHIA	ATLANTA
<b>APPLICATION OF NATIONAL'S MICROPROCESSORS</b> This short course is an intensive introduction to National Semiconductor's IMP-8, IMP-16 and QMP-8. Emphasis will be on how to use these products in systems, how to interface and how to program them. Limited hands-on experience will be provided. (3 days, Mon-Wed or Wed-Fri, \$350 or \$325)	May 29-30-31	June 17-18-19	July 24-25-26	July 31 August 1-2

\*The lower price always prevails if you attend another of our seminars in this series.

### MICROCOMPUTER TECHNIQUE, INC.

11227 Handlebar Rd. Reston, Va. 22091  
(703) 620-9676

CIRCLE NO. 175

## DETERMINE SEMICONDUCTOR CHARACTERISTICS



Important information about a semiconductor device or material can be determined by measuring the capacitance and conductance characteristics as a function of voltage and frequency. Measurement of flat band voltage, mobile ion concentration, doping profiles, carrier lifetime and surface state concentrations using lock-in amplifier (i.e. phase sensitive detection) techniques are described in a series of application notes. Equipment available for R&D as well as Production/QC applications.

### PRINCETON APPLIED RESEARCH CORPORATION

P.O. Box 2565  
Princeton, New Jersey 08540 (609) 452-2111

CIRCLE NO. 176



recruitment  
and  
classified ads

**IMMEDIATE  
DELIVERY**

Minis & Peripherals  
DEC - HIS - NOVA  
SEL - HP - MOHAWK  
CPU, Card, Printer, Tape, Disk  
NEW • MOHAWK 4320  
PRINTERS

**PDP11 PERIPHERALS  
CPU, MEMORY**

**PDP 8 CPU \$1500**

**\$750 Minis**

TELETYPE 35 & 37  
DEC & HONEYWELL Modules  
617/261-1100

Send for Free Report "Maintenance  
of Computers"

**AMERICAN USED COMPUTER CORP.**  
P.O. Box 68, Kenmore Sta.  
Boston, MA 02215  
"Members Computer Dealers Association"

CIRCLE NO. 239

**SAN DIEGO**

Specializing in placement of engrs &  
scientists. Openings in Calif. & na-  
tionwide. No fee to appl. Contact  
Jerry Halloran. (714) 299-7820  
**RAFFERY & KING INC., Agency**  
2384 San Diego Ave.  
San Diego, Calif. 92110

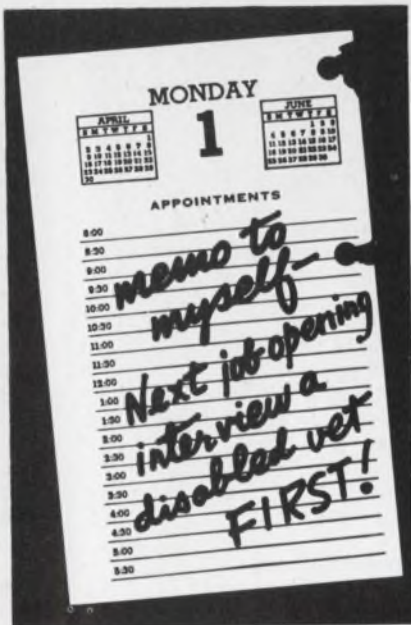

The President's Committee  
on Employment of the Handicapped  
Washington, D.C. 20210

**Buy Bonds  
where you work  
...now  
that you can.**



**1903—a time of no credit, a 12-hour  
workday, and no Payroll Savings Plan.**

It's sort of like your  
grandfather telling you  
he used to walk 15 miles  
through the snow to get  
to school.

But it's true: today's  
working men and women  
have more advantages  
than their grandparents.

One of them is the  
Payroll Savings Plan—  
the easy, safe, automatic  
way to build a nest egg  
for the future.

When you sign up for  
the Payroll Savings  
Plan, an amount you  
specify is automatically  
set aside from your  
paycheck and used to

buy U.S. Savings Bonds.

That way, even if you  
spend all your take-home  
pay, you're still building  
a steady savings.

Grandpa would approve.



**Take  
stock  
in America.**

Buy U.S. Savings Bonds

Now E Bonds pay 5 1/2% interest when held to maturity  
of 5 years, 10 months (4% the first year). Bonds are  
replaced if lost, stolen, or destroyed. When needed they  
can be cashed at your bank. Interest is not subject to  
state or local income taxes, and federal tax may be  
deferred until redemption.

The U. S. Government does not pay for this advertisement.  
It is presented as a public service in cooperation with The  
Department of the Treasury and The Advertising Council.

# product index

**Information Retrieval Service.** New Products, Evaluation Samples (ES), Design Aids (DA), Application Notes (AN), and New Literature (NL) in this issue are listed here with page and Information Retrieval numbers. Reader requests will be promptly processed by computer and mailed to the manufacturer within three days.

Category	Page	IRN	Category	Page	IRN	Category	Page	IRN
<b>Components</b>			<b>Discrete Semiconductors</b>			transistors	174	343
capacitors	19	7	diodes	169	328	<b>Modules &amp; Subassemblies</b>		
capacitors	143	66	diodes, zener	170	96	amplifier	168	94
capacitors	172	100	display, alphanumeric	167	323	amplifier, bridge	156	288
capacitors	183	119	drivers, complementary	169	327	amplifier, power	142	65
capacitors, discrete	50	25	fetrons	170	330	amplifier, power	178	109
capacitors, trimmer	7	6	LEDs, green	166	310	amplifiers	171	97
components	165	91	phototransistor	37	18	controllers	151	274
displays	179	112	rectifiers, multistac	168	325	converter	152	74
displays	181	115	SCR	168	324	converters, d/a	156	285
displays, plug-in	39	9	semiconductors	107	43	converters, v/f	154	283
displays, pushbutton	177	108	sensor, gas	169	329	detector, level	152	276
indicator	183	118	transistors	109	45	display modules	156	287
knobs	187	130	transistors, Darlington	168	326	filter, active	154	279
knobs	191	139				filters, crystal	164	90
LEDs	99	39	<b>Integrated Circuits</b>			filters, i-f	171	98
LEDs	101	41	CMOS	146	68	inclinometers, force	154	281
lights, indicator	169	95	decoder, IC	167	321	multiplexers, analog	151	273
lights, panel	163	87	ICs, JAN	45	22	multipliers	177	107
motors	163	88	ICs, regulator	147	268	multipliers, voltage	150	270
potentiometer	21	9	microprocessor, NMOS	144	255	op amp, FET-input	150	272
readout	43	21	op amp, programmable	147	267	op amps	79	33
relay	53	29	RAM	5	4	op amps	141	64
relays	III	242	RAM, NMOS	148	254	photo controls	180	114
relays	31	15	RAMs, CMOS	115	48	protector, power line	154	282
relays	157	77	ROMs	147	69	regulator, voltage	154	280
relays	191	137	register, shift	144	264	VCOs	184	125
resistor	29	14				<b>Packaging &amp; Materials</b>		
resistors	2	3	<b>Instrumentation</b>			backplanes	188	133
resistors	59	245	analyzer, memory			board, circuit	24	11
resistors	167	93	system	105	42	board, multilayer	87	36
sensors	175	105	analyzer, spectrum	137	250	boards, circuit	166	92
sockets, relay	183	121	bridges, test	182	117	boards, wrapped-wire	163	89
solenoids	160	84	counter, frequency	46	23	circuit breaker	35	17
solenoids	179	111	DMM	41	20	connector	186	373
switch	183	120	DMM	140	256	connectors	159	81
switch, lighted	182	364	generator, function	150	72	connectors	180	113
switch, rotary	184	366	generator, signal	190	137	enclosure	139	63
switches	159	83	indicator, audio	187	131	enclosures	175	104
switches	161	85	indicator, thermocouple	143	262	equipment, rental	120	51
switches, keyboard	65	31	microvoltmeter	142	258	heat pipe	100	40
switches, low-energy	117	49	oscilloscope	49	24	interconnects	6	5
switches, pushbutton	II	241	printer	142	259	marker	190	136
transformer	173	101	scales	159	82	mounts, PC	151	73
			scopes	188	134	packaging	179	110
<b>Data Processing</b>			tester, memory	140	252	packaging	185	127
calculator,			tester, transistor			points, temp. sensitive	186	374
programmable	153	75	and diode	89	37	rods, phenolic	187	132
controller, limit	160	290	VOM, digital	113	47	silicones	23	121
counter, printing	164	303	voltmeter	119	50	sockets	33	16
data logger	185	126				tool kits	175	103
drive, disc	158	253	<b>Microwaves &amp; Lasers</b>			<b>Power Sources</b>		
key-to-disc system	164	302	capacitors, microwave	174	344	converters, dc/dc	180	358
memory, floppy-disc	164	301	diodes, transferred-			inverter, dc	176	350
modem, data	162	298	electron	173	339	regulator, ac	178	354
monitor, TV	161	292	isolator	174	341	supplies, dc-to-dc	178	355
programmers	176	106	klystron, uhf	172	338	supplies, power	85	34
readers, card	149	71	magnetrons	55	204	supplies, switching	178	356
recorder, event	162	295	oscillators, phase-			supply, laboratory	180	359
terminal, data	162	296	locked	173	340	supply, power	138	62
terminal, storage	164	300	splitter/combiners	189	135			
tester, capacitor	165	306	TWT	172	337			
winder, capacitor	182	362						



# AMP CHAMPS

THE RELAYS WITH MAXIMUM POWER SWITCHING CAPABILITIES



When it comes to switching real power we call our team the Amp Champs. Contacts are rated from 15 - 100 amps at 28VDC or 115/220VAC with a wide variety of contact combinations and packaging techniques. Each relay is designed to function with absolute reliability for long life at lowest cost. Versions offered include the space saver, UL listed, auxiliary contact, magnetic blowout for DC switching, enclosed plug-in or stud mounting, hermetically sealed, and mercury displacement power relays. Over 230 different types of power relays are in stock for immediate delivery thru our chain of nationwide distributors and Magnecraft's main plant. If you don't find what you need here, we will make it for you!



- 1) 15 amp Class 94 2) 35 amp Mercury Displacement Class BSX
- 3) UL 25 amp Class 99 4) 20 amp Class 99DB with blowout magnet
- 5) 20 amp Class 89CQ 6) 25 amp Class 97 7) 20 amp Class 93
- 8) 15 or 30 amp Class 96 9) 15 amp Class 88R 10) 50 amp Class 88KD
- 11) 50 amp Class 99SD



**Free!**  
STOCK CATALOG

To help specify all your relay needs, ask for Magnecraft's new 1974 Stock Catalog with the most diversified line of over 1060 relays. A Power Relay Catalog with specific data drawings, and photos on all the various relays will accompany the Stock Catalog.

Find Magnecraft Relays in EEM sec. 4500.

**Magnecraft** ELECTRIC COMPANY

5575 NORTH LYNCH AVENUE • CHICAGO, ILLINOIS 60630 • 312 • 282-5500 TWX 910 221 5221

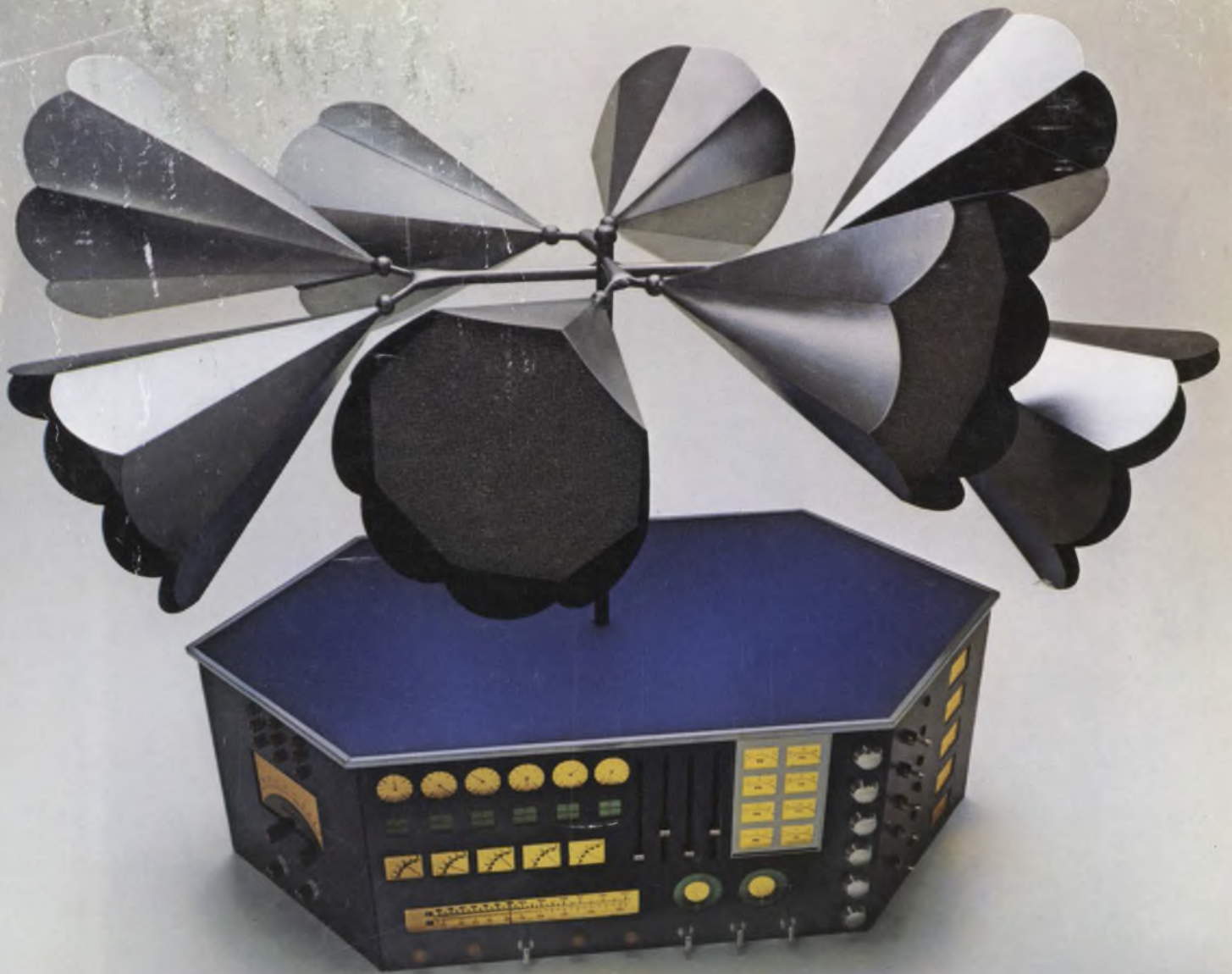

## The octophonic amplifier. If you want to create one tomorrow, we're ready with your power transistors today.

No matter what product you want to design — from stereo amps to ignition systems to electronic ranges — there's one thing you want to remember. Nobody's design is any better than the devices that go into it.

And at RCA, we've got the devices that make the difference. Ready now to help your product perform the way you designed it. In numbers all the way from

one to one million and beyond.

We're a commodity supplier of power transistors; a recognized leader in CMOS building blocks; developers of liquid crystal displays; a leading producer of linear IC's; technology innovators of RF power components; and a major supplier of thyristors.

In addition to comprehensive technical product data, RCA also gives you professional and experi-

enced field engineering and applications support. As well as a commitment to excellence in everything from research to manufacturing.

So whatever you're into, and whatever you need, check with us first. Chances are one or more of our products anticipate your needs. A good place to start is to check our handy product line guide. Write: RCA Solid State, Section 57D12 Box 3200, Somerville, N.J. 08876.

**RCA** Solid State